



AHB

TOOLING & MACHINERY, INC.

COMPLETE METALWORKING SOLUTIONS

(800) 991-4225
ISO Certified

www.ahbinc.com
customerservice@ahbinc.com

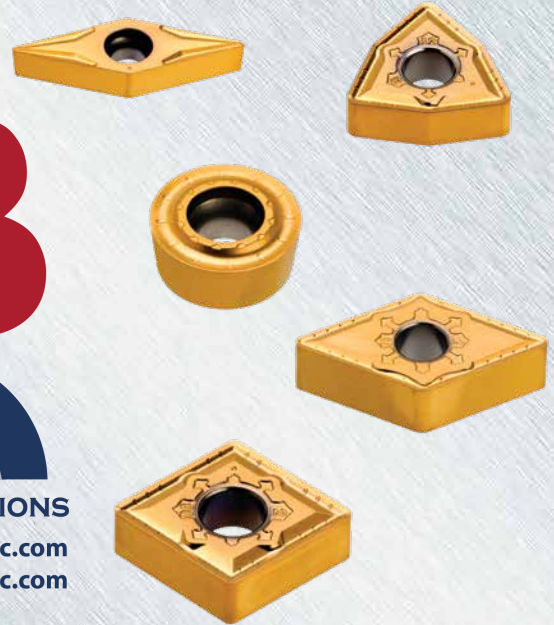

Insert Shapes & Sizes

- CNMG 432, 433
- DNMG 432, 442, 443
- SNMG 432, 433, 644
- WNMG 432, 433
- RCMT 120400
- VBGT 331, 332, 333

Chip Breakers

- MGS - Negative inserts
- FGS - Positive, VBGT inserts

Grades

- TT3010 - Hard submicron substrate, PVD Coated
- TT3020 - Medium submicron substrate, PVD Coated

NEW GRADES AND CHIP BREAKERS FOR HEAT RESISTANT SUPER ALLOYS (HRSA)

Ingersoll is introducing two new grades and two new chip breakers suitable for high performance turning of super alloys.

Grade TT3010 is characterized by high abrasion resistance and high bonding strength due to an ultra-fine grain substrate combined with a special, PVD coating that resists chipping and build up on the cutting edges. This new, glossy yellow coated insert grade is suitable for low depths-of-cut finishing applications.

Grade TT3020 also features a glossy yellow sheen from its PVD coating along with an ultra-fine grain substrate that generates high abrasion resistance along with added toughness. A smooth, post-coating surface provides excellent resistance to build up on the cutting edge. It is ideal for lighter cutting depths in parts with scaled surfaces at low to medium cutting speeds.

The **MGS Chip Breaker** is applied to a negative, pressed insert and features a sharp cutting edge that reduces cutting resistance and heat generation during machining. Additionally, the insert's high rake angle generates smooth chip evacuation while the insert's wide top face provides very secure insert seating.

The **FGS Chip Breaker** is applied to a positive, ground insert. It also features a sharp cutting edge that provides low cutting resistance while guaranteeing high precision machining. The chip breaker design minimizes heat when machining high-temperature alloys and the small protrusion located in the corner of the rake face geometry improves chip control. It is possible to finish turn with this chip breaker without workpiece deformation, even in thin-walled parts.

• **NEW** •
**PRODUCT
ANNOUNCEMENT
2019**

FEATURES & BENEFITS**TT3010 grade (PVD coating) features**

- Ultra-fine substrate for maximum abrasion resistance
- Improved bonding properties of PVD coating reduces chipping
- Post-coat surface treatment prevents built-up-edges
- Suitable for low depths-of-cut finishing applications
- Glossy yellow sheen

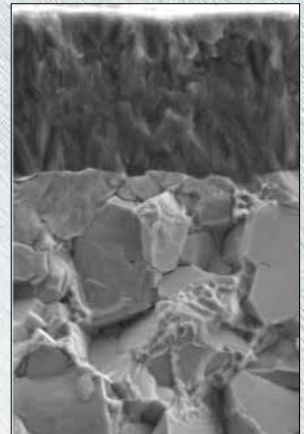
**TT3020 grade (PVD coating) features**

- Tougher ultra-fine substrate with excellent abrasion resistance
- Strong bonding of PVD coating prevents cracking
- Post-coat surface treatment prevents built-up-edges
- Suitable for low to medium speeds
- First choice grade for general turning of HRSA material
- Suitable for scaled surfaces and light external cutting applications
- Glossy yellow sheen

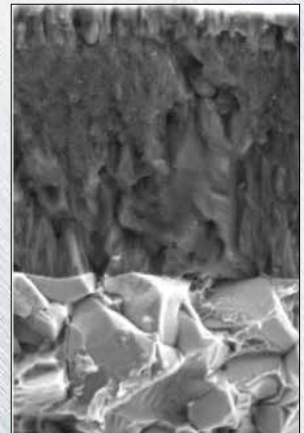

APPLICATION RANGE

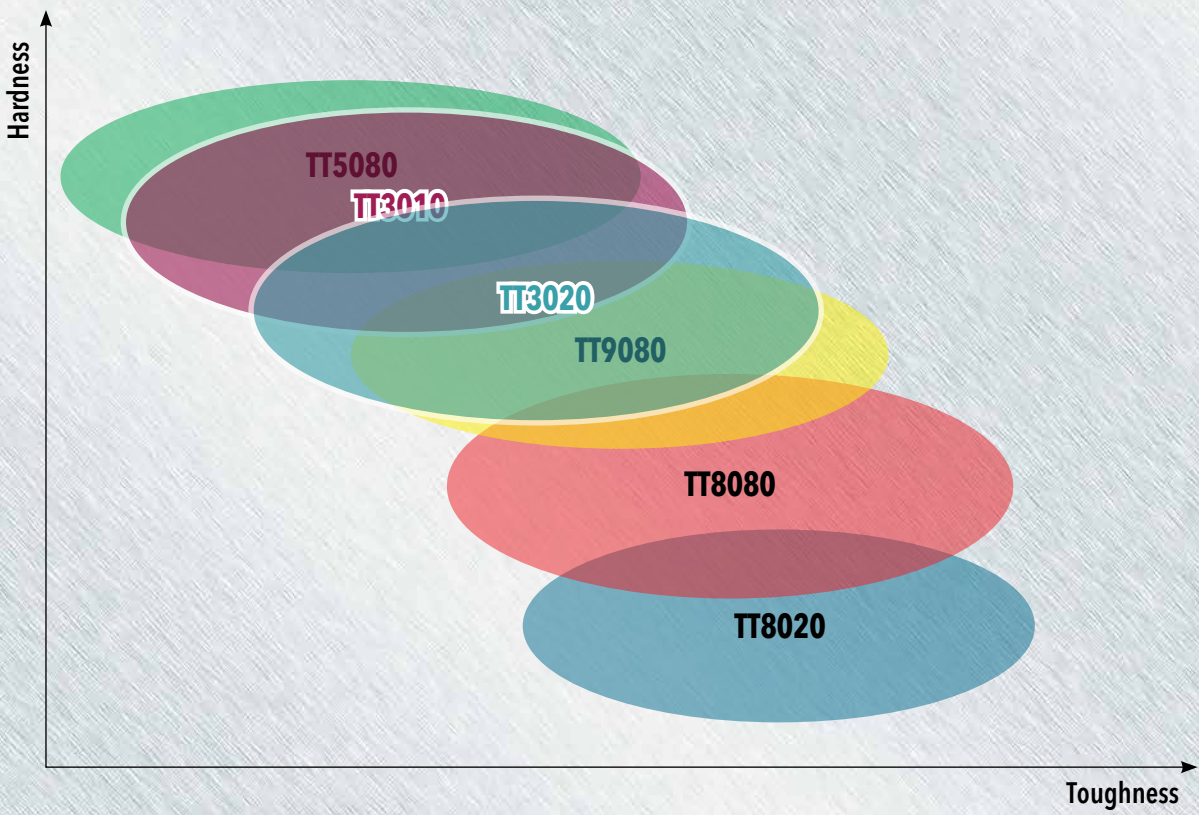
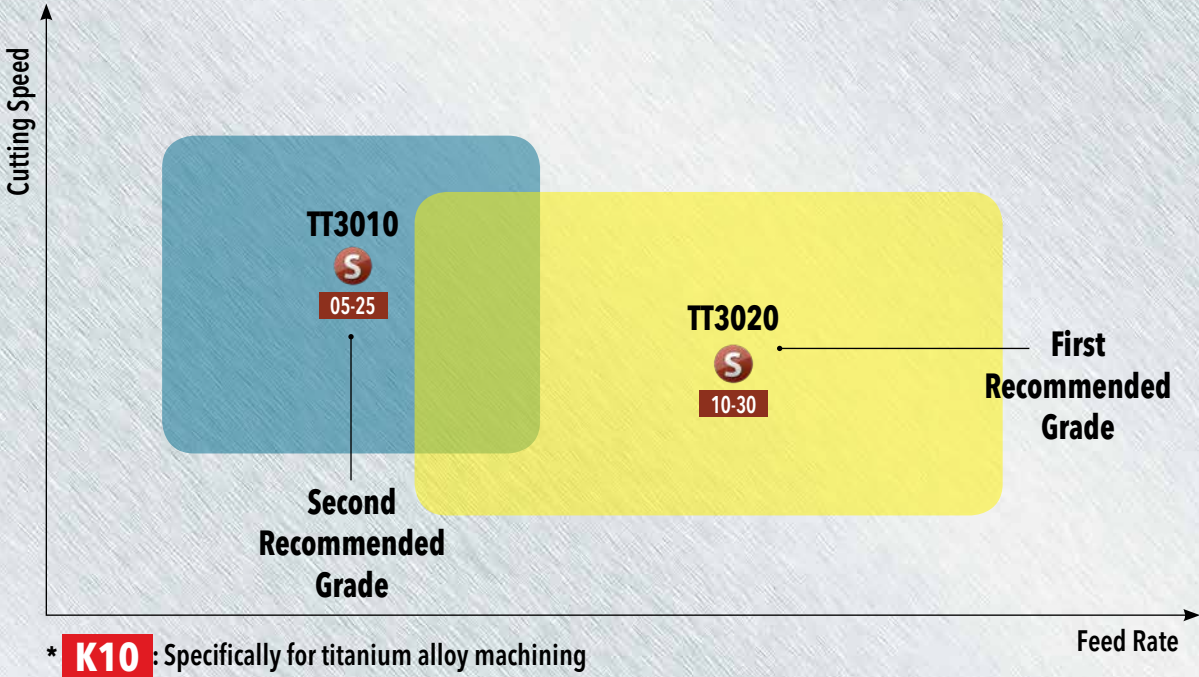

EDGE GEOMETRY MGS Chip Breaker (Negative Pressed Type)

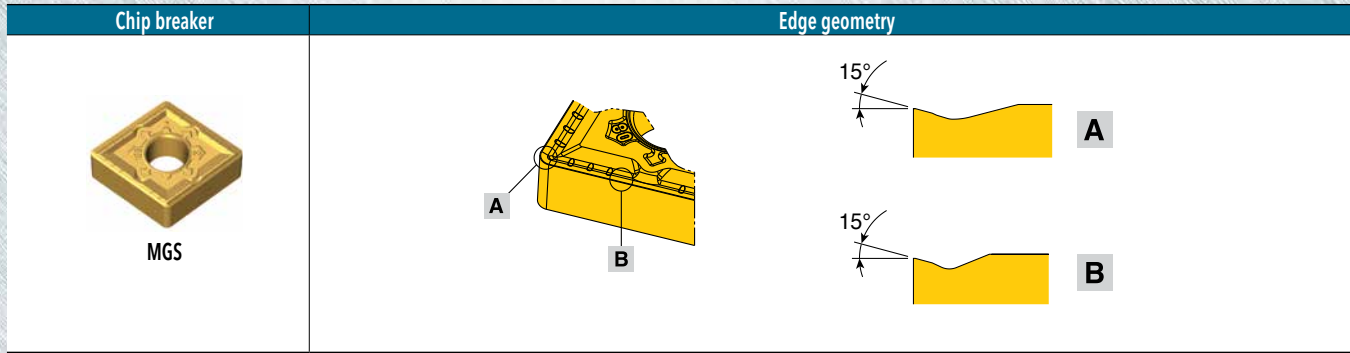

MGS Chip Breaker Range

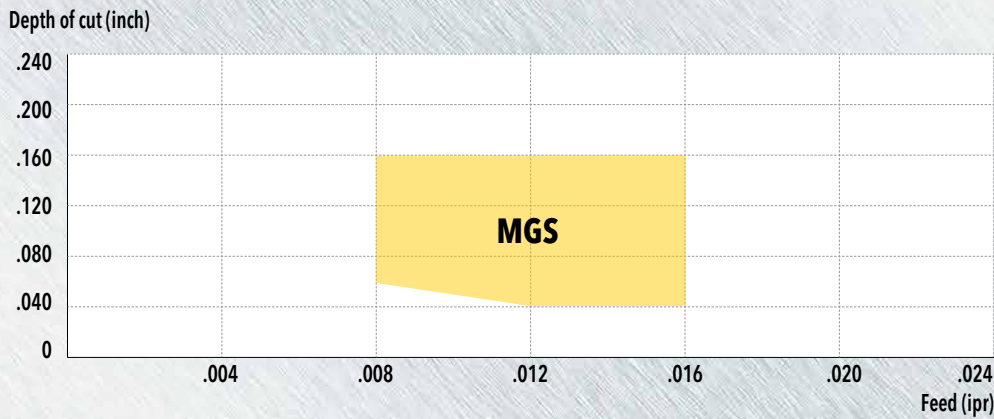

- Insert: CNMG 432 MGS
- Cutting speed (V): 130 sfm
- Material: Inconel 718 (HB340-360)

MGS Chip Breaker Features

Sharp cutting edge

- Low cutting resistance and heat generation in high-temperature alloy machining
- High rake angle for smooth chip formation
- Reliable cutting edge

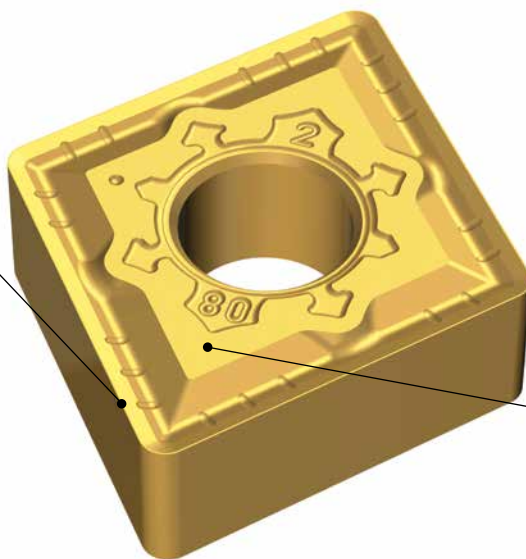

Insert's wide top face

- Enhanced stability during machining

EDGE GEOMETRY FGS Chip Breaker (Positive Ground Type)

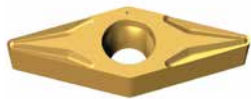
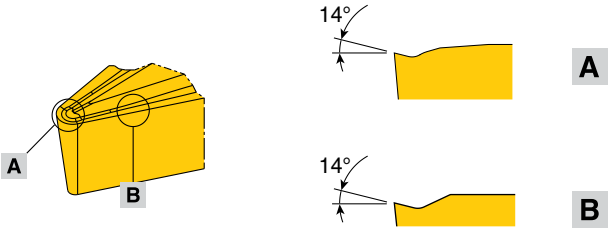
Chip breaker	Edge geometry
 <p>FGS</p>	

FGS Chip Breaker Range

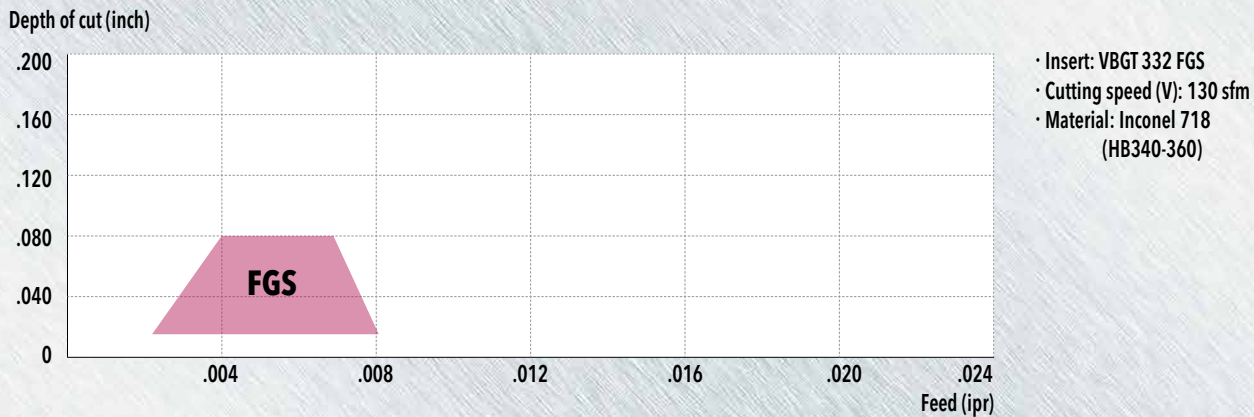

FGS Chip Breaker Features

A small dot (corner)

- Efficient chip control under low depth-of-cut and low feed conditions

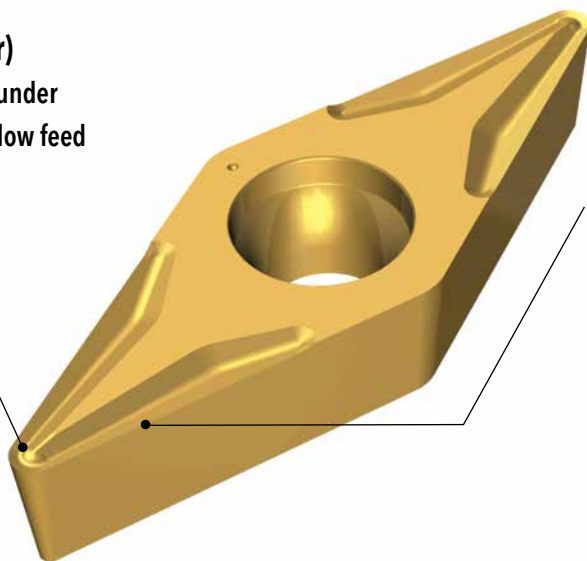

Sharp cutting edge

- Lower cutting resistance and heat generation in heat resistant super alloys machining
- High rake angle for smooth chip formation
- Peripheral ground cutting edge for high-precision machining

CASE STUDY 1

		Competitor	Ingersoll
Component	Large square bolt		
Workpiece material	Inconel 718		
Operation	External turning		
Insert	CNMG 432		CNMG 432 MGS TT3010
Cutting speed	V (sfm)	150	150
Feed rate	f (ipr)	.005	.005
Depth of cut	ap (inch)	.060	.060
Coolant	wet		
Tool life (pcs/corner)	10		15

Tool life
(pcs/corner)

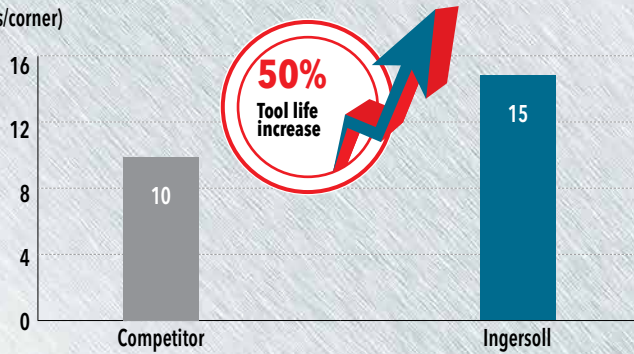

CASE STUDY 2

		Competitor	Ingersoll
Component	Inner flange		
Workpiece material	Hastalloy		
Operation	Internal turning		
Insert	SNMG 433		SNMG 433 MGS TT3020
Cutting speed	V (sfm)	200	200
Feed rate	f (ipr)	.012	.012
Depth of cut	ap (inch)	.080	.080
Coolant	wet		
Tool life (pcs/corner)	3		8

Tool life
(pcs/corner)

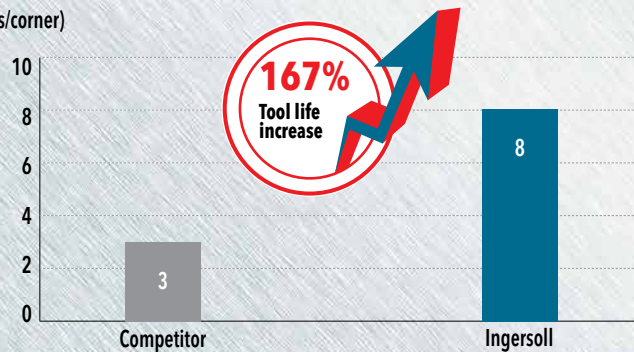

CASE STUDY 3

		Competitor	Ingersoll
Component	Case		
Workpiece material	Titanium alloy (Ti6Al4V)		
Operation	External turning		
Insert	SNMG 432		SNMG 432 MGS K10
Cutting speed	V (sfm)	180	180
Feed rate	f (ipr)	.010	.010
Depth of cut	ap (inch)	.100	.100
Coolant	wet		
Tool life (pcs/corner)	30		40

Tool life (pcs/corner)

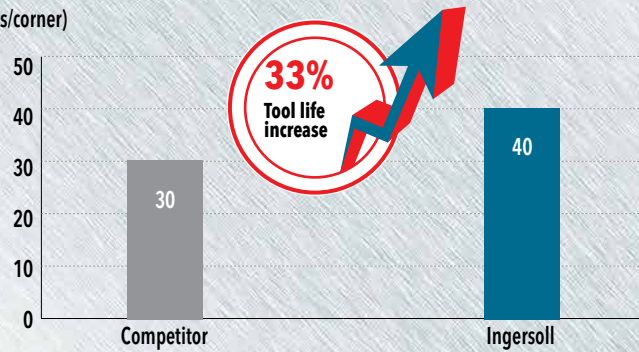

CASE STUDY 4

		Competitor	Ingersoll
Component	Outer case housing		
Workpiece material	Inconel 718		
Operation	Internal turning		
Insert	SNMG 432		SNMG 432 MGS TT3020
Cutting speed	V (sfm)	120	120
Feed rate	f (ipr)	.008	.010
Depth of cut	ap (inch)	.060	.060
Coolant	wet		
Tool life (pcs/corner)	25		25

Tool life (pcs/corner)

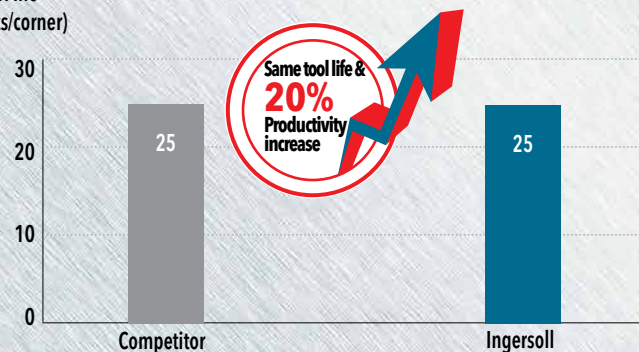

■ CNMG Negative 80° rhombic inserts

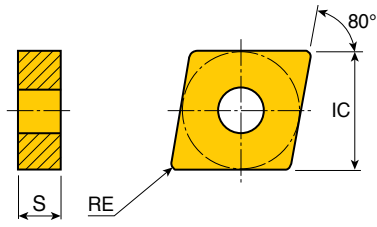

Size	Dimensions (inch)		
	IC Inscribed Circle	S Insert Thickness	RE Corner Radius
43_	.500	.187	.031 - .047

Insert	Designation	Feed (ipr)	ap (inch)	PVD coated		Uncoated
				TT3010	TT3020	K10
	CNMG 432 (120408) MGS	.006 - .016	.040 - .160	●	●	●
	CNMG 433 (120412) MGS	.007 - .020	.060 - .160	●	●	●

●: Standard items

■ DNMG Negative 55° rhombic inserts

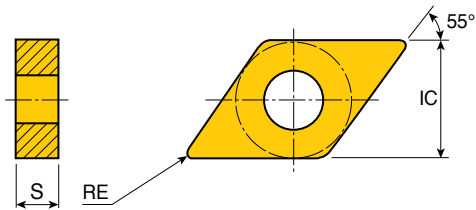

Size	Dimensions (inch)		
	IC Inscribed Circle	S Insert Thickness	RE Corner Radius
43_	.500	.187	.031 - .047
44_	.500	.250	.031 - .047

Insert	Designation	Feed (ipr)	ap (inch)	PVD coated		Uncoated
				TT3010	TT3020	K10
	DNMG 432 (150408) MGS	.006 - .016	.040 - .160	●	●	●
	DNMG 442 (150608) MGS	.006 - .016	.040 - .160	●	●	●
	DNMG 443 (150612) MGS	.007 - .016	.040 - .160	●	●	●

●: Standard items

SNMG Negative square inserts

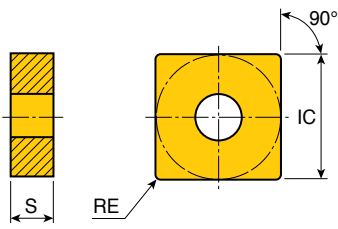

Size	Dimensions (inch)		
	IC Inscribed Circle	S Insert Thickness	RE Corner Radius
43_	.500	.187	.031 - .047
64_	.750	.250	.063

Insert	Designation	Feed (ipr)	ap (inch)	PVD coated		Uncoated
				TT3010	TT3020	K10
	SNMG 432 (120408) MGS	.006 - .016	.040 - .160	●	●	●
	SNMG 433 (120412) MGS	.007 - .016	.051 - .160	●	●	●
	SNMG 644 (190616) MGS	.007 - .024	.060 - .315	●	●	●

●: Standard items

WNMG Negative 80° trigon inserts

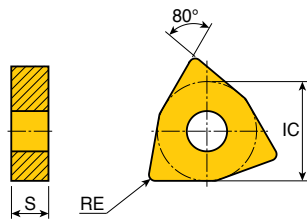

Size	Dimensions (inch)		
	IC Inscribed Circle	S Insert Thickness	RE Corner Radius
43_	.500	.187	.031 - .047

Insert	Designation	Feed (ipr)	ap (inch)	PVD coated		Uncoated
				TT3010	TT3020	K10
	WNMG 432 (080408) MGS	.006 - .016	.040 - .160	●	●	●
	WNMG 433 (080412) MGS	.007 - .016	.051 - .160	●	●	●

●: Standard items

RCMT Positive 7° clearance round inserts

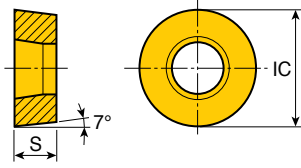

Size	Dimensions (mm)	
	IC Inscribed Circle	S Insert Thickness
12	12	4.76

Insert	Designation	Feed (ipr)	ap (inch)	PVD coated		Uncoated
				TT3010	TT3020	K10
	RCMT 120400 MGS	.008 - .020	.080 - .200	●	●	●

●: Standard items

VBGT Positive 5° clearance 35° rhombic inserts

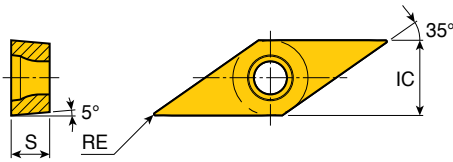

Size	Dimensions (inch)		
	IC Inscribed Circle	S Insert Thickness	RE Corner Radius
33_	.375	.187	.016 - .047

Insert	Designation	Feed (ipr)	ap (inch)	PVD coated		Uncoated
				TT3010	TT3020	K10
	VBGT 160404 FGS	.001 - .008	.008 - .100	●	●	●
	VBGT 160408 FGS	.002 - .008	.012 - .100	●	●	●
	VBGT 160412 FGS	.003 - .008	.012 - .100	●	●	●

●: Standard items

RECOMMENDED CUTTING CONDITIONS

ISO	Material	Condition	Tensile strength (Kpsi)	Hardness HB	Material No.	Cutting speed Vc (sfm)					
						Coated					
						K10	TT5080	TT3010	TT3020	TT9080	
P	Non-alloy steel, cast steel, free cutting steel	< 0.25%C	Annealed	61	125	1					
		>= 0.25%C	Annealed	94	190	2					
		< 0.55%C	Quenched and tempered	123	250	3					
		>= 0.55%C	Annealed	109	220	4					
		>= 0.55%C	Quenched and tempered	145	300	5					
	Low alloy steel and cast steel (less than 5% of alloying elements)	Annealed	87	200	6						
		Quenched and tempered	135	275	7						
			145	300	8						
	High alloy steel, cast steel and tool steel	Annealed	99	200	10						
		Quenched and tempered	160	325	11						
M	Stainless steel and cast steel	Ferritic / martensitic	99	200	12						
		Martensitic	119	240	13						
		Austenitic	87	180	14						
K	Gray cast iron (GG)	Ferritic		160	15						
		Pearlitic		250	16						
	Cast iron nodular (GGG)	Ferritic		180	17						
		Pearlitic		260	18						
	Malleable cast iron	Ferritic		130	19						
		Pearlitic		230	20						
N	Aluminum - wrought alloy	Not cureable		60	21						
		Cured		100	22						
	Aluminum-cast, alloyed	<=12% Si	Not cureable		75	23					
			Cured		90	24					
		>12% Si	High temp.		130	25					
	Copper alloys	>1% Pb	Free cutting		110	26					
			Brass		90	27					
			Electrolitic copper		100	28					
	Non-metallic	Duroplastics, fiber plastics			29						
		Hard rubber			30						
S	High temp. alloys	Fe based	Annealed		200	31	160-270	165-590	165-560	130-540	130-525
			Cured		280	32	175-210	130-525	130-490	100-475	100-425
		Ni or Co based	Annealed		250	33	130-175	150-330	150-295	115-280	115-260
			Cured		350	34	102-130	115-295	115-260	100-245	100-230
	Titanium, Ti alloys	Cast		320	35	65-80	100-260	100-230	100-210	100-195	
			Rm 58		36	50-240	360-655	360-625	330-605	295-590	
		Alpha+beta alloys cured	Rm 152		37	160-225	165-330	165-295	130-280	130-260	
H	Hardened steel	Hardened		55HRC	38						
		Hardened		60HRC	39						
	Chilled cast iron	Cast		400	40						
	Cast iron nodular	Hardened		55HRC	41						

■ Steel
 ■ Stainless steel
 ■ Cast iron
 ■ Nonferrous
 ■ High temp. alloys
 ■ Hardened steel