

# INCH CATALOG

Indexable Tools, Tool Holder Systems  
And Cutting Inserts

# 2026



# AHB

TOOLING & MACHINERY

COMPLETE METALWORKING SOLUTIONS

(800) 991-4225

[www.ahbinc.com](http://www.ahbinc.com)

ISO Certified

[customerservice@ahbinc.com](mailto:customerservice@ahbinc.com)

the spoken  
quality



Version: 0100/0226

[www.akkousa.us](http://www.akkousa.us)







TS EN ISO 9001:2015



[www.akkousa.us](http://www.akkousa.us)

## the spoken quality

AKKO Metalworking Tools, founded in 1986 continues its vision of “Spoken Quality” with indexable tools, tool holder systems and cutting insert solutions that make a difference in the competition of machining players in the global arena.

AKKO Makina Sanayi ve Ticaret A.Ş., an experienced machining specialist, produces Turning Tools, Threading and Grooving Tools, Antivibration Tools, Drilling and Holemaking Tools, Milling Tools, Monoblock Tools, Holders and Profile Inserts.

Every step of the manufacturing process, from raw material input to final product, occurs at AKKO’s integrated facility which is approximately 430,000 square feet equipped with expert production technologies. Furthermore, quality standards are continuously maintained as the processes that are decisive for product quality, including heat treatments and coating, are carried out under one roof. By continuously focusing on its R&D and innovation activities with precision, AKKO increases its global market share day by day without compromising on quality and service with developed innovative products.

AKKO, which produces 14,000 types of tool holders as standard with a production capacity of 750,000 pieces of tools and 400,000 special profile inserts per year, is an expert in developing fast solutions for special tool needs as well as standard tools with its wide stock range. With its experience, AKKO has expanded its presence in the global arena with AKKO Europe GmbH, which was established in Germany in 2018, and AKKO USA INC, in the United States in 2024. Today, AKKO’s solutions are shaping metal in 90 countries, including Europe, Asia, Africa, North and South American Countries and Australia.

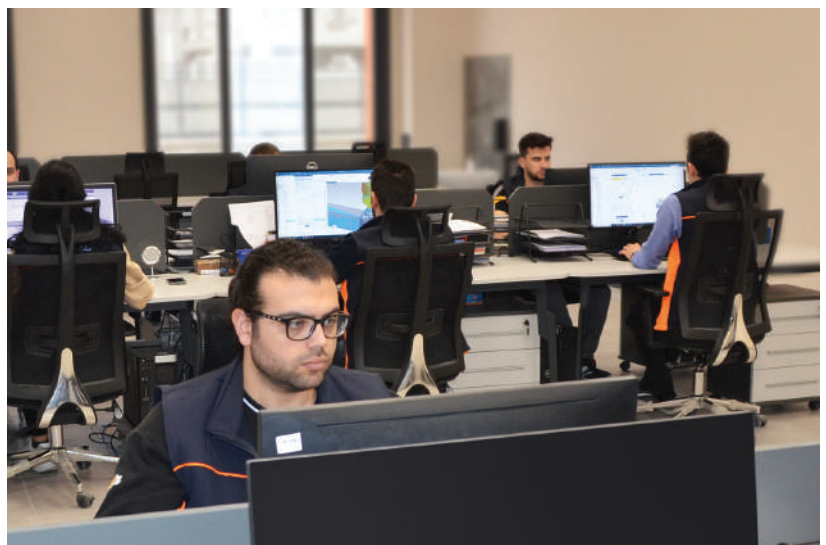

## &gt; TOOL HOLDERS

<b>01</b>	MONOBLOCK TOOLS WITH POLYGONAL SHANK	07-42
<b>02</b>	D-SYSTEM EXTERNAL TURNING TOOLHOLDERS	43-64
<b>03</b>	M-SYSTEM EXTERNAL TURNING TOOLHOLDERS	65-94
<b>04</b>	P-SYSTEM EXTERNAL TURNING TOOLHOLDERS	95-100
<b>05</b>	S-SYSTEM EXTERNAL TURNING TOOLHOLDERS	101-132
<b>06</b>	D-SYSTEM BORING BARS	133-138
<b>07</b>	M-SYSTEM BORING BARS	139-146
<b>08</b>	S-SYSTEM BORING BARS	147-158
<b>09</b>	ANTI VIBRATION TOOLS	159-168
<b>10</b>	THREADING TOOLHOLDERS	169-180
<b>11</b>	GROOVING TOOLHOLDERS	181-188
<b>12</b>	DRILLING AND HOLEMAKING TOOLS	189-214
<b>13</b>	S-SYSTEM END MILLS	215-224
<b>14</b>	S-SYSTEM HIGHFEED FACE MILLS	225-226
<b>15</b>	FACE AND COPY MILLING TOOLS	227-228
<b>16</b>	FACE MILLING	229-232

## &gt; HOLDERS

<b>01</b>	POLYGONAL SHANK END MILL HOLDER	233-237
<b>02</b>	POLYGONAL SHANK COLLET CHUCKS ER	238-239
<b>03</b>	POLYGONAL SHANK COLLET CHUCKS ER MINI	239
<b>04</b>	POLYGONAL SHANK SHELL MILL HOLDER	240
<b>05</b>	POLYGONAL SHANK MILLING CUTTER ARBORS FOR SCREW-ON TYPE MILLING CUTTERS	241
<b>06</b>	POLYGONAL SHANK SHELL MILL HOLDER	242
<b>07</b>	POLYGONAL SHANK TOOLHOLDER AXIAL	243
<b>08</b>	POLYGONAL SHANK BLANK HOLDERS	244
<b>09</b>	POLYGONAL SHANK EXTENSION	244-245

## &gt; INSERTS

<b>01</b>	BROACHING INSERTS and TOOLHOLDERS	247-248
-----------	-----------------------------------	---------



*the spoken quality...*

# MONOBLOCK TOOLS

MONOBLOCK TOOLS WITH POLYGONAL SHANK



1	2	3	4	5	6	7	8	9	10	11
<b>A</b>	<b>C6</b>	<b>S</b>	<b>C</b>	<b>L</b>	<b>C</b>	<b>R</b>	<b>17</b> WF	<b>090</b> LF	<b>12</b>	<b>H</b>
AKKO	SHANK TYPE	TIGHTENING ANGLE	INSERT TYPE	ENTERING ANGLE	INSERT CLEARANCE ANGLE	CUTTING DIRECTION	FUNCTIONAL WIDTH	FUNCTIONAL LENGTH	CUTTING EDGE LENGTH	COOLANT

MONOBLOCK TOOLS WITH POLYGONAL SHANK **C3-C4-C5-C6-C8**

EXTERNAL TURNING TOOLS WITH POLYGONSHANK  
 INTERNAL TURNING TOOLS WITH POLYGONSHANK  
 EXTERNAL THREADING TOOLS WITH POLYGONSHANK  
 INTERNAL THREADING TOOLS WITH POLYGONSHANK

<b>S</b> 3	<b>C</b> 4	<b>L</b> 5	<b>C</b> 6	<b>R</b> 7
---------------	---------------	---------------	---------------	---------------

**3 Method of Mounting of Insert**

Top Clamping Without Hole	Top and Hole Clamping	Top and Hole Clamping	Hole Clamping (Lever Lock)	Screw on
<b>C</b>	<b>T</b>	<b>M</b>	<b>P</b>	<b>S</b>

**4 Type of Insert**

<b>C</b>	<b>D</b>	<b>E</b>	<b>K</b>
<b>L</b>	<b>R</b>	<b>S</b>	<b>T</b>
<b>V</b>	<b>W</b>	<b>A</b>	<b>B</b>
<b>H</b>	<b>M</b>	<b>O</b>	<b>P</b>

**5 Tool Holder Shape Bar Geometry**

<b>A</b>	<b>B</b>	<b>D</b>	<b>E</b>	<b>F</b>	<b>G</b>
<b>J</b>	<b>K</b>	<b>L</b>	<b>M</b>	<b>N</b>	<b>R</b>
<b>S</b>	<b>T</b>	<b>V</b>	<b>Y</b>	<b>Z</b>	

**6 Insert Clearance Angel**

<b>A</b>	<b>B</b>	<b>C</b>
<b>D</b>	<b>E</b>	<b>F</b>
<b>G</b>	<b>N</b>	<b>P</b>

**7 Cutting Direction**

<b>L</b>	<b>N</b>	<b>R</b>

<b>8 WF</b>	<b>9 LF</b>
WF: Functional Width	LF: Functional Length

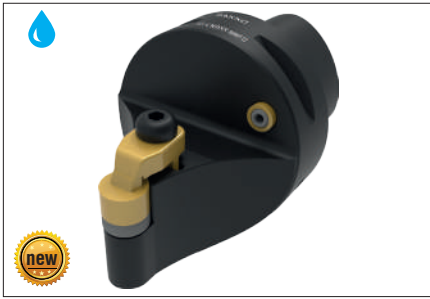

Illustrations shown may vary from actual product.

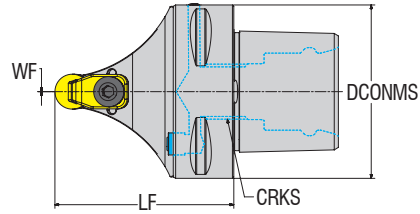

Ordering Code	Dimensions in Inch					KG	Insert Inch/Metric	Wedge Clamp	Clamp Screw	Nozzle	Ring	Radial Adj. Screw	Allen Key
	DCONMS	LF	WF	CRKS									
<b>AC6 CRDNN 00065 12</b>	2.480	2.559	0	M20x2		1.000	RN.. 1204..	ACK-39	AKV-11-M8x29	ACN-01	ACS-01	2725-M5X8	AAL-04-3.5



Illustrations shown may vary from actual product.

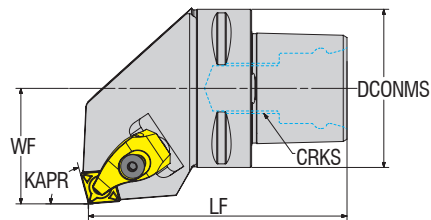

Ordering Code	Dimensions in Inch					KG	Insert Inch/Metric	Wedge Clamp	Clamp Screw	Shim	Shim Screw	Spring	Ring	Allen Key
	DCONMS	LF	WF	CRKS										
<b>AC4 DCKNR 27050 12 H</b>	1.575	1.969	1.063	M14x1.5		0.440	CN.. 432 CN.. 120408	ATKH-01-R	AKV-33-M6X22	AACN-3-0001	AAV-02-M5X10	AKY-01	AXR-01	AAL-03-3
<b>AC5 DCKNR 35060 12 H</b>	1.969	2.362	1.378	M16x1.5		0.825	CN.. 432 CN.. 120408	ATKH-01-R	AKV-33-M6X22	AACN-3-0001	AAV-02-M5X10	AKY-01	AXR-01	AAL-03-3
<b>AC6 DCKNR 45065 12 H</b>	2.480	2.559	1.772	M20x2		1.310	CN.. 432 CN.. 120408	ATKH-01-R	AKV-33-M6X22	AACN-3-0001	AAV-02-M5X10	AKY-01	AXR-01	AAL-03-3
<b>AC4 DCKNR 27050 16 H</b>	1.575	1.969	1.063	M14x1.5		0.440	CN.. 543 CN.. 160612	ATKH-07-R	AKV-39-M7X21	AACN-3-0001	AAV-02-M5X10	AKY-01	AXR-01	AAL-05-4
<b>AC5 DCKNR 35060 16 H</b>	1.969	2.362	1.378	M16x1.5		0.825	CN.. 543 CN.. 160612	ATKH-07-R	AKV-39-M7X21	AACN-3-0001	AAV-02-M5X10	AKY-01	AXR-01	AAL-05-4
<b>AC6 DCKNR 45065 16 H</b>	2.480	2.559	1.772	M20x2		1.310	CN.. 543 CN.. 160612	ATKH-07-R	AKV-39-M7X21	AACN-3-0001	AAV-02-M5X10	AKY-01	AXR-01	AAL-05-4
<b>AC6 DCKNR 45065 19 H</b>	2.480	2.559	1.772	M20x2		1.310	CN.. 643 CN.. 190612	ATKH-09-R	AKV-39-M7X21	AACN-3-0001	AAV-02-M5X10	AKY-01	AXR-01	AAL-05-4
<b>AC8 DCKNR 55080 19 H</b>	3.150	3.150	2.165	M20x2		2.587	CN.. 643 CN.. 190612	ATKH-09-R	AKV-39-M7X21	AACN-3-0001	AAV-02-M5X10	AKY-01	AXR-01	AAL-05-4
<b>AC4 DCKNL 27050 12 H</b>	1.575	1.969	1.063	M14x1.5		0.440	CN.. 432 CN.. 120408	ATKH-02-L	AKV-33-M6X22	AACN-3-0001	AAV-02-M5X10	AKY-01	AXR-01	AAL-03-3
<b>AC5 DCKNL 35060 12 H</b>	1.969	2.362	1.378	M16x1.5		0.825	CN.. 432 CN.. 120408	ATKH-02-L	AKV-33-M6X22	AACN-3-0001	AAV-02-M5X10	AKY-01	AXR-01	AAL-03-3
<b>AC6 DCKNL 45065 12 H</b>	2.480	2.559	1.772	M20x2		1.310	CN.. 432 CN.. 120408	ATKH-02-L	AKV-33-M6X22	AACN-3-0001	AAV-02-M5X10	AKY-01	AXR-01	AAL-03-3
<b>AC4 DCKNL 27050 16 H</b>	1.575	1.969	1.063	M14x1.5		0.440	CN.. 543 CN.. 160612	ATKH-08-L	AKV-39-M7X21	AACN-3-0001	AAV-02-M5X10	AKY-01	AXR-01	AAL-05-4
<b>AC5 DCKNL 35060 16 H</b>	1.969	2.362	1.378	M16x1.5		0.825	CN.. 543 CN.. 160612	ATKH-08-L	AKV-39-M7X21	AACN-3-0001	AAV-02-M5X10	AKY-01	AXR-01	AAL-05-4
<b>AC6 DCKNL 45065 16 H</b>	2.480	2.559	1.772	M20x2		1.310	CN.. 543 CN.. 160612	ATKH-08-L	AKV-39-M7X21	AACN-3-0001	AAV-02-M5X10	AKY-01	AXR-01	AAL-05-4
<b>AC6 DCKNL 45065 19 H</b>	2.480	2.559	1.772	M20x2		1.310	CN.. 643 CN.. 190612	ATKH-10-L	AKV-39-M7X21	AACN-3-0001	AAV-02-M5X10	AKY-01	AXR-01	AAL-05-4
<b>AC8 DCKNL 55080 19 H</b>	3.150	3.150	2.165	M20x2		2.587	CN.. 643 CN.. 190612	ATKH-10-L	AKV-39-M7X21	AACN-3-0001	AAV-02-M5X10	AKY-01	AXR-01	AAL-05-4



Illustrations shown may vary from actual product.

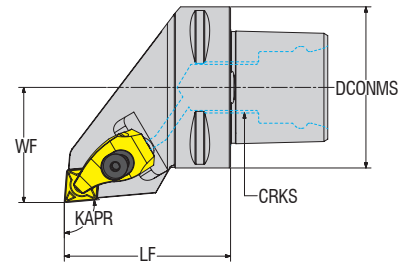

Dimensions in Inch



Ordering Code	DCONMS	LF	WF	CRKS	KG	Insert Inch/Metric	Wedge Clamp	Clamp Screw	Shim	Shim Screw	Spring	Ring	Stamp	Allen Key
<b>new</b> AC3 DCLNR 22040 09 H	1.260	1.575	0.866	M12x1.5	0.242	CN.. 322 CN.. 090308	ATK-01	AKV-01-M5x22	AACN-2-0001	AAV-09-M5x9	-	-	ABPL-01	AAL-03-3
<b>new</b> AC4 DCLNR 27050 09 H	1.575	1.969	1.063	M14x1.5	0.440	CN.. 322 CN.. 090308	ATK-01	AKV-01-M5x22	AACN-2-0001	AAV-09-M5x9	-	-	ABPL-01	AAL-03-3
<b>new</b> AC3 DCLNR 22045 12 H	1.260	1.772	0.866	M12x1.5	0.242	CN.. 432 CN.. 120408	ATKH-01-R	AKV-33-M6x22	AACN-3-0001	AAV-13-M5x8	AKY-01	AXR-01	-	AAL-03-3
AC4 DCLNR 27060 12 H	1.575	2.362	1.063	M14x1.5	0.534	CN.. 432 CN.. 120408	ATKH-01-R	AKV-33-M6x22	AACN-3-0001	AAV-13-M5x8	AKY-01	AXR-01	-	AAL-03-3
AC5 DCLNR 35060 12 H	1.969	2.362	1.378	M16x1.5	0.825	CN.. 432 CN.. 120408	ATKH-01-R	AKV-33-M6x22	AACN-3-0001	AAV-13-M5x8	AKY-01	AXR-01	-	AAL-03-3
AC6 DCLNR 45065 12 H	2.480	2.559	1.772	M20x2	1.310	CN.. 432 CN.. 120408	ATKH-01-R	AKV-33-M6x22	AACN-3-0001	AAV-13-M5x8	AKY-01	AXR-01	-	AAL-03-3
AC8 DCLNR 55080 12 H	3.150	3.150	2.165	M20x2	2.587	CN.. 432 CN.. 120408	ATKH-01-R	AKV-33-M6x22	AACN-3-0001	AAV-13-M5x8	AKY-01	AXR-01	-	AAL-03-3
<b>new</b> AC4 DCLNR 27055 16 H	1.575	2.165	1.063	M14x1.5	0.445	CN.. 543 CN.. 160612	ATKH-07-R	AKV-39-M7X21	AACN-3-0002	AAV-05-M6X10	AKY-01	AXR-01	-	AAL-05-4
<b>new</b> AC5 DCLNR 35060 16 H	1.969	2.362	1.378	M16x1.5	0.825	CN.. 543 CN.. 160612	ATKH-07-R	AKV-39-M7X21	AACN-3-0002	AAV-05-M6X10	AKY-01	AXR-01	-	AAL-05-4
<b>new</b> AC6 DCLNR 45065 16 H	2.480	2.559	1.772	M20x2	1.310	CN.. 543 CN.. 160612	ATKH-07-R	AKV-39-M7X21	AACN-3-0002	AAV-05-M6X10	AKY-01	AXR-01	-	AAL-05-4
<b>new</b> AC8 DCLNR 55080 16 H	3.150	3.150	2.165	M20x2	2.587	CN.. 543 CN.. 160612	ATKH-07-R	AKV-39-M7X21	AACN-3-0002	AAV-05-M6X10	AKY-01	AXR-01	-	AAL-05-4
<b>new</b> AC5 DCLNR 35060 19 H	1.969	2.362	1.378	M16x1.5	0.825	CN.. 643 CN.. 190612	ATKH-09-R	AKV-39-M7X21	AACN-3-0003	AAV-17-M6x14	AKY-02	AXR-01	-	AAL-05-4
<b>new</b> AC6 DCLNR 45065 19 H	2.480	2.559	1.772	M20x2	1.310	CN.. 643 CN.. 190612	ATKH-09-R	AKV-39-M7X21	AACN-3-0003	AAV-17-M6x14	AKY-02	AXR-01	-	AAL-05-4
<b>new</b> AC8 DCLNR 55080 19 H	3.150	3.150	2.165	M20x2	2.587	CN.. 643 CN.. 190612	ATKH-09-R	AKV-39-M7X21	AACN-3-0003	AAV-17-M6x14	AKY-02	AXR-01	-	AAL-05-4
<b>new</b> AC3 DCLNL 22040 09 H	1.260	1.575	0.866	M12x1.5	0.242	CN.. 322 CN.. 090308	ATK-01	AKV-01-M5x22	AACN-2-0001	AAV-09-M5x9	-	-	ABPL-01	AAL-03-3
<b>new</b> AC4 DCLNL 27050 09 H	1.575	1.969	1.063	M14x1.5	0.440	CN.. 322 CN.. 090308	ATK-01	AKV-01-M5x22	AACN-2-0001	AAV-09-M5x9	-	-	ABPL-01	AAL-03-3
<b>new</b> AC3 DCLNL 22045 12 H	1.260	1.772	0.866	M12x1.5	0.242	CN.. 432 CN.. 120408	ATKH-01-R	AKV-33-M6x22	AACN-3-0001	AAV-13-M5x8	AKY-01	AXR-01	-	AAL-03-3
AC4 DCLNL 27060 12 H	1.575	2.362	1.063	M14x1.5	0.534	CN.. 432 CN.. 120408	ATKH-02-L	AKV-33-M6x22	AACN-3-0001	AAV-13-M5x8	AKY-01	AXR-01	-	AAL-03-3
AC5 DCLNL 35060 12 H	1.969	2.362	1.378	M16x1.5	0.825	CN.. 432 CN.. 120408	ATKH-02-L	AKV-33-M6x22	AACN-3-0001	AAV-13-M5x8	AKY-01	AXR-01	-	AAL-03-3
AC6 DCLNL 45065 12 H	2.480	2.559	1.772	M20x2	1.310	CN.. 432 CN.. 120408	ATKH-02-L	AKV-33-M6x22	AACN-3-0001	AAV-13-M5x8	AKY-01	AXR-01	-	AAL-03-3
AC8 DCLNL 55080 12 H	3.150	3.150	2.165	M20x2	2.587	CN.. 432 CN.. 120408	ATKH-02-L	AKV-33-M6x22	AACN-3-0001	AAV-13-M5x8	AKY-01	AXR-01	-	AAL-03-3
<b>new</b> AC4 DCLNL 27055 16 H	1.575	2.165	1.063	M14x1.5	0.445	CN.. 543 CN.. 160612	ATKH-07-R	AKV-39-M7X21	AACN-3-0002	AAV-05-M6X10	AKY-01	AXR-01	-	AAL-05-4
<b>new</b> AC5 DCLNL 35060 16 H	1.969	2.362	1.378	M16x1.5	0.825	CN.. 543 CN.. 160612	ATKH-07-R	AKV-39-M7X21	AACN-3-0002	AAV-05-M6X10	AKY-01	AXR-01	-	AAL-05-4
<b>new</b> AC6 DCLNL 45065 16 H	2.480	2.559	1.772	M20x2	1.310	CN.. 543 CN.. 160612	ATKH-07-R	AKV-39-M7X21	AACN-3-0002	AAV-05-M6X10	AKY-01	AXR-01	-	AAL-05-4
<b>new</b> AC8 DCLNL 55080 16 H	3.150	3.150	2.165	M20x2	2.587	CN.. 543 CN.. 160612	ATKH-07-R	AKV-39-M7X21	AACN-3-0002	AAV-05-M6X10	AKY-01	AXR-01	-	AAL-05-4
<b>new</b> AC5 DCLNL 35060 19 H	1.969	2.362	1.378	M16x1.5	0.825	CN.. 643 CN.. 190612	ATKH-10-L	AKV-39-M7X21	AACN-3-0003	AAV-17-M6x14	AKY-02	AXR-01	-	AAL-05-4
<b>new</b> AC6 DCLNL 45065 19 H	2.480	2.559	1.772	M20x2	1.310	CN.. 643 CN.. 190612	ATKH-10-L	AKV-39-M7X21	AACN-3-0003	AAV-17-M6x14	AKY-02	AXR-01	-	AAL-05-4
<b>new</b> AC8 DCLNL 55080 19 H	3.150	3.150	2.165	M20x2	2.587	CN.. 643 CN.. 190612	ATKH-10-L	AKV-39-M7X21	AACN-3-0003	AAV-17-M6x14	AKY-02	AXR-01	-	AAL-05-4



Illustrations shown may vary from actual product.

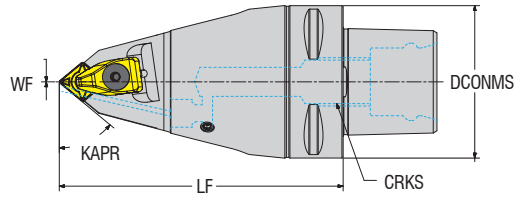

Dimensions in Inch



Ordering Code	DCONMS	LF	WF	CRKS	KG	Insert Inch/Metric	Wedge Clamp	Clamp Screw	Shim	Shim Screw	Ring	Stamp	Nozzle	Allen Key
AC6 DCMNN 00115 12	2.480	4.528	0	M20x2	1.995	CN.. 432 CN.. 120408	ATK-02	AKV-30-M6x22	AACN-3-0001	AAV-13-M5x8	AS-01	ABPL-01	ACN-M12-12.5	AAL-03-3
AC8 DCMNN 00150 16	3.150	5.906	0	M20x2	4.200	CN.. 542 CN.. 160608	ATK-04	AKV-19-M7x25	AACN-3-0002	AAV-05-M6x15	AS-02	ABPL-02	ACN-M12-12.5	AAL-05-4



Illustrations shown may vary from actual product.

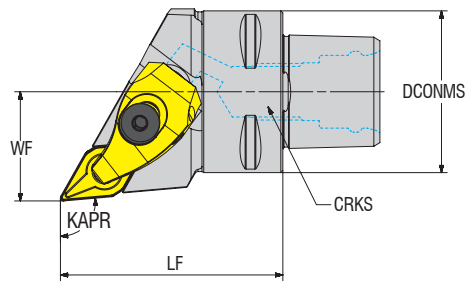

Dimensions in Inch



Ordering Code	DCONMS	LF	WF	CRKS	KG	Insert Inch/Metric	Wedge Clamp	Clamp Screw	Shim	Shim Screw	Radial Adj. Screw	Allen Key
AC4 DDLNR 27055 1504 H	1.575	2.165	1.063	M14x1.5	0.445	DN.. 432 DN.. 150408	ATKH-01-R	AKV-33-M6X22	AADN-2-0003	AAV-02-M5x12	2725-M5X5	AAL-03-3



Illustrations shown may vary from actual product.

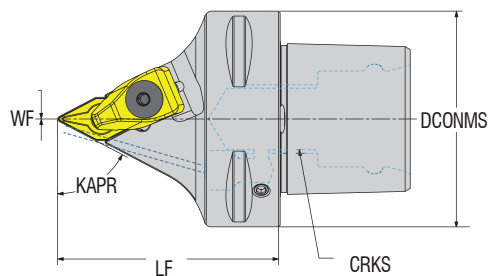

Dimensions in Inch



Ordering Code	DCONMS	LF	WF	CRKS	KG	Insert Inch/Metric	Wedge Clamp	Clamp Screw	Shim	Shim Screw	Ring	Stamp	Nozzle	Allen Key
AC4 DDNNN 00050 11	1.575	1.969	0	M14x1.5	0.300	DN.. 332 DN.. 110408	ATK-01	AKV-01-M5x22	AADN-2-0001	AAV-04-M5x12	-	ABPL-01	ACN-M8-8.5	AAL-03-3
AC5 DDNNN 00060 11	1.969	2.362	0	M16x1.5	0.600	DN.. 332 DN.. 110408	ATK-01	2725-M5X5	AADN-2-0001	AAV-04-M5x12	-	ABPL-01	ACN-M10-10.5	AAL-03-3
AC4 DDNNN 00055 15	1.575	2.165	0	M14x1.5	0.330	DN.. 442 DN.. 150608	ATK-02	AKV-30-M6x22	AADN-3-0001	AAV-02-M5x12	AS-01	ABPL-01	ACN-M8-8.5	AAL-03-3
AC5 DDNNN 00060 15	1.969	2.362	0	M16x1.5	0.600	DN.. 442 DN.. 150608	ATK-02	AKV-30-M6x22	AADN-3-0001	AAV-02-M5x12	AS-01	ABPL-01	ACN-M10-10.5	AAL-03-3
AC6 DDNNN 00065 15	2.480	2.559	0	M20x2	1.000	DN.. 442 DN.. 150608	ATK-02	AKV-30-M6x22	AADN-3-0001	AAV-02-M5x12	AS-01	ABPL-01	ACN-M12-12.5	AAL-03-3
AC8 DDNNN 00080 15	3.150	3.150	0	M20x2	2.150	DN.. 442 DN.. 150608	ATK-02	AKV-30-M6x22	AADN-3-0001	AAV-02-M5x12	AS-01	ABPL-01	ACN-M12-12.5	AAL-03-3

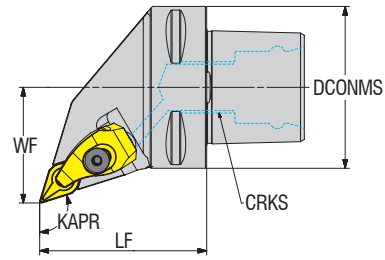

Illustrations shown may vary from actual product.

Dimensions in Inch

Ordering Code	DCONMS	LF	WF	CRKS	KG	Insert Inch/Metric	Wedge Clamp	Clamp Screw	Shim	Shim Screw	Spring	Ring	Allen Key
AC4 DDHNR 27055 15 H	1.575	2.165	1.063	M14x1.5	0.445	DN.. 442 DN.. 150608	ATKH-01-R	AKV-33-M6x22	AADN-3-0001	AAV-13-M5x8	AKY-01	AXR-01	AAL-03-3
AC5 DDHNR 35060 15 H	1.969	2.362	1.378	M16x1.5	0.825	DN.. 442 DN.. 150608	ATKH-01-R	AKV-33-M6X22	AADN-3-0001	AAV-13-M5x8	AKY-01	AXR-01	AAL-03-3
AC6 DDHNR 45065 15 H	2.480	2.559	1.772	M20x2	1.178	DN.. 442 DN.. 150608	ATKH-01-R	AKV-33-M6X22	AADN-3-0001	AAV-13-M5x8	AKY-01	AXR-01	AAL-03-3
AC8 DDHNR 55080 15 H	3.150	3.150	2.165	M20x2	2.568	DN.. 442 DN.. 150608	ATKH-01-R	AKV-33-M6X22	AADN-3-0001	AAV-13-M5x8	AKY-01	AXR-01	AAL-03-3
AC4 DDHNL 27055 15 H	1.575	2.165	1.063	M14x1.5	0.445	DN.. 442 DN.. 150608	ATKH-02-L	AKV-33-M6X22	AADN-3-0001	AAV-13-M5x8	AKY-01	AXR-01	AAL-03-3
AC5 DDHNL 35060 15 H	1.969	2.362	1.378	M16x1.5	0.825	DN.. 442 DN.. 150608	ATKH-02-L	AKV-33-M6X22	AADN-3-0001	AAV-13-M5x8	AKY-01	AXR-01	AAL-03-3
AC6 DDHNL 45065 15 H	2.480	2.559	1.772	M20x2	1.178	DN.. 442 DN.. 150608	ATKH-02-L	AKV-33-M6X22	AADN-3-0001	AAV-13-M5x8	AKY-01	AXR-01	AAL-03-3
AC8 DDHNL 55080 15 H	3.150	3.150	2.165	M20x2	2.568	DN.. 442 DN.. 150608	ATKH-02-L	AKV-33-M6X22	AADN-3-0001	AAV-13-M5x8	AKY-01	AXR-01	AAL-03-3

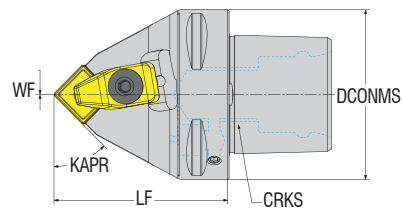

Illustrations shown may vary from actual product.

Dimensions in Inch

Ordering Code	DCONMS	LF	WF	CRKS	KG	Insert Inch/Metric	Wedge Clamp	Clamp Screw	Shim	Shim Screw	Ring	Stamp	Nozzle	Allen Key
AC3 DSDNN 00048 12	1.260	1.890	0	M12x1.5	0.200	SN.. 432 SN.. 120408	ATK-02	AKV-30-M6x22	AASN-3-0004	AAV-02-M5x12	AS-01	ABPL-01	-	AAL-03-3
AC4 DSDNN 00050 12	1.575	1.969	0	M14x1.5	0.350	SN.. 432 SN.. 120408	ATK-02	AKV-30-M6x22	AASN-3-0004	AAV-02-M5x12	AS-01	ABPL-01	ACN-M8-8.5	AAL-03-3
AC5 DSDNN 00060 12	1.969	2.362	0	M16x1.5	0.600	SN.. 432 SN.. 120408	ATK-02	AKV-30-M6x22	AASN-3-0004	AAV-02-M5x12	AS-01	ABPL-01	ACN-M10-10.5	AAL-03-3
AC6 DSDNN 00065 12	2.480	2.559	0	M20x2	1.050	SN.. 432 SN.. 120408	ATK-02	AKV-30-M6x22	AASN-3-0004	AAV-02-M5x12	AS-01	ABPL-01	ACN-M12-12.5	AAL-03-3
AC5 DSDNN 00060 15	1.969	2.362	0	M16x1.5	0.600	SN.. 542 SN.. 150608	ATK-02	AKV-19-M7x25	AASN-3-0023	AAV-05-M6x15	AS-02	ABPL-02	ACN-M10-10.5	AAL-05-4
AC6 DSDNN 00065 15	2.480	2.559	0	M20x2	1.100	SN.. 542 SN.. 150608	ATK-02	AKV-19-M7x25	AASN-3-0023	AAV-05-M6x15	AS-02	ABPL-02	ACN-M12-12.5	AAL-05-4
AC5 DSDNN 00065 19	1.969	2.559	0	M16x1.5	0.700	SN.. 642 SN.. 190608	ATK-04	AKV-19-M7x25	AASN-3-0005	AAV-17-M6x14	AS-02	ABPL-02	ACN-M10-10.5	AAL-05-4
AC6 DSDNN 00070 19	2.480	2.756	0	M20x2	1.120	SN.. 642 SN.. 190608	ATK-04	AKV-19-M7x25	AASN-3-0005	AAV-17-M6x14	AS-02	ABPL-02	ACN-M12-12.5	AAL-05-4

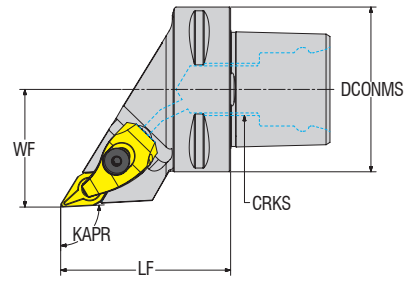

Illustrations shown may vary from actual product.

Dimensions in Inch



Ordering Code	DCONMS	LF	WF	CRKS	KG	Insert Inch/Metric	Wedge Clamp	Clamp Screw	Shim	Shim Screw	Spring	Ring	Allen Key
AC3 DDJNR 22045 11	1.260	1.772	0.866	M12x1.5	0.242	DN.. 332 DN.. 110408	ATK-01	AKV-01-M5x22	AADN-2-0001	AAV-04-M5x12	-	-	AAL-03-3
AC4 DDJNR 27050 11	1.575	1.969	1.063	M14x1.5	0.407	DN.. 332 DN.. 110408	ATK-01	AKV-01-M5x22	AADN-2-0001	AAV-04-M5x12	AKY-01	AXR-01	AAL-03-3
AC5 DDJNR 35060 11 H	1.969	2.362	1.378	M16x1.5	0.708	DN.. 332 DN.. 110408	ATKH-05-R	AKV-33-M6x22	AADN-2-0001	AAV-04-M5x12	AKY-01	AXR-01	AAL-03-3
AC6 DDJNR 45065 11 H	2.480	2.559	1.772	M20x2	1.178	DN.. 332 DN.. 110408	ATKH-05-R	AKV-33-M6x22	AADN-2-0001	AAV-04-M5x12	AKY-01	AXR-01	AAL-03-3
AC4 DDJNR 27060 15 H	1.575	2.362	1.063	M14x1.5	0.488	DN.. 442 DN.. 150608	ATKH-01-R	AKV-33-M6x22	AADN-3-0001	AAV-13-M5x8	AKY-01	AXR-01	AAL-03-3
AC5 DDJNR 35060 15 H	1.969	2.362	1.378	M16x1.5	0.730	DN.. 442 DN.. 150608	ATKH-01-R	AKV-33-M6x22	AADN-3-0001	AAV-13-M5x8	AKY-01	AXR-01	AAL-03-3
AC6 DDJNR 45065 15 H	2.480	2.559	1.772	M20x2	1.178	DN.. 442 DN.. 150608	ATKH-01-R	AKV-33-M6x22	AADN-3-0001	AAV-13-M5x8	AKY-01	AXR-01	AAL-03-3
AC8 DDJNR 55080 15 H	3.150	3.150	2.165	M20x2	2.568	DN.. 442 DN.. 150608	ATKH-01-R	AKV-33-M6x22	AADN-3-0001	AAV-13-M5x8	AKY-01	AXR-01	AAL-03-3
AC3 DDJNL 22045 11	1.260	1.772	0.866	M12x1.5	0.242	DN.. 332 DN.. 110408	ATK-01	AKV-01-M5x22	AADN-2-0001	AAV-04-M5x12	-	-	AAL-03-3
AC4 DDJNL 27050 11	1.575	1.969	1.063	M14x1.5	0.407	DN.. 332 DN.. 110408	ATK-01	AKV-01-M5x22	AADN-2-0001	AAV-04-M5x12	AKY-01	AXR-01	AAL-03-3
AC5 DDJNL 35060 11 H	1.969	2.362	1.378	M16x1.5	0.708	DN.. 332 DN.. 110408	ATKH-06-L	AKV-33-M6x22	AADN-2-0001	AAV-04-M5x12	AKY-01	AXR-01	AAL-03-3
AC6 DDJNL 45065 11 H	2.480	2.559	1.772	M20x2	1.178	DN.. 332 DN.. 110408	ATKH-06-L	AKV-33-M6x22	AADN-2-0001	AAV-04-M5x12	AKY-01	AXR-01	AAL-03-3
AC4 DDJNL 27060 15 H	1.575	2.362	1.063	M14x1.5	0.488	DN.. 442 DN.. 150608	ATKH-02-L	AKV-33-M6x22	AADN-3-0001	AAV-13-M5x8	AKY-01	AXR-01	AAL-03-3
AC5 DDJNL 35060 15 H	1.969	2.362	1.378	M16x1.5	0.730	DN.. 442 DN.. 150608	ATKH-02-L	AKV-33-M6x22	AADN-3-0001	AAV-13-M5x8	AKY-01	AXR-01	AAL-03-3
AC6 DDJNL 45065 15 H	2.480	2.559	1.772	M20x2	1.178	DN.. 442 DN.. 150608	ATKH-02-L	AKV-33-M6x22	AADN-3-0001	AAV-13-M5x8	AKY-01	AXR-01	AAL-03-3
AC8 DDJNL 55080 15 H	3.150	3.150	2.165	M20x2	2.568	DN.. 442 DN.. 150608	ATKH-02-L	AKV-33-M6x22	AADN-3-0001	AAV-13-M5x8	AKY-01	AXR-01	AAL-03-3



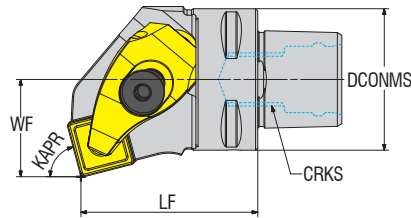

Fig. 1

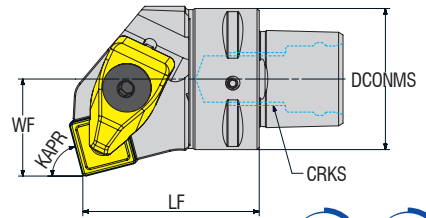

Fig. 2



Illustrations shown may vary from actual product.

Dimensions in Inch



Ordering Code	DCONMS	LF	WF	CRKS	KG	Fig.	Insert Inch/Metric	Wedge Clamp	Clamp Screw	Shim	Shim Screw	Spring	Stamp	Ring	Nozzle	Allen Key
AC3 DSKNR 22040 12	1.260	1.575	0.866	M12x1.5	0.242	2	SN.. 432 SN.. 120408	ATK-02	AKV-30-M6X22	AASN-3-0004	AAV-02-M5x12	-	ABPL-01	AS-01	ACN-M8-8.5	AAL-03-3
AC4 DSKNR 27050 12 H	1.575	1.969	1.063	M14x1.5	0.473	1	SN.. 432 SN.. 120408	ATKH-01-R	AKV-33-M6X22	AASN-3-0004	AAV-02-M5x12	AKY-01	-	AXR-01	-	AAL-03-3
AC5 DSKNR 35060 12 H	1.969	2.362	1.378	M16x1.5	0.854	1	SN.. 432 SN.. 120408	ATKH-01-R	AKV-33-M6X22	AASN-3-0004	AAV-02-M5x12	AKY-01	-	AXR-01	-	AAL-03-3
AC6 DSKNR 45065 12 H	2.480	2.559	1.772	M20x2	1.310	1	SN.. 432 SN.. 120408	ATKH-01-R	AKV-33-M6X22	AASN-3-0004	AAV-02-M5x12	AKY-01	-	AXR-01	-	AAL-03-3
AC5 DSKNR 35060 15 H	1.969	2.362	1.378	M16x1.5	0.854	1	SN.. 543 SN.. 150612	ATKH-07-R	AKV-39-M7X21	AASN-3-0023	AAV-05-M6x10	AKY-01	-	AXR-01	-	AAL-05-4
AC6 DSKNR 45065 15 H	2.480	2.559	1.772	M20x2	1.310	1	SN.. 543 SN.. 150612	ATKH-07-R	AKV-39-M7X21	AASN-3-0023	AAV-05-M6x10	AKY-01	-	AXR-01	-	AAL-05-4
AC5 DSKNR 35060 19 H	1.969	2.362	1.378	M16x1.5	0.854	1	SN.. 643 SN.. 190612	ATKH-09-R	AKV-39-M7X21	AASN-3-0023	AAV-17-M6x14	AKY-01	-	AXR-01	-	AAL-05-4
AC6 DSKNR 45065 19 H	2.480	2.559	1.772	M20x2	1.310	1	SN.. 643 SN.. 190612	ATKH-09-R	AKV-39-M7X21	AASN-3-0023	AAV-17-M6x14	AKY-01	-	AXR-01	-	AAL-05-4
AC8 DSKNR 55080 19 H	3.150	3.150	2.165	M20x2	2.568	1	SN.. 643 SN.. 190612	ATKH-09-R	AKV-39-M7X21	AASN-3-0023	AAV-17-M6x14	AKY-01	-	AXR-01	-	AAL-05-4
AC3 DSKNL 22040 12	1.260	1.575	0.866	M12x1.5	0.242	2	SN.. 432 SN.. 120408	ATK-02	AKV-30-M6X22	AASN-3-0004	AAV-02-M5x12	-	ABPL-01	AS-01	ACN-M8-8.5	AAL-03-3
AC4 DSKNL 27050 12 H	1.575	1.969	1.063	M14x1.5	0.473	1	SN.. 432 SN.. 120408	ATKH-02-L	AKV-33-M6X22	AASN-3-0004	AAV-02-M5x12	AKY-01	-	AXR-01	-	AAL-03-3
AC5 DSKNL 35060 12 H	1.969	2.362	1.378	M16x1.5	0.854	1	SN.. 432 SN.. 120408	ATKH-02-L	AKV-33-M6X22	AASN-3-0004	AAV-02-M5x12	AKY-01	-	AXR-01	-	AAL-03-3
AC6 DSKNL 45065 12 H	2.480	2.559	1.772	M20x2	1.310	1	SN.. 432 SN.. 120408	ATKH-02-L	AKV-33-M6X22	AASN-3-0004	AAV-02-M5x12	AKY-01	-	AXR-01	-	AAL-03-3
AC5 DSKNL 35060 15 H	1.969	2.362	1.378	M16x1.5	0.854	1	SN.. 543 SN.. 150612	ATKH-08-L	AKV-39-M7X21	AASN-3-0023	AAV-05-M6x10	AKY-01	-	AXR-01	-	AAL-05-4
AC6 DSKNL 45065 15 H	2.480	2.559	1.772	M20x2	1.310	1	SN.. 543 SN.. 150612	ATKH-08-L	AKV-39-M7X21	AASN-3-0023	AAV-05-M6x10	AKY-01	-	AXR-01	-	AAL-05-4
AC5 DSKNL 35060 19 H	1.969	2.362	1.378	M16x1.5	0.854	1	SN.. 643 SN.. 190612	ATKH-10-L	AKV-39-M7X21	AASN-3-0023	AAV-17-M6x14	AKY-01	-	AXR-01	-	AAL-05-4
AC6 DSKNL 45065 19 H	2.480	2.559	1.772	M20x2	1.310	1	SN.. 643 SN.. 190612	ATKH-10-L	AKV-39-M7X21	AASN-3-0023	AAV-17-M6x14	AKY-01	-	AXR-01	-	AAL-05-4
AC8 DSKNL 55080 19 H	3.150	3.150	2.165	M20x2	2.568	1	SN.. 643 SN.. 190612	ATKH-10-L	AKV-39-M7X21	AASN-3-0023	AAV-17-M6x14	AKY-01	-	AXR-01	-	AAL-05-4



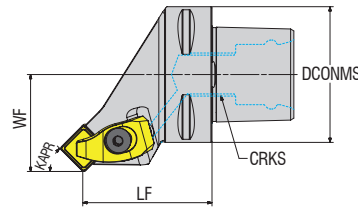

(figure.1)

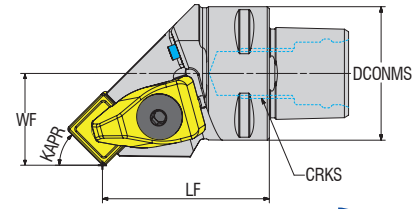

(figure.2)



Illustrations shown may vary from actual product.

Dimensions in Inch



Ordering Code	DCONMS	LF	WF	CRKS	KG	Fig.	Insert Inch/Metric	Wedge Clamp	Clamp Screw	Shim	Shim Screw	Spring	Stamp	Ring	Nozzle	Allen Key
AC3 DSSNR 22040 12	1.260	1.575	0.866	M12x1.5	0.242	2	SN.. 432 SN.. 120408	ATK-02	AKV-30-M6x22	AASN-3-0004	AAV-02-M5x12	-	ABPL-01	AS-01	ACN-M8-8.5	AAL-03-3
AC4 DSSNR 27042 12	1.575	1.654	1.063	M14x1.5	0.385	2	SN.. 432 SN.. 120408	ATK-02	AKV-30-M6x22	AASN-3-0004	AAV-02-M5x12	-	ABPL-01	AS-01	ACN-M8-8.5	AAL-03-3
AC5 DSSNR 35052 12 H	1.969	2.047	1.378	M16x1.5	0.854	1	SN.. 432 SN.. 120408	ATKH-01-R	AKV-30-M6x22	AASN-3-0004	AAV-02-M5x12	AKY-01	-	AXR-01	-	AAL-03-3
AC6 DSSNR 45056 12 H	2.480	2.205	1.772	M20x2	1.355	1	SN.. 432 SN.. 120408	ATKH-01-R	AKV-33-M6x22	AASN-3-0004	AAV-02-M5x12	AKY-01	-	AXR-01	-	AAL-03-3
AC4 DSSNR 27045 15	1.575	1.772	1.063	M14x1.5	0.745	2	SN.. 543 SN.. 150612	ATK-04	AKV-19-M7x25	AASN-3-0023	AAV-05-M6x15	-	-	AS-02	ACN-M8-8.5	AAL-05-4
AC5 DSSNR 35050 15 H	1.969	1.969	1.378	M16x1.5	0.854	1	SN.. 543 SN.. 150612	ATKH-07-R	AKV-39-M7x21	AASN-3-0023	AAV-05-M6x15	AKY-01	-	AXR-01	-	AAL-05-4
AC6 DSSNR 45054 15 H	2.480	2.126	1.772	M20x2	1.357	1	SN.. 543 SN.. 150612	ATKH-07-R	AKV-39-M7x21	AASN-3-0023	AAV-05-M6x15	AKY-01	-	AXR-01	-	AAL-05-4
AC5 DSSNR 35048 19 H	1.969	1.890	1.378	M16x1.5	0.831	1	SN.. 643 SN.. 190612	ATKH-09-R	AKV-39-M7x21	AASN-3-0005	AAV-17-M6x14	AKY-01	-	AXR-01	-	AAL-05-4
AC6 DSSNR 45052 19 H	2.480	2.047	1.772	M20x2	1.355	1	SN.. 643 SN.. 190612	ATKH-09-R	AKV-39-M7x21	AASN-3-0005	AAV-17-M6x14	AKY-01	-	AXR-01	-	AAL-05-4
AC3 DSSNL 22040 12	1.260	1.575	0.866	M12x1.5	0.242	2	SN.. 432 SN.. 120408	ATK-02	AKV-30-M6x22	AASN-3-0004	AAV-02-M5x12	-	ABPL-01	AS-01	ACN-M8-8.5	AAL-03-3
AC4 DSSNL 27042 12	1.575	1.654	1.063	M14x1.5	0.385	2	SN.. 432 SN.. 120408	ATK-02	AKV-30-M6x22	AASN-3-0004	AAV-02-M5x12	-	ABPL-01	AS-01	ACN-M8-8.5	AAL-03-3
AC5 DSSNL 35052 12 H	1.969	2.047	1.378	M16x1.5	0.854	1	SN.. 432 SN.. 120408	ATKH-02-L	AKV-30-M6x22	AASN-3-0004	AAV-02-M5x12	AKY-01	-	AXR-01	-	AAL-03-3
AC6 DSSNL 45056 12 H	2.480	2.205	1.772	M20x2	1.355	1	SN.. 432 SN.. 120408	ATKH-02-L	AKV-33-M6x22	AASN-3-0004	AAV-02-M5x12	AKY-01	-	AXR-01	-	AAL-03-3
AC4 DSSNL 27045 15	1.575	1.772	1.063	M14x1.5	0.745	2	SN.. 543 SN.. 150612	ATK-04	AKV-19-M7x25	AASN-3-0023	AAV-05-M6x15	-	-	AS-02	ACN-M8-8.5	AAL-05-4
AC5 DSSNL 35050 15 H	1.969	1.969	1.378	M16x1.5	0.854	1	SN.. 543 SN.. 150612	ATKH-08-L	AKV-39-M7x21	AASN-3-0023	AAV-05-M6x15	AKY-01	-	AXR-01	-	AAL-05-4
AC6 DSSNL 45054 15 H	2.480	2.126	1.772	M20x2	1.357	1	SN.. 543 SN.. 150612	ATKH-08-L	AKV-39-M7x21	AASN-3-0023	AAV-05-M6x15	AKY-01	-	AXR-01	-	AAL-05-4
AC5 DSSNL 35048 19 H	1.969	1.890	1.378	M16x1.5	0.831	1	SN.. 643 SN.. 190612	ATKH-10-L	AKV-39-M7x21	AASN-3-0005	AAV-17-M6x14	AKY-01	-	AXR-01	-	AAL-05-4
AC6 DSSNL 45052 19 H	2.480	2.047	1.772	M20x2	1.355	1	SN.. 643 SN.. 190612	ATKH-10-L	AKV-39-M7x21	AASN-3-0005	AAV-17-M6x14	AKY-01	-	AXR-01	-	AAL-05-4

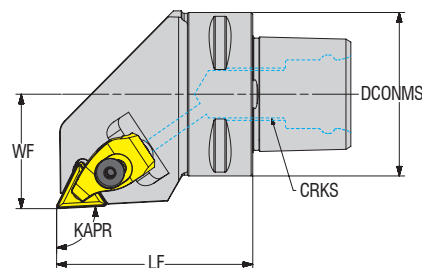

Illustrations shown may vary from actual product.

Dimensions in Inch



Ordering Code	DCONMS	LF	WF	CRKS	KG	Insert Inch/Metric	Wedge Clamp	Clamp Screw	Shim	Shim Screw	Spring	Ring	Radial Adj. Screw	Allen Key
AC5 DTJNR 35060 16 H	1.969	2.362	1.378	M16x1.5	0.620	TN.. 332 TN.. 160408	ATKH-03-R	AKV-37-M5x18	AATN-2-0002	AAV-3-M5x12	AKY-03	AXR-02	2725-M5x5	AAL-02-2.5
AC5 DTJNL 35060 16 H	1.969	2.362	1.378	M16x1.5	0.620	TN.. 332 TN.. 160408	ATKH-04-L	AKV-37-M5x18	AATN-2-0002	AAV-3-M5x12	AKY-03	AXR-02	2725-M5x5	AAL-02-2.5

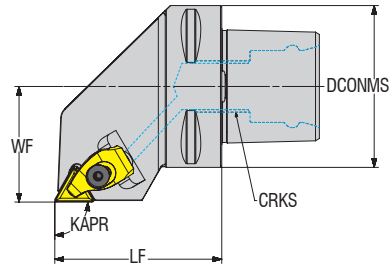

Illustrations shown may vary from actual product.

Ordering Code	Dimensions in Inch					Insert Inch/Metric	Wedge Clamp	Clamp Screw	Shim	Shim Screw	Spring	Ring	Allen Key
	DCONMS	LF	WF	CRKS	KG								
AC4 DTGNR 27050 22 H	1.575	1.969	1.063	M14x1.5	0.420	TN.. 432 TNM. 220408	ATKH-01-R	AKV-33-M6x22	AATN-3-0015	AAV-02-M5x12	AKY-01	AXR-01	AAL-03-3
AC5 DTGNR 35060 22 H	1.969	2.362	1.378	M16x1.5	0.810	TN.. 432 TNM. 220408	ATKH-01-R	AKV-33-M6x22	AATN-3-0015	AAV-02-M5x12	AKY-01	AXR-01	AAL-03-3
AC6 DTGNR 45065 16 H	2.480	2.559	1.772	M20x2	1.100	TN.. 332 TNM. 160408	ATKH-03-R	AKV-37-M5x18	AATN-2-0002	AAV-03-M5x12	AKY-02	AXR-02	AAL-02-2.5
AC6 DTGNR 45065 22 H	2.480	2.559	1.772	M20x2	1.100	TN.. 432 TNM. 220408	ATKH-01-R	AKV-33-M6x22	AATN-3-0015	AAV-02-M5x12	AKY-01	AXR-01	AAL-03-3
AC4 DTGNL 27050 22 H	1.575	1.969	1.063	M14x1.5	0.420	TN.. 432 TNM. 220408	ATKH-02-L	AKV-33-M6x22	AATN-3-0015	AAV-02-M5x12	AKY-01	AXR-01	AAL-03-3
AC5 DTGNL 35060 22 H	1.969	2.362	1.378	M16x1.5	0.810	TN.. 432 TNM. 220408	ATKH-02-L	AKV-33-M6x22	AATN-3-0015	AAV-02-M5x12	AKY-01	AXR-01	AAL-03-3
AC6 DTGNL 45065 16 H	2.480	2.559	1.772	M20x2	1.100	TN.. 332 TNM. 160408	ATKH-04-L	AKV-37-M5x18	AATN-2-0002	AAV-03-M5x12	AKY-02	AXR-02	AAL-02-2.5
AC6 DTGNL 45065 22 H	2.480	2.559	1.772	M20x2	1.100	TN.. 432 TNM. 220408	ATKH-02-L	AKV-33-M6x22	AATN-3-0015	AAV-02-M5x12	AKY-01	AXR-01	AAL-03-3

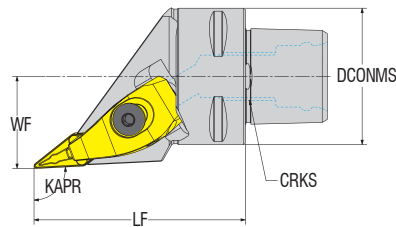

Illustrations shown may vary from actual product.

Ordering Code	Dimensions in Inch					Insert Inch/Metric	Wedge Clamp	Clamp Screw	Shim	Shim Screw	Spring	Ring	Allen Key
	DCONMS	LF	WF	CRKS	KG								
AC4 DVJNR 27062 16 H	1.575	2.362	1.378	M14x1.5	0.457	VN.. 332 VN.. 160408	ATKH-05-R	AKV-33-M6x22	AAVN-2-0002	AAV-04-M5x12	AKY-01	AXR-01	AAL-03-3
<b>new</b> AC5 DVJNR 35065 16 H	1.969	2.559	1.378	M16x1.5	0.831	VN.. 332 VN.. 160408	ATKH-05-R	AKV-33-M6x22	AAVN-2-0002	AAV-04-M5x12	AKY-01	AXR-01	AAL-03-3
<b>new</b> AC6 DVJNR 45065 16 H	2.480	2.559	1.772	M20x2	1.115	VN.. 332 VN.. 160408	ATKH-05-R	AKV-33-M6x22	AAVN-2-0002	AAV-04-M5x12	AKY-01	AXR-01	AAL-03-3
<b>new</b> AC8 DVJNR 55080 16 H	3.150	3.150	2.165	M20x2	2.620	VN.. 332 VN.. 160408	ATKH-05-R	AKV-33-M6x22	AAVN-2-0002	AAV-04-M5x12	AKY-01	AXR-01	AAL-03-3
AC4 DVJNL 27062 16 H	1.575	2.362	1.378	M14x1.5	0.457	VN.. 332 VN.. 160408	ATKH-06-L	AKV-33-M6x22	AAVN-2-0002	AAV-04-M5x12	AKY-01	AXR-01	AAL-03-3
<b>new</b> AC5 DVJNL 35065 16 H	1.969	2.559	1.378	M16x1.5	0.831	VN.. 332 VN.. 160408	ATKH-06-L	AKV-33-M6x22	AAVN-2-0002	AAV-04-M5x12	AKY-01	AXR-01	AAL-03-3
<b>new</b> AC6 DVJNL 45065 16 H	2.480	2.559	1.772	M20x2	1.115	VN.. 332 VN.. 160408	ATKH-06-L	AKV-33-M6x22	AAVN-2-0002	AAV-04-M5x12	AKY-01	AXR-01	AAL-03-3
<b>new</b> AC8 DVJNL 55080 16 H	3.150	3.150	2.165	M20x2	2.620	VN.. 332 VN.. 160408	ATKH-06-L	AKV-33-M6x22	AAVN-2-0002	AAV-04-M5x12	AKY-01	AXR-01	AAL-03-3

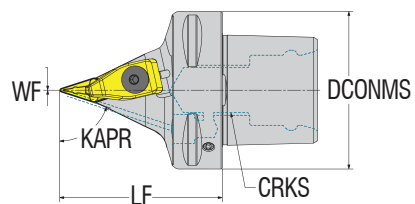

Illustrations shown may vary from actual product.

Dimensions in Inch

Ordering Code	DCONMS	LF	WF	CRKS	KG										
						Insert Inch/Metric	Wedge Clamp	Clamp Screw	Shim	Shim Screw	Ring	Stamp	Nozzle	Allen Key	
<b>AC4 DVVNN 00062 16</b>	1.575	2.441	0	M14x1.5	0.400	VN.. 332 VN.. 160408	ATK-03	AKV-30-M6x22	AAVN-2-0002	AAV-04-M5x12	AS-01	ABPL-01	ACN-M8-8.5	AAL-03-3	
<b>AC5 DVVNN 00065 16</b>	1.969	2.559	0	M16x1.5	0.600	VN.. 332 VN.. 160408	ATK-03	AKV-30-M6x22	AAVN-2-0002	AAV-04-M5x12	AS-01	ABPL-01	ACN-M10-10.5	AAL-03-3	
<b>AC6 DVVNN 00065 16</b>	2.480	2.559	0	M20x2	0.950	VN.. 332 VN.. 160408	ATK-03	AKV-30-M6x22	AAVN-2-0002	AAV-04-M5x12	AS-01	ABPL-01	ACN-M12-12.5	AAL-03-3	
<b>AC8 DVVNN 00080 16</b>	3.150	3.150	0	M20x2	2.000	VN.. 332 VN.. 160408	ATK-03	AKV-30-M6x22	AAVN-2-0002	AAV-04-M5x12	AS-01	ABPL-01	ACN-M12-12.5	AAL-03-3	

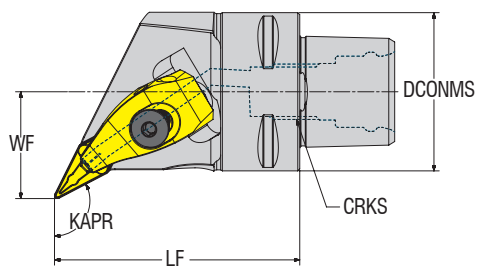

Illustrations shown may vary from actual product.

Dimensions in Inch

Ordering Code	DCONMS	LF	WF	CRKS	KG										
						Insert Inch/Metric	Wedge Clamp	Clamp Screw	Shim	Shim Screw	Spring	Ring	Radial Adj. Screw	Allen Key	
<b>AC4 DVQNR 27062 16 H</b>	1.575	2.440	1.063	M14x1.5	0.457	VN.. 332 VN.. 160408	ATKH-05-R	AKV-33-M6x22	AAVN-2-0002	AAV-04-M5x12	AKY-01	AXR-01	2725-M5X5	AAL-03-3	

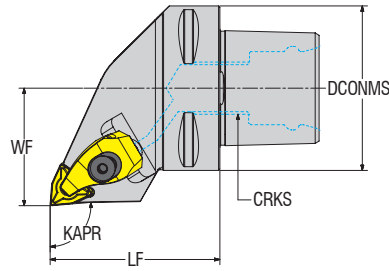

Illustrations shown may vary from actual product.

Dimensions in Inch



Ordering Code	DCONMS	LF	WF	CRKS	KG	Insert Inch/Metric	Wedge Clamp	Clamp Screw	Shim	Shim Screw	Spring	Ring	Allen Key
<b>NEW</b> AC3 DWLNR 22040 06 H	1.260	1.575	0.866	M12x1.5	0.242	WN. 332 WN.. 060408	ATKH-03-R	AKV-37-M5X18	AAWN-SW317	AAV-01-M3x10	AKY-03	AXR-02	AAL-02-2.5
<b>NEW</b> AC4 DWLNR 27050 06 H	1.575	1.969	1.063	M14x1.5	0.415	WN. 332 WN.. 060408	ATKH-03-R	AKV-37-M5X18	AAWN-SW317	AAV-01-M3x10	AKY-03	AXR-02	AAL-02-2.5
<b>NEW</b> AC5 DWLNR 35060 06 H	1.969	2.362	1.378	M16x1.5	0.779	WN. 332 WN.. 060408	ATKH-03-R	AKV-37-M5X18	AAWN-SW317	AAV-01-M3x10	AKY-03	AXR-02	AAL-02-2.5
<b>NEW</b> AC6 DWLNR 45065 06 H	2.480	2.559	1.772	M20x2	1.320	WN. 332 WN.. 060408	ATKH-03-R	AKV-37-M5X18	AAWN-SW317	AAV-01-M3x10	AKY-03	AXR-02	AAL-02-2.5
AC4 DWLNR 27060 08 H	1.575	2.362	1.063	M14x1.5	0.515	WN. 432 WN.. 080408	ATKH-01-R	AKV-33-M6X22	AAWN-3-0001	AAV-13-M5x8	AKY-01	AXR-01	AAL-03-3
AC5 DWLNR 35060 08 H	1.969	2.362	1.378	M16x1.5	0.779	WN. 432 WN.. 080408	ATKH-01-R	AKV-33-M6X22	AAWN-3-0001	AAV-13-M5x8	AKY-01	AXR-01	AAL-03-3
AC6 DWLNR 45065 08 H	2.480	2.559	1.772	M20x2	1.320	WN. 432 WN.. 080408	ATKH-01-R	AKV-33-M6X22	AAWN-3-0001	AAV-13-M5x8	AKY-01	AXR-01	AAL-03-3
AC8 DWLNR 55080 08 H	3.150	3.150	2.165	M20x2	2.620	WN. 432 WN.. 080408	ATKH-01-R	AKV-33-M6X22	AAWN-3-0001	AAV-13-M5x8	AKY-01	AXR-01	AAL-03-3
<b>NEW</b> AC3 DWLNL 22040 06 H	1.260	1.575	0.866	M12x1.5	0.242	WN. 332 WN.. 060408	ATKH-04-L	AKV-37-M5X18	AAWN-SW317	AAV-01-M3x10	AKY-03	AXR-02	AAL-02-2.5
<b>NEW</b> AC4 DWLNL 27050 06 H	1.575	1.969	1.063	M14x1.5	0.415	WN. 332 WN.. 060408	ATKH-04-L	AKV-37-M5X18	AAWN-SW317	AAV-01-M3x10	AKY-03	AXR-02	AAL-02-2.5
<b>NEW</b> AC5 DWLNL 35060 06 H	1.969	2.362	1.378	M16x1.5	0.779	WN. 332 WN.. 060408	ATKH-04-L	AKV-37-M5X18	AAWN-SW317	AAV-01-M3x10	AKY-03	AXR-02	AAL-02-2.5
<b>NEW</b> AC6 DWLNL 45065 06 H	2.480	2.559	1.772	M20x2	1.320	WN. 332 WN.. 060408	ATKH-04-L	AKV-37-M5X18	AAWN-SW317	AAV-01-M3x10	AKY-03	AXR-02	AAL-02-2.5
AC4 DWLNL 27060 08 H	1.575	2.362	1.063	M14x1.5	0.515	WN. 432 WN.. 080408	ATKH-02-L	AKV-33-M6X22	AAWN-3-0001	AAV-13-M5x8	AKY-01	AXR-01	AAL-03-3
AC5 DWLNL 35060 08 H	1.969	2.362	1.378	M16x1.5	0.779	WN. 432 WN.. 080408	ATKH-02-L	AKV-33-M6X22	AAWN-3-0001	AAV-13-M5x8	AKY-01	AXR-01	AAL-03-3
AC6 DWLNL 45065 08 H	2.480	2.559	1.772	M20x2	1.320	WN. 432 WN.. 080408	ATKH-02-L	AKV-33-M6X22	AAWN-3-0001	AAV-13-M5x8	AKY-01	AXR-01	AAL-03-3
AC8 DWLNL 55080 08 H	3.150	3.150	2.165	M20x2	2.620	WN. 432 WN.. 080408	ATKH-02-L	AKV-33-M6X22	AAWN-3-0001	AAV-13-M5x8	AKY-01	AXR-01	AAL-03-3

KAPR=95°

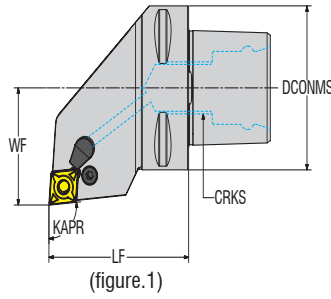

(figure.1)

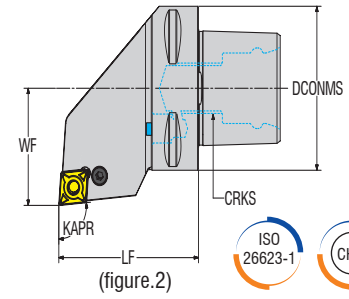

(figure.2)

Illustrations shown may vary from actual product.

Dimensions in Inch



Ordering Code	DCONMS	LF	WF	CRKS	KG	Fig.	Insert Inch/Metric	Wedge Clamp	Clamp Screw	Lever	Lever Screw	Shim	Shim Spring	Ring	Nozzle	Nozzle Screw	Allen Key
<b>new</b> AC3 PCLNR 22040 12 H	1.260	1.575	0.866	M12x1.5	0.242	1	CN.. 432 CN.. 120408	-	-	APL-02	ALV-03-M8X19	AACN-3-0001	AAV-02	AXR-01 / AOR-01	AN-01	2715-M3x5	AAL-03-3
AC4 PCLNR 27050 12 H	1.575	1.969	1.063	M14x1.5	0.440	1	CN.. 432 CN.. 120408	-	-	APL-02	ALV-03-M8X19	AACN-3-0001	AAV-02	AXR-01 / AOR-01	AN-01	2715-M3x11	AAL-03-3
<b>new</b> AC4 PCLNR 27050 16 H	1.575	1.969	1.063	M14x1.5	0.455	1	CN.. 543 CN.. 160612	-	-	APL-04	ALV-04-M8X22	AACN-3-0002	AAV-03	AXR-01 / AOR-01	AN-01	2715-M3x5	AAL-03-3
AC5 PCLNR 35060 12 H	1.969	2.362	1.378	M16x1.5	0.783	1	CN.. 432 CN.. 120408	-	-	APL-02	ALV-03-M8X19	AACN-3-0001	AAV-02	AXR-01 / AOR-01	AN-01	2715-M3x11	AAL-03-3
<b>new</b> AC5 PCLNR 35060 16 H	1.969	2.362	1.378	M16x1.5	0.783	1	CN.. 543 CN.. 160612	-	-	APL-04	ALV-04-M8X22	AACN-3-0002	AAV-03	AXR-01 / AOR-01	AN-01	2715-M3x5	AAL-03-3
<b>new</b> AC5 PCLNR 35060 19 H	1.969	2.362	1.378	M16x1.5	0.783	1	CN.. 643 CN.. 190612	-	-	APL-05	ALV-05-M10x27	AACN-3-0003	AAV-04	AXR-01 / AOR-01	AN-01	2715-M3x5	AAL-03-3
<b>new</b> AC6 PCLNR 45065 12 H	2.480	2.559	1.772	M20x2	1.230	1	CN.. 432 CN.. 120408	-	-	APL-02	ALV-03-M8X19	AACN-3-0001	AAV-02	AXR-01 / AOR-01	AN-01	2715-M3x11	AAL-03-3
<b>new</b> AC6 PCLNR 45065 16 H	2.480	2.559	1.772	M20x2	1.357	1	CN.. 543 CN.. 160612	-	-	APL-04	ALV-04-M8X22	AACN-3-0002	AAV-03	AXR-01 / AOR-01	AN-01	2715-M3x5	AAL-03-3
<b>new</b> AC6 PCLNR 45065 19 H	2.480	2.559	1.772	M20x2	1.357	1	CN.. 643 CN.. 190612	-	-	APL-05	ALV-05-M10x27	AACN-3-0003	AAV-04	AXR-01 / AOR-01	AN-01	2715-M3x5	AAL-03-3
<b>new</b> AC6 PCLNR 45165 12 H	2.480	2.559	1.772	M20x2	1.357	1	CN.. 432 CN.. 120408	-	-	APL-02	ALV-03-M8X19	AACN-3-0001	AAV-02	AXR-01 / AOR-01	AN-01	2715-M3x11	AAL-03-3
AC8 PCLNR 55080 12 H	3.150	3.150	2.165	M20x2	2.655	1	CN.. 432 CN.. 120408	-	-	APL-02	ALV-03-M8X19	AACN-3-0001	AAV-02	AXR-01 / AOR-01	AN-01	2715-M3x11	AAL-03-3
<b>new</b> AC8 PCLNR 55080 16 H	3.150	3.150	2.165	M20x2	2.655	1	CN.. 543 CN.. 160612	-	-	APL-04	ALV-04-M8X22	AACN-3-0002	AAV-03	AXR-01 / AOR-01	AN-01	2715-M3x5	AAL-03-3
<b>new</b> AC8 PCLNR 55080 19 H	3.150	3.150	2.165	M20x2	2.655	1	CN.. 643 CN.. 190612	-	-	APL-05	ALV-05-M10x27	AACN-3-0003	AAV-04	AXR-01 / AOR-01	AN-01	2715-M3x5	AAL-03-3
<b>new</b> AC8 PCLNR 55080 25 C	3.150	3.150	2.165	M20x2	2.655	2	CN.. 866 CN.. 250924	ACK-04	AKV-16-M6x16	APL-06	ALV-06-M12x36	AACN-3-0008	AAV-05	-	ACN-M12 -12.5	2715-M3x11	AAL-07-5
<b>new</b> AC3 PCLNL 22040 12 H	1.260	1.575	0.866	M12x1.5	0.242	1	CN.. 432 CN.. 120408	-	-	APL-02	ALV-03-M8X19	AACN-3-0001	AAV-02	AXR-01 / AOR-01	AN-01	2715-M3x5	AAL-03-3
AC4 PCLNL 27050 12 H	1.575	1.969	1.063	M14x1.5	0.440	1	CN.. 432 CN.. 120408	-	-	APL-02	ALV-03-M8X19	AACN-3-0001	AAV-02	AXR-01 / AOR-01	AN-01	2715-M3x11	AAL-03-3
<b>new</b> AC4 PCLNL 27050 16 H	1.575	1.969	1.063	M14x1.5	0.455	1	CN.. 543 CN.. 160612	-	-	APL-04	ALV-04-M8X22	AACN-3-0002	AAV-03	AXR-01 / AOR-01	AN-01	2715-M3x5	
AC5 PCLNL 35060 12 H	1.969	2.362	1.378	M16x1.5	0.783	1	CN.. 432 CN.. 120408	-	-	APL-02	ALV-03-M8X19	AACN-3-0001	AAV-02	AXR-01 / AOR-01	AN-01	2715-M3x11	AAL-03-3
<b>new</b> AC5 PCLNL 35060 16 H	1.969	2.362	1.378	M16x1.5	0.783	1	CN.. 543 CN.. 160612	-	-	APL-04	ALV-04-M8X22	AACN-3-0002	AAV-03	AXR-01 / AOR-01	AN-01	2715-M3x5	
<b>new</b> AC5 PCLNL 35060 19 H	1.969	2.362	1.378	M16x1.5	0.783	1	CN.. 643 CN.. 190612	-	-	APL-05	ALV-05-M10x27	AACN-3-0003	AAV-04	AXR-01 / AOR-01	AN-01	2715-M3x5	
<b>new</b> AC6 PCLNL 45065 12 H	2.480	2.559	1.772	M20x2	1.230	1	CN.. 432 CN.. 120408	-	-	APL-02	ALV-03-M8X19	AACN-3-0001	AAV-02	AXR-01 / AOR-01	AN-01	2715-M3x11	AAL-03-3
<b>new</b> AC6 PCLNL 45065 16 H	2.480	2.559	1.772	M20x2	1.357	1	CN.. 543 CN.. 160612	-	-	APL-04	ALV-04-M8X22	AACN-3-0002	AAV-03	AXR-01 / AOR-01	AN-01	2715-M3x5	
<b>new</b> AC6 PCLNL 45065 19 H	2.480	2.559	1.772	M20x2	1.357	1	CN.. 643 CN.. 190612	-	-	APL-05	ALV-05-M10x27	AACN-3-0003	AAV-04	AXR-01 / AOR-01	AN-01	2715-M3x5	AAL-03-3
<b>new</b> AC6 PCLNL 45165 12 H	2.480	2.559	1.772	M20x2	1.357	1	CN.. 432 CN.. 120408	-	-	APL-02	ALV-03-M8X19	AACN-3-0001	AAV-02	AXR-01 / AOR-01	AN-01	2715-M3x11	AAL-03-3
AC8 PCLNL 55080 12 H	3.150	3.150	2.165	M20x2	2.655	1	CN.. 432 CN.. 120408	-	-	APL-02	ALV-03-M8X19	AACN-3-0001	AAV-02	AXR-01 / AOR-01	AN-01	2715-M3x11	AAL-03-3
<b>new</b> AC8 PCLNL 55080 16 H	3.150	3.150	2.165	M20x2	2.655	1	CN.. 543 CN.. 160612	-	-	APL-04	ALV-04-M8X22	AACN-3-0002	AAV-03	AXR-01 / AOR-01	AN-01	2715-M3x5	
<b>new</b> AC8 PCLNL 55080 19 H	3.150	3.150	2.165	M20x2	2.655	1	CN.. 643 CN.. 190612	-	-	APL-05	ALV-05-M10x27	AACN-3-0003	AAV-04	AXR-01 / AOR-01	AN-01	2715-M3x5	
<b>new</b> AC8 PCLNL 55080 25C	3.150	3.150	2.165	M20x2	2.655	2	CN.. 866 CN.. 250924	ACK-04	AKV-16-M6x16	APL-06	ALV-06-M12x36	AACN-3-0008	AAV-05	-	ACN-M12 -12.5	2715-M3x11	

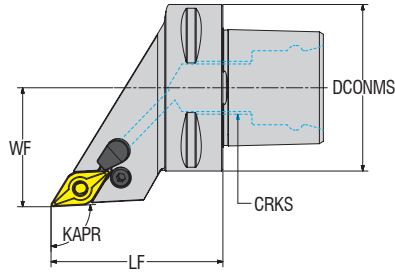

Illustrations shown may vary from actual product.

Dimensions in Inch



Ordering Code	DCONMS	LF	WF	CRKS	KG	Insert Inch/Metric	Lever	Lever Screw	Shim	Shim Spring	Ring	Nozzle	Nozzle Screw	Allen Key
<b>new</b> AC5 PDJNR 35060 11 H	1.969	2.362	1.378	M16x1.5	0.703	DN.. 332 DN.. 110408	APL-01	ALV-02-M6x17	AADN-SD317	AAY-01	AXR-01 AOR-01	AN-01	2715-M3x5	AAL-02-2.5
AC4 PDJNR 27060 15 H	1.575	2.362	1.063	M14x1.5	0.512	DN.. 442 DN.. 150608	APL-03	ALV-03-M8X19	AADN-3-0001	AAY-02	AXR-01 AOR-01	AN-01	2715-M3x5	AAL-03-3
AC5 PDJNR 35060 15 H	1.969	2.362	1.378	M16x1.5	0.703	DN.. 442 DN.. 150608	APL-03	ALV-03-M8X19	AADN-3-0001	AAY-02	AXR-01 AOR-01	AN-01	2715-M3x5	AAL-03-3
AC6 PDJNR 45065 15 H	2.480	2.559	1.772	M20x2	1.153	DN.. 442 DN.. 150608	APL-03	ALV-03-M8X19	AADN-3-0001	AAY-02	AXR-01 AOR-01	AN-01	2715-M3x5	AAL-03-3
AC6 PDJNR 45165 15 H	2.480	6.496	1.772	M20x2	3.440	DN.. 442 DN.. 150608	APL-03	ALV-03-M8X19	AADN-3-0001	AAY-02	AXR-01 AOR-01	AN-01	2715-M3x5	AAL-03-3
AC8 PDJNR 55080 15 H	3.150	3.150	2.165	M20x2	2.482	DN.. 442 DN.. 150608	APL-03	ALV-03-M8X19	AADN-3-0001	AAY-02	AXR-01 AOR-01	AN-01	2715-M3x5	AAL-03-3
<b>new</b> AC5 PDJNL 35060 11 H	1.969	2.362	1.378	M16x1.5	0.703	DN.. 332 DN.. 110408	APL-01	ALV-02-M6x17	AADN-SD317	AAY-01	AXR-01 AOR-01	AN-01	2715-M3x5	AAL-02-2.5
AC4 PDJNL 27060 15 H	1.575	2.362	1.063	M14x1.5	0.512	DN.. 442 DN.. 150608	APL-03	ALV-03-M8X19	AADN-3-0001	AAY-02	AXR-01 AOR-01	AN-01	2715-M3x5	AAL-03-3
AC5 PDJNL 35060 15 H	1.969	2.362	1.378	M16x1.5	0.703	DN.. 442 DN.. 150608	APL-03	ALV-03-M8X19	AADN-3-0001	AAY-02	AXR-01 AOR-01	AN-01	2715-M3x5	AAL-03-3
AC6 PDJNL 45065 15 H	2.480	2.559	1.772	M20x2	1.153	DN.. 442 DN.. 150608	APL-03	ALV-03-M8X19	AADN-3-0001	AAY-02	AXR-01 AOR-01	AN-01	2715-M3x5	AAL-03-3
AC6 PDJNL 45165 15 H	2.480	6.496	1.772	M20x2	3.440	DN.. 442 DN.. 150608	APL-03	ALV-03-M8X19	AADN-3-0001	AAY-02	AXR-01 AOR-01	AN-01	2715-M3x5	AAL-03-3
AC8 PDJNL 55080 15 H	3.150	3.150	2.165	M20x2	2.482	DN.. 442 DN.. 150608	APL-03	ALV-03-M8X19	AADN-3-0001	AAY-02	AXR-01 AOR-01	AN-01	2715-M3x5	AAL-03-3

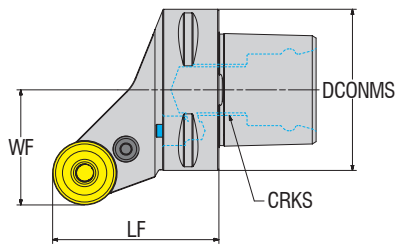

Illustrations shown may vary from actual product.

Dimensions in Inch



Ordering Code	DCONMS	LF	WF	CRKS	KG	Insert Inch/Metric	Lever	Lever Screw	Shim	Shim Spring	Ring	Nozzle	Nozzle Screw	Allen Key
AC6 PRSCR 45065 25	2.480	2.559	1.772	M20x2	1.357	RC.. 250700	APL-12	ALV-05-M10x27	AARN-1-0002	AAY-04	-	ACN-M12-12.5	-	AAL-05-4
AC8 PRSCR 55080 25	3.150	3.150	2.165	M20x2	2.655	RC.. 250700	APL-12	ALV-05-M10x27	AARN-1-0002	AAY-04	-	ACN-M12-12.5	-	AAL-05-4
AC8 PRSCR 55080 32	3.150	3.150	2.165	M20x2	2.655	RC.. 32090	APL-13	ALV-06-M12x36	AARN-1-0001	AAY-05	-	ACN-M12-12.5	-	AAL-07-5
AC6 PRSCL 45065 25	2.480	2.559	1.772	M20x2	1.357	RC.. 250700	APL-12	ALV-05-M10x27	AARN-1-0002	AAY-04	-	ACN-M12-12.5	-	AAL-05-4
AC8 PRSCL 55080 25	3.150	3.150	2.165	M20x2	2.655	RC.. 250700	APL-12	ALV-05-M10x27	AARN-1-0002	AAY-04	-	ACN-M12-12.5	-	AAL-05-4
AC8 PRSCL 55080 32	3.150	3.150	2.165	M20x2	2.655	RC.. 32090	APL-13	ALV-06-M12x36	AARN-1-0001	AAY-05	-	ACN-M12-12.5	-	AAL-07-5



Illustrations shown may vary from actual product.

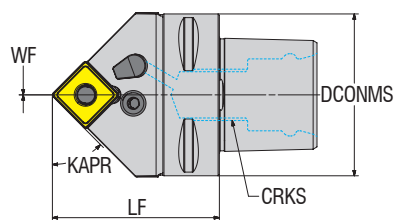

(figure.1)

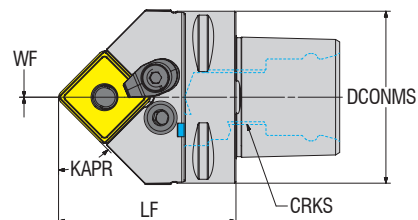

(figure.2)



Dimensions in Inch



Ordering Code	DCONMS	LF	WF	CRKS	KG	Fig.	Insert Inch/Metric	Lever	Lever Screw	Shim	Shim Spring	Ring	Nozzle	Nozzle Screw	Allen Key
<b>AC4 PSDNN 00050 12 H</b>	1.575	1.969	0	M14x1.5	0.350	1	SN.. 432 SN.. 120408	APL-02	ALV-03-M8X19	AASN-3-0004	AAY-02	AXR-01 AOR-01	AN-01	2715-M3x8	AAL-03-3
<b>AC5 PSDNN 00060 12 H</b>	1.969	2.362	0	M16x1.5	0.600	1	SN.. 432 SN.. 120408	APL-02	ALV-03-M8X19	AASN-3-0004	AAY-02	AXR-01 AOR-01	AN-01	2715-M3x8	AAL-03-3
<b>AC6 PSDNN 00065 12 H</b>	2.480	2.559	0	M20x2	0.950	1	SN.. 432 SN.. 120408	APL-02	ALV-03-M8X19	AASN-3-0004	AAY-02	AXR-01 AOR-01	AN-01	2715-M3x8	AAL-03-3
<b>AC4 PSDNN 00050 15 H</b>	1.575	1.969	0	M14x1.5	0.350	1	SN.. 543 SN.. 150612	APL-04	ALV-04-M8X22	AASN-3-0023	AAY-03	AXR-01 AOR-01	AN-01	2715-M3x8	AAL-03-3
<b>AC5 PSDNN 00060 15 H</b>	1.969	2.362	0	M16x1.5	0.600	1	SN.. 543 SN.. 150612	APL-04	ALV-04-M8X22	AASN-3-0023	AAY-03	AXR-01 AOR-01	AN-01	2715-M3x8	AAL-03-3
<b>AC6 PSDNN 00065 15 H</b>	2.480	2.559	0	M20x2	0.950	1	SN.. 543 SN.. 150612	APL-04	ALV-04-M8X22	AASN-3-0023	AAY-03	AXR-01 AOR-01	AN-01	2715-M3x8	AAL-03-3
<b>AC5 PSDNN 00060 19 H</b>	1.969	2.362	0	M16x1.5	0.600	1	SN.. 643 SN.. 190612	APL-05	ALV-05-M10X27	AASN-3-0005	AAY-04	AXR-01 AOR-01	AN-01	2715-M3x8	AAL-05-4
<b>AC6 PSDNN 00065 19 H</b>	2.480	2.559	0	M20x2	0.950	1	SN.. 643 SN.. 190612	APL-05	ALV-05-M10X27	AASN-3-0005	AAY-04	AXR-01 AOR-01	AN-01	2715-M3x8	AAL-05-4
<b>AC6 PSDNN 00065 25C</b>	2.480	2.362	0	M20x2	0.950	2	SN.. 866 SN.. 250924	APL-06	ALV-06-M12X36	AASN-3-0020	AAY-05	-	ACN-M12-12.5	-	AAL-07-5
<b>AC8 PSDNN 00080 25C</b>	3.150	2.362	0	M20x2	2.150	2	SN.. 866 SN.. 250924	APL-06	ALV-06-M12X36	AASN-3-0020	AAY-05	-	ACN-M12-12.5	-	AAL-07-5



Illustrations shown may vary from actual product.

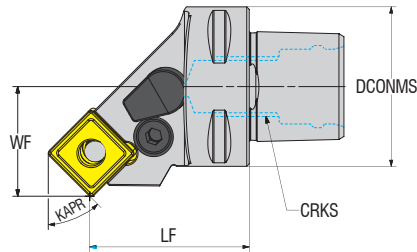

(figure.1)

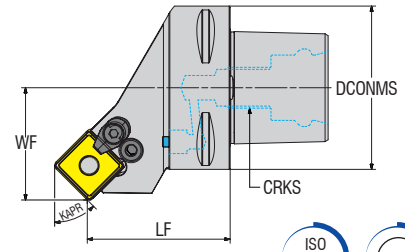

(figure.2)



Dimensions in Inch



Ordering Code	DCONMS	LF	WF	CRKS	KG	Fig.	Insert Inch/Metric	Lever	Lever Screw	Shim	Shim Spring	Wedge Clamp	Clamp Screw	Ring	Nozzle	Nozzle Screw	Allen Key
AC3 PSSNR 22032 12 H	1.260	1.260	0.866	M12x1.5	0.242	1	SN.. 432 SN.. 120408	APL-02	ALV-03-M8X19	AASN-3-0004	AAY-02	-	-	AXR-01 AOR-01	AN-01	2715-M3x4	AAL-03-3
AC4 PSSNR 27042 12 H	1.575	1.654	1.063	M14x1.5	0.377	1	SN.. 432 SN.. 120408	APL-02	ALV-03-M8X19	AASN-3-0004	AAY-02	-	-	AXR-01 AOR-01	AN-01	2715-M3x4	AAL-03-3
AC5 PSSNR 35052 12 H	1.969	2.047	1.378	M16x1.5	0.703	1	SN.. 432 SN.. 120408	APL-02	ALV-03-M8X19	AASN-3-0004	AAY-02	-	-	AXR-01 AOR-01	AN-01	2715-M3x4	AAL-03-3
AC6 PSSNR 45056 12 H	2.480	2.205	1.772	M20x2	1.355	1	SN.. 432 SN.. 120408	APL-02	ALV-03-M8X19	AASN-3-0004	AAY-02	-	-	AXR-01 AOR-01	AN-01	2715-M3x4	AAL-03-3
AC6 PSSNR 45054 15 H	2.480	2.126	1.772	M20x2	1.357	1	SN.. 543 SN.. 150612	APL-04	ALV-04-M8X19	AASN-3-0023	AAY-03	-	-	AXR-01 AOR-01	AN-01	2715-M3x5	AAL-03-3
AC6 PSSNR 45052 19 H	2.480	2.047	1.772	M20x2	1.355	1	SN.. 643 SN.. 190612	APL-05	ALV-05-M10X27	AASN-3-0005	AAY-04	-	-	AXR-01 AOR-01	AN-01	2715-M3x4	AAL-03-3
AC8 PSSNR 55070 25C	3.150	2.362	1.378	M20x2	2.555	2	SN.. 866 SN.. 250924	APL-06	ALV-06-M12X36	AASN-3-0020	AAY-05	ACK-04	AKV-16M6X16	-	ACN-M12-12.5	-	AAL-03-3
AC3 PSSNL 22032 12 H	1.260	1.260	0.866	M12x1.5	0.242	1	SN.. 432 SN.. 120408	APL-02	ALV-03-M8X19	AASN-3-0004	AAY-02	-	-	AXR-01 AOR-01	AN-01	2715-M3x4	AAL-03-3
AC4 PSSNL 27042 12 H	1.575	1.654	1.063	M14x1.5	0.377	1	SN.. 432 SN.. 120408	APL-02	ALV-03-M8X19	AASN-3-0004	AAY-02	-	-	AXR-01 AOR-01	AN-01	2715-M3x4	AAL-03-3
AC5 PSSNL 35052 12 H	1.969	2.047	1.378	M16x1.5	0.703	1	SN.. 432 SN.. 120408	APL-02	ALV-03-M8X19	AASN-3-0004	AAY-02	-	-	AXR-01 AOR-01	AN-01	2715-M3x4	AAL-03-3
AC6 PSSNL 45056 12 H	2.480	2.205	1.772	M20x2	1.355	1	SN.. 432 SN.. 120408	APL-02	ALV-03-M8X19	AASN-3-0004	AAY-02	-	-	AXR-01 AOR-01	AN-01	2715-M3x4	AAL-03-3
AC6 PSSNL 45054 15 H	2.480	2.126	1.772	M20x2	1.357	1	SN.. 543 SN.. 150612	APL-04	ALV-04-M8X19	AASN-3-0023	AAY-03	-	-	AXR-01 AOR-01	AN-01	2715-M3x5	AAL-03-3
AC6 PSSNL 45052 19 H	2.480	2.047	1.772	M20x2	1.355	1	SN.. 643 SN.. 190612	APL-05	ALV-05-M10X27	AASN-3-0005	AAY-04	-	-	AXR-01 AOR-01	AN-01	2715-M3x4	AAL-03-3
AC8 PSSNL 55070 25C	3.150	2.362	1.378	M20x2	2.555	2	SN.. 866 SN.. 250924	APL-06	ALV-06-M12X36	AASN-3-0020	AAY-05	ACK-04	AKV-16M6X16	-	ACN-M12-12.5	-	AAL-03-3



Illustrations shown may vary from actual product.

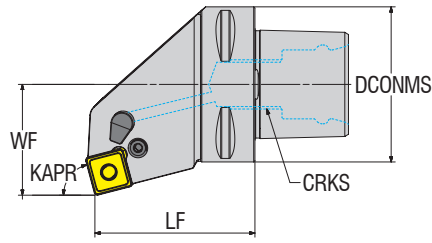

(figure.1)

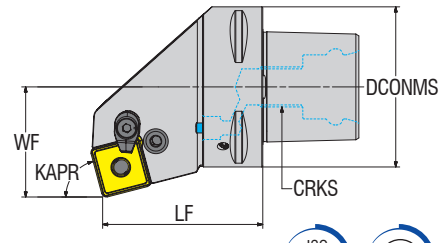

(figure.2)



Dimensions in Inch



Ordering Code	DCONMS	LF	WF	CRKS	KG	Fig.	Insert Inch/Metric	Lever	Lever Screw	Shim	Shim Spring	Ring	Nozzle	Nozzle Screw	Allen Key
AC4 PSKNR 27050 12 H	1.575	1.969	1.063	M14x1.5	0.440	1	SN.. 432 SN.. 120408	APL-02	ALV-03-M8X19	AASN-3-0004	AAY-02	AXR-01 AOR-01	AN-01	2715-M3x4	AAL-03-3
AC5 PSKNR 35060 12 H	1.969	2.362	1.378	M16x1.5	0.703	1	SN.. 432 SN.. 120408	APL-02	ALV-03-M8X19	AASN-3-0004	AAY-02	AXR-01 AOR-01	AN-01	2715-M3x4	AAL-03-3
AC6 PSKNR 45065 12 H	2.480	2.559	1.772	M20x2	1.357	1	SN.. 432 SN.. 120408	APL-02	ALV-03-M8X19	AASN-3-0004	AAY-02	AXR-01 AOR-01	AN-01	2715-M3x8	AAL-03-3
AC5 PSKNR 35060 15 H	1.969	2.362	1.378	M16x1.5	0.703	1	SN.. 543 SN.. 150612	APL-04	ALV-04-M8X22	AASN-3-0023	AAY-03	AXR-01 AOR-01	AN-01	2715-M3x8	AAL-03-3
AC6 PSKNR 45065 15 H	2.480	2.559	1.772	M20x2	1.357	1	SN.. 543 SN.. 150612	APL-04	ALV-04-M8X22	AASN-3-0023	AAY-03	AXR-01 AOR-01	AN-01	2715-M3x8	AAL-03-3
AC5 PSKNR 35060 19 H	1.969	2.362	1.378	M16x1.5	0.703	1	SN.. 643 SN.. 190612	APL-05	ALV-05-M10X27	AASN-3-0005	AAY-04	AXR-01 AOR-01	AN-01	2715-M3x8	AAL-03-3
AC6 PSKNR 45065 19 H	2.480	2.559	1.772	M20x2	1.357	1	SN.. 643 SN.. 190612	APL-05	ALV-05-M10X27	AASN-3-0005	AAY-04	AXR-01 AOR-01	AN-01	2715-M3x8	AAL-05-4
AC8 PSKNR 55080 19 H	3.150	3.150	2.165	M20x2	2.655	1	SN.. 643 SN.. 190612	APL-05	ALV-05-M10X27	AASN-3-0005	AAY-04	AXR-01 AOR-01	AN-01	2715-M3x8	AAL-05-4
AC8 PSKNR 55080 25C	3.150	3.150	2.165	M20x2	2.655	2	SN.. 866 SN.. 250924	APL-06	ALV-06-M12X36	AASN-3-0020	AAY-05	-	ACN-M12-12.5	-	AAL-07-5
AC4 PSKNL 27050 12 H	1.575	1.969	1.063	M14x1.5	0.440	1	SN.. 432 SN.. 120408	APL-02	ALV-03-M8X19	AASN-3-0004	AAY-02	AXR-01 AOR-01	AN-01	2715-M3x4	AAL-03-3
AC5 PSKNL 35060 12 H	1.969	2.362	1.378	M16x1.5	0.703	1	SN.. 432 SN.. 120408	APL-02	ALV-03-M8X19	AASN-3-0004	AAY-02	AXR-01 AOR-01	AN-01	2715-M3x4	AAL-03-3
AC6 PSKNL 45065 12 H	2.480	2.559	1.772	M20x2	1.357	1	SN.. 432 SN.. 120408	APL-02	ALV-03-M8X19	AASN-3-0004	AAY-02	AXR-01 AOR-01	AN-01	2715-M3x8	AAL-03-3
AC5 PSKNL 35060 15 H	1.969	2.362	1.378	M16x1.5	0.703	1	SN.. 543 SN.. 150612	APL-04	ALV-04-M8X22	AASN-3-0023	AAY-03	AXR-01 AOR-01	AN-01	2715-M3x8	AAL-03-3
AC6 PSKNL 45065 15 H	2.480	2.559	1.772	M20x2	1.357	1	SN.. 543 SN.. 150612	APL-04	ALV-04-M8X22	AASN-3-0023	AAY-03	AXR-01 AOR-01	AN-01	2715-M3x8	AAL-03-3
AC5 PSKNL 35060 19 H	1.969	2.362	1.378	M16x1.5	0.703	1	SN.. 643 SN.. 190612	APL-05	ALV-05-M10X27	AASN-3-0005	AAY-04	AXR-01 AOR-01	AN-01	2715-M3x8	AAL-03-3
AC6 PSKNL 45065 19 H	2.480	2.559	1.772	M20x2	1.357	1	SN.. 643 SN.. 190612	APL-05	ALV-05-M10X27	AASN-3-0005	AAY-04	AXR-01 AOR-01	AN-01	2715-M3x8	AAL-05-4
AC8 PSKNL 55080 19 H	3.150	3.150	2.165	M20x2	2.655	1	SN.. 643 SN.. 190612	APL-05	ALV-05-M10X27	AASN-3-0005	AAY-04	AXR-01 AOR-01	AN-01	2715-M3x8	AAL-05-4
AC8 PSKNL 55080 25C	3.150	3.150	2.165	M20x2	2.655	2	SN.. 866 SN.. 250924	APL-06	ALV-06-M12X36	AASN-3-0020	AAY-05	-	ACN-M12-12.5	-	AAL-07-5



Illustrations shown may vary from actual product.

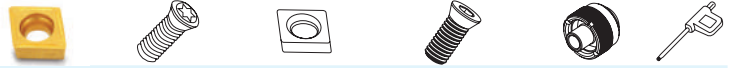
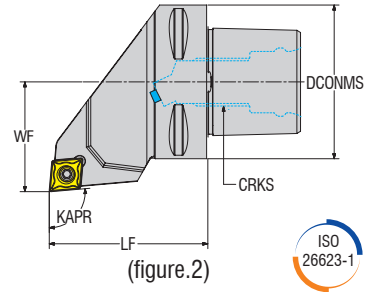
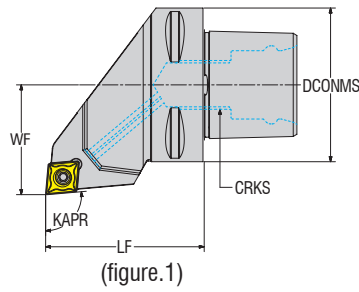

Dimensions in Inch

Ordering Code	DCONMS	LF	WF	CRKS	KG	Fig.	Insert Inch/Metric	Screw	Shim	Shim Screw	Nozzle	Torx Key
<b>NEW</b> AC3 SCLCR 22040 09	1.260	1.575	0.866	M12x1.5	0.242	2	CC.. 3252 CC.. 09T308	4015-M3.5x14	AACN-2-0001	AAV-06-M3.5x11	ACN-M8-8.5	80-T15
<b>NEW</b> AC4 SCLCR 27050 09	1.575	1.969	1.063	M14x1.5	0.425	1	CC.. 3252 CC.. 09T308	4015-M3.5x14	AACN-2-0001	AAV-06-M3.5x11	-	80-T15
<b>NEW</b> AC5 SCLCR 35060 09	1.969	2.362	1.378	M16x1.5	0.777	1	CC.. 3252 CC.. 09T308	4015-M3.5x14	AACN-2-0001	AAV-06-M3.5x11	-	80-T15
<b>NEW</b> AC6 SCLCR 45065 09	2.480	2.559	1.772	M20x2	1.287	1	CC.. 3252 CC.. 09T308	4015-M3.5x14	AACN-2-0001	AAV-06-M3.5x11	-	80-T15
<b>NEW</b> AC3 SCLCR 22040 12	1.260	1.575	0.866	M12x1.5	0.242	1	CC.. 432 CC.. 120408	1020-M4.5x16	AACN-2-0003	AAV-10-M4.5x8	-	80-T20
AC4 SCLCR 27050 12 H	1.575	1.969	1.063	M14x1.5	0.425	1	CC.. 432 CC.. 120408	1020-M4.5x16	AACN-2-0003	AAV-10-M4.5x8	-	80-T20
AC5 SCLCR 35060 12 H	1.969	2.362	1.378	M16x1.5	0.777	1	CC.. 432 CC.. 120408	1020-M4.5x16	AACN-2-0003	AAV-10-M4.5x8	-	80-T20
AC6 SCLCR 45065 12 H	2.480	2.559	1.772	M20x2	1.287	1	CC.. 432 CC.. 120408	1020-M4.5x16	AACN-2-0003	AAV-10-M4.5x8	-	80-T20
<b>NEW</b> AC3 SCLCL 22040 09	1.260	1.575	0.866	M12x1.5	0.242	2	CC.. 3252 CC.. 09T308	4015-M3.5x14	AACN-2-0001	AAV-06-M3.5x11	ACN-M8-8.5	80-T15
<b>NEW</b> AC4 SCLCL 27050 09	1.575	1.969	1.063	M14x1.5	0.425	1	CC.. 3252 CC.. 09T308	4015-M3.5x14	AACN-2-0001	AAV-06-M3.5x11	-	80-T15
<b>NEW</b> AC5 SCLCL 35060 09	1.969	2.362	1.378	M16x1.5	0.777	1	CC.. 3252 CC.. 09T308	4015-M3.5x14	AACN-2-0001	AAV-06-M3.5x11	-	80-T15
<b>NEW</b> AC6 SCLCL 45065 09	2.480	2.559	1.772	M20x2	1.287	1	CC.. 3252 CC.. 09T308	4015-M3.5x14	AACN-2-0001	AAV-06-M3.5x11	-	80-T15
<b>NEW</b> AC3 SCLCL 22040 12	1.260	1.575	0.866	M12x1.5	0.242	1	CC.. 432 CC.. 120408	1020-M4.5x16	AACN-2-0003	AAV-10-M4.5x8	-	80-T20
AC4 SCLCL 27050 12 H	1.575	1.969	1.063	M14x1.5	0.425	1	CC.. 432 CC.. 120408	1020-M4.5x16	AACN-2-0003	AAV-10-M4.5x8	-	80-T20
AC5 SCLCL 35060 12 H	1.969	2.362	1.378	M16x1.5	0.777	1	CC.. 432 CC.. 120408	1020-M4.5x16	AACN-2-0003	AAV-10-M4.5x8	-	80-T20
AC6 SCLCL 45065 12 H	2.480	2.559	1.772	M20x2	1.287	1	CC.. 432 CC.. 120408	1020-M4.5x16	AACN-2-0003	AAV-10-M4.5x8	-	80-T20



Illustrations shown may vary from actual product.

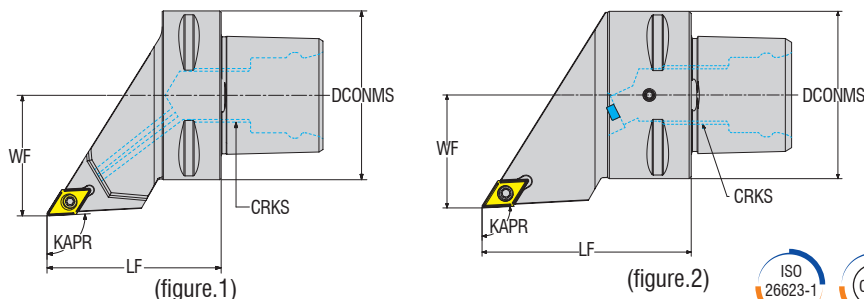

Ordering Code	Dimensions in Inch						Fig.	Insert Inch/Metric	Screw	Shim	Shim Screw	Nozzle	Torx Key
	DCONMS	LF	WF	CRKS	KG								
<b>new</b> AC3 SDJCR 22040 07	1.260	1.575	0.866	M12x1.5	0.242	2	DC.. 2151 DC.. 070204	4008-M2.5x6	-	-	ACN-M8-8.5	82-T08	
<b>new</b> AC4 SDJCR 27050 07	1.575	1.969	1.063	M14x1.5	0.376	2	DC.. 2151 DC.. 070204	4008-M2.5x6	-	-	ACN-M8-8.5	82-T08	
<b>new</b> AC3 SDJCR 22040 11	1.260	1.575	0.866	M12x1.5	0.242	2	DC.. 3252 DC.. 11T308	4015-M3.5x11	AADN-2-0001	AAV-08-M3.5X8	ACN-M8-8.5	80-T15	
AC4 SDJCR 27050 11 H	1.575	1.969	1.063	M14x1.5	0.396	1	DC.. 3252 DC.. 11T308	4015-M3.5x11	AADN-2-0001	AAV-08-M3.5X8	-	80-T15	
AC5 SDJCR 35060 11 H	1.969	2.362	1.378	M16x1.5	0.720	1	DC.. 3252 DC.. 11T308	4015-M3.5x11	AADN-2-0001	AAV-06-M3.5X11	-	80-T15	
AC6 SDJCR 45065 11 H	2.480	2.559	1.772	M20x2	1.165	1	DC.. 3252 DC.. 11T308	4015-M3.5x11	AADN-2-0001	AAV-06-M3.5X11	-	80-T15	
<b>new</b> AC3 SDJCL 22040 07	1.260	1.575	0.866	M12x1.5	0.242	2	DC.. 2151 DC.. 070204	4008-M2.5x6	-	-	ACN-M8-8.5	82-T08	
<b>new</b> AC4 SDJCL 27050 07	1.575	1.969	1.063	M14x1.5	0.376	2	DC.. 2151 DC.. 070204	4008-M2.5x6	-	-	ACN-M8-8.5	82-T08	
<b>new</b> AC3 SDJCL 22040 11	1.260	1.575	0.866	M12x1.5	0.242	2	DC.. 3252 DC.. 11T308	4015-M3.5x11	AADN-2-0001	AAV-08-M3.5X8	ACN-M8-8.5	80-T15	
AC4 SDJCL 27050 11 H	1.575	1.969	1.063	M14x1.5	0.396	1	DC.. 3252 DC.. 11T308	4015-M3.5x11	AADN-2-0001	AAV-08-M3.5X8	-	80-T15	
AC5 SDJCL 35060 11 H	1.969	2.362	1.378	M16x1.5	0.720	1	DC.. 3252 DC.. 11T308	4015-M3.5x11	AADN-2-0001	AAV-06-M3.5X11	-	80-T15	
AC6 SDJCL 45065 11 H	2.480	2.559	1.772	M20x2	1.165	1	DC.. 3252 DC.. 11T308	4015-M3.5x11	AADN-2-0001	AAV-06-M3.5X11	-	80-T15	



Illustrations shown may vary from actual product.

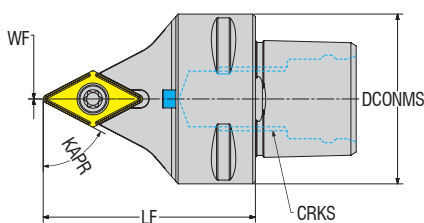

Ordering Code	Dimensions in Inch					Fig.	Insert Inch/Metric	Screw	Shim	Shim Screw	Nozzle	Torx Key
	DCONMS	LF	WF	CRKS	KG							
AC3 SDNCN 00040 11	1.260	1.575	0	M12x1.5	0.185		DC.. 3252 DC.. 11T308	4015-M3.5x14	AADN-2-0001	AAV-06-M3.5X11	ACN-M8-8.5	80-T15
AC4 SDNCN 00050 11	1.575	1.969	0	M14x1.5	0.350		DC.. 3252 DC.. 11T308	4015-M3.5x14	AADN-2-0001	AAV-06-M3.5X11	ACN-M8-8.5	80-T15
AC5 SDNCN 00060 11	1.969	2.362	0	M16x1.5	0.600		DC.. 3252 DC.. 11T308	4015-M3.5x14	AADN-2-0001	AAV-06-M3.5X11	ACN-M10-10.5	80-T15

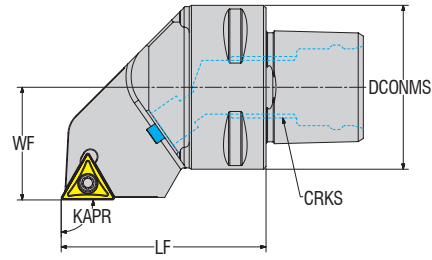

Illustrations shown may vary from actual product.

Dimensions in Inch



Ordering Code	DCONMS	LF	WF	CRKS	KG	Insert Inch/Metric	Screw	Shim	Shim Screw	Nozzle	Torx Key
<b>AC3 STGCR 22040 11</b>	1.260	1.575	0.866	M12x1.5	0.242	TC.. 2151 TC.. 110204	4008-M2.5x6	-	-	ACN-M8-8.5	82-T08
<b>AC4 STGCR 27050 11</b>	1.575	1.969	1.063	M14x1.5	0.446	TC.. 2151 TC.. 110204	4008-M2.5x6	-	-	ACN-M8-8.5	82-T08
<b>AC3 STGCR 22040 16</b>	1.260	1.575	0.866	M12x1.5	0.242	TC.. 3252 TC.. 16T308	4008-M2.5x6	AATN-2-0001	AAV-06-M3.5x11	ACN-M8-8.5	80-T15
<b>AC4 STGCR 27050 16</b>	1.575	1.969	1.063	M14x1.5	0.446	TC.. 3252 TC.. 16T308	4008-M2.5x6	AATN-2-0001	AAV-06-M3.5x11	ACN-M8-8.5	80-T15
<b>AC5 STGCR 35060 16</b>	1.969	2.362	1.378	M16x1.5	0.777	TC.. 3252 TC.. 16T308	4008-M2.5x6	AATN-2-0001	AAV-06-M3.5x11	ACN-M10-10.5	80-T15
<b>AC6 STGCR 45065 16</b>	2.480	2.559	1.772	M20x2	1.165	TC.. 3252 TC.. 16T308	4015-M3.5x14	AATN-2-0001	AAV-06-M3.5x11	ACN-M12-12.5	80-T15
<b>AC3 STGCL 22040 11</b>	1.260	1.575	0.866	M12x1.5	0.242	TC.. 2151 TC.. 110204	4008-M2.5x6	-	-	ACN-M8-8.5	82-T08
<b>AC4 STGCL 27050 11</b>	1.575	1.969	1.063	M14x1.5	0.446	TC.. 2151 TC.. 110204	4008-M2.5x6	-	-	ACN-M8-8.5	82-T08
<b>AC3 STGCL 22040 16</b>	1.260	1.575	0.866	M12x1.5	0.242	TC.. 3252 TC.. 16T308	4008-M2.5x6	AATN-2-0001	AAV-06-M3.5x11	ACN-M8-8.5	80-T15
<b>AC4 STGCL 27050 16</b>	1.575	1.969	1.063	M14x1.5	0.446	TC.. 3252 TC.. 16T308	4008-M2.5x6	AATN-2-0001	AAV-06-M3.5x11	ACN-M8-8.5	80-T15
<b>AC5 STGCL 35060 16</b>	1.969	2.362	1.378	M16x1.5	0.777	TC.. 3252 TC.. 16T308	4008-M2.5x6	AATN-2-0001	AAV-06-M3.5x11	ACN-M10-10.5	80-T15
<b>AC6 STGCL 45065 16</b>	2.480	2.559	1.772	M20x2	1.165	TC.. 3252 TC.. 16T308	4015-M3.5x14	AATN-2-0001	AAV-06-M3.5x11	ACN-M12-12.5	80-T15

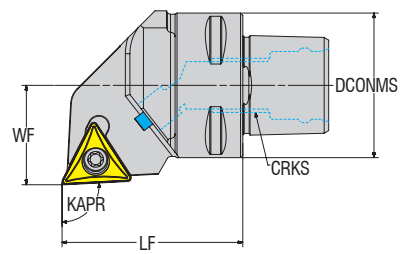

Illustrations shown may vary from actual product.

Ordering Code	Dimensions in Inch					Insert Inch/Metric	Screw	Shim	Shim Screw	Nozzle	Torx Key
	DCONMS	LF	WF	CRKS	KG						
AC3 STJCR 22040 11	1.260	1.575	0.866	M12x1.5	0.190	TC.. 2151 TC.. 110204	4008-M2.5x6	-	-	ACN-M8-8.5	82-T08
AC3 STJCR 22040 16	1.260	1.575	0.866	M12x1.5	0.190	TC.. 3252 TC.. 16T308	4015-M3.5x14	AATN-2-0001	AAV-06-M3.5x11	ACN-M8-8.5	80-T15
AC4 STJCR 27050 11	1.575	1.969	1.063	M14x1.5	0.360	TC.. 2151 TC.. 110204	4008-M2.5x6	-	-	ACN-M8-8.5	82-T08
AC4 STJCR 27050 16	1.575	1.969	1.063	M14x1.5	0.370	TC.. 3252 TC.. 16T308	4015-M3.5x14	AATN-2-0001	AAV-06-M3.5x11	ACN-M8-8.5	80-T15
AC5 STJCR 35060 16	1.969	2.362	1.378	M16x1.5	0.680	TC.. 3252 TC.. 16T308	4015-M3.5x14	AATN-2-0001	AAV-06-M3.5x11	ACN-M8-8.5	80-T15
AC3 STJCL 22040 11	1.260	1.575	0.866	M12x1.5	0.190	TC.. 2151 TC.. 110204	4008-M2.5x6	-	-	ACN-M8-8.5	82-T08
AC3 STJCL 22040 16	1.260	1.575	0.866	M12x1.5	0.190	TC.. 3252 TC.. 16T308	4015-M3.5x14	AATN-2-0001	AAV-06-M3.5x11	ACN-M8-8.5	80-T15
AC4 STJCL 27050 11	1.575	1.969	1.063	M14x1.5	0.360	TC.. 2151 TC.. 110204	4008-M2.5x6	-	-	ACN-M8-8.5	82-T08
AC4 STJCL 27050 16	1.575	1.969	1.063	M14x1.5	0.370	TC.. 3252 TC.. 16T308	4015-M3.5x14	AATN-2-0001	AAV-06-M3.5x11	ACN-M8-8.5	80-T15
AC5 STJCL 35060 16	1.969	2.362	1.378	M16x1.5	0.680	TC.. 3252 TC.. 16T308	4015-M3.5x14	AATN-2-0001	AAV-06-M3.5x11	ACN-M8-8.5	80-T15

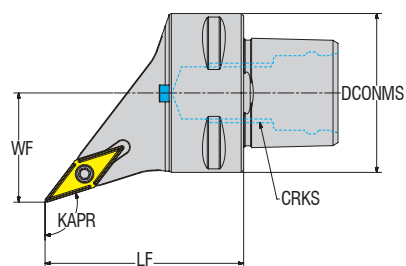

Illustrations shown may vary from actual product.

Ordering Code	Dimensions in Inch					Insert Inch/Metric	Screw	Shim	Shim Screw	Nozzle	Allen Key
	DCONMS	LF	WF	CRKS	KG						
AC4 SVHBR 27050 16	1.575	1.969	1.063	M14x1.5	0.300	VB.. 332 VB.. 160408	4015-M3.5x14	AAVN-2-0002	AAV-06-M3.5x11	ACN-M8-8.5	80-T15
AC5 SVHBR 35060 16	1.969	2.362	1.378	M16x1.5	0.550	VB.. 332 VB.. 160408	4015-M3.5x14	AAVN-2-0002	AAV-06-M3.5x11	ACN-M10-10.5	80-T15
AC6 SVHBR 45065 16	2.480	2.559	1.772	M20x2	0.960	VB.. 332 VB.. 160408	4015-M3.5x14	AAVN-02-0002	AAV-06-M3.5x11	ACN-M12-12.5	80-T15
AC4 SVHBL 27050 16	1.575	1.969	1.063	M14x1.5	0.300	VB.. 332 VB.. 160408	4015-M3.5x14	AAVN-2-0002	AAV-06-M3.5x11	ACN-M8-8.5	80-T15
AC5 SVHBL 35060 16	1.969	2.362	1.378	M16x1.5	0.550	VB.. 332 VB.. 160408	4015-M3.5x14	AAVN-2-0002	AAV-06-M3.5x11	ACN-M10-10.5	80-T15
AC6 SVHBL 45065 16	2.480	2.559	1.772	M20x2	0.960	VB.. 332 VB.. 160408	4015-M3.5x14	AAVN-02-0002	AAV-06-M3.5x11	ACN-M12-12.5	80-T15



Illustrations shown may vary from actual product.

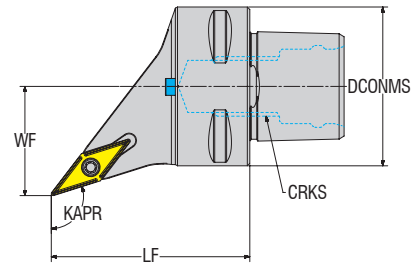

Ordering Code	Dimensions in Inch					Insert Inch/Metric	Screw	Shim	Shim Screw	Nozzle	Allen Key
	DCONMS	LF	WF	CRKS	KG						
AC3 SVHCR 22040 11	1.260	1.575	0.866	M12x1.5	0.140	VC.. 221 VC.. 110304	4008-M2.5x6	-	-	ACN-M8-8.5	82-T08
AC4 SVHCR 27050 11	1.575	1.969	1.063	M14x1.5	0.300	VC.. 221 VC.. 110304	4008-M2.5x6	-	-	ACN-M8-8.5	82-T08
AC4 SVHCR 27050 16	1.575	1.969	1.063	M14x1.5	0.300	VC.. 332 VC.. 160408	4015-M3.5x14	AAVN-2-0002	AAV-06-M3.5x11	ACN-M8-8.5	80-T15
AC5 SVHCR 35060 11	1.969	2.362	1.378	M16x1.5	0.550	VC.. 221 VC.. 110304	4008-M2.5x6	-	-	ACN-M10-10.5	82-T08
AC5 SVHCR 35060 16	1.969	2.362	1.378	M16x1.5	0.550	VC.. 332 VC.. 160408	4015-M3.5x14	AAVN-2-0002	AAV-06-M3.5x11	ACN-M10-10.5	80-T15
AC6 SVHCR 45065 16	2.480	2.559	1.772	M20x2	0.960	VC.. 332 VC.. 160408	4015-M3.5x14	AAVN-02-0002	AAV-06-M3.5x11	ACN-M12-12.5	80-T15
AC3 SVHCL 22040 11	1.260	1.575	0.866	M12x1.5	0.140	VC.. 221 VC.. 110304	4008-M2.5x6	-	-	ACN-M8-8.5	82-T08
AC4 SVHCL 27050 11	1.575	1.969	1.063	M14x1.5	0.300	VC.. 221 VC.. 110304	4008-M2.5x6	-	-	ACN-M8-8.5	82-T08
AC4 SVHCL 27050 16	1.575	1.969	1.063	M14x1.5	0.300	VC.. 332 VC.. 160408	4015-M3.5x14	AAVN-2-0002	AAV-06-M3.5x11	ACN-M8-8.5	80-T15
AC5 SVHCL 35060 11	1.969	2.362	1.378	M16x1.5	0.550	VC.. 221 VC.. 110304	4008-M2.5x6	-	-	ACN-M10-10.5	82-T08
AC5 SVHCL 35060 16	1.969	2.362	1.378	M16x1.5	0.550	VC.. 332 VC.. 160408	4015-M3.5x14	AAVN-2-0002	AAV-06-M3.5x11	ACN-M10-10.5	80-T15
AC6 SVHCL 45065 16	2.480	2.559	1.772	M20x2	0.960	VC.. 332 VC.. 160408	4015-M3.5x14	AAVN-02-0002	AAV-06-M3.5x11	ACN-M12-12.5	80-T15



Illustrations shown may vary from actual product.

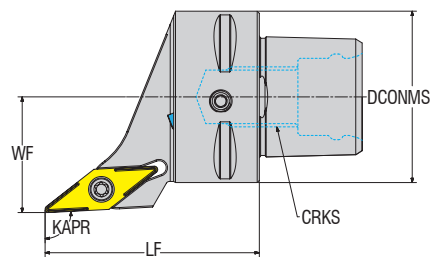

Ordering Code	Dimensions in Inch					Insert Inch/Metric	Screw	Shim	Shim Screw	Nozzle	Torx Key
	DCONMS	LF	WF	CRKS	KG						
AC4 SVJBR 27050 16	1.575	1.969	1.063	M14x1.5	0.446	VB.. 332 VB.. 160408	4015-M3.5x14	AAVN-02-0002	AAV-06-M3.5x11	ACN-M8-8.5	80-T15
AC5 SVJBR 35060 16	1.969	2.362	1.378	M16x1.5	0.777	VB.. 332 VB.. 160408	4015-M3.5x14	AAVN-02-0002	AAV-06-M3.5x11	ACN-M10-10.5	80-T15
AC6 SVJBR 45065 16	2.480	2.559	1.772	M20x2	1.165	VB.. 332 VB.. 160408	4015-M3.5x14	AAVN-02-0002	AAV-06-M3.5x11	ACN-M12-12.5	80-T15
AC4 SVJBL 27050 16	1.575	1.969	1.063	M14x1.5	0.446	VB.. 332 VB.. 160408	4015-M3.5x14	AAVN-02-0002	AAV-06-M3.5x11	ACN-M8-8.5	80-T15
AC5 SVJBL 35060 16	1.969	2.362	1.378	M16x1.5	0.777	VB.. 332 VB.. 160408	4015-M3.5x14	AAVN-02-0002	AAV-06-M3.5x11	ACN-M10-10.5	80-T15
AC6 SVJBL 45065 16	2.480	2.559	1.772	M20x2	1.165	VB.. 332 VB.. 160408	4015-M3.5x14	AAVN-02-0002	AAV-06-M3.5x11	ACN-M12-12.5	80-T15



Illustrations shown may vary from actual product.

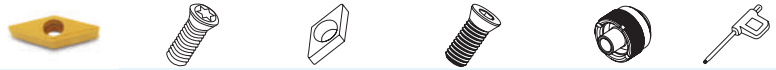
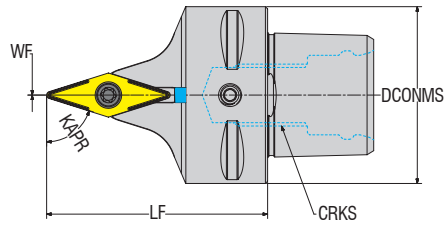

Ordering Code	Dimensions in Inch					Insert Inch/Metric	Screw	Shim	Shim Screw	Nozzle	Torx Key
	DCONMS	LF	WF	CRKS	KG						
AC4 SVVBN 00050 16	1.575	1.969	0	M14x1.5	0.350	VB.. 332 VB.. 160408	4015-M3.5x14	AAVN-2-0002	AAV-06-M3.5x11	ACN-M8-8.5	80-T15
AC5 SVVBN 00060 16	1.969	2.362	0	M16x1.5	0.600	VB.. 332 VB.. 160408	4015-M3.5x14	AAVN-2-0002	AAV-06-M3.5x11	ACN-M10-10.5	80-T15
AC6 SVVBN 00065 16	2.480	2.559	0	M20x2	0.830	VB.. 332 VB.. 160408	4015-M3.5x14	AAVN-2-0002	AAV-06-M3.5x11	ACN-M12-12.5	82-T15



Illustrations shown may vary from actual product.

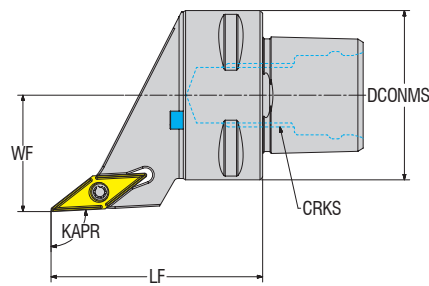

Ordering Code	Dimensions in Inch					Insert Inch/Metric	Screw	Shim	Shim Screw	Nozzle	Torx Key
	DCONMS	LF	WF	CRKS	KG						
AC3 SVJCR 22040 11	1.260	1.575	0.866	M12x1.5	0.242	VC.. 221 VC.. 110304	4008-M2.5x6	-	-	ACN-M8-8.5	82-T08
AC4 SVJCR 27050 11	1.575	1.969	1.063	M14x1.5	0.446	VC.. 221 VC.. 110304	4008-M2.5x6	-	-	ACN-M8-8.5	82-T08
AC4 SVJCR 27050 16	1.575	1.969	1.063	M14x1.5	0.290	VC.. 332 VC.. 160408	4015-M3.5x14	AAVN-02-0002	AAV-06-M3.5x11	ACN-M8-8.5	80-T15
AC5 SVJCR 35060 11	1.969	2.362	1.378	M16x1.5	0.777	VC.. 221 VC.. 110304	4008-M2.5x6	AAVN-02-0002	AAV-06-M3.5x11	ACN-M10-10.5	82-T08
AC5 SVJCR 35060 16	1.969	2.362	1.378	M16x1.5	0.530	VC.. 332 VC.. 160408	4015-M3.5x14	AAVN-02-0002	AAV-06-M3.5x11	ACN-M10-10.5	80-T15
AC6 SVJCR 45065 16	2.480	2.559	1.772	M20x2	1.230	VC.. 332 VC.. 160408	4015-M3.5x14	AAVN-02-0002	AAV-06-M3.5x11	ACN-M12-12.5	82-T15
AC3 SVJCL 22040 11	1.260	1.575	0.866	M12x1.5	0.242	VC.. 221 VC.. 110304	4008-M2.5x6	-	-	ACN-M8-8.5	82-T08
AC4 SVJCL 27050 11	1.575	1.969	1.063	M14x1.5	0.446	VC.. 221 VC.. 110304	4008-M2.5x6	-	-	ACN-M8-8.5	82-T08
AC4 SVJCL 27050 16	1.575	1.969	1.063	M14x1.5	0.290	VC.. 332 VC.. 160408	4015-M3.5x14	AAVN-02-0002	AAV-06-M3.5x11	ACN-M8-8.5	80-T15
AC5 SVJCL 35060 11	1.969	2.362	1.378	M16x1.5	0.777	VC.. 221 VC.. 110304	4008-M2.5x6	AAVN-02-0002	AAV-06-M3.5x11	ACN-M10-10.5	82-T08
AC5 SVJCL 35060 16	1.969	2.362	1.378	M16x1.5	0.530	VC.. 332 VC.. 160408	4015-M3.5x14	AAVN-02-0002	AAV-06-M3.5x11	ACN-M10-10.5	80-T15
AC6 SVJCL 45065 16	2.480	2.559	1.772	M20x2	1.230	VC.. 332 VC.. 160408	4015-M3.5x14	AAVN-02-0002	AAV-06-M3.5x11	ACN-M12-12.5	82-T15

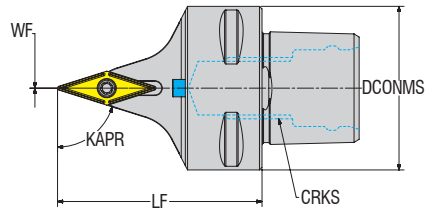

Illustrations shown may vary from actual product.

Ordering Code	Dimensions in Inch					Insert Inch/Metric	Screw	Shim	Shim Screw	Nozzle	Allen Key
	DCONMS	LF	WF	CRKS	KG						
AC3 SVVCN 00040 11	1.260	1.575	0	M12x1.5	0.135	VC.. 221 VC.. 110304	4008-M2.5x6	-	-	ACN-M8-8.5	82-T08
AC4 SVVCN 00050 11	1.575	1.969	0	M14x1.5	0.135	VC.. 221 VC.. 110304	4008-M2.5x6	-	-	ACN-M8-8.5	82-T08
AC4 SVVCN 00050 16	1.575	1.969	0	M14x1.5	0.135	VC.. 332 VC.. 160408	4015-M3.5x14	AAVN-2-0002	AAV-06-M3.5x11	ACN-M8-8.5	80-T15
AC5 SVVCN 00060 16	1.969	2.362	0	M16x1.5	0.520	VC.. 332 VC.. 160408	4015-M3.5x14	AAVN-2-0002	AAV-06-M3.5x11	ACN-M10-10.5	80-T15
AC6 SVVCN 00065 16	2.480	2.559	0	M20x2	0.930	VC.. 332 VC.. 160408	4015-M3.5x14	AAVN-2-0002	AAV-06-M3.5x11	ACN-M12-12.5	80-T15

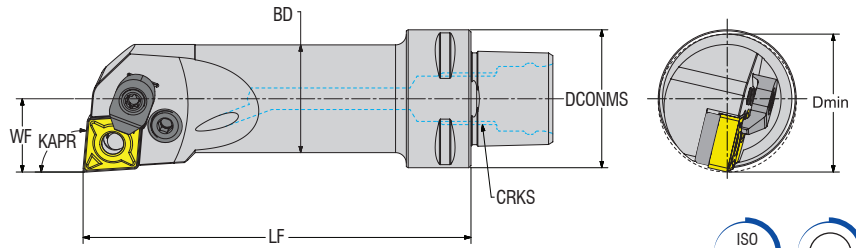

Illustrations shown may vary from actual product.

Dimensions in Inch



Ordering Code	DCONMS	LF	WF	BD	D.min	CRKS	KG	Insert Inch/Metric	Lever	Lever Screw	Shim	Shim Spring	Wedge Clamp	Clamp Screw	Allen Key
AC4 PCLNR 13080 09 H	1.575	3.150	0.512	0.787	0.984	M14x1.5	0.421	CN.. 322 CN.. 090308	APL-01	ALV-01-M6x14	AACN-2-0002	AAY-01	-	-	AAL-02-2.5
AC5 PCLNR 13080 09 H	1.969	3.150	0.512	0.787	0.984	M16x1.5	0.595	CN.. 322 CN.. 090308	APL-01	ALV-01-M6x14	AACN-2-0002	AAY-01	-	-	AAL-02-2.5
AC3 PCLNR 17090 12 HC	1.260	3.500	0.669	0.984	1.260	M12x1.5	0.390	CN.. 432 CN.. 120408	APL-02	ALV-08-M8x16	AACN-3-0001	AAY-02	ACK-05	4015-M4x11	AAL-03-3
AC3 PCLNR 22064 12 HC	1.260	2.520	0.866	1.260	1.575	M12x1.5	0.377	CN.. 432 CN.. 120408	APL-02	ALV-08-M8x16	AACN-3-0001	AAY-02	ACK-05	4015-M4x11	AAL-03-3
AC3 PCLNR 22096 12 H	1.260	3.780	0.866	1.260	1.575	M12x1.5	0.321	CN.. 432 CN.. 120408	APL-02	ALV-03-M8x19	AACN-3-0001	AAY-02	ACK-05	-	AAL-03-3
AC4 PCLNR 17090 12 HC	1.575	3.500	0.669	0.984	1.260	M14x1.5	0.529	CN.. 432 CN.. 120408	APL-02	ALV-08-M8x16	AACN-3-0001	AAY-02	ACK-05	4015-M4x11	AAL-03-3
AC4 PCLNR 22110 12 HC	1.575	4.331	0.866	1.260	1.575	M14x1.5	0.765	CN.. 432 CN.. 120408	APL-02	ALV-08-M8x16	AACN-3-0001	AAY-02	ACK-05	4015-M4x11	AAL-03-3
AC4 PCLNR 27080 12 HC	1.575	3.150	1.063	1.575	1.575	M14x1.5	0.783	CN.. 432 CN.. 120408	APL-02	ALV-08-M8x16	AACN-3-0001	AAY-02	ACK-05	4015-M4x11	AAL-03-3
AC4 PCLNR 27120 12 HC	1.575	4.724	1.063	1.575	1.575	M14x1.5	1.152	CN.. 432 CN.. 120408	APL-02	ALV-08-M8x16	AACN-3-0001	AAY-02	ACK-05	4015-M4x11	AAL-03-3
AC5 PCLNR 17090 12 HC	1.969	3.500	0.669	0.984	1.260	M16x1.5	0.698	CN.. 432 CN.. 120408	APL-02	ALV-08-M8x16	AACN-3-0001	AAY-02	ACK-05	4015-M4x11	AAL-03-3
AC5 PCLNR 22110 12 HC	1.969	4.331	0.866	1.260	1.575	M16x1.5	0.973	CN.. 432 CN.. 120408	APL-02	ALV-08-M8x16	AACN-3-0001	AAY-02	ACK-05	4015-M4x11	AAL-03-3
AC5 PCLNR 27140 12 HC	1.969	5.512	1.063	1.575	1.575	M16x1.5	1.262	CN.. 432 CN.. 120408	APL-02	ALV-08-M8x16	AACN-3-0001	AAY-02	ACK-05	4015-M4x11	AAL-03-3
AC5 PCLNR 35100 12 HC	1.969	3.937	1.378	1.969	2.480	M16x1.5	2.214	CN.. 432 CN.. 120408	APL-02	ALV-08-M8x16	AACN-3-0001	AAY-02	ACK-05	4015-M4x11	AAL-03-3
AC6 PCLNR 17100 12 HC	2.480	3.937	0.669	0.984	1.260	M20x2	1.063	CN.. 432 CN.. 120408	APL-02	ALV-08-M8x16	AACN-3-0001	AAY-02	ACK-05	4015-M4x11	AAL-03-3
AC6 PCLNR 22110 12 HC	2.480	4.331	0.866	1.260	1.575	M20x2	1.290	CN.. 432 CN.. 120408	APL-02	ALV-08-M8x16	AACN-3-0001	AAY-02	ACK-05	4015-M4x11	AAL-03-3
AC5 PCLNR 35150 16 HC	1.969	5.906	1.378	1.969	2.480	M16x1.5	2.314	CN.. 543 CN.. 160612	APL-04	ALV-04-M8x22	AACN-3-0002	AAY-03	ACK-09	AAV-05-M6x15	AAL-03-3
AC6 PCLNR 27140 16 HC	2.480	6.890	1.378	1.969	2.480	M20x2	3.533	CN.. 543 CN.. 160612	APL-04	ALV-04-M8x22	AACN-3-0002	AAY-03	ACK-09	AAV-05-M6x15	AAL-03-3
AC6 PCLNR 35175 16 HC	2.480	6.889	1.378	1.969	2.480	M20x2	2.850	CN.. 543 CN.. 160612	APL-04	ALV-04-M8x22	AACN-3-0002	AAY-03	ACK-09	AAV-05-M6x15	AAL-03-3

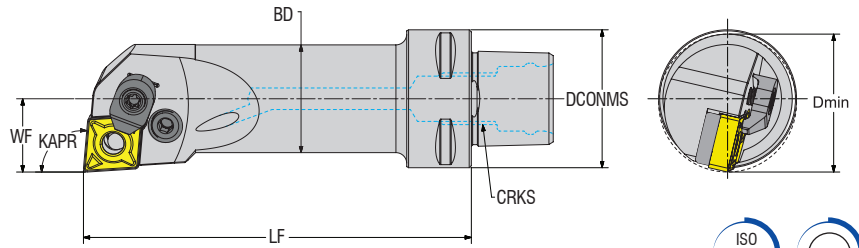

Illustrations shown may vary from actual product.

Dimensions in Inch

Ordering Code	Dimensions in Inch							Insert Inch/Metric	Lever	Lever Screw	Shim	Shim Spring	Wedge Clamp	Clamp Screw	Allen Key
	DCONMS	LF	WF	BD	D.min	CRKS	KG								
AC4 PCLNL 13080 09 H	1.575	3.150	0.512	0.787	0.984	M14x1.5	0.421	CN.. 322 CN.. 090308	APL-01	ALV-01-M6x14	AACN-2-0002	AAY-01	-	-	AAL-02-2.5
AC5 PCLNL 13080 09 H	1.969	3.150	0.512	0.787	0.984	M16x1.5	0.595	CN.. 322 CN.. 090308	APL-01	ALV-01-M6x14	AACN-2-0002	AAY-01	-	-	AAL-02-2.5
AC3 PCLNL 17090 12 HC	1.260	3.500	0.669	0.984	1.260	M12x1.5	0.390	CN.. 432 CN.. 120408	APL-02	ALV-08-M8x16	AACN-3-0001	AAY-02	ACK-05	4015-M4x11	AAL-03-3
AC3 PCLNL 22064 12 HC	1.260	2.520	0.866	1.260	1.575	M12x1.5	0.377	CN.. 432 CN.. 120408	APL-02	ALV-08-M8x16	AACN-3-0001	AAY-02	ACK-05	4015-M4x11	AAL-03-3
AC3 PCLNL 22096 12 H	1.260	3.780	0.866	1.260	1.575	M12x1.5	0.321	CN.. 432 CN.. 120408	APL-02	ALV-03-M8x19	AACN-3-0001	AAY-02	ACK-05	-	AAL-03-3
AC4 PCLNL 17090 12 HC	1.575	3.500	0.669	0.984	1.260	M14x1.5	0.529	CN.. 432 CN.. 120408	APL-02	ALV-08-M8x16	AACN-3-0001	AAY-02	ACK-05	4015-M4x11	AAL-03-3
AC4 PCLNL 22110 12 HC	1.575	4.331	0.866	1.260	1.575	M14x1.5	0.765	CN.. 432 CN.. 120408	APL-02	ALV-08-M8x16	AACN-3-0001	AAY-02	ACK-05	4015-M4x11	AAL-03-3
AC4 PCLNL 27080 12 HC	1.575	3.150	1.063	1.575	1.575	M14x1.5	0.783	CN.. 432 CN.. 120408	APL-02	ALV-08-M8x16	AACN-3-0001	AAY-02	ACK-05	4015-M4x11	AAL-03-3
AC4 PCLNL 27120 12 HC	1.575	4.724	1.063	1.575	1.575	M14x1.5	1.152	CN.. 432 CN.. 120408	APL-02	ALV-08-M8x16	AACN-3-0001	AAY-02	ACK-05	4015-M4x11	AAL-03-3
AC5 PCLNL 17090 12 HC	1.969	3.500	0.669	0.984	1.260	M16x1.5	0.698	CN.. 432 CN.. 120408	APL-02	ALV-08-M8x16	AACN-3-0001	AAY-02	ACK-05	4015-M4x11	AAL-03-3
AC5 PCLNL 22110 12 HC	1.969	4.331	0.866	1.260	1.575	M16x1.5	0.973	CN.. 432 CN.. 120408	APL-02	ALV-08-M8x16	AACN-3-0001	AAY-02	ACK-05	4015-M4x11	AAL-03-3
AC5 PCLNL 27140 12 HC	1.969	5.512	1.063	1.575	1.575	M16x1.5	1.262	CN.. 432 CN.. 120408	APL-02	ALV-08-M8x16	AACN-3-0001	AAY-02	ACK-05	4015-M4x11	AAL-03-3
AC5 PCLNL 35100 12 HC	1.969	3.937	1.378	1.969	2.480	M16x1.5	2.214	CN.. 432 CN.. 120408	APL-02	ALV-08-M8x16	AACN-3-0001	AAY-02	ACK-05	4015-M4x11	AAL-03-3
AC6 PCLNL 17100 12 HC	2.480	3.937	0.669	0.984	1.260	M20x2	1.063	CN.. 432 CN.. 120408	APL-02	ALV-08-M8x16	AACN-3-0001	AAY-02	ACK-05	4015-M4x11	AAL-03-3
AC6 PCLNL 22110 12 HC	2.480	4.331	0.866	1.260	1.575	M20x2	1.290	CN.. 432 CN.. 120408	APL-02	ALV-08-M8x16	AACN-3-0001	AAY-02	ACK-05	4015-M4x11	AAL-03-3
AC5 PCLNL 35150 16 HC	1.969	5.906	1.378	1.969	2.480	M16x1.5	2.314	CN.. 543 CN.. 160612	APL-04	ALV-04-M8x22	AACN-3-0002	AAY-03	ACK-09	AAV-05-M6x15	AAL-03-3
AC6 PCLNL 27140 16 HC	2.480	6.890	1.378	1.969	2.480	M20x2	3.533	CN.. 543 CN.. 160612	APL-04	ALV-04-M8x22	AACN-3-0002	AAY-03	ACK-09	AAV-05-M6x15	AAL-03-3
AC6 PCLNL 35175 16 HC	2.480	6.889	1.378	1.969	2.480	M20x2	2.850	CN.. 543 CN.. 160612	APL-04	ALV-04-M8x22	AACN-3-0002	AAY-03	ACK-09	AAV-05-M6x15	AAL-03-3



Illustrations shown may vary from actual product.

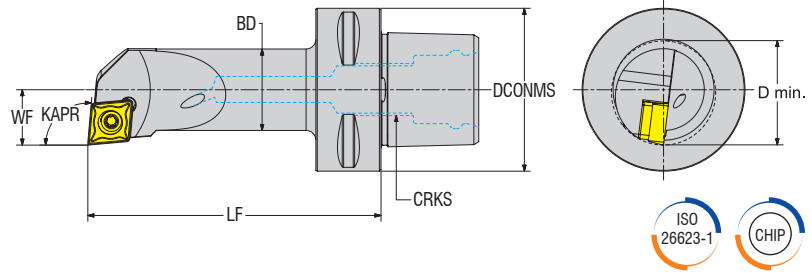

Dimensions in Inch



Ordering Code	DCONMS	LF	WF	BD	D.min	CRKS	KG	Insert Inch/Metric	Screw	Shim	Shim Screw	Torx Key
<b>NEW</b> AC3 SCLCR 11065 09 H	1.260	2.559	0.433	0.630	0.788	M12x1.5	0.192	CC.. 3252 CC.. 09T308	4015-M3.5x9	-	-	80-T15
<b>NEW</b> AC3 SCLCR 13075 09 H	1.260	2.953	0.512	0.787	0.984	M12x1.5	0.258	CC.. 3252 CC.. 09T308	4015-M3.5x9	-	-	80-T15
<b>NEW</b> AC3 SCLCR 17090 09 H	1.260	3.500	0.669	0.984	1.260	M12x1.5	0.390	CC.. 3252 CC.. 09T308	4015-M3.5x12	AACN-2-0001	AAV-08-M3.5x8	80-T15
<b>NEW</b> AC4 SCLCR 11070 09 H	1.575	2.756	0.433	0.630	0.788	M14x1.5	0.365	CC.. 3252 CC.. 09T308	4015-M3.5x9	-	-	80-T15
<b>NEW</b> AC4 SCLCR 13080 09 H	1.575	3.150	0.512	0.787	0.984	M14x1.5	0.421	CC.. 3252 CC.. 09T308	4015-M3.5x9	-	-	80-T15
<b>NEW</b> AC4 SCLCR 17090 09 H	1.575	3.500	0.669	0.984	1.260	M14x1.5	0.529	CC.. 3252 CC.. 09T308	4015-M3.5x12	AACN-2-0001	AAV-08-M3.5x8	80-T15
<b>NEW</b> AC4 SCLCR 27080 09 H	1.575	3.150	1.063	1.575	1.575	M14x1.5	0.783	CC.. 3252 CC.. 09T308	4015-M3.5x12	AACN-2-0001	AAV-08-M3.5x8	80-T15
<b>NEW</b> AC5 SCLCR 11070 09 H	1.969	2.756	0.433	0.630	0.788	M16x1.5	0.481	CC.. 3252 CC.. 09T308	4015-M3.5x9	-	-	80-T15
<b>NEW</b> AC5 SCLCR 13080 09 H	1.969	3.150	0.512	0.787	0.984	M16x1.5	0.595	CC.. 3252 CC.. 09T308	4015-M3.5x9	-	-	80-T15
<b>NEW</b> AC5 SCLCR 17090 09 H	1.969	3.500	0.669	0.984	1.260	M16x1.5	0.698	CC.. 3252 CC.. 09T308	4015-M3.5x12	AACN-2-0001	AAV-08-M3.5x8	80-T15
<b>NEW</b> AC5 SCLCR 35100 09 H	1.969	3.937	1.378	1.969	2.480	M16x1.5	2.214	CC.. 3252 CC.. 09T308	4015-M3.5x12	AACN-2-0001	AAV-08-M3.5x8	80-T15
<b>NEW</b> AC3 SCLCR 17090 12 H	1.260	3.500	0.669	0.984	1.260	M12x1.5	0.390	CC.. 432 CC.. 120408	4020-M4.5x12	AACN-2-0003	AAV-10-M4.5x8	80-T20
<b>NEW</b> AC3 SCLCR 22064 12 H	1.260	2.520	0.866	1.260	1.575	M12x1.5	0.377	CC.. 432 CC.. 120408	4020-M4.5x12	AACN-2-0003	AAV-10-M4.5x8	80-T20
<b>NEW</b> AC3 SCLCR 22096 12 H	1.260	3.780	0.866	1.260	1.575	M12x1.5	0.321	CC.. 432 CC.. 120408	4020-M4.5x12	AACN-2-0003	AAV-10-M4.5x8	80-T20
AC4 SCLCR 17090 12 H	1.575	3.500	0.669	0.984	1.260	M14x1.5	0.529	CC.. 432 CC.. 120408	4020-M4.5x12	AACN-2-0003	AAV-10-M4.5x8	80-T20
<b>NEW</b> AC4 SCLCR 22110 12 H	1.575	4.331	0.866	1.260	1.575	M14x1.5	0.765	CC.. 432 CC.. 120408	4020-M4.5x12	AACN-2-0003	AAV-10-M4.5x8	80-T20
<b>NEW</b> AC4 SCLCR 27080 12 H	1.575	3.150	1.063	1.575	1.575	M14x1.5	0.783	CC.. 432 CC.. 120408	1020-M4.5x16	AACN-2-0003	AAV-10-M4.5x8	80-T20
AC5 SCLCR 17090 12 H	1.969	3.500	0.669	0.984	1.260	M16x1.5	0.698	CC.. 432 CC.. 120408	4020-M4.5x12	AACN-2-0003	AAV-10-M4.5x8	80-T20
<b>NEW</b> AC5 SCLCR 22110 12 H	1.969	4.331	0.866	1.260	1.575	M16x1.5	0.973	CC.. 432 CC.. 120408	4020-M4.5x12	AACN-2-0003	AAV-10-M4.5x8	80-T20
<b>NEW</b> AC5 SCLCR 27140 12 H	1.969	5.512	1.063	1.575	1.575	M16x1.5	1.262	CC.. 432 CC.. 120408	4020-M4.5x12	AACN-2-0003	AAV-10-M4.5x8	80-T20
<b>NEW</b> AC5 SCLCR 35100 12 H	1.969	3.937	1.378	1.969	2.480	M16x1.5	2.214	CC.. 432 CC.. 120408	4020-M4.5x12	AACN-2-0003	AAV-10-M4.5x8	80-T20



Illustrations shown may vary from actual product.

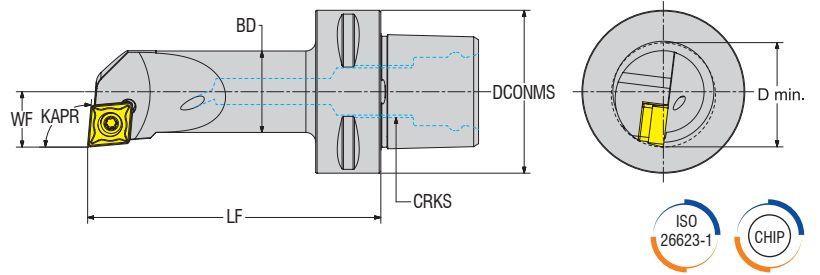

Dimensions in Inch

Ordering Code	DCONMS	LF	WF	BD	D.min	CRKS	KG					
								Insert Inch/Metric	Screw	Shim	Shim Screw	Torx Key
<b>NEW</b> AC3 SCLCL 11065 09 H	1.260	2.559	0.433	0.630	0.788	M12x1.5	0.192	CC.. 3252 CC.. 09T308	4015-M3.5x9	-	-	80-T15
<b>NEW</b> AC3 SCLCL 13075 09 H	1.260	2.953	0.512	0.787	0.984	M12x1.5	0.258	CC.. 3252 CC.. 09T308	4015-M3.5x9	-	-	80-T15
<b>NEW</b> AC3 SCLCL 17090 09 H	1.260	3.500	0.669	0.984	1.260	M12x1.5	0.390	CC.. 3252 CC.. 09T308	4015-M3.5x12	AACN-2-0001	AAV-08-M3.5x8	80-T15
<b>NEW</b> AC4 SCLCL 11070 09 H	1.575	2.756	0.433	0.630	0.788	M14x1.5	0.365	CC.. 3252 CC.. 09T308	4015-M3.5x9	-	-	80-T15
<b>NEW</b> AC4 SCLCL 13080 09 H	1.575	3.150	0.512	0.787	0.984	M14x1.5	0.421	CC.. 3252 CC.. 09T308	4015-M3.5x9	-	-	80-T15
<b>NEW</b> AC4 SCLCL 17090 09 H	1.575	3.500	0.669	0.984	1.260	M14x1.5	0.529	CC.. 3252 CC.. 09T308	4015-M3.5x12	AACN-2-0001	AAV-08-M3.5x8	80-T15
<b>NEW</b> AC4 SCLCL 27080 09 H	1.575	3.150	1.063	1.575	1.575	M14x1.5	0.783	CC.. 3252 CC.. 09T308	4015-M3.5x12	AACN-2-0001	AAV-08-M3.5x8	80-T15
<b>NEW</b> AC5 SCLCL 11070 09 H	1.969	2.756	0.433	0.630	0.788	M16x1.5	0.481	CC.. 3252 CC.. 09T308	4015-M3.5x9	-	-	80-T15
<b>NEW</b> AC5 SCLCL 13080 09 H	1.969	3.150	0.512	0.787	0.984	M16x1.5	0.595	CC.. 3252 CC.. 09T308	4015-M3.5x9	-	-	80-T15
<b>NEW</b> AC5 SCLCL 17090 09 H	1.969	3.500	0.669	0.984	1.260	M16x1.5	0.698	CC.. 3252 CC.. 09T308	4015-M3.5x12	AACN-2-0001	AAV-08-M3.5x8	80-T15
<b>NEW</b> AC5 SCLCL 35100 09 H	1.969	3.937	1.378	1.969	2.480	M16x1.5	2.214	CC.. 3252 CC.. 09T308	4015-M3.5x12	AACN-2-0001	AAV-08-M3.5x8	80-T15
<b>NEW</b> AC3 SCLCL 17090 12 H	1.260	3.500	0.669	0.984	1.260	M12x1.5	0.390	CC.. 432 CC.. 120408	4020-M4.5x12	AACN-2-0003	AAV-10-M4.5x8	80-T20
<b>NEW</b> AC3 SCLCL 22064 12 H	1.260	2.520	0.866	1.260	1.575	M12x1.5	0.377	CC.. 432 CC.. 120408	4020-M4.5x12	AACN-2-0003	AAV-10-M4.5x8	80-T20
<b>NEW</b> AC3 SCLCL 22096 12 H	1.260	3.780	0.866	1.260	1.575	M12x1.5	0.321	CC.. 432 CC.. 120408	4020-M4.5x12	AACN-2-0003	AAV-10-M4.5x8	80-T20
<b>NEW</b> AC4 SCLCL 17090 12 H	1.575	3.500	0.669	0.984	1.260	M14x1.5	0.529	CC.. 432 CC.. 120408	4020-M4.5x12	AACN-2-0003	AAV-10-M4.5x8	80-T20
<b>NEW</b> AC4 SCLCL 22110 12 H	1.575	4.331	0.866	1.260	1.575	M14x1.5	0.765	CC.. 432 CC.. 120408	4020-M4.5x12	AACN-2-0003	AAV-10-M4.5x8	80-T20
<b>NEW</b> AC4 SCLCL 27080 12 H	1.575	3.150	1.063	1.575	1.575	M14x1.5	0.783	CC.. 432 CC.. 120408	1020-M4.5x16	AACN-2-0003	AAV-10-M4.5x8	80-T20
<b>NEW</b> AC5 SCLCL 17090 12 H	1.969	3.500	0.669	0.984	1.260	M16x1.5	0.698	CC.. 432 CC.. 120408	4020-M4.5x12	AACN-2-0003	AAV-10-M4.5x8	80-T20
<b>NEW</b> AC5 SCLCL 22110 12 H	1.969	4.331	0.866	1.260	1.575	M16x1.5	0.973	CC.. 432 CC.. 120408	4020-M4.5x12	AACN-2-0003	AAV-10-M4.5x8	80-T20
<b>NEW</b> AC5 SCLCL 27140 12 H	1.969	5.512	1.063	1.575	1.575	M16x1.5	1.262	CC.. 432 CC.. 120408	4020-M4.5x12	AACN-2-0003	AAV-10-M4.5x8	80-T20
<b>NEW</b> AC5 SCLCL 35100 12 H	1.969	3.937	1.378	1.969	2.480	M16x1.5	2.214	CC.. 432 CC.. 120408	4020-M4.5x12	AACN-2-0003	AAV-10-M4.5x8	80-T20



Illustrations shown may vary from actual product.

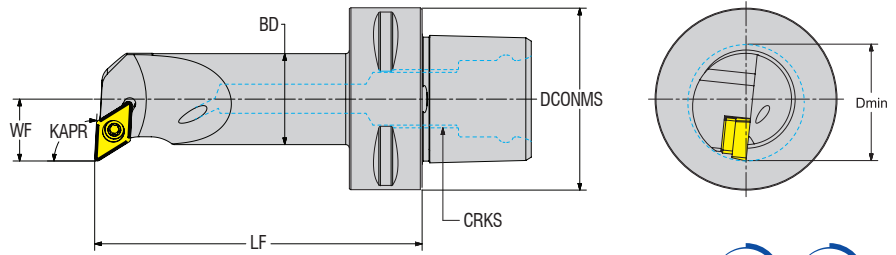

Dimensions in Inch								Insert	Screw	Shim	Shim Screw	Torx Key
Ordering Code	DCONMS	LF	WF	BD	D.min	CRKS	KG	Inch/Metric				
<b>NEW</b> AC3 SDUCR 11065 07 H	1.260	2.559	0.433	0.630	0.788	M12x1.5	0.192	DC.. 2151 DC.. 070204	4008-M2.5x6	-	-	82-T08
<b>NEW</b> AC4 SDUCR 11070 07 H	1.575	2.756	0.433	0.630	0.788	M14x1.5	0.365	DC.. 2151 DC.. 070204	4008-M2.5x6	-	-	82-T08
<b>NEW</b> AC5 SDUCR 11070 07 H	1.969	2.756	0.433	0.630	0.788	M16x1.5	0.481	DC.. 2151 DC.. 070204	4008-M2.5x6	-	-	82-T08
<b>NEW</b> AC3 SDUCR 13075 11 H	1.260	2.953	0.512	0.787	0.984	M12x1.5	0.258	DC.. 3252 DC.. 11T308	4015-M3.5x11	AADN-2-0001	AAV-08-M3.5X8	80-T15
<b>NEW</b> AC3 SDUCR 17090 11 H	1.260	3.500	0.669	0.984	1.260	M12x1.5	0.390	DC.. 3252 DC.. 11T308	4015-M3.5x11	AADN-2-0001	AAV-08-M3.5X8	80-T15
<b>NEW</b> AC3 SDUCR 22064 11 H	1.260	2.520	0.866	1.260	1.575	M12x1.5	0.377	DC.. 3252 DC.. 11T308	4015-M3.5x11	AADN-2-0001	AAV-08-M3.5X8	80-T15
<b>NEW</b> AC3 SDUCR 22096 11 H	1.260	3.780	0.866	1.260	1.575	M12x1.5	0.321	DC.. 3252 DC.. 11T308	4015-M3.5x11	AADN-2-0001	AAV-08-M3.5X8	80-T15
AC4 SDUCR 13080 11 H	1.575	3.150	0.512	0.787	0.984	M14x1.5	0.421	DC.. 3252 DC.. 11T308	4015-M3.5x11	AADN-2-0001	AAV-08-M3.5X8	80-T15
AC4 SDUCR 17090 11 H	1.575	3.500	0.669	0.984	1.260	M14x1.5	0.529	DC.. 3252 DC.. 11T308	4015-M3.5x11	AADN-2-0001	AAV-08-M3.5X8	80-T15
<b>NEW</b> AC4 SDUCR 22110 11 H	1.575	4.331	0.866	1.260	1.575	M14x1.5	0.765	DC.. 3252 DC.. 11T308	4015-M3.5x11	AADN-2-0001	AAV-08-M3.5X8	80-T15
<b>NEW</b> AC4 SDUCR 27080 11 H	1.575	3.150	1.063	1.575	1.575	M14x1.5	0.783	DC.. 3252 DC.. 11T308	4015-M3.5x11	AADN-2-0001	AAV-08-M3.5X8	80-T15
AC5 SDUCR 13080 11 H	1.969	3.150	0.512	0.787	0.984	M16x1.5	0.595	DC.. 3252 DC.. 11T308	4015-M3.5x11	AADN-2-0001	AAV-08-M3.5X8	80-T15
AC5 SDUCR 17090 11 H	1.969	3.500	0.669	0.984	1.260	M16x1.5	0.698	DC.. 3252 DC.. 11T308	4015-M3.5x14	AADN-2-0001	AAV-06-M3.5x11	80-T15
<b>NEW</b> AC5 SDUCR 35100 11 H	1.969	3.937	1.378	1.969	2.480	M16x1.5	2.214	DC.. 3252 DC.. 11T308	4015-M3.5x14	AADN-2-0001	AAV-06-M3.5x11	80-T15
<b>NEW</b> AC3 SDUCL 11065 07 H	1.260	2.559	0.433	0.630	0.788	M12x1.5	0.192	DC.. 2151 DC.. 070204	4008-M2.5x6	-	-	82-T08
<b>NEW</b> AC4 SDUCL 11070 07 H	1.575	2.756	0.433	0.630	0.788	M14x1.5	0.365	DC.. 2151 DC.. 070204	4008-M2.5x6	-	-	82-T08
<b>NEW</b> AC5 SDUCL 11070 07 H	1.969	2.756	0.433	0.630	0.788	M16x1.5	0.481	DC.. 2151 DC.. 070204	4008-M2.5x6	-	-	82-T08
<b>NEW</b> AC3 SDUCL 13075 11 H	1.260	2.953	0.512	0.787	0.984	M12x1.5	0.258	DC.. 3252 DC.. 11T308	4015-M3.5x11	AADN-2-0001	AAV-08-M3.5X8	80-T15
<b>NEW</b> AC3 SDUCL 17090 11 H	1.260	3.500	0.669	0.984	1.260	M12x1.5	0.390	DC.. 3252 DC.. 11T308	4015-M3.5x11	AADN-2-0001	AAV-08-M3.5X8	80-T15
<b>NEW</b> AC3 SDUCL 22064 11 H	1.260	2.520	0.866	1.260	1.575	M12x1.5	0.377	DC.. 3252 DC.. 11T308	4015-M3.5x11	AADN-2-0001	AAV-08-M3.5X8	80-T15
<b>NEW</b> AC3 SDUCL 22096 11 H	1.260	3.780	0.866	1.260	1.575	M12x1.5	0.321	DC.. 3252 DC.. 11T308	4015-M3.5x11	AADN-2-0001	AAV-08-M3.5X8	80-T15
AC4 SDUCL 13080 11 H	1.575	3.150	0.512	0.787	0.984	M14x1.5	0.421	DC.. 3252 DC.. 11T308	4015-M3.5x11	AADN-2-0001	AAV-08-M3.5X8	80-T15
AC4 SDUCL 17090 11 H	1.575	3.500	0.669	0.984	1.260	M14x1.5	0.529	DC.. 3252 DC.. 11T308	4015-M3.5x11	AADN-2-0001	AAV-08-M3.5X8	80-T15
<b>NEW</b> AC4 SDUCL 22110 11 H	1.575	4.331	0.866	1.260	1.575	M14x1.5	0.765	DC.. 3252 DC.. 11T308	4015-M3.5x11	AADN-2-0001	AAV-08-M3.5X8	80-T15
<b>NEW</b> AC4 SDUCL 27080 11 H	1.575	3.150	1.063	1.575	1.575	M14x1.5	0.783	DC.. 3252 DC.. 11T308	4015-M3.5x11	AADN-2-0001	AAV-08-M3.5X8	80-T15
AC5 SDUCL 13080 11 H	1.969	3.150	0.512	0.787	0.984	M16x1.5	0.595	DC.. 3252 DC.. 11T308	4015-M3.5x11	AADN-2-0001	AAV-08-M3.5X8	80-T15
AC5 SDUCL 17090 11 H	1.969	3.500	0.669	0.984	1.260	M16x1.5	0.698	DC.. 3252 DC.. 11T308	4015-M3.5x14	AADN-2-0001	AAV-06-M3.5x11	80-T15
<b>NEW</b> AC5 SDUCL 35100 11 H	1.969	3.937	1.378	1.969	2.480	M16x1.5	2.214	DC.. 3252 DC.. 11T308	4015-M3.5x14	AADN-2-0001	AAV-06-M3.5x11	80-T15

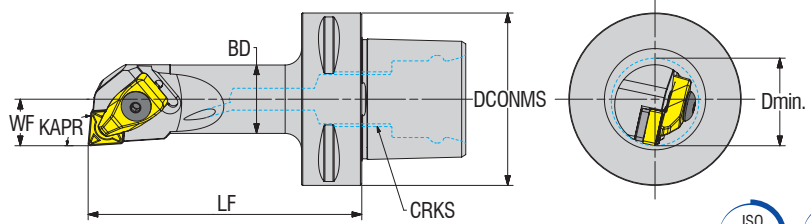

Illustrations shown may vary from actual product.

Ordering Code	Dimensions in Inch							Insert Inch/Metric	Wedge Clamp	Clamp Screw	Shim	Shim Screw	Ring	Stamp	Allen Key
	DCONMS	LF	WF	BD	D.min	CRKS	KG								
AC4 DCLNR 13080 09 H	1.575	3.150	0.512	0.787	0.984	M14x1.5	0.421	CN.. 322 CN.. 090308	ATK-01	AKV-01-M5x22	AACN-2-0001	AAV-09-M5x9	-	ABPL-01	AAL-03-3
AC5 DCLNR 13080 09 H	1.969	3.150	0.512	0.787	0.984	M16x1.5	0.595	CN.. 322 CN.. 090308	ATK-01	AKV-01-M5x22	AACN-2-0001	AAV-09-M5x9	-	ABPL-01	AAL-03-3
AC4 DCLNR 17090 12 H	1.575	3.500	0.669	0.984	1.260	M14x1.5	0.529	CN.. 432 CN.. 120408	ATK-02	AKV-30-M6x22	AACN-3-0001	AAV-13-M5x8	AS-01	ABPL-01	AAL-03-3
AC5 DCLNR 17090 12 H	1.969	3.500	0.669	0.984	1.260	M16x1.5	0.698	CN.. 432 CN.. 120408	ATK-02	AKV-30-M6x22	AACN-3-0001	AAV-13-M5x8	AS-01	ABPL-01	AAL-03-3
AC6 DCLNR 17100 12 H	2.480	3.937	0.669	0.984	1.260	M20x2	1.063	CN.. 432 CN.. 120408	ATK-02	AKV-30-M6x22	AACN-3-0001	AAV-13-M5x8	AS-01	ABPL-01	AAL-03-3
AC6 DCLNR 27140 16 H	2.480	5.512	1.063	1.575	1.575	M20x2	3.533	CN.. 543 CN.. 160612	ATK-02	AKV-30-M6x22	AACN-3-0001	AAV-13-M5x8	AS-01	ABPL-01	AAL-03-3
AC4 DCLNL 13080 09 H	1.575	3.150	0.512	0.787	0.984	M14x1.5	0.421	CN.. 322 CN.. 090308	ATK-01	AKV-01-M5x22	AACN-2-0001	AAV-09-M5x9	-	ABPL-01	AAL-03-3
AC5 DCLNL 13080 09 H	1.969	3.150	0.512	0.787	0.984	M16x1.5	0.595	CN.. 322 CN.. 090308	ATK-01	AKV-01-M5x22	AACN-2-0001	AAV-09-M5x9	-	ABPL-01	AAL-03-3
AC4 DCLNL 17090 12 H	1.575	3.500	0.669	0.984	1.260	M14x1.5	0.529	CN.. 432 CN.. 120408	ATK-02	AKV-30-M6x22	AACN-3-0001	AAV-13-M5x8	AS-01	ABPL-01	AAL-03-3
AC5 DCLNL 17090 12 H	1.969	3.500	0.669	0.984	1.260	M16x1.5	0.698	CN.. 432 CN.. 120408	ATK-02	AKV-30-M6x22	AACN-3-0001	AAV-13-M5x8	AS-01	ABPL-01	AAL-03-3
AC6 DCLNL 17100 12 H	2.480	3.937	0.669	0.984	1.260	M20x2	1.063	CN.. 432 CN.. 120408	ATK-02	AKV-30-M6x22	AACN-3-0001	AAV-13-M5x8	AS-01	ABPL-01	AAL-03-3
AC6 DCLNL 27140 16 H	2.480	5.512	1.063	1.575	1.575	M20x2	3.533	CN.. 543 CN.. 160612	ATK-02	AKV-30-M6x22	AACN-3-0001	AAV-13-M5x8	AS-01	ABPL-01	AAL-03-3

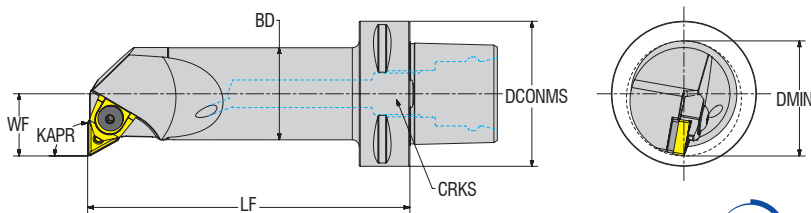

Illustrations shown may vary from actual product.

Ordering Code	Dimensions in Inch							Insert Inch/Metric	Wedge Clamp	Clamp Screw	Shim	Shim Screw	Ring	Stamp	Pin	Allen Key
	DCONMS	LF	WF	BD	D.min	CRKS	KG									
AC6 MTFNR 27140 16 H	2.480	6.890	1.378	1.575	1.575	M20x2	3.533	TN.. 332 TN.. 160408	AMK-04	2725-M5x5	AATN-2-0002	AKV-30-M6x22	AS-01	ABPL-01	APM-01	AAL-03-3

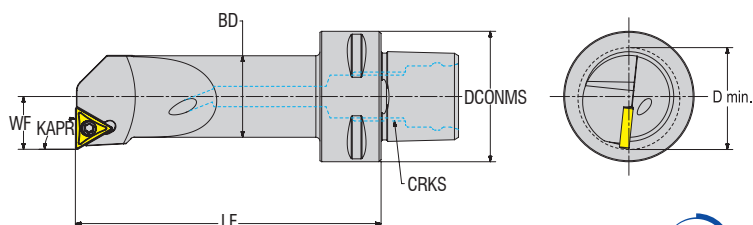

Illustrations shown may vary from actual product.

Dimensions in Inch



Ordering Code	DCONMS	LF	WF	BD	D.min	CRKS	KG	Insert Inch/Metric	Screw	Shim	Shim Screw	Allen Key
AC3 STFCL 11065 11 H	1.260	2.559	0.433	0.630	0.788	M12x1.5	0.180	TC.. 2151 TC.. 110204	4008-M2.5x6	-	-	82-T08
AC3 STFCL 13075 11 H	1.260	2.953	0.512	0.787	0.984	M12x1.5	0.230	TC.. 2151 TC.. 110204	4008-M2.5x6	-	-	82-T08
AC3 STFCL 17090 16 H	1.260	3.500	0.669	0.787	1.260	M12x1.5	0.360	TC.. 3252 TC.. 16T308	4015-M3.5x14	AATN-2-0001	AAV-08-M3.5x8	80-T15
AC4 STFCL 11070 11 H	1.575	2.756	0.433	0.630	0.788	M14x1.5	0.330	TC.. 2151 TC.. 110204	4008-M2.5x6	-	-	82-T08
AC4 STFCL 13080 11 H	1.575	3.150	0.512	0.787	0.984	M14x1.5	0.400	TC.. 2151 TC.. 110204	4008-M2.5x6	-	-	82-T08
AC4 STFCL 17090 16 H	1.575	3.500	0.669	0.787	1.260	M14x1.5	0.440	TC.. 3252 TC.. 16T308	4015-M3.5x14	AATN-2-0001	AAV-08-M3.5x8	80-T15
AC4 STFCL 22110 16 H	1.575	4.331	0.866	1.260	1.575	M14x1.5	0.750	TC.. 3252 TC.. 16T308	4015-M3.5x14	AATN-2-0001	AAV-06-M3.5x11	80-T15
AC5 STFCL 11070 11 H	1.969	2.756	0.433	0.630	0.788	M16x1.5	0.500	TC.. 2151 TC.. 110204	4008-M2.5x6	-	-	82-T08
AC5 STFCL 13080 11 H	1.969	3.150	0.512	0.787	0.984	M16x1.5	0.570	TC.. 2151 TC.. 110204	4008-M2.5x6	-	-	82-T08
AC5 STFCL 17090 16 H	1.969	3.500	0.669	0.787	1.260	M16x1.5	0.700	TC.. 3252 TC.. 16T308	4015-M3.5x14	AATN-2-0001	AAV-08-M3.5x8	80-T15
AC5 STFCL 22110 16 H	1.969	4.331	0.866	1.260	1.575	M16x1.5	0.930	TC.. 3252 TC.. 16T308	4015-M3.5x14	AATN-2-0001	AAV-06-M3.5x11	80-T15
AC3 STFCL 11065 11 H	1.260	2.559	0.433	0.630	0.788	M12x1.5	0.180	TC.. 2151 TC.. 110204	4008-M2.5x6	-	-	82-T08
AC3 STFCL 13075 11 H	1.260	2.953	0.512	0.787	0.984	M12x1.5	0.230	TC.. 2151 TC.. 110204	4008-M2.5x6	-	-	82-T08
AC3 STFCL 17090 16 H	1.260	3.500	0.669	0.787	1.260	M12x1.5	0.360	TC.. 3252 TC.. 16T308	4015-M3.5x14	AATN-2-0001	AAV-08-M3.5x8	80-T15
AC4 STFCL 11070 11 H	1.575	2.756	0.433	0.630	0.788	M14x1.5	0.330	TC.. 2151 TC.. 110204	4008-M2.5x6	-	-	82-T08
AC4 STFCL 13080 11 H	1.575	3.150	0.512	0.787	0.984	M14x1.5	0.400	TC.. 2151 TC.. 110204	4008-M2.5x6	-	-	82-T08
AC4 STFCL 17090 16 H	1.575	3.500	0.669	0.787	1.260	M14x1.5	0.440	TC.. 3252 TC.. 16T308	4015-M3.5x14	AATN-2-0001	AAV-08-M3.5x8	80-T15
AC4 STFCL 22110 16 H	1.575	4.331	0.866	1.260	1.575	M14x1.5	0.750	TC.. 3252 TC.. 16T308	4015-M3.5x14	AATN-2-0001	AAV-06-M3.5x11	80-T15
AC5 STFCL 11070 11 H	1.969	2.756	0.433	0.630	0.788	M16x1.5	0.500	TC.. 2151 TC.. 110204	4008-M2.5x6	-	-	82-T08
AC5 STFCL 13080 11 H	1.969	3.150	0.512	0.787	0.984	M16x1.5	0.570	TC.. 2151 TC.. 110204	4008-M2.5x6	-	-	82-T08
AC5 STFCL 17090 16 H	1.969	3.500	0.669	0.787	1.260	M16x1.5	0.700	TC.. 3252 TC.. 16T308	4015-M3.5x14	AATN-2-0001	AAV-08-M3.5x8	80-T15
AC5 STFCL 22110 16 H	1.969	4.331	0.866	1.260	1.575	M16x1.5	0.930	TC.. 3252 TC.. 16T308	4015-M3.5x14	AATN-2-0001	AAV-06-M3.5x11	80-T15



Illustrations shown may vary from actual product.

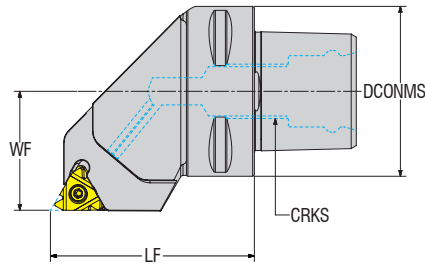

Dimensions in Inch



Ordering Code	DCONMS	LF	WF	CRKS	KG	Insert	Screw	Right Shim	Left Shim	Shim Screw	Ring	Nozzle	Torx Key
<b>AC3 TER 22040 16</b>	1.260	1.575	0.866	M12x1.5	0.367	16 ER	1710-U5-40x12.2	ATS-16E	ATS-16I	AAV-11-U5-40x4.5	ABPL-03	ACN-M8-8.5	82-T10
<b>AC4 TER 27050 16 H</b>	1.575	1.969	1.063	M14x1.5	0.440	16 ER	1710-U5-40x12.2	ATS-16E	ATS-16I	AAV-11-U5-40x4.5	ABPL-03	-	82-T10
<b>AC5 TER 35060 16 H</b>	1.969	2.362	1.378	M16x1.5	0.781	16 ER	1710-U5-40x12.2	ATS-16E	ATS-16I	AAV-11-U5-40x4.5	ABPL-03	-	82-T10
<b>AC6 TER 45065 16 H</b>	2.480	2.559	1.772	M20x2	1.358	16 ER	1710-U5-40x12.2	ATS-16E	ATS-16I	AAV-11-U5-40x4.5	ABPL-03	-	82-T10
<b>AC3 TER 22040 22</b>	1.260	1.575	0.866	M12x1.5	0.367	22 ER	1720-U8-32x15	ATS-22E	ATS-22I	AAV-12-U8-32x5.5	ABPL-04	ACN-M8-8.5	82-T20
<b>AC4 TER 27050 22</b>	1.575	1.969	1.063	M14x1.5	0.440	22 ER	1720-U8-32x15	ATS-22E	ATS-22I	AAV-12-U8-32x5.5	ABPL-04	ACN-M8-8.5	82-T20
<b>AC5 TER 35060 22</b>	1.969	2.362	1.378	M16x1.5	0.781	22 ER	1720-U8-32x15	ATS-22E	ATS-22I	AAV-12-U8-32x5.5	ABPL-04	ACN-M10-10.5	82-T20
<b>AC6 TER 45065 22</b>	2.480	2.559	1.772	M20x2	1.358	22 ER	1720-U8-32x15	ATS-22E	ATS-22I	AAV-12-U8-32x5.5	ABPL-04	ACN-M12-12.5	82-T20
<b>AC8 TER 55080 22</b>	3.150	3.150	2.165	M20X2	2.560	22 ER	1720-U8-32x15	ATS-22E	ATS-22I	AAV-12-U8-32x5.5	ABPL-04	ACN-M12-12.5	82-T20
<b>AC3 TEL 22040 16</b>	1.260	1.575	0.866	M12x1.5	0.367	16 EL	1710-U5-40x12.2	ATS-16E	ATS-16I	AAV-11-U5-40x4.5	ABPL-03	ACN-M8-8.5	82-T10
<b>AC4 TEL 27050 16 H</b>	1.575	1.969	1.063	M14x1.5	0.360	16 EL	1710-U5-40x12.2	ATS-16E	ATS-16I	AAV-11-U5-40x4.5	ABPL-03	-	82-T10
<b>AC5 TEL 35060 16 H</b>	1.969	2.362	1.378	M16x1.5	0.781	16 EL	1710-U5-40x12.2	ATS-16E	ATS-16I	AAV-11-U5-40x4.5	ABPL-03	-	82-T10
<b>AC6 TEL 45065 16 H</b>	2.480	2.559	1.772	M20x2	1.358	16 EL	1710-U5-40x12.2	ATS-16E	ATS-16I	AAV-11-U5-40x4.5	ABPL-03	-	82-T10
<b>AC3 TEL 22040 22</b>	1.260	1.575	0.866	M12x1.5	0.367	22 EL	1720-U8-32x15	ATS-22E	ATS-22I	AAV-12-U8-32x5.5	ABPL-04	ACN-M8-8.5	82-T20
<b>AC4 TEL 27050 22</b>	1.575	1.969	1.063	M14x1.5	0.440	22 EL	1720-U8-32x15	ATS-22E	ATS-22I	AAV-12-U8-32x5.5	ABPL-04	ACN-M8-8.5	82-T20
<b>AC5 TEL 35060 22</b>	1.969	2.362	1.378	M16x1.5	0.781	22 EL	1720-U8-32x15	ATS-22E	ATS-22I	AAV-12-U8-32x5.5	ABPL-04	ACN-M10-10.5	82-T20
<b>AC6 TEL 45065 22</b>	2.480	2.559	1.772	M20x2	1.358	22 EL	1720-U8-32x15	ATS-22E	ATS-22I	AAV-12-U8-32x5.5	ABPL-04	ACN-M12-12.5	82-T20
<b>AC8 TEL 55080 22</b>	3.150	3.150	2.165	M20X2	2.560	22 ER	1720-U8-32x15	ATS-22E	ATS-22I	AAV-12-U8-32x5.5	ABPL-04	ACN-M12-12.5	82-T20



Illustrations shown may vary from actual product.

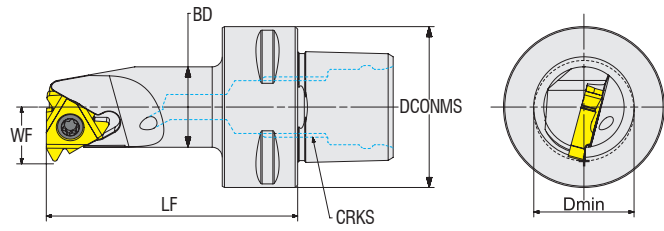

Dimensions in Inch

Ordering Code	DCONMS	LF	WF	BD	D.min	CRKS	KG	Insert	Screw	Shim	Shim Screw	Ring	Torx Key
AC3 SIR 12050 16 H	1.260	1.969	0.473	0.630	0.787	M12x1.5	0.192	16 IR	4015-M3.5x10	-	-	-	80-T15
AC4 SIR 12060 16 H	1.575	2.362	0.473	0.630	0.787	M14x1.5	0.197	16 IR	4015-M3.5x10	-	-	-	80-T15
AC5 SIR 12060 16 H	1.969	2.362	0.473	0.630	0.787	M16x1.5	0.197	16 IR	4015-M3.5x10	-	-	-	80-T15
AC4 SIR 15065 22 H	1.575	2.559	0.590	0.787	0.984	M14x1.5	0.421	22 IR	4020-M4.5x12	-	-	-	80-T20
AC5 SIR 15065 22 H	1.969	2.559	0.590	0.787	0.984	M16x1.5	0.595	22 IR	4020-M4.5x12	-	-	-	80-T20
AC3 SIL 12050 16 H	1.260	1.969	0.473	0.630	0.787	M12x1.5	0.192	16 IL	4015-M3.5x10	-	-	-	80-T15
AC4 SIL 12060 16 H	1.575	2.362	0.473	0.630	0.787	M14x1.5	0.197	16 IL	4015-M3.5x10	-	-	-	80-T15
AC5 SIL 12060 16 H	1.969	2.362	0.473	0.630	0.787	M16x1.5	0.197	16 IL	4015-M3.5x10	-	-	-	80-T15
AC4 SIL 15065 22 H	1.575	2.559	0.590	0.787	0.984	M14x1.5	0.421	22 IL	4020-M4.5x12	-	-	-	80-T20
AC5 SIL 15065 22 H	1.969	2.559	0.590	0.787	0.984	M16x1.5	0.595	22 IL	4020-M4.5x12	-	-	-	80-T20





Illustrations shown may vary from actual product.

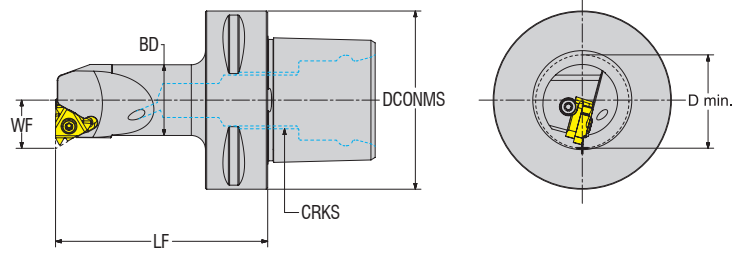

Dimensions in Inch



Ordering Code	DCONMS	LF	WF	BD	D.min	CRKS	KG	Insert	Screw	Right Shim	Left Shim	Shim Screw	Ring	Torx Key
AC3 TIR 14060 16 H	1.260	2.520	0.551	0.787	0.984	M12x1.5	0.258	16 IR	1710-U5-40x12.2	ATS-16E	ATS-16I	AAV-11-U5-40x4.5	ABPL-03	82-T10
AC3 TIR 22085 16 H	1.260	3.350	0.866	1.260	1.575	M12x1.5	0.397	16 IR	1710-U5-40x12.2	ATS-16E	ATS-16I	AAV-11-U5-40x4.5	ABPL-03	82-T10
AC4 TIR 14060 16 H	1.575	2.520	0.551	0.787	0.984	M14x1.5	0.383	16 IR	1710-U5-40x12.2	ATS-16E	ATS-16I	AAV-11-U5-40x4.5	ABPL-03	82-T10
AC4 TIR 17070 16 H	1.575	2.756	0.669	0.984	1.260	M14x1.5	0.466	16 IR	1710-U5-40x12.2	ATS-16E	ATS-16I	AAV-11-U5-40x4.5	ABPL-03	82-T10
AC4 TIR 19070 22 H	1.575	2.756	0.750	1.260	1.260	M14x1.5	0.458	22 IR	1720-U832x15	ATS-22E	ATS-22E	AAV-12-U832x5.5	ABPL-04	80-T20
AC4 TIR 22090 16 H	1.575	3.543	0.866	1.260	1.575	M14x1.5	0.659	16 IR	1710-U5-40x12.2	ATS-16E	ATS-16I	AAV-11-U5-40x4.5	ABPL-03	82-T10
AC4 TIR 22090 22 H	1.575	3.543	0.866	1.260	1.575	M14x1.5	0.659	22 IR	1720-U832x15	ATS-22E	ATS-22E	AAV-12-U832x5.5	ABPL-04	80-T20
AC4 TIR 27080 16 H	1.575	3.150	1.063	1.260	1.969	M14x1.5	0.783	16 IR	1710-U5-40x12.2	ATS-16E	ATS-16I	AAV-11-U5-40x4.5	ABPL-03	82-T10
AC4 TIR 27080 22 H	1.575	3.150	1.063	1.260	1.969	M14x1.5	0.783	22 IR	1720-U832x15	ATS-22E	ATS-22E	AAV-12-U832x5.5	ABPL-04	80-T20
AC5 TIR 14060 16 H	1.969	2.520	0.551	0.787	0.984	M16x1.5	0.480	16 IR	1710-U5-40x12.2	ATS-16E	ATS-16I	AAV-11-U5-40x4.5	ABPL-03	82-T10
AC5 TIR 17070 16 H	1.969	2.756	0.669	0.984	1.260	M16x1.5	0.642	16 IR	1710-U5-40x12.2	ATS-16E	ATS-16I	AAV-11-U5-40x4.5	ABPL-03	82-T10
AC5 TIR 19070 22 H	1.969	2.756	0.750	0.984	1.260	M16x1.5	0.550	22 IR	1720-U8-32x15	ATS-22E	ATS-22I	AAV-12-U8-32x5.5	ABPL-04	80-T20
AC5 TIR 22090 16 H	1.969	3.543	0.866	1.260	1.575	M16x1.5	0.834	16 IR	1710-U5-40x12.2	ATS-16E	ATS-16I	AAV-11-U5-40x4.5	ABPL-03	82-T10
AC5 TIR 22090 22 H	1.969	3.543	0.866	1.260	1.575	M16x1.5	0.750	22 IR	1720-U8-32x15	ATS-22E	ATS-22I	AAV-12-U8-32x5.5	ABPL-04	80-T20
AC5 TIR 27105 16 H	1.969	4.134	1.063	1.575	1.969	M16x1.5	1.152	16 IR	1710-U5-40x12.2	ATS-16E	ATS-16I	AAV-11-U5-40x4.5	ABPL-03	82-T10
AC5 TIR 27105 22 H	1.969	4.134	1.063	1.575	1.969	M16x1.5	1.080	22 IR	1720-U8-32x15	ATS-22E	ATS-22I	AAV-12-U8-32x5.5	ABPL-04	80-T20
AC6 TIR 14070 16 H	2.480	2.756	0.551	0.787	0.984	M20x2	0.830	16 IR	1710-U5-40x12.2	ATS-16E	ATS-16I	AAV-11-U5-40x4.5	ABPL-03	82-T10
AC6 TIR 17075 16 H	2.480	2.953	0.669	0.984	1.260	M20x2	1.013	16 IR	1710-U5-40x12.2	ATS-16E	ATS-16I	AAV-11-U5-40x4.5	ABPL-03	82-T10
AC6 TIR 19075 22 H	2.480	2.952	0.750	0.984	1.260	M20x2	0.880	22 IR	1720-U8-32x15	ATS-22E	ATS-22I	AAV-12-U8-32x5.5	ABPL-04	80-T20
AC6 TIR 22090 16 H	2.480	3.543	0.866	1.260	1.575	M20x2	1.175	16 IR	1710-U5-40x12.2	ATS-16E	ATS-16I	AAV-11-U5-40x4.5	ABPL-03	82-T10
AC6 TIR 22090 22 H	2.480	3.543	0.866	1.260	1.575	M20x2	1.050	22 IR	1720-U8-32x15	ATS-22E	ATS-22I	AAV-12-U8-32x5.5	ABPL-04	80-T20
AC6 TIR 27105 16 H	2.480	4.134	1.063	1.575	1.969	M20x2	1.477	16 IR	1710-U5-40x12.2	ATS-16E	ATS-16I	AAV-11-U5-40x4.5	ABPL-03	82-T10
AC6 TIR 27105 22 H	2.480	4.134	1.063	1.575	1.969	M20x2	1.477	22 IR	1720-U8-32x15	ATS-22E	ATS-22E	AAV-12-U8-32x5.5	ABPL-04	80-T20



Illustrations shown may vary from actual product.

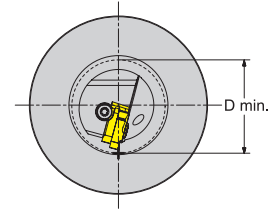
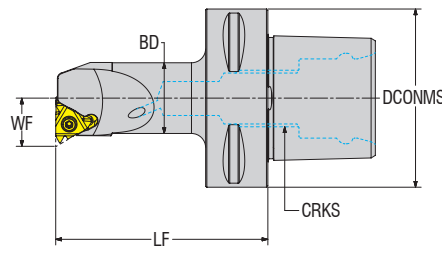

Dimensions in Inch



Ordering Code	DCONMS	LF	WF	BD	D.min	CRKS	KG	Insert	Screw	Right Shim	Left Shim	Shim Screw	Ring	Torx Key
AC3 TIL 14060 16 H	1.260	2.520	0.551	0.787	0.984	M12x1.5	0.258	16 IR	1710-U5-40x12.2	ATS-16E	ATS-16I	AAV-11-U5-40x4.5	ABPL-03	82-T10
AC3 TIL 22085 16 H	1.260	3.350	0.866	1.260	1.575	M12x1.5	0.397	16 IR	1710-U5-40x12.2	ATS-16E	ATS-16I	AAV-11-U5-40x4.5	ABPL-03	82-T10
AC4 TIL 14060 16 H	1.575	2.520	0.551	0.787	0.984	M14x1.5	0.383	16 IR	1710-U5-40x12.2	ATS-16E	ATS-16I	AAV-11-U5-40x4.5	ABPL-03	82-T10
AC4 TIL 17070 16 H	1.575	2.756	0.669	0.984	1.260	M14x1.5	0.466	16 IR	1710-U5-40x12.2	ATS-16E	ATS-16I	AAV-11-U5-40x4.5	ABPL-03	82-T10
AC4 TIL 19070 22 H	1.575	2.756	0.750	1.260	1.260	M14x1.5	0.458	22 IR	1720-U832x15	ATS-22E	ATS-22E	AAV-12-U832x5.5	ABPL-04	80-T20
AC4 TIL 22090 16 H	1.575	3.543	0.866	1.260	1.575	M14x1.5	0.659	16 IR	1710-U5-40x12.2	ATS-16E	ATS-16I	AAV-11-U5-40x4.5	ABPL-03	82-T10
AC4 TIL 22090 22 H	1.575	3.543	0.866	1.260	1.575	M14x1.5	0.659	22 IR	1720-U832x15	ATS-22E	ATS-22E	AAV-12-U832x5.5	ABPL-04	80-T20
AC4 TIL 27080 16 H	1.575	3.150	1.063	1.260	1.969	M14x1.5	0.783	16 IR	1710-U5-40x12.2	ATS-16E	ATS-16I	AAV-11-U5-40x4.5	ABPL-03	82-T10
AC4 TIL 27080 22 H	1.575	3.150	1.063	1.260	1.969	M14x1.5	0.783	22 IR	1720-U832x15	ATS-22E	ATS-22E	AAV-12-U832x5.5	ABPL-04	80-T20
AC5 TIL 14060 16 H	1.969	2.520	0.551	0.787	0.984	M16x1.5	0.480	16 IR	1710-U5-40x12.2	ATS-16E	ATS-16I	AAV-11-U5-40x4.5	ABPL-03	82-T10
AC5 TIL 17070 16 H	1.969	2.756	0.669	0.984	1.260	M16x1.5	0.642	16 IR	1710-U5-40x12.2	ATS-16E	ATS-16I	AAV-11-U5-40x4.5	ABPL-03	82-T10
AC5 TIL 19070 22 H	1.969	2.756	0.750	0.984	1.260	M16x1.5	0.550	22 IR	1720-U8-32x15	ATS-22E	ATS-22I	AAV-12-U8-32x5.5	ABPL-04	80-T20
AC5 TIL 22090 16 H	1.969	3.543	0.866	1.260	1.575	M16x1.5	0.834	16 IR	1710-U5-40x12.2	ATS-16E	ATS-16I	AAV-11-U5-40x4.5	ABPL-03	82-T10
AC5 TIL 22090 22 H	1.969	3.543	0.866	1.260	1.575	M16x1.5	0.750	22 IR	1720-U8-32x15	ATS-22E	ATS-22I	AAV-12-U8-32x5.5	ABPL-04	80-T20
AC5 TIL 27105 16 H	1.969	4.134	1.063	1.575	1.969	M16x1.5	1.152	16 IR	1710-U5-40x12.2	ATS-16E	ATS-16I	AAV-11-U5-40x4.5	ABPL-03	82-T10
AC5 TIL 27105 22 H	1.969	4.134	1.063	1.575	1.969	M16x1.5	1.080	22 IR	1720-U8-32x15	ATS-22E	ATS-22I	AAV-12-U8-32x5.5	ABPL-04	80-T20
AC6 TIL 14070 16 H	2.480	2.756	0.551	0.787	0.984	M20x2	0.830	16 IR	1710-U5-40x12.2	ATS-16E	ATS-16I	AAV-11-U5-40x4.5	ABPL-03	82-T10
AC6 TIL 17075 16 H	2.480	2.953	0.669	0.984	1.260	M20x2	1.013	16 IR	1710-U5-40x12.2	ATS-16E	ATS-16I	AAV-11-U5-40x4.5	ABPL-03	82-T10
AC6 TIL 19075 22 H	2.480	2.952	0.750	0.984	1.260	M20x2	0.880	22 IR	1720-U8-32x15	ATS-22E	ATS-22I	AAV-12-U8-32x5.5	ABPL-04	80-T20
AC6 TIL 22090 16 H	2.480	3.543	0.866	1.260	1.575	M20x2	1.175	16 IR	1710-U5-40x12.2	ATS-16E	ATS-16I	AAV-11-U5-40x4.5	ABPL-03	82-T10
AC6 TIL 22090 22 H	2.480	3.543	0.866	1.260	1.575	M20x2	1.050	22 IR	1720-U8-32x15	ATS-22E	ATS-22I	AAV-12-U8-32x5.5	ABPL-04	80-T20
AC6 TIL 27105 16 H	2.480	4.134	1.063	1.575	1.969	M20x2	1.477	16 IR	1710-U5-40x12.2	ATS-16E	ATS-16I	AAV-11-U5-40x4.5	ABPL-03	82-T10
AC6 TIL 27105 22 H	2.480	4.134	1.063	1.575	1.969	M20x2	1.477	22 IR	1720-U8-32x15	ATS-22E	ATS-22E	AAV-12-U8-32x5.5	ABPL-04	80-T20

KAPR=90°



Illustrations shown may vary from actual product.

Dimensions in Inch

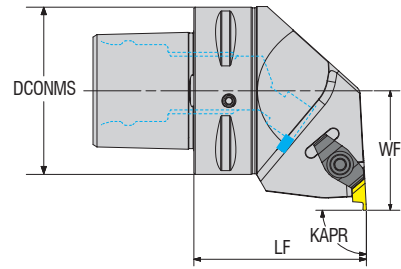

Ordering Code	DCONMS	LF	WF	CRKS	KG	Insert	Wedge Clamp	Clamp Screw	Allen Key
AC4 ANER/L 27045 3	1.575	1.772	1.063	M14x1.5	0.430	N.. 3	CM-73LP	AKV-41-U10-32x18.5	AAL-17-5/32
AC6 ANER/L 45065 3	2.480	2.559	1.772	M20x2	1.190	N.. 3	CM-73LP	AKV-41-U10-32x18.5	AAL-17-5/32

Compatible with KNMTL insert.

KAPR=90°



Illustrations shown may vary from actual product.

Dimensions in Inch

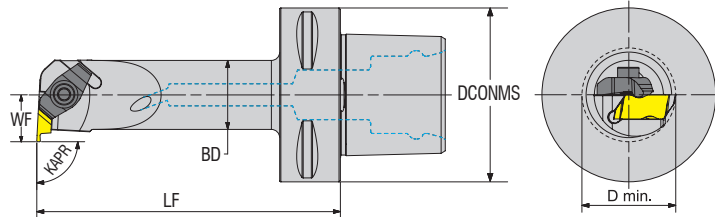

Ordering Code	DCONMS	LF	WF	BD	D.min	CRKS	KG	Insert	Wedge Clamp	Clamp Screw	Allen Key
AC6 ANER 13100 2 H	2.480	3.937	0.512	0.788	0.945	M20x2	0.890	N.. 2	CM-75	AKV-43-U6-32x12.5	AAL-17-5/32
AC6 ANER 17110 3 H	2.480	4.331	0.669	0.984	1.339	M20x2	0.980	N.. 3	CM-73LP	AKV-41-U10-32x18.5	AAL-17-5/32
AC6 ANER 27140 3 H	2.480	5.512	1.063	1.575	1.890	M20x2	1.670	N.. 3	CM-73LP	AKV-41-U10-32x18.5	AAL-17-5/32
AC6 ANEL 13100 2 H	2.480	3.937	0.512	0.788	0.945	M20x2	0.890	N.. 2	CM-75	AKV-43-U6-32x12.5	AAL-17-5/32
AC6 ANEL 17110 3 H	2.480	4.331	0.669	0.984	1.339	M20x2	0.980	N.. 3	CM-73LP	AKV-41-U10-32x18.5	AAL-17-5/32
AC6 ANEL 27140 3 H	2.480	5.512	1.063	1.575	1.890	M20x2	1.670	N.. 3	CM-73LP	AKV-41-U10-32x18.5	AAL-17-5/32

Compatible with KNMTL insert.

KAPR=90°



Illustrations shown may vary from actual product.

Dimensions in Inch

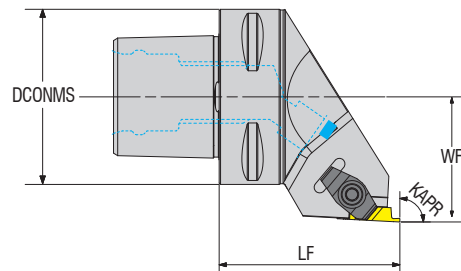

Ordering Code	DCONMS	LF	WF	CRKS	KG	Insert	Wedge Clamp	Clamp Screw
AC4 ANSR 27060 3	1.575	2.362	1.063	M14x1.5	0.400	N.. 3	CM-73LP	AKV-41-U10-32x18.5
AC6 ANSR 45065 3	2.480	2.559	1.772	M20x2	1.190	N.. 3	CM-73LP	AKV-41-U10-32x18.5
AC4 ANSL 27060 3	1.575	2.362	1.063	M14x1.5	0.400	N.. 3	CM-73LP	AKV-41-U10-32x18.5
AC6 ANSL 45065 3	2.480	2.559	1.772	M20x2	1.190	N.. 3	CM-73LP	AKV-41-U10-32x18.5

Compatible with KNMTL insert.



*the spoken quality...*

# D-SYSTEM

D-SYSTEM EXTERNAL TURNING TOOLHOLDERS

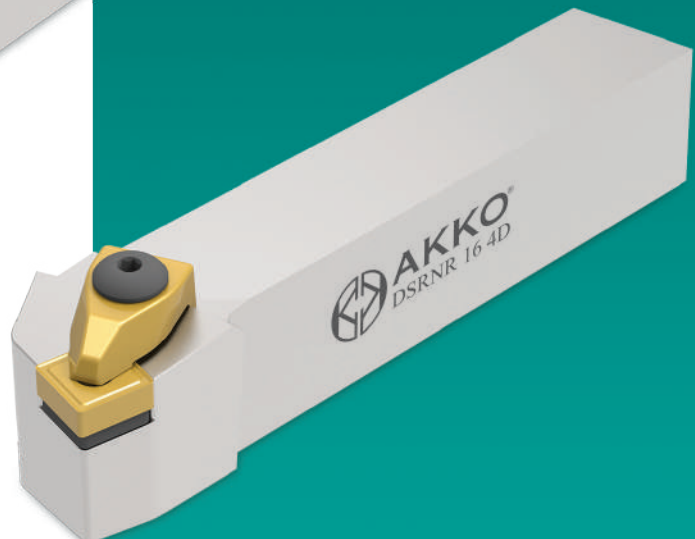
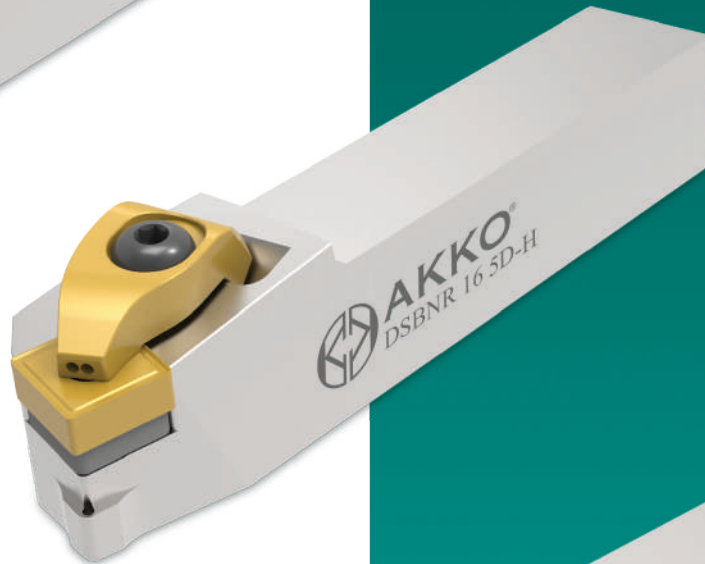

**D** **C** **K** **N** **R**

1 2 3 4 5

**1 Method of Mounting of Insert**

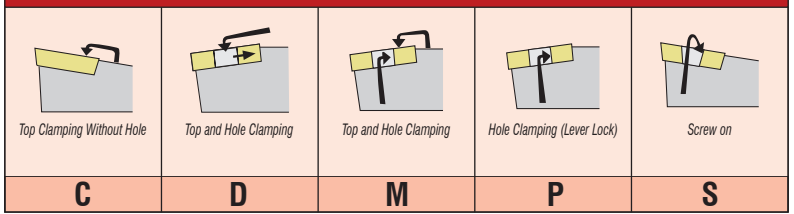

**2 Type of Insert**

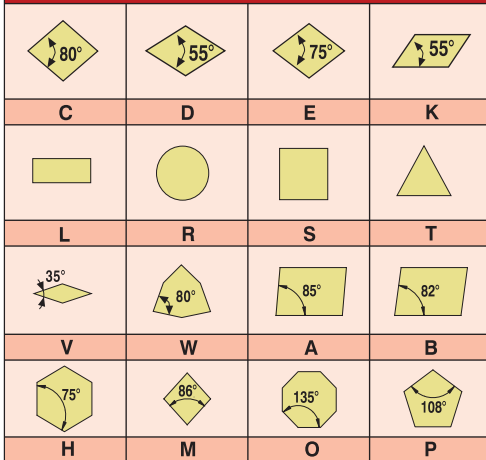

**3 Tool Holder Shape Bar Geometry**

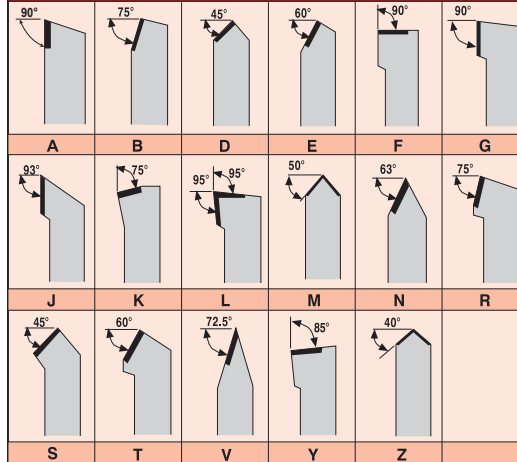

**4 Insert Clearance Angle**

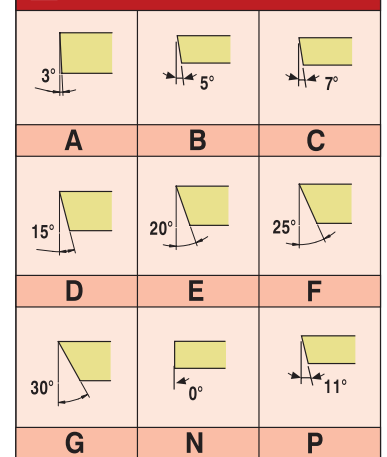

**16** **4** **D** **C**

6 7 8 9

**5 Cutting Direction**

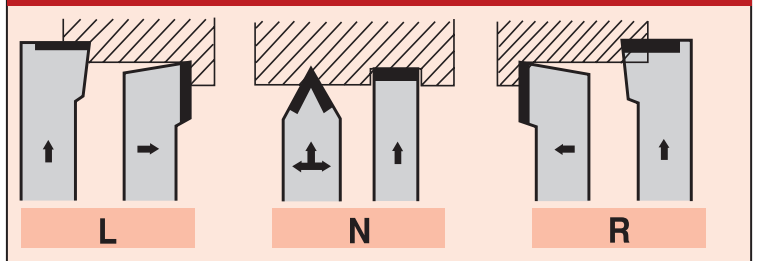

**6 Cutting Edge Height**

	B	H
05	0.3125	0.3125
06	0.375	0.375
08	0.50	0.50
10	0.625	0.625
12	0.75	0.75
16	1.00	1.00
20	1.25	1.25
85	1.00	1.25
86	1.00	1.50

7 Cutting Edge Length

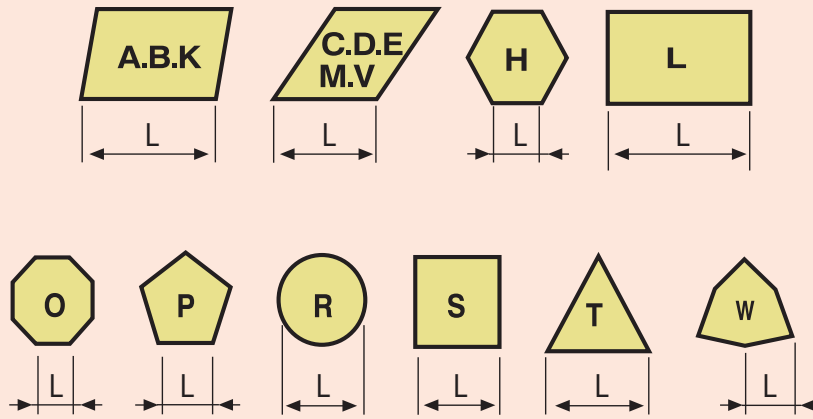

8 Shank Length

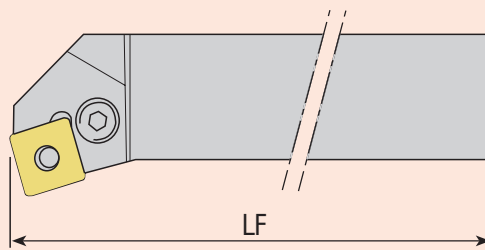

(A): 4.00	Qualified back and end. 4.00" long
(B): 4.50	Qualified back and end. 4.50" long
(C): 5.00	Qualified back and end. 5.00" long
(D): 6.00	Qualified back and end. 6.00" long
(E): 7.00	Qualified back and end. 7.00" long
(F): 8.00	Qualified back and end. 8.00" long
(V): 3.50	Qualified back and end. 3.50" long
(X): Special	

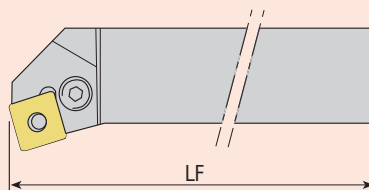

A - 32	H - 100	Q - 180	x-special
B - 40	J - 110	R - 200	
C - 50	K - 125	S - 250	
D - 60	L - 140	T - 300	
E - 70	M - 150	U - 350	
F - 80	N - 160	V - 400	
G - 90	P - 170	W - 450	

(mm)

9 Wedge Clamp

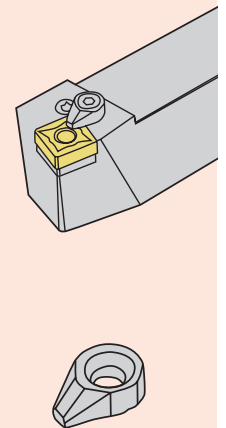

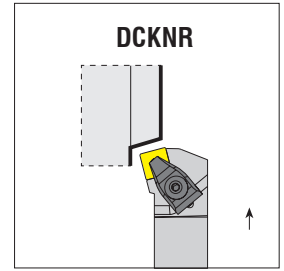
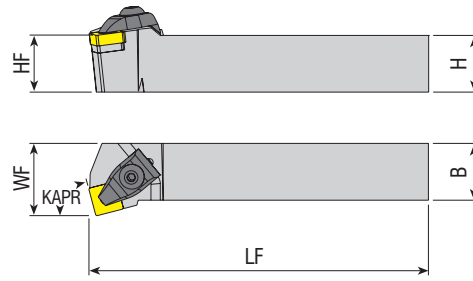

Illustrations shown may vary from actual product.

Dimensions in Inch

Ordering Code	Dimensions in Inch					Insert Inch/Metric	Wedge Clamp	Clamp Screw	Shim	Shim Screw	Ring	Stamp	Allen Key
	HF=H	B	LF	LH	WF								
DCKNR 12 4B	0.750	0.750	4.500	1.250	1.000	CN.. 432 CN.. 120408	ATK-02	AKV-30-M6x22	AACN-3-0001	AAV-02-M5x12	AS-01	ABPL-01	AAL-03-3
DCKNR 16 4C	1.000	1.000	5.000	1.250	1.250	CN.. 432 CN.. 120408	ATK-02	AKV-30-M6x22	AACN-3-0001	AAV-02-M5x12	AS-01	ABPL-01	AAL-03-3
DCKNR 16 4D	1.000	1.000	6.000	1.250	1.250	CN.. 432 CN.. 120408	ATK-02	AKV-30-M6x22	AACN-3-0001	AAV-02-M5x12	AS-01	ABPL-01	AAL-03-3
DCKNR 20 4D	1.250	1.250	6.000	1.250	1.500	CN.. 432 CN.. 120408	ATK-02	AKV-30-M6x22	AACN-3-0001	AAV-02-M5x12	AS-01	ABPL-01	AAL-03-3
DCKNR 20 5D	1.250	1.250	6.000	1.250	1.500	CN.. 543 CN.. 160612	ATK-04	AKV-19-M7x25	AACN-3-0001	AAV-05-M6x15	AS-02	ABPL-02	AAL-05-4
DCKNL 16 4D	1.000	1.000	6.000	1.250	1.250	CN.. 432 CN.. 120408	ATK-02	AKV-30-M6x22	AACN-3-0001	AAV-02-M5x12	AS-01	ABPL-01	AAL-03-3
DCKNL 20 4D	1.250	1.250	6.000	1.250	1.500	CN.. 432 CN.. 120408	ATK-02	AKV-30-M6x22	AACN-3-0001	AAV-02-M5x12	AS-01	ABPL-01	AAL-03-3

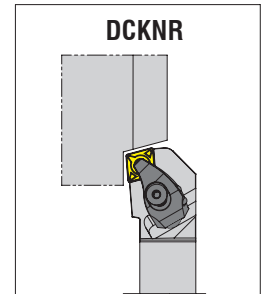
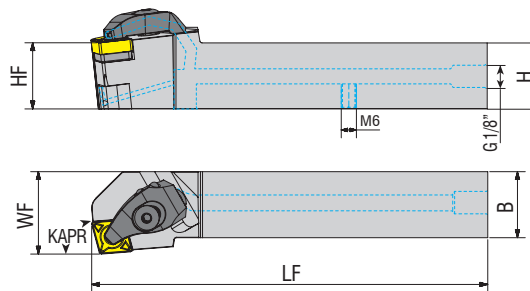

Illustrations shown may vary from actual product.

Dimensions in Inch

Ordering Code	Dimensions in Inch					Insert Inch/Metric	Wedge Clamp	Clamp Screw	Shim	Shim Screw	Spring	Ring	Threaded Pin	Allen Key
	HF=H	B	LF	LH	WF									
DCKNR 16 4D-H	1.000	1.000	6.000	1.650	1.250	CN.. 432 CN.. 120408	ATKH-01-R	AKV-33-M6x22	AACN-3-0001	AAV-13-M5x8	AKY-01	AXR-01	2705-G1/8x5.5	AAL-03-3
DCKNR 20 4D-H	1.250	1.250	6.000	1.650	1.500	CN.. 432 CN.. 120408	ATKH-01-R	AKV-33-M6x22	AACN-3-0001	AAV-13-M5x8	AKY-01	AXR-01	2705-G1/8x5.5	AAL-03-3
DCKNR 12 4D-H	0.750	0.750	6.000	1.690	1.000	CN.. 432 CN.. 120408	ATKH-02-L	AKV-33-M6x22	AACN-3-0001	AAV-13-M5x8	AKY-01	AXR-01	2705-G1/8x5.5	AAL-03-3
DCKNL 16 4D-H	1.000	1.000	6.000	1.650	1.250	CN.. 432 CN.. 120408	ATKH-02-L	AKV-33-M6x22	AACN-3-0001	AAV-13-M5x8	AKY-01	AXR-01	2705-G1/8x5.5	AAL-03-3
DCKNL 20 4D-H	1.250	1.250	6.000	1.650	1.500	CN.. 432 CN.. 120408	ATKH-02-L	AKV-33-M6x22	AACN-3-0001	AAV-13-M5x8	AKY-01	AXR-01	2705-G1/8x5.5	AAL-03-3
DCKNL 12 4D-H	0.750	0.750	6.000	1.690	1.000	CN.. 432 CN.. 120408	ATKH-01-R	AKV-33-M6x22	AACN-3-0001	AAV-13-M5x8	AKY-01	AXR-01	2705-G1/8x5.5	AAL-03-3

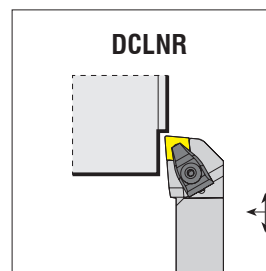
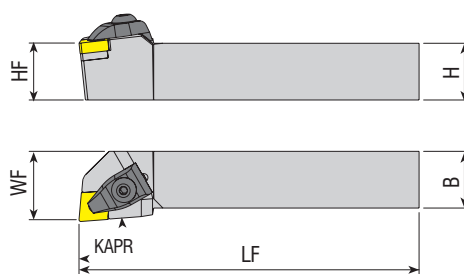
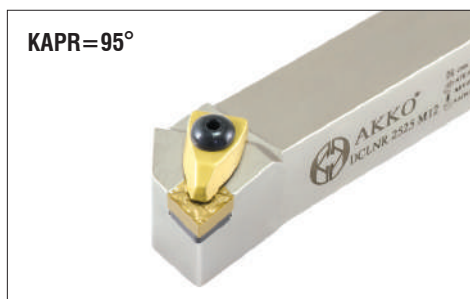

Illustrations shown may vary from actual product.

Dimensions in Inch



Ordering Code	HF=H	B	LF	LH	WF	Insert Inch/Metric	Wedge Clamp	Clamp Screw	Shim	Shim Screw	Ring	Stamp	Allen Key
DCLNR 12 3B	0.750	0.750	4.500	1.000	1.000	CN.. 322 CN.. 09T308	ATK-01	AKV-01-M5x22	AACN -2-0001	AAV-09-M5x9	-	ABPL-01	AAL-03-3
DCLNR 16 3D	1.000	1.000	6.000	1.000	1.250	CN.. 322 CN.. 09T308	ATK-01	AKV-01-M5x22	AACN -2-0001	AAV-09-M5x9	-	ABPL-01	AAL-03-3
DCLNR 12 4B	0.750	0.750	4.500	1.250	1.000	CN.. 432 CN.. 120408	ATK-02	AKV-30-M6x22	AACN-3-0001	AAV-02-M5x12	AS-01	ABPL-01	AAL-03-3
DCLNR 16 4C	1.000	1.000	5.000	1.250	1.250	CN.. 432 CN.. 120408	ATK-02	AKV-30-M6x22	AACN-3-0001	AAV-02-M5x12	AS-01	ABPL-01	AAL-03-3
DCLNR 16 4D	1.000	1.000	6.000	1.250	1.250	CN.. 432 CN.. 120408	ATK-02	AKV-30-M6x22	AACN-3-0001	AAV-02-M5x12	AS-01	ABPL-01	AAL-03-3
DCLNR 20 4D	1.250	1.250	6.000	1.250	1.500	CN.. 432 CN.. 120408	ATK-02	AKV-30-M6x22	AACN-3-0001	AAV-02-M5x12	AS-01	ABPL-01	AAL-03-3
DCLNR 24 4D	1.500	1.500	6.000	1.250	2.000	CN.. 432 CN.. 120408	ATK-02	AKV-30-M6x22	AACN-3-0001	AAV-02-M5x12	AS-01	ABPL-01	AAL-03-3
DCLNR 16 5C	1.000	1.000	5.000	1.380	1.250	CN.. 543 CN.. 160612	ATK-04	AKV-19-M7x25	AACN-3-0002	AAV-05-M6x15	AS-02	ABPL-02	AAL-05-4
DCLNR 16 5D	1.000	1.000	6.000	1.380	1.250	CN.. 543 CN.. 160612	ATK-04	AKV-19-M7x25	AACN-3-0002	AAV-05-M6x15	AS-02	ABPL-02	AAL-05-4
DCLNR 20 5D	1.250	1.250	6.000	1.380	1.500	CN.. 543 CN.. 160612	ATK-04	AKV-19-M7x25	AACN-3-0002	AAV-05-M6x15	AS-02	ABPL-02	AAL-05-4
DCLNR 24 5D	1.500	1.500	6.000	1.380	2.000	CN.. 543 CN.. 160612	ATK-04	AKV-19-M7x25	AACN-3-0002	AAV-05-M6x15	AS-02	ABPL-02	AAL-05-4
DCLNL 12 3B	0.750	0.750	4.500	1.000	1.000	CN.. 322 CN.. 09T308	ATK-01	AKV-01-M5x22	AACN -2-0001	AAV-09-M5x9	-	ABPL-01	AAL-03-3
DCLNL 16 3D	1.000	1.000	6.000	1.000	1.250	CN.. 322 CN.. 09T308	ATK-01	AKV-01-M5x22	AACN -2-0001	AAV-09-M5x9	-	ABPL-01	AAL-03-3
DCLNL 12 4B	0.750	0.750	4.500	1.250	1.000	CN.. 432 CN.. 120408	ATK-02	AKV-30-M6x22	AACN-3-0001	AAV-02-M5x12	AS-01	ABPL-01	AAL-03-3
DCLNL 16 4C	1.000	1.000	5.000	1.250	1.250	CN.. 432 CN.. 120408	ATK-02	AKV-30-M6x22	AACN-3-0001	AAV-02-M5x12	AS-01	ABPL-01	AAL-03-3
DCLNL 16 4D	1.000	1.000	6.000	1.250	1.250	CN.. 432 CN.. 120408	ATK-02	AKV-30-M6x22	AACN-3-0001	AAV-02-M5x12	AS-01	ABPL-01	AAL-03-3
DCLNL 20 4D	1.250	1.250	6.000	1.250	1.500	CN.. 432 CN.. 120408	ATK-02	AKV-30-M6x22	AACN-3-0001	AAV-02-M5x12	AS-01	ABPL-01	AAL-03-3
DCLNL 24 4D	1.500	1.500	6.000	1.250	2.000	CN.. 432 CN.. 120408	ATK-02	AKV-30-M6x22	AACN-3-0001	AAV-02-M5x12	AS-01	ABPL-01	AAL-03-3
DCLNL 16 5C	1.000	1.000	5.000	1.380	1.250	CN.. 543 CN.. 160612	ATK-04	AKV-19-M7x25	AACN-3-0002	AAV-05-M6x15	AS-02	ABPL-02	AAL-05-4
DCLNL 16 5D	1.000	1.000	6.000	1.380	1.250	CN.. 543 CN.. 160612	ATK-04	AKV-19-M7x25	AACN-3-0002	AAV-05-M6x15	AS-02	ABPL-02	AAL-05-4
DCLNL 20 5D	1.250	1.250	6.000	1.380	1.500	CN.. 543 CN.. 160612	ATK-04	AKV-19-M7x25	AACN-3-0002	AAV-05-M6x15	AS-02	ABPL-02	AAL-05-4
DCLNL 24 5D	1.500	1.500	6.000	1.380	2.000	CN.. 543 CN.. 160612	ATK-04	AKV-19-M7x25	AACN-3-0002	AAV-05-M6x15	AS-02	ABPL-02	AAL-05-4

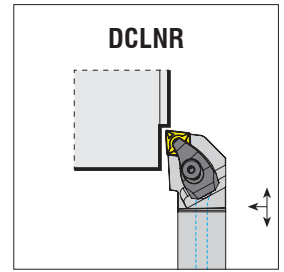
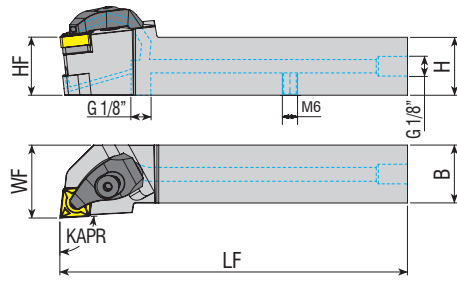

Illustrations shown may vary from actual product.

Dimensions in Inch







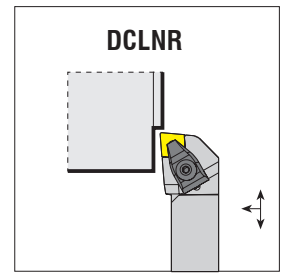
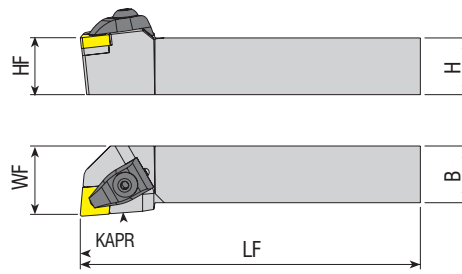



Ordering Code	HF=H	B	LF	LH	WF	Insert Inch/Metric	Wedge Clamp	Clamp Screw	Shim	Shim Screw	Spring	Ring	Threaded Pin	Allen Key
DCLNR 12 4B-H	0.750	0.750	4.500	1.690	1.000	CN.. 432 CN.. 120408	ATKH-01-R	AKV-33-M6x22	AACN-3-0001	AAV-13-M5x8	AKY-01	AXR-01	2705-G1/8x5.5	AAL-03-3
DCLNR 16 4D-H	1.000	1.000	6.000	1.650	1.250	CN.. 432 CN.. 120408	ATKH-01-R	AKV-33-M6x22	AACN-3-0001	AAV-13-M5x8	AKY-01	AXR-01	2705-G1/8x5.5	AAL-03-3
DCLNR 16 5D-H	1.000	1.000	6.000	1.770	1.250	CN.. 543 CN.. 160612	ATKH-07-R	AKV-39-M7X21	AACN-3-0002	AAV-05-M6X10	AKY-02	AXR-01	2705-G1/8x5.5	AAL-05-4
DCLNR 20 4D-H	1.250	1.250	6.000	1.650	1.500	CN.. 432 CN.. 120408	ATKH-01-R	AKV-33-M6x22	AACN-3-0001	AAV-13-M5x8	AKY-01	AXR-01	2705-G1/8x5.5	AAL-03-3
DCLNR 20 5D-H	1.250	1.250	6.000	1.770	1.500	CN.. 543 CN.. 160612	ATKH-07-R	AKV-39-M7X21	AACN-3-0002	AAV-05-M6X10	AKY-01	AXR-01	2705-G1/8x5.5	AAL-05-4
DCLNR 20 6D-H	1.250	1.250	6.000	1.960	1.500	CN.. 643 CN.. 190612	ATKH-09-R	AKV-39-M7X21	AACN-3-0003	AAV-17-M6X14	AKY-01	AXR-01	2705-G1/8x5.5	AAL-05-4
DCLNR 24 5E-H	1.500	1.500	7.000	1.770	2.000	CN.. 543 CN.. 160612	ATKH-07-R	AKV-39-M7X21	AACN-3-0002	AAV-05-M6X10	AKY-01	AXR-01	2705-G1/8x5.5	AAL-05-4
DCLNR 24 6E-H	1.500	1.500	7.000	1.960	2.000	CN.. 643 CN.. 190612	ATKH-09-R	AKV-39-M7X21	AACN-3-0003	AAV-17-M6X14	AKY-01	AXR-01	2705-G1/8x5.5	AAL-05-4
DCLNL 12 4B-H	0.750	0.750	4.500	1.690	1.000	CN.. 432 CN.. 120408	ATKH-02-L	AKV-33-M6x22	AACN-3-0001	AAV-13-M5x8	AKY-01	AXR-01	2705-G1/8x5.5	AAL-03-3
DCLNL 16 4D-H	1.000	1.000	6.000	1.650	1.250	CN.. 432 CN.. 120408	ATKH-02-L	AKV-33-M6x22	AACN-3-0001	AAV-13-M5x8	AKY-01	AXR-01	2705-G1/8x5.5	AAL-03-3
DCLNL 16 5D-H	1.000	1.000	6.000	1.770	1.250	CN.. 543 CN.. 160612	ATKH-08-L	AKV-39-M7X21	AACN-3-0002	AAV-05-M6X10	AKY-02	AXR-01	2705-G1/8x5.5	AAL-05-4
DCLNL 20 4D-H	1.250	1.250	6.000	1.650	1.500	CN.. 432 CN.. 120408	ATKH-02-L	AKV-33-M6x22	AACN-3-0001	AAV-13-M5x8	AKY-01	AXR-01	2705-G1/8x5.5	AAL-03-3
DCLNL 20 5D-H	1.250	1.250	6.000	1.770	1.500	CN.. 543 CN.. 160612	ATKH-08-L	AKV-39-M7X21	AACN-3-0002	AAV-05-M6X10	AKY-01	AXR-01	2705-G1/8x5.5	AAL-05-4
DCLNL 20 6D-H	1.250	1.250	6.000	1.960	1.500	CN.. 643 CN.. 190612	ATKH-10-L	AKV-39-M7X21	AACN-3-0003	AAV-17-M6X14	AKY-01	AXR-01	2705-G1/8x5.5	AAL-05-4
DCLNL 24 5E-H	1.500	1.500	7.000	1.770	2.000	CN.. 543 CN.. 160612	ATKH-08-L	AKV-39-M7X21	AACN-3-0002	AAV-05-M6X10	AKY-01	AXR-01	2705-G1/8x5.5	AAL-05-4
DCLNL 24 6E-H	1.500	1.500	7.000	1.960	2.000	CN.. 643 CN.. 190612	ATKH-10-L	AKV-39-M7X21	AACN-3-0003	AAV-17-M6X14	AKY-01	AXR-01	2705-G1/8x5.5	AAL-05-4









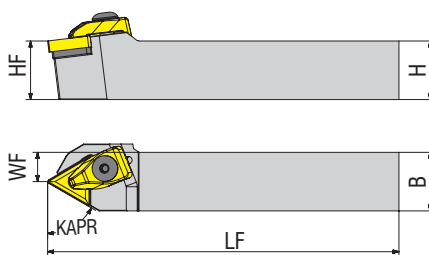
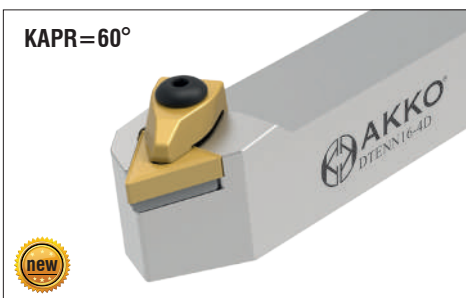

Illustrations shown may vary from actual product.

Dimensions in Metric												
Ordering Code	HF=H	B	LF	WF	Insert Inch/Metric	Wedge Clamp	Clamp Screw	Shim	Shim Screw	Ring	Stamp	Allen Key
DCLNR 2020 K12	20	20	125	25	CN.. 43.. CN.. 1204..	ATK-02	AKV-30-M6x22	AACN-3-0001	AAV-02-M5x12	AS-01	ABPL-01	AAL-03-3
DCLNR 2525 M12	25	25	150	32	CN.. 43.. CN.. 1204..	ATK-02	AKV-30-M6x22	AACN-3-0001	AAV-02-M5x12	AS-01	ABPL-01	AAL-03-3
DCLNR 3232 P12	32	32	170	40	CN.. 43.. CN.. 1204..	ATK-02	AKV-30-M6x22	AACN-3-0001	AAV-02-M5x12	AS-01	ABPL-01	AAL-03-3
DCLNR 4040 S12	40	40	250	50	CN.. 43.. CN.. 1204..	ATK-02	AKV-30-M6x22	AACN-3-0001	AAV-02-M5x12	AS-01	ABPL-01	AAL-03-3
DCLNR 5050 S12	50	50	250	63	CN.. 43.. CN.. 1204..	ATK-02	AKV-30-M6x22	AACN-3-0001	AAV-02-M5x12	AS-01	ABPL-01	AAL-03-3
DCLNR 2525 M16	25	25	150	32	CN.. 54.. CN.. 1606..	ATK-04	AKV-19-M7x25	AACN-3-0002	AAV-05-M6x15	AS-02	ABPL-02	AAL-05-4
DCLNR 3232 P16	32	32	170	40	CN.. 54.. CN.. 1606..	ATK-04	AKV-19-M7x25	AACN-3-0002	AAV-05-M6x15	AS-02	ABPL-02	AAL-05-4
DCLNL 2020 K12	20	20	125	25	CN.. 43.. CN.. 1204..	ATK-02	AKV-30-M6x22	AACN-3-0001	AAV-02-M5x12	AS-01	ABPL-01	AAL-03-3
DCLNL 2525 M12	25	25	150	32	CN.. 43.. CN.. 1204..	ATK-02	AKV-30-M6x22	AACN-3-0001	AAV-02-M5x12	AS-01	ABPL-01	AAL-03-3
DCLNL 3232 P12	32	32	170	40	CN.. 43.. CN.. 1204..	ATK-02	AKV-30-M6x22	AACN-3-0001	AAV-02-M5x12	AS-01	ABPL-01	AAL-03-3
DCLNL 4040 S12	40	40	250	50	CN.. 43.. CN.. 1204..	ATK-02	AKV-30-M6x22	AACN-3-0001	AAV-02-M5x12	AS-01	ABPL-01	AAL-03-3
DCLNL 5050 S12	50	50	250	63	CN.. 43.. CN.. 1204..	ATK-02	AKV-30-M6x22	AACN-3-0001	AAV-02-M5x12	AS-01	ABPL-01	AAL-03-3
DCLNL 2525 M16	25	25	150	32	CN.. 54.. CN.. 1606..	ATK-04	AKV-19-M7x25	AACN-3-0002	AAV-05-M6x15	AS-02	ABPL-02	AAL-05-4
DCLNL 3232 P16	32	32	170	40	CN.. 54.. CN.. 1606..	ATK-04	AKV-19-M7x25	AACN-3-0002	AAV-05-M6x15	AS-02	ABPL-02	AAL-05-4



Illustrations shown may vary from actual product.

Dimensions in Inch												
Ordering Code	HF=H	B	LF	LH	WF	Insert Inch/Metric	Wedge Clamp	Clamp Screw	Shim	Shim Screw	Spring	Allen Key
DTENN 12 3B	0.750	0.750	4.500	1.375	0.750	TN.. 332 TN.. 160408	ATK-01	AKV-01-M5x22	AATN-2-0002	AAV-03-M5x12	ABPL-01	AAL-03-3
DTENN 16 3D	1.000	1.000	6.000	1.375	1.000	TN.. 332 TN.. 160408	ATK-01	AKV-01-M5x22	AATN-2-0002	AAV-03-M5x12	ABPL-01	AAL-03-3
DTENN 16 4D	1.000	1.000	6.000	1.375	1.000	TN.. 432 TN.. 220408	ATK-02	AKV-30-M6x22	AATN-3-0015	AAV-02-M5x12	AS-01	AAL-03-3
DTENN 20 4D	1.250	1.250	6.000	1.500	1.250	TN.. 432 TN.. 220408	ATK-02	AKV-30-M6x22	AATN-3-0015	AAV-02-M5x12	AS-01	AAL-03-3

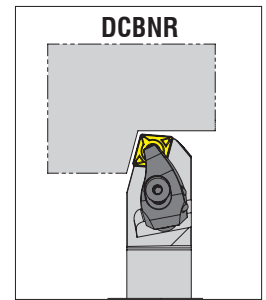
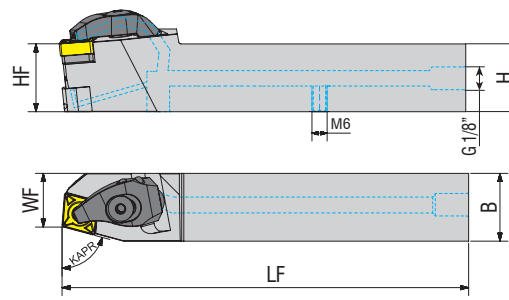
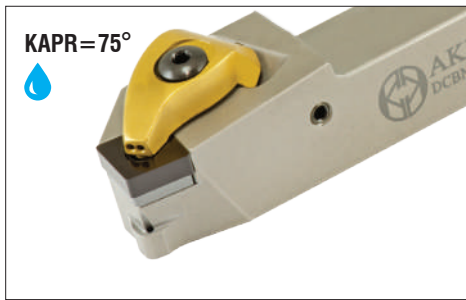

Illustrations shown may vary from actual product.

Dimensions in Inch

Ordering Code	HF=H	B	LF	LH	WF	Insert Inch/Metric	Wedge Clamp	Clamp Screw	Shim	Shim Screw	Spring	Ring	Threaded Pin	Allen Key
DCBNR 12 4D-H	0.750	0.750	6.000	1.770	0.600	CN.. 432 CN.. 120408	ATKH-01-R	AKV-33-M6x22	AACN-3-0001	AAV-13-M5X8	AKY-01	AXR-01	2705-G1/8x5.5	AAL-03-3
DCBNR 16 4D-H	1.000	1.000	6.000	1.770	0.910	CN.. 432 CN.. 120408	ATKH-01-R	AKV-33-M6x22	AACN-3-0001	AAV-13-M5X8	AKY-01	AXR-01	2705-G1/8x5.5	AAL-03-3
DCBNR 20 4D-H	1.250	1.250	6.000	1.770	0.990	CN.. 432 CN.. 120408	ATKH-01-R	AKV-33-M6x22	AACN-3-0001	AAV-13-M5X8	AKY-01	AXR-01	2705-G1/8x5.5	AAL-03-3
DCBNL 12 4D-H	0.750	0.750	6.000	1.770	0.600	CN.. 432 CN.. 120408	ATKH-02-L	AKV-33-M6x22	AACN-3-0001	AAV-13-M5X8	AKY-01	AXR-01	2705-G1/8x5.5	AAL-03-3
DCBNL 16 4D-H	1.000	1.000	6.000	1.770	0.910	CN.. 432 CN.. 120408	ATKH-02-L	AKV-33-M6x22	AACN-3-0001	AAV-13-M5X8	AKY-01	AXR-01	2705-G1/8x5.5	AAL-03-3
DCBNL 20 4D-H	1.250	1.250	6.000	1.770	0.990	CN.. 432 CN.. 120408	ATKH-02-L	AKV-33-M6x22	AACN-3-0001	AAV-13-M5X8	AKY-01	AXR-01	2705-G1/8x5.5	AAL-03-3

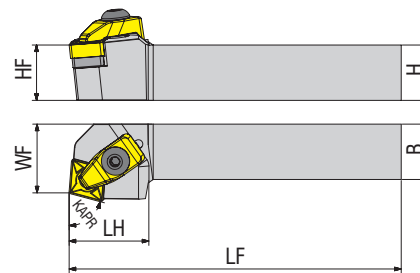
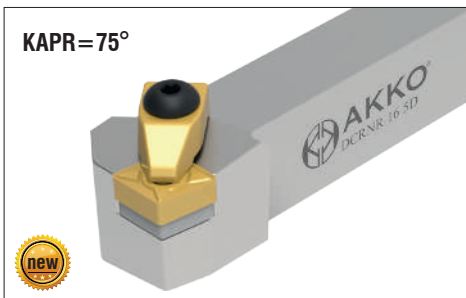

Illustrations shown may vary from actual product.

Dimensions in Inch

Ordering Code	HF=H	B	LF	LH	WF	Insert Inch/Metric	Wedge Clamp	Clamp Screw	Shim	Shim Screw	Ring	Stamp	Allen Key
DCRNR 16 5D	1.000	1.000	6.000	1.380	1.250	CN.. 543 CN.. 160612	ATK-04	AKV-19-M7x25	AACN-3-0002	AAV-05-M6x15	AS-02	ABPL-02	AAL-05-4
DCRNL 16 5D	1.000	1.000	6.000	1.380	1.250	CN.. 543 CN.. 160612	ATK-04	AKV-19-M7x25	AACN-3-0002	AAV-05-M6x15	AS-02	ABPL-02	AAL-05-4

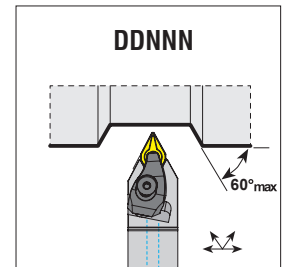
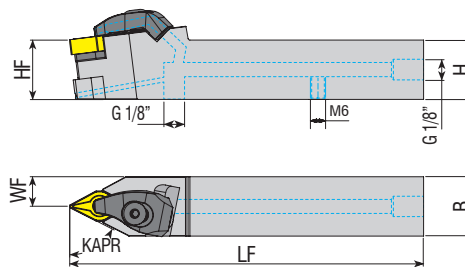

Illustrations shown may vary from actual product.

Dimensions in Inch

Ordering Code	HF=H	B	LF	LH	WF	Insert Inch/Metric	Wedge Clamp	Clamp Screw	Shim	Shim Screw	Spring	Ring	Threaded Pin	Allen Key
DDNNN 16 4D-H	1.000	1.000	6.000	2.000	0.500	DN.. 432 DN.. 150408	ATKH-01-R	AKV-33-M6x22	AADN-2-0003	AAV-13-M5X8	AKY-01	AXR-01	2703-M6X5	AAL-03-3
DDNNN 20 4D-H	1.250	1.250	6.000	2.000	0.625	DN.. 432 DN.. 150408	ATKH-01-R	AKV-33-M6x22	AADN-2-0003	AAV-13-M5X8	AKY-01	AXR-01	2703-M6X5	AAL-03-3

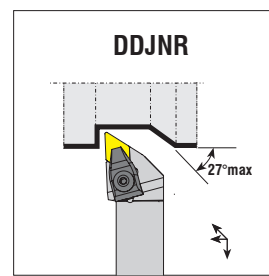
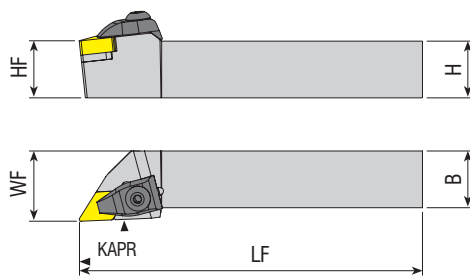

Illustrations shown may vary from actual product.

Dimensions in Inch

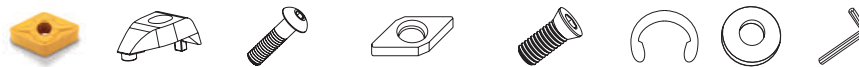

Ordering Code	HF=H	B	LF	LH	WF	Insert Inch/Metric	Wedge Clamp	Clamp Screw	Shim	Shim Screw	Ring	Stamp	Allen Key
DDJNR 12 3B	0.750	0.750	4.500	1.250	1.000	DN.. 332 DN.. 110408	ATK-01	AKV-01-M5x22	AADN-2-0001	AAV-04-M5x12	AS-01	ABPL-01	AAL-03-3
DDJNR 16 3C	1.000	1.000	5.000	1.250	1.250	DN.. 332 DN.. 110408	ATK-01	AKV-01-M5x22	AADN-2-0001	AAV-04-M5x12	AS-01	ABPL-01	AAL-03-3
DDJNR 16 3D	1.000	1.000	6.000	1.250	1.250	DN.. 332 DN.. 110408	ATK-01	AKV-01-M5x22	AADN-2-0001	AAV-04-M5x12	AS-01	ABPL-01	AAL-03-3
DDJNR 20 3D	1.250	1.250	6.000	1.250	1.500	DN.. 332 DN.. 110408	ATK-01	AKV-01-M5x22	AADN-2-0001	AAV-04-M5x12	AS-01	ABPL-01	AAL-03-3
DDJNR 12 4B	0.750	0.750	4.500	1.000	1.500	DN.. 432 DN.. 150408	ATK-02	AKV-30-M6x22	AADN-2-0003	AAV-02-M5x12	AS-01	ABPL-01	AAL-03-3
DDJNR 16 4C	1.000	1.000	5.000	1.500	1.250	DN.. 432 DN.. 150408	ATK-02	AKV-30-M6x22	AADN-2-0003	AAV-02-M5x12	AS-01	ABPL-01	AAL-03-3
DDJNR 16 4D	1.000	1.000	6.000	1.500	1.250	DN.. 432 DN.. 150408	ATK-02	AKV-30-M6x22	AADN-2-0003	AAV-02-M5x12	AS-01	ABPL-01	AAL-03-3
DDJNR 20 4D	1.250	1.250	6.000	1.500	1.500	DN.. 432 DN.. 150408	ATK-02	AKV-30-M6x22	AADN-2-0003	AAV-02-M5x12	AS-01	ABPL-01	AAL-03-3
DDJNL 12 3B	0.750	0.750	4.500	1.250	1.000	DN.. 332 DN.. 110408	ATK-01	AKV-01-M5x22	AADN-2-0001	AAV-04-M5x12	AS-01	ABPL-01	AAL-03-3
DDJNL 16 3C	1.000	1.000	5.000	1.250	1.250	DN.. 332 DN.. 110408	ATK-01	AKV-01-M5x22	AADN-2-0001	AAV-04-M5x12	AS-01	ABPL-01	AAL-03-3
DDJNL 16 3D	1.000	1.000	6.000	1.250	1.250	DN.. 332 DN.. 110408	ATK-01	AKV-01-M5x22	AADN-2-0001	AAV-04-M5x12	AS-01	ABPL-01	AAL-03-3
DDJNL 16 4C	1.000	1.000	5.000	1.500	1.250	DN.. 432 DN.. 150408	ATK-02	AKV-30-M6x22	AADN-2-0003	AAV-02-M5x12	AS-01	ABPL-01	AAL-03-3
DDJNL 16 4D	1.000	1.000	6.000	1.500	1.250	DN.. 432 DN.. 150408	ATK-02	AKV-30-M6x22	AADN-2-0003	AAV-02-M5x12	AS-01	ABPL-01	AAL-03-3
DDJNL 20 4D	1.250	1.250	6.000	1.500	1.500	DN.. 432 DN.. 150408	ATK-02	AKV-30-M6x22	AADN-2-0003	AAV-02-M5x12	AS-01	ABPL-01	AAL-03-3



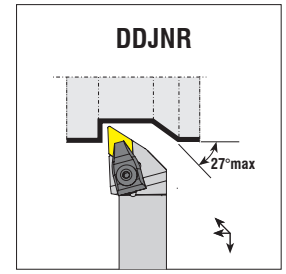
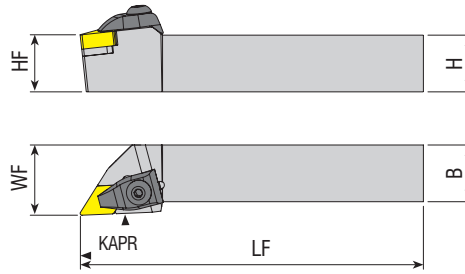

Illustrations shown may vary from actual product.

Dimensions in Metric



Ordering Code	HF=H	B	LF	WF	Insert Inch/Metric	Wedge Clamp	Clamp Screw	Shim	Shim Screw	Ring	Stamp	Allen Key
DDJNR 1616 H11	16	16	100	20	DN.. 33.. DN.. 1104..	ATK-01	AKV-01-M5x22	AADN-2-0001	AAV-04-M5x12	-	ABPL-01	AAL-03-3
DDJNR 2020 K11	20	20	125	25	DN.. 33.. DN.. 1104..	ATK-01	AKV-01-M5x22	AADN-2-0001	AAV-04-M5x12	-	ABPL-01	AAL-03-3
DDJNR 2525 M11	25	25	150	32	DN.. 33.. DN.. 1104..	ATK-01	AKV-01-M5x22	AADN-2-0001	AAV-04-M5x12	-	ABPL-01	AAL-03-3
DDJNR 2020 K15	20	20	125	25	DN.. 44.. DN.. 1506..	ATK-02	AKV-30-M6x22	AADN-3-0001	AAV-02-M5x12	AS-01	ABPL-01	AAL-03-3
DDJNR 2525 M15	25	25	150	32	DN.. 44.. DN.. 1506..	ATK-02	AKV-30-M6x22	AADN-3-0001	AAV-02-M5x12	AS-01	ABPL-01	AAL-03-3
DDJNR 3232 P15	32	32	170	40	DN.. 44.. DN.. 1506..	ATK-02	AKV-30-M6x22	AADN-3-0001	AAV-02-M5x12	AS-01	ABPL-01	AAL-03-3
DDJNR 4040 S15	40	40	250	50	DN.. 44.. DN.. 1506..	ATK-02	AKV-30-M6x22	AADN-3-0001	AAV-02-M5x12	AS-01	ABPL-01	AAL-03-3
DDJNR 5050 S15	50	50	250	63	DN.. 44.. DN.. 1506..	ATK-02	AKV-30-M6x22	AADN-3-0001	AAV-02-M5x12	AS-01	ABPL-01	AAL-03-3
DDJNR 2020 K1504	20	20	125	25	DN.. 43.. DN.. 1504..	ATK-02	AKV-30-M6x22	AADN-2-0003	AAV-02-M5x12	AS-01	ABPL-01	AAL-03-3
DDJNR 2525 M1504	25	25	150	32	DN.. 43.. DN.. 1504..	ATK-02	AKV-30-M6x22	AADN-2-0003	AAV-02-M5x12	AS-01	ABPL-01	AAL-03-3
DDJNR 3232 P1504	32	32	170	40	DN.. 43.. DN.. 1504..	ATK-02	AKV-30-M6x22	AADN-2-0003	AAV-02-M5x12	AS-01	ABPL-01	AAL-03-3
DDJNR 4040 S1504	40	40	250	50	DN.. 43.. DN.. 1504..	ATK-02	AKV-30-M6x22	AADN-2-0003	AAV-02-M5x12	AS-01	ABPL-01	AAL-03-3
DDJNL 1616 H11	16	16	100	20	DN.. 33.. DN.. 1104..	ATK-01	AKV-01-M5x22	AADN-2-0001	AAV-04-M5x12	-	ABPL-01	AAL-03-3
DDJNL 2020 K11	20	20	125	25	DN.. 33.. DN.. 1104..	ATK-01	AKV-01-M5x22	AADN-2-0001	AAV-04-M5x12	-	ABPL-01	AAL-03-3
DDJNL 2525 M11	25	25	150	32	DN.. 33.. DN.. 1104..	ATK-01	AKV-01-M5x22	AADN-2-0001	AAV-04-M5x12	-	ABPL-01	AAL-03-3
DDJNL 2020 K15	20	20	125	25	DN.. 44.. DN.. 1506..	ATK-02	AKV-30-M6x22	AADN-3-0001	AAV-02-M5x12	AS-01	ABPL-01	AAL-03-3
DDJNL 2525 M15	25	25	150	32	DN.. 44.. DN.. 1506..	ATK-02	AKV-30-M6x22	AADN-3-0001	AAV-02-M5x12	AS-01	ABPL-01	AAL-03-3
DDJNL 3232 P15	32	32	170	40	DN.. 44.. DN.. 1506..	ATK-02	AKV-30-M6x22	AADN-3-0001	AAV-02-M5x12	AS-01	ABPL-01	AAL-03-3
DDJNL 4040 S15	40	40	250	50	DN.. 44.. DN.. 1506..	ATK-02	AKV-30-M6x22	AADN-3-0001	AAV-02-M5x12	AS-01	ABPL-01	AAL-03-3
DDJNL 5050 S15	50	50	250	63	DN.. 44.. DN.. 1506..	ATK-02	AKV-30-M6x22	AADN-3-0001	AAV-02-M5x12	AS-01	ABPL-01	AAL-03-3
DDJNL 2020 K1504	20	20	125	25	DN.. 43.. DN.. 1504..	ATK-02	AKV-30-M6x22	AADN-2-0003	AAV-02-M5x12	AS-01	ABPL-01	AAL-03-3
DDJNL 2525 M1504	25	25	150	32	DN.. 43.. DN.. 1504..	ATK-02	AKV-30-M6x22	AADN-2-0003	AAV-02-M5x12	AS-01	ABPL-01	AAL-03-3
DDJNL 3232 P1504	32	32	170	40	DN.. 43.. DN.. 1504..	ATK-02	AKV-30-M6x22	AADN-2-0003	AAV-02-M5x12	AS-01	ABPL-01	AAL-03-3
DDJNL 4040 S1504	40	40	250	50	DN.. 43.. DN.. 1504..	ATK-02	AKV-30-M6x22	AADN-2-0003	AAV-02-M5x12	AS-01	ABPL-01	AAL-03-3

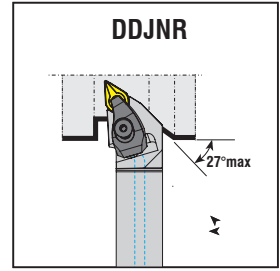
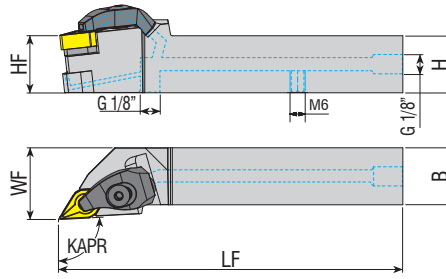

Illustrations shown may vary from actual product.

Dimensions in Inch														
Ordering Code	HF=H	B	LF	LH	WF	Insert Inch/Metric	Wedge Clamp	Clamp Screw	Shim	Shim Screw	Spring	Ring	Threaded Pin	Allen Key
DDJNR 12 4B-H	0.750	0.750	4.500	1.930	1.000	DN.. 432 DN.. 150408	ATKH-01-R	AKV-33-M6x22	AADN-2-0003	AAV-13-M5x8	AKY-01	AXR-01	2703-M6X5	AAL-03-3
DDJNR 16 4D-H	1.000	1.000	6.000	1.930	1.250	DN.. 432 DN.. 150408	ATKH-01-R	AKV-33-M6x22	AADN-2-0003	AAV-13-M5x8	AKY-01	AXR-01	2705-G1/8x5.5	AAL-03-3
DDJNR 20 4D-H	1.250	1.250	6.000	1.930	1.500	DN.. 432 DN.. 150408	ATKH-01-R	AKV-33-M6x22	AADN-2-0003	AAV-13-M5x8	AKY-01	AXR-01	2705-G1/8x5.5	AAL-03-3
DDJNL 12 4B-H	0.750	0.750	4.500	1.930	1.000	DN.. 432 DN.. 150408	ATKH-02-L	AKV-33-M6x22	AADN-2-0003	AAV-13-M5x8	AKY-01	AXR-01	2703-M6X5	AAL-03-3
DDJNL 16 4D-H	1.000	1.000	6.000	1.930	1.250	DN.. 432 DN.. 150408	ATKH-02-L	AKV-33-M6x22	AADN-2-0003	AAV-13-M5x8	AKY-01	AXR-01	2705-G1/8x5.5	AAL-03-3
DDJNL 20 4D-H	1.250	1.250	6.000	1.930	1.500	DN.. 432 DN.. 150408	ATKH-02-L	AKV-33-M6x22	AADN-2-0003	AAV-13-M5x8	AKY-01	AXR-01	2705-G1/8x5.5	AAL-03-3

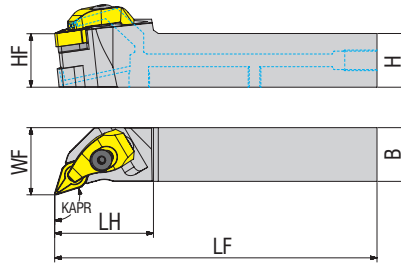

Illustrations shown may vary from actual product.

Dimensions in Inch														
Ordering Code	HF=H	B	LF	LH	WF	Insert Inch/Metric	Wedge Clamp	Clamp Screw	Shim	Shim Screw	Spring	Ring	Threaded Pin	Allen Key
DDQNR 16 4D-H	1.000	1.000	6.000	1.930	1.250	DN.. 432 DN.. 150408	ATKH-01-R	AKV-30-M6x22	AADN-2-0003	AAV-13-M5x8	AKY-01	AXR-01	2705-G1/8x5.5	AAL-03-3

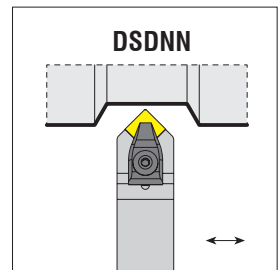
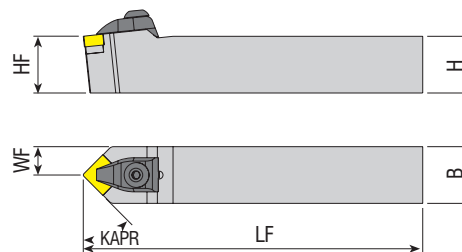

Illustrations shown may vary from actual product.

Dimensions in Inch													
Ordering Code	HF=H	B	LF	LH	WF	Insert Inch/Metric	Wedge Clamp	Clamp Screw	Shim	Shim Screw	Ring	Stamp	Allen Key
DSDNN 12 4B	0.750	0.750	4.500	1.440	0.375	SN.. 432 SN.. 120408	ATK-02	AKV-30-M6x22	AASN-3-0004	AAV-02-M5x12	AS-01	ABPL-01	AAL-03-3
DSDNN 16 4D	1.000	1.000	6.000	1.440	0.500	SN.. 432 SN.. 120408	ATK-02	AKV-30-M6x22	AASN-3-0004	AAV-02-M5x12	AS-01	ABPL-01	AAL-03-3
DSDNN 20 4D	1.250	1.250	6.000	1.440	0.625	SN.. 432 SN.. 120408	ATK-02	AKV-30-M6x22	AASN-3-0004	AAV-02-M5x12	AS-01	ABPL-01	AAL-03-3



Illustrations shown may vary from actual product.

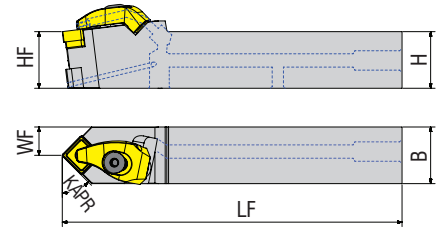

Dimensions in Inch

Ordering Code	HF=H	B	LF	LH	WF	Insert Inch/Metric	Wedge Clamp	Clamp Screw	Shim	Shim Screw	Ring	Spring	Allen Key
DSDNN 16 4D-H	1.000	1.000	6.000	1.850	0.500	SN.. 432 SN.. 120408	ATKH-01-R	AKV-33-M6x22	AASN-3-0004	AAV-13-M5x8	AXR-01	AKY-02	AAL-03-3
DSDNN 20 4D-H	1.250	1.250	6.000	1.850	0.625	SN.. 432 SN.. 120408	ATKH-01-R	AKV-33-M6x22	AASN-3-0004	AAV-13-M5x8	AXR-01	AKY-01	AAL-03-3
DSDNN 16 5D-H	1.000	1.000	6.000	2.000	0.500	SN.. 543 SN.. 150612	ATKH-07-R	AKV-39-M7x21	AASN-3-0023	AAV-05-M6x10	AXR-01	AKY-01	AAL-05-4
DSDNN 20 5D-H	1.250	1.250	6.000	2.000	0.625	SN.. 543 SN.. 150612	ATKH-07-R	AKV-39-M7x21	AASN-3-0023	AAV-05-M6x10	AXR-01	AKY-01	AAL-05-4
DSDNN 24 5E-H	1.500	1.500	7.000	2.150	0.750	SN.. 543 SN.. 150612	ATKH-07-R	AKV-39-M7x21	AASN-3-0023	AAV-05-M6x10	AXR-01	AKY-02	AAL-05-4



Illustrations shown may vary from actual product.

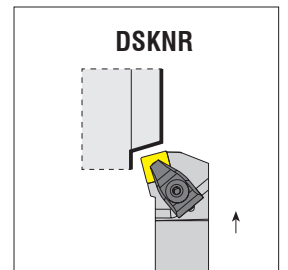
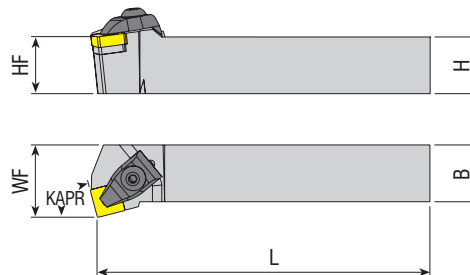

Dimensions in Inch

Ordering Code	HF=H	B	LF	LH	WF	Insert Inch/Metric	Wedge Clamp	Clamp Screw	Shim	Shim Screw	Ring	Stamp	Allen Key
DSKNR 16 4C	1.000	1.000	5.000	1.300	1.250	SN.. 432 SN.. 120408	ATK-02	AKV-30-M6x22	AASN-3-0004	AAV-02-M5x12	AS-01	ABPL-01	AAL-03-3
DSKNL 16 4C	1.000	1.000	5.000	1.300	1.250	SN.. 432 SN.. 120408	ATK-02	AKV-30-M6x22	AASN-3-0004	AAV-02-M5x12	AS-01	ABPL-01	AAL-03-3



Illustrations shown may vary from actual product.

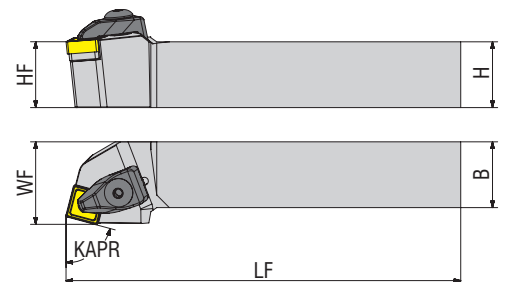

Dimensions in Inch

Ordering Code	HF=H	B	LF	LH	WF	Insert Inch/Metric	Wedge Clamp	Clamp Screw	Shim	Shim Screw	Ring	Stamp	Allen Key
DSRNL 16 4D	1.000	1.000	6.000	1.300	1.130	SN.. 432 SN.. 120408	ATK-02	AKV-30-M6x22	AASN-3-0004	AAV-02-M5x12	AS-01	ABPL-01	AAL-03-3
DSRNL 20 4D	1.250	1.250	6.000	1.300	1.380	SN.. 432 SN.. 120408	ATK-02	AKV-30-M6x22	AASN-3-0004	AAV-02-M5x12	AS-01	ABPL-01	AAL-03-3





Illustrations shown may vary from actual product.

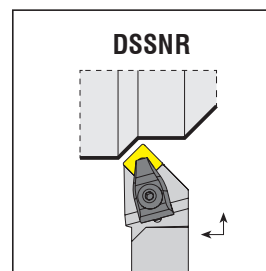
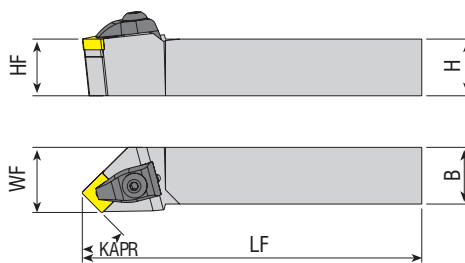

Dimensions in Inch

Ordering Code	Dimensions in Inch					Insert Inch/Metric	Wedge Clamp	Clamp Screw	Shim	Shim Screw	Ring	Stamp	Allen Key
	HF=H	B	LF	LH	WF								
DSSNR 16 4D	1.000	1.000	6.000	1.300	0.912	SN.. 432 SN.. 120408	ATK-02	AKV-30-M6x22	AASN-3-0004	AAV-02-M5x12	AS-01	ABPL-01	AAL-03-3



Illustrations shown may vary from actual product.

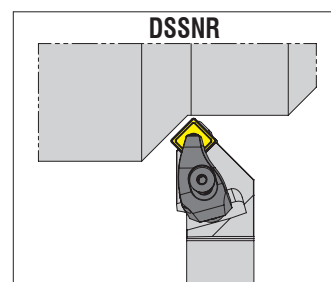
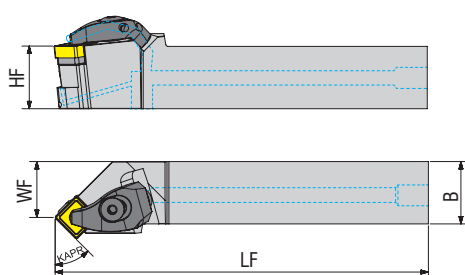







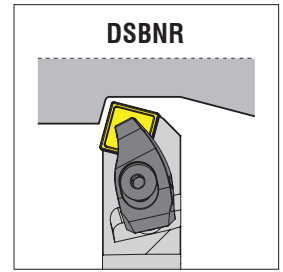
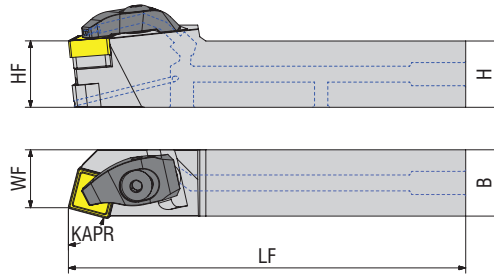

Dimensions in Inch

Ordering Code	Dimensions in Inch					Insert Inch/Metric	Wedge Clamp	Clamp Screw	Shim	Shim Screw	Spring	Ring	Threaded Pin	Allen Key
	HF=H	B	LF	LH	WF									
DSSNR 16 4D-H	1.000	1.000	6.000	1.810	1.250	SN.. 432 SN.. 120408	ATKH-02-L	AKV-33-M6x22	AASN-3-0004	AAV-13-M5X8	AKY-01	AXR-01	2705-G1/8x5.5	AAL-03-3
DSSNR 20 4D-H	1.250	1.250	6.000	1.810	1.500	SN.. 432 SN.. 120408	ATKH-02-L	AKV-33-M6x22	AASN-3-0004	AAV-13-M5X8	AKY-01	AXR-01	2705-G1/8x5.5	AAL-03-3
DSSNR 16 5D-H	1.000	1.000	6.000	2.000	1.250	SN.. 543 SN.. 150612	ATKH-08-L	AKV-39-M7x21	AASN-3-0023	AAV-05-M6x10	AKY-01	AXR-01	2705-G1/8x5.5	AAL-05-4
DSSNR 20 5D-H	1.250	1.250	6.000	2.000	1.500	SN.. 543 SN.. 150612	ATKH-08-L	AKV-39-M7x21	AASN-3-0023	AAV-05-M6x10	AKY-02	AXR-01	2705-G1/8x5.5	AAL-05-4
DSSNR 24 5E-H	1.500	1.500	7.000	2.000	2.000	SN.. 543 SN.. 150612	ATKH-08-L	AKV-39-M7x21	AASN-3-0023	AAV-05-M6x10	AKY-01	AXR-01	2705-G1/8x5.5	AAL-05-4
DSSNL 16 4D-H	1.000	1.000	6.000	1.810	1.250	SN.. 432 SN.. 120408	ATKH-01-R	AKV-33-M6x22	AASN-3-0004	AAV-13-M5X8	AKY-01	AXR-01	2705-G1/8x5.5	AAL-03-3
DSSNL 20 4D-H	1.250	1.250	6.000	1.810	1.500	SN.. 432 SN.. 120408	ATKH-01-R	AKV-33-M6x22	AASN-3-0004	AAV-13-M5X8	AKY-01	AXR-01	2705-G1/8x5.5	AAL-03-3
DSSNL 16 5D-H	1.000	1.000	6.000	2.000	1.250	SN.. 543 SN.. 150612	ATKH-07-R	AKV-39-M7x21	AASN-3-0023	AAV-05-M6x10	AKY-01	AXR-01	2705-G1/8x5.5	AAL-05-4
DSSNL 20 5D-H	1.250	1.250	6.000	2.000	1.500	SN.. 543 SN.. 150612	ATKH-07-R	AKV-39-M7x21	AASN-3-0023	AAV-05-M6x10	AKY-02	AXR-01	2705-G1/8x5.5	AAL-05-4
DSSNL 24 5E-H	1.500	1.500	7.000	2.000	2.000	SN.. 543 SN.. 150612	ATKH-07-R	AKV-39-M7x21	AASN-3-0023	AAV-05-M6x10	AKY-01	AXR-01	2705-G1/8x5.5	AAL-05-4

The left wedge clamp should be used on right-hand tools. and the right wedge clamp should be used on left-hand tools.







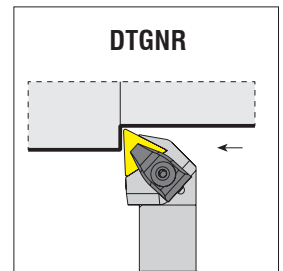
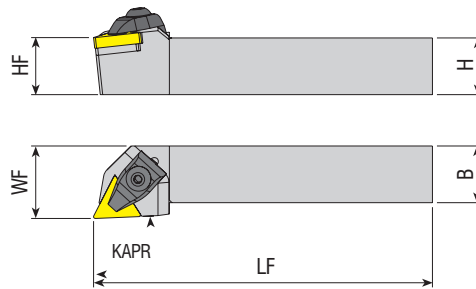



Illustrations shown may vary from actual product.

Dimensions in Inch														
Ordering Code	HF=H	B	LF	LH	WF	Insert Inch/Metric	Wedge Clamp	Clamp Screw	Shim	Shim Screw	Spring	Ring	Threaded Pin	Allen Key
DSBNR 16 4D-H	1.000	1.000	6.000	1.730	0.790	SN.. 432 SN.. 120408	ATKH-01-R	AKV-33-M6x22	AASN-3-0004	AAV-13-M5x8	AKY-01	AXR-01	2705-G1/8x5.5	AAL-03-3
DSBNR 20 4D-H	1.250	1.250	6.000	1.770	0.990	SN.. 432 SN.. 120408	ATKH-01-R	AKV-33-M6x22	AASN-3-0004	AAV-13-M5x8	AKY-01	AXR-01	2705-G1/8x5.5	AAL-03-3
DSBNR 16 5D-H	1.000	1.000	6.000	1.960	0.790	SN.. 543 SN.. 150612	ATKH-07-R	AKV-39-M7x21	AASN-3-0023	AAV-05-M6x10	AKY-01	AXR-01	2705-G1/8x5.5	AAL-05-4
DSBNR 20 5D-H	1.250	1.250	6.000	1.960	0.990	SN.. 543 SN.. 150612	ATKH-07-R	AKV-39-M7x21	AASN-3-0023	AAV-05-M6x10	AKY-01	AXR-01	2705-G1/8x5.5	AAL-05-4
DSBNL 16 4D-H	1.000	1.000	6.000	1.730	0.790	SN.. 432 SN.. 120408	ATKH-02-L	AKV-33-M6x22	AASN-3-0004	AAV-13-M5x8	AKY-01	AXR-01	2705-G1/8x5.5	AAL-03-3
DSBNL 20 4D-H	1.250	1.250	6.000	1.770	0.990	SN.. 432 SN.. 120408	ATKH-02-L	AKV-33-M6x22	AASN-3-0004	AAV-13-M5x8	AKY-01	AXR-01	2705-G1/8x5.5	AAL-03-3
DSBNL 16 5D-H	1.000	1.000	6.000	1.960	0.790	SN.. 543 SN.. 150612	ATKH-08-L	AKV-39-M7x21	AASN-3-0023	AAV-05-M6x10	AKY-01	AXR-01	2705-G1/8x5.5	AAL-05-4
DSBNL 20 5D-H	1.250	1.250	6.000	1.960	0.990	SN.. 543 SN.. 150612	ATKH-08-L	AKV-39-M7x21	AASN-3-0023	AAV-05-M6x10	AKY-01	AXR-01	2705-G1/8x5.5	AAL-05-4



Illustrations shown may vary from actual product.

Dimensions in Inch													
Ordering Code	HF=H	B	LF	LH	WF	Insert Inch/Metric	Wedge Clamp	Clamp Screw	Shim	Shim Screw	Ring	Stamp	Allen Key
DTGNR 12 3B	0.750	0.750	4.500	1.250	1.000	TN.. 332 TN.. 160408	ATK-01	AKV-01-M5x22	AATN-2-0002	AAV-03-M5x12	-	ABPL-01	AAL-03-3
DTGNR 16 4D	1.000	1.000	6.000	1.250	1.250	TN.. 432 TN.. 220408	ATK-02	AKV-30-M6x22	AATN-3-0015	AAV-02-M5x12	AS-01	ABPL-01	AAL-03-3
DTGNL 16 3D	1.000	1.000	6.000	1.250	1.250	TN.. 332 TN.. 160408	ATK-01	AKV-01-M5x22	AATN-2-0002	AAV-03-M5x12	-	ABPL-01	AAL-03-3



Illustrations shown may vary from actual product.

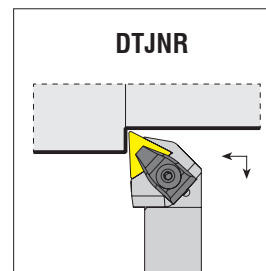
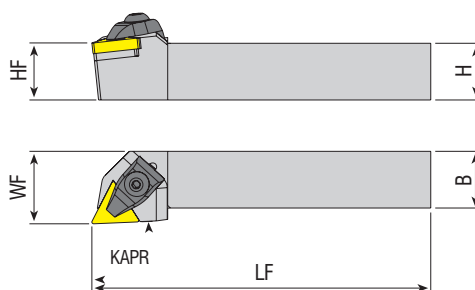

Dimensions in Inch

Ordering Code	HF=H	B	LF	LH	WF	Insert Inch/Metric	Wedge Clamp	Clamp Screw	Shim	Shim Screw	Ring	Stamp	Allen Key
DTJNR 16 4D	1.000	1.000	6.000	1.250	1.250	TN.. 432 TN.. 220408	ATK-02	AKV-30-M6x22	AATN-3-0015	AAV-02-M5x12	AS-01	ABPL-01	AAL-03-3



Illustrations shown may vary from actual product.

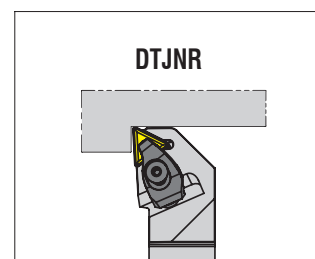
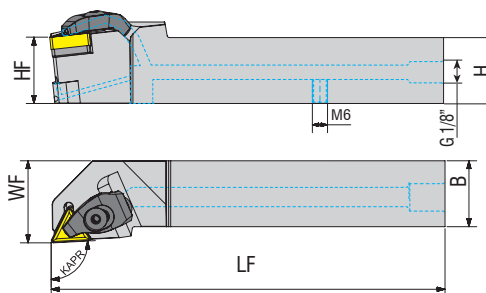

Dimensions in Inch

Ordering Code	HF=H	B	LF	LH	WF	Insert Inch/Metric	Wedge Clamp	Clamp Screw	Shim	Shim Screw	Spring	Ring	Threaded Pin	Allen Key
DTJNR 16 3D-H	1.000	1.000	6.000	1.810	1.250	TN.. 332 TN.. 160408	ATKH-03-R	AKV-37-M5x18	AATN-2-0002	AAV-03-M5x12	AKY-03	AXR-02	2705-G1/8x5.5	AAL-02-2.5
DTJNR 20 3D-H	1.250	1.250	6.000	1.810	1.500	TN.. 332 TN.. 160408	ATKH-03-R	AKV-37-M5x18	AATN-2-0002	AAV-03-M5x12	AKY-03	AXR-02	2705-G1/8x5.5	AAL-02-2.5
DTJNR 16 4D-H	1.000	1.000	6.000	1.810	1.250	TN.. 432 TN.. 220408	ATKH-01-R	AKV-33-M6x22	AATN-3-0015	AAV-13-M5X8	AKY-01	AXR-01	2705-G1/8x5.5	AAL-03-3
DTJNR 20 4D-H	1.250	1.250	6.000	1.810	1.500	TN.. 432 TN.. 220408	ATKH-01-R	AKV-33-M6x22	AATN-3-0015	AAV-13-M5X8	AKY-01	AXR-01	2705-G1/8x5.5	AAL-03-3
DTJNL 16 3D-H	1.000	1.000	6.000	1.810	1.250	TN.. 332 TN.. 160408	ATKH-04-L	AKV-37-M5x18	AATN-2-0002	AAV-03-M5x12	AKY-03	AXR-02	2705-G1/8x5.5	AAL-02-2.5
DTJNL 20 3D-H	1.250	1.250	6.000	1.810	1.500	TN.. 332 TN.. 160408	ATKH-04-L	AKV-37-M5x18	AATN-2-0002	AAV-03-M5x12	AKY-03	AXR-02	2705-G1/8x5.5	AAL-02-2.5
DTJNL 16 4D-H	1.000	1.000	6.000	1.810	1.250	TN.. 432 TN.. 220408	ATKH-02-L	AKV-33-M6x22	AATN-3-0015	AAV-13-M5X8	AKY-01	AXR-01	2705-G1/8x5.5	AAL-03-3
DTJNL 20 4D-H	1.250	1.250	6.000	1.810	1.500	TN.. 432 TN.. 220408	ATKH-02-L	AKV-33-M6x22	AATN-3-0015	AAV-13-M5X8	AKY-01	AXR-01	2705-G1/8x5.5	AAL-03-3



Illustrations shown may vary from actual product.

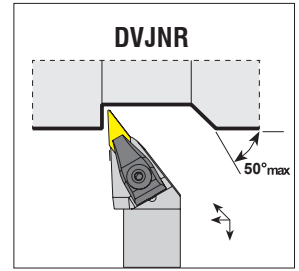
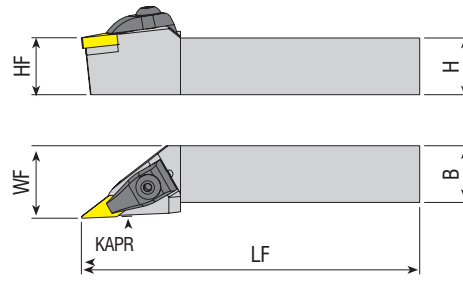

Dimensions in Inch

Ordering Code	HF=H	B	LF	LH	WF	Insert Inch/Metric	Wedge Clamp	Clamp Screw	Shim	Shim Screw	Ring	Stamp	Allen Key
DVJNR 12 3C	0.750	0.750	5.000	1.750	1.000	VN.. 332 VN.. 160408	ATK-03	AKV-30-M6x22	AAVN-2-0002	AAV-04-M5x12	AS-01	ABPL-01	AAL-03-3
DVJNR 16 3D	1.000	1.000	6.000	1.750	1.250	VN.. 332 VN.. 160408	ATK-03	AKV-30-M6x22	AAVN-2-0002	AAV-04-M5x12	AS-01	ABPL-01	AAL-03-3
DVJNR 85 3D	1.250	1.000	6.000	1.750	1.250	VN.. 332 VN.. 160408	ATK-03	AKV-30-M6x22	AAVN-2-0002	AAV-04-M5x12	AS-01	ABPL-01	AAL-03-3
DVJNL 12 3C	0.750	0.750	5.000	1.750	1.000	VN.. 332 VN.. 160408	ATK-03	AKV-30-M6x22	AAVN-2-0002	AAV-04-M5x12	AS-01	ABPL-01	AAL-03-3
DVJNL 16 3D	1.000	1.000	6.000	1.750	1.250	VN.. 332 VN.. 160408	ATK-03	AKV-30-M6x22	AAVN-2-0002	AAV-04-M5x12	AS-01	ABPL-01	AAL-03-3
DVJNL 85 3D	1.250	1.000	6.000	1.750	1.250	VN.. 332 VN.. 160408	ATK-03	AKV-30-M6x22	AAVN-2-0002	AAV-04-M5x12	AS-01	ABPL-01	AAL-03-3



Illustrations shown may vary from actual product.

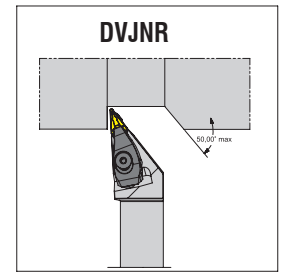
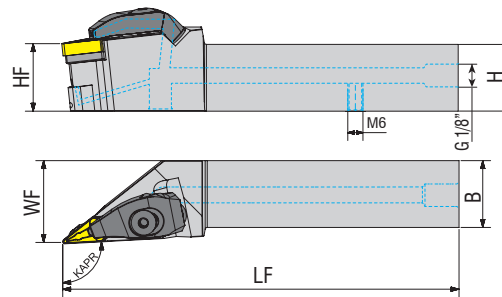

Dimensions in Inch

Ordering Code	HF=H	B	LF	LH	WF	Insert Inch/Metric	Wedge Clamp	Clamp Screw	Shim	Shim Screw	Spring	Ring	Threaded Pin	Allen Key
DVJNR 12 3B-H	0.750	0.750	4.500	2.200	1.000	VN.. 332 VN.. 160408	ATKH-05-R	AKV-33-M6x22	AAVN-2-0002	AAV-04-M5x12	AKY-01	AXR-01	2705-G1/8x5.5	AAL-03-3
DVJNR 16 3D-H	1.000	1.000	6.000	2.200	1.250	VN.. 332 VN.. 160408	ATKH-05-R	AKV-33-M6x22	AAVN-2-0002	AAV-04-M5x12	AKY-01	AXR-01	2705-G1/8x5.5	AAL-03-3
DVJNR 20 3D-H	1.250	1.250	6.000	2.200	1.500	VN.. 332 VN.. 160408	ATKH-05-R	AKV-33-M6x22	AAVN-2-0002	AAV-04-M5x12	AKY-01	AXR-01	2705-G1/8x5.5	AAL-03-3
DVJNL 12 3B-H	0.750	0.750	4.500	2.200	1.000	VN.. 332 VN.. 160408	ATKH-06-L	AKV-33-M6x22	AAVN-2-0002	AAV-04-M5x12	AKY-01	AXR-01	2705-G1/8x5.5	AAL-03-3
DVJNL 16 3D-H	1.000	1.000	6.000	2.200	1.250	VN.. 332 VN.. 160408	ATKH-06-L	AKV-33-M6x22	AAVN-2-0002	AAV-04-M5x12	AKY-01	AXR-01	2705-G1/8x5.5	AAL-03-3
DVJNL 20 3D-H	1.250	1.250	6.000	2.200	1.500	VN.. 332 VN.. 160408	ATKH-06-L	AKV-33-M6x22	AAVN-2-0002	AAV-04-M5x12	AKY-01	AXR-01	2705-G1/8x5.5	AAL-03-3



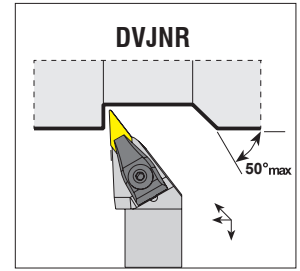
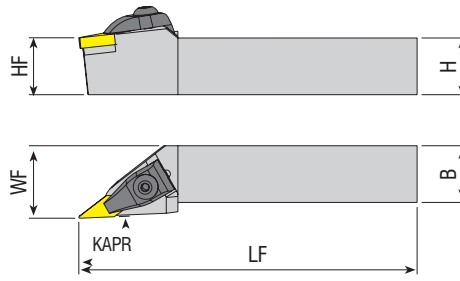

Illustrations shown may vary from actual product.

Dimensions in Metric

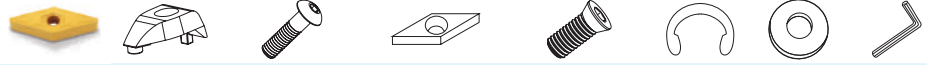

Ordering Code	HF=H	B	LF	WF	Insert Inch/Metric	Wedge Clamp	Clamp Screw	Shim	Shim Screw	Ring	Stamp	Allen Key
DVJNR 2020 K16	20	20	125	25	VN.. 33.. VN.. 1604..	ATK-03	AKV-30-M6x22	AAVN-2-0002	AAV-04-M5x12	AS-01	ABPL-01	AAL-03-3
DVJNR 2525 M16	25	25	150	32	VN.. 33.. VN.. 1604..	ATK-03	AKV-30-M6x22	AAVN-2-0002	AAV-04-M5x12	AS-01	ABPL-01	AAL-03-3
DVJNR 3232 P16	32	32	170	40	VN.. 33.. VN.. 1604..	ATK-03	AKV-30-M6x22	AAVN-2-0002	AAV-04-M5x12	AS-01	ABPL-01	AAL-03-3
DVJNL 2020 K16	20	20	125	25	VN.. 33.. VN.. 1604..	ATK-03	AKV-30-M6x22	AAVN-2-0002	AAV-04-M5x12	AS-01	ABPL-01	AAL-03-3
DVJNL 2525 M16	25	25	150	32	VN.. 33.. VN.. 1604..	ATK-03	AKV-30-M6x22	AAVN-2-0002	AAV-04-M5x12	AS-01	ABPL-01	AAL-03-3
DVJNL 3232 P16	32	32	170	40	VN.. 33.. VN.. 1604..	ATK-03	AKV-30-M6x22	AAVN-2-0002	AAV-04-M5x12	AS-01	ABPL-01	AAL-03-3

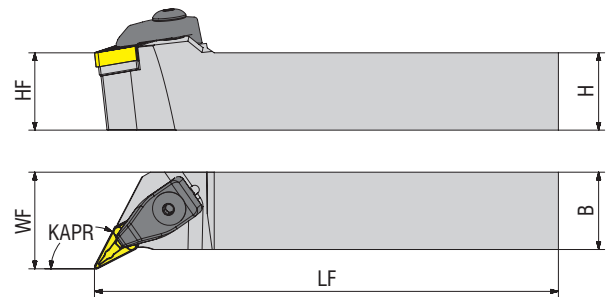

Illustrations shown may vary from actual product.

Dimensions in Inch

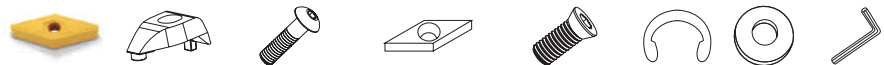

Ordering Code	HF=H	B	LF	LH	WF	Insert Inch/Metric	Wedge Clamp	Clamp Screw	Shim	Shim Screw	Ring	Stamp	Allen Key
DVONR 12 3C	0.750	0.750	5.000	1.500	1.000	VN.. 332 VN.. 160408	ATK-03	AKV-30-M6x22	AAVN-2-0002	AAV-04-M5x12	AS-01	ABPL-01	AAL-03-3
DVONR 16 3D	1.000	1.000	6.000	1.470	1.250	VN.. 332 VN.. 160408	ATK-03	AKV-30-M6x22	AAVN-2-0002	AAV-04-M5x12	AS-01	ABPL-01	AAL-03-3
DVONR 85 3D	1.250	1.000	6.000	1.470	1.250	VN.. 332 VN.. 160408	ATK-03	AKV-30-M6x22	AAVN-2-0002	AAV-04-M5x12	AS-01	ABPL-01	AAL-03-3
DVONL 12 3C	0.750	0.750	5.000	1.500	1.000	VN.. 332 VN.. 160408	ATK-03	AKV-30-M6x22	AAVN-2-0002	AAV-04-M5x12	AS-01	ABPL-01	AAL-03-3
DVONL 16 3D	1.000	1.000	6.000	1.470	1.250	VN.. 332 VN.. 160408	ATK-03	AKV-30-M6x22	AAVN-2-0002	AAV-04-M5x12	AS-01	ABPL-01	AAL-03-3
DVONL 85 3D	1.250	1.000	6.000	1.470	1.250	VN.. 332 VN.. 160408	ATK-03	AKV-30-M6x22	AAVN-2-0002	AAV-04-M5x12	AS-01	ABPL-01	AAL-03-3

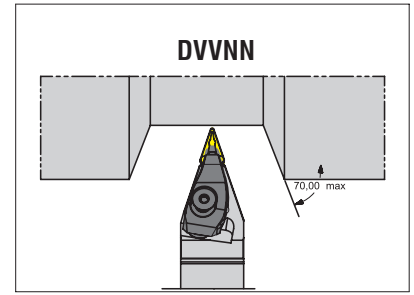
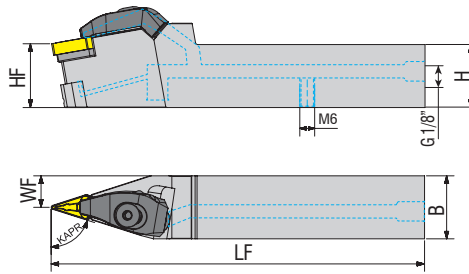

Illustrations shown may vary from actual product.

Dimensions in Inch

Ordering Code	HF=H	B	LF	LH	WF	Insert Inch/Metric	Wedge Clamp	Clamp Screw	Shim	Shim Screw	Spring	Ring	Threaded Pin	Allen Key
DVVNN 16 3D-H	1.000	1.000	6.000	2.360	0.500	VN.. 332 VN.. 160408	ATKH-05-R	AKV-33-M6x22	AAVN-2-0002	AAV-04-M5x12	AKY-01	AXR-01	2705-G1/8x5.5	AAL-03-3
DVVNN 12 3B-H	0.750	0.750	4.500	2.250	0.375	VN.. 332 VN.. 160408	ATKH-05-R	AKV-33-M6x22	AAVN-2-0002	AAV-04-M5x12	AKY-01	AXR-01	2705-G1/8x5.5	AAL-03-3

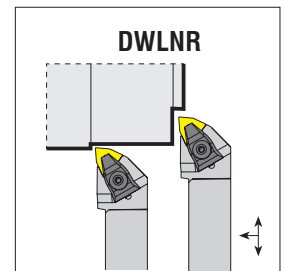
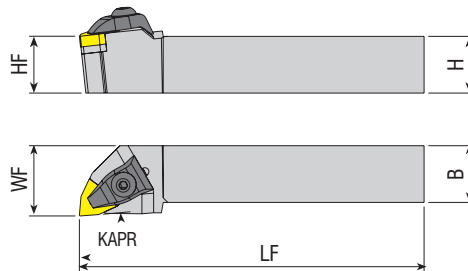

Illustrations shown may vary from actual product.

Dimensions in Inch

Ordering Code	HF=H	B	LF	LH	WF	Insert Inch/Metric	Wedge Clamp	Clamp Screw	Shim	Shim Screw	Ring	Stamp	Allen Key
DWLNR 12 3B	0.750	0.750	4.500	1.000	1.000	WN.. 332 WN.. 060408	ATK-01	AKV-01-M5x22	AAWN-SW317	AAV-01-M3x10	-	ABPL-01	AAL-03-3
DWLNR 16 3C	1.000	1.000	5.000	1.000	1.250	WN.. 332 WN.. 060408	ATK-01	AKV-01-M5x22	AAWN-SW317	AAV-01-M3x10	-	ABPL-01	AAL-03-3
DWLNR 16 3D	1.000	1.000	6.000	1.000	1.250	WN.. 332 WN.. 060408	ATK-01	AKV-01-M5x22	AAWN-SW317	AAV-01-M3x10	-	ABPL-01	AAL-03-3
DWLNR 16 4C	1.000	1.000	5.000	1.250	1.250	WN.. 432 WN.. 080408	ATK-02	AKV-30-M6x22	AAWN-3-0001	AAV-02-M5x12	AS-01	ABPL-01	AAL-03-3
DWLNR 16 4D	1.000	1.000	6.000	1.250	1.250	WN.. 432 WN.. 080408	ATK-02	AKV-30-M6x22	AAWN-3-0001	AAV-02-M5x12	AS-01	ABPL-01	AAL-03-3
DWLNR 20 4D	1.250	1.250	6.000	1.250	1.500	WN.. 432 WN.. 080408	ATK-02	AKV-30-M6x22	AAWN-3-0001	AAV-02-M5x12	AS-01	ABPL-01	AAL-03-3
DWLNL 12 3B	0.750	0.750	4.500	1.000	1.000	WN.. 332 WN.. 060408	ATK-01	AKV-01-M5x22	AAWN-SW317	AAV-01-M3x10	-	ABPL-01	AAL-03-3
DWLNL 16 3C	1.000	1.000	5.000	1.000	1.250	WN.. 332 WN.. 060408	ATK-01	AKV-01-M5x22	AAWN-SW317	AAV-01-M3x10	-	ABPL-01	AAL-03-3
DWLNL 16 3D	1.000	1.000	6.000	1.000	1.250	WN.. 332 WN.. 060408	ATK-01	AKV-01-M5x22	AAWN-SW317	AAV-01-M3x10	-	ABPL-01	AAL-03-3
DWLNL 16 4C	1.000	1.000	5.000	1.250	1.250	WN.. 432 WN.. 080408	ATK-02	AKV-30-M6x22	AAWN-3-0001	AAV-02-M5x12	AS-01	ABPL-01	AAL-03-3
DWLNL 16 4D	1.000	1.000	6.000	1.250	1.250	WN.. 432 WN.. 080408	ATK-02	AKV-30-M6x22	AAWN-3-0001	AAV-02-M5x12	AS-01	ABPL-01	AAL-03-3
DWLNL 20 4D	1.250	1.250	6.000	1.250	1.500	WN.. 432 WN.. 080408	ATK-02	AKV-30-M6x22	AAWN-3-0001	AAV-02-M5x12	AS-01	ABPL-01	AAL-03-3



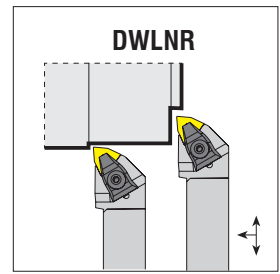
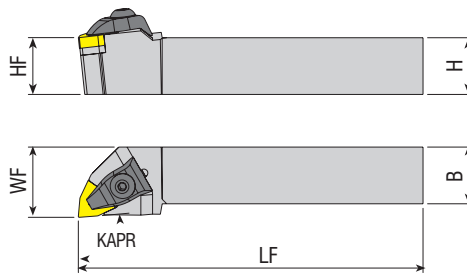
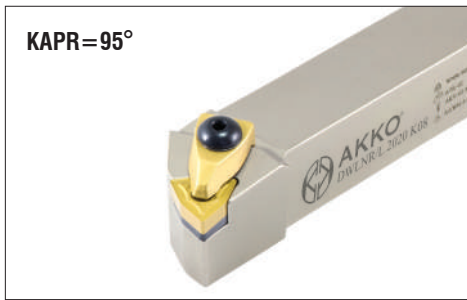

Illustrations shown may vary from actual product.

Dimensions in Metric



Ordering Code	HF=H	B	LF	WF	Insert Inch/Metric	Wedge Clamp	Clamp Screw	Shim	Shim Screw	Ring	Stamp	Allen Key
DWLNR 1616 H06	16	16	100	20	WN.. 33.. WN.. 0604..	ATK-01	AKV-01-M5x22	AAWN-SW317	AAV-01-M3x10	-	ABPL-01	AAL-03-3
DWLNR 2020 K06	20	20	125	25	WN.. 33.. WN.. 0604..	ATK-01	AKV-01-M5x22	AAWN-SW317	AAV-01-M3x10	-	ABPL-01	AAL-03-3
DWLNR 2525 M06	25	25	150	32	WN.. 33.. WN.. 0604..	ATK-01	AKV-01-M5x22	AAWN-SW317	AAV-01-M3x10	-	ABPL-01	AAL-03-3
DWLNR 2020 K08	20	20	125	25	WN.. 43.. WN.. 0804..	ATK-02	AKV-30-M6x22	AAWN-3-0001	AAV-02-M5x12	AS-01	ABPL-01	AAL-03-3
DWLNR 2525 M08	25	25	150	32	WN.. 43.. WN.. 0804..	ATK-02	AKV-30-M6x22	AAWN-3-0001	AAV-02-M5x12	AS-01	ABPL-01	AAL-03-3
DWLNR 3232 P08	32	32	170	40	WN.. 43.. WN.. 0804..	ATK-02	AKV-30-M6x22	AAWN-3-0001	AAV-02-M5x12	AS-01	ABPL-01	AAL-03-3
DWLNR 4040 S08	40	40	250	50	WN.. 43.. WN.. 0804..	ATK-02	AKV-30-M6x22	AAWN-3-0001	AAV-02-M5x12	AS-01	ABPL-01	AAL-03-3
DWLNR 5050 S08	50	50	250	60	WN.. 43.. WN.. 0804..	ATK-02	AKV-30-M6x22	AAWN-3-0001	AAV-02-M5x12	AS-01	ABPL-01	AAL-03-3
DWLNL 1616 H06	16	16	100	20	WN.. 33.. WN.. 0604..	ATK-01	AKV-01-M5x22	AAWN-SW317	AAV-01-M3x10	-	ABPL-01	AAL-03-3
DWLNL 2020 K06	20	20	125	25	WN.. 33.. WN.. 0604..	ATK-01	AKV-01-M5x22	AAWN-SW317	AAV-01-M3x10	-	ABPL-01	AAL-03-3
DWLNL 2525 M06	25	25	150	32	WN.. 33.. WN.. 0604..	ATK-01	AKV-01-M5x22	AAWN-SW317	AAV-01-M3x10	-	ABPL-01	AAL-03-3
DWLNL 2020 K08	20	20	125	25	WN.. 43.. WN.. 0804..	ATK-02	AKV-30-M6x22	AAWN-3-0001	AAV-02-M5x12	AS-01	ABPL-01	AAL-03-3
DWLNL 2525 M08	25	25	150	32	WN.. 43.. WN.. 0804..	ATK-02	AKV-30-M6x22	AAWN-3-0001	AAV-02-M5x12	AS-01	ABPL-01	AAL-03-3
DWLNL 3232 P08	32	32	170	40	WN.. 43.. WN.. 0804..	ATK-02	AKV-30-M6x22	AAWN-3-0001	AAV-02-M5x12	AS-01	ABPL-01	AAL-03-3
DWLNL 4040 S08	40	40	250	50	WN.. 43.. WN.. 0804..	ATK-02	AKV-30-M6x22	AAWN-3-0001	AAV-02-M5x12	AS-01	ABPL-01	AAL-03-3
DWLNL 5050 S08	50	50	250	60	WN.. 43.. WN.. 0804..	ATK-02	AKV-30-M6x22	AAWN-3-0001	AAV-02-M5x12	AS-01	ABPL-01	AAL-03-3

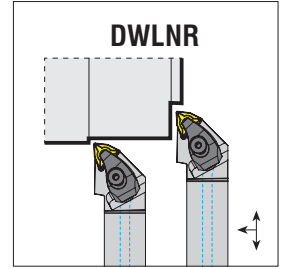
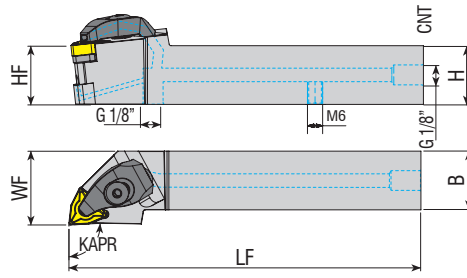

Illustrations shown may vary from actual product.

Dimensions in Inch

Ordering Code	Dimensions in Inch					Insert Inch/Metric	Wedge Clamp	Clamp Screw	Shim	Shim Screw	Spring	Ring	Threaded Pin	Allen Key
	HF=H	B	LF	LH	WF									
DWLNR 12 3B-H	0.750	0.750	4.500	1.380	1.000	WN.. 332 WN.. 060408	ATKH-03-R	AKV-37-M5x18	AAWN-SW317	AAV-01-M3X10	AKY-03	AXR-02	2705-G1/8x5.5	AAL-02-2.5
DWLNR 16 3D-H	1.000	1.000	6.000	1.650	1.250	WN.. 332 WN.. 060408	ATKH-03-R	AKV-37-M5x18	AAWN-SW317	AAV-01-M3X10	AKY-03	AXR-02	2705-G1/8x5.5	AAL-02-2.5
DWLNR 12 4B-H	0.750	0.750	4.500	1.690	1.000	WN.. 432 WN.. 080408	ATKH-01-R	AKV-33-M6x22	AAWN-3-0001	AAV-13-M5x8	AKY-01	AXR-01	2705-G1/8x5.5	AAL-03-3
DWLNR 16 4D-H	1.000	1.000	6.000	1.650	1.250	WN.. 432 WN.. 080408	ATKH-01-R	AKV-33-M6x22	AAWN-3-0001	AAV-13-M5x8	AKY-01	AXR-01	2705-G1/8x5.5	AAL-03-3
DWLNR 20 4D-H	1.250	1.250	6.000	1.650	1.500	WN.. 432 WN.. 080408	ATKH-01-R	AKV-33-M6x22	AAWN-3-0001	AAV-13-M5x8	AKY-01	AXR-01	2705-G1/8x5.5	AAL-03-3
DWLNL 12 3B-H	0.750	0.750	4.500	1.380	1.000	WN.. 332 WN.. 060408	ATKH-04-L	AKV-37-M5x18	AAWN-SW317	AAV-01-M3X10	AKY-03	AXR-02	2705-G1/8x5.5	AAL-02-2.5
DWLNL 16 3D-H	1.000	1.000	6.000	1.650	1.250	WN.. 332 WN.. 060408	ATKH-04-L	AKV-37-M5x18	AAWN-SW317	AAV-01-M3X10	AKY-03	AXR-02	2705-G1/8x5.5	AAL-02-2.5
DWLNL 12 4B-H	0.750	0.750	4.500	1.690	1.000	WN.. 432 WN.. 080408	ATKH-02-L	AKV-33-M6x22	AAWN-3-0001	AAV-13-M5x8	AKY-01	AXR-01	2705-G1/8x5.5	AAL-03-3
DWLNL 16 4D-H	1.000	1.000	6.000	1.650	1.250	WN.. 432 WN.. 080408	ATKH-02-L	AKV-33-M6x22	AAWN-3-0001	AAV-13-M5x8	AKY-01	AXR-01	2705-G1/8x5.5	AAL-03-3
DWLNL 20 4D-H	1.250	1.250	6.000	1.650	1.500	WN.. 432 WN.. 080408	ATKH-02-L	AKV-33-M6x22	AAWN-3-0001	AAV-13-M5x8	AKY-01	AXR-01	2705-G1/8x5.5	AAL-03-3

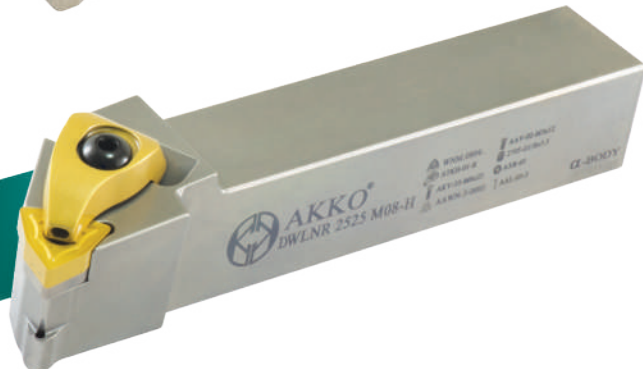

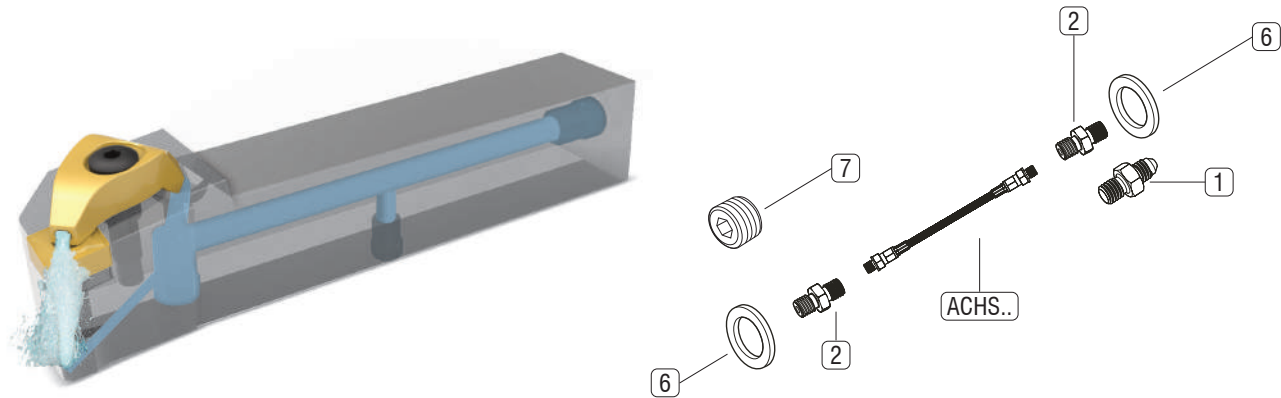

Note: 3 types of cooling hose sets are designed that can be used in all external turning lathes. Before using the tools, care should be taken to ensure that the unused connections are closed with the screw in the set and that sealing is ensured. Cooling hose sets for lathe tools can be used in the pressure range of ACHS ... 10 bar to max 150 bar.

Parts In The Set				Length Code		
				Set Code: ACHS-1-250	Set Code: ACHS-2-250	Set Code: ACHS-3-250
	Picture	Set Code	Product Description			
1		AMP-01	M10 Fastener	1x	-	-
2		AMP-02	G 1/8" Double Fastener	2x	1x	-
3		AMP-03	G 1/8" Angle Connection	-	1x	2x
4		AMP-04	M10" Angle Connection	-	1x	1x
5		AMP-05	G1 / 4"-G1/8" Capillary Piece	-	1x	1x
6		AG-01	Copper Gasket	2x	3x	4x
7		2705-G1/8-5.5	G1/8" Sealing Bolt	1x	1x	1x
8		AH-1-250	Hose	1x	-	-
9		AH-2-250	Hose	-	1x	-
10		AH-3-250	Hose	-	-	1x

# D-SYSTEM EXTERNAL TURNING TOOLHOLDERS

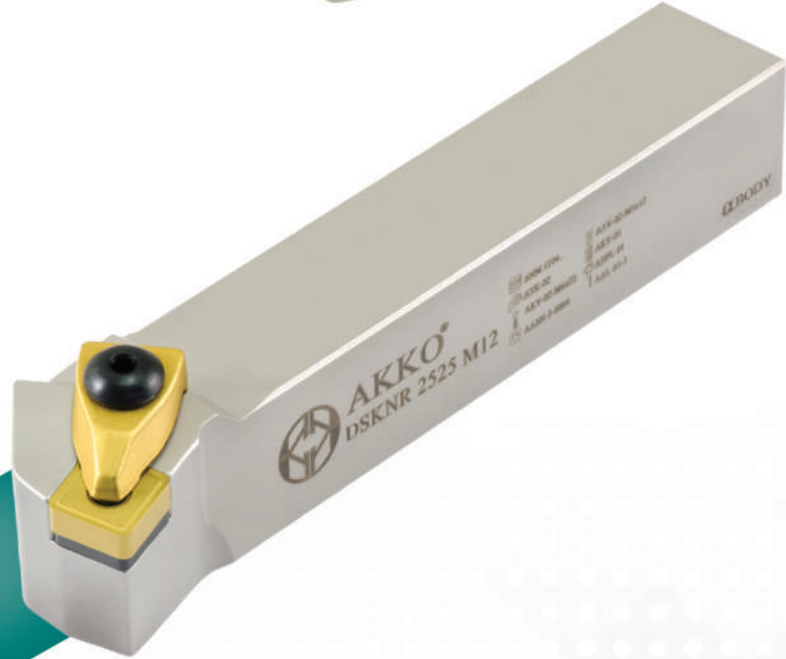



*the spoken quality...*

# M-SYSTEM

M-SYSTEM EXTERNAL TURNING TOOLHOLDERS

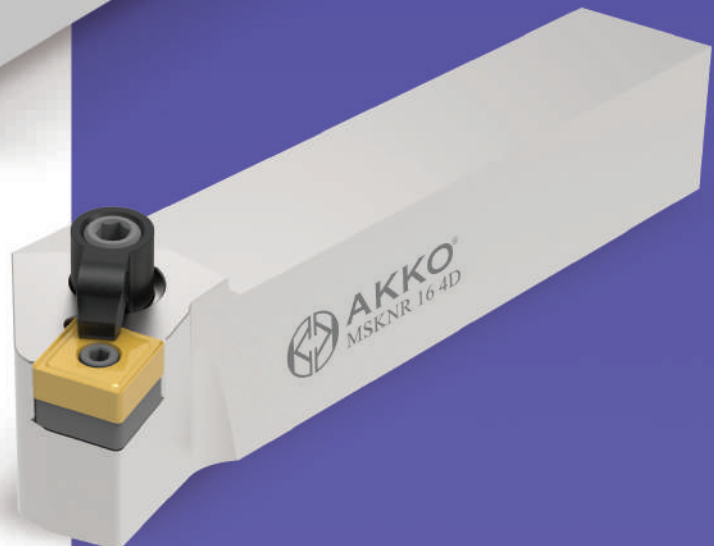
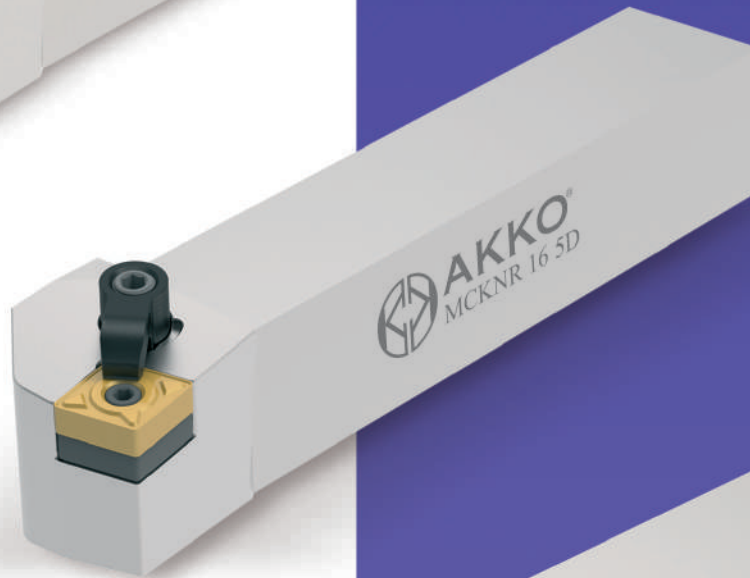

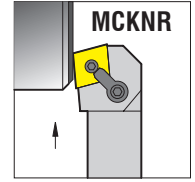
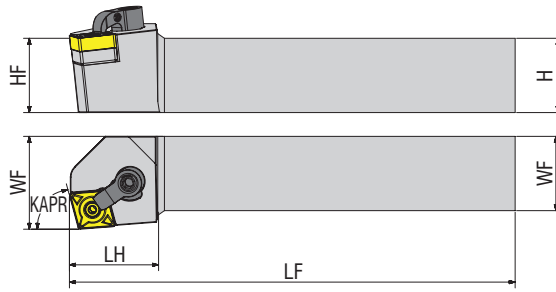

Illustrations shown may vary from actual product.

Dimensions in Inch

Ordering Code	Dimensions in Inch											
	HF=H	B	LF	LH	WF	Insert Inch/Metric	Wedge Clamp	Clamp Screw	Allen Key	Shim	Lock Pin	Allen Key
MCKNR 12 4B	0.750	0.750	4.500	1.200	1.000	CN.. 432 CN.. 120408	CK-20	STC-20	AAL-14-1/8	ICSN-433	KL-46	AAL-16-3/32
MCKNR 16 4C	1.000	1.000	5.000	1.200	1.250	CN.. 432 CN.. 120408	CK-20	STC-20	AAL-14-1/8	ICSN-433	KL-46	AAL-16-3/32
MCKNR 16 4D	1.000	1.000	6.000	1.200	1.250	CN.. 432 CN.. 120408	CK-20	STC-20	AAL-14-1/8	ICSN-433	KL-46	AAL-16-3/32
MCKNR 16 5D	1.000	1.000	6.000	1.260	1.250	CN.. 543 CN.. 160612	CK-9	STC-4	AAL-17-5/32	ICSN-533	KL-58	AAL-14-1/8
MCKNR 20 4D	1.250	1.250	6.000	1.200	1.500	CN.. 432 CN.. 120408	CK-20	STC-20	AAL-14-1/8	ICSN-433	KL-46	AAL-16-3/32
MCKNR 20 5D	1.250	1.250	6.000	1.260	1.500	CN.. 543 CN.. 160612	CK-9	STC-4	AAL-17-5/32	ICSN-533	KL-58	AAL-14-1/8
MCKNR 20 6D	1.250	1.250	6.000	1.470	1.500	CN.. 643 CN.. 190612	CK-12	STC-4	AAL-17-5/32	ICSN-633	KL-68	AAL-19-9/64
MCKNR 24 5D	1.500	1.500	6.000	1.260	2.000	CN.. 543 CN.. 160612	CK-9	STC-4	AAL-17-5/32	ICSN-533	KL-58	AAL-14-1/8
MCKNR 24 6D	1.500	1.500	6.000	1.470	2.000	CN.. 643 CN.. 190612	CK-12	STC-4	AAL-17-5/32	ICSN-633	KL-68	AAL-19-9/64
MCKNL 12 4B	0.750	0.750	4.500	1.200	1.000	CN.. 432 CN.. 120408	CK-20	STC-20	AAL-14-1/8	ICSN-433	KL-46	AAL-16-3/32
MCKNL 16 4C	1.000	1.000	5.000	1.200	1.250	CN.. 432 CN.. 120408	CK-20	STC-20	AAL-14-1/8	ICSN-433	KL-46	AAL-16-3/32
MCKNL 16 4D	1.000	1.000	6.000	1.200	1.250	CN.. 432 CN.. 120408	CK-20	STC-20	AAL-14-1/8	ICSN-433	KL-46	AAL-16-3/32
MCKNL 16 5D	1.000	1.000	6.000	1.260	1.250	CN.. 543 CN.. 160612	CK-9	STC-4	AAL-17-5/32	ICSN-533	KL-58	AAL-14-1/8
MCKNL 20 4D	1.250	1.250	6.000	1.200	1.500	CN.. 432 CN.. 120408	CK-20	STC-20	AAL-14-1/8	ICSN-433	KL-46	AAL-16-3/32
MCKNL 20 5D	1.250	1.250	6.000	1.260	1.500	CN.. 543 CN.. 160612	CK-9	STC-4	AAL-17-5/32	ICSN-533	KL-58	AAL-14-1/8
MCKNL 20 6D	1.250	1.250	6.000	1.470	1.500	CN.. 643 CN.. 190612	CK-12	STC-4	AAL-17-5/32	ICSN-633	KL-68	AAL-19-9/64
MCKNL 24 5D	1.500	1.500	6.000	1.260	2.000	CN.. 543 CN.. 160612	CK-9	STC-4	AAL-17-5/32	ICSN-533	KL-58	AAL-14-1/8
MCKNL 24 6D	1.500	1.500	6.000	1.470	2.000	CN.. 643 CN.. 190612	CK-12	STC-4	AAL-17-5/32	ICSN-633	KL-68	AAL-19-9/64

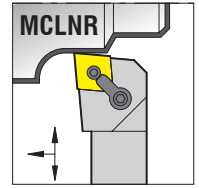
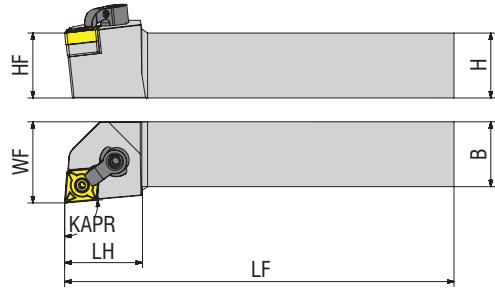
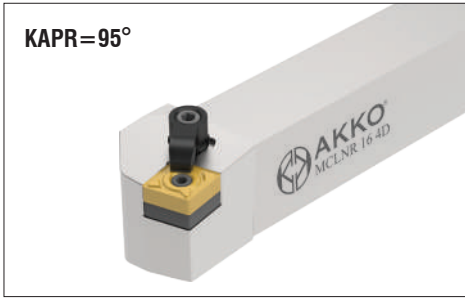

Illustrations shown may vary from actual product.

Dimensions in Inch



Ordering Code	HF=H	B	LF	LH	WF	Insert Inch/Metric	Wedge Clamp	Clamp Screw	Allen Key	Shim	Lock Pin	Allen Key
MCLNR 08 3A	0.500	0.500	4.000	1.000	0.750	CN.. 322 CN.. 09T308	CK-6	STC-5	AAL-16-3/32	-	KL-33	AAL-18-5/64
MCLNR 10 3A	0.625	0.625	4.000	1.000	0.875	CN.. 322 CN.. 09T308	CK-6	STC-5	AAL-16-3/32	-	KL-33	AAL-18-5/64
<b>new</b> MCLNR 10 4B	0.625	0.625	4.500	1.250	0.875	CN.. 432 CN.. 120408	CK-20	STC-20	AAL-14-1/8	ICSN-433	KL-46	AAL-16-3/32
MCLNR 12 3B	0.750	0.750	4.500	1.000	1.000	CN.. 322 CN.. 09T308	CK-6	STC-5	AAL-16-3/32	ICSN-332	KL-34L	AAL-18-5/64
MCLNR 12 4A	0.750	0.750	4.000	1.200	1.000	CN.. 432 CN.. 120408	CK-20	STC-20	AAL-14-1/8	ICSN-433	KL-46	AAL-16-3/32
MCLNR 12 4B	0.750	0.750	4.500	1.200	1.000	CN.. 432 CN.. 120408	CK-20	STC-20	AAL-14-1/8	ICSN-433	KL-46	AAL-16-3/32
MCLNR 16 3C	1.000	1.000	5.000	1.000	1.250	CN.. 322 CN.. 09T308	CK-6	STC-5	AAL-16-3/32	ICSN-332	KL-34L	AAL-18-5/64
MCLNR 16 3D	1.000	1.000	6.000	1.000	1.250	CN.. 322 CN.. 09T308	CK-6	STC-5	AAL-16-3/32	ICSN-332	KL-34L	AAL-18-5/64
MCLNR 16 4C	1.000	1.000	5.000	1.200	1.250	CN.. 432 CN.. 120408	CK-20	STC-20	AAL-14-1/8	ICSN-433	KL-46	AAL-16-3/32
MCLNR 16 4D	1.000	1.000	6.000	1.200	1.250	CN.. 432 CN.. 120408	CK-20	STC-20	AAL-14-1/8	ICSN-433	KL-46	AAL-16-3/32
MCLNR 16 5C	1.000	1.000	5.000	1.370	1.250	CN.. 543 CN.. 160612	CK-12	STC-4	AAL-17-5/32	ICSN-533	KL-58	AAL-14-1/8
MCLNR 16 5D	1.000	1.000	6.000	1.370	1.250	CN.. 543 CN.. 160612	CK-12	STC-4	AAL-17-5/32	ICSN-533	KL-58	AAL-14-1/8
MCLNR 16 6C	1.000	1.000	5.000	1.500	1.250	CN.. 643 CN.. 190612	CK-12	STC-4	AAL-17-5/32	ICSN-633	KL-68	AAL-19-9/64
MCLNR 16 6D	1.000	1.000	6.000	1.500	1.250	CN.. 643 CN.. 190612	CK-12	STC-4	AAL-17-5/32	ICSN-633	KL-68	AAL-19-9/64
MCLNR 20 4D	1.250	1.250	6.000	1.200	1.500	CN.. 432 CN.. 120408	CK-20	STC-20	AAL-14-1/8	ICSN-433	KL-46	AAL-16-3/32
MCLNR 20 5D	1.250	1.250	6.000	1.370	1.500	CN.. 543 CN.. 160612	CK-12	STC-4	AAL-17-5/32	ICSN-533	KL-58	AAL-14-1/8
MCLNR 20 6D	1.250	1.250	6.000	1.500	1.500	CN.. 643 CN.. 190612	CK-12	STC-4	AAL-17-5/32	ICSN-633	KL-68	AAL-19-9/64
<b>new</b> MCLNR 20 6E	1.250	1.250	7.000	1.500	1.500	CN.. 643 CN.. 190612	CK-12	STC-4	AAL-17-5/32	ICSN-633	KL-68	AAL-19-9/64
MCLNR 24 4D	1.500	1.500	6.000	1.200	2.000	CN.. 432 CN.. 120408	CK-20	STC-20	AAL-14-1/8	ICSN-433	KL-46	AAL-16-3/32
<b>new</b> MCLNR 24 4E	1.500	1.500	7.000	1.250	2.000	CN.. 432 CN.. 120408	CK-20	STC-20	AAL-14-1/8	ICSN-433	KL-46	AAL-16-3/32
MCLNR 24 5D	1.500	1.500	6.000	1.370	2.000	CN.. 543 CN.. 160612	CK-12	STC-4	AAL-17-5/32	ICSN-533	KL-58	AAL-14-1/8
MCLNR 24 5E	1.500	1.500	7.000	1.370	2.000	CN.. 543 CN.. 160612	CK-12	STC-4	AAL-17-5/32	ICSN-533	KL-58	AAL-14-1/8

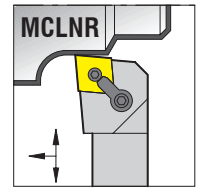
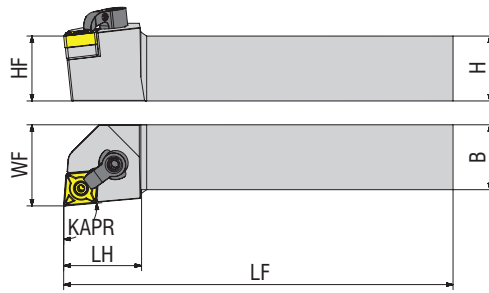
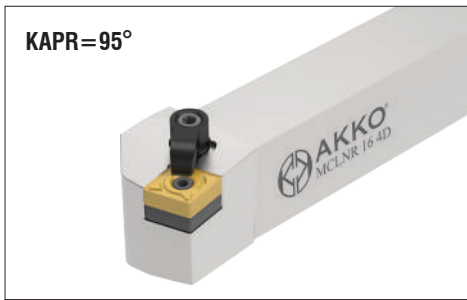

Illustrations shown may vary from actual product.

Dimensions in Inch



Ordering Code	HF=H	B	LF	LH	WF	Insert Inch/Metric	Wedge Clamp	Clamp Screw	Allen Key	Shim	Lock Pin	Allen Key
MCLNR 24 6D	1.500	1.500	6.000	1.500	2.000	CN.. 643 CN.. 190612	CK-12	STC-4	AAL-17-5/32	ICSN-633	KL-68	AAL-19-9/64
MCLNR 24 6E	1.500	1.500	7.000	1.500	2.000	CN.. 643 CN.. 190612	CK-12	STC-4	AAL-17-5/32	ICSN-633	KL-68	AAL-19-9/64
MCLNR 24 8E	1.500	1.500	7.000	1.500	2.000	CN.. 866 CN.. 250924	CK-24	STC-19	AAL-15-3/16	ICSN-846	KL-810	AAL-17-5/32
MCLNR 32 6F	2.000	2.000	8.000	1.500	2.500	CN.. 643 CN.. 190612	CK-12	STC-4	AAL-17-5/32	ICSN-633	KL-68	AAL-19-9/64
MCLNR 85 4D	1.250	1.000	6.000	1.200	1.250	CN.. 432 CN.. 120408	CK-20	STC-20	AAL-14-1/8	ICSN-433	KL-46	AAL-16-3/32
MCLNR 85 6D	1.250	1.000	6.000	1.500	1.250	CN.. 643 CN.. 190612	CK-12	STC-4	AAL-17-5/32	ICSN-633	KL-68	AAL-19-9/64
<b>NEW</b> MCLNR 86 5E	1.500	1.000	7.000	1.375	1.250	CN.. 543 CN.. 160612	CK-12	STC-4	AAL-17-5/32	ICSN-533	KL-58	AAL-14-1/8
MCLNR 86 6E	1.500	1.000	7.000	1.500	1.250	CN.. 643 CN.. 190612	CK-12	STC-4	AAL-17-5/32	ICSN-633	KL-68	AAL-19-9/64
MCLNL 08 3A	0.500	0.500	4.000	1.000	0.750	CN.. 322 CN.. 09T308	CK-6	STC-5	AAL-16-3/32	-	KL-33	AAL-18-5/64
MCLNL 10 3A	0.625	0.625	4.000	1.000	0.875	CN.. 322 CN.. 09T308	CK-6	STC-5	AAL-16-3/32	-	KL-33	AAL-18-5/64
<b>NEW</b> MCLNL 10 4B	0.625	0.625	4.500	1.250	0.875	CN.. 432 CN.. 120408	CK-20	STC-20	AAL-14-1/8	ICSN-433	KL-46	AAL-16-3/32
MCLNL 12 3B	0.750	0.750	4.500	1.000	1.000	CN.. 322 CN.. 09T308	CK-6	STC-5	AAL-16-3/32	ICSN-332	KL-34L	AAL-18-5/64
MCLNL 12 4A	0.750	0.750	4.000	1.200	1.000	CN.. 432 CN.. 120408	CK-20	STC-20	AAL-14-1/8	ICSN-433	KL-46	AAL-16-3/32
MCLNL 12 4B	0.750	0.750	4.500	1.200	1.000	CN.. 432 CN.. 120408	CK-20	STC-20	AAL-14-1/8	ICSN-433	KL-46	AAL-16-3/32
<b>NEW</b> MCLNL 16 3C	1.000	1.000	5.000	1.000	1.250	CN.. 322 CN.. 090308	CK-6	STC-5	AAL-16-3/32	ICSN-332	KL-34L	AAL-18-5/64
MCLNL 16 4C	1.000	1.000	5.000	1.200	1.250	CN.. 432 CN.. 120408	CK-20	STC-20	AAL-14-1/8	ICSN-433	KL-46	AAL-16-3/32
MCLNL 16 4D	1.000	1.000	6.000	1.200	1.250	CN.. 432 CN.. 120408	CK-20	STC-20	AAL-14-1/8	ICSN-433	KL-46	AAL-16-3/32
MCLNL 16 5C	1.000	1.000	5.000	1.370	1.250	CN.. 543 CN.. 160612	CK-12	STC-4	AAL-17-5/32	ICSN-533	KL-58	AAL-14-1/8
MCLNL 16 5D	1.000	1.000	6.000	1.370	1.250	CN.. 543 CN.. 160612	CK-12	STC-4	AAL-17-5/32	ICSN-533	KL-58	AAL-14-1/8
MCLNL 16 6C	1.000	1.000	5.000	1.500	1.250	CN.. 643 CN.. 190612	CK-12	STC-4	AAL-17-5/32	ICSN-633	KL-68	AAL-19-9/64
MCLNL 16 6D	1.000	1.000	6.000	1.500	1.250	CN.. 643 CN.. 190612	CK-12	STC-4	AAL-17-5/32	ICSN-633	KL-68	AAL-19-9/64

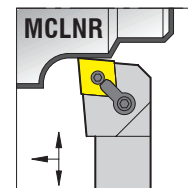
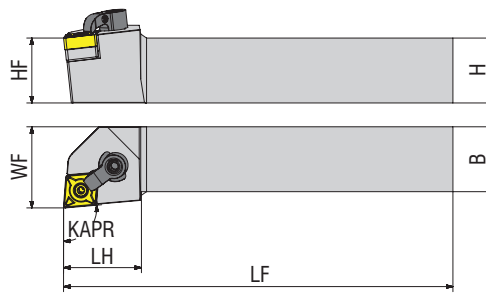

Illustrations shown may vary from actual product.

Dimensions in Inch



Ordering Code	HF=H	B	LF	LH	WF	Insert Inch/Metric	Wedge Clamp	Clamp Screw	Allen Key	Shim	Lock Pin	Allen Key
MCLNL 20 4D	1.250	1.250	6.000	1.200	1.500	CN.. 432 CN.. 120408	CK-20	STC-20	AAL-14-1/8	ICSN-433	KL-46	AAL-16-3/32
<b>new</b> MCLNL 20 5D	1.250	1.250	6.000	1.375	1.500	CN.. 543 CN.. 160612	CK-12	STC-4	AAL-17-5/32	ICSN-533	KL-58	AAL-14-1/8
<b>new</b> MCLNL 20 6D	1.250	1.250	6.000	1.500	1.500	CN.. 643 CN.. 190612	CK-12	STC-4	AAL-17-5/32	ICSN-633	KL-68	AAL-19-9/64
<b>new</b> MCLNL 20 6E	1.250	1.250	7.000	1.500	1.500	CN.. 643 CN.. 190612	CK-12	STC-4	AAL-17-5/32	ICSN-633	KL-68	AAL-19-9/64
MCLNL 24 4D	1.500	1.500	6.000	1.200	2.000	CN.. 432 CN.. 120408	CK-20	STC-20	AAL-14-1/8	ICSN-433	KL-46	AAL-16-3/32
<b>new</b> MCLNL 24 4E	1.500	1.500	7.000	1.250	2.000	CN.. 432 CN.. 120408	CK-20	STC-20	AAL-14-1/8	ICSN-433	KL-46	AAL-16-3/32
MCLNL 24 5D	1.500	1.500	6.000	1.370	2.000	CN.. 543 CN.. 160612	CK-12	STC-4	AAL-17-5/32	ICSN-533	KL-58	AAL-14-1/8
MCLNL 24 5E	1.500	1.500	7.000	1.370	2.000	CN.. 543 CN.. 160612	CK-12	STC-4	AAL-17-5/32	ICSN-533	KL-58	AAL-14-1/8
MCLNL 24 6D	1.500	1.500	6.000	1.500	2.000	CN.. 643 CN.. 190612	CK-12	STC-4	AAL-17-5/32	ICSN-633	KL-68	AAL-19-9/64
MCLNL 24 6E	1.500	1.500	7.000	1.500	2.000	CN.. 643 CN.. 190612	CK-12	STC-4	AAL-17-5/32	ICSN-633	KL-68	AAL-19-9/64
MCLNL 24 8E	1.500	1.500	7.000	1.500	2.000	CN.. 866 CN.. 250924	CK-24	STC-19	AAL-15-3/16	ICSN-846	KL-810	AAL-17-5/32
MCLNL 32 6F	2.000	2.000	8.000	1.500	2.500	CN.. 643 CN.. 190612	CK-12	STC-4	AAL-17-5/32	ICSN-633	KL-68	AAL-19-9/64
MCLNL 85 4D	1.250	1.000	6.000	1.200	1.250	CN.. 432 CN.. 120408	CK-20	STC-20	AAL-14-1/8	ICSN-433	KL-46	AAL-16-3/32
<b>new</b> MCLNL 85 6D	1.250	1.000	6.000	1.500	1.250	CN.. 643 CN.. 190612	CK-12	STC-4	AAL-17-5/32	ICSN-633	KL-68	AAL-19-9/64
<b>new</b> MCLNL 86 5E	1.500	1.000	7.000	1.375	1.250	CN.. 543 CN.. 160612	CK-12	STC-4	AAL-17-5/32	ICSN-533	KL-58	AAL-14-1/8
MCLNL 86 6E	1.500	1.000	7.000	1.500	1.250	CN.. 643 CN.. 190612	CK-12	STC-4	AAL-17-5/32	ICSN-633	KL-68	AAL-19-9/64



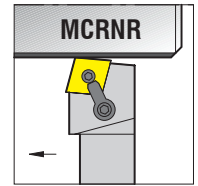
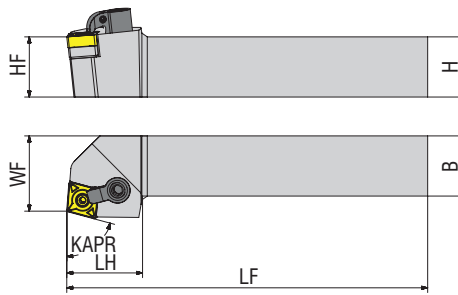

Illustrations shown may vary from actual product.

Dimensions in Inch



Ordering Code	HF=H	B	LF	LH	WF	Insert Inch/Metric	Wedge Clamp	Clamp Screw	Allen Key	Shim	Lock Pin	Allen Key
MCRNR 12 4B	0.750	0.750	4.500	1.260	0.751	CN.. 432 CN.. 120408	CK-9	STC-4	AAL-17-5/32	ICSN-433	KL-46	AAL-16-3/32
MCRNR 16 4C	1.000	1.000	5.000	1.260	1.251	CN.. 432 CN.. 120408	CK-9	STC-4	AAL-17-5/32	ICSN-433	KL-46	AAL-16-3/32
MCRNR 16 4D	1.000	1.000	6.000	1.260	1.251	CN.. 432 CN.. 120408	CK-9	STC-4	AAL-17-5/32	ICSN-433	KL-46	AAL-16-3/32
MCRNR 16 5D	1.000	1.000	6.000	1.340	1.251	CN.. 543 CN.. 160612	CK-9	STC-4	AAL-17-5/32	ICSN-533	KL-58	AAL-14-1/8
MCRNR 16 6D	1.000	1.000	6.000	1.500	1.251	CN.. 643 CN.. 190612	CK-12	STC-4	AAL-17-5/32	ICSN-633	KL-68	AAL-19-9/64
MCRNR 20 4D	1.250	1.250	6.000	1.260	1.500	CN.. 432 CN.. 120408	CK-9	STC-4	AAL-17-5/32	ICSN-433	KL-46	AAL-16-3/32
MCRNR 20 5D	1.250	1.250	6.000	1.340	1.501	CN.. 543 CN.. 160612	CK-9	STC-4	AAL-17-5/32	ICSN-533	KL-58	AAL-14-1/8
MCRNR 20 6D	1.250	1.250	6.000	1.500	1.501	CN.. 643 CN.. 190612	CK-12	STC-4	AAL-17-5/32	ICSN-633	KL-68	AAL-19-9/64
MCRNR 24 6D	1.500	1.500	6.000	1.500	2.001	CN.. 643 CN.. 190612	CK-12	STC-4	AAL-17-5/32	ICSN-633	KL-68	AAL-19-9/64
MCRNR 24 6E	1.500	1.500	7.000	1.500	2.001	CN.. 643 CN.. 190612	CK-12	STC-4	AAL-17-5/32	ICSN-633	KL-68	AAL-19-9/64
MCRNL 12 4B	0.750	0.750	4.500	1.260	0.751	CN.. 432 CN.. 120408	CK-9	STC-4	AAL-17-5/32	ICSN-433	KL-46	AAL-16-3/32
MCRNL 16 4C	1.000	1.000	5.000	1.260	1.251	CN.. 432 CN.. 120408	CK-9	STC-4	AAL-17-5/32	ICSN-433	KL-46	AAL-16-3/32
MCRNL 16 4D	1.000	1.000	6.000	1.260	1.251	CN.. 432 CN.. 120408	CK-9	STC-4	AAL-17-5/32	ICSN-433	KL-46	AAL-16-3/32
MCRNL 16 5D	1.000	1.000	6.000	1.340	1.251	CN.. 543 CN.. 160612	CK-9	STC-4	AAL-17-5/32	ICSN-533	KL-58	AAL-14-1/8
MCRNL 16 6D	1.000	1.000	6.000	1.500	1.251	CN.. 643 CN.. 190612	CK-12	STC-4	AAL-17-5/32	ICSN-633	KL-68	AAL-19-9/64
MCRNL 20 4D	1.250	1.250	6.000	1.260	1.500	CN.. 432 CN.. 120408	CK-9	STC-4	AAL-17-5/32	ICSN-433	KL-46	AAL-16-3/32
MCRNL 20 5D	1.250	1.250	6.000	1.340	1.501	CN.. 543 CN.. 160612	CK-9	STC-4	AAL-17-5/32	ICSN-533	KL-58	AAL-14-1/8
MCRNL 20 6D	1.250	1.250	6.000	1.500	1.501	CN.. 643 CN.. 190612	CK-12	STC-4	AAL-17-5/32	ICSN-633	KL-68	AAL-19-9/64
MCRNL 24 6D	1.500	1.500	6.000	1.500	2.001	CN.. 643 CN.. 190612	CK-12	STC-4	AAL-17-5/32	ICSN-633	KL-68	AAL-19-9/64
MCRNL 24 6E	1.500	1.500	7.000	1.500	2.001	CN.. 643 CN.. 190612	CK-12	STC-4	AAL-17-5/32	ICSN-633	KL-68	AAL-19-9/64



Illustrations shown may vary from actual product.

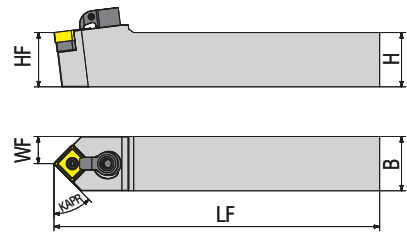

Dimensions in Inch												
Ordering Code	HF=H	B	LF	LH	WF	Insert Inch/Metric	Wedge Clamp	Clamp Screw	Allen Key	Shim	Lock Pin	Allen Key
MCMNN 12 4B	0.750	0.750	4.500	1.500	0.750	CN.. 432 CN.. 120408	CK-20	STC-20	AAL-14-1/8	ICSN-433	KL-46	AAL-16-3/32
MCMNN 16 4D	1.000	1.000	6.000	1.500	1.000	CN.. 432 CN.. 120408	CK-20	STC-20	AAL-14-1/8	ICSN-433	KL-46	AAL-16-3/32
MCMNN 16 5D	1.000	1.000	6.000	1.750	1.000	CN.. 543 CN.. 160612	CK-12	STC-4	AAL-17-5/32	ICSN-533	KL-58	AAL-14-1/8
MCMNN 16 6D	1.000	1.000	6.000	2.000	1.000	CN.. 643 CN.. 190612	CK-12	STC-4	AAL-17-5/32	ICSN-633	KL-68	AAL-19-9/64
MCMNN 20 5D	1.250	1.250	6.000	1.750	1.500	CN.. 543 CN.. 160612	CK-12	STC-4	AAL-17-5/32	ICSN-533	KL-58	AAL-14-1/8
MCMNN 20 6D	1.250	1.250	6.000	2.000	1.250	CN.. 643 CN.. 190612	CK-12	STC-4	AAL-17-5/32	ICSN-633	KL-68	AAL-19-9/64



Illustrations shown may vary from actual product.

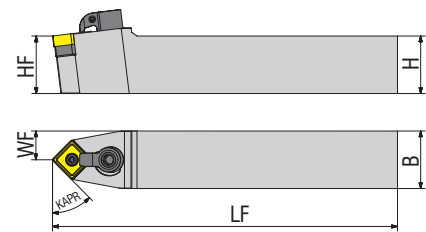

Dimensions in Inch												
Ordering Code	HF=H	B	LF	LH	WF	Insert Inch/Metric	Wedge Clamp	Clamp Screw	Allen Key	Shim	Lock Pin	Allen Key
MCZNN 12 4B	0.750	0.750	4.500	1.375	0.750	CN.. 432 CN.. 120408	CK-20	STC-20	AAL-14-1/8	ICSN-433	KL-46	AAL-16-3/32
MCZNN 16 4D	1.000	1.000	6.000	1.375	1.000	CN.. 432 CN.. 120408	CK-20	STC-20	AAL-14-1/8	ICSN-433	KL-46	AAL-16-3/32
MCZNN 16 5D	1.000	1.000	6.000	1.625	1.000	CN.. 543 CN.. 160612	CK-12	STC-4	AAL-17-5/32	ICSN-533	KL-58	AAL-14-1/8
MCZNN 16 6D	1.000	1.000	6.000	1.750	1.000	CN.. 643 CN.. 190612	CK-12	STC-4	AAL-17-5/32	ICSN-633	KL-68	AAL-19-9/64
MCZNN 20 6D	1.250	1.250	6.000	1.750	1.250	CN.. 643 CN.. 190612	CK-12	STC-4	AAL-17-5/32	ICSN-633	KL-68	AAL-19-9/64
MCZNN 24 6E	1.500	1.500	7.000	1.750	1.500	CN.. 643 CN.. 190612	CK-12	STC-4	AAL-17-5/32	ICSN-633	KL-68	AAL-19-9/64
MCZNN 85 4D	1.250	1.000	6.000	1.375	1.250	CN.. 432 CN.. 120408	CK-20	STC-20	AAL-14-1/8	ICSN-433	KL-46	AAL-16-3/32

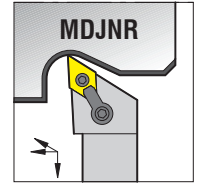
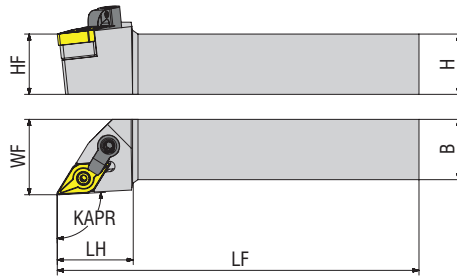

Illustrations shown may vary from actual product.

Dimensions in Inch



Ordering Code	HF=H	B	LF	LH	WF	Insert Inch/Metric	Wedge Clamp	Clamp Screw	Allen Key	Shim	Lock Pin	Allen Key
<b>new</b> MDJNR 10 3B	0.625	0.625	4.500	1.250	0.875	DN.. 332 DN.. 110408	CK-7	STC-5	AAL-16-3/32	IDSN-322	KL-34L	AAL-18-5/64
MDJNR 12 3B	0.750	0.750	4.500	1.260	1.000	DN.. 332 DN.. 110408	CK-7	STC-5	AAL-16-3/32	IDSN-322	KL-34L	AAL-18-5/64
MDJNR 12 4A	0.750	0.750	4.000	1.380	1.000	DN.. 432 DN.. 150408	CK-23	STC-20	AAL-14-1/8	IDSN-443	KL-46L	AAL-16-3/32
MDJNR 12 4B	0.750	0.750	4.500	1.380	1.000	DN.. 432 DN.. 150408	CK-23	STC-20	AAL-14-1/8	IDSN-443	KL-46L	AAL-16-3/32
MDJNR 16 3C	1.000	1.000	5.000	1.260	1.250	DN.. 332 DN.. 110408	CK-7	STC-5	AAL-16-3/32	IDSN-322	KL-34L	AAL-18-5/64
MDJNR 16 3D	1.000	1.000	6.000	1.260	1.250	DN.. 332 DN.. 110408	CK-7	STC-5	AAL-16-3/32	IDSN-322	KL-34L	AAL-18-5/64
MDJNR 16 4C	1.000	1.000	5.000	1.260	1.250	DN.. 432 DN.. 150408	CK-20	STC-20	AAL-14-1/8	IDSN-443	KL-46L	AAL-16-3/32
MDJNR 16 4D	1.000	1.000	6.000	1.260	1.250	DN.. 432 DN.. 150408	CK-20	STC-20	AAL-14-1/8	IDSN-443	KL-46L	AAL-16-3/32
<b>new</b> MDJNR 16 5C	1.000	1.000	5.000	1.750	1.250	DN.. 543 DN.. 190612	CK-12	STC-4	AAL-17-5/32	IDSN-533	KL-58	AAL-14-1/8
MDJNR 16 5D	1.000	1.000	6.000	1.470	1.250	DN.. 543 DN.. 190612	CK-12	STC-4	AAL-17-5/32	IDSN-533	KL-58	AAL-14-1/8
MDJNR 20 3D	1.250	1.250	6.000	1.260	1.500	DN.. 332 DN.. 110408	CK-7	STC-5	AAL-16-3/32	IDSN-322	KL-34L	AAL-18-5/64
MDJNR 20 4D	1.250	1.250	6.000	1.260	1.500	DN.. 432 DN.. 150408	CK-20	STC-20	AAL-14-1/8	IDSN-443	KL-46L	AAL-16-3/32
MDJNR 20 5D	1.250	1.250	6.000	1.470	1.500	DN.. 543 DN.. 190612	CK-12	STC-4	AAL-17-5/32	IDSN-533	KL-58	AAL-14-1/8
<b>new</b> MDJNR 24 4D	1.500	1.500	6.000	1.250	2.000	DN.. 432 DN.. 150408	CK-20	STC-20	AAL-14-1/8	IDSN-443	KL-46L	AAL-16-3/32
<b>new</b> MDJNR 24 4E	1.500	1.500	7.000	1.250	2.000	DN.. 432 DN.. 150408	CK-20	STC-20	AAL-14-1/8	IDSN-443	KL-46L	AAL-16-3/32
MDJNR 24 5D	1.500	1.500	6.000	1.470	2.000	DN.. 543 DN.. 190612	CK-12	STC-4	AAL-17-5/32	IDSN-533	KL-58	AAL-14-1/8
MDJNR 24 5E	1.500	1.500	7.000	1.470	2.000	DN.. 543 DN.. 190612	CK-12	STC-4	AAL-17-5/32	IDSN-533	KL-58	AAL-14-1/8
MDJNR 85 4D	1.250	1.000	6.000	1.260	1.250	DN.. 432 DN.. 150408	CK-20	STC-20	AAL-14-1/8	IDSN-443	KL-46L	AAL-16-3/32
<b>new</b> MDJNR 86 5E	1.500	1.000	7.000	1.750	1.250	DN.. 543 DN.. 190612	CK-12	STC-4	AAL-17-5/32	IDSN-533	KL-58	AAL-14-1/8

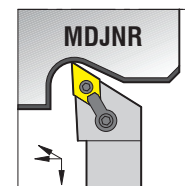
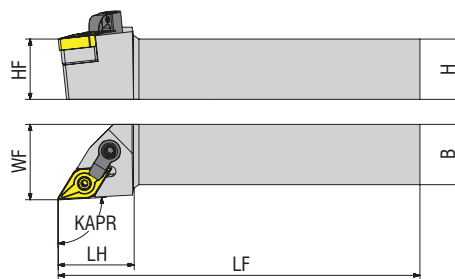

Illustrations shown may vary from actual product.

Dimensions in Inch



Ordering Code	HF=H	B	LF	LH	WF	Insert Inch/Metric	Wedge Clamp	Clamp Screw	Allen Key	Shim	Lock Pin	Allen Key
<b>new</b> MDJNL 10 3B	0.625	0.625	4.500	1.250	0.875	DN.. 332 DN.. 110408	CK-7	STC-5	AAL-16-3/32	IDSN-322	KL-34L	AAL-18-5/64
MDJNL 12 3B	0.750	0.750	4.500	1.260	1.000	DN.. 332 DN.. 110408	CK-7	STC-5	AAL-16-3/32	IDSN-322	KL-34L	AAL-18-5/64
MDJNL 12 4A	0.750	0.750	4.000	1.380	1.000	DN.. 432 DN.. 150408	CK-23	STC-20	AAL-14-1/8	IDSN-443	KL-46L	AAL-16-3/32
MDJNL 12 4B	0.750	0.750	4.500	1.380	1.000	DN.. 432 DN.. 150408	CK-23	STC-20	AAL-14-1/8	IDSN-443	KL-46L	AAL-16-3/32
MDJNL 16 3C	1.000	1.000	5.000	1.260	1.250	DN.. 332 DN.. 110408	CK-7	STC-5	AAL-16-3/32	IDSN-322	KL-34L	AAL-18-5/64
MDJNL 16 3D	1.000	1.000	6.000	1.260	1.250	DN.. 332 DN.. 110408	CK-7	STC-5	AAL-16-3/32	IDSN-322	KL-34L	AAL-18-5/64
MDJNL 16 4C	1.000	1.000	5.000	1.260	1.250	DN.. 432 DN.. 150408	CK-20	STC-20	AAL-14-1/8	IDSN-443	KL-46L	AAL-16-3/32
MDJNL 16 4D	1.000	1.000	6.000	1.260	1.250	DN.. 432 DN.. 150408	CK-20	STC-20	AAL-14-1/8	IDSN-443	KL-46L	AAL-16-3/32
<b>new</b> MDJNL 16 5C	1.000	1.000	5.000	1.750	1.250	DN.. 543 DN.. 190612	CK-12	STC-4	AAL-17-5/32	IDSN-533	KL-58	AAL-14-1/8
<b>new</b> MDJNL 16 5D	1.000	1.000	6.000	1.750	1.250	DN.. 543 DN.. 190612	CK-12	STC-4	AAL-17-5/32	IDSN-533	KL-58	AAL-14-1/8
MDJNL 20 3D	1.250	1.250	6.000	1.260	1.500	DN.. 332 DN.. 110408	CK-7	STC-5	AAL-16-3/32	IDSN-322	KL-34L	AAL-18-5/64
MDJNL 20 4D	1.250	1.250	6.000	1.260	1.500	DN.. 432 DN.. 150408	CK-20	STC-20	AAL-14-1/8	IDSN-443	KL-46L	AAL-16-3/32
MDJNL 20 5D	1.250	1.250	6.000	1.470	1.500	DN.. 543 DN.. 190612	CK-12	STC-4	AAL-17-5/32	IDSN-533	KL-58	AAL-14-1/8
<b>new</b> MDJNL 24 4D	1.500	1.500	6.000	1.250	2.000	DN.. 432 DN.. 120408	CK-20	STC-20	AAL-14-1/8	IDSN-443	KL-46L	AAL-16-3/32
<b>new</b> MDJNL 24 4E	1.500	1.500	7.000	1.250	2.000	DN.. 432 DN.. 150408	CK-20	STC-20	AAL-14-1/8	IDSN-443	KL-46L	AAL-16-3/32
MDJNL 24 5D	1.500	1.500	6.000	1.470	2.000	DN.. 543 DN.. 190612	CK-12	STC-4	AAL-17-5/32	IDSN-533	KL-58	AAL-14-1/8
MDJNL 24 5E	1.500	1.500	7.000	1.470	2.000	DN.. 543 DN.. 190612	CK-12	STC-4	AAL-17-5/32	IDSN-533	KL-58	AAL-14-1/8
<b>new</b> MDJNL 85 4D	1.250	1.000	6.000	1.250	1.250	DN.. 432 DN.. 150408	CK-20	STC-20	AAL-14-1/8	IDSN-443	KL-46L	AAL-16-3/32
<b>new</b> MDJNL 86 5E	1.500	1.000	7.000	1.750	1.250	DN.. 543 DN.. 190612	CK-12	STC-4	AAL-17-5/32	IDSN-533	KL-58	AAL-14-1/8



Illustrations shown may vary from actual product.

Dimensions in Inch

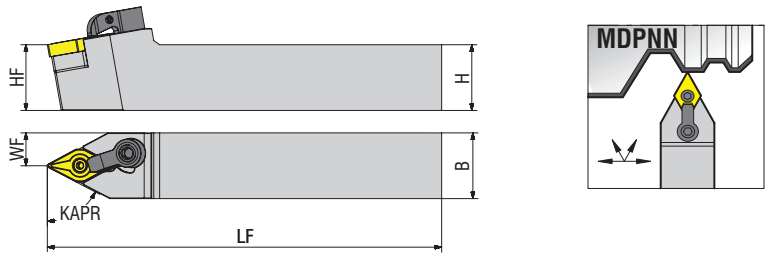

Ordering Code	HF=H	B	LF	LH	WF	Insert Inch/Metric	Wedge Clamp	Clamp Screw	Allen Key	Shim	Lock Pin	Allen Key
MDPNN 12 3B	0.750	0.750	4.500	1.500	0.375	DN.. 332 DN.. 110408	CK-7	STC-5	AAL-16-3/32	IDSN-322	KL-34L	AAL-18-5/64
<b>NEW</b> MDPNN 12 4B	0.750	0.750	4.500	1.750	0.750	DN.. 432 DN.. 150408	CK-23	STC-20	AAL-14-1/8	IDSN-443	KL-46L	AAL-16-3/32
MDPNN 16 3D	1.000	1.000	6.000	1.500	0.500	DN.. 332 DN.. 110408	CK-7	STC-5	AAL-16-3/32	IDSN-322	KL-34L	AAL-18-5/64
MDPNN 16 4D	1.000	1.000	6.000	1.630	0.500	DN.. 432 DN.. 150408	CK-12	STC-4	AAL-17-5/32	IDSN-443	KL-46L	AAL-16-3/32
<b>NEW</b> MDPNN 16 5D	1.000	1.000	6.000	2.000	1.000	DN.. 543 DN.. 190612	CK-12	STC-4	AAL-17-5/32	IDSN-533	KL-58	AAL-14-1/8
<b>NEW</b> MDPNN 20 4D	1.250	1.250	6.000	1.750	1.250	DN.. 432 DN.. 150408	CK-20	STC-20	AAL-14-1/8	IDSN-443	KL-46L	AAL-16-3/32
MDPNN 20 5D	1.250	1.250	6.000	1.920	0.625	DN.. 543 DN.. 190612	CK-12	STC-4	AAL-17-5/32	IDSN-533	KL-58	AAL-14-1/8
MDPNN 24 5D	1.500	1.500	6.000	1.920	0.750	DN.. 543 DN.. 190612	CK-12	STC-4	AAL-17-5/32	IDSN-533	KL-58	AAL-14-1/8



Illustrations shown may vary from actual product.

Dimensions in Inch

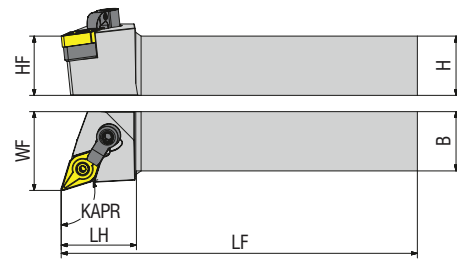

Ordering Code	HF=H	B	LF	LH	WF	Insert Inch/Metric	Wedge Clamp	Clamp Screw	Allen Key	Shim	Lock Pin	Allen Key
MDHNR 12 4B	0.750	0.750	4.500	1.370	1.000	DN.. 432 DN.. 150408	CK-23	STC-20	AAL-14-1/8	IDSN-443	KL-46L	AAL-16-3/32
MDHNR 16 4C	1.000	1.000	5.000	1.370	1.250	DN.. 432 DN.. 150408	CK-20	STC-20	AAL-14-1/8	IDSN-443	KL-46L	AAL-16-3/32
MDHNR 16 4D	1.000	1.000	6.000	1.370	1.250	DN.. 432 DN.. 150408	CK-20	STC-20	AAL-14-1/8	IDSN-443	KL-46L	AAL-16-3/32
MDHNR 20 4D	1.250	1.250	6.000	1.370	1.500	DN.. 432 DN.. 150408	CK-20	STC-20	AAL-14-1/8	IDSN-443	KL-46L	AAL-16-3/32
MDHNR 20 5D	1.250	1.250	6.000	1.470	1.500	DN.. 543 DN.. 190612	CK-12	STC-4	AAL-17-5/32	IDSN-533	KL-58	AAL-14-1/8
MDHNR 24 4D	1.500	1.500	6.000	1.370	2.000	DN.. 432 DN.. 150408	CK-20	STC-20	AAL-14-1/8	IDSN-443	KL-46L	AAL-16-3/32
MDHNR 24 5E	1.500	1.500	7.000	1.470	2.000	DN.. 543 DN.. 190612	CK-12	STC-4	AAL-17-5/32	IDSN-533	KL-58	AAL-14-1/8
MDHNL 12 4B	0.750	0.750	4.500	1.370	1.000	DN.. 432 DN.. 150408	CK-20	STC-20	AAL-14-1/8	IDSN-443	KL-46L	AAL-16-3/32
MDHNL 16 4C	1.000	1.000	5.000	1.370	1.250	DN.. 432 DN.. 150408	CK-20	STC-20	AAL-14-1/8	IDSN-443	KL-46L	AAL-16-3/32
MDHNL 16 4D	1.000	1.000	6.000	1.370	1.250	DN.. 432 DN.. 150408	CK-20	STC-20	AAL-14-1/8	IDSN-443	KL-46L	AAL-16-3/32
MDHNL 20 4D	1.250	1.250	6.000	1.370	1.500	DN.. 432 DN.. 150408	CK-20	STC-20	AAL-14-1/8	IDSN-443	KL-46L	AAL-16-3/32
MDHNL 20 5D	1.250	1.250	6.000	1.470	1.500	DN.. 543 DN.. 190612	CK-12	STC-4	AAL-17-5/32	IDSN-533	KL-58	AAL-14-1/8
MDHNL 24 4D	1.500	1.500	6.000	1.370	2.000	DN.. 432 DN.. 150408	CK-20	STC-20	AAL-14-1/8	IDSN-443	KL-46L	AAL-16-3/32
MDHNL 24 5E	1.500	1.500	7.000	1.470	2.000	DN.. 543 DN.. 190612	CK-12	STC-4	AAL-17-5/32	IDSN-533	KL-58	AAL-14-1/8

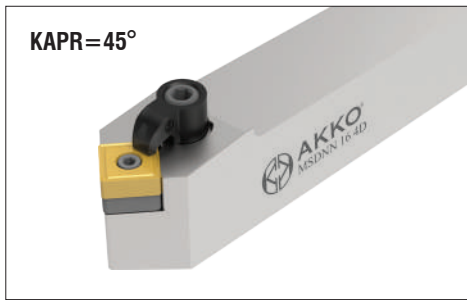

Illustrations shown may vary from actual product.

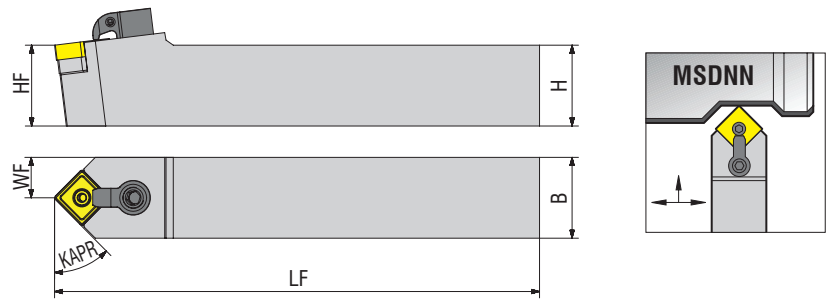

Dimensions in Inch



Ordering Code	HF=H	B	LF	LH	WF	Insert Inch/Metric	Wedge Clamp	Clamp Screw	Allen Key	Shim	Lock Pin	Allen Key
<b>new</b> MSDNN 08 3A	0.500	0.500	4.000	1.000	0.250	SN.. 322 SN.. 090308	CK-6	STC-5	AAL-16-3/32	ISSN-322	KL-34	AAL-18-5/64
MSDNN 08 3B	0.500	0.500	4.500	1.140	0.250	SN.. 322 SN.. 090308	CK-6	STC-5	AAL-16-3/32	ISSN-322	KL-34	AAL-18-5/64
MSDNN 10 3B	0.625	0.625	4.500	1.140	0.312	SN.. 322 SN.. 090308	CK-6	STC-5	AAL-16-3/32	ISSN-322	KL-34	AAL-18-5/64
MSDNN 12 3B	0.750	0.750	4.500	1.140	0.375	SN.. 322 SN.. 090308	CK-6	STC-5	AAL-16-3/32	ISSN-322	KL-34	AAL-18-5/64
MSDNN 12 4B	0.750	0.750	4.500	1.390	0.375	SN.. 432 SN.. 120408	CK-9	STC-4	AAL-17-5/32	ISSN-433	KL-46	AAL-16-3/32
MSDNN 16 4D	1.000	1.000	6.000	1.390	0.500	SN.. 432 SN.. 120408	CK-9	STC-4	AAL-17-5/32	ISSN-433	KL-46	AAL-16-3/32
<b>new</b> MSDNN 16 5D	1.000	1.000	6.000	1.625	1.000	SN.. 543 SN.. 150612	CK-12	STC-4	AAL-17-5/32	ISSN-533	KL-58	AAL-14-1/8
<b>new</b> MSDNN 16 6D	1.000	1.000	6.000	1.750	1.000	SN.. 643 SN.. 190612	CK-12	STC-4	AAL-17-5/32	ISSN-633	KL-68	AAL-19-9/64
<b>new</b> MSDNN 20 5D	1.250	1.250	6.000	1.625	1.250	SN.. 543 SN.. 150612	CK-12	STC-4	AAL-17-5/32	ISSN-533	KL-58	AAL-14-1/8
<b>new</b> MSDNN 20 6D	1.250	1.250	6.000	1.750	1.250	SN.. 643 SN.. 190612	CK-12	STC-4	AAL-17-5/32	ISSN-633	KL-68	AAL-19-9/64
MSDNN 20 6E	1.250	1.250	7.000	1.680	0.625	SN.. 643 SN.. 190612	CK-12	STC-4	AAL-17-5/32	ISSN-633	KL-68	AAL-19-9/64
MSDNN 24 6E	1.500	1.500	7.000	1.680	0.750	SN.. 643 SN.. 190612	CK-12	STC-4	AAL-17-5/32	ISSN-633	KL-68	AAL-19-9/64
<b>new</b> MSDNN 24 8E	1.500	1.500	7.000	2.200	0.750	SN.. 866 SN.. 250924	CK-24	STC-19	AAL-15-3/16	ISSN-846	KL-810	AAL-17-5/32
MSDNN 85 4D	1.250	1.000	6.000	1.390	0.500	SN.. 432 SN.. 120408	CK-9	STC-4	AAL-17-5/32	ISSN-433	KL-46	AAL-16-3/32
MSDNN 85 5D	1.250	1.000	6.000	1.620	0.500	SN.. 543 SN.. 150612	CK-12	STC-4	AAL-17-5/32	ISSN-533	KL-58	AAL-14-1/8
MSDNN 85 6D	1.250	1.000	6.000	1.620	0.500	SN.. 643 SN.. 190612	CK-12	STC-4	AAL-17-5/32	ISSN-633	KL-68	AAL-19-9/64
<b>new</b> MSDNN 86 5E	1.500	1.000	7.000	1.625	1.500	SN.. 543 SN.. 150612	CK-12	STC-4	AAL-17-5/32	ISSN-533	KL-58	AAL-14-1/8
<b>new</b> MSDNN 86 6E	1.500	1.000	7.000	1.750	1.500	SN.. 643 SN.. 190612	CK-12	STC-4	AAL-17-5/32	ISSN-633	KL-68	AAL-19-9/64

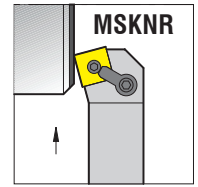
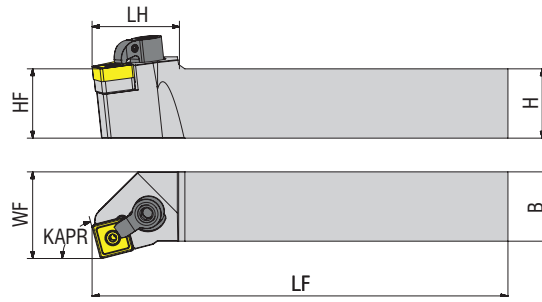

Illustrations shown may vary from actual product.

Dimensions in Inch



Ordering Code	HF=H	B	LF	LH	WF	Insert Inch/Metric	Wedge Clamp	Clamp Screw	Allen Key	Shim	Lock Pin	Allen Key
<b>NEW</b> MSKNR 08 3A	0.500	0.500	4.000	1.000	0.625	SN.. 322 SN.. 090308	CK-6	STC-5	AAL-16-3/32	ISSN-322	KL-34	AAL-18-5/64
<b>NEW</b> MSKNR 08 3B	0.500	0.500	4.500	1.000	0.625	SN.. 322 SN.. 090308	CK-6	STC-5	AAL-16-3/32	ISSN-322	KL-34	AAL-18-5/64
<b>NEW</b> MSKNR 10 3B	0.625	0.625	4.500	1.000	0.750	SN.. 322 SN.. 090308	CK-6	STC-5	AAL-16-3/32	ISSN-322	KL-34	AAL-18-5/64
<b>NEW</b> MSKNR 12 3B	0.750	0.750	4.500	1.000	0.875	SN.. 322 SN.. 090308	CK-6	STC-5	AAL-16-3/32	ISSN-322	KL-34	AAL-18-5/64
MSKNR 12 4B	0.750	0.750	4.500	1.260	1.000	SN.. 432 SN.. 120408	CK-9	STC-4	AAL-17-5/32	ISSN-433	KL-46	AAL-16-3/32
MSKNR 16 4C	1.000	1.000	5.000	1.260	1.250	SN.. 432 SN.. 120408	CK-9	STC-4	AAL-17-5/32	ISSN-433	KL-46	AAL-16-3/32
MSKNR 16 4D	1.000	1.000	6.000	1.260	1.250	SN.. 432 SN.. 120408	CK-9	STC-4	AAL-17-5/32	ISSN-433	KL-46	AAL-16-3/32
<b>NEW</b> MSKNR 16 5D	1.000	1.000	6.000	1.375	1.250	SN.. 543 SN.. 150612	CK-12	STC-4	AAL-17-5/32	ISSN-533	KL-58	AAL-14-1/8
MSKNR 20 5D	1.250	1.250	6.000	1.340	1.500	SN.. 543 SN.. 150612	CK-12	STC-4	AAL-17-5/32	ISSN-533	KL-58	AAL-14-1/8
MSKNR 20 6D	1.250	1.250	6.000	1.500	1.500	SN.. 643 SN.. 190612	CK-12	STC-4	AAL-17-5/32	ISSN-633	KL-68	AAL-19-9/64
<b>NEW</b> MSKNR 24 6D	1.500	1.500	6.000	1.500	2.000	SN.. 643 SN.. 190612	CK-12	STC-4	AAL-17-5/32	ISSN-633	KL-68	AAL-19-9/64
<b>NEW</b> MSKNR 24 6E	1.500	1.500	7.000	1.500	2.000	SN.. 643 SN.. 190612	CK-12	STC-4	AAL-17-5/32	ISSN-633	KL-68	AAL-19-9/64
MSKNR 24 8D	1.500	1.500	8.000	1.620	2.000	SN.. 866 SN.. 250924	CK-24	STC-19	AAL-15-3/16	ISSN-846	KL-810	AAL-17-5/32
<b>NEW</b> MSKNR 24 8F	1.500	1.500	8.000	1.620	1.770	SN.. 866 SN.. 250924	CK-24	STC-19	AAL-17-5/32	ISSN-846	KL-810	AAL-15-3/16
<b>NEW</b> MSKNR 85 5D	1.250	1.000	6.000	1.375	1.250	SN.. 543 SN.. 150612	CK-12	STC-4	AAL-17-5/32	ISSN-533	KL-58	AAL-14-1/8
<b>NEW</b> MSKNL 08 3A	0.500	0.500	4.000	1.000	0.625	SN.. 322 SN.. 090308	CK-6	STC-5	AAL-16-3/32	ISSN-322	KL-34	AAL-18-5/64
<b>NEW</b> MSKNL 08 3B	0.500	0.500	4.500	1.000	0.625	SN.. 322 SN.. 090308	CK-6	STC-5	AAL-16-3/32	ISSN-322	KL-34	AAL-18-5/64
<b>NEW</b> MSKNL 10 3B	0.625	0.625	4.500	1.000	0.750	SN.. 322 SN.. 090308	CK-6	STC-5	AAL-16-3/32	ISSN-322	KL-34	AAL-18-5/64
<b>NEW</b> MSKNL 12 3B	0.750	0.750	4.500	1.000	0.875	SN.. 322 SN.. 090308	CK-6	STC-5	AAL-16-3/32	ISSN-322	KL-34	AAL-18-5/64
<b>NEW</b> MSKNL 12 4B	0.750	0.750	4.500	1.250	1.000	SN.. 432 SN.. 120408	CK-9	STC-4	AAL-17-5/32	ISSN-433	KL-46	AAL-16-3/32
<b>NEW</b> MSKNL 16 4C	1.000	1.000	5.000	1.250	1.250	SN.. 432 SN.. 120408	CK-9	STC-4	AAL-17-5/32	ISSN-433	KL-46	AAL-16-3/32
<b>NEW</b> MSKNL 16 4D	1.000	1.000	6.000	1.000	1.250	SN.. 432 SN.. 120408	CK-9	STC-4	AAL-17-5/32	ISSN-433	KL-46	AAL-16-3/32
<b>NEW</b> MSKNL 16 5D	1.000	1.000	6.000	1.375	1.250	SN.. 543 SN.. 150612	CK-12	STC-4	AAL-17-5/32	ISSN-533	KL-58	AAL-14-1/8
MSKNL 20 5D	1.250	1.250	6.000	1.340	1.500	SN.. 543 SN.. 150612	CK-12	STC-4	AAL-17-5/32	ISSN-533	KL-58	AAL-14-1/8
MSKNL 20 6D	1.250	1.250	6.000	1.500	1.500	SN.. 643 SN.. 190612	CK-12	STC-4	AAL-17-5/32	ISSN-633	KL-68	AAL-19-9/64
MSKNL 24 6D	1.500	1.500	6.000	1.500	2.000	SN.. 643 SN.. 190612	CK-12	STC-4	AAL-17-5/32	ISSN-633	KL-68	AAL-19-9/64
<b>NEW</b> MSKNL 24 6E	1.500	1.500	7.000	1.500	2.000	SN.. 643 SN.. 190612	CK-12	STC-4	AAL-17-5/32	ISSN-633	KL-68	AAL-19-9/64
<b>NEW</b> MSKNL 85 5D	1.250	1.000	6.000	1.375	1.250	SN.. 543 SN.. 150612	CK-12	STC-4	AAL-17-5/32	ISSN-533	KL-58	AAL-14-1/8

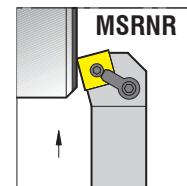
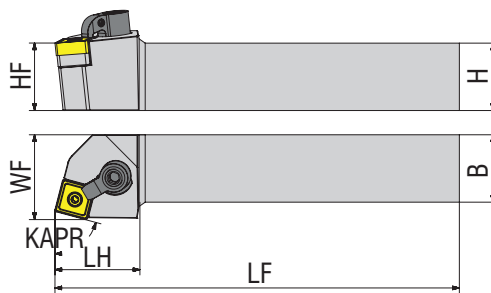

Illustrations shown may vary from actual product.

Dimensions in Inch



Ordering Code	HF=H	B	LF	LH	WF	Insert Inch/Metric	Wedge Clamp	Clamp Screw	Allen Key	Shim	Lock Pin	Allen Key
<b>new</b> MSRNR 08 3A	0.500	0.500	4.000	1.000	0.666	SN.. 322 SN.. 090308	CK-6	STC-5	AAL-16-3/32	ISSN-322	KL-34	AAL-18-5/64
<b>new</b> MSRNR 08 3B	0.500	0.500	4.500	1.000	0.666	SN.. 322 SN.. 090308	CK-6	STC-5	AAL-16-3/32	ISSN-322	KL-34	AAL-18-5/64
<b>new</b> MSRNR 10 3B	0.625	0.625	4.500	1.000	0.875	SN.. 322 SN.. 090308	CK-6	STC-5	AAL-16-3/32	ISSN-322	KL-34	AAL-18-5/64
<b>new</b> MSRNR 12 3B	0.750	0.750	4.500	1.000	0.910	SN.. 322 SN.. 090308	CK-6	STC-5	AAL-16-3/32	ISSN-332	KL-34	AAL-18-5/64
MSRNR 12 4B	0.750	0.750	4.500	1.260	0.880	SN.. 432 SN.. 120408	CK-9	STC-4	AAL-17-5/32	ISSN-433	KL-46	AAL-16-3/32
MSRNR 16 4C	1.000	1.000	5.000	1.260	1.130	SN.. 432 SN.. 120408	CK-9	STC-4	AAL-17-5/32	ISSN-433	KL-46	AAL-16-3/32
MSRNR 16 4D	1.000	1.000	6.000	1.260	1.130	SN.. 432 SN.. 120408	CK-9	STC-4	AAL-17-5/32	ISSN-433	KL-46	AAL-16-3/32
MSRNR 16 5C	1.000	1.000	5.000	1.470	1.103	SN.. 543 SN.. 150612	CK-12	STC-4	AAL-17-5/32	ISSN-533	KL-58	AAL-14-1/8
<b>new</b> MSRNR 16 5D	1.000	1.000	6.000	1.375	1.103	SN.. 543 SN.. 150612	CK-12	STC-4	AAL-17-5/32	ISSN-533	KL-58	AAL-14-1/8
<b>new</b> MSRNR 16 6D	1.000	1.000	6.000	1.500	1.071	SN.. 643 SN.. 190612	CK-12	STC-4	AAL-17-5/32	ISSN-633	KL-68	AAL-19-9/64
<b>new</b> MSRNR 20 4D	1.250	1.250	6.000	1.250	1.380	SN.. 432 SN.. 120408	CK-9	STC-4	AAL-17-5/32	ISSN-433	KL-46	AAL-16-3/32
MSRNR 20 5D	1.250	1.250	6.000	1.470	1.353	SN.. 543 SN.. 150612	CK-12	STC-4	AAL-17-5/32	ISSN-533	KL-58	AAL-14-1/8
MSRNR 20 6D	1.250	1.250	6.000	1.500	1.321	SN.. 643 SN.. 190612	CK-12	STC-4	AAL-17-5/32	ISSN-633	KL-68	AAL-19-9/64
MSRNR 24 6D	1.500	1.500	6.000	1.500	1.821	SN.. 643 SN.. 190612	CK-12	STC-4	AAL-17-5/32	ISSN-633	KL-68	AAL-19-9/64
MSRNR 24 6E	1.500	1.500	7.000	1.500	1.821	SN.. 643 SN.. 190612	CK-12	STC-4	AAL-17-5/32	ISSN-633	KL-68	AAL-19-9/64
MSRNR 24 8F	1.500	1.500	8.000	1.620	1.770	SN.. 866 SN.. 250924	CK-24	STC-19	AAL-15-3/16	ISSN-846	KL-810	AAL-17-5/32
<b>new</b> MSRNR 85 4D	1.250	1.000	6.000	1.250	1.130	SN.. 432 SN.. 120408	CK-9	STC-4	AAL-17-5/32	ISSN-433	KL-46	AAL-16-3/32
<b>new</b> MSRNR 85 5D	1.250	1.000	6.000	1.375	1.103	SN.. 543 SN.. 150612	CK-12	STC-4	AAL-17-5/32	ISSN-533	KL-58	AAL-14-1/8
MSRNR 85 6D	1.250	1.000	6.000	1.500	1.071	SN.. 643 SN.. 190612	CK-12	STC-4	AAL-17-5/32	ISSN-633	KL-68	AAL-19-9/64

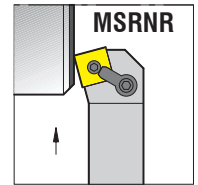
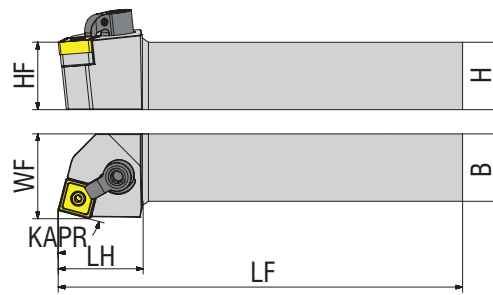

Illustrations shown may vary from actual product.

Dimensions in Inch



Ordering Code	HF=H	B	LF	LH	WF	Insert Inch/Metric	Wedge Clamp	Clamp Screw	Allen Key	Shim	Lock Pin	Allen Key
<b>new</b> MSRNL 08 3A	0.500	0.500	4.000	1.000	0.666	SN.. 322 SN.. 090308	CK-6	STC-5	AAL-16-3/32	ISSN-322	KL-34	AAL-18-5/64
<b>new</b> MSRNL 08 3B	0.500	0.500	4.500	1.000	0.666	SN.. 322 SN.. 090308	CK-6	STC-5	AAL-16-3/32	ISSN-322	KL-34	AAL-18-5/64
<b>new</b> MSRNL 10 3B	0.625	0.625	4.500	1.000	0.785	SN.. 322 SN.. 090308	CK-6	STC-5	AAL-16-3/32	ISSN-322	KL-34	AAL-18-5/64
<b>new</b> MSRNL 12 3B	0.750	0.750	4.500	1.000	0.910	SN.. 322 SN.. 090308	CK-6	STC-5	AAL-16-3/32	ISSN-322	KL-34	AAL-18-5/64
MSRNL 12 4B	0.750	0.750	4.500	1.260	0.880	SN.. 432 SN.. 120408	CK-9	STC-4	AAL-17-5/32	ISSN-433	KL-46	AAL-16-3/32
MSRNL 16 4C	1.000	1.000	5.000	1.260	1.130	SN.. 432 SN.. 120408	CK-9	STC-4	AAL-17-5/32	ISSN-433	KL-46	AAL-16-3/32
MSRNL 16 4D	1.000	1.000	6.000	1.260	1.130	SN.. 432 SN.. 120408	CK-9	STC-4	AAL-17-5/32	ISSN-433	KL-46	AAL-16-3/32
MSRNL 16 5C	1.000	1.000	5.000	1.470	1.103	SN.. 543 SN.. 150612	CK-12	STC-4	AAL-17-5/32	ISSN-533	KL-58	AAL-14-1/8
<b>new</b> MSRNL 16 5D	1.000	1.000	6.000	1.375	1.103	SN.. 543 SN.. 150612	CK-12	STC-4	AAL-17-5/32	ISSN-533	KL-58	AAL-14-1/8
<b>new</b> MSRNL 16 6D	1.000	1.000	6.000	1.500	1.071	SN.. 643 SN.. 190612	CK-12	STC-4	AAL-17-5/32	ISSN-633	KL-68	AAL-19-9/64
MSRNL 20 4D	1.250	1.250	6.000	1.260	1.380	SN.. 432 SN.. 120408	CK-9	STC-4	AAL-17-5/32	ISSN-433	KL-46	AAL-16-3/32
MSRNL 20 5D	1.250	1.250	6.000	1.470	1.353	SN.. 543 SN.. 150612	CK-12	STC-4	AAL-17-5/32	ISSN-533	KL-58	AAL-14-1/8
MSRNL 20 6D	1.250	1.250	6.000	1.500	1.321	SN.. 643 SN.. 190612	CK-12	STC-4	AAL-17-5/32	ISSN-633	KL-68	AAL-19-9/64
<b>new</b> MSRNL 20 8D	1.250	1.250	6.000	1.620	1.321	SN.. 866 SN.. 250924	CK-24	STC-19	AAL-15-3/16	ISSN-846	KL-810	AAL-17-5/32
MSRNL 24 6D	1.500	1.500	6.000	1.500	1.821	SN.. 643 SN.. 190612	CK-12	STC-4	AAL-17-5/32	ISSN-633	KL-68	AAL-19-9/64
MSRNL 24 6E	1.500	1.500	7.000	1.500	1.821	SN.. 643 SN.. 190612	CK-12	STC-4	AAL-17-5/32	ISSN-633	KL-68	AAL-19-9/64
<b>new</b> MSRNL 24 8E	1.500	1.500	7.000	1.620	1.770	SN.. 866 SN.. 250924	CK-24	STC-19	AAL-15-3/16	ISSN-846	KL-810	AAL-17-5/32
<b>new</b> MSRNL 24 8F	1.500	1.500	8.000	1.620	1.770	SN.. 866 SN.. 250924	CK-24	STC-19	AAL-15-3/16	ISSN-846	KL-810	AAL-17-5/32
MSRNL 85 4D	1.250	1.250	6.000	1.260	1.130	SN.. 432 SN.. 120408	CK-9	STC-4	AAL-17-5/32	ISSN-433	KL-46	AAL-16-3/32
<b>new</b> MSRNL 85 5D	1.250	1.000	6.000	1.375	1.103	SN.. 543 SN.. 150612	CK-12	STC-4	AAL-17-5/32	ISSN-533	KL-58	AAL-14-1/8
<b>new</b> MSRNL 85 6D	1.250	1.000	6.000	1.500	1.071	SN.. 643 SN.. 190612	CK-12	STC-4	AAL-17-5/32	ISSN-633	KL-68	AAL-19-9/64

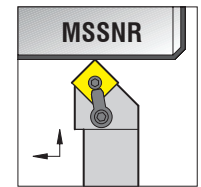
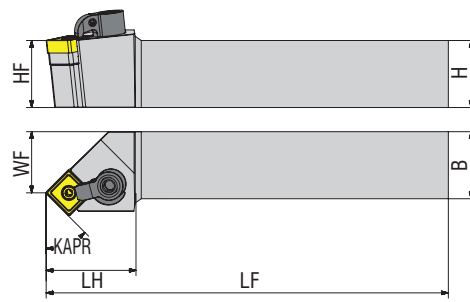

Illustrations shown may vary from actual product.

Dimensions in Inch



Ordering Code	HF=H	B	LF	LH	WF	Insert Inch/Metric	Wedge Clamp	Clamp Screw	Allen Key	Shim	Lock Pin	Allen Key
<b>new</b> MSSNR 08 3A	0.500	0.500	4.000	1.000	0.391	SN.. 322 SN.. 090308	CK-6	STC-5	AAL-16-3/32	ISSN-322	KL-34	AAL-18-5/64
<b>new</b> MSSNR 08 3B	0.500	0.500	4.500	1.000	0.391	SN.. 322 SN.. 090308	CK-6	STC-5	AAL-16-3/32	ISSN-322	KL-34	AAL-18-5/64
MSSNR 12 3B	0.750	0.750	4.500	1.000	0.641	SN.. 322 SN.. 090308	CK-6	STC-5	AAL-16-3/32	ISSN-322	KL-34	AAL-18-5/64
MSSNR 12 4B	0.750	0.750	4.500	1.340	0.662	SN.. 432 SN.. 120408	CK-9	STC-4	AAL-17-5/32	ISSN-433	KL-46	AAL-16-3/32
MSSNR 16 4C	1.000	1.000	5.000	1.340	0.912	SN.. 432 SN.. 120408	CK-9	STC-4	AAL-17-5/32	ISSN-433	KL-46	AAL-16-3/32
MSSNR 16 4D	1.000	1.000	6.000	1.340	0.912	SN.. 432 SN.. 120408	CK-9	STC-4	AAL-17-5/32	ISSN-433	KL-46	AAL-16-3/32
MSSNR 16 5D	1.000	1.000	6.000	1.378	0.828	SN.. 543 SN.. 150612	CK-9	STC-4	AAL-17-5/32	ISSN-533	KL-58	AAL-14-1/8
MSSNR 20 5D	1.250	1.250	6.000	1.378	1.078	SN.. 543 SN.. 150612	CK-9	STC-4	AAL-17-5/32	ISSN-533	KL-58	AAL-14-1/8
<b>new</b> MSSNR 20 5E	1.250	1.250	7.000	1.375	1.078	SN.. 543 SN.. 150612	CK-9	STC-4	AAL-17-5/32	ISSN-533	KL-58	AAL-14-1/8
MSSNR 20 6D	1.250	1.250	6.000	1.480	0.992	SN.. 643 SN.. 190612	CK-9	STC-4	AAL-17-5/32	ISSN-633	KL-68	AAL-19-9/64
MSSNR 24 6D	1.500	1.500	6.000	1.480	1.511	SN.. 643 SN.. 190612	CK-9	STC-4	AAL-17-5/32	ISSN-633	KL-68	AAL-19-9/64
<b>new</b> MSSNR 24 6E	1.500	1.500	7.000	1.500	1.492	SN.. 643 SN.. 190612	CK-12	STC-4	AAL-17-5/32	ISSN-633	KL-68	AAL-19-9/64
MSSNR 85 4D	1.250	1.000	6.000	1.340	0.912	SN.. 432 SN.. 120408	CK-9	STC-4	AAL-17-5/32	ISSN-433	KL-46	AAL-16-3/32
<b>new</b> MSSNL 08 3A	0.500	0.500	4.000	1.000	0.391	SN.. 322 SN.. 090308	CK-6	STC-5	AAL-16-3/32	ISSN-322	KL-34	AAL-18-5/64
<b>new</b> MSSNL 08 3B	0.500	0.500	4.500	1.000	0.391	SN.. 322 SN.. 090308	CK-6	STC-5	AAL-16-3/32	ISSN-322	KL-34	AAL-18-5/64
<b>new</b> MSSNL 12 4B	0.750	0.750	4.500	1.250	0.662	SN.. 432 SN.. 120408	CK-9	STC-4	AAL-17-5/32	ISSN-433	KL-46	AAL-16-3/32
MSSNL 16 4C	1.000	1.000	5.000	1.340	0.912	SN.. 432 SN.. 120408	CK-9	STC-4	AAL-17-5/32	ISSN-433	KL-46	AAL-16-3/32
MSSNL 16 4D	1.000	1.000	6.000	1.340	0.912	SN.. 432 SN.. 120408	CK-9	STC-4	AAL-17-5/32	ISSN-433	KL-46	AAL-16-3/32
MSSNL 16 5D	1.000	1.000	6.000	1.378	0.828	SN.. 543 SN.. 150612	CK-9	STC-4	AAL-17-5/32	ISSN-533	KL-58	AAL-14-1/8
MSSNL 20 5D	1.250	1.250	6.000	1.378	1.078	SN.. 543 SN.. 150612	CK-9	STC-4	AAL-17-5/32	ISSN-533	KL-58	AAL-14-1/8
<b>new</b> MSSNL 20 5E	1.250	1.250	7.000	1.375	1.078	SN.. 543 SN.. 150612	CK-9	STC-4	AAL-17-5/32	ISSN-533	KL-58	AAL-14-1/8
MSSNL 20 6D	1.250	1.250	6.000	1.480	0.992	SN.. 643 SN.. 190612	CK-9	STC-4	AAL-17-5/32	ISSN-633	KL-68	AAL-19-9/64
MSSNL 24 6D	1.500	1.500	6.000	1.480	1.511	SN.. 643 SN.. 190612	CK-9	STC-4	AAL-17-5/32	ISSN-633	KL-68	AAL-19-9/64
<b>new</b> MSSNL 24 6E	1.500	1.500	7.000	1.500	1.492	SN.. 643 SN.. 190612	CK-12	STC-4	AAL-17-5/32	ISSN-633	KL-68	AAL-19-9/64
MSSNL 85 4D	1.250	1.000	6.000	1.340	0.912	SN.. 432 SN.. 120408	CK-9	STC-4	AAL-17-5/32	ISSN-433	KL-46	AAL-16-3/32

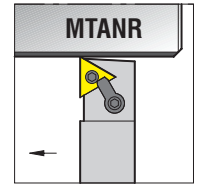
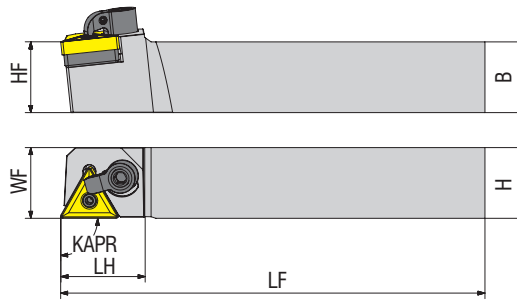
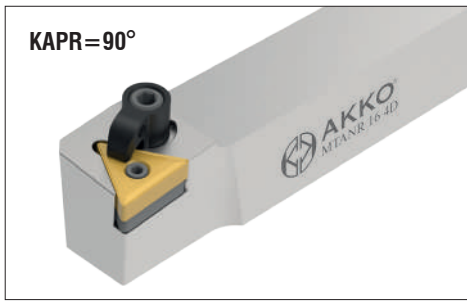

Illustrations shown may vary from actual product.

Dimensions in Inch



Ordering Code	HF=H	B	LF	LH	WF	Insert Inch/Metric	Wedge Clamp	Clamp Screw	Allen Key	Shim	Lock Pin	Allen Key
MTANR 08 2B	0.500	0.500	4.500	0.960	0.500	TN.. 221 TN.. 110304	CK-19	STC-9	AAL-16-3/32	-	KL-23	AAL-13-1/16
MTANR 10 3B	0.625	0.625	4.500	1.130	0.625	TN.. 332 TN.. 160408	CK-6	STC-5	AAL-16-3/32	ITSN-323	KL-34L	AAL-18-5/64
MTANR 12 3B	0.750	0.750	4.500	1.130	0.750	TN.. 332 TN.. 160408	CK-6	STC-5	AAL-16-3/32	ITSN-323	KL-34L	AAL-18-5/64
MTANR 16 4D	1.000	1.000	6.000	1.200	1.000	TN.. 432 TN.. 220408	CK-9	STC-4	AAL-17-5/32	ITSN-433	KL-46	AAL-16-3/32
MTANL 10 3B	0.625	0.625	4.500	1.130	0.625	TN.. 332 TN.. 160408	CK-6	STC-5	AAL-16-3/32	ITSN-323	KL-34L	AAL-18-5/64
MTANL 12 3B	0.750	0.750	4.500	1.130	0.750	TN.. 332 TN.. 160408	CK-6	STC-5	AAL-16-3/32	ITSN-323	KL-34L	AAL-18-5/64
MTANL 16 4D	1.000	1.000	6.000	1.200	1.000	TN.. 432 TN.. 220408	CK-9	STC-4	AAL-17-5/32	ITSN-433	KL-46	AAL-16-3/32



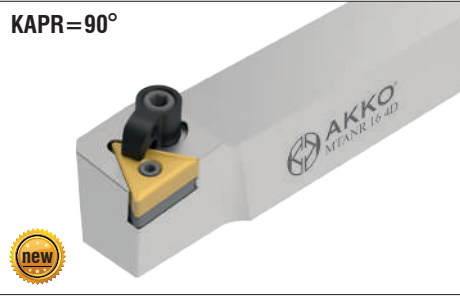

Illustrations shown may vary from actual product.

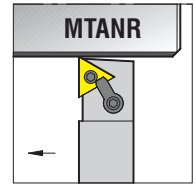
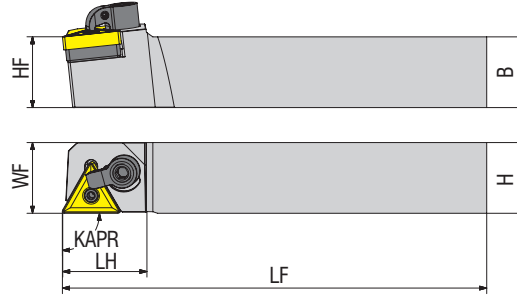

Dimensions in Inch



Ordering Code	HF=H	B	LF	LH	WF	Insert Inch/Metric	Wedge Clamp	Clamp Screw	Allen Key	Shim	Lock Pin	Allen Key
MTANR 08 2A-S	0.500	0.500	4.000	0.875	0.500	TN.. 221 TN.. 110304	CK-19	STC-9	AAL-16-3/32	-	KL-23	AAL-13-1/16
MTANR 10 2B-S	0.625	0.625	4.500	0.875	0.625	TN.. 221 TN.. 110304	CK-19	STC-9	AAL-16-3/32	-	KL-58	AAL-13-1/16
MTANR 16 3D-S	1.000	1.000	6.000	1.000	1.000	TN.. 332 TN.. 160408	CK-6	STC-5	AAL-16-3/32	ITSN-323	KL-34L	AAL-18-5/64
MTANR 16 5D-S	1.000	1.000	6.000	1.500	1.000	TN.. 543 TN.. 270612	CK-12	STC-4	AAL-17-5/32	ITSN-534	KL-58	AAL-14-1/8
MTANR 20 5D-S	1.250	1.250	6.000	1.500	1.250	TN.. 543 TN.. 270612	CK-12	STC-4	AAL-17-5/32	ITSN-534	KL-58	AAL-14-1/8
MTANR 20 5E-S	1.250	1.250	7.000	1.500	1.500	TN.. 543 TN.. 270612	CK-12	STC-4	AAL-17-5/32	ITSN-534	KL-58	AAL-14-1/8
MTANR 24 6E-S	1.500	1.500	7.000	1.750	1.500	TN.. 663 TN.. 330924	CK-12	STC-4	AAL-17-5/32	ITSN-636	KL-68L	AAL-19-9/64
MTANR 64 3D-S	1.000	0.750	6.000	1.000	0.750	TN.. 332 TN.. 160408	CK-6	STC-5	AAL-16-3/32	ITSN-323	KL-34L	AAL-18-5/64
MTANR 85 4D-S	1.250	1.000	6.000	1.375	1.000	TN.. 432 TN.. 220408	CK-9	STC-4	AAL-17-5/32	ITSN-433	KL-58	AAL-16-3/32
MTANR 86 4E-S	1.500	1.000	7.000	1.375	1.000	TN.. 432 TN.. 220408	CK-9	STC-4	AAL-17-5/32	ITSN-433	KL-58	AAL-16-3/32
MTANL 08 2A-S	0.500	0.500	4.000	0.875	0.500	TN.. 221 TN.. 110304	CK-19	STC-9	AAL-16-3/32	-	KL-23	AAL-13-1/16
MTANL 10 2B-S	0.625	0.625	4.500	0.875	0.625	TN.. 221 TN.. 110304	CK-19	STC-9	AAL-16-3/32	-	KL-58	AAL-13-1/16
MTANL 16 3D-S	1.000	1.000	6.000	1.000	1.000	TN.. 332 TN.. 160408	CK-6	STC-5	AAL-16-3/32	ITSN-323	KL-34L	AAL-18-5/64
MTANL 16 5D-S	1.000	1.000	6.000	1.500	1.000	TN.. 543 TN.. 270612	CK-12	STC-4	AAL-17-5/32	ITSN-534	KL-58	AAL-14-1/8
MTANL 20 5D-S	1.250	1.250	6.000	1.500	1.250	TN.. 543 TN.. 270612	CK-12	STC-4	AAL-17-5/32	ITSN-534	KL-58	AAL-14-1/8
MTANL 20 5E-S	1.250	1.250	7.000	1.500	1.250	TN.. 543 TN.. 270612	CK-12	STC-4	AAL-17-5/32	ITSN-534	KL-58	AAL-14-1/8
MTANL 24 6E-S	1.500	1.500	7.000	1.750	1.500	TN.. 663 TN.. 330924	CK-12	STC-4	AAL-17-5/32	ITSN-636	KL-68L	AAL-19-9/64
MTANL 64 3D-S	1.000	0.750	6.000	1.000	0.750	TN.. 332 TN.. 160408	CK-6	STC-5	AAL-16-3/32	ITSN-323	KL-34L	AAL-18-5/64
MTANL 85 4D-S	1.250	1.000	6.000	1.375	1.000	TN.. 432 TN.. 220408	CK-9	STC-4	AAL-17-5/32	ITSN-433	KL-58	AAL-16-3/32
MTANL 86 4E-S	1.500	1.000	7.000	1.375	1.000	TN.. 432 TN.. 220408	CK-9	STC-4	AAL-17-5/32	ITSN-433	KL-58	AAL-16-3/32

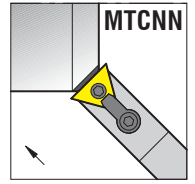
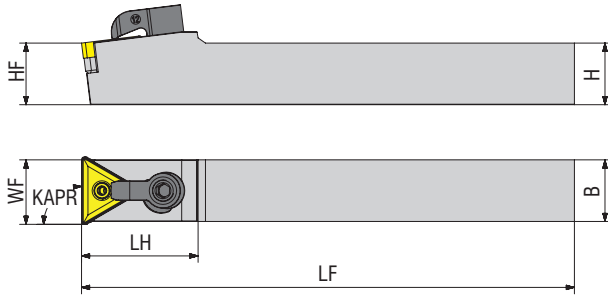

Illustrations shown may vary from actual product.

Dimensions in Inch

Ordering Code	HF=H	B	LF	LH	WF	Insert Inch/Metric	Wedge Clamp	Clamp Screw	Allen Key	Shim	Lock Pin	Allen Key
<b>NEW</b> MTCNN 08 3A	0.500	0.500	4.000	1.000	1.000	TN.. 332 TN.. 160408	CK-6	STC-5	AAL-16-3/32	ITSN-323	KL-34L	AAL-18-5/64
MTCNN 08 3B	0.500	0.500	4.500	1.130	0.552	TN.. 332 TN.. 160408	CK-7	STC-9	AAL-16-3/32	ITSN-323	KL-34L	AAL-18-5/64
<b>NEW</b> MTCNN 12 4B	0.750	0.750	4.500	1.375	1.375	TN.. 432 TN.. 220408	CK-9	STC-4	AAL-17-5/32	ITSN-433	KL-58	AAL-16-3/32
MTCNN 12 4D	0.750	0.750	6.000	1.430	0.785	TN.. 432 TN.. 220408	CK-12	STC-4	AAL-17-5/32	ITSN-433	KL-46	AAL-16-3/32
<b>NEW</b> MTCNN 44 3D	1.000	0.500	6.000	1.000	1.000	TN.. 332 TN.. 160408	CK-6	STC-5	AAL-16-3/32	ITSN-323	KL-34L	AAL-18-5/64
MTCNN 44 3F	1.000	0.500	8.000	1.130	0.552	TN.. 332 TN.. 160408	CK-7	STC-9	AAL-16-3/32	ITSN-323	KL-34L	AAL-18-5/64
<b>NEW</b> MTCNN 64 4D	1.000	0.750	6.000	1.375	1.375	TN.. 432 TN.. 220408	CK-9	STC-4	AAL-17-5/32	ITSN-433	KL-58	AAL-16-3/32
MTCNN 64 4F	1.000	0.750	8.000	1.430	0.775	TN.. 432 TN.. 220408	CK-12	STC-4	AAL-17-5/32	ITSN-433	KL-46	AAL-16-3/32
<b>NEW</b> MTCNN 66 4E	1.500	0.750	7.000	1.375	1.375	TN.. 432 TN.. 220408	CK-9	STC-4	AAL-17-5/32	ITSN-433	KL-58	AAL-16-3/32
<b>NEW</b> MTCNN 66 4F	1.500	0.750	8.000	1.375	1.375	TN.. 432 TN.. 220408	CK-9	STC-4	AAL-17-5/32	ITSN-433	KL-58	AAL-16-3/32

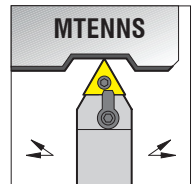
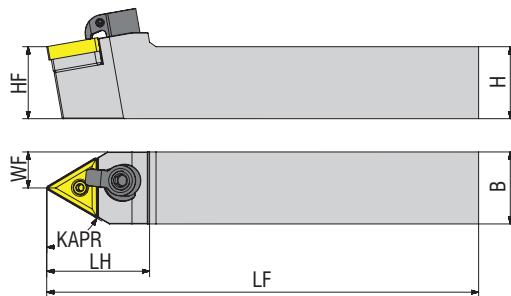

Illustrations shown may vary from actual product.

Dimensions in Inch

Ordering Code	HF=H	B	LF	LH	WF	Insert Inch/Metric	Wedge Clamp	Clamp Screw	Allen Key	Shim	Lock Pin	Allen Key
MTENNS 08 2B	0.500	0.500	4.500	1.000	0.250	TN.. 221 TN.. 110304	CK-6	STC-5	AAL-16-3/32	-	KL-23	AAL-13-1/16
MTENNS 10 3B	0.625	0.625	4.500	1.160	0.312	TN.. 332 TN.. 160408	CK-6	STC-5	AAL-16-3/32	ITSN-323	KL-34L	AAL-18-5/64
MTENNS 12 3B	0.750	0.750	4.500	1.160	0.375	TN.. 332 TN.. 160408	CK-6	STC-5	AAL-16-3/32	ITSN-323	KL-34L	AAL-18-5/64
MTENNS 16 3C	1.000	1.000	5.000	1.160	0.500	TN.. 332 TN.. 160408	CK-6	STC-5	AAL-16-3/32	ITSN-323	KL-34L	AAL-18-5/64
MTENNS 16 4D	1.000	1.000	6.000	1.440	0.500	TN.. 432 TN.. 220408	CK-9	STC-4	AAL-17-5/32	ITSN-433	KL-46	AAL-16-3/32
MTENNS 85 4D	1.250	1.000	6.000	1.420	0.500	TN.. 432 TN.. 220408	CK-9	STC-4	AAL-17-5/32	ITSN-433	KL-46	AAL-16-3/32
MTENNS 20 5D	1.250	1.250	6.000	1.630	0.625	TN.. 543 TN.. 270612	CK-9	STC-4	AAL-17-5/32	ITSN-534	KL-58	AAL-14-1/8
MTENNS 24 6E	1.500	1.500	7.000	1.950	0.750	TN.. 666 TN.. 330924	CK-12	STC-4	AAL-17-5/32	ITSN-636	KL-68L	AAL-19-9/64

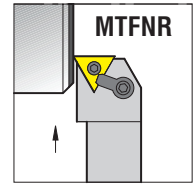
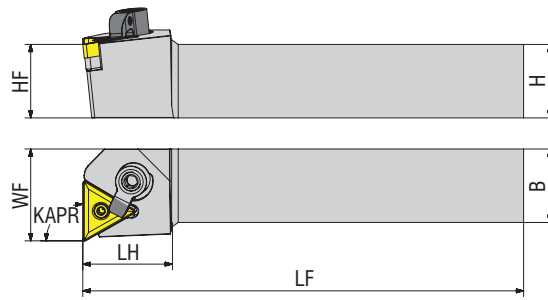

Illustrations shown may vary from actual product.

Dimensions in Inch

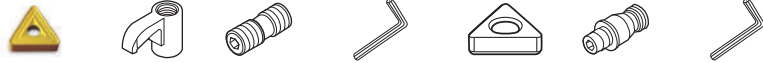

Ordering Code	HF=H	B	LF	LH	WF	Insert Inch/Metric	Wedge Clamp	Clamp Screw	Allen Key	Shim	Lock Pin	Allen Key
<b>new</b> MTFNR 08 2A	0.500	0.500	4.000	0.875	0.750	TN.. 221 TN.. 110304	CK-19	STC-9	AAL-16-3/32	-	KL-23	AAL-13-1/16
<b>new</b> MTFNR 10 2B	0.625	0.625	4.500	0.875	0.875	TN.. 221 TN.. 110304	CK-19	STC-9	AAL-16-3/32	-	KL-23	AAL-13-1/16
<b>new</b> MTFNR 10 3B	0.625	0.625	4.500	1.000	0.875	TN.. 332 TN.. 160408	CK-6	STC-5	AAL-16-3/32	ITSN-323	KL-34L	AAL-18-5/64
<b>new</b> MTFNR 12 2B	0.750	0.750	4.500	0.875	1.000	TN.. 221 TN.. 110304	CK-19	STC-9	AAL-16-3/32	-	KL-23	AAL-13-1/16
MTFNR 12 3B	0.750	0.750	4.500	0.940	1.000	TN.. 332 TN.. 160408	CK-6	STC-5	AAL-16-3/32	ITSN-323	KL-34L	AAL-18-5/64
<b>new</b> MTFNR 16 3C	1.000	1.000	5.000	1.000	1.250	TN.. 332 TN.. 160408	CK-6	STC-5	AAL-16-3/32	ITSN-323	KL-34L	AAL-18-5/64
<b>new</b> MTFNR 16 3D	1.000	1.000	6.000	1.000	1.250	TN.. 332 TN.. 160408	CK-6	STC-5	AAL-16-3/32	ITSN-323	KL-34L	AAL-18-5/64
MTFNR 16 4C	1.000	1.000	5.000	1.220	1.250	TN.. 432 TN.. 220408	CK-9	STC-4	AAL-17-5/32	ITSN-433	KL-46	AAL-16-3/32
MTFNR 16 4D	1.000	1.000	6.000	1.220	1.250	TN.. 432 TN.. 220408	CK-9	STC-4	AAL-17-5/32	ITSN-433	KL-46	AAL-16-3/32
<b>new</b> MTFNR 16 5D	1.000	1.000	6.000	1.375	1.250	TN.. 543 TN.. 270612	CK-12	STC-4	AAL-17-5/32	ITSN-534	KL-58	AAL-14-1/8
MTFNR 20 4D	1.250	1.250	6.000	1.220	1.500	TN.. 432 TN.. 220408	CK-9	STC-4	AAL-17-5/32	ITSN-433	KL-46	AAL-16-3/32
MTFNR 20 5D	1.250	1.250	6.000	1.440	1.500	TN.. 543 TN.. 270612	CK-12	STC-4	AAL-17-5/32	ITSN-534	KL-58	AAL-14-1/8
<b>new</b> MTFNR 24 4E	1.500	1.500	7.000	1.250	2.000	TN.. 432 TN.. 220408	CK-9	STC-4	AAL-17-5/32	ITSN-433	KL-58	AAL-16-3/32
<b>new</b> MTFNR 24 5E	1.500	1.500	7.000	1.375	2.000	TN.. 543 TN.. 270612	CK-12	STC-4	AAL-17-5/32	ITSN-534	KL-58	AAL-14-1/8
MTFNR 24 6E	1.500	1.500	7.000	1.500	2.000	TN.. 666 TN.. 330924	CK-12	STC-4	AAL-17-5/32	ITSN-636	KL-68L	AAL-19-9/64
<b>new</b> MTFNR 85 4D	1.250	1.000	6.000	1.250	1.250	TN.. 432 TN.. 220408	CK-9	STC-4	AAL-17-5/32	ITSN-433	KL-58	AAL-16-3/32
<b>new</b> MTFNR 85 5D	1.250	1.000	6.000	1.375	1.250	TN.. 543 TN.. 270612	CK-12	STC-4	AAL-17-5/32	ITSN-534	KL-58	AAL-14-1/8
<b>new</b> MTFNR 86 5E	1.500	1.000	7.000	1.375	1.250	TN.. 543 TN.. 270612	CK-12	STC-4	AAL-17-5/32	ITSN-534	KL-58	AAL-14-1/8





Illustrations shown may vary from actual product.

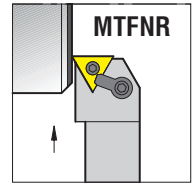
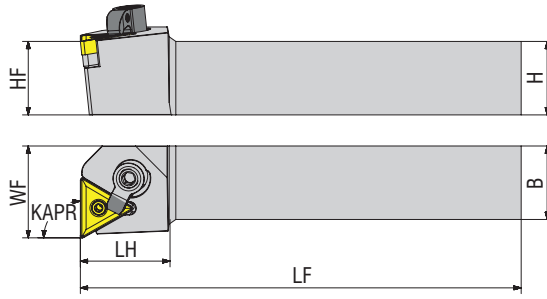

Dimensions in Inch



Ordering Code	HF=H	B	LF	LH	WF	Insert Inch/Metric	Wedge Clamp	Clamp Screw	Allen Key	Shim	Lock Pin	Allen Key
<b>new</b> MTFNL 08 2A	0.500	0.500	4.000	0.875	0.750	TN.. 221 TN.. 110304	CK-19	STC-9	AAL-16-3/32	-	KL-23	AAL-13-1/16
<b>new</b> MTFNL 10 2B	0.625	0.625	4.500	0.875	0.875	TN.. 221 TN.. 110304	CK-19	STC-9	AAL-16-3/32	-	KL-23	AAL-13-1/16
<b>new</b> MTFNL 10 3B	0.625	0.625	4.500	1.000	0.875	TN.. 332 TN.. 160408	CK-6	STC-5	AAL-16-3/32	ITSN-323	KL-34L	AAL-18-5/64
<b>new</b> MTFNL 12 2B	0.750	0.750	4.500	0.875	1.000	TN.. 221 TN.. 110304	CK-19	STC-9	AAL-16-3/32	-	KL-23	AAL-13-1/16
MTFNL 12 3B	0.750	0.750	4.500	0.940	1.000	TN.. 332 TN.. 160408	CK-6	STC-5	AAL-16-3/32	ITSN-323	KL-34L	AAL-18-5/64
<b>new</b> MTFNL 16 3C	1.000	1.000	5.000	1.000	1.250	TN.. 332 TN.. 160408	CK-6	STC-5	AAL-16-3/32	ITSN-323	KL-34L	AAL-18-5/64
<b>new</b> MTFNL 16 3D	1.000	1.000	6.000	1.000	1.250	TN.. 332 TN.. 160408	CK-6	STC-5	AAL-16-3/32	ITSN-323	KL-34L	AAL-18-5/64
MTFNL 16 4C	1.000	1.000	5.000	1.220	1.250	TN.. 432 TN.. 220408	CK-9	STC-4	AAL-17-5/32	ITSN-433	KL-46	AAL-16-3/32
MTFNL 16 4D	1.000	1.000	6.000	1.220	1.250	TN.. 432 TN.. 220408	CK-9	STC-4	AAL-17-5/32	ITSN-433	KL-46	AAL-16-3/32
<b>new</b> MTFNL 16 5D	1.000	1.000	6.000	1.375	1.250	TN.. 543 TN.. 270612	CK-12	STC-4	AAL-17-5/32	ITSN-534	KL-58	AAL-14-1/8
MTFNL 20 4D	1.250	1.250	6.000	1.220	1.500	TN.. 432 TN.. 220408	CK-9	STC-4	AAL-17-5/32	ITSN-433	KL-46	AAL-16-3/32
<b>new</b> MTFNL 20 5D	1.250	1.250	6.000	1.375	1.500	TN.. 543 TN.. 270612	CK-12	STC-4	AAL-17-5/32	ITSN-534	KL-58	AAL-14-1/8
<b>new</b> MTFNL 24 4E	1.500	1.500	7.000	1.250	2.000	TN.. 432 TN.. 220408	CK-9	STC-4	AAL-17-5/32	ITSN-433	KL-58	AAL-16-3/32
MTFNL 24 5D	1.500	1.500	6.000	1.440	2.000	TN.. 543 TN.. 270612	CK-12	STC-4	AAL-17-5/32	ITSN-534	KL-58	AAL-14-1/8
<b>new</b> MTFNL 24 5E	1.500	1.500	7.000	1.375	2.000	TN.. 543 TN.. 270612	CK-12	STC-4	AAL-17-5/32	ITSN-534	KL-58	AAL-14-1/8
MTFNL 24 6E	1.500	1.500	7.000	1.500	2.000	TN.. 666 TN.. 330924	CK-12	STC-4	AAL-17-5/32	ITSN-636	KL-68L	AAL-19-9/64
MTFNL 85 4D	1.250	1.250	6.000	1.220	1.250	TN.. 432 TN.. 220408	CK-9	STC-4	AAL-17-5/32	ITSN-433	KL-46	AAL-16-3/32
<b>new</b> MTFNL 85 5D	1.250	1.000	6.000	1.375	1.250	TN.. 543 TN.. 270612	CK-12	STC-4	AAL-17-5/32	ITSN-534	KL-58	AAL-14-1/8
<b>new</b> MTFNL 86 5E	1.500	1.000	7.000	1.375	1.250	TN.. 543 TN.. 270612	CK-12	STC-4	AAL-17-5/32	ITSN-534	KL-58	AAL-14-1/8

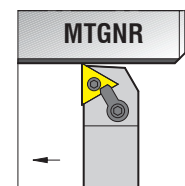
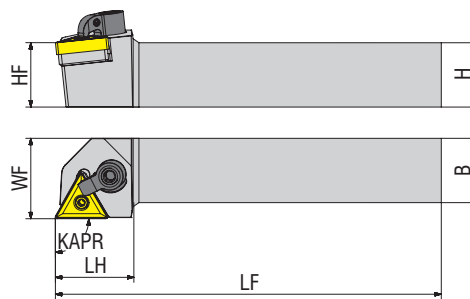

Illustrations shown may vary from actual product.

Dimensions in Inch



Ordering Code	HF=H	B	LF	LH	WF	Insert Inch/Metric	Wedge Clamp	Clamp Screw	Allen Key	Shim	Lock Pin	Allen Key
<b>new</b> MTG NR 08 2A	0.500	0.500	4.000	0.875	0.625	TN.. 221 TN.. 110304	CK-19	STC-9	AAL-16-3/32	-	KL-23	AAL-13-1/16
MTG NR 08 2B	0.500	0.500	4.500	0.960	0.625	TN.. 221 TN.. 110304	CK-19	STC-9	AAL-16-3/32	-	KL-23	AAL-13-1/16
<b>new</b> MTG NR 10 2B	0.625	0.625	4.500	0.875	0.750	TN.. 221 TN.. 110304	CK-19	STC-9	AAL-16-3/32	-	KL-23	AAL-13-1/16
MTG NR 10 3B	0.625	0.625	4.500	1.120	0.875	TN.. 332 TN.. 160408	CK-6	STC-5	AAL-16-3/32	ITSN-323	KL-34L	AAL-18-5/64
MTG NR 12 3B	0.750	0.750	4.500	1.120	1.000	TN.. 332 TN.. 160408	CK-6	STC-5	AAL-16-3/32	ITSN-323	KL-34L	AAL-18-5/64
MTG NR 12 4B	0.750	0.750	4.500	1.200	1.000	TN.. 432 TN.. 220408	CK-9	STC-4	AAL-17-5/32	ITSN-433	KL-46	AAL-16-3/32
<b>new</b> MTG NR 16 3C	1.000	1.000	5.000	1.000	1.250	TN.. 332 TN.. 160408	CK-6	STC-5	AAL-16-3/32	ITSN-323	KL-34L	AAL-18-5/64
<b>new</b> MTG NR 16 3D	1.000	1.000	6.000	1.000	1.250	TN.. 332 TN.. 160408	CK-6	STC-5	AAL-16-3/32	ITSN-323	KL-34L	AAL-18-5/64
MTG NR 16 4C	1.000	1.000	5.000	1.200	1.250	TN.. 432 TN.. 220408	CK-9	STC-4	AAL-17-5/32	ITSN-433	KL-46	AAL-16-3/32
MTG NR 16 4D	1.000	1.000	6.000	1.200	1.250	TN.. 432 TN.. 220408	CK-9	STC-4	AAL-17-5/32	ITSN-433	KL-46	AAL-16-3/32
MTG NR 16 5C	1.000	1.000	5.000	1.380	1.250	TN.. 543 TN.. 270612	CK-9	STC-4	AAL-17-5/32	ITSN-534	KL-58	AAL-14-1/8
<b>new</b> MTG NR 16 5D	1.000	1.000	6.000	1.500	1.250	TN.. 543 TN.. 270612	CK-9	STC-4	AAL-17-5/32	ITSN-534	KL-58	AAL-14-1/8
MTG NR 20 4D	1.250	1.250	6.000	1.200	1.500	TN.. 432 TN.. 220408	CK-9	STC-4	AAL-17-5/32	ITSN-433	KL-46	AAL-16-3/32
MTG NR 20 5D	1.250	1.250	6.000	1.440	1.500	TN.. 543 TN.. 270612	CK-9	STC-4	AAL-17-5/32	ITSN-534	KL-58	AAL-14-1/8
<b>new</b> MTG NR 24 4D	1.500	1.500	6.000	1.375	2.000	TN.. 432 TN.. 220408	CK-9	STC-4	AAL-17-5/32	ITSN-433	KL-58	AAL-16-3/32
<b>new</b> MTG NR 24 4E	1.500	1.500	7.000	1.375	2.000	TN.. 432 TN.. 220408	CK-9	STC-4	AAL-17-5/32	ITSN-433	KL-58	AAL-16-3/32
<b>new</b> MTG NR 24 5E	1.500	1.500	7.000	1.500	2.000	TN.. 543 TN.. 270612	CK-9	STC-4	AAL-17-5/32	ITSN-534	KL-58	AAL-14-1/8
<b>new</b> MTG NR 24 6E	1.500	1.500	7.000	1.750	2.000	TN.. 663 TN.. 330924	CK-12	STC-4	AAL-17-5/32	ITSN-636	KL-68L	AAL-19-9/64
<b>new</b> MTG NR 85 4D	1.250	1.000	6.000	1.375	1.250	TN.. 432 TN.. 220408	CK-9	STC-4	AAL-17-5/32	ITSN-433	KL-58	AAL-16-3/32
<b>new</b> MTG NR 85 5D	1.250	1.000	6.000	1.500	1.250	TN.. 543 TN.. 270612	CK-9	STC-4	AAL-17-5/32	ITSN-534	KL-58	AAL-14-1/8
<b>new</b> MTG NR 86 4E	1.500	1.000	7.000	1.375	1.250	TN.. 432 TN.. 220408	CK-9	STC-4	AAL-17-5/32	ITSN-433	KL-58	AAL-16-3/32

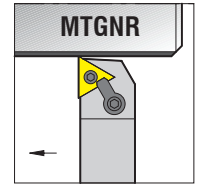
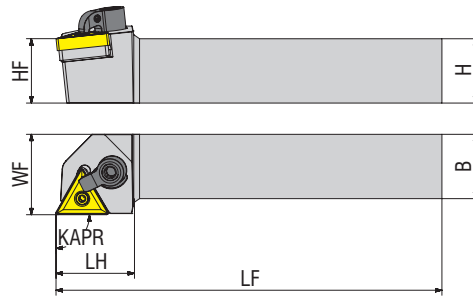
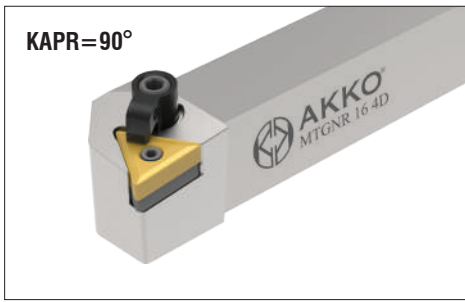

Illustrations shown may vary from actual product.

Dimensions in Inch



Ordering Code	HF=H	B	LF	LH	WF	Insert Inch/Metric	Wedge Clamp	Clamp Screw	Allen Key	Shim	Lock Pin	Allen Key
<b>NEW</b> MTGNL 08 2A	0.500	0.500	4.000	0.875	0.625	TN.. 221 TN.. 110304	CK-19	STC-9	AAL-16-3/32	-	KL-23	AAL-13-1/16
<b>NEW</b> MTGNL 10 2B	0.625	0.625	4.500	0.875	0.750	TN.. 221 TN.. 110304	CK-19	STC-9	AAL-16-3/32	-	KL-23	AAL-13-1/16
MTGNL 10 3B	0.625	0.625	4.500	1.120	0.875	TN.. 332 TN.. 160408	CK-6	STC-5	AAL-16-3/32	ITSN-333	KL-34L	AAL-18-5/64
MTGNL 12 3B	0.750	0.750	4.500	1.120	1.000	TN.. 332 TN.. 160408	CK-6	STC-5	AAL-16-3/32	ITSN-323	KL-34L	AAL-18-5/64
MTGNL 12 4B	0.750	0.750	4.500	1.200	1.000	TN.. 432 TN.. 220408	CK-9	STC-4	AAL-17-5/32	ITSN-433	KL-46	AAL-16-3/32
<b>NEW</b> MTGNL 16 3C	1.000	1.000	5.000	1.000	1.250	TN.. 332 TN.. 160408	CK-6	STC-5	AAL-16-3/32	ITSN-323	KL-34L	AAL-18-5/64
<b>NEW</b> MTGNL 16 3D	1.000	1.000	6.000	1.000	1.250	TN.. 332 TN.. 160408	CK-6	STC-5	AAL-16-3/32	ITSN-323	KL-34L	AAL-18-5/64
MTGNL 16 4C	1.000	1.000	5.000	1.200	1.250	TN.. 432 TN.. 220408	CK-9	STC-4	AAL-17-5/32	ITSN-433	KL-46	AAL-16-3/32
MTGNL 16 4D	1.000	1.000	6.000	1.200	1.250	TN.. 432 TN.. 220408	CK-9	STC-4	AAL-17-5/32	ITSN-433	KL-46	AAL-16-3/32
<b>NEW</b> MTGNL 16 5C	1.000	1.000	5.000	1.500	1.250	TN.. 543 TN.. 270612	CK-9	STC-4	AAL-17-5/32	ITSN-534	KL-58	AAL-14-1/8
<b>NEW</b> MTGNL 16 5D	1.000	1.000	6.000	1.500	1.250	TN.. 543 TN.. 270612	CK-9	STC-4	AAL-17-5/32	ITSN-534	KL-58	AAL-14-1/8
MTGNL 20 4D	1.250	1.250	6.000	1.200	1.500	TN.. 432 TN.. 220408	CK-9	STC-4	AAL-17-5/32	ITSN-433	KL-46	AAL-16-3/32
MTGNL 20 5D	1.250	1.250	6.000	1.440	1.500	TN.. 543 TN.. 270612	CK-9	STC-4	AAL-17-5/32	ITSN-534	KL-58	AAL-14-1/8
<b>NEW</b> MTGNL 24 4D	1.500	1.500	6.000	1.375	2.000	TN.. 432 TN.. 220408	CK-9	STC-4	AAL-17-5/32	ITSN-433	KL-58	AAL-16-3/32
<b>NEW</b> MTGNL 24 4E	1.500	1.500	7.000	1.375	2.000	TN.. 432 TN.. 220408	CK-9	STC-4	AAL-17-5/32	ITSN-433	KL-58	AAL-16-3/32
<b>NEW</b> MTGNL 24 5E	1.500	1.500	7.000	1.500	2.000	TN.. 543 TN.. 270612	CK-9	STC-4	AAL-17-5/32	ITSN-534	KL-58	AAL-14-1/8
<b>NEW</b> MTGNL 24 6E	1.500	1.500	7.000	1.750	2.000	TN.. 663 TN.. 330924	CK-12	STC-4	AAL-17-5/32	ITSN-636	KL-68L	AAL-19-9/64
<b>NEW</b> MTGNL 85 4D	1.250	1.000	6.000	1.375	1.250	TN.. 432 TN.. 220408	CK-9	STC-4	AAL-17-5/32	ITSN-433	KL-58	AAL-16-3/32
<b>NEW</b> MTGNL 85 5D	1.250	1.000	6.000	1.500	1.250	TN.. 543 TN.. 270612	CK-9	STC-4	AAL-17-5/32	ITSN-534	KL-58	AAL-14-1/8
<b>NEW</b> MTGNL 86 4E	1.500	1.000	7.000	1.375	1.250	TN.. 432 TN.. 220408	CK-9	STC-4	AAL-17-5/32	ITSN-433	KL-58	AAL-16-3/32

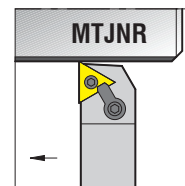
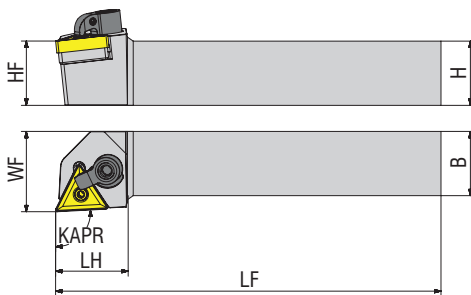

Illustrations shown may vary from actual product.

Dimensions in Inch



Ordering Code	HF=H	B	LF	LH	WF	Insert Inch/Metric	Wedge Clamp	Clamp Screw	Allen Key	Shim	Lock Pin	Allen Key
<b>new</b> MTJNR 08 2A	0.500	0.500	4.000	1.000	0.625	TN.. 221 TN.. 110304	CK-19	STC-9	AAL-16-3/32	-	KL-23	AAL-13-1/16
MTJNR 08 2B	0.500	0.500	4.500	0.720	0.625	TN.. 221 TN.. 110304	CK-19	STC-9	AAL-16-3/32	-	KL-23	AAL-13-1/16
<b>new</b> MTJNR 10 2B	0.625	0.625	4.500	1.000	0.750	TN.. 221 TN.. 110304	CK-19	STC-9	AAL-16-3/32	-	KL-23	AAL-13-1/16
MTJNR 10 3B	0.625	0.625	4.500	0.880	0.875	TN.. 322 TN.. 160308	CK-6	STC-5	AAL-16-3/32	ITSN-333	KL-34L	AAL-18-5/64
MTJNR 12 3B	0.750	0.750	4.500	0.880	1.000	TN.. 322 TN.. 160308	CK-6	STC-5	AAL-16-3/32	ITSN-333	KL-34L	AAL-18-5/64
MTJNR 16 3C	1.000	1.000	5.000	0.880	1.250	TN.. 322 TN.. 160308	CK-6	STC-5	AAL-16-3/32	ITSN-333	KL-34L	AAL-18-5/64
MTJNR 16 3D	1.000	1.000	6.000	0.880	1.250	TN.. 322 TN.. 160308	CK-6	STC-5	AAL-16-3/32	ITSN-333	KL-34L	AAL-18-5/64
MTJNR 16 4D	1.000	1.000	6.000	1.130	1.250	TN.. 432 TN.. 220408	CK-9	STC-4	AAL-17-5/32	ITSN-433	KL-46	AAL-16-3/32
<b>new</b> MTJNR 16 5D	1.000	1.000	6.000	1.500	1.250	TN.. 543 TN.. 270612	CK-9	STC-4	AAL-17-5/32	ITSN-534	KL-58	AAL-14-1/8
MTJNR 20 4D	1.250	1.250	6.000	1.130	1.500	TN.. 432 TN.. 220408	CK-9	STC-4	AAL-17-5/32	ITSN-433	KL-46	AAL-16-3/32
<b>new</b> MTJNR 20 4E	1.250	1.250	7.000	1.250	1.500	TN.. 432 TN.. 220408	CK-9	STC-4	AAL-17-5/32	ITSN-433	KL-58	AAL-16-3/32
MTJNR 20 5D	1.250	1.250	6.000	1.260	1.500	TN.. 543 TN.. 270612	CK-9	STC-4	AAL-17-5/32	ITSN-534	KL-58	AAL-14-1/8
<b>new</b> MTJNR 24 5E	1.500	1.500	7.000	1.500	2.000	TN.. 543 TN.. 270612	CK-9	STC-4	AAL-17-5/32	ITSN-534	KL-58	AAL-14-1/8
<b>new</b> MTJNR 24 6E	1.500	1.500	7.000	1.625	2.000	TN.. 663 TN.. 330924	CK-12	STC-4	AAL-17-5/32	ITSN-636	KL-68L	AAL-19-9/64
<b>new</b> MTJNR 85 4D	1.250	1.000	6.000	1.250	1.250	TN.. 432 TN.. 220408	CK-9	STC-4	AAL-17-5/32	ITSN-433	KL-58	AAL-16-3/32
<b>new</b> MTJNR 85 5D	1.250	1.000	6.000	1.500	1.250	TN.. 543 TN.. 270612	CK-9	STC-4	AAL-17-5/32	ITSN-534	KL-58	AAL-14-1/8
<b>new</b> MTJNR 86 5E	1.500	1.000	7.000	1.500	1.250	TN.. 543 TN.. 270612	CK-9	STC-4	AAL-17-5/32	ITSN-534	KL-58	AAL-14-1/8

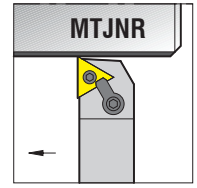
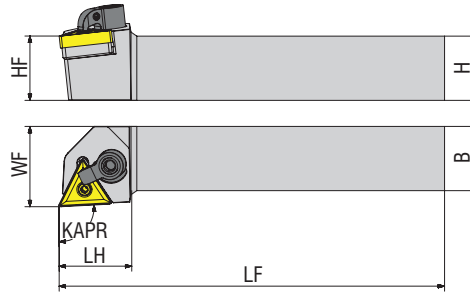

Illustrations shown may vary from actual product.

Dimensions in Inch

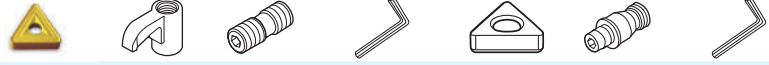

Ordering Code	HF=H	B	LF	LH	WF	Insert Inch/Metric	Wedge Clamp	Clamp Screw	Allen Key	Shim	Lock Pin	Allen Key
<b>NEW</b> MTJNL 08 2A	0.500	0.500	4.000	1.000	0.625	TN.. 221 TN.. 110304	CK-19	STC-9	AAL-16-3/32	-	KL-23	AAL-13-1/16
MTJNL 08 2B	0.500	0.500	4.500	0.720	0.625	TN.. 221 TN.. 110304	CK-19	STC-9	AAL-16-3/32	-	KL-23	AAL-13-1/16
<b>NEW</b> MTJNL 10 2B	0.625	0.625	4.500	1.000	0.750	TN.. 221 TN.. 110304	CK-19	STC-9	AAL-16-3/32	-	KL-23	AAL-13-1/16
MTJNL 10 3B	0.625	0.625	4.500	0.880	0.875	TN.. 322 TN.. 160308	CK-6	STC-5	AAL-16-3/32	ITSN-333	KL-34L	AAL-18-5/64
MTJNL 12 3B	0.750	0.750	4.500	0.880	1.000	TN.. 322 TN.. 160308	CK-6	STC-5	AAL-16-3/32	ITSN-333	KL-34L	AAL-18-5/64
MTJNL 16 3C	1.000	1.000	5.000	0.880	1.250	TN.. 322 TN.. 160308	CK-6	STC-5	AAL-16-3/32	ITSN-333	KL-34L	AAL-18-5/64
MTJNL 16 3D	1.000	1.000	6.000	0.880	1.250	TN.. 322 TN.. 160308	CK-6	STC-5	AAL-16-3/32	ITSN-333	KL-34L	AAL-18-5/64
MTJNL 16 4D	1.000	1.000	6.000	1.130	1.250	TN.. 432 TN.. 220408	CK-9	STC-4	AAL-17-5/32	ITSN-433	KL-46	AAL-16-3/32
<b>NEW</b> MTJNL 16 5D	1.000	1.000	6.000	1.500	1.250	TN.. 543 TN.. 270612	CK-9	STC-4	AAL-17-5/32	ITSN-534	KL-58	AAL-14-1/8
MTJNL 20 4D	1.250	1.250	6.000	1.130	1.500	TN.. 432 TN.. 220408	CK-9	STC-4	AAL-17-5/32	ITSN-433	KL-46	AAL-16-3/32
<b>NEW</b> MTJNL 20 4E	1.250	1.250	7.000	1.250	1.500	TN.. 432 TN.. 220408	CK-9	STC-4	AAL-17-5/32	ITSN-433	KL-58	AAL-16-3/32
MTJNL 20 5D	1.250	1.250	6.000	1.260	1.500	TN.. 543 TN.. 270612	CK-9	STC-4	AAL-17-5/32	ITSN-534	KL-58	AAL-14-1/8
<b>NEW</b> MTJNL 24 5E	1.500	1.500	7.000	1.500	2.000	TN.. 543 TN.. 270612	CK-9	STC-4	AAL-17-5/32	ITSN-534	KL-58	AAL-14-1/8
<b>NEW</b> MTJNL 24 6E	1.500	1.500	7.000	1.625	2.000	TN.. 663 TN.. 330924	CK-12	STC-4	AAL-17-5/32	ITSN-636	KL-68L	AAL-19-9/64
<b>NEW</b> MTJNL 85 4D	1.250	1.000	6.000	1.250	1.250	TN.. 432 TN.. 220408	CK-9	STC-4	AAL-17-5/32	ITSN-433	KL-58	AAL-16-3/32
<b>NEW</b> MTJNL 85 5D	1.250	1.000	6.000	1.500	1.250	TN.. 543 TN.. 270612	CK-9	STC-4	AAL-17-5/32	ITSN-534	KL-58	AAL-14-1/8
<b>NEW</b> MTJNL 86 5E	1.500	1.000	7.000	1.500	1.250	TN.. 543 TN.. 270612	CK-9	STC-4	AAL-17-5/32	ITSN-534	KL-58	AAL-14-1/8



Illustrations shown may vary from actual product.

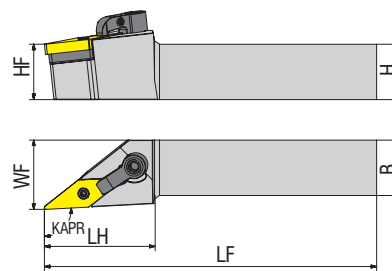

Dimensions in Inch

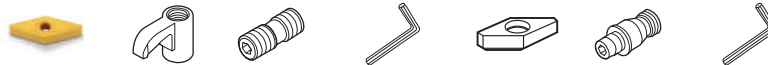

Ordering Code	HF=H	B	LF	LH	WF	Insert Inch/Metric	Wedge Clamp	Clamp Screw	Allen Key	Shim	Lock Pin	Allen Key
MVGNR 12 3B	0.750	0.750	4.500	1.750	1.000	VN.. 332 VN.. 160408	CK-43	STC-4	AAL-17-5/32	IVSN-322	KL-34L	AAL-18-5/64
MVGNR 16 3D	1.000	1.000	6.000	1.750	1.250	VN.. 332 VN.. 160408	CK-43	STC-4	AAL-17-5/32	IVSN-322	KL-34L	AAL-18-5/64
MVGNR 16 4D	1.000	1.000	6.000	2.125	1.250	VN.. 432 VN.. 220408	CK-43	STC-4	AAL-17-5/32	IVSN-433	KL-46	AAL-16-3/32
MVGNL 12 3B	0.750	0.750	4.500	1.750	1.000	VN.. 332 VN.. 160408	CK-43	STC-4	AAL-17-5/32	IVSN-322	KL-34L	AAL-18-5/64
MVGNL 16 3D	1.000	1.000	6.000	1.750	1.250	VN.. 332 VN.. 160408	CK-43	STC-4	AAL-17-5/32	IVSN-322	KL-34L	AAL-18-5/64
MVGNL 16 4D	1.000	1.000	6.000	2.125	1.250	VN.. 432 VN.. 220408	CK-43	STC-4	AAL-17-5/32	IVSN-433	KL-46	AAL-16-3/32



Illustrations shown may vary from actual product.

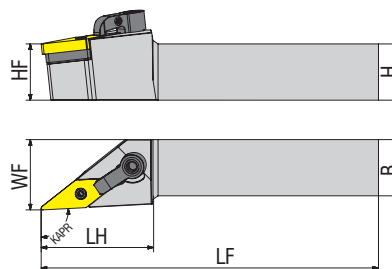

Dimensions in Inch



Ordering Code	HF=H	B	LF	LH	WF	Insert Inch/Metric	Wedge Clamp	Clamp Screw	Allen Key	Shim	Lock Pin	Allen Key
MVTNR 12 3B	0.750	0.750	4.500	1.625	1.000	VN.. 332 VN.. 160408	CK-43	STC-4	AAL-17-5/32	IVSN-322	KL-34L	AAL-18-5/64
MVTNR 16 3C	1.000	1.000	5.000	1.625	1.250	VN.. 332 VN.. 160408	CK-43	STC-4	AAL-17-5/32	IVSN-322	KL-34L	AAL-18-5/64
MVTNR 16 3D	1.000	1.000	6.000	1.625	1.250	VN.. 332 VN.. 160408	CK-43	STC-4	AAL-17-5/32	IVSN-322	KL-34L	AAL-18-5/64
MVTNR 20 3D	1.250	1.250	6.000	1.625	1.500	VN.. 332 VN.. 160408	CK-43	STC-4	AAL-17-5/32	IVSN-322	KL-34L	AAL-18-5/64
MVTNR 24 3E	1.500	1.500	7.000	1.625	1.750	VN.. 332 VN.. 160408	CK-43	STC-4	AAL-17-5/32	IVSN-322	KL-34L	AAL-18-5/64
MVTNL 12 3B	0.750	0.750	4.500	1.625	1.000	VN.. 332 VN.. 160408	CK-43	STC-4	AAL-17-5/32	IVSN-322	KL-34L	AAL-18-5/64
MVTNL 16 3C	1.000	1.000	5.000	1.625	1.250	VN.. 332 VN.. 160408	CK-43	STC-4	AAL-17-5/32	IVSN-322	KL-34L	AAL-18-5/64
MVTNL 16 3D	1.000	1.000	6.000	1.625	1.250	VN.. 332 VN.. 160408	CK-43	STC-4	AAL-17-5/32	IVSN-322	KL-34L	AAL-18-5/64
MVTNL 20 3D	1.250	1.250	6.000	1.625	1.500	VN.. 332 VN.. 160408	CK-43	STC-4	AAL-17-5/32	IVSN-322	KL-34L	AAL-18-5/64
MVTNL 24 3E	1.500	1.500	7.000	1.625	1.750	VN.. 332 VN.. 160408	CK-43	STC-4	AAL-17-5/32	IVSN-322	KL-34L	AAL-18-5/64

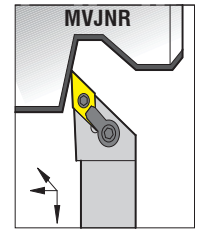
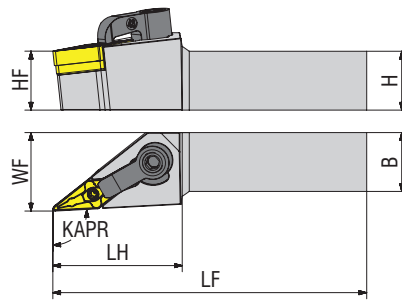

Illustrations shown may vary from actual product.

Dimensions in Inch



Ordering Code	HF=H	B	LF	LH	WF	Insert Inch/Metric	Wedge Clamp	Clamp Screw	Allen Key	Shim	Lock Pin	Allen Key
MVJNR 12 3A	0.750	0.750	4.000	1.660	1.000	VN.. 332 VN.. 160408	CK-43	STC-4	AAL-17-5/32	IVSN-322	KL-34L	AAL-18-5/64
MVJNR 12 3B	0.750	0.750	4.500	1.660	1.000	VN.. 332 VN.. 160408	CK-43	STC-4	AAL-17-5/32	IVSN-322	KL-34L	AAL-18-5/64
MVJNR 12 4B	0.750	0.750	4.500	2.125	1.000	VN.. 432 VN.. 220408	CK-43	STC-4	AAL-17-5/32	IVSN-433	KL-46	AAL-16-3/32
MVJNR 16 3C	1.000	1.000	5.000	1.660	1.250	VN.. 332 VN.. 160408	CK-43	STC-4	AAL-17-5/32	IVSN-322	KL-34L	AAL-18-5/64
MVJNR 16 3D	1.000	1.000	6.000	1.660	1.250	VN.. 332 VN.. 160408	CK-43	STC-4	AAL-17-5/32	IVSN-322	KL-34L	AAL-18-5/64
MVJNR 16 4C	1.000	1.000	5.000	2.000	1.250	VN.. 432 VN.. 220408	CK-43	STC-4	AAL-17-5/32	IVSN-433	KL-46	AAL-16-3/32
MVJNR 16 4D	1.000	1.000	6.000	2.000	1.250	VN.. 432 VN.. 220408	CK-43	STC-4	AAL-17-5/32	IVSN-433	KL-46	AAL-16-3/32
MVJNR 20 3D	1.250	1.250	6.000	1.660	1.500	VN.. 332 VN.. 160408	CK-43	STC-4	AAL-17-5/32	IVSN-322	KL-34L	AAL-18-5/64
MVJNR 20 4D	1.250	1.250	6.000	2.000	1.500	VN.. 432 VN.. 220408	CK-43	STC-4	AAL-17-5/32	IVSN-433	KL-46	AAL-16-3/32
MVJNR 24 3D	1.500	1.500	6.000	1.660	2.000	VN.. 332 VN.. 160408	CK-43	STC-4	AAL-17-5/32	IVSN-322	KL-34L	AAL-18-5/64
<b>new</b> MVJNR 24 3E	1.500	1.500	7.000	2.000	2.000	VN.. 332 VN.. 160408	CK-43	STC-4	AAL-17-5/32	IVSN-322	KL-34L	AAL-18-5/64
MVJNR 24 4D	1.500	1.500	6.000	2.000	2.000	VN.. 432 VN.. 220408	CK-43	STC-4	AAL-17-5/32	IVSN-433	KL-46	AAL-16-3/32
<b>new</b> MVJNR 24 4E	1.500	1.500	7.000	2.125	2.000	VN.. 432 VN.. 220408	CK-43	STC-4	AAL-17-5/32	IVSN-433	KL-46	AAL-16-3/32



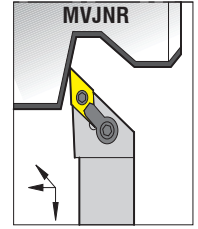
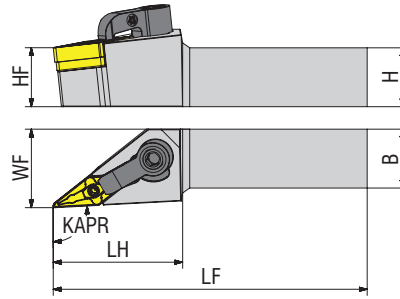

Illustrations shown may vary from actual product.

Dimensions in Inch



Ordering Code	HF=H	B	LF	LH	WF	Insert Inch/Metric	Wedge Clamp	Clamp Screw	Allen Key	Shim	Lock Pin	Allen Key
MVJNL 12 3A	0.750	0.750	4.000	1.660	1.000	VN.. 332 VN.. 160408	CK-43	STC-4	AAL-17-5/32	IVSN-322	KL-34L	AAL-18-5/64
MVJNL 12 3B	0.750	0.750	4.500	1.660	1.000	VN.. 332 VN.. 160408	CK-43	STC-4	AAL-17-5/32	IVSN-322	KL-34L	AAL-18-5/64
<b>new</b> MVJNL 12 4B	0.750	0.750	4.500	2.125	1.000	VN.. 432 VN.. 220408	CK-43	STC-4	AAL-17-5/32	IVSN-433	KL-46	AAL-16-3/32
MVJNL 16 3C	1.000	1.000	5.000	1.660	1.250	VN.. 332 VN.. 160408	CK-43	STC-4	AAL-17-5/32	IVSN-322	KL-34L	AAL-18-5/64
MVJNL 16 3D	1.000	1.000	6.000	1.660	1.250	VN.. 332 VN.. 160408	CK-43	STC-4	AAL-17-5/32	IVSN-322	KL-34L	AAL-18-5/64
MVJNL 16 4C	1.000	1.000	5.000	2.000	1.250	VN.. 432 VN.. 220408	CK-43	STC-4	AAL-17-5/32	IVSN-433	KL-46	AAL-16-3/32
MVJNL 16 4D	1.000	1.000	6.000	2.000	1.250	VN.. 432 VN.. 220408	CK-43	STC-4	AAL-17-5/32	IVSN-433	KL-46	AAL-16-3/32
MVJNL 20 3D	1.250	1.250	6.000	1.660	1.500	VN.. 332 VN.. 160408	CK-43	STC-4	AAL-17-5/32	IVSN-322	KL-34L	AAL-18-5/64
MVJNL 20 4D	1.250	1.250	6.000	2.000	1.500	VN.. 432 VN.. 220408	CK-43	STC-4	AAL-17-5/32	IVSN-433	KL-46	AAL-16-3/32
<b>new</b> MVJNL 24 3E	1.500	1.500	7.000	2.000	2.000	VN.. 332 VN.. 160408	CK-43	STC-4	AAL-17-5/32	IVSN-322	KL-34L	AAL-18-5/64
MVJNL 24 4D	1.500	1.500	6.000	2.000	2.000	VN.. 432 VN.. 220408	CK-43	STC-4	AAL-17-5/32	IVSN-433	KL-46	AAL-16-3/32
<b>new</b> MVJNL 24 4E	1.500	1.500	7.000	2.125	2.000	VN.. 432 VN.. 220408	CK-43	STC-4	AAL-17-5/32	IVSN-433	KL-46	AAL-16-3/32





Illustrations shown may vary from actual product.

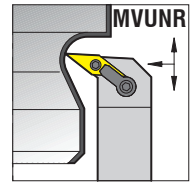
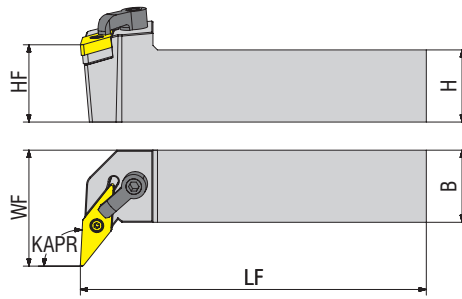

Ordering Code	Dimensions in Inch					Insert Inch/Metric	Wedge Clamp	Clamp Screw	Allen Key	Shim	Lock Pin	Allen Key
	HF=H	B	LF	LH	WF							
<b>MVUNR 20 4C</b>	1.250	1.250	5.000	1.250	2.000	VN.. 432 VN.. 220408	CK-43	STC-4	AAL-17-5/32	IVSN-433	KL-46	AAL-16-3/32
<b>MVUNR 20 4D</b>	1.250	1.250	6.000	1.250	2.000	VN.. 432 VN.. 220408	CK-43	STC-4	AAL-17-5/32	IVSN-433	KL-46	AAL-16-3/32
<b>MVUNR 24 4D</b>	1.500	1.500	6.000	1.250	2.250	VN.. 432 VN.. 220408	CK-43	STC-4	AAL-17-5/32	IVSN-433	KL-46	AAL-16-3/32
<b>MVUNL 20 4D</b>	1.250	1.250	6.000	1.250	2.000	VN.. 432 VN.. 220408	CK-43	STC-4	AAL-17-5/32	IVSN-433	KL-46	AAL-16-3/32
<b>MVUNL 24 4D</b>	1.500	1.500	6.000	1.250	2.250	VN.. 432 VN.. 220408	CK-43	STC-4	AAL-17-5/32	IVSN-433	KL-46	AAL-16-3/32



Illustrations shown may vary from actual product.

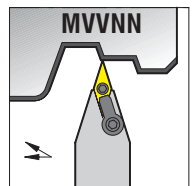
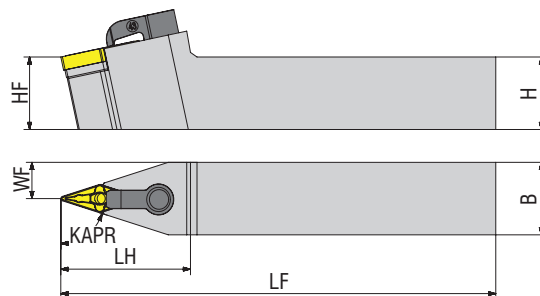

Ordering Code	Dimensions in Inch					Insert Inch/Metric	Wedge Clamp	Clamp Screw	Allen Key	Shim	Lock Pin	Allen Key
	HF=H	B	LF	LH	WF							
<b>MVVNN 12 3B</b>	0.750	0.750	4.500	1.770	0.375	VN.. 332 VN.. 160408	CK-43	STC-4	AAL-17-5/32	IVSN-322	KL-34L	AAL-18-5/64
<b>MVVNN 16 3C</b>	1.000	1.000	5.000	1.770	0.500	VN.. 332 VN.. 160408	CK-43	STC-4	AAL-17-5/32	IVSN-322	KL-34L	AAL-18-5/64
<b>MVVNN 16 3D</b>	1.000	1.000	6.000	1.800	0.500	VN.. 332 VN.. 160408	CK-43	STC-4	AAL-17-5/32	IVSN-322	KL-34L	AAL-18-5/64
<b>MVVNN 20 3D</b>	1.250	1.250	6.000	1.770	0.625	VN.. 332 VN.. 160408	CK-43	STC-4	AAL-17-5/32	IVSN-322	KL-34L	AAL-18-5/64
<b>MVVNN 16 4D</b>	1.000	1.000	6.000	2.250	0.500	VN.. 432 VN.. 220408	CK-43	STC-4	AAL-17-5/32	IVSN-433	KL-46	AAL-16-3/32
<b>MVVNN 20 4D</b>	1.250	1.250	6.000	2.250	0.625	VN.. 432 VN.. 220408	CK-43	STC-4	AAL-17-5/32	IVSN-433	KL-46	AAL-16-3/32
<b>MVVNN 24 4E</b>	1.500	1.500	7.000	2.250	0.750	VN.. 432 VN.. 220408	CK-43	STC-4	AAL-17-5/32	IVSN-433	KL-46	AAL-16-3/32

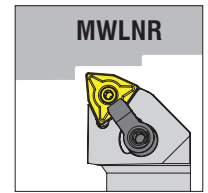
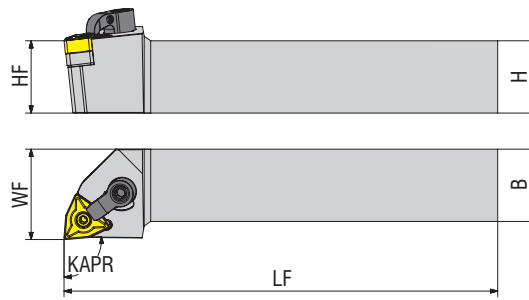
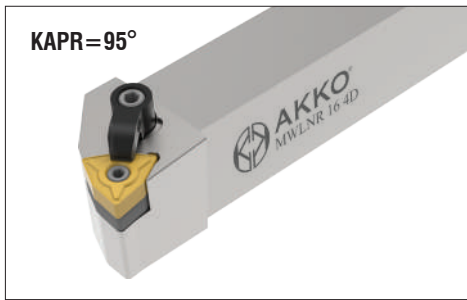

Illustrations shown may vary from actual product.

Dimensions in Inch



Ordering Code	HF=H	B	LF	LH	WF	Insert Inch/Metric	Wedge Clamp	Clamp Screw	Allen Key	Shim	Lock Pin	Allen Key
MWLNR 12 3B	0.750	0.750	4.500	0.880	1.000	WN.. 332 WN.. 060408	CK-6	STC-5	AAL-16-3/32	IWSN-322	KL-34L	AAL-18-5/64
MWLNR 12 4B	0.750	0.750	4.500	1.120	1.000	WN.. 432 WN.. 080408	CK-20	STC-20	AAL-14-1/8	IWSN-433	KL-46	AAL-16-3/32
<b>new</b> MWLNR 12 4D	0.750	0.750	6.000	1.250	1.000	WN.. 432 WN.. 080408	CK-20	STC-4	AAL-14-1/8	IWSN-433	KL-46	AAL-16-3/32
MWLNR 16 3C	1.000	1.000	5.000	0.880	1.250	WN.. 332 WN.. 060408	CK-6	STC-5	AAL-16-3/32	IWSN-322	KL-34L	AAL-18-5/64
MWLNR 16 3D	1.000	1.000	6.000	0.880	1.250	WN.. 332 WN.. 060408	CK-6	STC-5	AAL-16-3/32	IWSN-322	KL-34L	AAL-18-5/64
MWLNR 16 4C	1.000	1.000	5.000	1.130	1.250	WN.. 432 WN.. 080408	CK-20	STC-20	AAL-14-1/8	IWSN-433	KL-46	AAL-16-3/32
MWLNR 16 4D	1.000	1.000	6.000	1.120	1.250	WN.. 432 WN.. 080408	CK-20	STC-20	AAL-14-1/8	IWSN-433	KL-46	AAL-16-3/32
MWLNR 20 4D	1.250	1.250	6.000	1.120	1.500	WN.. 432 WN.. 080408	CK-20	STC-20	AAL-14-1/8	IWSN-433	KL-46	AAL-16-3/32
<b>new</b> MWLNR 20 4E	1.250	1.250	7.000	1.250	1.500	WN.. 432 WN.. 080408	CK-20	STC-20	AAL-14-1/8	IWSN-433	KL-46	AAL-16-3/32
<b>new</b> MWLNR 85 4E	1.250	1.000	7.000	1.250	1.250	WN.. 432 WN.. 080408	CK-20	STC-20	AAL-14-1/8	IWSN-433	KL-46	AAL-16-3/32
MWLNL 12 3B	0.750	0.750	4.500	0.880	1.000	WN.. 332 WN.. 060408	CK-6	STC-5	AAL-16-3/32	IWSN-322	KL-34L	AAL-18-5/64
MWLNL 12 4B	0.750	0.750	4.500	1.120	1.000	WN.. 432 WN.. 080408	CK-20	STC-20	AAL-14-1/8	IWSN-433	KL-46	AAL-16-3/32
<b>new</b> MWLNL 12 4D	0.750	0.750	6.000	1.250	1.000	WN.. 432 WN.. 080408	CK-20	STC-20	AAL-14-1/8	IWSN-433	KL-46	AAL-16-3/32
MWLNL 16 3C	1.000	1.000	5.000	0.880	1.250	WN.. 332 WN.. 060408	CK-6	STC-5	AAL-16-3/32	IWSN-322	KL-34L	AAL-18-5/64
MWLNL 16 3D	1.000	1.000	6.000	0.880	1.250	WN.. 332 WN.. 060408	CK-6	STC-5	AAL-16-3/32	IWSN-322	KL-34L	AAL-18-5/64
MWLNL 16 4C	1.000	1.000	5.000	1.130	1.250	WN.. 432 WN.. 080408	CK-20	STC-20	AAL-14-1/8	IWSN-433	KL-46	AAL-16-3/32
MWLNL 16 4D	1.000	1.000	6.000	1.120	1.250	WN.. 432 WN.. 080408	CK-20	STC-20	AAL-14-1/8	IWSN-433	KL-46	AAL-16-3/32
MWLNL 20 4D	1.250	1.250	6.000	1.120	1.500	WN.. 432 WN.. 080408	CK-20	STC-20	AAL-14-1/8	IWSN-433	KL-46	AAL-16-3/32
<b>new</b> MWLNL 20 4E	1.250	1.250	7.000	1.250	1.500	WN.. 432 WN.. 080408	CK-20	STC-20	AAL-14-1/8	IWSN-433	KL-46	AAL-16-3/32
<b>new</b> MWLNL 85 4E	1.250	1.000	7.000	1.250	1.250	WN.. 432 WN.. 080408	CK-20	STC-20	AAL-14-1/8	IWSN-433	KL-46	AAL-16-3/32

M-SYSTEM  
EXTERNAL TURNING TOOLHOLDERS

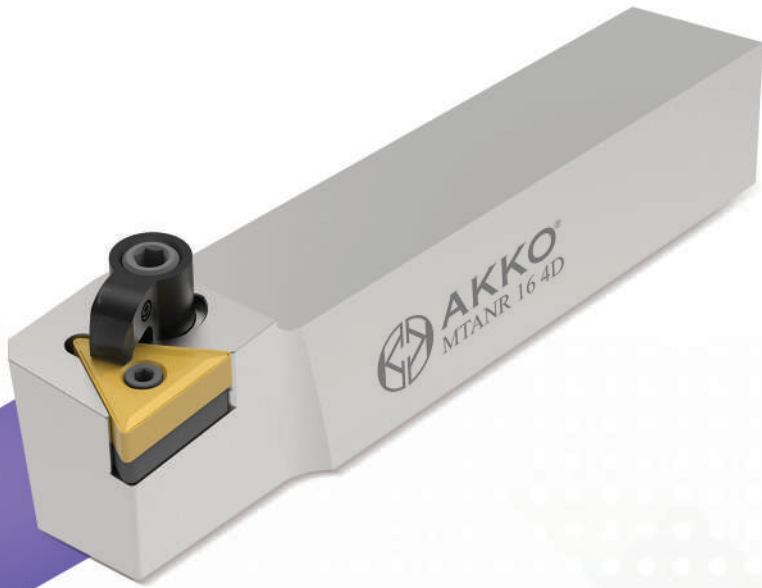



*the spoken quality...*

# P-SYSTEM

P-SYSTEM EXTERNAL TURNING TOOLHOLDERS

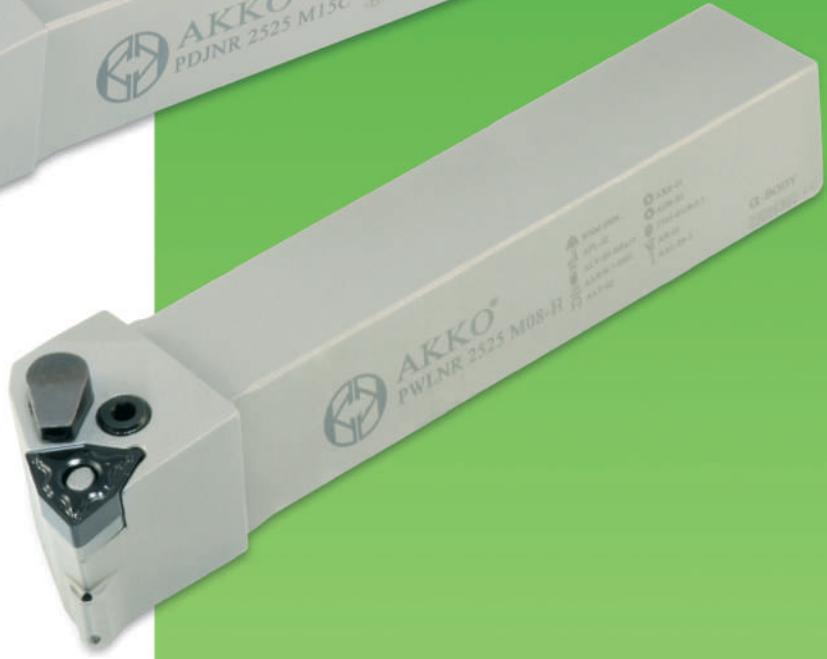

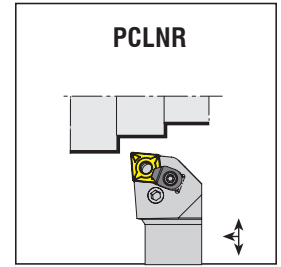
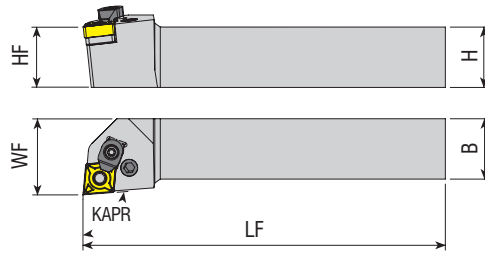

Illustrations shown may vary from actual product.

Dimensions in Metric



Ordering Code	HF=H	B	LF	WF	Insert Inch/Metric	Lever	Lever Screw	Shim	Shim Spring	Wedge Clamp	Clamp Screw	Allen Key
PCLNR 1616 H09	16	16	100	20	CN.. 32.. CN.. 0903..	APL-01	ALV-02-M6x17	AACN-2-0002	AAY-01	-	-	AAL-02-2.5
PCLNR 2020 K09	20	20	125	25	CN.. 32.. CN.. 0903..	APL-01	ALV-02-M6x17	AACN-2-0002	AAY-01	-	-	AAL-02-2.5
PCLNR 2525 M09	25	25	150	32	CN.. 32.. CN.. 0903..	APL-01	ALV-02-M6x17	AACN-2-0002	AAY-01	-	-	AAL-02-2.5
PCLNR 1616 H12	16	16	100	20	CN.. 43.. CN.. 1204..	APL-02	ALV-03-M8x19	AACN-3-0001	AAY-02	-	-	AAL-03-3
PCLNR 2020 K12C	20	20	125	25	CN.. 43.. CN.. 1204..	APL-02	ALV-03-M8x19	AACN-3-0001	AAY-02	ACK-05	4015-M4x11	AAL-03-3
PCLNR 2525 M12C	25	25	150	32	CN.. 43.. CN.. 1204..	APL-02	ALV-03-M8x19	AACN-3-0001	AAY-02	ACK-05	4015-M4x11	AAL-03-3
PCLNR 3232 P12C	32	32	170	40	CN.. 43.. CN.. 1204..	APL-02	ALV-03-M8x19	AACN-3-0001	AAY-02	ACK-05	4015-M4x11	AAL-03-3
PCLNR 2525 M16C	25	25	150	32	CN.. 54.. CN.. 1606..	APL-04	ALV-04-M8x22	AACN-3-0002	AAY-03	ACK-09	AAV-05-M6x15	AAL-03-3
PCLNR 3232 P16C	32	32	170	40	CN.. 54.. CN.. 1606..	APL-04	ALV-04-M8x22	AACN-3-0002	AAY-03	ACK-09	AAV-05-M6x15	AAL-03-3
PCLNR 2525 M19C	25	25	150	32	CN.. 64.. CN.. 1906..	APL-05	ALV-05-M10x27	AACN-3-0003	AAY-04	ACK-09	AAV-05-M6x15	AAL-05-4
PCLNR 3232 P19C	32	32	170	40	CN.. 64.. CN.. 1906..	APL-05	ALV-05-M10x27	AACN-3-0003	AAY-04	ACK-09	AAV-05-M6x15	AAL-05-4
PCLNR 4040 S19C	40	40	250	50	CN.. 64.. CN.. 1906..	APL-05	ALV-05-M10x27	AACN-3-0003	AAY-04	ACK-09	AAV-05-M6x15	AAL-05-4
PCLNR 5050 S19C	50	50	250	60	CN.. 64.. CN.. 1906..	APL-05	ALV-05-M10x27	AACN-3-0003	AAY-04	ACK-09	AAV-05-M6x15	AAL-05-4
PCLNR 4040 S25C	40	40	250	50	CN.. 86.. CN.. 2509..	APL-06	ALV-06-M12x36	AACN-3-0008	AAY-05	ACK-04	AKV-16-M6x16	AAL-07-5
PCLNR 5050 S25C	50	50	250	60	CN.. 86.. CN.. 2509..	APL-06	ALV-06-M12x36	AACN-3-0008	AAY-05	ACK-04	AKV-16-M6x16	AAL-07-5
PCLNL 1616 H09	16	16	100	20	CN.. 32.. CN.. 0903..	APL-01	ALV-02-M6x17	AACN-2-0002	AAY-01	-	-	AAL-02-2.5
PCLNL 2020 K09	20	20	125	25	CN.. 32.. CN.. 0903..	APL-01	ALV-02-M6x17	AACN-2-0002	AAY-01	-	-	AAL-02-2.5
PCLNL 2525 M09	25	25	150	32	CN.. 32.. CN.. 0903..	APL-01	ALV-02-M6x17	AACN-2-0002	AAY-01	-	-	AAL-02-2.5
PCLNL 1616 H12	16	16	100	20	CN.. 43.. CN.. 1204..	APL-02	ALV-03-M8x19	AACN-3-0001	AAY-02	-	-	AAL-03-3
PCLNL 2020 K12C	20	20	125	25	CN.. 43.. CN.. 1204..	APL-02	ALV-03-M8x19	AACN-3-0001	AAY-02	ACK-05	4015-M4x11	AAL-03-3
PCLNL 2525 M12C	25	25	150	32	CN.. 43.. CN.. 1204..	APL-02	ALV-03-M8x19	AACN-3-0001	AAY-02	ACK-05	4015-M4x11	AAL-03-3
PCLNL 3232 P12C	32	32	170	40	CN.. 43.. CN.. 1204..	APL-02	ALV-03-M8x19	AACN-3-0001	AAY-02	ACK-05	4015-M4x11	AAL-03-3
PCLNL 2525 M16C	25	25	150	32	CN.. 54.. CN.. 1606..	APL-04	ALV-04-M8x22	AACN-3-0002	AAY-03	ACK-09	AAV-05-M6x15	AAL-03-3
PCLNL 3232 P16C	32	32	170	40	CN.. 54.. CN.. 1606..	APL-04	ALV-04-M8x22	AACN-3-0002	AAY-03	ACK-09	AAV-05-M6x15	AAL-03-3
PCLNL 2525 M19C	25	25	150	32	CN.. 64.. CN.. 1906..	APL-05	ALV-05-M10x27	AACN-3-0003	AAY-04	ACK-09	AAV-05-M6x15	AAL-05-4
PCLNL 3232 P19C	32	32	170	40	CN.. 64.. CN.. 1906..	APL-05	ALV-05-M10x27	AACN-3-0003	AAY-04	ACK-09	AAV-05-M6x15	AAL-05-4

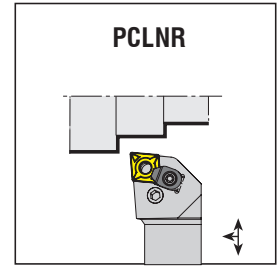
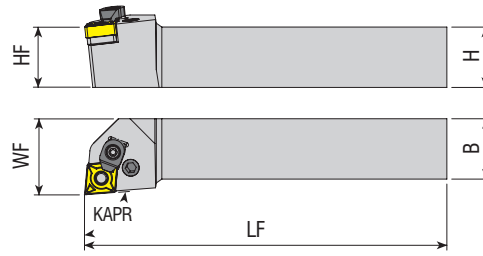

Illustrations shown may vary from actual product.

Dimensions in Metric												
Ordering Code	HF=H	B	LF	WF	Insert Inch/Metric	Lever	Lever Screw	Shim	Shim Spring	Wedge Clamp	Clamp Screw	Allen Key
PCLNL 4040 S19C	40	40	250	50	CN.. 64.. CN.. 1906..	APL-05	ALV-05-M10x27	AACN-3-0003	AAV-04	ACK-09	AAV-05-M6x15	AAL-05-4
PCLNL 5050 S19C	50	50	250	60	CN.. 64.. CN.. 1906..	APL-05	ALV-05-M10x27	AACN-3-0003	AAV-04	ACK-09	AAV-05-M6x15	AAL-05-4
PCLNL 4040 S25C	40	40	250	50	CN.. 86.. CN.. 2509..	APL-06	ALV-06-M12x36	AACN-3-0008	AAV-05	ACK-04	AKV-16-M6x16	AAL-07-5
PCLNL 5050 S25C	50	50	250	60	CN.. 86.. CN.. 2509..	APL-06	ALV-06-M12x36	AACN-3-0008	AAV-05	ACK-04	AKV-16-M6x16	AAL-07-5

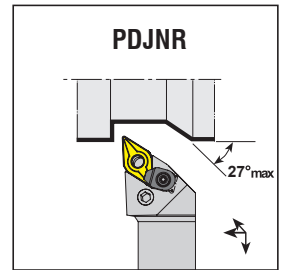
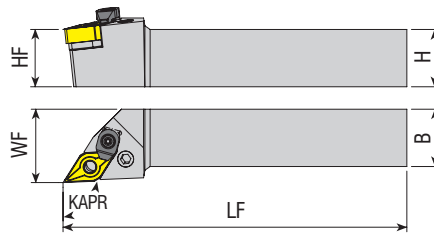

Illustrations shown may vary from actual product.

Dimensions in Metric												
Ordering Code	HF=H	B	LF	WF	Insert Inch/Metric	Lever	Lever Screw	Shim	Shim Spring	Wedge Clamp	Clamp Screw	Allen Key
PDJNR 1616 H11	16	16	100	20	DN.. 33.. DN.. 1104..	APL-01	ALV-02-M6x17	AADN-SD317	AAV-01	-	-	AAL-02-2.5
PDJNR 2020 K11	20	20	125	25	DN.. 33.. DN.. 1104..	APL-01	ALV-02-M6x17	AADN-SD317	AAV-01	-	-	AAL-02-2.5
PDJNR 2525 M11	25	25	150	32	DN.. 33.. DN.. 1104..	APL-01	ALV-02-M6x17	AADN-SD317	AAV-01	-	-	AAL-02-2.5
PDJNR 2020 K15C	20	20	125	25	DN.. 44.. DN.. 1506..	APL-03	ALV-03-M8x19	AADN-3-0001	AAV-02	ACK-05	4015-M4x11	AAL-03-3
PDJNR 2525 M15C	25	25	150	32	DN.. 44.. DN.. 1506..	APL-03	ALV-03-M8x19	AADN-3-0001	AAV-02	ACK-05	4015-M4x11	AAL-03-3
PDJNR 3232 P15C	32	32	170	40	DN.. 44.. DN.. 1506..	APL-03	ALV-03-M8x19	AADN-3-0001	AAV-02	ACK-05	4015-M4x11	AAL-03-3
PDJNR 4040 S15C	40	40	250	50	DN.. 44.. DN.. 1506..	APL-03	ALV-03-M8x19	AADN-3-0001	AAV-02	ACK-05	4015-M4x11	AAL-03-3
PDJNL 1616 H11	16	16	100	20	DN.. 33.. DN.. 1104..	APL-01	ALV-02-M6x17	AADN-SD317	AAV-01	-	-	AAL-02-2.5
PDJNL 2020 K11	20	20	125	25	DN.. 33.. DN.. 1104..	APL-01	ALV-02-M6x17	AADN-SD317	AAV-01	-	-	AAL-02-2.5
PDJNL 2525 M11	25	25	150	32	DN.. 33.. DN.. 1104..	APL-01	ALV-02-M6x17	AADN-SD317	AAV-01	-	-	AAL-02-2.5
PDJNL 2020 K15C	20	20	125	25	DN.. 44.. DN.. 1506..	APL-03	ALV-03-M8x19	AADN-3-0001	AAV-02	ACK-05	4015-M4x11	AAL-03-3
PDJNL 2525 M15C	25	25	150	32	DN.. 44.. DN.. 1506..	APL-03	ALV-03-M8x19	AADN-3-0001	AAV-02	ACK-05	4015-M4x11	AAL-03-3
PDJNL 3232 P15C	32	32	170	40	DN.. 44.. DN.. 1506..	APL-03	ALV-03-M8x19	AADN-3-0001	AAV-02	ACK-05	4015-M4x11	AAL-03-3
PDJNL 4040 S15C	40	40	250	50	DN.. 44.. DN.. 1506..	APL-03	ALV-03-M8x19	AADN-3-0001	AAV-02	ACK-05	4015-M4x11	AAL-03-3

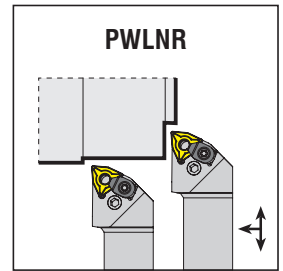
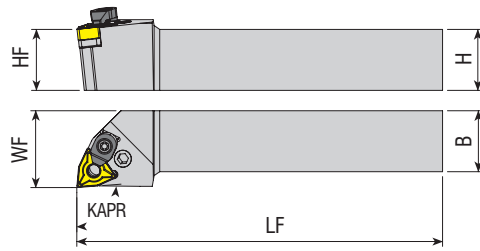

Illustrations shown may vary from actual product.

Dimensions in Metric



Ordering Code	HF=H	B	LF	WF	Insert Inch/Metric	Lever	Lever Screw	Shim	Shim Spring	Wedge Clamp	Clamp Screw	Allen Key
PWLNK 1616 H06	16	16	100	20	WN.. 33.. WN.. 0604..	APL-01	ALV-02-M6x17	AAWN-SW317	AAY-01	-	-	AAL-02-2.5
PWLNK 2020 K06	20	20	125	25	WN.. 33.. WN.. 0604..	APL-01	ALV-02-M6x17	AAWN-SW317	AAY-01	-	-	AAL-02-2.5
PWLNK 2525 M06	25	25	150	32	WN.. 33.. WN.. 0604..	APL-01	ALV-02-M6x17	AAWN-SW317	AAY-01	-	-	AAL-02-2.5
PWLNK 3232 P06	32	32	170	40	WN.. 33.. WN.. 0604..	APL-01	ALV-02-M6x17	AAWN-SW317	AAY-01	-	-	AAL-02-2.5
PWLNK 1616 H08	16	16	100	20	WN.. 43.. WN.. 0804..	APL-02	ALV-03-M8x19	AAWN-3-0001	AAY-02	-	-	AAL-03-3
PWLNK 2020 K08C	20	20	125	25	WN.. 43.. WN.. 0804..	APL-02	ALV-03-M8x19	AAWN-3-0001	AAY-02	ACK-05	4015-M4x11	AAL-03-3
PWLNK 2525 M08C	25	25	150	32	WN.. 43.. WN.. 0804..	APL-02	ALV-03-M8x19	AAWN-3-0001	AAY-02	ACK-05	4015-M4x11	AAL-03-3
PWLNK 3232 P08C	32	32	170	40	WN.. 43.. WN.. 0804..	APL-02	ALV-03-M8x19	AAWN-3-0001	AAY-02	ACK-05	4015-M4x11	AAL-03-3
PWLNK 1616 H06	16	16	100	20	WN.. 33.. WN.. 0604..	APL-01	ALV-02-M6x17	AAWN-SW317	AAY-01	-	-	AAL-02-2.5
PWLNK 2020 K06	20	20	125	25	WN.. 33.. WN.. 0604..	APL-01	ALV-02-M6x17	AAWN-SW317	AAY-01	-	-	AAL-02-2.5
PWLNK 2525 M06	25	25	150	32	WN.. 33.. WN.. 0604..	APL-01	ALV-02-M6x17	AAWN-SW317	AAY-01	-	-	AAL-02-2.5
PWLNK 3232 P06	32	32	170	40	WN.. 33.. WN.. 0604..	APL-01	ALV-02-M6x17	AAWN-SW317	AAY-01	-	-	AAL-02-2.5
PWLNK 1616 H08	16	16	100	20	WN.. 43.. WN.. 0804..	APL-02	ALV-03-M8x19	AAWN-3-0001	AAY-02	-	-	AAL-03-3
PWLNK 2020 K08C	20	20	125	25	WN.. 43.. WN.. 0804..	APL-02	ALV-03-M8x19	AAWN-3-0001	AAY-02	ACK-05	4015-M4x11	AAL-03-3
PWLNK 2525 M08C	25	25	150	32	WN.. 43.. WN.. 0804..	APL-02	ALV-03-M8x19	AAWN-3-0001	AAY-02	ACK-05	4015-M4x11	AAL-03-3
PWLNK 3232 P08C	32	32	170	40	WN.. 43.. WN.. 0804..	APL-02	ALV-03-M8x19	AAWN-3-0001	AAY-02	ACK-05	4015-M4x11	AAL-03-3

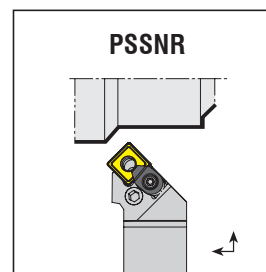
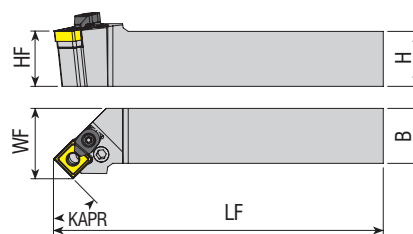

Illustrations shown may vary from actual product.

Ordering Code	Dimensions in Metric				Insert Inch/Metric	Lever	Lever Screw	Shim	Shim Spring	Wedge Clamp	Clamp Screw	Allen Key
	HF=H	B	LF	WF								
PSSNR 1616 H09	16	16	100	20	SN.. 32.. SN.. 0903..	APL-01	ALV-02-M6x17	AASN-2-0002	AAY-01	-	-	AAL-02-2.5
PSSNR 2020 K09	20	20	125	25	SN.. 32.. SN.. 0903..	APL-01	ALV-02-M6x17	AASN-2-0002	AAY-01	-	-	AAL-02-2.5
PSSNR 2020 K12C	20	20	125	25	SN.. 43.. SN.. 1204..	APL-02	ALV-03-M8x19	AASN-3-0004	AAY-02	ACK-05	4015-M4x11	AAL-03-3
PSSNR 2525 M12C	25	25	150	32	SN.. 43.. SN.. 1204..	APL-02	ALV-03-M8x19	AASN-3-0004	AAY-02	ACK-05	4015-M4x11	AAL-03-3
PSSNR 3232 P12C	32	32	170	40	SN.. 43.. SN.. 1204..	APL-02	ALV-03-M8x19	AASN-3-0004	AAY-02	ACK-05	4015-M4x11	AAL-03-3
PSSNR 3232 P15C	32	32	170	40	SN.. 54.. SN.. 1506..	APL-04	ALV-04-M8x22	AASN-3-0023	AAY-03	ACK-09	AAV-05-M6x15	AAL-03-3
PSSNR 3232 P19C	32	32	170	40	SN.. 64.. SN.. 1906..	APL-05	ALV-05-M10x27	AASN-3-0005	AAY-04	ACK-09	AAV-05-M6x15	AAL-05-4
PSSNR 4040 S19C	40	40	250	50	SN.. 64.. SN.. 1906..	APL-05	ALV-05-M10x27	AASN-3-0005	AAY-04	ACK-09	AAV-05-M6x15	AAL-05-4
PSSNR 4040 S25C	40	40	250	50	SN.. 86.. SN.. 2509..	APL-06	ALV-06-M12x36	AASN-3-0020	AAY-05	ACK-04	AKV-16-M6x16	AAL-07-5
PSSNL 1616 H09	16	16	100	20	SN.. 32.. SN.. 0903..	APL-01	ALV-02-M6x17	AASN-2-0002	AAY-01	-	-	AAL-02-2.5
PSSNL 2020 K09	20	20	125	25	SN.. 32.. SN.. 0903..	APL-01	ALV-02-M6x17	AASN-2-0002	AAY-01	-	-	AAL-02-2.5
PSSNL 2020 K12C	20	20	125	25	SN.. 43.. SN.. 1204..	APL-02	ALV-03-M8x19	AASN-3-0004	AAY-02	ACK-05	4015-M4x11	AAL-03-3
PSSNL 2525 M12C	25	25	150	32	SN.. 43.. SN.. 1204..	APL-02	ALV-03-M8x19	AASN-3-0004	AAY-02	ACK-05	4015-M4x11	AAL-03-3
PSSNL 3232 P12C	32	32	170	40	SN.. 43.. SN.. 1204..	APL-02	ALV-03-M8x19	AASN-3-0004	AAY-02	ACK-05	4015-M4x11	AAL-03-3
PSSNL 3232 P15C	32	32	170	40	SN.. 54.. SN.. 1506..	APL-04	ALV-04-M8x22	AASN-3-0023	AAY-03	ACK-09	AAV-05-M6x15	AAL-03-3
PSSNL 3232 P19C	32	32	170	40	SN.. 64.. SN.. 1906..	APL-05	ALV-05-M10x27	AASN-3-0005	AAY-04	ACK-09	AAV-05-M6x15	AAL-05-4
PSSNL 4040 S19C	40	40	250	50	SN.. 64.. SN.. 1906..	APL-05	ALV-05-M10x27	AASN-3-0005	AAY-04	ACK-09	AAV-05-M6x15	AAL-05-4
PSSNL 4040 S25C	40	40	250	50	SN.. 86.. SN.. 2509..	APL-06	ALV-06-M12x36	AASN-3-0020	AAY-05	ACK-04	AKV-16-M6x16	AAL-07-5

# P-SYSTEM EXTERNAL TURNING TOOLHOLDERS

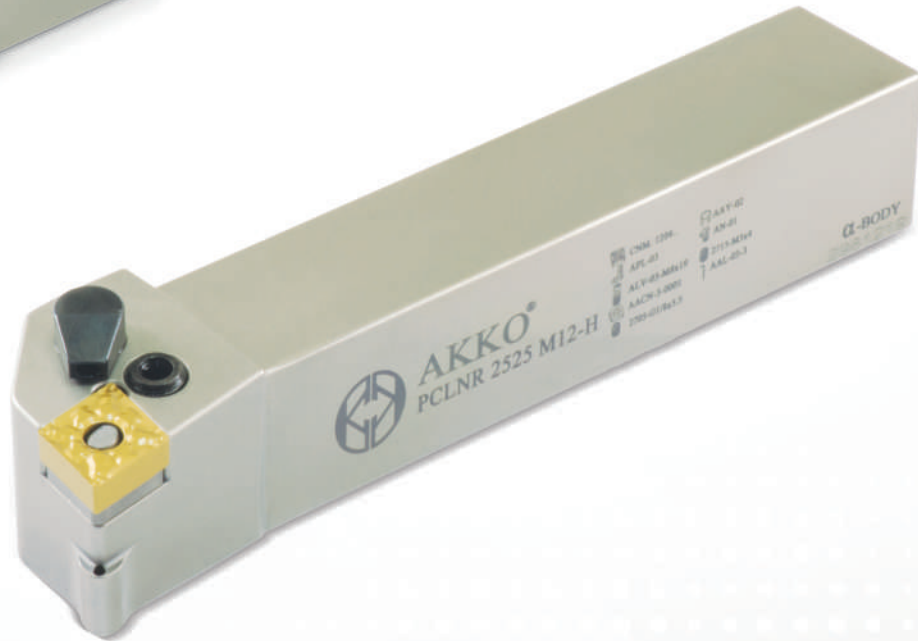
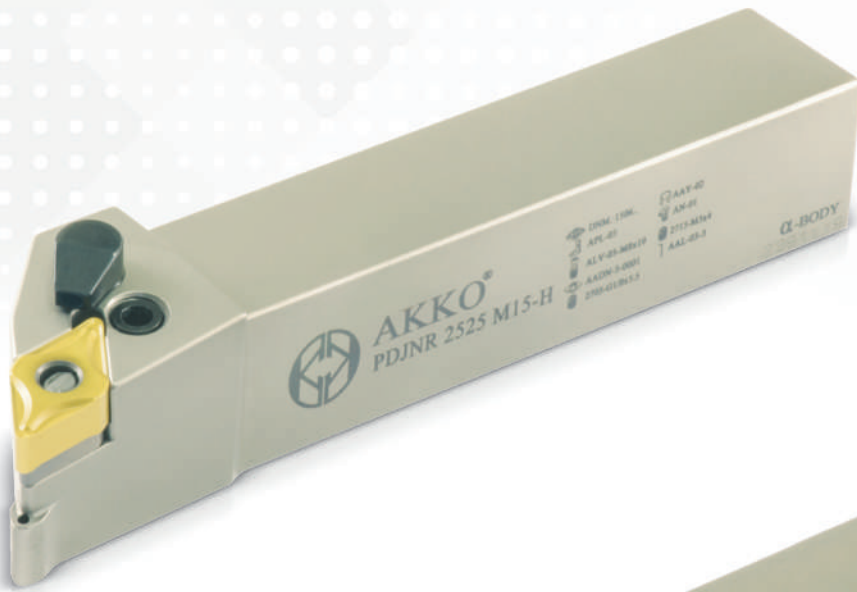



*the spoken quality...*

# S-SYSTEM

S-SYSTEM EXTERNAL TURNING TOOLHOLDERS



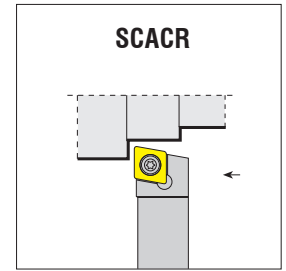
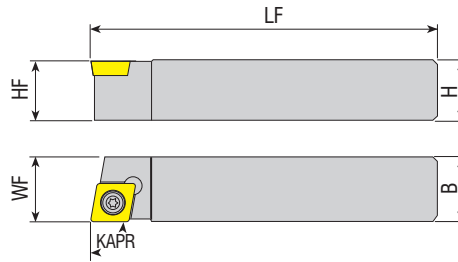

Illustrations shown may vary from actual product.

Ordering Code	Dimensions in Inch					Insert Inch/Metric	Screw	Shim	Shim Screw	Torx Key
	HF=H	B	LF	LH	WF					
SCACR 05 2D-S	0.312	0.312	6.000	0.440	0.313	CC.. 2151 CC.. 060204	4008-M2.5x6	-	-	82-T08
SCACR 06 2D-S	0.375	0.375	6.000	0.440	0.375	CC.. 2151 CC.. 060204	4008-M2.5x6	-	-	82-T08
SCACR 08 3D-S	0.500	0.500	6.000	0.620	0.500	CC.. 3252 CC.. 09T308	4015-M3.5x11	-	-	80-T15
SCACR 10 3B-S	0.625	0.625	4.500	0.620	0.625	CC.. 3252 CC.. 09T308	4015-M3.5x14	AACN-2-0001	AAV-06-M3.5x11	80-T15
SCACL 06 2D-S	0.375	0.375	6.000	0.440	0.375	CC.. 2151 CC.. 060204	4008-M2.5x6	-	-	82-T08
SCACL 08 3D-S	0.500	0.500	6.000	0.620	0.500	CC.. 3252 CC.. 09T308	4015-M3.5x11	-	-	80-T15
SCACL 10 3B-S	0.625	0.625	4.500	0.620	0.625	CC.. 3252 CC.. 09T308	4015-M3.5x14	AACN-2-0001	AAV-06-M3.5x11	80-T15

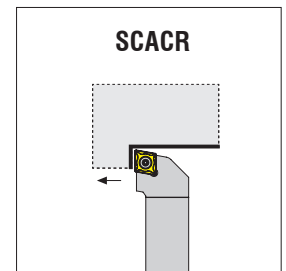
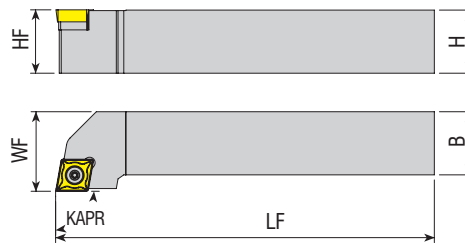
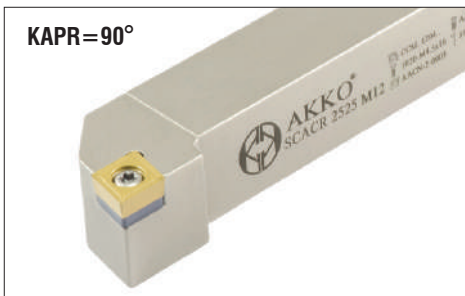

Illustrations shown may vary from actual product.

Ordering Code	Dimensions in Inch					Insert Inch/Metric	Screw	Shim	Shim Screw	Torx Key
	HF=H	B	LF	LH	WF					
SCACR 10 2A	0.625	0.625	4.000	0.500	0.750	CC.. 2151 CC.. 060204	4008-M2.5x6	-	-	82-T08
SCACR 10 3A	0.625	0.625	4.000	0.620	0.750	CC.. 3252 CC.. 09T308	4015-M3.5x14	AACN-2-0001	AAV-06-M3.5x11	80-T15
SCACR 12 3B	0.750	0.750	4.500	0.620	1.000	CC.. 3252 CC.. 09T308	4015-M3.5x14	AACN-2-0001	AAV-06-M3.5x11	80-T15
SCACR 16 3D	1.000	1.000	6.000	0.620	1.250	CC.. 3252 CC.. 09T308	4015-M3.5x14	AACN-2-0001	AAV-06-M3.5x11	80-T15
SCACL 12 3B	0.750	0.750	4.500	0.620	1.000	CC.. 3252 CC.. 09T308	4015-M3.5x14	AACN-2-0001	AAV-06-M3.5x11	80-T15
SCACL 16 3D	1.000	1.000	6.000	0.620	1.250	CC.. 3252 CC.. 09T308	4015-M3.5x14	AACN-2-0001	AAV-06-M3.5x11	80-T15

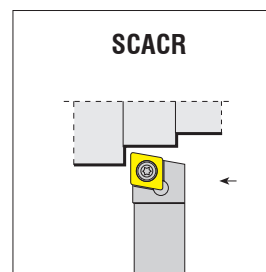
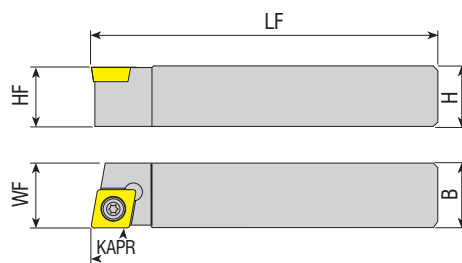

Illustrations shown may vary from actual product.

Dimensions in Metric



Ordering Code	HF=H	B	LF	WF	Insert Inch/Metric	Screw	Shim	Shim Screw	Torx Key
SCACR 0808 X06-S	08	08	115	08	CC.. 215.. CC.. 0602..	4008-M2.5x6	-	-	82-T08
SCACR 1010 K06-S	10	10	125	10	CC.. 215.. CC.. 0602..	4008-M2.5x6	-	-	82-T08
SCACR 1212 G06-S	12	12	90	12	CC.. 215.. CC.. 0602..	4008-M2.5x6	-	-	82-T08
SCACR 1212 K06-S	12	12	125	12	CC.. 215.. CC.. 0602..	4008-M2.5x6	-	-	82-T08
SCACR 1616 F06-S	16	16	75	16	CC.. 215.. CC.. 0602..	4008-M2.5x6	-	-	82-T08
SCACR 1616 K06-S	16	16	125	16	CC.. 215.. CC.. 0602..	4008-M2.5x6	-	-	82-T08
SCACR 1212 G09-S	12	12	90	12	CC.. 325.. CC.. 09T3..	4015-M3.5x11	-	-	80-T15
SCACR 1212 K09-S	12	12	125	12	CC.. 325.. CC.. 09T3..	4015-M3.5x11	-	-	80-T15
SCACR 1616 F09-S	16	16	75	16	CC.. 325.. CC.. 09T3..	4015-M3.5x11	-	-	80-T15
SCACR 1616 K09-S	16	16	125	16	CC.. 325.. CC.. 09T3..	4015-M3.5x11	-	-	80-T15
SCACR 2020 K09-S	20	20	125	20	CC.. 325.. CC.. 09T3..	4015-M3.5x11	-	-	80-T15
SCACL 0808 X06-S	08	08	115	08	CC.. 215.. CC.. 0602..	4008-M2.5x6	-	-	82-T08
SCACL 1010 K06-S	10	10	125	10	CC.. 215.. CC.. 0602..	4008-M2.5x6	-	-	82-T08
SCACL 1212 G06-S	12	12	90	12	CC.. 215.. CC.. 0602..	4008-M2.5x6	-	-	82-T08
SCACL 1212 K06-S	12	12	125	12	CC.. 215.. CC.. 0602..	4008-M2.5x6	-	-	82-T08
SCACL 1616 F06-S	16	16	75	16	CC.. 215.. CC.. 0602..	4008-M2.5x6	-	-	82-T08
SCACL 1616 K06-S	16	16	125	16	CC.. 215.. CC.. 0602..	4008-M2.5x6	-	-	82-T08
SCACL 1212 G09-S	12	12	90	12	CC.. 325.. CC.. 09T3..	4015-M3.5x11	-	-	80-T15
SCACL 1212 K09-S	12	12	125	12	CC.. 325.. CC.. 09T3..	4015-M3.5x11	-	-	80-T15
SCACL 1616 F09-S	16	16	75	16	CC.. 325.. CC.. 09T3..	4015-M3.5x11	-	-	80-T15
SCACL 1616 K09-S	16	16	125	16	CC.. 325.. CC.. 09T3..	4015-M3.5x11	-	-	80-T15
SCACL 2020 K09-S	20	20	125	20	CC.. 325.. CC.. 09T3..	4015-M3.5x11	-	-	80-T15

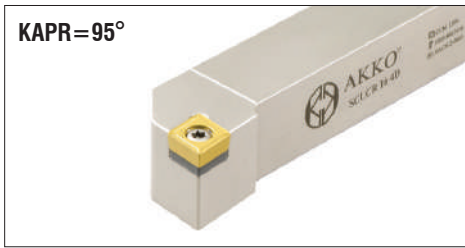

Illustrations shown may vary from actual product.

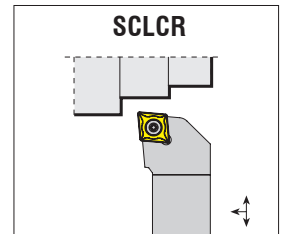
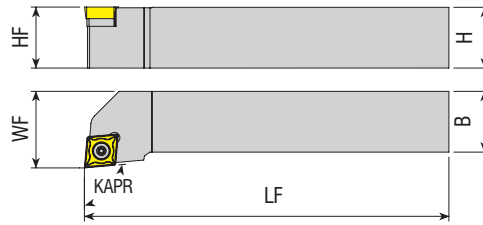

Dimensions in Inch										
Ordering Code	HF=H	B	LF	LH	WF	Insert Inch/Metric	Screw	Shim	Shim Screw	Torx Key
<b>NEW</b> SCLCR 05 2	0.312	0.312	2.500	0.500	0.375	CC.. 2151 CC.. 060204	4008-M2.5x6	-	-	82-T08
<b>NEW</b> SCLCR 06 2J	0.375	0.375	3.500	0.500	0.500	CC.. 2151 CC.. 060204	4008-M2.5x6	-	-	82-T08
<b>NEW</b> SCLCR 08 3A	0.500	0.500	4.000	0.688	0.625	CC.. 3252 CC.. 09T308	4015-M3.5x14	AACN-2-0001	AAV-06-M3.5x11	82-T15
SCLCR 10 2A	0.625	0.625	4.000	0.500	0.750	CC.. 2151 CC.. 060204	4008-M2.5x6	-	-	82-T08
SCLCR 10 3A	0.625	0.625	4.000	0.620	0.750	CC.. 3252 CC.. 09T308	4015-M3.5x14	AACN-2-0001	AAV-06-M3.5x11	80-T15
<b>NEW</b> SCLCR 10 3B	0.625	0.625	4.500	0.688	0.750	CC.. 3252 CC.. 09T308	4015-M3.5x14	AACN-2-0001	AAV-06-M3.5x11	82-T15
SCLCR 12 3B	0.750	0.750	4.500	0.620	1.000	CC.. 3252 CC.. 09T308	4015-M3.5x14	AACN-2-0001	AAV-06-M3.5x11	80-T15
SCLCR 16 3D	1.000	1.000	6.000	0.620	1.250	CC.. 3252 CC.. 09T308	4015-M3.5x14	AACN-2-0001	AAV-06-M3.5x11	80-T15
SCLCR 12 4B	0.750	0.750	4.500	0.750	1.000	CC.. 432 CC.. 120408	1020-M4.5x16	AACN-2-0003	AAV-07-M4.5x13	80-T20
SCLCR 16 4D	1.000	1.000	6.000	0.750	1.250	CC.. 432 CC.. 120408	1020-M4.5x16	AACN-2-0003	AAV-07-M4.5x13	80-T20
<b>NEW</b> SCLCL 05 2	0.312	0.312	2.500	0.500	0.375	CC.. 2151 CC.. 060204	4008-M2.5x6	-	-	82-T08
<b>NEW</b> SCLCL 06 2J	0.375	0.375	3.500	0.500	0.500	CC.. 2151 CC.. 060204	4008-M2.5x6	-	-	82-T08
<b>NEW</b> SCLCL 08 3A	0.500	0.500	4.000	0.688	0.625	CC.. 3252 CC.. 09T308	4015-M3.5x14	AACN-2-0001	AAV-06-M3.5x11	82-T15
SCLCL 10 2A	0.625	0.625	4.000	0.500	0.750	CC.. 2151 CC.. 060204	4008-M2.5x6	-	-	82-T08
SCLCL 10 3A	0.625	0.625	4.000	0.620	0.750	CC.. 3252 CC.. 09T308	4015-M3.5x14	AACN-2-0001	AAV-06-M3.5x11	80-T15
<b>NEW</b> SCLCL 10 3B	0.625	0.625	4.500	0.688	0.750	CC.. 3252 CC.. 09T308	4015-M3.5x14	AACN-2-0001	AAV-06-M3.5x11	82-T15
SCLCL 12 3B	0.750	0.750	4.500	0.620	1.000	CC.. 3252 CC.. 09T308	4015-M3.5x14	AACN-2-0001	AAV-06-M3.5x11	80-T15
SCLCL 16 3D	1.000	1.000	6.000	0.620	1.250	CC.. 3252 CC.. 09T308	4015-M3.5x14	AACN-2-0001	AAV-06-M3.5x11	80-T15
SCLCL 12 4B	0.750	0.750	4.500	0.750	1.000	CC.. 432 CC.. 120408	1020-M4.5x16	AACN-2-0003	AAV-07-M4.5x13	80-T20
SCLCL 16 4D	1.000	1.000	6.000	0.750	1.250	CC.. 432 CC.. 120408	1020-M4.5x16	AACN-2-0003	AAV-07-M4.5x13	80-T20

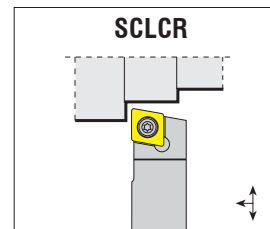
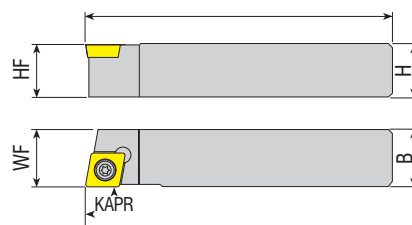

Illustrations shown may vary from actual product.  
Dimensions in Inch



Ordering Code	HF=H	B	LF	LH	WF	Insert Inch/Metric	Screw	Shim	Shim Screw	Torx Key
SCLCR 06 2D-S	0.375	0.375	6.000	0.500	0.375	CC.. 2151 CC.. 060204	4008-M2.5x6	-	-	82-T08
SCLCR 08 2D-S	0.500	0.500	6.000	0.500	0.500	CC.. 2151 CC.. 060204	4008-M2.5x6	-	-	82-T08
SCLCR 08 3D-S	0.500	0.500	6.000	0.620	0.500	CC.. 3252 CC.. 09T308	4015-M3.5x11	-	-	80-T15
SCLCR 10 3B-S	0.625	0.625	4.500	0.620	0.625	CC.. 3252 CC.. 09T308	4015-M3.5x14	AACN-2-0001	AAV-06-M3.5x11	80-T15
SCLCL 06 2D-S	0.375	0.375	6.000	0.500	0.375	CC.. 2151 CC.. 060204	4008-M2.5x6	-	-	82-T08
SCLCL 08 2D-S	0.500	0.500	6.000	0.500	0.500	CC.. 2151 CC.. 060204	4008-M2.5x6	-	-	82-T08
SCLCL 08 3D-S	0.500	0.500	6.000	0.620	0.500	CC.. 3252 CC.. 09T308	4015-M3.5x11	-	-	80-T15
SCLCL 10 3B-S	0.625	0.625	4.500	0.620	0.625	CC.. 3252 CC.. 09T308	4015-M3.5x14	AACN-2-0001	AAV-06-M3.5x11	80-T15

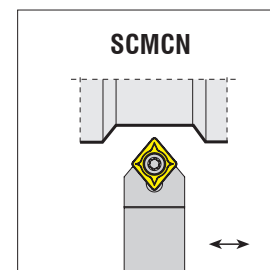
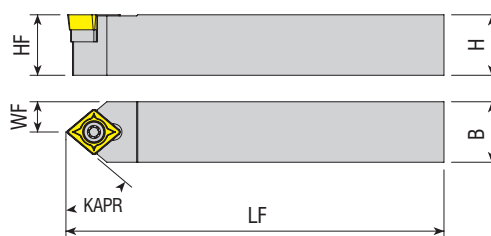
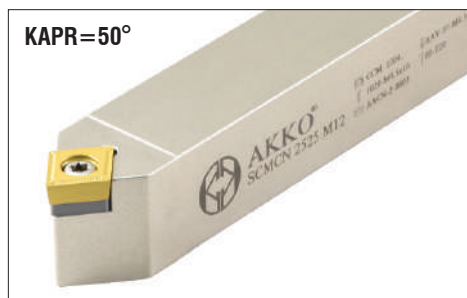

Illustrations shown may vary from actual product.

Dimensions in Inch



Ordering Code	HF=H	B	LF	LH	WF	Insert Inch/Metric	Screw	Shim	Shim Screw	Torx Key
SCMCN 08 2J	0.500	0.500	3.500	0.500	0.625	CC.. 2151 CC.. 060204	4015-M3.5x14	AACN-2-0001	AAV-06-M3.5x11	82-T15
SCMCN 08 3A	0.500	0.500	4.000	1.000	0.625	CC.. 3252 CC.. 09T308	4015-M3.5x14	AACN-2-0001	AAV-06-M3.5x11	82-T15
SCMCN 08 3J	0.500	0.500	3.500	0.500	0.625	CC.. 3252 CC.. 09T308	4015-M3.5x14	AACN-2-0001	AAV-06-M3.5x11	82-T15
SCMCN 10 2A	0.625	0.625	4.000	0.625	0.625	CC.. 2151 CC.. 060204	4015-M3.5x14	AACN-2-0001	AAV-06-M3.5x11	82-T15
SCMCN 10 3A	0.625	0.625	4.000	0.620	0.313	CC.. 3252 CC.. 09T308	4015-M3.5x14	AACN-2-0001	AAV-06-M3.5x11	80-T15
SCMCN 10 3B	0.625	0.625	4.500	1.380	0.625	CC.. 3252 CC.. 09T308	4015-M3.5x14	AACN-2-0001	AAV-06-M3.5x11	82-T15
SCMCN 12 3B	0.750	0.750	4.500	0.620	0.375	CC.. 3252 CC.. 09T308	4015-M3.5x14	AACN-2-0001	AAV-06-M3.5x11	82-T15
SCMCN 16 3D	1.000	1.000	6.000	0.620	0.500	CC.. 3252 CC.. 09T308	4015-M3.5x14	AACN-2-0001	AAV-06-M3.5x11	82-T15

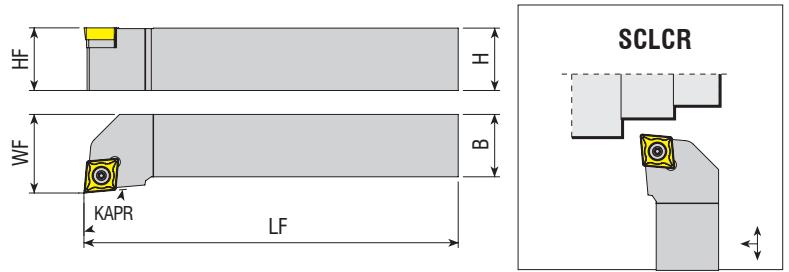
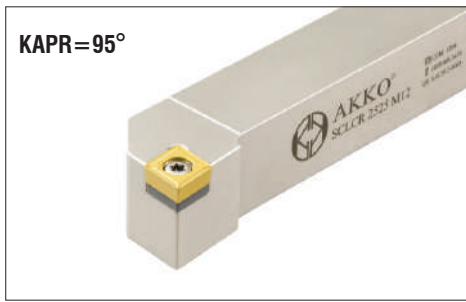

Illustrations shown may vary from actual product.

Dimensions in Metric



Ordering Code	HF=H	B	LF	WF	Insert Inch/Metric	Screw	Shim	Shim Screw	Torx Key
SCLCR 0808 E06	8	8	70	10	CC.. 215.. CC.. 0602..	4008-M2.5x6	-	-	82-T08
SCLCR 1010 E06	10	10	70	12	CC.. 215.. CC.. 0602..	4008-M2.5x6	-	-	82-T08
SCLCR 1212 F06	12	12	80	16	CC.. 215.. CC.. 0602..	4008-M2.5x6	-	-	82-T08
SCLCR 1010 E09	10	10	70	12	CC.. 325.. CC.. 09T3..	4015-M3.5x9	-	-	80-T15
SCLCR 1212 F09	12	12	80	16	CC.. 325.. CC.. 09T3..	4015-M3.5x11	-	-	80-T15
SCLCR 1212 M09	12	12	150	16	CC.. 325.. CC.. 09T3..	4015-M3.5x14	-	-	80-T15
SCLCR 1616 H09	16	16	100	20	CC.. 325.. CC.. 09T3..	4015-M3.5x14	AACN-2-0001	AAV-06-M3.5x11	80-T15
SCLCR 2020 K09	20	20	125	25	CC.. 325.. CC.. 09T3..	4015-M3.5x14	AACN-2-0001	AAV-06-M3.5x11	80-T15
SCLCR 2525 M09	25	25	150	32	CC.. 325.. CC.. 09T3..	4015-M3.5x14	-	-	80-T15
SCLCR 1616 H12	16	16	100	20	CC.. 43.. CC.. 1204..	1020-M5x11	AACN-2-0003	AAV-07-M4.5x13	80-T20
SCLCR 2020 K12	20	20	125	25	CC.. 43.. CC.. 1204..	1020-M4.5x16	AACN-2-0003	AAV-07-M4.5x13	80-T20
SCLCR 2525 M12	25	25	150	32	CC.. 43.. CC.. 1204..	1020-M4.5x16	AACN-2-0003	AAV-07-M4.5x13	80-T20
SCLCL 0808 E06	8	8	70	10	CC.. 215.. CC.. 0602..	4008-M2.5x6	-	-	82-T08
SCLCL 1010 E06	10	10	70	12	CC.. 215.. CC.. 0602..	4008-M2.5x6	-	-	82-T08
SCLCL 1212 F06	12	12	80	16	CC.. 215.. CC.. 0602..	4008-M2.5x6	-	-	82-T08
SCLCL 1010 E09	10	10	70	12	CC.. 325.. CC.. 09T3..	4015-M3.5x9	-	-	80-T15
SCLCL 1212 F09	12	12	80	16	CC.. 325.. CC.. 09T3..	4015-M3.5x11	-	-	80-T15
SCLCL 1212 M09	12	12	150	16	CC.. 325.. CC.. 09T3..	4015-M3.5x14	-	-	80-T15
SCLCL 1616 H09	16	16	100	20	CC.. 325.. CC.. 09T3..	4015-M3.5x14	AACN-2-0001	AAV-06-M3.5x11	80-T15
SCLCL 2020 K09	20	20	125	25	CC.. 325.. CC.. 09T3..	4015-M3.5x14	AACN-2-0001	AAV-06-M3.5x11	80-T15
SCLCL 2525 M09	25	25	150	32	CC.. 325.. CC.. 09T3..	4015-M3.5x14	-	-	80-T15
SCLCL 1616 H12	16	16	100	20	CC.. 43.. CC.. 1204..	1020-M5x11	AACN-2-0003	AAV-07-M4.5x13	80-T20
SCLCL 2020 K12	20	20	125	25	CC.. 43.. CC.. 1204..	1020-M4.5x16	AACN-2-0003	AAV-07-M4.5x13	80-T20
SCLCL 2525 M12	25	25	150	32	CC.. 43.. CC.. 1204..	1020-M4.5x16	AACN-2-0003	AAV-07-M4.5x13	80-T20

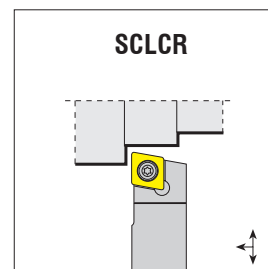
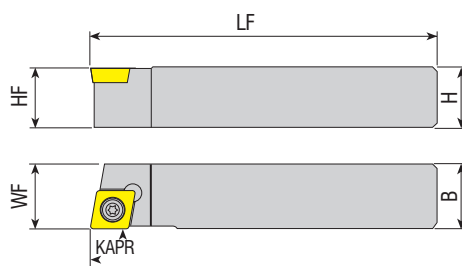

Illustrations shown may vary from actual product.

Dimensions in Metric



Ordering Code	HF=H	B	LF	WF	Insert Inch/Metric	Screw	Shim	Shim Screw	Torx Key
SCLCR 0808 X06-S	08	08	115	08	CC.. 215.. CC.. 0602..	4008-M2.5x6	-	-	82-T08
SCLCR 1010 X06-S	10	10	115	10	CC.. 215.. CC.. 0602..	4008-M2.5x6	-	-	82-T08
SCLCR 1212 G06-S	12	12	90	12	CC.. 215.. CC.. 0602..	4008-M2.5x6	-	-	82-T08
SCLCR 1212 X06-S	12	12	130	12	CC.. 215.. CC.. 0602..	4008-M2.5x6	-	-	82-T08
SCLCR 1212 K06-S	12	12	125	12	CC.. 215.. CC.. 0602..	4008-M2.5x6	-	-	82-T08
SCLCR 1616 F06-S	16	16	75	16	CC.. 215.. CC.. 0602..	4008-M2.5x6	-	-	82-T08
SCLCR 1616 X06-S	16	16	130	16	CC.. 215.. CC.. 0602..	4008-M2.5x6	-	-	82-T08
SCLCR 1212 G09-S	12	12	90	12	CC.. 325.. CC.. 09T3..	4015-M3.5x11	-	-	80-T15
SCLCR 1212 X09-S	12	12	130	12	CC.. 325.. CC.. 09T3..	4015-M3.5x11	-	-	80-T15
SCLCR 1616 F09-S	16	16	75	16	CC.. 325.. CC.. 09T3..	4015-M3.5x11	-	-	80-T15
SCLCR 1616 G09-S	16	16	90	16	CC.. 325.. CC.. 09T3..	4015-M3.5x11	-	-	80-T15
SCLCR 1616 X09-S	16	16	115	16	CC.. 325.. CC.. 09T3..	4015-M3.5x11	-	-	80-T15
SCLCR 2020 X09-S	20	20	120	20	CC.. 325.. CC.. 09T3..	4015-M3.5x11	-	-	80-T15
SCLCL 0808 X06-S	08	08	115	08	CC.. 215.. CC.. 0602..	4008-M2.5x6	-	-	82-T08
SCLCL 1010 X06-S	10	10	115	10	CC.. 215.. CC.. 0602..	4008-M2.5x6	-	-	82-T08
SCLCL 1212 G06-S	12	12	90	12	CC.. 215.. CC.. 0602..	4008-M2.5x6	-	-	82-T08
SCLCL 1212 X06-S	12	12	130	12	CC.. 215.. CC.. 0602..	4008-M2.5x6	-	-	82-T08
SCLCL 1212 K06-S	12	12	125	12	CC.. 215.. CC.. 0602..	4008-M2.5x6	-	-	82-T08
SCLCL 1616 F06-S	16	16	75	16	CC.. 215.. CC.. 0602..	4008-M2.5x6	-	-	82-T08
SCLCL 1616 X06-S	16	16	130	16	CC.. 215.. CC.. 0602..	4008-M2.5x6	-	-	82-T08
SCLCL 1212 G09-S	12	12	90	12	CC.. 325.. CC.. 09T3..	4015-M3.5x11	-	-	80-T15
SCLCL 1212 X09-S	12	12	130	12	CC.. 325.. CC.. 09T3..	4015-M3.5x11	-	-	80-T15
SCLCL 1616 F09-S	16	16	75	16	CC.. 325.. CC.. 09T3..	4015-M3.5x11	-	-	80-T15
SCLCL 1616 G09-S	16	16	90	16	CC.. 325.. CC.. 09T3..	4015-M3.5x11	-	-	80-T15
SCLCL 1616 X09-S	16	16	115	16	CC.. 325.. CC.. 09T3..	4015-M3.5x11	-	-	80-T15
SCLCL 2020 X09-S	20	20	120	20	CC.. 325.. CC.. 09T3..	4015-M3.5x11	-	-	80-T15

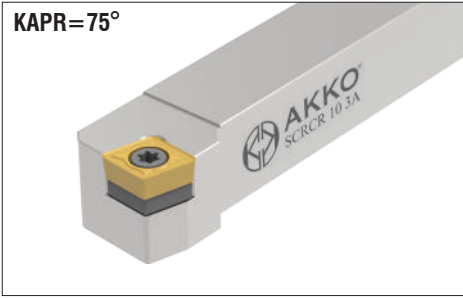

Illustrations shown may vary from actual product.

Dimensions in Inch

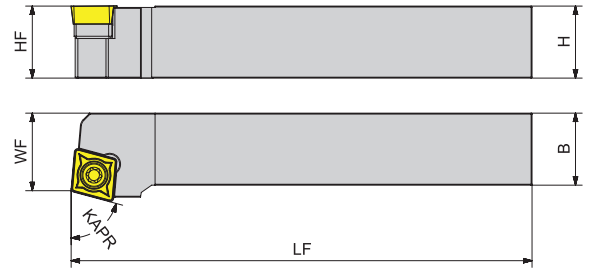

Ordering Code	HF=H	B	LF	LH	WF	Insert Inch/Metric	Screw	Shim	Shim Screw	Torx Key
<b>NEW</b> SCRCR 06 2	0.375	0.375	2.500	0.500	0.439	CC.. 2151 CC.. 060204	4008-M2.5x6			82-T08
<b>NEW</b> SCRCR 08 2J	0.500	0.500	3.500	0.500	0.564	CC.. 2151 CC.. 060204	4008-M2.5x6	-	-	82-T08
SCRCR 10 3A	0.625	0.625	4.000	0.620	0.673	CC.. 3252 CC.. 09T308	4015-M3.5x14	AACN-2-0001	AAV-06-M3.5x11	82-T15
<b>NEW</b> SCRCR 06 2	0.375	0.375	2.500	0.500	0.439	CC.. 2151 CC.. 060204	4008-M2.5x6	-	-	82-T08
<b>NEW</b> SCRCR 08 2J	0.500	0.500	3.500	0.500	0.564	CC.. 2151 CC.. 060204	4008-M2.5x6	-	-	82-T08
<b>NEW</b> SCRCR 10 3A	0.625	0.625	4.000	0.688	0.673	CC.. 3252 CC.. 09T308	4015-M3.5x14	AACN-2-0001	AAV-06-M3.5x11	82-T15



Illustrations shown may vary from actual product.

Dimensions in Inch

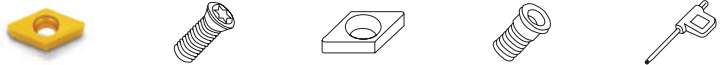
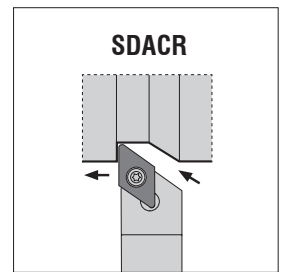
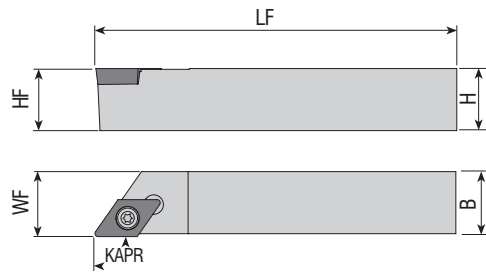

Ordering Code	HF=H	B	LF	LH	WF	Insert Inch/Metric	Screw	Shim	Shim Screw	Torx Key
SDACR 06 2D-S	0.375	0.375	6.000	0.620	0.375	DC.. 2151 DC.. 070204	4008-M2.5x6	-	-	82-T08
SDACR 08 2D-S	0.500	0.500	6.000	0.620	0.500	DC.. 2151 DC.. 070204	4008-M2.5x6	-	-	82-T08
SDACR 10 3B-S	0.625	0.625	4.500	0.880	0.625	DC.. 3252 DC.. 11T308	4015-M3.5x14	AADN-2-0001	AAV-06-M3.5x11	80-T15
SDACR 08 3D-S	0.500	0.500	6.000	0.880	0.500	DC.. 3252 DC.. 11T308	4015-M3.5x11			80-T15
SDACL 06 2D-S	0.375	0.375	6.000	0.620	0.375	DC.. 2151 DC.. 070204	4008-M2.5x6	-	-	82-T08
SDACL 08 2D-S	0.500	0.500	6.000	0.620	0.500	DC.. 2151 DC.. 070204	4008-M2.5x6	-	-	82-T08
SDACL 10 3B-S	0.625	0.625	4.500	0.880	0.625	DC.. 3252 DC.. 11T308	4015-M3.5x14	AADN-2-0001	AAV-06-M3.5x11	80-T15
SDACL 08 3D-S	0.500	0.500	6.000	0.880	0.500	DC.. 3252 DC.. 11T308	4015-M3.5x11			80-T15

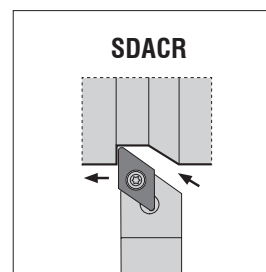
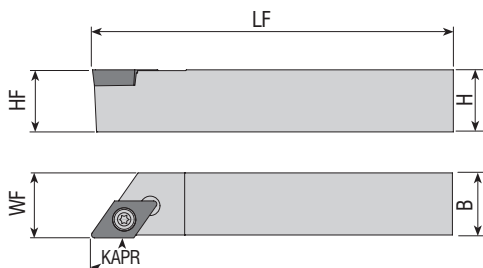
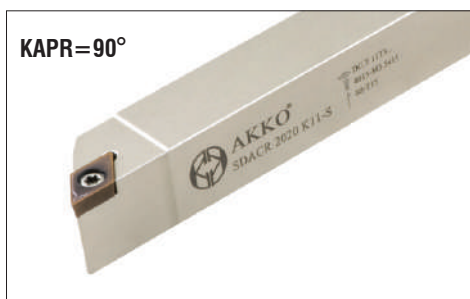

Illustrations shown may vary from actual product.

Dimensions in Metric

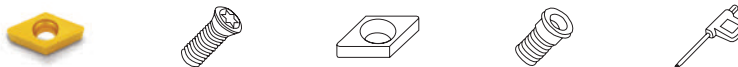

Ordering Code	HF=H	B	LF	WF	Insert Inch/Metric	Screw	Shim	Shim Screw	Torx Key
SDACR 0808 X07-S	08	08	115	08	DC.. 215.. DC.. 0702..	4008-M2.5x6	-	-	82-T08
SDACR1010 K07-S	10	10	125	10	DC.. 215.. DC.. 0702..	4008-M2.5x6	-	-	82-T08
SDACR 1212 G07-S	12	12	90	12	DC.. 215.. DC.. 0702..	4008-M2.5x6	-	-	82-T08
SDACR 1212 K07-S	12	12	125	12	DC.. 215.. DC.. 0702..	4008-M2.5x6	-	-	82-T08
SDACR 1616 F07-S	16	16	75	16	DC.. 215.. DC.. 0702..	4008-M2.5x6	-	-	82-T08
SDACR 1616 K07-S	16	16	125	16	DC.. 215.. DC.. 0702..	4008-M2.5x6	-	-	82-T08
SDACR 1212 G11-S	12	12	90	12	DC.. 325 DC.. 11T3..	4015-M3.5x11	-	-	80-T15
SDACR 1212 K11-S	12	12	125	12	DC.. 325 DC.. 11T3..	4015-M3.5x11	-	-	80-T15
SDACR 1616 F11-S	16	16	75	16	DC.. 325 DC.. 11T3..	4015-M3.5x11	-	-	80-T15
SDACR 1616 K11-S	16	16	125	16	DC.. 325 DC.. 11T3..	4015-M3.5x11	-	-	80-T15
SDACR 2020 K11-S	20	20	125	20	DC.. 325 DC.. 11T3..	4015-M3.5x11	-	-	80-T15
SDACL 0808 X07-S	08	08	115	08	DC.. 215.. DC.. 0702...	4008-M2.5x6	-	-	82-T08
SDACL 1010 K07-S	10	10	125	10	DC.. 215.. DC.. 0702..	4008-M2.5x6	-	-	82-T08
SDACL 1212 G07-S	12	12	90	12	DC.. 215.. DC.. 0702..	4008-M2.5x6	-	-	82-T08
SDACL 1212 K07-S	12	12	125	12	DC.. 215.. DC.. 0702..	4008-M2.5x6	-	-	82-T08
SDACL 1616 F07-S	16	16	75	16	DC.. 215.. DC.. 0702..	4008-M2.5x6	-	-	82-T08
SDACL 1616 K07-S	16	16	125	16	DC.. 215.. DC.. 0702..	4008-M2.5x6	-	-	82-T08
SDACL 1212 G11-S	12	12	90	12	DC.. 325 DC.. 11T3..	4015-M3.5x11	-	-	80-T15
SDACL 1212 K11-S	12	12	125	12	DC.. 325 DC.. 11T3..	4015-M3.5x11	-	-	80-T15
SDACL 1616 F11-S	16	16	75	16	DC.. 325 DC.. 11T3..	4015-M3.5x11	-	-	80-T15
SDACL 1616 K11-S	16	16	125	16	DC.. 325 DC.. 11T3..	4015-M3.5x11	-	-	80-T15
SDACL 2020 K11-S	20	20	125	20	DC.. 325 DC.. 11T3..	4015-M3.5x11	-	-	80-T15



Illustrations shown may vary from actual product.



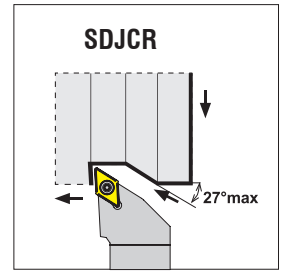
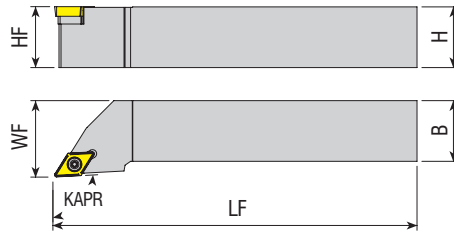

Dimensions in Inch

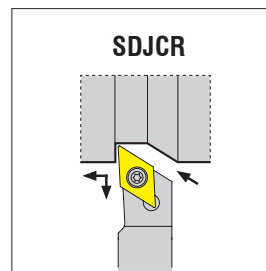
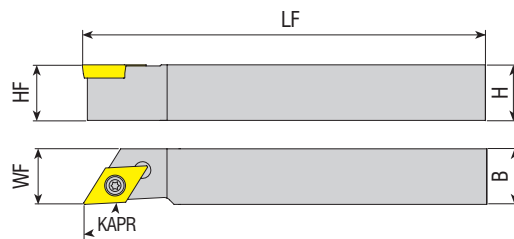

Ordering Code	HF=H	B	LF	LH	WF	Insert Inch/Metric	Screw	Shim	Shim Screw	Torx Key
<b>new</b> SDJCR 06 2J	0.375	0.375	3.500	0.688	0.500	DC.. 2151 DC.. 070204	4008-M2.5x6	-	-	82-T08
<b>new</b> SDJCR 08 2A	0.500	0.500	4.000	0.688	0.625	DC.. 2151 DC.. 070204	4008-M2.5x6	-	-	82-T08
<b>new</b> SDJCR 08 3A	0.500	0.500	4.000	1.000	0.625	DC.. 3252 DC.. 11T308	4015-M3.5x14	AADN-2-0001	AAV-06-M3.5x11	82-T15
SDJCR 10 2A	0.625	0.625	4.000	0.620	0.750	DC.. 2151 DC.. 070204	4008-M2.5x6	-	-	82-T08
SDJCR 10 3A	0.625	0.625	4.000	0.880	0.750	DC.. 3252 DC.. 11T308	4015-M3.5x14	AADN-2-0001	AAV-06-M3.5x11	80-T15
<b>new</b> SDJCR 10 3B	0.625	0.625	4.500	1.000	0.750	DC.. 3252 DC.. 11T308	4015-M3.5x14	AADN-2-0001	AAV-06-M3.5x11	82-T15
SDJCR 12 3B	0.750	0.750	4.500	0.880	1.000	DC.. 3252 DC.. 11T308	4015-M3.5x14	AADN-2-0001	AAV-06-M3.5x11	82-T15
SDJCR 16 3D	1.000	1.000	6.000	1.000	1.250	DC.. 3252 DC.. 11T308	4015-M3.5x14	AADN-2-0001	AAV-06-M3.5x11	82-T15
<b>new</b> SDJCL 06 2J	0.375	0.375	3.500	0.688	0.500	DC.. 2151 DC.. 070204	4008-M2.5x6	-	-	82-T08
<b>new</b> SDJCL 08 2A	0.500	0.500	4.000	0.688	0.625	DC.. 2151 DC.. 070204	4008-M2.5x6	-	-	82-T08
<b>new</b> SDJCL 08 3A	0.500	0.500	4.000	1.000	0.625	DC.. 3252 DC.. 11T308	4015-M3.5x14	AADN-2-0001	AAV-06-M3.5x11	82-T15
SDJCL 10 2A	0.625	0.625	4.000	0.620	0.750	DC.. 2151 DC.. 070204	4008-M2.5x6	-	-	82-T08
SDJCL 10 3A	0.625	0.625	4.000	0.880	0.750	DC.. 3252 DC.. 11T308	4015-M3.5x14	AADN-2-0001	AAV-06-M3.5x11	80-T15
<b>new</b> SDJCL 10 3B	0.625	0.625	4.500	1.000	0.750	DC.. 3252 DC.. 11T308	4015-M3.5x14	AADN-2-0001	AAV-06-M3.5x11	82-T15
SDJCL 12 3B	0.750	0.750	4.500	0.880	1.000	DC.. 3252 DC.. 11T308	4015-M3.5x14	AADN-2-0001	AAV-06-M3.5x11	82-T15
SDJCL 16 3D	1.000	1.000	6.000	1.000	1.250	DC.. 3252 DC.. 11T308	4015-M3.5x14	AADN-2-0001	AAV-06-M3.5x11	82-T15





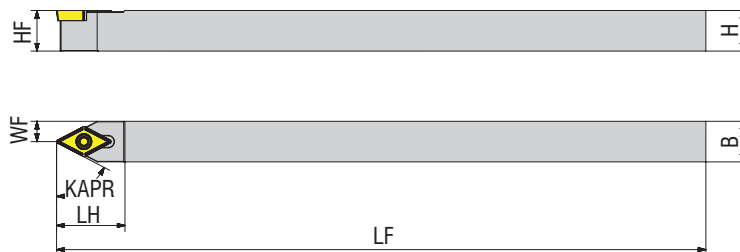

Illustrations shown may vary from actual product.

Dimensions in Inch										
Ordering Code	HF=H	B	LF	LH	WF	Insert Inch/Metric	Screw	Shim	Shim Screw	Torx Key
SDJCR 06 2D-S	0.375	0.375	6.000	0.620	0.375	DC.. 2151 DC.. 070204	4008-M2.5x6	-	-	82-T08
SDJCR 08 2D-S	0.500	0.500	6.000	0.620	0.500	DC.. 2151 DC.. 070204	4008-M2.5x6	-	-	82-T08
SDJCR 08 3D-S	0.500	0.500	6.000	0.880	0.500	DC.. 3252 DC.. 11T308	4015-M3.5x11	-	-	80-T15
SDJCR 10 3B-S	0.625	0.625	4.500	0.880	0.625	DC.. 3252 DC.. 11T308	4015-M3.5x14	AADN-2-0001	AAV-06-M3.5x11	80-T15
SDJCL 06 2D-S	0.375	0.375	6.000	0.620	0.375	DC.. 2151 DC.. 070204	4008-M2.5x6	-	-	82-T08
SDJCL 08 2D-S	0.500	0.500	6.000	0.620	0.500	DC.. 2151 DC.. 070204	4008-M2.5x6	-	-	82-T08
SDJCL 08 3D-S	0.500	0.500	6.000	0.880	0.500	DC.. 3252 DC.. 11T308	4015-M3.5x11	-	-	80-T15
SDJCL 10 3B-S	0.625	0.625	4.500	0.880	0.625	DC.. 3252 DC.. 11T308	4015-M3.5x14	AADN-2-0001	AAV-06-M3.5x11	80-T15



Illustrations shown may vary from actual product.

Dimensions in Inch										
Ordering Code	HF=H	B	LF	LH	WF	Insert Inch/Metric	Screw	Shim	Shim Screw	Torx Key
SDPCN 06 2D	0.375	0.375	6.000	0.620	0.187	DC.. 2151 DC.. 070204	4008-M2.5x6	-	-	82-T08
SDPCN 06 2J	0.375	0.375	3.500	0.620	0.187	DC.. 2151 DC.. 070204	4008-M2.5x6	-	-	82-T08
SDPCN 08 2A	0.500	0.500	1.000	0.620	0.250	DC.. 2151 DC.. 070204	4008-M2.5x6	-	-	82-T08
SDPCN 08 2D	0.500	0.500	6.000	0.620	0.250	DC.. 2151 DC.. 070204	4008-M2.5x6	-	-	82-T08
SDPCN 08 3D	0.500	0.500	6.000	0.880	0.250	DC.. 3252 DC.. 11T308	4015-M3.5x11	AADN-2-0001	AAV-06-M3.5x11	82-T15
SDPCN 10 3B	0.625	0.625	4.500	0.880	0.313	DC.. 3252 DC.. 11T308	4015-M3.5x14	AADN-2-0001	AAV-06-M3.5x11	82-T08
SDPCN 10 3D	0.625	0.625	6.000	0.880	0.313	DC.. 3252 DC.. 11T308	4015-M3.5x14	AADN-2-0001	AAV-06-M3.5x11	82-T15
SDPCN 12 3B	0.750	0.750	4.500	0.620	0.375	DC.. 3252 DC.. 11T308	4015-M3.5x11	-	-	82-T08
SDPCN 16 3D	1.000	1.000	6.000	0.880	0.500	DC.. 3252 DC.. 11T308	4015-M3.5x11	-	-	82-T08

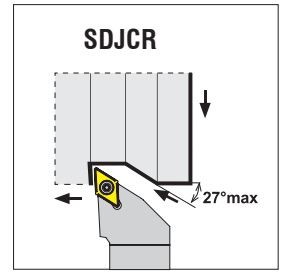
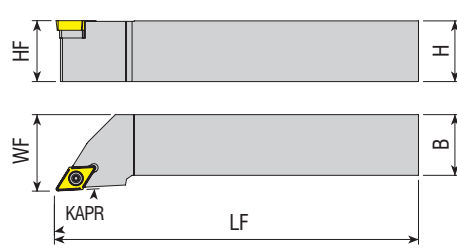
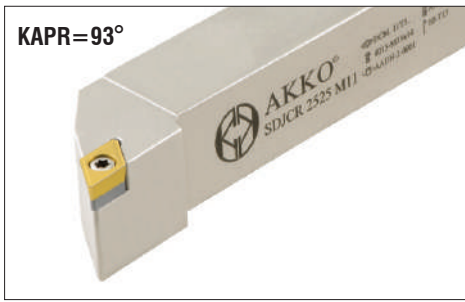

Illustrations shown may vary from actual product.

Dimensions in Metric

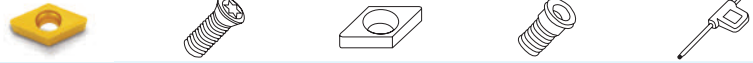

Ordering Code	HF=H	B	LF	WF	Insert Inch/Metric	Screw	Shim	Shim Screw	Torx Key
SDJCR 0808 E07	8	8	70	10	DC.. 215.. DC.. 0702...	4008-M2.5x6	-	-	82-T08
SDJCR 1010 E07	10	10	70	12	DC.. 215.. DC.. 0702...	4008-M2.5x6	-	-	82-T08
SDJCR 1212 F07	12	12	80	16	DC.. 215.. DC.. 0702...	4008-M2.5x6	-	-	82-T08
SDJCR 1616 H07	16	16	100	20	DC.. 215.. DC.. 0702...	4008-M2.5x6	-	-	82-T08
SDJCR 1212 F11	12	12	80	16	DC.. 325 DC.. 11T3..	4015-M3.5x14	AADN-2-0001	AAV-06-M3.5x11	80-T15
SDJCR 1616 H11	16	16	100	20	DC.. 325 DC.. 11T3..	4015-M3.5x14	AADN-2-0001	AAV-06-M3.5x11	80-T15
SDJCR 2020 K11	20	20	125	25	DC.. 325 DC.. 11T3..	4015-M3.5x14	AADN-2-0001	AAV-06-M3.5x11	80-T15
SDJCR 2525 M11	25	25	150	32	DC.. 325 DC.. 11T3..	4015-M3.5x14	AADN-2-0001	AAV-06-M3.5x11	80-T15
SDJCR 3232 P11	32	32	170	40	DC.. 325 DC.. 11T3..	4015-M3.5x14	AADN-2-0001	AAV-06-M3.5x11	80-T15
SDJCL 0808 E07	8	8	70	10	DC.. 215.. DC.. 0702...	4008-M2.5x6	-	-	82-T08
SDJCL 1010 E07	10	10	70	12	DC.. 215.. DC.. 0702...	4008-M2.5x6	-	-	82-T08
SDJCL 1212 F07	12	12	80	16	DC.. 215.. DC.. 0702...	4008-M2.5x6	-	-	82-T08
SDJCL 1616 H07	16	16	100	20	DC.. 215.. DC.. 0702...	4008-M2.5x6	-	-	82-T08
SDJCL 1212 F11	12	12	80	16	DC.. 325 DC.. 11T3..	4015-M3.5x14	AADN-2-0001	AAV-06-M3.5x11	80-T15
SDJCL 1616 H11	16	16	100	20	DC.. 325 DC.. 11T3..	4015-M3.5x14	AADN-2-0001	AAV-06-M3.5x11	80-T15
SDJCL 2020 K11	20	20	125	25	DC.. 325 DC.. 11T3..	4015-M3.5x14	AADN-2-0001	AAV-06-M3.5x11	80-T15
SDJCL 2525 M11	25	25	150	32	DC.. 325 DC.. 11T3..	4015-M3.5x14	AADN-2-0001	AAV-06-M3.5x11	80-T15
SDJCL 3232 P11	32	32	170	40	DC.. 325 DC.. 11T3..	4015-M3.5x14	AADN-2-0001	AAV-06-M3.5x11	80-T15



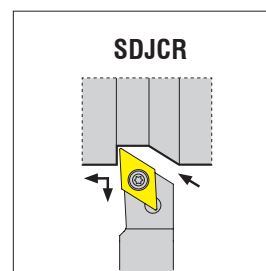
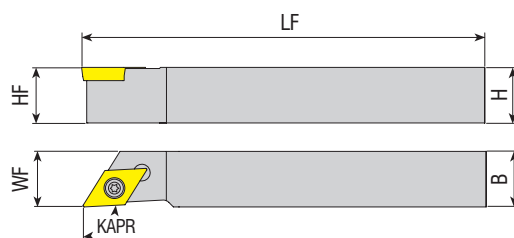

Illustrations shown may vary from actual product.

Dimensions in Metric







Ordering Code	HF=H	B	LF	WF	Insert Inch/Metric	Screw	Shim	Shim Screw	Torx Key
SDJCR 0808 X07-S	08	08	115	08	DC.. 215.. DC.. 0702...	4008-M2.5x6	-	-	82-T08
SDJCR 1010 X07-S	10	10	115	10	DC.. 215.. DC.. 0702...	4008-M2.5x6	-	-	82-T08
SDJCR 1212 G07-S	12	12	90	12	DC.. 215.. DC.. 0702...	4008-M2.5x6	-	-	82-T08
SDJCR 1212 X07-S	12	12	130	12	DC.. 215.. DC.. 0702...	4008-M2.5x6	-	-	82-T08
SDJCR 1616 F07-S	16	16	75	16	DC.. 215.. DC.. 0702...	4008-M2.5x6	-	-	82-T08
SDJCR 1616 X07-S	16	16	130	16	DC.. 215.. DC.. 0702...	4008-M2.5x6	-	-	82-T08
SDJCR 2020 X07-S	20	20	120	20	DC.. 215.. DC.. 0702...	4008-M2.5x6	-	-	82-T08
SDJCR 1212 G11-S	12	12	90	12	DC.. 325 DC.. 11T3..	4015-M3.5x11	-	-	80-T15
SDJCR 1212 X11-S	12	12	130	12	DC.. 325 DC.. 11T3..	4015-M3.5x11	-	-	80-T15
SDJCR 1212 K11-S	12	12	125	12	DC.. 325 DC.. 11T3..	4015-M3.5x11	-	-	80-T15
SDJCR 1616 F11-S	16	16	75	16	DC.. 325 DC.. 11T3..	4015-M3.5x11	-	-	80-T15
SDJCR 1616 X11-S	16	16	130	16	DC.. 325 DC.. 11T3..	4015-M3.5x11	-	-	80-T15
SDJCR 1616 K11-S	16	16	125	16	DC.. 325 DC.. 11T3..	4015-M3.5x11	-	-	80-T15
SDJCR 2020 X11-S	20	20	120	20	DC.. 325 DC.. 11T3..	4015-M3.5x11	-	-	80-T15
SDJCL 0808 X07-S	08	08	115	08	DC.. 215.. DC.. 0702...	4008-M2.5x6	-	-	82-T08
SDJCL 1010 X07-S	10	10	115	10	DC.. 215.. DC.. 0702...	4008-M2.5x6	-	-	82-T08
SDJCL 1212 G07-S	12	12	90	12	DC.. 215.. DC.. 0702...	4008-M2.5x6	-	-	82-T08
SDJCL 1212 X07-S	12	12	130	12	DC.. 215.. DC.. 0702...	4008-M2.5x6	-	-	82-T08
SDJCL 1616 F07-S	16	16	75	16	DC.. 215.. DC.. 0702...	4008-M2.5x6	-	-	82-T08
SDJCL 1616 X07-S	16	16	130	16	DC.. 215.. DC.. 0702...	4008-M2.5x6	-	-	82-T08
SDJCL 2020 X07-S	20	20	120	20	DC.. 215.. DC.. 0702...	4008-M2.5x6	-	-	82-T08
SDJCL 1212 G11-S	12	12	90	12	DC.. 325 DC.. 11T3..	4015-M3.5x11	-	-	80-T15
SDJCL 1212 X11-S	12	12	130	12	DC.. 325 DC.. 11T3..	4015-M3.5x11	-	-	80-T15
SDJCL 1212 K11-S	12	12	125	12	DC.. 325 DC.. 11T3..	4015-M3.5x11	-	-	80-T15
SDJCL 1616 F11-S	16	16	75	16	DC.. 325 DC.. 11T3..	4015-M3.5x11	-	-	80-T15
SDJCL 1616 X11-S	16	16	130	16	DC.. 325 DC.. 11T3..	4015-M3.5x11	-	-	80-T15
SDJCL 1616 K11-S	16	16	125	16	DC.. 325 DC.. 11T3..	4015-M3.5x11	-	-	80-T15
SDJCL 2020 X11-S	20	20	120	20	DC.. 325 DC.. 11T3..	4015-M3.5x11	-	-	80-T15

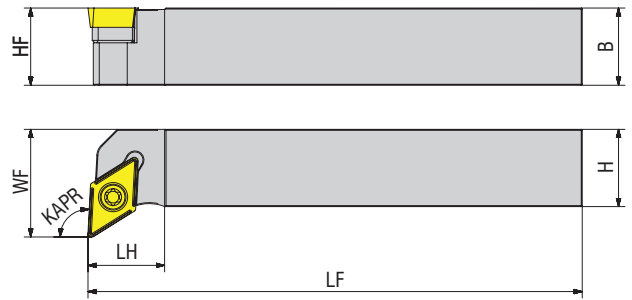

Illustrations shown may vary from actual product.





Dimensions in Inch										
Ordering Code	HF=H	B	LF	LH	WF	Insert Inch/Metric	Screw	Shim	Shim Screw	Torx Key
SDUCR 10 3A	0.625	0.625	4.000	0.620	0.871	DC.. 3252 DC.. 11T308	4015-M3.5x14	AADN-2-0001	AAV-06-M3.5x11	80-T15
SDUCL 10 3A	0.625	0.625	4.000	0.620	0.871	DC.. 3252 DC.. 11T308	4015-M3.5x14	AADN-2-0001	AAV-06-M3.5x11	80-T15

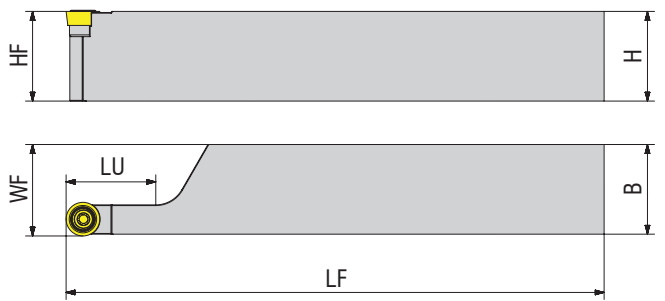

Illustrations shown may vary from actual product.



Dimensions in Inch									
Ordering Code	HF=H	B	LF	WF	LU	Insert Inch/Metric	Screw	Shim	Torx Key
SRACR 16 3D	1.000	1.000	6.000	1.020	1.000	RC.. 325.. RC.. 09T3..	4015-M3.5x12	SR3	80-T15
SRACR 20 3D	1.250	1.250	6.000	1.270	1.000	RC.. 325.. RC.. 09T3..	4015-M3.5x12	SR3	80-T15
SRACR 16 4D	1.000	1.000	6.000	1.020	1.000	RC.. 43.. RC.. 1204..	4015-M4x05x14	SR4	80-T15
SRACR 20 4D	1.250	1.250	6.000	1.270	1.000	RC.. 43.. RC.. 1204..	4015-M4x05x14	SR4	80-T15
SRACR 24 4D	1.500	1.500	6.000	1.520	1.000	RC.. 43.. RC.. 1204..	4015-M4x05x14	SR4	80-T15
SRACR 16 2D	1.000	1.000	6.000	1.020	1.000	RC.. 215.. RC.. 0602.	4108-M2.5x6.5	-	82-T08
SRACR 20 2D	1.250	1.250	6.000	1.270	1.000	RC.. 215.. RC.. 0602.	4108-M2.5x6.5	-	82-T08
SRACL 20 3D	1.250	1.250	6.000	1.270	1.000	RC.. 325.. RC.. 09T3..	4015-M3.5x12	SR3	80-T15
SRACL 16 4D	1.000	1.000	6.000	1.020	1.000	RC.. 43.. RC.. 1204..	4015-M4x05x14	SR4	80-T15
SRACL 20 4D	1.250	1.250	6.000	1.270	1.000	RC.. 43.. RC.. 1204..	4015-M4x05x14	SR4	80-T15
SRACL 24 4D	1.500	1.500	6.000	1.520	1.000	RC.. 43.. RC.. 1204..	4015-M4x05x14	SR4	80-T15
SRACL 16 2D	1.000	1.000	6.000	1.020	1.000	RC.. 215.. RC.. 0602.	4108-M2.5x6.5	-	82-T08
SRACL 20 2D	1.250	1.250	6.000	1.270	1.000	RC.. 215.. RC.. 0602.	4108-M2.5x6.5	-	82-T08

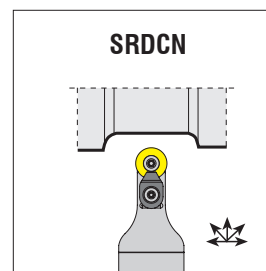
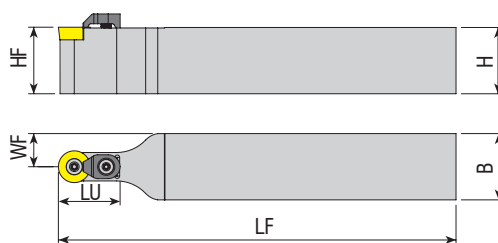

Illustrations shown may vary from actual product.

Dimensions in Metric



Ordering Code	HF=H	B	LF	LU	WF	Insert Inch/Metric	Screw	Wedge Clamp	Clamp Screw	Torx Key
SRDCN 1616 H06	16	16	100	15	8	RC.. 215.. RC.. 0602..	3008-M2.5x6	-	-	82-T08
SRDCN 2020 K06	20	20	125	17	10	RC.. 215.. RC.. 0602..	3008-M2.5x6	-	-	82-T08
SRDCN 2525 M06	25	25	150	17	12.5	RC.. 215.. RC.. 0602..	3008-M2.5x6	-	-	82-T08
SRDCN 1616 H08C	16	16	100	15	8	- RC.. 0803..	3008-M3x8	ACK-15	4015-M3.5x11	82-T08
SRDCN 2020 K08C	20	20	125	20	10	- RC.. 0803..	3008-M3x8	ACK-15	4015-M3.5x11	82-T08
SRDCN 2525 M08C	25	25	150	20	12.5	- RC.. 0803..	3008-M3x8	ACK-15	4015-M3.5x11	82-T08
SRDCN 1616 H10C	16	16	100	20	8	- RC.. 10T3..	4015-M3.5x11	ACK-15	4015-M3.5x11	80-T15
SRDCN 2020 K10C	20	20	125	20	10	- RC.. 10T3..	4015-M3.5x11	ACK-15	4015-M3.5x11	80-T15
SRDCN 2525 M10C	25	25	150	20	12.5	- RC.. 10T3..	4015-M3.5x11	ACK-15	4015-M3.5x11	80-T15
SRDCN 3232 P10C	32	32	170	20	16	- RC.. 10T3..	4015-M3.5x11	ACK-15	4015-M3.5x11	80-T15
SRDCN 2020 K12C	20	20	125	22	10	RC.. 43.. RC.. 1204..	4015-M3.5x11	ACK-05	4015-M4x11	80-T15
SRDCN 2525 M12C	25	25	150	22	12.5	RC.. 43.. RC.. 1204..	4015-M3.5x11	ACK-05	4015-M4x11	80-T15
SRDCN 3232 P12C	32	32	170	22	16	RC.. 43.. RC.. 1204..	4015-M3.5x11	ACK-05	4015-M4x11	80-T15
SRDCN 2525 M16C	25	25	150	32	12.5	- RC.. 1605..	1020-M5x11	ACK-05	4015-M4x11	80-T20
SRDCN 3232 P16C	32	32	170	35	16	- RC.. 1605..	1020-M5x11	ACK-05	4015-M4x11	80-T20
SRDCN 2525 M20C	25	25	150	32	12.5	- RC.. 2006..	1420-M6x16	ACK-09	AAV-05-M6x15	80-T20
SRDCN 3232 P20C	32	32	170	40	16	- RC.. 2006..	1420-M6x16	ACK-09	AAV-05-M6x15	80-T20
SRDCN 3232 P25C	32	32	170	40	16	RC.. 85.. RC.. 2507..	1520-M6x16	ACK-09	AAV-05-M6x15	80-T20
SRDCN 3232 P32C	32	32	170	45	16	- RC.. 3209..	1904-M8x1x20	ACK-09	AAV-05-M6x15	AAL-05-4

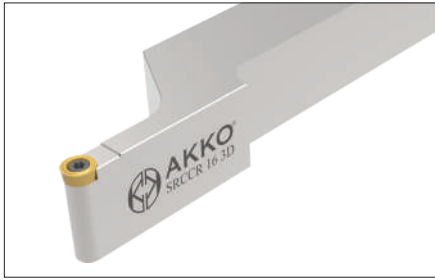

Illustrations shown may vary from actual product.

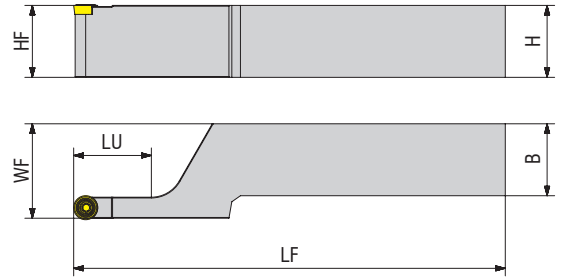

Dimensions in Inch										
Ordering Code	HF=H	B	LF	LH	WF	LU	Insert Inch/Metric	Screw	Shim	Torx Key
SRCCR 12 2B	0.750	0.750	4.500	1.660	1.000	0.810	RC.. 215.. RC.. 0602.	4108-M2.5x6.5	-	82-T08
SRCCR 16 2D	1.000	1.000	6.000	1.660	1.250	0.810	RC.. 215.. RC.. 0602.	4108-M2.5x6.5	-	82-T08
SRCCR 12 3B	0.750	0.750	4.500	1.880	1.000	1.200	RC.. 325.. RC.. 09T3..	4015-M3.5x12	SR3	80-T15
SRCCR 16 3D	1.000	1.000	6.000	1.880	1.250	1.200	RC.. 325.. RC.. 09T3..	4015-M3.5x12	SR3	80-T15
SRCCR 20 3D	1.250	1.250	6.000	1.880	1.500	1.200	RC.. 325.. RC.. 09T3..	4015-M3.5x12	SR3	80-T15
SRCL 16 2D	1.000	1.000	6.000	1.660	1.250	0.810	RC.. 215.. RC.. 0602.	4108-M2.5x6.5	-	82-T08
SRCL 16 3D	1.000	1.000	6.000	1.880	1.250	1.200	RC.. 325.. RC.. 09T3..	4015-M3.5x12	SR3	80-T15
SRCL 20 3D	1.250	1.250	6.000	1.880	1.500	1.200	RC.. 325.. RC.. 09T3..	4015-M3.5x12	SR3	80-T15



Illustrations shown may vary from actual product.

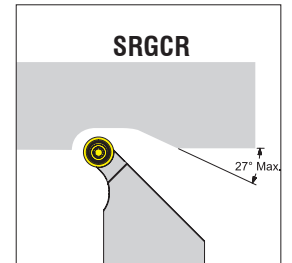
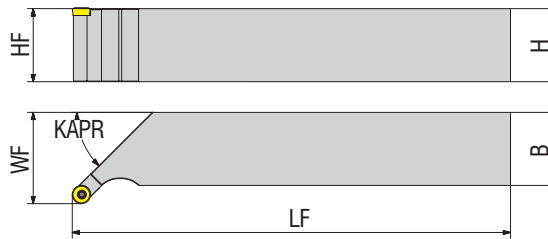





Dimensions in Inch									
Ordering Code	HF=H	B	LF	LH	WF	Insert Inch/Metric	Screw	Shim	Torx Key
SRGCR 12 2B	0.750	0.750	4.500	0.400	1.000	RC.. 215.. RC.. 0602.	4108-M2.5x6.5	-	82-T08
SRGCR 16 2D	1.000	1.000	6.000	0.400	1.250	RC.. 215.. RC.. 0602.	4108-M2.5x6.5	-	82-T08
SRGCR 16 3D	1.000	1.000	6.000	0.410	1.250	RC.. 325.. RC.. 09T3..	4015-M3.5x12	SR3	80-T15
SRGCR 20 3D	1.250	1.250	6.000	0.430	1.500	RC.. 325.. RC.. 09T3..	4015-M3.5x12	SR3	80-T15
SRGL 16 2D	1.000	1.000	6.000	0.400	1.250	RC.. 215.. RC.. 0602.	4015-M3.5x12	-	82-T08
SRGL 20 3D	1.250	1.250	6.000	0.430	1.500	RC.. 325.. RC.. 09T3..	4108-M2.5x6.5	SR3	80-T15

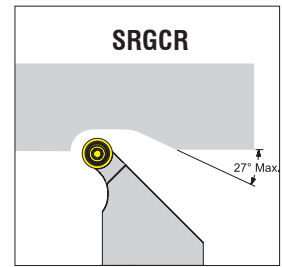
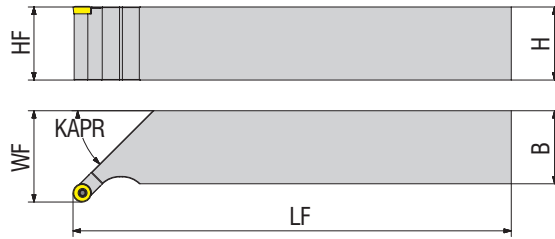

Illustrations shown may vary from actual product.





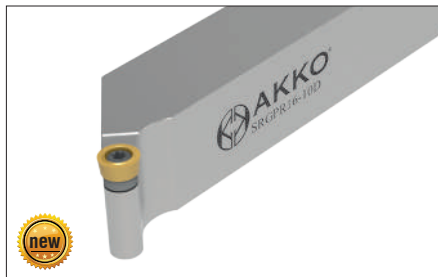

Ordering Code	Dimensions in Inch								
	HF=H	B	LF	LH	WF	Insert Inch/Metric	Screw	Shim	Torx Key
SRGCR 12 08B	0.750	0.750	4.500	0.450	1.000	RC.. 0803M0	3008-M3x8	-	82-T08
SRGCR 12 10B	0.750	0.750	4.500	0.470	1.000	RC.. 1003M0	4015-M3.5x11	-	80-T15
SRGCR 16 06D	1.000	1.000	6.000	0.420	1.250	RC.. 0602M0	3008-M2.5x6	-	82-T08
SRGCR 20 10D	1.250	1.250	6.000	0.470	1.500	RC.. 1003M0	4015-M3.5x11	-	80-T15
SRGCL 12 08B	0.750	0.750	4.500	0.450	1.000	RC.. 0803M0	3008-M3x8	-	82-T08
SRGCL 12 10B	0.750	0.750	4.500	0.470	1.000	RC.. 1003M0	4015-M3.5x11	-	80-T15
SRGCL 16 06D	1.000	1.000	6.000	0.420	1.250	RC.. 0602M0	3008-M2.5x6	-	82-T08
SRGCL 20 10D	1.250	1.250	6.000	0.470	1.500	RC.. 1003M0	4015-M3.5x11	-	80-T15

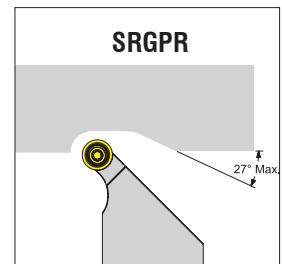
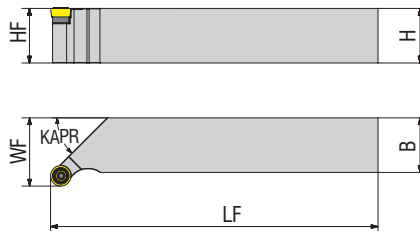

Illustrations shown may vary from actual product.







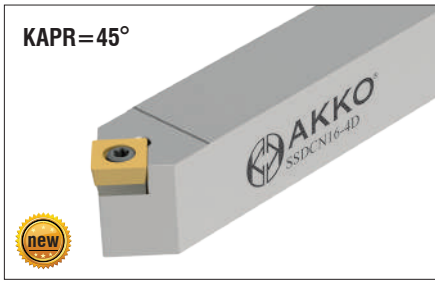

Ordering Code	Dimensions in Inch								
	HF=H	B	LF	LH	WF	Insert Inch/Metric	Screw	Shim	Torx Key
SRGPR 16 10D	1.000	1.000	6.000	0.470	1.250	RP. 1003M0	4015-M3.5x11	-	80-T15
SRGPL 16 10D	1.000	1.000	6.000	0.470	1.250	RP. 1003M0	4015-M3.5x11	-	80-T15

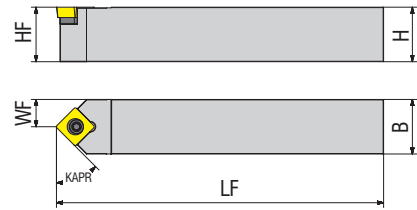



Illustrations shown may vary from actual product.





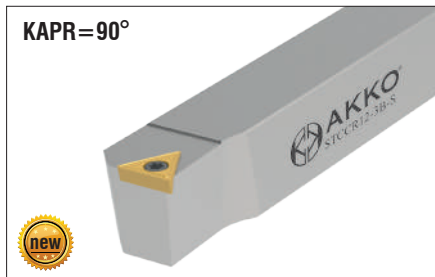

Dimensions in Inch									
Ordering Code	HF=H	B	LF	WF	Insert Inch/Metric	Screw	Shim	Shim Screw	Torx Key
SSDCN 08 3A	0.500	0.500	4.000	0.250	SC.. 3252 SC.. 09T308	4015-M3.5x11	-		82-T15
SSDCN 10 3B	0.625	0.625	4.500	0.313	SC.. 3252 SC.. 09T308	4015-M3.5x14	AASN-2-0001	AAV-06-M3.5x11	82-T15
SSDCN 12 3B	0.750	0.750	4.500	0.375	SC.. 3252 SC.. 09T308	4015-M3.5x14	AASN-2-0001	AAV-06-M3.5x11	82-T15
SSDCN 16 4D	1.000	1.000	6.000	0.500	SC.. 432 SC.. 120408	1020-M4.5x16	AASN-2-0004	AAV-07-M4.5x13	80-T20

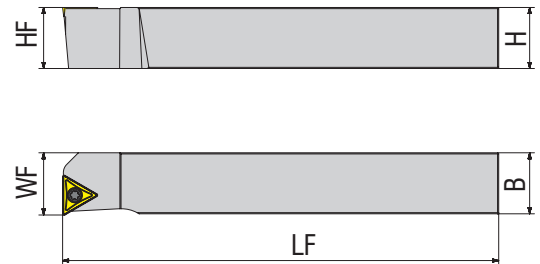

Illustrations shown may vary from actual product.



Dimensions in Inch										
Ordering Code	HF=H	B	LF	LH	WF	Insert Inch/Metric	Screw	Shim	Shim Screw	Torx Key
STCCR 06 2-S	0.375	0.375	2.500	0.520	0.395	TC.. 2151 TC.. 110204	4008-M2.5x6	-	-	82-T08
STCCR 12 3B-S	0.750	0.750	4.500	1.140	0.770	TC.. 3252 TC.. 16T308	4015-M3.5x14	AATN-2-0001	AAV-06-M3.5x11	82-T15
STCCR 64 3D-S	1.000	0.750	6.000	1.140	0.770	TC.. 3252 TC.. 16T308	4015-M3.5x14	AATN-2-0001	AAV-06-M3.5x11	82-T15
STCCL 06 2-S	0.375	0.375	2.500	0.520	0.395	TC.. 2151 TC.. 110204	4008-M2.5x6	-	-	82-T08
STCCL 12 3B-S	0.750	0.750	4.500	1.140	0.770	TC.. 3252 TC.. 16T308	4015-M3.5x14	AATN-2-0001	AAV-06-M3.5x11	82-T15
STCCL 64 3D-S	1.000	0.750	6.000	1.140	0.770	TC.. 3252 TC.. 16T308	4015-M3.5x14	AATN-2-0001	AAV-06-M3.5x11	82-T15

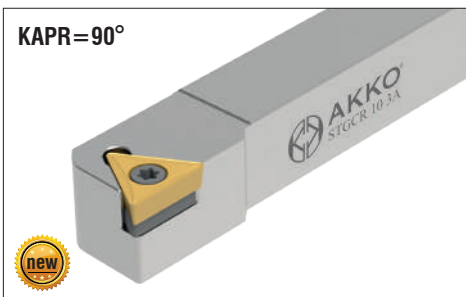

Illustrations shown may vary from actual product.

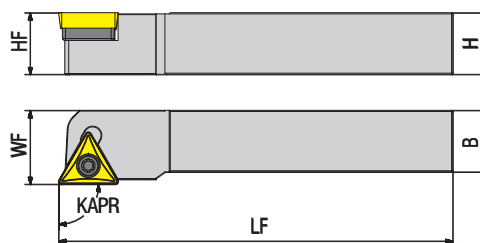

Dimensions in Inch										
Ordering Code	HF=H	B	LF	LH	WF	Insert Inch/Metric	Screw	Shim	Shim Screw	Torx Key
STGCR 06 2	0.375	0.375	2.500	0.500	0.500	TC.. 2151 TC.. 110204	4008-M2.5x6	-	-	82-T08
STGCR 08 2J	0.500	0.500	3.500	0.500	0.625	TC.. 2151 TC.. 110204	4008-M2.5x6	-	-	82-T08
STGCR 10 3A	0.625	0.625	4.000	0.620	0.313	TC.. 3252 TC.. 16T308	4015-M3.5x14	AATN-2-0001	AAV-06-M3.5x11	82-T15
STGCR 10 3B	0.625	0.625	4.500	0.850	0.750	TC.. 3252 TC.. 16T308	4015-M3.5x14	AATN-2-0001	AAV-06-M3.5x11	82-T15
STGCR 12 3B	0.750	0.750	4.500	0.620	0.375	TC.. 3252 TC.. 16T308	4015-M3.5x14	AATN-2-0001	AAV-06-M3.5x11	82-T15
STGCR 16 3D	1.000	1.000	6.000	0.620	0.500	TC.. 3252 TC.. 16T308	4015-M3.5x14	AATN-2-0001	AAV-06-M3.5x11	82-T15
STGCL 10 2A	0.625	0.625	4.000	0.500	0.750	TC.. 2151 TC.. 110204	4008-M2.5x6	-	-	82-T08
STGCL 10 3A	0.625	0.625	4.000	0.620	0.313	TC.. 3252 TC.. 16T308	4015-M3.5x14	AATN-2-0001	AAV-06-M3.5x11	82-T15
STGCL 10 3B	0.625	0.625	4.500	0.850	0.750	TC.. 3252 TC.. 16T308	4015-M3.5x14	AATN-2-0001	AAV-06-M3.5x11	82-T15
STGCL 12 3B	0.750	0.750	4.500	0.620	0.375	TC.. 3252 TC.. 16T308	4015-M3.5x14	AATN-2-0001	AAV-06-M3.5x11	82-T15
STGCL 16 3D	1.000	1.000	6.000	0.620	0.500	TC.. 3252 TC.. 16T308	4015-M3.5x14	AATN-2-0001	AAV-06-M3.5x11	82-T15



Illustrations shown may vary from actual product.

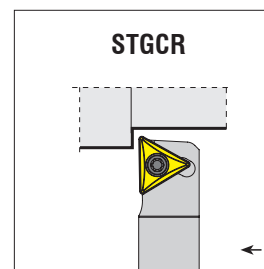
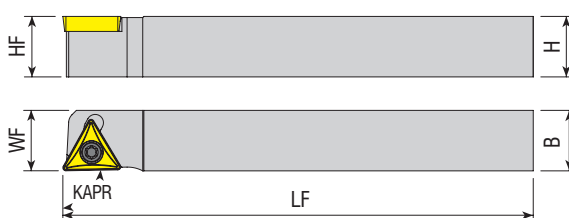

Dimensions in Metric										
Ordering Code	HF=H	B	LF	WF	Insert Inch/Metric	Screw	Shim	Shim Screw	Torx Key	
STGCR 1216 K11-S	12	16	125	16	TC.. 215.. TC.. 1102..	4008-M2.5x6	-	-	82-T08	
STGCR 1616 K11-S	16	16	125	16	TC.. 215.. TC.. 1102..	4008-M2.5x6	-	-	82-T08	
STGCR 1216 K16-S	12	16	125	16	TC.. 325.. TC.. 16T3..	4015-M3.5x11	-	-	80-T15	
STGCR 1616 K16-S	16	16	125	16	TC.. 325.. TC.. 16T3..	4015-M3.5x11	-	-	80-T15	
STGCL 1216 K11-S	12	16	125	16	TC.. 215.. TC.. 1102..	4008-M2.5x6	-	-	82-T08	
STGCL 1616 K11-S	16	16	125	16	TC.. 215.. TC.. 1102..	4008-M2.5x6	-	-	82-T08	
STGCL 1216 K16-S	12	16	125	16	TC.. 325.. TC.. 16T3..	4015-M3.5x11	-	-	80-T15	
STGCL 1616 K16-S	16	16	125	16	TC.. 325.. TC.. 16T3..	4015-M3.5x11	-	-	80-T15	

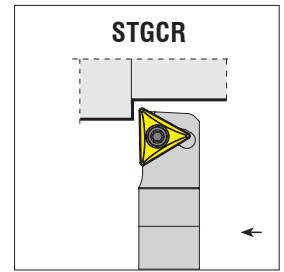
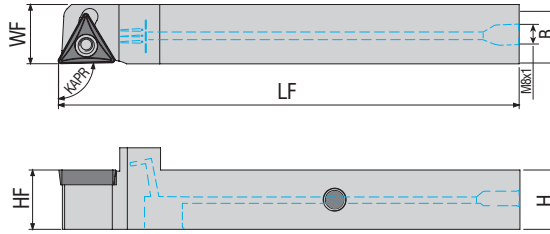

Illustrations shown may vary from actual product.

Dimensions in Metric

Ordering Code	Dimensions in Metric				Insert	Screw	Thread Pin	Allen Key	Torx Key
	HF=H	B	LF	WF	Inch/Metric				
STGCR 1216 K16-SHC	12	16	125	16	TC.. 325.. TC.. 16T3..	4015-M3.5x11	2703-M6X4	AAL-03-3	80-T15
STGCR 1616 K16-SHC	16	16	125	16	TC.. 325.. TC.. 16T3..	4015-M3.5x11	2704-M8X1X5	AAL-05-4	80-T15
STGCL 1216 K16-SHC	12	16	125	16	TC.. 325.. TC.. 16T3..	4015-M3.5x11	2703-M6X4	AAL-03-3	80-T15
STGCL 1616 K16-SHC	16	16	125	16	TC.. 325.. TC.. 16T3..	4015-M3.5x11	2704-M8X1X5	AAL-05-4	80-T15

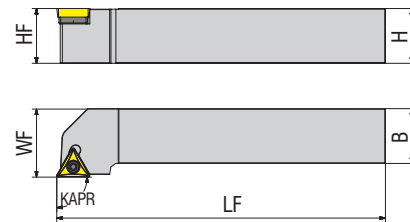
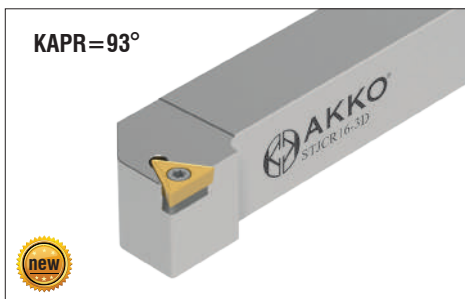



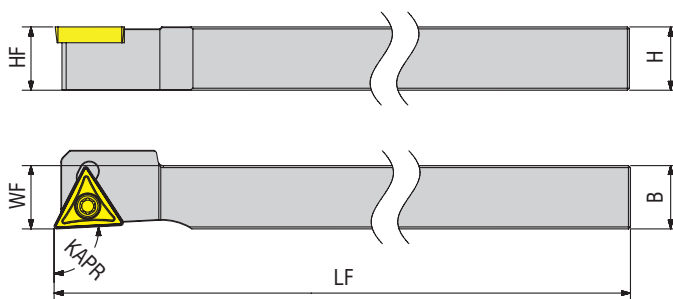
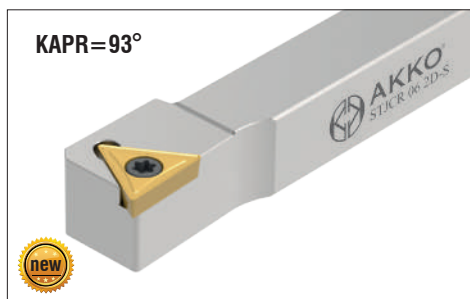

Illustrations shown may vary from actual product.

Dimensions in Inch

Ordering Code	Dimensions in Inch					Insert	Screw	Shim	Shim Screw	Torx Key
	HF=H	B	LF	LH	WF	Inch/Metric				
STJCR 06 2	0.375	0.375	2.500	0.500	0.500	TC.. 2151 TC.. 110204	4008-M2.5x6	-	-	82-T08
STJCR 08 2J	0.500	0.500	3.500	0.500	0.625	TC.. 2151 TC.. 110204	4008-M2.5x6	-	-	82-T08
STJCR 10 2A	0.625	0.625	4.000	0.500	0.750	TC.. 2151 TC.. 110204	4008-M2.5x6	-	-	82-T08
STJCR 10 3B	0.625	0.625	4.500	0.850	0.750	TC.. 3252 TC.. 16T308	4015-M3.5x14	AATN-2-0001	AAV-06-M3.5x11	82-T15
STJCR 12 3B	0.750	0.750	4.500	0.850	1.000	TC.. 3252 TC.. 16T308	4015-M3.5x14	AATN-2-0001	AAV-06-M3.5x11	82-T15
STJCR 16 3D	1.000	1.000	6.000	0.850	1.250	TC.. 3252 TC.. 16T308	4015-M3.5x14	AATN-2-0001	AAV-06-M3.5x11	82-T15
STJCL 06 2	0.375	0.375	2.500	0.500	0.500	TC.. 2151 TC.. 110204	4008-M2.5x6	-	-	82-T08
STJCL 08 2J	0.500	0.500	3.500	0.500	0.625	TC.. 2151 TC.. 110204	4008-M2.5x6	-	-	82-T08
STJCL 10 2A	0.625	0.625	4.000	0.500	0.750	TC.. 2151 TC.. 110204	4008-M2.5x6	-	-	82-T08
STJCL 10 3B	0.625	0.625	4.500	0.850	0.750	TC.. 3252 TC.. 16T308	4015-M3.5x14	AATN-2-0001	AAV-06-M3.5x11	82-T15
STJCL 12 3B	0.750	0.750	4.500	0.850	1.000	TC.. 3252 TC.. 16T308	4015-M3.5x14	AATN-2-0001	AAV-06-M3.5x11	82-T15
STJCL 16 3D	1.000	1.000	6.000	0.850	1.250	TC.. 3252 TC.. 16T308	4015-M3.5x14	AATN-2-0001	AAV-06-M3.5x11	82-T15



Illustrations shown may vary from actual product.

Ordering Code	Dimensions in Inch									
	HF=H	B	LF	LH	WF	Insert Inch/Metric	Screw	Shim	Shim Screw	Torx Key
STJCR 06 2-S	0.375	0.375	2.500	0.625	0.375	TC.. 2151 TC.. 110204	4008-M2.5x6	-	-	82-T08
STJCR 06 2D-S	0.375	0.375	6.000	0.620	0.375	TC.. 2151 TC.. 110204	4008-M2.5x6	-	-	82-T08
STJCR 08 2D-S	0.500	0.500	6.000	0.620	0.500	TC.. 2151 TC.. 110204	4008-M2.5x6	-	-	82-T08
STJCR 08 2J-S	0.500	0.500	3.500	0.625	0.500	TC.. 2151 TC.. 110204	4008-M2.5x6	-	-	82-T08
STJCR 10 2A-S	0.625	0.625	4.000	0.625	0.625	TC.. 2151 TC.. 110204	4008-M2.5x6	-	-	82-T08
STJCR 10 2B-S	0.625	0.625	4.500	0.625	0.625	TC.. 2151 TC.. 110204	4008-M2.5x6	-	-	82-T08
STJCR 12 3B-S	0.750	0.750	4.500	1.125	0.750	TC.. 3252 TC.. 16T308	4015-M3.5x14	AATN-2-0001	AAV-06-M3.5x11	82-T15
STJCR 64 3D-S	1.000	0.750	6.000	1.125	0.750	TC.. 3252 TC.. 16T308	4015-M3.5x14	AATN-2-0001	AAV-06-M3.5x11	82-T15
STJCL 10 2A-S	0.625	0.625	4.000	0.625	0.625	TC.. 2151 TC.. 110204	4008-M2.5x6	-	-	82-T08
STJCL 10 2B-S	0.625	0.625	4.500	0.625	0.625	TC.. 2151 TC.. 110204	4008-M2.5x6	-	-	82-T08
STJCL 12 3B-S	0.750	0.750	4.500	1.125	0.750	TC.. 3252 TC.. 16T308	4015-M3.5x14	AATN-2-0001	AAV-06-M3.5x11	82-T15
STJCL 64 3D-S	1.000	0.750	6.000	1.125	0.750	TC.. 3252 TC.. 16T308	4015-M3.5x14	AATN-2-0001	AAV-06-M3.5x11	82-T15



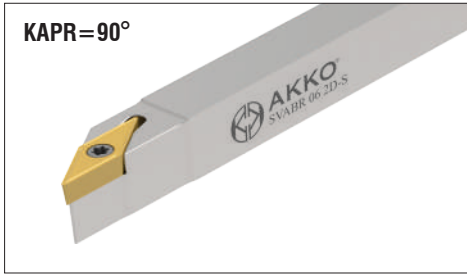

Illustrations shown may vary from actual product.

Dimensions in Inch

Ordering Code	HF=H	B	LF	LH	WF	Insert Inch/Metric	Screw	Shim	Shim Screw	Torx Key
SVABR 06 2D-S	0.375	0.375	6.000	0.880	0.375	VB.. 221 VB.. 110304	4008-M2.5x6	-	-	82-T08
SVABR 08 2D-S	0.500	0.500	6.000	0.880	0.500	VB.. 221 VB.. 110304	4008-M2.5x6	-	-	82-T08
SVABR 10 3B-S	0.625	0.625	4.500	1.380	0.625	VB.. 332 VB.. 160408	4015-M3.5x11	-	-	82-T15
SVABL 06 2D-S	0.375	0.375	6.000	0.880	0.375	VB.. 221 VB.. 110304	4008-M2.5x6	-	-	82-T08
SVABL 08 2D-S	0.500	0.500	6.000	0.880	0.500	VB.. 221 VB.. 110304	4008-M2.5x6	-	-	82-T08
SVABL 10 3B-S	0.625	0.625	4.500	1.380	0.625	VB.. 332 VB.. 160408	4015-M3.5x11	-	-	82-T15

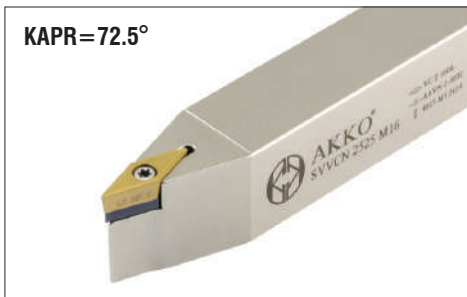
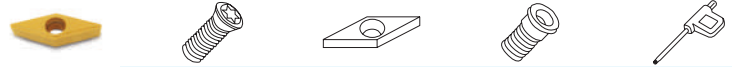
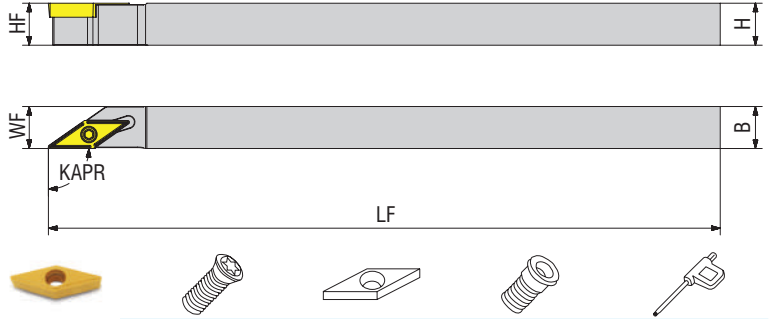

Illustrations shown may vary from actual product.

Dimensions in Metric

Ordering Code	HF=H	B	LF	WF	Insert Inch/Metric	Screw	Shim	Shim Screw	Torx Key
SVVBN 1212 F11	12	12	80	06	VB.. 22.. VB.. 1103..	4008-M2.5x6	-	-	82-T08
SVVBN 1616 H11	16	16	100	08	VB.. 22.. VB.. 1103..	4008-M2.5x6	-	-	82-T08
SVVBN 2020 K11	20	20	125	10	VB.. 22.. VB.. 1103..	4008-M2.5x6	-	-	82-T08
SVVBN 2020 K16	20	20	125	10	VB.. 33.. VB.. 1604..	4015-M3.5x14	AAVN-2-0002	AAV-06-M3.5x11	80-T15
SVVBN 2525 M16	25	25	150	12.5	VB.. 33.. VB.. 1604..	4015-M3.5x14	AAVN-2-0002	AAV-06-M3.5x11	80-T15
SVVBN 3232 P16	32	32	170	16	VB.. 33.. VB.. 1604..	4015-M3.5x14	AAVN-2-0002	AAV-06-M3.5x11	80-T15

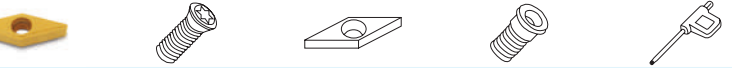
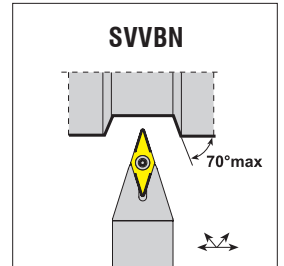
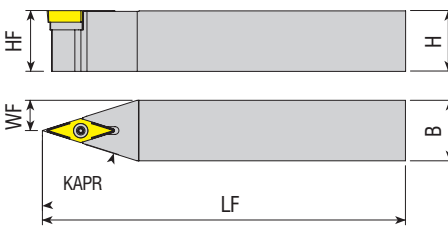

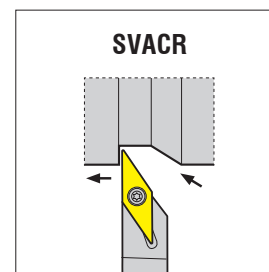
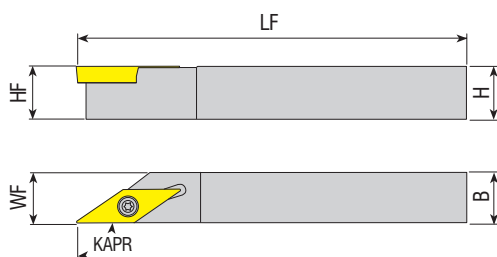

Illustrations shown may vary from actual product.

Dimensions in Metric

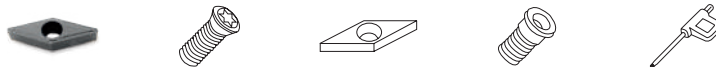

Ordering Code	HF=H	B	LF	WF	Insert Inch/Metric	Screw	Shim	Shim Screw	Torx Key
SVACR 0808 X11-S	08	08	115	08	VC.. 22.. VC.. 1103..	4008-M2.5x6	-	-	82-T08
SVACR1010 K11-S	10	10	125	10	VC.. 22.. VC.. 1103..	4008-M2.5x6	-	-	82-T08
SVACR 1212 G11-S	12	12	90	12	VC.. 22.. VC.. 1103..	4008-M2.5x6	-	-	82-T15
SVACR 1212 K11-S	12	12	125	12	VC.. 22.. VC.. 1103..	4008-M2.5x6	-	-	82-T08
SVACR 1616 F11-S	16	16	75	16	VC.. 22.. VC.. 1103..	4008-M2.5x6	-	-	82-T08
SVACR 1616 K11-S	16	16	125	16	VC.. 22.. VC.. 1103..	4008-M2.5x6	-	-	82-T15
SVACR 2020 K11-S	20	20	125	20	VC.. 22.. VC.. 1103..	4008-M2.5x6	-	-	82-T15
SVACR 1212 K16-S	12	12	125	12	VC.. 33.. VC.. 1604...	4015-M3.5x11	-	-	80-T15
SVACR 1616 K16-S	16	16	125	16	VC.. 33.. VC.. 1604...	4015-M3.5x11	-	-	80-T15
SVACL 0808 X11-S	08	08	115	08	VC.. 22.. VC.. 1103..	4008-M2.5x6	-	-	82-T08
SVACL 1010 K11-S	10	10	125	10	VC.. 22.. VC.. 1103..	4008-M2.5x6	-	-	82-T08
SVACL 1212 G11-S	12	12	90	12	VC.. 22.. VC.. 1103..	4008-M2.5x6	-	-	82-T15
SVACL 1212 K11-S	12	12	125	12	VC.. 22.. VC.. 1103..	4008-M2.5x6	-	-	82-T08
SVACL 1616 F11-S	16	16	75	16	VC.. 22.. VC.. 1103..	4008-M2.5x6	-	-	82-T08
SVACL 1616 K11-S	16	16	125	16	VC.. 22.. VC.. 1103..	4008-M2.5x6	-	-	82-T15
SVACL 2020 K11-S	20	20	125	20	VC.. 22.. VC.. 1103..	4008-M2.5x6	-	-	82-T15
SVACL 1212 K16-S	12	12	125	12	VC.. 33.. VC.. 1604...	4015-M3.5x11	-	-	80-T15
SVACL 1616 K16-S	16	16	125	16	VC.. 33.. VC.. 1604...	4015-M3.5x11	-	-	80-T15



Illustrations shown may vary from actual product.

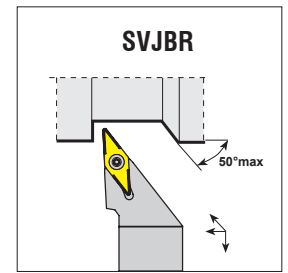
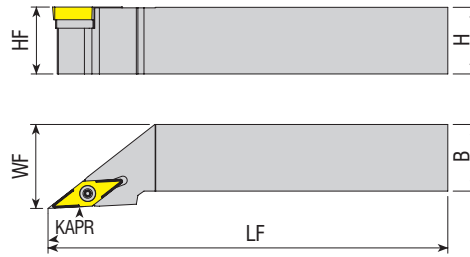

Dimensions in Inch

Ordering Code	HF=H	B	LF	LH	WF	Insert Inch/Metric	Screw	Shim	Shim Screw	Torx Key
<b>NEW</b> SVJBR 06 2	0.375	0.375	2.500	0.875	0.500	VB.. 221 VB.. 110304	4008-M2.5x6	-	-	82-T08
<b>NEW</b> SVJBR 08 2J	0.500	0.500	3.500	0.875	0.625	VB.. 221 VB.. 110304	4008-M2.5x6	-	-	82-T08
SVJBR 10 2A	0.625	0.625	4.000	0.880	0.750	VB.. 221 VB.. 110304	4008-M2.5x6	-	-	82-T08
SVJBR 12 3B	0.750	0.750	4.500	1.380	1.000	VB.. 332 VB.. 160408	4015-M3.5x14	AAVN-2-0002	AAV-06-M3.5x11	82-T15
<b>NEW</b> SVJBR 16 3C	1.000	1.000	5.000	1.250	1.250	VB.. 332 VB.. 160408	4015-M3.5x11	AAVN-2-0002	AAV-06-M3.5x11	82-T15
SVJBR 16 3D	1.000	1.000	6.000	1.380	1.250	VB.. 332 VB.. 160408	4015-M3.5x14	AAVN-2-0002	AAV-06-M3.5x11	82-T15
<b>NEW</b> SVJBR 20 3D	1.250	1.250	6.000	1.250	1.500	VB.. 332 VB.. 160408	4015-M3.5x11	AAVN-2-0002	AAV-06-M3.5x11	82-T15
<b>NEW</b> SVJBL 06 2	0.375	0.375	2.500	0.875	0.500	VB.. 221 VB.. 110304	4008-M2.5x6	-	-	82-T08
<b>NEW</b> SVJBL 08 2J	0.500	0.500	3.500	0.875	0.625	VB.. 221 VB.. 110304	4008-M2.5x6	-	-	82-T08
SVJBL 10 2A	0.625	0.625	4.000	0.880	0.750	VB.. 221 VB.. 110304	4008-M2.5x6	-	-	82-T08
SVJBL 12 3B	0.750	0.750	4.500	1.380	1.000	VB.. 332 VB.. 160408	4015-M3.5x14	AAVN-2-0002	AAV-06-M3.5x11	82-T15
<b>NEW</b> SVJBL 16 3C	1.000	1.000	5.000	1.250	1.250	VB.. 332 VB.. 160408	4015-M3.5x11	AAVN-2-0002	AAV-06-M3.5x11	82-T15
SVJBL 16 3D	1.000	1.000	6.000	1.380	1.250	VB.. 332 VB.. 160408	4015-M3.5x14	AAVN-2-0002	AAV-06-M3.5x11	82-T15
<b>NEW</b> SVJBL 20 3D	1.250	1.250	6.000	1.250	1.500	VB.. 332 VB.. 160408	4015-M3.5x11	AAVN-2-0002	AAV-06-M3.5x11	82-T15

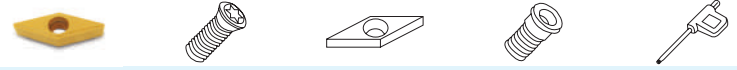

Illustrations shown may vary from actual product.

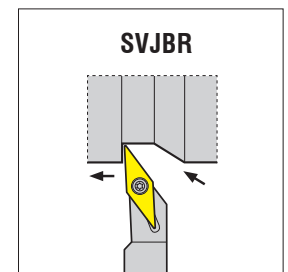
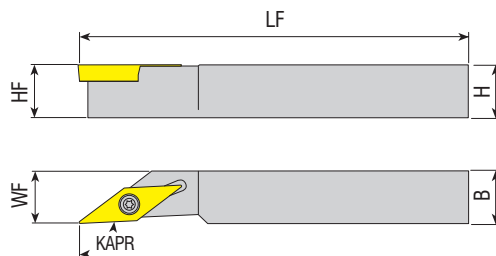

Dimensions in Inch

Ordering Code	HF=H	B	LF	LH	WF	Insert Inch/Metric	Screw	Shim	Shim Screw	Torx Key
SVJBR 06 2D-S	0.375	0.375	6.000	0.930	0.375	VB.. 221 VB.. 110304	4008-M2.5x6	-	-	82-T08
SVJBR 08 2D-S	0.500	0.500	6.000	0.930	0.500	VB.. 221 VB.. 110304	4008-M2.5x6	-	-	82-T08
SVJBR 10 3B-S	0.625	0.625	4.500	1.430	0.625	VB.. 332 VB.. 160408	4015-M3.5x11	-	-	82-T15
SVJBL 06 2D-S	0.375	0.375	6.000	0.930	0.375	VB.. 221 VB.. 110304	4008-M2.5x6	-	-	82-T08
SVJBL 08 2D-S	0.500	0.500	6.000	0.930	0.500	VB.. 221 VB.. 110304	4008-M2.5x6	-	-	82-T08
SVJBL 10 3B-S	0.625	0.625	4.500	1.430	0.625	VB.. 332 VB.. 160408	4015-M3.5x11	-	-	82-T15

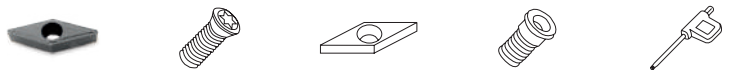



Illustrations shown may vary from actual product.

Dimensions in Metric

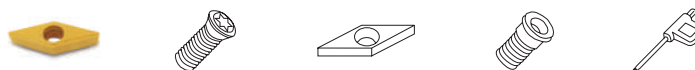
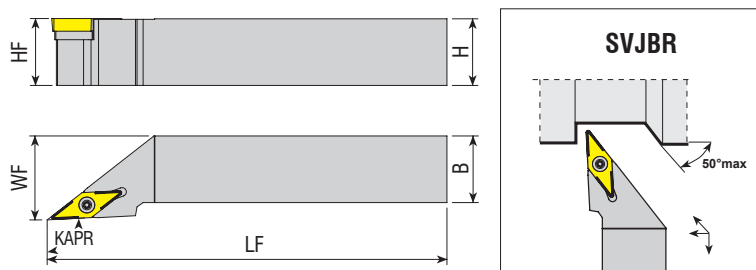

Ordering Code	HF=H	B	LF	WF	Insert Inch/Metric	Screw	Shim	Shim Screw	Torx Key
SVJBR 1212 F11	12	12	80	16	VB.. 22.. VB.. 1103..	4008-M2.5x6	-		82-T08
SVJBR 1616 H11	16	16	100	20	VB.. 22.. VB.. 1103..	4008-M2.5x6	-		82-T08
SVJBR 2020 K11	20	20	125	25	VB.. 22.. VB.. 1103..	4008-M2.5x6	-		82-T08
SVJBR 1616 H16	16	16	100	20	VB.. 33.. VB.. 1604..	4015-M3.5x12	AAVN-2-0002	AAV-08-M3.5x8	80-T15
SVJBR 2020 K16	20	20	125	25	VB.. 33.. VB.. 1604..	4015-M3.5x14	AAVN-2-0002	AAV-06-M3.5x11	80-T15
SVJBR 2525 M16	25	25	150	32	VB.. 33.. VB.. 1604..	4015-M3.5x14	AAVN-2-0002	AAV-06-M3.5x11	80-T15
SVJBR 3232 P16	32	32	170	40	VB.. 33.. VB.. 1604..	4015-M3.5x14	AAVN-2-0002	AAV-06-M3.5x11	80-T15
SVJBL 1212 F11	12	12	80	16	VB.. 22.. VB.. 1103..	4008-M2.5x6	-		82-T08
SVJBL 1616 H11	16	16	100	20	VB.. 22.. VB.. 1103..	4008-M2.5x6	-		82-T08
SVJBL 2020 K11	20	20	125	25	VB.. 22.. VB.. 1103..	4008-M2.5x6	-		82-T08
SVJBL 1616 H16	16	16	100	20	VB.. 33.. VB.. 1604..	4015-M3.5x12	AAVN-2-0002	AAV-08-M3.5x8	80-T15
SVJBL 2020 K16	20	20	125	25	VB.. 33.. VB.. 1604..	4015-M3.5x14	AAVN-2-0002	AAV-06-M3.5x11	80-T15
SVJBL 2525 M16	25	25	150	32	VB.. 33.. VB.. 1604..	4015-M3.5x14	AAVN-2-0002	AAV-06-M3.5x11	80-T15
SVJBL 3232 P16	32	32	170	40	VB.. 33.. VB.. 1604..	4015-M3.5x14	AAVN-2-0002	AAV-06-M3.5x11	80-T15



Illustrations shown may vary from actual product.

Dimensions in Metric

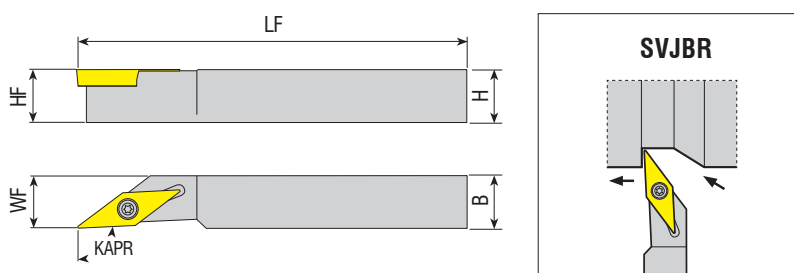

Ordering Code	HF=H	B	LF	WF	Insert Inch/Metric	Screw	Shim	Shim Screw	Torx Key
SVJBR 1616 K11-S	16	16	125	16	VB.. 22.. VB.. 1103..	4008-M2.5x6	-	-	82-T08
SVJBL 1616 K11-S	16	16	125	16	VB.. 22.. VB.. 1103..	4008-M2.5x6	-	-	82-T08

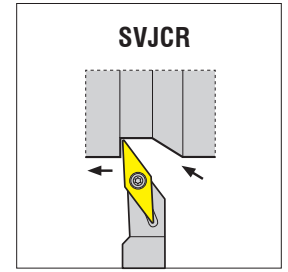
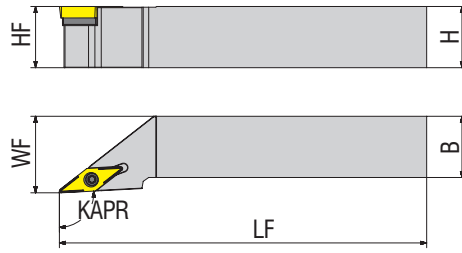

Illustrations shown may vary from actual product.

Dimensions in Metric

Ordering Code	HF=H	B	LF	LH	WF	Insert Inch/Metric	Screw	Shim	Shim Screw	Torx Key
SVJCR 06 2J	0.375	0.375	3.500	1.000	0.500	VC.. 221 VC.. 110304	4008-M2.5x6	-	-	82-T08
SVJCR 08 2A	0.500	0.500	4.000	1.000	0.625	VC.. 221 VC.. 110304	4008-M2.5x6	-	-	82-T08
SVJCR 10 2B	0.625	0.625	4.500	1.000	0.750	VC.. 221 VC.. 110304	4008-M2.5x6	-	-	82-T08
SVJCR 12 3B	0.750	0.750	4.500	1.250	1.000	VC.. 332 VC.. 160408	4015-M3.5x14	AAVN-2-0002	AAV-06- M3.5x11	82-T15
SVJCR 16 3C	1.000	1.000	5.000	1.250	1.250	VC.. 332 VC.. 160408	4015-M3.5x11	AAVN-2-0002	AAV-06- M3.5x11	82-T15
SVJCR 16 3D	1.000	1.000	6.000	1.250	1.250	VC.. 332 VC.. 160408	4015-M3.5x14	AAVN-2-0002	AAV-06- M3.5x11	82-T15
SVJCR 20 3D	1.250	1.250	6.000	1.250	1.500	VC.. 332 VC.. 160408	4015-M3.5x11	AAVN-2-0002	AAV-06- M3.5x11	82-T15
SVJCL 06 2J	0.375	0.375	3.500	1.000	0.500	VC.. 221 VC.. 110304	4008-M2.5x6	-	-	82-T08
SVJCL 08 2A	0.500	0.500	4.000	1.000	0.625	VC.. 221 VC.. 110304	4008-M2.5x6	-	-	82-T08
SVJCL 10 2B	0.625	0.625	4.500	1.000	0.750	VC.. 221 VC.. 110304	4008-M2.5x6	-	-	82-T08
SVJCL 12 3B	0.750	0.750	4.500	1.250	1.000	VC.. 332 VC.. 160408	4015-M3.5x11	AAVN-2-0002	AAV-06- M3.5x11	82-T15
SVJCL 16 3C	1.000	1.000	5.000	1.250	1.250	VC.. 332 VC.. 160408	4015-M3.5x11	AAVN-2-0002	AAV-06- M3.5x11	82-T15
SVJCL 16 3D	1.000	1.000	6.000	1.250	1.250	VC.. 332 VC.. 160408	4015-M3.5x11	AAVN-2-0002	AAV-06- M3.5x11	82-T15
SVJCL 20 3D	1.250	1.250	6.000	1.250	1.500	VC.. 332 VC.. 160408	4015-M3.5x11	AAVN-2-0002	AAV-06- M3.5x11	82-T15





KAPR=93°

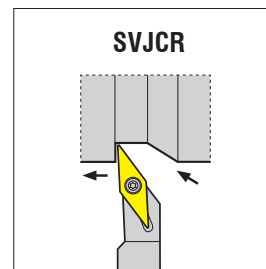
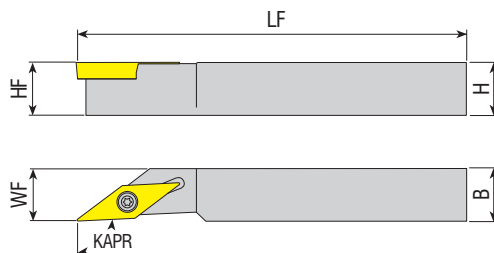

Illustrations shown may vary from actual product.

Dimensions in Metric

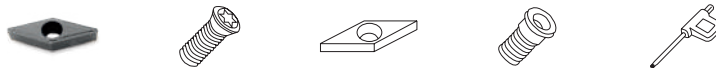

Ordering Code	HF=H	B	LF	WF	Insert Inch/Metric	Screw	Shim	Shim Screw	Torx Key
SVJCR 0808 X11-S	08	08	115	08	VC.. 22.. VC.. 1103..	4008-M2.5x6	-	-	82-T08
SVJCR 1010 K11-S	10	10	125	10	VC.. 22.. VC.. 1103..	4008-M2.5x6	-	-	82-T08
SVJCR 1212 G11-S	12	12	90	12	VC.. 22.. VC.. 1103..	4008-M2.5x6	-	-	82-T15
SVJCR 1212 K11-S	12	12	125	12	VC.. 22.. VC.. 1103..	4008-M2.5x6	-	-	82-T08
SVJCR 1616 F11-S	16	16	75	16	VC.. 22.. VC.. 1103..	4008-M2.5x6	-	-	82-T08
SVJCR 1616 K11-S	16	16	125	16	VC.. 22.. VC.. 1103..	4008-M2.5x6	-	-	82-T08
SVJCR 2020 K11-S	20	20	125	20	VC.. 22.. VC.. 1103..	4008-M2.5x6	-	-	82-T08
SVJCR 1616 K16-S	16	16	125	16	VC.. 33.. VC.. 1604...	4015-M3.5x11	AAVN-2-0002	AAV-08-M3.5x8	80-T15
SVJCR 2020 K16-S	20	20	125	20	VC.. 33.. VC.. 1604...	4015-M3.5x11	AAVN-2-0002	AAV-06-M3.5x11	80-T15
SVJCL 0808 X11-S	08	08	115	08	VC.. 22.. VC.. 1103..	4008-M2.5x6	-	-	82-T08
SVJCL 1010 K11-S	10	10	125	10	VC.. 22.. VC.. 1103..	4008-M2.5x6	-	-	82-T08
SVJCL 1212 G11-S	12	12	90	12	VC.. 22.. VC.. 1103..	4008-M2.5x6	-	-	82-T15
SVJCL 1212 K11-S	12	12	125	12	VC.. 22.. VC.. 1103..	4008-M2.5x6	-	-	82-T08
SVJCL 1616 F11-S	16	16	75	16	VC.. 22.. VC.. 1103..	4008-M2.5x6	-	-	82-T08
SVJCL 1616 K11-S	16	16	125	16	VC.. 22.. VC.. 1103..	4008-M2.5x6	-	-	82-T08
SVJCL 2020 K11-S	20	20	125	20	VC.. 22.. VC.. 1103..	4008-M2.5x6	-	-	82-T08
SVJCL 1616 K16-S	16	16	125	16	VC.. 33.. VC.. 1604...	4015-M3.5x11	AAVN-2-0002	AAV-08-M3.5x8	80-T15
SVJCL 2020 K16-S	20	20	125	20	VC.. 33.. VC.. 1604...	4015-M3.5x11	AAVN-2-0002	AAV-06-M3.5x11	80-T15

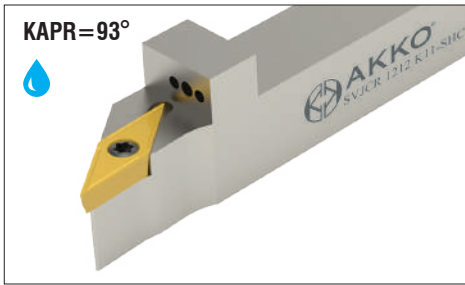

Illustrations shown may vary from actual product.

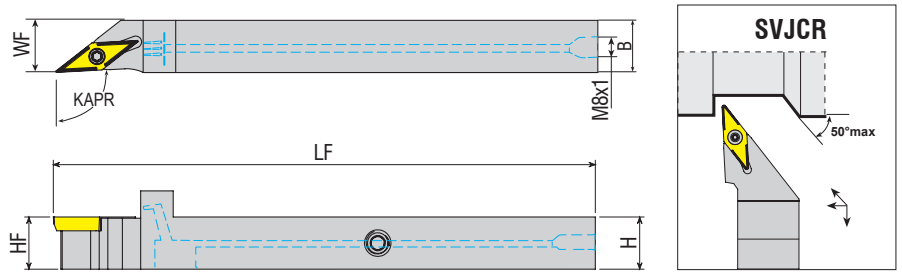

Dimensions in Metric										
Ordering Code	HF=H	B	LF	WF	Insert Inch/Metric	Screw	Thread Pin	Allen Key	Torx Key	
SVJCR 1212 K11-SHC	12	12	125	12	VC.. 22.. VC.. 1103..	4008-M2.5x6	2703-M6X4	AAL-03-3	82-T08	
SVJCR 1616 K11-SHC	16	16	125	16	VC.. 22.. VC.. 1103..	4008-M2.5x6	2704-M8X1X5	AAL-05-4	82-T08	
SVJCL 1212 K11-SHC	12	12	125	12	VC.. 22.. VC.. 1103..	4008-M2.5x6	2703-M6X4	AAL-03-3	82-T08	
SVJCL 1616 K11-SHC	16	16	125	16	VC.. 22.. VC.. 1103..	4008-M2.5x6	2704-M8X1X5	AAL-05-4	82-T08	

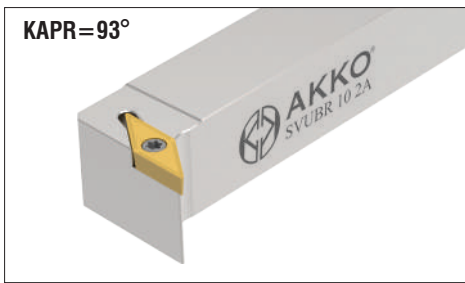

Illustrations shown may vary from actual product.

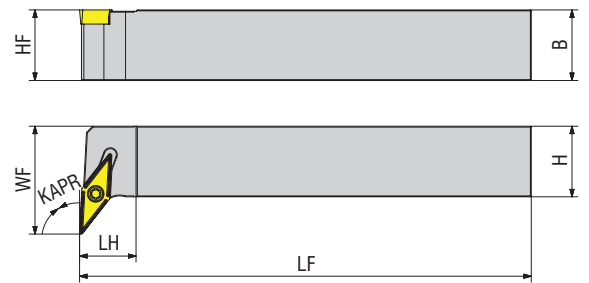

Dimensions in Inch										
Ordering Code	HF=H	B	LF	LH	WF	Insert Inch/Metric	Screw	Shim	Shim Screw	Torx Key
<b>new</b> SVUBR 08 2J	0.500	0.500	3.500	0.500	0.830	VB.. 221 VB.. 110304	4008-M2.5x6	-	-	82-T08
SVUBR 10 2A	0.625	0.625	4.000	0.500	0.955	VB.. 221 VB.. 110304	4008-M2.5x6	-	-	82-T08
<b>new</b> SVUBL 08 2J	0.500	0.500	3.500	0.500	0.830	VB.. 221 VB.. 110304	4008-M2.5x6	-	-	82-T08
SVUBL 10 2A	0.625	0.625	4.000	0.500	0.955	VB.. 221 VB.. 110304	4008-M2.5x6	-	-	82-T08

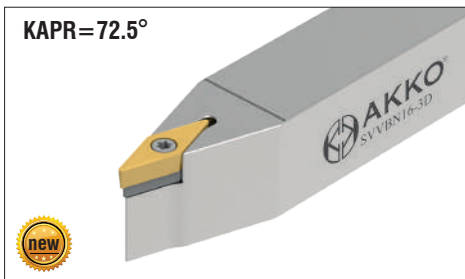

Illustrations shown may vary from actual product.

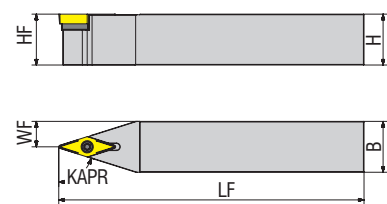

Dimensions in Inch										
Ordering Code	HF=H	B	LF	LH	WF	Insert Inch/Metric	Screw	Shim	Shim Screw	Torx Key
SVVBN 12 3B	0.750	0.750	4.500	-	0.375	VB.. 332 VB.. 160408	4015-M3.5x11	AAVN-2-0002	AAV-06-M3.5x11	82-T15
SVVBN 16 3D	1.000	1.000	6.000	-	0.500	VB.. 332 VB.. 160408	4015-M3.5x11	AAVN-2-0002	AAV-06-M3.5x11	82-T15
SVVBN 20 3D	1.250	1.250	6.000	-	0.625	VB.. 332 VB.. 160408	4015-M3.5x11	AAVN-2-0002	AAV-06-M3.5x11	82-T15



Illustrations shown may vary from actual product.

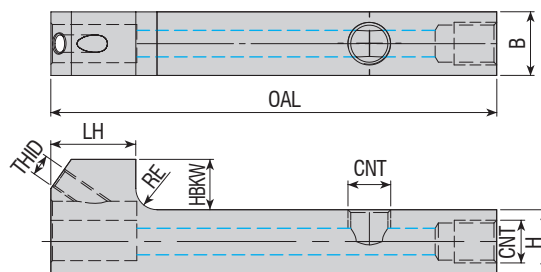

Dimensions in Metric

Ordering Code	H	B	RE	HBKW	LH	OAL	CNT	THID			
									Thread Pin	Mounting Screw	Allen Key
ASTB-1212-L84-H	12	12	4	9.5	16	84	M8X1X5	M4x0.7	2704-M8X1X5	2503-M4x12-C	AAL-03-3
ASTB-1616-L90-H	16	16	1	9.5	16	90	M8X1X5	M4x0.7	2704-M8X1X5	2503-M4x12-C	AAL-03-3

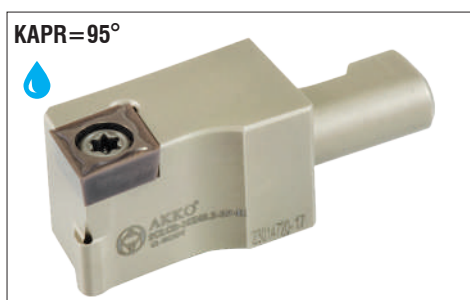

Illustrations shown may vary from actual product.

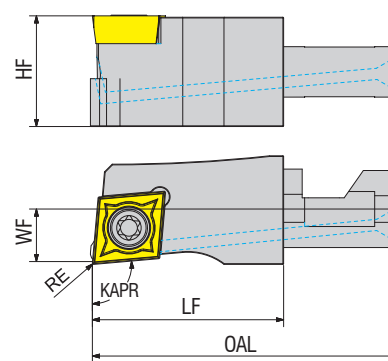

Dimensions in Metric

Ordering Code	HF	WF	RE	LF	OAL			
						Insert Inch/Metric	Screw	Torx Key
SCLCR-12X43.3-06-H	11.8	8	0.2	27.3	43.3	CC.. 215.. CC.. 0602..	4008-M2.5x6	82-T08
SCLCR-16X43.3-06-H	15.8	8	0.2	27.3	43.3	CC.. 215.. CC.. 0602..	4008-M2.5x6	82-T08
SCLCR-12X43.3-09-H	11.8	8	0.2	27.3	43.3	CC.. 325.. CC.. 09T3..	4015-M3.5x8	80-T15
SCLCR-16X43.3-09-H	15.8	8	0.2	27.3	43.3	CC.. 325.. CC.. 09T3..	4015-M3.5x8	80-T15
SCLCL-12X43.3-06-H	11.8	8	0.2	27.3	43.3	CC.. 215.. CC.. 0602..	4008-M2.5x6	82-T08
SCLCL-16X43.3-06-H	15.8	8	0.2	27.3	43.3	CC.. 215.. CC.. 0602..	4008-M2.5x6	82-T08
SCLCL-12X43.3-09-H	11.8	8	0.2	27.3	43.3	CC.. 325.. CC.. 09T3..	4015-M3.5x8	80-T15
SCLCL-16X43.3-09-H	15.8	8	0.2	27.3	43.3	CC.. 325.. CC.. 09T3..	4015-M3.5x8	80-T15

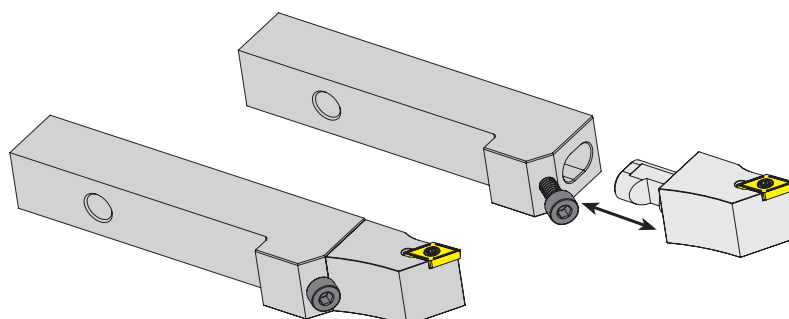



Illustrations shown may vary from actual product.

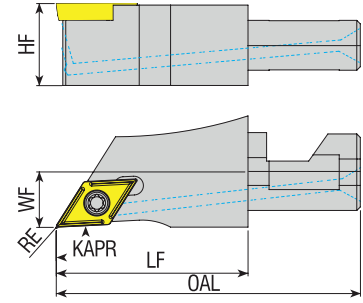

Dimensions in Metric



Ordering Code	HF	WF	RE	LF	OAL	Insert Inch/Metric	Screw	Torx Key
SDJCR-12X43.3-07	11.8	8	0.2	27.3	43.3	DC.. 215.. DC.. 0702...	4008-M2.5x6	82-T08
SDJCR-12X43.3-07-H	11.8	8	0.2	27.3	43.3	DC.. 215.. DC.. 0702...	4008-M2.5x6	82-T08
SDJCR-16X43.3-07	15.8	8	0.2	27.3	43.3	DC.. 215.. DC.. 0702...	4008-M2.5x6	82-T08
SDJCR-16X43.3-07-H	15.8	8	0.2	27.3	43.3	DC.. 215.. DC.. 0702...	4008-M2.5x6	82-T08
SDJCR-12X43.3-11	11.8	8	0.2	27.3	43.3	DC.. 325.. DC.. 11T3..	4015-M3.5x9	80-T15
SDJCR-12X43.3-11-H	11.8	8	0.2	27.3	43.3	DC.. 325.. DC.. 11T3..	4015-M3.5x9	80-T15
SDJCR-16X43.3-11	15.8	8	0.2	27.3	43.3	DC.. 325.. DC.. 11T3..	4015-M3.5x9	80-T15
SDJCR-16X43.3-11-H	15.8	8	0.2	27.3	43.3	DC.. 325.. DC.. 11T3..	4015-M3.5x9	80-T15
SDJCL-12X43.3-07	11.8	8	0.2	27.3	43.3	DC.. 215.. DC.. 0702...	4008-M2.5x6	82-T08
SDJCL-12X43.3-07-H	11.8	8	0.2	27.3	43.3	DC.. 215.. DC.. 0702...	4008-M2.5x6	82-T08
SDJCL-16X43.3-07	15.8	8	0.2	27.3	43.3	DC.. 215.. DC.. 0702...	4008-M2.5x6	82-T08
SDJCL-16X43.3-07-H	15.8	8	0.2	27.3	43.3	DC.. 215.. DC.. 0702...	4008-M2.5x6	82-T08
SDJCL-12X43.3-11	11.8	8	0.2	27.3	43.3	DC.. 325.. DC.. 11T3..	4015-M3.5x9	80-T15
SDJCL-12X43.3-11-H	11.8	8	0.2	27.3	43.3	DC.. 325.. DC.. 11T3..	4015-M3.5x9	80-T15
SDJCL-16X43.3-11	15.8	8	0.2	27.3	43.3	DC.. 325.. DC.. 11T3..	4015-M3.5x9	80-T15
SDJCL-16X43.3-11-H	15.8	8	0.2	27.3	43.3	DC.. 325.. DC.. 11T3..	4015-M3.5x9	80-T15



Illustrations shown may vary from actual product.

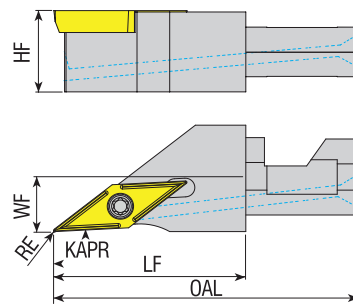

Dimensions in Metric

Ordering Code	HF	WF	RE	LF	OAL	Insert	Screw	Torx Key
						Inch/Metric		
SVJCR-12X43.3-11	11.8	8	0.2	27.3	43.3	VC.. 22.. VC.. 1103..	4008-M2.5x6	82-T08
SVJCR-12X43.3-11-H	11.8	8	0.2	27.3	43.3	VC.. 22.. VC.. 1103..	4008-M2.5x6	82-T08
SVJCR-16X43.3-11	15.8	8	0.2	27.3	43.3	VC.. 22.. VC.. 1103..	4008-M2.5x6	82-T08
SVJCR-16X43.3-11-H	15.8	8	0.2	27.3	43.3	VC.. 22.. VC.. 1103..	4008-M2.5x6	82-T08
SVJCL-12X43.3-11	11.8	8	0.2	27.3	43.3	VC.. 22.. VC.. 1103..	4008-M2.5x6	82-T08
SVJCL-12X43.3-11-H	11.8	8	0.2	27.3	43.3	VC.. 22.. VC.. 1103..	4008-M2.5x6	82-T08
SVJCL-16X43.3-11	15.8	8	0.2	27.3	43.3	VC.. 22.. VC.. 1103..	4008-M2.5x6	82-T08
SVJCL-16X43.3-11-H	15.8	8	0.2	27.3	43.3	VC.. 22.. VC.. 1103..	4008-M2.5x6	82-T08



Illustrations shown may vary from actual product.

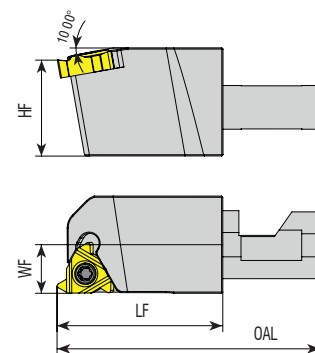

Dimensions in Metric

Ordering Code	HF	WF	LF	OAL	Insert	Screw	Right Shim	Left Shim	Shim Screw	Shim Screw Ring	Torx Key
					11 ER	4008-M2.5x6	-	-	-	-	82-T08
SER-16x43.3-11	15.8	8	27.3	43.3	11 ER	4008-M2.5x6	-	-	-	-	82-T08
TER-16x43.3-16	15.8	8	27.3	43.3	16 ER	1710-U5-40x12.2	ATS-16E	ATS-16I	AAV-11-U5-40x4.5	ABPL-03	82-T10
SEL-12x43.3-11	11.8	8	27.3	43.3	11 EL	4008-M2.5x6	-	-	-	-	82-T08
SEL-16x43.3-11	15.8	8	27.3	43.3	11 EL	4008-M2.5x6	-	-	-	-	82-T08
TEL-16x43.3-16	15.8	8	27.3	43.3	16 EL	1710-U5-40x12.2	ATS-16E	ATS-16I	AAV-11-U5-40x4.5	ABPL-03	82-T10





*the spoken quality...*

# D-SYSTEM

D SYSTEM BORING BARS



**A** **16** **T** | **D** **C** **L** **N** **R** **4** **C**

1 2 3 | 4 5 6 7 8 9 10

**1** Type of Boring Bar

“A” Solid steel with coolant hole  
 “E” Carbide bar with fixed steel head and coolant hole  
 “C” Carbide shank  
 “S” Steel shank

**2** Shank Diameter

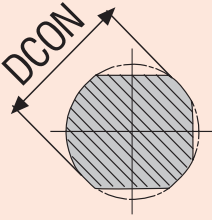

03	0.1875	16	1.000
04	0.2500	20	1.250
05	0.3125	24	1.500
06	0.3750	28	1.750
08	0.5000	32	2.000
10	0.6250	36	2.250
12	0.7500	40	2.500

**3** Shank Length

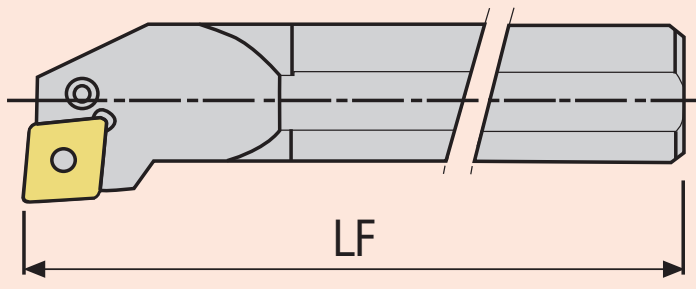





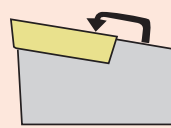
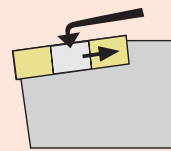
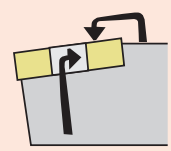
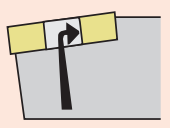
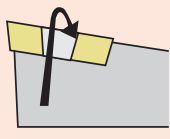

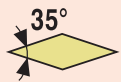

F	3	R	8
G	3.5	S	10
H	4	T	12
J	4.5	U	14
K	5	V	16
L	5.5	W	18
M	6	Y	20
N	6.5	P	6.75
Q	7	X	Special

**4** Method of Mounting of Insert

				
Top Clamping Without Hole	Top and Hole Clamping	Top and Hole Clamping	Hole Clamping (Lever Lock)	Screw on
<b>C</b>	<b>D</b>	<b>M</b>	<b>P</b>	<b>S</b>

**5** Type of Insert

				
<b>C</b>	<b>D</b>	<b>E</b>	<b>V</b>	<b>R</b>
				
<b>S</b>	<b>W</b>	<b>K</b>	<b>T</b>	

**6** Tool Holder Shape Bar Geometry

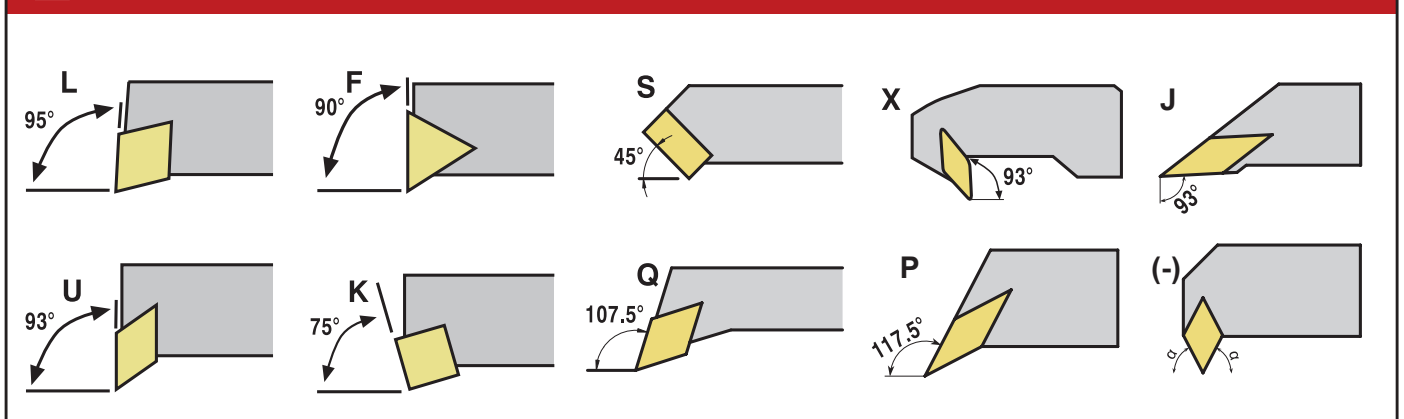

**7** Insert Clearance Angle

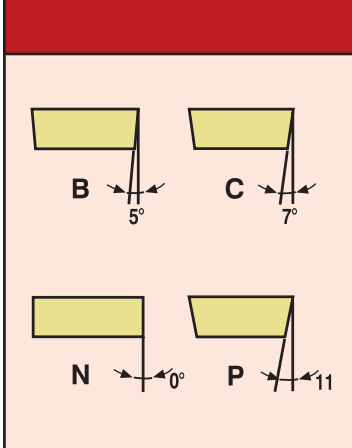

**8** Cutting Direction

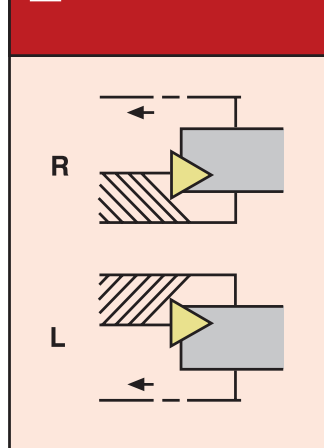

**9** Cutting Edge Length

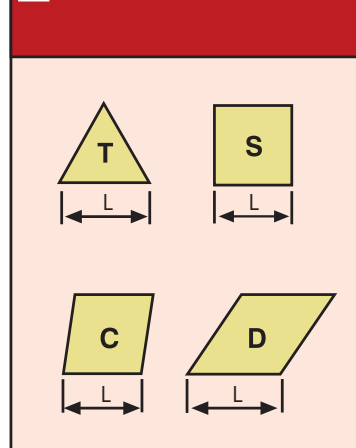

**10** Wedge Clamp

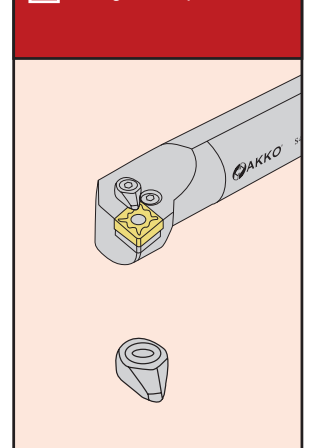

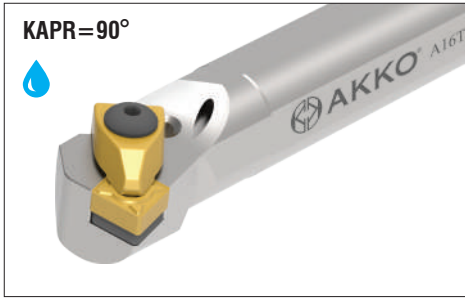

Illustrations shown may vary from actual product.

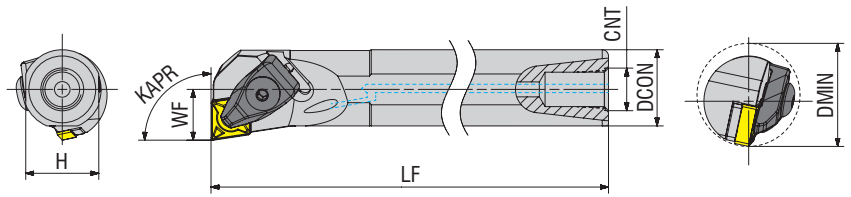

Dimensions in Inch

Ordering Code	DCON	H	LF	WF	DMIN	CNT	Insert Inch/Metric	Wedge Clamp	Clamp Screw	Shim	Shim Screw	Ring	Stamp	Allen Key
<b>A16T DCFNR 4</b>	1.000	0.921	12.000	0.640	1.300	1/4-18 NPT	CN.. 432 CN.. 120408	ATK-02	AKV-30-M6x22	AACN-3-0001	AAV-13-M5x8	AS-01	ABPL-01	AAL-03-3
<b>A24U DCFNR 4</b>	1.500	1.378	14.000	0.890	1.760	1/4-18 NPT	CN.. 432 CN.. 120408	ATK-02	AKV-30-M6x22	AACN-3-0001	AAV-02-M5x12	AS-01	ABPL-01	AAL-03-3



Illustrations shown may vary from actual product.

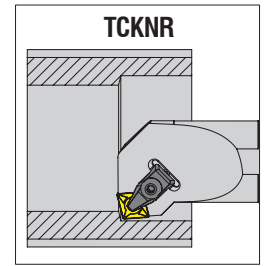
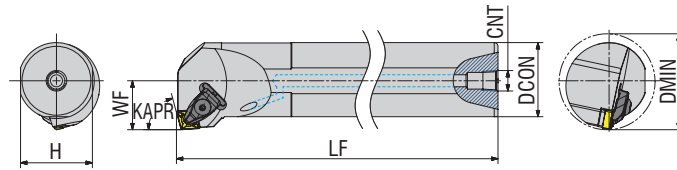

Dimensions in Inch

Ordering Code	DCON	H	LF	WF	DMIN	CNT	Insert Inch/Metric	Wedge Clamp	Clamp Screw	Shim	Shim Screw	Ring	Stamp	Allen Key
<b>A32V DCKNL 4</b>	2.000	1.882	16.000	1.281	2.400	1/4-18 NPT	CN.. 432 CN.. 120408	ATK-02	AKV-30-M6x22	AACN-3-0001	AAV-02-M5x12	AS-01	ABPL-01	AAL-03-3
<b>A32V DCKNL 5</b>	2.000	1.882	16.000	1.281	2.400	1/4-18 NPT	CN.. 543 CN.. 160612	ATK-04	AKV-19-M7x25	AACN-3-0002	AAV-05-M6x15	AS-02	ABPL-02	AAL-05-4



Illustrations shown may vary from actual product.

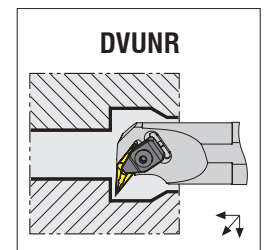
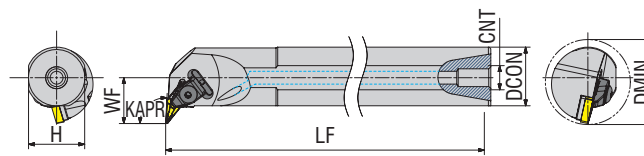

Dimensions in Inch

Ordering Code	DCON	H	LF	WF	DMIN	CNT	Insert Inch/Metric	Wedge Clamp	Clamp Screw	Shim	Shim Screw	Ring	Stamp	Allen Key
<b>A20U DVUNR 3</b>	1.250	1.170	14.000	1.000	1.705	1/4-18 NPT	VN.. 332 VN.. 160408	ATK-01	AKV-01-M5x22	AAVN-2-0002	AAV-03-M5x12	-	ABPL-01	AAL-03-3
<b>A24U DVUNR 3</b>	1.500	1.378	14.000	1.125	2.000	1/4-18 NPT	VN.. 332 VN.. 160408	ATK-01	AKV-01-M5x22	AAVN-2-0002	AAV-03-M5x12	-	ABPL-01	AAL-03-3
<b>A24U DVUNL 3</b>	1.500	1.378	14.000	1.125	2.000	1/4-18 NPT	VN.. 332 VN.. 160408	ATK-01	AKV-01-M5x22	AAVN-2-0002	AAV-03-M5x12	-	ABPL-01	AAL-03-3

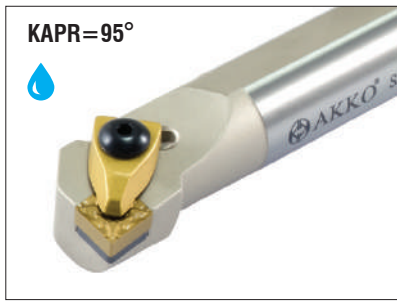

Illustrations shown may vary from actual product.

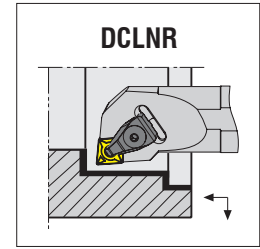
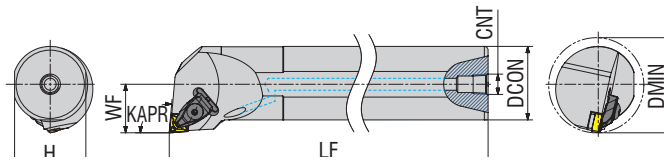

Dimensions in Inch



Ordering Code	DCON	H	LF	WF	DMIN	CNT	Insert Inch/Metric	Wedge Clamp	Clamp Screw	Shim	Shim Screw	Ring	Stamp	Allen Key
A16T DCLNR 3	1.000	0.921	12.000	0.640	1.200	1/4-18 NPT	CN.. 322 CN.. 09T308	ATK-01	AKV-01-M5x22	AACN -2-0001	AAV-09-M5x9	-	ABPL-01	AAL-03-3
A16T DCLNR 4	1.000	0.921	12.000	0.640	1.200	1/4-18 NPT	CN.. 432 CN.. 120408	ATK-02	AKV-30-M6x22	AACN-3-0001	AAV-13-M5x8	AS-01	ABPL-01	AAL-03-3
A20U DCLNR 4	1.250	1.170	14.000	0.765	1.470	1/4-18 NPT	CN.. 432 CN.. 120408	ATK-02	AKV-30-M6x22	AACN-3-0001	AAV-02-M5x12	AS-01	ABPL-01	AAL-03-3
A24U DCLNR 4	1.500	1.378	14.000	0.890	1.760	1/4-18 NPT	CN.. 432 CN.. 120408	ATK-02	AKV-30-M6x22	AACN-3-0001	AAV-02-M5x12	AS-01	ABPL-01	AAL-03-3
A24U DCLNR 5	1.500	1.378	14.000	0.890	1.760	1/4-18 NPT	CN.. 543 CN.. 160612	ATK-04	AKV-19-M7x25	AACN-3-0002	AAV-05-M6x15	AS-02	ABPL-02	AAL-05-4
A28U DCLNR 4	1.750	1.632	14.000	1.015	2.010	1/4-18 NPT	CN.. 432 CN.. 120408	ATK-02	AKV-30-M6x22	AACN-3-0001	AAV-02-M5x12	AS-01	ABPL-01	AAL-03-3
A32V DCLNR 4	2.000	1.882	16.000	1.281	2.400	1/4-18 NPT	CN.. 432 CN.. 120408	ATK-02	AKV-30-M6x22	AACN-3-0001	AAV-02-M5x12	AS-01	ABPL-01	AAL-03-3
A32V DCLNR 5	2.000	1.882	16.000	1.281	2.400	1/4-18 NPT	CN.. 543 CN.. 160612	ATK-04	AKV-19-M7x25	AACN-3-0002	AAV-05-M6x15	AS-02	ABPL-02	AAL-05-4
A40V DCLNR 4	2.500	2.374	16.000	1.531	3.030	1/4-18 NPT	CN.. 432 CN.. 120408	ATK-02	AKV-30-M6x22	AACN-3-0001	AAV-02-M5x12	AS-01	ABPL-01	AAL-03-3
A16T DCLNL 4	1.000	0.921	12.000	0.640	1.200	1/4-18 NPT	CN.. 432 CN.. 120408	ATK-02	AKV-30-M6x22	AACN-3-0001	AAV-13-M5x8	AS-01	ABPL-01	AAL-03-3
A20U DCLNL 4	1.250	1.170	14.000	0.765	1.470	1/4-18 NPT	CN.. 432 CN.. 120408	ATK-02	AKV-30-M6x22	AACN-3-0001	AAV-02-M5x12	AS-01	ABPL-01	AAL-03-3
A24U DCLNL 4	1.500	1.378	14.000	0.890	1.760	1/4-18 NPT	CN.. 432 CN.. 120408	ATK-02	AKV-30-M6x22	AACN-3-0001	AAV-02-M5x12	AS-01	ABPL-01	AAL-03-3
A28U DCLNL 4	1.750	1.632	14.000	1.015	2.010	1/4-18 NPT	CN.. 432 CN.. 120408	ATK-02	AKV-30-M6x22	AACN-3-0001	AAV-02-M5x12	AS-01	ABPL-01	AAL-03-3
A32V DCLNL 4	2.000	1.882	16.000	1.281	2.400	1/4-18 NPT	CN.. 432 CN.. 120408	ATK-02	AKV-30-M6x22	AACN-3-0001	AAV-02-M5x12	AS-01	ABPL-01	AAL-03-3
A40V DCLNL 4	2.500	2.374	16.000	1.531	3.030	1/4-18 NPT	CN.. 432 CN.. 120408	ATK-02	AKV-30-M6x22	AACN-3-0001	AAV-02-M5x12	AS-01	ABPL-01	AAL-03-3



Illustrations shown may vary from actual product.

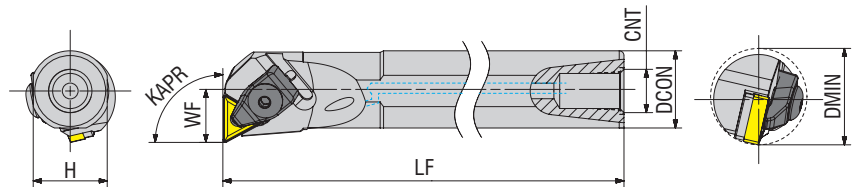

Ordering Code	DCON	H	LF	WF	DMIN	CNT	Insert Inch/Metric	Wedge Clamp	Clamp Screw	Shim	Shim Screw	Ring	Stamp	Allen Key
A16T DTFNR 3	1.000	0.921	12.000	0.640	1.200	1/4-18 NPT	TN.. 332 TN.. 160408	ATK-01	AKV-01-M5x22	AATN-2-0002	AAV-03-M5x12	-	ABPL-01	AAL-03-3



Illustrations shown may vary from actual product.

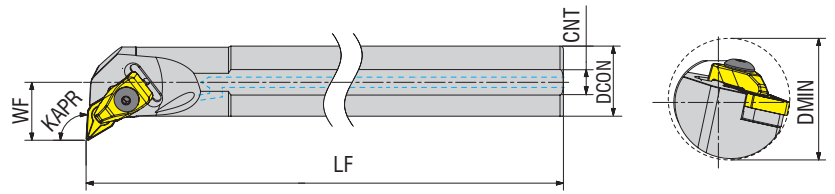

Dimensions in Inch

Ordering Code	DCON	H	LF	WF	DMIN	CNT									
							Insert Inch/Metric	Wedge Clamp	Clamp Screw	Shim	Shim Screw	Ring	Stamp	Allen Key	
<b>A16T DDUNR 3</b>	1.000	0.921	12.000	0.750	1.300	1/4-18 NPT	DN.. 332 DN.. 110408	ATK-01	AKV-01-M5x22	AADN-2-0001	AAV-09-M5x9	-	ABPL-01	AAL-03-3	
<b>A20U DDUNR 3</b>	1.250	1.170	14.000	1.000	1.705	1/4-18 NPT	DN.. 332 DN.. 110408	ATK-01	AKV-01-M5x22	AADN-2-0001	AAV-09-M5x9	-	ABPL-01	AAL-03-3	
<b>A20U DDUNR 4</b>	1.250	1.170	14.000	1.000	1.705	1/4-18 NPT	DN.. 432 DN.. 150408	ATK-02	AKV-30-M6x22	AADN-2-0003	AAV-02-M5x12	AS-01	ABPL-01	AAL-03-3	
<b>A24U DDUNR 4</b>	1.500	1.378	14.000	1.125	2.000	1/4-18 NPT	DN.. 432 DN.. 150408	ATK-02	AKV-30-M6x22	AADN-2-0003	AAV-02-M5x12	AS-01	ABPL-01	AAL-03-3	
<b>A32V DDUNR 4</b>	2.000	1.882	16.000	1.375	2.500	1/4-18 NPT	DN.. 432 DN.. 150408	ATK-02	AKV-30-M6x22	AADN-2-0003	AAV-02-M5x12	AS-01	ABPL-01	AAL-03-3	
<b>A16T DDUNL 3</b>	1.000	0.921	12.000	0.750	1.300	1/4-18 NPT	DN.. 332 DN.. 110408	ATK-01	AKV-01-M5x22	AADN-2-0001	AAV-09-M5x9	-	ABPL-01	AAL-03-3	
<b>A20U DDUNL 3</b>	1.250	1.170	14.000	1.000	1.705	1/4-18 NPT	DN.. 332 DN.. 110408	ATK-01	AKV-01-M5x22	AADN-2-0001	AAV-09-M5x9	-	ABPL-01	AAL-03-3	
<b>A16T DDUNL 4</b>	1.000	0.921	12.000	0.750	1.417	1/4-18 NPT	DN.. 432 DN.. 150408	ATK-02	AKV-30-M6x22	AADN-2-0003	AAV-02-M5x12	-	ABPL-01	AAL-03-3	
<b>A20U DDUNL 4</b>	1.250	1.170	14.000	1.000	1.705	1/4-18 NPT	DN.. 432 DN.. 150408	ATK-02	AKV-30-M6x22	AADN-2-0003	AAV-02-M5x12	AS-01	ABPL-01	AAL-03-3	
<b>A24U DDUNL 4</b>	1.500	1.378	14.000	1.125	2.000	1/4-18 NPT	DN.. 432 DN.. 150408	ATK-02	AKV-30-M6x22	AADN-2-0003	AAV-02-M5x12	AS-01	ABPL-01	AAL-03-3	
<b>A32V DDUNL 4</b>	2.000	1.882	16.000	1.375	2.500	1/4-18 NPT	DN.. 432 DN.. 150408	ATK-02	AKV-30-M6x22	AADN-2-0003	AAV-02-M5x12	AS-01	ABPL-01	AAL-03-3	



Illustrations shown may vary from actual product.

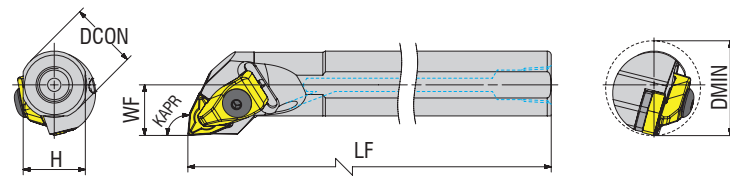

Dimensions in Inch

Ordering Code	DCON	H	LF	WF	DMIN	CNT								
							Insert Inch/Metric	Wedge Clamp	Clamp Screw	Shim	Shim Screw	Ring	Stamp	Allen Key
<b>A16T DWLNR 4</b>	1.000	0.921	12.000	0.640	1.200	1/4-18 NPT	WN.. 432 WN.. 080408	ATK-02	AKV-30-M6x22	AAWN-3-0001	AAV-02-M5x10	AS-01	ABPL-01	AAL-03-3



*the spoken quality...*

# M-SYSTEM

M-SYSTEM BORING BARS



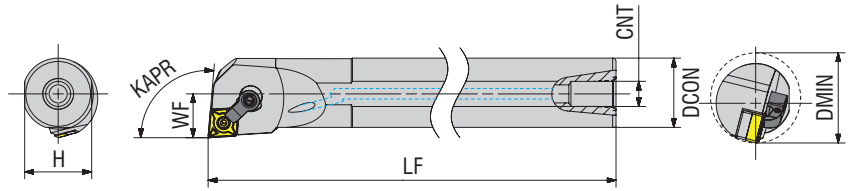

Illustrations shown may vary from actual product.

Dimensions in Inch



Ordering Code	DCON	H	LF	WF	DMIN	CNT	Insert Inch/Metric	Wedge Clamp	Clamp Screw	Allen Key	Shim	Lock Pin	Allen Key
<b>NEW</b> A12S MCLNR 3	0.750	0.683	10.000	0.500	0.980	1/8-27 NPT	CN.. 322 CN.. 090308	CK-20	STC-11	AAL-14-1/8	-	KL-44	AAL-16-3/32
<b>NEW</b> A12S MCLNR 4	0.750	0.683	10.000	0.500	0.980	1/8-27 NPT	CN.. 432 CN.. 120408	CK-7	STC-5	AAL-14-1/8	-	KL-44	AAL-16-3/32
A16T MCLNR 3	1.000	0.921	12.000	0.640	1.200	1/4-18 NPT	CN.. 322 CN.. 090308	CK-6	STC-5	AAL-16-3/32	ICSN-332	KL-34L	AAL-18-5/64
A16T MCLNR 4	1.000	0.921	12.000	0.640	1.200	1/4-18 NPT	CN.. 432 CN.. 120408	CK-20	STC-20	AAL-14-1/8	ICSN-433	KL-46	AAL-16-3/32
A20U MCLNR 4	1.250	1.170	14.000	0.765	1.470	1/4-18 NPT	CN.. 432 CN.. 120408	CK-20	STC-20	AAL-14-1/8	ICSN-433	KL-46	AAL-16-3/32
A24U MCLNR 4	1.500	1.378	14.000	0.890	1.760	1/4-18 NPT	CN.. 432 CN.. 120408	CK-20	STC-20	AAL-14-1/8	ICSN-433	KL-46	AAL-16-3/32
A24U MCLNR 5	1.500	1.378	14.000	0.890	2.000	1/4-18 NPT	CN.. 543 CN.. 160612	CK-12	STC-4	AAL-17-5/32	ICSN-533	KL-58	AAL-14-1/8
A28U MCLNR 4	1.750	1.632	14.000	1.015	2.010	1/4-18 NPT	CN.. 432 CN.. 120408	CK-20	STC-20	AAL-14-1/8	ICSN-433	KL-46	AAL-16-3/32
A32V MCLNR 4	2.000	1.882	16.000	1.281	2.400	1/4-18 NPT	CN.. 432 CN.. 120408	CK-20	STC-20	AAL-14-1/8	ICSN-433	KL-46	AAL-16-3/32
A32V MCLNR 5	2.000	1.882	16.000	1.281	2.400	1/4-18 NPT	CN.. 543 CN.. 160612	CK-12	STC-4	AAL-17-5/32	ICSN-533	KL-58	AAL-14-1/8
A32V MCLNR 6	2.000	1.882	16.000	1.281	2.400	1/4-18 NPT	CN.. 643 CN.. 190612	CK-12	STC-4	AAL-17-5/32	ICSN-633	KL-68	AAL-19-9/64
A40V MCLNR 4	2.500	2.374	16.000	1.531	3.030	1/4-18 NPT	CN.. 432 CN.. 120408	CK-20	STC-20	AAL-14-1/8	ICSN-433	KL-46	AAL-16-3/32
A40V MCLNR 5	2.500	2.374	16.000	1.531	3.030	1/4-18 NPT	CN.. 543 CN.. 160612	CK-12	STC-4	AAL-17-5/32	ICSN-533	KL-58	AAL-14-1/8
A40V MCLNR 6	2.500	2.374	16.000	1.531	3.030	1/4-18 NPT	CN.. 643 CN.. 190612	CK-12	STC-4	AAL-17-5/32	ICSN-633	KL-68	AAL-19-9/64
<b>NEW</b> S48Y MCLNR 5	3.000	2.849	18.000	1.781	-	-	CN.. 543 CN.. 160612	CK-12	STC-4	AAL-17-5/32	ICSN-533	KL-58	AAL-14-1/8

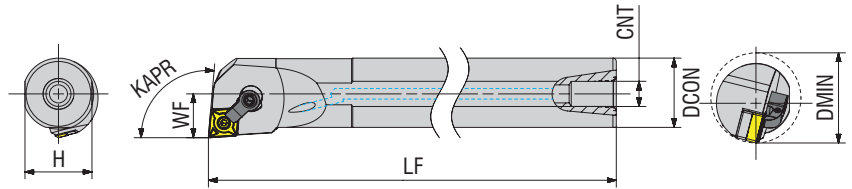

Illustrations shown may vary from actual product.

Dimensions in Inch

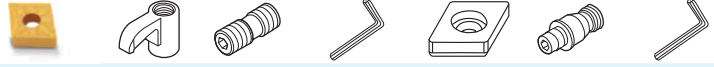

Ordering Code	DCON	H	LF	WF	DMIN	CNT	Insert Inch/Metric	Wedge Clamp	Clamp Screw	Allen Key	Shim	Lock Pin	Allen Key
<b>NEW</b> A12S MCLNL 3	0.750	0.683	10.000	0.500	0.980	1/8-27 NPT	CN.. 322 CN.. 090308	CK-20	STC-11	AAL-14-1/8	-	KL-44	AAL-16-3/32
<b>NEW</b> A12S MCLNL 4	0.750	0.683	10.000	0.500	0.980	1/8-27 NPT	CN.. 432 CN.. 120408	CK-7	STC-5	AAL-14-1/8	-	KL-44	AAL-16-3/32
A16T MCLNL 3	1.000	0.921	12.000	0.640	1.200	1/4-18 NPT	CN.. 322 CN.. 090308	CK-6	STC-5	AAL-16-3/32	ICSN-332	KL-34L	AAL-18-5/64
A16T MCLNL 4	1.000	0.921	12.000	0.640	1.200	1/4-18 NPT	CN.. 432 CN.. 120408	CK-20	STC-20	AAL-14-1/8	ICSN-433	KL-46	AAL-16-3/32
A20U MCLNL 4	1.250	1.170	14.000	0.765	1.470	1/4-18 NPT	CN.. 432 CN.. 120408	CK-20	STC-20	AAL-14-1/8	ICSN-433	KL-46	AAL-16-3/32
A24U MCLNL 4	1.500	1.378	14.000	0.890	1.760	1/4-18 NPT	CN.. 432 CN.. 120408	CK-20	STC-20	AAL-14-1/8	ICSN-433	KL-46	AAL-16-3/32
A24U MCLNL 5	1.500	1.378	14.000	0.890	2.000	1/4-18 NPT	CN.. 543 CN.. 160612	CK-12	STC-4	AAL-17-5/32	ICSN-533	KL-58	AAL-14-1/8
A28U MCLNL 4	1.750	1.632	14.000	1.015	2.010	1/4-18 NPT	CN.. 432 CN.. 120408	CK-20	STC-20	AAL-14-1/8	ICSN-433	KL-46	AAL-16-3/32
A32V MCLNL 4	2.000	1.882	16.000	1.281	2.400	1/4-18 NPT	CN.. 432 CN.. 120408	CK-20	STC-20	AAL-14-1/8	ICSN-433	KL-46	AAL-16-3/32
A32V MCLNL 5	2.000	1.882	16.000	1.281	2.400	1/4-18 NPT	CN.. 543 CN.. 160612	CK-12	STC-4	AAL-17-5/32	ICSN-533	KL-58	AAL-14-1/8
A32V MCLNL 6	2.000	1.882	16.000	1.281	2.400	1/4-18 NPT	CN.. 643 CN.. 190612	CK-12	STC-4	AAL-17-5/32	ICSN-633	KL-68	AAL-19-9/64
A40V MCLNL 4	2.500	2.374	16.000	1.531	3.030	1/4-18 NPT	CN.. 432 CN.. 120408	CK-20	STC-20	AAL-14-1/8	ICSN-433	KL-46	AAL-16-3/32
A40V MCLNL 5	2.500	2.374	16.000	1.531	3.030	1/4-18 NPT	CN.. 543 CN.. 160612	CK-12	STC-4	AAL-17-5/32	ICSN-533	KL-58	AAL-14-1/8
<b>NEW</b> A40V MCLNL 6	2.500	2.374	16.000	1.531	3.030	1/4-18 NPT	CN.. 643 CN.. 190612	CK-12	STC-4	AAL-17-5/32	ICSN-633	KL-68	AAL-19-9/64
<b>NEW</b> S48Y MCLNL 5	3.000	2.849	18.000	1.781	-	-	CN.. 543 CN.. 160612	CK-12	STC-4	AAL-17-5/32	ICSN-533	KL-58	AAL-14-1/8

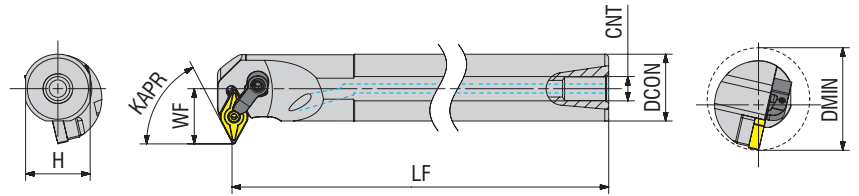

Illustrations shown may vary from actual product.

Dimensions in Inch													
Ordering Code	DCON	H	LF	WF	DMIN	CNT	Insert Inch/Metric	Wedge Clamp	Clamp Screw	Allen Key	Shim	Lock Pin	Allen Key
A20U MDPNR 4	1.250	1.170	14.000	1.000	1.705	1/4-18 NPT	DN.. 432 DN.. 150408	CK-22	STC-20	AAL-14-1/8	IDSN-443	KL-46L	AAL-16-3/32
A24U MDPNR 4	1.500	1.378	14.000	1.125	2.000	1/4-18 NPT	DN.. 432 DN.. 150408	CK-22	STC-20	AAL-14-1/8	IDSN-443	KL-46L	AAL-16-3/32
A20U MDPNL 4	1.250	1.170	14.000	1.000	1.705	1/4-18 NPT	DN.. 432 DN.. 150408	CK-22	STC-20	AAL-14-1/8	IDSN-443	KL-46L	AAL-16-3/32
A24U MDPNL 4	1.500	1.378	14.000	1.125	2.000	1/4-18 NPT	DN.. 432 DN.. 150408	CK-22	STC-20	AAL-14-1/8	IDSN-443	KL-46L	AAL-16-3/32

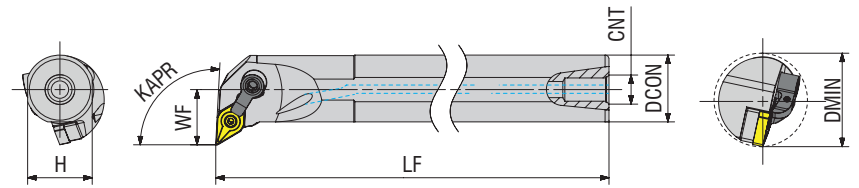

Illustrations shown may vary from actual product.

Dimensions in Inch													
Ordering Code	DCON	H	LF	WF	DMIN	CNT	Insert Inch/Metric	Wedge Clamp	Clamp Screw	Allen Key	Shim	Lock Pin	Allen Key
A16T MDUNR 3	1.000	0.921	12.000	0.750	1.300	1/4-18 NPT	DN.. 332 DN.. 110408	CK-7	STC-5	AAL-16-3/32	-	KL-33L	AAL-18-5/64
A20U MDUNR 4	1.250	1.170	14.000	1.000	1.705	1/4-18 NPT	DN.. 432 DN.. 150408	CK-12	STC-4	AAL-17-5/32	IDSN-443	KL-46L	AAL-16-3/32
A24U MDUNR 4	1.500	1.378	14.000	1.125	2.000	1/4-18 NPT	DN.. 432 DN.. 150408	CK-12	STC-4	AAL-17-5/32	IDSN-443	KL-46L	AAL-16-3/32
A28U MDUNR 4	1.750	1.632	14.000	1.250	2.250	1/4-18 NPT	DN.. 432 DN.. 150408	CK-12	STC-4	AAL-17-5/32	IDSN-443	KL-46L	AAL-16-3/32
A32V MDUNR 4	2.000	1.882	16.000	1.375	2.500	1/4-18 NPT	DN.. 432 DN.. 150408	CK-12	STC-4	AAL-17-5/32	IDSN-443	KL-46L	AAL-16-3/32
A16T MDUNL 3	1.000	0.921	12.000	0.750	1.300	1/4-18 NPT	DN.. 332 DN.. 110408	CK-7	STC-5	AAL-16-3/32	-	KL-33L	AAL-18-5/64
A20U MDUNL 4	1.250	1.170	14.000	1.000	1.705	1/4-18 NPT	DN.. 432 DN.. 150408	CK-12	STC-4	AAL-17-5/32	IDSN-443	KL-46L	AAL-16-3/32
A24U MDUNL 4	1.500	1.378	14.000	1.125	2.000	1/4-18 NPT	DN.. 432 DN.. 150408	CK-12	STC-4	AAL-17-5/32	IDSN-443	KL-46L	AAL-16-3/32
A28U MDUNL 4	1.750	1.632	14.000	1.250	2.250	1/4-18 NPT	DN.. 432 DN.. 150408	CK-12	STC-4	AAL-17-5/32	IDSN-443	KL-46L	AAL-16-3/32
A32V MDUNL 4	2.000	1.882	16.000	1.375	2.500	1/4-18 NPT	DN.. 432 DN.. 150408	CK-12	STC-4	AAL-17-5/32	IDSN-443	KL-46L	AAL-16-3/32

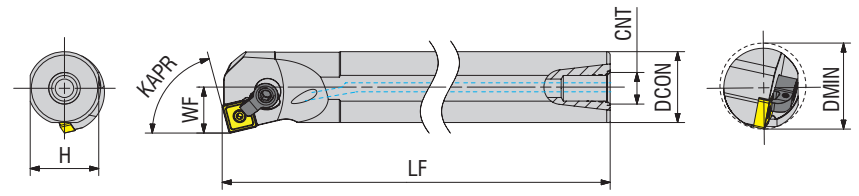

Illustrations shown may vary from actual product.

Dimensions in Inch													
Ordering Code	DCON	H	LF	WF	DMIN	CNT	Insert Inch/Metric	Wedge Clamp	Clamp Screw	Allen Key	Shim	Lock Pin	Allen Key
<b>A20U MSKNR 4</b>	1.250	1.170	14.000	0.765	1.470	1/4-18 NPT	SN.. 432 SN.. 120408	CK-9	STC-4	AAL-17-5/32	-	KL-44	AAL-16-3/32
<b>A40V MSKNR 6</b>	2.500	2.374	16.000	1.531	3.030	1/4-18 NPT	SN.. 643 SN.. 190612	CK-12	STC-4	AAL-17-5/32	ISSN-633	KL-68	AAL-19-9/64

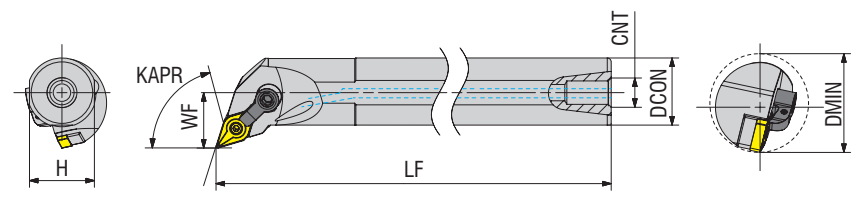

Illustrations shown may vary from actual product.

Dimensions in Inch													
Ordering Code	DCON	H	LF	WF	DMIN	CNT	Insert Inch/Metric	Wedge Clamp	Clamp Screw	Allen Key	Shim	Lock Pin	Allen Key
<b>A20U MDQNR 4</b>	1.250	1.170	14.000	1.000	1.705	1/4-18 NPT	DN.. 432 DN.. 150408	CK-12	STC-4	AAL-17-5/32	IDSN-443	KL-46L	AAL-16-3/32
<b>A24U MDQNR 4</b>	1.500	1.378	14.000	1.125	2.000	1/4-18 NPT	DN.. 432 DN.. 150408	CK-12	STC-4	AAL-17-5/32	IDSN-443	KL-46L	AAL-16-3/32
<b>A20U MDQNL 4</b>	1.250	1.170	14.000	1.000	1.705	1/4-18 NPT	DN.. 432 DN.. 150408	CK-12	STC-4	AAL-17-5/32	IDSN-443	KL-46L	AAL-16-3/32
<b>A24U MDQNL 4</b>	1.500	1.378	14.000	1.125	2.000	1/4-18 NPT	DN.. 432 DN.. 150408	CK-12	STC-4	AAL-17-5/32	IDSN-443	KL-46L	AAL-16-3/32



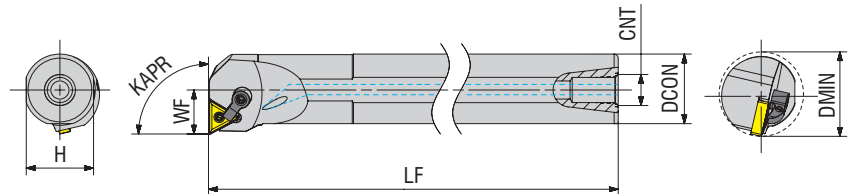

Illustrations shown may vary from actual product.

Dimensions in Inch													
Ordering Code	DCON	H	LF	WF	DMIN	CNT	Insert Inch/Metric	Wedge Clamp	Clamp Screw	Allen Key	Shim	Lock Pin	Allen Key
A16T MTFNR 3	1.000	0.921	12.000	0.640	1.220	1/4-18 NPT	TN.. 332 TN.. 160408	CK-7	STC-9	AAL-16-3/32	ITSN-333	KL-33L	AAL-18-5/64
A20U MTFNR 3	1.250	1.170	14.000	0.765	1.470	1/4-18 NPT	TN.. 332 TN.. 160408	CK-7	STC-9	AAL-16-3/32	ITSN-333	KL-33L	AAL-18-5/64
A24U MTFNR 3	1.500	1.378	14.000	0.890	1.760	1/4-18 NPT	TN.. 332 TN.. 160408	CK-7	STC-9	AAL-16-3/32	ITSN-323	KL-34L	AAL-18-5/64
A24U MTFNR 4	1.500	1.378	14.000	0.890	1.760	1/4-18 NPT	TN.. 432 TN.. 220408	CK-9	STC-4	AAL-17-5/32	ITSN-433	KL-46	AAL-16-3/32
A28U MTFNR 3	1.750	1.632	14.000	1.015	2.010	1/4-18 NPT	TN.. 332 TN.. 160408	CK-7	STC-9	AAL-16-3/32	ITSN-323	KL-34L	AAL-18-5/64
A28U MTFNR 4	1.750	1.632	14.000	1.015	2.010	1/4-18 NPT	TN.. 432 TN.. 220408	CK-9	STC-4	AAL-17-5/32	ITSN-433	KL-46	AAL-16-3/32
A32V MTFNR 4	2.000	1.882	16.000	1.281	2.400	1/4-18 NPT	TN.. 432 TN.. 220408	CK-9	STC-4	AAL-17-5/32	ITSN-433	KL-46	AAL-16-3/32
A16T MTFNL 3	1.000	0.921	12.000	0.640	1.220	1/4-18 NPT	TN.. 332 TN.. 160408	CK-7	STC-9	AAL-16-3/32	-	KL-33L	AAL-18-5/64

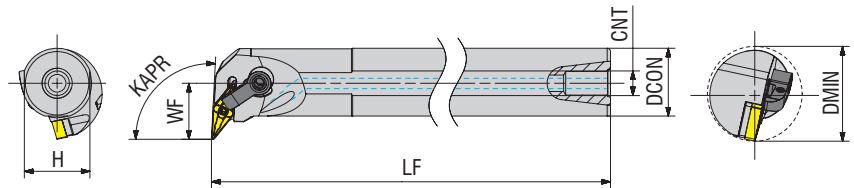

Illustrations shown may vary from actual product.

Dimensions in Inch													
Ordering Code	DCON	H	LF	WF	DMIN	CNT	Insert Inch/Metric	Wedge Clamp	Clamp Screw	Allen Key	Shim	Lock Pin	Allen Key
A20U MVUNR 3	1.250	1.170	14.000	1.000	1.705	1/4-18 NPT	VN.. 332 VN.. 160408	CK-43	STC-4	AAL-17-5/32	IVSN-322	KL-34L	AAL-18-5/64
A24U MVUNR 3	1.500	1.378	14.000	1.125	2.000	1/4-18 NPT	VN.. 332 VN.. 160408	CK-43	STC-4	AAL-17-5/32	IVSN-322	KL-34L	AAL-18-5/64
A32V MVUNR 4	2.000	1.882	16.000	1.375	2.500	1/4-18 NPT	VN.. 432 VN.. 220408	CK-43	STC-4	AAL-17-5/32	IVSN-433	KL-46	AAL-16-3/32
A40V MVUNR 4	2.500	2.374	16.000	1.750	3.250	1/4-18 NPT	VN.. 432 VN.. 220408	CK-43	STC-4	AAL-17-5/32	IVSN-433	KL-46	AAL-16-3/32
A20U MVUNL 3	1.250	1.170	14.000	1.000	1.705	1/4-18 NPT	VN.. 332 VN.. 160408	CK-43	STC-4	AAL-17-5/32	IVSN-322	KL-34L	AAL-18-5/64
A24U MVUNL 3	1.500	1.378	14.000	1.125	2.000	1/4-18 NPT	VN.. 332 VN.. 160408	CK-43	STC-4	AAL-17-5/32	IVSN-322	KL-34L	AAL-18-5/64
A32V MVUNL 4	2.000	1.882	16.000	1.375	2.500	1/4-18 NPT	VN.. 432 VN.. 220408	CK-43	STC-4	AAL-17-5/32	IVSN-433	KL-46	AAL-16-3/32
A40V MVUNL 4	2.500	2.374	16.000	1.750	3.250	1/4-18 NPT	VN.. 432 VN.. 220408	CK-43	STC-4	AAL-17-5/32	IVSN-433	KL-46	AAL-16-3/32

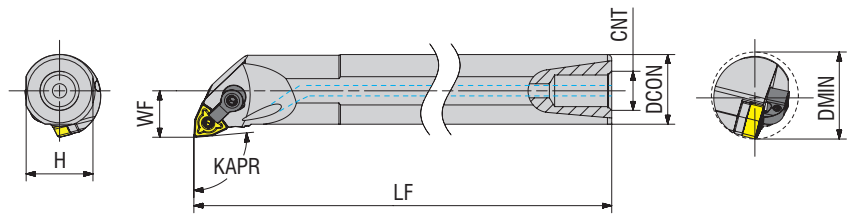

Illustrations shown may vary from actual product.

Dimensions in Inch

Ordering Code	DCON	H	LF	WF	DMIN	CNT							
							Insert Inch/Metric	Wedge Clamp	Clamp Screw	Allen Key	Shim	Lock Pin	Allen Key
A16T MWLNR 3	1.000	0.921	12.000	0.640	1.200	1/4-18 NPT	WN.. 332 WN.. 060408	CK-6	STC-5	AAL-16-3/32	IWSN-322	KL-34L	AAL-18-5/64
A16T MWLNR 4	1.000	0.921	12.000	0.640	1.220	1/4-18 NPT	WN.. 432 WN.. 080408	CK-20	STC-20	AAL-14-1/8	IWSN-433	KL-46	AAL-16-3/32
A24U MWLNR 3	1.500	1.378	14.000	0.890	1.760	1/4-18 NPT	WN.. 332 WN.. 060408	CK-6	STC-5	AAL-16-3/32	IWSN-322	KL-34L	AAL-18-5/64
A20U MWLNR 4	1.250	1.170	14.000	0.765	1.470	1/4-18 NPT	WN.. 432 WN.. 080408	CK-20	STC-20	AAL-14-1/8	IWSN-433	KL-46	AAL-16-3/32
A24U MWLNR 4	1.500	1.378	14.000	0.890	1.760	1/4-18 NPT	WN.. 432 WN.. 080408	CK-20	STC-20	AAL-14-1/8	IWSN-433	KL-46	AAL-16-3/32
A16T MWLNL 3	1.000	0.921	12.000	0.640	1.200	1/4-18 NPT	WN.. 332 WN.. 060408	CK-6	STC-5	AAL-16-3/32	IWSN-322	KL-34L	AAL-18-5/64
A16T MWLNL 4	1.000	0.921	12.000	0.640	1.220	1/4-18 NPT	WN.. 432 WN.. 080408	CK-20	STC-20	AAL-14-1/8	IWSN-433	KL-46	AAL-16-3/32
A20U MWLNL 4	1.250	1.170	14.000	0.765	1.470	1/4-18 NPT	WN.. 432 WN.. 080408	CK-20	STC-20	AAL-14-1/8	IWSN-433	KL-46	AAL-16-3/32
A24U MWLNL 4	1.500	1.378	14.000	0.890	1.760	1/4-18 NPT	WN.. 432 WN.. 080408	CK-20	STC-20	AAL-14-1/8	IWSN-433	KL-46	AAL-16-3/32



M-SYSTEM  
BORING BARS

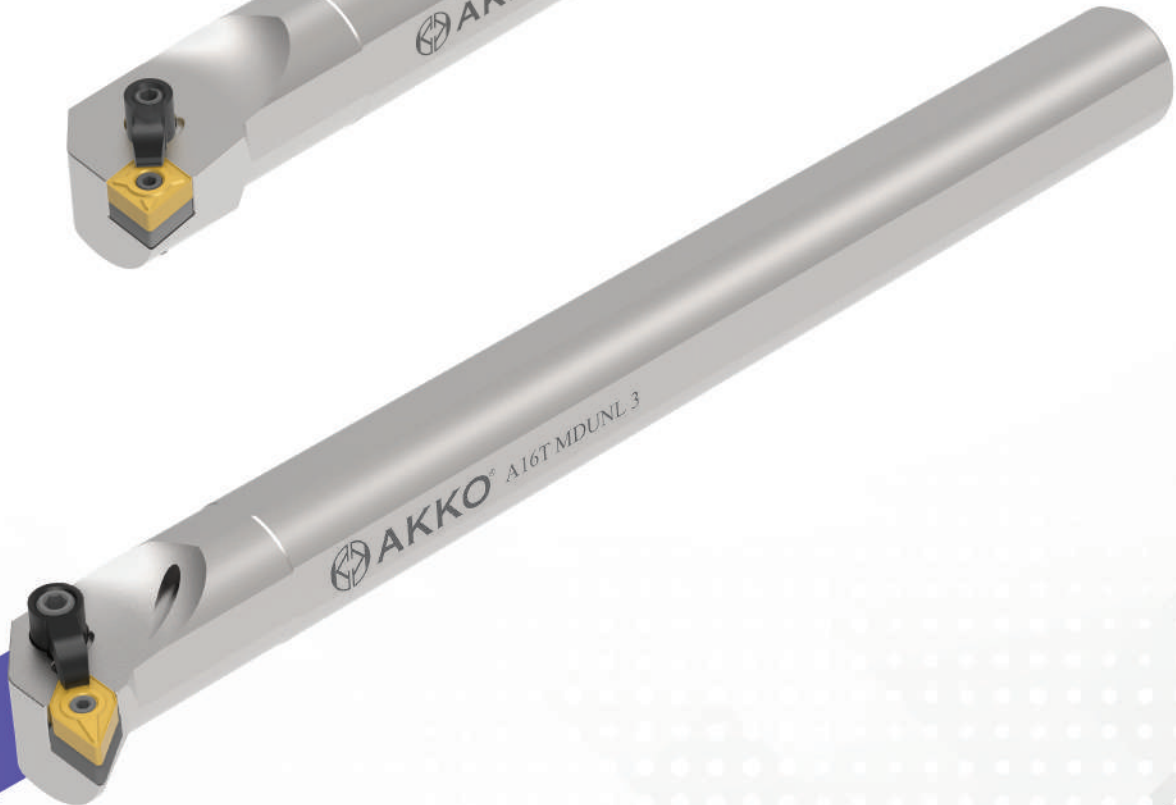
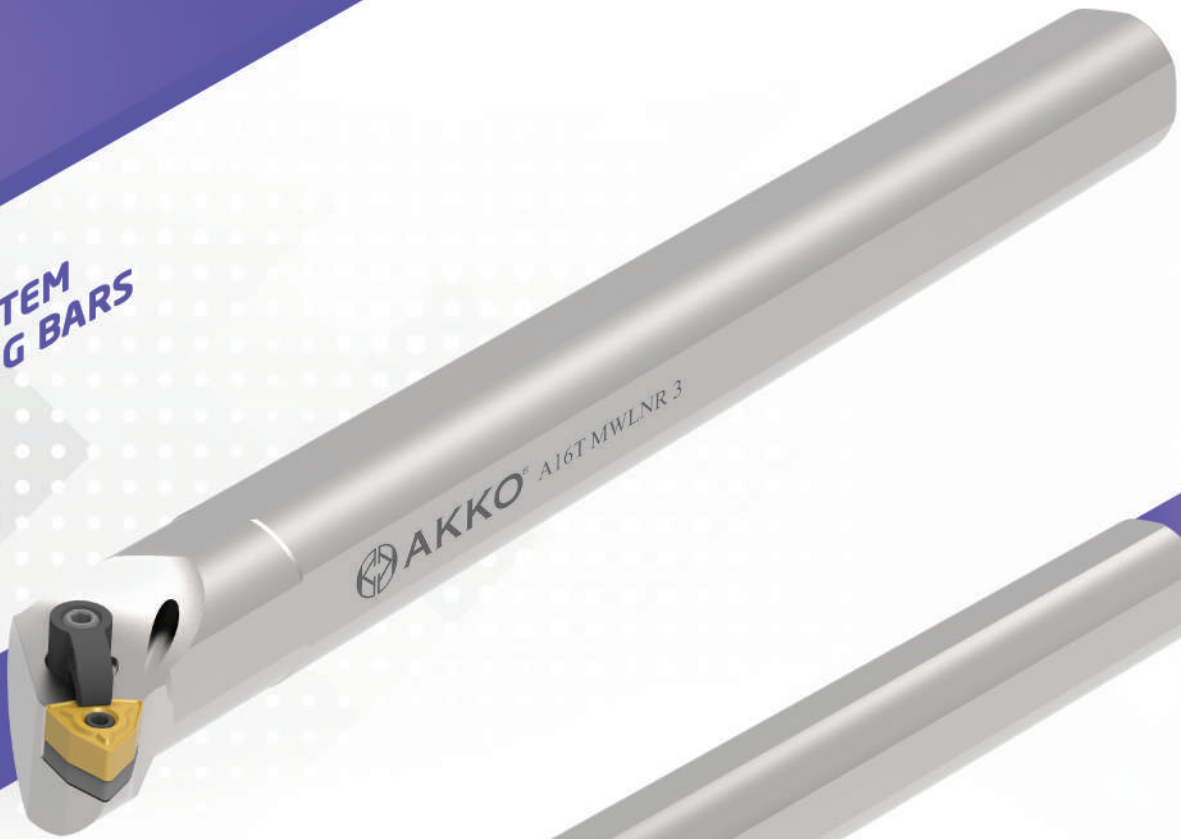



*the spoken quality...*

# S-SYSTEM

S-SYSTEM BORING BARS



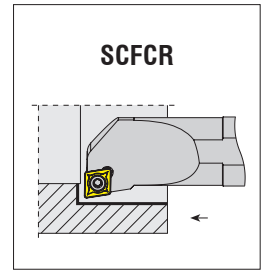
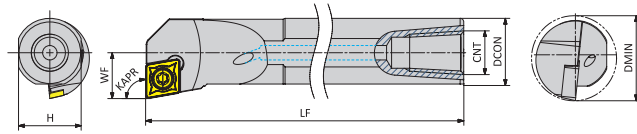

Illustrations shown may vary from actual product.

Dimensions in Inch

Ordering Code	DCON	H	LF	WF	DMIN	OHN	CNT					
								Insert Inch/Metric	Screw	Shim	Shim Screw	Torx Key
A06M SCFCR 2	0.375	0.339	6.000	0.250	0.480	1.000	-	CC.. 2151 CC.. 060204	4008-M2.5x6	-	-	82-T08
A08R SCFCR 2	0.500	0.461	8.000	0.312	0.600	1.000	1/16-27 NPT	CC.. 2151 CC.. 060204	4008-M2.5x6	-	-	82-T08
A10S SCFCR 2	0.625	0.563	10.000	0.406	0.770	1.500	1/8-27 NPT	CC.. 2151 CC.. 060204	4008-M2.5x6	-	-	82-T08
A12S SCFCR 3	0.750	0.683	10.000	0.500	0.930	1.500	1/8-27 NPT	CC.. 3252 CC.. 09T308	4015-M3.5x9	-	-	80-T15
A16T SCFCR 3	1.000	0.921	12.000	0.640	1.300	2.000	1/4-18 NPT	CC.. 3252 CC.. 09T308	4015-M3.5x12	AACN-2-0001	AAV-08-M3.5x8	80-T15
A10S SCFCL 2	0.625	0.563	10.000	0.406	0.770	1.500	1/8-27 NPT	CC.. 2151 CC.. 060204	4008-M2.5x6	-	-	82-T08
A12S SCFCL 3	0.750	0.683	10.000	0.500	0.930	1.500	1/8-27 NPT	CC.. 3252 CC.. 09T308	4015-M3.5x9	-	-	80-T15

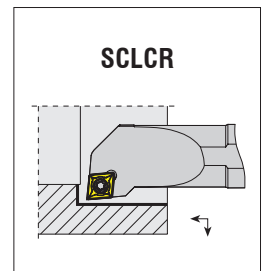
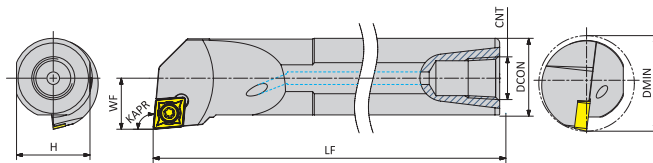

Illustrations shown may vary from actual product.

Dimensions in Inch

Ordering Code	DCON	H	LF	WF	DMIN	OHN	CNT					
								Insert Inch/Metric	Screw	Shim	Shim Screw	Torx Key
A06M SCLCR 2	0.375	0.339	6.000	0.250	0.480	1.000	-	CC.. 2151 CC.. 060204	4008-M2.5x6	-	-	82-T08
A08R SCLCR 2	0.500	0.461	8.000	0.312	0.600	1.000	1/16-27 NPT	CC.. 2151 CC.. 060204	4008-M2.5x6	-	-	82-T08
A10S SCLCR 2	0.625	0.563	10.000	0.406	0.770	1.000	1/8-27 NPT	CC.. 2151 CC.. 060204	4008-M2.5x6	-	-	82-T08
A10S SCLCR 3	0.625	0.563	10.000	0.406	0.770	1.000	1/8-27 NPT	CC.. 3252 CC.. 09T308	4015-M3.5x9	-	-	80-T15
A12S SCLCR 3	0.750	0.683	10.000	0.500	0.930	1.500	1/8-27 NPT	CC.. 3252 CC.. 09T308	4015-M3.5x9	-	-	80-T15
A16T SCLCR 3	1.000	0.921	12.000	0.640	1.200	2.000	1/4-18 NPT	CC.. 3252 CC.. 09T308	4015-M3.5x9	-	-	80-T15
A06M SCLCL 2	0.375	0.339	6.000	0.250	0.480	1.000	-	CC.. 2151 CC.. 060204	4008-M2.5x6	-	-	82-T08
A08R SCLCL 2	0.500	0.461	8.000	0.312	0.600	1.000	1/16-27 NPT	CC.. 2151 CC.. 060204	4008-M2.5x6	-	-	82-T08
A10S SCLCL 2	0.625	0.563	10.000	0.406	0.770	1.500	1/8-27 NPT	CC.. 2151 CC.. 060204	4008-M2.5x6	-	-	82-T08
A10S SCLCL 3	0.625	0.563	10.000	0.406	0.770	1.500	1/8-27 NPT	CC.. 3252 CC.. 09T308	4015-M3.5x9	-	-	80-T15
A12S SCLCL 3	0.750	0.683	10.000	0.500	0.930	1.500	1/8-27 NPT	CC.. 3252 CC.. 09T308	4015-M3.5x9	-	-	80-T15
A16T SCLCL 3	1.000	0.921	12.000	0.640	1.200	2.000	1/4-18 NPT	CC.. 3252 CC.. 09T308	4015-M3.5x9	-	-	80-T15

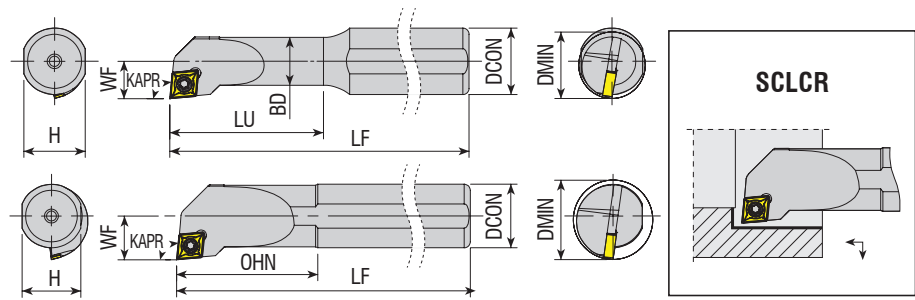

Illustrations shown may vary from actual product.

Dimensions in Metric

Ordering Code	DCON	BD	H	LU=OHN	LF	WF	DMIN					
								Insert Inch/Metric	Screw	Shim	Shim Screw	Torx Key
S0508H SCLCR 03	8	5	7.3	18	100	3	≥6	CC.. 121.. CC.. 0301..	4006-M1.6x3.2	-	-	82-T06
S0608H SCLCR 06	8	6	7.3	25	100	4.5	≥8	CC.. 215.. CC.. 0602..	4008-M2.5x4.5	-	-	82-T08
S08H SCLCR 06	8	8	7.3	20	100	6	≥11	CC.. 215.. CC.. 0602..	4008-M2.5x4.5	-	-	82-T08
S08K SCLCR 06	8	7.5	7.3	20	125	6	≥11	CC.. 215.. CC.. 0602..	4008-M2.5x5	-	-	82-T08
S08M SCLCR 06	8	7.5	7.3	20	150	6	≥11	CC.. 215.. CC.. 0602..	4008-M2.5x5	-	-	82-T08
S10K SCLCR 06	10	10	9	25	125	7	≥13	CC.. 215.. CC.. 0602..	4008-M2.5x6	-	-	82-T08
S12K SCLCR 06	12	12	11	25	125	9	≥16	CC.. 215.. CC.. 0602..	4008-M2.5x6	-	-	82-T08
S1216P SCLCR 06	16	11.5	14.8	37	170	9	≥16	CC.. 215.. CC.. 0602..	4008-M2.5x6	-	-	82-T08
S16P SCLCR 06	16	16	14.8	35	170	11	≥20	CC.. 215.. CC.. 0602..	4008-M2.5x6	-	-	82-T08
S12K SCLCR 09	12	12	11	30	125	9	≥16	CC.. 325.. CC.. 09T3..	4015-M3.5x8	-	-	80-T15
S12M SCLCR 09	12	11.5	11	30	150	9	≥16	CC.. 325.. CC.. 09T3..	4015-M3.5x9	-	-	80-T15
S1416P SCLCR 09	16	14	14.8	45	170	9.5	≥17	CC.. 325.. CC.. 09T3..	4015-M3.5x9	-	-	80-T15
S16P SCLCR 09	16	16	14.8	35	170	11	≥20	CC.. 325.. CC.. 09T3..	4015-M3.5x12	AACN-2-0001	AAV-08-M3.5x8	80-T15
S1620R SCLCR 09	20	16	18.3	50	200	11	≥20	CC.. 325.. CC.. 09T3..	4015-M3.5x12	AACN-2-0001	AAV-08-M3.5x8	80-T15
S16R SCLCR 09	16	15.5	14.8	35	200	11	≥20	CC.. 325.. CC.. 09T3..	4015-M3.5x9	AACN-2-0001	AAV-08-M3.5x8	80-T15
S20R SCLCR 09	20	20	18.3	40	200	13	≥25	CC.. 325.. CC.. 09T3..	4015-M3.5x9	AACN-2-0003	AAV-10-M4.5x8	80-T15
S20S SCLCR 09	20	19.5	18.3	40	250	13	≥25	CC.. 325.. CC.. 09T3..	4015-M3.5x9	AACN-2-0003	AAV-10-M4.5x8	80-T15
S25S SCLCR 09	25	25	23	50	250	17	≥32	CC.. 325.. CC.. 09T3..	4015-M3.5x9	AACN-2-0003	AAV-10-M4.5x8	80-T15
S32T SCLCR 09	32	32	30	60	300	22	≥40	CC.. 325.. CC.. 09T3..	4015-M3.5x9	-	-	80-T15
S25S SCLCR 12	25	25	23	50	250	17	≥32	CC.. 43.. CC.. 1204..	4020-M4.5x12	-	-	80-T20
S32T SCLCR 12	32	32	30	60	300	22	≥40	CC.. 43.. CC.. 1204..	4020-M4.5x12	-	-	80-T20
S40U SCLCR 12	40	40	37.5	70	350	27	≥50	CC.. 43.. CC.. 1204..	1020-M4.5x16	-	-	80-T20
A08H SCLCR 06	8	8	7.3	20	100	6	≥11	CC.. 215.. CC.. 0602..	4015-M3.5x14	AACN-2-0001	AAV-06-M3.5x11	82-T08
A10H SCLCR 06	10	10	9	25	100	7	≥13	CC.. 215.. CC.. 0602..	4015-M3.5x14	AACN-2-0001	AAV-06-M3.5x11	82-T08
A12H SCLCR 06	12	12	11	25	100	9	≥16	CC.. 215.. CC.. 0602..	4015-M3.5x14	AACN-2-0003	AAV-06-M3.5x11	82-T08
A16M SCLCR 09	16	16	14.8	35	150	11	≥20	CC.. 325.. CC.. 09T3..	4015-M3.5x9	AACN-2-0001	AAV-08-M3.5x8	80-T15
A20P SCLCR 09	20	20	18.3	40	170	13	≥25	CC.. 325.. CC.. 09T3..	4015-M3.5x9	AACN-2-0001	AAV-08-M3.5x8	80-T15
A25R SCLCR 09	25	25	23	50	200	17	≥32	CC.. 325.. CC.. 09T3..	4015-M3.5x12	AACN-2-0001	AAV-08-M3.5x8	80-T15
A32S SCLCR 09	32	32	30	60	250	22	≥40	CC.. 325.. CC.. 09T3..	4015-M3.5x12	AACN-2-0001	AAV-08-M3.5x8	80-T15
A25R SCLCR 12	25	25	23	50	200	17	≥32	CC.. 43.. CC.. 1204..	4020-M4.5x12	AACN-2-0003	AAV-10-M4.5x8	80-T20

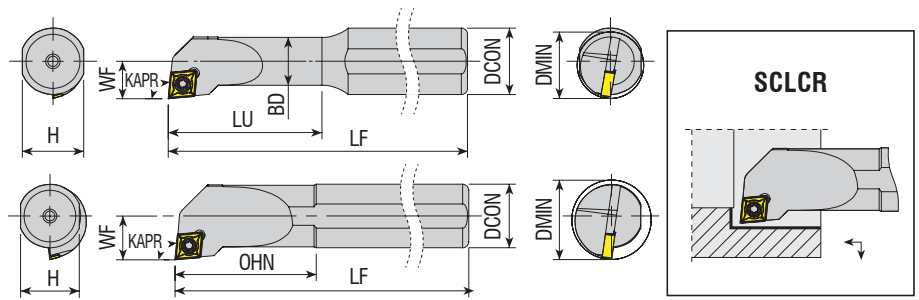

Illustrations shown may vary from actual product.

Dimensions in Metric



Ordering Code	DCON	BD	H	LU=OHN	LF	WF	DMIN	Insert Inch/Metric	Screw	Shim	Shim Screw	Torx Key
S0508H SCLCL 03	8	5	7.3	18	100	3	≥6	CC.. 121.. CC.. 0301..	4006-M1.6x3.2	-	-	82-T06
S0608H SCLCL 06	8	6	7.3	25	100	4.5	≥8	CC.. 215.. CC.. 0602..	4008-M2.5x4.5	-	-	82-T08
S08H SCLCL 06	8	8	7.3	20	100	6	≥11	CC.. 215.. CC.. 0602..	4008-M2.5x4.5	-	-	82-T08
S08K SCLCL 06	8	7.5	7.3	20	125	6	≥11	CC.. 215.. CC.. 0602..	4008-M2.5x5	-	-	82-T08
S08M SCLCL 06	8	7.5	7.3	20	150	6	≥11	CC.. 215.. CC.. 0602..	4008-M2.5x5	-	-	82-T08
S10K SCLCL 06	10	10	9	25	125	7	≥13	CC.. 215.. CC.. 0602..	4008-M2.5x6	-	-	82-T08
S12K SCLCL 06	12	12	11	25	125	9	≥16	CC.. 215.. CC.. 0602..	4008-M2.5x6	-	-	82-T08
S1216P SCLCL 06	16	11.5	14.8	37	170	9	≥16	CC.. 215.. CC.. 0602..	4008-M2.5x6	-	-	82-T08
S16P SCLCL 06	16	16	14.8	35	170	11	≥20	CC.. 215.. CC.. 0602..	4008-M2.5x6	-	-	82-T08
S12K SCLCL 09	12	12	11	30	125	9	≥16	CC.. 325.. CC.. 09T3..	4015-M3.5x8	-	-	80-T15
S12M SCLCL 09	12	11.5	11	30	150	9	≥16	CC.. 325.. CC.. 09T3..	4015-M3.5x9	-	-	80-T15
S1416P SCLCL 09	16	14	14.8	45	170	9.5	≥17	CC.. 325.. CC.. 09T3..	4015-M3.5x9	-	-	80-T15
S16P SCLCL 09	16	16	14.8	35	170	11	≥20	CC.. 325.. CC.. 09T3..	4015-M3.5x12	AACN-2-0001	AAV-08-M3.5x8	80-T15
S1620R SCLCL 09	20	16	18.3	50	200	11	≥20	CC.. 325.. CC.. 09T3..	4015-M3.5x12	AACN-2-0001	AAV-08-M3.5x8	80-T15
S16R SCLCL 09	16	15.5	14.8	35	200	11	≥20	CC.. 325.. CC.. 09T3..	4015-M3.5x9	AACN-2-0001	AAV-08-M3.5x8	80-T15
S20R SCLCL 09	20	20	18.3	40	200	13	≥25	CC.. 325.. CC.. 09T3..	4015-M3.5x9	AACN-2-0003	AAV-10-M4.5x8	80-T15
S20S SCLCL 09	20	19.5	18.3	40	250	13	≥25	CC.. 325.. CC.. 09T3..	4015-M3.5x9	AACN-2-0003	AAV-10-M4.5x8	80-T15
S25S SCLCL 09	25	25	23	50	250	17	≥32	CC.. 325.. CC.. 09T3..	4015-M3.5x9	AACN-2-0003	AAV-10-M4.5x8	80-T15
S32T SCLCL 09	32	32	30	60	300	22	≥40	CC.. 325.. CC.. 09T3..	4015-M3.5x9	-	-	80-T15
S25S SCLCL 12	25	25	23	50	250	17	≥32	CC.. 43.. CC.. 1204..	4020-M4.5x12	-	-	80-T20
S32T SCLCL 12	32	32	30	60	300	22	≥40	CC.. 43.. CC.. 1204..	4020-M4.5x12	-	-	80-T20
S40U SCLCL 12	40	40	37.5	70	350	27	≥50	CC.. 43.. CC.. 1204..	1020-M4.5x16	-	-	80-T20
A08H SCLCL 06	8	8	7.3	20	100	6	≥11	CC.. 215.. CC.. 0602..	4015-M3.5x14	AACN-2-0001	AAV-06-M3.5x11	82-T08
A10H SCLCL 06	10	10	9	25	100	7	≥13	CC.. 215.. CC.. 0602..	4015-M3.5x14	AACN-2-0001	AAV-06-M3.5x11	82-T08
A12H SCLCL 06	12	12	11	25	100	9	≥16	CC.. 215.. CC.. 0602..	4015-M3.5x14	AACN-2-0003	AAV-06-M3.5x11	82-T08
A16M SCLCL 09	16	16	14.8	35	150	11	≥20	CC.. 325.. CC.. 09T3..	4015-M3.5x9	AACN-2-0001	AAV-08-M3.5x8	80-T15
A20P SCLCL 09	20	20	18.3	40	170	13	≥25	CC.. 325.. CC.. 09T3..	4015-M3.5x9	AACN-2-0001	AAV-08-M3.5x8	80-T15
A25R SCLCL 09	25	25	23	50	200	17	≥32	CC.. 325.. CC.. 09T3..	4015-M3.5x12	AACN-2-0001	AAV-08-M3.5x8	80-T15
A32S SCLCL 09	32	32	30	60	250	22	≥40	CC.. 325.. CC.. 09T3..	4015-M3.5x12	AACN-2-0001	AAV-08-M3.5x8	80-T15
A25R SCLCL 12	25	25	23	50	200	17	≥32	CC.. 43.. CC.. 1204..	4020-M4.5x12	AACN-2-0003	AAV-10-M4.5x8	80-T20



Illustrations shown may vary from actual product.  
Dimensions in Inch

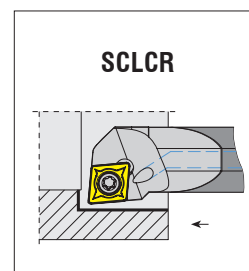
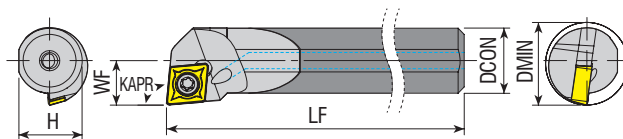

Ordering Code	Dcon	H	LF	WF	DMIN	Insert Inch/Metric	Screw	Torx Key
E04H SCLCR 2	0.250	0.230	4.000	0.117	0.334	CC.. 2151 CC.. 060204..	4008-M2.5X4.5	82-T08
E05K SCLCR 2	0.312	0.280	5.000	0.117	0.354	CC.. 2151 CC.. 060204..	4008-M2.5X4.5	82-T08
E06M SCLCR 2	0.375	0.355	6.000	0.250	0.480	CC.. 2151 CC.. 060204..	4008-M2.5x6	82-T08
E08R SCLCR 2	0.500	0.461	8.000	0.312	0.600	CC.. 2151 CC.. 060204..	4008-M2.5x6	82-T08
E08R SCLCR 3	0.500	0.461	8.000	0.312	0.625	CC.. 3252 CC.. 09T308..	4015-M3.5x9	82-T15
E10R SCLCR 2	0.625	0.563	8.000	0.406	0.770	CC.. 2151 CC.. 060204	4008-M2.5x6	82-T08
E10R SCLCR 3	0.625	0.588	8.000	0.406	0.750	CC.. 3252 CC.. 09T308..	4015-M3.5x9	82-T15
E12S SCLCR 3	0.750	0.771	10.000	0.500	0.930	CC.. 3252 CC.. 09T308..	4015-M3.5x9	82-T15
E04H SCLCL 2	0.250	0.230	4.000	0.117	0.334	CC.. 2151 CC.. 060204..	4008-M2.5X4.5	82-T08
E05K SCLCL 2	0.312	0.280	5.000	0.117	0.354	CC.. 2151 CC.. 060204..	4008-M2.5X4.5	82-T08
E06M SCLCL 2	0.375	0.355	6.000	0.250	0.480	CC.. 2151 CC.. 060204..	4008-M2.5x6	82-T08
E08R SCLCL 2	0.500	0.461	8.000	0.312	0.600	CC.. 2151 CC.. 060204..	4008-M2.5x6	82-T08
E08R SCLCL 3	0.500	0.461	8.000	0.312	0.625	CC.. 3252 CC.. 09T308..	4015-M3.5x9	82-T15
E10R SCLCL 3	0.625	0.588	8.000	0.406	0.750	CC.. 3252 CC.. 09T308..	4015-M3.5x9	82-T15
E12S SCLCL 3	0.750	0.771	10.000	0.500	0.930	CC.. 3252 CC.. 09T308..	4015-M3.5x9	82-T15



Illustrations shown may vary from actual product.  
Dimensions in Inch

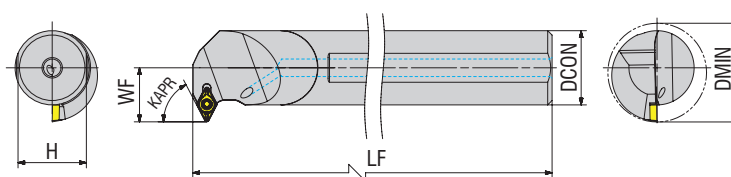

Ordering Code	Dcon	H	LF	WF	DMIN	Insert Inch/Metric	Screw	Torx Key
E08R SDPPR 2	0.500	0.461	8.000	0.312	0.600	DP. 2151 DP.. 060204	4008-M2.5X6	82-T08
E16T SDPPR 2	1.000	0.921	12.000	0.750	1.300	DP. 2151 DP.. 060204	4008-M2.5X6	82-T08

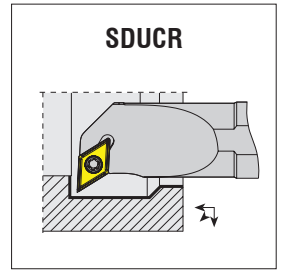
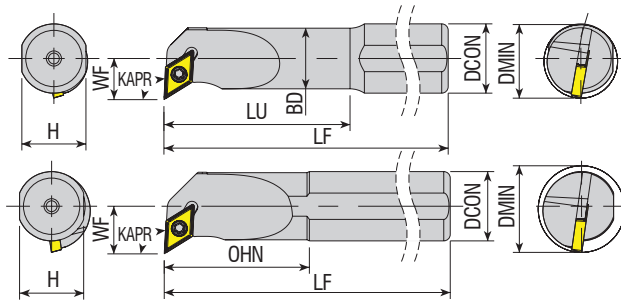

Illustrations shown may vary from actual product.

Dimensions in Metric



Ordering Code	DCON	BD	H	LU=OHN	LF	WF	DMIN	Insert Inch/Metric	Screw	Shim	Shim Screw	Torx Key
S0810K SDUCR 07	10	8	9	30	125	8	≥13	DC.. 215.. DC.. 0702..	4008-M2.5x6	-	-	82-T08
S0810M SDUCR 07	10	9.5	9	30	150	8	≥13	DC.. 215.. DC.. 0702..	4008-M2.5x6	-	-	82-T08
S10K SDUCR 07	10	10	9	25	125	8	≥13	DC.. 215.. DC.. 0702..	4008-M2.5x6	-	-	82-T08
S12K SDUCR 07	12	12	11	25	125	9	≥16	DC.. 215.. DC.. 0702..	4008-M2.5x6	-	-	82-T08
S1216P SDUCR 07	16	11.5	14.8	37	170	9	≥16	DC.. 215.. DC.. 0702..	4008-M2.5x6	-	-	82-T08
S1416P SDUCR 07	16	14	14.8	45	170	9.5	≥17	DC.. 215.. DC.. 0702..	4008-M2.5x6	-	-	82-T08
S16P SDUCR 07	16	16	14.8	35	170	11	≥20	DC.. 215.. DC.. 0702..	4008-M2.5x6	-	-	82-T08
S20R SDUCR 07	20	20	18.3	40	200	13	≥25	DC.. 215.. DC.. 0702..	4008-M2.5x6	-	-	82-T08
S1416P SDUCR 11	16	14	14.8	45	170	11	≥18	DC.. 325 DC.. 11T3..	4015-M3.5x9	-	-	80-T15
S16P SDUCR 11	16	16	14.8	35	170	11	≥20	DC.. 325 DC.. 11T3..	4015-M3.5x9	-	-	80-T15
S1620R SDUCR 11	20	16	18.3	50	200	11	≥20	DC.. 325 DC.. 11T3..	4015-M3.5x11	-	-	80-T15
S20R SDUCR 11	20	20	18.3	40	200	13	≥25	DC.. 325 DC.. 11T3..	4015-M3.5x12	-	-	80-T15
S25S SDUCR 11	25	25	23	50	250	17	≥32	DC.. 325 DC.. 11T3..	4015-M3.5x14	AADN-2-0001	AAV-08-M3.5x8	80-T15
S25T SDUCR 11	25	25	23	50	300	17	≥32	DC.. 325 DC.. 11T3..	4015-M3.5x14	AADN-2-0001	AAV-06-M3.5x11	80-T15
S32T SDUCR 11	32	32	30	60	300	22	≥40	DC.. 325 DC.. 11T3..	4015-M3.5x14	AADN-2-0001	AAV-06-M3.5x11	80-T15
S40U SDUCR 11	40	40	37.5	70	350	27	≥50	DC.. 325 DC.. 11T3..	4015-M3.5x14	AADN-2-0001	AAV-06-M3.5x11	80-T15
S50V SDUCR 11	50	50	47	80	400	35	≥63	DC.. 325 DC.. 11T3..	4015-M3.5x14	AADN-2-0001	AAV-06-M3.5x11	80-T15
A0810H SDUCR 07	10	8	9	30	100	8	≥13	DC.. 215.. DC.. 0702..	4008-M2.5x6	AADN-2-0001	AAV-06-M3.5x11	82-T08
A10H SDUCR 07	10	10	9	25	100	8	≥13	DC.. 215.. DC.. 0702..	4008-M2.5x6	-	-	82-T08
A12H SDUCR 07	12	12	11	25	100	9	≥16	DC.. 215.. DC.. 0702..	4008-M2.5x6	-	-	82-T08
A16M SDUCR 07	16	16	14.8	35	150	11	≥20	DC.. 215.. DC.. 0702..	4008-M2.5x6	-	-	82-T08
A20P SDUCR 07	20	20	18.3	40	170	13	≥25	DC.. 215.. DC.. 0702..	4008-M2.5x6	-	-	82-T08
A16M SDUCR 11	16	16	14.8	35	150	11	≥20	DC.. 325 DC.. 11T3..	4015-M3.5x9	-	-	80-T15
A20P SDUCR 11	20	20	18.3	40	170	13	≥25	DC.. 325 DC.. 11T3..	4015-M3.5x11	-	AAV-08-M3.5x8	80-T15
A25R SDUCR 11	25	25	23	50	200	17	≥32	DC.. 325 DC.. 11T3..	4015-M3.5x12	AADN-2-0001	AAV-08-M3.5x8	80-T15
A25T SDUCR 11	25	25	23	50	300	17	≥32	DC.. 325 DC.. 11T3..	4015-M3.5x14	AADN-2-0001	AAV-06-M3.5x11	80-T15
A32S SDUCR 11	32	32	30	60	250	22	≥40	DC.. 325 DC.. 11T3..	4015-M3.5x14	AADN-2-0001	AAV-06-M3.5x11	80-T15
A50U SDUCR 11	50	50	47	80	350	35	≥63	DC.. 325 DC.. 11T3..	4015-M3.5x14	AADN-2-0001	AAV-06-M3.5x11	80-T15

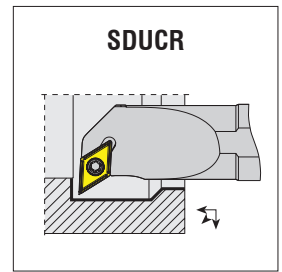
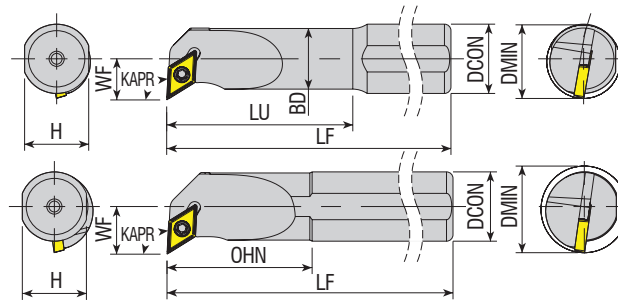

Illustrations shown may vary from actual product.

Dimensions in Metric

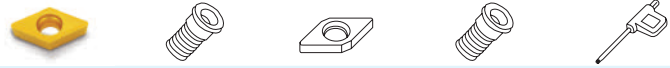

Ordering Code	DCON	BD	H	LU=OHN	LF	WF	DMIN	Insert Inch/Metric	Screw	Shim	Shim Screw	Torx Key
S0810K SDUCL 07	10	8	9	30	125	8	≥13	DC.. 215.. DC.. 0702..	4008-M2.5x6	-	-	82-T08
S0810M SDUCL 07	10	9.5	9	30	150	8	≥13	DC.. 215.. DC.. 0702..	4008-M2.5x6	-	-	82-T08
S10K SDUCL 07	10	10	9	25	125	8	≥13	DC.. 215.. DC.. 0702..	4008-M2.5x6	-	-	82-T08
S12K SDUCL 07	12	12	11	25	125	9	≥16	DC.. 215.. DC.. 0702..	4008-M2.5x6	-	-	82-T08
S1216P SDUCL 07	16	11.5	14.8	37	170	9	≥16	DC.. 215.. DC.. 0702..	4008-M2.5x6	-	-	82-T08
S1416P SDUCL 07	16	14	14.8	45	170	9.5	≥17	DC.. 215.. DC.. 0702..	4008-M2.5x6	-	-	82-T08
S16P SDUCL 07	16	16	14.8	35	170	11	≥20	DC.. 215.. DC.. 0702..	4008-M2.5x6	-	-	82-T08
S20R SDUCL 07	20	20	18.3	40	200	13	≥25	DC.. 215.. DC.. 0702..	4008-M2.5x6	-	-	82-T08
S1416P SDUCL 11	16	14	14.8	45	170	11	≥18	DC.. 325 DC.. 11T3..	4015-M3.5x9	-	-	80-T15
S16P SDUCL 11	16	16	14.8	35	170	11	≥20	DC.. 325 DC.. 11T3..	4015-M3.5x9	-	-	80-T15
S1620R SDUCL 11	20	16	18.3	50	200	11	≥20	DC.. 325 DC.. 11T3..	4015-M3.5x11	-	-	80-T15
S20R SDUCL 11	20	20	18.3	40	200	13	≥25	DC.. 325 DC.. 11T3..	4015-M3.5x12	-	-	80-T15
S25S SDUCL 11	25	25	23	50	250	17	≥32	DC.. 325 DC.. 11T3..	4015-M3.5x14	AADN-2-0001	AAV-08-M3.5x8	80-T15
S25T SDUCL 11	25	25	23	50	300	17	≥32	DC.. 325 DC.. 11T3..	4015-M3.5x14	AADN-2-0001	AAV-06-M3.5x11	80-T15
S32T SDUCL 11	32	32	30	60	300	22	≥40	DC.. 325 DC.. 11T3..	4015-M3.5x14	AADN-2-0001	AAV-06-M3.5x11	80-T15
S40U SDUCL 11	40	40	37.5	70	350	27	≥50	DC.. 325 DC.. 11T3..	4015-M3.5x14	AADN-2-0001	AAV-06-M3.5x11	80-T15
S50V SDUCL 11	50	50	47	80	400	35	≥63	DC.. 325 DC.. 11T3..	4015-M3.5x14	AADN-2-0001	AAV-06-M3.5x11	80-T15
A0810H SDUCL 07	10	8	9	30	100	8	≥13	DC.. 215.. DC.. 0702..	4008-M2.5x6	AADN-2-0001	AAV-06-M3.5x11	82-T08
A10H SDUCL 07	10	10	9	25	100	8	≥13	DC.. 215.. DC.. 0702..	4008-M2.5x6	-	-	82-T08
A12H SDUCL 07	12	12	11	25	100	9	≥16	DC.. 215.. DC.. 0702..	4008-M2.5x6	-	-	82-T08
A16M SDUCL 07	16	16	14.8	35	150	11	≥20	DC.. 215.. DC.. 0702..	4008-M2.5x6	-	-	82-T08
A20P SDUCL 07	20	20	18.3	40	170	13	≥25	DC.. 215.. DC.. 0702..	4008-M2.5x6	-	-	82-T08
A16M SDUCL 11	16	16	14.8	35	150	11	≥20	DC.. 325 DC.. 11T3..	4015-M3.5x9	-	-	80-T15
A20P SDUCL 11	20	20	18.3	40	170	13	≥25	DC.. 325 DC.. 11T3..	4015-M3.5x11	-	AAV-08-M3.5x8	80-T15
A25R SDUCL 11	25	25	23	50	200	17	≥32	DC.. 325 DC.. 11T3..	4015-M3.5x12	AADN-2-0001	AAV-08-M3.5x8	80-T15
A25T SDUCL 11	25	25	23	50	300	17	≥32	DC.. 325 DC.. 11T3..	4015-M3.5x14	AADN-2-0001	AAV-06-M3.5x11	80-T15
A32S SDUCL 11	32	32	30	60	250	22	≥40	DC.. 325 DC.. 11T3..	4015-M3.5x14	AADN-2-0001	AAV-06-M3.5x11	80-T15
A50U SDUCL 11	50	50	47	80	350	35	≥63	DC.. 325 DC.. 11T3..	4015-M3.5x14	AADN-2-0001	AAV-06-M3.5x11	80-T15



Illustrations shown may vary from actual product.

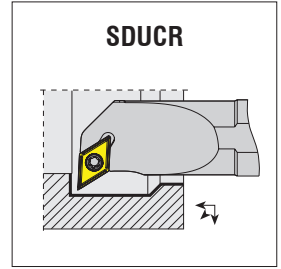
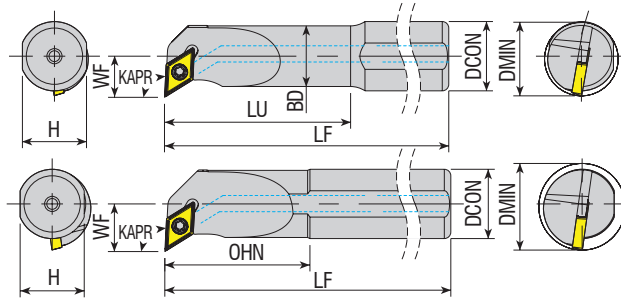

Ordering Code	Dimensions in Inch							Insert Inch/Metric	Screw	Shim	Shim Screw	Torx Key
	DCON	H	LF	WF	DMIN	OHN	CNT					
A06M SDUCR 2	0.375	0.339	6.000	0.375	0.600	1.000	-	DC.. 2151 DC.. 070204	4008-M2.5x6	-	-	82-T08
A08R SDUCR 2	0.500	0.461	8.000	0.437	0.730	1.000	1/16-27 NPT	DC.. 2151 DC.. 070204	4008-M2.5x6	-	-	82-T08
A10S SDUCR 2	0.625	0.563	10.000	0.500	0.850	1.500	1/8-27 NPT	DC.. 2151 DC.. 070204	4008-M2.5x6	-	-	82-T08
A12S SDUCR 3	0.750	0.683	10.000	0.562	0.980	1.500	1/8-27 NPT	DC.. 3252 DC.. 11T308	4015-M3.5x9	-	-	80-T15
A16T SDUCR 3	1.000	0.921	12.000	0.750	1.300	2.000	1/4-18 NPT	DC.. 3252 DC.. 11T308	4015-M3.5x12	AADN-2-0001	AAV-08-M3.5x8	80-T15
A06M SDUCL 2	0.375	0.339	6.000	0.375	0.600	1.000	-	DC.. 2151 DC.. 070204	4008-M2.5x6	-	-	82-T08
A08R SDUCL 2	0.500	0.461	8.000	0.437	0.730	1.000	1/16-27 NPT	DC.. 2151 DC.. 070204	4008-M2.5x6	-	-	82-T08
A10S SDUCL 2	0.625	0.563	10.000	0.500	0.850	1.500	1/8-27 NPT	DC.. 2151 DC.. 070204	4008-M2.5x6	-	-	82-T08
A12S SDUCL 3	0.750	0.683	10.000	0.562	0.980	1.500	1/8-27 NPT	DC.. 3252 DC.. 11T308	4015-M3.5x9	-	-	80-T15
A16T SDUCL 3	1.000	0.921	12.000	0.750	1.300	2.000	1/4-18 NPT	DC.. 3252 DC.. 11T308	4015-M3.5x12	AADN-2-0001	AAV-08-M3.5x8	80-T15



Illustrations shown may vary from actual product.

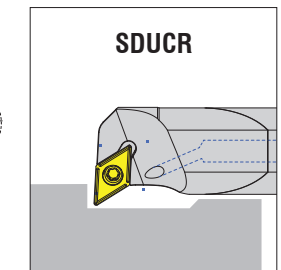
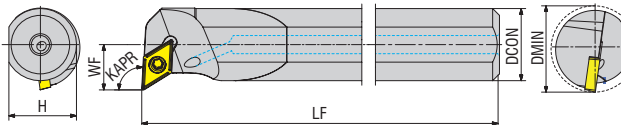

Ordering Code	Dimensions in Inch					Insert Inch/Metric	Screw	Torx Key
	Dcon	H	LF	WF	DMIN			
E06M SDUCR 2	0.375	0.355	6.000	0.250	0.500	DC.. 2151 DC.. 070204	4008-M2.5x6	82-T08
E08R SDUCR 2	0.500	0.461	8.000	0.313	0.625	DC.. 2151 DC.. 070204	4008-M2.5x6	82-T08
E10R SDUCR 2	0.625	0.605	8.000	0.406	0.625	DC.. 2151 DC.. 070204	4008-M2.5x6	82-T08
E06M SDUCL 2	0.375	0.355	6.000	0.250	0.500	DC.. 2151 DC.. 070204	4008-M2.5x6	82-T08
E08R SDUCL 2	0.500	0.461	8.000	0.313	0.625	DC.. 2151 DC.. 070204	4008-M2.5x6	82-T08
E10R SDUCL 2	0.625	0.605	8.000	0.406	0.625	DC.. 2151 DC.. 070204	4008-M2.5x6	82-T08

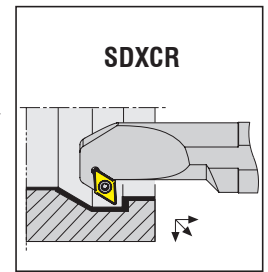
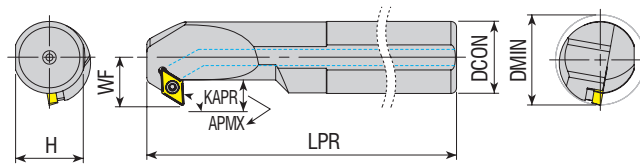

Illustrations shown may vary from actual product.

Dimensions in Inch														
Ordering Code	DCON	H	LF	LPR	APMX	WF	DMIN	OHN	CNT	Insert Inch/Metric	Screw	Shim	Shim Screw	Torx Key
A08R SDXCR 2	0.500	0.461	8.000	8.500	0.187	0.437	0.730	1.500	1/16-27 NPT	DC.. 2151 DC.. 070204	4008-M2.5x6	-	-	82-T08
A12S SDXCR 3	0.750	0.683	10.000	10.630	0.187	0.562	0.980	2.000	1/8-27 NPT	DC.. 3252 DC.. 11T308	4015-M3.5x9	-	-	80-T15
A16T SDXCR 3	1.000	0.921	12.000	12.630	0.250	0.750	1.300	2.500	1/4-18 NPT	DC.. 3252 DC.. 11T308	4015-M3.5x14	AADN-2-0001	AAV-08-M3.5x8	80-T15
A08R SDXCL 2	0.500	0.461	8.000	8.500	0.187	0.437	0.730	1.500	1/16-27 NPT	DC.. 2151 DC.. 070204	4008-M2.5x6	-	-	82-T08
A16T SDXCL 3	1.000	0.921	12.000	12.630	0.250	0.750	1.300	2.500	1/4-18 NPT	DC.. 3252 DC.. 11T308	4015-M3.5x14	AADN-2-0001	AAV-08-M3.5x8	80-T15

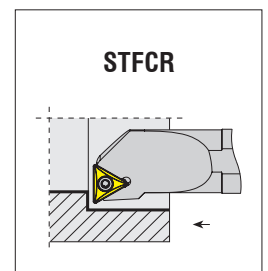
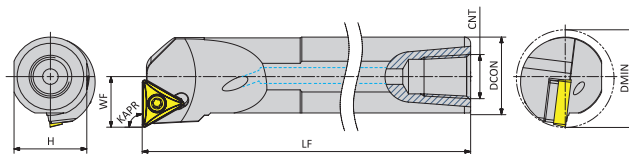

Illustrations shown may vary from actual product.

Dimensions in Inch														
Ordering Code	DCON	H	LF	WF	DMIN	OHN	CNT	Insert Inch/Metric	Screw	Shim	Shim Screw	Torx Key		
A06M STFCR 2	0.375	0.339	6.000	0.250	0.480	1.000	-	TC.. 2151 TC.. 110204	4008-M2.5x6	-	-	82-T08		
A08R STFCR 2	0.500	0.461	8.000	0.312	0.600	1.000	1/16-27 NPT	TC.. 2151 TC.. 110204	4008-M2.5x6	-	-	82-T08		
A10S STFCR 2	0.625	0.563	10.000	0.406	0.770	1.500	1/8-27 NPT	TC.. 2151 TC.. 110204	4008-M2.5x6	-	-	82-T08		
A12S STFCR 3	0.750	0.683	10.000	0.500	0.930	1.500	1/8-27 NPT	TC.. 3252 TC.. 16T308	4015-M3.5x11	-	-	80-T15		
A16T STFCR 3	1.000	0.921	12.000	0.640	1.200	2.000	1/4-18 NPT	TC.. 3252 TC.. 16T308	4015-M3.5x14	AATN-2-0001	AAV-08-M3.5x8	80-T15		
A08R STFCL 2	0.500	0.461	8.000	0.312	0.600	1.000	1/16-27 NPT	TC.. 2151 TC.. 110204	4008-M2.5x6	-	-	82-T08		
A12S STFCL 3	0.750	0.683	10.000	0.500	0.930	1.500	1/8-27 NPT	TC.. 3252 TC.. 16T308	4015-M3.5x11	-	-	80-T15		
A16T STFCL 3	1.000	0.921	12.000	0.640	1.200	2.000	1/4-18 NPT	TC.. 3252 TC.. 16T308	4015-M3.5x14	AATN-2-0001	AAV-08-M3.5x8	80-T15		

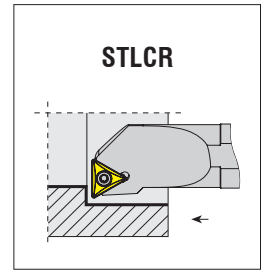
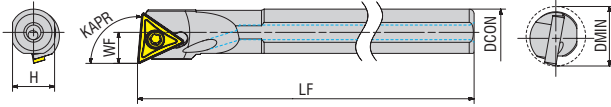

Illustrations shown may vary from actual product.

Dimensions in Inch

Ordering Code	DCON	H	LF	WF	DMIN	OHN	CNT					
								Insert Inch/Metric	Screw	Shim	Shim Screw	Torx Key
<b>A06M STLCL 2</b>	0.375	0.339	6.000	0.250	0.480	1.000	-	TC.. 2151 TC.. 110204	4008-M2.5x6	-	-	82-T07
<b>A08R STLCL 2</b>	0.500	0.461	8.000	0.312	0.600	1.000	1/16-27 NPT	TC.. 2151 TC.. 110204	4008-M2.5x6	-	-	82-T07
<b>A10S STLCL 2</b>	0.625	0.563	10.000	0.406	0.770	1.500	1/8-27 NPT	TC.. 2151 TC.. 110204	4008-M2.5x6	-	-	82-T07
<b>A12S STLCL 3</b>	0.750	0.683	10.000	0.500	0.930	1.500	1/8-27 NPT	TC.. 3252 TC.. 16T308	4015-M3.5x11			80-T15
<b>A16T STLCL 3</b>	1.000	0.921	12.000	0.640	1.200	2.000	1/4-18 NPT	TC.. 3252 TC.. 16T308	4015-M3.5x11	AATN-2-0001	AAV-08-M3.5x8	80-T15
<b>A06M STLCL 2</b>	0.375	0.339	6.000	0.250	0.480	1.000	-	TC.. 2151 TC.. 110204	4008-M2.5x6	-	-	82-T07
<b>A08R STLCL 2</b>	0.500	0.461	8.000	0.312	0.600	1.000	1/16-27 NPT	TC.. 2151 TC.. 110204	4008-M2.5x6	-	-	82-T07
<b>A10S STLCL 2</b>	0.625	0.563	10.000	0.406	0.770	1.500	1/8-27 NPT	TC.. 2151 TC.. 110204	4008-M2.5x6	-	-	82-T07
<b>A12S STLCL 3</b>	0.750	0.683	10.000	0.500	0.930	1.575	1/8-27 NPT	TC.. 3252 TC.. 16T308	4015-M3.5x11			80-T15
<b>A16T STLCL 3</b>	1.000	0.921	12.000	0.640	1.200	2.000	1/4-18 NPT	TC.. 3252 TC.. 16T308	4015-M3.5x11	AATN-2-0001	AAV-08-M3.5x8	80-T15

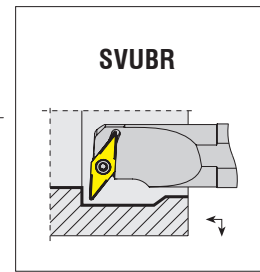
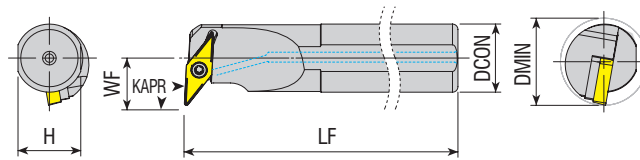

Illustrations shown may vary from actual product.

Dimensions in Inch

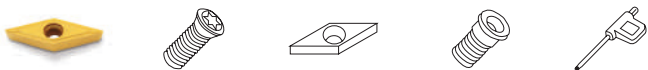
Ordering Code	DCON	H	LF	WF	DMIN	OHN	CNT					
								Insert Inch/Metric	Screw	Shim	Shim Screw	Torx Key
<b>A12S SVUBR 2</b>	0.750	0.683	10.000	0.562	0.980	1.500	1/8-27 NPT	VB.. 221 VB.. 110304	4008-M2.5x6	-	-	82-T08
<b>A16T SVUBR 3</b>	1.000	0.921	12.000	0.750	1.300	2.000	1/4-18 NPT	VB.. 332 VB.. 160408	4015-M3.5x14	AAVN-2-0002	AAV-06-M3.5x11	82-T15
<b>A12S SVUBL 2</b>	0.750	0.683	10.000	0.562	0.980	1.500	1/8-27 NPT	VB.. 221 VB.. 110304	4008-M2.5x6	-	-	82-T08
<b>A16T SVUBL 3</b>	1.000	0.921	12.000	0.750	1.300	2.000	1/4-18 NPT	VB.. 332 VB.. 160408	4015-M3.5x14	AAVN-2-0002	AAV-06-M3.5x11	82-T15

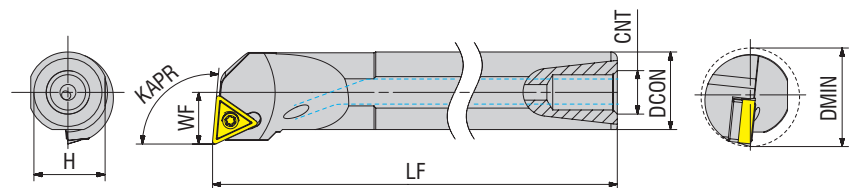

Illustrations shown may vary from actual product.

Dimensions in Inch

Ordering Code	DCON	H	LF	WF	DMIN	OHN	CNT					
								Insert Inch/Metric	Screw	Shim	Shim Screw	Torx Key
<b>A06M STLPR 2</b>	0.375	0.339	6.000	0.250	0.480	1.000	-	TP. 2151	4008-M2.5x6	-	-	82-T08
<b>A08R STLPR 2</b>	0.500	0.461	8.000	0.312	0.600	1.000	1/16-27 NPT	TP. 2151	4008-M2.5x6	-	-	82-T08
<b>A10S STLPR 2</b>	0.625	0.563	10.000	0.406	0.770	1.500	1/8-27 NPT	TP. 2151	4008-M2.5x6	-	-	82-T08
<b>A12S STLPR 3</b>	0.750	0.683	10.000	0.500	0.930	1.500	1/8-27 NPT	TP. 3252	4015-M3.5x11	-	-	80-T15
<b>A16T STLPR 3</b>	1.000	0.921	12.000	0.640	1.220	2.000	1/4-18 NPT	TP. 3252	4015-M3.5x11	AATN-2-0001	AAV-08-M3.5x8	80-T15
<b>A06M STLPL 2</b>	0.375	0.339	6.000	0.250	0.480	1.000	-	TP. 2151	4008-M2.5x6	-	-	82-T08
<b>A08R STLPL 2</b>	0.500	0.461	8.000	0.312	0.600	1.000	1/16-27 NPT	TP. 2151	4008-M2.5x6	-	-	82-T08
<b>A10S STLPL 2</b>	0.625	0.563	10.000	0.406	0.770	1.500	1/8-27 NPT	TP. 2151	4008-M2.5x6	-	-	82-T08
<b>A12S STLPL 3</b>	0.750	0.683	10.000	0.500	0.930	1.500	1/8-27 NPT	TP. 3252	4015-M3.5x11	-	-	80-T15

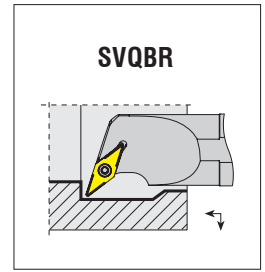
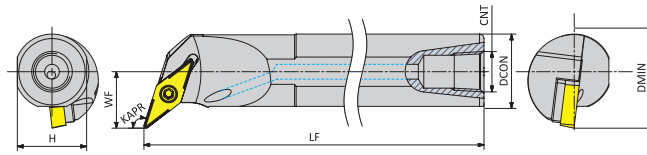

Illustrations shown may vary from actual product.

Dimensions in Inch												
Ordering Code	DCON	H	LF	WF	DMIN	OHN	CNT	Insert Inch/Metric	Screw	Shim	Shim Screw	Torx Key
A10S SVQBR 2	0.625	0.563	10.000	0.500	0.850	1.500	1/8-27 NPT	VB.. 221 VB.. 110304	4008-M2.5x6	-	-	82-T08
A12S SVQBR 2	0.750	0.683	10.000	0.562	0.930	1.500	1/8-27 NPT	VB.. 221 VB.. 110304	4008-M2.5x6	-	-	82-T08
A16T SVQBR 3	1.000	0.921	12.000	0.750	1.300	2.000	1/4-18 NBT	VB.. 332 VB.. 160408	4015-M3.5x11	AAVN-2-0002	AAV-08-M3.5x8	82-T15
A10S SVQBL 2	0.625	0.563	10.000	0.500	0.850	1.500	1/8-27 NPT	VB.. 221 VB.. 110304	4008-M2.5x6	-	-	82-T08
A12S SVQBL 2	0.750	0.683	10.000	0.562	0.930	1.500	1/8-27 NPT	VB.. 221 VB.. 110304	4008-M2.5x6	-	-	82-T08
A16T SVQBL 3	1.000	0.921	12.000	0.750	1.300	2.000	1/4-18 NBT	VB.. 332 VB.. 160408	4015-M3.5x11	AAVN-2-0002	AAV-08-M3.5x8	82-T15

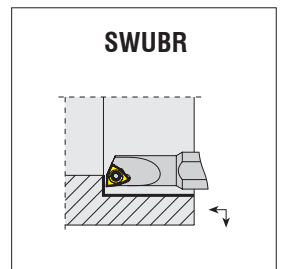
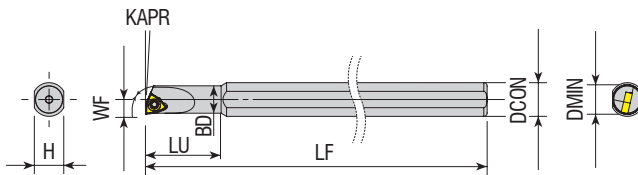

Illustrations shown may vary from actual product.

Dimensions in Metric												
Ordering Code	DCON	BD	H	LU	LF	DMIN	WF	Insert Inch/Metric	Screw	Shim	Shim Screw	Torx Key
S0610H SWUBR 06	10	5	7.3	18	100	≥6	3	WBGT 310.5-R WBGT 060102-R	3006-M2x3.3	-	-	82-T06
S08H SWUBR 06-5.5	8	5	7.3	18	100	≥5.7	2.75	WBGT 310.5-R WBGT 060102-R	3006-M2x3.3	-	-	82-T06
S08H SWUBR 06-7	8	6.5	7.3	18	100	≥7	3.5	WBGT 310.5-R WBGT 060102-R	3006-M2x4	-	-	82-T06
S0610H SWUBL 06	10	5	7.3	18	100	≥6	3	WBGT 310.5-L WBGT 060102-L	3006-M2x3.3	-	-	82-T06
S08H SWUBL 06-5.5	8	5	7.3	18	100	≥5.7	2.75	WBGT 310.5-L WBGT 060102-L	3006-M2x3.3	-	-	82-T06
S08H SWUBL 06-7	8	6.5	7.3	18	100	≥7	3.5	WBGT 310.5-L WBGT 060102-L	3006-M2x4	-	-	82-T06



the spoken  
quality...

# ANTI VIBRATION TOOLS



**AKKO** **A** **TT** **B** **D16** **204** **10D** **H** **E**

<b>2</b> Tool Type	<b>3</b> Body	<b>4</b> Connection Diameter	<b>5</b> Overall length	<b>6</b> Overhang maximum	<b>7</b> With Coolant Hole
Anti Vibration Tool					
<b>8</b> Type of Boring Bar					
Carbide reinforced					

**AKKO** **A** **TT** **C** **A** **16** **SDUCR11**

<b>2</b> Tool Type	<b>3</b> Cartridge Code	<b>4</b> With Coolant Hole	<b>5</b> Connection Diameter
Anti Vibration Tool Cartridge	Cartridge	With Coolant Hole	Ø16 - Ø20 - Ø25 Ø32 - Ø40
<b>6</b> Cartridge Type			
SDUCR/L. SCLCR/L. SVUCR/L. TCLNR/L. TDUNR/L			

**AKKO** **A** **TT** **C** **16-25**

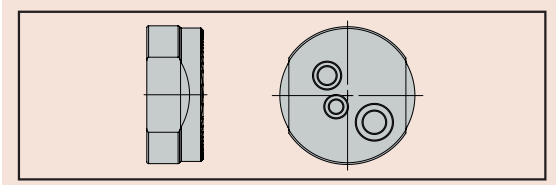

<b>2</b> Tool Type	<b>3</b> Cartridge	<b>4</b> Usable diameter range for body
Anti Vibration Tool Cartridge	Centering Cartridge Code	ATTB-D16/D20/D25 ATTB-D32/D40/D50/D60

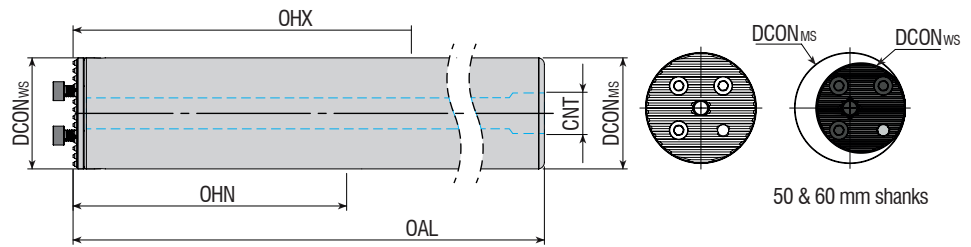

Dimensions in Inch

Ordering Code	DCONMS	DCONWS	OAL	OHN	OHX	CNT	DMIN	DCON	Shim Screw	Mounting Screw Key
ATTB-D16-10-7D-H	1.000	0.984	10.039	3.346	6.220	G1/4	1.2598	0.9842	2525-M3X10	AAL-02-2.5
ATTB-D20-12-7D-H	1.250	1.260	12.598	3.937	7.480	G3/8	1.5748	1.2598	2503-M3.5x10	AAL-02-2.5
ATTB-D32-21-7D-H	2.000	1.575	20.74	6.811	12.756	G1/2	1.9685	1.5748	2504-M5x12	AAL-05-4

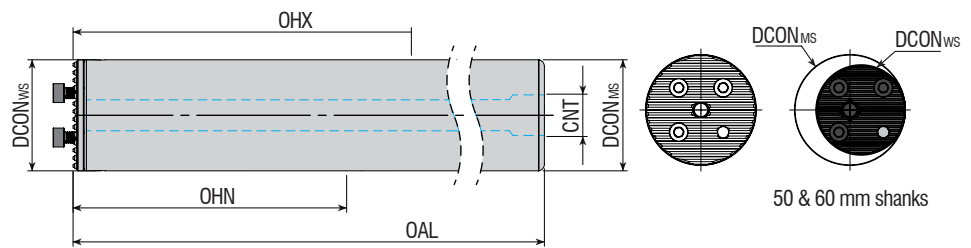

Dimensions in Metric/Inch

Ordering Code	DCONMS METRIC/INCH	DCONWS METRIC/INCH	OAL METRIC/INCH	OHN METRIC/INCH	OHX METRIC/INCH	CNT METRIC/INCH	DMIN / DCON INCH / METRIC	Shim Screw	Mounting Screw Key
ATTB-D16-156-7D-H	16 / 0.630	16 / 0.630	156 / 6.141	55 / 2.165	92 / 3.622	G1/8	20 / 0.787 16 / 0.630	2525-M3X10	AAL-02-2.5
ATTB-D20-200-7D-H	20 / 0.787	20 / 0.787	200 / 7.874	70 / 2.756	120 / 4.724	G1/4	25 / 0.984 20 / 0.787	2503-M3.5x10	AAL-02-2.5
ATTB-D25-255-7D-H	25 / 0.984	25 / 0.984	255 / 10.039	88 / 3.465	158 / 6.220	G1/4	32 / 1.260 25 / 0.984	2503-M4X12	AAL-03-3
ATTB-D32-320-7D-H	32 / 1.260	32 / 1.260	320 / 12.598	100 / 3.937	192 / 7.559	G3/8	40 / 1.575 32 / 1.260	2504-M5x12	AAL-05-4
ATTB-D40-408-7D-H	40 / 1.575	40 / 1.575	408 / 16.063	128 / 5.039	248 / 9.764	G1/2	50 / 1.969 40 / 1.575	2505-M6X16	AAL-07-5
ATTB-D50-519-7D-H	50 / 1.969	40 / 1.575	519 / 20.433	168 / 6.614	318 / 12.520	G1/2	63 / 2.480 40 / 1.575	2505-M6X16	AAL-07-5
ATTB-D60-628-7D-H	60 / 2.362	40 / 1.575	628 / 24.724	208 / 8.189	388 / 15.276	G3/4	80 / 3.150 40 / 1.575	2505-M6X16	AAL-07-5

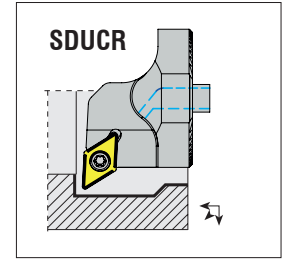
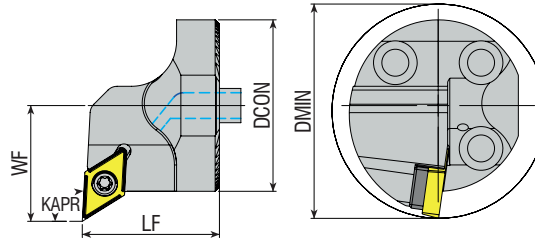

Illustrations shown may vary from actual product.

Ordering Code	Dimensions in Metric/Inch				Insert Inch/Metric	Screw	Shim	Shim Screw	Connection Part	Torx Key
	DCON METRIC/INCH	LF METRIC/INCH	WF METRIC/INCH	DMIN METRIC/INCH						
ATTC-A16 SDUCR/L 07	16 / 0.625	20 / 0.787	11 / 0.433	20 / 0.787	DC..215 DC.. 0702..	4008-M2.5x6	-	-	ACP-02	82-T08
ATTC-A20 SDUCR/L 11	20 / 0.787	20 / 0.787	13 / 0.512	25 / 0.984	DC..325 DC.. 11T3..	4015-M3.5x11	-	-	ACP-02	82-T08
ATTC-A25 SDUCR/L 11	25 / 0.984	23 / 0.905	17 / 0.669	32 / 1.260	DC..325 DC.. 11T3..	4015-M3.5x12	AADN-2-0001	AAV-08-M3.5x8	ACP-01	80-T15
ATTC-A32 SDUCR/L 11	32 / 1.260	32 / 1.260	22 / 0.866	40 / 1.575	DC..325 DC.. 11T3..	4015-M3.5x11	AADN-2-0001	AAV-06-M3.5x11	ACP-01	80-T15
ATTC-A40 SDUCR/L 11	40 / 1.575	32 / 1.260	27 / 1.063	50 / 1.969	DC..325 DC.. 11T3..	4015-M3.5x14	AADN-2-0001	AAV-06-M3.5x11	ACP-01	80-T15

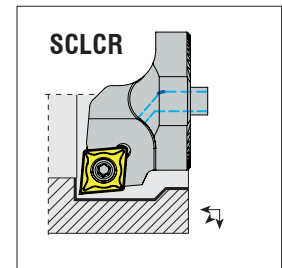
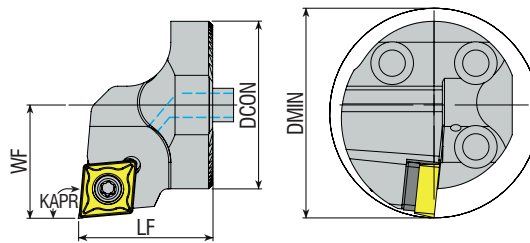

Illustrations shown may vary from actual product.

Ordering Code	Dimensions in Metric/Inch				Insert Inch/Metric	Screw	Shim	Shim Screw	Connection Part	Torx Key
	DCON METRIC/INCH	LF METRIC/INCH	WF METRIC/INCH	DMIN METRIC/INCH						
ATTC-A16 SCLCR/L 06	16 / 0.625	20 / 0.787	11 / 0.433	20 / 0.787	CC..215 CC.. 0602..	4008-M2.5x6	-	-	ACP-02	82-T08
ATTC-A20 SCLCR/L 09	20 / 0.787	20 / 0.787	13 / 0.512	25 / 0.984	CC..325 CC.. 09T3..	4015-M3.5x9	-	-	ACP-02	82-T08
ATTC-A25 SCLCR/L 09	25 / 0.984	23 / 0.905	17 / 0.669	32 / 1.260	CC..325 CC.. 09T3..	4015-M3.5x12	AACN-2-0001	AAV-08-M3.5x8	ACP-01	80-T15
ATTC-A32 SCLCR/L 09	32 / 1.260	32 / 1.260	22 / 0.866	40 / 1.575	CC..325 CC.. 09T3..	4015-M3.5x12	AACN-2-0001	AAV-08-M3.5x8	ACP-01	80-T15
ATTC-A40 SCLCR/L 09	40 / 1.575	32 / 1.260	27 / 1.063	50 / 1.969	CC..325 CC.. 09T3..	4015-M3.5x12	AACN-2-0003	AAV-08-M3.5x8	ACP-01	80-T20

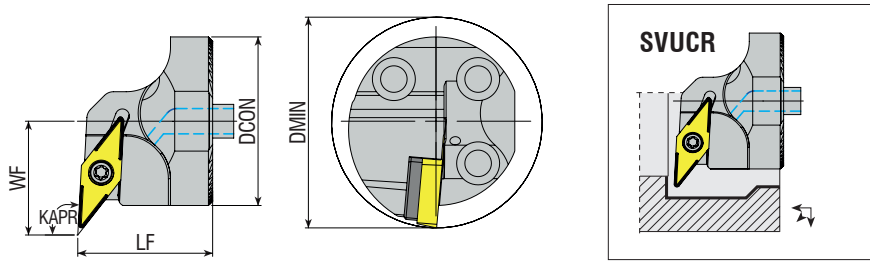

Illustrations shown may vary from actual product.

Ordering Code	Dimensions in Metric/Inch				Insert Inch/Metric	Screw	Shim	Shim Screw	Connection Part	Torx Key
	DCON METRIC/INCH	LF METRIC/INCH	WF METRIC/INCH	DMIN METRIC/INCH						
ATTC-A20 SVUCR/L 11	20 / 0.787	20 / 0.787	15 / 0.590	27 / 1.063	VC..22.. VC.. 1103..	4008-M2.5x6	-	-	ACP-02	82-T08
ATTC-A25 SVUCR/L 11	25 / 0.984	23 / 0.905	17 / 0.669	32 / 1.260	VC..22.. VC.. 1103..	4008-M2.5x6	-	-	ACP-02	82-T08
ATTC-A32 SVUCR/L 16	32 / 1.260	32 / 1.260	22 / 0.866	40 / 1.575	VC..33.. VC.. 1604..	4015-M3.5x14	AAVN-2-0002	AAV-06-M3.5x11	ACP-01	82-T08
ATTC-A40 SVUCR/L 16	40 / 1.575	32 / 1.260	27 / 1.063	50 / 1.969	VC..33.. VC.. 1604..	4015-M3.5x14	AAVN-2-0002	AAV-06-M3.5x11	ACP-01	82-T08

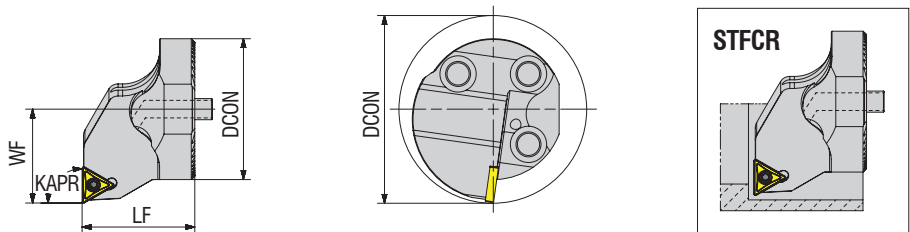

Illustrations shown may vary from actual product.

Ordering Code	Dimensions in Metric/Inch				Insert Inch/Metric	Screw	Shim	Shim Screw	Connection Part	Torx Key
	DCON METRIC/INCH	LF METRIC/INCH	WF METRIC/INCH	DMIN METRIC/INCH						
ATTC-A20 STFCL/L 11	20 / 0.787	20 / 0.787	13 / 0.512	25 / 0.984	TC.. 215.. TC.. 1102..	4008-M2.5X6	TC.. 1102..	-	ACP-02	82-T08
ATTC-A40 STFCL/L 11	40 / 1.575	32 / 1.260	27 / 1.063	50 / 1.969	TC.. 215.. TC.. 1102..	4008-M2.5X6	TC.. 1102..	-	ACP-01	82-T08

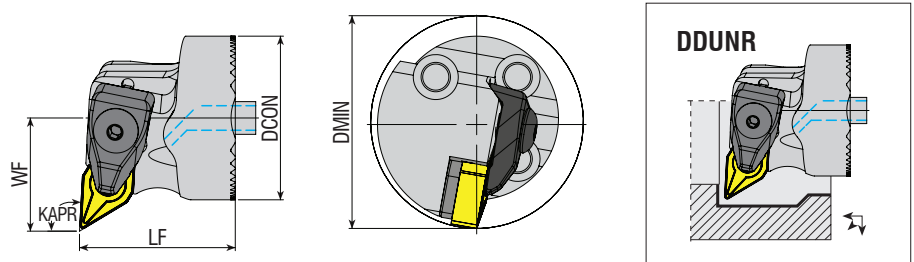

Illustrations shown may vary from actual product.

Ordering Code	Dimensions in Metric/Inch				Insert Inch/Metric	Wedge Clamp	Clamp Screw	Shim	Shim Screw	Ring	Stamp	Connection Part	Torx Key
	DCON Inch/Metric	LF Inch/Metric	WF Inch/Metric	DMIN Inch/Metric									
ATTC-A32 DDUNR/L 11	32 / 1.260	32 / 1.260	22 / 0.866	40 / 1.575	DN..33.. DN.. 1104..	ATK-01	AKV-01-M5x22	AADN -2-0001	AAV-04-M5x12	AS-01	ABPL-01	ACP-01	AAL-03-3
ATTC-A40 DDUNR/L 15	40 / 1.575	32 / 1.260	27 / 1.063	50 / 1.969	DN..44.. DN.. 1506..	ATK-02	AKV-30-M6x22	AADN -3-0001	AAV-02-M5x12	AS-01	ABPL-01	ACP-01	AAL-03-3



Illustrations shown may vary from actual product.

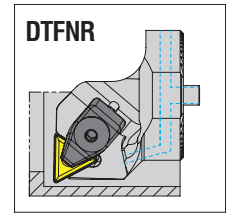
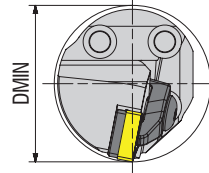
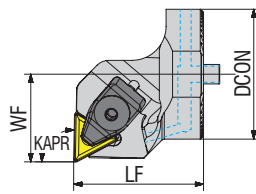

Ordering Code	Dimensions in Metric/Inch				Insert Inch/Metric	Wedge Clamp	Clamp Screw	Shim	Shim Screw	Stamp	Connection Part	Allen Key
	DCON Inch/Metric	LF Inch/Metric	WF Inch/Metric	DMIN Inch/Metric								
ATTC-A40 DTFNR/L 16	40 / 1.575	40 / 1.575	27 / 1.063	50 / 1.969	TN.. 33.. TN.. 1604..	ATK-01	AKV-01-M5X22	AATN-2-0002	AAV-03-M5X12	ABPL-01	ACP-01	AAL-03-3



Illustrations shown may vary from actual product.

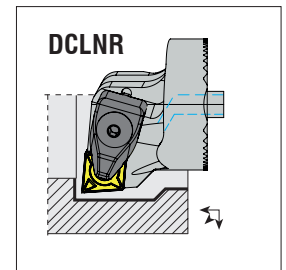
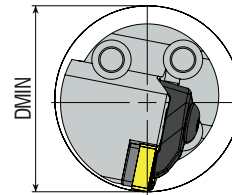
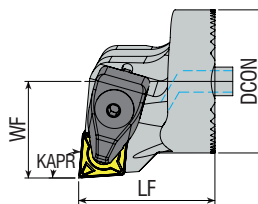

Ordering Code	Dimensions in Metric/Inch				Insert Inch/Metric	Wedge Clamp	Clamp Screw	Shim	Shim Screw	Ring	Stamp	Connection Part	Allen Key
	DCON Inch/Metric	LF Inch/Metric	WF Inch/Metric	DMIN Inch/Metric									
ATTC-A32 DCLNR/L 12	32 / 1.260	32 / 1.260	22 / 0.866	40 / 1.575	CN.. 43.. CN.. 1204..	ATK-02	AKV-30-M6x22	AACN-3-0001	AAV-02-M5x12	AS-01	ABPL-01	ACP-01	AAL-03-3
ATTC-A40 DCLNR/L 12	40 / 1.575	32 / 1.260	27 / 1.063	50 / 1.969	CN.. 43.. CN.. 1204..	ATK-02	AKV-30-M6x22	AACN-3-0001	AAV-02-M5x12	AS-01	ABPL-01	ACP-01	AAL-03-3
ATTC-A40 DCLNR/L 16	40 / 1.575	40 / 1.575	32 / 1.259	57 / 2.244	CN.. 54.. CN.. 1606..	ATK-02	AKV-30-M6x22	AACN-3-0001	AAV-02-M5x12	AS-01	ABPL-01	ACP-01	AAL-03-3



Illustrations shown may vary from actual product.

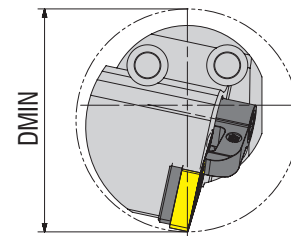
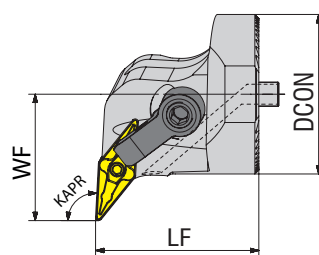

Ordering Code	Dimensions in Metric/Inch				Insert Inch/Metric	Wedge Clamp	Clamp Screw	Shim	Shim Screw	Ring	Stamp	Connection Part	Allen Key
	DCON Inch/Metric	LF Inch/Metric	WF Inch/Metric	DMIN Inch/Metric									
ATTC-A40 MVUNR/L 16	40 / 1.575	40 / 1.575	32 / 1.259	57 / 2.240	VN.. 332 VN.. 160408	ATK-02 ATK-01	AKV-30-M6x22	AADN-3-0001	AAV-02-M5x12	AS-01	ABPL-01		AAL-03-3

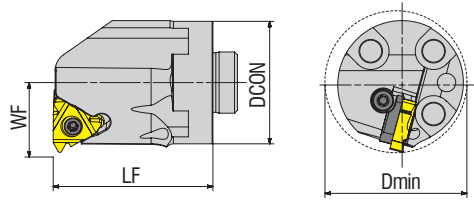

Illustrations shown may vary from actual product.

Dimensions in Inch



Ordering Code	DCON Inch	LF Inch	WF Inch	DMIN Inch	Insert Inch	Screw	Right Shim	Left Shim	Shim Screw	Stamp	Torks Key
H20 TIR/L 3	1.250	1.630	0.760	1.450	16 IR/IL	1710-U5-40x12.2	ATS-16E	ATS-16I	AAV-11-U5-40x4.5	ABPL-03	82-T10
H24 TIR/L 3	1.500	1.630	0.885	1.760	16 IR/IL	1710-U5-40x12.2	ATS-16E	ATS-16I	AAV-11-U5-40x4.5	ABPL-03	82-T10
H32 TIR/L 3	2.000	1.630	1.276	2.400	16 IR/IL	1710-U5-40x12.2	ATS-16E	ATS-16I	AAV-11-U5-40x4.5	ABPL-03	82-T10
H40 TIR/L 3	2.500	1.630	1.531	3.030	16 IR/IL	1710-U5-40x12.2	ATS-16E	ATS-16I	AAV-11-U5-40x4.5	ABPL-03	82-T10
H24 TIR/L 4	1.500	1.630	0.973	1.782	22 IR/IL	1720-U8-32x15	ATS-22E	ATS-22I	AAV-12-U8-32x5.5	ABPL-04	80-T20
H32 TIR/L 4	2.000	1.630	1.276	2.400	22 IR/IL	1720-U8-32x15	ATS-22E	ATS-22I	AAV-12-U8-32x5.5	ABPL-04	80-T20

Insert Compatible with ISO.  
Head Compatible with KNMTL body.





Illustrations shown may vary from actual product.

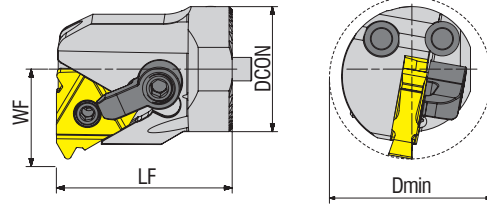

Dimensions in Metric

Ordering Code	DCON Metric	LF Metric	WF Metric	DMIN Metric	Insert Metric	Wedge Clamp	Clamp Screw	Pin	Coolant Hole Pin	Shim Screw
ATTC-A32 MIR/L L54	32	45	25	41	V0.038 2TPF	CK-13	XNS-58	NL-56	ACP-01	2702-M4x4
ATTC-A40 MIR/L L54	40	45	29	50	V0.038 2TPF	CK-13	XNS-58	NL-56	ACP-01	2702-M4x4

Compatible with Posithread insert.  
Head Compatible with KNMTL body.



Illustrations shown may vary from actual product.

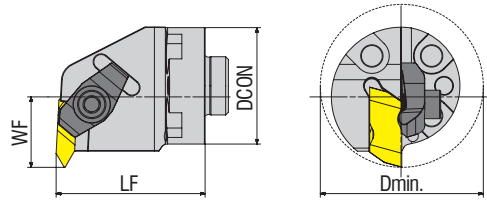

Dimensions in Inch

Ordering Code	DCON Inch	LF Inch	WF Inch	DMIN Inch	Insert Inch	Right Clamp	Left Clamp	Clamp Screw	Allen Key
H20 ANER/L 3	1.250	1.625	0.875	1.750	N.3L	CM-73LP	CM-72LP	AKV-41-U10-32x18.5	AAL-05-4
H24 ANER/L 3	1.500	1.625	1.000	2.000	N.3L	CM-73LP	CM-72LP	AKV-41-U10-32x18.5	AAL-05-4
H32 ANER/L 3	2.000	1.625	1.250	2.500	N.3L	CM-73LP	CM-72LP	AKV-41-U10-32x18.5	AAL-05-4
H40 ANER/L 3	2.500	1.625	1.500	3.000	N.3L	CM-73LP	CM-72LP	AKV-41-U10-32x18.5	AAL-05-4
H32 ANER/L 4	2.000	1.625	1.250	2.750	N.4L	CM-73LP	CM-72LP	AKV-41-U10-32x18.5	AAL-05-4
H40 ANER/L 4	2.500	1.625	1.500	3.250	N.4L	CM-73LP	CM-72LP	AKV-41-U10-32x18.5	AAL-05-4

Compatible with KNMTL insert.



Illustrations shown may vary from actual product.

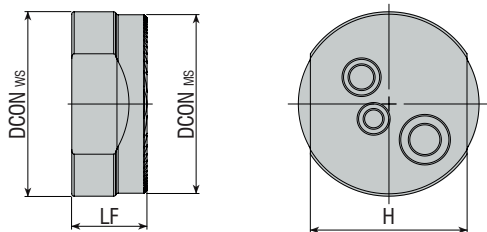

Dimensions in Metric/Inch

Boring Bars

Ordering Code	DCONWS Inch/Metric	DCONMS Inch/Metric	LF Inch/Metric	H Inch/Metric	
ATTC-16-25	28 / 1.102	25 / 0.984	15 / 0.590	22 / 0.866	ATTB-D16/D20/D25
ATTC-32-60	53 / 2.087	40 / 1.575	20 / 0.787	35 / 1.780	ATTB-D32/D40/D50/D60

### 1 Assembly and Adjusting

The surface of the cartridge and the shank to be mounted, as well as the inner part of the toolholder should be cleaned. Check A and B in the image below.

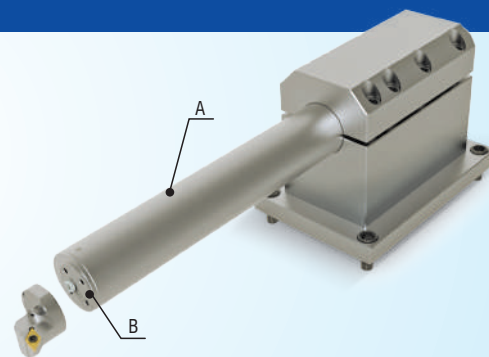

### 2 Assembly for the Shank

The clamping length should not be less than 4 L/D ratio. Suggest using the clamping cover with opening method and other holding clamping methods. (Type C). Do not use screw clamping method. Use inner cooling please when working a long time.

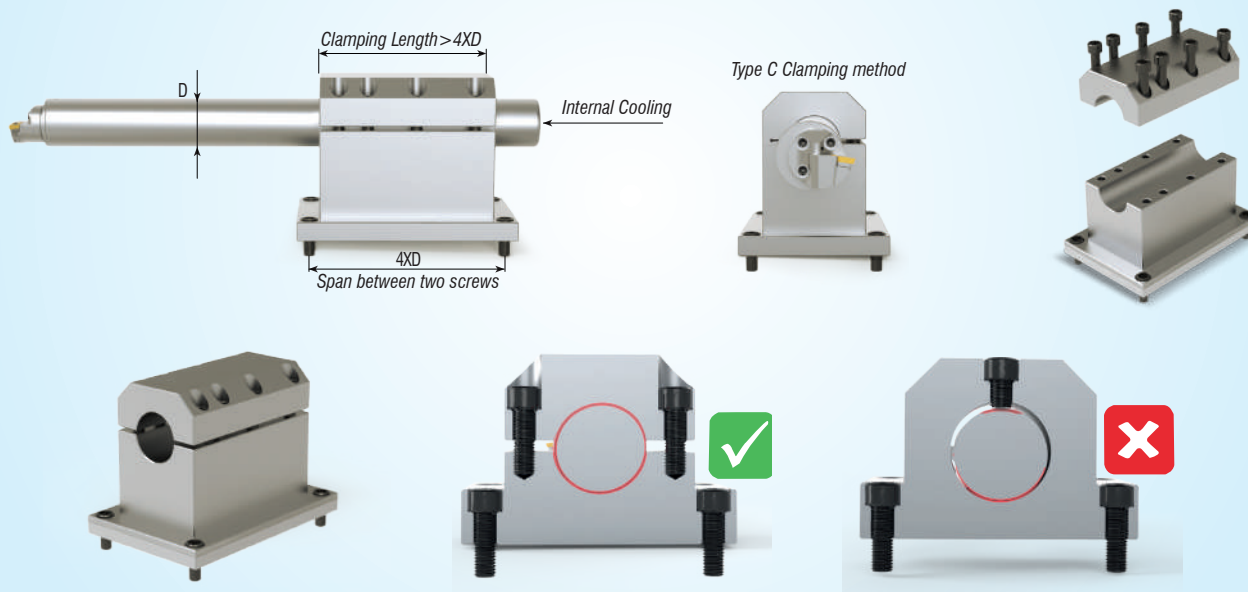

### 3 Adjusting the Height of Centre Assembly

When mounting the body for the first time, a special calibration tool should be used for the center height. First mount the shank on the holder, then calibrate it within 0.01 tolerance on the X axis direction. Please make the adjustment with the dial indicator device.

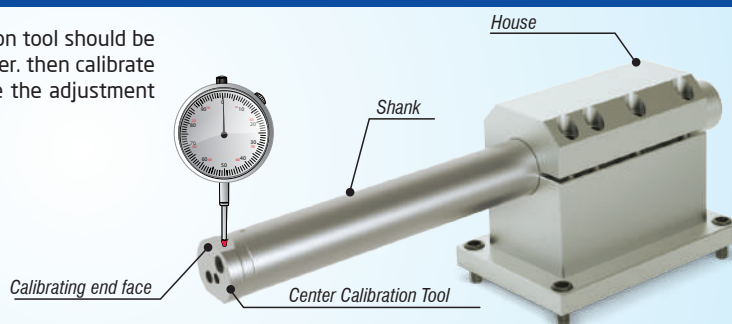

### 4 Assembly the Right Cartridge

See the figure on the side:



### Choosing the Correct Insert

Choosing the correct insert can have a big influence on the overall success of vibration damping. The main way the insert can improve the machining stability is by minimizing the cutting forces. Following the guidelines below should be your first step to eliminate vibrations: If possible, use it always short drilling tools. Otherwise, reduce your speeds to minimize vibration.

**A** Choose an entry angle that is as close as possible to 90° to reduce the radial forces to a minimum.

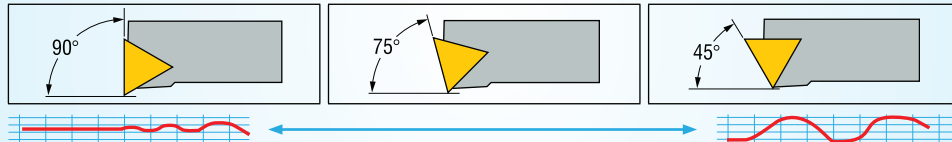

**B** Choose the smallest insert head angle possible. This will reduce overall cutting forces and increase the clearance.

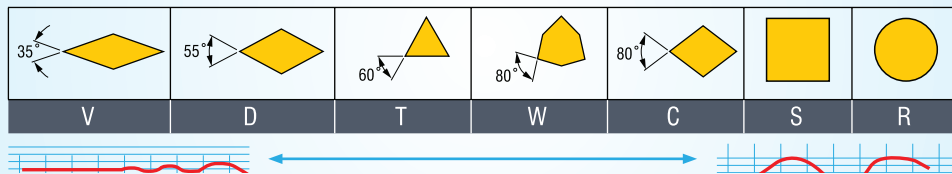

**C** Choose a small nose radius to reduce the cutting forces and to enable machining in a lower depth of cut.

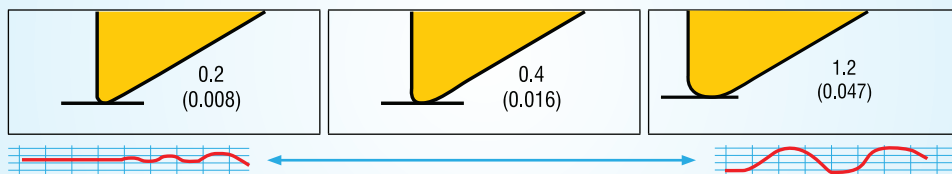

**D** Machining depth ( $a_p$ ) should be larger than the nose radius.

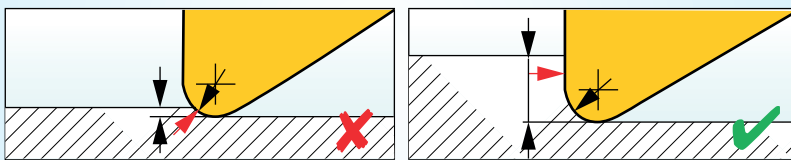

**E** Use an insert with an overall positive geometry to reduce the cutting forces:

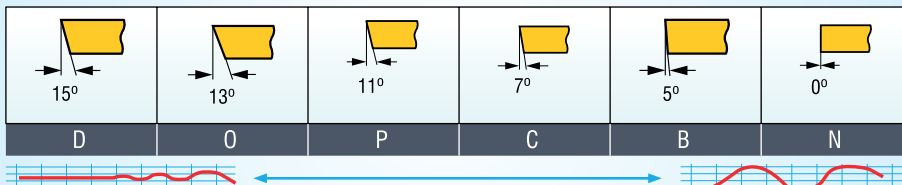

**F** Choose a positive top rake geometry:

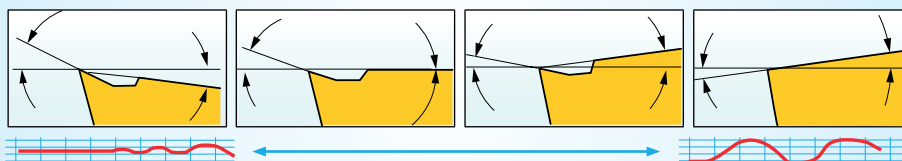

**G** For-dampened-straight-adaptor:

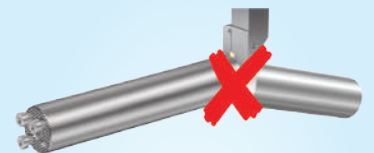

*L. min length after cut off*

$\emptyset$	Short Design 4-7x $\emptyset$ (mm)	Long Design 7-10x $\emptyset$ (mm)
16	100	155
20	125	200
25	155	255
32	190	320
40	240	410
50	305	520
60	380	630

*the spoken quality...*

# THREADING TOOLHOLDERS

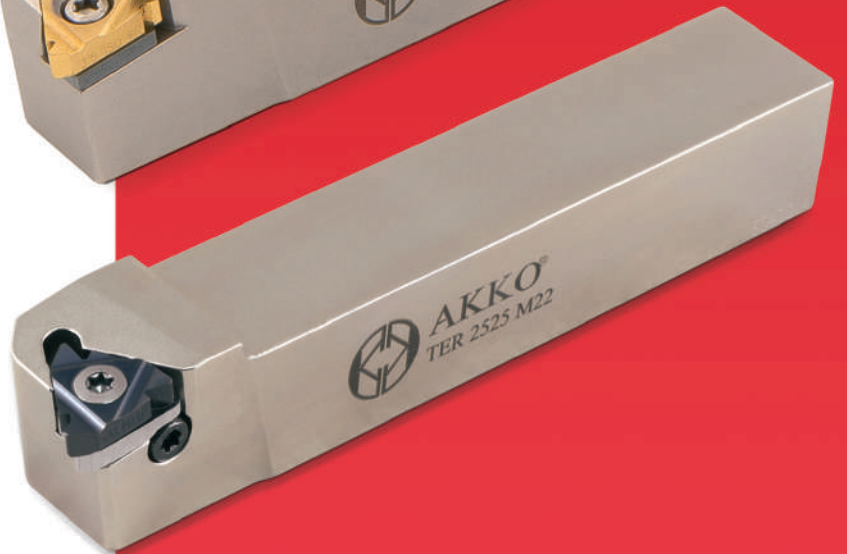

**S** **E** **R** **25 25** **M** **16** **C**

**1** Method of Mounting of Insert

S: Screw Clamping  
T: Screw Clamping with Helix Angle

**2** Application

E: External  
I: Internal

**3** Cutting Direction

R: Sağ Yan  
Right-Hand  
R: Rechts  
L: Sol Yan  
Left-Hand  
L: Links

**4** Type of Boring

"A" Solid steel with coolant hole  
"E" Carbide bar with fixed steel head and coolant hole  
"C" Carbide shank  
"S" Steel shank

**4-5** External Shank Size

Shank : hxb  
2525 - 25 x 25 mm

**5** Shank Diameter

**6** Shank Length

A - 32	H - 100	Q - 180	x-special
B - 40	J - 110	R - 200	
C - 50	K - 125	S - 250	
D - 60	L - 140	T - 300	
E - 70	M - 150	U - 350	
F - 80	N - 160	V - 400	
G - 90	P - 170	W - 450	

**7** Insert Size

l (mm)	d
06	5/32"
08	3/16"
11	1/4"
16	3/8"
22	1/2"
27	5/8"

**8** Wedge Clamp

**S** **I** **R** **S** **25** **R** **16** **C**

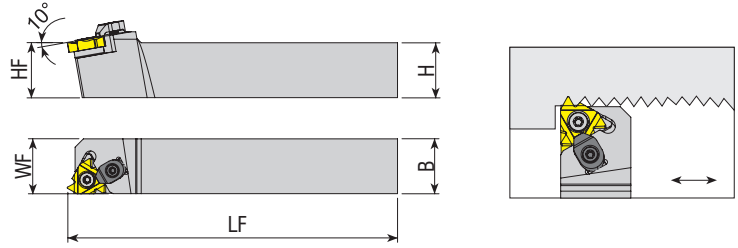





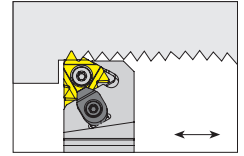
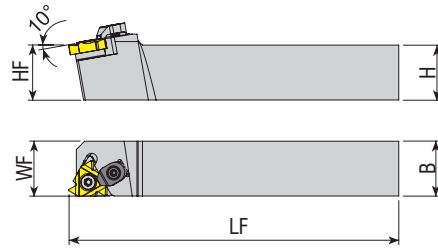

Illustrations shown may vary from actual product.

Ordering Code	Dimensions in Metric				Insert	Screw	Shim	Shim Screw	Wedge Clamp	Clamp Screw	Torx Key
	HF=H	B	LF	WF							
SER 0808 E11	8	8	70	11	11 ER/EL	4008-M2.5x6	-	-	-	-	82-T08
SER 1010 E11	10	10	70	11	11 ER/EL	4008-M2.5x6	-	-	-	-	82-T08
SER 1212 F11	12	12	80	12	11 ER/EL	4008-M2.5x6	-	-	-	-	82-T08
SER 1616 H11	16	16	100	16	11 ER/EL	4008-M2.5x6	-	-	-	-	82-T08
SER 2020 H11	20	20	100	20	11 ER/EL	4008-M2.5x6	-	-	-	-	82-T08
SER 1616 H16C	16	16	100	16	16 ER/EL (0.35 – 3) ISO METRIC	4015-M3.5x14	AATN-2-0020	AAV-06-M3.5x11	ACK-05	4015 M4x11	80-T15
SER 2020 K16C	20	20	125	20	16 ER/EL (0.35 – 3) ISO METRIC	4015-M3.5x14	AATN-2-0020	AAV-06-M3.5x11	ACK-05	4015 M4x11	80-T15
SER 2525 M16C	25	25	150	25	16 ER/EL (0.35 – 3) ISO METRIC	4015-M3.5x14	AATN-2-0020	AAV-06-M3.5x11	ACK-05	4015 M4x11	80-T15
SER 3232 P16C	32	32	170	32	16 ER/EL (0.35 – 3) ISO METRIC	4015-M3.5x14	AATN-2-0020	AAV-06-M3.5x11	ACK-05	4015 M4x11	80-T15
SER 2525 M22C	25	25	150	25	22 ER/EL (3.5 – 4.5) ISO METRIC	1020-M4.5x16	AATN-2-0004	AAV-07-M4.5x13	ACK-05	4015 M4x11	80-T20
SER 3232 P22C	32	32	170	32	22 ER/EL (3.5 – 4.5) ISO METRIC	1020-M4.5x16	AATN-2-0004	AAV-07-M4.5x13	ACK-05	4015 M4x11	80-T20
SER 4040 S22C	40	40	250	40	22 ER/EL (3.5 – 4.5) ISO METRIC	1020-M4.5x16	AATN-2-0004	AAV-07-M4.5x13	ACK-05	4015 M4x11	80-T20
SER 2525 M16C-T	25	25	150	25	16 ER/L (1.5-3 TR)	4015-M3.5x14	-	-	ACK-05	4015 M4x11	80-T15
SER 2525 M22C-T	25	25	150	25	22 ER/L (4-6 TR)	1020-M4.5x16	-	-	ACK-05	4015 M4x11	80-T20
SER 2020 K16C-S	20	20	125	25	SNDVK 166 ER/L16	4015-M3.5x14	AATN-2-0020	AAV-06-M3.5x11	ACK-05	4015 M4x11	80-T15
SER 2525 M16C-S	25	25	150	31	SNDVK 166 ER/L16	4015-M3.5x14	AATN-2-0020	AAV-06-M3.5x11	ACK-05	4015 M4x11	80-T15
SER 3232 P16C-S	32	32	170	38.5	SNDVK 166 ER/L16	4015-M3.5x14	AATN-2-0020	AAV-06-M3.5x11	ACK-05	4015 M4x11	80-T15





Illustrations shown may vary from actual product.

Dimensions in Metric											
Ordering Code	HF=H	B	LF	WF	Insert	Screw	Shim	Shim Screw	Wedge Clamp	Clamp Screw	Torx Key
SEL 0808 E11	8	8	70	11	11 ER/EL	4008-M2.5x6	-	-	-	-	82-T08
SEL 1010 E11	10	10	70	11	11 ER/EL	4008-M2.5x6	-	-	-	-	82-T08
SEL 1212 F11	12	12	80	12	11 ER/EL	4008-M2.5x6	-	-	-	-	82-T08
SEL 1616 H11	16	16	100	16	11 ER/EL	4008-M2.5x6	-	-	-	-	82-T08
SEL 2020 H11	20	20	100	20	11 ER/EL	4008-M2.5x6	-	-	-	-	82-T08
SEL 1616 H16C	16	16	100	16	16 ER/EL (0.35 - 3) ISO METRIC	4015-M3.5x14	AATN-2-0020	AAV-06-M3.5x11	ACK-05	4015 M4x11	80-T15
SEL 2020 K16C	20	20	125	20	16 ER/EL (0.35 - 3) ISO METRIC	4015-M3.5x14	AATN-2-0020	AAV-06-M3.5x11	ACK-05	4015 M4x11	80-T15
SEL 2525 M16C	25	25	150	25	16 ER/EL (0.35 - 3) ISO METRIC	4015-M3.5x14	AATN-2-0020	AAV-06-M3.5x11	ACK-05	4015 M4x11	80-T15
SEL 3232 P16C	32	32	170	32	16 ER/EL (0.35 - 3) ISO METRIC	4015-M3.5x14	AATN-2-0020	AAV-06-M3.5x11	ACK-05	4015 M4x11	80-T15
SEL 2525 M22C	25	25	150	25	22 ER/EL (3.5 - 4.5) ISO METRIC	1020-M4.5x16	AATN-2-0004	AAV-07-M4.5x13	ACK-05	4015 M4x11	80-T20
SEL 3232 P22C	32	32	170	32	22 ER/EL (3.5 - 4.5) ISO METRIC	1020-M4.5x16	AATN-2-0004	AAV-07-M4.5x13	ACK-05	4015 M4x11	80-T20
SEL 4040 S22C	40	40	250	40	22 ER/EL (3.5 - 4.5) ISO METRIC	1020-M4.5x16	AATN-2-0004	AAV-07-M4.5x13	ACK-05	4015 M4x11	80-T20
SEL 2525 M16C-T	25	25	150	25	16 ER/L (1.5-3 TR)	4015-M3.5x14	-	-	ACK-05	4015 M4x11	80-T15
SEL 2525 M22C-T	25	25	150	25	22 ER/L (4-6 TR)	1020-M4.5x16	-	-	ACK-05	4015 M4x11	80-T20
SEL 2020 K16C-S	20	20	125	25	SNDVK 166 ER/L16	4015-M3.5x14	AATN-2-0020	AAV-06-M3.5x11	ACK-05	4015 M4x11	80-T15
SEL 2525 M16C-S	25	25	150	31	SNDVK 166 ER/L16	4015-M3.5x14	AATN-2-0020	AAV-06-M3.5x11	ACK-05	4015 M4x11	80-T15
SEL 3232 P16C-S	32	32	170	38.5	SNDVK 166 ER/L16	4015-M3.5x14	AATN-2-0020	AAV-06-M3.5x11	ACK-05	4015 M4x11	80-T15

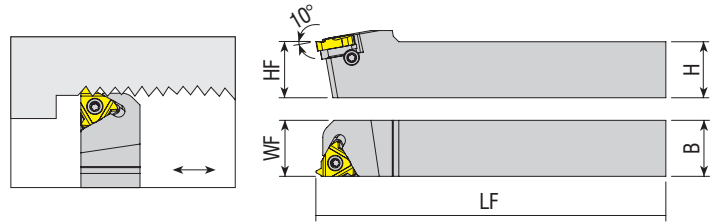

Illustrations shown may vary from actual product.

Dimensions in Metric



Ordering Code	HF=H	B	LF	WF	Insert	Screw	Right Shim	Left Shim	Shim Screw	Shim Screw Ring	Torx Key
TER 1616 H16	16	16	100	16	16 ER/EL	1710-U5-40x12.2	ATS-16E	ATS-16I	AAV-11-U5-40x4.5	ABPL-03	82-T10
TER 2020 K16	20	20	125	20	16 ER/EL	1710-U5-40x12.2	ATS-16E	ATS-16I	AAV-11-U5-40x4.5	ABPL-03	82-T10
TER 2525 M16	25	25	150	25	16 ER/EL	1710-U5-40x12.2	ATS-16E	ATS-16I	AAV-11-U5-40x4.5	ABPL-03	82-T10
TER 3232 P16	32	32	170	32	16 ER/EL	1710-U5-40x12.2	ATS-16E	ATS-16I	AAV-11-U5-40x4.5	ABPL-03	82-T10
TER 2525 M22	25	25	150	25	22 ER/EL	1720-U8-32x15	ATS-22E	ATS-22I	AAV-12-U8-32x5.5	ABPL-04	80-T20
TER 3232 P22	32	32	170	32	22 ER/EL	1720-U8-32x15	ATS-22E	ATS-22I	AAV-12-U8-32x5.5	ABPL-04	80-T20
TER 4040 S22	40	40	250	40	22 ER/EL	1720-U8-32x15	ATS-22E	ATS-22I	AAV-12-U8-32x5.5	ABPL-04	80-T20
TER 2525 M27	25	25	150	25	27 ER/EL	1620-M5x22	ATS-27E	ATS-27I	AAV-15-M5x5.7	ABPL-05	80-T20
TER 3232 P27	32	32	170	32	27 ER/EL	1620-M5x22	ATS-27E	ATS-27I	AAV-15-M5x5.7	ABPL-05	80-T20
TER 4040 S27	40	40	250	40	27 ER/EL	1620-M5x22	ATS-27E	ATS-27I	AAV-15-M5x5.7	ABPL-05	80-T20
TEL 1616 H16	16	16	100	16	16 ER/EL	1710-U5-40x12.2	ATS-16E	ATS-16I	AAV-11-U5-40x4.5	ABPL-03	82-T10
TEL 2020 K16	20	20	125	20	16 ER/EL	1710-U5-40x12.2	ATS-16E	ATS-16I	AAV-11-U5-40x4.5	ABPL-03	82-T10
TEL 2525 M16	25	25	150	25	16 ER/EL	1710-U5-40x12.2	ATS-16E	ATS-16I	AAV-11-U5-40x4.5	ABPL-03	82-T10
TEL 3232 P16	32	32	170	32	16 ER/EL	1710-U5-40x12.2	ATS-16E	ATS-16I	AAV-11-U5-40x4.5	ABPL-03	82-T10
TEL 2525 M22	25	25	150	25	22 ER/EL	1720-U8-32x15	ATS-22E	ATS-22I	AAV-12-U8-32x5.5	ABPL-04	80-T20
TEL 3232 P22	32	32	170	32	22 ER/EL	1720-U8-32x15	ATS-22E	ATS-22I	AAV-12-U8-32x5.5	ABPL-04	80-T20
TEL 4040 S22	40	40	250	40	22 ER/EL	1720-U8-32x15	ATS-22E	ATS-22I	AAV-12-U8-32x5.5	ABPL-04	80-T20
TEL 2525 M27	25	25	150	25	27 ER/EL	1620-M5x22	ATS-27E	ATS-27I	AAV-15-M5x5.7	ABPL-05	80-T20
TEL 3232 P27	32	32	170	32	27 ER/EL	1620-M5x22	ATS-27E	ATS-27I	AAV-15-M5x5.7	ABPL-05	80-T20
TEL 4040 S27	40	40	250	40	27 ER/EL	1620-M5x22	ATS-27E	ATS-27I	AAV-15-M5x5.7	ABPL-05	80-T20



Illustrations shown may vary from actual product.

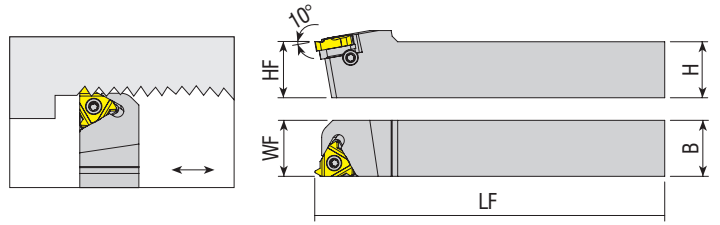

Dimensions in Inch

Ordering Code	HF=H	B	LF	WF	Insert	Screw	Right Shim	Left Shim	Shim Screw	Shim Screw Ring	Torx Key
TER 12 3B	0.750	0.750	4.500	1.000	16 ER	1710-U5-40X12.2	ATS-16E	ATS-16I	AAV-11-U5-40X4.5	ABPL-03	82-T10
TER 12 3C	0.750	0.750	5.000	1.000	16 ER	1710-U5-40X12.2	ATS-16E	ATS-16I	AAV-11-U5-40X4.5	ABPL-03	82-T10
TER 16 3D	1.000	1.000	6.000	1.250	16 ER	1710-U5-40X12.2	ATS-16E	ATS-16I	AAV-11-U5-40X4.5	ABPL-03	82-T10
TER 16 4D	1.000	1.000	6.000	1.250	22 ER	1720-U8-32X15	ATS-22E	ATS-22I	AAV-12-U8-32X5.5	ABPL-04	80-T20
TEL 12 3B	0.750	0.750	4.500	1.000	16 EL	1710-U5-40X12.2	ATS-16E	ATS-16I	AAV-11-U5-40X4.5	ABPL-03	82-T10
TEL 12 3C	0.750	0.750	5.000	1.000	16 EL	1710-U5-40X12.2	ATS-16E	ATS-16I	AAV-11-U5-40X4.5	ABPL-03	82-T10
TEL 16 3D	1.000	1.000	6.000	1.250	16 EL	1710-U5-40X12.2	ATS-16E	ATS-16I	AAV-11-U5-40X4.5	ABPL-03	82-T10
TEL 16 4D	1.000	1.000	6.000	1.250	22 EL	1720-U8-32X15	ATS-22E	ATS-22I	AAV-12-U8-32X5.5	ABPL-04	80-T20



Illustrations shown may vary from actual product.

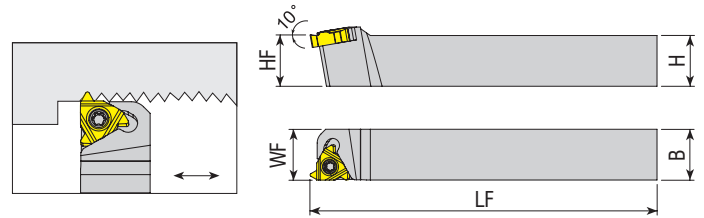

Dimensions in Metric

Ordering Code	HF=H	B	LF	WF	Insert	Screw	Shim	Shim Screw	Wedge Clamp	Clamp Screw	Torx Key
SER 1010 K11-S	10	10	125	10	11 ER/EL	4008-M2.5x6	-	-	-	-	82-T08
SER 1212 K11-S	12	12	125	12	11 ER/EL	4008-M2.5x6	-	-	-	-	82-T08
SER 1212 K16-S	12	12	125	12	16 ER 3.5 (0.35 - 3)	4015-M3.5X14	AATN-2-0020	AAV-08-M3.5X8	-	-	80-T15
SEL 1010 K11-S	10	10	125	10	11 ER/EL	4008-M2.5x6	-	-	-	-	82-T08
SEL 1212 K11-S	12	12	125	12	11 ER/EL	4008-M2.5x6	-	-	-	-	82-T08
SEL 1212 K16-S	12	12	125	12	16 ER 3.5 (0.35 - 3)	4015-M3.5X14	AATN-2-0020	AAV-08-M3.5X8	-	-	80-T15

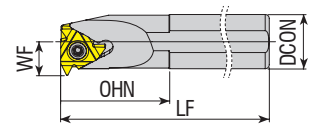
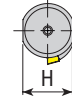
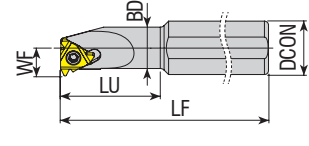
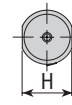
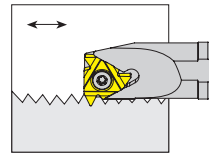

Illustrations shown may vary from actual product.

Dimensions in Metric



Ordering Code	DCON	BD	LF	LU=OHN	WF	DMIN	Insert	Screw	Shim	Shim Screw	Wedge Clamp	Clamp Screw	Torx Key
SIR S12X05H 06	12	5	100	15	4.3	6.4	06 IR/L	3006-M2X3.6	-	-	-	-	82-T06
SIR S16X05H 06	16	5	100	15	4.3	6.4	06 IR/L	3006-M2X3.6	-	-	-	-	82-T06
SIR S16X07M 08	16	7	150	18	5.3	7.8	08 IR/L	3007-M2.2x4.6	-	-	-	-	82-T07
SIR S10H 11	10	10	100	-	7.4	12	11 IR/L	4008-M2.5x6	-	-	-	-	82-T08
SIR A10H 11	10	10	100	-	7.4	12	11 IR/L	4008-M2.5x6	-	-	-	-	82-T08
SIR S12K 11	12	12	125	-	8.4	15	11 IR/L	4008-M2.5x6	-	-	-	-	82-T08
SIR A12K 11	12	12	125	-	8.4	15	11 IR/L	4008-M2.5x6	-	-	-	-	82-T08
SIR S16X10M 11	16	10	150	25	7.4	12	11 IR/L	4008-M2.5x6	-	-	-	-	82-T08
SIR S16X13M 11	16	13	150	32	8.9	15	11 IR/L	4008-M2.5x6	-	-	-	-	82-T08
SIR S16M 11	16	16	150	-	11.7	19	11 IR/L	4008-M2.5x6	-	-	-	-	82-T08
SIR A16X13M 16	16	12.8	150	32	10.2	16	16 IR/L (0.35 - 3) ISO METRIC	4015-M3.5x9	-	-	-	-	80-T15
SIR S16X13M 16	16	13	150	32	10.2	16	16 IR/L (0.35 - 3) ISO METRIC	4015-M3.5x9	-	-	-	-	80-T15
SIR S16M 16	16	16	150	-	11.7	19	16 IR/L (0.35 - 3) ISO METRIC	4015-M3.5x11	-	-	-	-	80-T15
SIR S20X16P 16	20	16	170	40	11.7	19	16 IR/L (0.35 - 3) ISO METRIC	4015-M3.5x11	-	-	-	-	80-T15
SIR A20X16P 16	20	16	170	40	11.7	19	16 IR/L (0.35 - 3) ISO METRIC	4015-M3.5x14	AATN-2-0020	AAV-08-M3.5x8	ACK-05	4015-M4x11	80-T15
SIR S20P 16	20	20	170	-	13.7	24	16 IR/L (0.35 - 3) ISO METRIC	4015-M3.5x14	AATN-2-0020	AAV-06-M3.5x11	ACK-05	4015-M4x11	80-T15
SIR S25R 16C	25	25	200	-	16.2	29	16 IR/L (0.35 - 3) ISO METRIC	4015-M3.5x14	AATN-2-0020	AAV-06-M3.5x11	ACK-05	4015-M4x11	80-T15
SIR S32S 16C	32	32	250	-	19.7	36	16 IR/L (0.35 - 3) ISO METRIC	4015-M3.5x14	AATN-2-0020	AAV-06-M3.5x11	ACK-05	4015-M4x11	80-T15
SIR S40T 16C	40	40	300	-	23.7	44	16 IR/L (0.35 - 3) ISO METRIC	4015-M3.5x14	AATN-2-0020	AAV-06-M3.5x11	ACK-05	4015-M4x11	80-T15
SIR S50U 16C	50	50	350	-	28.7	54	16 IR/L (0.35 - 3) ISO METRIC	4020-M4.5x12	-	-	-	-	80-T15
SIR S20P 22	20	20	170	-	15.7	24	22 IR/L (3.5 - 4.5) ISO METRIC	1020-M4.5x16	AATN-2-0004	AAV-10-M4.5x8	ACK-05	4015-M4x11	-
SIR S25R 22C	25	25	200	-	18.1	30	22 IR/L (3.5 - 4.5) ISO METRIC	1020-M4.5x16	AATN-2-0004	AAV-10-M4.5x8	ACK-05	4015-M4x11	80-T20
SIR S32S 22C	32	32	250	-	21.6	38	22 IR/L (3.5 - 4.5) ISO METRIC	1020-M4.5x16	AATN-2-0004	AAV-07-M4.5x13	ACK-05	4015-M4x11	80-T20
SIR S40T 22C	40	40	300	-	25.6	46	22 IR/L (3.5 - 4.5) ISO METRIC	1020-M4.5x16	AATN-2-0004	AAV-07-M4.5x13	ACK-05	4015-M4x11	80-T15
SIR S50U 22C	50	50	350	-	30.6	58	22 IR/L (3.5 - 4.5) ISO METRIC	1020-M4.5x16	AATN-2-0004	AAV-07-M4.5x13	ACK-05	4015-M4x11	80-T15
SIR S25R 16C-T	25	25	200	-	16.2	29	16 IR/L (1.5-3 TR)	4015-M3.5x14	-	-	ACK-05	4015-M4x11	80-T15
SIR S32S 16C-T	32	32	250	-	19.7	36	16 IR/L (1.5-3 TR)	4015-M3.5x14	-	-	-	-	80-T15
SIR S25R 22C-T	25	25	200	-	18.1	30	22 IR/L (4-6 TR)	4015-M4x11	-	-	-	-	80-T20
SIR S32S 22C-T	32	32	250	-	21.6	38	22 IR/L (4-6 TR)	4015-M4x11	-	-	-	-	80-T20

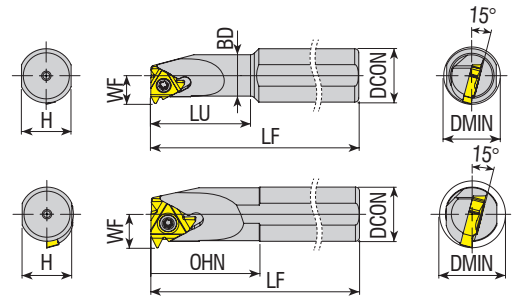
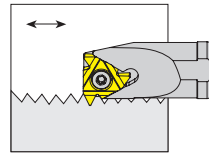

Illustrations shown may vary from actual product.

Dimensions in Metric

Ordering Code	DCON	BD	LF	LU=OHN	WF	DMIN							
							Insert	Screw	Shim	Shim Screw	Wedge Clamp	Clamp Screw	Torx Key
SIL S12X05H 06	12	5	100	15	4.3	6.4	06 IR/L	3006-M2X3.6	-	-	-	-	82-T06
SIL S16X05H 06	16	5	100	15	4.3	6.4	06 IR/L	3006-M2X3.6	-	-	-	-	82-T06
SIL S16X07M 08	16	7	150	18	5.3	7.8	08 IR/L	3007-M2.2x4.6	-	-	-	-	82-T07
SIL S10H 11	10	10	100	-	7.4	12	11 IR/L	4008-M2.5x6	-	-	-	-	82-T08
SIL A10H 11	10	10	100	-	7.4	12	11 IR/L	4008-M2.5x6	-	-	-	-	82-T08
SIL S12K 11	12	12	125	-	8.4	15	11 IR/L	4008-M2.5x6	-	-	-	-	82-T08
SIL A12K 11	12	12	125	-	8.4	15	11 IR/L	4008-M2.5x6	-	-	-	-	82-T08
SIL S16X10M 11	16	10	150	25	7.4	12	11 IR/L	4008-M2.5x6	-	-	-	-	82-T08
SIL S16X13M 11	16	13	150	32	8.9	15	11 IR/L	4008-M2.5x6	-	-	-	-	82-T08
SIL S16M 11	16	16	150	-	11.7	19	11 IR/L	4008-M2.5x6	-	-	-	-	82-T08
SIL A16X13M 16	16	12.8	150	32	10.2	16	16 IR/L (0.35 - 3) ISO METRIC	4015-M3.5x9	-	-	-	-	80-T15
SIL S16X13M 16	16	13	150	32	10.2	16	16 IR/L (0.35 - 3) ISO METRIC	4015-M3.5x9	-	-	-	-	80-T15
SIL S16M 16	16	16	150	-	11.7	19	16 IR/L (0.35 - 3) ISO METRIC	4015-M3.5x11	-	-	-	-	80-T15
SIL S20X16P 16	20	16	170	40	11.7	19	16 IR/L (0.35 - 3) ISO METRIC	4015-M3.5x11	-	-	-	-	80-T15
SIL A20X16P 16	20	16	170	40	11.7	19	16 IR/L (0.35 - 3) ISO METRIC	4015-M3.5x14	AATN-2-0020	AAV-08-M3.5x8	ACK-05	4015-M4x11	80-T15
SIL S20P 16	20	20	170	-	13.7	24	16 IR/L (0.35 - 3) ISO METRIC	4015-M3.5x14	AATN-2-0020	AAV-06-M3.5x11	ACK-05	4015-M4x11	80-T15
SIL S25R 16C	25	25	200	-	16.2	29	16 IR/L (0.35 - 3) ISO METRIC	4015-M3.5x14	AATN-2-0020	AAV-06-M3.5x11	ACK-05	4015-M4x11	80-T15
SIL S32S 16C	32	32	250	-	19.7	36	16 IR/L (0.35 - 3) ISO METRIC	4015-M3.5x14	AATN-2-0020	AAV-06-M3.5x11	ACK-05	4015-M4x11	80-T15
SIL S40T 16C	40	40	300	-	23.7	44	16 IR/L (0.35 - 3) ISO METRIC	4015-M3.5x14	AATN-2-0020	AAV-06-M3.5x11	ACK-05	4015-M4x11	80-T15
SIL S50U 16C	50	50	350	-	28.7	54	16 IR/L (0.35 - 3) ISO METRIC	4020-M4.5x12	-	-	-	-	80-T15
SIL S20P 22	20	20	170	-	15.7	24	22 IR/L (3.5 - 4.5) ISO METRIC	1020-M4.5x16	AATN-2-0004	AAV-10-M4.5x8	ACK-05	4015-M4x11	-
SIL S25R 22C	25	25	200	-	18.1	30	22 IR/L (3.5 - 4.5) ISO METRIC	1020-M4.5x16	AATN-2-0004	AAV-10-M4.5x8	ACK-05	4015-M4x11	80-T20
SIL S32S 22C	32	32	250	-	21.6	38	22 IR/L (3.5 - 4.5) ISO METRIC	1020-M4.5x16	AATN-2-0004	AAV-07-M4.5x13	ACK-05	4015-M4x11	80-T20
SIL S40T 22C	40	40	300	-	25.6	46	22 IR/L (3.5 - 4.5) ISO METRIC	1020-M4.5x16	AATN-2-0004	AAV-07-M4.5x13	ACK-05	4015-M4x11	80-T15
SIL S50U 22C	50	50	350	-	30.6	58	22 IR/L (3.5 - 4.5) ISO METRIC	1020-M4.5x16	AATN-2-0004	AAV-07-M4.5x13	ACK-05	4015-M4x11	80-T15
SIL S25R 16C-T	25	25	200	-	16.2	29	16 IR/L (1.5-3 TR)	4015-M3.5x14	-	-	ACK-05	4015-M4x11	80-T15
SIL S32S 16C-T	32	32	250	-	19.7	36	16 IR/L (1.5-3 TR)	4015-M3.5x14	-	-	-	-	80-T15
SIL S25R 22C-T	25	25	200	-	18.1	30	22 IR/L (4-6 TR)	4015-M4x11	-	-	-	-	80-T20
SIL S32S 22C-T	32	32	250	-	21.6	38	22 IR/L (4-6 TR)	4015-M4x11	-	-	-	-	80-T20

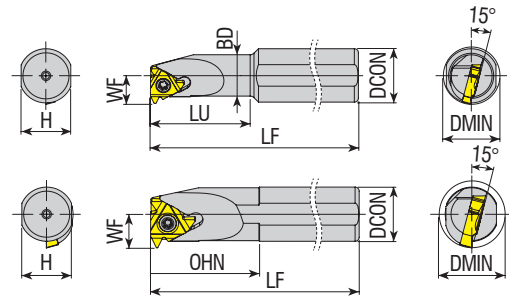
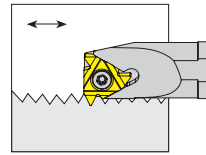

Illustrations shown may vary from actual product.

Dimensions in Metric

Ordering Code	DCON	H	LF	OHN	WF	DMIN							
							Insert	Screw	Left Shim	Right Shim	Shim Screw	Shim Screw Ring	Torx Key
TIR S25R 16	25	23	200	-	16.2	29	16 IR/L	1710-U5-40x12.2	ATS-16E	ATS-16I	AAV-11-U5-40x4.5	ABPL-03	82-T10
TIR S32S 16	32	30	250	-	19.7	36	16 IR/L	1710-U5-40x12.2	ATS-16E	ATS-16I	AAV-11-U5-40x4.5	ABPL-03	82-T10
TIR S40T 16	40	37.5	300	-	23.7	44	16 IR/L	1710-U5-40x12.2	ATS-16E	ATS-16I	AAV-11-U5-40x4.5	ABPL-03	82-T10
TIR S50U 16	50	47	350	-	28.7	54	16 IR/L	1710-U5-40x12.2	ATS-16E	ATS-16I	AAV-11-U5-40x4.5	ABPL-03	82-T10
TIR S25R 22	25	23	200	-	18.1	29	22 IR/L	1720-U8-32x15	ATS-22E	ATS-22I	AAV-12-U8-32x5.5	ABPL-04	80-T20
TIR S32S 22	32	30	250	-	21.6	38	22 IR/L	1720-U8-32x15	ATS-22E	ATS-22I	AAV-12-U8-32x5.5	ABPL-04	80-T20
TIR S40T 22	40	37.5	300	-	25.6	46	22 IR/L	1720-U8-32x15	ATS-22E	ATS-22I	AAV-12-U8-32x5.5	ABPL-04	80-T20
TIR S50U 22	50	47	350	-	30.6	58	22 IR/L	1720-U8-32x15	ATS-22E	ATS-22I	AAV-12-U8-32x5.5	ABPL-04	80-T20
TIR S32S 27	32	30	250	-	22.6	40	27 IR/L	1620-M5x18	ATS-27E	ATS-27I	AAV-15-M5x5.7	ABPL-05	80-T20
TIR S40T 27	40	37.5	300	-	26.6	48	27 IR/L	1620-M5x22	ATS-27E	ATS-27I	AAV-15-M5x5.7	ABPL-05	80-T20
TIR S50U 27	50	47	350	-	31.6	58	27 IR/L	1620-M5x22	ATS-27E	ATS-27I	AAV-15-M5x5.7	ABPL-05	80-T20
TIR A20P 16	20	18	170	40	13.7	24	16 IR/L	1710-U5-40x12.2	ATS-16E	ATS-16I	AAV-11-U5-40x4.5	ABPL-03	82-T10
TIR A25R 16	25	23	200	50	16.2	29	16 IR/L	1710-U5-40x12.2	ATS-16E	ATS-16I	AAV-11-U5-40x4.5	ABPL-03	82-T10
TIR A32S 16	32	30	250	60	19.7	36	16 IR/L	1710-U5-40x12.2	ATS-16E	ATS-16I	AAV-11-U5-40x4.5	ABPL-03	82-T10
TIR A40T 16	40	37.5	300	65	23.9	44	16 IR/L	1710-U5-40x12.2	ATS-16E	ATS-16I	AAV-11-U5-40x4.5	ABPL-03	82-T10
TIL S25R 16	25	23	200	-	16.2	29	16 IR/L	1710-U5-40x12.2	ATS-16E	ATS-16I	AAV-11-U5-40x4.5	ABPL-03	82-T10
TIL S32S 16	32	30	250	-	19.7	36	16 IR/L	1710-U5-40x12.2	ATS-16E	ATS-16I	AAV-11-U5-40x4.5	ABPL-03	82-T10
TIL S40T 16	40	37.5	300	-	23.7	44	16 IR/L	1710-U5-40x12.2	ATS-16E	ATS-16I	AAV-11-U5-40x4.5	ABPL-03	82-T10
TIL S50U 16	50	47	350	-	28.7	54	16 IR/L	1710-U5-40x12.2	ATS-16E	ATS-16I	AAV-11-U5-40x4.5	ABPL-03	82-T10
TIL S25R 22	25	23	200	-	18.1	29	22 IR/L	1720-U8-32x15	ATS-22E	ATS-22I	AAV-12-U8-32x5.5	ABPL-04	80-T20
TIL S32S 22	32	30	250	-	21.6	38	22 IR/L	1720-U8-32x15	ATS-22E	ATS-22I	AAV-12-U8-32x5.5	ABPL-04	80-T20
TIL S40T 22	40	37.5	300	-	25.6	46	22 IR/L	1720-U8-32x15	ATS-22E	ATS-22I	AAV-12-U8-32x5.5	ABPL-04	80-T20
TIL S50U 22	50	47	350	-	30.6	58	22 IR/L	1720-U8-32x15	ATS-22E	ATS-22I	AAV-12-U8-32x5.5	ABPL-04	80-T20
TIL S32S 27	32	30	250	-	22.6	40	27 IR/L	1620-M5x18	ATS-27E	ATS-27I	AAV-15-M5x5.7	ABPL-05	80-T20
TIL S40T 27	40	37.5	300	-	26.6	48	27 IR/L	1620-M5x22	ATS-27E	ATS-27I	AAV-15-M5x5.7	ABPL-05	80-T20
TIL S50U 27	50	47	350	-	31.6	58	27 IR/L	1620-M5x22	ATS-27E	ATS-27I	AAV-15-M5x5.7	ABPL-05	80-T20
TIL A20P 16	20	18	170	40	13.7	24	16 IR/L	1710-U5-40x12.2	ATS-16E	ATS-16I	AAV-11-U5-40x4.5	ABPL-03	82-T10
TIL A25R 16	25	23	200	50	16.2	29	16 IR/L	1710-U5-40x12.2	ATS-16E	ATS-16I	AAV-11-U5-40x4.5	ABPL-03	82-T10
TIL A32S 16	32	30	250	60	19.7	36	16 IR/L	1710-U5-40x12.2	ATS-16E	ATS-16I	AAV-11-U5-40x4.5	ABPL-03	82-T10
TIL A40T 16	40	37.5	300	65	23.9	44	16 IR/L	1710-U5-40x12.2	ATS-16E	ATS-16I	AAV-11-U5-40x4.5	ABPL-03	82-T10

## Thread Helix Angle

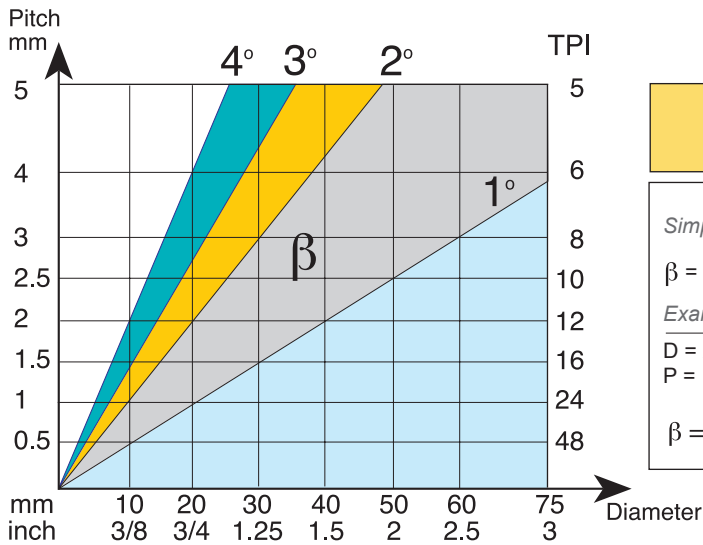

$$\tan \beta = \frac{P}{\pi \times D}$$

Simplified formula  
 $\beta = 20 P/D$   
 Example  
 $D = 25 \text{ mm (0.98")}$   
 $P = 1.5 \text{ mm (16 TPI)}$   
 $\beta = \frac{20 \times 1.5}{25} = 1.2^\circ$

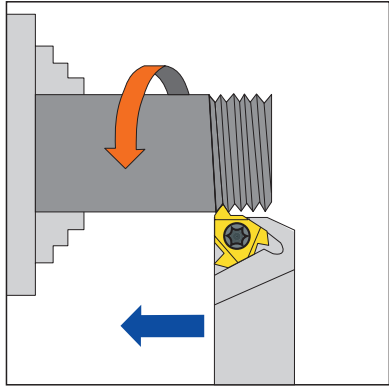

## Standard and Slanted Shim

Akko Toolholders Pockets have a built in 1.5° helix angle. This angle may be adjusted to better match the thread helix angle by simply changing the shim.

Negative helix is usually used when threading RH thread with LH Holder or LH thread with RH Holder.

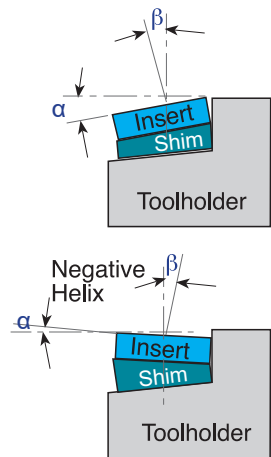

L	IC	Tool Type	Pocket's Angle (α)						
			4.5°	3.5°	2.5°	1.5°	0.5°	-0.5°	-1.5°
16	3/8	EX-RH or IN-LH	ATS-16E+4.5	ATS-16E+3.5	ATS-16E+2.5	ATS-16E	ATS-16E+0.5	ATS-16E-0.5	ATS-16E-1.5
16	3/8	EX-LH or IN-RH	ATS-16I+4.5	ATS-16I+3.5	ATS-16I+2.5	ATS-16I	ATS-16I+0.5	ATS-16I-0.5	ATS-16I-1.5
22	1/2	EX-RH or IN-LH	ATS-22E+4.5	ATS-22E+3.5	ATS-22E+2.5	ATS-22E	ATS-22E+0.5	ATS-22E-0.5	ATS-22E-1.5
22	1/2	EX-LH or IN-RH	ATS-22I+4.5	ATS-22I+3.5	ATS-22I+2.5	ATS-22I	ATS-22I+0.5	ATS-22I-0.5	ATS-22I-1.5
27	5/8	EX-RH or IN-LH	ATS-27E+4.5	ATS-27E+3.5	ATS-27E+2.5	ATS-27E	ATS-27E+0.5	ATS-27E-0.5	ATS-27E-1.5
27	5/8	EX-LH or IN-RH	ATS-27I+4.5	ATS-27I+3.5	ATS-27I+2.5	ATS-27I	ATS-27I+0.5	ATS-27I-0.5	ATS-27I-1.5

## Shim Change Recommendation

As can be seen from the chart, some Pitch to Diameter combinations require a shim change. If change is required, use ATS-E shim for EX-RH and IN-LH toolholders and ATS-I shims for IN-RH and EX-LH toolholders.

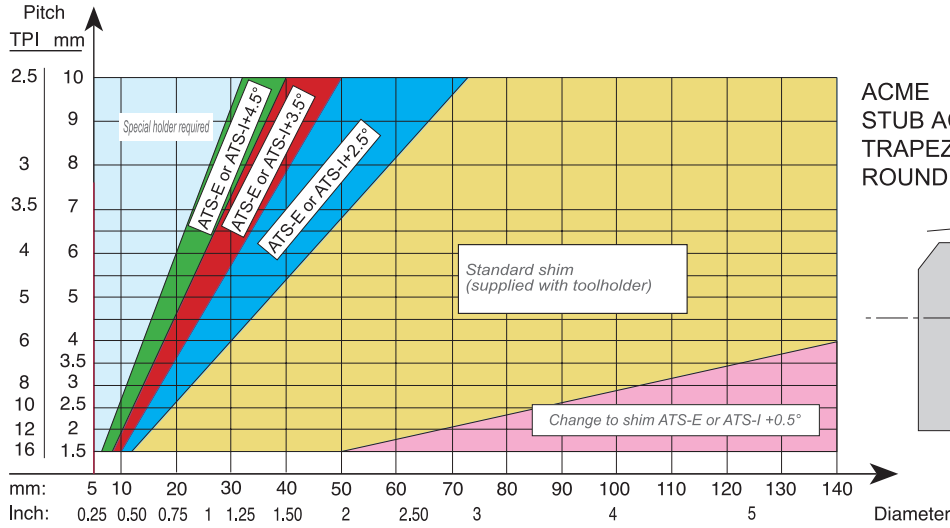

ACME  
STUB ACME  
TRAPEZ (DIN 103)  
ROUND (DIN 405)

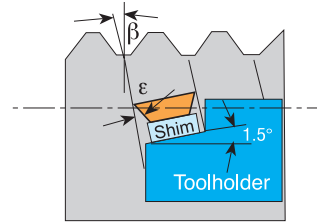

As can be seen from the chart, most applications do not require a shim change. If change is required, use ATS-E shims for EX-RH and IN-LH toolholders and ATS-I shims for IN-RH and EX-LH toolholders.

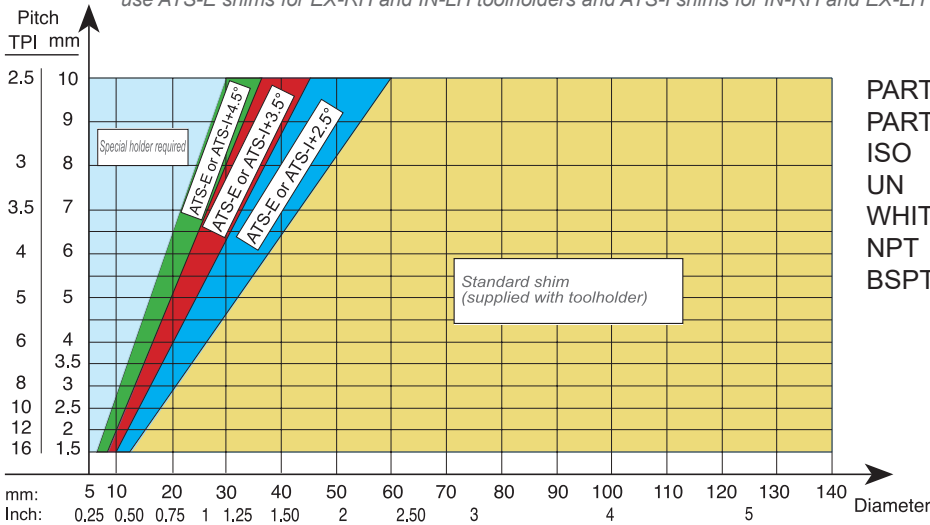

PARTIAL PROFILES 60°  
PARTIAL PROFILES 55°  
ISO  
UN  
WHIT.  
NPT  
BSPT

As can be seen from the chart, most applications require a shim change. In most cases a negative shim is required. use ATS-E shims for EX-RH and IN-LH toolholders. ATS-I shims for IN-RH and EX-LH toolholders.

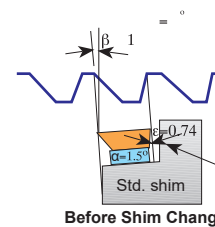
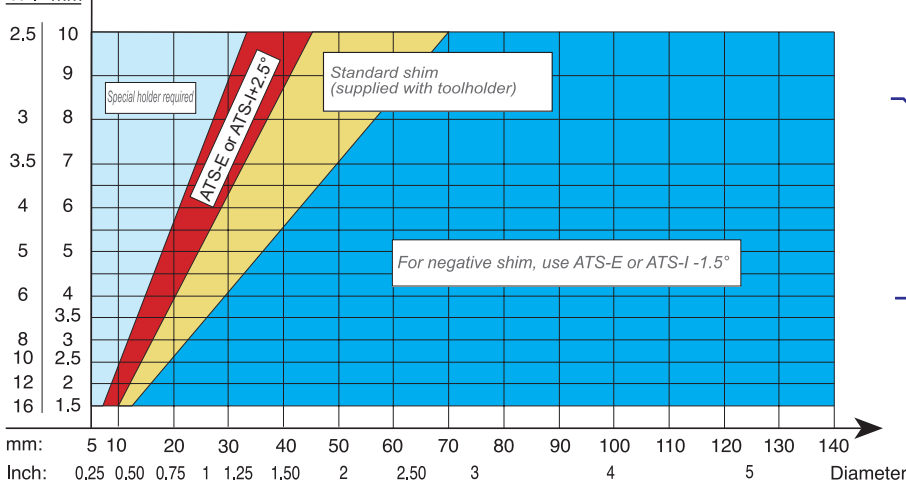

AMERICAN  
BUTTRESS  
SAGENGWINDE  
(DIN 513)

Before Shim Change

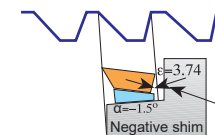

Replacing the standard shim with a shim has negative angle, will eliminate side rubbing

After Shim Change



# THE SPOKEN QUALITY

Indexable Tools, Tool Holder Systems and Cutting Inserts  
[www.akkousa.us](http://www.akkousa.us)



*the spoken quality...*

# GROOVING TOOLHOLDERS



**AKKO** **A** **AKT** - **TD** - **R** - **10**

1 2 3 4 5

**04-06** - **4** - **T22**

6 7 8

**2** *Cutter Style*

DKT: External Grooving Toolholders  
 IKT: Internal Grooving Toolholders  
 AKT: Face Grooving Toolholders  
 LKT: L Type Face Grooving Toolholders

**3** *Insert Type*

KRLY / MGM. HRN / S312, S229, S224, S223 ISCR / DGN, GI, GTN SNDVK / 123, 151, 154.91 ZCC KM / A4. ARN / LOMR.	TGTC / TD.
--	------------

**4** *Cutting Direction*

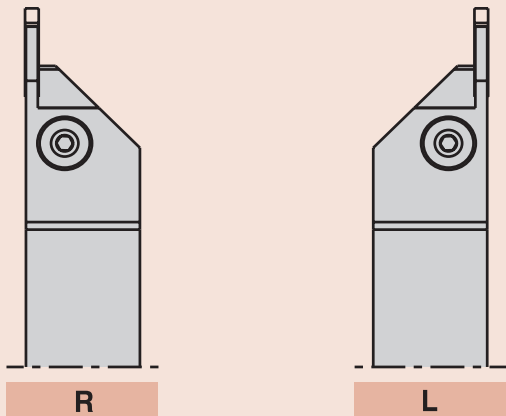

*Please be informed that for AAKT products cutting direction is vice versa what is shown.*

**5** *Cutting Edge Height and Shank Width*

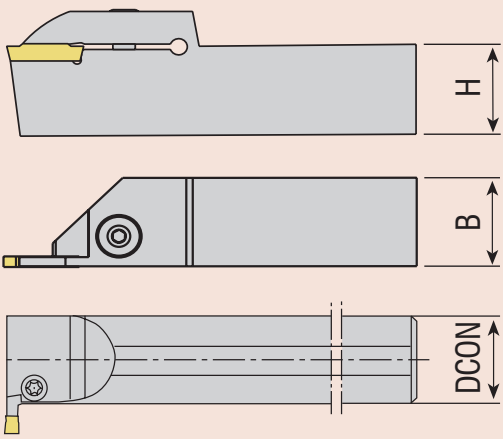

**6** Cutting Diameter

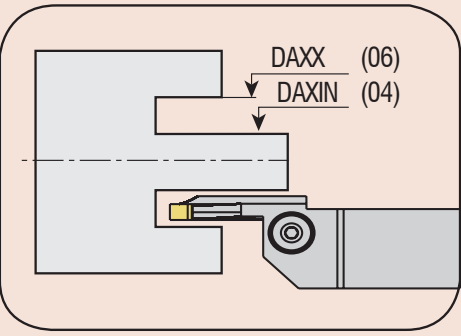

**7** Cutting Width Edge

ÖR/E.G :

2	=0.0787 inch
3	=0.1181 inch
4	=0.1574 inch
5	=0.1968 inch
6	=0.2362 inch
8	= 0.3149

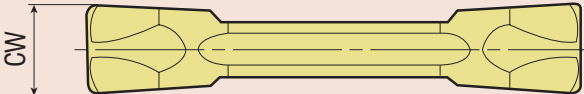

**8** Shank Length



A	4
B	4.5
C	5
D	6
E	7
F	8
G	10
H	12
X	Special

**9** Cutting Depth

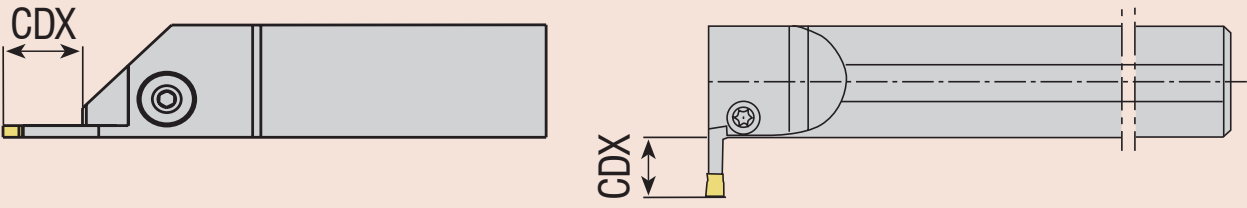

Company Name:

Date:

**Type of Grooving Toolholders**

A Type     B Type     C Type     D Type     E Type

**Cutting Direction**

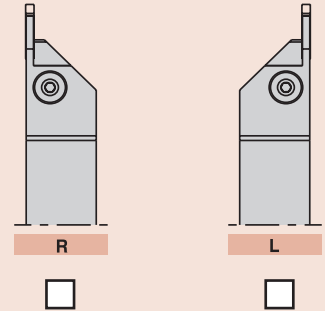

**Coolant Info**



Coolant Hole

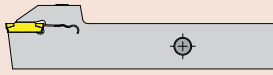

Without Coolant Hole

Can you send the original body/insert ? If Needed!

Yes     No

Insert Code

Insert Brand

**Cutting Width Edge**



CW

**A Type - External Grooving Toolholders**

HF	
WF	
CDX	
LF	
H	
B	

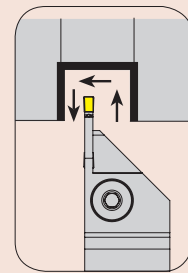
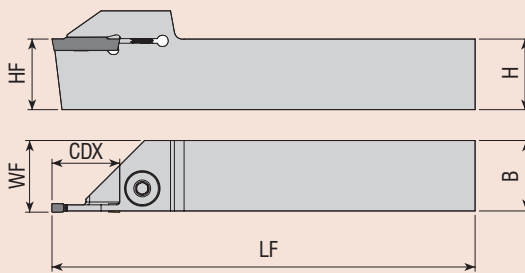

**B Type - Internal Grooving Toolholders**

WF	
OHN	
LF	
DCON	
H	
DMIN	
CDX	

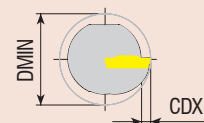
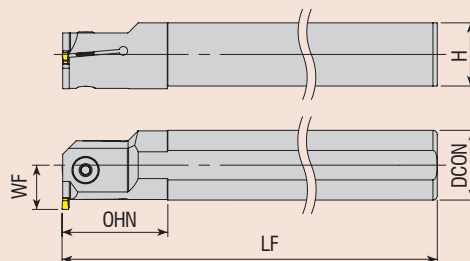

**C Type - L Type Face Grooving**

HF	
WF	
CDX	
LF	
H	
B	
DAXX	
DAXIN	

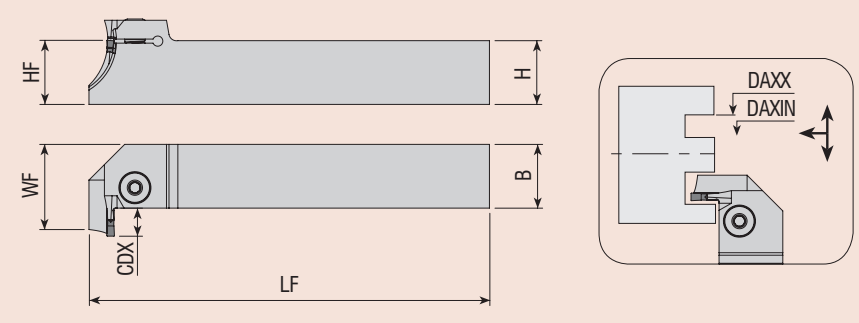

**D Type - Face Grooving Toolholders**

HF	
WF	
CDX	
LF	
H	
B	
DAXX	
DAXIN	

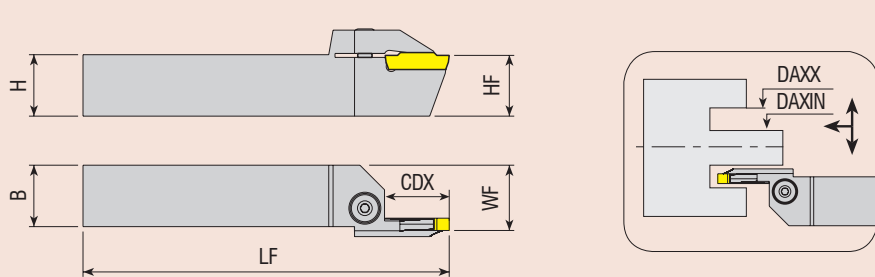

**E Type - Blade Grooving Toolholders**

WF	
WB	
WB2	
L	
CUTDIA	
H	

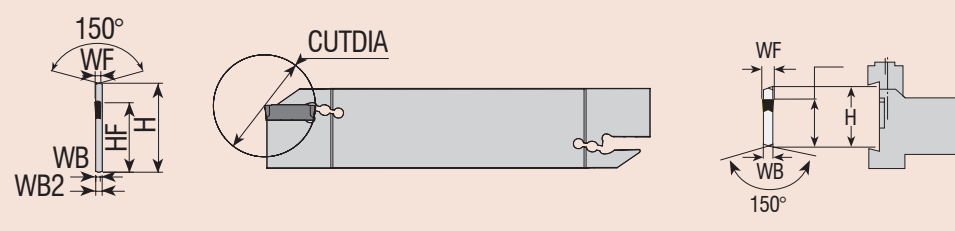



Illustrations shown may vary from actual product.

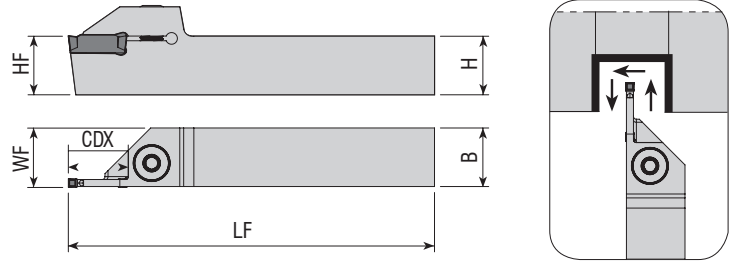

Dimensions in Inch

Ordering Code	HF=H	B	LF	WF	CDX	Insert	Screw	Allen Key
ADKT-GPR-R-10-2C-R063	0.625	0.625	5.000	0.633	0.630	GP.-2	AKV-02-M6x22	AAL-03-3
ADKT-GPR-R-12-2C-R094	0.750	0.750	5.000	0.758	0.940	GP.-2	AKV-02-M6x22	AAL-03-3
ADKT-GPR-R-16-2E-R094	1.000	1.000	7.000	10.080	0.940	GP.-2	2004-M8x1x20	AAL-05-4
ADKT-GPR-R-10-3C-R063	0.625	0.625	5.000	0.637	0.630	GP.-3	2004-M8x1x20	AAL-05-4
ADKT-GPR-R-12-3C-R079	0.750	0.750	5.000	0.762	0.790	GP.-3	2004-M8x1x20	AAL-05-4
ADKT-GPR-R-12-3C-R094	0.750	0.750	5.000	0.762	0.940	GP.-3	2004-M8x1x20	AAL-05-4
ADKT-GPR-R-16-3D-R079	1.000	1.000	6.000	10.120	0.790	GP.-3	2004-M8x1x20	AAL-05-4
ADKT-GPR-R-16-3E-R126	1.000	1.000	7.000	10.120	1.260	GP.-3	2004-M8x1x20	AAL-05-4
ADKT-GPR-R-16-4E-R126	1.000	1.000	7.000	10.157	1.260	GP.-4	2004-M8x1x20	AAL-05-4
ADKT-GPR-R-16-5E-R126	1.000	1.000	7.000	10.196	1.260	GP.-5	2004-M8x1x20	AAL-05-4
ADKT-GPR-R-16-6E-R126	1.000	1.000	7.000	10.196	1.260	GP.-6	2004-M8x1x20	AAL-05-4
ADKT-GPR-L-10-2C-R063	0.625	0.625	5.000	0.633	0.630	GP.-2	AKV-02-M6x22	AAL-03-3
ADKT-GPR-L-12-2C-R094	0.750	0.750	5.000	0.758	0.940	GP.-2	AKV-02-M6x22	AAL-03-3
ADKT-GPR-L-16-2E-R094	1.000	1.000	7.000	10.080	0.940	GP.-2	2004-M8x1x20	AAL-05-4
ADKT-GPR-L-10-3C-R063	0.625	0.625	5.000	0.637	0.630	GP.-3	2004-M8x1x20	AAL-05-4
ADKT-GPR-L-12-3C-R079	0.750	0.750	5.000	0.762	0.790	GP.-3	2004-M8x1x20	AAL-05-4
ADKT-GPR-L-12-3C-R094	0.750	0.750	5.000	0.762	0.940	GP.-3	2004-M8x1x20	AAL-05-4
ADKT-GPR-L-16-3D-R079	1.000	1.000	6.000	10.120	0.790	GP.-3	2004-M8x1x20	AAL-05-4
ADKT-GPR-L-16-3E-R126	1.000	1.000	7.000	10.120	1.260	GP.-3	2004-M8x1x20	AAL-05-4
ADKT-GPR-L-16-4E-R126	1.000	1.000	7.000	10.157	1.260	GP.-4	2004-M8x1x20	AAL-05-4
ADKT-GPR-L-16-5E-R126	1.000	1.000	7.000	10.196	1.260	GP.-5	2004-M8x1x20	AAL-05-4
ADKT-GPR-L-16-6E-R126	1.000	1.000	7.000	10.196	1.260	GP.-6	2004-M8x1x20	AAL-05-4

Compatible with PRMT Insert.

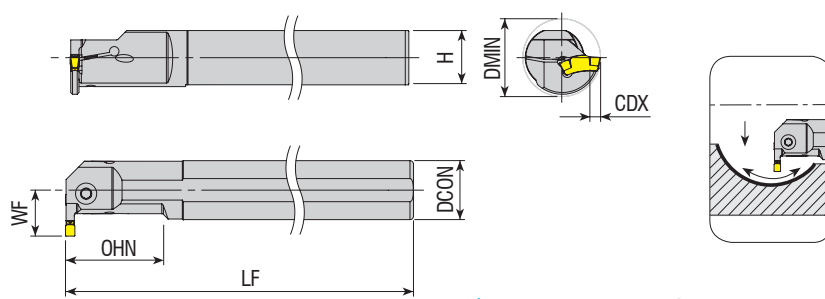

Illustrations shown may vary from actual product.

Dimensions in Inch

Ordering Code	DCON	DMIN	LF	OHN	CDX	H	WF	Insert	Screw	Torx Key
<b>AIKT-IGI-R-12-3-T020</b>	0.714	0.787	8.000	1.750	0.570	0.677	0.570	GIMIY-3	1020-M5X14	80-T20
<b>AIKT-IGI-R-16-4-T019</b>	0.961	0.984	8.000	2.300	0.19	0.921	0.690	GIMIY-4	1020-M5X14	80-T20
<b>AIKT-IGI-R-20-4-T021</b>	1.195	1.496	10.000	1.750	0.21	1.142	0.830	GIMIY-4	1020-M5X14	80-T20



Compatible with ISCR insert.

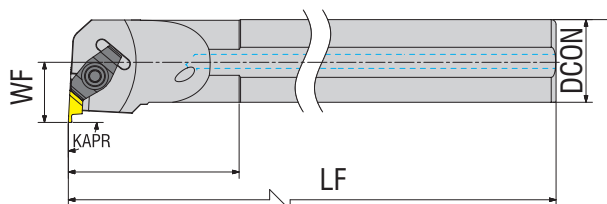

Illustrations shown may vary from actual product.

Dimensions in Inch

Ordering Code	DCON	H	LF	OHN	WF	DMIN	Insert	Wedge Clamp	Clamp Screw	Allen Key
<b>A16T ANER 3</b>	1.000	0.960	12.000	2.250	0.688	1.375	N.. 3	CM-73LP	AKV-41-U10-32x18.5	AAL-17-5/32
<b>A20U ANER 3</b>	1.250	1.170	14.000	2.500	0.880	1.750	N.. 3	CM-73LP	AKV-41-U10-32x18.5	AAL-17-5/32
<b>A24U ANER 3</b>	1.500	1.378	14.000	2.750	1.000	2.000	N.. 3	CM-73LP	AKV-41-U10-32x18.5	AAL-17-5/32
<b>A32V ANER 3</b>	2.000	1.882	16.000	3.000	1.250	2.500	N.. 3	CM-73LP	AKV-41-U10-32x18.5	AAL-17-5/32
<b>A32V ANER 4</b>	2.000	1.882	16.000	3.000	1.296	2.750	N.. 4	CM-73LP	AKV-41-U10-32x18.5	AAL-17-5/32
<b>A16T ANEL 3</b>	1.000	0.960	12.000	2.250	0.688	1.375	N.. 3	CM-73LP	AKV-41-U10-32x18.5	AAL-17-5/32
<b>A20U ANEL 3</b>	1.250	1.170	14.000	2.500	0.880	1.750	N.. 3	CM-73LP	AKV-41-U10-32x18.5	AAL-17-5/32
<b>A24U ANEL 3</b>	1.500	1.378	14.000	2.750	1.000	2.000	N.. 3	CM-73LP	AKV-41-U10-32x18.5	AAL-17-5/32
<b>A32V ANEL 3</b>	2.000	1.882	16.000	3.000	1.250	2.500	N.. 3	CM-73LP	AKV-41-U10-32x18.5	AAL-17-5/32
<b>A32V ANEL 4</b>	2.000	1.882	16.000	3.000	1.296	2.750	N.. 4	CM-73LP	AKV-41-U10-32x18.5	AAL-17-5/32



Compatible with KNMTL insert.



*the spoken quality...*





*the spoken quality...*

# U-DRILL

DRILLING AND HOLEMAKING TOOLS



**AKKO** **A** **TUM** **750** x **D3**

**S** **P** **G** **T** **06** **02** **04**

**2** *Cutter Style*

TUM: U-Drill

**3** *Tool Diameter*

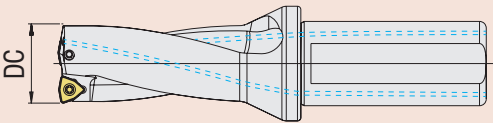

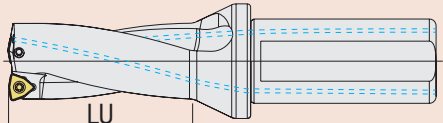

**4** *Drilling Depth*





D x 2  
D x 3  
D x 4  
D x 5

**5** *Insert Form*

	
<b>W</b>	<b>S</b>

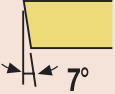
**6** *Clearance angle of Insert*

	
<b>C</b>	<b>P</b>

**7** Tolerance Classes

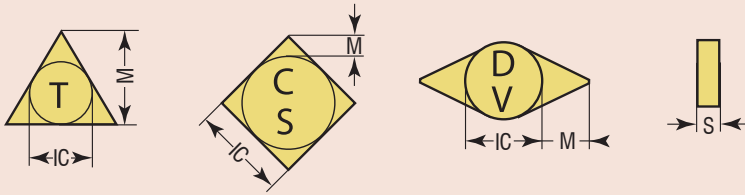

IC :Inscribed Circle  
 M : Refer to Figure  
 S : Thickness

	IC	M	S
A	±0.00098	±0.00019	±0.00098
C	±0.00098	±0.00051	±0.00098
E	±0.00098	±0.00098	±0.00098
F	±0.00051	±0.00019	±0.00098
G	±0.00098	±0.00098	±0.00051
H	±0.00051	±0.00051	±0.00098
J	±0.00196-0.0059	±0.00019	±0.00098
K	±0.00196-0.0059	±0.00051	±0.00098
L	±0.00196-0.0059	±0.00098	±0.00098
M	±0.00196-0.0059	±0.00196-0.00787	±0.00051
N	±0.00196-0.0059	±0.00196-0.00787	±0.00098
U	±0.00314-0.00984	±0.00512-0.01496	±0.00051

**8** Insert Type

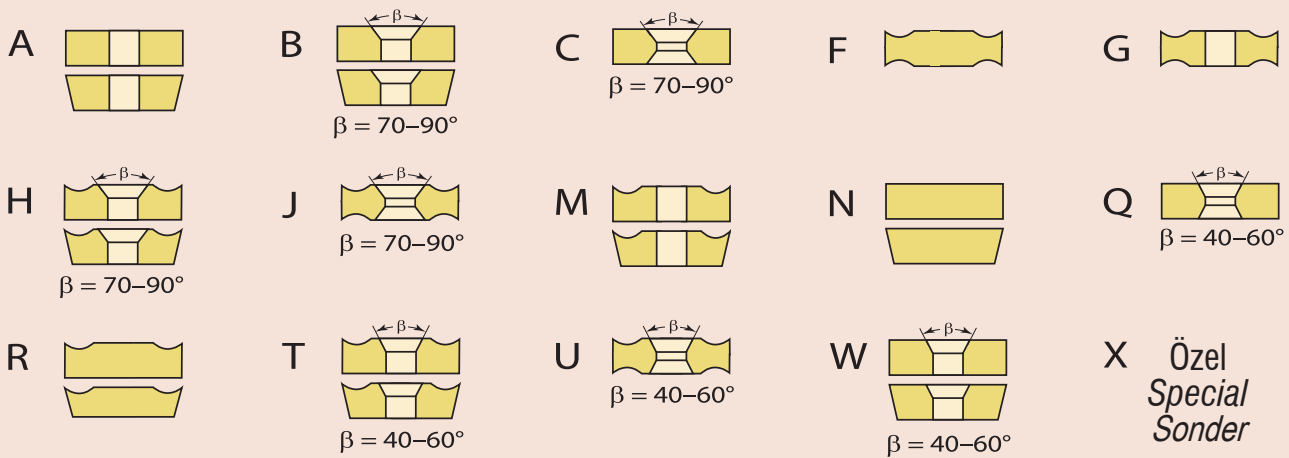

**9** Cutting Edge Length

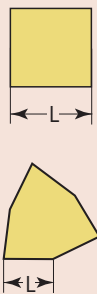

**10** Thickness

	A	01	1/16	04	3/16
	S	T0	9/128	05	7/32
	A	T1	5/64	06	1/4
	S	02	3/32	07	5/16
	A	T2	7/64	09	3/8
	S	03	1.8	11	7/16
	A	T3	5/32	12	1/2

**11** Corner Radius

	r	
	01	0.004
	02	0.008
	04	1/64
	08	1/32
	12	3/64
	16	1/16
	24	3/32
	28	7/64
	32	1/8

Company Name:

Date:

**Coolant type**

Oil Hole On the Plunge Part

"Oil hole On the Shank"

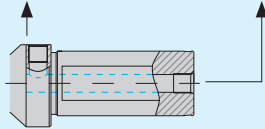

**Types of Shank**

Flat Type

Weldon Type

Whistle Notch Type

**Hole Type**

Blind Hole

Thru Hole

**Location of Side Lock**

Parallel to Peripheral Insert (Standard)

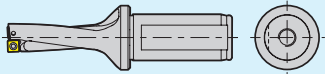

90° angle to peripheral insert

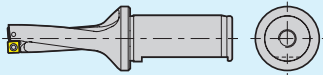

150° angle to peripheral insert

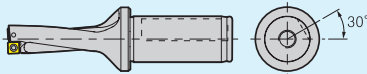

180° angle to peripheral insert

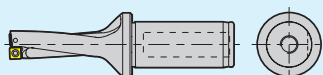

**Note**

Currently Using Tool

Current Cutting Condition

RPM or vc(m/min)

vf(mm/min) or fn(mm/rev) vf

Depth of Cut(mm)

Standard of Measuring Tool Life

Currently Using Machine

Machining Center

General Lathe

CNC Lathe

Can you send the original body/insert ? If Needed!

Yes  No

Insert Code

Insert Brand

**Rectangular Shank Tool Size**

ØD	<input type="text"/>
L2	<input type="text"/>
L1	<input type="text"/>
L3	<input type="text"/>
Ød	<input type="text"/>
Ød1	<input type="text"/>

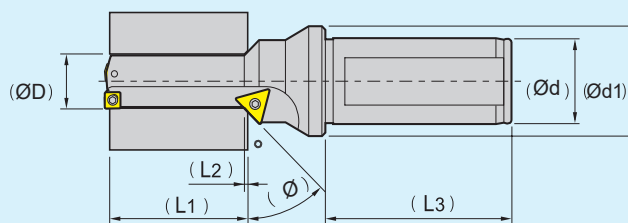

A Type

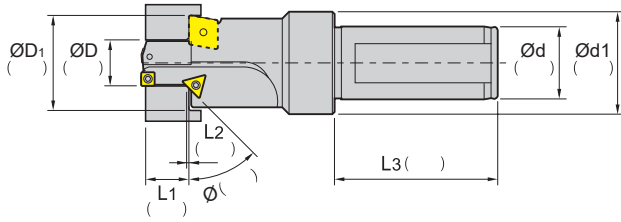

B Type

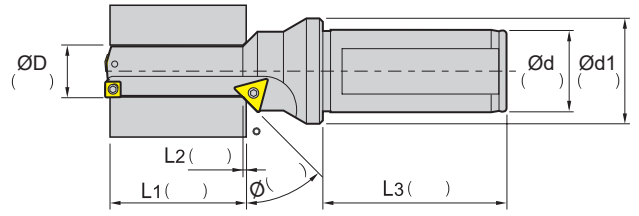

C Type

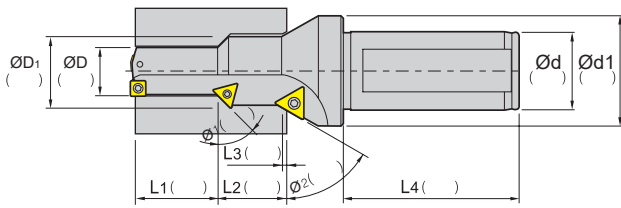

D Type

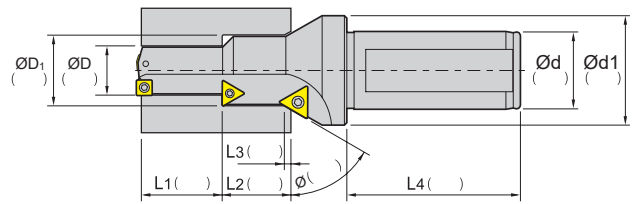

E Type

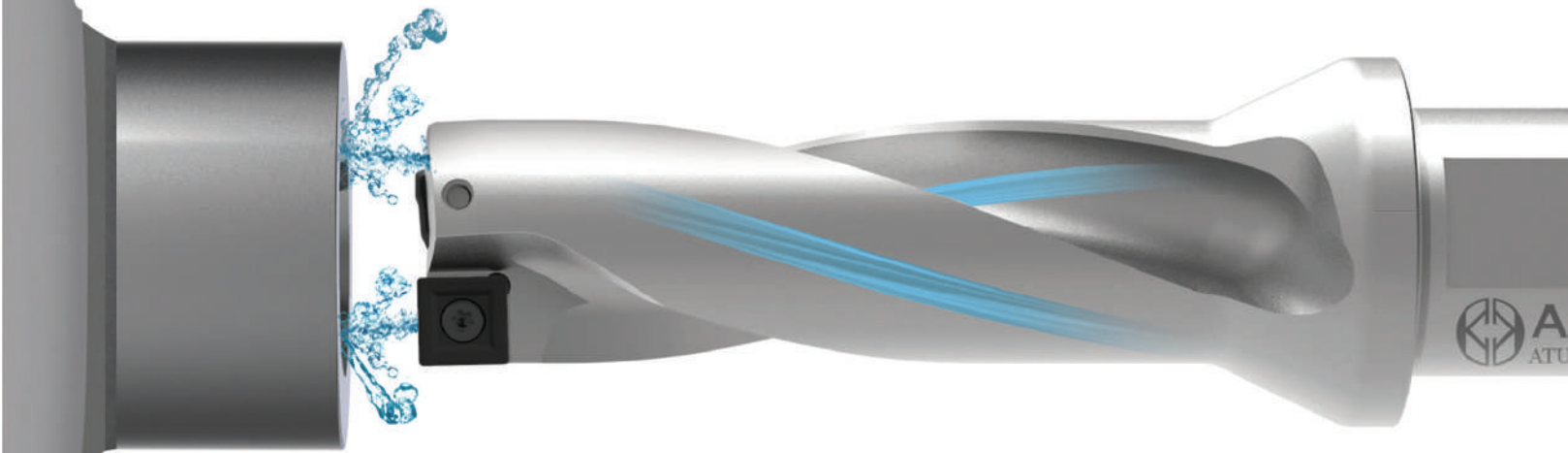
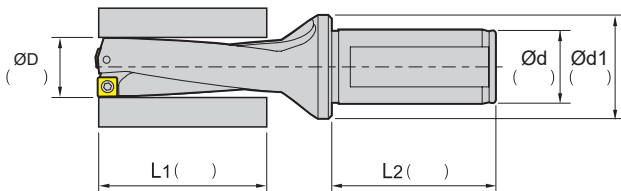

**AKKO HELICAL CHANNEL TECHNOLOGY**

**COMPETITORS**

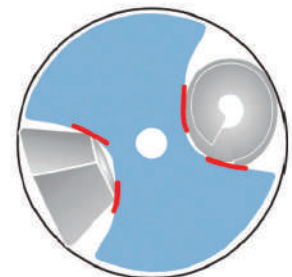

**D2 / D3 / D4 / D5**

\* Twisted Coolant Hole

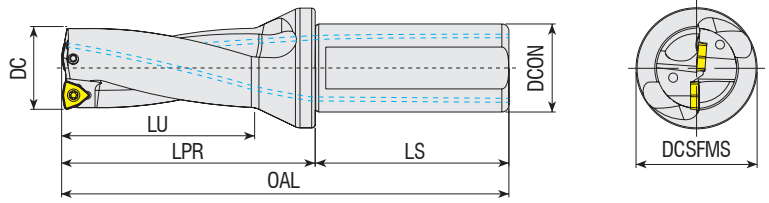

Illustrations shown may vary from actual product.

Dimensions in Inch

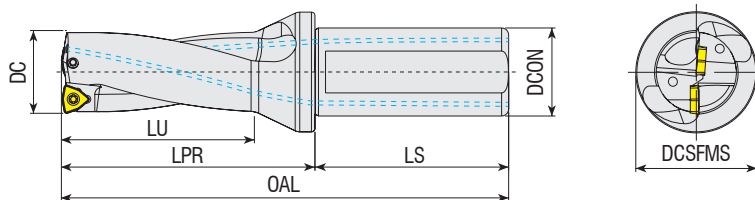

Ordering Code	DC	DCON	DCSFMS	OAL	LU	LPR	LS	Xmax	DCmax			
										Insert Inch/Metric	Screw	Torx Key
ATUM 0750XD3 WCM. 18152 WCM. 030208	0.750	1.000	1.339	5.321	2.250	3.116	2.205	0.047	0.844	WCM. 18152 WCM. 030208	3008-M2.5x6	82-T08
ATUM 0812XD3 WCM. 2152 WCM. 040208	0.812	1.000	1.339	5.507	2.436	3.302	2.205	0.591	1.993	WCM. 2152 WCM. 040208	3008-M2.5x6	82-T08
ATUM 0875XD3 WCM. 2152 WCM. 040208	0.875	1.000	1.339	5.696	2.625	3.491	2.205	0.039	0.954	WCM. 2152 WCM. 040208	3008-M2.5x6	82-T08
ATUM 0938XD3 WCM. 2522 WCM. 050308	0.938	1.000	1.339	5.885	2.814	3.680	2.205	0.039	1.017	WCM. 2522 WCM. 050308	3008-M3x8	82-T08
ATUM 1000XD3 WCM. 2522 WCM. 050308	1.000	1.000	1.339	6.071	3.000	3.866	2.205	0.057	1.114	WCM. 2522 WCM. 050308	3008-M3x8	82-T08
ATUM 1062XD3 WCM. 2522 WCM. 050308	1.062	1.000	1.339	6.257	3.186	4.052	2.205	0.057	1.176	WCM. 2522 WCM. 050308	3008-M3x8	82-T08
ATUM 1125XD3 WCM. 2522 WCM. 050308	1.125	1.000	1.339	6.446	3.375	4.241	2.205	0.063	1.251	WCM. 2522 WCM. 050308	3008-M3x8	82-T08
ATUM 1250XD3 WCM. 3252 WCM. 06T308	1.250	1.250	1.732	7.175	3.750	4.813	2.362	0.087	1.423	WCM. 3252 WCM. 06T308	3010-M3.5x9	82-T10
ATUM 1375XD3 WCM. 3252 WCM. 06T308	1.375	1.250	1.732	7.550	4.125	5.188	2.362	0.075	1.525	WCM. 3252 WCM. 06T308	3010-M3.5x9	82-T10
ATUM 1500XD3 WCM. 3252 WCM. 06T308	1.500	1.250	1.732	7.925	4.500	5.563	2.362	0.059	1.618	WCM. 3252 WCM. 06T308	3010-M3.5x9	82-T10
ATUM 1750XD3 WCM. 3252 WCM. 06T308	1.750	1.250	1.732	8.675	5.250	6.313	2.362	0.000	1.750	WCM. 3252 WCM. 06T308	3010-M3.5x9	82-T10
ATUM 2000XD3 WCM. 433 WCM. 080412	2.000	1.500	2.126	10.016	6.000	7.260	2.756	0.079	2.157	WCM. 433 WCM. 080412	4015-M4x11	80-T15
ATUM 0750XD5 WCM. 18152 WCM. 030208	0.750	1.000	1.339	6.821	3.750	4.616	2.205	0.047	0.844	WCM. 18152 WCM. 030208	3008-M2.5x6	82-T08
ATUM 0812XD5 WCM. 2152 WCM. 040208	0.812	1.000	1.339	7.131	4.060	4.926	2.205	0.059	0.930	WCM. 2152 WCM. 040208	3008-M2.5x6	82-T08
ATUM 0875XD5 WCM. 2152 WCM. 040208	0.875	1.000	1.339	7.446	4.375	5.241	2.205	0.039	0.954	WCM. 2152 WCM. 040208	3008-M2.5x6	82-T08
ATUM 0938XD5 WCM. 2522 WCM. 050308	0.938	1.000	1.339	7.762	4.690	5.556	2.205	0.039	1.017	WCM. 2522 WCM. 050308	3008-M3x8	82-T08
ATUM 1000XD5 WCM. 2522 WCM. 050308	1.000	1.000	1.339	8.071	5.000	5.866	2.205	0.057	1.114	WCM. 2522 WCM. 050308	3008-M3x8	82-T08
ATUM 1062XD5 WCM. 2522 WCM. 050308	1.062	1.000	1.339	8.381	5.310	6.176	2.205	0.057	1.176	WCM. 2522 WCM. 050308	3008-M3x8	82-T08
ATUM 1125XD5 WCM. 2522 WCM. 050308	1.125	1.000	1.339	8.696	5.625	6.491	2.205	0.063	1.251	WCM. 2522 WCM. 050308	3008-M3x8	82-T08
ATUM 1250XD5 WCM. 3252 WCM. 06T308	1.250	1.250	1.732	9.675	6.250	7.313	2.362	0.087	1.423	WCM. 3252 WCM. 06T308	3010-M3.5x9	82-T10
ATUM 1375XD5 WCM. 3252 WCM. 06T308	1.375	1.250	1.732	10.300	6.875	7.938	2.362	0.075	1.525	WCM. 3252 WCM. 06T308	3010-M3.5x9	82-T10
ATUM 1500XD5 WCM. 3252 WCM. 06T308	1.500	1.250	1.732	10.925	7.500	8.563	2.362	0.059	1.618	WCM. 3252 WCM. 06T308	3010-M3.5x9	82-T10
ATUM 1750XD5 WCM. 3252 WCM. 06T308	1.750	1.250	1.732	12.175	8.750	9.813	2.362	0.000	1.750	WCM. 3252 WCM. 06T308	3010-M3.5x9	82-T10

Compatible with ISO Insert.



Illustrations shown may vary from actual product.

Dimensions in Inch

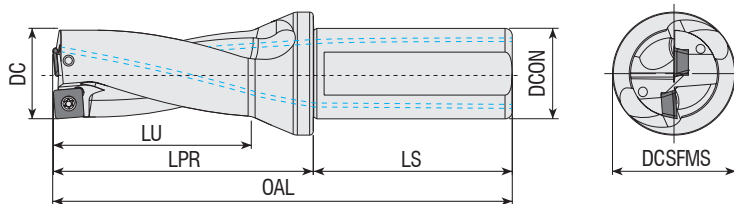

Ordering Code	DC	DCON	DCSFMS	OAL	LU	LPR	LS	Xmax	DCmax	  		
										Insert Inch/Metric	Screw	Torx Key
<b>ATUM 2000XD5 WCM. 433 WCM. 080412</b>	2.000	1.500	2.126	14.016	10.000	11.260	2.756	0.079	2.157	WCM. 433 WCM. 080412	4015-M4x11	80-T15
<b>ATUM 2125XD5 WCM. 433 WCM. 080412</b>	2.125	1.500	2.126	14.509	10.625	11.884	2.756	0.039	2.204	WCM. 433 WCM. 080412	4015-M4x11	80-T15
<b>ATUM 2225XD5 WCM. 433 WCM. 080412</b>	2.225	1.500	2.519	15.009	11.125	12.384	2.756	0.020	2.264	WCM. 433 WCM. 080412	4015-M4x11	80-T15

Compatible with ISO Insert.



Illustrations shown may vary from actual product.

Dimensions in Inch

Ordering Code	DC	DCON	DCSFMS	OAL	LU	LPR	LS	Xmax	DCmax	  		
										Insert Inch/Metric	Screw	Torx Key
<b>ATUM 0656XD3 SP. 2151 SP. 060204</b>	0.656	1.000	1.339	4.961	2.086	2.756	2.205	0.031	0.719	SP. 2151 SP. 060204	3007-M2.2x5	80-T07
<b>ATUM 1000XD5 SP. 25252 SP. 07T308</b>	1.000	1.250	1.732	8.438	5.000	6.063	2.375	0.010	1.020	SP. 25252 SP. 07T308	3008-M2.5x6	80-T08
<b>ATUM 1125XD5 SP. 332 SP. 090408</b>	1.125	1.250	1.732	9.062	5.434	6.687	2.375	0.039	1.204	SP. 332 SP. 090408	4015-M3.5x9	80-T15
<b>ATUM 1250XD5 SP. 332 SP. 090408</b>	1.250	1.500	2.126	10.134	6.053	7.509	2.625	0.010	1.270	SP. 332 SP. 090408	4015-M3.5x9	80-T15
<b>ATUM 1500XD5 SP. 3532 SP. 110408</b>	1.500	1.500	2.126	11.385	7.303	8.760	2.625	0.010	1.520	SP. 3532 SP. 110408	4015-M4x11	80-T15
<b>ATUM 1625XD5 SP. 3532 SP. 110408</b>	1.625	1.500	2.126	12.010	7.928	9.385	2.625	0.000	1.625	SP. 3532 SP. 110408	4015-M4x11	80-T15
<b>ATUM 1750XD5 SP. 3532 SP. 110408</b>	1.750	1.500	2.126	12.634	8.553	10.009	2.625	0.031	1.813	SP. 3532 SP. 110408	1020-M5x11	80-T20
<b>ATUM 1875XD5 SP. 5532 SP.140512</b>	1.875	1.500	2.126	13.259	9.178	10.634	2.625	0.008	1.891	SP. 5532 SP.140512	1020-M5x11	80-T20

Compatible with TGTC Insert.

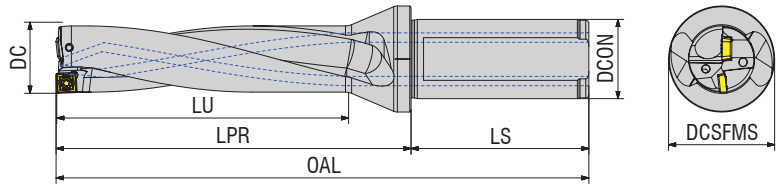

Illustrations shown may vary from actual product.

Dimensions in Inch

Ordering Code	DC	DCON	DCSFMS	OAL	LU	LPR	LS	Xmax	DCmax				
										Inner Insert Inch/Metric	Outer Insert Inch/Metric	Inner Screw	Torx Key
ATUM 0594XD3 SC.. 0502-XP.. 0502	0.594	1.000	1.339	5.012	1.783	2.768	2.244	0.020	0.633	XP.. 1815.. XP.0502..	SC.. 1815.. SC..0502..	3007-M2.2x5	80-T07
ATUM 0625XD3 SC.. 0502-XP.. 0502	0.625	1.000	1.339	5.109	1.875	2.865	2.244	0.035	0.696	XP.. 1815.. XP.0502..	SC.. 1815.. SC..0502..	3007-M2.2x5	80-T07
ATUM 0656XD3 SC.. 0502-XP.. 0502	0.656	1.000	1.339	5.197	1.969	2.953	2.244	0.031	0.719	XP.. 1815.. XP.0502..	SC.. 1815.. SC..0502..	3007-M2.2x5	80-T07
ATUM 0687XD3 SC.. 0502-XP.. 0602	0.687	1.000	1.339	5.285	2.061	3.041	2.244	0.030	0.746	XP.. 215.. XP.0602..	SC.. 1815.. SC..0502..	3007-M2.2x5	80-T07
ATUM 0709XD3 SC.. 0502-XP.. 0602	0.709	1.000	1.339	5.354	2.127	3.110	2.244	0.020	0.748	XP.. 215.. XP.0602..	SC.. 1815.. SC..0502..	3007-M2.2x5	80-T07
ATUM 0750XD3 SC.. 0502-XP.. 0602	0.75	1.000	1.339	5.476	2.250	3.232	2.244	0.012	0.774	XP.. 215.. XP.0602..	SC.. 1815.. SC..0502..	3007-M2.2x5	80-T07
ATUM 0766XD3 SC.. 0602-XP.. 0602	0.766	1.000	1.339	5.528	2.298	3.284	2.244	0.012	0.790	XP.. 215.. XP.0602..	SC.. 215.. SC..0602..	3007-M2.2x5	80-T08
ATUM 0787XD3 SC.. 0602-XP.. 0602	0.787	1.000	1.339	5.591	2.361	3.347	2.244	0.000	0.787	XP.. 215.. XP.0602..	SC.. 215.. SC..0602..	3007-M2.2x5	80-T08
ATUM 0812XD3 SC.. 0602-XP.. 0602	0.812	1.000	1.339	5.665	2.436	3.421	2.244	0.000	0.812	XP.. 215.. XP.0602..	SC.. 215.. SC..0602..	3007-M2.2x5	80-T08
ATUM 0827XD3 SC.. 0602-XP.. 0602	0.827	1.000	1.339	5.709	2.481	3.465	2.244	0.000	0.827	XP.. 215.. XP.0602..	SC.. 215.. SC..0602..	3007-M2.2x5	80-T08
ATUM 0875XD3 SC.. 0602-XP.. 0703	0.875	1.000	1.339	5.854	2.625	3.610	2.244	0.039	0.954	XP.. 252.. XP.0703..	SC.. 215.. SC..0602..	3008-M2.5x6	80-T08
ATUM 0906XD3 SC.. 0703-XP.. 0703	0.906	1.000	1.339	5.954	2.718	3.710	2.244	0.030	0.965	XP.. 252.. XP.0703..	SC.. 252.. SC..0703..	3008-M2.5x6	80-T08
ATUM 0922XD3 SC.. 0703-XP.. 0703	0.922	1.000	1.339	5.996	2.766	3.752	2.244	0.030	0.981	XP.. 252.. XP.0703..	SC.. 252.. SC..0703..	3008-M2.5x6	80-T08
ATUM 0937XD3 SC.. 0703-XP.. 0703	0.937	1.000	1.339	6.039	2.811	3.795	2.244	0.024	0.984	XP.. 252.. XP.0703..	SC.. 252.. SC..0703..	3008-M2.5x6	80-T08
ATUM 0984XD3 SC.. 0703-XP.. 0703	0.984	1.250	1.732	6.299	2.952	3.937	2.362	0.010	1.004	XP.. 252.. XP.0703..	SC.. 252.. SC..0703..	3008-M2.5x6	80-T08
ATUM 1000XD3 SC.. 0703-XP.. 0703	1.000	1.250	1.732	6.346	2.992	3.984	2.362	0.010	1.020	XP.. 252.. XP.0703..	SC.. 252.. SC..0703..	3008-M2.5x6	80-T08
ATUM 1032XD3 SC.. 0703-XP.. 0903	1.032	1.250	1.732	6.441	3.096	4.079	2.362	0.000	1.032	XP.. 32.. XP.0903..	SC.. 252.. SC..0703..	3008-M3x7	80-T08
ATUM 1062XD3 SC.. 0703-XP.. 0903	1.062	1.250	1.732	6.531	3.186	4.169	2.362	0.000	1.062	XP.. 32.. XP.0903..	SC.. 252.. SC..0703..	3008-M3x7	80-T08
ATUM 1109XD3 SC.. 09T3-XP.. 0903	1.109	1.250	1.732	6.673	3.327	4.311	2.362	0.039	1.188	XP.. 32.. XP.0903..	SC.. 325.. SC..09T3..	3008-M3x7	80-T15
ATUM 1125XD3 SC.. 09T3-XP.. 0903	1.125	1.250	1.732	6.720	3.375	4.358	2.362	0.039	1.204	XP.. 32.. XP.0903..	SC.. 325.. SC..09T3..	3008-M3x7	80-T15
ATUM 1172XD3 SC.. 09T3-XP.. 0903	1.172	1.250	1.732	6.862	3.516	4.500	2.362	0.030	1.231	XP.. 32.. XP.0903..	SC.. 325.. SC..09T3..	3008-M3x7	80-T15
ATUM 1187XD3 SC.. 09T3-XP.. 0903	1.187	1.250	1.732	6.906	3.561	4.544	2.362	0.020	1.226	XP.. 32.. XP.0903..	SC.. 325.. SC..09T3..	3008-M3x7	80-T15

Compatible with PRMT Insert.

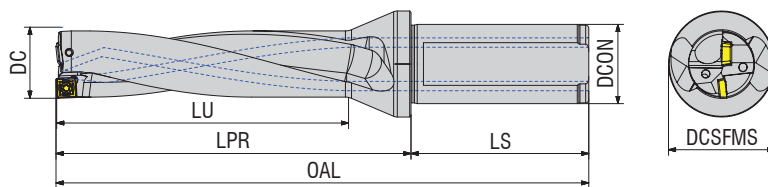

Illustrations shown may vary from actual product.

Dimensions in Inch

Ordering Code	DC	DCON	DCSFMS	OAL	LU	LPR	LS	Xmax	DCmax	Inserts		Screw	Torx Key
										Inner Insert Inch/Metric	Outer Insert Inch/Metric		
ATUM 1250XD3 SC.. 09T3-XP.. 11T3	1.250	1.500	2.126	7.370	3.750	4.732	2.638	0.010	1.270	XP.. 3525.. XP..11T3..	SC.. 325.. SC..09T3..	4015-M3.5x9	80-T15
ATUM 1312XD3 SC.. 09T3-XP.. 11T3	1.312	1.500	2.126	7.559	3.936	4.921	2.638	0.000	1.312	XP.. 3525.. XP..11T3..	SC.. 325.. SC..09T3..	4015-M3.5x9	80-T15
ATUM 1344XD3 SC.. 09T3-XP.. 11T3	1.344	1.500	2.126	7.654	4.032	5.016	2.638	0.039	1.423	XP.. 3525.. XP..11T3..	SC.. 325.. SC..09T3..	4015-M3.5x9	80-T15
ATUM 1375XD3 SC.. 1204-XP.. 11T3	1.375	1.500	2.126	7.748	4.125	5.110	2.638	0.030	1.434	XP.. 3525.. XP..11T3..	SC.. 43.. SC..1204..	4015-M3.5x9	80-T20
ATUM 1437XD3 SC.. 1204-XP.. 11T3	1.437	1.500	2.126	7.933	4.311	5.295	2.638	0.024	1.484	XP.. 3525.. XP..11T3..	SC.. 43.. SC..1204..	4015-M3.5x9	80-T20
ATUM 1500XD3 SC.. 1204-XP.. 11T3	1.500	1.500	2.126	8.112	4.500	5.474	2.638	0.010	1.520	XP.. 3525.. XP..11T3..	SC.. 43.. SC..1204..	4015-M3.5x9	80-T20
ATUM 1750XD3 SC.. 1204-XP.. 1504	1.750	1.500	2.126	8.843	5.250	6.205	2.638	0.031	1.813	XP.. 53.. XP..1504..	SC.. 43.. SC..1204..	4015-M4x11	80-T20
ATUM 2000XD3 SC.. 1505-XP.. 1504	2.000	1.500	2.126	9.626	6.000	6.988	2.638	0.000	2.000	XP.. 53.. XP..1504..	SC.. 535.. SC..1505..	4015-M4x11	80-T20
ATUM 0625XD4 SC.. 0502-XP.. 0502	0.625	1.000	1.339	5.728	2.500	3.484	2.244	0.020	0.665	XP.. 1815.. XP..0502..	SC.. 1815.. SC..0502..	3007-M2.2x5	80-T07
ATUM 0687XD4 SC.. 0502-XP.. 0602	0.687	1.000	1.339	5.976	2.748	3.732	2.244	0.030	0.746	XP.. 215.. XP..0602..	SC.. 1815.. SC..0502..	3007-M2.2x5	80-T07
ATUM 0709XD4 SC.. 0502-XP.. 0602	0.709	1.000	1.339	6.063	2.836	3.819	2.244	0.020	0.748	XP.. 215.. XP..0602..	SC.. 1815.. SC..0502..	3007-M2.2x5	80-T07
ATUM 0750XD4 SC.. 0502-XP.. 0602	0.750	1.000	1.339	6.228	3.000	3.984	2.244	0.012	0.774	XP.. 215.. XP..0602..	SC.. 1815.. SC..0502..	3007-M2.2x5	80-T07
ATUM 0812XD4 SC.. 0602-XP.. 0602	0.812	1.000	1.339	6.476	3.248	4.232	2.244	0.000	0.812	XP.. 215.. XP..0602..	SC.. 215.. SC..0602..	3007-M2.2x5	80-T08
ATUM 0875XD4 SC.. 0602-XP.. 0703	0.875	1.000	1.339	6.728	3.500	4.484	2.244	0.039	0.954	XP.. 252.. XP..0703..	SC.. 215.. SC..0602..	3008-M2.5x6	80-T08
ATUM 0906XD4 SC.. 0703-XP.. 0703	0.906	1.000	1.339	6.850	3.624	4.606	2.244	0.030	0.965	XP.. 252.. XP..0703..	SC.. 252.. SC..0703..	3008-M2.5x6	80-T08
ATUM 0922XD4 SC.. 0703-XP.. 0703	0.922	1.000	1.339	6.917	3.688	4.673	2.244	0.030	0.981	XP.. 252.. XP..0703..	SC.. 252.. SC..0703..	3008-M2.5x6	80-T08
ATUM 1000XD4 SC.. 0703-XP.. 0703	1.000	1.250	1.732	7.346	4.000	4.984	2.362	0.010	1.020	XP.. 252.. XP..0703..	SC.. 252.. SC..0703..	3008-M2.5x6	80-T08
ATUM 1062XD4 SC.. 0703-XP.. 0903	1.062	1.250	1.732	7.594	4.248	5.232	2.362	0.000	1.062	XP.. 32.. XP..0903..	SC.. 252.. SC..0703..	3008-M3x7	80-T08
ATUM 1125XD4 SC.. 09T3-XP.. 0903	1.125	1.250	1.732	7.846	4.500	5.484	2.362	0.039	1.204	XP.. 32.. XP..0903..	SC.. 325.. SC..09T3..	3008-M3x7	80-T15
ATUM 1187XD4 SC.. 09T3-XP.. 0903	1.187	1.250	1.732	8.094	4.748	5.732	2.362	0.020	1.226	XP.. 32.. XP..0903..	SC.. 325.. SC..09T3..	3008-M3x7	80-T15

Compatible with PRMT Insert.

*the spoken  
quality...*



[www.akkousa.us](http://www.akkousa.us)

# ADJUSTABLE BORING HEADS

*the spoken quality...*



**AKKO** **A** **BH** **F** - **D18x22** - **W16**

1 2 3 4 5

<p><b>2</b> Cutter Style</p> <p>BH : Boring Head</p>	<p><b>3</b> Cutter Type</p> <p>R : Rough Boring F : Fine Boring</p>	<p><b>5</b> Assembly Form</p> <p>W : Weldon</p>
--	---	---

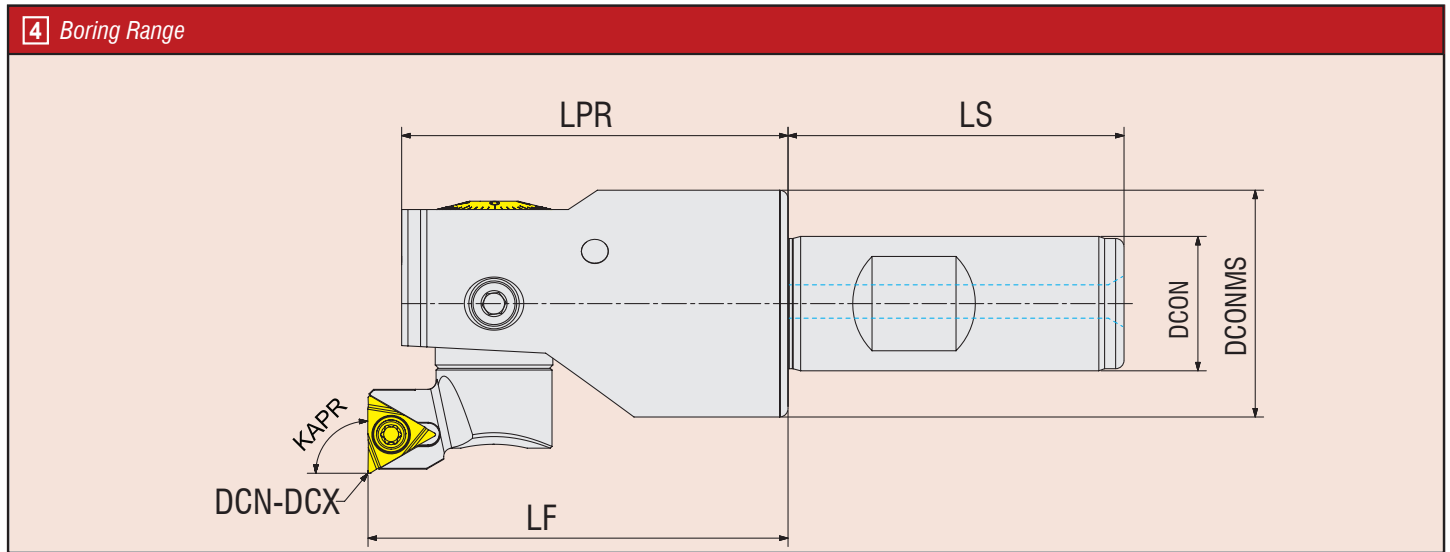

KAPR = 90°

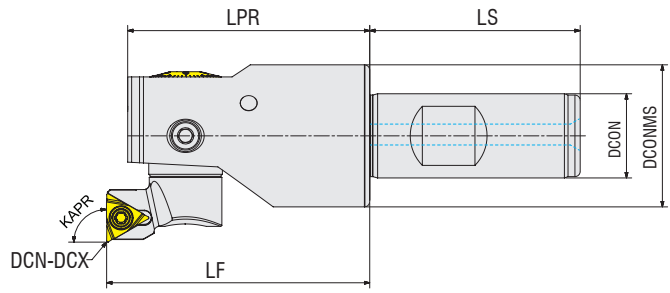

Dimensions in Metric

Ordering Code	BORING RANGE (DCN-DCX)	LF	LPR	LS	DCN	DCONMS	DCN	DCX	CARTRIDGES		INSERTS Inch/Metric		EXTENSION	BORING HEAD BODY CODE
									STFPR-D29x35 STFPR-D34x40	SCFCR-D29x35 SCFCR-D34x40	TPGX 1815.L TPGX 0902.L	CCGT 21505 CCGT 060202		
SET-I-ABHF-D29X40-WA16	29-40	50	46	40	16	27	29 34	35 40	STFPR-D29x35 STFPR-D34x40	SCFCR-D29x35 SCFCR-D34x40	TPGX 1815.L TPGX 0902.L	CCGT 21505 CCGT 060202	-	ABHF-D29X40-WA0.75
SET-I-ABHF-D39X54-WA20	39-54	60	55	50	20	36	39 46	47 54	STFPR-D39x47 STFPR-D46x54	SCFCR-D39x47 SCFCR-D46x54				ABHF-D39X54-WA1.00
SET-I-ABHF-D52X80-WA25	52-80	70	65	56	25	48	52 64	68 80	STFPR-D52x68 STFPR-D64x80	SCFCR-D52x68 SCFCR-D64x80				ABHF-D52X80-WA1.25
SET-I-ABHF-D78X170-WA32	78-170	83	77	60	32	72	78 96	98 116	STFPR-D78x98 STFPR-D96x116	SCFCR-D78x98 SCFCR-D96x116			AEA-114x134 AEA-132x152	ABHF-D78X170-WA1.50



KAPR = 90°

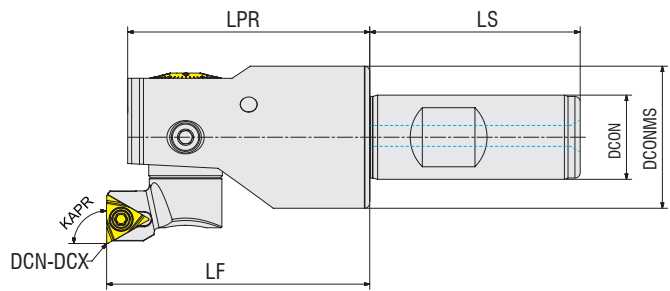

Dimensions in Inch

Ordering Code	BORING RANGE (DCN-DCX)	LF	LPR	LS	DCN	DCONMS	DCN	DCX	CARTRIDGES		INSERTS Inch/Metric		EXTENSION	BORING HEAD BODY CODE
									STFPR-D29x35 STFPR-D34x40	SCFCR-D29x35 SCFCR-D34x40	TPGX 1815.L TPGX 0902.L	CCGT 21505 CCGT 060202		
SET-I-ABHF-D29X40-WA0.75	1.141-1.574	1.969	1.811	2.031	0.750	1.063	1.141-1.338	1.375-1.574	STFPR-D29x35 STFPR-D34x40	SCFCR-D29x35 SCFCR-D34x40	TPGX 1815.L TPGX 0902.L	CCGT 21505 CCGT 060202	-	ABHF-D29X40-WA0.75
SET-I-ABHF-D39X54-WA1.00	1.535-2.126	2.362	2.165	2.283	1.000	1.417	1.535-1.811	1.850-2.126	STFPR-D39x47 STFPR-D46x54	SCFCR-D39x47 SCFCR-D46x54				ABHF-D39X54-WA1.00
SET-I-ABHF-D52X80-WA1.25	2.047-3.149	2.756	2.559	2.283	1.250	1.890	2.047-2.519	2.677-3.149	STFPR-D52x68 STFPR-D64x80	SCFCR-D52x68 SCFCR-D64x80				ABHF-D52X80-WA1.25
SET-I-ABHF-D78X170-WA1.50	3.070-6.693	3.268	3.031	3.689	1.500	2.835	3.070-3.779	3.858-4.567	STFPR-D78x98 STFPR-D96x116	SCFCR-D78x98 SCFCR-D96x116			AEA-114x134 AEA-132x152	ABHF-D78X170-WA1.50



Ordering Example 1 pcs. SET-I-ABHF-D29X40-WA0.75

Explanations: SET-I-ABHF-D78X170-WA32 operates in the 117-170 size range by using the extension adapter. Our fine boring sets consist of inserts with 0.2(1.5) or 0.4 (1.0) radius. Both STFPR and SCFCR cartridges are suitable for the ABHF body. We kindly ask you to share the insert radius and cartridge details with the sales representative with your order.

KAPR = 90°

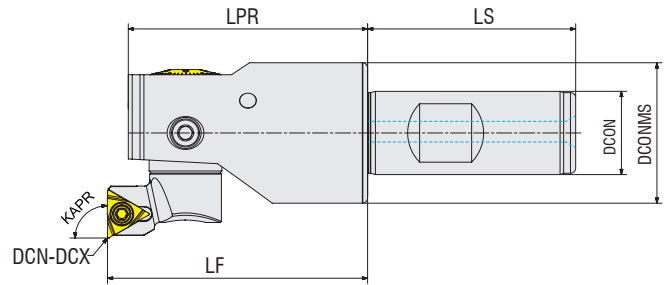

Dimensions in Metric

Ordering Code	BORING RANGE (DCN-DCX)	LF	LPR	LS	DCON	DCONMS	DCN	DCX	CARTRIDGES	INSERTS Inch/Metric	EXTENSION	BORING HEAD BODY CODE	
SET-ABHF-D29X40-WA16	29-40	50	46	40	16	27	29 34	35 40	STFPR-D29x35 STFPR-D34x40	SCFCR-D29x35 SCFCR-D34x40	TPGX 1815..L TPGX 0902..L	CCGT 21505 CCGT 060202	ABHF-D29X40-WA0.75
SET-ABHF-D39X54-WA20	39-54	60	55	50	20	36	39 46	47 54	STFPR-D39x47 STFPR-D46x54	SCFCR-D39x47 SCFCR-D46x54			ABHF-D39X54-WA1.00
SET-ABHF-D52X80-WA25	52-80	70	65	56	25	48	52 64	68 80	STFPR-D52x68 STFPR-D64x80	SCFCR-D52x68 SCFCR-D64x80			ABHF-D52X80-WA1.25
SET-ABHF-D78X170-WA32	78-170	83	77	60	32	72	78 96	98 116	STFPR-D78x98 STFPR-D96x116	SCFCR-D78x98 SCFCR-D96x116			AEA-114x134 AEA-132x152

KAPR = 90°

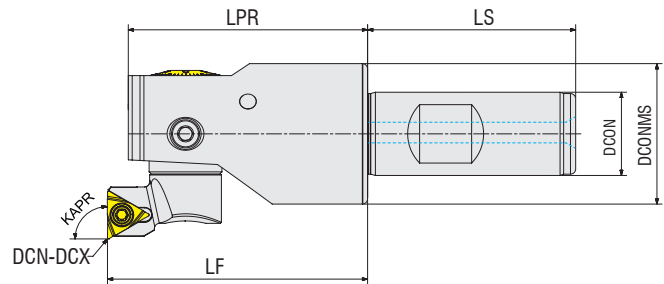

Dimensions in Inch

Ordering Code	BORING RANGE (DCN-DCX)	LF	LPR	LS	DCON	DCONMS	DCN	DCX	CARTRIDGES	INSERTS Inch/Metric	EXTENSION	BORING HEAD BODY CODE	
SET-ABHF-D29X40-WA0.75	1.141-1.574	1.969	1.811	2.031	0.750	1.063	1.141-1.338	1.375-1.574	STFPR-D29x35 STFPR-D34x40	SCFCR-D29x35 SCFCR-D34x40	TPGX 1815..L TPGX 0902..L	CCGT 21505 CCGT 060202	ABHF-D29X40-WA0.75
SET-ABHF-D39X54-WA1.00	1.535-2.126	2.362	2.165	2.283	1.000	1.417	1.535-1.811	1.850-2.126	STFPR-D39x47 STFPR-D46x54	SCFCR-D39x47 SCFCR-D46x54			ABHF-D39X54-WA1.00
SET-ABHF-D52X80-WA1.25	2.047-3.149	2.756	2.559	2.283	1.250	1.890	2.047-2.519	2.677-3.149	STFPR-D52x68 STFPR-D64x80	SCFCR-D52x68 SCFCR-D64x80			ABHF-D52X80-WA1.25
SET-ABHF-D78X170-WA1.50	3.070-6.693	3.268	3.031	3.689	1.500	2.835	3.070-3.779	3.858-4.567	STFPR-D78x98 STFPR-D96x116	SCFCR-D78x98 SCFCR-D96x116			AEA-114x134 AEA-132x152

Ordering Example 1 pcs. SET-ABHF-D06X30-WA25

Explanations: SET-ABHF-D78X170-WA32 operates in the 117-170 size range by using the extension adapter. Our fine boring sets consist of inserts with 0.2(1.5) or 0.4 (1.0) radius. Both STFPR and SCFCR cartridges are suitable for the ABHF body. We kindly ask you to share the insert radius and cartridge details with the sales representative with your order.

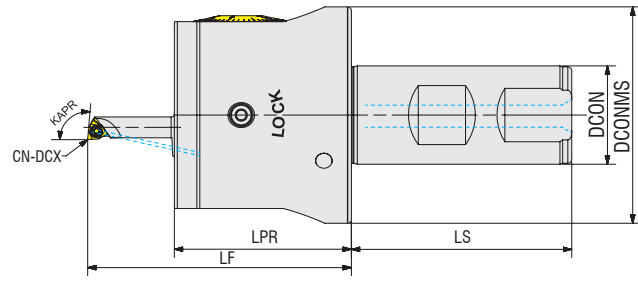

Dimensions in Metric

Ordering Code	BORING RANGE (DCN-DCX)	LF	LPR	LS	DCON	DCONMS	KAPR	DCN	DCX	CARTRIDGES	INSERTS Inch/Metric	BORING HEAD BODY CODE	
SET-I-ABHF-D06X30-WA25	06-30	67	45	56	25	55	95°	6	10	SWLCR-D06X10-22	WCGT 0201..L	ABHF-D06X30-WA25	
		75						8	14	SWLCR-D08X14-30			
		85						93°	12	18	STUPR-D12X18-40		TPGX 0902..L
		16							22	STUPR-D16X22-40			
		20							26	STUPR-D20X26-40			
		24							30	STUPR-D24X30-50			
83													

Our fine boring sets consist of inserts with 0.2 or 0.4 radius. We kindly ask you to share the insert radius details with the sales representative with your order.  
Ordering Example: SET-I-ABHF-D06X30-WA25

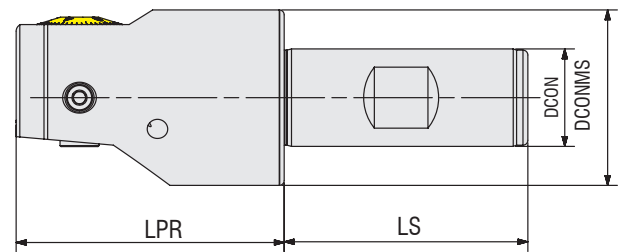
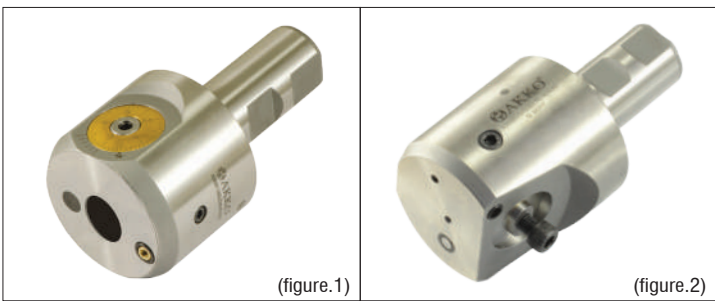

Dimensions in Metric

Ordering Code	Fig.	BORING RANGE (DCN-DCX)	LPR	LS	DCON	DCONMS	ALLEN KEY
ABHF-D06X30-WA25	1	06-30	45	56	25	55	AAL-05-4
ABHF-D29X40-WA16	2	29-40	46	40	16	27	AAL-01-2      AAL-02-2.5
ABHF-D39X54-WA20	2	39-54	55	50	20	36	AAL-02-2.5      AAL-03-3      AAL-05-4
ABHF-D52X80-WA25	2	52-80	65	56	25	48	AAL-05-4      AAL-07-5
ABHF-D78X170-WA32	2	78-170	77	60	32	72	AAL-07-5      AAL-08-6

Ordering Example 1 pcs. ABHF-D06X30-WA25

KAPR=95°

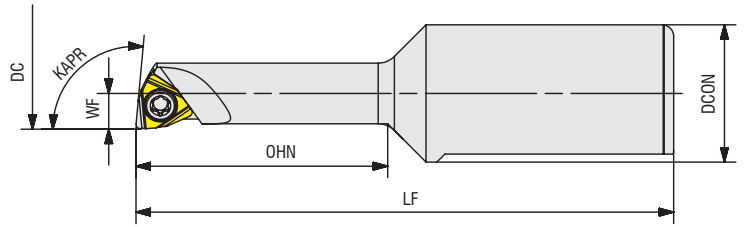

Dimensions in Metric

Ordering Code	DC	WF	LF	OHN	DCON	INSERT	SCREW	TORX KEY
SWLCR-D06X10-22	6	3	47	22	12	WCGT 020104L	3006-M2x3.3	82-T06
SWLCR-D08X14-30	8	4	55	30				



KAPR=93°

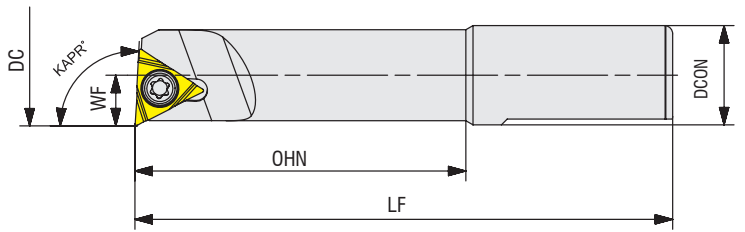





Dimensions in Metric

Ordering Code	DC	WF	LF	OHN	DCON	INSERT	SCREW	TORX KEY
STUPR-D12X18-40	12	6	65	40	12	TPGX 090202L	4008-M2.5x4.5	82-T08
STUPR-D16X22-40	16	8						
STUPR-D20X26-40	20	10						
STUPR-D24X30-50	24	12	75	50				

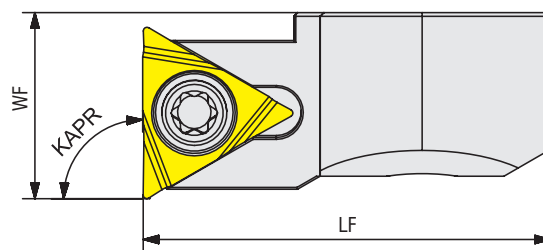



Ordering Example 1 pcs. STUPR-D12X18-40

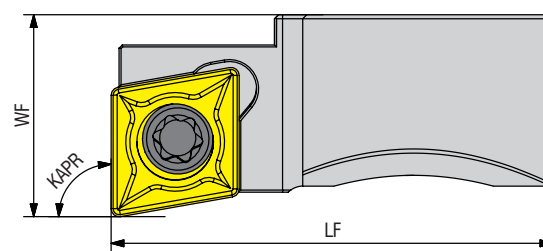

Dimensions in Metric					
Ordering Code	WF	LF	INSERT	SCREW	TORX KEY
STFPR-D29x35	10	21.90	<b>TPGX 0902..L</b> <b>TPGX 1815..L</b>	4008-M2.5x6	82-T08
STFPR-D34x40	12.50	21.90			
STFPR-D39x47	12	26.90			
STFPR-D46x54	15.50	26.90			
STFPR-D52x68	14	34.90			
STFPR-D64x80	20	34.90			
STFPR-D78x98	20	44.90			
STFPR-D96x116	29	44.90			



Dimensions in Metric					
Ordering Code	WF	LF	INSERT	SCREW	TORX KEY
SCFCR-D29x35	10	21.90	<b>CCGT 060202</b> <b>CCGT 21505</b>	4008-M2.5x6	82-T08
SCFCR-D34x40	12.50	21.90			
SCFCR-D39x47	12	26.90			
SCFCR-D46x54	15.50	26.90			
SCFCR-D52x68	14	34.90			
SCFCR-D64x80	20	34.90			
SCFCR-D78x98	20	44.90			
SCFCR-D96x116	29	44.90			

Ordering Example 1 pcs. SCFCR-D29X35

Assembling Boring Bar

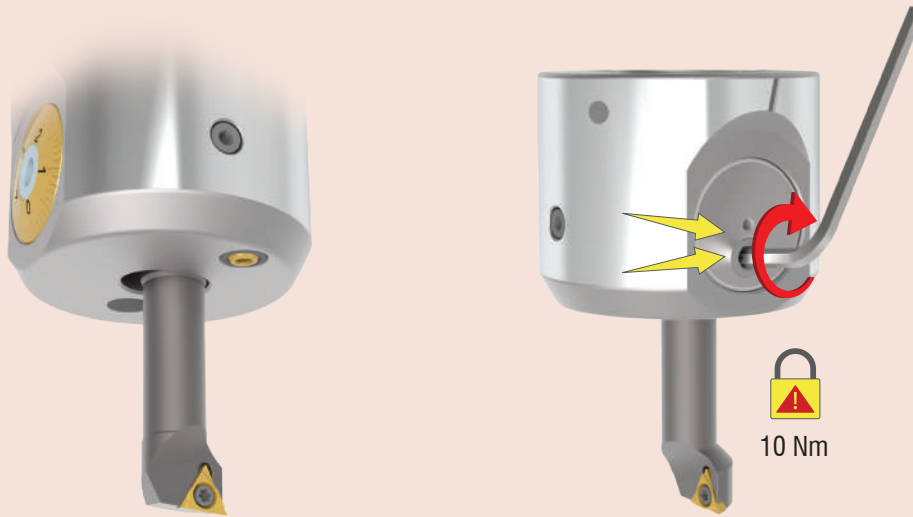

Diameter Adjustment

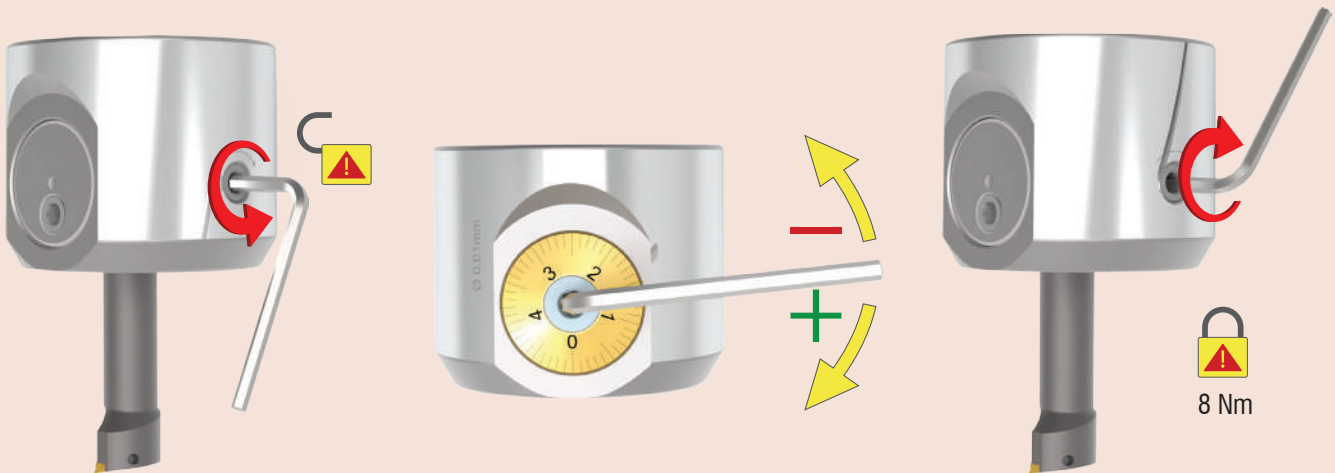

Scale - Vernier

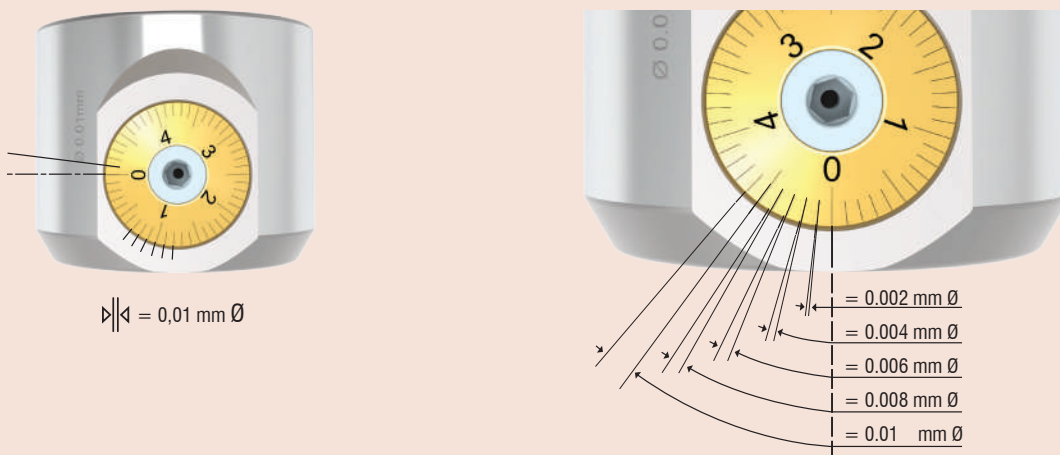

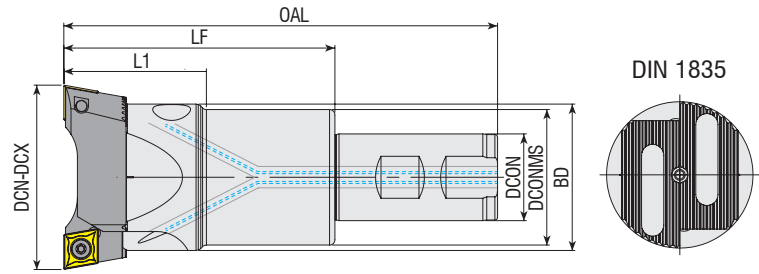

Dimensions in Metric

Ordering Code	Boring Range DCN-DCX	DCON	DCONMS	BD	OAL	LF	L1	CARTRIDGES	BORING HEAD BODY CODE
ABHR-D18x22-W16-L90-CC06	18-22	16	-	-	90	42	-	AK.. 18-22	ABHRS-D16x42-W16-L90 ABHRS-D16x102-W16-L150 ABHRS-D16x152-W16-L200
ABHR-D18x22-W16-L150-CC06	18-22	16	-	-	150	102	-		
ABHR-D18x22-W16-L200-CC06	18-22	16	-	-	200	152	-		
ABHR-D22x28-W20-L100-CC06	22-28	20	-	-	100	50	-	AK.. 22-28	ABHRS-D20x50-W20-L100 ABHRS-D20x100-W20-L150 ABHRS-D20x150-W20-L200
ABHR-D22x28-W20-L150-CC06	22-28	20	-	-	150	100	-		
ABHR-D22x28-W20-L200-CC06	22-28	20	-	-	200	150	-		
ABHR-D28x38-W20-L110-CC06	28-38	20	25	-	110	60	-	AK.. 28-38	ABHRS-D25x60-W20-L110 ABHRS-D25x110-W20-L160 ABHRS-D25x180-W20-L230
ABHR-D28x38-W20-L160-CC06	28-38	20	25	-	160	110	-		
ABHR-D28x38-W20-L230-CC06	28-38	20	25	-	230	180	-		
ABHR-D36x50-W25-L120-CC06	36-50	25	32	-	120	64	-	AK.. 36-50	ABHRS-D32X64-W25-L120 ABHRS-D32X114-W25-L170 ABHRS-D32X194-W25-L250
ABHR-D36x50-W25-L170-CC06	36-50	25	32	-	170	114	-		
ABHR-D36x50-W25-L250-CC06	36-50	25	32	-	250	194	-		
ABHR-D36x50-W25-L120-CC09	36-50	25	32	-	120	64	-	AK.. 36-50-09	ABHRS-D32X64-W25-L120 ABHRS-D32X114-W25-L170 ABHRS-D32X194-W25-L250
ABHR-D36x50-W25-L170-CC09	36-50	25	32	-	170	114	-		
ABHR-D36x50-W25-L250-CC09	36-50	25	32	-	250	194	-		
ABHR-D50x68-W32-L140-CC09	50-68	32	40	-	140	80	-	AK.. 50-68	ABHRS-D40x80-W32-L140 ABHRS-D40x140-W32-L200 ABHRS-D40x220-W32-L280
ABHR-D50x68-W32-L200-CC09	50-68	32	40	-	200	140	-		
ABHR-D50x68-W32-L280-CC09	50-68	32	40	-	280	220	-		
ABHR-D50x68-W32-L140-CC12	50-68	32	40	-	140	80	-	AK.. 50-68-12	ABHRS-D40x80-W32-L140 ABHRS-D40x140-W32-L200 ABHRS-D40x220-W32-L280
ABHR-D50x68-W32-L200-CC12	50-68	32	40	-	200	140	-		
ABHR-D50x68-W32-L280-CC12	50-68	32	40	-	280	220	-		
ABHR-D68x90-W32-L160-CC12	68-90	32	50	54	160	100	50	AK.. 68-90	ABHRS-D50x100-W32-L160 ABHRS-D50x150-W32-L210 ABHRS-D50x220-W32-L280
ABHR-D68x90-W32-L210-CC12	68-90	32	50	54	210	150	50		
ABHR-D68x90-W32-L280-CC12	68-90	32	50	54	280	220	50		
ABHR-D90x120-W32-L140-CC12	90-120	32	63	72	140	80	63	AK.. 90-120	ABHRS-D63x80-W32-L140 ABHRS-D63x130-W40-L200 ABHRS-D63x230-W40-L300
ABHR-D90x120-W40-L200-CC12	90-120	40	63	72	200	130	63		
ABHR-D90x120-W40-L300-CC12	90-120	40	63	72	300	230	63		
ABHR-D120x160-W40-L210-CC12	120-160	40	80	95	210	140	75	AK.. 120-160	ABHRS-D80x140-W40-L210 ABHRS-D80x230-W40-L300
ABHR-D120x160-W40-L300-CC12	120-160	40	80	95	300	230	75		
ABHR-D160x200-W40-L210-B-CC12	160-200	40	80	95	210	140	75	AK.. 160-200	ABHRS-D80x140-W40-L210 ABHRS-D80x230-W40-L300
ABHR-D160x200-W40-L300-B-CC12	160-200	40	80	95	300	230	75		

Our rough boring sets consist of -SR, -CR, and -SC cartridges. Please share the requested cartridge details with your sales representative along with your order.

Ordering Example 1 pcs. ABHR-D28x38-W20-L110-CC06-SR

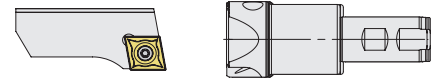
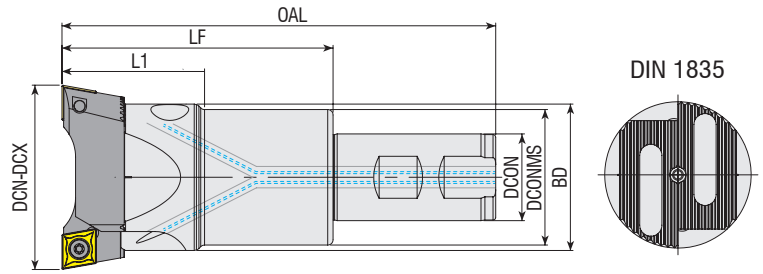

Dimensions in Inch

Ordering Code	Boring Range DCN-DCX	DCON	DCONMS	BD	OAL	LF	L1	CARTRIDGES	BORING HEAD BODY CODE
ABHR-D18x22-W16-L90-CC06	0.709-0.866	0.630	-	-	3.543	1.654	-	AK.. 18-22	ABHRS-D16x42-W16-L90 ABHRS-D16x102-W16-L150 ABHRS-D16x152-W16-L200
ABHR-D18x22-W16-L150-CC06	0.709-0.866	0.630	-	-	5.905	4.016	-		
ABHR-D18x22-W16-L200-CC06	0.709-0.866	0.630	-	-	7.874	5.984	-		
ABHR-D22x28-W20-L100-CC06	0.866-1.102	0.787	-	-	3.937	1.968	-	AK.. 22-28	ABHRS-D20x50-W20-L100 ABHRS-D20x100-W20-L150 ABHRS-D20x150-W20-L200
ABHR-D22x28-W20-L150-CC06	0.866-1.102	0.787	-	-	5.905	3.937	-		
ABHR-D22x28-W20-L200-CC06	0.866-1.102	0.787	-	-	7.874	5.905	-		
ABHR-D28x38-W20-L110-CC06	1.102-1.496	0.787	0.984	-	4.330	2.362	-	AK.. 28-38	ABHRS-D25x60-W20-L110 ABHRS-D25x110-W20-L160 ABHRS-D25x180-W20-L230
ABHR-D28x38-W20-L160-CC06	1.102-1.496	0.787	0.984	-	6.300	4.330	-		
ABHR-D28x38-W20-L230-CC06	1.102-1.496	0.787	0.984	-	8.950	7.086	-		
ABHR-D36x50-W25-L120-CC06	1.417-1.968	0.984	1.260	-	4.725	2.520	-	AK.. 36-50	ABHRS-D32x64-W25-L120 ABHRS-D32x114-W25-L170 ABHRS-D32x194-W25-L250
ABHR-D36x50-W25-L170-CC06	1.417-1.968	0.984	1.260	-	6.693	4.488	-		
ABHR-D36x50-W25-L250-CC06	1.417-1.968	0.984	1.260	-	9.842	7.638	-		
ABHR-D36x50-W25-L120-CC09	1.417-1.968	0.984	1.260	-	4.725	2.520	-	AK.. 36-50-09	ABHRS-D32x64-W25-L120 ABHRS-D32x114-W25-L170 ABHRS-D32x194-W25-L250
ABHR-D36x50-W25-L170-CC09	1.417-1.968	0.984	1.260	-	6.693	4.488	-		
ABHR-D36x50-W25-L250-CC09	1.417-1.968	0.984	1.260	-	9.842	7.638	-		
ABHR-D50x68-W32-L140-CC09	1.968-2.677	1.260	1.575	-	5.512	3.150	-	AK.. 50-68	ABHRS-D40x80-W32-L140 ABHRS-D40x140-W32-L200 ABHRS-D40x220-W32-L280
ABHR-D50x68-W32-L200-CC09	1.968-2.677	1.260	1.575	-	7.874	5.519	-		
ABHR-D50x68-W32-L280-CC09	1.968-2.677	1.260	1.575	-	11.023	8.660	-		
ABHR-D50x68-W32-L140-CC12	1.968-2.677	1.260	1.575	-	5.512	3.150	-	AK.. 50-68-12	ABHRS-D40x80-W32-L140 ABHRS-D40x140-W32-L200 ABHRS-D40x220-W32-L280
ABHR-D50x68-W32-L200-CC12	1.968-2.677	1.260	1.575	-	7.874	5.519	-		
ABHR-D50x68-W32-L280-CC12	1.968-2.677	1.260	1.575	-	11.023	8.660	-		
ABHR-D68x90-W32-L160-CC12	2.677-3.543	1.260	1.968	2.126	6.300	3.937	1.968	AK.. 68-90	ABHRS-D50x100-W32-L160 ABHRS-D50x150-W32-L210 ABHRS-D50x220-W32-L280
ABHR-D68x90-W32-L210-CC12	2.677-3.543	1.260	1.968	2.126	8.268	5.905	1.968		
ABHR-D68x90-W32-L280-CC12	2.677-3.543	1.260	1.968	2.126	11.023	8.660	1.968		
ABHR-D90x120-W32-L140-CC12	3.543-4.724	1.260	2.480	2.835	5.512	3.150	2.480	AK.. 90-120	ABHRS-D63x80-W32-L140 ABHRS-D63x130-W40-L200 ABHRS-D63x230-W40-L300
ABHR-D90x120-W40-L200-CC12	3.543-4.724	1.575	2.480	2.835	7.874	5.118	2.480		
ABHR-D90x120-W40-L300-CC12	3.543-4.724	1.575	2.480	2.835	11.811	9.055	2.480		
ABHR-D120x160-W40-L210-CC12	4.724-6.299	1.575	3.150	3.740	8.268	5.519	2.953	AK.. 120-160	ABHRS-D80x140-W40-L210 ABHRS-D80x230-W40-L300
ABHR-D120x160-W40-L300-CC12	4.724-6.299	1.575	3.150	3.740	11.811	9.055	2.953		
ABHR-D160x200-W40-L210-B-CC12	6.299-7.874	1.575	3.150	3.740	8.268	5.519	2.953	AK.. 160-200	ABHRS-D80x140-W40-L210 ABHRS-D80x230-W40-L300
ABHR-D160x200-W40-L300-B-CC12	6.299-7.874	1.575	3.150	3.740	11.811	9.055	2.953		

Our rough boring sets consist of -SR, -CR, and -SC cartridges. Please share the requested cartridge details with your sales representative along with your order.

Ordering Example 1 pcs. ABHR-D28x38-W20-L110-CC06-SR

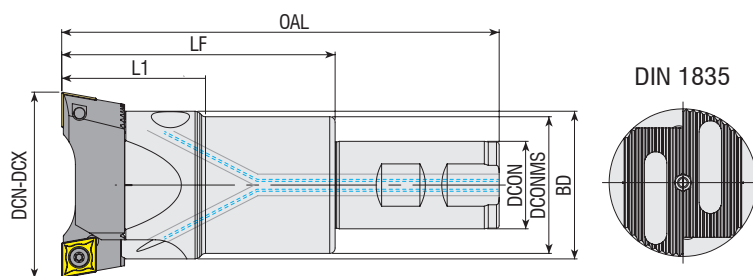

Dimensions in Metric

Ordering Code	Boring Range DCN-DCX	DCON	DCONMS	BD	OAL	LF	L1							
								Mounting Screw	Mounting Screw Key	Clamp	Adjusting Screw	Allen Key		
ABHRS-D16x42-W16-L90	18-22	16	-	-	90	42	-							
ABHRS-D16x102-W16-L150	18-22	16	-	-	150	102	-	2525-M3x14	AAL-02-2.5	ABKS-D16	2715-M3x4			
ABHRS-D16x152-W16-L200	18-22	16	-	-	200	152	-							
ABHRS-D20x50-W20-L100	22-28	20	-	-	100	50	-							
ABHRS-D20x100-W20-L150	22-28	20	-	-	150	100	-	2503-M4x15		ABKS-D20	2715-M3x5	AAL-09-1.5		
ABHRS-D20x150-W20-L200	22-28	20	-	-	200	150	-		AAL-03-3					
ABHRS-D25x60-W20-L110	28-38	20	25	-	110	60	-							
ABHRS-D25x110-W20-L160	28-38	20	25	-	160	110	-	2503-M4x20		ABKS-D25	2715-M3x8			
ABHRS-D25x180-W20-L230	28-38	20	25	-	230	180	-							
ABHRS-D32X64-W25-L120	36-50	25	32	-	120	64	-							
ABHRS-D32X114-W25-L170	36-50	25	32	-	170	114	-	2504-M5x25	AAL-05-4	ABKS-D32	2702-M4x12	AAL-01-2		
ABHRS-D32X194-W25-L250	36-50	25	32	-	250	194	-							
ABHRS-D40x80-W32-L140	50-68	32	40	-	140	80	-							
ABHRS-D40x140-W32-L200	50-68	32	40	-	200	140	-	2505-M6x30	AAL-07-5	ABKS-D40	2725-M5x16			
ABHRS-D40x220-W32-L280	50-68	32	40	-	280	220	-						AAL-02-2.5	
ABHRS-D50x100-W32-L160	68-90	32	50	54	160	100	50							
ABHRS-D50x150-W32-L210	68-90	32	50	54	210	150	50	2506-M8x35	AAL-08-6	ABKS-D50	2725-M5x12			
ABHRS-D50x220-W32-L280	68-90	32	50	54	280	220	50							
ABHRS-D63x80-W32-L140	90-120	32	63	72	140	80	63							
ABHRS-D63x130-W40-L200	90-120	40	63	72	200	130	63	2508-M10x40	AAL-11-8	ABKS-D63	2703-M6x16	AAL-03-3		
ABHRS-D63x230-W40-L300	90-120	40	63	72	300	230	63							
ABHRS-D80x140-W40-L210	120-160	40	80	95	210	140	75							
ABHRS-D80x230-W40-L300	120-160	40	80	95	300	230	75	2510-M12x40	AAL-12-10	ABKS-D80	2704-M8x25	AAL-05-4		

Ordering Example 1 pcs. ABHRS-D16x42-W16-L90

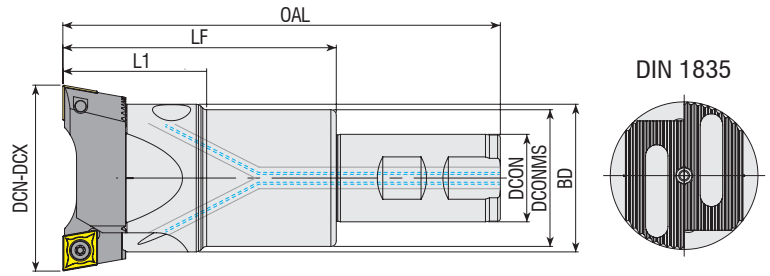



Dimensions in Inch

Ordering Code	Boring Range DCN-DCX	DCON	DCONMS	BD	OAL	LF	L1						
								Mounting Screw	Mounting Screw Key	Clamp	Adjusting Screw	Allen Key	
ABHRS-D16x42-W16-L90	0.709-0.866	0.630	-	-	3.543	1.654	-						
ABHRS-D16x102-W16-L150	0.709-0.866	0.630	-	-	5.905	4.016	-	2525-M3x14	AAL-02-2.5	ABKS-D16	2715-M3x4		
ABHRS-D16x152-W16-L200	0.709-0.866	0.630	-	-	7.874	5.984	-						
ABHRS-D20x50-W20-L100	0.866-1.102	0.787	-	-	3.937	1.968	-						
ABHRS-D20x100-W20-L150	0.866-1.102	0.787	-	-	5.905	3.937	-	2503-M4x15		ABKS-D20	2715-M3x5	AAL-09-1.5	
ABHRS-D20x150-W20-L200	0.866-1.102	0.787	-	-	7.874	5.905	-		AAL-03-3				
ABHRS-D25x60-W20-L110	1.102-1.496	0.787	0.984	-	4.330	2.362	-						
ABHRS-D25x110-W20-L160	1.102-1.496	0.787	0.984	-	6.300	4.330	-	2503-M4x20		ABKS-D25	2715-M3x8		
ABHRS-D25x180-W20-L230	1.102-1.496	0.787	0.984	-	8.950	7.086	-						
ABHRS-D32X64-W25-L120	1.417-1.968	0.984	1.260	-	4.725	2.520	-						
ABHRS-D32X114-W25-L170	1.417-1.968	0.984	1.260	-	6.693	4.488	-	2504-M5x25	AAL-05-4	ABKS-D32	2702-M4x12	AAL-01-2	
ABHRS-D32X194-W25-L250	1.417-1.968	0.984	1.260	-	9.842	7.638	-						
ABHRS-D40x80-W32-L140	1.968-2.677	1.260	1.575	-	5.512	3.150	-						
ABHRS-D40x140-W32-L200	1.968-2.677	1.260	1.575	-	7.874	5.519	-	2505-M6x30	AAL-07-5	ABKS-D40	2725-M5x16		
ABHRS-D40x220-W32-L280	1.968-2.677	1.260	1.575	-	11.023	8.660	-						AAL-02-2.5
ABHRS-D50x100-W32-L160	2.677-3.543	1.260	1.968	2.126	6.300	3.937	1.968						
ABHRS-D50x150-W32-L210	2.677-3.543	1.260	1.968	2.126	8.268	5.905	1.968	2506-M8x35	AAL-08-6	ABKS-D50	2725-M5x12		
ABHRS-D50x220-W32-L280	2.677-3.543	1.260	1.968	2.126	11.023	8.660	1.968						
ABHRS-D63x80-W32-L140	3.543-4.724	1.260	2.480	2.835	5.512	3.150	2.480						
ABHRS-D63x130-W40-L200	3.543-4.724	1.575	2.480	2.835	7.874	5.118	2.480	2508-M10x40	AAL-11-8	ABKS-D63	2703-M6x16	AAL-03-3	
ABHRS-D63x230-W40-L300	3.543-4.724	1.575	2.480	2.835	11.811	9.055	2.480						
ABHRS-D80x140-W40-L210	4.724-6.299	1.575	3.150	3.740	8.268	5.519	2.953						
ABHRS-D80x230-W40-L300	4.724-6.299	1.575	3.150	3.740	11.811	9.055	2.953	2510-M12x40	AAL-12-10	ABKS-D80	2704-M8x25	AAL-05-4	

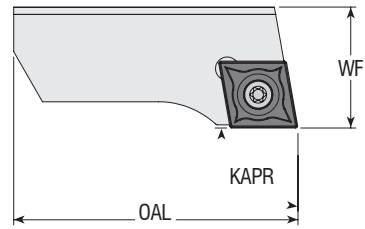
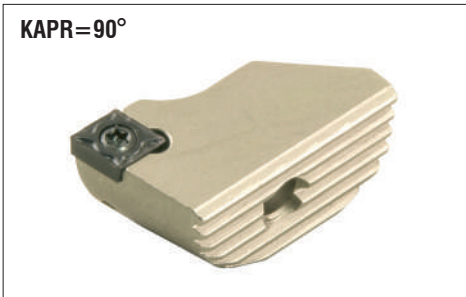
Ordering Example 1 pcs. ABHRS-D16x42-W16-L90



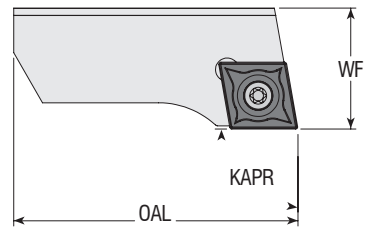

Dimensions in Metric

Ordering Code	Boring Range	WF	OAL			
				INSERT	SCREW	TORX KEY
AKSR 18-22	18-22	9	15	CC.T 0602.. CC.T 215..	4008-M2.5x6	82-T08
AKSR 22-28	22-28	10	19			
AKSR 28-38	28-38	13	23			
AKSR 36-50	36-50	16	32			
AKSR 36-50-09	36-50	16	32	CC.T 09T3.. CC.T 325..	4015-M3.5x8	80-T15
AKSR 50-68	50-68	20	40			
AKSR 50-68-12	50-68	20	40	CC.T 1204.. CC.T 43..	1020-M5x11	80-T20
AKSR 68-90	68-90	23	54			
AKSR 90-120	90-120	28	70			
AKSR 120-160	120-160	32	95			
AKSR 160-200	160-200	32	120			



Dimensions in Inch

Ordering Code	Boring Range	WF	OAL			
				INSERT	SCREW	TORX KEY
AKSR 18-22	0.709-0.866	0.354	0.590	CC.T 0602.. CC.T 215..	4008-M2.5x6	82-T08
AKSR 22-28	0.866-1.102	0.394	0.748			
AKSR 28-38	1.102-1.496	0.512	0.905			
AKSR 36-50	1.417-1.968	0.630	1.260			
AKSR 36-50-09	1.417-1.968	0.630	1.260	CC.T 09T3.. CC.T 325..	4015-M3.5x8	80-T15
AKSR 50-68	1.968-2.677	0.787	1.575			
AKSR 50-68-12	1.968-2.677	0.787	1.575	CC.T 1204.. CC.T 43..	1020-M5x11	80-T20
AKSR 68-90	2.677-3.543	0.905	2.126			
AKSR 90-120	3.543-4.724	1.102	2.756			
AKSR 120-160	4.724-6.299	1.260	3.740			
AKSR 160-200	6.299-7.874	1.260	4.725			

Ordering Example 1 pcs. AKSR 18-22

KAPR=90°

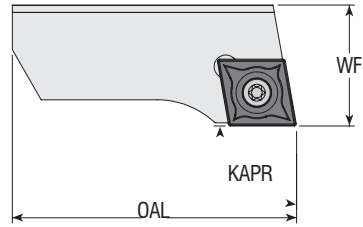

Dimensions in Metric

Ordering Code	Boring Range	WF	OAL	INSERT	SCREW	TORX KEY
AKCR 28-38	28-38	12.8	23	CC.T 0602.. CC.T 215..	4008-M2.5x6	82-T08
AKCR 36-50	36-50	15.8	32			
AKCR 36-50-09	36-50	15.8	32	CC.T 09T3.. CC.T 325..	4015-M3.5x8	80-T15
AKCR 50-68	50-68	19.7	40			
AKCR 50-68-12	50-68	19.7	40	CC.T 1204.. CC.T 43..	1020-M5x11	80-T20
AKCR 68-90	68-90	22.7	54			
AKCR 90-120	90-120	27.7	70			
AKCR 120-160	120-160	31.7	95			
AKCR 160-200	160-200	31.7	120			

KAPR=90°

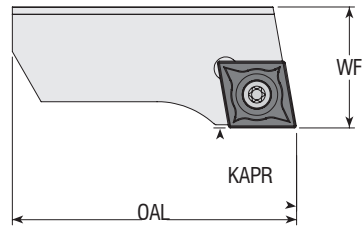

Dimensions in Inch

Ordering Code	Boring Range	WF	OAL	INSERT	SCREW	TORX KEY
AKCR 28-38	1.102-1.496	0.504	0.905	CC.T 0602.. CC.T 215..	4008-M2.5x6	82-T08
AKCR 36-50	1.417-1.968	0.622	1.260			
AKCR 36-50-09	1.417-1.968	0.622	1.260	CC.T 09T3.. CC.T 325..	4015-M3.5x8	80-T15
AKCR 50-68	1.968-2.677	0.776	1.575			
AKCR 50-68-12	1.968-2.677	0.776	1.575	CC.T 1204.. CC.T 43..	1020-M5x11	80-T20
AKCR 68-90	2.677-3.543	0.894	2.126			
AKCR 90-120	3.543-4.724	1.090	2.756			
AKCR 120-160	4.724-6.299	1.248	3.740			
AKCR 160-200	6.299-7.874	1.248	4.725			

Ordering Example 1 pcs. AKCR 28-38

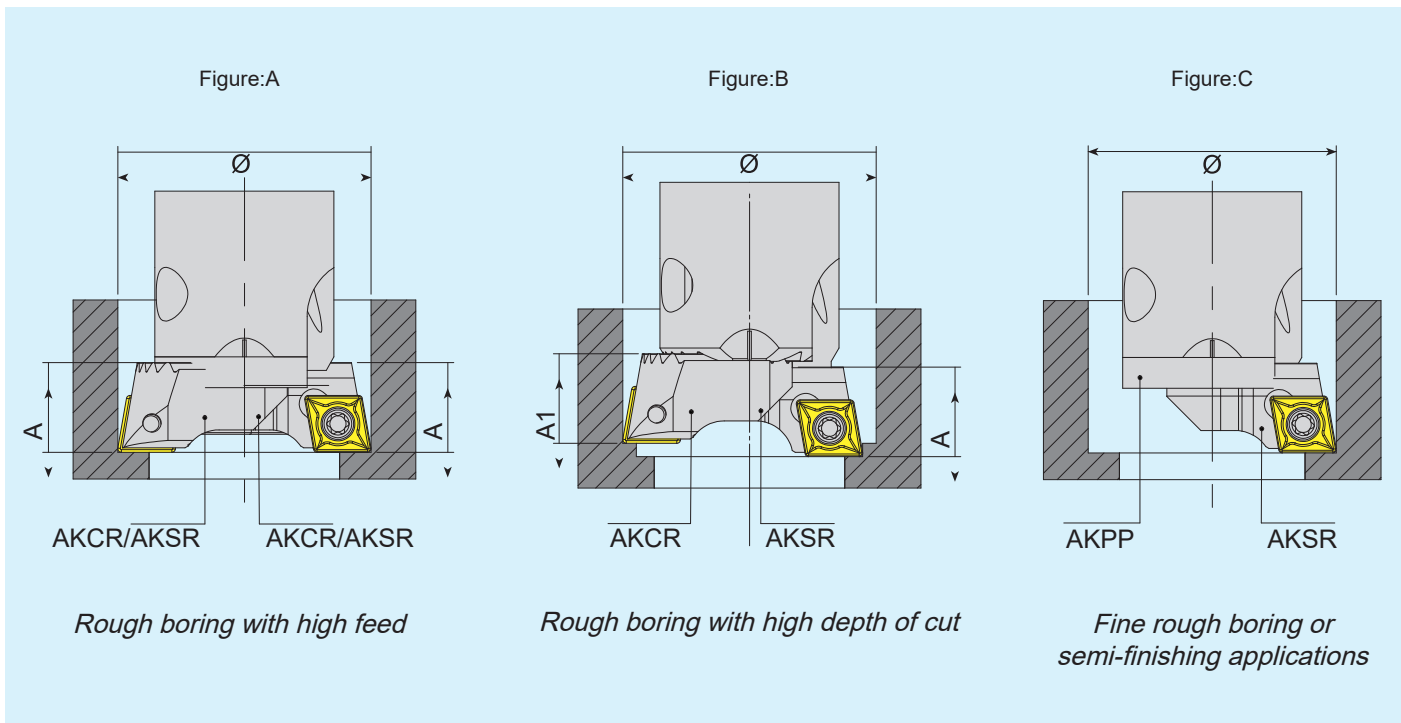

1. The -SR in the rough boring set codes indicates that two AKSR cartridges are installed, the -CR indicates that two AKCR cartridges are installed, -SC indicates that one AKSR and one AKCR cartridge are installed.
2. Radial setting of the cutting edges should be carried out with tool presetting equipment.
3. Boring bars fitted with two insert pockets are for roughing operations involving heavy chip removal. The double-insert boring bars include:
  - 3.1. Two AKSR cartridges on the same plane with two cutting edges set at identical radial distance for high feed rate roughing operations.(fig. A) Sets with -SR and -CR cartridges are for high feed operations.
  - 3.2. An AKCR cartridge and an AKSR cartridge not on the same plane for high-debth roughing operations. (fig. B) -SC cartridge sets are for heavy chip removal operations.
    - 3.2.1. With the rough boring operation, this allows double the cutting width, using only a single feed rate. (  $f=f1$  )
    - 3.2.2. With the finish boring operation, the cutting width is divided so that some of the intermediate machining can be omitted.
4. Boring bars fitted with a single cartridge are for roughing and finishing operations involving normal chip removal. The serrated surface protection plate AKPP should always be used. (fig. C)



# ADJUSTABLE FINISH BORING HEADS

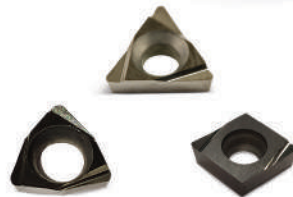



*the spoken quality...*

## S-SYSTEM END MILLS





**2** *Cutter Style*

FM: Face Milling Tools  
 EM: End Face Milling Tools  
 CM: Chamfering End Milling Tools  
 HM: Helix End Milling Tools  
 TSM: T Slot Milling Tools  
 HFM: High Feed Milling Tools  
 PMR: Ball Nose End Milling Tools  
 SDM: Slot Disc Milling  
 CBM: Countersink Milling Tool for Cylindrical Allen Head Screws

**3** *Lead Angle*

90° - 75° - 60° - 45°  
 20° - 15° - 11° - 5° - 0°



**4** *Lead Angle*

L: Left  
 C: Clamp  
 S: Shim  
 CL: Left Way with Clamp  
 CS: Clamp with Shim  
 CSL: Left Way Clamp with Shim

**5** *Type of Insert*

<b>C</b>	<b>D</b>	<b>E</b>	<b>K</b>	<b>L</b>	<b>R</b>	<b>S</b>	<b>T</b>
<b>V</b>	<b>W</b>	<b>A</b>	<b>B</b>	<b>H</b>	<b>M</b>	<b>O</b>	<b>P</b>

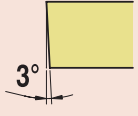
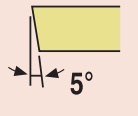
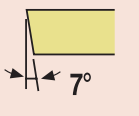
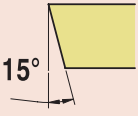
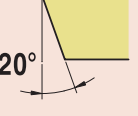
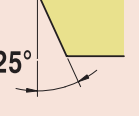
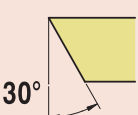
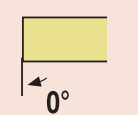
**6** Clearance angle of Insert

		
<b>A</b>	<b>B</b>	<b>C</b>
		
<b>D</b>	<b>E</b>	<b>F</b>
		
<b>G</b>	<b>N</b>	<b>P</b>

**7** Cutting Edge Length

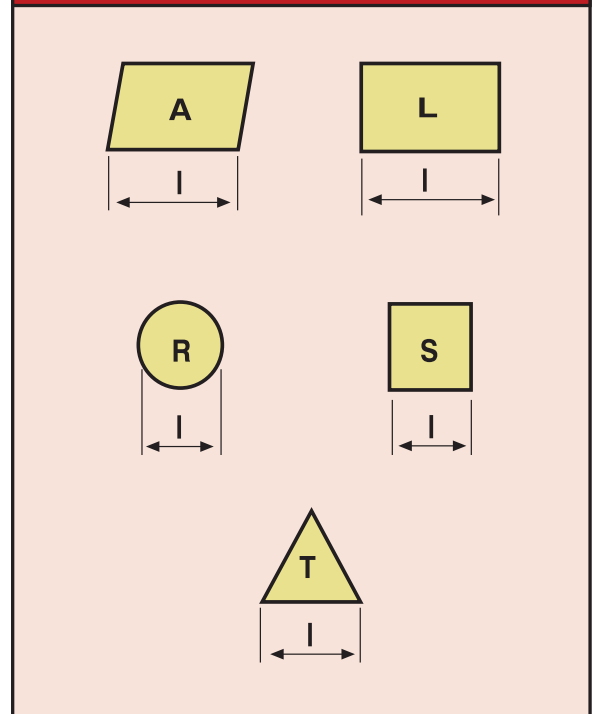

**8** Tool Diameter

**9** Assembly Form and Diameter

Assembly Form and Diameter  
Cylindrical Shank  
W: Weldon

**10** Tool Length

**11** Number of Effective Tooth

**12** With Coolant Hole

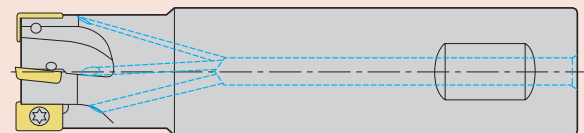

Company Name:

Date:

**Milling Body Types**

- A Type  
  B Type  
  C Type  
  D Type  
  E Type  
  F Type  
  Special Type

**Coolant Info**

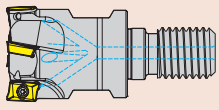

Coolant Hole

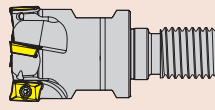

Without Coolant Hole

**Differential Pitch**

Yes  
  No

Insert Code

Insert Brand

**Can you send the original body/insert ? If Needed!**

Yes  
  No

**Shank Type**

- Weldon Type  
  Cylindrical Type  
  Moduler Type  
  Mors Type  
  HSK Type  
  Polygonal Type  
  Arbor Type

**Cutter Type**

- Highfeed Type  
  Angle Type

**Milling Tool Size**

DC	
DCON	
LF	
Z (number of the flutes)	
DCX	
KAPR	
CW	
LH	
THUB	

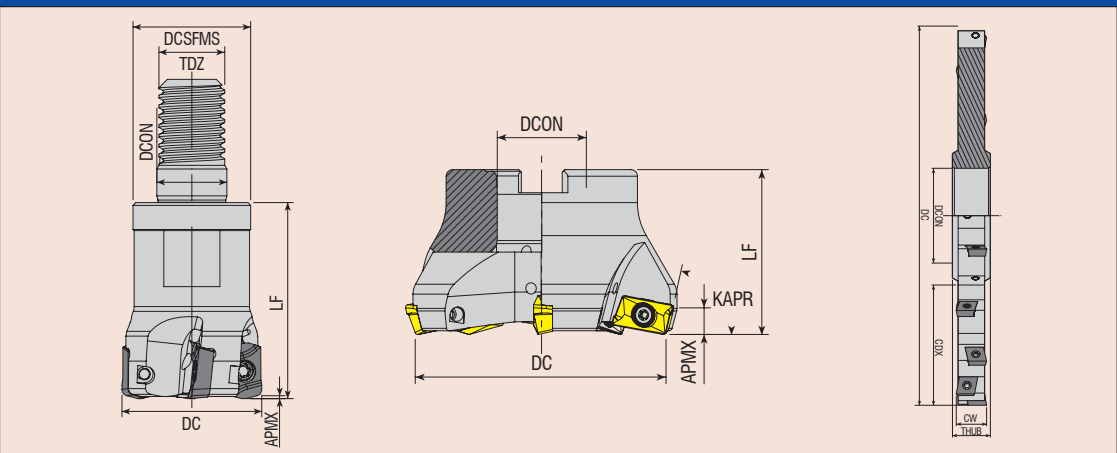



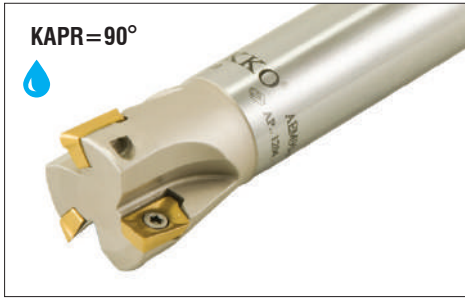

Illustrations shown may vary from actual product.

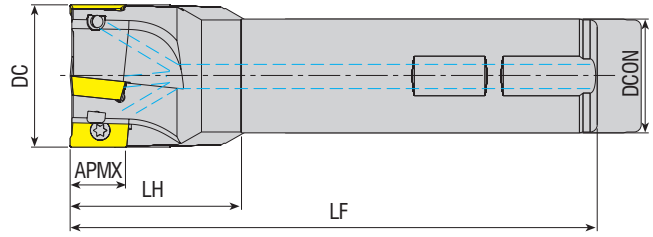

Dimensions in Inch

Ordering Code	DC	ZEFP	DCON	LF	LH	APMX	Insert Inch/Metric	Screw	Torx Key
AEM90-AP10-D0625-W0625-L0350-Z02-H	0.625	2	0.625	3.500	1.200	0.394	AP. 1003..	3008-M2.5x6	80-T08
AEM90-AP10-D0625-W0625-L1000-Z02-H	0.625	2	0.625	10.000	1.200	0.394	AP. 1003..	3008-M2.5x6	80-T08
AEM90-AP10-D0750-W0750-L0350-Z03-H	0.750	3	0.750	3.500	1.200	0.394	AP. 1003..	3008-M2.5x6	80-T08
AEM90-AP10-D0750-W0750-L0400-Z03-H	0.750	3	0.750	4.000	1.500	0.394	AP. 1003..	3008-M2.5x6	80-T08
AEM90-AP10-D0750-W0750-L1000-Z03-H	0.750	3	0.750	10.000	1.200	0.394	AP. 1003..	3008-M2.5x6	80-T08
AEM90-AP10-D1000-W0750-L0400-Z03-H	1.000	3	0.750	4.000	1.300	0.394	AP. 1003..	3008-M2.5x6	80-T08
AEM90-AP10-D1000-W1000-L0400-Z03-H	1.000	3	1.000	4.000	1.500	0.394	AP. 1003..	3008-M2.5x6	80-T08

Compatible with ISO insert



Illustrations shown may vary from actual product.

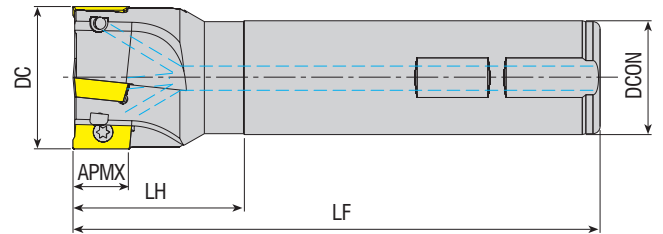



Dimensions in Inch

Ordering Code	DC	ZEFP	DCON	LF	LH	APMX	Insert Inch/Metric	Screw	Torx Key
AEM90-AP10PR-D0375-W0500-L0300-Z01-H	0.375	1	0.500	3.000	0.640	0.394	AP. 1003..	3008-M2.5x5	80-T08
AEM90-AP10PR-D0500-W0625-L0325-Z01-H	0.500	1	0.625	3.250	0.750	0.394	AP. 1003..	3008-M2.5x5	80-T08
AEM90-AP10PR-D0625-W0625-L0325-Z02-H	0.625	2	0.625	3.250	1.000	0.394	AP. 1003..	3008-M2.5x5	80-T08
AEM90-AP10PR-D0750-W0750-L0400-Z02-H	0.750	2	0.750	4.000	1.000	0.394	AP. 1003..	3008-M2.5x5	80-T08
AEM90-AP10PR-D0750-W0750-L0400-Z03-H	0.750	3	0.750	4.000	1.000	0.394	AP. 1003..	3008-M2.5x5	80-T08
AEM90-AP10PR-D0750-W0750-L0787-Z03-H	0.750	3	0.750	7.870	1.000	0.394	AP. 1003..	3008-M2.5x5	80-T08
AEM90-AP10PR-D1000-W1000-L0450-Z04-H	1.000	4	1.000	4.500	1.260	0.394	AP. 1003..	3008-M2.5x5	80-T08
AEM90-AP10PR-D1250-W1000-L0500-Z05-H	1.250	5	1.000	5.000	1.000	0.394	AP. 1003..	3008-M2.5x5	80-T08

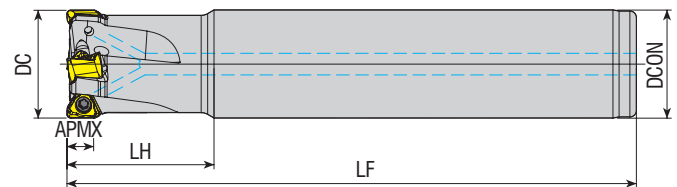
Compatible with PRMT insert





Illustrations shown may vary from actual product.

Ordering Code	Dimensions in Inch								
	DC	ZEFP	DCON	LF	LH	APMX	Insert Inch/Metric	Screw	Torx Key
AEM90-TNG16-D1000-W1000-L0400-Z02-H	1.000	2	1.000	4.000	1.654	0.394	TNGX 34.. TNGX 1606..	3015-M4x11	80-T15
AEM90-TNG16-D1000-W1000-L0600-Z02-H	1.000	2	1.000	6.000	1.654	0.394	TNGX 34.. TNGX 1606..	3015-M4x11	80-T15
AEM90-TNG16-D1250-W1000-L0450-Z03-H	1.250	3	1.000	4.500	1.654	0.394	TNGX 34.. TNGX 1606..	3015-M4x11	80-T15

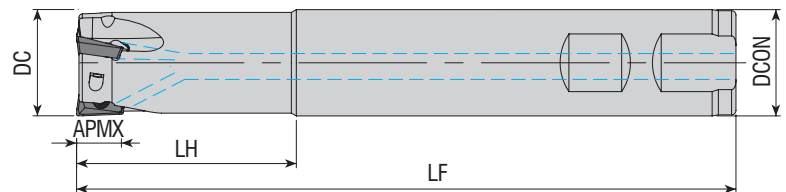
Compatible with PRMT insert



Illustrations shown may vary from actual product.

Ordering Code	Dimensions in Inch								
	DC	ZEFP	DCON	LF	LH	APMX	Insert Inch/Metric	Screw	Torx Key
AEM90-AD16PR-D1000-W1000-L0378-Z02-H	1.000	2	1.000	3.780	1.280	0.600	- AD.. 1606..	4015-M4x9	80-T15
AEM90-AD16PR-D1000-C1000-L0650-Z02-H	1.000	2	1.000	6.500	1.300	0.600	- AD.. 1606..	4015-M4x9	80-T15
AEM90-AD16PR-D1500-W1250-L0435-Z04-H	1.500	4	1.250	4.350	1.500	0.600	- AD.. 1606..	4015-M4x9	80-T15

Compatible with PRMT insert



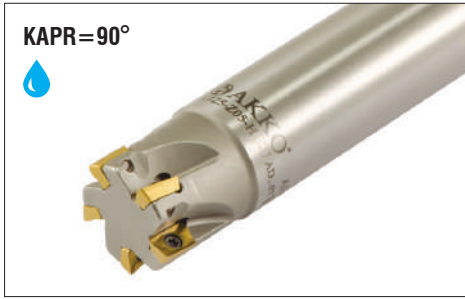

Illustrations shown may vary from actual product.

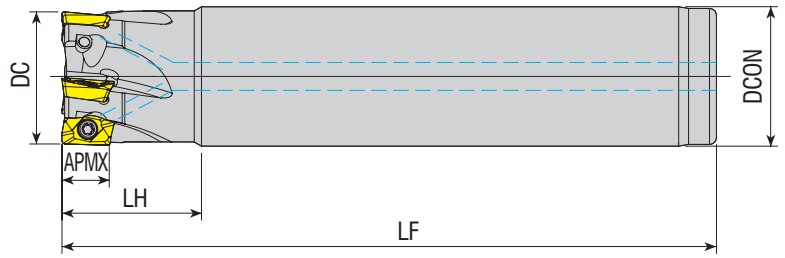

Dimensions in Inch

Ordering Code	DC	ZEFP	DCON	LF	LH	APMX	Insert Inch/Metric	Screw	Torx Key
AEM90-AD11-D0625-W0625-L0325-Z02-H	0.625	2	0.625	3.250	1.063	0.354	- ADMX 11T3	3008-M2.5x5	80-T08
AEM90-AD11-D0625-C0625-L0325-Z02-H	0.625	2	0.625	3.250	1.063	0.354	- ADMX 11T3	3008-M2.5x5	80-T08
AEM90-AD11-D0625-C0625-L0531-Z02-H	0.625	2	0.625	5.315	1.969	0.354	- ADMX 11T3	3008-M2.5x5	80-T08
AEM90-AD11-D0750-W0750-L0400-Z02-H	0.750	2	0.750	4.000	1.260	0.354	- ADMX 11T3	3008-M2.5x5	80-T08
AEM90-AD11-D0750-W0750-L0400-Z03-H	0.750	3	0.750	4.000	1.260	0.354	- ADMX 11T3	3008-M2.5x5	80-T08
AEM90-AD11-D0750-C0750-L0600-Z03-H	0.750	3	0.750	6.000	1.142	0.354	- ADMX 11T3	3008-M2.5x5	80-T08
AEM90-AD11-D1000-W1000-L0450-Z03-H	1.000	3	1.000	4.500	1.280	0.354	- ADMX 11T3	3008-M2.5x5	80-T08
AEM90-AD11-D1000-W1000-L0450-Z04-H	1.000	4	1.000	4.500	1.260	0.354	- ADMX 11T3	3008-M2.5x5	80-T08
AEM90-AD11-D1000-C1000-L0670-Z03-H	1.000	3	1.000	6.700	3.150	0.354	- ADMX 11T3	3008-M2.5x5	80-T08
AEM90-AD11-D1000-C1000-L0670-Z04-H	1.000	4	1.000	6.700	1.339	0.354	- ADMX 11T3	3008-M2.5x5	80-T08

Compatible with PRMT insert



Illustrations shown may vary from actual product.

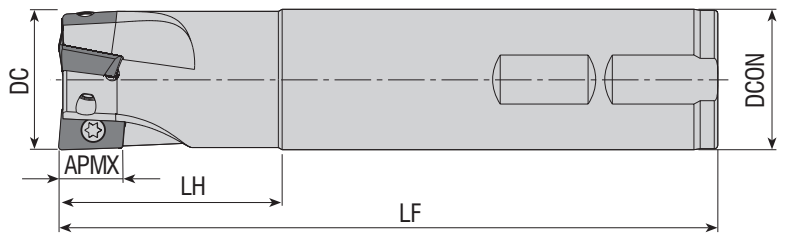

Dimensions in Inch

Ordering Code	DC	ZEFP	DCON	LF	LH	APMX	Insert Inch/Metric	Screw	Torx Key
AEM90-AD1505-D1000-W1000-L0450-Z02-PR	1.000	2	1.000	4.500	1.570	0.551	- AD.. 1505..	4015-M3.5x9	80-T15
AEM90-AD1505-D1250-W1000-L0500-Z03-PR	1.250	3	1.000	5.000	1.570	0.551	- AD.. 1505..	4015-M3.5x9	80-T15
AEM90-AD1505-D1500-W1000-L0535-Z04-PR	1.500	4	1.000	5.315	2.000	0.551	- AD.. 1505..	4015-M3.5x9	80-T15

Compatible with PRMT insert



Illustrations shown may vary from actual product.

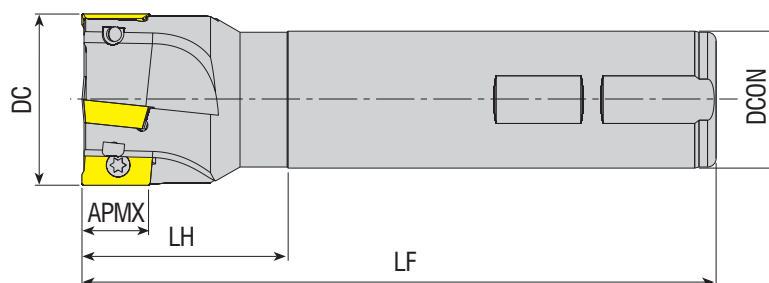

Dimensions in Inch

Ordering Code	DC	ZEFP	DCON	LF	LH	APMX	Insert Inch/Metric	Screw	Torx Key
AEM90-AP16PR-D0250-W0100-L425-Z06	2.500	6	1.000	4.250	2.000	0.630	- AP. 1604..	4015-M4x9	80-T15

Compatible with PRMT



Illustrations shown may vary from actual product.

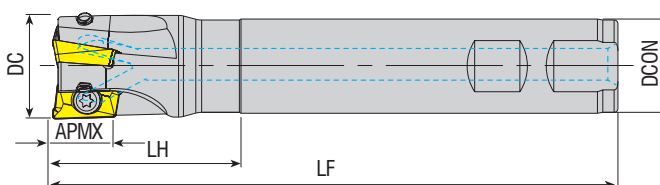

Dimensions in Inch

Ordering Code	DC	ZEFP	DCON	LF	LH	APMX	Insert Inch/Metric	Screw	Torx Key
AEM90-R390.11-D0500-W0625-L0288-Z01-H	0.500	1	0.625	2.880	0.715	0.394	- R390-11T3..	3008-M2.5x5	82-T08
AEM90-R390.11-D1000-W0750-L0350-Z03-H	1.000	3	0.750	3.500	1.468	0.394	- R390-11T3..	3008-M2.5x6	82-T08
AEM90-R390.11-D1000-W1000-L0375-Z03-H	1.000	3	1.000	3.750	1.250	0.394	- R390-11T3..	3008-M2.5x6	82-T08

Compatible with SNDVK insert



Illustrations shown may vary from actual product.

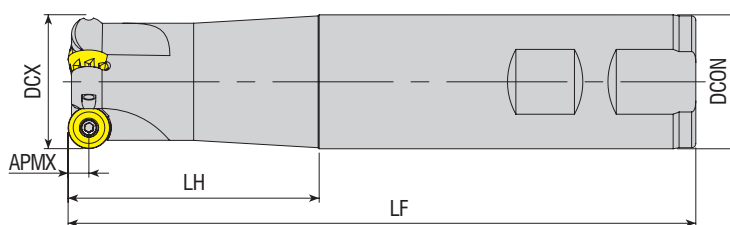

Dimensions in Inch

Ordering Code	DCX	ZEFP	DCON	LF	LH	APMX	Insert	Screw	Torx Key
AEMR-RP1204SC-D1000-W1000-L0450-Z02	0.714	0.787	8.000	1.750	0.570	0.677	RP. 1204	3015-M4X11	82-T15
AEMR-RP1204SC-D1000-W1000-L0600-Z02	0.961	0.984	8.000	2.300	0.19	0.921	RP. 1204	3015-M4X11	82-T15

Compatible with SC insert



*the spoken quality...*



*the spoken quality...*

## S-SYSTEM HIGHFEED FACE MILLS





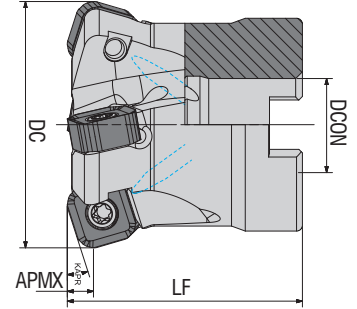

Illustrations shown may vary from actual product.



Dimensions in Inch

Ordering Code	DC	ZEFP	DCON	LF	APMX			
						Insert Inch/Metric	Screw	Torx Key
AHFM-SN1104-D0200-A075-Z05-H	2.000	5	0.750	1.575	0.080	SN.. 353.. SN.. 1104..	1715-M4x11	80-T15
AHFM-SN1104-D0250-A075-Z06-H	2.500	6	0.750	1.575	0.080	SN.. 353.. SN.. 1104..	1715-M4x11	80-T15
AHFM-SN1104-D0300-A100-Z07-H	3.000	7	1.000	1.969	0.080	SN.. 353.. SN.. 1104..	1715-M4x11	80-T15

Compatible with PRMT insert





*the spoken quality...*

## FACE AND COPY MILLING TOOLS







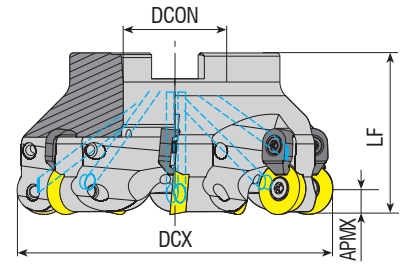

Illustrations shown may vary from actual product.



Dimensions in Inch

Ordering Code	DC	ZEFP	DCON	LF	APMX					
						Insert Inch/Metric	Screw	Clamp	Clamp Screw	Torx Key
AFMRC-RD1003-D0150-A050-Z04-H	1.500	4	0.500	1.500	0.196	RD..1003	4015-M3.5x11	ACK-15	4015-M3.5x11	80-T15
AFMRC-RD1003-D0200-A075-Z05-H	2.000	5	0.750	1.750	0.196	RD..1003	4015-M3.5x11	ACK-15	4015-M3.5x11	80-T15
AFMR-RD12T3-D0200-A075-Z05-H	2.000	5	0.750	1.570	0.236	RD..12T3	4015-M3.5x10	-	-	80-T15
AFMRC-RD12T3-D0300-B100-Z07	3.000	7	1.000	1.750	0.236	RD..12T3	4015-M3.5x11	ACK-15	4015-M3.5x11	80-T15
AFMRC-RD12T3-D0400-B125-Z08	4.000	8	1.250	2.000	0.236	RD..12T3	4015-M3.5x11	ACK-15	4015-M3.5x11	80-T15

Compatible with ISO insert





*the spoken quality...*

## FACE MILLING

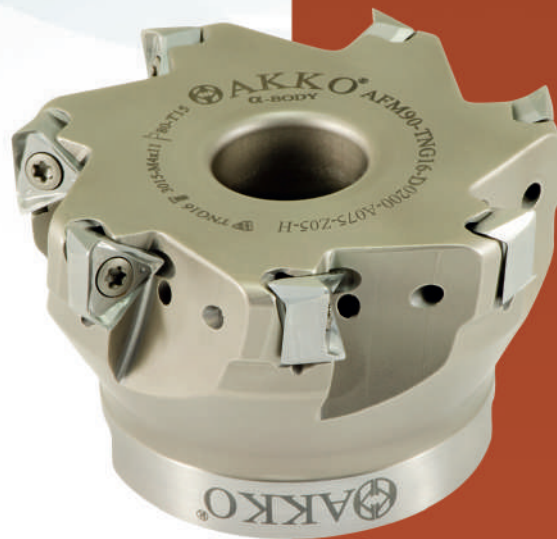

KAPR=90°



Illustrations shown may vary from actual product.

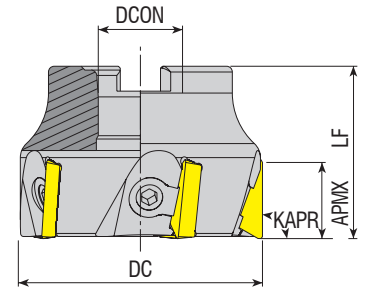

Dimensions in Inch

Ordering Code	DC	ZEFP	DCON	LF	APMX	Insert Inch/Metric	Screw	Clamp Screw	Allen Key
AFM90C-TP16-D0200-A075-Z04	2.000	4	1.700	1.575	0.472	TP. 32.. TP.1603..	ACK-10	AKV-22-M8x1x14	AAL-05-4
AFM90C-TP16-D0300-A100-Z07	3.000	7	2.283	2.000	0.472	TP. 32.. TP.1603..	ACK-11	AKV-14-M8x1x18	AAL-05-4

Compatible with ISO insert

KAPR=90°



Illustrations shown may vary from actual product.

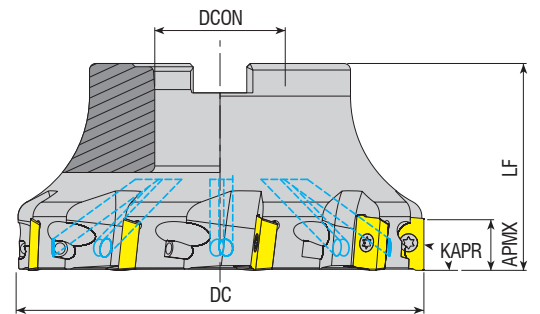

Dimensions in Inch

Ordering Code	DC	ZEFP	DCON	LF	APMX	Insert Inch/Metric	Screw	Torx Key
AFM90-AP10-D0200-A075-Z06-H	2.000	6	1.700	1.575	0.394	- AP. 1003..	3008-M2.5x6	80-T08
AFM90-AP10-D0300-A100-Z08-H	3.000	8	2.283	1.700	0.394	- AP. 1003..	3008-M2.5x6	80-T08
AFM90-AP16-D0300-A100-Z07-H	3.000	7	2.283	1.700	0.590	- AP. 1604..	4015-M4x11	80-T15

Compatible with ISO insert

KAPR=90°

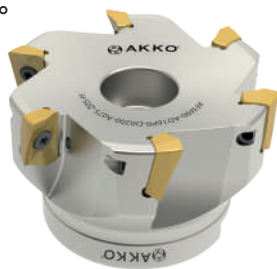

Illustrations shown may vary from actual product.

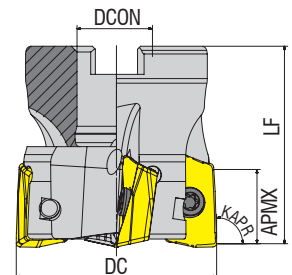

Dimensions in Inch

Ordering Code	DC	ZEFP	DCON	LF	APMX	Insert Inch/Metric	Screw	Torx Key
AFM90-AD16PR-D0200-A075-Z05-H	2.000	5	1.654	1.575	0.590	- AD.. 1606..	4015-M4x10	80-T15
AFM90-AD16PR-D0300-A100-Z07-H	3.000	7	2.283	1.970	0.590	- AD.. 1606..	4015-M4x10	80-T15

Compatible with PRMT insert



Illustrations shown may vary from actual product.

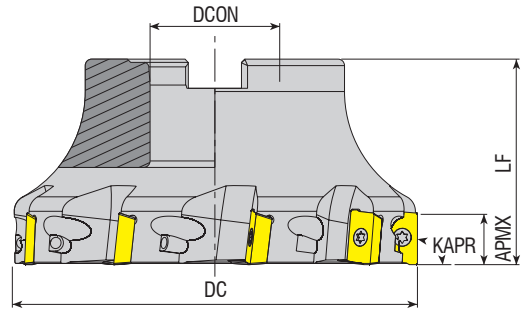

Dimensions in Inch

Ordering Code	DC	ZEFP	DCON	LF	APMX			
						Insert Inch/Metric	Screw	Torx Key
AFM90-AP16PR-D0200-A075-Z04	2.000	4	1.730	1.575	0.630	- AP. 1604..	4015-M3.5x11	80-T15
AFM90-AP16PR-D0250-A075-Z05	2.500	5	1.980	1.575	0.630	- AP. 1604..	4015-M3.5x11	80-T15
AFM90-AP16PR-D0300-A100-Z06	3.000	6	2.000	1.970	0.630	- AP. 1604..	4015-M3.5x11	80-T15
AFM90-AP16PR-D0400-A150-Z07	4.000	7	3.000	1.970	0.630	- AP. 1604..	4015-M3.5x11	80-T15

Compatible with PRMT insert

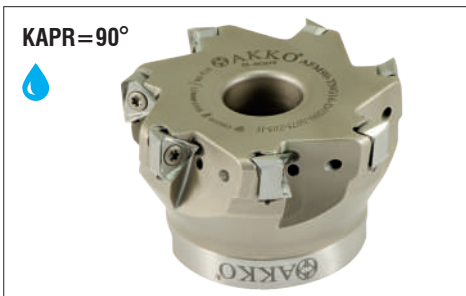

Illustrations shown may vary from actual product.

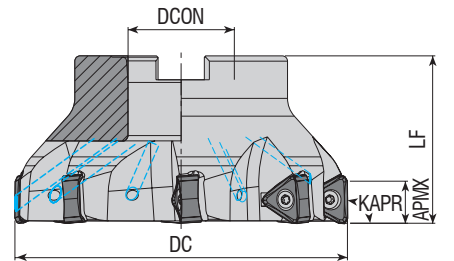

Dimensions in Inch

Ordering Code	DC	ZEFP	DCON	LF	APMX			
						Insert Inch/Metric	Screw	Torx Key
AFM90-TNG16-D0200-A075-Z05-H	2.000	5	1.700	1.575	0.394	TNGX 34.. TNGX 1606..	3015-M4x11	80-T15
AFM90-TNG16-D0250-A075-Z05-H	2.500	5	1.892	1.575	0.394	TNGX 34.. TNGX 1606..	3015-M4x11	80-T15
AFM90-TNG16-D0300-A100-Z05-H	3.000	5	2.283	1.970	0.394	TNGX 34.. TNGX 1606..	3015-M4x11	80-T15
AFM90-TNG16-D0300-A100-Z07-H	3.000	7	2.283	1.970	0.394	TNGX 34.. TNGX 1606..	3015-M4x11	80-T15

Compatible with PRMT insert



Illustrations shown may vary from actual product.

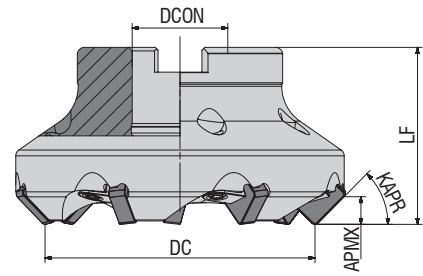

Dimensions in Inch

Ordering Code	DC	ZEFP	DCON	LF	APMX	Insert Metric	Screw	Wedge Clamp	Torx Key
AFM45C-SE12S-D0197-A075-Z04	1.970	4	0.750	1.570	6	SE.. 1203	AKV-13-M8X1X16	ACK-10	AAL-05-4
AFM45C-SE12S-D0630-B150-Z07	6.300	7	1.500	2.500	6	SE.. 1203	AKV-13-M8X1X16	ACK-10	AAL-05-4

Compatible with SC insert



Illustrations shown may vary from actual product.

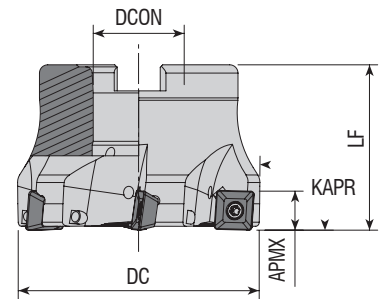

Dimensions in Inch

Ordering Code	DC	ZEFP	DCON	LF	APMX	Insert Metric	Screw	Torx Key
AFM90-SN1306-D0250-A075-Z06-H	2.250	6	0.750	1.570	12	SN.. 1306..	1115-M4X10	82-T15
AFM90-SN1306-D0300-A100-Z07-H	3.000	7	1.000	1.750	12	SN.. 1306..	1115-M4X10	82-T15
AFM90-SN1306-D0400-A150-Z08-H	4.000	8	1.500	2.380	12	SN.. 1306..	1115-M4X10	82-T15

Compatible with TGTC insert

*the spoken quality...*

# HOLDER





**POLYGONAL SHANK 3-4-5-6-8**

- EM : END MILL HOLDER
- ER : COLLET CHUCKS (ER)
- FM : SHELL MILL HOLDERS
- MM : MILLING CUTTER ARBORS FOR SCREW-ON TYPE MILLING CUTTERS

- FMC : COMBI SHELL MILL HOLDER
- ASHR : TOOLHOLDER AXIAL
- EX : EXTENSION
- BL41 : BLANK HOLDERS



**QUALITY CONTROL**

[www.akkousa.us](http://www.akkousa.us)

**POLYGONAL SHANK**

POLYGONAL SHANK 3-4-5-6-8

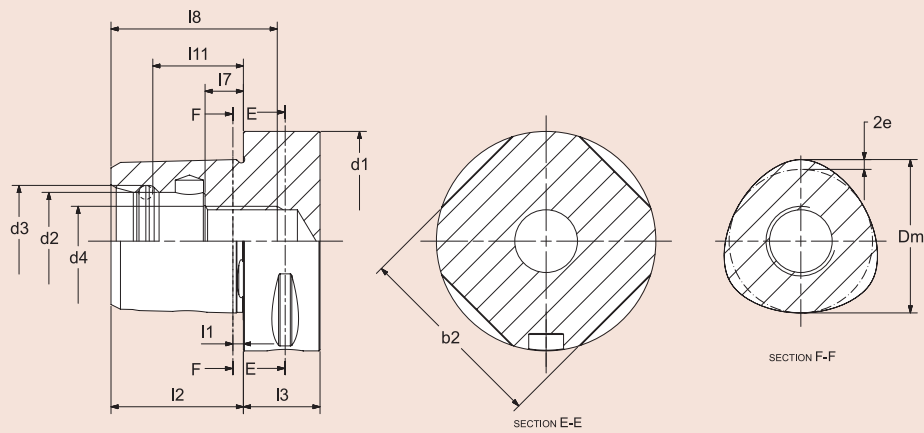

**Compared to the steep taper the POLYGON SHANK has the following advantages:**

- Highly repeatable accuracy when clamping tools into spindle
- Fixed axial positioning with flat contact surface
- Suitable for high speed cutting
- No pull stud necessary
- Interface with a unique tapered polygon and flange face contact
- Exact positioning in the circumferential direction
- Highest runout accuracy, torque and rigidity
- Innovative modular tool system with highest precision
- Suitable for both turning and milling centres
- Incl. bore for data chip Ø 10 mm

**Material:**

- Special case-hardening steel for highly stressed parts
- Surface hardness: 58 ± 2 HRC
- Tensile strength in core min. 950 N/mm<sup>2</sup>

POLYGON SHANK	d1 ±0.1	d2 0.1 -0.05	d3 ±0.05	d4	b2	Dm	e	l1	l2 ±0.1	l3 min.	l7 ±0.15	l8 min.	l11 ±0.1
3	32	15	16.5	M12x1.5	28.3	22	0.7	2.5	19	15	6	25	13.5
4	40	18	20	M14x1.5	35.3	28	0.9	2.5	24	20	9	30	17.5
5	50	21	24	M16x1.5	44.4	35	1.12	3	30	20	10	37	22
6	63	28	32	M20x2	55.8	44	1.4	3	38	22	11	47	26
8	80	32	38	M20x2	71.1	55	2	3	48	30	20	48	34

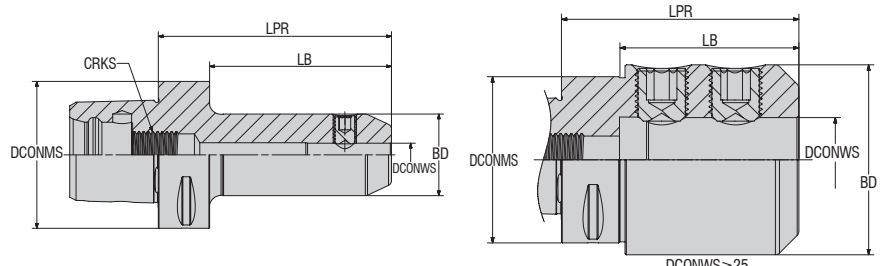

ISO 26623-1   HRC 58±2   H5   DIN 1835-B   G 2.5 25,000 min-1 U ≤ 1gmm   CHIP    $\sqrt{0.003}$

Dimensions in Metric

Ordering Code	DCONMS	DCONWS	LPR	BD	LB	CRKS	KG
AC3-EM-06-046	32	6	46	25	31	M12x1.5	0.220
AC3-EM-08-046	32	8	46	28	31	M12x1.5	0.250
AC3-EM-10-050	32	10	50	34	35	M12x1.5	0.330
AC3-EM-12-055	32	12	55	42	40	M12x1.5	0.460
AC4-EM-06-050	40	6	50	25	30	M14x1.5	0.340
AC4-EM-08-050	40	8	50	28	30	M14x1.5	0.370
AC4-EM-10-050	40	10	50	35	30	M14x1.5	0.430
AC4-EM-12-055	40	12	55	42	35	M14x1.5	0.550
AC4-EM-14-055	40	14	55	44	35	M14x1.5	0.550
AC4-EM-16-060	40	16	60	48	40	M14x1.5	0.630
AC5-EM-06-050	50	6	50	25	30	M16x1.5	0.510
AC5-EM-08-050	50	8	50	28	30	M16x1.5	0.540
AC5-EM-10-055	50	10	55	35	35	M16x1.5	0.640
AC5-EM-12-060	50	12	60	42	40	M16x1.5	0.780
AC5-EM-14-060	50	14	60	44	40	M16x1.5	0.800
AC5-EM-16-060	50	16	60	48	40	M16x1.5	0.860
AC5-EM-18-060	50	18	60	50	40	M16x1.5	0.890
AC5-EM-20-060	50	20	60	52	40	M16x1.5	0.900
AC5-EM-25-080	50	25	80	65	60	M16x1.5	1.530
AC6-EM-06-075	63	6	75	25	53	M20x2	0.900
AC6-EM-06-100	63	6	100	25	78	M20x2	1.000
AC6-EM-08-055	63	8	55	28	33	M20x2	0.880
AC6-EM-08-075	63	8	75	28	53	M20x2	0.960
AC6-EM-08-100	63	8	100	28	78	M20x2	1.080
AC6-EM-10-060	63	10	60	35	35	M20x2	0.990
AC6-EM-10-075	63	10	75	35	53	M20x2	1.100
AC6-EM-10-100	63	10	100	35	78	M20x2	1.250
AC6-EM-12-065	63	12	65	42	43	M20x2	1.120
AC6-EM-12-100	63	12	100	42	78	M20x2	1.480
AC6-EM-14-065	63	14	65	44	43	M20x2	1.150
AC6-EM-14-100	63	14	100	44	78	M20x2	1.550
AC6-EM-16-065	63	16	65	48	43	M20x2	1.240
AC6-EM-16-085	63	16	85	48	63	M20x2	1.350

Spare Part

Clamping Screw Weldon DIN 1835 B  
Delivered With

Coolant Tube  
Delivered Without



Illustrations shown may vary from actual product.

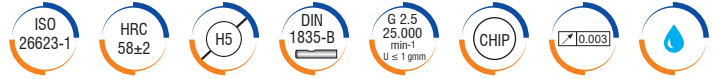
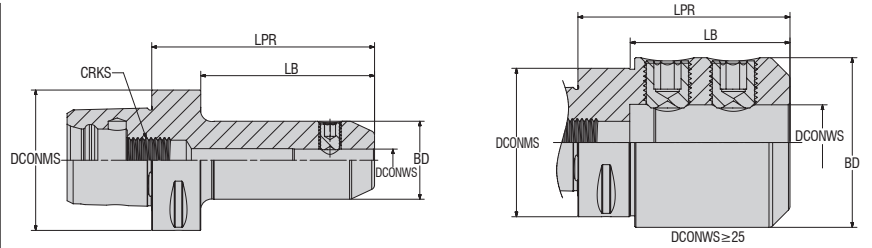

Dimensions in Metric

Ordering Code	DCONMS	DCONWS	LPR	BD	LB	CRKS	KG
AC6-EM-06-055	63	06	55	25	33	M20x2	0.880
AC6-EM-12-080	63	12	80	42	58	M20x2	1.185
AC6-EM-16-100	63	16	100	48	78	M20x2	1.700
AC6-EM-18-065	63	18	65	50	43	M20x2	1.270
AC6-EM-18-100	63	18	100	50	78	M20x2	1.550
AC6-EM-20-065	63	20	65	52	43	M20x2	1.290
AC6-EM-20-100	63	20	100	52	78	M20x2	1.830
AC6-EM-25-080	63	25	80	63	58	M20x2	1.820
AC6-EM-32-090	63	32	90	72	68	M20x2	2.350
AC6-EM-40-100	63	40	100	79	78	M20x2	2.850
AC8-EM-06-070	80	6	70	25	40	M20x2	1.840
AC8-EM-08-070	80	8	70	28	40	M20x2	1.880
AC8-EM-10-070	80	10	70	35	40	M20x2	1.960
AC8-EM-12-070	80	12	70	42	40	M20x2	2.070
AC8-EM-14-070	80	14	70	44	40	M20x2	2.090
AC8-EM-16-070	80	16	70	48	40	M20x2	2.160
AC8-EM-18-070	80	18	70	50	40	M20x2	2.180
AC8-EM-20-070	80	20	70	52	40	M20x2	2.190
AC8-EM-25-090	80	25	90	63	60	M20x2	2.650
AC8-EM-32-100	80	32	100	72	70	M20x2	2.900
AC8-EM-40-110	80	40	110	80	80	M20x2	3.920
AC8-EM-50-120	80	50	120	100	90	M20x2	5.300

Spare Part



Clamping Screw Weldon DIN 1835 B

Delivered With



Coolant Tube

Delivered Without



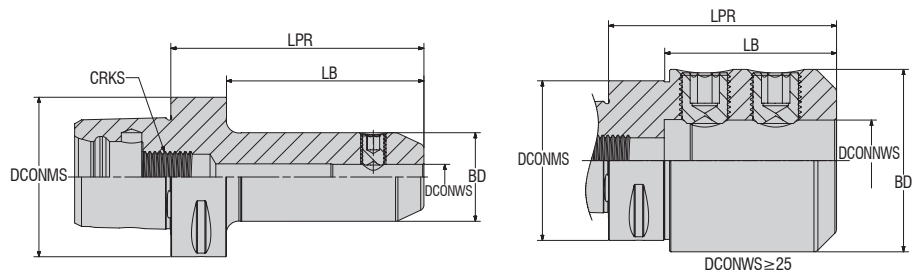

Illustrations shown may vary from actual product.

Dimensions in Inch

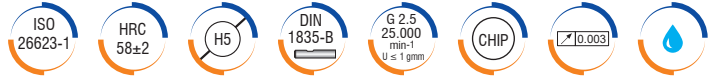

Ordering Code	DCONMS	DCONWS	LPR	BD	LB	CRKS	KG
AC6-EM-0375-237	2.480	0.375	2.370	1.000	1.504	M20x2	0.870
AC6-EM-0500-237	2.480	0.500	2.370	1.380	1.504	M20x2	0.960
AC6-EM-0625-256	2.480	0.625	2.560	1.650	1.694	M20x2	1.100
AC6-EM-0750-256	2.480	0.750	2.560	1.890	1.694	M20x2	1.200
AC6-EM-1000-335	2.480	1.000	3.350	2.360	2.634	M20x2	1.730
AC6-EM-1250-335	2.480	1.250	3.350	2.480	2.634	M20x2	1.690
AC6-EM-1500-354	2.480	1.500	3.540	2.755	-	M20x2	-

**Spare Part**



Delivered With



Delivered Without



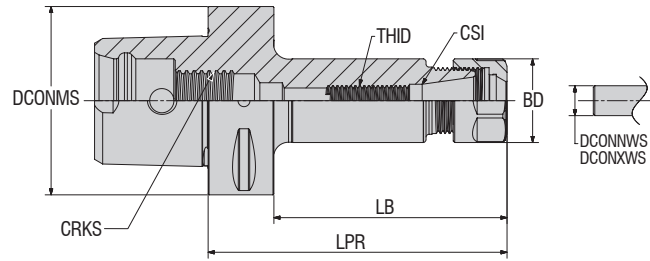

Illustrations shown may vary from actual product.

Dimensions in Metric

Ordering Code	DCONMS	CSI	DCONNWS	DCONXWS	BD	LPR	LB	THID	CRKS	KG
AC3-ER-16-045	32	ER16	1.0	10	28	45	30	M10	M12x1.5	0.190
AC4-ER-16-070	40	ER16	1.0	10	28	70	50	M10	M14x1.5	0.410
AC4-ER-25-055	40	ER25	1.0	16	42	55	35	M16	M14x1.5	0.400
AC4-ER-32-055	40	ER32	2.0	20	50	55	35	M16	M14x1.5	0.440
AC5-ER-16-055	50	ER16	1.0	10	28	55	35	M10	M16x1.5	0.520
AC5-ER-16-100	50	ER16	1.0	10	28	100	80	M10	M16x1.5	0.710
AC5-ER-16-130	50	ER16	1.0	10	28	130	110	M10	M16x1.5	0.820
AC5-ER-25-055	50	ER25	1.0	16	42	55	35	M16	M16x1.5	0.600
AC5-ER-25-100	50	ER25	1.0	16	42	100	80	M16	M16x1.5	1.030
AC5-ER-32-055	50	ER32	2.0	20	50	55	35	M16	M16x1.5	0.650
AC5-ER-32-100	50	ER32	2.0	20	50	100	80	M16	M16x1.5	1.250
AC6-ER-16-060	63	ER16	1.0	10	28	60	38	M10	M20x2	0.870
AC6-ER-16-100	63	ER16	1.0	10	28	100	78	M10	M20x2	1.030
AC6-ER-16-130	63	ER16	1.0	10	28	130	108	M10	M20x2	1.150
AC6-ER-25-060	63	ER25	1.0	16	42	60	38	M16	M20x2	0.950
AC6-ER-25-100	63	ER25	1.0	16	42	100	78	M16	M20x2	1.340
AC6-ER-25-130	63	ER25	1.0	16	42	130	108	M16	M20x2	1.650
AC6-ER-32-060	63	ER32	2.0	20	50	60	38	M16	M20x2	1.000
AC6-ER-32-100	63	ER32	2.0	20	50	100	78	M16	M20x2	1.560
AC6-ER-32-130	63	ER32	2.0	20	50	130	108	M16	M20x2	1.990
AC6-ER-40-065	63	ER40	3.0	26	63	65	43	M16	M20x2	1.210
AC6-ER-40-100	63	ER40	3.0	26	63	100	78	M16	M20x2	2.010
AC6-ER-40-130	63	ER40	3.0	26	63	130	108	M16	M20x2	2.710
AC8-ER-32-070	80	ER32	2.0	20	50	70	40	M16	M20x2	1.980
AC8-ER-32-100	80	ER32	2.0	20	50	100	70	M16	M20x2	2.420
AC8-ER-32-160	80	ER32	2.0	20	50	160	130	M16	M20x2	3.300
AC8-ER-40-070	80	ER40	3.0	26	63	70	40	M16	M20x2	2.090
AC8-ER-40-100	80	ER40	3.0	26	63	100	70	M16	M20x2	2.800
AC8-ER-40-160	80	ER40	3.0	26	63	160	130	M16	M20x2	4.230

Spare Part



Delivered With

Delivered Without

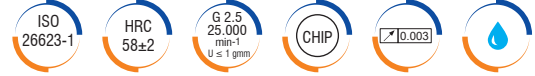
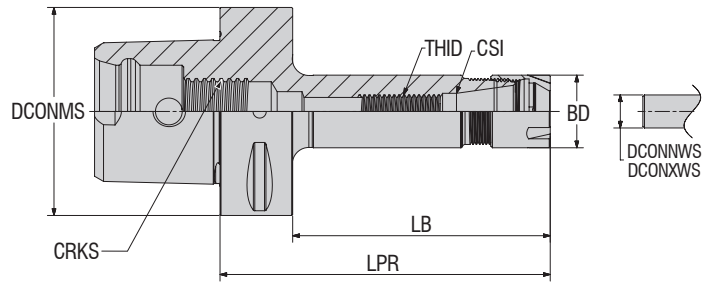

Illustrations shown may vary from actual product.

Dimensions in Inch

Ordering Code	DCONMS	CSI	DCONNWS Minimum diameter	DCONXWS Maximum diameter	BD	LPR	LB	THID	KG
AC6-ER-16-3.0	2.480	ER16	0.039	0.394	1.102	3.000	2.134	M10	0.930
AC6-ER-32-3.0	2.480	ER32	0.079	0.787	1.969	3.000	2.134	-	1.100
<b>new</b> AC6-ER-16-6.0	2.480	ER16	0.039	0.394	1.102	6.000	5.134	M10	1.333
<b>new</b> AC6-ER-32-6.0	2.480	ER32	0.079	0.787	1.969	6.000	5.134	-	2.220

Spare Part



Delivered With



Collet Chuck ER DIN6499/ISO 15488-B



Wrench ER Mini (M)



Coolant Tube

Delivered Without

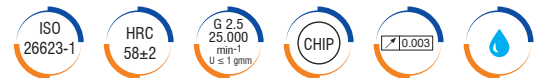
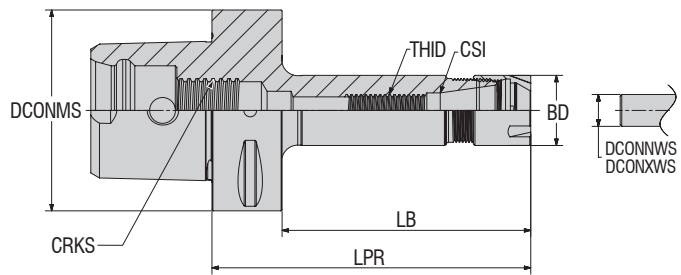

Illustrations shown may vary from actual product.

Dimensions in Metric

Ordering Code	DCONMS	CSI	DCONNWS	DCONXWS	BD	LPR	LB	THID	CRKS	KG
AC4-ER-16-070-M	40	ER16	0.5	10	22	70	50	M10	M14x1.5	0.320
AC5-ER-16-100-M	50	ER16	0.5	10	22	100	80	M10	M16x1.5	0.580
AC5-ER-16-130-M	50	ER16	0.5	10	22	130	108	M10	M16x1.5	0.754
AC6-ER-16-100-M	63	ER16	0.5	10	22	100	78	M10	M20x2	0.910
AC6-ER-16-130-M	63	ER16	0.5	10	22	130	108	M10	M20x2	1.000

Spare Part



Delivered With



Collet Chuck ER DIN6499/ISO 15488-B



Wrench ER Mini (M)



Coolant Tube

Delivered Without

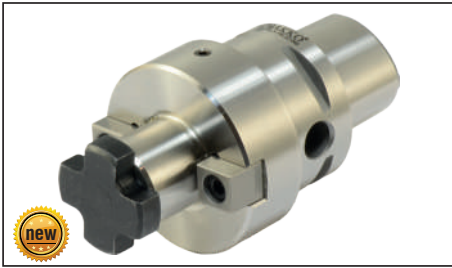

Illustrations shown may vary from actual product.

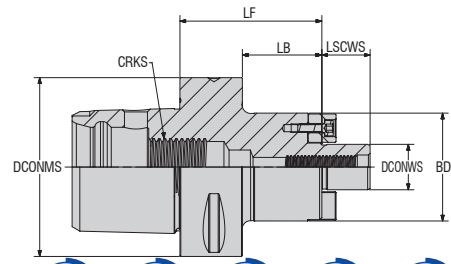

ISO 26623-1 | HRC 58±2 | G 2.5 25.000 min-1 U ≤ 1 gmm | CHIP | g4 | 0.005 | Water icon

Dimensions in Metric

Ordering Code	DCONMS	DCONWS	BD	LSCWS	LB	LF	CRKS	KG
AC3-FM-16-030	32	16	38	17	15	30	M12x1.5	0.270
AC4-FM-16-035	40	16	38	17	15	35	M14x1.5	0.410
AC4-FM-22-040	40	22	48	19	20	40	M14x1.5	0.590
AC5-FM-16-035	50	16	38	17	15	35	M16x1.5	0.590
AC5-FM-16-070	50	16	36	17	50	70	M16x1.5	0.880
AC5-FM-22-040	50	22	48	19	20	40	M16x1.5	0.770
AC5-FM-22-070	50	22	48	19	50	70	M16x1.5	1.170
AC5-FM-27-040	50	27	60	21.5	20	40	M16x1.5	0.950
AC6-FM-16-035	63	16	38	17	13	35	M20x2	0.900
AC6-FM-16-100	63	16	38	17	78	100	M20x2	1.450
AC6-FM-22-050	63	22	48	19	28	50	M20x2	1.120
AC6-FM-22-100	63	22	48	19	78	100	M20x2	1.870
AC6-FM-27-050	63	27	60	21.5	28	50	M20x2	1.350
AC6-FM-27-100	63	27	60	21.5	78	100	M20x2	2.540
AC6-FM-32-060	63	32	78	24	38	60	M20x2	4.800
AC8-FM-27-100	80	27	60	21.5	70	100	M20x2	3.340
AC8-FM-32-100	80	32	78	24	70	100	M20x2	4.480
AC8-FM-40-060	80	40	88	27	30	60	M20x2	3.180

Spare Part



Drive Key



Bolt For Shell Arbor DIN 6367



Wrench For Shell Arbor DIN 6368



Coolant Tube

Delivered With

Delivered Without



Illustrations shown may vary from actual product.

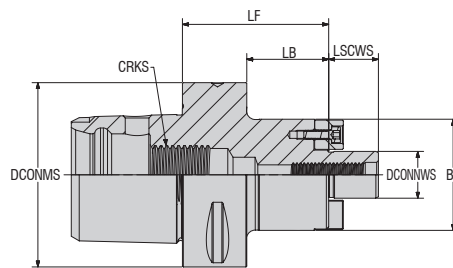

ISO 26623-1 | HRC 58±2 | G 2.5 25.000 min-1 U ≤ 1 gmm | CHIP | g4 | 0.005 | Water icon

Dimensions in Inch

Ordering Code	DCONMS	DCONWS	BD	LSCWS	LB	LF	CRKS	KG
AC6-FM-0750-118	2.480	0.750	1.693	3/8-24 UNF	1.180	0.314	M20x2	1.250
AC6-FM-0750-480	2.480	0.750	1.693	3/8-24 UNF	4.180	3.314	M20x2	1.900
AC6-FM-0750-756	2.480	0.750	1.693	3/8-24 UNF	7.560	5.150	M20x2	2.730
AC6-FM-1000-118	2.480	1.000	2.165	1/2-20 UNF	1.180	0.314	M20x2	1.350
AC6-FM-1250-157	2.480	1.250	2.756	5/8-18 UNF	1.570	0.704	M20x2	4.500

Spare Part



Drive Key



Bolt For Shell Arbor DIN 6367



Wrench For Shell Arbor DIN 6368



Coolant Tube

Delivered With

Delivered Without



Illustrations shown may vary from actual product.

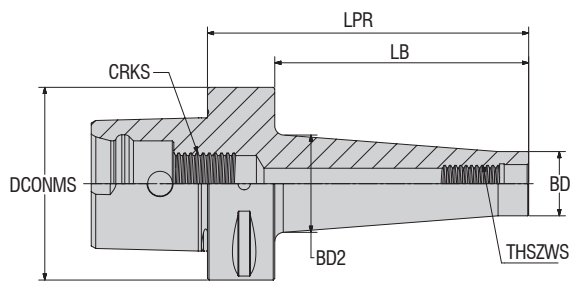

Dimensions in Metric

Ordering Code	DCONMS	THSZWS	BD	BD2	LPR	LB	CRKS	KG
AC3-MM-08-030	32	M8	13	14.5	30	15	M12x1.5	0.120
AC3-MM-10-030	32	M10	18	19.5	30	15	M12x1.5	0.130
AC3-MM-12-035	32	M12	21	23.5	35	20	M12x1.5	0.150
AC3-MM-16-040	32	M16	29	-	40	25	M12x1.5	0.200
AC4-MM-08-030	40	M8	13	14.5	30	10	M14x1.5	0.250
AC4-MM-10-035	40	M10	18	19.5	35	15	M14x1.5	0.270
AC4-MM-12-040	40	M12	21	23.5	40	20	M14x1.5	0.290
AC4-MM-16-045	40	M16	29	-	45	25	M14x1.5	0.330
AC5-MM-08-050	50	M8	13	15	50	30	M16x1.5	0.440
AC5-MM-08-075	50	M8	13	22.5	75	55	M16x1.5	0.510
AC5-MM-10-050	50	M10	18	20	50	30	M16x1.5	0.470
AC5-MM-10-075	50	M10	18	23	75	55	M16x1.5	0.540
AC5-MM-12-050	50	M12	21	24	50	30	M16x1.5	0.490
AC5-MM-12-075	50	M12	21	24	75	55	M16x1.5	0.560
AC5-MM-16-050	50	M16	29	-	50	30	M16x1.5	0.520
AC5-MM-16-075	50	M16	29	34	75	55	M16x1.5	0.690
AC6-MM-08-050	63	M8	13	15	50	28	M16x1.5	0.770
AC6-MM-08-075	63	M8	13	22.5	75	53	M16x1.5	0.840
AC6-MM-10-050	63	M10	18	20	50	28	M16x1.5	0.790
AC6-MM-10-075	63	M10	18	23	75	53	M16x1.5	0.860
AC6-MM-12-050	63	M12	21	24	50	28	M16x1.5	0.810
AC6-MM-12-075	63	M12	21	24	75	53	M16x1.5	0.880
AC6-MM-16-050	63	M16	29	-	50	28	M16x1.5	0.850
AC6-MM-16-075	63	M16	29	34	75	53	M16x1.5	1.010
AC8-MM-08-085	80	M8	13	22.5	85	55	M20x2	1.810
AC8-MM-10-085	80	M10	18	23	85	55	M20x2	1.840
AC8-MM-12-085	80	M12	21	24	85	55	M20x2	1.850
AC8-MM-16-085	80	M16	29	34	85	55	M20x2	1.990

Spare Part



Coolant Tube

Delivered Without



Illustrations shown may vary from actual product.

Dimensions in Metric

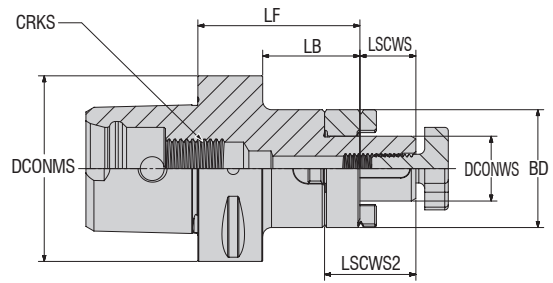

Ordering Code	DCONMS	DCONWS	LF	BD	LSCWS	LSCWS2	LB	CRKS	KG
AC3-FMC-16-045	32	16	45	32	17	27	30	M12x1.5	0.320
AC4-FMC-16-045	40	16	45	32	17	27	25	M14x1.5	0.430
AC4-FMC-22-050	40	22	50	40	19	31	30	M14x1.5	0.590
AC5-FMC-16-045	50	16	45	32	17	27	25	M16x1.5	0.600
AC5-FMC-16-070	50	16	70	32	17	27	50	M16x1.5	0.750
AC5-FMC-22-045	50	22	45	40	19	31	25	M16x1.5	0.720
AC5-FMC-22-070	50	22	70	40	19	31	50	M16x1.5	0.950
AC5-FMC-27-055	50	27	55	48	21	33.5	35	M16x1.5	1.010
AC5-FMC-32-055	50	32	55	58	24	38	35	M16x1.5	1.290
AC6-FMC-16-050	63	16	50	32	17	27	28	M20x2	0.950
AC6-FMC-16-100	63	16	100	32	17	27	78	M20x2	1.240
AC6-FMC-22-055	63	22	55	40	19	31	33	M20x2	1.120
AC6-FMC-22-100	63	22	100	40	19	31	78	M20x2	1.530
AC6-FMC-27-055	63	27	55	48	21	33.5	33	M20x2	1.310
AC6-FMC-27-100	63	27	100	48	21	33.5	78	M20x2	1.910
AC6-FMC-32-055	63	32	55	58	24	38	33	M20x2	1.590
AC6-FMC-40-060	63	40	60	70	27	41	38	M20x2	2.180
AC8-FMC-16-060	80	16	60	32	17	27	30	M20x2	1.930
AC8-FMC-22-060	80	22	60	40	19	31	30	M20x2	2.060
AC8-FMC-27-065	80	27	65	48	21	33.5	35	M20x2	2.300
AC8-FMC-32-065	80	32	65	58	24	38	35	M20x2	2.600
AC8-FMC-40-070	80	40	70	70	27	41	40	M20x2	3.210

Spare Part



Bolt For Shell Arbor DIN 6367



Drive Key DIN 6885



Clutch Drive Rings To DIN 6366



Wrench For Shell Arbor DIN 6368



Coolant Tube

Delivered With

Delivered Without



Illustrations shown may vary from actual product.  
Dimensions in Inch

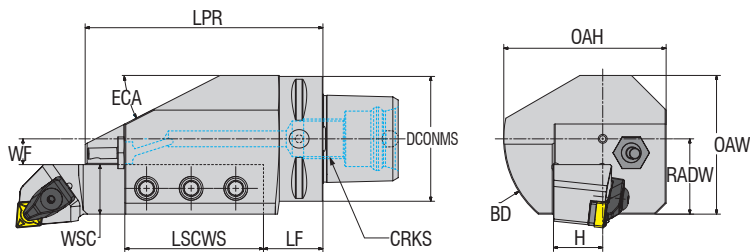

Ordering Code	DCONMS	LPR	LSCWS	LF	WF	H	WSC	OAH	RADW	OAW	BD	ECA	HAND	CRKS	KG
AC6-ASHR-16-1-H	2.480	4.724	2.756	1.181	0.504	1.039	0.992	3.228	1.496	2.756	3.937	27	R	M20x2	2.139
AC6-ASHL-16-1-H	2.480	4.724	2.756	1.181	0.504	1.039	0.992	3.228	1.496	2.756	3.937	27	L	M20x2	2.139

Spare Part



Illustrations shown may vary from actual product.  
Dimensions in Metric

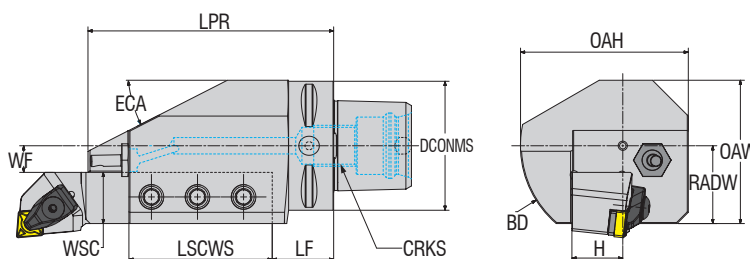

Ordering Code	DCONMS	LPR	LSCWS	LF	WF	H	WSC	OAH	RADW	OAW	BD	ECA	HAND	CRKS	KG
AC4-ASHR-1616-1-H	40	104	70	29	7	16	16	48	23	43.5	60	30	R	M14x1.5	1.500
AC5-ASHR-2020-1-H	50	98	63.5	24.5	10	20	20	74	30	59	90	30	R	M16x1.5	2.180
AC6-ASHR-2020-1-H	63	100	63.5	26.5	10	20	20	74	30	59	90	30	R	M20x2	2.510
AC6-ASHR-2525-1-H	63	120	70	30	13	25	25	82	38	70	100	27	R	M20x2	3.630
AC8-ASHR-3232-1-H	80	140	90	40	8	32	32	87	40	80	109	27	R	M20x2	6.640
AC6-ASHL-2020-1-H	63	100	63.5	26.5	10	20	20	74	30	59	90	30	L	M20x2	2.510
AC6-ASHL-2525-1-H	63	120	70	30	13	25	25	82	38	70	100	27	L	M20x2	3.630

Spare Part



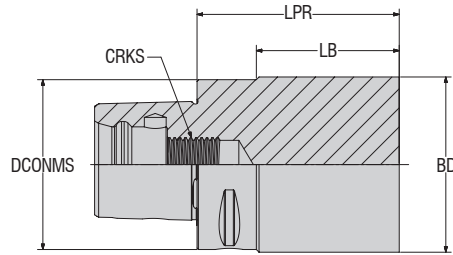
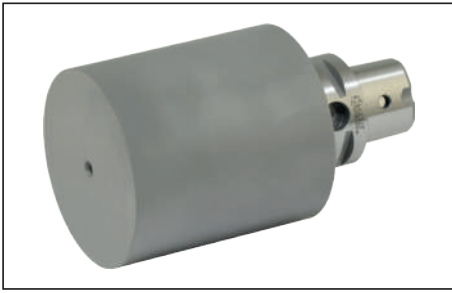

Illustrations shown may vary from actual product.

Dimensions in Inch

Ordering Code	DCONMS	BD	LPR	LB	CRKS	KG
AC3-BL41-032-090	1.260	1.260	3.543	2.953	M12x1.5	0.600
AC3-BL41-032-125	1.260	1.260	4.921	4.331	M12x1.5	0.800
<b>new</b> AC3-BL41-060-090	1.260	2.362	3.543	2.953	M12x1.5	1.780
AC4-BL41-040-045	1.575	1.575	1.772	0.984	M14x1.5	0.500
AC4-BL41-040-165	1.575	1.575	6.496	5.709	M14x1.5	1.670
AC4-BL41-052-065	1.575	2.047	2.559	1.772	M14x1.5	0.990
AC4-BL41-070-100	1.575	2.756	3.937	3.150	M14x1.5	2.610
AC5-BL41-050-050	1.969	1.969	1.969	1.181	M16x1.5	0.900
AC5-BL41-050-175	1.969	1.969	6.890	6.102	M16x1.5	2.800
AC5-BL41-075-070	1.969	2.953	2.756	1.969	M16x1.5	2.110
<b>new</b> AC5-BL41-075-175	1.969	2.953	6.890	6.102	M16x1.5	5.790
AC6-BL41-063-048	2.480	2.480	1.890	1.024	M20X2	1.380
AC6-BL41-063-100	2.480	2.480	3.937	3.071	M20X2	2.720
AC6-BL41-063-195	2.480	2.480	7.677	6.811	M20X2	4.960
AC6-BL41-063-310	2.480	2.480	12.205	11.339	M20X2	7.750
AC6-BL41-080-250	2.480	3.150	9.843	8.976	M20X2	9.660
AC8-BL41-080-055	3.150	3.150	2.165	0.945	M20X2	2.710
<b>new</b> AC8-BL41-120-160	3.150	4.724	6.299	5.079	M20X2	13.260

Spare Part



ISO 26623-1 / POLYGONAL SHANK FLAT EXTENSION ADAPTER HOLDER

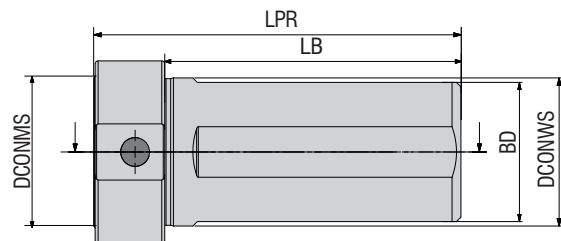

Illustrations shown may vary from actual product.

Dimensions in Metric

Ordering Code	DCONMS	DCONWS	LPR	BD	LB	CRKS
AC5-NC3000-10024-D050	50	50	124	47	100	M16



Illustrations shown may vary from actual product.

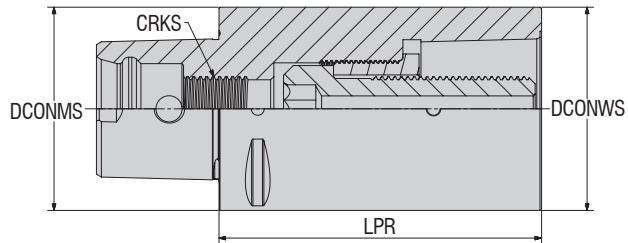

Dimensions in Metric						Spare Parts		
Ordering Code	DCONMS	DCONWS	LPR	CRKS	KG	Mounting Screw	Screw	Ring
AC3-EX-C3-060	32	32	60	M12	0.670	2508-M12x1.5x42	5000-M18x1.5x12	-
AC3-EX-C3-080	32	32	80	M12	0.893	2508-M12x1.5x42	5000-M18x1.5x12	-
AC4-EX-C4-060	40	40	60	M14	0.892	2510-M14x1.5x48	5000-M22x1.5x14	-
AC4-EX-C4-080	40	40	80	M14	1.190	2510-M14x1.5x48	5000-M22x1.5x14	-
AC5-EX-C5-080	50	50	80	M16	1.487	2510-M16x1.5x57	5000-M25x1.5x17	-
AC5-EX-C5-100	50	50	100	M16	1.858	2510-M16x1.5x57	5000-M25x1.5x17	-
AC6-EX-C6-060	63	63	100	M20	1.150	2514-M20x2x62	-	AS-04
AC6-EX-C6-100	63	63	100	M20	2.230	2514-M20x2x70	5000-M30x1.5x21	-
AC6-EX-C6-140	63	63	140	M20	2.900	2514-M20x2x70	5000-M30x1.5x21	-
AC8-EX-C8-100	80	80	100	M20	2.750	2514-M20x2x70	5000-M30x1.5x21	-
AC8-EX-C8-125	80	80	125	M20	3.437	2514-M20x2x70	5000-M30x1.5x21	-

Spare Part



Illustrations shown may vary from actual product.

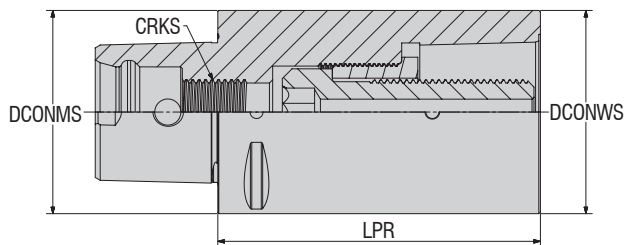

Dimensions in Metric						Spare Parts		
Ordering Code	DCONMS	DCONWS	LPR	CRKS	KG	Mounting Screw	Screw	Ring
AC5-RE-C3-060	50	32	60	M16	1.356	2508-M12x1.5x42	5000-M18x1.5x12	-
AC5-RE-C4-065	50	40	65	M16	1.808	2510-M14x1.5x48	5000-M22x1.5x14	-
AC6-RE-C4-080	63	40	80	M20	3.270	2510-M14x1.5x48	5000-M22x1.5x14	-
AC6-RE-C5-080	63	50	80	M20	3.470	2510-M16x1.5x57	5000-M25x1.5x17	-
AC8-RE-C3-060	80	32	60	M20	1.068	2508-M12x1.5x42	5000-M18x1.5x12	-
AC8-RE-C4-070	80	40	70	M20	1.424	2510-M14x1.5x48	5000-M22x1.5x14	-
AC8-RE-C5-080	80	50	80	M20	1.782	2510-M16x1.5x57	5000-M25x1.5x17	-
AC8-RE-C6-055	80	63	55	M20	1.468	2514-M20x2x67-30.8	-	AS-05
AC8-RE-C6-080	80	63	80	M20	2.136	2514-M20x2x70	5000-M30x1.5x21	-

Spare Part





Illustrations shown may vary from actual product.

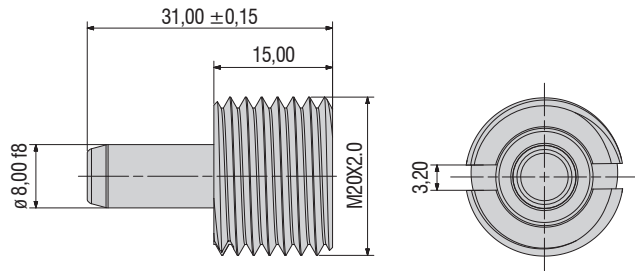

Dimensions in Metric

Ordering Code	OAL	LB	THID	Product Detail
AC6-CT-01	31	15	M20x2	FOR POLYGONAL SHANK HOLDERS





*the spoken quality...*

# INSERT

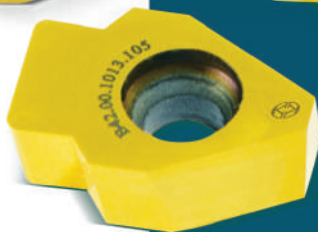
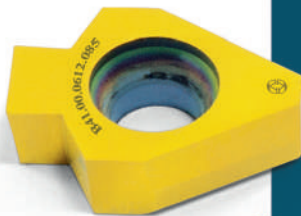

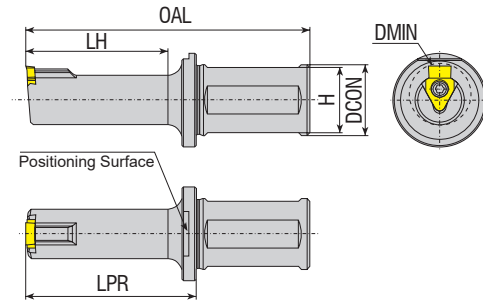

Illustrations shown may vary from actual product.

Dimensions in Metric/Inch



Ordering Code	DMIN METRIC/INCH	LH METRIC/INCH	DCON METRIC/INCH	OAL METRIC/INCH	LPR METRIC/INCH	H METRIC/INCH	Insert	Screw	Torx Key
ABT-B41.00.03-D22-Y25-L125-I070	22 - 0.870	70 - 2.760	25 - 0.980	125 - 4.920	80 - 3.150	23 - 0.906	B41..00	4015-M4x11	80-T15
ABT-B42.00.06-D30-Y32-L125-I075	30 - 1.180	75-2.950	32 - 1.260	125 - 4.920	85 - 3.350	30 - 1.810	B42..00	1020-M5x14	80-T20
ABT-B42.00.09-D38-Y32-L125-I075	38 - 1.500	75-2.950	32 - 1.260	125 - 4.920	85 - 3.350	30 - 1.810	B42..00	1020-M5x14	80-T20
ABT-B42.00.12-D40-Y32-L125-I075	40 - 1.580	75-2.950	32 - 1.260	125 - 4.920	85 - 3.350	30 - 1.810	B42..00	1020-M5x14	80-T20
ABT-B44.00.15-D40-Y32-L125-I075	40 - 1.580	75-2.950	32 - 1.260	125 - 4.920	85 - 3.350	30 - 1.810	B44..00	1020-M5x14	80-T20

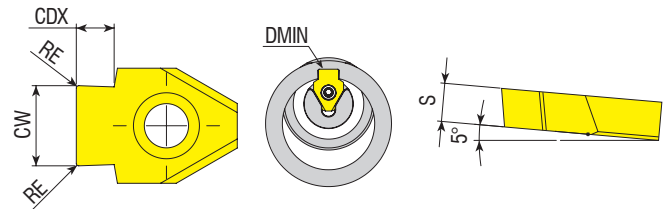

Illustrations shown may vary from actual product.

Dimensions in Inch

Insert Code	CW	RE	CDX	S	DMIN
B41.00.0317.020 VP3001	1/8"	0.008"	0.126"	0.157"	0.866"
B42.00.0635.030 VP3001	1/4"	0.012"	0.252"	0.236"	1.181"
B42.00.0953.030 VP3001	3/8"	0.012"	0.375"	0.236"	1.496"
B42.00.1111.030 VP3001	7/16"	0.012"	0.356"	0.236"	1.496"
B42.00.1270.030 VP3001	1/2"	0.012"	0.356"	0.236"	1.496"
B44.00.1588.030 VP3001	5/8"	0.012"	0.470"	0.236"	1.771"

A series of horizontal dotted lines for writing notes, spanning the width of the page.



Lined writing area with horizontal dotted lines.

A series of horizontal dotted lines for writing notes, spanning most of the page width.



Lined area for notes with horizontal dotted lines.



Lined area for notes with horizontal dotted lines.







# AKKO GLOBAL NETWORK

Europe's Largest Integrated Tool and Holder Facility

the spoken  
quality



Konya 5. Organize Sanayi Bölgesi  
Aşağıpınarbaşı Osb Mh. 526 Nolu Sk. No:1  
Selçuklu / KONYA / TÜRKİYE

Tel : +90 332 239 17 57 (pbx)  
Fax : +90 332 239 17 52  
GPS : 38.005409, 32.635734

www.akkocom.tr  
akko@akko.com.tr  
export@akko.com.tr



AKKO Metalworking Tools

Yenilikler için bizi takip edin!  
Follow us for news!  
Für Neuheiten bitte uns folgen!



Balgheimer Str. 40 78549 Spaichingen  
GERMANY

Phone : +49 7424 905 4013  
GPS : 48.06906079976586, 8.754463836369949

www.akkoeurope.eu / office@akkoeurope.eu / info@akkoeurope.eu



AKKO Metalworking Tools

Für Neuheiten bitte uns folgen!



Office: 900 N Arlington Heights Rd Itasca, IL 60143  
Warehouse: 1055 W Devon Avenue Suite 300  
Itasca IL 60143 Illinois, USA

Phone: +1 847 600 9606  
GPS : 41.982969625099386, -88.00574353196833



AKKO USA INC.

Follow us for news!  
www.akkousa.us  
info@akkousa.us



No.998,Baicao Road,Gaoxinxi District,  
Chengdu China

Phone: +86 18328589975