

AHB

TOOLING & MACHINERY

COMPLETE METALWORKING SOLUTIONS

(800) 991-4225

www.ahbinc.com

ISO Certified

customerservice@ahbinc.com

ARCH[®] Cutting Tools

- Milling
- Drilling
- Finishing
- Contouring
- Slotting
- Turning
- Boring
- Tool Holding
- Custom Solutions

THE
COLLECTION

THE COMPLETE TOOL MAKING AUTHORITY™

2021 1st Edition

THE COLLECTION



ARCH Cutting Tools Master Catalog : The Collection

This publication is produced by ARCH Cutting Tools Corp. in 2020

1st Edition, 2021

Copyright © 2020, ARCH Cutting Tools Corp. All rights reserved. Printed in the United States of America. Except as permitted under the United States Copyright Act of 1976, no part of the publication may be reproduced or distributed in any form or by any means, or stored in a data base or retrieval system, without the prior written permission of the publisher

Published by ARCH Cutting Tools, V.1.2.12

Completed by ARCH Cutting Tools Marketing

ARCH[®]

Cutting Tools



With great enthusiasm, the team at ARCH[®] Cutting Tools debuts our first integrated standard cutting tool collection.

Building on a rich heritage of high-quality domestic manufacturing, ARCH Cutting Tools has significantly expanded our standard solid round tool offering under the trusted KEO[®] brand name and our indexable portfolio under the Ultra-Dex[®] brand. The catalog integrates all heritage KEO products, a full line of micro tools, and a comprehensive new offering of Patriot High Performance[™] milling and drilling tools in an *Easy to choose, Easy to use[™]* format designed with the end-user in mind.

We've listened to our customers. You called for ease of doing business and a broader tooling portfolio with new and innovative stocked standards. The refined format includes supplemental technical and application information to make selecting tools intuitive and straightforward and will serve as a platform for planned product expansions.

The newly integrated catalog coincides with the start-up of a new state-of-the-art centralized warehouse that further streamlines our speed and service.

ARCH Cutting Tools ambition is to be, Your Complete Tool Making Authority[™]. And is making significant investments to build a mid-sized, full-service cutting tool company capable of providing nimble, streamlined solutions to our valued customers. Resulting in dynamic, customer-driven enhancements that include an expanded stocked standard tooling offering and an industry-leading breadth of custom tooling capabilities.

Jeff Cederstrom

President, ARCH Cutting Tools

TABLE OF CONTENTS

Chapter 1: Rotating

Indexable Milling

	13
Patriot High Performance Indexable Mills PM1	14
Patriot High Performance Indexable Mills PM4	16
Patriot High Performance Indexable Mills PM2	18
Patriot High Performance Indexable Mills PM3	20
Revere F90AP Indexable Face Mill	22
Revere FR Arbor Mount Indexable Round Cutter	26
Revere E90 AP Indexable Mill	28
Revere ER Weldon Shank Indexable Round Cutter	32



Solid Milling

	34
Patriot High Performance, Square End, Standard & Stub	36,44,50
Patriot High Performance, Square End, Long & X-Long	37,45,51
Patriot High Performance, Corner Radius, Standard & Stub	38,46,51
Patriot High Performance, Corner Radius, Standard, Roughing/Chipbreaker	40
Patriot High Performance, Corner Radius Long & X-Long	41,49,53
Patriot High Performance, Ball End, Standard & Stub	42
Patriot High Performance, Ball End, Long & X-Long	43
Square End, Standard	54
Square End, Stub 30° Helix	58
Square End, Long Shank, Stub 30° Helix	62
Square End, Long Shank, Long Reach, Stub 30° Helix	63
Square End, Long Reach	66
Square End, Long Flute, Long Reach 30° Helix	67
Square End, Extra Long Flute 30° Helix	68
Square End, Multi - Flute/High Helix 35° / 45° Helix	69
Square End, Standard & Stub, CVD Coated 30° Helix	70
Square End, Long Reach, CVD Coated	71
Square End, Standard & Stub 30° Helix	72
Square End, Double End, Stub 30° Helix	74
Square End, Long Flute, Long Reach-Stub Gmills 35° Helix	76
Square End, Multi-Flute	78
QSR & QB Mills Stub, Reached 35° Helix	78
Square End, High Helix 45° / 60° Helix	79
Square End, Standard Metric 30° Helix	80
Square End G Mills Metric 35° Helix	81
Corner Radius, Standard 30° Helix	82
Corner Radius, Stub 30° Helix	85
Hard Mill, Stub 18° Low Helix	86
Ball End, Standard 30° Helix	87
Ball End, Stub 30° Helix	91
Ball End, Long Shank, Stub 30° Helix	95
Ball End, Long Shank, Long Reach, Stub 30° Helix	96
Ball End, Long Reach 30° Helix	99
Ball End, Long Flute, Long Reach 30° Helix	100
Ball End, Extra Long Flute 30° Helix	101
Ball End, Standard & Stub, CVD Coated 30° Helix	102
Ball End, Long Reach, CVD Coated	103
Q Mills, Standard & Stub 35° Helix	104
QSR & QB Mills 35° Helix	105
Ball End, Standard & Stub 30° Helix	106
Ball End, Long Flute 30° / 35° Helix	108
Ball End, Long Reach G Mills 35° Helix	109
Ball End, Standard Metric 30° Helix	111
Ball End G Mills Metric 35° Helix	112





TABLE OF CONTENTS

Chapter 1: Rotating

Ball Tapered Rib Cutters	113
Corner Radius Tapered Rib Cutters	114
Single End, Square End, Standard 35° / 40° Helix	115
Single End, Square End, Stub 35° / 40° Helix	116
Single End, Square End, Standard 35° / 40° Helix	117
Double End, Square End, Standard 35° / 40° Helix	118
Double End, Square End, Stub 35° / 40° Helix	119
Double End, Square End, Long Flute 35° / 40° Helix	120
Single End, Ball End, Standard 35° / 40° Helix	121
Single End, Ball End, Stub 35° / 40° Helix	123
Double End, Ball End, Standard 35° / 40° Helix	124
Double End, Ball End, Stub 35° / 40° Helix	125
Double End, Ball End, Long Flute 35° / 40° Helix	126
PCD Tipped End Mills	127



Indexable Drills

Patriot High Performance Indexable Drills	128
PD1 High Performance Indexable Drills-2xD	129
PD1 High Performance Indexable Drills-3xD	130
PD1 High Performance Indexable Drills-4xD	131
PD1 Indexable Drill Recommended Speeds & Feeds	132
Revere Indexable Drills	133
Revere Indexable Drills-2xD	134
Revere Indexable Drills-2.5xD	135
Revere Indexable Drills-4xD	136
Revere Indexable Drill Recommended Speeds & Feeds	136
Revere Indexable Drill Recommended Speeds & Feeds	138



Solid Drills

Patriot High Performance Solid Carbide, Coolant Through, Imperial	139
Patriot High Performance Solid Carbide, Coolant Through, Metric	140
Circuit Board Drills 20° Angle	149
	156



Spotting Drills

NC Spotting Drills 82° / 90° / 100° Angle	160
NC Spotting Drills 120° / 130° / 140° / 150° Angle	161
NC Spotting Drills 90° / 120° / 140° Angle	162
NC 82° / 90° / 120° / 142° Angle	163
NC 82° / 90° Angle	164
NC 120° Angle	165
Metric NC 90° / 120° Angle	166
90° / 118° Angle	166
	167



Center Drills

Solid Carbide Plain Type 60° Angle	168
Solid Plain Type 82° / 90° Angle	169
Double End Plain Type 60° Angle	170
Double End Plain Type 82° / 90° Angle	171
Double End Radius Type 82° / 90° Angle	172
Double End Bell Type 60° Angle	173
Single End Plain Type Hey 60° Angle	174
Single End Bell Type Hey 60° Angle	175
Double End Plain Type Hey 60° Angle	176
Double End Bell Type Hey 60° Angle	177
Jig Bore Type 60° Angle	178
Metric Double End Type A 60° Angle	179
Metric Double End Type B 60° Angle	180
	181



TABLE OF CONTENTS

Chapter 1: Rotating

Metric Double End Type R	182
Double End Long Series 60° / 82° / 90° Angle	183
Metric Double End Long Series 60° Angle	185

Countersinks

187

Zero-Flute Countersinks 60° / 82° / 90° Angle	188
Zero-Flute Countersinks 100° Angle	189
Single-Flute Countersinks 60° / 82° / 90° / 100° Angle	190
Single-Flute Countersinks 60° / 82° / 90° Angle	191
Single-Flute Countersinks 100° / 110° / 120° Angle	192
Single-Flute Countersinks 60° / 82° / 90° Angle	193
Single-Flute Countersinks 100° / 110° / 120° Angle	194
Single-Flute Countersinks Set	194
3-Flute Countersinks 60° / 82° / 90° / 100° Angle	195
3-Flute Euro Style Countersinks 60° / 82° / 90° / 100° Angle	196
3-Flute Center Reamers 60° / 82° / 90° Angle	197
3-flute Center Reamers 100° / 110° / 120° Angle	198
3-Flute Center Reamers 60° / 82° / 90° Angle	199
3-Flute Center Reamers 100° / 110° / 120° Angle	200
4-flute Machine Straight Shank 60° / 82° / 90° Angle	201
4-flute Center Reamers 60° / 82° / 90° Angle	202
6-Flute Countersinks 60° / 82° / 90° / 100° Angle	203
6-Flute Countersinks 60° / 82° Angle	204
6-Flute Countersinks 90° / 100° Angle	205
6-Flute Countersinks 110° / 120° Angle	206
6-Flute Countersinks 60° / 82° Angle	207
6-Flute Countersinks 90° / 100° Angle	208
6-Flute Countersinks 110° / 120° Angle	209



Counterbores

210

Patriot Indexable Counterbores	211
PC1 Patriot High Performance Indexable Counterbores	212
PC2 Patriot High Performance Indexable Counterbores	214
PC3 Patriot High Performance Indexable Counterbores	216
Socket Head Cap Screw Imperial	218
Socket Head Cap Screw Metric (DIN373)	219
Countersink CAP Screw Drill 82° Angle	220



Drill & Chamfer Mills

221

Revere EC Indexable Chamfer Mills	222
2-Flute Chamfer Mills Single End 30° - 150° Angle	224
4-Flute Chamfer Mills Single End 60° - 120° Angle	226
3-Flute & 4-Flute Tipped Off Chamfer Mills 30° - 150° Angle	227
2-Flute & 4-Flute Double End Chamfer Mills 60° / 82° / 90° / 120° Angle	228
2-Flute & 4-Flute Single End Chamfer Mills 60° / 90° Angle	229
2-Flute & 4-Flute Coated Drill Point Mills 60° / 90° Angle	230



Engraving Tools

231

1-Flute Engraving Cutters Pointed End 10° - 120° Angle	232
1-Flute Engraving Cutters Radius End 30° / 40° / 60° / 90° Angle	234
1-Flute Engraving Cutters Flat End 30° / 40° / 60° / 90° Angle	235
1-Flute & 2-Flute Engraving Cutters Flat End 30° - 120° Angle	236
2-Flute Web Marking Radius End 30° - 120° Angle	237





TABLE OF CONTENTS

Chapter 1: Rotating

Corner Rounding

2-Flute Imperial Double End Radius	239
4-Flute Imperial Double End Radius	241
2-Flute Imperial Single End Micro Long Reach Radius.....	242
2-Flute & 4-Flute Imperial Double End Radius.....	243
4-Flute Imperial & Metric Single End Radius.....	245
Concave & Convex Radius	247



Keyseat Cutters

6-Flute Small Solid Shank Type	249
6-Flute & 8-Flute Solid Shank Type.....	251
Woodruff Shank Type	252
Woodruff Combination Sets	258
Metric Woodruff Shank Type	259
Imperial Narrow Width Shank Type.....	260



Dovetail Cutters

Single Angle Carbide Tipped 45° / 60°	263
Single Angle 45° / 60°	264
Double Angle Shank Type 45° / 60° / 90°	266



T-Slot Cutters

Imperial Standard Slot.....	268
Imperial Rough/Finish Slot	269



Slotting Mills

Side, Staggered Tooth.....	272
Staggered Tooth Woodruff Keyseat.....	281
Side, Straight Tooth	282
Double-Angle & Standard Diameter Convex.....	286
Right/Left-Hand Single-Angle 45° / 60° / 90° Helix	287
Large Diameter Convex & Concave.....	288
Right/Left-Hand Corner-Rounding.....	289
Concave	290
Side, Staggered Tooth.....	291
Side, Staggered/Straight Tooth	292



Plain/Shell Mills

Right-Hand Cut.....	294
Right-Hand Cut & Roughing.....	295
Plain Mill Right/Left Hand 18° Helix	297
Plain Mill Right/Left Hand 45° Helix	298



Slitting/Jeweler Saws

Straight Side Tooth	300
Staggered Tooth	302
Concave, Slitting Saw	304
Screw Slotting	305
Jewelers Saw	306
Slitting Saw, Straight Tooth & Staggered Tooth.....	309



Custom Solutions

ARCH Specials Overview	311
ARCH Specials Solid Round Tools	313
ARCH Specials Indexables:Rotating & Non-Rotating.....	314
ARCH Specials Custom PCD Tooling	315
ARCH Services	316





TABLE OF CONTENTS

Chapter 1: Rotating

Tool Holders	317
Revere CAT40 ER Collet	318
CAT40 Weldon Side Lock	320
Revere CAT40 Arbor Mount	324
Patriot High Performance CAT40 Imperial Shrink Fit	325
Revere CAT40 Jacobs Taper/Blanks	326
Revere CAT50 ER Collet	327
CAT50 Weldon Side Lock	329
Revere CAT50 Arbor Mount	333
Patriot High Performance CAT50 Imperial Shrink Fit	334
Revere CAT50 Jacobs Taper/Blank	335
CAT Retention Knobs	336
CAT40-50 Machine Cross Reference	337
Revere HSK40-63A ER Collect	339
Revere HSK63A Weldon Side Lock	341
Revere HSK63A Arbor Mount /Blanks	343
Patriot High Performance HSK63A Imperial Shrink-Fit	344
Patriot High Performance HSK63A Metric Shrink-Fit	345
Revere HSK80-125A ER Collet	346
Revere HSK100A Weldon Side Lock	348
Revere HSK100A Arbor Mount/Blanks	350
Patriot High Performance HSK100A Imperial Shrink-Fit	351
Patriot High Performance HSK100A Metric Shrink-Fit	352
Patriot High Performance HSK Coolant Tubes/Sockets & Shrink Fit Extensions	353
Revere Straight Shank ER Collet Extensions	354
Revere Carbide Straight Shank ER Collet Extensions	355
Revere Imperial Sealed Collets	356
Revere Metric Sealed Collets	357
Revere Imperial Standard Collets	358
Revere Metric Standard Collets	360
Revere ISO Milling Bars	362



Chapter 2: Non-Rotating

Inserts	364
Insert Speeds & Feeds/ Chipbreaker Designation	366
Insert Grades	367
Turning Inserts	368
Threading Inserts	380
Grooving Inserts	382
OD Turning	383
Revere Square Shank Pullback	384
Square Shank	386
Square Shank Threading/Grooving	396
Square Shank Undercut & Profiling and Swiss Style	397
ID Turning	398
Steel Boring Bars	399
Steel Boring Bars, Positive	400, 409
Steel Boring Bars, Negative	408, 413
Steel Boring Bars, Threading/Grooving	417
Steel Boring Bars Kits	418
Steel Boring Bars, Reduced Neck	419
Revere Carbide Boring Bars	422
Revere Carbide Boring Bars, Metric, Positive	423





TABLE OF CONTENTS

Chapter 2: Non-Rotating

Revere Carbide Boring Bars, Positive.....	424
Revere Carbide Boring Bars, Negative.....	437
Revere Carbide Boring Bars, Threading/Grooving.....	439
Revere Carbide Boring Bars, Reduced Neck.....	440
Revere Solid Carbide Boring Bars.....	441
Boring Bars Services.....	442
Revere Heavy Metal Boring Bars.....	443
Revere Heavy Metal Boring Bars, Positive.....	444
Modular Boring Bars.....	447
Modular Bars.....	448
Modular Heads, Positive.....	450
Modular Heads, Negative.....	454
Modular Heads, Threading/Grooving.....	459
Patriot High Performance Chatter-Free Boring Bars.....	461
Patriot High Performance Imperial Boring Bars.....	462
Patriot High Performance Metric Boring Bars.....	463
Patriot High Performance Imperial Solid Boring Bars.....	464
Patriot High Performance Standard Boring Bars, CFT style.....	465
Patriot High Performance Standard Heads, Positive.....	466
Patriot High Performance Standard Heads, Negative.....	468
Patriot High Performance Imperial Serrated Modular Boring Bars.....	473
Patriot High Performance Imperial Serrated Boring Bars.....	474
Patriot High Performance Metric Serrated Boring Bars.....	475
Patriot High Performance Serrated Heads, Positive.....	476
Patriot High Performance Serrated Heads, Pullback.....	478
Patriot High Performance Serrated Heads, Threading/Grooving.....	480
Patriot High Performance Chatter-Free Boring Bars Setup Recommendations.....	481
Tool Bushings Sleeves.....	485



Technical Information.....	486
Coatings Guide.....	487
Patriot Indexable High Performance PM1 Indexable Mill Speeds & Feeds.....	488
Patriot Indexable High Performance PM4 Indexable Mill Speeds & Feeds.....	489
Patriot Indexable High Performance PM2 Indexable Mill Speeds & Feeds.....	490
Patriot Indexable High Performance PM3 Indexable Mill Speeds & Feeds.....	491
Revere E90AP/F90AP Indexable Face/Shoulder Mill Speeds & Feeds.....	492
Revere ER/FR Indexable Profile/Button Cutter Speeds & Feeds.....	494
Patriot High Performance End Mill Speeds & Feeds.....	495
End/Chamfer Mill Speeds & Feeds.....	496
PD1 High Performance Indexable Drill Speeds & Feeds.....	497
PD1 High Performance Drill Offset.....	498
Revere Indexable Drill Speeds & Feeds.....	499
Patriot High Performance Solid Carbide Drill Speeds & Feeds.....	500
Standard Drills Speeds & Feeds.....	501
PC1, PC2, PC3 High Performance Indexable Counterbores Speeds & Feeds.....	502
Revere EC Indexable Chamfer Mill Speeds & Feeds.....	503
Corner Rounding Mill Speeds & Feeds.....	504
Woodruff Keyseat Cutter Speeds & Feeds.....	505
Slitting/Jewelers Saw Speeds and Feeds.....	506
OD Turning Tool Nomenclature.....	507
ID Turning Tool Nomenclature.....	508
Tolerances For Arbor Mount Cutters & Saws.....	512
Interlocking Set Information.....	513
Millimeters to Inches Conversion Chart.....	514
Technical Formulas.....	515



ARCH[®]
Cutting Tools

CHAPTER 1

ROTATING



INDEXABLE MILLING

THE COMPLETE TOOL MAKING AUTHORITY™



PM1

- General first choice for face and chamfer milling applications
- Well balanced radial and axial cutting forces
- Smooth entry into cut
- Low vibration tendency when used in long overhang situations
- Face and Chamfer milling applications (in every shop)
- Double-sided insert – 8 cutting edges
- Positive geometry insert – Free cutting
- Efficient cutting parameters due to chip thinning (Hex)
- Directed through coolant at each insert providing excellent chip evacuation

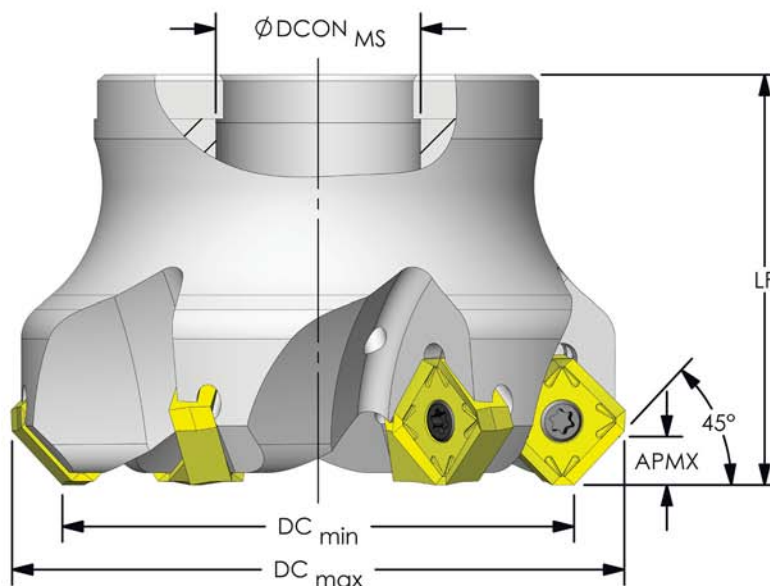

PRODUCT #	Designation	DCX	DC	APMX	ZC	LF	DCON MS	Insert	Screw	Price
970-000-092	PM1-1.25-3-.500-12	1.738	1.250	0.236	3	1.750	0.500	PM1 1205	PM1-4	\$290.40
970-000-093	PM1-1.50-4-.500-12	1.988	1.500	0.236	4	1.750	0.500	PM1 1205	PM1-4	\$338.80
970-000-094	PM1-2.00-5-.750-12	2.488	2.000	0.236	5	1.750	0.750	PM1 1205	PM1-4	\$376.20
970-000-095	PM1-2.50-6-1.00-12	2.988	2.500	0.236	6	2.000	1.000	PM1 1205	PM1-4	\$447.70
970-000-096	PM1-3.00-8-1.00-12	3.488	3.000	0.236	8	2.000	1.000	PM1 1205	PM1-4	\$577.50
970-000-097	PM1-4.00-10-1.25-12	4.488	4.000	0.236	10	2.000	1.250	PM1 1205	PM1-4	\$705.10



Recommendations:

- Keep the cutter constantly engaged, when possible, to reduce enter and exit onto the machined component
- Utilize roll technique around all corners to avoid harsh directional changes
- The width of cut, ae, should be 30% or 70% of DC to ensure maximum efficiency and process security
- Program tool paths around interruptions and holes when possible



HCX



SCX



PRODUCT #	Designation	HP470	HM470	HS470	HS480	HK430	HN432
914-000-104	PM1 1205-HCX	\$24.80					
914-000-105	PM1 1205-HCX					\$24.80	
914-000-106	PM1 1205-SCX		\$24.80				
914-000-107	PM1 1205-SCX			\$28.00			

Inserts sold in packs of 10

Part #	Insert Screw	Price Each
968-000-119	PM1-4	\$4.30
968-000-120	PM2-3	\$4.30
968-000-121	PM2-4	\$5.20
968-000-122	PM3-35	\$4.30
968-000-123	PM4-4	\$5.20

PACKAGE SIZE OF 5

Chipbreaker:

HCX : Medium to roughing applications in steel and cast iron

SCX : Medium to finishing application in steels, stainless steels, hardened steels, and super alloys

ISO	MATERIAL	HARDNESS	CHIPBREAKER	GRADE	Vc (SFM)*	Fz (INCH PER TOOTH)*
P	CARBON STEELS 1018, 1040, 1080, 1090, 10L50, 1140, 1212, 12L15, 1525, 1536	≤ 275 BHN or ≤ 28 HRC	HCX	HP470	300-800	.005 - .020
	ALLOY STEELS 4140, 4150, 4320, 5120, 5150, 8630, 86L20, 17-4 PH	≤ 375 BHN or ≤ 40 HRC			220-720	.003 - .018
M	STAINLESS STEELS (FREE MACHINING) 303, 416, 420F, 430F, 440F	≤ 275 BHN or ≤ 28 HRC	SCX	HM470	230-650	.003 - .0015
	STAINLESS STEELS (DIFFICULT) 304, 304L, 316, 316L	≤ 275 BHN or ≤ 28 HRC			260-700	.003 - .015
K	GRAY IRONS Class 20, 30, 40, 50, 60, G3000, G3500	≤ 220 BHN or ≤ 19 HRC	HCX	HK430	400 - 1100	.005 - .022
	DUCTILE IRONS D&M series, 250, 300, 350, 400, 60-40-18, 65-45-12	≤ 260 BHN or ≤ 26 HRC			350 - 850	.005 - .016
H	TOOL STEELS A2, D2, H13, L2, M2, P20, S7, T15, W2	≤ 375 BHN or ≤ 55 HRC	SCX	HS470	80-280	.004 - .011
S	HR SUPER ALLOYS Inconel 718, Waspaloy, Hastelloy, Inconel 625, Stellite 31, Haynes 25, Rene 41	≤ 275 BHN or ≤ 28 HRC	SCX	HS470	60 - 250	.003 - .009
	TITANIUM 6AL-4V, ASTM 1, 2, 3, 6AL-2S	≤ 275 BHN or ≤ 28 HRC			90 - 300	.004 - .012

Speeds & feeds are starting recommendations only. Factors such as machine type, fixture, tooling rigidity, available horsepower, coolant delivery method and others will affect the performance significantly.

*LOWER Vc AND Fz = MED.- HEAVY Ap / Ae

*HIGHER Vc AND Fz = LIGHT-MED. Ap / Ae



PM4

- Face and chamfer milling in all ISO material applications
- Well balanced radial and axial cutting forces
- Ideal in low-powered machines due to very low cutting forces
- Smooth entry into cut with a true 45° entering angle
- Low vibration tendency when used in long overhang situations
- Cost efficient insert – 6 cutting edges
- Positive geometry insert and cutter body – High shear cutting action
- Efficient cutting parameters due to chip thinning (Hex)
- Directed through coolant at each insert providing excellent chip evacuation

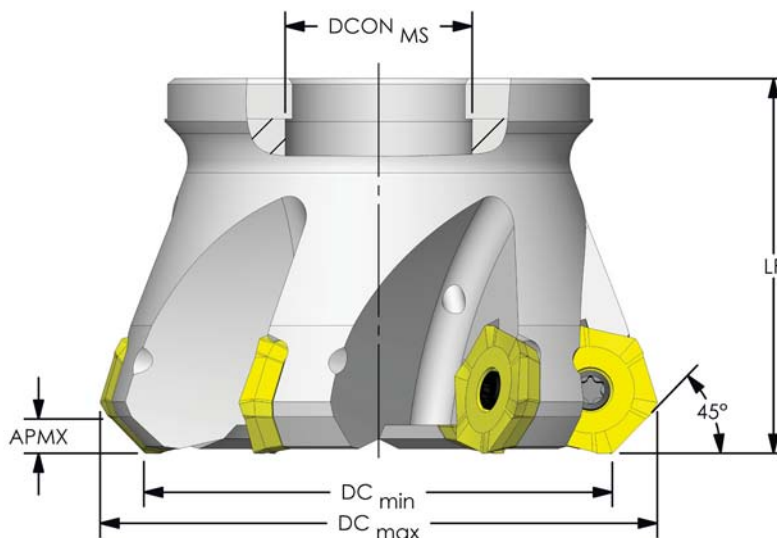

PRODUCT #	Designation	DCX	DC	APMX	ZC	LF	DCON MS	Insert	Screw	Price
970-000-110	PM4-1.50-4-.500-06	1.980	1.500	0.177	4	1.750	0.500	PM4 0604	PM4-4	\$338.80
970-000-111	PM4-2.00-5-.750-06	2.480	2.000	0.177	5	1.750	0.750			\$376.20
970-000-112	PM4-2.50-6-1.00-06	2.980	2.500	0.177	6	2.000	1.000			\$447.70
970-000-113	PM4-3.00-7-1.00-06	3.480	3.000	0.177	7	2.000	1.000			\$566.50
970-000-114	PM4-4.00-9-1.25-06	4.480	4.000	0.177	9	2.000	1.250			\$680.90

Recommendations:

- Keep the cutter constantly engaged, when possible, to reduce enter and exit onto the machined component
- Utilize roll technique around all corners to avoid harsh directional changes
- The width of cut, ae, should be 30% or 70% of DC to ensure maximum efficiency and process security
- Program tool paths around interruptions and holes when possible



HCX

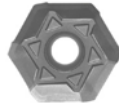

SCX



LCX

PRODUCT #	Designation	HP470	HM470	HS470	HS480	HK430	HN432
914-000-125	PM4 0604-HCX	\$16.60	-	-	-	-	-
914-000-124						\$16.60	
914-000-127	PM4 0604-SCX	-	\$16.60	-	-	-	-
914-000-128				\$21.30			
914-000-126	PM4 0604-LCX	-	-	-	-	-	\$23.60

Inserts sold in packs of 10

Part #	Insert Screw	Price Each
968-000-119	PM1-4	\$4.30
968-000-120	PM2-3	\$4.30
968-000-121	PM2-4	\$5.20
968-000-122	PM3-35	\$4.30
968-000-123	PM4-4	\$5.20

PACKAGE SIZE OF 5

Chipbreaker:

HCX : Strong cutting edge. Medium to roughing applications in steels and cast irons

SCX : Sharp cutting edge. Medium to finishing application in steels, stainless steels, hardened steels, and super alloys

LCX : Positive up sharp cutting edge. Light finishing to medium roughing applications in non ferrous materials

ISO	MATERIAL	HARDNESS	CHIPBREAKER	GRADE	Vc (SFM)*	Fz (INCH PER TOOTH)*
P	CARBON STEELS 1018, 1040, 1080, 1090, 10L50, 1140, 1212, 12L15, 1525, 1536	≤ 275 BHN or ≤ 28 HRC	HCX	HP470	300-800	.005 - .018
	ALLOY STEELS 4140, 4150, 4320, 5120, 5150, 8630, 86L20, 17-4 PH	≤ 375 BHN or ≤ 40 HRC			220-720	.005 - .016
M	STAINLESS STEELS (FREE MACHINING) 303, 416, 420F, 430F, 440F	≤ 275 BHN or ≤ 28 HRC	SCX	HM470	230-650	.003 - .012
	STAINLESS STEELS (DIFFICULT) 304, 304L, 316, 316L	≤ 275 BHN or ≤ 28 HRC			260-700	.003 - .014
K	GRAY IRONS Class 20, 30, 40, 50, 60, G3000, G3500	≤ 220 BHN or ≤ 19 HRC	HCX	HK430	400 - 950	.005 - .020
	DUCTILE IRONS D&M series, 250, 300, 350, 400, 60-40-18, 65-45-12	≤ 260 BHN or ≤ 26 HRC			350 - 800	.005 - .016
N	NON-FERROUS Aluminum, Aluminum cast, Brass, Copper, Bronze, Non Metallic	≤ 271 BHN or ≤ 28 HRC	LCX	HK430	400 - 1100	.007 - .020
H	TOOL STEELS A2, D2, H13, L2, M2, P20, S7, T15, W2	≤ 375 BHN or ≤ 55 HRC	SCX	HS470	80-250	.004 - .011
S	HR SUPER ALLOYS Inconel 718, Waspaloy, Hastelloy, Inconel 625, Stellite 31, Haynes 25, Rene 41	≤ 275 BHN or ≤ 28 HRC	SCX	HS470	60 - 200	.003 - .008
	TITANIUM 6AL-4V, ASTM 1, 2, 3, 6AL-2S	≤ 275 BHN or ≤ 28 HRC				.003 - .010

Speeds & feeds are starting recommendations only. Factors such as machine type, fixture, tooling rigidity, available horsepower, coolant delivery method and others will affect the performance significantly.

*LOWER Vc AND Fz = MED.- HEAVY Ap / Ae

*HIGHER Vc AND Fz = LIGHT-MED. Ap / Ae



PM2

- General first choice for shoulder and slot milling applications
- Face milling, high feed edge milling, and plunge milling
- Cost efficient insert – 4 cutting edges
- Excellent surface finish and higher utilization of low-powered machines
- Precise insert location providing a true 90° shoulder with minimal mismatch
- Positive geometry insert – Free cutting
- Directed through coolant at each insert providing excellent chip evacuation

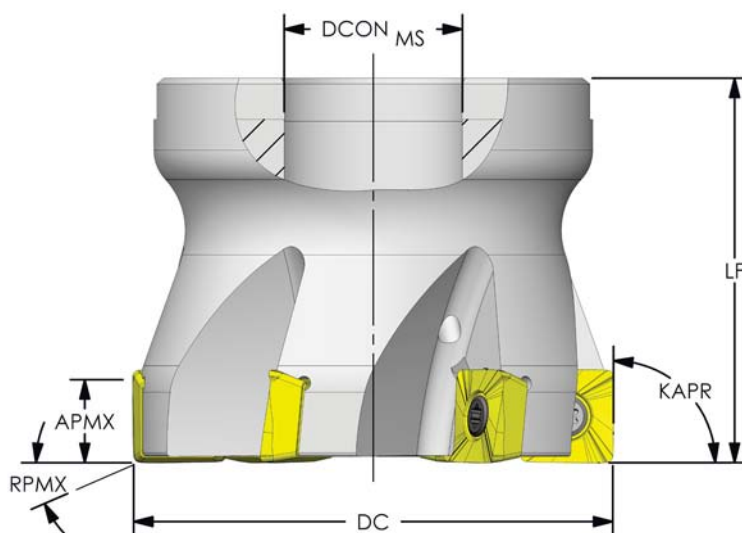

PRODUCT #	Designation	DC	APMX	ZC	LF	DCON MS	RPMX	Insert	Screw	Price
970-000-098	PM2-1.25-4-.500-09	1.250	0.314	4	1.750	0.500	2.20°	PM2 09T308	PM2-3	\$298.10
970-000-100	PM2-1.50-5-.500-09	1.500	0.314	5	1.750	0.500	0.75°			\$335.50
970-000-102	PM2-2.00-6-.750-09	2.000	0.314	6	1.750	0.750	0.50°			\$400.40
970-000-104	PM2-2.50-7-1.00-09	2.500	0.314	7	2.000	1.000	0.35°			\$455.40
970-000-106	PM2-3.00-9-1.00-09	3.000	0.314	9	2.000	1.000	0.25°			\$569.80
970-000-099	PM2-1.50-4-0.500-12	1.500	0.394	4	1.750	0.500	0.75°	PM2 120508	PM2-4	\$335.50
970-000-101	PM2-2.00-5-.750-12	2.000	0.394	5	1.750	0.750	0.40°			\$400.40
970-000-103	PM2-2.50-6-1.00-12	2.500	0.394	6	2.000	1.000	0.30°			\$455.40
970-000-105	PM2-3.00-7-1.00-12	3.000	0.394	7	2.000	1.000	0.25°			\$569.80

Recommendations:

- Keep the cutter constantly engaged, when possible, to reduce enter and exit onto the machined component
- Utilize roll technique around all corners to avoid harsh directional changes
- The width of cut, ae, should be 30% or 70% of DC to ensure maximum efficiency and process security
- Program tool paths around interruptions and holes when possible



PRODUCT #	Designation	HP470	HM470	HS470	HS480	HK430	HN432
914-000-109	PM2 09T308-HCX	\$14.20					
914-000-111			\$14.20				
914-000-112	PM2 09T308-SCX			\$22.50			
914-000-113					\$22.50		
914-000-114	PM2 09T308-CCX					\$17.70	
914-000-110	PM2 09T308-LCX						\$16.60
914-000-115	PM2 120508-HCX	\$17.70					
914-000-116			\$17.70				
914-000-117	PM2 120508-SCX			\$27.20			
914-000-118					\$27.20		
914-000-114	PM2 120508-CCX					\$17.70	

Inserts sold in packs of 10

Chipbreaker:

HCX : Strong cutting edge. Medium to roughing applications in steels and cast irons

SCX : Sharp cutting edge. Medium to finishing application in steels, stainless steels, hardened steels, and super alloys

CCX : Strong cutting edge for cast iron applications

LCX : Positive up sharp cutting edge. Light finishing to medium roughing applications in non ferrous materials



Part #	Insert Screw	Price Each
968-000-119	PM1-4	\$4.30
968-000-120	PM2-3	\$4.30
968-000-121	PM2-4	\$5.20
968-000-122	PM3-35	\$4.30
968-000-123	PM4-4	\$5.20

PACKAGE SIZE OF 5

ISO	MATERIAL	HARDNESS	CHIPBREAKER	GRADE	Vc (SFM)*	Fz (INCH PER TOOTH)*
P	CARBON STEELS 1018, 1040, 1080, 1090, 10L50, 1140, 1212, 12L15, 1525, 1536	≤ 275 BHN or ≤ 28 HRC	HCX	HP470	230-800	.003 - .010
	ALLOY STEELS 4140, 4150, 4320, 5120, 5150, 8630, 86L20, 17-4 PH	≤ 375 BHN or ≤ 40 HRC			230-700	.003 - .008
M	STAINLESS STEELS (FREE MACHINING) 303, 416, 420F, 430F, 440F	≤ 275 BHN or ≤ 28 HRC	SCX	HM470	200-600	.003 - .009
	STAINLESS STEELS (DIFFICULT) 304, 304L, 316, 316L	≤ 275 BHN or ≤ 28 HRC			200-600	.003 - .009
K	GRAY IRONS Class 20, 30, 40, 50, 60, G3000, G3500	≤ 220 BHN or ≤ 19 HRC	CCX / HCX	HK430	400 - 950	.004 - .015
	DUCTILE IRONS D&M series, 250, 300, 350, 400, 60-40-18, 65-45-12	≤ 260 BHN or ≤ 26 HRC			300 - 700	.003 - .011
N	NON-FERROUS Aluminum, Aluminum cast, Brass, Copper, Bronze, Non Metallic	≤ 271 BHN or ≤ 28 HRC	LCX	HK430	400 - 1000	.006 - .018
H	TOOL STEELS A2, D2, H13, L2, M2, P20, S7, T15, W2	≤ 375 BHN or ≤ 55 HRC	SCX / HCX	HS470	80-250	.003 - .009
S	HR SUPER ALLOYS Inconel 718, Waspaloy, Hastelloy, Inconel 625, Stellite 31, Haynes 25, Rene 41	≤ 275 BHN or ≤ 28 HRC	SCX	HS470	60 - 200	.0025 - .007
	TITANIUM 6AL-4V, ASTM 1, 2, 3, 6AL-2S	≤ 275 BHN or ≤ 28 HRC			90 - 350	.003 - .010

*LOWER Vc AND Fz = MED.- HEAVY Ap / Ae

*HIGHER Vc AND Fz = LIGHT-MED. Ap / Ae

Speeds & feeds are starting recommendations only. Factors such as machine type, fixture, tooling rigidity, available horsepower, coolant delivery method and others will affect the performance significantly.



PM3

- General first choice for high feed face and plunge milling applications
- Multipurpose tool with helical boring, ramping and plunging capabilities
- Extremely low radial cutting forces allowing for aggressive feed rates
- Cost efficient insert geometries that excel in HRSA and Stainless steels
- High table feed due to the chip thinning effect – high metal removal rates
- First consideration when face milling in long overhang machining applications
- Positive geometry insert – Free cutting
- Directed through coolant at each insert providing excellent chip evacuation

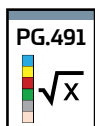
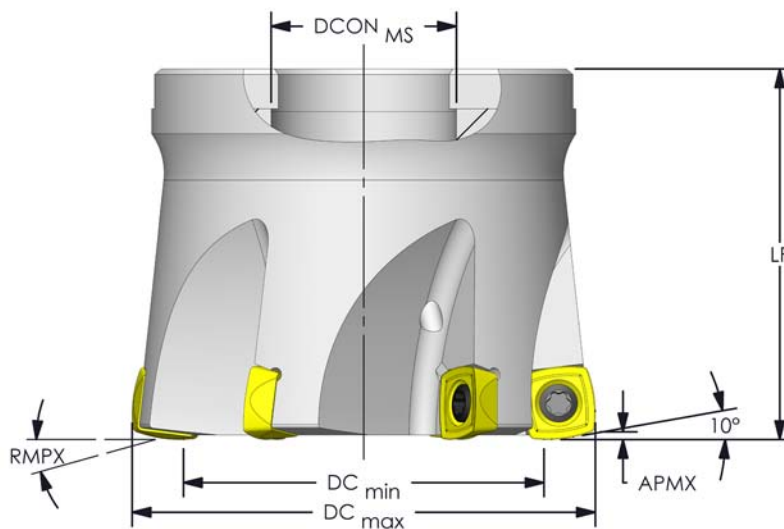

PRODUCT #	Designation	DCX	DC	APMX	ZC	LF	DCON MS	RMPX	Insert	Screw	Price
970-000-107	PM3-1.50-4-.500-10	1.500	1.035	0.039	4	1.750	0.500	1.2°	PM3 10T308	PM3-3.5	\$335.50
970-000-108	PM3-2.00-5-.750-10	2.000	1.535	0.039	5	1.750	0.750	0.9°			\$400.40
970-000-109	PM3-2.50-6-1.00-10	2.500	2.035	0.039	6	1.750	1.000	0.8°			\$434.50



Recommendations:

- Keep the cutter constantly engaged, when possible, to reduce enter and exit onto the machined component
- Utilize roll technique around all corners to avoid harsh directional changes
- The width of cut, ae, should be 30% or 70% of DC to ensure maximum efficiency and process security
- Program tool paths around interruptions and holes when possible



HCX



SCX



PRODUCT #	Designation	HP470	HM470	HS470	HS480	HK430	HN432
914-000-119	PM3 10T308-HCX	\$14.20					
914-000-120						\$14.20	
914-000-121		-	\$14.20			-	-
914-000-122	PM3 10T308-SCX			\$17.70			
914-000-123					\$20.10		

Inserts sold in packs of 10

Part #	Insert Screw	Price Each
968-000-119	PM1-4	\$4.30
968-000-120	PM2-3	\$4.30
968-000-121	PM2-4	\$5.20
968-000-122	PM3-35	\$4.30
968-000-123	PM4-4	\$5.20

PACKAGE SIZE OF 5

Chipbreaker:

HCX : Strong cutting edge for general steels, cast irons, and hard conditions in milling application

SCX : Sharp cutting edge for general stainless steels and super alloy applications

ISO	MATERIAL	HARDNESS	CHIPBREAKER	GRADE	Vc (SFM)*	Fz (INCH PER TOOTH)*
P	CARBON STEELS 1018, 1040, 1080, 1090, 10L50, 1140, 1212, 12L15, 1525, 1536	≤ 275 BHN or ≤ 28 HRC	HCX	HP470	220 - 820	.009 - .075
	ALLOY STEELS 4140, 4150, 4320, 5120, 5150, 8630, 86L20, 17-4 PH	≤ 375 BHN or ≤ 40 HRC			220-720	.009 - .065
M	STAINLESS STEELS (FREE MACHINING) 303, 416, 420F, 430F, 440F	≤ 275 BHN or ≤ 28 HRC	SCX	HM470	230-650	.009 - .045
	STAINLESS STEELS (DIFFICULT) 304, 304L, 316, 316L	≤ 275 BHN or ≤ 28 HRC			260-700	.009 - .045
K	GRAY IRONS Class 20, 30, 40, 50, 60, G3000, G3500	≤ 220 BHN or ≤ 19 HRC	HCX	HK430	400 - 900	.009 - .063
	DUCTILE IRONS D&M series, 250, 300, 350, 400, 60-40-18, 65-45-12	≤ 260 BHN or ≤ 26 HRC			300 - 850	.009 - .055
H	TOOL STEELS A2, D2, H13, L2, M2, P20, S7, T15, W2	≤ 375 BHN or ≤ 55 HRC	SCX	HS470	100-350	.009 - .040
S	HR SUPER ALLOYS Inconel 718, Waspaloy, Hastelloy, Inconel 625, Stellite 31, Haynes 25, Rene 41	≤ 275 BHN or ≤ 28 HRC	SCX	HS470	60 - 220	.007 - .035
	TITANIUM 6AL-4V, ASTM 1, 2, 3, 6AL-2S	≤ 275 BHN or ≤ 28 HRC			90 - 400	.008 - .050

*Speeds & feeds are starting recommendations only. Factors such as machine type, fixture, tooling rigidity, available horsepower, coolant delivery method and others will affect the performance significantly.



F90AP

- Shoulder and slot milling in all ISO material applications
- Linear and helical ramping capabilities
- Deep shoulder milling based on APMX of insert
- Excellent surface finish and higher utilization of low-powered machines
- Positive geometry insert – Free cutting

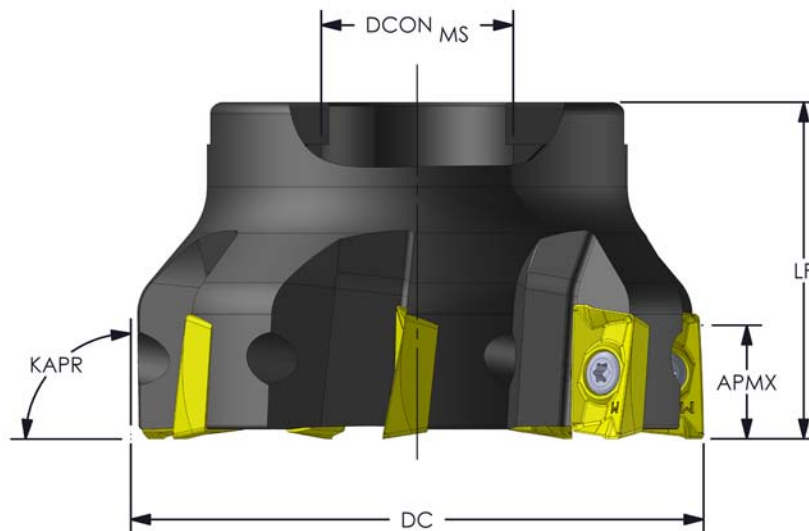

KAPR: 95°

PRODUCT #	Designation	DC	ZC	LF	APMX	DCON MS	Inserts	Screw	Price
946-000-032	F90AP D2.00-5-.750-11	2.000	5	1.570	.315	0.750	APKT 11T308	SR34505L	\$255.30
946-000-035	F90AP D2.50-7-1.00-11	2.500	7	1.750	.315	1.000		SR34505L	\$343.90
946-000-038	F90AP D3.00-8-1.00-11	3.000	8	1.750	.315	1.000		SR34505L	\$427.80
946-000-033	F90AP D2.00-5-.750-16	2.000	5	1.570	.472	0.750	APKT 160408	SR14544	\$248.40
946-000-034	F90AP D2.50-5-1.00-16	2.500	5	1.750	.472	1.000		SR14544	\$327.80
946-000-036	F90AP D3.00-5-1.00-16	3.000	5	1.750	.472	1.000		SR14544	\$401.40
946-000-037	F90AP D3.00-7-1.00-16	3.000	7	1.750	.472	1.000		SR14544	\$427.80
946-000-039	F90AP D4.00-7-1.25-16	4.000	7	2.000	.472	1.250		SR14544	\$518.70

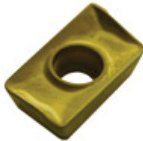

PRODUCT #	Designation	Radius	UD1	UD204	UD404	UD602
913-000-029				\$11.20		
913-000-030	APKT 11T304-PF	.015			\$11.20	
913-000-031						\$11.20
913-000-039				\$11.20		
913-000-040	APKT 11T308-PF	.031			\$11.20	
913-000-046				\$11.20		
913-000-047	APKT 11T316-PF	.062			\$11.20	
913-000-051					\$13.00	
913-000-052	APKT 160408-PF	.031				\$13.00
913-000-032				\$11.20		
913-000-033	APKT 11T304-PM	.015			\$11.20	
913-000-034						\$11.20
913-000-041				\$11.20		
913-000-042	APKT 11T308-PM	.031			\$11.20	
913-000-043						\$11.20
913-000-045	APKT 11T312-PM	.046			\$11.20	
913-000-048	APKT 11T316-PM	.062		\$11.20		
913-000-049					\$11.20	
913-000-053				\$13.00		
913-000-054	APKT 160408-PM	.031			\$13.00	
913-000-055						\$13.00
913-000-035				\$11.20		
913-000-036	APKT 11T304-PR	.015			\$11.20	
913-000-037						\$11.20
913-000-028	APKT 11T304-AL	.015	\$11.20			
913-000-038	APKT 11T308-AL	.031	\$11.20			
913-000-050	APKT 160408-AL	.031	\$13.00			

PRODUCT #	Insert Screw	Price Each
968-000-134	SR34505	\$2.90
968-000-133	SR14544	\$2.90
968-000-135	SR34505L	\$3.20

PACKAGE SIZE OF 5

Inserts sold in packs of 10

APKT 11T308



Feed Per Tooth (inch)

AP (inch)	Light	Medium	Heavy
.315	.0028	.0031	.0039
.236	.0039	.0047	.0059
.157	.0047	.0059	.0079

f/t

APKT 160408



Feed Per Tooth (inch)

AP (inch)	Light	Medium	Heavy
.472	.0028	.0031	.0039
.315	.0039	.0047	.0059
.197	.0047	.0059	.0079

f/t

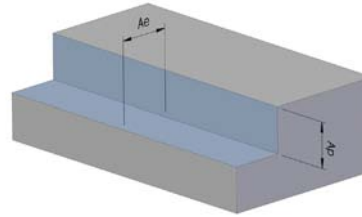

				SQUARE SHOULDER MILLING			
				Fz (INCH PER TOOTH)*		APMX	
ISO	MATERIAL	HARDNESS	Vc (SFM)*	-PF /-AL	-PM /-PR	APKT11T3	APKT1604
P	CARBON STEELS 1018, 1040, 1080, 1090, 10L50, 1140, 1212, 12L15, 1525, 1536	≤ 275 BHN or ≤ 28 HRC	550-900	0.003 - 0.009	0.003 - 0.012	0.315	0.472
	ALLOY STEELS 4140, 4150, 4320, 5120, 5150, 8630, 86L20, 17-4 PH	≤ 375 BHN or ≤ 40 HRC	450-850	0.003 - 0.0075	0.003 - 0.010	0.315	0.472
M	STAINLESS STEELS (FREE MACHINING) 303, 416, 420F, 430F, 440F	≤ 275 BHN or ≤ 28 HRC	350 - 875	0.003 - 0.009	0.003 - 0.012	0.315	0.472
	STAINLESS STEELS (DIFFICULT) 304, 304L, 316, 316L	≤ 275 BHN or ≤ 28 HRC	250 - 800	0.003 - 0.0075	0.003 - 0.010	0.315	0.472
K	GRAY IRONS Class 20, 30, 40, 50, 60, G3000, G3500	≤ 220 BHN or ≤ 19 HRC	400 - 1000	0.004 - 0.010	0.004 - 0.012	0.315	0.472
	DUCTILE IRONS D&M series, 250, 300, 350, 400, 60-40-18, 65-45-12	≤ 260 BHN or ≤ 26 HRC	300 - 800	0.004 - 0.012	0.004 - 0.012	0.315	0.472
N	NON-FERROUS Aluminum, Aluminum cast, Brass, Copper, Bronze, Non Metallic	≤ 271 BHN or ≤ 28 HRC	600-1200	0.004 - 0.014	0.004 - 0.016	0.315	0.472
H	TOOL STEELS A2, D2, H13, L2, M2, P20, S7, T15, W2	≤ 555 BHN or ≤ 55 HRC	190 - 500	0.003 - 0.007	0.003 - 0.009	0.315	0.472
S	HR SUPER ALLOYS Inconel 718, Waspaloy, Hastelloy, Inconel 625, Stellite 31, Haynes 25, Rene 41	≤ 275 BHN or ≤ 28 HRC	70-220	0.002 - 0.006	0.002 - 0.007	0.315	0.472
	TITANIUM 6AL-4V, ASTM 1, 2, 3, 6AL-2S	≤ 275 BHN or ≤ 28 HRC	230-450	0.003 - 0.0085	0.003 - 0.010	0.315	0.472

*Speeds & feeds are starting recommendations only. Factors such as machine type, fixture, tooling rigidity, available horsepower, coolant delivery method and others will affect the performance significantly.

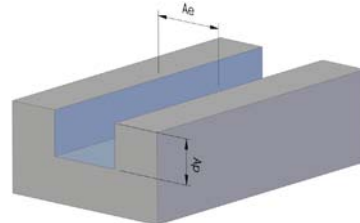

				SQUARE SLOT MILLING			
				Fz (INCH PER TOOTH)*		APMX	
ISO	MATERIAL	HARDNESS	Vc (SFM)*	-PF /-AL	-PM /-PR	APKT11T3	APKT1604
P	CARBON STEELS 1018, 1040, 1080, 1090, 10L50, 1140, 1212, 12L15, 1525, 1536	≤ 275 BHN or ≤ 28 HRC	550-900	0.003 - 0.006	0.003 - 0.010	0.315	0.472
	ALLOY STEELS 4140, 4150, 4320, 5120, 5150, 8630, 86L20, 17-4 PH	≤ 375 BHN or ≤ 40 HRC	450-850	0.003 - 0.006	0.003 - 0.0085	0.315	0.472
M	STAINLESS STEELS (FREE MACHINING) 303, 416, 420F, 430F, 440F	≤ 275 BHN or ≤ 28 HRC	350 - 875	0.003 - 0.007	0.003 - 0.010	0.315	0.472
	STAINLESS STEELS (DIFFICULT) 304, 304L, 316, 316L	≤ 275 BHN or ≤ 28 HRC	250 - 800	0.003 - 0.006	0.003 - 0.010	0.315	0.472
K	GRAY IRONS Class 20, 30, 40, 50, 60, G3000, G3500	≤ 220 BHN or ≤ 19 HRC	400 - 1000	0.004 - 0.008	0.004 - 0.010	0.315	0.472
	DUCTILE IRONS D&M series, 250, 300, 350, 400, 60-40-18, 65-45-12	≤ 260 BHN or ≤ 26 HRC	300 - 800	0.004 - 0.008	0.004 - 0.010	0.315	0.472
N	NON-FERROUS Aluminum, Aluminum cast, Brass, Copper, Bronze, Non Metallic	≤ 271 BHN or ≤ 28 HRC	600-1200	0.004 - 0.011	0.004 - 0.014	0.315	0.472
H	TOOL STEELS A2, D2, H13, L2, M2, P20, S7, T15, W2	≤ 555 BHN or ≤ 55 HRC	190 - 500	0.003 - 0.006	0.003 - 0.007	0.315	0.472
S	HR SUPER ALLOYS Inconel 718, Waspaloy, Hastelloy, Inconel 625, Stellite 31, Haynes 25, Rene 41	≤ 275 BHN or ≤ 28 HRC	70-220	0.002 - 0.006	0.002 - 0.007	0.315	0.472
	TITANIUM 6AL-4V, ASTM 1, 2, 3, 6AL-2S	≤ 275 BHN or ≤ 28 HRC	230-450	0.003 - 0.006	0.003 - 0.008	0.315	0.472

*Speeds & feeds are starting recommendations only. Factors such as machine type, fixture, tooling rigidity, available horsepower, coolant delivery method and others will affect the performance significantly.



FR ARBOR MOUNT

- Profile, contouring and slot milling in all ISO material applications
- Linear and helical ramping capabilities
- High feed milling capabilities based on programed AP of insert
- Excellent surface finish and higher utilization of low-powered machines
- Positive geometry insert – Free cutting

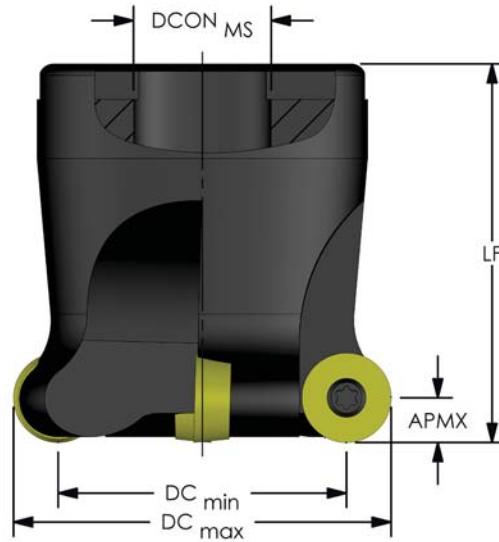

PRODUCT #	Designation	DCX	DC	RADIUS	L	DCON MS	ZC	Insert	Screw	Price
946-000-041	FR-D2.00-4-.750-12	2.000	1.528	0.236 (6mm)	2.000	0.750	4	RCKT 1204	MTS-35	\$288.70
946-000-042	FR-D2.00-4-.750-4	2.000	1.500	0.250	2.000	0.750	4	RCMT 43	MTS-4	\$288.70
946-000-040	FR-D2.00-3-.750-16	2.000	1.370	0.315 (8mm)	2.000	0.750	3	RCKT 1606	MTS-4	\$261.10
946-000-044	FR-D3.00-5-1.00-4	3.000	2.500	0.250	1.750	1.000	5	RCMT 43	MTS-4	\$330.10
946-000-043	FR-D3.00-5-1.00-16	3.000	2.370	0.315 (8mm)	1.750	1.000	5	RCKT 1606	MTS-4	\$330.10
946-000-046	FR-D4.00-6-1.25-4	4.000	3.500	0.250	1.750	1.250	6	RCMT 43	MTS-4	\$380.70
946-000-045	FR-D4.00-6-1.25-16	4.000	3.370	0.315 (8mm)	1.750	1.250	6	RCKT 1606	MTS-4	\$380.70

Recommendations:

Productivity and tooling performance is not only influenced by grade and geometry, but also by clamping the tool securely and accurately as possible.

It is recommended to use precision holders i.e. hydraulic, shrink fit



PRODUCT #	Designation	UD1	UD404	UD602
913-000-360	RDKW 0803	-	\$7.40	
913-000-361				\$7.40
913-000-337	RCKT 10T3	\$7.00		
913-000-338			\$7.00	
913-000-339				\$7.00
913-000-340	RCKT 1204	\$8.30		
913-000-341			\$8.30	
913-000-342				\$8.30
913-000-343			-	\$12.10
913-000-344	RCKT 1606			\$12.10

Inserts sold in packs of 10



PRODUCT #	Insert Screw	Price Each
968-000-087	MTS-184	\$3.20
968-000-088	MTS-2	\$2.90
968-000-092	MTS-255	\$3.20
968-000-082	MTS 25-DR	\$2.90
968-000-084	MTS 3-DR	\$2.90
968-000-083	MTS 35-DR	\$3.50
968-000-085	MTS 4-DR	\$2.90

PACKAGE SIZE OF 5

PRODUCT #	Designation	UD51	UD52	UD2	UD21	UD22
913-000-348	RCMT 21.5	\$10.40				
913-000-349			\$12.00			
913-000-345				\$7.00		
913-000-346					\$9.20	
913-000-347						\$7.80
913-000-353	RCMT 32.5	\$11.50				
913-000-354			\$13.00			
913-000-350				\$10.90		
913-000-351					\$9.60	
913-000-352						\$12.60
913-000-358	RCMT 43	\$13.00				
913-000-359			\$15.40			
913-000-355				\$11.00		
913-000-356					\$14.20	
913-000-357						\$12.90

Inserts sold in packs of 10

ISO	MATERIAL	HARDNESS	GRADE	Vc (SFM)*	Fz (INCH PER TOOTH)* at 50% insert I.C. APMX**
P	CARBON STEELS 1018, 1040, 1080, 1090, 10L50, 1140, 1212, 12L15, 1525, 1536	≤ 275 BHN or ≤ 28 HRC	UD51 UD52 UD404 UD602	300-850	.006 - .018
	ALLOY STEELS 4140, 4150, 4320, 5120, 5150, 8630, 86L20, 17-4 PH	≤ 375 BHN or ≤ 40 HRC		200-700	.005 - .015
M	STAINLESS STEELS (FREE MACHINING) 303, 416, 420F, 430F, 440F	≤ 275 BHN or ≤ 28 HRC	UD32	200-650	.003 - .010
	STAINLESS STEELS (DIFFICULT) 304, 304L, 316, 316L	≤ 275 BHN or ≤ 28 HRC		260-700	.003 - .012
K	GRAY IRONS Class 20, 30, 40, 50, 60, G3000, G3500	≤ 220 BHN or ≤ 19 HRC	UD21	250-900	.005 - .020
	DUCTILE IRONS D&M series, 250, 300, 350, 400, 60-40-18, 65-45-12	≤ 260 BHN or ≤ 26 HRC		200-700	.005 - .015
N	NON-FERROUS Aluminum, Aluminum cast, Brass, Copper, Bronze, Non Metallic	≤ 271 BHN or ≤ 28 HRC	UD1 UD2	400-975	.006 - .020
H	TOOL STEELS A2, D2, H13, L2, M2, P20, S7, T15, W2	≤ 375 BHN or ≤ 55 HRC	UD32 UD404	80-400	.004 - .012
S	HR SUPER ALLOYS Inconel 718, Waspaloy, Hastelloy, Inconel 625, Stellite 31, Haynes 25, Rene 41	≤ 275 BHN or ≤ 28 HRC	UD32 UD52 UD404	40-250	.003 - .008
	TITANIUM 6AL-4V, ASTM 1, 2, 3, 6AL-2S	≤ 275 BHN or ≤ 28 HRC		100-550	.003 - .010

*Speeds & feeds are starting recommendations only. Factors such as machine type, fixture, tooling rigidity, available horsepower, coolant delivery method and others will affect the performance significantly.

** If the axial depth of cut (Ap) is less than 50% of the full radius Insert I.C., increase the feed rate (Fz) to compensate for the thinning (Hex) of the actual chip thickness.



by Ultra-Dex

E90 AP

- Shoulder and slot milling in all ISO material applications
- Linear and helical ramping capabilities
- Deep shoulder milling based on APMX of insert
- Excellent surface finish and higher utilization of low-powered machines
- Positive geometry insert – Free cutting
- Directed through coolant at each insert providing excellent chip evacuation

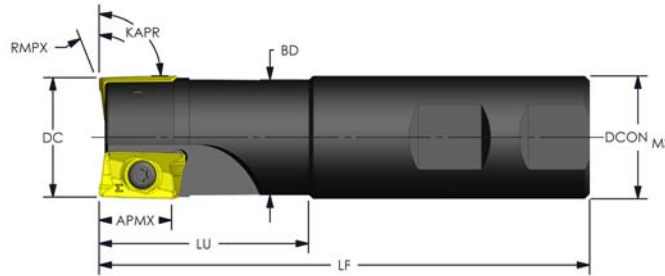

KAPR: 90°

No Coolant



PRODUCT #	Designation	DC	LF	LS	APMX	DCON MS	BD	RMPX	ZC	Insert	Screw	Price
946-000-001	E90AP D0.500-1-W.500-11	0.500	3.375	0.975	.315	0.500	0.455	10°	1	APKT 11T308	SR34505	\$123.10
946-000-002	E90AP D.625-2-W.625-11	0.625	3.375	0.975	.315	0.625	0.580	10°	2		SR34505	\$123.10
946-000-003	E90AP D.750-2-W.750-11	0.750	3.375	0.975	.315	0.750	0.705	5°	2		SR34505L	\$136.90
946-000-005	E90AP D.750-3-W.750-11	0.750	3.375	0.975	.315	0.750	0.705	5°	3		SR34505L	\$164.50
946-000-007	E90AP D.750-3-W.750-6-11	0.750	6.000	3.000	.315	0.750	0.705	5°	3		SR34505L	\$205.90
946-000-010	E90AP D1.00-3-W.750-11	1.000	4.000	1.500	.315	0.750	0.955	5°	3		SR34505L	\$164.50
946-000-011	E90AP D1.00-3-W1.00-11	1.000	4.000	1.500	.315	1.000	0.955	4.5°	3		SR34505L	\$178.30
946-000-013	E90AP D1.00-3-W1.00-6-11	1.000	6.000	3.000	.315	1.000	0.955	4.5°	3		SR34505L	\$191.00
946-000-015	E90AP D1.250-3-W.750-11	1.250	4.000	1.500	.315	0.750	1.205	3°	3		SR34505L	\$164.50
946-000-016	E90AP D1.250-3-W1.00-11	1.250	4.000	1.500	.315	1.000	1.205	3°	3		SR34505L	\$178.30
946-000-021	E90AP D1.500-5-W1.00-11	1.500	4.000	1.500	.315	1.000	1.475	2°	5	SR34505L	\$167.00	
946-000-008	E90AP D1.00-2-W1.00-16	1.000	4.000	1.750	.472	1.000	0.940		2	APKT 160408	SR14544	\$150.70
946-000-009	E90AP D1.00-2-W1.00-6-16	1.000	6.000	4.000	.472	1.000	0.940		2		SR14544	\$192.10
946-000-014	E90AP D1.250-2-W1.00-16	1.250	4.000	1.500	.472	1.000	1.190		2		SR14544	\$164.50
946-000-017	E90AP D1.250-3-W1.00-16	1.250	4.000	1.500	.472	1.000	1.190		3		SR14544	\$178.30
946-000-019	E90AP D1.500-3-W1.00-16	1.500	4.000	1.500	.472	1.000	1.425		3		SR14544	\$178.30

Coolant Thru

PRODUCT #	Designation	DC	LF	LS	APMX	DCON MS	BD	RMPX	ZC	Insert	Screw	Price
946-000-004	E90AP D.750-2-W.750-11-C	0.750	3.375	0.975	.315	0.750	0.705	5°	2	APKT 11T308	SR34505L	\$157.60
946-000-006	E90AP D.750-3-W.750-11-C	0.750	3.375	0.975	.315	0.750	0.705	5°	3		SR34505L	\$185.20
946-000-012	E90AP D1.00-3-W1.00-11-C	1.000	4.000	1.500	.315	1.000	0.940	4.5°	3		SR34505L	\$199.00
946-000-018	E90AP D1.250-3-W1.00-16-C	1.250	4.000	1.500	.472	1.000	1.190		3	APKT 160408	SR14544	\$205.90
946-000-020	E90AP D1.500-3-W1.00-16-C	1.500	4.000	1.500	.472	1.000	1.425		3		SR14544	\$205.90



PRODUCT #	Designation	Radius	UD1	UD204	UD404	UD602
913-000-029				\$11.20		
913-000-030	APKT 11T304-PF	.015			\$11.20	
913-000-031						\$11.20
913-000-039	APKT 11T308-PF	.031		\$11.20		
913-000-040					\$11.20	
913-000-046	APKT 11T316-PF	.062		\$11.20		
913-000-047					\$11.20	
913-000-051	APKT 160408-PF	.031			\$13.00	
913-000-052						\$13.00
913-000-032				\$11.20		
913-000-033	APKT 11T304-PM	.015			\$11.20	
913-000-034						\$11.20
913-000-041				\$11.20		
913-000-042	APKT 11T308-PM	.031			\$11.20	
913-000-043						\$11.20
913-000-045	APKT 11T312-PM	.046			\$11.20	
913-000-048	APKT 11T316-PM	.062		\$11.20		
913-000-049					\$11.20	
913-000-053				\$13.00		
913-000-054	APKT 160408-PM	.031			\$13.00	
913-000-055						\$13.00
913-000-035				\$11.20		
913-000-036	APKT 11T304-PR	.015			\$11.20	
913-000-037						\$11.20
913-000-028	APKT 11T304-AL	.015	\$11.20			
913-000-038	APKT 11T308-AL	.031	\$11.20			
913-000-050	APKT 160408-AL	.031	\$13.00			

PRODUCT #	Insert Screw	Price Each
968-000-134	SR34505	\$2.90
968-000-133	SR14544	\$2.90
968-000-135	SR34505L	\$3.20

PACKAGE SIZE OF 5

Inserts sold in packs of 10

APKT 11T308



Feed Per Tooth (inch)

AP (inch)	Light	Medium	Heavy
.315	.0028	.0031	.0039
.236	.0039	.0047	.0059
.157	.0047	.0059	.0079

f/t

APKT 160408



Feed Per Tooth (inch)

AP (inch)	Light	Medium	Heavy
.472	.0028	.0031	.0039
.315	.0039	.0047	.0059
.197	.0047	.0059	.0079

f/t

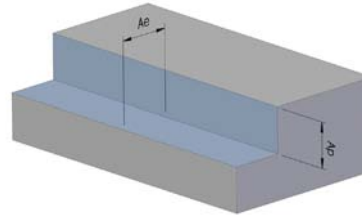

				SQUARE SHOULDER MILLING			
				Fz (INCH PER TOOTH)*		APMX	
ISO	MATERIAL	HARDNESS	Vc (SFM)*	-PF /-AL	-PM /-PR	APKT11T3	APKT1604
P	CARBON STEELS 1018, 1040, 1080, 1090, 10L50, 1140, 1212, 12L15, 1525, 1536	≤ 275 BHN or ≤ 28 HRC	550-900	0.003 - 0.009	0.003 - 0.012	0.315	0.472
	ALLOY STEELS 4140, 4150, 4320, 5120, 5150, 8630, 86L20, 17-4 PH	≤ 375 BHN or ≤ 40 HRC	450-850	0.003 - 0.0075	0.003 - 0.010	0.315	0.472
M	STAINLESS STEELS (FREE MACHINING) 303, 416, 420F, 430F, 440F	≤ 275 BHN or ≤ 28 HRC	350 - 875	0.003 - 0.009	0.003 - 0.012	0.315	0.472
	STAINLESS STEELS (DIFFICULT) 304, 304L, 316, 316L	≤ 275 BHN or ≤ 28 HRC	250 - 800	0.003 - 0.0075	0.003 - 0.010	0.315	0.472
K	GRAY IRONS Class 20, 30, 40, 50, 60, G3000, G3500	≤ 220 BHN or ≤ 19 HRC	400 - 1000	0.004 - 0.010	0.004 - 0.012	0.315	0.472
	DUCTILE IRONS D&M series, 250, 300, 350, 400, 60-40-18, 65-45-12	≤ 260 BHN or ≤ 26 HRC	300 - 800	0.004 - 0.012	0.004 - 0.012	0.315	0.472
N	NON-FERROUS Aluminum, Aluminum cast, Brass, Copper, Bronze, Non Metallic	≤ 271 BHN or ≤ 28 HRC	600-1200	0.004 - 0.014	0.004 - 0.016	0.315	0.472
H	TOOL STEELS A2, D2, H13, L2, M2, P20, S7, T15, W2	≤ 555 BHN or ≤ 55 HRC	190 - 500	0.003 - 0.007	0.003 - 0.009	0.315	0.472
S	HR SUPER ALLOYS Inconel 718, Waspaloy, Hastelloy, Inconel 625, Stellite 31, Haynes 25, Rene 41	≤ 275 BHN or ≤ 28 HRC	70-220	0.002 - 0.006	0.002 - 0.007	0.315	0.472
	TITANIUM 6AL-4V, ASTM 1, 2, 3, 6AL-2S	≤ 275 BHN or ≤ 28 HRC	230-450	0.003 - 0.0085	0.003 - 0.010	0.315	0.472

*Speeds & feeds are starting recommendations only. Factors such as machine type, fixture, tooling rigidity, available horsepower, coolant delivery method and others will affect the performance significantly.

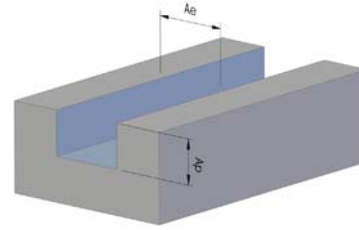

								SQUARE SLOT MILLING			
				Fz (INCH PER TOOTH)*		APMX					
ISO	MATERIAL	HARDNESS	Vc (SFM)*	-PF /-AL	-PM /-PR	APKT11T3	APKT1604				
P	CARBON STEELS 1018, 1040, 1080, 1090, 10L50, 1140, 1212, 12L15, 1525, 1536	≤ 275 BHN or ≤ 28 HRC	550-900	0.003 - 0.006	0.003 - 0.010	0.315	0.472				
	ALLOY STEELS 4140, 4150, 4320, 5120, 5150, 8630, 86L20, 17-4 PH	≤ 375 BHN or ≤ 40 HRC	450-850	0.003 - 0.006	0.003 - 0.0085	0.315	0.472				
M	STAINLESS STEELS (FREE MACHINING) 303, 416, 420F, 430F, 440F	≤ 275 BHN or ≤ 28 HRC	350 - 875	0.003 - 0.007	0.003 - 0.010	0.315	0.472				
	STAINLESS STEELS (DIFFICULT) 304, 304L, 316, 316L	≤ 275 BHN or ≤ 28 HRC	250 - 800	0.003 - 0.006	0.003 - 0.010	0.315	0.472				
K	GRAY IRONS Class 20, 30, 40, 50, 60, G3000, G3500	≤ 220 BHN or ≤ 19 HRC	400 - 1000	0.004 - 0.008	0.004 - 0.010	0.315	0.472				
	DUCTILE IRONS D&M series, 250, 300, 350, 400, 60-40-18, 65-45-12	≤ 260 BHN or ≤ 26 HRC	300 - 800	0.004 - 0.008	0.004 - 0.010	0.315	0.472				
N	NON-FERROUS Aluminum, Aluminum cast, Brass, Copper, Bronze, Non Metallic	≤ 271 BHN or ≤ 28 HRC	600-1200	0.004 - 0.011	0.004 - 0.014	0.315	0.472				
H	TOOL STEELS A2, D2, H13, L2, M2, P20, S7, T15, W2	≤ 555 BHN or ≤ 55 HRC	190 - 500	0.003 - 0.006	0.003 - 0.007	0.315	0.472				
S	HR SUPER ALLOYS Inconel 718, Waspaloy, Hastelloy, Inconel 625, Stellite 31, Haynes 25, Rene 41	≤ 275 BHN or ≤ 28 HRC	70-220	0.002 - 0.006	0.002 - 0.007	0.315	0.472				
	TITANIUM 6AL-4V, ASTM 1, 2, 3, 6AL-2S	≤ 275 BHN or ≤ 28 HRC	230-450	0.003 - 0.006	0.003 - 0.008	0.315	0.472				

*Speeds & feeds are starting recommendations only. Factors such as machine type, fixture, tooling rigidity, available horsepower, coolant delivery method and others will affect the performance significantly.



ER WELDON SHANK

- Shoulder and slot milling in all ISO material applications
- Linear and helical ramping capabilities
- Deep shoulder milling based on APMX of insert
- Excellent surface finish and higher utilization of low-powered machines
- Positive geometry insert – Free cutting
- Directed through coolant at each insert providing excellent chip evacuation

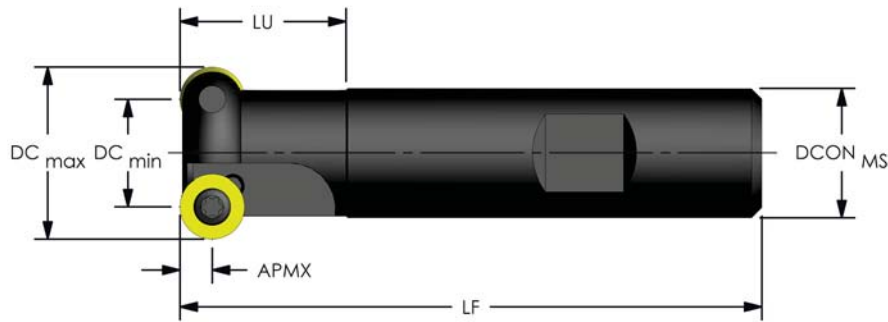

PRODUCT #	Designation	DCX	DC	Radius	LF	LU	DCON MS	ZC	Insert	Screw	Price
946-000-022	ER-D.750-2-.750-08	0.750	0.436	0.157 / 4mm	3.380	0.975	0.750	2	RDKW 0803	MTS 3-DR	\$164.50
946-000-023	ER-D.750-2-.750-2	0.750	0.500	0.125	3.380	0.975	0.750	2	RCMT 21.5	MTS-2.5L	\$164.50
946-000-025	ER-D1.00-2-.750-10	1.000	0.606	0.197 / 5mm	3.380	1.500	0.750	2	RCKT 10T3	MTS-35	\$178.30
946-000-027	ER-D1.00-2-.750-3	1.000	0.625	0.188	3.380	1.500	.750	2	RCMT 32.5	MTS 4-DR	\$178.30
946-000-024	ER-D1.00-2-.750-08	1.000	0.686	0.157 / 4mm	3.380	1.500	0.750	2	RDKW 0803	MTS 3-DR	\$178.30
946-000-026	ER-D1.00-2-.750-2	1.000	0.750	0.125	3.380	1.500	0.750	2	RCMT 21.5	MTS-2.5L	\$178.30
946-000-029	ER-D1.25-3-1.00-10	1.250	0.856	0.197 / 5mm	4.000	1.500	1.000	3	RCKT 10T3	MTS-35	\$192.10
946-000-028	ER-D1.25-2-1.00-3	1.250	0.875	0.188	4.000	1.500	1.000	2	RCMT 32.5	MTS 4-DR	\$192.10
946-000-031	ER-D1.50-3-1.00-4	1.500	1.000	0.250	4.000	1.500	1.000	3	RCMT 43	MTS-4	\$219.70
946-000-030	ER-D1.50-3-1.00-12	1.500	1.028	0.236 / 6mm	4.000	1.500	1.000	3	RCKT 1204	MTS-35	\$219.70

Recommendations:

Productivity and tooling performance is not only influenced by grade and geometry, but also by clamping the tool securely and accurately as possible.

It is recommended to use precision holders i.e. hydraulic, shrink fit



PRODUCT #	Designation	UD1	UD404	UD602
913-000-360	RDKW 0803	-	\$7.40	
913-000-361				\$7.40
913-000-337	RCKT 10T3	\$7.00		
913-000-338			\$7.00	
913-000-339				\$7.00
913-000-340	RCKT 1204	\$8.30		
913-000-341			\$8.30	
913-000-342				\$8.30
913-000-343			-	\$12.10
913-000-344	RCKT 1606			\$12.10

Inserts sold in packs of 10

PRODUCT #	Insert Screw	Price Each
968-000-087	MTS-184	\$3.20
968-000-088	MTS-2	\$2.90
968-000-092	MTS-255	\$3.20
968-000-082	MTS 25-DR	\$2.90
968-000-084	MTS 3-DR	\$2.90
968-000-083	MTS 35-DR	\$3.50
968-000-085	MTS 4-DR	\$2.90

PACKAGE SIZE OF 5

PRODUCT #	Designation	UD51	UD52	UD2	UD21	UD22
913-000-348	RCMT 21.5	\$10.40				
913-000-349			\$12.00			
913-000-345				\$7.00		
913-000-346					\$9.20	
913-000-347						\$7.80
913-000-353	RCMT 32.5	\$11.50				
913-000-354			\$13.00			
913-000-350				\$10.90		
913-000-351					\$9.60	
913-000-352						\$12.60
913-000-358	RCMT 43	\$13.00				
913-000-359			\$15.40			
913-000-355				\$11.00		
913-000-356					\$14.20	
913-000-357						\$12.90

Inserts sold in packs of 10

ISO	MATERIAL	HARDNESS	GRADE	Vc (SFM)*	Fz (INCH PER TOOTH)* at 50% insert I.C. APMX**
P	CARBON STEELS 1018, 1040, 1080, 1090, 10L50, 1140, 1212, 12L15, 1525, 1536	≤ 275 BHN or ≤ 28 HRC	UD51 UD52 UD404 UD602	300-850	.006 - .018
	ALLOY STEELS 4140, 4150, 4320, 5120, 5150, 8630, 86L20, 17-4 PH	≤ 375 BHN or ≤ 40 HRC		200-700	.005 - .015
M	STAINLESS STEELS (FREE MACHINING) 303, 416, 420F, 430F, 440F	≤ 275 BHN or ≤ 28 HRC	UD32	200-650	.003 - .010
	STAINLESS STEELS (DIFFICULT) 304, 304L, 316, 316L	≤ 275 BHN or ≤ 28 HRC		260-700	.003 - .012
K	GRAY IRONS Class 20, 30, 40, 50, 60, G3000, G3500	≤ 220 BHN or ≤ 19 HRC	UD21	250-900	.005 - .020
	DUCTILE IRONS D&M series, 250, 300, 350, 400, 60-40-18, 65-45-12	≤ 260 BHN or ≤ 26 HRC		200-700	.005 - .015
N	NON-FERROUS Aluminum, Aluminum cast, Brass, Copper, Bronze, Non Metallic	≤ 271 BHN or ≤ 28 HRC	UD1 UD2	400-975	.006 - .020
H	TOOL STEELS A2, D2, H13, L2, M2, P20, S7, T15, W2	≤ 375 BHN or ≤ 55 HRC	UD32 UD404	80-400	.004 - .012
S	HR SUPER ALLOYS Inconel 718, Waspaloy, Hastelloy, Inconel 625, Stellite 31, Haynes 25, Rene 41	≤ 275 BHN or ≤ 28 HRC	UD32 UD52 UD404	40-250	.003 - .008
	TITANIUM 6AL-4V, ASTM 1, 2, 3, 6AL-2S	≤ 275 BHN or ≤ 28 HRC		100-550	.003 - .010

*Speeds & feeds are starting recommendations only. Factors such as machine type, fixture, tooling rigidity, available horsepower, coolant delivery method and others will affect the performance significantly.

** If the axial depth of cut (Ap) is less than 50% of the full radius Insert I.C., increase the feed rate (Fz) to compensate for the thinning (Hex) of the actual chip thickness.

S
P
I
D

ARCH[®]
Cutting Tools

SOLID MILLING

THE COMPLETE TOOL MAKING AUTHORITY™

Originally optimized to tackle difficult to machine applications such as in titanium & pre-hardened steels, this High-Performance End Mill has excelled in a wide array of exotic, alloyed and ferrous part materials. The Patriot family of high-performance end mills is designed with advanced proprietary geometry. There is a thin film coating that consistently delivers increased tool life, superior part finish and aggressive metal removal rates. This is all accomplished within a machining environment that generates extreme working temperatures.



TOOL BENEFITS:

- Ranging from 0.125”- 1.00” diameters
- Can be used in roughing, profiling, slotting, and finishing applications
- Increased tool life — high performance coating that offers high wear resistance complimented by toughness and stability at high temperatures
- Significantly reduces chatter and improve surface finish
- Increase material removal rates by increased cutting depth and feed rates

CASE STUDIES

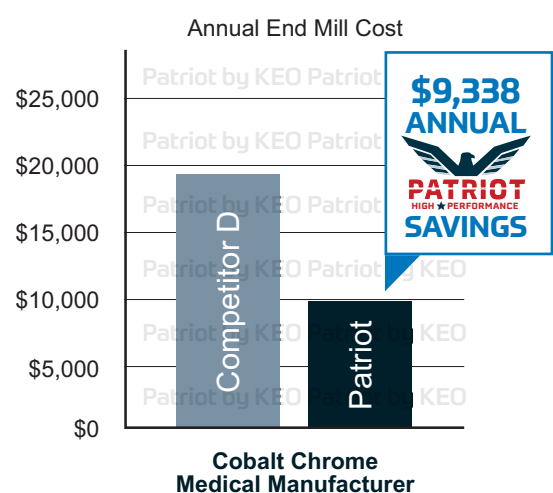
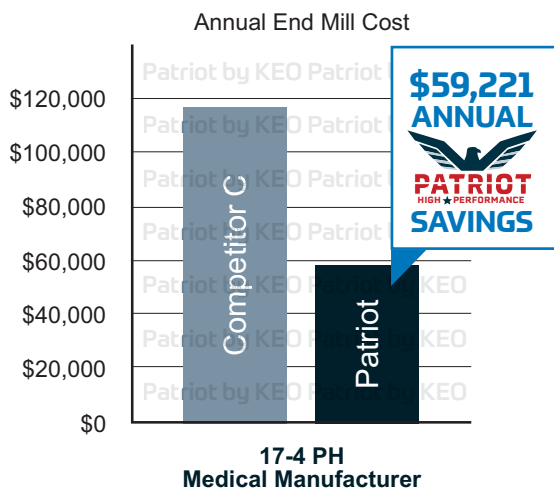
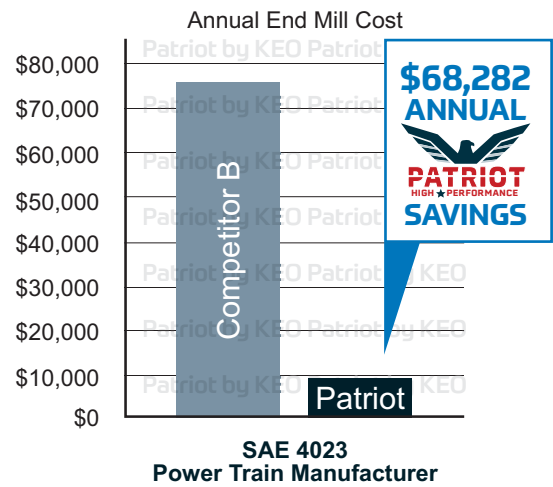
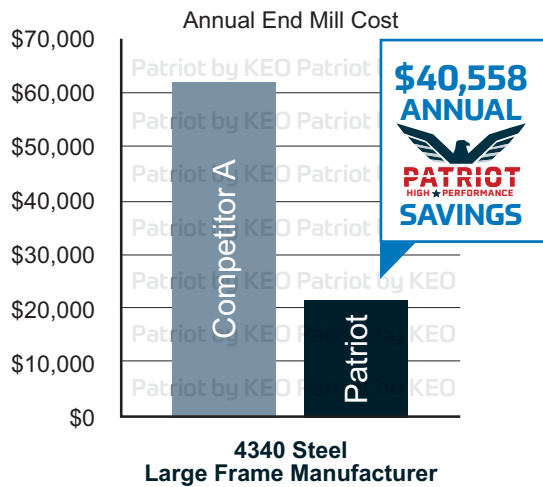

Proprietary to ARCH Cutting Tools

www.archcuttingtools.com

CARBIDE



VARIABLE HELIX

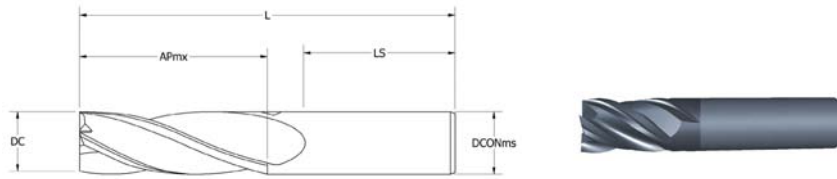

4-FLUTE - STUB LENGTH - SQUARE END



DC	DCONms	APmx	LS	L	PRODUCT #	Price
0.1250	0.1250	0.2500	0.8750	1.5000	976-000-001	\$15.05
0.1875	0.1875	0.3750	1.2500	2.0000	976-000-002	\$23.60
0.2500	0.2500	0.5000	1.1250	2.0000	976-000-003	\$26.30
0.3125	0.3125	0.5000	1.1250	2.0000	976-000-004	\$36.60
0.3750	0.3750	0.6250	1.0000	2.0000	976-000-005	\$40.50
0.4375	0.4375	0.6250	1.5000	2.5000	976-000-006	\$55.60
0.5000	0.5000	0.7500	1.3750	2.5000	976-000-007	\$62.90
0.6250	0.6250	0.7500	1.8750	3.0000	976-000-008	\$101.30
0.7500	0.7500	1.0000	1.6250	3.0000	976-000-009	\$147.01

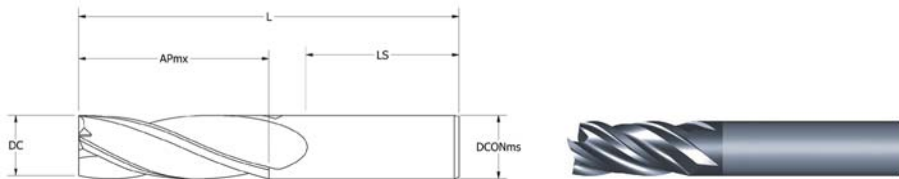

4-FLUTE - STANDARD LENGTH - SQUARE END



DC	DCONms	APmx	LS	L	PRODUCT #	Price
0.1250	0.1250	0.5000	0.6250	1.5000	976-000-010	\$15.70
0.1875	0.1875	0.6250	1.0000	2.0000	976-000-011	\$24.00
0.2500	0.2500	0.7500	1.3750	2.5000	976-000-012	\$27.80
0.2500	0.2500	1.0000	1.1250	2.5000	976-000-013	\$28.30
0.2500	0.2500	1.2500	0.8750	2.5000	976-000-014	\$28.90
0.3125	0.3125	0.8125	1.3125	2.5000	976-000-015	\$39.60
0.3750	0.3750	0.8750	1.2500	2.5000	976-000-016	\$45.20
0.3750	0.3750	1.0000	1.1250	2.5000	976-000-017	\$45.90
0.3750	0.3750	1.2500	0.8750	2.5000	976-000-018	\$46.90
0.4375	0.4375	1.0000	1.3750	2.7500	976-000-019	\$58.90
0.5000	0.5000	1.0000	1.6250	3.0000	976-000-020	\$65.70
0.5000	0.5000	1.2500	1.3750	3.0000	976-000-021	\$67.10
0.5000	0.5000	1.5000	1.1250	3.0000	976-000-022	\$70.05
0.5000	0.5000	1.5000	1.6250	3.5000	976-000-023	\$81.06
0.5000	0.5000	1.7500	1.3750	3.5000	976-000-024	\$84.30
0.6250	0.6250	1.5000	1.6250	3.5000	976-000-025	\$108.10
0.6250	0.6250	1.7500	1.3750	3.5000	976-000-026	\$111.00
0.7500	0.7500	1.7500	1.8750	4.0000	976-000-027	\$174.90
1.0000	1.0000	1.7500	1.8750	4.0000	976-000-028	\$283.30

VARIABLE HELIX

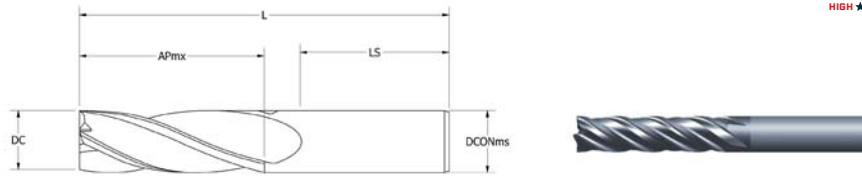

4-FLUTE - LONG LENGTH - SQUARE END



DC	DCONms	APmax	LS	L	PRODUCT #	Price
0.1250	0.1250	0.7500	1.3750	2.5000	976-000-029	\$24.60
0.1875	0.1875	0.7500	1.3750	2.5000	976-000-030	\$28.20
0.2500	0.2500	1.1250	1.5000	3.0000	976-000-031	\$32.30
0.3125	0.3125	1.1250	1.5000	3.0000	976-000-032	\$45.66
0.3750	0.3750	1.2500	1.3750	3.0000	976-000-033	\$61.80
0.4375	0.4375	2.0000	1.6250	4.0000	976-000-034	\$77.60
0.5000	0.5000	2.0000	1.6250	4.0000	976-000-035	\$99.10
0.6250	0.6250	2.2500	2.3750	5.0000	976-000-036	\$178.60
0.7500	0.7500	2.2500	2.3750	5.0000	976-000-037	\$201.70
1.0000	1.0000	2.2500	2.3750	5.0000	976-000-038	\$318.90

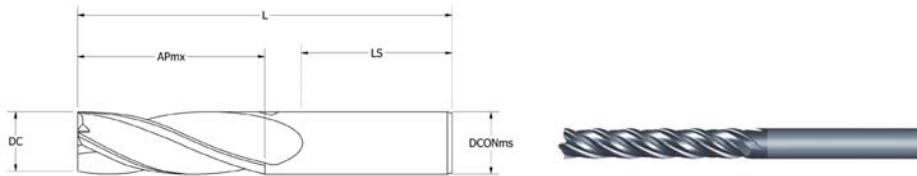

4-FLUTE - X LONG LENGTH - SQUARE END



DC	DCONms	APmax	LS	L	PRODUCT #	Price
0.1250	0.1250	1.0000	1.6250	3.0000	976-000-039	\$33.01
0.1875	0.1875	1.1250	1.5000	3.0000	976-000-040	\$36.90
0.2500	0.2500	1.5000	2.1250	4.0000	976-000-041	\$41.70
0.3125	0.3125	1.6250	2.0000	4.0000	976-000-042	\$58.30
0.3750	0.3750	2.0000	1.6250	4.0000	976-000-043	\$73.50
0.4375	0.4375	3.0000	2.6250	6.0000	976-000-044	\$121.40
0.5000	0.5000	3.0000	2.6250	6.0000	976-000-045	\$135.90
0.6250	0.6250	3.0000	2.6250	6.0000	976-000-046	\$191.30
0.7500	0.7500	3.0000	2.6250	6.0000	976-000-047	\$227.20
1.0000	1.0000	3.0000	2.6250	6.0000	976-000-048	\$375.60

CARBIDE



VARIABLE HELIX

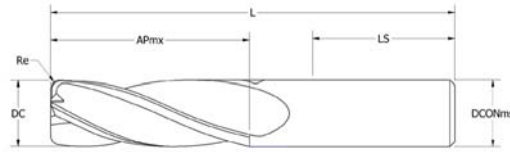

4-FLUTE - STUB LENGTH - CORNER RADIUS



DC	DCONms	Re	APmx	LS	L	PRODUCT #	Price
0.1250	0.1250	0.0100	0.2500	0.8750	1.5000	976-000-128	\$15.90
0.1875	0.1875	0.0100	0.3750	1.2500	2.0000	976-000-129	\$24.50
0.2500	0.2500	0.0200	0.5000	1.1250	2.0000	976-000-130	\$28.01
0.3125	0.3125	0.0200	0.5000	1.1250	2.0000	976-000-131	\$38.05
0.3750	0.3750	0.0200	0.6250	1.0000	2.0000	976-000-132	\$42.30
0.4375	0.4375	0.0300	0.6250	1.5000	2.5000	976-000-133	\$58.01
0.5000	0.5000	0.0300	0.7500	1.3750	2.5000	976-000-134	\$65.20
0.6250	0.6250	0.0400	0.7500	1.8750	3.0000	976-000-135	\$106.30
0.7500	0.7500	0.0400	1.0000	1.6250	3.0000	976-000-136	\$155.30

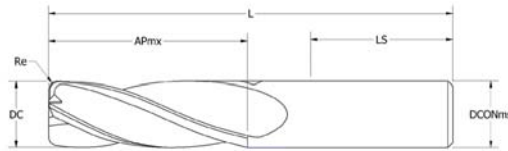

4-FLUTE - STANDARD LENGTH - CORNER RADIUS



DC	DCONms	Re	APmx	LS	L	PRODUCT #	Price
0.1250	0.1250	0.0100	0.5000	0.6250	1.5000	976-000-137	\$17.05
0.1250	0.1250	0.0150	0.5000	0.6250	1.5000	976-000-138	\$17.50
0.1250	0.1250	0.0200	0.5000	0.6250	1.5000	976-000-139	\$17.90
0.1875	0.1875	0.0100	0.6250	1.0000	2.0000	976-000-140	\$25.40
0.1875	0.1875	0.0150	0.6250	1.0000	2.0000	976-000-141	\$25.70
0.1875	0.1875	0.0200	0.6250	1.0000	2.0000	976-000-142	\$25.90
0.1875	0.1875	0.0300	0.6250	1.0000	2.0000	976-000-143	\$26.02
0.2500	0.2500	0.0100	0.7500	1.3750	2.5000	976-000-144	\$29.30
0.2500	0.2500	0.0150	0.7500	1.3750	2.5000	976-000-145	\$29.60
0.2500	0.2500	0.0200	0.7500	1.3750	2.5000	976-000-146	\$29.80
0.2500	0.2500	0.0300	0.7500	1.3750	2.5000	976-000-147	\$30.00
0.2500	0.2500	0.0600	0.7500	1.3750	2.5000	976-000-148	\$30.80
0.2500	0.2500	0.0100	1.0000	1.1250	2.5000	976-000-149	\$29.90
0.2500	0.2500	0.0150	1.0000	1.1250	2.5000	976-000-150	\$30.20
0.2500	0.2500	0.0200	1.0000	1.1250	2.5000	976-000-151	\$30.60
0.2500	0.2500	0.0300	1.0000	1.1250	2.5000	976-000-152	\$30.90
0.2500	0.2500	0.0600	1.0000	1.1250	2.5000	976-000-153	\$32.00
0.2500	0.2500	0.0100	1.2500	0.8750	2.5000	976-000-154	\$32.30
0.2500	0.2500	0.0150	1.2500	0.8750	2.5000	976-000-155	\$32.70
0.2500	0.2500	0.0200	1.2500	0.8750	2.5000	976-000-156	\$33.00
0.2500	0.2500	0.0300	1.2500	0.8750	2.5000	976-000-157	\$33.40
0.2500	0.2500	0.0600	1.2500	0.8750	2.5000	976-000-158	\$33.90
0.3125	0.3125	0.0100	0.8125	1.3125	2.5000	976-000-159	\$41.30
0.3125	0.3125	0.0150	0.8125	1.3125	2.5000	976-000-160	\$41.60
0.3125	0.3125	0.0200	0.8125	1.3125	2.5000	976-000-161	\$41.90



4-FLUTE - STANDARD LENGTH - CORNER RADIUS



CARBIDE

DC	DCONms	Re	APmx	LS	L	PRODUCT #	Price
0.3125	0.3125	0.0300	0.8125	1.3125	2.5000	976-000-162	\$42.10
0.3125	0.3125	0.0600	0.8125	1.3125	2.5000	976-000-163	\$42.80
0.3750	0.3750	0.0100	0.8750	1.2500	2.5000	976-000-164	\$48.00
0.3750	0.3750	0.0150	0.8750	1.2500	2.5000	976-000-165	\$48.20
0.3750	0.3750	0.0200	0.8750	1.2500	2.5000	976-000-166	\$48.80
0.3750	0.3750	0.0300	0.8750	1.2500	2.5000	976-000-167	\$49.10
0.3750	0.3750	0.0600	0.8750	1.2500	2.5000	976-000-168	\$49.60
0.3750	0.3750	0.0100	1.0000	1.1250	2.5000	976-000-169	\$48.90
0.3750	0.3750	0.0150	1.0000	1.1250	2.5000	976-000-170	\$49.40
0.3750	0.3750	0.0200	1.0000	1.1250	2.5000	976-000-171	\$49.80
0.3750	0.3750	0.0300	1.0000	1.1250	2.5000	976-000-172	\$50.30
0.3750	0.3750	0.0600	1.0000	1.1250	2.5000	976-000-173	\$50.60
0.3750	0.3750	0.0100	1.2500	0.8750	2.5000	976-000-174	\$50.02
0.3750	0.3750	0.0150	1.2500	0.8750	2.5000	976-000-175	\$50.40
0.3750	0.3750	0.0200	1.2500	0.8750	2.5000	976-000-176	\$50.90
0.3750	0.3750	0.0300	1.2500	0.8750	2.5000	976-000-177	\$51.30
0.3750	0.3750	0.0600	1.2500	0.8750	2.5000	976-000-178	\$51.80
0.4375	0.4375	0.0150	1.0000	1.3750	2.7500	976-000-179	\$62.30
0.4375	0.4375	0.0200	1.0000	1.3750	2.7500	976-000-180	\$62.60
0.4375	0.4375	0.0300	1.0000	1.3750	2.7500	976-000-181	\$62.90
0.4375	0.4375	0.0600	1.0000	1.3750	2.7500	976-000-182	\$63.00
0.5000	0.5000	0.0100	1.0000	1.6250	3.0000	976-000-183	\$63.20
0.5000	0.5000	0.0150	1.0000	1.6250	3.0000	976-000-184	\$63.80
0.5000	0.5000	0.0300	1.0000	1.6250	3.0000	976-000-185	\$64.05
0.5000	0.5000	0.0600	1.0000	1.6250	3.0000	976-000-186	\$64.30
0.5000	0.5000	0.0900	1.0000	1.6250	3.0000	976-000-187	\$64.90
0.5000	0.5000	0.1200	1.0000	1.6250	3.0000	976-000-188	\$65.02
0.5000	0.5000	0.0100	1.2500	1.3750	3.0000	976-000-189	\$71.60
0.5000	0.5000	0.0150	1.2500	1.3750	3.0000	976-000-190	\$71.90
0.5000	0.5000	0.0300	1.2500	1.3750	3.0000	976-000-191	\$72.20
0.5000	0.5000	0.0600	1.2500	1.3750	3.0000	976-000-192	\$72.80
0.5000	0.5000	0.0900	1.2500	1.3750	3.0000	976-000-193	\$73.20
0.5000	0.5000	0.1200	1.2500	1.3750	3.0000	976-000-194	\$73.60
0.5000	0.5000	0.0100	1.5000	1.1250	3.0000	976-000-195	\$74.10
0.5000	0.5000	0.0150	1.5000	1.1250	3.0000	976-000-196	\$74.60
0.5000	0.5000	0.0300	1.5000	1.1250	3.0000	976-000-197	\$74.80
0.5000	0.5000	0.0600	1.5000	1.1250	3.0000	976-000-198	\$75.10
0.5000	0.5000	0.0900	1.5000	1.1250	3.0000	976-000-199	\$75.40
0.5000	0.5000	0.1200	1.5000	1.1250	3.0000	976-000-200	\$74.10
0.5000	0.5000	0.0100	1.5000	1.6250	3.5000	976-000-201	\$85.02
0.5000	0.5000	0.0150	1.5000	1.6250	3.5000	976-000-202	\$85.40
0.5000	0.5000	0.0300	1.5000	1.6250	3.5000	976-000-203	\$85.90
0.5000	0.5000	0.0600	1.5000	1.6250	3.5000	976-000-204	\$86.20
0.5000	0.5000	0.0900	1.5000	1.6250	3.5000	976-000-205	\$86.90
0.5000	0.5000	0.1200	1.5000	1.6250	3.5000	976-000-206	\$87.30
0.5000	0.5000	0.0100	1.7500	1.3750	3.5000	976-000-207	\$88.90
0.5000	0.5000	0.0150	1.7500	1.3750	3.5000	976-000-208	\$90.20

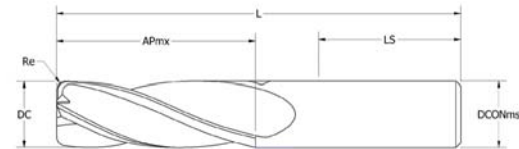

CARBIDE

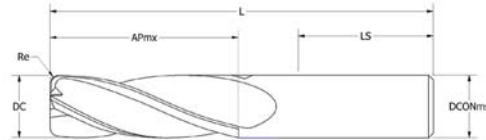

4-FLUTE - STANDARD LENGTH - CORNER RADIUS



DC	DCONms	Re	APmx	LS	L	PRODUCT #	Price
0.5000	0.5000	0.0300	1.7500	1.3750	3.5000	976-000-209	\$90.60
0.5000	0.5000	0.0600	1.7500	1.3750	3.5000	976-000-210	\$90.90
0.5000	0.5000	0.0900	1.7500	1.3750	3.5000	976-000-211	\$91.20
0.5000	0.5000	0.1200	1.7500	1.3750	3.5000	976-000-212	\$91.80
0.6250	0.6250	0.0300	1.5000	1.6250	3.5000	976-000-213	\$113.60
0.6250	0.6250	0.0400	1.5000	1.6250	3.5000	976-000-214	\$113.90
0.6250	0.6250	0.0600	1.5000	1.6250	3.5000	976-000-215	\$114.20
0.6250	0.6250	0.0900	1.5000	1.6250	3.5000	976-000-216	\$114.60
0.6250	0.6250	0.1200	1.5000	1.6250	3.5000	976-000-217	\$114.90
0.6250	0.6250	0.0300	1.7500	1.3750	3.5000	976-000-218	\$116.30
0.6250	0.6250	0.0400	1.7500	1.3750	3.5000	976-000-219	\$116.90
0.6250	0.6250	0.0600	1.7500	1.3750	3.5000	976-000-220	\$117.30
0.6250	0.6250	0.0900	1.7500	1.3750	3.5000	976-000-221	\$117.60
0.6250	0.6250	0.1200	1.7500	1.3750	3.5000	976-000-222	\$117.90
0.7500	0.7500	0.0300	1.7500	1.8750	4.0000	976-000-223	\$179.30
0.7500	0.7500	0.0400	1.7500	1.8750	4.0000	976-000-224	\$179.80
0.7500	0.7500	0.0600	1.7500	1.8750	4.0000	976-000-225	\$181.40
0.7500	0.7500	0.0900	1.7500	1.8750	4.0000	976-000-226	\$181.90
0.7500	0.7500	0.1200	1.7500	1.8750	4.0000	976-000-227	\$182.30
1.0000	1.0000	0.0300	1.7500	1.8750	4.0000	976-000-228	\$298.90
1.0000	1.0000	0.0400	1.7500	1.8750	4.0000	976-000-229	\$299.20
1.0000	1.0000	0.0600	1.7500	1.8750	4.0000	976-000-230	\$299.60
1.0000	1.0000	0.0900	1.7500	1.8750	4.0000	976-000-231	\$299.90
1.0000	1.0000	0.1200	1.7500	1.8750	4.0000	976-000-232	\$300.30

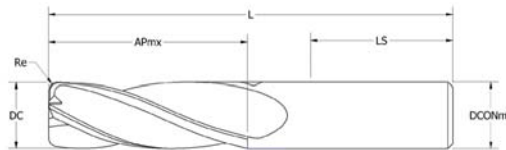

ROUGHING/CHIP BREAKER

4-FLUTE - STANDARD LENGTH - CORNER RADIUS



DC	DCONms	Re	APmx	LS	L	PRODUCT #	Price
0.2500	0.2500	0.0200	0.7500	1.3750	2.5000	976-000-529	\$48.90
0.3750	0.3750	0.0200	0.8750	1.2500	2.5000	976-000-530	\$70.00
0.5000	0.5000	0.0300	1.0000	1.6250	3.0000	976-000-531	\$92.30
0.6250	0.6250	0.0400	1.5000	1.6250	3.5000	976-000-532	\$149.10
0.7500	0.7500	0.0400	1.7500	1.8750	4.0000	976-000-533	\$220.00
1.0000	1.0000	0.0400	1.7500	1.8750	4.0000	976-000-534	\$340.00



4-FLUTE - LONG LENGTH - CORNER RADIUS

DC	DCONms	Re	APmx	LS	L	PRODUCT #	Price
0.1250	0.1250	0.0150	0.7500	1.3750	2.5000	976-000-233	\$26.90
0.1250	0.1250	0.0300	0.7500	1.3750	2.5000	976-000-234	\$27.20
0.1875	0.1875	0.0150	0.7500	1.3750	2.5000	976-000-235	\$30.80
0.1875	0.1875	0.0300	0.7500	1.3750	2.5000	976-000-236	\$31.20
0.2500	0.2500	0.0150	1.1250	1.5000	3.0000	976-000-237	\$35.06
0.2500	0.2500	0.0300	1.1250	1.5000	3.0000	976-000-238	\$35.90
0.3125	0.3125	0.0150	1.1250	1.5000	3.0000	976-000-239	\$48.60
0.3125	0.3125	0.0300	1.1250	1.5000	3.0000	976-000-240	\$49.00
0.3750	0.3750	0.0300	1.2500	1.3750	3.0000	976-000-241	\$67.30
0.3750	0.3750	0.0600	1.2500	1.3750	3.0000	976-000-242	\$67.90
0.4375	0.4375	0.0300	2.0000	1.6250	4.0000	976-000-243	\$83.20
0.4375	0.4375	0.0600	2.0000	1.6250	4.0000	976-000-244	\$83.90
0.5000	0.5000	0.0300	2.0000	1.6250	4.0000	976-000-245	\$105.70
0.5000	0.5000	0.0600	2.0000	1.6250	4.0000	976-000-246	\$106.10
0.6250	0.6250	0.0300	2.2500	2.3750	5.0000	976-000-247	\$179.60
0.6250	0.6250	0.0600	2.2500	2.3750	5.0000	976-000-248	\$180.80
0.7500	0.7500	0.0300	2.2500	2.3750	5.0000	976-000-249	\$215.00
0.7500	0.7500	0.0600	2.2500	2.3750	5.0000	976-000-250	\$215.40
1.0000	1.0000	0.0300	2.2500	2.3750	5.0000	976-000-251	\$335.00
1.0000	1.0000	0.0600	2.2500	2.3750	5.0000	976-000-252	\$335.40

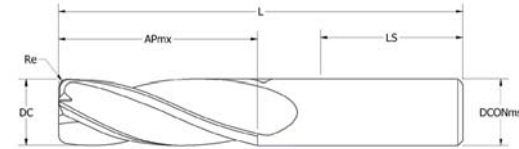

4-FLUTE - X LONG LENGTH - CORNER RADIUS

DC	DCONms	Re	APmx	LS	L	PRODUCT #	Price
0.1250	0.1250	0.0150	1.0000	1.6250	3.0000	976-000-253	\$36.02
0.1250	0.1250	0.0300	1.0000	1.6250	3.0000	976-000-255	\$36.40
0.1875	0.1875	0.0150	1.1250	1.5000	3.0000	976-000-256	\$39.20
0.1875	0.1875	0.0300	1.1250	1.5000	3.0000	976-000-257	\$39.80
0.2500	0.2500	0.0150	1.5000	2.1250	4.0000	976-000-258	\$44.90
0.2500	0.2500	0.0300	1.5000	2.1250	4.0000	976-000-259	\$45.10
0.3125	0.3125	0.0300	1.6250	2.0000	4.0000	976-000-260	\$62.30
0.3125	0.3125	0.0600	1.6250	2.0000	4.0000	976-000-262	\$62.80
0.3750	0.3750	0.0300	2.0000	1.6250	4.0000	976-000-263	\$80.30
0.3750	0.3750	0.0600	2.0000	1.6250	4.0000	976-000-264	\$80.90
0.4375	0.4375	0.0300	3.0000	2.6250	6.0000	976-000-265	\$129.60
0.4375	0.4375	0.0600	3.0000	2.6250	6.0000	976-000-267	\$130.00
0.5000	0.5000	0.0300	3.0000	2.6250	6.0000	976-000-268	\$142.90
0.5000	0.5000	0.0600	3.0000	2.6250	6.0000	976-000-269	\$143.30
0.6250	0.6250	0.0300	3.0000	2.6250	6.0000	976-000-270	\$201.30
0.6250	0.6250	0.0600	3.0000	2.6250	6.0000	976-000-271	\$201.90
0.7500	0.7500	0.0300	3.0000	2.6250	6.0000	976-000-272	\$240.00
0.7500	0.7500	0.0600	3.0000	2.6250	6.0000	976-000-273	\$244.60
1.0000	1.0000	0.0300	3.0000	2.6250	6.0000	976-000-274	\$401.90
1.0000	1.0000	0.0600	3.0000	2.6250	6.0000	976-000-275	\$402.10

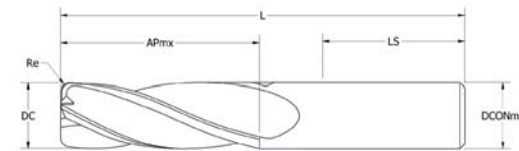

CARBIDE



VARIABLE HELIX

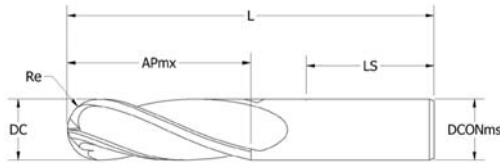

4-FLUTE - STUB LENGTH - BALL END



DC	DCONms	Re	APmx	LS	L	PRODUCT #	Price
0.1250	0.1250	0.0625	0.2500	0.8750	1.5000	976-000-488	\$19.70
0.1875	0.1875	0.0938	0.3750	1.2500	2.0000	976-000-489	\$26.90
0.2500	0.2500	0.1250	0.5000	1.1250	2.0000	976-000-490	\$31.20
0.3125	0.3125	0.1563	0.5000	1.1250	2.0000	976-000-491	\$42.60
0.3750	0.3750	0.1875	0.6250	1.0000	2.0000	976-000-492	\$47.30
0.4375	0.4375	0.2188	0.6250	1.5000	2.5000	976-000-493	\$59.30
0.5000	0.5000	0.2500	0.7500	1.3750	2.5000	976-000-494	\$67.60
0.6250	0.6250	0.3125	0.7500	1.8750	3.0000	976-000-495	\$130.20
0.7500	0.7500	0.3750	1.0000	1.6250	3.0000	976-000-496	\$170.50

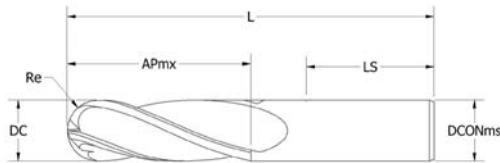

4-FLUTE - STANDARD LENGTH - BALL END



DC	DCONms	Re	APmx	LS	L	PRODUCT #	Price
0.1250	0.1250	0.0625	0.5000	0.6250	1.5000	976-000-497	\$24.30
0.1875	0.1875	0.0938	0.6250	1.0000	2.0000	976-000-498	\$28.80
0.2500	0.2500	0.1250	0.7500	1.3750	2.5000	976-000-499	\$35.90
0.3125	0.3125	0.1563	0.8125	1.3125	2.5000	976-000-500	\$45.30
0.3750	0.3750	0.1875	0.8750	1.2500	2.5000	976-000-501	\$52.60
0.3750	0.3750	0.1875	1.0000	1.1250	2.5000	976-000-502	\$54.60
0.4375	0.4375	0.2188	1.0000	1.3750	2.7500	976-000-503	\$70.02
0.5000	0.5000	0.2500	1.0000	1.6250	3.0000	976-000-504	\$78.30
0.5000	0.5000	0.2500	1.2500	1.3750	3.0000	976-000-505	\$80.20
0.6250	0.6250	0.3125	1.5000	1.6250	3.5000	976-000-506	\$139.60
0.7500	0.7500	0.3750	1.7500	1.8750	4.0000	976-000-507	\$189.00
1.0000	1.0000	0.5000	1.7500	1.8750	4.0000	976-000-508	\$350.60

VARIABLE HELIX

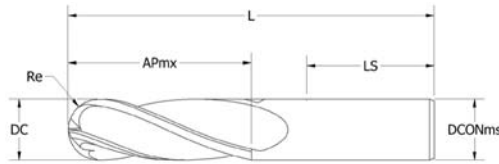

4-FLUTE - LONG LENGTH - BALL END



DC	DCONms	Re	APmx	LS	L	PRODUCT #	Price
0.1250	0.1250	0.0625	0.7500	1.3750	2.5000	976-000-509	\$29.70
0.1875	0.1875	0.0938	0.7500	1.3750	2.5000	976-000-510	\$33.80
0.2500	0.2500	0.1250	1.1250	1.5000	3.0000	976-000-511	\$38.60
0.3125	0.3125	0.1563	1.1250	1.5000	3.0000	976-000-512	\$52.30
0.3750	0.3750	0.1875	1.2500	1.3750	3.0000	976-000-513	\$69.60
0.4375	0.4375	0.2188	2.0000	1.6250	4.0000	976-000-514	\$87.10
0.5000	0.5000	0.2500	2.0000	1.6250	4.0000	976-000-515	\$107.10
0.6250	0.6250	0.3125	2.2500	2.3750	5.0000	976-000-516	\$185.60
0.7500	0.7500	0.3750	2.2500	2.3750	5.0000	976-000-517	\$225.00
1.0000	1.0000	0.5000	2.2500	2.3750	5.0000	976-000-518	\$373.60

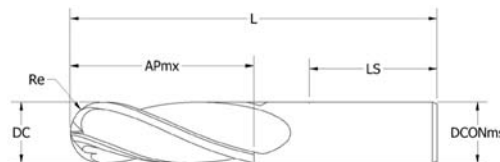

4-FLUTE - X LONG LENGTH - BALL END



DC	DCONms	Re	APmx	LS	L	PRODUCT #	Price
0.1250	0.1250	0.0625	1.0000	1.6250	3.0000	976-000-519	\$38.02
0.1875	0.1875	0.0938	1.1250	1.5000	3.0000	976-000-520	\$41.80
0.2500	0.2500	0.1250	1.5000	2.1250	4.0000	976-000-521	\$52.90
0.3125	0.3125	0.1563	1.6250	2.0000	4.0000	976-000-522	\$65.90
0.3750	0.3750	0.1875	1.7500	1.8750	4.0000	976-000-523	\$75.90
0.4375	0.4375	0.2188	3.0000	2.6250	6.0000	976-000-524	\$132.60
0.5000	0.5000	0.2500	3.0000	2.6250	6.0000	976-000-525	\$163.50
0.6250	0.6250	0.3125	3.0000	2.6250	6.0000	976-000-526	\$206.10
0.7500	0.7500	0.3750	3.0000	2.6250	6.0000	976-000-527	\$263.50
1.0000	1.0000	0.5000	3.0000	2.6250	6.0000	976-000-528	\$420.00

CARBIDE

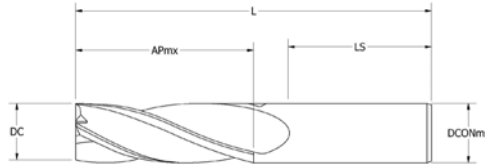

5-FLUTE - STUB LENGTH - SQUARE END



DC	DCONms	APmx	LS	L	PRODUCT #	Price
0.1250	0.1250	0.2500	0.8750	1.5000	976-000-049	\$17.60
0.1875	0.1875	0.3750	1.2500	2.0000	976-000-050	\$26.90
0.2500	0.2500	0.5000	1.1250	2.0000	976-000-051	\$29.60
0.3125	0.3125	0.5000	1.1250	2.0000	976-000-052	\$39.80
0.3750	0.3750	0.6250	1.0000	2.0000	976-000-053	\$46.70
0.4375	0.4375	0.6250	1.5000	2.5000	976-000-054	\$62.90
0.5000	0.5000	0.7500	1.3750	2.5000	976-000-055	\$69.70
0.6250	0.6250	0.7500	1.8750	3.0000	976-000-056	\$108.20
0.7500	0.7500	1.0000	1.6250	3.0000	976-000-057	\$157.90

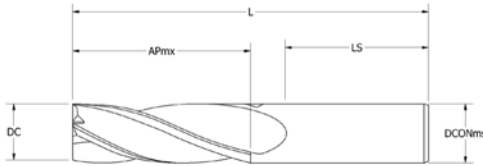

5-FLUTE - STANDARD LENGTH - SQUARE END



DC	DCONms	APmx	LS	L	PRODUCT #	Price
0.1250	0.1250	0.5000	0.6250	1.5000	976-000-058	\$18.50
0.1875	0.1875	0.6250	1.0000	2.0000	976-000-059	\$28.30
0.2500	0.2500	0.7500	1.3750	2.5000	976-000-060	\$31.20
0.2500	0.2500	1.0000	1.1250	2.5000	976-000-061	\$31.80
0.2500	0.2500	1.2500	0.8750	2.5000	976-000-062	\$32.00
0.3125	0.3125	0.8125	1.3125	2.5000	976-000-063	\$43.70
0.3750	0.3750	0.8750	1.2500	2.5000	976-000-064	\$53.05
0.3750	0.3750	1.0000	1.1250	2.5000	976-000-065	\$53.20
0.3750	0.3750	1.2500	0.8750	2.5000	976-000-066	\$53.60
0.4375	0.4375	1.0000	1.3750	2.7500	976-000-067	\$65.80
0.5000	0.5000	1.0000	1.6250	3.0000	976-000-068	\$76.01
0.5000	0.5000	1.2000	1.4250	3.0000	976-000-069	\$79.80
0.5000	0.5000	1.5000	1.1250	3.0000	976-000-070	\$82.10
0.5000	0.5000	1.5000	1.6250	3.5000	976-000-071	\$90.60
0.5000	0.5000	1.7500	1.3750	3.5000	976-000-072	\$94.00
0.6250	0.6250	1.5000	1.6250	3.5000	976-000-073	\$118.60
0.6250	0.6250	1.7500	1.3750	3.5000	976-000-074	\$119.50
0.7500	0.7500	1.7500	1.8750	4.0000	976-000-075	\$186.30
1.0000	1.0000	1.7500	1.8750	4.0000	976-000-076	\$305.00

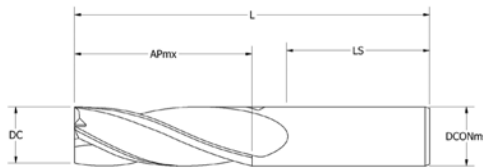

5-FLUTE - LONG LENGTH - SQUARE END



DC	DCONms	APmx	LS	L	PRODUCT #	Price
0.1250	0.1250	0.7500	1.3750	2.5000	976-000-077	\$26.60
0.1875	0.1875	0.7500	1.3750	2.5000	976-000-078	\$31.25
0.2500	0.2500	1.1250	1.5000	3.0000	976-000-079	\$35.90
0.3125	0.3125	1.1250	1.5000	3.0000	976-000-080	\$49.60
0.3750	0.3750	1.2500	1.3750	3.0000	976-000-081	\$68.90
0.4375	0.4375	2.0000	1.6250	4.0000	976-000-082	\$85.60
0.5000	0.5000	2.0000	1.6250	4.0000	976-000-083	\$109.90
0.6250	0.6250	2.2500	2.3750	5.0000	976-000-084	\$185.60
0.7500	0.7500	2.2500	2.3750	5.0000	976-000-085	\$221.00
1.0000	1.0000	2.2500	2.3750	5.0000	976-000-086	\$351.00

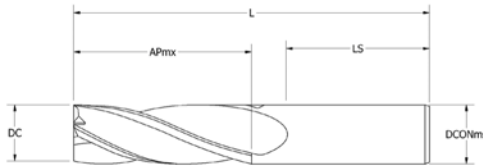

5-FLUTE - X LONG LENGTH - SQUARE END



DC	DCONms	APmx	LS	L	PRODUCT #	Price
0.1250	0.1250	1.0000	1.6250	3.0000	976-000-087	\$37.05
0.1875	0.1875	1.1250	1.5000	3.0000	976-000-088	\$40.20
0.2500	0.2500	1.5000	2.1250	4.0000	976-000-089	\$46.30
0.3125	0.3125	1.6250	2.0000	4.0000	976-000-090	\$64.10
0.3750	0.3750	2.0000	1.6250	4.0000	976-000-091	\$81.60
0.4375	0.4375	3.0000	2.6250	6.0000	976-000-092	\$135.20
0.5000	0.5000	3.0000	2.6250	6.0000	976-000-093	\$147.90
0.6250	0.6250	3.0000	2.6250	6.0000	976-000-094	\$206.10
0.7500	0.7500	3.0000	2.6250	6.0000	976-000-095	\$250.00
1.0000	1.0000	3.0000	2.6250	6.0000	976-000-096	\$405.00

CARBIDE

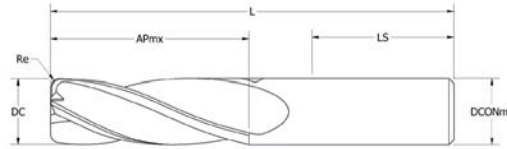

5-FLUTE - STUB LENGTH - CORNER RADIUS



DC	DCONms	Re	APmx	LS	L	PRODUCT #	Price
0.1250	0.1250	0.0100	0.2500	0.8750	1.5000	976-000-276	\$19.05
0.1875	0.1875	0.0100	0.3750	1.2500	2.0000	976-000-277	\$28.20
0.2500	0.2500	0.0200	0.5000	1.1250	2.0000	976-000-278	\$32.50
0.3125	0.3125	0.0200	0.5000	1.1250	2.0000	976-000-279	\$41.10
0.3750	0.3750	0.0200	0.6250	1.0000	2.0000	976-000-280	\$49.00
0.4375	0.4375	0.0300	0.6250	1.5000	2.5000	976-000-281	\$66.80
0.5000	0.5000	0.0300	0.7500	1.3750	2.5000	976-000-282	\$74.80
0.6250	0.6250	0.0400	0.7500	1.8750	3.0000	976-000-283	\$115.30
0.7500	0.7500	0.0400	1.0000	1.6250	3.0000	976-000-284	\$162.50

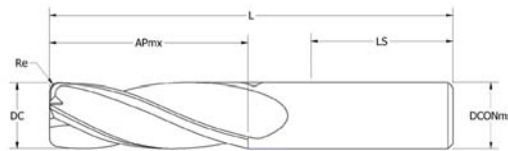

5-FLUTE - STANDARD LENGTH - CORNER RADIUS



DC	DCONms	Re	APmx	LS	L	PRODUCT #	Price
0.1250	0.1250	0.0100	0.5000	0.6250	1.5000	976-000-285	\$19.80
0.1250	0.1250	0.0150	0.5000	0.6250	1.5000	976-000-286	\$20.10
0.1250	0.1250	0.0200	0.5000	0.6250	1.5000	976-000-287	\$20.60
0.1875	0.1875	0.0100	0.6250	1.0000	2.0000	976-000-288	\$29.05
0.1875	0.1875	0.0150	0.6250	1.0000	2.0000	976-000-289	\$30.15
0.1875	0.1875	0.0200	0.6250	1.0000	2.0000	976-000-290	\$30.50
0.1875	0.1875	0.0300	0.6250	1.0000	2.0000	976-000-291	\$30.90
0.2500	0.2500	0.0100	0.7500	1.3750	2.5000	976-000-292	\$31.20
0.2500	0.2500	0.0150	0.7500	1.3750	2.5000	976-000-293	\$31.80
0.2500	0.2500	0.0200	0.7500	1.3750	2.5000	976-000-294	\$33.20
0.2500	0.2500	0.0300	0.7500	1.3750	2.5000	976-000-295	\$33.60
0.2500	0.2500	0.0600	0.7500	1.3750	2.5000	976-000-296	\$33.90
0.2500	0.2500	0.0100	1.0000	1.1250	2.5000	976-000-297	\$34.20
0.2500	0.2500	0.0150	1.0000	1.1250	2.5000	976-000-298	\$34.60
0.2500	0.2500	0.0200	1.0000	1.1250	2.5000	976-000-299	\$34.90
0.2500	0.2500	0.0300	1.0000	1.1250	2.5000	976-000-300	\$35.20
0.2500	0.2500	0.0600	1.0000	1.1250	2.5000	976-000-301	\$35.60
0.2500	0.2500	0.0100	1.2500	0.8750	2.5000	976-000-302	\$35.90
0.2500	0.2500	0.0150	1.2500	0.8750	2.5000	976-000-303	\$36.20
0.2500	0.2500	0.0200	1.2500	0.8750	2.5000	976-000-304	\$36.60
0.2500	0.2500	0.0300	1.2500	0.8750	2.5000	976-000-305	\$36.90
0.2500	0.2500	0.0600	1.2500	0.8750	2.5000	976-000-306	\$37.20

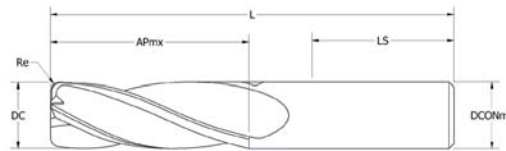

CARBIDE



5-FLUTE - STANDARD LENGTH - CORNER RADIUS



DC	DCONms	Re	APmx	LS	L	PRODUCT #	Price
0.3125	0.3125	0.0100	0.8125	1.3125	2.5000	976-000-307	\$46.01
0.3125	0.3125	0.0150	0.8125	1.3125	2.5000	976-000-308	\$46.40
0.3125	0.3125	0.0200	0.8125	1.3125	2.5000	976-000-309	\$46.60
0.3125	0.3125	0.0300	0.8125	1.3125	2.5000	976-000-310	\$46.90
0.3125	0.3125	0.0600	0.8125	1.3125	2.5000	976-000-311	\$47.20
0.3750	0.3750	0.0100	0.8750	1.2500	2.5000	976-000-312	\$56.00
0.3750	0.3750	0.0150	0.8750	1.2500	2.5000	976-000-313	\$56.40
0.3750	0.3750	0.0200	0.8750	1.2500	2.5000	976-000-314	\$56.80
0.3750	0.3750	0.0300	0.8750	1.2500	2.5000	976-000-315	\$57.10
0.3750	0.3750	0.0600	0.8750	1.2500	2.5000	976-000-316	\$57.40
0.3750	0.3750	0.0100	1.0000	1.1250	2.5000	976-000-317	\$57.80
0.3750	0.3750	0.0150	1.0000	1.1250	2.5000	976-000-318	\$58.10
0.3750	0.3750	0.0200	1.0000	1.1250	2.5000	976-000-319	\$58.40
0.3750	0.3750	0.0300	1.0000	1.1250	2.5000	976-000-320	\$58.60
0.3750	0.3750	0.0600	1.0000	1.1250	2.5000	976-000-321	\$58.90
0.3750	0.3750	0.0100	1.2500	0.8750	2.5000	976-000-322	\$59.20
0.3750	0.3750	0.0150	1.2500	0.8750	2.5000	976-000-323	\$59.40
0.3750	0.3750	0.0200	1.2500	0.8750	2.5000	976-000-324	\$59.60
0.3750	0.3750	0.0300	1.2500	0.8750	2.5000	976-000-325	\$59.90
0.3750	0.3750	0.0600	1.2500	0.8750	2.5000	976-000-326	\$60.20
0.4375	0.4375	0.0150	1.0000	1.3750	2.7500	976-000-327	\$68.90
0.4375	0.4375	0.0200	1.0000	1.3750	2.7500	976-000-328	\$69.20
0.4375	0.4375	0.0300	1.0000	1.3750	2.7500	976-000-329	\$69.40
0.4375	0.4375	0.0600	1.0000	1.3750	2.7500	976-000-330	\$69.60
0.5000	0.5000	0.0100	1.0000	1.6250	3.0000	976-000-331	\$79.80
0.5000	0.5000	0.0150	1.0000	1.6250	3.0000	976-000-332	\$80.10
0.5000	0.5000	0.0300	1.0000	1.6250	3.0000	976-000-333	\$80.40
0.5000	0.5000	0.0600	1.0000	1.6250	3.0000	976-000-334	\$80.60
0.5000	0.5000	0.0900	1.0000	1.6250	3.0000	976-000-335	\$80.90
0.5000	0.5000	0.1200	1.0000	1.6250	3.0000	976-000-336	\$81.30
0.5000	0.5000	0.0100	1.2500	1.3750	3.0000	976-000-337	\$82.30
0.5000	0.5000	0.0150	1.2500	1.3750	3.0000	976-000-338	\$82.60
0.5000	0.5000	0.0300	1.2500	1.3750	3.0000	976-000-339	\$82.90
0.5000	0.5000	0.0600	1.2500	1.3750	3.0000	976-000-340	\$83.20
0.5000	0.5000	0.0900	1.2500	1.3750	3.0000	976-000-341	\$83.40
0.5000	0.5000	0.1200	1.2500	1.3750	3.0000	976-000-342	\$83.60
0.5000	0.5000	0.0100	1.5000	1.1250	3.0000	976-000-343	\$84.90
0.5000	0.5000	0.0150	1.5000	1.1250	3.0000	976-000-344	\$85.20
0.5000	0.5000	0.0300	1.5000	1.1250	3.0000	976-000-345	\$85.40
0.5000	0.5000	0.0600	1.5000	1.1250	3.0000	976-000-346	\$85.60
0.5000	0.5000	0.0900	1.5000	1.1250	3.0000	976-000-347	\$85.90
0.5000	0.5000	0.1200	1.5000	1.1250	3.0000	976-000-348	\$86.20

CARBIDE

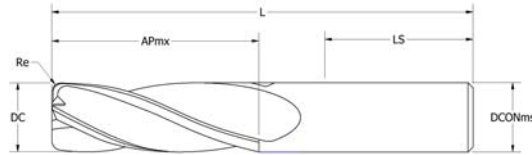

5-FLUTE - STANDARD LENGTH - CORNER RADIUS



DC	DCONms	Re	APmx	LS	L	PRODUCT #	Price
0.5000	0.5000	0.0100	1.5000	1.6250	3.5000	976-000-349	\$94.00
0.5000	0.5000	0.0150	1.5000	1.6250	3.5000	976-000-350	\$94.20
0.5000	0.5000	0.0300	1.5000	1.6250	3.5000	976-000-351	\$94.40
0.5000	0.5000	0.0600	1.5000	1.6250	3.5000	976-000-352	\$94.60
0.5000	0.5000	0.0900	1.5000	1.6250	3.5000	976-000-353	\$94.80
0.5000	0.5000	0.1200	1.5000	1.6250	3.5000	976-000-354	\$95.20
0.5000	0.5000	0.0100	1.7500	1.3750	3.5000	976-000-355	\$97.30
0.5000	0.5000	0.0150	1.7500	1.3750	3.5000	976-000-356	\$97.60
0.5000	0.5000	0.0300	1.7500	1.3750	3.5000	976-000-357	\$97.80
0.5000	0.5000	0.0600	1.7500	1.3750	3.5000	976-000-358	\$98.10
0.5000	0.5000	0.0900	1.7500	1.3750	3.5000	976-000-359	\$98.40
0.5000	0.5000	0.1200	1.7500	1.3750	3.5000	976-000-360	\$98.60
0.6250	0.6250	0.0300	1.5000	1.6250	3.5000	976-000-361	\$122.30
0.6250	0.6250	0.0400	1.5000	1.6250	3.5000	976-000-362	\$123.60
0.6250	0.6250	0.0600	1.5000	1.6250	3.5000	976-000-363	\$123.90
0.6250	0.6250	0.0900	1.5000	1.6250	3.5000	976-000-364	\$124.20
0.6250	0.6250	0.1200	1.5000	1.6250	3.5000	976-000-365	\$124.40
0.6250	0.6250	0.0300	1.7500	1.8750	4.0000	976-000-366	\$124.60
0.6250	0.6250	0.0400	1.7500	1.8750	4.0000	976-000-367	\$124.90
0.6250	0.6250	0.0600	1.7500	1.8750	4.0000	976-000-368	\$125.30
0.6250	0.6250	0.0900	1.7500	1.8750	4.0000	976-000-369	\$125.60
0.6250	0.6250	0.1200	1.7500	1.8750	4.0000	976-000-370	\$125.90
0.7500	0.7500	0.0300	1.7500	1.8750	4.0000	976-000-371	\$190.50
0.7500	0.7500	0.0400	1.7500	1.8750	4.0000	976-000-372	\$191.00
0.7500	0.7500	0.0600	1.7500	1.8750	4.0000	976-000-373	\$191.20
0.7500	0.7500	0.0900	1.7500	1.8750	4.0000	976-000-374	\$191.40
0.7500	0.7500	0.1200	1.7500	1.8750	4.0000	976-000-375	\$191.60
1.0000	1.0000	0.0300	1.7500	1.8750	4.0000	976-000-376	\$320.60
1.0000	1.0000	0.0400	1.7500	1.8750	4.0000	976-000-377	\$320.90
1.0000	1.0000	0.0600	1.7500	1.8750	4.0000	976-000-378	\$321.20
1.0000	1.0000	0.0900	1.7500	1.8750	4.0000	976-000-379	\$321.40
1.0000	1.0000	0.1200	1.7500	1.8750	4.0000	976-000-380	\$321.60



5-FLUTE - LONG LENGTH - CORNER RADIUS



CARBIDE

DC	DCONms	Re	APmx	LS	L	PRODUCT #	Price
0.1250	0.1250	0.0150	0.7500	1.3750	2.5000	976-000-381	\$29.70
0.1250	0.1250	0.0300	0.7500	1.3750	2.5000	976-000-382	\$30.00
0.1875	0.1875	0.0150	0.7500	1.3750	2.5000	976-000-383	\$34.60
0.1875	0.1875	0.0300	0.7500	1.3750	2.5000	976-000-384	\$34.80
0.2500	0.2500	0.0150	1.1250	1.5000	3.0000	976-000-385	\$39.05
0.2500	0.2500	0.0300	1.1250	1.5000	3.0000	976-000-386	\$39.40
0.3125	0.3125	0.0150	1.1250	1.5000	3.0000	976-000-387	\$53.90
0.3125	0.3125	0.0300	1.1250	1.5000	3.0000	976-000-388	\$54.05
0.3750	0.3750	0.0300	1.2500	1.3750	3.0000	976-000-389	\$74.90
0.3750	0.3750	0.0600	1.2500	1.3750	3.0000	976-000-390	\$75.20
0.4375	0.4375	0.0300	2.0000	1.6250	4.0000	976-000-391	\$93.90
0.4375	0.4375	0.0600	2.0000	1.6250	4.0000	976-000-392	\$94.20
0.5000	0.5000	0.0300	2.0000	1.6250	4.0000	976-000-393	\$118.90
0.5000	0.5000	0.0600	2.0000	1.6250	4.0000	976-000-394	\$119.20
0.6250	0.6250	0.0300	2.2500	2.3750	5.0000	976-000-395	\$195.60
0.6250	0.6250	0.0600	2.2500	2.3750	5.0000	976-000-396	\$198.30
0.7500	0.7500	0.0300	2.2500	2.3750	5.0000	976-000-397	\$236.20
0.7500	0.7500	0.0600	2.2500	2.3750	5.0000	976-000-398	\$236.40
1.0000	1.0000	0.0300	2.2500	2.3750	5.0000	976-000-399	\$374.90
1.0000	1.0000	0.0600	2.2500	2.3750	5.0000	976-000-400	\$375.20

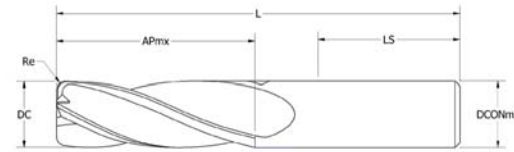

5-FLUTE - X - LONG LENGTH - CORNER RADIUS



DC	DCONms	Re	APmx	LS	L	PRODUCT #	Price
0.1250	0.1250	0.0150	0.7500	1.3750	2.5000	976-000-401	\$40.02
0.1250	0.1250	0.0300	0.7500	1.3750	2.5000	976-000-403	\$40.40
0.1875	0.1875	0.0150	0.7500	1.3750	2.5000	976-000-404	\$42.90
0.1875	0.1875	0.0300	0.7500	1.3750	2.5000	976-000-405	\$43.10
0.2500	0.2500	0.0150	1.1250	1.5000	3.0000	976-000-406	\$49.80
0.2500	0.2500	0.0300	1.1250	1.5000	3.0000	976-000-407	\$50.10
0.3125	0.3125	0.0300	1.1250	1.5000	3.0000	976-000-408	\$68.00
0.3125	0.3125	0.0600	1.1250	1.5000	3.0000	976-000-410	\$68.20
0.3750	0.3750	0.0300	1.2500	1.3750	3.0000	976-000-411	\$89.30
0.3750	0.3750	0.0600	1.2500	1.3750	3.0000	976-000-412	\$89.60
0.4375	0.4375	0.0300	2.0000	1.6250	4.0000	976-000-413	\$140.60
0.4375	0.4375	0.0600	2.0000	1.6250	4.0000	976-000-415	\$140.90
0.5000	0.5000	0.0300	2.0000	1.6250	4.0000	976-000-416	\$154.60
0.5000	0.5000	0.0600	2.0000	1.6250	4.0000	976-000-417	\$154.90
0.6250	0.6250	0.0300	2.2500	2.3750	5.0000	976-000-418	\$220.40
0.6250	0.6250	0.0600	2.2500	2.3750	5.0000	976-000-419	\$220.60
0.7500	0.7500	0.0300	2.2500	2.3750	5.0000	976-000-420	\$266.30
0.7500	0.7500	0.0600	2.2500	2.3750	5.0000	976-000-421	\$366.60
1.0000	1.0000	0.0300	2.2500	2.3750	5.0000	976-000-422	\$432.80
1.0000	1.0000	0.0600	2.2500	2.3750	5.0000	976-000-423	\$433.00

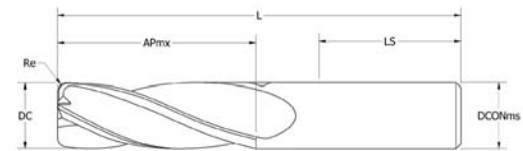

CARBIDE

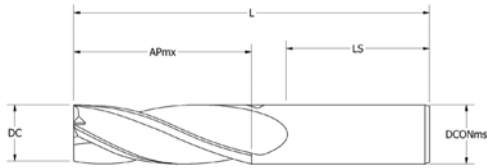

7-FLUTE - STUB LENGTH - SQUARE END



DC	DCONms	APmx	LS	L	PRODUCT #	Price
0.1875	0.1875	3.7500	2.1250	2.0000	976-000-097	\$34.60
0.2500	0.2500	0.5000	1.1250	2.0000	976-000-098	\$36.90
0.3125	0.3125	0.5000	1.1250	2.0000	976-000-099	\$49.30
0.3750	0.3750	0.6250	1.0000	2.0000	976-000-100	\$56.20
0.4375	0.4375	0.6250	1.5000	2.5000	976-000-101	\$73.30
0.5000	0.5000	0.7500	1.3750	2.5000	976-000-102	\$82.60
0.6250	0.6250	0.7500	1.8750	3.0000	976-000-103	\$127.00
0.7500	0.7500	1.0000	1.6250	3.0000	976-000-104	\$172.30

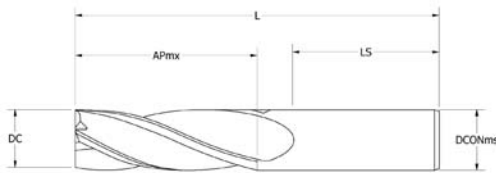

7-FLUTE - STANDARD LENGTH - SQUARE END



DC	DCONms	APmx	LS	L	PRODUCT #	Price
0.1875	0.1875	0.6250	1.0000	2.0000	976-000-105	\$35.30
0.2500	0.2500	0.7500	1.3750	2.5000	976-000-106	\$39.50
0.2500	0.2500	1.0000	1.1250	2.5000	976-000-107	\$41.90
0.3125	0.3125	0.8125	1.3125	2.5000	976-000-108	\$54.02
0.3750	0.3750	0.8750	1.2500	2.5000	976-000-109	\$63.30
0.3750	0.3750	1.0000	1.1250	2.5000	976-000-110	\$65.20
0.4375	0.4375	1.0000	1.3750	2.7500	976-000-111	\$77.60
0.5000	0.5000	1.0000	1.6250	3.0000	976-000-112	\$90.60
0.5000	0.5000	1.2500	1.3750	3.0000	976-000-113	\$93.50
0.5000	0.5000	1.5000	1.6250	3.5000	976-000-114	\$108.60
0.5000	0.5000	1.7500	1.3750	3.5000	976-000-115	\$112.30
0.6250	0.6250	1.5000	1.6250	3.5000	976-000-116	\$136.70
0.7500	0.7500	1.7500	1.8750	4.0000	976-000-117	\$207.40
1.0000	1.0000	1.7500	1.8750	4.0000	976-000-118	\$326.30

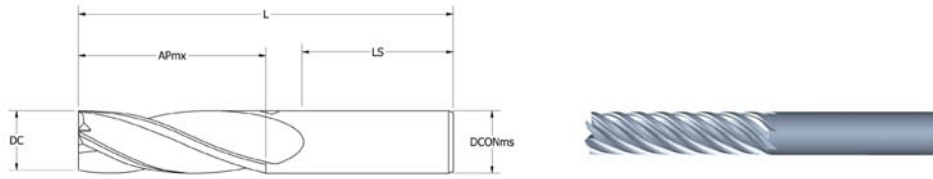

7-FLUTE - LONG LENGTH - SQUARE END



DC	DCONms	APmx	LS	L	PRODUCT #	Price
0.1875	0.1875	0.7500	1.3750	2.5000	976-000-119	\$45.20
0.2500	0.2500	1.1250	1.5000	3.0000	976-000-120	\$51.50
0.3125	0.3125	1.1250	1.5000	3.0000	976-000-121	\$68.20
0.3750	0.3750	1.2500	1.3750	3.0000	976-000-122	\$80.00
0.4375	0.4375	2.0000	1.6250	4.0000	976-000-123	\$102.30
0.5000	0.5000	2.0000	1.6250	4.0000	976-000-124	\$124.90
0.6250	0.6250	2.2500	2.3750	5.0000	976-000-125	\$210.05
0.7500	0.7500	2.2500	2.3750	5.0000	976-000-126	\$241.30
1.0000	1.0000	2.2500	2.3750	5.0000	976-000-127	\$371.30

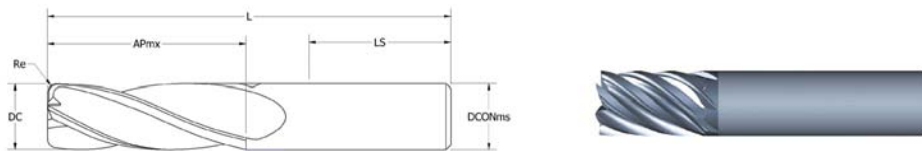

7-FLUTE - STUB LENGTH - CORNER RADIUS



DC	DCONms	APmx	Re	LS	L	PRODUCT #	Price
0.1875	0.1875	0.0100	0.3750	1.2500	2.0000	976-000-424	\$38.10
0.2500	0.2500	0.0200	0.5000	1.1250	2.0000	976-000-425	\$41.50
0.3125	0.3125	0.0200	0.5000	1.1250	2.0000	976-000-426	\$54.00
0.3750	0.3750	0.0200	0.6250	1.0000	2.0000	976-000-427	\$65.90
0.4375	0.4375	0.0300	0.6250	1.5000	2.5000	976-000-428	\$84.02
0.5000	0.5000	0.0300	0.7500	1.3750	2.5000	976-000-429	\$93.60
0.6250	0.6250	0.0400	0.7500	1.8750	3.0000	976-000-430	\$141.90
0.7500	0.7500	0.0400	1.0000	1.6250	3.0000	976-000-431	\$191.02

CARBIDE

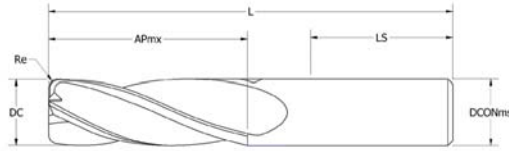

7-FLUTE - STANDARD LENGTH - CORNER RADIUS



DC	DCONms	APmx	Re	LS	L	PRODUCT #	Price
0.1875	0.1875	0.0150	0.6250	1.0000	2.0000	976-000-432	\$39.02
0.1875	0.1875	0.0300	0.6250	1.0000	2.0000	976-000-433	\$39.20
0.2500	0.2500	0.0150	0.7500	1.3750	2.5000	976-000-434	\$44.20
0.2500	0.2500	0.0300	0.7500	1.3750	2.5000	976-000-435	\$43.90
0.2500	0.2500	0.0150	1.0000	1.1250	2.5000	976-000-436	\$46.90
0.2500	0.2500	0.0300	1.0000	1.1250	2.5000	976-000-437	\$47.10
0.3125	0.3125	0.0150	0.8125	1.3125	2.5000	976-000-438	\$58.60
0.3125	0.3125	0.0300	0.8125	1.3125	2.5000	976-000-439	\$58.90
0.3750	0.3750	0.0150	0.8750	1.2500	2.5000	976-000-440	\$73.06
0.3750	0.3750	0.0300	0.8750	1.2500	2.5000	976-000-441	\$73.60
0.3750	0.3750	0.0600	0.8750	1.2500	2.5000	976-000-442	\$73.90
0.3750	0.3750	0.0150	1.0000	1.1250	2.5000	976-000-443	\$75.60
0.3750	0.3750	0.0300	1.0000	1.1250	2.5000	976-000-444	\$75.80
0.3750	0.3750	0.0600	1.0000	1.1250	2.5000	976-000-445	\$76.05
0.4375	0.4375	0.0150	1.0000	1.3750	2.7500	976-000-446	\$87.10
0.4375	0.4375	0.0300	1.0000	1.3750	2.7500	976-000-447	\$87.40
0.4375	0.4375	0.0600	1.0000	1.3750	2.7500	976-000-448	\$87.60
0.5000	0.5000	0.0150	1.0000	1.6250	3.0000	976-000-449	\$101.90
0.5000	0.5000	0.0300	1.0000	1.6250	3.0000	976-000-450	\$102.30
0.5000	0.5000	0.0600	1.0000	1.6250	3.0000	976-000-451	\$102.60
0.5000	0.5000	0.0150	1.2500	1.3750	3.0000	976-000-452	\$104.60
0.5000	0.5000	0.0300	1.2500	1.3750	3.0000	976-000-453	\$104.90
0.5000	0.5000	0.0600	1.2500	1.3750	3.0000	976-000-454	\$105.20
0.5000	0.5000	0.0150	1.5000	1.1250	3.0000	976-000-455	\$120.00
0.5000	0.5000	0.0300	1.5000	1.1250	3.0000	976-000-456	\$121.20
0.5000	0.5000	0.0600	1.5000	1.1250	3.0000	976-000-457	\$121.40
0.5000	0.5000	0.0150	1.7500	1.3750	3.5000	976-000-458	\$121.60
0.5000	0.5000	0.0300	1.7500	1.3750	3.5000	976-000-459	\$121.92
0.5000	0.5000	0.0600	1.7500	1.3750	3.5000	976-000-460	\$122.00
0.6250	0.6250	0.0300	1.5000	1.6250	3.5000	976-000-461	\$152.60
0.6250	0.6250	0.0600	1.5000	1.6250	3.5000	976-000-462	\$152.90
0.6250	0.6250	0.0900	1.5000	1.6250	3.5000	976-000-463	\$153.20
0.7500	0.7500	0.0300	1.7500	1.8750	4.0000	976-000-464	\$225.20
0.7500	0.7500	0.0600	1.7500	1.8750	4.0000	976-000-465	\$225.40
0.7500	0.7500	0.0900	1.7500	1.8750	4.0000	976-000-466	\$225.60
1.0000	1.0000	0.0300	1.7500	1.8750	4.0000	976-000-467	\$361.90
1.0000	1.0000	0.0600	1.7500	1.8750	4.0000	976-000-468	\$362.20
1.0000	1.0000	0.0900	1.7500	1.8750	4.0000	976-000-469	\$362.40

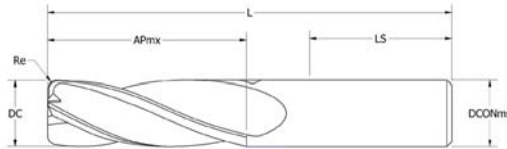

7-FLUTE - LONG LENGTH - CORNER RADIUS



DC	DCONms	APmx	Re	LS	L	PRODUCT #	Price
0.1875	0.1875	0.0150	0.7500	1.3750	2.5000	976-000-470	\$49.60
0.1875	0.1875	0.0300	0.7500	1.3750	2.5000	976-000-471	\$50.00
0.2500	0.2500	0.0150	1.1250	1.5000	3.0000	976-000-472	\$55.90
0.2500	0.2500	0.0300	1.1250	1.5000	3.0000	976-000-473	\$56.20
0.3125	0.3125	0.0150	1.1250	1.5000	3.0000	976-000-474	\$74.60
0.3125	0.3125	0.0300	1.1250	1.5000	3.0000	976-000-475	\$74.90
0.3750	0.3750	0.0300	1.2500	1.3750	3.0000	976-000-476	\$91.30
0.3750	0.3750	0.0600	1.2500	1.3750	3.0000	976-000-477	\$91.60
0.4375	0.4375	0.0300	2.0000	1.6250	4.0000	976-000-478	\$112.60
0.4375	0.4375	0.0600	2.0000	1.6250	4.0000	976-000-479	\$112.90
0.5000	0.5000	0.0300	2.0000	1.6250	4.0000	976-000-480	\$136.00
0.5000	0.5000	0.0600	2.0000	1.6250	4.0000	976-000-481	\$136.20
0.6250	0.6250	0.0300	2.2500	2.3750	5.0000	976-000-482	\$228.90
0.6250	0.6250	0.0600	2.2500	2.3750	5.0000	976-000-483	\$259.40
0.7500	0.7500	0.0300	2.2500	2.3750	5.0000	976-000-484	\$259.90
0.7500	0.7500	0.0600	2.2500	2.3750	5.0000	976-000-485	\$260.20
1.0000	1.0000	0.0300	2.2500	2.3750	5.0000	976-000-486	\$409.00
1.0000	1.0000	0.0600	2.2500	2.3750	5.0000	976-000-487	\$409.40

CARBIDE



METRIC .005" - .045"

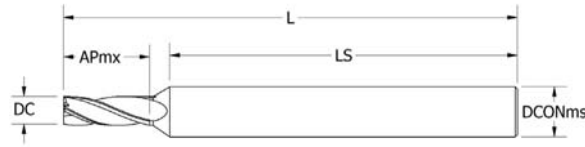

DC	DCONms	APmx	LS	L	UNCOATED				ALTiN COATED		
					2 FLUTE	3 FLUTE	4 FLUTE	Price	2 FLUTE	4 FLUTE	Price
0.0050	0.1250	0.0150	1.1342	1.5000	930-000-243			\$26.81	930-000-527		\$31.16
0.0060	0.1250	0.0180	1.1342	1.5000	930-000-245			\$26.81	930-000-528		\$31.16
0.0070	0.1250	0.0210	1.1342	1.5000	930-000-246			\$26.81	930-000-529		\$31.16
0.0080	0.1250	0.0240	1.1342	1.5000	930-000-247			\$26.81	930-000-530		\$31.16
0.0090	0.1250	0.0270	1.1342	1.5000	930-000-248			\$26.81	930-000-531		\$31.16
0.0100	0.1250	0.0300	1.1742	1.5000	930-000-249	930-002-678	930-000-635	\$21.65	930-000-532	930-001-031	\$26.04
0.0100	0.1250	0.0330	1.1738	1.5000	930-000-251	930-002-679	930-000-637	\$21.65	930-000-533	930-001-032	\$26.04
0.0110	0.1250	0.0360	1.1733	1.5000	930-000-252	930-002-680	930-000-638	\$21.65	930-000-534	930-001-033	\$26.04
0.0120	0.1250	0.0390	1.1729	1.5000	930-000-253	930-002-681	930-000-639	\$21.65	930-000-535	930-001-034	\$26.04
0.0130	0.1250	0.0420	1.1725	1.5000	930-000-254	930-002-682	930-000-640	\$21.65	930-000-536	930-001-035	\$26.04
0.0140	0.1250	0.0450	1.1720	1.5000	930-000-255	930-002-683	930-000-641	\$19.22	930-000-537	930-001-036	\$22.39
0.0150	0.1250	0.0468	1.1718	1.5000	930-000-362	930-002-727	930-000-748	\$19.22			
0.0160	0.1250	0.0480	1.1716	1.5000	930-000-257		930-000-643	\$19.22	930-000-538	930-001-037	\$23.62
0.0170	0.1250	0.0510	1.1712	1.5000	930-000-258		930-000-644	\$19.22	930-000-539	930-001-038	\$23.62
0.0180	0.1250	0.0540	1.1708	1.5000	930-000-259	930-002-684	930-000-645	\$19.22	930-000-540	930-001-039	\$23.62
0.0190	0.1250	0.0570	1.1703	1.5000	930-000-260		930-000-646	\$19.22	930-000-541	930-001-040	\$23.62
0.0197	0.1250	0.0591	1.1700	1.5000	930-000-343	930-002-715	930-000-729	\$19.22			
0.0200	0.1250	0.0600	1.1699	1.5000	930-000-261	930-002-685	930-000-647	\$18.35	930-000-542	930-001-041	\$22.75
0.0200	0.1250	0.0600	1.2600	1.5000	930-000-263		930-000-649	\$18.35	930-000-543	930-001-042	\$22.75
0.0210	0.1250	0.0630	1.1695	1.5000	930-000-264		930-000-650	\$18.35	930-000-544	930-001-043	\$22.75
0.0220	0.1250	0.0660	1.1691	1.5000	930-000-265	930-002-686	930-000-651	\$18.35	930-000-545	930-001-044	\$22.75
0.0230	0.1250	0.0690	1.1686	1.5000	930-000-266	930-002-687	930-000-652	\$18.35	930-000-546	930-001-045	\$22.75
0.0240	0.1250	0.0720	1.1682	1.5000	930-000-267	930-002-688	930-000-653	\$16.91	930-000-547	930-001-046	\$21.31
0.0250	0.1250	0.0750	1.1678	1.5000	930-000-269	930-002-689	930-000-655	\$16.91	930-000-548	930-001-047	\$21.31
0.0270	0.1250	0.0810	1.1669	1.5000	930-000-270		930-000-656	\$16.91	930-000-549	930-001-048	\$21.31
0.0280	0.1250	0.0840	1.1665	1.5000	930-000-271		930-000-657	\$16.91	930-000-550	930-001-049	\$21.31
0.0290	0.1250	0.0870	1.1661	1.5000	930-000-272	930-002-690	930-000-658	\$16.91	930-000-551	930-001-050	\$21.31
0.0300	0.1250	0.0900	1.1656	1.5000	930-000-273	930-002-691	930-000-659	\$16.91	930-000-552	930-001-051	\$21.31
0.0310	0.1250	0.0930	1.1652	1.5000	930-000-275	930-002-692	930-000-661	\$16.91	930-000-553	930-001-052	\$21.31
0.0320	0.1250	0.0960	1.1648	1.5000	930-000-276		930-000-662	\$16.91	930-000-554	930-001-053	\$21.31
0.0330	0.1250	0.0990	1.1644	1.5000	930-000-277	930-002-693	930-000-663	\$16.91	930-000-555	930-001-054	\$21.31
0.0340	0.1250	0.1020	1.1639	1.5000	930-000-278		930-000-664	\$16.91	930-000-556	930-001-055	\$21.31
0.0350	0.1250	0.1050	1.1635	1.5000	930-000-279	930-002-694	930-000-665	\$14.27	930-000-557	930-001-056	\$18.67
0.0360	0.1250	0.1080	1.1631	1.5000	930-000-281		930-000-667	\$14.27	930-000-558	930-001-057	\$18.67
0.0370	0.1250	0.1110	1.1626	1.5000	930-000-282		930-000-668	\$14.27	930-000-559	930-001-058	\$18.67
0.0380	0.1250	0.1140	1.1622	1.5000	930-000-283		930-000-669	\$14.27	930-000-560	930-001-059	\$18.67
0.0390	0.1250	0.1170	1.1618	1.5000	930-000-284		930-000-670	\$14.27	930-000-561	930-001-060	\$18.67
0.0394	0.1250	0.1182	1.1616	1.5000	930-000-350	930-002-716	930-000-736	\$14.27	930-000-601	930-001-103	\$18.67
0.0400	0.1250	0.1200	1.1614	1.5000	930-000-285	930-002-695	930-000-671	\$14.27	930-000-562	930-001-061	\$18.67
0.0410	0.1250	0.1230	1.1609	1.5000	930-000-287		930-000-673	\$14.27	930-000-563	930-001-062	\$18.67
0.0420	0.1250	0.1260	1.1605	1.5000	930-000-288		930-000-674	\$14.27	930-000-564	930-001-063	\$18.67
0.0430	0.1250	0.1290	1.1601	1.5000	930-000-289		930-000-675	\$14.27	930-000-565	930-001-064	\$18.67
0.0440	0.1250	0.1320	1.1596	1.5000	930-000-290		930-000-676	\$14.27	930-000-566	930-001-065	\$18.67
0.0450	0.1250	0.1350	1.1592	1.5000	930-000-291	930-002-696	930-000-677	\$14.27	930-000-567	930-001-066	\$18.67

METRIC .005" - .045"



CARBIDE

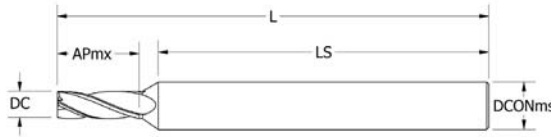

DC	DCONms	APmx	LS	L	TIALN COATED				AMORPHOUS DIAMOND COATED				
					2 FLUTE	3 FLUTE	4 FLUTE	Price	2 FLUTE	3 FLUTE	4 FLUTE	Price	
0.0050	0.1250	0.0150	1.1342	1.5000	930-000-439			\$31.16	930-000-364				\$43.42
0.0060	0.1250	0.0180	1.1342	1.5000	930-000-440			\$31.16	930-000-365				\$43.42
0.0070	0.1250	0.0210	1.1342	1.5000	930-000-441			\$31.16	930-000-366				\$43.42
0.0080	0.1250	0.0240	1.1342	1.5000	930-000-442			\$31.16	930-000-367				\$43.42
0.0090	0.1250	0.0270	1.1342	1.5000	930-000-443			\$31.16	930-000-368				\$43.42
0.0100	0.1250	0.0300	1.1742	1.5000	930-000-444	930-002-750	930-000-880	\$26.04	930-000-369	930-002-729	930-000-750		\$33.18
0.0110	0.1250	0.0330	1.1738	1.5000	930-000-445	930-002-751	930-000-881	\$26.04	930-000-370		930-000-751		\$33.18
0.0120	0.1250	0.0360	1.1733	1.5000	930-000-446	930-002-752	930-000-882	\$26.04	930-000-371		930-000-752		\$33.18
0.0130	0.1250	0.0390	1.1729	1.5000	930-000-447	930-002-753	930-000-883	\$26.04	930-000-372		930-000-753		\$33.18
0.0140	0.1250	0.0420	1.1725	1.5000	930-000-448	930-002-754	930-000-884	\$26.04	930-000-373		930-000-754		\$33.18
0.0150	0.1250	0.0450	1.1720	1.5000	930-000-449	930-002-755	930-000-885	\$23.62	930-000-374	930-002-730	930-000-755		\$30.76
0.0156	0.1250	0.0468	1.1718	1.5000	930-000-525	930-002-795	930-000-961	\$23.62					
0.0160	0.1250	0.0480	1.1716	1.5000	930-000-450		930-000-886	\$23.62	930-000-375		930-000-756		\$30.76
0.0170	0.1250	0.0510	1.1712	1.5000	930-000-451		930-000-887	\$23.62	930-000-376		930-000-757		\$30.76
0.0180	0.1250	0.0540	1.1708	1.5000	930-000-452	930-002-756	930-000-888	\$23.62	930-000-377		930-000-758		\$30.76
0.0190	0.1250	0.0570	1.1703	1.5000	930-000-453		930-000-889	\$23.62	930-000-378		930-000-759		\$30.76
0.0197	0.1250	0.0591	1.1700	1.5000	930-000-513	930-002-783	930-000-949	\$23.62					
0.0200	0.1250	0.0600	1.1699	1.5000	930-000-454	930-002-757	930-000-890	\$22.75	930-000-379	930-002-731	930-000-760		\$29.88
0.0210	0.1250	0.0630	1.1695	1.5000	930-000-455		930-000-891	\$22.75	930-000-380		930-000-761		\$29.88
0.0220	0.1250	0.0660	1.1691	1.5000	930-000-456		930-000-892	\$22.75	930-000-381		930-000-762		\$29.88
0.0230	0.1250	0.0690	1.1686	1.5000	930-000-457	930-002-758	930-000-893	\$22.75	930-000-382		930-000-763		\$29.88
0.0240	0.1250	0.0720	1.1682	1.5000	930-000-458	930-002-759	930-000-894	\$22.75	930-000-383		930-000-764		\$29.88
0.0250	0.1250	0.0750	1.1678	1.5000	930-000-459	930-002-760	930-000-895	\$21.31	930-000-384	930-002-732	930-000-765		\$28.44
0.0260	0.1250	0.0780	1.1673	1.5000	930-000-460		930-000-896	\$21.31	930-000-385		930-000-766		\$28.44
0.0270	0.1250	0.0810	1.1669	1.5000	930-000-461		930-000-897	\$21.31	930-000-386		930-000-767		\$28.44
0.0280	0.1250	0.0840	1.1665	1.5000	930-000-462		930-000-898	\$21.31	930-000-387		930-000-768		\$28.44
0.0290	0.1250	0.0870	1.1661	1.5000	930-000-463	930-002-761	930-000-899	\$21.31	930-000-388		930-000-769		\$28.44
0.0300	0.1250	0.0900	1.1656	1.5000	930-000-464	930-002-762	930-000-900	\$21.31	930-000-389	930-002-733	930-000-770		\$28.44
0.0310	0.1250	0.0930	1.1652	1.5000	930-000-465	930-002-763	930-000-901	\$21.31	930-000-390	930-002-734	930-000-771		\$28.44
0.0320	0.1250	0.0960	1.1648	1.5000	930-000-466		930-000-902	\$21.31	930-000-391		930-000-772		\$28.44
0.0330	0.1250	0.0990	1.1644	1.5000	930-000-467		930-000-903	\$21.31	930-000-392		930-000-773		\$28.44
0.0340	0.1250	0.1020	1.1639	1.5000	930-000-468		930-000-904	\$21.31	930-000-393		930-000-774		\$28.44
0.0350	0.1250	0.1050	1.1635	1.5000	930-000-469	930-002-764	930-000-905	\$18.67	930-000-394	930-002-735	930-000-775		\$25.82
0.0360	0.1250	0.1080	1.1631	1.5000	930-000-470		930-000-906	\$18.67	930-000-395		930-000-776		\$25.82
0.0370	0.1250	0.1110	1.1626	1.5000	930-000-471		930-000-907	\$18.67	930-000-396		930-000-777		\$25.82
0.0380	0.1250	0.1140	1.1622	1.5000	930-000-472		930-000-908	\$18.67	930-000-397		930-000-778		\$25.82
0.0390	0.1250	0.1170	1.1618	1.5000	930-000-473		930-000-909	\$18.67	930-000-398		930-000-779		\$25.82
0.0394	0.1250	0.1182	1.1616	1.5000	930-000-514	930-002-784	930-000-950	\$18.67	930-000-434		930-000-815		\$25.82
0.0400	0.1250	0.1200	1.1614	1.5000	930-000-474	930-002-765	930-000-910	\$18.67	930-000-399	930-002-736	930-000-780		\$25.82
0.0410	0.1250	0.1230	1.1609	1.5000	930-000-475		930-000-911	\$18.67	930-000-400		930-000-781		\$25.82
0.0420	0.1250	0.1260	1.1605	1.5000	930-000-476		930-000-912	\$18.67	930-000-401		930-000-782		\$25.82
0.0430	0.1250	0.1290	1.1601	1.5000	930-000-477		930-000-913	\$18.67	930-000-402		930-000-783		\$25.82
0.0440	0.1250	0.1320	1.1596	1.5000	930-000-478		930-000-914	\$18.67	930-000-403		930-000-784		\$25.82
0.0450	0.1250	0.1350	1.1592	1.5000	930-000-479	930-002-766	930-000-915	\$18.67	930-000-404	930-002-737	930-000-785		\$25.82

CARBIDE



METRIC .046" - .1772"

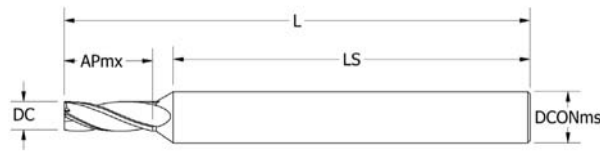

DC	DCONms	APmx	LS	L	UNCOATED				ALTiN COATED		
					2 FLUTE	3 FLUTE	4 FLUTE	Price	2 FLUTE	4 FLUTE	Price
0.0460	0.1250	0.1380	1.1588	1.5000	930-000-293		930-000-679	\$14.27			
0.0470	0.1250	0.1410	1.1584	1.5000	930-000-294	930-000-697	930-000-680	\$14.27			
0.0480	0.1250	0.1440	1.1579	1.5000	930-000-295		930-000-681	\$14.27			
0.0490	0.1250	0.1470	1.1575	1.5000	930-000-296		930-000-682	\$14.27			
0.0492	0.1250	0.1476	1.1574	1.5000	930-000-351	930-002-717	930-000-737	\$14.27			
0.0500	0.1250	0.1500	1.1571	1.5000	930-000-297	930-000-698	930-000-683	\$14.27			
0.0510	0.1250	0.1530	1.1567	1.5000	930-000-299		930-000-685	\$14.27	930-000-573	930-001-072	\$18.67
0.0520	0.1250	0.1560	1.1562	1.5000	930-000-300		930-000-686	\$14.27	930-000-574	930-001-073	\$18.67
0.0530	0.1250	0.1590	1.1558	1.5000	930-000-301		930-000-687	\$14.27	930-000-575	930-001-074	\$18.67
0.0540	0.1250	0.1620	1.1554	1.5000	930-000-302		930-000-688	\$14.27	930-000-576	930-001-075	\$18.67
0.0550	0.1250	0.1650	1.1549	1.5000	930-000-303	930-002-699	930-000-689	\$14.27	930-000-577	930-001-076	\$18.67
0.0560	0.1250	0.1680	1.1545	1.5000	930-000-305		930-000-691	\$14.27	930-000-578	930-001-077	\$18.67
0.0570	0.1250	0.1710	1.1541	1.5000	930-000-306		930-000-692	\$14.27	930-000-579	930-001-078	\$18.67
0.0580	0.1250	0.1740	1.1537	1.5000	930-000-307		930-000-693	\$14.27	930-000-580	930-001-079	\$18.67
0.0590	0.1250	0.1770	1.1532	1.5000	930-000-308		930-000-694	\$14.27	930-000-581	930-001-080	\$18.67
0.0591	0.1250	0.1773	1.1532	1.5000	930-000-353	930-002-718	930-000-739	\$14.27	930-000-603	930-001-105	\$18.67
0.0600	0.1250	0.1800	1.1528	1.5000	930-000-309	930-002-700	930-000-695	\$14.27	930-000-582	930-001-081	\$18.67
0.0620	0.1250	0.1860	1.1519	1.5000	930-000-311	930-002-701	930-000-697	\$12.74	930-000-583	930-001-082	\$17.13
0.0630	0.1250	0.1890	1.1515	1.5000	930-000-354	930-002-719	930-000-740	\$12.74			
0.0640	0.1250	0.1920	1.1511	1.5000	930-000-312	930-002-702	930-000-698	\$12.74			
0.0650	0.1250	0.1950	1.1507	1.5000	930-000-313	930-002-703	930-000-699	\$12.74	930-000-584	930-001-083	\$17.13
0.0700	0.1250	0.2100	1.1485	1.5000	930-000-315	930-002-704	930-000-701	\$12.74	930-000-585	930-001-084	\$17.13
0.0709	0.1250	0.2127	1.1481	1.5000	930-000-355	930-002-720	930-000-741	\$12.74			
0.0750	0.1250	0.2250	1.1464	1.5000	930-000-317	930-002-705	930-000-703	\$12.74	930-000-586	930-001-085	\$17.13
0.0780	0.1250	0.2340	1.1451	1.5000	930-000-318	930-002-706	930-000-704	\$12.74	930-000-587	930-001-086	\$17.13
0.0787	0.1250	0.2361	1.1448	1.5000	930-000-356	930-002-721	930-000-742	\$12.74			
0.0800	0.1250	0.2400	1.1442	1.5000	930-000-319	930-002-707	930-000-705	\$12.74	930-000-588	930-001-087	\$17.13
0.0850	0.1250	0.2550	1.1421	1.5000	930-000-321	930-002-708	930-000-707	\$12.74	930-000-589	930-001-088	\$17.13
0.0866	0.1250	0.2598	1.1414	1.5000	930-000-357	930-002-722	930-000-743	\$12.74			
0.0900	0.1250	0.2700	1.1400	1.5000	930-000-322	930-002-709	930-000-708	\$12.74	930-000-590	930-001-089	\$17.13
0.0930	0.1250	0.2790	1.1387	1.5000	930-000-324	930-002-710	930-000-710	\$12.74	930-000-591	930-001-090	\$17.13
0.0950	0.1250	0.2850	1.1378	1.5000	930-000-325	930-002-711	930-000-711	\$12.74	930-000-592	930-001-091	\$17.13
0.0984	0.1250	0.2952	1.1364	1.5000	930-000-358	930-002-723	930-000-744	\$12.74			
0.1000	0.1250	0.3000	1.1357	1.5000	930-000-326	930-002-712	930-000-712	\$12.74	930-000-593	930-001-092	\$17.13
0.1030	0.1250	0.3090	1.1344	1.5000	930-000-328	930-002-713	930-000-714	\$12.74			
0.1050	0.1250	0.3150	1.1336	1.5000	930-000-329		930-000-715	\$12.74	930-000-594	930-001-093	\$17.13
0.1102	0.1250	0.3306	1.1313	1.5000	930-000-359	930-002-724	930-000-745	\$12.74	930-000-604	930-001-106	\$17.13
0.1150	0.1250	0.3450	1.1293	1.5000	930-000-330		930-000-716	\$12.74	930-000-595	930-001-094	\$17.13
0.1181	0.1250	0.3543	1.1280	1.5000	930-000-360	930-002-725	930-000-746	\$12.74	930-000-605	930-001-107	\$17.13
0.1200	0.1250	0.3600	1.1271	1.5000	930-000-331	930-002-714	930-000-717	\$12.74	930-000-596	930-001-095	\$17.13
0.1378	0.1875	0.4134	1.4588	2.0000	930-000-361	930-002-726	930-000-747	\$13.95			
0.1772	0.1875	0.5316	1.4419	2.0000	930-000-363	930-002-728	930-000-749	\$13.95			

METRIC .046" - .1772"



CARBIDE

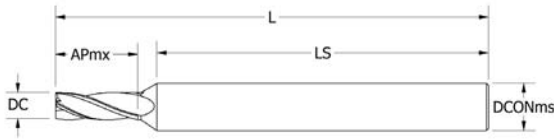

DC	DCONms	APmx	LS	L	TIALN COATED				AMORPHOUS DIAMOND			
					2 FLUTE	3 FLUTE	4 FLUTE	Price	2 FLUTE	3 FLUTE	4 FLUTE	Price
0.0460	0.1250	0.1380	1.1588	1.5000	930-000-480		930-000-916	\$18.67	930-000-405		930-000-786	\$25.82
0.0470	0.1250	0.1410	1.1584	1.5000	930-000-481	930-002-767	930-000-917	\$18.67	930-000-406	930-000-738	930-000-787	\$25.82
0.0480	0.1250	0.1440	1.1579	1.5000	930-000-482		930-000-918	\$18.67	930-000-407		930-000-788	\$25.82
0.0490	0.1250	0.1470	1.1575	1.5000	930-000-483		930-000-919	\$18.67	930-000-408		930-000-789	\$25.82
0.0492	0.1250	0.1476	1.1574	1.5000	930-000-515	930-002-785	930-000-951	\$18.67	930-000-435			\$25.82
0.0500	0.1250	0.1500	1.1571	1.5000	930-000-484	930-002-768	930-000-920	\$18.67	930-000-409	930-000-739	930-000-790	\$25.82
0.0510	0.1250	0.1530	1.1567	1.5000	930-000-485		930-000-921	\$18.67	930-000-410		930-000-791	\$25.82
0.0520	0.1250	0.1560	1.1562	1.5000	930-000-486		930-000-922	\$18.67	930-000-411		930-000-792	\$25.82
0.0530	0.1250	0.1590	1.1558	1.5000	930-000-487		930-000-923	\$18.67	930-000-412		930-000-793	\$25.82
0.0540	0.1250	0.1620	1.1554	1.5000	930-000-488		930-000-924	\$18.67	930-000-413		930-000-794	\$25.82
0.0550	0.1250	0.1650	1.1549	1.5000	930-000-489	930-002-769	930-000-925	\$18.67	930-000-414	930-000-740	930-000-795	\$25.82
0.0560	0.1250	0.1680	1.1545	1.5000	930-000-490		930-000-926	\$18.67	930-000-415		930-000-796	\$25.82
0.0570	0.1250	0.1710	1.1541	1.5000	930-000-491		930-000-927	\$18.67	930-000-416		930-000-797	\$25.82
0.0580	0.1250	0.1740	1.1537	1.5000	930-000-492		930-000-928	\$18.67	930-000-417		930-000-798	\$25.82
0.0590	0.1250	0.1770	1.1532	1.5000	930-000-493		930-000-929	\$18.67	930-000-418		930-000-799	\$25.82
0.0591	0.1250	0.1773	1.1532	1.5000	930-000-516	930-002-786	930-000-952	\$18.67	930-000-436		930-000-815	\$25.82
0.0600	0.1250	0.1800	1.1528	1.5000	930-000-494	930-002-770	930-000-930	\$18.67	930-000-419	930-000-741	930-000-800	\$25.82
0.0620	0.1250	0.1860	1.1519	1.5000	930-000-495	930-002-771	930-000-931	\$17.13	930-000-420	930-000-742	930-000-801	\$24.29
0.0630	0.1250	0.1890	1.1515	1.5000	930-000-517	930-002-787	930-000-953	\$17.13				
0.0650	0.1250	0.1950	1.1507	1.5000	930-000-496	930-002-772	930-000-932	\$17.13	930-000-421	930-000-743	930-000-802	\$24.29
0.0700	0.1250	0.2100	1.1485	1.5000	930-000-497	930-002-773	930-000-933	\$17.13	930-000-422	930-000-744	930-000-803	\$24.29
0.0709	0.1250	0.2127	1.1481	1.5000	930-000-518	930-002-788	930-000-954	\$17.13				
0.0750	0.1250	0.2250	1.1464	1.5000	930-000-498	930-002-774	930-000-934	\$17.13	930-000-423		930-000-804	\$24.29
0.0780	0.1250	0.2340	1.1451	1.5000	930-000-499	930-002-775	930-000-935	\$17.13	930-000-424	930-000-745	930-000-805	\$24.29
0.0787	0.1250	0.2361	1.1448	1.5000	930-000-519	930-002-789	930-000-955	\$17.13				
0.0800	0.1250	0.2400	1.1442	1.5000	930-000-500	930-002-776	930-000-936	\$17.13	930-000-425	930-000-746	930-000-806	\$24.29
0.0850	0.1250	0.2550	1.1421	1.5000	930-000-501	930-002-777	930-000-937	\$17.13	930-000-426		930-000-807	\$24.29
0.0866	0.1250	0.2598	1.1414	1.5000	930-000-520	930-002-790	930-000-956	\$17.13				
0.0900	0.1250	0.2700	1.1400	1.5000	930-000-502	930-002-778	930-000-938	\$17.13	930-000-427	930-000-747	930-000-808	\$24.29
0.0930	0.1250	0.2790	1.1387	1.5000	930-000-503	930-002-779	930-000-939	\$17.13	930-000-428	930-000-748	930-000-809	\$24.29
0.0950	0.1250	0.2850	1.1378	1.5000	930-000-504	930-002-780	930-000-940	\$17.13	930-000-429		930-000-810	\$24.29
0.0984	0.1250	0.2952	1.1364	1.5000	930-000-521	930-002-791	930-000-957	\$17.13				
0.1000	0.1250	0.3000	1.1357	1.5000	930-000-505	930-002-781	930-000-941	\$17.13	930-000-430	930-000-749	930-000-811	\$24.29
0.1050	0.1250	0.3150	1.1336	1.5000					930-000-431		930-000-812	\$24.29
0.1102	0.1250	0.3306	1.1313	1.5000	930-000-522	930-002-792	930-000-958	\$17.13	930-000-437		930-000-816	\$24.29
0.1150	0.1250	0.3450	1.1293	1.5000					930-000-432		930-000-813	\$24.29
0.1181	0.1250	0.3543	1.1280	1.5000	930-000-523	930-002-793	930-000-959	\$17.13	930-000-438		930-000-818	\$24.29
0.1200	0.1250	0.3600	1.1271	1.5000	930-000-506	930-002-782	930-000-942	\$17.13	930-000-433		930-000-814	\$24.29
0.1378	0.1875	0.4134	1.4588	2.0000	930-000-524	930-002-794	930-000-960	\$18.67				
0.1772	0.1875	0.5316	1.4419	2.0000	930-000-526	930-002-796	930-000-961	\$18.67				

CARBIDE



METRIC .005" - .040"

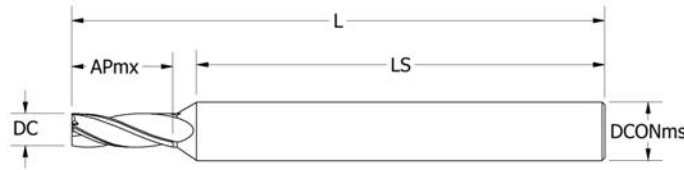

DC	DCONms	APmx	LS	L	UNCOATED			ALTiN COATED	
					2 FLUTE	4 FLUTE	Price	2 FLUTE	Price
0.0050	0.1250	0.0075	1.1342	1.5000	930-001-391		\$26.81	930-001-564	\$31.16
0.0060	0.1250	0.0090	1.1342	1.5000	930-001-392		\$26.81	930-001-565	\$31.16
0.0070	0.1250	0.0105	1.1342	1.5000	930-001-393		\$26.81	930-001-566	\$31.16
0.0080	0.1250	0.0120	1.1342	1.5000	930-001-394		\$26.81	930-001-567	\$31.16
0.0090	0.1250	0.0135	1.1342	1.5000	930-001-395		\$26.81	930-001-568	\$31.16
0.0100	0.1250	0.0150	1.1892	1.5000	930-001-396	930-001-622	\$21.65	930-001-569	\$26.04
0.0110	0.1250	0.0165	1.1903	1.5000	930-001-397	930-001-623	\$21.65	930-001-570	\$26.04
0.0120	0.1250	0.0180	1.1913	1.5000	930-001-398	930-001-624	\$21.65	930-001-571	\$26.04
0.0130	0.1250	0.0195	1.1924	1.5000	930-001-399	930-001-625	\$21.65	930-001-572	\$26.04
0.0140	0.1250	0.0210	1.1935	1.5000	930-001-400	930-001-626	\$21.65	930-001-573	\$26.04
0.0150	0.1250	0.0225	1.1945	1.5000	930-001-401	930-001-627	\$19.22	930-001-574	\$23.62
0.0156	0.1250	0.0234	1.1952	1.5000	930-001-467	930-001-685	\$19.22		
0.0160	0.1250	0.0240	1.1956	1.5000	930-001-402	930-001-628	\$19.22	930-001-575	\$23.62
0.0170	0.1250	0.0255	1.1967	1.5000	930-001-403	930-001-629	\$19.22	930-001-576	\$23.62
0.0180	0.1250	0.0270	1.1978	1.5000	930-001-404	930-001-630	\$19.22	930-001-577	\$23.62
0.0190	0.1250	0.0285	1.1988	1.5000	930-001-405	930-001-631	\$19.22	930-001-578	\$23.62
0.0197	0.1250	0.0296	1.1996	1.5000	930-001-454	930-001-673	\$19.22		
0.0200	0.1250	0.0300	1.1999	1.5000	930-001-406	930-001-632	\$18.35	930-001-579	\$22.75
0.0210	0.1250	0.0315	1.2010	1.5000	930-001-407	930-001-633	\$18.35	930-001-580	\$22.75
0.0220	0.1250	0.0330	1.2021	1.5000	930-001-408	930-001-634	\$18.35	930-001-581	\$22.75
0.0230	0.1250	0.0345	1.2031	1.5000	930-001-409	930-001-635	\$18.35	930-001-582	\$22.75
0.0240	0.1250	0.0360	1.2042	1.5000	930-001-410	930-001-636	\$18.35	930-001-583	\$22.75
0.0250	0.1250	0.0375	1.2053	1.5000	930-001-411	930-001-637	\$16.91	930-001-584	\$21.31
0.0260	0.1250	0.0390	1.2063	1.5000	930-001-412	930-001-638	\$16.91	930-001-585	\$21.31
0.0270	0.1250	0.0405	1.2074	1.5000	930-001-413	930-001-639	\$16.91	930-001-586	\$21.31
0.0280	0.1250	0.0420	1.2085	1.5000	930-001-414	930-001-640	\$16.91	930-001-587	\$21.31
0.0290	0.1250	0.0435	1.2096	1.5000	930-001-415	930-001-641	\$16.91	930-001-588	\$21.31
0.0300	0.1250	0.0450	1.2106	1.5000	930-001-416	930-001-642	\$16.91	930-001-589	\$21.31
0.0310	0.1250	0.0465	1.2117	1.5000	930-001-417	930-001-643	\$16.91	930-001-590	\$21.31
0.0320	0.1250	0.0480	1.2128	1.5000	930-001-418	930-001-644	\$16.91	930-001-591	\$21.31
0.0330	0.1250	0.0495	1.2139	1.5000	930-001-419	930-001-645	\$16.91	930-001-592	\$21.31
0.0340	0.1250	0.0510	1.2149	1.5000	930-001-420	930-001-646	\$16.91	930-001-593	\$18.67
0.0350	0.1250	0.0525	1.2160	1.5000	930-001-421	930-001-647	\$14.27	930-001-594	\$18.67
0.0360	0.1250	0.0540	1.2171	1.5000	930-001-422	930-001-648	\$14.27	930-001-595	\$18.67
0.0370	0.1250	0.0555	1.2181	1.5000	930-001-423	930-001-649	\$14.27	930-001-596	\$18.67
0.0380	0.1250	0.0570	1.2192	1.5000	930-001-424	930-001-650	\$14.27	930-001-597	\$18.67
0.0390	0.1250	0.0585	1.2203	1.5000	930-001-425	930-001-651	\$14.27	930-001-598	\$18.67
0.0394	0.1250	0.0591	1.2207	1.5000	930-001-456	930-001-674	\$14.27	930-001-619	\$18.67
0.0400	0.1250	0.0600	1.2214	1.5000	930-001-426	930-001-652	\$14.27	930-001-599	\$18.67

METRIC .005"-.040"



CARBIDE

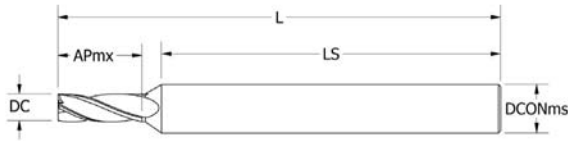

DC	DCONms	APmx	LS	L	TIALN COATED			AMORPHOUS DIAMOND		
					2 FLUTE	4 FLUTE	Price	2 FLUTE	4 FLUTE	Price
0.0050	0.1250	0.0075	1.1342	1.5000	930-001-523		\$31.16	930-001-468		\$43.42
0.0060	0.1250	0.0090	1.1342	1.5000	930-001-524		\$31.16	930-001-469		\$43.42
0.0070	0.1250	0.0105	1.1342	1.5000	930-001-525		\$31.16	930-001-470		\$43.42
0.0080	0.1250	0.0120	1.1342	1.5000	930-001-526		\$31.16	930-001-471		\$43.42
0.0090	0.1250	0.0135	1.1342	1.5000	930-001-527		\$31.16	930-001-472		\$43.42
0.0100	0.1250	0.0150	1.1892	1.5000	930-001-528	930-001-750	\$26.04	930-001-473	930-001-686	\$33.18
0.0110	0.1250	0.0165	1.1903	1.5000	930-001-529	930-001-751	\$26.04	930-001-474	930-001-687	\$33.18
0.0120	0.1250	0.0180	1.1913	1.5000	930-001-530	930-001-752	\$26.04	930-001-475	930-001-688	\$33.18
0.0130	0.1250	0.0195	1.1924	1.5000	930-001-531	930-001-753	\$26.04	930-001-476	930-001-689	\$33.18
0.0140	0.1250	0.0210	1.1935	1.5000	930-001-532	930-001-754	\$26.04	930-001-477	930-001-690	\$33.18
0.0150	0.1250	0.0225	1.1945	1.5000	930-001-533	930-001-755	\$23.62	930-001-478	930-001-691	\$30.76
0.0160	0.1250	0.0240	1.1956	1.5000	930-001-534	930-001-756	\$23.62	930-001-479	930-001-692	\$30.76
0.0170	0.1250	0.0255	1.1967	1.5000	930-001-535	930-001-757	\$23.62	930-001-480	930-001-693	\$30.76
0.0180	0.1250	0.0270	1.1978	1.5000	930-001-536	930-001-758	\$23.62	930-001-481	930-001-694	\$30.76
0.0190	0.1250	0.0285	1.1988	1.5000	930-001-537	930-001-759	\$23.62	930-001-482	930-001-695	\$30.76
0.0200	0.1250	0.0300	1.1999	1.5000	930-001-538	930-001-760	\$22.75	930-001-483	930-001-696	\$29.88
0.0210	0.1250	0.0315	1.2010	1.5000	930-001-539	930-001-761	\$22.75	930-001-484	930-001-697	\$29.88
0.0220	0.1250	0.0330	1.2021	1.5000	930-001-540	930-001-762	\$22.75	930-001-485	930-001-698	\$29.88
0.0230	0.1250	0.0345	1.2031	1.5000	930-001-541	930-001-763	\$22.75	930-001-486	930-001-699	\$29.88
0.0240	0.1250	0.0360	1.2042	1.5000	930-001-542	930-001-764	\$22.75	930-001-487	930-001-700	\$29.88
0.0250	0.1250	0.0375	1.2053	1.5000	930-001-543	930-001-765	\$21.31	930-001-488	930-001-701	\$28.44
0.0260	0.1250	0.0390	1.2063	1.5000	930-001-544	930-001-766	\$21.31	930-001-489	930-001-702	\$28.44
0.0270	0.1250	0.0405	1.2074	1.5000	930-001-545	930-001-767	\$21.31	930-001-490	930-001-703	\$28.44
0.0280	0.1250	0.0420	1.2085	1.5000	930-001-546	930-001-768	\$21.31	930-001-491	930-001-704	\$28.44
0.0290	0.1250	0.0435	1.2096	1.5000	930-001-547	930-001-769	\$21.31	930-001-492	930-001-705	\$28.44
0.0300	0.1250	0.0450	1.2106	1.5000	930-001-548	930-001-770	\$21.31	930-001-493	930-001-706	\$28.44
0.0310	0.1250	0.0465	1.2117	1.5000	930-001-549	930-001-771	\$21.31	930-001-494	930-001-707	\$28.44
0.0320	0.1250	0.0480	1.2128	1.5000	930-001-550	930-001-772	\$21.31	930-001-495	930-001-708	\$28.44
0.0330	0.1250	0.0495	1.2139	1.5000	930-001-551	930-001-773	\$21.31	930-001-496	930-001-709	\$28.44
0.0340	0.1250	0.0510	1.2149	1.5000	930-001-552	930-001-774	\$21.31	930-001-497	930-001-710	\$28.44
0.0350	0.1250	0.0525	1.2160	1.5000	930-001-553	930-001-775	\$18.67	930-001-498	930-001-711	\$25.82
0.0360	0.1250	0.0540	1.2171	1.5000	930-001-554	930-001-776	\$18.67	930-001-499	930-001-712	\$25.82
0.0370	0.1250	0.0555	1.2181	1.5000	930-001-555	930-001-777	\$18.67	930-001-500	930-001-713	\$25.82
0.0380	0.1250	0.0570	1.2192	1.5000	930-001-556	930-001-778	\$18.67	930-001-501	930-001-714	\$25.82
0.0390	0.1250	0.0585	1.2203	1.5000	930-001-557	930-001-779	\$18.67	930-001-502	930-001-715	\$25.82
0.0400	0.1250	0.0600	1.2214	1.5000	930-001-558	930-001-780	\$18.67	930-001-503	930-001-716	\$25.82

CARBIDE



METRIC .045" - .1378"

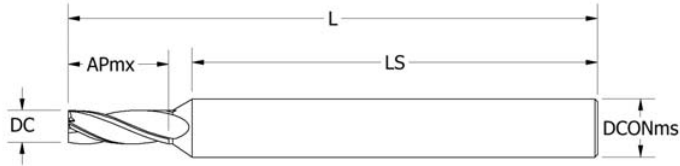

DC	DCONms	APmx	LS	L	UNCOATED			ALTiN COATED	
					2 FLUTE	4 FLUTE	Price	2 FLUTE	Price
0.0450	0.1250	0.0675	1.2267	1.5000	930-001-427	930-001-653	\$14.27	930-001-600=	\$18.67
0.0470	0.1250	0.0705	1.2289	1.5000	930-001-428	930-001-654	\$14.27	930-001-601	\$18.67
0.0492	0.1250	0.0738	1.2312	1.5000	930-001-457	930-001-675	\$14.27		
0.0500	0.1250	0.0750	1.2321	1.5000	930-001-429	930-001-655	\$14.27	930-001-602	\$18.67
0.0550	0.1250	0.0825	1.2374	1.5000	930-001-430	930-001-656	\$14.27	930-001-603	\$18.67
0.0591	0.1250	0.0887	1.2418	1.5000	930-001-458	930-001-676	\$14.27		
0.0600	0.1250	0.0900	1.2428	1.5000	930-001-431	930-001-657	\$14.27	930-001-604	\$18.67
0.0620	0.1250	0.0930	1.2449	1.5000	930-001-432	930-001-658	\$12.74	930-001-605	\$17.13
0.0630	0.1250	0.0945	1.2460	1.5000	930-001-459	930-001-677	\$12.74		
0.0650	0.1250	0.0975	1.2482	1.5000	930-001-433	930-001-659	\$12.74	930-001-606	\$17.13
0.0700	0.1250	0.1050	1.2535	1.5000	930-001-434	930-001-660	\$12.74	930-001-607	\$17.13
0.0709	0.1250	0.1064	1.2545	1.5000	930-001-460	930-001-678	\$12.74		
0.0740	0.1250	0.1110	1.2578	1.5000	930-001-435	930-001-661	\$12.74		
0.0750	0.1250	0.1125	1.2589	1.5000	930-001-436	930-001-662	\$12.74	930-001-608	\$17.13
0.0780	0.1250	0.1170	1.2621	1.5000	930-001-437	930-001-663	\$12.74	930-001-609	\$17.13
0.0787	0.1250	0.1181	1.2629	1.5000	930-001-461	930-001-679	\$12.74		
0.0800	0.1250	0.1200	1.2642	1.5000	930-001-438	930-001-664	\$12.74	930-001-610	\$17.13
0.0850	0.1250	0.1275	1.2696	1.5000	930-001-439	930-001-665	\$12.74	930-001-611	\$17.13
0.0866	0.1250	0.1299	1.2713	1.5000	930-001-462	930-001-680	\$12.74		
0.0900	0.1250	0.1350	1.2750	1.5000	930-001-440	930-001-666	\$12.74	930-001-612	\$17.13
0.0930	0.1250	0.1395	1.2782	1.5000	930-001-441	930-001-667	\$12.74	930-001-613	\$17.13
0.0950	0.1250	0.1425	1.2803	1.5000	930-001-442	930-001-668	\$12.74	930-001-614	\$17.13
0.0984	0.1250	0.1476	1.2840	1.5000	930-001-463	930-001-681	\$12.74		
0.1000	0.1250	0.1500	1.2857	1.5000	930-001-443	930-001-669	\$12.74	930-001-615	\$17.13
0.1050	0.1250	0.1575 (4mm)	1.2911	1.5000	930-001-444	930-001-670	\$12.74	930-001-616	\$17.13
0.1102	0.1250	0.1653	1.2966	1.5000	930-001-464	930-001-682	\$12.74	930-001-620	\$17.13
0.1150	0.1250	0.1725	1.3018	1.5000	930-001-445	930-001-671	\$12.74	930-001-617	\$17.13
0.1181	0.1250	0.1772	1.3051	1.5000	930-001-465	930-001-683	\$12.74	930-001-621	\$17.13
0.1200	0.1250	0.1800	1.3071	1.5000	930-001-446	930-001-672	\$12.74	930-001-618	\$17.13
0.1378	0.1875	0.2067	1.6655	2.0000	930-001-466	930-001-684	\$13.95		

METRIC .045" - .120"



CARBIDE

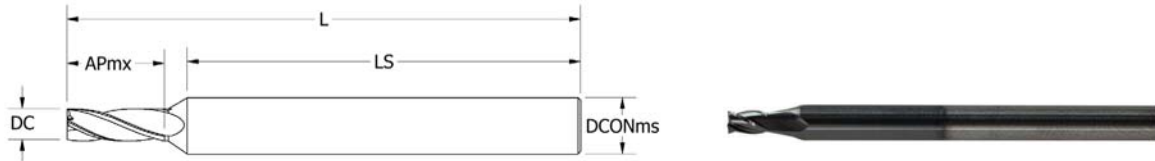

DC	DCONms	APmx	LS	L	AMORPHOUS DIAMOND		
					2 FLUTE	4 FLUTE	Price
0.0450	0.1250	0.0675	1.2267	1.5000	930-001-504	930-001-717	\$25.82
0.0470	0.1250	0.0705	1.2289	1.5000	930-001-505	930-001-718	\$25.82
0.0500	0.1250	0.0750	1.2321	1.5000	930-001-506	930-001-719	\$25.82
0.0550	0.1250	0.0825	1.2374	1.5000	930-001-507	930-001-720	\$25.82
0.0600	0.1250	0.0900	1.2428	1.5000	930-001-508	930-001-721	\$25.82
0.0620	0.1250	0.0930	1.2449	1.5000	930-001-509	930-001-722	\$24.29
0.0650	0.1250	0.0975	1.2482	1.5000	930-001-510	930-001-723	\$24.29
0.0700	0.1250	0.1050	1.2535	1.5000	930-001-511	930-001-724	\$24.29
0.0750	0.1250	0.1125	1.2589	1.5000	930-001-512	930-001-725	\$24.29
0.0780	0.1250	0.1170	1.2621	1.5000	930-001-513	930-001-726	\$24.29
0.0800	0.1250	0.1200	1.2642	1.5000	930-001-514	930-001-727	\$24.29
0.0850	0.1250	0.1275	1.2696	1.5000	930-001-515	930-001-728	\$24.29
0.0900	0.1250	0.1350	1.2750	1.5000	930-001-516	930-001-729	\$24.29
0.0930	0.1250	0.1395	1.2782	1.5000	930-001-517	930-001-730	\$24.29
0.1000	0.1250	0.1500	1.2857	1.5000	930-001-518	930-001-731	\$24.29
0.1050	0.1250	0.1575 (4mm)	1.2911	1.5000	930-001-519	930-001-732	\$24.29
0.1181	0.1250	0.1772	1.3051	1.5000	930-001-520	930-001-733	\$24.29
0.1181	0.1250	0.1772	1.3051	1.5000	930-001-522	930-001-735	\$24.29
0.1200	0.1250	0.1800	1.3071	1.5000	930-001-521	930-001-734	\$24.29

CARBIDE

METRIC .010"-.250"

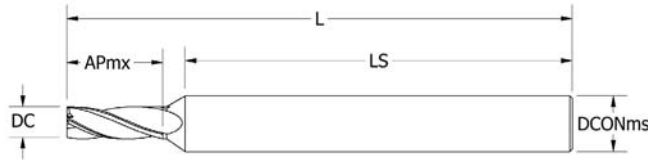

DC	DCONms	APmx	LS	L	UNCOATED		ALTIM COATED		AMORPHOUS DIAMOND	
					3 FLUTE	Price	3 FLUTE	Price	3 FLUTE	Price
0.0100	0.1250	0.0150	2.1892	2.5000	930-003-004	\$22.97	930-003-569	\$27.37	930-003-032	\$34.50
0.0150	0.1250	0.0225	2.1945	2.5000	930-003-005	\$20.54	930-003-570	\$24.95	930-003-033	\$32.08
0.0200	0.1250	0.0300	2.1999	2.5000	930-003-006	\$19.67	930-003-571	\$24.06	930-003-034	\$31.20
0.0250	0.1250	0.0375	2.2053	2.5000	930-003-007	\$18.23	930-003-572	\$24.94	930-003-035	\$29.76
0.0300	0.1250	0.0450	2.2106	2.5000	930-003-008	\$18.23	930-003-573	\$24.94	930-003-036	\$29.76
0.0310	0.1250	0.0465	2.2117	2.5000	930-003-009	\$18.23	930-003-574	\$24.94	930-003-037	\$29.76
0.0350	0.1250	0.0525	2.2160	2.5000	930-003-010	\$18.23	930-003-575	\$24.94	930-003-038	\$29.76
0.0390	0.1250	0.0585	2.2203	2.5000	930-003-011	\$18.23	930-003-576	\$24.94	930-003-039	\$29.76
0.0400	0.1250	0.0600	2.2214	2.5000	930-003-012	\$17.57	930-003-577	\$24.94	930-003-040	\$29.76
0.0450	0.1250	0.0675	2.2267	2.5000	930-003-013	\$17.57	930-003-578	\$21.97	930-003-041	\$29.76
0.0470	0.1250	0.0705	2.2289	2.5000	930-003-014	\$17.57	930-003-579	\$21.97	930-003-042	\$29.76
0.0500	0.1250	0.0750	2.2321	2.5000	930-003-015	\$17.57	930-003-580	\$21.97	930-003-043	\$29.10
0.0550	0.1250	0.0825	2.2374	2.5000	930-003-016	\$17.57	930-003-581	\$21.97	930-003-044	\$29.10
0.0600	0.1250	0.0900	2.2428	2.5000	930-003-017	\$17.57	930-003-582	\$21.97	930-003-045	\$29.10
0.0620	0.1250	0.0930	2.2449	2.5000	930-003-018	\$17.57	930-003-583	\$21.97	930-003-046	\$29.10
0.0650	0.1250	0.0975	2.2482	2.5000	930-003-019	\$17.57	930-003-584	\$21.97	930-003-047	\$29.10
0.0700	0.1250	0.1050	2.2535	2.5000	930-003-020	\$17.57	930-003-585	\$21.97	930-003-048	\$29.10
0.0750	0.1250	0.1125	2.2589	2.5000	930-003-021	\$17.57	930-003-586	\$21.97	930-003-049	\$29.10
0.0780	0.1250	0.1170	2.2621	2.5000	930-003-022	\$17.57	930-003-587	\$21.97	930-003-050	\$29.10
0.0800	0.1250	0.1200	2.2642	2.5000	930-003-023	\$17.57	930-003-588	\$21.97	930-003-051	\$29.10
0.0850	0.1250	0.1275	2.2696	2.5000	930-003-024	\$17.57	930-003-589	\$21.97	930-003-052	\$29.10
0.0900	0.1250	0.1350	2.2750	2.5000	930-003-025	\$17.57	930-003-590	\$21.97	930-003-053	\$29.10
0.0930	0.1250	0.1395	2.2782	2.5000	930-003-026	\$17.57	930-003-591	\$21.97	930-003-054	\$29.10
0.0950	0.1250	0.1425	2.2803	2.5000	930-003-027	\$17.57	930-003-592	\$21.97	930-003-055	\$29.10
0.1000	0.1250	0.1500	2.2857	2.5000	930-003-028	\$17.57	930-003-593	\$21.97	930-003-056	\$29.10
0.1250	0.1250	0.1875	1.9375	2.5000	930-003-029	\$17.57	931-000-380	\$21.97	931-000-345	\$29.10
0.1875	0.1875	0.2813	2.3438	3.0000	930-003-030	\$23.27	931-000-381	\$29.26	931-000-346	\$39.21
0.2500	0.2500	0.3750	3.2500	4.0000	930-003-031	\$27.45	931-000-382	\$35.15	931-000-347	\$45.59

METRIC .010"-.035"



CARBIDE

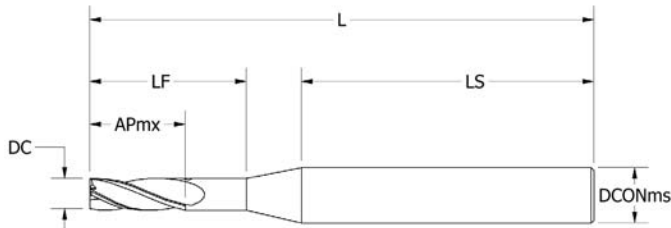

DC	DCONms	APmx	LS	L	LF	UNCOATED		ALTiN COATED		AMORPHOUS DIAMOND	
						3 FLUTE	Price	3 FLUTE	Price	3 FLUTE	Price
0.0100	0.1250	0.0150	2.3925	2.5000	0.0500	930-003-794	\$40.42	930-003-658	\$44.82	930-003-114	\$51.87
0.0100	0.1250	0.0150	2.3625	2.5000	0.0800	930-003-821	\$40.42	930-003-685	\$44.82	930-003-138	\$51.87
0.0100	0.1250	0.0150	2.3175	2.5000	0.1250	930-003-730	\$42.62	930-003-594	\$47.02	930-003-057	\$54.06
0.0100	0.1250	0.0150	2.2925	2.5000	0.1500	930-003-757	\$49.33	930-003-621	\$58.68	930-003-081	\$60.76
0.0150	0.1250	0.0225	2.4000	2.5000	0.0450	930-003-788	\$35.02	930-003-652	\$37.91	930-003-108	\$45.04
0.0150	0.1250	0.0225	2.3670	2.5000	0.0780	930-003-795	\$35.02	930-003-659	\$37.91	930-003-115	\$45.04
0.0150	0.1250	0.0225	2.3200	2.5000	0.1250	930-003-822	\$35.02	930-003-686	\$37.91	930-003-139	\$45.04
0.0150	0.1250	0.0225	2.2575	2.5000	0.1875	930-003-731	\$34.72	930-003-595	\$39.12	930-003-058	\$46.25
0.0150	0.1250	0.0225	2.2200	2.5000	0.2250	930-003-758	\$39.44	930-003-622	\$43.84	930-003-082	\$50.98
0.0150	0.1250	0.0225	2.1450	2.5000	0.3000	930-003-776	\$46.03	930-003-640	\$50.43	930-003-097	\$57.57
0.0200	0.1250	0.0300	2.3475	2.5000	0.1000	930-003-796	\$32.19	930-003-660	\$36.59	930-003-116	\$43.72
0.0200	0.1250	0.0300	2.2875	2.5000	0.1600	930-003-823	\$32.19	930-003-687	\$36.59	930-003-140	\$43.72
0.0200	0.1250	0.0300	2.1975	2.5000	0.2500	930-003-732	\$34.90	930-003-596	\$39.88	930-003-059	\$44.93
0.0200	0.1250	0.0300	2.1475	2.5000	0.3000	930-003-759	\$37.90	930-003-623	\$42.51	930-003-083	\$49.55
0.0200	0.1250	0.0300	2.0475	2.5000	0.4000	930-003-777	\$44.49	930-003-642	\$48.89	930-003-098	\$56.03
0.0250	0.1250	0.0375	2.3250	2.5000	0.1250	930-003-797	\$30.87	930-003-661	\$35.27	930-003-117	\$42.40
0.0250	0.1250	0.0375	2.2500	2.5000	0.2000	930-003-824	\$30.87	930-003-688	\$35.27	930-003-141	\$42.40
0.0250	0.1250	0.0375	2.1375	2.5000	0.3125	930-003-733	\$31.97	930-003-597	\$36.37	930-003-060	\$43.50
0.0250	0.1250	0.0375	2.0750	2.5000	0.3750	930-003-760	\$37.24	930-003-624	\$41.64	930-003-084	\$48.77
0.0250	0.1250	0.0375	1.9500	2.5000	0.5000	930-003-778	\$37.24	930-003-642	\$41.64	930-003-099	\$48.77
0.0300	0.1250	0.0450	2.3025	2.5000	0.1500	930-003-798	\$30.87	930-003-662	\$35.27	930-003-118	\$42.40
0.0300	0.1250	0.0450	2.2025	2.5000	0.2500	930-003-825	\$30.87	930-003-689	\$35.27	930-003-142	\$42.40
0.0300	0.1250	0.0450	2.0775	2.5000	0.3750	930-003-734	\$31.97	930-003-598	\$36.37	930-003-061	\$43.50
0.0300	0.1250	0.0450	2.0025	2.5000	0.4500	930-003-761	\$37.24	930-003-625	\$41.64	930-003-085	\$48.77
0.0310	0.1250	0.0465	2.3600	2.5000	0.0930	930-003-789	\$30.87	930-003-653	\$35.27	930-003-109	\$42.40
0.0310	0.1250	0.0465	2.2980	2.5000	0.1550	930-003-799	\$30.87	930-003-663	\$35.27	930-003-119	\$42.40
0.0310	0.1250	0.0465	2.2030	2.5000	0.2500	930-003-826	\$30.87	930-003-690	\$36.37	930-003-143	\$42.40
0.0310	0.1250	0.0465	2.0780	2.5000	0.3750	930-003-735	\$31.97	930-003-599	\$36.37	930-003-062	\$43.50
0.0310	0.1250	0.0465	1.9830	2.5000	0.4700	930-003-762	\$37.24	930-003-626	\$41.64	930-003-086	\$48.77
0.0310	0.1250	0.0465	1.8280	2.5000	0.6250	930-003-779	\$43.84	930-003-643	\$48.23	930-003-100	\$57.86
0.0350	0.1250	0.0525	2.2680	2.5000	0.1870	930-003-800	\$30.87	930-003-664	\$35.27	930-003-120	\$42.40
0.0350	0.1250	0.0525	2.1750	2.5000	0.2800	930-003-827	\$30.87	930-003-691	\$35.27	930-003-144	\$42.40
0.0350	0.1250	0.0525	2.0300	2.5000	0.4250	930-003-736	\$31.97	930-003-600	\$36.37	930-003-063	\$43.50
0.0350	0.1250	0.0525	1.9300	2.5000	0.5250	930-003-763	\$37.24	930-003-627	\$41.64	930-003-087	\$48.77
0.0350	0.1250	0.0525	1.7550	2.5000	0.7000	930-003-780	\$43.84	930-003-644	\$48.23	930-003-101	\$57.86

CARBIDE



METRIC .040" - .075"

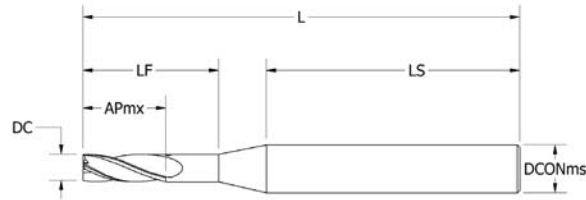

DC	DCONms	APmx	LS	L	LF	UNCOATED		ALTiN COATED		AMORPHOUS DIAMOND	
						3 FLUTE	Price	3 FLUTE	Price	3 FLUTE	Price
0.0400	0.1250	0.0600	2.2575	2.5000	0.2000	930-003-801	\$30.87	930-003-665	\$35.27	930-003-121	\$42.40
0.0400	0.1250	0.0600	2.1325	2.5000	0.3250	930-003-692	\$30.87	930-003-692	\$35.27	930-003-145	\$42.40
0.0400	0.1250	0.0600	1.9775	2.5000	0.4800	930-003-737	\$31.97	930-003-601	\$36.37	930-003-064	\$43.50
0.0400	0.1250	0.0600	1.8575	2.5000	0.6000	930-003-764	\$37.24	930-003-628	\$41.64	930-003-088	\$48.77
0.0400	0.1250	0.0600	1.6575	2.5000	0.8000	930-003-781	\$43.84	930-003-645	\$48.23	930-003-102	\$57.86
0.0450	0.1250	0.0675	2.2350	2.5000	0.2250	930-003-802	\$30.20	930-003-666	\$34.60	930-003-122	\$41.75
0.0450	0.1250	0.0675	2.0850	2.5000	0.3750	930-003-829	\$30.20	930-003-693	\$34.60	930-003-146	\$41.75
0.0450	0.1250	0.0675	1.9100	2.5000	0.5500	930-003-738	\$31.20	930-003-602	\$35.60	930-003-065	\$42.74
0.0450	0.1250	0.0675	1.7800	2.5000	0.6800	930-003-765	\$35.26	930-003-629	\$39.66	930-003-089	\$46.80
0.0450	0.1250	0.0675	1.5600	2.5000	0.9000	930-003-782	\$41.20	930-003-646	\$45.60	930-003-103	\$52.73
0.0470	0.1250	0.0705	2.3200	2.5000	0.1410	930-003-790	\$30.20	930-003-654	\$34.60	930-003-110	\$41.75
0.0470	0.1250	0.0705	2.2110	2.5000	0.2500	930-003-803	\$30.20	930-003-667	\$34.60	930-003-123	\$41.75
0.0470	0.1250	0.0705	2.0860	2.5000	0.3750	930-003-830	\$30.20	930-003-694	\$34.60	930-003-147	\$41.75
0.0470	0.1250	0.0705	1.8910	2.5000	0.5700	930-003-739	\$31.20	930-003-603	\$35.60	930-003-066	\$42.74
0.0470	0.1250	0.0705	1.7510	2.5000	0.7100	930-003-766	\$35.26	930-003-630	\$39.66	930-003-090	\$46.80
0.0470	0.1250	0.0705	1.5110	2.5000	0.9500	930-003-783	\$41.20	930-003-647	\$45.60	930-003-104	\$52.73
0.0500	0.1250	0.0750	2.2125	2.5000	0.2500	930-003-804	\$30.20	930-003-668	\$34.60	930-003-124	\$41.75
0.0500	0.1250	0.0750	2.0625	2.5000	0.4000	930-003-831	\$30.20	930-003-695	\$34.60	930-003-148	\$41.75
0.0500	0.1250	0.0750	1.8625	2.5000	0.6000	930-003-740	\$31.20	930-003-604	\$35.60	930-003-067	\$42.74
0.0500	0.1250	0.0750	1.7125	2.5000	0.7500	930-003-767	\$35.26	930-003-631	\$39.66	930-003-091	\$46.80
0.0550	0.1250	0.0825	2.1900	2.5000	0.2750	930-003-805	\$30.20	930-003-669	\$34.60	930-003-125	\$41.75
0.0550	0.1250	0.0825	2.0150	2.5000	0.4500	930-003-832	\$30.20	930-003-696	\$34.60	930-003-149	\$41.75
0.0550	0.1250	0.0825	1.8050	2.5000	0.6600	930-003-741	\$31.20	930-003-605	\$35.60	930-003-068	\$42.74
0.0550	0.1250	0.0825	1.6400	2.5000	0.8250	930-003-768	\$35.26	930-003-632	\$39.66	930-003-092	\$46.80
0.0600	0.1250	0.0900	2.1555	2.5000	0.3120	930-003-806	\$30.20	930-003-670	\$34.60	930-003-126	\$41.75
0.0600	0.1250	0.0900	1.9675	2.5000	0.5000	930-003-833	\$30.20	930-003-697	\$34.60	930-003-150	\$41.75
0.0600	0.1250	0.0900	1.7475	2.5000	0.7200	930-003-742	\$31.20	930-003-606	\$35.60	930-003-069	\$42.74
0.0600	0.1250	0.0900	1.5675	2.5000	0.9000	930-003-769	\$35.26	930-003-633	\$39.66	930-003-093	\$46.80
0.0620	0.1250	0.0930	2.2825	2.5000	0.1860	930-003-791	\$30.20	930-003-655	\$34.60	930-003-111	\$41.75
0.0620	0.1250	0.0930	2.1565	2.5000	0.3120	930-003-807	\$30.20	930-003-671	\$34.60	930-003-127	\$41.75
0.0620	0.1250	0.0930	1.9685	2.5000	0.5000	930-003-834	\$30.20	930-003-698	\$34.60	930-003-151	\$41.75
0.0620	0.1250	0.0930	1.7185	2.5000	0.7500	930-003-743	\$31.20	930-003-607	\$35.60	930-003-070	\$42.74
0.0620	0.1250	0.0930	1.5185	2.5000	0.9500	930-003-770	\$35.26	930-003-634	\$39.66	930-003-094	\$46.80
0.0620	0.1250	0.0930	1.2185	2.5000	1.2500	930-003-784	\$41.20	930-003-648	\$45.60	930-003-105	\$52.73
0.0650	0.1250	0.0975	2.1450	2.5000	0.3250	930-003-808	\$30.20	930-003-672		930-003-128	\$41.75
0.0650	0.1250	0.0975	1.9450	2.5000	0.5250	930-003-835	\$30.20	930-003-699		930-003-152	\$41.75
0.0650	0.1250	0.0975	1.6700	2.5000	0.8000	930-003-744	\$31.20	930-003-608		930-003-071	\$42.74
0.0700	0.1250	0.1050	2.0975	2.5000	0.3750	930-003-809	\$30.20	930-003-673		930-003-129	\$41.75
.070"	0.1250	0.1050	1.9025	2.5000	0.5700	930-003-836	\$30.20	930-003-700		930-003-153	\$41.75
.070"	0.1250	0.1050	1.6225	2.5000	0.8500	930-003-745	\$31.20	930-003-609		930-003-072	\$42.74
0.0750	0.1250	0.1125	2.1000	2.5000	0.3750	930-003-810	\$30.20	930-003-674		930-003-130	\$41.75
.075"	0.1250	0.1125	1.8500	2.5000	0.6250	930-003-837	\$30.20	930-003-701		930-003-154	\$41.75
.075"	0.1250	0.1125	1.5750	2.5000	0.9000	930-003-746	\$31.20	930-003-610		930-003-073	\$42.74

METRIC .078" - .250"



CARBIDE

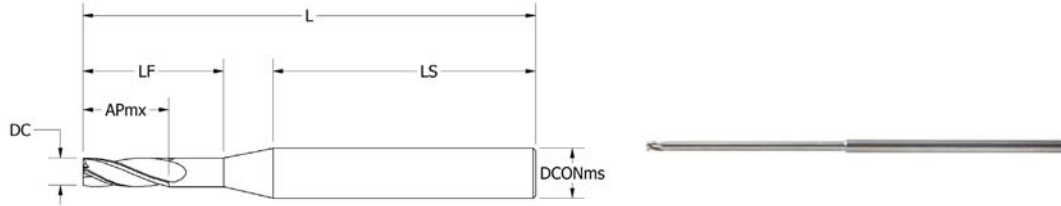

DC	DCONms	APmx	LS	L	LF	UNCOATED		ALTiN COATED		AMORPHOUS DIAMOND	
						3 FLUTE	Price	3 FLUTE	Price	3 FLUTE	Price
0.0780	0.1250	0.1170	2.2425	2.5000	0.2340	930-003-792	\$30.20	930-003-656	\$34.60	930-003-112	\$41.75
0.0780	0.1250	0.1170	2.0765	2.5000	0.4000	930-003-811	\$30.20	930-003-675	\$34.60	930-003-131	\$41.75
0.0780	0.1250	0.1170	1.8515	2.5000	0.6250	930-003-838	\$30.20	930-003-702	\$34.60	930-003-155	\$41.75
0.0780	0.1250	0.1170	1.5365	2.5000	0.9400	930-003-747	\$31.20	930-003-611	\$35.60	930-003-074	\$42.74
0.0780	0.1250	0.1170	1.2895	2.5000	1.1870	930-003-771	\$35.26	930-003-635	\$39.66	930-003-095	\$46.80
0.0780	0.1250	0.1170	1.4145	3.0000	1.5620	930-003-785	\$41.20	930-003-649	\$45.60	930-003-106	\$52.73
0.0800	0.1250	0.1200	2.0775	2.5000	0.4000	930-003-812	\$30.20	930-003-676	\$34.60	930-003-132	\$41.75
0.0800	0.1250	0.1200	1.8275	2.5000	0.6500	930-003-839	\$30.20	930-003-703	\$34.60	930-003-156	\$41.75
0.0800	0.1250	0.1200	1.5175	2.5000	0.9600	930-003-748	\$31.20	930-003-612	\$35.60	930-003-075	\$42.74
0.0850	0.1250	0.1275	2.0550	2.5000	0.4250	930-003-813		930-003-677	\$34.60	930-003-133	\$41.75
0.0850	0.1250	0.1275	1.7800	2.5000	0.7000	930-003-840		930-003-704	\$34.60	930-003-157	\$41.75
0.0850	0.1250	0.1275	1.4600	2.5000	1.0200	930-003-749		930-003-613	\$35.60	930-003-076	\$42.75
0.0900	0.1250	0.1350	2.0325	2.5000	0.4500	930-003-814		930-003-678	\$34.60	930-003-134	\$41.75
0.0900	0.1250	0.1350	1.7325	2.5000	0.7500	930-003-841		930-003-705	\$34.60	930-003-158	\$41.75
0.0900	0.1250	0.1350	1.4025	2.5000	1.0800	930-003-750		930-003-614	\$35.60	930-003-077	\$42.74
0.0930	0.1250	0.1395	2.2140	2.5000	0.2700	930-003-793		930-003-657	\$34.60	930-003-113	\$41.75
0.0930	0.1250	0.1395	1.9840	2.5000	0.5000	930-003-815		930-003-679	\$34.60	930-003-135	\$41.75
0.0930	0.1250	0.1395	1.7340	2.5000	0.7500	930-003-842		930-003-706	\$34.60	930-003-159	\$41.75
0.0930	0.1250	0.1395	1.3590	2.5000	1.1250	930-003-751	\$31.20	930-003-615	\$35.60	930-003-078	\$42.74
0.0930	0.1250	0.1395	1.5840	3.0000	1.4000	930-003-772	\$37.36	930-003-636	\$41.75	930-003-096	\$48.89
0.0930	0.1250	0.1395	2.1090	4.0000	1.8750	930-003-786	\$43.50	930-003-650	\$47.90	930-003-107	\$55.04
0.0950	0.1250	0.1425	1.9850	2.5000	0.5000	930-003-816	\$30.20	930-003-680	\$34.60	930-003-136	\$41.75
0.0950	0.1250	0.1425	1.7350	2.5000	0.7500	930-003-843	\$30.20	930-003-707	\$34.60	930-003-160	\$41.75
0.0950	0.1250	0.1425	1.3350	2.5000	1.1500	930-003-752	\$31.20	930-003-616	\$35.60	930-003-079	\$42.74
0.1000	0.1250	0.1500	1.9875	2.5000	0.5000	930-003-817	\$30.20	930-003-681	\$34.60	930-003-137	\$41.75
0.1000	0.1250	0.1500	1.6875	2.5000	0.8000	930-003-844	\$30.20	930-003-708	\$34.60	930-003-161	\$41.75
0.1000	0.1250	0.1500	1.2875	2.5000	1.2000	930-003-753	\$31.20	930-003-617	\$35.60	930-003-080	\$48.77
0.1250	0.1250	0.1875	1.8750	2.5000	0.6250	930-003-818	\$30.20	930-003-682	\$34.60	931-000-355	\$41.75
0.1250	0.1250	0.1875	1.5000	2.5000	1.0000	930-003-845	\$30.20	930-003-709	\$34.60	931-000-358	\$41.75
0.1250	0.1250	0.1875	1.5000	3.0000	1.5000	930-003-754	\$31.13	930-003-618	\$37.24	931-000-348	\$47.80
0.1250	0.1250	0.1875	1.1250	3.0000	1.8750	930-003-773	\$37.36	930-003-637	\$41.75	931-000-351	\$54.93
0.1250	0.1250	0.1875	1.5000	4.0000	2.5000	930-003-787	\$43.50	930-003-651	\$47.90	931-000-354	\$61.08
0.1875	0.1875	0.2813	2.0000	3.0000	1.0000	930-003-819	\$35.92	930-003-683	\$40.32	931-000-356	\$51.85
0.1875	0.1875	0.2813	1.5000	3.0000	1.5000	930-003-846	\$35.92	930-003-710	\$40.32	931-000-359	\$51.85
0.1875	0.1875	0.2813	1.7500	4.0000	2.2500	930-003-755	\$38.45	930-003-619	\$42.84	931-000-349	\$55.47
0.1875	0.1875	0.2813	1.1880	4.0000	2.8120	930-003-774	\$41.08	930-003-638	\$45.48	931-000-352	\$61.31
0.2500	0.2500	0.3750	2.7500	4.0000	1.2500	930-003-820	\$40.10	930-003-684	\$40.32	931-000-357	\$58.23
0.2500	0.2500	0.3750	2.0000	4.0000	2.0000	930-003-847	\$40.10	930-003-711	\$44.50	931-000-360	\$58.23
0.2500	0.2500	0.3750	0.3750	3.0000	6.0000	930-003-756	\$52.11	930-003-620	\$54.27	931-000-350	\$76.24
0.2500	0.2500	0.3750	2.2500	6.0000	3.7500	930-003-775	\$52.11	930-003-639	\$54.27	931-000-353	\$76.24

CARBIDE



METRIC .005" - .100"

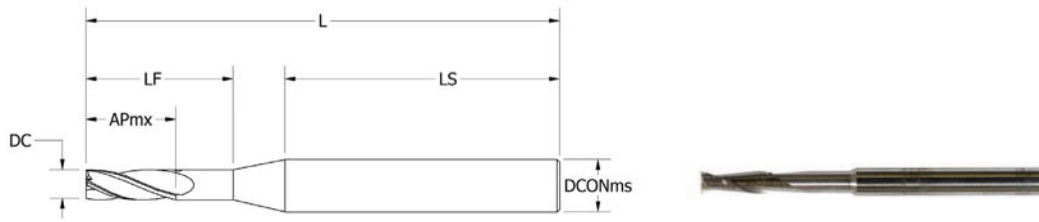

DC	DCONms	APmx	LS	L	LF	UNCOATED		
						2 FLUTE	4 FLUTE	Price
0.0050	0.1250	0.0150	1.1342	1.5000	0.0470	930-000-244	-	\$43.94
0.0100	0.1250	0.0300	1.3625	1.5000	0.0800	930-000-620	930-001-140	\$39.11
0.0100	0.1250	0.0300	1.3488	1.5000	0.0937	930-000-250	930-000-636	\$39.11
0.0150	0.1250	0.0450	1.3200	1.5000	0.1250	930-000-256	930-000-642	\$32.19
0.0200	0.1250	0.0600	1.2775	1.5000	0.1700	930-000-621	930-001-141	\$30.87
0.0200	0.1250	0.0600	1.2600	1.5000	0.1875	930-000-262	930-000-648	\$30.87
0.0250	0.1250	0.0750	1.2370	1.5000	0.2130	930-000-622	930-001-142	\$29.55
0.0250	0.1250	0.0750	1.2000	1.5000	0.2500	930-000-268	930-000-654	\$29.55
0.0300	0.1250	0.0900	1.2025	1.5000	0.2500	930-000-274	930-000-660	\$29.55
0.0300	0.1250	0.0900	1.1825	1.5000	0.2700	930-000-623	930-001-143	\$29.55
0.0310	0.1250	0.0930	1.1740	1.5000	0.2790	930-000-624	930-001-144	\$29.55
0.0350	0.1250	0.1050	1.2050	1.5000	0.2500	930-000-280	930-000-666	\$29.55
0.0350	0.1250	0.1050	1.1400	1.5000	0.3150 (8mm)	930-000-625	930-001-145	\$29.55
0.0400	0.1250	0.1200	1.2075	1.5000	0.2500	930-000-286	930-000-672	\$29.55
0.0400	0.1250	0.1200	1.0975	1.5000	0.3600	930-000-626	930-001-146	\$29.55
0.0450	0.1250	0.1350	1.0550	1.5000	0.4050	930-000-627	930-001-147	\$28.89
0.0450	0.1250	0.1350	0.9600	1.5000	0.5000	930-000-292	930-000-678	\$28.89
0.0470	0.1250	0.1410	1.0380	1.5000	0.4230	930-000-628	930-001-148	\$28.89
0.0500	0.1250	0.1500	0.9625	1.5000	0.5000	930-000-298	930-000-684	\$28.89
0.0550	0.1250	0.1650	0.9650	1.5000	0.5000	930-000-304	930-000-690	\$28.89
0.0600	0.1250	0.1800	0.9675	1.5000	0.5000	930-000-310	930-000-696	\$28.89
0.0620	0.1250	0.1860	0.9685	1.5000	0.5000	930-000-629	930-001-149	\$28.89
0.0650	0.1250	0.1950	0.9700	1.5000	0.5000	930-000-314	930-000-700	\$28.89
0.0700	0.1250	0.2100	0.9725	1.5000	0.5000	930-000-316	930-000-702	\$28.89
0.0780	0.1250	0.2340	0.9765	1.5000	0.5000	930-000-630	930-001-150	\$28.89
0.0800	0.1250	0.2400	0.9775	1.5000	0.5000	930-000-320	930-000-706	\$28.89
0.0900	0.1250	0.2700	0.9825	1.5000	0.5000	930-000-323	930-000-709	\$28.89
0.0900	0.1250	0.2700	0.8575	1.5000	0.6250	930-000-631	930-001-151	\$28.89
0.0930	0.1250	0.2790	0.8590	1.5000	0.6250	930-000-632	930-001-152	\$28.89
0.0950	0.1250	0.2850	0.8600	1.5000	0.6250	930-000-633	930-001-153	\$28.89
0.1000	0.1250	0.3000	0.9875	1.5000	0.5000	930-000-327	930-000-713	\$28.89
0.1000	0.1250	0.3000	0.8625	1.5000	0.6250	930-000-634	930-001-154	\$28.89

METRIC .010" - .250"



CARBIDE

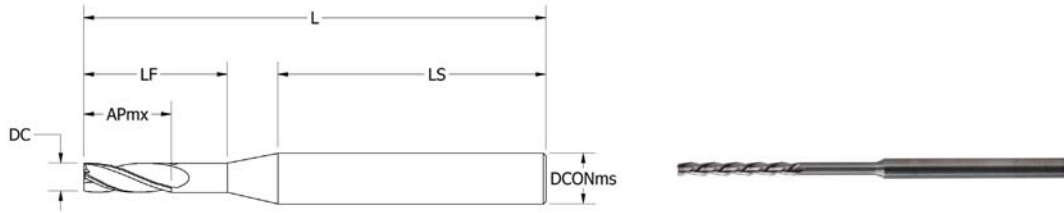

DC	DCONms	APmx	LS	L	LF	UNCOATED		ALTiN COATED		AMORPHOUS DIAMOND	
						3 FLUTE	Price	3 FLUTE	Price	3 FLUTE	Price
0.0100	0.1250	0.0500	2.3425	2.5000	0.1000	930-002-966	\$41.52			930-002-797	\$53.07
0.0150	0.1250	0.0750	2.2950	2.5000	0.1500	930-002-967	\$34.60			930-002-798	\$46.14
0.0200	0.1250	0.1000	2.2475	2.5000	0.2000	930-002-968	\$33.29	930-002-933	\$37.68	930-002-799	\$44.82
0.0250	0.1250	0.1250	2.2000	2.5000	0.2500	930-002-969	\$31.97	930-002-934	\$36.37	930-002-800	\$43.50
0.0300	0.1250	0.1500	2.1525	2.5000	0.3000	930-002-970	\$31.97	930-002-935	\$36.37	930-002-801	\$43.50
0.0310	0.1250	0.1550	2.1530	2.5000	0.3000	930-002-971	\$31.97	930-002-936	\$36.37	930-002-802	\$43.50
0.0350	0.1250	0.1750	2.1050	2.5000	0.3500	930-002-972	\$31.97	930-002-937	\$36.37	930-002-803	\$43.50
0.0400	0.1250	0.2000	2.0575	2.5000	0.4000	930-002-973	\$31.97	930-002-938	\$36.37	930-002-804	\$43.50
0.0450	0.1250	0.2250	2.0100	2.5000	0.4500	930-002-974	\$32.71	930-002-939	\$35.70	930-002-805	\$42.84
0.0470	0.1250	0.2500	1.9610	2.5000	0.5000	930-002-975	\$32.71	930-002-940	\$35.70	930-002-806	\$42.84
0.0500	0.1250	0.3000	1.8625	2.5000	0.6000	930-002-976	\$32.71	930-002-941	\$35.70	930-002-807	\$42.84
0.0550	0.1250	0.3850	1.6950	2.5000	0.7700	930-002-977	\$32.71	930-002-942	\$35.70	930-002-808	\$42.84
0.0600	0.1250	0.5000	1.4675	2.5000	1.0000	930-002-978	\$32.71	930-002-943	\$35.70	930-002-809	\$42.84
0.0620	0.1250	0.5000	1.4685	2.5000	1.0000	930-002-979	\$32.71	-		930-002-810	\$42.84
0.0650	0.1250	0.5000	1.4700	2.5000	1.0000	930-002-980	\$32.71	930-002-944	\$35.70	930-002-811	\$42.84
0.0700	0.1250	0.5000	1.4725	2.5000	1.0000	930-002-981	\$32.71	930-002-945	\$35.70	930-002-812	\$42.84
0.0750	0.1250	0.5000	1.4750	2.5000	1.0000	930-002-982	\$32.71	930-002-946	\$35.70	930-002-813	\$42.84
0.0780	0.1250	0.5000	1.4765	2.5000	1.0000	930-002-983	\$32.71	930-002-947	\$35.70	930-002-814	\$42.84
0.0800	0.1250	0.7500	1.2275	2.5000	1.2500	930-002-984	\$32.71	930-002-948	\$35.70	930-002-815	\$42.84
0.0850	0.1250	0.7500	1.2300	2.5000	1.2500	930-002-985	\$32.71	930-002-949	\$35.70	930-002-816	\$42.84
0.0900	0.1250	0.7500	1.2325	2.5000	1.2500	930-002-986	\$32.71	930-002-950	\$35.70	930-002-817	\$42.84
0.0930	0.1250	0.7500	1.2340	2.5000	1.2500	930-002-987	\$32.71	930-002-951	\$35.70	930-002-818	\$42.84
0.0950	0.1250	0.7500	1.2350	2.5000	1.2500	930-002-988	\$32.71	930-002-952	\$35.70	930-002-819	\$42.84
0.1000	0.1250	0.7500	1.2375	2.5000	1.2500	930-002-989	\$32.71	930-002-953	\$35.70	930-002-820	\$42.84
0.1250	0.1250	1.0000	2.5000	2.5000		930-002-990	\$32.71	930-002-954	\$35.70	931-000-333	\$42.84
0.1875	0.1875	1.1250	3.0000	3.0000		930-002-991	\$37.02	930-002-955	\$41.42	931-000-334	\$52.95
0.2500	0.2500	1.5000	2.0000	4.0000		930-002-992	\$41.20			931-000-335	\$61.99

CARBIDE

METRIC .031" - .125"

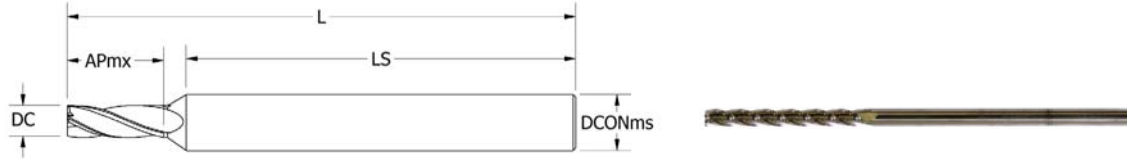

12X FLUTE LENGTH



DC	DCONms	APmx	LS	L	UNCOATED		ALTIM COATED		AMORPHOUS DIAMOND	
					3 FLUTE	Price	3 FLUTE	Price	3 FLUTE	Price
0.0310	0.1250	0.3750	1.8832	2.5000	930-002-993	\$53.07	930-002-956	\$57.46	930-002-821	\$64.60
0.0470	0.1250	0.5700	1.7294	2.5000	930-002-994	\$49.33	930-002-957	\$58.68	930-002-822	\$60.86
0.0620	0.1250	0.7500	1.5879	2.5000	930-002-995	\$41.63	930-002-958	\$46.03	930-002-823	\$53.17
0.0780	0.1250	0.9400	1.4391	2.5000	930-002-996	\$41.63	930-002-959	\$46.03	930-002-824	\$53.17
0.0930	0.1250	1.1250	1.2927	2.5000	930-002-997	\$41.63	930-002-960	\$46.03	930-002-825	\$53.17
0.1250	0.1250	1.5000	1.1250	3.0000	930-002-998	\$43.94	930-002-961	\$48.34	930-002-826	\$60.86

METRIC .062" - .125"

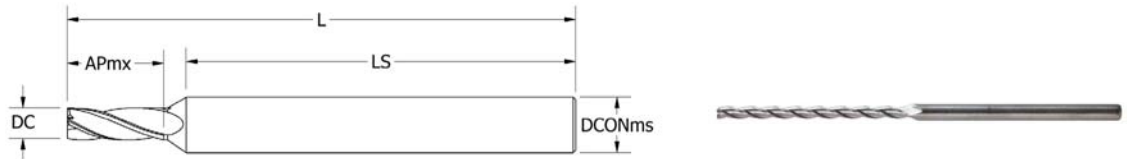

15X FLUTE LENGTH



DC	DCONms	APmx	LS	L	UNCOATED		ALTIM COATED		AMORPHOUS DIAMOND	
					3 FLUTE	Price	3 FLUTE	Price	3 FLUTE	Price
0.0620	0.1250	0.9500	1.3879	2.5000	930-002-999	\$56.91	930-002-962	\$61.31	930-002-827	\$68.45
0.0780	0.1250	1.1870	1.1921	2.5000	930-003-001	\$56.91	930-002-963	\$61.31	930-002-828	\$68.45
0.0930	0.1250	1.4000	1.5177	3.0000	930-003-002	\$59.21	930-002-964	\$63.61	930-002-829	\$76.79
0.1250	0.1250	1.8750	0.7500	3.0000	930-003-003	\$59.21	930-002-965	\$63.61	931-000-336	\$76.79

METRIC .156" - .250"

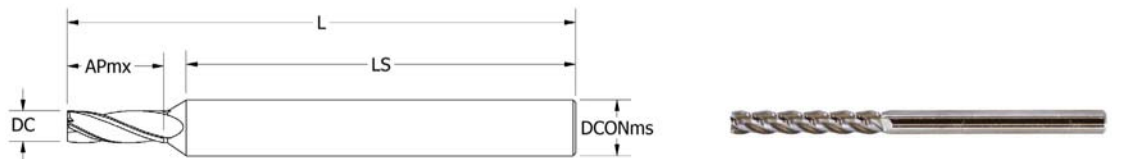

12X FLUTE LENGTH



DC	DCONms	APmx	LS	L	UNCOATED		ALTIM COATED		AMORPHOUS DIAMOND	
					4 FLUTE	Price	4 FLUTE	Price	4 FLUTE	Price
0.1563	0.1875	1.8750	2.0446	4.0000	930-001-170	\$56.24	930-001-161	\$60.67	931-000-256	\$73.28
0.1875	0.1875	2.2500	1.3750	4.0000	930-001-171	\$56.24	930-001-162	\$60.67	931-000-257	\$72.18
0.2500	0.2500	3.0000	2.6250	6.0000	930-001-172	\$61.74	930-001-163	\$66.17	931-000-258	\$84.57

METRIC .015" - .100"

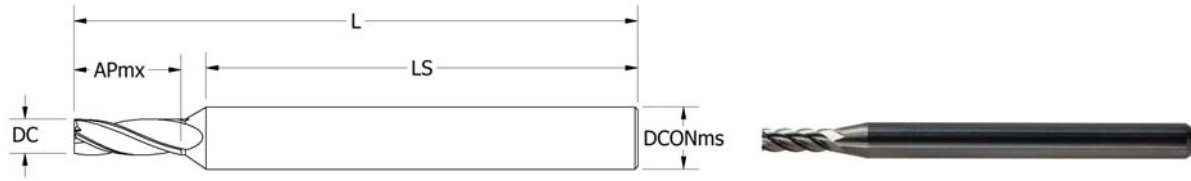

MULTI - FLUTE



DC	DCONms	APmx	LS	L	UNCOATED		ALTiN COATED	
					5 FLUTE	Price	5 FLUTE	Price
0.0310	0.1250	0.0930	1.1652	1.5000	930-003-848	\$26.26	930-003-867	\$31.70
0.0400	0.1250	0.1200	1.1614	1.5000	930-003-849	\$26.26	930-003-868	\$31.70
0.0470	0.1250	0.1410	1.1584	1.5000	930-003-850	\$26.26	930-003-869	\$31.70
0.0500	0.1250	0.1500	1.1571	1.5000	930-003-851	\$26.26	930-003-870	\$31.70
0.0600	0.1250	0.1800	1.1528	1.5000	930-003-852	\$27.35	930-003-871	\$31.70
0.0620	0.1250	0.1860	1.1519	1.5000	930-003-853	\$24.39	930-003-872	\$29.84
0.0700	0.1250	0.2100	1.1485	1.5000	930-003-854	\$24.39	930-003-873	\$29.84
0.0780	0.1250	0.2340	1.1451	1.5000	930-003-855	\$24.39	930-003-874	\$29.84
0.0800	0.1250	0.2400	1.1442	1.5000	930-003-856	\$24.39	930-003-875	\$29.84
0.0930	0.1250	0.2790	1.1387	1.5000	930-003-857	\$24.39	930-003-876	\$29.84
0.1000	0.1250	0.3000	1.1357	1.5000	930-003-858	\$24.39	930-003-877	\$29.84

METRIC .093" - .100"

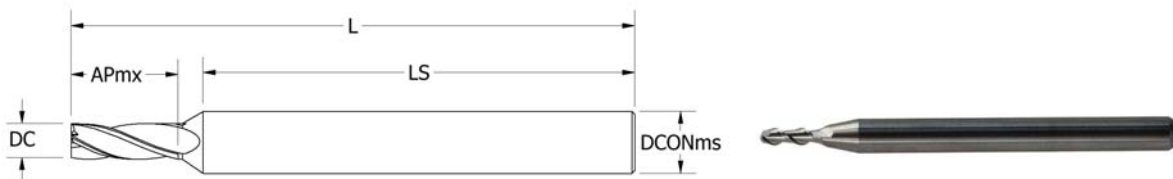

HIGH HELIX



DC	DCONms	APmx	LS	L	UNCOATED	
					2 FLUTE	Price
0.0150	0.1250	0.0450	1.1720	1.5000	930-000-606	\$25.60
0.0310	0.1250	0.0930	1.1652	1.5000	930-000-607	\$19.67
0.0470	0.1250	0.1410	1.1584	1.5000	930-000-608	\$19.67
0.0620	0.1250	0.1860	1.1519	1.5000	930-000-609	\$16.69
0.0780	0.1250	0.2340	1.1451	1.5000	930-000-610	\$16.29
0.0930	0.1250	0.2790	1.1387	1.5000	930-000-611	\$16.29

CARBIDE

METRIC .015"- .093"

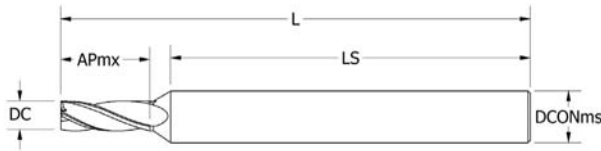

DC	DCONms	APmx	LS	L	CVD COATED	
					4 FLUTE	Price
0.0150	0.1250	0.0450	1.1720	1.5000	930-001-025	\$73.38
0.0200	0.1250	0.0600	1.1699	1.5000	930-001-026	\$73.38
0.0310	0.1250	0.0930	1.1652	1.5000	930-001-027	\$73.38
0.0470	0.1250	0.1410	1.1584	1.5000	930-001-028	\$73.38
0.0620	0.1250	0.1860	1.1519	1.5000	930-001-029	\$71.30
0.0930	0.1250	0.2790	1.1387	1.5000	930-001-030	\$71.30

METRIC .015"- .093"

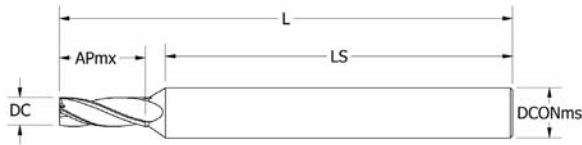

LONG SHANK, STUB

DC	DCONms	APmx	LS	L	CVD COATED	
					3 FLUTE	Price
0.0150	0.1250	0.0225	2.1945	2.5000	930-003-563	\$82.93
0.0200	0.1250	0.0300	2.1999	2.5000	930-003-564	\$82.93
0.0310	0.1250	0.0465	2.2117	2.5000	930-003-565	\$82.93
0.0470	0.1250	0.0705	2.2289	2.5000	930-003-566	\$82.93
0.0620	0.1250	0.0930	2.2449	2.5000	930-003-567	\$81.08
0.0930	0.1250	0.1395	2.2782	2.5000	930-003-568	\$81.08

METRIC .015"- .093"

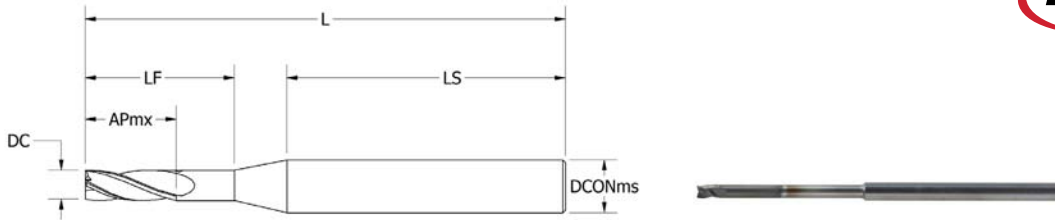

LONG REACH, STUB



DC	DCONms	APmx	LS	L	LF	CVD COATED	
						3 FLUTE	Price
0.0150	0.1250	0.0225	2.3670	2.5000	0.0780	930-003-718	\$101.94
0.0150	0.1250	0.0225	2.3200	2.5000	0.1250	930-003-724	\$101.94
0.0150	0.1250	0.0225	2.2575	2.5000	0.1875	930-003-712	\$104.70
0.0200	0.1250	0.0300	2.3475	2.5000	0.1000	930-003-719	\$101.94
0.0200	0.1250	0.0300	2.2875	2.5000	0.1600	930-003-725	\$101.94
0.0200	0.1250	0.0300	2.1975	2.5000	0.2500	930-003-713	\$104.70
0.0310	0.1250	0.0465	2.2980	2.5000	0.1550	930-003-720	\$101.94
0.0310	0.1250	0.0465	2.2030	2.5000	0.2500	930-003-726	\$101.94
0.0310	0.1250	0.0465	2.0780	2.5000	0.3750	930-003-714	\$104.70
0.0470	0.1250	0.0705	2.2110	2.5000	0.2500	930-003-721	\$101.94
0.0470	0.1250	0.0705	2.0860	2.5000	0.3750	930-003-727	\$101.94
0.0470	0.1250	0.0705	1.8910	2.5000	0.5700	930-003-715	\$104.70
0.0620	0.1250	0.0930	2.1565	2.5000	0.3120	930-003-722	\$90.85
0.0620	0.1250	0.0930	1.9685	2.5000	0.5000	930-003-728	\$90.85
0.0620	0.1250	0.0930	1.7185	2.5000	0.7500	930-003-716	\$93.59
0.0930	0.1250	0.1395	1.9840	2.5000	0.5000	930-003-723	\$90.85
0.0930	0.1250	0.1395	1.7340	2.5000	0.7500	930-003-729	\$90.85
0.0930	0.1250	0.1395	1.3590	2.5000	1.1250	930-003-717	\$93.59

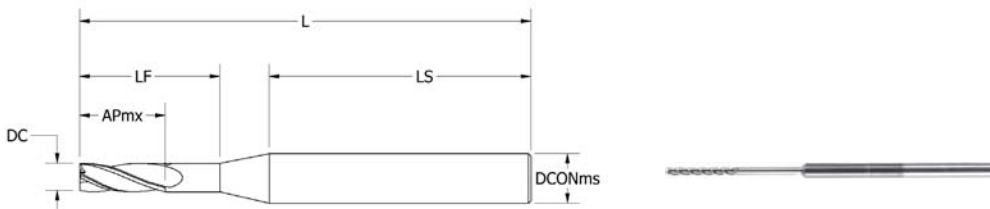

5X FLUTE, 10X REACH



DC	DCONms	APmx	LS	L	LF	CVD COATED	
						4 FLUTE	Price
0.0150	0.1250	0.0750	2.2890	2.5000	0.1560	930-001-164	\$116.77
0.0310	0.1250	0.1550	2.1410	2.5000	0.3120	930-001-165	\$116.77
0.0470	0.1250	0.2350	1.9810	2.5000	0.4800	930-001-166	\$116.77
0.0620	0.1250	0.3120	1.8435	2.5000	0.6250	930-001-167	\$104.58
0.0780	0.1250	0.3900	1.6765	2.5000	0.8000	930-001-168	\$104.58
0.0930	0.1250	0.4650	1.5340	2.5000	0.9500	930-001-169	\$104.58

CARBIDE

IMPERIAL 1/32" - 1/2"

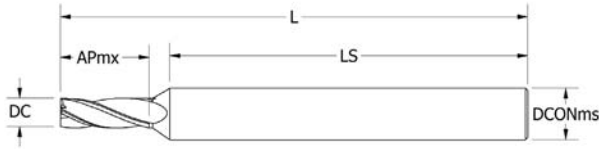

DC	DCONms	APmx	LS	L	UNCOATED			ALTIM COATED		
					2 FLUTE	4 FLUTE	Price	2 FLUTE	4 FLUTE	Price
0.0313	0.1250	0.0938	1.1651	1.5000	930-000-332	930-000-718	\$16.49			
0.0469	0.1250	0.1406	1.1584	1.5000	930-000-333	930-000-719	\$13.93			
0.0625	0.1250	0.1875	1.1517	1.5000	930-000-334	930-000-720	\$12.99			
0.0781	0.1250	0.2344	1.1450	1.5000	930-000-335	930-000-721	\$12.99			
0.0938	0.1250	0.2813	1.1384	1.5000	930-000-336	930-000-722	\$12.99			
0.1094	0.1250	0.3281	1.1317	1.5000	930-000-337	930-000-723	\$12.74			
0.1250	0.1250	0.5000	0.6250	1.5000	930-000-338	930-000-724	\$12.74	930-000-597	931-000-252	\$17.13
0.1406	0.1875	0.4219	1.4575	2.0000	930-000-339	930-000-725	\$13.95	931-000-247	930-001-096	\$18.67
0.1563	0.1875	0.4688	1.4509	2.0000	930-000-340	930-000-726	\$13.95	930-000-598	930-001-097	\$18.67
0.1719	0.1875	0.5156	1.4442	2.0000	930-000-341	930-000-727	\$13.95		930-001-098	\$18.35
0.1875	0.1875	0.6250	1.0000	2.0000	930-000-342	930-000-728	\$13.95	930-000-599	930-001-099	\$18.35
0.2031	0.2500	0.6094	1.7700	2.5000	930-000-344	930-000-730	\$15.37		930-001-100	\$19.77
0.2188	0.2500	0.6563	1.7634	2.5000	930-000-345	930-000-731	\$15.37	931-000-248	930-001-101	\$19.77
0.2344	0.2500	0.7031	1.7567	2.5000	930-000-346	930-000-732	\$15.37		930-001-102	\$19.77
0.2500	0.2500	0.7500	1.3750	2.5000	930-000-347	930-000-733	\$15.37	930-000-600	931-000-253	\$21.97
0.3125	0.3125	0.8125	1.3125	2.5000	930-000-348	930-000-734	\$21.75	931-000-249	931-000-254	\$35.74
0.3750	0.3750	1.0000	1.1250	2.5000	930-000-349	930-000-735	\$29.76	931-000-250	931-000-255	\$43.76
0.5000	0.5000	1.0000	1.6250	3.0000	930-000-352	930-000-738	\$61.74	931-000-251	930-001-104	\$77.71

IMPERIAL 1/32" - 1/4"

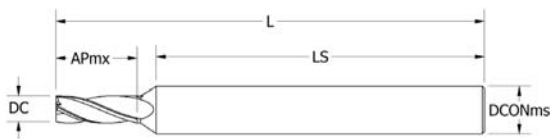

STUB



DC	DCONms	APmx	LS	L	UNCOATED		
					2 FLUTE	4 FLUTE	Price
0.0313	0.1250	0.0625	1.1963	1.5000	930-001-447	931-000-265	\$16.49
0.0469	0.1250	0.0625	1.2365	1.5000	930-001-448	931-000-266	\$13.93
0.0625	0.1250	0.1250	1.2142	1.5000	930-001-449	931-000-267	\$12.99
0.0938	0.1250	0.1875	1.2321	1.5000	930-001-450	931-000-268	\$12.99
0.1250	0.1250	0.2500	0.8750	1.5000	930-001-451	931-000-269	\$12.74
0.1563	0.1875	0.3750	1.5446	2.0000	930-001-452	931-000-270	\$13.95
0.1875	0.1875	0.3750	1.2500	2.0000	930-001-453	931-000-271	\$13.95
0.2500	0.2500	0.5000	1.1250	2.0000	930-001-455	931-000-272	\$15.37

IMPERIAL 1/32" - 1/2"

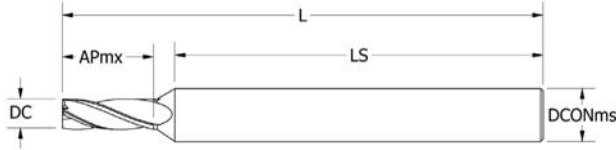

DC	DCONms	APmx	LS	L	TIALN COATED				AMORPHOUS DIAMOND		
					2 FLUTE	3 FLUTE	4 FLUTE	Price	2 FLUTE	4 FLUTE	Price
0.0313	0.1250	0.0938	1.1651	1.5000	930-000-507	931-000-120	930-000-943	\$20.78	931-000-386	931-000-412	\$27.74
0.0469	0.1250	0.1406	1.1584	1.5000	930-000-508	931-000-123	930-000-944	\$18.21	931-000-388	931-000-414	\$25.17
0.0625	0.1250	0.1875	1.1517	1.5000	930-000-509	931-000-126	930-000-945	\$16.70	931-000-390	931-000-416	\$23.67
0.0781	0.1250	0.2344	1.1450	1.5000	930-000-510	931-000-129	930-000-946	\$16.70	931-000-392	931-000-418	\$23.67
0.0938	0.1250	0.2813	1.1384	1.5000	930-000-511	931-000-132	930-000-947	\$16.70	931-000-394	931-000-420	\$23.67
0.1094	0.1250	0.4375	1.0223	1.5000					931-000-396	931-000-422	\$24.29
0.1250	0.1250	0.5000	0.6250	1.5000	930-000-512	931-000-136	930-000-948	\$17.13	931-000-398	931-000-424	\$24.29
0.1406	0.1875	0.5000	1.3794	2.0000					931-000-400	931-000-429	\$29.88
0.1563	0.1875	0.5625	1.3571	2.0000					931-000-402	931-000-431	\$29.88
0.1875	0.1875	0.6250	1.0000	2.0000					931-000-404	931-000-433	\$29.88
0.2500	0.2500	0.7500	1.3750	2.5000					931-000-406	931-000-438	\$35.02
0.3750	0.3750	1.0000	1.1250	2.5000					931-000-408	931-000-445	\$64.94
0.5000	0.5000	1.0000	1.6250	3.0000					931-000-410	931-000-449	\$103.24

IMPERIAL 1/32" - 1/8"

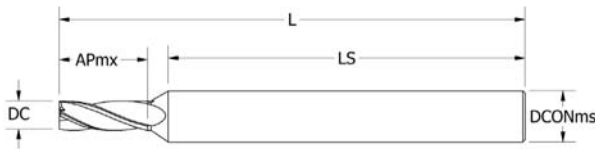

STUB



DC	DCONms	APmx	LS	L	TIALN COATED		
					2 FLUTE	4 FLUTE	Price
0.0313	0.1250	0.0625	1.1963	1.5000	930-001-559	931-000-273	\$20.78
0.0469	0.1250	0.0625	1.2365	1.5000	930-001-560	931-000-274	\$18.21
0.0625	0.1250	0.1250	1.2142	1.5000	930-001-561	931-000-275	\$16.70
0.0938	0.1250	0.1875	1.2321	1.5000	930-001-562	931-000-276	\$16.70
0.1250	0.1250	0.2500	0.8750	1.5000	930-001-563	931-000-277	\$17.13

CARBIDE

IMPERIAL 1/32" - 3/8"

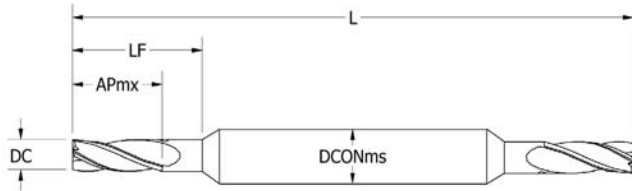

DC	DCONms	APmx	LS	L	LF	UNCOATED	
						2 FLUTE	Price
0.0313	0.1250	0.0625	0.7500	1.5000	0.0625	931-000-217	\$18.84
0.0469	0.1250	0.0625	0.7500	1.5000	0.0625	931-000-218	\$18.84
0.0625	0.1250	0.1250	0.7500	1.5000	0.1250	931-000-219	\$17.95
0.0781	0.1250	0.1250	0.7500	1.5000	0.1250	931-000-220	\$17.95
0.0938	0.1250	0.1875	0.7500	1.5000	0.1875	931-000-221	\$17.95
0.1094	0.1250	0.2500	0.7500	1.5000	0.2500	931-000-222	\$17.95
0.1250	0.1250	0.2500	0.7500	1.5000		931-000-223	\$17.95
0.1406	0.1875	0.3125	1.0000	2.0000	0.3125	931-000-224	\$24.36
0.1563	0.1875	0.3125	1.0000	2.0000	0.3125	931-000-225	\$24.36
0.1719	0.1875	0.3750	1.0000	2.0000	0.3750	931-000-226	\$24.36
0.1875	0.1875	0.3750	1.0000	2.0000		931-000-227	\$24.36
0.2188	0.2500	0.5000	1.2500	2.5000	0.5000	931-000-228	\$30.20
0.2500	0.2500	0.5000	1.2500	2.5000		931-000-229	\$30.20
0.3125	0.3125	0.5000	1.2500	2.5000		931-000-230	\$41.73
0.3750	0.3125	0.5000	1.2500	2.5000		931-000-231	\$44.62

IMPERIAL 1/32" - 3/8"



CARBIDE

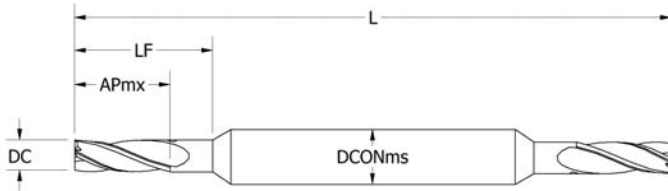

DC	DCONms	APmx	LS	L	LF	UNCOATED	
						4 FLUTE	Price
0.0313	0.1250	0.0625	0.7500	1.5000	0.0625	931-000-232	\$19.81
0.0469	0.1250	0.0625	0.7500	1.5000	0.0625	931-000-233	\$19.81
0.0625	0.1250	0.1250	0.7500	1.5000	0.1250	931-000-234	\$18.85
0.0781	0.1250	0.1250	0.7500	1.5000	0.1250	931-000-235	\$18.85
0.0938	0.1250	0.1875	0.7500	1.5000	0.1875	931-000-236	\$18.85
0.1094	0.1250	0.2500	0.7500	1.5000	0.2500	931-000-237	\$18.85
0.1250	0.1250	0.2500	0.7500	1.5000		931-000-238	\$18.85
0.1406	0.1875	0.3125	1.0000	2.0000	0.3125	931-000-239	\$25.54
0.1563	0.1875	0.3125	1.0000	2.0000	0.3125	931-000-240	\$25.54
0.1719	0.1875	0.3750	1.0000	2.0000	0.3750	931-000-241	\$25.54
0.1875	0.1875	0.3750	1.0000	2.0000		931-000-242	\$25.54
0.2188	0.2500	0.5000	1.2500	2.5000	0.5000	931-000-243	\$31.68
0.2500	0.2500	0.5000	1.2500	2.5000		931-000-244	\$31.68
0.3125	0.3125	0.5000	1.2500	2.5000		931-000-245	\$43.84
0.3750	0.3750	0.5000	1.2500	2.5000		931-000-246	\$46.83

CARBIDE



IMPERIAL 1/64" - 1/8"

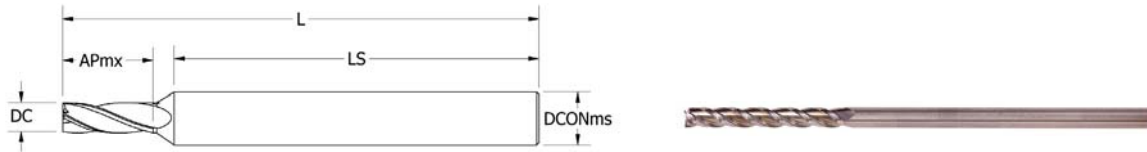

G MILLS



DC	DCONms	APmx	LS	L	UNCOATED		ALTIM COATED		AMORPHOUS DIAMOND	
					3 FLUTE	Price	3 FLUTE	Price	3 FLUTE	Price
0.0156	0.1250	0.0781	2.1405	2.5000	931-000-193	\$30.99	930-000-126	\$37.44	931-000-456	\$42.52
0.0313	0.1250	0.1563	2.1026	2.5000	931-000-195	\$24.39	930-000-127	\$30.85	931-000-462	\$35.92
0.0469	0.1250	0.2500	2.0490	2.5000	931-000-200	\$23.73	930-000-129	\$30.18	931-000-474	\$35.26
0.0625	0.1250	0.5000	1.8392	2.5000	931-000-202	\$24.29	930-000-131	\$30.74	931-000-480	\$35.82
0.0781	0.1250	0.5000	1.8794	2.5000	931-000-206	\$21.75	930-000-132	\$28.21	931-000-492	\$33.29
0.0938	0.1250	0.7500	1.6696	2.5000	931-000-209	\$24.29	930-000-133	\$30.74	931-000-498	\$35.82
0.1250	0.1250	1.0000	1.6250	3.0000	931-000-214	\$22.85	930-000-134	\$29.31	931-000-510	\$34.38

IMPERIAL 1/32" - 3/32"

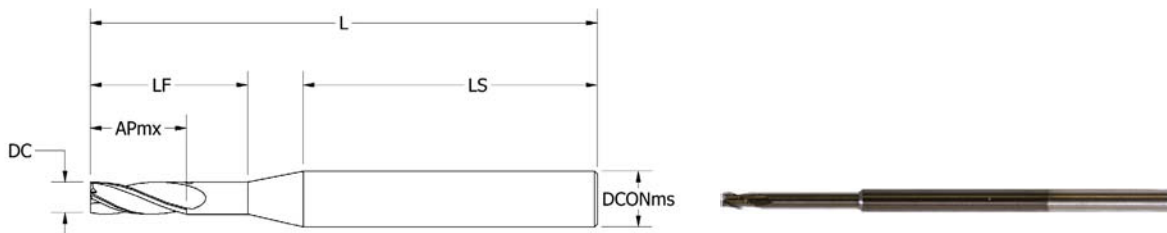

STUB



DC	DCONms	APmx	LS	L	LF	UNCOATED		AMORPHOUS DIAMOND	
						3 FLUTE	Price	3 FLUTE	Price
0.0313	0.1250	0.0625	2.2031	2.5000	0.2500	931-000-198	\$29.18	931-000-464	\$41.55
0.0313	0.1250	0.0625	2.0781	2.5000	0.3750			931-000-472	\$55.79
0.0313	0.1250	0.0625	1.9531	2.5000	0.5000			931-000-468	\$59.77
0.0625	0.1250	0.1250	1.9688	2.5000	0.5000	931-000-204	\$29.18	931-000-482	\$41.74
0.0625	0.1250	0.1250	1.7188	2.5000	0.7500			931-000-490	\$42.74
0.0625	0.1250	0.1250	1.4688	2.5000	1.0000			931-000-486	\$46.80
0.0938	0.1250	0.1875	1.7344	2.5000	0.7500	931-000-212	\$29.18	931-000-500	\$41.74
0.0938	0.1250	0.1875	1.4844	2.5000	1.0000			931-000-508	\$55.79
0.0938	0.1250	0.1875	1.2344	2.5000	1.2500			931-000-504	\$42.74

IMPERIAL 1/64" - 1/4"



CARBIDE

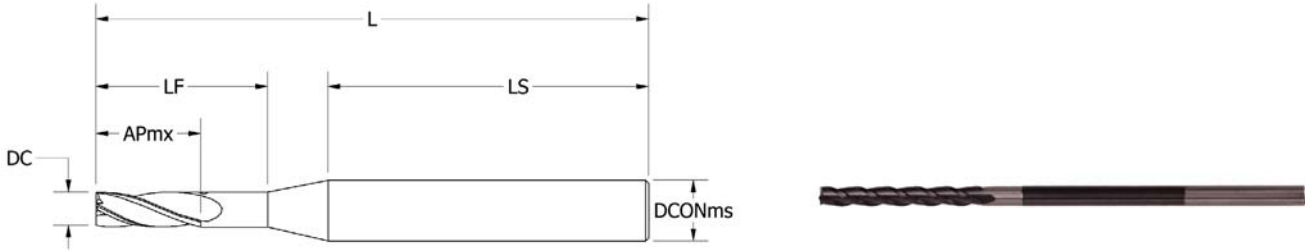

LONG FLUTE



DC	DCONms	APmx	LS	L	LF	AMORPHOUS DIAMOND	
						3 FLUTE	Price
0.0156	0.1250	0.0781	2.2953	2.5000	0.1500	931-000-460	\$59.21
0.0156	0.1250	0.0781	2.1953	2.5000	0.2500	931-000-458	\$66.89
0.0313	0.1250	0.1563	2.2031	2.5000	0.2500	931-000-470	\$47.75
0.0313	0.1250	0.1563	2.0781	2.5000	0.3750	931-000-466	\$59.77
0.0469	0.1250	0.2500	2.0859	2.5000	0.3750	931-000-478	\$47.75
0.0469	0.1250	0.2500	1.9609	2.5000	0.5000	931-000-476	\$59.77
0.0625	0.1250	0.5000	1.7188	2.5000	0.7500	931-000-488	\$47.75
0.0625	0.1250	0.5000	1.4688	2.5000	1.0000	931-000-484	\$59.77
0.0781	0.1250	0.5000	1.7266	2.5000	0.7500	931-000-496	\$47.75
0.0781	0.1250	0.5000	1.4766	2.5000	1.0000	931-000-494	\$59.77
0.0938	0.1250	0.7500	1.4844	2.5000	1.0000	931-000-506	\$47.75
0.0938	0.1250	0.7500	1.2344	2.5000	1.2500	931-000-502	\$59.77
0.1250	0.1250	1.0000	1.7500	3.0000	1.2500	931-000-514	\$47.75
0.1250	0.1250	1.0000	1.5000	3.0000	1.5000	931-000-512	\$59.77



DC	DCONms	APmx	LS	L	LF	4 FLUTE	Price
0.1875	0.1875	1.1250	1.5000	3.0000	1.5000	931-000-520	\$56.00
0.1875	0.1875	1.1250	1.2500	3.0000	1.7500	931-000-518	\$63.58
0.2500	0.2500	1.5000	2.0000	4.0000	2.0000	931-000-526	\$69.40
0.2500	0.2500	1.5000	1.5000	4.0000	2.5000	931-000-524	\$78.32

CARBIDE



IMPERIAL 1/32" - 1/4"

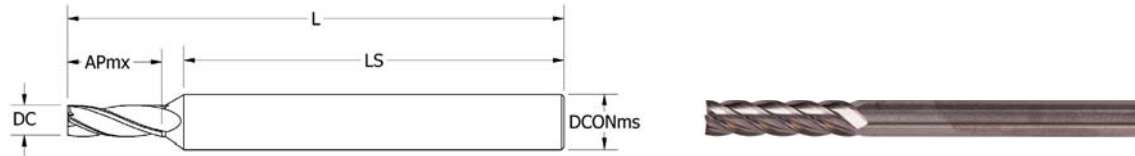

MULTI - FLUTE



DC	DCONms	APmx	LS	L	UNCOATED		ALTIM COATED	
					5 FLUTE	Price	5 FLUTE	Price
0.0313	0.1250	0.0938	1.1651	1.5000	930-003-859	\$25.60		
0.0469	0.1250	0.1406	1.1584	1.5000	930-003-860	\$25.60		
0.0625	0.1250	0.1875	1.1517	1.5000	930-003-861	\$23.77		
0.0781	0.1250	0.1875	1.1919	1.5000	930-003-862	\$23.77		
0.0938	0.1250	0.3750	1.0446	1.5000	930-003-863	\$23.77		
0.1250	0.1250	0.5000	0.6250	1.5000	930-003-864	\$22.85	931-000-383	\$28.31
0.1875	0.1875	0.6250	1.0000	2.0000	930-003-865	\$26.92	931-000-384	\$32.36
0.2500	0.2500	0.7500	1.3750	2.5000	930-003-866	\$35.92	931-000-385	\$41.36

IMPERIAL 1/32" - 1/4"

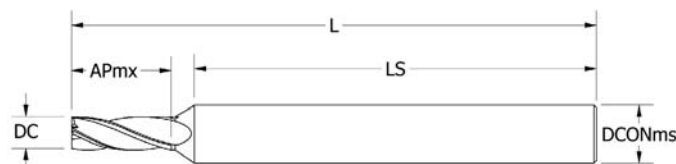

STUB, REACHED



DC	DCONms	APmx	LS	L	LF	UNCOATED		TICN COATED	
						3 FLUTE	Price	3 FLUTE	Price
0.0313	0.2500	0.0625	2.2356	2.5000	0.1550	930-002-640	\$32.76	931-000-295	\$38.79
0.0469	0.2500	0.0938	2.1684	2.5000	0.2300	930-002-642	\$32.76	931-000-297	\$38.79
0.0625	0.2500	0.1250	2.0943	2.5000	0.3120	930-002-644	\$29.23	931-000-299	\$35.27
0.0781	0.2500	0.1563	2.0241	2.5000	0.3900	930-002-646	\$29.23	931-000-301	\$35.27
0.0938	0.2500	0.1875	1.9569	2.5000	0.4650	930-002-648	\$29.23	931-000-303	\$35.27
0.1094	0.2500	0.2188	1.8847	2.5000	0.5450	930-002-650	\$25.44	931-000-305	\$32.88
0.1250	0.2500	0.2500	1.8125	2.5000	0.6250	930-002-652	\$25.44	931-000-307	\$32.88
0.1563	0.2500	0.3750	1.6731	2.5000	0.7800	930-002-654	\$28.90	931-000-309	\$34.94
0.1875	0.2500	0.3750	1.5313	2.5000	0.9375	930-002-656	\$28.90	931-000-311	\$34.94
0.2188	0.2500	0.3750	1.3914	2.5000	1.0930	930-002-658	\$29.58	931-000-313	\$35.62
0.2500	0.2500	0.5000	1.2500	2.5000	1.2500	930-002-660	\$29.58	931-000-315	\$35.62

IMPERIAL 1/32"- 3/8"



CARBIDE

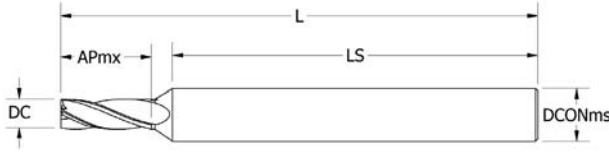

45 DEG. HELIX



DC	DCONms	APmx	LS	L	UNCOATED	
					2 FLUTE	Price
0.0313	0.1250	0.0938	1.1651	1.5000	930-000-612	\$19.48
0.0469	0.1250	0.1406	1.1584	1.5000	930-000-613	\$19.48
0.0625	0.1250	0.1875	1.1517	1.5000	930-000-614	\$16.15
0.0781	0.1250	0.1875	1.1919	1.5000	930-000-615	\$16.29
0.0938	0.1250	0.3750	1.0446	1.5000	930-000-616	\$16.29
0.1250	0.1250	0.3750	0.7500	1.5000	930-000-617	\$16.15
0.1875	0.1875	0.6250	1.0000	2.0000	930-000-618	\$18.23
0.2500	0.2500	0.7500	1.3750	2.5000	930-000-619	\$22.75

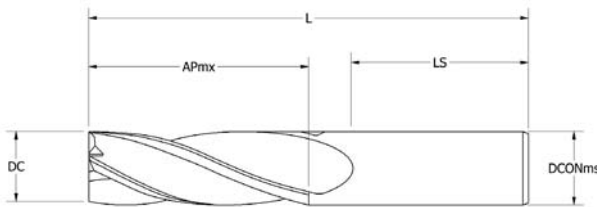

60 DEG. HELIX IMPERIAL 1/8"- 3/8"



DC	DCONms	APmx	LS	L	UNCOATED		ALTIM COATED	
					3 FLUTE	Price	3 FLUTE	Price
0.1250	0.1250	0.5000	0.6250	1.5000	931-000-011	\$22.49	931-000-016	\$28.08
0.1875	0.1875	0.6250	1.0000	2.0000	931-000-012	\$26.92	931-000-017	\$33.62
0.2500	0.2500	0.7500	1.3750	2.5000	931-000-013	\$28.85	931-000-018	\$36.06
0.3125	0.3125	0.8125	1.3125	2.5000	931-000-014	\$34.90	931-000-019	\$43.59
0.3750	0.3750	0.8750	1.2500	2.5000	931-000-015	\$46.69	931-000-020	\$58.38

CARBIDE



METRIC .5 mm - 12 mm

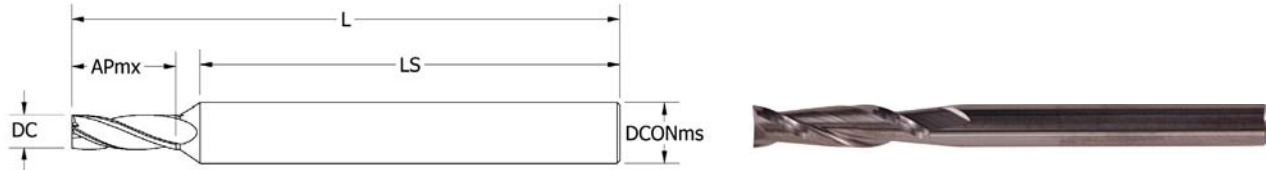

DC	DCONms	APmx	LS	L	UNCOATED		
					2 FLUTE	4 FLUTE	Price
0.50	3.00	1.50	30.07	38.00	930-000-001	930-000-033	\$14.96
1.00	3.00	3.00	29.86	38.00	930-000-002	930-000-034	\$13.57
1.50	3.00	4.50	29.64	38.00	930-000-003	930-000-035	\$12.85
3.00	3.00	6.00	29.43	38.00	930-000-004	930-000-036	\$11.91
2.50	3.00	8.00	28.71	38.00	930-000-005	930-000-037	\$11.91
3.00	3.00	10.00	18.00	38.00	930-000-006	930-000-038	\$11.91
3.50	4.00	12.00	36.71	50.00	930-000-007	930-000-039	\$15.56
4.00	4.00	12.00	28.00	50.00	930-000-008	930-000-040	\$15.56
4.50	5.00	14.00	34.71	50.00	930-000-009	930-000-041	\$19.67
5.00	5.00	15.00	25.00	50.00	930-000-010	930-000-042	\$19.67
6.00	6.00	18.00	35.00	63.00	930-000-011	930-000-043	\$19.67
7.00	8.00	20.00	40.43	63.00	930-000-012	930-000-044	\$20.88
8.00	8.00	20.00	33.00	63.00	930-000-013	930-000-045	\$20.88
9.00	10.00	22.00	38.43	63.00	930-000-014	930-000-046	\$34.56
10.00	10.00	22.00	31.00	63.00	930-000-015	930-000-047	\$34.56
12.00	12.00	25.00	40.00	75.00	930-000-016	930-000-048	\$49.96

METRIC .4 mm - 12 mm

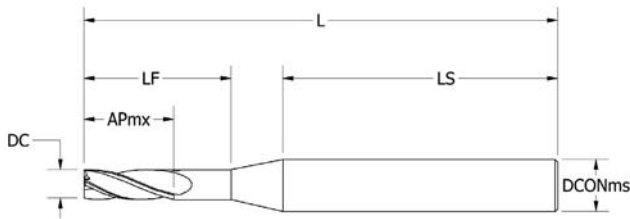

STUB, 8X REACH LENGTH



DC	DCONms	APmx	LS	L	LF	AMORPHOUS DIAMOND	
						3 FLUTE	Price
0.40	3.00	0.60	70.50	75.00	3.20	930-000-095	\$56.66
0.50	3.00	0.75	69.75	75.00	4.00	930-000-096	\$56.66
0.60	3.00	0.90	69.00	75.00	4.80	930-000-097	\$56.66
0.80	3.00	1.20	67.50	75.00	6.40	930-000-098	\$45.20
1.00	3.00	1.50	66.00	75.00	8.00	930-000-099	\$45.20
1.50	3.00	2.25	62.25	75.00	12.00	930-000-100	\$45.20
2.00	3.00	3.00	58.50	75.00	16.00	930-000-101	\$45.20
2.50	3.00	3.75	54.75	75.00	20.00	930-000-102	\$45.20
3.00	3.00	4.50	51.00	75.00	24.00	930-000-103	\$45.20
4.00	4.00	6.00	43.00	75.00	32.00	930-000-104	\$49.02
6.00	6.00	9.00	52.00	100.00	48.00	930-000-105	\$66.24
8.00	8.00	12.00	36.00	100.00	64.00	930-000-106	\$95.54
10.00	10.00	15.00	40.00	120.00	80.00	930-000-107	\$139.13
12.00	12.00	18.00	54.00	150.00	96.00	930-000-108	\$165.61

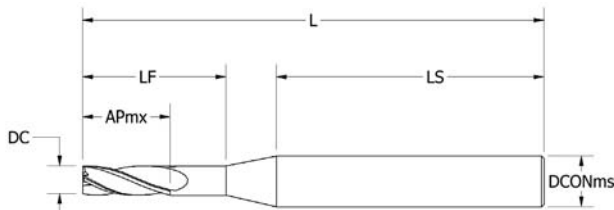

5X FLUTE LENGTH, 10X REACH LENGTH



DC	DCONms	APmx	LS	L	LF	AMORPHOUS DIAMOND	
						3 FLUTE	Price
0.40	3.00	2.00	69.70	75.00	4.00	930-000-065	\$49.02
0.50	3.00	2.50	68.75	75.00	5.00	930-000-066	\$49.02
0.60	3.00	3.00	67.80	75.00	6.00	930-000-067	\$49.02
0.80	3.00	4.00	65.90	75.00	8.00	930-000-068	\$39.16
1.00	3.00	5.00	64.00	75.00	10.00	930-000-069	\$39.16
1.20	3.00	6.00	62.10	75.00	12.00	930-000-070	\$39.16
1.50	3.00	7.50	59.25	75.00	15.00	930-000-071	\$39.16
2.00	3.00	10.00	54.50	75.00	20.00	930-000-072	\$39.16
2.50	3.00	12.50	49.75	75.00	25.00	930-000-073	\$39.16
3.00	3.00	15.00	45.00	75.00	30.00	930-000-074	\$39.16
4.00	4.00	20.00	35.00	75.00	40.00	930-000-075	\$42.65
6.00	6.00	30.00	40.00	100.00	60.00	930-000-076	\$57.60
8.00	8.00	40.00	30.00	100.00	70.00	930-000-077	\$82.81
10.00	10.00	50.00	40.00	120.00	80.00	930-000-078	\$125.45
12.00	12.00	60.00	65.00	150.00	85.00	930-000-079	\$152.87

CARBIDE

METRIC .020" - .100"

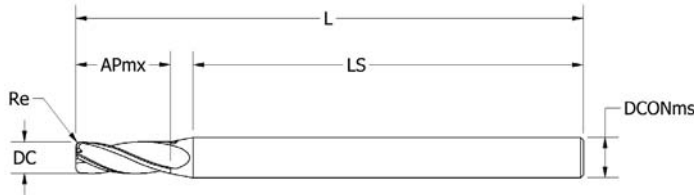

DC	DCONms	Re	APmx	LS	L	UNCOATED		ALTiN COATED		AMORPHOUS DIAMOND	
						4 FLUTE	Price	4 FLUTE	Price	4 FLUTE	Price
0.0200	0.1250	0.0050	0.0600	1.1699	1.5000	930-001-003	\$37.67	930-001-125	\$42.94	930-000-858	\$49.22
0.0250	0.1250	0.0050	0.0750	1.1678	1.5000	930-001-004	\$34.28	930-001-126	\$39.37	930-000-859	\$45.81
0.0300	0.1250	0.0050	0.0900	1.1656	1.5000	930-001-005	\$31.97	930-001-127	\$36.94	930-000-860	\$43.50
0.0300	0.1250	0.0100	0.0900	1.1656	1.5000	930-000-963	\$31.97			930-000-819	\$43.50
0.0310	0.1250	0.0050	0.0930	1.1652	1.5000	930-001-006	\$31.97	930-001-128	\$36.94	930-000-861	\$43.50
0.0310	0.1250	0.0100	0.0930	1.1652	1.5000	930-000-964	\$31.97			930-000-820	\$43.50
0.0350	0.1250	0.0050	0.1050	1.1635	1.5000	930-001-007	\$26.81	930-001-129	\$31.53	930-000-862	\$38.34
0.0350	0.1250	0.0100	0.1050	1.1635	1.5000	930-000-965	\$26.81			930-000-821	\$38.34
0.0400	0.1250	0.0050	0.1200	1.1614	1.5000	930-001-008	\$20.33	930-001-130	\$24.72	930-000-863	\$31.86
0.0400	0.1250	0.0100	0.1200	1.1614	1.5000	930-000-966	\$20.33	930-001-108	\$24.72	930-000-822	\$31.86
0.0450	0.1250	0.0050	0.1350	1.1592	1.5000	930-001-009	\$20.33	930-001-131	\$24.72	930-000-864	\$31.86
0.0450	0.1250	0.0100	0.1350	1.1592	1.5000	930-000-967	\$20.33	930-001-109	\$24.72	930-000-823	\$31.86
0.0450	0.1250	0.0150	0.1350	1.1592	1.5000	930-000-983	\$20.33			930-000-839	\$31.86
0.0470	0.1250	0.0050	0.1410	1.1584	1.5000	930-001-010	\$20.33	930-001-132	\$24.72	930-000-865	\$31.86
0.0470	0.1250	0.0100	0.1410	1.1584	1.5000	930-000-968	\$20.33	930-001-110	\$24.72	930-000-824	\$31.86
0.0470	0.1250	0.0150	0.1410	1.1584	1.5000	930-000-984	\$20.33	930-001-117	\$24.72	930-000-840	\$31.86
0.0500	0.1250	0.0050	0.1500	1.1571	1.5000	930-001-011	\$20.33	930-001-133	\$24.72	930-000-866	\$31.86
0.0500	0.1250	0.0100	0.1500	1.1571	1.5000	930-000-969	\$20.33	930-001-111	\$24.72	930-000-825	\$31.86
0.0500	0.1250	0.0150	0.1500	1.1571	1.5000	930-000-985	\$20.33	930-001-118	\$24.72	930-000-841	\$31.86
0.0550	0.1250	0.0050	0.1650	1.1549	1.5000	930-001-012	\$20.33	930-001-134	\$24.72	930-000-867	\$31.86
0.0550	0.1250	0.0100	0.1650	1.1549	1.5000	930-000-970	\$20.33			930-000-826	\$31.86
0.0550	0.1250	0.0150	0.1650	1.1549	1.5000	930-000-986	\$20.33			930-000-842	\$31.86
0.0600	0.1250	0.0050	0.1800	1.1528	1.5000	930-001-013	\$20.33	930-001-135	\$24.72	930-000-868	\$31.86
0.0600	0.1250	0.0100	0.1800	1.1528	1.5000	930-000-971	\$20.33	930-001-112	\$24.72	930-000-827	\$31.86
0.0600	0.1250	0.0150	0.1800	1.1528	1.5000	930-000-987	\$20.33	930-001-119	\$24.72	930-000-843	\$31.86
0.0620	0.1250	0.0050	0.1860	1.1519	1.5000	930-001-014	\$20.33			930-000-869	\$31.86
0.0620	0.1250	0.0100	0.1860	1.1519	1.5000	930-000-972	\$20.33			930-000-828	\$31.86
0.0620	0.1250	0.0150	0.1860	1.1519	1.5000	930-000-988	\$20.33			930-000-844	\$31.86
0.0620	0.1250	0.0200	0.1860	1.1519	1.5000	930-000-999	\$20.33			930-000-855	\$31.86
0.0650	0.1250	0.0050	0.1950	1.1507	1.5000	930-001-015	\$20.33			930-000-870	\$31.86
0.0650	0.1250	0.0100	0.1950	1.1507	1.5000	930-000-973	\$20.33			930-000-829	\$31.86
0.0650	0.1250	0.0150	0.1950	1.1507	1.5000	930-000-989	\$20.33			930-000-845	\$31.86

METRIC .020" - .100"



CARBIDE

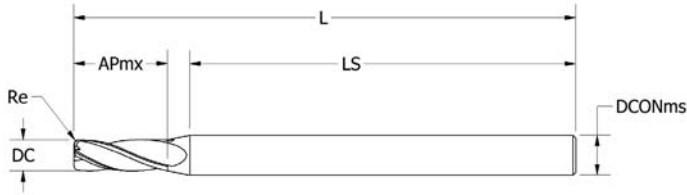

DC	DCONms	Re	APmx	LS	L	UNCOATED		ALTiN COATED		AMORPHOUS DIAMOND	
						4 FLUTE	Price	4 FLUTE	Price	4 FLUTE	Price
0.0700	0.1250	0.0050	0.2100	1.1485	1.5000	930-001-016	\$20.33	930-001-136	\$24.72	930-000-871	\$31.86
0.0700	0.1250	0.0100	0.2100	1.1485	1.5000	930-000-974	\$20.33	930-001-113	\$24.72	930-000-830	\$31.86
0.0700	0.1250	0.0150	0.2100	1.1485	1.5000	930-000-990	\$20.33	930-001-121	\$24.72	930-000-846	\$31.86
0.0750	0.1250	0.0050	0.2250	1.1464	1.5000	930-001-017	\$20.33			930-000-872	\$31.86
0.0750	0.1250	0.0100	0.2250	1.1464	1.5000	930-000-975	\$20.33			930-000-831	\$31.86
0.0750	0.1250	0.0150	0.2250	1.1464	1.5000	930-000-991	\$20.33			930-000-847	\$31.86
0.0780	0.1250	0.0050	0.2340	1.1451	1.5000	930-001-018	\$20.33			930-000-873	\$31.86
0.0780	0.1250	0.0100	0.2340	1.1451	1.5000	930-000-976	\$20.33			930-000-832	\$31.86
0.0780	0.1250	0.0150	0.2340	1.1451	1.5000	930-000-992	\$20.33			930-000-848	\$31.86
0.0780	0.1250	0.0200	0.2340	1.1451	1.5000	930-001-001	\$20.33			930-000-856	\$31.86
0.0800	0.1250	0.0050	0.2400	1.1442	1.5000	930-001-019	\$20.33	930-001-137	\$24.72	930-000-874	\$31.86
0.0800	0.1250	0.0100	0.2400	1.1442	1.5000	930-000-977	\$20.33	930-001-114	\$24.72	930-000-833	\$31.86
0.0800	0.1250	0.0150	0.2400	1.1442	1.5000	930-000-993	\$20.33	930-001-122	\$24.72	930-000-849	\$31.86
0.0850	0.1250	0.0050	0.2550	1.1421	1.5000	930-001-020	\$20.33			930-000-875	\$31.86
0.0850	0.1250	0.0100	0.2550	1.1421	1.5000	930-000-978	\$20.33			930-000-834	\$31.86
0.0850	0.1250	0.0150	0.2550	1.1421	1.5000	930-000-994	\$20.33			930-000-850	\$31.86
0.0900	0.1250	0.0050	0.2700	1.1400	1.5000	930-001-021	\$20.33	930-001-138	\$24.72	930-000-876	\$31.86
0.0900	0.1250	0.0100	0.2700	1.1400	1.5000	930-000-979	\$20.33	930-001-115	\$24.72	930-000-835	\$31.86
0.0900	0.1250	0.0150	0.2700	1.1400	1.5000	930-000-995	\$20.33	930-001-123	\$24.72	930-000-851	\$31.86
0.0930	0.1250	0.0050	0.2790	1.1387	1.5000	930-001-022	\$20.33			930-000-877	\$31.86
0.0930	0.1250	0.0100	0.2790	1.1387	1.5000	930-000-980	\$20.33			930-000-836	\$31.86
0.0930	0.1250	0.0150	0.2790	1.1387	1.5000	930-000-996	\$20.33			930-000-852	\$31.86
0.0930	0.1250	0.0200	0.2790	1.1387	1.5000	930-001-002	\$20.33			930-000-857	\$31.86
0.0950	0.1250	0.0050	0.2850	1.1378	1.5000	930-001-023	\$20.33			930-000-878	\$31.86
0.0950	0.1250	0.0100	0.2850	1.1378	1.5000	930-000-981	\$20.33			930-000-837	\$31.86
0.0950	0.1250	0.0150	0.2850	1.1378	1.5000	930-000-997	\$20.33			930-000-853	\$31.86
0.1000	0.1250	0.0050	0.3000	1.1357	1.5000	930-001-024	\$20.33	930-001-139	\$24.72	930-000-879	\$20.33
0.1000	0.1250	0.0100	0.3000	1.1357	1.5000	930-000-982	\$20.33	930-001-116	\$24.72	930-000-838	\$20.33
0.1000	0.1250	0.0150	0.3000	1.1357	1.5000	930-000-998	\$20.33	930-001-124	\$24.72	930-000-854	\$20.33

CARBIDE

IMPERIAL 1/32" - 3/8"

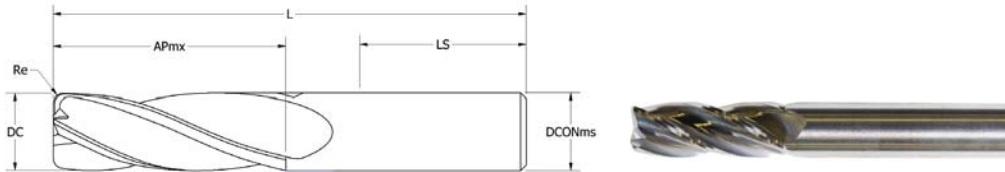

DC	DCONms	Re	APmx	LS	L	UNCOATED			ALTIM COATED		AMORPHOUS DIAMOND	
						2 FLUTE	4 FLUTE	Price	4 FLUTE	Price	4 FLUTE	Price
0.1250	0.1250	0.0100	0.5000	0.6250	1.5000	931-000-098	931-000-147	\$20.33	931-000-150	\$24.73	931-000-426	\$30.20
0.1250	0.1250	0.0150	0.5000	0.6250	1.5000	931-000-099	931-000-148	\$20.33	931-000-151	\$24.73	931-000-427	\$30.20
0.1250	0.1250	0.0200	0.5000	0.6250	1.5000	931-000-100	931-000-149	\$20.33	931-000-152	\$24.73	931-000-428	\$30.20
0.1875	0.1875	0.0100	0.6250	1.0000	2.0000	931-000-101	931-000-153	\$22.75	931-000-156	\$27.15	931-000-435	\$38.68
0.1875	0.1875	0.0150	0.6250	1.0000	2.0000	931-000-102	931-000-154	\$22.75	931-000-157	\$29.52	931-000-436	\$38.68
0.1875	0.1875	0.0300	0.6250	1.0000	2.0000	931-000-103	931-000-155	\$22.75	931-000-158	\$29.36	931-000-437	\$38.68
0.2500	0.2500	0.0150	0.7500	1.3750	2.5000	931-000-104	931-000-159	\$27.68	931-000-164	\$35.41	931-000-440	\$45.82
0.2500	0.2500	0.0200	0.7500	1.3750	2.5000	931-000-105	931-000-160	\$27.68	931-000-165	\$36.48	931-000-441	\$45.82
0.2500	0.2500	0.0300	0.7500	1.3750	2.5000	931-000-106	931-000-161	\$27.68	931-000-166	\$36.48	931-000-442	\$45.82
0.2500	0.2500	0.0450	0.7500	1.3750	2.5000	931-000-107	931-000-162	\$27.68	931-000-167	\$36.48	931-000-443	\$45.82
0.2500	0.2500	0.0600	0.7500	1.3750	2.5000	931-000-108	931-000-163	\$27.68	931-000-168	\$36.48	931-000-444	\$45.82
0.3125	0.3125	0.0150	0.8125	1.3125	2.5000	931-000-109	931-000-169	\$34.94				
0.3125	0.3125	0.0200	0.8125	1.3125	2.5000	931-000-110	931-000-170	\$34.94				
0.3125	0.3125	0.0300	0.8125	1.3125	2.5000	931-000-111	931-000-171	\$34.94	931-000-174	\$43.73		
0.3125	0.3125	0.0450	0.8125	1.3125	2.5000	931-000-112	931-000-172	\$34.94	931-000-175	\$43.73		
0.3125	0.3125	0.0600	0.8125	1.3125	2.5000	931-000-113	931-000-173	\$34.94	931-000-176	\$43.73		
0.3750	0.3750	0.0150	1.0000	1.1250	2.5000	931-000-114	931-000-177	\$42.18				
0.3750	0.3750	0.0300	1.0000	1.1250	2.5000	931-000-115	931-000-178	\$42.18	931-000-181	\$50.98	931-000-447	\$62.87
0.3750	0.3750	0.0450	1.0000	1.1250	2.5000	931-000-116	931-000-179	\$42.18	931-000-182	\$50.98		
0.3750	0.3750	0.0600	1.0000	1.1250	2.5000	931-000-117	931-000-180	\$42.18	931-000-183	\$50.98	931-000-448	\$62.87

METRIC .020" - .093"



CARBIDE

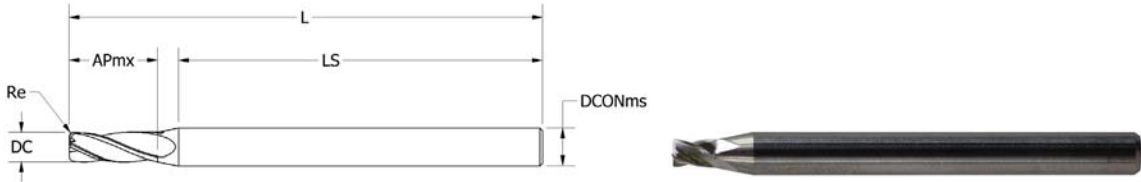

DC	DCONms	Re	APmx	LS	L	UNCOATED		ALTiN COATED		AMORPHOUS DIAMOND	
						4 FLUTE	Price	4 FLUTE	Price	4 FLUTE	Price
0.0200	0.1250	0.0050	0.0300	1.1999	1.5000	930-001-802	\$37.67	930-001-788	\$42.07	930-001-743	\$49.22
0.0250	0.1250	0.0050	0.0375	1.2053	1.5000	930-001-803	\$34.28	930-001-789	\$38.68	930-001-744	\$45.82
0.0310	0.1250	0.0050	0.0465	1.2117	1.5000	930-001-804	\$31.97	930-001-790	\$36.36	930-001-745	\$43.50
0.0470	0.1250	0.0050	0.0705	1.2289	1.5000	930-001-805	\$20.33	930-001-791	\$24.72	930-001-746	\$30.20
0.0470	0.1250	0.0100	0.0705	1.2289	1.5000	930-001-795	\$20.33	930-001-781	\$24.72	930-001-736	\$30.20
0.0620	0.1250	0.0050	0.0930	1.2449	1.5000	930-001-806	\$20.33	930-001-792	\$24.72	930-001-747	\$30.20
0.0620	0.1250	0.0100	0.0930	1.2449	1.5000	930-001-796	\$20.33	930-001-782	\$24.72	930-001-737	\$30.20
0.0620	0.1250	0.0150	0.0930	1.2449	1.5000	930-001-799	\$20.33	930-001-785	\$24.72	930-001-740	\$30.20
0.0780	0.1250	0.0050	0.1170	1.2621	1.5000	930-001-807	\$20.33	930-001-793	\$24.72	930-001-748	\$30.20
0.0780	0.1250	0.0100	0.1170	1.2621	1.5000	930-001-797	\$20.33	930-001-783	\$24.72	930-001-738	\$30.20
0.0780	0.1250	0.0150	0.1170	1.2621	1.5000	930-001-800	\$20.33	930-001-786	\$24.72	930-001-741	\$30.20
0.0930	0.1250	0.0050	0.1395	1.2782	1.5000	930-001-808	\$20.33	930-001-794	\$24.72	930-001-749	\$30.20
0.0930	0.1250	0.0100	0.1395	1.2782	1.5000	930-001-798	\$20.33	930-001-784	\$24.72	930-001-739	\$30.20
0.0930	0.1250	0.0150	0.1395	1.2782	1.5000	930-001-801	\$20.33	930-001-787	\$24.72	930-001-742	\$30.20

CARBIDE

METRIC .015" - .093"

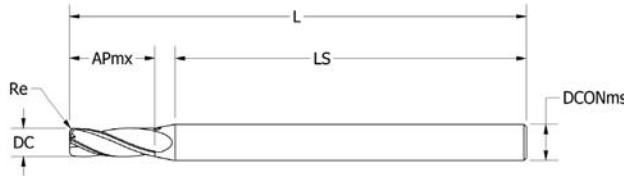

HARD MILL



DC	DCONms	Re	APmx	LS	L	HARD MILL COATED	
						4 FLUTE	Price
0.0150	0.1250	0.0020	0.0225	1.1945	1.5000	930-001-809	\$61.74
0.0310	0.1250	0.0030	0.0465	1.2117	1.5000	930-001-810	\$54.60
0.0470	0.1250	0.0050	0.0705	1.2289	1.5000	930-001-811	\$54.60
0.0620	0.1250	0.0060	0.0930	1.2449	1.5000	930-001-812	\$54.60
0.0780	0.1250	0.0080	0.1170	1.2621	1.5000	930-001-813	\$54.60
0.0930	0.1250	0.0090	0.1395	1.2782	1.5000	930-001-814	\$54.60

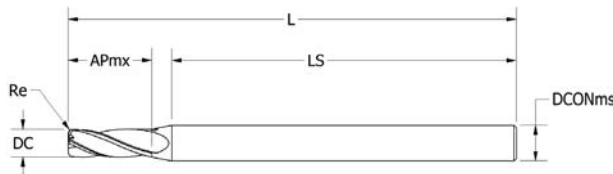

HARD MILL, STUB



DC	DCONms	Re	APmx	LS	L	HARD MILL COATED	
						4 FLUTE	Price
0.0313	0.1250	0.0030	0.0625	1.1963	1.5000	931-000-278	\$53.24
0.0469	0.1250	0.0050	0.0625	1.2365	1.5000	931-000-279	\$53.24
0.0625	0.1250	0.0060	0.1250	1.2142	1.5000	931-000-280	\$53.24
0.0781	0.1250	0.0080	0.1250	1.2544	1.5000	931-000-281	\$53.24
0.0938	0.1250	0.0090	0.1875	1.2321	1.5000	931-000-282	\$53.24
0.1250	0.1250	0.0130	0.2500	0.8750	1.5000	931-000-283	\$61.69
0.1875	0.1875	0.0190	0.3750	1.2500	2.0000	931-000-284	\$61.69
0.2500	0.2500	0.0250	0.5000	1.6250	2.5000	931-000-285	\$61.69

METRIC .005" - .044"



CARBIDE

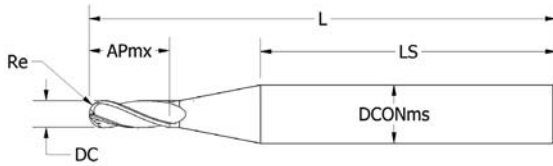

DC	DCONms	Re	APmx	LS	L	UNCOATED			ALTIM COATED	
						2 FLUTE	4 FLUTE	Price	2 FLUTE	Price
0.0050	0.1250	0.0025	0.0150	1.1342	1.5000	930-001-965		\$39.66	930-002-249	\$43.94
0.0060	0.1250	0.0030	0.0180	1.1342	1.5000	930-001-967		\$39.66	930-002-250	\$43.94
0.0070	0.1250	0.0035	0.0210	1.1342	1.5000	930-001-968		\$39.66	930-002-251	\$43.94
0.0080	0.1250	0.0040	0.0240	1.1342	1.5000	930-001-969		\$39.66	930-002-252	\$43.94
0.0090	0.1250	0.0045	0.0270	1.1342	1.5000	930-001-970		\$39.66	930-002-253	\$43.94
0.0100	0.1250	0.0050	0.0300	1.1742	1.5000	930-001-971	930-002-341	\$32.52	930-002-254	\$36.91
0.0110	0.1250	0.0055	0.0330	1.1738	1.5000	930-001-973	930-002-343	\$32.52	930-002-255	\$36.91
0.0120	0.1250	0.0060	0.0360	1.1733	1.5000	930-001-974	930-002-344	\$32.52	930-002-256	\$36.91
0.0130	0.1250	0.0065	0.0390	1.1729	1.5000	930-001-975	930-002-345	\$32.52	930-002-257	\$36.91
0.0140	0.1250	0.0070	0.0420	1.1725	1.5000	930-001-976	930-002-346	\$32.52	930-002-258	\$36.91
0.0150	0.1250	0.0075	0.0450	1.1720	1.5000	930-001-977	930-002-347	\$26.04	930-002-259	\$30.43
0.0156	0.1250	0.0078	0.0468	1.1718	1.5000	930-002-084	930-002-453	\$26.04		
0.0160	0.1250	0.0080	0.0480	1.1716	1.5000	930-001-979	930-002-349	\$26.04	930-002-260	\$30.43
0.0170	0.1250	0.0085	0.0510	1.1712	1.5000	930-001-980	930-002-350	\$26.04	930-002-261	\$30.43
0.0180	0.1250	0.0090	0.0540	1.1708	1.5000	930-001-981	930-002-351	\$26.04	930-002-262	\$30.43
0.0190	0.1250	0.0095	0.0570	1.1703	1.5000	930-001-982	930-002-352	\$26.04	930-002-263	\$30.43
0.0197	0.1250	0.0099	0.0591	1.1700	1.5000	930-002-065	930-002-434	\$25.05		
0.0200	0.1250	0.0100	0.0600	1.1699	1.5000	930-001-983	930-002-353	\$25.05	930-002-264	\$29.45
0.0210	0.1250	0.0105	0.0630	1.1695	1.5000	930-001-985	930-002-355	\$25.05	930-002-265	\$29.45
0.0220	0.1250	0.0110	0.0660	1.1691	1.5000	930-001-986	930-002-356	\$25.05	930-002-266	\$29.45
0.0230	0.1250	0.0115	0.0690	1.1686	1.5000	930-001-987	930-002-357	\$25.05	930-002-267	\$29.45
0.0240	0.1250	0.0120	0.0720	1.1682	1.5000	930-001-988	930-002-358	\$25.05	930-002-268	\$29.45
0.0250	0.1250	0.0125	0.0750	1.1678	1.5000	930-001-989	930-002-359	\$22.75	930-002-269	\$27.12
0.0260	0.1250	0.0130	0.0780	1.1673	1.5000	930-001-991	930-002-361	\$22.75	930-002-270	\$27.12
0.0270	0.1250	0.0135	0.0810	1.1669	1.5000	930-001-992	930-002-362	\$22.75	930-002-271	\$27.12
0.0280	0.1250	0.0140	0.0840	1.1665	1.5000	930-001-993	930-002-363	\$22.75	930-002-272	\$27.12
0.0290	0.1250	0.0145	0.0870	1.1661	1.5000	930-001-994	930-002-364	\$22.75	930-002-273	\$27.12
0.0300	0.1250	0.0150	0.0900	1.1656	1.5000	930-001-995	930-002-365	\$20.54	930-002-274	\$24.94
0.0312	0.1250	0.0156	0.0936	1.1651	1.5000	930-001-997	930-002-367	\$20.54	930-002-275	\$24.94
0.0320	0.1250	0.0160	0.0960	1.1648	1.5000	930-001-998	930-002-368	\$20.54	930-002-276	\$24.94
0.0330	0.1250	0.0165	0.0990	1.1644	1.5000	930-001-999	930-002-369	\$20.54	930-002-277	\$24.94
0.0340	0.1250	0.0170	0.1020	1.1639	1.5000	930-002-001	930-002-370	\$20.54	930-002-278	\$24.94
0.0350	0.1250	0.0175	0.1050	1.1635	1.5000	930-002-002	930-002-371	\$19.33	930-002-279	\$23.73
0.0360	0.1250	0.0180	0.1080	1.1631	1.5000	930-002-004	930-002-373	\$19.33	930-002-280	\$23.73
0.0370	0.1250	0.0185	0.1110	1.1626	1.5000	930-002-005	930-002-374	\$19.33	930-002-281	\$23.73
0.0380	0.1250	0.0190	0.1140	1.1622	1.5000	930-002-006	930-002-375	\$19.33	930-002-282	\$23.73
0.0390	0.1250	0.0195	0.1170	1.1618	1.5000	930-002-007	930-002-376	\$19.33	930-002-283	\$23.73
0.0394	0.1250	0.0197	0.1182	1.1616	1.5000	930-002-072	930-002-441	\$19.33	882-E-0394	\$23.73
0.0400	0.1250	0.0200	0.1200	1.1614	1.5000	930-002-008	930-002-377	\$19.33	930-002-284	\$23.73
0.0410	0.1250	0.0205	0.1230	1.1609	1.5000	930-002-010	930-002-379	\$19.33	930-002-285	\$23.73
0.0420	0.1250	0.0210	0.1260	1.1605	1.5000	930-002-011	930-002-380	\$19.33	930-002-286	\$23.73
0.0430	0.1250	0.0215	0.1290	1.1601	1.5000	930-002-012	930-002-381	\$19.33	930-002-287	\$23.73
0.0440	0.1250	0.0220	0.1320	1.1596	1.5000	930-002-013	930-002-382	\$19.33	930-002-288	\$23.73

CARBIDE

METRIC .005" - .044"

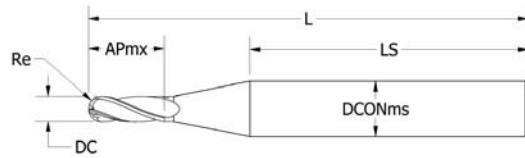

DC	DCONms	Re	APmx	LS	L	TIALN COATED			AMORPHOUS DIAMOND		
						2 FLUTE	4 FLUTE	Price	2 FLUTE	4 FLUTE	Price
0.0050	0.1250	0.0025	0.0150	1.1342	1.5000	930-002-161		\$43.94	930-002-086		\$50.90
0.0060	0.1250	0.0030	0.0180	1.1342	1.5000	930-002-162		\$43.94	930-002-087		\$50.90
0.0070	0.1250	0.0035	0.0210	1.1342	1.5000	930-002-163		\$43.94	930-002-088		\$50.90
0.0080	0.1250	0.0040	0.0240	1.1342	1.5000	930-002-164		\$43.94	930-002-089		\$50.90
0.0090	0.1250	0.0045	0.0270	1.1342	1.5000	930-002-165		\$43.94	930-002-090		\$50.90
0.0100	0.1250	0.0050	0.0300	1.1742	1.5000	930-002-166	930-002-523	\$36.91	930-002-091	930-002-455	\$46.04
0.0110	0.1250	0.0055	0.0330	1.1738	1.5000	930-002-167	930-002-524	\$36.91	930-002-092	930-002-456	\$46.04
0.0120	0.1250	0.0060	0.0360	1.1733	1.5000	930-002-168	930-002-525	\$36.91	930-002-093	930-002-457	\$46.04
0.0130	0.1250	0.0065	0.0390	1.1729	1.5000	930-002-169	930-002-526	\$36.91	930-002-094	930-002-458	\$46.04
0.0140	0.1250	0.0070	0.0420	1.1725	1.5000	930-002-170	930-002-527	\$36.91	930-002-095	930-002-459	\$46.04
0.0150	0.1250	0.0075	0.0450	1.1720	1.5000	930-002-171	930-002-528	\$30.43	930-002-096	930-002-460	\$37.58
0.0156	0.1250	0.0078	0.0468	1.1718	1.5000	930-002-247	883-C-1560	\$30.43			
0.0160	0.1250	0.0080	0.0480	1.1716	1.5000	930-002-172	930-002-529	\$30.43	930-002-097	930-002-461	\$37.58
0.0170	0.1250	0.0085	0.0510	1.1712	1.5000	930-002-173	930-002-530	\$30.43	930-002-098	930-002-462	\$37.58
0.0180	0.1250	0.0090	0.0540	1.1708	1.5000	930-002-174	930-002-531	\$30.43	930-002-099	930-002-463	\$37.58
0.0190	0.1250	0.0095	0.0570	1.1703	1.5000	930-002-175	930-002-532	\$30.43	930-002-100	930-002-464	\$37.58
0.0197	0.1250	0.0099	0.0591	1.1700	1.5000	930-002-235	930-002-592	\$29.45			
0.0200	0.1250	0.0100	0.0600	1.1699	1.5000	930-002-176	930-002-533	\$29.45	930-002-101	930-002-465	\$36.58
0.0210	0.1250	0.0105	0.0630	1.1695	1.5000	930-002-177	930-002-534	\$29.45	930-002-102	930-002-466	\$36.58
0.0220	0.1250	0.0110	0.0660	1.1691	1.5000	930-002-178	930-002-535	\$29.45	930-002-103	930-002-467	\$36.58
0.0230	0.1250	0.0115	0.0690	1.1686	1.5000	930-002-179	930-002-536	\$29.45	930-002-104	930-002-468	\$36.58
0.0240	0.1250	0.0120	0.0720	1.1682	1.5000	930-002-180	930-002-537	\$29.45	930-002-105	930-002-469	\$36.58
0.0250	0.1250	0.0125	0.0750	1.1678	1.5000	930-002-181	930-002-538	\$27.12	930-002-106	930-002-470	\$34.28
0.0260	0.1250	0.0130	0.0780	1.1673	1.5000	930-002-182	930-002-539	\$27.12	930-002-107	930-002-471	\$34.28
0.0270	0.1250	0.0135	0.0810	1.1669	1.5000	930-002-183	930-002-540	\$27.12	930-002-108	930-002-472	\$34.28
0.0280	0.1250	0.0140	0.0840	1.1665	1.5000	930-002-184	930-002-541	\$27.12	930-002-109	930-002-473	\$34.28
0.0290	0.1250	0.0145	0.0870	1.1661	1.5000	930-002-185	930-002-542	\$27.12	930-002-110	930-002-474	\$34.28
0.0300	0.1250	0.0150	0.0900	1.1656	1.5000	930-002-186	930-002-543	\$24.94	930-002-111	930-002-475	\$32.08
0.0310	0.1250	0.0155	0.0930	1.1652	1.5000	930-002-187	930-002-544	\$24.94	930-002-112	930-002-476	\$32.08
0.0320	0.1250	0.0160	0.0960	1.1648	1.5000	930-002-188	930-002-545	\$24.94	930-002-113	930-002-477	\$32.08
0.0330	0.1250	0.0165	0.0990	1.1644	1.5000	930-002-189	930-002-546	\$24.94	930-002-114	930-002-478	\$32.08
0.0340	0.1250	0.0170	0.1020	1.1639	1.5000	930-002-190	930-002-547	\$24.94	930-002-115	930-002-479	\$32.08
0.0350	0.1250	0.0175	0.1050	1.1635	1.5000	930-002-191	930-002-548	\$23.73	930-002-116	930-002-480	\$30.87
0.0360	0.1250	0.0180	0.1080	1.1631	1.5000	930-002-192	930-002-549	\$23.73	930-002-117	930-002-481	\$30.87
0.0370	0.1250	0.0185	0.1110	1.1626	1.5000	930-002-193	930-002-550	\$23.73	930-002-118	930-002-482	\$30.87
0.0380	0.1250	0.0190	0.1140	1.1622	1.5000	930-002-194	930-002-551	\$23.73	930-002-119	930-002-483	\$30.87
0.0390	0.1250	0.0195	0.1170	1.1618	1.5000	930-002-195	930-002-552	\$23.73	930-002-120	930-002-484	\$30.87
0.0394	0.1250	0.0197	0.1182	1.1616	1.5000	930-002-236	930-002-593	\$23.73	930-002-156	930-002-518	\$30.87
0.0400	0.1250	0.0200	0.1200	1.1614	1.5000	930-002-196	930-002-553	\$23.73	930-002-121	930-002-485	\$30.87
0.0410	0.1250	0.0205	0.1230	1.1609	1.5000	930-002-197	930-002-554	\$23.73	930-002-122	930-002-486	\$30.87
0.0420	0.1250	0.0210	0.1260	1.1605	1.5000	930-002-198	930-002-555	\$23.73	930-002-123	930-002-487	\$30.87
0.0430	0.1250	0.0215	0.1290	1.1601	1.5000	930-002-199	930-002-556	\$23.73	930-002-124	930-002-488	\$30.87
0.0440	0.1250	0.0220	0.1320	1.1596	1.5000	930-002-200	930-002-557	\$23.73	930-002-125	930-002-489	\$30.87

METRIC .045" - .1772"



CARBIDE

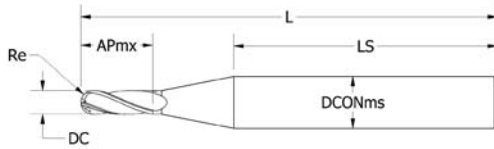

DC	DCONms	Re	APmx	LS	L	UNCOATED			ALTIM COATED	
						2 FLUTE	4 FLUTE	Price	2 FLUTE	Price
0.0450	0.1250	0.0225	0.1350	1.1592	1.5000	930-002-014	930-002-383	\$19.33	930-002-289	\$23.73
0.0460	0.1250	0.0230	0.1380	1.1588	1.5000	930-002-016	930-002-385	\$19.33	930-002-290	\$23.73
0.0468	0.1250	0.0234	0.1404	1.1584	1.5000	930-002-017	930-002-386	\$19.33	930-002-291	\$23.73
0.0480	0.1250	0.0240	0.1440	1.1579	1.5000	930-002-018	930-002-387	\$19.33	930-002-292	\$23.73
0.0490	0.1250	0.0245	0.1470	1.1575	1.5000	930-002-019	930-002-388	\$19.33	930-002-293	\$23.73
0.0492	0.1250	0.0246	0.1476	1.1574	1.5000	930-002-073	930-002-442	\$19.33	-	-
0.0500	0.1250	0.0250	0.1500	1.1571	1.5000	930-002-020	930-002-389	\$19.33	930-002-294	\$23.73
0.0510	0.1250	0.0255	0.1530	1.1567	1.5000	930-002-022	930-002-391	\$19.33	930-002-295	\$23.73
0.0520	0.1250	0.0260	0.1560	1.1562	1.5000	930-002-023	930-002-392	\$19.33	930-002-296	\$23.73
0.0530	0.1250	0.0265	0.1590	1.1558	1.5000	930-002-024	930-002-393	\$19.33	930-002-297	\$23.73
0.0540	0.1250	0.0270	0.1620	1.1554	1.5000	930-002-025	930-002-394	\$19.33	930-002-298	\$23.73
0.0550	0.1250	0.0275	0.1650	1.1549	1.5000	930-002-026	930-002-395	\$19.33	930-002-299	\$23.73
0.0560	0.1250	0.0280	0.1680	1.1545	1.5000	930-002-028	930-002-397	\$19.33	930-002-300	\$23.73
0.0570	0.1250	0.0285	0.1710	1.1541	1.5000	930-002-029	930-002-398	\$19.33	930-002-301	\$23.73
0.0580	0.1250	0.0290	0.1740	1.1537	1.5000	930-002-030	930-002-399	\$19.33	930-002-302	\$23.73
0.0590	0.1250	0.0295	0.1770	1.1532	1.5000	930-002-031	930-002-400	\$19.33	930-002-303	\$23.73
0.0591	0.1250	0.0296	0.1773	1.1532	1.5000	930-002-075	930-002-444	\$19.33	930-002-322	\$23.73
0.0600	0.1250	0.0300	0.1800	1.1528	1.5000	930-002-032	930-002-401	\$19.33	930-002-304	\$23.73
0.0620	0.1250	0.0310	0.1860	1.1519	1.5000	930-002-034	930-002-403	\$18.90	930-002-305	\$23.28
0.0630	0.1250	0.0315	0.1890	1.1515	1.5000	930-002-076	930-002-445	\$18.90		
0.0640	0.1250	0.0320	0.1920	1.1511	1.5000	930-002-035	930-002-404	\$18.90		
0.0650	0.1250	0.0325	0.1950	1.1507	1.5000	930-002-036	930-002-405	\$18.90	930-002-304	\$23.28
0.0700	0.1250	0.0350	0.2100	1.1485	1.5000	930-002-038	930-002-407	\$18.90	930-002-305	\$23.28
0.0709	0.1250	0.0355	0.2127	1.1481	1.5000	930-002-077	930-002-446	\$18.90		
0.0750	0.1250	0.0375	0.2250	1.1464	1.5000	930-002-040	930-002-409	\$18.90	930-002-308	\$23.28
0.0781	0.1250	0.0391	0.2343	1.1451	1.5000	930-002-041	930-002-410	\$18.90	930-002-309	\$23.28
0.0787	0.1250	0.0394	0.2361	1.1448	1.5000	930-002-078	930-002-447	\$18.90		
0.0800	0.1250	0.0400	0.2400	1.1442	1.5000	930-002-042	930-002-411	\$18.90	930-002-310	\$23.28
0.0850	0.1250	0.0425	0.2550	1.1421	1.5000	930-002-044	930-002-413	\$18.90	930-002-311	\$23.28
0.0866	0.1250	0.0433	0.2598	1.1414	1.5000	930-002-079	930-002-448	\$18.90		
0.0900	0.1250	0.0450	0.2700	1.1400	1.5000	930-002-045	930-002-414	\$18.90	930-002-312	\$23.28
0.0938	0.1250	0.0469	0.2814	1.1383	1.5000	930-002-047	930-002-416	\$18.90	930-002-313	\$23.28
0.0950	0.1250	0.0475	0.2850	1.1378	1.5000	930-002-048	930-002-417	\$18.90	930-002-314	\$23.28
0.0984	0.1250	0.0492	0.2952	1.1364	1.5000	930-002-080	930-002-449	\$18.90		
0.1000	0.1250	0.0500	0.3000	1.1357	1.5000	930-002-049	930-002-418	\$18.90	930-002-315	\$23.28
0.1050	0.1250	0.0525	0.3150	1.1336	1.5000	930-002-051	930-002-420	\$18.90	930-002-316	\$23.28
0.1102	0.1250	0.0551	0.3306	1.1313	1.5000	930-002-081	930-002-450	\$18.90	930-002-323	\$23.28
0.1150	0.1250	0.0575	0.3450	1.1293	1.5000	930-002-052	930-002-421	\$18.90	930-002-317	\$23.28
0.1181	0.1250	0.0591	0.3543	1.1280	1.5000	930-002-082	930-002-451	\$18.90	930-002-324	\$23.28
0.1200	0.1250	0.0600	0.3600	1.1271	1.5000	930-002-053	930-002-422	\$18.90	930-002-318	\$23.28
0.1378	0.1875	0.0689	0.4134	1.4588	2.0000	930-002-083	930-002-452	\$20.11		
0.1772	0.1875	0.0886	0.5316	1.4419	2.0000	930-002-085	930-002-454	\$20.11		

CARBIDE

METRIC .045" - .1772"

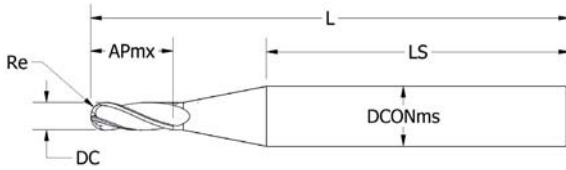

DC	DCONms	Re	APmx	LS	L	TIALN COATED			AMORPHOUS DIAMOND		
						2 FLUTE	4 FLUTE	Price	2 FLUTE	4 FLUTE	Price
0.0450	0.1250	0.0225	0.1350	1.1592	1.5000	930-002-201	930-002-558	\$23.73	930-002-126	930-002-490	\$30.87
0.0460	0.1250	0.0230	0.1380	1.1588	1.5000	930-002-202	930-002-559	\$23.73	930-002-127	930-002-491	\$30.87
0.0470	0.1250	0.0235	0.1410	1.1584	1.5000	930-002-203	930-002-560	\$23.73	930-002-128	930-002-492	\$30.87
0.0480	0.1250	0.0240	0.1440	1.1579	1.5000	930-002-204	930-002-561	\$23.73	930-002-129	930-002-493	\$30.87
0.0490	0.1250	0.0245	0.1470	1.1575	1.5000	930-002-205	930-002-562	\$23.73	930-002-130	930-002-494	\$30.87
0.0492	0.1250	0.0246	0.1476	1.1574	1.5000	930-002-237	930-002-594	\$23.73	930-002-157	930-002-519	\$30.87
0.0500	0.1250	0.0250	0.1500	1.1571	1.5000	930-002-206	930-002-563	\$23.73	930-002-131	930-002-495	\$30.87
0.0510	0.1250	0.0255	0.1530	1.1567	1.5000	930-002-207	930-002-564	\$23.73	930-002-132	930-002-496	\$30.87
0.0520	0.1250	0.0260	0.1560	1.1562	1.5000	930-002-208	930-002-565	\$23.73	930-002-133	930-002-497	\$30.87
0.0530	0.1250	0.0265	0.1590	1.1558	1.5000	930-002-209	930-002-566	\$23.73	930-002-134	930-002-498	\$30.87
0.0540	0.1250	0.0270	0.1620	1.1554	1.5000	930-002-210	930-002-567	\$23.73	930-002-135	930-002-499	\$30.87
0.0550	0.1250	0.0275	0.1650	1.1549	1.5000	930-002-211	930-002-568	\$23.73	930-002-136	930-002-500	\$30.87
0.0560	0.1250	0.0280	0.1680	1.1545	1.5000	930-002-212	930-002-569	\$23.73	930-002-137	930-002-501	\$30.87
0.0570	0.1250	0.0285	0.1710	1.1541	1.5000	930-002-213	930-002-570	\$23.73	930-002-138	930-002-502	\$30.87
0.0580	0.1250	0.0290	0.1740	1.1537	1.5000	930-002-214	930-002-571	\$23.73	930-002-139	930-002-503	\$30.87
0.0590	0.1250	0.0295	0.1770	1.1532	1.5000	930-002-215	930-002-572	\$23.73	930-002-140	930-002-504	\$30.87
0.0591	0.1250	0.0296	0.1773	1.1532	1.5000	930-002-238	930-002-595	\$23.73	930-002-158	930-002-520	\$30.87
0.0600	0.1250	0.0300	0.1800	1.1528	1.5000	930-002-216	930-002-573	\$23.73	930-002-141	930-002-505	\$30.87
0.0620	0.1250	0.0310	0.1860	1.1519	1.5000	930-002-217	930-002-574	\$23.28	930-002-142	930-002-506	\$30.43
0.0630	0.1250	0.0315	0.1890	1.1515	1.5000	930-002-239	930-002-596	\$23.73			
0.0650	0.1250	0.0325	0.1950	1.1507	1.5000	930-002-218	930-002-575	\$23.28	930-002-143	930-002-507	\$30.43
0.0700	0.1250	0.0350	0.2100	1.1485	1.5000	930-002-219	930-002-576	\$23.28			
0.0709	0.1250	0.0355	0.2127	1.1481	1.5000	930-002-240	930-002-597	\$23.28			
0.0750	0.1250	0.0375	0.2250	1.1464	1.5000	930-002-220	930-002-577	\$23.28	930-002-145	930-002-509	\$30.43
0.0781	0.1250	0.0391	0.2343	1.1451	1.5000	930-002-221	930-002-578	\$23.28	930-002-146	930-002-510	\$30.43
0.0787	0.1250	0.0394	0.2361	1.1448	1.5000	930-002-241	930-002-598	\$23.28			
0.0800	0.1250	0.0400	0.2400	1.1442	1.5000	930-002-222	930-002-579	\$23.28	930-002-147	930-002-511	\$30.43
0.0850	0.1250	0.0425	0.2550	1.1421	1.5000	930-002-223	930-002-580	\$23.28	930-002-148	930-002-512	\$30.43
0.0866	0.1250	0.0433	0.2598	1.1414	1.5000	930-002-242	930-002-599	\$23.28			
0.0900	0.1250	0.0450	0.2700	1.1400	1.5000	930-002-224	930-002-581	\$23.28	930-002-149	930-002-513	\$30.43
0.0938	0.1250	0.0469	0.2814	1.1383	1.5000	930-002-225	930-002-582	\$23.28	930-002-150	930-002-514	\$30.43
0.0950	0.1250	0.0475	0.2850	1.1378	1.5000	930-002-226	930-002-583	\$23.28	930-002-151	930-002-515	\$30.43
0.0984	0.1250	0.0492	0.2952	1.1364	1.5000	930-002-243	930-002-600	\$23.28			
0.1000	0.1250	0.0500	0.3000	1.1357	1.5000	930-002-227	930-002-584	\$23.28	930-002-152	930-002-516	\$30.43
0.1102	0.1250	0.0551	0.3306	1.1313	1.5000	930-002-244	930-002-601	\$23.28	930-002-159	930-002-521	\$30.43
0.1181	0.1250	0.0591	0.3543	1.1280	1.5000	930-002-245	930-002-602	\$23.28	930-002-160	930-002-522	\$30.43
0.1200	0.1250	0.0600	0.3600	1.1271	1.5000	930-002-228	930-002-585	\$23.28	930-002-155	930-002-517	\$30.43
0.1378	0.1875	0.0689	0.4134	1.4588	2.0000	930-002-246	930-002-603	\$24.82			
0.1772	0.1875	0.0886	0.5316	1.4419	2.0000	930-002-248	930-002-605	\$24.82			

METRIC .005"-.040"



CARBIDE

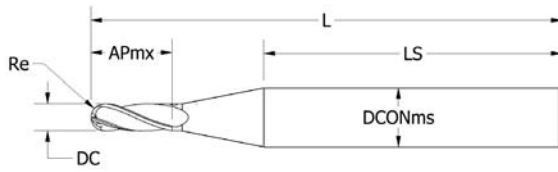

DC	DCONms	Re	APmx	LS	L	UNCOATED			ALTiN COATED	
						2 FLUTE	4 FLUTE	Price	2 FLUTE	Price
0.0050	0.1250	0.0025	0.0080	1.1342	1.5000	930-001-173		\$39.66	930-001-337	\$43.94
0.0060	0.1250	0.0030	0.0090	1.1342	1.5000	930-001-174		\$39.66	930-001-338	\$43.94
0.0070	0.1250	0.0035	0.0110	1.1342	1.5000	930-001-175		\$39.66	930-001-339	\$43.94
0.0080	0.1250	0.0040	0.0120	1.1342	1.5000	930-001-176		\$39.66	930-001-340	\$43.94
0.0090	0.1250	0.0045	0.0140	1.1342	1.5000	930-001-177		\$39.66	930-001-341	\$43.94
0.0100	0.1250	0.0050	0.0150	1.1892	1.5000	930-001-178	930-001-815	\$32.52	930-001-342	\$36.91
0.0110	0.1250	0.0055	0.0165	1.1903	1.5000	930-001-179	930-001-816	\$32.52	930-001-343	\$36.91
0.0120	0.1250	0.0060	0.0180	1.1913	1.5000	930-001-180	930-001-817	\$32.52	930-001-344	\$36.91
0.0130	0.1250	0.0065	0.0195	1.1924	1.5000	930-001-181	930-001-818	\$32.52	930-001-345	\$36.91
0.0140	0.1250	0.0070	0.0210	1.1935	1.5000	930-001-182	930-001-819	\$32.52	930-001-346	\$36.91
0.0150	0.1250	0.0075	0.0225	1.1945	1.5000	930-001-183	930-001-820	\$26.04	930-001-347	\$30.43
0.0156	0.1250	0.0078	0.0234	1.1952	1.5000	930-001-246	930-001-883	\$26.04		
0.0160	0.1250	0.0080	0.0240	1.1956	1.5000	930-001-184	930-001-821	\$26.04	930-001-348	\$30.43
0.0170	0.1250	0.0085	0.0255	1.1967	1.5000	930-001-185	930-001-822	\$26.04	930-001-349	\$30.43
0.0180	0.1250	0.0090	0.0270	1.1978	1.5000	930-001-186	930-001-823	\$26.04	930-001-350	\$30.43
0.0190	0.1250	0.0095	0.0285	1.1988	1.5000	930-001-187	930-001-824	\$26.04	930-001-351	\$30.43
0.0197	0.1250	0.0099	0.0296	1.1996	1.5000	930-001-233	930-001-870	\$25.05		
0.0200	0.1250	0.0100	0.0300	1.1999	1.5000	930-001-188	930-001-825	\$25.05	930-001-352	\$29.45
0.0210	0.1250	0.0105	0.0315	1.2010	1.5000	930-001-189	930-001-826	\$25.05	930-001-353	\$29.45
0.0220	0.1250	0.0110	0.0330	1.2021	1.5000	930-001-190	930-001-827	\$25.05	930-001-354	\$29.45
0.0230	0.1250	0.0115	0.0345	1.2031	1.5000	930-001-191	930-001-828	\$25.05	930-001-355	\$29.45
0.0240	0.1250	0.0120	0.0360	1.2042	1.5000	930-001-192	930-001-829	\$25.05	930-001-356	\$29.45
0.0250	0.1250	0.0125	0.0375	1.2053	1.5000	930-001-193	930-001-830	\$22.75	930-001-357	\$27.12
0.0260	0.1250	0.0130	0.0390	1.2063	1.5000	930-001-194	930-001-831	\$22.75	930-001-358	\$27.12
0.0270	0.1250	0.0135	0.0405	1.2074	1.5000	930-001-195	930-001-832	\$22.75	930-001-359	\$27.12
0.0280	0.1250	0.0140	0.0420	1.2085	1.5000	930-001-196	930-001-833	\$22.75	930-001-360	\$27.12
0.0290	0.1250	0.0145	0.0435	1.2096	1.5000	930-001-197	930-001-834	\$22.75	930-001-361	\$27.12
0.0300	0.1250	0.0150	0.0450	1.2106	1.5000	930-001-198	930-001-835	\$20.54	930-001-362	\$24.94
0.0310	0.1250	0.0155	0.0465	1.2117	1.5000	930-001-199	930-001-836	\$20.54	930-001-363	\$24.94
0.0320	0.1250	0.0160	0.0480	1.2128	1.5000	930-001-200	930-001-837	\$20.54	930-001-364	\$24.94
0.0330	0.1250	0.0165	0.0495	1.2139	1.5000	930-001-201	930-001-838	\$20.54	930-001-365	\$24.94
0.0340	0.1250	0.0170	0.0510	1.2149	1.5000	930-001-202	930-001-839	\$20.54	930-001-366	\$24.94
0.0350	0.1250	0.0175	0.0525	1.2160	1.5000	930-001-203	930-001-840	\$19.33	930-001-367	\$23.73
0.0360	0.1250	0.0180	0.0540	1.2171	1.5000	930-001-204	930-001-841	\$19.33	930-001-368	\$23.73
0.0370	0.1250	0.0185	0.0555	1.2181	1.5000	930-001-205	930-001-842	\$19.33	930-001-369	\$23.73
0.0380	0.1250	0.0190	0.0570	1.2192	1.5000	930-001-206	930-001-843	\$19.33	930-001-370	\$23.73
0.0390	0.1250	0.0195	0.0585	1.2203	1.5000	930-001-207	930-001-844	\$19.33	930-001-371	\$23.73
0.0394	0.1250	0.0197	0.0591	1.2207	1.5000	930-001-235	930-001-872	\$19.33	930-001-390	\$23.73
0.0400	0.1250	0.0200	0.0600	1.2214	1.5000	930-001-208	930-001-845	\$19.33	930-001-372	\$23.73

CARBIDE

METRIC .005" - .040"

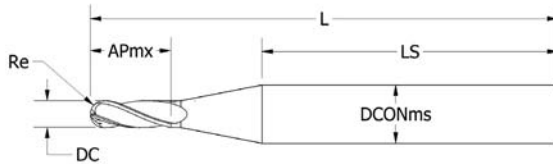

DC	DCONms	Re	APmx	LS	L	TIALN COATED			AMORPHOUS DIAMOND		
						2 FLUTE	4 FLUTE	Price	2 FLUTE	4 FLUTE	Price
0.0050	0.1250	0.0025	0.0080	1.1342	1.5000	930-001-296		\$43.94	930-001-247		\$50.90
0.0060	0.1250	0.0030	0.0090	1.1342	1.5000	930-001-297		\$43.94	930-001-248		\$50.90
0.0070	0.1250	0.0035	0.0110	1.1342	1.5000	930-001-298		\$43.94	930-001-249		\$50.90
0.0080	0.1250	0.0040	0.0120	1.1342	1.5000	930-001-299		\$43.94	930-001-250		\$50.90
0.0090	0.1250	0.0045	0.0140	1.1342	1.5000	930-001-300		\$43.94	930-001-251		\$50.90
0.0100	0.1250	0.0050	0.0150	1.1892	1.5000	930-001-301	930-001-929	\$36.91	930-001-252	930-001-884	\$46.04
0.0110	0.1250	0.0055	0.0165	1.1903	1.5000	930-001-302	930-001-930	\$36.91	930-001-253	930-001-885	\$46.04
0.0120	0.1250	0.0060	0.0180	1.1913	1.5000	930-001-303	930-001-931	\$36.91	930-001-254	930-001-886	\$46.04
0.0130	0.1250	0.0065	0.0195	1.1924	1.5000	930-001-304	930-001-932	\$36.91	930-001-255	930-001-887	\$46.04
0.0140	0.1250	0.0070	0.0210	1.1935	1.5000	930-001-305	930-001-933	\$36.91	930-001-256	930-001-888	\$46.04
0.0150	0.1250	0.0075	0.0225	1.1945	1.5000	930-001-306	930-001-934	\$30.43	930-001-257	930-001-889	\$37.58
0.0160	0.1250	0.0080	0.0240	1.1956	1.5000	930-001-307	930-001-935	\$30.43	930-001-258	930-001-890	\$37.58
0.0170	0.1250	0.0085	0.0255	1.1967	1.5000	930-001-308	930-001-936	\$30.43	930-001-259	930-001-891	\$37.58
0.0180	0.1250	0.0090	0.0270	1.1978	1.5000	930-001-309	930-001-937	\$30.43	930-001-260	930-001-892	\$37.58
0.0190	0.1250	0.0095	0.0285	1.1988	1.5000	930-001-310	930-001-938	\$30.43	930-001-261	930-001-893	\$37.58
0.0190	0.1250	0.0095	0.0285	1.1988	1.5000	930-001-311	930-001-939	\$29.45	930-001-262	930-001-894	\$37.58
0.0210	0.1250	0.0105	0.0315	1.2010	1.5000	930-001-312	930-001-940	\$29.45	930-001-263	930-001-895	\$36.58
0.0220	0.1250	0.0110	0.0330	1.2021	1.5000	930-001-313	930-001-941	\$29.45	930-001-264	930-001-896	\$36.58
0.0230	0.1250	0.0115	0.0345	1.2031	1.5000	930-001-314	930-001-942	\$29.45	930-001-265	930-001-897	\$36.58
0.0240	0.1250	0.0120	0.0360	1.2042	1.5000	930-001-315	930-001-943	\$29.45	930-001-266	930-001-898	\$36.58
0.0250	0.1250	0.0125	0.0375	1.2053	1.5000	930-001-316	930-001-944	\$27.12	930-001-267	930-001-899	\$34.28
0.0260	0.1250	0.0130	0.0390	1.2063	1.5000	930-001-317	930-001-945	\$27.12	930-001-268	930-001-900	\$34.28
0.0270	0.1250	0.0135	0.0405	1.2074	1.5000	930-001-318	930-001-946	\$27.12	930-001-269	930-001-901	\$34.28
0.0280	0.1250	0.0140	0.0420	1.2085	1.5000	930-001-319	930-001-947	\$27.12	930-001-270	930-001-902	\$34.28
0.0290	0.1250	0.0145	0.0435	1.2096	1.5000	930-001-320	930-001-948	\$27.12	930-001-271	930-001-903	\$34.28
0.0300	0.1250	0.0150	0.0450	1.2106	1.5000	930-001-321	930-001-949	\$24.94	930-001-272	930-001-904	\$34.28
0.0310	0.1250	0.0155	0.0465	1.2117	1.5000	930-001-322	930-001-950	\$24.94	930-001-273	930-001-905	\$32.08
0.0320	0.1250	0.0160	0.0480	1.2128	1.5000	930-001-323	930-001-951	\$24.94	930-001-274	930-001-906	\$32.08
0.0330	0.1250	0.0165	0.0495	1.2139	1.5000	930-001-324	930-001-952	\$24.94	930-001-275	930-001-907	\$32.08
0.0340	0.1250	0.0170	0.0510	1.2149	1.5000	930-001-325	930-001-953	\$24.94	930-001-276	930-001-908	\$32.08
0.0350	0.1250	0.0175	0.0525	1.2160	1.5000	930-001-326	930-001-954	\$23.73	930-001-277	930-001-909	\$30.87
0.0360	0.1250	0.0180	0.0540	1.2171	1.5000	930-001-327	930-001-955	\$23.73	930-001-278	930-001-910	\$30.87
0.0370	0.1250	0.0185	0.0555	1.2181	1.5000	930-001-328	930-001-956	\$23.73	930-001-279	930-001-911	\$30.87
0.0380	0.1250	0.0190	0.0570	1.2192	1.5000	930-001-329	930-001-957	\$23.73	930-001-280	930-001-912	\$30.87
0.0390	0.1250	0.0195	0.0585	1.2203	1.5000	930-001-330	930-001-958	\$23.73	930-001-281	930-001-913	\$30.87
0.0400	0.1250	0.0200	0.0600	1.2214	1.5000	930-001-331	930-001-959	\$23.73	930-001-282	930-001-914	\$30.87

METRIC .045" - .1378"



CARBIDE

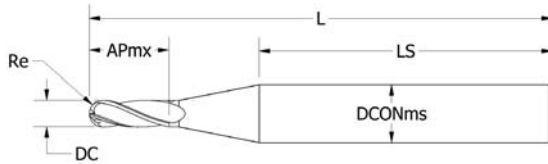

DC	DCONms	Re	APmx	LS	L	UNCOATED			ALTIM COATED	
						2 FLUTE	4 FLUTE	Price	2 FLUTE	Price
0.0450	0.1250	0.0225	0.0675	1.2267	1.5000	930-001-209	930-001-846	\$19.33	930-001-373	\$23.73
0.0470	0.1250	0.0235	0.0705	1.2289	1.5000	930-001-210	930-001-847	\$19.33	930-001-374	\$23.73
0.0492	0.1250	0.0246	0.0738	1.2312	1.5000	930-001-236	930-001-873	\$19.33		
0.0500	0.1250	0.0250	0.0750	1.2321	1.5000	930-001-211	930-001-848	\$19.33	930-001-375	\$23.73
0.0550	0.1250	0.0275	0.0825	1.2374	1.5000	930-001-212	930-001-849	\$19.33	930-001-376	\$23.73
0.0591	0.1250	0.0296	0.0887	1.2418	1.5000	930-001-237	930-001-874	\$19.33		
0.0600	0.1250	0.0300	0.0900	1.2428	1.5000	930-001-213	930-001-850	\$19.33	930-001-377	\$23.73
0.0620	0.1250	0.0310	0.0930	1.2449	1.5000	930-001-214	930-001-851	\$18.90	930-001-378	\$23.28
0.0630	0.1250	0.0315	0.0945	1.2460	1.5000	930-001-238	930-001-875	\$18.90		
0.0650	0.1250	0.0325	0.0975	1.2482	1.5000	930-001-215	930-001-852	\$18.90	930-001-379	\$23.28
0.0700	0.1250	0.0350	0.1050	1.2535	1.5000	930-001-216	930-001-853	\$18.90	930-001-380	\$23.28
0.0709	0.1250	0.0355	0.1064	1.2545	1.5000	930-001-239	930-001-876	\$18.90		
0.0750	0.1250	0.0375	0.1125	1.2589	1.5000	930-001-217	930-001-854	\$18.90	930-001-381	\$23.28
0.0780	0.1250	0.0390	0.1170	1.2621	1.5000	930-001-218	930-001-855	\$18.90	930-001-382	\$23.28
0.0787	0.1250	0.0394	0.1181	1.2629	1.5000	930-001-240	930-001-877	\$23.28		
0.0800	0.1250	0.0400	0.1200	1.2642	1.5000	930-001-219	930-001-856	\$18.90	930-001-383	\$23.28
0.0850	0.1250	0.0425	0.1275	1.2696	1.5000	930-001-220	930-001-857	\$18.90	930-001-384	\$23.28
0.0866	0.1250	0.0433	0.1299	1.2713	1.5000	930-001-241	930-001-878	\$18.90		
0.0900	0.1250	0.0450	0.1350	1.2750	1.5000	930-001-221	930-001-858	\$18.90	930-001-385	\$23.28
0.0930	0.1250	0.0465	0.1395	1.2782	1.5000	930-001-222	930-001-859	\$18.90		
0.0950	0.1250	0.0475	0.1425	1.2803	1.5000	930-001-223	930-001-860	\$18.90	930-001-387	\$23.28
0.0984	0.1250	0.0492	0.1476	1.2840	1.5000	930-001-242	930-001-879	\$18.90		
0.1000	0.1250	0.0500	0.1500	1.2857	1.5000	930-001-224	930-001-861	\$18.90	930-001-388	\$23.28
0.1102	0.1250	0.0551	0.1653	1.2966	1.5000	930-001-243	930-001-880	\$18.90		
0.1181	0.1250	0.0591	0.1772	1.3051	1.5000	930-001-244	930-001-881	\$18.90		
0.1200	0.1250	0.0600	0.1800	1.3071	1.5000	930-001-225	930-001-862	\$18.90		
0.1378	0.1875	0.0689	0.2067	1.6655	2.0000	930-001-245	930-001-882	\$20.11		

METRIC .045" - .100"

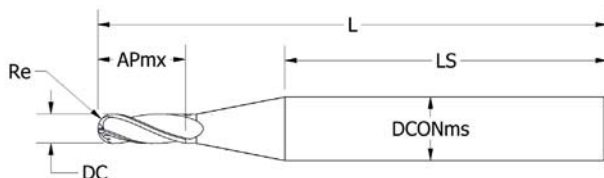

DC	DCONms	Re	APmx	LS	L	AMORPHOUS DIAMOND		
						2 FLUTE	4 FLUTE	Price
0.0450	0.1250	0.0225	0.0675	1.2267	1.5000	930-001-283	930-001-915	\$30.87
0.0470	0.1250	0.0235	0.0705	1.2289	1.5000	930-001-284	930-001-916	\$30.87
0.0500	0.1250	0.0250	0.0750	1.2321	1.5000	930-001-285	930-001-917	\$30.87
0.0550	0.1250	0.0275	0.0825	1.2374	1.5000	930-001-286	930-001-918	\$30.87
0.0600	0.1250	0.0300	0.0900	1.2428	1.5000	930-001-287	930-001-919	\$30.87
0.0620	0.1250	0.0310	0.0930	1.2449	1.5000	930-001-288	930-001-920	\$30.43
0.0650	0.1250	0.0325	0.0975	1.2482	1.5000	930-001-289	930-001-921	\$30.43
0.0700	0.1250	0.0350	0.1050	1.2535	1.5000	930-001-290	930-001-922	\$30.43
0.0780	0.1250	0.0390	0.1170	1.2621	1.5000	930-001-291	930-001-923	\$30.43
0.0800	0.1250	0.0400	0.1200	1.2642	1.5000	930-001-292	930-001-924	\$30.43
0.0900	0.1250	0.0450	0.1350	1.2750	1.5000	930-001-293	930-001-925	\$30.43
0.0930	0.1250	0.0465	0.1395	1.2782	1.5000	930-001-294	930-001-926	\$30.43
0.1000	0.1250	0.0500	0.1500	1.2857	1.5000	930-001-295	930-001-928	\$30.43

METRIC .010" - .250"



CARBIDE

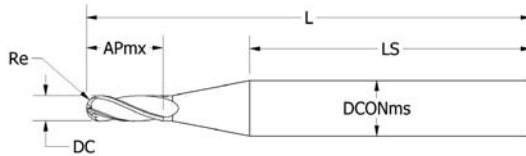

DC	DCONms	Re	APmx	LS	L	UNCOATED		ALTiN COATED		AMORPHOUS DIAMOND	
						3 FLUTE	Price	3 FLUTE	Price	3 FLUTE	Price
0.0100	0.1250	0.0050	0.0150	2.1892	2.5000	930-003-162	\$33.90	930-003-311	\$37.80	930-003-189	\$44.93
0.0150	0.1250	0.0075	0.0225	2.1945	2.5000	930-003-163	\$30.54	930-003-312	\$34.94	930-003-190	\$42.07
0.0200	0.1250	0.0100	0.0300	2.1999	2.5000	930-003-164	\$29.55	930-003-313	\$33.95	930-003-191	\$41.08
0.0250	0.1250	0.0125	0.0375	2.2053	2.5000	930-003-165	\$23.73	930-003-314	\$28.13	930-003-192	\$35.26
0.0300	0.1250	0.0150	0.0450	2.2106	2.5000	930-003-166	\$23.73	930-003-315	\$28.13	930-003-193	\$35.26
0.0310	0.1250	0.0155	0.0465	2.2117	2.5000	930-003-167	\$23.73	930-003-316	\$28.13	930-003-194	\$35.26
0.0350	0.1250	0.0175	0.0525	2.2160	2.5000	930-003-168	\$23.73	930-003-317	\$28.13	930-003-195	\$35.26
0.0400	0.1250	0.0200	0.0600	2.2214	2.5000	930-003-169	\$23.73	930-003-318	\$28.13	930-003-196	\$35.26
0.0450	0.1250	0.0225	0.0675	2.2267	2.5000	930-003-170	\$22.84	930-003-319	\$27.24	930-003-197	\$34.37
0.0470	0.1250	0.0235	0.0705	2.2289	2.5000	930-003-171	\$22.84	930-003-320	\$27.24	930-003-198	\$34.37
0.0500	0.1250	0.0250	0.0750	2.2321	2.5000	930-003-172	\$22.84	930-003-321	\$27.24	930-003-199	\$34.37
0.0550	0.1250	0.0275	0.0825	2.2374	2.5000	930-003-173	\$22.84	930-003-322	\$27.24	930-003-200	\$34.37
0.0600	0.1250	0.0300	0.0900	2.2428	2.5000	930-003-174	\$22.84	930-003-323	\$27.24	930-003-201	\$34.37
0.0620	0.1250	0.0310	0.0930	2.2449	2.5000	930-003-175	\$22.84	930-003-324	\$27.24	930-003-202	\$34.37
0.0650	0.1250	0.0325	0.0975	2.2482	2.5000	930-003-176	\$22.84	930-003-325	\$27.24	930-003-203	\$34.37
0.0700	0.1250	0.0350	0.1050	2.2535	2.5000	930-003-177	\$22.84	930-003-326	\$27.24	930-003-204	\$34.37
0.0750	0.1250	0.0375	0.1125	2.2589	2.5000	930-003-178	\$22.84	930-003-327	\$27.24	930-003-205	\$34.37
0.0780	0.1250	0.0390	0.1170	2.2621	2.5000	930-003-179	\$22.84	930-003-328	\$27.24	930-003-206	\$34.37
0.0800	0.1250	0.0400	0.1200	2.2642	2.5000	930-003-180	\$22.84	930-003-329	\$27.24	930-003-207	\$34.37
0.0850	0.1250	0.0425	0.1275	2.2696	2.5000	930-003-181	\$22.84	930-003-330	\$27.24	930-003-208	\$34.37
0.0900	0.1250	0.0450	0.1350	2.2750	2.5000	930-003-182	\$22.84	930-003-331	\$27.24	930-003-209	\$34.37
0.0930	0.1250	0.0465	0.1395	2.2782	2.5000	930-003-183	\$22.84	930-003-332	\$27.24	930-003-210	\$34.37
0.0950	0.1250	0.0475	0.1425	2.2803	2.5000	930-003-184	\$22.84	930-003-333	\$27.24	930-003-211	\$34.37
0.1000	0.1250	0.0500	0.1500	2.2857	2.5000	930-003-185	\$22.84	930-003-334	\$27.24	930-003-212	\$34.37
0.1250	0.1250	0.0625	0.1875	1.9375	2.5000	930-003-186	\$22.84	931-000-377	\$27.24	931-000-361	\$34.37
0.1875	0.1875	0.0938	0.2813	2.3438	3.0000	930-003-187	\$26.46	931-000-378	\$31.20	931-000-362	\$38.01
0.2500	0.2500	0.1250	0.3750	3.2500	4.0000	930-003-188	\$30.64	931-000-379	\$38.33	931-000-363	\$42.18

CARBIDE

METRIC .010" - .035"

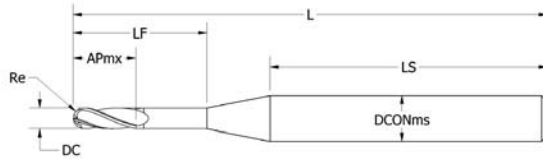

DC	DCONms	Re	APmx	LS	L	LF	UNCOATED		ALTiN COATED		AMORPHOUS DIAMOND	
							3 FLUTE	Price	3 FLUTE	Price	3 FLUTE	Price
0.0100	0.1250	0.0050	0.0150	2.3925	2.5000	0.0500	930-003-509	\$50.86	930-003-386	\$55.25	930-003-257	\$62.40
0.0100	0.1250	0.0050	0.0150	2.3625	2.5000	0.0800	930-003-536	\$50.86	930-003-413	\$55.25	930-003-281	\$62.40
0.0100	0.1250	0.0050	0.0150	2.3175	2.5000	0.1250	930-003-458	\$53.07	930-003-335	\$57.46	930-003-213	\$64.60
0.0100	0.1250	0.0050	0.0150	2.2925	2.5000	0.1500	930-003-477	\$59.65	930-003-354	\$64.05	930-003-229	\$71.18
0.0150	0.1250	0.0075	0.0225	2.4000	2.5000	0.0450	930-003-503	\$43.50	930-003-380	\$47.90	930-003-251	\$55.04
0.0150	0.1250	0.0075	0.0225	2.3670	2.5000	0.0780	930-003-510	\$43.50	930-003-387	\$47.90	930-003-258	\$55.04
0.0150	0.1250	0.0075	0.0225	2.3200	2.5000	0.1250	930-003-537	\$43.50	930-003-414	\$47.90	930-003-282	\$55.04
0.0150	0.1250	0.0075	0.0225	2.2575	2.5000	0.1875	930-003-459	\$44.59	930-003-336	\$48.99	930-003-214	\$56.14
0.0150	0.1250	0.0075	0.0225	2.2200	2.5000	0.2250	930-003-478	\$49.33	930-003-355	\$58.68	930-003-230	\$60.86
0.0150	0.1250	0.0075	0.0225	2.1450	2.5000	0.3000	930-003-494	\$54.71	930-003-371	\$59.11	930-003-243	\$66.24
0.0200	0.1250	0.0100	0.0300	2.3475	2.5000	0.1000	930-003-511	\$42.07	930-003-388	\$48.56	930-003-259	\$53.62
0.0200	0.1250	0.0100	0.0300	2.2875	2.5000	0.1600	930-003-538	\$42.07	930-003-415	\$48.56	930-003-283	\$53.62
0.0200	0.1250	0.0100	0.0300	2.1975	2.5000	0.2500	930-003-460	\$43.28	930-003-337	\$49.83	930-003-215	\$54.82
0.0200	0.1250	0.0100	0.0300	2.1475	2.5000	0.3000	930-003-479	\$47.79	930-003-356	\$52.19	930-003-231	\$59.43
0.0200	0.1250	0.0100	0.0300	2.0475	2.5000	0.4000	930-003-495	\$54.37	930-003-372	\$59.11	930-003-244	\$65.92
0.0250	0.1250	0.0125	0.0375	2.3250	2.5000	0.1250	930-003-512	\$36.36	930-003-389	\$40.75	930-003-260	\$47.90
0.0250	0.1250	0.0125	0.0375	2.2500	2.5000	0.2000	930-003-539	\$36.36	930-003-416	\$40.75	930-003-284	\$47.90
0.0250	0.1250	0.0125	0.0375	2.1375	2.5000	0.3125	930-003-461	\$37.46	930-003-338	\$43.74	930-003-216	\$48.99
0.0250	0.1250	0.0125	0.0375	2.0750	2.5000	0.3750	930-003-480	\$42.74	930-003-357	\$47.14	930-003-232	\$54.27
0.0300	0.1250	0.0150	0.0450	2.3025	2.5000	0.1500	930-003-513	\$36.36	930-003-390	\$40.75	930-003-261	\$47.90
0.0300	0.1250	0.0150	0.0450	2.2025	2.5000	0.2500	930-003-540	\$36.36	930-003-417	\$40.75	930-003-285	\$47.90
0.0300	0.1250	0.0150	0.0450	2.0775	2.5000	0.3750	930-003-462	\$37.46	930-003-339	\$43.74	930-003-217	\$48.99
0.0300	0.1250	0.0150	0.0450	2.0025	2.5000	0.4500	930-003-481	\$42.74	930-003-358	\$47.14	930-003-233	\$54.27
0.0310	0.1250	0.0155	0.0465	2.3600	2.5000	0.0930	930-003-504	\$36.36	930-003-381	\$40.75	930-003-252	\$47.90
0.0310	0.1250	0.0155	0.0465	2.2980	2.5000	0.1550	930-003-514	\$36.36	930-003-391	\$40.75	930-003-262	\$47.90
0.0310	0.1250	0.0155	0.0465	2.2030	2.5000	0.2500	930-003-541	\$36.36	930-003-418	\$40.75	930-003-286	\$47.90
0.0310	0.1250	0.0155	0.0465	2.0780	2.5000	0.3750	930-003-463	\$37.46	930-003-340	\$43.74	930-003-218	\$48.99
0.0310	0.1250	0.0155	0.0465	1.9830	2.5000	0.4700	930-003-482	\$42.74	930-003-359	\$47.14	930-003-234	\$54.27
0.0310	0.1250	0.0155	0.0465	1.8280	2.5000	0.6250	930-003-496	\$49.33	930-003-373	\$59.11	930-003-245	\$60.86
0.0350	0.1250	0.0175	0.0525	2.2680	2.5000	0.1870	930-003-515	\$36.36	930-003-392	\$40.75	930-003-263	\$47.90
0.0350	0.1250	0.0175	0.0525	2.1750	2.5000	0.2800	930-003-542	\$36.36	930-003-419	\$40.75	930-003-287	\$47.90
0.0350	0.1250	0.0175	0.0525	2.0300	2.5000	0.4250	930-003-464	\$37.46	930-003-341	\$43.74	930-003-219	\$48.99
0.0350	0.1250	0.0175	0.0525	1.9300	2.5000	0.5250	930-003-483	\$42.74	930-003-360	\$47.14	930-003-235	\$54.27

METRIC .040" - .075"



CARBIDE

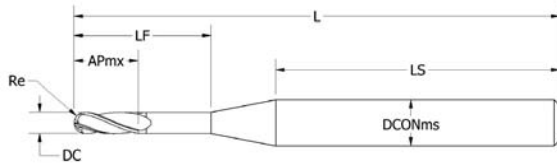

DC	DCONms	Re	APmx	LS	L	LF	UNCOATED		ALTiN COATED		AMORPHOUS DIAMOND	
							3 FLUTE	Price	3 FLUTE	Price	3 FLUTE	Price
0.0400	0.1250	0.0200	0.0600	2.2575	2.5000	0.2000	930-003-516	\$36.36	930-003-393	\$40.75	930-003-264	\$47.90
0.0400	0.1250	0.0200	0.0600	2.1325	2.5000	0.3250	930-003-543	\$36.36	930-003-420	\$40.75	930-003-288	\$40.77
0.0400	0.1250	0.0200	0.0600	1.9775	2.5000	0.4800	930-003-465	\$37.46	930-003-342	\$43.74	930-003-220	\$48.99
0.0400	0.1250	0.0200	0.0600	1.8575	2.5000	0.6000	930-003-484	\$42.74	930-003-361	\$47.14	930-003-236	\$54.27
0.0400	0.1250	0.0200	0.0600	1.6575	2.5000	0.8000	930-003-497	\$49.33	930-003-374	\$59.11	930-003-246	\$60.86
0.0450	0.1250	0.0225	0.0675	2.2350	2.5000	0.2250	930-003-517	\$35.48	930-003-394	\$39.88	930-003-265	\$47.02
0.0450	0.1250	0.0225	0.0675	2.0850	2.5000	0.3750	930-003-544	\$35.48	930-003-421	\$39.88	930-003-289	\$47.02
0.0450	0.1250	0.0225	0.0675	1.9100	2.5000	0.5500	930-003-466	\$36.47	930-003-343	\$40.86	930-003-221	\$48.99
0.0450	0.1250	0.0225	0.0675	1.7800	2.5000	0.6800	930-003-485	\$40.53	930-003-362	\$44.93	930-003-237	\$52.07
0.0470	0.1250	0.0235	0.0705	2.3200	2.5000	0.1410	930-003-505	\$35.48	930-003-382	\$39.88	930-003-253	\$47.02
0.0470	0.1250	0.0235	0.0705	2.2110	2.5000	0.2500	930-003-518	\$35.48	930-003-395	\$39.88	930-003-266	\$47.02
0.0470	0.1250	0.0235	0.0705	2.0860	2.5000	0.3750	930-003-545	\$35.48	930-003-422	\$39.88	930-003-290	\$47.02
0.0470	0.1250	0.0235	0.0705	1.8910	2.5000	0.5700	930-003-467	\$36.47	930-003-344	\$40.86	930-003-222	\$48.01
0.0470	0.1250	0.0235	0.0705	1.7510	2.5000	0.7100	930-003-486	\$40.53	930-003-363	\$44.93	930-003-238	\$52.07
0.0470	0.1250	0.0235	0.0705	1.5110	2.5000	0.9500	930-003-498	\$48.56	930-003-375	\$50.87	930-003-247	\$58.00
0.0500	0.1250	0.0250	0.0750	2.2125	2.5000	0.2500	930-003-519	\$35.48	930-003-396	\$39.88	930-003-267	\$47.02
0.0500	0.1250	0.0250	0.0750	2.0625	2.5000	0.4000	930-003-546	\$35.48	930-003-423	\$39.88	930-003-291	\$47.02
0.0500	0.1250	0.0250	0.0750	1.8625	2.5000	0.6000	930-003-468	\$36.47	930-003-345	\$40.86	930-003-223	\$48.01
0.0550	0.1250	0.0275	0.0825	2.1900	2.5000	0.2750	930-003-520	\$35.48	930-003-397	\$39.88	930-003-268	\$47.02
0.0550	0.1250	0.0275	0.0825	2.0150	2.5000	0.4500	930-003-547	\$35.48	930-003-424	\$39.88	930-003-292	\$47.02
0.0550	0.1250	0.0275	0.0825	1.8050	2.5000	0.6600	930-003-469	\$36.47	930-003-346	\$40.86	930-003-224	\$48.01
0.0600	0.1250	0.0300	0.0900	2.1555	2.5000	0.3120	930-003-521	\$35.48	930-003-398	\$39.88	930-003-269	\$47.02
0.0600	0.1250	0.0300	0.0900	1.9675	2.5000	0.5000	930-003-548	\$35.48	930-003-425	\$39.88	930-003-293	\$47.02
0.0600	0.1250	0.0300	0.0900	1.7475	2.5000	0.7200	930-003-470	\$36.47	930-003-347	\$40.86	930-003-225	\$48.01
0.0600	0.1250	0.0300	0.0900	1.5675	2.5000	0.9000	930-003-487	\$40.53	930-003-364	\$44.93	930-003-239	\$52.07
0.0620	0.1250	0.0310	0.0930	2.2825	2.5000	0.1860	930-003-506	\$35.48	930-003-383	\$39.88	930-003-254	\$47.02
0.0620	0.1250	0.0310	0.0930	2.1565	2.5000	0.3120	930-003-522	\$35.48	930-003-399	\$39.88	930-003-270	\$47.02
0.0620	0.1250	0.0310	0.0930	1.9685	2.5000	0.5000	930-003-549	\$35.48	930-003-426	\$39.88	930-003-294	\$47.02
0.0620	0.1250	0.0310	0.0930	1.7185	2.5000	0.7500	930-003-471	\$36.47	930-003-348	\$40.86	930-003-226	\$48.01
0.0620	0.1250	0.0310	0.0930	1.5185	2.5000	0.9500	930-003-488	\$40.53	930-003-365	\$44.93	930-003-240	\$52.07
0.0620	0.1250	0.0310	0.0930	1.2185	2.5000	1.2500	930-003-499	\$48.56	930-003-376	\$50.87	930-003-248	\$58.00
0.0650	0.1250	0.0325	0.0975	2.1450	2.5000	0.3250	930-003-523	\$35.48	930-003-400	\$39.88	930-003-271	\$47.02
0.0650	0.1250	0.0325	0.0975	1.9450	2.5000	0.5250	930-003-550	\$35.48	930-003-427	\$39.88	930-003-295	\$47.02
0.0700	0.1250	0.0350	0.1050	2.0975	2.5000	0.3750	930-003-524	\$35.48	930-003-401	\$39.88	930-003-272	\$47.02
0.0700	0.1250	0.0350	0.1050	1.9025	2.5000	0.5700	930-003-551	\$35.48	930-003-428	\$39.88	930-003-296	\$47.02
0.0750	0.1250	0.0375	0.1125	2.1000	2.5000	0.3750	930-003-525	\$35.48	930-003-402	\$39.88	930-003-273	\$47.02
0.0750	0.1250	0.0375	0.1125	1.8500	2.5000	0.6250	930-003-552	\$35.48	930-003-429	\$39.88	930-003-297	\$47.02

CARBIDE

METRIC .078" - .250"

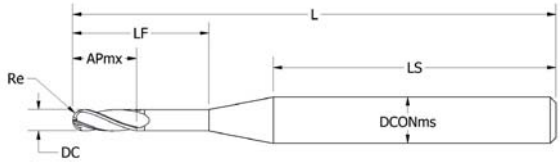

DC	DCONms	Re	APmx	LS	L	LF	UNCOATED		ALTiN COATED		AMORPHOUS DIAMOND	
							3 FLUTE	Price	3 FLUTE	Price	3 FLUTE	Price
0.0780	0.1250	0.0390	0.1170	2.2425	2.5000	0.2340	930-003-507	\$35.48	930-003-384	\$39.88	930-003-255	\$47.02
0.0780	0.1250	0.0390	0.1170	2.0765	2.5000	0.4000	930-003-526	\$35.48	930-003-403	\$39.88	930-003-274	\$47.02
0.0780	0.1250	0.0390	0.1170	1.8515	2.5000	0.6250	930-003-553	\$35.48	930-003-430	\$39.88	930-003-298	\$47.02
0.0780	0.1250	0.0390	0.1170	1.5365	2.5000	0.9400	930-003-472	\$36.47	930-003-349	\$40.86	930-003-227	\$48.01
0.0780	0.1250	0.0390	0.1170	1.2895	2.5000	1.1870	930-003-489	\$40.53	930-003-366	\$44.93	930-003-241	\$52.07
0.0780	0.1250	0.0390	0.1170	1.4145	3.0000	1.5620	930-003-500	\$48.56	930-003-377	\$50.87	930-003-249	\$64.05
0.0800	0.1250	0.0400	0.1200	2.0775	2.5000	0.4000	930-003-527	\$35.48	930-003-404	\$39.88	930-003-275	\$47.02
0.0800	0.1250	0.0400	0.1200	1.8275	2.5000	0.6500	930-003-554	\$35.48	930-003-431	\$39.88	930-003-299	\$47.02
0.0850	0.1250	0.0425	0.1275	2.0550	2.5000	0.4250	930-003-528	\$35.48	930-003-405	\$39.88	930-003-276	\$47.02
0.0850	0.1250	0.0425	0.1275	1.7800	2.5000	0.7000	930-003-555	\$35.48	930-003-432	\$39.88	930-003-300	\$47.02
0.0900	0.1250	0.0450	0.1350	2.0325	2.5000	0.4500	930-003-529	\$35.48	930-003-406	\$39.88	930-003-277	\$47.02
0.0900	0.1250	0.0450	0.1350	1.7325	2.5000	0.7500	930-003-556	\$35.48	930-003-433	\$39.88	930-003-301	\$47.02
0.0930	0.1250	0.0465	0.1395	2.2140	2.5000	0.2700	930-003-508	\$35.48	930-003-385	\$39.88	930-003-256	\$47.02
0.0930	0.1250	0.0465	0.1395	1.9840	2.5000	0.5000	930-003-530	\$35.48	930-003-407	\$39.88	930-003-278	\$47.02
0.0930	0.1250	0.0465	0.1395	1.7340	2.5000	0.7500	930-003-557	\$35.48	930-003-434	\$39.88	930-003-302	\$47.02
0.0930	0.1250	0.0465	0.1395	1.3590	2.5000	1.1250	930-003-473	\$36.47	930-003-350	\$40.86	930-003-228	\$48.01
0.0930	0.1250	0.0465	0.1395	1.5840	3.0000	1.4000	930-003-490	\$42.62	930-003-367	\$47.02	930-003-242	\$54.15
0.0930	0.1250	0.0465	0.1395	2.1090	4.0000	1.8750	930-003-501	\$49.11	930-003-378	\$58.44	930-003-250	\$66.69
0.0950	0.1250	0.0475	0.1425	1.9850	2.5000	0.5000	930-003-531	\$35.48	930-003-408	\$39.88	930-003-279	\$47.02
0.0950	0.1250	0.0475	0.1425	1.7350	2.5000	0.7500	930-003-558	\$35.48	930-003-435	\$39.88	930-003-303	\$47.02
0.1000	0.1250	0.0500	0.1500	1.9875	2.5000	0.5000	930-003-532	\$35.48	930-003-409	\$39.88	930-003-280	\$47.02
0.1000	0.1250	0.0500	0.1500	1.6875	2.5000	0.8000	930-003-559	\$35.48	930-003-436	\$39.88	930-003-304	\$47.02
0.1250	0.1250	0.0625	0.1875	1.8750	2.5000	0.6250	930-003-533	\$35.48	930-003-410	\$39.88	931-000-371	\$47.02
0.1250	0.1250	0.0625	0.1875	1.5000	2.5000	1.0000	930-003-560	\$35.48	930-003-437	\$39.88	931-000-374	\$47.02
0.1250	0.1250	0.0625	0.1875	1.5000	3.0000	1.5000	930-003-474	\$38.12	930-003-351	\$42.52	931-000-364	\$55.69
0.1250	0.1250	0.0625	0.1875	1.1250	3.0000	1.8750	930-003-491	\$42.62	930-003-368	\$47.02	931-000-367	\$54.15
0.1250	0.1250	0.0625	0.1875	1.5000	4.0000	2.5000	930-003-502	\$49.11	930-003-379	\$58.44	931-000-370	\$66.69
0.1875	0.1875	0.0938	0.2813	2.0000	3.0000	1.0000	930-003-534	\$39.11	930-003-411	\$43.50	931-000-372	\$55.04
0.1875	0.1875	0.0938	0.2813	1.5000	3.0000	1.5000	930-003-561	\$39.11	930-003-438	\$43.50	931-000-375	\$55.04
0.1875	0.1875	0.0938	0.2813	1.7500	4.0000	2.2500	930-003-475	\$41.63	930-003-352	\$46.03	931-000-365	\$58.67
0.1875	0.1875	0.0938	0.2813	1.1880	4.0000	2.8120	930-003-492	\$44.27	930-003-369	\$48.67	931-000-368	\$61.31
0.2500	0.2500	0.1250	0.3750	2.7500	4.0000	1.2500	930-003-535	\$43.28	930-003-412	\$49.83	931-000-373	\$61.41
0.2500	0.2500	0.1250	0.3750	2.0000	4.0000	2.0000	930-003-562	\$43.28	930-003-439	\$49.83	931-000-376	\$61.41
0.2500	0.2500	0.1250	0.3750	3.0000	6.0000	3.0000	930-003-476	\$48.45	930-003-353	\$55.22	931-000-366	\$74.82
0.2500	0.2500	0.1250	0.3750	2.2500	6.0000	3.7500	930-003-493	\$53.07	930-003-370	\$57.46	931-000-369	\$79.43

METRIC .005" - .100"



CARBIDE

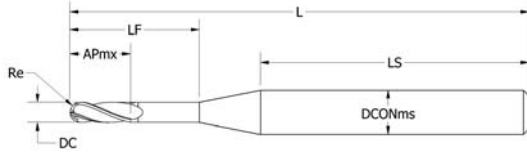

DC	DCONms	Re	APmx	LS	L	LF	UNCOATED		
							2 FLUTE	4 FLUTE	Price
0.0050	0.1250	0.0025	0.0150	1.3930	1.5000	0.0470	930-001-966		\$62.07
0.0100	0.1250	0.0050	0.0300	1.3625	1.5000	0.0800	930-002-326	930-002-624	\$54.92
0.0100	0.1250	0.0050	0.0300	1.3488	1.5000	0.0937	930-001-972	930-002-342	\$54.92
0.0150	0.1250	0.0075	0.0450	1.3200	1.5000	0.1250	930-001-978	930-002-348	\$46.04
0.0200	0.1250	0.0100	0.0600	1.2775	1.5000	0.1700	930-002-327	930-002-625	\$42.40
0.0200	0.1250	0.0100	0.0600	1.2600	1.5000	0.1875	930-001-984	930-002-354	\$42.40
0.0250	0.1250	0.0125	0.0750	1.2370	1.5000	0.2130	930-002-328	930-002-626	\$38.78
0.0250	0.1250	0.0125	0.0750	1.2000	1.5000	0.2500	930-001-990	930-002-360	\$38.78
0.0300	0.1250	0.0150	0.0900	1.2025	1.5000	0.2500	930-001-996	930-002-366	\$38.78
0.0300	0.1250	0.0150	0.0900	1.1825	1.5000	0.2700	930-002-329	930-002-627	\$38.78
0.0310	0.1250	0.0155	0.0930	1.1740	1.5000	0.2790	930-002-330	930-002-628	\$38.78
0.0350	0.1250	0.0175	0.1050	1.2050	1.5000	0.2500	930-002-003	930-002-372	\$38.78
0.0350	0.1250	0.0175	0.1050	1.1400	1.5000	0.3150	930-002-331	930-002-629	\$38.78
0.0400	0.1250	0.0200	0.1200	1.2075	1.5000	0.2500	930-002-009	930-002-378	\$38.78
0.0400	0.1250	0.0200	0.1200	1.0975	1.5000	0.3600	930-002-332	930-002-630	\$38.78
0.0450	0.1250	0.0225	0.1350	1.0550	1.5000	0.4050	930-002-333	930-002-631	\$37.46
0.0450	0.1250	0.0225	0.1350	0.9600	1.5000	0.5000	930-002-015	930-002-384	\$37.46
0.0470	0.1250	0.0235	0.1410	1.0380	1.5000	0.4230	930-002-334	930-002-632	\$37.46
0.0500	0.1250	0.0250	0.1500	0.9625	1.5000	0.5000	930-002-021	930-002-390	\$37.46
0.0550	0.1250	0.0275	0.1650	0.9650	1.5000	0.5000	930-002-027	930-002-396	\$37.46
0.0600	0.1250	0.0300	0.1800	0.9675	1.5000	0.5000	930-002-033	930-002-402	\$37.46
0.0620	0.1250	0.0310	0.1860	0.9685	1.5000	0.5000	930-002-335	930-002-633	\$37.46
0.0650	0.1250	0.0325	0.1950	0.9700	1.5000	0.5000	930-002-037	930-002-406	\$37.46
0.0700	0.1250	0.0350	0.2100	0.9725	1.5000	0.5000	930-002-039	930-002-408	\$37.46
0.0780	0.1250	0.0390	0.2340	0.9765	1.5000	0.5000	930-002-336	930-002-634	\$37.46
0.0800	0.1250	0.0400	0.2400	0.9775	1.5000	0.5000	930-002-043	930-002-412	\$37.46
0.0900	0.1250	0.0450	0.2700	0.9825	1.5000	0.5000	930-002-046	930-002-415	\$37.46
0.0900	0.1250	0.0450	0.2700	0.8575	1.5000	0.6250	930-002-337	930-002-635	\$37.46
0.0930	0.1250	0.0465	0.2790	0.8590	1.5000	0.6250	930-002-338	930-002-636	\$37.46
0.0950	0.1250	0.0475	0.2850	0.8600	1.5000	0.6250	930-002-339	930-002-637	\$37.46
0.1000	0.1250	0.0500	0.3000	0.9875	1.5000	0.5000	930-002-050	930-002-419	\$37.46
0.1000	0.1250	0.0500	0.3000	0.8625	1.5000	0.6250	930-002-340	930-002-638	\$37.46

CARBIDE

METRIC .010" - .250"

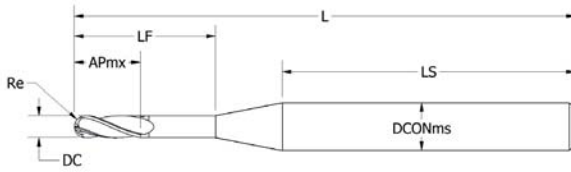

DC	DCONms	Re	APmx	LS	L	LF	UNCOATED		ALTiN COATED		AMORPHOUS DIAMOND	
							3 FLUTE	Price	3 FLUTE	Price	3 FLUTE	Price
0.0100	0.1250	0.0050	0.0500	2.3425	2.5000	0.1000	930-002-896	\$53.72	930-002-862	\$55.81	930-002-830	\$62.95
0.0150	0.1250	0.0075	0.0750	2.2950	2.5000	0.1500	930-002-897	\$46.04	930-002-863	\$48.46	930-002-831	\$55.59
0.0200	0.1250	0.0100	0.1000	2.2475	2.5000	0.2000	930-002-898	\$42.62	930-002-864	\$47.02	930-002-832	\$54.15
0.0250	0.1250	0.0125	0.1250	2.2000	2.5000	0.2500	930-002-899	\$36.91	930-002-865	\$41.30	930-002-833	\$48.46
0.0300	0.1250	0.0150	0.1500	2.1525	2.5000	0.3000	930-002-900	\$36.91	930-002-866	\$41.30	930-002-834	\$48.46
0.0310	0.1250	0.0155	0.1550	2.1530	2.5000	0.3000	930-002-901	\$36.91	930-002-867	\$41.30	930-002-835	\$48.46
0.0350	0.1250	0.0175	0.1750	2.1050	2.5000	0.3500	930-002-902	\$36.91	930-002-868	\$41.30	930-002-836	\$48.46
0.0400	0.1250	0.0200	0.2000	2.0575	2.5000	0.4000	930-002-903	\$36.91	930-002-869	\$41.30	930-002-837	\$48.46
0.0450	0.1250	0.0225	0.2250	2.0100	2.5000	0.4500	930-002-904	\$37.66	930-002-870	\$40.44	930-002-838	\$47.57
0.0470	0.1250	0.0235	0.2500	1.9610	2.5000	0.5000	930-002-905	\$37.66	930-002-871	\$40.44	930-002-839	\$47.57
0.0500	0.1250	0.0250	0.3000	1.8625	2.5000	0.6000	930-002-906	\$37.66	930-002-872	\$40.44	930-002-840	\$47.57
0.0550	0.1250	0.0275	0.3850	1.6950	2.5000	0.7700	930-002-907	\$37.66	930-002-873	\$40.44	930-002-841	\$47.57
0.0600	0.1250	0.0300	0.5000	1.4675	2.5000	1.0000	930-002-908	\$37.66	930-002-874	\$40.44	930-002-842	\$47.57
0.0620	0.1250	0.0310	0.5000	1.4685	2.5000	1.0000	930-002-909	\$37.66	930-002-875	\$40.44	930-002-843	\$47.57
0.0650	0.1250	0.0325	0.5000	1.4700	2.5000	1.0000	930-002-910	\$37.66	930-002-876	\$40.44	930-002-844	\$47.57
0.0700	0.1250	0.0350	0.5000	1.4725	2.5000	1.0000	930-002-911	\$37.66	930-002-877	\$40.44	930-002-845	\$47.57
0.0750	0.1250	0.0375	0.5000	1.4750	2.5000	1.0000	930-002-912	\$37.66	930-002-878	\$40.44	930-002-846	\$47.57
0.0780	0.1250	0.0390	0.5000	1.4765	2.5000	1.0000	930-002-913	\$37.66	930-002-879	\$40.44	930-002-847	\$47.57
0.0800	0.1250	0.0400	0.7500	1.2275	2.5000	1.2500	930-002-914	\$37.66	930-002-880	\$40.44	930-002-848	\$47.57
0.0850	0.1250	0.0425	0.7500	1.2300	2.5000	1.2500	930-002-915	\$37.66	930-002-881	\$40.44	930-002-849	\$47.57
0.0900	0.1250	0.0450	0.7500	1.2325	2.5000	1.2500	930-002-916	\$37.66	930-002-882	\$40.44	930-002-850	\$47.57
0.0930	0.1250	0.0465	0.7500	1.2340	2.5000	1.2500	930-002-917	\$37.66	930-002-883	\$40.44	930-002-851	\$47.57
0.0950	0.1250	0.0475	0.7500	1.2350	2.5000	1.2500	930-002-918	\$37.66	930-002-884	\$40.44	930-002-852	\$47.57
0.1000	0.1250	0.0500	0.7500	1.2375	2.5000	1.2500	930-002-919	\$37.66	930-002-885	\$40.44	930-002-853	\$47.57
0.1250	0.1250	0.0625	1.0000	1.0000	2.5000	1.5000	930-002-920	\$37.66	930-002-886	\$40.44	931-000-337	\$47.57
0.1875	0.1875	0.0938	1.1250	1.3750	3.0000	1.6250	930-002-921	\$38.99	931-000-342	\$43.94	931-000-338	\$55.59
0.2500	0.2500	0.1250	1.5000	2.0000	4.0000	2.0000	930-002-922	\$43.84	931-000-343	\$48.99	931-000-339	\$61.96

METRIC .031" - .125"

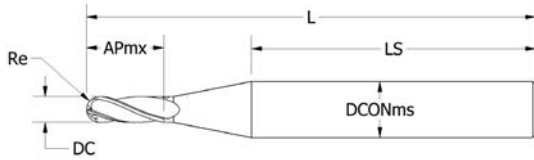

12X FLUTE LENGTH



DC	DCONms	Re	APmx	LS	L	UNCOATED		ALTIM COATED		AMORPHOUS DIAMOND	
						3 FLUTE	Price	3 FLUTE	Price	3 FLUTE	Price
0.0310	0.1250	0.0155	0.3750	1.8832	2.5000	930-002-923	\$60.86	930-002-887	\$65.26	930-002-854	\$75.66
0.0470	0.1250	0.0235	0.5700	1.7294	2.5000	930-002-924	\$56.57	930-002-888	\$60.97	930-002-855	\$68.11
0.0620	0.1250	0.0310	0.7500	1.5879	2.5000	930-002-925	\$49.83	930-002-889	\$52.07	930-002-856	\$59.22
0.0780	0.1250	0.0390	0.9400	1.4391	2.5000	930-002-926	\$49.83	930-002-890	\$52.07	930-002-857	\$59.22
0.0930	0.1250	0.0465	1.1250	1.2927	2.5000	930-002-927	\$49.83	930-002-891	\$52.07	930-002-858	\$59.22
0.1250	0.1250	0.0625	1.5000	1.1250	3.0000	930-002-928	\$49.33	930-002-892	\$58.68	931-000-340	\$66.91

METRIC .062" - .125"

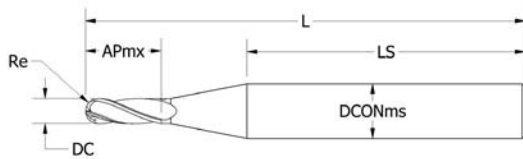

15X FLUTE LENGTH



DC	DCONms	Re	APmx	LS	L	UNCOATED		ALTIM COATED		AMORPHOUS DIAMOND	
						3 FLUTE	Price	3 FLUTE	Price	3 FLUTE	Price
0.0620	0.1250	0.0310	0.9500	1.3879	2.5000	930-002-929	\$65.26	930-002-893	\$69.65	930-002-859	\$76.79
0.0780	0.1250	0.0390	1.1870	1.1921	2.5000	930-002-930	\$65.26	930-002-894	\$69.65	930-002-860	\$76.79
0.0930	0.1250	0.0465	1.4000	1.5177	3.0000	930-002-931	\$66.68	930-002-895	\$74.61	930-002-861	\$84.26
0.1250	0.1250	0.0625	1.8750	0.7500	3.0000	930-002-932	\$66.68	931-000-344	\$74.61	931-000-341	\$84.26

CARBIDE

METRIC .015" - .093"

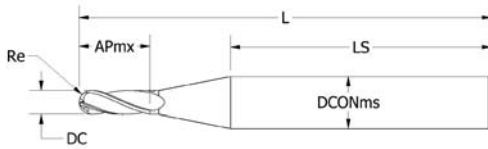

STANDARD



DC	DCONms	Re	APmx	LS	L	CVD COATED	
						4 FLUTE	Price
0.0150	0.1250	0.0075	0.0450	1.1720	1.5000	930-002-606	\$79.97
0.0200	0.1250	0.0100	0.0600	1.1699	1.5000	930-002-607	\$79.97
0.0310	0.1250	0.0155	0.0930	1.1652	1.5000	930-002-608	\$79.97
0.0470	0.1250	0.0235	0.1410	1.1584	1.5000	930-002-609	\$79.97
0.0620	0.1250	0.0310	0.1860	1.1519	1.5000	930-002-610	\$75.70
0.0930	0.1250	0.0465	0.2790	1.1387	1.5000	930-002-611	\$75.70

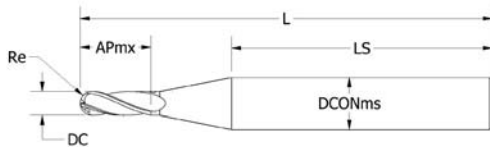

LONG SHANK, STUB



DC	DCONms	Re	APmx	LS	L	CVD COATED	
						3 FLUTE	Price
0.0150	0.1250	0.0075	0.0225	2.1945	2.5000	930-003-305	\$89.53
0.0200	0.1250	0.0100	0.0300	2.1999	2.5000	930-003-306	\$89.53
0.0310	0.1250	0.0155	0.0465	2.2117	2.5000	930-003-307	\$89.53
0.0470	0.1250	0.0235	0.0705	2.2289	2.5000	930-003-308	\$89.53
0.0620	0.1250	0.0310	0.0930	2.2449	2.5000	930-003-309	\$85.24
0.0930	0.1250	0.0465	0.1395	2.2782	2.5000	930-003-310	\$85.24

METRIC .015" - .093"

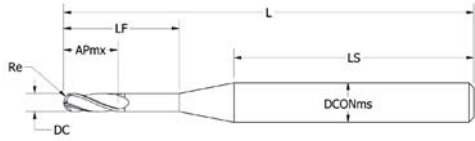

LONG REACH, STUB



DC	DCONms	Re	APmx	LS	L	LF	CVD COATED	
							3 FLUTE	Price
0.0150	0.1250	0.0075	0.0225	2.3670	2.5000	0.0780	930-003-446	\$106.66
0.0150	0.1250	0.0075	0.0225	2.3200	2.5000	0.1250	930-003-452	\$106.66
0.0150	0.1250	0.0075	0.0225	2.2575	2.5000	0.1875	930-003-440	\$109.41
0.0200	0.1250	0.0100	0.0300	2.3475	2.5000	0.1000	930-003-447	\$106.66
0.0200	0.1250	0.0100	0.0300	2.2875	2.5000	0.1600	930-003-453	\$106.66
0.0200	0.1250	0.0100	0.0300	2.1975	2.5000	0.2500	930-003-441	\$109.41
0.0310	0.1250	0.0155	0.0465	2.2980	2.5000	0.1550	930-003-448	\$106.66
0.0310	0.1250	0.0155	0.0465	2.2030	2.5000	0.2500	930-003-454	\$106.66
0.0310	0.1250	0.0155	0.0465	2.0780	2.5000	0.3750	930-003-442	\$109.41
0.0470	0.1250	0.0235	0.0705	2.2110	2.5000	0.2500	930-003-449	\$106.66
0.0470	0.1250	0.0235	0.0705	2.0860	2.5000	0.3750	930-003-455	\$106.66
0.0470	0.1250	0.0235	0.0705	1.8910	2.5000	0.5700	930-003-443	\$109.41
0.0620	0.1250	0.0310	0.0930	2.1565	2.5000	0.3120	930-003-450	\$93.48
0.0620	0.1250	0.0310	0.0930	1.9685	2.5000	0.5000	930-003-456	\$93.48
0.0620	0.1250	0.0310	0.0930	1.7185	2.5000	0.7500	930-003-444	\$96.23
0.0930	0.1250	0.0465	0.1395	1.9840	2.5000	0.5000	930-003-451	\$93.48
0.0930	0.1250	0.0465	0.1395	1.7340	2.5000	0.7500	930-003-457	\$93.48
0.0930	0.1250	0.0465	0.1395	1.3590	2.5000	1.1250	930-003-445	\$96.23

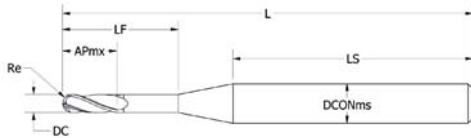

5X FLUTE, 10X REACH



DC	DCONms	Re	APmx	LS	L	LF	CVD COATED	
							4 FLUTE	Price
0.0150	0.1250	0.0075	0.0750	2.2890	2.5000	0.1560	930-001-155	\$124.79
0.0310	0.1250	0.0155	0.1550	2.1410	2.5000	0.3120	930-001-156	\$124.79
0.0470	0.1250	0.0235	0.2350	1.9810	2.5000	0.4800	930-001-157	\$124.79
0.0620	0.1250	0.0310	0.3125	1.8435	2.5000	0.6250	930-001-158	\$109.74
0.0780	0.1250	0.0390	0.3900	1.6765	2.5000	0.8000	930-001-159	\$109.74
0.0930	0.1250	0.0465	0.4650	1.5340	2.5000	0.9500	930-001-160	\$109.74

CARBIDE

IMPERIAL 1/32" - 1/4"

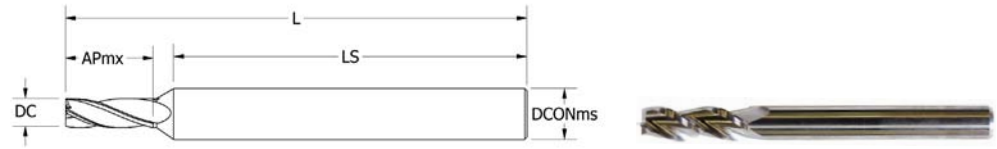

DC	DCONms	APmx	LS	L	UNCOATED		TICN COATED	
					3 FLUTE	Price	3 FLUTE	Price
0.0313	0.2500	0.0938	1.8436	2.5000	930-002-667	\$22.31	931-000-322	\$28.33
0.0469	0.2500	0.1406	1.8369	2.5000	930-002-668	\$22.31	931-000-323	\$28.33
0.0625	0.2500	0.1875	1.8302	2.5000	930-002-669	\$22.03	931-000-324	\$28.05
0.0781	0.2500	0.1875	1.8704	2.5000	930-002-670	\$22.03	931-000-325	\$28.05
0.0938	0.2500	0.3750	1.7231	2.5000	930-002-671	\$22.03	931-000-326	\$28.05
0.1094	0.2500	0.4375	1.7008	2.5000	930-002-672	\$22.03	931-000-327	\$28.05
0.1250	0.2500	0.5000	1.6785	2.5000	930-002-673	\$22.03	931-000-328	\$28.05
0.1563	0.2500	0.5625	1.6963	2.5000	930-002-674	\$16.30	931-000-329	\$23.30
0.1875	0.2500	0.6250	1.7142	2.5000	930-002-675	\$16.30	931-000-330	\$23.30
0.2188	0.2500	0.6250	1.7946	2.5000	930-002-676	\$27.54	931-000-331	\$33.57
0.2500	0.2500	0.7500	1.3750	2.5000	930-002-677	\$23.62	931-000-332	\$29.65

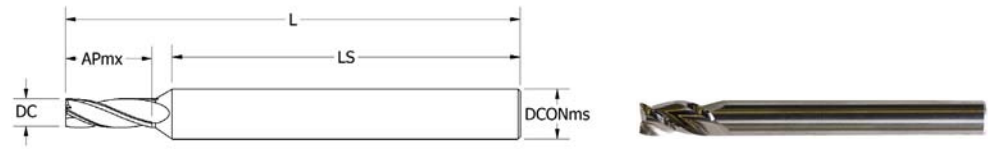

STUB



DC	DCONms	APmx	LS	L	UNCOATED		TICN COATED	
					3 FLUTE	Price	3 FLUTE	Price
0.0313	0.2500	0.0625	1.8748	2.5000	930-002-639	\$16.30	931-000-294	\$23.30
0.0469	0.2500	0.0938	1.8838	2.5000	930-002-641	\$16.30	931-000-296	\$23.30
0.0625	0.2500	0.1250	1.8927	2.5000	930-002-643	\$16.07	931-000-298	\$22.07
0.0781	0.2500	0.1250	1.9329	2.5000	930-002-645	\$16.07	931-000-300	\$22.07
0.0938	0.2500	0.1875	1.9106	2.5000	930-002-647	\$16.07	931-000-302	\$22.07
0.1094	0.2500	0.1875	1.9508	2.5000	930-002-649	\$16.07	931-000-304	\$22.07
0.1250	0.2500	0.2500	1.9285	2.5000	930-002-651	\$16.07	931-000-306	\$22.07
0.1563	0.2500	0.3750	1.8838	2.5000	930-002-653	\$18.91	931-000-308	\$24.93
0.1875	0.2500	0.3750	1.9642	2.5000	930-002-655	\$18.91	931-000-310	\$24.93
0.2188	0.2500	0.3750	2.0446	2.5000	930-002-657	\$17.31	931-000-312	\$23.33
0.2500	0.2500	0.5000	1.6250	2.5000	930-002-659	\$17.31	931-000-314	\$23.33

IMPERIAL 1/32" - 1/4"



STUB, REACHED



DC	DCONms	APmx	LS	L	LF	UNCOATED		TICN COATED	
						3 FLUTE	PRICE	3 FLUTE	Price
0.0313	0.2500	0.0625	2.2356	2.5000	0.1550	930-002-640	\$32.76	931-000-295	\$38.79
0.0469	0.2500	0.0938	2.1684	2.5000	0.2300	930-002-642	\$32.76	931-000-297	\$38.79
0.0625	0.2500	0.1250	2.0943	2.5000	0.3120	930-002-644	\$29.23	931-000-299	\$35.27
0.0781	0.2500	0.1563	2.0241	2.5000	0.3900	930-002-646	\$29.23	931-000-301	\$35.27
0.0938	0.2500	0.1875	1.9569	2.5000	0.4650	930-002-648	\$29.23	931-000-303	\$35.27
0.1094	0.2500	0.2188	1.8847	2.5000	0.5450	930-002-650	\$25.44	931-000-305	\$31.46
0.1250	0.2500	0.2500	1.8125	2.5000	0.6250	930-002-652	\$25.44	931-000-307	\$31.46
0.1563	0.2500	0.3750	1.6731	2.5000	0.7800	930-002-654	\$28.90	931-000-309	\$34.94
0.1875	0.2500	0.3750	1.5313	2.5000	0.9375	930-002-656	\$28.90	931-000-311	\$34.94
0.2188	0.2500	0.3750	1.3914	2.5000	1.0930	930-002-658	\$29.58	931-000-313	\$35.62
0.2500	0.2500	0.5000	1.2500	2.5000	1.2500	930-002-660	\$29.58	931-000-315	\$35.62

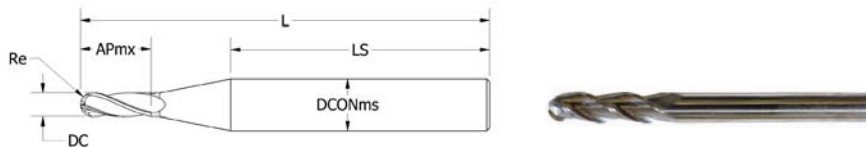

BALL, STANDARD



DC	DCONms	Re	APmx	LS	L	UNCOATED		TICN COATED	
						3 FLUTE	Price	3 FLUTE	Price
0.0313	0.2500	0.0156	0.0938	1.8436	2.5000	930-002-661	\$29.07	931-000-316	\$35.10
0.0625	0.2500	0.0313	0.1875	1.8302	2.5000	930-002-662	\$29.54	931-000-317	\$34.31
0.0938	0.2500	0.0469	0.3750	1.7231	2.5000	930-002-663	\$27.60	931-000-318	\$33.62
0.1250	0.2500	0.0625	0.5000	1.6785	2.5000	930-002-664	\$27.60	931-000-319	\$33.62
0.1875	0.2500	0.0938	0.6250	1.7142	2.5000	930-002-665	\$27.60	931-000-320	\$33.62
0.2500	0.2500	0.1250	0.7500	1.3750	2.5000	930-002-666	\$27.60	931-000-321	\$33.62

CARBIDE

IMPERIAL 1/32" - 1/2"

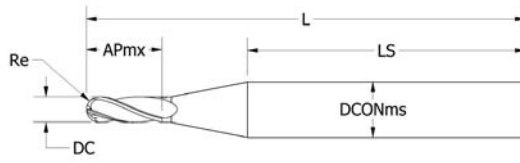

DC	DCONms	Re	APmx	LS	L	UNCOATED			ALTIM COATED		
						2 FLUTE	4 FLUTE	Price	2 FLUTE	4 FLUTE	Price
0.0313	0.1250	0.0156	0.0938	1.1651	1.5000	930-002-054	930-002-423	\$20.02		930-002-612	\$24.32
0.0469	0.1250	0.0234	0.1406	1.1584	1.5000	930-002-055	930-002-424	\$18.85		930-002-613	\$23.13
0.0625	0.1250	0.0313	0.1875	1.1517	1.5000	930-002-056	930-002-425	\$18.42		930-002-614	\$22.71
0.0781	0.1250	0.0391	0.1875	1.1919	1.5000	930-002-057	930-002-426	\$18.42		930-002-615	\$22.71
0.0938	0.1250	0.0469	0.3750	1.0446	1.5000	930-002-058	930-002-427	\$18.42		930-002-616	\$22.71
0.1094	0.1250	0.0547	0.4375	1.0223	1.5000	930-002-059	930-002-428	\$18.90		930-002-617	\$23.29
0.1250	0.1250	0.0625	0.5000	0.6250	1.5000	930-002-060	930-002-429	\$18.90	931-000-289	930-002-618	\$23.28
0.1406	0.1875	0.0703	0.5000	1.3794	2.0000	930-002-061	930-002-430	\$20.11	930-002-319	930-002-619	\$30.03
0.1563	0.1875	0.0781	0.5625	1.3571	2.0000	930-002-062	930-002-431	\$20.11	931-000-290	930-002-620	\$24.82
0.1719	0.1875	0.0859	0.6250	1.3348	2.0000	930-002-063	930-002-432	\$20.11			
0.1875	0.1875	0.0938	0.6250	1.0000	2.0000	930-002-064	930-002-433	\$20.11	931-000-291	930-002-621	\$24.82
0.2031	0.2500	0.1016	0.6250	1.7544	2.5000	930-002-066	930-002-435	\$22.63			
0.2188	0.2500	0.1094	0.6250	1.7946	2.5000	930-002-067	930-002-436	\$22.63	930-002-320	930-002-622	\$29.22
0.2344	0.2500	0.1172	0.6250	1.8348	2.5000	930-002-068	930-002-437	\$22.63			
0.2500	0.2500	0.1250	0.7500	1.3750	2.5000	930-002-069	930-002-438	\$22.63	931-000-292	930-002-623	\$29.22
0.3125	0.3125	0.1563	0.8125	1.3125	2.5000	930-002-070	930-002-439	\$31.85			
0.3750	0.3750	0.1875	1.0000	1.1250	2.5000	930-002-071	930-002-440	\$37.88			
0.5000	0.5000	0.2500	1.0000	1.6250	3.0000	930-002-074	930-002-443	\$74.37		931-000-293	\$89.12

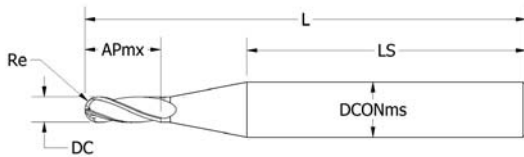

STUB



DC	DCONms	Re	APmx	LS	L	UNCOATED			ALTIM COATED	
						2 FLUTE	4 FLUTE	Price	2 FLUTE	Price
0.0313	0.1250	0.0156	0.0625	1.1963	1.5000	930-001-226	930-001-863	\$20.02		
0.0469	0.1250	0.0234	0.0625	1.2365	1.5000	930-001-227	930-001-864	\$18.85		
0.0625	0.1250	0.0313	0.1250	1.2142	1.5000	930-001-228	930-001-865	\$18.42		
0.0938	0.1250	0.0469	0.1875	1.2321	1.5000	930-001-229	930-001-866	\$18.42		
0.1250	0.1250	0.0625	0.2500	0.8750	1.5000	930-001-230	930-001-867	\$18.90	931-000-262	\$23.28
0.1563	0.1875	0.0781	0.3750	1.5446	2.0000	930-001-231	930-001-868	\$20.11	930-001-389	\$30.03
0.1875	0.1875	0.0938	0.3750	1.2500	2.0000	930-001-232	930-001-869	\$20.11	931-000-263	\$24.82
0.2500	0.2500	0.1250	0.5000	1.1250	2.0000	930-001-234	930-001-871	\$22.63	931-000-264	\$29.22

IMPERIAL 1/32" - 1/2"



CARBIDE

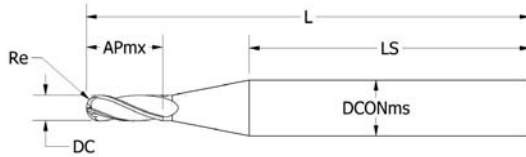

DC	DCONms	Re	APmx	LS	L	TIALN COATED				AMORPHOUS DIAMOND		
						2 FLUTE	3 FLUTE	4 FLUTE	Price	2 FLUTE	4 FLUTE	Price
0.0313	0.1250	0.0156	0.0938	1.1651	1.5000	930-002-229	931-000-119	930-002-586	\$24.32	931-000-387	931-000-413	\$32.68
0.0469	0.1250	0.0234	0.1406	1.1584	1.5000	930-002-230	931-000-122	930-002-587	\$23.13	931-000-389	931-000-415	\$30.10
0.0625	0.1250	0.0313	0.1875	1.1517	1.5000	930-002-231	931-000-125	930-002-588	\$22.71	931-000-391	931-000-417	\$29.67
0.0781	0.1250	0.0391	0.1875	1.1919	1.5000	930-002-232	931-000-128	930-002-589	\$22.71	931-000-393	931-000-419	\$29.67
0.0938	0.1250	0.0469	0.3750	1.0446	1.5000	930-002-233	931-000-131	930-002-590	\$22.71	931-000-395	931-000-421	\$29.67
0.1094	0.1250	0.0547	0.4375	1.0223	1.5000					931-000-397	931-000-423	\$30.43
0.1250	0.1250	0.0625	0.5000	0.6250	1.5000	930-002-234	931-000-135	930-002-591	\$23.28	931-000-399	931-000-425	\$30.43
0.1406	0.1875	0.0703	0.5000	1.3794	2.0000					931-000-401	931-000-430	\$36.04
0.1563	0.1875	0.0781	0.5625	1.3571	2.0000					931-000-403	931-000-432	\$36.04
0.1875	0.1875	0.0938	0.6250	1.0000	2.0000					931-000-405	931-000-434	\$36.04
0.2500	0.2500	0.1250	0.7500	1.3750	2.5000					931-000-407	931-000-439	\$40.75
0.3750	0.3750	0.1875	1.0000	1.1250	2.5000					931-000-409	931-000-446	\$71.41
0.5000	0.5000	0.2500	1.0000	1.6250	3.0000					931-000-411	931-000-450	\$115.88

IMPERIAL 1/32" - 1/4"

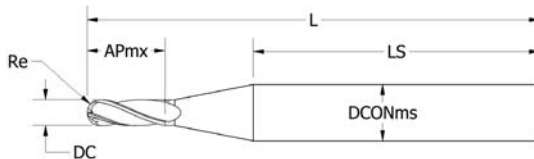

STUB

DC	DCONms	Re	APmx	LS	L	TIALN COATED			AMORPHOUS DIAMOND		
						2 FLUTE	4 FLUTE	Price	2 FLUTE	4 FLUTE	Price
0.0313	0.1250	0.0156	0.0625	1.1963	1.5000	930-001-332	930-001-960	\$24.32			
0.0469	0.1250	0.0234	0.0625	1.2365	1.5000	930-001-333	930-001-961	\$23.13			
0.0625	0.1250	0.0313	0.1250	1.2142	1.5000	930-001-334	930-001-962	\$22.71			
0.0938	0.1250	0.0469	0.1875	1.2321	1.5000	930-001-335	930-001-963	\$22.71			
0.1250	0.1250	0.0625	0.2500	0.8750	1.5000	930-001-336	930-001-964	\$23.28	931-000-259	931-000-286	\$30.43
0.1875	0.1875	0.0938	0.3750	1.2500	2.0000				931-000-260	931-000-287	\$37.66
0.2500	0.2500	0.1250	0.5000	1.1250	2.0000				931-000-261	931-000-288	\$40.75

CARBIDE

IMPERIAL 1/8"-1/2"

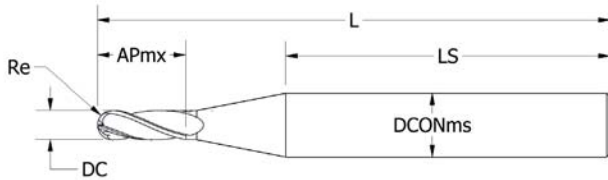

3 FLUTE G MILLS



DC	DCONms	Re	APmx	LS	L	UNCOATED		ALTIM COATED		AMORPHOUS DIAMOND	
						3 FLUTE	Price	3 FLUTE	Price	3 FLUTE	Price
0.0156	0.1250	0.0078	0.0780	2.1407	2.5000	931-000-194	\$35.48	930-000-125	\$41.94	931-000-457	\$47.01
0.0313	0.1250	0.0156	0.1560	2.1028	2.5000	931-000-196	\$27.90	931-000-197	\$32.30	931-000-463	\$39.44
0.0469	0.1250	0.0234	0.2500	2.0490	2.5000	931-000-201	\$27.12	930-000-128	\$33.59	931-000-475	\$38.68
0.0625	0.1250	0.0313	0.5000	1.8392	2.5000	931-000-203	\$27.79	930-000-130	\$35.80	931-000-481	\$39.33
0.0781	0.1250	0.0391	0.5000	1.8794	2.5000	931-000-207	\$24.82	931-000-208	\$29.22	931-000-493	\$36.36
0.0938	0.1250	0.0469	0.7500	1.6696	2.5000	931-000-210	\$27.79	931-000-211	\$32.19	931-000-499	\$39.33
0.1250	0.1250	0.0625	1.0000	1.6250	3.0000	931-000-215	\$25.38	931-000-216	\$31.11	931-000-511	\$36.91

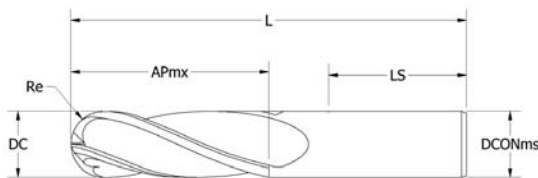

4 FLUTE



DC	DCONms	Re	APmx	LS	L	AMORPHOUS DIAMOND	
						4 FLUTE	Price
0.1875	0.1875	0.0938	1.1250	1.5000	3.0000	931-000-517	\$43.05
0.2500	0.2500	0.1250	1.5000	2.1250	4.0000	931-000-523	\$48.67

IMPERIAL 1/8"-1/2"



CARBIDE

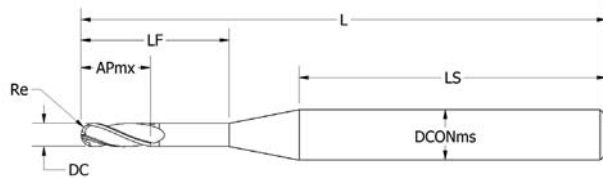

STUB, LONG REACH



DC	DCONms	Re	APmx	LS	L	LF	UNCOATED		AMORPHOUS DIAMOND	
							3 FLUTE	Price	3 FLUTE	Price
0.0313	0.1250	0.0156	0.0625	2.2031	2.5000	0.2500	931-000-199	\$30.47	931-000-465	\$47.90
0.0313	0.1250	0.0156	0.0625	2.0781	2.5000	0.3750			931-000-473	\$48.99
0.0313	0.1250	0.0156	0.0625	1.9531	2.5000	0.5000			931-000-469	\$54.27
0.0625	0.1250	0.0313	0.1250	1.9688	2.5000	0.5000	931-000-205	\$39.88	931-000-483	\$47.01
0.0625	0.1250	0.0313	0.1250	1.7188	2.5000	0.7500			931-000-491	\$48.01
0.0625	0.1250	0.0313	0.1250	1.4688	2.5000	1.0000			931-000-487	\$52.07
0.0938	0.1250	0.0469	0.1875	1.7344	2.5000	0.7500	931-000-213	\$30.47	931-000-501	\$47.01
0.0938	0.1250	0.0469	0.1875	1.4844	2.5000	1.0000			931-000-509	\$55.95
0.0938	0.1250	0.0469	0.1875	1.2344	2.5000	1.2500			931-000-505	\$62.31

CARBIDE

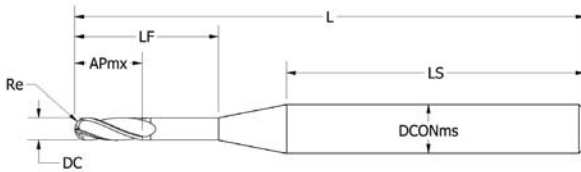

LONG FLUTE, LONG REACH



DC	DCONms	Re	APmx	LS	L	LF	AMORPHOUS DIAMOND	
							3 FLUTE	Price
0.0156	0.1250	0.0078	0.0781	2.2953	2.5000	0.1500	931-000-461	\$61.76
0.0156	0.1250	0.0078	0.0781	2.1953	2.5000	0.2500	931-000-459	\$73.23
0.0313	0.1250	0.0156	0.1563	2.2031	2.5000	0.2500	931-000-471	\$50.29
0.0313	0.1250	0.0156	0.1563	2.0781	2.5000	0.3750	931-000-467	\$55.95
0.0469	0.1250	0.0234	0.2500	2.0859	2.5000	0.3750	931-000-479	\$50.29
0.0469	0.1250	0.0234	0.2500	1.9609	2.5000	0.5000	931-000-477	\$55.95
0.0625	0.1250	0.0313	0.5000	1.7188	2.5000	0.7500	931-000-489	\$50.29
0.0625	0.1250	0.0313	0.5000	1.4688	2.5000	1.0000	931-000-485	\$55.95
0.0781	0.1250	0.0391	0.5000	1.7266	2.5000	0.7500	931-000-497	\$50.29
0.0781	0.1250	0.0391	0.5000	1.4766	2.5000	1.0000	931-000-495	\$55.95
0.0938	0.1250	0.0469	0.7500	1.4844	2.5000	1.0000	931-000-507	\$50.29
0.0938	0.1250	0.0469	0.7500	1.2344	2.5000	1.2500	931-000-503	\$55.95
0.1250	0.1250	0.0625	1.0000	1.7500	3.0000	1.2500	931-000-515	\$50.29
0.1250	0.1250	0.0625	1.0000	1.5000	3.0000	1.5000	931-000-513	\$55.95

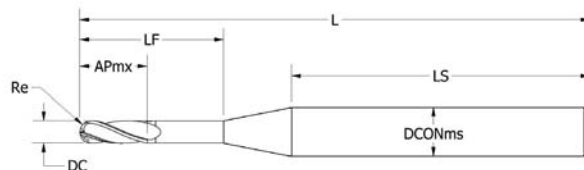

DC	DCONms	Re	APmx	LS	L	LF	4 FLUTE	Price
0.1875	0.1875	0.0938	1.1250	1.5000	3.0000	1.5000	931-000-521	\$55.59
0.1875	0.1875	0.0938	1.1250	1.2500	3.0000	1.7500	931-000-519	\$67.40
0.2500	0.2500	0.1250	1.5000	2.0000	4.0000	2.0000	931-000-527	\$74.49
0.2500	0.2500	0.1250	1.5000	1.5000	4.0000	2.5000	931-000-525	\$83.42

METRIC .5 mm - 12 mm



CARBIDE

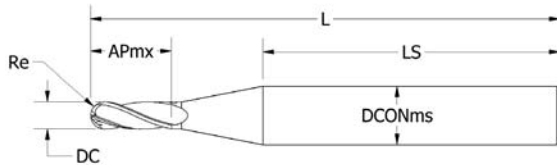

DC	DCONms	Re	APmx	LS	L	UNCOATED		
						2 FLUTE	4 FLUTE	Price
0.50	3.00	0.25	1.50	30.07	38.00	930-000-017	930-000-049	\$19.27
1.00	3.00	0.50	3.00	29.86	38.00	930-000-018	930-000-050	\$19.27
1.50	3.00	0.75	4.50	29.64	38.00	930-000-019	930-000-051	\$19.27
2.00	3.00	1.00	6.00	29.43	38.00	930-000-020	930-000-052	\$16.95
2.50	3.00	1.25	8.00	28.71	38.00	930-000-021	930-000-053	\$16.95
3.00	3.00	1.50	10.00	18.00	38.00	930-000-022	930-000-054	\$16.95
3.50	4.00	1.75	12.00	36.71	50.00	930-000-023	930-000-055	\$22.10
4.00	4.00	2.00	12.00	28.00	50.00	930-000-024	930-000-056	\$22.10
4.50	5.00	2.25	14.00	34.71	50.00	930-000-025	930-000-057	\$29.23
5.00	5.00	2.50	15.00	25.00	50.00	930-000-026	930-000-058	\$29.23
6.00	6.00	3.00	18.00	35.00	63.00	930-000-027	930-000-059	\$29.23
7.00	8.00	3.50	20.00	40.43	63.00	930-000-028	930-000-060	\$29.74
8.00	4.00	4.00	20.00	33.00	63.00	930-000-029	930-000-061	\$29.74
9.00	10.00	4.50	22.00	38.43	63.00	930-000-030	930-000-062	\$49.08
10.00	10.00	5.00	22.00	31.00	63.00	930-000-031	930-000-063	\$49.08
12.00	12.00	6.00	25.00	40.00	75.00	930-000-032	930-000-064	\$70.84

CARBIDE



METRIC .4 mm - 12 mm

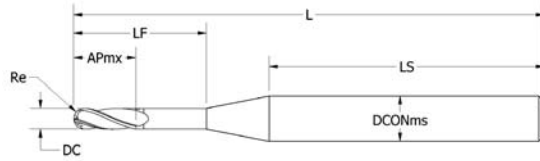

STUB, 8X REACH LENGTH



DC	DCONms	Re	APmx	LS	L	LF	AMORPHOUS DIAMOND	
							3 FLUTE	Price
0.40	3.00	0.20	0.60	70.50	75.00	3.20	930-000-109	\$63.70
0.50	3.00	0.25	0.75	69.75	75.00	4.00	930-000-110	\$63.70
0.60	3.00	0.30	0.90	69.00	75.00	4.80	930-000-111	\$63.70
0.80	3.00	0.40	1.20	67.50	75.00	6.40	930-000-112	\$47.75
1.00	3.00	0.50	1.50	66.00	75.00	8.00	930-000-113	\$47.75
1.50	3.00	0.75	2.25	62.25	75.00	12.00	930-000-114	\$47.75
2.00	3.00	1.00	3.00	58.50	75.00	16.00	930-000-115	\$47.75
2.50	3.00	1.25	3.75	54.75	75.00	20.00	930-000-116	\$47.75
3.00	3.00	1.50	4.50	51.00	75.00	24.00	930-000-117	\$47.75
4.00	4.00	2.00	6.00	43.00	75.00	32.00	930-000-118	\$53.17
6.00	6.00	3.00	9.00	52.00	100.00	48.00	930-000-119	\$71.95
8.00	8.00	4.00	12.00	36.00	100.00	64.00	930-000-120	\$102.85
10.00	10.00	5.00	15.00	40.00	120.00	80.00	930-000-121	\$146.50
12.00	12.00	6.00	18.00	54.00	150.00	96.00	930-000-122	\$184.72

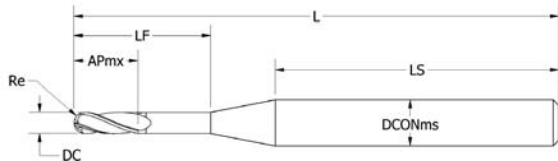

5X FLUTE LENGTH, 10X REACH LENGTH



DC	DCONms	Re	APmx	LS	L	LF	AMORPHOUS DIAMOND	
							3 FLUTE	Price
0.40	3.00	0.20	2.00	69.70	75.00	4 mm	930-000-080	\$56.05
0.50	3.00	0.25	2.50	68.75	75.00	5 mm	930-000-081	\$56.05
0.60	3.00	0.30	3.00	67.80	75.00	6 mm	930-000-082	\$56.05
0.80	3.00	0.40	4.00	65.90	75.00	8 mm	930-000-083	\$41.93
1.00	3.00	0.50	5.00	64.00	75.00	10 mm	930-000-084	\$41.93
1.20	3.00	0.60	6.00	62.10	75.00	12 mm	930-000-085	\$41.93
1.50	3.00	0.75	7.50	59.25	75.00	15 mm	930-000-086	\$41.93
2.00	3.00	1.00	10.00	54.50	75.00	20 mm	930-000-087	\$41.93
2.50	3.00	1.25	12.50	49.75	75.00	25 mm	930-000-088	\$41.93
3.00	3.00	1.50	15.00	45.00	75.00	30 mm	930-000-089	\$41.93
4.00	4.00	2.00	20.00	35.00	75.00	40 mm	930-000-090	\$48.56
6.00	6.00	3.00	30.00	40.00	100.00	60 mm	930-000-091	\$63.04
8.00	8.00	4.00	40.00	30.00	100.00	70 mm	930-000-092	\$96.21
10.00	10.00	5.00	50.00	40.00	120.00	80 mm	930-000-093	\$140.14
12.00	12.00	6.00	60.00	65.00	150.00	85 mm	930-000-094	\$171.98

METRIC .020" - .060"



CARBIDE

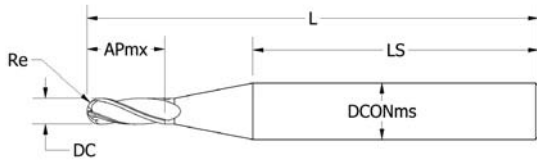

LONG FLUTE



DC	DCONms	Re	APmx	LS	L	A	UNCOATED		TIALN NANO COATED	
							4 FLUTE	Price	4 FLUTE	Price
0.0200	0.1875	0.0100	0.1400	2.4291	3.0000		930-000-151	\$62.34	930-000-161	\$68.54
0.0300	0.1875	0.0150	0.2100	2.3849	3.0000		930-000-152	\$58.11	930-000-162	\$64.83
0.0400	0.1875	0.0200	0.2800	2.3406	3.0000		930-000-153	\$59.24	930-000-163	\$65.96
0.0500	0.1875	0.0250	0.3500	2.2963	3.0000		930-000-154	\$59.24	930-000-164	\$65.96
0.0600	0.1875	0.0300	0.4200	2.2520	3.0000		930-000-155	\$58.11	930-000-165	\$64.83
0.0200	0.1875	0.0100	0.1400	2.4350	3.0000	1.0	930-000-203	\$62.34	930-000-223	\$68.54
0.0300	0.1875	0.0150	0.2100	2.3936	3.0000	1.0	930-000-204	\$58.11	930-000-224	\$64.83
0.0400	0.1875	0.0200	0.2800	2.3523	3.0000	1.0	930-000-205	\$59.24	930-000-225	\$65.96
0.0500	0.1875	0.0250	0.3500	2.3109	3.0000	1.0	930-000-206	\$59.24	930-000-226	\$65.96
0.0600	0.1875	0.0300	0.4200	2.2695	3.0000	1.0	930-000-207	\$58.11	930-000-227	\$64.83
0.0200	0.1875	0.0100	0.1400	2.4408	3.0000	2.0	930-000-213	\$62.34	930-000-233	\$68.54
0.0300	0.1875	0.0150	0.2100	2.4024	3.0000	2.0	930-000-214	\$58.11	930-000-234	\$64.83
0.0400	0.1875	0.0200	0.2800	2.3639	3.0000	2.0	930-000-215	\$59.24	930-000-235	\$65.96
0.0500	0.1875	0.0250	0.3500	2.3255	3.0000	2.0	930-000-216	\$59.24	930-000-236	\$65.96
0.0600	0.1875	0.0300	0.4200	2.2871	3.0000	2.0	930-000-217	\$58.11	930-000-237	\$64.83

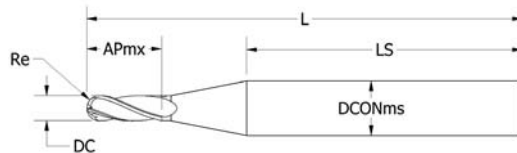

EXTRA LONG FLUTE



DC	DCONms	Re	APmx	LS	L	A	UNCOATED		TIALN NANO COATED	
							4 FLUTE	Price	4 FLUTE	Price
0.0200	0.1875	0.0100	0.2800	2.2891	3.0000		930-000-156	\$58.11	930-000-166	\$68.54
0.0300	0.1875	0.0150	0.4100	2.1849	3.0000		930-000-157	\$59.24	930-000-167	\$64.83
0.0400	0.1875	0.0200	0.5600	2.0606	3.0000		930-000-158	\$59.24	930-000-168	\$65.96
0.0500	0.1875	0.0250	0.7000	1.9463	3.0000		930-000-159	\$58.11	930-000-169	\$65.96
0.0600	0.1875	0.0300	0.8400	1.8320	3.0000		930-000-160	\$58.11	930-000-170	\$64.83
0.0200	0.1875	0.0100	0.2800	2.3013	3.0000	1.0	930-000-208	\$59.24	930-000-228	\$68.54
0.0300	0.1875	0.0150	0.4100	2.2026	3.0000	1.0	930-000-209	\$59.24	930-000-229	\$64.83
0.0400	0.1875	0.0200	0.5600	2.0848	3.0000	1.0	930-000-210	\$58.11	930-000-230	\$65.96
0.0500	0.1875	0.0250	0.7000	1.9766	3.0000	1.0	930-000-211	\$58.11	930-000-231	\$65.96
0.0600	0.1875	0.0300	0.8400	1.8684	3.0000	1.0	930-000-212	\$59.24	930-000-232	\$64.83
0.0200	0.1875	0.0100	0.2800	2.3134	3.0000	2.0	930-000-218	\$59.24	930-000-238	\$68.54
0.0300	0.1875	0.0150	0.4100	2.2203	3.0000	2.0	930-000-219	\$58.11	930-000-239	\$64.83
0.0400	0.1875	0.0200	0.5600	2.1091	3.0000	2.0	930-000-220	\$59.24	930-000-240	\$65.96
0.0500	0.1875	0.0250	0.7000	2.0069	3.0000	2.0	930-000-221	\$59.24	930-000-241	\$65.96
0.0600	0.1875	0.0300	0.8400	1.9048	3.0000	2.0	930-000-222	\$58.11	930-000-242	\$64.83

CARBIDE

METRIC .030"-.060"

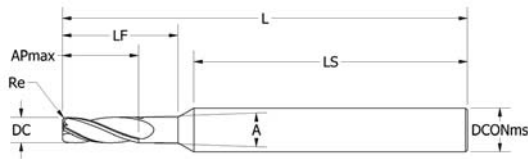

LONG FLUTE



DC	DCONms	Re	APmx	LS	L	A	UNCOATED 4 FLUTE		TIALN NANO COATED	
							4 FLUTE	Price	4 FLUTE	Price
0.0300	0.1875	0.0100	0.2100	2.3849	3.0000	-	930-000-135	\$58.11	930-000-143	\$64.83
0.0400	0.1875	0.0100	0.2800	2.3406	3.0000	-	930-000-136	\$59.24	930-000-144	\$65.96
0.0500	0.1875	0.0100	0.3500	2.2963	3.0000	-	930-000-137	\$59.24	930-000-145	\$65.96
0.0600	0.1875	0.0100	0.4200	2.2520	3.0000	-	930-000-138	\$58.11	930-000-146	\$64.83
0.0300	0.1875	0.0100	0.2100	2.3938	3.0000	1.0	930-000-171	\$58.11	930-000-187	\$64.83
0.0400	0.1875	0.0100	0.2800	2.3527	3.0000	1.0	930-000-172	\$59.24	930-000-188	\$65.96
0.0500	0.1875	0.0100	0.3500	2.3116	3.0000	1.0	930-000-173	\$59.24	930-000-189	\$65.96
0.0600	0.1875	0.0100	0.4200	2.2704	3.0000	1.0	930-000-174	\$58.11	930-000-190	\$64.83
0.0300	0.1875	0.0100	0.2100	2.4028	3.0000	2.0	930-000-179	\$58.11	930-000-195	\$64.83
0.0400	0.1875	0.0100	0.2800	2.3648	3.0000	2.0	930-000-180	\$59.24	930-000-196	\$65.96
0.0500	0.1875	0.0100	0.3500	2.3268	3.0000	2.0	930-000-181	\$59.24	930-000-197	\$65.96
0.0600	0.1875	0.0100	0.4200	2.2889	3.0000	2.0	930-000-182	\$58.11	930-000-198	\$64.83

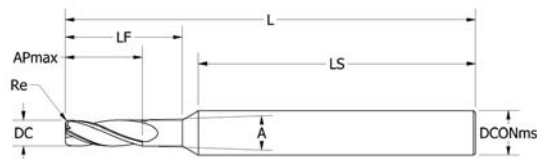

EXTRA LONG FLUTE



DC	DCONms	Re	APmx	LS	L	A	UNCOATED 4 FLUTE		TIALN NANO COATED	
							4 FLUTE	Price	4 FLUTE	Price
0.0300	0.1875	0.0100	0.4100	2.1849	3.0000	-	930-000-139	\$58.11	930-000-147	\$64.83
0.0400	0.1875	0.0100	0.5600	2.0606	3.0000	-	930-000-140	\$59.24	930-000-148	\$65.96
0.0500	0.1875	0.0100	0.7000	1.9463	3.0000	-	930-000-141	\$59.24	930-000-149	\$65.96
0.0600	0.1875	0.0100	0.8400	1.8320	3.0000	-	930-000-142	\$58.11	930-000-150	\$64.83
0.0300	0.1875	0.0100	0.4100	2.2028	3.0000	1.0	930-000-175	\$58.11	930-000-191	\$64.83
0.0400	0.1875	0.0100	0.5600	2.0853	3.0000	1.0	930-000-176	\$59.24	930-000-192	\$65.96
0.0500	0.1875	0.0100	0.7000	1.9773	3.0000	1.0	930-000-177	\$59.24	930-000-193	\$65.96
0.0600	0.1875	0.0100	0.8400	1.8693	3.0000	1.0	930-000-178	\$58.11	930-000-194	\$64.83
0.0300	0.1875	0.0100	0.4100	2.2208	3.0000	2.0	930-000-183	\$58.11	930-000-199	\$64.83
0.0400	0.1875	0.0100	0.5600	2.1100	3.0000	2.0	930-000-184	\$59.24	930-000-200	\$65.96
0.0500	0.1875	0.0100	0.7000	2.0083	3.0000	2.0	930-000-185	\$59.24	930-000-201	\$65.96
0.0600	0.1875	0.0100	0.8400	1.9066	3.0000	2.0	930-000-186	\$58.11	930-000-202	\$64.83

METRIC .005" - .1378"



CARBIDE

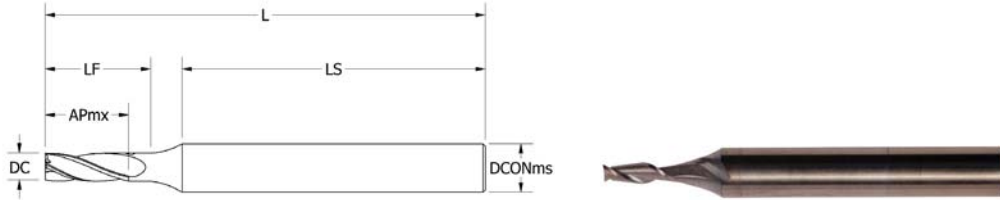

DC	DCONms	APmx	LS	L	LF	UNCOATED		TICN COATED	
						2 FLUTE	Price	2 FLUTE	Price
0.0050	0.1250	0.0150	1.2815	1.5000		934-000-109	\$21.12	934-000-154	\$23.20
0.0100	0.1250	0.0300	1.2705	1.5000	0.0310	934-000-110	\$21.12	934-000-155	\$23.20
0.0150	0.1250	0.0450	1.2595	1.5000	0.0475	934-000-111	\$16.95	934-000-156	\$23.20
0.0050	0.1250	0.0150	1.2815	1.5000		934-000-154	\$16.95		
0.0197	0.1250	0.0591	1.2493	1.5000		934-000-141	\$16.95		
0.0200	0.1250	0.0600	1.2486	1.5000	0.0630	934-000-112	\$17.35	934-000-157	\$19.43
0.0250	0.1250	0.0750	1.2379	1.5000	0.0780	934-000-113	\$17.35		
0.0300	0.1250	0.0900	1.2273	1.5000	0.0930	934-000-114	\$16.09	934-000-158	\$18.38
0.0350	0.1875	0.1050	1.1683	1.5000	0.1100	934-000-115	\$13.46		
0.0394	0.1875	0.1182	1.1581	1.5000	0.1232	934-000-142	\$13.46		
0.0400	0.1875	0.1200	1.1567	1.5000	0.1250	934-000-116	\$13.46	934-000-159	\$17.28
0.0450	0.1875	0.1350	1.1451	1.5000	0.1400	934-000-117	\$13.46		
0.0492	0.1875	0.1476	1.1354	1.5000	0.1526	934-000-143	\$13.46		
0.0500	0.1875	0.1500	1.1336	1.5000	0.1550	934-000-118	\$13.46	934-000-160	\$17.28
0.0550	0.1875	0.1650	1.1222	1.5000	0.1700	934-000-119	\$13.96		
0.0591	0.1875	0.1773	1.1129	1.5000	0.1823	934-000-144	\$13.96		
0.0600	0.1875	0.1800	1.1108	1.5000	0.1850	934-000-120	\$13.96	934-000-161	\$17.78
0.0630	0.1875	0.1890	1.1041	1.5000	0.1940	934-000-145	\$13.96		
0.0650	0.1875	0.1950	1.0996	1.5000	0.2000	934-000-121	\$13.96		
0.0700	0.1875	0.2100	1.0885	1.5000	0.2150	934-000-122	\$13.96	934-000-162	\$17.78
0.0709	0.1875	0.2127	1.0865	1.5000	0.2177	934-000-146	\$13.96		
0.0750	0.1875	0.2250	1.0775	1.5000	0.2300	934-000-123	\$13.96		
0.0787	0.1875	0.2361	1.0694	1.5000	0.2411	934-000-147	\$13.96		
0.0800	0.1875	0.2400	1.0665	1.5000	0.2450	934-000-124	\$13.96	934-000-163	\$17.78
0.0850	0.1875	0.2550	1.0558	1.5000	0.2600	934-000-125	\$13.96		
0.0866	0.1875	0.2598	1.0523	1.5000	0.2648	934-000-148	\$13.96		
0.0900	0.1875	0.2700	1.0451	1.5000	0.2750	934-000-126	\$15.05	934-000-164	\$18.22
0.0950	0.1875	0.2850	1.0346	1.5000	0.2900	934-000-127	\$15.05		
0.0984	0.1875	0.2952	1.0275	1.5000	0.3002	934-000-149	\$15.05		
0.1000	0.1875	0.3000	1.0242	1.5000	0.3050	934-000-128	\$15.05	934-000-165	\$18.22
0.1102	0.1875	0.3306	1.0036	1.5000	0.3356	934-000-150	\$15.05		
0.1181	0.1875	0.3543	0.9882	1.5000	0.3593	934-000-151	\$15.05		
0.1200	0.1875	0.3600	0.9845	1.5000	0.3650	934-000-129	\$15.05		
0.1378	0.1875	0.4134	0.9524	1.5000	0.4184	934-000-152	\$15.05		

METRIC .005" - .1378"

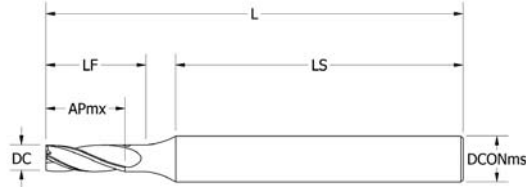

DC	DCONms	APmx	LS	L	LF	UNCOATED	
						2 FLUTE	Price
0.0050	0.1250	0.0075	1.3300	1.5000		934-000-190	\$21.07
0.0100	0.1250	0.0150	1.2855	1.5000	0.0150	934-000-191	\$21.07
0.0150	0.1250	0.0225	1.2820	1.5000	0.0225	934-000-192	\$16.95
0.0156	0.1250	0.0234	1.2816	1.5000	0.0234	934-000-223	\$16.95
0.0197	0.1250	0.0296	1.2788	1.5000	0.0296	934-000-211	\$16.95
0.0200	0.1250	0.0300	1.2786	1.5000	0.0300	934-000-193	\$16.39
0.0250	0.1250	0.0375	1.2754	1.5000	0.0375	934-000-194	\$15.85
0.0300	0.1250	0.0450	1.2723	1.5000	0.0450	934-000-195	\$16.09
0.0350	0.1875	0.0525	1.2208	1.5000	0.0525	934-000-196	\$14.01
0.0394	0.1875	0.0591	1.2172	1.5000	0.0591	934-000-212	\$14.01
0.0400	0.1875	0.0600	1.2167	1.5000	0.0600	934-000-197	\$14.01
0.0450	0.1875	0.0675	1.2126	1.5000	0.0675	934-000-198	\$14.01
0.0492	0.1875	0.0738	1.2092	1.5000	0.0738	934-000-213	\$14.01
0.0500	0.1875	0.0750	1.2086	1.5000	0.0750	934-000-199	\$14.01
0.0550	0.1875	0.0825	1.2047	1.5000	0.0825	934-000-200	\$13.96
0.0591	0.1875	0.0887	1.2015	1.5000	0.0887	934-000-214	\$13.96
0.0600	0.1875	0.0900	1.2008	1.5000	0.0900	934-000-201	\$13.96
0.0630	0.1875	0.0945	1.1986	1.5000	0.0945	934-000-215	\$13.96
0.0650	0.1875	0.0975	1.1971	1.5000	0.0975	934-000-202	\$13.96
0.0700	0.1875	0.1050	1.1935	1.5000	0.1050	934-000-203	\$13.96
0.0709	0.1875	0.1064	1.1928	1.5000	0.1064	934-000-216	\$13.96
0.0750	0.1875	0.1125	1.1900	1.5000	0.1125	934-000-204	\$13.96
0.0787	0.1875	0.1181	1.1874	1.5000	0.1181	934-000-217	\$13.96
0.0800	0.1875	0.1200	1.1865	1.5000	0.1200	934-000-205	\$13.96
0.0850	0.1875	0.1275	1.1833	1.5000	0.1275	934-000-206	\$13.96
0.0866	0.1875	0.1299	1.1822	1.5000	0.1299	934-000-218	\$13.96
0.0900	0.1875	0.1350	1.1801	1.5000	0.1350	934-000-207	\$15.05
0.0950	0.1875	0.1425	1.1771	1.5000	0.1425	934-000-208	\$15.05
0.0984	0.1875	0.1476	1.1751	1.5000	0.1476	934-000-219	\$15.05
0.1000	0.1875	0.1500	1.1742	1.5000	0.1500	934-000-209	\$15.05
0.1102	0.1875	0.1653	1.1689	1.5000	0.1653	934-000-220	\$15.05
0.1181	0.1875	0.1772	1.1653	1.5000	0.1772	934-000-221	\$15.05
0.1200	0.1875	0.1800	1.1645	1.5000	0.1800	934-000-210	\$15.05
0.1378	0.1875	0.2067	1.1591	1.5000	0.2067	934-000-222	\$15.05

HSS

IMPERIAL 1/64" - 3/16"



HSS

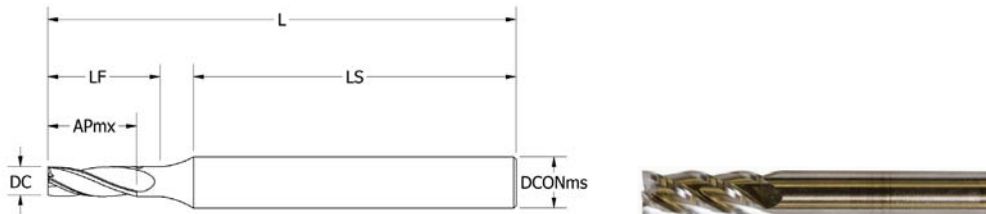

DC	DCONms	APmx	LS	L	LF	UNCOATED			TICN COATED		
						2 FLUTE	4 FLUTE	Price	2 FLUTE	4 FLUTE	Price
0.0156	0.1250	0.0468	1.2582	1.5000	0.0493	934-000-153		\$16.95	934-000-172		\$23.20
0.0313	0.1875	0.0938	1.1771	1.5000	0.0988	934-000-130	934-000-173	\$12.62	934-000-166	934-000-184	\$15.90
0.0469	0.1875	0.1406	1.1408	1.5000	0.1456	934-000-131	934-000-174	\$12.62	934-000-167	934-000-185	\$15.90
0.0625	0.1875	0.1875	1.1052	1.5000	0.1925	934-000-132	934-000-175	\$12.62	934-000-168	934-000-186	\$15.90
0.0781	0.1875	0.2344	1.0706	1.5000	0.2394	934-000-133	934-000-176	\$12.62	934-000-169	934-000-187	\$15.90
0.0938	0.1875	0.2813	1.0372	1.5000	0.2863	934-000-134	934-000-177	\$12.62	934-000-170	934-000-188	\$15.90
0.1094	0.1875	0.3281	1.0052	1.5000	0.3331	934-000-135	934-000-178	\$12.62			
0.1250	0.1875	0.3750	0.9751	1.5000	0.3800	934-000-136	934-000-179	\$12.62	934-000-171	934-000-189	\$15.90
0.1406	0.1875	0.4063	0.9633	1.5000	0.4113	934-000-137	934-000-180	\$12.62			
0.1563	0.1875	0.4375	0.9554	1.5000	0.4425	934-000-138	934-000-181	\$12.62			
0.1719	0.1875	0.5000	0.9239	1.5000	0.5050	934-000-139	934-000-182	\$12.62			
0.1875	0.1875	0.5000	0.6250	1.5000		934-000-140	934-000-183	\$12.62			

3/16": +000/.0025



IMPERIAL 1/32" - 3/16"

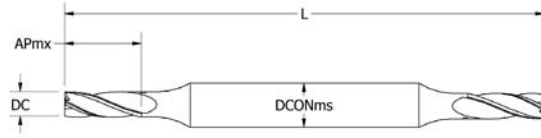

DC	DCONms	APmx	LS	L	UNCOATED	
					2 FLUTE	Price
0.0313	0.1875	0.0938	1.1250	2.2500	934-000-001	\$21.86
0.0469	0.1875	0.1406	1.1250	2.2500	934-000-002	\$21.86
0.0625	0.1875	0.1875	1.1250	2.2500	934-000-003	\$18.28
0.0781	0.1875	0.2344	1.1250	2.2500	934-000-004	\$18.28
0.0938	0.1875	0.2813	1.1250	2.2500	934-000-005	\$18.28
0.1094	0.1875	0.3281	1.1250	2.2500	934-000-006	\$18.28
0.1250	0.1875	0.3750	1.1250	2.2500	934-000-007	\$18.28
0.1406	0.1875	0.4063	1.1250	2.2500	934-000-008	\$19.83
0.1563	0.1875	0.4375	1.1250	2.2500	934-000-009	\$19.83
0.1719	0.1875	0.5025	1.1250	2.2500	934-000-010	\$19.83
0.1875*	0.1875	0.5000	1.2500	2.5000	934-000-011	\$19.83

3/16": +000/.0025

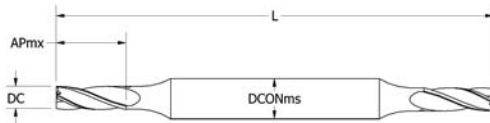

DC	DCONms	APmx	LS	L	UNCOATED	
					4 FLUTE	Price
0.0313	0.1875	0.0938	1.1250	2.2500	934-000-055	\$20.60
0.0469	0.1875	0.1406	1.1250	2.2500	934-000-056	\$20.60
0.0625	0.1875	0.1875	1.1250	2.2500	934-000-057	\$18.73
0.0781	0.1875	0.2344	1.1250	2.2500	934-000-058	\$18.73
0.0938	0.1875	0.2813	1.1250	2.2500	934-000-059	\$18.73
0.1094	0.1875	0.3281	1.1250	2.2500	934-000-060	\$18.73
0.1250	0.1875	0.3750	1.1250	2.2500	934-000-061	\$18.73
0.1406	0.1875	0.4063	1.1250	2.2500	934-000-062	\$19.83
0.1563	0.1875	0.4375	1.1250	2.2500	934-000-063	\$19.83
0.1719	0.1875	0.5000	1.1250	2.2500	934-000-064	\$19.83
0.1875*	0.1875	0.5000	1.1250	2.2500	934-000-065	\$19.83

3/16": +000/.0025

COBALT

IMPERIAL 1/32" - 3/16"

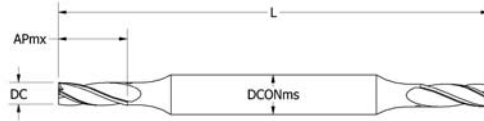

DC	DCONms	APmx	LS	L	UNCOATED	
					2 FLUTE	Price
0.0313	0.1875	0.0469	1.0000	2.0000	934-000-023	\$18.39
0.0469	0.1875	0.0625	1.0000	2.0000	934-000-024	\$18.39
0.0625	0.1875	0.0938	1.0000	2.0000	934-000-025	\$17.28
0.0781	0.1875	0.1250	1.0000	2.0000	934-000-026	\$17.28
0.0938	0.1875	0.1406	1.0000	2.0000	934-000-027	\$17.28
0.1094	0.1875	0.1563	1.0000	2.0000	934-000-028	\$17.28
0.1250	0.1875	0.1875	1.0000	2.0000	934-000-029	\$17.28
0.1406	0.1875	0.2188	1.0000	2.0000	934-000-030	\$20.26
0.1563	0.1875	0.2344	1.0000	2.0000	934-000-031	\$20.26
0.1719	0.1875	0.2500	1.0000	2.0000	934-000-032	\$20.26
0.1875*	0.1875	0.2813	1.0000	2.0000	934-000-033	\$20.26

3/16": +000/.0025

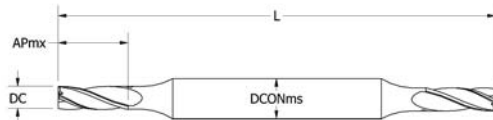

DC	DCONms	APmx	LS	L	UNCOATED	
					4 FLUTE	Price
0.0313	0.1875	0.0469	1.0000	2.0000	934-000-077	\$19.83
0.0469	0.1875	0.0625	1.0000	2.0000	934-000-078	\$19.83
0.0625	0.1875	0.0938	1.0000	2.0000	934-000-079	\$17.72
0.0781	0.1875	0.1250	1.0000	2.0000	934-000-080	\$17.72
0.0938	0.1875	0.1406	1.0000	2.0000	934-000-081	\$17.72
0.1094	0.1875	0.1563	1.0000	2.0000	934-000-082	\$17.72
0.1250	0.1875	0.1875	1.0000	2.0000	934-000-083	\$17.72
0.1406	0.1875	0.2188	1.0000	2.0000	934-000-084	\$18.95
0.1563	0.1875	0.2344	1.0000	2.0000	934-000-085	\$18.95
0.1719	0.1875	0.2500	1.0000	2.0000	934-000-086	\$18.95
0.1875*	0.1875	0.2813	1.0000	2.0000	934-000-087	\$18.95

3/16": +000/.0025

COBALT



IMPERIAL 1/32" - 3/16"

Cobalt

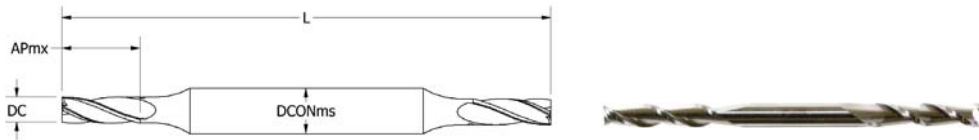

DC	DCONms	APmx	LS	L	UNCOATED	
					2 FLUTE	Price
0.0625	0.1875	0.2188	1.2500	2.5000	934-000-045	\$22.16
0.0938	0.1875	0.2813	1.3125	2.6250	934-000-046	\$22.16
0.1250	0.1875	0.7500	1.5625	3.1250	934-000-047	\$22.16
0.1563	0.1875	0.8750	1.6250	3.2500	934-000-048	\$25.04
0.1875*	0.1875	1.0000	1.6875	3.3750	934-000-049	\$25.04

3/16": +000/.0025

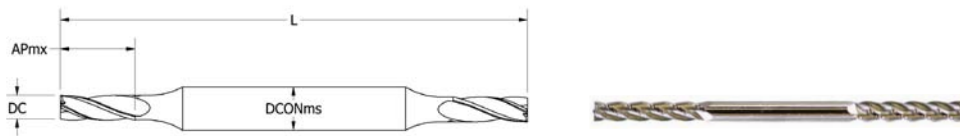

DC	DCONms	APmx	LS	L	UNCOATED	
					4 FLUTE	Price
0.0625	0.1875	0.2188	1.2500	2.5000	934-000-099	\$23.48
0.0938	0.1875	0.2813	1.3125	2.6250	934-000-100	\$23.48
0.1250	0.1875	0.7500	1.5625	3.1250	934-000-101	\$23.48
0.1563	0.1875	0.8750	1.6250	3.2500	934-000-102	\$25.48
0.1875*	0.1875	1.0000	1.6875	3.3750	934-000-103	\$25.48

3/16": +000/.0025

METRIC .005" - .1378"

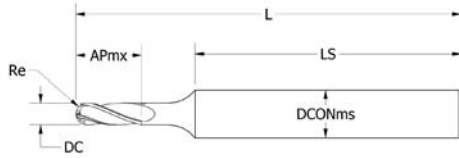

DC	DCONms	Re	APmx	LS	L	LF	UNCOATED		TICN COATED	
							2 FLUTE	Price	2 FLUTE	Price
0.0050	0.1250	0.0025	0.0150	1.3225	1.5000		934-000-258	\$22.31	934-000-303	\$26.52
0.0100	0.1250	0.0050	0.0300	1.2705	1.5000	0.0310	934-000-259	\$19.69	934-000-304	\$23.75
0.0150	0.1250	0.0075	0.0450	1.2595	1.5000	0.0475	934-000-260	\$21.16	934-000-305	\$23.61
0.0156	0.1250	0.0078	0.0468	1.2582	1.5000	0.0493	934-000-302	\$21.16	934-000-321	\$23.61
0.0197	0.1250	0.0099	0.0591	1.2493	1.5000	0.0621	934-000-290	\$20.44		
0.0200	0.1250	0.0100	0.0600	1.2486	1.5000	0.0630	934-000-261	\$19.55	934-000-306	\$23.61
0.0250	0.1250	0.0125	0.0750	1.2379	1.5000	0.0780	934-000-262	\$19.89		
0.0300	0.1250	0.0150	0.0900	1.2273	1.5000	0.0930	934-000-263	\$19.27	934-000-307	\$23.09
0.0350	0.1875	0.0175	0.1050	1.1683	1.5000	0.1100	934-000-264	\$16.95		
0.0394	0.1875	0.0197	0.1182	1.1581	1.5000	0.1232	934-000-291	\$16.95		
0.0400	0.1875	0.0200	0.1200	1.1567	1.5000	0.1250	934-000-265	\$16.95	934-000-308	\$20.77
0.0450	0.1875	0.0225	0.1350	1.1451	1.5000	0.1400	934-000-266	\$16.95		
0.0492	0.1875	0.0246	0.1476	1.1354	1.5000	0.1526	934-000-292	\$16.95		
0.0500	0.1875	0.0250	0.1500	1.1336	1.5000	0.1550	934-000-267	\$16.95	934-000-309	\$20.77
0.0550	0.1875	0.0275	0.1650	1.1222	1.5000	0.1700	934-000-268	\$17.62		
0.0591	0.1875	0.0296	0.1773	1.1129	1.5000	0.1823	934-000-293	\$17.62		
0.0600	0.1875	0.0300	0.1800	1.1108	1.5000	0.1850	934-000-269	\$17.62	934-000-310	\$21.44
0.0630	0.1875	0.0315	0.1890	1.1041	1.5000	0.1940	934-000-294	\$17.62		
0.0650	0.1875	0.0325	0.1950	1.0996	1.5000	0.2000	934-000-270	\$17.62		
0.0700	0.1875	0.0350	0.2100	1.0885	1.5000	0.2150	934-000-271	\$17.62	934-000-311	\$21.44
0.0709	0.1875	0.0355	0.2127	1.0865	1.5000	0.2177	934-000-295	\$17.62		
0.0750	0.1875	0.0375	0.2250	1.0775	1.5000	0.2300	934-000-272	\$17.62		
0.0787	0.1875	0.0394	0.2361	1.0694	1.5000	0.2411	934-000-296	\$17.62		
0.0800	0.1875	0.0400	0.2400	1.0665	1.5000	0.2450	934-000-273	\$17.62	934-000-312	\$21.44
0.0850	0.1875	0.0425	0.2550	1.0558	1.5000	0.2600	934-000-274	\$17.62		
0.0866	0.1875	0.0433	0.2598	1.0523	1.5000	0.2648	934-000-297	\$17.62		
0.0900	0.1875	0.0450	0.2700	1.0451	1.5000	0.2750	934-000-275	\$18.06	934-000-313	\$21.88
0.0950	0.1875	0.0475	0.2850	1.0346	1.5000	0.2900	934-000-276	\$18.06		
0.0984	0.1875	0.0492	0.2952	1.0275	1.5000	0.3002	934-000-298	\$18.06		
0.1000	0.1875	0.0500	0.3000	1.0242	1.5000	0.3050	934-000-277	\$18.06	934-000-314	\$21.88
0.1102	0.1875	0.0551	0.3306	1.0036	1.5000	0.3356	934-000-299	\$18.06		
0.1181	0.1875	0.0591	0.3543	0.9882	1.5000	0.3593	934-000-300	\$18.06		
0.1200	0.1875	0.0600	0.3600	0.9845	1.5000	0.3650	934-000-278	\$18.06		
0.1378	0.1875	0.0689	0.4134	0.9524	1.5000	0.4184	934-000-301	\$18.06		

IMPERIAL 1/32" - 3/16"



HSS

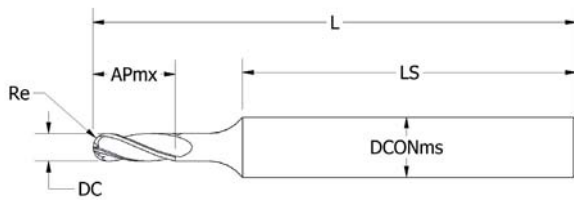

1.50 Length



DC	DCONms	Re	APmx	LS	L	LF	UNCOATED		TICN COATED	
							2 FLUTE	Price	2 FLUTE	Price
0.0313	0.1875	0.0156	0.0938	1.1771	1.5000	0.0988	934-000-279	\$18.06	934-000-315	\$21.88
0.0469	0.1875	0.0234	0.1406	1.1408	1.5000	0.1456	934-000-280	\$18.06	934-000-316	\$21.88
0.0625	0.1875	0.0313	0.1875	1.1052	1.5000	0.1925	934-000-281	\$16.62	934-000-317	\$20.44
0.0781	0.1875	0.0391	0.2344	1.0706	1.5000	0.2394	934-000-282	\$16.62	934-000-318	\$20.44
0.0938	0.1875	0.0469	0.2188	1.0997	1.5000	0.2238	934-000-283	\$16.62	934-000-319	\$20.44
0.1094	0.1875	0.0547	0.3281	1.0052	1.5000	0.3331	934-000-284	\$16.62		
0.1250	0.1875	0.0625	0.7500	0.6001	1.5000	0.7550	934-000-285	\$16.62	934-000-320	\$20.44
0.1406	0.1875	0.0703	0.4063	0.9633	1.5000	0.4113	934-000-286	\$17.40		
0.1563	0.1875	0.0781	0.4375	0.9554	1.5000	0.4425	934-000-287	\$17.40		
0.1719	0.1875	0.0859	0.5000	0.9239	1.5000	0.5050	934-000-288	\$17.40		
0.1875*	0.1875	0.0938	0.5000	0.6250	1.5000		934-000-289	\$17.40		

3/16": +000/.0025

METRIC .005" - .1378"

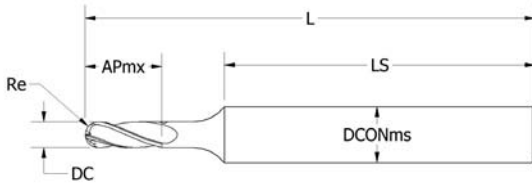

HSS

DC	DCONms	Re	APmx	LS	L	LF	UNCOATED	
							2 FLUTE	Price
0.0050	0.1250	0.0025	0.0075	1.3300	1.5000		934-000-224	\$25.31
0.0100	0.1250	0.0050	0.0150	1.2855	1.5000	0.0150	934-000-225	\$25.31
0.0150	0.1250	0.0075	0.0225	1.2820	1.5000	0.0225	934-000-226	\$21.16
0.0156	0.1250	0.0078	0.0234	1.2816	1.5000	0.0234	934-000-257	\$21.16
0.0197	0.1875	0.0099	0.0296	1.2340	1.5000	0.0296	934-000-245	\$21.16
0.0200	0.1250	0.0100	0.0300	1.2786	1.5000	0.0300	934-000-227	\$20.60
0.0250	0.1250	0.0125	0.0375	1.2754	1.5000	0.0375	934-000-228	\$19.89
0.0300	0.1250	0.0150	0.0450	1.2723	1.5000	0.0450	934-000-229	\$19.27
0.0350	0.1875	0.0175	0.0525	1.2208	1.5000	0.0525	934-000-230	\$16.95
0.0394	0.1875	0.0197	0.0591	1.2172	1.5000	0.0591	934-000-246	\$16.95
0.0400	0.1875	0.0200	0.0600	1.2167	1.5000	0.0600	934-000-231	\$16.95
0.0450	0.1875	0.0225	0.0675	1.2126	1.5000	0.0675	934-000-232	\$16.95
0.0492	0.1875	0.0246	0.0738	1.2092	1.5000	0.0738	934-000-247	\$16.95
0.0500	0.1875	0.0250	0.0750	1.2086	1.5000	0.0750	934-000-233	\$16.95
0.0550	0.1875	0.0275	0.0825	1.2047	1.5000	0.0825	934-000-234	\$17.62
0.0591	0.1875	0.0296	0.0887	1.2015	1.5000	0.0887	934-000-248	\$17.62
0.0600	0.1875	0.0300	0.0900	1.2008	1.5000	0.0900	934-000-235	\$17.62
0.0630	0.1875	0.0315	0.0945	1.1986	1.5000	0.0945	934-000-249	\$17.62
0.0650	0.1875	0.0325	0.0975	1.1971	1.5000	0.0975	934-000-236	\$17.62
0.0700	0.1875	0.0350	0.1050	1.1935	1.5000	0.1050	934-000-237	\$17.62
0.0709	0.1875	0.0355	0.1064	1.1928	1.5000	0.1064	934-000-250	\$17.62
0.0750	0.1875	0.0375	0.1125	1.1900	1.5000	0.1125	934-000-238	\$17.62
0.0787	0.1875	0.0394	0.1181	1.1874	1.5000	0.1181	934-000-251	\$17.62
0.0800	0.1875	0.0400	0.1200	1.1865	1.5000	0.1200	934-000-239	\$17.62
0.0850	0.1875	0.0425	0.1275	1.1833	1.5000	0.1275	934-000-240	\$17.62
0.0866	0.1875	0.0433	0.1299	1.1822	1.5000	0.1299	934-000-252	\$17.62
0.0900	0.1875	0.0450	0.1350	1.1801	1.5000	0.1350	934-000-241	\$18.06
0.0950	0.1875	0.0475	0.1425	1.1771	1.5000	0.1425	934-000-242	\$18.06
0.0984	0.1875	0.0492	0.1476	1.1751	1.5000	0.1476	934-000-253	\$18.06
0.1000	0.1875	0.0500	0.1500	1.1742	1.5000	0.1500	934-000-243	\$18.06
0.1102	0.1875	0.0551	0.1653	1.1689	1.5000	0.1653	934-000-254	\$18.06
0.1181	0.1875	0.0591	0.1772	1.1653	1.5000	0.1772	934-000-255	\$18.06
0.1200	0.1875	0.0600	0.1800	1.1645	1.5000	0.1800	934-000-244	\$18.06
0.1378	0.1875	0.0689	0.2067	1.1591	1.5000	0.2067	934-000-256	\$18.06



IMPERIAL 1/32" - 3/16"

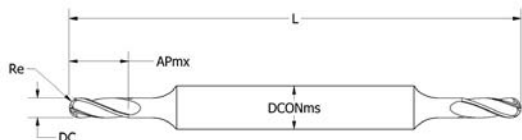

DC	DCONms	Re	APmx	LS	L	UNCOATED	
						2 FLUTE	Price
0.0313	0.1875	0.0156	0.0938	1.1250	2.2500	934-000-012	\$28.36
0.0469	0.1875	0.0234	0.1406	1.1250	2.2500	934-000-013	\$28.36
0.0625	0.1875	0.0313	0.1875	1.1250	2.2500	934-000-014	\$25.92
0.0781	0.1875	0.0391	0.2344	1.1250	2.2500	934-000-015	\$25.92
0.0938	0.1875	0.0469	0.2813	1.1250	2.2500	934-000-016	\$25.92
0.1094	0.1875	0.0547	0.3281	1.1250	2.2500	934-000-017	\$25.92
0.1250	0.1875	0.0625	0.3750	1.1250	2.2500	934-000-018	\$25.92
0.1406	0.1875	0.0703	0.4063	1.1250	2.2500	934-000-019	\$27.15
0.1563	0.1875	0.0781	0.4375	1.1250	2.2500	934-000-020	\$27.15
0.1719	0.1875	0.0859	0.5000	1.1250	2.2500	934-000-021	\$27.15
0.1875*	0.1875	0.0938	0.5000	1.1250	2.2500	934-000-022	\$27.15

3/16": +000/.0025

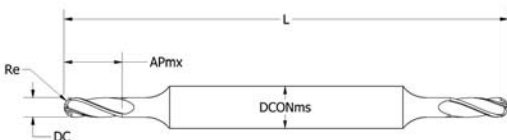

DC	DCONms	Re	APmx	LS	L	UNCOATED	
						4 FLUTE	Price
0.0313	0.1875	0.0156	0.0938	1.1250	2.2500	934-000-066	\$\$\$37.11
0.0469	0.1875	0.0234	0.1406	1.1250	2.2500	934-000-067	\$\$\$37.11
0.0625	0.1875	0.0313	0.1875	1.1250	2.2500	934-000-068	\$33.79
0.0781	0.1875	0.0391	0.2344	1.1250	2.2500	934-000-069	\$33.79
0.0938	0.1875	0.0469	0.2188	1.1250	2.2500	934-000-070	\$33.79
0.1094	0.1875	0.0547	0.3281	1.1250	2.2500	934-000-071	\$33.79
0.1250	0.1875	0.0625	0.3750	1.1250	2.2500	934-000-072	\$33.79
0.1406	0.1875	0.0703	0.4063	1.1250	2.2500	934-000-073	\$36.33
0.1563	0.1875	0.0781	0.4375	1.1250	2.2500	934-000-074	\$36.33
0.1719	0.1875	0.0859	0.5000	1.1250	2.2500	934-000-075	\$36.33
0.1875*	0.1875	0.0938	0.5000	1.1250	2.2500	934-000-076	\$36.33

3/16": +000/.0025

COBALT

IMPERIAL 1/32" - 3/16"

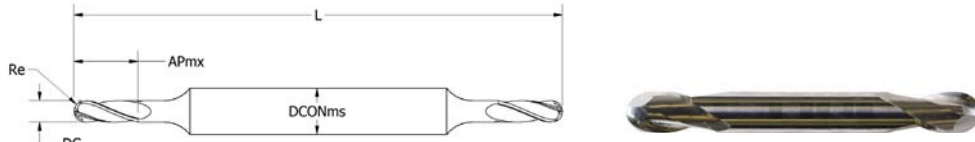

2.000 Length



DC	DCONms	Re	APmx	LS	L	UNCOATED	
						2 FLUTE	Price
0.0313	0.1875	0.0156	0.0469	1.0000	2.0000	934-000-034	\$27.15
0.0469	0.1875	0.0234	0.0625	1.0000	2.0000	934-000-035	\$27.15
0.0625	0.1875	0.0313	0.0938	1.0000	2.0000	934-000-036	\$24.49
0.0781	0.1875	0.0391	0.1250	1.0000	2.0000	934-000-037	\$24.49
0.0938	0.1875	0.0469	0.1406	1.0000	2.0000	934-000-038	\$24.49
0.1094	0.1875	0.0547	0.1563	1.0000	2.0000	934-000-039	\$24.49
0.1250	0.1875	0.0625	0.1875	1.0000	2.0000	934-000-040	\$24.49
0.1406	0.1875	0.0703	0.2188	1.0000	2.0000	934-000-041	\$28.71
0.1563	0.1875	0.0781	0.2344	1.0000	2.0000	934-000-042	\$28.71
0.1719	0.1875	0.0859	0.2500	1.0000	2.0000	934-000-043	\$28.71
0.1875*	0.1875	0.0938	0.2813	1.0000	2.0000	934-000-044	\$28.71

3/16": +000/.0025

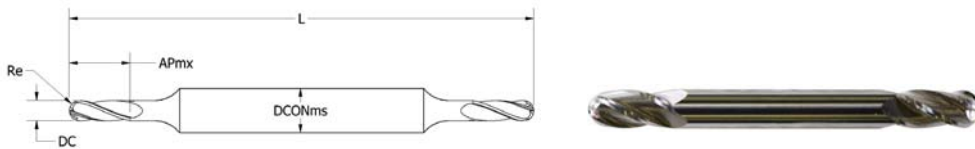

DC	DCONms	Re	APmx	LS	L	UNCOATED	
						4 FLUTE	Price
0.0313	0.1875	0.0156	0.0469	1.0000	2.0000	934-000-088	\$34.56
0.0469	0.1875	0.0234	0.0625	1.0000	2.0000	934-000-089	\$34.56
0.0625	0.1875	0.0313	0.0938	1.0000	2.0000	934-000-090	\$32.88
0.0781	0.1875	0.0391	0.1250	1.0000	2.0000	934-000-091	\$32.88
0.0938	0.1875	0.0469	0.1406	1.0000	2.0000	934-000-092	\$32.88
0.1094	0.1875	0.0547	0.1563	1.0000	2.0000	934-000-093	\$32.88
0.1250	0.1875	0.0625	0.1875	1.0000	2.0000	934-000-094	\$32.88
0.1406	0.1875	0.0703	0.2188	1.0000	2.0000	934-000-095	\$33.01
0.1563	0.1875	0.0781	0.2344	1.0000	2.0000	934-000-096	\$33.01
0.1719	0.1875	0.0859	0.2500	1.0000	2.0000	934-000-097	\$33.01
0.1875*	0.1875	0.0938	0.2813	1.0000	2.0000	934-000-098	\$33.01

3/16": +000/.0025



IMPERIAL 1/16" - 3/16"

COBALT

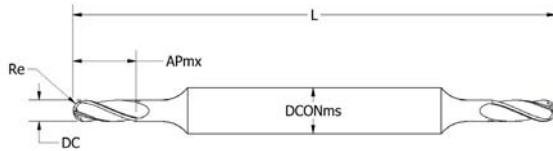

2-FLUTE



DC	DCONms	Re	APmx	LS	L	UNCOATED	
						2 FLUTE	Price
0.0625	0.1875	0.0313	0.2188	1.2500	2.5000	934-000-050	\$33.79
0.0938	0.1875	0.0469	0.2813	1.3125	2.6250	934-000-051	\$33.79
0.1250	0.1875	0.0625	0.7500	1.5625	3.1250	934-000-052	\$33.79
0.1563	0.1875	0.0781	0.8750	1.6250	3.2500	934-000-053	\$35.23
0.1875*	0.1875	0.0938	1.0000	1.6875	3.3750	934-000-054	\$35.23

*3/16": +000/.0025

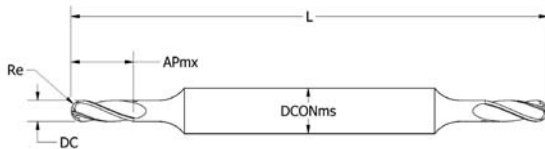

4-FLUTE



DC	DCONms	Re	APmx	LS	L	UNCOATED	
						4 FLUTE	Price
0.0625	0.1875	0.0313	0.2188	1.2500	2.5000	934-000-104	\$36.70
0.0938	0.1875	0.0469	0.2813	1.3125	2.6250	934-000-105	\$36.70
0.1250	0.1875	0.0625	0.7500	1.5625	3.1250	934-000-106	\$36.70
0.1563	0.1875	0.0781	0.8750	1.6250	3.2500	934-000-107	\$36.56
0.1875*	0.1875	0.0938	1.0000	1.6875	3.3750	934-000-108	\$36.56

*3/16": +000/.0025

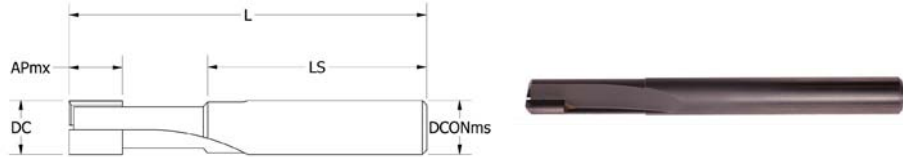

IMPERIAL 3/32"- 3/4"



DC	DCONms	APmx	LS	L	PCD BRAZED			
					1 FLUTE	Price	2 FLUTE	Price
0.0938	0.1250	0.1875	1.1250	1.5000	935-000-001	\$164.77		
0.1250	0.1250	0.2500	1.0000	1.5000	935-000-002	\$164.77		
0.1875	0.1875	0.2500	1.3750	2.0000			935-000-003	\$225.55
0.2500	0.2500	0.2500	1.7500	2.5000			935-000-004	\$242.49
0.3750	0.3750	0.2500	1.5625	2.5000			935-000-005	\$280.38
0.5000	0.5000	0.0250	2.0000	3.0000			935-000-006	\$325.17
0.6250	0.6250	0.3750	2.5000	3.5000			935-000-007	\$459.35
0.7500	0.7500	0.3750	2.8750	4.0000			935-000-008	\$535.34

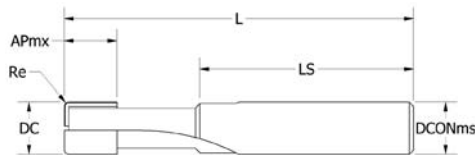

CORNER RADIUS



IMPERIAL 3/32"- 1/2"



DC	DCONms	Re	APmx	LS	L	PCD BRAZED			
						1 FLUTE	Price	2 FLUTE	Price
0.0938	0.1250	0.0100	0.1875	1.1250	1.5000	935-000-009	\$200.36		
0.1250	0.1250	0.0150	0.2500	1.0000	1.5000	935-000-010	\$200.36		
0.1875	0.1875	0.0150	0.2500	1.3750	2.0000			935-000-011	\$259.20
0.2500	0.2500	0.0300	0.2500	1.7500	2.5000			935-000-012	\$276.14
0.3750	0.3750	0.0300	0.2500	1.5625	2.5000			935-000-013	\$314.03
0.5000	0.5000	0.0300	0.2500	2.0000	3.0000			935-000-014	\$358.83

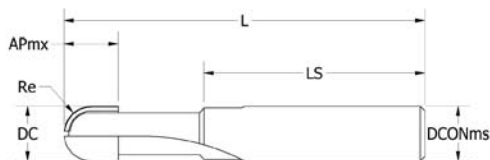

BALL END



DC	DCONms	Re	APmx	LS	L	PCD BRAZED			
						1 FLUTE	Price	2 FLUTE	Price
0.0938	0.1250	0.0469	0.1875	1.1250	1.5000	935-000-015	\$200.36		
0.1250	0.1250	0.0625	0.2500	1.0000	1.5000	935-000-016	\$200.36		
0.1875	0.1875	0.0938	0.2500	1.3750	2.0000			935-000-017	\$268.56
0.2500	0.2500	0.1250	0.3125	1.7500	2.5000			935-000-018	\$299.99
0.3750	0.3750	0.1875	0.4375	1.5625	2.5000			935-000-019	\$318.70
0.5000	0.5000	0.2500	0.5000	2.0000	3.0000			935-000-020	\$366.86





INDEXABLE DRILLS

THE COMPLETE TOOL MAKING AUTHORITY™



ARCH Cutting Tools Patriot High-Performance PD1 portfolio of indexable drills excels across a broad spectrum of ISO class workpiece materials. From general steels, cast irons, HSRA, and many more, when there is a high demand to reduce cost per feature in hole making applications. With diameters from 0.5625" (15mm) to 2.125" (54mm) offered in both imperial and metric sizes. Our range covers a comprehensive application base providing universal insert geometries and grades, suitable for most applications across all industry segments that focus on hole quality. These include general engineering, die and mold, automotive, and aerospace & defense.

- Available in diameters 0.562" (15mm) - 2.125" (54mm), 2xD, 3xD, and 4xD
- 2-ported precision through coolant for excellent chip evacuation
- Versatility - Facing, boring, O.D. and I.D. turning capabilities
- Capable of drilling into slanted workpieces without pre-drilling
- Radial offset capability to adjust diameter size in non-rotating applications
- Economical 4-edge insert design providing excellent chip formation and lower spindle loads
- High quality tool steel bodies for added rigidity, wear resistance and reduced chip wash

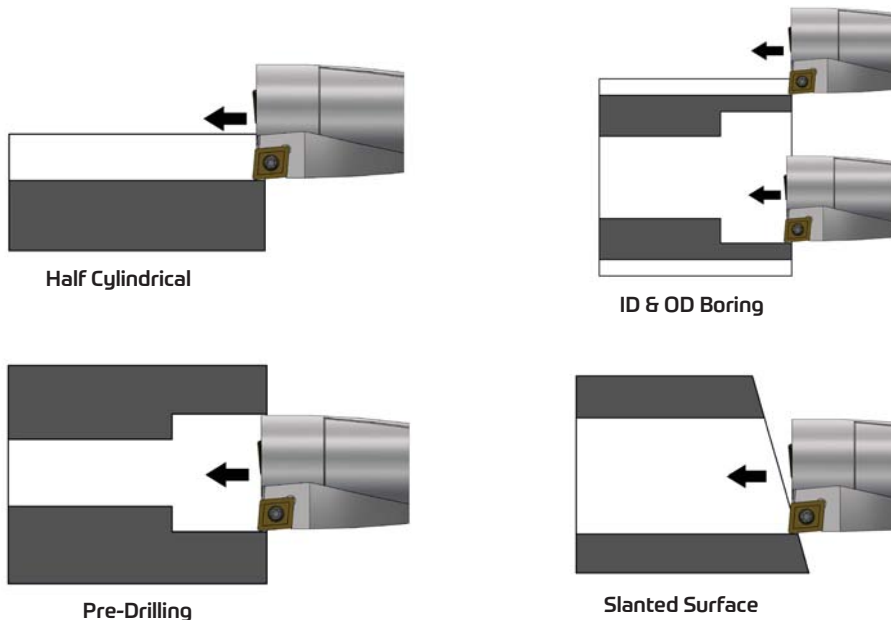

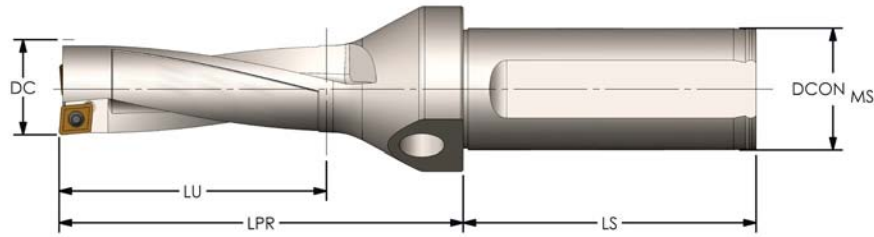

2xD

PRODUCT #	Designation	DC	DCON MS	LS	LPR	LU	INSERT	SCREW	WRENCH	PRICE	
970-000-034	PD1-0562-2D-075	0.562	0.750	1.900	2.042	1.242	PD1 042004	PD1-16	T-6-S	\$254.90	
970-000-038	PD1-0625-2D-075	0.625	0.750	1.900	2.168	1.368	PD1 052804	PD1-2		\$254.90	
970-000-042	PD1-0687-2D-075	0.687	0.750	1.900	2.292	1.492	PD1 052804			\$236.00	
970-000-047	PD1-0750-2D-100	0.750	1.000	2.400	2.561	1.618	PD1 063306	PD1-22	T-7-S	\$289.50	
970-000-051	PD1-0812-2D-100	0.812	1.000	2.400	2.686	1.743	PD1 063306				\$289.50
970-000-055	PD1-0875-2D-100	0.875	1.000	2.400	2.811	1.868	PD1 063306				\$289.50
970-000-058	PD1-0937-2D-125	0.937	1.250	2.900	2.936	1.993	PD1 074006	PD1-25		\$289.50	
970-000-062	PD1-1000-2D-125	1.000	1.250	2.900	3.061	2.118	PD1 074006				\$327.30
970-000-066	PD1-1125-2D-125	1.125	1.250	2.900	3.311	2.368	PD1 074006			\$327.30	
970-000-070	PD1-1250-2D-125	1.250	1.250	2.900	3.600	2.657	PD1 094508	PD1-35	T-15-S	\$369.40	
970-000-074	PD1-1375-2D-125	1.375	1.250	2.900	3.850	2.907	PD1 094508			\$369.40	
970-000-078	PD1-1500-2D-150	1.500	1.500	2.900	4.100	3.157	PD1 125812	PD1-5	T-20-S	\$423.40	
970-000-081	PD1-1625-2D-150	1.625	1.500	2.900	4.390	3.447	PD1 125812				\$448.20
970-000-084	PD1-1750-2D-150	1.750	1.500	2.900	4.600	3.657	PD1 125812				\$466.60
970-000-088	PD1-2000-2D-150	2.000	1.500	2.900	5.100	4.157	PD1 156812	PD1-6	T-25-S	\$560.60	
970-000-131	PD1-2125-2D-150	2.125	1.500	2.900	5.350	4.407	PD1 156812				

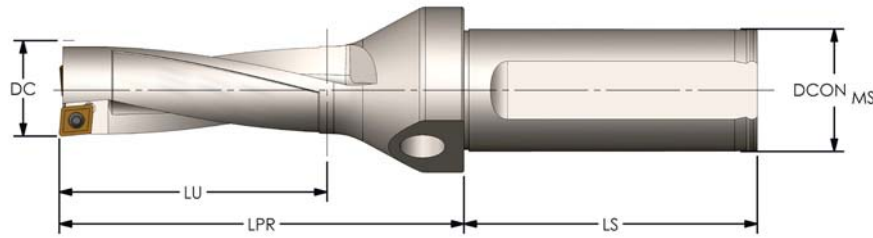

3xD

PRODUCT #	Designation	DC	DCON MS	LS	LPR	LU	Insert	Screw	Wrench	Price			
970-000-035	PD1-0562-3D-075	0.562	0.750	1.900	2.747	1.804	PD1 042004	PD1-16	T-6-S	\$262.50			
970-000-036	PD1-0594-3D-075	0.594	0.750	1.900	2.843	1.900				\$262.50			
970-000-037	PD1-0609-3D-075	0.609	0.750	1.900	2.888	1.945				\$262.50			
970-000-039	PD1-0625-3D-075	0.625	0.750	1.900	2.936	1.993	PD1 052804	PD1-2	T-6-S	\$262.50			
970-000-041	PD1-0669-3D-075	0.669 (17mm)	0.750	1.900	3.069	2.126				\$262.50			
970-000-043	PD1-0687-3D-075	0.687	0.750	1.900	3.122	2.179				\$262.50			
970-000-045	PD1-0709-3D-075	0.709 (18mm)	0.750	1.900	3.187	2.244	PD1 063306	PD1-22	T-6-S	\$262.50			
970-000-046	PD1-0734-3D-100	0.734	1.000	2.400	3.263	2.320				\$298.10			
970-000-048	PD1-0750-3D-100	0.750	1.000	2.400	3.311	2.368				\$298.10			
970-000-050	PD1-0787-3D-100	0.787 (20mm)	1.000	2.400	3.422	2.479				\$298.10			
970-000-052	PD1-0812-3D-100	0.812	1.000	2.400	3.499	2.556				\$298.10			
970-000-054	PD1-0844-3D-100	0.844	1.000	2.400	3.637	2.694				\$298.10			
970-000-056	PD1-0875-3D-100	0.875	1.000	2.400	3.686	2.743				\$298.10			
970-000-121	PD1-0230-3D-25MM	23mm	25mm	56mm	96mm	72mm				PD1 074006	PD1-25	T-7-S	\$298.10
970-000-059	PD1-0937-3D-125	0.937	1.250	2.900	3.874	2.931							\$298.10
970-000-061	PD1-0984-3D-125	0.984 (25mm)	1.250	2.900	4.014	3.071							\$337.00
970-000-063	PD1-1000-3D-125	1.000	1.250	2.900	4.061	3.118	\$337.00						
970-000-065	PD1-1062-3D-125	1.062	1.250	2.900	4.249	3.306	\$337.00						
970-000-067	PD1-1125-3D-125	1.125	1.250	2.900	4.436	3.493	\$337.00						
970-000-069	PD1-1181-3D-125	1.181 (30mm)	1.250	2.900	4.645	3.702	\$381.30						
970-000-071	PD1-1250-3D-125	1.250	1.250	2.900	4.850	3.907	\$381.30						
970-000-073	PD1-1312-3D-125	1.312	1.250	2.900	5.039	4.095	\$381.30						
970-000-075	PD1-1375-3D-125	1.375	1.250	2.900	5.225	4.282	\$381.30						
970-000-077	PD1-1437-3D-125	1.437	1.250	2.900	5.413	4.470	\$436.40						
970-000-079	PD1-1500-3D-150	1.500	1.500	2.900	50.640	4.697	PD1 125812	PD1-5	T-20-S	\$461.20			
970-000-082	PD1-1625-3D-150	1.625	1.500	2.900	6.015	5.072				\$480.60			
970-000-085	PD1-1750-3D-150	1.750	1.500	2.900	6.390	5.447				\$545.40			
970-000-087	PD1-1875-3D-150	1.875	1.500	2.900	6.825	5.882	PD1 156812	PD1-6	T-25-S	\$577.80			
970-000-089	PD1-2000-3D-150	2.000	1.500	2.900	7.140	6.197				\$632.90			
970-000-091	PD1-2125-3D-150	2.125	1.500	2.900	7.515	6.572							

PRODUCT #	Designation	DC	DCON MS	LS	LPR	LU	Insert	Screw	Wrench
970-000-115	PD1-0170-3D-20MM	17mm	20mm	44mm	74mm	54mm	PD1 052804	PD1-2	T-6-S
970-000-116	PD1-0180-3D-25MM	18mm	25mm	56mm	81mm	57mm	PD1 063306	PD1-22	T-7-S
970-000-117	PD1-0190-3D-25MM	19mm	25mm	56mm	84mm	60mm			
970-000-119	PD1-0210-3D-25MM	21mm	25mm	56mm	90mm	66mm			
970-000-120	PD1-0220-3D-25MM	22mm	25mm	56mm	93mm	69mm	PD1 074006	PD1-25	T-7-S
970-000-121	PD1-0230-3D-25MM	23mm	25mm	56mm	96mm	72mm			
970-000-123	PD1-0250-3D-25MM	25mm	25mm	56mm	102mm	78mm			
970-000-124	PD1-0260-3D-32MM	26mm	32mm	60mm	105mm	81mm			
970-000-125	PD1-0270-3D-32MM	27mm	32mm	60mm	108mm	84mm			
970-000-126	PD1-0280-3D-32MM	28mm	32mm	60mm	111mm	87mm			
970-000-127	PD1-0290-3D-32MM	29mm	32mm	60mm	115mm	91mm	PD1 094508	PD1-35	T-15-S
970-000-128	PD1-0300-3D-32MM	30mm	32mm	60mm	118mm	94mm			

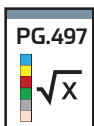
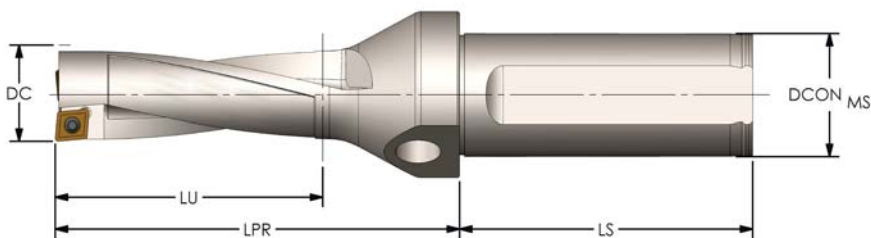

4xD

PRODUCT #	Designation	DC	DCON MS	LS	LPR	LU	Insert	Screw	Wrench	Price
970-000-129	PD1-0562-4D-075	0.562	0.750	1.900	3.166	2.366	PD1 042004	PD1-16	T-6-S	
970-000-040	PD1-0625-4D-075	0.625	0.750	1.900	3.418	2.618	PD1 052804	PD1-2	T-6-S	\$344.00
970-000-044	PD1-0687-4D-075	0.687	0.750	1.900	3.667	2.867				\$344.00
970-000-049	PD1-0750-4D-100	0.750	1.000	2.400	4.061	3.118	PD1 063306	PD1-22	T-7-S	\$390.00
970-000-053	PD1-0812-4D-100	0.812	1.000	2.400	4.312	3.369				\$390.00
970-000-057	PD1-0875-4D-100	0.875	1.000	2.400	4.561	3.618				\$390.00
970-000-060	PD1-0937-4D-125	0.937	1.250	2.900	4.812	3.869	PD1 074006	PD1-25	T-7-S	\$390.00
970-000-064	PD1-1000-4D-125	1.000	1.250	2.900	5.061	4.118				\$442.00
970-000-068	PD1-1125-4D-125	1.125	1.250	2.900	5.561	4.618	PD1 094508	PD1-35	T-15-S	\$442.00
970-000-072	PD1-1250-4D-125	1.250	1.250	2.900	6.100	5.157				\$499.00
970-000-076	PD1-1375-4D-125	1.375	1.250	2.900	6.600	5.627				\$499.00
970-000-080	PD1-1500-4D-150	1.500	1.500	2.900	7.140	6.197	PD1 125812	PD1-5	T-20-S	\$571.00
970-000-083	PD1-1625-4D-150	1.625	1.500	2.900	7.640	6.697				\$605.00
970-000-086	PD1-1750-4D-150	1.750	1.500	2.900	8.140	7.197	PD1 156812	PD1-6	T-25-S	\$630.00
970-000-090	PD1-2000-4D-150	2.000	1.500	2.900	9.140	8.197				\$757.00
970-000-130	PD1-2125-4D-150	2.125	1.500	2.900	9.640	8.697				



PD1

PRODUCT #	Designation	HP600	HK356	HN300
914-000-085	PD1 042004	\$11.20		
914-000-083			\$11.20	
914-000-084				\$19.80
914-000-088	PD1 052804	\$11.20		
914-000-086			\$11.20	
914-000-087				\$19.80
914-000-091	PD1 063306	\$11.40		
914-000-089			\$11.40	
914-000-090				\$20.10
914-000-094	PD1 074006	\$11.90		
914-000-092			\$11.90	
914-000-093				\$20.50
914-000-097	PD1 094508	\$13.00		
914-000-095			\$13.00	
914-000-096				\$18.00
914-000-100	PD1 125812	\$15.40		
914-000-098			\$15.40	
914-000-99				\$23.10
914-000-103	PD1 156812	\$16.60		
914-000-101			\$16.60	
914-000-102				\$25.70

Inserts sold in packs of 10

PRODUCT #	Insert Screw	Price Each
968-000-112	PD1-16	\$6.00
968-000-113	PD1-2	\$5.40
968-000-114	PD1-22	\$5.40
968-000-115	PD1-25	\$5.40
968-000-116	PD1-35	\$5.40
968-000-117	PD1-5	\$6.40
968-000-118	PD1-6	\$9.10

PACKAGE SIZE OF 5



ISO	MATERIAL	HARDNESS	GRADE	Vc (SFM)*	INDEXABLE DRILL DIAMETER (INCH)		
					0.5620"-0.7499"	0.7500" - 1.4999"	1.5000" - 2.2500"
					Fz = IPR (INCH PER REVOLUTION)*		
P	CARBON STEELS 1018, 1040, 1080, 1090, 10L50, 1140, 1212, 12L15, 1525, 1536	≤ 275 BHN or ≤ 28 HRC	HP 600	350-900	.0015-.0060	.0020-.0075	.0030-.0120
	ALLOY STEELS 4140, 4150, 4320, 5120, 5150, 8630, 86L20, 17-4 PH	≤ 375 BHN or ≤ 40 HRC		260-750	.0020-.0070	.0020-.0085	.0030-.0095
M	STAINLESS STEELS (FREE MACHINING) 303, 416, 420F, 430F, 440F	≤ 275 BHN or ≤ 28 HRC	HP 600	230-700	.0018-.0040	.0030-.0065	.0030-.0085
	STAINLESS STEELS (DIFFICULT) 304, 304L, 316, 316L	≤ 275 BHN or ≤ 28 HRC		260-750	.0018-.0040	.0030-.0065	.0030-.0085
K	GRAY IRONS Class 20, 30, 40, 50, 60, G3000, G3500	≤ 220 BHN or ≤ 19 HRC	HP 600	285-1000	.0025-.0055	.0035-.0070	.0040-.0085
	DUCTILE IRONS D&M series, 250, 300, 350, 400, 60-40-18, 65-45-12	≤ 260 BHN or ≤ 26 HRC		230-740	.0020-.0050	.0028-.0065	.0030-.0070
N	NON-FERROUS Aluminum, Aluminum cast, Brass, Copper, Bronze, Non Metallic	≤ 271 BHN or ≤ 28 HRC	HP 600	600-1150	.0020-.0075	.0030-.0090	.0045-.0115
H	TOOL STEELS A2, D2, H13, L2, M2, P20, S7, T15, W2"	≤ 375 BHN or ≤ 55 HRC	HP 600	80-275	.0018-.0065	.0020-.0075	.0030-.0080
S	HR SUPER ALLOYS Inconel 718, Waspaloy, Hastelloy, Inconel 625, Stellite 31, Haynes 25, Rene 41	≤ 275 BHN or ≤ 28 HRC	HP 600	55-270	.0016-.0032	.0020-.0055	.0025-.0060
	TITANIUM 6AL-4V, ASTM 1, 2, 3, 6AL-2S	≤ 275 BHN or ≤ 28 HRC		95-460	.0019-.0055	.0020-.0065	.0025-.008

Recommendations

Productivity and tooling performance is not only influenced by grade and geometry, but also by clamping the tool securely and accurately as possible.

- It is recommended to use precision holders i.e. hydraulic, shrink fit
- It is recommended to use internal coolant – minimum recommended pressure 145 psi

*Speeds & feeds are starting recommendations only. Factors such as machine type, fixture, tooling rigidity, available horsepower, coolant delivery method and others will affect the performance significantly.



- Diameter range from 0.625" – 2.375"
- Close bore tolerances up to IT 8 achievable
- Excellent surface finish can be achieved
- Machining to production dimension without separate fine bore machining
- Universal use – suitable for both rotating and stationary operations
- Come equipped with 1/8-27 NPT side and end entry coolant ports

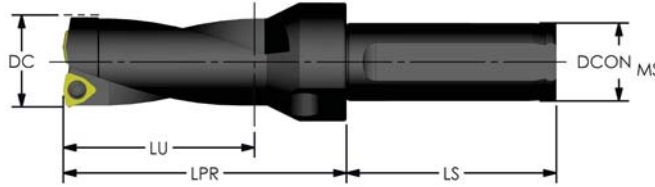

2xD



PRODUCT # Coated	PRODUCT # Uncoated	Designation	DC	DCON MS	LS	LPR	LU	Insert	Screw	Price Coated*	Price Uncoated					
926-000-014	926-000-013	UD-0625-2D-063	.625	.625	1.687	2.280	1.375	WCMX 1.81.52	MTS-255 T-7-S Wrench	\$168.30	\$151.80					
926-000-018	926-000-017	UD-0656-2D-063	.656				1.406			\$168.30	\$151.80					
926-000-022	926-000-021	UD-0687-2D-063	.687				1.437			\$168.30	\$151.80					
926-000-026	926-000-025	UD-0719-2D-063	.719				1.467			\$168.30	\$151.80					
926-000-030	926-000-029	UD-0750-2D-075	.750	.750	2.000	2.810	1.748	WCMX 21.52	MTS 25-DR T-8-S Wrench	\$198.00	\$168.30					
926-000-034	926-000-033	UD-0781-2D-075	.781				1.780			\$198.00	\$168.30					
926-000-038	926-000-037	UD-0812-2D-075	.812				1.811			\$198.00	\$168.30					
926-000-042	926-000-041	UD-0844-2D-075	.844				1.850			\$198.00	\$168.30					
926-000-046	926-000-045	UD-0875-2D-075	.875				1.874			\$198.00	\$168.30					
926-000-050	926-000-049	UD-0906-2D-075	.906				1.910			\$198.00	\$168.30					
926-000-054	926-000-053	UD-0937-2D-075	.937				1.935			\$198.00	\$168.30					
926-000-058	926-000-057	UD-0968-2D-075	.968				1.970			\$198.00	\$168.30					
926-000-062	926-000-061	UD-1000-2D-100	1.000				1.000			2.375	3.235	2.345	WCMX 2.522	MTS 3-DR T-9-S Wrench	\$232.10	\$184.80
926-000-066	926-000-065	UD-1031-2D-100	1.031									2.375			\$232.10	\$184.80
926-000-070	926-000-069	UD-1062-2D-100	1.062	2.406	\$232.10	\$184.80										
926-000-074	926-000-073	UD-1094-2D-100	1.094	2.438	\$232.10	\$184.80										
926-000-078	926-000-077	UD-1125-2D-100	1.125	2.469	\$232.10	\$184.80										
926-000-082	926-000-081	UD-1156-2D-100	1.156	2.500	\$232.10	\$184.80										
926-000-086	926-000-085	UD-1187-2D-100	1.187	2.532	\$232.10	\$184.80										
926-000-090	926-000-089	UD-1219-2D-100	1.219	2.564	\$232.10	\$184.80										
926-000-094	926-000-093	UD-1250-2D-125	1.250	1.250	2.619	3.886		2.710	WCMX 32.52			MTS 35-DR T-10-S Wrench			\$272.80	\$220.00
926-000-098	926-000-097	UD-1312-2D-125	1.312					2.771							\$272.80	\$220.00
926-000-102	926-000-101	UD-1343-2D-125	1.343				2.802	\$272.80		\$220.00						
926-000-104	926-000-103	UD-1375-2D-125	1.375				2.833	\$272.80		\$220.00						
926-000-108	926-000-107	UD-1437-2D-125	1.437				2.896	\$272.80		\$220.00						
926-000-112	926-000-111	UD-1500-2D-125	1.500			3.250	\$311.30	\$254.10								
926-000-116	926-000-115	UD-1562-2D-125	1.562			4.426	3.312	\$311.30		\$254.10						
926-000-120	926-000-119	UD-1625-2D-125	1.625				3.375	\$334.40		\$272.80						
926-000-124	926-000-123	UD-1687-2D-125	1.687				3.437	\$334.40		\$272.80						
926-000-128	926-000-127	UD-1750-2D-150	1.750				1.500	2.875		5.025	3.850		WCMX 433	MTS 4-DR T-15-S Wrench	\$356.40	\$289.30
926-000-132	926-000-131	UD-1812-2D-150	1.812	3.912	\$356.40				\$289.30							
926-000-136	926-000-135	UD-1875-2D-150	1.875	3.975	\$414.70	\$338.80										
926-000-140	926-000-139	UD-1937-2D-150	1.937	4.036	\$414.70	\$338.80										
926-000-144	926-000-143	UD-2000-2D-150	2.000	4.469	\$447.70	\$374.00										
926-000-148	926-000-147	UD-2125-2D-150	2.125	5.687	4.593	\$488.40			\$408.10							
926-000-152	926-000-151	UD-2250-2D-150	2.250		4.717	\$522.50			\$442.20							
926-000-156	926-000-155	UD-2375-2D-150	2.375		4.840	\$555.50			\$476.30							

*Coated with ION Nitride (Add -C to the end of designation)



by Ultra-Dex

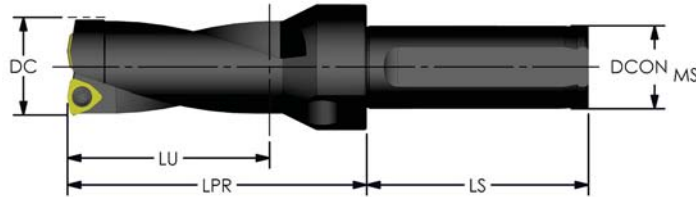

2.5xD



PRODUCT # Coated	PRODUCT # Uncoated	Designation	DC	DCON MS	LS	LPR	LU	Insert	Screw	Price Coated*	Price Uncoated
926-000-002	926-000-001	UD-0437-2D-063	.437	.625	1.687	2.280	1.280	WCMT 1.211	MTS 184 T-6-S Wrench	\$168.30	\$151.80
926-000-004	926-000-003	UD-0468-2D-063	.468				1.310			\$168.30	\$151.80
926-000-006	926-000-005	UD-0500-2D-063	.500				1.340			\$168.30	\$151.80
926-000-008	926-000-007	UD-0531-2D-063	.531				WCMT 1.51.51	MTS 2 T-6-S Wrench	1.370	\$168.30	\$151.80
926-000-010	926-000-009	UD-0562-2D-063	.562						1.400	\$168.30	\$151.80
926-000-012	926-000-011	UD-0593-2D-063	.593						1.430	\$168.30	\$151.80

*Coated with ION Nitride (Add -C to the end of designation)

4xD



PRODUCT # Coated	PRODUCT # Uncoated	Designation	DC	DCON MS	LS	LPR	LU	Insert	Screw	Price Coated*	Price Uncoated					
926-000-016	926-000-015	UD-0625-4D-063	.625	.625	1.687	3.720	2.815	WCMX 1.81.52	MTS-255 T-7-S Wrench	\$242.00	\$218.90					
926-000-020	926-000-019	UD-0656-4D-063	.656				2.847			\$242.00	\$218.90					
926-000-024	926-000-023	UD-0687-4D-063	.687				2.878			\$242.00	\$218.90					
926-000-028	926-000-027	UD-0719-4D-063	.719				2.911			\$242.00	\$218.90					
926-000-032	926-000-031	UD-0750-4D-075	.750	.750	2.000	4.763	3.698	WCMX 21.52	MTS 25-DR T-8-S Wrench	\$283.80	\$242.00					
926-000-036	926-000-035	UD-0781-4D-075	.781				3.729			\$283.80	\$242.00					
926-000-040	926-000-039	UD-0812-4D-075	.812				3.761			\$283.80	\$242.00					
926-000-044	926-000-043	UD-0844-4D-075	.844				3.792			\$283.80	\$242.00					
926-000-048	926-000-047	UD-0875-4D-075	.875				3.824			\$283.80	\$242.00					
926-000-052	926-000-051	UD-0906-4D-075	.906				3.855			\$283.80	\$242.00					
926-000-056	926-000-055	UD-0937-4D-075	.937				3.885			\$283.80	\$242.00					
926-000-060	926-000-059	UD-0968-4D-075	.968				3.918			\$283.80	\$242.00					
926-000-064	926-000-063	UD-1000-4D-100	1.000				1.000			2.375	5.685	4.635	WCMX 2.522	MTS 3-DR T-9-S Wrench	\$332.20	\$267.30
926-000-068	926-000-067	UD-1031-4D-100	1.031									4.666			\$332.20	\$267.30
926-000-072	926-000-071	UD-1062-4D-100	1.062	4.696	\$332.20	\$267.30										
926-000-076	926-000-075	UD-1094-4D-100	1.094	4.728	\$332.20	\$267.30										
926-000-080	926-000-079	UD-1125-4D-100	1.125	4.760	\$332.20	\$267.30										
926-000-084	926-000-083	UD-1156-4D-100	1.156	4.792	\$332.20	\$267.30										
926-000-088	926-000-087	UD-1187-4D-100	1.187	4.822	\$332.20	\$267.30										
926-000-092	926-000-091	UD-1219-4D-100	1.219	4.864	\$332.20	\$267.30										

*Coated with ION Nitride (Add -C to the end of designation)

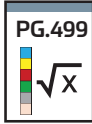
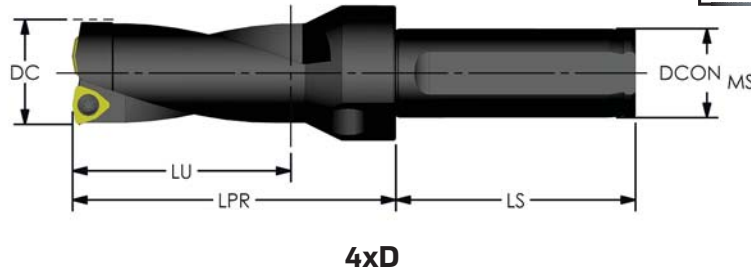

PRODUCT # Coated	PRODUCT # Uncoated	Designation	DC	DCON MS	LS	LPR	LU	Insert	Screw	Price Coated*	Price Uncoated	
926-000-096	926-000-095	UD-1250-4D-125	1.250	1.250	2.619	6.760	5.585	WCMX 32.52	MTS 35-DR	\$388.30	\$315.70	
926-000-100	926-000-099	UD-1312-4D-125	1.312				5.646			\$388.30	\$315.70	
926-000-106	926-000-105	UD-1375-4D-125	1.375				5.708			\$388.30	\$315.70	
926-000-110	926-000-109	UD-1437-4D-125	1.437				5.771			\$388.30	\$315.70	
926-000-114	926-000-113	UD-1500-4D-125	1.500			7.800	6.632			T-10-S Wrench	\$445.50	\$365.20
926-000-118	926-000-117	UD-1562-4D-125	1.562				6.695				\$445.50	\$365.20
926-000-122	926-000-121	UD-1625-4D-125	1.625				6.757				\$478.50	\$388.30
926-000-126	926-000-125	UD-1687-4D-125	1.687				6.820				\$478.50	\$388.30
926-000-130	926-000-129	UD-1750-4D-150	1.750	1.500	2.875	8.900	7.724	WCMX 433	MTS 4-DR		\$510.40	\$413.60
926-000-134	926-000-133	UD-1812-4D-150	1.812				7.786				\$510.40	\$413.60
926-000-138	926-000-137	UD-1875-4D-150	1.875				7.849				\$591.80	\$487.30
926-000-142	926-000-141	UD-1937-4D-150	1.937				7.911				\$591.80	\$487.30
926-000-146	926-000-145	UD-2000-4D-150	2.000			10.347	9.263			T-15-S Wrench	\$634.70	\$528.00
926-000-150	926-000-149	UD-2125-4D-150	2.125				9.387				\$698.50	\$584.10
926-000-154	926-000-153	UD-2250-4D-150	2.250				9.512				\$746.90	\$633.60
926-000-158	926-000-157	UD-2375-4D-150	2.375				9.637				\$795.30	\$682.00

*Coated with ION Nitride (Add -C to the end of designation)

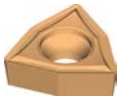

PRODUCT #	Designation	UD51	UD52	UD2	UD21	UD32
913-000-596	WCMX 1.81.52	\$9.80				
913-000-597			\$12.00			
913-000-593				\$9.80		
913-000-594					\$12.00	
913-000-595						\$10.90
913-000-606	WCMX 21.52	\$9.80				
913-000-607			\$12.00			
913-000-603				\$9.80		
913-000-604					\$12.00	
913-000-605						\$10.90
913-000-601	WCMX 2.522	\$9.80				
913-000-602			\$12.00			
913-000-598				\$9.80		
913-000-599					\$12.00	
913-000-600						\$10.90

Inserts sold in packs of 10

PRODUCT #	Designation	UD51	UD52	UD2	UD21	UD32
913-000-611	WCMX 32.52	\$10.70				
913-000-612			\$12.40			
913-000-608					\$10.70	
913-000-609						\$12.40
913-000-610						
913-000-616	WCMX 433	\$10.70				
913-000-617			\$13.00			
913-000-613					\$10.70	
913-000-614						\$13.00
913-000-615						

Inserts sold in packs of 10

PRODUCT #	Insert Screw	Price Each
968-000-087	MTS-184	\$3.20
968-000-088	MTS-2	\$2.90
968-000-092	MTS-255	\$3.20
968-000-082	MTS 25-DR	\$2.90
968-000-084	MTS 3-DR	\$2.90
968-000-083	MTS 35-DR	\$3.50
968-000-085	MTS 4-DR	\$2.90

PACKAGE SIZE OF 5



ISO	MATERIAL	HARDNESS	GRADE	Vc (SFM)*	INDEXABLE DRILL DIAMETER (INCH)		
					0.5620"-0.7499"	0.7500" - 1.4999"	1.5000" - 2.2500"
Fz = IPR (INCH PER REVOLUTION)*							
P	CARBON STEELS 1018, 1040, 1080, 1090, 10L50, 1140, 1212, 12L15, 1525, 1536	≤ 275 BHN or ≤ 28 HRC	UD51 /UD52	300-800	.0015-.0060	.0025-.0080	.0030-.009
	ALLOY STEELS 4140, 4150, 4320, 5120, 5150, 8630, 86L20, 17-4 PH	≤ 375 BHN or ≤ 40 HRC		250-700	.0020-.0070	.0025-.0070	.0030-.0080
M	STAINLESS STEELS (FREE MACHINING) 303, 416, 420F, 430F, 440F	≤ 275 BHN or ≤ 28 HRC	UD32	230-650	.0018-.0040	.0025-.0065	.0030-.0070
	STAINLESS STEELS (DIFFICULT) 304, 304L, 316, 316L	≤ 275 BHN or ≤ 28 HRC		260-700	.0018-.0040	.0023-.0055	.0030-.0065
K	GRAY IRONS Class 20, 30, 40, 50, 60, G3000, G3500	≤ 220 BHN or ≤ 19 HRC	UD21	285-900	.0025-.0055	.0035-.0070	.0040-.0080
	DUCTILE IRONS D&M series, 250, 300, 350, 400, 60-40-18, 65-45-12	≤ 260 BHN or ≤ 26 HRC		230-700	.0020-.0050	.0028-.0055	.0030-.0060
N	NON-FERROUS Aluminum, Aluminum cast, Brass, Copper, Bronze, Non Metallic	≤ 271 BHN or ≤ 28 HRC	UD2	400-975	.0020-.0075	.0030-.0070	.0045-.0100
H	TOOL STEELS A2, D2, H13, L2, M2, P20, S7, T15, W2"	≤ 375 BHN or ≤ 55 HRC	UD32	75-200	.0018-.0065	.0020-.0065	.0030-.0070
S	HR SUPER ALLOYS Inconel 718, Waspaloy, Hastelloy, Inconel 625, Stellite 31, Haynes 25, Rene 41	≤ 275 BHN or ≤ 28 HRC	UD32 /UD52	40-200	.0016-.0032	.0020-.0050	.0020-.0050
	TITANIUM 6AL-4V, ASTM 1, 2, 3,6AL-2S	≤ 275 BHN or ≤ 28 HRC		90-350	.0019-.0055	.0020-.0050	.0020-.0065

Recommendations

Productivity and tooling performance is not only influenced by grade and geometry, but also by clamping the tool securely and accurately as possible.

- It is recommended to use precision holders i.e. hydraulic, shrink fit
- It is recommended to use internal coolant – minimum recommended pressure 145 psi

*Speeds & feeds are starting recommendations only. Factors such as machine type, fixture, tooling rigidity, available horsepower, coolant delivery method and others will affect the performance significantly.

ARCH[®]
Cutting Tools

SOLID DRILLS

THE COMPLETE TOOL MAKING AUTHORITY™



Through select
outlets only

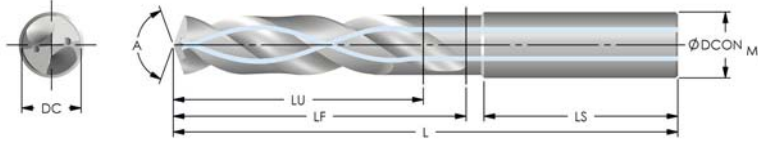

DC	DC	DCONMS	A	LU	LF	LS	L	LD Ratio	PRODUCT #	Price
#67	0.0320	0.1575 (4mm)	140	0.1181	0.1969	1.1024	2.2835	3XD	928-000-002	\$61.00
#67	0.0320	0.1575 (4mm)	140	0.1969	0.2756	1.1024	2.2835	5XD	928-000-240	\$83.50
#67	0.0320	0.1575 (4mm)	140	0.2756	0.3543	1.1024	2.2835	8XD	928-000-478	\$110.00
#66	0.0330	0.1575 (4mm)	140	0.1181	0.1969	1.1024	2.2835	3XD	928-000-003	\$61.00
#66	0.0330	0.1575 (4mm)	140	0.1969	0.2756	1.1024	2.2835	5XD	928-000-241	\$83.50
#66	0.0330	0.1575 (4mm)	140	0.2756	0.3543	1.1024	2.2835	8XD	928-000-479	\$110.00
#65	0.0350	0.1575 (4mm)	140	0.1181	0.1969	1.1024	2.2835	3XD	928-000-004	\$61.00
#65	0.0350	0.1575 (4mm)	140	0.1969	0.2756	1.1024	2.2835	5XD	928-000-242	\$83.50
#65	0.0350	0.1575 (4mm)	140	0.2756	0.3543	1.1024	2.2835	8XD	928-000-480	\$110.00
#64	0.0360	0.1575 (4mm)	140	0.1181	0.1969	1.1024	2.2835	3XD	928-000-006	\$61.00
#64	0.0360	0.1575 (4mm)	140	0.1969	0.2756	1.1024	2.2835	5XD	928-000-244	\$83.50
#64	0.0360	0.1575 (4mm)	140	0.2756	0.3543	1.1024	2.2835	8XD	928-000-482	\$110.00
#63	0.0370	0.1575 (4mm)	140	0.1181	0.1969	1.1024	2.2835	3XD	928-000-007	\$61.00
#63	0.0370	0.1575 (4mm)	140	0.1969	0.2756	1.1024	2.2835	5XD	928-000-245	\$83.50
#63	0.0370	0.1575 (4mm)	140	0.2756	0.3543	1.1024	2.2835	8XD	928-000-483	\$110.00
#62	0.0380	0.1575 (4mm)	140	0.1181	0.1969	1.1024	2.2835	3XD	928-000-008	\$61.00
#62	0.0380	0.1575 (4mm)	140	0.1969	0.2756	1.1024	2.2835	5XD	928-000-246	\$83.50
#62	0.0380	0.1575 (4mm)	140	0.2756	0.3543	1.1024	2.2835	8XD	928-000-484	\$110.00
#61	0.0390	0.1575 (4mm)	140	0.1181	0.1969	1.1024	2.2835	3XD	928-000-009	\$61.00
#61	0.0390	0.1575 (4mm)	140	0.1969	0.2756	1.1024	2.2835	5XD	928-000-247	\$83.50
#61	0.0390	0.1575 (4mm)	140	0.2756	0.3543	1.1024	2.2835	8XD	928-000-485	\$110.00
#60	0.0400	0.1575 (4mm)	140	0.1969	0.2756	1.1024	2.2835	3XD	928-000-011	\$61.00
#60	0.0400	0.1575 (4mm)	140	0.2362	0.3543	1.1024	2.2835	5XD	928-000-249	\$83.50
#60	0.0400	0.1575 (4mm)	140	0.3937	0.4724	1.1024	2.2835	8XD	928-000-487	\$110.00
#59	0.0410	0.1575 (4mm)	140	0.1969	0.2756	1.1024	2.2835	3XD	928-000-012	\$61.00
#59	0.0410	0.1575 (4mm)	140	0.2362	0.3543	1.1024	2.2835	5XD	928-000-250	\$83.50
#59	0.0410	0.1575 (4mm)	140	0.3937	0.4724	1.1024	2.2835	8XD	928-000-488	\$110.00
#58	0.0420	0.1575 (4mm)	140	0.1969	0.2756	1.1024	2.2835	3XD	928-000-013	\$56.60
#58	0.0420	0.1575 (4mm)	140	0.2362	0.3543	1.1024	2.2835	5XD	928-000-251	\$71.00
#58	0.0420	0.1575 (4mm)	140	0.3937	0.4724	1.1024	2.2835	8XD	928-000-489	\$113.00
#57	0.0430	0.1575 (4mm)	140	0.1969	0.2756	1.1024	2.2835	3XD	928-000-014	\$56.60
#57	0.0430	0.1575 (4mm)	140	0.2362	0.3543	1.1024	2.2835	5XD	928-000-252	\$71.00
#57	0.0430	0.1575 (4mm)	140	0.3937	0.4724	1.1024	2.2835	8XD	928-000-490	\$113.00
#56	0.0465	0.1575 (4mm)	140	0.1969	0.2756	1.1024	2.2835	3XD	928-000-017	\$56.60
#56	0.0465	0.1575 (4mm)	140	0.2362	0.3543	1.1024	2.2835	5XD	928-000-255	\$71.00
#56	0.0465	0.1575 (4mm)	140	0.3937	0.4724	1.1024	2.2835	8XD	928-000-493	\$113.00
3/64	0.0469	0.1575 (4mm)	140	0.1969	0.2756	1.1024	2.2835	3XD	928-000-018	\$56.60
3/64	0.0469	0.1575 (4mm)	140	0.2362	0.3543	1.1024	2.2835	5XD	928-000-256	\$71.00
3/64	0.0469	0.1575 (4mm)	140	0.3937	0.4724	1.1024	2.2835	8XD	928-000-494	\$113.00
#55	0.0520	0.1575 (4mm)	140	0.1969	0.2756	1.1024	2.2835	3XD	928-000-023	\$56.60
#55	0.0520	0.1575 (4mm)	140	0.2362	0.3543	1.1024	2.2835	5XD	928-000-261	\$71.00
#55	0.0520	0.1575 (4mm)	140	0.3937	0.4724	1.1024	2.2835	8XD	928-000-499	\$113.30
#54	0.0550	0.1575 (4mm)	140	0.1969	0.2756	1.1024	2.2835	3XD	928-000-025	\$56.60
#54	0.0550	0.1575 (4mm)	140	0.2362	0.3543	1.1024	2.2835	5XD	928-000-263	\$71.00
#54	0.0550	0.1575 (4mm)	140	0.3937	0.4724	1.1024	2.2835	8XD	928-000-501	\$113.30



CARBIDE



Through select outlets only

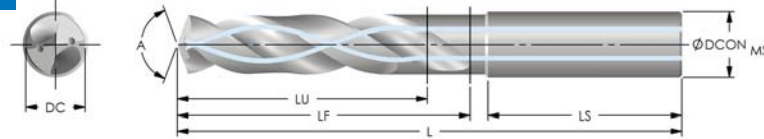
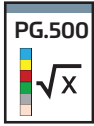

DC	DC	DCONMS	A	LU	LF	LS	L	LD Ratio	PRODUCT #	Price
#53	0.0595	0.1575 (4mm)	140	0.2362	0.3543	1.1024	2.2835	3XD	928-000-028	\$56.60
#53	0.0595	0.1575 (4mm)	140	0.3543	0.4724	1.1024	2.2835	5XD	928-000-266	\$71.00
#53	0.0595	0.1575 (4mm)	140	0.5906	0.7087	1.1024	2.2835	8XD	928-000-504	\$113.30
1/16	0.0625	0.1575 (4mm)	140	0.2362	0.3543	1.1024	2.2835	3XD	928-000-030	\$56.60
1/16	0.0625	0.1575 (4mm)	140	0.3543	0.4724	1.1024	2.2835	5XD	928-000-268	\$71.00
1/16	0.0625	0.1575 (4mm)	140	0.5906	0.7087	1.1024	2.2835	8XD	928-000-506	\$113.30
#52	0.0635	0.1575 (4mm)	140	0.2362	0.3543	1.1024	2.2835	3XD	928-000-032	\$56.60
#52	0.0635	0.1575 (4mm)	140	0.3543	0.4724	1.1024	2.2835	5XD	928-000-270	\$71.00
#52	0.0635	0.1575 (4mm)	140	0.5906	0.7087	1.1024	2.2835	8XD	928-000-508	\$113.30
#51	0.0670	0.1575 (4mm)	140	0.2362	0.3543	1.1024	2.2835	3XD	928-000-033	\$56.60
#51	0.0670	0.1575 (4mm)	140	0.3543	0.4724	1.1024	2.2835	5XD	928-000-271	\$71.00
#51	0.0670	0.1575 (4mm)	140	0.5906	0.7087	1.1024	2.2835	8XD	928-000-509	\$113.30
#50	0.0700	0.1575 (4mm)	140	0.2362	0.3543	1.1024	2.2835	3XD	928-000-034	\$56.60
#50	0.0700	0.1575 (4mm)	140	0.3543	0.4724	1.1024	2.2835	5XD	928-000-272	\$71.00
#50	0.0700	0.1575 (4mm)	140	0.5906	0.7087	1.1024	2.2835	8XD	928-000-510	\$113.30
#49	0.0730	0.1575 (4mm)	140	0.2362	0.3543	1.1024	2.2835	3XD	928-000-035	\$56.60
#49	0.0730	0.1575 (4mm)	140	0.3543	0.4724	1.1024	2.2835	5XD	928-000-273	\$71.00
#49	0.0730	0.1575 (4mm)	140	0.5906	0.7087	1.1024	2.2835	8XD	928-000-511	\$113.30
#48	0.0760	0.1575 (4mm)	140	0.2362	0.3543	1.1024	2.2835	3XD	928-000-036	\$56.6
#48	0.0760	0.1575 (4mm)	140	0.5512	0.7087	1.1024	2.2835	5XD	928-000-274	\$71.0
#48	0.0760	0.1575 (4mm)	140	0.8661	1.0236	1.1024	2.5984	8XD	928-000-512	\$113.3
5/64	0.0781	0.1575 (4mm)	140	0.2362	0.3543	1.1024	2.2835	3XD	928-000-037	\$56.60
5/64	0.0781	0.1575 (4mm)	140	0.5512	0.7087	1.1024	2.2835	5XD	928-000-275	\$71.00
5/64	0.0781	0.1575 (4mm)	140	0.8661	1.0236	1.1024	2.5984	8XD	928-000-513	\$113.30
#47	0.0785	0.1575 (4mm)	140	0.2362	0.3543	1.1024	2.2835	3XD	928-000-038	\$56.60
#47	0.0785	0.1575 (4mm)	140	0.5512	0.7087	1.1024	2.2835	5XD	928-000-276	\$71.00
#47	0.0785	0.1575 (4mm)	140	0.8661	1.0236	1.1024	2.5984	8XD	928-000-514	\$113.30
#46	0.0810	0.1575 (4mm)	140	0.3543	0.5118	1.1024	2.2835	3XD	928-000-040	\$56.60
#46	0.0810	0.1575 (4mm)	140	0.5512	0.7087	1.1024	2.2835	5XD	928-000-278	\$71.00
#46	0.0810	0.1575 (4mm)	140	0.8661	1.0236	1.1024	2.5984	8XD	928-000-516	\$113.30
#45	0.0820	0.1575 (4mm)	140	0.3543	0.5118	1.1024	2.2835	3XD	928-000-041	\$56.60
#45	0.0820	0.1575 (4mm)	140	0.5512	0.7087	1.1024	2.2835	5XD	928-000-279	\$71.00
#45	0.0820	0.1575 (4mm)	140	0.8661	1.0236	1.1024	2.5984	8XD	928-000-517	\$113.30
#44	0.0860	0.1575 (4mm)	140	0.3543	0.5118	1.1024	2.2835	3XD	928-000-042	\$56.60
#44	0.0860	0.1575 (4mm)	140	0.5512	0.7087	1.1024	2.2835	5XD	928-000-280	\$71.00
#44	0.0860	0.1575 (4mm)	140	0.8661	1.0236	1.1024	2.5984	8XD	928-000-518	\$113.30
#43	0.0890	0.1575 (4mm)	140	0.3543	0.5118	1.1024	2.2835	3XD	928-000-043	\$56.60
#43	0.0890	0.1575 (4mm)	140	0.5512	0.7087	1.1024	2.2835	5XD	928-000-281	\$71.00
#43	0.0890	0.1575 (4mm)	140	0.8661	1.0236	1.1024	2.5984	8XD	928-000-519	\$113.30
#42	0.0935	0.1575 (4mm)	140	0.4724	0.6693	1.1024	2.2835	3XD	928-000-044	\$63.70
#42	0.0935	0.1575 (4mm)	140	0.6693	0.8661	1.1024	2.2835	5XD	928-000-282	\$83.30
#42	0.0935	0.1575 (4mm)	140	0.9843	1.1811	1.1024	2.5984	8XD	928-000-520	\$115.00
3/32	0.0938	0.1575 (4mm)	140	0.4724	0.6693	1.1024	2.2835	3XD	928-000-045	\$63.70
3/32	0.0938	0.1575 (4mm)	140	0.6693	0.8661	1.1024	2.2835	5XD	928-000-283	\$83.30
3/32	0.0938	0.1575 (4mm)	140	0.9843	1.1811	1.1024	2.5984	8XD	928-000-521	\$115.00

CARBIDE

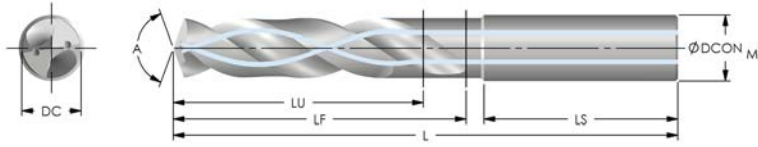
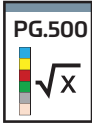

Through select
outlets only



DC	DC	DCONMS	A	LU	LF	LS	L	LD Ratio	PRODUCT #	Price
#41	0.0960	0.1575 (4mm)	140	0.4724	0.6693	1.1024	2.2835	3XD	928-000-046	\$63.70
#41	0.0960	0.1575 (4mm)	140	0.6693	0.8661	1.1024	2.2835	5XD	928-000-284	\$83.30
#41	0.0960	0.1575 (4mm)	140	0.9843	1.1811	1.1024	2.5984	8XD	928-000-522	\$115.00
#40	0.0980	0.1575 (4mm)	140	0.4724	0.6693	1.1024	2.2835	3XD	928-000-047	\$63.70
#40	0.0980	0.1575 (4mm)	140	0.6693	0.8661	1.1024	2.2835	5XD	928-000-285	\$83.30
#40	0.0980	0.1575 (4mm)	140	0.9843	1.1811	1.1024	2.5984	8XD	928-000-523	\$115.00
#39	0.0995	0.1575 (4mm)	140	0.4724	0.6693	1.1024	2.2835	3XD	928-000-049	\$63.70
#39	0.0995	0.1575 (4mm)	140	0.6693	0.8661	1.1024	2.2835	5XD	928-000-287	\$83.30
#39	0.0995	0.1575 (4mm)	140	0.9843	1.1811	1.1024	2.5984	8XD	928-000-525	\$115.00
#38	0.1015	0.1575 (4mm)	140	0.4724	0.6693	1.1024	2.2835	3XD	928-000-050	\$63.70
#38	0.1015	0.1575 (4mm)	140	0.6693	0.8661	1.1024	2.2835	5XD	928-000-288	\$83.30
#38	0.1015	0.1575 (4mm)	140	0.9843	1.1811	1.1024	2.5984	8XD	928-000-526	\$115.00
#37	0.1040	0.1575 (4mm)	140	0.4724	0.6693	1.1024	2.2835	3XD	928-000-051	\$63.70
#37	0.1040	0.1575 (4mm)	140	0.6693	0.8661	1.1024	2.2835	5XD	928-000-289	\$83.30
#37	0.1040	0.1575 (4mm)	140	0.9843	1.1811	1.1024	2.5984	8XD	928-000-527	\$115.00
#36	0.1065	0.1575 (4mm)	140	0.4724	0.6693	1.1024	2.2835	3XD	928-000-052	\$63.70
#36	0.1065	0.1575 (4mm)	140	0.6693	0.8661	1.1024	2.2835	5XD	928-000-290	\$83.30
#36	0.1065	0.1575 (4mm)	140	0.9843	1.1811	1.1024	2.5984	8XD	928-000-528	\$115.00
7/64	0.1094	0.1575 (4mm)	140	0.4724	0.6693	1.1024	2.2835	3XD	928-000-053	\$63.70
7/64	0.1094	0.1575 (4mm)	140	0.6693	0.8661	1.1024	2.2835	5XD	928-000-291	\$83.30
7/64	0.1094	0.1575 (4mm)	140	0.9843	1.1811	1.1024	2.5984	8XD	928-000-529	\$115.00
#35	0.1100	0.1575 (4mm)	140	0.4724	0.6693	1.1024	2.2835	3XD	928-000-054	\$63.70
#35	0.1100	0.1575 (4mm)	140	0.6693	0.8661	1.1024	2.2835	5XD	928-000-292	\$83.30
#35	0.1100	0.1575 (4mm)	140	0.9843	1.1811	1.1024	2.5984	8XD	928-000-530	\$115.00
#34	0.1110	0.1575 (4mm)	140	0.4724	0.6693	1.1024	2.2835	3XD	928-000-055	\$63.70
#34	0.1110	0.1575 (4mm)	140	0.6693	0.8661	1.1024	2.2835	5XD	928-000-293	\$83.30
#34	0.1110	0.1575 (4mm)	140	0.9843	1.1811	1.1024	2.5984	8XD	928-000-531	\$115.00
#33	0.1130	0.1575 (4mm)	140	0.4724	0.6693	1.1024	2.2835	3XD	928-000-056	\$63.70
#33	0.1130	0.1575 (4mm)	140	0.6693	0.8661	1.1024	2.2835	5XD	928-000-294	\$83.30
#33	0.1130	0.1575 (4mm)	140	0.9843	1.1811	1.1024	2.5984	8XD	928-000-532	\$115.00
#32	0.1160	0.1575 (4mm)	140	0.4724	0.6693	1.1024	2.2835	3XD	928-000-057	\$63.70
#32	0.1160	0.1575 (4mm)	140	0.6693	0.8661	1.1024	2.2835	5XD	928-000-295	\$83.30
#32	0.1160	0.1575 (4mm)	140	0.9843	1.1811	1.1024	2.5984	8XD	928-000-533	\$115.00
#31	0.1200	0.2362 (6mm)	140	0.5512	0.7874	1.4173	2.4409	3XD	928-000-059	\$74.30
#31	0.1200	0.2362 (6mm)	140	0.9055	1.1024	1.4173	2.5984	5XD	928-000-297	\$83.30
#31	0.1200	0.2362 (6mm)	140	1.2992	1.5748	1.4173	3.0709	8XD	928-000-535	\$115.00
1/8	0.1250	0.2362 (6mm)	140	0.5512	0.7874	1.4173	2.4409	3XD	928-000-060	\$74.30
1/8	0.1250	0.2362 (6mm)	140	0.9055	1.1024	1.4173	2.5984	5XD	928-000-298	\$83.30
1/8	0.1250	0.2362 (6mm)	140	1.2992	1.5748	1.4173	3.0709	8XD	928-000-536	\$115.00
#30	0.1285	0.2362 (6mm)	140	0.5512	0.7874	1.4173	2.4409	3XD	928-000-062	\$74.30
#30	0.1285	0.2362 (6mm)	140	0.9055	1.1024	1.4173	2.5984	5XD	928-000-300	\$83.30
#30	0.1285	0.2362 (6mm)	140	1.2992	1.5748	1.4173	3.0709	8XD	928-000-538	\$115.00
#29	0.1360	0.2362 (6mm)	140	0.5512	0.7874	1.4173	2.4409	3XD	928-000-063	\$74.30
#29	0.1360	0.2362 (6mm)	140	0.9055	1.1024	1.4173	2.5984	5XD	928-000-301	\$83.30
#29	0.1360	0.2362 (6mm)	140	1.2992	1.5748	1.4173	3.0709	8XD	928-000-539	\$115.00



Through select outlets only

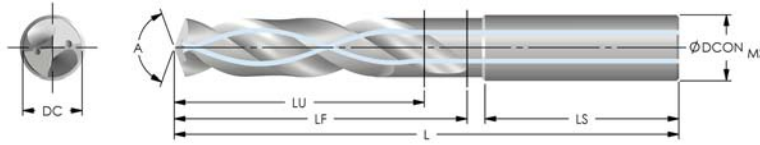

DC	DC	DCONMS	A	LU	LF	LS	L	LD Ratio	PRODUCT #	Price
#28	0.1405	0.2362 (6mm)	140	0.5512	0.7874	1.4173	2.4409	3XD	928-000-065	\$74.30
#28	0.1405	0.2362 (6mm)	140	0.9055	1.1024	1.4173	2.5984	5XD	928-000-303	\$83.30
#28	0.1405	0.2362 (6mm)	140	1.2992	1.5748	1.4173	3.0709	8XD	928-000-541	\$115.00
9/64	0.1406	0.2362 (6mm)	140	0.5512	0.7874	1.4173	2.4409	3XD	928-000-066	\$74.30
9/64	0.1406	0.2362 (6mm)	140	0.9055	1.1024	1.4173	2.5984	5XD	928-000-304	\$83.30
9/64	0.1406	0.2362 (6mm)	140	1.2992	1.5748	1.4173	3.0709	8XD	928-000-542	\$115.00
#27	0.1440	0.2362 (6mm)	140	0.5512	0.7874	1.4173	2.4409	3XD	928-000-068	\$74.30
#27	0.1440	0.2362 (6mm)	140	0.9055	1.1024	1.4173	2.5984	5XD	928-000-306	\$83.30
#27	0.1440	0.2362 (6mm)	140	1.2992	1.5748	1.4173	3.0709	8XD	928-000-544	\$115.00
#26	0.1470	0.2362 (6mm)	140	0.5512	0.7874	1.4173	2.4409	3XD	928-000-069	\$74.30
#26	0.1470	0.2362 (6mm)	140	0.9055	1.1024	1.4173	2.5984	5XD	928-000-307	\$83.30
#26	0.1470	0.2362 (6mm)	140	1.2992	1.5748	1.4173	3.0709	8XD	928-000-545	\$115.00
#25	0.1495	0.2362 (6mm)	140	0.6693	0.9449	1.4173	2.5984	3XD	928-000-070	\$81.00
#25	0.1495	0.2362 (6mm)	140	1.1417	1.4173	1.4173	2.9134	5XD	928-000-308	\$87.00
#25	0.1495	0.2362 (6mm)	140	1.6142	1.9291	1.4173	3.4252	8XD	928-000-546	\$117.20
#24	0.1520	0.2362 (6mm)	140	0.6693	0.9449	1.4173	2.5984	3XD	928-000-071	\$81.00
#24	0.1520	0.2362 (6mm)	140	1.1417	1.4173	1.4173	2.9134	5XD	928-000-309	\$87.00
#24	0.1520	0.2362 (6mm)	140	1.6142	1.9291	1.4173	3.4252	8XD	928-000-547	\$117.20
#23	0.1540	0.2362 (6mm)	140	0.6693	0.9449	1.4173	2.5984	3XD	928-000-073	\$81.00
#23	0.1540	0.2362 (6mm)	140	1.1417	1.4173	1.4173	2.9134	5XD	928-000-311	\$87.00
#23	0.1540	0.2362 (6mm)	140	1.6142	1.9291	1.4173	3.4252	8XD	928-000-549	\$117.20
5/32	0.1562	0.2362 (6mm)	140	0.6693	0.9449	1.4173	2.5984	3XD	928-000-074	\$81.00
5/32	0.1562	0.2362 (6mm)	140	1.1417	1.4173	1.4173	2.9134	5XD	928-000-312	\$87.00
5/32	0.1562	0.2362 (6mm)	140	1.6142	1.9291	1.4173	3.4252	8XD	928-000-550	\$117.20
#22	0.1570	0.2362 (6mm)	140	0.6693	0.9449	1.4173	2.5984	3XD	928-000-075	\$81.00
#22	0.1570	0.2362 (6mm)	140	1.1417	1.4173	1.4173	2.9134	5XD	928-000-313	\$87.00
#22	0.1570	0.2362 (6mm)	140	1.6142	1.9291	1.4173	3.4252	8XD	928-000-551	\$117.20
#21	0.1590	0.2362 (6mm)	140	0.6693	0.9449	1.4173	2.5984	3XD	928-000-077	\$81.00
#21	0.1590	0.2362 (6mm)	140	1.1417	1.4173	1.4173	2.9134	5XD	928-000-315	\$87.00
#21	0.1590	0.2362 (6mm)	140	1.6142	1.9291	1.4173	3.4252	8XD	928-000-553	\$117.20
#20	0.1610	0.2362 (6mm)	140	0.6693	0.9449	1.4173	2.5984	3XD	928-000-078	\$81.00
#20	0.1610	0.2362 (6mm)	140	1.1417	1.4173	1.4173	2.9134	5XD	928-000-316	\$87.00
#20	0.1610	0.2362 (6mm)	140	1.6142	1.9291	1.4173	3.4252	8XD	928-000-554	\$117.20
#19	0.1660	0.2362 (6mm)	140	0.6693	0.9449	1.4173	2.5984	3XD	928-000-080	\$81.00
#19	0.1660	0.2362 (6mm)	140	1.1417	1.4173	1.4173	2.9134	5XD	928-000-318	\$87.00
#19	0.1660	0.2362 (6mm)	140	1.6142	1.9291	1.4173	3.4252	8XD	928-000-556	\$117.20
#18	0.1695	0.2362 (6mm)	140	0.6693	0.9449	1.4173	2.5984	3XD	928-000-081	\$81.00
#18	0.1695	0.2362 (6mm)	140	1.1417	1.4173	1.4173	2.9134	5XD	928-000-319	\$87.00
#18	0.1695	0.2362 (6mm)	140	1.6142	1.9291	1.4173	3.4252	8XD	928-000-557	\$117.20
11/64	0.1719	0.2362 (6mm)	140	0.6693	0.9449	1.4173	2.5984	3XD	928-000-082	\$81.00
11/64	0.1719	0.2362 (6mm)	140	1.1417	1.4173	1.4173	2.9134	5XD	928-000-320	\$87.00
11/64	0.1719	0.2362 (6mm)	140	1.6142	1.9291	1.4173	3.4252	8XD	928-000-558	\$117.20
#17	0.1730	0.2362 (6mm)	140	0.6693	0.9449	1.4173	2.5984	3XD	928-000-083	\$81.00
#17	0.1730	0.2362 (6mm)	140	1.1417	1.4173	1.4173	2.9134	5XD	928-000-321	\$87.00
#17	0.1730	0.2362 (6mm)	140	1.6142	1.9291	1.4173	3.4252	8XD	928-000-559	\$117.20

CARBIDE

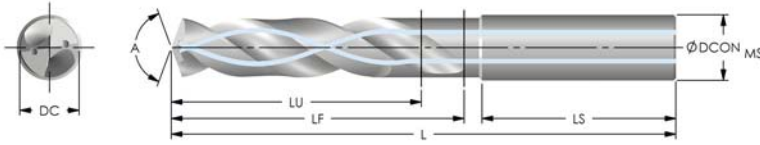

Through select
outlets only



DC	DC	DCONMS	A	LU	LF	LS	L	LD Ratio	PRODUCT #	Price
#16	0.1770	0.2362 (6mm)	140	0.6693	0.9449	1.4173	2.5984	3XD	928-000-085	\$81.00
#16	0.1770	0.2362 (6mm)	140	1.1417	1.4173	1.4173	2.9134	5XD	928-000-323	\$87.00
#16	0.1770	0.2362 (6mm)	140	1.6142	1.9291	1.4173	3.4252	8XD	928-000-561	\$117.20
#15	0.1800	0.2362 (6mm)	140	0.6693	0.9449	1.4173	2.5984	3XD	928-000-087	\$81.00
#15	0.1800	0.2362 (6mm)	140	1.1417	1.4173	1.4173	2.9134	5XD	928-000-325	\$87.00
#15	0.1800	0.2362 (6mm)	140	1.6142	1.9291	1.4173	3.4252	8XD	928-000-563	\$117.20
#14	0.1820	0.2362 (6mm)	140	0.6693	0.9449	1.4173	2.5984	3XD	928-000-089	\$81.00
#14	0.1820	0.2362 (6mm)	140	1.1417	1.4173	1.4173	2.9134	5XD	928-000-327	\$87.00
#14	0.1820	0.2362 (6mm)	140	1.6142	1.9291	1.4173	3.4252	8XD	928-000-565	\$117.20
3/16	0.1875	0.2362 (6mm)	140	0.7874	1.1024	1.4173	2.5984	3XD	928-000-091	\$88.00
3/16	0.1875	0.2362 (6mm)	140	1.378	1.7323	1.4173	3.2283	5XD	928-000-329	\$94.80
3/16	0.1875	0.2362 (6mm)	140	1.8898	2.2047	1.4173	3.7008	8XD	928-000-567	\$119.30
#11	0.1910	0.2362 (6mm)	140	0.7874	1.1024	1.4173	2.5984	3XD	928-000-093	\$88.00
#11	0.1910	0.2362 (6mm)	140	1.378	1.7323	1.4173	3.2283	5XD	928-000-331	\$94.80
#11	0.1910	0.2362 (6mm)	140	1.8898	2.2047	1.4173	3.7008	8XD	928-000-569	\$119.30
#10	0.1935	0.2362 (6mm)	140	0.7874	1.1024	1.4173	2.5984	3XD	928-000-095	\$88.00
#10	0.1935	0.2362 (6mm)	140	1.378	1.7323	1.4173	3.2283	5XD	928-000-333	\$94.80
#10	0.1935	0.2362 (6mm)	140	1.8898	2.2047	1.4173	3.7008	8XD	928-000-571	\$119.30
#9	0.1960	0.2362 (6mm)	140	0.7874	1.1024	1.4173	2.5984	3XD	928-000-096	\$88.00
#9	0.1960	0.2362 (6mm)	140	1.378	1.7323	1.4173	3.2283	5XD	928-000-334	\$94.80
#9	0.1960	0.2362 (6mm)	140	1.8898	2.2047	1.4173	3.7008	8XD	928-000-572	\$119.30
#8	0.1990	0.2362 (6mm)	140	0.7874	1.1024	1.4173	2.5984	3XD	928-000-098	\$88.00
#8	0.1990	0.2362 (6mm)	140	1.378	1.7323	1.4173	3.2283	5XD	928-000-336	\$94.80
#8	0.1990	0.2362 (6mm)	140	1.8898	2.2047	1.4173	3.7008	8XD	928-000-574	\$119.30
#7	0.2010	0.2362 (6mm)	140	0.7874	1.1024	1.4173	2.5984	3XD	928-000-100	\$88.00
#7	0.2010	0.2362 (6mm)	140	1.378	1.7323	1.4173	3.2283	5XD	928-000-338	\$94.80
#7	0.2010	0.2362 (6mm)	140	1.8898	2.2047	1.4173	3.7008	8XD	928-000-576	\$119.30
13/64	0.2031	0.2362 (6mm)	140	0.7874	1.1024	1.4173	2.5984	3XD	928-000-101	\$88.00
13/64	0.2031	0.2362 (6mm)	140	1.378	1.7323	1.4173	3.2283	5XD	928-000-339	\$94.80
13/64	0.2031	0.2362 (6mm)	140	1.8898	2.2047	1.4173	3.7008	8XD	928-000-577	\$119.30
#6	0.2040	0.2362 (6mm)	140	0.7874	1.1024	1.4173	2.5984	3XD	928-000-102	\$88.00
#6	0.2040	0.2362 (6mm)	140	1.378	1.7323	1.4173	3.2283	5XD	928-000-340	\$94.80
#6	0.2040	0.2362 (6mm)	140	1.8898	2.2047	1.4173	3.7008	8XD	928-000-578	\$119.30
#5	0.2055	0.2362 (6mm)	140	0.7874	1.1024	1.4173	2.5984	3XD	928-000-104	\$88.00
#5	0.2055	0.2362 (6mm)	140	1.378	1.7323	1.4173	3.2283	5XD	928-000-342	\$94.80
#5	0.2055	0.2362 (6mm)	140	1.8898	2.2047	1.4173	3.7008	8XD	928-000-580	\$119.30
#4	0.2090	0.2362 (6mm)	140	0.7874	1.1024	1.4173	2.5984	3XD	928-000-106	\$88.00
#4	0.2090	0.2362 (6mm)	140	1.378	1.7323	1.4173	3.2283	5XD	928-000-344	\$94.80
#4	0.2090	0.2362 (6mm)	140	1.8898	2.2047	1.4173	3.7008	8XD	928-000-582	\$119.30
#3	0.2130	0.2362 (6mm)	140	0.7874	1.1024	1.4173	2.5984	3XD	928-000-108	\$88.00
#3	0.2130	0.2362 (6mm)	140	1.378	1.7323	1.4173	3.2283	5XD	928-000-346	\$94.80
#3	0.2130	0.2362 (6mm)	140	1.8898	2.2047	1.4173	3.7008	8XD	928-000-584	\$119.30
7/32	0.2188	0.2362 (6mm)	140	0.7874	1.1024	1.4173	2.5984	3XD	928-000-110	\$94.00
7/32	0.2188	0.2362 (6mm)	140	1.378	1.7323	1.4173	3.2283	5XD	928-000-348	\$102.00
7/32	0.2188	0.2362 (6mm)	140	1.8898	2.2047	1.4173	3.7008	8XD	928-000-586	\$128.00



Through select outlets only

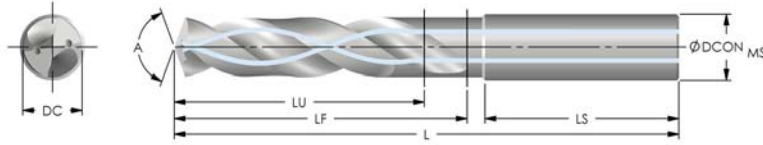

DC	DC	DCONMS	A	LU	LF	LS	L	LD Ratio	PRODUCT #	Price
#2	0.2210	0.2362 (6mm)	140	0.7874	1.1024	1.4173	2.5984	3XD	928-000-112	\$94.00
#2	0.2210	0.2362 (6mm)	140	1.378	1.7323	1.4173	3.2283	5XD	928-000-350	\$102.00
#2	0.2210	0.2362 (6mm)	140	1.8898	2.2047	1.4173	3.7008	8XD	928-000-588	\$128.00
#1	0.2280	0.2362 (6mm)	140	0.7874	1.1024	1.4173	2.5984	3XD	928-000-114	\$94.00
#1	0.2280	0.2362 (6mm)	140	1.378	1.7323	1.4173	3.2283	5XD	928-000-352	\$102.00
#1	0.2280	0.2362 (6mm)	140	1.8898	2.2047	1.4173	3.7008	8XD	928-000-590	\$128.00
A	0.2340	0.2362 (6mm)	140	0.7874	1.1024	1.4173	2.5984	3XD	928-000-117	\$94.00
A	0.2340	0.2362 (6mm)	140	1.378	1.7323	1.4173	3.2283	5XD	928-000-355	\$102.00
A	0.2340	0.2362 (6mm)	140	1.8898	2.2047	1.4173	3.7008	8XD	928-000-593	\$128.00
15/64	0.2344	0.2362 (6mm)	140	0.7874	1.1024	1.4173	2.5984	3XD	928-000-118	\$94.00
15/64	0.2344	0.2362 (6mm)	140	1.378	1.7323	1.4173	3.2283	5XD	928-000-356	\$102.00
15/64	0.2344	0.2362 (6mm)	140	1.8898	2.2047	1.4173	3.7008	8XD	928-000-594	\$128.00
B	0.2380	0.3150 (8mm)	140	0.9449	1.3386	1.4173	3.1102	3XD	928-000-120	\$98.00
B	0.2380	0.3150 (8mm)	140	1.6929	2.0866	1.4173	3.5827	5XD	928-000-358	\$113.00
B	0.2380	0.3150 (8mm)	140	2.2441	2.6378	1.4173	4.1339	8XD	928-000-596	\$149.00
C	0.2420	0.3150 (8mm)	140	0.9449	1.3386	1.4173	3.1102	3XD	928-000-122	\$98.00
C	0.2420	0.3150 (8mm)	140	1.6929	2.0866	1.4173	3.5827	5XD	928-000-360	\$113.00
C	0.2420	0.3150 (8mm)	140	2.2441	2.6378	1.4173	4.1339	8XD	928-000-598	\$149.00
D	0.2460	0.3150 (8mm)	140	0.9449	1.3386	1.4173	3.1102	3XD	928-000-124	\$98.00
D	0.2460	0.3150 (8mm)	140	1.6929	2.0866	1.4173	3.5827	5XD	928-000-362	\$113.00
D	0.2460	0.3150 (8mm)	140	2.2441	2.6378	1.4173	4.1339	8XD	928-000-600	\$149.00
E(1/4)	0.2500	0.3150 (8mm)	140	0.9449	1.3386	1.4173	3.1102	3XD	928-000-126	\$98.00
E(1/4)	0.2500	0.3150 (8mm)	140	1.6929	2.0866	1.4173	3.5827	5XD	928-000-364	\$113.00
E(1/4)	0.2500	0.3150 (8mm)	140	2.2441	2.6378	1.4173	4.1339	8XD	928-000-602	\$149.00
F	0.2570	0.3150 (8mm)	140	0.9449	1.3386	1.4173	3.1102	3XD	928-000-129	\$102.00
F	0.2570	0.3150 (8mm)	140	1.6929	2.0866	1.4173	3.5827	5XD	928-000-367	\$126.40
F	0.2570	0.3150 (8mm)	140	2.2441	2.6378	1.4173	4.1339	8XD	928-000-605	\$166.30
G	0.2610	0.3150 (8mm)	140	0.9449	1.3386	1.4173	3.1102	3XD	928-000-131	\$102.00
G	0.2610	0.3150 (8mm)	140	1.6929	2.0866	1.4173	3.5827	5XD	928-000-369	\$126.40
G	0.2610	0.3150 (8mm)	140	2.2441	2.6378	1.4173	4.1339	8XD	928-000-607	\$166.30
17/64	0.2656	0.3150 (8mm)	140	0.9449	1.3386	1.4173	3.1102	3XD	928-000-133	\$102.00
17/64	0.2656	0.3150 (8mm)	140	1.6929	2.0866	1.4173	3.5827	5XD	928-000-371	\$126.40
17/64	0.2656	0.3150 (8mm)	140	2.2441	2.6378	1.4173	4.1339	8XD	928-000-609	\$166.30
H	0.2660	0.3150 (8mm)	140	0.9449	1.3386	1.4173	3.1102	3XD	928-000-134	\$102.00
H	0.2660	0.3150 (8mm)	140	1.6929	2.0866	1.4173	3.5827	5XD	928-000-372	\$126.40
H	0.2660	0.3150 (8mm)	140	2.2441	2.6378	1.4173	4.1339	8XD	928-000-610	\$166.30
I	0.2720	0.3150 (8mm)	140	0.9449	1.3386	1.4173	3.1102	3XD	928-000-137	\$102.00
I	0.2720	0.3150 (8mm)	140	1.6929	2.0866	1.4173	3.5827	5XD	928-000-375	\$126.40
I	0.2720	0.3150 (8mm)	140	2.2441	2.6378	1.4173	4.1339	8XD	928-000-613	\$166.30
J	0.2770	0.3150 (8mm)	140	1.1417	1.6142	1.4173	3.1102	3XD	928-000-139	\$102.00
J	0.2770	0.3150 (8mm)	140	1.6929	2.0866	1.4173	3.5827	5XD	928-000-377	\$126.40
J	0.2770	0.3150 (8mm)	140	2.5197	3.0315	1.4173	4.5276	8XD	928-000-615	\$166.00
K	0.2810	0.3150 (8mm)	140	1.1417	1.6142	1.4173	3.1102	3XD	928-000-141	\$110.00
K	0.2810	0.3150 (8mm)	140	1.6929	2.0866	1.4173	3.5827	5XD	928-000-379	\$142.90
K	0.2810	0.3150 (8mm)	140	2.5197	3.0315	1.4173	4.5276	8XD	928-000-617	\$178.00
9/32	0.2812	0.3150 (8mm)	140	1.1417	1.6142	1.4173	3.1102	3XD	928-000-142	\$110.00
9/32	0.2812	0.3150 (8mm)	140	1.6929	2.0866	1.4173	3.5827	5XD	928-000-380	\$142.90
9/32	0.2812	0.3150 (8mm)	140	2.5197	3.0315	1.4173	4.5276	8XD	928-000-618	\$178.00

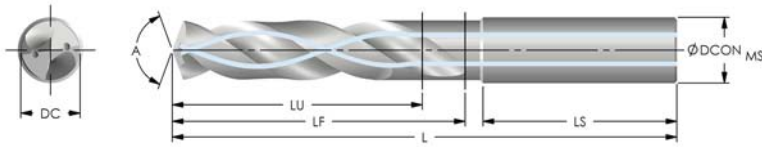
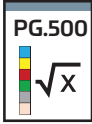

Through select
outlets only



DC	DC	DCONMS	A	LU	LF	LS	L	LD Ratio	PRODUCT #	Price
L	0.2900	0.3150 (8mm)	140	1.1417	1.6142	1.4173	3.1102	3XD	928-000-145	\$110.00
L	0.2900	0.3150 (8mm)	140	1.6929	2.0866	1.4173	3.5827	5XD	928-000-383	\$142.90
L	0.2900	0.3150 (8mm)	140	2.5197	3.0315	1.4173	4.5276	8XD	928-000-621	\$178.00
M	0.2950	0.3150 (8mm)	140	1.1417	1.6142	1.4173	3.1102	3XD	928-000-147	\$110.00
M	0.2950	0.3150 (8mm)	140	1.6929	2.0866	1.4173	3.5827	5XD	928-000-385	\$142.90
M	0.2950	0.3150 (8mm)	140	2.5197	3.0315	1.4173	4.5276	8XD	928-000-623	\$178.00
19/64	0.2969	0.3150 (8mm)	140	1.1417	1.6142	1.4173	3.1102	3XD	928-000-149	\$110.00
19/64	0.2969	0.3150 (8mm)	140	1.6929	2.0866	1.4173	3.5827	5XD	928-000-387	\$142.90
19/64	0.2969	0.3150 (8mm)	140	2.5197	3.0315	1.4173	4.5276	8XD	928-000-625	\$178.00
N	0.3020	0.3150 (8mm)	140	1.1417	1.6142	1.4173	3.1102	3XD	928-000-151	\$110.00
N	0.3020	0.3150 (8mm)	140	1.6929	2.0866	1.4173	3.5827	5XD	928-000-389	\$142.90
N	0.3020	0.3150 (8mm)	140	2.5197	3.0315	1.4173	4.5276	8XD	928-000-627	\$178.00
5/16	0.3125	0.3150 (8mm)	140	1.1417	1.6142	1.4173	3.1102	3XD	928-000-155	\$110.00
5/16	0.3125	0.3150 (8mm)	140	1.6929	2.0866	1.4173	3.5827	5XD	928-000-393	\$142.90
5/16	0.3125	0.3150 (8mm)	140	2.5197	3.0315	1.4173	4.5276	8XD	928-000-631	\$178.00
O	0.3160	0.3937 (10mm)	140	1.378	1.8504	1.5748	3.5039	3XD	928-000-157	\$116.00
O	0.3160	0.3937 (10mm)	140	1.9291	2.4016	1.5748	4.0551	5XD	928-000-395	\$167.00
O	0.3160	0.3937 (10mm)	140	2.9528	3.5039	1.5748	5.1575	8XD	928-000-633	\$210.40
P	0.3230	0.3937 (10mm)	140	1.378	1.8504	1.5748	3.5039	3XD	928-000-160	\$116.00
P	0.3230	0.3937 (10mm)	140	1.9291	2.4016	1.5748	4.0551	5XD	928-000-398	\$167.00
P	0.3230	0.3937 (10mm)	140	2.9528	3.5039	1.5748	5.1575	8XD	928-000-636	\$210.40
21/64	0.3281	0.3937 (10mm)	140	1.378	1.8504	1.5748	3.5039	3XD	928-000-162	\$116.00
21/64	0.3281	0.3937 (10mm)	140	1.9291	2.4016	1.5748	4.0551	5XD	928-000-400	\$167.00
21/64	0.3281	0.3937 (10mm)	140	2.9528	3.5039	1.5748	5.1575	8XD	928-000-638	\$210.40
Q	0.3320	0.3937 (10mm)	140	1.378	1.8504	1.5748	3.5039	3XD	928-000-164	\$116.00
Q	0.3320	0.3937 (10mm)	140	1.9291	2.4016	1.5748	4.0551	5XD	928-000-402	\$167.00
Q	0.3320	0.3937 (10mm)	140	2.9528	3.5039	1.5748	5.1575	8XD	928-000-640	\$210.40
R	0.3390	0.3937 (10mm)	140	1.378	1.8504	1.5748	3.5039	3XD	928-000-167	\$116.00
R	0.3390	0.3937 (10mm)	140	1.9291	2.4016	1.5748	4.0551	5XD	928-000-405	\$167.00
R	0.3390	0.3937 (10mm)	140	2.9528	3.5039	1.5748	5.1575	8XD	928-000-643	\$210.40
11/32	0.3438	0.3937 (10mm)	140	1.378	1.8504	1.5748	3.5039	3XD	928-000-169	\$116.00
11/32	0.3438	0.3937 (10mm)	140	1.9291	2.4016	1.5748	4.0551	5XD	928-000-407	\$167.00
11/32	0.3438	0.3937 (10mm)	140	2.9528	3.5039	1.5748	5.1575	8XD	928-000-645	\$210.40
S	0.3480	0.3937 (10mm)	140	1.378	1.8504	1.5748	3.5039	3XD	928-000-171	\$116.00
S	0.3480	0.3937 (10mm)	140	1.9291	2.4016	1.5748	4.0551	5XD	928-000-409	\$167.00
S	0.3480	0.3937 (10mm)	140	2.9528	3.5039	1.5748	5.1575	8XD	928-000-647	\$210.40
T	0.3580	0.3937 (10mm)	140	1.378	1.8504	1.5748	3.5039	3XD	928-000-174	\$116.00
T	0.3580	0.3937 (10mm)	140	1.9291	2.4016	1.5748	4.0551	5XD	928-000-412	\$167.00
T	0.3580	0.3937 (10mm)	140	2.9528	3.5039	1.5748	5.1575	8XD	928-000-650	\$210.40
23/64	0.3594	0.3937 (10mm)	140	1.378	1.8504	1.5748	3.5039	3XD	928-000-176	\$116.00
23/64	0.3594	0.3937 (10mm)	140	1.9291	2.4016	1.5748	4.0551	5XD	928-000-414	\$167.00
23/64	0.3594	0.3937 (10mm)	140	2.9528	3.5039	1.5748	5.1575	8XD	928-000-652	\$210.40
U	0.3680	0.3937 (10mm)	140	1.378	1.8504	1.5748	3.5039	3XD	928-000-179	\$116.00
U	0.3680	0.3937 (10mm)	140	1.9291	2.4016	1.5748	4.0551	5XD	928-000-417	\$167.00
U	0.3680	0.3937 (10mm)	140	2.9528	3.5039	1.5748	5.1575	8XD	928-000-655	\$210.40



Through select outlets only

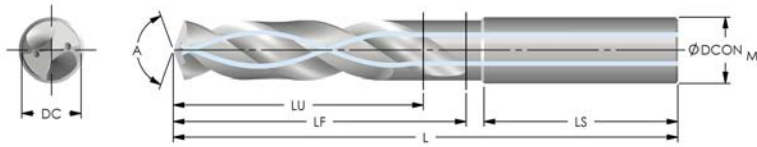

DC	DC	DCONMS	A	LU	LF	LS	L	LD Ratio	PRODUCT #	Price
3/8	0.3750	0.3937 (10mm)	140	1.378	1.8504	1.5748	3.5039	3XD	928-000-182	\$116.00
3/8	0.3750	0.3937 (10mm)	140	1.9291	2.4016	1.5748	4.0551	5XD	928-000-420	\$167.00
3/8	0.3750	0.3937 (10mm)	140	2.9528	3.5039	1.5748	5.1575	8XD	928-000-658	\$210.40
V	0.3770	0.3937 (10mm)	140	1.378	1.8504	1.5748	3.5039	3XD	928-000-183	\$116.00
V	0.3770	0.3937 (10mm)	140	1.9291	2.4016	1.5748	4.0551	5XD	928-000-421	\$167.00
V	0.3770	0.3937 (10mm)	140	2.9528	3.5039	1.5748	5.1575	8XD	928-000-659	\$210.40
W	0.3860	0.3937 (10mm)	140	1.378	1.8504	1.5748	3.5039	3XD	928-000-187	\$116.00
W	0.3860	0.3937 (10mm)	140	1.9291	2.4016	1.5748	4.0551	5XD	928-000-425	\$167.00
W	0.3860	0.3937 (10mm)	140	2.9528	3.5039	1.5748	5.1575	8XD	928-000-663	\$210.40
25/64	0.3906	0.3937 (10mm)	140	1.378	1.8504	1.5748	3.5039	3XD	928-000-189	\$116.00
25/64	0.3906	0.3937 (10mm)	140	1.9291	2.4016	1.5748	4.0551	5XD	928-000-427	\$167.00
25/64	0.3906	0.3937 (10mm)	140	2.9528	3.5039	1.5748	5.1575	8XD	928-000-665	\$210.40
X	0.3970	0.4724 (12mm)	140	1.5748	2.1654	1.7717	4.0157	3XD	928-000-191	\$152.00
X	0.3970	0.4724 (12mm)	140	2.2047	2.7953	1.7717	4.6457	5XD	928-000-429	\$202.30
X	0.3970	0.4724 (12mm)	140	3.622	4.252	1.7717	6.1024	8XD	928-000-667	\$273.20
Y	0.4040	0.4724 (12mm)	140	1.5748	2.1654	1.7717	4.0157	3XD	928-000-192	\$152.00
Y	0.4040	0.4724 (12mm)	140	2.2047	2.7953	1.7717	4.6457	5XD	928-000-430	\$202.30
Y	0.4040	0.4724 (12mm)	140	3.622	4.252	1.7717	6.1024	8XD	928-000-668	\$273.20
13/32	0.4062	0.4724 (12mm)	140	1.5748	2.1654	1.7717	4.0157	3XD	928-000-193	\$152.00
13/32	0.4062	0.4724 (12mm)	140	2.2047	2.7953	1.7717	4.6457	5XD	928-000-431	\$202.30
13/32	0.4062	0.4724 (12mm)	140	3.622	4.252	1.7717	6.1024	8XD	928-000-669	\$273.20
Z	0.4130	0.4724 (12mm)	140	1.5748	2.1654	1.7717	4.0157	3XD	928-000-194	\$152.00
Z	0.4130	0.4724 (12mm)	140	2.2047	2.7953	1.7717	4.6457	5XD	928-000-432	\$202.30
Z	0.4130	0.4724 (12mm)	140	3.622	4.252	1.7717	6.1024	8XD	928-000-670	\$273.20
27/64	0.4219	0.4724 (12mm)	140	1.5748	2.1654	1.7717	4.0157	3XD	928-000-196	\$152.00
27/64	0.4219	0.4724 (12mm)	140	2.2047	2.7953	1.7717	4.6457	5XD	928-000-434	\$202.30
27/64	0.4219	0.4724 (12mm)	140	3.622	4.252	1.7717	6.1024	8XD	928-000-672	\$273.20
7/16	0.4375	0.4724 (12mm)	140	1.5748	2.1654	1.7717	4.0157	3XD	928-000-198	\$152.00
7/16	0.4375	0.4724 (12mm)	140	2.2047	2.7953	1.7717	4.6457	5XD	928-000-436	\$202.30
7/16	0.4375	0.4724 (12mm)	140	3.622	4.252	1.7717	6.1024	8XD	928-000-674	\$273.20
29/64	0.4531	0.4724 (12mm)	140	1.5748	2.1654	1.7717	4.0157	3XD	928-000-200	\$152.00
29/64	0.4531	0.4724 (12mm)	140	2.2047	2.7953	1.7717	4.6457	5XD	928-000-438	\$202.30
29/64	0.4531	0.4724 (12mm)	140	3.622	4.252	1.7717	6.1024	8XD	928-000-676	\$273.20
15/32	0.4688	0.4724 (12mm)	140	1.5748	2.1654	1.7717	4.0157	3XD	928-000-201	\$152.00
15/32	0.4688	0.4724 (12mm)	140	2.2047	2.7953	1.7717	4.6457	5XD	928-000-439	\$202.30
15/32	0.4688	0.4724 (12mm)	140	3.622	4.252	1.7717	6.1024	8XD	928-000-677	\$273.20
31/64	0.4844	0.5512 (14mm)	140	1.6929	2.3622	1.7717	4.2126	3XD	928-000-203	\$178.00
31/64	0.4844	0.5512 (14mm)	140	2.3622	3.0315	1.7717	4.8819	5XD	928-000-441	\$228.00
31/64	0.4844	0.5512 (14mm)	140	4.3307	5.315	1.7717	7.1654	8XD	928-000-679	\$359.30
1/2	0.5000	0.5512 (14mm)	140	1.6929	2.3622	1.7717	4.2126	3XD	928-000-205	\$178.00
1/2	0.5000	0.5512 (14mm)	140	2.3622	3.0315	1.7717	4.8819	5XD	928-000-443	\$228.00
1/2	0.5000	0.5512 (14mm)	140	4.3307	5.315	1.7717	7.1654	8XD	928-000-681	\$359.30
33/64	0.5156	0.5512 (14mm)	140	1.6929	2.3622	1.7717	4.2126	3XD	928-000-207	\$178.00
33/64	0.5156	0.5512 (14mm)	140	2.3622	3.0315	1.7717	4.8819	5XD	928-000-445	\$228.00
33/64	0.5156	0.5512 (14mm)	140	4.3307	5.315	1.7717	7.1654	8XD	928-000-683	\$359.30



by **KEO**



Through select
outlets only

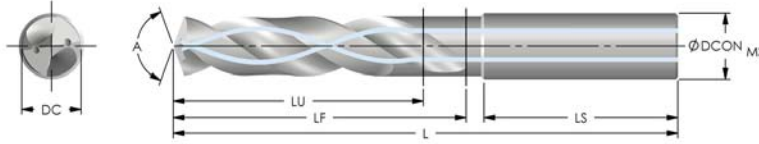

DC	DC	DCONMS	A	LU	LF	LS	L	LD Ratio	PRODUCT #	Price
17/32	0.5312	0.5512 (14mm)	140	1.6929	2.3622	1.7717	4.2126	3XD	928-000-208	\$178.00
17/32	0.5312	0.5512 (14mm)	140	2.3622	3.0315	1.7717	4.8819	5XD	928-000-446	\$228.00
17/32	0.5312	0.5512 (14mm)	140	4.3307	5.315	1.7717	7.1654	8XD	928-000-684	\$359.30
35/64	0.5469	0.5512 (14mm)	140	1.6929	2.3622	1.7717	4.2126	3XD	928-000-210	\$178.00
35/64	0.5469	0.5512 (14mm)	140	2.3622	3.0315	1.7717	4.8819	5XD	928-000-448	\$228.00
35/64	0.5469	0.5512 (14mm)	140	4.3307	5.315	1.7717	7.1654	8XD	928-000-686	\$359.30
9/16	0.5625	0.6299 (16mm)	140	1.7717	2.5591	1.8898	4.5276	3XD	928-000-212	\$244.70
9/16	0.5625	0.6299 (16mm)	140	2.4803	3.2677	1.8898	5.2362	5XD	928-000-450	\$319.40
9/16	0.5625	0.6299 (16mm)	140	5.0394	6.1024	1.8898	8.0315	8XD	928-000-688	\$521.80
37/64	0.5781	0.6299 (16mm)	140	1.7717	2.5591	1.8898	4.5276	3XD	928-000-214	\$244.70
37/64	0.5781	0.6299 (16mm)	140	2.4803	3.2677	1.8898	5.2362	5XD	928-000-452	\$319.40
37/64	0.5781	0.6299 (16mm)	140	5.0394	6.1024	1.8898	8.0315	8XD	928-000-690	\$521.80
19/32	0.5938	0.6299 (16mm)	140	1.7717	2.5591	1.8898	4.5276	3XD	928-000-216	\$244.70
19/32	0.5938	0.6299 (16mm)	140	2.4803	3.2677	1.8898	5.2362	5XD	928-000-454	\$319.40
19/32	0.5938	0.6299 (16mm)	140	5.0394	6.1024	1.8898	8.0315	8XD	928-000-692	\$521.80
39/64	0.6094	0.6299 (16mm)	140	1.7717	2.5591	1.8898	4.5276	3XD	928-000-217	\$244.70
39/64	0.6094	0.6299 (16mm)	140	2.4803	3.2677	1.8898	5.2362	5XD	928-000-455	\$319.40
39/64	0.6094	0.6299 (16mm)	140	5.0394	6.1024	1.8898	8.0315	8XD	928-000-693	\$521.80
5/8	0.6250	0.6299 (16mm)	140	1.7717	2.5591	1.8898	4.5276	3XD	928-000-219	\$244.70
5/8	0.6250	0.6299 (16mm)	140	2.4803	3.2677	1.8898	5.2362	5XD	928-000-457	\$319.40
5/8	0.6250	0.6299 (16mm)	140	5.0394	6.1024	1.8898	8.0315	8XD	928-000-695	\$521.80
41/64	0.6406	0.7087 (18mm)	140	2.0079	2.874	1.8898	4.8425	3XD	928-000-221	\$315.10
41/64	0.6406	0.7087 (18mm)	140	2.7953	3.6614	1.8898	5.6299	5XD	928-000-459	\$420.40
41/64	0.6406	0.7087 (18mm)	140	5.6693	6.6929	1.8898	8.7795	8XD	928-000-697	\$697.80
21/32	0.6562	0.7087 (18mm)	140	2.0079	2.874	1.8898	4.8425	3XD	928-000-223	\$315.10
21/32	0.6562	0.7087 (18mm)	140	2.7953	3.6614	1.8898	5.6299	5XD	928-000-461	\$420.40
21/32	0.6562	0.7087 (18mm)	140	5.6693	6.6929	1.8898	8.7795	8XD	928-000-699	\$697.80
43/64	0.6719	0.7087 (18mm)	140	2.0079	2.874	1.8898	4.8425	3XD	928-000-225	\$315.10
43/64	0.6719	0.7087 (18mm)	140	2.7953	3.6614	1.8898	5.6299	5XD	928-000-463	\$420.40
43/64	0.6719	0.7087 (18mm)	140	5.6693	6.6929	1.8898	8.7795	8XD	928-000-701	\$697.80
11/16	0.6875	0.7087 (18mm)	140	2.0079	2.874	1.8898	4.8425	3XD	928-000-226	\$315.10
11/16	0.6875	0.7087 (18mm)	140	2.7953	3.6614	1.8898	5.6299	5XD	928-000-464	\$420.40
11/16	0.6875	0.7087 (18mm)	140	5.6693	6.6929	1.8898	8.7795	8XD	928-000-702	\$697.80
45/64	0.7031	0.7087 (18mm)	140	2.0079	2.874	1.8898	4.8425	3XD	928-000-228	\$315.10
45/64	0.7031	0.7087 (18mm)	140	2.7953	3.6614	1.8898	5.6299	5XD	928-000-466	\$420.40
45/64	0.7031	0.7087 (18mm)	140	5.6693	6.6929	1.8898	8.7795	8XD	928-000-704	\$697.80
23/32	0.7188	0.7874 (20.00mm)	140	2.1654	3.1102	1.9685	5.1969	3XD	928-000-230	\$375.70
23/32	0.7188	0.7874 (20.00mm)	140	3.0315	3.9764	1.9685	6.063	5XD	928-000-468	\$517.70
23/32	0.7188	0.7874 (20.00mm)	140	6.2992	7.2835	1.9685	9.6457	8XD	928-000-706	\$823.30
47/64	0.7344	0.7874 (20.00mm)	140	2.1654	3.1102	1.9685	5.1969	3XD	928-000-232	\$375.70
47/64	0.7344	0.7874 (20.00mm)	140	3.0315	3.9764	1.9685	6.063	5XD	928-000-470	\$517.70
47/64	0.7344	0.7874 (20.00mm)	140	6.2992	7.2835	1.9685	9.6457	8XD	928-000-708	\$823.30
3/4	0.7500	0.7874 (20.00mm)	140	2.1654	3.1102	1.9685	5.1969	3XD	928-000-234	\$404.60
3/4	0.7500	0.7874 (20.00mm)	140	3.0315	3.9764	1.9685	6.063	5XD	928-000-472	\$517.70
3/4	0.7500	0.7874 (20.00mm)	140	6.2992	7.2835	1.9685	9.6457	8XD	928-000-710	\$823.30
49/64	0.7656	0.7874 (20.00mm)	140	2.1654	3.1102	1.9685	5.1969	3XD	928-000-235	\$404.60
49/64	0.7656	0.7874 (20.00mm)	140	3.0315	3.9764	1.9685	6.063	5XD	928-000-473	\$517.70
49/64	0.7656	0.7874 (20.00mm)	140	6.2992	7.2835	1.9685	9.6457	8XD	928-000-711	\$888.30
25/32	0.7812	0.7874 (20.00mm)	140	2.1654	3.1102	1.9685	5.1969	3XD	928-000-237	\$404.60
25/32	0.7812	0.7874 (20.00mm)	140	3.0315	3.9764	1.9685	6.063	5XD	928-000-475	\$517.70
25/32	0.7812	0.7874 (20.00mm)	140	6.2992	7.2835	1.9685	9.6457	8XD	928-000-713	\$888.30



Through select outlets only



CARBIDE

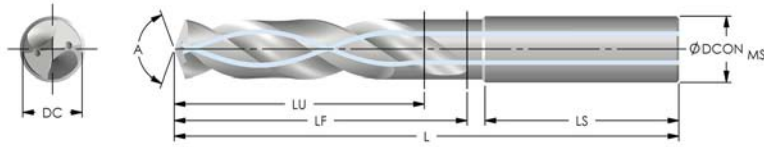

DC	DC	DCONMS	A	LU	LF	LS	L	LD Ratio	PRODUCT #	Price
0.80MM	0.80	4.00	140	3.00	5.00	28.00	58.00	3XD	928-000-001	\$61.00
0.80MM	0.80	4.00	140	5.00	7.00	28.00	58.00	5XD	928-000-239	\$83.50
0.80MM	0.80	4.00	140	7.00	9.00	28.00	58.00	8XD	928-000-477	\$110.00
0.90MM	0.90	4.00	140	3.00	5.00	28.00	58.00	3XD	928-000-005	\$61.00
0.90MM	0.90	4.00	140	5.00	7.00	28.00	58.00	5XD	928-000-243	\$83.50
0.90MM	0.90	4.00	140	7.00	9.00	28.00	58.00	8XD	928-000-481	\$110.00
1.00MM	1.00	4.00	140	5.00	7.00	28.00	58.00	3XD	928-000-010	\$61.00
1.00MM	1.00	4.00	140	6.00	9.00	28.00	58.00	5XD	928-000-248	\$83.50
1.00MM	1.00	4.00	140	10.00	12.00	28.00	58.00	8XD	928-000-486	\$110.00
1.10MM	1.10	4.00	140	5.00	7.00	28.00	58.00	3XD	928-000-015	\$56.60
1.10MM	1.10	4.00	140	6.00	9.00	28.00	58.00	5XD	928-000-253	\$71.00
1.10MM	1.10	4.00	140	10.00	12.00	28.00	58.00	8XD	928-000-491	\$113.00
1.12MM	1.12	4.00	140	5.00	7.00	28.00	58.00	3XD	928-000-016	\$56.60
1.12MM	1.12	4.00	140	6.00	9.00	28.00	58.00	5XD	928-000-254	\$71.00
1.12MM	1.12	4.00	140	10.00	12.00	28.00	58.00	8XD	928-000-492	\$113.00
1.20MM	1.20	4.00	140	5.00	7.00	28.00	58.00	3XD	928-000-019	\$56.60
1.20MM	1.20	4.00	140	6.00	9.00	28.00	58.00	5XD	928-000-257	\$71.00
1.20MM	1.20	4.00	140	10.00	12.00	28.00	58.00	8XD	928-000-495	\$113.00
1.25MM	1.25	4.00	140	5.00	7.00	28.00	58.00	3XD	928-000-020	\$56.60
1.25MM	1.25	4.00	140	6.00	9.00	28.00	58.00	5XD	928-000-258	\$71.00
1.25MM	1.25	4.00	140	10.00	12.00	28.00	58.00	8XD	928-000-496	\$113.30
1.27MM	1.27	4.00	140	5.00	7.00	28.00	58.00	3XD	928-000-021	\$56.60
1.27MM	1.27	4.00	140	6.00	9.00	28.00	58.00	5XD	928-000-259	\$71.00
1.27MM	1.27	4.00	140	10.00	12.00	28.00	58.00	8XD	928-000-497	\$113.30
1.30MM	1.30	4.00	140	5.00	7.00	28.00	58.00	3XD	928-000-022	\$56.60
1.30MM	1.30	4.00	140	6.00	9.00	28.00	58.00	5XD	928-000-260	\$71.00
1.30MM	1.30	4.00	140	10.00	12.00	28.00	58.00	8XD	928-000-498	\$113.30
1.35MM	1.35	4.00	140	5.00	7.00	28.00	58.00	3XD	928-000-024	\$56.60
1.35MM	1.35	4.00	140	6.00	9.00	28.00	58.00	5XD	928-000-262	\$71.00
1.35MM	1.35	4.00	140	10.00	12.00	28.00	58.00	8XD	928-000-500	\$113.30
1.45MM	1.45	4.00	140	6.00	9.00	28.00	58.00	3XD	928-000-026	\$56.60
1.45MM	1.45	4.00	140	9.00	12.00	28.00	58.00	5XD	928-000-264	\$71.00
1.45MM	1.45	4.00	140	15.00	18.00	28.00	58.00	8XD	928-000-502	\$113.30
1.50MM	1.50	4.00	140	6.00	9.00	28.00	58.00	3XD	928-000-027	\$56.60
1.50MM	1.50	4.00	140	9.00	12.00	28.00	58.00	5XD	928-000-265	\$71.00
1.50MM	1.50	4.00	140	15.00	18.00	28.00	58.00	8XD	928-000-503	\$113.30
1.55MM	1.55	4.00	140	6.00	9.00	28.00	58.00	3XD	928-000-029	\$56.60
1.55MM	1.55	4.00	140	9.00	12.00	28.00	58.00	5XD	928-000-267	\$71.00
1.55MM	1.55	4.00	140	15.00	18.00	28.00	58.00	8XD	928-000-505	\$113.30
1.60MM	1.60	4.00	140	6.00	9.00	28.00	58.00	3XD	928-000-031	\$56.60
1.60MM	1.60	4.00	140	9.00	12.00	28.00	58.00	5XD	928-000-269	\$71.00
1.60MM	1.60	4.00	140	15.00	18.00	28.00	58.00	8XD	928-000-507	\$113.30
2.00MM	2.00	4.00	140	9.00	13.00	28.00	58.00	3XD	928-000-039	\$56.60
2.00MM	2.00	4.00	140	14.00	18.00	28.00	58.00	5XD	928-000-277	\$71.00
2.00MM	2.00	4.00	140	22.00	26.00	28.00	66.00	8XD	928-000-515	\$113.30

CARBIDE

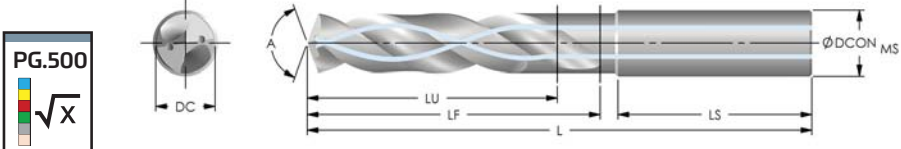

Through select outlets only



DC	DC	DCONMS	A	LU	LF	LS	L	LD Ratio	PRODUCT #	Price
2.50MM	2.50	4.00	140	12.00	17.00	28.00	58.00	3XD	928-000-048	\$63.70
2.50MM	2.50	4.00	140	17.00	22.00	28.00	58.00	5XD	928-000-286	\$83.30
2.50MM	2.50	4.00	140	25.00	30.00	28.00	66.00	8XD	928-000-524	\$115.00
3.00MM	3.00	6.00	140	14.00	20.00	36.00	62.00	3XD	928-000-058	\$74.30
3.00MM	3.00	6.00	140	23.00	28.00	36.00	66.00	5XD	928-000-296	\$83.30
3.00MM	3.00	6.00	140	33.00	40.00	36.00	78.00	8XD	928-000-534	\$115.00
3.20MM	3.20	6.00	140	14.00	20.00	36.00	62.00	3XD	928-000-061	\$74.30
3.20MM	3.20	6.00	140	23.00	28.00	36.00	66.00	5XD	928-000-299	\$83.30
3.20MM	3.20	6.00	140	33.00	40.00	36.00	78.00	8XD	928-000-537	\$115.00
3.50MM	3.50	6.00	140	14.00	20.00	36.00	62.00	3XD	928-000-064	\$74.30
3.50MM	3.50	6.00	140	23.00	28.00	36.00	66.00	5XD	928-000-302	\$83.30
3.50MM	3.50	6.00	140	33.00	40.00	36.00	78.00	8XD	928-000-540	\$115.00
3.60MM	3.60	6.00	140	14.00	20.00	36.00	62.00	3XD	928-000-067	\$74.30
3.60MM	3.60	6.00	140	23.00	28.00	36.00	66.00	5XD	928-000-305	\$83.30
3.60MM	3.60	6.00	140	33.00	40.00	36.00	78.00	8XD	928-000-543	\$115.00
3.90MM	3.90	6.00	140	17.00	24.00	36.00	66.00	3XD	928-000-072	\$81.00
3.90MM	3.90	6.00	140	29.00	36.00	36.00	74.00	5XD	928-000-310	\$87.00
3.90MM	3.90	6.00	140	41.00	49.00	36.00	87.00	8XD	928-000-548	\$117.20
4.00MM	4.00	6.00	140	17.00	24.00	36.00	66.00	3XD	928-000-076	\$81.00
4.00MM	4.00	6.00	140	29.00	36.00	36.00	74.00	5XD	928-000-314	\$87.00
4.00MM	4.00	6.00	140	41.00	49.00	36.00	87.00	8XD	928-000-552	\$117.20
4.10MM	4.10	6.00	140	17.00	24.00	36.00	66.00	3XD	928-000-079	\$81.00
4.10MM	4.10	6.00	140	29.00	36.00	36.00	74.00	5XD	928-000-317	\$87.00
4.10MM	4.10	6.00	140	41.00	49.00	36.00	87.00	8XD	928-000-555	\$117.20
4.40MM	4.40	6.00	140	17.00	24.00	36.00	66.00	3XD	928-000-084	\$81.00
4.40MM	4.40	6.00	140	29.00	36.00	36.00	74.00	5XD	928-000-322	\$87.00
4.40MM	4.40	6.00	140	41.00	49.00	36.00	87.00	8XD	928-000-560	\$117.20
4.50MM	4.50	6.00	140	17.00	24.00	36.00	66.00	3XD	928-000-086	\$81.00
4.50MM	4.50	6.00	140	29.00	36.00	36.00	74.00	5XD	928-000-324	\$87.00
4.50MM	4.50	6.00	140	41.00	49.00	36.00	87.00	8XD	928-000-562	\$117.20
4.60MM	4.60	6.00	140	17.00	24.00	36.00	66.00	3XD	928-000-088	\$81.00
4.60MM	4.60	6.00	140	29.00	36.00	36.00	74.00	5XD	928-000-326	\$87.00
4.60MM	4.60	6.00	140	41.00	49.00	36.00	87.00	8XD	928-000-564	\$117.20
4.70MM	4.70	6.00	140	17.00	24.00	36.00	66.00	3XD	928-000-090	\$81.00
4.70MM	4.70	6.00	140	29.00	36.00	36.00	74.00	5XD	928-000-328	\$87.00
4.70MM	4.70	6.00	140	41.00	49.00	36.00	87.00	8XD	928-000-566	\$117.20
4.80MM	4.80	6.00	140	20.00	28.00	36.00	66.00	3XD	928-000-092	\$88.00
4.80MM	4.80	6.00	140	35.00	44.00	36.00	82.00	5XD	928-000-330	\$94.80
4.80MM	4.80	6.00	140	48.00	56.00	36.00	94.00	8XD	928-000-568	\$119.30
4.90MM	4.90	6.00	140	20.00	28.00	36.00	66.00	3XD	928-000-094	\$88.00
4.90MM	4.90	6.00	140	35.00	44.00	36.00	82.00	5XD	928-000-332	\$94.80
4.90MM	4.90	6.00	140	48.00	56.00	36.00	94.00	8XD	928-000-570	\$119.30
5.00MM	5.00	6.00	140	20.00	28.00	36.00	66.00	3XD	928-000-097	\$88.00
5.00MM	5.00	6.00	140	35.00	44.00	36.00	82.00	5XD	928-000-335	\$94.80
5.00MM	5.00	6.00	140	48.00	56.00	36.00	94.00	8XD	928-000-573	\$119.30



Through select outlets only

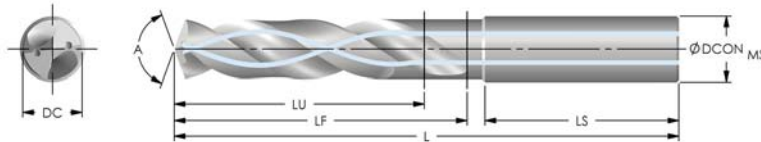

DC	DC	DCONMS	A	LU	LF	LS	L	LD Ratio	PRODUCT #	Price
5.10MM	5.10	6.00	140	20.00	28.00	36.00	66.00	3XD	928-000-099	\$88.00
5.10MM	5.10	6.00	140	35.00	44.00	36.00	82.00	5XD	928-000-337	\$94.80
5.10MM	5.10	6.00	140	48.00	56.00	36.00	94.00	8XD	928-000-575	\$119.30
5.20MM	5.20	6.00	140	20.00	28.00	36.00	66.00	3XD	928-000-103	\$88.00
5.20MM	5.20	6.00	140	35.00	44.00	36.00	82.00	5XD	928-000-341	\$94.80
5.20MM	5.20	6.00	140	48.00	56.00	36.00	94.00	8XD	928-000-579	\$119.30
5.30MM	5.30	6.00	140	20.00	28.00	36.00	66.00	3XD	928-000-105	\$88.00
5.30MM	5.30	6.00	140	35.00	44.00	36.00	82.00	5XD	928-000-343	\$94.80
5.30MM	5.30	6.00	140	48.00	56.00	36.00	94.00	8XD	928-000-581	\$119.30
5.40MM	5.40	6.00	140	20.00	28.00	36.00	66.00	3XD	928-000-107	\$88.00
5.40MM	5.40	6.00	140	35.00	44.00	36.00	82.00	5XD	928-000-345	\$94.80
5.40MM	5.40	6.00	140	48.00	56.00	36.00	94.00	8XD	928-000-583	\$119.30
5.50MM	5.50	6.00	140	20.00	28.00	36.00	66.00	3XD	928-000-109	\$88.00
5.50MM	5.50	6.00	140	35.00	44.00	36.00	82.00	5XD	928-000-347	\$94.80
5.50MM	5.50	6.00	140	48.00	56.00	36.00	94.00	8XD	928-000-585	\$119.30
5.60MM	5.60	6.00	140	20.00	28.00	36.00	66.00	3XD	928-000-111	\$94.00
5.60MM	5.60	6.00	140	35.00	44.00	36.00	82.00	5XD	928-000-349	\$102.00
5.60MM	5.60	6.00	140	48.00	56.00	36.00	94.00	8XD	928-000-587	\$128.00
5.70MM	5.70	6.00	140	20.00	28.00	36.00	66.00	3XD	928-000-113	\$94.00
5.70MM	5.70	6.00	140	35.00	44.00	36.00	82.00	5XD	928-000-351	\$102.00
5.70MM	5.70	6.00	140	48.00	56.00	36.00	94.00	8XD	928-000-589	\$128.00
5.80MM	5.80	6.00	140	20.00	28.00	36.00	66.00	3XD	928-000-115	\$94.00
5.80MM	5.80	6.00	140	35.00	44.00	36.00	82.00	5XD	928-000-353	\$102.00
5.80MM	5.80	6.00	140	48.00	56.00	36.00	94.00	8XD	928-000-591	\$128.00
5.90MM	5.90	6.00	140	20.00	28.00	36.00	66.00	3XD	928-000-116	\$94.00
5.90MM	5.90	6.00	140	35.00	44.00	36.00	82.00	5XD	928-000-354	\$102.00
5.90MM	5.90	6.00	140	48.00	56.00	36.00	94.00	8XD	928-000-592	\$128.00
6.00MM	6.00	6.00	140	20.00	28.00	36.00	66.00	3XD	928-000-119	\$94.00
6.00MM	6.00	6.00	140	35.00	44.00	36.00	82.00	5XD	928-000-357	\$102.00
6.00MM	6.00	6.00	140	48.00	56.00	36.00	94.00	8XD	928-000-595	\$128.00
6.10MM	6.10	8.00	140	24.00	34.00	36.00	79.00	3XD	928-000-121	\$98.00
6.10MM	6.10	8.00	140	43.00	53.00	36.00	91.00	5XD	928-000-359	\$113.00
6.10MM	6.10	8.00	140	57.00	67.00	36.00	105.00	8XD	928-000-597	\$149.00
6.20MM	6.20	8.00	140	24.00	34.00	36.00	79.00	3XD	928-000-123	\$98.00
6.20MM	6.20	8.00	140	43.00	53.00	36.00	91.00	5XD	928-000-361	\$113.00
6.20MM	6.20	8.00	140	57.00	67.00	36.00	105.00	8XD	928-000-599	\$149.00
6.30MM	6.30	8.00	140	24.00	34.00	36.00	79.00	3XD	928-000-125	\$98.00
6.30MM	6.30	8.00	140	43.00	53.00	36.00	91.00	5XD	928-000-363	\$113.00
6.30MM	6.30	8.00	140	57.00	67.00	36.00	105.00	8XD	928-000-601	\$149.00
6.40MM	6.40	8.00	140	24.00	34.00	36.00	79.00	3XD	928-000-127	\$102.00
6.40MM	6.40	8.00	140	43.00	53.00	36.00	91.00	5XD	928-000-365	\$126.40
6.40MM	6.40	8.00	140	57.00	67.00	36.00	105.00	8XD	928-000-603	\$166.30
6.50MM	6.50	8.00	140	24.00	34.00	36.00	79.00	3XD	928-000-128	\$102.00
6.50MM	6.50	8.00	140	43.00	53.00	36.00	91.00	5XD	928-000-366	\$126.40
6.50MM	6.50	8.00	140	57.00	67.00	36.00	105.00	8XD	928-000-604	\$166.30

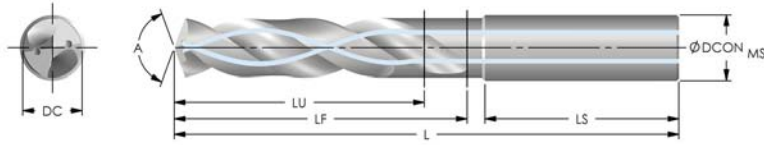

Through select
outlets only



DC	DC	DCONMS	A	LU	LF	LS	L	LD Ratio	PRODUCT #	Price
6.60MM	6.60	8.00	140	24.00	34.00	36.00	79.00	3XD	928-000-130	\$102.00
6.60MM	6.60	8.00	140	43.00	53.00	36.00	91.00	5XD	928-000-368	\$126.40
6.60MM	6.60	8.00	140	57.00	67.00	36.00	105.00	8XD	928-000-606	\$166.30
6.70MM	6.70	8.00	140	24.00	34.00	36.00	79.00	3XD	928-000-132	\$102.00
6.70MM	6.70	8.00	140	43.00	53.00	36.00	91.00	5XD	928-000-370	\$126.40
6.70MM	6.70	8.00	140	57.00	67.00	36.00	105.00	8XD	928-000-608	\$166.30
6.80MM	6.80	8.00	140	24.00	34.00	36.00	79.00	3XD	928-000-135	\$102.00
6.80MM	6.80	8.00	140	43.00	53.00	36.00	91.00	5XD	928-000-373	\$126.40
6.80MM	6.80	8.00	140	57.00	67.00	36.00	105.00	8XD	928-000-611	\$166.30
6.90MM	6.90	8.00	140	24.00	34.00	36.00	79.00	3XD	928-000-136	\$102.00
6.90MM	6.90	8.00	140	43.00	53.00	36.00	91.00	5XD	928-000-374	\$126.40
6.90MM	6.90	8.00	140	57.00	67.00	36.00	105.00	8XD	928-000-612	\$166.30
7.00MM	7.00	8.00	140	24.00	34.00	36.00	79.00	3XD	928-000-138	\$102.00
7.00MM	7.00	8.00	140	43.00	53.00	36.00	91.00	5XD	928-000-376	\$126.40
7.00MM	7.00	8.00	140	57.00	67.00	36.00	105.00	8XD	928-000-614	\$166.30
7.10MM	7.10	8.00	140	29.00	41.00	36.00	79.00	3XD	928-000-140	\$110.00
7.10MM	7.10	8.00	140	43.00	53.00	36.00	91.00	5XD	928-000-378	\$142.90
7.10MM	7.10	8.00	140	64.00	77.00	36.00	115.00	8XD	928-000-616	\$178.00
7.20MM	7.20	8.00	140	29.00	41.00	36.00	79.00	3XD	928-000-143	\$110.00
7.20MM	7.20	8.00	140	43.00	53.00	36.00	91.00	5XD	928-000-381	\$142.90
7.20MM	7.20	8.00	140	64.00	77.00	36.00	115.00	8XD	928-000-619	\$178.00
7.30MM	7.30	8.00	140	29.00	41.00	36.00	79.00	3XD	928-000-144	\$110.00
7.30MM	7.30	8.00	140	43.00	53.00	36.00	91.00	5XD	928-000-382	\$142.90
7.30MM	7.30	8.00	140	64.00	77.00	36.00	115.00	8XD	928-000-620	\$178.00
7.40MM	7.40	8.00	140	29.00	41.00	36.00	79.00	3XD	928-000-146	\$110.00
7.40MM	7.40	8.00	140	43.00	53.00	36.00	91.00	5XD	928-000-384	\$142.90
7.40MM	7.40	8.00	140	64.00	77.00	36.00	115.00	8XD	928-000-622	\$178.00
7.50MM	7.50	8.00	140	29.00	41.00	36.00	79.00	3XD	928-000-148	\$110.00
7.50MM	7.50	8.00	140	43.00	53.00	36.00	91.00	5XD	928-000-386	\$142.90
7.50MM	7.50	8.00	140	64.00	77.00	36.00	115.00	8XD	928-000-624	\$178.00
7.60MM	7.60	8.00	140	29.00	41.00	36.00	79.00	3XD	928-000-150	\$110.00
7.60MM	7.60	8.00	140	43.00	53.00	36.00	91.00	5XD	928-000-388	\$142.90
7.60MM	7.60	8.00	140	64.00	77.00	36.00	115.00	8XD	928-000-626	\$178.00
7.70MM	7.70	8.00	140	29.00	41.00	36.00	79.00	3XD	928-000-152	\$110.00
7.70MM	7.70	8.00	140	43.00	53.00	36.00	91.00	5XD	928-000-390	\$142.90
7.70MM	7.70	8.00	140	64.00	77.00	36.00	115.00	8XD	928-000-628	\$178.00
7.80MM	7.80	8.00	140	29.00	41.00	36.00	79.00	3XD	928-000-153	\$110.00
7.80MM	7.80	8.00	140	43.00	53.00	36.00	91.00	5XD	928-000-391	\$142.90
7.80MM	7.80	8.00	140	64.00	77.00	36.00	115.00	8XD	928-000-629	\$178.00
7.90MM	7.90	8.00	140	29.00	41.00	36.00	79.00	3XD	928-000-154	\$110.00
7.90MM	7.90	8.00	140	43.00	53.00	36.00	91.00	5XD	928-000-392	\$142.90
7.90MM	7.90	8.00	140	64.00	77.00	36.00	115.00	8XD	928-000-630	\$178.00
8.00MM	8.00	8.00	140	29.00	41.00	36.00	79.00	3XD	928-000-156	\$110.00
8.00MM	8.00	8.00	140	43.00	53.00	36.00	91.00	5XD	928-000-394	\$142.90
8.00MM	8.00	8.00	140	64.00	77.00	36.00	115.00	8XD	928-000-632	\$178.00
8.10MM	8.10	10.00	140	35.00	47.00	40.00	89.00	3XD	928-000-158	\$116.00
8.10MM	8.10	10.00	140	49.00	61.00	40.00	103.00	5XD	928-000-396	\$167.00
8.10MM	8.10	10.00	140	75.00	89.00	40.00	131.00	8XD	928-000-634	\$210.40



Through select outlets only

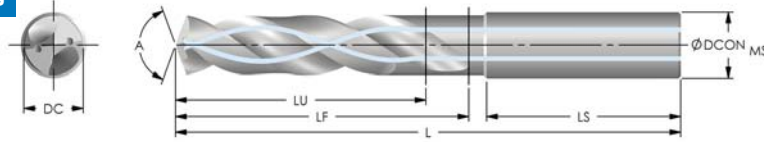

DC	DC	DCONMS	A	LU	LF	LS	L	LD Ratio	PRODUCT #	Price
8.20MM	8.20	10.00	140	35.00	47.00	40.00	89.00	3XD	928-000-159	\$116.00
8.20MM	8.20	10.00	140	49.00	61.00	40.00	103.00	5XD	928-000-397	\$167.00
8.20MM	8.20	10.00	140	75.00	89.00	40.00	131.00	8XD	928-000-635	\$210.40
8.30MM	8.30	10.00	140	35.00	47.00	40.00	89.00	3XD	928-000-161	\$116.00
8.30MM	8.30	10.00	140	49.00	61.00	40.00	103.00	5XD	928-000-399	\$167.00
8.30MM	8.30	10.00	140	75.00	89.00	40.00	131.00	8XD	928-000-637	\$210.40
8.40MM	8.40	10.00	140	35.00	47.00	40.00	89.00	3XD	928-000-163	\$116.00
8.40MM	8.40	10.00	140	49.00	61.00	40.00	103.00	5XD	928-000-401	\$167.00
8.40MM	8.40	10.00	140	75.00	89.00	40.00	131.00	8XD	928-000-639	\$210.40
8.50MM	8.50	10.00	140	35.00	47.00	40.00	89.00	3XD	928-000-165	\$116.00
8.50MM	8.50	10.00	140	49.00	61.00	40.00	103.00	5XD	928-000-403	\$167.00
8.50MM	8.50	10.00	140	75.00	89.00	40.00	131.00	8XD	928-000-641	\$210.40
8.60MM	8.60	10.00	140	35.00	47.00	40.00	89.00	3XD	928-000-166	\$116.00
8.60MM	8.60	10.00	140	49.00	61.00	40.00	103.00	5XD	928-000-404	\$167.00
8.60MM	8.60	10.00	140	75.00	89.00	40.00	131.00	8XD	928-000-642	\$210.40
8.70MM	8.70	10.00	140	35.00	47.00	40.00	89.00	3XD	928-000-168	\$116.00
8.70MM	8.70	10.00	140	49.00	61.00	40.00	103.00	5XD	928-000-406	\$167.00
8.70MM	8.70	10.00	140	75.00	89.00	40.00	131.00	8XD	928-000-644	\$210.40
8.80MM	8.80	10.00	140	35.00	47.00	40.00	89.00	3XD	928-000-170	\$116.00
8.80MM	8.80	10.00	140	49.00	61.00	40.00	103.00	5XD	928-000-408	\$167.00
8.80MM	8.80	10.00	140	75.00	89.00	40.00	131.00	8XD	928-000-646	\$210.40
8.90MM	8.90	10.00	140	35.00	47.00	40.00	89.00	3XD	928-000-172	\$116.00
8.90MM	8.90	10.00	140	49.00	61.00	40.00	103.00	5XD	928-000-410	\$167.00
8.90MM	8.90	10.00	140	75.00	89.00	40.00	131.00	8XD	928-000-648	\$210.40
9.00MM	9.00	10.00	140	35.00	47.00	40.00	89.00	3XD	928-000-173	\$116.00
9.00MM	9.00	10.00	140	49.00	61.00	40.00	103.00	5XD	928-000-411	\$167.00
9.00MM	9.00	10.00	140	75.00	89.00	40.00	131.00	8XD	928-000-649	\$210.40
9.10MM	9.10	10.00	140	35.00	47.00	40.00	89.00	3XD	928-000-175	\$116.00
9.10MM	9.10	10.00	140	49.00	61.00	40.00	103.00	5XD	928-000-413	\$167.00
9.10MM	9.10	10.00	140	75.00	89.00	40.00	131.00	8XD	928-000-651	\$210.40
9.20MM	9.20	10.00	140	35.00	47.00	40.00	89.00	3XD	928-000-177	\$116.00
9.20MM	9.20	10.00	140	49.00	61.00	40.00	103.00	5XD	928-000-415	\$167.00
9.20MM	9.20	10.00	140	75.00	89.00	40.00	131.00	8XD	928-000-653	\$210.40
9.30MM	9.30	10.00	140	35.00	47.00	40.00	89.00	3XD	928-000-178	\$116.00
9.30MM	9.30	10.00	140	49.00	61.00	40.00	103.00	5XD	928-000-416	\$167.00
9.30MM	9.30	10.00	140	75.00	89.00	40.00	131.00	8XD	928-000-654	\$210.40
9.40MM	9.40	10.00	140	35.00	47.00	40.00	89.00	3XD	928-000-180	\$116.00
9.40MM	9.40	10.00	140	49.00	61.00	40.00	103.00	5XD	928-000-418	\$167.00
9.40MM	9.40	10.00	140	75.00	89.00	40.00	131.00	8XD	928-000-656	\$210.40
9.50MM	9.50	10.00	140	35.00	47.00	40.00	89.00	3XD	928-000-181	\$116.00
9.50MM	9.50	10.00	140	49.00	61.00	40.00	103.00	5XD	928-000-419	\$167.00
9.50MM	9.50	10.00	140	75.00	89.00	40.00	131.00	8XD	928-000-657	\$210.40
9.60MM	9.60	10.00	140	35.00	47.00	40.00	89.00	3XD	928-000-184	\$116.00
9.60MM	9.60	10.00	140	49.00	61.00	40.00	103.00	5XD	928-000-422	\$167.00
9.60MM	9.60	10.00	140	75.00	89.00	40.00	131.00	8XD	928-000-660	\$210.40

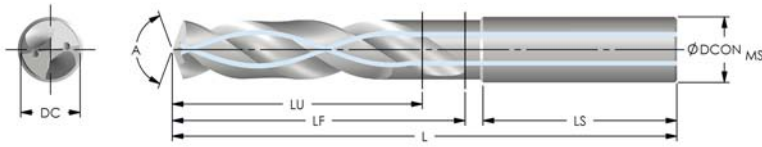
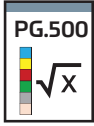

Through select
outlets only



DC	DC	DCONMS	A	LU	LF	LS	L	LD Ratio	PRODUCT #	Price
9.70MM	9.70	10.00	140	35.00	47.00	40.00	89.00	3XD	928-000-185	\$116.00
9.70MM	9.70	10.00	140	49.00	61.00	40.00	103.00	5XD	928-000-423	\$167.00
9.70MM	9.70	10.00	140	75.00	89.00	40.00	131.00	8XD	928-000-661	\$210.40
9.80MM	9.80	10.00	140	35.00	47.00	40.00	89.00	3XD	928-000-186	\$116.00
9.80MM	9.80	10.00	140	49.00	61.00	40.00	103.00	5XD	928-000-424	\$167.00
9.80MM	9.80	10.00	140	75.00	89.00	40.00	131.00	8XD	928-000-662	\$210.40
9.90MM	9.90	10.00	140	35.00	47.00	40.00	89.00	3XD	928-000-188	\$116.00
9.90MM	9.90	10.00	140	49.00	61.00	40.00	103.00	5XD	928-000-426	\$167.00
9.90MM	9.90	10.00	140	75.00	89.00	40.00	131.00	8XD	928-000-664	\$210.40
10.00MM	10.00	10.00	140	35.00	47.00	40.00	89.00	3XD	928-000-190	\$116.00
10.00MM	10.00	10.00	140	49.00	61.00	40.00	103.00	5XD	928-000-428	\$167.00
10.00MM	10.00	10.00	140	75.00	89.00	40.00	131.00	8XD	928-000-666	\$210.40
10.50MM	10.50	12.00	140	40.00	55.00	45.00	102.00	3XD	928-000-195	\$152.00
10.50MM	10.50	12.00	140	56.00	71.00	45.00	118.00	5XD	928-000-433	\$202.30
10.50MM	10.50	12.00	140	92.00	108.00	45.00	155.00	8XD	928-000-671	\$273.20
11.00MM	11.00	12.00	140	40.00	55.00	45.00	102.00	3XD	928-000-197	\$152.00
11.00MM	11.00	12.00	140	56.00	71.00	45.00	118.00	5XD	928-000-435	\$202.30
11.00MM	11.00	12.00	140	92.00	108.00	45.00	155.00	8XD	928-000-673	\$273.20
11.50MM	11.50	12.00	140	40.00	55.00	45.00	102.00	3XD	928-000-199	\$152.00
11.50MM	11.50	12.00	140	56.00	71.00	45.00	118.00	5XD	928-000-437	\$202.30
11.50MM	11.50	12.00	140	92.00	108.00	45.00	155.00	8XD	928-000-675	\$273.20
12.00MM	12.00	12.00	140	40.00	55.00	45.00	102.00	3XD	928-000-202	\$152.00
12.00MM	12.00	12.00	140	56.00	71.00	45.00	118.00	5XD	928-000-440	\$202.30
12.00MM	12.00	12.00	140	92.00	108.00	45.00	155.00	8XD	928-000-678	\$273.20
12.50MM	12.50	14.00	140	43.00	60.00	45.00	107.00	3XD	928-000-204	\$178.00
12.50MM	12.50	14.00	140	60.00	77.00	45.00	124.00	5XD	928-000-442	\$228.00
12.50MM	12.50	14.00	140	110.00	135.00	45.00	182.00	8XD	928-000-680	\$359.30
13.00MM	13.00	14.00	140	43.00	60.00	45.00	107.00	3XD	928-000-206	\$178.00
13.00MM	13.00	14.00	140	60.00	77.00	45.00	124.00	5XD	928-000-444	\$228.00
13.00MM	13.00	14.00	140	110.00	135.00	45.00	182.00	8XD	928-000-682	\$359.30
13.50MM	13.50	14.00	140	43.00	60.00	45.00	107.00	3XD	928-000-209	\$178.00
13.50MM	13.50	14.00	140	60.00	77.00	45.00	124.00	5XD	928-000-447	\$228.00
13.50MM	13.50	14.00	140	110.00	135.00	45.00	182.00	8XD	928-000-685	\$359.30
14.00MM	14.00	14.00	140	43.00	60.00	45.00	107.00	3XD	928-000-211	\$178.00
14.00MM	14.00	14.00	140	60.00	77.00	45.00	124.00	5XD	928-000-449	\$228.00
14.00MM	14.00	14.00	140	110.00	135.00	45.00	182.00	8XD	928-000-687	\$359.30
14.50MM	14.50	16.00	140	45.00	65.00	48.00	115.00	3XD	928-000-213	\$244.70
14.50MM	14.50	16.00	140	63.00	83.00	48.00	133.00	5XD	928-000-451	\$319.40
14.50MM	14.50	16.00	140	128.00	155.00	48.00	204.00	8XD	928-000-689	\$521.80
15.00MM	15.00	16.00	140	45.00	65.00	48.00	115.00	3XD	928-000-215	\$244.70
15.00MM	15.00	16.00	140	63.00	83.00	48.00	133.00	5XD	928-000-453	\$319.40
15.00MM	15.00	16.00	140	128.00	155.00	48.00	204.00	8XD	928-000-691	\$521.80
15.50MM	15.50	16.00	140	45.00	65.00	48.00	115.00	3XD	928-000-218	\$244.70
15.50MM	15.50	16.00	140	63.00	83.00	48.00	133.00	5XD	928-000-456	\$319.40
15.50MM	15.50	16.00	140	128.00	155.00	48.00	204.00	8XD	928-000-694	\$521.80



Through select outlets only

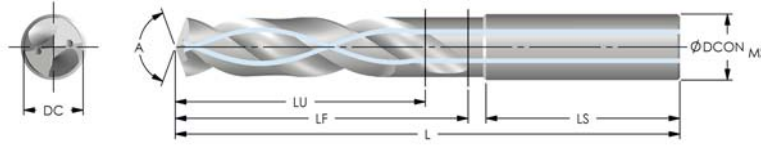

DC	DC	DCONMS	A	LU	LF	LS	L	LD Ratio	PRODUCT #	Price
16.00MM	16.00	16.00	140	45.00	65.00	48.00	115.00	3XD	928-000-220	\$244.70
16.00MM	16.00	16.00	140	63.00	83.00	48.00	133.00	5XD	928-000-458	\$319.40
16.00MM	16.00	16.00	140	128.00	155.00	48.00	204.00	8XD	928-000-696	\$521.80
16.50MM	16.50	18.00	140	51.00	73.00	48.00	123.00	3XD	928-000-222	\$315.10
16.50MM	16.50	18.00	140	71.00	93.00	48.00	143.00	5XD	928-000-460	\$420.40
16.50MM	16.50	18.00	140	144.00	170.00	48.00	223.00	8XD	928-000-698	\$697.80
17.00MM	17.00	18.00	140	51.00	73.00	48.00	123.00	3XD	928-000-224	\$315.10
17.00MM	17.00	18.00	140	71.00	93.00	48.00	143.00	5XD	928-000-462	\$420.40
17.00MM	17.00	18.00	140	144.00	170.00	48.00	223.00	8XD	928-000-700	\$697.80
17.50MM	17.50	18.00	140	51.00	73.00	48.00	123.00	3XD	928-000-227	\$315.10
17.50MM	17.50	18.00	140	71.00	93.00	48.00	143.00	5XD	928-000-465	\$420.40
17.50MM	17.50	18.00	140	144.00	170.00	48.00	223.00	8XD	928-000-703	\$697.80
18.00MM	18.00	18.00	140	51.00	73.00	48.00	123.00	3XD	928-000-229	\$315.10
18.00MM	18.00	18.00	140	71.00	93.00	48.00	143.00	5XD	928-000-467	\$420.40
18.00MM	18.00	18.00	140	144.00	170.00	48.00	223.00	8XD	928-000-705	\$697.80
18.50MM	18.50	20.00	140	55.00	79.00	50.00	132.00	3XD	928-000-231	\$375.70
18.50MM	18.50	20.00	140	77.00	101.00	50.00	154.00	5XD	928-000-469	\$517.70
18.50MM	18.50	20.00	140	160.00	185.00	50.00	245.00	8XD	928-000-707	\$823.30
19.00MM	19.00	20.00	140	55.00	79.00	50.00	132.00	3XD	928-000-233	\$404.60
19.00MM	19.00	20.00	140	77.00	101.00	50.00	154.00	5XD	928-000-471	\$517.70
19.00MM	19.00	20.00	140	160.00	185.00	50.00	245.00	8XD	928-000-709	\$823.30
19.50MM	19.50	20.00	140	55.00	79.00	50.00	132.00	3XD	928-000-236	\$404.60
19.50MM	19.50	20.00	140	77.00	101.00	50.00	154.00	5XD	928-000-474	\$517.70
19.50MM	19.50	20.00	140	160.00	185.00	50.00	245.00	8XD	928-000-712	\$888.30
20.00MM	20.00	20.00	140	55.00	79.00	50.00	132.00	3XD	928-000-238	\$404.60
20.00MM	20.00	20.00	140	77.00	101.00	50.00	154.00	5XD	928-000-476	\$517.70
20.00MM	20.00	20.00	140	160.00	185.00	50.00	245.00	8XD	928-000-714	\$888.30

CARBIDE



METRIC .004"- .025"

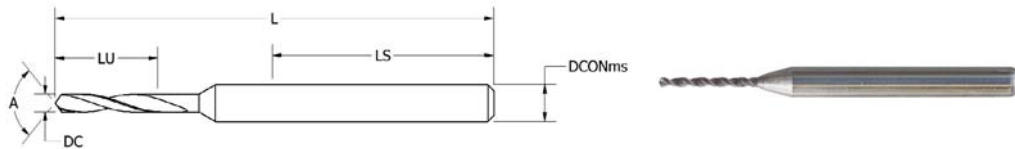

DC	DC	DC (mm)	DCONms	LU	A	LS	L	UNCOATED	
								2 FLUTE	Price
0.0040	# 102	.10mm	0.1250	0.0700	118.0	0.7500	1.5000	925-000-001	\$30.99
0.0050	# 99	.13mm	0.1250	0.0700	118.0	0.7500	1.5000	925-000-002	\$30.99
0.0059	# 97	.15mm	0.1250	0.1200	118.0	0.7500	1.5000	925-000-003	\$28.39
0.0063	# 96	.16mm	0.1250	0.1200	118.0	0.7500	1.5000	925-000-004	\$28.39
0.0067	# 95	.17mm	0.1250	0.1200	118.0	0.7500	1.5000	925-000-005	\$28.39
0.0071	# 94	.18mm	0.1250	0.1500	118.0	0.7500	1.5000	925-000-006	\$24.30
0.0075	# 93	.19mm	0.1250	0.1500	118.0	0.7500	1.5000	925-000-007	\$24.30
0.0079	# 92	.20mm	0.1250	0.1500	118.0	0.7500	1.5000	925-000-008	\$18.58
0.0083	# 91	.21mm	0.1250	0.1500	118.0	0.7500	1.5000	925-000-009	\$18.58
0.0087	# 90	.22mm	0.1250	0.1500	118.0	0.7500	1.5000	925-000-010	\$18.58
0.0091	# 89	.23mm	0.1250	0.2200	118.0	0.7500	1.5000	925-000-011	\$18.01
0.0095	# 88	.24mm	0.1250	0.2200	118.0	0.7500	1.5000	925-000-012	\$18.01
0.0098	.25mm	.25mm	0.1250	0.2200	118.0	0.7500	1.5000	925-000-013	\$18.01
0.0100	# 87	.25mm	0.1250	0.2200	118.0	0.7500	1.5000	925-000-014	\$18.01
0.0105	# 86	.27mm	0.1250	0.2200	118.0	0.7500	1.5000	925-000-015	\$18.01
0.0110	# 85	.28mm	0.1250	0.2200	118.0	0.7500	1.5000	925-000-016	\$18.01
0.0115	# 84	.29mm	0.1250	0.2200	118.0	0.7500	1.5000	925-000-017	\$14.97
0.0118	.30mm	.30mm	0.1250	0.2800	118.0	0.7500	1.5000	925-000-018	\$14.97
0.0120	# 83	.305mm	0.1250	0.2800	118.0	0.7500	1.5000	925-000-019	\$14.97
0.0125	# 82	.32mm	0.1250	0.2800	118.0	0.7500	1.5000	925-000-020	\$11.71
0.0130	# 81	.33mm	0.1250	0.2800	130.0	0.7500	1.5000	925-000-021	\$11.71
0.0135	# 80	.34mm	0.1250	0.2800	130.0	0.7500	1.5000	925-000-022	\$8.40
0.0138	.35mm	.35mm	0.1250	0.2800	130.0	0.7500	1.5000	925-000-023	\$8.40
0.0145	# 79	.37mm	0.1250	0.2800	130.0	0.7500	1.5000	925-000-024	\$8.40
0.0156	1/64"	.396mm	0.1250	0.2950	130.0	0.7500	1.5000	925-000-025	\$8.16
0.0157	.40mm	.40mm	0.1250	0.2950	130.0	0.7500	1.5000	925-000-026	\$8.16
0.0160	# 78	.41mm	0.1250	0.2950	130.0	0.7500	1.5000	925-000-027	\$7.60
0.0177	.45mm	.45mm	0.1250	0.2950	130.0	0.7500	1.5000	925-000-028	\$7.60
0.0180	# 77	.46mm	0.1250	0.2950	130.0	0.7500	1.5000	925-000-029	\$7.60
0.0197	.50mm	.50mm	0.1250	0.3100	130.0	0.7500	1.5000	925-000-030	\$7.60
0.0200	# 76	.51mm	0.1250	0.3100	130.0	0.7500	1.5000	925-000-031	\$7.25
0.0210	# 75	.53mm	0.1250	0.3100	130.0	0.7500	1.5000	925-000-032	\$7.25
0.0217	.55mm	.55mm	0.1250	0.3400	130.0	0.7500	1.5000	925-000-033	\$7.25
0.0225	# 74	.57mm	0.1250	0.3400	130.0	0.7500	1.5000	925-000-034	\$7.25
0.0236	.60mm	.60mm	0.1250	0.3400	130.0	0.7500	1.5000	925-000-035	\$7.25
0.0240	# 73	.61mm	0.1250	0.3400	130.0	0.7500	1.5000	925-000-036	\$7.25
0.0250	# 72	.64mm	0.1250	0.3400	130.0	0.7500	1.5000	925-000-037	\$7.25

METRIC .0256"- .0571"

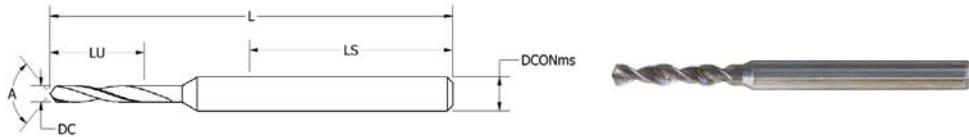

DC	DC	DC (mm)	DCONms	LU	A	LS	L	UNCOATED	
								2 FLUTE	Price
0.0256	.65mm	.65mm	0.1250	0.3400	130.0	0.7500	1.5000	925-000-038	\$7.25
0.0260	# 71	.66mm	0.1250	0.3400	130.0	0.7500	1.5000	925-000-039	\$7.25
0.0276	.70mm	.70mm	0.1250	0.4000	130.0	0.7500	1.5000	925-000-040	\$7.25
0.0280	# 70	.71mm	0.1250	0.4000	130.0	0.7500	1.5000	925-000-041	\$7.25
0.0292	# 69	.74mm	0.1250	0.4000	130.0	0.7500	1.5000	925-000-042	\$7.25
0.0295	.75mm	.75mm	0.1250	0.4000	130.0	0.7500	1.5000	925-000-043	\$7.25
0.0310	# 68	.787mm	0.1250	0.4000	130.0	0.7500	1.5000	925-000-044	\$7.25
0.0312	1/32"	.79mm	0.1250	0.4000	130.0	0.7500	1.5000	925-000-045	\$7.25
0.0315	.80mm	.80mm	0.1250	0.4000	130.0	0.7500	1.5000	925-000-046	\$7.25
0.0320	# 67	.81mm	0.1250	0.4000	130.0	0.7500	1.5000	925-000-047	\$7.25
0.0330	# 66	.84mm	0.1250	0.4000	130.0	0.7500	1.5000	925-000-048	\$7.25
0.0335	.85mm	.85mm	0.1250	0.4000	130.0	0.7500	1.5000	925-000-049	\$7.25
0.0350	# 65	.89mm	0.1250	0.4000	130.0	0.7500	1.5000	925-000-050	\$7.25
0.0354	.90mm	.90mm	0.1250	0.4000	130.0	0.7500	1.5000	925-000-051	\$7.25
0.0360	# 64	.91mm	0.1250	0.4000	130.0	0.7500	1.5000	925-000-052	\$7.25
0.0370	# 63	.94mm	0.1250	0.4000	130.0	0.7500	1.5000	925-000-053	\$7.25
0.0374	.95mm	.95mm	0.1250	0.4000	130.0	0.7500	1.5000	925-000-054	\$7.25
0.0380	# 62	.97mm	0.1250	0.4000	130.0	0.7500	1.5000	925-000-055	\$7.25
0.0390	# 61	.99mm	0.1250	0.4000	130.0	0.7500	1.5000	925-000-056	\$7.25
0.0394	1.0mm	1.00mm	0.1250	0.4000	130.0	0.7500	1.5000	925-000-057	\$7.25
0.0400	# 60	1.02mm	0.1250	0.4000	130.0	0.7500	1.5000	925-000-058	\$7.25
0.0410	# 59	1.04mm	0.1250	0.4000	130.0	0.7500	1.5000	925-000-059	\$7.25
0.0413	1.05mm	1.05mm	0.1250	0.4000	130.0	0.7500	1.5000	925-000-060	\$7.25
0.0420	# 58	1.07mm	0.1250	0.4000	130.0	0.7500	1.5000	925-000-061	\$7.25
0.0420	# 57	1.09mm	0.1250	0.4000	130.0	0.7500	1.5000	925-000-062	\$7.25
0.0433	1.10mm	1.10mm	0.1250	0.4000	130.0	0.7500	1.5000	925-000-063	\$7.25
0.0440	1.12mm	1.12mm	0.1250	0.4000	130.0	0.7500	1.5000	925-000-064	\$7.25
0.0453	1.15mm	1.15mm	0.1250	0.4000	130.0	0.7500	1.5000	925-000-065	\$7.25
0.0465	# 56	1.18mm	0.1250	0.4000	130.0	0.7500	1.5000	925-000-066	\$7.25
0.0469	3/64"	1.19mm	0.1250	0.4000	130.0	0.7500	1.5000	925-000-067	\$7.25
0.0472	1.20mm	1.20mm	0.1250	0.4000	130.0	0.7500	1.5000	925-000-068	\$7.25
0.0492	1.25mm	1.25mm	0.1250	0.4000	130.0	0.7500	1.5000	925-000-069	\$7.25
0.0512	1.30mm	1.30mm	0.1250	0.4000	130.0	0.7500	1.5000	925-000-070	\$7.25
0.0520	# 55	1.32mm	0.1250	0.4000	130.0	0.7500	1.5000	925-000-071	\$7.25
0.0531	1.35mm	1.35mm	0.1250	0.4000	130.0	0.7500	1.5000	925-000-072	\$7.25
0.0550	# 54	1.397mm	0.1250	0.4000	130.0	0.7500	1.5000	925-000-073	\$7.25
0.0551	1.40mm	1.40mm	0.1250	0.4000	130.0	0.7500	1.5000	925-000-074	\$7.25
0.0571	1.45mm	1.45mm	0.1250	0.4000	130.0	0.7500	1.5000	925-000-075	\$7.25

CARBIDE



METRIC .0591"- .0925"

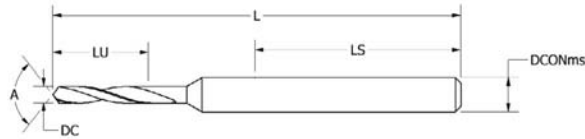

DC	DC	DC (mm)	DCONms	LU	A	LS	L	UNCOATED	
								2 FLUTE	Price
0.0591	1.50mm	1.50mm	0.1250	0.4000	130.0	0.7500	1.5000	925-000-076	\$7.25
0.0595	# 53	1.51mm	0.1250	0.4000	130.0	0.7500	1.5000	925-000-077	\$7.25
0.0610	1.55mm	1.55mm	0.1250	0.4000	130.0	0.7500	1.5000	925-000-078	\$7.25
0.0625	1/16"	1.59mm	0.1250	0.4000	130.0	0.7500	1.5000	925-000-079	\$7.25
0.0630	1.60mm	1.60mm	0.1250	0.4000	130.0	0.7500	1.5000	925-000-080	\$7.71
0.0635	# 52	1.61mm	0.1250	0.4000	130.0	0.7500	1.5000	925-000-081	\$7.71
0.0650	1.65mm	1.65mm	0.1250	0.4000	130.0	0.7500	1.5000	925-000-082	\$7.71
0.0669	1.70mm	1.699mm	0.1250	0.4000	130.0	0.7500	1.5000	925-000-083	\$7.71
0.0670	# 51	1.70mm	0.1250	0.4000	130.0	0.7500	1.5000	925-000-084	\$7.71
0.0689	1.75mm	1.75mm	0.1250	0.4000	130.0	0.7500	1.5000	925-000-085	\$7.71
0.0700	# 50	1.78mm	0.1250	0.4000	130.0	0.7500	1.5000	925-000-086	\$7.71
0.0709	1.80mm	1.80mm	0.1250	0.4000	130.0	0.7500	1.5000	925-000-087	\$7.71
0.0728	1.85mm	1.85mm	0.1250	0.4000	130.0	0.7500	1.5000	925-000-088	\$7.71
0.0730	# 49	1.85mm	0.1250	0.4000	130.0	0.7500	1.5000	925-000-089	\$7.71
0.0748	1.90mm	1.90mm	0.1250	0.4000	130.0	0.7500	1.5000	925-000-090	\$7.71
0.0760	# 48	1.93mm	0.1250	0.4000	130.0	0.7500	1.5000	925-000-091	\$7.71
0.0768	1.95mm	1.95mm	0.1250	0.4000	130.0	0.7500	1.5000	925-000-092	\$7.71
0.0781	5/64"	1.98mm	0.1250	0.4000	130.0	0.7500	1.5000	925-000-093	\$7.71
0.0785	# 47	1.99mm	0.1250	0.4000	130.0	0.7500	1.5000	925-000-094	\$7.71
0.0787	2.0mm	2.00mm	0.1250	0.4000	130.0	0.7500	1.5000	925-000-095	\$7.71
0.0807	2.05mm	2.05mm	0.1250	0.4000	130.0	0.7500	1.5000	925-000-096	\$7.71
0.0810	# 46	2.06mm	0.1250	0.4000	130.0	0.7500	1.5000	925-000-097	\$7.71
0.0820	# 45	2.08mm	0.1250	0.4000	130.0	0.7500	1.5000	925-000-098	\$7.71
0.0827	2.10mm	2.10mm	0.1250	0.4000	130.0	0.7500	1.5000	925-000-099	\$7.71
0.0846	2.15mm	2.15mm	0.1250	0.4000	130.0	0.7500	1.5000	925-000-100	\$7.71
0.0860	# 44	2.18mm	0.1250	0.4000	130.0	0.7500	1.5000	925-000-101	\$7.71
0.0866	2.20mm	2.20mm	0.1250	0.4000	130.0	0.7500	1.5000	925-000-102	\$7.71
0.0886	2.25mm	2.25mm	0.1250	0.4000	130.0	0.7500	1.5000	925-000-103	\$7.71
0.0890	# 43	2.26mm	0.1250	0.4000	130.0	0.7500	1.5000	925-000-104	\$7.71
0.0906	2.30mm	2.30mm	0.1250	0.4000	130.0	0.7500	1.5000	925-000-105	\$7.71
0.0925	2.35mm	2.35mm	0.1250	0.4000	130.0	0.7500	1.5000	925-000-106	\$7.71



METRIC .0935"- .1250"

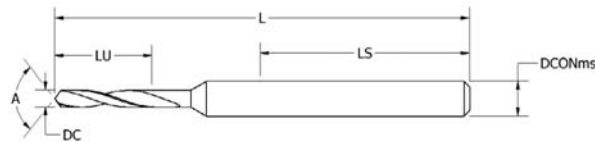

DC	DC	DC (mm)	DCONms	LU	A	LS	L	UNCOATED	
								2 FLUTE	Price
0.0935	# 42	2.37mm	0.1250	0.4000	130.0	0.7500	1.5000	925-000-107	\$7.71
0.0938	3/32"	2.38mm	0.1250	0.4000	130.0	0.7500	1.5000	925-000-108	\$7.71
0.0945	2.40mm	2.40mm	0.1250	0.4000	130.0	0.7500	1.5000	925-000-109	\$7.71
0.0960	# 41	2.44mm	0.1250	0.4000	130.0	0.7500	1.5000	925-000-110	\$7.71
0.0965	2.45mm	2.45mm	0.1250	0.4000	130.0	0.7500	1.5000	925-000-111	\$7.71
0.0980	# 40	2.49mm	0.1250	0.4000	130.0	0.7500	1.5000	925-000-112	\$7.71
0.0984	2.50mm	2.50mm	0.1250	0.4000	130.0	0.7500	1.5000	925-000-113	\$7.71
0.0995	# 39	2.53mm	0.1250	0.4000	130.0	0.7500	1.5000	925-000-114	\$7.71
0.1004	2.55mm	2.55mm	0.1250	0.4000	130.0	0.7500	1.5000	925-000-115	\$7.71
0.1015	# 38	2.58mm	0.1250	0.4000	130.0	0.7500	1.5000	925-000-116	\$7.71
0.1024	2.60mm	2.60mm	0.1250	0.4000	130.0	0.7500	1.5000	925-000-117	\$7.71
0.1040	# 37	2.64mm	0.1250	0.4000	130.0	0.7500	1.5000	925-000-118	\$7.71
0.1043	2.65mm	2.65mm	0.1250	0.4000	130.0	0.7500	1.5000	925-000-119	\$7.71
0.1063	2.70mm	2.70mm	0.1250	0.4000	130.0	0.7500	1.5000	925-000-120	\$7.71
0.1065	# 36	2.71mm	0.1250	0.4000	130.0	0.7500	1.5000	925-000-121	\$7.71
0.1083	2.75mm	2.75mm	0.1250	0.4000	130.0	0.7500	1.5000	925-000-122	\$7.71
0.1094	7/64"	2.78mm	0.1250	0.4000	130.0	0.7500	1.5000	925-000-123	\$7.71
0.1100	# 35	2.79mm	0.1250	0.4000	130.0	0.7500	1.5000	925-000-124	\$7.71
0.1102	2.80mm	2.80mm	0.1250	0.4000	130.0	0.7500	1.5000	925-000-125	\$7.71
0.1110	# 34	2.82mm	0.1250	0.4000	130.0	0.7500	1.5000	925-000-126	\$7.71
0.1122	2.85mm	2.85mm	0.1250	0.4000	130.0	0.7500	1.5000	925-000-127	\$7.71
0.1130	# 33	2.87mm	0.1250	0.4000	130.0	0.7500	1.5000	925-000-128	\$7.71
0.1142	2.90mm	2.90mm	0.1250	0.4000	130.0	0.7500	1.5000	925-000-129	\$7.71
0.1160	# 32	2.946mm	0.1250	0.4000	130.0	0.7500	1.5000	925-000-130	\$7.71
0.1161	2.95mm	2.95mm	0.1250	0.4000	130.0	0.7500	1.5000	925-000-131	\$7.71
0.1181	3.00mm	3.00mm	0.1250	0.4000	130.0	0.7500	1.5000	925-000-132	\$7.71
0.1200	# 31	3.05mm	0.1250	0.4000	130.0	0.7500	1.5000	925-000-133	\$7.71
0.1201	3.05mm	3.05mm	0.1250	0.4000	130.0	0.7500	1.5000	925-000-134	\$7.71
0.1220	3.10mm	3.10mm	0.1250	0.4000	130.0	0.7500	1.5000	925-000-135	\$7.71
0.1240	3.15mm	3.15mm	0.1250	0.4000	130.0	0.7500	1.5000	925-000-136	\$7.71
0.1250	1/8"	3.18mm	0.1250	0.4000	130.0	0.7500	1.5000	925-000-137	\$7.71



SPOTTING DRILLS

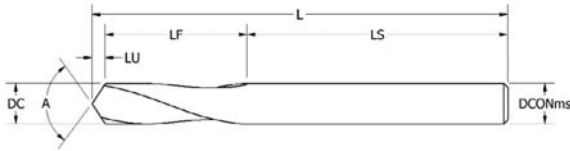

DC	DCONms	LS	L	LF	LU	A	UNCOATED		ALTiN COATED	
							2 FLUTE	Price	2 FLUTE	Price
0.0300	0.1250	1.1656	1.5000	0.0900	0.0161	82.0	956-000-262	\$23.84	956-000-329	\$28.23
0.0600	0.1250	1.1528	1.5000	0.1800	0.0334	82.0	956-000-286	\$21.43	956-000-347	\$27.25
0.1250	0.1250	1.1250	1.5000	0.3750	0.0702	82.0	956-000-308	\$19.33	956-000-369	\$23.73
0.0050	0.1250	1.1663	1.5000	0.0250	0.0007	90.0	956-000-238	\$37.24	956-000-311	\$41.64
0.0100	0.1250	1.1692	1.5000	0.0350	0.0040	90.0	956-000-242	\$29.76	956-000-315	\$34.17
0.0150	0.1250	1.1720	1.5000	0.0450	0.0065	90.0	956-000-248	\$29.76	956-000-319	\$34.17
0.0200	0.1250	1.1799	1.5000	0.0500	0.0090	90.0	956-000-254	\$25.49	956-000-323	\$29.89
0.0250	0.1250	1.1678	1.5000	0.0750	0.0115	90.0	956-000-255	\$25.49	956-000-324	\$29.89
0.0300	0.1250	1.1656	1.5000	0.0900	0.0140	90.0	956-000-263	\$23.84	956-000-330	\$28.23
0.0312	0.1250	1.1687	1.5000	0.0900	0.0146	90.0	956-000-267	\$23.84	956-000-334	\$28.23
0.0400	0.1250	1.1614	1.5000	0.1200	0.0190	90.0	956-000-272	\$21.65	956-000-335	\$26.05
0.0450	0.1250	1.1592	1.5000	0.1350	0.0215	90.0	956-000-275	\$21.65	956-000-338	\$26.05
0.0215	0.1250	1.1584	1.5000	0.1410	0.0225	90.0	956-000-278	\$21.65	956-000-341	\$26.05
0.0500	0.1250	1.1571	1.5000	0.1500	0.0240	90.0	956-000-279	\$21.65	956-000-342	\$26.05
0.0600	0.1250	1.1528	1.5000	0.1800	0.0290	90.0	956-000-287	\$21.43	956-000-348	\$27.25
0.0625	0.1250	1.1392	1.5000	0.2000	0.0303	90.0	956-000-291	\$21.43	956-000-352	\$27.25
0.0780	0.1250	1.1451	1.5000	0.2340	0.0375	90.0	956-000-294	\$21.43	956-000-355	\$27.25
0.0900	0.1250	1.1400	1.5000	0.2700	0.0435	90.0	956-000-297	\$20.33	956-000-358	\$24.73
0.0938	0.1250	1.1407	1.5000	0.2790	0.0165	90.0	956-000-300	\$20.33	956-000-361	\$24.73
0.1000	0.1250	1.1357	1.5000	0.3000	0.0485	90.0	956-000-302	\$20.33	956-000-363	\$24.73
0.1180	0.1250	1.1280	1.5000	0.3540	0.0575	90.0	956-000-303	\$20.33	956-000-364	\$24.73
0.1250	0.1250	1.1250	1.5000	0.3750	0.0610	90.0	956-000-309	\$19.33	956-000-370	\$23.73
0.0300	0.1250	1.1656	1.5000	0.0900	0.0117	100.0	956-000-258	\$23.84	956-000-325	\$28.23
0.0600	0.1250	1.1528	1.5000	0.1800	0.0243	100.0	956-000-282	\$21.43	956-000-343	\$27.25
0.1250	0.1250	1.1250	1.5000	0.3750	0.0512	100.0	956-000-304	\$19.33	956-000-365	\$23.73

CARBIDE

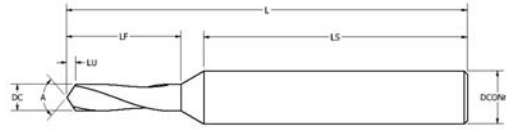

DC	DCONms	LS	L	LF	LU	A	UNCOATED		ALTIM COATED	
							2 FLUTE	Price	2 FLUTE	Price
0.0100	0.1250	1.1742	1.5000	0.0300	0.0023	120.0	956-000-239	\$29.76	956-000-312	\$34.17
0.0150	0.1250	1.1720	1.5000	0.0450	0.0038	120.0	956-000-245	\$29.76	956-000-316	\$34.17
0.0200	0.1250	1.1799	1.5000	0.0500	0.0052	120.0	956-000-251	\$25.49	956-000-320	\$29.89
0.0300	0.1250	1.1656	1.5000	0.0900	0.0081	120.0	956-000-259	\$23.84	956-000-326	\$28.23
0.0312	0.1250	1.1687	1.5000	0.0900	0.0084	120.0	956-000-264	\$23.84	956-000-331	\$28.23
0.0450	0.1250	1.1592	1.5000	0.1350	0.0124	120.0	956-000-273	\$21.65	956-000-336	\$26.05
0.0470	0.1250	1.1584	1.5000	0.1410	0.0130	120.0	956-000-276	\$21.65	956-000-339	\$26.05
0.0600	0.1250	1.1528	1.5000	0.1800	0.0167	120.0	956-000-283	\$21.43	956-000-344	\$25.83
0.0625	0.1250	1.1532	1.5000	0.1860	0.0175	120.0	956-000-288	\$21.43	956-000-349	\$25.83
0.0780	0.1250	1.1451	1.5000	0.2340	0.0217	120.0	956-000-292	\$21.43	956-000-353	\$25.83
0.0900	0.1250	1.1400	1.5000	0.2700	0.0158	120.0	956-000-295	\$20.33	956-000-356	\$24.73
0.0938	0.1250	1.1407	1.5000	0.2790	0.0165	120.0	956-000-298	\$20.33	956-000-359	\$24.73
0.1250	0.1250	1.1250	1.5000	0.3750	0.0163	120.0	956-000-305	\$19.33	956-000-366	\$23.73
0.0050	0.1250	1.1663	1.5000	0.0250	0.0007	130.0	956-000-237	\$37.24	956-000-310	\$41.64
0.0100	0.1250	1.1692	1.5000	0.0350	0.0019	130.0	956-000-240	\$29.76	956-000-313	\$34.17
0.0150	0.1250	1.1720	1.5000	0.0450	0.0030	130.0	956-000-246	\$29.76	956-000-317	\$34.17
0.0200	0.1250	1.1799	1.5000	0.0500	0.0042	130.0	956-000-252	\$25.49	956-000-321	\$29.89
0.0312	0.1250	1.1687	1.5000	0.0900	0.0068	130.0	956-000-265	\$23.84	956-000-332	\$28.23
0.0625	0.1250	1.1392	1.5000	0.2000	0.0141	130.0	956-000-289	\$21.43	956-000-350	\$27.25
0.0938	0.1250	1.1407	1.5000	0.2790	0.0212	130.0	956-000-301	\$20.33	956-000-362	\$22.52
0.0100	0.1250	1.1742	1.5000	0.0300	0.0015	140.0	956-000-241	\$29.76	956-000-314	\$34.17
0.0150	0.1250	1.1720	1.5000	0.0450	0.0024	140.0	956-000-247	\$29.76	956-000-318	\$34.17
0.0200	0.1250	1.1799	1.5000	0.0500	0.0042	140.0	956-000-253	\$25.49	956-000-322	\$29.89
0.0300	0.1250	1.1656	1.5000	0.0900	0.0051	140.0	956-000-260	\$23.84	956-000-327	\$28.23
0.0312	0.1250	1.1687	1.5000	0.0900	0.0053	140.0	956-000-266	\$23.84	956-000-333	\$28.23
0.0450	0.1250	1.1592	1.5000	0.1350	0.0078	140.0	956-000-274	\$21.65	956-000-337	\$26.05
0.0470	0.1250	1.1584	1.5000	0.1410	0.0082	140.0	956-000-277	\$21.65	956-000-340	\$26.05
0.0600	0.1250	1.1528	1.5000	0.1800	0.0106	140.0	956-000-284	\$21.43	956-000-345	\$25.83
0.0625	0.1250	1.1532	1.5000	0.1860	0.0110	140.0	956-000-290	\$21.43	956-000-351	\$25.83
0.0780	0.1250	1.1451	1.5000	0.2340	0.0136	140.0	956-000-293	\$21.43	956-000-354	\$25.83
0.0900	0.1250	1.1400	1.5000	0.2700	0.0158	140.0	956-000-296	\$20.33	956-000-357	\$24.73
0.0938	0.1250	1.1407	1.5000	0.2790	0.0165	140.0	956-000-299	\$20.33	956-000-360	\$24.73
0.1250	0.1250	1.1250	1.5000	0.3750	0.0222	140.0	956-000-306	\$19.33	956-000-367	\$23.73
0.0300	0.1250	1.1656	1.5000	0.0900	0.0038	150.0	956-000-261	\$23.84	956-000-328	\$28.23
0.0600	0.1250	1.1528	1.5000	0.1800	0.0078	150.0	956-000-285	\$21.43	956-000-346	\$25.83
0.1250	0.1250	1.1250	1.5000	0.3750	0.0163	150.0	956-000-307	\$19.33	956-000-368	\$23.73

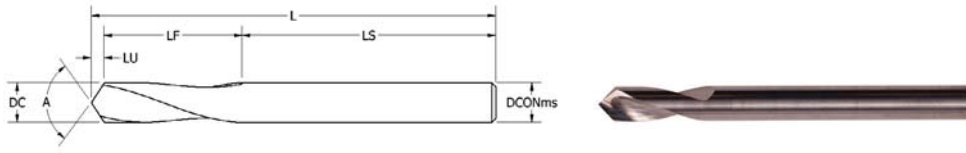

DC	DCONms	LS	L	LF	LU	A	UNCOATED		ALTiN COATED	
							2 FLUTE	Price	2 FLUTE	Price
0.1250	0.1250	1.1250	1.5000	0.3750	0.0580	90.0	956-000-388	\$19.33	956-000-373	\$23.73
0.1250	0.1250	3.6250	4.0000	0.3750	0.0580	90.0	956-000-383	\$25.92	956-000-380	\$32.84
0.1870	0.1875	1.3750	2.0000	0.6250	0.0880	90.0	956-000-391	\$22.52	956-000-376	\$27.25
0.1870	0.1875	3.3750	4.0000	0.6250	0.0880	90.0	956-000-384	\$33.30	956-000-381	\$40.12
0.2500	0.2500	1.7500	2.5000	0.7500	0.1180	90.0	956-000-394	\$27.68	956-000-379	\$34.28
0.2500	0.2500	5.2500	6.0000	0.7500	0.1180	90.0	956-000-385	\$45.38	956-000-382	\$54.15
0.1250	0.1250	1.1250	1.5000	0.3750	0.0335	120.0	956-000-386	\$19.33	956-000-371	\$23.73
0.1870	0.1875	1.3750	2.0000	0.6250	0.0508	120.0	956-000-389	\$22.52	956-000-374	\$27.25
0.2500	0.2500	1.7500	2.5000	0.7500	0.0681	120.0	956-000-392	\$27.68	956-000-377	\$34.28
0.1250	0.1250	1.1250	1.5000	0.3750	0.0211	140.0	956-000-387	\$19.33	956-000-372	\$23.73
0.1870	0.1875	1.3750	2.0000	0.6250	0.0320	140.0	956-000-390	\$22.52	956-000-375	\$27.25
0.2500	0.2500	1.7500	2.5000	0.7500	0.0429	140.0	956-000-393	\$27.68	956-000-378	\$34.28

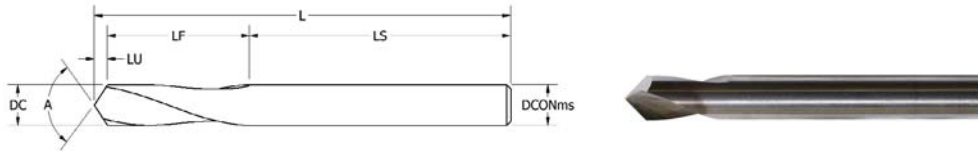

DC	DCONms	LS	L	LF	LU	A	UNCOATED	
							2 FLUTE	Price
0.1250	0.1250	1.1250	1.5000	0.3225	0.0525	90.0	956-000-121	\$19.33
0.1875	0.1875	1.4375	2.0000	0.4853	0.0773	90.0	956-000-128	\$22.52
0.2500	0.2500	1.7500	2.5000	0.6465	0.1035	90.0	956-000-115	\$27.68
0.3125	0.3125	1.7500	2.5000	0.6188	0.1313	90.0	956-000-133	\$34.84
0.3750	0.3750	1.7500	2.5000	0.5935	0.1565	90.0	956-000-145	\$39.87
0.5000	0.5000	2.0000	3.0000	0.7900	0.2100	90.0	956-000-109	\$62.33
0.1250	0.1250	1.1250	1.5000	0.3447	0.0303	120.0	956-000-123	\$19.33
0.1875	0.1875	1.4375	2.0000	0.5179	0.0446	120.0	956-000-130	\$22.52
0.2500	0.2500	1.7500	2.5000	0.6902	0.0598	120.0	956-000-117	\$27.68
0.3125	0.3125	1.7500	2.5000	0.6742	0.0758	120.0	956-000-135	\$34.84
0.3750	0.3750	1.7500	2.5000	0.6596	0.0904	120.0	956-000-147	\$39.87
0.5000	0.5000	2.0000	3.0000	0.8788	0.1212	120.0	956-000-111	\$62.33

CARBIDE

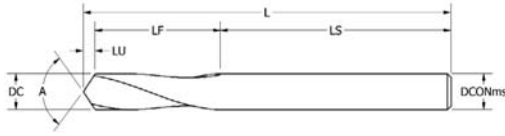

DC	DCONms	LS	L	LF	LU	82°	Price	90°	Price	90° TiN	Price	120°	Price	120° TiN	Price
0.1250	0.1250	1.1250	1.5000	0.3146	0.0604	956-000-125	\$16.65	956-000-121	\$17.43	956-000-122	\$18.49	956-000-123	\$17.43	956-000-124	\$18.49
0.1875	0.1875	1.4375	2.0000	0.4736	0.0889	956-000-127	\$21.88	956-000-128	\$22.91	956-000-129	\$24.44	956-000-130	\$22.91	956-000-131	\$24.44
0.2500	0.2500	1.7500	2.5000	0.6309	0.1191	956-000-120	\$27.92	956-000-115	\$29.23	956-000-116	\$32.01	956-000-117	\$29.23	956-000-118	\$32.01
0.3125	0.3125	1.7500	2.5000	0.5990	0.1510	956-000-138	\$33.69	956-000-133	\$35.26	956-000-134	\$38.72	956-000-135	\$35.26	956-000-136	\$38.72
0.3750	0.3750	1.7500	2.5000	0.5700	0.1800	956-000-150	\$38.55	956-000-145	\$40.36	956-000-146	\$43.87	956-000-147	\$40.36	956-000-148	\$43.87
0.5000	0.5000	2.0000	3.0000	0.7584	0.2416	956-000-114	\$60.28	956-000-109	\$63.11	956-000-110	\$68.71	956-000-111	\$63.11	956-000-112	\$68.71
0.6250	0.6250	2.5000	3.5000	0.7067	0.2933	956-000-156	\$111.01	956-000-151	\$116.22	956-000-152	\$125.03	956-000-153	\$116.22	956-000-154	\$125.03
0.7500	0.7500	2.8750	4.0000	0.7713	0.3537	956-000-144	\$185.27	956-000-139	\$193.98	956-000-140	\$205.64	956-000-141	\$193.98	956-000-142	\$205.64

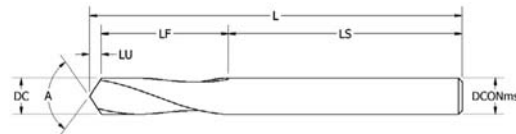

DC	DCONms	LS	L	LF	LU	CAR 142°	Price
0.1250	0.1250	1.1250	1.5000	0.3569	0.0181	956-000-126	\$17.43
0.1875	0.1875	1.4375	2.0000	0.5359	0.0266	956-000-132	\$22.91
0.2500	0.2500	1.7500	2.5000	0.7144	0.0356	956-000-119	\$29.23
0.3125	0.3125	1.7500	2.5000	0.7048	0.0452	956-000-137	\$35.26
0.3750	0.3750	1.7500	2.5000	0.6961	0.0539	956-000-149	\$40.36
0.5000	0.5000	2.0000	3.0000	0.9277	0.0723	956-000-113	\$63.11
0.6250	0.6250	2.5000	3.5000	0.9122	0.0878	956-000-155	\$116.22
0.7500	0.7500	2.8750	4.0000	1.0191	0.1059	956-000-143	\$193.98

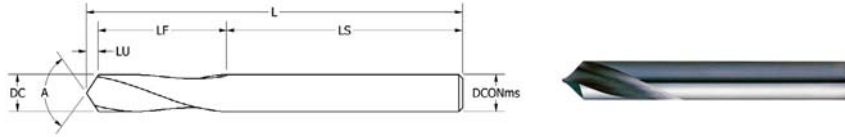

DC	DCONms	LS	L	LF	LU	A	HSS	Price	HSS-TiN	Price	COBALT	Price
0.2500	0.2500	1.6229	2.6271	0.8771	0.1271	82.0	956-000-213	\$24.70			956-000-214	\$29.26
0.2500	0.2500	3.1229	4.1271	0.8771	0.1271	82.0	956-000-215	\$37.14			956-000-216	\$42.11
0.2500	0.2500	5.1229	6.1271	0.8771	0.1271	82.0	956-000-217	\$48.71			956-000-218	\$57.84
0.3750	0.3750	1.8102	3.3148	1.3148	0.1898	82.0	956-000-225	\$26.66			956-000-226	\$31.60
0.3750	0.3750	3.6852	5.1898	1.3148	0.1898	82.0	956-000-227	\$37.88			956-000-228	\$44.90
0.3750	0.3750	5.6852	7.1898	1.3148	0.1898	82.0	956-000-229	\$52.50			956-000-230	\$62.20
0.5000	0.5000	2.1196	4.0054	1.6304	0.2554	82.0	956-000-207	\$34.18			956-000-208	\$40.50
0.5000	0.5000	4.3696	6.2554	1.6304	0.2554	82.0	956-000-209	\$47.39			956-000-210	\$58.68
0.5000	0.5000	6.3696	8.2554	1.6304	0.2554	82.0	956-000-211	\$64.45			956-000-212	\$76.37
0.6250	0.6250	2.0977	4.3750	1.9511	0.3261	82.0	956-000-231	\$44.49			956-000-232	\$52.71
0.6250	0.6250	5.0489	7.3261	1.9511	0.3261	82.0	956-000-233	\$59.89			956-000-234	\$70.97
0.6250	0.6250	7.0489	9.3261	1.9511	0.3261	82.0	956-000-235	\$82.80			956-000-236	\$98.10
0.7500	0.7500	2.7281	5.3969	2.2719	0.3969	82.0	956-000-219	\$60.86			956-000-220	\$72.11
0.7500	0.7500	5.7281	8.3969	2.2719	0.3969	82.0	956-000-221	\$82.27			956-000-222	\$97.49
0.7500	0.7500	7.7281	10.3969	2.2719	0.3969	82.0	956-000-223	\$109.97			956-000-224	\$130.29
1.0000	1.0000	3.4801	6.2699	2.5199	0.2699	82.0	956-000-201	\$104.69			956-000-202	\$124.05
1.0000	1.0000	5.2122	8.5378	2.7878	0.5378	82.0	956-000-203	\$111.44			956-000-204	\$132.05
1.0000	1.0000	7.2122	10.5378	2.7878	0.5378	82.0	956-000-205	\$137.15			956-000-206	\$162.50
0.2500	0.2500	1.6395	2.6105	0.8605	0.1105	90.0	956-000-019	\$25.85	956-000-020	\$28.44	956-000-023	\$29.26
0.2500	0.2500	3.1395	4.1105	0.8605	0.1105	90.0	956-000-021	\$37.21	956-000-022	\$40.44	956-000-026	\$42.11
0.2500	0.2500	5.1395	6.1105	0.8605	0.1105	90.0	956-000-024	\$51.10	956-000-025	\$55.65	956-000-027	\$57.84
0.3750	0.3750	1.8350	3.2900	1.2900	0.1650	90.0	956-000-037	\$27.91	956-000-038	\$31.96	956-000-041	\$31.60
0.3750	0.3750	3.7100	5.1650	1.2900	0.1650	90.0	956-000-039	\$39.67	956-000-040	\$44.55	956-000-044	\$44.90
0.3750	0.3750	5.7100	7.1650	1.2900	0.1650	90.0	956-000-042	\$54.97	956-000-043	\$61.43	956-000-045	\$62.20
0.5000	0.5000	2.1530	3.9720	1.5970	0.2220	90.0	956-000-010	\$35.78	956-000-011	\$42.79	956-000-014	\$40.50
0.5000	0.5000	4.4030	6.2220	1.5970	0.2220	90.0	956-000-012	\$49.62	956-000-013	\$58.68	956-000-017	\$56.15
0.5000	0.5000	6.4030	8.2220	1.5970	0.2220	90.0	956-000-015	\$67.47	956-000-016	\$79.13	956-000-018	\$76.37
0.6250	0.6250	2.1830	4.3750	1.9085	0.2835	90.0	956-000-046	\$46.58	956-000-047	\$56.30	956-000-050	\$52.71
0.6250	0.6250	5.0915	7.2835	1.9085	0.2835	90.0	956-000-048	\$62.70	956-000-049	\$75.65	956-000-053	\$70.97
0.6250	0.6250	7.0915	9.2835	1.9085	0.2835	90.0	956-000-051	\$86.68	956-000-052	\$102.83	956-000-054	\$98.10
0.7500	0.7500	2.7800	5.3450	2.2200	0.3450	90.0	956-000-028	\$63.72	956-000-029	\$74.80	956-000-032	\$72.11
0.7500	0.7500	5.7800	8.3450	2.2200	0.3450	90.0	956-000-030	\$86.14	956-000-031	\$102.72	956-000-035	\$97.49
0.7500	0.7500	7.7800	10.3450	2.2200	0.3450	90.0	956-000-033	\$115.13	956-000-034	\$135.42	956-000-036	\$130.29
1.0000	1.0000	3.2825	6.4675	2.7175	0.4675	90.0	956-000-001	\$109.62	956-000-002	\$132.24	956-000-005	\$124.05
1.0000	1.0000	5.2825	8.4675	2.7175	0.4675	90.0	956-000-003	\$116.67	956-000-004	\$145.76	956-000-008	\$132.05
1.0000	1.0000	7.2825	10.4675	2.7175	0.4675	90.0	956-000-006	\$143.59	956-000-007	\$179.15	956-000-009	\$162.50

HSS

COBALT

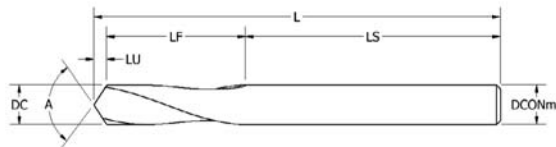

DC	DCONms	LS	L	LF	LU	A	HSS	Price	HSS-TiN	Price	COBALT	Price
0.2500	0.2500	1.6395	2.6105	0.8605	0.1105	120.0	956-000-073	\$25.85	956-000-074	\$28.44	956-000-077	\$29.26
0.2500	0.2500	3.1395	4.1105	0.8605	0.1105	120.0	956-000-075	\$37.21	956-000-076	\$40.44	956-000-080	\$42.11
0.2500	0.2500	5.1395	6.1105	0.8605	0.1105	120.0	956-000-078	\$51.10	956-000-079	\$55.65	956-000-081	\$57.84
0.3750	0.3750	1.8350	3.2900	1.2900	0.1650	120.0	956-000-091	\$27.91	956-000-092	\$31.96	956-000-095	\$31.60
0.3750	0.3750	3.7100	5.1650	1.2900	0.1650	120.0	956-000-093	\$39.67	956-000-094	\$44.55	956-000-098	\$44.90
0.3750	0.3750	5.7100	7.1650	1.2900	0.1650	120.0	956-000-096	\$54.97	956-000-097	\$61.43	956-000-099	\$62.20
0.5000	0.5000	2.1530	3.9720	1.5970	0.2220	120.0	956-000-064	\$35.78	956-000-065	\$42.79	956-000-068	\$40.50
0.5000	0.5000	4.4030	6.2220	1.5970	0.2220	120.0	956-000-066	\$49.62	956-000-067	\$58.68	956-000-071	\$58.68
0.5000	0.5000	6.4030	8.2220	1.5970	0.2220	120.0	956-000-069	\$67.47	956-000-070	\$79.13	956-000-072	\$76.37
0.6250	0.6250	2.1830	4.3750	1.9085	0.2835	120.0	956-000-100	\$46.58	956-000-101	\$56.30	956-000-104	\$52.71
0.6250	0.6250	5.0915	7.2835	1.9085	0.2835	120.0	956-000-102	\$62.70	956-000-103	\$75.65	956-000-107	\$70.97
0.6250	0.6250	7.0915	9.2835	1.9085	0.2835	120.0	956-000-105	\$86.68	956-000-106	\$102.83	956-000-108	\$98.10
0.7500	0.7500	2.7800	5.3450	2.2200	0.3450	120.0	956-000-082	\$63.72	956-000-083	\$74.80	956-000-086	\$72.11
0.7500	0.7500	5.7800	8.3450	2.2200	0.3450	120.0	956-000-084	\$86.14	956-000-085	\$102.72	956-000-089	\$97.49
0.7500	0.7500	7.7800	10.3450	2.2200	0.3450	120.0	956-000-087	\$115.13	956-000-088	\$135.42	956-000-090	\$130.29
1.0000	1.0000	3.2825	6.4675	2.7175	0.4675	120.0	956-000-055	\$109.62	956-000-056	\$132.24	956-000-059	\$124.05
1.0000	1.0000	5.2825	8.4675	2.7175	0.4675	120.0	956-000-057	\$116.67	956-000-058	\$145.76	956-000-062	\$132.05
1.0000	1.0000	7.2825	10.4675	2.7175	0.4675	120.0	956-000-060	\$143.59	956-000-061	\$179.15	956-000-063	\$162.50

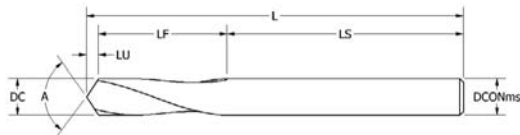

METRIC



DC	DCONms	LS	L	LF	LU	90°	Price	120°	Price
2.00	2.00	41.00	49.00	7.15	0.85	956-000-157	\$29.15	956-000-170	\$29.15
3.00	3.00	40.00	50.00	8.68	1.32	956-000-158	\$25.10	956-000-171	\$25.10
4.00	4.00	40.00	52.00	10.22	1.78	956-000-159	\$26.13	956-000-172	\$26.13
5.00	5.00	45.00	60.00	12.78	2.22	956-000-160	\$28.12	956-000-173	\$26.91
6.00	6.00	46.00	66.00	17.38	2.62	956-000-161	\$28.84	956-000-174	\$28.84
8.00	8.00	54.00	79.00	21.48	3.52	956-000-162	\$29.45	956-000-175	\$28.18
10.00	10.00	64.00	89.00	20.50	4.50	956-000-163	\$33.71	956-000-176	\$33.71
12.00	12.00	72.00	102.00	24.71	5.29	956-000-164	\$36.82	956-000-177	\$36.82
14.00	14.00	80.00	115.00	28.71	6.29	956-000-165	\$42.10	956-000-178	\$40.29
16.00	16.00	80.00	115.00	27.71	7.29	956-000-166	\$51.76	956-000-179	\$51.76
18.00	18.00	90.00	130.00	31.76	8.24	956-000-167	\$67.79	956-000-180	\$67.79
20.00	20.00	91.00	131.00	30.76	9.24	956-000-168	\$76.74	956-000-181	\$76.74
25.00	25.00	93.00	138.00	33.41	11.59	956-000-169	\$118.67	956-000-182	\$118.67
3.00	3.00	70.00	80.00	8.68	1.32	956-000-183	\$43.72	956-000-192	\$43.72
4.00	4.00	88.00	100.00	10.22	1.78	956-000-184	\$41.84	956-000-193	\$41.84
5.00	5.00	105.00	120.00	12.78	2.22	956-000-185	\$42.98	956-000-194	\$42.98
6.00	6.00	120.00	140.00	17.38	2.62	956-000-186	\$44.32	956-000-195	\$44.32
8.00	8.00	115.00	140.00	21.48	3.52	956-000-187	\$53.15	956-000-196	\$53.15
10.00	10.00	145.00	170.00	20.50	4.50	956-000-188	\$58.50	956-000-197	\$58.50
12.00	12.00	140.00	170.00	24.71	5.29	956-000-189	\$62.17	956-000-198	\$62.17
16.00	16.00	165.00	200.00	27.71	7.29	956-000-190	\$82.78	956-000-199	\$82.78
20.00	20.00	160.00	200.00	30.76	9.24	956-000-191	\$98.86	956-000-200	\$98.86

COBALT

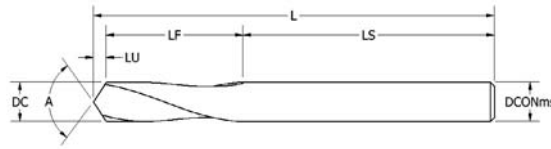

DC	DCNms	LS	L	LF	LU	A	RH	Price	RH-TiN	Price	LH	Price
0.1250	0.1250	0.8750	1.2500	0.3185	0.0565	90.0	955-000-009	\$5.32	955-000-010	\$6.07	955-000-012	\$16.65
0.1875	0.1875	0.8750	1.3750	0.4148	0.0853	90.0	955-000-015	\$5.77	955-000-016	\$7.24	955-000-018	\$15.51
0.2500	0.2500	0.8750	1.5000	0.5120	0.1130	90.0	955-000-021	\$6.37	955-000-022	\$8.33	955-000-024	\$15.98
0.3125	0.3125	0.8750	1.5000	0.4843	0.1408	90.0	955-000-027	\$7.24	955-000-028	\$9.74	955-000-030	\$17.12
0.3750	0.3750	1.0000	2.0000	0.8305	0.1695	90.0	955-000-039	\$8.20	955-000-040	\$10.69	955-000-042	\$20.60
0.4375	0.4375	1.0000	2.0000	0.8003	0.1998	90.0	955-000-051	\$11.05	955-000-052	\$15.05	955-000-054	\$21.80
0.5000	0.5000	1.0000	2.0000	0.7720	0.2280	90.0	955-000-003	\$13.53	955-000-004	\$17.54	955-000-006	\$22.92
0.5625	0.5625	1.0000	2.0000	0.7433	0.2568	90.0	955-000-063	\$20.15	955-000-064	\$25.13	955-000-066	\$26.86
0.6250	0.6250	1.1250	2.2500	0.8375	0.2875	90.0	955-000-045	\$22.38	955-000-046	\$29.02	955-000-048	\$29.52
0.7500	0.7500	1.1250	2.2500	0.7755	0.3495	90.0	955-000-033	\$31.11	955-000-034	\$38.72	955-000-036	\$44.92
0.8750	0.8750	1.2500	2.5000	0.8425	0.4075	90.0	955-000-057	\$38.13	955-000-058	\$48.56	955-000-060	\$50.47
1.0000	1.0000	1.2500	2.5000	0.7830	0.4670	90.0	955-000-069	\$48.74	955-000-070	\$61.99	955-000-072	\$65.05
1.2500	1.2500	2.0000	4.0000	1.4155	0.5845	90.0	955-000-081	\$95.47	955-000-082	\$115.35	955-000-084	\$126.03
1.5000	1.5000	2.5000	5.0000	1.8005	0.6995	90.0	955-000-075	\$148.90	955-000-076	\$175.75	955-000-078	\$196.60
1.7500	1.7500	2.7500	5.5000	1.9330	0.8170	90.0	955-000-087	\$224.55	955-000-088	\$280.16	955-000-090	\$283.16
0.1250	0.1250	0.8750	1.2500	0.3411	0.0339	118.0	955-000-007	\$5.32	955-000-008	\$6.07	955-000-011	\$16.65
0.1875	0.1875	0.8750	1.3750	0.4488	0.0512	118.0	955-000-013	\$5.77	955-000-014	\$7.24	955-000-017	\$15.51
0.2500	0.2500	0.8750	1.5000	0.5571	0.0679	118.0	955-000-019	\$6.37	955-000-020	\$8.33	955-000-023	\$15.98
0.3125	0.3125	0.8750	1.5000	0.5404	0.0846	118.0	955-000-025	\$7.24	955-000-026	\$9.74	955-000-029	\$17.12
0.3750	0.3750	1.0000	2.0000	0.8982	0.1018	118.0	955-000-037	\$8.20	955-000-038	\$10.69	955-000-041	\$20.60
0.4375	0.4375	1.0000	2.0000	0.8800	0.1200	118.0	955-000-049	\$11.05	955-000-050	\$15.05	955-000-053	\$21.80
0.5000	0.5000	1.0000	2.0000	0.8630	0.1370	118.0	955-000-001	\$13.53	955-000-002	\$17.54	955-000-005	\$22.92
0.5625	0.5625	1.0000	2.0000	0.8457	0.1543	118.0	955-000-061	\$20.15	955-000-062	\$25.13	955-000-065	\$26.86
0.6250	0.6250	1.1250	2.2500	0.9523	0.1727	118.0	955-000-043	\$22.38	955-000-044	\$29.02	955-000-047	\$29.52
0.7500	0.7500	1.1250	2.2500	0.9150	0.2100	118.0	955-000-031	\$31.11	955-000-032	\$38.72	955-000-035	\$44.92
0.8750	0.8750	1.2500	2.5000	1.0051	0.2449	118.0	955-000-055	\$38.13	955-000-056	\$48.56	955-000-059	\$50.47
1.0000	1.0000	1.2500	2.5000	0.9694	0.2806	118.0	955-000-067	\$48.74	955-000-068	\$61.99	955-000-071	\$65.05
1.2500	1.2500	2.0000	4.0000	1.6488	0.3512	118.0	955-000-079	\$95.47	955-000-080	\$115.35	955-000-083	\$126.03
1.5000	1.5000	2.5000	5.0000	2.0797	0.4203	118.0	955-000-073	\$148.90	955-000-074	\$175.75	955-000-077	\$196.60
1.7500	1.7500	2.7500	5.5000	2.2591	0.4909	118.0	955-000-085	\$224.55	955-000-086	\$280.16	955-000-089	\$283.16



CENTER DRILLS

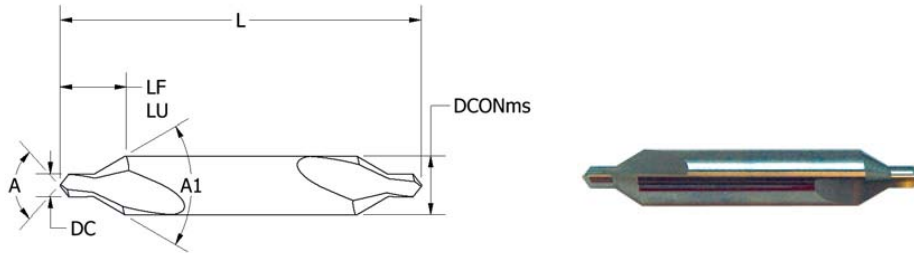

2 Flute RH



DC	DC	DCONms	LU	LS	L	LF	A	A1	Product #	Price	TIALN COATED	Price
0.0100	#5-0	0.1250	0.1121	0.7500	1.5000	0.1121	118.0	60.0	906-000-409	\$33.21	906-000-501	\$40.53
0.0150	#4-0	0.1250	0.1140	0.7500	1.5000	0.1140	118.0	60.0	906-000-412	\$29.05	906-000-502	\$36.14
0.0200	#3-0	0.1250	0.1159	0.7500	1.5000	0.1159	118.0	60.0	906-000-415	\$22.28	906-000-503	\$29.00
0.0250	#2-0	0.1250	0.1178	0.7500	1.5000	0.1178	118.0	60.0	906-000-418	\$17.18	906-000-504	\$23.62
0.0313	#0	0.1250	0.1202	0.7500	1.5000	0.1202	118.0	60.0	906-000-421	\$17.80	906-000-505	\$23.62
0.0469	#1	0.1250	0.1262	0.7500	1.5000	0.1262	118.0	60.0	906-000-424	\$14.67	906-000-493	\$20.65
0.0781	#2	0.1875	0.1922	0.9375	1.8750	0.1922	118.0	60.0	906-000-433	\$22.28	906-000-494	\$29.88
0.1094	#3	0.2500	0.2583	1.0000	2.0000	0.2583	118.0	60.0	906-000-436	\$29.45	906-000-495	\$33.18
0.1250	#4	0.3125	0.3184	1.0625	2.1250	0.3184	118.0	60.0	906-000-439	\$37.47	906-000-496	\$42.74
0.1875	#5	0.4375	0.4505	1.3750	2.7500	0.4505	118.0	60.0	906-000-442	\$58.42	906-000-497	\$65.47
0.2188	#6	0.5000	0.5165	1.5000	3.0000	0.5165	118.0	60.0	906-000-445	\$76.96	906-000-498	\$107.80
0.2500	#7	0.6250	0.6367	1.6250	3.2500	0.6367	118.0	60.0	906-000-448	\$171.88	906-000-499	\$215.84
0.3125	#8	0.7500	0.7688	1.7500	3.5000	0.7688	118.0	60.0	906-000-451	\$234.40	906-000-500	\$285.93

CARBIDE

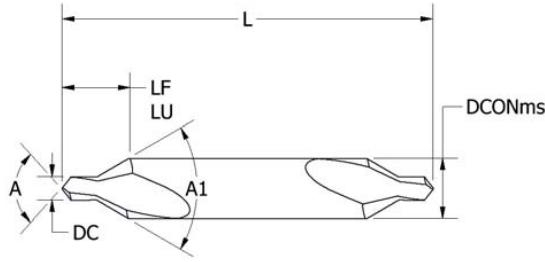

DC	DCONms	LU	LS	L	LF	A	A1	TIALN COATED	
								2 FLUTE	Price
0.0100	0.1250	0.0786	0.7500	1.5000	0.0786	118.0	82.0	906-001-569	\$40.53
0.0150	0.1250	0.0820	0.7500	1.5000	0.0820	118.0	82.0	906-001-578	\$36.14
0.0200	0.1250	0.0854	0.7500	1.5000	0.0854	118.0	82.0	906-001-587	\$29.00
0.0250	0.1250	0.0887	0.7500	1.5000	0.0887	118.0	82.0	906-001-596	\$23.62
0.0313	0.1250	0.0929	0.7500	1.5000	0.0929	118.0	82.0	906-001-605	\$23.62
0.0469	0.1250	0.1034	0.7500	1.5000	0.1034	118.0	82.0	906-001-614	\$20.65
0.0781	0.1875	0.1604	0.9375	1.8750	0.1604	118.0	82.0	906-001-641	\$29.88
0.1094	0.2500	0.2174	1.0000	2.0000	0.2174	118.0	82.0	906-001-651	\$33.18
0.1250	0.3125	0.2638	1.0625	2.1250	0.2638	118.0	82.0	906-001-660	\$42.74
0.1875	0.4375	0.3778	1.3750	2.7500	0.3778	118.0	82.0	906-001-669	\$65.47
0.2188	0.5000	0.4347	1.5000	3.0000	0.4347	118.0	82.0	906-001-678	\$107.80
0.2500	0.6250	0.5277	1.8750	3.7500	0.5277	118.0	82.0	906-001-688	\$215.84
0.3125	0.7500	0.6416	2.0000	4.0000	0.6416	118.0	82.0	906-001-697	\$285.93
0.0100	0.1250	0.0700	0.7500	1.5000	0.0700	118.0	90.0	906-001-572	\$40.53
0.0150	0.1250	0.0737	0.7500	1.5000	0.0737	118.0	90.0	906-001-581	\$36.14
0.0200	0.1250	0.0775	0.7500	1.5000	0.0775	118.0	90.0	906-001-590	\$29.00
0.0250	0.1250	0.0812	0.7500	1.5000	0.0812	118.0	90.0	906-001-599	\$23.62
0.0313	0.1250	0.0859	0.7500	1.5000	0.0859	118.0	90.0	906-001-608	\$23.62
0.0469	0.1250	0.0976	0.7500	1.5000	0.0976	118.0	90.0	906-001-617	\$20.65
0.0781	0.1875	0.1522	0.9375	1.8750	0.1522	118.0	90.0	906-001-644	\$29.88
0.1094	0.2500	0.2068	1.0000	2.0000	0.2068	118.0	90.0	906-001-654	\$33.18
0.1563	0.4375	0.3880	1.3750	2.7500	0.3880	118.0	90.0	906-001-633	\$47.61
0.1875	0.4375	0.3590	1.3750	2.7500	0.3590	118.0	90.0	906-001-672	\$65.47
0.2188	0.5000	0.4136	1.5000	3.0000	0.4136	118.0	90.0	906-001-681	\$107.80
0.2500	0.6250	0.4995	1.8750	3.7500	0.4995	118.0	90.0	906-001-691	\$215.84
0.3125	0.7500	0.6087	2.0000	4.0000	0.6087	118.0	90.0	906-001-700	\$285.93



RH



A
I
R
C
R
A
F
T

DC	DC	DCONms	LU	L	LF	A	82°	Price	90°	Price
0.0100	#5-0	0.1250	0.0786	1.5000	0.0786	118.0	906-000-410	\$29.08	906-000-411	\$29.08
0.0150	#4-0	0.1250	0.0820	1.5000	0.0820	118.0	906-000-413	\$27.32	906-000-414	\$27.32
0.0200	#3-0	0.1250	0.0854	1.5000	0.0854	118.0	906-000-416	\$20.03	906-000-417	\$20.03
0.0250	#2-0	0.1250	0.0887	1.5000	0.0887	118.0	906-000-419	\$15.42	906-000-420	\$15.42
0.0313	#0	0.1250	0.0929	1.5000	0.0929	118.0	906-000-422	\$14.01	906-000-423	\$14.01
0.0469	#1	0.1250	0.1034	1.5000	0.1034	118.0	906-000-425	\$14.01	906-000-426	\$14.01
0.0781	#2	0.1875	0.1604	1.8750	0.1604	118.0	906-000-434	\$21.12	906-000-435	\$21.12
0.1094	#3	0.2500	0.2174	2.0000	0.2174	118.0	906-000-437	\$28.12	906-000-438	\$28.12
0.1250	#4	0.3125	0.2638	2.1250	0.2638	118.0	906-000-440	\$35.80	906-000-441	\$35.80
0.1875	#5	0.4375	0.3778	2.7500	0.3778	118.0	906-000-443	\$55.79	906-000-444	\$55.79
0.2188	#6	0.5000	0.4347	3.0000	0.4347	118.0	906-000-446	\$73.52	906-000-447	\$73.52
0.2500	#7	0.6250	0.5277	3.7500	0.5277	118.0	906-000-449	\$164.17	906-000-450	\$164.17
0.3125	#8	0.7500	0.6416	4.0000	0.6416	118.0	906-000-452	\$223.88	906-000-453	\$223.88

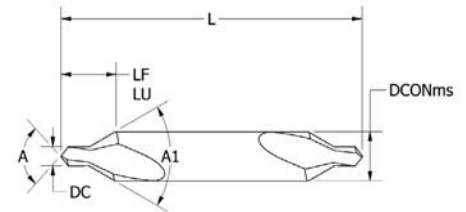

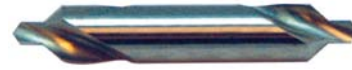
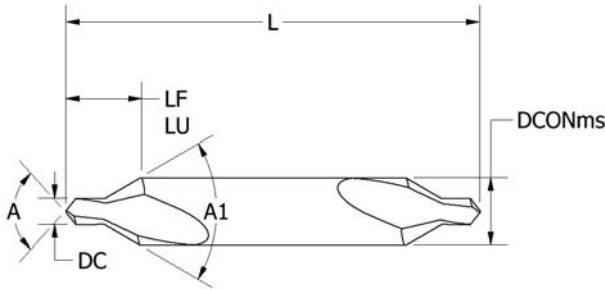

DC	DC	DCONms	LU	L	LF	A	HSS	Price	HSS-TiN	Price	HSS-LH	Price	COBALT	Price	T15	Price
0.0100	#5-0	0.1250	0.1121	1.2500	0.1121	118.0	906-000-005	\$8.96	906-000-006	\$9.98	906-000-009	\$33.43	906-000-008	\$35.22	906-000-007	\$52.85
0.0150	#4-0	0.1250	0.1140	1.2500	0.1140	118.0	906-000-012	\$8.22	906-000-013	\$9.26	906-000-016	\$33.43	906-000-015	\$34.22	906-000-014	\$51.37
0.0200	#3-0	0.1250	0.1159	1.2500	0.1159	118.0	906-000-019	\$7.79	906-000-020	\$8.46	906-000-023	\$21.07	906-000-022	\$23.25	906-000-021	\$34.90
0.0250	#2-0	0.1250	0.1178	1.2500	0.1178	118.0	906-000-026	\$7.79	906-000-027	\$8.46	906-000-030	\$21.07	906-000-029	\$23.25	906-000-027	\$34.90
0.0313	#0	0.1250	0.1202	1.2500	0.1202	118.0	906-000-035	\$7.79	906-000-036	\$8.46	906-000-039	\$21.07	906-000-038	\$23.25	906-000-037	\$34.90
0.0200	#0	0.0938	0.1235	1.1250	0.1235	118.0	906-000-590	\$9.26								
0.0250	#00	0.0938	0.0907	1.1250	0.0907	118.0	906-000-591	\$9.26								
0.0310	#000	0.0938	0.0930	1.1250	0.0930	118.0	906-000-592	\$9.26								
0.0469	#1	0.1250	0.1262	1.2500	0.1262	118.0	906-000-060	\$5.43	906-000-061	\$6.47	906-000-070	\$11.59	906-000-069	\$12.59	906-000-064	\$18.73
0.0781	#2	0.1875	0.1922	1.8750	0.1922	118.0	906-000-075	\$5.67	906-000-076	\$7.14	906-000-085	\$11.83	906-000-084	\$13.00	906-000-079	\$19.26
0.1094	#3	0.2500	0.2583	2.0000	0.2583	118.0	906-000-090	\$5.91	906-000-091	\$7.90	906-000-100	\$11.62	906-000-099	\$13.43	906-000-094	\$19.78
0.1250	#4	0.3125	0.3184	2.1250	0.3184	118.0	906-000-105	\$6.09	906-000-106	\$9.45	906-000-115	\$12.50	906-000-114	\$13.99	906-000-109	\$19.96
0.1406	#4.5000	0.3750	0.3785	2.5000	0.3785	118.0	906-000-309	\$8.40	906-000-310	\$11.75	906-000-315	\$17.48	906-000-314	\$20.80	906-000-313	\$26.26
0.1875	#5	0.4375	0.4505	2.7500	0.4505	118.0	906-000-120	\$9.67	906-000-121	\$15.00	906-000-130	\$19.02	906-000-129	\$22.05	906-000-124	\$31.36
0.2188	#6	0.5000	0.5165	3.0000	0.5165	118.0	906-000-135	\$14.54	906-000-136	\$19.88	906-000-145	\$27.60	906-000-144	\$34.20	906-000-139	\$48.37
0.2500	#7	0.6250	0.6367	3.2500	0.6367	118.0	906-000-150	\$22.05	906-000-151	\$30.44	906-000-160	\$38.33	906-000-159	\$51.47	906-000-154	\$71.84
0.3125	#8	0.7500	0.7688	3.5000	0.7688	118.0	906-000-165	\$30.29	906-000-166	\$39.84	906-000-175	\$51.88	906-000-174	\$72.87	906-000-169	\$104.21
0.3438	#9	0.8750	0.8890	3.6250	0.8890	118.0	906-000-180	\$54.96	906-000-181	\$68.07	906-000-186	\$95.38	906-000-185	\$134.91	906-000-184	\$193.96
0.3750	#10	1.0000	1.0092	3.7500	1.0092	118.0	906-000-191	\$72.14	906-000-192	\$88.84	906-000-197	\$125.20	906-000-196	\$177.14	906-000-195	\$254.66

Center Drill & Countersink Set

This 5-piece set includes one piece each of the following plain type center drill with a standard 60° included countersink angle.

C'Drills	PKG QTY.	HSS	Price	HSS-TiN	Price	Cobalt	Price	Carbide	Price
#1, #2, #3, #4, #5.	1	906-000-001	\$49.20	906-000-002	\$62.95	906-000-003	\$91.48	906-000-004	\$163.46



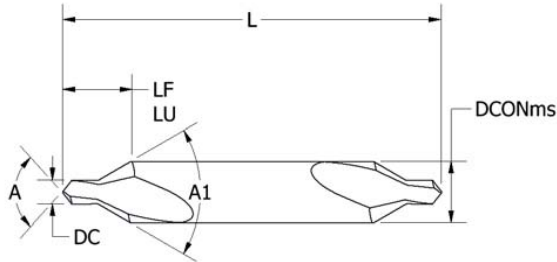

Tolerances		High	Low
OAL		+1/32	-1/16
Point Ø		+0.003	-0.0
Point Length	Point Ø < 1/32	+0.005	-0.005
	1/32 ≤ Point Ø ≤ 5/64	+0.008	-0.008
	Point > 5/64	+1/64	-1/64
CS Angle		+1°	-1°
Body Ø		+0.0	-0.002



DC	DC	DCONms	LU	L	LF	A	A1	HSS	Price	HSS-TiN	Price
0.0100	#5-0	0.1250	0.0786	1.2500	0.0786	118.0	82.0	906-000-044	\$30.33	906-000-045	\$31.95
0.0150	#4-0	0.1250	0.0820	1.2500	0.0820	118.0	82.0	906-000-046	\$30.33	906-000-047	\$31.95
0.0200	#3-0	0.1250	0.0854	1.2500	0.0854	118.0	82.0	906-000-048	\$19.43	906-000-049	\$20.83
0.0250	#2-0	0.1250	0.0887	1.2500	0.0887	118.0	82.0	906-000-031	\$19.43	906-000-032	\$20.83
0.0313	#0	0.1250	0.0929	1.2500	0.0929	118.0	82.0	906-000-040	\$19.43	906-000-041	\$20.83
0.0469	#1	0.1250	0.1034	1.2500	0.1034	118.0	82.0	906-000-071	\$8.88	906-000-072	\$9.89
0.0781	#2	0.1875	0.1604	1.8750	0.1604	118.0	82.0	906-000-086	\$9.09	906-000-087	\$10.56
0.1094	#3	0.2500	0.2174	2.0000	0.2174	118.0	82.0	906-000-101	\$9.41	906-000-102	\$11.36
0.1250	#4	0.3125	0.2638	2.1250	0.2638	118.0	82.0	906-000-116	\$9.78	906-000-117	\$13.04
0.1406	#4	0.3750	0.3103	2.5000	0.3103	118.0	82.0	906-000-316	\$13.39	906-000-317	\$16.67
0.1875	#5	0.4375	0.3778	2.7500	0.3778	118.0	82.0	906-000-131	\$14.91	906-000-132	\$20.12
0.2188	#6	0.5000	0.4347	3.0000	0.4347	118.0	82.0	906-000-146	\$22.56	906-000-147	\$27.78
0.2500	#7	0.6250	0.5277	3.2500	0.5277	118.0	82.0	906-000-161	\$31.94	906-000-162	\$40.12
0.3125	#8	0.7500	0.6416	3.5000	0.6416	118.0	82.0	906-000-176	\$44.78	906-000-177	\$54.08
0.3438	#9	0.8750	0.7345	3.6250	0.7345	118.0	82.0	906-000-187	\$82.59	906-000-188	\$95.38
0.3750	#10	1.0000	0.8274	3.7500	0.8274	118.0	82.0	906-000-198	\$108.65	906-000-199	\$124.94
0.0100	#5-0	0.1250	0.0700	1.2500	0.0700	118.0	90.0	906-000-010	\$30.93	906-000-011	\$31.95
0.0150	#4-0	0.1250	0.0737	1.2500	0.0737	118.0	90.0	906-000-017	\$30.93	906-000-018	\$31.95
0.0200	#3-0	0.1250	0.0775	1.2500	0.0775	118.0	90.0	906-000-024	\$18.96	906-000-025	\$20.83
0.0250	#2-0	0.1250	0.0812	1.2500	0.0812	118.0	90.0	906-000-033	\$18.96	906-000-034	\$20.83
0.0313	#0	0.1250	0.0859	1.2500	0.0859	118.0	90.0	906-000-042	\$18.96	906-000-043	\$20.83
0.0469	#1	0.1250	0.0976	1.2500	0.0976	118.0	90.0	906-000-073	\$8.88	906-000-074	\$9.89
0.0781	#2	0.1875	0.1522	1.8750	0.1522	118.0	90.0	906-000-088	\$9.09	906-000-089	\$10.54
0.1094	#3	0.2500	0.2068	2.0000	0.2068	118.0	90.0	906-000-103	\$9.41	906-000-104	\$11.34
0.1250	#4	0.3125	0.2497	2.1250	0.2497	118.0	90.0	906-000-118	\$9.78	906-000-119	\$13.04
0.1406	#4	0.3750	0.2927	2.5000	0.2927	118.0	90.0	906-000-318	\$13.39	906-000-319	\$16.66
0.1875	#5	0.4375	0.3590	2.7500	0.3590	118.0	90.0	906-000-133	\$14.91	906-000-134	\$20.11
0.2188	#6	0.5000	0.4136	3.0000	0.4136	118.0	90.0	906-000-148	\$22.56	906-000-149	\$27.78
0.2500	#7	0.6250	0.4995	3.2500	0.4995	118.0	90.0	906-000-163	\$31.94	906-000-164	\$40.12
0.3125	#8	0.7500	0.6087	3.5000	0.6087	118.0	90.0	906-000-178	\$44.78	906-000-179	\$54.08
0.3438	#9	0.8750	0.6946	3.6250	0.6946	118.0	90.0	906-000-189	\$82.59	906-000-190	\$95.38
0.3750	#10	1.0000	0.7804	3.7500	0.7804	118.0	90.0	906-000-200	\$108.65	906-000-201	\$124.94

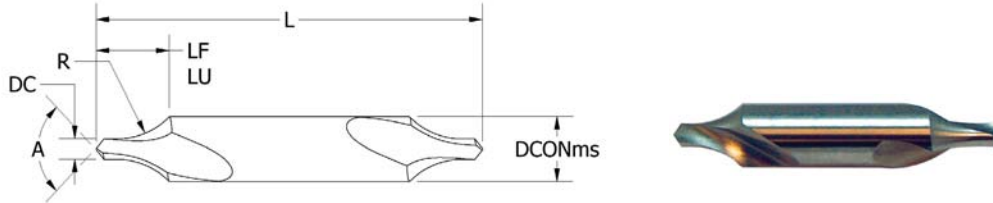

RADIUS TYPE

DC	DC	DCONms	LU	L	LF	A	R	HSS	Price	HSS-TiN	Price
0.0100	#5-0	0.1250	0.0705	1.2500	0.0705	118.0	0.0625	906-000-050	\$10.93	906-000-051	\$11.50
0.0150	#4-0	0.1250	0.0867	1.2500	0.0867	118.0	0.0781	906-000-052	\$9.92	906-000-053	\$10.96
0.0200	#3-0	0.1250	0.1020	1.2500	0.1020	118.0	0.0938	906-000-054	\$8.58	906-000-055	\$10.04
0.0250	#2-0	0.1250	0.1152	1.2500	0.1152	118.0	0.1094	906-000-056	\$8.58	906-000-057	\$10.04
0.0313	#0	0.1250	0.1257	1.2500	0.1257	118.0	0.1250	906-000-058	\$8.58	906-000-059	\$10.04
0.0469	#1	0.1250	0.1436	1.2500	0.1436	118.0	0.1563	906-000-062	\$6.71	906-000-063	\$7.73
0.0781	#2	0.1875	0.2234	1.8750	0.2234	118.0	0.2188	906-000-077	\$7.12	906-000-078	\$8.61
0.1094	#3	0.2500	0.3021	2.0000	0.3021	118.0	0.2813	906-000-092	\$7.70	906-000-093	\$9.70
0.1250	#4	0.3125	0.3747	2.1250	0.3747	118.0	0.3750	906-000-107	\$8.64	906-000-108	\$12.01
0.1406	#4	0.3750	0.4411	2.5000	0.4411	118.0	0.4375	906-000-311	\$10.60	906-000-312	\$13.95
0.1875	#5	0.4375	0.5308	2.7500	0.5308	118.0	0.5000	906-000-122	\$12.04	906-000-123	\$17.40
0.2188	#6	0.5000	0.6011	3.0000	0.6011	118.0	0.5625	906-000-137	\$18.19	906-000-138	\$23.54
0.2500	#7	0.6250	0.7338	3.2500	0.7338	118.0	0.7031	906-000-152	\$26.68	906-000-153	\$35.10
0.3125	#8	0.7500	0.8900	3.5000	0.8900	118.0	0.8750	906-000-167	\$37.66	906-000-168	\$45.61
0.3438	#9	0.8750	1.0227	3.6250	1.0227	118.0	1.0000	906-000-182	\$67.38	906-000-183	\$80.56
0.3750	#10	1.0000	1.1554	3.7500	1.1554	118.0	1.1094	906-000-193	\$88.12	906-000-194	\$104.89

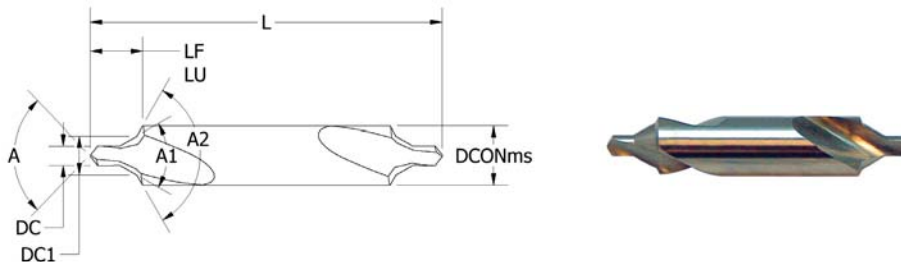

PG.501 	DC	DC	DCONms	DC1	LU	LS	L	LF	A	A1	A2	CARBIDE	Price
	0.0469	#11	0.1250	0.1000	0.1117	0.6250	1.2500	0.1117	118.0	60.0	120.0	906-000-427	\$23.27
	0.0625	#12	0.1875	0.1500	0.1646	0.9375	1.8750	0.1646	118.0	60.0	120.0	906-000-428	\$27.06
	0.0938	#13	0.2500	0.2000	0.2234	1.0000	2.0000	0.2234	118.0	60.0	120.0	906-000-429	\$35.39
	0.1094	#14	0.3125	0.2500	0.2763	1.0625	2.1250	0.2763	118.0	60.0	120.0	906-000-430	\$45.46
	0.1563	#15	0.4375	0.3500	0.3880	1.3750	2.7500	0.3880	118.0	60.0	120.0	906-000-431	\$72.11
	0.1875	#16	0.5000	0.4000	0.4469	1.5000	3.0000	0.4469	118.0	60.0	120.0	906-000-432	\$93.32

PG.501 	DC	DC	DCONms	DC1	LU	LS	L	LF	A	A1	A2	HSS	Price	HSS-TiN	Price	HSS-LH	Price
	0.0469	#11	0.1250	0.1000	0.7804	0.6250	1.2500	0.7804	118.0	60.0	120.0	906-000-202	\$6.48	906-000-203	\$7.51	906-000-210	\$15.07
	0.0625	#12	0.1875	0.1500	0.1646	0.9375	1.8750	0.1646	118.0	60.0	120.0	906-000-211	\$6.79	906-000-212	\$8.28	906-000-219	\$15.55
	0.0938	#13	0.2500	0.2000	0.2234	1.0000	2.0000	0.2234	118.0	60.0	120.0	906-000-220	\$6.89	906-000-221	\$8.88	906-000-228	\$16.00
	0.1094	#14	0.3125	0.2500	0.2763	1.0625	2.1250	0.2763	118.0	60.0	120.0	906-000-229	\$7.12	906-000-230	\$10.47	906-000-237	\$16.63
	0.1563	#15	0.4375	0.3500	0.3880	1.3750	2.7500	0.3880	118.0	60.0	120.0	906-000-238	\$10.82	906-000-239	\$16.18	906-000-246	\$23.23
	0.1875	#16	0.5000	0.4000	0.4469	1.5000	3.0000	0.4469	118.0	60.0	120.0	906-000-247	\$16.68	906-000-248	\$22.03	906-000-255	\$33.85
	0.2188	#17	0.6250	0.5000	0.5526	1.6250	3.2500	0.5526	118.0	60.0	120.0	906-000-256	\$25.82	906-000-257	\$35.78	906-000-264	\$47.70
	0.2500	#18	0.7500	0.6000	0.6584	1.7500	3.5000	0.6584	118.0	60.0	120.0	906-000-265	\$34.22	906-000-266	\$43.80	906-000-273	\$62.81
	0.3125	#19	0.8750	0.7000	0.7761	1.8125	3.6250	0.7761	118.0	60.0	120.0	906-000-274	\$59.06	906-000-275	\$72.23	906-000-278	\$111.01
	0.3750	#20	1.0000	0.8000	0.8937	1.8750	3.7500	0.8937	118.0	60.0	120.0	906-000-279	\$76.12	906-000-280	\$92.88	906-000-283	\$143.08

PG.501 	DC	DC	DCONms	DC1	LU	LS	L	LF	A	A1	A2	COBALT	Price	T15	Price
	0.0469	#11	0.1250	0.1000	0.7804	0.6250	1.2500	0.7804	118.0	60.0	120.0	906-000-209	\$15.38	906-000-204	\$20.61
	0.0625	#12	0.1875	0.1500	0.1646	0.9375	1.8750	0.1646	118.0	60.0	120.0	906-000-218	\$15.78	906-000-213	\$21.10
	0.0938	#13	0.2500	0.2000	0.2234	1.0000	2.0000	0.2234	118.0	60.0	120.0	906-000-227	\$16.20	906-000-222	\$21.66
	0.1094	#14	0.3125	0.2500	0.2763	1.0625	2.1250	0.2763	118.0	60.0	120.0	906-000-236	\$16.74	906-000-231	\$22.13
	0.1563	#15	0.4375	0.3500	0.3880	1.3750	2.7500	0.3880	118.0	60.0	120.0	906-000-245	\$26.69	906-000-240	\$35.00
	0.1875	#16	0.5000	0.4000	0.4469	1.5000	3.0000	0.4469	118.0	60.0	120.0	906-000-254	\$41.27	906-000-249	\$53.27
	0.2188	#17	0.6250	0.5000	0.5526	1.6250	3.2500	0.5526	118.0	60.0	120.0	906-000-263	\$61.43	906-000-258	\$79.97
	0.2500	#18	0.7500	0.6000	0.6584	1.7500	3.5000	0.6584	118.0	60.0	120.0	906-000-272	\$85.70	906-000-267	\$113.97
	0.3125	#19	0.8750	0.7000	0.7761	1.8125	3.6250	0.7761	118.0	60.0	120.0	906-000-277	\$145.35	906-000-276	\$194.53
	0.3750	#20	1.0000	0.8000	0.8937	1.8750	3.7500	0.8937	118.0	60.0	120.0	906-000-282	\$187.39	906-000-281	\$250.87

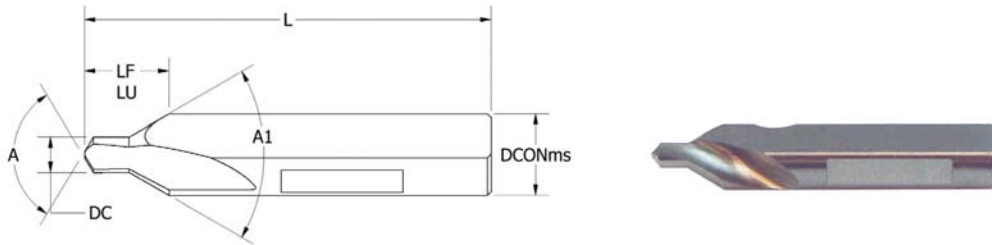

DC	DC	DCONms	LU	L	LF	A	A1	HSS	Price	HSS-TiN	Price
0.0469	#1	0.1250	0.1262	1.2500	0.1262	118.0	60.0	906-000-067	\$10.84	906-000-068	\$11.95
0.0781	#2	0.1875	0.1922	1.8750	0.1922	118.0	60.0	906-000-082	\$12.17	906-000-083	\$13.79
0.1094	#3	0.2500	0.2583	2.0000	0.2583	118.0	60.0	906-000-097	\$12.38	906-000-098	\$14.53
0.1250	#4	0.3125	0.3184	2.1250	0.3184	118.0	60.0	906-000-112	\$13.10	906-000-113	\$16.18
0.1875	#5	0.4375	0.4505	2.7500	0.4505	118.0	60.0	906-000-127	\$14.69	906-000-128	\$20.47
0.2188	#6	0.5000	0.5165	3.0000	0.5165	118.0	60.0	906-000-142	\$18.43	906-000-143	\$24.19
0.2500	#7	0.6250	0.6367	3.2500	0.6367	118.0	60.0	906-000-157	\$25.74	906-000-158	\$34.81
0.3125	#8	0.7500	0.7688	3.5000	0.7688	118.0	60.0	906-000-172	\$34.21	906-000-173	\$44.54



HSS

- Bell hey-type single end center drills with a bell tip have flats on their end that accept carbide inserts
- Used on Hey machines for facing a workpiece and creating center holes on it so it can be turned between centers on a lathe
- Have a bell tip with an additional 120° chamfer that bevels the outer edge of the hole to help protect the hole from damage during machining applications
- Commonly used in applications where parts will go through multiple machining passes and there is risk of marring the edges of the center hole
- Set screw flats for locking the center drills into the tool holder

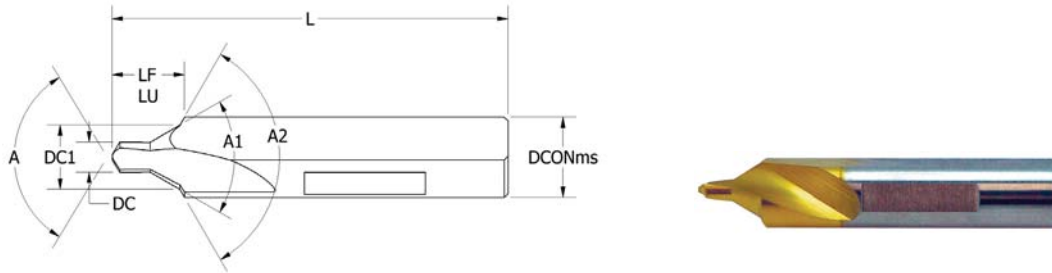

DC	DC	DCNms	DC1	LU	L	LF	A	A1	A2	HSS	Price	HSS-TiN	Price
0.0469	#11	0.1250	0.1000	0.1117	1.2500	0.1117	118.0	60.0	120.0	906-000-207	\$20.92	906-000-208	\$22.01
0.0625	#12	0.1875	0.1500	0.1646	1.8750	0.1646	118.0	60.0	120.0	906-000-216	\$13.81	906-000-217	\$15.46
0.0938	#13	0.2500	0.2000	0.2234	2.0000	0.2234	118.0	60.0	120.0	906-000-225	\$13.71	906-000-226	\$15.85
0.1094	#14	0.3125	0.2500	0.2763	2.1250	0.2763	118.0	60.0	120.0	906-000-234	\$13.89	906-000-235	\$17.51
0.1563	#15	0.4375	0.3500	0.3880	2.7500	0.3880	118.0	60.0	120.0	906-000-243	\$16.31	906-000-244	\$22.08
0.1875	#16	0.5000	0.4000	0.4469	3.0000	0.4469	118.0	60.0	120.0	906-000-252	\$20.54	906-000-253	\$26.32
0.2188	#17	0.6250	0.5000	0.5526	3.2500	0.5526	118.0	60.0	120.0	906-000-261	\$28.56	906-000-262	\$39.31
0.2500	#18	0.7500	0.6000	0.6584	3.5000	0.6584	118.0	60.0	120.0	906-000-270	\$37.95	906-000-271	\$48.28



- Plain hey-type center drills with a bell tip have flats on their end that accept carbide inserts
- Standard choice for creating center holes in a piece of stock to prepare it for turning between centers on a lathe
- Commonly used in applications where parts will go through multiple machining passes and there is risk of marring the edges of the center hole
- Set screw flats for locking the center drills into the tool holder

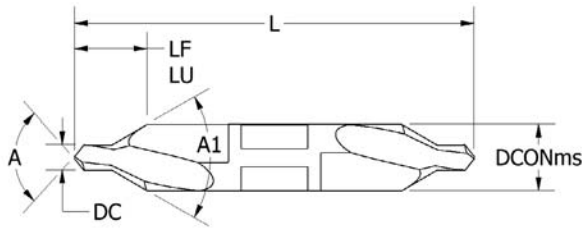

DC	DC	DCNms	LU	L	LF	A	A1	HSS	Price	HSS-TiN	Price
0.0469	#1	0.1250	0.1262	1.2500	0.1262	118.0	60.0	906-000-065	\$16.53	906-000-066	\$17.64
0.0781	#2	0.1875	0.1922	1.8750	0.1922	118.0	60.0	906-000-080	\$18.57	906-000-081	\$20.18
0.1094	#3	0.2500	0.2583	2.0000	0.2583	118.0	60.0	906-000-095	\$18.87	906-000-096	\$21.03
0.1250	#4	0.3125	0.3184	2.1250	0.3184	118.0	60.0	906-000-110	\$19.99	906-000-111	\$22.76
0.1875	#5	0.4375	0.4505	2.7500	0.4505	118.0	60.0	906-000-125	\$22.42	906-000-126	\$28.18
0.2188	#6	0.5000	0.5165	3.0000	0.5165	118.0	60.0	906-000-140	\$28.11	906-000-141	\$33.89
0.2500	#7	0.6250	0.6367	3.2500	0.6367	118.0	60.0	906-000-155	\$39.26	906-000-156	\$48.33
0.3125	#8	0.7500	0.7688	3-1/2	0.7688	118.0	60.0	906-000-170	\$52.19	906-000-171	\$62.50



HSS

- Bell hey-type double end center drills with a bell tip have flats on their end that accept carbide inserts
- Used on Hey machines for facing a workpiece and creating center holes on it so it can be turned between centers on a lathe
- Have a bell tip with an additional 120° chamfer that bevels the outer edge of the hole to help protect the hole from damage during machining applications
- Commonly used in applications where parts will go through multiple machining passes and there is risk of marring the edges of the center hole
- Set screw flats for locking the center drills into the tool holder

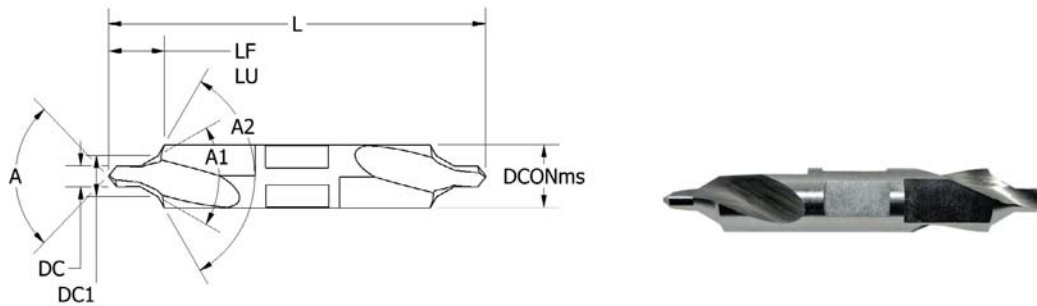

DC	DC	DCONms	DC1	LU	L	LF	A	A1	A2	HSS	Price	HSS-TiN	Price
0.0469	#11	0.1250	0.1000	0.1117	1.2500	0.1117	118.0	60.0	120.0	906-000-205	\$31.89	906-000-206	\$33.01
0.0625	#12	0.1875	0.1500	0.1646	1.8750	0.1646	118.0	60.0	120.0	906-000-214	\$21.08	906-000-215	\$22.70
0.0938	#13	0.2500	0.2000	0.2234	2.0000	0.2234	118.0	60.0	120.0	906-000-223	\$20.89	906-000-224	\$23.04
0.1094	#14	0.3125	0.2500	0.2763	2.1250	0.2763	118.0	60.0	120.0	906-000-232	\$21.19	906-000-233	\$24.82
0.1563	#15	0.4375	0.3500	0.3880	2.7500	0.3880	118.0	60.0	120.0	906-000-241	\$24.88	906-000-242	\$32.04
0.1875	#16	0.5000	0.4000	0.4469	3.0000	0.4469	118.0	60.0	120.0	906-000-250	\$31.34	906-000-251	\$37.13
0.2188	#17	0.6250	0.5000	0.5526	3.2500	0.5526	118.0	60.0	120.0	906-000-259	\$43.56	906-000-260	\$52.63
0.2500	#18	0.7500	0.6000	0.6000	3.5000	0.6000	118.0	60.0	120.0	906-000-268	\$57.87	906-000-269	\$68.21



Jig Bore Type and countersinks are used for producing center holes in components or workpieces which require machining between centers and are manufactured with a locking set screw flat.

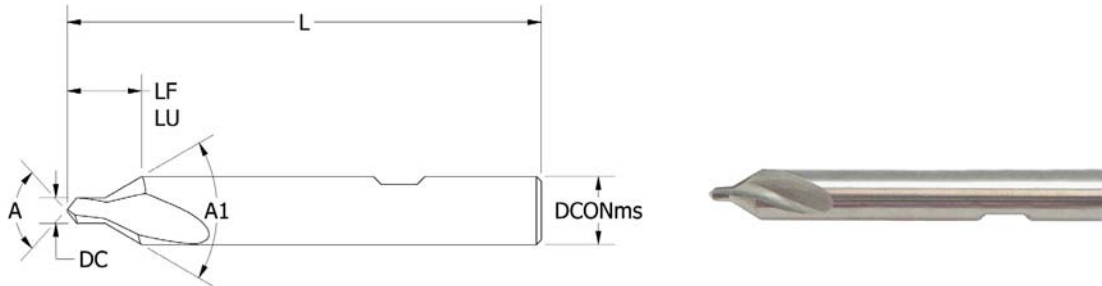

DC	DCONms	LU	L	LF	A	A1	HSS	Price
0.0625	0.3750	0.3486	3.0000	0.3486	118.0	60.0	906-000-291	\$20.88
0.0938	0.3750	0.3606	3.0000	0.3606	118.0	60.0	906-000-294	\$20.88
0.1250	0.3750	0.3725	3.0000	0.3725	118.0	60.0	906-000-292	\$20.88
0.1563	0.3750	0.3844	3.0000	0.3844	118.0	60.0	906-000-295	\$20.88
0.1875	0.3750	0.3964	3.0000	0.3964	118.0	60.0	906-000-293	\$20.88
0.1250	0.5000	0.4807	3.5000	0.4807	118.0	60.0	906-000-285	\$25.30
0.1875	0.5000	0.5046	3.5000	0.5046	118.0	60.0	906-000-286	\$25.30
0.2188	0.5000	0.5165	3.5000	0.5165	118.0	60.0	906-000-287	\$25.30
0.2500	0.5000	0.5285	3.5000	0.5285	118.0	60.0	906-000-284	\$25.30
0.2813	0.5000	0.5404	3.5000	0.5404	118.0	60.0	906-000-288	\$25.30

Jig Bore Center Drill & Countersink Sets

Each 5-piece set includes one piece each of the following jig bore type Center drill and countersinks.



Body Dia.	Point Dia.	Product #	Price
3/8	1/16	906-000-290	\$127.44
	3/32		
	1/8		
	5/32		
	3/16		
1/2	1/8	906-000-289	\$150.00
	3/16		
	1/4		
	9/32		



CARBIDE
HSS
COBALT

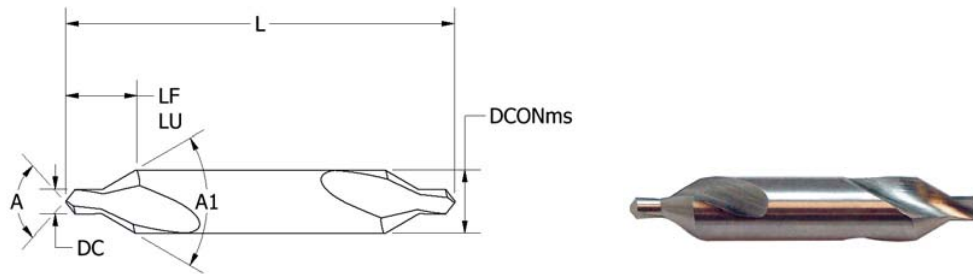

DC	DCONms	LU	L	LF	A	A1	CARBIDE	Price	HSS	Price	COBALT	Price
0.50	3.15	0.37	25.00	0.37	118.0	60.0	906-000-348	\$16.13	906-000-320	\$5.37	906-000-334	\$15.87
0.80	3.15	0.41	25.00	0.41	118.0	60.0	906-000-349	\$14.55	906-000-321	\$5.37	906-000-335	\$15.87
1.00	3.15	3.16	31.50	3.16	118.0	60.0	906-000-350	\$14.68	906-000-322	\$4.90	906-000-336	\$14.48
1.25	3.15	3.25	31.50	3.25	118.0	60.0	906-000-351	\$14.68	906-000-323	\$4.72	906-000-337	\$13.95
1.60	4.00	4.08	35.50	4.08	118.0	60.0	906-000-355	\$22.12	906-000-324	\$4.61	906-000-344	\$10.44
2.00	5.00	5.10	40.00	5.10	118.0	60.0	906-000-356	\$22.91	906-000-325	\$5.01	906-000-345	\$11.33
2.50	6.30	6.39	45.00	6.39	118.0	60.0	906-000-357	\$24.07	906-000-326	\$5.68	906-000-346	\$12.91
3.15	8.00	8.10	50.00	8.10	118.0	60.0	906-000-358	\$33.42	906-000-327	\$7.13	906-000-347	\$16.17
4.00	10.0	10.20	56.00	10.20	118.0	60.0	906-000-352	\$51.10	906-000-328	\$11.81	906-000-338	\$26.16
5.00	12.50	12.80	63.00	12.80	118.0	60.0	906-000-353	\$63.85	906-000-329	\$17.62	906-000-339	\$39.15
6.30	16.00	16.40	71.00	16.40	118.0	60.0	906-000-354	\$164.17	906-000-330	\$23.92	906-000-340	\$54.28
8.00	20.00	20.49	80.00	20.49	118.0	60.0			906-000-331	\$39.12	906-000-341	\$90.89
10.00	25.00	25.79	100.00	25.79	118.0	60.0			906-000-332	\$75.25	906-000-342	\$183.52
12.50	31.50	32.95	125.00	32.95	118.0	60.0			906-000-333	\$126.79	906-000-343	\$309.26

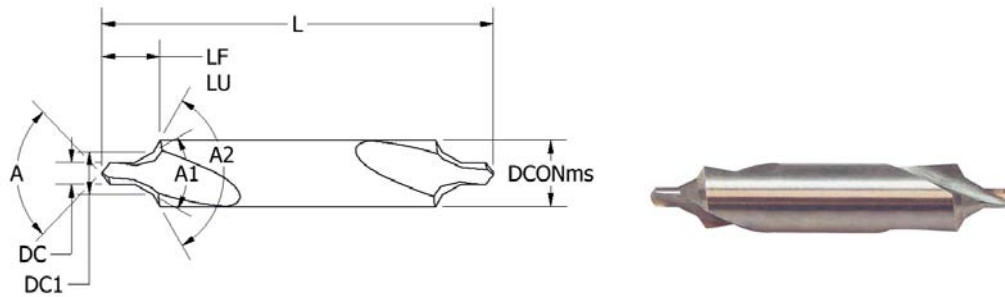

DC	DCONms	DC1	LU	L	LF	A	A1	A2	HSS	Price	COBALT	Price
1.00	4.00	2.12	2.81	35.50	2.81	118.0	60.0	120.0	906-000-359	\$6.92	906-000-377	\$17.26
1.25	5.00	2.65	3.49	40.00	3.49	118.0	60.0	120.0	906-000-360	\$6.96	906-000-378	\$18.60
1.60	6.30	3.35	4.37	45.00	4.37	118.0	60.0	120.0	906-000-361	\$7.38	906-000-379	\$18.40
2.00	8.00	4.25	5.53	50.00	5.53	118.0	60.0	120.0	906-000-362	\$9.23	906-000-380	\$23.52
2.50	10.00	5.30	6.88	56.00	6.88	118.0	60.0	120.0	906-000-363	\$11.59	906-000-370	\$30.32
3.15	11.20	6.70	8.27	60.00	8.27	118.0	60.0	120.0	906-000-364	\$14.33	906-000-371	\$37.52
4.00	14.00	8.50	10.48	67.00	10.48	118.0	60.0	120.0	906-000-365	\$18.54	906-000-372	\$48.53
5.00	18.00	10.60	13.29	75.00	13.29	118.0	60.0	120.0	906-000-366	\$25.09	906-000-373	\$65.65
6.30	20.00	13.20	15.94	80.00	15.94	118.0	60.0	120.0	906-000-367	\$33.15	906-000-374	\$88.94
8.00	25.00	17.00	20.20	100.00	20.20	118.0	60.0	120.0	906-000-368	\$65.53	906-000-375	\$175.76
10.00	31.50	21.20	25.47	125.00	25.47	118.0	60.0	120.0	906-000-369	\$131.17	906-000-376	\$341.42

HSS
COBALT



HSS

COBALT

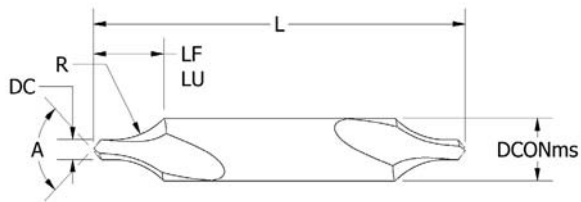

DC	DCONms	LU	L	LF	R	A	HSS	Price	COBALT	Price
0.50	3.15	2.12	25.00	2.12	1.60	118.0	906-000-381	\$5.37	906-000-395	\$15.87
0.80	3.15	2.65	25.00	2.65	2.50	118.0	906-000-382	\$5.37	906-000-396	\$15.87
1.00	3.15	3.00	31.50	3.00	3.15	118.0	906-000-383	\$4.90	906-000-397	\$14.48
1.25	3.15	3.35	31.50	3.35	4.00	118.0	906-000-384	\$4.72	906-000-398	\$13.95
1.60	4.00	4.25	35.50	4.25	5.00	118.0	906-000-385	\$4.61	906-000-405	\$10.44
2.00	5.00	5.30	40.00	5.30	6.30	118.0	906-000-386	\$5.01	906-000-406	\$11.33
2.50	6.30	6.70	45.00	6.70	8.00	118.0	906-000-387	\$5.68	906-000-407	\$12.91
3.15	8.00	8.50	50.00	8.50	10.00	118.0	906-000-388	\$7.13	906-000-408	\$16.17
4.00	10.0	10.60	56.00	10.60	12.50	118.0	906-000-389	\$11.81	906-000-399	\$26.16
5.00	12.50	13.20	63.00	13.20	16.00	118.0	906-000-390	\$17.62	906-000-400	\$39.15
6.30	16.00	17.00	71.00	17.00	20.00	118.0	906-000-391	\$23.92	906-000-401	\$54.28
8.00	20.00	21.20	80.00	21.20	25.00	118.0	906-000-392	\$39.12	906-000-402	\$90.89
10.00	25.00	26.50	100.00	26.50	31.50	118.0	906-000-393	\$75.25	906-000-403	\$183.52
12.50	31.50	33.50	125.00	33.50	40.00	118.0	906-000-394	\$126.79	906-000-404	\$309.26

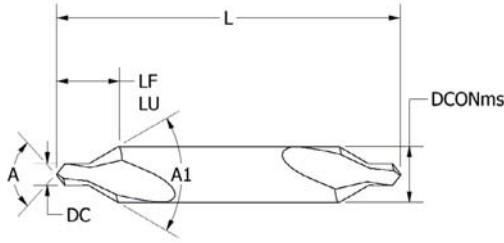

DC	DCONms	LU	L	LF	A	A1	CARBIDE	Price
0.0250	0.1250	0.1178	4.0000	0.1178	118.0	60.0	907-000-185	\$64.85
0.0250	0.1250	0.1178	6.0000	0.1178	118.0	60.0	907-000-186	\$71.49
0.0313	0.1250	0.1202	4.0000	0.1202	118.0	60.0	907-000-187	\$64.85
0.0313	0.1250	0.1202	6.0000	0.1202	118.0	60.0	907-000-188	\$71.49
0.0469	0.1250	0.1262	4.0000	0.1262	118.0	60.0	907-000-189	\$59.58
0.0469	0.1250	0.1262	6.0000	0.1262	118.0	60.0	907-000-190	\$66.16
0.0781	0.1875	0.1922	4.0000	0.1922	118.0	60.0	907-000-191	\$61.97
0.0781	0.1875	0.1922	6.0000	0.1922	118.0	60.0	907-000-192	\$71.74
0.1094	0.2500	0.2583	4.0000	0.2583	118.0	60.0	907-000-193	\$75.48
0.1094	0.2500	0.2583	6.0000	0.2583	118.0	60.0	907-000-194	\$90.09
0.1250	0.3125	0.3184	4.0000	0.3184	118.0	60.0	907-000-195	\$85.52
0.1250	0.3125	0.3184	6.0000	0.3184	118.0	60.0	907-000-196	\$103.62
0.1875	0.4375	0.4505	4.0000	0.4505	118.0	60.0	907-000-197	\$129.34
0.1875	0.4375	0.4505	6.0000	0.4505	118.0	60.0	907-000-198	\$166.77
0.2188	0.5000	0.5165	4.0000	0.5165	118.0	60.0	907-000-199	\$178.28
0.2188	0.5000	0.5165	6.0000	0.5165	118.0	60.0	907-000-200	\$222.22
0.2500	0.6250	0.6367	6.0000	0.6367	118.0	60.0	907-000-201	\$318.67
0.3125	0.7500	0.7688	6.0000	0.7688	118.0	60.0	907-000-202	\$439.63

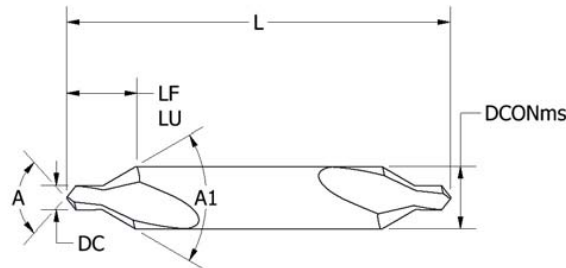

DC	DCONms	LU	L	LF	A	A1	HSS	Price	HSS-TiN	Price	HSS 82°	Price	HSS 90°	Price	COBALT	Price
0.1406	0.3750	0.3785	4.0000	0.3785	118.0	60.0	907-000-125	\$19.70	907-000-126	\$23.86	907-000-128	\$32.44	907-000-129	\$32.44	907-000-127	\$57.32
0.1406	0.3750	0.3785	5.0000	0.3785	118.0	60.0	907-000-130	\$23.28	907-000-131	\$28.30	907-000-133	\$38.47	907-000-134	\$38.47	907-000-132	\$67.96
0.1406	0.3750	0.3785	6.0000	0.3785	118.0	60.0	907-000-135	\$28.10	907-000-136	\$33.89	907-000-138	\$46.38	907-000-139	\$46.38	907-000-137	\$82.00
0.1875	0.4375	0.4505	4.0000	0.4505	118.0	60.0	907-000-141	\$23.03	907-000-142	\$29.67	907-000-144	\$37.99	907-000-145	\$37.99	907-000-143	\$67.21
0.1875	0.4375	0.4505	5.0000	0.4505	118.0	60.0	907-000-146	\$26.67	907-000-147	\$34.64	907-000-149	\$44.04	907-000-150	\$44.04	907-000-148	\$74.46
0.1875	0.4375	0.4505	6.0000	0.4505	118.0	60.0	907-000-151	\$29.94	907-000-152	\$39.26	907-000-154	\$49.40	907-000-155	\$49.40	907-000-153	\$87.32
0.2188	0.5000	0.5165	4.0000	0.5165	118.0	60.0	907-000-157	\$24.99	907-000-158	\$31.63	907-000-160	\$31.07	907-000-161	\$31.07	907-000-159	\$71.37
0.2188	0.5000	0.5165	5.0000	0.5165	118.0	60.0	907-000-162	\$28.65	907-000-163	\$36.64	907-000-165	\$46.38	907-000-166	\$46.38	907-000-164	\$82.10
0.2188	0.5000	0.5165	6.0000	0.5165	118.0	60.0	907-000-167	\$34.63	907-000-168	\$43.96	907-000-170	\$55.98	907-000-171	\$55.98	907-000-169	\$99.03
0.2500	0.6250	0.6367	6.0000	0.6367	118.0	60.0	907-000-173	\$64.54	907-000-174	\$76.17	907-000-176	\$103.97	907-000-177	\$103.97	907-000-175	\$183.66
0.3125	0.7500	0.7688	6.0000	0.7688	118.0	60.0	907-000-179	\$69.69	907-000-180	\$82.99	907-000-182	\$112.36	907-000-183	\$112.36	907-000-181	\$198.28

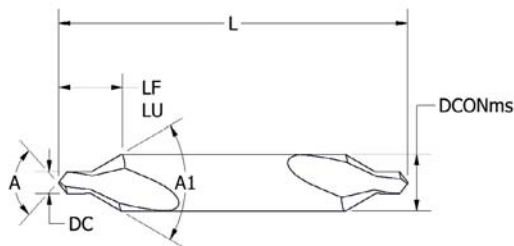

DC	DCONms	LU	L	LF	A	A1	HSS	Price
0.0469	0.1250	0.1262	8.0000	0.1262	118.0	60.0	907-000-061	\$32.99
0.0781	0.1875	0.1922	8.0000	0.1922	118.0	60.0	907-000-082	\$33.47
0.1094	0.2500	0.2583	8.0000	0.2583	118.0	60.0	907-000-103	\$32.41
0.1250	0.3125	0.3184	8.0000	0.3184	118.0	60.0	907-000-124	\$33.87
0.1406	0.3750	0.3785	8.0000	0.3785	118.0	60.0	907-000-140	\$37.23
0.1875	0.4375	0.4505	8.0000	0.4505	118.0	60.0	907-000-156	\$37.12
0.2188	0.5000	0.5165	8.0000	0.5165	118.0	60.0	907-000-172	\$42.93
0.2500	0.6250	0.6367	8.0000	0.6367	118.0	60.0	907-000-178	\$77.87
0.3125	0.7500	0.7688	8.0000	0.7688	118.0	60.0	907-000-184	\$86.40

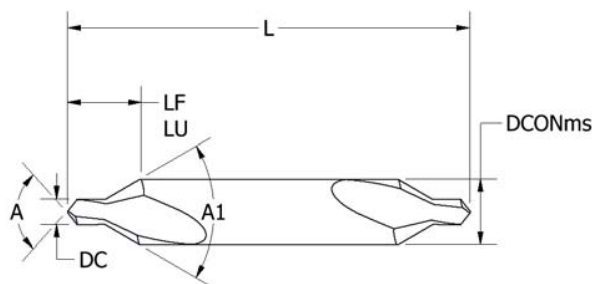

DC	DCONms	LU	L	LF	A	A1	HSS	Price	HSS-TiN	Price	HSS 82°	Price	HSS 90°	Price	COBALT	Price
0.0469	0.1250	0.1262	3.0000	0.1262	118.0	60.0	907-000-041	\$13.13	907-000-042	\$14.48	907-000-044	\$20.29	907-000-045	\$20.29	907-000-043	\$39.41
0.0469	0.1250	0.1262	4.0000	0.1262	118.0	60.0	907-000-046	\$13.70	907-000-047	\$15.05	907-000-049	\$23.05	907-000-050	\$23.05	907-000-048	\$40.74
0.0469	0.1250	0.1262	5.0000	0.1262	118.0	60.0	907-000-051	\$19.03	907-000-052	\$20.39	907-000-054	\$32.03	907-000-055	\$32.03	907-000-053	\$56.69
0.0469	0.1250	0.1262	6.0000	0.1262	118.0	60.0	907-000-056	\$24.92	907-000-057	\$27.30	907-000-059	\$41.91	907-000-060	\$41.91	907-000-058	\$74.08
0.0781	0.1875	0.1922	3.0000	0.1922	118.0	60.0	907-000-062	\$13.28	907-000-063	\$15.10	907-000-065	\$22.28	907-000-066	\$22.28	907-000-064	\$39.51
0.0781	0.1875	0.1922	4.0000	0.1922	118.0	60.0	907-000-067	\$15.02	907-000-068	\$16.82	907-000-070	\$25.22	907-000-071	\$25.22	907-000-069	\$44.66
0.0781	0.1875	0.1922	5.0000	0.1922	118.0	60.0	907-000-072	\$19.24	907-000-073	\$21.04	907-000-075	\$32.03	907-000-076	\$32.03	907-000-074	\$57.26
0.0781	0.1875	0.1922	6.0000	0.1922	118.0	60.0	907-000-077	\$25.02	907-000-078	\$28.32	907-000-080	\$42.10	907-000-081	\$42.10	907-000-079	\$74.54
0.1094	0.2500	0.2583	3.0000	0.2583	118.0	60.0	907-000-083	\$13.87	907-000-084	\$16.54	907-000-086	\$23.30	907-000-087	\$23.30	907-000-085	\$41.19
0.1094	0.2500	0.2583	4.0000	0.2583	118.0	60.0	907-000-088	\$15.82	907-000-089	\$19.14	907-000-091	\$26.58	907-000-092	\$26.58	907-000-090	\$46.96
0.1094	0.2500	0.2583	5.0000	0.2583	118.0	60.0	907-000-093	\$20.81	907-000-094	\$24.83	907-000-096	\$35.02	907-000-097	\$35.02	907-000-095	\$61.96
0.1094	0.2500	0.2583	6.0000	0.2583	118.0	60.0	907-000-098	\$25.25	907-000-099	\$29.94	907-000-101	\$42.40	907-000-102	\$42.40	907-000-100	\$75.13
0.1250	0.3125	0.3184	3.0000	0.3184	118.0	60.0	907-000-104	\$16.28	907-000-105	\$19.60	907-000-107	\$27.33	907-000-108	\$27.33	907-000-106	\$48.39
0.1250	0.3125	0.3184	4.0000	0.3184	118.0	60.0	907-000-109	\$17.52	907-000-110	\$21.67	907-000-112	\$29.49	907-000-113	\$29.49	907-000-111	\$52.17
0.1250	0.3125	0.3184	5.0000	0.3184	118.0	60.0	907-000-114	\$22.40	907-000-115	\$27.40	907-000-117	\$37.66	907-000-118	\$37.66	907-000-116	\$66.65
0.1250	0.3125	0.3184	6.0000	0.3184	118.0	60.0	907-000-119	\$25.86	907-000-120	\$31.67	907-000-122	\$43.53	907-000-123	\$43.53	907-000-121	\$76.94

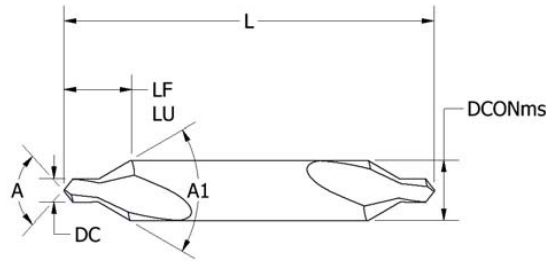

DC	DCONms	LU	L	LF	A	A1	PRODUCT #	Price
0.75	3.50	3.38	60.00	3.38	118.0	60.0	907-000-001	\$36.22
1.00	4.00	3.90	60.00	3.90	118.0	60.0	907-000-002	\$37.45
1.50	5.00	5.03	60.00	5.03	118.0	60.0	907-000-003	\$41.02
2.00	6.00	5.96	80.00	5.96	118.0	60.0	907-000-004	\$39.84
2.50	8.00	7.86	80.00	7.86	118.0	60.0	907-000-005	\$40.77
3.00	8.00	8.23	80.00	8.23	118.0	60.0	907-000-006	\$41.63
1.00	4.00	3.90	100.0	3.90	118.0	60.0	907-000-007	\$42.35
1.50	5.00	5.03	100.0	5.03	118.0	60.0	907-000-008	\$43.80
2.00	6.00	5.96	100.0	5.96	118.0	60.0	907-000-009	\$45.21
2.50	8.00	7.86	100.0	7.86	118.0	60.0	907-000-010	\$46.19
3.00	8.00	8.23	100.0	8.23	118.0	60.0	907-000-011	\$49.02
3.00	10.00	9.96	100.0	9.96	118.0	60.0	907-000-012	\$58.63
4.00	10.00	10.20	100.0	10.20	118.0	60.0	907-000-013	\$59.63
4.00	12.00	11.93	100.0	11.93	118.0	60.0	907-000-014	\$67.20
5.00	12.00	12.36	100.0	12.36	118.0	60.0	907-000-015	\$67.82
0.75	3.50	3.38	120.0	3.38	118.0	60.0	907-000-016	\$56.57
1.00	4.00	3.90	120.0	3.90	118.0	60.0	907-000-017	\$57.30
1.60	5.00	4.94	120.0	4.94	118.0	60.0	907-000-018	\$59.19
2.00	6.00	5.96	120.0	5.96	118.0	60.0	907-000-019	\$61.10
2.50	8.00	7.86	120.0	7.86	118.0	60.0	907-000-020	\$62.60
3.00	8.00	8.23	120.0	8.23	118.0	60.0	907-000-021	\$63.27
3.00	10.00	9.96	120.0	9.96	118.0	60.0	907-000-022	\$69.03
3.15	10.00	9.83	120.0	9.83	118.0	60.0	907-000-023	\$71.77
3.15	10.00	9.83	120.0	9.83	118.0	60.0	907-000-024	\$73.91
4.00	12.00	11.93	120.0	11.93	118.0	60.0	907-000-025	\$82.31
5.00	14.00	14.09	120.0	14.09	118.0	60.0	907-000-026	\$84.82
1.50	5.00	5.03	150.00	5.03	118.0	60.0	907-000-027	\$58.16
1.00	4.00	3.90	150.0	3.90	118.0	60.0	907-000-028	\$72.78
1.50	5.00	5.03	150.0	5.03	118.0	60.0	907-000-029	\$74.17
2.00	6.00	5.96	150.0	5.96	118.0	60.0	907-000-030	\$74.58
2.50	8.00	7.86	150.0	7.86	118.0	60.0	907-000-031	\$76.36
3.00	8.00	8.23	150.0	8.23	118.0	60.0	907-000-032	\$76.97
3.00	10.00	9.96	150.0	9.96	118.0	60.0	907-000-033	\$80.48
4.00	10.00	10.20	150.0	10.20	118.0	60.0	907-000-034	\$81.93
4.00	12.00	11.93	150.0	11.93	118.0	60.0	907-000-035	\$88.78
6.30	16.00	16.40	150.0	16.40	118.0	60.0	907-000-036	\$181.59
2.00	5.00	5.10	200.0	5.10	118.0	60.0	907-000-037	\$83.84
2.50	6.30	6.39	200.0	6.39	118.0	60.0	907-000-038	\$86.47
3.15	8.00	8.10	200.0	8.10	118.0	60.0	907-000-039	\$89.27
4.00	10.00	10.20	200.0	10.20	118.0	60.0	907-000-040	\$93.71

COBALT

The ultimate just in time solution: HOSHOP! By ARCH.

HOSHOP!
by **ARCH**

When a precision tool urgently needs to be in hand, in days.

No problem!

ARCH Cutting Tools premium made from blank HOSHOP! Quick turn full special service delivers quickly to beat those tight deadlines.

Most conventional solid carbide cutting tool profiles for milling, single & multi-step drilling & reaming are included. Choose from a myriad of optional specialty & performance-enhancing custom tool features for chamfering, pre-drill hole preparation, finishing, and corner edge contouring.



- Quotes in four hours or less!
- 24-hour coating service on select coatings!
- Thousands of tooling options produced & shipped under five business days.

HOSHOP! By ARCH Service
available through select outlets only.

- Order has to be in by 2PM EST
- Quantity limits for quick-turn service apply
- Solid Carbide combinations that fall outside of quick turn service will be quoted by ARCH Specials
- Indexable & HSS tooling are excluded from the program and will be referred to ARCH Specials
- Quick turn form tools also available through ARCH Specials

Go to:
archcuttingtools.com/services



Quotes:

HOSHOP@ARCHGP.COM
or call (844) 321-ARCH

ARCH[®]
Cutting Tools

COUNTERSINKS

THE COMPLETE TOOL MAKING AUTHORITY™

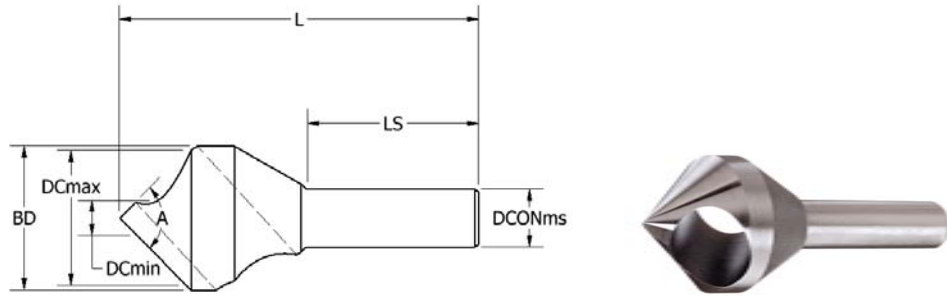

ZERO-FLUTE

DCONms	BD	LS	L	DCmax	DCmin	A	Uncoated	Price	TiN	Price
0.2500	0.3125	1.2500	1.8750	0.2813	0.1094	60.0	919-000-185	\$14.09	919-000-186	\$16.61
0.2500	0.3750	1.2500	1.8750	0.3438	0.1563	60.0	919-000-187	\$16.09	919-000-188	\$18.60
0.3125	0.5000	1.2500	2.0000	0.4531	0.1719	60.0	919-000-189	\$19.27	919-000-190	\$23.30
0.3750	0.6250	1.3750	2.5000	0.5781	0.1875	60.0	919-000-191	\$21.17	919-000-192	\$28.81
0.3750	0.7500	1.5000	2.7500	0.7031	0.2500	60.0	919-000-193	\$33.68	919-000-194	\$41.36
0.3750	1.0000	1.2500	3.0000	0.8438	0.2969	60.0	919-000-195	\$41.89	919-000-196	\$55.27
0.5000	1.2500	1.5000	3.5000	1.0313	0.4219	60.0	919-000-197	\$101.50	919-000-198	\$121.56
0.2500	0.3125	1.2500	1.6250	0.2813	0.0938	82.0	919-000-202	\$14.09	919-000-203	\$16.61
0.2500	0.3750	1.2500	1.7500	0.3438	0.1406	82.0	919-000-204	\$16.09	919-000-205	\$18.60
0.3125	0.5000	1.2500	1.7500	0.4531	0.1563	82.0	919-000-206	\$19.27	919-000-207	\$23.30
0.3750	0.6250	1.3750	2.1250	0.5781	0.1719	82.0	919-000-208	\$21.17	919-000-209	\$28.81
0.3750	0.7500	1.5000	2.3750	0.7031	0.2031	82.0	919-000-210	\$33.68	919-000-211	\$41.36
0.3750	1.0000	1.2500	2.6250	0.9219	0.2969	82.0	919-000-212	\$41.89	919-000-213	\$55.27
0.5000	1.2500	1.5000	3.1250	1.0938	0.3594	82.0	919-000-214	\$101.50	919-000-215	\$121.56
0.2500	5/16	1.2500	1.6250	1.0938	0.3594	90.0	919-000-219	\$14.09	919-000-220	\$16.61
0.2500	0.3750	1.2500	1.7500	0.3438	0.1406	90.0	919-000-221	\$16.09	919-000-222	\$18.60
0.3125	0.5000	1.2500	1.7500	0.4531	0.1563	90.0	919-000-223	\$19.27	919-000-224	\$23.30
0.3750	0.6250	1.3750	2.1250	0.5781	0.1719	90.0	919-000-225	\$21.17	919-000-226	\$28.81
0.3750	0.7500	1.5000	2.3750	0.7031	0.2031	90.0	919-000-227	\$33.68	919-000-228	\$41.36
0.3750	1.0000	1.2500	2.6250	0.9219	0.2969	90.0	919-000-229	\$41.89	919-000-230	\$55.27
0.5000	1.2500	1.5000	3.1250	1.0938	0.3594	90.0	919-000-231	\$101.50	919-000-232	\$121.56

COBALT

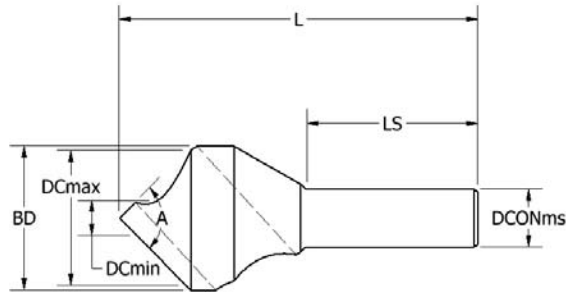

ZERO-FLUTE

DCONms	BD	LS	L	DCmax	DCmin	A	Uncoated	Price	TiN	Price
0.2500	0.3125	1.2500	1.6250	0.2813	0.0938	100.0	919-000-236	\$14.09	919-000-237	\$16.61
0.2500	0.3750	1.2500	1.7500	0.3438	0.1406	100.0	919-000-238	\$16.09	919-000-239	\$18.60
0.3125	0.5000	1.2500	1.7500	0.4531	0.1563	100.0	919-000-240	\$19.27	919-000-241	\$23.30
0.3750	0.6250	1.3750	2.1250	0.5781	0.1719	100.0	919-000-242	\$21.17	919-000-243	\$28.81
0.3750	0.7500	1.5000	2.3750	0.7031	0.2031	100.0	919-000-244	\$33.68	919-000-245	\$41.36
0.3750	1.0000	1.2500	2.6250	0.9219	0.2969	100.0	919-000-246	\$41.89	919-000-247	\$55.27
0.5000	1.2500	1.5000	3.1250	1.1250	0.3594	100.0	919-000-248	\$101.50	919-000-249	\$121.56

Zero Countersink & Deburring Tools

Straight Shank, CNC Precision Cam Ground, Cobalt, Chatter-free Cutting Action.

Sets include: 4 piece - 5/16, 3/8, 1/2, 5/8

5 piece - 5/16, 3/8, 1/2, 3/4, 1



Countersink Angle	4-Piece	Price	5-Piece	Price	5-Piece Coated	Price
60°	919-000-199	\$76.12	919-000-200	\$129.64	919-000-201	\$163.86
82°	919-000-216	\$76.12	919-000-217	\$129.64	919-000-218	\$163.86
90°	919-000-233	\$76.12	919-000-234	\$129.64	919-000-235	\$163.86
100°	919-000-250	\$76.12	919-000-251	\$129.64	919-000-252	\$163.86
Head Diameter	5/16, 3/8, 1/2, 5/8		5/16, 3/8, 1/2, 3/4, 1		5/16, 3/8, 1/2, 3/4, 1	

CARBIDE

SINGLE-FLUTE



DC	DCONms	LS	L	A	CARBIDE	Price	CARBIDE -TiAlN	Price
0.1250	0.1250	0.7500	1.5000	60.0	919-000-909	\$15.07	919-000-910	\$17.62
0.1875	0.1875	1.0000	2.0000	60.0	919-000-911	\$16.02	919-000-912	\$20.21
0.2500	0.2500	1.0000	2.0000	60.0	919-000-913	\$22.33	919-000-914	\$28.97
0.3750	0.2500	1.7500	2.8750	60.0	919-000-915	\$32.04	919-000-916	\$43.00
0.5000	0.2500	1.6250	2.8750	60.0	919-000-917	\$47.09	919-000-918	\$61.23
0.6250	0.3750	1.6250	3.0000	60.0	919-000-919	\$66.59	919-000-920	\$88.81
0.7500	0.3750	1.5000	3.0000	60.0	919-000-921	\$98.63	919-000-922	\$122.00
1.0000	0.5000	1.5000	3.2500	60.0	919-000-923	\$164.00	919-000-924	\$185.09
1.2500	0.7500	1.5000	3.7500	60.0	919-000-925	\$260.86	919-000-926	\$324.41
0.1250	0.1250	0.7500	1.5000	82.0	919-000-929	\$15.07	919-000-930	\$17.62
0.1875	0.1875	1.0000	2.0000	82.0	919-000-931	\$16.02	919-000-932	\$20.21
0.2500	0.2500	1.0000	2.0000	82.0	919-000-933	\$22.33	919-000-934	\$28.97
0.3750	0.2500	1.7500	2.6250	82.0	919-000-935	\$32.04	919-000-936	\$43.00
0.5000	0.2500	1.6250	2.6250	82.0	919-000-937	\$47.09	919-000-938	\$61.23
0.6250	0.3750	1.6250	2.7500	82.0	919-000-939	\$66.59	919-000-940	\$84.99
0.7500	0.3750	1.5000	2.7500	82.0	919-000-941	\$98.63	919-000-942	\$122.00
1.0000	0.5000	1.5000	3.0000	82.0	919-000-943	\$164.00	919-000-944	\$185.09
1.2500	0.7500	1.5000	3.2500	82.0	919-000-945	\$260.86	919-000-946	\$324.41
0.1250	0.1250	0.7500	1.5000	90.0	919-000-949	\$15.07	919-000-950	\$17.62
0.1875	0.1875	1.0000	2.0000	90.0	919-000-951	\$16.02	919-000-952	\$20.21
0.2500	0.2500	1.0000	2.0000	90.0	919-000-953	\$22.33	919-000-954	\$28.97
0.3750	0.2500	1.7500	2.6250	90.0	919-000-955	\$32.04	919-000-956	\$43.00
0.5000	0.2500	1.6250	2.6250	90.0	919-000-957	\$47.09	919-000-958	\$61.23
0.6250	0.3750	1.6250	2.7500	90.0	919-000-959	\$66.59	919-000-960	\$84.99
0.7500	0.3750	1.5000	2.7500	90.0	919-000-961	\$98.63	919-000-962	\$122.00
1.0000	0.5000	1.5000	3.0000	90.0	919-000-963	\$164.00	919-000-964	\$185.09
1.2500	0.7500	1.5000	3.2500	90.0	919-000-965	\$260.86	919-000-966	\$324.41
0.1250	0.1250	0.7500	1.5000	100.0	919-000-969	\$15.07	919-000-970	\$17.62
0.1875	0.1875	1.0000	2.0000	100.0	919-000-971	\$16.02	919-000-972	\$20.21
0.2500	0.2500	1.0000	2.0000	100.0	919-000-973	\$22.33	919-000-974	\$28.97
0.3750	0.2500	1.7500	2.6250	100.0	919-000-975	\$32.04	919-000-976	\$43.00
0.5000	0.2500	1.6250	2.6250	100.0	919-000-977	\$47.09	919-000-978	\$61.23
0.6250	0.3750	1.6250	2.7500	100.0	919-000-979	\$66.59	919-000-980	\$84.99
0.7500	0.3750	1.5000	2.7500	100.0	919-000-981	\$98.63	919-000-982	\$122.00
1.0000	0.5000	1.5000	3.0000	100.0	919-000-983	\$164.00	919-000-984	\$185.09
1.2500	0.7500	1.5000	3.2500	100.0	919-000-985	\$260.86	919-000-986	\$324.41

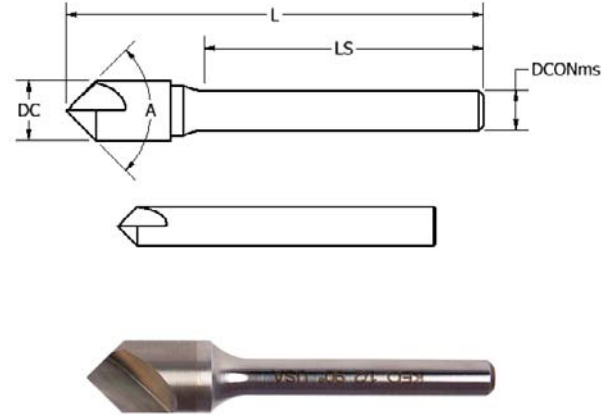

Carbide Countersink Sets

Carbide sets include one 1/4, 3/8, 1/2, 5/8 and 3/4" body diameter with a particular included point angle.



Countersink Angle	Single-Flute KIT#	Price	3-Flute KIT#	Price	6-Flute KIT#	Price
60°	919-000-927	\$366.23	917-000-319	\$373.55	919-001-010	\$384.75
60°	919-000-928	\$444.03	917-000-320	\$452.91	919-001-011	\$466.51
82°	919-000-947	\$366.23	917-000-339	\$373.55	919-001-032	\$384.75
82°	919-000-948	\$444.03	917-000-340	\$452.91	919-001-033	\$466.51
90°	919-000-967	\$366.23	917-000-359	\$373.55	919-001-054	\$384.75
90°	919-000-968	\$444.03	917-000-360	\$452.91	919-001-055	\$466.51
100°	919-000-987	\$366.23	917-000-379	\$373.55	919-001-077	\$384.75
100°	919-000-988	\$444.03	917-000-380	\$452.91	919-001-078	\$466.51

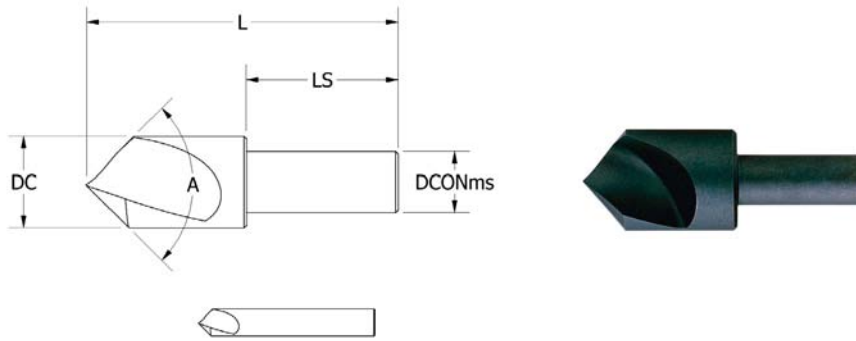

SINGLE-FLUTE



DC	DCONms	LS	L	A	HSS	Price	HSS-TiN	Price
0.1250	0.1250	0.6250	1.2500	60.0	919-000-107	\$8.73	919-000-108	\$9.74
0.1875	0.1875	0.6875	1.3750	60.0	919-000-095	\$8.95	919-000-096	\$10.40
0.2500	0.2500	0.7500	1.5000	60.0	919-000-083	\$9.31	919-000-084	\$11.24
0.3750	0.2500	0.8750	1.7500	60.0	919-000-167	\$10.62	919-000-168	\$13.08
0.5000	0.2500	1.0000	2.0000	60.0	919-000-071	\$12.99	919-000-072	\$16.95
0.6250	0.3750	1.0000	2.2500	60.0	919-000-259	\$17.39	919-000-260	\$23.91
0.7500	0.5000	1.2500	2.6250	60.0	919-000-155	\$25.37	919-000-156	\$32.88
1.0000	0.5000	1.2500	2.7500	60.0	919-000-059	\$43.52	919-000-060	\$56.57
1.2500	0.5000	1.2500	3.0000	60.0	919-000-143	\$85.19	919-000-144	\$100.83
1.5000	0.7500	1.2500	3.2500	60.0	919-000-131	\$115.35	919-000-132	\$139.82
1.7500	0.7500	1.2500	3.5000	60.0	919-000-179	\$147.26	919-000-180	\$186.41
2.0000	0.7500	1.2500	3.7500	60.0	919-000-119	\$206.11	919-000-120	\$245.25
0.1250	0.1250	0.6250	1.2500	82.0	919-000-109	\$8.73	919-000-110	\$9.74
0.1875	0.1875	0.6875	1.3750	82.0	919-000-097	\$8.95	919-000-098	\$10.40
0.2500	0.2500	0.7500	1.5000	82.0	919-000-085	\$9.31	919-000-086	\$11.24
0.3750	0.2500	0.8750	1.7500	82.0	919-000-169	\$10.62	919-000-170	\$13.08
0.5000	0.2500	1.0000	2.0000	82.0	919-000-073	\$12.99	919-000-074	\$16.95
0.6250	0.3750	1.0000	2.2500	82.0	919-000-261	\$17.39	919-000-262	\$23.91
0.7500	0.5000	1.2500	2.6250	82.0	919-000-157	\$25.37	919-000-158	\$32.88
1.0000	0.5000	1.2500	2.7500	82.0	919-000-061	\$43.52	919-000-062	\$56.57
1.2500	0.5000	1.2500	2.7500	82.0	919-000-145	\$85.19	919-000-146	\$100.83
1.5000	0.7500	1.2500	2.8750	82.0	919-000-133	\$115.35	919-000-134	\$139.82
1.7500	0.7500	1.2500	3.0000	82.0	919-000-181	\$147.26	919-000-182	\$186.41
2.0000	0.7500	1.2500	3.2500	82.0	919-000-121	\$206.11	919-000-122	\$245.25
0.1250	0.1250	0.6250	1.2500	90.0	919-000-111	\$8.73	919-000-112	\$9.74
0.1875	0.1875	0.6875	1.3750	90.0	919-000-099	\$8.95	919-000-100	\$10.40
0.2500	0.2500	0.7500	1.5000	90.0	919-000-087	\$9.31	919-000-088	\$11.24
0.3750	0.2500	0.8750	1.7500	90.0	919-000-171	\$10.62	919-000-172	\$13.08
0.5000	0.2500	1.0000	2.0000	90.0	919-000-075	\$12.99	919-000-076	\$16.95
0.6250	0.3750	1.0000	2.2500	90.0	919-000-263	\$17.39	919-000-264	\$23.91
0.7500	0.5000	1.2500	2.6250	90.0	919-000-159	\$25.37	919-000-160	\$32.88
1.0000	0.5000	1.2500	2.7500	90.0	919-000-063	\$43.52	919-000-064	\$56.57
1.2500	0.5000	1.2500	2.7500	90.0	919-000-147	\$85.19	919-000-148	\$100.83
1.5000	0.7500	1.2500	2.8750	90.0	919-000-135	\$115.35	919-000-136	\$139.82
1.7500	0.7500	1.2500	3.0000	90.0	919-000-183	\$147.26	919-000-184	\$186.41
2.0000	0.7500	1.2500	3.2500	90.0	919-000-123	\$206.11	919-000-124	\$245.25

For set information see **page 194**

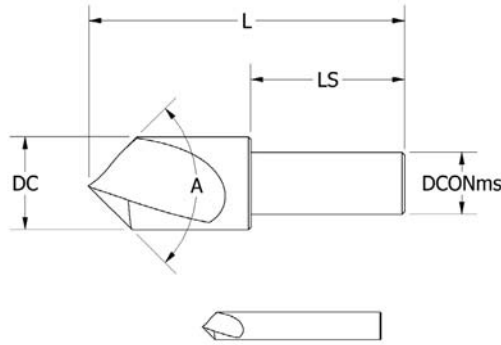

SINGLE-FLUTE



DC	DCONms	LS	L	A	HSS	Price	HSS-TiN	Price
0.1250	0.1250	0.6250	1.2500	100.0	919-000-101	\$8.73	919-000-102	\$9.74
0.1875	0.1875	0.6875	1.3750	100.0	919-000-089	\$8.95	919-000-090	\$10.40
0.2500	0.2500	0.7500	1.5000	100.0	919-000-077	\$9.31	919-000-078	\$11.24
0.3750	0.2500	0.8750	1.7500	100.0	919-000-161	\$10.62	919-000-162	\$13.08
0.5000	0.2500	1.0000	2.0000	100.0	919-000-065	\$12.99	919-000-066	\$16.95
0.6250	0.3750	1.0000	2.2500	100.0	919-000-253	\$17.39	919-000-254	\$23.91
0.7500	0.5000	1.2500	2.6250	100.0	919-000-149	\$25.37	919-000-150	\$32.88
1.0000	0.5000	1.2500	2.7500	100.0	919-000-053	\$43.52	919-000-054	\$56.57
1.2500	0.5000	1.2500	2.7500	100.0	919-000-137	\$85.19	919-000-138	\$100.83
1.5000	0.7500	1.2500	2.8750	100.0	919-000-125	\$115.35	919-000-126	\$139.82
1.7500	0.7500	1.2500	3.0000	100.0	919-000-173	\$147.26	919-000-174	\$186.41
0.1250	0.1250	0.6250	1.2500	110.0	919-000-103	\$8.73	919-000-104	\$9.74
0.1875	0.1875	0.6875	1.3750	110.0	919-000-091	\$8.95	919-000-092	\$10.40
0.2500	0.2500	0.7500	1.5000	110.0	919-000-079	\$9.31	919-000-080	\$11.24
0.3750	0.2500	0.8750	1.7500	110.0	919-000-163	\$10.62	919-000-164	\$13.08
0.5000	0.2500	1.0000	2.0000	110.0	919-000-067	\$12.99	919-000-068	\$16.95
0.6250	0.3750	1.0000	2.2500	110.0	919-000-255	\$17.39	919-000-256	\$23.91
0.7500	0.5000	1.2500	2.6250	110.0	919-000-151	\$25.37	919-000-152	\$32.88
1.0000	0.5000	1.2500	2.7500	110.0	919-000-055	\$43.52	919-000-056	\$56.57
1.2500	0.5000	1.2500	2.7500	110.0	919-000-139	\$85.19	919-000-140	\$100.83
1.5000	0.7500	1.2500	2.8750	110.0	919-000-127	\$115.35	919-000-128	\$139.82
1.7500	0.7500	1.2500	3.0000	110.0	919-000-175	\$147.26	919-000-176	\$186.41
2.0000	0.7500	1.2500	3.2500	110.0	919-000-115	\$206.11	919-000-116	\$245.25
0.1250	0.1250	0.6250	1.2500	120.0	919-000-105	\$8.73	919-000-106	\$9.74
0.1875	0.1875	0.6875	1.3750	120.0	919-000-093	\$8.95	919-000-094	\$10.40
0.2500	0.2500	0.7500	1.5000	120.0	919-000-081	\$9.31	919-000-082	\$11.24
0.3750	0.2500	0.8750	1.7500	120.0	919-000-165	\$10.62	919-000-166	\$13.08
0.5000	0.2500	1.0000	2.0000	120.0	919-000-069	\$12.99	919-000-070	\$16.95
0.3750	0.2500	0.8750	1.7500	120.0	919-000-165	\$17.39	919-000-166	\$23.91
0.7500	0.5000	1.2500	2.6250	120.0	919-000-153	\$25.37	919-000-154	\$32.88
1.0000	0.5000	1.2500	2.7500	120.0	919-000-057	\$43.52	919-000-058	\$56.57
1.2500	0.5000	1.2500	2.7500	120.0	919-000-141	\$85.19	919-000-142	\$100.83
1.5000	0.7500	1.2500	2.8750	120.0	919-000-129	\$115.35	919-000-130	\$139.82
1.7500	0.7500	1.2500	3.0000	120.0	919-000-177	\$147.26	919-000-178	\$186.41
2.0000	0.7500	1.2500	3.2500	120.0	919-000-117	\$206.11	919-000-118	\$245.25

For set information see **page 194**

HSS

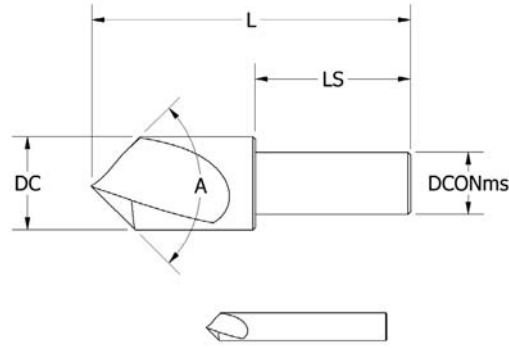

SINGLE-FLUTE



DC	DCONms	LS	L	A	COBALT	Price	COBALT-TiN	Price
0.1250	0.1250	0.6250	1.2500	60.0	919-000-549	\$10.04	919-000-550	\$11.19
0.1875	0.1875	0.6875	1.3750	60.0	919-000-551	\$10.29	919-000-552	\$11.97
0.2500	0.2500	0.7500	1.5000	60.0	919-000-553	\$10.71	919-000-554	\$13.53
0.3750	0.2500	0.8750	1.7500	60.0	919-000-555	\$12.22	919-000-556	\$15.04
0.5000	0.2500	1.0000	2.0000	60.0	919-000-557	\$14.95	919-000-558	\$19.48
0.6250	0.3750	1.0000	2.2500	60.0	919-000-559	\$19.99	919-000-560	\$27.49
0.7500	0.5000	1.2500	2.6250	60.0	919-000-561	\$29.18	919-000-562	\$37.81
1.0000	0.5000	1.2500	2.7500	60.0	919-000-563	\$50.05	919-000-564	\$65.06
1.2500	0.5000	1.2500	3.0000	60.0	919-000-565	\$97.97	919-000-566	\$115.96
1.5000	0.7500	1.2500	3.2500	60.0	919-000-567	\$132.65	919-000-568	\$160.79
1.7500	0.7500	1.2500	3.5000	60.0	919-000-569	\$169.35	919-000-570	\$214.37
2.0000	0.7500	1.2500	3.7500	60.0	919-000-571	\$237.02	919-000-572	\$282.04
0.1250	0.1250	0.6250	1.2500	82.0	919-000-573	\$10.04	919-000-574	\$11.19
0.1875	0.1875	0.6875	1.3750	82.0	919-000-575	\$10.29	919-000-576	\$11.97
0.2500	0.2500	0.7500	1.5000	82.0	919-000-577	\$10.71	919-000-578	\$13.53
0.3750	0.2500	0.8750	1.7500	82.0	919-000-579	\$12.22	919-000-580	\$15.04
0.5000	0.2500	1.0000	2.0000	82.0	919-000-581	\$14.95	919-000-582	\$19.48
0.6250	0.3750	1.0000	2.2500	82.0	919-000-583	\$19.99	919-000-584	\$27.49
0.7500	0.5000	1.2500	2.6250	82.0	919-000-585	\$29.18	919-000-586	\$37.81
1.0000	0.5000	1.2500	2.7500	82.0	919-000-587	\$50.05	919-000-588	\$65.06
1.2500	0.5000	1.2500	2.7500	82.0	919-000-589	\$97.97	919-000-590	\$115.96
1.5000	0.7500	1.2500	2.8750	82.0	919-000-591	\$132.65	919-000-592	\$160.79
1.7500	0.7500	1.2500	3.0000	82.0	919-000-593	\$169.35	919-000-594	\$214.37
2.0000	0.7500	1.2500	3.2500	82.0	919-000-595	\$237.02	919-000-596	\$282.04
0.1250	0.1250	0.6250	1.2500	90.0	919-000-597	\$10.04	919-000-598	\$11.19
0.1875	0.1875	0.6875	1.3750	90.0	919-000-599	\$10.29	919-000-600	\$11.97
0.2500	0.2500	0.7500	1.5000	90.0	919-000-601	\$10.71	919-000-602	\$13.53
0.3750	0.2500	0.8750	1.7500	90.0	919-000-603	\$12.22	919-000-604	\$15.04
0.5000	0.2500	1.0000	2.0000	90.0	919-000-605	\$14.95	919-000-606	\$19.48
0.6250	0.3750	1.0000	2.2500	90.0	919-000-607	\$19.99	919-000-608	\$27.49
0.7500	0.5000	1.2500	2.6250	90.0	919-000-609	\$29.18	919-000-610	\$37.81
1.0000	0.5000	1.2500	2.7500	90.0	919-000-611	\$50.05	919-000-612	\$65.06
1.2500	0.5000	1.2500	2.7500	90.0	919-000-613	\$97.97	919-000-614	\$115.96
1.5000	0.7500	1.2500	2.8750	90.0	919-000-615	\$132.65	919-000-616	\$160.79
1.7500	0.7500	1.2500	3.0000	90.0	919-000-617	\$169.35	919-000-618	\$214.37
2.0000	0.7500	1.2500	3.2500	90.0	919-000-619	\$237.02	919-000-620	\$282.04

For set information see page 194

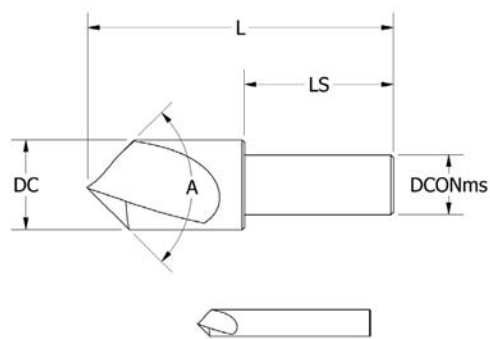

SINGLE-FLUTE



DC	DCONms	LS	L	A	COBALT	Price	COBALT-TiN	Price
0.1250	0.1250	0.6250	1.2500	100.0	919-000-621	\$10.04	919-000-622	\$11.19
0.1875	0.1875	0.6875	1.3750	100.0	919-000-623	\$10.29	919-000-624	\$11.97
0.2500	0.2500	0.7500	1.5000	100.0	919-000-625	\$10.71	919-000-626	\$13.53
0.3750	0.2500	0.8750	1.7500	100.0	919-000-627	\$12.22	919-000-628	\$15.04
0.5000	0.2500	1.0000	2.0000	100.0	919-000-629	\$14.95	919-000-630	\$19.48
0.6250	0.3750	1.0000	2.2500	100.0	919-000-631	\$19.99	919-000-632	\$27.49
0.7500	0.5000	1.2500	2.6250	100.0	919-000-633	\$29.18	919-000-634	\$37.81
1.0000	0.5000	1.2500	2.7500	100.0	919-000-635	\$50.05	919-000-636	\$65.06
1.2500	0.5000	1.2500	2.7500	100.0	919-000-637	\$97.97	919-000-638	\$115.96
1.5000	0.7500	1.2500	2.8750	100.0	919-000-639	\$132.65	919-000-640	\$160.79
1.7500	0.7500	1.2500	3.0000	100.0	919-000-641	\$169.35	919-000-642	\$214.37
2.0000	0.7500	1.2500	3.2500	100.0	919-000-643	\$237.02	919-000-644	\$282.04
0.1250	0.1250	0.6250	1.2500	110.0	919-000-645	\$10.04	919-000-646	\$11.19
0.1875	0.1875	0.6875	1.3750	110.0	919-000-647	\$10.29	919-000-648	\$11.97
0.2500	0.2500	0.7500	1.5000	110.0	919-000-649	\$10.71	919-000-650	\$13.53
0.3750	0.2500	0.8750	1.7500	110.0	919-000-651	\$12.22	919-000-652	\$15.04
0.5000	0.2500	1.0000	2.0000	110.0	919-000-653	\$14.95	919-000-654	\$19.48
0.6250	0.3750	1.0000	2.2500	110.0	919-000-655	\$19.99	919-000-656	\$27.49
0.7500	0.5000	1.2500	2.6250	110.0	919-000-657	\$29.18	919-000-658	\$37.81
1.0000	0.5000	1.2500	2.7500	110.0	919-000-659	\$50.05	919-000-660	\$65.06
1.2500	0.5000	1.2500	2.7500	110.0	919-000-661	\$97.97	919-000-662	\$115.96
1.5000	0.7500	1.2500	2.8750	110.0	919-000-663	\$132.65	919-000-664	\$160.79
1.7500	0.7500	1.2500	3.0000	110.0	919-000-665	\$169.35	919-000-666	\$214.37
2.0000	0.7500	1.2500	3.2500	110.0	919-000-667	\$237.02	919-000-668	\$282.04
0.1250	0.1250	0.6250	1.2500	120.0	919-000-669	\$10.04	919-000-670	\$11.19
0.1875	0.1875	0.6875	1.3750	120.0	919-000-671	\$10.29	919-000-672	\$11.97
0.2500	0.2500	0.7500	1.5000	120.0	919-000-673	\$10.71	919-000-674	\$13.53
0.3750	0.2500	0.8750	1.7500	120.0	919-000-675	\$12.22	919-000-676	\$15.04
0.5000	0.2500	1.0000	2.0000	120.0	919-000-677	\$14.95	919-000-678	\$19.48
0.6250	0.3750	1.0000	2.2500	120.0	919-000-679	\$19.99	919-000-680	\$27.49
0.7500	0.5000	1.2500	2.6250	120.0	919-000-681	\$29.18	919-000-682	\$37.81
1.0000	0.5000	1.2500	2.7500	120.0	919-000-683	\$50.05	919-000-684	\$65.06
1.2500	0.5000	1.2500	2.7500	120.0	919-000-685	\$97.97	919-000-686	\$115.96
1.5000	0.7500	1.2500	2.8750	120.0	919-000-687	\$132.65	919-000-688	\$160.79
1.7500	0.7500	1.2500	3.0000	120.0	919-000-689	\$169.35	919-000-690	\$214.37
2.0000	0.7500	1.2500	3.2500	120.0	919-000-691	\$237.02	919-000-692	\$282.04



Countersink Angle	HSS KIT#	Price	COBALT KIT#	Price
60°	919-000-050	\$108.60	919-000-044	\$124.90
82°	919-000-051	\$108.60	919-000-045	\$124.90
90°	919-000-052	\$108.60	919-000-046	\$124.90
100°	919-000-047	\$108.60	919-000-041	\$124.90
110°	919-000-048	\$108.60	919-000-042	\$124.90
120°	919-000-049	\$108.60	919-000-043	\$124.90

Single-Flute Countersink Sets - Available in HSS & Cobalt

Each 5-piece set includes one piece each of 1/4, 3/8, 1/2, 3/4, and 1" body diameter with a particular included point angle.

Cobalt



CARBIDE

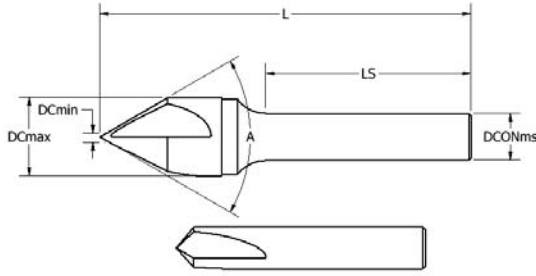

3-FLUTE



DCONms	LS	L	DCmax	DCmin	A	CARBIDE	Price	CARBIDE-TiAlN	Price
0.1250	0.7500	1.5000	0.1250	0.0156	60.0	917-000-301	\$15.37	917-000-302	\$18.78
0.1875	1.0000	2.0000	0.1875	0.0313	60.0	917-000-303	\$16.34	917-000-304	\$20.62
0.2500	1.0000	2.0000	0.2500	0.0625	60.0	917-000-305	\$22.78	917-000-306	\$29.54
0.2500	1.7500	2.8750	0.3750	0.0625	60.0	917-000-307	\$32.68	917-000-308	\$43.86
0.2500	1.6250	2.8750	0.5000	0.0625	60.0	917-000-309	\$48.03	917-000-310	\$62.45
0.3750	1.6250	3.0000	0.6250	0.0625	60.0	917-000-311	\$70.99	917-000-312	\$94.67
0.3750	1.5000	3.0000	0.7500	0.0625	60.0	917-000-313	\$100.60	917-000-314	\$124.44
0.5000	1.5000	3.2500	1.0000	0.1250	60.0	917-000-315	\$167.27	917-000-316	\$197.31
0.7500	1.5000	3.2500	1.2500	0.1875	60.0	917-000-317	\$266.08	917-000-318	\$330.89
0.1250	0.7500	1.5000	0.1250	0.0156	82.0	917-000-321	\$15.37	917-000-322	\$18.78
0.1875	1.0000	2.0000	0.1875	0.0313	82.0	917-000-323	\$16.34	917-000-324	\$20.62
0.2500	1.0000	2.0000	0.2500	0.0625	82.0	917-000-325	\$22.78	917-000-326	\$29.54
0.2500	1.7500	2.6250	0.3750	0.0625	82.0	917-000-327	\$32.68	917-000-328	\$43.86
0.2500	1.6250	2.6250	0.5000	0.0625	82.0	917-000-329	\$48.03	917-000-330	\$62.45
0.3750	1.6250	2.7500	0.6250	0.0625	82.0	917-000-331	\$70.99	917-000-332	\$94.67
0.3750	1.5000	2.7500	0.7500	0.0625	82.0	917-000-333	\$100.60	917-000-334	\$124.44
0.5000	1.5000	3.0000	1.0000	0.0938	82.0	917-000-335	\$167.27	917-000-336	\$197.31
0.7500	1.5000	3.2500	1.2500	0.1250	82.0	917-000-337	\$266.08	917-000-338	\$330.89
0.1250	0.7500	1.5000	0.1250	0.0156	90.0	917-000-341	\$15.37	917-000-342	\$18.78
0.1875	1.0000	2.0000	0.1875	0.0313	90.0	917-000-343	\$16.34	917-000-344	\$20.62
0.2500	1.0000	2.0000	0.2500	0.0625	90.0	917-000-345	\$22.78	917-000-346	\$29.54
0.2500	1.7500	2.6250	0.3750	0.0625	90.0	917-000-347	\$32.68	917-000-348	\$43.86
0.2500	1.6250	2.6250	0.5000	0.0625	90.0	917-000-349	\$48.03	917-000-350	\$62.45
0.3750	1.6250	2.7500	0.6250	0.0625	90.0	917-000-351	\$70.99	917-000-352	\$94.67
0.3750	1.5000	2.7500	0.7500	0.0625	90.0	917-000-353	\$100.60	917-000-354	\$124.44
0.5000	1.5000	3.0000	1.0000	0.0938	90.0	917-000-355	\$167.27	917-000-356	\$197.31
0.7500	1.5000	3.2500	1.2500	0.1250	90.0	917-000-357	\$266.08	917-000-358	\$330.89
0.1250	0.7500	1.5000	0.1250	0.0156	100.0	917-000-361	\$15.37	917-000-362	\$18.78
0.1875	1.0000	2.0000	0.1875	0.0313	100.0	917-000-363	\$16.34	917-000-364	\$20.62
0.2500	1.0000	2.0000	0.2500	0.0625	100.0	917-000-365	\$22.78	917-000-366	\$29.54
0.2500	1.7500	2.6250	0.3750	0.0625	100.0	917-000-367	\$32.68	917-000-368	\$43.86
0.2500	1.6250	2.6250	0.5000	0.0625	100.0	917-000-369	\$48.03	917-000-370	\$62.45
0.3750	1.6250	2.7500	0.6250	0.0625	100.0	917-000-371	\$70.99	917-000-372	\$94.67
0.3750	1.5000	2.7500	0.7500	0.0625	100.0	917-000-373	\$100.60	917-000-374	\$124.44
0.5000	1.5000	3.0000	1.0000	0.0625	100.0	917-000-375	\$167.27	917-000-376	\$197.31
0.7500	1.5000	3.2500	1.2500	0.0938	100.0	917-000-377	\$266.08	917-000-378	\$330.89

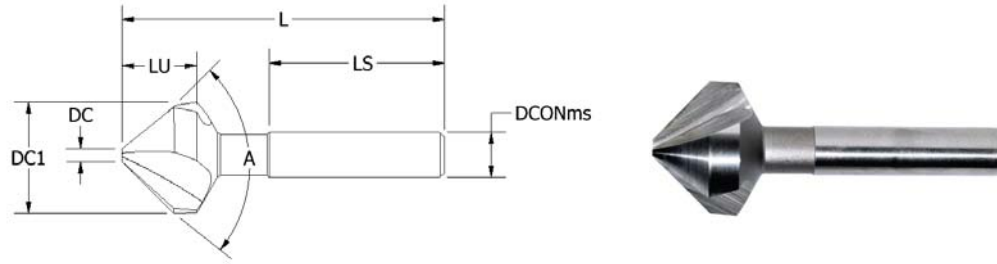

COBALT

3-FLUTE



DC	DCONms	DC1	LU	LS	L	A	COBALT	Price
0.0590	0.2031	0.2500	0.2550	1.2500	1.7500	60.0	919-000-265	\$16.28
0.0510	0.2500	0.3125	0.3360	1.2031	1.7500	60.0	919-000-266	\$15.73
0.0870	0.2500	0.3750	0.4060	1.2031	1.7500	60.0	919-000-267	\$16.22
0.0980	0.2500	0.5000	0.5350	1.2500	1.8750	60.0	919-000-268	\$17.62
0.1100	0.3750	0.6250	0.6490	1.5000	2.2500	60.0	919-000-269	\$22.47
0.1180	0.3750	0.7500	0.7500	1.5000	2.5000	60.0	919-000-270	\$25.16
0.1260	0.3750	1.0000	0.9760	1.5000	2.7500	60.0	919-000-271	\$37.41
0.1970	0.5000	1.2500	1.1620	1.7500	3.2500	60.0	919-000-272	\$76.89
0.0590	0.2031	0.2500	0.2000	1.2500	1.7500	82.0	919-000-273	\$14.13
0.0510	0.2500	0.3125	0.2600	1.2031	1.7500	82.0	919-000-274	\$13.03
0.0870	0.2500	0.3750	0.3220	1.2031	1.7500	82.0	919-000-275	\$13.11
0.0980	0.2500	0.5000	0.4180	1.2500	1.8750	82.0	919-000-276	\$13.50
0.1100	0.3750	0.6250	0.4990	1.5000	2.2500	82.0	919-000-277	\$18.06
0.1180	0.3750	0.7500	0.5670	1.5000	2.5000	82.0	919-000-278	\$20.90
0.1260	0.3750	1.0000	0.7210	1.5000	2.7500	82.0	919-000-279	\$28.86
0.1970	0.5000	1.2500	0.8560	1.7500	3.2500	82.0	919-000-280	\$58.76
0.0590	0.2031	0.2500	0.1850	1.2500	1.7500	90.0	919-000-281	\$14.13
0.0510	0.2500	0.3125	0.2400	1.2031	1.7500	90.0	919-000-282	\$13.03
0.0870	0.2500	0.3750	0.3000	1.2031	1.7500	90.0	919-000-283	\$13.11
0.0980	0.2500	0.5000	0.3880	1.2500	1.8750	90.0	919-000-284	\$13.50
0.1100	0.3750	0.6250	0.4610	1.5000	2.2500	90.0	919-000-285	\$18.06
0.1180	0.3750	0.7500	0.5190	1.5000	2.5000	90.0	919-000-286	\$20.90
0.1260	0.3750	1.0000	0.6560	1.5000	2.7500	90.0	919-000-287	\$29.98
0.1970	0.5000	1.2500	0.7770	1.7500	3.2500	90.0	919-000-288	\$57.37
0.0590	0.2031	0.2500	0.1700	1.2500	1.7500	100.0	919-000-289	\$16.28
0.0510	0.2500	0.3125	0.2190	1.2031	1.7500	100.0	919-000-290	\$15.73
0.0870	0.2500	0.3750	0.2770	1.2031	1.7500	100.0	919-000-291	\$16.22
0.0980	0.2500	0.5000	0.3560	1.2500	1.8750	100.0	919-000-292	\$17.62
0.1100	0.3750	0.6250	0.4190	1.5000	2.2500	100.0	919-000-293	\$22.47
0.1180	0.3750	0.7500	0.4680	1.5000	2.5000	100.0	919-000-294	\$25.74
0.1260	0.3750	1.0000	0.5850	1.5000	2.7500	100.0	919-000-295	\$36.26
0.1970	0.5000	1.2500	0.6920	1.7500	3.2500	100.0	919-000-296	\$75.21

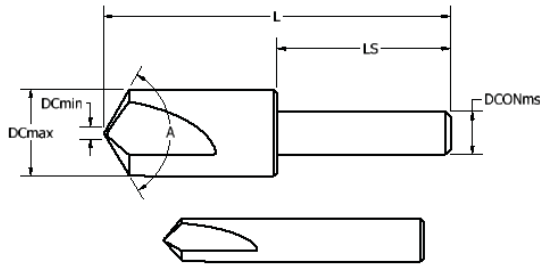

HSS

3-FLUTE



DCONms	LS	L	DCmax	DCmin	A	HSS	Price	HSS-TiN	Price
0.2500	0.7500	1.5000	0.2500	0.0625	60.0	917-000-031	\$9.43	917-000-032	\$11.36
0.2500	0.8750	1.7500	0.3750	0.0625	60.0	917-000-055	\$10.60	917-000-056	\$13.05
0.2500	1.0000	2.0000	0.5000	0.0938	60.0	917-000-019	\$13.05	917-000-020	\$17.00
0.3750	1.0000	2.2500	0.6250	0.0938	60.0	917-000-067	\$17.36	917-000-068	\$23.88
0.5000	1.2500	2.6250	0.7500	0.1250	60.0	917-000-043	\$25.39	917-000-044	\$32.87
0.5000	1.2500	2.7500	1.0000	0.1250	60.0	917-000-079	\$40.39	917-000-080	\$53.43
0.5000	1.2500	3.0000	1.2500	0.1250	60.0	917-000-103	\$98.17	917-000-104	\$113.81
0.7500	1.2500	3.2500	1.5000	0.1250	60.0	917-000-121	\$149.60	917-000-122	\$174.05
0.7500	1.2500	3.5000	1.7500	0.1250	60.0	917-000-133	\$188.59	917-000-134	\$227.68
0.7500	1.2500	3.7500	2.0000	0.1250	60.0	917-000-151	\$250.95	917-000-152	\$290.05
0.2500	0.7500	1.5000	0.2500	0.0625	82.0	917-000-033	\$9.43	917-000-034	\$11.36
0.2500	0.8750	1.7500	0.3750	0.0625	82.0	917-000-057	\$10.60	917-000-058	\$13.05
0.2500	1.0000	2.0000	0.5000	0.0625	82.0	917-000-021	\$13.05	917-000-022	\$17.00
0.3750	1.0000	2.2500	0.6250	0.0625	82.0	917-000-069	\$17.36	917-000-070	\$23.88
0.5000	1.2500	2.6250	0.7500	0.0938	82.0	917-000-045	\$25.39	917-000-046	\$32.87
0.5000	1.2500	2.7500	1.0000	0.0938	82.0	917-000-081	\$40.39	917-000-082	\$53.43
0.5000	1.2500	2.7500	1.2500	0.0938	82.0	917-000-105	\$94.72	917-000-106	\$110.34
0.7500	1.2500	2.8750	1.5000	0.0938	82.0	917-000-123	\$135.58	917-000-124	\$160.02
0.7500	1.2500	3.0000	1.7500	0.0938	82.0	917-000-135	\$179.47	917-000-136	\$218.56
0.7500	1.2500	3.2500	2.0000	0.0938	82.0	917-000-153	\$220.56	917-000-154	\$259.66
0.2500	0.7500	1.5000	0.2500	0.0625	90.0	917-000-035	\$9.43	917-000-036	\$11.36
0.2500	0.8750	1.7500	0.3750	0.0625	90.0	917-000-059	\$10.60	917-000-060	\$13.05
0.2500	1.0000	2.0000	0.5000	0.0625	90.0	917-000-023	\$13.05	917-000-024	\$17.00
0.3750	1.0000	2.2500	0.6250	0.0625	90.0	917-000-071	\$17.36	917-000-072	\$23.88
0.5000	1.2500	2.6250	0.7500	0.0938	90.0	917-000-047	\$25.39	917-000-048	\$32.87
0.5000	1.2500	2.7500	1.0000	0.0938	90.0	917-000-083	\$40.39	917-000-084	\$53.43
0.5000	1.2500	2.7500	1.2500	0.0938	90.0	917-000-107	\$94.72	917-000-108	\$110.34
0.7500	1.2500	2.8750	1.5000	0.0938	90.0	917-000-125	\$135.58	917-000-126	\$160.02
0.7500	1.2500	3.0000	1.7500	0.0938	90.0	917-000-137	\$179.47	917-000-138	\$218.56
0.7500	1.2500	3.2500	2.0000	0.0938	90.0	917-000-155	\$220.56	917-000-156	\$259.66

For set information see **page 200**.

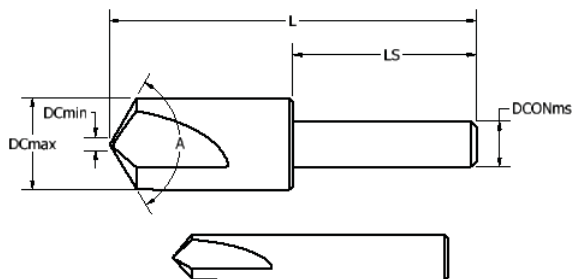

3-FLUTE



DCONms	LS	L	DCmax	DCmin	A	HSS	Price	HSS-TiN	Price
0.2500	0.7500	1.5000	0.5000	0.0625	100.0	917-000-025	\$9.43	917-000-026	\$11.36
0.2500	0.8750	1.7500	0.3750	0.0625	100.0	917-000-049	\$10.60	917-000-050	\$13.05
0.2500	1.0000	2.0000	0.5000	0.0625	100.0	917-000-013	\$13.05	917-000-014	\$17.00
0.3750	1.0000	2.2500	0.6250	0.0625	100.0	917-000-061	\$17.36	917-000-062	\$23.88
0.5000	1.2500	2.6250	0.7500	0.0625	100.0	917-000-037	\$25.39	917-000-038	\$32.87
0.5000	1.2500	2.7500	1.0000	0.0625	100.0	917-000-073	\$40.39	917-000-074	\$53.43
0.5000	1.2500	2.7500	1.2500	0.0625	100.0	917-000-097	\$94.72	917-000-098	\$110.34
0.7500	1.2500	2.8750	1.5000	0.0625	100.0	917-000-115	\$135.58	917-000-116	\$160.02
0.7500	1.2500	3.0000	1.7500	0.0625	100.0	917-000-127	\$179.47	917-000-128	\$218.56
0.7500	1.2500	3.2500	2.0000	0.0625	100.0	917-000-145	\$220.56	917-000-146	\$259.66
0.2500	0.7500	1.5000	0.2500	0.0313	110.0	917-000-027	\$9.43	917-000-028	\$11.36
0.2500	0.8750	1.7500	0.3750	0.0313	110.0	917-000-051	\$10.60	917-000-052	\$13.05
0.2500	1.0000	2.0000	0.5000	0.0625	110.0	917-000-015	\$13.05	917-000-016	\$17.00
0.3750	1.0000	2.2500	0.6250	0.0625	110.0	917-000-063	\$17.36	917-000-064	\$23.88
0.5000	1.2500	2.6250	0.7500	0.0625	110.0	917-000-039	\$25.39	917-000-040	\$32.87
0.5000	1.2500	2.7500	1.0000	0.0625	110.0	917-000-075	\$40.39	917-000-076	\$53.43
0.5000	1.2500	2.7500	1.2500	0.0625	110.0	917-000-099	\$94.72	917-000-100	\$110.34
0.7500	1.2500	2.8750	1.5000	0.0625	110.0	917-000-117	\$135.58	917-000-118	\$160.02
0.7500	1.2500	3.0000	1.7500	0.0625	110.0	917-000-129	\$179.47	917-000-130	\$218.56
0.7500	1.2500	3.2500	2.0000	0.0625	110.0	917-000-147	\$220.56	917-000-148	\$259.66
0.2500	0.7500	1.5000	0.2500	0.0313	120.0	917-000-029	\$9.43	917-000-030	\$11.36
0.2500	0.8750	1.7500	0.3750	0.0313	120.0	917-000-053	\$10.60	917-000-054	\$13.05
0.2500	1.0000	2.0000	0.5000	0.0625	120.0	917-000-017	\$13.05	917-000-018	\$17.00
0.3750	1.0000	2.2500	0.6250	0.0625	120.0	917-000-065	\$17.36	917-000-066	\$23.88
0.5000	1.2500	2.6250	0.7500	0.0625	120.0	917-000-041	\$25.39	917-000-042	\$32.87
0.5000	1.2500	2.7500	1.0000	0.0625	120.0	917-000-077	\$40.39	917-000-078	\$53.43
0.5000	1.2500	2.7500	1.2500	0.0625	120.0	917-000-101	\$94.72	917-000-102	\$110.34
0.7500	1.2500	2.8750	1.5000	0.0625	120.0	917-000-119	\$135.58	917-000-120	\$160.02
0.7500	1.2500	3.0000	1.7500	0.0625	120.0	917-000-131	\$179.47	917-000-132	\$218.56
0.7500	1.2500	3.2500	2.0000	0.0625	120.0	917-000-149	\$220.56	917-000-150	\$259.66

For set information see page 200.

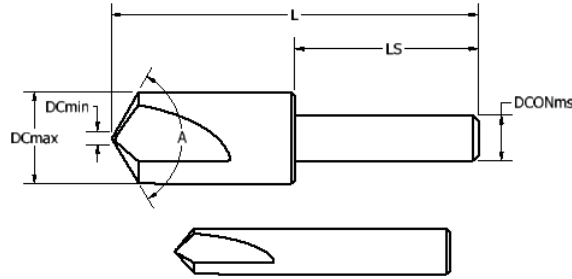

3-FLUTE



DCONms	LS	L	DCmax	DCmin	A	COBALT	Price	COBALT-TiN	Price
0.2500	0.7500	1.5000	0.2500	0.0625	60.0	917-000-157	\$11.32	917-000-158	\$13.66
0.2500	0.8750	1.7500	0.3750	0.0625	60.0	917-000-159	\$12.74	917-000-160	\$15.69
0.2500	1.0000	2.0000	0.5000	0.0938	60.0	917-000-161	\$15.69	917-000-162	\$20.42
0.3750	1.0000	2.2500	0.6250	0.0938	60.0	917-000-163	\$21.81	917-000-164	\$28.71
0.5000	1.2500	2.6250	0.7500	0.1250	60.0	917-000-165	\$29.19	917-000-166	\$39.50
0.5000	1.2500	2.7500	1.0000	0.1250	60.0	917-000-167	\$48.53	917-000-168	\$64.22
0.5000	1.2500	3.0000	1.2500	0.1250	60.0	917-000-169	\$117.98	917-000-170	\$136.76
0.7500	1.2500	3.2500	1.5000	0.1250	60.0	917-000-171	\$179.79	917-000-172	\$209.16
0.7500	1.2500	3.5000	1.7500	0.1250	60.0	917-000-173	\$226.64	917-000-174	\$273.62
0.7500	1.2500	3.7500	2.0000	0.1250	60.0	917-000-175	\$301.58	917-000-176	\$348.57
0.2500	0.7500	1.5000	0.2500	0.0625	82.0	917-000-177	\$11.32	917-000-178	\$13.66
0.2500	0.8750	1.7500	0.3750	0.0625	82.0	917-000-179	\$12.74	917-000-180	\$15.69
0.2500	1.0000	2.0000	0.5000	0.0625	82.0	917-000-181	\$15.69	917-000-182	\$20.42
0.3750	1.0000	2.2500	0.6250	0.0625	82.0	917-000-183	\$21.81	917-000-184	\$28.71
0.5000	1.2500	2.7500	0.7500	0.0938	82.0	917-000-185	\$29.19	917-000-186	\$39.50
0.5000	1.2500	2.7500	1.0000	0.0938	82.0	917-000-187	\$48.53	917-000-188	\$64.22
0.5000	2.7500	3.0000	1.2500	0.0938	82.0	917-000-189	\$117.98	917-000-190	\$136.76
0.7500	1.2500	2.8750	1.5000	0.0938	82.0	917-000-191	\$179.79	917-000-192	\$209.16
0.7500	1.2500	3.0000	1.7500	0.0938	82.0	917-000-193	\$226.64	917-000-194	\$273.62
0.7500	1.2500	3.2500	2.0000	0.0938	82.0	917-000-195	\$301.58	917-000-196	\$348.57
0.2500	0.7500	1.5000	0.2500	0.0625	90.0	917-000-197	\$11.32	917-000-198	\$13.66
0.2500	0.8750	1.7500	0.3750	0.0625	90.0	917-000-199	\$12.74	917-000-200	\$15.69
0.2500	1.0000	2.0000	0.5000	0.0625	90.0	917-000-201	\$15.69	917-000-202	\$20.42
0.3750	1.0000	2.2500	0.6250	0.0625	90.0	917-000-203	\$21.81	917-000-204	\$28.71
0.5000	1.2500	2.6250	0.7500	0.0938	90.0	917-000-205	\$29.19	917-000-206	\$39.50
0.5000	1.2500	2.7500	1.0000	0.0938	90.0	917-000-207	\$48.53	917-000-208	\$64.22
0.5000	1.2500	2.7500	1.2500	0.0938	90.0	917-000-209	\$117.98	917-000-210	\$136.76
0.7500	1.2500	2.8750	1.5000	0.0938	90.0	917-000-211	\$179.79	917-000-212	\$209.16
0.7500	1.2500	3.0000	1.7500	0.0938	90.0	917-000-213	\$226.64	917-000-214	\$273.62
0.7500	1.2500	3.2500	2.0000	0.0938	90.0	917-000-215	\$301.58	917-000-216	\$348.57

For set information see page 200.

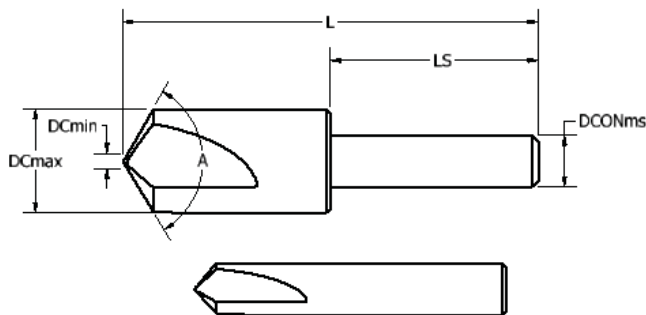

3-FLUTE



DCONms	LS	L	DCmax	DCmin	A	COBALT	Price	COBALT-TiN	Price
0.2500	0.7500	1.5000	0.2500	0.0625	100.0	917-000-217	\$11.32	917-000-218	\$13.66
0.2500	0.8750	1.7500	0.3750	0.0625	100.0	917-000-219	\$12.74	917-000-220	\$15.69
0.2500	1.0000	2.0000	0.5000	0.0625	100.0	917-000-221	\$15.69	917-000-222	\$20.42
0.3750	1.0000	2.2500	0.6250	0.0625	100.0	917-000-223	\$21.81	917-000-224	\$28.71
0.5000	1.2500	2.6250	0.7500	0.0625	100.0	917-000-225	\$29.19	917-000-226	\$39.50
0.5000	1.2500	2.7500	1.0000	0.0625	100.0	917-000-227	\$48.53	917-000-228	\$64.22
0.5000	1.2500	2.7500	1.2500	0.0625	100.0	917-000-229	\$117.98	917-000-230	\$136.76
0.7500	1.2500	2.8750	1.5000	0.0625	100.0	917-000-231	\$179.79	917-000-232	\$209.16
0.7500	1.2500	3.0000	1.7500	0.0625	100.0	917-000-233	\$226.64	917-000-234	\$273.62
0.7500	1.2500	3.2500	2.0000	0.0625	100.0	917-000-235	\$301.58	917-000-236	\$348.57
0.2500	0.7500	1.5000	0.2500	0.0313	110.0	917-000-237	\$11.32	917-000-238	\$13.66
0.2500	0.8750	1.7500	0.3750	0.0313	110.0	917-000-239	\$12.74	917-000-240	\$15.69
0.2500	1.0000	2.0000	0.5000	0.0625	110.0	917-000-241	\$15.69	917-000-242	\$20.42
0.3750	1.0000	2.2500	0.6250	0.0625	110.0	917-000-243	\$21.81	917-000-244	\$28.71
0.5000	1.2500	2.6250	0.7500	0.0625	110.0	917-000-245	\$29.19	917-000-246	\$39.50
0.5000	1.2500	2.7500	1.0000	0.0625	110.0	917-000-247	\$48.53	917-000-248	\$64.22
0.5000	1.2500	2.7500	1.2500	0.0625	110.0	917-000-249	\$117.98	917-000-250	\$136.76
0.7500	1.2500	2.8750	1.5000	0.0625	110.0	917-000-251	\$179.79	917-000-252	\$209.16
0.7500	1.2500	3.0000	1.7500	0.0625	110.0	917-000-253	\$226.64	917-000-254	\$273.62
0.7500	1.2500	3.2500	2.0000	0.0625	110.0	917-000-255	\$301.58	917-000-256	\$348.57
0.2500	0.7500	1.5000	0.2500	0.0313	120.0	917-000-257	\$11.32	917-000-258	\$13.66
0.2500	0.8750	1.7500	0.3750	0.0313	120.0	917-000-259	\$12.74	917-000-260	\$15.69
0.2500	1.0000	2.0000	0.5000	0.0625	120.0	917-000-261	\$15.69	917-000-262	\$20.42
0.3750	1.0000	2.2500	0.6250	0.0625	120.0	917-000-263	\$21.81	917-000-264	\$28.71
0.5000	1.2500	2.6250	0.7500	0.0625	120.0	917-000-265	\$29.19	917-000-266	\$39.50
0.5000	1.2500	2.7500	1.0000	0.0625	120.0	917-000-267	\$48.53	917-000-268	\$64.22
0.5000	1.2500	2.7500	1.2500	0.0625	120.0	917-000-269	\$117.98	917-000-270	\$136.76
0.7500	1.2500	2.8750	1.5000	0.0625	120.0	917-000-271	\$179.79	917-000-272	\$209.16
0.7500	1.2500	3.0000	1.7500	0.0625	120.0	917-000-273	\$226.64	917-000-274	\$273.62
0.7500	1.2500	3.2500	2.0000	0.0625	120.0	917-000-275	\$301.58	917-000-276	\$348.57

COBALT



Countersink Angle	HSS KIT#	Price	COBALT KIT#	Price
60°	917-000-004	\$119.33	917-000-010	\$137.22
82°	917-000-005	\$119.33	917-000-011	\$137.22
90°	917-000-006	\$119.33	917-000-012	\$137.22
100°	917-000-001	\$119.33	917-000-007	\$137.22
110°	917-000-002	\$119.33	917-000-008	\$137.22
120°	917-000-003	\$119.33	917-000-009	\$137.22

3-Flute Center Reamer Sets - Available in HSS & Cobalt

Each 5-piece set includes one piece each of 1/4, 3/8, 1/2, 3/4, and 1" body diameter with a particular included point angle.

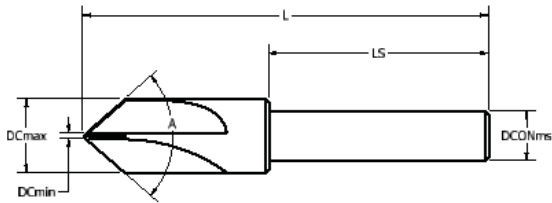

4-FLUTE



DCONms	LS	L	DCmax	DCmin	A	HSS	Price	HSS-TiN	Price	CO	Price	COBALT-TiN	Price
0.5000	2.2500	3.8750	0.5000	0.1094	60.0	919-000-001	\$34.18	919-000-002	\$41.02	919-000-519	\$39.31	919-000-520	\$47.17
0.5000	2.2500	4.0000	0.6250	0.1563	60.0	919-000-013	\$38.38	919-000-014	\$46.04	919-000-521	\$44.13	919-000-522	\$52.95
0.5000	2.2500	4.1250	0.7500	0.2031	60.0	919-000-007	\$51.18	919-000-008	\$61.43	919-000-523	\$58.86	919-000-524	\$70.64
0.5000	2.2500	4.2500	0.8750	0.2031	60.0	919-000-019	\$60.63	919-000-020	\$72.74	919-000-525	\$69.72	919-000-526	\$83.65
0.5000	2.2500	4.3750	1.0000	0.2031	60.0	919-000-025	\$70.99	919-000-026	\$85.19	919-000-527	\$85.32	919-000-528	\$97.96
0.5000	2.2500	3.8750	0.5000	0.1094	82.0	919-000-003	\$34.18	919-000-004	\$41.02	919-000-529	\$39.31	919-000-530	\$47.17
0.5000	2.2500	4.0000	0.6250	0.1250	82.0	919-000-015	\$38.38	919-000-016	\$46.04	919-000-531	\$44.13	919-000-532	\$52.95
0.5000	2.2500	4.1250	0.7500	0.1406	82.0	919-000-009	\$51.18	919-000-010	\$61.43	919-000-533	\$58.86	919-000-534	\$70.64
0.5000	2.2500	4.2500	0.8750	0.1563	82.0	919-000-021	\$60.63	919-000-022	\$72.74	919-000-535	\$69.72	919-000-536	\$83.65
0.5000	2.2500	4.3750	1.0000	0.1719	82.0	919-000-027	\$70.99	919-000-028	\$85.19	919-000-537	\$85.32	919-000-538	\$97.96
0.5000	2.2500	3.8750	0.5000	0.1094	90.0	919-000-005	\$34.18	919-000-006	\$41.02	919-000-539	\$39.31	919-000-540	\$47.17
0.5000	2.2500	4.0000	0.6250	0.1250	90.0	919-000-017	\$38.38	919-000-018	\$46.04	919-000-541	\$44.13	919-000-542	\$52.95
0.5000	2.2500	4.1250	0.7500	0.1406	90.0	919-000-011	\$51.18	919-000-012	\$61.43	919-000-543	\$58.86	919-000-544	\$70.64
0.5000	2.2500	4.2500	0.8750	0.1563	90.0	919-000-023	\$60.63	919-000-024	\$72.74	919-000-545	\$69.72	919-000-546	\$83.65
0.5000	2.2500	4.3750	1.0000	0.1719	90.0	919-000-029	\$70.99	919-000-030	\$85.19	919-000-547	\$85.32	919-000-548	\$97.96

HSS
COBALT



HSS
COBALT

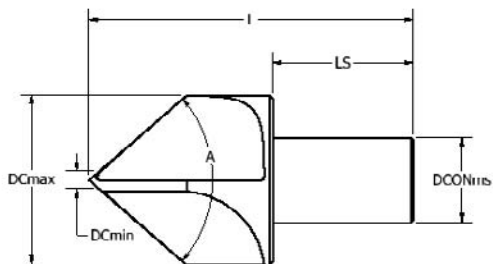

4-FLUTE



DCONms	LS	L	DCmax	DCmin	A	HSS	Price	HSS-TiN	Price	COBALT	Price	COBALT-TiN	Price
0.5000	1.2500	3.0000	1.2500	0.4375	60.0	917-000-091	\$88.01	917-000-092	\$105.63	917-000-277	\$101.22	917-000-278	\$121.47
0.7500	1.2500	3.2500	1.5000	0.5625	60.0	917-000-085	\$120.24	917-000-086	\$144.28	917-000-279	\$138.27	917-000-280	\$158.77
0.7500	1.2500	3.5000	1.7500	0.5625	60.0	917-000-109	\$152.20	917-000-110	\$182.66	917-000-281	\$175.05	917-000-282	\$210.05
0.7500	1.2500	3.7500	2.0000	0.5625	60.0	917-000-139	\$213.03	917-000-140	\$255.65	917-000-283	\$244.99	917-000-284	\$293.99
0.5000	1.2500	2.7500	1.2500	0.3750	82.0	917-000-093	\$88.01	917-000-094	\$105.63	917-000-285	\$101.22	917-000-286	\$121.47
0.7500	1.2500	2.8750	1.5000	0.5156	82.0	917-000-087	\$120.24	917-000-088	\$144.28	917-000-287	\$138.27	917-000-288	\$158.77
0.7500	1.2500	3.0000	1.7500	0.5156	82.0	917-000-111	\$152.20	917-000-112	\$182.66	917-000-289	\$175.05	917-000-290	\$210.05
0.7500	1.2500	3.2500	2.0000	0.5313	82.0	917-000-141	\$213.03	917-000-142	\$255.65	917-000-291	\$244.99	917-000-292	\$293.99
0.5000	1.2500	2.7500	1.2500	0.3594	90.0	917-000-095	\$88.01	917-000-096	\$105.63	917-000-293	\$101.22	917-000-294	\$121.47
0.7500	1.2500	2.8750	1.5000	0.5000	90.0	917-000-089	\$120.24	917-000-090	\$144.28	917-000-295	\$138.27	917-000-296	\$158.77
0.7500	1.2500	3.0000	1.7500	0.5000	90.0	917-000-113	\$152.20	917-000-114	\$182.66	917-000-297	\$175.05	917-000-298	\$210.05
0.7500	1.2500	3.2500	2.0000	0.5000	90.0	917-000-143	\$213.03	917-000-144	\$255.65	917-000-299	\$244.99	917-000-300	\$293.99

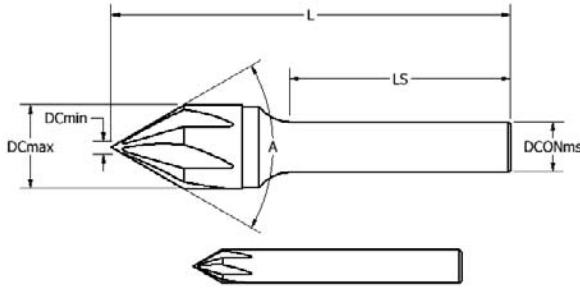

6-FLUTE



DCONms	LS	L	DCmax	DCmin	A	CARBIDE	Price	CARBIDE-TiAlN	Price
0.1250	0.7500	1.5000	0.1250	0.0469	60.0	919-000-989	\$15.83	919-000-990	\$19.34
0.1875	1.0000	2.0000	0.1875	0.0469	60.0	919-000-991	\$16.83	919-000-992	\$21.23
0.2500	1.0000	2.0000	0.2500	0.0625	60.0	919-000-993	\$23.47	919-000-994	\$30.43
0.2500	1.7500	2.7500	0.3750	0.0781	60.0	919-000-995	\$33.66	919-000-996	\$45.18
0.2500	1.6250	2.7500	0.5000	0.0938	60.0	919-000-997	\$49.46	919-000-998	\$64.32
0.3750	1.6250	2.8750	0.6250	0.1094	60.0	919-000-999	\$73.12	919-001-001	\$93.31
0.3750	1.5000	3.0000	0.7500	0.1094	60.0	919-001-002	\$103.62	919-001-003	\$128.17
0.5000	1.5000	3.2500	1.0000	0.1563	60.0	919-001-004	\$172.29	919-001-005	\$203.20
0.7500	1.5000	3.7500	1.2500	0.1563	60.0	919-001-006	\$274.06	919-001-007	\$340.82
0.7500	1.5000	3.7500	1.5000	0.1875	60.0	919-001-008	\$394.95	919-001-009	\$478.89
0.1250	0.7500	1.5000	0.1250	0.0469	82.0	919-001-012	\$15.83	919-001-013	\$19.34
0.1875	1.0000	2.0000	0.1875	0.0625	82.0	919-001-014	\$16.83	919-001-015	\$21.23
0.2500	1.0000	2.0000	0.2500	0.0781	82.0	919-001-016	\$23.47	919-001-017	\$30.43
0.2500	1.7500	2.6250	0.3750	0.1094	82.0	919-001-018	\$33.66	919-001-019	\$45.18
0.2500	1.6250	2.6250	0.5000	0.1250	82.0	919-001-020	\$49.46	919-001-021	\$64.32
0.3750	1.6250	2.7500	0.6250	0.1406	82.0	919-001-022	\$73.12	919-001-023	\$93.31
0.3750	1.5000	2.7500	0.7500	0.1563	82.0	919-001-024	\$103.62	919-001-025	\$128.17
0.5000	1.5000	3.0000	1.0000	0.1719	82.0	919-001-026	\$172.29	919-001-027	\$203.20
0.7500	1.5000	3.2500	1.2500	0.1719	82.0	919-001-028	\$274.06	919-001-029	\$340.82
0.7500	1.5000	3.2500	1.5000	0.1875	82.0	919-001-030	\$394.95	919-001-031	\$478.89
0.1250	0.7500	1.5000	0.1250	0.0469	90.0	919-001-034	\$15.83	919-001-035	\$19.34
0.1875	1.0000	2.0000	0.1875	0.0625	90.0	919-001-036	\$16.83	919-001-037	\$21.23
0.2500	1.0000	2.0000	0.2500	0.0781	90.0	919-001-038	\$23.47	919-001-039	\$30.43
0.2500	1.7500	2.6250	0.3750	0.1094	90.0	919-001-040	\$33.66	919-001-041	\$45.18
0.2500	1.6250	2.6250	0.5000	0.1250	90.0	919-001-042	\$49.46	919-001-043	\$64.32
0.3750	1.6250	2.7500	0.6250	0.1406	90.0	919-001-044	\$73.12	919-001-045	\$93.31
0.3750	1.5000	2.7500	0.7500	0.1563	90.0	919-001-046	\$103.62	919-001-047	\$128.17
0.5000	1.5000	3.0000	1.0000	0.1719	90.0	919-001-048	\$172.29	919-001-049	\$203.20
0.7500	1.5000	3.2500	1.2500	0.1719	90.0	919-001-050	\$274.06	919-001-051	\$340.82
0.7500	1.5000	3.2500	1.5000	0.1875	90.0	919-001-052	\$394.95	919-001-053	\$478.89
0.1250	0.7500	1.5000	0.1250	0.0625	100.0	919-001-056	\$15.83	919-001-057	\$19.34
0.1875	1.0000	2.0000	0.1875	0.0781	100.0	919-001-058	\$16.83	919-001-059	\$21.23
0.2500	1.0000	2.0000	0.2500	0.0781	100.0	919-001-060	\$23.47	919-001-061	\$30.43
0.2500	1.7500	2.6250	0.3750	0.1094	100.0	919-001-062	\$33.66	919-001-063	\$45.18
0.2500	1.6250	2.6250	0.5000	0.1250	100.0	919-001-064	\$49.46	919-001-065	\$64.32
0.3750	1.6250	2.7500	0.6250	0.1563	100.0	919-001-066	\$73.12	919-001-067	\$93.31
0.3750	1.5000	2.7500	0.7500	0.1719	100.0	919-001-068	\$103.62	919-001-069	\$128.17
0.5000	1.5000	3.0000	1.0000	0.1875	100.0	919-001-071	\$172.29	919-001-072	\$203.20
0.7500	1.5000	3.2500	1.2500	0.1875	100.0	919-001-073	\$274.06	919-001-074	\$340.82
0.7500	1.5000	3.2500	1.5000	0.2188	100.0	919-001-075	\$394.95	919-001-076	\$478.89

For set information see page 209.

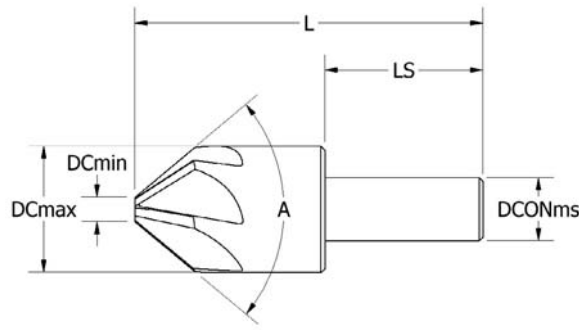

6-FLUTE



DCONms	LS	L	DCmax	DCmin	A	HSS	Price	HSS-TiN	Price
0.1250	0.6250	1.2500	0.1250	0.0469	60.0	919-000-297	\$8.02	919-000-298	\$9.06
0.1875	0.6875	1.3750	0.1875	0.0625	60.0	919-000-299	\$8.75	919-000-300	\$10.27
0.2500	0.7500	1.5000	0.2500	0.0781	60.0	919-000-301	\$8.90	919-000-302	\$10.93
0.2500	0.8750	1.7500	0.3125	0.0938	60.0	919-000-303	\$10.53	919-000-304	\$13.10
0.2500	0.8750	1.7500	0.3750	0.1250	60.0	919-000-305	\$10.99	919-000-306	\$13.55
0.2500	1.0000	2.0000	0.5000	0.1563	60.0	919-000-307	\$13.51	919-000-308	\$17.62
0.3750	1.0000	2.0000	0.5000	0.1563	60.0	919-000-309	\$13.51	919-000-310	\$17.62
0.2500	1.0000	2.2500	0.6250	0.2031	60.0	919-000-311	\$19.59	919-000-312	\$26.41
0.3750	1.0000	2.2500	0.6250	0.2031	60.0	919-000-313	\$19.59	919-000-314	\$26.41
0.5000	1.2500	2.6250	0.7500	0.2500	60.0	919-000-315	\$26.87	919-000-316	\$34.69
0.5000	1.2500	2.7500	0.8750	0.2813	60.0	919-000-317	\$38.02	919-000-318	\$48.74
0.5000	1.2500	2.7500	1.0000	0.3281	60.0	919-000-319	\$42.29	919-000-320	\$58.44
0.5000	1.2500	3.0000	1.2500	0.4063	60.0	919-000-321	\$64.87	919-000-322	\$85.32
0.7500	1.2500	3.2500	1.5000	0.5000	60.0	919-000-323	\$92.96	919-000-324	\$118.51
0.7500	1.2500	3.5000	1.7500	0.5781	60.0	919-000-325	\$123.65	919-000-326	\$164.51
0.7500	1.2500	3.7500	2.0000	0.6563	60.0	919-000-327	\$157.23	919-000-328	\$198.09
1.0000	1.5000	5.0000	2.5000	0.8281	60.0	919-000-329	\$407.58	919-000-330	\$479.54
1.0000	1.5000	5.2500	3.0000	1.0000	60.0	919-000-331	\$561.76	919-000-332	\$724.01
0.1250	0.6250	1.2500	0.1250	0.0250	82.0	919-000-334	\$8.02	919-000-335	\$9.06
0.1875	0.6875	1.3750	0.1875	0.0313	82.0	919-000-336	\$8.75	919-000-337	\$10.27
0.2500	0.7500	1.5000	0.2500	0.0469	82.0	919-000-338	\$8.90	919-000-339	\$10.93
0.2500	0.8750	1.7500	0.3125	0.0625	82.0	919-000-340	\$10.53	919-000-341	\$13.10
0.2500	0.8750	1.7500	0.3750	0.0781	82.0	919-000-342	\$10.99	919-000-343	\$13.55
0.2500	1.0000	2.0000	0.5000	0.1094	82.0	919-000-344	\$13.51	919-000-345	\$17.62
0.3750	1.0000	2.0000	0.5000	0.1094	82.0	919-000-346	\$13.51	919-000-347	\$17.62
0.2500	1.0000	2.2500	0.6250	0.1250	82.0	919-000-348	\$19.59	919-000-349	\$26.41
0.3750	1.0000	2.2500	0.6250	0.1250	82.0	919-000-350	\$19.59	919-000-351	\$26.41
0.5000	1.2500	2.6250	0.7500	0.1563	82.0	919-000-352	\$26.87	919-000-353	\$34.69
0.5000	1.2500	2.7500	0.8750	0.1719	82.0	919-000-354	\$38.02	919-000-355	\$48.74
0.5000	1.2500	2.7500	1.0000	0.2031	82.0	919-000-356	\$42.29	919-000-357	\$58.44
0.5000	1.2500	2.7500	1.2500	0.2500	82.0	919-000-358	\$64.87	919-000-359	\$85.32
0.7500	1.2500	2.8750	1.5000	0.3125	82.0	919-000-360	\$92.96	919-000-361	\$118.51
0.7500	1.2500	3.0000	1.7500	0.3594	82.0	919-000-362	\$123.65	919-000-363	\$164.51
0.7500	1.2500	3.2500	2.0000	0.4063	82.0	919-000-364	\$157.23	919-000-365	\$198.09
1.0000	1.5000	5.0000	2.5000	0.5000	82.0	919-000-366	\$407.58	919-000-367	\$479.54
1.0000	1.5000	5.2500	3.0000	0.5938	82.0	919-000-368	\$561.76	919-000-369	\$724.01

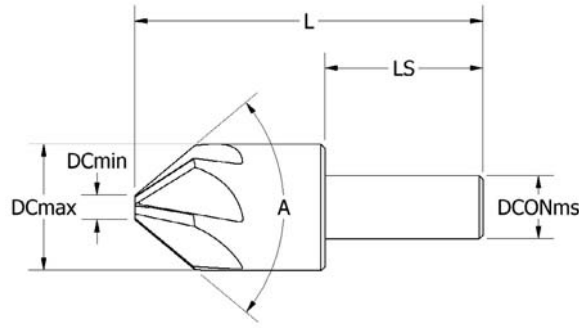

6-FLUTE



DCONms	LS	L	DCmax	DCmin	A	HSS	Price	HSS-TIN	Price
0.1250	0.6250	1.2500	0.1250	0.0250	90.0	919-000-371	\$8.02	919-000-372	\$9.06
0.1875	0.6875	1.3750	0.1875	0.0313	90.0	919-000-373	\$8.75	919-000-374	\$10.27
0.2500	0.7500	1.5000	0.2500	0.0469	90.0	919-000-375	\$8.90	919-000-376	\$10.93
0.2500	0.8750	1.7500	0.3125	0.0625	90.0	919-000-377	\$10.53	919-000-378	\$13.10
0.2500	0.8750	1.7500	0.3750	0.0781	90.0	919-000-379	\$10.99	919-000-380	\$13.55
0.2500	1.0000	2.0000	0.5000	0.1094	90.0	919-000-381	\$13.51	919-000-382	\$17.62
0.3750	1.0000	2.0000	0.5000	0.1094	90.0	919-000-383	\$13.51	919-000-384	\$17.62
0.2500	1.0000	2.2500	0.6250	0.1250	90.0	919-000-385	\$19.59	919-000-386	\$26.41
0.3750	1.0000	2.2500	0.6250	0.1250	90.0	919-000-387	\$19.59	919-000-388	\$26.41
0.5000	1.2500	2.6250	0.7500	0.1563	90.0	919-000-389	\$26.87	919-000-390	\$34.69
0.5000	1.2500	2.7500	0.8750	0.1719	90.0	919-000-391	\$38.02	919-000-392	\$48.74
0.5000	1.2500	2.7500	1.0000	0.2031	90.0	919-000-393	\$42.29	919-000-394	\$58.44
0.5000	1.2500	2.7500	1.2500	0.2500	90.0	919-000-395	\$64.87	919-000-396	\$85.32
0.7500	1.2500	2.8750	1.5000	0.3125	90.0	919-000-397	\$92.96	919-000-398	\$118.51
0.7500	1.2500	3.0000	1.7500	0.3594	90.0	919-000-399	\$123.65	919-000-400	\$164.51
0.7500	1.2500	3.2500	2.0000	0.4063	90.0	919-000-401	\$157.23	919-000-402	\$198.09
1.0000	1.5000	5.0000	2.5000	0.5000	90.0	919-000-403	\$407.58	919-000-404	\$479.54
1.0000	1.5000	5.2500	3.0000	0.5938	90.0	919-000-405	\$561.76	919-000-406	\$724.01
0.1250	0.6250	1.2500	0.1250	0.0250	100.0	919-000-408	\$8.02	919-000-409	\$9.06
0.1875	0.6875	1.3750	0.1875	0.0313	100.0	919-000-410	\$8.75	919-000-411	\$10.27
0.2500	0.7500	1.5000	0.2500	0.0469	100.0	919-000-412	\$8.90	919-000-413	\$10.93
0.2500	0.8750	1.7500	0.3125	0.0625	100.0	919-000-414	\$10.53	919-000-415	\$13.10
0.2500	0.8750	1.7500	0.3750	0.0781	100.0	919-000-416	\$10.99	919-000-417	\$13.55
0.2500	1.0000	2.0000	0.5000	0.1094	100.0	919-000-418	\$13.51	919-000-419	\$17.62
0.3750	1.0000	2.0000	0.5000	0.1094	100.0	919-000-420	\$13.51	919-000-421	\$17.62
0.2500	1.0000	2.2500	0.6250	0.1250	100.0	919-000-422	\$19.59	919-000-423	\$26.41
0.3750	1.0000	2.2500	0.6250	0.1250	100.0	919-000-424	\$19.59	919-000-425	\$26.41
0.5000	1.2500	2.6250	0.7500	0.1563	100.0	919-000-426	\$26.87	919-000-427	\$34.69
0.5000	1.2500	2.7500	0.8750	0.1719	100.0	919-000-428	\$38.02	919-000-429	\$48.74
0.5000	1.2500	2.7500	1.0000	0.2031	100.0	919-000-430	\$42.29	919-000-431	\$58.44
0.5000	1.2500	2.7500	1.2500	0.2500	100.0	919-000-432	\$64.87	919-000-433	\$85.32
0.7500	1.2500	2.8750	1.5000	0.3125	100.0	919-000-434	\$92.96	919-000-435	\$118.51
0.7500	1.2500	3.0000	1.7500	0.3594	100.0	919-000-436	\$123.65	919-000-437	\$164.51
0.7500	1.2500	3.2500	2.0000	0.4063	100.0	919-000-438	\$157.23	919-000-439	\$198.09
1.0000	1.5000	5.0000	2.5000	0.5000	100.0	919-000-440	\$407.58	919-000-441	\$479.54
1.0000	1.5000	5.0000	2.5000	0.5000	100.0	919-000-442	\$561.76	919-000-443	\$724.01

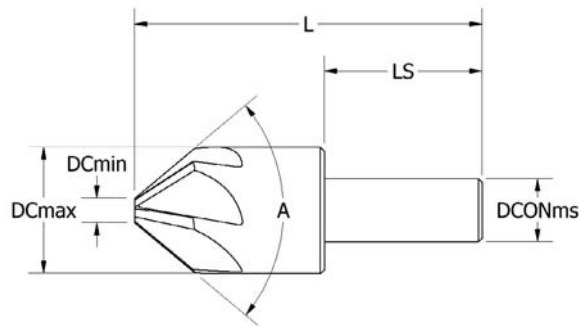

6-FLUTE



DCONms	LS	L	DCmax	DCmin	A	HSS	Price	HSS-TiN	Price
0.1250	0.6250	1.2500	0.1250	0.0200	110.0	919-000-445	\$8.02	919-000-446	\$9.06
0.1875	0.6875	1.3750	0.1875	0.0313	110.0	919-000-447	\$8.75	919-000-448	\$10.27
0.2500	0.7500	1.5000	0.2500	0.0469	110.0	919-000-449	\$8.90	919-000-450	\$10.93
0.2500	0.8750	1.7500	0.3125	0.0469	110.0	919-000-451	\$10.53	919-000-452	\$13.10
0.2500	0.8750	1.7500	0.3750	0.0625	110.0	919-000-453	\$10.99	919-000-454	\$13.55
0.2500	1.0000	2.0000	0.5000	0.0781	110.0	919-000-455	\$13.51	919-000-456	\$17.62
0.3750	1.0000	2.0000	0.5000	0.0781	110.0	919-000-457	\$13.51	919-000-458	\$17.62
0.2500	1.0000	2.2500	0.6250	0.1094	110.0	919-000-459	\$19.59	919-000-460	\$26.41
0.3750	1.0000	2.2500	0.6250	0.1094	110.0	919-000-461	\$19.59	919-000-462	\$26.41
0.5000	1.2500	2.6250	0.7500	0.1250	110.0	919-000-463	\$26.87	919-000-464	\$34.69
0.5000	1.2500	2.7500	0.8750	0.1406	110.0	919-000-465	\$38.02	919-000-466	\$48.74
0.5000	1.2500	2.7500	1.0000	0.1719	110.0	919-000-467	\$42.29	919-000-468	\$58.44
0.5000	1.2500	2.7500	1.2500	0.2188	110.0	919-000-469	\$64.87	919-000-470	\$85.32
0.7500	1.2500	2.8750	1.5000	0.2500	110.0	919-000-471	\$92.96	919-000-472	\$118.51
0.7500	1.2500	3.0000	1.7500	0.2969	110.0	919-000-473	\$123.65	919-000-474	\$164.51
0.7500	1.2500	3.2500	2.0000	0.3438	110.0	919-000-475	\$157.23	919-000-476	\$198.09
1.0000	1.5000	5.0000	2.5000	0.4375	110.0	919-000-477	\$407.58	919-000-478	\$479.54
1.0000	1.5000	5.2500	3.0000	0.5156	110.0	919-000-479	\$561.76	919-000-480	\$724.01
0.1250	0.6250	1.2500	0.1250	0.0200	120.0	919-000-482	\$8.02	919-000-483	\$9.06
0.1875	0.6875	1.3750	0.1875	0.0313	120.0	919-000-484	\$8.75	919-000-485	\$10.27
0.2500	0.7500	1.5000	0.2500	0.0469	120.0	919-000-486	\$8.90	919-000-487	\$10.93
0.2500	0.8750	1.7500	0.3125	0.0469	120.0	919-000-488	\$10.53	919-000-489	\$13.10
0.2500	0.8750	1.7500	0.3750	0.0625	120.0	919-000-490	\$10.99	919-000-491	\$13.55
0.2500	1.0000	2.0000	0.5000	0.0781	120.0	919-000-492	\$13.51	919-000-493	\$17.62
0.3750	1.0000	2.0000	0.5000	0.0781	120.0	919-000-494	\$13.51	919-000-495	\$17.62
0.2500	1.0000	2.2500	0.6250	0.1094	120.0	919-000-496	\$19.59	919-000-497	\$26.41
0.3750	1.0000	2.2500	0.6250	0.1094	120.0	919-000-498	\$19.59	919-000-499	\$26.41
0.5000	1.2500	2.6250	0.7500	0.1250	120.0	919-000-500	\$26.87	919-000-501	\$34.69
0.5000	1.2500	2.7500	0.8750	0.1406	120.0	919-000-502	\$38.02	919-000-503	\$48.74
0.5000	1.2500	2.7500	1.0000	0.1719	120.0	919-000-504	\$42.29	919-000-505	\$58.44
0.5000	1.2500	2.7500	1.2500	0.2188	120.0	919-000-506	\$64.87	919-000-507	\$85.32
0.7500	1.2500	2.8750	1.5000	0.2500	120.0	919-000-508	\$92.96	919-000-509	\$118.51
0.7500	1.2500	3.0000	1.7500	0.2969	120.0	919-000-510	\$123.65	919-000-511	\$164.51
0.7500	1.2500	3.2500	2.0000	0.3438	120.0	919-000-512	\$157.23	919-000-513	\$198.09
1.0000	1.5000	5.0000	2.5000	0.4375	120.0	919-000-514	\$407.58	919-000-515	\$479.54
1.0000	1.5000	5.2500	3.0000	0.5156	120.0	919-000-516	\$561.76	919-000-517	\$724.01

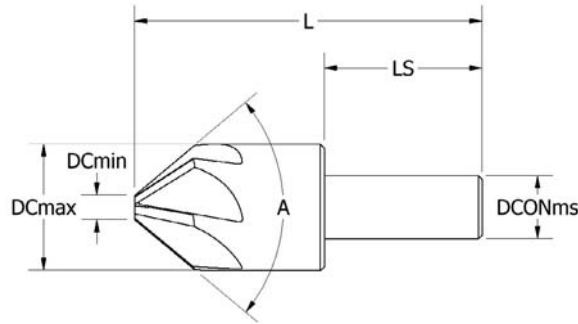

6-FLUTE



DCONms	LS	L	DCmax	DCmin	A	COBALT	Price	COBALT-TIN	Price
0.1250	0.6250	1.2500	0.1250	0.0469	60.0	919-000-693	\$9.23	919-000-694	\$10.42
0.1875	0.6875	1.3750	0.1875	0.0625	60.0	919-000-695	\$10.07	919-000-696	\$11.82
0.2500	0.7500	1.5000	0.2500	0.0781	60.0	919-000-697	\$10.24	919-000-698	\$12.56
0.2500	0.8750	1.7500	0.3125	0.0938	60.0	919-000-699	\$12.12	919-000-700	\$15.06
0.2500	0.8750	1.7500	0.3750	0.1250	60.0	919-000-701	\$12.62	919-000-702	\$15.57
0.2500	1.0000	2.0000	0.5000	0.1563	60.0	919-000-703	\$15.53	919-000-704	\$20.26
0.3750	1.0000	2.0000	0.5000	0.1563	60.0	919-000-705	\$15.53	919-000-706	\$20.26
0.2500	1.0000	2.2500	0.6250	0.2031	60.0	919-000-707	\$22.54	919-000-708	\$30.37
0.3750	1.0000	2.2500	0.6250	0.2031	60.0	919-000-709	\$22.54	919-000-710	\$30.37
0.5000	1.2500	2.6250	0.7500	0.2500	60.0	919-000-711	\$30.89	919-000-712	\$39.89
0.5000	1.2500	2.7500	0.8750	0.2813	60.0	919-000-713	\$43.70	919-000-714	\$56.04
0.5000	1.2500	2.7500	1.0000	0.3281	60.0	919-000-715	\$48.63	919-000-716	\$64.31
0.5000	1.2500	2.7500	1.2500	0.4063	60.0	919-000-717	\$74.61	919-000-718	\$98.13
0.7500	1.2500	2.8750	1.5000	0.5000	60.0	919-000-719	\$106.91	919-000-720	\$136.29
0.7500	1.2500	3.0000	1.7500	0.5781	60.0	919-000-721	\$142.19	919-000-722	\$189.19
0.7500	1.2500	3.2500	2.0000	0.6563	60.0	919-000-723	\$180.82	919-000-724	\$227.80
1.0000	1.5000	5.0000	2.5000	0.8281	60.0	919-000-725	\$468.72	919-000-726	\$551.48
1.0000	1.5000	5.2500	3.0000	1.0000	60.0	919-000-727	\$646.03	919-000-728	\$832.60
0.1250	0.6250	1.2500	0.1250	0.0250	82.0	919-000-729	\$9.23	919-000-730	\$10.42
0.1875	0.6875	1.3750	0.1875	0.0313	82.0	919-000-731	\$10.07	919-000-732	\$11.82
0.2500	0.7500	1.5000	0.2500	0.0469	82.0	919-000-733	\$10.24	919-000-734	\$12.56
0.2500	0.8750	1.7500	0.3125	0.0625	82.0	919-000-735	\$12.12	919-000-736	\$15.06
0.2500	0.8750	1.7500	0.3750	0.0781	82.0	919-000-737	\$12.62	919-000-738	\$15.57
0.2500	1.0000	2.0000	0.5000	0.1094	82.0	919-000-739	\$15.53	919-000-740	\$20.26
0.3750	1.0000	2.0000	0.5000	0.1094	82.0	919-000-741	\$15.53	919-000-742	\$20.26
0.2500	1.0000	2.2500	0.6250	0.1250	82.0	919-000-743	\$22.54	919-000-744	\$30.37
0.3750	1.0000	2.2500	0.6250	0.1250	82.0	919-000-745	\$22.54	919-000-746	\$30.37
0.5000	1.2500	2.6250	0.7500	0.1563	82.0	919-000-747	\$30.89	919-000-748	\$39.89
0.5000	1.2500	2.7500	0.8750	0.1719	82.0	919-000-749	\$43.70	919-000-750	\$56.04
0.5000	1.2500	2.7500	1.0000	0.2031	82.0	919-000-751	\$48.63	919-000-752	\$64.31
0.5000	1.2500	2.7500	1.2500	0.2500	82.0	919-000-753	\$74.61	919-000-754	\$93.30
0.7500	1.2500	2.8750	1.5000	0.3125	82.0	919-000-755	\$106.91	919-000-756	\$136.29
0.7500	1.2500	3.0000	1.7500	0.3594	82.0	919-000-757	\$142.19	919-000-758	\$189.19
0.7500	1.2500	3.2500	2.0000	0.4063	82.0	919-000-759	\$180.82	919-000-760	\$227.80
1.0000	1.5000	5.0000	2.0000	0.5000	82.0	919-000-761	\$468.72	919-000-762	\$551.48
1.0000	1.5000	5.2500	3.0000	0.5938	82.0	919-000-763	\$646.03	919-000-764	\$832.60

COBALT

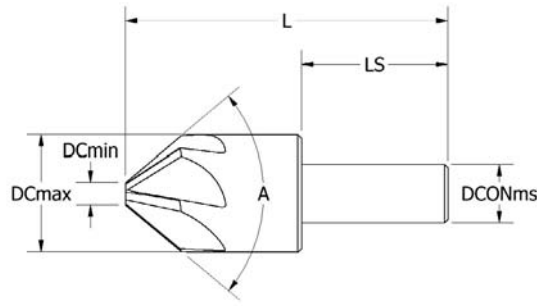

6-FLUTE



COBALT

DCONms	LS	L	DCmax	DCmin	A	COBALT	Price	COBALT-TiN	Price
0.1250	0.6250	1.2500	0.1250	0.0250	90.0	919-000-765	\$9.23	919-000-766	\$10.42
0.1875	0.6875	1.3750	0.1875	0.0313	90.0	919-000-767	\$10.07	919-000-768	\$11.82
0.2500	0.7500	1.5000	0.2500	0.0469	90.0	919-000-769	\$10.24	919-000-770	\$12.56
0.2500	0.8750	1.7500	0.3125	0.0625	90.0	919-000-771	\$12.12	919-000-772	\$15.06
0.2500	0.8750	1.7500	0.3750	0.0781	90.0	919-000-773	\$12.62	919-000-774	\$15.57
0.2500	1.0000	2.0000	0.5000	0.1094	90.0	919-000-775	\$15.53	919-000-776	\$20.26
0.3750	1.0000	2.0000	0.5000	0.1094	90.0	919-000-777	\$15.53	919-000-778	\$20.26
0.2500	1.0000	2.2500	0.6250	0.1250	90.0	919-000-779	\$22.54	919-000-780	\$30.37
0.3750	1.0000	2.2500	0.6250	0.1250	90.0	919-000-781	\$22.54	919-000-782	\$30.37
0.5000	1.2500	2.6250	0.7500	0.1563	90.0	919-000-783	\$30.89	919-000-784	\$39.89
0.5000	1.2500	2.7500	0.8750	0.1719	90.0	919-000-785	\$43.70	919-000-786	\$56.04
0.5000	1.2500	2.7500	1.0000	0.2031	90.0	919-000-787	\$48.63	919-000-788	\$64.31
0.5000	1.2500	2.7500	1.2500	0.2500	90.0	919-000-789	\$74.61	919-000-790	\$98.13
0.7500	1.2500	2.8750	1.5000	0.3125	90.0	919-000-791	\$106.91	919-000-792	\$136.29
0.7500	1.2500	3.0000	1.7500	0.3594	90.0	919-000-793	\$142.19	919-000-794	\$189.19
0.7500	1.2500	3.2500	2.0000	0.4063	90.0	919-000-795	\$180.82	919-000-796	\$227.80
1.0000	1.5000	5.0000	2.5000	0.5000	90.0	919-000-797	\$468.72	919-000-798	\$551.48
1.0000	1.5000	5.2500	3.0000	0.5938	90.0	919-000-799	\$646.03	919-000-800	\$832.60
0.1250	0.6250	1.2500	0.1250	0.0250	100.0	919-000-801	\$9.23	919-000-802	\$10.42
0.1875	0.6875	1.3750	0.1875	0.0313	100.0	919-000-803	\$10.07	919-000-804	\$11.82
0.2500	0.7500	1.5000	0.2500	0.0469	100.0	919-000-805	\$10.24	919-000-806	\$12.56
0.2500	0.8750	1.7500	0.3125	0.0625	100.0	919-000-807	\$12.12	919-000-808	\$15.06
0.2500	0.8750	1.7500	0.3750	0.0781	100.0	919-000-809	\$12.62	919-000-810	\$15.57
0.2500	1.0000	2.0000	0.5000	0.1094	100.0	919-000-811	\$15.53	919-000-812	\$20.26
0.3750	1.0000	2.0000	0.5000	0.1094	100.0	919-000-813	\$15.53	919-000-814	\$20.26
0.2500	1.0000	2.2500	0.6250	0.1250	100.0	919-000-815	\$22.54	919-000-816	\$30.37
0.3750	1.0000	2.2500	0.6250	0.1250	100.0	919-000-817	\$22.54	919-000-818	\$30.37
0.5000	1.2500	2.6250	0.7500	0.1563	100.0	919-000-819	\$30.89	919-000-820	\$39.89
0.5000	1.2500	2.7500	0.8750	0.1719	100.0	919-000-821	\$43.70	919-000-822	\$56.04
0.5000	1.2500	2.7500	1.0000	0.2031	100.0	919-000-823	\$48.63	919-000-824	\$64.31
0.5000	1.2500	2.7500	1.2500	0.2500	100.0	919-000-825	\$74.61	919-000-826	\$98.13
0.7500	1.2500	2.8750	1.5000	0.3125	100.0	919-000-827	\$106.91	919-000-828	\$136.29
0.7500	1.2500	3.0000	1.7500	0.3594	100.0	919-000-829	\$142.19	919-000-830	\$189.19
0.7500	1.2500	3.2500	2.0000	0.4063	100.0	919-000-831	\$180.82	919-000-832	\$227.80
1.0000	1.5000	5.0000	2.5000	0.5000	100.0	919-000-833	\$468.72	919-000-834	\$551.48
1.0000	1.5000	5.2500	3.0000	0.5938	100.0	919-000-835	\$646.03	919-000-836	\$832.60

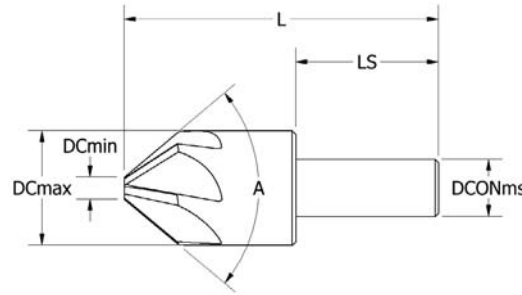

6-FLUTE



DCONms	LS	L	DCmax	DCmin	A	HSS	Price	HSS-TiN	Price
0.1250	0.6250	1.2500	0.1250	0.0200	110.0	919-000-837	\$9.23	919-000-838	\$10.42
0.1875	0.6875	1.3750	0.1875	0.0313	110.0	919-000-839	\$10.07	919-000-840	\$11.82
0.2500	0.7500	1.5000	0.2500	0.0469	110.0	919-000-841	\$10.24	919-000-842	\$12.56
0.2500	0.8750	1.7500	0.3125	0.0469	110.0	919-000-843	\$12.12	919-000-844	\$15.06
0.2500	0.8750	1.7500	0.3750	0.0625	110.0	919-000-845	\$12.62	919-000-846	\$15.57
0.2500	1.0000	2.0000	0.5000	0.0781	110.0	919-000-847	\$15.53	919-000-848	\$20.26
0.3750	1.0000	2.0000	0.5000	0.0781	110.0	919-000-849	\$15.53	919-000-850	\$20.26
0.2500	1.0000	2.2500	0.6250	0.1094	110.0	919-000-851	\$22.54	919-000-852	\$30.37
0.3750	1.0000	2.2500	0.6250	0.1094	110.0	919-000-853	\$22.54	919-000-854	\$30.37
0.5000	1.2500	2.6250	0.7500	0.1250	110.0	919-000-855	\$30.89	919-000-856	\$39.89
0.5000	1.2500	2.7500	0.8750	0.1406	110.0	919-000-857	\$43.70	919-000-858	\$56.04
0.5000	1.2500	2.7500	1.0000	0.1719	110.0	919-000-859	\$48.63	919-000-860	\$64.31
0.5000	1.2500	2.7500	1.2500	0.2188	110.0	919-000-861	\$74.61	919-000-862	\$98.13
0.7500	1.2500	2.8750	1.5000	0.2500	110.0	919-000-863	\$106.91	919-000-864	\$136.29
0.7500	1.2500	3.0000	1.7500	0.2969	110.0	919-000-865	\$142.19	919-000-866	\$189.19
0.7500	1.2500	3.2500	2.0000	0.3438	110.0	919-000-867	\$180.82	919-000-868	\$227.80
1.0000	1.5000	5.0000	2.5000	0.4375	110.0	919-000-869	\$468.72	919-000-870	\$551.48
1.0000	1.5000	5.2500	3.0000	0.5156	110.0	919-000-871	\$646.03	919-000-872	\$832.60
0.1250	0.6250	1.2500	0.1250	0.0200	120.0	919-000-873	\$9.23	919-000-874	\$10.42
0.1875	0.6875	1.3750	0.1875	0.0313	120.0	919-000-875	\$10.07	919-000-876	\$11.82
0.2500	0.7500	1.5000	0.2500	0.0469	120.0	919-000-877	\$10.24	919-000-878	\$12.56
0.2500	0.8750	1.7500	0.3125	0.0469	120.0	919-000-879	\$12.12	919-000-880	\$15.06
0.2500	0.8750	1.7500	0.3750	0.0625	120.0	919-000-881	\$12.62	919-000-882	\$15.57
0.2500	1.0000	2.0000	0.5000	0.0781	120.0	919-000-883	\$15.53	919-000-884	\$20.26
0.3750	1.0000	2.0000	0.5000	0.0781	120.0	919-000-885	\$15.53	919-000-886	\$20.26
0.2500	1.0000	2.2500	0.6250	0.1094	120.0	919-000-887	\$22.54	919-000-888	\$30.37
0.3750	1.0000	2.2500	0.6250	0.1094	120.0	919-000-889	\$22.54	919-000-890	\$30.37
0.5000	1.2500	2.6250	0.7500	0.1250	120.0	919-000-891	\$30.89	919-000-892	\$39.89
0.5000	1.2500	2.7500	0.8750	0.1406	120.0	919-000-893	\$43.70	919-000-894	\$56.04
0.5000	1.2500	2.7500	1.0000	0.1719	120.0	919-000-895	\$48.63	919-000-896	\$64.31
0.5000	1.2500	2.7500	1.2500	0.2188	120.0	919-000-897	\$74.61	919-000-898	\$98.13
0.7500	1.2500	2.8750	1.5000	0.2500	120.0	919-000-899	\$106.91	919-000-900	\$136.29
0.7500	1.2500	3.0000	1.7500	0.2969	120.0	919-000-901	\$142.19	919-000-902	\$189.19
0.7500	1.2500	3.2500	2.0000	0.3438	120.0	919-000-903	\$180.82	919-000-904	\$227.80
1.0000	1.5000	5.0000	2.5000	0.4375	120.0	919-000-905	\$468.72	919-000-906	\$551.48
1.0000	1.5000	5.2500	3.0000	0.5156	120.0	919-000-907	\$646.03	919-000-908	\$832.60



Countersink Angle	HSS KIT #	Price	CO KIT #	Price
60°	919-000-333	\$170.23	919-000-038	\$195.77
82°	919-000-370	\$170.23	919-000-039	\$195.77
90°	919-000-407	\$170.23	919-000-040	\$195.77
100°	919-000-444	\$170.23	919-000-035	\$195.77
110°	919-000-481	\$170.23	919-000-036	\$195.77
120°	919-000-518	\$170.23	919-000-037	\$195.77

6-Flute Countersink Sets- Available in HSS & Cobalt

HSS includes 1/4, 5/16, 3/8, 1/2, 5/8, 3/4, and 1" body diameter with a particular included point angle. Cobalt includes 1/4, 5/16, 3/8, 1/2, 5/8, 3/4, and 1" body diameter with a particular included point angle.

5
1
0
1



COUNTERBORES



- Diameter range from 0.562" – 0.750" (8mm-20mm) socket head cap screw bore
- Single tool to counterbore, dual chamfer all in one setup* (PC2 series)
- Back boring reduces production time by eliminating second operation* (PC3 series)
- Achieves a true 90° bottom with all PC- series tool holders
- Excellent surface finish can be achieved
- Machining to production dimension without separate fine bore process



PC1

- Diameter range from 0.562" – 0.750" (8mm-20mm) socket head cap screw bore
- Achieves a true 90° bottom with all PC- series tool holders
- Excellent surface finish can be achieved
- Machining to production dimension without separate fine bore process

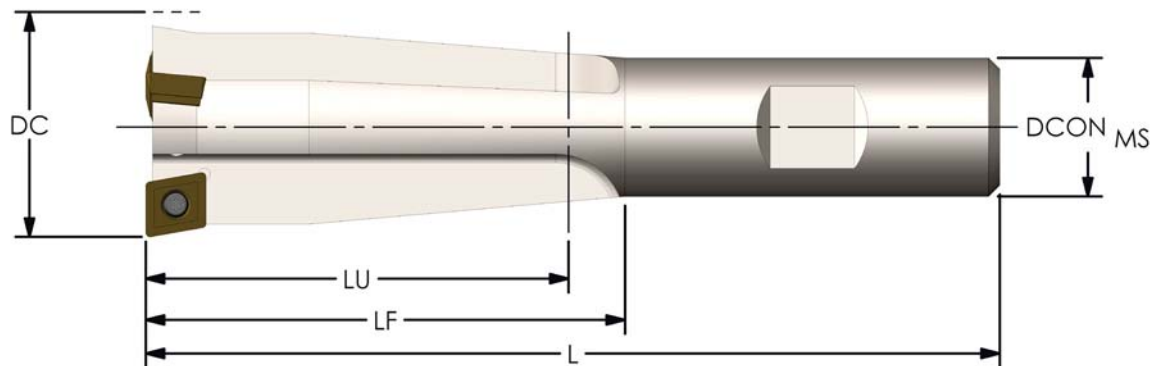

PRODUCT #	Designation	C'bore Size	DC	DCONMS	LU	L	LF	Insert	Screw	ZC	Price
970-000-001	PC1-312-2-750-04	5/16	0.500	0.750	1.000	3.375	1.345	PD1 042004	PD1-16	2	\$180.60
970-000-003	PC1-375-2-750-04	3/8	0.594	0.750	1.188	3.500	1.470	PD1 042004	PD1-16	2	\$189.80
970-000-005	PC1-437-2-750-05	7/16	0.687	0.750	1.374	3.625	1.595	PD1 052804	PD1-2	2	\$199.00
970-000-007	PC1-500-2-750-06	1/2	0.781	0.750	1.562	3.750	1.720	PD1 063306	PD1-22	2	\$183.00
970-000-008	PC1-625-3-750-06	5/8	1.000	0.750	2.000	4.250	2.220	PD1 063306	PD1-22	3	\$227.70
970-000-010	PC1-750-3-750-07	3/4	1.188	0.750	2.376	4.625	2.595	PD1 074006	PD1-25	3	\$246.10
970-000-002	PC1-315-2-750-04	8mm	0.591	0.750	1.182	3.500	1.470	PD1 042004	PD1-16	2	\$180.60
970-000-004	PC1-394-2-750-05	10mm	0.709	0.750	1.418	3.625	1.595	PD1 052804	PD1-2	2	\$199.00
970-000-006	PC1-472-2-750-06	12mm	0.787	0.750	1.574	3.750	1.720	PD1 063306	PD1-22	2	\$210.50
970-000-009	PC1-630-3-750-06	16mm	1.024	0.750	2.048	4.250	2.220	PD1 063306	PD1-22	3	\$227.70
970-000-011	PC1-787-3-750-07	20mm	1.299	0.750	2.598	4.750	2.720	PD1 074006	PD1-25	3	\$246.10

Recommendations:

Productivity and tooling performance is not only influenced by grade and geometry, but also by clamping the tool securely and accurately as possible.

- It is recommended to use precision holders i.e. hydraulic, shrink fit
- It is recommended to use internal coolant – minimum recommended pressure 145 psi



PRODUCT #	Designation	HP600	HK356	HN300
914-000-085		\$11.20		
914-000-083	PD1 042004		\$11.20	
914-000-084				\$19.80
914-000-088		\$11.20		
914-000-086	PD1 052804		\$11.20	
914-000-087				\$19.80
914-000-091		\$11.40		
914-000-089	PD1 063306		\$11.40	
914-000-090				\$20.10
914-000-094		\$11.90		
914-000-092	PD1 074006		\$11.90	
914-000-093				\$20.50
914-000-097		\$13.00		
914-000-095	PD1 094508		\$13.00	
914-000-096				\$18.00
914-000-100		\$15.40		
914-000-098	PD1 125812		\$15.40	
914-000-99				\$23.10
914-000-103		\$16.60		
914-000-101	PD1 156812		\$16.60	
914-000-102				\$25.70



PD1

PRODUCT #	Insert Screw	Price Each
968-000-112	PD1-16	\$6.00
968-000-113	PD1-2	\$5.40
968-000-114	PD1-22	\$5.40
968-000-115	PD1-25	\$5.40
968-000-116	PD1-35	\$5.40
968-000-117	PD1-5	\$6.40
968-000-118	PD1-6	\$9.10



PACKAGE SIZE OF 5

Inserts sold in packs of 10

ISO	MATERIAL	HARDNESS	GRADE	Vc (SFM)*	DIAMETER inch (metric)	
					5/16" (8mm) - 1/2" (12mm)	1/2" (12mm) - 3/4" (20mm)
					Fz (INCH PER TOOTH)*	
P	CARBON STEELS 1018, 1040, 1080, 1090, 10L50, 1140, 1212, 12L15, 1525, 1536	≤ 275 BHN or ≤ 28 HRC	HP600	250-675	.0015-.0040	.0020-.0060
	ALLOY STEELS 4140, 4150, 4320, 5120, 5150, 8630, 86L20, 17-4 PH	≤ 375 BHN or ≤ 40 HRC		200-550	.0020-.0050	.0020-.0075
M	STAINLESS STEELS (FREE MACHINING) 303, 416, 420F, 430F, 440F	≤ 275 BHN or ≤ 28 HRC	HP600	150-450	.0018-.0025	.0025-.0060
	STAINLESS STEELS (DIFFICULT) 304, 304L, 316, 316L	≤ 275 BHN or ≤ 28 HRC		100-400	.0018-.0025	.0025-.0060
K	GRAY IRONS Class 20, 30, 40, 50, 60, G3000, G3500	≤ 220 BHN or ≤ 19 HRC	HK365	200-700	.0025-.0045	.0035-.0070
	DUCTILE IRONS D&M series, 250, 300, 350, 400, 60-40-18, 65-45-12	≤ 260 BHN or ≤ 26 HRC		200-600	.0020-.0045	.0025-.0065
N	NON-FERROUS Aluminum, Aluminum cast, Brass, copper, Bronze, Non Metallic"	≤ 271 BHN or ≤ 28 HRC	HN300	300-750	.0020-.0060	.0030-.0090
H	TOOL STEELS A2, D2, H13, L2, M2, P20, S7, T15, W2	≤ 375 BHN or ≤ 55 HRC	HP600	60-275	.0018-.0055	.0020-.0060
S	HR SUPER ALLOYS Inconel 718, Waspaloy, Hastelloy, Inconel 625, Stellite 31, Haynes 25, Rene 41	≤ 275 BHN or ≤ 28 HRC	HP600	45-200	.0015-.0030	.0017-.0050
	TITANIUM 6AL-4V, ASTM 1, 2, 3, 6AL-2S	≤ 275 BHN or ≤ 28 HRC		75-300	.0019-.0045	.0020-.0060

Speeds & feeds are starting recommendations only. Factors such as machine type, fixture, tooling rigidity, available horsepower, coolant delivery method and others will affect the performance significantly.



PC2

- Diameter range from 0.562" – 0.750" (8mm-20mm) socket head cap screw bore
- Single tool to counterbore, dual chamfer all in one setup* (PC2 series)
- Achieves a true 90° bottom with all PC- series tool holders
- Excellent surface finish can be achieved
- Machining to production dimension without separate fine bore process

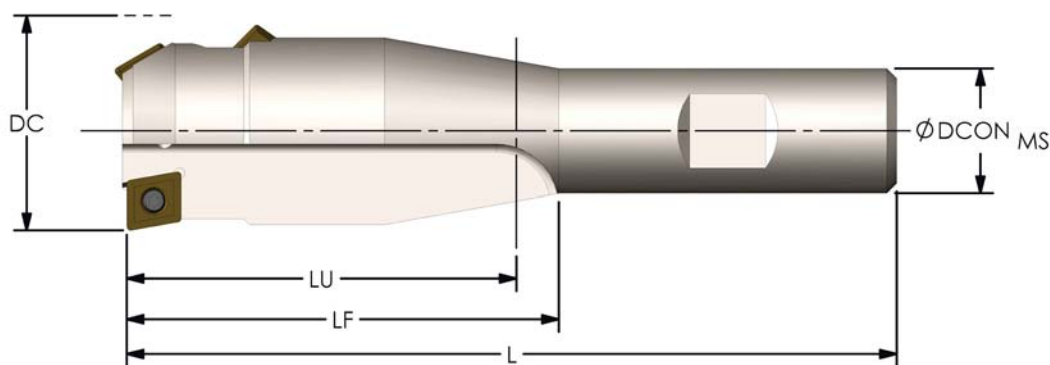

PRODUCT #	Designation	C'bore Size	DC	DCONMS	LU	L	LF	Insert	Screw	ZC	Price
970-000-012	PC2-312-3-750-04	5/16	0.500	0.750	1.000	3.375	1.345	PD1 042004	PD1-16	3	\$180.60
970-000-014	PC2-375-3-750-04	3/8	0.594	0.750	1.188	30.500	1.470	PD1 042004	PD1-16	3	\$189.80
970-000-016	PC2-437-3-750-05	7/16	0.687	0.750	1.374	3.625	1.595	PD1 052804	PD1-2	3	\$199.00
970-000-018	PC2-500-3-750-06	1/2	0.781	0.750	1.562	3.750	1.720	PD1 063306	PD1-22	3	\$210.50
970-000-019	PC2-625-3-750-06	5/8	1.000	0.750	2.000	4.250	2.220	PD1 063306	PD1-22	3	\$227.70
970-000-021	PC2-750-3-750-07	3/4	1.188	0.750	2.376	4.625	2.595	PD1 074006	PD1-25	3	\$246.10
970-000-013	PC2-315-3-750-04	8mm	0.591	0.750	1.182	30.500	1.470	PD1 042004	PD1-16	3	\$180.60
970-000-015	PC2-394-3-750-05	10mm	0.709	0.750	1.418	3.625	1.595	PD1 052804	PD1-2	3	\$199.00
970-000-017	PC2-472-3-750-06	12mm	0.787	0.750	1.574	3.750	1.720	PD1 063306	PD1-22	3	\$210.50
970-000-020	PC2-630-3-750-06	16mm	1.024	0.750	2.048	4.250	2.220	PD1 063306	PD1-22	3	\$227.70
970-000-022	PC2-787-3-750-07	20mm	1.299	0.750	2.598	4.750	2.720	PD1 074006	PD1-25	3	\$246.10

Recommendations:

Productivity and tooling performance is not only influenced by grade and geometry, but also by clamping the tool securely and accurately as possible.

- It is recommended to use precision holders i.e. hydraulic, shrink fit
- It is recommended to use internal coolant – minimum recommended pressure 145 psi



PRODUCT #	Designation	HP600	HK356	HN300
914-000-085		\$11.20		
914-000-083	PD1 042004		\$11.20	
914-000-084				\$19.80
914-000-088		\$11.20		
914-000-086	PD1 052804		\$11.20	
914-000-087				\$19.80
914-000-091		\$11.40		
914-000-089	PD1 063306		\$11.40	
914-000-090				\$20.10
914-000-094		\$11.90		
914-000-092	PD1 074006		\$11.90	
914-000-093				\$20.50
914-000-097		\$13.00		
914-000-095	PD1 094508		\$13.00	
914-000-096				\$18.00
914-000-100		\$15.40		
914-000-098	PD1 125812		\$15.40	
914-000-99				\$23.10
914-000-103		\$16.60		
914-000-101	PD1 156812		\$16.60	
914-000-102				\$25.70



PD1

PRODUCT #	Insert Screw	Price Each
968-000-112	PD1-16	\$6.00
968-000-113	PD1-2	\$5.40
968-000-114	PD1-22	\$5.40
968-000-115	PD1-25	\$5.40
968-000-116	PD1-35	\$5.40
968-000-117	PD1-5	\$6.40
968-000-118	PD1-6	\$9.10

PACKAGE SIZE OF 5



FIGURE 1



FIGURE 2

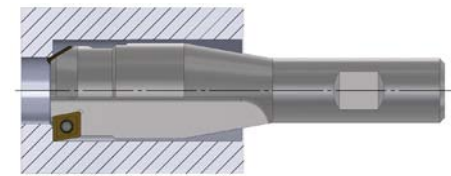

Inserts sold in packs of 10

ISO	MATERIAL	HARDNESS	GRADE	Vc (SFM)*	DIAMETER inch (metric)	
					5/16" (8mm) - 1/2" (12mm)	1/2" (12mm) - 3/4" (20mm)
					Fz (INCH PER TOOTH)*	
P	CARBON STEELS 1018, 1040, 1080, 1090, 10L50, 1140, 1212, 12L15, 1525, 1536	≤ 275 BHN or ≤ 28 HRC	HP600	250-675	.0015-.0040	.0020-.0060
	ALLOY STEELS 4140, 4150, 4320, 5120, 5150, 8630, 86L20, 17-4 PH	≤ 375 BHN or ≤ 40 HRC		200-550	.0020-.0050	.0020-.0075
M	STAINLESS STEELS (FREE MACHINING) 303, 416, 420F, 430F, 440F	≤ 275 BHN or ≤ 28 HRC	HP600	150-450	.0018-.0025	.0025-.0060
	STAINLESS STEELS (DIFFICULT) 304, 304L, 316, 316L	≤ 275 BHN or ≤ 28 HRC		100-400	.0018-.0025	.0025-.0060
K	GRAY IRONS Class 20, 30, 40, 50, 60, G3000, G3500	≤ 220 BHN or ≤ 19 HRC	HK365	200-700	.0025-.0045	.0035-.0070
	DUCTILE IRONS D&M series, 250, 300, 350, 400, 60-40-18, 65-45-12	≤ 260 BHN or ≤ 26 HRC		200-600	.0020-.0045	.0025-.0065
N	NON-FERROUS Aluminum, Aluminum cast, Brass, copper, Bronze, Non Metallic"	≤ 271 BHN or ≤ 28 HRC	HN300	300-750	.0020-.0060	.0030-.0090
H	TOOL STEELS A2, D2, H13, L2, M2, P20, S7, T15, W2	≤ 375 BHN or ≤ 55 HRC	HP600	60-275	.0018-.0055	.0020-.0060
S	HR SUPER ALLOYS Inconel 718, Waspaloy, Hastelloy, Inconel 625, Stellite 31, Haynes 25, Rene 41	≤ 275 BHN or ≤ 28 HRC	HP600	45-200	.0015-.0030	.0017-.0050
	TITANIUM 6AL-4V, ASTM 1, 2, 3, 6AL-2S	≤ 275 BHN or ≤ 28 HRC		75-300	.0019-.0045	.0020-.0060

Speeds & feeds are starting recommendations only. Factors such as machine type, fixture, tooling rigidity, available horsepower, coolant delivery method and others will affect the performance significantly.



PC3

- Diameter range from 0.562" – 0.750" (8mm-20mm) socket head cap screw bore
- Back boring reduces production time by eliminating second operation* (PC3 series)
- Achieves a true 90° bottom with all PC- series tool holders
- Excellent surface finish can be achieved
- Machining to production dimension without separate fine bore process

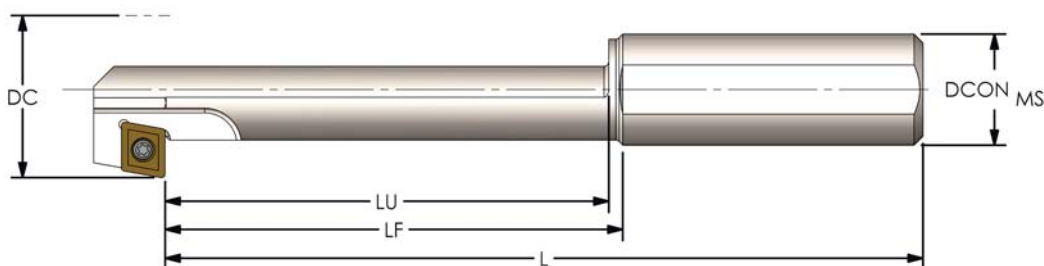

PRODUCT #	Designation	C'bore Size	DC	DCONMS	LU	L	LF	Insert	Screw	ZC	Price
970-000-023	PC3-312-1-750-04	5/16	0.500	0.750	1.030	3.375	1.345	PD1 042004	PD1-16	1	\$165.60
970-000-025	PC3-375-1-750-04	3/8	0.594	0.750	1.218	3.500	1.470	PD1 042004	PD1-16	1	\$174.80
970-000-027	PC3-437-1-750-05	7/16	0.687	0.750	1.748	4.000	1.970	PD1 052804	PD1-2	1	\$184.00
970-000-029	PC3-500-1-750-06	1/2	0.781	0.750	1.983	4.250	2.220	PD1 063306	PD1-22	1	\$193.20
970-000-030	PC3-625-1-750-06	5/8	1.000	0.750	2.530	4.750	2.720	PD1 063306	PD1-22	1	\$210.50
970-000-032	PC3-750-1-750-07	3/4	1.188	0.750	3.000	5.125	3.095	PD1 074006	PD1-25	1	\$227.70
970-000-024	PC3-315-1-750-04	8mm	0.591	0.750	1.212	3.500	1.470	PD1 042004	PD1-16	1	\$167.90
970-000-026	PC3-394-1-750-05	10mm	0.709	0.750	1.448	3.750	1.720	PD1 052804	PD1-2	1	\$184.00
970-000-028	PC3-472-1-750-06	12mm	0.787	0.750	1.998	4.250	2.220	PD1 063306	PD1-22	1	\$193.20
970-000-031	PC3-630-1-750-06	16mm	1.024	0.750	2.590	4.750	2.720	PD1 063306	PD1-22	1	\$210.50
970-000-033	PC3-787-1-750-07	20mm	1.299	0.750	3.278	5.375	3.345	PD1 074006	PD1-25	1	\$227.70

Recommendations:

Productivity and tooling performance is not only influenced by grade and geometry, but also by clamping the tool securely and accurately as possible.

- It is recommended to use precision holders i.e. hydraulic, shrink fit
- It is recommended to use internal coolant – minimum recommended pressure 145 psi



PRODUCT #	Designation	HP600	HK356	HN300
914-000-085		\$11.20		
914-000-083	PD1 042004		\$11.20	
914-000-084				\$19.80
914-000-088		\$11.20		
914-000-086	PD1 052804		\$11.20	
914-000-087				\$19.80
914-000-091		\$11.40		
914-000-089	PD1 063306		\$11.40	
914-000-090				\$20.10
914-000-094		\$11.90		
914-000-092	PD1 074006		\$11.90	
914-000-093				\$20.50
914-000-097		\$13.00		
914-000-095	PD1 094508		\$13.00	
914-000-096				\$18.00
914-000-100		\$15.40		
914-000-098	PD1 125812		\$15.40	
914-000-99				\$23.10
914-000-103		\$16.60		
914-000-101	PD1 156812		\$16.60	
914-000-102				\$25.70



PD1

PRODUCT #	Insert Screw	Price Each
968-000-112	PD1-16	\$6.00
968-000-113	PD1-2	\$5.40
968-000-114	PD1-22	\$5.40
968-000-115	PD1-25	\$5.40
968-000-116	PD1-35	\$5.40
968-000-117	PD1-5	\$6.40
968-000-118	PD1-6	\$9.10

PACKAGE SIZE OF 5

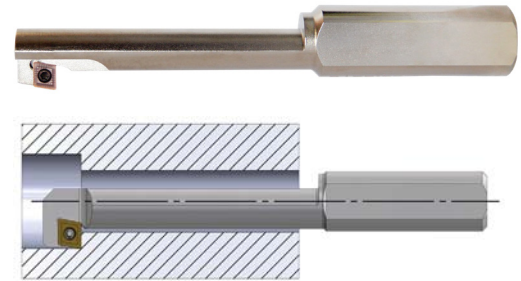

Inserts sold in packs of 10

ISO	MATERIAL	HARDNESS	GRADE	Vc (SFM)*	DIAMETER inch (metric)	
					5/16" (8mm) - 1/2" (12mm)	1/2" (12mm) - 3/4" (20mm)
					Fz (INCH PER TOOTH)*	
P	CARBON STEELS 1018, 1040, 1080, 1090, 10L50, 1140, 1212, 12L15, 1525, 1536	≤ 275 BHN or ≤ 28 HRC	HP600	250-675	.0015-.0040	.0020-.0060
	ALLOY STEELS 4140, 4150, 4320, 5120, 5150, 8630, 86L20, 17-4 PH	≤ 375 BHN or ≤ 40 HRC		200-550	.0020-.0050	.0020-.0075
M	STAINLESS STEELS (FREE MACHINING) 303, 416, 420F, 430F, 440F	≤ 275 BHN or ≤ 28 HRC	HP600	150-450	.0018-.0025	.0025-.0060
	STAINLESS STEELS (DIFFICULT) 304, 304L, 316, 316L	≤ 275 BHN or ≤ 28 HRC		100-400	.0018-.0025	.0025-.0060
K	GRAY IRONS Class 20, 30, 40, 50, 60, G3000, G3500	≤ 220 BHN or ≤ 19 HRC	HK365	200-700	.0025-.0045	.0035-.0070
	DUCTILE IRONS D&M series, 250, 300, 350, 400, 60-40-18, 65-45-12	≤ 260 BHN or ≤ 26 HRC		200-600	.0020-.0045	.0025-.0065
N	NON-FERROUS Aluminum, Aluminum cast, Brass, copper, Bronze, Non Metallic"	≤ 271 BHN or ≤ 28 HRC	HN300	300-750	.0020-.0060	.0030-.0090
H	TOOL STEELS A2, D2, H13, L2, M2, P20, S7, T15, W2	≤ 375 BHN or ≤ 55 HRC	HP600	60-275	.0018-.0055	.0020-.0060
S	HR SUPER ALLOYS Inconel 718, Waspaloy, Hastelloy, Inconel 625, Stellite 31, Haynes 25, Rene 41	≤ 275 BHN or ≤ 28 HRC	HP600	45-200	.0015-.0030	.0017-.0050
	TITANIUM 6AL-4V, ASTM 1, 2, 3, 6AL-2S	≤ 275 BHN or ≤ 28 HRC		75-300	.0019-.0045	.0020-.0060

Speeds & feeds are starting recommendations only. Factors such as machine type, fixture, tooling rigidity, available horsepower, coolant delivery method and others will affect the performance significantly.

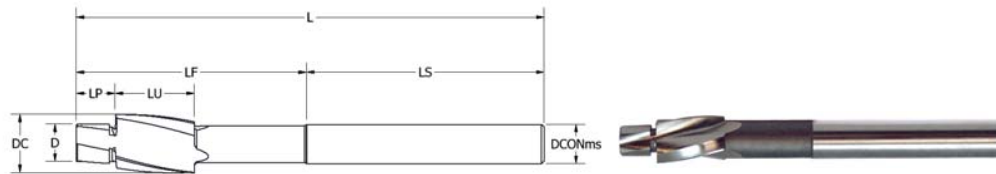

COBALT

DC	DCONms	D	LU	LS	L	LF	LP	Size/ Application	Assembly Criteria	COBALT	Price
0.1860	0.1563	0.1120	0.5000	1.6250	3.0000	1.3750	0.1875	#4 Nominal	Close Fit	902-000-001	\$42.01
0.2020	0.1563	0.1270	0.5000	1.6250	3.0000	1.3750	0.1875	#4 +1/64 O/S	1/64" Clearance	902-000-002	\$42.01
0.2170	0.1563	0.1430	0.5000	1.6250	3.0000	1.3750	0.1875	#4 +1/32 O/S	1/32" Clearance	902-000-003	\$42.01
0.2050	0.1875	0.1250	0.5000	1.6250	3.0000	1.3750	0.1875	#5 Nominal	Close Fit	902-000-004	\$44.81
0.2210	0.1875	0.1400	0.5000	1.6250	3.0000	1.3750	0.1875	#5 +1/64 O/S	1/64" Clearance	902-000-005	\$44.81
0.2370	0.1875	0.1560	0.5000	1.6250	3.0000	1.3750	0.1875	#5 +1/32 O/S	1/32" Clearance	902-000-006	\$44.81
0.2280	0.2188	0.1380	0.5000	1.6250	3.0000	1.3750	0.2031	#6 Nominal	Close Fit	902-000-007	\$49.42
0.2440	0.2188	0.1530	0.5000	1.6250	3.0000	1.3750	0.2031	#6 +1/64 O/S	1/64" Clearance	902-000-008	\$49.42
0.2600	0.2188	0.1690	0.5000	1.6250	3.0000	1.3750	0.2031	#6 +1/32 O/S	1/32" Clearance	902-000-009	\$49.42
0.2720	0.2500	0.1640	0.5000	1.6250	3.0000	1.3750	0.2500	#8 Nominal	Close Fit	902-000-010	\$50.69
0.2880	0.2500	0.1790	0.5000	1.6250	3.0000	1.3750	0.2500	#8 +1/64 O/S	1/64" Clearance	902-000-011	\$50.69
0.3040	0.2500	0.1950	0.5000	1.6250	3.0000	1.3750	0.2500	#8 +1/32 O/S	1/32" Clearance	902-000-012	\$50.69
0.3140	0.2813	0.1900	0.7813	2.4687	4.5000	2.0313	0.2656	#10 Nominal	Close Fit	902-000-013	\$53.36
0.3300	0.2813	0.2050	0.7813	2.4687	4.5000	2.0313	0.2656	#10 +1/64 O/S	1/64" Clearance	902-000-014	\$53.36
0.3460	0.2813	0.2210	0.7813	2.4687	4.5000	2.0313	0.2656	#10 +1/32 O/S	1/32" Clearance	902-000-015	\$53.36
0.3820	0.3125	0.2500	0.7813	2.4218	4.5000	2.0782	0.3125	1/4" Nominal	Close Fit	902-000-016	\$53.95
0.3980	0.3125	0.2650	0.7813	2.4218	4.5000	2.0782	0.3125	1/4" +1/64 O/S	1/64" Clearance	902-000-017	\$53.95
0.4140	0.3125	0.2810	0.7813	2.4218	4.5000	2.0782	0.3125	1/4" +1/32 O/S	1/32" Clearance	902-000-018	\$53.95
0.4750	0.3750	0.3120	0.7813	2.4218	4.5000	2.0782	0.3594	5/16" Nominal	Close Fit	902-000-019	\$56.90
0.4910	0.3750	0.3280	0.7813	2.4218	4.5000	2.0782	0.3594	5/16" +1/64 O/S	1/64" Clearance	902-000-020	\$56.90
0.5070	0.3750	0.3430	0.7813	2.4218	4.5000	2.0782	0.3594	5/16" +1/32 O/S	1/32" Clearance	902-000-021	\$56.90
0.5720	0.5000	0.3750	0.9063	2.4687	5.0000	2.5313	0.5000	3/8" Nominal	Close Fit	902-000-022	\$64.46
0.5880	0.5000	0.3900	0.9063	2.4687	5.0000	2.5313	0.5000	3/8" +1/64 O/S	1/64" Clearance	902-000-023	\$64.46
0.6040	0.5000	0.4060	0.9063	2.4687	5.0000	2.5313	0.5000	3/8" +1/32 O/S	1/32" Clearance	902-000-024	\$64.46
0.6630	0.5000	0.4370	0.9375	2.5000	5.0000	2.5000	0.5000	7/16" Nominal	Close Fit	902-000-025	\$77.05
0.6790	0.5000	0.4520	0.9375	2.5000	5.0000	2.5000	0.5000	7/16" +1/64 O/S	1/64" Clearance	902-000-026	\$77.05
0.6950	0.5000	0.4680	0.9375	2.5000	5.0000	2.5000	0.5000	7/16" +1/32 O/S	1/32" Clearance	902-000-027	\$77.05
0.7570	0.5000	0.5000	1.0156	3.0468	6.0000	2.9532	0.5000	1/2" Nominal	Close Fit	902-000-028	\$85.19
0.7730	0.5000	0.5150	1.0156	3.0468	6.0000	2.9532	0.5000	1/2" +1/64 O/S	1/64" Clearance	902-000-029	\$85.19
0.7890	0.5000	0.5310	1.0156	3.0468	6.0000	2.9532	0.5000	1/2" +1/32 O/S	1/32" Clearance	902-000-030	\$85.19
0.9450	0.6250	0.6250	1.0156	3.0625	6.0000	2.9375	0.6250	5/8" Nominal	Close Fit	902-000-031	\$126.16
0.9610	0.6250	0.6410	1.0156	3.0625	6.0000	2.9375	0.6250	5/8" +1/64 O/S	1/64" Clearance	902-000-032	\$126.16
0.9770	0.6250	0.6560	1.0156	3.0625	6.0000	2.9375	0.6250	5/8" +1/32 O/S	1/32" Clearance	902-000-033	\$126.16
1.1870	0.7500	0.7660	1.2500	3.0625	7.0000	3.9375	0.7344	3/4" Nominal	Close Fit	902-000-034	\$181.19
1.2030	0.7500	0.7810	1.2500	3.0625	7.0000	3.9375	0.7344	3/4" +1/32 O/S	1/32" Clearance	902-000-035	\$181.19
1.3750	0.8750	0.8910	1.2500	3.0000	7.0000	4.0000	0.8906	7/8" Nominal	Close Fit	902-000-036	\$276.36
1.3910	0.8750	0.9060	1.2500	3.0000	7.0000	4.0000	0.8906	7/8" +1/32 O/S	1/32" Clearance	902-000-037	\$276.36
1.5620	1.0000	1.0160	1.2500	3.0000	7.0000	4.0000	1.0625	1" Nominal	Close Fit	902-000-038	\$380.68
1.5880	1.0000	1.0320	1.2500	3.0000	7.0000	4.0000	1.0625	1" +1/32 O/S	1/32" Clearance	902-000-039	\$380.68



Complete 7-Piece Tool Sets	Assembly Criteria	Product #	Price
#6, #8, #10, 1/4", 5/16", 3/8", 1/2" Nominal	Close Fit	902-000-040	\$413.98
#6, #8, #10, 1/4", 5/16", 3/8", 1/2" +1/64 O/S	1/64" Clearance	902-000-041	\$413.98
#6, #8, #10, 1/4", 5/16", 3/8", 1/2" +1/32 O/S	1/32" Clearance	902-000-042	\$413.98

Precision Cap Screw Counterbores

Integral Pilot, Straight Shank, CNC Precision Ground, Cobalt HSS.



DC	DCONms	D	LU	LS	L	LF	LP	Application	COBALT	Price
6.00	5.00	2.50	14.00	31.50	71.00	39.50	3.50	M3 - Before Thread	902-000-043	\$41.57
6.00	5.00	3.20	14.00	31.50	71.00	39.50	3.50	M3 - Fine	902-000-044	\$41.57
6.00	5.00	3.40	14.00	31.50	71.00	39.50	3.50	M3 - Medium	902-000-045	\$41.57
6.50	5.00	2.90	14.00	31.50	71.00	39.50	3.50	M3.5 - Before Thread	902-000-046	\$46.57
6.50	5.00	3.70	14.00	31.50	71.00	39.50	3.50	M3.5 - Fine	902-000-047	\$46.57
6.50	5.00	3.90	14.00	31.50	71.00	39.50	4.00	M3.5 - Medium	902-000-048	\$46.57
8.00	5.00	3.30	14.00	31.50	71.00	39.50	4.50	M4 - Before Thread	902-000-049	\$49.12
8.00	5.00	4.30	14.00	31.50	71.00	39.50	4.50	M4 - Fine	902-000-050	\$49.12
8.00	5.00	4.50	14.00	31.50	71.00	39.50	4.50	M4 - Medium	902-000-051	\$49.12
10.00	8.00	4.20	18.00	35.50	80.00	44.50	4.50	M5 - Before Thread	902-000-052	\$52.20
10.00	8.00	5.30	18.00	35.50	80.00	44.50	4.50	M5 - Fine	902-000-053	\$52.20
10.00	8.00	5.50	18.00	35.50	80.00	44.50	4.50	M5 - Medium	902-000-054	\$52.20
11.00	8.00	5.00	18.00	35.50	80.00	44.50	5.50	M6 - Before Thread	902-000-055	\$54.24
11.00	8.00	6.40	18.00	35.50	80.00	44.50	5.50	M6 - Fine	902-000-056	\$54.24
11.00	8.00	6.60	18.00	35.50	80.00	44.50	7.00	M6 - Medium	902-000-057	\$54.24
15.00	12.50	6.80	22.00	40.00	100.00	60.00	7.00	M8 - Before Thread	902-000-058	\$58.21
15.00	12.50	8.40	22.00	40.00	100.00	60.00	9.00	M8 - Fine	902-000-059	\$58.21
15.00	12.50	9.00	22.00	40.00	100.00	60.00	9.00	M8 - Medium	902-000-060	\$58.21
18.00	12.50	8.50	22.00	40.00	100.00	60.00	9.00	M10 - Before Thread	902-000-061	\$66.68
18.00	12.50	10.50	22.00	40.00	100.00	60.00	11.00	M10 - Fine	902-000-062	\$66.68
18.00	12.50	11.00	22.00	40.00	100.00	60.00	11.00	M10 - Medium	902-000-063	\$66.68
20.00	12.50	10.20	22.00	40.00	100.00	60.00	10.50	M12 - Before Thread	902-000-064	\$79.68
20.00	12.50	13.00	22.00	40.00	100.00	60.00	14.00	M12 - Fine	902-000-065	\$79.68
20.00	12.50	14.00	22.00	40.00	100.00	60.00	14.00	M12 - Medium	902-000-066	\$79.68



Precision Metric Cap Screw Counterbores

Integral Pilot, Straight Shank, CNC Precision Ground, Cobalt HSS.

Complete 6-Piece Tool Sets	Application	Product #	Price
M3, M4, M5, M6, M8, M10	Before Thread	902-000-067	\$322.00
M3, M4, M5, M6, M8, M10	Fine	902-000-068	\$322.00
M3, M4, M5, M6, M8, M10	Medium	902-000-069	\$322.00

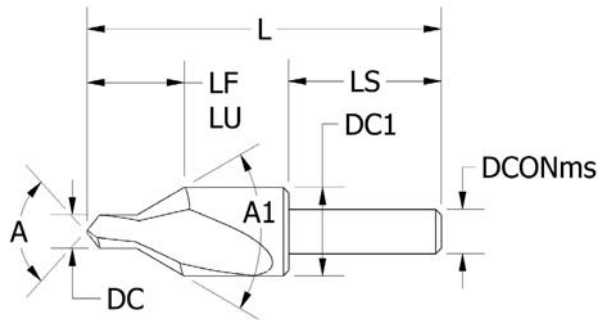

MACHINE SCREW

DC	DCONms	DC1	LU	LS	L	LF	A	A1	Flat Head Screws Machine Screw	Price
0.1270	0.2500	0.3125	0.3022	0.8750	1.7500	0.3022	118.0	82.0	906-000-296	\$15.47
0.1400	0.2500	0.3125	0.2979	0.8750	1.7500	0.2979	118.0	82.0	906-000-297	\$15.57
0.1660	0.2500	0.3750	0.4144	0.8750	1.7500	0.4144	118.0	82.0	906-000-298	\$18.48
0.1920	0.2500	0.4375	0.4059	1.0000	2.0000	0.4059	118.0	82.0	906-000-299	\$18.68
0.2200	0.2500	0.4375	0.4280	1.0000	2.0000	0.4280	118.0	82.0	906-000-300	\$21.56
0.2520	0.2500	0.5000	0.4488	1.0000	2.0000	0.4488	118.0	82.0	906-000-301	\$24.61
0.3150	0.3750	0.6250	0.5531	1.0000	2.2500	0.5531	118.0	82.0	906-000-302	\$27.67
0.3780	0.5000	0.7500	0.6575	1.2500	2.6250	0.6575	118.0	82.0	906-000-303	\$33.86

SELF TAPPING SCREW

DC	DCONms	DC1	LU	LS	L	LF	A	A1	Flat Head Screws Self-tapping Screw	Price
0.0990	0.2500	0.3125	0.2801	0.8750	1.7500	0.2801	118.0	82.0	906-000-304	\$15.57
0.1160	0.2500	0.3750	0.3214	0.8750	1.7500	0.3214	118.0	82.0	906-000-305	\$18.48
0.1350	0.2500	0.4375	0.3777	1.0000	2.0000	0.3777	118.0	82.0	906-000-306	\$18.68
0.1570	0.2500	0.4375	0.4017	1.0000	2.0000	0.4017	118.0	82.0	906-000-307	\$21.56
0.1840	0.2500	0.5000	0.4554	1.0000	2.0000	0.4554	118.0	82.0	906-000-308	\$24.61



DRILL & CHAMFER MILLS

THE COMPLETE TOOL MAKING AUTHORITY™



EC WELDON SHANK

- Cost effective chamfer milling in all ISO materials
- Increase machine utilization when chamfering in process
- Versatile tool for many different weld prep, hole prep, and chamfer operations
- Value add when machining small batches in different material classes
- Easy indexing with three effective cutting edges

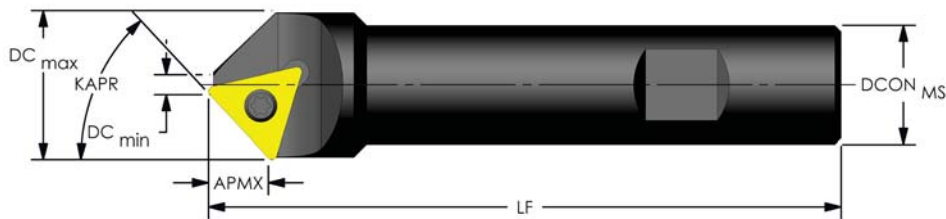

FIGURE 1

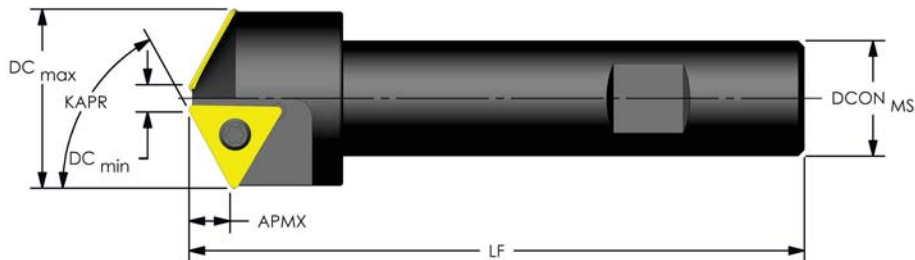

FIGURE 2



PRODUCT #	Designation	Figure	KAPR°	DCmax	DCmin	LF	DCON MS	APMX	Insert	Screw	Price
909-000-520	E05C-D0.500-1-.750-3	1	5	0.594	0.500	4.000	.750	.568	TCMT 32.52	MTS-35	\$121.20
909-000-521	E10C-D0.500-1-.750-3	1	10	0.688	0.500	4.000	.750	.558		MTS-35	\$121.20
909-000-522	E15C-D0.500-1-.750-3	1	15	0.782	0.500	4.000	.750	.546		MTS-35	\$121.20
909-000-523	E15C-D1.00-2-.750-3	2	15	1.280	1.000	4.000	.750	.546		MTS-35	\$142.80
909-000-524	E20C-D.375-1-.750-3	1	20	0.750	0.375	4.000	.750	.527		MTS-35	\$121.20
909-000-525	E30C-D.250-1-.750-3	1	30	0.800	0.250	4.000	.750	.484		MTS-35	\$121.20
909-000-526	E30C-D.750-2-.750-3	2	30	1.300	0.750	4.000	.750	.484		MTS-35	\$142.80
909-000-527	E41C-D.188-1-.750-3	1	41	0.914	0.188	4.000	.750	.418		MTS-35	\$121.20
909-000-528	E41C-D.562-2-.750-3	2	41	1.288	0.562	4.000	.750	.418		MTS-35	\$142.80
909-000-529	E45C-D.188-1-.750-3	1	45	0.972	0.188	4.000	.750	.390		MTS-35	\$121.20
909-000-530	E45C-D0.500-2-.750-3	2	45	1.290	0.500	4.000	.750	.390		MTS-35	\$142.80
909-000-531	E60C-D.188-2-.750-3	2	60	1.160	0.188	4.000	.750	.266		MTS-35	\$142.80



PRODUCT #	Designation	Price
913-000-451	TCMT 32.52-ZM1	\$9.60

PRODUCT #	Insert Screw	Price Each
968-000-087	MTS-184	\$3.20
968-000-088	MTS-2	\$2.90
968-000-092	MTS-255	\$3.20
968-000-082	MTS 25-DR	\$2.90
968-000-084	MTS 3-DR	\$2.90
968-000-083	MTS 35-DR	\$3.50
968-000-085	MTS 4-DR	\$2.90

PACKAGE SIZE OF 5

ISO	MATERIAL	HARDNESS	Vc (SFM)*	Fz (INCH PER TOOTH)*
P	CARBON STEELS 1018, 1040, 1080, 1090, 10L50, 1140, 1212, 12L15, 1525, 1536	≤ 275 BHN or ≤ 28 HRC	220-650	.0032 - .0080
	ALLOY STEELS 4140, 4150, 4320, 5120, 5150, 8630, 86L20, 17-4 PH	≤ 375 BHN or ≤ 40 HRC	180-500	.0030 - .0065
M	STAINLESS STEELS (FREE MACHINING) 303, 416, 420F, 430F, 440F	≤ 275 BHN or ≤ 28 HRC	200-450	.0026 - .0065
	STAINLESS STEELS (DIFFICULT) 304, 304L, 316, 316L	≤ 275 BHN or ≤ 28 HRC	120-350	.0025 - .0075
K	GRAY IRONS Class 20, 30, 40, 50, 60, G3000, G3500	≤ 220 BHN or ≤ 19 HRC	250-700	.0030 - .0100
	DUCTILE IRONS D&M series, 250, 300, 350, 400, 60- 40-18, 65-45-12	≤ 260 BHN or ≤ 26 HRC	150-450	.0030 - .0092
N	NON-FERROUS Aluminum, Aluminum cast, Brass, copper, Bronze, Non Metallic"	≤ 271 BHN or ≤ 28 HRC	250-950	.0050 - .0130
H	TOOL STEELS A2, D2, H13, L2, M2, P20, S7, T15, W2	≤ 375 BHN or ≤ 55 HRC	80-250	.0030 - .0065
S	HR SUPER ALLOYS Inconel 718, Waspaloy, Hastelloy, Inconel 625, Stellite 31, Haynes 25, Rene 41	≤ 275 BHN or ≤ 28 HRC	50-160	.0025 - .0060
	TITANIUM 6AL-4V, ASTM 1, 2, 3, 6AL-2S	≤ 275 BHN or ≤ 28 HRC	90-250	.0025 - .0075
* HIGHER VC AND FZ APPLY TO LIGHT/FINISHING ENGAGEMENT				
* LOWER VC AND FZ APPLY TO HEAVY/ROUGHING ENGAGEMENT				

Speeds & feeds are starting recommendations only. Factors such as machine type, fixture, tooling rigidity, available horsepower, coolant delivery method and others will affect the performance significantly.

CARBIDE

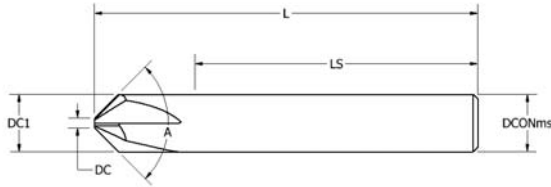

2-FLUTE



DC	DCONms	DC1	LS	L	A	UNCOATED		ALTiN COATED		TiAlN COATED	
						2 FLUTE	Price	2 FLUTE	Price	2 FLUTE	Price
0.0060	0.1250	0.1250	0.7500	1.5000	30.0	909-000-198	\$17.35	909-000-342	\$21.75	909-000-249	\$21.75
0.0060	0.1250	0.1250	0.7500	1.5000	40.0	909-000-203	\$17.35	909-000-347	\$21.75	909-000-254	\$21.75
0.0060	0.1250	0.1250	0.7500	1.5000	45.0	909-000-207	\$17.35	909-000-351	\$21.75	909-000-258	\$21.75
0.0060	0.1250	0.1250	0.7500	1.5000	50.0	909-000-209	\$17.35	909-000-353	\$21.75	909-000-260	\$21.75
0.0060	0.1250	0.1250	0.7500	1.5000	60.0	909-000-035	\$16.38	909-000-355	\$20.67	909-000-262	\$20.67
0.0060	0.1250	0.1250	0.7500	1.5000	70.0	909-000-214	\$17.35	909-000-360	\$21.75	909-000-267	\$21.75
0.0060	0.1250	0.1250	0.7500	1.5000	80.0	909-000-215	\$17.35	909-000-361	\$21.75	909-000-268	\$21.75
0.0060	0.1250	0.1250	0.7500	1.5000	82.0	909-000-036	\$16.38	909-000-362	\$20.67	909-000-269	\$20.67
0.0060	0.1250	0.1250	0.7500	1.5000	90.0	909-000-037	\$16.38	909-000-367	\$20.67	909-000-274	\$20.67
0.0060	0.1250	0.1250	0.7500	1.5000	100.0	909-000-033	\$16.38	909-000-326	\$20.67	909-000-233	\$20.67
0.0060	0.1250	0.1250	0.7500	1.5000	110.0	909-000-188	\$17.35	909-000-330	\$21.75	909-000-237	\$21.75
0.0060	0.1250	0.1250	0.7500	1.5000	120.0	909-000-034	\$16.38	909-000-331	\$20.67	909-000-238	\$20.67
0.0060	0.1250	0.1250	0.7500	1.5000	130.0	909-000-192	\$17.35	909-000-336	\$21.75	909-000-243	\$21.75
0.0060	0.1250	0.1250	0.7500	1.5000	140.0	909-000-193	\$17.35	909-000-337	\$21.75	909-000-244	\$21.75
0.0060	0.1250	0.1250	0.7500	1.5000	150.0	909-000-194	\$17.35	909-000-338	\$21.75	909-000-245	\$21.75
0.0060	0.1875	0.1875	1.0000	2.0000	30.0	909-000-199	\$22.85	909-000-343	\$28.81	909-000-250	\$28.81
0.0060	0.1875	0.1875	1.0000	2.0000	40.0	909-000-204	\$22.85	909-000-348	\$28.81	909-000-255	\$28.81
0.0060	0.1875	0.1875	1.0000	2.0000	45.0	909-000-208	\$21.75	909-000-352	\$26.48	909-000-259	\$26.48
0.0060	0.1875	0.1875	1.0000	2.0000	50.0	909-000-210	\$21.75	909-000-354	\$26.48	909-000-261	\$26.48
0.0060	0.1875	0.1875	1.0000	2.0000	60.0	909-000-211	\$22.85	909-000-356	\$28.81	909-000-263	\$28.81
0.0060	0.1875	0.1875	1.0000	2.0000	82.0	909-000-216	\$22.85	909-000-363	\$26.48	909-000-270	\$26.48
0.0060	0.1875	0.1875	1.0000	2.0000	90.0	909-000-219	\$22.85	909-000-368	\$28.81	909-000-275	\$28.81
0.0060	0.1875	0.1875	1.0000	2.0000	120.0	909-000-189	\$22.85	909-000-332	\$28.81	909-000-239	\$28.81
0.0060	0.1875	0.1875	1.2500	2.5000	150.0	909-000-195	\$22.85	909-000-339	\$28.81	909-000-246	\$28.81

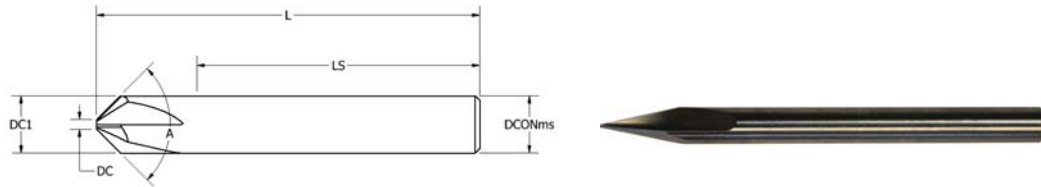

2-FLUTE



DC	DCONms	DC1	LS	L	A	UNCOATED		ALTiN COATED		TiAlN COATED	
						2 FLUTE	Price	2 FLUTE	Price	2 FLUTE	Price
0.0400	0.2500	0.2500	1.2500	2.5000	30.0	909-000-200	\$32.74	909-000-344	\$39.33	909-000-251	\$39.33
0.0400	0.2500	0.2500	1.2500	2.5000	40.0	909-000-205	\$32.74	909-000-349	\$39.33	909-000-256	\$39.33
0.0400	0.2500	0.2500	1.2500	2.5000	60.0	909-000-046	\$26.41	909-000-357	\$31.98	909-000-264	\$31.98
0.0400	0.2500	0.2500	1.2500	2.5000	82.0	909-000-050	\$26.41	909-000-364	\$31.98	909-000-271	\$31.98
0.0400	0.2500	0.2500	1.2500	2.5000	90.0	909-000-054	\$26.41	909-000-369	\$31.98	909-000-276	\$31.98
0.0400	0.2500	0.2500	1.2500	2.5000	100.0	909-000-038	\$26.41	909-000-327	\$31.99	909-000-234	\$31.99
0.0400	0.2500	0.2500	1.2500	2.5000	120.0	909-000-042	\$26.41	909-000-333	\$31.99	909-000-240	\$31.99
0.0600	0.3750	0.3750	1.2500	2.5000	30.0	909-000-201	\$43.84	909-000-345	\$52.62	909-000-252	\$52.62
0.0600	0.3750	0.3750	1.2500	2.5000	40.0	909-000-206	\$43.84	909-000-350	\$52.52	909-000-257	\$52.62
0.0600	0.3750	0.3750	1.2500	2.5000	60.0	909-000-061	\$33.69	909-000-358	\$40.82	909-000-265	\$40.82
0.0600	0.3750	0.3750	1.2500	2.5000	82.0	909-000-062	\$33.69	909-000-365	\$40.82	909-000-272	\$40.82
0.0600	0.3750	0.3750	1.2500	2.5000	90.0	909-000-063	\$33.69	909-000-300	\$40.82	909-000-277	\$40.82
0.0600	0.3750	0.3750	1.2500	2.5000	100.0	909-000-059	\$33.69	909-000-328	\$40.81	909-000-235	\$40.81
0.0600	0.3750	0.3750	1.2500	2.5000	120.0	909-000-060	\$33.69	909-000-334	\$40.81	909-000-241	\$40.81
0.0600	0.3750	0.3750	1.2500	2.5000	150.0	909-000-196	\$43.84	909-000-340	\$52.62	909-000-247	\$52.62
0.0800	0.5000	0.5000	1.5000	3.0000	30.0	909-000-202	\$73.82	909-000-346	\$85.91	909-000-253	\$85.91
0.0800	0.5000	0.5000	1.5000	3.0000	60.0	909-000-066	\$56.53	909-000-359	\$66.78	909-000-266	\$66.78
0.0800	0.5000	0.5000	1.5000	3.0000	82.0	909-000-067	\$56.53	909-000-366	\$66.78	909-000-273	\$66.78
0.0800	0.5000	0.5000	1.5000	3.0000	90.0	909-000-068	\$56.53	909-000-371	\$66.78	909-000-278	\$66.78
0.0800	0.5000	0.5000	1.5000	3.0000	100.0	909-000-064	\$56.53	909-000-329	\$66.78	909-000-236	\$66.78
0.0800	0.5000	0.5000	1.5000	3.0000	120.0	909-000-065	\$56.53	909-000-335	\$66.78	909-000-242	\$66.78

CARBIDE

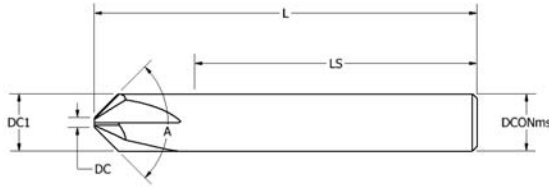

4-FLUTE



DC	DCONms	DC1	LS	L	A	UNCOATED		TIALN COATED	
						2 FLUTE	Price	2 FLUTE	Price
0.0250	0.1250	0.1250	0.7500	1.5000	60.0	909-000-071	\$16.38	909-000-286	\$20.67
0.0250	0.1250	0.1250	0.7500	1.5000	82.0	909-000-072	\$16.38	909-000-290	\$20.67
0.0250	0.1250	0.1250	0.7500	1.5000	90.0	909-000-073	\$16.38	909-000-294	\$20.67
0.0250	0.1250	0.1250	0.7500	1.5000	100.0	909-000-069	\$16.38	909-000-279	\$20.67
0.0250	0.1250	0.1250	0.7500	1.5000	120.0	909-000-070	\$16.38	909-000-283	\$20.67
0.0400	0.2500	0.2500	1.2500	2.5000	60.0	909-000-082	\$26.41	909-000-287	\$31.99
0.0400	0.2500	0.2500	1.2500	2.5000	82.0	909-000-086	\$26.41	909-000-291	\$31.99
0.0400	0.2500	0.2500	1.2500	2.5000	90.0	909-000-090	\$26.41	909-000-295	\$31.99
0.0400	0.2500	0.2500	1.2500	2.5000	100.0	909-000-074	\$26.41	909-000-280	\$31.99
0.0400	0.2500	0.2500	1.2500	2.5000	120.0	909-000-078	\$26.41	909-000-079	\$31.99
0.0600	0.3750	0.3750	1.2500	2.5000	60.0	909-000-097	\$33.69	909-000-288	\$40.81
0.0600	0.3750	0.3750	1.2500	2.5000	82.0	909-000-098	\$33.69	909-000-292	\$40.81
0.0600	0.3750	0.3750	1.2500	2.5000	90.0	909-000-099	\$33.69	909-000-296	\$40.81
0.0600	0.3750	0.3750	1.2500	2.5000	100.0	909-000-095	\$33.69	909-000-281	\$40.81
0.0600	0.3750	0.3750	1.2500	2.5000	120.0	909-000-096	\$33.69	909-000-284	\$40.81
0.0800	0.5000	0.5000	1.5000	3.0000	60.0	909-000-108	\$56.53	909-000-109	\$66.78
0.0800	0.5000	0.5000	1.5000	3.0000	82.0	909-000-112	\$56.53	909-000-113	\$66.78
0.0800	0.5000	0.5000	1.5000	3.0000	90.0	909-000-116	\$56.53	909-000-297	\$66.78
0.0800	0.5000	0.5000	1.5000	3.0000	100.0	909-000-100	\$56.53	909-000-282	\$66.78
0.0800	0.5000	0.5000	1.5000	3.0000	120.0	909-000-104	\$56.53	909-000-285	\$66.78

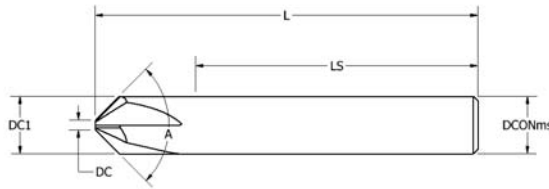

3-FLUTE



DC	DCONms	DC1	LS	L	A	UNCOATED		ALTIM COATED		TIALN COATED	
						3 FLUTE	Price	3 FLUTE	Price	3 FLUTE	Price
0.0600	0.2500	0.2500	1.2500	2.5000	30.0	909-000-404	\$32.74	909-000-376	\$45.59	909-000-302	\$45.59
0.0600	0.3750	0.3750	1.2500	2.5000	30.0	909-000-405	\$43.84	909-000-377	\$52.62	909-000-303	\$52.62
0.0600	0.2500	0.2500	1.2500	2.5000	40.0	909-000-406	\$32.74	909-000-378	\$39.33	909-000-304	\$39.33
0.0600	0.3750	0.3750	1.2500	2.5000	40.0	909-000-407	\$43.84	909-000-379	\$52.62	909-000-305	\$52.62
0.0600	0.2500	0.2500	1.2500	2.5000	45.0	909-000-408	\$32.74	909-000-380	\$39.33	909-000-306	\$39.33
0.0600	0.3750	0.3750	1.2500	2.5000	45.0	909-000-409	\$43.84	909-000-381	\$50.97	909-000-307	\$50.97
0.0600	0.2500	0.2500	1.2500	2.5000	50.0	909-000-410	\$32.74	909-000-382	\$39.33	909-000-308	\$39.33
0.0600	0.3750	0.3750	1.2500	2.5000	50.0	909-000-411	\$43.84	909-000-383	\$50.97	909-000-309	\$50.97
0.0600	0.2500	0.2500	1.2500	2.5000	60.0	909-000-412	\$32.74	909-000-384	\$39.33	909-000-310	\$39.33
0.0600	0.3750	0.3750	1.2500	2.5000	60.0	909-000-413	\$43.84	909-000-385	\$52.62	909-000-311	\$52.62
0.0600	0.2500	0.2500	1.2500	2.5000	82.0	909-000-414	\$32.74	909-000-386	\$39.33	909-000-312	\$39.33
0.0600	0.3750	0.3750	1.2500	2.5000	82.0	909-000-415	\$43.84	909-000-387	\$50.97	909-000-313	\$50.97
0.0600	0.2500	0.2500	1.2500	2.5000	90.0	909-000-416	\$32.74	909-000-388	\$39.33	909-000-314	\$39.33
0.0600	0.3750	0.3750	1.2500	2.5000	90.0	909-000-417	\$43.84	909-000-389	\$52.62	909-000-315	\$52.62
0.0600	0.2500	0.2500	1.2500	2.5000	100.0	909-000-400	\$32.74	909-000-372	\$39.33	909-000-298	\$39.33
0.0600	0.2500	0.2500	1.2500	2.5000	120.0	909-000-401	\$32.74	909-000-373	\$39.33	909-000-299	\$39.33
0.0600	0.3750	0.3750	1.2500	2.5000	120.0	909-000-402	\$43.84	909-000-374	\$52.62	909-000-300	\$52.62
0.0600	0.2500	0.2500	1.2500	2.5000	150.0	909-000-403	\$32.74	909-000-375	\$39.33	909-000-301	\$39.33

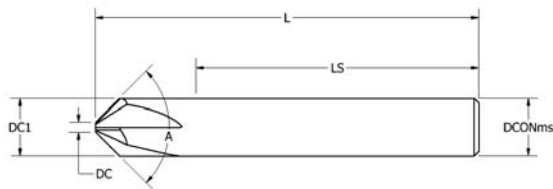

4-FLUTE



DC	DCONms	DC1	LS	L	A	UNCOATED		ALTIM COATED		TIALN COATED	
						4 FLUTE	Price	4 FLUTE	Price	4 FLUTE	Price
0.0800	0.5000	0.5000	1.5000	3.0000	30.0	909-000-421	\$65.15	909-000-393	\$77.23	909-000-319	\$77.23
0.0800	0.5000	0.5000	1.5000	3.0000	40.0	909-000-422	\$65.15	909-000-394	\$77.23	909-000-320	\$77.23
0.0800	0.5000	0.5000	1.5000	3.0000	45.0	909-000-423	\$61.40	909-000-395	\$73.49	909-000-321	\$73.49
0.0800	0.5000	0.5000	1.5000	3.0000	50.0	909-000-424	\$61.40	909-000-396	\$73.49	909-000-322	\$73.49
0.0800	0.5000	0.5000	1.5000	3.0000	60.0	909-000-425	\$61.40	909-000-397	\$73.49	909-000-323	\$73.49
0.0800	0.5000	0.5000	1.5000	3.0000	82.0	909-000-426	\$61.40	909-000-398	\$73.49	909-000-324	\$73.49
0.0800	0.5000	0.5000	1.5000	3.0000	90.0	909-000-427	\$61.40	909-000-399	\$73.49	909-000-325	\$73.49
0.0800	0.5000	0.5000	1.5000	3.0000	100.0	909-000-418	\$61.40	909-000-390	\$73.49	909-000-316	\$73.49
0.0800	0.5000	0.5000	1.5000	3.0000	120.0	909-000-419	\$61.40	909-000-391	\$73.49	909-000-317	\$73.49
0.0800	0.5000	0.5000	1.5000	3.0000	150.0	909-000-420	\$61.40	909-000-392	\$73.49	909-000-318	\$73.49

CARBIDE

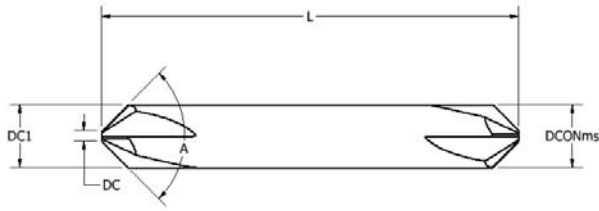

2-FLUTE



DC	DCONms	DC1	LS	L	60°	Price	82°	Price	90°	Price	100°	Price	120°	Price
0.0060	0.1250	0.1250	1.0000	2.0000	909-000-119	\$26.29	909-000-120	\$26.29	909-000-121	\$26.29	909-000-117	\$26.29	909-000-118	\$26.29
0.0060	0.1875	0.1875	1.2500	2.5000	909-000-124	\$31.57	909-000-125	\$31.57	909-000-126	\$31.57	909-000-122	\$31.57	909-000-123	\$31.57
0.0400	0.2500	0.2500	1.2500	2.5000	909-000-135	\$39.32	909-000-139	\$39.32	909-000-140	\$39.32	909-000-127	\$39.32	909-000-131	\$39.32
0.0600	0.3125	0.3125	1.2500	2.5000	909-000-143	\$50.30	909-000-144	\$50.30	909-000-145	\$50.30	909-000-141	\$50.30	909-000-142	\$50.30
0.0600	0.3750	0.3750	1.2500	2.5000	909-000-148	\$61.32	909-000-149	\$61.32	909-000-150	\$61.32	909-000-146	\$61.32	909-000-147	\$61.32
0.0800	0.5000	0.5000	1.5000	3.0000	909-000-153	\$101.72	909-000-154	\$101.72	909-000-155	\$101.72	909-000-151	\$101.72	909-000-152	\$101.72

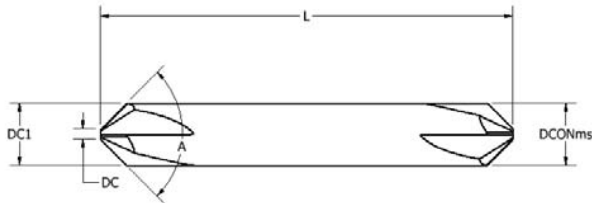

4-FLUTE



DC	DCONms	DC1	LS	L	60°	Price	82°	Price	90°	Price	100°	Price	120°	Price
0.0250	0.1250	0.1250	1.0000	2.0000	909-000-158	\$26.04	909-000-159	\$26.04	909-000-160	\$26.04	909-000-156	\$26.04	909-000-157	\$26.04
0.0400	0.1875	0.1875	1.2500	2.5000	909-000-163	\$31.27	909-000-164	\$31.27	909-000-165	\$31.27	909-000-161	\$31.27	909-000-162	\$31.27
0.0400	0.2500	0.2500	1.2500	2.5000	909-000-168	\$38.95	909-000-169	\$38.95	909-000-170	\$38.95	909-000-166	\$38.95	909-000-167	\$38.95
0.0600	0.3125	0.3125	1.2500	2.5000	909-000-173	\$49.83	909-000-174	\$49.83	909-000-175	\$49.83	909-000-171	\$49.83	909-000-172	\$49.83
0.0600	0.3750	0.3750	1.2500	2.5000	909-000-178	\$60.74	909-000-179	\$60.74	909-000-180	\$60.74	909-000-176	\$60.74	909-000-177	\$60.74
0.0800	0.5000	0.5000	1.5000	3.0000	909-000-183	\$100.76	909-000-184	\$100.76	909-000-185	\$100.76	909-000-181	\$100.76	909-000-182	\$100.76

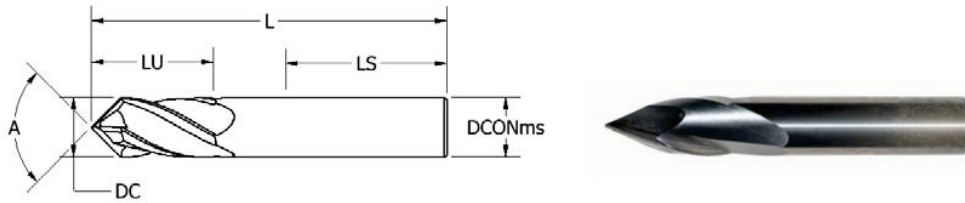

2-FLUTE



DC	DCONms	LS	L	LU	60°	Price	90°	Price
0.0313	0.1250	1.1338	1.5000	0.1250	933-000-001	\$20.59	933-000-002	\$20.59
0.0625	0.1250	1.1517	1.5000	0.1875	933-000-003	\$20.59	933-000-004	\$20.59
0.0938	0.1250	1.0446	1.5000	0.3750	933-000-005	\$20.59	933-000-006	\$20.59
0.1250	0.1250	0.6250	1.5000	0.5000	933-000-007	\$20.59	933-000-008	\$20.59
0.1875	0.1875	1.0000	2.0000	0.6250	933-000-009	\$21.81	933-000-010	\$21.81
0.2500	0.2500	1.3750	2.5000	0.7500	933-000-011	\$23.62	933-000-012	\$23.62
0.2500	0.2500	1.3750	2.5000	0.7500	933-000-013	\$24.94	933-000-014	\$24.94
0.3750	0.3750	1.1250	2.5000	1.0000	933-000-015	\$31.15	933-000-016	\$31.15
0.4375	0.4375	1.3750	2.7500	1.0000	933-000-017	\$40.37	933-000-018	\$40.37
0.5000	0.5000	1.6250	3.0000	1.0000	933-000-019	\$48.77	933-000-020	\$48.77
0.6250	0.6250	1.8750	3.5000	1.2500	933-000-021	\$94.67	933-000-022	\$94.67
0.7500	0.7500	2.1250	4.0000	1.5000	933-000-023	\$137.68	933-000-024	\$137.68

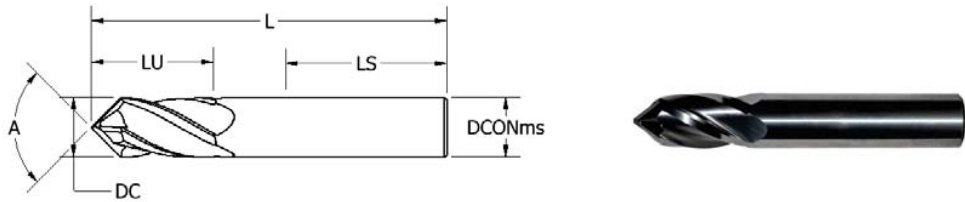

4-FLUTE



DC	DCONms	LS	L	LU	60°	Price	90°	Price
0.0313	0.1250	1.1338	1.5000	0.1250	933-000-025	\$20.59	933-000-026	\$20.59
0.0625	0.1250	1.1517	1.5000	0.1875	933-000-027	\$20.59	933-000-028	\$20.59
0.0938	0.1250	1.0446	1.5000	0.3750	933-000-029	\$20.59	933-000-030	\$20.59
0.1250	0.1250	0.6250	1.5000	0.5000	933-000-031	\$20.59	933-000-032	\$20.59
0.1875	0.1875	1.0000	2.0000	0.6250	933-000-033	\$21.81	933-000-034	\$21.81
0.2500	0.2500	1.3750	2.5000	0.7500	933-000-035	\$23.62	933-000-036	\$23.62
0.3125	0.3125	1.3125	2.5000	0.8125	933-000-040	\$24.94	933-000-041	\$24.94
0.3750	0.3750	1.1250	2.5000	1.0000	933-000-042	\$31.15	933-000-043	\$31.15
0.4375	0.4375	1.3750	2.7500	1.0000	933-000-044	\$40.37	933-000-045	\$40.37
0.5000	0.5000	1.6250	3.0000	1.0000	933-000-046	\$48.77	933-000-047	\$48.77
0.6250	0.6250	1.8750	3.5000	1.2500	933-000-048	\$94.67	933-000-049	\$94.67
0.7500	0.7500	2.1250	4.0000	1.5000	933-000-050	\$137.68	933-000-051	\$137.68

CARBIDE



IMPERIAL 1/32"- 3/4"

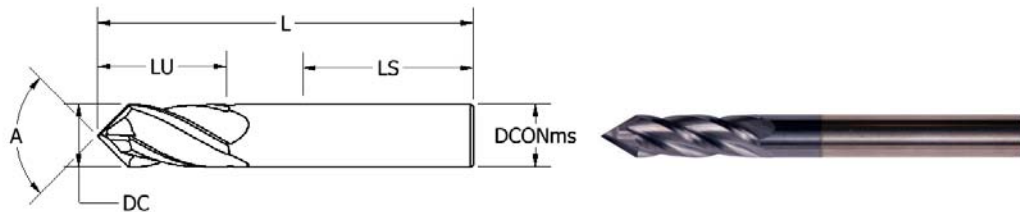

DC	DCONms	LS	L	LU	A	ALTIM COATED		
						2 FLUTE	4 FLUTE	Price
0.0313	0.1250	1.1338	1.5000	0.1250	60.0	933-000-066	933-000-104	\$25.13
0.0625	0.1250	1.1517	1.5000	0.1875	60.0	933-000-067	933-000-105	\$25.13
0.0938	0.1250	1.0446	1.5000	0.3750	60.0	933-000-068	933-000-106	\$25.13
0.1250	0.1250	0.6250	1.5000	0.5000	60.0	933-000-069	933-000-107	\$25.13
0.1875	0.1875	1.0000	2.0000	0.6250	60.0	933-000-070	933-000-108	\$25.60
0.2500	0.2500	1.3750	2.5000	0.7500	60.0	933-000-071	933-000-109	\$27.65
0.3125	0.3125	1.3125	2.5000	0.8125	60.0	933-000-072	933-000-110	\$29.67
0.3750	0.3750	1.1250	2.5000	1.0000	60.0	933-000-073	933-000-111	\$36.80
0.4375	0.4375	1.3750	2.7500	1.0000	60.0	933-000-074	933-000-112	\$46.05
0.5000	0.5000	1.6250	3.0000	1.0000	60.0	933-000-075	933-000-113	\$55.88
0.6250	0.6250	1.8750	3.5000	1.2500	60.0	933-000-076	933-000-114	\$105.69
0.7500	0.7500	2.1250	4.0000	1.5000	60.0	933-000-077	933-000-115	\$149.42
0.0313	0.1250	1.1338	1.5000	0.1250	90.0	933-000-078	933-000-116	\$25.13
0.0625	0.1250	1.1517	1.5000	0.1875	90.0	933-000-079	933-000-117	\$25.13
0.0938	0.1250	1.0446	1.5000	0.3750	90.0	933-000-080	933-000-118	\$25.13
0.1250	0.1250	0.6250	1.5000	0.5000	90.0	933-000-081	933-000-119	\$25.13
0.1875	0.1875	1.0000	2.0000	0.6250	90.0	933-000-082	933-000-120	\$25.60
0.2500	0.2500	1.3750	2.5000	0.7500	90.0	933-000-083	933-000-121	\$27.65
0.3125	0.3125	1.3125	2.5000	0.8125	90.0	933-000-084	933-000-122	\$29.67
0.3750	0.3750	1.1250	2.5000	1.0000	90.0	933-000-085	933-000-123	\$36.80
0.4375	0.4375	1.3750	2.7500	1.0000	90.0	933-000-086	933-000-124	\$46.05
0.5000	0.5000	1.6250	3.0000	1.0000	90.0	933-000-087	933-000-125	\$55.88
0.6250	0.6250	1.8750	3.5000	1.2500	90.0	933-000-088	933-000-126	\$105.69
0.7500	0.7500	2.1250	4.0000	1.5000	90.0	933-000-089	933-000-127	\$149.42

ARCH[®]
Cutting Tools

ENGRAVING TOOLS

THE COMPLETE TOOL MAKING AUTHORITY™

CARBIDE



IMPERIAL 1/8"

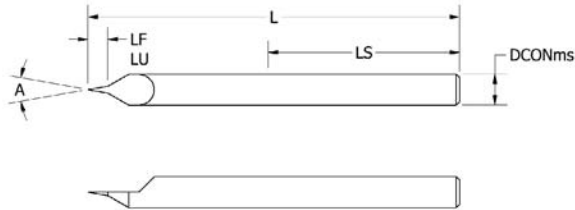

DCONms	LU	LS	L	LF	A	UNCOATED		ALTIN COATED	
						1 FLUTE	Price	1 FLUTE	Price
0.1250	0.0800	0.7500	1.5000	0.0800	10.0	937-000-002	\$16.37	937-000-135	\$20.76
0.1250	0.0800	0.7500	1.5000	0.0800	15.0	937-000-004	\$16.37	937-000-137	\$20.76
0.1250	0.0800	0.7500	1.5000	0.0800	20.0	937-000-005	\$16.37	937-000-138	\$20.76

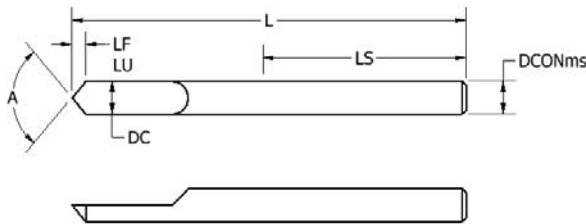

DC	DCONms	LU	LS	L	LF	A	UNCOATED		ALTIN COATED	
							1 FLUTE	Price	1 FLUTE	Price
0.1250	0.1250	0.2330	0.7500	1.5000	0.2330	30.0	937-000-010	\$11.65	937-000-143	\$16.04
0.1250	0.1250	0.1720	0.7500	1.5000	0.1720	40.0	937-000-020	\$11.65	937-000-153	\$16.04
0.1250	0.1250	0.1510	0.7500	1.5000	0.1510	45.0	937-000-026	\$11.65	937-000-159	\$16.04
0.1250	0.1250	0.1340	0.7500	1.5000	0.1340	50.0	937-000-027	\$11.65	937-000-160	\$16.04
0.1250	0.1250	0.1080	0.7500	1.5000	0.1080	60.0	937-000-032	\$11.65	937-000-165	\$16.04
0.1250	0.1250	0.0720	0.7500	1.5000	0.0720	82.0	937-000-038	\$11.65	937-000-171	\$16.04
0.1250	0.1250	0.0630	0.7500	1.5000	0.0630	90.0	937-000-043	\$11.65	937-000-176	\$16.04
0.1250	0.1250	0.0520	0.7500	1.5000	0.0520	100.0	937-000-001	\$11.65	937-000-134	\$16.04
0.1250	0.1250	0.0360	0.7500	1.5000	0.0360	120.0	937-000-003	\$11.65	937-000-136	\$16.04



IMPERIAL 1/8"

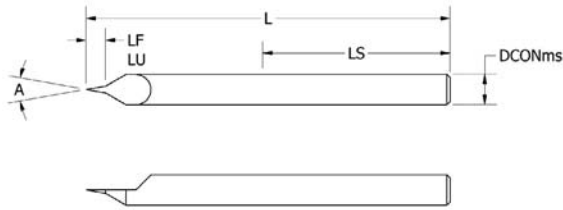

DCONms	LU	LS	L	LF	A	TIALN COATED		AMORPHOUS DIAMOND	
						1 FLUTE	Price	1 FLUTE	Price
0.1250	0.0800	0.7500	1.5000	0.0800	10.0	937-000-062	\$20.76	937-000-050	\$31.91
0.1250	0.0800	0.7500	1.5000	0.0800	15.0	937-000-064	\$20.76	937-000-052	\$31.91
0.1250	0.0800	0.7500	1.5000	0.0800	20.0	937-000-065	\$20.76	937-000-053	\$31.91

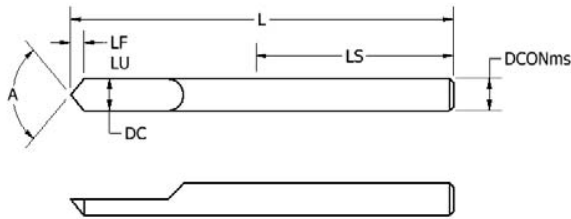

DC	DCONms	LU	LS	L	LF	A	TIALN COATED		AMORPHOUS DIAMOND	
							1 FLUTE	Price	1 FLUTE	Price
0.1250	0.1250	0.2330	0.7500	1.5000	0.2330	30.0	937-000-070	\$16.04	937-000-054	\$23.18
0.1250	0.1250	0.1720	0.7500	1.5000	0.1720	40.0	937-000-080	\$16.04	937-000-055	\$23.18
0.1250	0.1250	0.1510	0.7500	1.5000	0.1510	45.0	937-000-086	\$16.04	937-000-056	\$23.18
0.1250	0.1250	0.1340	0.7500	1.5000	0.1340	50.0	937-000-087	\$16.04	937-000-057	\$23.18
0.1250	0.1250	0.1080	0.7500	1.5000	0.1080	60.0	937-000-092	\$16.04	937-000-058	\$23.18
0.1250	0.1250	0.0720	0.7500	1.5000	0.0720	82.0	937-000-098	\$16.04	937-000-059	\$23.18
0.1250	0.1250	0.0630	0.7500	1.5000	0.0630	90.0	937-000-103	\$16.04	937-000-060	\$23.18
0.1250	0.1250	0.0520	0.7500	1.5000	0.0520	100.0	937-000-061	\$16.04	937-000-049	\$23.18
0.1250	0.1250	0.0360	0.7500	1.5000	0.0360	120.0	937-000-063	\$16.04	937-000-051	\$23.18

CARBIDE

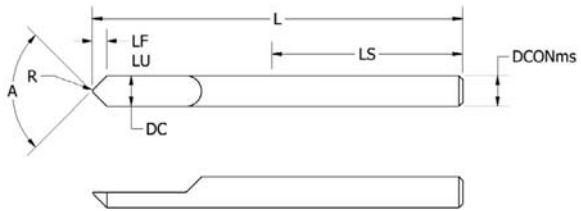

IMPERIAL 1/8"



DC	DCONms	LU	LS	L	LF	R	A	UNCOATED		ALTiN COATED		TiAlN COATED	
								1 FLUTE	Price	1 FLUTE	Price	1 FLUTE	Price
0.1250	0.1250	0.2260	0.7500	1.5000	0.2260	0.0025	30.0	937-000-011	\$19.01	937-000-144	\$23.40	937-000-071	\$23.40
0.1250	0.1250	0.1670	0.7500	1.5000	0.1670	0.0025	40.0	937-000-021	\$19.01	937-000-154	\$23.40	937-000-081	\$23.40
0.1250	0.1250	0.1060	0.7500	1.5000	0.1060	0.0025	60.0	937-000-033	\$19.01	937-000-166	\$23.40	937-000-093	\$23.40
0.1250	0.1250	0.0610	0.7500	1.5000	0.0610	0.0025	90.0	937-000-044	\$19.01	937-000-177	\$23.40	937-000-104	\$23.40
0.1250	0.1250	0.2190	0.7500	1.5000	0.2190	0.0050	30.0	937-000-012	\$19.01	937-000-145	\$23.40	937-000-072	\$23.40
0.1250	0.1250	0.1620	0.7500	1.5000	0.1620	0.0050	40.0	937-000-022	\$19.01	937-000-155	\$23.40	937-000-082	\$23.40
0.1250	0.1250	0.1030	0.7500	1.5000	0.1030	0.0050	60.0	937-000-034	\$19.01	937-000-167	\$23.40	937-000-094	\$23.40
0.1250	0.1250	0.0600	0.7500	1.5000	0.0600	0.0050	90.0	937-000-045	\$19.01	937-000-178	\$23.40	937-000-105	\$23.40
0.1250	0.1250	0.2050	0.7500	1.5000	0.2050	0.0100	30.0	937-000-013	\$19.01	937-000-146	\$23.40	937-000-073	\$23.40
0.1250	0.1250	0.1520	0.7500	1.5000	0.1520	0.0100	40.0	937-000-023	\$19.01	937-000-156	\$23.40	937-000-083	\$23.40
0.1250	0.1250	0.0980	0.7500	1.5000	0.0980	0.0100	60.0	937-000-035	\$19.01	937-000-168	\$23.40	937-000-095	\$23.40
0.1250	0.1250	0.0580	0.7500	1.5000	0.0580	0.0100	90.0	937-000-046	\$19.01	937-000-179	\$23.40	937-000-106	\$23.40
0.1250	0.1250	0.1900	0.7500	1.5000	0.1900	0.0150	30.0	937-000-014	\$19.01	937-000-147	\$23.40	937-000-074	\$23.40
0.1250	0.1250	0.1430	0.7500	1.5000	0.1430	0.0150	40.0	937-000-024	\$19.01	937-000-157	\$23.40	937-000-084	\$23.40
0.1250	0.1250	0.0930	0.7500	1.5000	0.0930	0.0150	60.0	937-000-036	\$19.01	937-000-169	\$23.40	937-000-096	\$23.40
0.1250	0.1250	0.0560	0.7500	1.5000	0.0560	0.0150	90.0	937-000-047	\$19.01	937-000-180	\$23.40	937-000-107	\$23.40
0.1250	0.1250	0.1760	0.7500	1.5000	0.1760	0.0200	30.0	937-000-015	\$19.01	937-000-148	\$23.40	937-000-075	\$23.40
0.1250	0.1250	0.1280	0.7500	1.5000	0.1280	0.0200	40.0	937-000-025	\$19.01	937-000-158	\$23.40	937-000-085	\$23.40
0.1250	0.1250	0.0880	0.7500	1.5000	0.0880	0.0200	60.0	937-000-037	\$19.01	937-000-170	\$23.40	937-000-097	\$23.40
0.1250	0.1250	0.0540	0.7500	1.5000	0.0540	0.0200	90.0	937-000-048	\$19.01	937-000-181	\$23.40	937-000-108	\$23.40



CARBIDE

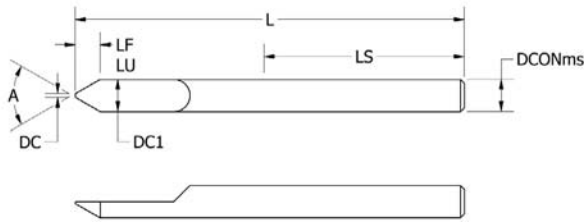

IMPERIAL 1/8"



DC	DCONms	DC1	LU	LS	L	LF	A	UNCOATED		ALTiN COATED		TiAlN COATED	
								1 FLUTE	Price	1 FLUTE	Price	1 FLUTE	Price
0.0050	0.1250	0.1250	0.2240	0.7500	1.5000	0.2240	30.0	937-000-006	\$13.74	937-000-139	\$18.12	937-000-066	\$18.12
0.0050	0.1250	0.1250	0.1650	0.7500	1.5000	0.1650	40.0	937-000-016	\$13.74	937-000-149	\$18.12	937-000-076	\$18.12
0.0050	0.1250	0.1250	0.1040	0.7500	1.5000	0.1040	60.0	937-000-028	\$13.74	937-000-161	\$18.12	937-000-088	\$18.12
0.0050	0.1250	0.1250	0.0600	0.7500	1.5000	0.0600	90.0	937-000-039	\$13.74	937-000-172	\$18.12	937-000-099	\$18.12
0.0100	0.1250	0.1250	0.2150	0.7500	1.5000	0.2150	30.0	937-000-007	\$13.74	937-000-140	\$18.12	937-000-067	\$18.12
0.0100	0.1250	0.1250	0.1580	0.7500	1.5000	0.1580	40.0	937-000-017	\$13.74	937-000-150	\$18.12	937-000-077	\$18.12
0.0100	0.1250	0.1250	0.1000	0.7500	1.5000	0.1000	60.0	937-000-029	\$13.74	937-000-162	\$18.12	937-000-089	\$18.12
0.0100	0.1250	0.1250	0.0580	0.7500	1.5000	0.0580	90.0	937-000-040	\$13.74	937-000-173	\$18.12	937-000-100	\$18.12
0.0150	0.1250	0.1250	0.2050	0.7500	1.5000	0.2050	30.0	937-000-008	\$13.74	937-000-141	\$18.12	937-000-068	\$18.12
0.0150	0.1250	0.1250	0.1510	0.7500	1.5000	0.1510	40.0	937-000-018	\$13.74	937-000-151	\$18.12	937-000-078	\$18.12
0.0150	0.1250	0.1250	0.0950	0.7500	1.5000	0.0950	60.0	937-000-030	\$13.74	937-000-163	\$18.12	937-000-090	\$18.12
0.0150	0.1250	0.1250	0.0550	0.7500	1.5000	0.0550	90.0	937-000-041	\$13.74	937-000-174	\$18.12	937-000-101	\$18.12
0.0200	0.1250	0.1250	0.1960	0.7500	1.5000	0.1960	30.0	937-000-009	\$13.74	937-000-142	\$18.12	937-000-069	\$18.12
0.0200	0.1250	0.1250	0.1440	0.7500	1.5000	0.1440	40.0	937-000-019	\$13.74	937-000-152	\$18.12	937-000-079	\$18.12
0.0200	0.1250	0.1250	0.0910	0.7500	1.5000	0.0910	60.0	937-000-031	\$13.74	937-000-164	\$18.12	937-000-091	\$18.12
0.0200	0.1250	0.1250	0.0530	0.7500	1.5000	0.0530	90.0	937-000-042	\$13.74	937-000-175	\$18.12	937-000-102	\$18.12

CARBIDE



IMPERIAL 1/8"

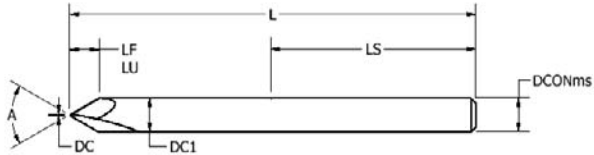

DC	DCONms	DC1	LU	LS	L	LF	A	UNCOATED		ALTiN COATED		TiAlN COATED	
								2 FLUTE	Price	1 FLUTE	Price	1 FLUTE	Price
0.0050	0.1250	0.1250	0.2240	0.7500	1.5000	0.2240	30.0	947-000-006	\$15.27	947-000-030	\$19.67	937-000-113	\$19.67
0.0050	0.1250	0.1250	0.1650	0.7500	1.5000	0.1650	40.0	947-000-011	\$15.27	947-000-034	\$19.67	937-000-117	\$19.67
0.0050	0.1250	0.1250	0.1040	0.7500	1.5000	0.1040	60.0	947-000-016	\$15.27	947-000-038	\$19.67	937-000-121	\$19.67
0.0050	0.1250	0.1250	0.0600	0.7500	1.5000	0.0600	90.0	947-000-021	\$15.27	947-000-042	\$19.67	937-000-125	\$19.67
0.0050	0.1250	0.1250	0.0350	0.7500	1.5000	0.0350	120.0	947-000-001	\$15.27	947-000-026	\$19.67	937-000-109	\$19.67
0.0100	0.1250	0.1250	0.2150	0.7500	1.5000	0.2150	30.0	947-000-008	\$15.27	947-000-031	\$19.67	937-000-114	\$19.67
0.0100	0.1250	0.1250	0.1580	0.7500	1.5000	0.1580	40.0	947-000-013	\$15.27	947-000-035	\$19.67	937-000-118	\$19.67
0.0100	0.1250	0.1250	0.1000	0.7500	1.5000	0.1000	60.0	947-000-018	\$15.27	947-000-039	\$19.67	937-000-122	\$19.67
0.0100	0.1250	0.1250	0.0580	0.7500	1.5000	0.0580	90.0	947-000-023	\$15.27	947-000-043	\$19.67	937-000-126	\$19.67
0.0100	0.1250	0.1250	0.0330	0.7500	1.5000	0.0330	120.0	947-000-003	\$15.27	947-000-027	\$19.67	937-000-110	\$19.67

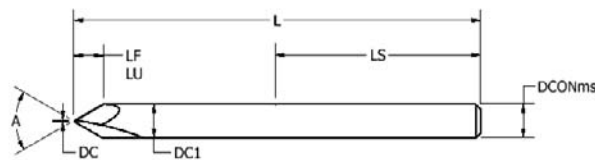

For Non-Ferrous Applications



DC	DCONms	DC1	LU	LS	L	LF	A	UNCOATED		DLC COATED	
								2 FLUTE	Price	2 FLUTE	Price
0.0050	0.1250	0.1250	0.2240	0.7500	1.5000	0.2240	30.0	947-000-007	\$15.27	937-000-130	\$21.86
0.0050	0.1250	0.1250	0.1650	0.7500	1.5000	0.1650	40.0	947-000-012	\$15.27	937-000-131	\$21.86
0.0050	0.1250	0.1250	0.1040	0.7500	1.5000	0.1040	60.0	947-000-017	\$15.27	937-000-132	\$21.86
0.0050	0.1250	0.1250	0.0600	0.7500	1.5000	0.0600	90.0	947-000-022	\$15.27	937-000-133	\$21.86
0.0050	0.1250	0.1250	0.0350	0.7500	1.5000	0.0350	120.0	947-000-002	\$15.27	937-000-129	\$21.86



IMPERIAL 1/8"

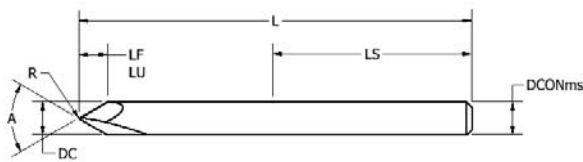

DC	DCONms	LU	LS	L	LF	R	A	UNCOATED		ALTiN COATED		TiAlN COATED	
								2 FLUTE	Price	2 FLUTE	Price	2 FLUTE	Price
0.1250	0.1250	0.2180	0.7500	1.5000	0.2180	0.0050	30.0	947-000-009	\$19.67	947-000-032	\$24.06	937-000-115	\$24.06
0.1250	0.1250	0.1600	0.7500	1.5000	0.1600	0.0050	40.0	947-000-014	\$19.67	947-000-036	\$24.06	937-000-119	\$24.06
0.1250	0.1250	0.1030	0.7500	1.5000	0.1030	0.0050	60.0	947-000-019	\$19.67	947-000-040	\$24.06	937-000-123	\$24.06
0.1250	0.1250	0.0600	0.7500	1.5000	0.0600	0.0050	90.0	947-000-024	\$19.67	947-000-044	\$24.06	937-000-127	\$24.06
0.1250	0.1250	0.0350	0.7500	1.5000	0.0350	0.0050	120.0	937-000-111	\$19.67	947-000-028	\$24.06	937-000-111	\$24.06
0.1250	0.1250	0.2040	0.7500	1.5000	0.2040	0.0100	30.0	947-000-010	\$19.67	947-000-033	\$24.06	937-000-116	\$24.06
0.1250	0.1250	0.1500	0.7500	1.5000	0.1500	0.0100	40.0	947-000-015	\$19.67	947-000-037	\$24.06	937-000-120	\$24.06
0.1250	0.1250	0.0980	0.7500	1.5000	0.0980	0.0100	60.0	947-000-020	\$19.67	947-000-041	\$24.06	937-000-124	\$24.06
0.1250	0.1250	0.0580	0.7500	1.5000	0.0580	0.0100	90.0	947-000-025	\$19.67	947-000-045	\$24.06	937-000-128	\$24.06
0.1250	0.1250	0.0340	0.7500	1.5000	0.0340	0.0100	120.0	947-000-005	\$19.67	947-000-029	\$24.06	937-000-112	\$24.06



CORNER ROUNDING

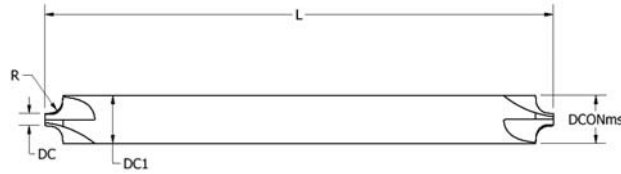

CARBIDE



METRIC .005"-.030"



DC	DCONms	DC1	L	R	UNCOATED		ALTIM COATED		TIALN COATED	
					2 FLUTE	Price	2 FLUTE	Price	2 FLUTE	Price
0.0080	0.1250	0.1250	1.5000	0.0050	932-000-634	\$43.28	932-000-745	\$46.34	932-000-463	\$48.89
0.0200	0.1250	0.1250	1.5000	0.0050	932-000-635	\$38.34	932-000-746	\$43.84	932-000-464	\$43.84
0.0460	0.1250	0.1250	1.5000	0.0050	932-000-636	\$35.37	932-000-747	\$38.84	932-000-465	\$40.98
0.0460	0.1875	0.1875	4.0000	0.0050	932-000-856	\$59.43	932-000-874	\$64.38	932-000-574	\$64.38
0.0200	0.1250	0.1250	1.5000	0.0060	932-000-637	\$38.34	932-000-748	\$43.84	932-000-466	\$43.84
0.0460	0.1250	0.1250	1.5000	0.0060	932-000-638	\$35.37	932-000-749	\$38.84	932-000-467	\$38.84
0.0200	0.1250	0.1250	1.5000	0.0070	932-000-639	\$38.34	932-000-750	\$43.84	932-000-468	\$43.84
0.0460	0.1250	0.1250	1.5000	0.0070	932-000-640	\$35.37	932-000-751	\$38.84	932-000-469	\$38.84
0.0080	0.1250	0.1250	1.5000	0.0080	932-000-641	\$43.28	932-000-752	\$46.34	932-000-470	\$48.89
0.0200	0.1250	0.1250	1.5000	0.0080	932-000-642	\$38.34	932-000-753	\$43.84	932-000-471	\$43.84
0.0460	0.1250	0.1250	1.5000	0.0080	932-000-643	\$35.37	932-000-754	\$38.84	932-000-472	\$40.98
0.0460	0.1875	0.1875	4.0000	0.0080	932-000-857	\$59.43	932-000-875	\$64.38	932-000-575	\$64.38
0.0200	0.1250	0.1250	1.5000	0.0090	932-000-644	\$38.34	932-000-755	\$43.84	932-000-473	\$43.84
0.0460	0.1250	0.1250	1.5000	0.0090	932-000-645	\$35.37	932-000-756	\$38.84	932-000-474	\$40.98
0.0080	0.1250	0.1250	1.5000	0.0100	932-000-646	\$43.28	932-000-757	\$46.34	932-000-475	\$48.89
0.0460	0.1250	0.1250	1.5000	0.0100	932-000-647	\$38.34	932-000-758	\$43.84	932-000-476	\$43.84
0.0460	0.1250	0.1250	1.5000	0.0100	932-000-648	\$35.37	932-000-759	\$38.84	932-000-477	\$40.98
0.0460	0.1875	0.1875	4.0000	0.0100	932-000-858	\$59.43	932-000-876	\$64.38	932-000-576	\$64.38
0.0200	0.1250	0.1250	1.5000	0.0110	932-000-649	\$38.34	932-000-760	\$43.84	932-000-478	\$43.84
0.0460	0.1250	0.1250	1.5000	0.0110	932-000-650	\$35.37	932-000-761	\$38.84	932-000-479	\$40.98
0.0200	0.1250	0.1250	1.5000	0.0120	932-000-651	\$38.34	932-000-762	\$43.84	932-000-480	\$43.84
0.0460	0.1250	0.1250	1.5000	0.0120	932-000-652	\$35.37	932-000-763	\$38.84	932-000-481	\$40.98
0.0200	0.1250	0.1250	1.5000	0.0130	932-000-653	\$38.34	932-000-764	\$43.84	932-000-482	\$43.84
0.0460	0.1250	0.1250	1.5000	0.0130	932-000-654	\$35.37	932-000-765	\$38.84	932-000-483	\$40.98
0.0200	0.1250	0.1250	1.5000	0.0140	932-000-655	\$38.34	932-000-766	\$43.84	932-000-484	\$43.84
0.0460	0.1250	0.1250	1.5000	0.0140	932-000-656	\$35.37	932-000-767	\$38.84	932-000-485	\$40.98
0.0080	0.1250	0.1250	1.5000	0.0150	932-000-657	\$43.28	932-000-768	\$46.34	932-000-486	\$48.89
0.0200	0.1250	0.1250	1.5000	0.0150	932-000-658	\$38.34	932-000-769	\$43.84	932-000-487	\$43.84
0.0460	0.1250	0.1250	1.5000	0.0150	932-000-659	\$35.37	932-000-770	\$38.84	932-000-488	\$40.98
0.0460	0.1875	0.1875	4.0000	0.0150	932-000-859	\$59.43	932-000-877	\$64.38	932-000-577	\$64.38
0.0460	0.1250	0.1250	1.5000	0.0180	932-000-660	\$35.37	932-000-771	\$38.84	932-000-489	\$40.98
0.0080	0.1250	0.1250	1.5000	0.0200	932-000-661	\$43.28	932-000-772	\$46.34	932-000-490	\$48.89
0.0200	0.1250	0.1250	1.5000	0.0200	932-000-662	\$38.34	932-000-773	\$43.84	932-000-491	\$43.84
0.0460	0.1250	0.1250	1.5000	0.0200	932-000-663	\$35.37	932-000-774	\$38.84	932-000-492	\$40.98
0.0460	0.1875	0.1875	4.0000	0.0200	932-000-860	\$59.43	932-000-878	\$64.38	932-000-578	\$64.38
0.0460	0.1250	0.1250	1.5000	0.0220	932-000-664	\$35.37	932-000-775	\$38.84	932-000-493	\$40.98
0.0200	0.1250	0.1250	1.5000	0.0250	932-000-665	\$38.34	932-000-776	\$43.84	932-000-494	\$43.84
0.0460	0.1250	0.1250	1.5000	0.0250	932-000-666	\$35.37	932-000-777	\$38.84	932-000-495	\$40.98
0.0460	0.1875	0.1875	4.0000	0.0250	932-000-861	\$59.43	932-000-879	\$64.38	932-000-579	\$64.38
0.0460	0.1250	0.1250	1.5000	0.0270	932-000-667	\$35.37	932-000-778	\$38.84	932-000-496	\$40.98
0.0200	0.1250	0.1250	1.5000	0.0300	932-000-668	\$38.34	932-000-779	\$43.84	932-000-497	\$43.84
0.0460	0.1250	0.1250	1.5000	0.0300	932-000-669	\$35.37	932-000-780	\$38.84	932-000-498	\$40.98
0.0460	0.1875	0.1875	4.0000	0.0300	932-000-862	\$59.43	932-000-880	\$64.38	932-000-580	\$64.38

CARBIDE

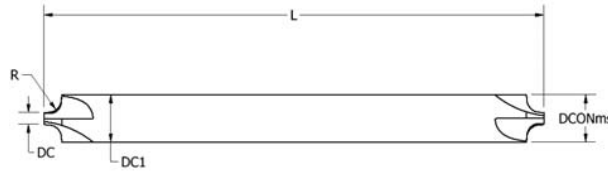

IMPERIAL .031"-.156"



DC	DCONms	DC1	L	R	UNCOATED		ALTIM COATED		TIALN COATED	
					2 FLUTE	Price	2 FLUTE	Price	2 FLUTE	Price
0.0200	0.1250	0.1250	1.5000	0.0310	932-000-670	\$38.34	932-000-781	\$43.84	932-000-499	\$43.84
0.0460	0.1250	0.1250	1.5000	0.0310	932-000-671	\$35.37	932-000-782	\$40.98	932-000-500	\$40.98
0.0460	0.1875	0.1875	4.0000	0.0310	932-000-863	\$59.43	932-000-881	\$64.38	932-000-581	\$64.38
0.0460	0.1250	0.1250	1.5000	0.0320	932-000-672	\$35.37	932-000-783	\$40.98	932-000-501	\$40.98
0.0200	0.1250	0.1250	1.5000	0.0350	932-000-673	\$38.34	932-000-784	\$43.84	932-000-502	\$43.84
0.0460	0.1250	0.1250	1.5000	0.0350	932-000-674	\$35.37	932-000-785	\$40.98	932-000-503	\$40.98
0.0460	0.1875	0.1875	4.0000	0.0350	932-000-864	\$59.43	932-000-882	\$64.38	932-000-582	\$64.38
0.0200	0.1250	0.1250	1.5000	0.0390	932-000-675	\$38.34	932-000-786	\$43.84	932-000-504	\$43.84
0.0460	0.1250	0.1250	1.5000	0.0390	932-000-676	\$35.37	932-000-787	\$40.98	932-000-505	\$40.98
0.0460	0.1875	0.1875	4.0000	0.0390	932-000-865	\$59.43	932-000-883	\$64.38	932-000-583	\$64.38
0.1000	0.1875	0.1875	2.0000	0.0390	932-000-677	\$45.38	932-000-788	\$51.75	932-000-506	\$51.75
0.0460	0.1875	0.1875	2.0000	0.0430	932-000-678	\$45.38	932-000-789	\$51.75	932-000-507	\$51.75
0.0200	0.1250	0.1250	1.5000	0.0470	932-000-679	\$38.34	932-000-790	\$43.84	932-000-508	\$43.84
0.0460	0.1875	0.1875	2.0000	0.0470	932-000-680	\$45.38	932-000-791	\$49.54	932-000-509	\$49.54
0.0460	0.1875	0.1875	4.0000	0.0470	932-000-866	\$59.43	932-000-884	\$64.38	932-000-584	\$64.38
0.1250	0.2500	0.2500	2.0000	0.0470	932-000-681	\$51.97	932-000-792	\$60.86	932-000-510	\$60.86
0.0200	0.1250	0.1250	1.5000	0.0500	932-000-682	\$38.34	932-000-793	\$43.84	932-000-511	\$43.84
0.0460	0.1875	0.1875	2.0000	0.0500	932-000-683	\$45.38	932-000-794	\$49.54	932-000-512	\$49.54
0.0460	0.2500	0.2500	4.0000	0.0500	932-000-867	\$70.42	932-000-885	\$79.31	932-000-585	\$79.31
0.1250	0.2500	0.2500	2.0000	0.0500	932-000-684	\$51.97	932-000-795	\$60.86	932-000-513	\$60.86
0.0460	0.1875	0.1875	2.0000	0.0550	932-000-685	\$45.38	932-000-796	\$49.54	932-000-514	\$49.54
0.0200	0.1875	0.1875	2.0000	0.0600	932-000-686	\$46.91	932-000-797	\$49.54	932-000-515	\$49.54
0.0460	0.1875	0.1875	2.0000	0.0600	932-000-687	\$45.38	932-000-798	\$45.76	932-000-516	\$45.76
0.0460	0.2500	0.2500	4.0000	0.0600	932-000-868	\$70.42	8932-000-886	\$79.31	932-000-586	\$79.31
0.0200	0.1875	0.2500	2.0000	0.0600	932-000-689	\$51.97	932-000-799	\$60.86	932-000-517	\$60.86
0.0460	0.1875	0.1875	2.0000	0.0620	932-000-690	\$46.91	932-000-800	\$47.31	932-000-518	\$47.31
0.1250	0.2500	0.1875	2.0000	0.0620	932-000-691	\$45.38	932-000-801	\$45.76	932-000-519	\$45.76
0.0460	0.2500	0.2500	4.0000	0.0620	932-000-869	\$70.42	932-000-887	\$79.31	932-000-587	\$79.31
0.1250	0.2500	0.2500	2.0000	0.0620	932-000-691	\$51.97	932-000-802	\$60.86	932-000-520	\$60.86
0.0460	0.2500	0.2500	2.0000	0.0720	932-000-692	\$51.97	932-000-803	\$60.86	932-000-521	\$60.86
0.0460	0.2500	0.2500	2.0000	0.0780	932-000-693	\$51.97	932-000-804	\$60.86	932-000-522	\$60.86
0.0460	0.2500	0.2500	4.0000	0.0780	932-000-870	\$70.42	932-000-888	\$79.31	932-000-588	\$79.31
0.0450	0.2500	0.2500	2.0000	0.0890	932-000-694	\$51.97	932-000-805	\$60.86	932-000-523	\$60.86
0.0450	0.2500	0.2500	2.0000	0.0930	932-000-695	\$51.97	932-000-806	\$60.86	932-000-524	\$60.86
0.0450	0.3125	0.3125	4.0000	0.0930	932-000-871	\$92.83	932-000-889	\$105.13	932-000-589	\$105.13
0.0450	0.2500	0.2500	2.0000	0.1000	932-000-696	\$51.97	932-000-807	\$60.86	932-000-525	\$60.86
0.0450	0.3125	0.3125	4.0000	0.1000	932-000-872	\$92.83	932-000-890	\$105.13	932-000-590	\$105.13
0.0580	0.3125	0.3125	2.5000	0.1090	932-000-697	\$76.68	932-000-808	\$87.77	932-000-526	\$87.77
0.0580	0.3125	0.3125	2.5000	0.1180	932-000-698	\$76.68	932-000-809	\$87.77	932-000-527	\$87.77
0.0580	0.3125	0.3125	2.5000	0.1250	932-000-699	\$76.68	932-000-810	\$87.77	932-000-528	\$87.77
0.0580	0.3750	0.3750	4.0000	0.1250	932-000-873	\$107.87	932-000-891	\$115.79	932-000-591	\$115.79
0.0580	0.3750	0.3750	2.5000	0.1400	932-000-700	\$92.50	932-000-811	\$105.90	932-000-529	\$105.90
0.0580	0.3750	0.3750	2.5000	0.1560	932-000-701	\$92.50	932-000-812	\$105.90	932-000-530	\$105.90

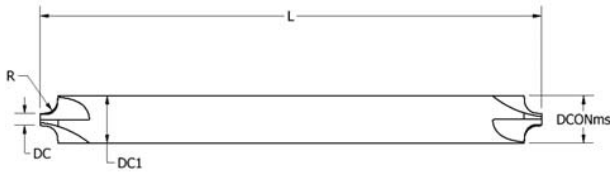

CARBIDE



IMPERIAL .005"-.125"



DC	DCONms	DC1	L	R	UNCOATED		ALTIM COATED		TIALN COATED	
					4 FLUTE	Price	4 FLUTE	Price	4 FLUTE	Price
0.0580	0.1250	0.1250	1.5000	0.0050	932-000-702	\$46.69	932-000-813	\$52.40	932-000-531	\$52.40
0.2490	0.3750	0.3750	2.5000	0.0050	932-000-703	\$54.71	932-000-814	\$67.89	932-000-532	\$67.89
0.0580	0.1250	0.1250	1.5000	0.0080	932-000-704	\$46.69	932-000-815	\$52.40	932-000-533	\$52.40
0.2490	0.3750	0.3750	2.5000	0.0080	932-000-705	\$54.71	932-000-816	\$64.25	932-000-534	\$67.78
0.0580	0.1250	0.1250	1.5000	0.0100	932-000-706	\$46.69	932-000-817	\$52.40	932-000-535	\$52.40
0.2490	0.3750	0.3750	2.5000	0.0100	932-000-707	\$54.71	932-000-818	\$67.89	932-000-536	\$67.89
0.0580	0.1250	0.1250	1.5000	0.0150	932-000-708	\$46.69	932-000-819	\$52.40	932-000-537	\$52.40
0.1070	0.1875	0.1875	2.0000	0.0150	932-000-709	\$50.86	932-000-820	\$57.44	932-000-538	\$57.44
0.2490	0.3750	0.3750	2.5000	0.0150	932-000-710	\$54.71	932-000-821	\$67.89	932-000-539	\$67.89
0.0580	0.1250	0.1250	1.5000	0.0200	932-000-711	\$46.69	932-000-822	\$52.40	932-000-540	\$52.40
0.1070	0.1875	0.1875	2.0000	0.0200	932-000-712	\$50.86	932-000-823	\$57.44	932-000-541	\$57.44
0.2490	0.3750	0.3750	2.5000	0.0200	932-000-713	\$54.71	932-000-824	\$67.89	932-000-542	\$67.89
0.0580	0.1250	0.1250	1.5000	0.0250	932-000-714	\$46.69	932-000-825	\$52.40	932-000-543	\$52.40
0.1070	0.1875	0.1875	2.0000	0.0250	932-000-715	\$50.86	932-000-826	\$57.44	932-000-544	\$57.44
0.2490	0.3750	0.3750	2.5000	0.0250	932-000-716	\$54.71	932-000-827	\$67.89	932-000-545	\$67.89
0.0580	0.1250	0.1250	1.5000	0.0300	932-000-717	\$46.69	932-000-828	\$52.40	932-000-546	\$52.40
0.1070	0.1875	0.1875	2.0000	0.0300	932-000-718	\$50.86	932-000-829	\$57.44	932-000-547	\$57.44
0.2490	0.3750	0.3750	2.5000	0.0300	932-000-719	\$60.20	932-000-830	\$67.89	932-000-548	\$73.71
0.0580	0.1250	0.1250	1.5000	0.0310	932-000-720	\$46.69	932-000-831	\$52.40	932-000-549	\$52.40
0.1070	0.1875	0.1875	2.0000	0.0310	932-000-721	\$50.86	932-000-832	\$57.44	932-000-550	\$57.44
0.2490	0.3750	0.3750	2.5000	0.0310	932-000-722	\$60.20	932-000-833	\$73.71	932-000-551	\$73.71
0.2490	0.3750	0.3750	2.5000	0.0320	932-000-723	\$60.20	932-000-834	\$73.71	932-000-552	\$73.71
0.2490	0.3750	0.3750	2.5000	0.0350	932-000-724	\$60.20	932-000-835	\$73.71	932-000-553	\$73.71
0.0580	0.1875	0.1875	2.0000	0.0390	932-000-725	\$59.10	932-000-836	\$59.10	932-000-554	\$59.10
0.2490	0.3750	0.3750	2.5000	0.0390	932-000-726	\$60.20	932-000-837	\$73.71	932-000-555	\$73.71
0.2490	0.3750	0.3750	2.5000	0.0430	932-000-727	\$72.72	932-000-838	\$86.24	932-000-556	\$86.24
0.0580	0.1875	0.1875	2.0000	0.0470	932-000-728	\$59.10	932-000-839	\$59.10	932-000-557	\$59.10
0.1070	0.2500	0.2500	2.0000	0.0470	932-000-729	\$62.94	932-000-840	\$71.74	932-000-558	\$71.74
0.2490	0.3750	0.3750	2.5000	0.0470	932-000-730	\$72.72	932-000-841	\$86.24	932-000-559	\$86.24
0.0580	0.1875	0.1875	2.0000	0.0500	932-000-731	\$59.10	932-000-842	\$59.10	932-000-560	\$59.10
0.1070	0.2500	0.2500	2.0000	0.0500	932-000-732	\$66.47	932-000-843	\$75.47	932-000-561	\$75.47
0.2490	0.3750	0.3750	2.5000	0.0500	932-000-733	\$72.72	932-000-844	\$86.24	932-000-562	\$86.24
0.0580	0.1875	0.1875	2.0000	0.0600	932-000-734	\$59.10	932-000-845	\$59.10	932-000-563	\$59.10
0.1070	0.2500	0.2500	2.0000	0.0600	932-000-735	\$66.47	932-000-846	\$75.47	932-000-564	\$75.47
0.0580	0.1875	0.1875	2.0000	0.0620	932-000-736	\$59.10	932-000-847	\$59.10	932-000-565	\$59.10
0.1070	0.2500	0.2500	2.0000	0.0620	932-000-737	\$66.47	932-000-848	\$75.47	932-000-566	\$75.47
0.0580	0.2500	0.2500	2.0000	0.0780	932-000-738	\$66.47	932-000-849	\$75.47	932-000-567	\$75.47
0.1070	0.3125	0.3125	2.5000	0.0780	932-000-739	\$76.68	932-000-850	\$87.77	932-000-568	\$87.77
0.0580	0.2500	0.2500	2.0000	0.0930	932-000-740	\$66.47	932-000-851	\$75.47	932-000-569	\$75.47
0.1070	0.3125	0.3125	2.5000	0.0930	932-000-741	\$76.68	932-000-852	\$87.77	932-000-570	\$87.77
0.1070	0.3125	0.3125	2.5000	0.1000	932-000-742	\$76.68	932-000-853	\$87.77	932-000-571	\$87.77
0.1070	0.3750	0.3750	2.5000	0.1180	932-000-743	\$93.93	932-000-854	\$107.54	932-000-572	\$107.54
0.1070	0.3750	0.3750	2.5000	0.1250	932-000-744	\$93.93	932-000-855	\$107.54	932-000-573	\$107.54

CARBIDE

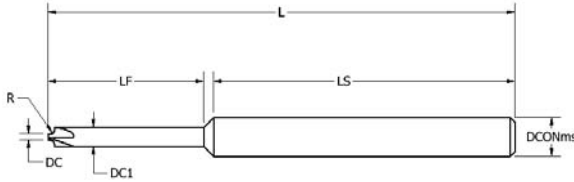

IMPERIAL .005"-.030"



DC	DCONms	DC1	LS	L	LF	R	UNCOATED		ALTiN COATED		TiAlN COATED	
							2 FLUTE	Price	2 FLUTE	Price	2 FLUTE	Price
0.0100	0.1250	0.0310	1.2970	1.5000	0.1560	0.0050	932-000-265	\$31.74	932-000-301	\$36.41	932-000-229	\$36.41
0.0100	0.1250	0.0310	1.2030	1.5000	0.2500	0.0050	932-000-266	\$31.74	932-000-302	\$36.41	932-000-230	\$36.41
0.0100	0.1250	0.0310	1.0780	1.5000	0.3750	0.0050	932-000-267	\$31.74	932-000-303	\$36.41	932-000-231	\$36.41
0.0100	0.1250	0.0310	1.2970	1.5000	0.1560	0.0050	932-000-268	\$31.74	932-000-304	\$36.41	932-000-232	\$36.41
0.0100	0.1250	0.0310	1.2030	1.5000	0.2500	0.0050	932-000-269	\$31.74	932-000-305	\$36.41	932-000-233	\$36.41
0.0100	0.1250	0.0310	1.0780	1.5000	0.3750	0.0050	932-000-270	\$32.74	932-000-306	\$36.41	932-000-234	\$36.41
0.0100	0.1250	0.0620	1.1565	1.5000	0.3120	0.0050	932-000-271	\$31.74	932-000-307	\$36.41	932-000-235	\$36.41
0.0100	0.1250	0.0620	0.9685	1.5000	0.5000	0.0050	932-000-272	\$31.74	932-000-308	\$36.41	932-000-236	\$36.41
0.0100	0.1250	0.0620	1.2185	2.0000	0.7500	0.0050	932-000-273	\$32.74	932-000-309	\$36.41	932-000-237	\$36.41
0.0100	0.1250	0.0930	1.2340	2.0000	0.7500	0.0050	932-000-274	\$36.47	932-000-310	\$36.41	932-000-238	\$36.41
0.0100	0.1250	0.0930	0.8590	2.0000	1.1250	0.0050	932-000-275	\$36.47	932-000-311	\$36.41	932-000-239	\$36.41
0.0100	0.1250	0.0310	1.2970	1.5000	0.1560	0.0080	932-000-276	\$31.74	932-000-312	\$36.41	932-000-240	\$36.41
0.0100	0.1250	0.0310	1.2030	1.5000	0.2500	0.0080	932-000-277	\$31.74	932-000-313	\$36.41	932-000-241	\$36.41
0.0100	0.1250	0.0310	1.0780	1.5000	0.3750	0.0080	932-000-278	\$31.74	932-000-314	\$36.41	932-000-242	\$36.41
0.0100	0.1250	0.0310	1.2970	1.5000	0.1560	0.0100	932-000-279	\$31.74	932-000-315	\$36.41	932-000-243	\$36.41
0.0100	0.1250	0.0310	1.2030	1.5000	0.2500	0.0100	932-000-280	\$31.74	932-000-316	\$36.41	932-000-244	\$36.41
0.0100	0.1250	0.0310	1.0780	1.5000	0.3750	0.0100	932-000-281	\$32.74	932-000-317	\$36.41	932-000-245	\$36.41
0.0200	0.1250	0.0620	1.1565	1.5000	0.3120	0.0100	932-000-282	\$31.74	932-000-318	\$36.41	932-000-246	\$36.41
0.0200	0.1250	0.0620	0.9685	1.5000	0.5000	0.0100	932-000-283	\$31.74	932-000-319	\$36.41	932-000-247	\$36.41
0.0200	0.1250	0.0620	1.2185	2.0000	0.7500	0.0100	932-000-284	\$32.74	932-000-320	\$36.41	932-000-248	\$36.41
0.0200	0.1250	0.0930	1.2340	2.0000	0.7500	0.0100	932-000-285	\$36.47	932-000-321	\$43.00	932-000-249	\$43.00
0.0200	0.1250	0.0930	0.8590	2.0000	1.1250	0.0100	932-000-286	\$36.47	932-000-322	\$43.00	932-000-250	\$43.00
0.0200	0.1250	0.0620	1.1565	1.5000	0.3120	0.0150	932-000-287	\$31.74	932-000-323	\$36.41	932-000-251	\$36.41
0.0200	0.1250	0.0620	0.9685	1.5000	0.5000	0.0150	932-000-288	\$31.74	932-000-324	\$36.41	932-000-252	\$36.41
0.0200	0.1250	0.0620	1.2185	2.0000	0.7500	0.0150	932-000-289	\$32.74	932-000-325	\$36.41	932-000-253	\$36.41
0.0200	0.1250	0.0930	1.2340	2.0000	0.7500	0.0150	932-000-290	\$36.47	932-000-326	\$43.00	932-000-254	\$43.00
0.0200	0.1250	0.0930	0.8590	2.0000	1.1250	0.0150	932-000-291	\$36.47	932-000-327	\$43.00	932-000-255	\$43.00
0.0200	0.1250	0.0620	1.1565	1.5000	0.3120	0.0200	932-000-292	\$31.74	932-000-328	\$36.41	932-000-256	\$36.41
0.0200	0.1250	0.0620	0.9685	1.5000	0.5000	0.0200	932-000-293	\$31.74	932-000-329	\$36.41	932-000-257	\$36.41
0.0200	0.1250	0.0620	1.2185	2.0000	0.7500	0.0200	932-000-294	\$32.74	932-000-330	\$36.41	932-000-258	\$36.41
0.0200	0.1250	0.0930	1.2340	2.0000	0.7500	0.0200	932-000-295	\$36.47	932-000-331	\$43.00	932-000-259	\$43.00
0.0200	0.1250	0.0930	0.8590	2.0000	1.1250	0.0200	932-000-296	\$36.47	932-000-332	\$43.00	932-000-260	\$43.00
0.0200	0.1250	0.0930	1.2340	2.0000	0.7500	0.0250	932-000-297	\$36.47	932-000-333	\$43.00	932-000-261	\$43.00
0.0200	0.1250	0.0930	0.8590	2.0000	1.1250	0.0250	932-000-298	\$36.47	932-000-334	\$43.00	932-000-262	\$43.00
0.0200	0.1250	0.0930	1.2340	2.0000	0.7500	0.0300	932-000-299	\$36.47	932-000-335	\$43.00	932-000-263	\$43.00
0.0200	0.1250	0.0930	0.8590	2.0000	1.1250	0.0300	932-000-300	\$36.47	932-000-336	\$43.00	932-000-264	\$43.00

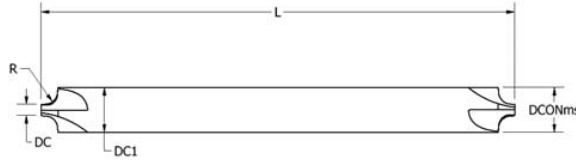

IMPERIAL .005"-.156"



DC	DCONms	DC1	L	R	UNCOATED		TIN COATED		ALTIM COATED	
					2 FLUTE	Price	2 FLUTE	Price	2 FLUTE	Price
0.0470	0.1250	0.1250	1.5000	0.0050	932-000-337	\$28.66	932-000-892	\$34.11	932-000-592	\$34.16
0.0470	0.1250	0.1250	1.5000	0.0080	932-000-338	\$28.66	932-000-893	\$34.11	932-000-593	\$34.16
0.0470	0.1250	0.1250	1.5000	0.0100	932-000-339	\$28.66	932-000-894	\$34.11	932-000-594	\$34.16
0.0470	0.1250	0.1250	1.5000	0.0120	932-000-340	\$28.66	932-000-895	\$34.11	932-000-595	\$34.16
0.0470	0.1250	0.1250	1.5000	0.0150	932-000-341	\$28.66	932-000-896	\$34.11	932-000-596	\$34.16
0.0470	0.1250	0.1250	1.5000	0.0180	932-000-342	\$28.66	932-000-897	\$34.11	932-000-597	\$34.16
0.0470	0.1250	0.1250	1.5000	0.0200	932-000-343	\$28.66	932-000-898	\$34.11	932-000-598	\$34.16
0.0470	0.1250	0.1250	1.5000	0.0220	932-000-344	\$28.66	932-000-899	\$34.11	932-000-599	\$34.16
0.0470	0.1250	0.1250	1.5000	0.0250	932-000-345	\$28.66	932-000-900	\$34.11	932-000-600	\$34.16
0.0470	0.1250	0.1250	1.5000	0.0270	932-000-346	\$28.66	932-000-901	\$34.11	932-000-601	\$34.16
0.0470	0.1250	0.1250	1.5000	0.0300	932-000-347	\$28.66	932-000-902	\$34.11	932-000-602	\$34.16
0.0470	0.1250	0.1250	1.5000	0.0310	932-000-348	\$28.66	932-000-903	\$34.11	932-000-603	\$34.16
0.0470	0.1250	0.1250	1.5000	0.0320	932-000-349	\$28.66	932-000-904	\$34.11	932-000-604	\$34.16
0.0470	0.1250	0.1250	1.5000	0.0350	932-000-350	\$28.66	932-000-905	\$34.11	932-000-605	\$34.16
0.0470	0.1250	0.1250	1.5000	0.0390	932-000-351	\$28.66	932-000-906	\$34.11	932-000-606	\$34.16
0.0470	0.1875	0.1875	2.0000	0.0430	932-000-352	\$37.58	932-000-907	\$43.87	932-000-607	\$43.94
0.0470	0.1875	0.1875	2.0000	0.0470	932-000-353	\$37.58	932-000-908	\$43.87	932-000-608	\$43.94
0.0470	0.1875	0.1875	2.0000	0.0500	932-000-354	\$37.58	932-000-909	\$43.87	932-000-609	\$43.94
0.0470	0.1875	0.1875	2.0000	0.0550	932-000-355	\$37.58	932-000-910	\$43.87	932-000-610	\$43.94
0.0470	0.1875	0.1875	2.0000	0.0600	932-000-356	\$38.34	932-000-911	\$44.65	932-000-611	\$44.71
0.0470	0.1875	0.1875	2.0000	0.0620	932-000-357	\$38.34	932-000-912	\$44.65	932-000-612	\$44.71
0.0470	0.1875	0.1875	2.0000	0.0670	932-000-358	\$38.34	932-000-913	\$44.65	932-000-613	\$44.71
0.0470	0.2500	0.2500	2.0000	0.0720	932-000-359	\$44.16	932-000-914	\$55.25	932-000-614	\$52.95
0.0470	0.2500	0.2500	2.0000	0.0780	932-000-360	\$44.16	932-000-915	\$55.25	932-000-615	\$52.95
0.0470	0.2500	0.2500	2.0000	0.0890	932-000-361	\$44.16	932-000-916	\$55.25	932-000-616	\$52.95
0.0470	0.2500	0.2500	2.0000	0.0930	932-000-362	\$44.16	932-000-917	\$55.25	932-000-617	\$52.95
0.0470	0.2500	0.2500	2.0000	0.1000	932-000-363	\$44.16	932-000-918	\$55.25	932-000-618	\$52.95
0.0600	0.3125	0.3125	2.5000	0.1040	932-000-364	\$61.31	932-000-919	\$72.17	932-000-619	\$72.28
0.0600	0.3125	0.3125	2.5000	0.1090	932-000-365	\$61.31	932-000-920	\$72.17	932-000-620	\$72.28
0.0600	0.3125	0.3125	2.5000	0.1180	932-000-366	\$62.40	932-000-921	\$73.27	932-000-621	\$73.38
0.0600	0.3125	0.3125	2.5000	0.1250	932-000-367	\$62.40	932-000-922	\$73.27	932-000-622	\$73.38
0.0600	0.3750	0.3750	2.5000	0.1400	932-000-368	\$71.52	932-000-923	\$84.56	932-000-623	\$84.70
0.0600	0.3750	0.3750	2.5000	0.1560	932-000-369	\$77.45	932-000-924	\$90.48	932-000-624	\$90.62



DC	DCONms	DC1	L	R	UNCOATED		TIN COATED		ALTIM COATED	
					4 FLUTE	Price	4 FLUTE	Price	4 FLUTE	Price
0.2500	0.3750	0.3750	2.5000	0.0100	932-000-370	\$49.33	932-000-925	\$62.41	932-000-625	\$62.51
0.2500	0.3750	0.3750	2.5000	0.0150	932-000-371	\$49.33	932-000-926	\$62.41	932-000-626	\$62.51
0.2500	0.3750	0.3750	2.5000	0.0200	932-000-372	\$49.33	932-000-927	\$62.41	932-000-627	\$62.51
0.2500	0.3750	0.3750	2.5000	0.0250	932-000-373	\$49.33	932-000-928	\$62.41	932-000-628	\$62.51
0.2500	0.3750	0.3750	2.5000	0.0300	932-000-374	\$56.48	932-000-929	\$67.12	932-000-629	\$67.22
0.2500	0.3750	0.3750	2.5000	0.0310	932-000-375	\$56.48	932-000-930	\$67.12	932-000-630	\$67.22
0.2500	0.3750	0.3750	2.5000	0.0390	932-000-376	\$56.48	932-000-931	\$67.12	932-000-631	\$67.22
0.2500	0.3750	0.3750	2.5000	0.0470	932-000-377	\$56.48	932-000-932	\$67.12	932-000-632	\$67.22
0.2500	0.3750	0.3750	2.5000	0.0500	932-000-378	\$56.48	932-000-933	\$67.12	932-000-633	\$67.22

CARBIDE

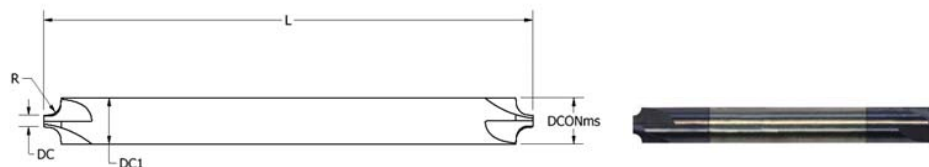

DC	DCONms	DC1	L	R	TIALN COATED		AMORPHOUS DIAMOND	
					2 FLUTE	Price	2 FLUTE	Price
0.0470	0.1250	0.1250	1.5000	0.0050	932-000-421	\$34.16	932-000-379	\$45.64
0.0470	0.1250	0.1250	1.5000	0.0080	932-000-422	\$34.16	932-000-380	\$45.64
0.0470	0.1250	0.1250	1.5000	0.0100	932-000-423	\$34.16	932-000-381	\$45.64
0.0470	0.1250	0.1250	1.5000	0.0120	932-000-424	\$34.16	932-000-382	\$45.64
0.0470	0.1250	0.1250	1.5000	0.0150	932-000-425	\$34.16	932-000-383	\$45.64
0.0470	0.1250	0.1250	1.5000	0.0180	932-000-426	\$34.16	932-000-384	\$45.64
0.0470	0.1250	0.1250	1.5000	0.0200	932-000-427	\$34.16	932-000-385	\$45.64
0.0470	0.1250	0.1250	1.5000	0.0220	932-000-428	\$34.16	932-000-386	\$45.64
0.0470	0.1250	0.1250	1.5000	0.0270	932-000-429	\$34.16	932-000-387	\$45.64
0.0470	0.1250	0.1250	1.5000	0.0270	932-000-430	\$34.16	932-000-388	\$45.64
0.0470	0.1250	0.1250	1.5000	0.0300	932-000-431	\$34.16	932-000-389	\$45.64
0.0470	0.1250	0.1250	1.5000	0.0310	932-000-432	\$34.16	932-000-390	\$45.64
0.0470	0.1250	0.1250	1.5000	0.0320	932-000-433	\$34.16	932-000-391	\$45.64
0.0470	0.1250	0.1250	1.5000	0.0350	932-000-434	\$34.16	932-000-392	\$45.64
0.0470	0.1250	0.1250	1.5000	0.0390	932-000-435	\$34.16	932-000-393	\$45.64
0.0470	0.1875	0.1875	2.0000	0.0430	932-000-436	\$43.94	932-000-394	\$45.64
0.0470	0.1875	0.1875	2.0000	0.0470	932-000-437	\$43.94	932-000-395	\$61.10
0.0470	0.1875	0.1875	2.0000	0.0500	932-000-438	\$43.94	932-000-396	\$61.10
0.0470	0.1875	0.1875	2.0000	0.0550	932-000-439	\$43.94	932-000-397	\$61.10
0.0470	0.1875	0.1875	2.0000	0.0600	932-000-440	\$44.71	932-000-398	\$61.85
0.0470	0.1875	0.1875	2.0000	0.0620	932-000-441	\$44.71	932-000-399	\$61.85
0.0470	0.1875	0.1875	2.0000	0.0670	932-000-442	\$44.71	932-000-400	\$63.70
0.0470	0.2500	0.2500	2.0000	0.0720	932-000-443	\$52.95	932-000-401	\$73.16
0.0470	0.2500	0.2500	2.0000	0.0780	932-000-444	\$52.95	932-000-402	\$70.96
0.0470	0.2500	0.2500	2.0000	0.0890	932-000-445	\$52.95	932-000-403	\$73.16
0.0470	0.2500	0.2500	2.0000	0.0930	932-000-446	\$52.95	932-000-404	\$70.96
0.0470	0.2500	0.2500	2.0000	0.1000	932-000-447	\$52.95	932-000-405	\$70.96
0.0600	0.3125	0.3125	2.5000	0.1040	932-000-448	\$72.28	932-000-406	\$91.13
0.0600	0.3125	0.3125	2.5000	0.1090	932-000-449	\$72.28	932-000-407	\$90.07
0.0600	0.3125	0.3125	2.5000	0.1180	932-000-450	\$73.38	932-000-408	\$89.16
0.0600	0.3125	0.3125	2.5000	0.1250	932-000-451	\$73.38	932-000-409	\$89.16
0.0600	0.3750	0.3750	2.5000	0.1400	932-000-452	\$84.70	932-000-410	\$99.81
0.0600	0.3750	0.3750	2.5000	0.1560	932-000-453	\$90.62	932-000-411	\$103.82



DC	DCONms	DC1	L	R	TIALN COATED		AMORPHOUS DIAMOND	
					2 FLUTE	Price	2 FLUTE	Price
0.2500	0.3750	0.3750	2.5000	0.0100	932-000-454	\$62.51	932-000-412	\$65.47
0.2500	0.3750	0.3750	2.5000	0.0150	932-000-455	\$62.51	932-000-413	\$65.47
0.2500	0.3750	0.3750	2.5000	0.0200	932-000-456	\$62.51	932-000-414	\$65.47
0.2500	0.3750	0.3750	2.5000	0.0250	932-000-457	\$62.51	932-000-415	\$65.47
0.2500	0.3750	0.3750	2.5000	0.0300	932-000-458	\$67.22	932-000-416	\$69.86
0.2500	0.3750	0.3750	2.5000	0.0310	932-000-459	\$67.22	932-000-417	\$69.86
0.2500	0.3750	0.3750	2.5000	0.0390	932-000-460	\$67.22	932-000-418	\$69.86
0.2500	0.3750	0.3750	2.5000	0.0470	932-000-461	\$67.22	932-000-419	\$69.86
0.2500	0.3750	0.3750	2.5000	0.0500	932-000-462	\$67.22	932-000-420	\$69.86

METRIC RADIUS

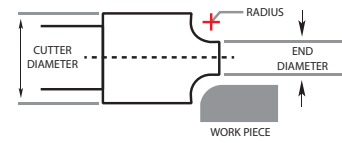
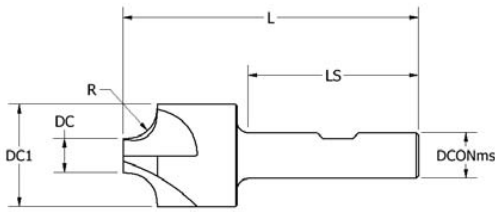

4-FLUTE CRM125



DC	DCONms	DC1	LS	L	R	Uncoated	Price	TiN Coated	Price	TiCN Coated	Price	TiAlN Coated	Price
0.2270	0.3750	0.4375	1.6880	2.5000	0.0394(1mm)	932-000-133	\$62.54	932-000-136	\$71.48	932-000-135	\$75.01	932-000-134	\$75.01
0.2500	0.3750	0.4375	1.6880	2.5000	0.0591(1.5mm)	932-000-137	\$62.54	932-000-140	\$71.48	932-000-139	\$75.01	932-000-138	\$75.01
0.2730	0.3750	0.5000	1.6880	2.5000	0.0787(2mm)	932-000-141	\$66.62	932-000-144	\$76.30	932-000-143	\$79.81	932-000-142	\$79.81
0.2330	0.3750	0.5000	1.6880	2.5000	0.0984(2.5mm)	932-000-145	\$66.62	932-000-148	\$76.30	932-000-147	\$79.81	932-000-146	\$79.81
0.2570	0.5000	0.6250	2.0000	3.0000	0.1181(3mm)	932-000-149	\$77.99	932-000-152	\$89.27	932-000-151	\$93.54	932-000-150	\$93.54
0.2790	0.5000	0.7500	2.0000	3.0000	0.1378(3.5mm)	932-000-153	\$82.08	932-000-156	\$93.89	932-000-155	\$98.32	932-000-154	\$98.32
0.3030	0.5000	0.7500	2.0000	3.0000	0.1575(4mm)	932-000-157	\$82.08	932-000-160	\$93.89	932-000-159	\$98.32	932-000-158	\$98.32
0.3890	0.5000	0.8750	2.0000	3.0000	0.1772(4.5mm)	932-000-161	\$92.60	932-000-164	\$105.92	932-000-163	\$111.11	932-000-162	\$111.11
0.3490	0.5000	0.8750	2.0000	3.0000	0.1969(5mm)	932-000-165	\$92.60	932-000-168	\$105.92	932-000-167	\$111.11	932-000-166	\$111.11
0.3950	0.7500	1.0000	2.2500	3.2500	0.2362(6mm)	932-000-169	\$104.49	932-000-172	\$119.65	932-000-171	\$125.38	932-000-170	\$125.38
0.3790	0.7500	1.0000	2.2500	3.2500	0.2756(7mm)	932-000-173	\$104.49	932-000-176	\$119.65	932-000-175	\$125.38	932-000-174	\$125.38
0.3630	0.7500	1.1250	2.2500	3.2500	0.3150(8mm)	932-000-177	\$130.49	932-000-180	\$149.27	932-000-179	\$156.50	932-000-178	\$156.50
0.3460	0.7500	1.1250	2.2500	3.2500	0.3543(9mm)	932-000-181	\$130.49	932-000-184	\$149.27	932-000-183	\$156.50	932-000-182	\$156.50
0.3920	0.7500	1.3750	2.2500	3.7500	0.3937(10mm)	932-000-185	\$168.38	932-000-188	\$192.80	932-000-187	\$201.86	932-000-186	\$201.86
0.3760	1.0000	1.3750	2.5000	3.7500	0.4331(11mm)	932-000-189	\$168.38	932-000-192	\$192.80	932-000-191	\$201.86	932-000-190	\$201.86
0.4220	1.0000	1.5000	2.5000	4.1250	0.4724(12mm)	932-000-193	\$182.14	932-000-196	\$208.55	932-000-195	\$218.34	932-000-194	\$218.34
0.3430	1.0000	1.5000	2.5000	4.1250	0.5118(13mm)	932-000-197	\$182.14	932-000-200	\$208.55	932-000-199	\$218.34	932-000-198	\$218.34
0.4520	1.0000	1.6250	2.5000	4.1250	0.5512(14mm)	932-000-201	\$202.35	932-000-204	\$231.69	932-000-203	\$242.63	932-000-202	\$242.63
0.4980	1.0000	1.8750	2.5000	4.2500	0.5906(15mm)	932-000-205	\$202.35	932-000-208	\$231.69	932-000-207	\$242.63	932-000-206	\$242.63
0.5440	1.0000	2.0000	2.5000	4.2500	0.6299(16mm)	932-000-209	\$214.60	932-000-212	\$245.59	932-000-211	\$257.25	932-000-210	\$257.25
0.5280	1.0000	2.1250	2.5000	4.2500	0.6693(17mm)	932-000-213	\$214.60	932-000-216	\$245.59	932-000-215	\$257.25	932-000-214	\$257.25
0.6410	1.0000	2.2500	2.5000	4.2500	0.7087(18mm)	932-000-217	\$228.37	932-000-220	\$261.31	932-000-219	\$273.75	932-000-218	\$273.75
0.6200	1.0000	2.2500	2.5000	4.2500	0.7480(19mm)	932-000-221	\$228.37	932-000-224	\$261.31	932-000-223	\$273.75	932-000-222	\$273.75
0.6040	1.0000	2.3125	2.5000	4.2500	0.7874(20mm)	932-000-225	\$249.08	932-000-228	\$285.03	932-000-227	\$298.74	932-000-226	\$298.74

IMPERIAL RADIUS

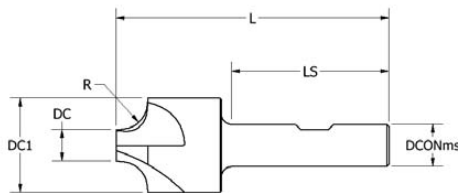

4-FLUTE-GENERAL PURPOSE M42 8% Cobalt Steel

CRCO126



DC	DCONms	DC1	LS	L	R	Uncoated	Price	TiN Coated	Price	TiCN Coated	Price	TiAlN Coated	Price
0.2430	0.3750	0.4375	1.6880	2.5000	0.0313	932-000-001	\$50.64	932-000-004	\$57.97	932-000-003	\$60.76	932-000-002	\$60.76
0.2430	0.3750	0.4375	1.6880	2.5000	0.0625	932-000-005	\$51.14	932-000-008	\$58.52	932-000-007	\$61.30	932-000-006	\$61.30
0.2430	0.3750	0.5000	1.6880	2.5000	0.0938	932-000-009	\$54.88	932-000-012	\$62.79	932-000-011	\$65.76	932-000-010	\$65.76
0.2430	0.5000	0.6250	1.9370	3.0000	0.1250	932-000-013	\$67.10	932-000-016	\$76.85	932-000-015	\$80.57	932-000-014	\$80.57
0.3050	0.5000	0.7500	2.0000	3.0000	0.1563	932-000-017	\$74.07	932-000-020	\$84.84	932-000-019	\$88.91	932-000-018	\$88.91
0.3680	0.7500	0.8750	2.2500	3.1250	0.1875	932-000-021	\$84.62	932-000-024	\$96.88	932-000-023	\$101.50	932-000-022	\$101.50
0.3680	0.7500	1.0000	2.2500	3.2500	0.2500	932-000-025	\$95.65	932-000-028	\$109.45	932-000-027	\$114.66	932-000-026	\$114.66
0.3680	0.8750	1.1250	2.1870	3.5000	0.3125	932-000-029	\$119.97	932-000-032	\$137.23	932-000-031	\$143.90	932-000-030	\$143.90
0.3670	0.8750	1.2500	2.2500	3.7500	0.3750	932-000-033	\$136.45	932-000-036	\$156.12	932-000-035	\$163.54	932-000-034	\$163.54
0.3670	1.0000	1.5000	2.5000	4.1250	0.5000	932-000-037	\$162.79	932-000-040	\$186.31	932-000-039	\$195.20	932-000-038	\$195.20



IMPERIAL RADIUS

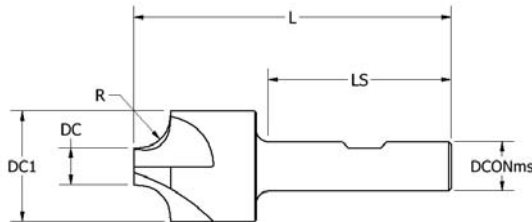

HSS



CRE124



DC	DCONms	DC1	LS	L	R	Uncoated	Price	TiN Coated	Price	TiCN Coated	Price	TiAlN Coated	Price
0.2430	0.3750	0.4375	1.6880	2.5000	0.0313	932-000-041	\$47.75	932-000-044	\$54.64	932-000-043	\$57.22	932-000-042	\$57.22
0.2430	0.3750	0.4375	1.6880	2.5000	0.0625	932-000-045	\$48.25	932-000-048	\$55.20	932-000-047	\$57.78	932-000-046	\$57.78
0.2430	0.3750	0.5000	1.6880	2.5000	0.0938	932-000-049	\$51.30	932-000-052	\$58.71	932-000-051	\$61.48	932-000-050	\$61.48
0.2430	0.5000	0.6250	1.9370	3.0000	0.1250	932-000-053	\$63.18	932-000-056	\$72.42	932-000-055	\$75.75	932-000-054	\$75.75
0.3050	0.5000	0.7500	2.0000	3.0000	0.1563	932-000-057	\$69.16	932-000-060	\$79.06	932-000-059	\$82.99	932-000-058	\$82.99
0.3680	0.5000	0.8750	1.9380	2.9375	0.1875	932-000-065	\$78.32	932-000-068	\$89.64	932-000-067	\$93.89	932-000-066	\$93.89
0.3680	0.7500	0.8750	2.2500	3.1250	0.1875	932-000-061	\$78.32	932-000-064	\$89.64	932-000-063	\$93.89	932-000-062	\$93.89
0.3680	0.5000	1.0000	1.9370	3.0000	0.2500	932-000-073	\$87.34	932-000-076	\$100.00	932-000-075	\$104.64	932-000-070	\$104.64
0.3680	0.7500	1.0000	2.2500	3.2500	0.2500	932-000-069	\$87.34	932-000-072	\$100.00	932-000-071	\$104.64	932-000-074	\$104.64
0.3680	0.5000	1.1250	1.9370	3.2500	0.3125	932-000-081	\$107.05	932-000-084	\$122.60	932-000-083	\$128.35	932-000-078	\$128.35
0.3680	0.7500	1.1250	2.1870	3.5000	0.3125	932-000-077	\$107.05	932-000-080	\$122.60	932-000-079	\$128.35	932-000-082	\$128.35
0.3670	0.5000	1.2500	2.0000	3.5000	0.3750	932-000-089	\$121.84	932-000-092	\$139.47	932-000-091	\$146.14	932-000-086	\$146.14
0.3670	0.8750	1.2500	2.2500	3.7500	0.3750	932-000-085	\$121.84	932-000-088	\$139.47	932-000-087	\$146.14	932-000-090	\$146.14
0.3670	0.7500	1.3750	2.1870	3.7500	0.4375	932-000-097	\$134.41	932-000-100	\$153.91	932-000-099	\$161.12	932-000-094	\$161.12
0.3670	1.0000	1.3750	2.4370	4.0000	0.4375	932-000-093	\$134.41	932-000-096	\$153.91	932-000-095	\$161.12	932-000-098	\$161.12
0.3670	0.7500	1.5000	2.3120	3.8750	0.5000	932-000-105	\$142.72	932-000-108	\$163.33	932-000-107	\$171.13	932-000-106	\$171.13
0.3670	1.0000	1.5000	2.5000	4.1250	0.5000	932-000-101	\$142.72	932-000-104	\$163.33	932-000-103	\$171.13	932-000-102	\$171.13
0.5540	0.7500	1.9375	2.2500	4.0000	0.6250	932-000-113	\$173.98	932-000-116	\$199.08	932-000-115	\$208.55	932-000-114	\$208.55
0.5540	1.0000	1.9375	2.5000	4.2500	0.6250	932-000-109	\$173.98	932-000-112	\$199.08	932-000-111	\$208.55	932-000-110	\$208.55
0.6160	0.7500	2.2500	2.2500	4.1250	0.7500	932-000-121	\$195.93	932-000-124	\$224.28	932-000-123	\$234.84	932-000-122	\$234.84
0.6160	1.0000	2.2500	2.4380	4.3125	0.7500	932-000-117	\$195.93	932-000-120	\$224.28	932-000-119	\$234.84	932-000-118	\$234.84
0.6160	0.7500	2.7500	2.2500	4.5000	1.0000	932-000-129	\$234.13	932-000-132	\$267.98	932-000-131	\$280.77	932-000-130	\$280.77
0.6160	1.0000	2.7500	2.5000	4.7500	1.0000	932-000-125	\$234.13	932-000-128	\$267.98	932-000-127	\$280.77	932-000-126	\$280.77



CONCAVE

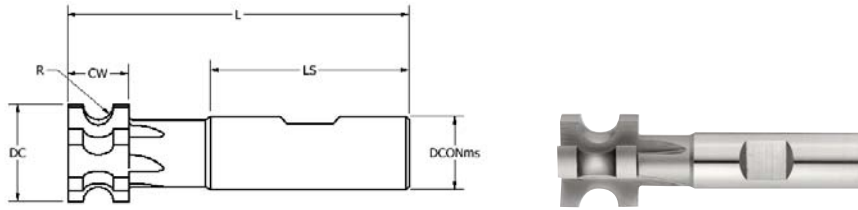

CCS150



DC	DCONms	LS	L	CW	R	Zc	Uncoated	Price	TiN Coated	Price	TiCN Coated	Price	TiAlN Coated	Price
0.7500	0.5000	2.1250	3.0000	0.3750	0.0313	6	905-000-008	\$110.46	905-000-035	\$126.33	905-000-025	\$132.44	905-000-017	\$132.44
0.7500	0.5000	2.1250	3.0000	0.3750	0.0625	6	905-000-007	\$110.46	905-000-034	\$126.33	905-000-026	\$132.44	905-000-016	\$132.44
0.7500	0.5000	2.1250	3.0000	0.3750	0.1250	6	905-000-009	\$110.46	905-000-036	\$126.33	905-000-027	\$132.44	905-000-018	\$132.44
1.0000	0.7500	2.2500	3.5000	0.6250	0.1250	6	905-000-004	\$134.73	905-000-031	\$154.23	905-000-022	\$161.62	905-000-013	\$161.62
1.0000	0.7500	2.2500	3.5000	0.6250	0.1563	6	905-000-006	\$143.48	905-000-033	\$164.13	905-000-023	\$172.03	905-000-015	\$172.03
1.0000	0.7500	2.2500	3.5000	0.6250	0.1563	6	905-000-005	\$173.20	905-000-032	\$198.14	905-000-024	\$207.67	905-000-014	\$207.67
1.2500	0.7500	2.2500	4.0000	1.0000	0.2500	4	905-000-003	\$182.94	905-000-030	\$209.29	905-000-020	\$219.37	905-000-012	\$219.37
1.2500	0.7500	2.2500	4.0000	1.0000	0.3125	4	905-000-002	\$202.27	905-000-029	\$231.44	905-000-021	\$242.60	905-000-011	\$242.60
1.5000	0.7500	2.2500	4.1875	1.0000	0.3750	4	905-000-001	\$240.73	905-000-028	\$275.50	905-000-019	\$288.66	905-000-010	\$288.66

CONVEX

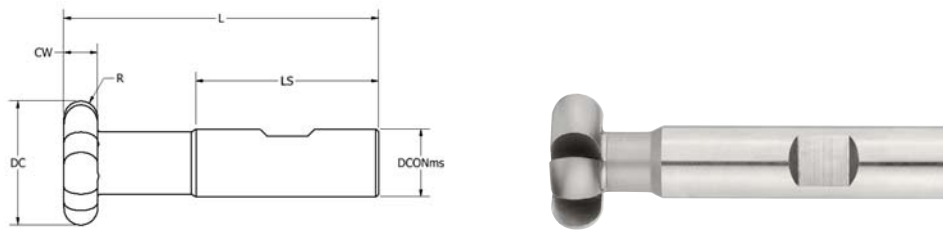

CVS130



DC	DCONms	LS	L	CW	R	Zc	Uncoated	Price	TiN Coated	Price	TiCN Coated	Price	TiAlN Coated	Price
0.7500	0.5000	2.4375	3.0000	0.0625	0.0313	6	922-000-001	\$124.49	922-000-004	\$142.53	922-000-003	\$149.17	922-000-002	\$149.17
0.7500	0.5000	2.2500	3.0000	0.1250	0.0625	6	922-000-005	\$119.18	922-000-008	\$136.42	922-000-007	\$142.89	922-000-006	\$142.89
0.8750	0.5000	2.1875	3.0000	0.1875	0.0938	6	922-000-009	\$127.44	922-000-012	\$145.94	922-000-011	\$152.79	922-000-010	\$152.79
1.2500	0.7500	2.6250	3.5000	0.2500	0.1250	6	922-000-013	\$134.89	922-000-016	\$154.43	922-000-015	\$161.78	922-000-014	\$161.78
1.3125	0.7500	2.5625	3.5000	0.3125	0.1563	6	922-000-017	\$148.29	922-000-020	\$169.72	922-000-019	\$177.81	922-000-018	\$177.81
1.3750	0.7500	2.5000	3.5000	0.3750	0.1875	6	922-000-021	\$154.05	922-000-024	\$176.36	922-000-023	\$184.63	922-000-022	\$184.63
1.5000	0.7500	2.8750	4.0000	0.5000	0.2500	6	922-000-025	\$173.34	922-000-028	\$198.51	922-000-027	\$207.85	922-000-026	\$207.85
1.6250	0.7500	2.7500	4.0000	0.6250	0.3125	6	922-000-029	\$231.14	922-000-032	\$264.54	922-000-031	\$277.13	922-000-030	\$277.13
1.7500	0.7500	2.6250	4.0000	0.7500	0.3750	6	922-000-033	\$240.73	922-000-036	\$275.50	922-000-035	\$288.66	922-000-034	\$288.66



KEYSEAT CUTTERS

THE COMPLETE TOOL MAKING AUTHORITY™



METRIC .0625"-.1875"

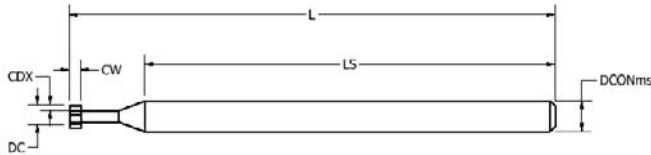

DC	DCONms	LS	L	CDX	CW	UNCOATED		ALTiN COATED		TiAlN COATED	
						6 FLUTE	Price	6 FLUTE	Price	6 FLUTE	Price
0.0625	0.1250	1.7138	2.0000	0.0153	0.0156	943-000-811	\$39.66	943-000-941	\$46.04	943-000-873	\$46.04
0.0625	0.1250	1.6982	2.0000	0.0153	0.0313	943-000-812	\$39.66	943-000-942	\$46.04	943-000-874	\$46.04
0.0625	0.1250	1.6901	2.0000	0.0153	0.0394	943-000-813	\$39.66	943-000-943	\$46.04	943-000-875	\$46.04
0.0625	0.1250	1.6826	2.0000	0.0153	0.0469	943-000-814	\$39.66	943-000-944	\$46.04	943-000-876	\$46.04
0.0625	0.1250	1.6669	2.0000	0.0153	0.0625	943-000-815	\$39.66	943-000-945	\$46.04	943-000-877	\$46.04
0.0781	0.1250	1.7371	2.0000	0.0191	0.0156	943-000-816	\$39.21	943-000-946	\$43.61	943-000-878	\$43.61
0.0781	0.1250	1.7215	2.0000	0.0191	0.0313	943-000-817	\$39.21	943-000-947	\$43.61	943-000-879	\$43.61
0.0781	0.1250	1.7134	2.0000	0.0191	0.0394	943-000-818	\$39.21	943-000-948	\$43.61	943-000-880	\$43.61
0.0781	0.1250	1.7059	2.0000	0.0191	0.0469	943-000-819	\$39.21	943-000-949	\$43.61	943-000-881	\$43.61
0.0781	0.1250	1.6903	2.0000	0.0191	0.0625	943-000-820	\$39.21	943-000-950	\$43.61	943-000-882	\$43.61
0.0937	0.1250	1.7148	2.0000	0.0234	0.0156	943-000-821	\$38.78	943-000-951	\$43.17	943-000-883	\$43.17
0.0937	0.1250	1.6991	2.0000	0.0234	0.0313	943-000-822	\$38.78	943-000-952	\$43.17	943-000-884	\$43.17
0.0937	0.1250	1.6910	2.0000	0.0234	0.0394	943-000-823	\$38.78	943-000-953	\$43.17	943-000-885	\$43.17
0.0937	0.1250	1.6835	2.0000	0.0234	0.0469	943-000-824	\$38.78	943-000-954	\$43.17	943-000-886	\$43.17
0.0937	0.1250	1.6679	2.0000	0.0234	0.0625	943-000-825	\$38.78	943-000-955	\$43.17	943-000-887	\$43.17
0.1250	0.1250	1.6772	2.0000	0.0310	0.0156	943-000-826	\$37.24	943-000-956	\$41.63	943-000-888	\$41.63
0.1250	0.1250	1.6615	2.0000	0.0310	0.0313	943-000-827	\$37.24	943-000-957	\$41.63	943-000-889	\$41.63
0.1250	0.1250	1.6534	2.0000	0.0310	0.0394	943-000-828	\$37.24	943-000-958	\$41.63	943-000-890	\$41.63
0.1250	0.1250	1.6459	2.0000	0.0310	0.0469	943-000-829	\$37.24	943-000-959	\$41.63	943-000-891	\$41.63
0.1250	0.1250	1.6303	2.0000	0.0310	0.0625	943-000-830	\$37.24	943-000-960	\$41.63	943-000-892	\$41.63
0.1250	0.1250	1.5990	2.0000	0.0310	0.0938	943-000-831	\$37.24	943-000-961	\$41.63	943-000-893	\$41.63
0.1250	0.1250	1.5678	2.0000	0.0310	0.1250	943-000-832	\$37.24	943-000-962	\$41.63	943-000-894	\$41.63
0.1875	0.1875	1.5249	2.0000	0.0468	0.0156	943-000-833	\$38.56	943-000-963	\$43.28	943-000-895	\$43.28
0.1875	0.1875	1.5093	2.0000	0.0468	0.0313	943-000-834	\$38.56	943-000-964	\$43.28	943-000-896	\$43.28
0.1875	0.1875	1.5011	2.0000	0.0468	0.0394	943-000-835	\$38.56	943-000-965	\$43.28	943-000-897	\$43.28
0.1875	0.1875	1.4936	2.0000	0.0468	0.0469	943-000-836	\$38.56	943-000-966	\$43.28	943-000-898	\$43.28
0.1875	0.1875	1.4780	2.0000	0.0468	0.0625	943-000-837	\$38.56	943-000-967	\$43.28	943-000-899	\$43.28
0.1875	0.1875	1.4468	2.0000	0.0468	0.0938	943-000-838	\$38.56	943-000-968	\$43.28	943-000-900	\$43.28
0.1875	0.1875	1.4155	2.0000	0.0468	0.1250	943-000-839	\$38.56	943-000-969	\$43.28	943-000-901	\$43.28
0.1875	0.1875	1.3530	2.0000	0.0468	0.1875	943-000-840	\$38.56	943-000-970	\$43.28	943-000-902	\$43.28

CARBIDE

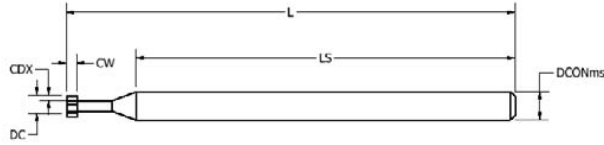

6 FLUTE, 8 FLUTE

DC	DCONms	LS	L	CDX	CW	Zc	Product #	Price
0.1250	0.2500	1.4744	2.0000	0.0310	0.0156	6	943-000-378	\$39.02
0.1250	0.2500	1.4588	2.0000	0.0310	0.0313	6	943-000-379	\$39.02
0.1250	0.2500	1.4507	2.0000	0.0310	0.0394	6	943-000-380	\$39.02
0.1250	0.2500	1.4432	2.0000	0.0310	0.0469	6	943-000-381	\$39.02
0.1250	0.2500	1.4275	2.0000	0.0310	0.0625	6	943-000-382	\$39.02
0.1875	0.2500	1.4393	2.0000	0.0468	0.0156	6	943-000-383	\$38.73
0.1875	0.2500	1.4236	2.0000	0.0468	0.0313	6	943-000-384	\$38.73
0.1875	0.2500	1.4155	2.0000	0.0468	0.0394	6	943-000-385	\$38.73
0.1875	0.2500	1.4080	2.0000	0.0468	0.0469	6	943-000-386	\$38.73
0.1875	0.2500	1.3924	2.0000	0.0468	0.0625	6	943-000-387	\$38.73
0.2500	0.2500	1.4971	2.0000	0.0625	0.0156	8	943-000-388	\$41.94
0.2500	0.2500	1.4815	2.0000	0.0625	0.0313	8	943-000-389	\$41.94
0.2500	0.2500	1.4734	2.0000	0.0625	0.0394	8	943-000-390	\$41.94
0.2500	0.2500	1.4659	2.0000	0.0625	0.0469	8	943-000-391	\$41.94
0.2500	0.2500	1.4502	2.0000	0.0625	0.0625	8	943-000-392	\$41.94
0.3125	0.3750	1.3236	2.0000	0.0778	0.0156	8	943-000-393	\$54.12
0.3125	0.3750	1.3079	2.0000	0.0778	0.0313	8	943-000-394	\$54.12
0.3125	0.3750	1.2998	2.0000	0.0778	0.0394	8	943-000-395	\$54.12
0.3125	0.3750	1.2923	2.0000	0.0778	0.0469	8	943-000-396	\$54.12
0.3125	0.3750	1.2767	2.0000	0.0778	0.0625	8	943-000-397	\$54.12
0.3125	0.3750	1.2604	2.0000	0.0778	0.0787	8	943-000-398	\$54.12
0.3125	0.3750	1.2454	2.0000	0.0778	0.0938	8	943-000-399	\$54.12
0.3750	0.3750	1.3814	2.0000	0.0935	0.0156	8	943-000-400	\$54.64
0.3750	0.3750	1.3658	2.0000	0.0935	0.0313	8	943-000-401	\$54.64
0.3750	0.3750	1.3577	2.0000	0.0935	0.0394	8	943-000-402	\$54.63
0.3750	0.3750	1.3502	2.0000	0.0935	0.0469	8	943-000-403	\$54.64
0.3750	0.3750	1.3345	2.0000	0.0935	0.0625	8	943-000-404	\$54.64
0.3750	0.3750	1.3183	2.0000	0.0935	0.0787	8	943-000-405	\$54.64
0.3750	0.3750	1.3033	2.0000	0.0935	0.0938	8	943-000-406	\$54.64
0.3750	0.3750	1.2720	2.0000	0.0935	0.1250	8	943-000-407	\$54.64

METRIC .125"- .375"

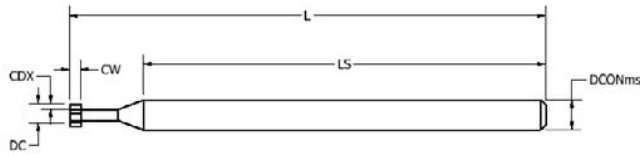

6 FLUTE



DC	DCONms	LS	L	CDX	CW	UNCOATED		TIALN COATED	
						6 FLUTE	Price	6 FLUTE	Price
0.1250	0.2500	1.4744	2.0000	0.0310	0.0156	943-000-378	\$43.72	943-001-143	\$50.31
0.1250	0.2500	1.4588	2.0000	0.0310	0.0313	943-000-379	\$43.72	943-001-146	\$50.31
0.1250	0.2500	1.4507	2.0000	0.0310	0.0394	943-000-380	\$43.72	943-001-149	\$50.31
0.1250	0.2500	1.4432	2.0000	0.0310	0.0469	943-000-381	\$43.72	943-001-152	\$50.31
0.1250	0.2500	1.4275	2.0000	0.0310	0.0625	943-000-382	\$43.72	943-001-155	\$50.31
0.1250	0.2500	1.3963	2.0000	0.0310	0.0938	943-000-845	\$43.72	943-000-908	\$50.31
0.1250	0.2500	1.3650	2.0000	0.0310	0.1250	943-000-846	\$43.72	943-000-909	\$50.31
0.1875	0.2500	1.4393	2.0000	0.0468	0.0156	943-000-383	\$43.72	943-001-158	\$50.31
0.1875	0.2500	1.4236	2.0000	0.0468	0.0313	943-000-384	\$43.72	943-001-161	\$50.31
0.1875	0.2500	1.4155	2.0000	0.0468	0.0394	943-000-385	\$43.72	943-001-164	\$50.31
0.1875	0.2500	1.4080	2.0000	0.0468	0.0469	943-000-386	\$43.72	943-001-167	\$50.31
0.1875	0.2500	1.3924	2.0000	0.0468	0.0625	943-000-387	\$43.72	943-001-170	\$50.31
0.1875	0.2500	1.3611	2.0000	0.0468	0.0938	943-000-851	\$43.72	943-000-915	\$50.31
0.1875	0.2500	1.3299	2.0000	0.0468	0.1250	943-000-852	\$43.72	943-000-916	\$50.31
0.1875	0.2500	1.2674	2.0000	0.0468	0.1875	943-000-853	\$43.72	943-000-917	\$50.31



8 FLUTE

DC	DCONms	LS	L	CDX	CW	UNCOATED		ALTIM COATED		TIALN COATED	
						8 FLUTE	Price	8 FLUTE	Price	8 FLUTE	Price
0.2500	0.2500	1.4971	2.0000	0.0625	0.0156	943-000-388	\$43.72	943-000-971	\$50.31	943-001-173	\$50.31
0.2500	0.2500	1.4815	2.0000	0.0625	0.0313	943-000-389	\$43.72	943-000-972	\$50.31	943-001-176	\$50.31
0.2500	0.2500	1.4734	2.0000	0.0625	0.0394	943-000-390	\$43.72	943-000-973	\$50.31	943-001-179	\$50.31
0.2500	0.2500	1.4502	2.0000	0.0625	0.0625	943-000-392	\$43.72	943-000-974	\$50.31	943-001-182	\$50.31
0.2500	0.2500	1.4502	2.0000	0.0625	0.0625	943-000-854	\$43.72	943-000-975	\$50.31	943-001-185	\$50.31
0.2500	0.2500	1.3877	2.0000	0.0625	0.1250	943-000-855	\$43.72	943-000-976	\$50.31	943-000-923	\$50.31
0.2500	0.2500	1.3252	2.0000	0.0625	0.1875	943-000-856	\$43.72	943-000-977	\$50.31	943-000-924	\$50.31
0.2500	0.2500	1.2627	2.0000	0.0625	0.2500	943-000-857	\$43.72	943-000-978	\$50.31	943-000-925	\$50.31
0.3125	0.3750	1.3236	2.0000	0.0778	0.0156	943-000-393	\$58.45	943-000-979	\$66.14	943-001-188	\$66.14
0.3125	0.3750	1.3079	2.0000	0.0778	0.0313	943-000-394	\$58.45	943-000-980	\$66.14	943-001-191	\$66.14
0.3125	0.3750	1.2998	2.0000	0.0778	0.0394	943-000-395	\$58.45	943-000-981	\$66.14	943-001-194	\$66.14
0.3125	0.3750	1.2923	2.0000	0.0778	0.0469	943-000-396	\$58.45	943-000-982	\$66.14	943-001-197	\$66.14
0.3125	0.3750	1.2767	2.0000	0.0778	0.0625	943-000-397	\$58.45	943-000-983	\$66.14	943-001-200	\$66.14
0.3125	0.3750	1.2604	2.0000	0.0778	0.0787	943-000-398	\$58.45	943-000-984	\$66.14	943-001-203	\$66.14
0.3125	0.3750	1.2454	2.0000	0.0778	0.0938	943-000-399	\$58.45	943-000-985	\$66.14	943-001-206	\$66.14
0.3750	0.3750	1.3814	2.0000	0.0935	0.0156	943-000-400	\$67.99	943-000-986	\$76.79	943-001-209	\$76.79
0.3750	0.3750	1.3658	2.0000	0.0935	0.0313	943-000-401	\$65.58	943-000-987	\$74.38	943-001-212	\$74.38
0.3750	0.3750	1.3577	2.0000	0.0935	0.0394	943-000-402	\$65.58	943-000-988	\$74.38	943-001-215	\$74.38
0.3750	0.3750	1.3502	2.0000	0.0935	0.0469	943-000-403	\$65.58	943-000-989	\$74.38	943-001-218	\$74.38
0.3750	0.3750	1.3345	2.0000	0.0935	0.0625	943-000-404	\$65.58	943-000-990	\$74.38	943-001-221	\$74.38
0.3750	0.3750	1.3183	2.0000	0.0935	0.0787	943-000-405	\$65.58	943-000-991	\$74.38	943-001-224	\$74.38
0.3750	0.3750	1.3033	2.0000	0.0935	0.0938	943-000-406	\$65.58	943-000-992	\$74.38	943-001-227	\$74.38
0.3750	0.3750	1.2720	2.0000	0.0935	0.1250	943-000-407	\$65.58	943-000-993	\$74.38	943-001-231	\$74.38

CARBIDE

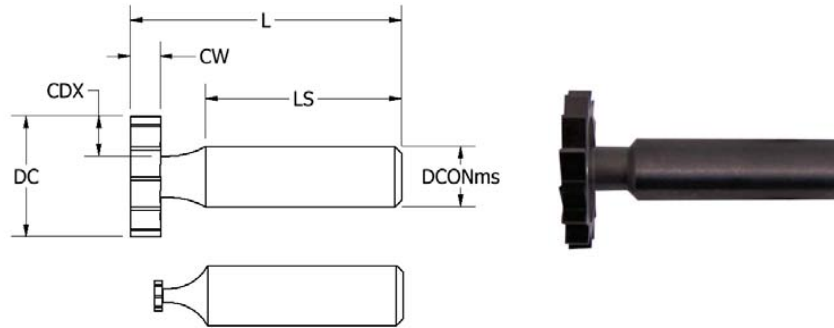

CARBIDE HEAD/STEEL SHANK

American Standard#	DC	DCONms	LS	L	CDX	CW	Zc	Product #	Price
204	0.5100	0.5000	1.6250	2.0625	0.1460	0.0625	10	943-000-343	\$114.96
304	0.5100	0.5000	1.6250	2.0938	0.1460	0.0938	10	943-000-344	\$114.96
404	0.5100	0.5000	1.6250	2.1250	0.1460	0.1250	10	943-000-345	\$114.96
305	0.6350	0.5000	1.6250	2.0938	0.1925	0.0938	10	943-000-346	\$121.44
405	0.6350	0.5000	1.6250	2.1250	0.1925	0.1250	10	943-000-347	\$121.44
505	0.6350	0.5000	1.6250	2.1563	0.1770	0.1563	10	943-000-348	\$121.44
605	0.6350	0.5000	1.6250	2.1875	0.1770	0.1875	10	943-000-349	\$121.44
406	0.7600	0.5000	1.6250	2.1250	0.2550	0.1250	10	943-000-350	\$132.77
506	0.7600	0.5000	1.6250	2.1563	0.2550	0.1563	10	943-000-351	\$132.77
606	0.7600	0.5000	1.6250	2.1875	0.2395	0.1875	10	943-000-352	\$132.77
806	0.7600	0.5000	1.6250	2.2500	0.2395	0.2500	10	943-000-353	\$132.77
507	0.8970	0.5000	1.6250	2.1563	0.3080	0.1563	12	943-000-354	\$155.29
607	0.8970	0.5000	1.6250	2.1875	0.3080	0.1875	12	943-000-355	\$155.29
707	0.8970	0.5000	1.6250	2.2188	0.2925	0.2188	12	943-000-356	\$155.29
807	0.8970	0.5000	1.6250	2.2500	0.2925	0.2500	12	943-000-357	\$155.29
608	1.0120	0.5000	1.6250	2.1875	0.3500	0.1875	12	943-000-358	\$171.64
708	1.0120	0.5000	1.6250	2.2188	0.3500	0.2188	12	943-000-359	\$171.64
808	1.0120	0.5000	1.6250	2.2500	0.3500	0.2500	12	943-000-360	\$171.64
1008	1.0120	0.5000	1.6250	2.3125	0.3345	0.3125	12	943-000-361	\$171.64
1208	1.0120	0.5000	1.6250	2.3750	0.3345	0.3750	12	943-000-362	\$171.64



Solid Carbide

American Standard#	DC	DCONms	LS	L	CDX	CW	Zc	Product #	Price
609	1.1370	0.5000	1.6250	2.1875	0.3970	0.1875	12	943-000-363	\$186.33
709	1.1370	0.5000	1.6250	2.2188	0.3970	0.2188	12	943-000-364	\$186.33
809	1.1370	0.5000	1.6250	2.2500	0.3810	0.2500	12	943-000-365	\$186.33
1009	1.1370	0.5000	1.6250	2.3125	0.3810	0.3125	12	943-000-366	\$186.33
610	1.2650	0.5000	1.6250	2.1875	0.4610	0.1875	14	943-000-367	\$199.41
710	1.2650	0.5000	1.6250	2.2188	0.4610	0.2188	14	943-000-368	\$199.41
810	1.2650	0.5000	1.6250	2.2500	0.4450	0.2500	14	943-000-369	\$199.41
1010	1.2650	0.5000	1.6250	2.3125	0.4140	0.3125	14	943-000-370	\$199.41
1210	1.2650	0.5000	1.6250	2.3750	0.3985	0.3750	14	943-000-371	\$199.41
811	1.3900	0.5000	1.6250	2.2500	0.4945	0.2500	14	943-000-372	\$259.80
1011	1.3900	0.5000	1.6250	2.3125	0.4610	0.3125	14	943-000-373	\$259.80
1211	1.3900	0.5000	1.6250	2.3750	0.4610	0.3750	14	943-000-374	\$259.80
812	1.5150	0.5000	1.6250	2.2500	0.5400	0.2500	14	943-000-375	\$299.77
1012	1.5150	0.5000	1.6250	2.3125	0.5235	0.3125	14	943-000-376	\$299.77
1212	1.5150	0.5000	1.6250	2.3750	0.5235	0.3750	14	943-000-377	\$299.77

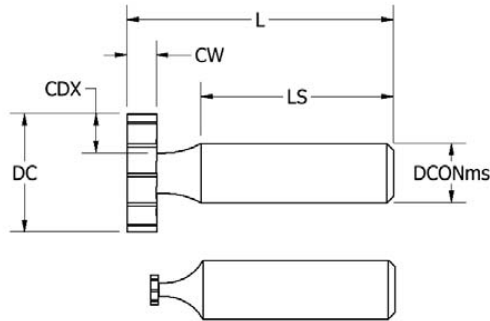

CARBIDE TIPPED

American Standard#	DC	DCONms	LS	L	CDX	CW	Zc	Straight Tooth	Price	Stagger Tooth	Price
204	0.5100	0.5000	1.6250	2.0625	0.1875	0.0625	6	943-000-640	\$102.85	943-000-641	\$120.40
304	0.5100	0.5000	1.6250	2.0938	0.1750	0.0938	6	943-000-645	\$102.85	943-000-646	\$120.40
404	0.5100	0.5000	1.6250	2.1250	0.1595	0.1250	6	943-000-650	\$102.85	943-000-651	\$120.40
305	0.6350	0.5000	1.6250	2.0938	0.2220	0.0938	6	943-000-655	\$106.58	943-000-656	\$124.52
405	0.6350	0.5000	1.6250	2.1250	0.2060	0.1250	6	943-000-660	\$106.58	943-000-661	\$124.52
505	0.6350	0.5000	1.6250	2.1563	0.1910	0.1563	6	943-000-665	\$106.58	943-000-666	\$124.52
605	0.6350	0.5000	1.6250	2.1875	0.1910	0.1875	6	943-000-670	\$106.58	943-000-671	\$124.52
406	0.7600	0.5000	1.6250	2.1250	0.2715	0.1250	6	943-000-675	\$116.26	943-000-676	\$130.31
506	0.7600	0.5000	1.6250	2.1563	0.2565	0.1563	6	943-000-680	\$116.26	943-000-681	\$130.31
606	0.7600	0.5000	1.6250	2.1875	0.2405	0.1875	6	943-000-685	\$116.26	943-000-686	\$130.31
806	0.7600	0.5000	1.6250	2.2500	0.2405	0.2500	6	943-000-690	\$116.26	943-000-691	\$130.31
507	0.8970	0.5000	1.6250	2.1563	0.3250	0.1563	6	943-000-695	\$133.96	943-000-696	\$156.73
607	0.8970	0.5000	1.6250	2.1875	0.3090	0.1875	6	943-000-700	\$133.96	943-000-701	\$156.73
707	0.8970	0.5000	1.6250	2.2188	0.3090	0.2188	6	943-000-705	\$133.96	943-000-706	\$156.73
807	0.8970	0.5000	1.6250	2.2500	0.2775	0.2500	6	943-000-710	\$133.96	943-000-711	\$156.73
608	1.0120	0.5000	1.6250	2.1875	0.3665	0.1875	8	943-000-715	\$151.15	943-000-716	\$176.71
708	1.0120	0.5000	1.6250	2.2188	0.3665	0.2188	8	943-000-720	\$151.15	943-000-721	\$176.71
808	1.0120	0.5000	1.6250	2.2500	0.3350	0.2500	8	943-000-725	\$151.15	943-000-726	\$176.71
1008	1.0120	0.5000	1.6250	2.3125	0.3055	0.3125	8	943-000-730	\$151.15	943-000-731	\$176.71
1208	1.0120	0.5000	1.6250	2.3750	0.3055	0.3750	8	943-000-735	\$151.15	943-000-736	\$176.71
609	1.1370	0.5000	1.6250	2.1875	0.4125	0.1875	8	943-000-740	\$158.66	943-000-741	\$184.65
709	1.1370	0.5000	1.6250	2.2188	0.4125	0.2188	8	943-000-745	\$158.66	943-000-746	\$184.65
809	1.1370	0.5000	1.6250	2.2500	0.3820	0.2500	8	943-000-750	\$158.66	943-000-751	\$184.65
1009	1.1370	0.5000	1.6250	2.3125	0.3510	0.3125	8	943-000-755	\$158.66	943-000-756	\$184.65
610	1.2650	0.5000	1.6250	2.1875	0.4460	0.1875	8	943-000-760	\$166.61	943-000-761	\$194.98
710	1.2650	0.5000	1.6250	2.2188	0.4460	0.2188	8	943-000-765	\$166.61	943-000-766	\$194.98
810	1.2650	0.5000	1.6250	2.2500	0.4460	0.2500	8	943-000-770	\$166.61	943-000-771	\$194.98
1010	1.2650	0.5000	1.6250	2.3125	0.4150	0.3125	8	943-000-775	\$166.61	943-000-776	\$194.98
1210	1.2650	0.5000	1.6250	2.3750	0.3990	0.3750	8	943-000-780	\$166.61	943-000-781	\$194.98
811	1.3900	0.5000	1.6250	2.2500	0.4945	0.2500	8	943-000-785	\$175.00	943-000-786	\$204.86
1011	1.3900	0.5000	1.6250	2.3125	0.4615	0.3125	8	943-000-790	\$175.00	943-000-791	\$204.86
1211	1.3900	0.5000	1.6250	2.3750	0.4615	0.3750	8	943-000-795	\$175.00	943-000-796	\$204.86
812	1.5150	0.5000	1.6250	2.2500	0.5400	0.2500	8	943-000-800	\$183.60	943-000-801	\$214.73
1012	1.5150	0.5000	1.6250	2.3125	0.5240	0.3125	8	943-000-805	\$183.60	943-000-806	\$214.73
1212	1.5150	0.5000	1.6250	2.3750	0.5240	0.3750	8	943-000-809	\$183.60	943-000-810	\$214.73

For set information see page 258.



HSS

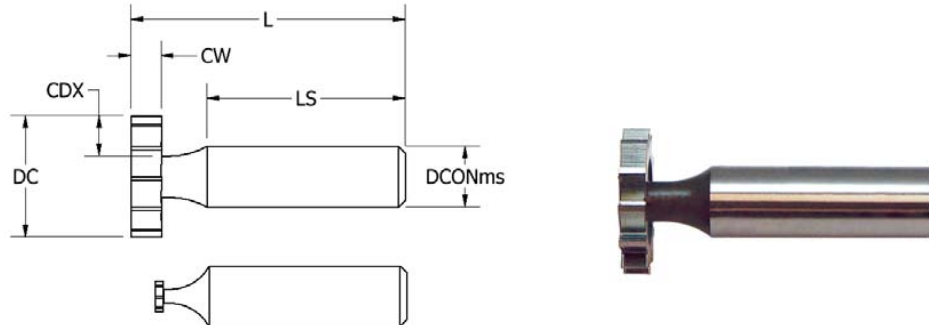

American Standard#	DC	DCONms	LS	L	CDX	CW	Zc		Straight Tooth	Price	Stagger Tooth	Price
							Straight	Staggered				
202	0.2600	0.5000	1.6250	2.0625	0.0750	0.0625	8	6	943-000-001	\$28.33	943-000-005	\$36.97
202 1/2	0.3225	0.5000	1.6250	2.0625	0.1063	0.0625	8	6	943-000-009	\$28.33	943-000-013	\$36.97
302 1/2	0.3225	0.5000	1.6250	2.0938	0.1063	0.0938	8	6	943-000-017	\$28.33	943-000-021	\$36.97
203	0.3850	0.5000	1.6250	2.0625	0.1375	0.0625	8	6	943-000-025	\$28.33	943-000-029	\$36.97
303	0.3850	0.5000	1.6250	2.0938	0.1375	0.0938	8	6	943-000-033	\$28.33	943-000-037	\$36.97
403	0.3850	0.5000	1.6250	2.1250	0.1275	0.1250	8	6	943-000-041	\$28.33	943-000-045	\$36.97
204	0.5100	0.5000	1.6250	2.0625	0.1900	0.0625	10	8	943-000-049	\$28.33	943-000-053	\$36.97
304	0.5100	0.5000	1.6250	2.0938	0.1750	0.0938	10	8	943-000-057	\$28.33	943-000-061	\$36.97
404	0.5100	0.5000	1.6250	2.1250	0.1595	0.1250	10	8	943-000-065	\$28.33	943-000-069	\$36.97
305	0.6350	0.5000	1.6250	2.0938	0.2220	0.0938	10	8	943-000-073	\$28.61	943-000-077	\$37.23
405	0.6350	0.5000	1.6250	2.1250	0.2060	0.1250	10	8	943-000-081	\$28.61	943-000-085	\$37.23
505	0.6350	0.5000	1.6250	2.1563	0.1910	0.1563	10	8	943-000-089	\$28.61	943-000-093	\$37.23
605	0.6350	0.5000	1.6250	2.1875	0.1910	0.1875	10	8	943-000-097	\$28.61	943-000-101	\$37.23
406	0.7600	0.5000	1.6250	2.1250	0.2685	0.1250	10	8	943-000-105	\$29.98	943-000-109	\$38.42
506	0.7600	0.5000	1.6250	2.1563	0.2535	0.1563	10	8	943-000-113	\$29.98	943-000-117	\$38.42
606	0.7600	0.5000	1.6250	2.1875	0.2405	0.1875	10	8	943-000-121	\$29.98	943-000-125	\$38.42
806	0.7600	0.5000	1.6250	2.2500	0.2405	0.2500	10	8	943-000-129	\$29.98	943-000-133	\$38.42

DC(Cutter Diameter)		
1/4" up to and including 3/4"	+0.010"	+0.015"
7/8" up to and including 1-1/8"	+0.012"	+0.017"
1-1/4" up to and including 1-1/2"	+0.015"	+0.020"
DCONms(Shank Diameter)		
	-0.0001"	-0.0005"

CW(Width)		
1/16" up to and including 5/32"	+0.0000"	-0.0005"
3/16" up to and including 7/32"	-0.0002"	-0.0007"
1/4"	-0.0003"	-0.0008"
5/16"	-0.0004"	-0.0009"
3/8"	-0.0005"	-0.0010"

For set information see page 258.

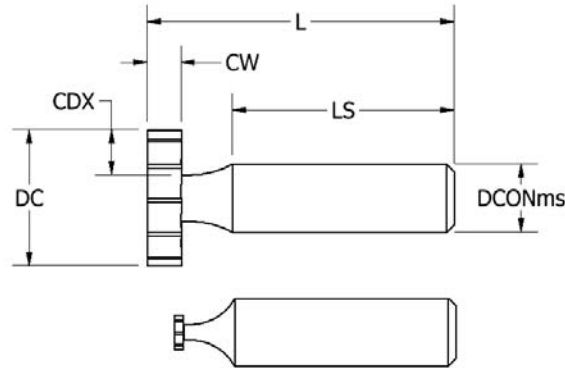

American Standard#	DC	DCONms	LS	L	CDX	CW	Zc		Straight Tooth	Price	Stagger Tooth	Price
							Straight	Staggered				
507	0.8970	0.5000	1.6250	2.1563	0.3250	0.1563	12	10	943-000-137	\$32.71	943-000-141	\$42.07
607	0.8970	0.5000	1.6250	2.1875	0.3090	0.1875	12	10	943-000-145	\$32.71	943-000-149	\$42.07
707	0.8970	0.5000	1.6250	2.2188	0.3090	0.2188	12	10	943-000-153	\$33.30	943-000-157	\$42.07
807	0.8970	0.5000	1.6250	2.2500	0.2775	0.2500	12	10	943-000-161	\$33.30	943-000-165	\$42.07
608	1.0120	0.5000	1.6250	2.1875	0.3665	0.1875	12	10	943-000-169	\$35.81	943-000-173	\$47.05
708	1.0120	0.5000	1.6250	2.2188	0.3350	0.2188	12	10	943-000-177	\$34.58	943-000-181	\$47.37
808	1.0120	0.5000	1.6250	2.2500	0.3350	0.2500	12	10	943-000-185	\$34.58	943-000-189	\$47.37
1008	1.0120	0.5000	1.6250	2.3125	0.3055	0.3125	12	10	943-000-193	\$37.14	943-000-197	\$48.05
1208	1.0120	0.5000	1.6250	2.3750	0.3055	0.3750	12	10	943-000-201	\$37.14	943-000-205	\$48.05
609	1.1370	0.5000	1.6250	2.1875	0.4125	0.1875	12	10	943-000-209	\$40.25	943-000-213	\$54.50
709	1.1370	0.5000	1.6250	2.2188	0.4125	0.2188	12	10	943-000-217	\$40.25	943-000-221	\$54.50
809	1.1370	0.5000	1.6250	2.2500	0.3810	0.2500	12	10	943-000-225	\$41.02	943-000-229	\$54.50
1009	1.1370	0.5000	1.6250	2.3125	0.3510	0.3125	12	10	943-000-233	\$43.01	943-000-237	\$53.08
610	1.2650	0.5000	1.6250	2.1875	0.4765	0.1875	14	12	943-000-241	\$44.92	943-000-245	\$56.67
710	1.2650	0.5000	1.6250	2.2188	0.4450	0.2188	14	12	943-000-249	\$44.92	943-000-253	\$56.67
810	1.2650	0.5000	1.6250	2.2500	0.4450	0.2500	14	12	943-000-257	\$46.41	943-000-261	\$59.85
1010	1.2650	0.5000	1.6250	2.6250	0.4150	0.3125	14	12	943-000-268	\$48.28	943-000-269	\$61.34
1210	1.2650	0.5000	1.6250	2.3750	0.3990	0.3750	14	12	943-000-273	\$48.28	943-000-277	\$61.34
811	1.3900	0.5000	1.6250	2.2500	0.4945	0.2500	14	12	943-000-281	\$52.02	943-000-285	\$66.64
1011	1.3900	0.5000	1.6250	2.3125	0.4615	0.3125	14	12	943-000-289	\$52.02	943-000-293	\$66.64
1211	1.3900	0.5000	1.6250	2.3750	0.4615	0.3750	14	12	943-000-297	\$52.96	943-000-301	\$67.55
812	1.5150	0.5000	1.6250	2.2500	0.5400	0.2500	16	14	943-000-305	\$53.85	943-000-309	\$71.26
1012	1.5150	0.5000	1.6250	2.3125	0.5240	0.3125	16	14	943-000-313	\$55.73	943-000-317	\$71.26
1212	1.5150	0.5000	1.6250	2.3750	0.5240	0.3750	16	14	943-000-321	\$57.58	943-000-325	\$78.43

DC(Cutter Diameter)	
1/4" up to and including 3/4"	+0.010" +0.015"
7/8" up to and including 1-1/8"	+0.012" +0.017"
1-1/4" up to and including 1-1/2"	+0.015" +0.020"
DCONms(Shank Diameter)	
	-0.0001" -0.0005"

CW(Width)	
1/16" up to and including 5/32"	+0.0000" -0.0005"
3/16" up to and including 7/32"	-0.0002" -0.0007"
1/4"	-0.0003" -0.0008"
5/16"	-0.0004" -0.0009"
3/8"	-0.0005" -0.0010"

For set information see **page 258**.

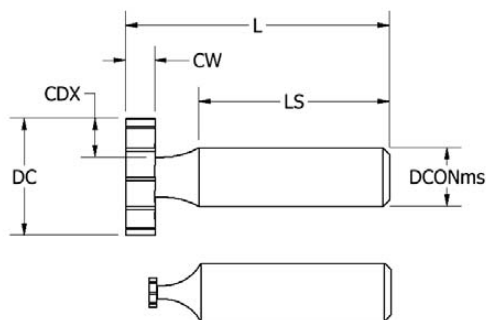

LEFT HAND

American Standard#	DC	DCONms	LS	L	CDX	CW	Zc	Straight Tooth	Price
202	0.2600	0.5000	1.6250	2.0625	0.0750	0.0625	8	943-000-618	\$34.41
202 1/2	0.3225	0.5000	1.6250	2.0625	0.1063	0.0625	8	943-000-621	\$39.41
302 1/2	0.3225	0.5000	1.6250	2.0938	0.1063	0.0938	8	943-000-624	\$39.82
203	0.3850	0.5000	1.6250	2.0625	0.1375	0.0625	8	943-000-627	\$35.45
303	0.3850	0.5000	1.6250	2.0938	0.1375	0.0938	8	943-000-630	\$35.49
403	0.3850	0.5000	1.6250	2.1250	0.1275	0.1250	8	943-000-633	\$35.78
204	0.5100	0.5000	1.6250	2.0625	0.1900	0.0625	10	943-000-636	\$46.17
304	0.5100	0.5000	1.6250	2.0938	0.1750	0.0938	10	943-000-639	\$46.64
404	0.5100	0.5000	1.6250	2.1250	0.1595	0.1250	10	943-000-649	\$46.65
305	0.6350	0.5000	1.6250	2.0938	0.2220	0.0938	10	943-000-644	\$48.38
405	0.6350	0.5000	1.6250	2.1250	0.2060	0.1250	10	943-000-654	\$48.82
505	0.6350	0.5000	1.6250	2.1563	0.1910	0.1563	10	943-000-664	\$48.98
605	0.6350	0.5000	1.6250	2.1875	0.1910	0.1875	10	943-000-669	\$50.44
406	0.7600	0.5000	1.6250	2.1250	0.2685	0.1250	10	943-000-659	\$52.11
506	0.7600	0.5000	1.6250	2.1563	0.2535	0.1563	10	943-000-674	\$51.96
606	0.7600	0.5000	1.6250	2.1875	0.2405	0.1875	10	943-000-689	\$39.02
806	0.7600	0.5000	1.6250	2.2500	0.2405	0.2500	10	943-000-679	\$40.36
507	0.8970	0.5000	1.6250	2.1563	0.3250	0.1563	12	943-000-684	\$57.86
607	0.8970	0.5000	1.6250	2.1875	0.3090	0.1875	12	943-000-694	\$57.81
707	0.8970	0.5000	1.6250	2.2188	0.3090	0.2188	12	943-000-699	\$59.40
807	0.8970	0.5000	1.6250	2.2500	0.2775	0.2500	12	943-000-724	\$58.44
608	1.0120	0.5000	1.6250	2.1875	0.3665	0.1875	12	943-000-704	\$61.46
708	1.0120	0.5000	1.6250	2.2188	0.3350	0.2188	12	943-000-709	\$63.06
808	1.0120	0.5000	1.6250	2.2500	0.3350	0.2500	12	943-000-729	\$53.88
1008	1.0120	0.5000	1.6250	2.3125	0.3055	0.3125	12	943-000-769	\$63.76
1208	1.0120	0.5000	1.6250	2.3750	0.3055	0.3750	12	943-000-714	\$64.32
609	1.1370	0.5000	1.6250	2.1875	0.4125	0.1875	12	943-000-719	\$68.34
709	1.1370	0.5000	1.6250	2.2188	0.4125	0.2188	12	943-000-734	\$67.32
809	1.1370	0.5000	1.6250	2.2500	0.3810	0.2500	12	943-000-739	\$69.31
1009	1.1370	0.5000	1.6250	2.3125	0.3510	0.3125	12	943-000-774	\$69.88
610	1.2650	0.5000	1.6250	2.1875	0.4765	0.1875	14	943-000-744	\$72.06
710	1.2650	0.5000	1.6250	2.2188	0.4450	0.2188	14	943-000-749	\$73.54
810	1.2650	0.5000	1.6250	2.2500	0.4450	0.2500	14	943-000-754	\$74.17
1010	1.2650	0.5000	1.6250	2.3125	0.4150	0.3125	14	943-000-779	\$75.66
1210	1.2650	0.5000	1.6250	2.3750	0.3990	0.3750	14	943-000-794	\$75.67
811	1.3900	0.5000	1.6250	2.2500	0.4945	0.2500	14	943-000-759	\$75.67
1011	1.3900	0.5000	1.6250	2.3125	0.4615	0.3125	14	943-000-784	\$84.13
1211	1.3900	0.5000	1.6250	2.3750	0.4615	0.3750	14	943-000-799	\$85.33
812	1.5150	0.5000	1.6250	2.2500	0.5400	0.2500	16	943-000-764	\$91.19
1012	1.5150	0.5000	1.6250	2.3125	0.5240	0.3125	16	943-000-789	\$92.02
1212	1.5150	0.5000	1.6250	2.3750	0.5240	0.3750	16	943-000-804	\$93.22

For set information see page 258.

HSS

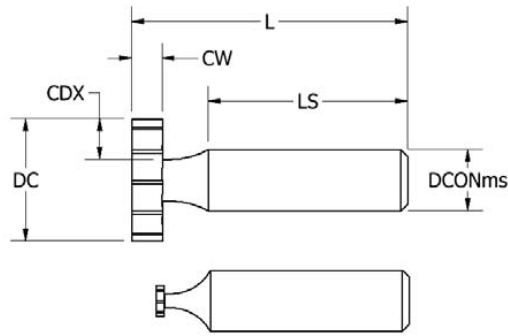

American Standard#	DC	DCONms	LS	L	CDX	CW	Zc		Straight Tooth	Price	Stagger Tooth	Price
							Straight	Staggered				
202	0.2600	0.5000	1.6250	2.0625	0.0750	0.0625	8	6	943-000-619	\$34.42	943-000-620	\$42.79
202 1/2	0.3225	0.5000	1.6250	2.0625	0.1063	0.0625	8	6	943-000-622	\$34.42	943-000-623	\$42.79
302 1/2	0.3225	0.5000	1.6250	2.0938	0.1063	0.0938	8	6	943-000-625	\$34.42	943-000-626	\$42.79
203	0.3850	0.5000	1.6250	2.0625	0.1375	0.0625	8	6	943-000-628	\$34.42	943-000-629	\$42.79
303	0.3850	0.5000	1.6250	2.0938	0.1375	0.0938	8	6	943-000-631	\$34.42	943-000-632	\$42.79
403	0.3850	0.5000	1.6250	2.1250	0.1275	0.1250	8	6	943-000-634	\$34.42	943-000-635	\$42.79
204	0.5100	0.5000	1.6250	2.0625	0.1900	0.0625	10	8	943-000-637	\$34.42	943-000-638	\$42.79
304	0.5100	0.5000	1.6250	2.0938	0.1750	0.0938	10	8	943-000-642	\$34.42	943-000-643	\$42.79
404	0.5100	0.5000	1.6250	2.1250	0.1595	0.1250	10	8	943-000-652	\$34.42	943-000-653	\$43.11
305	0.6350	0.5000	1.6250	2.0938	0.2220	0.0938	10	8	943-000-647	\$34.78	943-000-648	\$43.11
405	0.5100	0.5000	1.6250	2.1250	0.1595	0.1250	10	8	943-000-649	\$34.78	943-000-650	\$43.11
505	0.6350	0.5000	1.6250	2.1563	0.1910	0.1563	10	8	943-000-667	\$34.78	943-000-668	\$43.11
605	0.6350	0.5000	1.6250	2.1875	0.1910	0.1875	10	8	943-000-672	\$34.78	943-000-673	\$43.11
406	0.7600	0.5000	1.6250	2.1250	0.2685	0.1250	10	8	943-000-662	\$36.44	943-000-663	\$44.57
506	0.7600	0.5000	1.6250	2.1563	0.2535	0.1563	10	8	943-000-677	\$36.44	943-000-678	\$44.57
606	0.7600	0.5000	1.6250	2.1875	0.2405	0.1875	10	8	943-000-692	\$36.44	943-000-693	\$44.57
806	0.7600	0.5000	1.6250	2.2500	0.2405	0.2500	10	8	943-000-682	\$36.44	943-000-683	\$44.57
507	0.8970	0.5000	1.6250	2.1563	0.3250	0.1563	12	10	943-000-687	\$39.75	943-000-688	\$48.78
607	0.8970	0.5000	1.6250	2.1875	0.3090	0.1875	12	10	943-000-697	\$39.75	943-000-698	\$48.78
707	0.8970	0.5000	1.6250	2.2188	0.3090	0.2188	12	10	943-000-702	\$40.49	943-000-703	\$48.92
807	0.8970	0.5000	1.6250	2.2500	0.2775	0.2500	12	10	943-000-727	\$40.49	943-000-728	\$44.69
608	1.0120	0.5000	1.6250	2.1875	0.3665	0.1875	12	10	943-000-707	\$43.52	943-000-708	\$52.04
708	1.0120	0.5000	1.6250	2.2188	0.3350	0.2188	12	10	943-000-712	\$43.93	943-000-713	\$54.78
808	1.0120	0.5000	1.6250	2.2500	0.3350	0.2500	12	10	943-000-732	\$43.93	943-000-733	\$54.78
1008	1.0120	0.5000	1.6250	2.3125	0.3055	0.3125	12	10	943-000-772	\$45.13	943-000-773	\$55.68
1208	1.0120	0.5000	1.6250	2.3750	0.3055	0.3750	12	10	943-000-717	\$45.13	943-000-718	\$55.68
609	1.1370	0.5000	1.6250	2.1875	0.4125	0.1875	12	10	943-000-722	\$48.92	943-000-723	\$62.74
709	1.1370	0.5000	1.6250	2.2188	0.4125	0.2188	12	10	943-000-737	\$48.92	943-000-738	\$62.74
809	1.1370	0.5000	1.6250	2.2500	0.3810	0.2500	12	10	943-000-742	\$47.70	943-000-743	\$62.92
1009	1.1370	0.5000	1.6250	2.3125	0.3510	0.3125	12	10	943-000-777	\$50.03	943-000-778	\$64.31
610	1.2650	0.5000	1.6250	2.1875	0.4765	0.1875	14	12	943-000-747	\$54.60	943-000-748	\$65.92
710	1.2650	0.5000	1.6250	2.2188	0.4450	0.2188	14	12	943-000-752	\$54.60	943-000-753	\$65.92
810	1.2650	0.5000	1.6250	2.2500	0.4450	0.2500	14	12	943-000-757	\$56.41	943-000-758	\$69.38
1010	1.2650	0.5000	1.6250	2.3125	0.4150	0.3125	14	12	943-000-782	\$58.68	943-000-783	\$71.25
1210	1.2650	0.5000	1.6250	2.3750	0.3990	0.3750	14	12	943-000-797	\$58.68	943-000-798	\$71.25
811	1.3900	0.5000	1.6250	2.2500	0.4945	0.2500	14	12	943-000-762	\$63.24	943-000-763	\$77.34
1011	1.3900	0.5000	1.6250	2.3125	0.4615	0.3125	14	12	943-000-787	\$63.24	943-000-788	\$77.34
1211	1.3900	0.5000	1.6250	2.3750	0.4615	0.3750	14	12	943-000-802	\$64.36	943-000-803	\$78.43
812	1.5150	0.5000	1.6250	2.2500	0.5400	0.2500	16	14	943-000-767	\$65.46	943-000-768	\$82.31
1012	1.5150	0.5000	1.6250	2.3125	0.5240	0.3125	16	14	943-000-792	\$67.74	943-000-793	\$82.31
1212	1.5150	0.5000	1.6250	2.3750	0.5240	0.3750	16	14	943-000-807	\$69.98	943-000-808	\$86.87

For set information see page 258.



10-Piece Woodruff Keyseat Cutter Sets

The 10-piece set includes one piece each of the following sizes with straight or staggered teeth.



Teeth	Product #	Price
Straight	943-000-337	\$332.85
Staggered	943-000-338	\$427.75

American Standard Sizes	
403	406
204	606
404	806
305	608
505	808

*For detailed information see page 244-247
Many tools are available with additional coatings.
Please call for quote.*

41-Piece Woodruff Keyseat Cutter Sets

The 41-piece set includes one piece each of all the American Standard woodruff keyseat cutter sizes with straight or staggered teeth.

Teeth	Product #	Price
Straight	943-000-329	\$1,635.21
Staggered	943-000-330	\$2,101.16



HSS
COBALT

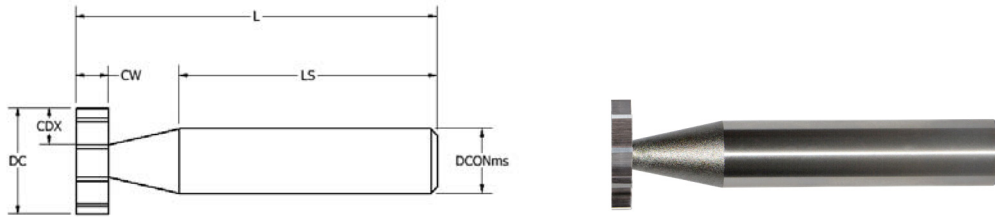

HSS



***DIN850-Form A,B**

DC	DCONms	LS	L	CDX	CW	Zc		Straight Tooth	Price	Stagger Tooth	Price
						Straight	Staggered				
4.50	6.00	36.00	50.00	1.35	1.00	6	4	943-000-480	\$33.83	943-000-481	\$44.14
7.50	6.00	36.00	50.00	2.35	1.50	8	6	943-000-482	\$33.83	943-000-483	\$44.14
7.50	6.00	36.00	50.00	2.15	2.00	8	6	943-000-484	\$33.83	943-000-485	\$44.14
10.50	6.00	36.00	50.00	3.25	2.00	8	6	943-000-486	\$33.83	943-000-487	\$44.14
10.50	6.00	36.00	50.00	3.25	2.50	8	6	943-000-488	\$33.83	943-000-489	\$44.14
10.50	6.00	36.00	50.00	3.15	3.00	8	6	943-000-490	\$33.83	943-000-491	\$44.14
13.50	10.00	40.00	56.00	4.45	3.00	10	8	943-000-492	\$33.83	943-000-493	\$44.14
13.50	10.00	40.00	56.00	4.45	4.00	10	8	943-000-494	\$33.83	943-000-495	\$44.14
16.50	10.00	40.00	56.00	5.95	3.00	10	8	943-000-496	\$34.16	943-000-497	\$44.45
16.50	10.00	40.00	56.00	5.95	4.00	10	8	943-000-498	\$34.16	943-000-499	\$44.45
16.50	10.00	40.00	56.00	5.75	5.00	10	8	943-000-500	\$34.16	943-000-501	\$44.45
19.50	10.00	40.00	63.00	6.95	4.00	10	8	943-000-502	\$39.39	943-000-503	\$50.46
19.50	10.00	40.00	63.00	6.75	5.00	10	8	943-000-504	\$39.39	943-000-505	\$50.46
19.50	10.00	40.00	63.00	6.50	6.00	10	8	943-000-506	\$39.39	943-000-507	\$50.46
22.50	10.00	40.00	63.00	8.25	5.00	12	10	943-000-508	\$42.96	943-000-509	\$55.25
22.50	10.00	40.00	63.00	8.25	6.00	12	10	943-000-510	\$43.74	943-000-511	\$55.25
22.50	10.00	40.00	63.00	8.00	8.00	12	10	943-000-512	\$43.74	943-000-513	\$55.25
25.50	10.00	40.00	63.00	9.00	6.00	12	10	943-000-514	\$45.43	943-000-515	\$62.20
28.50	10.00	40.00	71.00	10.00	6.00	12	10	943-000-516	\$53.86	943-000-517	\$71.58
28.50	10.00	40.00	71.00	10.00	8.00	12	10	943-000-518	\$56.48	943-000-519	\$72.85
28.50	12.00	45.00	71.00	9.60	10.00	12	10	943-000-520	\$56.48	943-000-521	\$72.85
32.50	12.00	45.00	71.00	12.00	7.00	14	12	943-000-522	\$66.48	943-000-523	\$85.73
32.50	12.00	45.00	71.00	12.00	8.00	14	12	943-000-524	\$69.17	943-000-525	\$87.88
32.50	12.00	45.00	71.00	11.60	10.00	14	12	943-000-526	\$69.17	943-000-527	\$87.88
45.50	12.00	45.00	71.00	16.85	10.00	18	16	943-000-528	\$159.73	943-000-529	\$208.16

*DIN 850 - Form A: Straight Shank, Straight Teeth

*DIN 850 - Form B: Straight Shank, Staggered Teeth

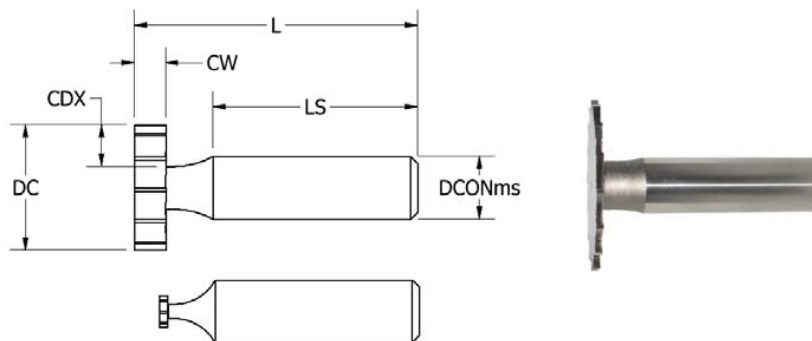

NARROW WIDTH

DC	DCONms	LS	L	CDX	CW	Zc	Product #	Price
0.2500	0.5000	1.6250	2.0156	0.0700	0.0156	8	943-000-533	\$74.69
0.2500	0.5000	1.6250	2.0200	0.0700	0.0200	8	943-000-530	\$53.72
0.2500	0.5000	1.6250	2.0313	0.0700	0.0313	8	943-000-534	\$37.93
0.2500	0.5000	1.6250	2.0469	0.0700	0.0469	8	943-000-535	\$53.72
0.3125	0.5000	1.6250	2.0156	0.1013	0.0156	8	943-000-536	\$75.20
0.3125	0.5000	1.6250	2.0200	0.1013	0.0200	8	943-000-531	\$54.23
0.3125	0.5000	1.6250	2.0313	0.1013	0.0313	8	943-000-537	\$38.21
0.3125	0.5000	1.6250	2.0469	0.1013	0.0469	8	943-000-538	\$54.23
0.3750	0.5000	1.6250	2.0156	0.1325	0.0156	8	943-000-539	\$73.94
0.3750	0.5000	1.6250	2.0200	0.1325	0.0200	8	943-000-532	\$53.67
0.3750	0.5000	1.6250	2.0313	0.1325	0.0313	8	943-000-540	\$39.29
0.3750	0.5000	1.6250	2.0469	0.1325	0.0469	8	943-000-541	\$53.67
0.5000	0.5000	1.6250	2.0156	0.1850	0.0156	10	943-000-542	\$75.18
0.5000	0.5000	1.6250	2.0200	0.1850	0.0200	10	943-000-543	\$67.73
0.5000	0.5000	1.6250	2.0313	0.1850	0.0313	10	943-000-544	\$36.36
0.5000	0.5000	1.6250	2.0469	0.1850	0.0469	10	943-000-545	\$67.73
0.6250	0.5000	1.6250	2.0200	0.2170	0.0200	10	943-000-546	\$67.73
0.6250	0.5000	1.6250	2.0313	0.2170	0.0313	10	943-000-547	\$36.70
0.6250	0.5000	1.6250	2.0469	0.2170	0.0469	10	943-000-548	\$67.73
0.6250	0.5000	1.6250	2.0625	0.2170	0.0625	10	943-000-549	\$36.70
0.6250	0.5000	1.6250	2.0781	0.2170	0.0781	10	943-000-550	\$67.73
0.7500	0.5000	1.6250	2.0313	0.2635	0.0313	10	943-000-551	\$38.47
0.7500	0.5000	1.6250	2.0469	0.2635	0.0469	10	943-000-552	\$72.43
0.7500	0.5000	1.6250	2.0625	0.2635	0.0625	10	943-000-553	\$38.47
0.7500	0.5000	1.6250	2.0781	0.2635	0.0781	10	943-000-554	\$72.43
0.7500	0.5000	1.6250	2.0938	0.2635	0.0938	10	943-000-555	\$38.47
0.7500	0.5000	1.6250	2.1094	0.2635	0.1094	10	943-000-556	\$72.43
0.8750	0.5000	1.6250	2.0313	0.3140	0.0313	12	943-000-557	\$42.45
0.8750	0.5000	1.6250	2.0469	0.3140	0.0469	12	943-000-558	\$80.92
0.8750	0.5000	1.6250	2.0625	0.3140	0.0625	12	943-000-559	\$42.45
0.8750	0.5000	1.6250	2.0781	0.3140	0.0781	12	943-000-560	\$80.92
0.8750	0.5000	1.6250	2.0938	0.3140	0.0938	12	943-000-561	\$42.45
0.8750	0.5000	1.6250	2.1094	0.3140	0.1094	12	943-000-562	\$80.92
0.8750	0.5000	1.6250	2.1250	0.3140	0.1250	12	943-000-563	\$42.45
0.8750	0.5000	1.6250	2.1406	0.3140	0.1406	12	943-000-564	\$80.92
1.0000	0.5000	1.6250	2.0313	0.3605	0.0313	12	943-000-565	\$89.91
1.0000	0.5000	1.6250	2.0469	0.3605	0.0469	12	943-000-566	\$89.91
1.0000	0.5000	1.6250	2.0625	0.3605	0.0625	12	943-000-567	\$46.40
1.0000	0.5000	1.6250	2.0781	0.3605	0.0781	12	943-000-568	\$89.91
1.0000	0.5000	1.6250	2.0938	0.3605	0.0938	12	943-000-569	\$46.40
1.0000	0.5000	1.6250	2.1094	0.3605	0.1094	12	943-000-570	\$89.91
1.0000	0.5000	1.6250	2.1250	0.3605	0.1250	12	943-000-571	\$46.40
1.0000	0.5000	1.6250	2.1406	0.3605	0.1406	12	943-000-572	\$89.91
1.0000	0.5000	1.6250	2.1563	0.3605	0.1563	12	943-000-573	\$46.40
1.0000	0.5000	1.6250	2.1719	0.3605	0.1719	12	943-000-574	\$89.91

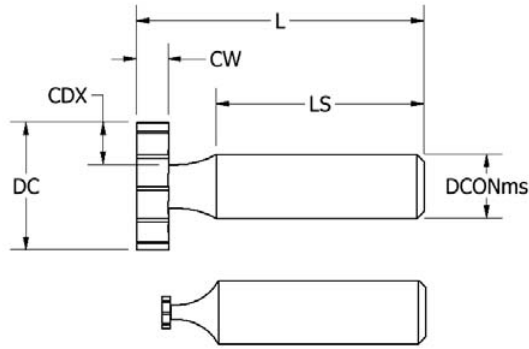

Tolerance		
DC(Cutter Diameter)		
1/4" up to and including 3/4"	+0.010"	+0.015"
7/8" up to and including 1-1/8"	+0.012"	+0.017"
1-1/4" up to and including 1-1/2"	+0.015"	+0.020"
DCONms(Shank Diameter)		
-0.0001"	-0.0005"	
CW(Width)		
+0.0005"	-0.0005"	



NARROW WIDTH

DC	DCONms	LS	L	CDX	CW	Zc	Product #	Price
1.1250	0.5000	1.6250	2.0469	0.4065	0.0469	12	943-000-575	\$97.32
1.1250	0.5000	1.6250	2.0625	0.4065	0.0625	12	943-000-576	\$55.22
1.1250	0.5000	1.6250	2.0781	0.4065	0.0781	12	943-000-577	\$97.32
1.1250	0.5000	1.6250	2.0938	0.4065	0.0938	12	943-000-578	\$55.22
1.1250	0.5000	1.6250	2.1094	0.4065	0.1094	12	943-000-579	\$97.32
1.1250	0.5000	1.6250	2.1250	0.4065	0.1250	12	943-000-580	\$55.22
1.1250	0.5000	1.6250	2.1406	0.4065	0.1406	12	943-000-581	\$97.32
1.1250	0.5000	1.6250	2.1563	0.4065	0.1563	12	943-000-582	\$55.22
1.1250	0.5000	1.6250	2.1719	0.4065	0.1719	12	943-000-583	\$97.32
1.2500	0.5000	1.6250	2.0469	0.4690	0.0469	14	943-000-584	\$104.65
1.2500	0.5000	1.6250	2.0625	0.4690	0.0625	14	943-000-585	\$61.97
1.2500	0.5000	1.6250	2.0781	0.4690	0.0781	14	943-000-586	\$104.65
1.2500	0.5000	1.6250	2.0938	0.4690	0.0938	14	943-000-587	\$61.97
1.2500	0.5000	1.6250	2.1094	0.4690	0.1094	14	943-000-588	\$104.65
1.2500	0.5000	1.6250	2.1250	0.4690	0.1250	14	943-000-589	\$61.97
1.2500	0.5000	1.6250	2.1406	0.4690	0.1406	14	943-000-590	\$104.65
1.2500	0.5000	1.6250	2.1563	0.4690	0.1563	14	943-000-591	\$61.97
1.2500	0.5000	1.6250	2.1719	0.4690	0.1719	14	943-000-592	\$104.65
1.3750	0.5000	1.6250	2.0469	0.4870	0.0469	14	943-000-593	\$114.90
1.3750	0.5000	1.6250	2.0625	0.4870	0.0625	14	943-000-594	\$67.74
1.3750	0.5000	1.6250	2.0781	0.4870	0.0781	14	943-000-595	\$114.90
1.3750	0.5000	1.6250	2.0938	0.4870	0.0938	14	943-000-596	\$67.74
1.3750	0.5000	1.6250	2.1094	0.4870	0.1094	14	943-000-597	\$114.90
1.3750	0.5000	1.6250	2.1250	0.4870	0.1250	14	943-000-598	\$67.74
1.3750	0.5000	1.6250	2.1406	0.4870	0.1406	14	943-000-599	\$114.90
1.3750	0.5000	1.6250	2.1563	0.4870	0.1563	14	943-000-600	\$67.74
1.3750	0.5000	1.6250	2.1719	0.4870	0.1719	14	943-000-601	\$114.90
1.3750	0.5000	1.6250	2.1875	0.4870	0.1875	14	943-000-602	\$67.74
1.3750	0.5000	1.6250	2.2031	0.4870	0.2031	14	943-000-603	\$114.90
1.3750	0.5000	1.6250	2.2188	0.4870	0.2188	14	943-000-604	\$67.74
1.5000	0.5000	1.6250	2.0469	0.5325	0.0469	16	943-000-605	\$122.10
1.5000	0.5000	1.6250	2.0625	0.5325	0.0625	16	943-000-606	\$74.53
1.5000	0.5000	1.6250	2.0781	0.5325	0.0781	16	943-000-607	\$122.10
1.5000	0.5000	1.6250	2.0938	0.5325	0.0938	16	943-000-608	\$74.53
1.5000	0.5000	1.6250	2.1094	0.5325	0.1094	16	943-000-609	\$122.10
1.5000	0.5000	1.6250	2.1250	0.5325	0.1250	16	943-000-610	\$74.53
1.5000	0.5000	1.6250	2.1406	0.5325	0.1406	16	943-000-611	\$122.10
1.5000	0.5000	1.6250	2.1563	0.5325	0.1563	16	943-000-612	\$74.17
1.5000	0.5000	1.6250	2.1719	0.5325	0.1719	16	943-000-613	\$116.26
1.5000	0.5000	1.6250	2.1875	0.5325	0.1875	16	943-000-614	\$74.17
1.5000	0.5000	1.6250	2.2031	0.5325	0.2031	16	943-000-615	\$116.26
1.5000	0.5000	1.6250	2.2188	0.5325	0.2188	16	943-000-616	\$74.17
1.5000	0.5000	1.6250	2.2344	0.5325	0.2344	16	943-000-617	\$116.26

HSS



DOVETAIL CUTTERS

THE COMPLETE TOOL MAKING AUTHORITY™

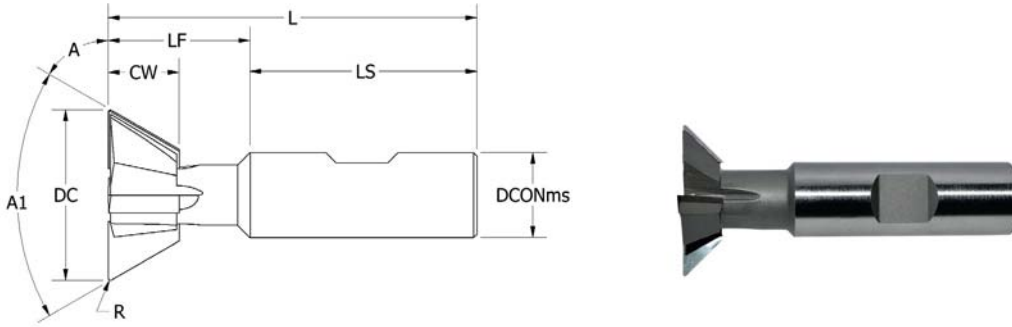

STANDARD WELDON SHANK

DC	DCONms	LS	L	LF	CW	A	A1	R	Zc	Carbide Tipped	Price
0.5000	0.3750	1.5625	2.1250	0.5625	0.1563	45.0	90.0	0.0200	3	929-000-061	\$115.14
0.7500	0.3750	1.5469	2.2500	0.7031	0.2500	45.0	90.0	0.0200	3	929-000-063	\$128.23
1.0000	0.5000	1.6875	2.5000	0.8125	0.3125	45.0	90.0	0.0200	4	929-000-065	\$141.55
1.2500	0.6250	1.8750	2.7500	0.8750	0.3125	45.0	90.0	0.0200	4	929-000-067	\$157.11
1.5000	0.7500	1.9375	3.2500	1.3125	0.5000	45.0	90.0	0.0200	4	929-000-069	\$198.44
2.0000	1.0000	2.2500	4.2500	2.0000	0.6250	45.0	90.0	0.0200	6	929-000-071	\$301.40
2.5000	1.2500	2.3125	4.3750	2.0625	0.7500	45.0	90.0	0.0200	6	929-000-073	\$437.74
3.0000	1.2500	2.2500	4.5000	2.2500	1.0000	45.0	90.0	0.0200	6	929-000-075	\$508.56
0.5000	0.3750	1.5625	2.1250	0.5625	0.2188	60.0	60.0	0.0200	3	929-000-062	\$115.14
0.7500	0.3750	1.5313	2.2500	0.7188	0.2500	60.0	60.0	0.0200	3	929-000-064	\$128.23
1.0000	0.5000	1.7500	2.5000	0.7500	0.3750	60.0	60.0	0.0200	4	929-000-066	\$141.55
1.2500	0.6250	1.8750	2.7500	0.8750	0.5000	60.0	60.0	0.0200	4	929-000-068	\$157.11
1.5000	0.7500	1.9375	3.2500	1.3125	0.6250	60.0	60.0	0.0200	4	929-000-070	\$198.44
2.0000	1.0000	2.1250	4.2500	2.1250	0.7500	60.0	60.0	0.0200	6	929-000-072	\$301.40
2.5000	1.2500	2.1875	4.3750	2.1875	0.8750	60.0	60.0	0.0200	6	929-000-074	\$437.74
3.0000	1.2500	2.1250	4.5000	2.3750	1.1250	60.0	60.0	0.0200	6	929-000-076	\$508.56



HSS

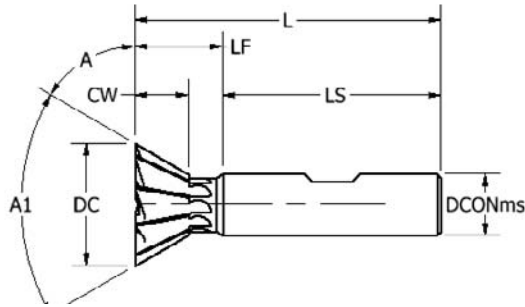

DC	DCONms	LS	L	LF	CW	A	A1	Zc	HSS	Price	COBALT	Price
0.3750	0.3750	1.7500	2.1250	0.3750	0.1250	45.0	90.0	6	929-000-077	\$61.58	929-000-080	\$64.09
0.5000	0.3750	1.6875	2.1250	0.4375	0.1250	45.0	90.0	8	929-000-005	\$66.21	929-000-082	\$69.38
0.7500	0.3750	1.5625	2.1250	0.5625	0.1875	45.0	90.0	8	929-000-013	\$67.78	929-000-084	\$81.12
1.0000	0.5000	1.9375	2.5000	0.5625	0.2500	45.0	90.0	10	929-000-078	\$122.68	929-000-086	\$100.43
1.3750	0.6250	1.9063	2.8750	0.9688	0.3750	45.0	90.0	10	929-000-021	\$122.68	929-000-088	\$126.64
1.8750	0.8750	2.0313	3.2500	1.2188	0.5000	45.0	90.0	12	929-000-037	\$267.30	929-000-090	\$275.95
2.2500	1.0000	2.2813	3.7500	1.4688	0.6875	45.0	90.0	12	929-000-045	\$318.64	929-000-092	\$328.97
2.5000	1.0000	2.2813	3.7500	1.4688	0.7500	45.0	90.0	12	929-000-053	\$376.94	929-000-094	\$389.12
0.3750	0.3750	1.6875	2.1250	0.4375	0.1875	60.0	60.0	8	929-000-001	\$61.58	929-000-081	\$64.09
0.5000	0.3750	1.6875	2.1250	0.4375	0.2188	60.0	60.0	8	929-000-009	\$66.21	929-000-083	\$69.38
0.7500	0.3750	1.5625	2.1250	0.5625	0.3125	60.0	60.0	8	929-000-017	\$77.76	929-000-085	\$81.12
1.0000	0.5000	1.7500	2.5000	0.7500	0.4375	60.0	60.0	10	929-000-079	\$122.68	929-000-087	\$100.43
1.3750	0.6250	1.9063	2.8750	0.9688	0.5625	60.0	60.0	12	929-000-029	\$122.68	929-000-089	\$126.64
1.8750	0.8750	2.0313	3.2500	1.2188	0.8125	60.0	60.0	12	929-000-041	\$267.30	929-000-091	\$275.95
2.2500	1.0000	2.2813	3.7500	1.4688	1.0625	60.0	60.0	12	929-000-049	\$318.64	929-000-093	\$328.97
2.5000	1.0000	2.2813	3.7500	1.4688	1.1250	60.0	60.0	12	929-000-057	\$376.94	929-000-095	\$389.12

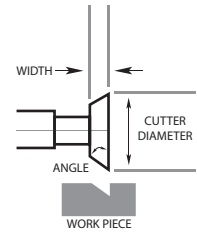
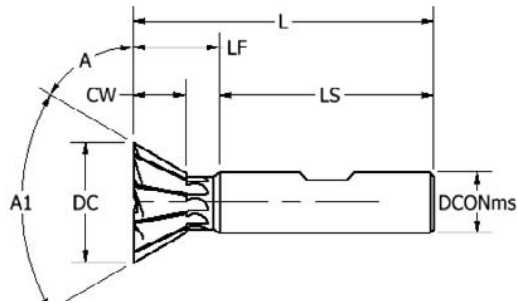

DT456

DC	DCONms	LS	L	LF	CW	A	A1	Zc	TiN Coated	Price	TiCN Coated	Price	TiAlN Coated	Price
0.5000	0.3750	1.6875	2.1250	0.4375	0.1250	45.0	90.0	8	929-000-008	\$75.76	929-000-007	\$79.37	929-000-006	\$79.37
0.7500	0.3750	1.5625	2.1250	0.5625	0.1875	45.0	90.0	8	929-000-016	\$89.08	929-000-015	\$93.22	929-000-014	\$93.22
1.3750	0.6250	1.9063	2.8750	0.9688	0.3750	45.0	90.0	10	929-000-028	\$140.36	929-000-024	\$147.03	929-000-023	\$147.03
1.3750	0.5000	1.7813	2.8750	1.0937	0.3750	45.0	90.0	10	929-000-025	\$140.36	929-000-027	\$147.03	929-000-026	\$147.03
1.8750	0.8750	2.0313	3.2500	1.2188	0.5000	45.0	90.0	12	929-000-040	\$305.93	929-000-039	\$320.51	929-000-038	\$320.51
2.2500	1.0000	2.2813	3.7500	1.4688	0.6875	45.0	90.0	12	929-000-048	\$364.78	929-000-047	\$382.06	929-000-046	\$382.06
2.5000	1.0000	2.2813	3.7500	1.4688	0.7500	45.0	90.0	12	929-000-056	\$431.37	929-000-055	\$451.86	929-000-054	\$451.86
0.3750	0.3750	1.6875	2.1250	0.4375	0.1875	60.0	60.0	8	929-000-004	\$70.56	929-000-003	\$73.80	929-000-002	\$73.80
0.5000	0.3750	1.6875	2.1250	0.4375	0.2188	60.0	60.0	8	929-000-012	\$75.76	929-000-011	\$79.37	929-000-010	\$79.37
0.7500	0.3750	1.5625	2.1250	0.5625	0.3125	60.0	60.0	8	929-000-020	\$89.08	929-000-019	\$93.22	929-000-018	\$93.22
1.3750	0.6250	1.9063	2.8750	0.9688	0.5625	60.0	60.0	12	929-000-036	\$140.36	929-000-035	\$147.03	929-000-031	\$147.03
1.3750	0.5000	1.7813	2.8750	1.0937	0.5625	60.0	60.0	12	929-000-033	\$140.36	929-000-032	\$147.03	929-000-034	\$147.03
1.8750	0.8750	2.0313	3.2500	1.2188	0.8125	60.0	60.0	12	929-000-044	\$305.93	929-000-043	\$320.51	929-000-042	\$320.51
2.2500	1.0000	2.2813	3.7500	1.4688	1.0625	60.0	60.0	12	929-000-052	\$364.78	929-000-051	\$382.06	929-000-050	\$382.06
2.5000	1.0000	2.2813	3.7500	1.4688	1.1250	60.0	60.0	12	929-000-060	\$431.37	929-000-059	\$451.86	929-000-058	\$451.86

DC(Cutter Dia.)	+ 0.015"	- 0.015"
L(Overall Length)	± 0.060	



HSS

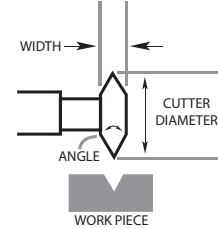
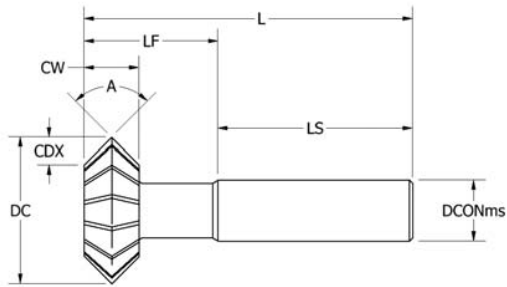

DA129

DC	DCONms	LS	L	LF	CDX	CW	A	Zc	Uncoated	Price	TiN Coated	Price	TiCN Coated	Price	TiAlN Coated	Price
0.7500	0.3750	1.5625	2.3750	0.8125	0.1624	0.1875	60.0	10	924-000-001	\$43.42	924-000-004	\$49.66	924-000-003	\$52.01	924-000-002	\$52.01
1.0000	0.5000	1.7813	2.8438	1.0625	0.2706	0.3125	60.0	12	924-000-005	\$69.34	924-000-008	\$79.37	924-000-007	\$83.15	924-000-006	\$83.15
1.3750	0.6250	1.9063	3.2188	1.3125	0.3789	0.4375	60.0	14	924-000-009	\$92.47	924-000-012	\$105.81	924-000-011	\$110.85	924-000-010	\$110.85
1.5000	0.6250	2.0000	3.3750	1.3750	0.4330	0.5000	60.0	14	924-000-013	\$121.36	924-000-016	\$138.91	924-000-015	\$145.60	924-000-014	\$145.60
1.8750	0.7500	2.0313	3.7813	1.7500	0.5413	0.6250	60.0	16	924-000-017	\$140.65	924-000-020	\$161.07	924-000-019	\$168.62	924-000-018	\$168.62
2.2500	0.8750	2.0313	4.1563	2.1250	0.6495	0.7500	60.0	18	924-000-021	\$206.05	924-000-024	\$235.76	924-000-023	\$247.09	924-000-022	\$247.09
2.2500	0.7500	2.0313	3.1250	1.0938	0.4330	0.5000	60.0	16	924-000-025	\$167.25	924-000-028	\$49.66	924-000-027	\$200.48	924-000-026	\$200.48
0.7500	0.3750	0.7500	0.3750	0.8750	0.1250	0.2500	90.0	10	924-000-029	\$43.42	924-000-032	\$79.37	924-000-031	\$52.01	924-000-030	\$52.01
1.0000	0.5000	1.7813	2.9063	1.1250	0.1875	0.3750	90.0	12	924-000-033	\$69.34	924-000-036	\$105.81	924-000-035	\$83.15	924-000-034	\$83.15
1.3750	0.6250	1.9063	3.2813	1.3750	0.2500	0.5000	90.0	14	924-000-037	\$92.47	924-000-040	\$138.91	924-000-039	\$110.85	924-000-038	\$110.85
1.5000	0.6250	2.0000	3.4375	1.4375	0.2813	0.5625	90.0	14	924-000-041	\$121.36	924-000-044	\$161.07	924-000-043	\$145.60	924-000-042	\$145.60
1.8750	0.7500	2.0313	3.7813	1.7500	0.3125	0.6250	90.0	16	924-000-045	\$140.65	924-000-048	\$235.76	924-000-047	\$168.62	924-000-046	\$168.62
2.2500	0.8750	2.0313	4.1563	2.1250	0.3750	0.7500	90.0	18	924-000-049	\$206.05	924-000-052	\$235.76	924-000-051	\$247.09	924-000-050	\$247.09
2.2500	0.7500	2.0313	3.1250	1.0938	0.2500	0.5000	90.0	16	924-000-053	\$167.25	924-000-056	\$191.49	924-000-055	\$200.48	924-000-054	\$200.48

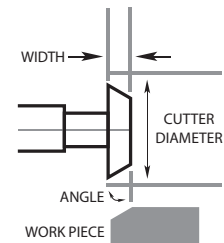
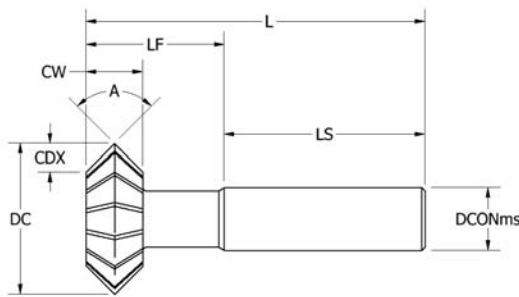

CH126 CHAMFERING CUTTER SINGLE-ANGLE

DC	DCONms	LS	L	LF	CW	A	A1	Zc	Uncoated	Price	TiN Coated	Price	TiCN Coated	Price	TiAlN Coated	Price
0.5000	0.3750	1.6875	2.1250	0.4375	0.1250	45.0	90.0	8	909-000-001	\$57.12	909-000-004	\$65.33	909-000-003	\$68.55	909-000-002	\$68.55
0.7500	0.3750	1.6250	2.1250	0.1875	0.1875	45.0	90.0	8	909-000-009	\$67.19	909-000-012	\$76.83	909-000-011	\$80.64	909-000-010	\$80.64
1.0000	0.5000	1.8125	2.5000	0.6875	0.3125	45.0	90.0	10	909-000-017	\$83.55	909-000-020	\$95.53	909-000-019	\$100.23	909-000-018	\$100.23
1.5000	0.7500	1.8750	2.7500	0.8750	0.5000	45.0	90.0	12	909-000-025	\$107.82	909-000-028	\$123.44	909-000-027	\$129.22	909-000-026	\$129.22
0.5000	0.3750	1.5938	2.1250	0.5313	0.2188	60.0	60.0	8	909-000-005	\$57.12	909-000-008	\$65.33	909-000-007	\$68.55	909-000-006	\$68.55
0.7500	0.3750	1.5625	2.1250	0.5625	0.3125	60.0	60.0	8	909-000-013	\$67.19	909-000-016	\$76.83	909-000-015	\$80.64	909-000-014	\$80.64
1.0000	0.5000	1.7500	2.5000	0.7500	0.4375	60.0	60.0	10	909-000-021	\$83.55	909-000-024	\$95.53	909-000-023	\$100.23	909-000-022	\$100.23
1.5000	0.7500	1.7500	2.7500	1.0000	0.6250	60.0	60.0	12	909-000-029	\$107.82	909-000-032	\$123.44	909-000-031	\$129.22	909-000-030	\$129.22



T-SLOT CUTTERS

THE COMPLETE TOOL MAKING AUTHORITY™



HSS

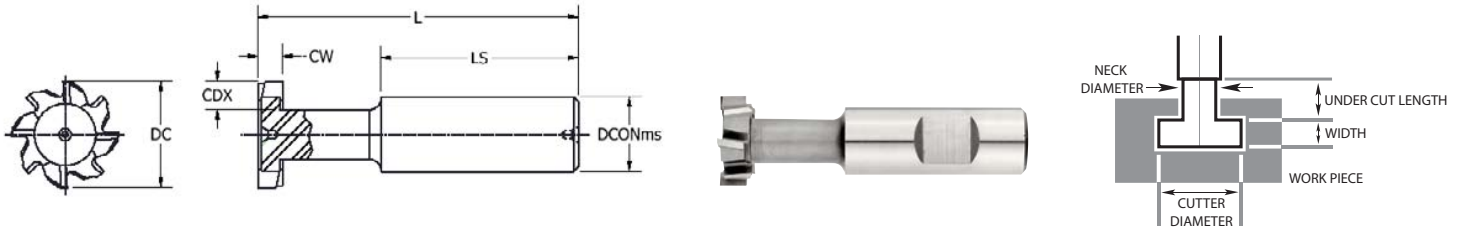

TS109

DC	DCONms	LS	L	CDX	CW	Zc	Uncoated	Price	TiN Coated	Price	TiCN Coated	Price	TiAlN Coated	Price
0.5625	0.5000	1.8125	2.5938	0.1484	0.2344	8	964-000-025	\$93.57	964-000-029	\$95.19	964-000-028	\$99.70	964-000-027	\$99.70
0.6563	0.5000	1.8125	2.6875	0.1641	0.2656	8	964-000-030	\$100.63	964-000-034	\$102.40	964-000-033	\$107.26	964-000-032	\$107.26
0.7813	0.7500	2.0625	3.2500	0.1875	0.3281	8	964-000-035	\$148.40	964-000-039	\$148.12	964-000-038	\$155.13	964-000-037	\$155.13
0.9688	0.7500	2.0625	3.4375	0.2188	0.3906	8	964-000-040	\$168.52	964-000-044	\$166.81	964-000-043	\$174.74	964-000-042	\$174.74
1.0000	0.7500	2.0313	3.1250	0.2500	0.0938	8	964-000-045	\$163.62	964-000-048	\$187.35	964-000-047	\$196.16	964-000-046	\$196.16
1.0000	0.7500	2.0000	3.1250	0.2500	0.1250	8	964-000-049	\$167.75	964-000-052	\$192.01	964-000-051	\$201.21	964-000-050	\$201.21
1.0000	0.7500	2.0313	3.1875	0.2500	0.1563	8	964-000-053	\$169.90	964-000-056	\$194.37	964-000-055	\$203.71	964-000-054	\$203.71
1.0000	0.7500	2.0000	3.1875	0.2500	0.1875	8	964-000-057	\$172.37	964-000-060	\$197.23	964-000-059	\$206.60	964-000-058	\$206.60
1.0000	0.7500	2.0000	3.2500	0.2500	0.2500	8	964-000-061	\$174.01	964-000-064	\$199.20	964-000-063	\$208.58	964-000-062	\$208.58
1.0000	0.7500	2.0000	3.3125	0.2500	0.3125	8	964-000-065	\$176.51	964-000-068	\$201.90	964-000-067	\$211.64	964-000-066	\$211.64
1.0000	0.7500	2.0000	3.3750	0.2500	0.3750	8	964-000-069	\$178.15	964-000-072	\$203.90	964-000-071	\$213.61	964-000-070	\$213.61
1.0000	0.7500	2.0000	3.5000	0.2500	0.5000	8	964-000-073	\$178.15	964-000-076	\$203.90	964-000-075	\$213.61	964-000-074	\$213.61
1.2500	1.0000	2.3125	3.9375	0.2969	0.4844	8	964-000-077	\$205.38	964-000-081	\$235.02	964-000-080	\$246.20	964-000-079	\$246.20
1.4688	1.0000	2.3125	4.4375	0.3438	0.6250	8	964-000-082	\$267.84	964-000-086	\$268.50	964-000-085	\$281.28	964-000-084	\$281.28
1.5000	1.0000	2.5313	4.1250	0.3750	0.0938	8	964-000-087	\$244.20	964-000-090	\$279.51	964-000-089	\$292.79	964-000-088	\$292.79
1.5000	1.0000	2.5000	4.1250	0.3750	0.1250	8	964-000-091	\$244.20	964-000-094	\$279.51	964-000-093	\$292.79	964-000-092	\$292.79
1.5000	1.0000	2.5313	4.1875	0.3750	0.1563	8	964-000-095	\$247.15	964-000-098	\$282.88	964-000-097	\$296.39	964-000-096	\$296.39
1.5000	1.0000	2.5000	4.1875	0.3750	0.1875	8	964-000-099	\$249.47	964-000-102	\$285.60	964-000-101	\$299.10	964-000-100	\$299.10
1.5000	1.0000	2.5000	4.2500	0.3750	0.2500	8	964-000-103	\$256.89	964-000-106	\$294.05	964-000-105	\$308.10	964-000-104	\$308.10
2.0000	1.2500	2.6563	4.5000	0.4375	0.0938	8	964-000-107	\$256.89	964-000-110	\$294.05	964-000-109	\$308.10	964-000-108	\$308.10
1.5000	1.0000	2.5000	4.3750	0.3750	0.3750	8	964-000-111	\$272.10	964-000-114	\$311.34	964-000-113	\$326.27	964-000-112	\$326.27
1.5000	1.0000	2.5000	4.5000	0.3750	0.5000	8	964-000-115	\$272.10	964-000-118	\$311.34	964-000-117	\$326.27	964-000-116	\$326.27
1.8438	1.2500	2.3125	4.8125	0.4063	0.8281	12	964-000-119	\$453.24	964-000-123	\$424.72	964-000-122	\$445.04	964-000-121	\$445.04
2.0000	1.2500	2.6563	4.5000	0.4375	0.0938	12	964-000-124	\$399.05	964-000-127	\$456.74	964-000-126	\$478.53	964-000-125	\$478.53
2.0000	1.2500	2.6250	4.5000	0.4375	0.1250	12	964-000-128	\$399.05	964-000-131	\$456.74	964-000-130	\$478.53	964-000-129	\$478.53
2.0000	1.2500	2.6563	4.5625	0.4375	0.1563	12	964-000-132	\$405.84	964-000-135	\$464.47	964-000-134	\$486.60	964-000-133	\$486.60
2.0000	1.2500	2.6250	4.5625	0.4375	0.1875	12	964-000-136	\$405.84	964-000-139	\$464.47	964-000-138	\$486.60	964-000-137	\$486.60
2.0000	1.2500	2.6250	4.6250	0.4375	0.2500	12	964-000-140	\$444.46	964-000-143	\$508.75	964-000-142	\$532.86	964-000-141	\$532.86
2.0000	1.2500	2.6250	4.6875	0.4375	0.3125	12	964-000-144	\$444.46	964-000-147	\$508.75	964-000-146	\$532.86	964-000-145	\$532.86
2.0000	1.2500	2.6250	4.7500	0.4375	0.3750	12	964-000-148	\$459.30	964-000-151	\$525.66	964-000-150	\$550.69	964-000-149	\$550.69
2.0000	1.2500	2.6250	4.8750	0.4375	0.5000	12	964-000-152	\$459.30	964-000-155	\$525.66	964-000-154	\$550.69	964-000-153	\$550.69
2.2188	1.2500	2.2813	5.3750	0.5000	1.0938	12	964-000-156	\$598.16	964-000-157	\$563.84	964-000-159	\$590.62	964-000-158	\$590.62
2.6563	1.2500	2.4375	5.9063	0.5625	1.3438	12	964-000-161	\$774.69	964-000-165	\$705.09	964-000-164	\$738.57	964-000-163	\$738.57

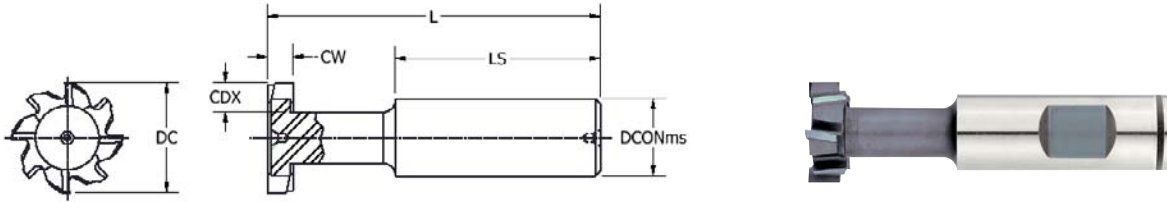

TS112 M42 8% Cobalt Steel

DC	DCONms	LS	L	CDX	CW	Zc	AlCrN Coated	Price
0.5625	0.5000	1.8125	2.5938	0.1484	0.2344	8	964-000-026	\$98.57
0.6563	0.5000	1.8125	2.6875	0.1641	0.2656	8	964-000-031	\$111.20
0.7813	0.7500	2.0625	3.2500	0.1875	0.3281	8	964-000-036	\$158.36
0.9688	0.7500	2.0625	3.4375	0.2188	0.3906	8	964-000-041	\$181.94
1.2500	1.0000	2.3125	3.9375	0.2969	0.4844	8	964-000-078	\$247.65
1.4688	1.0000	2.3125	4.4375	0.3438	0.6250	8	964-000-083	\$288.47
1.8438	1.2500	2.3125	4.8125	0.3594	0.8281	12	964-000-120	\$471.46
2.2188	1.2500	2.2813	5.3750	0.5000	1.0938	12	964-000-157	\$598.85
2.6563	1.2500	2.4375	5.9063	0.5625	1.3438	12	964-000-162	\$809.13

COBALT

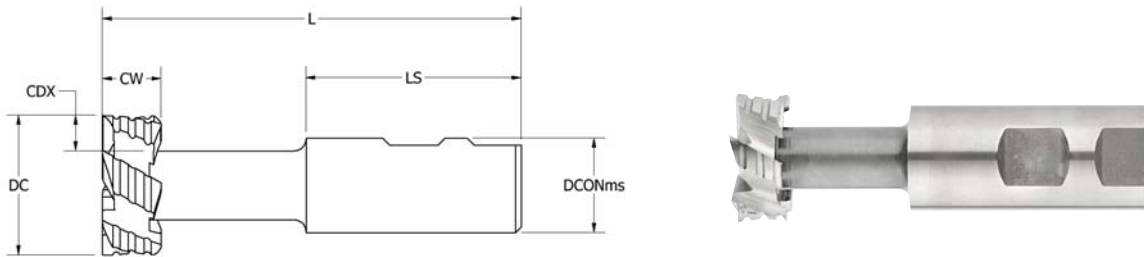

TS111 ROUGHER/FINISHER

DC	DCONms	LS	L	CDX	CW	Zc	Uncoated	Price	TiN Coated	Price	TiCN Coated	Price	TiAlN Coated	Price
0.9688	0.7500	2.0313	3.4375	0.2444	0.3906	5	964-000-006	\$231.47	964-000-024	\$264.90	964-000-018	\$277.50	964-000-012	\$277.50
1.2500	1.0000	2.2813	3.9375	0.3225	0.4844	6	964-000-001	\$333.29	964-000-019	\$333.29	964-000-013	\$349.11	964-000-007	\$349.11
1.4688	1.0000	2.2813	4.4375	0.3694	0.6250	6	964-000-002	\$368.20	964-000-020	\$421.47	964-000-014	\$441.46	964-000-008	\$441.46
1.8438	1.2500	2.2813	4.8125	0.4319	0.8281	6	964-000-003	\$502.90	964-000-021	\$575.52	964-000-015	\$603.06	964-000-009	\$603.06
2.2188	1.2500	2.2813	5.3750	0.4944	1.0938	8	964-000-005	\$656.95	964-000-023	\$751.90	964-000-017	\$787.69	964-000-011	\$787.69
2.6563	1.2500	2.3750	5.9063	0.5881	1.3438	10	964-000-004	\$968.16	964-000-022	\$1108.03	964-000-016	\$1160.73	964-000-010	\$1160.73

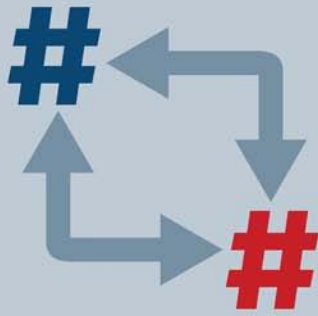

THE COMPLETE TOOL MAKING AUTHORITY'S

NEW PART NUMBER CONVERTER

FIND YOUR NEW PART NUMBER

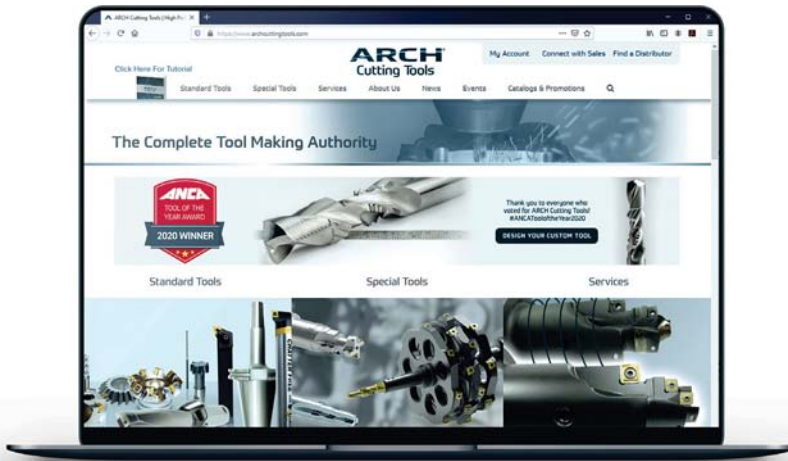

- Need to convert the new numbers in this catalog? Fret not!
- Visit our website to convert your part numbers
- Click through the part number links to discovery inventory
- Simply type in your old or new part number to look it up

1. Type Old or New Part Number In This Box

2. Click on "Find Part Number"

3. Our converter shows you the old and new part number & product description

Part Number Lookup

Enter Old or New Part Number	Old Part Number	New Part Number	Description	
956-000-115	103-034140	956-000-115	RH 1/4" x 2-1/2" Body 3/4" Flute Length	View Product

Find Part Number



SLOTTING MILLS

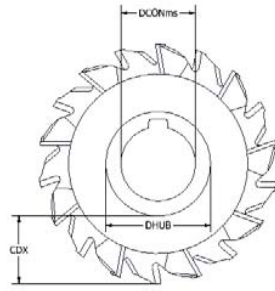
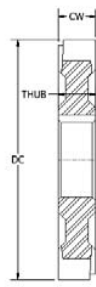

"S" Style

- General Purpose
- Ideal for Deep Slotting
- Alternate tooth design allows excellent chip removal



DC	CW	DCONms	CDX	DHUB	THUB	Zc	Uncoated	Price	TiN Coated*	Price	TiCN Coated*	Price	TiAlN Coated	Price
2.1250	0.1875	0.7500	0.5313	1.0000	0.1875	14	952-001-237	\$83.73	952-001-240	\$95.88	952-001-239	\$100.33	952-001-238	\$100.33
2.1250	0.2500	0.7500	0.5313	1.0000	0.2500	14	952-001-241	\$84.57	952-001-244	\$96.83	952-001-243	\$84.57	952-001-242	\$101.44
2.1250	0.3125	0.7500	0.5313	1.0000	0.3125	14	952-001-245	\$90.69	952-001-248	\$103.84	952-001-247	\$90.69	952-001-246	\$108.65
2.1250	0.3750	0.7500	0.5313	1.0000	0.3750	14	952-001-249	\$94.57	952-001-252	\$108.28	952-001-251	\$113.47	952-001-250	\$113.47
2.5000	0.2500	0.8750	0.6248	1.1880	0.2500	16	952-001-253	\$83.56	952-001-256	\$95.69	952-001-255	\$100.14	952-001-254	\$100.14
2.5000	0.3125	0.8750	0.6248	1.1880	0.3125	16	952-001-257	\$82.51	952-001-260	\$94.41	952-001-259	\$99.02	952-001-258	\$99.02
2.5000	0.3750	0.8750	0.6248	1.1880	0.3750	16	952-001-261	\$94.77	952-001-264	\$108.46	952-001-263	\$113.64	952-001-262	\$113.64
2.5000	0.5000	0.8750	0.6248	1.1880	0.5000	16	952-001-265	\$99.50	952-001-268	\$113.82	952-001-267	\$119.39	952-001-266	\$119.39
2.7500	0.2500	1.0000	0.6248	1.4380	0.2500	16	952-001-269	\$105.46	952-001-272	\$120.68	952-001-271	\$126.42	952-001-270	\$126.42
2.7500	0.3125	1.0000	0.6248	1.4380	0.3125	16	952-001-273	\$118.36	952-001-276	\$135.51	952-001-275	\$141.97	952-001-274	\$141.97
2.7500	0.3750	1.0000	0.6248	1.4380	0.3750	16	952-001-277	\$118.36	952-001-280	\$135.51	952-001-279	\$141.97	952-001-278	\$141.97
2.7500	0.4375	1.0000	0.6248	1.4380	0.4375	16	952-001-281	\$121.73	952-001-284	\$139.40	952-001-283	\$146.05	952-001-282	\$146.05
2.7500	0.5000	1.0000	0.6248	1.4380	0.5000	16	952-001-285	\$129.07	952-001-288	\$147.72	952-001-287	\$154.74	952-001-286	\$154.74
3.0000	0.1875	1.0000	0.7188	1.5000	0.1875	16	952-001-289	\$80.99	952-001-292	\$92.75	952-001-291	\$97.16	952-001-290	\$97.16
3.0000	0.1875	1.2500	0.5938	1.7500	0.1875	18	952-001-293	\$97.16	952-001-296	\$111.24	952-001-295	\$116.45	952-001-294	\$116.45
3.0000	0.2188	1.0000	0.7188	1.5000	0.2188	16	952-001-577	\$139.40	952-001-580	\$139.40	952-001-579	\$129.39	952-001-578	\$129.39
3.0000	0.2188	1.2500	0.5938	1.7500	0.2188	18	952-001-581	\$107.83	952-001-584	\$123.46	952-001-583	\$129.39	952-001-582	\$129.39
3.0000	0.2500	1.0000	0.7188	1.5000	0.2500	16	952-001-297	\$86.94	952-001-300	\$99.61	952-001-299	\$104.21	952-001-298	\$104.21
3.0000	0.2500	1.2500	0.5938	1.7500	0.2500	18	952-001-301	\$100.38	952-001-304	\$114.94	952-001-303	\$120.31	952-001-302	\$120.31
3.0000	0.2813	1.0000	0.7188	1.5000	0.2813	16	952-001-585	\$109.69	952-001-588	\$139.40	952-001-587	\$131.62	952-001-586	\$131.62
3.0000	0.2813	1.2500	0.5938	1.7500	0.2813	18	952-001-589	\$109.69	952-001-592	\$125.53	952-001-591	\$131.62	952-001-590	\$131.62
3.0000	0.3125	1.0000	0.7188	1.5000	0.3125	16	952-001-305	\$97.14	952-001-308	\$111.24	952-001-307	\$116.45	952-001-298	\$116.45
3.0000	0.3125	1.2500	0.5938	1.7500	0.3125	18	952-001-309	\$108.85	952-001-312	\$124.58	952-001-311	\$130.50	952-001-302	\$130.50
3.0000	0.3438	1.0000	0.7188	1.5000	0.3438	16	952-001-593	\$110.22	952-001-596	\$126.05	952-001-595	\$132.16	952-001-594	\$132.16
3.0000	0.3438	1.2500	0.5938	1.7500	0.3438	18	952-001-597	\$110.22	952-001-600	\$126.05	952-001-599	\$132.16	952-001-598	\$132.16
3.0000	0.3750	1.0000	0.7188	1.5000	0.3750	16	952-001-313	\$98.83	952-001-316	\$113.09	952-001-315	\$118.46	952-001-314	\$118.46
3.0000	0.3750	1.2500	0.5938	1.7500	0.3750	18	952-001-317	\$112.75	952-001-320	\$129.01	952-001-319	\$135.14	952-001-318	\$135.14
3.0000	0.4063	1.0000	0.7188	1.5000	0.4063	16	952-001-601	\$118.87	952-001-604	\$136.04	952-001-603	\$142.53	952-001-602	\$142.53
3.0000	0.4063	1.2500	0.5938	1.7500	0.4063	18	952-001-605	\$118.87	952-001-608	\$136.04	952-001-607	\$183.82	952-001-606	\$183.82
3.0000	0.4375	1.0000	0.7188	1.5000	0.4375	16	952-001-321	\$118.70	952-001-324	\$135.87	952-001-323	\$142.36	952-001-322	\$142.36
3.0000	0.4375	1.2500	0.5938	1.7500	0.4375	18	952-001-325	\$118.70	952-001-328	\$135.87	952-001-327	\$142.36	952-001-326	\$142.36
3.0000	0.5000	1.0000	0.7188	1.5000	0.5000	16	952-001-329	\$119.55	952-001-332	\$136.79	952-001-331	\$143.26	952-001-330	\$143.26
3.0000	0.5000	1.2500	0.5938	1.7500	0.5000	18	952-001-333	\$105.62	952-001-336	\$120.89	952-001-335	\$126.60	952-001-334	\$126.60
3.0000	0.5625	1.0000	0.7188	1.5000	0.5625	16	952-001-337	\$127.55	952-001-340	\$146.05	952-001-339	\$152.89	952-001-338	\$152.89
3.0000	0.5625	1.2500	0.5938	1.7500	0.5625	18	952-001-341	\$127.55	952-001-344	\$146.05	952-001-343	\$152.89	952-001-342	\$152.89
3.0000	0.6250	1.0000	0.7188	1.5000	0.6250	16	952-001-345	\$138.92	952-001-348	\$159.01	952-001-347	\$166.58	952-001-346	\$166.58
3.0000	0.6250	1.2500	0.5938	1.7500	0.6250	18	952-001-349	\$122.28	952-001-352	\$139.92	952-001-351	\$146.60	952-001-350	\$146.60
3.0000	0.6875	1.0000	0.7188	1.5000	0.6875	16	952-001-353	\$143.31	952-001-356	\$164.00	952-001-355	\$171.80	952-001-354	\$171.80
3.0000	0.6875	1.2500	0.5938	1.7500	0.6875	18	952-001-357	\$143.31	952-001-360	\$164.00	952-001-359	\$171.80	952-001-358	\$171.80
3.0000	0.7500	1.0000	0.7188	1.5000	0.7500	16	952-001-361	\$148.09	952-001-364	\$169.56	952-001-363	\$177.52	952-001-362	\$177.52
3.0000	0.7500	1.2500	0.5938	1.7500	0.7500	18	952-001-365	\$132.46	952-001-368	\$151.62	952-001-367	\$158.84	952-001-366	\$158.84
3.0000	0.8125	1.0000	0.7188	1.5000	0.8125	16	952-001-369	\$152.33	952-001-372	\$174.37	952-001-371	\$182.69	952-001-370	\$182.69
3.0000	0.8125	1.2500	0.5938	1.7500	0.8125	18	952-001-373	\$152.33	952-001-376	\$174.37	952-001-375	\$182.69	952-001-374	\$182.69
3.0000	0.8750	1.0000	0.7188	1.5000	0.8750	16	952-001-377	\$157.76	952-001-380	\$180.48	952-001-379	\$189.16	952-001-378	\$189.16
3.0000	0.8750	1.2500	0.5938	1.7500	0.8750	18	952-001-381	\$157.76	952-001-384	\$180.48	952-001-383	\$189.16	952-001-382	\$189.16
3.0000	0.9375	1.0000	0.7188	1.5000	0.9375	16	952-001-385	\$169.31	952-001-388	\$193.80	952-001-387	\$203.05	952-001-386	\$203.05
3.0000	0.9375	1.2500	0.5938	1.7500	0.9375	18	952-001-389	\$169.31	952-001-392	\$193.80	952-001-391	\$203.05	952-001-390	\$203.05

*Make To Order

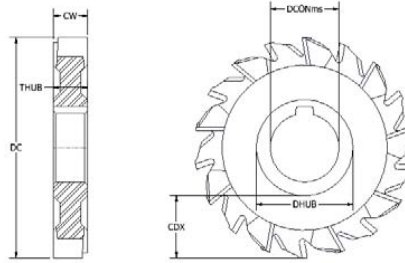

SSH

DC	CW	DCONms	CDX	DHUB	THUB	Zc	Uncoated	Price	TiN Coated*	Price	TiCN Coated*	Price	TiAlN Coated	Price
3.0000	1.0000	1.0000	0.7188	1.5000	1.0000	16	952-001-393	\$165.74	952-001-396	\$189.73	952-001-395	\$198.80	952-001-394	\$198.80
3.0000	1.0000	1.2500	0.5938	1.7500	1.0000	18	952-001-397	\$165.74	952-001-400	\$189.73	952-001-399	\$198.80	952-001-398	\$198.80
3.0000	1.2500	1.0000	0.7188	1.5000	1.2500	16	952-001-401	\$228.75	952-001-404	\$261.74	952-001-403	\$274.31	952-001-402	\$274.31
3.0000	1.2500	1.2500	0.5938	1.7500	1.2500	18	952-001-405	\$228.75	952-001-408	\$261.74	952-001-407	\$274.31	952-001-406	\$274.31
3.2500	0.2500	1.2500	0.7188	1.7500	0.2500	18	952-001-409	\$144.19	952-001-412	\$164.93	952-001-411	\$172.90	952-001-410	\$172.90
3.2500	0.3750	1.2500	0.7188	1.7500	0.3750	18	952-001-413	\$157.25	952-001-416	\$179.92	952-001-415	\$188.62	952-001-414	\$188.62
3.2500	0.5000	1.2500	0.7188	1.7500	0.5000	18	952-001-417	\$173.91	952-001-420	\$198.99	952-001-419	\$208.43	952-001-418	\$208.43
3.2500	0.7500	1.2500	0.7188	1.7500	0.7500	18	952-001-421	\$184.93	952-001-424	\$211.57	952-001-423	\$221.75	952-001-422	\$221.75
3.5000	0.2188	1.0000	0.9688	1.5000	0.2188	18	952-001-529	\$144.51	952-001-532	\$165.47	952-001-531	\$173.26	952-001-530	\$173.26
3.5000	0.2188	1.2500	0.8438	1.7500	0.2188	18	952-001-533	\$144.51	952-001-536	\$165.47	952-001-535	\$173.26	952-001-534	\$173.26
3.5000	0.2500	1.0000	0.9688	1.5000	0.2500	18	952-001-425	\$148.92	952-001-428	\$170.48	952-001-427	\$178.62	952-001-426	\$178.62
3.5000	0.2500	1.2500	0.8438	1.7500	0.2500	18	952-001-429	\$148.92	952-001-432	\$170.48	952-001-431	\$178.62	952-001-430	\$178.62
3.5000	0.2813	1.0000	0.9688	1.5000	0.2813	18	952-001-537	\$154.86	952-001-540	\$177.33	952-001-539	\$185.64	952-001-538	\$185.64
3.5000	0.2813	1.2500	0.8438	1.7500	0.2813	18	952-001-541	\$154.86	952-001-544	\$177.33	952-001-543	\$185.64	952-001-542	\$185.64
3.5000	0.3125	1.0000	0.9688	1.5000	0.3125	18	952-001-433	\$157.61	952-001-436	\$180.30	952-001-435	\$188.99	952-001-434	\$188.99
3.5000	0.3125	1.2500	0.8438	1.7500	0.3125	18	952-001-437	\$157.61	952-001-440	\$180.30	952-001-439	\$188.99	952-001-438	\$188.99
3.5000	0.3438	1.0000	0.9688	1.5000	0.3438	18	952-001-545	\$160.32	952-001-548	\$183.44	952-001-547	\$192.14	952-001-546	\$192.14
3.5000	1.2500	1.2500	3.5000	1.7500	0.3438	18	952-001-549	\$160.32	952-001-552	\$183.44	952-001-551	\$192.14	952-001-550	\$192.14
3.5000	0.3750	1.0000	0.9688	1.5000	0.3750	18	952-001-441	\$150.10	952-001-444	\$171.80	952-001-443	\$179.92	952-001-442	\$179.92
3.5000	0.3750	1.2500	0.8438	1.7500	0.3750	18	952-001-445	\$150.10	952-001-448	\$171.80	952-001-447	\$179.92	952-001-446	\$179.92
3.5000	0.4063	1.0000	0.9688	1.5000	0.4063	18	952-001-553	\$163.88	952-001-556	\$187.53	952-001-555	\$196.60	952-001-554	\$196.60
3.5000	0.4063	1.2500	0.8438	1.7500	0.4063	18	952-001-557	\$163.88	952-001-560	\$187.53	952-001-559	\$196.60	952-001-558	\$196.60
3.5000	0.4375	1.0000	0.9688	1.5000	0.4375	18	952-001-449	\$157.25	952-001-452	\$179.92	952-001-451	\$188.62	952-001-450	\$188.62
3.5000	0.4375	1.2500	0.8438	1.7500	0.4375	18	952-001-453	\$158.61	952-001-456	\$181.59	952-001-455	\$190.10	952-001-454	\$190.10
3.5000	0.5000	1.0000	0.9688	1.5000	0.5000	18	952-001-457	\$160.66	952-001-460	\$183.82	952-001-459	\$192.69	952-001-458	\$192.69
3.5000	0.5000	1.2500	0.8438	1.7500	0.5000	18	952-001-461	\$177.81	952-001-464	\$203.44	952-001-463	\$213.23	952-001-462	\$213.23
3.5000	0.5625	1.0000	0.9688	1.5000	0.5625	18	952-001-465	\$176.61	952-001-468	\$202.10	952-001-467	\$211.76	952-001-466	\$211.76
3.5000	0.5625	1.2500	0.8438	1.7500	0.5625	18	952-001-469	\$181.19	952-001-472	\$202.10	952-001-471	\$217.32	952-001-470	\$217.32
3.5000	0.6250	1.0000	0.9688	1.5000	0.6250	18	952-001-473	\$176.61	952-001-476	\$202.10	952-001-475	\$211.76	952-001-474	\$211.76
3.5000	0.6250	1.2500	0.8438	1.7500	0.6250	18	952-001-477	\$181.55	952-001-480	\$207.67	952-001-479	\$217.69	952-001-478	\$217.69
3.5000	0.6875	1.0000	0.9688	1.5000	0.6875	18	952-001-481	\$188.81	952-001-484	\$216.21	952-001-483	\$226.39	952-001-482	\$226.39
3.5000	0.6875	1.2500	0.8438	1.7500	0.6875	18	952-001-485	\$192.74	952-001-488	\$220.64	952-001-487	\$231.19	952-001-486	\$231.19
3.5000	0.7500	1.0000	0.9688	1.5000	0.6875	18	952-001-489	\$188.81	952-001-492	\$216.21	952-001-491	\$226.39	952-001-490	\$226.39
3.5000	0.7500	1.2500	0.8438	1.7500	0.7500	18	952-001-493	\$196.82	952-001-496	\$225.26	952-001-495	\$236.00	952-001-494	\$236.00
3.5000	0.8125	1.0000	0.9688	1.5000	0.8125	18	952-001-497	\$202.94	952-001-500	\$232.29	952-001-499	\$243.40	952-001-498	\$243.40
3.5000	0.8125	1.2500	0.8438	1.7500	0.8125	18	952-001-501	\$202.94	952-001-504	\$232.29	952-001-503	\$243.40	952-001-502	\$243.40
3.5000	0.8750	1.0000	0.9688	1.5000	0.8750	18	952-001-505	\$210.06	952-001-508	\$240.46	952-001-507	\$251.91	952-001-506	\$251.91
3.5000	0.8750	1.2500	0.8438	1.7500	0.8750	18	952-001-509	\$210.06	952-001-512	\$240.46	952-001-511	\$251.91	952-001-510	\$251.91
3.5000	0.9375	1.0000	0.9688	1.5000	0.9375	18	952-001-513	\$232.97	952-001-516	\$266.74	952-001-515	\$279.34	952-001-514	\$279.34
3.5000	0.9375	1.2500	0.8438	1.7500	0.9375	18	952-001-517	\$232.97	952-001-520	\$266.74	952-001-519	\$279.34	952-001-518	\$279.34
3.5000	1.0000	1.0000	0.9688	1.5000	1.0000	18	952-001-521	\$244.38	952-001-524	\$279.70	952-001-523	\$293.02	952-001-522	\$293.02
3.5000	1.0000	1.2500	0.8438	1.7500	1.0000	18	952-001-525	\$244.38	952-001-528	\$279.70	952-001-527	\$293.02	952-001-526	\$293.02
3.7500	0.2500	1.2500	0.9688	1.7500	0.2500	18	952-001-561	\$153.33	952-001-564	\$175.48	952-001-563	\$183.82	952-001-562	\$183.82
3.7500	0.3750	1.2500	0.9688	1.7500	0.3750	18	952-001-565	\$166.26	952-001-568	\$190.28	952-001-567	\$199.35	952-001-566	\$199.35
3.7500	0.5000	1.2500	0.9688	1.7500	0.5000	18	952-001-569	\$191.56	952-001-572	\$219.17	952-001-571	\$229.72	952-001-570	\$229.72
3.7500	0.7500	1.2500	0.9688	1.7500	0.7500	18	952-001-573	\$214.50	952-001-576	\$245.44	952-001-575	\$257.13	952-001-574	\$257.13
4.0000	0.1875	1.0000	1.1563	1.6250	0.1875	18	952-001-609	\$132.99	952-001-612	\$152.13	952-001-611	\$159.36	952-001-610	\$159.36

*Make To Order

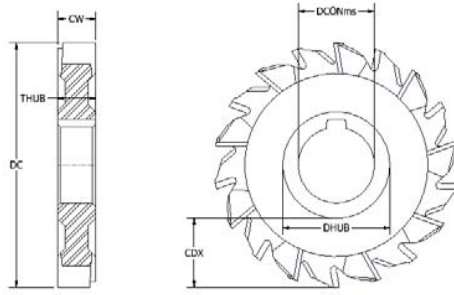

SSH

DC	CW	DCONms	CDX	DHUB	THUB	Zc	Uncoated	Price	TiN Coated*	Price	TiCN Coated*	Price	TiAlN Coated	Price
4.0000	0.1875	1.2500	1.0938	1.7500	0.1875	18	952-001-613	\$132.99	952-001-616	\$152.13	952-001-615	\$159.36	952-001-614	\$159.36
4.0000	0.2188	1.0000	1.1563	1.6250	0.2188	18	952-001-817	\$146.05	952-001-820	\$167.15	952-001-819	\$175.12	952-001-818	\$175.12
4.0000	0.2188	1.2500	1.0938	1.7500	0.2188	18	952-001-821	\$146.05	952-001-824	\$167.15	952-001-823	\$175.12	952-001-822	\$175.12
4.0000	0.2500	1.0000	1.1563	1.6250	0.2500	18	952-001-617	\$143.49	952-001-620	\$164.19	952-001-619	\$172.14	952-001-618	\$172.14
4.0000	0.2500	1.2500	1.0938	1.7500	0.2500	18	952-001-621	\$126.52	952-001-624	\$144.75	952-001-623	\$151.80	952-001-622	\$151.80
4.0000	0.2813	1.0000	1.1563	1.6250	0.2813	18	952-001-825	\$148.77	952-001-828	\$170.29	952-001-827	\$178.44	952-001-826	\$178.44
4.0000	0.2813	1.2500	1.0938	1.7500	0.2813	18	952-001-829	\$148.77	952-001-832	\$170.29	952-001-831	\$178.44	952-001-830	\$178.44
4.0000	0.3125	1.0000	1.1563	1.6250	0.3125	18	952-001-625	\$149.28	952-001-628	\$170.85	952-001-627	\$178.99	952-001-626	\$178.99
4.0000	0.3125	1.2500	1.0938	1.7500	0.3125	18	952-001-629	\$128.55	952-001-632	\$147.15	952-001-631	\$154.19	952-001-630	\$154.19
4.0000	0.3438	1.0000	1.1563	1.6250	0.3438	18	952-001-833	\$161.66	952-001-836	\$185.10	952-001-835	\$193.80	952-001-834	\$193.80
4.0000	0.3438	1.2500	1.0938	1.7500	0.3438	18	952-001-837	\$161.66	952-001-840	\$185.10	952-001-839	\$193.80	952-001-838	\$193.80
4.0000	0.3750	1.0000	1.1563	1.6250	0.3750	18	952-001-633	\$156.41	952-001-636	\$178.99	952-001-635	\$187.53	952-001-634	\$187.53
4.0000	0.3750	1.2500	1.0938	1.7500	0.3750	18	952-001-637	\$131.10	952-001-640	\$150.11	952-001-639	\$157.16	952-001-638	\$157.16
4.0000	0.4063	1.0000	1.1563	1.6250	0.4063	18	952-001-841	\$166.09	952-001-844	\$190.10	952-001-843	\$199.17	952-001-842	\$199.17
4.0000	0.4063	1.2500	1.0938	1.7500	0.4063	18	952-001-845	\$166.09	952-001-848	\$190.10	952-001-847	\$199.17	952-001-846	\$199.17
4.0000	0.4375	1.0000	1.1563	1.6250	0.4375	18	952-001-641	\$167.95	952-001-644	\$192.14	952-001-643	\$201.40	952-001-642	\$201.40
4.0000	0.4375	1.2500	1.0938	1.7500	0.4375	18	952-001-645	\$142.49	952-001-648	\$163.07	952-001-647	\$170.85	952-001-646	\$170.85
4.0000	0.5000	1.0000	1.1563	1.6250	0.5000	18	952-001-649	\$172.21	952-001-652	\$197.13	952-001-651	\$206.39	952-001-650	\$206.39
4.0000	0.5000	1.2500	1.0938	1.7500	0.5000	18	952-001-653	\$148.60	952-001-656	\$170.11	952-001-655	\$178.28	952-001-654	\$178.28
4.0000	0.5625	1.0000	1.1563	1.6250	0.5625	18	952-001-657	\$185.27	952-001-660	\$212.12	952-001-659	\$222.11	952-001-658	\$222.11
4.0000	0.5625	1.2500	1.0938	1.7500	0.5625	18	952-001-661	\$185.27	952-001-664	\$212.12	952-001-663	\$222.11	952-001-662	\$222.11
4.0000	0.6250	1.0000	1.1563	1.6250	0.6250	18	952-001-665	\$191.73	952-001-668	\$219.35	952-001-667	\$229.90	952-001-666	\$229.90
4.0000	0.6250	1.2500	1.0938	1.7500	0.6250	18	952-001-669	\$171.18	952-001-672	\$171.18	952-001-671	\$205.28	952-001-670	\$205.28
4.0000	0.6875	1.0000	1.1563	1.6250	0.6875	18	952-001-673	\$206.32	952-001-676	\$236.18	952-001-675	\$247.48	952-001-674	\$247.48
4.0000	0.6875	1.2500	1.0938	1.7500	0.6875	18	952-001-677	\$206.32	952-001-680	\$236.18	952-001-679	\$247.48	952-001-678	\$247.48
4.0000	0.7500	1.0000	1.1563	1.6250	0.7500	18	952-001-681	\$211.43	952-001-684	\$241.92	952-001-683	\$253.61	952-001-682	\$253.61
4.0000	0.7500	1.2500	1.0938	1.7500	0.7500	18	952-001-685	\$182.55	952-001-688	\$208.98	952-001-687	\$218.98	952-001-686	\$218.98
4.0000	0.8125	1.0000	1.1563	1.6250	0.8125	18	952-001-689	\$219.91	952-001-692	\$251.76	952-001-691	\$263.77	952-001-690	\$263.77
4.0000	0.8125	1.2500	1.0938	1.7500	0.8125	18	952-001-693	\$219.91	952-001-696	\$251.76	952-001-695	\$263.77	952-001-694	\$263.77
4.0000	0.8750	1.0000	1.1563	1.6250	0.8750	18	952-001-697	\$220.08	952-001-700	\$251.91	952-001-699	\$263.96	952-001-698	\$263.96
4.0000	0.8750	1.2500	1.0938	1.7500	0.8750	18	952-001-701	\$192.74	952-001-704	\$220.64	952-001-703	\$231.19	952-001-702	\$231.19
4.0000	0.9375	1.0000	1.1563	1.6250	0.9375	18	952-001-705	\$247.61	952-001-708	\$283.38	952-001-707	\$296.91	952-001-706	\$296.91
4.0000	0.9375	1.2500	1.0938	1.7500	0.9375	18	952-001-709	\$247.61	952-001-712	\$283.38	952-001-711	\$296.91	952-001-710	\$296.91
4.0000	1.0000	1.0000	1.1563	1.6250	1.0000	18	952-001-713	\$259.32	952-001-716	\$296.71	952-001-715	\$310.98	952-001-714	\$310.98
4.0000	1.0000	1.2500	1.0938	1.7500	1.0000	18	952-001-717	\$259.32	952-001-720	\$296.71	952-001-719	\$310.98	952-001-718	\$310.98
4.0000	1.1250	1.2500	1.0938	1.7500	1.1250	18	952-001-721	\$280.05	952-001-724	\$320.41	952-001-723	\$335.78	952-001-722	\$335.78
4.0000	1.2500	1.2500	1.0938	1.7500	1.1250	18	952-001-725	\$289.03	952-001-728	\$330.77	952-001-727	\$346.50	952-001-726	\$346.50
4.0000	1.3750	1.2500	1.0938	1.7500	1.3750	18	952-001-745	\$329.60	952-001-748	\$377.25	952-001-747	\$395.19	952-001-746	\$395.19
4.0000	1.5000	1.2500	1.0938	1.7500	1.5000	18	952-001-749	\$335.55	952-001-752	\$384.10	952-001-751	\$402.42	952-001-750	\$402.42
4.2500	0.2500	1.2500	1.2188	1.7500	0.2500	18	952-001-729	\$169.81	952-001-732	\$194.37	952-001-731	\$203.63	952-001-730	\$203.63
4.2500	0.3750	1.2500	1.2188	1.7500	0.3750	18	952-001-733	\$191.56	952-001-736	\$219.17	952-001-735	\$229.72	952-001-734	\$229.72
4.2500	0.5000	1.2500	1.2188	1.7500	0.5000	18	952-001-737	\$212.78	952-001-740	\$243.60	952-001-739	\$255.08	952-001-738	\$255.08
4.2500	0.7500	1.2500	1.2188	1.7500	0.7500	18	952-001-741	\$258.80	952-001-744	\$296.18	952-001-743	\$310.24	952-001-742	\$310.24
4.5000	0.2188	1.0000	1.4063	1.6250	0.2188	18	952-001-809	\$170.83	952-001-812	\$195.47	952-001-811	\$204.90	952-001-810	\$204.90
4.5000	0.2188	1.2500	1.2813	1.8750	0.2188	18	952-001-813	\$170.83	952-001-816	\$195.47	952-001-815	\$204.90	952-001-814	\$204.90
4.5000	0.2500	1.0000	1.4063	1.6250	0.2500	18	952-001-753	\$171.69	952-001-756	\$196.60	952-001-755	\$205.81	952-001-754	\$205.81
4.5000	0.2500	1.2500	1.2813	1.8750	0.2500	18	952-001-757	\$171.69	952-001-760	\$196.60	952-001-759	\$205.81	952-001-758	\$205.81

*Make To Order

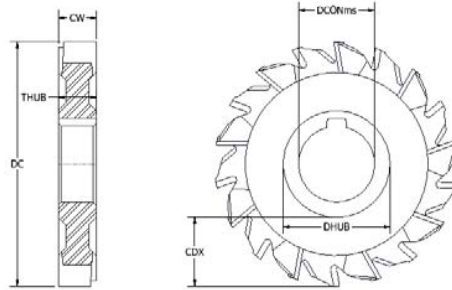

SSH

DC	CW	DCONms	CDX	DHUB	THUB	Zc	Uncoated	Price	TiN Coated*	Price	TiCN Coated*	Price	TiAlN Coated	Price
4.5000	0.3125	1.0000	1.4063	1.6250	0.3125	18	952-001-761	\$179.32	952-001-764	\$205.28	952-001-763	\$215.06	952-001-762	\$215.06
4.5000	1.2500	1.2500	4.5000	1.8750	0.3125	18	952-001-765	\$179.32	952-001-768	\$205.28	952-001-767	\$215.06	952-001-766	\$215.06
4.5000	0.3750	1.0000	1.4063	1.6250	0.3750	18	952-001-769	\$193.08	952-001-772	\$221.03	952-001-771	\$231.56	952-001-770	\$231.56
4.5000	0.3750	1.2500	1.2813	1.8750	0.3750	18	952-001-773	\$193.08	952-001-776	\$221.03	952-001-775	\$231.56	952-001-774	\$231.56
4.5000	0.5000	1.0000	1.4063	1.6250	0.5000	18	952-001-777	\$215.16	952-001-780	\$246.20	952-001-779	\$258.03	952-001-778	\$258.03
4.5000	0.5000	1.2500	1.2813	1.8750	0.5000	18	952-001-781	\$243.86	952-001-784	\$279.15	952-001-783	\$258.03	952-001-782	\$258.03
4.5000	0.6250	1.0000	1.4063	1.6250	0.6250	18	952-001-785	\$243.86	952-001-788	\$279.15	952-001-787	\$292.47	952-001-786	\$292.47
4.5000	0.6250	1.2500	1.2813	1.8750	0.6250	18	952-001-789	\$243.86	952-001-792	\$279.15	952-001-791	\$292.47	952-001-790	\$292.47
4.5000	0.7500	1.0000	1.4063	1.6250	0.7500	18	952-001-793	\$259.32	952-001-796	\$296.71	952-001-795	\$310.98	952-001-794	\$310.98
4.5000	0.7500	1.2500	1.2813	1.8750	0.7500	18	952-001-797	\$259.32	952-001-800	\$296.71	952-001-799	\$310.98	952-001-798	\$310.98
4.5000	1.0000	1.0000	1.4063	1.6250	1.0000	18	952-001-801	\$355.45	952-001-804	\$406.86	952-001-803	\$426.11	952-001-802	\$426.11
4.5000	1.0000	1.2500	1.2813	1.8750	1.0000	18	952-001-805	\$355.45	952-001-808	\$406.86	952-001-807	\$426.11	952-001-806	\$426.11
5.0000	0.1875	1.0000	1.6563	1.6250	0.1875	24	952-001-849	\$215.68	952-001-852	\$246.92	952-001-851	\$258.59	952-001-850	\$258.59
5.0000	0.1875	1.2500	1.5313	1.8750	0.1875	24	952-001-853	\$215.68	952-001-856	\$246.92	952-001-855	\$258.59	952-001-854	\$258.59
5.0000	0.2188	1.0000	1.6563	1.6250	0.2188	24	952-001-945	\$209.05	952-001-948	\$239.35	952-001-947	\$250.62	952-001-946	\$250.62
5.0000	0.2188	1.2500	1.5313	1.8750	0.2188	24	952-001-949	\$209.05	952-001-952	\$239.35	952-001-951	\$250.62	952-001-950	\$250.62
5.0000	0.2500	1.0000	1.6563	1.6250	0.2500	24	952-001-857	\$199.21	952-001-860	\$228.04	952-001-859	\$238.80	952-001-858	\$238.80
5.0000	0.2500	1.2500	1.5313	1.8750	0.2500	24	952-001-861	\$199.21	952-001-864	\$228.04	952-001-863	\$238.80	952-001-862	\$238.80
5.0000	0.2813	1.0000	1.6563	1.6250	0.2813	24	952-001-953	\$223.83	952-001-956	\$256.18	952-001-955	\$268.41	952-001-954	\$268.41
5.0000	0.2813	1.2500	1.5313	1.8750	0.2813	24	952-001-957	\$223.83	952-001-960	\$256.18	952-001-959	\$268.41	952-001-958	\$268.41
5.0000	0.3125	1.0000	1.6563	1.6250	0.3125	24	952-001-865	\$218.54	952-001-868	\$250.08	952-001-867	\$262.11	952-001-866	\$262.11
5.0000	0.3125	1.2500	1.5313	1.8750	0.3125	24	952-001-869	\$218.54	952-001-872	\$250.08	952-001-871	\$262.11	952-001-870	\$262.11
5.0000	0.3438	1.0000	1.6563	1.6250	0.3438	24	952-001-961	\$236.38	952-001-964	\$270.60	952-001-963	\$283.38	952-001-962	\$283.38
5.0000	0.3438	1.2500	1.5313	1.8750	0.3438	24	952-001-965	\$270.60	952-001-968	\$270.60	952-001-967	\$283.38	952-001-966	\$283.38
5.0000	0.3750	1.0000	1.6563	1.6250	0.3750	24	952-001-873	\$232.97	952-001-876	\$266.74	952-001-875	\$279.34	952-001-874	\$279.34
5.0000	0.3750	1.2500	1.5313	1.8750	0.3750	24	952-001-877	\$232.97	952-001-880	\$266.74	952-001-879	\$279.34	952-001-878	\$279.34
5.0000	0.4063	1.0000	1.6563	1.6250	0.4063	24	952-001-969	\$252.18	952-001-972	\$288.59	952-001-971	\$302.45	952-001-970	\$302.45
5.0000	0.4063	1.2500	1.5313	1.8750	0.4063	24	952-001-973	\$252.18	952-001-976	\$288.59	952-001-975	\$302.45	952-001-974	\$302.45
5.0000	0.4375	1.0000	1.6563	1.6250	0.4375	24	952-001-881	\$255.57	952-001-884	\$292.47	952-001-883	\$306.53	952-001-882	\$306.53
5.0000	0.4375	1.2500	1.5313	1.8750	0.4375	24	952-001-885	\$255.57	952-001-888	\$292.47	952-001-887	\$306.53	952-001-886	\$306.53
5.0000	0.4688	1.0000	1.6563	1.6250	0.4688	24	952-001-977	\$260.15	952-001-980	\$297.85	952-001-979	\$311.91	952-001-978	\$311.91
5.0000	0.4688	1.2500	1.5313	1.8750	0.4688	24	952-001-981	\$260.15	952-001-984	\$297.85	952-001-983	\$311.91	952-001-982	\$311.91
5.0000	0.5000	1.0000	1.6563	1.6250	0.5000	24	952-001-889	\$257.26	952-001-892	\$294.50	952-001-891	\$308.58	952-001-890	\$308.58
5.0000	0.5000	1.2500	1.5313	1.8750	0.5000	24	952-001-893	\$257.26	952-001-896	\$294.50	952-001-895	\$308.58	952-001-894	\$308.58
5.0000	0.5313	1.2500	1.5313	1.8750	0.5313	24	952-001-985	\$267.29	952-001-988	\$305.98	952-001-987	\$320.41	952-001-986	\$320.41
5.0000	0.5625	1.2500	1.5313	1.8750	0.5625	24	952-001-897	\$262.20	952-001-900	\$300.03	952-001-899	\$314.32	952-001-898	\$314.32
5.0000	0.5938	1.2500	1.5313	1.8750	0.5938	24	952-001-989	\$279.88	952-001-992	\$320.24	952-001-991	\$314.32	952-001-990	\$314.32
5.0000	0.6250	1.2500	1.5313	1.8750	0.6250	24	952-001-901	\$226.71	952-001-904	\$259.50	952-001-903	\$271.93	952-001-902	\$271.93
5.0000	0.6875	1.2500	1.5313	1.8750	0.6875	24	952-001-905	\$281.39	952-001-908	\$322.09	952-001-907	\$337.44	952-001-906	\$337.44
5.0000	0.7500	1.2500	1.5313	1.8750	0.7500	24	952-001-909	\$249.11	952-001-912	\$285.08	952-001-911	\$298.76	952-001-910	\$298.76
5.0000	0.8125	1.2500	1.5313	1.8750	0.8125	24	952-001-913	\$308.39	952-001-916	\$352.99	952-001-915	\$369.85	952-001-914	\$369.85
5.0000	0.8750	1.2500	1.5313	1.8750	0.8750	24	952-001-917	\$318.93	952-001-920	\$365.03	952-001-919	\$382.42	952-001-918	\$382.42
5.0000	0.9375	1.2500	1.5313	1.8750	0.9375	24	952-001-921	\$342.35	952-001-924	\$391.85	952-001-923	\$410.57	952-001-922	\$410.57
5.0000	1.0000	1.2500	1.5313	1.8750	1.0000	24	952-001-925	\$341.86	952-001-928	\$391.32	952-001-927	\$409.83	952-001-926	\$409.83
5.5000	0.2500	1.2500	1.7813	1.8750	0.2500	24	952-001-929	\$222.13	952-001-932	\$254.13	952-001-931	\$266.37	952-001-930	\$266.37
5.5000	0.3750	1.2500	1.7813	1.8750	0.3750	24	952-001-933	\$254.57	952-001-936	\$291.35	952-001-935	\$305.25	952-001-934	\$305.25
5.5000	0.5000	1.2500	1.7813	1.8750	0.5000	24	952-001-937	\$286.66	952-001-940	\$327.99	952-001-939	\$343.73	952-001-938	\$343.73

*Make To Order

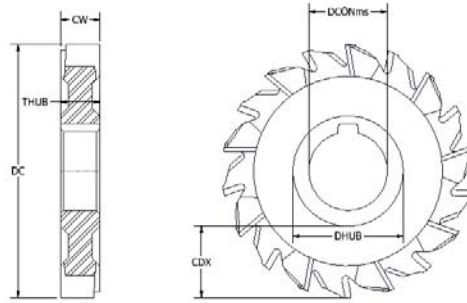

HSS

DC	CW	DCONms	CDX	DHUB	THUB	Zc	Uncoated	Price	TiN Coated*	Price	TiCN Coated*	Price	TiAlN Coated	Price
5.5000	0.7500	1.2500	1.7813	1.8750	0.7500	24	952-001-941	\$324.50	952-001-944	\$371.50	952-001-943	\$389.07	952-001-942	\$389.07
6.0000	0.1875	1.0000	2.1563	1.6250	0.1875	24	952-001-993	\$280.36	952-001-996	\$320.98	952-001-995	\$336.15	952-001-994	\$336.15
6.0000	0.1875	1.2500	2.0313	1.8750	0.1875	24	952-001-997	\$280.36	952-002-000	\$320.98	952-001-999	\$336.15	952-001-998	\$336.15
6.0000	0.1875	1.5000	1.8438	2.2500	0.1875	28	952-002-001	\$280.36	952-002-004	\$320.98	952-002-003	\$336.15	952-002-002	\$336.15
6.0000	0.2188	1.0000	2.1563	1.6250	0.2188	24	952-002-145	\$281.39	952-002-148	\$322.09	952-002-147	\$337.44	952-002-146	\$337.44
6.0000	0.2188	1.2500	2.0313	1.8750	0.2188	24	952-002-149	\$281.39	952-002-152	\$322.09	952-002-151	\$337.44	952-002-150	\$337.44
6.0000	0.2188	1.5000	1.8438	2.2500	0.2188	28	952-002-153	\$281.39	952-002-156	\$322.09	952-002-155	\$337.44	952-002-154	\$337.44
6.0000	0.2500	1.0000	2.1563	1.6250	0.2500	24	952-002-005	\$269.33	952-002-008	\$308.20	952-002-007	\$323.01	952-002-006	\$323.01
6.0000	0.2500	1.2500	2.0313	1.8750	0.2500	24	952-002-009	\$262.90	952-002-012	\$300.78	952-002-011	\$315.23	952-002-010	\$315.23
6.0000	0.2500	1.5000	1.8438	2.2500	0.2500	28	952-002-013	\$276.65	952-002-016	\$316.51	952-002-015	\$331.70	952-002-014	\$331.70
6.0000	0.2813	1.0000	2.1563	1.6250	0.2813	24	952-002-157	\$301.10	952-002-160	\$344.65	952-002-159	\$360.94	952-002-158	\$360.94
6.0000	0.2813	1.2500	2.0313	1.8750	0.2813	24	952-002-161	\$301.10	952-002-164	\$344.65	952-002-163	\$360.94	952-002-162	\$360.94
6.0000	0.2813	1.5000	1.8438	2.2500	0.2813	28	952-002-165	\$301.10	952-002-168	\$344.65	952-002-167	\$360.94	952-002-166	\$360.94
6.0000	0.3125	1.0000	2.1563	1.6250	0.3125	24	952-002-017	\$280.71	952-002-020	\$321.34	952-002-019	\$336.52	952-002-018	\$336.52
6.0000	0.3125	1.2500	2.0313	1.8750	0.3125	24	952-002-021	\$280.71	952-002-024	\$321.34	952-002-023	\$336.52	952-002-022	\$336.52
6.0000	0.3125	1.5000	1.8438	2.2500	0.3125	28	952-002-025	\$280.71	952-002-028	\$321.34	952-002-027	\$336.52	952-002-026	\$336.52
6.0000	0.3438	1.0000	2.1563	1.6250	0.3438	24	952-002-169	\$315.87	952-002-172	\$361.53	952-002-171	\$378.72	952-002-170	\$378.72
6.0000	0.3438	1.2500	2.0313	1.8750	0.3438	24	952-002-173	\$315.87	952-002-176	\$361.53	952-002-175	\$378.72	952-002-174	\$378.72
6.0000	0.3438	1.5000	1.8438	2.2500	0.3438	28	952-002-177	\$315.87	952-002-180	\$361.53	952-002-179	\$378.72	952-002-178	\$378.72
6.0000	0.3750	1.0000	2.1563	1.6250	0.3750	24	952-002-029	\$297.51	952-002-032	\$340.60	952-002-031	\$356.69	952-002-030	\$356.69
6.0000	0.3750	1.2500	2.0313	1.8750	0.3750	24	952-002-033	\$232.68	952-002-036	\$266.37	952-002-035	\$278.93	952-002-034	\$278.93
6.0000	0.3750	1.5000	1.8438	2.2500	0.3750	28	952-002-037	\$319.10	952-002-040	\$365.23	952-002-039	\$382.60	952-002-038	\$382.60
6.0000	0.4063	1.0000	2.1563	1.6250	0.4063	24	952-002-181	\$319.10	952-002-184	\$365.23	952-002-183	\$382.60	952-002-182	\$382.60
6.0000	0.4063	1.2500	2.0313	1.8750	0.4063	24	952-002-185	\$319.10	952-002-188	\$365.23	952-002-187	\$382.60	952-002-186	\$382.60
6.0000	0.4063	1.5000	1.8438	2.2500	0.4063	28	952-002-189	\$319.10	952-002-192	\$365.23	952-002-191	\$382.60	952-002-190	\$382.60
6.0000	0.4375	1.0000	2.1563	1.6250	0.4375	24	952-002-041	\$313.16	952-002-044	\$358.37	952-002-043	\$375.38	952-002-042	\$375.38
6.0000	0.4375	1.2500	2.0313	1.8750	0.4375	24	952-002-045	\$313.16	952-002-048	\$358.37	952-002-047	\$375.38	952-002-046	\$375.38
6.0000	0.4375	1.5000	1.8438	2.2500	0.4375	28	952-002-049	\$322.15	952-002-052	\$368.73	952-002-051	\$386.31	952-002-050	\$386.31
6.0000	0.4688	1.0000	2.1563	1.6250	0.4688	24	952-002-193	\$329.97	952-002-196	\$377.60	952-002-195	\$395.56	952-002-194	\$395.56
6.0000	0.4688	1.2500	2.0313	1.8750	0.4688	24	952-002-197	\$329.97	952-002-200	\$377.60	952-002-199	\$395.56	952-002-198	\$395.56
6.0000	0.4688	1.5000	1.8438	2.2500	0.4688	28	952-002-201	\$329.97	952-002-204	\$377.60	952-002-203	\$395.56	952-002-202	\$395.56
6.0000	0.5000	1.0000	2.1563	1.6250	0.5000	24	952-002-053	\$310.62	952-002-056	\$355.38	952-002-055	\$372.43	952-002-054	\$372.43
6.0000	0.5000	1.2500	2.0313	1.8750	0.5000	24	952-002-057	\$260.15	952-002-060	\$297.85	952-002-059	\$311.91	952-002-058	\$311.91
6.0000	0.5000	1.5000	1.8438	2.2500	0.5000	28	952-002-061	\$316.55	952-002-064	\$362.24	952-002-063	\$379.46	952-002-062	\$379.46
6.0000	0.5313	1.2500	2.0313	1.8750	0.5313	24	952-002-205	\$346.61	952-002-208	\$396.68	952-002-207	\$415.55	952-002-206	\$415.55
6.0000	0.5625	1.2500	2.0313	1.8750	0.5625	24	952-002-065	\$334.21	952-002-068	\$382.42	952-002-067	\$400.76	952-002-066	\$400.76
6.0000	0.5625	1.5000	1.8438	2.2500	0.5625	28	952-002-069	\$349.67	952-002-072	\$400.18	952-002-071	\$419.25	952-002-070	\$419.25
6.0000	0.6250	1.2500	2.0313	1.8750	0.6250	24	952-002-073	\$303.29	952-002-076	\$347.07	952-002-075	\$363.73	952-002-074	\$363.73
6.0000	0.6250	1.5000	1.8438	2.2500	0.6250	28	952-002-077	\$365.62	952-002-080	\$418.51	952-002-079	\$438.35	952-002-078	\$438.35
6.0000	0.6875	1.2500	2.0313	1.8750	0.6875	24	952-002-081	\$380.57	952-002-084	\$435.55	952-002-083	\$456.30	952-002-082	\$456.30
6.0000	0.6875	1.5000	1.8438	2.2500	0.6875	28	952-002-085	\$380.57	952-002-088	\$435.55	952-002-087	\$456.30	952-002-086	\$456.30
6.0000	0.7500	1.2500	2.0313	1.8750	0.7500	28	952-002-089	\$336.07	952-002-092	\$384.65	952-002-091	\$402.97	952-002-090	\$402.97
6.0000	0.7500	1.5000	1.8438	2.2500	0.7500	24	952-002-093	\$402.15	952-002-096	\$460.17	952-002-095	\$482.20	952-002-094	\$482.20
6.0000	0.8125	1.2500	2.0313	1.8750	0.8125	24	952-002-097	\$407.89	952-002-100	\$466.82	952-002-099	\$489.04	952-002-098	\$489.04
6.0000	0.8125	1.5000	1.8438	2.2500	0.8125	28	952-002-101	\$429.98	952-002-104	\$492.18	952-002-103	\$515.52	952-002-102	\$515.52
6.0000	0.8750	1.2500	2.0313	1.8750	0.8750	24	952-002-105	\$392.27	952-002-108	\$449.08	952-002-107	\$470.34	952-002-106	\$470.34
6.0000	0.8750	1.5000	1.8438	2.2500	0.8750	28	952-002-109	\$433.72	952-002-112	\$496.44	952-002-111	\$519.95	952-002-110	\$519.95

*Make To Order

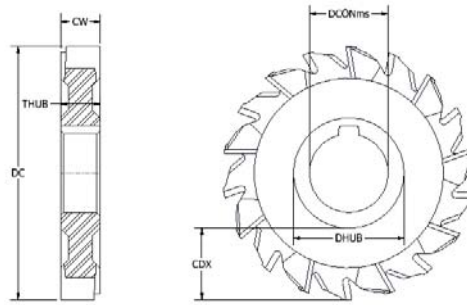

DC	CW	DCONms	CDX	DHUB	THUB	Zc	Uncoated	Price	TiN Coated*	Price	TiCN Coated*	Price	TiAlN Coated	Price
6.0000	0.9375	1.2500	2.0313	1.8750	0.9375	24	952-002-113	\$498.09	952-002-116	\$570.12	952-002-115	\$597.12	952-002-114	\$597.12
6.0000	0.9375	1.5000	1.8438	2.2500	0.9375	28	952-002-117	\$504.70	952-002-120	\$577.71	952-002-119	\$605.11	952-002-118	\$605.11
6.0000	1.0000	1.2500	2.0313	1.8750	1.0000	24	952-002-121	\$420.63	952-002-124	\$481.44	952-002-123	\$504.42	952-002-122	\$504.42
6.0000	1.0000	1.5000	1.8438	2.2500	1.0000	28	952-002-125	\$479.92	952-002-128	\$549.18	952-002-127	\$575.49	952-002-126	\$575.49
6.0000	1.2500	1.0625	2.0313	1.8750	1.0625	24	952-002-129	\$518.63	952-002-132	\$593.61	952-002-131	\$621.76	952-002-130	\$621.76
6.0000	1.1250	1.2500	2.0313	1.8750	1.1250	24	952-002-133	\$530.18	952-002-136	\$606.78	952-002-135	\$635.66	952-002-134	\$635.66
6.0000	1.1875	1.2500	2.0313	1.8750	1.1875	24	952-002-137	\$544.11	952-002-140	\$622.69	952-002-139	\$652.32	952-002-138	\$652.32
6.0000	1.2500	1.2500	2.0313	1.8750	1.2500	24	952-002-141	\$543.42	952-002-144	\$621.94	952-002-143	\$651.56	952-002-142	\$651.56
7.0000	0.2500	1.2500	2.5313	1.8750	0.2500	24	952-002-209	\$402.15	952-002-212	\$460.17	952-002-211	\$482.20	952-002-210	\$482.20
7.0000	0.2500	1.5000	2.3438	2.2500	0.2500	28	952-002-213	\$402.15	952-002-216	\$460.17	952-002-215	\$482.20	952-002-214	\$482.20
7.0000	0.3125	1.2500	2.5313	1.8750	0.3125	24	952-002-217	\$426.08	952-002-220	\$487.57	952-002-219	\$510.88	952-002-218	\$510.88
7.0000	0.3125	1.5000	2.3438	2.2500	0.3125	28	952-002-221	\$426.08	952-002-224	\$487.57	952-002-223	\$510.88	952-002-222	\$510.88
7.0000	0.3750	1.2500	2.5313	1.8750	0.3750	24	952-002-225	\$437.63	952-002-228	\$500.90	952-002-227	\$524.78	952-002-226	\$524.78
7.0000	0.3750	1.5000	2.3438	2.2500	0.3750	28	952-002-229	\$437.63	952-002-232	\$500.90	952-002-231	\$524.78	952-002-230	\$524.78
7.0000	0.4375	1.2500	2.5313	1.8750	0.4375	24	952-002-233	\$453.75	952-002-236	\$519.40	952-002-235	\$544.01	952-002-234	\$544.01
7.0000	0.4375	1.5000	2.3438	2.2500	0.4375	28	952-002-237	\$453.75	952-002-240	\$519.40	952-002-239	\$544.01	952-002-238	\$544.01
7.0000	0.5000	1.2500	2.5313	1.8750	0.5000	24	952-002-241	\$473.79	952-002-244	\$542.34	952-002-243	\$568.09	952-002-242	\$568.09
7.0000	0.5000	1.5000	2.3438	2.2500	0.5000	28	952-002-245	\$473.79	952-002-248	\$542.34	952-002-247	\$568.09	952-002-246	\$568.09
7.0000	0.5625	1.2500	2.5313	1.8750	0.5625	24	952-002-249	\$493.67	952-002-252	\$564.95	952-002-251	\$591.96	952-002-250	\$591.96
7.0000	0.5625	1.5000	2.3438	2.2500	0.5625	28	952-002-253	\$493.67	952-002-256	\$564.95	952-002-255	\$591.96	952-002-254	\$591.96
7.0000	0.6250	1.2500	2.5313	1.8750	0.6250	24	952-002-257	\$509.79	952-002-260	\$583.44	952-002-259	\$611.21	952-002-258	\$611.21
7.0000	0.6250	1.5000	2.3438	2.2500	0.6250	28	952-002-261	\$509.79	952-002-264	\$583.44	952-002-263	\$611.21	952-002-262	\$611.21
7.0000	0.6875	1.2500	2.5313	1.8750	0.6875	24	952-002-265	\$545.45	952-002-268	\$624.35	952-002-267	\$653.99	952-002-266	\$653.99
7.0000	0.6875	1.5000	2.3438	2.2500	0.6875	28	952-002-269	\$545.45	952-002-272	\$624.35	952-002-271	\$653.99	952-002-270	\$653.99
7.0000	0.7500	1.2500	2.5313	1.8750	0.7500	24	952-002-273	\$566.37	952-002-276	\$648.23	952-002-275	\$679.15	952-002-274	\$679.15
7.0000	0.7500	1.5000	2.3438	2.2500	0.7500	28	952-002-277	\$566.37	952-002-280	\$648.23	952-002-279	\$679.15	952-002-278	\$679.15
7.0000	0.8125	1.2500	2.5313	1.8750	0.8125	24	952-002-281	\$593.54	952-002-284	\$679.32	952-002-283	\$711.72	952-002-282	\$711.72
7.0000	0.8125	1.5000	2.3438	2.2500	0.8125	28	952-002-285	\$593.54	952-002-288	\$679.32	952-002-287	\$711.72	952-002-286	\$711.72
7.0000	0.8750	1.2500	2.5313	1.8750	0.8750	24	952-002-289	\$616.44	952-002-292	\$705.63	952-002-291	\$739.13	952-002-290	\$739.13
7.0000	0.8750	1.5000	2.3438	2.2500	0.8750	28	952-002-293	\$616.44	952-002-296	\$705.63	952-002-295	\$739.13	952-002-294	\$739.13
7.0000	0.9375	1.2500	2.5313	1.8750	0.9375	24	952-002-297	\$633.25	952-002-300	\$724.68	952-002-299	\$759.29	952-002-298	\$759.29
7.0000	0.9375	1.5000	2.3438	2.2500	0.9375	28	952-002-301	\$633.25	952-002-304	\$724.68	952-002-303	\$759.29	952-002-302	\$759.29
7.0000	1.0000	1.2500	2.5313	1.8750	1.0000	24	952-002-305	\$650.25	952-002-308	\$744.12	952-002-307	\$779.65	952-002-306	\$779.65
7.0000	1.0000	1.5000	2.3438	2.2500	1.0000	28	952-002-309	\$650.25	952-002-312	\$744.12	952-002-311	\$779.65	952-002-310	\$779.65
8.0000	0.1875	1.2500	3.0313	1.8750	0.1875	28	952-002-313	\$512.19	952-002-316	\$586.21	952-002-315	\$614.19	952-002-314	\$614.19
8.0000	0.1875	1.5000	2.7188	2.5000	0.1875	28	952-002-317	\$512.19	952-002-320	\$586.21	952-002-319	\$614.19	952-002-318	\$614.19
8.0000	0.2188	1.2500	3.0313	1.8750	0.2188	28	952-002-425	\$529.16	952-002-428	\$605.65	952-002-427	\$634.54	952-002-426	\$634.54
8.0000	0.2188	1.5000	2.7188	2.5000	0.2188	28	952-002-429	\$529.16	952-002-432	\$605.65	952-002-431	\$634.54	952-002-430	\$634.54
8.0000	0.2500	1.2500	3.0313	1.8750	0.2500	28	952-002-321	\$482.97	952-002-324	\$552.72	952-002-323	\$579.01	952-002-322	\$579.01
8.0000	0.2500	1.5000	2.7188	2.5000	0.2500	28	952-002-325	\$482.97	952-002-328	\$552.72	952-002-327	\$598.44	952-002-326	\$598.44
8.0000	0.2813	1.2500	3.0313	1.8750	0.2813	28	952-002-433	\$532.72	952-002-436	\$609.73	952-002-435	\$638.79	952-002-434	\$638.79
8.0000	0.2813	1.5000	2.7188	2.5000	0.2813	28	952-002-437	\$532.72	952-002-440	\$609.73	952-002-439	\$638.79	952-002-438	\$638.79
8.0000	0.3125	1.2500	3.0313	1.8750	0.3125	28	952-002-329	\$529.16	952-002-332	\$605.65	952-002-331	\$634.54	952-002-330	\$634.54
8.0000	0.3125	1.5000	2.7188	2.5000	0.3125	28	952-002-333	\$529.16	952-002-336	\$605.65	952-002-335	\$634.54	952-002-334	\$634.54
8.0000	0.3438	1.2500	3.0313	1.8750	0.3438	28	952-002-441	\$542.74	952-002-444	\$621.20	952-002-443	\$650.82	952-002-442	\$650.82
8.0000	0.3438	1.5000	2.7188	2.5000	0.3438	28	952-002-445	\$542.74	952-002-448	\$621.20	952-002-447	\$650.82	952-002-446	\$650.82
8.0000	0.3750	1.2500	3.0313	1.8750	0.3750	28	952-002-337	\$556.32	952-002-340	\$636.76	952-002-339	\$667.12	952-002-338	\$667.12

*Make To Order

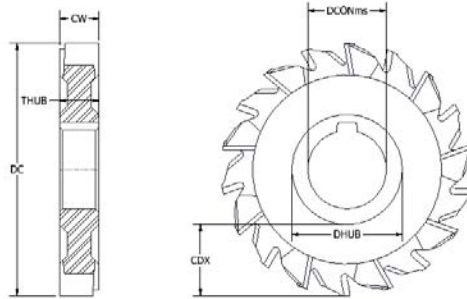

DC	CW	DCONms	CDX	DHUB	THUB	Zc	Uncoated	Price	TiN Coated*	Price	TiCN Coated*	Price	TiAlN Coated	Price
8.0000	0.3750	1.5000	2.8438	2.2500	0.3750	28	952-002-341	\$506.07	952-002-344	\$579.19	952-002-343	\$606.78	952-002-342	\$606.78
8.0000	0.4063	1.2500	3.0313	1.8750	0.4063	28	952-002-449	\$583.67	952-002-452	\$668.04	952-002-451	\$699.88	952-002-450	\$699.88
8.0000	0.4063	1.5000	2.7188	2.5000	0.4063	28	952-002-453	\$583.67	952-002-456	\$668.04	952-002-455	\$699.88	952-002-454	\$699.88
8.0000	0.4375	1.2500	3.0313	1.8750	0.4375	28	952-002-345	\$599.62	952-002-348	\$686.36	952-002-347	\$718.96	952-002-346	\$718.96
8.0000	0.4375	1.5000	2.8438	2.2500	0.4375	28	952-002-349	\$599.62	952-002-352	\$686.36	952-002-351	\$718.96	952-002-350	\$718.96
8.0000	0.4688	1.2500	3.0313	1.8750	0.4688	28	952-002-457	\$617.80	952-002-460	\$707.11	952-002-459	\$740.79	952-002-458	\$740.79
8.0000	0.4688	1.5000	2.7188	2.5000	0.4688	28	952-002-461	\$617.80	952-002-464	\$707.11	952-002-463	\$740.79	952-002-462	\$740.79
8.0000	0.5000	1.2500	3.0313	1.8750	0.5000	28	952-002-353	\$614.24	952-002-356	\$703.01	952-002-355	\$736.54	952-002-354	\$736.54
8.0000	0.5000	1.5000	2.8438	2.2500	0.5000	28	952-002-357	\$572.14	952-002-360	\$654.70	952-002-359	\$686.00	952-002-358	\$686.00
8.0000	0.5313	1.2500	3.0313	1.8750	0.5313	28	952-002-465	\$659.43	952-002-468	\$754.67	952-002-467	\$790.58	952-002-466	\$790.58
8.0000	0.5313	1.5000	2.7188	2.5000	0.5313	28	952-002-469	\$659.43	952-002-472	\$754.67	952-002-471	\$790.58	952-002-470	\$790.58
8.0000	0.5625	1.2500	3.0313	1.8750	0.5625	28	952-002-361	\$663.67	952-002-364	\$759.49	952-002-363	\$795.77	952-002-362	\$795.77
8.0000	0.5625	1.5000	2.7188	2.5000	0.5625	28	952-002-365	\$663.67	952-002-368	\$759.49	952-002-367	\$795.77	952-002-366	\$795.77
8.0000	0.5938	1.2500	3.0313	1.8750	0.5938	28	952-002-473	\$667.07	952-002-476	\$763.36	952-002-475	\$799.83	952-002-474	\$799.83
8.0000	0.5938	1.5000	2.7188	2.5000	0.5938	28	952-002-477	\$667.07	952-002-480	\$763.36	952-002-479	\$799.83	952-002-478	\$799.83
8.0000	0.6250	1.2500	3.0313	1.8750	0.6250	28	952-002-369	\$667.07	952-002-372	\$763.36	952-002-371	\$799.83	952-002-370	\$799.83
8.0000	0.6250	1.5000	2.8438	2.2500	0.6250	28	952-002-373	\$613.91	952-002-376	\$702.64	952-002-375	\$736.14	952-002-374	\$736.14
8.0000	0.6875	1.2500	3.0313	1.8750	0.6875	28	952-002-377	\$700.49	952-002-380	\$801.68	952-002-379	\$840.00	952-002-378	\$840.00
8.0000	0.6875	1.5000	2.7188	2.5000	0.6875	28	952-002-381	\$700.49	952-002-384	\$801.68	952-002-383	\$840.00	952-002-382	\$840.00
8.0000	0.7500	1.2500	3.0313	1.8750	0.7500	28	952-002-385	\$725.14	952-002-388	\$830.01	952-002-387	\$869.41	952-002-386	\$869.41
8.0000	0.7500	1.5000	2.8438	2.2500	0.7500	28	952-002-389	\$663.47	952-002-392	\$759.29	952-002-391	\$795.58	952-002-390	\$795.58
8.0000	0.8125	1.2500	3.0313	1.8750	0.8125	28	952-002-393	\$770.65	952-002-396	\$882.01	952-002-395	\$924.02	952-002-394	\$924.02
8.0000	0.8125	1.5000	2.8438	2.2500	0.8125	28	952-002-397	\$770.65	952-002-400	\$882.01	952-002-399	\$924.02	952-002-398	\$924.02
8.0000	0.8750	1.2500	3.0313	1.8750	0.8750	28	952-002-401	\$787.63	952-002-404	\$901.47	952-002-403	\$944.39	952-002-402	\$944.39
8.0000	0.8750	1.5000	2.8438	2.2500	0.8750	28	952-002-405	\$756.55	952-002-408	\$865.94	952-002-407	\$907.20	952-002-406	\$907.20
8.0000	0.9375	1.2500	3.0313	1.8750	0.9375	28	952-002-409	\$807.33	952-002-412	\$924.02	952-002-411	\$967.92	952-002-410	\$967.92
8.0000	0.9375	1.5000	2.8438	2.2500	0.9375	28	952-002-413	\$807.33	952-002-416	\$924.02	952-002-415	\$967.92	952-002-414	\$967.92
8.0000	1.0000	1.2500	3.0313	1.8750	1.0000	28	952-002-417	\$832.62	952-002-420	\$952.93	952-002-419	\$998.26	952-002-418	\$998.26
8.0000	1.0000	1.5000	2.8438	2.2500	1.0000	28	952-002-421	\$818.72	952-002-424	\$936.99	952-002-423	\$981.61	952-002-422	\$981.61
9.0000	0.2500	1.2500	3.2188	2.5000	0.2500	28	952-002-481	\$620.36	952-002-484	\$710.05	952-002-483	\$743.76	952-002-482	\$743.76
9.0000	0.2500	1.5000	3.2188	2.5000	0.2500	28	952-002-485	\$620.36	952-002-488	\$710.05	952-002-487	\$743.76	952-002-486	\$743.76
9.0000	0.3125	1.2500	3.2188	2.5000	0.3125	28	952-002-489	\$683.20	952-002-492	\$781.87	952-002-491	\$819.09	952-002-490	\$819.09
9.0000	0.3125	1.5000	3.2188	2.5000	0.3125	28	952-002-493	\$683.20	952-002-496	\$781.87	952-002-495	\$819.09	952-002-494	\$819.09
9.0000	0.3750	1.2500	3.2188	2.5000	0.3750	28	952-002-497	\$700.33	952-002-500	\$801.50	952-002-499	\$839.63	952-002-498	\$839.63
9.0000	0.3750	1.5000	3.2188	2.5000	0.3750	28	952-002-501	\$700.33	952-002-504	\$801.50	952-002-503	\$839.63	952-002-502	\$839.63
9.0000	0.4375	1.2500	3.2188	2.5000	0.4375	28	952-002-505	\$791.03	952-002-508	\$905.35	952-002-507	\$948.46	952-002-506	\$948.46
9.0000	0.4375	1.5000	3.2188	2.5000	0.4375	28	952-002-509	\$791.03	952-002-512	\$905.35	952-002-511	\$948.46	952-002-510	\$948.46
9.0000	0.5000	1.2500	3.2188	2.5000	0.5000	28	952-002-513	\$799.85	952-002-516	\$915.53	952-002-515	\$959.01	952-002-514	\$959.01
9.0000	0.5000	1.5000	3.2188	2.5000	0.5000	28	952-002-517	\$799.85	952-002-520	\$915.53	952-002-519	\$959.01	952-002-518	\$959.01

*Make To Order

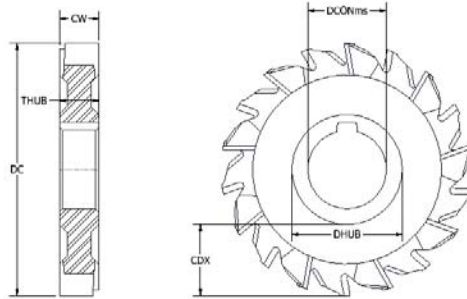

SSH

DC	CW	DCONms	CDX	DHUB	THUB	Zc	Uncoated	Price	TiN Coated*	Price	TiCN Coated*	Price	TiAlN Coated	Price
9.0000	0.5625	1.2500	3.2188	2.5000	0.5625	28	952-002-521	\$875.26	952-002-524	\$1001.77	952-002-523	\$1049.37	952-002-522	\$1049.37
9.0000	0.5625	1.5000	3.2188	2.5000	0.5625	28	952-002-525	\$875.26	952-002-528	\$1001.77	952-002-527	\$1049.37	952-002-526	\$1049.37
9.0000	0.6250	1.2500	3.2188	2.5000	0.6250	28	952-002-529	\$879.34	952-002-532	\$1006.41	952-002-531	\$1054.35	952-002-530	\$1054.35
9.0000	0.6250	1.5000	3.2188	2.5000	0.6250	28	952-002-533	\$879.34	952-002-536	\$1006.41	952-002-535	\$1054.35	952-002-534	\$1054.35
9.0000	0.6875	1.2500	3.2188	2.5000	0.6875	28	952-002-537	\$922.99	952-002-540	\$1056.36	952-002-539	\$1106.73	952-002-538	\$1106.73
9.0000	0.6875	1.5000	3.2188	2.5000	0.6875	28	952-002-541	\$922.99	952-002-544	\$1056.36	952-002-543	\$1106.73	952-002-542	\$1106.73
9.0000	0.7500	1.2500	3.2188	2.5000	0.7500	28	952-002-545	\$949.62	952-002-548	\$1086.90	952-002-547	\$1138.55	952-002-546	\$1138.55
9.0000	0.7500	1.5000	3.2188	2.5000	0.7500	28	952-002-549	\$949.62	952-002-552	\$1086.90	952-002-551	\$1138.55	952-002-550	\$1138.55
9.0000	0.8125	1.2500	3.2188	2.5000	0.8125	28	952-002-553	\$993.60	952-002-556	\$1137.28	952-002-555	\$1191.32	952-002-554	\$1191.32
9.0000	0.8125	1.5000	3.2188	2.5000	0.8125	28	952-002-557	\$993.60	952-002-560	\$1137.28	952-002-559	\$1191.32	952-002-558	\$1191.32
9.0000	0.8750	1.2500	3.2188	2.5000	0.8750	28	952-002-561	\$1013.32	952-002-564	\$1159.67	952-002-563	\$1215.01	952-002-562	\$1215.01
9.0000	0.8750	1.5000	3.2188	2.5000	0.8750	28	952-002-565	\$1013.32	952-002-568	\$1159.67	952-002-567	\$1215.01	952-002-566	\$1215.01
9.0000	0.9375	1.2500	3.2188	2.5000	0.9375	28	952-002-569	\$1047.48	952-002-572	\$1198.72	952-002-571	\$1255.94	952-002-570	\$1255.94
9.0000	0.9375	1.5000	3.2188	2.5000	0.9375	28	952-002-573	\$1047.48	952-002-576	\$1198.72	952-002-575	\$1255.94	952-002-574	\$1255.94
9.0000	1.0000	1.2500	3.2188	2.5000	1.0000	28	952-002-577	\$1064.59	952-002-580	\$1218.34	952-002-579	\$1276.47	952-002-578	\$1276.47
9.0000	1.0000	1.5000	3.2188	2.5000	1.0000	28	952-002-581	\$1064.59	952-002-584	\$1218.34	952-002-583	\$936.45	952-002-582	\$936.45
10.0000	0.1875	1.5000	3.8438	2.2500	0.1875	32	952-001-157	\$781.00	952-001-160	\$893.87	952-001-159	\$896.10	952-001-158	\$896.10
10.0000	0.2188	1.5000	3.3438	3.2500	0.2188	32	952-001-213	\$828.39	952-001-216	\$948.08	952-001-215	\$993.26	952-001-214	\$993.26
10.0000	0.2500	1.5000	3.8438	2.2500	0.2500	32	952-001-161	\$747.36	952-001-164	\$855.36	952-001-215	\$993.26	952-001-162	\$993.26
10.0000	0.2813	1.5000	3.3438	3.2500	0.2813	32	952-001-217	\$835.69	952-001-220	\$956.44	952-001-219	\$1001.98	952-001-218	\$1001.98
10.0000	0.3125	1.5000	3.8438	2.2500	0.3125	32	952-001-165	\$747.36	952-001-168	\$855.36	952-001-167	\$896.10	952-001-166	\$896.10
10.0000	0.3438	1.5000	3.3438	3.2500	0.3438	32	952-001-221	\$890.02	952-001-224	\$1018.63	952-001-223	\$1067.11	952-001-222	\$1067.11
10.0000	0.3750	1.5000	3.8438	2.2500	0.3750	32	952-001-169	\$893.41	952-001-172	\$1022.52	952-001-171	\$1071.20	952-001-170	\$1071.20
10.0000	0.4063	1.5000	3.3438	3.2500	0.4063	32	952-001-225	\$961.51	952-001-228	\$1100.45	952-001-227	\$1152.81	952-001-226	\$1152.81
10.0000	0.4375	1.5000	3.8438	2.2500	0.4375	32	952-001-173	\$795.43	952-001-176	\$910.35	952-001-175	\$953.64	952-001-174	\$953.64
10.0000	0.4688	1.5000	3.3438	3.2500	0.4688	32	952-001-229	\$1002.96	952-001-232	\$1147.83	952-001-231	\$1202.60	952-001-230	\$1202.60
10.0000	0.5000	1.5000	3.8438	2.2500	0.5000	32	952-001-177	\$995.83	952-001-180	\$1139.69	952-001-179	\$1193.91	952-001-178	\$1193.91
10.0000	0.5313	1.5000	3.3438	3.2500	0.5313	32	952-001-233	\$1077.68	952-001-236	\$1233.35	952-001-235	\$1292.19	952-001-234	\$1292.19
10.0000	0.5625	1.5000	3.8438	2.2500	0.5625	32	952-001-181	\$1041.68	952-001-184	\$1192.25	952-001-183	\$1248.89	952-001-182	\$1248.89
10.0000	0.6250	1.5000	3.8438	2.2500	0.6250	32	952-001-185	\$1083.78	952-001-188	\$1240.37	952-001-187	\$1299.43	952-001-186	\$1299.43
10.0000	0.6875	1.5000	3.8438	2.2500	0.6875	32	952-001-189	\$1117.93	952-001-192	\$1279.42	952-001-191	\$1340.34	952-001-190	\$1340.34
10.0000	0.7500	1.5000	3.8438	2.2500	0.7500	32	952-001-193	\$1122.18	952-001-196	\$1284.24	952-001-195	\$1345.52	952-001-194	\$1345.52
10.0000	0.8125	1.5000	3.8438	2.2500	0.8125	32	952-001-197	\$1209.63	952-001-200	\$1384.40	952-001-199	\$1450.28	952-001-198	\$1450.28
10.0000	0.8750	1.5000	3.8438	2.2500	0.8750	32	952-001-201	\$1239.68	952-001-204	\$1418.83	952-001-203	\$1486.39	952-001-202	\$1486.39
10.0000	0.9375	1.5000	3.8438	2.2500	0.9375	32	952-001-205	\$1300.82	952-001-208	\$1488.82	952-001-207	\$1559.68	952-001-206	\$1559.68
10.0000	1.0000	1.5000	3.8438	2.2500	1.0000	32	952-001-209	\$1328.17	952-001-212	\$1520.08	952-001-211	\$1592.44	952-001-210	\$1592.44

*Make To Order

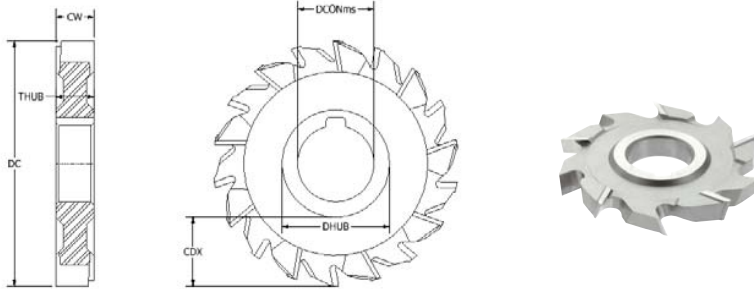

A Style

- Coarse Pitch Design
- Ground Flutes
- Flutes ground on 20° helix with 15° radial rake
- Refer to page 513 for interlocking set information



DC	CW	DCONms	CDX	DHUB	THUB	Zc	Uncoated	Price	TiN Coated*	Price	TiCN Coated*	Price	TiAlN Coated	Price
4.0000	0.2188	1.2500	1.0938	1.7500	0.2188	10	952-000-041	\$206.32	952-000-044	\$236.18	952-000-043	\$247.48	952-000-042	\$247.48
4.0000	0.2500	1.2500	1.0938	1.7500	0.2500	10	952-000-001	\$158.25	952-000-004	\$181.22	952-000-003	\$189.73	952-000-002	\$189.73
4.0000	0.2813	1.2500	1.0938	1.7500	0.2813	10	952-000-045	\$207.36	952-000-048	\$237.30	952-000-047	\$248.60	952-000-046	\$248.60
4.0000	0.3125	1.2500	1.0938	1.7500	0.3125	10	952-000-005	\$209.89	952-000-008	\$240.28	952-000-007	\$251.76	952-000-006	\$251.76
4.0000	0.3438	1.2500	1.0938	1.7500	0.3438	10	952-000-049	\$224.49	952-000-052	\$256.94	952-000-051	\$269.14	952-000-050	\$269.14
4.0000	0.3750	1.2500	1.0938	1.7500	0.3750	10	952-000-009	\$174.92	952-000-012	\$200.26	952-000-014	\$209.73	952-000-010	\$209.73
4.0000	0.4375	1.2500	1.0938	1.7500	0.4375	10	952-000-013	\$244.72	952-000-016	\$280.08	952-000-018	\$293.38	952-000-014	\$293.38
4.0000	0.5000	1.2500	1.0938	1.7500	0.5000	10	952-000-017	\$195.81	952-000-020	\$224.17	952-000-019	\$234.71	952-000-018	\$234.71
4.0000	0.5625	1.2500	1.0938	1.7500	0.5625	10	952-000-021	\$265.60	952-000-024	\$303.93	952-000-023	\$318.38	952-000-022	\$318.38
4.0000	0.6250	1.2500	1.0938	1.7500	0.6250	10	952-000-025	\$266.79	952-000-028	\$305.42	952-000-027	\$319.86	952-000-026	\$319.86
4.0000	0.6875	1.2500	1.0938	1.7500	0.6875	10	952-000-029	\$278.35	952-000-032	\$318.56	952-000-031	\$333.75	952-000-030	\$333.75
4.0000	0.7500	1.2500	1.0938	1.7500	0.7500	10	952-000-033	\$291.06	952-000-036	\$333.18	952-000-035	\$348.93	952-000-034	\$348.93
4.0000	1.0000	1.2500	1.0938	1.7500	1.0000	10	952-000-037	\$302.60	952-000-040	\$346.30	952-000-039	\$362.78	952-000-038	\$362.78
6.0000	0.2188	1.2500	2.0313	1.8750	0.2188	16	952-000-093	\$343.21	952-000-096	\$392.78	952-000-095	\$411.49	952-000-094	\$411.49
6.0000	0.2500	1.2500	2.0313	1.8750	0.2500	16	952-000-053	\$326.56	952-000-056	\$373.73	952-000-055	\$391.49	952-000-054	\$391.49
6.0000	0.2813	1.2500	2.0313	1.8750	0.2813	16	952-000-097	\$361.72	952-000-100	\$414.07	952-000-099	\$433.71	952-000-098	\$433.71
6.0000	0.3125	1.2500	2.0313	1.8750	0.3125	16	952-000-057	\$345.08	952-000-060	\$395.01	952-000-059	\$413.72	952-000-058	\$413.72
6.0000	0.3438	1.2500	2.0313	1.8750	0.3438	16	952-000-101	\$372.23	952-000-104	\$426.11	952-000-103	\$446.28	952-000-102	\$446.28
6.0000	0.3750	1.2500	2.0313	1.8750	0.3750	16	952-000-061	\$311.27	952-000-064	\$356.32	952-000-063	\$373.16	952-000-062	\$373.16
6.0000	0.4375	1.2500	2.0313	1.8750	0.4375	16	952-000-065	\$411.48	952-000-068	\$470.89	952-000-067	\$493.30	952-000-066	\$493.30
6.0000	0.5000	1.2500	2.0313	1.8750	0.5000	16	952-000-069	\$352.22	952-000-072	\$403.18	952-000-071	\$422.22	952-000-070	\$422.22
6.0000	0.5625	1.2500	2.0313	1.8750	0.5625	16	952-000-073	\$424.22	952-000-076	\$485.53	952-000-075	\$508.66	952-000-074	\$508.66
6.0000	0.6250	1.2500	2.0313	1.8750	0.6250	16	952-000-077	\$416.90	952-000-080	\$477.21	952-000-079	\$499.95	952-000-078	\$499.95
6.0000	0.6875	1.2500	2.0313	1.8750	0.6875	16	952-000-081	\$483.30	952-000-084	\$553.09	952-000-083	\$579.55	952-000-082	\$579.55
6.0000	0.7500	1.2500	2.0313	1.8750	0.7500	16	952-000-085	\$452.75	952-000-088	\$518.10	952-000-087	\$542.91	952-000-086	\$542.91
6.0000	1.0000	1.2500	2.0313	1.8750	1.0000	16	952-000-089	\$569.41	952-000-092	\$651.76	952-000-091	\$682.67	952-000-090	\$682.67
8.0000	0.3750	1.2500	2.7188	2.5000	0.3750	20	952-000-105	\$654.82	952-000-108	\$749.49	952-000-107	\$785.21	952-000-106	\$785.21
8.0000	0.5000	1.2500	2.7188	2.5000	0.5000	20	952-000-109	\$739.73	952-000-112	\$846.67	952-000-111	\$887.01	952-000-110	\$887.01
8.0000	0.7500	1.2500	2.7188	2.5000	0.7500	20	952-000-113	\$867.27	952-000-116	\$992.51	952-000-115	\$1039.94	952-000-114	\$1039.94

*Make To Order



HSS

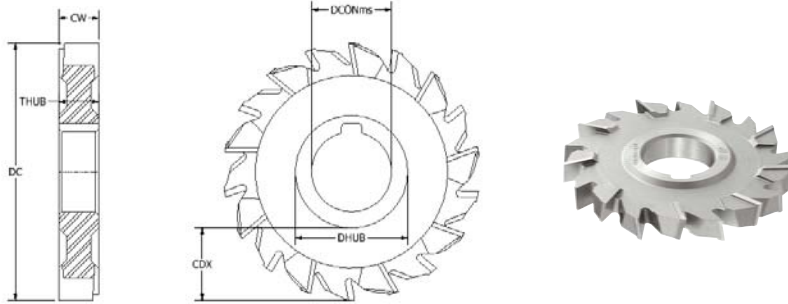

WK Style

- Excellent for Milling Keys
- Reduced Side Clearance to Maintain Width
- Diameters Furnished 1/32" Oversized for Resharpening
- Refer to page 513 for interlocking set information



DC	CW	DCONms	CDX	DHUB	THUB	Zc	Uncoated	Price	TiN Coated*	Price	TiCN Coated*	Price	TiAlN Coated	Price
2.1563	0.1875	0.7500	0.5469	1.0000	0.1875	14	952-002-637	\$83.73	952-002-640	\$95.88	952-002-639	\$100.33	952-002-638	\$100.33
2.1563	0.2500	0.7500	0.5469	1.0000	0.2500	14	952-002-641	\$84.57	952-002-644	\$96.83	952-002-643	\$101.44	952-002-642	\$101.44
2.1563	0.3125	0.7500	0.5469	1.0000	0.3125	14	952-002-585	\$90.69	952-002-588	\$103.84	952-002-587	\$108.65	952-002-586	\$108.65
2.1563	0.3750	0.7500	0.5469	1.0000	0.3750	14	952-002-593	\$94.57	952-002-596	\$108.28	952-002-595	\$113.47	952-002-594	\$113.47
2.7813	0.2500	1.0000	0.6404	1.4380	0.2500	16	952-002-645	\$105.46	952-002-648	\$120.68	952-002-647	\$126.42	952-002-646	\$126.42
2.7813	0.3125	1.0000	0.6404	1.4380	0.3125	16	952-002-589	\$118.36	952-002-592	\$135.51	952-002-591	\$141.97	952-002-590	\$141.97
2.7813	0.3750	1.0000	0.6404	1.4380	0.3750	16	952-002-597	\$118.36	952-002-600	\$135.51	952-002-599	\$141.97	952-002-598	\$141.97
2.7813	0.4375	1.0000	0.6404	1.4380	0.4375	16	952-002-605	\$121.73	952-002-608	\$139.40	952-002-607	\$146.05	952-002-606	\$146.05
2.7813	0.5000	1.0000	0.6404	1.4380	0.5000	16	952-002-613	\$129.07	952-002-616	\$147.72	952-002-615	\$154.74	952-002-614	\$154.74
3.5313	0.3750	1.0000	1.0154	1.4380	0.3750	18	952-002-601	\$150.10	952-002-604	\$171.80	952-002-603	\$179.92	952-002-602	\$179.92
3.5313	0.4375	1.0000	1.0154	1.4380	0.4375	18	952-002-609	\$157.25	952-002-612	\$179.92	952-002-611	\$188.62	952-002-610	\$188.62
3.5313	0.5000	1.0000	0.9844	1.5000	0.5000	18	952-002-617	\$160.66	952-002-620	\$183.82	952-002-619	\$192.69	952-002-618	\$192.69
3.5313	0.5625	1.0000	0.9844	1.5000	0.5625	18	952-002-621	\$176.61	952-002-624	\$202.10	952-002-623	\$211.76	952-002-622	\$211.76
3.5313	0.6250	1.0000	0.9844	1.5000	0.6250	18	952-002-625	\$176.61	952-002-628	\$202.10	952-002-627	\$211.76	952-002-626	\$211.76
3.5313	0.6875	1.0000	0.9844	1.5000	0.6875	18	952-002-629	\$188.81	952-002-632	\$216.21	952-002-631	\$226.39	952-002-630	\$226.39
3.5313	0.7500	1.0000	0.9844	1.5000	0.7500	18	952-002-633	\$188.81	952-002-636	\$216.21	952-002-635	\$226.39	952-002-634	\$226.39

*Make To Order

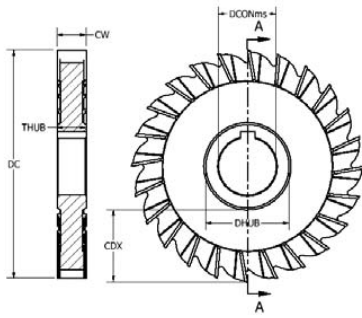

B Style

- Additional teeth for improved finish
- Excellent for thin walled parts, interrupted cuts or finish requirements



DC	CW	DCONms	CDX	DHUB	THUB	Zc	Uncoated	Price	TiN Coated*	Price	TiCN Coated*	Price	TiAlN Coated	Price
2.0000	0.1875	0.5000	0.4998	0.9380	0.1875	14	952-000-169	\$58.44	952-000-172	\$66.83	952-000-171	\$69.97	952-000-170	\$69.97
2.0000	0.1875	0.6250	0.4998	0.9380	0.1875	14	952-000-173	\$58.44	952-000-176	\$66.83	952-000-175	\$69.97	952-000-174	\$69.97
2.0000	0.2500	0.5000	0.4998	0.9380	0.2500	14	952-000-177	\$61.47	952-000-180	\$70.32	952-000-179	\$73.68	952-000-178	\$73.68
2.0000	0.2500	0.6250	0.4998	0.9380	0.2500	14	952-000-181	\$61.47	952-000-184	\$70.32	952-000-183	\$73.68	952-000-182	\$73.68
2.0000	0.3750	0.5000	0.4998	0.9380	0.3750	14	952-000-185	\$65.21	952-000-188	\$74.60	952-000-187	\$78.11	952-000-186	\$78.11
2.0000	0.3750	0.6250	0.4998	0.9380	0.3750	14	952-000-189	\$65.21	952-000-192	\$74.60	952-000-191	\$78.11	952-000-190	\$78.11
2.5000	0.2500	0.8750	0.6248	1.1880	0.2500	16	952-000-193	\$68.45	952-000-196	\$78.31	952-000-195	\$82.02	952-000-194	\$82.02
2.5000	0.3125	0.8750	0.6248	1.1880	0.3125	16	952-000-197	\$72.51	952-000-200	\$82.92	952-000-199	\$87.00	952-000-198	\$87.00
2.5000	0.3750	0.8750	0.6248	1.1880	0.3750	16	952-000-201	\$78.12	952-000-204	\$89.42	952-000-203	\$93.64	952-000-202	\$93.64
2.5000	0.5000	1.0000	0.6248	1.1880	0.5000	16	952-000-205	\$78.12	952-000-208	\$89.42	952-000-207	\$93.64	952-000-206	\$93.64
3.0000	0.1875	1.0000	0.7188	1.5000	0.1875	20	952-000-209	\$72.02	952-000-212	\$82.38	952-000-211	\$86.25	952-000-210	\$86.25
3.0000	0.2188	1.0000	0.7188	1.5000	0.2188	20	952-000-265	\$91.02	952-000-268	\$104.21	952-000-267	\$109.22	952-000-266	\$109.22
3.0000	0.2500	1.0000	0.7188	1.5000	0.2500	20	952-000-213	\$72.69	952-000-216	\$83.11	952-000-215	\$87.18	952-000-214	\$87.18
3.0000	0.2813	1.0000	0.7188	1.5000	0.2813	20	952-000-269	\$97.31	952-000-272	\$111.43	952-000-271	\$116.61	952-000-270	\$116.61
3.0000	0.3125	1.0000	0.7188	1.5000	0.3125	20	952-000-217	\$78.64	952-000-220	\$89.94	952-000-219	\$87.18	952-000-218	\$87.18
3.0000	0.3438	1.0000	0.7188	1.5000	0.3438	20	952-000-273	\$110.38	952-000-276	\$126.42	952-000-275	\$132.35	952-000-274	\$132.35
3.0000	0.3750	1.0000	0.7188	1.5000	0.3750	20	952-000-221	\$85.44	952-000-224	\$97.73	952-000-223	\$102.38	952-000-222	\$102.38
3.0000	0.4063	1.0000	0.7188	1.5000	0.4063	20	952-000-277	\$111.92	952-000-280	\$128.10	952-000-279	\$134.20	952-000-278	\$134.20
3.0000	0.4375	1.0000	0.7188	1.5000	0.4375	20	952-000-225	\$90.53	952-000-228	\$103.66	952-000-227	\$108.46	952-000-226	\$108.46
3.0000	0.5000	1.0000	0.7188	1.5000	0.5000	20	952-000-229	\$86.61	952-000-232	\$99.21	952-000-231	\$190.85	952-000-230	\$190.85
3.0000	0.5625	1.0000	0.7188	1.5000	0.5625	20	952-000-233	\$107.51	952-000-236	\$123.08	952-000-235	\$128.83	952-000-234	\$128.83
3.0000	0.6250	1.0000	0.7188	1.5000	0.6250	20	952-000-237	\$112.75	952-000-240	\$198.40	952-000-239	\$135.14	952-000-238	\$135.14
3.0000	0.6875	1.0000	0.7188	1.5000	0.6875	20	952-000-241	\$111.75	952-000-244	\$127.90	952-000-243	\$134.02	952-000-242	\$134.02
3.0000	0.7500	1.0000	0.7188	1.5000	0.7500	20	952-000-245	\$118.87	952-000-248	\$136.04	952-000-247	\$142.53	952-000-246	\$142.53
3.0000	0.8125	1.0000	0.7188	1.5000	0.8125	24	952-000-249	\$129.90	952-000-252	\$148.65	952-000-251	\$155.83	952-000-250	\$155.83
3.0000	0.8750	1.0000	0.7188	1.5000	0.8750	24	952-000-253	\$142.66	952-000-256	\$163.25	952-000-255	\$171.05	952-000-254	\$171.05
3.0000	0.9375	1.0000	0.7188	1.5000	0.9375	24	952-000-257	\$150.10	952-000-260	\$171.80	952-000-259	\$179.92	952-000-258	\$179.92
3.0000	1.0000	1.0000	0.7188	1.5000	1.0000	24	952-000-261	\$149.77	952-000-264	\$171.41	952-000-263	\$179.54	952-000-262	\$179.54
4.0000	0.2188	1.0000	1.1563	1.6250	0.2188	24	952-000-385	\$124.81	952-000-388	\$142.89	952-000-387	\$149.75	952-000-386	\$149.75
4.0000	0.2188	1.2500	1.0938	1.7500	0.2188	24	952-000-389	\$124.81	952-000-392	\$142.89	952-000-391	\$149.75	952-000-390	\$149.75
4.0000	0.2500	1.0000	1.1563	1.6250	0.2500	24	952-000-281	\$97.14	952-000-284	\$111.24	952-000-283	\$116.45	952-000-282	\$116.45
4.0000	0.2500	1.2500	1.0938	1.7500	0.2500	24	952-000-285	\$118.19	952-000-288	\$135.32	952-000-287	\$141.78	952-000-286	\$141.78
4.0000	0.2813	1.0000	1.1563	1.6250	0.2813	24	952-000-393	\$128.04	952-000-396	\$146.60	952-000-395	\$153.46	952-000-394	\$153.46
4.0000	0.2813	1.2500	1.0938	1.7500	0.2813	24	952-000-397	\$128.04	952-000-400	\$146.60	952-000-399	\$153.46	952-000-398	\$153.46
4.0000	0.3125	1.0000	1.1563	1.6250	0.3125	24	952-000-289	\$121.73	952-000-292	\$139.40	952-000-291	\$146.05	952-000-290	\$146.05
4.0000	0.3125	1.2500	1.0938	1.7500	0.3125	24	952-000-293	\$121.73	952-000-296	\$139.40	952-000-295	\$146.05	952-000-294	\$146.05
4.0000	0.3438	1.0000	1.1563	1.6250	0.3438	24	952-000-401	\$130.07	952-000-404	\$148.82	952-000-403	\$156.03	952-000-402	\$156.03
4.0000	0.3438	1.2500	1.0938	1.7500	0.3438	24	952-000-405	\$130.07	952-000-408	\$148.82	952-000-407	\$156.03	952-000-406	\$156.03
4.0000	0.3750	1.0000	1.1563	1.6250	0.3750	24	952-000-297	\$109.02	952-000-300	\$124.76	952-000-299	\$130.68	952-000-298	\$130.68
4.0000	0.3750	1.2500	1.0938	1.7500	0.3750	24	952-000-301	\$134.32	952-000-304	\$153.82	952-000-303	\$161.06	952-000-302	\$161.06
4.0000	0.4063	1.0000	1.1563	1.6250	0.4063	24	952-000-409	\$142.96	952-000-412	\$163.63	952-000-411	\$171.41	952-000-410	\$171.41
4.0000	0.4063	1.2500	1.0938	1.7500	0.4063	24	952-000-413	\$142.96	952-000-416	\$163.63	952-000-415	\$171.41	952-000-414	\$171.41
4.0000	0.4375	1.0000	1.1563	1.6250	0.4375	24	952-000-305	\$136.85	952-000-308	\$156.59	952-000-307	\$164.19	952-000-306	\$164.19
4.0000	0.4375	1.2500	1.0938	1.7500	0.4375	24	952-000-309	\$136.85	952-000-312	\$156.59	952-000-311	\$164.19	952-000-310	\$164.19
4.0000	0.5000	1.0000	1.1563	1.6250	0.5000	24	952-000-313	\$122.43	952-000-316	\$140.12	952-000-315	\$146.80	952-000-314	\$146.80
4.0000	0.5000	1.2500	1.0938	1.7500	0.5000	24	952-000-317	\$122.43	952-000-320	\$140.12	952-000-319	\$146.80	952-000-318	\$146.80

*Make To Order

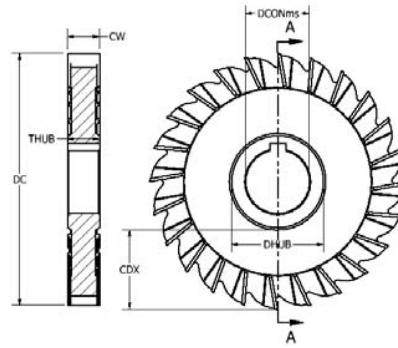

SSH

DC	CW	DCONms	CDX	DHUB	THUB	Zc	Uncoated	Price	TiN Coated*	Price	TiCN Coated*	Price	TiAlN Coated	Price
4.0000	0.5625	1.0000	1.1563	1.6250	0.5625	24	952-000-321	\$148.24	952-000-324	\$169.74	952-000-323	\$177.70	952-000-322	\$177.70
4.0000	0.5625	1.2500	1.0938	1.7500	0.5625	24	952-000-325	\$148.24	952-000-328	\$169.74	952-000-327	\$177.70	952-000-326	\$177.70
4.0000	0.6250	1.0000	1.1563	1.6250	0.6250	24	952-000-329	\$140.43	952-000-332	\$160.68	952-000-331	\$168.45	952-000-330	\$168.45
4.0000	0.6250	1.2500	1.0938	1.7500	0.6250	24	952-000-333	\$140.43	952-000-336	\$160.68	952-000-335	\$168.45	952-000-334	\$168.45
4.0000	0.6875	1.0000	1.1563	1.6250	0.6875	24	952-000-337	\$162.69	952-000-340	\$186.21	952-000-339	\$195.09	952-000-338	\$195.09
4.0000	0.6875	1.2500	1.0938	1.7500	0.6875	24	952-000-341	\$162.69	952-000-344	\$186.21	952-000-343	\$195.09	952-000-342	\$195.09
4.0000	0.7500	1.0000	1.1563	1.6250	0.7500	24	952-000-345	\$152.00	952-000-348	\$174.00	952-000-347	\$182.33	952-000-346	\$182.33
4.0000	0.7500	1.2500	1.0938	1.7500	0.7500	24	952-000-349	\$152.00	952-000-352	\$174.00	952-000-351	\$182.33	952-000-350	\$182.33
4.0000	0.8125	1.0000	1.1563	1.6250	0.8125	24	952-000-353	\$171.86	952-000-356	\$196.76	952-000-355	\$206.02	952-000-354	\$206.02
4.0000	0.8125	1.2500	1.0938	1.7500	0.8125	24	952-000-357	\$171.86	952-000-360	\$196.76	952-000-359	\$206.02	952-000-358	\$206.02
4.0000	0.8750	1.0000	1.1563	1.6250	0.8750	24	952-000-361	\$166.92	952-000-364	\$191.03	952-000-363	\$200.11	952-000-362	\$200.11
4.0000	0.8750	1.2500	1.0938	1.7500	0.8750	24	952-000-365	\$166.92	952-000-368	\$191.03	952-000-367	\$200.11	952-000-366	\$200.11
4.0000	0.9375	1.0000	1.1563	1.6250	0.9375	24	952-000-369	\$200.07	952-000-372	\$228.96	952-000-371	\$239.89	952-000-370	\$239.89
4.0000	0.9375	1.2500	1.0938	1.7500	0.9375	24	952-000-373	\$200.07	952-000-376	\$228.96	952-000-375	\$239.89	952-000-374	\$239.89
4.0000	1.0000	1.0000	1.1563	1.6250	1.0000	24	952-000-377	\$210.40	952-000-380	\$240.82	952-000-379	\$252.29	952-000-378	\$252.29
4.0000	1.0000	1.2500	1.0938	1.7500	1.0000	24	952-000-381	\$210.40	952-000-384	\$240.82	952-000-383	\$252.29	952-000-382	\$252.29
5.0000	0.2500	1.0000	1.6563	1.6250	0.2500	26	952-000-417	\$159.13	952-000-420	\$182.14	952-000-419	\$190.85	952-000-418	\$190.85
5.0000	0.2500	1.2500	1.5313	1.8750	0.2500	26	952-000-421	\$159.13	952-000-424	\$182.14	952-000-423	\$190.85	952-000-422	\$190.85
5.0000	0.2813	1.0000	1.6563	1.6250	0.2813	26	952-000-521	\$171.69	952-000-524	\$198.40	952-000-523	\$205.81	952-000-522	\$205.81
5.0000	0.2813	1.2500	1.5313	1.8750	0.2813	26	952-000-525	\$171.69	952-000-528	\$198.40	952-000-527	\$205.81	952-000-526	\$205.81
5.0000	0.3125	1.0000	1.6563	1.6250	0.3125	26	952-000-425	\$162.02	952-000-428	\$185.46	952-000-427	\$194.18	952-000-426	\$194.18
5.0000	0.3125	1.2500	1.5313	1.8750	0.3125	26	952-000-429	\$162.02	952-000-432	\$185.46	952-000-431	\$194.18	952-000-430	\$194.18
5.0000	0.3438	1.0000	1.6563	1.6250	0.3438	26	952-000-529	\$172.36	952-000-532	\$197.32	952-000-531	\$206.75	952-000-530	\$206.75
5.0000	0.3438	1.2500	1.5313	1.8750	0.3438	26	952-000-533	\$172.36	952-000-536	\$197.32	952-000-535	\$206.75	952-000-534	\$206.75
5.0000	0.3750	1.0000	1.6563	1.6250	0.3750	26	952-000-433	\$173.38	952-000-436	\$196.60	952-000-435	\$207.87	952-000-434	\$207.87
5.0000	0.3750	1.2500	1.5313	1.8750	0.3750	26	952-000-437	\$173.38	952-000-440	\$196.60	952-000-439	\$207.87	952-000-438	\$207.87
5.0000	0.4063	1.0000	1.6563	1.6250	0.4063	26	952-000-537	\$184.09	952-000-540	\$210.66	952-000-539	\$220.64	952-000-538	\$220.64
5.0000	0.4063	1.2500	1.5313	1.8750	0.4063	26	952-000-541	\$184.09	952-000-544	\$210.66	952-000-543	\$220.64	952-000-542	\$220.64
5.0000	0.4375	1.0000	1.6563	1.6250	0.4375	26	952-000-441	\$186.64	952-000-444	\$213.61	952-000-443	\$223.80	952-000-442	\$223.80
5.0000	0.4375	1.2500	1.5313	1.8750	0.4375	26	952-000-445	\$186.64	952-000-448	\$213.61	952-000-447	\$223.80	952-000-446	\$223.80
5.0000	0.5000	1.0000	1.6563	1.6250	0.5000	26	952-000-449	\$167.11	952-000-452	\$191.22	952-000-451	\$200.26	952-000-450	\$200.26
5.0000	0.5000	1.2500	1.5313	1.8750	0.5000	26	952-000-453	\$167.11	952-000-456	\$191.22	952-000-455	\$200.26	952-000-454	\$200.26
5.0000	0.5625	1.0000	1.6563	1.6250	0.5625	26	952-000-457	\$207.00	952-000-460	\$236.94	952-000-459	\$248.24	952-000-458	\$248.24
5.0000	0.5625	1.2500	1.5313	1.8750	0.5625	26	952-000-461	\$207.00	952-000-464	\$236.94	952-000-463	\$248.24	952-000-462	\$248.24
5.0000	0.6250	1.0000	1.6563	1.6250	0.6250	26	952-000-465	\$184.93	952-000-468	\$211.57	952-000-467	\$221.75	952-000-466	\$221.75
5.0000	0.6250	1.2500	1.5313	1.8750	0.6250	26	952-000-469	\$184.93	952-000-472	\$211.57	952-000-471	\$221.75	952-000-470	\$221.75
5.0000	0.6875	1.0000	1.6563	1.6250	0.6875	26	952-000-473	\$219.59	952-000-476	\$251.37	952-000-475	\$263.21	952-000-474	\$263.21
5.0000	0.6875	1.2500	1.5313	1.8750	0.6875	26	952-000-477	\$219.59	952-000-480	\$251.37	952-000-479	\$263.21	952-000-478	\$263.21
5.0000	0.7500	1.0000	1.6563	1.6250	0.7500	26	952-000-481	\$210.06	952-000-484	\$240.46	952-000-483	\$251.91	952-000-482	\$251.91

*Make To Order

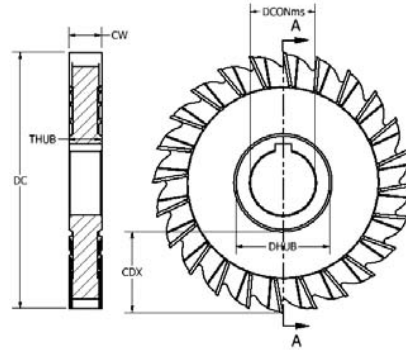

DC	CW	DCONms	CDX	DHUB	THUB	Zc	Uncoated	Price	TiN Coated*	Price	TiCN Coated*	Price	TiAlN Coated	Price
5.0000	0.7500	1.2500	1.5313	1.8750	0.7500	26	952-000-485	\$210.06	952-000-488	\$240.46	952-000-487	\$251.91	952-000-486	\$251.91
5.0000	0.8125	1.0000	1.6563	1.6250	0.8125	26	952-000-489	\$235.53	952-000-492	\$269.52	952-000-491	\$282.45	952-000-490	\$282.45
5.0000	0.8125	1.2500	1.5313	1.8750	0.8125	26	952-000-493	\$235.53	952-000-496	\$269.52	952-000-495	\$282.45	952-000-494	\$282.45
5.0000	0.8750	1.0000	1.6563	1.6250	0.8750	26	952-000-497	\$241.48	952-000-500	\$276.36	952-000-499	\$289.50	952-000-498	\$289.50
5.0000	0.8750	1.2500	1.5313	1.8750	0.8750	26	952-000-501	\$241.48	952-000-504	\$276.36	952-000-503	\$289.50	952-000-502	\$289.50
5.0000	0.9375	1.0000	1.6563	1.6250	0.9375	26	952-000-505	\$249.97	952-000-508	\$286.17	952-000-507	\$299.70	952-000-506	\$299.70
5.0000	0.9375	1.2500	1.5313	1.8750	0.9375	26	952-000-509	\$249.97	952-000-512	\$286.17	952-000-511	\$299.70	952-000-510	\$299.70
5.0000	1.0000	1.0000	1.6563	1.6250	1.0000	26	952-000-513	\$262.90	952-000-516	\$300.78	952-000-515	\$315.23	952-000-514	\$315.23
5.0000	1.0000	1.2500	1.5313	1.8750	1.0000	26	952-000-517	\$251.34	952-000-520	\$287.65	952-000-519	\$301.37	952-000-518	\$301.37
6.0000	0.2500	1.2500	2.0313	1.8750	0.2500	26	952-000-545	\$195.62	952-000-548	\$223.97	952-000-547	\$234.52	952-000-546	\$234.52
6.0000	0.2813	1.2500	2.0313	1.8750	0.2813	30	952-000-605	\$209.55	952-000-608	\$239.89	952-000-607	\$149.37	952-000-606	\$149.37
6.0000	0.3125	1.2500	2.0313	1.8750	0.3125	30	952-000-549	\$215.86	952-000-552	\$247.12	952-000-551	\$258.79	952-000-550	\$258.79
6.0000	0.3438	1.2500	2.0313	1.8750	0.3438	30	952-000-609	\$230.27	952-000-612	\$263.60	952-000-611	\$185.64	952-000-610	\$185.64
6.0000	0.3750	1.2500	2.0313	1.8750	0.3750	30	952-000-553	\$231.11	952-000-556	\$264.51	952-000-555	\$277.08	952-000-554	\$277.08
6.0000	0.4063	1.2500	2.0313	1.8750	0.4063	30	952-000-613	\$243.86	952-000-616	\$279.15	952-000-615	\$279.34	952-000-614	\$279.34
6.0000	0.4375	1.2500	2.0313	1.8750	0.4375	30	952-000-557	\$244.22	952-000-560	\$279.52	952-000-559	\$292.82	952-000-558	\$292.82
6.0000	0.5000	1.0000	2.1563	1.6250	0.5000	30	952-000-561	\$215.16	952-000-564	\$246.20	952-000-563	\$258.03	952-000-562	\$258.03
6.0000	0.5000	1.2500	2.0313	1.8750	0.5000	30	952-000-565	\$215.16	952-000-568	\$246.20	952-000-567	\$258.03	952-000-566	\$258.03
6.0000	0.5625	1.2500	2.0313	1.8750	0.5625	30	952-000-569	\$260.83	952-000-572	\$298.57	952-000-571	\$312.81	952-000-570	\$312.81
6.0000	0.6250	1.2500	2.0313	1.8750	0.6250	30	952-000-573	\$236.38	952-000-576	\$270.60	952-000-575	\$283.38	952-000-574	\$283.38
6.0000	0.6875	1.2500	2.0313	1.8750	0.6875	30	952-000-577	\$285.63	952-000-580	\$326.89	952-000-579	\$342.43	952-000-578	\$342.43
6.0000	0.7500	1.0000	2.1563	1.6250	0.7500	30	952-000-581	\$277.48	952-000-584	\$317.64	952-000-583	\$332.62	952-000-582	\$332.62
6.0000	0.7500	1.2500	2.0313	1.8750	0.7500	30	952-000-585	\$277.48	952-000-588	\$317.64	952-000-587	\$332.62	952-000-586	\$332.62
6.0000	0.8125	1.2500	2.0313	1.8750	0.8125	30	952-000-589	\$307.05	952-000-592	\$351.34	952-000-591	\$368.17	952-000-590	\$368.17
6.0000	0.8750	1.2500	2.0313	1.8750	0.8750	30	952-000-593	\$317.05	952-000-596	\$362.78	952-000-595	\$380.20	952-000-594	\$380.20
6.0000	0.9375	1.2500	2.0313	1.8750	0.9375	30	952-000-597	\$336.41	952-000-600	\$385.00	952-000-599	\$403.33	952-000-598	\$403.33
6.0000	1.0000	1.2500	2.0313	1.8750	1.0000	30	952-000-601	\$327.24	952-000-604	\$374.49	952-000-603	\$392.43	952-000-602	\$392.43
7.0000	0.2500	1.2500	2.5313	1.8750	0.2500	32	952-000-617	\$310.09	952-000-620	\$354.85	952-000-619	\$371.86	952-000-618	\$371.86
7.0000	0.3125	1.2500	2.5313	1.8750	0.3125	32	952-000-621	\$326.37	952-000-624	\$373.55	952-000-623	\$391.32	952-000-622	\$391.32
7.0000	0.3750	1.2500	2.5313	1.8750	0.3750	32	952-000-625	\$356.77	952-000-628	\$408.33	952-000-627	\$427.77	952-000-626	\$427.77
7.0000	0.4375	1.2500	2.5313	1.8750	0.4375	32	952-000-629	\$374.45	952-000-632	\$428.50	952-000-631	\$449.08	952-000-630	\$449.08
7.0000	0.5000	1.2500	2.5313	1.8750	0.5000	32	952-000-633	\$401.10	952-000-636	\$459.05	952-000-635	\$480.91	952-000-634	\$480.91
7.0000	0.5625	1.2500	2.5313	1.8750	0.5625	32	952-000-637	\$417.25	952-000-640	\$477.57	952-000-639	\$500.35	952-000-638	\$500.35
7.0000	0.6250	1.2500	2.5313	1.8750	0.6250	32	952-000-641	\$431.33	952-000-644	\$493.68	952-000-643	\$517.19	952-000-642	\$517.19
7.0000	0.6875	1.2500	2.5313	1.8750	0.6875	32	952-000-645	\$447.81	952-000-648	\$512.56	952-000-647	\$536.98	952-000-646	\$536.98
7.0000	0.7500	1.2500	2.5313	1.8750	0.7500	32	952-000-649	\$416.90	952-000-652	\$477.21	952-000-651	\$499.95	952-000-650	\$499.95
7.0000	0.8125	1.2500	2.5313	1.8750	0.8125	32	952-000-653	\$478.38	952-000-656	\$547.53	952-000-655	\$573.64	952-000-654	\$573.64
7.0000	0.8750	1.2500	2.5313	1.8750	0.8750	32	952-000-657	\$505.23	952-000-660	\$578.26	952-000-659	\$605.86	952-000-658	\$605.86
7.0000	0.9375	1.2500	2.5313	1.8750	0.9375	32	952-000-661	\$521.86	952-000-664	\$597.31	952-000-663	\$625.64	952-000-662	\$625.64
7.0000	1.0000	1.2500	2.5313	1.8750	1.0000	32	952-000-665	\$535.61	952-000-668	\$613.07	952-000-667	\$642.12	952-000-666	\$642.12
8.0000	0.2500	1.2500	3.0313	1.8750	0.2500	34	952-000-669	\$430.16	952-000-672	\$492.36	952-000-671	\$515.70	952-000-670	\$515.70
8.0000	0.3125	1.2500	3.0313	1.8750	0.3125	34	952-000-673	\$451.04	952-000-676	\$516.25	952-000-675	\$540.88	952-000-674	\$540.88
8.0000	0.3750	1.2500	3.0313	1.8750	0.3750	34	952-000-677	\$474.97	952-000-680	\$543.64	952-000-679	\$569.55	952-000-678	\$569.55

*Make To Order

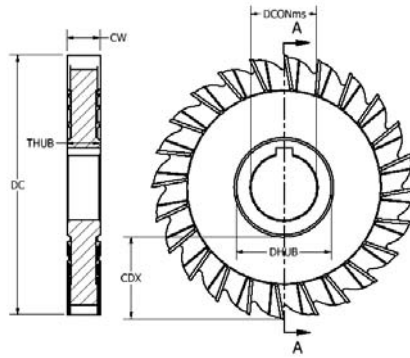

SSH

DC	CW	DCONms	CDX	DHUB	THUB	Zc	Uncoated	Price	TiN Coated*	Price	TiCN Coated*	Price	TiAlN Coated	Price
8.0000	0.4375	1.2500	3.0313	1.8750	0.4375	34	952-000-681	\$498.42	952-000-684	\$570.49	952-000-683	\$597.71	952-000-682	\$597.71
8.0000	0.5000	1.2500	3.0313	1.8750	0.5000	34	952-000-685	\$501.83	952-000-688	\$574.38	952-000-687	\$601.76	952-000-686	\$601.76
8.0000	0.5625	1.2500	3.0313	1.8750	0.5625	34	952-000-689	\$532.22	952-000-692	\$609.18	952-000-691	\$638.04	952-000-690	\$638.04
8.0000	0.6250	1.2500	3.0313	1.8750	0.6250	34	952-000-693	\$558.88	952-000-696	\$639.72	952-000-695	\$670.07	952-000-694	\$670.07
8.0000	0.6875	1.0000	3.0313	1.8750	0.6875	34	952-000-697	\$602.69	952-000-700	\$689.68	952-000-699	\$722.65	952-000-698	\$722.65
8.0000	0.7500	1.2500	3.0313	1.8750	0.7500	34	952-000-701	\$504.54	952-000-704	\$577.54	952-000-703	\$604.92	952-000-702	\$604.92
8.0000	0.8125	1.2500	3.0313	1.8750	0.8125	34	952-000-705	\$629.51	952-000-708	\$720.42	952-000-707	\$754.87	952-000-706	\$754.87
8.0000	0.8750	1.2500	3.0313	1.8750	0.8750	34	952-000-709	\$656.52	952-000-712	\$751.34	952-000-711	\$787.27	952-000-710	\$787.27
8.0000	0.9375	1.2500	3.0313	1.8750	0.9375	34	952-000-713	\$679.62	952-000-716	\$777.81	952-000-715	\$814.82	952-000-714	\$814.82
8.0000	1.0000	1.2500	3.0313	1.8750	1.0000	34	952-000-717	\$615.76	952-000-720	\$704.67	952-000-719	\$738.39	952-000-718	\$738.39
9.0000	0.2500	1.2500	3.2188	2.5000	0.2500	36	952-000-721	\$551.91	952-000-724	\$631.77	952-000-723	\$661.75	952-000-722	\$661.75
9.0000	0.3125	1.2500	3.2188	2.5000	0.3125	36	952-000-725	\$613.57	952-000-728	\$702.29	952-000-727	\$735.61	952-000-726	\$735.61
9.0000	0.3750	1.2500	3.2188	2.5000	0.3750	36	952-000-729	\$620.01	952-000-732	\$709.69	952-000-731	\$743.36	952-000-730	\$743.36
9.0000	0.4375	1.2500	3.2188	2.5000	0.4375	36	952-000-733	\$693.54	952-000-736	\$793.73	952-000-735	\$831.50	952-000-734	\$831.50
9.0000	0.5000	1.2500	3.2188	2.5000	0.5000	36	952-000-737	\$713.59	952-000-740	\$816.69	952-000-739	\$855.54	952-000-738	\$855.54
9.0000	0.5625	1.2500	3.2188	2.5000	0.5625	36	952-000-741	\$756.38	952-000-744	\$865.73	952-000-743	\$906.84	952-000-742	\$906.84
9.0000	0.6250	1.2500	3.2188	2.5000	0.6250	36	952-000-745	\$766.58	952-000-748	\$877.39	952-000-747	\$919.04	952-000-746	\$919.04
9.0000	0.6875	1.0000	3.2188	2.5000	0.6875	36	952-000-749	\$793.23	952-000-752	\$907.94	952-000-751	\$951.09	952-000-750	\$951.09
9.0000	0.7500	1.2500	3.2188	2.5000	0.7500	36	952-000-753	\$819.71	952-000-756	\$938.13	952-000-755	\$982.91	952-000-754	\$982.91
9.0000	0.8125	1.2500	3.2188	2.5000	0.8125	36	952-000-757	\$838.75	952-000-760	\$959.96	952-000-759	\$1005.68	952-000-758	\$1005.68
9.0000	0.8750	1.2500	3.2188	2.5000	0.8750	36	952-000-761	\$846.88	952-000-764	\$969.20	952-000-763	\$1015.47	952-000-762	\$1015.47
9.0000	0.9375	1.2500	3.2188	2.5000	0.9375	36	952-000-765	\$889.35	952-000-768	\$1017.89	952-000-767	\$1066.37	952-000-766	\$1066.37
9.0000	1.0000	1.2500	3.2188	2.5000	1.0000	36	952-000-769	\$986.62	952-000-772	\$862.01	952-000-771	\$1033.61	952-000-770	\$1033.61
10.0000	0.2500	1.5000	3.3438	3.2500	0.2500	38	952-000-117	\$692.87	952-000-120	\$792.97	952-000-119	\$830.73	952-000-118	\$830.73
10.0000	0.3125	1.5000	3.3438	3.2500	0.3125	38	952-000-121	\$865.73	952-000-124	\$756.38	952-000-123	\$906.84	952-000-122	\$906.84
10.0000	0.3750	1.5000	3.3438	3.2500	0.3750	38	952-000-125	\$817.51	952-000-128	\$935.68	952-000-127	\$980.13	952-000-126	\$980.13
10.0000	0.4375	1.5000	3.3438	3.2500	0.4375	38	952-000-129	\$863.19	952-000-132	\$987.89	952-000-131	\$1034.92	952-000-130	\$1034.92
10.0000	0.5000	1.5000	3.3438	3.2500	0.5000	38	952-000-133	\$902.60	952-000-136	\$1033.07	952-000-135	\$1082.32	952-000-134	\$1082.32
10.0000	0.5625	1.5000	3.3438	3.2500	0.5625	38	952-000-137	\$935.20	952-000-140	\$1070.26	952-000-139	\$1121.37	952-000-138	\$1121.37
10.0000	0.6250	1.5000	3.3438	3.2500	0.6250	38	952-000-141	\$968.31	952-000-144	\$1108.22	952-000-143	\$1160.97	952-000-142	\$1160.97
10.0000	0.6875	1.5000	3.3438	3.2500	0.6875	38	952-000-145	\$1010.60	952-000-148	\$1156.71	952-000-147	\$1211.68	952-000-146	\$1211.68
10.0000	0.7500	1.5000	3.3438	3.2500	0.7500	38	952-000-149	\$1029.62	952-000-152	\$1178.36	952-000-151	\$1234.46	952-000-150	\$1234.46
10.0000	0.8125	1.5000	3.3438	3.2500	0.8125	38	952-000-153	\$1058.15	952-000-156	\$1211.14	952-000-155	\$1268.71	952-000-154	\$1268.71
10.0000	0.8750	1.5000	3.3438	3.2500	0.8750	38	952-000-157	\$1090.07	952-000-160	\$1247.59	952-000-159	\$1307.02	952-000-158	\$1307.02
10.0000	0.9375	1.5000	3.3438	3.2500	0.9375	38	952-000-161	\$1195.01	952-000-164	\$1367.74	952-000-163	\$1432.89	952-000-162	\$1432.89
10.0000	1.0000	1.5000	3.3438	3.2500	1.0000	38	952-000-165	\$1165.81	952-000-168	\$1334.22	952-000-167	\$1397.90	952-000-166	\$1397.90

*Make To Order

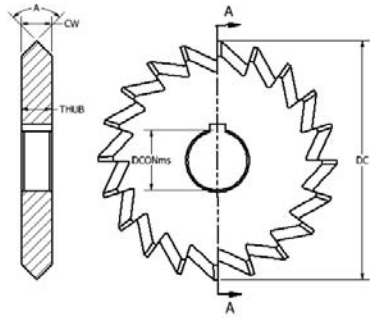

DA Style

- Three Standard Angles
- Excellent for thin Milling Notches, Chamfers, Serrations and Angles

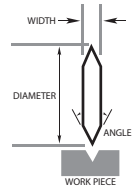

DC	CW	DCONms	THUB	A	Zc	Uncoated	Price	TiN Coated*	Price	TiCN Coated*	Price	TiAlN Coated	Price
2.7500	0.5000	1.0000	1.2500	45.0	20	900-000-001	\$108.16	900-000-004	\$123.83	900-000-003	\$129.76	900-000-002	\$129.76
2.7500	0.5000	1.0000	0.5000	60.0	20	900-000-005	\$108.16	900-000-008	\$123.83	900-000-007	\$129.76	900-000-006	\$129.76
2.7500	0.5000	1.0000	0.5000	90.0	20	900-000-041	\$108.16	900-000-044	\$123.83	900-000-043	\$129.76	900-000-042	\$129.76
4.0000	0.5000	1.2500	0.5000	60.0	20	900-000-009	\$227.21	900-000-012	\$260.08	900-000-011	\$272.46	900-000-010	\$272.46
4.0000	0.5000	1.2500	0.5000	90.0	20	900-000-045	\$227.21	900-000-048	\$260.08	900-000-047	\$272.46	900-000-046	\$272.46
4.0000	0.7500	1.2500	0.7500	60.0	20	900-000-013	\$247.61	900-000-016	\$283.38	900-000-015	\$296.91	900-000-014	\$296.91
4.0000	0.7500	1.2500	0.7500	90.0	20	900-000-049	\$247.61	900-000-052	\$283.38	900-000-051	\$296.91	900-000-050	\$296.91
4.0000	1.0000	1.2500	1.0000	60.0	20	900-000-017	\$305.83	900-000-020	\$350.02	900-000-019	\$366.68	900-000-018	\$366.68
4.0000	1.0000	1.2500	1.0000	90.0	20	900-000-053	\$305.83	900-000-056	\$350.02	900-000-055	\$366.68	900-000-054	\$366.68
5.0000	0.7500	1.2500	0.7500	60.0	24	900-000-021	\$345.58	900-000-024	\$395.56	900-000-023	\$414.44	900-000-022	\$414.44
5.0000	0.7500	1.2500	0.7500	90.0	24	900-000-057	\$345.58	900-000-060	\$395.56	900-000-059	\$414.44	900-000-058	\$414.44
5.0000	1.0000	1.2500	1.0000	60.0	24	900-000-025	\$419.44	900-000-028	\$480.15	900-000-027	\$502.91	900-000-026	\$502.91
5.0000	1.0000	1.2500	1.0000	90.0	24	900-000-061	\$419.44	900-000-064	\$480.15	900-000-063	\$502.91	900-000-062	\$502.91
6.0000	1.0000	1.2500	1.0000	60.0	28	900-000-029	\$521.19	900-000-032	\$596.40	900-000-031	\$624.91	900-000-030	\$624.91
6.0000	1.0000	1.2500	1.0000	90.0	28	900-000-065	\$521.19	900-000-068	\$596.40	900-000-067	\$624.91	900-000-066	\$624.91
6.0000	1.2500	1.2500	1.2500	60.0	28	900-000-033	\$668.57	900-000-036	\$765.21	900-000-035	\$801.68	900-000-034	\$801.68
6.0000	1.0000	1.2500	1.0000	90.0	28	900-000-069	\$668.57	900-000-072	\$765.21	900-000-071	\$801.68	900-000-070	\$801.68
6.0000	1.5000	1.2500	1.5000	60.0	28	900-000-037	\$707.83	900-000-040	\$810.02	900-000-039	\$848.71	900-000-038	\$848.71
6.0000	1.2500	1.2500	1.2500	90.0	28	900-000-073	\$707.83	900-000-076	\$810.02	900-000-075	\$848.71	900-000-074	\$848.71

*Make To Order

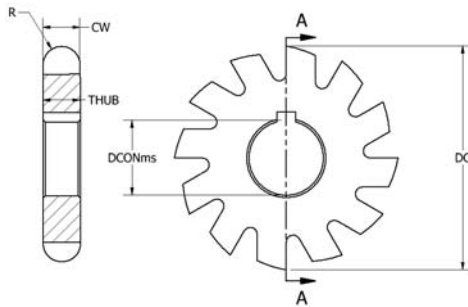

CVS Style

- Convex Radius

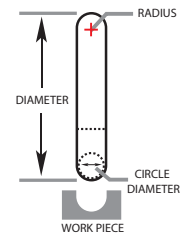

DC	CW	DCONms	THUB	R	Zc	Uncoated	Price	TiN Coated*	Price	TiCN Coated*	Price	TiAlN Coated	Price
2.2500	0.1250	1.0000	0.1250	0.0625	16	921-000-001	\$96.98	921-000-004	\$111.07	921-000-003	\$116.27	921-000-002	\$116.27
2.2500	0.1875	1.0000	0.1875	0.0625	16	921-000-005	\$103.61	921-000-008	\$118.66	921-000-007	\$124.20	921-000-006	\$124.20
2.5000	0.2500	1.0000	0.2500	0.1250	14	921-000-009	\$112.61	921-000-012	\$128.83	921-000-011	\$134.94	921-000-010	\$134.94
2.7500	0.3125	1.0000	0.3125	0.1563	14	921-000-013	\$124.65	921-000-016	\$142.72	921-000-015	\$149.37	921-000-014	\$149.37
2.7500	0.3750	1.0000	0.1875	0.3750	12	921-000-017	\$136.21	921-000-020	\$155.83	921-000-019	\$163.25	921-000-018	\$163.25
3.0000	0.4375	1.0000	0.2188	0.4375	12	921-000-021	\$154.86	921-000-024	\$177.33	921-000-023	\$185.64	921-000-022	\$185.64
3.0000	0.5000	1.0000	0.2500	0.5000	12	921-000-025	\$178.32	921-000-028	\$204.17	921-000-027	\$213.80	921-000-026	\$213.80
3.5000	0.6250	1.2500	0.3125	0.6250	12	921-000-029	\$232.97	921-000-032	\$266.74	921-000-031	\$279.34	921-000-030	\$279.34
3.7500	0.7500	1.2500	0.7500	0.3750	12	921-000-033	\$267.62	921-000-036	\$306.34	921-000-035	\$320.98	921-000-034	\$320.98
4.0000	0.8750	1.2500	0.8750	0.4375	12	921-000-037	\$304.99	921-000-040	\$349.10	921-000-039	\$365.75	921-000-038	\$365.75
4.2500	1.0000	1.2500	0.5000	1.0000	10	921-000-041	\$362.73	921-000-044	\$415.19	921-000-043	\$434.99	921-000-042	\$434.99
4.2500	1.1250	1.2500	0.5625	1.1250	10	921-000-045	\$544.78	921-000-048	\$623.45	921-000-047	\$653.24	921-000-046	\$653.24
4.5000	1.2500	1.2500	0.6250	1.2500	10	921-000-049	\$625.80	921-000-052	\$716.17	921-000-051	\$750.40	921-000-050	\$750.40
4.7500	1.3750	1.2500	0.6875	1.3750	10	921-000-053	\$660.60	921-000-056	\$756.14	921-000-055	\$792.07	921-000-054	\$792.07
5.0000	1.5000	1.2500	0.7500	1.5000	10	921-000-057	\$719.20	921-000-060	\$823.15	921-000-059	\$862.40	921-000-058	\$862.40

*Make To Order

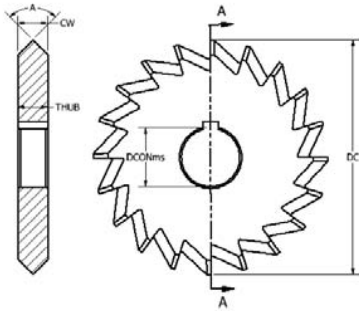

FL Style

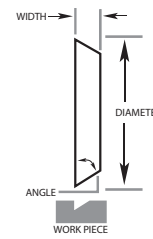

DC	CW	DCONms	CDX	THUB	A	Zc	Uncoated	Price	TiN Coated*	Price	TiCN Coated*	Price	TiAlN Coated	Price
2.7500	0.5000	1.0000	0.5000	0.5000	45.0	20	900-000-077	\$108.16	900-000-080	\$123.83	900-000-079	\$129.76	900-000-078	\$129.76
2.7500	0.5000	1.0000	0.2887	0.5000	60.0	20	900-000-157	\$108.16	900-000-160	\$123.83	900-000-159	\$129.76	900-000-158	\$129.76
3.0000	0.5000	1.2500	0.5000	0.5000	45.0	20	900-000-085	\$128.19	900-000-088	\$146.80	900-000-087	\$153.82	900-000-086	\$153.82
3.0000	0.5000	1.2500	0.2887	0.5000	60.0	20	900-000-165	\$128.19	900-000-168	\$146.80	900-000-167	\$153.82	900-000-166	\$153.82
4.0000	0.5000	1.2500	0.5000	0.5000	45.0	20	900-000-093	\$227.21	900-000-096	\$260.08	900-000-095	\$272.46	900-000-094	\$272.46
4.0000	0.5000	1.2500	0.2887	0.5000	60.0	20	900-000-173	\$227.21	900-000-176	\$260.08	900-000-175	\$272.46	900-000-174	\$272.46
4.0000	0.7500	1.2500	0.7500	0.7500	45.0	20	900-000-101	\$247.61	900-000-104	\$283.38	900-000-103	\$296.91	900-000-102	\$296.91
4.0000	0.7500	1.2500	0.4330	0.7500	60.0	20	900-000-181	\$247.61	900-000-184	\$283.38	900-000-183	\$296.91	900-000-182	\$296.91
4.0000	1.0000	1.2500	1.0000	1.0000	45.0	20	900-000-109	\$305.83	900-000-112	\$350.02	900-000-111	\$366.68	900-000-110	\$366.68
4.0000	1.0000	1.2500	0.5774	1.0000	60.0	20	900-000-189	\$305.83	900-000-192	\$350.02	900-000-191	\$366.68	900-000-190	\$366.68
5.0000	0.7500	1.2500	0.7500	0.7500	45.0	24	900-000-117	\$345.58	900-000-120	\$395.56	900-000-119	\$414.44	900-000-118	\$414.44
4.0000	0.7500	1.2500	0.4330	0.7500	60.0	24	900-000-197	\$345.58	900-000-200	\$395.56	900-000-199	\$414.44	900-000-198	\$414.44
5.0000	1.0000	1.2500	1.0000	1.0000	45.0	24	900-000-125	\$419.44	900-000-128	\$480.15	900-000-127	\$502.91	900-000-126	\$502.91
5.0000	1.0000	1.2500	0.5774	1.0000	60.0	24	900-000-205	\$419.44	900-000-208	\$480.15	900-000-207	\$502.91	900-000-206	\$502.91
6.0000	0.7500	1.2500	0.7500	0.7500	45.0	28	900-000-133	\$464.62	900-000-136	\$531.81	900-000-135	\$557.16	900-000-134	\$557.16
6.0000	0.7500	1.2500	0.4330	0.7500	60.0	28	900-000-213	\$464.62	900-000-216	\$531.81	900-000-215	\$557.16	900-000-214	\$557.16
6.0000	1.0000	1.2500	1.0000	1.0000	45.0	28	900-000-141	\$521.02	900-000-144	\$596.21	900-000-143	\$624.73	900-000-142	\$624.73
6.0000	1.0000	1.2500	0.5774	1.0000	60.0	28	900-000-221	\$521.02	900-000-224	\$596.21	900-000-223	\$624.73	900-000-222	\$624.73
6.0000	1.2500	1.2500	1.2500	1.2500	45.0	28	900-000-149	\$668.57	900-000-152	\$765.21	900-000-151	\$801.68	900-000-150	\$801.68
6.0000	1.2500	1.2500	0.7217	1.2500	60.0	28	900-000-229	\$668.57	900-000-232	\$765.21	900-000-231	\$801.68	900-000-230	\$801.68

*Make To Order

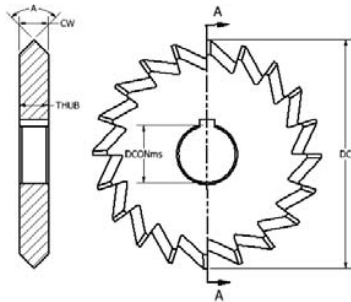

FR Style

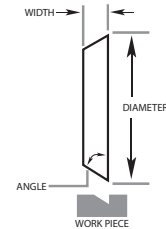

DC	CW	DCONms	CDX	THUB	A	Zc	Uncoated	Price	TiN Coated*	Price	TiCN Coated*	Price	TiAlN Coated	Price
2.7500	0.5000	1.0000	0.5000	0.5000	45.0	20	900-000-081	\$108.16	900-000-084	\$123.83	900-000-083	\$129.76	900-000-082	\$129.76
2.7500	0.5000	1.0000	0.2887	0.5000	60.0	20	900-000-161	\$108.16	900-000-164	\$123.83	900-000-163	\$129.76	900-000-162	\$129.76
3.0000	0.5000	1.2500	0.5000	0.5000	45.0	20	900-000-089	\$128.19	900-000-092	\$146.80	900-000-091	\$153.82	900-000-090	\$153.82
3.0000	0.5000	1.2500	0.2887	0.5000	60.0	20	900-000-169	\$128.19	900-000-172	\$146.80	900-000-171	\$153.82	900-000-170	\$153.82
4.0000	0.5000	1.2500	0.5000	0.5000	45.0	20	900-000-097	\$227.21	900-000-100	\$260.08	900-000-099	\$272.46	900-000-098	\$272.46
4.0000	0.5000	1.2500	0.2887	0.5000	60.0	20	900-000-177	\$227.21	900-000-180	\$260.08	900-000-179	\$272.46	900-000-178	\$272.46
4.0000	0.7500	1.2500	0.7500	0.7500	45.0	20	900-000-105	\$247.61	900-000-108	\$283.38	900-000-107	\$296.91	900-000-106	\$296.91
4.0000	0.7500	1.2500	0.4330	0.7500	60.0	20	900-000-185	\$247.61	900-000-188	\$283.38	900-000-187	\$296.91	900-000-186	\$296.91
4.0000	1.0000	1.2500	1.0000	1.0000	45.0	20	900-000-113	\$305.83	900-000-116	\$350.02	900-000-115	\$366.68	900-000-114	\$366.68
4.0000	1.0000	1.2500	0.5774	1.0000	60.0	20	900-000-193	\$305.83	900-000-196	\$350.02	900-000-195	\$366.68	900-000-194	\$366.68
5.0000	0.7500	1.2500	0.7500	0.7500	45.0	24	900-000-121	\$345.58	900-000-124	\$395.56	900-000-123	\$414.44	900-000-122	\$414.44
5.0000	0.7500	1.2500	0.4330	0.7500	60.0	24	900-000-201	\$345.58	900-000-204	\$395.56	900-000-203	\$414.44	900-000-202	\$414.44
5.0000	1.0000	1.2500	1.0000	1.0000	45.0	24	900-000-129	\$419.44	900-000-132	\$480.15	900-000-131	\$502.91	900-000-130	\$502.91
5.0000	1.0000	1.2500	0.5774	1.0000	60.0	24	900-000-209	\$419.44	900-000-212	\$480.15	900-000-211	\$502.91	900-000-210	\$502.91
6.0000	0.7500	1.2500	0.7500	0.7500	45.0	28	900-000-137	\$464.62	900-000-140	\$531.81	900-000-139	\$557.16	900-000-138	\$557.16
6.0000	0.7500	1.2500	0.4330	0.7500	60.0	28	900-000-217	\$464.62	900-000-220	\$531.81	900-000-219	\$557.16	900-000-218	\$557.16
6.0000	1.0000	1.2500	1.0000	1.0000	45.0	28	900-000-145	\$521.02	900-000-148	\$596.21	900-000-147	\$624.73	900-000-146	\$624.73
6.0000	1.0000	1.2500	0.5774	1.0000	60.0	28	900-000-225	\$521.02	900-000-228	\$596.21	900-000-227	\$624.73	900-000-226	\$624.73
6.0000	1.2500	1.2500	1.2500	1.2500	45.0	28	900-000-153	\$668.57	900-000-156	\$765.21	900-000-155	\$801.68	900-000-154	\$801.68
6.0000	1.2500	1.2500	0.7217	1.2500	60.0	28	900-000-233	\$668.57	900-000-236	\$765.21	900-000-235	\$801.68	900-000-234	\$801.68

*Make To Order

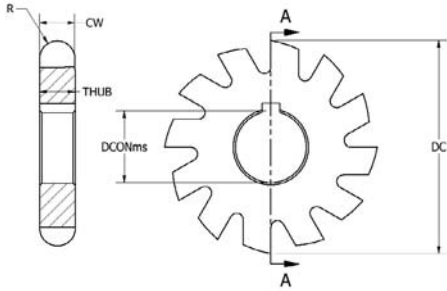

CVL Style
• Convex Radius

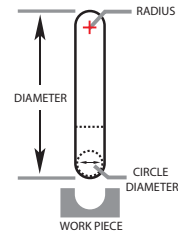

DC	CW	DCONms	THUB	R	Zc	Uncoated	Price	TiN Coated*	Price	TiCN Coated*	Price	TiAlN Coated	Price
4.0000	0.1250	1.2500	0.1250	0.0625	22	921-000-061	\$227.88	921-000-064	\$260.81	921-000-063	\$273.20	921-000-062	\$273.20
4.0000	0.1875	1.2500	0.0938	0.1875	22	921-000-065	\$245.55	921-000-068	\$280.99	921-000-067	\$294.50	921-000-066	\$294.50
4.0000	0.2500	1.2500	0.1250	0.2500	22	921-000-069	\$253.55	921-000-072	\$290.25	921-000-071	\$303.93	921-000-070	\$303.93
5.0000	0.3125	1.2500	0.3125	0.1563	18	921-000-073	\$299.89	921-000-076	\$343.19	921-000-075	\$359.66	921-000-083	\$359.66
5.0000	0.3750	1.2500	0.1875	0.3750	18	921-000-077	\$319.25	921-000-080	\$365.39	921-000-079	\$382.80	921-000-078	\$382.80
5.0000	0.4375	1.2500	0.2188	0.4375	18	921-000-081	\$337.78	921-000-084	\$386.50	921-000-083	\$405.00	921-000-082	\$405.00
5.0000	0.5000	1.2500	0.2500	0.5000	18	921-000-085	\$344.56	921-000-088	\$394.27	921-000-087	\$413.15	921-000-086	\$413.15
5.0000	0.6250	1.2500	0.3125	0.6250	18	921-000-089	\$368.20	921-000-092	\$421.28	921-000-091	\$441.46	921-000-090	\$441.46
6.0000	0.7500	1.2500	0.3750	0.7500	14	921-000-093	\$509.30	921-000-096	\$582.90	921-000-095	\$610.67	921-000-094	\$610.67
6.0000	0.8750	1.2500	0.8750	0.8750	14	921-000-097	\$554.79	921-000-100	\$634.90	921-000-099	\$665.27	921-000-098	\$665.27
6.0000	1.0000	1.2500	0.5000	1.0000	14	921-000-101	\$597.94	921-000-104	\$684.31	921-000-103	\$716.91	921-000-102	\$716.91
6.0000	1.2500	1.2500	0.6250	1.2500	14	921-000-105	\$621.70	921-000-108	\$711.54	921-000-107	\$745.40	921-000-106	\$745.40

*Make To Order

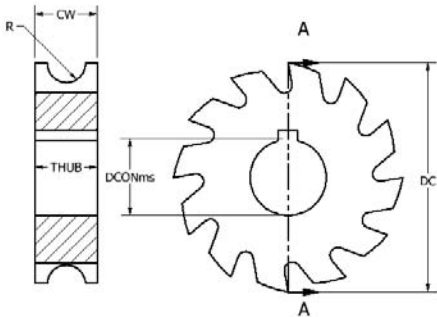

CC Style
• Concave Radius

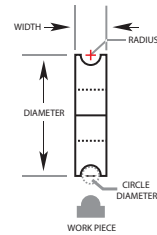

DC	CW	DCONms	THUB	R	Zc	Uncoated	Price	TiN Coated*	Price	TiCN Coated*	Price	TiAlN Coated	Price
2.2500	0.2500	1.0000	0.2500	0.0625	16	904-000-005	\$103.61	904-000-012	\$118.66	904-000-011	\$124.20	904-000-010	\$124.20
2.2500	0.3750	1.0000	0.0938	0.3750	16	904-000-029	\$113.96	904-000-032	\$130.50	904-000-031	\$136.61	904-000-030	\$136.61
2.5000	0.4375	1.0000	0.4375	0.1250	14	904-000-033	\$127.38	904-000-036	\$145.87	904-000-035	\$152.70	904-000-034	\$152.70
2.7500	0.5625	1.0000	0.1563	0.5625	14	904-000-037	\$156.92	904-000-040	\$179.54	904-000-039	\$188.06	904-000-038	\$188.06
2.7500	0.6250	1.0000	0.1875	0.6250	12	904-000-041	\$156.92	904-000-044	\$179.54	904-000-043	\$188.06	904-000-042	\$188.06
3.0000	0.7500	1.0000	0.7500	0.2188	12	904-000-045	\$195.13	904-000-048	\$223.23	904-000-047	\$233.99	904-000-046	\$233.99
3.0000	0.8125	1.0000	0.2500	0.8125	12	904-000-049	\$201.40	904-000-052	\$230.45	904-000-051	\$241.55	904-000-050	\$241.55
3.5000	1.0000	1.2500	0.3125	1.0000	12	904-000-053	\$265.43	904-000-056	\$303.74	904-000-055	\$318.20	904-000-054	\$318.20
3.7500	1.1875	1.2500	0.3750	1.1875	12	904-000-057	\$333.88	904-000-060	\$382.05	904-000-059	\$400.39	904-000-058	\$400.39
4.0000	1.3750	1.2500	0.4375	1.3750	12	904-000-001	\$407.56	904-000-004	\$466.47	904-000-003	\$488.66	904-000-002	\$488.66
4.2500	1.5625	1.2500	0.5000	1.5625	10	904-000-006	\$487.05	904-000-009	\$557.35	904-000-008	\$584.01	904-000-007	\$584.01
4.2500	1.6875	1.2500	0.5625	1.6875	10	904-000-013	\$658.89	904-000-016	\$754.10	904-000-015	\$790.03	904-000-014	\$790.03
4.5000	1.8750	1.2500	0.6250	1.8750	10	904-000-017	\$702.38	904-000-020	\$803.93	904-000-019	\$842.22	904-000-018	\$842.22
4.7500	2.0625	1.2500	0.6875	2.0625	10	904-000-021	\$792.04	904-000-024	\$906.45	904-000-023	\$949.58	904-000-022	\$949.58
5.0000	2.2500	1.2500	0.7500	2.2500	10	904-000-025	\$848.08	904-000-028	\$970.70	904-000-027	\$1016.79	904-000-026	\$1016.79

*Make To Order

SSH



HSS

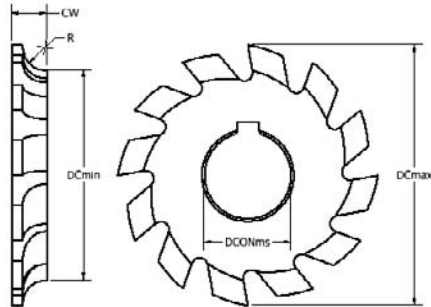

CR Style
• Right hand rotation

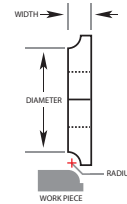

CW	DCONms	R	DCmax	DCmin	Zc	HAND	Uncoated	Price	TiN Coated*	Price	TiCN Coated*	Price	TiAlN Coated	Price
0.2500	1.0000	0.1250	2.5000	2.2500	14	L	918-000-025	\$115.98	918-000-028	\$132.69	918-000-027	\$139.02	918-000-026	\$139.02
0.4063	1.0000	0.2500	3.0000	2.5000	12	L	918-000-029	\$157.09	918-000-032	\$179.73	918-000-031	\$188.43	918-000-030	\$188.43
0.5625	1.2500	0.3750	3.7500	3.0000	12	L	918-000-033	\$229.43	918-000-036	\$262.67	918-000-035	\$275.05	918-000-034	\$275.05
0.7500	1.2500	0.5000	4.2500	3.2500	10	L	918-000-037	\$312.98	918-000-040	\$358.18	918-000-039	\$375.20	918-000-038	\$375.20
0.9375	1.2500	0.6250	4.2500	3.0000	10	L	918-000-041	\$352.55	918-000-044	\$403.53	918-000-043	\$422.77	918-000-042	\$422.77
1.1250	1.2500	0.7500	4.5000	3.0000	10	L	918-000-045	\$425.39	918-000-048	\$486.81	918-000-047	\$510.14	918-000-046	\$510.14

*Make To Order

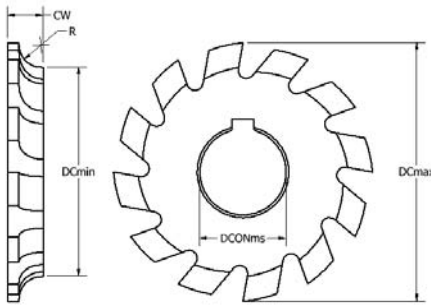

CL Style
• Left hand rotation

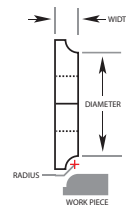

CW	DCONms	R	DCmax	DCmin	Zc	HAND	Uncoated	Price	TiN Coated*	Price	TiCN Coated*	Price	TiAlN Coated	Price
0.2500	1.0000	0.1250	2.5000	2.2500	14	R	918-000-001	\$115.98	918-000-004	\$132.69	918-000-003	\$139.02	918-000-002	\$139.02
0.4063	1.0000	0.2500	3.0000	2.5000	12	R	918-000-005	\$157.09	918-000-008	\$179.73	918-000-007	\$188.43	918-000-006	\$188.43
0.5625	1.2500	0.3750	3.7500	3.0000	12	R	918-000-009	\$229.43	918-000-012	\$262.67	918-000-011	\$275.05	918-000-010	\$275.05
0.7500	1.2500	0.5000	4.2500	3.2500	10	R	918-000-013	\$312.98	918-000-016	\$358.18	918-000-015	\$375.20	918-000-014	\$375.20
0.9375	1.2500	0.6250	4.2500	3.0000	10	R	918-000-017	\$352.55	918-000-020	\$403.53	918-000-019	\$422.77	918-000-018	\$422.77
1.1250	1.2500	0.7500	4.5000	3.0000	10	R	918-000-021	\$425.39	918-000-024	\$486.81	918-000-023	\$510.14	918-000-022	\$510.14

*Make To Order



HSS
COBALT

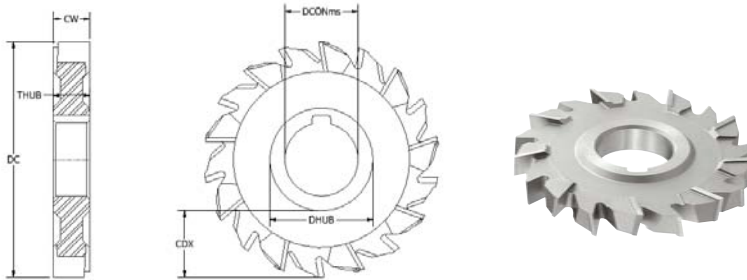

DS Style

- Free Cutting Design
- Long Tool Life
- Refer to page 513 for interlocking set information



DC	CW	DCONms	CDX	DHUB	THUB	Zc	Uncoated	Price	TiN Coated*	Price	TiCN Coated*	Price	TiAlN Coated	Price
3.0000	0.1875	1.0000	0.7188	1.5000	0.1875	16	952-000-841	\$94.42	952-000-844	\$108.09	952-000-843	\$113.28	952-000-842	\$113.28
3.0000	0.2500	1.0000	0.7188	1.5000	0.2500	16	952-000-845	\$100.86	952-000-848	\$115.50	952-000-847	\$120.89	952-000-846	\$120.89
3.0000	0.3125	1.0000	0.7188	1.5000	0.3125	16	952-000-849	\$113.45	952-000-852	\$129.76	952-000-851	\$136.04	952-000-850	\$136.04
3.0000	0.3750	1.0000	0.7188	1.5000	0.3750	16	952-000-853	\$115.31	952-000-856	\$131.99	952-000-855	\$138.26	952-000-854	\$138.26
3.0000	0.5000	1.0000	0.7188	1.5000	0.5000	16	952-000-857	\$140.27	952-000-860	\$160.48	952-000-859	\$168.27	952-000-858	\$168.27
3.0000	0.5000	1.2500	0.5938	1.7500	0.5000	16	952-000-861	\$140.27	952-000-864	\$160.48	952-000-863	\$168.27	952-000-862	\$168.27
4.0000	0.2500	1.0000	1.2188	1.5000	0.2500	18	952-000-865	\$146.22	952-000-868	\$167.33	952-000-867	\$175.28	952-000-866	\$175.28
4.0000	0.2500	1.2500	1.0938	1.7500	0.2500	18	952-000-869	\$146.22	952-000-872	\$167.33	952-000-871	\$175.28	952-000-870	\$175.28
4.0000	0.3125	1.0000	1.2188	1.5000	0.3125	18	952-000-873	\$148.92	952-000-876	\$170.48	952-000-875	\$178.62	952-000-874	\$178.62
4.0000	0.3125	1.2500	1.0938	1.7500	0.3125	18	952-000-877	\$148.92	952-000-880	\$170.48	952-000-879	\$178.62	952-000-878	\$178.62
4.0000	0.3750	1.2500	1.0938	1.7500	0.3750	18	952-000-881	\$152.68	952-000-884	\$174.74	952-000-883	\$183.06	952-000-882	\$183.06
4.0000	0.5000	1.2500	1.0938	1.7500	0.5000	18	952-000-885	\$173.54	952-000-888	\$198.61	952-000-887	\$208.05	952-000-886	\$208.05
4.0000	0.7500	1.2500	1.0938	1.7500	0.7500	18	952-000-889	\$214.81	952-000-892	\$245.82	952-000-891	\$257.64	952-000-890	\$257.64
6.0000	0.2500	1.2500	2.0313	1.8750	0.2500	24	952-000-893	\$296.15	952-000-896	\$338.92	952-000-895	\$355.05	952-000-894	\$355.05
6.0000	0.3750	1.2500	2.0313	1.8750	0.3750	24	952-000-897	\$266.79	952-000-900	\$305.42	952-000-899	\$319.86	952-000-898	\$319.86
6.0000	0.5000	1.2500	2.0313	1.8750	0.5000	24	952-000-901	\$300.74	952-000-904	\$344.31	952-000-903	\$360.59	952-000-902	\$360.59
6.0000	0.7500	1.2500	2.0313	1.8750	0.7500	24	952-000-905	\$391.59	952-000-908	\$448.13	952-000-907	\$469.61	952-000-906	\$469.61
6.0000	1.0000	1.2500	2.0313	1.8750	1.0000	24	952-000-909	\$491.63	952-000-912	\$562.71	952-000-911	\$589.56	952-000-910	\$589.56

*Make To Order



T15 Supreme

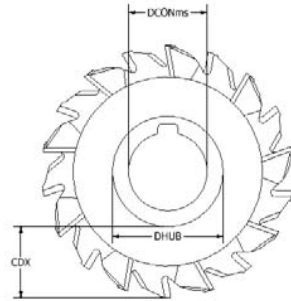
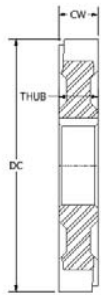

NS Style

- Resistant to High Heat and Abrasive Wear
- Free Cutting Design
- Refer to page 513 for interlocking set information



DC	CW	DCONms	CDX	DHUB	THUB	Zc	Uncoated	Price	TiN Coated*	Price	TiCN Coated*	Price	TiAlN Coated	Price
3.0000	0.1875	1.0000	0.7188	1.5000	0.1875	18	952-000-913	\$107.51	952-000-916	\$123.08	952-000-915	\$128.83	952-000-914	\$128.83
3.0000	0.2188	1.0000	0.7188	1.5000	0.2188	18	952-000-937	\$141.28	952-000-940	\$161.78	952-000-939	\$169.37	952-000-938	\$169.37
3.0000	0.2500	1.0000	0.7188	1.5000	0.2500	18	952-000-917	\$117.70	952-000-920	\$134.76	952-000-919	\$141.05	952-000-918	\$141.05
3.0000	0.2813	1.0000	0.7188	1.5000	0.2813	18	952-000-941	\$146.72	952-000-944	\$167.89	952-000-943	\$175.84	952-000-942	\$175.84
3.0000	0.3125	1.0000	0.7188	1.5000	0.3125	18	952-000-921	\$133.30	952-000-924	\$152.51	952-000-923	\$159.92	952-000-922	\$159.92
3.0000	0.3438	1.0000	0.7188	1.5000	0.3438	18	952-000-945	\$150.46	952-000-948	\$172.14	952-000-947	\$180.48	952-000-946	\$180.48
3.0000	0.3750	1.0000	0.7188	1.5000	0.3750	18	952-000-925	\$138.74	952-000-928	\$158.84	952-000-927	\$166.42	952-000-926	\$166.42
3.0000	0.4063	1.0000	0.7188	1.5000	0.4063	18	952-000-949	\$167.11	952-000-952	\$191.22	952-000-951	\$200.26	952-000-950	\$200.26
3.0000	0.4375	1.0000	0.7188	1.5000	0.4375	18	952-000-929	\$165.90	952-000-932	\$189.91	952-000-931	\$198.99	952-000-930	\$198.99
3.0000	0.4688	1.0000	0.7188	1.5000	0.4688	18	952-000-953	\$172.69	952-000-956	\$197.70	952-000-955	\$207.14	952-000-954	\$207.14
3.0000	0.5000	1.0000	0.7188	1.5000	0.5000	18	952-000-933	\$170.32	952-000-936	\$194.94	952-000-935	\$204.17	952-000-934	\$204.17
4.0000	0.2188	1.2500	1.0938	1.7500	0.2188	22	952-000-993	\$191.56	952-000-996	\$219.17	952-000-995	\$229.72	952-000-994	\$229.72
4.0000	0.2500	1.2500	1.0938	1.7500	0.2500	22	952-000-957	\$172.05	952-000-960	\$196.95	952-000-959	\$206.21	952-000-958	\$206.21
4.0000	0.2813	1.2500	1.0938	1.7500	0.2813	22	952-000-997	\$200.55	952-001-000	\$229.54	952-000-999	\$240.46	952-000-998	\$240.46
4.0000	0.3125	1.2500	1.0938	1.7500	0.3125	22	952-000-961	\$180.18	952-000-964	\$206.21	952-000-963	\$216.01	952-000-962	\$216.01
4.0000	0.3438	1.2500	1.0938	1.7500	0.3438	22	952-001-001	\$221.95	952-001-004	\$253.95	952-001-003	\$266.19	952-001-002	\$266.19
4.0000	0.3750	1.2500	1.0938	1.7500	0.3750	22	952-000-965	\$189.51	952-000-968	\$216.94	952-000-967	\$227.32	952-000-966	\$227.32
4.0000	0.4063	1.2500	1.0938	1.7500	0.4063	22	952-001-005	\$233.49	952-001-008	\$267.29	952-001-007	\$280.08	952-001-006	\$280.08
4.0000	0.4375	1.2500	1.0938	1.7500	0.4375	22	952-000-969	\$209.21	952-000-972	\$239.52	952-000-971	\$250.81	952-000-970	\$250.81
4.0000	0.4688	1.2500	1.0938	1.7500	0.4688	22	952-001-009	\$235.91	952-001-012	\$269.89	952-001-011	\$282.85	952-001-010	\$282.85
4.0000	0.5000	1.2500	1.0938	1.7500	0.5000	22	952-000-973	\$222.31	952-000-976	\$254.33	952-000-975	\$266.56	952-000-974	\$266.56
4.0000	0.5625	1.2500	1.0938	1.7500	0.5625	22	952-000-977	\$271.21	952-000-980	\$310.42	952-000-979	\$325.22	952-000-978	\$325.22
4.0000	0.6250	1.2500	1.0938	1.7500	0.6250	22	952-000-981	\$261.00	952-000-984	\$298.76	952-000-983	\$312.99	952-000-982	\$312.99
4.0000	0.6875	1.2500	1.0938	1.7500	0.6875	22	952-000-985	\$308.06	952-000-988	\$352.62	952-000-987	\$369.28	952-000-986	\$369.28
5.0000	0.7500	1.2500	1.5313	1.8750	0.7500	22	952-000-989	\$286.83	952-000-992	\$328.19	952-000-991	\$343.94	952-000-990	\$343.94
5.0000	0.2188	1.2500	1.5313	1.8750	0.2188	26	952-001-065	\$270.85	952-001-068	\$310.04	952-001-067	\$324.85	952-001-066	\$324.85
5.0000	0.2500	1.2500	1.5313	1.8750	0.2500	26	952-001-013	\$264.93	952-001-016	\$303.21	952-001-015	\$317.64	952-001-014	\$317.64
5.0000	0.2500	1.2500	1.5313	1.8750	0.2500	26	952-001-069	\$298.03	952-001-072	\$341.15	952-001-071	\$357.42	952-001-070	\$357.42
5.0000	0.3125	1.2500	1.5313	1.8750	0.3125	26	952-001-017	\$296.84	952-001-020	\$339.67	952-001-019	\$355.96	952-001-018	\$355.96
5.0000	0.3438	1.2500	1.5313	1.8750	0.3438	26	952-001-073	\$321.97	952-001-076	\$368.52	952-001-075	\$386.12	952-001-074	\$386.12
5.0000	0.3750	1.2500	1.5313	1.8750	0.3750	26	952-001-021	\$323.17	952-001-024	\$369.85	952-001-023	\$387.43	952-001-022	\$387.43
5.0000	0.4063	1.2500	1.5313	1.8750	0.4063	26	952-001-077	\$349.82	952-001-080	\$400.39	952-001-079	\$419.44	952-001-078	\$419.44
5.0000	0.4375	1.2500	1.5313	1.8750	0.4375	26	952-001-025	\$349.50	952-001-028	\$400.01	952-001-027	\$419.08	952-001-026	\$419.08
5.0000	0.4688	1.2500	1.5313	1.8750	0.4688	26	952-001-081	\$368.20	952-001-084	\$421.28	952-001-083	\$441.46	952-001-082	\$441.46
5.0000	0.5000	1.2500	1.5313	1.8750	0.5000	26	952-001-029	\$325.88	952-001-032	\$372.98	952-001-031	\$390.75	952-001-030	\$390.75
5.0000	0.5625	1.2500	1.5313	1.8750	0.5625	26	952-001-033	\$386.49	952-001-036	\$442.39	952-001-035	\$463.51	952-001-034	\$463.51
5.0000	0.6250	1.2500	1.5313	1.8750	0.6250	26	952-001-037	\$356.28	952-001-040	\$407.80	952-001-039	\$427.24	952-001-038	\$427.24
5.0000	0.6875	1.2500	1.5313	1.8750	0.6875	26	952-001-041	\$428.12	952-001-044	\$489.97	952-001-043	\$513.30	952-001-042	\$513.30
5.0000	0.7500	1.2500	1.5313	1.8750	0.7500	26	952-001-045	\$401.79	952-001-048	\$459.81	952-001-047	\$481.83	952-001-046	\$481.83

*Make To Order

COBALT

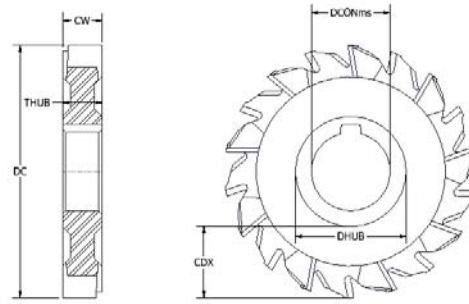

DC	CW	DCONms	CDX	DHUB	THUB	Zc	Uncoated	Price	TiN Coated*	Price	TiCN Coated*	Price	TiAlN Coated	Price
5.0000	0.8125	1.2500	1.5313	1.8750	0.8125	26	952-001-049	\$478.56	952-001-052	\$547.72	952-001-051	\$573.83	952-001-050	\$573.83
5.0000	0.8750	1.2500	1.5313	1.8750	0.8750	26	952-001-053	\$496.74	952-001-056	\$568.45	952-001-055	\$595.66	952-001-054	\$595.66
5.0000	0.9375	1.2500	1.5313	1.8750	0.9375	26	952-001-057	\$518.48	952-001-060	\$593.46	952-001-059	\$621.58	952-001-058	\$621.58
5.0000	1.0000	1.2500	1.5313	1.8750	1.0000	26	952-001-061	\$507.08	952-001-064	\$580.30	952-001-063	\$608.05	952-001-062	\$608.05
6.0000	0.2188	1.2500	2.0313	1.8750	0.2188	30	952-001-137	\$373.78	952-001-140	\$427.77	952-001-139	\$448.13	952-001-138	\$448.13
6.0000	0.2500	1.2500	2.0313	1.8750	0.2500	30	952-001-085	\$347.44	952-001-088	\$397.61	952-001-087	\$416.66	952-001-086	\$416.66
6.0000	0.2813	1.2500	2.0313	1.8750	0.2813	30	952-001-141	\$392.62	952-001-144	\$449.45	952-001-143	\$470.72	952-001-142	\$470.72
6.0000	0.3125	1.2500	2.0313	1.8750	0.3125	30	952-001-089	\$381.77	952-001-092	\$436.85	952-001-091	\$457.76	952-001-090	\$457.76
6.0000	0.3438	1.2500	2.0313	1.8750	0.3438	30	952-001-145	\$426.08	952-001-148	\$426.08	952-001-147	\$510.88	952-001-146	\$510.88
6.0000	0.3750	1.2500	2.0313	1.8750	0.3750	30	952-001-093	\$383.62	952-001-096	\$439.06	952-001-095	\$460.00	952-001-094	\$460.00
6.0000	0.4063	1.2500	2.0313	1.8750	0.4063	30	952-001-149	\$445.62	952-001-152	\$509.95	952-001-151	\$534.21	952-001-150	\$534.21
6.0000	0.4375	1.2500	2.0313	1.8750	0.4375	30	952-001-097	\$433.56	952-001-100	\$496.25	952-001-099	\$519.77	952-001-098	\$519.77
6.0000	0.4688	1.2500	2.0313	1.8750	0.4688	30	952-001-153	\$471.42	952-001-156	\$539.59	952-001-155	\$565.30	952-001-154	\$565.30
6.0000	0.5000	1.2500	2.0313	1.8750	0.5000	30	952-001-101	\$402.48	952-001-104	\$460.72	952-001-103	\$482.57	952-001-102	\$482.57
6.0000	0.5625	1.2500	2.0313	1.8750	0.5625	30	952-001-105	\$498.42	952-001-108	\$570.49	952-001-107	\$597.71	952-001-106	\$597.71
6.0000	0.6250	1.2500	2.0313	1.8750	0.6250	30	952-001-109	\$478.89	952-001-112	\$548.10	952-001-111	\$574.19	952-001-110	\$574.19
6.0000	0.6875	1.2500	2.0313	1.8750	0.6875	30	952-001-113	\$578.08	952-001-116	\$661.57	952-001-115	\$693.04	952-001-114	\$693.04
6.0000	0.7500	1.2500	2.0313	1.8750	0.7500	30	952-001-117	\$547.99	952-001-120	\$627.15	952-001-119	\$657.12	952-001-118	\$657.12
6.0000	0.8125	1.2500	2.0313	1.8750	0.8125	30	952-001-121	\$636.29	952-001-124	\$728.22	952-001-123	\$763.00	952-001-122	\$763.00
6.0000	0.8750	1.2500	2.0313	1.8750	0.8750	30	952-001-125	\$634.12	952-001-128	\$725.78	952-001-127	\$760.23	952-001-126	\$760.23
6.0000	0.9375	1.2500	2.0313	1.8750	0.9375	30	952-001-129	\$724.79	952-001-132	\$829.45	952-001-131	\$869.06	952-001-130	\$869.06
6.0000	1.0000	1.2500	2.0313	1.8750	1.0000	30	952-001-133	\$688.96	952-001-136	\$788.55	952-001-135	\$826.15	952-001-134	\$826.15

*Make To Order

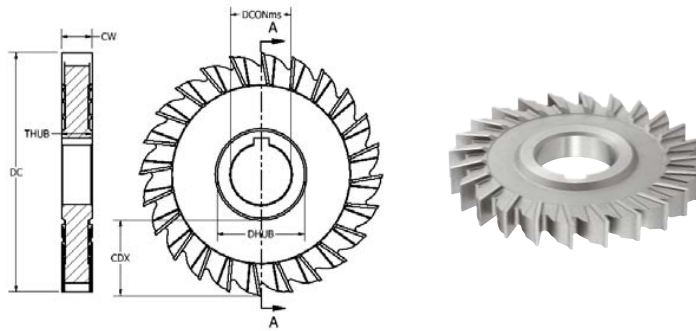

DB Style

- Additional Teeth for Fine Finishes



DC	CW	DCONms	CDX	DHUB	THUB	Zc	Uncoated	Price	TiN Coated*	Price	TiCN Coated*	Price	TiAlN Coated	Price
3.0000	0.2500	1.0000	0.7188	1.5000	0.2500	20	952-000-773	\$84.93	952-000-776	\$97.16	952-000-775	\$101.81	952-000-774	\$101.81
3.0000	0.3125	1.0000	0.7188	1.5000	0.3125	20	952-000-777	\$92.04	952-000-780	\$105.34	952-000-779	\$110.30	952-000-778	\$110.30
3.0000	0.3750	1.0000	0.7188	1.5000	0.3750	20	952-000-781	\$100.38	952-000-784	\$114.94	952-000-783	\$120.31	952-000-782	\$120.31
3.0000	0.5000	1.0000	0.7188	1.5000	0.5000	20	952-000-785	\$102.05	952-000-788	\$116.80	952-000-787	\$122.36	952-000-786	\$122.36
4.0000	0.2500	1.0000	1.1563	1.6250	0.2500	24	952-000-789	\$114.11	952-000-792	\$130.68	952-000-791	\$136.79	952-000-790	\$136.79
4.0000	0.2500	1.2500	1.0938	1.7500	0.2500	24	952-000-793	\$114.11	952-000-796	\$130.68	952-000-795	\$136.79	952-000-794	\$136.79
4.0000	0.3125	1.0000	1.1563	1.6250	0.3125	24	952-000-797	\$142.82	952-000-800	\$163.44	952-000-799	\$171.22	952-000-798	\$171.22
4.0000	1.0938	1.2500	1.0938	1.7500	1.0938	24	952-000-801	\$142.82	952-000-804	\$163.44	952-000-803	\$171.22	952-000-802	\$171.22
4.0000	0.3750	1.0000	1.1563	1.6250	0.3750	24	952-000-805	\$143.49	952-000-808	\$164.19	952-000-807	\$172.14	952-000-806	\$172.14
4.0000	0.3750	1.2500	1.0938	1.7500	0.3750	24	952-000-809	\$143.49	952-000-812	\$164.19	952-000-811	\$172.14	952-000-810	\$172.14
4.0000	0.5000	1.0000	1.1563	1.6250	0.5000	24	952-000-813	\$145.55	952-000-816	\$166.58	952-000-815	\$174.56	952-000-814	\$174.56
4.0000	0.5000	1.2500	1.0938	1.7500	0.5000	24	952-000-817	\$145.55	952-000-820	\$166.58	952-000-819	\$174.56	952-000-818	\$174.56
4.0000	0.7500	1.0000	1.1563	1.6250	0.7500	24	952-000-821	\$181.87	952-000-824	\$208.23	952-000-823	\$218.07	952-000-822	\$218.07
4.0000	0.7500	1.2500	1.0938	1.7500	0.7500	24	952-000-825	\$181.87	952-000-828	\$208.23	952-000-827	\$218.07	952-000-826	\$218.07
6.0000	0.2500	1.2500	2.0313	1.8750	0.2500	30	952-000-829	\$230.27	952-000-832	\$263.60	952-000-831	\$276.17	952-000-830	\$276.17
6.0000	0.3750	1.2500	2.0313	1.8750	0.3750	30	952-000-833	\$257.80	952-000-836	\$295.05	952-000-835	\$309.13	952-000-834	\$309.13
6.0000	0.5000	1.2500	2.0313	1.8750	0.5000	30	952-000-837	\$273.56	952-000-840	\$313.18	952-000-839	\$327.99	952-000-838	\$327.99

*Make To Order



PLAIN/SHELL MILLS

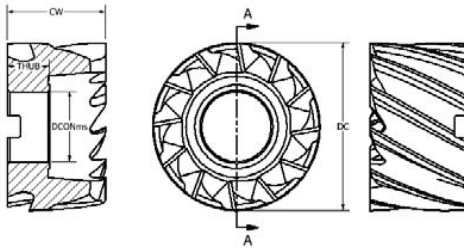

SMGP

- Ground Flutes
- Available in Right-Hand or Left-Hand by special order

General Purpose

DC	CW	DCONms	THUB	Zc	Uncoated	Price	TiN Coated*	Price	TiCN Coated*	Price	TiAlN Coated	Price
1.2500	1.0000	0.5000	0.6250	8	938-000-001	\$92.04	938-000-004	\$105.34	938-000-003	\$110.30	938-000-002	\$110.30
1.5000	1.1250	0.5000	0.6250	8	938-000-005	\$105.34	938-000-008	\$108.65	938-000-007	\$113.82	938-000-006	\$113.82
1.7500	1.2500	0.7500	0.7500	8	938-000-009	\$120.92	938-000-012	\$138.47	938-000-011	\$144.95	938-000-010	\$144.95
2.0000	1.3750	0.7500	0.7500	10	938-000-013	\$135.87	938-000-016	\$155.50	938-000-015	\$162.88	938-000-014	\$162.88
2.2500	1.5000	1.0000	0.7500	10	938-000-017	\$149.45	938-000-020	\$171.05	938-000-019	\$179.18	938-000-018	\$179.18
2.5000	1.6250	1.0000	0.7500	10	938-000-021	\$179.32	938-000-024	\$205.28	938-000-023	\$215.06	938-000-022	\$215.06
2.7500	1.6250	1.0000	0.7500	10	938-000-025	\$223.65	938-000-028	\$256.00	938-000-027	\$268.22	938-000-026	\$268.22
3.0000	1.7500	1.2500	0.7500	12	938-000-029	\$242.85	938-000-032	\$278.02	938-000-031	\$291.17	938-000-030	\$291.17
3.5000	1.8750	1.2500	0.7500	12	938-000-033	\$335.73	938-000-036	\$384.28	938-000-035	\$402.60	938-000-034	\$402.60
4.0000	2.2500	1.5000	1.0000	14	938-000-037	\$405.54	938-000-040	\$464.04	938-000-039	\$486.27	938-000-038	\$486.27
4.5000	2.2500	1.5000	1.0000	14	938-000-041	\$509.46	938-000-044	\$583.07	938-000-043	\$610.85	938-000-042	\$610.85
5.0000	2.2500	1.5000	1.0000	16	938-000-045	\$636.99	938-000-048	\$729.12	938-000-047	\$763.75	938-000-046	\$763.75
5.0000	2.2500	1.5000	1.0000	16	938-000-049	\$921.95	938-000-052	\$1055.09	938-000-051	\$1105.42	938-000-050	\$1105.42

*Make To Order

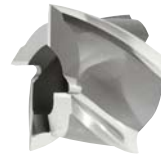
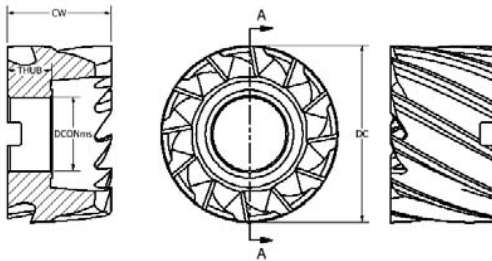

SMAL

- Deep Gullet Space
- Excellent for Non-Ferrous Materials
- High Rake and Polished Flutes

Aluminum Cutting

DC	CW	DCONms	THUB	Zc	Uncoated	Price	TiN Coated*	Price	TiCN Coated*	Price	TiAlN Coated	Price
1.2500	1.0000	0.5000	0.6250	4	938-000-053	\$103.07	938-000-056	\$117.91	938-000-055	\$123.67	938-000-054	\$123.67
1.5000	1.1250	0.5000	0.6250	4	938-000-057	\$105.62	938-000-060	\$120.89	938-000-059	\$126.60	938-000-058	\$126.60
2.0000	1.3750	0.7500	0.7500	4	938-000-061	\$144.19	938-000-064	\$164.93	938-000-063	\$172.90	938-000-062	\$172.90
2.5000	1.6250	1.0000	0.7500	4	938-000-065	\$192.74	938-000-068	\$220.64	938-000-067	\$231.19	938-000-066	\$231.19
3.0000	1.7500	1.2500	0.7500	6	938-000-069	\$263.89	938-000-072	\$302.08	938-000-071	\$316.34	938-000-070	\$316.34
5.0000	2.2500	1.5000	1.0000	6	938-000-073	\$422.85	938-000-076	\$484.04	938-000-075	\$506.99	938-000-074	\$506.99
5.0000	2.2500	1.5000	1.0000	8	938-000-077	\$714.60	938-000-080	\$817.79	938-000-079	\$856.84	938-000-078	\$856.84
5.0000	2.2500	1.5000	1.0000	8	938-000-081	\$1026.39	938-000-084	\$1174.66	938-000-083	\$1230.57	938-000-082	\$1230.57

*Make To Order

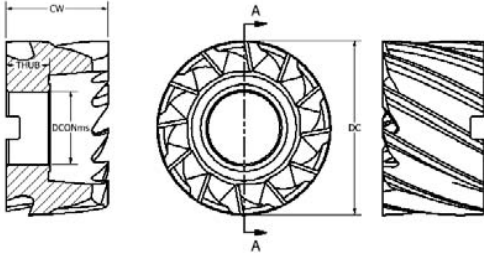

SMT15

- Recommended for finishing
- Resistant to High Heat and Abrasive Wear

DC	CW	DCONms	THUB	Zc	Uncoated	Price	TiN Coated*	Price	TiCN Coated*	Price	TiAlN Coated	Price
1.2500	1.0000	0.5000	0.6250	8	938-000-133	\$119.73	938-000-136	\$136.98	938-000-135	\$143.62	938-000-134	\$143.62
1.5000	1.1250	0.5000	0.6250	8	938-000-137	\$129.24	938-000-140	\$147.91	938-000-139	\$154.93	938-000-138	\$154.93
2.0000	1.3750	0.7500	0.7500	10	938-000-141	\$196.49	938-000-144	\$224.90	938-000-143	\$235.65	938-000-142	\$235.65
2.5000	1.6250	1.0000	0.7500	10	938-000-145	\$276.81	938-000-148	\$316.89	938-000-147	\$331.91	938-000-146	\$331.91
3.0000	1.7500	1.2500	0.7500	12	938-000-149	\$386.86	938-000-152	\$442.76	938-000-151	\$463.87	938-000-150	\$463.87
4.0000	2.2500	1.5000	1.0000	14	938-000-153	\$699.50	938-000-156	\$800.57	938-000-155	\$838.72	938-000-154	\$838.72

*Make To Order

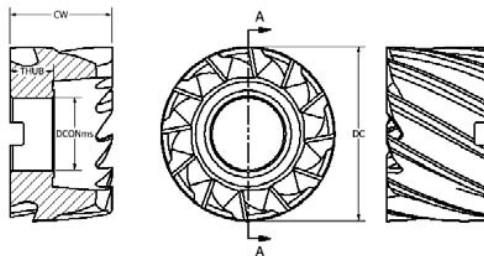

RM750

Coarse-Pitch

DC	CW	DCONms	THUB	Zc	Uncoated	Price	TiN Coated*	Price	TiCN Coated*	Price	TiAlN Coated	Price
2.0000	1.3750	0.7500	0.7500	8	949-000-001	\$225.53	949-000-004	\$258.03	949-000-003	\$270.43	949-000-002	\$270.43
2.2500	1.5000	1.0000	0.7500	8	949-000-005	\$277.66	949-000-008	\$317.82	949-000-007	\$333.00	949-000-006	\$333.00
2.5000	1.6250	1.0000	0.7500	8	949-000-009	\$333.18	949-000-012	\$381.31	949-000-011	\$399.46	949-000-010	\$399.46
2.7500	1.6250	1.0000	0.7500	10	949-000-013	\$368.68	949-000-016	\$422.03	949-000-015	\$422.03	949-000-014	\$422.03
3.0000	2.0000	1.2500	0.7500	10	949-000-017	\$432.54	949-000-020	\$494.99	949-000-019	\$518.68	949-000-018	\$518.68
3.5000	1.8750	1.2500	0.7500	10	949-000-021	\$555.83	949-000-024	\$636.20	949-000-023	\$666.38	949-000-022	\$666.38
4.0000	2.2500	1.5000	1.0000	10	949-000-025	\$759.61	949-000-028	\$869.41	949-000-027	\$910.71	949-000-026	\$910.71
4.5000	2.2500	1.5000	1.0000	12	949-000-029	\$957.94	949-000-032	\$1096.37	949-000-031	\$1148.57	949-000-030	\$1148.57
5.0000	2.2500	1.5000	1.0000	12	949-000-033	\$1082.09	949-000-036	\$1238.52	949-000-035	\$1297.39	949-000-034	\$1297.39
6.0000	2.2500	1.5000	1.0000	14	949-000-037	\$1475.73	949-000-040	\$1689.06	949-000-039	\$1769.41	949-000-038	\$1769.41

*Make To Order

COBALT

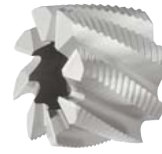
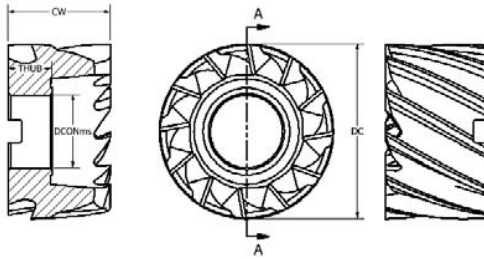

RP450

Fine-Pitch

DC	CW	DCONms	THUB	Zc	Uncoated	Price	TiN Coated*	Price	TiCN Coated*	Price	TiAlN Coated	Price
2.0000	1.3750	0.7500	0.7500	8	949-000-041	\$225.53	949-000-042	\$258.03	949-000-043	\$270.43	949-000-044	\$270.43
2.2500	1.5000	1.0000	0.7500	8	949-000-045	\$277.66	949-000-046	\$317.82	949-000-047	\$333.00	949-000-048	\$333.00
2.5000	1.6250	1.0000	0.7500	8	949-000-049	\$333.18	949-000-050	\$381.31	949-000-051	\$399.46	949-000-052	\$399.46
2.7500	1.6250	1.0000	0.7500	10	949-000-053	\$368.68	949-000-054	\$422.03	949-000-055	\$442.05	949-000-056	\$442.05
3.0000	2.0000	1.2500	0.7500	10	949-000-057	\$432.54	949-000-058	\$494.99	949-000-059	\$518.68	949-000-060	\$518.68
3.5000	1.2500	1.8750	0.7500	10	949-000-061	\$555.83	949-000-062	\$636.2	949-000-063	\$666.38	949-000-064	\$666.38
4.0000	2.2500	1.5000	1.0000	10	949-000-065	\$759.61	949-000-066	\$869.41	949-000-067	\$910.71	949-000-068	\$910.71
4.5000	2.2500	1.5000	1.0000	12	949-000-069	\$957.94	949-000-070	\$1096.37	949-000-071	\$1148.57	949-000-072	\$1148.57
5.0000	2.2500	1.5000	1.0000	12	949-000-073	\$1082.09	949-000-074	\$1238.52	949-000-075	\$1297.39	949-000-076	\$1297.39
6.0000	2.2500	1.5000	1.0000	14	949-000-077	\$1475.73	949-000-078	\$1689.06	949-000-079	\$1769.41	949-000-080	\$1769.41

*Make To Order

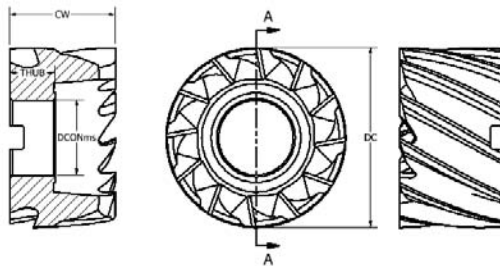

SMM42

DC	CW	DCONms	THUB	Zc	Uncoated	Price	TiN Coated*	Price	TiCN Coated*	Price	TiAlN Coated	Price
1.2500	1.0000	0.5000	0.6250	8	938-000-085	\$106.84	938-000-088	\$122.18	938-000-087	\$128.10	938-000-086	\$128.10
1.5000	1.1250	0.5000	0.6250	8	938-000-089	\$110.55	938-000-092	\$126.60	938-000-091	\$132.53	938-000-090	\$132.53
1.7500	1.2500	0.7500	0.7500	8	938-000-093	\$141.12	938-000-096	\$161.59	938-000-095	\$169.18	938-000-094	\$169.18
2.0000	1.3750	0.7500	0.7500	10	938-000-097	\$159.63	938-000-100	\$182.69	938-000-099	\$191.39	938-000-098	\$191.39
2.2500	1.5000	1.0000	0.7500	10	938-000-101	\$176.27	938-000-104	\$201.76	938-000-103	\$211.36	938-000-102	\$211.36
2.5000	1.6250	1.0000	0.7500	10	938-000-105	\$211.94	938-000-108	\$242.50	938-000-107	\$254.13	938-000-106	\$254.13
2.7500	1.6250	1.0000	0.7500	10	938-000-109	\$261.53	938-000-112	\$299.32	938-000-111	\$313.56	938-000-110	\$313.56
3.0000	1.7500	1.2500	0.7500	12	938-000-113	\$288.18	938-000-116	\$329.84	938-000-115	\$345.58	938-000-114	\$345.58
3.5000	1.8750	1.2500	0.7500	12	938-000-117	\$393.65	938-000-120	\$450.54	938-000-119	\$472.02	938-000-118	\$472.02
4.0000	2.2500	1.5000	1.0000	14	938-000-121	\$489.06	938-000-124	\$559.76	938-000-123	\$586.41	938-000-122	\$586.41
5.0000	2.2500	1.5000	1.0000	16	938-000-125	\$793.23	938-000-128	\$907.94	938-000-127	\$951.09	938-000-126	\$951.09
6.0000	2.2500	1.5000	1.0000	16	938-000-129	\$1091.77	938-000-132	\$1249.44	938-000-131	\$1309.05	938-000-130	\$1309.05

*Make To Order

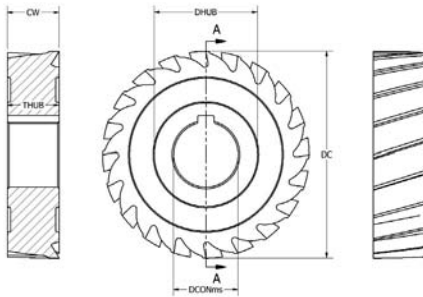

LD Style

- Cutters up to 3/4" face width have straight teeth
- Cutters 3/4" face width and over have 18° left hand helix
- Right-Hand Cut, Left-Hand Helix allows for Rigidity and Improved Surface Finish

Light-Duty

DC	CW	DCONms	DHUB	THUB	Zc	Uncoated	Price	TiN Coated*	Price	TiCN Coated*	Price	TiAlN Coated	Price
2.5000	0.1875	1.0000	1.5000	0.1875	16	948-000-045	\$43.15	948-000-048	\$49.42	948-000-047	\$51.64	948-000-046	\$51.64
2.5000	0.2500	1.0000	1.5000	0.2500	16	948-000-049	\$51.11	948-000-052	\$58.48	948-000-051	\$61.28	948-000-050	\$61.28
2.5000	0.3125	1.0000	1.5000	0.3125	16	948-000-053	\$53.66	948-000-056	\$61.45	948-000-055	\$64.42	948-000-054	\$64.42
2.5000	0.3750	1.0000	1.5000	0.3750	16	948-000-057	\$59.77	948-000-060	\$68.49	948-000-059	\$71.63	948-000-058	\$71.63
2.5000	0.5000	1.0000	1.5000	0.5000	16	948-000-061	\$66.40	948-000-064	\$76.09	948-000-063	\$79.61	948-000-062	\$79.61
2.5000	0.6250	1.0000	1.5000	0.6250	16	948-000-065	\$73.04	948-000-068	\$83.66	948-000-067	\$87.56	948-000-066	\$87.56
2.5000	0.7500	1.0000	1.5000	0.7500	14	948-000-069	\$80.66	948-000-072	\$92.37	948-000-071	\$96.83	948-000-070	\$96.83
2.5000	1.0000	1.0000	1.5000	1.0000	14	948-000-073	\$98.17	948-000-076	\$112.35	948-000-075	\$117.72	948-000-074	\$117.72
2.5000	1.5000	1.0000			14	948-000-077	\$125.66	948-000-080	\$143.82	948-000-079	\$150.67	948-000-078	\$150.67
2.5000	2.0000	1.0000			14	948-000-081	\$151.81	948-000-084	\$173.80	948-000-083	\$181.94	948-000-082	\$181.94
2.5000	2.5000	1.0000			14	948-000-085	\$185.95	948-000-088	\$212.86	948-000-087	\$223.06	948-000-086	\$223.06
2.5000	3.0000	1.0000			14	948-000-089	\$198.69	948-000-092	\$227.50	948-000-091	\$238.22	948-000-090	\$238.22
3.0000	0.1875	1.0000	1.6300	0.1875	18	948-000-093	\$52.99	948-000-096	\$60.72	948-000-095	\$63.50	948-000-094	\$63.50
3.0000	0.2500	1.0000	1.6300	0.2500	18	948-000-097	\$64.87	948-000-100	\$74.23	948-000-099	\$77.74	948-000-098	\$77.74
3.0000	0.3125	1.0000	1.6300	0.3125	18	948-000-101	\$73.04	948-000-104	\$83.66	948-000-103	\$87.56	948-000-102	\$87.56
3.0000	0.3750	1.0000	1.6300	0.3750	18	948-000-105	\$78.64	948-000-108	\$89.94	948-000-107	\$94.23	948-000-106	\$94.23
3.0000	0.3750	1.2500	1.8800	0.3750	18	948-000-109	\$78.64	948-000-112	\$89.94	948-000-111	\$94.23	948-000-110	\$94.23
3.0000	0.5000	1.2500	1.8800	0.5000	18	948-000-113	\$83.56	948-000-116	\$95.69	948-000-115	\$100.14	948-000-114	\$100.14
3.0000	0.6250	1.2500	1.8800	0.6250	18	948-000-117	\$94.77	948-000-120	\$108.46	948-000-119	\$113.64	948-000-118	\$113.64
3.0000	0.7500	1.2500	1.8800	0.7500	16	948-000-121	\$98.83	948-000-124	\$113.09	948-000-123	\$118.46	948-000-122	\$118.46
3.0000	1.0000	1.2500	1.8800	1.0000	16	948-000-125	\$130.60	948-000-128	\$149.37	948-000-127	\$156.59	948-000-126	\$156.59
3.0000	1.2500	1.2500			16	948-000-129	\$145.01	948-000-132	\$166.04	948-000-131	\$173.8	948-000-130	\$173.8
3.0000	1.5000	1.2500			16	948-000-133	\$159.13	948-000-136	\$182.14	948-000-135	\$190.85	948-000-134	\$190.85
3.0000	2.0000	1.2500			16	948-000-137	\$199.21	948-000-140	\$228.04	948-000-139	\$238.80	948-000-138	\$238.80
3.0000	3.0000	1.2500			16	948-000-141	\$271.03	948-000-144	\$310.24	948-000-143	\$325.05	948-000-142	\$325.05
4.0000	0.2500	1.0000	1.6300	0.2500	20	948-000-145	\$94.77	948-000-148	\$108.46	948-000-147	\$113.64	948-000-146	\$113.64
4.0000	0.2500	1.2500	2.0000	0.2500	20	948-000-149	\$96.81	948-000-152	\$110.88	948-000-151	\$116.05	948-000-150	\$116.05
4.0000	0.3125	1.0000	1.6300	0.3125	20	948-000-153	\$103.75	948-000-156	\$118.84	948-000-155	\$124.39	948-000-154	\$124.39
4.0000	0.3750	1.0000	1.6300	0.3750	20	948-000-157	\$108.85	948-000-160	\$124.58	948-000-159	\$130.50	948-000-158	\$130.50
4.0000	0.3750	1.2500	2.0000	0.3750	20	948-000-161	\$108.85	948-000-164	\$124.58	948-000-163	\$130.50	948-000-162	\$130.50
4.0000	0.5000	1.2500	2.0000	0.5000	20	948-000-165	\$132.80	948-000-168	\$151.98	948-000-167	\$159.20	948-000-166	\$159.20
4.0000	0.6250	1.2500	2.0000	0.6250	20	948-000-169	\$141.45	948-000-172	\$161.96	948-000-171	\$169.56	948-000-170	\$169.56
4.0000	0.7500	1.2500	2.0000	0.7500	20	948-000-173	\$156.06	948-000-176	\$178.62	948-000-175	\$187.15	948-000-174	\$187.15
4.0000	1.0000	1.2500	2.0000	1.0000	20	948-000-177	\$189.35	948-000-180	\$216.76	948-000-179	\$227.11	948-000-178	\$227.11
4.0000	1.5000	1.2500			20	948-000-181	\$241.67	948-000-184	\$276.56	948-000-183	\$289.68	948-000-182	\$289.68
4.0000	2.0000	1.2500			20	948-000-185	\$296.84	948-000-188	\$339.67	948-000-187	\$355.96	948-000-186	\$355.96
4.0000	3.0000	1.2500			20	948-000-189	\$441.21	948-000-192	\$504.95	948-000-191	\$529.04	948-000-190	\$529.04
4.0000	4.0000	1.2500			20	948-000-193	\$588.27	948-000-196	\$673.21	948-000-195	\$705.26	948-000-194	\$705.26

*Make To Order

COBALT



HSS

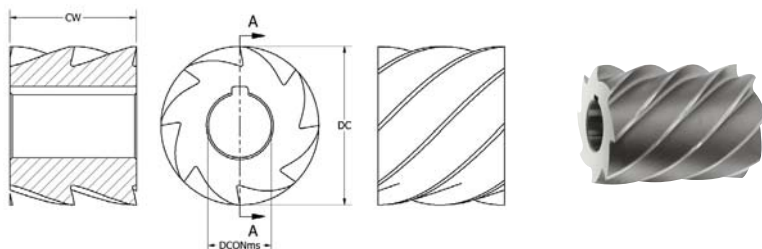

HD Style

- 45° Left-Hand Helix, Right-Hand Cuts
- Fewer teeth than "LD" Style making it better suited for heavy stock removal

45° Spiral Heavy-Duty

DC	CW	DCONms	Zc	Uncoated	Price	TiN Coated*	Price	TiCN Coated*	Price	TiAlN Coated	Price
2.5000	2.0000	1.0000	8	948-000-001	\$163.72	948-000-004	\$187.33	948-000-003	\$196.21	948-000-002	\$196.21
2.5000	4.0000	1.0000	8	948-000-005	\$278.49	948-000-008	\$318.74	948-000-007	\$333.93	948-000-006	\$333.93
3.0000	2.0000	1.2500	8	948-000-009	\$211.94	948-000-012	\$242.50	948-000-011	\$254.13	948-000-010	\$254.13
3.0000	2.5000	1.2500	8	948-000-013	\$259.32	948-000-016	\$296.71	948-000-015	\$310.98	948-000-014	\$310.98
3.0000	3.0000	1.2500	8	948-000-017	\$287.85	948-000-020	\$329.47	948-000-019	\$345.23	948-000-018	\$345.23
3.0000	4.0000	1.2500	8	948-000-021	\$376.68	948-000-024	\$431.11	948-000-023	\$451.65	948-000-022	\$451.65
3.0000	6.0000	1.2500	8	948-000-025	\$590.80	948-000-028	\$676.21	948-000-027	\$708.38	948-000-026	\$708.38
4.0000	2.0000	1.5000	10	948-000-029	\$314.85	948-000-032	\$360.38	948-000-031	\$377.43	948-000-030	\$377.43
4.0000	3.0000	1.5000	10	948-000-033	\$462.60	948-000-036	\$529.40	948-000-035	\$554.57	948-000-034	\$554.57
4.0000	4.0000	1.5000	10	948-000-037	\$666.02	948-000-040	\$762.26	948-000-039	\$798.54	948-000-038	\$798.54
4.0000	6.0000	1.5000	10	948-000-041	\$938.79	948-000-044	\$1074.33	948-000-043	\$1125.60	948-000-042	\$1125.60

*Make To Order



SLITTING/JEWELER SAWS

THE COMPLETE TOOL MAKING AUTHORITY™

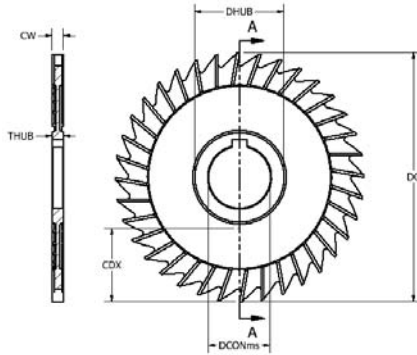

MT Style

- Fully Ground Surfaces
- Recommended for Thin Walled Parts



DC	CW	DCONms	CDX	DHUB	THUB	Zc	Uncoated	Price	TiN Coated*	Price	TiCN Coated*	Price	TiAlN Coated	Price
2.5000	0.0625	0.8750	0.5938	1.2500	0.0625	28	950-001-169	\$68.45	950-001-172	\$78.31	950-001-171	\$82.02	950-001-170	\$82.02
2.5000	0.0938	0.8750	0.5938	1.2500	0.0938	28	950-001-177	\$68.45	950-001-180	\$78.31	950-001-179	\$82.02	950-001-178	\$82.02
2.5000	0.1250	0.8750	0.5938	1.2500	0.1250	28	950-001-173	\$68.45	950-001-176	\$78.31	950-001-175	\$82.02	950-001-174	\$82.02
3.0000	0.0625	1.0000	0.7188	1.5000	0.0625	32	950-001-181	\$82.21	950-001-184	\$94.03	950-001-183	\$98.49	950-001-182	\$98.49
3.0000	0.0781	1.0000	0.7188	1.5000	0.0781	32	950-001-197	\$106.84	950-001-200	\$122.18	950-001-199	\$128.10	950-001-198	\$128.10
3.0000	0.0938	1.0000	0.7188	1.5000	0.0938	32	950-001-209	\$82.21	950-001-212	\$94.03	950-001-211	\$98.49	950-001-210	\$98.49
3.0000	0.1094	1.0000	0.7188	1.5000	0.1094	32	950-001-221	\$107.66	950-001-224	\$123.27	950-001-223	\$129.01	950-001-222	\$129.01
3.0000	0.1250	1.0000	0.7188	1.5000	0.1250	32	950-001-185	\$82.21	950-001-188	\$94.03	950-001-187	\$98.49	950-001-186	\$98.49
3.0000	0.1406	1.0000	0.7188	1.5000	0.1406	32	950-001-201	\$110.22	950-001-204	\$126.05	950-001-203	\$132.16	950-001-202	\$132.16
3.0000	0.1563	1.0000	0.7188	1.5000	0.1563	32	950-001-213	\$82.21	950-001-216	\$94.03	950-001-215	\$98.49	950-001-214	\$98.49
3.0000	0.1719	1.0000	0.7188	1.5000	0.1719	32	950-001-225	\$117.34	950-001-228	\$134.38	950-001-227	\$140.68	950-001-226	\$140.68
3.0000	0.1875	1.0000	0.7188	1.5000	0.1875	32	950-001-189	\$119.88	950-001-192	\$137.16	950-001-191	\$143.82	950-001-190	\$143.82
3.0000	0.2031	1.0000	0.7188	1.5000	0.2031	32	950-001-205	\$123.28	950-001-208	\$141.05	950-001-207	\$147.91	950-001-206	\$147.91
3.0000	0.2188	1.0000	0.7188	1.5000	0.2188	32	950-001-217	\$120.57	950-001-220	\$138.08	950-001-219	\$144.58	950-001-218	\$144.58
3.0000	0.2344	1.0000	0.7188	1.5000	0.2344	32	950-001-229	\$124.65	950-001-232	\$142.72	950-001-231	\$149.37	950-001-230	\$149.37
3.0000	0.2500	1.0000	0.7188	1.5000	0.2500	32	950-001-193	\$120.92	950-001-196	\$138.47	950-001-195	\$144.95	950-001-194	\$144.95
4.0000	0.0625	1.0000	1.2188	1.5000	0.0625	36	950-001-233	\$107.51	950-001-236	\$123.08	950-001-235	\$128.83	950-001-234	\$128.83
4.0000	0.0625	1.2500	1.0313	1.8750	0.0625	36	950-001-237	\$140.78	950-001-240	\$161.06	950-001-239	\$168.79	950-001-238	\$168.79
4.0000	0.0781	1.0000	1.2188	1.5000	0.0781	36	950-001-265	\$147.91	950-001-268	\$169.37	950-001-267	\$177.33	950-001-266	\$177.33
4.0000	0.0781	1.2500	1.0313	1.8750	0.0781	36	950-001-269	\$147.91	950-001-272	\$169.37	950-001-271	\$177.33	950-001-270	\$177.33
4.0000	0.0938	1.0000	1.2188	1.5000	0.0938	36	950-001-289	\$107.51	950-001-292	\$123.08	950-001-291	\$128.83	950-001-290	\$128.83
4.0000	0.0938	1.2500	1.0313	1.8750	0.0938	36	950-001-293	\$140.43	950-001-296	\$160.68	950-001-295	\$168.45	950-001-294	\$168.45
4.0000	0.1094	1.0000	1.2188	1.5000	0.1094	36	950-001-313	\$153.51	950-001-316	\$175.66	950-001-315	\$184.00	950-001-314	\$184.00
4.0000	0.1094	1.2500	1.0313	1.8750	0.1094	36	950-001-317	\$153.51	950-001-320	\$175.66	950-001-319	\$184.00	950-001-318	\$184.00
4.0000	0.1250	1.0000	1.2188	1.5000	0.1250	36	950-001-241	\$108.16	950-001-244	\$123.83	950-001-243	\$129.76	950-001-242	\$129.76
4.0000	0.1250	1.2500	1.0313	1.8750	0.1250	36	950-001-245	\$146.05	950-001-248	\$167.15	950-001-247	\$175.12	950-001-246	\$175.12
4.0000	0.1406	1.0000	1.2188	1.5000	0.1406	36	950-001-273	\$158.61	950-001-276	\$181.59	950-001-275	\$190.10	950-001-274	\$190.10
4.0000	0.1406	1.2500	1.0313	1.8750	0.1406	36	950-001-277	\$158.61	950-001-280	\$181.59	950-001-279	\$190.10	950-001-278	\$190.10
4.0000	0.1563	1.0000	1.2188	1.5000	0.1563	36	950-001-297	\$112.25	950-001-300	\$128.46	950-001-299	\$134.56	950-001-298	\$134.56
4.0000	0.1563	1.2500	1.0313	1.8750	0.1563	36	950-001-301	\$152.51	950-001-304	\$174.56	950-001-303	\$182.89	950-001-302	\$182.89
4.0000	0.1719	1.0000	1.2188	1.5000	0.1719	36	950-001-321	\$163.20	950-001-324	\$186.77	950-001-323	\$195.64	950-001-322	\$195.64
4.0000	0.1719	1.2500	1.0313	1.8750	0.1719	36	950-001-325	\$163.20	950-001-328	\$186.77	950-001-327	\$195.64	950-001-326	\$195.64
4.0000	0.1875	1.0000	1.2188	1.5000	0.1875	36	950-001-249	\$116.32	950-001-252	\$133.09	950-001-251	\$139.56	950-001-250	\$139.56
4.0000	0.1875	1.2500	1.0313	1.8750	0.1875	36	950-001-253	\$145.88	950-001-256	\$166.96	950-001-255	\$174.93	950-001-254	\$174.93
4.0000	0.2031	1.0000	1.2188	1.5000	0.2031	36	950-001-281	\$167.27	950-001-284	\$191.39	950-001-283	\$200.65	950-001-282	\$200.65
4.0000	0.2031	1.2500	1.0313	1.8750	0.2031	36	950-001-285	\$167.27	950-001-288	\$191.39	950-001-287	\$200.65	950-001-286	\$200.65
4.0000	0.2188	1.0000	1.2188	1.5000	0.2188	36	950-001-305	\$156.56	950-001-308	\$179.18	950-001-307	\$187.70	950-001-306	\$187.70
4.0000	0.2188	1.2500	1.0313	1.8750	0.2188	36	950-001-309	\$156.56	950-001-312	\$179.18	950-001-311	\$187.70	950-001-310	\$187.70
4.0000	0.2344	1.0000	1.2188	1.5000	0.2344	36	950-001-329	\$169.31	950-001-332	\$193.80	950-001-331	\$203.05	950-001-330	\$203.05
4.0000	0.2344	1.2500	1.0313	1.8750	0.2344	36	950-001-333	\$169.31	950-001-336	\$193.80	950-001-335	\$203.05	950-001-334	\$203.05
4.0000	0.2500	1.0000	1.2188	1.5000	0.2500	36	950-001-257	\$159.29	950-001-260	\$182.33	950-001-259	\$191.03	950-001-258	\$191.03
4.0000	0.2500	1.2500	1.0313	1.8750	0.2500	36	950-001-261	\$159.29	950-001-264	\$182.33	950-001-263	\$191.03	950-001-262	\$191.03

*Make To Order

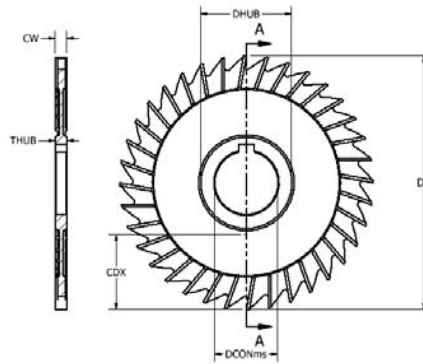

DC	CW	DCONms	CDX	DHUB	THUB	Zc	Uncoated	Price	TiN Coated*	Price	TiCN Coated*	Price	TiAlN Coated	Price
6.0000	0.3594	1.2500	2.0313	1.8750	0.3594	42	950-001-557	\$312.48	950-001-560	\$356.32	950-001-559	\$373.16	950-001-558	\$373.16
6.0000	0.3750	1.0000	2.2188	1.5000	0.3750	42	950-001-433	\$302.44	950-001-436	\$346.14	950-001-435	\$362.62	950-001-434	\$362.62
6.0000	0.3750	1.2500	2.0313	1.8750	0.3750	42	950-001-437	\$302.44	950-001-440	\$346.14	950-001-439	\$362.62	950-001-438	\$362.62
7.0000	0.1250	1.0000	2.6563	1.6250	0.1250	48	950-001-561	\$405.54	950-001-564	\$464.04	950-001-563	\$486.27	950-001-562	\$486.27
7.0000	0.1250	1.2500	2.5313	1.8750	0.1250	48	950-001-565	\$405.54	950-001-568	\$464.04	950-001-567	\$486.27	950-001-566	\$486.27
7.0000	0.1875	1.0000	2.6563	1.6250	0.1875	48	950-001-569	\$405.54	950-001-572	\$464.04	950-001-571	\$486.27	950-001-570	\$486.27
7.0000	0.1875	1.2500	2.5313	1.8750	0.1875	48	950-001-573	\$405.54	950-001-576	\$464.04	950-001-575	\$486.27	950-001-574	\$486.27
8.0000	0.1250	1.0000	3.1563	1.6250	0.1250	48	950-001-577	\$363.40	950-001-580	\$415.92	950-001-579	\$435.72	950-001-578	\$435.72
8.0000	0.1250	1.2500	3.0313	1.8750	0.1250	48	950-001-581	\$363.40	950-001-584	\$415.92	950-001-583	\$435.72	950-001-582	\$435.72
8.0000	0.1250	1.5000	3.0313	1.8750	0.1250	48	950-001-585	\$453.75	950-001-588	\$519.40	950-001-587	\$544.01	950-001-586	\$544.01
8.0000	0.1563	1.2500	3.0313	0.1250	0.1563	48	950-001-613	\$485.83	950-001-616	\$556.07	950-001-615	\$582.51	950-001-614	\$582.51
8.0000	0.1563	1.5000	3.0313	1.8750	0.1563	48	950-001-617	\$485.83	950-001-620	\$556.07	950-001-619	\$582.51	950-001-618	\$582.51
8.0000	0.1875	1.2500	3.0313	1.8750	0.1875	48	950-001-589	\$385.33	950-001-592	\$440.91	950-001-591	\$462.03	950-001-590	\$462.03
8.0000	0.1875	1.5000	3.0313	1.8750	0.1875	48	950-001-593	\$477.02	950-001-596	\$545.86	950-001-595	\$571.97	950-001-594	\$571.97
8.0000	0.2188	1.2500	3.0313	1.8750	0.2188	48	950-001-621	\$493.84	950-001-624	\$565.14	950-001-623	\$592.14	950-001-622	\$592.14
8.0000	0.2188	1.5000	3.0313	1.8750	0.2188	48	950-001-625	\$493.84	950-001-628	\$565.14	950-001-627	\$592.14	950-001-626	\$592.14
8.0000	0.2500	1.2500	3.0313	1.8750	0.2500	48	950-001-597	\$480.06	950-001-600	\$549.38	950-001-599	\$575.68	950-001-598	\$575.68
8.0000	0.2500	1.5000	3.0313	1.8750	0.2500	48	950-001-601	\$521.02	950-001-604	\$596.21	950-001-603	\$624.73	950-001-602	\$624.73
8.0000	0.3750	1.2500	3.0313	1.8750	0.3750	48	950-001-605	\$551.91	950-001-608	\$631.77	950-001-607	\$661.75	950-001-606	\$661.75
8.0000	0.3750	1.5000	3.0313	1.8750	0.3750	48	950-001-609	\$559.04	950-001-612	\$639.90	950-001-611	\$670.24	950-001-610	\$670.24
10.0000	0.1875	1.2500	3.4063	3.1250	0.1875	56	950-001-137	\$792.54	950-001-140	\$907.01	950-001-139	\$950.33	950-001-138	\$950.33
10.0000	0.1875	1.5000	3.4063	3.1250	0.1875	56	950-001-141	\$792.54	950-001-144	\$907.01	950-001-143	\$950.33	950-001-142	\$950.33
10.0000	0.2188	1.2500	3.4063	3.1250	0.2188	56	950-001-161	\$836.20	950-001-164	\$956.98	950-001-163	\$1002.52	950-001-162	\$1002.52
10.0000	0.2188	1.5000	3.4063	3.1250	0.2188	56	950-001-165	\$836.20	950-001-168	\$956.98	950-001-167	\$1002.52	950-001-166	\$1002.52
10.0000	0.2500	1.2500	3.4063	3.1250	0.2500	56	950-001-145	\$752.99	950-001-148	\$861.84	950-001-147	\$902.73	950-001-146	\$902.73
10.0000	0.2500	1.5000	3.4063	3.1250	0.2500	56	950-001-149	\$829.40	950-001-152	\$949.23	950-001-151	\$994.36	950-001-150	\$994.36
10.0000	0.3750	1.2500	3.4063	3.1250	0.3750	56	950-001-153	\$918.71	950-001-156	\$1051.57	950-001-155	\$1101.54	950-001-154	\$1101.54
10.0000	0.3750	1.5000	3.4063	3.1250	0.3750	56	950-001-157	\$918.71	950-001-160	\$1051.57	950-001-159	\$1101.54	950-001-158	\$1101.54

*Make To Order

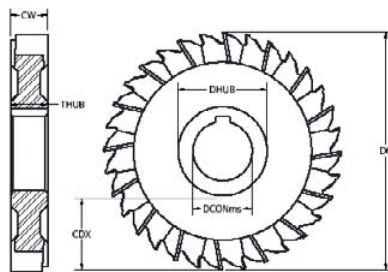

MS Style

- Excellent for Deep Slotting
- Free Cutting



DC	CW	DCONms	CDX	DHUB	THUB	Zc	Uncoated	Price	TiN Coated*	Price	TiCN Coated*	Price	TiAlN Coated	Price
3.0000	0.0938	1.0000	0.7188	1.5000	0.0938	28	950-000-917	\$111.75	950-000-920	\$127.90	950-000-919	\$134.02	950-000-918	\$134.02
3.0000	0.1250	1.0000	0.7188	1.5000	0.1250	28	950-000-905	\$114.30	950-000-908	\$130.85	950-000-907	\$136.98	950-000-906	\$136.98
3.0000	0.1563	1.0000	0.7188	1.5000	0.1563	28	950-000-921	\$116.32	950-000-924	\$133.09	950-000-923	\$139.56	950-000-922	\$139.56
3.0000	0.1875	1.0000	0.7188	1.5000	0.1875	28	950-000-909	\$93.40	950-000-912	\$107.00	950-000-911	\$111.98	950-000-910	\$111.98
3.0000	0.2188	1.0000	0.7188	1.5000	0.2188	28	950-000-925	\$125.14	950-000-928	\$143.26	950-000-927	\$150.11	950-000-926	\$150.11
3.0000	0.2500	1.0000	0.7188	1.5000	0.2500	28	950-000-913	\$124.30	950-000-916	\$142.36	950-000-915	\$148.99	950-000-914	\$148.99
4.0000	0.0938	1.0000	1.2188	1.5000	0.0938	32	950-000-953	\$148.60	950-000-956	\$170.11	950-000-955	\$178.28	950-000-954	\$178.28
4.0000	0.0938	1.2500	1.0313	1.8750	0.0938	32	950-000-957	\$148.60	950-000-960	\$170.11	950-000-959	\$178.28	950-000-958	\$178.28
4.0000	0.1250	1.0000	1.2188	1.5000	0.1250	32	950-000-929	\$148.77	950-000-932	\$170.29	950-000-931	\$178.44	950-000-930	\$178.44
4.0000	0.1250	1.2500	1.0313	1.8750	0.1250	32	950-000-933	\$148.77	950-000-936	\$170.29	950-000-935	\$178.44	950-000-934	\$178.44
4.0000	0.1563	1.0000	1.2188	1.5000	0.1563	32	950-000-961	\$159.63	950-000-964	\$182.69	950-000-963	\$191.39	950-000-962	\$191.39
4.0000	0.1563	1.2500	1.0313	1.8750	0.1563	32	950-000-965	\$159.63	950-000-968	\$182.69	950-000-967	\$191.39	950-000-966	\$191.39

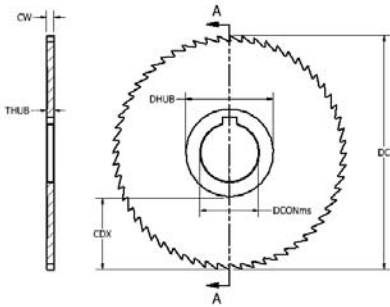

MC Style

- Designed for Slitting or Cutoff Operations
- O.D. Cutting Only, No Side Teeth
- Fully Ground Surfaces
- Square Cornered with Side Concavity



DC	CW	DCONms	CDX	DHUB	THUB	Zc	Uncoated	Price	TiN Coated*	Price	TiCN Coated*	Price	TiAlN Coated	Price
2.5000	0.0313	0.8750	0.5938	1.2500	0.0313	36	950-000-677	\$37.02	950-000-680	\$42.39	950-000-679	\$44.42	950-000-678	\$44.42
2.5000	0.0469	0.8750	0.5938	1.2500	0.0469	36	950-000-685	\$37.02	950-000-688	\$42.39	950-000-687	\$44.42	950-000-686	\$44.42
2.5000	0.0625	0.8750	0.5938	1.2500	0.0625	36	950-000-669	\$37.02	950-000-672	\$42.39	950-000-671	\$44.42	950-000-670	\$44.42
2.5000	0.0938	0.8750	0.5938	1.2500	0.0938	36	950-000-681	\$37.02	950-000-684	\$42.39	950-000-683	\$44.42	950-000-682	\$44.42
2.5000	0.1250	0.8750	0.5938	1.2500	0.1250	36	950-000-673	\$41.76	950-000-676	\$47.75	950-000-675	\$50.17	950-000-674	\$50.17
3.0000	0.0313	1.0000	0.7188	1.5000	0.0313	36	950-000-697	\$43.15	950-000-700	\$49.42	950-000-699	\$51.64	950-000-698	\$51.64
3.0000	0.0469	1.0000	0.7188	1.5000	0.0469	36	950-000-709	\$37.02	950-000-712	\$42.39	950-000-711	\$37.02	950-000-710	\$37.02
3.0000	0.0625	1.0000	0.7188	1.5000	0.0625	36	950-000-689	\$37.02	950-000-692	\$42.39	950-000-691	\$37.02	950-000-690	\$37.02
3.0000	0.0938	1.0000	0.7188	1.5000	0.0938	36	950-000-701	\$44.15	950-000-704	\$50.56	950-000-703	\$52.94	950-000-702	\$52.94
3.0000	0.1250	1.0000	0.7188	1.5000	0.1250	36	950-000-693	\$45.52	950-000-696	\$52.01	950-000-695	\$54.59	950-000-694	\$54.59
3.0000	0.1563	1.0000	0.7188	1.5000	0.1563	36	950-000-705	\$48.08	950-000-708	\$54.96	950-000-707	\$57.56	950-000-706	\$57.56
4.0000	0.0313	1.0000	1.2188	1.5000	0.0313	40	950-000-737	\$60.44	950-000-740	\$69.24	950-000-739	\$72.56	950-000-738	\$72.56
4.0000	0.0313	1.2500	1.0313	1.8750	0.0313	40	950-000-741	\$118.87	950-000-744	\$136.04	950-000-743	\$142.53	950-000-742	\$142.53
4.0000	0.0469	1.0000	1.2188	1.5000	0.0469	40	950-000-761	\$60.62	950-000-764	\$69.41	950-000-763	\$72.76	950-000-762	\$72.76
4.0000	0.0469	1.2500	1.0313	1.8750	0.0469	40	950-000-765	\$113.27	950-000-768	\$129.57	950-000-767	\$135.87	950-000-766	\$135.87
4.0000	0.0625	1.0000	1.2188	1.5000	0.0625	40	950-000-713	\$60.80	950-000-716	\$69.60	950-000-715	\$72.94	950-000-714	\$72.94
4.0000	0.0625	1.2500	1.0313	1.8750	0.0625	40	950-000-717	\$109.86	950-000-720	\$125.69	950-000-719	\$131.80	950-000-718	\$131.80
4.0000	0.0938	1.0000	1.2188	1.5000	0.0938	40	950-000-745	\$64.36	950-000-748	\$73.68	950-000-747	\$77.17	950-000-746	\$77.17
4.0000	0.0938	1.2500	1.0313	1.8750	0.0938	40	950-000-749	\$113.27	950-000-752	\$129.57	950-000-751	\$135.87	950-000-750	\$135.87
4.0000	0.1250	1.0000	1.2188	1.5000	0.1250	40	950-000-721	\$65.21	950-000-724	\$74.60	950-000-723	\$78.11	950-000-722	\$78.11
4.0000	0.1250	1.2500	1.0313	1.8750	0.1250	40	950-000-725	\$109.86	950-000-728	\$125.69	950-000-727	\$129.57	950-000-726	\$129.57
4.0000	0.1563	1.0000	1.2188	1.5000	0.1563	40	950-000-753	\$64.36	950-000-756	\$73.68	950-000-755	\$77.17	950-000-754	\$77.17
4.0000	0.1563	1.2500	1.0313	1.8750	0.1563	40	950-000-757	\$118.87	950-000-760	\$129.57	950-000-759	\$135.87	950-000-758	\$135.87
4.0000	0.1875	1.0000	1.2188	1.5000	0.1875	40	950-000-729	\$74.03	950-000-732	\$84.77	950-000-731	\$88.86	950-000-730	\$88.86
4.0000	0.1875	1.2500	1.0313	1.8750	0.1875	40	950-000-733	\$124.15	950-000-736	\$142.17	950-000-735	\$148.82	950-000-734	\$148.82
5.0000	0.0313	1.0000	1.7188	1.5000	0.0313	44	950-000-793	\$138.57	950-000-796	\$158.64	950-000-795	\$166.23	950-000-794	\$166.23
5.0000	0.0313	1.2500	1.5313	1.8750	0.0313	44	950-000-797	\$138.57	950-000-800	\$158.64	950-000-799	\$166.23	950-000-798	\$166.23
5.0000	0.0625	1.0000	1.7188	1.5000	0.0625	44	950-000-769	\$83.38	950-000-772	\$95.50	950-000-771	\$99.96	950-000-770	\$99.96
5.0000	0.0625	1.2500	1.5313	1.8750	0.0625	44	950-000-773	\$136.38	950-000-776	\$156.03	950-000-775	\$163.44	950-000-774	\$163.44
5.0000	0.0938	1.0000	1.7188	1.5000	0.0938	44	950-000-801	\$88.98	950-000-804	\$101.81	950-000-803	\$106.60	950-000-802	\$106.60
5.0000	0.0938	1.2500	1.5313	1.8750	0.0938	44	950-000-805	\$140.43	950-000-808	\$160.68	950-000-807	\$168.45	950-000-806	\$168.45
5.0000	0.1250	1.0000	1.7188	1.5000	0.1250	44	950-000-777	\$95.44	950-000-780	\$109.22	950-000-779	\$114.41	950-000-778	\$114.41
5.0000	0.1250	1.2500	1.5313	1.8750	0.1250	44	950-000-781	\$95.44	950-000-784	\$109.22	950-000-783	\$114.41	950-000-782	\$114.41
5.0000	0.1563	1.0000	1.7188	1.5000	0.1563	44	950-000-809	\$145.55	950-000-812	\$166.58	950-000-811	\$174.56	950-000-810	\$174.56
5.0000	0.1563	1.2500	1.5313	1.8750	0.1563	44	950-000-813	\$145.55	950-000-816	\$166.58	950-000-815	\$174.56	950-000-814	\$174.56
5.0000	0.1875	1.0000	1.7188	1.5000	0.1875	44	950-000-785	\$148.24	950-000-788	\$169.74	950-000-787	\$177.70	950-000-786	\$177.70
5.0000	0.1875	1.2500	1.5313	1.8750	0.1875	44	950-000-789	\$148.24	950-000-792	\$169.74	950-000-791	\$177.70	950-000-790	\$177.70
6.0000	0.0313	1.0000	2.2188	1.5000	0.0313	48	950-000-841	\$159.97	950-000-844	\$183.06	950-000-843	\$191.75	950-000-842	\$191.75
6.0000	0.0313	1.2500	2.0313	1.8750	0.0313	48	950-000-845	\$159.97	950-000-848	\$183.06	950-000-847	\$191.75	950-000-846	\$191.75
6.0000	0.0625	1.0000	2.2188	1.5000	0.0625	48	950-000-817	\$100.86	950-000-820	\$115.50	950-000-819	\$120.89	950-000-818	\$120.89
6.0000	0.0625	1.2500	2.0313	1.8750	0.0625	48	950-000-821	\$157.25	950-000-824	\$179.92	950-000-823	\$188.62	950-000-822	\$188.62
6.0000	0.0938	1.0000	2.2188	1.5000	0.0938	48	950-000-849	\$117.34	950-000-852	\$134.38	950-000-851	\$140.68	950-000-850	\$140.68
6.0000	0.0938	1.2500	2.0313	1.8750	0.0938	48	950-000-853	\$161.66	950-000-856	\$185.10	950-000-855	\$193.80	950-000-854	\$193.80
6.0000	0.1250	1.0000	2.2188	1.5000	0.1250	48	950-000-825	\$119.39	950-000-828	\$136.61	950-000-827	\$143.09	950-000-826	\$143.09
6.0000	0.1250	1.2500	2.0313	1.8750	0.1250	48	950-000-829	\$119.39	950-000-832	\$136.61	950-000-831	\$143.09	950-000-830	\$143.09
6.0000	0.1563	1.0000	2.2188	1.5000	0.1563	48	950-000-857	\$168.13	950-000-860	\$192.51	950-000-859	\$201.58	950-000-858	\$201.58
6.0000	0.1563	1.2500	2.0313	1.8750	0.1563	48	950-000-861	\$168.13	950-000-864	\$192.51	950-000-863	\$201.58	950-000-862	\$201.58
6.0000	0.1875	1.0000	2.2188	1.5000	0.1875	48	950-000-833	\$172.05	950-000-836	\$196.95	950-000-835	\$206.21	950-000-834	\$206.21
6.0000	0.1875	1.2500	2.0313	1.8750	0.1875	48	950-000-837	\$141.63	950-000-840	\$162.14	950-000-839	\$169.74	950-000-838	\$169.74
8.0000	0.1250	1.0000	3.2188	1.5000	0.1250	58	950-000-865	\$234.19	950-000-868	\$268.03	950-000-867	\$280.79	950-000-866	\$280.79
8.0000	0.1250	1.2500	3.0313	1.8750	0.1250	58	950-000-869	\$234.19	950-000-872	\$268.03	950-000-871	\$280.79	950-000-870	\$280.79

*Make To Order

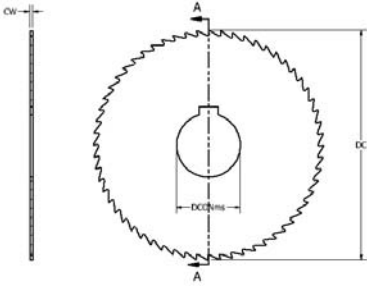

1470
• Fully Ground Surfaces



HSS

DC	CW	DCONms	THUB	Zc	Uncoated	Price	TiN Coated*	Price	TiCN Coated*	Price	TiAlN Coated	Price
1.7500	0.0640	0.6250	0.0640	90	950-001-644	\$16.81	950-001-812	\$19.27	950-001-756	\$20.18	950-001-700	\$20.18
1.7500	0.0570	0.6250	0.0570	90	950-001-643	\$16.13	950-001-811	\$18.52	950-001-755	\$19.43	950-001-699	\$19.43
1.7500	0.0510	0.6250	0.0510	90	950-001-642	\$14.77	950-001-810	\$16.85	950-001-754	\$17.78	950-001-698	\$17.78
1.7500	0.0450	0.6250	0.0450	90	950-001-641	\$14.77	950-001-809	\$16.85	950-001-753	\$17.78	950-001-697	\$17.78
1.7500	0.0400	0.6250	0.0400	90	950-001-640	\$14.77	950-001-808	\$16.85	950-001-752	\$17.78	950-001-696	\$17.78
1.7500	0.0360	0.6250	0.0360	90	950-001-639	\$14.77	950-001-807	\$16.85	950-001-751	\$17.78	950-001-695	\$17.78
1.7500	0.0320	0.6250	0.0320	90	950-001-638	\$13.60	950-001-806	\$15.55	950-001-750	\$16.29	950-001-694	\$16.29
1.7500	0.0280	0.6250	0.0280	90	950-001-637	\$13.60	950-001-805	\$15.55	950-001-749	\$16.29	950-001-693	\$16.29
1.7500	0.0250	0.6250	0.0250	90	950-001-636	\$13.60	950-001-804	\$15.55	950-001-748	\$16.29	950-001-692	\$16.29
1.7500	0.0230	0.6250	0.0230	90	950-001-635	\$13.60	950-001-803	\$15.55	950-001-747	\$16.29	950-001-691	\$16.29
1.7500	0.0200	0.6250	0.0200	90	950-001-634	\$13.60	950-001-802	\$15.55	950-001-746	\$16.29	950-001-690	\$16.29
1.7500	0.0180	0.6250	0.0180	90	950-001-633	\$13.91	950-001-801	\$15.90	950-001-745	\$16.66	950-001-689	\$16.66
1.7500	0.0160	0.6250	0.0160	90	950-001-632	\$14.43	950-001-800	\$16.48	950-001-744	\$17.42	950-001-688	\$17.42
1.7500	0.0140	0.6250	0.0140	90	950-001-631	\$15.29	950-001-799	\$17.59	950-001-743	\$18.33	950-001-687	\$18.33
1.7500	0.0130	0.6250	0.0130	90	950-001-630	\$15.62	950-001-798	\$17.94	950-001-742	\$18.67	950-001-686	\$18.67
1.7500	0.0100	0.6250	0.0100	90	950-001-629	\$16.30	950-001-797	\$18.67	950-001-741	\$19.61	950-001-685	\$19.61
2.2500	0.0720	0.6250	0.0720	60	950-001-661	\$21.57	950-001-829	\$24.64	950-001-773	\$25.91	950-001-717	\$25.91
2.2500	0.0640	0.6250	0.0640	60	950-001-660	\$19.86	950-001-828	\$22.77	950-001-772	\$23.89	950-001-716	\$23.89
2.2500	0.0570	0.6250	0.0570	60	950-001-659	\$19.86	950-001-827	\$22.77	950-001-771	\$23.89	950-001-715	\$23.89
2.2500	0.0510	0.6250	0.0510	60	950-001-658	\$19.86	950-001-826	\$22.77	950-001-770	\$23.89	950-001-714	\$23.89
2.2500	0.0450	0.6250	0.0450	60	950-001-657	\$19.86	950-001-825	\$22.77	950-001-769	\$23.89	950-001-713	\$23.89
2.2500	0.0400	0.6250	0.0400	60	950-001-656	\$18.85	950-001-824	\$21.64	950-001-768	\$22.57	950-001-712	\$22.57
2.2500	0.0360	0.6250	0.0360	60	950-001-655	\$17.83	950-001-823	\$20.37	950-001-767	\$21.46	950-001-711	\$21.46
2.2500	0.0320	0.6250	0.0320	60	950-001-654	\$17.83	950-001-822	\$20.37	950-001-766	\$21.46	950-001-710	\$21.46
2.2500	0.0280	0.6250	0.0280	60	950-001-653	\$17.83	950-001-821	\$20.37	950-001-765	\$21.46	950-001-709	\$21.46
2.2500	0.0250	0.6250	0.0250	60	950-001-652	\$18.85	950-001-820	\$21.64	950-001-764	\$22.57	950-001-708	\$22.57
2.2500	0.0230	0.6250	0.0230	60	950-001-651	\$18.85	950-001-819	\$21.64	950-001-763	\$22.57	950-001-707	\$22.57
2.2500	0.0200	0.6250	0.0200	60	950-001-650	\$18.85	950-001-818	\$21.64	950-001-762	\$22.57	950-001-706	\$22.57
2.2500	0.0180	0.6250	0.0180	60	950-001-649	\$19.37	950-001-817	\$22.21	950-001-761	\$23.13	950-001-705	\$23.13
2.2500	0.0160	0.6250	0.0160	60	950-001-648	\$20.04	950-001-816	\$22.96	950-001-760	\$24.07	950-001-704	\$24.07
2.2500	0.0140	0.6250	0.0140	60	950-001-647	\$20.38	950-001-815	\$23.32	950-001-759	\$24.41	950-001-703	\$24.41
2.2500	0.0130	0.6250	0.0130	60	950-001-646	\$21.22	950-001-814	\$24.25	950-001-758	\$25.55	950-001-702	\$25.55
2.2500	0.0100	0.6250	0.0100	60	950-001-645	\$21.57	950-001-813	\$24.64	950-001-757	\$25.91	950-001-701	\$25.91
2.7500	0.1440	1.0000	0.1440	72	950-001-684	\$38.22	950-001-852	\$43.68	950-001-796	\$45.91	950-001-740	\$45.91
2.7500	0.1280	1.0000	0.1280	72	950-001-683	\$33.80	950-001-851	\$38.69	950-001-795	\$40.54	950-001-739	\$40.54
2.7500	0.1140	1.0000	0.1140	72	950-001-682	\$30.05	950-001-850	\$34.43	950-001-794	\$36.10	950-001-738	\$36.10
2.7500	0.1020	1.0000	0.1020	72	950-001-681	\$27.87	950-001-849	\$31.83	950-001-793	\$33.33	950-001-737	\$33.33
2.7500	0.0910	1.0000	0.0910	72	950-001-680	\$26.99	950-001-847	\$30.91	950-001-792	\$32.38	950-001-736	\$32.38
2.7500	0.0810	1.0000	0.0810	72	950-001-679	\$25.14	950-001-847	\$28.69	950-001-791	\$30.19	950-001-735	\$30.19
2.7500	0.0720	1.0000	0.0720	72	950-001-678	\$21.75	950-001-846	\$24.81	950-001-790	\$26.09	950-001-734	\$26.09
2.7500	0.0640	1.0000	0.0640	72	950-001-677	\$21.75	950-001-845	\$24.81	950-001-789	\$26.09	950-001-733	\$26.09
2.7500	0.0570	1.0000	0.0570	72	950-001-676	\$21.75	950-001-844	\$24.81	950-001-788	\$26.09	950-001-732	\$26.09
2.7500	0.0510	1.0000	0.0510	72	950-001-675	\$20.38	950-001-843	\$23.32	950-001-787	\$24.41	950-001-731	\$24.41
2.7500	0.0450	1.0000	0.0450	72	950-001-674	\$20.38	950-001-842	\$23.32	950-001-786	\$24.41	950-001-730	\$24.41
2.7500	0.0400	1.0000	0.0400	72	950-001-673	\$18.85	950-001-841	\$21.64	950-001-785	\$22.57	950-001-729	\$22.57
2.7500	0.0360	1.0000	0.0360	72	950-001-672	\$17.31	950-001-840	\$19.80	950-001-784	\$20.73	950-001-728	\$20.73
2.7500	0.0320	1.0000	0.0320	72	950-001-671	\$17.31	950-001-839	\$19.80	950-001-783	\$20.73	950-001-727	\$20.73
2.7500	0.0280	1.0000	0.0280	72	950-001-670	\$17.31	950-001-838	\$19.80	950-001-782	\$20.73	950-001-726	\$20.73
2.7500	0.0250	1.0000	0.0250	72	950-001-669	\$17.31	950-001-837	\$19.80	950-001-781	\$20.73	950-001-725	\$20.73
2.7500	0.0230	1.0000	0.0230	72	950-001-668	\$17.31	950-001-836	\$19.80	950-001-780	\$20.73	950-001-724	\$20.73
2.7500	0.0200	1.0000	0.0200	72	950-001-667	\$18.35	950-001-835	\$20.93	950-001-779	\$22.03	950-001-723	\$22.03
2.7500	0.0180	1.0000	0.0180	72	950-001-666	\$19.21	950-001-834	\$22.03	950-001-778	\$22.96	950-001-722	\$22.96
2.7500	0.0160	1.0000	0.0160	72	950-001-665	\$20.04	950-001-833	\$22.96	950-001-777	\$24.07	950-001-721	\$24.07
2.7500	0.0140	1.0000	0.0140	72	950-001-664	\$21.22	950-001-832	\$24.25	950-001-776	\$25.55	950-001-720	\$25.55
2.7500	0.0130	1.0000	0.0130	72	950-001-663	\$21.91	950-001-831	\$24.99	950-001-775	\$26.28	950-001-719	\$26.28
2.7500	0.0100	1.0000	0.0100	72	950-001-662	\$23.44	950-001-830	\$26.85	950-001-774	\$28.12	950-001-718	\$28.12

*Make To Order

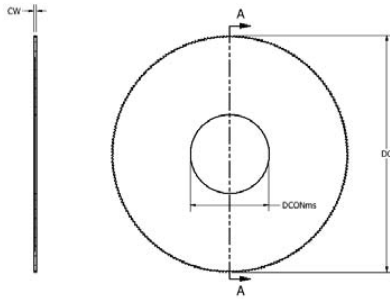

1490
• Fully Ground Surfaces



DC	CW	DCONms	Zc	Uncoated	Price	TiN Coated*	Price	TiCN Coated*	Price	TiAlN Coated	Price
1.0000	0.0320	0.3750	80	950-000-191	\$11.37	950-000-578	\$12.96	950-000-449	\$13.71	950-000-320	\$13.71
1.0000	0.0280	0.3750	80	950-000-190	\$11.37	950-000-577	\$12.96	950-000-448	\$13.71	950-000-319	\$13.71
1.0000	0.0250	0.3750	80	950-000-189	\$11.02	950-000-576	\$12.59	950-000-447	\$13.31	950-000-318	\$13.31
1.0000	0.0230	0.3750	80	950-000-188	\$11.37	950-000-575	\$12.96	950-000-446	\$13.71	950-000-317	\$13.71
1.0000	0.0200	0.3750	80	950-000-187	\$11.37	950-000-574	\$12.96	950-000-445	\$13.71	950-000-316	\$13.71
1.0000	0.0180	0.3750	80	950-000-186	\$12.40	950-000-573	\$14.25	950-000-444	\$14.82	950-000-315	\$14.82
1.0000	0.0160	0.3750	80	950-000-185	\$12.58	950-000-572	\$14.45	950-000-443	\$15.00	950-000-314	\$15.00
1.0000	0.0140	0.3750	80	950-000-184	\$12.91	950-000-571	\$14.82	950-000-442	\$15.55	950-000-313	\$15.55
1.0000	0.0120	0.3750	100	950-000-183	\$12.91	950-000-570	\$14.82	950-000-441	\$15.55	950-000-312	\$15.55
1.0000	0.0100	0.3750	100	950-000-182	\$13.60	950-000-569	\$15.55	950-000-440	\$16.29	950-000-311	\$16.29
1.2500	0.0320	0.3750	100	950-000-171	\$12.91	950-000-558	\$14.82	950-000-429	\$15.55	950-000-300	\$15.55
1.2500	0.0280	0.3750	100	950-000-170	\$12.91	950-000-557	\$14.82	950-000-428	\$15.55	950-000-299	\$16.66
1.2500	0.0250	0.3750	100	950-000-169	\$12.91	950-000-556	\$14.82	950-000-427	\$15.55	950-000-298	\$17.42
1.2500	0.0230	0.3750	100	950-000-168	\$12.91	950-000-555	\$14.82	950-000-426	\$15.55	950-000-297	\$18.33
1.2500	0.0200	0.3750	100	950-000-167	\$13.60	950-000-554	\$15.55	950-000-425	\$16.29	950-000-296	\$18.67
1.2500	0.0180	0.3750	100	950-000-166	\$13.91	950-000-553	\$15.90	950-000-424	\$16.66	950-000-295	\$19.61
1.2500	0.0160	0.3750	100	950-000-165	\$14.60	950-000-552	\$16.66	950-000-423	\$17.59	950-000-294	\$25.91
1.2500	0.0140	0.3750	100	950-000-164	\$14.77	950-000-551	\$16.85	950-000-422	\$17.78	950-000-293	\$23.89
1.2500	0.0120	0.3750	120	950-000-163	\$15.29	950-000-550	\$17.59	950-000-421	\$18.33	950-000-292	\$23.89
1.2500	0.0100	0.3750	120	950-000-162	\$15.46	950-000-549	\$17.78	950-000-420	\$18.52	950-000-291	\$23.89
1.5000	0.0280	0.5000	110	950-000-161	\$13.91	950-000-548	\$15.90	950-000-419	\$16.66	950-000-290	\$23.89
1.5000	0.0250	0.5000	110	950-000-160	\$13.91	950-000-547	\$15.90	950-000-418	\$16.66	950-000-289	\$22.57
1.5000	0.0230	0.5000	110	950-000-159	\$13.91	950-000-546	\$15.90	950-000-417	\$16.66	950-000-288	\$21.46
1.5000	0.0200	0.5000	110	950-000-158	\$14.77	950-000-545	\$16.85	950-000-416	\$17.78	950-000-287	\$21.46
1.5000	0.0180	0.5000	110	950-000-157	\$15.46	950-000-544	\$17.78	950-000-415	\$18.52	950-000-286	\$21.46
1.5000	0.0160	0.5000	110	950-000-156	\$16.13	950-000-543	\$18.52	950-000-414	\$19.43	950-000-285	\$22.57
1.5000	0.0140	0.5000	110	950-000-155	\$16.65	950-000-542	\$19.06	950-000-413	\$20.00	950-000-284	\$22.57
1.5000	0.0120	0.5000	140	950-000-154	\$17.49	950-000-541	\$20.00	950-000-412	\$20.93	950-000-283	\$22.57
1.5000	0.0100	0.5000	140	950-000-153	\$18.35	950-000-540	\$20.93	950-000-411	\$22.03	950-000-282	\$23.13
1.7500	0.0320	0.5000	130	950-000-181	\$16.30	950-000-568	\$18.67	950-000-439	\$19.61	950-000-310	\$19.61
1.7500	0.0280	0.5000	130	950-000-180	\$15.46	950-000-567	\$17.78	950-000-438	\$18.52	950-000-309	\$18.52
1.7500	0.0250	0.5000	130	950-000-179	\$14.77	950-000-566	\$16.85	950-000-437	\$17.78	950-000-308	\$17.78
1.7500	0.0230	0.5000	130	950-000-178	\$15.46	950-000-565	\$17.78	950-000-436	\$18.52	950-000-307	\$18.52
1.7500	0.0200	0.5000	130	950-000-177	\$16.13	950-000-564	\$18.52	950-000-435	\$19.43	950-000-306	\$19.43
1.7500	0.0180	0.5000	130	950-000-176	\$16.65	950-000-563	\$19.06	950-000-434	\$20.00	950-000-305	\$20.00
1.7500	0.0160	0.5000	130	950-000-175	\$17.49	950-000-562	\$20.00	950-000-433	\$20.93	950-000-304	\$20.93
1.7500	0.0140	0.5000	130	950-000-174	\$18.35	950-000-561	\$20.93	950-000-432	\$22.03	950-000-303	\$22.03
1.7500	0.0120	0.5000	160	950-000-173	\$18.85	950-000-560	\$21.64	950-000-431	\$22.57	950-000-302	\$22.57
1.7500	0.0100	0.5000	160	950-000-172	\$19.69	950-000-559	\$22.57	950-000-430	\$23.70	950-000-301	\$23.70
2.0000	0.0570	0.5000	110	950-000-221	\$21.75	950-000-608	\$24.64	950-000-479	\$25.91	950-000-350	\$25.91
2.0000	0.0510	0.5000	110	950-000-220	\$21.22	950-000-607	\$24.25	950-000-478	\$25.55	950-000-349	\$25.55
2.0000	0.0450	0.5000	110	950-000-219	\$20.21	950-000-606	\$23.13	950-000-477	\$24.25	950-000-348	\$24.25
2.0000	0.0400	0.5000	110	950-000-218	\$20.21	950-000-605	\$23.13	950-000-476	\$24.25	950-000-347	\$24.25
2.0000	0.0350	0.5000	110	950-000-217	\$18.85	950-000-604	\$21.64	950-000-475	\$22.57	950-000-346	\$22.57

*Make To Order

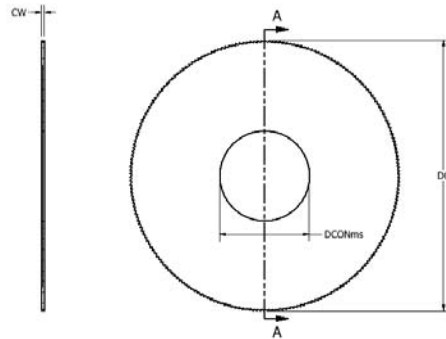

HSS

DC	CW	DCONms	Zc	Uncoated	Price	TiN Coated*	Price	TiCN Coated*	Price	TiAlN Coated	Price
2.0000	0.0320	0.5000	110	950-000-216	\$18.35	950-000-603	\$20.93	950-000-474	\$22.03	950-000-345	\$22.03
2.0000	0.0280	0.5000	150	950-000-215	\$18.35	950-000-602	\$20.93	950-000-473	\$22.03	950-000-344	\$22.03
2.0000	0.0250	0.5000	150	950-000-214	\$17.49	950-000-601	\$20.00	950-000-472	\$20.93	950-000-343	\$20.93
2.0000	0.0230	0.5000	150	950-000-213	\$18.35	950-000-600	\$20.93	950-000-471	\$22.03	950-000-342	\$22.03
2.0000	0.0200	0.5000	150	950-000-212	\$18.85	950-000-599	\$21.64	950-000-470	\$22.57	950-000-341	\$22.57
2.0000	0.0180	0.5000	150	950-000-211	\$19.69	950-000-598	\$22.57	950-000-469	\$23.70	950-000-340	\$23.70
2.0000	0.0160	0.5000	150	950-000-210	\$20.21	950-000-597	\$23.13	950-000-468	\$24.25	950-000-339	\$24.25
2.0000	0.0140	0.5000	150	950-000-209	\$21.22	950-000-596	\$24.25	950-000-467	\$25.55	950-000-338	\$25.55
2.0000	0.0120	0.5000	190	950-000-208	\$21.57	950-000-595	\$24.64	950-000-466	\$25.91	950-000-337	\$25.91
2.0000	0.0100	0.5000	190	950-000-207	\$22.39	950-000-594	\$25.73	950-000-465	\$26.85	950-000-336	\$26.85
2.5000	0.0570	0.5000	140	950-000-206	\$29.40	950-000-593	\$33.68	950-000-464	\$35.16	950-000-335	\$35.16
2.5000	0.0510	0.5000	140	950-000-205	\$27.87	950-000-592	\$31.83	950-000-463	\$33.33	950-000-334	\$33.33
2.5000	0.0450	0.5000	140	950-000-204	\$26.66	950-000-591	\$30.55	950-000-462	\$32.04	950-000-333	\$32.04
2.5000	0.0400	0.5000	140	950-000-203	\$25.14	950-000-590	\$28.69	950-000-461	\$30.19	950-000-332	\$30.19
2.5000	0.0350	0.5000	140	950-000-202	\$23.94	950-000-589	\$27.40	950-000-460	\$28.69	950-000-331	\$28.69
2.5000	0.0320	0.5000	140	950-000-201	\$22.39	950-000-588	\$25.73	950-000-459	\$26.85	950-000-330	\$26.85
2.5000	0.0280	0.5000	190	950-000-200	\$21.22	950-000-587	\$24.25	950-000-458	\$25.55	950-000-329	\$25.55
2.5000	0.0250	0.5000	190	950-000-199	\$19.69	950-000-586	\$22.57	950-000-457	\$23.70	950-000-328	\$23.70
2.5000	0.0230	0.5000	190	950-000-198	\$21.22	950-000-585	\$24.25	950-000-456	\$25.55	950-000-327	\$25.55
2.5000	0.0200	0.5000	190	950-000-197	\$22.39	950-000-584	\$25.73	950-000-455	\$26.85	950-000-326	\$26.85
2.5000	0.0180	0.5000	190	950-000-196	\$23.94	950-000-583	\$27.40	950-000-454	\$28.69	950-000-325	\$28.69
2.5000	0.0160	0.5000	190	950-000-195	\$25.14	950-000-582	\$28.69	950-000-453	\$30.19	950-000-324	\$30.19
2.5000	0.0140	0.5000	190	950-000-194	\$26.66	950-000-581	\$30.55	950-000-452	\$32.04	950-000-323	\$32.04
2.5000	0.0120	0.5000	240	950-000-193	\$27.87	950-000-580	\$31.83	950-000-451	\$33.33	950-000-322	\$33.33
3.0000	0.0100	0.5000	240	950-000-192	\$21.22	950-000-579	\$33.68	950-000-450	\$35.16	950-000-321	\$35.16
3.0000	0.0570	0.5000	170	950-000-250	\$32.96	950-000-637	\$37.78	950-000-508	\$39.45	950-000-379	\$39.45
3.0000	0.0570	1.0000	170	950-000-251	\$32.96	950-000-638	\$37.78	950-000-509	\$39.45	950-000-380	\$39.45
3.0000	0.0510	0.5000	170	950-000-248	\$31.27	950-000-635	\$35.74	950-000-506	\$37.39	950-000-377	\$37.39
3.0000	0.0510	1.0000	170	950-000-249	\$31.27	950-000-636	\$35.74	950-000-507	\$37.39	950-000-378	\$37.39
3.0000	0.0450	0.5000	170	950-000-246	\$30.23	950-000-633	\$34.61	950-000-504	\$36.27	950-000-375	\$36.27
3.0000	0.0450	1.0000	170	950-000-247	\$30.23	950-000-634	\$34.61	950-000-505	\$36.27	950-000-376	\$36.27
3.0000	0.0400	0.5000	170	950-000-244	\$28.36	950-000-631	\$32.38	950-000-502	\$34.08	950-000-373	\$34.08
3.0000	0.0400	1.0000	170	950-000-245	\$28.36	950-000-632	\$32.38	950-000-503	\$34.08	950-000-374	\$34.08
3.0000	0.0350	0.5000	170	950-000-242	\$27.34	950-000-629	\$31.28	950-000-500	\$32.75	950-000-371	\$32.75
3.0000	0.0350	1.0000	170	950-000-243	\$27.34	950-000-630	\$31.28	950-000-501	\$32.75	950-000-372	\$32.75
3.0000	0.0320	0.5000	170	950-000-240	\$25.80	950-000-627	\$29.62	950-000-498	\$30.91	950-000-369	\$30.91
3.0000	0.0320	1.0000	170	950-000-241	\$25.80	950-000-628	\$29.62	950-000-499	\$30.91	950-000-370	\$30.91
3.0000	0.0280	0.5000	230	950-000-238	\$24.30	950-000-625	\$27.74	950-000-496	\$29.06	950-000-367	\$29.06
3.0000	0.0280	1.0000	230	950-000-239	\$24.30	950-000-626	\$27.74	950-000-497	\$29.06	950-000-368	\$29.06
3.0000	0.0250	0.5000	230	950-000-236	\$24.30	950-000-623	\$27.74	950-000-494	\$29.06	950-000-365	\$29.06
3.0000	0.0250	1.0000	230	950-000-237	\$24.30	950-000-624	\$27.74	950-000-495	\$29.06	950-000-366	\$29.06
3.0000	0.0230	0.5000	230	950-000-234	\$24.30	950-000-621	\$27.74	950-000-492	\$29.06	950-000-363	\$29.06
3.0000	0.0230	1.0000	230	950-000-235	\$24.30	950-000-622	\$27.74	950-000-493	\$29.06	950-000-364	\$29.06
3.0000	0.0200	0.5000	230	950-000-232	\$24.11	950-000-619	\$27.60	950-000-490	\$28.86	950-000-361	\$28.86

*Make To Order

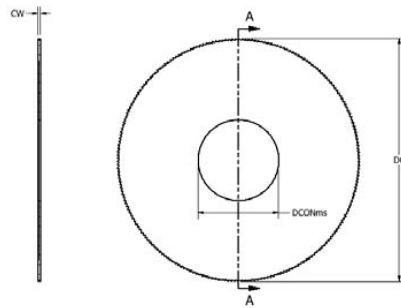

DC	CW	DCONms	Zc	Uncoated	Price	TiN Coated*	Price	TiCN Coated*	Price	TiAlN Coated	Price
3.0000	0.0200	1.0000	230	950-000-233	\$24.11	950-000-620	\$27.60	950-000-491	\$28.86	950-000-362	\$28.86
3.0000	0.018	0.5000	230	950-000-230	\$25.62	950-000-617	\$29.43	950-000-488	\$30.73	950-000-359	\$30.73
3.0000	0.018	1.0000	230	950-000-231	\$25.62	950-000-618	\$29.43	950-000-489	\$30.73	950-000-360	\$30.73
3.0000	0.016	0.5000	230	950-000-228	\$28.36	950-000-615	\$32.38	950-000-486	\$34.08	950-000-357	\$34.08
3.0000	0.016	1.0000	230	950-000-229	\$28.36	950-000-616	\$32.38	950-000-487	\$34.08	950-000-358	\$34.08
3.0000	0.014	0.5000	230	950-000-226	\$30.23	950-000-613	\$34.61	950-000-484	\$36.27	950-000-355	\$36.27
3.0000	0.014	1.0000	230	950-000-227	\$30.23	950-000-614	\$34.61	950-000-485	\$36.27	950-000-356	\$36.27
3.0000	0.012	0.5000	280	950-000-224	\$28.55	950-000-611	\$32.58	950-000-482	\$34.24	950-000-353	\$34.24
3.0000	0.012	1.0000	280	950-000-225	\$28.55	950-000-612	\$32.58	950-000-483	\$34.24	950-000-354	\$34.24
3.0000	0.010	0.5000	280	950-000-222	\$38.37	950-000-609	\$43.87	950-000-480	\$46.09	950-000-351	\$46.09
3.0000	0.010	1.0000	280	950-000-223	\$38.37	950-000-610	\$43.87	950-000-481	\$46.09	950-000-352	\$46.09
4.0000	0.0570	0.5000	220	950-000-280	\$54.34	950-000-667	\$62.19	950-000-538	\$65.16	950-000-409	\$65.16
4.0000	0.0570	1.0000	220	950-000-281	\$54.34	950-000-668	\$62.19	950-000-539	\$65.16	950-000-410	\$65.16
4.0000	0.0510	0.5000	220	950-000-278	\$51.79	950-000-665	\$59.23	950-000-536	\$62.19	950-000-407	\$62.19
4.0000	0.0510	1.0000	220	950-000-279	\$51.79	950-000-666	\$59.23	950-000-537	\$62.19	950-000-408	\$62.19
4.0000	0.0450	0.5000	220	950-000-276	\$48.73	950-000-663	\$55.71	950-000-534	\$58.49	950-000-405	\$58.49
4.0000	0.0450	1.0000	220	950-000-277	\$48.73	950-000-664	\$55.71	950-000-535	\$58.49	950-000-406	\$58.49
4.0000	0.0400	0.5000	220	950-000-274	\$46.21	950-000-661	\$52.94	950-000-532	\$55.34	950-000-403	\$55.34
4.0000	0.0400	1.0000	220	950-000-275	\$46.21	950-000-662	\$52.94	950-000-533	\$55.34	950-000-404	\$55.34
4.0000	0.0350	0.5000	220	950-000-272	\$43.46	950-000-659	\$49.79	950-000-530	\$52.22	950-000-401	\$52.22
4.0000	0.0350	1.0000	220	950-000-273	\$43.46	950-000-660	\$49.79	950-000-531	\$52.22	950-000-402	\$52.22
4.0000	0.0320	0.5000	220	950-000-270	\$40.92	950-000-657	\$46.86	950-000-528	\$49.04	950-000-399	\$49.04
4.0000	0.0320	1.0000	220	950-000-271	\$40.92	950-000-658	\$46.86	950-000-529	\$49.04	950-000-400	\$49.04
4.0000	0.0280	0.5000	300	950-000-268	\$38.05	950-000-655	\$43.50	950-000-526	\$45.52	950-000-397	\$45.52
4.0000	0.0280	1.0000	300	950-000-269	\$38.05	950-000-656	\$43.50	950-000-527	\$45.52	950-000-398	\$45.52
4.0000	0.0250	0.5000	300	950-000-266	\$40.92	950-000-653	\$46.86	950-000-524	\$49.04	950-000-395	\$49.04
4.0000	0.0250	1.0000	300	950-000-267	\$40.92	950-000-654	\$46.86	950-000-525	\$49.04	950-000-396	\$49.04
4.0000	0.0230	0.5000	300	950-000-264	\$43.46	950-000-651	\$49.79	950-000-522	\$52.22	950-000-393	\$52.22
4.0000	0.0230	1.0000	300	950-000-265	\$43.46	950-000-652	\$49.79	950-000-523	\$52.22	950-000-394	\$52.22
4.0000	0.0200	0.5000	300	950-000-262	\$46.21	950-000-649	\$52.94	950-000-520	\$55.34	950-000-391	\$55.34
4.0000	0.0200	1.0000	300	950-000-263	\$46.21	950-000-650	\$52.94	950-000-521	\$55.34	950-000-392	\$55.34
4.0000	0.0180	0.5000	300	950-000-260	\$48.73	950-000-647	\$55.71	950-000-518	\$58.49	950-000-389	\$58.49
4.0000	0.0180	1.0000	300	950-000-261	\$48.73	950-000-648	\$55.71	950-000-519	\$58.49	950-000-390	\$58.49
4.0000	0.0160	0.5000	300	950-000-258	\$51.79	950-000-645	\$59.23	950-000-516	\$62.19	950-000-387	\$62.19
4.0000	0.0160	1.0000	300	950-000-259	\$51.79	950-000-646	\$59.23	950-000-517	\$62.19	950-000-388	\$62.19
4.0000	0.0140	0.5000	300	950-000-256	\$54.34	950-000-643	\$62.19	950-000-514	\$65.16	950-000-385	\$65.16
4.0000	0.0140	1.0000	300	950-000-257	\$54.34	950-000-644	\$62.19	950-000-515	\$65.16	950-000-386	\$65.16
4.0000	0.0120	0.5000	380	950-000-254	\$57.06	950-000-641	\$65.34	950-000-512	\$68.49	950-000-383	\$68.49
4.0000	00.012	1.0000	380	950-000-255	\$57.06	950-000-642	\$65.34	950-000-513	\$68.49	950-000-384	\$68.49
4.0000	0.0100	0.5000	380	950-000-252	\$60.13	950-000-639	\$68.86	950-000-510	\$72.01	950-000-381	\$72.01
4.0000	0.0100	1.0000	380	950-000-253	\$60.13	950-000-640	\$68.86	950-000-511	\$72.01	950-000-382	\$72.01

*Make To Order

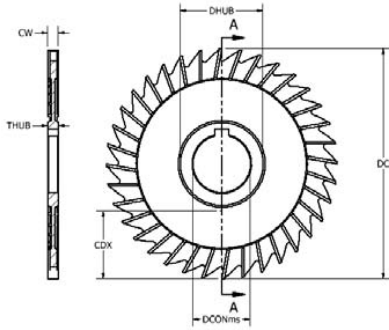

MT Style - Straight Tooth

- For use in fine finish applications



DC	CW	DCONms	CDX	DHUB	THUB	Zc	Uncoated	Price	TiN Coated*	Price	TiCN Coated*	Price	TiAlN Coated	Price
3.0000	0.0625	1.0000	0.7188	1.5000	0.0625	32	950-000-065	\$108.00	950-000-068	\$123.67	950-000-067	\$129.57	950-000-066	\$129.57
3.0000	0.0938	1.0000	0.7188	1.5000	0.0938	32	950-000-081	\$111.75	950-000-084	\$127.90	950-000-083	\$134.02	950-000-082	\$134.02
3.0000	0.1250	1.0000	0.7188	1.5000	0.1250	32	950-000-069	\$118.87	950-000-072	\$136.04	950-000-071	\$142.53	950-000-070	\$142.53
3.0000	0.1563	1.0000	0.7188	1.5000	0.1563	32	950-000-085	\$121.73	950-000-088	\$139.40	950-000-087	\$146.05	950-000-086	\$146.05
3.0000	0.1875	1.0000	0.7188	1.5000	0.1875	32	950-000-073	\$129.90	950-000-076	\$148.65	950-000-075	\$155.83	950-000-074	\$155.83
3.0000	0.2500	1.0000	0.7188	1.5000	0.2500	32	950-000-077	\$173.91	950-000-080	\$155.83	950-000-079	\$163.25	950-000-078	\$163.25
4.0000	0.0625	1.0000	1.2188	1.5000	0.0625	36	950-000-089	\$136.21	950-000-092	\$198.98	950-000-091	\$208.43	950-000-090	\$208.43
4.0000	0.0625	1.2500	1.0313	1.8750	0.0625	36	950-000-093	\$173.91	950-000-096	\$198.98	950-000-095	\$208.43	950-000-094	\$208.43
4.0000	0.0938	1.0000	1.2188	1.5000	0.0938	36	950-000-121	\$176.61	950-000-124	\$202.10	950-000-123	\$211.76	950-000-122	\$211.76
4.0000	0.0938	1.2500	1.0313	1.8750	0.0938	36	950-000-125	\$176.61	950-000-128	\$202.10	950-000-127	\$211.76	950-000-126	\$211.76
4.0000	0.1250	1.0000	1.2188	1.5000	0.1250	36	950-000-097	\$184.93	950-000-100	\$211.57	950-000-099	\$221.75	950-000-098	\$221.75
4.0000	0.1250	1.2500	1.0313	1.8750	0.1250	36	950-000-101	\$184.93	950-000-104	\$211.57	950-000-103	\$221.75	950-000-102	\$221.75
4.0000	0.1563	1.0000	1.2188	1.5000	0.1563	36	950-000-129	\$192.92	950-000-132	\$202.10	950-000-131	\$231.37	950-000-130	\$231.37
4.0000	0.1563	1.2500	1.0313	1.8750	0.1563	36	950-000-133	\$192.92	950-000-136	\$202.10	950-000-135	\$231.37	950-000-134	\$231.37
4.0000	0.1875	1.0000	1.2188	1.5000	0.1875	36	950-000-105	\$194.10	950-000-108	\$211.57	950-000-107	\$232.66	950-000-106	\$232.66
4.0000	0.1875	1.2500	1.0313	1.8750	0.1875	36	950-000-109	\$194.10	950-000-112	\$211.57	950-000-111	\$232.66	950-000-110	\$232.66
4.0000	0.2500	1.0000	1.2188	1.5000	0.2500	36	950-000-113	\$202.29	950-000-116	\$232.29	950-000-115	\$243.40	950-000-114	\$243.40
4.0000	0.2500	1.2500	1.0313	1.8750	0.2500	36	950-000-117	\$202.29	950-000-120	\$232.29	950-000-119	\$243.40	950-000-118	\$243.40
6.0000	0.1250	1.2500	2.0313	1.8750	0.1250	42	950-000-137	\$333.18	950-000-140	\$381.31	950-000-139	\$399.46	950-000-138	\$399.46
6.0000	0.1563	1.2500	2.0313	1.8750	0.1563	42	950-000-149	\$345.25	950-000-152	\$395.19	950-000-151	\$413.89	950-000-150	\$413.89
6.0000	0.1875	1.2500	2.0313	1.8750	0.1875	42	950-000-141	\$348.65	950-000-144	\$399.08	950-000-143	\$417.97	950-000-142	\$417.97
6.0000	0.2500	1.2500	2.0313	1.8750	0.2500	42	950-000-145	\$351.53	950-000-148	\$402.42	950-000-147	\$421.47	950-000-146	\$421.47

*Make To Order

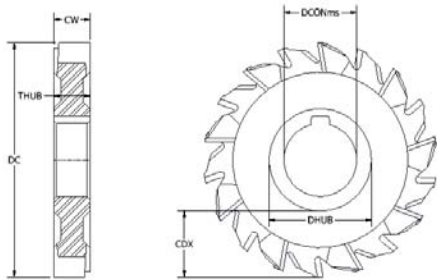

MS Style - Staggered Tooth

- For use in Deep Slotting Applications



DC	CW	DCONms	CDX	DHUB	THUB	Zc	Uncoated	Price	TiN Coated*	Price	TiCN Coated*	Price	TiAlN Coated	Price
3.0000	0.1250	1.0000	0.7188	1.5000	0.1250	28	950-000-001	\$141.97	950-000-004	\$162.53	950-000-003	\$170.29	950-000-002	\$170.29
3.0000	0.1563	1.0000	0.7188	1.5000	0.1563	28	950-000-013	\$146.22	950-000-016	\$167.33	950-000-015	\$175.28	950-000-014	\$175.28
3.0000	0.1875	1.0000	0.7188	1.5000	0.1875	28	950-000-005	\$153.18	950-000-008	\$175.28	950-000-007	\$183.63	950-000-006	\$183.63
3.0000	0.2500	1.0000	0.7188	1.5000	0.2500	28	950-000-009	\$160.48	950-000-012	\$183.63	950-000-011	\$192.51	950-000-010	\$192.51
4.0000	0.1250	1.0000	1.2188	1.5000	0.1250	32	950-000-017	\$188.33	950-000-020	\$215.47	950-000-019	\$225.81	950-000-018	\$225.81
4.0000	0.1250	1.2500	1.0313	1.8750	0.1250	32	950-000-021	\$188.33	950-000-024	\$215.47	950-000-023	\$225.81	950-000-022	\$225.81
4.0000	0.1563	1.0000	1.2188	1.5000	0.1563	32	950-000-041	\$200.90	950-000-044	\$229.90	950-000-043	\$240.82	950-000-042	\$240.82
4.0000	0.1563	1.2500	1.0313	1.8750	0.1563	32	950-000-045	\$200.90	950-000-048	\$229.90	950-000-047	\$240.82	950-000-046	\$240.82
4.0000	0.1875	1.0000	1.2188	1.5000	0.1875	32	950-000-025	\$206.50	950-000-028	\$236.37	950-000-027	\$247.67	950-000-026	\$247.67
4.0000	0.1875	1.2500	1.0313	1.8750	0.1875	32	950-000-029	\$206.50	950-000-032	\$236.37	950-000-031	\$247.67	950-000-030	\$247.67
4.0000	0.2500	1.0000	1.2188	1.5000	0.2500	32	950-000-033	\$200.90	950-000-036	\$229.90	950-000-035	\$240.82	950-000-034	\$240.82
4.0000	0.2500	1.2500	1.0313	1.8750	0.2500	32	950-000-037	\$200.90	950-000-040	\$229.90	950-000-039	\$240.82	950-000-038	\$240.82
6.0000	0.1250	1.2500	2.0313	1.8750	0.1250	40	950-000-049	\$347.62	950-000-052	\$397.82	950-000-051	\$416.85	950-000-050	\$416.85
6.0000	0.1563	1.2500	2.0313	1.8750	0.1563	40	950-000-061	\$351.53	950-000-064	\$402.42	950-000-063	\$421.47	950-000-062	\$421.47
6.0000	0.1875	1.2500	2.0313	1.8750	0.1875	40	950-000-053	\$421.47	950-000-056	\$409.08	950-000-055	\$428.69	950-000-054	\$428.69
6.0000	0.2500	1.2500	2.0313	1.8750	0.2500	40	950-000-057	\$118.87	950-000-060	\$118.87	950-000-059	\$453.51	950-000-058	\$453.51

*Make To Order



CUSTOM SOLUTIONS

THE COMPLETE TOOL MAKING AUTHORITY™



ARCH[®] Specials

Can't find what you need in our standard stocked inventory? We can create your custom tooling solution.



**Award Winning
Custom Tooling**



**COMBINED
400+ YEARS
EXPERIENCE**

- Solid tools
- Integral shank
- Form tools
- Indexable tools
- Micro tools
- Gang tools
- Multi-feature tools

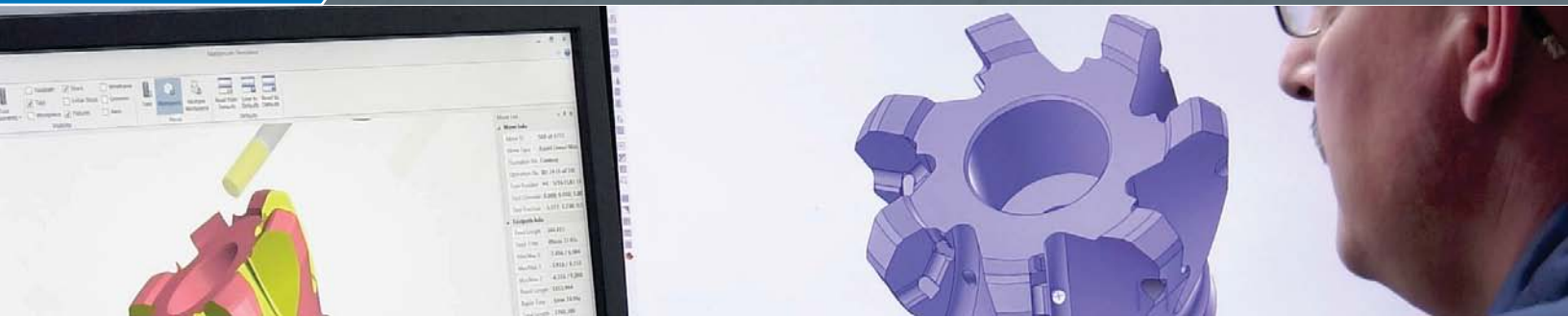

Productivity at the Spindle

Our customers do extraordinary things, but everybody needs a competitive edge. This requires a precision tooling partner that can deliver customs and specials that meet exacting standards. From napkin sketches to real working tools, we collaborate with our customers on design for manufacturability.

We provide:

- Cost-reducing efficiencies
- Process improvements
- Operational Consultation
- Advanced coatings and laser etching
- Comprehensive supply chain management
- Unmatched customer service

Our engineers talk to your engineers – fewer steps for better tools

When a customer consults with us, they get design-for-manufacturability guidance. We can help reduce the number of steps required to produce a component and the number of cutting tools needed to do it. Each time you take out a step in the manufacturing process, you remove the introduction of an inconsistency, divergence, or variation, no matter how small. Because, at high speeds, even the smallest variance is amplified.

Proven Competitive Advantages

Providing the special tools that our customers need to do their unparalleled work is just the beginning of the ARCH Specials story. Our engineers help identify your opportunities to increase value, improve quality and performance, and enhance manufacturing operations.



Contact ARCH Specials:
(844) 321-ARCH
sales@archgp.com



Solid Round Tools

Including:

- Specialty end mills
- Multi- step custom diameter drills
- Micro Tools
- Countersinks
- Reamers
- Chamfer Mills & Drills
- Engraving Cutters
- Corner Rounding tools
- Dovetail Cutters
- T-Slot Cutters
- Application specific geometry and coating
- Customizable shank types and diameters



Precise specifications - Extraordinary applications

The performance advantages of custom tools machined with greater precision — such as optimized cylindrical concentricity — produce increased throughput and enhanced machine usage. Simply put, achieving unique contours and cavities with tighter tolerances and reduced scrap saves time and money. Single tool solutions eliminate the need for multiple tools and passes resulting in improved cycle time and CPU.



Improved surface finish in cone taper

ARCH engineers modified the geometry and edge prep on a cone drill which tripled tool life and significantly improved surface finish to reduce scrap rates.

\$50,000

cost savings annually

30%

reduction in scrap

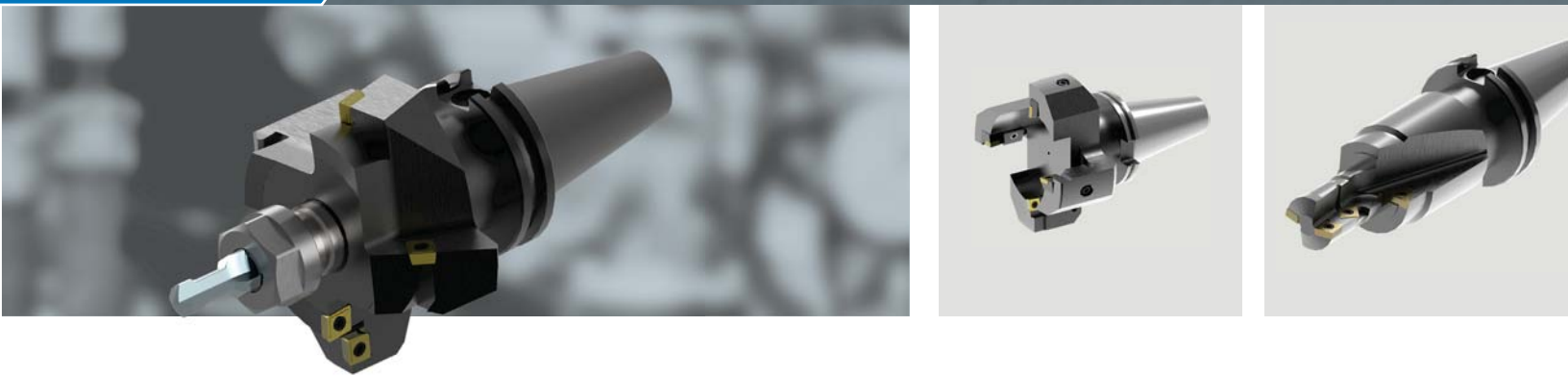

Indexables: Rotating & Non Rotating

Including:

- Custom Indexable profiles / lead angles
- Multi-step hole-making
- Indexable trepan
- Specialty square shank
- Custom straddle and grooving mills
- Multi -process combination tools
- Integral shank designs
- Modular / redundant tooling packages
- Precision insert pockets



Indexable milling, drilling, boring, turning, and holding tools can all be optimized with our proven full product life cycle process. Our customers invariably enjoy enhanced efficiencies when our process is applied to their unique needs. They are enabled to develop specialized cutting tool solutions that not only improve their final product, but also how they operate as an organization. From the initial on-site or virtual consultation, to engineering and design assist, ARCH Specials brings comprehensive and knowledge-driven results.



Performance and cost evaluation of inserts

ARCH reviewed customer's high-volume inserts for cost improvements.

\$36,000

cost savings
annually



Custom PCD Tooling

Key Features:

- Combining roughing and finishing tools
- Improved surface finishes
- Consistent results
- Tighter tolerances achievable
- Can be used in many materials including:
 - Aluminum Composite Material (ACM)
 - Composite panels
 - High pressure laminates (HPL)
 - Fiberglass

Our Capabilities

- Reconditioning, sharpening, re-tipping ANY manufacturers PCD tools and in any style connection, including steerable connections
- Combining PCD and carbide tooling in the same tool to lead to balanced, optimized solutions
- Custom solutions, specific for your application and part configuration

Before



After



After



Maximize tool life

Faster speeds and higher feed rates, results in increased through-put

25x
longer tool life
when compared to carbide



ARCH[®] Services

Repair - Retip - Recoat - Re grind - Resharpen



ARCH Cutting Tools is proud to offer our customers complete repair services for solid or indexable tooling.



Before



After

Indexable Tools

- Capable of repairing any manufacturers' tool or insert pocket type
- All tools brought back to original manufacturer's specifications
- Experienced with HSK, KM, CAPTO, and all standard machine tapers



Before



After

Solid Round Tools

- Carbide, HSS, Cobalt
- PCD/CBN Tipped
- Any coating

Save up to 75% off the cost of new tooling

Contact us at:
archcuttingtools.com/services

ARCH[®]
Cutting Tools

TOOL HOLDERS

THE COMPLETE TOOL MAKING AUTHORITY™



by Ultra-Dex

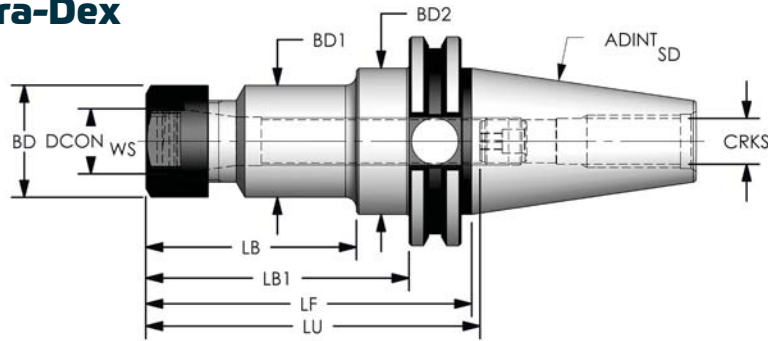

**Balanced to:
G2.5 (20,000 rpm)**

PRODUCT #	Designation	DCONWS	BD	BD1	BD2	LB	LB1	LF	LU	CRKS	Collet Nut	Stop Screw	Wrench	G2 Price*
966-000-065	CT40-ER11-250	ER11	0.750			1.750		2.500	1.940	5/8-11	ER-11HN	ER-11S	ER-11W	\$138.00
966-000-067	CT40-ER11-400	ER11	0.750		1.750	2.620	3.250	4.000	1.940	5/8-11	ER-11HN	ER-11S	ER-11W	\$141.00
966-000-069	CT40-ER11-600	ER11	0.750		1.750	4.620	5.250	6.000	1.940	5/8-11	ER-11HN	ER-11S	ER-11W	\$159.00
966-000-071	CT40-ER16-250	ER16	1.100			1.750		2.500	3.000	5/8-11	ER-16HN	ER-16S	ER-16W	\$126.00
966-000-073	CT40-ER16-300	ER16	1.100			2.250		3.000	3.000	5/8-11	ER-16HN	ER-16S	ER-16W	\$138.00
966-000-075	CT40-ER16-400	ER16	1.100			3.250		4.000	3.000	5/8-11	ER-16HN	ER-16S	ER-16W	\$141.00
966-000-077	CT40-ER16-500	ER16	1.100		1.750	3.620	4.250	5.000	3.000	5/8-11	ER-16HN	ER-16S	ER-16W	\$148.00
966-000-079	CT40-ER16-600	ER16	1.100		1.750	4.620	5.250	6.000	3.000	5/8-11	ER-16HN	ER-16S	ER-16W	\$159.00
966-000-081	CT40-ER20-300	ER20	1.340			2.250		3.000	30.500	5/8-11	ER-20HN	ER-20S	ER-20W	\$138.00
966-000-083	CT40-ER20-400	ER20	1.340		1.750	2.620	3.250	4.000	3.950	5/8-11	ER-20HN	ER-20S	ER-20W	\$141.00
966-000-085	CT40-ER20-600	ER20	1.340		1.750	4.620	5.250	6.000	3.950	5/8-11	ER-20HN	ER-20S	ER-20W	\$159.00
966-000-087	CT40-ER20-800	ER20	1.340		1.750	6.620	7.250	8.000	3.950	5/8-11	ER-20HN	ER-20S	ER-20W	\$241.00
966-000-089	CT40-ER25-250	ER25	1.660	1.590		1.750		2.500	2.800	5/8-11	ER-25SN	ER-25S	ER-25W	\$142.00
966-000-091	CT40-ER25-400	ER25	1.660	1.590	1.750	2.620	3.250	4.000	4.300	5/8-11	ER-25SN	ER-25S	ER-25W	\$142.00
966-000-093	CT40-ER25-600	ER25	1.660	1.590	1.750	4.620	5.250	6.000	4.400	5/8-11	ER-25SN	ER-25S	ER-25W	\$154.00
966-000-095	CT40-ER32-300	ER32	1.980	1.750		2.250		3.000	3.450	5/8-11	ER-32SN	ER-32S	ER-32W	\$151.00
966-000-097	CT40-ER32-400	ER32	1.980	1.750			3.250	4.000	4.300	5/8-11	ER-32SN	ER-32S	ER-32W	\$151.00
966-000-099	CT40-ER32-600	ER32	1.980	1.750			5.250	6.000	4.600	5/8-11	ER-32SN	ER-32S	ER-32W	\$159.00
966-000-101	CT40-ER32-800	ER32	1.980	1.750			7.250	8.000	4.600	5/8-11	ER-32SN	ER-32S	ER-32W	\$259.00
966-000-103	CT40-ER40-300	ER40	2.250				2.250	3.000	3.300	5/8-11	ER-40SN	ER-40S	ER-40W	\$151.00
966-000-105	CT40-ER40-400	ER40	2.250				3.250	4.000	4.000	5/8-11	ER-40SN	ER-40S	ER-40W	\$151.00
966-000-107	CT40-ER40-600	ER40	2.250				5.250	6.000	40.500	5/8-11	ER-40SN	ER-40S	ER-40W	\$174.00
966-000-109	CT40-ER40-800	ER40	2.250				7.250	8.00	4.50	5/8-11	ER-40SN	ER-40S	ER-40W	\$259.00

* Add -G2 to end of designation depending on the balance needed.

All Hardware Included. Wrenches Sold Separately.

PRODUCT #	Nut	Price Each
968-000-029	ER-11HN	\$22.50
968-000-033	ER-16HN	\$23.60
968-000-038	ER-20HN	\$27.20
968-000-044	ER-25SN	\$30.70
968-000-047	ER-32SN	\$31.90
968-000-050	ER-40SN	\$37.40
968-000-030	ER-11MN	\$24.80
968-000-034	ER-16MN	\$26.00
968-000-039	ER-20MN	\$28.40

PACKAGE SIZE OF 1

PRODUCT #	Adj. Screw	Price Each
968-000-032	ER-11S	\$8.20
968-000-036	ER-16S	\$8.70
968-000-041	ER-20S	\$9.70
968-000-043	ER-25S	\$11.40
968-000-046	ER-32S	\$12.40
968-000-049	ER-40S	\$14.20

PACKAGE SIZE OF 1

PRODUCT #	Wrench	Price Each
968-000-189	ER-11W	\$15.40
968-000-031	ER-11MW	\$39.60
968-000-035	ER-16MW	\$39.60
968-000-037	ER-16W	\$15.40
968-000-040	ER-20MW	\$44.00
968-000-042	ER-20W	\$15.40
968-000-045	ER-25W	\$17.70
968-000-048	ER-32W	\$20.10
968-000-051	ER-40W	\$28.40

PACKAGE SIZE OF 1

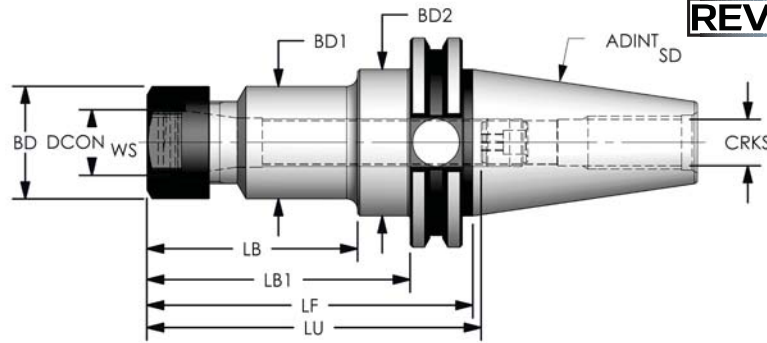

**Balanced to:
G6.3 (12,000 rpm)**

PRODUCT #	Designation	DCONWS	BD	BD1	BD2	LB	LB1	LF	LU	CRKS	Collet Nut	Stop Screw	Wrench	G6 Price*
966-000-066	CT40-ER11-250	ER11	.750			1.750		2.500	1.940	5/8-11	ER-11HN	ER-11S	ER-11W	\$114.00
966-000-068	CT40-ER11-400	ER11	.750		1.750	2.620	3.250	4.000	1.940	5/8-11	ER-11HN	ER-11S	ER-11W	\$116.00
966-000-070	CT40-ER11-600	ER11	.750		1.750	4.620	5.250	6.000	1.940	5/8-11	ER-11HN	ER-11S	ER-11W	\$135.00
966-000-072	CT40-ER16-250	ER16	1.100			1.750		2.500	3.000	5/8-11	ER-16HN	ER-16S	ER-16W	\$101.00
966-000-074	CT40-ER16-300	ER16	1.100			2.250		3.000	3.000	5/8-11	ER-16HN	ER-16S	ER-16W	\$114.00
966-000-076	CT40-ER16-400	ER16	1.100			3.250		4.000	3.000	5/8-11	ER-16HN	ER-16S	ER-16W	\$116.00
966-000-078	CT40-ER16-500	ER16	1.100		1.750	3.620	4.250	5.000	3.000	5/8-11	ER-16HN	ER-16S	ER-16W	\$124.00
966-000-080	CT40-ER16-600	ER16	1.100		1.750	4.620	5.250	6.000	3.000	5/8-11	ER-16HN	ER-16S	ER-16W	\$135.00
966-000-082	CT40-ER20-300	ER20	1.340			2.250		3.000	30.500	5/8-11	ER-20HN	ER-20S	ER-20W	\$114.00
966-000-084	CT40-ER20-400	ER20	1.340		1.750	2.620	3.250	4.000	3.950	5/8-11	ER-20HN	ER-20S	ER-20W	\$116.00
966-000-086	CT40-ER20-600	ER20	1.340		1.750	4.620	5.250	6.000	3.950	5/8-11	ER-20HN	ER-20S	ER-20W	\$135.00
966-000-088	CT40-ER20-800	ER20	1.340		1.750	6.620	7.250	8.000	3.950	5/8-11	ER-20HN	ER-20S	ER-20W	\$216.00
966-000-090	CT40-ER25-250	ER25	1.660	1.590		1.750		2.500	2.800	5/8-11	ER-25SN	ER-25S	ER-25W	\$117.00
966-000-092	CT40-ER25-400	ER25	1.660	1.590	1.750	2.620	3.250	4.000	4.300	5/8-11	ER-25SN	ER-25S	ER-25W	\$117.00
966-000-094	CT40-ER25-600	ER25	1.660	1.590	1.750	4.620	5.250	6.000	4.400	5/8-11	ER-25SN	ER-25S	ER-25W	\$130.00
966-000-096	CT40-ER32-300	ER32	1.980	1.750		2.250		3.000	3.450	5/8-11	ER-32SN	ER-32S	ER-32W	\$126.00
966-000-098	CT40-ER32-400	ER32	1.980	1.750			3.250	4.000	4.300	5/8-11	ER-32SN	ER-32S	ER-32W	\$126.00
966-000-100	CT40-ER32-600	ER32	1.980	1.750			5.250	6.000	4.600	5/8-11	ER-32SN	ER-32S	ER-32W	\$135.00
966-000-102	CT40-ER32-800	ER32	1.980	1.750			7.250	8.000	4.600	5/8-11	ER-32SN	ER-32S	ER-32W	\$235.00
966-000-104	CT40-ER40-300	ER40	2.250				2.250	3.000	3.300	5/8-11	ER-40SN	ER-40S	ER-40W	\$135.00
966-000-106	CT40-ER40-400	ER40	2.250				3.250	4.000	4.000	5/8-11	ER-40SN	ER-40S	ER-40W	\$135.00
966-000-108	CT40-ER40-600	ER40	2.250				5.250	6.000	40.500	5/8-11	ER-40SN	ER-40S	ER-40W	\$149.00
966-000-110	CT40-ER40-800	ER40	2.250				7.250	8.00	4.50	5/8-11	ER-40SN	ER-40S	ER-40W	\$235.00

* Add -G6 to end of designation depending on the balance needed.
All Hardware Included. Wrenches Sold Separately.

PRODUCT #	Nut	Price Each
968-000-029	ER-11HN	\$22.50
968-000-033	ER-16HN	\$23.60
968-000-038	ER-20HN	\$27.20
968-000-044	ER-25SN	\$30.70
968-000-047	ER-32SN	\$31.90
968-000-050	ER-40SN	\$37.40
968-000-030	ER-11MN	\$24.80
968-000-034	ER-16MN	\$26.00
968-000-039	ER-20MN	\$28.40

PACKAGE SIZE OF 1

PRODUCT #	Adj. Screw	Price Each
968-000-032	ER-11S	\$8.20
968-000-036	ER-16S	\$8.70
968-000-041	ER-20S	\$9.70
968-000-043	ER-25S	\$11.40
968-000-046	ER-32S	\$12.40
968-000-049	ER-40S	\$14.20

PACKAGE SIZE OF 1

PRODUCT #	Wrench	Price Each
968-000-189	ER-11W	\$15.40
968-000-031	ER-11MW	\$39.60
968-000-035	ER-16MW	\$39.60
968-000-037	ER-16W	\$15.40
968-000-040	ER-20MW	\$44.00
968-000-042	ER-20W	\$15.40
968-000-045	ER-25W	\$17.70
968-000-048	ER-32W	\$20.10
968-000-051	ER-40W	\$28.40

PACKAGE SIZE OF 1

ULTRA-DEX™

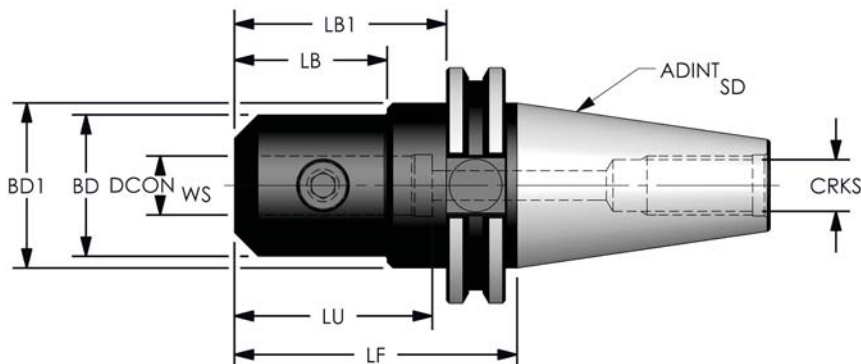

Balanced to:
G2.5 (20,000 rpm)

PRODUCT #	Designation	DCONWS	BD	BD1	LB	LB1	LF	CRKS	Set Screw	G2 Price*
966-000-001	CT40-EM012-250	0.125	0.690	1.750	1.120	1.750	2.50	5/8-11	SS10-250	\$117.00
966-000-017	CT40-EM188-250	0.188	0.750	1.750	1.120	1.750	2.50	5/8-11	SS10-250	\$105.00
966-000-019	CT40-EM188-400	0.188	0.750	1.750	2.620	3.250	4.00	5/8-11	SS10-250	\$135.00
966-000-021	CT40-EM250-250	0.250	0.880	1.750	1.125	1.750	2.50	5/8-11	SS1/4-250	\$105.00
966-000-023	CT40-EM250-400	0.250	0.880	1.750	2.620	3.250	4.00	5/8-11	SS1/4-250	\$121.00
966-000-025	CT40-EM250-600	0.250	0.880	1.750	4.625	5.250	6.00	5/8-11	SS1/4-250	\$128.00
966-000-027	CT40-EM312-250	0.312	0.880	1.750	1.120	1.750	2.50	5/8-11	SS1/4-250	\$105.00
966-000-029	CT40-EM312-400	0.312	0.880	1.750	2.625	3.250	4.00	5/8-11	SS1/4-250	\$121.00
966-000-031	CT40-EM312-600	0.312	0.880	1.750	4.625	5.250	6.00	5/8-11	SS1/4-250	\$128.00
966-000-033	CT40-EM375-250	0.375	1.000	1.750	1.120	1.750	2.50	5/8-11	SS3/8-375	\$105.00
966-000-035	CT40-EM375-400	0.375	1.000	1.750	2.620	3.250	4.00	5/8-11	SS3/8-375	\$121.00
966-000-037	CT40-EM375-600	0.375	1.000	1.750	4.620	5.250	6.00	5/8-11	SS3/8-375	\$121.00
966-000-039	CT40-EM437-250	0.437	1.000	1.750	1.125	1.750	2.50	5/8-11	SS3/8-375	\$105.00
966-000-041	CT40-EM437-400	0.437	1.000	1.750	2.620	3.250	4.00	5/8-11	SS3/8-375	\$128.00
966-000-043	CT40-EM500-262	0.500	1.375	1.750	1.245	1.870	2.62	5/8-11	SS7/16-500	\$105.00
966-000-045	CT40-EM500-400	0.500	1.375	1.750	2.620	3.250	4.00	5/8-11	SS7/16-500	\$121.00
966-000-047	CT40-EM500-600	0.500	1.375	1.750	4.620	5.250	6.00	5/8-11	SS7/16-500	\$128.00

* Add -G6 or -G2 to end of designation depending on the balance needed.

All Hardware Included

PRODUCT #	Set Screws	Price Each
968-000-137	SS10-250	\$3.30
968-000-136	SS1/4-250	\$3.30
968-000-142	SS3/8-375	\$3.30
968-000-144	SS7/16-500	\$5.30
968-000-145	SS9/16-500	\$10.20
968-000-143	SS5/8-500	\$10.20
968-000-139	SS3/4-375	\$11.30
968-000-140	SS3/4-500	\$11.30
968-000-138	SS1-750	\$11.90

PACKAGE SIZE OF 5

ULTRA-DEX

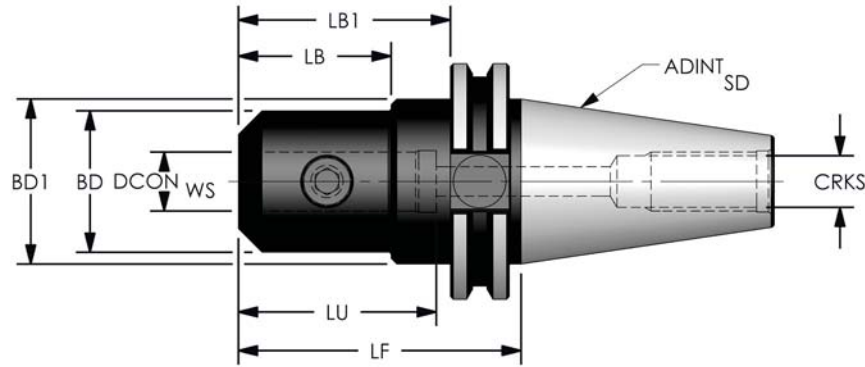

Balanced to:
G6.3 (12,000 rpm)

PRODUCT #	Designation	DCONWS	BD	BD1	LB	LB1	LF	CRKS	Set Screw	G6 Price*
966-000-002	CT40-EM012-250	.125	.690	1.750	1.120	1.750	2.50	5/8-11	SS10-250	\$93.00
966-000-018	CT40-EM188-250	.188	.750	1.750	1.120	1.750	2.50	5/8-11	SS10-250	\$80.00
966-000-020	CT40-EM188-400	.188	.750	1.750	2.620	3.250	4.00	5/8-11	SS10-250	\$110.00
966-000-022	CT40-EM250-250	.250	.880	1.750	1.125	1.750	2.50	5/8-11	SS1/4-250	\$80.00
966-000-024	CT40-EM250-400	.250	.880	1.750	2.620	3.250	4.00	5/8-11	SS1/4-250	\$96.00
966-000-026	CT40-EM250-600	.250	.880	1.750	4.625	5.250	6.00	5/8-11	SS1/4-250	\$104.00
966-000-028	CT40-EM312-250	.312	.880	1.750	1.120	1.750	2.50	5/8-11	SS1/4-250	\$80.00
966-000-030	CT40-EM312-400	.312	.880	1.750	2.625	3.250	4.00	5/8-11	SS1/4-250	\$96.00
966-000-032	CT40-EM312-600	.312	.880	1.750	4.625	5.250	6.00	5/8-11	SS1/4-250	\$104.00
966-000-034	CT40-EM375-250	.375	1.000	1.750	1.120	1.750	2.50	5/8-11	SS3/8-375	\$80.00
966-000-036	CT40-EM375-400	.375	1.000	1.750	2.620	3.250	4.00	5/8-11	SS3/8-375	\$96.00
966-000-038	CT40-EM375-600	.375	1.000	1.750	4.620	5.250	6.00	5/8-11	SS3/8-375	\$96.00
966-000-040	CT40-EM437-250	.437	1.000	1.750	1.125	1.750	2.50	5/8-11	SS3/8-375	\$80.00
966-000-042	CT40-EM437-400	.437	1.000	1.750	2.620	3.250	4.00	5/8-11	SS3/8-375	\$104.00
966-000-044	CT40-EM500-262	0.500	1.375	1.750	1.245	1.870	2.62	5/8-11	SS7/16-500	\$80.00
966-000-046	CT40-EM500-400	0.500	1.375	1.750	2.620	3.250	4.00	5/8-11	SS7/16-500	\$96.00
966-000-048	CT40-EM500-600	0.500	1.375	1.750	4.620	5.250	6.00	5/8-11	SS7/16-500	\$104.00

* Add -G6 or -G2 to end of designation depending on the balance needed.

All Hardware Included

PRODUCT #	Set Screws	Price Each
968-000-137	SS10-250	\$3.30
968-000-136	SS1/4-250	\$3.30
968-000-142	SS3/8-375	\$3.30
968-000-144	SS7/16-500	\$5.30
968-000-145	SS9/16-500	\$10.20
968-000-143	SS5/8-500	\$10.20
968-000-139	SS3/4-375	\$11.30
968-000-140	SS3/4-500	\$11.30
968-000-138	SS1-750	\$11.90

PACKAGE SIZE OF 5

ULTRA-DEX™

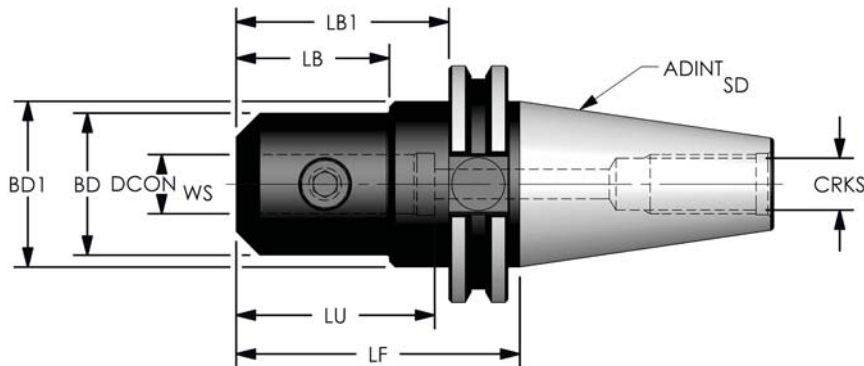

Balanced to:
G2.5 (20,000 rpm)

PRODUCT #	Designation	DCON WS	BD	BD1	LB	LB1	LF	LU	CRKS	Set Screw	G2 Price*
966-000-049	CT40-EM563-262	.563	1.375	1.750	1.240	1.870	2.62	2.05	5/8-11	SS7/16-500	\$105.00
966-000-051	CT40-EM625-175	.625	1.750		1.000		1.75	2.10	5/8-11	SS9/16-500	\$105.00
966-000-053	CT40-EM625-300	.625	1.500	1.750	1.620	2.250	3.00	2.10	5/8-11	SS9/16-500	\$121.00
966-000-055	CT40-EM625-600	.625	1.500	1.750	4.625	5.250	6.00	2.10	5/8-11	SS9/16-500	\$128.00
966-000-057	CT40-EM750-175	.750	1.750		1.000		1.75	2.25	5/8-11	SS5/8-500	\$105.00
966-000-059	CT40-EM750-300	.750	1.750		2.250		3.00	2.30	5/8-11	SS5/8-500	\$121.00
966-000-061	CT40-EM750-600	.750	1.750		5.280		6.00	2.30	5/8-11	SS5/8-500	\$128.00
966-000-063	CT40-EM875-600	.875	2.000	1.750	4.625	5.250	6.00	2.50	5/8-11	SS5/8-500	\$128.00
966-000-003	CT40-EM100-175	1.000	1.750		1.000		1.75	2.25	5/8-11	SS3/4-375	\$105.00
966-000-005	CT40-EM100-400	1.000	2.000	1.750	2.620	3.250	4.00	2.83	5/8-11	SS3/4-500	\$121.00
966-000-007	CT40-EM100-600	1.000	2.000	1.750	4.625	5.250	6.00	2.83	5/8-11	SS3/4-500	\$128.00
966-000-009	CT40-EM125-250	1.250	2.250		1.750		2.50	2.50	5/8-11	SS3/4-500	\$105.00
966-000-011	CT40-EM125-400	1.250	2.250		3.250		4.00	3.00	5/8-11	(2) SS3/4-500	\$121.00
966-000-013	CT40-EM125-600	1.250	2.250	1.750	4.625	5.250	6.00	3.00	5/8-11	(2) SS3/4-500	\$128.00
966-000-015	CT40-EM150-462	1.500	2.600	1.750	3.245	3.870	4.62	2.75	5/8-11	(2) SS3/4-500	\$121.00

* Add -G6 or -G2 to end of designation depending on the balance needed.

All Hardware Included

PRODUCT #	Set Screws	Price Each
968-000-137	SS10-250	\$3.30
968-000-136	SS1/4-250	\$3.30
968-000-142	SS3/8-375	\$3.30
968-000-144	SS7/16-500	\$5.30
968-000-145	SS9/16-500	\$10.20
968-000-143	SS5/8-500	\$10.20
968-000-139	SS3/4-375	\$11.30
968-000-140	SS3/4-500	\$11.30
968-000-138	SS1-750	\$11.90

PACKAGE SIZE OF 5

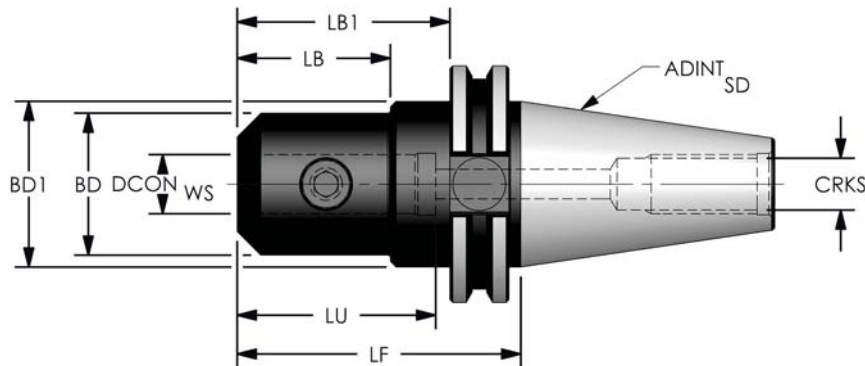

Balanced to:
G6.3 (12,000 rpm)

PRODUCT #	Designation	DCON WS	BD	BD1	LB	LB1	LF	LU	CRKS	Set Screw	G6 Price*
966-000-050	CT40-EM563-262	.563	1.375	1.750	1.240	1.870	2.62	2.05	5/8-11	SS7/16-500	\$80.00
966-000-052	CT40-EM625-175	.625	1.750		1.000		1.75	2.10	5/8-11	SS9/16-500	\$80.00
966-000-054	CT40-EM625-300	.625	1.500	1.750	1.620	2.250	3.00	2.10	5/8-11	SS9/16-500	\$96.00
966-000-056	CT40-EM625-600	.625	1.500	1.750	4.625	5.250	6.00	2.10	5/8-11	SS9/16-500	\$92.17
966-000-058	CT40-EM750-175	.750	1.750		1.000		1.75	2.25	5/8-11	SS5/8-500	\$80.00
966-000-060	CT40-EM750-300	.750	1.750		2.250		3.00	2.30	5/8-11	SS5/8-500	\$96.00
966-000-062	CT40-EM750-600	.750	1.750		5.280		6.00	2.30	5/8-11	SS5/8-500	\$104.00
966-000-064	CT40-EM875-600	.875	2.000	1.750	4.625	5.250	6.00	2.50	5/8-11	SS5/8-500	\$104.00
966-000-004	CT40-EM100-175	1.000	1.750		1.000		1.75	2.25	5/8-11	SS3/4-375	\$80.00
966-000-006	CT40-EM100-400	1.000	2.000	1.750	2.620	3.250	4.00	2.83	5/8-11	SS3/4-500	\$96.00
966-000-008	CT40-EM100-600	1.000	2.000	1.750	4.625	5.250	6.00	2.83	5/8-11	SS3/4-500	\$104.00
966-000-010	CT40-EM125-250	1.250	2.250		1.750		2.50	2.50	5/8-11	SS3/4-500	\$80.00
966-000-012	CT40-EM125-400	1.250	2.250		3.250		4.00	3.00	5/8-11	(2) SS3/4-500	\$96.00
966-000-014	CT40-EM125-600	1.250	2.250	1.750	4.625	5.250	6.00	3.00	5/8-11	(2) SS3/4-500	\$104.00
966-000-016	CT40-EM150-462	1.500	2.600	1.750	3.245	3.870	4.62	2.75	5/8-11	(2) SS3/4-500	\$96.00

* Add -G6 or -G2 to end of designation depending on the balance needed.

All Hardware Included

PRODUCT #	Set Screws	Price Each
968-000-137	SS10-250	\$3.30
968-000-136	SS1/4-250	\$3.30
968-000-142	SS3/8-375	\$3.30
968-000-144	SS7/16-500	\$5.30
968-000-145	SS9/16-500	\$10.20
968-000-143	SS5/8-500	\$10.20
968-000-139	SS3/4-375	\$11.30
968-000-140	SS3/4-500	\$11.30
968-000-138	SS1-750	\$11.90

PACKAGE SIZE OF 5



by **Ultra-Dex**

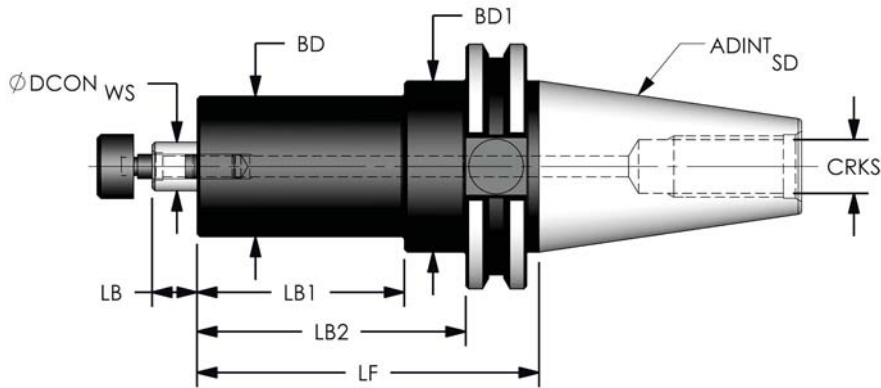

Balanced to:
G6.3 (12,000 rpm)

PRODUCT #	Designation	DCON WS	BD	BD1	LB	LB1	LB2	LF	CRKS	Drive Key	Lock Screw	Thread	Price
966-000-134	CT40-SM050-138	0.500	1.438		0.460	0.625		1.38	5/8-11	UDK 250	U5001	1/4-28	\$107.00
966-000-135	CT40-SM050-350	0.500	1.438	1.750	0.460	2.580	3.210	3.50	5/8-11	UDK 250	U5001	1/4-28	\$122.00
966-000-136	CT40-SM075-150	0.750	1.750		0.680	1.430		1.50	5/8-11	UDK 312	U5002	3/8-24	\$110.00
966-000-137	CT40-SM075-400	0.750	1.750		0.680	3.250		4.00	5/8-11	UDK 312	U5002	3/8-24	\$135.00
966-000-138	CT40-SM075-600	0.750	1.750		0.680	5.250		6.00	5/8-11	UDK 312	U5002	3/8-24	\$159.00
966-000-139	CT40-SM100-200	1.000	2.190	1.750	0.680	0.620	1.250	2.00	5/8-11	UDK 375	U5003	1/2-20	\$114.00
966-000-140	CT40-SM100-400	1.000	2.190	1.750	0.680	2.620	3.250	4.00	5/8-11	UDK 375	U5003	1/2-20	\$135.00
966-000-141	CT40-SM100-600	1.000	2.190	1.750	0.680	4.620	5.250	6.00	5/8-11	UDK 375	U5003	1/2-20	\$178.00
966-000-142	CT40-SM125-212	1.250	2.750	1.750	0.680	0.745	1.375	2.12	5/8-11	UDK 500	U5004	5/8-18	\$110.00
966-000-143	CT40-SM125-400	1.250	2.750	1.750	0.680	2.620	3.250	4.00	5/8-11	UDK 500	U5004	5/8-18	\$127.00
966-000-144	CT40-SM150-250	1.500	3.380	1.750	0.940	1.120	1.750	2.50	5/8-11	UDK 625	U5005	3/4-16	\$116.00
966-000-145	CT40-SM150-400	1.500	3.380	1.750	0.940	2.620	3.250	4.00	5/8-11	UDK 625	U5005	3/4-16	\$132.00

PRODUCT #	Arbor Screws	Price Each
968-000-162	U5001	\$11.00
968-000-163	U5002	\$11.80
968-000-164	U5003	\$14.20
968-000-165	U5004	\$18.90
968-000-166	U5005	\$27.20
968-000-167	U5006	\$31.90
968-000-168	U5007	\$44.00
968-000-008	AS1/4-100	\$1.80
968-000-009	AS3/8-125	\$1.80
968-000-007	AS1/2-150	\$3.30

PACKAGE SIZE OF 1

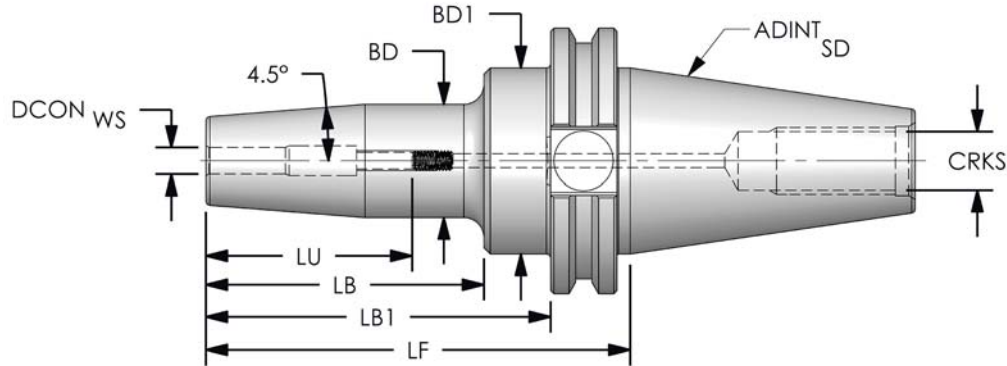

Standard Length

Balanced to:
G2.5 (20,000 rpm)

PRODUCT #	Designation	DCON WS	BD	BD1	LB	LB1	LF	LU	CRKS	THREAD	PRICE
966-000-116	CT40-SF012-400-G2	0.125	0.500	1.750	2.620	3.250	4.000	0.790	5 8/11		\$203.00
966-000-121	CT40-SF188-400-G2	0.188	0.500	1.750	2.620	3.250	4.000	0.790	5 8/11		\$190.00
966-000-123	CT40-SF250-400-G2	0.250	0.750	1.750	2.620	3.250	4.000	1.420	5 8/11	10-32	\$190.00
966-000-126	CT40-SF375-400-G2	0.375	0.750	1.750	2.620	3.250	4.000	1.530	5 8/11	1/4-28	\$190.00
966-000-128	CT40-SF500-400-G2	0.500	1.000	1.750	2.620	3.250	4.000	1.850	5 8/11	7/16-20	\$196.00
966-000-130	CT40-SF625-400-G2	0.625	1.000	1.750	2.625	3.250	4.000	1.970	5 8/11	9/16-18	\$196.00
966-000-132	CT40-SF750-400-G2	0.750	1.250	1.750	2.625	3.250	4.000	2.040	5 8/11	5/8-18	\$209.00
966-000-118	CT40-SF100-400-G2	1.000	2.090	1.750	2.625	3.250	4.000	2.280	5 8/11	3/4-16	\$209.00
966-000-120	CT40-SF125-400-G2	1.250	2.090	1.750	2.625	3.250	4.000	2.280	5 8/11	3/4-16	\$209.00

Extended Length

PRODUCT #	Designation	DCON WS	BD	BD1	LB	LB1	LF	LU	CRKS	THREAD	PRICE
966-000-117	CT40-SF012-600-G2	.125	.750	1.750	2.620	5.250	6.00	0.79	5/8-11		\$234.00
966-000-122	CT40-SF188-600-G2	.188	.750	1.750	2.620	5.250	6.00	0.79	5/8-11		\$221.00
966-000-124	CT40-SF250-600-G2	.250	.750	1.750	2.620	5.250	6.00	1.42	5/8-11	10-32	\$221.00
966-000-127	CT40-SF375-600-G2	.375	1.000	1.750	2.620	5.250	6.00	1.53	5/8-11	1/4-28	\$221.00
966-000-129	CT40-SF500-600-G2	0.500	1.000	1.750	2.620	5.250	6.00	1.85	5/8-11	7/16-20	\$221.00
966-000-131	CT40-SF625-600-G2	.625	1.250	1.750	2.625	5.250	6.00	1.97	5/8-11	9/16-18	\$227.00
966-000-133	CT40-SF750-600-G2	.750	1.250	1.750	2.625	5.250	6.00	2.04	5/8-11	5/8-18	\$227.00
966-000-119	CT40-SF100-600-G2	1.000	2.090	1.750	2.625	5.250	6.00	2.28	5/8-11	3/4-16	\$227.00
966-000-125	CT40-SF250-800-G2	.250	1.000	1.750	6.625	7.250	8.00	1.42	5/8-11	10-32	\$258.00

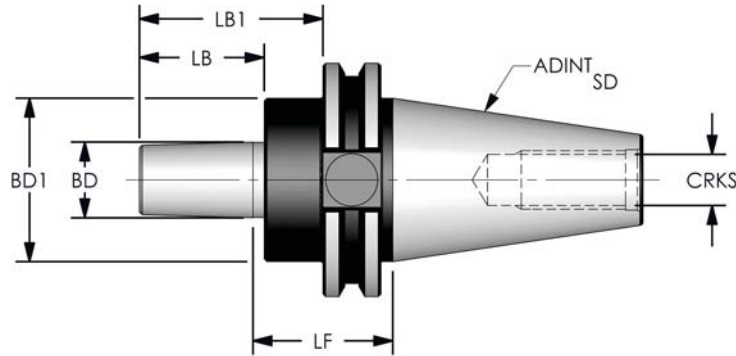

Balanced to:
G6.3 (12,000 rpm)

PRODUCT #	Designation	Taper No.	BD	BD1	LB	LB1	LF	CRKS	Taper Length	Price
966-000-111	CT40-JT02-150	2	0.559	1.750	1.025	1.625	1.50	5/8-11	0.875	\$86.00
966-000-112	CT40-JT03-150	3	0.811	1.750	1.339	1.969	1.50	5/8-11	1.219	\$86.00
966-000-113	CT40-JT04-150	4	1.124	1.750	1.776	2.406	1.50	5/8-11	1.656	\$86.00
966-000-114	CT40-JT06-150	6	0.676	1.750	1.120	1.750	1.50	5/8-11	1.000	\$86.00
966-000-115	CT40-JT33-150	33	0.624	1.750	1.120	1.750	1.50	5/8-11	1.000	\$89.00

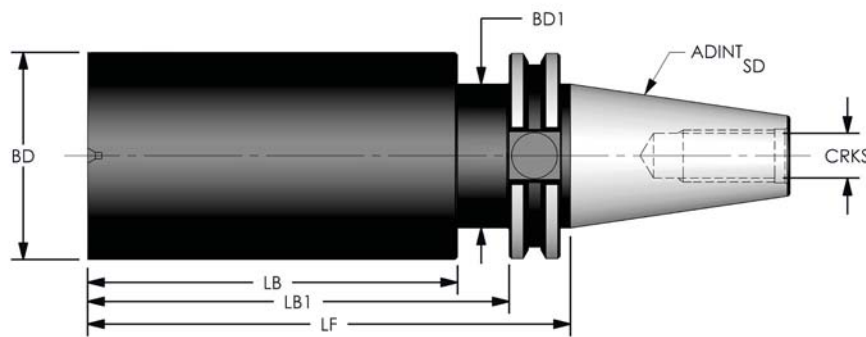

PRODUCT #	Designation	Taper	BD	BD1	LB	LB1	LF	Price
967-000-002	CT40-BB64-150	CAT40	2.520(64mm)	1.750	4.526	5.156	5.91(150mm)	\$159.00
967-000-003	CT40-BB64-250	CAT40	2.520(64mm)	1.750	4.526	5.156	9.84(250mm)	\$185.50
967-000-001	CT40-BB100-150	CAT40	3.940(100mm)	1.750	8.463	9.093	5.91(150mm)	\$198.30

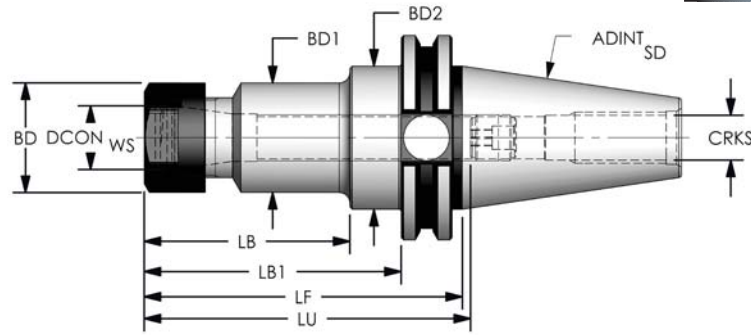

Balanced to:
G2.5 (15,000 rpm)

PRODUCT #	Designation	DCONWS	BD	BD1	BD2	LB	LB1	LF	LU	CRKS	Collet Nut	Stop Screw	Wrench	G2 Price*
966-000-216	CT50-ER11-600	ER11	0.750					6.000	1.940	1-8	ER-11HN	ER-11S	ER-11W	\$284.00
966-000-218	CT50-ER16-400	ER16	1.100	1.100	2.750	2.620	3.250	4.000	40.500	1-8	ER-16HN	ER-16S	ER-16W	\$195.00
966-000-220	CT50-ER16-600	ER16	1.100	1.100	2.750	4.620	5.250	6.000	40.500	1-8	ER-16HN	ER-16S	ER-16W	\$209.00
966-000-222	CT50-ER16-800	ER16	1.100	1.100	2.750	6.620	7.250	8.000	40.500	1-8	ER-16HN	ER-16S	ER-16W	\$284.00
966-000-224	CT50-ER20-250	ER20	1.340	1.340	1.340	1.750		2.500	3.380	1-8	ER-20HN	ER-20S	ER-20W	\$195.00
966-000-226	CT50-ER20-400	ER20	1.340	1.340	2.750	2.620	3.250	4.000	4.000	1-8	ER-20HN	ER-20S	ER-20W	\$195.00
966-000-228	CT50-ER20-600	ER20	1.340	1.340	2.750	4.620	5.250	6.000	4.000	1-8	ER-20HN	ER-20S	ER-20W	\$214.00
966-000-230	CT50-ER20-800	ER20	1.340	1.340	2.750	6.620	7.250	8.000	4.000	1-8	ER-20HN	ER-20S	ER-20W	\$245.00
966-000-232	CT50-ER25-250	ER25	1.660	1.590	2.750	1.120	1.750	2.500	40.500	1-8	ER-25SN	ER-25S	ER-25W	\$200.00
966-000-234	CT50-ER25-400	ER25	1.660	1.590	2.750	2.620	3.250	4.000	40.500	1-8	ER-25SN	ER-25S	ER-25W	\$200.00
966-000-236	CT50-ER25-600	ER25	1.660	1.590	2.750	4.620	5.250	6.000	40.500	1-8	ER-25SN	ER-25S	ER-25W	\$217.00
966-000-238	CT50-ER25-800	ER25	1.660	1.590	2.750	6.620	7.250	8.000	40.500	1-8	ER-25SN	ER-25S	ER-25W	\$247.00
966-000-240	CT50-ER32-300	ER32	1.980	2.000	2.750	1.620	2.250	3.000	30.500	1-8	ER-32SN	ER-32S	ER-32W	\$196.00
966-000-242	CT50-ER32-400	ER32	1.980	2.000	2.750	2.620	3.250	4.000	4.000	1-8	ER-32SN	ER-32S	ER-32W	\$203.00
966-000-244	CT50-ER32-500	ER32	1.980	2.000	2.750	3.620	4.250	5.000	4.000	1-8	ER-32SN	ER-32S	ER-32W	\$210.00
966-000-246	CT50-ER32-600	ER32	1.980	2.000	2.750	4.620	5.250	6.000	4.000	1-8	ER-32SN	ER-32S	ER-32W	\$210.00
966-000-248	CT50-ER32-800	ER32	1.980	2.000	2.750	6.620	7.250	8.000	4.000	1-8	ER-32SN	ER-32S	ER-32W	\$290.00
966-000-250	CT50-ER40-300	ER40	2.500	2.500	2.750	1.620	2.250	3.000	4.000	1-8	ER-40SN	ER-40S	ER-40W	\$196.00
966-000-252	CT50-ER40-400	ER40	2.500	2.500	2.750	2.620	3.250	4.000	40.500	1-8	ER-40SN	ER-40S	ER-40W	\$210.00
966-000-254	CT50-ER40-500	ER40	2.500	2.500	2.750	3.620	4.250	5.000	40.500	1-8	ER-40SN	ER-40S	ER-40W	\$217.00
966-000-256	CT50-ER40-600	ER40	2.500	2.500	2.750	4.620	5.250	6.000	40.500	1-8	ER-40SN	ER-40S	ER-40W	\$224.00
966-000-258	CT50-ER40-800	ER40	2.500	2.500	2.750	6.620	7.250	8.000	40.500	1-8	ER-40SN	ER-40S	ER-40W	\$297.00

* Add -G6 or -G2 to end of designation depending on the balance needed.

All Hardware Included. Wrenches Sold Separately.

PRODUCT #	Nut	Price Each
968-000-029	ER-11HN	\$22.50
968-000-033	ER-16HN	\$23.60
968-000-038	ER-20HN	\$27.20
968-000-044	ER-25SN	\$30.70
968-000-047	ER-32SN	\$31.90
968-000-050	ER-40SN	\$37.40
968-000-030	ER-11MN	\$24.80
968-000-034	ER-16MN	\$26.00
968-000-039	ER-20MN	\$28.40

PACKAGE SIZE OF 1

PRODUCT #	Adj. Screw	Price Each
968-000-032	ER-11S	\$8.20
968-000-036	ER-16S	\$8.70
968-000-041	ER-20S	\$9.70
968-000-043	ER-25S	\$11.40
968-000-046	ER-32S	\$12.40
968-000-049	ER-40S	\$14.20

PACKAGE SIZE OF 1

PRODUCT #	Wrench	Price Each
968-000-189	ER-11W	\$15.40
968-000-031	ER-11MW	\$39.60
968-000-035	ER-16MW	\$39.60
968-000-037	ER-16W	\$15.40
968-000-040	ER-20MW	\$44.00
968-000-042	ER-20W	\$15.40
968-000-045	ER-25W	\$17.70
968-000-048	ER-32W	\$20.10
968-000-051	ER-40W	\$28.40

PACKAGE SIZE OF 1

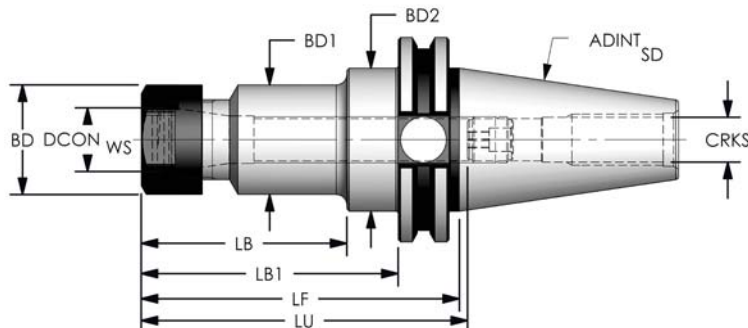

Balanced to:
G6.3 (12,000 rpm)

PRODUCT #	Designation	DCONWS	BD	BD1	BD2	LB	LB1	LF	LU	CRKS	Collet Nut	Stop Screw	Wrench	G6 Price*
966-000-217	CT50-ER11-600	ER11	0.750					6.000	1.940	1-8	ER-11HN	ER-11S	ER-11W	\$259.00
966-000-219	CT50-ER16-400	ER16	1.100	1.100	2.750	2.620	3.250	4.000	40.500	1-8	ER-16HN	ER-16S	ER-16W	\$170.00
966-000-221	CT50-ER16-600	ER16	1.100	1.100	2.750	4.620	5.250	6.000	40.500	1-8	ER-16HN	ER-16S	ER-16W	\$184.00
966-000-223	CT50-ER16-800	ER16	1.100	1.100	2.750	6.620	7.250	8.000	40.500	1-8	ER-16HN	ER-16S	ER-16W	\$259.00
966-000-225	CT50-ER20-250	ER20	1.340	1.340	1.340	1.750		2.500	3.380	1-8	ER-20HN	ER-20S	ER-20W	\$170.00
966-000-227	CT50-ER20-400	ER20	1.340	1.340	2.750	2.620	3.250	4.000	4.000	1-8	ER-20HN	ER-20S	ER-20W	\$170.00
966-000-229	CT50-ER20-600	ER20	1.340	1.340	2.750	4.620	5.250	6.000	4.000	1-8	ER-20HN	ER-20S	ER-20W	\$189.00
966-000-231	CT50-ER20-800	ER20	1.340	1.340	2.750	6.620	7.250	8.000	4.000	1-8	ER-20HN	ER-20S	ER-20W	\$220.00
966-000-233	CT50-ER25-250	ER25	1.660	1.590	2.750	1.120	1.750	2.500	40.500	1-8	ER-25SN	ER-25S	ER-25W	\$175.00
966-000-235	CT50-ER25-400	ER25	1.660	1.590	2.750	2.620	3.250	4.000	40.500	1-8	ER-25SN	ER-25S	ER-25W	\$175.00
966-000-237	CT50-ER25-600	ER25	1.660	1.590	2.750	4.620	5.250	6.000	40.500	1-8	ER-25SN	ER-25S	ER-25W	\$193.00
966-000-239	CT50-ER25-800	ER25	1.660	1.590	2.750	6.620	7.250	8.000	40.500	1-8	ER-25SN	ER-25S	ER-25W	\$222.00
966-000-241	CT50-ER32-300	ER32	1.980	2.000	2.750	1.620	2.250	3.000	30.500	1-8	ER-32SN	ER-32S	ER-32W	\$172.00
966-000-243	CT50-ER32-400	ER32	1.980	2.000	2.750	2.620	3.250	4.000	4.000	1-8	ER-32SN	ER-32S	ER-32W	\$178.00
966-000-245	CT50-ER32-500	ER32	1.980	2.000	2.750	3.620	4.250	5.000	4.000	1-8	ER-32SN	ER-32S	ER-32W	\$185.00
966-000-247	CT50-ER32-600	ER32	1.980	2.000	2.750	4.620	5.250	6.000	4.000	1-8	ER-32SN	ER-32S	ER-32W	\$185.00
966-000-249	CT50-ER32-800	ER32	1.980	2.000	2.750	6.620	7.250	8.000	4.000	1-8	ER-32SN	ER-32S	ER-32W	\$266.00
966-000-251	CT50-ER40-300	ER40	2.500	2.500	2.750	1.620	2.250	3.000	4.000	1-8	ER-40SN	ER-40S	ER-40W	\$172.00
966-000-253	CT50-ER40-400	ER40	2.500	2.500	2.750	2.620	3.250	4.000	40.500	1-8	ER-40SN	ER-40S	ER-40W	\$185.00
966-000-255	CT50-ER40-500	ER40	2.500	2.500	2.750	3.620	4.250	5.000	40.500	1-8	ER-40SN	ER-40S	ER-40W	\$193.00
966-000-257	CT50-ER40-600	ER40	2.500	2.500	2.750	4.620	5.250	6.000	40.500	1-8	ER-40SN	ER-40S	ER-40W	\$199.00
966-000-259	CT50-ER40-800	ER40	2.500	2.500	2.750	6.620	7.250	8.000	40.500	1-8	ER-40SN	ER-40S	ER-40W	\$272.00

PRODUCT #	Nut	Price Each
968-000-029	ER-11HN	\$22.50
968-000-033	ER-16HN	\$23.60
968-000-038	ER-20HN	\$27.20
968-000-044	ER-25SN	\$30.70
968-000-047	ER-32SN	\$31.90
968-000-050	ER-40SN	\$37.40
968-000-030	ER-11MN	\$24.80
968-000-034	ER-16MN	\$26.00
968-000-039	ER-20MN	\$28.40

PACKAGE SIZE OF 1

PRODUCT #	Adj. Screw	Price Each
968-000-032	ER-11S	\$8.20
968-000-036	ER-16S	\$8.70
968-000-041	ER-20S	\$9.70
968-000-043	ER-25S	\$11.40
968-000-046	ER-32S	\$12.40
968-000-049	ER-40S	\$14.20

PACKAGE SIZE OF 1

PRODUCT #	Wrench	Price Each
968-000-189	ER-11W	\$15.40
968-000-031	ER-11MW	\$39.60
968-000-035	ER-16MW	\$39.60
968-000-037	ER-16W	\$15.40
968-000-040	ER-20MW	\$44.00
968-000-042	ER-20W	\$15.40
968-000-045	ER-25W	\$17.70
968-000-048	ER-32W	\$20.10
968-000-051	ER-40W	\$28.40

PACKAGE SIZE OF 1

ULTRA-DEX

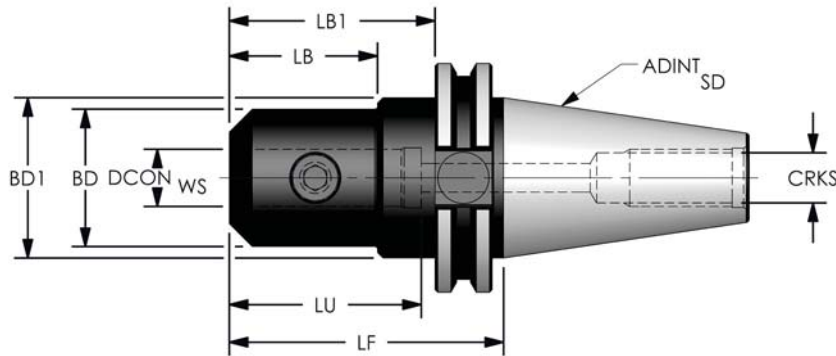

**Balanced to:
G2.5 (15,000 rpm)**

PRODUCT #	Designation	DCON WS	BD	BD1	LB	LB1	LF	CRKS	Set Screw	G2 Price*
966-000-162	CT50-EM188-250	0.188	0.680	2.750	1.125	1.750	2.50	1-8	SS10-250	\$135.00
966-000-164	CT50-EM188-400	0.188	0.680	2.750	2.625	3.250	4.00	1-8	SS10-250	\$146.00
966-000-170	CT50-EM250-250	0.250	0.880	2.750	1.125	1.750	2.50	1-8	SS1/4-250	\$135.00
966-000-172	CT50-EM250-400	0.250	0.880	2.750	2.625	3.250	4.00	1-8	SS1/4-250	\$146.00
966-000-174	CT50-EM250-600	0.250	0.880	2.750	4.625	5.250	6.00	1-8	SS1/4-250	\$159.00
966-000-176	CT50-EM312-250	0.312	1.000	2.750	1.125	1.750	2.50	1-8	SS1/4-250	\$135.00
966-000-178	CT50-EM312-400	0.312	1.000	2.750	2.625	3.250	4.00	1-8	SS1/4-250	\$146.00
966-000-180	CT50-EM312-600	0.312	1.000	2.750	4.625	5.250	6.00	1-8	SS1/4-250	\$159.00
966-000-182	CT50-EM375-250	0.375	1.000	2.750	1.125	1.750	2.50	1-8	SS3/8-375	\$135.00
966-000-184	CT50-EM375-400	0.375	1.000	2.750	2.625	3.250	4.00	1-8	SS3/8-375	\$146.00
966-000-186	CT50-EM375-600	0.375	1.000	2.750	4.625	5.250	6.00	1-8	SS3/8-375	\$159.00
966-000-188	CT50-EM437-250	0.437	1.000	2.750	1.125	1.750	2.50	1-8	SS3/8-375	\$135.00
966-000-190	CT50-EM437-400	0.437	1.000	2.750	2.625	3.250	4.00	1-8	SS3/8-375	\$170.00
966-000-192	CT50-EM437-600	0.437	1.000	2.750	4.625	5.250	6.00	1-8	SS3/8-375	\$183.00
966-000-194	CT50-EM500-262	0.500	1.375	2.750	1.245	1.870	2.62	1-8	SS7/16-500	\$135.00
966-000-196	CT50-EM500-400	0.500	1.375	2.750	2.620	3.250	4.00	1-8	SS7/16-500	\$146.00
966-000-198	CT50-EM500-600	0.500	1.375	2.750	4.625	5.250	6.00	1-8	SS7/16-500	\$159.00

* Add -G6 or -G2 to end of designation depending on the balance needed.

All Hardware Included

PRODUCT #	Set Screws	Price Each
968-000-137	SS10-250	\$3.30
968-000-136	SS1/4-250	\$3.30
968-000-142	SS3/8-375	\$3.30
968-000-144	SS7/16-500	\$5.30
968-000-145	SS9/16-500	\$10.20
968-000-143	SS5/8-500	\$10.20
968-000-139	SS3/4-375	\$11.30
968-000-140	SS3/4-500	\$11.30
968-000-138	SS1-750	\$11.90

PACKAGE SIZE OF 5

ULTRA-DEX™

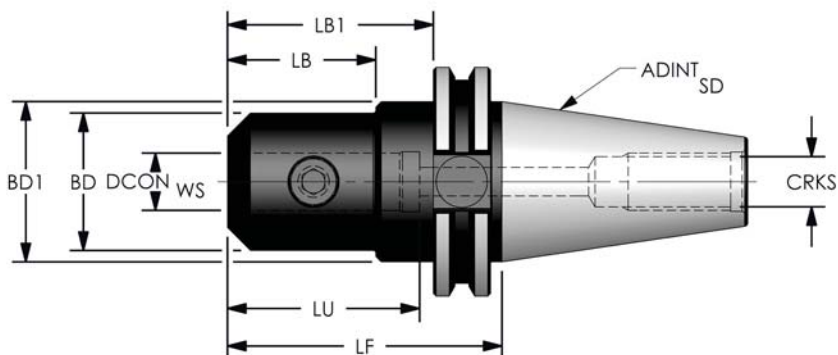

Balanced to:
G6.3 (12,000 rpm)

PRODUCT #	Designation	DCON WS	BD	BD1	LB	LB1	LF	CRKS	Set Screw	G6 Price*
966-000-163	CT50-EM188-250	.188	0.680	2.750	1.125	1.750	2.50	1-8	SS10-250	\$111.00
966-000-165	CT50-EM188-400	.188	0.680	2.750	2.625	3.250	4.00	1-8	SS10-250	\$121.00
966-000-171	CT50-EM250-250	.250	0.880	2.750	1.125	1.750	2.50	1-8	SS1/4-250	\$111.00
966-000-173	CT50-EM250-400	.250	0.880	2.750	2.625	3.250	4.00	1-8	SS1/4-250	\$121.00
966-000-175	CT50-EM250-600	.250	0.880	2.750	4.625	5.250	6.00	1-8	SS1/4-250	\$135.00
966-000-177	CT50-EM312-250	.312	1.000	2.750	1.125	1.750	2.50	1-8	SS1/4-250	\$111.00
966-000-179	CT50-EM312-400	.312	1.000	2.750	2.625	3.250	4.00	1-8	SS1/4-250	\$121.00
966-000-181	CT50-EM312-600	.312	1.000	2.750	4.625	5.250	6.00	1-8	SS1/4-250	\$135.00
966-000-183	CT50-EM375-250	.375	1.000	2.750	1.125	1.750	2.50	1-8	SS3/8-375	\$111.00
966-000-185	CT50-EM375-400	.375	1.000	2.750	2.625	3.250	4.00	1-8	SS3/8-375	\$121.00
966-000-187	CT50-EM375-600	.375	1.000	2.750	4.625	5.250	6.00	1-8	SS3/8-375	\$135.00
966-000-189	CT50-EM437-250	.437	1.000	2.750	1.125	1.750	2.50	1-8	SS3/8-375	\$111.00
966-000-191	CT50-EM437-400	.437	1.000	2.750	2.625	3.250	4.00	1-8	SS3/8-375	\$142.00
966-000-193	CT50-EM437-600	.437	1.000	2.750	4.625	5.250	6.00	1-8	SS3/8-375	\$154.00
966-000-195	CT50-EM500-262	.500	1.375	2.750	1.245	1.870	2.62	1-8	SS7/16-500	\$111.00
966-000-197	CT50-EM500-400	.500	1.375	2.750	2.620	3.250	4.00	1-8	SS7/16-500	\$121.00
966-000-199	CT50-EM500-600	.500	1.375	2.750	4.625	5.250	6.00	1-8	SS7/16-500	\$135.00

* Add -G6 or -G2 to end of designation depending on the balance needed.

All Hardware Included

PRODUCT #	Set Screws	Price Each
968-000-137	SS10-250	\$3.30
968-000-136	SS1/4-250	\$3.30
968-000-142	SS3/8-375	\$3.30
968-000-144	SS7/16-500	\$5.30
968-000-145	SS9/16-500	\$10.20
968-000-143	SS5/8-500	\$10.20
968-000-139	SS3/4-375	\$11.30
968-000-140	SS3/4-500	\$11.30
968-000-138	SS1-750	\$11.90

PACKAGE SIZE OF 5

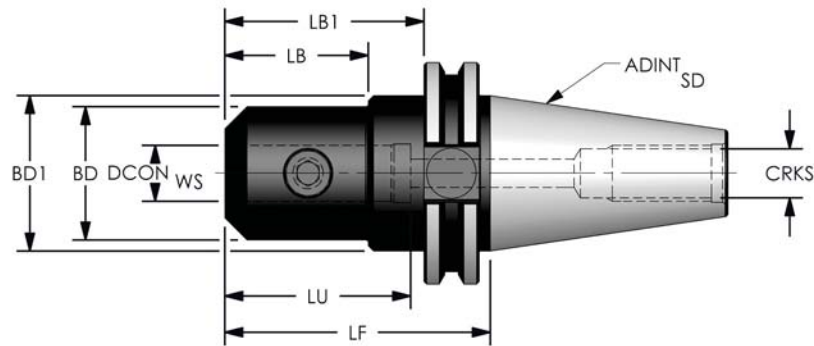

Balanced to:
G2.5 (15,000 rpm)

PRODUCT #	Designation	DCON WS	BD	BD1	LB	LB1	LF	LU	Set Screw	G2 Price*
966-000-200	CT50-EM625-138	0.625	2.750		0.630		1.38		SS9/16-500	\$135.00
966-000-202	CT50-EM625-300	0.625	1.750	2.750	1.625	2.250	3.00		SS9/16-500	\$146.00
966-000-204	CT50-EM625-600	0.625	1.750	2.750	4.625	5.250	6.00		SS9/16-500	\$159.00
966-000-206	CT50-EM750-138	0.750	2.750		0.630		1.38		SS5/8-500	\$135.00
966-000-208	CT50-EM750-300	0.750	1.750	2.750	1.625	2.250	3.00		SS5/8-500	\$146.00
966-000-210	CT50-EM750-600	0.750	1.750	2.750	4.625	5.250	6.00		SS5/8-500	\$159.00
966-000-212	CT50-EM875-400	0.875	2.000	2.750	2.625	3.250	4.00	2.50	SS5/8-500	\$147.00
966-000-214	CT50-EM875-600	0.875	2.000	1.750	4.625	5.250	6.00	2.50	SS5/8-500	\$157.00
966-000-146	CT50-EM100-138	1.000	2.750		0.630		1.38	2.25	SS3/4-500	\$135.00
966-000-148	CT50-EM100-400	1.000	2.000	2.750	2.620	3.250	4.00	2.83	SS3/4-500	\$146.00
966-000-150	CT50-EM100-600	1.000	2.000	2.750	4.620	5.250	6.00	2.83	SS3/4-500	\$159.00
966-000-152	CT50-EM125-200	1.250	2.750		1.250		2.00	2.55	SS3/4-750	\$142.00
966-000-154	CT50-EM125-400	1.250	2.750		3.250		4.00	3.00	(2) SS3/4-750	\$159.00
966-000-156	CT50-EM125-600	1.250	2.500	2.750	4.620	5.250	6.00	3.00	(2) SS3/4-750	\$178.00
966-000-158	CT50-EM150-200	1.500	2.750		1.250		2.00	2.75	SS3/4-500	\$142.00
966-000-160	CT50-EM150-450	1.500	2.500	2.750	3.120	3.750	4.50	2.75	(2) SS3/4-500	\$159.00
966-000-166	CT50-EM200-500	2.000	3.750	2.750	3.620	4.250	5.00	3.50	(2) SS1-750	\$158.00
966-000-168	CT50-EM200-800	2.000	3.750	2.750	6.625	7.250	8.00	3.50	(2) SS1-750	\$189.00

* Add -G6 or -G2 to end of designation depending on the balance needed.

All Hardware Included

PRODUCT #	Set Screws	Price Each
968-000-137	SS10-250	\$3.30
968-000-136	SS1/4-250	\$3.30
968-000-142	SS3/8-375	\$3.30
968-000-144	SS7/16-500	\$5.30
968-000-145	SS9/16-500	\$10.20
968-000-143	SS5/8-500	\$10.20
968-000-139	SS3/4-375	\$11.30
968-000-140	SS3/4-500	\$11.30
968-000-138	SS1-750	\$11.90

PACKAGE SIZE OF 5

ULTRA-DEX™

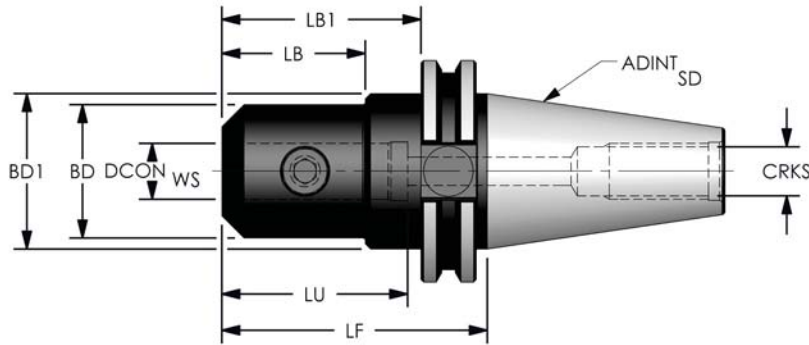

Balanced to:
G6.3 (12,000 rpm)

PRODUCT #	Designation	DCON WS	BD	BD1	LB	LB1	LF	LU	Set Screw	G6 Price*
966-000-201	CT50-EM625-138	0.625	2.750		0.630		1.38		SS9/16-500	\$111.00
966-000-203	CT50-EM625-300	0.625	1.750	2.750	1.625	2.250	3.00		SS9/16-500	\$121.00
966-000-205	CT50-EM625-600	0.625	1.750	2.750	4.625	5.250	6.00		SS9/16-500	\$135.00
966-000-207	CT50-EM750-138	0.750	2.750		0.630		1.38		SS5/8-500	\$111.00
966-000-209	CT50-EM750-300	0.750	1.750	2.750	1.625	2.250	3.00		SS5/8-500	\$121.00
966-000-211	CT50-EM750-600	0.750	1.750	2.750	4.625	5.250	6.00		SS5/8-500	\$135.00
966-000-213	CT50-EM875-400	0.875	2.000	2.750	2.625	3.250	4.00	2.50	SS5/8-500	\$120.00
966-000-215	CT50-EM875-600	0.875	2.000	1.750	4.625	5.250	6.00	2.50	SS5/8-500	\$128.00
966-000-147	CT50-EM100-138	1.000	2.750		0.630		1.38	2.25	SS3/4-500	\$111.00
966-000-149	CT50-EM100-400	1.000	2.000	2.750	2.620	3.250	4.00	2.83	SS3/4-500	\$121.00
966-000-151	CT50-EM100-600	1.000	2.000	2.750	4.620	5.250	6.00	2.83	SS3/4-500	\$135.00
966-000-153	CT50-EM125-200	1.250	2.750		1.250		2.00	2.55	SS3/4-750	\$117.00
966-000-155	CT50-EM125-400	1.250	2.750		3.250		4.00	3.00	(2) SS3/4-750	\$135.00
966-000-157	CT50-EM125-600	1.250	2.500	2.750	4.620	5.250	6.00	3.00	(2) SS3/4-750	\$153.00
966-000-159	CT50-EM150-200	1.500	2.750		1.250		2.00	2.75	SS3/4-500	\$117.00
966-000-161	CT50-EM150-450	1.500	2.500	2.750	3.120	3.750	4.50	2.75	(2) SS3/4-500	\$135.00
966-000-167	CT50-EM200-500	2.000	3.750	2.750	3.620	4.250	5.00	3.50	(2) SS1-750	\$130.00
966-000-169	CT50-EM200-800	2.000	3.750	2.750	6.625	7.250	8.00	3.50	(2) SS1-750	\$162.00

* Add -G6 or -G2 to end of designation depending on the balance needed.
All Hardware Included

PRODUCT #	Set Screws	Price Each
968-000-137	SS10-250	\$3.30
968-000-136	SS1/4-250	\$3.30
968-000-142	SS3/8-375	\$3.30
968-000-144	SS7/16-500	\$5.30
968-000-145	SS9/16-500	\$10.20
968-000-143	SS5/8-500	\$10.20
968-000-139	SS3/4-375	\$11.30
968-000-140	SS3/4-500	\$11.30
968-000-138	SS1-750	\$11.90

PACKAGE SIZE OF 5

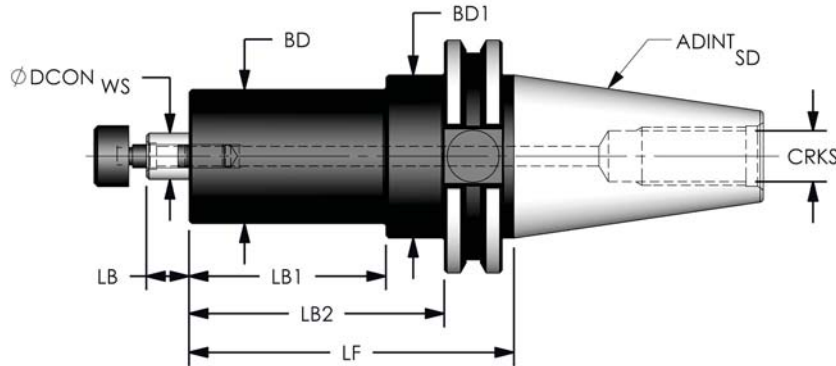

Balanced to:
G6.3 (12,000 rpm)

PRODUCT #	Designation	DCON WS	BD	BD1	LB	LB1	LB2	LF	CRKS	Drive Key	Lock Screw	Thread	Price
966-000-282	CT50-SM050-200	0.500	1.560	2.750	0.460	1.085	1.710	2.00	1-8	UDK 250	U5001	1/4-28	\$137.00
966-000-283	CT50-SM050-400	0.500	1.560	2.750	0.460	3.085	3.710	4.00	1-8	UDK 250	U5001	1/4-28	\$158.00
966-000-284	CT50-SM050-600	0.500	1.560	2.750	0.460	5.085	5.710	6.00	1-8	UDK 250	U5001	1/4-28	\$178.00
966-000-285	CT50-SM075-150	0.750	2.750		0.680	0.750		1.50	1-8	UDK 312	U5002	3/8-24	\$137.00
966-000-286	CT50-SM075-400	0.750	1.750	2.750	0.680	2.625	3.250	4.00	1-8	UDK 312	U5002	3/8-24	\$158.00
966-000-287	CT50-SM075-600	0.750	1.750	2.750	0.680	4.625	5.250	6.00	1-8	UDK 312	U5002	3/8-24	\$178.00
966-000-288	CT50-SM100-150	1.000	2.750		0.680	1.460		1.50	1-8	UDK 375	U5003	1/2-20	\$137.00
966-000-289	CT50-SM100-400	1.000	2.750	2.750	0.680	2.625	3.250	4.00	1-8	UDK 375	U5003	1/2-20	\$158.00
966-000-290	CT50-SM100-600	1.000	2.750	2.750	0.680	4.625	5.250	6.00	1-8	UDK 375	U5003	1/2-20	\$178.00
966-000-291	CT50-SM125-150	1.250	2.750		0.680	0.750		1.50	1-8	UDK 500	U5004	5/8-18	\$137.00
966-000-292	CT50-SM125-400	1.250	2.750		0.680	3.250		4.00	1-8	UDK 500	U5004	5/8-18	\$158.00
966-000-293	CT50-SM125-600	1.250	2.750		0.680	5.250		6.00	1-8	UDK 500	U5004	5/8-18	\$178.00
966-000-294	CT50-SM150-250	1.500	3.750	2.750	0.940	1.125	1.750	2.50	1-8	UDK 625	U5005	3/4-16	\$136.00
966-000-295	CT50-SM150-400	1.500	3.750	2.750	0.940	2.625	3.250	4.00	1-8	UDK 625	U5005	3/4-16	\$158.00
966-000-296	CT50-SM150-600	1.500	3.750	2.750	0.940	4.625	5.250	6.00	1-8	UDK 625	U5005	3/4-16	\$179.00
966-000-297	CT50-SM200-250	2.000	4.440	2.750	0.940	1.125	1.750	2.50	1-8	UDK 750	U5006	1-14	\$163.00
966-000-298	CT50-SM200-400	2.000	4.440	2.750	0.940	2.625	3.250	4.00	1-8	UDK 750	U5006	1-14	\$190.00
966-000-299	CT50-SM200-600	2.000	4.440	2.750	0.940	4.625	5.250	6.00	1-8	UDK 750	U5006	1-14	\$224.00
966-000-300	CT50-SM250-250*	2.500	4.880	2.750	0.940	1.125	1.750	2.50	1-8	UDK 100	U5007	1-14	\$220.00
966-000-301	CT50-SM250-400*	2.500	4.880	2.750	0.940	2.625	3.250	4.00	1-8	UDK 100	U5007	1-14	\$261.00
966-000-302	CT50-SM250-600*	2.500	4.880	2.750	0.940	4.625	5.250	6.00	1-8	UDK 100	U5007	1-14	\$316.00

* Features x4 5/8-11 tapped holes on a 4" bolt circle.
All Hardware Included

PRODUCT #	Set Screws	Price Each
968-000-137	SS10-250	\$3.30
968-000-136	SS1/4-250	\$3.30
968-000-142	SS3/8-375	\$3.30
968-000-144	SS7/16-500	\$5.30
968-000-145	SS9/16-500	\$10.20
968-000-143	SS5/8-500	\$10.20
968-000-139	SS3/4-375	\$11.30
968-000-140	SS3/4-500	\$11.30
968-000-138	SS1-750	\$11.90

PACKAGE SIZE OF 5

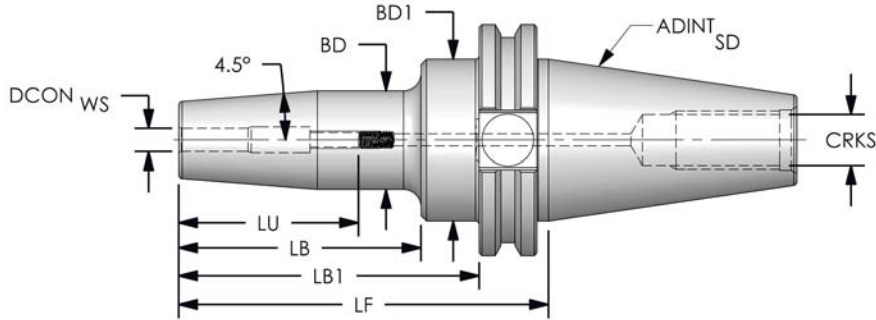

Standard Length

Balanced to:
G2.5 (20,000 rpm)

PRODUCT #	Designation	DCON WS	BD	BD1	LB	LB1	LF	LU	CRKS	Thread	Price
966-000-265	CT50-SF012-400-G2	.125	.787	2.750	2.620	3.250	4.00	.375	1-8		\$271.00
966-000-268	CT50-SF188-400-G2	.188	.750	2.750	2.620	3.250	4.00	.563	1-8		\$258.00
966-000-269	CT50-SF250-400-G2	.250	.750	2.750	2.620	3.250	4.00	1.420	1-8	10-32	\$258.00
966-000-272	CT50-SF375-400-G2	.375	.750	2.750	2.620	3.250	4.00	1.530	1-8	1/4-28	\$258.00
966-000-275	CT50-SF500-400-G2	.500	1.000	2.750	2.620	3.250	4.00	1.850	1-8	7/16-20	\$271.00
966-000-278	CT50-SF625-400-G2	.625	1.000	2.750	2.620	3.250	4.00	1.970	1-8	9/16-18	\$271.00
966-000-280	CT50-SF750-400-G2	.750	1.250	2.750	2.620	3.250	4.00	2.040	1-8	5/8-18	\$271.00
966-000-266	CT50-SF100-400-G2	1.000	2.090	2.750	2.620	3.250	4.00	2.280	1-8	3/4-16	\$283.00
966-000-267	CT50-SF125-400-G2	1.250	2.090	2.750	2.620	3.250	4.00	2.280	1-8	3/4-16	\$283.00

Extended Length

PRODUCT #	Designation	DCON WS	BD	BD1	LB	LB1	LF	LU	CRKS	Thread	Price
966-000-270	CT50-SF250-600-G2	.250	.750	2.750	4.620	5.250	6.00	1.420	1-8	10-32	\$308.00
966-000-273	CT50-SF375-600-G2	.375	1.000	2.750	4.620	5.250	6.00	1.530	1-8	1/4-28	\$308.00
966-000-276	CT50-SF500-600-G2	.500	1.000	2.750	4.620	5.250	6.00	1.850	1-8	7/16-20	\$308.00
966-000-279	CT50-SF625-600-G2	.625	1.250	2.750	4.620	5.250	6.00	1.970	1-8	9/16-18	\$320.00
966-000-281	CT50-SF750-600-G2	.750	1.250	2.750	4.620	5.250	6.00	2.040	1-8	5/8-18	\$320.00
966-000-271	CT50-SF250-800-G2	.250	1.000	2.750	6.620	7.250	8.00	1.420	1-8	10-32	\$345.00
966-000-274	CT50-SF375-800-G2	.375	1.250	2.750	6.620	7.250	8.00	1.530	1-8	1/4-28	\$357.00
966-000-277	CT50-SF500-800-G2	.500	1.250	2.750	6.620	7.250	8.00	1.850	1-8	7/16-20	\$357.00

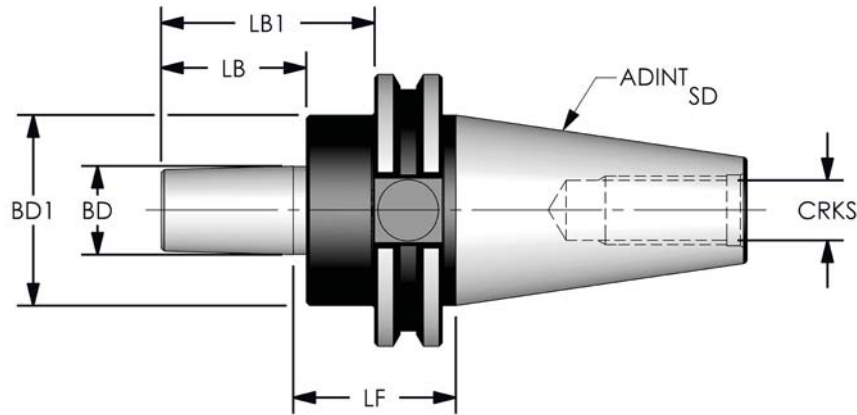

Balanced to:
G6.3 (12,000 rpm)

PRODUCT #	Designation	Taper No.	BD	B1	LB	LB1	LF	CRKS	Taper Length	Price
966-000-260	CT50-JT02-150	2	0.559	2.750	0.995	1.625	1.50	1-8	0.875	\$104.00
966-000-261	CT50-JT03-150	3	0.811	2.750	1.339	1.969	1.50	1-8	1.219	\$104.00
966-000-262	CT50-JT04-150	4	1.124	2.750	1.776	2.406	1.50	1-8	1.656	\$104.00
966-000-263	CT50-JT06-150	6	0.676	2.750	1.120	1.750	1.50	1-8	1.000	\$104.00
966-000-264	CT50-JT33-150	33	0.624	2.750	1.120	1.750	1.50	1-8	1.000	\$116.00

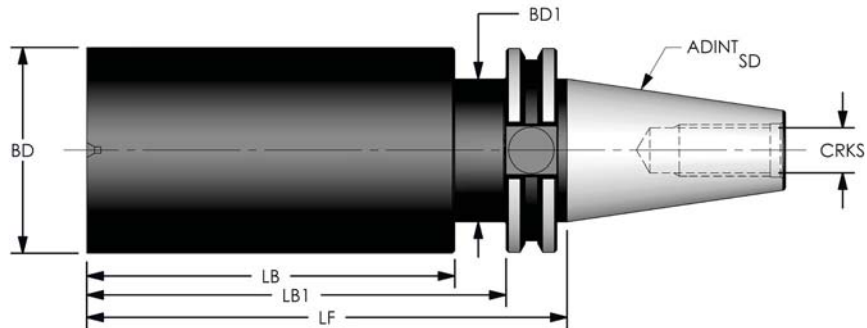

PRODUCT #	Designation	Taper	BD	BD1	LB	LB1	LF	Price
967-000-004	CT50-BB100-150	CAT50	3.940(100mm)	2.750	4.526	5.156	5.91(150mm)	\$225.80
967-000-005	CT50-BB100-250	CAT50	3.940(100mm)	2.750	8.460	9.090	9.84(250mm)	\$283.10
967-000-006	CT50-BB150-150	CAT50	5.910(150mm)	2.750	4.526	5.156	5.91(150mm)	\$371.00

ULTRA-DEX™

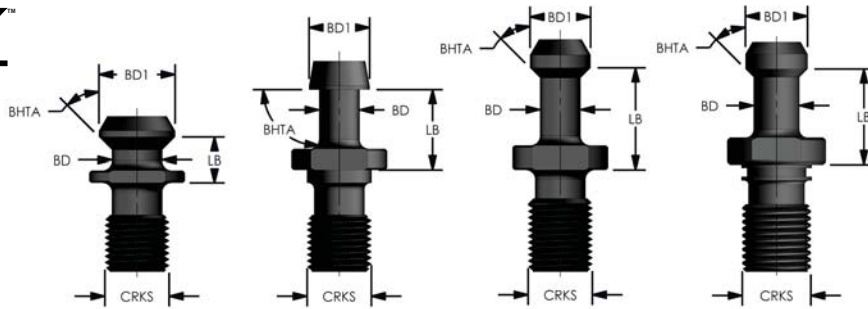

PRODUCT #	Designation	BD	BD1	LB	BHTA	CRKS	Coolant Thru	Figure	Price
971-000-015	PSC-475	.490	.740	.440	45°	5/8-11	YES	1	\$15.40
971-000-002	PS-475	.490	.740	.440	45°	5/8-11	NO	1	\$13.10
971-000-004	PS-532x15	.551	.747	.791	75°	5/8-11	NO	1	\$14.20
971-000-016	PSC-532x45	.392	.591	.984	45°	5/8-11	YES	2	\$16.60
971-000-005	PS-532x45	.392	.591	.984	45°	5/8-11	NO	2	\$15.40
971-000-006	PS-532x60	.392	.591	.984	60°	5/8-11	NO	2	\$14.20
971-000-007	PS-532x90	.392	.591	.984	90°	5/8-11	NO	2	\$14.20
971-000-003	PS-498	.392	.591	.775	90°	5/8-11	NO	3	\$16.60
971-000-019	PSC-552	.406	.594	1.139	45°	5/8-11	YES	2	\$18.90
971-000-012	PS-552	.406	.594	1.139	45°	5/8-11	NO	2	\$17.70

CAT40

PRODUCT #	Designation	BD	BD1	LB	BHTA	CRKS	Coolant Thru	Figure	Price
971-000-017	PSC-535x45	.667	.904	1.384	45°	1-8	YES	4	\$27.20
971-000-008	PS-535x45	.667	.904	1.384	45°	1-8	NO	4	\$24.80
971-000-018	PSC-536x45	.667	.904	1.384	45°	1-8	YES	2	\$24.80
971-000-009	PS-536x45	.667	.904	1.384	45°	1-8	NO	2	\$21.30
971-000-010	PS-536x60	.667	.904	1.384	60°	1-8	NO	2	\$21.30
971-000-011	PS-536x90	.667	.904	1.384	90°	1-8	NO	2	\$21.30
971-000-014	PSC-274	.820	1.140	.700	45°	1-8	YES	1	\$26.00
971-000-001	PS-274	.820	1.140	.700	45°	1-8	NO	1	\$23.60
971-000-013	PSC-271x15	.826	1.102	1.350	15°	1-8	YES	1	\$24.80

CAT50

Quick Reference Guide - Following page Machine Cross Reference

Each CAT taper machine requires its own style retention knob, on the following page is a general quick reference of the most common manufacturers. Be sure to check which knob your machine requires to ensure proper fit.

CAT40

- PSC-475 Fits Cincinnati Milacron, Maho, Mazak, Matsura
- PS-475 Fits Acrololc-Bayer, Maho, Mazak
- PSC-532x45 Fits Amura-Seiki, Comet, Daewoo, Dah Lih, Haas, Howa Kogyo, Ikegai, Kearny-Trecker, Kia, Kitamura, Miyano, Okuma Howa, YCI
- PS-532x45 Fits Amura-Seiki, Comet, Daewoo, Dah Lih, Haas, Howa Kogyo, Ikegai, Kearny-Trecker, Kia, Kitamura, Miyano, Okuma Howa, YCI
- PS-532x60 Fits Hitachi-Seiki, Kia, Mitsubishi, Okuma, Matsura, Howa Kogyo, Milltronic
- PS-532x90 Fits Kia, Mori Seiki
- PS-498 Fits Mazak
- PS-552 Fits Cincinnati Milacron
- PSC-552 Fits Cincinnati Milacron

CAT50

- PS-536x45 Fits Dah Lih, Haas, Ikegai, Kitamura, LeBlond Makino, YCI
- PSC-536x45 Fits Haas, LeBlond Makino
- PS-536x60 Fits Mitsubishi, Okuma, Matsura
- PS-536x90 Fits Hitachi-Seiki, Mori Seiki, Mazak
- PS-274 Fits Mazak
- PSC-274 Fits Burgmaster, Devlieg, Excello, Maho, Matsura, Mazak



PLEASE NOTE: Retention knobs are available in many different types and sizes. ARCH Cutting Tools has provided a list with common machines that fit each of our knobs. Due to the vast amount of machines, please check each machine to verify that you are ordering the proper knob. Retention knob dimensions for each machine can be typically found in the user manual or next to the power supply.

Quick Reference Guide

Each CAT taper machine requires its own style retention knob. Be sure to check which knob your machine requires to ensure proper fit.

MANUFACTURER	DESIGNATION									
	PSC-475	PS-475	PS-532x15	PSC-532x45	PS-532x45	PS-532x60	PS-532x90	PS-498	PSC-552	PS-552
ACROLOC-BAYER	X	X								
ATRUMP				X	X					
BRIDGEPORT	X	X								
CARMAN	X	X								
CHEVALIER				X	X					
CHIRON	X	X								
CINCINNATI	X	X							X	X
COMET				X	X					
DAEWOO				X	X					
DAH LIH				X	X					
DOOSAN			X							
ENSHU				X	X	X				
EXCEL				X	X					
FADAL	X	X								
HAAS				X	X					
HAMAI				X	X					
HITACHI-SEIKI				X	X	X				
HOWA KOGYO				X	X					
HURCO	X	X		X						
IKEGAI				X	X					
JOHN FORD				X	X					
KASHAHARA				X	X					
KEARNY-TRECKER				X	X					
KIA				X	X		X			
KITAMURA				X	X					
KIWA				X	X					
LEBLOND MAKINO			X	X	X					
MAHO	X	X								
MASCO	X	X								
MATSUURA			X			X				
MAZAK	X	X								
MILLPORT				X	X					
MILLTRONICS	X					X				
MITSUBISHI						X				
MIYANO				X	X					
MORI SEIKI							X			
NOMURA						X				
OKUMA						X				
OKUMA HOWA				X	X					
O OYA				X	X					
OSAKA KIKO				X	X		X			
PRATT & WHITNEY	X			X	X					
ROKU-ROKU				X	X					
SAEILO				X	X					
SAKAZAKI				X	X	X				
SHARONA				X	X					
SHARP	X	X								
SHIZUOKA				X	X					
SHODA				X	X					
STAMA	X	X								
TAKISAWA				X	X					
TOSHIBA				X	X					
TOYAMA				X	X					
TOYO				X	X					
TOYODA				X	X					
TREE	X	X								
ULTRAMILL				X	X					
URAWA				X	X					
VULCAN				X	X					
YAM (YANG)							X			
YASDA				X	X					
YCI				X	X					

Quick Reference Guide

Each CAT taper machine requires its own style retention knob. Be sure to check which knob your machine requires to ensure proper fit.

MANUFACTURER	DESIGNATION								
	PSC-535x45	PS-535x45	PSC-536x45	PS-536x45	PS-536x60	PS-536x90	PSC-274	PS-274	PSC-271x15
AMURA-SEIKI	X	X	X	X					
DAH LIH	X	X	X	X					
ENSHU					X				
FADAL							X	X	
HAAS	X	X	X	X					
HAMAI	X	X	X	X					
HITACHI-SEIKI					X	X			
IKEGAI	X	X	X	X					
JOHNFORD	X	X							
KITAMURA	X	X	X	X					
KURAKI	X	X	X	X					
LEBLOND MAKINO	X	X	X	X					
MIGHTY	X	X	X	X					
MILLTRONICS							X	X	
MITSUBISHI	X	X	X	X					
MORI-SEIKI						X			
OKUMA					X				



**For more assistance
or training, connect with
our cutting tool experts**

[My Account](#)

[Connect with Sales](#)

[Find a Distributor](#)



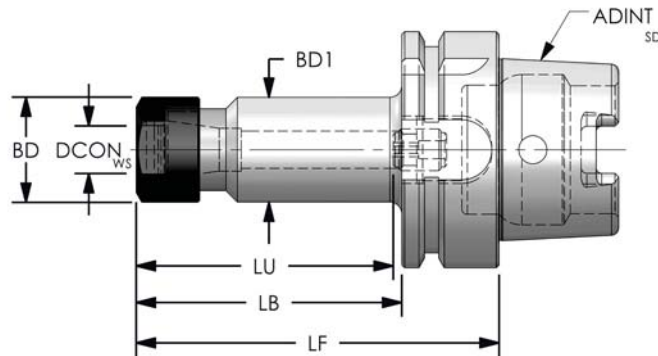

HSK40A

Balanced to:
G2.5 (20,000 rpm)

PRODUCT #	Designation	BD	LF	LU	Collet Nut	Stop Screw	Wrench	G2 Price*
966-000-384	HSK40A-ER11-250	.750	2.50	1.50	ER-11HN	ER-11S	ER-11W	\$257.00
966-000-386	HSK40A-ER16-300	1.100	3.00	1.70	ER-16HN	ER-16S	ER-16W	\$257.00
966-000-388	HSK40A-ER32-300	1.980	3.00	1.62	ER-32SN	ER-32S	ER-32W	\$269.00

HSK50A

PRODUCT #	Designation	BD	LF	LU	Collet Nut	Stop Screw	Wrench	G2 Price*
966-000-390	HSK50A-ER16-300	1.100	3.00	1.61	ER-16HN	ER-16S	ER-16W	\$308.00
966-000-392	HSK50A-ER32-300	1.980	3.00	1.50	ER-32SN	ER-32S	ER-32W	\$320.00

HSK63A

PRODUCT #	Designation	BD	BD1	BD2	LB	LB1	LF	LU	Collet Nut	Stop Screw	Wrench	G2 Price*
966-000-422	HSK63A-ER11-600	0.750	0.750		4.976		6.00	1.94	ER-11HN	ER-11S	ER-11W	\$289.00
966-000-424	HSK63A-ER16-400	1.100	1.100		2.976		4.00	3.00	ER-16HN	ER-16S	ER-16W	\$252.00
966-000-426	HSK63A-ER16-600	1.100	1.100		4.976		6.00	3.00	ER-16HN	ER-16S	ER-16W	\$277.00
966-000-428	HSK63A-ER32-400	1.980	1.750		2.976		4.00	4.30	ER-32SN	ER-32S	ER-32W	\$264.00
966-000-430	HSK63A-ER32-600	1.980	1.750		4.976		6.00	4.30	ER-32SN	ER-32S	ER-32W	\$289.00
966-000-432	HSK63A-ER40-400	2.250	2.366	2.08	2.344	2.976	4.00	4.00	ER-40SN	ER-40S	ER-40W	\$283.00
966-000-434	HSK63A-ER40-600	2.250	2.366	2.08	4.344	4.976	6.00	4.50	ER-40SN	ER-40S	ER-40W	\$308.00

* Add -G6 or -G2 to end of designation depending on the balance needed.
All Hardware Included. Wrenches Sold Separately.

PRODUCT #	Nut	Price Each
968-000-029	ER-11HN	\$22.50
968-000-033	ER-16HN	\$23.60
968-000-038	ER-20HN	\$27.20
968-000-044	ER-25SN	\$30.70
968-000-047	ER-32SN	\$31.90
968-000-050	ER-40SN	\$37.40
968-000-030	ER-11MN	\$24.80
968-000-034	ER-16MN	\$26.00
968-000-039	ER-20MN	\$28.40

PACKAGE SIZE OF 1

PRODUCT #	Adj. Screw	Price Each
968-000-032	ER-11S	\$8.20
968-000-036	ER-16S	\$8.70
968-000-041	ER-20S	\$9.70
968-000-043	ER-25S	\$11.40
968-000-046	ER-32S	\$12.40
968-000-049	ER-40S	\$14.20

PACKAGE SIZE OF 1

PRODUCT #	Wrench	Price Each
968-000-189	ER-11W	\$15.40
968-000-031	ER-11MW	\$39.60
968-000-035	ER-16MW	\$39.60
968-000-037	ER-16W	\$15.40
968-000-040	ER-20MW	\$44.00
968-000-042	ER-20W	\$15.40
968-000-045	ER-25W	\$17.70
968-000-048	ER-32W	\$20.10
968-000-051	ER-40W	\$28.40

PACKAGE SIZE OF 1



by Ultra-Dex

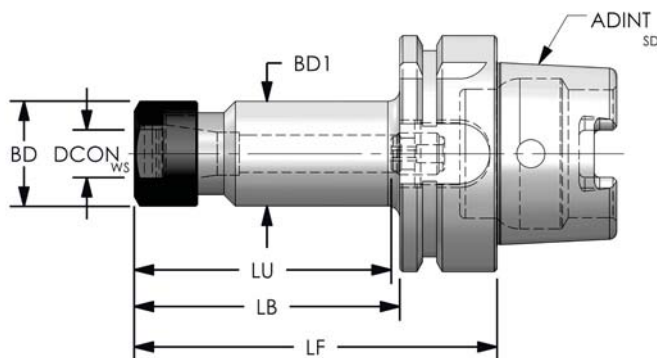

HSK40A

Balanced to:
G6.3 (12,000 rpm)

PRODUCT #	Designation	BD	LF	LU	Collet Nut	Stop Screw	Wrench	G6 Price*
966-000-385	HSK40A-ER11-250	0.750	2.50	1.50	ER-11HN	ER-11S	ER-11W	\$232.00
966-000-387	HSK40A-ER16-300	1.100	3.00	1.70	ER-16HN	ER-16S	ER-16W	\$232.00
966-000-389	HSK40A-ER32-300	1.980	3.00	1.62	ER-32SN	ER-32S	ER-32W	\$245.00

HSK50A

PRODUCT #	Designation	BD	LF	LU	Collet Nut	Stop Screw	Wrench	G6 Price*
966-000-391	HSK50A-ER16-300	1.100	3.00	1.61	ER-16HN	ER-16S	ER-16W	\$283.00
966-000-393	HSK50A-ER32-300	1.980	3.00	1.50	ER-32SN	ER-32S	ER-32W	\$295.00

HSK63A

PRODUCT #	Designation	BD	BD1	BD2	LB	LB1	LF	LU	Collet Nut	Stop Screw	Wrench	G6 Price*
966-000-423	HSK63A-ER11-600	0.750	0.750		4.976		6.00	1.94	ER-11HN	ER-11S	ER-11W	\$264.00
966-000-425	HSK63A-ER16-400	1.100	1.10		2.976		4.00	3.00	ER-16HN	ER-16S	ER-16W	\$227.00
966-000-427	HSK63A-ER16-600	1.100	1.10		4.976		6.00	3.00	ER-16HN	ER-16S	ER-16W	\$252.00
966-000-429	HSK63A-ER32-400	1.980	1.75		2.976		4.00	4.30	ER-32SN	ER-32S	ER-32W	\$240.00
966-000-431	HSK63A-ER32-600	1.980	1.75		4.976		6.00	4.30	ER-32SN	ER-32S	ER-32W	\$264.00
966-000-433	HSK63A-ER40-400	2.250	2.366	2.08	2.344	2.976	4.00	4.00	ER-40SN	ER-40S	ER-40W	\$258.00
966-000-435	HSK63A-ER40-600	2.250	2.366	2.08	4.344	4.976	6.00	4.50	ER-40SN	ER-40S	ER-40W	\$283.00

* Add -G6 or -G2 to end of designation depending on the balance needed.

All Hardware Included. Wrenches Sold Separately.

PRODUCT #	Nut	Price Each
968-000-029	ER-11HN	\$22.50
968-000-033	ER-16HN	\$23.60
968-000-038	ER-20HN	\$27.20
968-000-044	ER-25SN	\$30.70
968-000-047	ER-32SN	\$31.90
968-000-050	ER-40SN	\$37.40
968-000-030	ER-11MN	\$24.80
968-000-034	ER-16MN	\$26.00
968-000-039	ER-20MN	\$28.40

PACKAGE SIZE OF 1

PRODUCT #	Adj. Screw	Price Each
968-000-032	ER-11S	\$8.20
968-000-036	ER-16S	\$8.70
968-000-041	ER-20S	\$9.70
968-000-043	ER-25S	\$11.40
968-000-046	ER-32S	\$12.40
968-000-049	ER-40S	\$14.20

PACKAGE SIZE OF 1

PRODUCT #	Wrench	Price Each
968-000-189	ER-11W	\$15.40
968-000-031	ER-11MW	\$39.60
968-000-035	ER-16MW	\$39.60
968-000-037	ER-16W	\$15.40
968-000-040	ER-20MW	\$44.00
968-000-042	ER-20W	\$15.40
968-000-045	ER-25W	\$17.70
968-000-048	ER-32W	\$20.10
968-000-051	ER-40W	\$28.40

PACKAGE SIZE OF 1

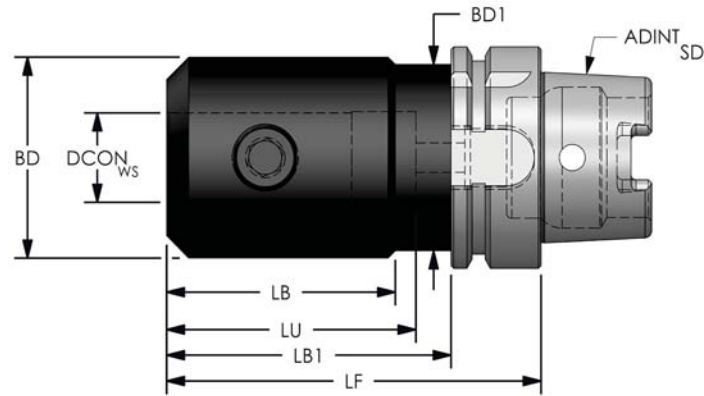

Balanced to:
G2.5 (20,000 rpm)

PRODUCT #	Designation	DCON WS	BD	BD1	LB	LF	LU	Set Screw	G2 Price*
966-000-402	HSK63A-EM250-300	.250	.880		1.976	3.00		SS1/4-250	\$221.00
966-000-404	HSK63A-EM250-600	.250	.880		4.976	6.00		SS1/4-250	\$271.00
966-000-406	HSK63A-EM375-300	.375	1.000		1.976	3.00		SS3/8-375	\$221.00
966-000-408	HSK63A-EM375-600	.375	1.000		4.976	6.00		SS3/8-375	\$271.00
966-000-410	HSK63A-EM500-300	0.500	1.375		1.976	3.00		SS7/16-500	\$221.00
966-000-412	HSK63A-EM500-600	0.500	1.375		4.976	6.00		SS7/16-500	\$271.00
966-000-414	HSK63A-EM625-300	.625	1.750		1.976	3.00	2.10	SS9/16-500	\$221.00
966-000-416	HSK63A-EM625-600	.625	1.750		4.976	6.00	2.10	SS9/16-500	\$271.00
966-000-418	HSK63A-EM750-300	.750	1.750		1.976	3.00	2.05	SS5/8-500	\$221.00
966-000-420	HSK63A-EM750-600	.750	1.750		4.976	6.00	2.30	SS5/8-500	\$271.00
966-000-394	HSK63A-EM100-425	1.000	2.250	2.087	3.226	4.25	2.83	SS3/4-500	\$234.00
966-000-396	HSK63A-EM100-600	1.000	2.250	2.087	4.976	6.00	2.83	SS3/4-500	\$283.00
966-000-398	HSK63A-EM125-425	1.250	2.250	2.087	3.226	4.25	3.00	(2) SS3/4-500	\$234.00
966-000-400	HSK63A-EM125-600	1.250	2.250	2.087	4.976	6.00	3.00	(2) SS3/4-500	\$283.00

* Add -G6 or -G2 to end of designation depending on the balance needed.

All Hardware Included

PRODUCT #	Set Screws	Price Each
968-000-137	SS10-250	\$3.30
968-000-136	SS1/4-250	\$3.30
968-000-142	SS3/8-375	\$3.30
968-000-144	SS7/16-500	\$5.30
968-000-145	SS9/16-500	\$10.20
968-000-143	SS5/8-500	\$10.20
968-000-139	SS3/4-375	\$11.30
968-000-140	SS3/4-500	\$11.30
968-000-138	SS1-750	\$11.90

PACKAGE SIZE OF 5

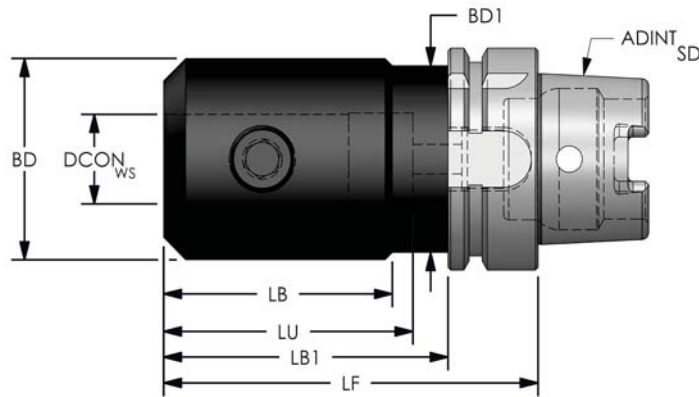

Balanced to:
G6.3 (12,000 rpm)

PRODUCT #	Designation	DCON WS	BD	BD1	LB	LF	LU	Set Screw	G6 Price*
966-000-403	HSK63A-EM250-300	.250	.880		1.976	3.00		SS1/4-250	\$196.00
966-000-405	HSK63A-EM250-600	.250	.880		4.976	6.00		SS1/4-250	\$246.00
966-000-407	HSK63A-EM375-300	.375	1.000		1.976	3.00		SS3/8-375	\$196.00
966-000-409	HSK63A-EM375-600	.375	1.000		4.976	6.00		SS3/8-375	\$246.00
966-000-411	HSK63A-EM500-300	0.500	1.375		1.976	3.00		SS7/16-500	\$196.00
966-000-413	HSK63A-EM500-600	0.500	1.375		4.976	6.00		SS7/16-500	\$246.00
966-000-415	HSK63A-EM625-300	.625	1.750		1.976	3.00	2.10	SS9/16-500	\$196.00
966-000-417	HSK63A-EM625-600	.625	1.750		4.976	6.00	2.10	SS9/16-500	\$246.00
966-000-419	HSK63A-EM750-300	.750	1.750		1.976	3.00	2.05	SS5/8-500	\$196.00
966-000-421	HSK63A-EM750-600	.750	1.750		4.976	6.00	2.30	SS5/8-500	\$246.00
966-000-395	HSK63A-EM100-425	1.000	2.250	2.087	3.226	4.25	2.83	SS3/4-500	\$209.00
966-000-397	HSK63A-EM100-600	1.000	2.250	2.087	4.976	6.00	2.83	SS3/4-500	\$258.00
966-000-399	HSK63A-EM125-425	1.250	2.250	2.087	3.226	4.25	3.00	(2) SS3/4-500	\$209.00
966-000-401	HSK63A-EM125-600	1.250	2.250	2.087	4.976	6.00	3.00	(2) SS3/4-500	\$258.00

* Add -G6 or -G2 to end of designation depending on the balance needed.

All Hardware Included

PRODUCT #	Set Screws	Price Each
968-000-137	SS10-250	\$3.30
968-000-136	SS1/4-250	\$3.30
968-000-142	SS3/8-375	\$3.30
968-000-144	SS7/16-500	\$5.30
968-000-145	SS9/16-500	\$10.20
968-000-143	SS5/8-500	\$10.20
968-000-139	SS3/4-375	\$11.30
968-000-140	SS3/4-500	\$11.30
968-000-138	SS1-750	\$11.90

PACKAGE SIZE OF 5

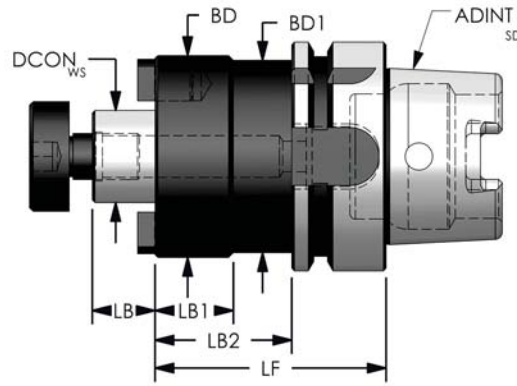

Balanced to:
G6.3 (12,000 rpm)

PRODUCT #	Designation	DCON WS	BD	BD1	LB	LB1	LB2	LF	Drive Key	Lock Screw	Thread	Price
966-000-463	HSK63A-SM075-200	0.750	1.750		0.68	0.976		2.00	UDK 312	U5002	3/8-24	\$283.00
966-000-464	HSK63A-SM100-250	1.000	2.190	2.087	0.68	0.846	1.476	2.50	UDK 375	U5003	1/2-20	\$289.00
966-000-465	HSK63A-SM125-250	1.250	2.750	2.087	0.68	0.846	1.476	2.50	UDK 500	U5004	5/8-18	\$301.00
966-000-466	HSK63A-SM150-250	1.500	3.380	2.087	0.94	0.846	1.476	2.50	UDK 625	U5005	3/4-16	\$320.00

All Hardware Included

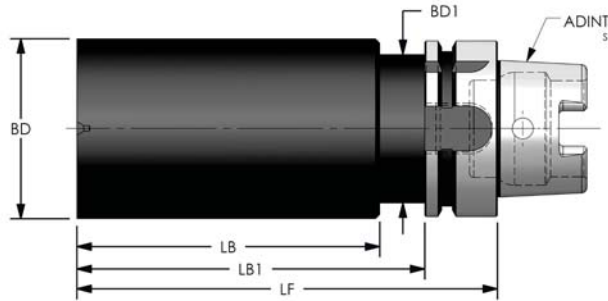

PRODUCT #	Designation	Taper	BD	BD1	LB	LB1	LF	Price
967-000-012	HSK40A-BB50-120	HSK40A	1.970/50mm	1.339	3.342	3.935	4.72/120mm	\$212.00
967-000-014	HSK50A-BB50-150	HSK50A	1.970/50mm	1.654	9.434	10.064	5.91/150mm	\$225.80
967-000-015	HSK50A-BB75-200	HSK50A	2.950/75mm	1.654	6.574	7.204	7.87/200mm	\$278.80
967-000-013	HSK50A-BB100-125	HSK50A	3.940/100mm	1.654	4.256	4.886	4.920/125mm	\$278.80
967-000-017	HSK63A-BB64-150	HSK63A	2.520/64mm	2.078	4.252	4.884	5.91/150mm	\$278.80
967-000-018	HSK63A-BB64-250	HSK63A	2.520/64mm	2.078	8.189	8.821	9.84/250mm	\$305.30
967-000-019	HSK63A-BB89-89	HSK63A	30.500/89mm	2.078	1.850	2.482	30.500/89mm	\$305.30
967-000-016	HSK63A-BB125-150	HSK63A	4.920/125mm	2.078	4.252	4.884	5.91/150mm	\$395.40

PRODUCT #	Arbor Screws	Price Each
968-000-162	U5001	\$11.00
968-000-163	U5002	\$11.80
968-000-164	U5003	\$14.20
968-000-165	U5004	\$18.90
968-000-166	U5005	\$27.20
968-000-167	U5006	\$31.90
968-000-168	U5007	\$44.00
968-000-008	AS1/4-100	\$1.80
968-000-009	AS3/8-125	\$1.80
968-000-007	AS1/2-150	\$3.30

PACKAGE SIZE OF 1



by Ultra-Dex

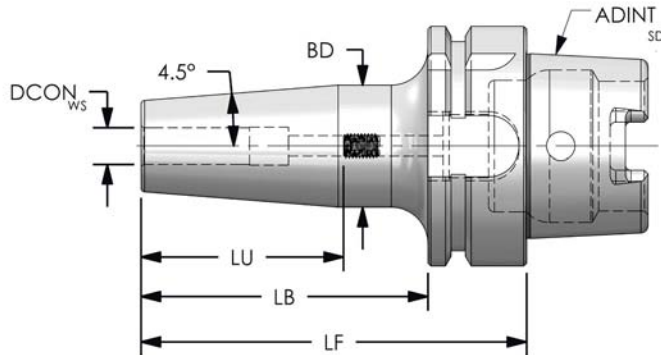

Standard Length

Balanced to:
G2.5 (20,000 rpm)

PRODUCT #	Designation	DCON WS	BD	LB	LF	LU	Thread	Price
966-000-436	HSK63A-SF012-400-G2	.125	1.063	2.976	4.00	.79		\$271.00
966-000-450	HSK63A-SF188-400-G2	.188	1.063	2.976	4.00	.79		\$246.00
966-000-453	HSK63A-SF250-400-G2	.250	1.063	2.976	4.00	1.42		\$246.00
966-000-456	HSK63A-SF375-400-G2	.375	1.260	2.976	4.00	1.53	1/4-28	\$246.00
966-000-458	HSK63A-SF500-400-G2	0.500	1.339	2.976	4.00	1.85	7/16-20	\$246.00
966-000-460	HSK63A-SF625-400-G2	.625	1.339	2.976	4.00	1.97	9/16-18	\$246.00
966-000-461	HSK63A-SF750-400-G2	.750	1.654	2.976	4.00	2.04	5/8-18	\$246.00
966-000-441	HSK63A-SF100-500-G2	1.000	2.087	3.976	5.00	2.28	3/4-16	\$258.00
966-000-446	HSK63A-SF125-500-G2	1.250	2.087	3.976	5.00	2.28	3/4-16	\$258.00

Extended Length

PRODUCT #	Designation	DCON WS	BD	LB	LF	LU	Thread	Price
966-000-457	HSK63A-SF375-600-G2	.375	1.260	4.976	6.00	1.53	1/4-28	\$283.00
966-000-459	HSK63A-SF500-600-G2	0.500	1.339	4.976	6.00	1.85	7/16-20	\$283.00
966-000-462	HSK63A-SF750-600-G2	.750	1.654	4.976	6.00	2.04	5/8-18	\$283.00
966-000-442	HSK63A-SF100-700-G2	1.000	2.087	5.976	7.00	2.28	3/4-16	\$295.00

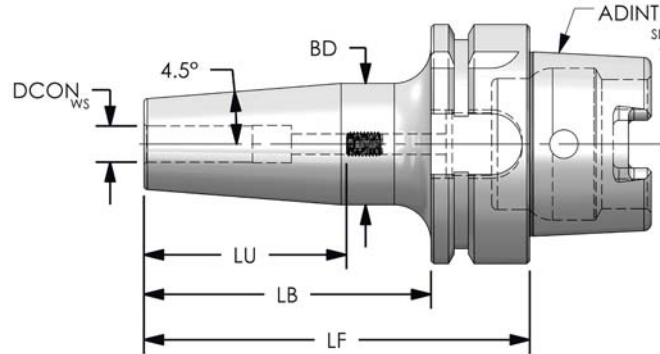

Standard Length

Balanced to:
G2.5 (20,000 rpm)

PRODUCT #	Designation	DCON WS	BD	LB	LF	LU	Thread	Price
966-000-437	HSK63A-SF06-400-G2	6mm	1.063	2.976	4.00	2.167	10-32	\$246.00
966-000-439	HSK63A-SF08-400-G2	8mm	1.063	2.976	4.00	1.970	1/4-28	\$246.00
966-000-443	HSK63A-SF10-400-G2	10mm	1.260	2.976	4.00	2.207	1/4-28	\$246.00
966-000-445	HSK63A-SF12-400-G2	12mm	1.260	2.976	4.00	2.404	7/16-20	\$246.00
966-000-448	HSK63A-SF16-400-G2	16mm	1.339	2.976	4.00	2.522	9/16-18	\$246.00
966-000-451	HSK63A-SF20-400-G2	20mm	1.654	2.976	4.00	2.600	5/8-18	\$246.00
966-000-454	HSK63A-SF25-500-G2	25mm	2.087	3.976	5.00	2.912	3/4-16	\$258.00

Extended Length

PRODUCT #	Designation	DCON WS	BD	LB	LF	LU	Thread	Price
966-000-438	HSK63A-SF06-600-G2	6mm	1.063	4.976	6.00	2.167	10-32	\$283.00
966-000-440	HSK63A-SF08-600-G2	8mm	1.063	4.976	6.00	1.970	1/4-28	\$283.00
966-000-444	HSK63A-SF10-600-G2	10mm	1.260	4.976	6.00	2.207	1/4-28	\$283.00
966-000-447	HSK63A-SF12-600-G2	12mm	1.260	4.976	6.00	2.404	7/16-20	\$283.00
966-000-449	HSK63A-SF16-600-G2	16mm	1.260	4.976	6.00	2.522	9/16-18	\$283.00
966-000-452	HSK63A-SF20-600-G2	20mm	1.654	4.976	6.00	2.600	5/8-18	\$283.00
966-000-455	HSK63A-SF25-700-G2	25mm	2.087	5.976	7.00	2.912	3/4-16	\$283.00

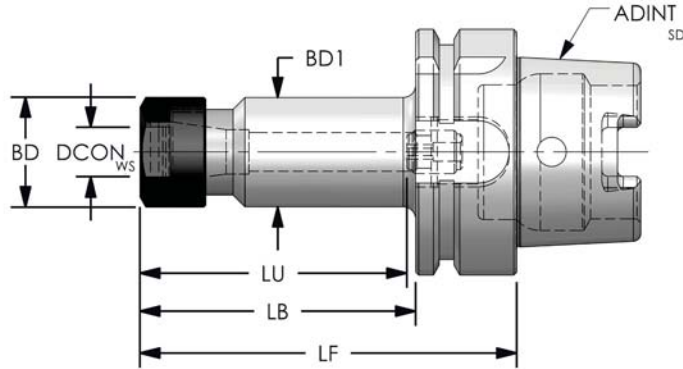

Balanced to:
G2.5 (15,000 rpm)

PRODUCT #	Designation	BD	LF	LU	H	Collet Nut	Stop Screw	Wrench	G2 Price*
966-000-467	HSK80A-ER16-400	1.100	4.00	2.40	3.15	ER-16N	ER-16S	ER-16W	\$369.00
966-000-469	HSK80A-ER32-400	1.980	4.00	2.05	3.15	ER-32N	ER-32S	ER-32W	\$382.00
966-000-335	HSK100A-ER16-400	1.100	4.00	3.00	3.93	ER-16HN	ER-16S	ER-16W	\$320.00
966-000-337	HSK100A-ER16-600	1.100	6.00	3.00	3.93	ER-16HN	ER-16S	ER-16W	\$345.00
966-000-339	HSK100A-ER32-400	1.980	4.00	4.30	3.93	ER-32SN	ER-32S	ER-32W	\$339.00
966-000-341	HSK100A-ER32-600	1.980	6.00	4.30	3.93	ER-32SN	ER-32S	ER-32W	\$363.00
966-000-343	HSK100A-ER40-400	2.250	4.00	4.00	3.93	ER-40SN	ER-40S	ER-40W	\$345.00
966-000-345	HSK100A-ER40-600	2.250	6.00	4.50	3.93	ER-40SN	ER-40S	ER-40W	\$369.00
966-000-382	HSK125A-ER16-500-G6	1.100	5.00	3.10	4.92	ER-16HN	ER-16S	ER-16W	
966-000-383	HSK125A-ER40-500-G6	2.250	5.00	2.80	4.92	ER-40SN	ER-40S	ER-40W	

* Add -G6 or -G2 to end of designation depending on the balance needed.
All Hardware Included. Wrenches Sold Separately.

PRODUCT #	Nut	Price Each
968-000-029	ER-11HN	\$22.50
968-000-033	ER-16HN	\$23.60
968-000-038	ER-20HN	\$27.20
968-000-044	ER-25SN	\$30.70
968-000-047	ER-32SN	\$31.90
968-000-050	ER-40SN	\$37.40
968-000-030	ER-11MN	\$24.80
968-000-034	ER-16MN	\$26.00
968-000-039	ER-20MN	\$28.40

PACKAGE SIZE OF 1

PRODUCT #	Adj. Screw	Price Each
968-000-032	ER-11S	\$8.20
968-000-036	ER-16S	\$8.70
968-000-041	ER-20S	\$9.70
968-000-043	ER-25S	\$11.40
968-000-046	ER-32S	\$12.40
968-000-049	ER-40S	\$14.20

PACKAGE SIZE OF 1

PRODUCT #	Wrench	Price Each
968-000-189	ER-11W	\$15.40
968-000-031	ER-11MW	\$39.60
968-000-035	ER-16MW	\$39.60
968-000-037	ER-16W	\$15.40
968-000-040	ER-20MW	\$44.00
968-000-042	ER-20W	\$15.40
968-000-045	ER-25W	\$17.70
968-000-048	ER-32W	\$20.10
968-000-051	ER-40W	\$28.40

PACKAGE SIZE OF 1

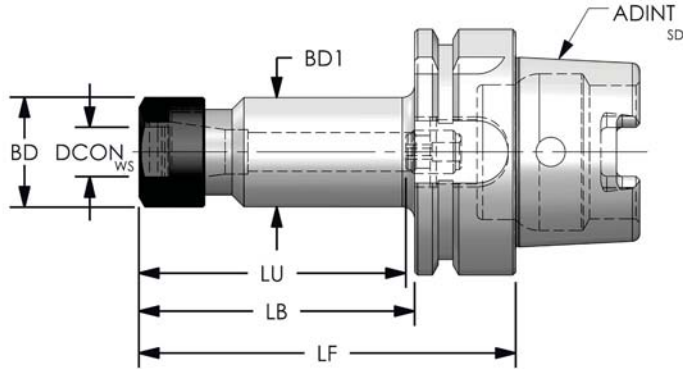

Balanced to:
G6.3 (12,000 rpm)

PRODUCT #	Designation	BD	LF	LU	H	Collet Nut	Stop Screw	Wrench	G6 Price*
966-000-468	HSK80A-ER16-400	1.100	4.00	2.40	3.15	ER-16N	ER-16S	ER-16W	\$345.00
966-000-470	HSK80A-ER32-400	1.980	4.00	2.05	3.15	ER-32N	ER-32S	ER-32W	\$357.00
966-000-336	HSK100A-ER16-400	1.100	4.00	3.00	3.93	ER-16HN	ER-16S	ER-16W	\$295.00
966-000-338	HSK100A-ER16-600	1.100	6.00	3.00	3.93	ER-16HN	ER-16S	ER-16W	\$320.00
966-000-340	HSK100A-ER32-400	1.980	4.00	4.30	3.93	ER-32SN	ER-32S	ER-32W	\$314.00
966-000-342	HSK100A-ER32-600	1.980	6.00	4.30	3.93	ER-32SN	ER-32S	ER-32W	\$339.00
966-000-344	HSK100A-ER40-400	2.250	4.00	4.00	3.93	ER-40SN	ER-40S	ER-40W	\$320.00
966-000-346	HSK100A-ER40-600	2.250	6.00	4.50	3.93	ER-40SN	ER-40S	ER-40W	\$345.00
966-000-382	HSK125A-ER16-500	1.100	5.00	3.10	4.92	ER-16HN	ER-16S	ER-16W	\$599.00
966-000-383	HSK125A-ER40-500	2.250	5.00	2.80	4.92	ER-40SN	ER-40S	ER-40W	\$612.00

* Add -G6 or -G2 to end of designation depending on the balance needed.
All Hardware Included. Wrenches Sold Separately.

PRODUCT #	Nut	Price Each
968-000-029	ER-11HN	\$22.50
968-000-033	ER-16HN	\$23.60
968-000-038	ER-20HN	\$27.20
968-000-044	ER-25SN	\$30.70
968-000-047	ER-32SN	\$31.90
968-000-050	ER-40SN	\$37.40
968-000-030	ER-11MN	\$24.80
968-000-034	ER-16MN	\$26.00
968-000-039	ER-20MN	\$28.40

PACKAGE SIZE OF 1

PRODUCT #	Adj. Screw	Price Each
968-000-032	ER-11S	\$8.20
968-000-036	ER-16S	\$8.70
968-000-041	ER-20S	\$9.70
968-000-043	ER-25S	\$11.40
968-000-046	ER-32S	\$12.40
968-000-049	ER-40S	\$14.20

PACKAGE SIZE OF 1

PRODUCT #	Wrench	Price Each
968-000-189	ER-11W	\$15.40
968-000-031	ER-11MW	\$39.60
968-000-035	ER-16MW	\$39.60
968-000-037	ER-16W	\$15.40
968-000-040	ER-20MW	\$44.00
968-000-042	ER-20W	\$15.40
968-000-045	ER-25W	\$17.70
968-000-048	ER-32W	\$20.10
968-000-051	ER-40W	\$28.40

PACKAGE SIZE OF 1

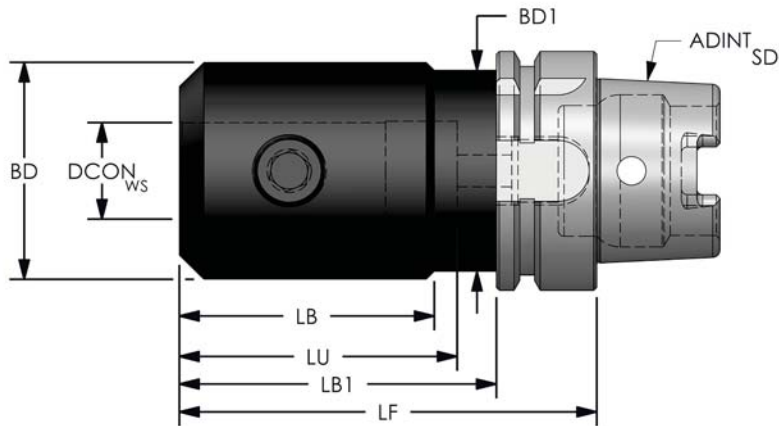

Balanced to:
G2.5 (15,000 rpm)

PRODUCT #	Designation	DCON WS	BD	LB	LF	LU	Set Screw	G2 Price*
966-000-315	HSK100A-EM250-400	.250	.880	2.858	4.00		SS1/4-250	\$271.00
966-000-317	HSK100A-EM250-600	.250	.880	4.858	6.00		SS1/4-250	\$320.00
966-000-319	HSK100A-EM375-400	.375	1.000	2.858	4.00		SS3/8-375	\$271.00
966-000-321	HSK100A-EM375-600	.375	1.000	4.858	6.00		SS3/8-375	\$320.00
966-000-323	HSK100A-EM500-400	.500	1.375	2.858	4.00		SS7/16-500	\$271.00
966-000-325	HSK100A-EM500-600	.500	1.375	4.858	6.00		SS7/16-500	\$320.00
966-000-327	HSK100A-EM625-400	.625	1.750	2.858	4.00	2.10	SS9/16-500	\$271.00
966-000-329	HSK100A-EM625-600	.625	1.750	4.858	6.00	2.10	SS9/16-500	\$320.00
966-000-331	HSK100A-EM750-400	.750	1.750	2.858	4.00	2.50	SS5/8-500	\$271.00
966-000-333	HSK100A-EM750-600	.750	1.750	4.858	6.00	2.50	SS5/8-500	\$320.00
966-000-303	HSK100A-EM100-400	1.000	2.250	2.858	4.00	2.83	SS3/4-500	\$271.00
966-000-305	HSK100A-EM100-600	1.000	2.250	4.858	6.00	2.83	SS3/4-500	\$320.00
966-000-307	HSK100A-EM125-425	1.250	2.250	3.108	4.25	3.00	(2) SS3/4-500	\$295.00
966-000-309	HSK100A-EM125-600	1.250	2.250	4.858	6.00	3.00	(2) SS3/4-500	\$369.00
966-000-311	HSK100A-EM150-450	1.500	2.750	3.358	4.50	2.75	(2)SS3/4-500	\$320.00

PRODUCT #	Designation	DCON WS	BD	BD1	LB	LB1	LF	LU	Set Screw	G2 Price*
966-000-313	HSK100A-EM200-550	2.000	3.750	3.347	4.358	3.728	5.50	3.50	(2)SS1-750	\$345.00

* Add -G6 or -G2 to end of designation depending on the balance needed.
All Hardware Included

PRODUCT #	Set Screws	Price Each
968-000-137	SS10-250	\$3.30
968-000-136	SS1/4-250	\$3.30
968-000-142	SS3/8-375	\$3.30
968-000-144	SS7/16-500	\$5.30
968-000-145	SS9/16-500	\$10.20
968-000-143	SS5/8-500	\$10.20
968-000-139	SS3/4-375	\$11.30
968-000-140	SS3/4-500	\$11.30
968-000-138	SS1-750	\$11.90

PACKAGE SIZE OF 5

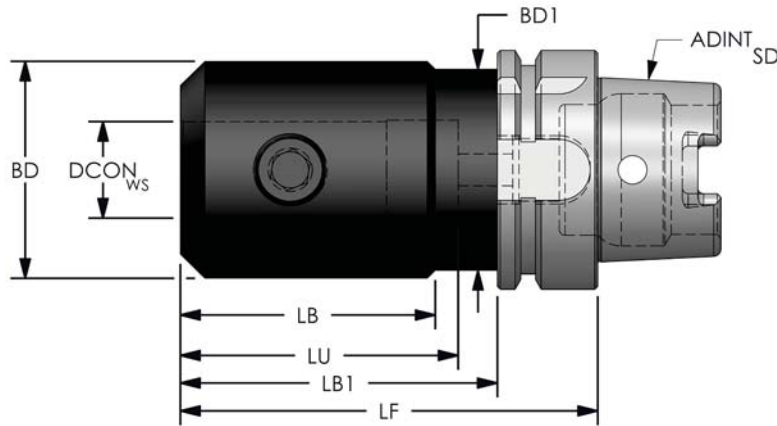

Balanced to:
G6.3 (12,000 rpm)

PRODUCT #	Designation	DCON WS	BD	LB	LF	LU	Set Screw	G6 Price*
966-000-316	HSK100A-EM250-400	.250	.880	2.858	4.00		SS1/4-250	\$246.00
966-000-318	HSK100A-EM250-600	.250	.880	4.858	6.00		SS1/4-250	\$295.00
966-000-320	HSK100A-EM375-400	.375	1.000	2.858	4.00		SS3/8-375	\$246.00
966-000-322	HSK100A-EM375-600	.375	1.000	4.858	6.00		SS3/8-375	\$295.00
966-000-324	HSK100A-EM500-400	.500	1.375	2.858	4.00		SS7/16-500	\$246.00
966-000-326	HSK100A-EM500-600	.500	1.375	4.858	6.00		SS7/16-500	\$295.00
966-000-328	HSK100A-EM625-400	.625	1.750	2.858	4.00	2.10	SS9/16-500	\$246.00
966-000-330	HSK100A-EM625-600	.625	1.750	4.858	6.00	2.10	SS9/16-500	\$295.00
966-000-332	HSK100A-EM750-400	.750	1.750	2.858	4.00	2.50	SS5/8-500	\$246.00
966-000-334	HSK100A-EM750-600	.750	1.750	4.858	6.00	2.50	SS5/8-500	\$295.00
966-000-304	HSK100A-EM100-400	1.000	2.250	2.858	4.00	2.83	SS3/4-500	\$246.00
966-000-306	HSK100A-EM100-600	1.000	2.250	4.858	6.00	2.83	SS3/4-500	\$295.00
966-000-308	HSK100A-EM125-425	1.250	2.250	3.108	4.25	3.00	(2) SS3/4-500	\$271.00
966-000-310	HSK100A-EM125-600	1.250	2.250	4.858	6.00	3.00	(2) SS3/4-500	\$345.00
966-000-312	HSK100A-EM150-450	1.500	2.750	3.358	4.50	2.75	(2)SS3/4-500	\$295.00

PRODUCT #	Designation	DCON WS	BD	BD1	LB	LB1	LF	LU	Set Screw	G6 Price*
966-000-314	HSK100A-EM200-550	2.000	3.750	3.347	4.358	3.728	5.50	3.50	(2)SS1-750	\$320.00

* Add -G6 or -G2 to end of designation depending on the balance needed.
All Hardware Included

PRODUCT #	Set Screws	Price Each
968-000-137	SS10-250	\$3.30
968-000-136	SS1/4-250	\$3.30
968-000-142	SS3/8-375	\$3.30
968-000-144	SS7/16-500	\$5.30
968-000-145	SS9/16-500	\$10.20
968-000-143	SS5/8-500	\$10.20
968-000-139	SS3/4-375	\$11.30
968-000-140	SS3/4-500	\$11.30
968-000-138	SS1-750	\$11.90

PACKAGE SIZE OF 5

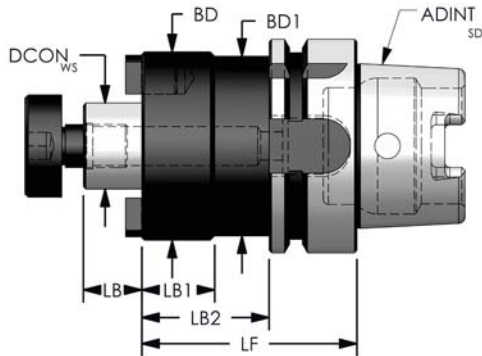

Balanced to:
G6.3 (12,000 rpm)

PRODUCT #	Designation	DCON WS	BD	BD1	LB	LB1	LB2	LF	Drive Key	Lock Screw	Thread	Price
966-000-377	HSK100A-SM075-200	0.750	1.750		0.68	0.858		2.00	UDK 312	U5002	3/8-24	\$332.00
966-000-378	HSK100A-SM100-200	1.000	2.190		0.68	0.858		2.00	UDK 375	U5003	1/2-20	\$332.00
966-000-379	HSK100A-SM125-250	1.250	2.750		0.68	1.358		2.50	UDK 500	U5004	5/8-18	\$345.00
966-000-380	HSK100A-SM150-250	1.500	3.380	3.347	0.94	1.358	0.728	2.50	UDK 625	U5005	3/4-16	\$345.00
966-000-381	HSK100A-SM200-300	2.000	4.440	3.347	0.94	1.858	1.226	3.00	UDK 750	U5006	1-14	\$382.00

All Hardware Included

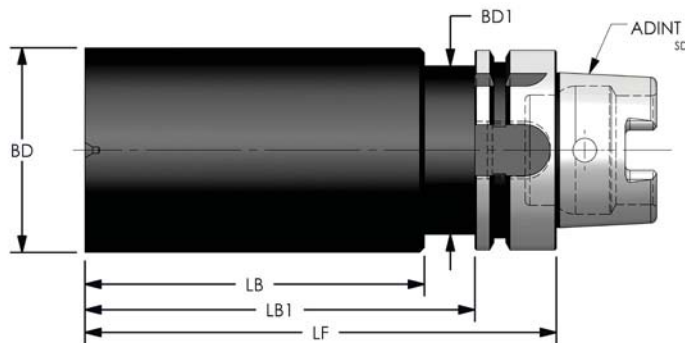

PRODUCT #	Designation	Taper	BD	BD1	LB	LB1	LF	Price
967-000-021	HSK80A-BB80-250	HSK80A	3.150/80mm	2.677	8.189	8.819	9.84/250mm	\$345.60
967-000-020	HSK80A-BB150-200	HSK80A	5.910/150mm	2.677	6.220	6.850	7.87/200mm	\$438.90
967-000-007	HSK100A-BB100-150	HSK100A	3.940/100mm	3.465	4.134	4.764	5.910/150mm	\$331.80
967-000-008	HSK100A-BB100-250	HSK100A	3.940/100mm	3.465	8.071	8.701	9.84/250mm	\$398.60
967-000-009	HSK100A-BB150-250	HSK100A	5.910/150mm	3.465	8.071	8.701	9.84/250mm	\$518.40
967-000-010	HSK125A-BB125-305	HSK125A	4.920/125mm	4.134	10.238	10.868	12.01/305mm	\$638.20
967-000-011	HSK125A-BB150-200	HSK125A	5.910/150mm	4.134	6.008	6.638	7.87/200mm	\$664.70

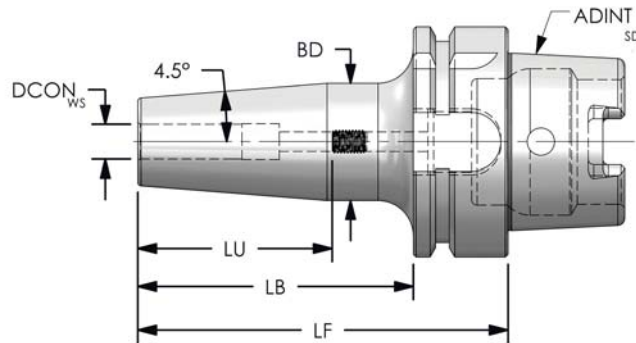

Standard Length

Balanced to:
G2.5 (15,000 rpm)

PRODUCT #	Designation	DCON WS	BD	LF	LU	LB	Thread	Price
966-000-347	HSK100A-SF012-400-G2	.125	1.060	4.00	.79	2.86		\$431.00
966-000-362	HSK100A-SF188-400-G2	.188	1.060	4.00	.79	2.86		\$406.00
966-000-365	HSK100A-SF250-400-G2	.250	1.060	4.00	1.42	2.86	10-32	\$406.00
966-000-370	HSK100A-SF375-400-G2	.375	1.260	4.00	1.53	2.86	1/4-28	\$406.00
966-000-372	HSK100A-SF500-400-G2	.500	1.340	4.00	1.85	2.86	7/16-20	\$406.00
966-000-374	HSK100A-SF625-400-G2	.625	1.340	4.00	1.97	2.86	9/16-18	\$406.00
966-000-375	HSK100A-SF750-500-G2	.750	1.650	5.00	2.04	3.86	5/8-18	\$419.00
966-000-352	HSK100A-SF100-500-G2	1.000	2.090	5.00	2.28	3.86	3/4-16	\$419.00
966-000-357	HSK100A-SF125-500-G2	1.250	2.090	5.00	2.28	3.86	3/4-16	\$419.00

Extended Length

PRODUCT #	Designation	DCON WS	BD	LF	LU	LB	Thread	Price
966-000-371	HSK100A-SF375-600-G2	.375	1.260	6.00	1.53	4.86	1/4-28	\$431.00
966-000-373	HSK100A-SF500-600-G2	.500	1.340	6.00	1.85	4.86	7/16-20	\$431.00
966-000-376	HSK100A-SF750-700-G2	.750	1.650	7.00	2.04	5.86	5/8-18	\$444.00
966-000-353	HSK100A-SF100-700-G2	1.000	2.090	7.00	2.28	5.86	3/4-16	\$444.00
966-000-358	HSK100A-SF125-700-G2	1.250	2.090	7.00	2.28	5.86	3/4-16	\$444.00



by Ultra-Dex

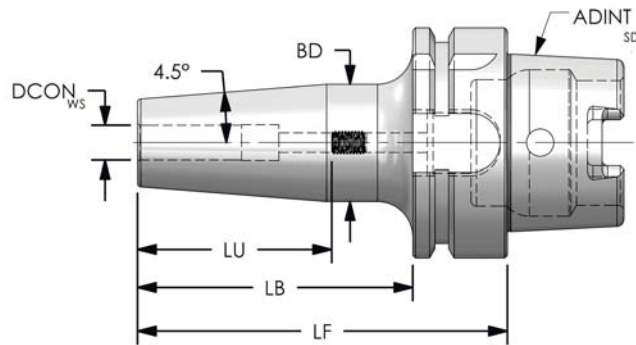

Standard Length

Balanced to:
G2.5 (15,000 rpm)

PRODUCT #	Designation	DCON WS	BD	LB	LF	LU	Thread	Price
966-000-348	HSK100A-SF06-400-G2	6mm	1.063	2.858	4.00	2.167	10-32	\$406.00
966-000-350	HSK100A-SF08-400-G2	8mm	1.063	2.858	4.00	1.970	1/4-28	\$406.00
966-000-354	HSK100A-SF10-400-G2	10mm	1.260	2.858	4.00	2.207	1/4-28	\$406.00
966-000-356	HSK100A-SF12-400-G2	12mm	1.260	2.858	4.00	2.404	7/16-20	\$406.00
966-000-360	HSK100A-SF16-400-G2	16mm	1.339	2.858	4.00	2.522	9/16-18	\$406.00
966-000-363	HSK100A-SF20-500-G2	20mm	1.654	3.858	5.00	2.600	5/8-18	\$419.00
966-000-366	HSK100A-SF25-500-G2	25mm	2.087	3.858	5.00	2.912	3/4-16	\$419.00
966-000-368	HSK100A-SF32-500-G2	32mm	2.087	3.858	5.00	2.912	3/4-16	\$419.00

Extended Length

PRODUCT #	Designation	DCON WS	BD	LB	LF	LU	Thread	Price
966-000-349	HSK100A-SF06-600-G2	6mm	1.063	4.858	6.00	2.167	10-32	\$431.00
966-000-351	HSK100A-SF08-600-G2	8mm	1.063	4.858	6.00	1.970	1/4-28	\$431.00
966-000-355	HSK100A-SF10-600-G2	10mm	1.260	4.858	6.00	2.207	1/4-28	\$431.00
966-000-359	HSK100A-SF12-600-G2	12mm	1.260	4.858	6.00	2.404	7/16-20	\$431.00
966-000-361	HSK100A-SF16-600-G2	16mm	1.260	4.858	6.00	2.522	9/16-18	\$431.00
966-000-364	HSK100A-SF20-700-G2	20mm	1.654	5.858	7.00	2.600	5/8-18	\$444.00
966-000-367	HSK100A-SF25-700-G2	25mm	2.087	5.858	7.00	2.912	3/4-16	\$444.00
966-000-369	HSK100A-SF32-700-G2	32mm	2.087	5.858	7.00	2.912	3/4-16	\$444.00



PRODUCT #	Designation	Description	Price
969-000-005	HSK40A-CT	HSK40A Coolant Tube	\$41.00
969-000-007	HSK50A-CT	HSK50A Coolant Tube	\$45.20
969-000-009	HSK63A-CT	HSK63A Coolant Tube	\$27.20
969-000-011	HSK80A-CT	HSK80A Coolant Tube	\$46.20
969-000-001	HSK100A-CT	HSK100A Coolant Tube	\$32.60
969-000-003	HSK125A-CT	HSK125A Coolant Tube	\$50.40

PRODUCT #	Designation	Description	Price
969-000-006	HSK40A-S	HSK40A Coolant Tube Socket (3/8" Drive)	\$63.00
969-000-008	HSK50A-S	HSK50A Coolant Tube Socket (3/8" Drive)	\$64.10
969-000-010	HSK63A-S	HSK63A Coolant Tube Socket (3/8" Drive)	\$35.70
969-000-012	HSK80A-S	HSK80A Coolant Tube Socket (3/8" Drive)	\$76.70
969-000-002	HSK100A-S	HSK100A Coolant Tube Socket (1/2" Drive)	\$43.10
969-000-004	HSK125A-S	HSK125A Coolant Tube Socket (1/2" Drive)	\$43.10

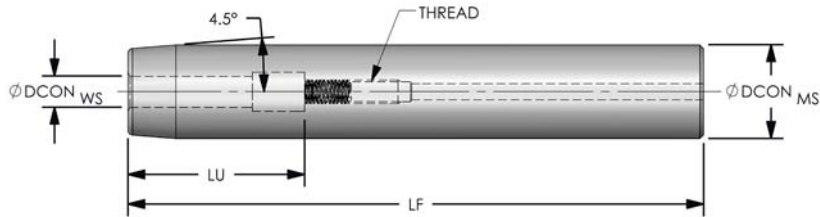

PRODUCT #	Designation	DCON WS	DCON MS	LF	LU	Thread	Price
973-000-001	SS050-SF012-463	0.125	0.500	4.63	0.79		\$142.80
973-000-003	SS075-SF012-463	0.125	0.750	4.63	0.79		\$149.10
973-000-004	SS075-SF012-663	0.125	0.750	6.63	0.79		\$160.70
973-000-010	SS100-SF012-863	0.125	1.000	8.63	0.79		\$182.70
973-000-002	SS050-SF188-463	0.188	0.500	4.63	0.79		\$131.30
973-000-005	SS075-SF188-463	0.188	0.750	4.63	0.79		\$137.60
973-000-006	SS075-SF188-663	0.188	0.750	6.63	0.79		\$149.10
973-000-011	SS100-SF188-863	0.188	1.000	8.63	0.79		\$172.20
973-000-007	SS075-SF250-463	0.250	0.750	4.63	1.42	10-32	\$137.60
973-000-008	SS075-SF250-663	0.250	0.750	6.63	1.42	10-32	\$149.10
973-000-012	SS100-SF250-863	0.250	1.000	8.63	1.42	10-32	\$172.20
973-000-009	SS075-SF375-463	0.375	0.750	4.63	1.53	1/4-28	\$137.60
973-000-013	SS100-SF375-663	0.375	1.000	6.63	1.53	1/4-28	\$149.10
973-000-017	SS125-SF375-900	0.375	1.250	9.00	1.53	1/4-28	\$205.80
973-000-014	SS100-SF500-463	0.500	1.000	4.63	1.85	7/16-20	\$154.40
973-000-015	SS100-SF500-663	0.500	1.000	6.63	1.85	7/16-20	\$165.90
973-000-018	SS125-SF500-900	0.500	1.250	9.00	1.85	7/16-20	\$205.80
973-000-016	SS100-SF625-463	0.625	1.000	4.63	1.97	9/16-18	\$154.40
973-000-019	SS125-SF625-700	0.625	1.250	7.00	1.97	1/4-28	\$182.70
973-000-020	SS125-SF750-500	0.750	1.250	5.00	2.04	5/8-18	\$160.70
973-000-021	SS125-SF750-700	0.750	1.250	7.00	1.42	5/8-18	\$205.80



by **Ultra-Dex**

- Adjustable Stop Screw Allows Drills to be Pre-Set
- Balanced for Less Vibration & Longer Tool Life
- T.I.R. .0002
- Hardened & Tempered to Prevent Cracking
- Balanced Nuts (G2.5 at 15,000 RPM)
- Special Lengths Available

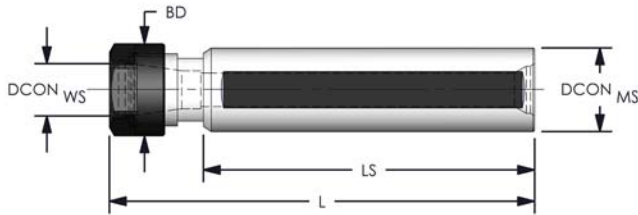

IMPERIAL

PRODUCT #	Designation	DCON WS	Range	BD	DCON MS	L	LS	Collet Nut	Screw	Collet Wrench	Price
958-000-001	SS075-ER16-250	ER16	.020" – .406" (.5mm - 10mm) 1/32" - 13/32"	1.100	0.750	3.800	2.500	ER-16HN	ER-16S	ER-16W	\$90.00
958-000-002	SS075-ER16-400	ER16		1.100	0.750	5.300	4.000	ER-16HN	ER-16S	ER-16W	\$98.40
958-000-005	SS100-ER16-250	ER16		1.100	1.000	3.800	2.500	ER-16HN	ER-16S	ER-16W	\$90.00
958-000-006	SS100-ER16-400	ER16		1.100	1.000	5.300	4.000	ER-16HN	ER-16S	ER-16W	\$98.40
958-000-007	SS100-ER16-600	ER16		1.100	1.000	7.300	6.000	ER-16HN	ER-16S	ER-16W	\$105.60
958-000-003	SS075-ER20-250	ER20	.020" – 0.500" (.5mm – 13mm) 1/32" - 1/2"	1.340	0.750	3.600	2.500	ER-20HN	ER-20S	ER-20W	\$90.00
958-000-004	SS075-ER20-400	ER20		1.340	0.750	5.100	4.000	ER-20HN	ER-20S	ER-20W	\$98.40
958-000-008	SS100-ER20-250	ER20		1.340	1.000	3.600	2.500	ER-20HN	ER-20S	ER-20W	\$90.00
958-000-009	SS100-ER20-400	ER20		1.340	1.000	5.100	4.000	ER-20HN	ER-20S	ER-20W	\$98.40
958-000-010	SS100-ER20-600	ER20		1.340	1.000	7.100	6.000	ER-20HN	ER-20S	ER-20W	\$105.60

METRIC

PRODUCT #	Designation	DCON WS	Range	BD	DCON MS	L	LS	Collet Nut	Screw	Collet Wrench	Price
958-000-011	SS22MM-ER16-250	ER16	.020" – .406" (.5mm - 10mm) 1/32" - 13/32"	1.100	22mm	3.800	2.500	ER-16HN	ER-16S	ER-16W	\$105.60
958-000-012	SS22MM-ER20-250	ER20	.020" – 0.500" (.5mm – 13mm) 1/32" - 1/2"	1.340	22mm	3.600	2.500	ER-20HN	ER-20S	ER-20W	\$105.60

All Hardware Included. Wrenches Sold Separately.

PRODUCT #	Nut	Price Each
968-000-029	ER-11HN	\$22.50
968-000-033	ER-16HN	\$23.60
968-000-038	ER-20HN	\$27.20
968-000-044	ER-25SN	\$30.70
968-000-047	ER-32SN	\$31.90
968-000-050	ER-40SN	\$37.40
968-000-030	ER-11MN	\$24.80
968-000-034	ER-16MN	\$26.00
968-000-039	ER-20MN	\$28.40

PACKAGE SIZE OF 1

PRODUCT #	Adj. Screw	Price Each
968-000-032	ER-11S	\$8.20
968-000-036	ER-16S	\$8.70
968-000-041	ER-20S	\$9.70
968-000-043	ER-25S	\$11.40
968-000-046	ER-32S	\$12.40
968-000-049	ER-40S	\$14.20

PACKAGE SIZE OF 1

PRODUCT #	Wrench	Price Each
968-000-189	ER-11W	\$15.40
968-000-031	ER-11MW	\$39.60
968-000-035	ER-16MW	\$39.60
968-000-037	ER-16W	\$15.40
968-000-040	ER-20MW	\$44.00
968-000-042	ER-20W	\$15.40
968-000-045	ER-25W	\$17.70
968-000-048	ER-32W	\$20.10
968-000-051	ER-40W	\$28.40

PACKAGE SIZE OF 1

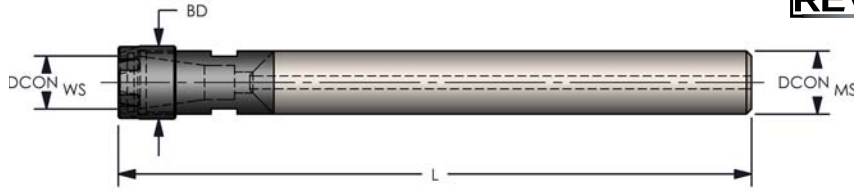

With Flat

PRODUCT #	Designation	DCON WS	Range	Collet Nut	L	DCON MS	BD	Price
903-000-011	ST1/2 X 8.000 ER11 C W	ER11	.062 -.250 (1.5mm - 6.4mm) 1/16" - 1/4"	ER11-MN	8	0.500	.625	\$316.80
903-000-027	ST5/8 X 7.000 ER11 C W	ER11		ER11-MN	7	.625	.625	\$379.90
903-000-021	ST5/8 X 10.000 ER11 C W	ER11		ER11-MN	10	.625	.625	\$445.20
903-000-029	ST5/8 X 7.000 ER16 C W	ER16	.062 -.406 (1.5mm - 10.3mm) 1/16" - 13/32"	ER16-MN	7	.625	.875	\$379.90
903-000-023	ST5/8 X 10.000 ER16 C W	ER16		ER16-MN	10	.625	.875	\$445.20
903-000-017	ST3/4 X 7.000 ER16 C W	ER16		ER16-MN	7	.750	.875	\$470.80
903-000-013	ST3/4 X 10.000 ER16 C W	ER16		ER16-MN	10	.750	.875	\$508.30
903-000-006	ST1 X 8.000 ER16 C W	ER16		ER16-MN	8	1.000	.875	\$680.60
903-000-002	ST1 X 12.000 ER16 C W	ER16	ER16-MN	12	1.000	.875	\$851.80	
903-000-031	ST5/8 X 7.000 ER20 C W	ER20	.094 -0.500 (2.4mm - 13mm) 3/32" - 1/2"	ER20-MN	7	.625	1.125	\$379.90
903-000-025	ST5/8 X 10.000 ER20 C W	ER20		ER20-MN	10	.625	1.125	\$416.00
903-000-019	ST3/4 X 7.000 ER20 C W	ER20		ER20-MN	7	.750	1.125	\$445.20
903-000-015	ST3/4 X 10.000 ER20 C W	ER20		ER20-MN	10	.750	1.125	\$508.30
903-000-008	ST1 X 8.000 ER20 C W	ER20		ER20-MN	8	1.000	1.125	\$680.60
903-000-004	ST1 X 12.000 ER20 C W	ER20	ER20-MN	12	1.000	1.125	\$851.80	

Without Flat

PRODUCT #	Designation	DCON WS	Range	Collet Nut	L	DCON MS	BD	Price
903-000-009	ST1/2 X 5.000 ER11 C	ER11	.062 -.250 (1.5mm - 6.4mm) 1/16" - 1/4"	ER11-MN	5	0.500	0.625	\$316.80
903-000-010	ST1/2 X 8.000 ER11 C	ER11		ER11-MN	8	0.500	0.625	\$316.80
903-000-026	ST5/8 X 7.000 ER11 C	ER11		ER11-MN	7	0.625	0.625	\$379.90
903-000-020	ST5/8 X 10.000 ER11 C	ER11		ER11-MN	10	0.625	0.625	\$445.20
903-000-028	ST5/8 X 7.000 ER16 C	ER16	.062 -.406 (1.5mm - 10.3mm) 1/16" - 13/32"	ER16-MN	7	0.625	0.875	\$379.90
903-000-022	ST5/8 X 10.000 ER16 C	ER16		ER16-MN	10	0.625	0.875	\$445.20
903-000-016	ST3/4 X 7.000 ER16 C	ER16		ER16-MN	7	0.750	0.875	\$470.80
903-000-012	ST3/4 X 10.000 ER16 C	ER16		ER16-MN	10	0.750	0.875	\$508.30
903-000-005	ST1 X 8.000 ER16 C	ER16		ER16-MN	8	1.000	0.875	\$680.60
903-000-001	ST1 X 12.000 ER16 C	ER16	ER16-MN	12	1.000	0.875	\$851.80	
903-000-030	ST5/8 X 7.000 ER20 C	ER20	.094 -0.500 (2.4mm - 13mm) 3/32" - 1/2"	ER20-MN	7	0.625	1.125	\$379.90
903-000-024	ST5/8 X 10.000 ER20 C	ER20		ER20-MN	10	0.625	1.125	\$445.20
903-000-018	ST3/4 X 7.000 ER20 C	ER20		ER20-MN	7	0.750	1.125	\$470.80
903-000-014	ST3/4 X 10.000 ER20 C	ER20		ER20-MN	10	0.750	1.125	\$508.30
903-000-007	ST1 X 8.000 ER20 C	ER20		ER20-MN	8	1.000	1.125	\$680.60
903-000-003	ST1 X 12.000 ER20 C	ER20		ER20-MN	12	1.000	1.125	\$851.80

All Hardware Included. Wrenches Sold Separately.

PRODUCT #	Nut	Price Each
968-000-029	ER-11HN	\$22.50
968-000-033	ER-16HN	\$23.60
968-000-038	ER-20HN	\$27.20
968-000-044	ER-25SN	\$30.70
968-000-047	ER-32SN	\$31.90
968-000-050	ER-40SN	\$37.40
968-000-030	ER-11MN	\$24.80
968-000-034	ER-16MN	\$26.00
968-000-039	ER-20MN	\$28.40

PACKAGE SIZE OF 1



	Ø	PRODUCT #	Designation	Price
ER16	1/8	916-000-041	ER16C-SS-1250	\$44.00
	5/32	916-000-042	ER16C-SS-1562	\$44.00
	3/16	916-000-043	ER16C-SS-1875	\$44.00
	7/32	916-000-044	ER16C-SS-2187	\$44.00
	1/4	916-000-045	ER16C-SS-2500	\$44.00
	9/32	916-000-046	ER16C-SS-2812	\$44.00
	5/16	916-000-047	ER16C-SS-3125	\$44.00
	11/32	916-000-048	ER16C-SS-3437	\$44.00
	3/8	916-000-049	ER16C-SS-3750	\$44.00
	13/32	916-000-050	ER16C-SS-4062	\$44.00
ER20	1/8	916-000-089	ER20C-SS-1250	\$49.00
	5/32	916-000-092	ER20C-SS-1562	\$49.00
	3/16	916-000-093	ER20C-SS-1875	\$49.00
	7/32	916-000-094	ER20C-SS-2187	\$49.00
	1/4	916-000-095	ER20C-SS-2500	\$49.00
	9/32	916-000-096	ER20C-SS-2812	\$49.00
	5/16	916-000-097	ER20C-SS-3125	\$49.00
	11/32	916-000-098	ER20C-SS-3437	\$49.00
	3/8	916-000-099	ER20C-SS-3750	\$49.00
	13/32	916-000-100	ER20C-SS-4062	\$49.00
	7/16	916-000-101	ER20C-SS-4375	\$49.00
	15/32	916-000-102	ER20C-SS-4687	\$49.00
	1/2	916-000-104	ER20C-SS-5000	\$49.00
	ER25	1/8	916-000-147	ER25C-SS-1250
5/32		916-000-151	ER25C-SS-1562	\$51.00
3/16		916-000-154	ER25C-SS-1875	\$51.00
7/32		916-000-155	ER25C-SS-2187	\$51.00
1/4		916-000-156	ER25C-SS-2500	\$51.00
9/32		916-000-157	ER25C-SS-2812	\$51.00
5/16		916-000-158	ER25C-SS-3125	\$51.00
11/32		916-000-159	ER25C-SS-3437	\$51.00
3/8		916-000-160	ER25C-SS-3750	\$51.00
13/32		916-000-161	ER25C-SS-4062	\$51.00
7/16		916-000-162	ER25C-SS-4375	\$51.00
15/32		916-000-163	ER25C-SS-4687	\$51.00
1/2		916-000-165	ER25C-SS-5000	\$51.00
17/32		916-000-166	ER25C-SS-5312	\$51.00
9/16		916-000-167	ER25C-SS-5625	\$51.00
19/32		916-000-168	ER25C-SS-5937	\$51.00
5/8		916-000-170	ER25C-SS-6250	\$51.00

	Ø	PRODUCT #	Designation	Price
ER32	1/8	916-000-220	ER32C-SS-1250	\$55.00
	5/32	916-000-224	ER32C-SS-1562	\$55.00
	3/16	916-000-228	ER32C-SS-1875	\$55.00
	7/32	916-000-232	ER32C-SS-2187	\$55.00
	1/4	916-000-233	ER32C-SS-2500	\$55.00
	9/32	916-000-234	ER32C-SS-2812	\$55.00
	5/16	916-000-235	ER32C-SS-3125	\$55.00
	11/32	916-000-236	ER32C-SS-3437	\$55.00
	3/8	916-000-237	ER32C-SS-3750	\$55.00
	13/32	916-000-238	ER32C-SS-4062	\$55.00
	7/16	916-000-239	ER32C-SS-4375	\$55.00
	15/32	916-000-240	ER32C-SS-4687	\$55.00
	1/2	916-000-242	ER32C-SS-5000	\$55.00
	17/32	916-000-243	ER32C-SS-5312	\$55.00
	9/16	916-000-244	ER32C-SS-5625	\$55.00
	19/32	916-000-245	ER32C-SS-5937	\$55.00
	5/8	916-000-247	ER32C-SS-6250	\$55.00
ER40	21/32	916-000-248	ER32C-SS-6562	\$55.00
	11/16	916-000-249	ER32C-SS-6875	\$55.00
	23/32	916-000-251	ER32C-SS-7187	\$55.00
	3/4	916-000-252	ER32C-SS-7500	\$55.00
	1/8	916-000-309	ER40C-SS-1250	\$61.00
	5/32	916-000-313	ER40C-SS-1562	\$61.00
	3/16	916-000-317	ER40C-SS-1875	\$61.00
	7/32	916-000-321	ER40C-SS-2187	\$61.00
	1/4	916-000-326	ER40C-SS-2500	\$61.00
	9/32	916-000-329	ER40C-SS-2812	\$61.00
	5/16	916-000-330	ER40C-SS-3125	\$61.00
	11/32	916-000-331	ER40C-SS-3437	\$61.00
	3/8	916-000-332	ER40C-SS-3750	\$61.00
	13/32	916-000-333	ER40C-SS-4062	\$61.00
	7/16	916-000-334	ER40C-SS-4375	\$61.00
	15/32	916-000-335	ER40C-SS-4687	\$61.00
	1/2	916-000-336	ER40C-SS-5000	\$61.00
17/32	916-000-337	ER40C-SS-5312	\$61.00	
9/16	916-000-338	ER40C-SS-5625	\$61.00	
19/32	916-000-339	ER405C-SS-5937	\$61.00	
5/8	916-000-340	ER40C-SS-6250	\$61.00	
21/32	916-000-341	ER40C-SS-6562	\$61.00	
11/16	916-000-342	ER40C-SS-6875	\$61.00	
23/32	916-000-298	ER40C-SS-7187	\$61.00	
3/4	916-000-299	ER40C-SS-7500	\$61.00	
13/16	916-000-347	ER40C-SS-8125	\$61.00	
7/8	916-000-348	ER40C-SS-8750	\$61.00	
1	916-000-257	ER40C-SS-1000	\$61.00	



	Ø	PRODUCT #	Designation	Price	
ER16	4mm	916-000-051	ER16C-SS-4MM	\$44.00	
	5mm	916-000-052	ER16C-SS-5MM	\$44.00	
	6mm	916-000-053	ER16C-SS-6MM	\$44.00	
	7mm	916-000-054	ER16C-SS-7MM	\$44.00	
	8mm	916-000-055	ER16C-SS-8MM	\$44.00	
	9mm	916-000-056	ER16C-SS-9MM	\$44.00	
ER20	10mm	916-000-040	ER16C-SS-10MM	\$44.00	
	4mm	916-000-105	ER20C-SS-4MM	\$49.00	
	5mm	916-000-106	ER20C-SS-5MM	\$49.00	
	6mm	916-000-107	ER20C-SS-6MM	\$49.00	
	7mm	916-000-108	ER20C-SS-7MM	\$49.00	
	8mm	916-000-109	ER20C-SS-8MM	\$49.00	
	9mm	916-000-085	ER20C-SS-9MM	\$49.00	
	10mm	916-000-087	ER20C-SS-10MM	\$49.00	
	11mm	916-000-088	ER20C-SS-11MM	\$49.00	
	12mm	916-000-090	ER20C-SS-12MM	\$49.00	
	13mm	916-000-091	ER20C-SS-13MM	\$49.00	
	14mm	916-000-064	ER20C-SS-14MM	\$49.00	
	ER25	4mm	916-000-164	ER25C-SS-4MM	\$51.00
		5mm	916-000-169	ER25C-SS-5MM	\$51.00
6mm		916-000-171	ER25C-SS-6MM	\$51.00	
7mm		916-000-172	ER25C-SS-7MM	\$51.00	
8mm		916-000-173	ER25C-SS-8MM	\$51.00	
9mm		916-000-174	ER25C-SS-9MM	\$51.00	
10mm		916-000-145	ER25C-SS-10MM	\$51.00	
11mm		916-000-146	ER25C-SS-11MM	\$51.00	
12mm		916-000-148	ER25C-SS-12MM	\$51.00	
13mm		916-000-149	ER25C-SS-13MM	\$51.00	
14mm		916-000-150	ER25C-SS-14MM	\$51.00	
15mm		916-000-152	ER25C-SS-15MM	\$51.00	
16mm		916-000-153	ER25C-SS-16MM	\$51.00	
17mm		916-000-120	ER25C-SS-17MM	\$51.00	

	Ø	PRODUCT #	Designation	Price	
ER32	4mm	916-000-241	ER32C-SS-4MM	\$55.00	
	5mm	916-000-246	ER32C-SS-5MM	\$55.00	
	6mm	916-000-250	ER32C-SS-6MM	\$55.00	
	7mm	916-000-253	ER32C-SS-7MM	\$55.00	
	8mm	916-000-254	ER32C-SS-8MM	\$55.00	
	9mm	916-000-255	ER32C-SS-9MM	\$55.00	
	10mm	916-000-218	ER32C-SS-10MM	\$55.00	
	11mm	916-000-219	ER32C-SS-11MM	\$55.00	
	12mm	916-000-221	ER32C-SS-12MM	\$55.00	
	13mm	916-000-222	ER32C-SS-13MM	\$55.00	
	14mm	916-000-223	ER32C-SS-14MM	\$55.00	
	15mm	916-000-225	ER32C-SS-15MM	\$55.00	
	16mm	916-000-226	ER32C-SS-16MM	\$55.00	
	17mm	916-000-227	ER32C-SS-17MM	\$55.00	
	18mm	916-000-229	ER32C-SS-18MM	\$55.00	
	19mm	916-000-230	ER32C-SS-19MM	\$55.00	
	20mm	916-000-231	ER32C-SS-20MM	\$55.00	
	ER40	6mm	916-000-343	ER40C-SS-6MM	\$61.00
		7mm	916-000-346	ER40C-SS-7MM	\$61.00
		8mm	916-000-349	ER40C-SS-8MM	\$61.00
9mm		916-000-350	ER40C-SS-9MM	\$61.00	
10mm		916-000-307	ER40C-SS-10MM	\$61.00	
11mm		916-000-308	ER40C-SS-11MM	\$61.00	
12mm		916-000-310	ER40C-SS-12MM	\$61.00	
13mm		916-000-311	ER40C-SS-13MM	\$61.00	
14mm		916-000-312	ER40C-SS-14MM	\$61.00	
15mm		916-000-314	ER40C-SS-15MM	\$61.00	
16mm		916-000-315	ER40C-SS-16MM	\$61.00	
17mm		916-000-316	ER40C-SS-17MM	\$61.00	
18mm		916-000-318	ER40C-SS-18MM	\$61.00	
19mm		916-000-319	ER40C-SS-19MM	\$61.00	
20mm		916-000-320	ER40C-SS-20MM	\$61.00	
21mm		916-000-322	ER40C-SS-21MM	\$61.00	
22mm		916-000-323	ER40C-SS-22MM	\$61.00	
23mm		916-000-324	ER40C-SS-23MM	\$61.00	
24mm	916-000-325	ER40C-SS-24MM	\$61.00		
25mm	916-000-327	ER40C-SS-25MM	\$61.00		
26mm	916-000-328	ER40C-SS-26MM	\$61.00		



	Ø	PRODUCT #	Designation	Price
ER11	1/16	916-000-001	ER11C-0625	\$20.10
	3/32	916-000-002	ER11C-0937	\$20.10
	1/8	916-000-003	ER11C-1250	\$20.10
	5/32	916-000-004	ER11C-1562	\$20.10
	3/16	916-000-005	ER11C-1875	\$20.10
	7/32	916-000-007	ER11C-2187	\$20.10
	1/4	916-000-008	ER11C-2500	\$20.10
ER16	1/16	916-000-017	ER16C-0625	\$17.70
	3/32	916-000-018	ER16C-0937	\$17.70
	1/8	916-000-020	ER16C-1250	\$17.70
	5/32	916-000-021	ER16C-1562	\$17.70
	3/16	916-000-022	ER16C-1875	\$17.70
	7/32	916-000-024	ER16C-2187	\$17.70
	1/4	916-000-025	ER16C-2500	\$17.70
	9/32	916-000-026	ER16C-2812	\$17.70
	5/16	916-000-028	ER16C-3125	\$17.70
	11/32	916-000-029	ER16C-3437	\$17.70
	3/8	916-000-030	ER16C-3750	\$17.70
ER20	13/32	916-000-032	ER16C-4062	\$17.70
	3/32	916-000-058	ER20C-0937	\$17.70
	1/8	916-000-061	ER20C-1250	\$17.70
	5/32	916-000-065	ER20C-1562	\$17.70
	3/16	916-000-066	ER20C-1875	\$17.70
	7/32	916-000-068	ER20C-2187	\$17.70
	1/4	916-000-069	ER20C-2500	\$17.70
	9/32	916-000-070	ER20C-2812	\$17.70
	5/16	916-000-072	ER20C-3125	\$17.70
	11/32	916-000-073	ER20C-3437	\$17.70
	3/8	916-000-074	ER20C-3750	\$17.70
	13/32	916-000-076	ER20C-4062	\$17.70
	7/16	916-000-077	ER20C-4375	\$17.70
ER25	15/32	916-000-078	ER20C-4687	\$17.70
	1/2	916-000-080	ER20C-5000	\$17.70
	1/8	916-000-113	ER25C-1250	\$18.90
	5/32	916-000-117	ER25C-1562	\$18.90
	3/16	916-000-121	ER25C-1875	\$18.90
	7/32	916-000-122	ER25C-2187	\$18.90
	1/4	916-000-123	ER25C-2500	\$18.90
	9/32	916-000-124	ER25C-2812	\$18.90
	5/16	916-000-126	ER25C-3125	\$18.90
	11/32	916-000-127	ER25C-3437	\$18.90
	3/8	916-000-128	ER25C-3750	\$18.90
	13/32	916-000-130	ER25C-4062	\$18.90
	7/16	916-000-131	ER25C-4375	\$18.90
	15/32	916-000-132	ER25C-4687	\$18.90
	1/2	916-000-134	ER25C-5000	\$18.90
ER32	17/32	916-000-135	ER25C-5312	\$18.90
	9/16	916-000-136	ER25C-5625	\$18.90
	19/32	916-000-137	ER25C-5937	\$18.90
	5/8	916-000-139	ER25C-6250	\$18.90



Product #	Designation	Description	Price
916-000-015	ER11CS	7 pcs (items with "*" in ER11 section included)	\$131.00
916-000-039	ER16CS	10 pcs (items with "*" in ER16 section included)	\$165.20
916-000-086	ER20CS	10 pcs (items with "*" in ER20 section included)	\$165.20
916-000-144	ER25CS	10 pcs (items with "*" in ER25 section included)	\$179.40
916-000-217	ER32CS	10 pcs (items with "*" in ER32 section included)	\$179.40
916-000-305	ER40CS	10 pcs (items with "*" in ER40 section included)	\$193.60



	Ø	PRODUCT #	Designation	Price
ER32	3/32	916-000-176	ER32C-0937	\$18.90
	1/8	916-000-179	ER32C-1250	\$18.90
	5/32	916-000-183	ER32C-1562	\$18.90
	3/16	916-000-187	ER32C-1875	\$18.90
	7/32	916-000-191	ER32C-2187	\$18.90
	1/4	916-000-193	ER32C-2500	\$18.90
	9/32	916-000-194	ER32C-2812	\$18.90
	5/16	916-000-195	ER32C-3125	\$18.90
	11/32	916-000-196	ER32C-3437	\$18.90
	3/8	916-000-197	ER32C-3750	\$18.90
	13/32	916-000-199	ER32C-4062	\$18.90
	7/16	916-000-200	ER32C-4375	\$18.90
	15/32	916-000-201	ER32C-4687	\$18.90
	1/2	916-000-203	ER32C-5000	\$18.90
	17/32	916-000-204	ER32C-5312	\$18.90
	9/16	916-000-205	ER32C-5625	\$18.90
	19/32	916-000-206	ER32C-5937	\$18.90
	5/8	916-000-208	ER32C-6250	\$18.90
	21/32	916-000-209	ER32C-6562	\$18.90
	11/16	916-000-210	ER32C-6875	\$18.90
23/32	916-000-212	ER32C-7187	\$18.90	
3/4	916-000-213	ER32C-7500	\$18.90	
ER40	1/8	916-000-260	ER40C-1250	\$22.50
	5/32	916-000-264	ER40C-1562	\$22.50
	3/16	916-000-268	ER40C-1875	\$22.50
	7/32	916-000-272	ER40C-2187	\$22.50
	1/4	916-000-277	ER40C-2500	\$22.50
	9/32	916-000-280	ER40C-2812	\$22.50
	5/16	916-000-281	ER40C-3125	\$22.50
	11/32	916-000-282	ER40C-3437	\$22.50
	3/8	916-000-283	ER40C-3750	\$22.50
	13/32	916-000-285	ER40C-4062	\$22.50
	7/16	916-000-286	ER40C-4375	\$22.50
	15/32	916-000-287	ER40C-4687	\$22.50
	1/2	916-000-289	ER40C-5000	\$22.50
	17/32	916-000-290	ER40C-5312	\$22.50
	9/16	916-000-291	ER40C-5625	\$22.50
	19/32	916-000-292	ER405C-5937	\$22.50
	5/8	916-000-294	ER40C-6250	\$22.50
	21/32	916-000-295	ER40C-6562	\$22.50
	11/16	916-000-296	ER40C-6875	\$22.50
	23/32	916-000-298	ER40C-7187	\$22.50
3/4	916-000-299	ER40C-7500	\$22.50	
13/16	916-000-301	ER40C-8125	\$22.50	
7/8	916-000-302	ER40C-8750	\$22.50	
1	916-000-257	ER40C-1000	\$22.50	

Product #	Designation	Description	Price
916-000-015	ER11CS	7 pcs (items with "*" in ER11 section included)	\$131.00
916-000-039	ER16CS	10 pcs (items with "*" in ER16 section included)	\$165.20
916-000-086	ER20CS	10 pcs (items with "*" in ER20 section included)	\$165.20
916-000-144	ER25CS	10 pcs (items with "*" in ER25 section included)	\$179.40
916-000-217	ER32CS	10 pcs (items with "*" in ER32 section included)	\$179.40
916-000-305	ER40CS	10 pcs (items with "*" in ER40 section included)	\$193.60



	Ø	PRODUCT #	Designation	Price
ER11	1mm	916-000-006	ER11C-1MM	\$20.10
	2mm	916-000-009	ER11C-2MM	\$20.10
	3mm	916-000-010	ER11C-3MM	\$20.10
	4mm	916-000-011	ER11C-4MM	\$20.10
	5mm	916-000-012	ER11C-5MM	\$20.10
	6mm	916-000-013	ER11C-6MM	\$20.10
	7mm	916-000-014	ER11C-7MM	\$20.10
ER16	1mm	916-000-023	ER16C-1MM	\$17.70
	2mm	916-000-027	ER16C-2MM	\$17.70
	3mm	916-000-031	ER16C-3MM	\$17.70
	4mm	916-000-033	ER16C-4MM	\$17.70
	5mm	916-000-034	ER16C-5MM	\$17.70
	6mm	916-000-035	ER16C-6MM	\$17.70
	7mm	916-000-036	ER16C-7MM	\$17.70
	8mm	916-000-037	ER16C-8MM	\$17.70
	9mm	916-000-038	ER16C-9MM	\$17.70
	10mm	916-000-019	ER16C-10MM	\$17.70
ER20	1mm	916-000-067	ER20C-1MM	\$17.70
	2mm	916-000-071	ER20C-2MM	\$17.70
	3mm	916-000-075	ER20C-3MM	\$17.70
	4mm	916-000-079	ER20C-4MM	\$17.70
	5mm	916-000-081	ER20C-5MM	\$17.70
	6mm	916-000-082	ER20C-6MM	\$17.70
	7mm	916-000-083	ER20C-7MM	\$17.70
	8mm	916-000-084	ER20C-8MM	\$17.70
	9mm	916-000-085	ER20C-9MM	\$17.70
	10mm	916-000-059	ER20C-10MM	\$17.70
	11mm	916-000-060	ER20C-11MM	\$17.70
	12mm	916-000-062	ER20C-12MM	\$17.70
	13mm	916-000-063	ER20C-13MM	\$17.70
	14mm	916-000-064	ER20C-14MM	\$17.70
ER25	2mm	916-000-125	ER25C-2MM	\$17.70
	3mm	916-000-129	ER25C-3MM	\$17.70
	4mm	916-000-133	ER25C-4MM	\$17.70
	5mm	916-000-138	ER25C-5MM	\$17.70
	6mm	916-000-140	ER25C-6MM	\$17.70
	7mm	916-000-141	ER25C-7MM	\$17.70
	8mm	916-000-142	ER25C-8MM	\$17.70
	9mm	916-000-143	ER25C-9MM	\$17.70
	10mm	916-000-111	ER25C-10MM	\$17.70
	11mm	916-000-112	ER25C-11MM	\$17.70
	12mm	916-000-114	ER25C-12MM	\$17.70
	13mm	916-000-115	ER25C-13MM	\$17.70
	14mm	916-000-116	ER25C-14MM	\$17.70
	15mm	916-000-118	ER25C-15MM	\$17.70
16mm	916-000-119	ER25C-16MM	\$17.70	
17mm	916-000-120	ER25C-17MM	\$17.70	



Product #	Designation	Description	Price
916-000-016	ER11MCS	6 pcs (items with "*" in ER11 section included)	\$111.00
916-000-057	ER16MCS	8 pcs (items with "*" in ER16 section included)	\$128.70
916-000-110	ER20MCS	9 pcs (items with "*" in ER20 section included)	\$145.20
916-000-175	ER25MCS	10 pcs (items with "*" in ER25 section included)	\$160.50
916-000-256	ER32MCS	11 pcs (items with "*" in ER32 section included)	\$191.20
916-000-351	ER40MCS	14 pcs (items with "*" in ER40 section included)	\$277.30



Product #	Designation	Description	Price
916-000-016	ER11MCS	6 pcs (items with "*" in ER11 section included)	\$111.00
916-000-057	ER16MCS	8 pcs (items with "*" in ER16 section included)	\$128.70
916-000-110	ER20MCS	9 pcs (items with "*" in ER20 section included)	\$145.20
916-000-175	ER25MCS	10 pcs (items with "*" in ER25 section included)	\$160.50
916-000-256	ER32MCS	11 pcs (items with "*" in ER32 section included)	\$191.20
916-000-351	ER40MCS	14 pcs (items with "*" in ER40 section included)	\$277.30

	Ø	PRODUCT #	Designation	Price	
ER32	3mm	916-000-198	ER32C-3MM	\$18.90	
	4mm	916-000-202	ER32C-4MM	\$18.90	
	5mm	916-000-207	ER32C-5MM	\$18.90	
	6mm	916-000-211	ER32C-6MM	\$18.90	
	7mm	916-000-214	ER32C-7MM	\$18.90	
	8mm	916-000-215	ER32C-8MM	\$18.90	
	9mm	916-000-216	ER32C-9MM	\$18.90	
	10mm	916-000-177	ER32C-10MM	\$18.90	
	11mm	916-000-178	ER32C-11MM	\$18.90	
	12mm	916-000-180	ER32C-12MM	\$18.90	
	13mm	916-000-181	ER32C-13MM	\$18.90	
	14mm	916-000-182	ER32C-14MM	\$18.90	
	15mm	916-000-184	ER32C-15MM	\$18.90	
	16mm	916-000-185	ER32C-16MM	\$18.90	
	17mm	916-000-186	ER32C-17MM	\$18.90	
	18mm	916-000-188	ER32C-18MM	\$18.90	
	19mm	916-000-189	ER32C-19MM	\$18.90	
	20mm	916-000-190	ER32C-20MM	\$18.90	
	21mm	916-000-192	ER32C-21MM	\$18.90	
	ER40	3mm	916-000-284	ER40C-2MM	\$22.50
		4mm	916-000-288	ER40C-3MM	\$22.50
5mm		916-000-293	ER40C-4MM	\$22.50	
6mm		916-000-297	ER40C-5MM	\$22.50	
7mm		916-000-300	ER40C-6MM	\$22.50	
8mm		916-000-303	ER40C-7MM	\$22.50	
9mm		916-000-304	ER40C-8MM	\$22.50	
10mm		916-000-258	ER40C-9MM	\$22.50	
11mm		916-000-259	ER40C-10MM	\$22.50	
12mm		916-000-261	ER40C-11MM	\$22.50	
13mm		916-000-262	ER40C-12MM	\$22.50	
14mm		916-000-263	ER40C-13MM	\$22.50	
15mm		916-000-265	ER40C-14MM	\$22.50	
16mm		916-000-266	ER40C-15MM	\$22.50	
17mm		916-000-267	ER40C-16MM	\$22.50	
18mm		916-000-269	ER40C-17MM	\$22.50	
19mm		916-000-270	ER40C-18MM	\$22.50	
20mm		916-000-271	ER40C-19MM	\$22.50	
21mm		916-000-273	ER40C-20MM	\$22.50	
22mm		916-000-274	ER40C-21MM	\$22.50	
23mm	916-000-275	ER40C-22MM	\$22.50		
24mm	916-000-276	ER40C-23MM	\$22.50		
25mm	916-000-278	ER40C-24MM	\$22.50		
26mm	916-000-279	ER40C-25MM	\$22.50		



by Ultra-Dex

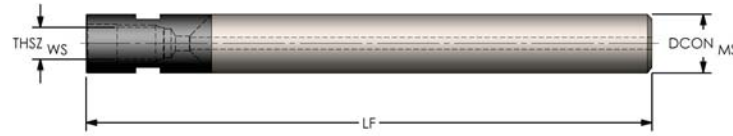

Carbide - With Flat

PRODUCT #	Designation	DCON MS	LF	THS2WS	Price
942-000-003	CM06 L6.00-W.375*	0.375	6	M6	\$231.00
942-000-005	CM08 L5.00-W.500*	0.500	5	M8	\$259.60
942-000-007	CM08 L8.00-W.500*	0.500	8	M8	\$302.50
942-000-012	CM10 L7.00-W.750	0.750	7	M10	\$476.30
942-000-009	CM10 L10.00-W.750	0.750	10	M10	\$520.30
942-000-019	CM12 L7.00-W.750	0.750	7	M12	\$476.30
942-000-014	CM12 L10.00-W.750	0.750	10	M12	\$520.30
942-000-021	CM12 L8.00-W1.00	1.000	8	M12	\$708.40
942-000-016	CM12 L12.00-W1.00	1.000	12	M12	\$896.50
942-000-023	CM16 L14.00-W1.25*	1.250	14	M16	\$1,577.40
942-000-024	CM16 L14.00-W1.500*	1.500	14	M16	\$1,933.80

Without Flat

PRODUCT #	Designation	DCON MS	LF	THS2WS	Price
942-000-006	CM08 L8.00-C.500*	0.500	8	M8	\$302.50
942-000-011	CM10 L7.00-C.750	0.750	7	M10	\$476.30
942-000-008	CM10 L10.00-C.750	0.750	10	M10	\$520.30
942-000-018	CM12 L7.00-C.750	0.750	7	M12	\$476.30
942-000-013	CM12 L10.00-C.750	0.750	10	M12	\$520.30
942-000-020	CM12 L8.00-C1.00	1.000	8	M12	\$708.40
942-000-015	CM12 L12.00-C1.00	1.000	12	M12	\$896.50
942-000-022	CM16 L14.00-C1.25*	1.250	14	M16	\$1,577.40

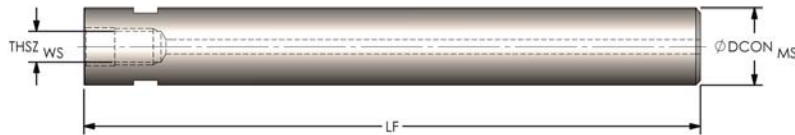

Heavy Metal - With Flat

PRODUCT #	Designation	DCON MS	LF	THS2WS	Price
942-000-026	HM06 L6.00-W.375*	0.375	6	M6	\$235.40
942-000-028	HM08 L6.00-W.500*	0.500	6	M8	\$311.30
942-000-031	HM12 L12.00-W.750*	0.750	12	M12	\$562.10
942-000-034	HM12 L8.00-W1.00*	1.000	8	M12	\$722.70
942-000-032	HM12 L12.00-W1.00*	1.000	12	M12	\$822.80
942-000-036	HM16 L12.00-W1.25*	1.250	12	M16	\$1,280.40
942-000-037	HM16 L12.00-W1.500*	1.500	12	M16	\$1,664.30

Without Flat

PRODUCT #	Designation	DCON MS	LF	THS2WS	Price
942-000-025	HM06 L6.00-C.375*	0.375	6	M6	\$235.40
942-000-027	HM08 L6.00-C.500*	0.500	6	M8	\$311.30
942-000-029	HM12 L12.00-C.750*	0.750	12	M12	\$562.10
942-000-033	HM12 L8.00-C1.00*	1.000	8	M12	\$722.70
942-000-030	HM12 L12.00-C1.00*	1.000	12	M12	\$822.80
942-000-035	HM16 L12.00-C1.25*	1.250	12	M16	\$1,280.40

* Please allow up to 1 week for processing.

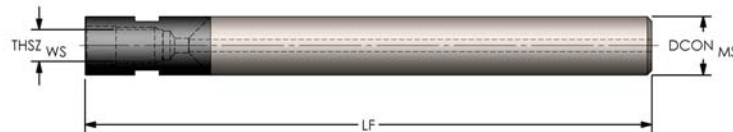

Carbide without Flat- Metric

ARCH[®]
Cutting Tools

CHAPTER 2
NON-ROTATING



INSERTS

THE COMPLETE TOOL MAKING AUTHORITY™

INSERTS

Our inserts are for a wide array of tools throughout our indexable milling, drilling, boring, and turning offering

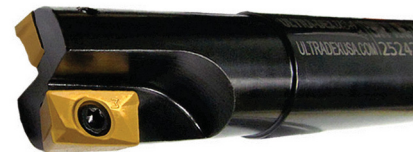

Insert Speeds & Feeds

Material	TURNING		MILLING		DRILLING	
	SFM	Inch/ Rev	SFM	Inch/ Rev	SFM	Inch/ Rev
P Mild Steel Annealed Alloy Steel Hardened Alloy Steel Cast Steel	490-1200	.004-.031	250-800	.003-.015	225-650	.0022-.006
	490-980		200-725		200-650	
	180-500		200-600		100-300	
	180-650		200-600		150-550	
M Stainless Steel	280-810	.004-.015	200-600	.003-.015	250-430	.002-.006
K Low Cast Iron High Cast Iron Cast Iron (CBN INSERTS)	590-1240	.004-.024	325-600	.004-.016	300-600	.0025-.009
	360-700		325-600		300-600	
	400-600	.002-.020				
N Alum. Alloy Un-heat Treated Alum. Alloy Heat Treated Cast Alum. & Copper Alloy	850-1980	.004-.018	860-1800	.007-.018	600-1100	.0038-.011
	550-1650		575-1230		315-790	
	360-950		280-930		250-760	
H Hardened Material (CBN INSERTS)	450-950	.002-.011				
S Heat Resistant Steels	100-300	.002-.006	100-300	.0024-.008	60-150	.0028-.008

Chipbreaker Designation

ISO	FINISHING	Medium	Roughing
P	CX2, LX6, SP1, SP2, SX1, ZX3 CM1, CM3, CX2, LX6, ZM1	CX1, LX3, ZP1 CM1, CM2, LX3	CP2, LX2 LX2
M			
K	ZX3	ZK1, ZK2 CS1	
N	SX1, ZN1	CN1, LX2, LX3	
S	ZX3	ZK1, ZK2 CS1	

○ Good
◐ Better
● Best

***HIGH PERFORMANCE GRADES**

Grade	Description	Steel	Stainless Steel	Cast Iron	Ferrite Materials	Heat-Resistant	Steel Hardened Metal
		P	M	K	N	S	H
UD51	General purpose TiN (CVD) coated steel grade - used for roughing and semi-finishing of carbon alloy and stainless steel.	●	○	○		◐	
UD52	Tough general purpose steel grade with multi-layer titanium aluminum nitride coating for alloy steel, aluminum alloys, austenitic stainless and carbon steels, copper alloys and exotic alloys.	●	○			●	
HP230*	Productive steel turning grade under stable conditions.	●	○	◐			
HP250*	Universal steel turning grade-The best in efficiency and productivity.	●	○	◐			
UD21	Multi-layer titanium aluminum nitride grade. Excellent for machining cast iron.		◐	●			
HM240*	Stainless steel turning grade. Finishing to light roughing.	○	●		○		
HM250*	Turning grade for wide application in the stainless steel range. Finishing to roughing.	◐	●			○	
HS220*	Excellent for heat resistance and titanium alloys		○			●	
UD2	Uncoated - Used to cut cast iron, aluminum, non-ferrous alloys, non-metals and most high temp alloys. Provides excellent wear resistance.			○	◐		
HN432*	Ideal grade for aluminum. Low tendency for adhesion.			◐	●		
UD22	TiN coated insert. Suitable for semi-finishing and finishing of high temp alloys. Intended for cast iron machining.			●		◐	
UD32	TiAlN coated insert. Used in high speed medium load applications of stainless steel and finishing to semi-finishing of high temperature alloys.	◐	●	○	○	●	
HK036*	Stability in a wide range of applications with long tool life. First choice for turning cast iron.			●			
UD5C	Uncoated cermet grade for semi-finishing and finishing applications at medium to high cutting speeds on carbon and alloyed steels. Also used on stainless. Normally used without coolant.		○	○			
UD5CT	TiAlN coated cermet grade performs extremely well for semi-finish and finish applications in alloyed steels, stainless and high carbon steels.	●	◐	◐			
UD1	Uncoated – Designed with a polished surface and large rake angle, Intended for machining aluminum and other non-ferrous alloys. Also works well for semi machining on cast iron.		◐		●		
HP470*	Suitable for demanding steel milling applications, interrupted cut.	●	◐				
HM470*	Stainless steel milling grade. PVD, TiAlN coating.	◐	●				
HS470*	First choice for milling heat-resistant alloys.		○			●	
HS480*	Extremely heat-resistant tough grade for milling titanium.					●	
HK430*	Milling grade for cast iron.			●			
HP600*	Super tough substrate with PVD coating. Excellent for drilling steel and stainless steel.	●	◐	○	○	○	
HK356*	Stable cutting performance for drilling cast iron. Suitable for aluminum. Recommended for mild structural steel, difficult chip controlled steel.	◐	●	●	◐	◐	
HN300*	Drilling Grade for Aluminum				●		
UD2CBN	A Polycrystalline Cubic Boron Nitride (PCBN) Insert for cast iron, gray cast iron, chilled cast, and powder metal with long tool life. Coolant not recommended for use.			●			◐
UD5CBN	A Polycrystalline Cubic Boron Nitride (PCBN) Insert for precision finishing of hardened steels 50-65 rockwell. Coolant not recommended for use.			◐			●
UD2PCD	Polycrystalline Diamond with Carbide Reinforced Diamond, Sharpness and Low Cutting Pressure allowing tight tolerances. Finishing of all non-ferrous metals and non-metallics.				●		
UD25	Uncoated - Used to cut aluminum, brass, copper, nickel base alloys, titanium and non-ferrous materials.			○	○		
UD204	A PVD TiAlN coated fine grain substrate. Excellent for light to medium feeds on cast iron and semi-finishing to finishing of high temperature alloys. Excellent for high SFM.	◐		●		◐	
UD404	A PVD TiAlN coated tough general purpose grade. Well suited for milling alloy steels, stainless steel, high temperature alloy steels and hardened steels up to 60 Rc.	●	●	◐		●	
UD602	A CVD coating of Ti Al ₂ O ₃ & TiN on a tough substrate. It is suitable for light to heavy milling of alloy steel and non alloy steel, even under unfavorable condition.	◐	◐			◐	



ZX3



CDGW Flat Top



CDHB Flat Top

PRODUCT #	DESIGNATION	Grade																
		HP230	HP250	HM240	HM250	HS220	HN432	HK036	UD51	UD52	UD21	UD2	UD22	UD32	UD5C	UD5CT	UD1	
913-000-133	CDGT 1.510.5-ZX3								\$11.30									
913-000-134										\$11.80								
913-000-132											\$11.80							
913-000-131												\$9.80						
913-000-135															\$11.30			
913-000-136																\$12.90		
913-000-139	CDGT 1.511-ZX3								\$11.30									
913-000-140										\$11.80								
913-000-138											\$11.80							
913-000-137												\$9.80						
913-000-141															\$11.30			
913-000-142																\$12.90		
913-000-145	CDGW 1.510								\$10.70									
913-000-146										\$11.80								
913-000-144											\$11.20							
913-000-143												\$10.70						
913-000-147															\$10.40			
913-000-148																\$12.70		
913-000-151	CDGW 1.510.5								\$10.70									
913-000-152										\$11.80								
913-000-150											\$11.20							
913-000-149												\$10.70						
913-000-153															\$10.40			
913-000-154																\$12.70		
913-000-157	CDGW 1.511								\$10.70									
913-000-158										\$11.80								
913-000-156											\$11.20							
913-000-155												\$10.70						
913-000-159															\$10.40			
913-000-160																\$12.70		
913-000-163	CDHB 1.20.60								\$10.20									
913-000-164										\$10.70								
913-000-162											\$10.70							
913-000-161												\$8.60						
913-000-165															\$9.60			
913-000-166																\$11.60		
913-000-169	CDHB 1.20.60.5								\$10.20									
913-000-170										\$10.70								
913-000-168											\$10.70							
913-000-167												\$8.60						
913-000-171															\$9.60			
913-000-172																\$11.60		

Inserts sold in packs of 10



CM1



CN1



CX1



CX2



ZM1

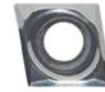

ZN1



ZX3

PRODUCT #	DESIGNATION	Grade																	
		HP230	HP250	HM240	HM250	HS220	HN432	HK036	UD51	UD52	UD21	UD2	UD22	UD32	UD5C	UD5CT	UD1		
914-000-001	CCGT 21.50-CM1			\$16.60															
914-000-004	CCGT 32.50.5-CM1			\$18.90															
914-000-005	CCGT 32.50-CM1			\$18.90															
914-000-002	CCGT 21.50-CN1							\$12.60											
914-000-003	CCGT 21.51-CN1							\$12.60											
914-000-006	CCGT 32.51-CN1							\$13.00											
914-000-007	CCGT 32.52-CN1							\$13.00											
914-000-010	CCMT 21.51-CX1	\$9.30																	
914-000-009			\$9.30																
914-000-011					\$9.30														
914-000-008	CCMT 21.52-CX1							\$9.30											
914-000-013			\$9.30																
914-000-012					\$9.30														
914-000-018	CCMT 32.51-CX1	\$9.80																	
914-000-019			\$9.80																
914-000-017					\$9.80														
914-000-016	CCMT 32.52-CX1							\$9.80											
914-000-022			\$9.80																
914-000-023				\$9.80															
914-000-021	CCMT 431-CX1				\$9.80														
914-000-020					\$9.80														
914-000-026			\$12.70						\$9.80										
914-000-025	CCMT 432-CX1				\$12.70														
914-000-024					\$12.70				\$12.70										
914-000-028			\$12.70																
914-000-029	CCMT 32.50.5-CX2				\$10.40														
914-000-027					\$10.40				\$10.40										
914-000-015			\$9.80																
913-000-076	CCMT 21.51-ZM1				\$9.80													\$8.20	
913-000-083	CCMT 32.50.5-ZM1																	\$8.70	
913-000-087	CCMT 32.51-ZM1																	\$8.70	
913-000-091	CCMT 32.52-ZM1																	\$8.70	
913-000-095	CCMT 431-ZM1																	\$9.80	
913-000-099	CCMT 432-ZM1																	\$9.80	
913-000-072	CCGX 21.50.5-ZN1																	\$9.60	
913-000-073	CCGX 21.51-ZN1																	\$9.60	
913-000-074	CCGX 32.51-ZN1																	\$9.90	
913-000-075	CCGX 32.52-ZN1																	\$9.90	
913-000-078	CCMT 21.51-ZX3								\$8.20										
913-000-079									\$8.20										
913-000-077										\$8.20									
913-000-081	CCMT 21.52-ZX3								\$8.20										
913-000-082									\$8.20										
913-000-080										\$8.20									
913-000-085	CCMT 32.50.5-ZX3								\$8.70										
913-000-086									\$8.70										
913-000-084										\$8.70									
913-000-089	CCMT 32.51-ZX3								\$8.70										
913-000-090									\$8.70										
913-000-088										\$8.70									
913-000-093	CCMT 32.52-ZX3								\$8.70										
913-000-094									\$8.70										
913-000-092										\$8.70									
913-000-097	CCMT 431-ZX3								\$9.80										
913-000-098									\$9.80										
913-000-096										\$9.80									
913-000-101	CCMT 432-ZX3								\$9.80										
913-000-102									\$9.80										
913-000-100										\$9.80									

Inserts sold in packs of 10



LX6

PRODUCT #	DESIGNATION	Grade															
		HP230	HP250	HM240	HM250	HS220	HN432	HK036	UD51	UD52	UD21	UD2	UD22	UD32	UD5C	UD5CT	UD1
913-000-207	CPMT 1.81.20.5-LX6								\$13.00								
913-000-208										\$15.40							
913-000-206											\$14.20						
913-000-205												\$11.60					
913-000-209															\$12.00		
913-000-210																\$14.20	
913-000-213	CPMT 1.81.21-LX6								\$13.00								
913-000-214										\$15.40							
913-000-212											\$14.20						
913-000-211												\$11.60					
913-000-215															\$12.00		
913-000-216																\$14.20	
913-000-219	CPMT 21.50.5-LX6								\$8.40								
913-000-220										\$10.60							
913-000-218											\$11.60						
913-000-217												\$8.70					
913-000-221															\$12.00		
913-000-222																\$14.20	
913-000-225	CPMT 21.51-LX6								\$8.40								
913-000-226										\$10.60							
913-000-224											\$11.60						
913-000-223												\$8.70					
913-000-227															\$12.00		
913-000-228																\$14.20	
913-000-231	CPMT 21.52-LX6								\$8.40								
913-000-232										\$12.60							
913-000-230											\$11.60						
913-000-229												\$8.70					
913-000-233															\$12.00		
913-000-234																\$14.20	
913-000-237	CPMT 32.51-LX6								\$10.80								
913-000-238										\$12.60							
913-000-236											\$11.60						
913-000-235												\$9.10					
913-000-241	CPMT 32.52-LX6								\$10.80								
913-000-242										\$12.60							
913-000-240											\$11.60						
913-000-239												\$9.10					

Inserts sold in packs of 10



PRODUCT #	DESIGNATION	Grade															
		HP230	HP250	HM240	HM250	HS220	HN432	HK036	UD51	UD52	UD21	UD2	UD22	UD32	UD5C	UD5CT	UD1
914-000-049	DCGT 21.50-CM1				\$17.70												
914-000-052	DCGT 32.50-CM1				\$18.90												
914-000-050	DCGT 21.50-CN1							\$12.60									
914-000-051	DCGT 21.51-CN1							\$12.60									
914-000-053	DCGT 32.51-CN1							\$14.20									
914-000-054	DCGT 32.52-CN1							\$14.20									
914-000-059			\$8.20														
914-000-058	DCMT 21.51-CX1				\$8.20												
914-000-057								\$8.20									
914-000-061	DCMT 21.52-CX1		\$8.20														
914-000-060					\$8.20												
914-000-066		\$10.30															
914-000-067	DCMT 32.51-CX1		\$10.30														
914-000-065					\$10.30												
914-000-064								\$10.30									
914-000-070		\$10.30															
914-000-071	DCMT 32.52-CX1		\$10.30														
914-000-069					\$10.30												
914-000-068								\$10.30									
914-000-056	DCMT 21.50.5-CX2		\$8.20														
914-000-055					\$8.20												
914-000-063	DCMT 32.50.5-CX2		\$10.30														
914-000-062					\$10.30												
913-000-258									\$9.80								
913-000-259	DCMT 21.50.5-LX6								\$11.90								
913-000-257										\$10.70							
913-000-260	DCMT 21.50.5-ZM1													\$7.90			
913-000-261	DCMT 21.51-ZM1													\$7.90			
913-000-265	DCMT 32.51-ZM1													\$9.60			
913-000-269	DCMT 32.52-ZM1													\$9.60			
913-000-253	DCGX 21.50.5-ZN1																\$9.20
913-000-254	DCGX 21.51-ZN1																\$9.20
913-000-255	DCGX 32.51-ZN1																\$10.20
913-000-256	DCGX 32.52-ZN1																\$10.20
913-000-263									\$7.90								
913-000-264	DCMT 21.51-ZX3									\$7.90							
913-000-262											\$7.90						
913-000-267									\$9.60								
913-000-268	DCMT 32.51-ZX3									\$9.60							
913-000-266											\$9.60						
913-000-271									\$9.60								
913-000-272	DCMT 32.52-ZX3									\$9.60							
913-000-270											\$9.60						
913-000-302									\$12.00								
913-000-303										\$13.00							
913-000-300	DPMT 32.51-LX6										\$11.00						
913-000-299												\$9.90					
913-000-301													\$12.10				
913-000-307									\$12.00								
913-000-308										\$13.00							
913-000-305	DPMT 32.52-LX6										\$13.00						
913-000-304												\$9.90					
913-000-306													\$12.10				

Inserts sold in packs of 10



CN1



CX1



LX6



ZM1



ZN1



ZX3



SCMW Flat Top

PRODUCT #	DESIGNATION	Grade															
		HP230	HP250	HM240	HM250	HS220	HN432	HK036	UD51	UD52	UD21	UD2	UD22	UD32	UD5C	UD5CT	UD1
914-000-130	SCGT 32.51-CN1						\$13.00										
914-000-133			\$9.80														
914-000-132	SCMT 32.51-CX1				\$9.80												
914-000-131								\$9.80									
914-000-136			\$9.80														
914-000-135	SCMT 32.52-CX1				\$9.80												
914-000-134								\$9.80									
914-000-138			\$12.70														
914-000-137	SCMT 431-CX1				\$12.70												
914-000-141			\$12.70														
914-000-140	SCMT 432-CX1				\$12.70												
914-000-139								\$12.70									
913-000-379									\$9.70								
913-000-380										\$11.80							
913-000-377	SCMT 21.51-LX6										\$10.70						
913-000-378																	
913-000-381	SCMT 32.51-LX6											\$9.30					
913-000-385	SCMT 32.52-LX6											\$7.90					
913-000-382	SCMT 32.51-ZM1												\$8.20				
913-000-386	SCMT 32.52-ZM1												\$8.20				
913-000-374	SCGX 32.50.5-ZN1																\$10.30
913-000-375	SCGX 32.51-ZN1																\$10.30
913-000-376	SCGX 32.52-ZN1																\$10.30
913-000-383									\$8.20								
913-000-384	SCMT 32.51-ZX3									\$8.20							
913-000-387									\$8.20								
913-000-388	SCMT 32.52-ZX3								\$8.20								
913-000-389									\$9.80								
913-000-390	SCMT 431-ZX3								\$9.80								
913-000-391									\$9.80								
913-000-392	SCMT 432-ZX3								\$9.80								
913-000-396									\$7.60								
913-000-397									\$8.20								
913-000-394	SCMW 21.51										\$8.20						
913-000-393											\$6.00						
913-000-395												\$7.60					

Inserts sold in packs of 10



CX1



LX6



ZM1



ZN1



ZX3

PRODUCT #	DESIGNATION	Grade																
		HP230	HP250	HM240	HM250	HS220	HN432	HK036	UD51	UD52	UD21	UD2	UD22	UD32	UD5C	UD5CT	UD1	
914-000-151	TCMT 21.51-CX1		\$8.60															
914-000-150					\$8.60													
914-000-149								\$8.60										
914-000-154	TCMT 21.52-CX1		\$8.60															
914-000-153					\$8.60													
914-000-152								\$8.60										
914-000-157	TCMT 32.51-CX1		\$10.90															
914-000-156					\$10.90													
914-000-155								\$10.90										
914-000-160	TCMT 32.52-CX1		\$10.90															
914-000-159					\$10.90													
914-000-158								\$10.90										
913-000-437	TCMT 1.21.20.5-LX6								\$10.30									
913-000-438										\$12.40								
913-000-436											\$10.10							
913-000-439	TCMT 21.51-ZM1													\$7.50				
913-000-446	TCMT 32.51-ZM1													\$9.60				
913-000-451	TCMT 32.52-ZM1													\$9.60				
913-000-431	TCGX 21.50.5-ZN1																\$9.90	
913-000-432	TCGX 21.51-ZN1																\$9.90	
913-000-433	TCGX 21.52-ZN1																\$9.90	
913-000-434	TCGX 32.51-ZN1																\$11.40	
913-000-435	TCGX 32.52-ZN1																\$11.40	
913-000-441	TCMT 21.51-ZX3								\$7.50									
913-000-442										\$7.50								
913-000-440											\$7.50							
913-000-444	TCMT 21.52-ZX3								\$7.50									
913-000-445										\$7.50								
913-000-443											\$7.50							
913-000-449	TCMT 32.51-ZX3								\$9.60									
913-000-450										\$9.60								
913-000-447											\$9.60							
913-000-448	TCMT 32.52-ZX3											\$9.00						
913-000-454									\$9.60									
913-000-455										\$9.60								
913-000-452										\$9.60								
913-000-453												\$9.00						

Inserts sold in packs of 10



LX6

PRODUCT #	DESIGNATION	Grade															
		HP230	HP250	HM240	HM250	HS220	HN432	HK036	UD51	UD52	UD21	UD2	UD22	UD32	UD5C	UD5CT	UD1
913-000-509	TPMT 21.51-LX6								\$10.20								
913-000-510										\$12.10							
913-000-508											\$11.30						
913-000-507	TPMT 21.52-LX6										\$8.30						
913-000-513									\$10.20								
913-000-514										\$12.10							
913-000-512	TPMT 32.51-LX6									\$11.30							
913-000-511											\$8.30						
913-000-517										\$12.10							
913-000-518	TPMT 32.52-LX6									\$13.00							
913-000-516											\$13.00						
913-000-515												\$10.20					
913-000-521	TPMT 32.52-LX6								\$11.80								
913-000-522										\$13.00							
913-000-520											\$12.60						
913-000-519											\$9.60						

Inserts sold in packs of 10



CP1



ZM1



ZX3

PRODUCT #	DESIGNATION	Grade															
		HP230	HP250	HM240	HM250	HS220	HN432	HK036	UD51	UD52	UD21	UD2	UD22	UD32	UD5C	UD5CT	UD1
914-000-175	VBMT 331-CP1		\$14.20														
914-000-176	VBMT 332-CP1		\$14.20														
913-000-539	VBMT 331-ZM1												\$10.80				
913-000-542	VBMT 332-ZM1												\$10.80				
913-000-535	VBMT 21.50.5-ZX3								\$10.80								
913-000-536										\$12.90							
913-000-537	VBMT 21.51-ZX3								\$10.80								
913-000-538										\$12.90							
913-000-540	VBMT 331-ZX3								\$10.80								
913-000-541										\$12.00							
913-000-543	VBMT 332-ZX3								\$10.80								
913-000-544										\$12.00							

Inserts sold in packs of 10



CX1



LX6



ZX3

PRODUCT #	DESIGNATION	Grade															
		HP230	HP250	HM240	HM250	HS220	HN432	HK036	UD51	UD52	UD21	UD2	UD22	UD32	UD5C	UD5CT	UD1
914-000-185	WCMT 21.51-CX1		\$9.00														
914-000-184					\$9.00												
914-000-187	WCMT 21.52-CX1		\$9.00														
914-000-186					\$9.00												
914-000-189	WCMT 32.51-CX1		\$10.50														
914-000-188					\$10.50												
914-000-191	WCMT 32.52-CX1		\$10.50														
914-000-190					\$10.50												
913-000-579	WCMT 21.51-LX6								\$12.40								
913-000-580										\$12.40							
913-000-578	WCMT 21.52-LX6										\$13.00						
913-000-577												\$9.10					
913-000-583	WCMT 21.52-LX6								\$11.60								
913-000-584										\$12.40							
913-000-582	WCMT 32.51-LX6										\$13.00						
913-000-581												\$9.10					
913-000-587	WCMT 32.52-LX6								\$13.00								
913-000-588										\$15.40							
913-000-586	WCMT 1.210.5-ZX3										\$14.20						
913-000-585												\$11.80					
913-000-591	WCMT 32.52-LX6								\$13.00								
913-000-592										\$15.40							
913-000-590	WCMT 1.211-ZX3										\$14.20						
913-000-589												\$11.80					
913-000-563	WCMT 1.51.50.5-ZX3								\$14.20								
913-000-564										\$13.00							
913-000-562	WCMT 1.51.51-ZX3										\$15.40						
913-000-561												\$14.20					
913-000-567	WCMT 1.211-ZX3								\$14.20								
913-000-568										\$15.40							
913-000-566	WCMT 1.51.50.5-ZX3										\$15.40						
913-000-565												\$14.20					
913-000-571	WCMT 1.51.51-ZX3								\$14.20								
913-000-572										\$15.40							
913-000-570	WCMT 1.51.51-ZX3										\$15.40						
913-000-569												\$14.20					
913-000-575	WCMT 1.51.51-ZX3								\$14.20								
913-000-576										\$15.40							
913-000-574	WCMT 1.51.51-ZX3										\$15.40						
913-000-573												\$14.20					

Inserts sold in packs of 10



PRODUCT #	DESIGNATION	Grade															
		HP230	HP250	HM240	HM250	HS220	HN432	HK036	UD51	UD52	UD21	UD2	UD22	UD32	UD5C	UD5CT	UD1
914-000-036	CNMG 321-CM2				\$9.80												
914-000-037	CNMG 322-CM2				\$9.80												
914-000-038	CNMG 431-CM2				\$12.00												
914-000-042	CNMG 432-CM2				\$12.00												
914-000-030	CNGP 431-CM3			\$21.30													
914-000-031	CNGP 432-CM3			\$21.30													
914-000-047	CNMG 543-CP2		\$21.30														
914-000-048	CNMG 643-CP2		\$27.20														
914-000-039	CNMG 431-CS1					\$12.00											
914-000-040	CNMG 431-CX1	\$12.00															
914-000-041		\$12.00															
914-000-044	CNMG 432-CX1	\$12.00															
914-000-045		\$12.00															
914-000-043								\$12.00									
914-000-046	CNMG 433-CX1						\$12.00										
913-000-177	CNMG 321-ZK1									\$8.30							
913-000-181	CNMG 322-ZK1									\$8.30							
913-000-185	CNMG 431-ZK1									\$10.50							
913-000-189	CNMG 432-ZK1									\$10.50							
913-000-193	CNMG 542-ZK1									\$14.20							
913-000-196	CNMG 543-ZK1									\$14.20							
913-000-199	CNMG 642-ZK1									\$17.70							
913-000-202	CNMG 643-ZK1									\$17.70							
913-000-178	CNMG 321-ZM1												\$8.30				
913-000-182	CNMG 322-ZM1												\$8.30				
913-000-186	CNMG 431-ZM1												\$10.50				
913-000-190	CNMG 432-ZM1												\$10.50				
913-000-179	CNMG 321-ZP1							\$8.30									
913-000-180		\$8.30															
913-000-183	CNMG 322-ZP1							\$10.50									
913-000-184		\$10.50															
913-000-187	CNMG 431-ZP1							\$10.50									
913-000-188		\$10.50															
913-000-191	CNMG 432-ZP1							\$10.50									
913-000-192		\$10.50															
913-000-194	CNMG 542-ZP1							\$14.20									
913-000-195		\$14.20															
913-000-197	CNMG 543-ZP1							\$14.20									
913-000-198		\$14.20															
913-000-200	CNMG 642-ZP1							\$17.70									
913-000-201		\$17.70															
913-000-203	CNMG 643-ZP1							\$17.70									
913-000-204		\$17.70															
914-000-032	CNMA 432							\$12.00									
914-000-033	CNMA 433							\$12.00									
914-000-034	CNMA 543							\$18.90									
914-000-035	CNMA 643							\$24.80									

Inserts sold in packs of 10



PRODUCT #	DESIGNATION	Grade															
		HP230	HP250	HM240	HM250	HS220	HN432	HK036	UD51	UD52	UD21	UD2	UD22	UD32	UD5C	UD5CT	UD1
914-000-075	DNMG 331-CM2				\$12.10												
914-000-077	DNMG 332-CM2				\$12.10												
914-000-079	DNMG 431-CM2				\$15.40												
914-000-081	DNMG 432-CM2				\$15.40												
914-000-072	DNGP 431-CM3			\$22.50													
914-000-076	DNMG 331-CX1		\$12.10														
914-000-078	DNMG 332-CX1		\$12.10														
914-000-080	DNMG 431-CX1		\$15.40														
914-000-082	DNMG 432-CX1		\$15.40														
913-000-294								\$17.70									
913-000-295	DNMG 542-LX2								\$18.90								
913-000-293										\$17.70							
913-000-297								\$17.70									
913-000-298	DNMG 543-LX2								\$18.90								
913-000-296										\$17.70							
913-000-277	DNMG 331-ZM1												\$10.70				
913-000-281	DNMG 332-ZM1												\$10.70				
913-000-285	DNMG 431-ZM1												\$11.90				
913-000-289	DNMG 432-ZM1												\$11.90				
913-000-278	DNMG 331-ZP1							\$10.70									
913-000-279									\$10.70								
913-000-282	DNMG 332-ZP1							\$10.70									
913-000-283									\$10.70								
913-000-286	DNMG 431-ZP1							\$11.90									
913-000-287									\$11.90								
913-000-290	DNMG 432-ZP1							\$11.90									
913-000-291									\$11.90								
913-000-280	DNMG 331-ZX2									\$10.70							
913-000-284	DNMG 332-ZX2									\$10.70							
913-000-288	DNMG 431-ZX2									\$11.90							
913-000-292	DNMG 432-ZX2									\$11.90							
914-000-073	DNMA 431							\$17.70									
914-000-074	DNMA 432							\$17.70									

Inserts sold in packs of 10



LX2



RNMA Flat Top

PRODUCT #	DESIGNATION	Grade															
		HP230	HP250	HM240	HM250	HS220	HN432	HK036	UD51	UD52	UD21	UD2	UD22	UD32	UD5C	UD5CT	UD1
913-000-363								\$9.00									
913-000-364	RNMG 32-LX2								\$11.30								
913-000-362										\$10.30							
913-000-366								\$10.90									
913-000-367	RNMG 43-LX2								\$13.00								
913-000-365										\$12.00							
913-000-369								\$16.60									
913-000-370	RNMG 54-LX2								\$18.90								
913-000-368										\$17.70							
913-000-372								\$21.30									
913-000-373	RNMG 64-LX2								\$19.00								
913-000-371										\$18.00							
914-000-129	RNMA 43							\$9.20									

Inserts sold in packs of 10



CP2



CS1



CX1



ZK1



ZM1



ZP1



ZX2



SNMA Flat Top

PRODUCT #	DESIGNATION	Grade															
		HP230	HP250	HM240	HM250	HS220	HN432	HK036	UD51	UD52	UD21	UD2	UD22	UD32	UD5C	UD5CT	UD1
914-000-147	SNMG 543-CP2		\$21.30														
914-000-148	SNMG 643-CP2		\$27.20														
914-000-144	SNMG 432-CS1					\$12.10											
914-000-146	SNMG 432-CX1		\$12.10														
914-000-145								\$12.10									
913-000-411	SNMG 643-ZK1										\$17.70						
913-000-414	SNMG 644-ZK1										\$17.70						
913-000-398	SNMG 431-ZM1													\$9.00			
913-000-402	SNMG 432-ZM1													\$9.00			
913-000-399	SNMG 431-ZP1								\$9.00								
913-000-400										\$9.00							
913-000-403	SNMG 432-ZP1								\$9.00								
913-000-404										\$9.00							
913-000-406	SNMG 542-ZP1								\$14.20								
913-000-407										\$14.20							
913-000-408	SNMG 543-ZP1								\$14.20								
913-000-409										\$14.20							
913-000-412	SNMG 643-ZP1								\$17.70								
913-000-413										\$17.70							
913-000-415	SNMG 644-ZP1								\$17.70								
913-000-416										\$17.70							
913-000-401	SNMG 431-ZX2										\$9.00						
913-000-405	SNMG 432-ZX2										\$9.00						
913-000-410	SNMG 543-ZX2										\$14.20						
914-000-142	SNMA 432							\$12.60									
914-000-143	SNMA 543							\$16.60									

Inserts sold in packs of 10



CM2



CS1



CX1



LX2



ZM1



ZP1



ZX2



TNMA Flat Top

PRODUCT #	DESIGNATION	Grade															
		HP230	HP250	HM240	HM250	HS220	HN432	HK036	UD51	UD52	UD21	UD2	UD22	UD32	UD5C	UD5CT	UD1
914-000-164	TNMG 331-CM2				\$11.20												
914-000-167	TNMG 332-CM2				\$11.20												
914-000-168	TNMG 332-CS1					\$11.20											
914-000-165	TNMG 331-CX1	\$11.20															
914-000-166			\$11.20														
914-000-170		\$11.20															
914-000-171	TNMG 332-CX1		\$11.20														
914-000-169								\$11.20									
914-000-172	TNMG 431-CX1		\$16.60		\$18.90												
914-000-174			\$16.60														
914-000-173	TNMG 432-CX1							\$16.60									
913-000-490								\$18.90									
913-000-491	TNMG 542-LX2								\$18.90								
913-000-489										\$17.70							
913-000-493									\$17.70								
913-000-494	TNMG 543-LX2								\$18.90								
913-000-492										\$17.70							
913-000-473	TNMG 331-ZM1										\$8.70						
913-000-477	TNMG 332-ZM1										\$8.70						
913-000-481	TNMG 431-ZM1										\$11.20						
913-000-485	TNMG 432-ZM1										\$11.20						
913-000-474	TNMG 331-ZP1							\$8.70									
913-000-475									\$8.70								
913-000-478								\$8.70									
913-000-479	TNMG 332-ZP1								\$8.70								
913-000-482								\$11.20									
913-000-483	TNMG 431-ZP1								\$11.20								
913-000-486								\$11.20									
913-000-487	TNMG 432-ZP1								\$11.20								
913-000-476	TNMG 331-ZX2										\$8.70						
913-000-480	TNMG 332-ZX2										\$8.70						
913-000-484	TNMG 431-ZX2										\$16.60						
913-000-488	TNMG 432-ZX2										\$16.60						
914-000-161	TNMA 332							\$9.60									
914-000-162	TNMA 432							\$14.20									
914-000-163	TNMA 543							\$23.60									

Inserts sold in packs of 10



PRODUCT #	DESIGNATION	Grade															
		HP230	HP250	HM240	HM250	HS220	HN432	HK036	UD51	UD52	UD21	UD2	UD22	UD32	UD5C	UD5CT	UD1
914-000-180	VNMG 332-CM2				\$15.40												
914-000-181	VNMG 332-CS1					\$15.40											
914-000-178	VNMG 331-CX1	\$15.40															
914-000-179			\$15.40														
914-000-182	VNMG 332-CX1	\$15.40															
914-000-183			\$15.40														
913-000-559									\$15.40								
913-000-560	VNMG 432-LX3									\$16.60							
913-000-558												\$17.70					
913-000-557												\$14.20					
913-000-549	VNMG 331-ZM1													\$13.00			
913-000-553	VNMG 332-ZM1													\$13.00			
913-000-551									\$13.00								
913-000-552	VNMG 331-ZX2									\$13.00							
913-000-550											\$13.00						
913-000-555									\$13.00								
913-000-556	VNMG 332-ZX2									\$13.00							
913-000-554											\$13.00						
914-000-177	VNMA 332								\$17.70								

Inserts sold in packs of 10



PRODUCT #	DESIGNATION	Grade															
		HP230	HP250	HM240	HM250	HS220	HN432	HK036	UD51	UD52	UD21	UD2	UD22	UD32	UD5C	UD5CT	UD1
914-000-199	WNMG 432-CM2				\$12.60												
914-000-200	WNMG 432-CS1					\$12.60											
914-000-193	WNMG 331-CX1	\$11.20															
914-000-194				\$11.20													
914-000-195	WNMG 332-CX1	\$11.20															
914-000-196				\$11.20													
914-000-197	WNMG 431-CX1	\$12.60															
914-000-198				\$12.60													
914-000-202	WNMG 432-CX1	\$12.60															
914-000-203				\$12.60													
914-000-201									\$12.60								
914-000-204	WNMG 433-CX1								\$12.60								
913-000-618	WNMG 331-ZM1													\$7.90			
913-000-622	WNMG 332-ZM1													\$7.90			
913-000-626	WNMG 431-ZM1													\$8.30			
913-000-631	WNMG 432-ZM1													\$8.30			
913-000-619	WNMG 331-ZP1								\$7.90								
913-000-620										\$7.90							
913-000-623	WNMG 332-ZP1								\$7.90								
913-000-624										\$7.90							
913-000-627	WNMG 431-ZP1								\$10.20								
913-000-628										\$10.20							
913-000-632	WNMG 432-ZP1								\$10.20								
913-000-633										\$10.20							
913-000-621	WNMG 331-ZX2										\$7.90						
913-000-625	WNMG 332-ZX2										\$7.90						
913-000-629	WNMG 431-ZX2										\$10.20						
913-000-634	WNMG 432-ZX2										\$10.20						
914-000-192	WNMA 432								\$12.50								

Inserts sold in packs of 10



PRODUCT #	Designation	UD5CBN	UD2CBN	UD2PCD
913-000-062		\$45.00		
913-000-060	CCGW 21.51-1		\$45.00	
913-000-061				\$64.00
913-000-065		\$45.00		
913-000-063	CCGW 21.52-1		\$45.00	
913-000-064				\$64.00
913-000-068		\$69.00		
913-000-066	CCGW 32.51-2		\$69.00	
913-000-067				\$67.00
913-000-071		\$69.00		
913-000-069	CCGW 32.52-2		\$69.00	
913-000-070				\$67.00
913-000-174	CNGA 431-2	\$69.00		-
913-000-173			\$69.00	
913-000-176	CNGA 432-2	\$69.00		-
913-000-175			\$69.00	
913-000-248		\$45.00		
913-000-246	DCGW 21.51-1		\$45.00	
913-000-247				\$65.00
913-000-250	DCGW 32.51-2	\$69.00		-
913-000-249			\$69.00	
913-000-252	DCGW 32.52-2	\$69.00		-
913-000-251			\$69.00	
913-000-274	DNGA 431-2	\$69.00		-
913-000-273			\$69.00	
913-000-276	DNGA 432-2	\$69.00		-
913-000-275			\$69.00	

Inserts sold individually



SP1



Flat Top



SX1

PRODUCT #	Designation	UD51	UD25
913-000-460	TDHB 1.280.750.1	\$13.00	
913-000-459			\$14.20
913-000-462	TDHB 1.280.750.5	\$15.40	
913-000-461			\$13.00
913-000-464	TDHB 1.280.751	\$14.20	
913-000-463			\$14.20
913-000-495	TPCB 220.5	\$13.00	
913-000-496			\$13.00
913-000-498	TPCB 221	\$14.20	
913-000-497			\$13.00
913-000-500	TPCB 222	\$13.00	
913-000-499			\$14.20
913-000-501	TPCH 220.5-SP1	\$14.20	
913-000-502	TPCH 221-SP1	\$14.20	
913-000-456	TD 320.5	\$14.00	
913-000-457	TD 321	\$14.00	
913-000-458	TD 322	\$14.00	
913-000-504	TPGH 321-SX1	\$21.30	
913-000-503			\$17.70
913-000-506	TPGH 322-SX1	\$17.70	
913-000-505			\$16.60

Inserts sold in packs of 10



SP2



TCGW



TNGA



VBGW



VNGA

PRODUCT #	Designation	UD5CBN	UD2CBN	UD2PCD
913-000-420			\$45.00	
913-000-421	TCGW 21.51-1			\$62.00
913-000-424		\$45.00		
913-000-422	TCGW 21.52-1		\$45.00	
913-000-423				\$62.00
913-000-427		\$45.00		
913-000-425	TCGW 32.51-1		\$45.00	
913-000-426				\$68.00
913-000-430		\$45.00		
913-000-428	TCGW 32.52-1		\$45.00	
913-000-429				\$68.00
913-000-466	TNGA 331-1	\$45.00		
913-000-465			\$45.00	
913-000-468	TNGA 332-1	\$45.00		
913-000-467			\$45.00	
913-000-531	VBGW 21.51-1			\$79.00
913-000-532	VBGW 21.52-1			\$79.00
913-000-533	VBGW 331-1			\$82.00
913-000-534	VBGW 332-1			\$94.00
913-000-546	VNGA 331-2	\$63.00		
913-000-545			\$63.00	
913-000-548	VNGA 332-2	\$63.00		
913-000-547			\$63.00	

Inserts sold individually

PRODUCT #	Designation	UD51
913-000-637	WPGT 1.510-SP2	\$10.40
913-000-636	WPGT 1.510.5-SP2	\$10.40
913-000-638	WPGT 1.511-SP2	\$13.00
913-000-640	WPGT 21.50-SP2	\$10.30
913-000-639	WPGT 21.50.5-SP2	\$9.90
913-000-641	WPGT 21.51-SP2	\$13.00
913-000-642	WPMT 32.51-SP2	\$20.10
913-000-643	WPMT 32.52-SP2	\$20.10

Inserts sold in packs of 10

Turning



CCGT



DCGT



PRODUCT #	Designation	UD2PCD
913-000-056	CCGT 21.51-CB-1 *	\$96.00
913-000-057	CCGT 21.52-CB-1 *	\$96.00
913-000-058	CCGT 32.51-CB-1 *	\$98.00
913-000-059	CCGT 32.52-CB-1 *	\$107.00
913-000-243	DCGT 21.51-CB-1 *	\$101.00
913-000-244	DCGT 32.51-CB-1 *	\$107.00
913-000-245	DCGT 32.52-CB-1 *	\$119.00

Inserts sold individually

PRODUCT #	Designation	UD2PCD
913-000-529	VBGT 331-CB-1 *	\$142.00
913-000-530	VBGT 332-CB-1 *	\$156.00

Inserts sold individually

PRODUCT #	Designation	UD2PCD
913-000-417	TCGT 21.51-CB-1 *	\$101.00
913-000-418	TCGT 32.51-CB-1 *	\$105.00
913-000-419	TCGT 32.52-CB-1 *	\$117.00

Inserts sold individually

Threading

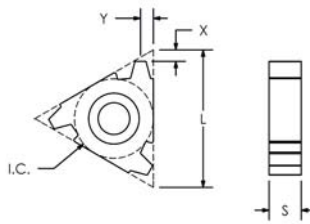

American Acme

PRODUCT #	Designation	PRODUCT #	Designation	I.C.	L	S	Pitch (tpi)	X	Y	Anvil Right	Anvil Left	UD51
	Right Hand		Left Hand									
913-000-017	3IR16ACME	913-000-005	3IL16ACME	3/8"	.630	.156	16	.040	.040	Y13	YE3	\$18.90
913-000-018	3IR14ACME	913-000-006	3IL14ACME	3/8"	.630	.156	14	.040	.050	Y13	YE3	\$18.90
913-000-019	3IR12ACME	913-000-007	3IL12ACME	3/8"	.630	.156	12	.050	.050	Y13	YE3	\$18.90
913-000-020	3IR10ACME	913-000-008	3IL10ACME	3/8"	.630	.156	10	.050	.050	Y13	YE3	\$18.90
913-000-021	3IR8ACME	913-000-009	3IL8ACME	3/8"	.630	.156	8	.060	.060	Y13	YE3	\$18.90

Inserts sold in packs of 10

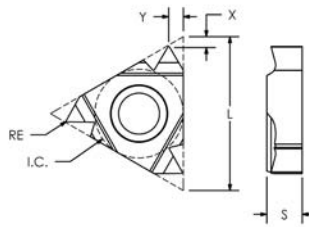

Partial Profile 60°

PRODUCT #	Designation	PRODUCT #	Designation	I.C.	L	S	Pitch (mm)	Pitch (tpi)	RE	X	Y	Anvil Right	Anvil Left	UD51
	Right Hand		Left Hand											
913-000-004	2JIRA60	913-000-002	2JILA60	1/4"	.630	.125	.7-1.5	36-18	.004	.040	.045	Y13	YE3	\$13.00
913-000-003	2JIR12UN	913-000-001	2JIL12UN	1/4"	.630	.125	1.0-2.0	28-12	.004	.030	.035	Y13	YE3	\$13.00
913-000-022	3IRA60	913-000-010	3ILA60	3/8"	.630	.156	.05-1.5	48-16	.002	.030	.040	Y13	YE3	\$17.70
913-000-023	3IRG60	913-000-011	3ILG60	3/8"	.630	.156	1.75-3.0	14-8	.006	.050	.070	Y13	YE3	\$17.70
913-000-024	3IRAG60	913-000-012	3ILAG60	3/8"	.630	.156	.05-3.0	48-8	.002	.050	.070	Y13	YE3	\$17.70
913-000-025	3JIRA60	-	-	3/8" SCB	.630	.156	.05-1.5	48-16	.002	.020	.030	Y13	-	\$17.70
913-000-026	3JIRG60	-	-	3/8" SCB	.630	.156	1.75-3.0	14-8	.006	.040	.060	Y13	-	\$17.70
913-000-027	3JIRAG60	-	-	3/8" SCB	.630	.156	.05-3.0	48-8	.002	.040	.060	Y13	-	\$17.70

Inserts sold in packs of 10

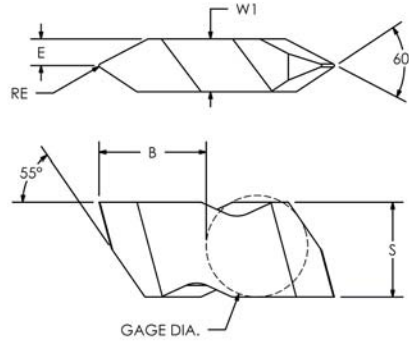

Top Notch Threading

PRODUCT #	Designation	PRODUCT #	Designation	S	W1	E	RE	Ext. TPI	Int. TPI	B	GAGE DIA.	UD51
	Right Hand		Left Hand									
913-000-332	NTP-2R	913-000-331	NTP-2L	.219	.150	.075	.003/.005	8-36	1-20	.266	.187	\$24.80
913-000-334	NTP-3R	913-000-333	NTP-3L	.344	.195	.098	.005/.008	6-20	5-12	.400	.375	\$26.00
913-000-336	NTP-4R	913-000-335	NTP-4L	.453	.255	.128	.005/.008	4-20	4-12	.629	.375	\$29.00

Inserts sold individually

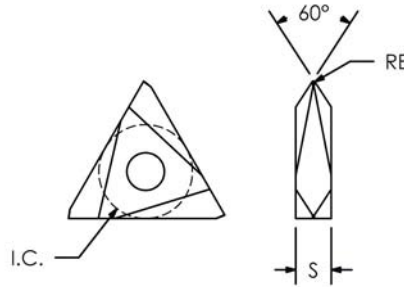

On Edge

PRODUCT #	Designation Right Hand	I.C.	S	RE	TPI	UD51
913-000-469	TNMA-43NV	0.500	.187	.003/.005	5-24	\$27.20
913-000-470	TNMA-43NV .010	0.500	.187	.001	4-20	\$30.70
913-000-471	TNMC-43NV	0.500	.187	.003/.005	5-24	\$27.20
913-000-472	TNMC-43NV .010	0.500	.187	.001	4-20	\$30.70

Inserts sold individually

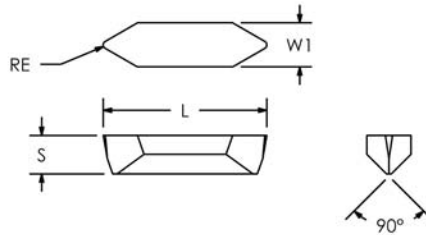

V-Bottom

PRODUCT #	Designation Right Hand	W1	L	RE	S	TPI	UD51
913-000-523	V84-NV	.250	1.000	.006/.008	.250	5-20	\$24.00
913-000-524	V84-NV-.010R	.250	1.000	.010	.250	4-20	\$26.00
913-000-525	V84-NV-.020R	.250	1.000	.020	.250	4-12	\$26.00
913-000-526	V84-NV-.025R	.250	1.000	.025	.250	4-8	\$26.00
913-000-527	V84-NV-.038R	.250	1.000	.038	.250	4-6	\$26.00
913-000-528	V85-NV	.312	1.000	.006/.008	.250	5-20	\$26.00

Inserts sold individually

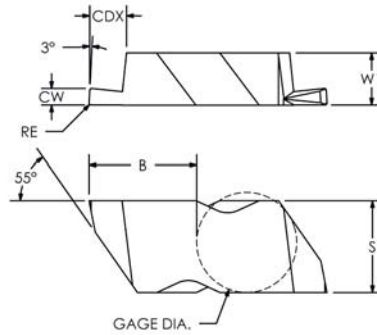

Top Notch Grooving

PRODUCT #	Designation	PRODUCT #	Designation	S	B	CDX	RE	W1	CW	GAGE DIA.	UD51
	Right Hand		Left Hand								
913-000-312	NG-2R W.031	913-000-309	NG-2L W.031	.219	.270	.050	.002 / .005	.150	.031	.187	\$29.50
913-000-313	NG-2R W.062	913-000-310	NG-2L W.062	.219	.270	.110	.005 / .010	.150	.062	.187	\$29.50
913-000-314	NG-2R W.094	913-000-311	NG-2L W.094	.219	.270	.110	.005 / .010	.150	.094	.187	\$29.50
913-000-318	NG-3R W.062	913-000-315	NG-3L W.062	.344	.405	.120	.005 / .010	.195	.062	.375	\$29.50
913-000-319	NG-3R W.094	913-000-316	NG-3L W.094	.344	.405	.180	.005 / .010	.195	.094	.375	\$29.50
913-000-320	NG-3R W.125	913-000-317	NG-3L W.125	.344	.405	.180	.005 / .010	.195	.125	.375	\$29.50
913-000-324	NG-4R W.125	913-000-321	NG-4L W.125	.453	.636	.250	.005 / .010	.255	.125	.375	\$36.00
913-000-325	NG-4R W.189	913-000-322	NG-4L W.189	.453	.636	.250	.020 / .025	.255	.189	.375	\$36.00
913-000-326	NG-4R W.250	913-000-323	NG-4L W.250	.453	.636	.250	.020 / .025	.255	.250	.375	\$36.00
913-000-327	NG-6R W.281	913-000-329	NG-6L W.281	.453	.636	.250	.030 / .035	.383	.281	.375	\$39.00
913-000-328	NG-6R W.375	913-000-330	NG-6L W.375	.453	.636	.250	.030 / .035	.383	.375	.375	\$39.00

Inserts sold individually

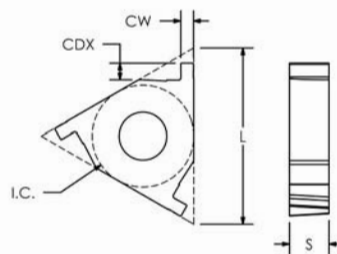

Grooving

PRODUCT #	Designation	I.C.	S	CW	CDX	Anvil	UD51
	Right Hand					Right	
913-000-013	3IR NG W.031	3/8"	.156	.031	.050	Y13M-1.5N	\$18.90
913-000-014	3IR NG W.047	3/8"	.156	.047	.070	Y13M-1.5N	\$18.90
913-000-015	3IR NG W.062	3/8"	.156	.062	.080	Y13M-1.5N	\$18.90
913-000-016	3IR NG W.093	3/8"	.156	.093	.070	Y13	\$18.90

Inserts sold in packs of 10

ARCH[®]
Cutting Tools

OD TURNING

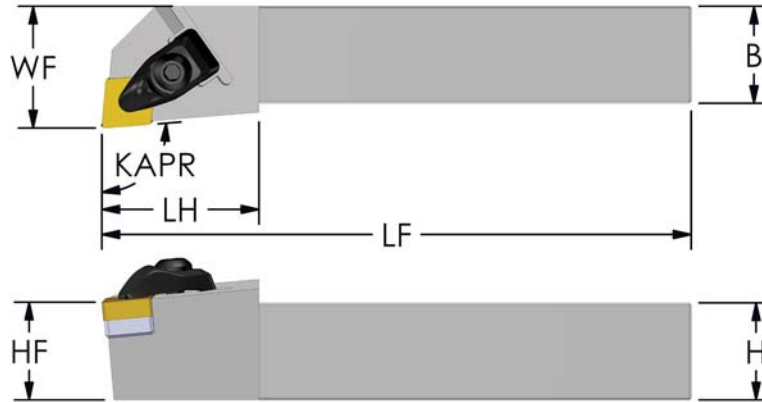

Negative 80° Diamond (KAPR: 95°)

PRODUCT # Left Hand	PRODUCT # Right hand	Designation	B	H	LF	LH	WF	HF	Insert	Shim	Shim Screw	Clamp Assy	Price
974-000-001	974-000-004	DCLNR/L 12-4B	0.750	0.750	4.5	1.300	1.000	0.750	CNMG 432	ICSN-433	PB4-SS	PB4-CA	\$79.00
974-000-002	974-000-005	DCLNR/L 16-4D	1.000	1.000	6	1.600	1.250	1.000	CNMG 432	ICSN-433	PB4-SS	PB4-CA	\$87.00
974-000-003	974-000-006	DCLNR/L 20-4D	1.250	1.250	6	1.600	1.500	1.250	CNMG 432	ICSN-433	PB4-SS	PB4-CA	\$96.00

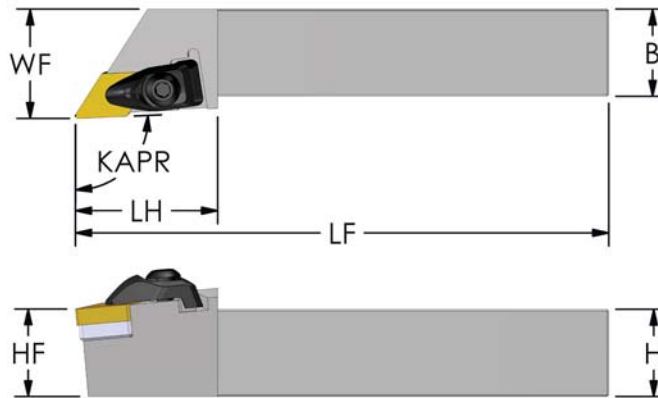

Negative 55° Diamond (KAPR: 93°)

PRODUCT # Left Hand	PRODUCT # Right hand	Designation	B	H	LF	LH	WF	HF	Insert	Shim	Shim Screw	Clamp Assy	Price
974-000-007	974-000-010	DDJNR/L 12-4B	0.750	0.750	4.5	1.770	1.000	0.750	DNMG 432	IDSN-433	PB4-SS	PB4-CA	\$119.00
974-000-008	974-000-011	DDJNR/L 16-4D	1.000	1.000	6	1.600	1.250	1.000	DNMG 432	IDSN-433	PB4-SS	PB4-CA	\$136.00
974-000-009	974-000-012	DDJNR/L 20-4D	1.250	1.250	6	1.600	1.500	1.250	DNMG 432	IDSN-433	PB4-SS	PB4-CA	\$149.00

PRODUCT #	Shim Seat	Price Each
968-000-053	ICSN-433	\$5.90
968-000-054	ICSN-533	\$7.10
968-000-055	ICSN-633	\$8.20
968-000-063	ISSN-432	\$5.80
968-000-064	ISSN-433	\$5.80
968-000-065	ISSN-533	\$6.80
968-000-066	ISSN-633	\$8.10
968-000-056	IDSN-322	\$4.70
968-000-057	IDSN-433	\$5.30
968-000-058	IDSN-533	\$8.10
968-000-067	ITSN-323	\$4.10
968-000-068	ITSN-433	\$6.50

PRODUCT #	Shim Seat	Price Each
968-000-069	ITSN-533	\$8.50
968-000-070	ITSN-636	\$11.40
968-000-071	IVSN-322	\$4.70
968-000-072	IVSN-432	\$6.30
968-000-073	IVSN-433	\$6.30
968-000-074	IWSN-322	\$5.30
968-000-075	IWSN-433	\$7.20
968-000-059	IRSN-32	\$5.20
968-000-060	IRSN-43	\$4.70
968-000-061	IRSN-53	\$7.50
968-000-062	IRSN-63	\$8.50

PRODUCT #	Lock Pin	Price Each
968-000-097	NL-33	\$3.00
968-000-098	NL-33L	\$3.00
968-000-099	NL-34	\$3.00
968-000-100	NL-34L	\$3.00
968-000-101	NL-44	\$3.00
968-000-102	NL-46	\$2.50
968-000-103	NL-56	\$3.30
968-000-104	NL-58	\$3.00
968-000-105	NL-68	\$3.30
968-000-106	NL-68L	\$6.50

PACKAGE SIZE OF 5

PACKAGE SIZE OF 10

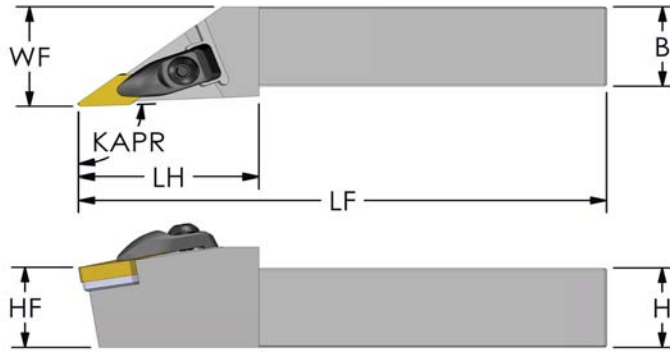

Negative 35° Diamond (KAPR: 93°)

PRODUCT # Left Hand	PRODUCT # Right hand	Designation	B	H	LF	LH	WF	HF	Insert	Shim	Shim Screw	Clamp Assy	Price
974-000-013	974-000-016	DVJNR/L 12-3B	0.750	0.750	4.5	1.770	1.000	0.750	VNMG 332	IVSN-322	PB3-SS	PB3L-CA	\$129.00
974-000-014	974-000-017	DVJNR/L 16-3D	1.000	1.000	6	1.600	1.250	1.000	VNMG 332	IVSN-322	PB3-SS	PB3L-CA	\$136.00
974-000-015	974-000-018	DVJNR/L 20-3D	1.250	1.250	6	1.600	1.500	1.250	VNMG 332	IVSN-322	PB3-SS	PB3L-CA	\$149.00

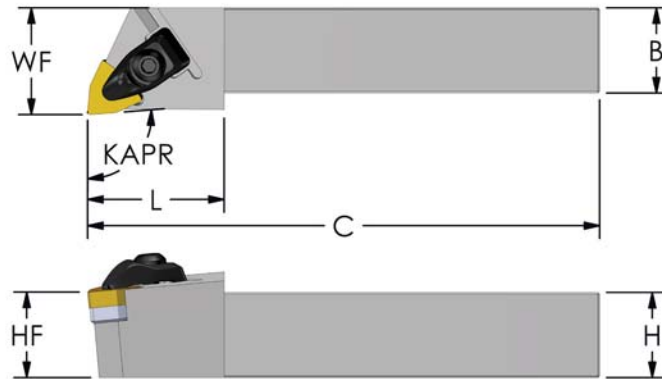

Negative Trigon (KAPR: 95°)

PRODUCT # Left Hand	PRODUCT # Right hand	Designation	B	H	LF	LH	WF	HF	Insert	Shim	Shim Screw	Clamp Assy	Price
974-000-019	974-000-022	DWLNRL 12-4B	0.750	0.750	4.5	1.300	1.000	0.750	WNMG 432	IWSN-433	PB4-SS	PB4-CA	\$79.00
974-000-020	974-000-023	DWLNRL 16-4D	1.000	1.000	6	1.600	1.250	1.000	WNMG 432	IWSN-433	PB4-SS	PB4-CA	\$87.00
974-000-021	974-000-024	DWLNRL 20-4D	1.250	1.250	6	1.600	1.500	1.250	WNMG 432	IWSN-433	PB4-SS	PB4-CA	\$96.00

PRODUCT #	Clamp	Price Each
968-000-016	CL-6	\$5.30
968-000-017	CL-7	\$5.30
968-000-020	CL-9	\$5.30
968-000-010	CL-12	\$5.30
968-000-011	CL-19	\$6.60
968-000-012	CL-20	\$5.30

PRODUCT #	Clamp	Price Each
968-000-013	CL-21	\$12.40
968-000-014	CL-22	\$12.60
968-000-015	CL-30	\$9.30
968-000-018	CL-84	\$28.40
968-000-019	CL-85	\$28.40

PRODUCT #	Clamp Screw	Price Each
968-000-176	XNS-36	\$2.20
968-000-177	XNS-47	\$2.20
968-000-178	XNS-48	\$2.20
968-000-179	XNS-510	\$2.20
968-000-180	XNS-58	\$2.20
968-000-181	XNS-59	\$2.20

PACKAGE SIZE OF 1

PACKAGE SIZE OF 5

ULTRA-DEX[®]

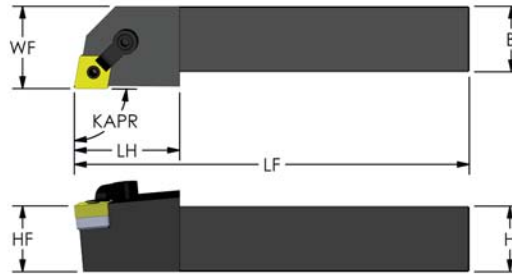

Negative 80° Diamond (KAPR: 90°)

PRODUCT # Left hand	PRODUCT # Right hand	Designation	B	H	LF	LH	WF	HF	Insert	Shim	Lock Pin	Clamp	Screw	Price
974-000-029	974-000-038	MCGNR/L 12-4B	0.750	0.750	4.5	1.300	1.000	0.750	CNMG 432	ICSN-433	NL-46	CL-20	XNS-48	\$70.40
974-000-030	974-000-039	MCGNR/L 16-4D	1.000	1.000	6	1.600	1.250	1.000	CNMG 432	ICSN-433	NL-46	CL-20	XNS-48	\$76.70
974-000-032	974-000-041	MCGNR/L 20-4D	1.250	1.250	6	1.600	1.500	1.250	CNMG 432	ICSN-433	NL-46	CL-20	XNS-48	\$84.00
974-000-035	974-000-044	MCGNR/L 24-4D	1.500	1.500	6	1.600	2.000	1.500	CNMG 432	ICSN-433	NL-46	CL-20	XNS-48	\$111.30
974-000-031	974-000-040	MCGNR/L 16-5D	1.000	1.000	6	1.600	1.250	1.000	CNMG 543	ICSN-533	NL-58	CL-12	XNS-510	\$76.70
974-000-033	974-000-042	MCGNR/L 20-5D	1.250	1.250	6	1.600	1.500	1.250	CNMG 543	ICSN-533	NL-58	CL-12	XNS-510	\$84.00
974-000-036	974-000-045	MCGNR/L 24-5D	1.500	1.500	6	1.600	2.000	1.500	CNMG 543	ICSN-533	NL-58	CL-12	XNS-510	\$111.30
974-000-034	974-000-043	MCGNR/L 20-6D	1.250	1.250	6	1.600	1.500	1.250	CNMG 643	ICSN-633	NL-68	CL-12	XNS-510	\$84.00
974-000-037	974-000-046	MCGNR/L 24-6D	1.500	1.500	6	1.600	2.000	1.500	CNMG 643	ICSN-633	NL-68	CL-12	XNS-510	\$111.30

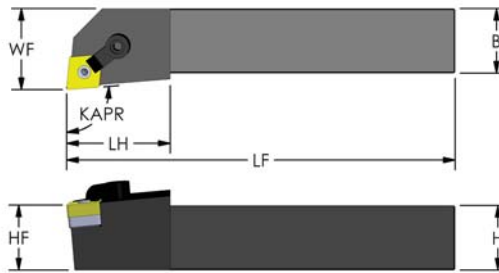

Negative 80° Diamond (KAPR: 95°)

PRODUCT # Left hand	PRODUCT # Right hand	Designation	B	H	LF	LH	WF	HF	Insert	Shim	Lock Pin	Clamp	Screw	Price
974-000-065	974-000-075	MCLNR/L 12-4B	0.750	0.750	4.5	1.300	1.000	0.750	CNMG 432	ICSN-433	NL-46	CL-20	XNS-48	\$70.40
974-000-066	974-000-076	MCLNR/L 16-4D	1.000	1.000	6	1.600	1.250	1.000	CNMG 432	ICSN-433	NL-46	CL-20	XNS-48	\$76.70
974-000-069	974-000-079	MCLNR/L 20-4D	1.250	1.250	6	1.600	1.500	1.250	CNMG 432	ICSN-433	NL-46	CL-20	XNS-48	\$84.00
974-000-067	974-000-077	MCLNR/L 16-5D	1.000	1.000	6	1.600	1.250	1.000	CNMG 543	ICSN-533	NL-58	CL-12	XNS-510	\$76.70
974-000-070	974-000-080	MCLNR/L 20-5D	1.250	1.250	6	1.600	1.570	1.250	CNMG 543	ICSN-533	NL-58	CL-12	XNS-510	\$84.00
974-000-072	974-000-082	MCLNR/L 24-5D	1.500	1.500	6	1.600	2.000	1.500	CNMG 543	ICSN-533	NL-58	CL-12	XNS-510	\$111.30
974-000-068	974-000-078	MCLNR/L 16-6D	1.000	1.000	6	1.600	1.250	1.000	CNMG 643	ICSN-633	NL-68	CL-12	XNS-510	\$76.70
974-000-071	974-000-081	MCLNR/L 20-6D	1.250	1.250	6	1.600	1.570	1.250	CNMG 643	ICSN-633	NL-68	CL-12	XNS-510	\$84.00
974-000-073	974-000-083	MCLNR/L 24-6D	1.500	1.500	6	1.600	2.000	1.500	CNMG 643	ICSN-633	NL-68	CL-12	XNS-510	\$111.30
974-000-074	974-000-084	MCLNR/L 24-6E	1.500	1.500	7	1.600	2.000	1.500	CNMG 643	ICSN-633	NL-68	CL-12	XNS-510	\$111.30

PRODUCT #	Shim Seat	Price Each
968-000-053	ICSN-433	\$5.90
968-000-054	ICSN-533	\$7.10
968-000-055	ICSN-633	\$8.20
968-000-063	ISSN-432	\$5.80
968-000-064	ISSN-433	\$5.80
968-000-065	ISSN-533	\$6.80
968-000-066	ISSN-633	\$8.10
968-000-056	IDSN-322	\$4.70
968-000-057	IDSN-433	\$5.30
968-000-058	IDSN-533	\$8.10
968-000-067	ITSN-323	\$4.10
968-000-068	ITSN-433	\$6.50

PRODUCT #	Shim Seat	Price Each
968-000-069	ITSN-533	\$8.50
968-000-070	ITSN-636	\$11.40
968-000-071	IVSN-322	\$4.70
968-000-072	IVSN-432	\$6.30
968-000-073	IVSN-433	\$6.30
968-000-074	IWSN-322	\$5.30
968-000-075	IWSN-433	\$7.20
968-000-059	IRSN-32	\$5.20
968-000-060	IRSN-43	\$4.70
968-000-061	IRSN-53	\$7.50
968-000-062	IRSN-63	\$8.50

PRODUCT #	Lock Pin	Price Each
968-000-097	NL-33	\$3.00
968-000-098	NL-33L	\$3.00
968-000-099	NL-34	\$3.00
968-000-100	NL-34L	\$3.00
968-000-101	NL-44	\$3.00
968-000-102	NL-46	\$2.50
968-000-103	NL-56	\$3.30
968-000-104	NL-58	\$3.00
968-000-105	NL-68	\$3.30
968-000-106	NL-68L	\$6.50

PACKAGE SIZE OF 5

PACKAGE SIZE OF 10

ULTRA-DEX[®]

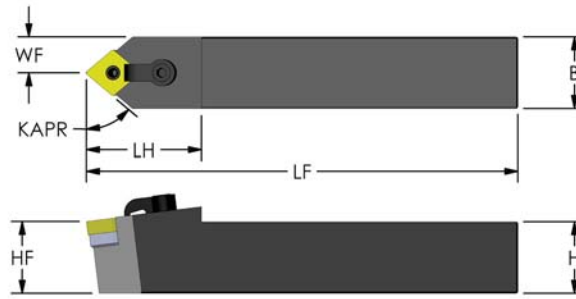

Negative 80° Diamond (KAPR: 50°)

PRODUCT #	Designation	B	H	LF	LH	HF	Insert	Shim	Lock Pin	Clamp	Screw	Price
974-000-085	MCMNN 12-4B	0.750	0.750	4.5	1.300	0.750	CNMG 432	ICSN-433	NL-46	CL-20	XNS-48	\$70.40
974-000-086	MCMNN 16-4D	1.000	1.000	6	1.600	1.000	CNMG 432	ICSN-433	NL-46	CL-20	XNS-48	\$76.70
974-000-088	MCMNN 20-4D	1.250	1.250	6	1.600	1.250	CNMG 432	ICSN-433	NL-46	CL-20	XNS-48	\$84.00
974-000-087	MCMNN 16-5D	1.000	1.000	6	1.600	1.000	CNMG 543	ICSN-533	NL-58	CL-12	XNS-510	\$76.70
974-000-089	MCMNN 20-5D	1.250	1.250	6	1.600	1.250	CNMG 543	ICSN-533	NL-58	CL-12	XNS-510	\$84.00
974-000-090	MCMNN 24-5D	1.500	1.500	6	1.600	1.500	CNMG 543	ICSN-533	NL-58	CL-12	XNS-510	\$111.30
974-000-091	MCMNN 24-6D	1.500	1.500	6	2.050	1.500	CNMG 643	ICSN-633	NL-68	CL-12	XNS-510	\$111.30
974-000-092	MCMNN 24-6E	1.500	1.500	7	2.050	1.500	CNMG 643	ICSN-633	NL-68	CL-12	XNS-510	\$111.30

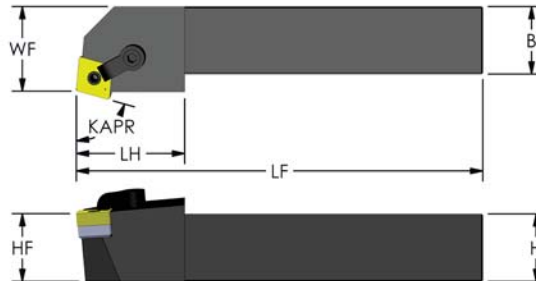

Negative 80° Diamond (KAPR: 75°)

PRODUCT # Left hand	PRODUCT # Right hand	Designation	B	H	LF	LH	WF	HF	Insert	Shim	Lock Pin	Clamp	Screw	Price
974-000-093	974-000-103	MCRNR/L 12-4B	0.750	0.750	4.5	1.300	0.750	0.750	CNMG 432	ICSN-433	NL-46	CL-20	XNS-48	\$70.40
974-000-094	974-000-104	MCRNR/L 16-4C	1.000	1.000	5	1.600	1.250	1.000	CNMG 432	ICSN-433	NL-46	CL-20	XNS-48	\$76.70
974-000-095	974-000-105	MCRNR/L 16-4D	1.000	1.000	6	1.600	1.250	1.000	CNMG 432	ICSN-433	NL-46	CL-20	XNS-48	\$76.70
974-000-098	974-000-108	MCRNR/L 20-4D	1.250	1.250	6	1.600	1.500	1.250	CNMG 432	ICSN-433	NL-46	CL-20	XNS-48	\$84.00
974-000-101	974-000-111	MCRNR/L 24-4D	1.500	1.500	6	1.600	2.000	1.500	CNMG 432	ICSN-433	NL-46	CL-20	XNS-48	\$111.30
974-000-096	974-000-106	MCRNR/L 16-5D	1.000	1.000	6	1.600	1.250	1.000	CNMG 543	ICSN-533	NL-58	CL-12	XNS-510	\$76.70
974-000-099	974-000-109	MCRNR/L 20-5D	1.250	1.250	6	1.600	1.500	1.250	CNMG 543	ICSN-533	NL-58	CL-12	XNS-510	\$84.00
974-000-097	974-000-107	MCRNR/L 16-6D	1.000	1.000	6	1.600	1.250	1.000	CNMG 643	ICSN-633	NL-68	CL-12	XNS-510	\$76.70
974-000-100	974-000-110	MCRNR/L 20-6D	1.250	1.250	6	1.600	1.500	1.250	CNMG 643	ICSN-633	NL-68	CL-12	XNS-510	\$84.00
974-000-102	974-000-112	MCRNR/L 24-6D	1.500	1.500	6	1.600	2.000	1.500	CNMG 643	ICSN-633	NL-68	CL-12	XNS-510	\$111.30

PRODUCT #	Clamp	Price Each
968-000-016	CL-6	\$5.30
968-000-017	CL-7	\$5.30
968-000-020	CL-9	\$5.30
968-000-010	CL-12	\$5.30
968-000-011	CL-19	\$6.60
968-000-012	CL-20	\$5.30

PRODUCT #	Clamp	Price Each
968-000-013	CL-21	\$12.40
968-000-014	CL-22	\$12.60
968-000-015	CL-30	\$9.30
968-000-018	CL-84	\$28.40
968-000-019	CL-85	\$28.40

PRODUCT #	Clamp Screw	Price Each
968-000-176	XNS-36	\$2.20
968-000-177	XNS-47	\$2.20
968-000-178	XNS-48	\$2.20
968-000-179	XNS-510	\$2.20
968-000-180	XNS-58	\$2.20
968-000-181	XNS-59	\$2.20

PACKAGE SIZE OF 1

PACKAGE SIZE OF 5

ULTRA-DEX[®]

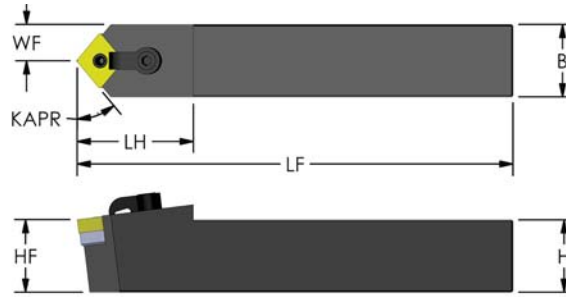

Negative 80° Diamond (KAPR: 40°)

PRODUCT #	Designation	B	H	LF	LH	HF	Insert	Shim	Lock Pin	Clamp	Screw	Price
974-000-113	MCYNN 12-4B	.750	.750	4.5	1.300	0.750	CNMG 432	ICSN-433	NL-46	CL-20	XNS-48	\$70.40
974-000-114	MCYNN 16-4D	1.000	1.000	6	1.600	1.000	CNMG 432	ICSN-433	NL-46	CL-20	XNS-48	\$76.70
974-000-117	MCYNN 20-4D	1.250	1.250	6	1.600	1.250	CNMG 432	ICSN-433	NL-46	CL-20	XNS-48	\$84.00
974-000-115	MCYNN 16-5D	1.000	1.000	6	1.600	1.000	CNMG 543	ICSN-533	NL-58	CL-12	XNS-510	\$76.70
974-000-118	MCYNN 20-5D	1.250	1.250	6	1.600	1.250	CNMG 543	ICSN-533	NL-58	CL-12	XNS-510	\$84.00
974-000-116	MCYNN 16-6D	1.000	1.000	6	2.050	1.000	CNMG 643	ICSN-633	NL-68	CL-12	XNS-510	\$76.70
974-000-119	MCYNN 20-6D	1.250	1.250	6	2.050	1.250	CNMG 643	ICSN-633	NL-68	CL-12	XNS-510	\$84.00
974-000-120	MCYNN 24-6D	1.500	1.500	6	2.050	1.500	CNMG 643	ICSN-633	NL-68	CL-12	XNS-510	\$111.30

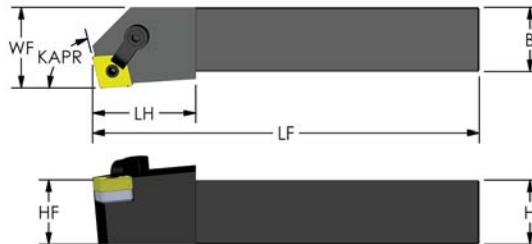

Negative 80° Diamond (KAPR: 75°)

PRODUCT # Left hand	PRODUCT # Right hand	Designation	B	H	LF	LH	WF	HF	Insert	Shim	Lock Pin	Clamp	Screw	Price
974-000-047	974-000-056	MCKNR/L 12-4B	0.750	0.750	4.5	1.300	1.000	0.750	CNMG 432	ICSN-433	NL-46	CL-20	XNS-48	\$70.40
974-000-048	974-000-057	MCKNR/L 16-4D	1.000	1.000	6	1.600	1.250	1.000	CNMG 432	ICSN-433	NL-46	CL-20	XNS-48	\$76.70
974-000-051	974-000-060	MCKNR/L 20-4D	1.250	1.250	6	1.600	1.500	1.250	CNMG 432	ICSN-433	NL-46	CL-20	XNS-48	\$84.00
974-000-049	974-000-058	MCKNR/L 16-5D	1.000	1.000	6	1.600	1.250	1.000	CNMG 543	ICSN-533	NL-58	CL-12	XNS-510	\$76.70
974-000-052	974-000-061	MCKNR/L 20-5D	1.250	1.250	6	1.600	1.500	1.250	CNMG 543	ICSN-533	NL-58	CL-12	XNS-510	\$84.00
974-000-050	974-000-059	MCKNR/L 16-6D	1.000	1.000	6	1.600	1.250	1.000	CNMG 643	ICSN-633	NL-68	CL-12	XNS-510	\$76.70
974-000-053	974-000-062	MCKNR/L 20-6D	1.250	1.250	6	1.600	1.500	1.250	CNMG 643	ICSN-633	NL-68	CL-12	XNS-510	\$84.00
974-000-054	974-000-063	MCKNR/L 24-6D	1.500	1.500	6	1.600	2.000	1.500	CNMG 643	ICSN-633	NL-68	CL-12	XNS-510	\$111.30
974-000-055	974-000-064	MCKNR/L 24-6E	1.500	1.500	7	1.600	2.000	1.500	CNMG 643	ICSN-633	NL-68	CL-12	XNS-510	\$111.30

PRODUCT #	Shim Seat	Price Each
968-000-053	ICSN-433	\$5.90
968-000-054	ICSN-533	\$7.10
968-000-055	ICSN-633	\$8.20
968-000-063	ISSN-432	\$5.80
968-000-064	ISSN-433	\$5.80
968-000-065	ISSN-533	\$6.80
968-000-066	ISSN-633	\$8.10
968-000-056	IDSN-322	\$4.70
968-000-057	IDSN-433	\$5.30
968-000-058	IDSN-533	\$8.10
968-000-067	ITSN-323	\$4.10
968-000-068	ITSN-433	\$6.50

PRODUCT #	Shim Seat	Price Each
968-000-069	ITSN-533	\$8.50
968-000-070	ITSN-636	\$11.40
968-000-071	IVSN-322	\$4.70
968-000-072	IVSN-432	\$6.30
968-000-073	IVSN-433	\$6.30
968-000-074	IWSN-322	\$5.30
968-000-075	IWSN-433	\$7.20
968-000-059	IRSN-32	\$5.20
968-000-060	IRSN-43	\$4.70
968-000-061	IRSN-53	\$7.50
968-000-062	IRSN-63	\$8.50

PRODUCT #	Lock Pin	Price Each
968-000-097	NL-33	\$3.00
968-000-098	NL-33L	\$3.00
968-000-099	NL-34	\$3.00
968-000-100	NL-34L	\$3.00
968-000-101	NL-44	\$3.00
968-000-102	NL-46	\$2.50
968-000-103	NL-56	\$3.30
968-000-104	NL-58	\$3.00
968-000-105	NL-68	\$3.30
968-000-106	NL-68L	\$6.50

PACKAGE SIZE OF 5

PACKAGE SIZE OF 10

ULTRA-DEX[®]

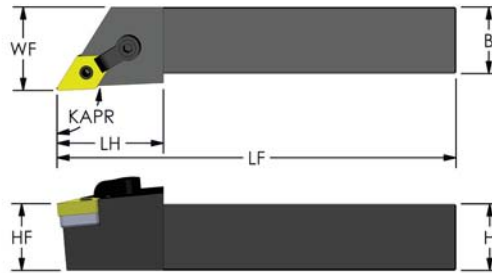

Negative 55° Diamond (KAPR: 93°)

PRODUCT # Left hand	PRODUCT # Right hand	Designation	B	H	LF	LH	WF	HF	Insert	Shim	Lock Pin	Clamp	Screw	Price
974-000-121	974-000-128	MDJNR/L 12-4B	0.750	0.750	4.5	1.770	1.000	0.750	DNMG 432	IDSN-433	NL-46	CL-20	XNS-48	\$99.80
974-000-122	974-000-129	MDJNR/L 16-4D	1.000	1.000	6	1.600	1.250	1.000	DNMG 432	IDSN-433	NL-46	CL-20	XNS-48	\$112.40
974-000-124	974-000-131	MDJNR/L 20-4D	1.250	1.250	6	1.600	1.500	1.250	DNMG 432	IDSN-433	NL-46	CL-20	XNS-48	\$129.20
974-000-126	974-000-133	MDJNR/L 24-4D	1.500	1.500	6	1.600	2.000	1.500	DNMG 432	IDSN-433	NL-46	CL-20	XNS-48	\$135.50
974-000-123	974-000-130	MDJNR/L 16-5D	1.000	1.000	6	1.600	1.250	1.000	DNMG 543	IDSN-533	NL-58	CL-12	XNS-510	\$112.40
974-000-125	974-000-132	MDJNR/L 20-5D	1.250	1.250	6	1.600	1.500	1.250	DNMG 543	IDSN-533	NL-58	CL-12	XNS-510	\$129.20
974-000-127	974-000-134	MDJNR/L 24-5D	1.500	1.500	6	2.050	2.000	1.500	DNMG 543	IDSN-533	NL-58	CL-12	XNS-510	\$135.50

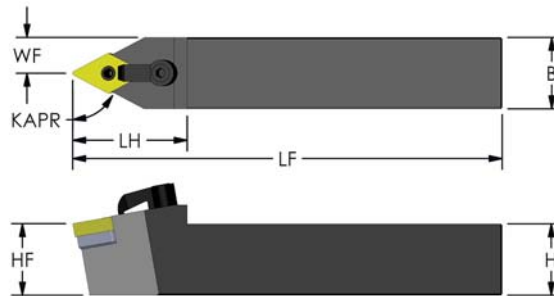

Negative 55° Diamond (KAPR: 62.5°)

PRODUCT #	Designation	B	H	LF	LH	HF	Insert	Shim	Lock Pin	Clamp	Screw	Price
974-000-135	MDPNN 12-4B	0.750	0.750	4.5	1.770	0.750	DNMG 432	IDSN-433	NL-46	CL-22	XNS-48	\$109.20
974-000-136	MDPNN 16-4D	1.000	1.000	6	1.600	1.000	DNMG 432	IDSN-433	NL-46	CL-22	XNS-48	\$113.40
974-000-138	MDPNN 20-4D	1.250	1.250	6	1.600	1.250	DNMG 432	IDSN-433	NL-46	CL-22	XNS-48	\$126.00
974-000-137	MDPNN 16-5D	1.000	1.000	6	2.050	1.000	DNMG 543	IDSN-533	NL-58	CL-12	XNS-510	\$113.40
974-000-139	MDPNN 20-5D	1.250	1.250	6	2.050	1.250	DNMG 543	IDSN-533	NL-58	CL-12	XNS-510	\$126.00
974-000-140	MDPNN 24-5D	1.500	1.500	6	2.050	1.500	DNMG 543	IDSN-533	NL-58	CL-12	XNS-510	\$135.50
974-000-141	MDPNN 24-5E	1.500	1.500	7	2.050	1.500	DNMG 543	IDSN-533	NL-58	CL-12	XNS-510	\$135.50

PRODUCT #	Clamp	Price Each
968-000-016	CL-6	\$5.30
968-000-017	CL-7	\$5.30
968-000-020	CL-9	\$5.30
968-000-010	CL-12	\$5.30
968-000-011	CL-19	\$6.60
968-000-012	CL-20	\$5.30

PRODUCT #	Clamp	Price Each
968-000-013	CL-21	\$12.40
968-000-014	CL-22	\$12.60
968-000-015	CL-30	\$9.30
968-000-018	CL-84	\$28.40
968-000-019	CL-85	\$28.40

PRODUCT #	Clamp Screw	Price Each
968-000-176	XNS-36	\$2.20
968-000-177	XNS-47	\$2.20
968-000-178	XNS-48	\$2.20
968-000-179	XNS-510	\$2.20
968-000-180	XNS-58	\$2.20
968-000-181	XNS-59	\$2.20

PACKAGE SIZE OF 1

PACKAGE SIZE OF 5

ULTRA-DEX[®]

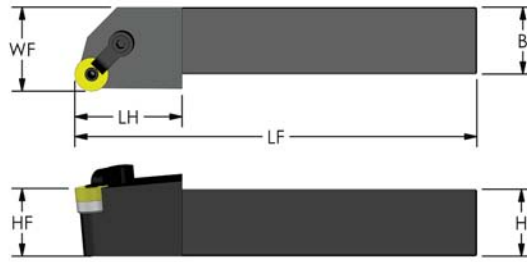

Negative Round (0° Lead)

PRODUCT # Left hand	PRODUCT # Right hand	Designation	B	H	LF	LH	WF	HF	Insert	Shim	Lock Pin	Clamp	Screw	Price
974-000-142	974-000-151	MRGNR/L 12-3B	0.750	0.750	4.5	1.300	1.000	0.750	RNMG 32	IRSN-32	NL-34	CL-6	XNS-36	\$70.40
974-000-143	974-000-152	MRGNR/L 12-4B	0.750	0.750	4.5	1.300	1.000	0.750	RNMG 43	IRSN-43	NL-46	CL-20	XNS-48	\$70.40
974-000-144	974-000-153	MRGNR/L 16-4D	1.000	1.000	6	1.600	1.250	1.000	RNMG 43	IRSN-43	NL-46	CL-20	XNS-48	\$76.70
974-000-147	974-000-156	MRGNR/L 20-4D	1.250	1.250	6	1.600	1.500	1.250	RNMG 43	IRSN-43	NL-46	CL-20	XNS-48	\$84.00
974-000-145	974-000-154	MRGNR/L 16-5D	1.000	1.000	6	1.600	1.250	1.000	RNMG 54	IRSN-53	NL-58	CL-12	XNS-510	\$76.70
974-000-148	974-000-157	MRGNR/L 20-5D	1.250	1.250	6	1.600	1.500	1.250	RNMG 54	IRSN-53	NL-58	CL-12	XNS-510	\$84.00
974-000-146	974-000-155	MRGNR/L 16-6D	1.000	1.000	6	1.600	1.250	1.000	RNMG 64	IRSN-63	NL-68	CL-12	XNS-510	\$76.70
974-000-149	974-000-158	MRGNR/L 20-6D	1.250	1.250	6	1.600	1.500	1.250	RNMG 64	IRSN-63	NL-68	CL-12	XNS-510	\$84.00
974-000-150	974-000-159	MRGNR/L 24-6D	1.500	1.500	6	1.600	2.000	1.500	RNMG 64	IRSN-63	NL-68	CL-12	XNS-510	\$111.30

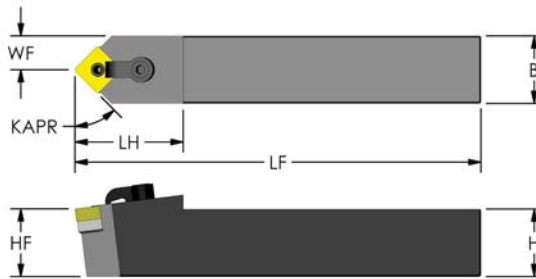

Negative Square (KAPR: 45°)

PRODUCT #	Designation	B	H	LF	LH	HF	Insert	Shim	Lock Pin	Clamp	Screw	Price
974-000-160	MSDNN 12-4B	.750	.750	4.5	1.300	.750	SNMG 432	ISSN-433	NL-46	CL-20	XNS-48	\$70.40
974-000-161	MSDNN 16-4D	1.000	1.000	6	1.600	1.000	SNMG 432	ISSN-433	NL-46	CL-20	XNS-48	\$76.70
974-000-162	MSDNN 16-5D	1.000	1.000	6	1.600	1.000	SNMG 543	ISSN-533	NL-58	CL-12	XNS-510	\$76.70
974-000-163	MSDNN 20-5D	1.250	1.250	6	1.600	1.250	SNMG 543	ISSN-533	NL-58	CL-12	XNS-510	\$76.70
974-000-164	MSDNN 16-6D	1.000	1.000	6	1.600	1.000	SNMG 643	ISSN-633	NL-68	CL-12	XNS-510	\$84.00
974-000-165	MSDNN 20-6D	1.250	1.250	6	1.600	1.250	SNMG 643	ISSN-633	NL-68	CL-12	XNS-510	\$84.00
974-000-166	MSDNN 24-6D	1.500	1.500	6	1.600	1.500	SNMG 643	ISSN-633	NL-68	CL-12	XNS-510	\$111.30

PRODUCT #	Shim Seat	Price Each
968-000-053	ICSN-433	\$5.90
968-000-054	ICSN-533	\$7.10
968-000-055	ICSN-633	\$8.20
968-000-063	ISSN-432	\$5.80
968-000-064	ISSN-433	\$5.80
968-000-065	ISSN-533	\$6.80
968-000-066	ISSN-633	\$8.10
968-000-056	IDSN-322	\$4.70
968-000-057	IDSN-433	\$5.30
968-000-058	IDSN-533	\$8.10
968-000-067	ITSN-323	\$4.10
968-000-068	ITSN-433	\$6.50

PRODUCT #	Shim Seat	Price Each
968-000-069	ITSN-533	\$8.50
968-000-070	ITSN-636	\$11.40
968-000-071	IVSN-322	\$4.70
968-000-072	IVSN-432	\$6.30
968-000-073	IVSN-433	\$6.30
968-000-074	IWSN-322	\$5.30
968-000-075	IWSN-433	\$7.20
968-000-059	IRSN-32	\$5.20
968-000-060	IRSN-43	\$4.70
968-000-061	IRSN-53	\$7.50
968-000-062	IRSN-63	\$8.50

PRODUCT #	Lock Pin	Price Each
968-000-097	NL-33	\$3.00
968-000-098	NL-33L	\$3.00
968-000-099	NL-34	\$3.00
968-000-100	NL-34L	\$3.00
968-000-101	NL-44	\$3.00
968-000-102	NL-46	\$2.50
968-000-103	NL-56	\$3.30
968-000-104	NL-58	\$3.00
968-000-105	NL-68	\$3.30
968-000-106	NL-68L	\$6.50

PACKAGE SIZE OF 5

PACKAGE SIZE OF 10

ULTRA-DEX[®]

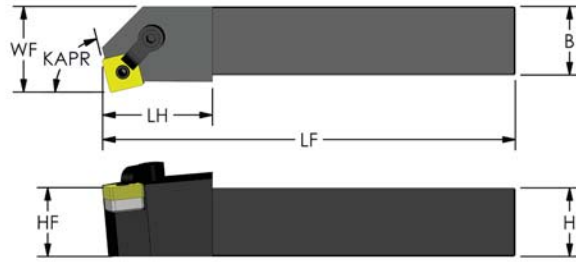

Negative Square (KAPR: 75°) End Cutting

PRODUCT # Left hand	PRODUCT # Right hand	Designation	B	H	LF	LH	WF	HF	Insert	Shim	Lock Pin	Clamp	Screw	Price
974-000-167	974-000-173	MSKNR/L 12-4B	0.750	0.750	4.5	1.300	1.000	0.750	SNMG 432	ISSN-433	NL-46	CL-20	XNS-48	\$70.40
974-000-168	974-000-174	MSKNR/L 16-4D	1.000	1.000	6	1.600	1.250	1.000	SNMG 432	ISSN-433	NL-46	CL-20	XNS-48	\$76.70
974-000-169	974-000-175	MSKNR/L 16-5D	1.000	1.000	6	1.600	1.250	1.000	SNMG 543	ISSN-533	NL-58	CL-12	XNS-510	\$76.70
974-000-170	974-000-176	MSKNR/L 20-5D	1.250	1.250	6	1.600	1.500	1.250	SNMG 543	ISSN-533	NL-58	CL-12	XNS-510	\$84.00
974-000-171	974-000-177	MSKNR/L 20-6D	1.250	1.250	6	1.600	1.500	1.250	SNMG 643	ISSN-633	NL-68	CL-12	XNS-510	\$84.00
974-000-172	974-000-178	MSKNR/L 24-6D	1.500	1.500	6	1.600	2.000	1.500	SNMG 643	ISSN-633	NL-68	CL-12	XNS-510	\$111.30

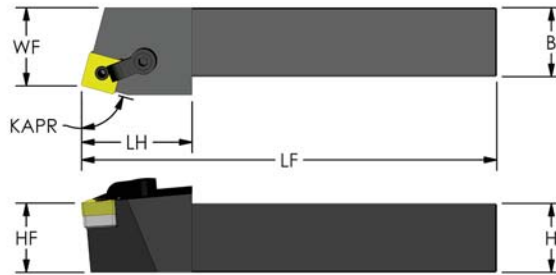

Negative Square (KAPR: 75°) Side Cutting

PRODUCT # Left hand	PRODUCT # Right hand	Designation	B	H	LF	LH	WF	HF	Insert	Shim	Lock Pin	Clamp	Screw	Price
974-000-179	974-000-187	MSRNR/L 12-4B	0.750	0.750	4.5	1.300	.880	0.750	SNMG 432	ISSN-433	NL-46	CL-20	XNS-48	\$70.40
974-000-180	974-000-188	MSRNR/L 16-4D	1.000	1.000	6	1.600	1.130	1.000	SNMG 432	ISSN-433	NL-46	CL-20	XNS-48	\$76.70
974-000-181	974-000-189	MSRNR/L 20-4D	1.250	1.250	6	1.600	1.380	1.250	SNMG 432	ISSN-433	NL-46	CL-20	XNS-48	\$76.70
974-000-182	974-000-190	MSRNR/L 16-5D	1.000	1.000	6	1.600	1.103	1.000	SNMG 543	ISSN-533	NL-58	CL-12	XNS-510	\$76.70
974-000-183	974-000-191	MSRNR/L 20-5D	1.250	1.250	6	1.600	1.353	1.250	SNMG 543	ISSN-533	NL-58	CL-12	XNS-510	\$84.00
974-000-184	974-000-192	MSRNR/L 16-6D	1.000	1.000	6	1.600	1.071	1.000	SNMG 643	ISSN-633	NL-68	CL-12	XNS-510	\$84.00
974-000-185	974-000-193	MSRNR/L 20-6D	1.250	1.250	6	1.600	1.315	1.250	SNMG 643	ISSN-633	NL-68	CL-12	XNS-510	\$84.00
974-000-186	974-000-194	MSRNR/L 24-6D	1.500	1.500	6	1.600	1.821	1.500	SNMG 643	ISSN-633	NL-68	CL-12	XNS-510	\$111.30

PRODUCT #	Clamp	Price Each
968-000-016	CL-6	\$5.30
968-000-017	CL-7	\$5.30
968-000-020	CL-9	\$5.30
968-000-010	CL-12	\$5.30
968-000-011	CL-19	\$6.60
968-000-012	CL-20	\$5.30

PRODUCT #	Clamp	Price Each
968-000-013	CL-21	\$12.40
968-000-014	CL-22	\$12.60
968-000-015	CL-30	\$9.30
968-000-018	CL-84	\$28.40
968-000-019	CL-85	\$28.40

PRODUCT #	Clamp Screw	Price Each
968-000-176	XNS-36	\$2.20
968-000-177	XNS-47	\$2.20
968-000-178	XNS-48	\$2.20
968-000-179	XNS-510	\$2.20
968-000-180	XNS-58	\$2.20
968-000-181	XNS-59	\$2.20

PACKAGE SIZE OF 1

PACKAGE SIZE OF 5

ULTRA-DEX

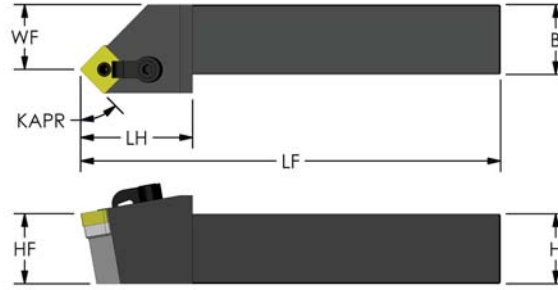

Negative Square (KAPR: 45°)

PRODUCT # Left hand	PRODUCT # Right hand	Designation	B	H	LF	LH	WF	HF	Insert	Shim	Lock Pin	Clamp	Screw	Price
974-000-195	974-000-201	MSSNR/L 12-4B	0.750	0.750	4.5	1.300	0.675	0.750	SNMG 432	ISSN-433	NL-46	CL-20	XNS-48	\$70.40
974-000-196	974-000-202	MSSNR/L 16-4D	1.000	1.000	6	1.600	0.925	1.000	SNMG 432	ISSN-433	NL-46	CL-20	XNS-48	\$76.70
974-000-197	974-000-203	MSSNR/L 16-5D	1.000	1.000	6	1.600	0.847	1.000	SNMG 543	ISSN-533	NL-58	CL-12	XNS-510	\$76.70
974-000-198	974-000-204	MSSNR/L 20-5D	1.250	1.250	6	1.600	1.097	1.250	SNMG 543	ISSN-533	NL-58	CL-12	XNS-510	\$84.00
974-000-199	974-000-205	MSSNR/L 20-6D	1.250	1.250	6	1.600	1.011	1.250	SNMG 643	ISSN-633	NL-68	CL-12	XNS-510	\$84.00
974-000-200	974-000-206	MSSNR/L 24-6D	1.500	1.500	6	1.600	1.511	1.500	SNMG 643	ISSN-633	NL-68	CL-12	XNS-510	\$111.30

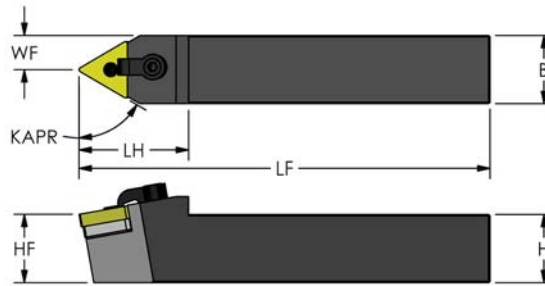

Negative Triangle (KAPR: 60°)

PRODUCT #	Designation	B	H	LF	LH	HF	Insert	Shim	Lock Pin	Clamp	Screw	Price
974-000-219	MTENN 10-3B	0.625	0.625	4.5	1.120	0.625	TNMG 332	ITSN-323	NL-34L	CL-6	XNS-36	\$60.90
974-000-220	MTENN 12-3B	0.750	0.750	4.5	1.300	0.750	TNMG 332	ITSN-323	NL-34L	CL-6	XNS-36	\$70.40
974-000-221	MTENN 12-4B	0.750	0.750	4.5	1.770	0.750	TNMG 432	ITSN-433	NL-46	CL-20	XNS-48	\$70.40
974-000-222	MTENN 16-4D	1.000	1.000	6	1.600	1.000	TNMG 432	ITSN-433	NL-46	CL-20	XNS-48	\$76.70
974-000-223	MTENN 20-5D	1.250	1.250	6	1.600	1.250	TNMG 543	ITSN-533	NL-58	CL-9	XNS-510	\$84.00
974-000-224	MTENN 24-5D	1.500	1.500	6	1.600	1.500	TNMG 543	ITSN-533	NL-58	CL-9	XNS-510	\$111.30

PRODUCT #	Shim Seat	Price Each
968-000-053	ICSN-433	\$5.90
968-000-054	ICSN-533	\$7.10
968-000-055	ICSN-633	\$8.20
968-000-063	ISSN-432	\$5.80
968-000-064	ISSN-433	\$5.80
968-000-065	ISSN-533	\$6.80
968-000-066	ISSN-633	\$8.10
968-000-056	IDSN-322	\$4.70
968-000-057	IDSN-433	\$5.30
968-000-058	IDSN-533	\$8.10
968-000-067	ITSN-323	\$4.10
968-000-068	ITSN-433	\$6.50

PRODUCT #	Shim Seat	Price Each
968-000-069	ITSN-533	\$8.50
968-000-070	ITSN-636	\$11.40
968-000-071	IVSN-322	\$4.70
968-000-072	IVSN-432	\$6.30
968-000-073	IVSN-433	\$6.30
968-000-074	IWSN-322	\$5.30
968-000-075	IWSN-433	\$7.20
968-000-059	IRSN-32	\$5.20
968-000-060	IRSN-43	\$4.70
968-000-061	IRSN-53	\$7.50
968-000-062	IRSN-63	\$8.50

PACKAGE SIZE OF 10

PRODUCT #	Lock Pin	Price Each
968-000-097	NL-33	\$3.00
968-000-098	NL-33L	\$3.00
968-000-099	NL-34	\$3.00
968-000-100	NL-34L	\$3.00
968-000-101	NL-44	\$3.00
968-000-102	NL-46	\$2.50
968-000-103	NL-56	\$3.30
968-000-104	NL-58	\$3.00
968-000-105	NL-68	\$3.30
968-000-106	NL-68L	\$6.50

PACKAGE SIZE OF 5

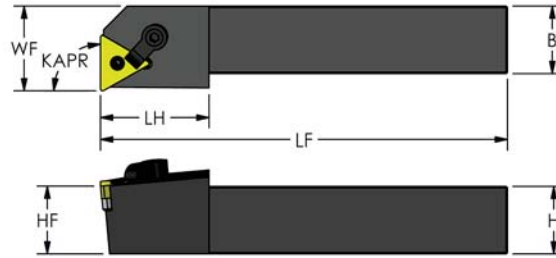

Negative Triangle (KAPR: 90°) End Cutting

PRODUCT # Left hand	PRODUCT # Right hand	Designation	B	H	LF	LH	WF	HF	Insert	Shim	Lock Pin	Clamp	Screw	Price
974-000-225	974-000-233	MTFNR/L 12-3B	0.750	0.750	4.5	1.300	1.000	0.750	TNMG 332	ITSN-323	NL-34L	CL-6	XNS-36	\$70.40
974-000-226	974-000-234	MTFNR/L 16-3D	1.000	1.000	6	1.600	1.250	1.000	TNMG 332	ITSN-323	NL-34L	CL-6	XNS-36	\$76.70
974-000-227	974-000-235	MTFNR/L 16-4D	1.000	1.000	6	1.600	1.250	1.000	TNMG 432	ITSN-433	NL-46	CL-20	XNS-48	\$76.70
974-000-228	974-000-236	MTFNR/L 20-4D	1.250	1.250	6	1.600	1.500	1.250	TNMG 432	ITSN-433	NL-46	CL-20	XNS-48	\$76.70
974-000-229	974-000-237	MTFNR/L 16-5D	1.000	1.000	6	1.600	1.250	1.000	TNMG 543	ITSN-533	NL-58	CL-12	XNS-510	\$84.00
974-000-230	974-000-238	MTFNR/L 20-5D	1.250	1.250	6	1.600	1.500	1.250	TNMG 543	ITSN-533	NL-58	CL-12	XNS-510	\$84.00
974-000-231	974-000-239	MTFNR/L 24-5D	1.500	1.500	6	1.600	2.000	1.500	TNMG 543	ITSN-533	NL-58	CL-12	XNS-510	\$111.30
974-000-232	974-000-240	MTFNR/L 24-6D	1.500	1.500	6	1.600	2.000	1.500	TNMG 663	ITSN-636	NL-68L	CL-12	XNS-510	\$111.30

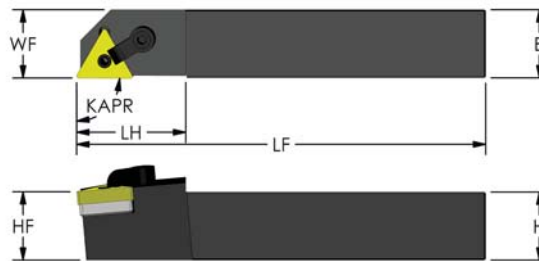

Negative Triangle (KAPR: 90°) Side Cutting

PRODUCT # Left hand	PRODUCT # Right hand	Designation	B	H	LF	LH	WF	HF	Insert	Shim	Lock Pin	Clamp	Screw	Price
974-000-207	974-000-213	MTANR/L 12-3B	0.750	0.750	4.5	1.300	.750	0.750	TNMG 332	ITSN-323	NL-34L	CL-6	XNS-36	\$76.70
974-000-208	974-000-214	MTANR/L 16-3D	1.000	1.000	6	1.600	1.000	1.000	TNMG 332	ITSN-323	NL-34L	CL-6	XNS-36	\$78.80
974-000-209	974-000-215	MTANR/L 16-4D	1.000	1.000	6	1.600	1.000	1.000	TNMG 432	ITSN-433	NL-46	CL-20	XNS-48	\$78.80
974-000-210	974-000-216	MTANR/L 20-5D	1.250	1.250	6	1.600	1.250	1.250	TNMG 543	ITSN-533	NL-58	CL-12	XNS-510	\$86.10
974-000-211	974-000-217	MTANR/L 24-5D	1.500	1.500	6	1.600	1.500	1.500	TNMG 543	ITSN-533	NL-58	CL-12	XNS-510	\$112.40
974-000-212	974-000-218	MTANR/L 24-6D	1.500	1.500	6	1.600	1.500	1.500	TNMG 663	ITSN-636	NL-68L	CL-12	XNS-510	\$112.40

PRODUCT #	Clamp	Price Each
968-000-016	CL-6	\$5.30
968-000-017	CL-7	\$5.30
968-000-020	CL-9	\$5.30
968-000-010	CL-12	\$5.30
968-000-011	CL-19	\$6.60
968-000-012	CL-20	\$5.30

PRODUCT #	Clamp	Price Each
968-000-013	CL-21	\$12.40
968-000-014	CL-22	\$12.60
968-000-015	CL-30	\$9.30
968-000-018	CL-84	\$28.40
968-000-019	CL-85	\$28.40

PRODUCT #	Clamp Screw	Price Each
968-000-176	XNS-36	\$2.20
968-000-177	XNS-47	\$2.20
968-000-178	XNS-48	\$2.20
968-000-179	XNS-510	\$2.20
968-000-180	XNS-58	\$2.20
968-000-181	XNS-59	\$2.20

PACKAGE SIZE OF 1

PACKAGE SIZE OF 5

ULTRA-DEX[®]

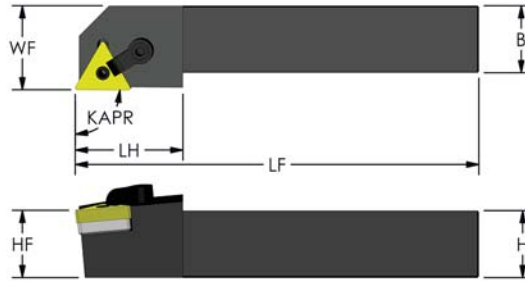

Negative Triangle (KAPR: 90°) Side Cutting

PRODUCT # Left hand	PRODUCT # Right hand	Designation	B	H	LF	LH	WF	HF	Insert	Shim	Lock Pin	Clamp	Screw	Price
974-000-241	974-000-251	MTGNR/L 10-3B	0.625	0.625	4.5	1.120	0.875	0.625	TNMG 332	ITSN-323	NL-34L	CL-6	XNS-36	\$60.90
974-000-242	974-000-252	MTGNR/L 12-3B	0.750	0.750	4.5	1.300	1.000	0.750	TNMG 332	ITSN-323	NL-34L	CL-6	XNS-36	\$70.40
974-000-243	974-000-253	MTGNR/L 16-3D	1.000	1.000	6	1.600	1.250	1.000	TNMG 332	ITSN-323	NL-34L	CL-6	XNS-36	\$76.70
974-000-244	974-000-254	MTGNR/L 16-4D	1.000	1.000	6	1.600	1.250	1.000	TNMG 432	ITSN-433	NL-46	CL-20	XNS-48	\$76.70
974-000-246	974-000-256	MTGNR/L 20-4D	1.250	1.250	6	1.600	1.500	1.250	TNMG 432	ITSN-433	NL-46	CL-20	XNS-48	\$80.00
974-000-248	974-000-258	MTGNR/L 24-4D	1.500	1.500	6	1.600	2.000	1.500	TNMG 432	ITSN-433	NL-46	CL-20	XNS-48	\$101.90
974-000-249	974-000-259	MTGNR/L 24-4E	1.500	1.500	7	1.600	2.000	1.500	TNMG 432	ITSN-433	NL-46	CL-20	XNS-48	\$101.90
974-000-245	974-000-255	MTGNR/L 16-5D	1.000	1.000	6	1.600	1.250	1.000	TNMG 543	ITSN-533	NL-58	CL-9	XNS-510	\$76.70
974-000-247	974-000-257	MTGNR/L 20-5D	1.250	1.250	6	1.600	1.500	1.250	TNMG 543	ITSN-533	NL-58	CL-9	XNS-510	\$84.00
974-000-250	974-000-260	MTGNR/L 24-5D	1.500	1.500	6	1.600	2.000	1.500	TNMG 543	ITSN-533	NL-58	CL-9	XNS-510	\$111.30

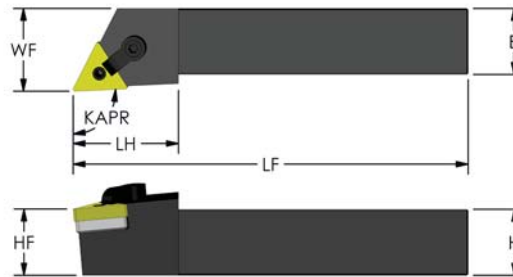

Negative Triangle (KAPR: 93°)

PRODUCT # Left hand	PRODUCT # Right hand	Designation	B	H	LF	LH	WF	HF	Insert	Shim	Lock Pin	Clamp	Screw	Price
974-000-261	974-000-269	MTJNR/L 12-3B	0.750	0.750	4.5	1.300	1.000	0.750	TNMG 332	ITSN-323	NL-34L	CL-6	XNS-36	\$70.40
974-000-262	974-000-270	MTJNR/L 16-3D	1.000	1.000	6	1.600	1.250	1.000	TNMG 332	ITSN-323	NL-34L	CL-6	XNS-36	\$76.70
974-000-263	974-000-271	MTJNR/L 16-4D	1.000	1.000	6	1.600	1.250	1.000	TNMG 432	ITSN-433	NL-46	CL-20	XNS-48	\$76.70
974-000-265	974-000-273	MTJNR/L 20-4D	1.250	1.250	6	1.600	1.500	1.250	TNMG 432	ITSN-433	NL-46	CL-20	XNS-48	\$84.00
974-000-264	974-000-272	MTJNR/L 16-5D	1.000	1.000	6	1.600	1.250	1.000	TNMG 543	ITSN-533	NL-58	CL-9	XNS-510	\$76.70
974-000-266	974-000-274	MTJNR/L 20-5D	1.250	1.250	6	1.600	1.500	1.250	TNMG 543	ITSN-533	NL-58	CL-9	XNS-510	\$84.00
974-000-267	974-000-275	MTJNR/L 24-5D	1.500	1.500	6	1.600	2.000	1.500	TNMG 543	ITSN-533	NL-58	CL-9	XNS-510	\$111.30
974-000-268	974-000-276	MTJNR/L 24-6D	1.500	1.500	6	1.600	2.000	1.500	TNMG 663	ITSN-636	NL-68L	CL-12	XNS-510	\$111.30

PRODUCT #	Shim Seat	Price Each
968-000-053	ICSN-433	\$5.90
968-000-054	ICSN-533	\$7.10
968-000-055	ICSN-633	\$8.20
968-000-063	ISSN-432	\$5.80
968-000-064	ISSN-433	\$5.80
968-000-065	ISSN-533	\$6.80
968-000-066	ISSN-633	\$8.10
968-000-056	IDSN-322	\$4.70
968-000-057	IDSN-433	\$5.30
968-000-058	IDSN-533	\$8.10
968-000-067	ITSN-323	\$4.10
968-000-068	ITSN-433	\$6.50

PRODUCT #	Shim Seat	Price Each
968-000-069	ITSN-533	\$8.50
968-000-070	ITSN-636	\$11.40
968-000-071	IVSN-322	\$4.70
968-000-072	IVSN-432	\$6.30
968-000-073	IVSN-433	\$6.30
968-000-074	IWSN-322	\$5.30
968-000-075	IWSN-433	\$7.20
968-000-059	IRSN-32	\$5.20
968-000-060	IRSN-43	\$4.70
968-000-061	IRSN-53	\$7.50
968-000-062	IRSN-63	\$8.50

PRODUCT #	Lock Pin	Price Each
968-000-097	NL-33	\$3.00
968-000-098	NL-33L	\$3.00
968-000-099	NL-34	\$3.00
968-000-100	NL-34L	\$3.00
968-000-101	NL-44	\$3.00
968-000-102	NL-46	\$2.50
968-000-103	NL-56	\$3.30
968-000-104	NL-58	\$3.00
968-000-105	NL-68	\$3.30
968-000-106	NL-68L	\$6.50

PACKAGE SIZE OF 5

PACKAGE SIZE OF 10

ULTRA-DEX

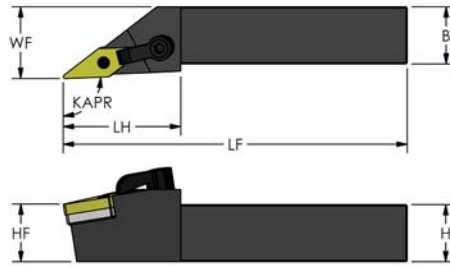

Negative 35° Diamond (KAPR: 93°)

PRODUCT # Left hand	PRODUCT # Right hand	Designation	B	H	LF	LH	WF	HF	Insert	Shim	Lock Pin	Clamp	Screw	Price
974-000-277	974-000-283	MVJNR/L 12-3B	0.750	0.750	4.5	1.770	1.000	0.750	VNMG 332	IVSN-322	NL-34L	CL-22	XNS-48	\$115.50
974-000-278	974-000-284	MVJNR/L 16-3D	1.000	1.000	6	1.600	1.250	1.000	VNMG 332	IVSN-322	NL-34L	CL-22	XNS-48	\$119.70
974-000-280	974-000-286	MVJNR/L 20-3D	1.250	1.250	6	1.600	1.500	1.250	VNMG 332	IVSN-322	NL-34L	CL-22	XNS-48	\$128.10
974-000-279	974-000-285	MVJNR/L 16-4D	1.000	1.000	6	2.050	1.250	1.000	VNMG 432	IVSN-432	NL-46	CL-30	XNS-510	\$119.70
974-000-281	974-000-287	MVJNR/L 20-4D	1.250	1.250	6	2.050	1.500	1.250	VNMG 432	IVSN-432	NL-46	CL-30	XNS-510	\$128.10
974-000-282	974-000-288	MVJNR/L 24-4D	1.500	1.500	6	2.050	2.000	1.500	VNMG 432	IVSN-432	NL-46	CL-30	XNS-510	\$142.80

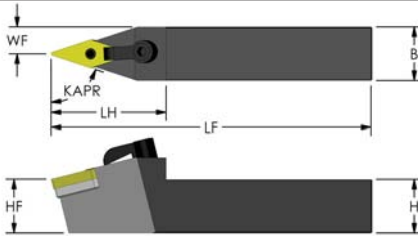

Negative 35° Diamond (KAPR: 72.5°)

PRODUCT #	Designation	B	H	LF	LH	HF	Insert	Shim	Lock Pin	Clamp	Screw	Price
974-000-289	MVVNN 12-3B	0.750	0.750	4.5	1.770	.750	VNMG 332	IVSN-322	NL-34L	CL-30	XNS-510	\$115.50
974-000-290	MVVNN 16-3D	1.000	1.000	6	2.050	1.000	VNMG 332	IVSN-322	NL-34L	CL-30	XNS-510	\$119.70
974-000-292	MVVNN 20-3D	1.250	1.250	6	2.050	1.250	VNMG 332	IVSN-322	NL-34L	CL-30	XNS-510	\$128.10
974-000-294	MVVNN 24-3D	1.500	1.500	6	2.050	1.500	VNMG 332	IVSN-322	NL-34L	CL-30	XNS-510	\$142.80
974-000-291	MVVNN 16-4D	1.000	1.000	6	2.050	1.000	VNMG 432	IVSN-432	NL-46	CL-30	XNS-510	\$119.70
974-000-293	MVVNN 20-4D	1.250	1.250	6	2.050	1.250	VNMG 432	IVSN-432	NL-46	CL-30	XNS-510	\$128.10
974-000-295	MVVNN 24-4D	1.500	1.500	6	2.050	1.500	VNMG 432	IVSN-432	NL-46	CL-30	XNS-510	\$142.80

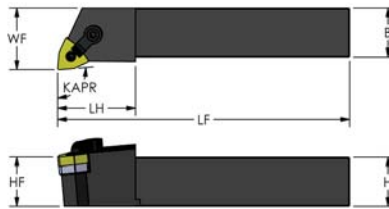

Negative Trigon (KAPR: 95°)

PRODUCT # Left hand	PRODUCT # Right hand	Designation	B	H	LF	LH	WF	HF	Insert	Shim	Lock Pin	Clamp	Screw	Price
974-000-296	974-000-301	MWLNRL 12-3B	0.750	0.750	4.5	1.300	1.000	0.750	WNMG 332	IWSN-322	NL-34L	CL-6	XNS-36	\$70.40
974-000-297	974-000-302	MWLNRL 12-4B	0.750	0.750	4.5	1.300	1.000	0.750	WNMG 432	IWSN-433	NL-46	CL-20	XNS-48	\$70.40
974-000-298	974-000-303	MWLNRL 16-4D	1.000	1.000	6	1.600	1.250	1.000	WNMG 432	IWSN-433	NL-46	CL-20	XNS-48	\$76.70
974-000-299	974-000-304	MWLNRL 20-4D	1.250	1.250	6	1.600	1.500	1.250	WNMG 432	IWSN-433	NL-46	CL-20	XNS-48	\$84.00
974-000-300	974-000-305	MWLNRL 24-4D	1.500	1.500	6	1.600	2.000	1.500	WNMG 432	IWSN-433	NL-46	CL-20	XNS-48	\$111.30

PRODUCT #	Clamp	Price Each
968-000-016	CL-6	\$5.30
968-000-017	CL-7	\$5.30
968-000-020	CL-9	\$5.30
968-000-010	CL-12	\$5.30
968-000-011	CL-19	\$6.60
968-000-012	CL-20	\$5.30

PRODUCT #	Clamp	Price Each
968-000-013	CL-21	\$12.40
968-000-014	CL-22	\$12.60
968-000-015	CL-30	\$9.30
968-000-018	CL-84	\$28.40
968-000-019	CL-85	\$28.40

PRODUCT #	Clamp Screw	Price Each
968-000-176	XNS-36	\$2.20
968-000-177	XNS-47	\$2.20
968-000-178	XNS-48	\$2.20
968-000-179	XNS-510	\$2.20
968-000-180	XNS-58	\$2.20
968-000-181	XNS-59	\$2.20

PACKAGE SIZE OF 1

PACKAGE SIZE OF 5

ULTRA-DEX[®]

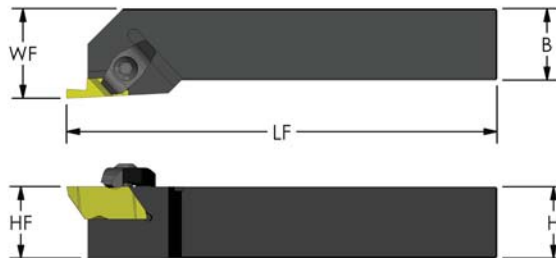

Threading/Grooving Top Notch

PRODUCT # Left hand	PRODUCT # Right hand	Designation	B	H	LF	WF	HF	Insert	RH Clamp	LH Clamp	Clamp Screw	Price
974-000-306	974-000-310	NSR/L 12-3B	0.750	0.750	4.5	1.000	0.750	NG 3R/3L	CM-72	CM-73	10-32	\$77.70
974-000-307	974-000-311	NSR/L 12-4B	0.750	0.750	4.5	1.000	0.750	NG 4R/4L	CM-72	CM-73	10-32	\$77.70
974-000-308	974-000-312	NSR/L 16-3D	1.000	1.000	6	1.250	1.000	NG 3R/3L	CM-72	CM-73	10-32	\$85.10
974-000-309	974-000-313	NSR/L 16-4D	1.000	1.000	6	1.250	1.000	NG 4R/4L	CM-72	CM-73	10-32	\$85.10

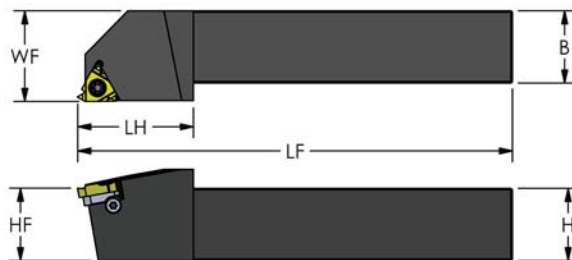

Threading/Grooving Laydown

PRODUCT # Left hand	PRODUCT # Right hand	Designation	B	H	LF	LH	WF	HF	Insert	Insert Screw	Anvil Screw	Anvil Right	Anvil Left	Price
974-000-025	974-000-027	LSSR/L 12-3B	0.750	0.750	4.5	1.300	1.000	.750	3 IL/IR	SA3T	SY3T	YE3	YI3	\$74.60
974-000-026	974-000-028	LSSR/L 16-3D	1.000	1.000	6	1.600	1.250	1.000	3 IL/IR	SA3T	SY3T	YE3	YI3	\$80.90

PRODUCT #	Clamp	Price Each
968-000-016	CL-6	\$5.30
968-000-017	CL-7	\$5.30
968-000-020	CL-9	\$5.30
968-000-010	CL-12	\$5.30
968-000-011	CL-19	\$6.60
968-000-012	CL-20	\$5.30

PRODUCT #	Clamp	Price Each
968-000-013	CL-21	\$12.40
968-000-014	CL-22	\$12.60
968-000-015	CL-30	\$9.30
968-000-018	CL-84	\$28.40
968-000-019	CL-85	\$28.40

PACKAGE SIZE OF 1

PRODUCT #	Anvil Screw	Price Each
968-000-146	SY3T	\$2.40
968-000-147	SY4T	\$3.00
968-000-148	SY5T	\$4.70

PACKAGE SIZE OF 5

PRODUCT #	Insert Screw	Price Each
968-000-124	SA3T	\$3.50
968-000-125	SA4T	\$4.70
968-000-126	SA5T	\$8.10

PACKAGE SIZE OF 5

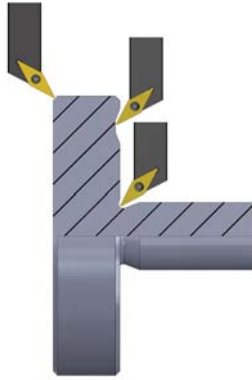

ULTRA-DEX[®]

Positive 35° Diamond (KAPR: 117.5°)

PRODUCT # Left hand	PRODUCT # Right hand	Designation	B	H	LF	WF	HF	Insert	Screw	Price
974-000-314	974-000-317	SVTBR/L 12-2B	0.750	0.750	4.5	0.935	0.750	VBMT 21.51	MTS-2.5L	\$63.00
974-000-315	974-000-318	SVTBR/L 12-3B	0.750	0.750	4.5	1.050	0.750	VBMT 331	MTS-3.5L	\$63.00
974-000-316	974-000-319	SVTBR/L 16-3D	1.00	1.00	6	1.300	1.00	VBMT 331	MTS-3.5L	\$69.30

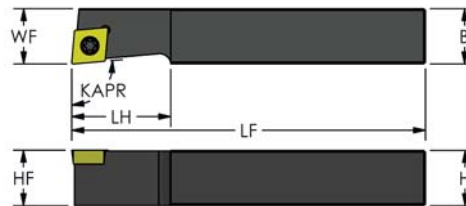

- Proper insert alignment for swiss processes
- Accepts standard ISO inserts
- Specials available upon request

Positive 80° Diamond (KAPR: 95°)

PRODUCT # Left hand	PRODUCT # Right hand	Designation	B	H	LF	WF	HF	Insert	Screw	Price
960-000-003	960-000-007	SCLCR/L 1212-3A	12mm	12mm	100mm	22mm	12mm	CCMT 32.51	MTS-35	\$73.70
960-000-004	960-000-008	SCLCR/L 1616-3A	16mm	16mm	100mm	28mm	16mm	CCMT 32.51	MTS-35	\$79.20
960-000-001	960-000-005	SCLCR/L 08-3A	0.500	0.500	4	0.865	0.500	CCMT 32.51	MTS-35	\$73.70
960-000-002	960-000-006	SCLCR/L 10-3A	0.625	0.625	4	1.120	0.625	CCMT 32.51	MTS-35	\$79.20

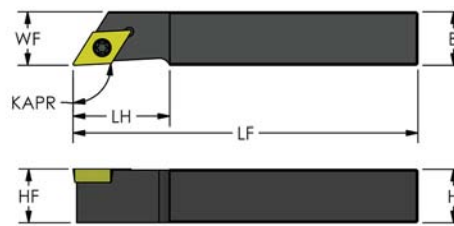

Positive 55° Diamond (KAPR: 93°)

PRODUCT # Left hand	PRODUCT # Right hand	Designation	B	H	LF	WF	HF	Insert	Screw	Price
960-000-011	960-000-015	SDJCR/L 1212-3A	12mm	12mm	100mm	22mm	12mm	DCMT 32.51	MTS-35	\$73.70
960-000-012	960-000-016	SDJCR/L 1616-3A	16mm	16mm	100mm	28mm	16mm	DCMT 32.51	MTS-35	\$79.20
960-000-009	960-000-013	SDJCR/L 08-3A	0.500	0.500	4	0.865	0.500	DCMT 32.51	MTS-35	\$73.70
960-000-010	960-000-014	SDJCR/L 10-3A	0.625	0.625	4	1.120	0.625	DCMT 32.51	MTS-35	\$79.20

PRODUCT #	Clamp Screw	Price Each
968-000-176	XNS-36	\$2.20
968-000-177	XNS-47	\$2.20
968-000-178	XNS-48	\$2.20
968-000-179	XNS-510	\$2.20
968-000-180	XNS-58	\$2.20
968-000-181	XNS-59	\$2.20

PACKAGE SIZE OF 5

PRODUCT #	Anvil	Price Each
968-000-185	YI3	\$20.10
968-000-182	YE3	\$20.10
968-000-187	YI4	\$31.90
968-000-186	YI3M-1.5N	\$30.80
968-000-183	YE4	\$31.90
968-000-188	YI5	\$50.60
968-000-184	YE5	\$50.60

PACKAGE SIZE OF 1

PRODUCT #	Insert Screws	Price Each
968-000-086	MTS-183	\$3.20
968-000-087	MTS-184	\$3.20
968-000-088	MTS-2	\$2.90
968-000-091	MTS-224	\$3.20
968-000-092	MTS-255	\$3.20
968-000-094	MTS-35	\$3.20
968-000-090	MTS-2.5L	\$2.90
968-000-052	ETS 4-40	\$3.20

PACKAGE SIZE OF 5



ID TURNING

STEEL BORING BARS

The economical choice
for general machining

Up to 4:1 Ratio

.156"-2" Diameters



ULTRA-DEX[®]

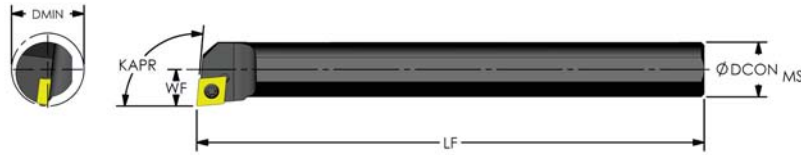

4:1 Ratio

Positive 80° Diamond (KAPR: 95°)

No Coolant

PRODUCT # Left hand	PRODUCT # Right hand	Designation	DCON MS	LF	WF	DMIN	Insert	Insert Screw	Key	Price
957-000-207	957-000-208	S02.5G SCLDR/L1.2 *	0.156	3.5	0.090	0.175	CDHB 1.20.60	MTS-182	T-6	\$60.50
957-000-211	957-000-212	S03G SCLDR/L1.2 *	0.187	3.5	0.102	0.205	CDHB 1.20.60	MTS-183	T-6	\$60.50
957-000-209	957-000-210	S03.5G SCLDR/L1.5 *	0.218	3.5	0.125	0.245	CDGW 1.510	MTS-184	T-6	\$60.50
957-000-214	957-000-216	S04G SCLDR/L1.5 *	0.250	3.5	0.172	0.312	CDGW 1.510	MTS-184	T-6	\$60.50
957-000-228	957-000-230	S05G SCLPR/L1.8 *	0.312	3.5	0.219	0.395	CPMT 1.81.20.5	MTS-224	T-7	\$60.50
957-000-248	957-000-250	S06K SCLPR/L2	0.375	5	0.250	0.460	CPMT 21.51	MTS-255	T-7	\$67.30
957-000-280	957-000-283	S08M SCLPR/L2	0.500	6	0.312	0.600	CPMT 21.51	MTS-255	T-7	\$75.30
957-000-317	957-000-319	S10Q SCLPR/L2	0.625	7	0.406	0.760	CPMT 21.51	MTS-255	T-7	\$93.50
957-000-282	957-000-285	S08M SCLPR/L3	0.500	6	0.344	0.625	CPMT 32.51	MTS-35	T-15	\$75.30
957-000-318	957-000-320	S10Q SCLPR/L3	0.625	7	0.406	0.760	CPMT 32.51	MTS-35	T-15	\$93.50
957-000-341	957-000-342	S12Q SCLPR/L3	0.750	7	0.500	0.920	CPMT 32.51	MTS-35	T-15	\$107.20
957-000-372	957-000-373	S16R SCLPR/L3	1.000	8	0.625	1.185	CPMT 32.51	MTS-35	T-15	\$148.20
957-000-244	957-000-246	S06K SCLCR/L2	0.375	5	0.250	0.460	CCMT 21.51	MTS-255	T-7	\$67.30
957-000-274	957-000-277	S08M SCLCR/L2	0.500	6	0.312	0.600	CCMT 21.51	MTS-255	T-7	\$75.30
957-000-313	957-000-315	S10Q SCLCR/L2	0.625	7	0.406	0.760	CCMT 21.51	MTS-255	T-7	\$93.50
957-000-276	957-000-279	S08M SCLCR/L3	0.500	6	0.344	0.625	CCMT 32.51	MTS-35	T-15	\$75.30
957-000-314	957-000-316	S10Q SCLCR/L3	0.625	7	0.406	0.760	CCMT 32.51	MTS-35	T-15	\$93.50
957-000-339	957-000-340	S12Q SCLCR/L3	0.750	7	0.500	0.920	CCMT 32.51	MTS-35	T-15	\$107.20
	957-000-367	S12S SCLCR3	0.750	10	0.500	.920	CCMT 32.51	MTS-35	T-15	\$115.20
957-000-370	957-000-371	S16R SCLCR/L3	1.000	8	0.625	1.185	CCMT 32.51	MTS-35	T-15	\$148.20
	957-000-401	S16T SCLCR3	1.000	12	0.625	1.185	CCMT 32.51	MTS-35	T-15	\$167.60
957-000-425	957-000-427	S20U SCLCR/L3	1.250	14	0.765	1.465	CCMT 32.51	MTS-35	T-15	\$230.30
957-000-428	957-000-428	S20U SCLCR/L4	1.250	14	0.765	1.465	CCMT 432	MTS-4	T-20	\$230.30
957-000-440	957-000-441	S24U SCLCR/L4	1.500	14	0.890	1.730	CCMT 432	MTS-4	T-20	\$257.70

Minimum Clearance

No Coolant

PRODUCT # Left hand	PRODUCT # Right hand	Designation	DCON MS	LF	WF	DMIN	Insert	Insert Screw	Key	Price
957-000-215	957-000-217	S04G SCLDR/L1.5-138 *	.250	3.5	.138	.275	CDGW 1.510	MTS-184	T-6	\$60.50
957-000-229	957-000-231	S05G SCLPR/L1.8-167 *	.312	3.5	.167	.340	CPMT 1.81.20.5	MTS-224	T-7	\$60.50
957-000-249	957-000-251	S06K SCLPR/L2-203	.375	5	.203	.410	CPMT 21.51	MTS-255	T-7	\$67.30
957-000-281	957-000-284	S08M SCLPR/L2-281	.500	6	.281	.560	CPMT 21.51	MTS-255	T-7	\$75.30
957-000-245	957-000-247	S06K SCLCR/L2-203	.375	5	.203	.410	CCMT 21.51	MTS-255	T-7	\$67.30
957-000-275	957-000-278	S08M SCLCR/L2-281	.500	6	.281	.560	CCMT 21.51	MTS-255	T-7	\$75.30

Minimum Clearance Bars are intended for light machining with minimum bore clearance. Max depth of cut .015" - .020" bars .312 and smaller do not have flats

PRODUCT #	Insert Screws	Price Each
968-000-086	MTS-183	\$3.20
968-000-087	MTS-184	\$3.20
968-000-088	MTS-2	\$2.90
968-000-091	MTS-224	\$3.20
968-000-092	MTS-255	\$3.20
968-000-094	MTS-35	\$3.20
968-000-090	MTS-2.5L	\$2.90
968-000-052	ETS 4-40	\$3.20

PRODUCT #	Key	Price Each
968-000-156	T-6	\$4.20
968-000-158	T-7	\$3.80
968-000-149	T-10	\$6.50
968-000-151	T-15	\$3.80
968-000-153	T-20	\$4.00

PACKAGE SIZE OF 5

PACKAGE SIZE OF 5

STEEL

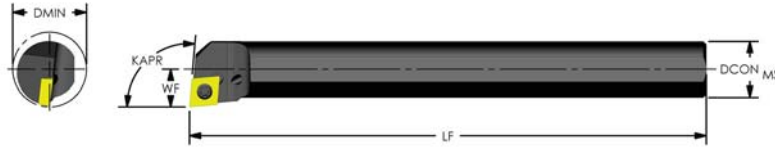

ULTRA-DEX

4:1 Ratio

Positive 80° Diamond (KAPR: 95°)

Coolant Thru

PRODUCT # Left hand	PRODUCT # Right hand	Designation	DCON MS	LF	WF	DMIN	Insert	Insert Screw	Key	Price
957-000-001	957-000-003	A04G SCLDR/L1.5 *	0.250	3.5	.172	0.312	CDGW 1.510	MTS-184	T-6	\$78.50
957-000-009	957-000-011	A05G SCLPR/L1.8 *	0.312	3.5	.219	0.395	CPMT 1.81.20.5	MTS-224	T-7	\$78.50
957-000-023	957-000-025	A06K SCLPR/L2	0.375	5	.250	0.460	CPMT 21.51	MTS-255	T-7	\$85.10
957-000-053	957-000-056	A08M SCLPR/L2	0.500	6	.312	0.600	CPMT 21.51	MTS-255	T-7	\$92.70
957-000-087	957-000-089	A10Q SCLPR/L2	0.625	7	.406	0.760	CPMT 21.51	MTS-255	T-7	\$114.50
957-000-055	957-000-058	A08M SCLPR/L3	0.500	6	.344	0.625	CPMT 32.51	MTS-35	T-15	\$92.70
957-000-088	957-000-090	A10Q SCLPR/L3	0.625	7	.406	0.760	CPMT 32.51	MTS-35	T-15	\$114.50
957-000-108	957-000-109	A12Q SCLPR/L3	0.750	7	.500	0.920	CPMT 32.51	MTS-35	T-15	\$134.10
957-000-135	957-000-136	A16R SCLPR/L3	1.000	8	.625	1.185	CPMT 32.51	MTS-35	T-15	\$176.60
957-000-019	957-000-021	A06K SCLCR/L2	0.375	5	.250	0.460	CCMT 21.51	MTS-255	T-7	\$85.10
957-000-047	957-000-050	A08M SCLCR/L2	0.500	6	.312	0.600	CCMT 21.51	MTS-255	T-7	\$92.70
957-000-083	957-000-085	A10Q SCLCR/L2	0.625	7	.406	0.760	CCMT 21.51	MTS-255	T-7	\$114.50
957-000-052	957-000-049	A08M SCLCR/L3	0.500	6	.344	0.625	CCMT 32.51	MTS-35	T-15	\$92.70
957-000-084	957-000-086	A10Q SCLCR/L3	0.625	7	.406	0.760	CCMT 32.51	MTS-35	T-15	\$114.50
957-000-106	957-000-107	A12Q SCLCR/L3	0.750	7	.500	0.920	CCMT 32.51	MTS-35	T-15	\$134.10
957-000-133	957-000-134	A16R SCLCR/L3	1.000	8	.625	1.185	CCMT 32.51	MTS-35	T-15	\$176.60
957-000-182	957-000-184	A20U SCLCR/L3	1.250	14	.765	1.465	CCMT 32.51	MTS-35	T-15	\$276.90
957-000-183	957-000-185	A20U SCLCR/L4	1.250	14	.765	1.465	CCMT 432	MTS-4	T-20	\$276.90
957-000-198	957-000-199	A24U SCLCR/L4	1.500	14	.890	1.730	CCMT 432	MTS-4	T-20	\$312.90

Minimum Clearance

Coolant Thru

PRODUCT # Left hand	PRODUCT # Right hand	Designation	DCON MS	LF	WF	DMIN	Insert	Insert Screw	Key	Price
957-000-002	957-000-004	A04G SCLDR/L1.5-138 *	.250	3.5	.138	.275	CDGW 1.510	MTS-184	T-6	\$78.50
957-000-010	957-000-012	A05G SCLPR/L1.8-167 *	.312	3.5	.167	.340	CPMT 1.81.20.5	MTS-224	T-7	\$78.50
957-000-024	957-000-026	A06K SCLPR/L2-203	.375	5	.203	.410	CPMT 21.51	MTS-255	T-7	\$85.10
957-000-054	957-000-057	A08M SCLPR/L2-281	0.500	6	.281	.560	CPMT 21.51	MTS-255	T-7	\$92.70
957-000-020	957-000-022	A06K SCLCR/L2-203	.375	5	.203	.410	CCMT 21.51	MTS-255	T-7	\$85.10
957-000-048	957-000-051	A08M SCLCR/L2-281	0.500	6	.281	.560	CCMT 21.51	MTS-255	T-7	\$92.70

Minimum Clearance Bars are intended for light machining with minimum bore clearance. Max depth of cut .015" - .020"
* bars .312 and smaller do not have flats

PRODUCT #	Insert Screws	Price Each
968-000-086	MTS-183	\$3.20
968-000-087	MTS-184	\$3.20
968-000-088	MTS-2	\$2.90
968-000-091	MTS-224	\$3.20
968-000-092	MTS-255	\$3.20
968-000-094	MTS-35	\$3.20
968-000-090	MTS-2.5L	\$2.90
968-000-052	ETS 4-40	\$3.20

PACKAGE SIZE OF 5

PRODUCT #	Key	Price Each
968-000-156	T-6	\$4.20
968-000-158	T-7	\$3.80
968-000-149	T-10	\$6.50
968-000-151	T-15	\$3.80
968-000-153	T-20	\$4.00

PACKAGE SIZE OF 5

STEEL

ULTRA-DEX[®]

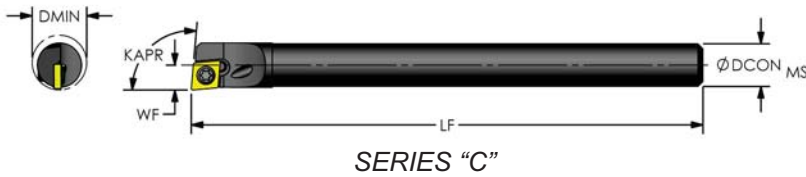

4:1 Ratio

Positive 80° Diamond (KAPR: 95°)

Coolant Thru

PRODUCT #	Designation	DCON MS	LF	WF	DMIN	Insert	Insert Screw	Key	Price
915-000-016	CSUD-180/187-2 1/2-5R *	.187	2.5	.104	.208	CDHB 1.20.60.5	MTS-183	T-6	\$88.50
915-000-021	CSUD-187-2 1/2-5R *	.187	2.5	.116	.230	CDHB 1.20.60.5	MTS-183	T-6	\$88.50
915-000-029	CSUD-250-3-5R *	.250	3	.145	.285	CDHB 1.20.60.5	MTS-184	T-6	\$88.50

*bars do not have flats

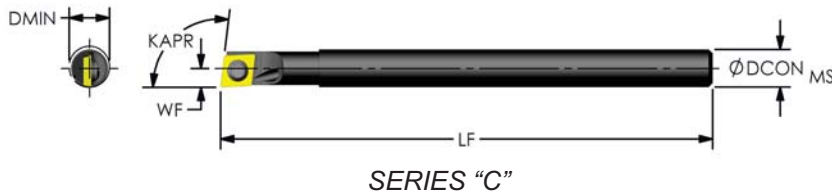

4:1 Ratio

Positive 80° Diamond (KAPR: 97°)

Coolant Thru

PRODUCT #	Designation	DCON MS	LF	WF	DMIN	Insert	Insert Screw	Key	Price
915-000-015	CSUD-165/187-2 1/2-7R *	.187	2.5	.095	.180	CDHB 1.20.60.5	MTS-183	T-6	\$88.50

*bars do not have flats

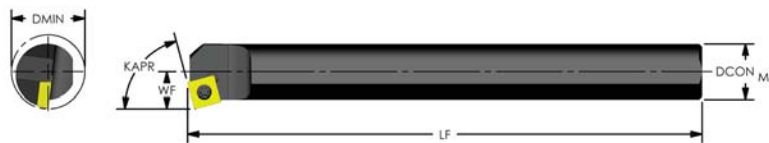

4:1 Ratio

Positive 80° Diamond (KAPR: 75°)

No Coolant

PRODUCT #	Designation	DCON MS	LF	WF	DMIN	Insert	Insert Screw	Key	Price
957-000-255	S06K SSKCR2	.375	5	.250	0.460	SCMT 21.51	MTS-255	T-7	\$74.10
957-000-292	S08M SSKCR3	0.500	6	.344	0.625	SCMT 32.51	MTS-35	T-15	\$83.30
957-000-325	S10Q SSKCR3	.625	7	.406	0.760	SCMT 32.51	MTS-35	T-15	\$103.80
957-000-350	S12Q SSKCR3	.750	7	.500	0.920	SCMT 32.51	MTS-35	T-15	\$119.70
957-000-379	S16R SSKCR4	1.000	8	.625	1.185	SCMT 432	MTS-4	T-20	\$164.20

PRODUCT #	Insert Screws	Price Each
968-000-086	MTS-183	\$3.20
968-000-087	MTS-184	\$3.20
968-000-088	MTS-2	\$2.90
968-000-091	MTS-224	\$3.20
968-000-092	MTS-255	\$3.20
968-000-094	MTS-35	\$3.20
968-000-090	MTS-2.5L	\$2.90
968-000-052	ETS 4-40	\$3.20

PACKAGE SIZE OF 5

PRODUCT #	Key	Price Each
968-000-156	T-6	\$4.20
968-000-158	T-7	\$3.80
968-000-149	T-10	\$6.50
968-000-151	T-15	\$3.80
968-000-153	T-20	\$4.00

PACKAGE SIZE OF 5

STEEL



ULTRA-DEX

4:1 Ratio

Positive Trigon (95° Lead)

No Coolant

PRODUCT # Left hand	PRODUCT # Right hand	Designation	DCON MS	LF	WF	DMIN	Insert	Insert Screw	Key	Price
	957-000-213	S03G SWLCR1.2 *	.187	3.5	.102	.205	WCMT 1.210.5	MTS-183	T-6	\$67.30
	957-000-226	S04G SWLCR1.2 *	.250	3.5	.172	.312	WCMT 1.210.5	MTS-184	T-6	\$67.30
	957-000-240	S05G SWLCR1.5 *	.312	3.5	.219	.395	WCMT 1.51.50.5	MTS-2	T-6	\$67.30
957-000-268	957-000-270	S06K SWLCR/L2	.375	5	.250	.460	WCMT 21.51	MTS-255	T-7	\$67.30
957-000-305	957-000-307	S08M SWLCR/L2	0.500	6	.312	.600	WCMT 21.51	MTS-255	T-7	\$75.30
957-000-333	957-000-335	S10Q SWLCR/L2	.625	7	.406	.760	WCMT 21.51	MTS-255	T-7	\$82.00
957-000-334	957-000-336	S10Q SWLCR/L3	.625	7	.406	.760	WCMT 32.51	MTS-35	T-15	\$82.00
957-000-359	957-000-360	S12Q SWLCR/L3	.750	7	0.500	.920	WCMT 32.51	MTS-35	T-15	\$94.00
957-000-386	957-000-387	S16R SWLCR/L3	1.000	8	.625	1.185	WCMT 32.51	MTS-35	T-15	\$130.00

Minimum Clearance

No Coolant

PRODUCT # Left hand	PRODUCT # Right hand	Designation	DCON MS	LF	WF	DMIN	Insert	Insert Screw	Key	Price
	957-000-227	S04G SWLCR1.2-138 *	.250	3.5	.138	.275	WCMT 1.210.5	MTS-184	T-6	\$67.30
	957-000-241	S05G SWLCR1.5-167 *	.312	3.5	.167	.342	WCMT 1.51.50.5	MTS-2	T-6	\$67.30
957-000-269	957-000-271	S06K SWLCR/L2-203	.375	5	.203	.410	WCMT 21.51	MTS-255	T-7	\$67.30
957-000-306	957-000-308	S08M SWLCR/L2-281	.500	6	.281	.560	WCMT 21.51	MTS-255	T-7	\$75.30

Minimum Clearance Bars are intended for light machining with minimum bore clearance. Max depth of cut .015" - .020"

*bars .312 and smaller do not have flats

4:1 Ratio

Positive Trigon (95° Lead)

Coolant Thru

PRODUCT # Left hand	PRODUCT # Right hand	Designation	DCON MS	LF	WF	DMIN	Insert	Insert Screw	Key	Price
957-000-042	957-000-044	A06K SWLCR/L2	0.375	5	.250	0.460	WCMT 21.51	MTS-255	T-7	\$85.10
957-000-076	957-000-078	A08M SWLCR/L2	0.500	6	.312	0.600	WCMT 21.51	MTS-255	T-7	\$92.70
957-000-100	957-000-102	A10Q SWLCR/L2	0.625	7	.406	0.760	WCMT 21.51	MTS-255	T-7	\$114.50
957-000-101	957-000-103	A10Q SWLCR/L3	0.625	7	.406	0.760	WCMT 32.51	MTS-35	T-15	\$114.50
957-000-123	957-000-124	A12Q SWLCR/L3	0.750	7	.500	0.920	WCMT 32.51	MTS-35	T-15	\$134.10
957-000-147	957-000-148	A16R SWLCR/L3	1.000	8	.625	1.185	WCMT 32.51	MTS-35	T-15	\$176.60

Minimum Clearance

Coolant Thru

PRODUCT # Left hand	PRODUCT # Right hand	Designation	DCON MS	LF	WF	DMIN	Insert	Insert Screw	Key	Price
957-000-043	957-000-045	A06K SWLCR/L2-203	.375	5	.203	.410	WCMT 21.51	MTS-255	T-7	\$85.10
957-000-077	957-000-079	A08M SWLCR/L2-281	.500	6	.281	.560	WCMT 21.51	MTS-255	T-7	\$92.70

Minimum Clearance Bars are intended for light machining with minimum bore clearance. Max depth of cut .015" - .020"

*bars .312 and smaller do not have flats

PRODUCT #	Insert Screws	Price Each
968-000-086	MTS-183	\$3.20
968-000-087	MTS-184	\$3.20
968-000-088	MTS-2	\$2.90
968-000-091	MTS-224	\$3.20
968-000-092	MTS-255	\$3.20
968-000-094	MTS-35	\$3.20
968-000-090	MTS-2.5L	\$2.90
968-000-052	ETS 4-40	\$3.20

PRODUCT #	Key	Price Each
968-000-156	T-6	\$4.20
968-000-158	T-7	\$3.80
968-000-149	T-10	\$6.50
968-000-151	T-15	\$3.80
968-000-153	T-20	\$4.00

PACKAGE SIZE OF 5

PACKAGE SIZE OF 5

STEEL

ULTRA-DEX[®]

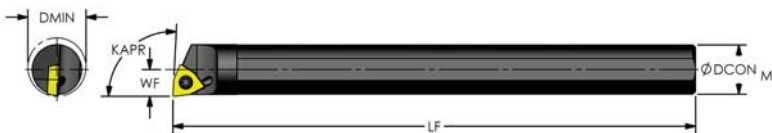

4:1 Ratio

Positive Trigon (KAPR: 93°)

SERIES "G, Q, S"

Coolant Thru

PRODUCT # Left hand	PRODUCT # Right hand	Designation	DCON MS	LF	WF	DMIN	Insert	Insert Screw	Key	Price
915-000-059	915-000-060	GSUDW-187-4-3R/L	.187	4	.126	.260	WPGT 1.511	MTS-184	T-6	\$81.80
915-000-061	915-000-062	GSUDW-250-4-3R/L	.250	4	.143	.285	WPGT 1.511	MTS-184	T-6	\$81.80
915-000-063	915-000-064	GSUDW-312-4-3R/L	.312	4	.174	.347	WPGT 1.511	MTS-184	T-6	\$81.80
915-000-082	915-000-083	QSUDW-375-5-3R/L	.375	5	.211	.415	WPGT 21.50	MTS-255	T-7	\$79.00
915-000-084	915-000-085	QSUDW-500-6-3R/L	0.500	6	.273	.540	WPGT 21.50	MTS-255	T-7	\$88.50
915-000-101	915-000-102	SSUDW-625-7-3R/L	.625	7	.345	.675	WPMT 32.51	MTS-35	T-15	\$88.50
915-000-103	915-000-104	SSUDW-750-8-3R/L	.750	8	.407	.800	WPMT 32.51	MTS-35	T-15	\$104.20



4:1 Ratio

Positive Triangle (KAPR: 90°)

SERIES "F, Q, S"

Coolant Thru

PRODUCT #	Designation	DCON MS	LF	WF	DMIN	Insert	Insert Screw	Key	Price
915-000-047	FSUD-250-4-0R *	.250	4	.156	.300	TDHB 1.280.750.5	MTS-224	T-7	\$81.80
915-000-077	QSUD-375-5-0R *	.375	5	.221	.438	TPCB 220.5	ETS 4-40	T-10	\$88.50
915-000-094	SSUD-500-6-0R *	0.500	6	.339	.668	TD 320.5	ETS 4-40	T-10	\$88.50
915-000-097	SSUD-625-7-0R *	.625	7	.393	.731	TD 320.5	ETS 4-40	T-10	\$96.40

* bars do not have flats



4:1 Ratio

Positive Triangle (KAPR: 95°)

SERIES "F, Q, S"

Coolant Thru

PRODUCT # Left hand	PRODUCT # Right hand	Designation	DCON MS	LF	WF	DMIN	Insert	Insert Screw	Key	Price
	915-000-040	FSUD-187-3 1/2-5R *	.187	3.5	.123	.275	TDHB 1.280.750.5	MTS-224	T-7	\$81.80
	915-000-048	FSUD-250-4-5R *	.250	4	.156	.300	TDHB 1.280.750.5	MTS-224	T-7	\$81.80
	915-000-052	FSUD-312-4-5R *	.312	4	.187	.360	TDHB 1.280.750.5	MTS-224	T-7	\$81.80
915-000-078	915-000-079	QSUD-375-5-5R/L *	.375	5	.221	.438	TPCB 220.5	ETS 4-40	T-10	\$88.50
	915-000-080	QSUD-500-6-5R *	0.500	6	.296	.563	TPCB 220.5	ETS 4-40	T-10	\$96.40
	915-000-095	SSUD-500-6-5R *	0.500	6	.339	.668	TD 320.5	ETS 4-40	T-10	\$88.50
	915-000-096	SSUD-625-4-5R *	.625	4	.393	.731	TD 320.5	ETS 4-40	T-10	\$88.50
	915-000-098	SSUD-625-7-5R *	.625	7	.393	.731	TD 320.5	ETS 4-40	T-10	\$96.40
	915-000-099	SSUD-750-4-5R *	.750	4	.460	.855	TD 320.5	ETS 4-40	T-10	\$96.40
	915-000-100	SSUD-750-8-5R *	.750	8	.460	.855	TD 320.5	ETS 4-40	T-10	\$104.20
	915-000-092	SSUD-1000-10-5R *	1.000	10	.585	1.105	TD 320.5	ETS 4-40	T-10	\$149.00
	915-000-093	SSUD-1250-12-5R *	1.250	12	.710	1.355	TD 320.5	ETS 4-40	T-10	\$194.90

* bars do not have flats

STEEL

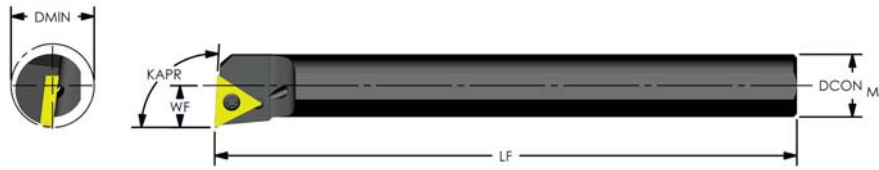

STEEL

4:1 Ratio

Positive Triangle (KAPR: 93°)

No Coolant

PRODUCT # Left hand	PRODUCT # Right hand	Designation	DCON MS	LF	WF	DMIN	Insert	Insert Screw	Key	Price
957-000-222	957-000-224	S04G STUCR/L1.2 *	.250	3.5	.172	.312	TCMT 1.21.20.5	MTS-184	T-6	\$60.50
957-000-236	957-000-238	S05G STUCR/L1.2 *	.312	3.5	.219	.395	TCMT 1.21.20.5	MTS-184	T-6	\$60.50
957-000-260	957-000-262	S06K STUCR/L2	.375	5	.250	.460	TCMT 21.51	MTS-255	T-7	\$67.30
957-000-297	957-000-299	S08M STUCR/L2	0.500	6	.312	.600	TCMT 21.51	MTS-255	T-7	\$66.00
957-000-328	957-000-329	S10Q STUCR/L2	.625	7	.406	.760	TCMT 21.51	MTS-255	T-7	\$93.50
957-000-353	957-000-354	S12Q STUCR/L3	.750	7	0.500	.920	TCMT 32.51	MTS-35	T-15	\$107.20
957-000-382	957-000-383	S16R STUCR/L3	1.000	8	.625	1.185	TCMT 32.51	MTS-35	T-15	\$148.20
957-000-266	957-000-264	S06K STUPR/L2	.375	5	.250	.460	TPMT 21.51	MTS-255	T-7	\$67.30
957-000-301	957-000-303	S08M STUPR/L2	0.500	6	.312	.600	TPMT 21.51	MTS-255	T-7	\$75.30
957-000-330	957-000-331	S10Q STUPR/L2	.625	7	.406	.760	TPMT 21.51	MTS-255	T-7	\$93.50
957-000-355	957-000-356	S12Q STUPR/L3	.750	7	0.500	.920	TPMT 32.51	MTS-35	T-15	\$107.20
957-000-384	957-000-385	S16R STUPR/L3	1.000	8	.625	1.185	TPMT 32.51	MTS-35	T-15	\$148.20

Minimum Clearance

No Coolant

PRODUCT # Left hand	PRODUCT # Right hand	Designation	DCON MS	LF	WF	DMIN	Insert	Insert Screw	Key	Price
957-000-223	957-000-225	S04G STUCR/L1.2-138 *	.250	3.5	.138	.275	TCMT 1.21.20.5	MTS-184	T-6	\$60.50
957-000-237	957-000-239	S05G STUCR/L1.2-167 *	.312	3.5	.167	.340	TCMT 1.21.20.5	MTS-184	T-6	\$60.50
957-000-261	957-000-263	S06K STUCR/L2-203	.375	5	.203	.410	TCMT 21.51	MTS-255	T-7	\$67.30
957-000-298	957-000-300	S08M STUCR/L2-281	0.500	6	.281	.560	TCMT 21.51	MTS-255	T-7	\$75.30
957-000-265	957-000-267	S06K STUPR/L2-203	.375	5	.203	.410	TPMT 21.51	MTS-255	T-7	\$67.30
957-000-302	957-000-304	S08M STUPR/L2-281	0.500	6	.281	.560	TPMT 21.51	MTS-255	T-7	\$75.30

Minimum Clearance Bars are intended for light machining with minimum bore clearance. Max depth of cut .015" - .020"
* bars .312 and smaller do not have flats

PRODUCT #	Insert Screws	Price Each
968-000-086	MTS-183	\$3.20
968-000-087	MTS-184	\$3.20
968-000-088	MTS-2	\$2.90
968-000-091	MTS-224	\$3.20
968-000-092	MTS-255	\$3.20
968-000-094	MTS-35	\$3.20
968-000-090	MTS-2.5L	\$2.90
968-000-052	ETS 4-40	\$3.20

PACKAGE SIZE OF 5

PRODUCT #	Key	Price Each
968-000-156	T-6	\$4.20
968-000-158	T-7	\$3.80
968-000-149	T-10	\$6.50
968-000-151	T-15	\$3.80
968-000-153	T-20	\$4.00

PACKAGE SIZE OF 5

ULTRA-DEX

STEEL

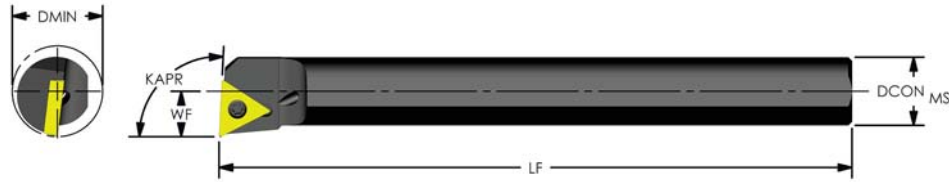

4:1 Ratio

Positive Triangle (KAPR: 93°)

Coolant Thru

PRODUCT # Left hand	PRODUCT # Right hand	Designation	DCON MS	LF	WF	DMIN	Insert	Insert Screw	Key	Price
957-000-005	957-000-007	A04G STUCR/L1.2 *	.250	3.5	.172	.312	TCMT 1.21.20.5	MTS-184	T-6	\$78.50
957-000-013	957-000-015	A05G STUCR/L1.2 *	.312	3.5	.219	.395	TCMT 1.21.20.5	MTS-184	T-6	\$78.50
957-000-033	957-000-035	A06K STUCR/L2	.375	5	.250	.460	TCMT 21.51	MTS-255	T-7	\$85.10
957-000-067	957-000-069	A08M STUCR/L2	0.500	6	.312	.600	TCMT 21.51	MTS-255	T-7	\$92.70
957-000-097	957-000-096	A10Q STUCR/L2	.625	7	.406	.760	TCMT 21.51	MTS-255	T-7	\$114.50
957-000-120	957-000-119	A12Q STUCR/L3	.750	7	0.500	.920	TCMT 32.51	MTS-35	T-15	\$134.10
957-000-143	957-000-144	A16R STUCR/L3	1.000	8	.625	1.185	TCMT 32.51	MTS-35	T-15	\$176.60
957-000-037	957-000-039	A06K STUPR/L2	.375	5	.250	.460	TPMT 21.51	MTS-255	T-7	\$85.10
957-000-071	957-000-073	A08M STUPR/L2	0.500	6	.312	.600	TPMT 21.51	MTS-255	T-7	\$92.70
957-000-097	957-000-098	A10Q STUPR/L2	.625	7	.406	.760	TPMT 21.51	MTS-255	T-7	\$114.50
957-000-119	957-000-120	A12Q STUPR/L3	.750	7	0.500	.920	TPMT 32.51	MTS-35	T-15	\$134.10
957-000-145	957-000-146	A16R STUPR/L3	1.000	8	.625	1.185	TPMT 32.51	MTS-35	T-15	\$176.60

Minimum Clearance

Coolant Thru

PRODUCT # Left hand	PRODUCT # Right hand	Designation	DCON MS	LF	WF	DMIN	Insert	Insert Screw	Key	Price
957-000-006	957-000-008	A04G STUCR/L1.2-138 *	.250	3.5	.138	.275	TCMT 1.21.20.5	MTS-184	T-6	\$78.50
957-000-014	957-000-016	A05G STUCR/L1.2-167 *	.312	3.5	.167	.340	TCMT 1.21.20.5	MTS-184	T-6	\$78.50
957-000-034	957-000-036	A06K STUCR/L2-203	.375	5	.203	.410	TCMT 21.51	MTS-255	T-7	\$85.10
957-000-068	957-000-070	A08M STUCR/L2-281	0.500	6	.281	.560	TCMT 21.51	MTS-255	T-7	\$92.70
957-000-038	957-000-040	A06K STUPR/L2-203	.375	5	.203	.410	TPMT 21.51	MTS-255	T-7	\$85.10
957-000-072	957-000-074	A08M STUPR/L2-281	0.500	6	.281	.560	TPMT 21.51	MTS-255	T-7	\$92.70

Minimum Clearance Bars are intended for light machining with minimum bore clearance. Max depth of cut .015" - .020"
* bars .312 and smaller do not have flats

PRODUCT #	Insert Screws	Price Each
968-000-086	MTS-183	\$3.20
968-000-087	MTS-184	\$3.20
968-000-088	MTS-2	\$2.90
968-000-091	MTS-224	\$3.20
968-000-092	MTS-255	\$3.20
968-000-094	MTS-35	\$3.20
968-000-090	MTS-2.5L	\$2.90
968-000-052	ETS 4-40	\$3.20

PACKAGE SIZE OF 5

PRODUCT #	Key	Price Each
968-000-156	T-6	\$4.20
968-000-158	T-7	\$3.80
968-000-149	T-10	\$6.50
968-000-151	T-15	\$3.80
968-000-153	T-20	\$4.00

PACKAGE SIZE OF 5

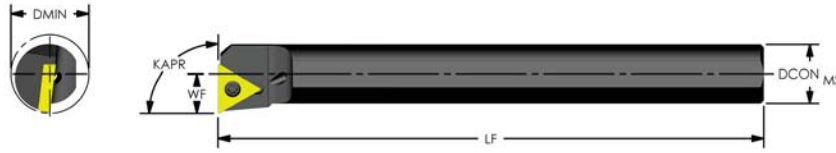

STEEL

4:1 Ratio

Positive Triangle (KAPR: 90°)

No Coolant

PRODUCT # Left hand	PRODUCT # Right hand	Designation	DCON MS	LF	WF	DMIN	Insert	Insert Screw	Key	Price
957-000-218	957-000-220	S04G STFCR/L1.2 *	.250	3.5	.172	.312	TCMT 1.21.20.5	MTS-184	T-6	\$60.50
957-000-232	957-000-234	S05G STFCR/L1.2 *	.312	3.5	.219	.395	TCMT 1.21.20.5	MTS-184	T-6	\$60.50
	957-000-256	S06K STFCR2	.375	5	.250	.460	TCMT 21.51	MTS-255	T-7	\$67.30
	957-000-293	S08M STFCR2	0.500	6	.312	.600	TCMT 21.51	MTS-255	T-7	\$75.30
	957-000-326	S10Q STFCR2	.625	7	.406	.760	TCMT 21.51	MTS-255	T-7	\$82.00
	957-000-351	S12Q STFCR3	.750	7	0.500	.920	TCMT 32.51	MTS-35	T-15	\$94.00
	957-000-380	S16R STFCR3	1.000	8	.625	1.185	TCMT 32.51	MTS-35	T-15	\$130.00
	957-000-258	S06K STFPR2	.375	5	.250	.460	TPMT 21.51	MTS-255	T-7	\$67.30
	957-000-295	S08M STFPR2	0.500	6	.312	.600	TPMT 21.51	MTS-255	T-7	\$75.30
	957-000-327	S10Q STFPR2	.625	7	.406	.760	TPMT 21.51	MTS-255	T-7	\$93.50
	957-000-352	S12Q STFPR3	.750	7	0.500	.920	TPMT 32.51	MTS-35	T-15	\$107.20
	957-000-381	S16R STFPR3	1.000	8	.625	1.185	TPMT 32.51	MTS-35	T-15	\$130.00

Minimum Clearance

No Coolant

PRODUCT # Left hand	PRODUCT # Right hand	Designation	DCON MS	LF	WF	DMIN	Insert	Insert Screw	Key	Price
957-000-219	957-000-221	S04G STFCR/L1.2-138 *	.250	3.5	.138	.275	TCMT 1.21.20.5	MTS-184	T-6	\$60.50
957-000-233	957-000-235	S05G STFCR/L1.2-167 *	.312	3.5	.167	.340	TCMT 1.21.20.5	MTS-184	T-6	\$60.50
	957-000-257	S06K STFCR2-203	.375	5	.203	.410	TCMT 21.51	MTS-255	T-7	\$67.30
	957-000-294	S08M STFCR2-281	0.500	6	.281	.560	TCMT 21.51	MTS-255	T-7	\$75.30
	957-000-259	S06K STFPR2-203	.375	5	.203	.410	TPMT 21.51	MTS-255	T-7	\$67.30
	957-000-296	S08M STFPR2-281	0.500	6	.281	.560	TPMT 21.51	MTS-255	T-7	\$75.30

Minimum Clearance Bars are intended for light machining with minimum bore clearance. Max depth of cut .015" - .020"
* bars .312 and smaller do not have flats

PRODUCT #	Insert Screws	Price Each
968-000-086	MTS-183	\$3.20
968-000-087	MTS-184	\$3.20
968-000-088	MTS-2	\$2.90
968-000-091	MTS-224	\$3.20
968-000-092	MTS-255	\$3.20
968-000-094	MTS-35	\$3.20
968-000-090	MTS-2.5L	\$2.90
968-000-052	ETS 4-40	\$3.20

PACKAGE SIZE OF 5

PRODUCT #	Key	Price Each
968-000-156	T-6	\$4.20
968-000-158	T-7	\$3.80
968-000-149	T-10	\$6.50
968-000-151	T-15	\$3.80
968-000-153	T-20	\$4.00

PACKAGE SIZE OF 5

ULTRA-DEX[®]



4:1 Ratio

Positive Triangle (KAPR: 90°)

Coolant Thru

PRODUCT #	Designation	DCON MS	LF	WF	DMIN	Insert	Insert Screw	Key	Price
957-000-029	A06K STFCR2	.375	5	.250	.460	TCMT 21.51	MTS-255	T-7	\$85.10
957-000-063	A08M STFCR2	0.500	6	.312	.600	TCMT 21.51	MTS-255	T-7	\$92.70
957-000-093	A10Q STFCR2	.625	7	.406	.760	TCMT 21.51	MTS-255	T-7	\$114.50
957-000-116	A12Q STFCR3	.750	7	0.500	.920	TCMT 32.51	MTS-35	T-15	\$134.10
957-000-141	A16R STFCR3	1.000	8	.625	1.185	TCMT 32.51	MTS-35	T-15	\$176.60
957-000-031	A06K STFPR2	.375	5	.250	.460	TPMT 21.51	MTS-255	T-7	\$85.10
957-000-063	A08M STFPR2	0.500	6	.312	.600	TPMT 21.51	MTS-255	T-7	\$92.70
957-000-094	A10Q STFPR2	.625	7	.406	.760	TPMT 21.51	MTS-255	T-7	\$114.50
957-000-117	A12Q STFPR3	.750	7	0.500	.920	TPMT 32.51	MTS-35	T-15	\$134.10
957-000-142	A16R STFPR3	1.000	8	.625	1.185	TPMT 32.51	MTS-35	T-15	\$176.60

Minimum Clearance

Coolant Thru

PRODUCT #	Designation	DCON MS	LF	WF	DMIN	Insert	Insert Screw	Key	Price
957-000-030	A06K STFCR2-203	.375	5	.203	.410	TCMT 21.51	MTS-255	T-7	\$85.10
957-000-064	A08M STFCR2-281	0.500	6	.281	.560	TCMT 21.51	MTS-255	T-7	\$92.70
957-000-032	A06K STFPR2-203	.375	5	.203	.410	TPMT 21.51	MTS-255	T-7	\$85.10
957-000-066	A08M STFPR2-281	0.500	6	.281	.560	TPMT 21.51	MTS-255	T-7	\$92.70

Minimum Clearance Bars are intended for light machining with minimum bore clearance. Max depth of cut .015" - .020"
* bars .312 and smaller do not have flats

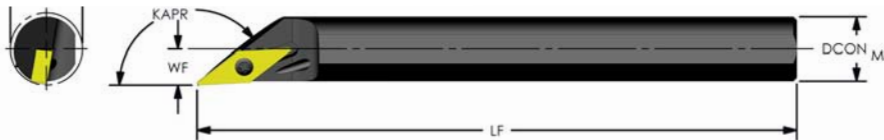

4:1 Ratio

Positive 35° Diamond (KAPR: 142°) Profiling

Coolant Thru

PRODUCT #	Designation	DCON MS	LF	WF	DMIN	Insert	Insert Screw	Key	Price
957-000-041	A06K SVJBR2	.375	5	.223	.445	VBMT 21.51	MTS-2.5L	T-7	\$85.10
957-000-075	A08M SVJBR2	0.500	6	.285	.570	VBMT 21.51	MTS-2.5L	T-7	\$92.70
957-000-099	A10Q SVJBR2	.625	7	.348	.700	VBMT 21.51	MTS-2.5L	T-7	\$112.30
957-000-122	A12Q SVJBR3	.750	7	.421	.840	VBMT 331	MTS-3.5L	T-15	\$130.80

STEEL



STEEL

4:1 Ratio

Positive 55° Diamond (KAPR: 93°) Profiling

No Coolant

PRODUCT # Left hand	PRODUCT # Right hand	Designation	DCON MS	LF	WF	DMIN	Insert	Insert Screw	Key	Price
957-000-253	957-000-254	S06K SDUCR/L2	.375	5	.375	.585	DCMT 21.51	MTS-255	T-7	\$82.10
957-000-288	957-000-289	S08M SDUCR/L2	0.500	6	.437	.720	DCMT 21.51	MTS-255	T-7	\$93.50
957-000-323	957-000-324	S10Q SDUCR/L2	.625	7	0.500	.850	DCMT 21.51	MTS-255	T-7	\$114.00
957-000-344	957-000-345	S12Q SDUCR/L3	.750	7	.625	1.050	DCMT 32.51	MTS-35	T-15	\$128.90
957-000-376	957-000-375	S16R SDUCR/L3	1.000	8	.750	1.310	DCMT 32.51	MTS-35	T-15	\$174.50
957-000-346	957-000-347	S12Q SDUPR/L3	.750	7	.625	1.050	DPMT 32.51	MTS-35	T-15	\$128.90
957-000-377	957-000-378	S16R SDUPR/L3	1.000	8	.750	1.310	DPMT 32.51	MTS-35	T-15	\$174.50

Positive 55° Diamond (KAPR: 93°) Profiling

Coolant Thru

PRODUCT # Left hand	PRODUCT # Right hand	Designation	DCON MS	LF	WF	DMIN	Insert	Insert Screw	Key	Price
957-000-027	957-000-028	A06K SDUCR/L2	.375	5	.375	.585	DCMT 21.51	MTS-255	T-7	\$92.70
957-000-059	957-000-060	A08M SDUCR/L2	0.500	6	.437	.720	DCMT 21.51	MTS-255	T-7	\$101.40
957-000-091	957-000-092	A10Q SDUCR/L2	.625	7	0.500	.850	DCMT 21.51	MTS-255	T-7	\$123.20
957-000-110	957-000-111	A12Q SDUCR/L3	.750	7	.625	1.050	DCMT 32.51	MTS-35	T-15	\$142.80
957-000-137	957-000-138	A16R SDUCR/L3	1.000	8	.750	1.310	DCMT 32.51	MTS-35	T-15	\$186.40
957-000-112	957-000-113	A12Q SDUPR/L3	.750	7	.625	1.050	DPMT 32.51	MTS-35	T-15	\$142.80
957-000-139	957-000-140	A16R SDUPR/L3	1.000	8	.750	1.310	DPMT 32.51	MTS-35	T-15	\$186.40

PRODUCT #	Insert Screws	Price Each
968-000-086	MTS-183	\$3.20
968-000-087	MTS-184	\$3.20
968-000-088	MTS-2	\$2.90
968-000-091	MTS-224	\$3.20
968-000-092	MTS-255	\$3.20
968-000-094	MTS-35	\$3.20
968-000-090	MTS-2.5L	\$2.90
968-000-052	ETS 4-40	\$3.20

PACKAGE SIZE OF 5

PRODUCT #	Key	Price Each
968-000-156	T-6	\$4.20
968-000-158	T-7	\$3.80
968-000-149	T-10	\$6.50
968-000-151	T-15	\$3.80
968-000-153	T-20	\$4.00

PACKAGE SIZE OF 5

ULTRA-DEX[®]

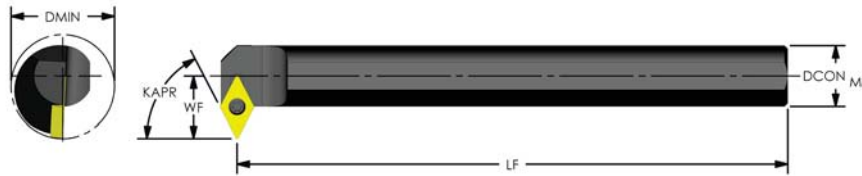

Positive 55° Diamond (KAPR: 62.5°) Profiling

4:1 Ratio

No Coolant

PRODUCT #	Designation	DCON MS	LF	WF	DMIN	Insert	Insert Screw	Key	Price
957-000-286	S08M SDNCR2	0.500	6.00	.508	.780	DCMT 21.51	MTS-255	T-7	\$93.50
957-000-321	S10Q SDNCR2	0.625	6.86	.562	.920	DCMT 21.51	MTS-255	T-7	\$114.00
957-000-343	S12Q SDNCR3	0.750	6.80	0.765	1.190	DCMT 32.51	MTS-35	T-15	\$128.90
957-000-374	S16R SDNCR3	1.00	7.80	.890	1.450	DCMT 32.51	MTS-35	T-15	\$174.50

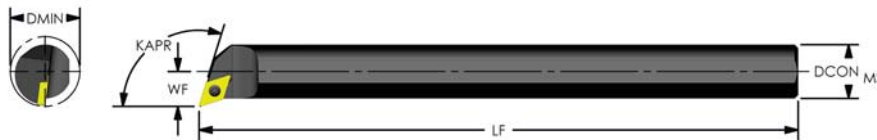

Positive 55° Diamond (KAPR: 72.5°) Profiling

4:1 Ratio

No Coolant

PRODUCT #	Designation	DCON MS	LF	WF	DMIN	Insert	Insert Screw	Key	Price
957-000-252	S06K SDQCR2	.375	5	.281	.490	DCMT 21.51	MTS-255	T-7	\$72.00
957-000-287	S08M SDQCR2	0.500	6	.341	.620	DCMT 21.51	MTS-255	T-7	\$93.50
957-000-322	S10Q SDQCR2	.625	7	.406	.760	DCMT 21.51	MTS-255	T-7	\$114.00

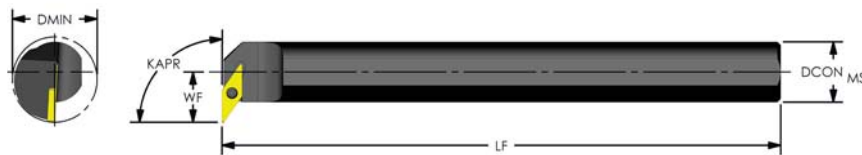

4:1 Ratio

Positive 35° Diamond (KAPR: 93°) Profiling

No Coolant

PRODUCT #	Designation	DCON MS	LF	WF	DMIN	Insert	Insert Screw	Key	Price
957-000-332	S10Q SVFBR2	0.625	7	0.500	.850	VBMT 21.51	MTS-2.5L	T-7	\$114.00
957-000-357	S12Q SVFBR2	0.750	7	.625	1.050	VBMT 21.51	MTS-2.5L	T-7	\$128.90
957-000-404	S16X SVFBR3	1.000	9	.750	1.310	VBMT 331	MTS-3.5L	T-15	\$174.50

STEEL

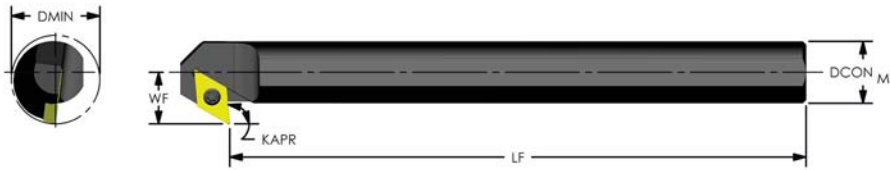

STEEL

4:1 Ratio

Positive 55° Diamond (KAPR: 95°) Back Facing

No Coolant

PRODUCT # Left hand	PRODUCT # Right hand	Designation	DCON MS	LF	WF	DMIN	Insert	Insert Screw	Key	Price
957-000-242	957-000-243	S06J SDXCR/L2	0.375	4.5	.375	0.585	DCMT 21.51	MTS-255	T-7	\$82.10
957-000-290	957-000-291	S08M SDXCR/L2	0.500	6	.437	0.720	DCMT 21.51	MTS-255	T-7	\$93.50
957-000-309	957-000-310	S10M SDXCR/L2	0.625	6	0.500	0.850	DCMT 21.51	MTS-255	T-7	\$114.00
957-000-348	957-000-349	S12Q SDXCR/L3	0.750	7	.625	1.050	DCMT 32.51	MTS-35	T-15	\$128.90
957-000-402	957-000-403	S16X SDXCR/L3	1.000	9	.750	1.310	DCMT 32.51	MTS-35	T-15	\$174.50

Coolant Thru

PRODUCT # Left hand	PRODUCT # Right hand	Designation	DCON MS	LF	WF	DMIN	Insert	Insert Screw	Key	Price
957-000-017	957-000-018	A06J SDXCR/L2	0.375	4.5	.375	0.585	DCMT 21.51	MTS-255	T-7	\$92.70
957-000-061	957-000-062	A08M SDXCR/L2	0.500	6	.437	0.720	DCMT 21.51	MTS-255	T-7	\$101.40
957-000-080	957-000-081	A10M SDXCR/L2	0.625	6	0.500	0.850	DCMT 21.51	MTS-255	T-7	\$123.20
957-000-114	957-000-115	A12Q SDXCR/L3	0.750	7	.625	1.050	DCMT 32.51	MTS-35	T-15	\$142.80
957-000-162	957-000-163	A16X SDXCR/L3	1.000	9	.750	1.310	DCMT 32.51	MTS-35	T-15	\$186.40

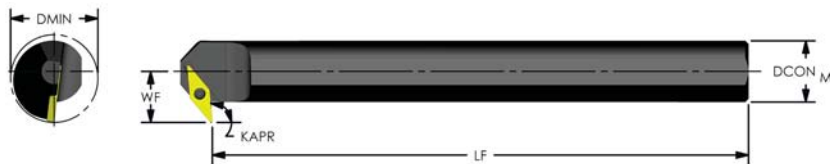

4:1 Ratio

Positive 35° Diamond (KAPR: 95°) Back Facing

No Coolant

PRODUCT #	Designation	DCON MS	LF	WF	DMIN	Insert	Insert Screw	Key	Price
957-000-358	S12Q SVXBR2	.750	6.6	.625	1.050	VBMT 21.51	MTS-2.5L	T-7	\$128.90
957-000-405	S16X SVXBR3	1.000	9	.875	1.435	VBMT 331	MTS-3.5L	T-15	\$174.50

PRODUCT #	Insert Screws	Price Each
968-000-086	MTS-183	\$3.20
968-000-087	MTS-184	\$3.20
968-000-088	MTS-2	\$2.90
968-000-091	MTS-224	\$3.20
968-000-092	MTS-255	\$3.20
968-000-094	MTS-35	\$3.20
968-000-090	MTS-2.5L	\$2.90
968-000-052	ETS 4-40	\$3.20

PACKAGE SIZE OF 5

PRODUCT #	Key	Price Each
968-000-156	T-6	\$4.20
968-000-158	T-7	\$3.80
968-000-149	T-10	\$6.50
968-000-151	T-15	\$3.80
968-000-153	T-20	\$4.00

PACKAGE SIZE OF 5

ULTRA-DEX

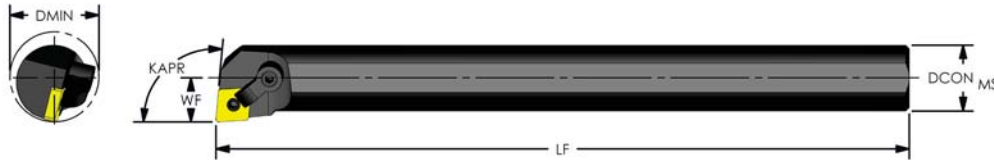

Negative 80° Diamond (KAPR: 95°)

4:1 Ratio

No Coolant

PRODUCT # Left hand	PRODUCT # Right hand	Designation	DCON MS	LF	WF	DMIN	Insert	Shim Seat	Clamp	Clamp Screw	Lock Pin	Price
957-000-361	957-000-362	S12R MCLNR/L3	0.750	8	0.500	.920	CNMG 322		CL-7	XNS-36	NL-33	\$134.60
957-000-388	957-000-390	S16S MCLNR/L3	1.000	10	0.640	1.200	CNMG 322		CL-7	XNS-36	NL-33	\$175.60
957-000-389	957-000-391	S16S MCLNR/L4	1.000	10	0.640	1.200	CNMG 432		CL-20	XNS-47	NL-44	\$175.60
957-000-406	957-000-407	S20S MCLNR/L4	1.250	10	0.765	1.470	CNMG 432	ICSN-433	CL-20	XNS-47	NL-46	\$203.00
957-000-419	957-000-420	S20U MCLNR/L4	1.250	14	0.765	1.470	CNMG 432	ICSN-433	CL-20	XNS-47	NL-46	\$260.00
957-000-429	957-000-430	S24U MCLNR/L4	1.500	14	.890	1.730	CNMG 432	ICSN-433	CL-20	XNS-47	NL-46	\$295.30
957-000-442	957-000-443	S32V MCLNR/L4	2.000	16	1.281	2.400	CNMG 432	ICSN-433	CL-20	XNS-47	NL-46	\$332.90

Coolant Thru

PRODUCT # Left hand	PRODUCT # Right hand	Designation	DCON MS	LF	WF	DMIN	Insert	Shim Seat	Clamp	Clamp Screw	Lock Pin	Price
957-000-125	957-000-126	A12R MCLNR/L3	0.750	8	0.500	.920	CNMG 322		CL-7	XNS-36	NL-33	\$166.80
957-000-151	957-000-153	A16S MCLNR/L3	1.000	10	0.640	1.200	CNMG 322		CL-7	XNS-36	NL-33	\$211.50
957-000-152	957-000-154	A16S MCLNR/L4	1.000	10	0.640	1.200	CNMG 432		CL-20	XNS-47	NL-44	\$211.50
957-000-164	957-000-165	A20S MCLNR/L4	1.250	10	0.765	1.470	CNMG 432	ICSN-433	CL-20	XNS-47	NL-46	\$237.70
957-000-178	957-000-179	A20U MCLNR/L4	1.250	14	0.765	1.470	CNMG 432	ICSN-433	CL-20	XNS-47	NL-46	\$309.60
957-000-189	957-000-190	A24U MCLNR/L4	1.500	14	0.890	1.730	CNMG 432	ICSN-433	CL-20	XNS-47	NL-46	\$351.00
957-000-200	957-000-201	A32V MCLNR/L4	2.000	16	1.281	2.400	CNMG 432	ICSN-433	CL-20	XNS-47	NL-46	\$392.40

PRODUCT #	Shim Seat	Price Each
968-000-053	ICSN-433	\$5.90
968-000-054	ICSN-533	\$7.10
968-000-055	ICSN-633	\$8.20
968-000-063	ISSN-432	\$5.80
968-000-064	ISSN-433	\$5.80
968-000-065	ISSN-533	\$6.80
968-000-066	ISSN-633	\$8.10
968-000-056	IDSN-322	\$4.70
968-000-057	IDSN-433	\$5.30
968-000-058	IDSN-533	\$8.10
968-000-067	ITSN-323	\$4.10
968-000-068	ITSN-433	\$6.50

PRODUCT #	Shim Seat	Price Each
968-000-069	ITSN-533	\$8.50
968-000-070	ITSN-636	\$11.40
968-000-071	IVSN-322	\$4.70
968-000-072	IVSN-432	\$6.30
968-000-073	IVSN-433	\$6.30
968-000-074	IWSN-322	\$5.30
968-000-075	IWSN-433	\$7.20
968-000-059	IRSN-32	\$5.20
968-000-060	IRSN-43	\$4.70
968-000-061	IRSN-53	\$7.50
968-000-062	IRSN-63	\$8.50

PACKAGE SIZE OF 10

PRODUCT #	Lock Pin	Price Each
968-000-097	NL-33	\$3.00
968-000-098	NL-33L	\$3.00
968-000-099	NL-34	\$3.00
968-000-100	NL-34L	\$3.00
968-000-101	NL-44	\$3.00
968-000-102	NL-46	\$2.50
968-000-103	NL-56	\$3.30
968-000-104	NL-58	\$3.00
968-000-105	NL-68	\$3.30
968-000-106	NL-68L	\$6.50

PACKAGE SIZE OF 5

STEEL

ULTRA-DEX[®]

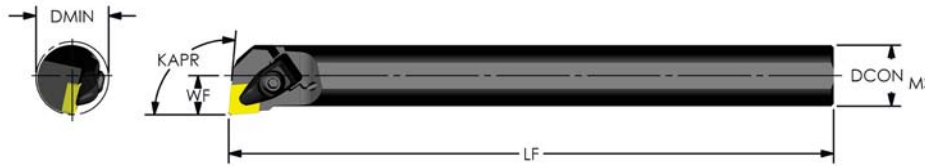

4:1 Ratio

Negative 80° Diamond (KAPR: 95°)

Coolant Thru

PRODUCT #	Designation	DCON MS	LF	WF	DMIN	Insert	Shim	Shim Screw	Clamp Assy.	Price
957-000-149	A16S DCLNR4	1.000	10	0.640	1.200	CNMG 432			PB4-CA	\$312.90
957-000-176	A20U DCLNR4	1.250	14	0.765	1.470	CNMG 432	ICSN 433	PB4-SS	PB4-CA	\$339.00
957-000-186	A24U DCLNR4	1.500	14	.890	1.730	CNMG 432	ICSN 433	PB4-SS	PB4-CA	\$444.80

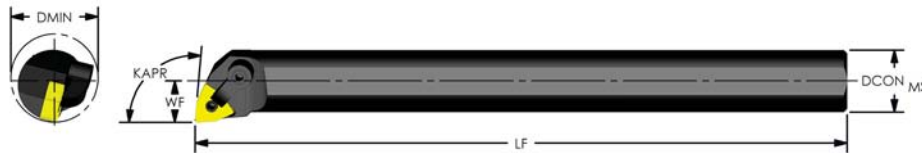

4:1 Ratio

Negative Trigon (KAPR: 95°)

No Coolant

PRODUCT # Left hand	PRODUCT # Right hand	Designation	DCON MS	LF	WF	DMIN	Insert	Shim Seat	Clamp	Clamp Screw	Lock Pin	Price
957-000-365	957-000-366	S12R MWLNR/L3	0.750	8	0.500	.920	WNMG 332		CL-7	XNS-36	NL-33L	\$134.60
957-000-397	957-000-399	S16S MWLNR/L3	1.000	10	0.640	1.200	WNMG 332		CL-7	XNS-36	NL-33L	\$175.60
957-000-398	957-000-400	S16S MWLNR/L4	1.000	10	0.640	1.200	WNMG 432		CL-20	XNS-47	NL-44	\$175.60
957-000-410	957-000-411	S20S MWLNR/L4	1.250	10	0.765	1.470	WNMG 432	IWSN-433	CL-20	XNS-47	NL-46	\$203.00
957-000-423	957-000-424	S20U MWLNR/L4	1.250	14	0.765	1.470	WNMG 432	IWSN-433	CL-20	XNS-47	NL-46	\$246.30
957-000-438	957-000-439	S24U MWLNR/L4	1.500	14	0.890	1.730	WNMG 432	IWSN-433	CL-20	XNS-47	NL-46	\$295.30
957-000-444	957-000-445	S32V MWLNR/L4	2.000	16	1.281	2.400	WNMG 432	IWSN-433	CL-20	XNS-47	NL-46	\$332.90

Coolant Thru

PRODUCT # Left hand	PRODUCT # Right hand	Designation	DCON MS	LF	WF	DMIN	Insert	Shim Seat	Clamp	Clamp Screw	Lock Pin	Price
957-000-129	957-000-130	A12R MWLNR/L3	0.750	8	0.500	0.920	WNMG 332	--	CL-7	XNS-36	NL-33L	\$166.80
957-000-158	957-000-160	A16S MWLNR/L3	1.000	10	0.640	1.200	WNMG 332	--	CL-7	XNS-36	NL-33L	\$211.50
957-000-159	957-000-161	A16S MWLNR/L4	1.000	10	0.640	1.200	WNMG 432	--	CL-20	XNS-47	NL-44	\$211.50
957-000-166	957-000-167	A20S MWLNR/L4	1.250	10	0.765	1.470	WNMG 432	IWSN-433	CL-20	XNS-47	NL-46	\$237.70
957-000-180	957-000-181	A20U MWLNR/L4	1.250	14	0.765	1.470	WNMG 432	IWSN-433	CL-20	XNS-47	NL-46	\$309.60
957-000-196	957-000-197	A24U MWLNR/L4	1.500	14	0.890	1.730	WNMG 432	IWSN-433	CL-20	XNS-47	NL-46	\$351.00
957-000-202	957-000-203	A32V MWLNR/L4	2.000	16	1.281	2.400	WNMG 432	IWSN-433	CL-20	XNS-47	NL-46	\$392.40

PRODUCT #	Clamp	Price Each
968-000-016	CL-6	\$5.30
968-000-017	CL-7	\$5.30
968-000-020	CL-9	\$5.30
968-000-010	CL-12	\$5.30
968-000-011	CL-19	\$6.60
968-000-012	CL-20	\$5.30

PRODUCT #	Clamp	Price Each
968-000-013	CL-21	\$12.40
968-000-014	CL-22	\$12.60
968-000-015	CL-30	\$9.30
968-000-018	CL-84	\$28.40
968-000-019	CL-85	\$28.40

PRODUCT #	Clamp Screw	Price Each
968-000-176	XNS-36	\$2.20
968-000-177	XNS-47	\$2.20
968-000-178	XNS-48	\$2.20
968-000-179	XNS-510	\$2.20
968-000-180	XNS-58	\$2.20
968-000-181	XNS-59	\$2.20

PACKAGE SIZE OF 1

PACKAGE SIZE OF 5

STEEL

ULTRA-DEX[®]

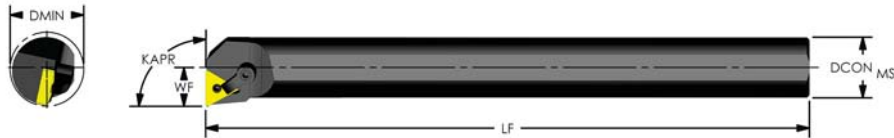

Negative Triangle (KAPR: 90°)

4:1 Ratio

No Coolant

PRODUCT #	Designation	DCON MS	LF	WF	DMIN	Insert	Shim Seat	Clamp	Clamp Screw	Lock Pin	Price
957-000-394	S16S MTFNR3	1.000	10	0.640	1.200	TNMG 332	--	CL-7	XNS-36	NL-33L	\$175.60
957-000-408	S20S MTFNR3	1.250	10	0.765	1.470	TNMG 332	ITSN-323	CL-7	XNS-36	NL-34L	\$203.00
957-000-421	S20U MTFNR3	1.250	14	0.765	1.470	TNMG 332	ITSN-323	CL-7	XNS-36	NL-34L	\$260.00
957-000-435	S24U MTFNR4	1.500	14	.890	1.730	TNMG 432	ITSN-433	CL-20	XNS-47	NL-46	\$295.30

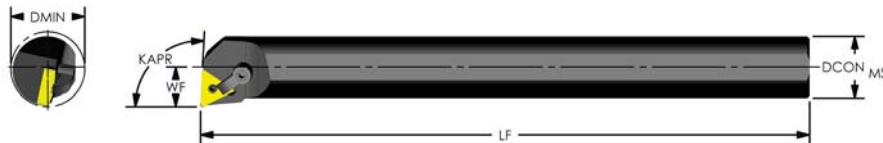

Negative Triangle (KAPR: 93°)

4:1 Ratio

No Coolant

PRODUCT #	Designation	DCON MS	LF	WF	DMIN	Insert	Shim Seat	Clamp	Clamp Screw	Lock Pin	Price
957-000-395	S16S MTUNR3	1.000	10	0.640	1.200	TNMG 332	--	CL-7	XNS-36	NL-33L	\$175.60
957-000-409	S20S MTUNR3	1.250	10	0.765	1.470	TNMG 332	ITSN-323	CL-7	XNS-36	NL-34L	\$203.00
957-000-422	S20U MTUNR3	1.250	14	0.765	1.470	TNMG 332	ITSN-323	CL-7	XNS-36	NL-34L	\$260.00
957-000-436	S24U MTUNR4	1.500	14	.890	1.730	TNMG 432	ITSN-433	CL-20	XNS-47	NL-46	\$295.30

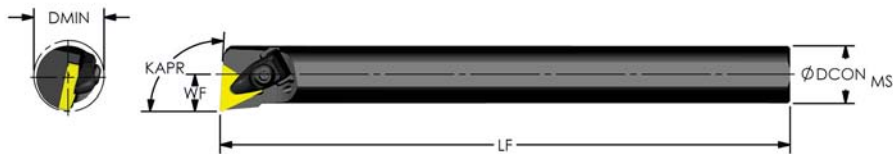

Negative Triangle (KAPR: 93°)

4:1 Ratio

Coolant Thru

PRODUCT #	Designation	DCON MS	LF	WF	DMIN	Insert	Shim	Shim Screw	Clamp Assy.	Price
957-000-150	A16S DTUNR4	1.000	10	0.640	1.200	TNMG 432	--	--	PB4-CA	\$312.90
957-000-177	A20U DTUNR4	1.250	14	0.765	1.470	TNMG 432	ITSN-433	PB4-SS	PB4-CA	\$339.00
957-000-188	A24U DTUNR4	1.500	14	.890	1.730	TNMG 432	ITSN-433	PB4-SS	PB4-CA	\$444.80

PRODUCT #	Shim Seat	Price Each
968-000-053	ICSN-433	\$5.90
968-000-054	ICSN-533	\$7.10
968-000-055	ICSN-633	\$8.20
968-000-063	ISSN-432	\$5.80
968-000-064	ISSN-433	\$5.80
968-000-065	ISSN-533	\$6.80
968-000-066	ISSN-633	\$8.10
968-000-056	IDSN-322	\$4.70
968-000-057	IDSN-433	\$5.30
968-000-058	IDSN-533	\$8.10
968-000-067	ITSN-323	\$4.10
968-000-068	ITSN-433	\$6.50

PRODUCT #	Shim Seat	Price Each
968-000-069	ITSN-533	\$8.50
968-000-070	ITSN-636	\$11.40
968-000-071	IVSN-322	\$4.70
968-000-072	IVSN-432	\$6.30
968-000-073	IVSN-433	\$6.30
968-000-074	IWSN-322	\$5.30
968-000-075	IWSN-433	\$7.20
968-000-059	IRSN-32	\$5.20
968-000-060	IRSN-43	\$4.70
968-000-061	IRSN-53	\$7.50
968-000-062	IRSN-63	\$8.50

PRODUCT #	Lock Pin	Price Each
968-000-097	NL-33	\$3.00
968-000-098	NL-33L	\$3.00
968-000-099	NL-34	\$3.00
968-000-100	NL-34L	\$3.00
968-000-101	NL-44	\$3.00
968-000-102	NL-46	\$2.50
968-000-103	NL-56	\$3.30
968-000-104	NL-58	\$3.00
968-000-105	NL-68	\$3.30
968-000-106	NL-68L	\$6.50

PACKAGE SIZE OF 5

PACKAGE SIZE OF 10

STEEL

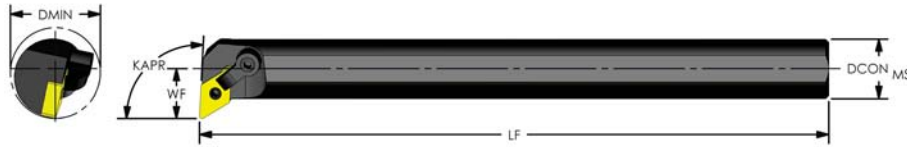

Negative 55° Diamond (KAPR: 93°) Profiling

4:1 Ratio

No Coolant

PRODUCT # Left hand	PRODUCT # Right hand	Designation	DCON MS	LF	WF	DMIN	Insert	Shim Seat	Clamp	Clamp Screw	Lock Pin	Price
957-000-363	957-000-364	S12R MDUNR/L3	0.750	8	0.625	1.050	DNMG 432	--	CL-7	XNS-36	NL-33L	\$161.90
957-000-392	957-000-393	S16S MDUNR/L3	1.000	10	0.750	1.310	DNMG 432	--	CL-7	XNS-36	NL-33L	\$207.50
957-000-414	957-000-416	S20T MDUNR/L3	1.250	12	1.000	1.700	DNMG 432	IDSN-322	CL-7	XNS-36	NL-34L	\$296.40
957-000-415	957-000-417	S20T MDUNR/L4	1.250	12	1.000	1.700	DNMG 432	IDSN-433	CL-22	XNS-48	NL-46	\$296.40
957-000-433	957-000-434	S24U MDUNR/L4	1.500	14	1.125	1.960	DNMG 432	IDSN-433	CL-22	XNS-48	NL-46	\$339.80

Coolant Thru

PRODUCT # Left hand	PRODUCT # Right hand	Designation	DCON MS	LF	WF	DMIN	Insert	Shim Seat	Clamp	Clamp Screw	Lock Pin	Price
957-000-127	957-000-128	A12R MDUNR/L3	0.750	8	0.625	1.050	DNMG 332	--	CL-7	XNS-36	NL-33L	\$178.80
957-000-155	957-000-156	A16S MDUNR/L3	1.000	10	0.750	1.310	DNMG 332	--	CL-7	XNS-36	NL-33L	\$222.40
957-000-171	957-000-173	A20T MDUNR/L3	1.250	12	1.000	1.700	DNMG 332	IDSN-322	CL-7	XNS-36	NL-34L	\$316.10
957-000-172	957-000-174	A20T MDUNR/L4	1.250	12	1.000	1.700	DNMG 432	IDSN-433	CL-22	XNS-48	NL-46	\$316.10
957-000-193	957-000-194	A24U MDUNR/L4	1.500	14	1.125	1.960	DNMG 432	IDSN-433	CL-22	XNS-48	NL-46	\$363.00

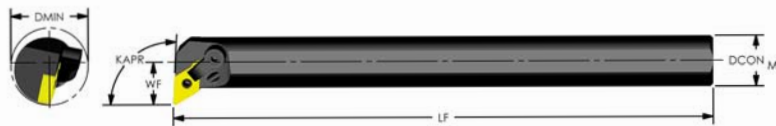

Negative 55° Diamond (KAPR: 93°)

4:1 Ratio

Coolant Thru

PRODUCT #	Designation	DCON MS	LF	WF	DMIN	Insert	Shim	Shim Screw	Clamp Assy.	Price
957-000-168	A20T DDUNR4	1.250	12	1.000	1.700	DNMG 432	IDSN 433	PB4-SS	PB4-CA	\$366.30
957-000-187	A24U DDUNR4	1.500	14	1.125	1.965	DNMG 432	IDSN 433	PB4-SS	PB4-CA	\$470.90

PRODUCT #	Shim Screw	Price Each
968-000-109	PB3-SS	\$3.10
968-000-111	PB4-SS	\$3.10

PACKAGE SIZE OF 5

PRODUCT #	Clamp Assy.	Price Each
968-000-107	PB3-CA	\$20.10
968-000-110	PB4-CA	\$21.30

PACKAGE SIZE OF 1

PRODUCT #	Clamp	Price Each
968-000-016	CL-6	\$5.30
968-000-017	CL-7	\$5.30
968-000-020	CL-9	\$5.30
968-000-010	CL-12	\$5.30
968-000-011	CL-19	\$6.60
968-000-012	CL-20	\$5.30

PACKAGE SIZE OF 1

PRODUCT #	Clamp	Price Each
968-000-013	CL-21	\$12.40
968-000-014	CL-22	\$12.60
968-000-015	CL-30	\$9.30
968-000-018	CL-84	\$28.40
968-000-019	CL-85	\$28.40

PRODUCT #	Clamp Screw	Price Each
968-000-176	XNS-36	\$2.20
968-000-177	XNS-47	\$2.20
968-000-178	XNS-48	\$2.20
968-000-179	XNS-510	\$2.20
968-000-180	XNS-58	\$2.20
968-000-181	XNS-59	\$2.20

PACKAGE SIZE OF 5

ULTRA-DEX

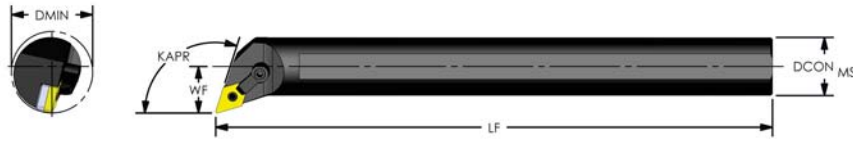

4:1 Ratio

Negative 55° Diamond (KAPR: 72.5°) Profiling

No Coolant

PRODUCT # Left hand	PRODUCT # Right hand	Designation	DCON MS	LF	WF	DMIN	Insert	Shim Seat	Clamp	Clamp Screw	Lock Pin	Price
957-000-412	957-000-413	S20T MDQNR/L4	1.250	12	1.000	1.700	DNMG 432	IDSN-433	CL-22	XNS-48	NL-46	\$296.40
957-000-431	957-000-432	S24U MDQNR/L4	1.500	14	1.125	1.960	DNMG 432	IDSN-433	CL-22	XNS-48	NL-46	\$339.80

Coolant Thru

PRODUCT # Left hand	PRODUCT # Right hand	Designation	DCON MS	LF	WF	DMIN	Insert	Shim Seat	Clamp	Clamp Screw	Lock Pin	Price
957-000-169	957-000-170	A20T MDQNR/L4	1.250	12	1.000	1.700	DNMG 432	IDSN-433	CL-22	XNS-48	NL-46	\$316.10
957-000-191	957-000-192	A24U MDQNR/L4	1.500	14	1.125	1.960	DNMG 432	IDSN-433	CL-22	XNS-48	NL-46	\$363.00

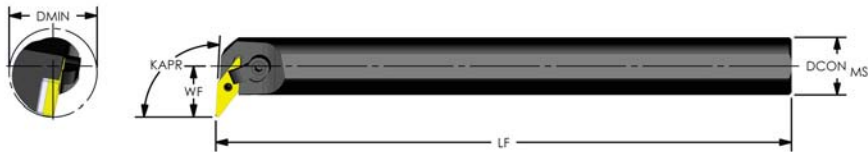

4:1 Ratio

Negative 35° Diamond (KAPR: 93°) Profiling

No Coolant

PRODUCT # Right hand	Designation	DCON MS	LF	WF	DMIN	Insert	Shim Seat	Clamp	Clamp Screw	Lock Pin	Price
957-000-396	S16S MVUNR3	1.000	10	.875	1.435	VNMG 332	IVSN-322	CL-20	XNS-47	NL-34L	\$234.90
957-000-418	S20T MVUNR3	1.250	12	1.000	1.705	VNMG 332	IVSN-322	CL-20	XNS-47	NL-34L	\$296.40
957-000-437	S24U MVUNR3	1.500	14	1.120	1.960	VNMG 332	IVSN-322	CL-20	XNS-47	NL-34L	\$339.80

Coolant Thru

PRODUCT # Right hand	Designation	DCON MS	LF	WF	DMIN	Insert	Shim Seat	Clamp	Clamp Screw	Lock Pin	Price
957-000-157	A16S MVUNR3	1.000	10	0.875	1.435	VNMG 332	IVSN-322	CL-20	XNS-47	NL-34L	\$248.60
957-000-175	A20T MVUNR3	1.250	12	1.000	1.705	VNMG 332	IVSN-322	CL-20	XNS-47	NL-34L	\$316.10
957-000-195	A24U MVUNR3	1.500	14	1.120	1.960	VNMG 332	IVSN-322	CL-20	XNS-47	NL-34L	\$363.00

PRODUCT #	Shim Seat	Price Each
968-000-053	ICSN-433	\$5.90
968-000-054	ICSN-533	\$7.10
968-000-055	ICSN-633	\$8.20
968-000-063	ISSN-432	\$5.80
968-000-064	ISSN-433	\$5.80
968-000-065	ISSN-533	\$6.80
968-000-066	ISSN-633	\$8.10
968-000-056	IDSN-322	\$4.70
968-000-057	IDSN-433	\$5.30
968-000-058	IDSN-533	\$8.10
968-000-067	ITSN-323	\$4.10
968-000-068	ITSN-433	\$6.50

PRODUCT #	Shim Seat	Price Each
968-000-069	ITSN-533	\$8.50
968-000-070	ITSN-636	\$11.40
968-000-071	IVSN-322	\$4.70
968-000-072	IVSN-432	\$6.30
968-000-073	IVSN-433	\$6.30
968-000-074	IWSN-322	\$5.30
968-000-075	IWSN-433	\$7.20
968-000-059	IRSN-32	\$5.20
968-000-060	IRSN-43	\$4.70
968-000-061	IRSN-53	\$7.50
968-000-062	IRSN-63	\$8.50

PRODUCT #	Lock Pin	Price Each
968-000-097	NL-33	\$3.00
968-000-098	NL-33L	\$3.00
968-000-099	NL-34	\$3.00
968-000-100	NL-34L	\$3.00
968-000-101	NL-44	\$3.00
968-000-102	NL-46	\$2.50
968-000-103	NL-56	\$3.30
968-000-104	NL-58	\$3.00
968-000-105	NL-68	\$3.30
968-000-106	NL-68L	\$6.50

PACKAGE SIZE OF 5

PACKAGE SIZE OF 10

STEEL

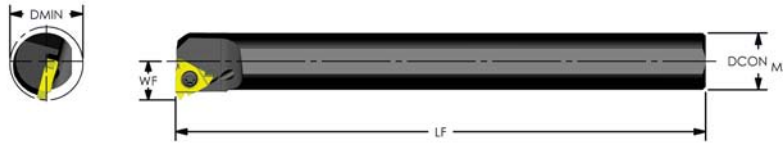

4:1 Ratio

Threading/Grooving Laydown

Coolant Thru

PRODUCT #	Designation Right Hand	DCON MS	LF	WF	L	DMIN	Insert	Insert Screw	Anvil Screw	Anvil	Price
957-000-046	A08M LSER2	0.500	6	.308	--	0.588	2IR	SR34505	--	--	\$101.40
957-000-082	A10Q LSER2	0.625	7	.371	--	0.721	2IR	SR34505	--	--	\$123.20
957-000-105	A12Q LSER3	0.750	7	.510	--	0.935	3IR	MTS-35	--	--	\$142.80
957-000-132	A16R LSER3	1.000	8	.650	--	1.210	3IR	SA3T	SY3T	YI3	\$196.20

PRODUCT #	Designation Left Hand	DCON MS	LF	WF	L	DMIN	Insert	Insert Screw	Anvil Screw	Anvil	Price
957-000-104	A12Q LSEL3	0.750	7	.510	--	.935	3IL	MTS-35	--	--	\$142.80
957-000-131	A16R LSEL3	1.000	8	.650	--	1.210	3IL	SA3T	SY3T	YE3	\$196.20

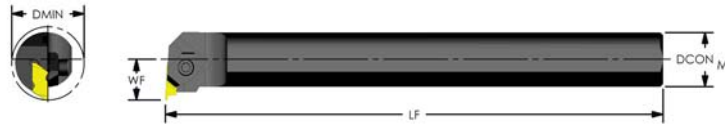

4:1 Ratio

Threading/Grooving Top Notch

No Coolant

PRODUCT #	Designation Right Hand	DCON MS	LF	WF	DMIN	Insert	Clamp	Clamp Screw	Price
957-000-273	S08M NER2	0.500	6	0.437	0.730	NG 2L	CM-147	6-32	\$176.70
957-000-312	S10Q NER2	0.625	7	0.500	1.000		CM-75	6-32	\$166.50
957-000-338	S12Q NER2	0.750	7	0.562	1.120		CM-75	6-32	\$169.90
957-000-369	S16R NER3	1.000	8	0.688	1.250	NG 3L	CM-73	10-32	\$225.80

PRODUCT #	Designation Left Hand	DCON MS	LF	WF	DMIN	Insert	Clamp	Clamp Screw	Price
957-000-272	S08M NEL2	0.500	6	.437	.730	NG 2R	CM-146	6-32	\$176.70
957-000-311	S10Q NEL2	.625	7	0.500	1.000	NG 2R	CM-74	6-32	\$166.50
957-000-337	S12Q NEL2	.750	7	.562	1.120	NG 2R	CM-74	6-32	\$169.90
957-000-368	S16R NEL3	1.000	8	.688	1.250	NG 3R	CM-72	10-32	\$225.80

PRODUCT #	Clamp	Price Each
968-000-016	CL-6	\$5.30
968-000-017	CL-7	\$5.30
968-000-020	CL-9	\$5.30
968-000-010	CL-12	\$5.30
968-000-011	CL-19	\$6.60
968-000-012	CL-20	\$5.30

PRODUCT #	Clamp	Price Each
968-000-013	CL-21	\$12.40
968-000-014	CL-22	\$12.60
968-000-015	CL-30	\$9.30
968-000-018	CL-84	\$28.40
968-000-019	CL-85	\$28.40

PACKAGE SIZE OF 1

PRODUCT #	Anvil	Price Each
968-000-185	YI3	\$20.10
968-000-182	YE3	\$20.10
968-000-187	YI4	\$31.90
968-000-186	YI3M-1.5N	\$30.80
968-000-183	YE4	\$31.90
968-000-188	YI5	\$50.60
968-000-184	YE5	\$50.60

PACKAGE SIZE OF 1

PRODUCT #	Anvil Screw	Price Each
968-000-146	SY3T	\$2.40
968-000-147	SY4T	\$3.00
968-000-148	SY5T	\$4.70

PACKAGE SIZE OF 5

PRODUCT #	Insert Screw	Price Each
968-000-124	SA3T	\$3.50
968-000-125	SA4T	\$4.70
968-000-126	SA5T	\$8.10

PACKAGE SIZE OF 5

ULTRA-DEX[®]

STEEL



Coolant Thru

- (1) A06K SCLCR2 (3/8" Bar)
- (1) A08M SCLCR2 (1/2" Bar)
- (1) A10Q SCLCR2 (5/8" Bar)
- (5) CCMT 21.51 ZX3-UD51



Coolant Thru

- (1) A10Q SCLCR3 (5/8" Bar)
- (1) A12Q SCLCR3 (3/4" Bar)
- (1) A16R SCLCR3 (1" Bar)
- (5) CCMT 32.51 ZX3-UD51



No Coolant

- (1) S03G SCLDR1.2
- (1) S03.5G SCLDR1.5
- (1) S04G SCLDR1.5
- (1) S05G SCLPR1.8
- (2) CDHB 1.20.60 UD51
- (2) CDGW 1.510 UD51
- (2) CPMT 1.81.20.5 LX6-UD52

PRODUCT #	Product kits	Price
957-000-204	PDBK-356	\$268.20
957-000-205	PDBK-671	\$351.00
957-000-206	PDBK-MINI	\$245.10

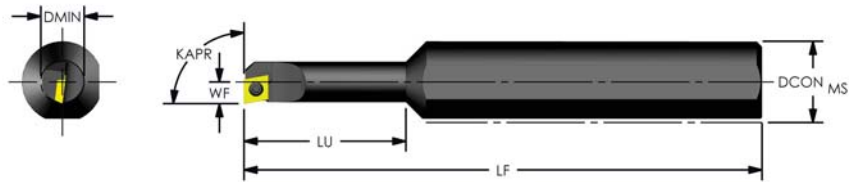

Positive 80° Diamond (KAPR: 90°) Reduced Neck

No Coolant

PRODUCT #	Designation	DCON MS	LF	LU	WF	DMIN	Insert	Insert Screw	Key	Price
957-000-450	SCFDR2-5	.625	4	0.500	.138	.276	CDGW 1.510	MTS-184	T-6	\$103.80
957-000-446	SCFDR2-15	.625	4	1.000	.138	.276	CDGW 1.510	MTS-184	T-6	\$103.80
957-000-447	SCFDR2-25	.625	4	.750	.167	.334	CDGW 1.510	MTS-184	T-6	\$103.80
957-000-448	SCFDR2-35	.625	4	1.250	.167	.334	CDGW 1.510	MTS-184	T-6	\$103.80
957-000-449	SCFDR2-45	.625	4	1.000	.203	.450	CDGW 1.510	MTS-184	T-6	\$103.80
957-000-451	SCFDR2-55	.625	4	1.500	.203	.450	CDGW 1.510	MTS-184	T-6	\$103.80

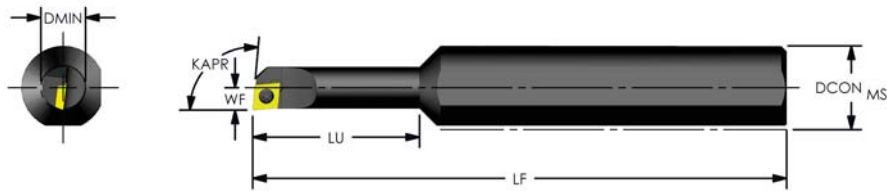

Positive 80° Diamond (KAPR: 95°) Reduced Neck

No Coolant

PRODUCT #	Designation	DCON MS	LF	LU	WF	DMIN	Insert	Insert Screw	Key	Price
957-000-456	SCLDR2-5	.625	4	0.500	.138	.276	CDGW 1.510	MTS-184	T-6	\$103.80
957-000-452	SCLDR2-15	.625	4	1.000	.138	.276	CDGW 1.510	MTS-184	T-6	\$103.80
957-000-453	SCLDR2-25	.625	4	.750	.167	.334	CDGW 1.510	MTS-184	T-6	\$103.80
957-000-454	SCLDR2-35	.625	4	1.250	.167	.334	CDGW 1.510	MTS-184	T-6	\$103.80
957-000-455	SCLDR2-45	.625	4	1.000	.203	.450	CDGW 1.510	MTS-184	T-6	\$103.80
957-000-457	SCLDR2-55	.625	4	1.500	.203	.450	CDGW 1.510	MTS-184	T-6	\$103.80

PRODUCT #	Insert Screws	Price Each
968-000-086	MTS-183	\$3.20
968-000-087	MTS-184	\$3.20
968-000-088	MTS-2	\$2.90
968-000-091	MTS-224	\$3.20
968-000-092	MTS-255	\$3.20
968-000-094	MTS-35	\$3.20
968-000-090	MTS-2.5L	\$2.90
968-000-052	ETS 4-40	\$3.20

PACKAGE SIZE OF 5

PRODUCT #	Key	Price Each
968-000-156	T-6	\$4.20
968-000-158	T-7	\$3.80
968-000-149	T-10	\$6.50
968-000-151	T-15	\$3.80
968-000-153	T-20	\$4.00

PACKAGE SIZE OF 5

ULTRA-DEX[®]

STEEL

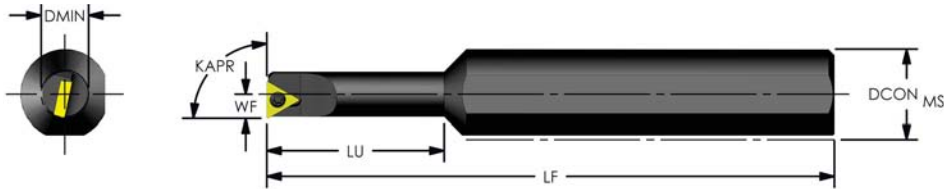

Positive Triangle (KAPR: 90°) Reduced Neck

No Coolant

PRODUCT #	Designation	DCON MS	LF	LU	WF	DMIN	Insert	Insert Screw	Key	Price
957-000-462	STFCR2-5	.625	4	0.500	.138	.276	TCMT 1.21.20.5	MTS-184	T-6	\$103.80
957-000-458	STFCR2-15	.625	4	1.000	.138	.276	TCMT 1.21.20.5	MTS-184	T-6	\$103.80
957-000-459	STFCR2-25	.625	4	.750	.167	.334	TCMT 1.21.20.5	MTS-184	T-6	\$103.80
957-000-460	STFCR2-35	.625	4	1.250	.167	.334	TCMT 1.21.20.5	MTS-184	T-6	\$103.80
957-000-461	STFCR2-45	.625	4	1.000	.203	.450	TCMT 1.21.20.5	MTS-184	T-6	\$103.80
957-000-463	STFCR2-55	.625	4	1.500	.203	.450	TCMT 1.21.20.5	MTS-184	T-6	\$103.80

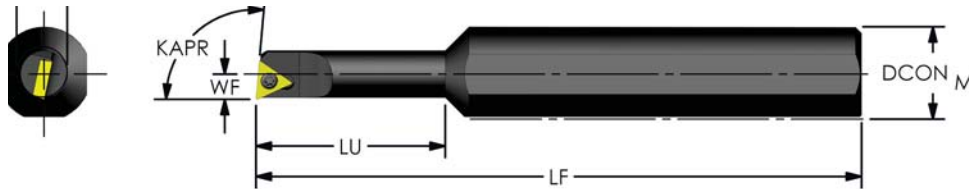

Positive Triangle (KAPR: 95°) Reduced Neck

No Coolant

PRODUCT #	Designation	DCON MS	LF	LU	WF	DMIN	Insert	Insert Screw	Key	Price
957-000-468	STLCR2-5	.625	4	0.500	.138	.276	TCMT 1.21.20.5	MTS-184	T-6	\$103.80
957-000-464	STLCR2-15	.625	4	1.000	.138	.276	TCMT 1.21.20.5	MTS-184	T-6	\$103.80
957-000-465	STLCR2-25	.625	4	.750	.167	.334	TCMT 1.21.20.5	MTS-184	T-6	\$103.80
957-000-466	STLCR2-35	.625	4	1.250	.167	.334	TCMT 1.21.20.5	MTS-184	T-6	\$103.80
957-000-467	STLCR2-45	.625	4	1.000	.203	.450	TCMT 1.21.20.5	MTS-184	T-6	\$103.80
957-000-469	STLCR2-55	.625	4	1.500	.203	.450	TCMT 1.21.20.5	MTS-184	T-6	\$103.80

PRODUCT #	Insert Screws	Price Each
968-000-086	MTS-183	\$3.20
968-000-087	MTS-184	\$3.20
968-000-088	MTS-2	\$2.90
968-000-091	MTS-224	\$3.20
968-000-092	MTS-255	\$3.20
968-000-094	MTS-35	\$3.20
968-000-090	MTS-2.5L	\$2.90
968-000-052	ETS 4-40	\$3.20

PACKAGE SIZE OF 5

PRODUCT #	Key	Price Each
968-000-156	T-6	\$4.20
968-000-158	T-7	\$3.80
968-000-149	T-10	\$6.50
968-000-151	T-15	\$3.80
968-000-153	T-20	\$4.00

PACKAGE SIZE OF 5

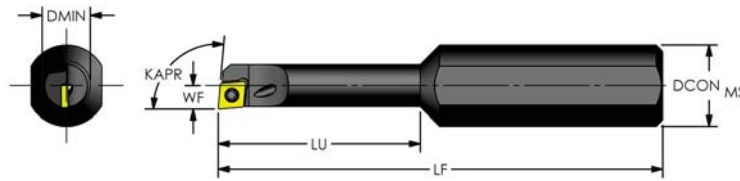

Positive 80° Diamond (KAPR: 95°) Reduced Neck **SERIES "C"** **Coolant Thru**

PRODUCT #	Designation	DCON MS	KAPR	LF	LU	WF	DMIN	Insert	Insert Screw	Key	Price
915-000-017	CSUD-180/375-1/2-5R	.375	.180	2.5	0.500	.104	.208	CDHB 1.20.60.5	MTS-183	T-6	\$133.30
915-000-018	CSUD-180/375-1-5R	.375	.180	2.5	1.000	.104	.208	CDHB 1.20.60.5	MTS-183	T-6	\$133.30
915-000-022	CSUD-203/375-1/2-5R	.375	.203	2.5	0.500	.116	.230	CDHB 1.20.60.5	MTS-183	T-6	\$133.30
915-000-023	CSUD-203/375-1-5R	.375	.203	2.5	1.000	.116	.230	CDHB 1.20.60.5	MTS-183	T-6	\$133.30
915-000-026	CSUD-250/375-1 1/4-5R	.375	.250	2.5	1.250	.145	.285	CDHB 1.20.60.5	MTS-183	T-6	\$130.00
915-000-019	CSUD-180/500-1/2-5R	0.500	.180	2.75	0.500	.104	.208	CDHB 1.20.60.5	MTS-183	T-6	\$138.90
915-000-020	CSUD-180/500-1-5R	0.500	.180	2.75	1.000	.104	.208	CDHB 1.20.60.5	MTS-183	T-6	\$138.90
915-000-024	CSUD-203/500-1/2-5R	0.500	.203	2.75	0.500	.116	.230	CDHB 1.20.60.5	MTS-183	T-6	\$145.60
915-000-025	CSUD-203/500-1-5R	0.500	.203	2.75	1.000	.116	.230	CDHB 1.20.60.5	MTS-183	T-6	\$138.90
915-000-028	CSUD-250/500-3/4-5R	0.500	.250	2.75	.750	.145	.285	CDHB 1.20.60.5	MTS-184	T-6	\$138.90
915-000-027	CSUD-250/500-1 1/4-5R	0.500	.250	2.75	1.250	.145	.285	CDHB 1.20.60.5	MTS-184	T-6	\$138.90

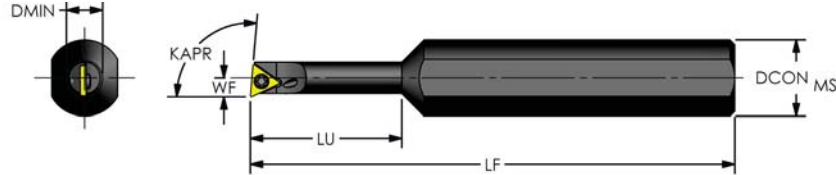

Positive Triangle (KAPR: 95°) Reduced Neck **SERIES "F, Q"** **Coolant Thru**

PRODUCT #	Designation	DCON MS	KAPR	LF	LU	WF	DMIN	Insert	Insert Screw	Key	Price
915-000-041	FSUD-203/500-1/2-5R	0.500	.203	3	0.500	.126	.275	TDHB 1.280.750.5	MTS-224	T-7	\$127.70
915-000-042	FSUD-203/500-1-5R	0.500	.203	3	1.000	.126	.275	TDHB 1.280.750.5	MTS-224	T-7	\$137.80
915-000-044	FSUD-250/500-3/4-5R	0.500	.259	3	0.750	.156	.300	TDHB 1.280.750.5	MTS-224	T-7	\$133.30
915-000-050	FSUD-312/500-1-5R	0.500	.321	3	1.000	.187	.360	TDHB 1.280.750.5	MTS-224	T-7	\$127.70
915-000-049	FSUD-312/500-1 1/2-5R	0.500	.321	3	1.500	.187	.360	TDHB 1.280.750.5	MTS-224	T-7	\$137.80
915-000-043	FSUD-203/625-1/2-5R	.625	.203	4	0.500	.126	.275	TDHB 1.280.750.5	MTS-224	T-7	\$146.80
915-000-046	FSUD-250/625-3/4-5R	.625	.259	4	0.750	.156	.300	TDHB 1.280.750.5	MTS-224	T-7	\$133.30
915-000-045	FSUD-250/625-1 1/4-5R	.625	.259	4	1.250	.156	.300	TDHB 1.280.750.5	MTS-224	T-7	\$133.30
915-000-051	FSUD-312/625-1-5R	.625	.321	4	1.000	.187	.360	TDHB 1.280.750.5	MTS-224	T-7	\$133.30
915-000-072	QSUD-375/500-1 1/8-5R	0.500	.390	3.75	1.125	.221	.438	TPCB 220.5	ETS 4-40	T-10	\$127.70
915-000-073	QSUD-375/500-1 7/8-5R	0.500	.390	3.75	1.875	.221	.438	TPCB 220.5	ETS 4-40	T-10	\$127.70
915-000-074	QSUD-375/625-1 1/8-5R	.625	.390	4.25	1.125	.221	.438	TPCB 220.5	ETS 4-40	T-10	\$138.90
915-000-075	QSUD-375/625-1 7/8-5R	.625	.390	4.25	1.875	.221	.438	TPCB 220.5	ETS 4-40	T-10	\$138.90
915-000-076	QSUD-375/750-1 1/2-5R	.750	.390	4	1.500	.221	.438	TPCB 220.5	ETS 4-40	T-10	\$149.00
915-000-081	QSUD-625/750-2 1/2-5R	.750	.635	4.5	2.500	.353	.688	TPCB 220.5	ETS 4-40	T-10	\$163.60

STEEL

CARBIDE BORING BARS

Maximum rigidity and efficiency for use in tougher applications

Up to 8:1 Ratio

.156" -1.5" Diameters





CARBIDE

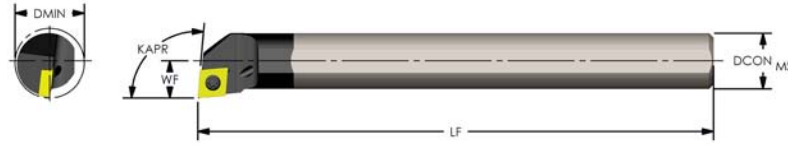

8:1 Ratio

Positive 80° Diamond (KAPR: 95°)

Coolant Thru

PRODUCT # Left hand	PRODUCT # Right hand	Designation	DCON MS (mm)	LF (mm)	WF (mm)	DMIN (mm)	Insert	Insert Screw	Key	Price
920-000-428	920-000-429	M-E06H SCLDR/L04*	6	100	3.5	7	CDGW 1.510	MTS-184	T-6	\$184.50
920-000-432	920-000-433	M-E08K SCLCR/L06*	8	125	6	11	CCMT 21.51	MTS-255	T-7	\$194.00
920-000-436	920-000-437	M-E10M SCLCR/L06	10	150	7	13	CCMT 21.51	MTS-255	T-7	\$220.50
920-000-442	920-000-443	M-E12Q SCLCR/L06	12	180	9	16	CCMT 21.51	MTS-255	T-7	\$242.80
920-000-448	920-000-449	M-E16R SCLCR/L09	16	200	11	20	CCMT 32.51	MTS-35	T-15	\$372.10
920-000-454	920-000-455	M-E20S SCLCR/L09	20	250	13	25	CCMT 32.51	MTS-35	T-15	\$516.30
920-000-460	920-000-461	M-E25T SCLCR/L09	25	300	17	32	CCMT 32.51	MTS-35	T-15	\$840.60

*bars 8mm and smaller do not have flats

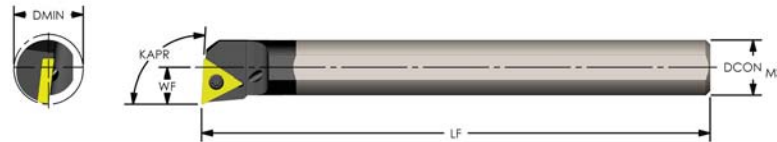

8:1 Ratio

Positive Triangle (KAPR: 93°)

Coolant Thru

PRODUCT # Left hand	PRODUCT # Right hand	Designation	DCON MS (mm)	LF (mm)	WF (mm)	DMIN (mm)	Insert	Insert Screw	Key	Price
920-000-430	920-000-431	M-E06H STUCR/L06*	6	100	3.5	7	TCMT 1.21.20.5	MTS-184	T-6	\$184.50
920-000-434	920-000-435	M-E08K STUCR/L06*	8	125	6	11	TCMT 1.21.20.5	MTS-184	T-6	\$194.00
920-000-440	920-000-441	M-E10M STUCR/L11	10	150	7	13	TCMT 21.51	MTS-255	T-7	\$220.50
920-000-446	920-000-447	M-E12Q STUCR/L11	12	180	9	16	TCMT 21.51	MTS-255	T-7	\$242.80
920-000-452	920-000-453	M-E16R STUCR/L11	16	200	11	20	TCMT 21.51	MTS-255	T-7	\$372.10
920-000-458	920-000-459	M-E20S STUCR/L16	20	250	13	25	TCMT 32.51	MTS-35	T-15	\$516.30
920-000-464	920-000-465	M-E25T STUCR/L16	25	300	17	32	TCMT 32.51	MTS-35	T-15	\$840.60

*bars 8mm and smaller do not have flats

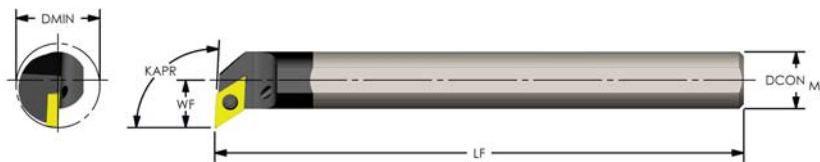

8:1 Ratio

Positive 55° Diamond (KAPR: 93°) Profiling

Coolant Thru

PRODUCT # Left hand	PRODUCT # Right hand	Designation	DCON MS (mm)	LF (mm)	WF (mm)	DMIN (mm)	Insert	Insert Screw	Key	Price
920-000-438	920-000-439	M-E10M SDUCR/L07	10	150	9	15	DCMT 21.51	MTS-255	T-7	\$230.10
920-000-444	920-000-445	M-E12Q SDUCR/L07	12	180	11	18	DCMT 21.51	MTS-255	T-7	\$283.10
920-000-450	920-000-451	M-E16R SDUCR/L07	16	200	13	22	DCMT 21.51	MTS-255	T-7	\$381.60
920-000-456	920-000-457	M-E20S SDUCR/L11	20	250	15	27	DCMT 32.51	MTS-35	T-15	\$526.90
920-000-462	920-000-463	M-E25T SDUCR/L11	25	300	18	33	DCMT 32.51	MTS-35	T-15	\$859.70

CARBIDE

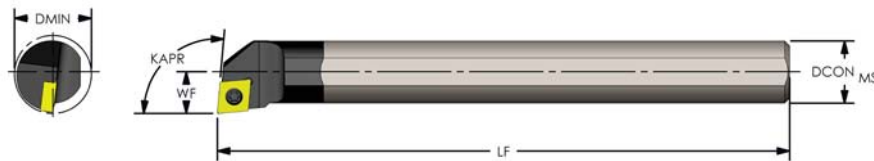

8:1 Ratio

Positive 80° Diamond (KAPR: 95°)

No Coolant

PRODUCT # Left hand	PRODUCT # Right hand	Designation	DCON MS	LF	WF	DMIN	Insert	Insert Screw	Key	Price
920-000-001	920-000-002	C02.5G SCLDR/L1.2*	.156	3.5	.090	.175	CDHB 1.20.60	MTS-182	T-6	\$165.40
920-000-005	920-000-006	C03H SCLDR/L1.2*	.187	4	.102	.205	CDHB 1.20.60	MTS-183	T-6	\$165.40
920-000-003	920-000-004	C03.5H SCLDR/L1.5*	.218	4	.125	.245	CDGW 1.510	MTS-184	T-6	\$165.40
920-000-008	920-000-010	C04H SCLDR/L1.5*	.250	4	.172	.312	CDGW 1.510	MTS-184	T-6	\$165.40
920-000-018	920-000-020	C05K SCLPR/L1.8*	.312	5	.219	.395	CPMT 1.81.20.5	MTS-224	T-7	\$165.40
920-000-032	920-000-034	C06M SCLPR/L2	.375	6	.250	.460	CPMT 21.51	MTS-255	T-7	\$189.80
920-000-062	920-000-065	C08J SCLPR/L2	.500	4.5	.312	.600	CPMT 21.51	MTS-255	T-7	\$214.20
920-000-094	920-000-097	C08R SCLPR/L2	.500	8	.312	.600	CPMT 21.51	MTS-255	T-7	\$246.00
920-000-064	920-000-067	C08J SCLPR/L3	.500	4.5	.344	.625	CPMT 32.51	MTS-35	T-15	\$214.20
920-000-096	920-000-099	C08R SCLPR/L3	.500	8	.344	.625	CPMT 32.51	MTS-35	T-15	\$246.00
920-000-028	920-000-030	C06M SCLCR/L2	.375	6	.250	.460	CCMT 21.51	MTS-255	T-7	\$189.80
920-000-056	920-000-059	C08J SCLCR/L2	.500	4.5	.312	.600	CCMT 21.51	MTS-255	T-7	\$214.20
920-000-088	920-000-091	C08R SCLCR/L2	.500	8	.312	.600	CCMT 21.51	MTS-255	T-7	\$246.00
920-000-058	920-000-061	C08J SCLCR/L3	.500	4.5	.344	.625	CCMT 32.51	MTS-35	T-15	\$214.20
920-000-090	920-000-093	C08R SCLCR/L3	.500	8	.344	.625	CCMT 32.51	MTS-35	T-15	\$246.00

Minimum Clearance

No Coolant

PRODUCT # Left hand	PRODUCT # Right hand	Designation	DCON MS	LF	WF	DMIN	Insert	Insert Screw	Key	Price
920-000-009	920-000-011	C04H SCLDR/L1.5-138 *	.250	4	.138	.275	CDGW 1.510	MTS-184	T-6	\$165.40
920-000-019	920-000-021	C05K SCLPR/L1.8-167 *	.312	5	.167	.340	CPMT 1.81.20.5	MTS-224	T-7	\$165.40
920-000-033	920-000-035	C06M SCLPR/L2-203	.375	6	.203	.410	CPMT 21.51	MTS-255	T-7	\$189.80
920-000-063	920-000-066	C08J SCLPR/L2-281	0.500	4.5	.281	.560	CPMT 21.51	MTS-255	T-7	\$214.20
920-000-095	920-000-098	C08R SCLPR/L2-281	0.500	8	.281	.560	CPMT 21.51	MTS-255	T-7	\$246.00
920-000-029	920-000-031	C06M SCLCR/L2-203	.375	6	.203	.410	CCMT 21.51	MTS-255	T-7	\$189.80
920-000-057	920-000-060	C08J SCLCR/L2-281	0.500	4.5	.281	.560	CCMT 21.51	MTS-255	T-7	\$214.20
920-000-089	920-000-092	C08R SCLCR/L2-281	0.500	8	.281	.560	CCMT 21.51	MTS-255	T-7	\$246.00

Minimum Clearance Bars are intended for light machining with minimum bore clearance. Max depth of cut .015" - .020"
* bars .312 and smaller do not have flats

USE THE RIGHT SET SCREW FLAT POINT, NOT CUP POINT



CARBIDE

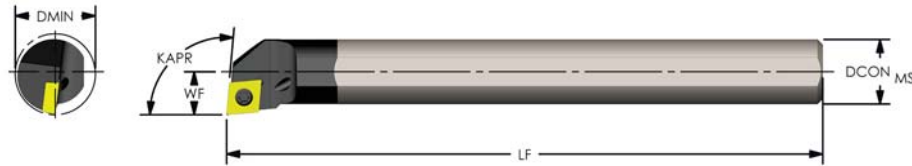

8:1 Ratio

Positive 80° Diamond (KAPR: 95°)

Coolant Thru

PRODUCT # Left hand	PRODUCT # Right hand	Designation	DCON MS	LF	WF	DMIN	Insert	Insert Screw	Key	Price
920-000-120	920-000-121	E02.5G SCLDR/L1.2 *	.156	3.5	.090	.175	CDHB 1.20.60	MTS-183	T-6	\$186.60
920-000-124	920-000-125	E03H SCLDR/L1.2 *	.187	4	.102	.205	CDHB 1.20.60	MTS-183	T-6	\$186.60
920-000-122	920-000-123	E03.5H SCLDR/L1.5 *	.218	4	.125	.245	CDGW 1.510	MTS-184	T-6	\$186.60
920-000-127	920-000-129	E04H SCLDR/L1.5 *	.250	4	.172	.312	CDGW 1.510	MTS-184	T-6	\$186.60
920-000-137	920-000-139	E05K SCLPR/L1.8 *	.312	5	.219	.395	CPMT 1.81.20.5	MTS 224	T-7	\$186.60
920-000-151	920-000-153	E06M SCLPR/L2	.375	6	.250	.460	CPMT 21.51	MTS-255	T-7	\$208.90
920-000-183	920-000-186	E08J SCLPR/L2	0.500	4.5	.312	.600	CPMT 21.51	MTS-255	T-7	\$234.30
920-000-219	920-000-222	E08R SCLPR/L2	0.500	8	.312	.600	CPMT 21.51	MTS-255	T-7	\$265.00
920-000-254	920-000-256	E10Q SCLPR/L2	.625	7	.406	.770	CPMT 21.51	MTS-255	T-7	\$329.70
920-000-279	920-000-281	E10S SCLPR/L2	.625	10	.406	.770	CPMT 21.51	MTS-255	T-7	\$401.80
920-000-185	920-000-188	E08J SCLPR/L3	0.500	4.5	.344	.625	CPMT 32.51	MTS-35	T-15	\$234.30
920-000-221	920-000-224	E08R SCLPR/L3	0.500	8	.344	.625	CPMT 32.51	MTS-35	T-15	\$265.00
920-000-255	920-000-257	E10Q SCLPR/L3	.625	7	.406	.760	CPMT 32.51	MTS-35	T-15	\$329.70
920-000-280	920-000-282	E10S SCLPR/L3	.625	10	.406	.760	CPMT 32.51	MTS-35	T-15	\$401.80
920-000-307	920-000-309	E12Q SCLPR/L3	.750	7	0.500	.920	CPMT 32.51	MTS-35	T-15	\$414.50
920-000-334	920-000-335	E12S SCLPR/L3	.750	10	0.500	.920	CPMT 32.51	MTS-35	T-15	\$479.20
920-000-364	920-000-365	E16R SCLPR/L3	1.000	8	.625	1.185	CPMT 32.51	MTS-35	T-15	\$618.50
920-000-394	920-000-395	E16T SCLPR/L3	1.000	12	.625	1.185	CPMT 32.51	MTS-35	T-15	\$787.60

Minimum Clearance

Coolant Thru

PRODUCT # Left hand	PRODUCT # Right hand	Designation	DCON MS	LF	WF	DMIN	Insert	Insert Screw	Key	Price
920-000-128	920-000-130	E04H SCLDR/L1.5-138 *	.250	4	.138	.270	CDGW 1.510	MTS-184	T-6	\$186.60
920-000-138	920-000-140	E05K SCLPR/L1.8-167 *	.312	5	.167	.340	CPMT 1.81.20.5	MTS 224	T-7	\$186.60
920-000-152	920-000-154	E06M SCLPR/L2-203	.375	6	.203	.410	CPMT 21.51	MTS-255	T-7	\$208.90
920-000-184	920-000-187	E08J SCLPR/L2-281	0.500	4.5	.281	.560	CPMT 21.51	MTS-255	T-7	\$234.30
920-000-220	920-000-223	E08R SCLPR/L2-281	0.500	8	.281	.560	CPMT 21.51	MTS-255	T-7	\$265.00

Minimum Clearance Bars are intended for light machining with minimum bore clearance. Max depth of cut .015" - .020"

* bars .312 and smaller do not have flats

PRODUCT #	Insert Screws	Price Each
968-000-086	MTS-183	\$3.20
968-000-087	MTS-184	\$3.20
968-000-088	MTS-2	\$2.90
968-000-091	MTS-224	\$3.20
968-000-092	MTS-255	\$3.20
968-000-094	MTS-35	\$3.20
968-000-090	MTS-2.5L	\$2.90
968-000-052	ETS 4-40	\$3.20

PACKAGE SIZE OF 5

PRODUCT #	Key	Price Each
968-000-156	T-6	\$4.20
968-000-158	T-7	\$3.80
968-000-149	T-10	\$6.50
968-000-151	T-15	\$3.80
968-000-153	T-20	\$4.00

PACKAGE SIZE OF 5

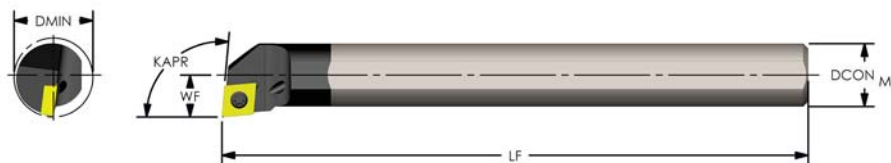

Positive 80° Diamond (KAPR: 95°)

Coolant Thru

PRODUCT # Left hand	PRODUCT # Right hand	Designation	DCON MS	LF	WF	DMIN	Insert	Insert Screw	Key	Price
920-000-147	920-000-149	E06M SCLCR/L2	.375	6	.250	.460	CCMT 21.51	MTS-255	T-7	\$208.90
920-000-177	920-000-180	E08J SCLCR/L2	0.500	4.5	.312	.600	CCMT 21.51	MTS-255	T-7	\$234.30
920-000-213	920-000-216	E08R SCLCR/L2	0.500	8	.312	.600	CCMT 21.51	MTS-255	T-7	\$265.00
920-000-250	920-000-252	E10Q SCLCR/L2	.625	7	.406	.760	CCMT 21.51	MTS-255	T-7	\$329.70
920-000-275	920-000-277	E10S SCLCR/L2	.625	10	.406	.760	CCMT 21.51	MTS-255	T-7	\$379.00
920-000-179	920-000-182	E08J SCLCR/L3	0.500	4.5	.344	.625	CCMT 32.51	MTS-35	T-15	\$234.30
920-000-215	920-000-218	E08R SCLCR/L3	0.500	8	.344	.625	CCMT 32.51	MTS-35	T-15	\$265.00
920-000-251	920-000-253	E10Q SCLCR/L3	.625	7	.406	.760	CCMT 32.51	MTS-35	T-15	\$329.70
920-000-276	920-000-278	E10S SCLCR/L3	.625	10	.406	.760	CCMT 32.51	MTS-35	T-15	\$401.80
920-000-306	920-000-307	E12Q SCLCR/L3	.750	7	0.500	.920	CCMT 32.51	MTS-35	T-15	\$414.50
920-000-332	920-000-333	E12S SCLCR/L3	.750	10	0.500	.920	CCMT 32.51	MTS-35	T-15	\$479.20
920-000-362	920-000-363	E16R SCLCR/L3	1.000	8	.625	1.185	CCMT 32.51	MTS-35	T-15	\$618.50
920-000-392	920-000-393	E16T SCLCR/L3	1.000	12	.625	1.185	CCMT 32.51	MTS-35	T-15	\$787.60
920-000-417	920-000-419	E20U SCLCR/L3	1.250	14	0.765	1.465	CCMT 32.51	MTS-35	T-15	\$1,471.30
920-000-418	920-000-420	E20U SCLCR/L4	1.250	14	0.765	1.465	CCMT 432	MTS-4	T-20	\$1,471.30
920-000-426	920-000-427	E24U SCLCR/L4	1.500	14	.890	1.730	CCMT 432	MTS-4	T-20	\$1,776.20

SERIES "C"

Minimum Clearance

Coolant Thru

PRODUCT # Left hand	PRODUCT # Right hand	Designation	DCON MS	LF	WF	DMIN	Insert	Insert Screw	Key	Price
920-000-148	920-000-150	E06M SCLCR/L2-203	.375	6	.203	.410	CCMT 21.51	MTS-255	T-7	\$208.90
920-000-178	920-000-181	E08J SCLCR/L2-281	0.500	4.5	.281	.560	CCMT 21.51	MTS-255	T-7	\$234.30
920-000-214	920-000-217	E08R SCLCR/L2-281	0.500	8	.281	.560	CCMT 21.51	MTS-255	T-7	\$265.00

Minimum Clearance Bars are intended for light machining with minimum bore clearance. Max depth of cut .015" - .020"

USE THE RIGHT SET SCREW FLAT POINT, NOT CUP POINT

PRODUCT #	Insert Screws	Price Each
968-000-086	MTS-183	\$3.20
968-000-087	MTS-184	\$3.20
968-000-088	MTS-2	\$2.90
968-000-091	MTS-224	\$3.20
968-000-092	MTS-255	\$3.20
968-000-094	MTS-35	\$3.20
968-000-090	MTS-2.5L	\$2.90
968-000-052	ETS 4-40	\$3.20

PRODUCT #	Key	Price Each
968-000-156	T-6	\$4.20
968-000-158	T-7	\$3.80
968-000-149	T-10	\$6.50
968-000-151	T-15	\$3.80
968-000-153	T-20	\$4.00

PACKAGE SIZE OF 5

PACKAGE SIZE OF 5



CARBIDE

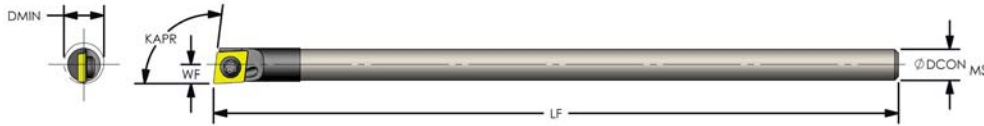

8:1 Ratio

Positive 80° Diamond (KAPR: 97°)

SERIES "C"

Coolant Thru

PRODUCT #	Designation	DCON MS	LF	WF	DMIN	Insert	Insert Screw	Key	Price
915-000-001	CCUD-165/156-6-7R *	.156	6	.095	.180	CDHB 1.20.60.5	MTS-183	T-6	\$237.50

* bars .312 and smaller do not have flats

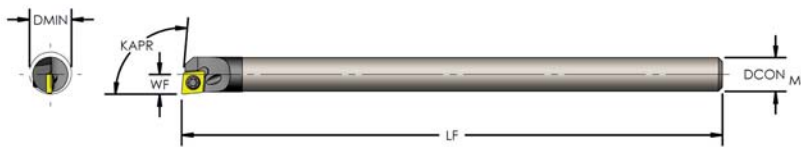

8:1 Ratio

Positive 80° Diamond (KAPR: 95°)

SERIES "C"

Coolant Thru

PRODUCT #	Designation	DCON MS	LF	WF	DMIN	Insert	Insert Screw	Key	Price
915-000-002	CCUD-180/187-4-5R *	.187	4	.104	.208	CDHB 1.20.60.5	MTS-183	T-6	\$224.00
915-000-003	CCUD-180/187-6-5R *	.187	6	.104	.208	CDHB 1.20.60.5	MTS-183	T-6	\$237.50
915-000-006	CCUD-187-4-5R *	.187	4	.111	.222	CDHB 1.20.60.5	MTS-183	T-6	\$224.00
915-000-007	CCUD-187-6-5R *	.187	6	.111	.222	CDHB 1.20.60.5	MTS-183	T-6	\$237.50
915-000-011	CCUD-250-4-5R *	.250	4	.145	.285	CDHB 1.20.60.5	MTS-184	T-6	\$224.00
915-000-013	CCUD-250-6-5R *	.250	6	.145	.285	CDHB 1.20.60.5	MTS-184	T-6	\$237.50
915-000-014	CCUD-312-5-5R *	.312	5	.185	.360	CDHB 1.20.60.5	MTS-184	T-6	\$237.50
915-000-012	CCUD-250-4-5R-1.5 *	.250	4	.145	.285	CDGW 1.510	MTS-184	T-6	\$224.00

* bars .312 and smaller do not have flats

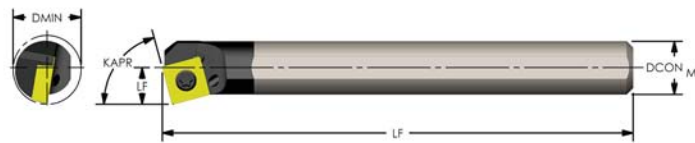

8:1 Ratio

Positive Square (KAPR: 75°)

Coolant Thru

PRODUCT #	Designation	DCON MS	LF	WF	DMIN	Insert	Insert Screw	Key	Price
920-000-230	E08R SSKCR3	0.500	8	.344	.625	SCMT 32.51	MTS-35	T-15	\$265.00
920-000-288	E10S SSKCR3	.625	10	.406	.760	SCMT 32.51	MTS-35	T-15	\$401.80

USE THE RIGHT SET SCREW FLAT POINT, NOT CUP POINT

PRODUCT #	Insert Screws	Price Each
968-000-086	MTS-183	\$3.20
968-000-087	MTS-184	\$3.20
968-000-088	MTS-2	\$2.90
968-000-091	MTS-224	\$3.20
968-000-092	MTS-255	\$3.20
968-000-094	MTS-35	\$3.20
968-000-090	MTS-2.5L	\$2.90
968-000-052	ETS 4-40	\$3.20

PACKAGE SIZE OF 5

PRODUCT #	Key	Price Each
968-000-156	T-6	\$4.20
968-000-158	T-7	\$3.80
968-000-149	T-10	\$6.50
968-000-151	T-15	\$3.80
968-000-153	T-20	\$4.00

PACKAGE SIZE OF 5

CARBIDE



SERIES "G, Q, S"



8:1 Ratio

Positive Trigon (KAPR: 93°)

Coolant Thru

PRODUCT # Left hand	PRODUCT # Right hand	Designation	DCON MS	LF	WF	DMIN	Insert	Insert Screw	Key	Price
915-000-053	915-000-054	GCUDW-187-6-3R/L	.187	6	.126	.260	WPGT 1.511	MTS-184	T-6	\$224.00
915-000-055	915-000-056	GCUDW-250-6-3R/L	.250	6	.143	.285	WPGT 1.511	MTS-184	T-6	\$224.00
915-000-057	915-000-058	GCUDW-312-6-3R/L	.312	6	.174	.374	WPGT 1.511	MTS-184	T-6	\$224.00
915-000-068	915-000-069	QCUDW-375-6-3R/L	.375	6	.211	.415	WPGT 21.50	MTS-255	T-7	\$253.20
915-000-070	915-000-071	QCUDW-500-8-3R/L	0.500	8	.273	.540	WPGT 21.50	MTS-255	T-7	\$327.10
	915-000-090	SCUDW-625-10-3R	.625	10	.345	.675	WPMT 32.51	MTS-35	T-15	\$566.80
	915-000-091	SCUDW-750-10-3R	.750	10	.407	.800	WPMT 32.51	MTS-35	T-15	\$617.20

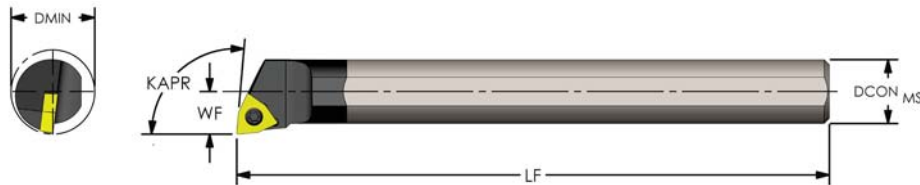

8:1 Ratio

Positive Trigon (KAPR: 95°)

No Coolant

PRODUCT # Left hand	PRODUCT # Right hand	Designation	DCON MS	LF	WF	DMIN	Insert	Insert Screw	Key	Price
	920-000-007	C03H SWLCR1.2 *	.187	4	.102	.205	WCMT 1.210.5	MTS-183	T-6	\$181.30
	920-000-016	C04H SWLCR1.2 *	.250	4	.172	.312	WCMT 1.210.5	MTS-184	T-6	\$181.30
	920-000-026	C05K SWLCR1.5 *	.312	5	.219	.395	WCMT 1.51.50.5	MTS-2	T-6	\$181.30
920-000-052	920-000-054	C06M SWLCR/L2	.375	6	.250	.460	WCMT 21.51	MTS-255	T-7	\$189.80
920-000-084	920-000-086	C08J SWLCR/L2	0.500	4.5	.312	.600	WCMT 21.51	MTS-255	T-7	\$214.20
920-000-116	920-000-118	C08R SWLCR/L2	0.500	8	.312	.600	WCMT 21.51	MTS-255	T-7	\$246.00

Minimum Clearance

No Coolant

PRODUCT # Left hand	PRODUCT # Right hand	Designation	DCON MS	LF	WF	DMIN	Insert	Insert Screw	Key	Price
	920-000-017	C04H SWLCR1.2-138 *	.250	4	.138	.275	WCMT 1.210.5	MTS-184	T-6	\$181.30
	920-000-027	C05K SWLCR1.5-167 *	.312	5	.167	.345	WCMT 1.51.50.5	MTS-2	T-6	\$181.30
920-000-053	920-000-055	C06M SWLCR/L2-203	.375	6	.203	.400	WCMT 21.51	MTS-255	T-7	\$189.80
920-000-085	920-000-087	C08J SWLCR/L2-281	0.500	4.5	.281	.560	WCMT 21.51	MTS-255	T-7	\$214.20
920-000-117	920-000-119	C08R SWLCR/L2-281	0.500	8	.281	.560	WCMT 21.51	MTS-255	T-7	\$246.00

Minimum Clearance Bars are intended for light machining with minimum bore clearance Max depth of cut .015" - .020"

* bars .312 and smaller do not have flats

USE THE RIGHT SET SCREW FLAT POINT, NOT CUP POINT



CARBIDE

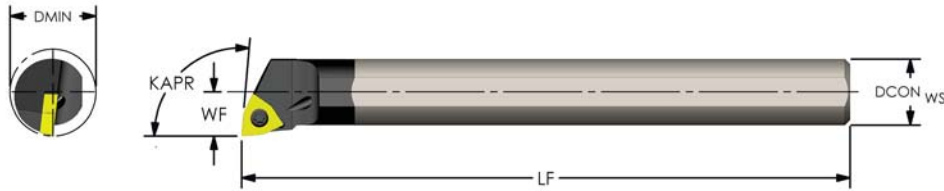

8:1 Ratio

Positive Trigon (KAPR: 95°)

Coolant Thru

PRODUCT # Left hand	PRODUCT # Right hand	Designation	DCON MS	LF	WF	DMIN	Insert	Insert Screw	Key	Price
	920-000-126	E03H SWLCR1.2 *	.187	4	.102	.205	WCMT 1.210.5	MTS-183	T-6	\$199.30
	920-000-135	E04H SWLCR1.2 *	.250	4	.172	.395	WCMT 1.210.5	MTS-184	T-6	\$199.30
	920-000-145	E05K SWLCR1.5 *	.312	5	.219	.410	WCMT1.51.50.5	MTS-2	T-6	\$199.30
920-000-147	920-000-149	E06M SWLCR/L2	.375	6	.250	.460	WCMT 21.51	MTS-255	T-7	\$208.90
920-000-205	920-000-207	E08J SWLCR/L2	0.500	4.5	.312	.600	WCMT 21.51	MTS-255	T-7	\$234.30
920-000-244	920-000-246	E08R SWLCR/L2	0.500	8	.312	.600	WCMT 21.51	MTS-255	T-7	\$265.00
920-000-269	920-000-271	E10Q SWLCR/L2	.625	7	.406	.760	WCMT 21.51	MTS-255	T-7	\$329.70
920-000-296	920-000-298	E10S SWLCR/L2	.625	10	.406	.760	WCMT 21.51	MTS-255	T-7	\$401.80
920-000-270	920-000-272	E10Q SWLCR/L3	.625	7	.406	.760	WCMT 32.51	MTS-35	T-15	\$329.70
920-000-297	920-000-299	E10S SWLCR/L3	.625	10	.406	.760	WCMT 32.51	MTS-35	T-15	\$401.80
920-000-322	920-000-323	E12Q SWLCR/L3	.750	7	0.500	.920	WCMT 32.51	MTS-35	T-15	\$414.50
920-000-350	920-000-351	E12S SWLCR/L3	.750	10	0.500	.920	WCMT 32.51	MTS-35	T-15	\$479.20
920-000-378	920-000-379	E16R SWLCR/L3	1.000	8	.625	1.185	WCMT 32.51	MTS-35	T-15	\$618.50
920-000-408	920-000-409	E16T SWLCR/L3	1.000	12	.625	1.185	WCMT 32.51	MTS-35	T-15	\$787.60

Minimum Clearance

Coolant Thru

PRODUCT # Left hand	PRODUCT # Right hand	Designation	DCON MS	LF	WF	DMIN	Insert	Insert Screw	Key	Price
	920-000-136	E04H SWLCR1.2-138 *	.250	4	.138	.275	WCMT 1.210.5	MTS-184	T-6	\$199.30
	920-000-146	E05K SWLCR1.5-167 *	.312	5	.167	.345	WCMT 1.51.50.5	MTS-2	T-6	\$199.30
920-000-174	920-000-176	E06M SWLCR/L2-203	.375	6	.203	.410	WCMT 21.51	MTS-255	T-7	\$208.90
920-000-206	920-000-208	E08J SWLCR/L2-281	0.500	4.5	.281	.560	WCMT 21.51	MTS-255	T-7	\$234.30
920-000-245	920-000-247	E08R SWLCR/L2-281	0.500	8	.281	.560	WCMT 21.51	MTS-255	T-7	\$265.00

Minimum Clearance Bars are intended for light machining with minimum bore clearance. Max depth of cut .015" - .020"
* bars .312 and smaller do not have flats

USE THE RIGHT SET SCREW FLAT POINT, NOT CUP POINT

PRODUCT #	Insert Screws	Price Each
968-000-086	MTS-183	\$3.20
968-000-087	MTS-184	\$3.20
968-000-088	MTS-2	\$2.90
968-000-091	MTS-224	\$3.20
968-000-092	MTS-255	\$3.20
968-000-094	MTS-35	\$3.20
968-000-090	MTS-2.5L	\$2.90
968-000-052	ETS 4-40	\$3.20

PACKAGE SIZE OF 5

PRODUCT #	Key	Price Each
968-000-156	T-6	\$4.20
968-000-158	T-7	\$3.80
968-000-149	T-10	\$6.50
968-000-151	T-15	\$3.80
968-000-153	T-20	\$4.00

PACKAGE SIZE OF 5

CARBIDE

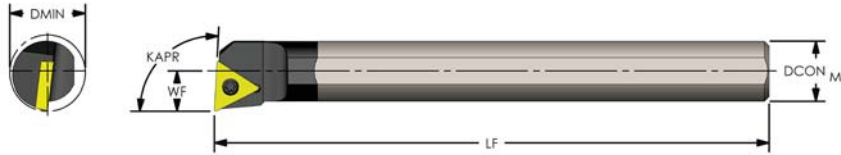

8:1 Ratio

Positive Triangle (KAPR: 93°)

No Coolant

PRODUCT # Left hand	PRODUCT # Right hand	Designation	DCON MS	LF	WF	DMIN	Insert	Insert Screw	Key	Price
920-000-012	920-000-014	C04H STUCR/L1.2 *	.250	4	.172	.312	TCMT 1.21.20.5	MTS-184	T-6	\$165.40
920-000-022	920-000-024	C05K STUCR/L1.2 *	.312	5	.219	.395	TCMT 1.21.20.5	MTS-184	T-6	\$165.40
920-000-044	920-000-046	C06M STUCR/L2	.375	6	.250	.460	TCMT 21.51	MTS-255	T-7	\$197.20
920-000-076	920-000-078	C08J STUCR/L2	0.500	4.5	.312	.600	TCMT 21.51	MTS-255	T-7	\$214.20
920-000-108	920-000-110	C08R STUCR/L2	0.500	8	.312	.600	TCMT 21.51	MTS-255	T-7	\$246.00
920-000-048	920-000-050	C06M STUPR/L2	.375	6	.250	.460	TPMT 21.51	MTS-255	T-7	\$197.20
920-000-080	920-000-082	C08J STUPR/L2	0.500	4.5	.312	.600	TPMT 21.51	MTS-255	T-7	\$214.20
920-000-112	920-000-114	C08R STUPR/L2	0.500	8	.312	.600	TPMT 21.51	MTS-255	T-7	\$246.00

Minimum Clearance

No Coolant

PRODUCT # Left hand	PRODUCT # Right hand	Designation	DCON MS	LF	WF	DMIN	Insert	Insert Screw	Key	Price
920-000-013	920-000-015	C04H STUCR/L1.2-138 *	.250	4	.138	.275	TCMT 1.21.20.5	MTS-184	T-6	\$165.40
920-000-023	920-000-025	C05K STUCR/L1.2-167 *	.312	5	.167	.340	TCMT 1.21.20.5	MTS-184	T-6	\$165.40
920-000-045	920-000-047	C06M STUCR/L2-203	.375	6	.203	.410	TCMT 21.51	MTS-255	T-7	\$197.20
920-000-077	920-000-079	C08J STUCR/L2-281	0.500	4.5	.281	.560	TCMT 21.51	MTS-255	T-7	\$214.20
920-000-109	920-000-111	C08R STUCR/L2-281	0.500	8	.281	.570	TCMT 21.51	MTS-255	T-7	\$246.00
920-000-049	920-000-051	C06M STUPR/L2-203	.375	6	.203	.410	TPMT 21.51	MTS-255	T-7	\$197.20
920-000-081	920-000-083	C08J STUPR/L2-281	0.500	4.5	.281	.560	TPMT 21.51	MTS-255	T-7	\$214.20
920-000-113	920-000-115	C08R STUPR/L2-281	0.500	8	.281	.560	TPMT 21.51	MTS-255	T-7	\$246.00

Minimum Clearance Bars are intended for light machining with minimum bore clearance. Max depth of cut .015" - .020"
* bars .312 and smaller do not have flats

USE THE RIGHT SET SCREW FLAT POINT, NOT CUP POINT

PRODUCT #	Insert Screws	Price Each
968-000-086	MTS-183	\$3.20
968-000-087	MTS-184	\$3.20
968-000-088	MTS-2	\$2.90
968-000-091	MTS-224	\$3.20
968-000-092	MTS-255	\$3.20
968-000-094	MTS-35	\$3.20
968-000-090	MTS-2.5L	\$2.90
968-000-052	ETS 4-40	\$3.20

PACKAGE SIZE OF 5

PRODUCT #	Key	Price Each
968-000-156	T-6	\$4.20
968-000-158	T-7	\$3.80
968-000-149	T-10	\$6.50
968-000-151	T-15	\$3.80
968-000-153	T-20	\$4.00

PACKAGE SIZE OF 5



CARBIDE

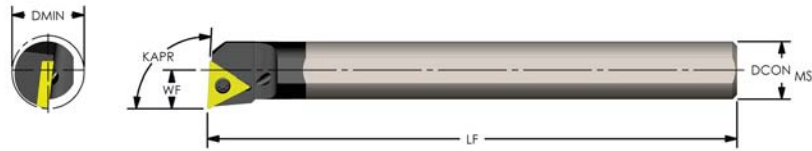

8:1 Ratio

Positive Triangle (KAPR: 93°)

Coolant Thru

PRODUCT # Left hand	PRODUCT # Right hand	Designation	DCON MS	LF	WF	DMIN	Insert	Insert Screw	Key	Price
920-000-131	920-000-133	E04H STUCR/L1.2 *	.250	4	.172	.312	TCMT 1.21.20.5	MTS-184	T-6	\$186.60
920-000-141	920-000-143	E05K STUCR/L1.2 *	.312	5	.219	.395	TCMT 1.21.20.5	MTS-184	T-6	\$186.60
920-000-164	920-000-166	E06M STUCR/L2	.375	6	.250	.460	TCMT 21.51	MTS-255	T-7	\$208.90
920-000-197	920-000-199	E08J STUCR/L2	0.500	4.5	.312	.600	TCMT 21.51	MTS-255	T-7	\$234.30
920-000-235	920-000-237	E08R STUCR/L2	0.500	8	.312	.600	TCMT 21.51	MTS-255	T-7	\$265.00
920-000-265	920-000-266	E10Q STUCR/L2	.625	7	.406	.760	TCMT 21.51	MTS-255	T-7	\$311.00
920-000-291	920-000-292	E10S STUCR/L2	.625	10	.406	.760	TCMT 21.51	MTS-255	T-7	\$401.80
920-000-318	920-000-319	E12Q STUCR/L3	.750	7	0.500	.920	TCMT 32.51	MTS-35	T-15	\$414.50
920-000-345	920-000-346	E12S STUCR/L3	.750	10	0.500	.920	TCMT 32.51	MTS-35	T-15	\$479.20
920-000-374	920-000-375	E16R STUCR/L3	1.000	8	.625	1.185	TCMT 32.51	MTS-35	T-15	\$618.50
920-000-404	920-000-405	E16T STUCR/L3	1.000	12	.625	1.185	TCMT 32.51	MTS-35	T-15	\$787.60
920-000-168	920-000-170	E06M STUPR/L2	.375	6	.250	.460	TPMT 21.51	MTS-255	T-7	\$208.90
920-000-201	920-000-203	E08J STUPR/L2	0.500	4.5	.312	.600	TPMT 21.51	MTS-255	T-7	\$234.30
920-000-239	920-000-241	E08R STUPR/L2	0.500	8	.312	.600	TPMT 21.51	MTS-255	T-7	\$265.00
920-000-267	920-000-268	E10Q STUPR/L2	.625	7	.406	.760	TPMT 21.51	MTS-255	T-7	\$329.70
920-000-293	920-000-294	E10S STUPR/L2	.625	10	.406	.760	TPMT 21.51	MTS-255	T-7	\$401.80
920-000-320	920-000-321	E12Q STUPR/L3	.750	7	0.500	.920	TPMT 32.51	MTS-35	T-15	\$391.00
920-000-347	920-000-348	E12S STUPR/L3	.750	10	0.500	.920	TPMT 32.51	MTS-35	T-15	\$479.20
920-000-376	920-000-377	E16R STUPR/L3	1.000	8	.625	1.185	TPMT 32.51	MTS-35	T-15	\$618.50
920-000-406	920-000-407	E16T STUPR/L3	1.000	12	.625	1.185	TPMT 32.51	MTS-35	T-15	\$787.60

Minimum Clearance

Coolant Thru

PRODUCT # Left hand	PRODUCT # Right hand	Designation	DCON MS	LF	WF	DMIN	Insert	Insert Screw	Key	Price
920-000-132	920-000-134	E04H STUCR/L1.2-138 *	.250	4	.138	.275	TCMT 1.21.20.5	MTS-184	T-6	\$186.60
920-000-142	920-000-144	E05K STUCR/L1.2-167 *	.312	5	.167	.340	TCMT 1.21.20.5	MTS-184	T-6	\$186.60
920-000-165	920-000-167	E06M STUCR/L2-203	.375	6	.203	.410	TCMT 21.51	MTS-255	T-7	\$208.90
920-000-198	920-000-200	E08J STUCR/L2-281	0.500	4.5	.281	.560	TCMT 21.51	MTS-255	T-7	\$234.30
920-000-236	920-000-238	E08R STUCR/L2-281	0.500	8	.281	.560	TCMT 21.51	MTS-255	T-7	\$265.00
920-000-169	920-000-170	E06M STUPR/L2-203	.375	6	.203	.410	TPMT 21.51	MTS-255	T-7	\$208.90
920-000-202	920-000-204	E08J STUPR/L2-281	0.500	4.5	.281	.560	TPMT 21.51	MTS-255	T-7	\$234.30
920-000-240	920-000-242	E08R STUPR/L2-281	0.500	8	.281	.560	TPMT 21.51	MTS-255	T-7	\$265.00

Minimum Clearance Bars are intended for light machining with minimum bore clearance. Max depth of cut .015" - .020"
* bars .312 and smaller do not have flats

USE THE RIGHT SET SCREW FLAT POINT, NOT CUP POINT

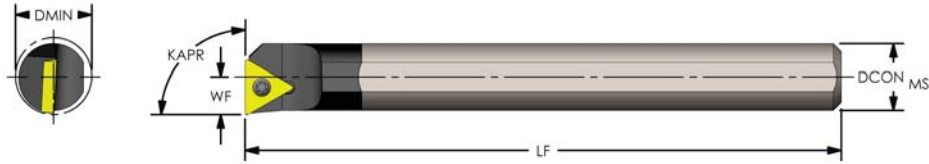

8:1 Ratio Positive Triangle (KAPR: 90°) No Coolant

PRODUCT #	Designation	DCON MS	LF	WF	DMIN	Insert	Insert Screw	Key	Price
920-000-042	C06M STFPR2	.375	6	.250	.460	TPMT 21.51	MTS-255	T-7	\$189.80
920-000-074	C08J STFPR2	0.500	4.5	.312	.600	TPMT 21.51	MTS-255	T-7	\$214.20
920-000-106	C08R STFPR2	0.500	8	.312	.600	TPMT 21.51	MTS-255	T-7	\$246.00
920-000-040	C06M STFPCR2	.375	6	.250	.460	TCMT 21.51	MTS-255	T-7	\$189.80
920-000-072	C08J STFPCR2	0.500	4.5	.312	.600	TCMT 21.51	MTS-255	T-7	\$214.20
920-000-104	C08R STFPCR2	0.500	8	.312	.600	TCMT 21.51	MTS-255	T-7	\$246.00

Minimum Clearance No Coolant

PRODUCT #	Designation	DCON MS	LF	WF	DMIN	Insert	Insert Screw	Key	Price
920-000-043	C06M STFPR2-203	.375	6	.203	.410	TPMT 21.51	MTS-255	T-7	\$189.80
920-000-075	C08J STFPR2-281	0.500	4.5	.281	.560	TPMT 21.51	MTS-255	T-7	\$214.20
920-000-107	C08R STFPR2-281	0.500	8	.281	.560	TPMT 21.51	MTS-255	T-7	\$246.00
920-000-041	C06M STFPCR2-203	.375	6	.203	.410	TCMT 21.51	MTS-255	T-7	\$189.80
920-000-073	C08J STFPCR2-281	0.500	4.5	.281	.560	TCMT 21.51	MTS-255	T-7	\$214.20
920-000-105	C08R STFPCR2-281	0.500	8	.281	.560	TCMT 21.51	MTS-255	T-7	\$246.00

Minimum Clearance Bars are intended for light machining with minimum bore clearance. Max depth of cut .015" - .020"

USE THE RIGHT SET SCREW FLAT POINT, NOT CUP POINT

PRODUCT #	Insert Screws	Price Each
968-000-086	MTS-183	\$3.20
968-000-087	MTS-184	\$3.20
968-000-088	MTS-2	\$2.90
968-000-091	MTS-224	\$3.20
968-000-092	MTS-255	\$3.20
968-000-094	MTS-35	\$3.20
968-000-090	MTS-2.5L	\$2.90
968-000-052	ETS 4-40	\$3.20

PRODUCT #	Key	Price Each
968-000-156	T-6	\$4.20
968-000-158	T-7	\$3.80
968-000-149	T-10	\$6.50
968-000-151	T-15	\$3.80
968-000-153	T-20	\$4.00

PACKAGE SIZE OF 5

PACKAGE SIZE OF 5



CARBIDE

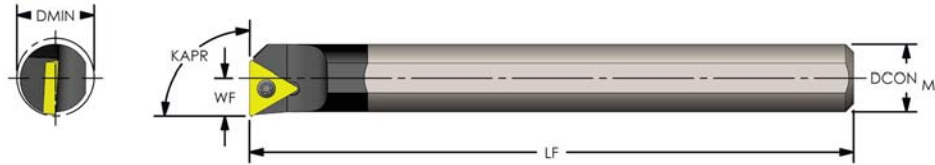

8:1 Ratio

Positive Triangle (KAPR: 90°)

Coolant Thru

PRODUCT #	Designation	DCON MS	LF	WF	DMIN	Insert	Insert Screw	Key	Price
920-000-162	E06M STFPR2	.375	6	.250	.460	TPMT 21.51	MTS-255	T-7	\$208.90
920-000-195	E08J STFPR2	0.500	4.5	.312	.600	TPMT 21.51	MTS-255	T-7	\$234.30
920-000-233	E08R STFPR2	0.500	8	.312	.600	TPMT 21.51	MTS-255	T-7	\$265.00
920-000-264	E10Q STFPR2	.625	7	.406	.760	TPMT 21.51	MTS-255	T-7	\$329.70
920-000-290	E10S STFPR2	.625	10	.406	.760	TPMT 21.51	MTS-255	T-7	\$401.80
920-000-317	E12Q STFPR3	.750	7	0.500	.920	TPMT 32.51	MTS-35	T-15	\$414.50
920-000-344	E12S STFPR3	.750	10	0.500	.920	TPMT 32.51	MTS-35	T-15	\$479.20
920-000-373	E16R STFPR3	1.000	8	.625	1.185	TPMT 32.51	MTS-35	T-15	\$618.50
920-000-403	E16T STFPR3	1.000	12	.625	1.185	TPMT 32.51	MTS-35	T-15	\$787.60
920-000-160	E06M STFPCR2	.375	6	.250	.460	TCMT 21.51	MTS-255	T-7	\$208.90
920-000-193	E08J STFPCR2	0.500	4.5	.312	.600	TCMT 21.51	MTS-255	T-7	\$234.30
920-000-231	E08R STFPCR2	0.500	8	.312	.600	TCMT 21.51	MTS-255	T-7	\$265.00
920-000-263	E10Q STFPCR2	.625	7	.406	.760	TCMT 21.51	MTS-255	T-7	\$329.70
920-000-289	E10S STFPCR2	.625	10	.406	.760	TCMT 21.51	MTS-255	T-7	\$401.80
920-000-316	E12Q STFPCR3	.750	7	0.500	.920	TCMT 32.51	MTS-35	T-15	\$414.50
920-000-343	E12S STFPCR3	.750	10	0.500	.920	TCMT 32.51	MTS-35	T-15	\$479.20
920-000-372	E16R STFPCR3	1.000	8	.625	1.185	TCMT 32.51	MTS-35	T-15	\$618.50
920-000-402	E16T STFPCR3	1.000	12	.625	1.185	TCMT 32.51	MTS-35	T-15	\$787.60

Minimum Clearance

Coolant Thru

PRODUCT #	Designation	DCON MS	LF	WF	DMIN	Insert	Insert Screw	Key	Price
920-000-163	E06M STFPR2-203	.375	6	.203	.410	TPMT 21.51	MTS-255	T-7	\$208.90
920-000-196	E08J STFPR2-281	0.500	4.5	.281	.560	TPMT 21.51	MTS-255	T-7	\$234.30
920-000-234	E08R STFPR2-281	0.500	8	.281	.560	TPMT 21.51	MTS-255	T-7	\$265.00
920-000-161	E06M STFPCR2-203	.375	6	.203	.410	TCMT 21.51	MTS-255	T-7	\$208.90
920-000-194	E08J STFPCR2-281	0.500	4.5	.281	.560	TCMT 21.51	MTS-255	T-7	\$234.30
920-000-232	E08R STFPCR2-281	0.500	8	.281	.560	TCMT 21.51	MTS-255	T-7	\$265.00

Minimum Clearance Bars are intended for light machining with minimum bore clearance. Max depth of cut .015" - .020"

USE THE RIGHT SET SCREW FLAT POINT, NOT CUP POINT

CARBIDE

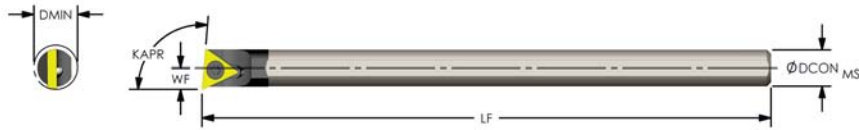

8:1 Ratio **Positive Triangle (KAPR: 95°)** **SERIES "F, Q, S"** **Coolant Thru**

PRODUCT #	Designation	DCON MS	LF	WF	DMIN	Insert	Insert Screw	Key	Price
915-000-030	FCUD-187-4-5R *	.187	4	.126	.275	TDHB 1.280.750.5	MTS-224	T-7	\$208.40
915-000-031	FCUD-187-6-5R *	.187	6	.126	.275	TDHB 1.280.750.5	MTS-224	T-7	\$217.00
915-000-034	FCUD-250-4-5R *	.250	4	.156	.300	TDHB 1.280.750.5	MTS-224	T-7	\$208.40
915-000-035	FCUD-250-6-5R *	.250	6	.156	.300	TDHB 1.280.750.5	MTS-224	T-7	\$224.00
915-000-038	FCUD-312-4-5R *	.312	4	.187	.360	TDHB 1.280.750.5	MTS-224	T-7	\$208.40
915-000-039	FCUD-312-6-5R *	.312	6	.187	.360	TDHB 1.280.750.5	MTS-224	T-7	\$224.00
915-000-066	QCUD-375-6-5R	.375	6	.228	.438	TPCB 220.5	ETS 4-40	T-10	\$253.20
915-000-065	QCUD-375-10-5R	.375	10	.228	.438	TPCB 220.5	ETS 4-40	T-10	\$277.80
915-000-067	QCUD-500-8-5R	0.500	8	.296	.563	TPCB 220.5	ETS 4-40	T-10	\$327.10
915-000-088	SCUD-625-6-5R	.625	6	.393	.731	TD 320.5	ETS 4-40	T-10	\$327.10
915-000-087	SCUD-625-10-5R	.625	10	.393	.731	TD 320.5	ETS 4-40	T-10	\$492.80
915-000-089	SCUD-750-10-5R	.750	10	.460	.855	TD 320.5	ETS 4-40	T-10	\$566.80
915-000-086	SCUD-1000-12-5R	1.000	12	.585	1.105	TD 320.5	ETS 4-40	T-10	\$694.40

*bars .312 and smaller do not have flats

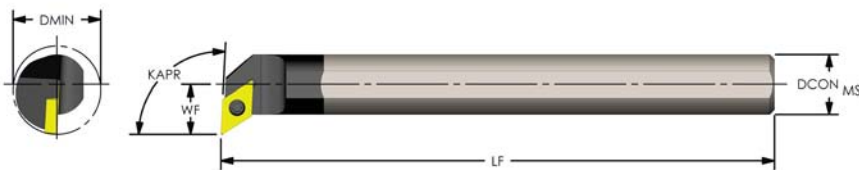

8:1 Ratio **Positive 55° Diamond (KAPR: 93°) Profiling** **No Coolant**

PRODUCT # Left hand	PRODUCT # Right hand	Designation	DCON MS	LF	WF	DMIN	Insert	Insert Screw	Key	Price
920-000-036	920-000-037	C06M SDUCR/L2	.375	6	.375	.585	DCMT 21.51	MTS-255	T-7	\$199.30
920-000-068	920-000-069	C08J SDUCR/L2	0.500	4.5	.437	.720	DCMT 21.51	MTS-255	T-7	\$232.20
920-000-100	920-000-101	C08R SDUCR/L2	0.500	8	.437	.720	DCMT 21.51	MTS-255	T-7	\$264.00

USE THE RIGHT SET SCREW FLAT POINT, NOT CUP POINT

PRODUCT #	Insert Screws	Price Each
968-000-086	MTS-183	\$3.20
968-000-087	MTS-184	\$3.20
968-000-088	MTS-2	\$2.90
968-000-091	MTS-224	\$3.20
968-000-092	MTS-255	\$3.20
968-000-094	MTS-35	\$3.20
968-000-090	MTS-2.5L	\$2.90
968-000-052	ETS 4-40	\$3.20

PRODUCT #	Key	Price Each
968-000-156	T-6	\$4.20
968-000-158	T-7	\$3.80
968-000-149	T-10	\$6.50
968-000-151	T-15	\$3.80
968-000-153	T-20	\$4.00

PACKAGE SIZE OF 5

PACKAGE SIZE OF 5



CARBIDE

Positive 55° Diamond (KAPR: 93°) Profiling

Coolant Thru

PRODUCT # Left hand	PRODUCT # Right hand	Designation	DCON MS	LF	WF	DMIN	Insert	Insert Screw	Key	Price
920-000-156	920-000-157	E06M SDUCR/L2	.375	6	.375	.585	DCMT 21.51	MTS-255	T-7	\$219.50
920-000-189	920-000-190	E08J SDUCR/L2	0.500	4.5	.437	.720	DCMT 21.51	MTS-255	T-7	\$241.70
920-000-226	920-000-227	E08R SDUCR/L2	0.500	8	.437	.720	DCMT 21.51	MTS-255	T-7	\$276.70
920-000-259	920-000-260	E10Q SDUCR/L2	.625	7	0.500	.850	DCMT 21.51	MTS-255	T-7	\$340.30
920-000-284	920-000-285	E10S SDUCR/L2	.625	10	0.500	.850	DCMT 21.51	MTS-255	T-7	\$413.40
920-000-310	920-000-311	E12Q SDUCR/L3	.750	7	.625	1.050	DCMT 32.51	MTS-35	T-15	\$424.00
920-000-337	920-000-338	E12S SDUCR/L3	.750	10	.625	1.050	DCMT 32.51	MTS-35	T-15	\$490.80
920-000-366	920-000-367	E16R SDUCR/L3	1.000	8	.750	1.310	DCMT 32.51	MTS-35	T-15	\$635.60
920-000-396	920-000-397	E16T SDUCR/L3	1.000	12	.750	1.310	DCMT 32.51	MTS-35	T-15	\$807.90
920-000-312	920-000-313	E12Q SDUPR/L3	.750	7	.625	1.050	DPMT 32.51	MTS-35	T-15	\$424.00
920-000-339	920-000-340	E12S SDUPR/L3	.750	10	.625	1.050	DPMT 32.51	MTS-35	T-15	\$490.80
920-000-368	920-000-369	E16R SDUPR/L3	1.000	8	.750	1.310	DPMT 32.51	MTS-35	T-15	\$635.60
920-000-398	920-000-399	E16T SDUPR/L3	1.000	12	.750	1.310	DPMT 32.51	MTS-35	T-15	\$807.90



8:1 Ratio

Positive 55° Diamond (KAPR: 62.5°) Profiling

Coolant Thru

PRODUCT #	Designation	DCON MS	LF	WF	DMIN	Insert	Insert Screw	Key	Price
920-000-258	E10Q SDNCR2	.625	6.86	.562	.920	DCMT 21.51	MTS-255	T-7	\$340.30
920-000-336	E12S SDNCR3	.750	9.80	0.765	1.190	DCMT 32.51	MTS-35	T-15	\$490.80

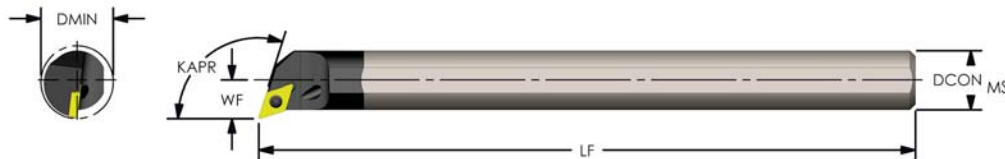

8:1 Ratio

Positive 55° Diamond (KAPR: 107.5°) Profiling

Coolant Thru

PRODUCT #	Designation	DCON MS	LF	WF	DMIN	Insert	Insert Screw	Key	Price
920-000-155	E06M SDQCR2	.375	6	.281	.490	DCMT 21.51	MTS-255	T-7	\$219.50
920-000-225	E08R SDQCR2	0.500	8	.341	.620	DCMT 21.51	MTS-255	T-7	\$276.70
920-000-283	E10S SDQCR2	.625	10	.406	.760	DCMT 21.51	MTS-255	T-7	\$413.40

USE THE RIGHT SET SCREW FLAT POINT, NOT CUP POINT

CARBIDE

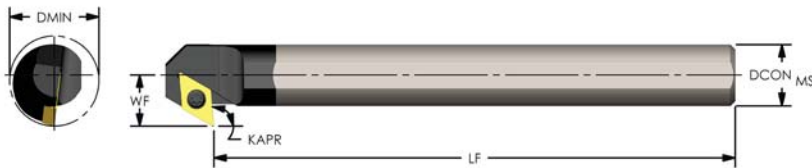

8:1 Ratio

Positive 55° Diamond (KAPR: 95°) Back Facing

No Coolant

PRODUCT # Left hand	PRODUCT # Right hand	Designation	DCON MS	LF	WF	DMIN	Insert	Insert Screw	Key	Price
920-000-038	920-000-039	C06M SDXCR/L2	.375	6	.375	.585	DCMT 21.51	MTS-255	T-7	\$199.30
920-000-070	920-000-071	C08J SDXCR/L2	0.500	4.5	.437	.720	DCMT 21.51	MTS-255	T-7	\$232.20
920-000-102	920-000-103	C08R SDXCR/L2	0.500	8	.437	.720	DCMT 21.51	MTS-255	T-7	\$264.00

Coolant Thru

PRODUCT # Left hand	PRODUCT # Right hand	Designation	DCON MS	LF	WF	DMIN	Insert	Insert Screw	Key	Price
920-000-158	920-000-159	E06M SDXCR/L2	.375	6	.375	.585	DCMT 21.51	MTS-255	T-7	\$219.50
920-000-191	920-000-192	E08J SDXCR/L2	0.500	4.5	.437	.720	DCMT 21.51	MTS-255	T-7	\$241.70
920-000-228	920-000-229	E08R SDXCR/L2	0.500	8	.437	.720	DCMT 21.51	MTS-255	T-7	\$276.70
920-000-261	920-000-262	E10Q SDXCR/L2	.625	7	0.500	.850	DCMT 21.51	MTS-255	T-7	\$340.30
920-000-286	920-000-287	E10S SDXCR/L2	.625	10	0.500	.850	DCMT 21.51	MTS-255	T-7	\$413.40
920-000-314	920-000-315	E12Q SDXCR/L3	.750	7	.625	1.050	DCMT 32.51	MTS-35	T-15	\$424.00
920-000-341	920-000-342	E12S SDXCR/L3	.750	10	.625	1.050	DCMT 32.51	MTS-35	T-15	\$490.80
920-000-370	920-000-371	E16R SDXCR/L3	1.000	8	.750	1.310	DCMT 32.51	MTS-35	T-15	\$635.60
920-000-400	920-000-401	E16T SDXCR/L3	1.000	12	.750	1.310	DCMT 32.51	MTS-35	T-15	\$807.90

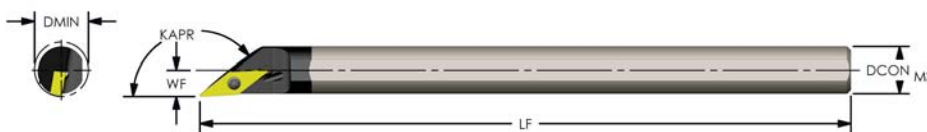

8:1 Ratio

Positive 35° Diamond (KAPR: 142.5°) Profiling

Coolant Thru

PRODUCT #	Designation	DCON MS	LF	WF	DMIN	Insert	Insert Screw	Key	Price
920-000-172	E06M SVJBR2	.375	6	.223	.445	VBMT 21.51	MTS-2.5L	T-7	\$219.50
920-000-243	E08R SVJBR2	0.500	8	.285	.570	VBMT 21.51	MTS-2.5L	T-7	\$276.70
920-000-295	E10S SVJBR2	.625	10	.348	.700	VBMT 21.51	MTS-2.5L	T-7	\$413.40
920-000-349	E12S SVJBR3	.750	10	.421	.840	VBMT 331	MTS-3.5L	T-15	\$490.80

PRODUCT #	Insert Screws	Price Each
968-000-086	MTS-183	\$3.20
968-000-087	MTS-184	\$3.20
968-000-088	MTS-2	\$2.90
968-000-091	MTS-224	\$3.20
968-000-092	MTS-255	\$3.20
968-000-094	MTS-35	\$3.20
968-000-090	MTS-2.5L	\$2.90
968-000-052	ETS 4-40	\$3.20

PRODUCT #	Key	Price Each
968-000-156	T-6	\$4.20
968-000-158	T-7	\$3.80
968-000-149	T-10	\$6.50
968-000-151	T-15	\$3.80
968-000-153	T-20	\$4.00

PACKAGE SIZE OF 5

PACKAGE SIZE OF 5



CARBIDE

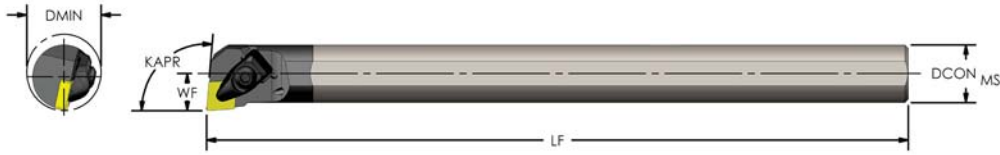

Negative 80° Diamond (KAPR: 95°) Shank

8:1 Ratio

Coolant Thru

PRODUCT #	Designation	DCON MS	LF	WF	DMIN	Insert	Shim	Shim Screw	Clamp Assy.	Price
920-000-380	E16T DCLNR4	1.000	12	0.640	1.200	CNMG 432	--	--	PB4-CA	\$849.60
920-000-410	E20U DCLNR4	1.250	14	0.765	1.470	CNMG 432	ICSN 433	PB4-SS	PB4-CA	\$1,553.70

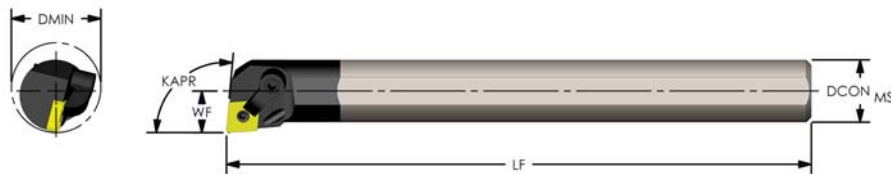

Negative 80° Diamond (KAPR: 95°)

8:1 Ratio

Coolant Thru

PRODUCT # Left hand	PRODUCT # Right hand	Designation	DCON MS	LF	WF	DMIN	Insert	Shim Seat	Clamp	Clamp Screw	Lock Pin	Price
920-000-302	920-000-303	E12Q MCLNR/L3	.750	7	0.500	.920	CNMG 322	--	CL-7	XNS-36	NL-33	\$450.50
920-000-326	920-000-327	E12S MCLNR/L3	.750	10	0.500	.920	CNMG 322	--	CL-7	XNS-36	NL-33	\$518.40
920-000-354	920-000-355	E16R MCLNR/L3	1.000	8	0.640	1.200	CNMG 322	--	CL-7	XNS-36	NL-33	\$656.00
920-000-383	920-000-384	E16T MCLNR/L3	1.000	12	0.640	1.200	CNMG 322	--	CL-7	XNS-36	NL-33	\$823.90
920-000-355	920-000-356	E16R MCLNR/L4	1.000	8	0.640	1.200	CNMG 432	--	CL-20	XNS-47	NL-44	\$656.00
920-000-384	920-000-385	E16T MCLNR/L4	1.000	12	0.640	1.200	CNMG 432	--	CL-20	XNS-47	NL-44	\$823.90
920-000-412	920-000-413	E20U MCLNR/L4	1.250	14	0.765	1.470	CNMG 432	ICSN-433	CL-20	XNS-47	NL-46	\$1,524.80
920-000-421	920-000-422	E24U MCLNR/L4	1.500	14	.890	1.730	CNMG 432	ICSN-433	CL-20	XNS-47	NL-46	\$1,816.90

USE THE RIGHT SET SCREW FLAT POINT, NOT CUP POINT

PRODUCT #	Clamp	Price Each
968-000-016	CL-6	\$5.30
968-000-017	CL-7	\$5.30
968-000-020	CL-9	\$5.30
968-000-010	CL-12	\$5.30
968-000-011	CL-19	\$6.60
968-000-012	CL-20	\$5.30

PACKAGE SIZE OF 1

PRODUCT #	Clamp	Price Each
968-000-013	CL-21	\$12.40
968-000-014	CL-22	\$12.60
968-000-015	CL-30	\$9.30
968-000-018	CL-84	\$28.40
968-000-019	CL-85	\$28.40

PACKAGE SIZE OF 5

PRODUCT #	Clamp Screw	Price Each
968-000-176	XNS-36	\$2.20
968-000-177	XNS-47	\$2.20
968-000-178	XNS-48	\$2.20
968-000-179	XNS-510	\$2.20
968-000-180	XNS-58	\$2.20
968-000-181	XNS-59	\$2.20

PRODUCT #	Shim Screw	Price Each
968-000-109	PB3-SS	\$3.10
968-000-111	PB4-SS	\$3.10

PACKAGE SIZE OF 5

PRODUCT #	Clamp Assy.	Price Each
968-000-107	PB3-CA	\$20.10
968-000-110	PB4-CA	\$20.10

PACKAGE SIZE OF 1

CARBIDE

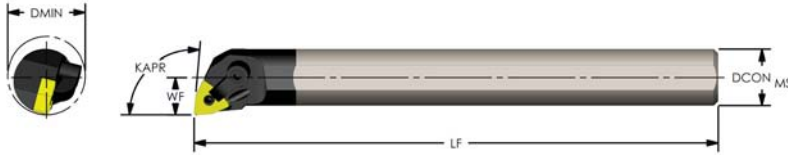

8:1 Ratio

Negative Trigon (KAPR: 95°)

Coolant Thru

PRODUCT # Left hand	PRODUCT # Right hand	Designation	DCON MS	LF	WF	DMIN	Insert	Shim Seat	Clamp	Clamp Screw	Lock Pin	Price
920-000-304	920-000-305	E12Q MWLNR/L3	0.750	7	0.500	0.920	WNMG 332	--	CL-7	XNS-36	NL-33L	\$450.50
920-000-328	920-000-329	E12S MWLNR/L3	0.750	10	0.500	0.920	WNMG 332	--	CL-7	XNS-36	NL-33L	\$518.40
920-000-358	920-000-360	E16R MWLNR/L3	1.000	8	0.640	1.200	WNMG 332	--	CL-7	XNS-36	NL-33L	\$656.00
920-000-388	920-000-390	E16T MWLNR/L3	1.000	12	0.640	1.200	WNMG 332	--	CL-7	XNS-36	NL-33L	\$823.90
920-000-359	920-000-361	E16R MWLNR/L4	1.000	8	0.640	1.200	WNMG 432	--	CL-20	XNS-47	NL-44	\$656.00
920-000-389	920-000-391	E16T MWLNR/L4	1.000	12	0.640	1.200	WNMG 432	--	CL-20	XNS-47	NL-44	\$823.90
920-000-415	920-000-416	E20U MWLNR/L4	1.250	14	0.765	1.470	WNMG 432	IWSN-433	CL-20	XNS-47	NL-46	\$1,524.80
920-000-424	920-000-425	E24U MWLNR/L4	1.500	14	0.890	1.730	WNMG 432	IWSN-433	CL-20	XNS-47	NL-46	\$1,816.90

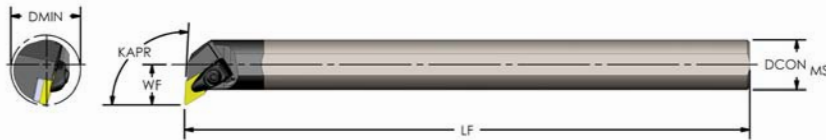

8:1 Ratio

Negative 55° Diamond (KAPR: 93°) Shank

Coolant Thru

PRODUCT #	Designation	DCON MS	LF	WF	DMIN	Insert	Shim	Shim Screw	Clamp Assy.	Price
920-000-411	E20U DDUNR4	1.250	14	1.000	1.700	DNMG 432	IDSN 433	PB4-SS	PB4-CA	\$1,553.70

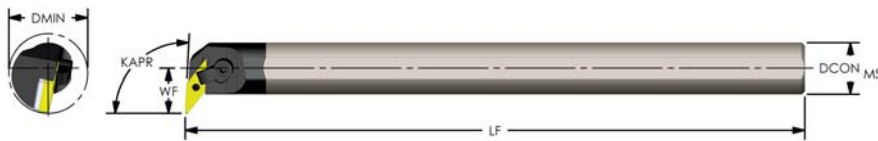

8:1 Ratio

Negative 35° Diamond (KAPR: 93°) Profiling

No Coolant

PRODUCT #	Designation	DCON MS	LF	WF	DMIN	Insert	Shim Seat	Clamp	Clamp Screw	Lock Pin	Price
920-000-387	E16T MVUNR3	1.000	12	0.875	1.435	VNMG 332	IVSN-322	CL-20	XNS-47	NL-34L	\$761.90
920-000-414	E20U MVUNR3	1.250	14	1.000	1.705	VNMG 332	IVSN-322	CL-20	XNS-47	NL-34L	\$1,401.70
920-000-423	E24U MVUNR3	1.500	14	1.120	1.960	VNMG 332	IVSN-322	CL-20	XNS-47	NL-34L	\$1,668.20

PRODUCT #	Shim Seat	Price Each
968-000-053	ICSN-433	\$4.80
968-000-054	ICSN-533	\$5.80
968-000-055	ICSN-633	\$6.70
968-000-063	ISSN-432	\$4.70
968-000-064	ISSN-433	\$4.70
968-000-065	ISSN-533	\$5.50
968-000-066	ISSN-633	\$6.60
968-000-056	IDSN-322	\$3.80
968-000-057	IDSN-433	\$4.30
968-000-058	IDSN-533	\$6.60
968-000-067	ITSN-323	\$3.30
968-000-068	ITSN-433	\$5.30

PRODUCT #	Shim Seat	Price Each
968-000-069	ITSN-533	\$6.90
968-000-070	ITSN-636	\$9.30
968-000-071	IVSN-322	\$3.80
968-000-072	IVSN-432	\$5.10
968-000-073	IVSN-433	\$5.10
968-000-074	IWSN-322	\$4.30
968-000-075	IWSN-433	\$5.90
968-000-059	IRSN-32	\$4.20
968-000-060	IRSN-43	\$3.80
968-000-061	IRSN-53	\$6.10
968-000-062	IRSN-63	\$6.90

PACKAGE SIZE OF 10

PRODUCT #	Lock Pin	Price Each
968-000-097	NL-33	\$2.40
968-000-098	NL-33L	\$2.40
968-000-099	NL-34	\$2.40
968-000-100	NL-34L	\$2.40
968-000-101	NL-44	\$2.40
968-000-102	NL-46	\$2.20
968-000-103	NL-56	\$2.70
968-000-104	NL-58	\$2.40
968-000-105	NL-68	\$2.70
968-000-106	NL-68L	\$5.30

PACKAGE SIZE OF 5

PRODUCT #	Shim Screw	Price Each
968-000-109	PB3-SS	\$3.10
968-000-111	PB4-SS	\$3.10

PACKAGE SIZE OF 5

PRODUCT #	Clamp Assy.	Price Each
968-000-107	PB3-CA	\$20.10
968-000-110	PB4-CA	\$20.10

PACKAGE SIZE OF 1



CARBIDE

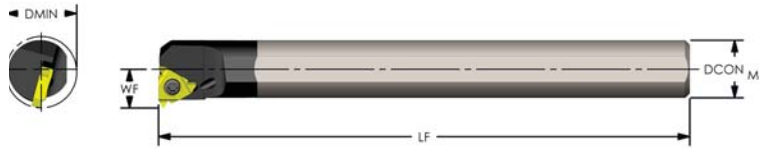

8:1 Ratio

Threading/Grooving Laydown

Coolant Thru

PRODUCT #	Designation Right Hand	DCON MS	LF	WF	DMIN	Insert	Insert Screw	Anvil Screw	Anvil	Price
920-000-210	E08R LSER2	0.500	8	.308	.588	2IR	SR34505L	--	--	\$276.70
920-000-249	E10Q LSER2	.625	7	.371	.721	2IR	SR34505L	--	--	\$341.40
920-000-301	E12Q LSER3	.750	7	.510	.935	3IR	MTS-35	--	--	\$450.50
920-000-325	E12S LSER3	.750	10	.510	.935	3IR	MTS-35	--	--	\$518.40
920-000-353	E16R LSER3	1.000	8	.650	1.210	3IR	SA3T	SY3T	YI3	\$656.00
920-000-381	E16T LSER3	1.000	12	.650	1.210	3IR	SA3T	SY3T	YI3	\$823.90

PRODUCT #	Designation Left Hand	DCON MS	LF	WF	DMIN	Insert	Insert Screw	Anvil Screw	Anvil	Price
920-000-209	E08R LSEL2	0.500	8	.308	.588	2IL	SR34505L	--	--	\$276.70
920-000-248	E10Q LSEL2	.625	7	.371	.721	2IL	SR34505L	--	--	\$341.40
920-000-300	E12Q LSEL3	.750	7	.510	.935	3IL	MTS-35	--	--	\$450.50
920-000-324	E12S LSEL3	.750	10	.510	.935	3IL	MTS-35	--	--	\$518.40
920-000-352	E16R LSEL3	1.000	8	.650	1.210	3IL	SA3T	SY3T	YE3	\$656.00
920-000-382	E16T LSEL3	1.000	12	.650	1.210	3IL	SA3T	SY3T	YE3	\$823.90

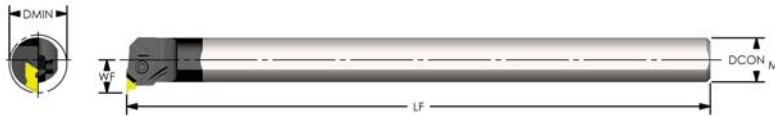

8:1 Ratio

Threading/Grooving Top Notch

Coolant Thru

PRODUCT #	Designation Right Hand	DCON MS	LF	WF	DMIN	Insert	Clamp	Clamp Screw	Price
920-000-212	E08R NER2	0.500	8	.437	.730	NG 2L	CM-147	6-32	\$377.40
920-000-274	E10S NER2	.625	10	0.500	1.000	NG 2L	CM-75	6-32	\$517.30
920-000-331	E12S NER2	.750	10	.562	1.120	NG 2L	CM-75	6-32	\$569.00

PRODUCT #	Designation Left Hand	DCON MS	LF	WF	DMIN	Insert	Clamp	Clamp Screw	Price
920-000-211	E08R NEL2	0.500	8	.437	.730	NG 2R	CM-146	6-32	\$377.40
920-000-273	E10S NEL2	.625	10	0.500	1.000	NG 2R	CM-74	6-32	\$517.30
920-000-330	E12S NEL2	.750	10	.562	1.120	NG 2R	CM-74	6-32	\$569.00

PRODUCT #	Clamp	Price Each
968-000-016	CL-6	\$5.30
968-000-017	CL-7	\$5.30
968-000-020	CL-9	\$5.30
968-000-010	CL-12	\$5.30
968-000-011	CL-19	\$6.60
968-000-012	CL-20	\$5.30

PRODUCT #	Clamp	Price Each
968-000-013	CL-21	\$12.40
968-000-014	CL-22	\$12.60
968-000-015	CL-30	\$9.30
968-000-018	CL-84	\$28.40
968-000-019	CL-85	\$28.40

PACKAGE SIZE OF 1

PRODUCT #	Anvil	Price Each
968-000-185	YI3	\$20.10
968-000-182	YE3	\$20.10
968-000-187	YI4	\$31.90
968-000-186	YI3M-1.5N	\$30.80
968-000-183	YE4	\$31.90
968-000-188	YI5	\$50.60
968-000-184	YE5	\$50.60

PACKAGE SIZE OF 1

PRODUCT #	Anvil Screw	Price Each
968-000-146	SY3T	\$2.40
968-000-147	SY4T	\$3.00
968-000-148	SY5T	\$4.70

PACKAGE SIZE OF 5

PRODUCT #	Insert Screw	Price Each
968-000-124	SA3T	\$3.50
968-000-125	SA4T	\$4.70
968-000-126	SA5T	\$8.10

PACKAGE SIZE OF 5

CARBIDE

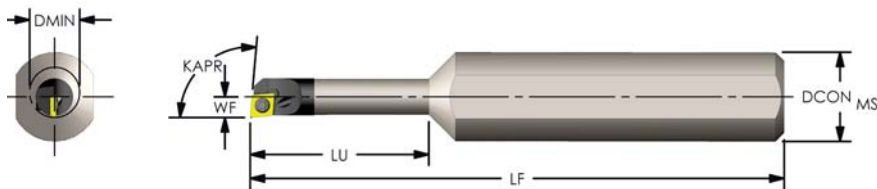

Positive 80° Diamond (KAPR: 95°) Reduced Neck *SERIES "C"* **Coolant Thru**

PRODUCT #	Designation	DCON MS	KAPR	LF	LU	WF	DMIN	Insert	Insert Screw	Key	Price
915-000-004	CCUD-180/500-7/8-5R	0.500	.189	2.38	.875	.104	.208	CDHB 1.20.60.5	MTS-183	T-6	\$299.10
915-000-008	CCUD-203/500-1-5R	0.500	.210	2.5	1.000	.119	.230	CDHB 1.20.60.5	MTS-183	T-6	\$299.10
915-000-005	CCUD-180/625-7/8-5R	.625	.189	3	.875	.104	.208	CDHB 1.20.60.5	MTS-183	T-6	\$331.60
915-000-009	CCUD-203/625-1-5R	.625	.210	3.5	1.000	.119	.230	CDHB 1.20.60.5	MTS-183	T-6	\$299.10
915-000-010	CCUD-250/625-1 1/4-5R	.625	.260	3	1.250	.145	.285	CDHB 1.20.60.5	MTS-184	T-6	\$320.40

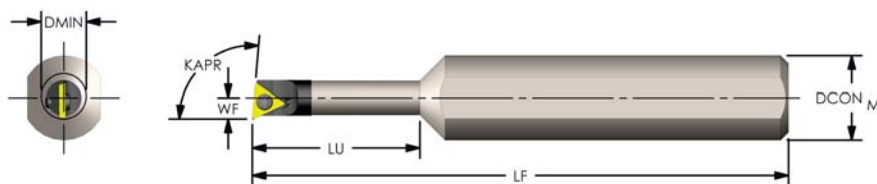

Positive Triangle (KAPR: 95°) Reduced Neck *SERIES "F"* **Coolant Thru**

PRODUCT #	Designation	DCON MS	KAPR	LF	LU	WF	DMIN	Insert	Insert Screw	Key	Price
915-000-032	FCUD-250/500-1 1/4-5R	0.500	.260	2.75	1.250	.156	.300	TDHB 1.280.750.5	MTS-224	T-7	\$284.50
915-000-036	FCUD-312/500-3 1/8-5R	0.500	.322	4.63	3.125	.187	.360	TDHB 1.280.750.5	MTS-224	T-7	\$290.10
915-000-033	FCUD-250/625-1 1/4-5R	.625	.260	4	1.250	.156	.300	TDHB 1.280.750.5	MTS-224	T-7	\$299.10
915-000-037	FCUD-312/625-1 1/2-5R	.625	.322	4	1.500	.187	.360	TDHB 1.280.750.5	MTS-224	T-7	\$299.10

PRODUCT #	Insert Screws	Price Each
968-000-086	MTS-183	\$3.20
968-000-087	MTS-184	\$3.20
968-000-088	MTS-2	\$2.90
968-000-091	MTS-224	\$3.20
968-000-092	MTS-255	\$3.20
968-000-094	MTS-35	\$3.20
968-000-090	MTS-2.5L	\$2.90
968-000-052	ETS 4-40	\$3.20

PACKAGE SIZE OF 5

PRODUCT #	Key	Price Each
968-000-156	T-6	\$4.20
968-000-158	T-7	\$3.80
968-000-149	T-10	\$6.50
968-000-151	T-15	\$3.80
968-000-153	T-20	\$4.00

PACKAGE SIZE OF 5

USE THE RIGHT SET SCREW FLAT POINT, NOT CUP POINT



CARBIDE

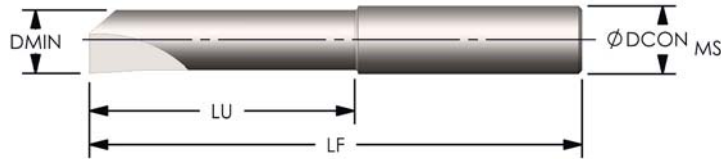

**Coated &
Uncoated**

8:1 Ratio

Positive 80° Diamond

No Coolant

PRODUCT #	Designation	DMIN	LU	DCON MS	LF	GRADE	Grade
951-000-037	UD125-020-75R	.020	0.075	0.125	1.500	UD5	\$39.60
951-000-038		.020	0.075	0.125	1.500	UD51	\$47.30
951-000-039		.020	0.075	0.125	1.500	UD52	\$49.50
951-000-040	UD125-030-100R	.030	0.100	0.125	1.500	UD5	\$36.30
951-000-041		.030	0.100	0.125	1.500	UD51	\$39.60
951-000-042		.030	0.100	0.125	1.500	UD52	\$47.30
951-000-043	UD125-040-150R	.040	0.150	0.125	1.500	UD5	\$36.30
951-000-044		.040	0.150	0.125	1.500	UD51	\$39.60
951-000-045		.040	0.150	0.125	1.500	UD52	\$47.30
951-000-046	UD125-050-150R	.050	0.150	0.125	1.500	UD5	\$30.70
951-000-047		.050	0.150	0.125	1.500	UD51	\$31.90
951-000-048		.050	0.150	0.125	1.500	UD52	\$30.80
951-000-001	UD125-060-188R	.060	0.188	0.125	1.500	UD5	\$27.20
951-000-002		.060	0.188	0.125	1.500	UD51	\$30.70
951-000-003		.060	0.188	0.125	1.500	UD52	\$31.90
951-000-004	UD125-080-375R	.080	0.375	0.125	1.500	UD5	\$27.20
951-000-005		.080	0.375	0.125	1.500	UD51	\$30.70
951-000-006		.080	0.375	0.125	1.500	UD52	\$31.90
951-000-007	UD125-090-500R	.090	0.500	0.125	1.500	UD5	\$27.20
951-000-008		.090	0.500	0.125	1.500	UD51	\$30.70
951-000-009		.090	0.500	0.125	1.500	UD52	\$31.90
951-000-010	UD125-120-625R	.120	0.625	0.125	1.500	UD5	\$27.20
951-000-011		.120	0.625	0.125	1.500	UD51	\$30.70
951-000-012		.120	0.625	0.125	1.500	UD52	\$31.90
951-000-013	UD188-150-750R	.150	0.750	.0188	2.000	UD5	\$30.80
951-000-014		.150	0.750	0.188	2.000	UD51	\$35.20
951-000-015		.150	0.750	0.188	2.000	UD52	\$35.20
951-000-016	UD188-180-1.00R	.180	1.000	0.188	2.000	UD5	\$30.80
951-000-017		.180	1.000	0.188	2.000	UD51	\$35.20
951-000-018		.180	1.000	0.188	2.000	UD52	\$35.20
951-000-019	UD250-210-1.25R	.210	1.250	0.250	2.500	UD5	\$39.60
951-000-020		.210	1.250	0.250	2.500	UD51	\$48.40
951-000-021		.210	1.250	0.250	2.500	UD52	\$50.60
951-000-022	UD250-240-1.25R	.240	1.250	0.250	2.500	UD5	\$40.70
951-000-023		.240	1.250	0.250	2.500	UD51	\$49.50
951-000-024		.240	1.250	0.250	2.500	UD52	\$51.70
951-000-025	UD312-270-1.25R	.270	1.250	0.312	2.500	UD5	\$50.60
951-000-026		.270	1.250	0.312	2.500	UD51	\$58.30
951-000-027		.270	1.250	0.312	2.500	UD52	\$60.50
951-000-028	UD312-300-1.25R	.300	1.250	0.312	2.500	UD5	\$50.60
951-000-029		.300	1.250	0.312	2.500	UD51	\$58.30
951-000-030		.300	1.250	0.312	2.500	UD52	\$60.50
951-000-031	UD375-330-1.50R	.330	1.500	0.375	2.500	UD5	\$69.30
951-000-032		.330	1.500	0.375	2.500	UD51	\$78.10
951-000-033		.330	1.500	0.375	2.500	UD52	\$80.30
951-000-034	UD375-360-1.50R	.360	1.500	0.375	2.500	UD5	\$69.30
951-000-035		.360	1.500	0.375	2.500	UD51	\$78.10
951-000-036		.360	1.500	0.375	2.500	UD52	\$80.30

The following services are for **Carbide** bars only:

Cut-Off Service	Extra-Flat Service
up to 3/8" diameter: \$15	up to 5/16" diameter: \$19
1/2" diameter: \$20	3/8" - 1/2" diameter: \$24
5/8" diameter: \$25	5/8" - 3/4" diameter: \$29
3/4" diameter: \$30	1" - 2" diameter: \$51
1" diameter: \$45	
1 1/4" diameter: \$55	
1 1/2" diameter: \$80	
1 3/4" diameter: \$90	
2" diameter: \$105	

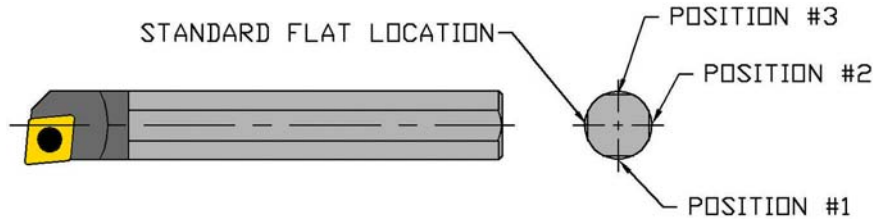

Ordering is easy, Use part # "Cut-Off" and specify the length in the item description
Use part # "Extra-Flat" and specify the location in the item description

Have us braze on a steel coolant adapter to any **Carbide** Boring Bar 1/2" or larger!



**ONLY
\$41.00**

Comes with 1/16-27 NPT (or) 1/8-27 NPT
Plastic loc-line NOT included

Item Designations:
Coolant Adapter - 1/16
Coolant Adapter - 1/8

Designation Depends on the Diameter of the Bar:
Coolant Adapter-1/16 for 1/2" Diameter Bars
Coolant Adapter-1/8 for 5/8" Diameter Bars and Larger

HEAVY METAL BORING BARS

Vibration dampening
to help reduce chatter
in your application

- Machine deeper bores
- Achieve better precision and finish

Up to 6:1 Ratio

.187”-.750” Diameters



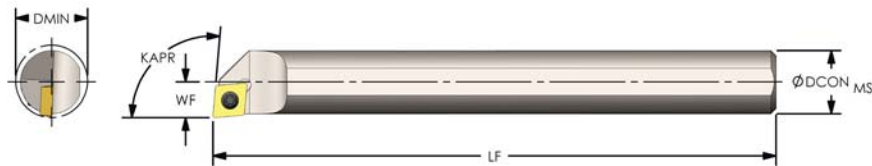

6:1 Ratio

Positive 80° Diamond (KAPR: 95°)

No Coolant

PRODUCT # Left hand	PRODUCT # Right hand	Designation	DCON MS	LF	WF	DMIN	Insert	Insert Screw	Key	Price
940-000-097	940-000-098	J03F SCLDR/L1.2 *	.187	3	.102	.205	CDHB 1.20.60	MTS-183	T-6	\$119.90
940-000-100	940-000-101	J04F SCLDR/L1.5-138 * ■	.250	3	.138	.275	CDGW 1.510	MTS-184	T-6	\$132.00
940-000-105	940-000-106	J05H SCLPR/L1.8-167 * ■	.312	4	.167	.340	CPMT 1.81.20.5	MTS-224	T-7	\$160.60

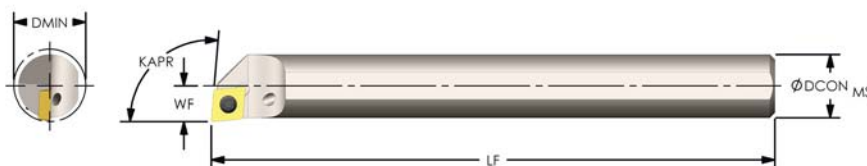

Positive 80° Diamond (KAPR: 95°)

Coolant Thru

PRODUCT # Left hand	PRODUCT # Right hand	Designation	DCON MS	LF	WF	DMIN	Insert	Insert Screw	Key	Price
940-000-003	940-000-004	HM06J SCLPR/L2-203 ■	.375	4.5	.203	.410	CPMT 21.51	MTS-255	T-7	\$158.40
940-000-015	940-000-016	HM06Q SCLPR/L2-203 ■	.375	7	.203	.410	CPMT 21.51	MTS-255	T-7	\$207.90
940-000-027	940-000-028	HM08J SCLPR/L2-281 ■	0.500	4.5	.281	.560	CPMT 21.51	MTS-255	T-7	\$203.50
940-000-037	940-000-038	HM08Q SCLPR/L2-281 ■	0.500	7	.281	.560	CPMT 21.51	MTS-255	T-7	\$282.70
940-000-049	940-000-051	HM10J SCLPR/L2	.625	4.5	.406	.760	CPMT 21.51	MTS-255	T-7	\$264.00
940-000-065	940-000-067	HM10Q SCLPR/L2	.625	7	.406	.760	CPMT 21.51	MTS-255	T-7	\$352.00
940-000-050	940-000-052	HM10J SCLPR/L3	.625	4.5	.406	.760	CPMT 32.51	MTS-35	T-15	\$264.00
940-000-066	940-000-067	HM10Q SCLPR/L3	.625	7	.406	.760	CPMT 32.51	MTS-35	T-15	\$352.00
940-000-079	940-000-080	HM12J SCLPR/L3	.750	4.5	0.500	.920	CPMT 32.51	MTS-35	T-15	\$376.20
940-000-089	940-000-090	HM12Q SCLPR/L3	.750	7	0.500	.920	CPMT 32.51	MTS-35	T-15	\$522.50
940-000-001	940-000-002	HM06J SCLCR/L2-203 ■	.375	4.5	.203	.410	CCMT 21.51	MTS-255	T-7	\$158.40
940-000-013	940-000-014	HM06Q SCLCR/L2-203 ■	.375	7	.203	.410	CCMT 21.51	MTS-255	T-7	\$207.90
940-000-025	940-000-026	HM08J SCLCR/L2-281 ■	0.500	4.5	.281	.560	CCMT 21.51	MTS-255	T-7	\$203.50
940-000-035	940-000-036	HM08Q SCLCR/L2-281 ■	0.500	7	.281	.560	CCMT 21.51	MTS-255	T-7	\$282.70
940-000-045	940-000-047	HM10J SCLCR/L2	.625	4.5	.406	.760	CCMT 21.51	MTS-255	T-7	\$264.00
940-000-061	940-000-063	HM10Q SCLCR/L2	.625	7	.406	.760	CCMT 21.51	MTS-255	T-7	\$352.00
940-000-046	940-000-048	HM10J SCLCR/L3	.625	4.5	.406	.760	CCMT 32.51	MTS-35	T-15	\$264.00
940-000-062	940-000-064	HM10Q SCLCR/L3	.625	7	.406	.760	CCMT 32.51	MTS-35	T-15	\$352.00
940-000-077	940-000-078	HM12J SCLCR/L3	.750	4.5	0.500	.920	CCMT 32.51	MTS-35	T-15	\$376.20
940-000-087	940-000-088	HM12Q SCLCR/L3	.750	7	0.500	.920	CCMT 32.51	MTS-35	T-15	\$522.50

■ Minimum Clearance Bars are intended for light machining with minimum bore clearance. Max depth of cut .015" - .020"

* bars .312 and smaller do not have flats

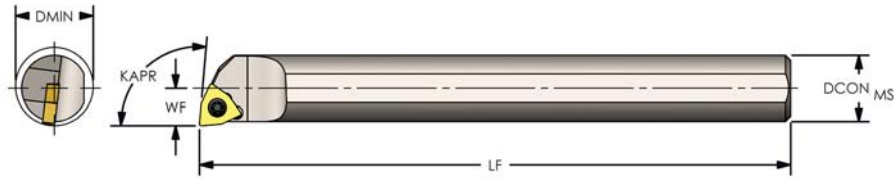

6:1 Ratio

Positive Trigon (KAPR: 95°)

No Coolant

PRODUCT # Right hand	Designation	DCON MS	LF	WF	DMIN	Insert	Insert Screw	Key	Price
940-000-099	J03F SWLCR1.2 *	.187	3	.102	.205	WCMT 1.210.5	MTS-183	T-6	\$119.90
940-000-104	J04F SWLCR1.2-138 * ■	.250	3	.138	.275	WCMT 1.210.5	MTS-184	T-6	\$132.00
940-000-109	J05H SWLCR1.5-167 * ■	.312	4	.167	.342	WCMT 1.51.50.5	MTS-2	T-6	\$160.60

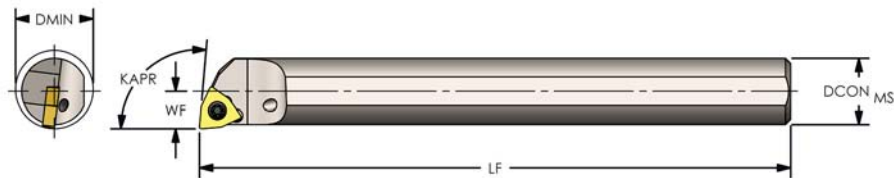

Positive Trigon (KAPR: 95°)

Coolant Thru

PRODUCT # Left hand	PRODUCT # Right hand	Designation	DCON MS	LF	WF	DMIN	Insert	Insert Screw	Key	Price
940-000-011	940-000-012	HM06J SWLCR/L2-203 ■	.375	4.5	.203	.410	WCMT 21.51	MTS-255	T-7	\$158.40
940-000-023	940-000-024	HM06Q SWLCR/L2-203 ■	.375	7	.203	.410	WCMT 21.51	MTS-255	T-7	\$207.90
940-000-033	940-000-034	HM08J SWLCR/L2-281 ■	0.500	4.5	.281	.560	WCMT 21.51	MTS-255	T-7	\$203.50
940-000-043	940-000-044	HM08Q SWLCR/L2-281 ■	0.500	7	.281	.560	WCMT 21.51	MTS-255	T-7	\$282.70
940-000-057	940-000-059	HM10J SWLCR/L2	.625	4.5	.406	.760	WCMT 21.51	MTS-255	T-7	\$264.00
940-000-073	940-000-075	HM10Q SWLCR/L2	.625	7	.406	.760	WCMT 21.51	MTS-255	T-7	\$352.00
940-000-058	940-000-060	HM10J SWLCR/L3	.625	4.5	.406	.760	WCMT 32.51	MTS-35	T-15	\$264.00
940-000-074	940-000-076	HM10Q SWLCR/L3	.625	7	.406	.760	WCMT 32.51	MTS-35	T-15	\$352.00
940-000-085	940-000-086	HM12J SWLCR/L3	.750	4.5	0.500	.920	WCMT 32.51	MTS-35	T-15	\$376.20
940-000-095	940-000-096	HM12Q SWLCR/L3	.750	7	0.500	.920	WCMT 32.51	MTS-35	T-15	\$522.50

■ Minimum Clearance Bars are intended for light machining with minimum bore clearance. Max depth of cut .015" - .020"
* bars .312 and smaller do not have flats

PRODUCT #	Insert Screws	Price Each
968-000-086	MTS-183	\$3.20
968-000-087	MTS-184	\$3.20
968-000-088	MTS-2	\$2.90
968-000-091	MTS-224	\$3.20
968-000-092	MTS-255	\$3.20
968-000-094	MTS-35	\$3.20
968-000-090	MTS-2.5L	\$2.90
968-000-052	ETS 4-40	\$3.20

PACKAGE SIZE OF 5

PRODUCT #	Key	Price Each
968-000-156	T-6	\$4.20
968-000-158	T-7	\$3.80
968-000-149	T-10	\$6.50
968-000-151	T-15	\$3.80
968-000-153	T-20	\$4.00

PACKAGE SIZE OF 5

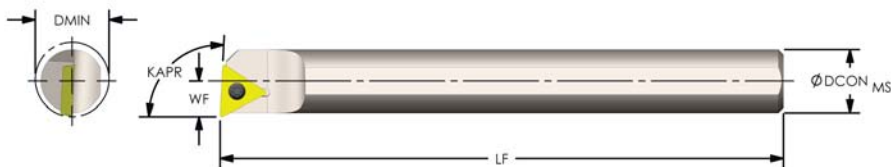

6:1 Ratio

Positive Triangle (KAPR: 93°)

No Coolant

PRODUCT # Left hand	PRODUCT # Right hand	Designation	DCON MS	LF	WF	DMIN	Insert	Insert Screw	Key	Price
940-000-102	940-000-103	J04F STUCR/L1.2-138 * ■	.250	3	.138	.275	TCMT 1.21.20.5	MTS-184	T-6	\$132.00
940-000-107	940-000-108	J05H STUCR/L1.2-167 * ■	.312	4	.167	.340	TCMT 1.21.20.5	MTS-184	T-6	\$160.60

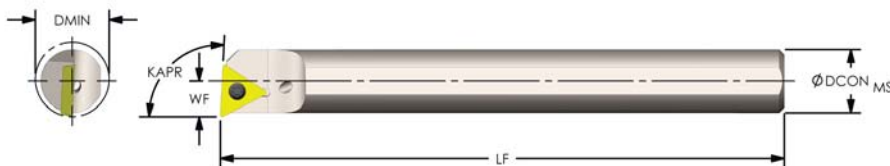

Coolant Thru

Positive Triangle (KAPR: 93°)

PRODUCT # Left hand	PRODUCT # Right hand	Designation	DCON MS	LF	WF	DMIN	Insert	Insert Screw	Key	Price
940-000-005	940-000-007	HM06J STUCR/L1.2-203 ■	.375	4.5	.203	.410	TCMT 1.21.20.5	MTS-184	T-6	\$158.40
940-000-017	940-000-019	HM06Q STUCR/L1.2-203 ■	.375	7	.203	.410	TCMT 1.21.20.5	MTS-184	T-6	\$207.90
940-000-009	940-000-010	HM06J STUPR/L2-203 ■	.375	4.5	.203	.410	TPMT 21.51	MTS-255	T-7	\$158.40
940-000-021	940-000-022	HM06Q STUPR/L2-203 ■	.375	7	.203	.410	TPMT 21.51	MTS-255	T-7	\$207.90
940-000-031	940-000-032	HM08J STUPR/L2-281 ■	0.500	4.5	.281	.560	TPMT 21.51	MTS-255	T-7	\$203.50
940-000-041	940-000-042	HM08Q STUPR/L2-281 ■	0.500	7	.281	.560	TPMT 21.51	MTS-255	T-7	\$282.70
940-000-055	940-000-056	HM10J STUPR/L2	.625	4.5	.406	.760	TPMT 21.51	MTS-255	T-7	\$264.00
940-000-071	940-000-072	HM10Q STUPR/L2	.625	7	.406	.760	TPMT 21.51	MTS-255	T-7	\$352.00
940-000-083	940-000-084	HM12J STUPR/L3	.750	4.5	0.500	.920	TPMT 32.51	MTS-35	T-15	\$376.20
940-000-093	940-000-094	HM12Q STUPR/L3	.750	7	0.500	.920	TPMT 32.51	MTS-35	T-15	\$522.50
940-000-006	940-000-008	HM06J STUCR/L2-203 ■	.375	4.5	.203	.410	TCMT 21.51	MTS-255	T-7	\$158.40
940-000-018	940-000-020	HM06Q STUCR/L2-203 ■	.375	7	.203	.410	TCMT 21.51	MTS-255	T-7	\$207.90
940-000-029	940-000-030	HM08J STUCR/L2-281 ■	0.500	4.5	.281	.560	TCMT 21.51	MTS-255	T-7	\$203.50
940-000-039	940-000-040	HM08Q STUCR/L2-281 ■	0.500	7	.281	.560	TCMT 21.51	MTS-255	T-7	\$282.70
940-000-053	940-000-054	HM10J STUCR/L2	.625	4.5	.406	.760	TCMT 21.51	MTS-255	T-7	\$264.00
940-000-069	940-000-070	HM10Q STUCR/L2	.625	7	.406	.760	TCMT 21.51	MTS-255	T-7	\$352.00
940-000-081	940-000-082	HM12J STUCR/L3	.750	4.5	0.500	.920	TCMT 32.51	MTS-35	T-15	\$376.20
940-000-091	940-000-092	HM12Q STUCR/L3	.750	7	0.500	.920	TCMT 32.51	MTS-35	T-15	\$522.50

■ Minimum Clearance Bars are intended for light machining with minimum bore clearance. Max depth of cut .015" - .020"
 * bars .312 and smaller do not have flats

PRODUCT #	Insert Screws	Price Each
968-000-086	MTS-183	\$3.20
968-000-087	MTS-184	\$3.20
968-000-088	MTS-2	\$2.90
968-000-091	MTS-224	\$3.20
968-000-092	MTS-255	\$3.20
968-000-094	MTS-35	\$3.20
968-000-090	MTS-2.5L	\$2.90
968-000-052	ETS 4-40	\$3.20

PACKAGE SIZE OF 5

PRODUCT #	Key	Price Each
968-000-156	T-6	\$4.20
968-000-158	T-7	\$3.80
968-000-149	T-10	\$6.50
968-000-151	T-15	\$3.80
968-000-153	T-20	\$4.00

PACKAGE SIZE OF 5

HEAVY METAL

MODULAR BORING BARS

Endless possibilities and the convenience of one bar with 28 different insert style configurations

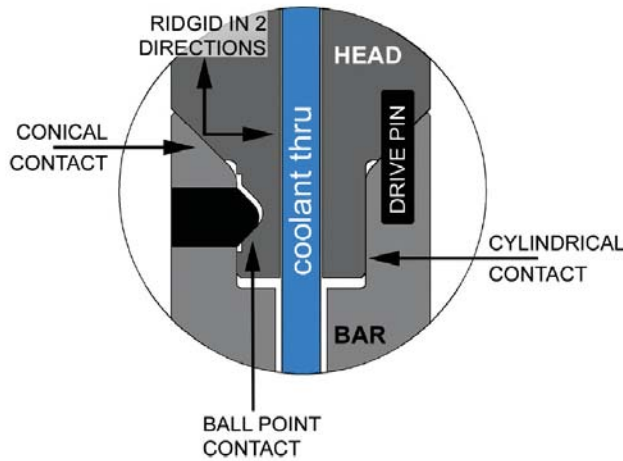

ULTRA-DEX[®]

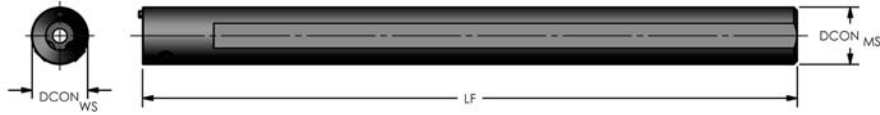

4:1 Ratio

Steel Shank

Coolant Thru

PRODUCT #	Designation	DCONMS	LF	DCONWS	Insert	Price
944-000-019	MBS 1295	0.750	9.5	0.750	MH12S	\$142.80
944-000-020	MBS 1612	1.000	11.5	1.000	MH16S	\$167.00
944-000-021	MBS 2014	1.250	14	1.250	MH20S	\$216.30
944-000-022	MBS 2414	1.500	14	1.500	MH24S	\$240.50
944-000-023	MBS 2816	1.750	16	1.750	MH28S	\$286.70
944-000-024	MBS 3210	2.000	10	2.000	MH32S	\$252.00
944-000-025	MBS 3220	2.000	20	2.000	MH32S	\$378.00
944-000-026	MBS 4012*	2.500	12	2.000	MH32S	\$430.50
944-000-027	MBS 4024*	2.500	24	2.000	MH32S	\$655.20
944-000-028	MBS 4828*	3.000	28	2.000	MH32S	\$804.30

*2.5" and 3" bars take 2" heads

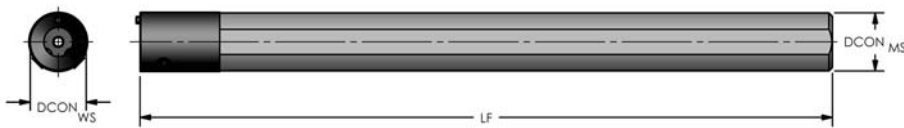

8:1 Ratio

Carbide Shank

Coolant Thru

PRODUCT #	Designation	DCONMS	LF	DCONWS	Insert	Price
944-000-002	MB 1295	0.750	9.5	0.750	MH12S	\$488.30
944-000-001	MB 1220M	20mm	241mm	0.750	MH12S	\$567.00
944-000-003	MB 1612	1.000	11.5	1.000	MH16S	\$734.00
944-000-004	MB 2014	1.250	14	1.250	MH20S	\$1,422.80
944-000-005	MB 2414	1.500	14	1.500	MH24S	\$1,672.70
944-000-006	MB 2816	1.750	16	1.750	MH28S	\$2,874.90
944-000-007	MB 3220	2.000	20	2.000	MH32S	\$4,787.00
944-000-026	MBS 4012*	2.500	12	2.000	MH32S	\$430.50
944-000-027	MBS 4024*	2.500	24	2.000	MH32S	\$655.20
944-000-028	MBS 4828*	3.000	28	2.000	MH32S	\$804.30

PRODUCT #	Set Screws	Price Each
968-000-076	MH12S	\$1.80
968-000-077	MH16S	\$2.10
968-000-078	MH20S	\$2.50
968-000-079	MH24S	\$2.50
968-000-080	MH28S	\$3.20
968-000-081	MH32S	\$3.60

SOLD IN QTY 2

MODULAR

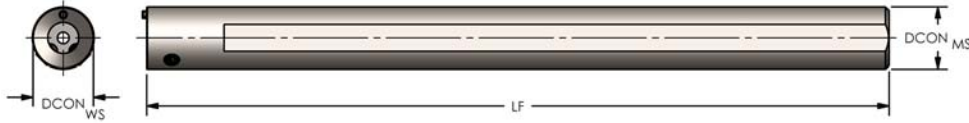

MODULAR

6:1 Ratio

Heavy Metal Shank

Coolant Thru

PRODUCT #	Designation	DCONMS	LF	DCONWS	Insert	Price
944-000-008	MBH 1212	0.750	12	0.750	MH12S	\$517.70
944-000-009	MBH 1612	1.000	12	1.000	MH16S	\$780.20
944-000-010	MBH 2012	1.250	12	1.250	MH20S	\$1,189.70
944-000-011	MBH 2412	1.500	12	1.500	MH24S	\$1,554.00
944-000-012	MBH 2414	1.500	14	1.500	MH24S	\$3,126.90
944-000-013	MBH 2812	1.750	12	1.750	MH28S	\$1,995.00
944-000-014	MBH 2816 *	1.750	16	1.750	MH28S	\$4,489.80
944-000-015	MBH 3212	2.000	12	2.000	MH32S	\$2,484.30
944-000-016	MBH 3218 *	2.000	18	2.000	MH32S	\$5,691.00
944-000-017	MBH 4024 **	2.500	24	2.000	MH32S	\$11,607.80
944-000-018	MBH 4828 **	3.000	28	2.000	MH32S	\$17,526.60

*non-stock item; call for delivery

**2.5" and 3" bars take 2" heads

PRODUCT #	Set Screws	Price Each
968-000-076	MH12S	\$1.80
968-000-077	MH16S	\$2.10
968-000-078	MH20S	\$2.50
968-000-079	MH24S	\$2.50
968-000-080	MH28S	\$3.20
968-000-081	MH32S	\$3.60

SOLD IN QTY 2

ULTRA-DEX[®]

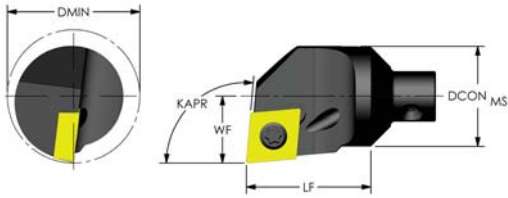

Positive 80° Diamond (KAPR: 95°)

Coolant Thru

PRODUCT # Left hand	PRODUCT # Right hand	Designation	DCON MS	LF	WF	DMIN	Insert	Insert Screw	Key	Price
945-000-017	945-000-018	MH12 SCLCR/L3	.750	0.940	0.500	.920	CCMT 32.51	MTS-35	T-15	\$88.60
945-000-065	945-000-066	MH16 SCLCR/L3	1.000	1.000	.625	1.185	CCMT 32.51	MTS-35	T-15	\$101.60
945-000-019	945-000-020	MH12 SCLPR/L3	.750	0.940	0.500	.920	CPMT 32.51	MTS-35	T-15	\$88.60
945-000-067	945-000-068	MH16 SCLPR/L3	1.000	1.000	.625	1.185	CPMT 32.51	MTS-35	T-15	\$101.60
	945-000-120	MH20 SCLCR4	1.250	1.300	0.765	1.465	CCMT 432	MTS-4	T-20	\$140.40
	945-000-156	MH24 SCLCR4	1.500	1.520	.890	1.730	CCMT 432	MTS-4	T-20	\$166.40
	945-000-190	MH28 SCLCR4	1.750	1.770	1.015	2.000	CCMT 432	MTS-4	T-20	\$192.30
	912-000-157	MH32 SCLCR4	2.000	2.030	1.281	2.400	CCMT 432	MTS-4	T-20	\$232.20

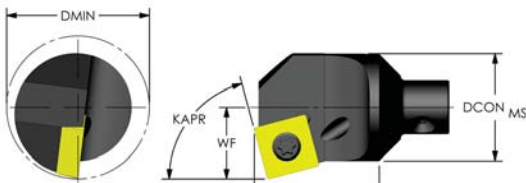

Positive Square (KAPR: 75°)

Coolant Thru

PRODUCT #	Designation	DCON MS	LF	WF	DMIN	Insert	Insert Screw	Key	Price
945-000-028	MH12 SSKCR3	.750	.875	0.500	.920	SCMT 32.51	MTS-35	T-15	\$88.60
945-000-078	MH16 SSKCR4	1.000	.935	.625	1.185	SCMT 432	MTS-4	T-20	\$101.60

PRODUCT #	Insert Screws	Price Each
968-000-086	MTS-183	\$3.20
968-000-087	MTS-184	\$3.20
968-000-088	MTS-2	\$2.90
968-000-091	MTS-224	\$3.20
968-000-092	MTS-255	\$3.20
968-000-094	MTS-35	\$3.20
968-000-090	MTS-2.5L	\$2.90
968-000-052	ETS 4-40	\$3.20

PACKAGE SIZE OF 5

PRODUCT #	Key	Price Each
968-000-156	T-6	\$4.20
968-000-158	T-7	\$3.80
968-000-149	T-10	\$6.50
968-000-151	T-15	\$3.80
968-000-153	T-20	\$4.00

PACKAGE SIZE OF 5

MODULAR

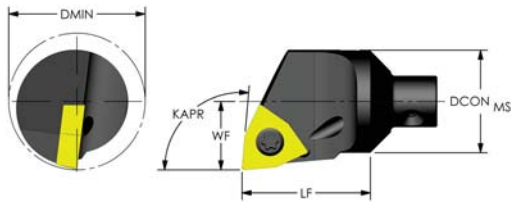

Positive Trigon (KAPR: 95°)

Coolant Thru

PRODUCT # Left hand	PRODUCT # Right hand	Designation	DCON MS	LF	WF	DMIN	Insert	Insert Screw	Key	Price
945-000-037	945-000-038	MH12 SWLCR/L3	.750	.940	0.500	.920	WCMT 32.51	MTS-35	T-15	\$88.60
945-000-087	945-000-088	MH16 SWLCR/L3	1.000	1.000	.625	1.185	WCMT 32.51	MTS-35	T-15	\$101.60

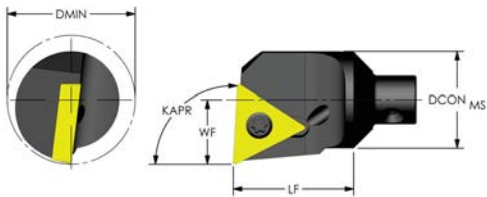

Positive Triangle (KAPR: 93°)

Coolant Thru

PRODUCT # Left hand	PRODUCT # Right hand	Designation	DCON MS	LF	WF	DMIN	Insert	Insert Screw	Key	Price
945-000-031	945-000-032	MH12 STUCR/L3	.750	.940	0.500	.920	TCMT 32.51	MTS-35	T-15	\$88.60
945-000-081	945-000-082	MH16 STUCR/L3	1.000	1.000	.625	1.185	TCMT 32.51	MTS-35	T-15	\$101.60

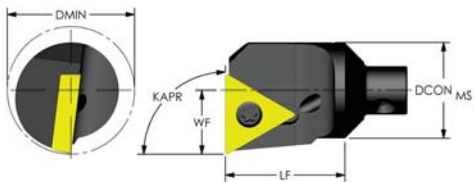

Positive Triangle (KAPR: 90°)

Coolant Thru

PRODUCT # Left hand	PRODUCT # Right hand	Designation	DCON MS	LF	WF	DMIN	Insert	Insert Screw	Key	Price
945-000-029	945-000-030	MH12 STFRCR/L3	.750	.940	0.500	.920	TCMT 32.51	MTS-35	T-15	\$88.60
945-000-079	945-000-080	MH16 STFRCR/L3	1.000	1.000	.625	1.185	TCMT 32.51	MTS-35	T-15	\$101.60

PRODUCT #	Insert Screws	Price Each
968-000-086	MTS-183	\$3.20
968-000-087	MTS-184	\$3.20
968-000-088	MTS-2	\$2.90
968-000-091	MTS-224	\$3.20
968-000-092	MTS-255	\$3.20
968-000-094	MTS-35	\$3.20
968-000-090	MTS-2.5L	\$2.90
968-000-052	ETS 4-40	\$3.20

PACKAGE SIZE OF 5

PRODUCT #	Key	Price Each
968-000-156	T-6	\$4.20
968-000-158	T-7	\$3.80
968-000-149	T-10	\$6.50
968-000-151	T-15	\$3.80
968-000-153	T-20	\$4.00

PACKAGE SIZE OF 5

ULTRA-DEX

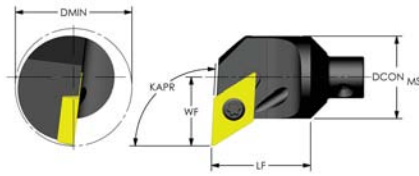

Positive 55° Diamond (KAPR: 95°) Profiling

Coolant Thru

PRODUCT # Left hand	PRODUCT # Right hand	Designation	DCON MS	LF	WF	DMIN	Insert	Insert Screw	Key	Price
945-000-024	945-000-025	MH12 SDUCR/L3	.750	.940	.625	1.050	DCMT 32.51	MTS-35	T-15	\$101.60
945-000-072	945-000-073	MH16 SDUCR/L3	1.000	1.000	.750	1.310	DCMT 32.51	MTS-35	T-15	\$114.50
	945-000-123	MH20 SDUCR3-8	1.250	1.300	.800	1.500	DCMT 32.51	MTS-35	T-15	\$140.40
945-000-121	945-000-122	MH20 SDUCR/L3	1.250	1.300	1.000	1.700	DCMT 32.51	MTS-35	T-15	\$140.40
945-000-157	945-000-158	MH24 SDUCR/L3	1.500	1.520	1.120	1.960	DCMT 32.51	MTS-35	T-15	\$166.40
945-000-191	945-000-192	MH28 SDUCR/L3	1.750	1.770	1.250	2.230	DCMT 32.51	MTS-35	T-15	\$192.30
945-000-226	945-000-227	MH32 SDUCR/L3	2.000	2.030	1.375	2.500	DCMT 32.51	MTS-35	T-15	\$230.10
	945-000-225	MH32 SCLCR4	2.000	2.030	1.281	2.400	CCMT 432	MTS-4	T-20	\$230.10

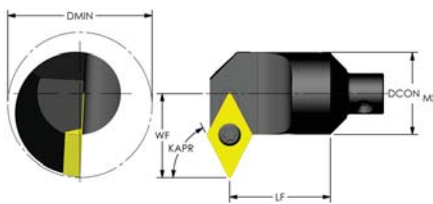

Positive 55° Diamond (KAPR: 62.5°) Profiling

Coolant Thru

PRODUCT #	Designation	DCON MS	LF	WF	DMIN	Insert	Insert Screw	Key	Price
945-000-021	MH12 SDNCR3	.750	.940	0.765	1.190	DCMT 32.51	MTS-35	T-15	\$109.10
945-000-069	MH16 SDNCR3	1.000	1.000	.890	1.450	DCMT 32.51	MTS-35	T-15	\$122.10

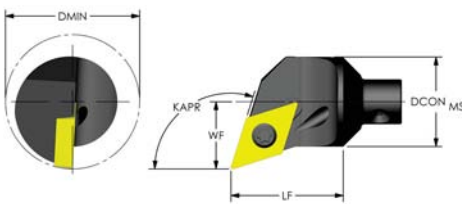

Positive 55° Diamond (KAPR: 107.5°) Profiling

Coolant Thru

PRODUCT # Left hand	PRODUCT # Right hand	Designation	DCON MS	LF	WF	DMIN	Insert	Insert Screw	Key	Price
945-000-022	945-000-023	MH12 SDQCR/L3	.750	.940	.562	1.000	DCMT 32.51	MTS-35	T-15	\$101.60
945-000-070	945-000-071	MH16 SDQCR/L3	1.000	1.000	.625	1.185	DCMT 32.51	MTS-35	T-15	\$114.50

PRODUCT #	Insert Screws	Price Each
968-000-086	MTS-183	\$3.20
968-000-087	MTS-184	\$3.20
968-000-088	MTS-2	\$2.90
968-000-091	MTS-224	\$3.20
968-000-092	MTS-255	\$3.20
968-000-094	MTS-35	\$3.20
968-000-090	MTS-2.5L	\$2.90
968-000-052	ETS 4-40	\$3.20

PACKAGE SIZE OF 5

PRODUCT #	Key	Price Each
968-000-156	T-6	\$4.20
968-000-158	T-7	\$3.80
968-000-149	T-10	\$6.50
968-000-151	T-15	\$3.80
968-000-153	T-20	\$4.00

PACKAGE SIZE OF 5

MODULAR

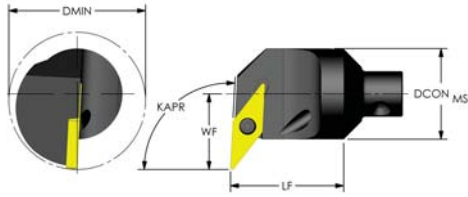

Positive 35° Diamond (KAPR: 93°) Profiling

Coolant Thru

PRODUCT # Left hand	PRODUCT # Right hand	Designation	DCON MS	LF	WF	DMIN	Insert	Insert Screw	Key	Price
945-000-035	945-000-036	MH12 SVUBR/L2	.750	.940	.625	1.045	VBMT 21.51	MTS-2.5L	T-7	\$101.60
945-000-085	945-000-086	MH16 SVUBR/L3	1.000	1.000	.875	1.435	VBMT 331	MTS-3.5L	T-15	\$114.50

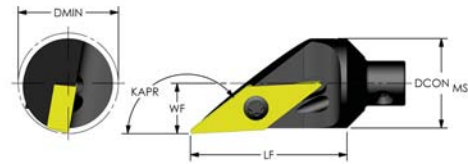

Positive 35° Diamond (KAPR: 142°) Profiling

Coolant Thru

PRODUCT # Left hand	PRODUCT # Right hand	Designation	DCON MS	LF	WF	DMIN	Insert	Insert Screw	Key	Price
945-000-033	945-000-034	MH12 SVJBR/L3	.750	1.315	.421	.840	VBMT 331	MTS-3.5L	T-15	\$101.60
945-000-083	945-000-084	MH16 SVJBR/L3	1.000	1.375	.546	1.110	VBMT 331	MTS-3.5L	T-15	\$114.50
945-000-124	945-000-125	MH20 SVJBR/L3	1.250	1.675	.671	1.700	VBMT 331	MTS-3.5L	T-15	\$140.40
945-000-161	945-000-162	MH24 SVJBR/L3	1.500	1.895	.796	1.960	VBMT 331	MTS-3.5L	T-15	\$166.40
945-000-193	945-000-194	MH28 SVJBR/L3	1.750	2.145	.921	2.230	VBMT 331	MTS-3.5L	T-15	\$192.30
945-000-228	945-000-229	MH32 SVJBR/L3	2.000	2.405	1.046	2.500	VBMT 331	MTS-3.5L	T-15	\$230.10

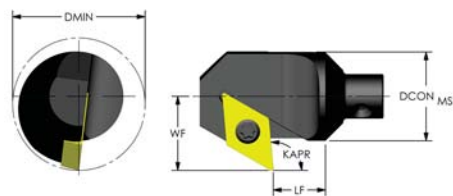

Positive 55° Diamond (KAPR: 95°) Back Facing

Coolant Thru

PRODUCT # Left hand	PRODUCT # Right hand	Designation	DCON MS	LF	WF	DMIN	Insert	Insert Screw	Key	Price
945-000-026	945-000-027	MH12 SDXCR/L3	.750	.440	.625	1.050	DCMT 32.51	MTS-35	T-15	\$101.60
945-000-074	945-000-075	MH16 SDXCR/L3	1.000	.525	.750	1.310	DCMT 32.51	MTS-35	T-15	\$114.50

PRODUCT #	Insert Screws	Price Each
968-000-086	MTS-183	\$3.20
968-000-087	MTS-184	\$3.20
968-000-088	MTS-2	\$2.90
968-000-091	MTS-224	\$3.20
968-000-092	MTS-255	\$3.20
968-000-094	MTS-35	\$3.20
968-000-090	MTS-2.5L	\$2.90
968-000-052	ETS 4-40	\$3.20

PACKAGE SIZE OF 5

PRODUCT #	Key	Price Each
968-000-156	T-6	\$4.20
968-000-158	T-7	\$3.80
968-000-149	T-10	\$6.50
968-000-151	T-15	\$3.80
968-000-153	T-20	\$4.00

PACKAGE SIZE OF 5

PRODUCT #	Insert Screws	Price Each
968-000-093	MTS-3.5L	\$8.60
968-000-095	MTS-4	\$10.10
968-000-096	MTS-526	\$11.50

PACKAGE SIZE OF 1

ULTRA-DEX

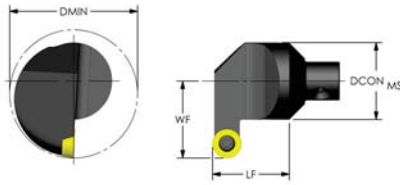

Positive Round

Coolant Thru

PRODUCT # Left hand	PRODUCT # Right hand	Designation	DCON MS	LF	WF	Zc	DMIN	Insert	Screw	Price
945-000-076	945-000-077	MH16 SRNCR/L3	1.000	1.000	1.000	.188	1.560	RCMT 32.5	MTS-35	\$101.60
945-000-159	945-000-160	MH24 SRNCR/L4	1.500	1.520	1.250	.250	2.090	RCMT 43	MTS-4	\$166.40

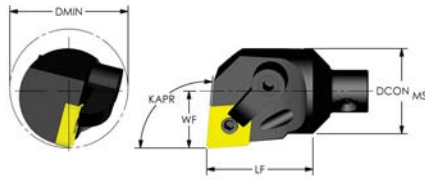

Negative 80° Diamond (KAPR: 95°)

Coolant Thru

PRODUCT # Left hand	PRODUCT # Right hand	Designation	DCON MS	LF	WF	DMIN	Insert	Shim	Clamp	Clamp Screw	Lock Pin	Price
945-000-005	945-000-006	MH12 MCLNR/L3	.750	.940	0.500	.920	CNMG 322	--	CL-7	XNS-36	NL-33	\$114.50
945-000-044	945-000-046	MH16 MCLNR/L3	1.000	1.000	0.640	1.200	CNMG 322	--	CL-7	XNS-36	NL-33	\$127.50
945-000-045	945-000-047	MH16 MCLNR/L4	1.000	1.000	0.640	1.200	CNMG 432	--	CL-20	XNS-47	NL-44	\$127.50
945-000-096	945-000-097	MH20 MCLNR/L4	1.250	1.300	0.765	1.470	CNMG 432	ICSN-433	CL-20	XNS-47	NL-46	\$166.40
945-000-133	945-000-134	MH24 MCLNR/L4	1.500	1.520	.890	1.730	CNMG 432	ICSN-433	CL-20	XNS-47	NL-46	\$192.30
945-000-170	945-000-171	MH28 MCLNR/L4	1.750	1.770	1.015	1.995	CNMG 432	ICSN-433	CL-20	XNS-47	NL-46	\$217.10
945-000-200	945-000-202	MH32 MCLNR/L4	2.000	2.030	1.281	2.400	CNMG 432	ICSN-433	CL-20	XNS-47	NL-46	\$256.00
945-000-203	945-000-205	MH32 MCLNR/L5	2.000	2.030	1.281	2.400	CNMG 543	ICSN-533	CL-12	XNS-510	NL-58	\$256.00

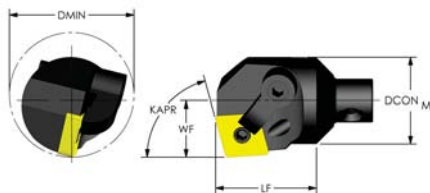

Negative 80° Diamond (KAPR: 75°)

Coolant Thru

PRODUCT # Left hand	PRODUCT # Right hand	Designation	DCON MS	LF	WF	DMIN	Insert	Shim	Clamp	Clamp Screw	Lock Pin	Price
945-000-003	945-000-004	MH12 MCKNR/L3	.750	.875	.490	.910	CNMG 322	--	CL-7	XNS-36	NL-33	\$114.50
945-000-042	945-000-043	MH16 MCKNR/L3	1.000	.935	.630	1.190		--	CL-7	XNS-36	NL-33	\$127.50
945-000-094	945-000-096	MH20 MCKNR/L4	1.250	1.210	.755	1.455	CNMG 432	ICSN-433	CL-20	XNS-47	NL-46	\$166.40
945-000-131	945-000-132	MH24 MCKNR/L4	1.500	1.430	.880	1.720		ICSN-433	CL-20	XNS-47	NL-46	\$192.30
945-000-168	945-000-169	MH28 MCKNR/L4	1.750	1.680	1.005	1.985		ICSN-433	CL-20	XNS-47	NL-46	\$217.10
945-000-200	945-000-201	MH32 MCKNR/L4	2.000	1.940	1.271	2.390		ICSN-433	CL-20	XNS-47	NL-46	\$256.00

PRODUCT #	Clamp Screw	Price Each
968-000-176	XNS-36	\$2.20
968-000-177	XNS-47	\$2.20
968-000-178	XNS-48	\$2.20
968-000-179	XNS-510	\$2.20
968-000-180	XNS-58	\$2.20
968-000-181	XNS-59	\$2.20

PACKAGE SIZE OF 5

PRODUCT #	Lock Pin	Price Each
968-000-097	NL-33	\$3.00
968-000-098	NL-33L	\$3.00
968-000-099	NL-34	\$3.00
968-000-100	NL-34L	\$3.00
968-000-101	NL-44	\$3.00
968-000-102	NL-46	\$2.50
968-000-103	NL-56	\$3.30
968-000-104	NL-58	\$3.00
968-000-105	NL-68	\$3.30
968-000-106	NL-68L	\$6.50

PACKAGE SIZE OF 5

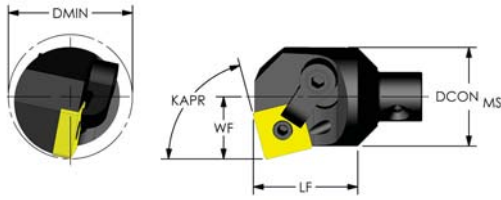

Negative Square (KAPR: 75°)

Coolant Thru

PRODUCT #	Designation	DCON MS	LF	WF	DMIN	Insert	Shim	Clamp	Clamp Screw	Lock Pin	Price
945-000-050	MH16 MSKNR4	1.000	1.060	.630	1.190	SNMG 432	--	CL-20	XNS-47	NL-44	\$127.50
945-000-105	MH20 MSKNR4	1.250	1.210	.755	1.455	SNMG 432	ISSN-432	CL-20	XNS-47	NL-46	\$166.40
945-000-141	MH24 MSKNR4	1.500	1.430	.880	1.720	SNMG 432	ISSN-432	CL-20	XNS-47	NL-46	\$192.30
945-000-212	MH32 MSKNR4	2.000	1.680	1.271	2.390	SNMG 432	ISSN-432	CL-20	XNS-47	NL-46	\$256.00

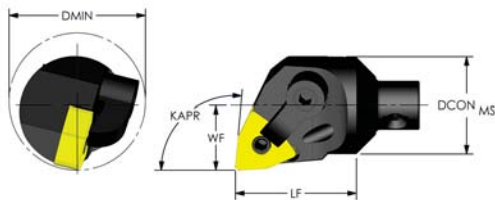

Negative Trigon (KAPR: 95°)

Coolant Thru

PRODUCT # Left hand	PRODUCT # Right hand	Designation	DCON MS	LF	WF	DMIN	Insert	Shim	Clamp	Clamp Screw	Lock Pin	Price
945-000-013	945-000-014	MH12 MWLNR/L3	.750	.940	0.500	.920	WNMG 332	--	CL-7	XNS-36	NL-33L	\$114.50
945-000-057	945-000-058	MH16 MWLNR/L3	1.000	1.000	0.640	1.200	WNMG 332	--	CL-7	XNS-36	NL-33L	\$127.50
945-000-058	945-000-060	MH16 MWLNR/L4	1.000	1.000	0.640	1.240	WNMG 432	--	CL-20	XNS-47	NL-44	\$127.50
945-000-116	945-000-117	MH20 MWLNR/L4	1.250	1.300	0.765	1.470	WNMG 432	IWSN-433	CL-20	XNS-47	NL-46	\$166.40
945-000-152	945-000-153	MH24 MWLNR/L4	1.500	1.520	.890	1.730	WNMG 432	IWSN-433	CL-20	XNS-47	NL-46	\$209.60
945-000-186	945-000-187	MH28 MWLNR/L4	1.750	1.770	1.015	1.995	WNMG 432	IWSN-433	CL-20	XNS-47	NL-46	\$217.10
945-000-221	945-000-222	MH32 MWLNR/L4	2.000	2.030	1.281	2.400	WNMG 432	IWSN-433	CL-20	XNS-47	NL-46	\$256.00

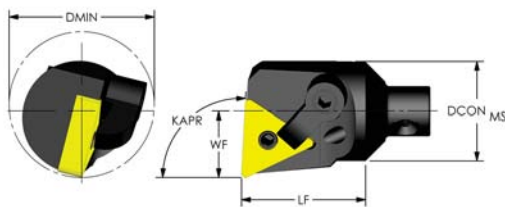

Negative Triangle (KAPR: 93°)

Coolant Thru

PRODUCT # Left hand	PRODUCT # Right hand	Designation	DCON MS	LF	WF	DMIN	Insert	Shim	Clamp	Clamp Screw	Lock Pin	Price
945-000-011	945-000-012	MH12 MTUNR/L3	.750	.940	0.500	.920	TNMG 332	--	CL-7	XNS-36	NL-33L	\$114.50
945-000-053	945-000-054	MH16 MTUNR/L3	1.000	1.000	0.640	1.200	TNMG 332	--	CL-7	XNS-36	NL-33L	\$127.50
945-000-110	945-000-112	MH20 MTUNR/L3	1.250	1.300	0.765	1.470	TNMG 332	ITSN-323	CL-7	XNS-36	NL-34L	\$166.40
945-000-146	945-000-148	MH24 MTUNR/L3	1.500	1.520	.890	1.470	TNMG 332	ITSN-323	CL-7	XNS-36	NL-34L	\$192.30
945-000-111	945-000-113	MH20 MTUNR/L4	1.250	1.300	0.765	1.730	TNMG 432	ITSN-433	CL-20	XNS-47	NL-46	\$166.40
945-000-147	945-000-149	MH24 MTUNR/L4	1.500	1.520	.890	1.730	TNMG 432	ITSN-433	CL-20	XNS-47	NL-46	\$192.30
945-000-180	945-000-181	MH28 MTUNR/L4	1.750	1.770	1.015	1.995	TNMG 432	ITSN-433	CL-20	XNS-47	NL-46	\$217.10
945-000-215	945-000-216	MH32 MTUNR/L4	2.000	2.030	1.281	2.400	TNMG 432	ITSN-433	CL-20	XNS-47	NL-46	\$256.00

ULTRA-DEX[®]

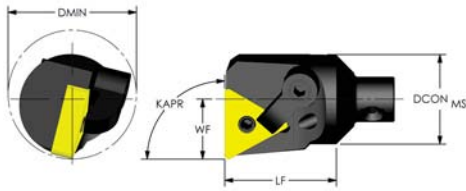

Negative Triangle (KAPR: 90°)

Coolant Thru

PRODUCT # Left hand	PRODUCT # Right hand	Designation	DCON MS	LF	WF	DMIN	Insert	Shim	Clamp	Clamp Screw	Lock Pin	Price
945-000-009	945-000-010	MH12 MTFNR/L3	.750	.940	0.500	.920	TNMG 332		CL-7	XNS-36	NL-33L	\$114.50
945-000-051	945-000-052	MH16 MTFNR/L3	1.000	1.000	0.640	1.200	TNMG 332		CL-7	XNS-36	NL-33L	\$127.50
945-000-106	945-000-108	MH20 MTFNR/L3	1.250	1.300	0.765	1.470	TNMG 332	ITSN-323	CL-7	XNS-36	NL-34L	\$166.40
945-000-142	945-000-144	MH24 MTFNR/L3	1.500	1.520	.890	1.730	TNMG 332	ITSN-323	CL-7	XNS-36	NL-34L	\$192.30
945-000-107	945-000-109	MH20 MTFNR/L4	1.250	1.300	0.765	1.470	TNMG 432	ITSN-433	CL-20	XNS-47	NL-46	\$166.40
945-000-143	945-000-145	MH24 MTFNR/L4	1.500	1.520	.890	1.730	TNMG 432	ITSN-433	CL-20	XNS-47	NL-46	\$192.30
945-000-178	945-000-179	MH28 MTFNR/L4	1.750	1.770	1.015	1.995	TNMG 432	ITSN-433	CL-20	XNS-47	NL-46	\$217.10
945-000-213	945-000-214	MH32 MTFNR/L4	2.000	2.030	1.281	1.995	TNMG 432	ITSN-433	CL-20	XNS-47	NL-46	\$256.00

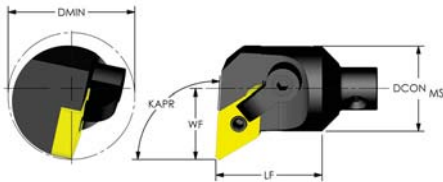

Negative 55° Diamond (KAPR: 93°) Profiling

Coolant Thru

PRODUCT # Left hand	PRODUCT # Right hand	Designation	DCON MS	LF	WF	DMIN	Insert	Shim	Clamp	Clamp Screw	Lock Pin	Price
945-000-007	945-000-008	MH12 MDUNR/L3	.750	.940	.625	1.050	DNMG 332		CL-7	XNS-36	NL-33L	\$127.50
945-000-048	945-000-049	MH16 MDUNR/L3	1.000	1.000	.750	1.310	DNMG 332		CL-7	XNS-36	NL-33L	\$140.40
	945-000-102	MH20 MDUNR4-7	1.250	1.300	.775	1.475	DNMG 432	IDSN-433	CL-22	XNS-48	NL-46	\$179.30
945-000-100	945-000-101	MH20 MDUNR/L4	1.250	1.300	1.000	1.700	DNMG 432	IDSN-433	CL-22	XNS-48	NL-46	\$179.30
945-000-137	945-000-138	MH24 MDUNR/L4	1.500	1.520	1.120	1.960	DNMG 432	IDSN-433	CL-22	XNS-48	NL-46	\$204.20
945-000-174	945-000-175	MH28 MDUNR/L4	1.750	1.770	1.250	2.250	DNMG 432	IDSN-433	CL-22	XNS-48	NL-46	\$230.10
945-000-208	945-000-209	MH32 MDUNR/L4	2.000	2.030	1.375	2.500	DNMG 432	IDSN-433	CL-22	XNS-48	NL-46	\$269.00

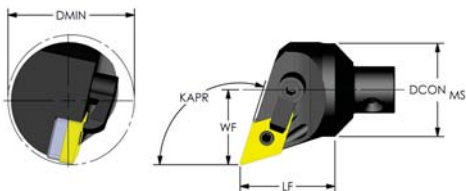

Negative 55° Diamond (KAPR: 107.5°) Profiling

Coolant Thru

PRODUCT # Left hand	PRODUCT # Right hand	Designation	DCON MS	LF	WF	DMIN	Insert	Shim	Clamp	Clamp Screw	Lock Pin	Price
945-000-098	945-000-099	MH20 MDQNR/L4	1.250	1.300	1.000	1.700	DNMG 432	IDSN-433	CL-22	XNS-48	NL-46	\$179.30
945-000-135	945-000-136	MH24 MDQNR/L4	1.500	1.520	1.120	1.960	DNMG 432	IDSN-433	CL-22	XNS-48	NL-46	\$204.20
945-000-172	945-000-173	MH28 MDQNR/L4	1.750	1.770	1.250	2.250	DNMG 432	IDSN-433	CL-22	XNS-48	NL-46	\$230.10
945-000-206	945-000-207	MH32 MDQNR/L4	2.000	2.030	1.281	2.400	DNMG 432	IDSN-433	CL-22	XNS-48	NL-46	\$269.00

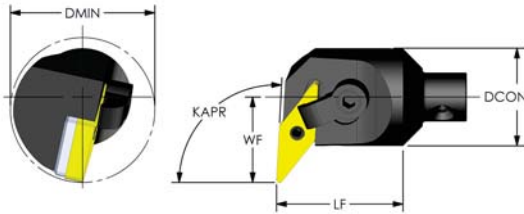

Negative 35° Diamond (KAPR: 93°) Profiling

Coolant Thru

PRODUCT # Left hand	PRODUCT # Right hand	Designation	DCON MS	LF	WF	DMIN	Insert	Shim	Clamp	Clamp Screw	Lock Pin	Price
945-000-055	945-000-056	MH16 MVUNR/L3	1.000	1.300	.875	1.435	VNMG 332	IVSN-322	CL-20	XNS-47	NL-34L	\$130.00
945-000-114	945-000-115	MH20 MVUNR/L3	1.250	1.300	1.000	1.700	VNMG 332	IVSN-322	CL-20	XNS-47	NL-34L	\$179.30
945-000-150	945-000-151	MH24 MVUNR/L3	1.500	1.520	1.120	2.000	VNMG 332	IVSN-322	CL-20	XNS-47	NL-34L	\$204.20
945-000-182	945-000-181	MH28 MVUNR/L3	1.750	1.770	1.250	2.250	VNMG 332	IVSN-322	CL-20	XNS-47	NL-34L	\$230.10
945-000-217	945-000-216	MH32 MVUNR/L3	2.000	2.030	1.375	2.500	VNMG 332	IVSN-322	CL-20	XNS-47	NL-34L	\$269.00
945-000-183	945-000-185	MH28 MVUNR/L4	1.750	1.770	1.250	2.250	VNMG 432	IVSN-432	CL-22	XNS-48	NL-46	\$230.10
945-000-218	945-000-220	MH32 MVUNR/L4	2.000	2.030	1.375	2.500	VNMG 432	IVSN-432	CL-22	XNS-48	NL-46	\$269.00

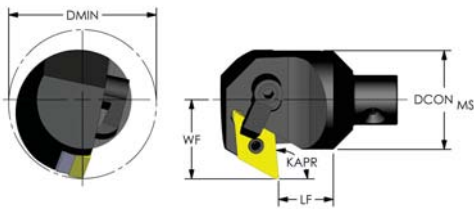

Negative 55° Diamond (KAPR: 95°) Back Facing

Coolant Thru

PRODUCT # Left hand	PRODUCT # Right hand	Designation	DCON MS	LF	WF	DMIN	Insert	Shim	Clamp	Clamp Screw	Lock Pin	Price
945-000-103	945-000-104	MH20 MDXNR/L4	1.250	.700	1.000	1.700	DNMG 432	IDSN-433	CL-22	XNS-48	NL-46	\$192.30
945-000-139	945-000-140	MH24 MDXNR/L4	1.500	.650	1.120	1.960	DNMG 432	IDSN-433	CL-22	XNS-48	NL-46	\$217.10
945-000-176	945-000-177	MH28 MDXNR/L4	1.750	.780	1.250	2.250	DNMG 432	IDSN-433	CL-22	XNS-48	NL-46	\$243.00
945-000-210	945-000-211	MH32 MDXNR/L4	2.000	.780	1.500	2.620	DNMG 432	IDSN-433	CL-22	XNS-48	NL-46	\$281.90

PRODUCT #	Clamp	Price Each
968-000-016	CL-6	\$5.30
968-000-017	CL-7	\$5.30
968-000-020	CL-9	\$5.30
968-000-010	CL-12	\$5.30
968-000-011	CL-19	\$6.60
968-000-012	CL-20	\$5.30

PRODUCT #	Clamp	Price Each
968-000-013	CL-21	\$12.40
968-000-014	CL-22	\$12.60
968-000-015	CL-30	\$9.30
968-000-018	CL-84	\$28.40
968-000-019	CL-85	\$28.40

PACKAGE SIZE OF 1

PRODUCT #	Clamp Screw	Price Each
968-000-176	XNS-36	\$2.20
968-000-177	XNS-47	\$2.20
968-000-178	XNS-48	\$2.20
968-000-179	XNS-510	\$2.20
968-000-180	XNS-58	\$2.20
968-000-181	XNS-59	\$2.20

PACKAGE SIZE OF 5

PRODUCT #	Lock Pin	Price Each
968-000-097	NL-33	\$3.00
968-000-098	NL-33L	\$3.00
968-000-099	NL-34	\$3.00
968-000-100	NL-34L	\$3.00
968-000-101	NL-44	\$3.00
968-000-102	NL-46	\$2.50
968-000-103	NL-56	\$3.30
968-000-104	NL-58	\$3.00
968-000-105	NL-68	\$3.30
968-000-106	NL-68L	\$6.50

PACKAGE SIZE OF 5

MODULAR

ULTRA-DEX[®]

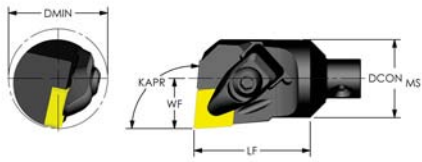

PULLBACK Clamp Negative 80° Diamond (KAPR: 95°)

Coolant Thru

PRODUCT #	Designation	DCON MS	LF	WF	DMIN	Insert	Shim	Shim Screw	Clamp Assy.	Price
945-000-039	MH16 DCLNR4	1.000	1.500	0.640	1.200	CNMG 432	--	--	PB4-CA	\$227.90
945-000-089	MH20 DCLNR4	1.250	1.500	0.765	1.470	CNMG 432	ICSN-433	PB4-SS	PB4-CA	\$266.80
945-000-126	MH24 DCLNR4	1.500	1.520	.890	1.730	CNMG 432	ICSN-433	PB4-SS	PB4-CA	\$324.00
945-000-163	MH28 DCLNR4	1.750	1.770	1.015	1.995	CNMG 432	ICSN-433	PB4-SS	PB4-CA	\$350.00
945-000-195	MH32 DCLNR4	2.000	2.030	1.281	2.400	CNMG 432	ICSN-433	PB4-SS	PB4-CA	\$388.80

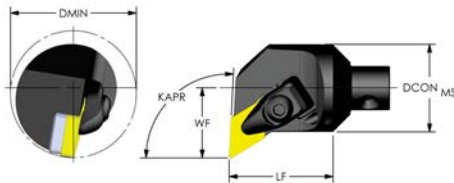

PULLBACK Clamp Negative 55° Diamond (KAPR: 93°)

Coolant Thru

PRODUCT #	Designation	DCON MS	LF	WF	DMIN	Insert	Shim	Shim Screw	Clamp Assy.	Price
945-000-090	MH20 DDUNR4	1.250	1.500	1.000	1.700	DNMG 432	IDSN-433	PB4-SS	PB4-CA	\$266.80
945-000-127	MH24 DDUNR4	1.500	1.520	1.120	1.960	DNMG 432	IDSN-433	PB4-SS	PB4-CA	\$324.00
945-000-164	MH28 DDUNR4	1.750	1.770	1.250	2.250	DNMG 432	IDSN-433	PB4-SS	PB4-CA	\$350.00
945-000-196	MH32 DDUNR4	2.000	2.030	1.375	2.500	DNMG 432	IDSN-433	PB4-SS	PB4-CA	\$388.80
945-000-195	MH32 DCLNR4	2.000	2.030	1.281	2.400	CNMG 432	ICSN-433	PB4-SS	PB4-CA	\$388.80

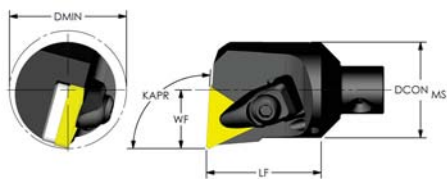

PULLBACK Clamp Negative Triangle (KAPR: 93°)

Coolant Thru

PRODUCT #	Designation	DCON MS	LF	WF	DMIN	Insert	Shim	Shim Screw	Clamp Assy.	Price
945-000-091	MH20 DTUNR4	1.250	1.500	0.765	1.470	TNMG 432	ITSN-433	PB4-SS	PB4-CA	\$266.80
945-000-128	MH24 DTUNR4	1.500	1.520	.890	1.730	TNMG 432	ITSN-433	PB4-SS	PB4-CA	\$324.00
945-000-165	MH28 DTUNR4	1.750	1.770	1.015	1.995	TNMG 432	ITSN-433	PB4-SS	PB4-CA	\$350.00
945-000-197	MH32 DTUNR4	2.000	2.030	1.281	2.400	TNMG 432	ITSN-433	PB4-SS	PB4-CA	\$388.80
945-000-195	MH32 DCLNR4	2.000	2.030	1.281	2.400	CNMG 432	ICSN-433	PB4-SS	PB4-CA	\$388.80

PRODUCT #	Shim Screw	Price Each
968-000-109	PB3-SS	\$3.10
968-000-111	PB4-SS	\$3.10

PACKAGE SIZE OF 5

PRODUCT #	Clamp Assy.	Price Each
968-000-107	PB3-CA	\$20.10
968-000-110	PB4-CA	\$21.30

PACKAGE SIZE OF 1

MODULAR

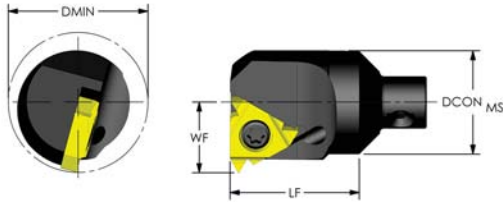

Threading / Grooving Laydown

Coolant Thru

PRODUCT #	Designation Right hand	DCON MS	LF	WF	DMIN	Insert	Insert Screw	Anvil Screw	Anvil	Price
945-000-002	MH12 LSER3	0.750	0.940	.510	0.930	3IR	MTS-35	--	--	\$114.50
945-000-041	MH16 LSER3	1.000	1.000	.650	1.210	3IR	SA3T	SY3T	YI3	\$140.40
945-000-093	MH20 LSER3	1.250	1.300	.770	1.470	3IR	SA3T	SY3T	YI3	\$179.30
945-000-130	MH24 LSER3	1.500	1.520	.900	1.740	3IR	SA3T	SY3T	YI3	\$204.20
945-000-167	MH28 LSER3	1.750	1.770	1.090	2.070	3IR	SA3T	SY3T	YI3	\$230.10
945-000-199	MH32 LSER3	2.000	2.030	1.281	2.400	3IR	SA3T	SY3T	YI3	\$269.00

PRODUCT #	Designation Left hand	DCON MS	LF	WF	DMIN	Insert	Insert Screw	Anvil Screw	Anvil	Price
945-000-001	MH12 LSEL3	0.750	0.940	.510	0.930	3IL	MTS-35	--	--	\$114.50
945-000-040	MH16 LSEL3	1.000	1.000	.650	1.210	3IL	SA3T	SY3T	YE3	\$140.40
945-000-092	MH20 LSEL3	1.250	1.300	.770	1.470	3IL	SA3T	SY3T	YE3	\$179.30
945-000-129	MH24 LSEL3	1.500	1.520	.900	1.740	3IL	SA3T	SY3T	YE3	\$204.20
945-000-166	MH28 LSEL3	1.750	1.770	1.090	2.070	3IL	SA3T	SY3T	YE3	\$230.10
945-000-198	MH32 LSEL3	2.000	2.030	1.281	2.400	3IL	SA3T	SY3T	YE3	\$269.00

PRODUCT #	Clamp	Price Each
968-000-016	CL-6	\$5.30
968-000-017	CL-7	\$5.30
968-000-020	CL-9	\$5.30
968-000-010	CL-12	\$5.30
968-000-011	CL-19	\$6.60
968-000-012	CL-20	\$5.30

PRODUCT #	Clamp	Price Each
968-000-013	CL-21	\$12.40
968-000-014	CL-22	\$12.60
968-000-015	CL-30	\$9.30
968-000-018	CL-84	\$28.40
968-000-019	CL-85	\$28.40

PACKAGE SIZE OF 1

PRODUCT #	Anvil	Price Each
968-000-185	YI3	\$20.10
968-000-182	YE3	\$20.10
968-000-187	YI4	\$31.90
968-000-186	YI3M-1.5N	\$30.80
968-000-183	YE4	\$31.90
968-000-188	YI5	\$50.60
968-000-184	YE5	\$50.60

PACKAGE SIZE OF 1

PRODUCT #	Anvil Screw	Price Each
968-000-146	SY3T	\$2.40
968-000-147	SY4T	\$3.00
968-000-148	SY5T	\$4.70

PACKAGE SIZE OF 5

PRODUCT #	Insert Screw	Price Each
968-000-124	SA3T	\$3.50
968-000-125	SA4T	\$4.70
968-000-126	SA5T	\$8.10

PACKAGE SIZE OF 5

MODULAR

ULTRA-DEX[®]

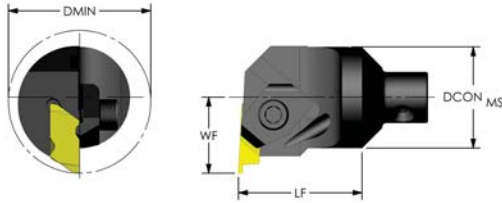

Threading / Grooving Top Notch

Coolant Thru

PRODUCT # Right hand	Designation	DCON MS	LF	WF	DMIN	Insert	Clamp	Clamp Screw	Price
945-000-016	MH12 NER2	.750	.920	.562	1.120	NG 2L	CM-75	6-32	\$127.50
945-000-063	MH16 NER2	1.000	1.180	.688	1.380	NG 2L	CM-75	6-32	\$140.40
945-000-064	MH16 NER3	1.000	1.180	.688	1.380	NG 3L	CM-73	10-32	\$140.40
945-000-119	MH20 NER3	1.250	1.300	.875	1.750	NG 3L	CM-73	10-32	\$181.50
945-000-155	MH24 NER3	1.500	1.520	1.000	2.000	NG 3L	CM-73	10-32	\$209.60
945-000-189	MH28 NER3	1.750	1.770	1.125	2.250	NG 3L	CM-73	10-32	\$237.60
945-000-224	MH32 NER3	2.000	2.030	1.250	2.500	NG 3L	CM-73	10-32	\$280.80

PRODUCT # Left hand	Designation	DCON MS	LF	WF	DMIN	Insert	Clamp	Clamp Screw	Price
945-000-015	MH12 NEL2	.750	.920	.562	1.120	NG 2R	CM-74	6-32	\$127.50
945-000-061	MH16 NEL2	1.000	1.180	.688	1.380	NG 2R	CM-74	6-32	\$140.40
945-000-062	MH16 NEL3	1.000	1.180	.688	1.380	NG 3R	CM-72	10-32	\$140.40
945-000-118	MH20 NEL3	1.250	1.300	.875	1.750	NG 3R	CM-72	10-32	\$181.50
945-000-154	MH24 NEL3	1.500	1.520	1.000	2.000	NG 3R	CM-72	10-32	\$209.60
945-000-188	MH28 NEL3	1.750	1.770	1.125	2.250	NG 3R	CM-72	10-32	\$237.60
945-000-223	MH32 NEL3	2.000	2.030	1.250	2.500	NG 3R	CM-72	10-32	\$280.80

PRODUCT #	Clamp	Price Each
968-000-025	CM-72	\$12.40
968-000-026	CM-73	\$12.40
968-000-027	CM-74	\$18.90
968-000-028	CM-75	\$18.90
968-000-021	CM-120	\$16.60
968-000-022	CM-121	\$16.60
968-000-023	CM-146	\$46.20
968-000-024	CM-147	\$46.20

PACKAGE SIZE OF 1

PRODUCT #	Clamp Screw	Price Each
968-000-005	6-32	\$1.00
968-000-003	10-32	\$1.00
968-000-096	MTS-526	\$11.50

PACKAGE SIZE OF 5

CHATTER-FREE BORING BARS

Tunable Internal Damping Technology

5:1 Up To
14:1 Ratio

.156"-1.5" Diameters



Product Highlights:

Tunable Internal Damping Technology provides optimal dynamic stability yielding significant increases in machining performance. Most importantly, the bars pay for themselves quickly by increasing speed and precision. Additionally, you can leave Chatter-Free Tooling "CFT" in the machine and use it for deep or shallow bore applications, thus reducing changeover and setup time.

- Fully tunable boring bar (arrives pre-tuned)
- Labeled dial for ease of tuning
- Quick setup flat located on connection end of bar
- Solves difficult deep boring applications
- Improved surface finish
- Increase output by more aggressive cutting
- Increase tool life from reduced vibration
- Multiple head configurations

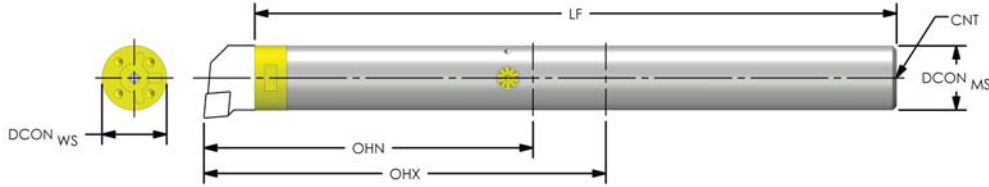

5:1 Ratio

Modular Chatter-Free Bars

Coolant Thru

PRODUCT #	Designation	DCON MS	DCON NS	LS	OHN	OHX	Head Bolts	CNT	Price
910-000-013	CFT B1500-9	1.500	1.500	9	7.000	7.500	10-24 HB	1/8-27 NPT	\$1,158.00
910-000-018	CFT B2000-12	2.000	2.000	12	7.500	10.000	1/4-20 HB	1/8-27 NPT	\$1,407.00
910-000-023	CFT B2500-16	2.500	2.500	16	8.000	12.500	5/16-18 HB	1/8-27 NPT	\$1,914.00

7:1 Ratio

910-000-001	CFT B1000-10	1.000	1.000	10	5.000	7.000	8-32 HB	1/8-27 NPT	\$889.00
910-000-005	CFT B1250-12	1.250	1.250	12	6.250	8.750	10-24 HB	1/8-27 NPT	\$993.00
910-000-009	CFT B1500-15	1.500	1.500	15	7.500	10.500	10-24 HB	1/8-27 NPT	\$1,158.00
910-000-014	CFT B1750-18	1.750	1.750	18	8.750	12.250	1/4-20 HB	1/8-27 NPT	\$1,328.00
910-000-019	CFT B2000-20	2.000	2.000	20	10.000	14.000	1/4-20 HB	1/8-27 NPT	\$1,407.00
910-000-024	CFT B2500-27	2.500	2.500	27	12.500	17.500	5/16-18 HB	1/4-18 NPT	\$1,914.00
910-000-028	CFT B3000-31	3.000	2.500	31	15.000	21.000	5/16-18 HB	1/4-18 NPT	\$2,304.00

10:1 Ratio

910-000-002	CFT B1000-14	1.000	1.000	14	7.000	10.000	8-32 HB	1/8-27 NPT	\$1,716.00
910-000-006	CFT B1250-16	1.250	1.250	16	8.750	12.500	10-24 HB	1/8-27 NPT	\$1,870.00
910-000-010	CFT B1500-19	1.500	1.500	19	10.500	15.000	10-24 HB	1/8-27 NPT	\$1,919.00
910-000-015	CFT B1750-23	1.750	1.750	23	12.250	17.500	1/4-20 HB	1/8-27 NPT	\$2,024.00
910-000-020	CFT B2000-26	2.000	2.000	26	14.000	20.000	1/4-20 HB	1/8-27 NPT	\$2,134.00
910-000-025	CFT B2500-33	2.500	2.500	33	17.500	25.000	5/16-18 HB	1/4-18 NPT	\$2,910.00
910-000-029	CFT B3000-40	3.000	2.500	40	21.000	30.000	5/16-18 HB	1/4-18 NPT	\$4,222.00
910-000-034	CFT B4000-50	4.000	2.500	50	28.000	40.000	5/16-18 HB	1/4-18 NPT	\$7,466.00

12:1 Ratio

910-000-003	CFT B1000-16	1.000	1.000	16	10.875	12.000	8-32 HB		\$3,805.00
910-000-058	CFT B1250-18	1.250	1.250	18	13.785	15.000	10-24 HB		\$5,158.40
910-000-011	CFT B1500-22	1.500	1.500	22	16.375	18.000	10-24 HB		\$5,807.00
910-000-016	CFT B1750-25	1.750	1.750	25	18.060	21.000	1/4-20 HB		\$7,098.00
910-000-021	CFT B2000-29	2.000	2.000	29	19.375	24.000	1/4-20 HB		\$8,904.00

14:1 Ratio

910-000-004	CFT B1000-18	1.000	1.000	18	10.875	12.000	8-32 HB		\$7,420.00
910-000-008	CFT B1250-21	1.250	1.250	21	13.875	15.000	10-24 HB		\$8,843.00
910-000-012	CFT B1500-25	1.500	1.500	25	16.375	18.000	10-24 HB		\$10,878.80
910-000-017	CFT B1750-29	1.750	1.750	29	18.060	21.000	1/4-20 HB		\$12,656.40
910-000-022	CFT B2000-33	2.000	2.000	33	19.375	24.000	1/4-20 HB		\$16,214.90

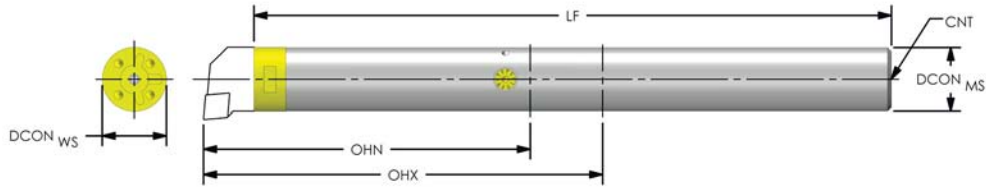

7:1 Ratio

Modular Chatter-Free Bars

Coolant Thru

PRODUCT #	Designation	DCON MS	DCON NS	LS	OHN	OHX	Head Bolts	CNT	Price
910-000-077	CFT B25MM-250	25mm	1.000	250mm	127mm	175mm	8-32 HB	1/8-27 NPT	\$924.60
910-000-079	CFT B32MM-320	32mm	1.250	320mm	159mm	224mm	10-24 HB	1/8-27 NPT	\$1,032.80
910-000-083	CFT B40MM-400	40mm	1.500	400mm	190mm	280mm	10-24 HB	1/8-27 NPT	\$1,204.40
910-000-087	CFT B50MM-500	50mm	2.000	500mm	254mm	350mm	1/4-20 HB	1/8-27 NPT	\$1,463.30
910-000-091	CFT B60MM-600	60mm	2.000	600mm	320mm	420mm	1/4-20 HB	1/8-27 NPT	\$1,990.60

10:1 Ratio

910-000-078	CFT B25MM-325	25mm	1.000	325mm	178mm	250mm	8-32 HB	1/8-27 NPT	\$1,854.40
910-000-080	CFT B32MM-416	32mm	1.250	416mm	223mm	320mm	10-24 HB	1/8-27 NPT	\$2,072.80
910-000-084	CFT B40MM-520	40mm	1.500	520mm	266mm	400mm	10-24 HB	1/8-27 NPT	\$2,179.90
910-000-088	CFT B50MM-650	50mm	2.000	650mm	356mm	500mm	1/4-20 HB	1/8-27 NPT	\$2,828.80
910-000-092	CFT B60MM-780	60mm	2.000	780mm	445mm	600mm	1/4-20 HB	1/8-27 NPT	\$3,555.80

12:1 Ratio

910-000-081	CFT B32MM-480	32mm	1.250	480mm	352mm	384mm	10-24 HB		\$5,158.40
910-000-085	CFT B40MM-600	40mm	1.500	600mm	416mm	480mm	10-24 HB		\$6,356.50
910-000-089	CFT B50MM-750	50mm	2.000	750mm	492mm	600mm	1/4-20 HB		\$9,935.40

14:1 Ratio

910-000-082	CFT B32MM-544	32mm	1.250	544mm	352mm	448mm	10-24 HB		\$9,677.20
910-000-086	CFT B40MM-680	40mm	1.500	680mm	416mm	560mm	10-24 HB		\$11,450.20
910-000-090	CFT B50MM-850	50mm	2.000	850mm	492mm	788mm	1/4-20 HB		\$17,067.10

PRODUCT #	Head Bolts	Price Each
968-000-006	8-32 HB	\$2.20
968-000-002	10-24 HB	\$2.20
968-000-001	1/4-20 HB	\$2.60
968-000-004	5/16-18 HB	\$3.00

PACKAGE SIZE OF 1

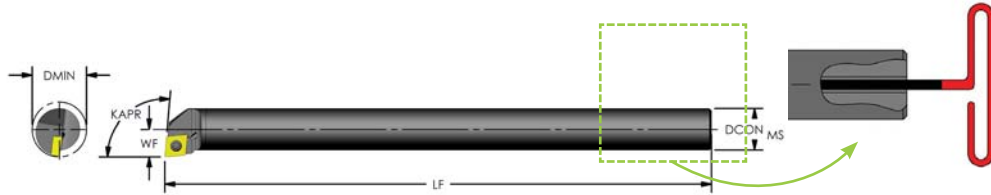

Tuneable from the end with supplied T-Handle Hex Wrench.

8:1 Ratio

SOLID Positive 80° Diamond (KAPR: 95°)

Coolant Thru

PRODUCT #	Designation	DCON MS	LF	WF	DMIN	Insert	Insert Screw	Key	Price
910-000-045	D08R SCLCR2	0.500	8	.281	.580	CCMT 21.51	MTS-255	T-7	\$653.00
910-000-047	D10X SCLCR3	.625	9	.406	.770	CCMT 32.51	MTS-35	T-15	\$708.00
910-000-050	D12S SCLCR3	.750	10	0.500	.930	CCMT 32.51	MTS-35	T-15	\$763.00

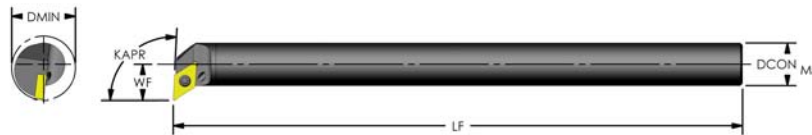

Tuneable from the end with supplied T-Handle Hex Wrench.

8:1 Ratio

SOLID Positive 55° Diamond (KAPR: 93°)

Coolant Thru

PRODUCT #	Designation	DCON MS	LF	WF	DMIN	Insert	Insert Screw	Key	Price
910-000-046	D08R SDUCR2	0.500	8	.437	.730	DCMT 21.51	MTS-255	T-7	\$653.00
910-000-048	D10X SDUCR2	.625	9	0.500	.850	DCMT 21.51	MTS-255	T-7	\$708.00
910-000-051	D12S SDUCR3	.750	10	.625	1.050	DCMT 32.51	MTS-35	T-15	\$763.00

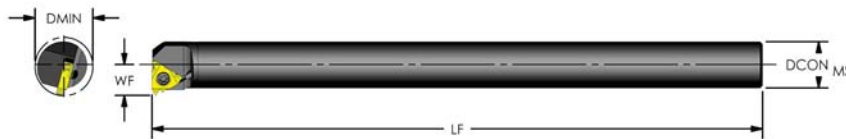

Tuneable from the end with supplied T-Handle Hex Wrench.

8:1 Ratio

SOLID Threading/Grooving Laydown

Coolant Thru

PRODUCT #	Designation	DCON MS	LF	WF	DMIN	Insert	Insert Screw	Price
910-000-049	D12S LSER3	.750	10	.510	.935	3IR	MTS-35	\$763.00

PRODUCT #	Insert Screws	Price Each
968-000-086	MTS-183	\$3.20
968-000-087	MTS-184	\$3.20
968-000-088	MTS-2	\$2.90
968-000-091	MTS-224	\$3.20
968-000-092	MTS-255	\$3.20
968-000-094	MTS-35	\$3.20
968-000-090	MTS-2.5L	\$2.90
968-000-052	ETS 4-40	\$3.20

PACKAGE SIZE OF 5

PRODUCT #	Key	Price Each
968-000-156	T-6	\$4.20
968-000-158	T-7	\$3.80
968-000-149	T-10	\$6.50
968-000-151	T-15	\$3.80
968-000-153	T-20	\$4.00

PACKAGE SIZE OF 5



In addition to our Chatter-Free bars, we offer a solid carbide or steel alternative with the same connection! These solid bars fit all heads following this page with the ending "CFT" designation.

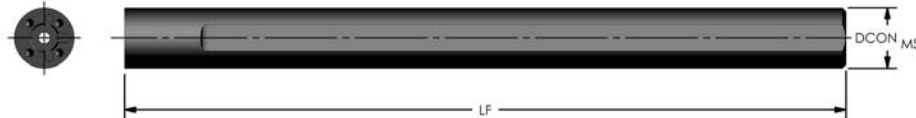

4:1 Ratio		STEEL SHANK			Coolant Thru		
PRODUCT #	Designation	DCON MS	DCON WS	LU	LF	Head Bolts	Price
911-000-001	A1000-12	1.000			12	8-32	\$176.00
911-000-002	A1250-14	1.250			14	10-24	\$227.00
911-000-003	A1500-14	1.500			14	10-24	\$251.00
911-000-004	A1750-16	1.750			16	1/4-20	\$300.00
911-000-005	A2000-20	2.000			20	1/4-20	\$395.00
911-000-006	A2500-12	2.500			12	5/16-18	\$452.00
911-000-007	A2500-24	2.500			24	5/16-18	\$646.00
911-000-008	A3000-18 *	3.000	2.000	3.000	18	5/16-18	\$742.00

* 3" bar takes 2.5" head



8:1 Ratio		CARBIDE SHANK			Coolant Thru	
PRODUCT #	Designation	DCONMS	LF	Head Bolts	Price	
911-000-016	E1000-12	1.000	12	8-32	\$1,025.00	
911-000-017	E1250-14	1.250	14	10-24	\$1,787.00	
911-000-018	E1500-14	1.500	14	10-24	\$2,116.00	
911-000-019	E1750-16	1.750	16	1/4-20	\$3,173.00	
911-000-020	E2000-20	2.000	20	1/4-20	\$4,702.00	

PRODUCT #	Head Bolts	Price Each
968-000-006	8-32 HB	\$2.20
968-000-002	10-24 HB	\$2.20
968-000-001	1/4-20 HB	\$2.60
968-000-004	5/16-18 HB	\$3.00

PACKAGE SIZE OF 1

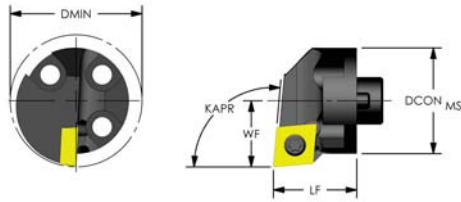

Positive 80° Diamond (KAPR: 93°)

Coolant Thru

PRODUCT # Left hand	PRODUCT # Right hand	Designation	DCON MS	LF	WF	DMIN	Insert	Insert Screw	Key	Price
912-000-014	912-000-015	MH16 SCLCR/L3-CFT	1.000	.790	.625	1.200	CCMT 32.51	MTS-35	T-15	\$182.60
912-000-041	912-000-042	MH20 SCLCR/L3-CFT	1.250	1.250	0.765	1.470	CCMT 32.51	MTS-35	T-15	\$188.00
912-000-074	912-000-075	MH24 SCLCR/L3-CFT	1.500	1.250	.890	1.760	CCMT 32.51	MTS-35	T-15	\$196.60
912-000-110	912-000-111	MH28 SCLCR/L3-CFT	1.750	1.250	1.015	2.030	CCMT 32.51	MTS-35	T-15	\$207.40
	912-000-076	MH24 SCLCR4-CFT	1.500	1.250	.890	1.760	CCMT 432	MTS-4	T-20	\$196.60
	912-000-112	MH28 SCLCR4-CFT	1.750	1.250	1.015	2.030	CCMT 432	MTS-4	T-20	\$207.40
912-000-156	912-000-157	MH32 SCLCR/L4-CFT	2.000	1.625	1.281	2.400	CCMT 432	MTS-4	T-20	\$232.20
912-000-195	912-000-196	MH40 SCLCR/L4-CFT	2.500	1.625	1.500	2.800	CCMT 432	MTS-4	T-20	\$248.40

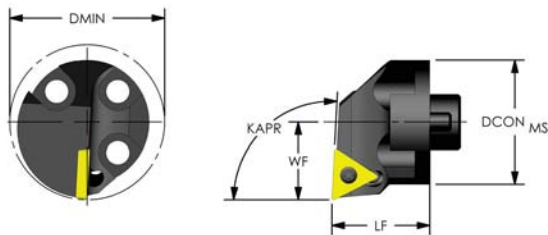

Positive Triangle (KAPR: 93°)

Coolant Thru

PRODUCT # Left hand	PRODUCT # Right hand	Designation	DCON MS	LF	WF	DMIN	Insert	Insert Screw	Key	Price
912-000-020	912-000-021	MH16 STUCR/L2-CFT	1.000	.790	.625	1.200	TCMT 21.51	MTS-255	T-7	\$182.60
912-000-047	912-000-048	MH20 STUCR/L3-CFT	1.250	1.250	0.765	1.470	TCMT 32.51	MTS-35	T-15	\$188.00
912-000-081	912-000-082	MH24 STUCR/L3-CFT	1.500	1.250	.890	1.760	TCMT 32.51	MTS-35	T-15	\$196.60
912-000-117	912-000-118	MH28 STUCR/L3-CFT	1.750	1.250	1.015	2.030	TCMT 32.51	MTS-35	T-15	\$207.40
912-000-162	912-000-163	MH32 STUCR/L3-CFT	2.000	1.625	1.281	2.400	TCMT 32.51	MTS-35	T-15	\$232.20
912-000-201	912-000-202	MH40 STUCR/L3-CFT	2.500	1.625	1.500	2.800	TCMT 32.51	MTS-35	T-15	\$248.40

PRODUCT #	Insert Screws	Price Each
968-000-086	MTS-183	\$3.20
968-000-087	MTS-184	\$3.20
968-000-088	MTS-2	\$2.90
968-000-091	MTS-224	\$3.20
968-000-092	MTS-255	\$3.20
968-000-094	MTS-35	\$3.20
968-000-090	MTS-2.5L	\$2.90
968-000-052	ETS 4-40	\$3.20

PACKAGE SIZE OF 5

PRODUCT #	Key	Price Each
968-000-156	T-6	\$4.20
968-000-158	T-7	\$3.80
968-000-149	T-10	\$6.50
968-000-151	T-15	\$3.80
968-000-153	T-20	\$4.00

PACKAGE SIZE OF 5

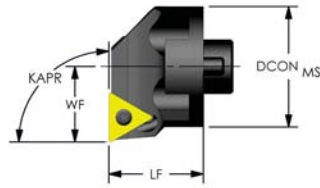

Positive Triangle (KAPR: 90°)

Coolant Thru

PRODUCT # Left hand	PRODUCT # Right hand	Designation	DCON MS	LF	WF	DMIN	Insert	Insert Screw	Key	Price
912-000-018	912-000-019	MH16 STFCR/L2-CFT	1.000	.790	.625	1.200	TCMT 21.51	MTS-255	T-7	\$182.60
912-000-045	912-000-046	MH20 STFCR/L3-CFT	1.250	1.250	0.765	1.470	TCMT 32.51	MTS-35	T-15	\$188.00
912-000-079	912-000-080	MH24 STFCR/L3-CFT	1.500	1.250	.890	1.760	TCMT 32.51	MTS-35	T-15	\$196.60
912-000-115	912-000-116	MH28 STFCR/L3-CFT	1.750	1.250	1.015	2.030	TCMT 32.51	MTS-35	T-15	\$207.40
912-000-160	912-000-161	MH32 STFCR/L3-CFT	2.000	1.625	1.281	2.400	TCMT 32.51	MTS-35	T-15	\$232.20
912-000-199	912-000-200	MH40 STFCR/L3-CFT	2.500	1.625	1.500	2.800	TCMT 32.51	MTS-35	T-15	\$248.40

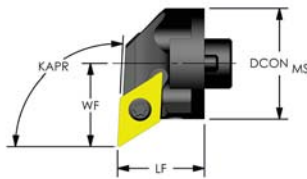
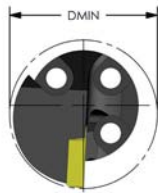

Positive 55° Diamond (KAPR: 93°) Profiling

Coolant Thru

PRODUCT # Left hand	PRODUCT # Right hand	Designation	DCON MS	LF	WF	DMIN	Insert	Insert Screw	Key	Price
912-000-018	912-000-019	MH16 STFCR/L2-CFT	1.000	.790	.625	1.200	TCMT 21.51	MTS-255	T-7	\$182.60
912-000-045	912-000-046	MH20 STFCR/L3-CFT	1.250	1.250	0.765	1.470	TCMT 32.51	MTS-35	T-15	\$188.00
912-000-079	912-000-080	MH24 STFCR/L3-CFT	1.500	1.250	.890	1.760	TCMT 32.51	MTS-35	T-15	\$196.60
912-000-115	912-000-116	MH28 STFCR/L3-CFT	1.750	1.250	1.015	2.030	TCMT 32.51	MTS-35	T-15	\$207.40
912-000-160	912-000-161	MH32 STFCR/L3-CFT	2.000	1.625	1.281	2.400	TCMT 32.51	MTS-35	T-15	\$232.20
912-000-199	912-000-200	MH40 STFCR/L3-CFT	2.500	1.625	1.500	2.800	TCMT 32.51	MTS-35	T-15	\$248.40

PRODUCT #	Insert Screws	Price Each
968-000-086	MTS-183	\$3.20
968-000-087	MTS-184	\$3.20
968-000-088	MTS-2	\$2.90
968-000-091	MTS-224	\$3.20
968-000-092	MTS-255	\$3.20
968-000-094	MTS-35	\$3.20
968-000-090	MTS-2.5L	\$2.90
968-000-052	ETS 4-40	\$3.20

PACKAGE SIZE OF 5

PRODUCT #	Key	Price Each
968-000-156	T-6	\$4.20
968-000-158	T-7	\$3.80
968-000-149	T-10	\$6.50
968-000-151	T-15	\$3.80
968-000-153	T-20	\$4.00

PACKAGE SIZE OF 5



by **Ultra-Dex**

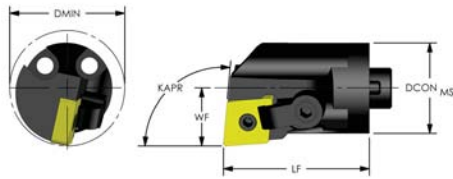

Negative 80° Diamond (KAPR: 95°)

Coolant Thru

PRODUCT # Left hand	PRODUCT # Right hand	Designation	DCON MS	LF	WF	DMIN	Insert	Shim	Clamp	Clamp Screw	Lock Pin	Price
912-000-003	912-000-004	MH16 MCLNR/L4-CFT	1.000	1.625	0.640	1.200	CNMG 432	--	CL-20	XNS-47	NL-44	\$194.40
912-000-024	912-000-025	MH20 MCLNR/L4-CFT	1.250	1.625	0.765	1.470	CNMG 432	ICSN-433	CL-20	XNS-47	NL-46	\$199.80
912-000-053	912-000-055	MH24 MCLNR/L4-CFT	1.500	1.625	.890	1.760	CNMG 432	ICSN-433	CL-20	XNS-47	NL-46	\$211.70
912-000-087	912-000-088	MH28 MCLNR/L4-CFT	1.750	1.625	1.015	2.010	CNMG 432	ICSN-433	CL-20	XNS-47	NL-46	\$218.20
912-000-125	912-000-127	MH32 MCLNR/L4-CFT	2.000	1.625	1.281	2.400	CNMG 432	ICSN-433	CL-20	XNS-47	NL-46	\$247.40
912-000-166	912-000-169	MH40 MCLNR/L4-CFT	2.500	1.625	1.531	2.980	CNMG 432	ICSN-433	CL-20	XNS-47	NL-46	\$266.80
912-000-054	912-000-056	MH24 MCLNR/L5-CFT	1.500	1.625	.890	1.760	CNMG 543	--	CL-20	XNS-47	NL-56	\$211.70
912-000-125	912-000-129	MH32 MCLNR/L5-CFT	2.000	1.625	1.281	2.400	CNMG 543	ICSN-533	CL-12	XNS-510	NL-58	\$247.40
912-000-167	912-000-169	MH40 MCLNR/L5-CFT	2.500	1.625	1.531	2.980	CNMG 543	ICSN-533	CL-12	XNS-510	NL-58	\$266.80
912-000-127	912-000-130	MH32 MCLNR/L6-CFT	2.000	1.625	1.281	2.400	CNMG 643	ICSN-633	CL-12	XNS-59	NL-68	\$247.40
912-000-168	912-000-171	MH40 MCLNR/L6-CFT	2.500	1.625	1.531	3.030	CNMG 643	ICSN-633	CL-12	XNS-59	NL-68	\$266.80

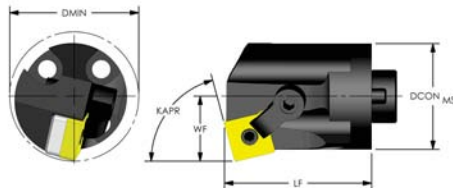

Negative Square (KAPR: 75°)

Coolant Thru

PRODUCT # Left hand	PRODUCT # Right hand	Designation	DCON MS	LF	WF	DMIN	Insert	Shim	Clamp	Clamp Screw	Lock Pin	Price
912-000-030	912-000-031	MH20 MSKNR/L4-CFT	1.250	1.744	0.765	1.470	SNMG 432	ISSN-433	CL-20	XNS-47	NL-46	\$199.80
912-000-061	912-000-062	MH24 MSKNR/L4-CFT	1.500	1.744	.890	1.760	SNMG 432	ISSN-433	CL-20	XNS-47	NL-46	\$211.70
912-000-093	912-000-094	MH28 MSKNR/L4-CFT	1.750	1.744	1.015	2.010	SNMG 432	ISSN-433	CL-20	XNS-47	NL-46	\$218.20
912-000-135	912-000-138	MH32 MSKNR/L4-CFT	2.000	1.744	1.281	2.400	SNMG 432	ISSN-433	CL-20	XNS-47	NL-46	\$247.40
912-000-176	912-000-179	MH40 MSKNR/L4-CFT	2.500	1.804	1.531	3.030	SNMG 432	ISSN-433	CL-20	XNS-47	NL-46	\$266.80
912-000-136	912-000-139	MH32 MSKNR/L5-CFT	2.000	1.744	1.281	2.400	SNMG 543	ISSN-533	CL-12	XNS-510	NL-58	\$247.40
912-000-177	912-000-180	MH40 MSKNR/L5-CFT	2.500	1.804	1.531	3.030	SNMG 543	ISSN-533	CL-12	XNS-510	NL-58	\$266.80
912-000-137	912-000-138	MH32 MSKNR/L6-CFT	2.000	1.744	1.281	2.400	SNMG 643	ISSN-633	CL-12	XNS-510	NL-68	\$247.40
912-000-178	912-000-181	MH40 MSKNR/L6-CFT	2.500	1.804	1.531	3.030	SNMG 643	ISSN-633	CL-12	XNS-510	NL-68	\$266.80

PRODUCT #	Clamp	Price Each
968-000-016	CL-6	\$5.30
968-000-017	CL-7	\$5.30
968-000-020	CL-9	\$5.30
968-000-010	CL-12	\$5.30
968-000-011	CL-19	\$6.60
968-000-012	CL-20	\$5.30

PRODUCT #	Clamp	Price Each
968-000-013	CL-21	\$12.40
968-000-014	CL-22	\$12.60
968-000-015	CL-30	\$9.30
968-000-018	CL-84	\$28.40
968-000-019	CL-85	\$28.40

PACKAGE SIZE OF 1

PRODUCT #	Clamp Screw	Price Each
968-000-176	XNS-36	\$2.20
968-000-177	XNS-47	\$2.20
968-000-178	XNS-48	\$2.20
968-000-179	XNS-510	\$2.20
968-000-180	XNS-58	\$2.20
968-000-181	XNS-59	\$2.20

PACKAGE SIZE OF 5

PRODUCT #	Lock Pin	Price Each
968-000-097	NL-33	\$3.00
968-000-098	NL-33L	\$3.00
968-000-099	NL-34	\$3.00
968-000-100	NL-34L	\$3.00
968-000-101	NL-44	\$3.00
968-000-102	NL-46	\$2.50
968-000-103	NL-56	\$3.30
968-000-104	NL-58	\$3.00
968-000-105	NL-68	\$3.30
968-000-106	NL-68L	\$6.50

PACKAGE SIZE OF 5

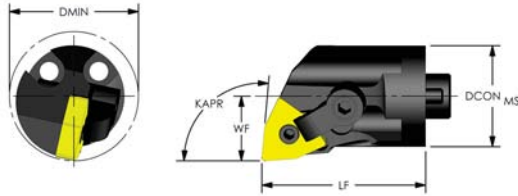

Negative Trigon (KAPR: 95°)

Coolant Thru

PRODUCT # Left hand	PRODUCT # Right hand	Designation	DCON MS	LF	WF	DMIN	Insert	Shim	Clamp	Clamp Screw	Lock Pin	Price
912-000-012	912-000-013	MH16 MWLNR/L4-CFT	1.000	1.625	0.640	1.200	WNMG 432	--	CL-20	XNS-47	NL-44	\$194.40
912-000-037	912-000-038	MH20 MWLNR/L4-CFT	1.250	1.625	0.765	1.470	WNMG 432	IWSN-433	CL-20	XNS-47	NL-46	\$199.80
912-000-070	912-000-071	MH24 MWLNR/L4-CFT	1.500	1.625	.890	1.760	WNMG 432	IWSN-433	CL-20	XNS-47	NL-46	\$211.70
912-000-102	912-000-103	MH28 MWLNR/L4-CFT	1.750	1.625	1.015	2.010	WNMG 432	IWSN-433	CL-20	XNS-47	NL-46	\$218.20
912-000-148	912-000-149	MH32 MWLNR/L4-CFT	2.000	1.625	1.281	2.400	WNMG 432	IWSN-433	CL-20	XNS-47	NL-46	\$247.40
912-000-189	912-000-190	MH40 MWLNR/L4-CFT	2.500	1.625	1.500	2.980	WNMG 432	IWSN-433	CL-20	XNS-47	NL-46	\$266.80

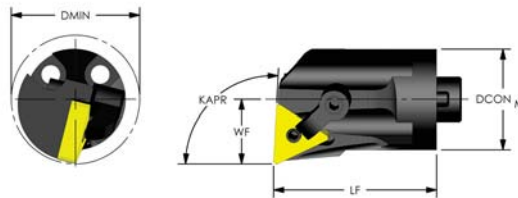

Negative Triangle (KAPR: 93°)

Coolant Thru

PRODUCT #	Designation	DCON MS	LF	WF	DMIN	Insert	Shim	Clamp	Clamp Screw	Lock Pin	Price
912-000-007	MH16 MTUNR3-CFT	1.000	1.625	0.640	1.200	TNMG 332	--	CL-7	XNS-36	NL-33L	\$194.40
912-000-032	MH20 MTUNR3-CFT	1.250	1.625	0.765	1.470	TNMG 332	ITSN-323	CL-7	XNS-36	NL-34L	\$199.80
912-000-065	MH24 MTUNR4-CFT	1.500	1.625	.890	1.760	TNMG 432	ITSN-433	CL-20	XNS-47	NL-46	\$211.70
912-000-097	MH28 MTUNR4-CFT	1.750	1.625	1.015	2.010	TNMG 432	ITSN-433	CL-20	XNS-47	NL-46	\$218.20
912-000-143	MH32 MTUNR4-CFT	2.000	1.625	1.281	2.400	TNMG 432	ITSN-433	CL-20	XNS-47	NL-46	\$247.40
912-000-182	MH40 MTUNR4-CFT	2.500	1.625	1.531	2.900	TNMG 432	ITSN-433	CL-20	XNS-47	NL-46	\$266.80

PRODUCT #	Clamp	Price Each
968-000-016	CL-6	\$5.30
968-000-017	CL-7	\$5.30
968-000-020	CL-9	\$5.30
968-000-010	CL-12	\$5.30
968-000-011	CL-19	\$6.60
968-000-012	CL-20	\$5.30

PRODUCT #	Clamp	Price Each
968-000-013	CL-21	\$12.40
968-000-014	CL-22	\$12.60
968-000-015	CL-30	\$9.30
968-000-018	CL-84	\$28.40
968-000-019	CL-85	\$28.40

PACKAGE SIZE OF 1

PRODUCT #	Clamp Screw	Price Each
968-000-176	XNS-36	\$2.20
968-000-177	XNS-47	\$2.20
968-000-178	XNS-48	\$2.20
968-000-179	XNS-510	\$2.20
968-000-180	XNS-58	\$2.20
968-000-181	XNS-59	\$2.20

PACKAGE SIZE OF 5

PRODUCT #	Lock Pin	Price Each
968-000-097	NL-33	\$3.00
968-000-098	NL-33L	\$3.00
968-000-099	NL-34	\$3.00
968-000-100	NL-34L	\$3.00
968-000-101	NL-44	\$3.00
968-000-102	NL-46	\$2.50
968-000-103	NL-56	\$3.30
968-000-104	NL-58	\$3.00
968-000-105	NL-68	\$3.30
968-000-106	NL-68L	\$6.50

PACKAGE SIZE OF 5

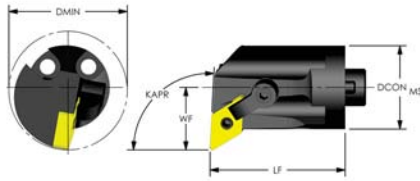

Negative 55° Diamond (KAPR: 93°)

Coolant Thru

PRODUCT # Left hand	PRODUCT # Right hand	Designation	DCON MS	LF	WF	DMIN	Insert	Shim	Clamp	Clamp Screw	Lock Pin	Price
912-000-005	912-000-006	MH16 MDUNR/L3-CFT	1.000	1.625	.750	1.300	DNMG 332		CL-7	XNS-36	NL-33L	\$194.40
912-000-026	912-000-027	MH20 MDUNR/L3-CFT	1.250	1.625	1.000	1.705	DNMG 332	IDSN-322	CL-7	XNS-36	NL-34L	\$199.80
912-000-057	912-000-059	MH24 MDUNR/L3-CFT	1.500	1.625	1.125	2.000	DNMG 332	IDSN-322	CL-7	XNS-36	NL-34L	\$211.70
912-000-089	912-000-091	MH28 MDUNR/L3-CFT	1.750	1.625	1.250	2.250	DNMG 332	IDSN-322	CL-7	XNS-36	NL-34L	\$218.20
912-000-131	912-000-133	MH32 MDUNR/L3-CFT	2.000	1.625	1.375	2.500	DNMG 332	IDSN-322	CL-7	XNS-36	NL-34L	\$247.40
912-000-172	912-000-174	MH40 MDUNR/L3-CFT	2.500	1.625	1.500	2.950	DNMG 332	IDSN-322	CL-7	XNS-36	NL-34L	\$266.80
912-000-027	912-000-029	MH20 MDUNR/L4-CFT	1.250	1.625	1.000	1.705	DNMG 432	IDSN-433	CL-20	XNS-48	NL-46	\$199.80
912-000-058	912-000-060	MH24 MDUNR/L4-CFT	1.500	1.625	1.125	2.000	DNMG 432	IDSN-433	CL-22	XNS-48	NL-46	\$211.70
912-000-090	912-000-092	MH28 MDUNR/L4-CFT	1.750	1.625	1.250	2.250	DNMG 432	IDSN-433	CL-22	XNS-48	NL-46	\$218.20
912-000-132	912-000-134	MH32 MDUNR/L4-CFT	2.000	1.625	1.375	2.500	DNMG 432	IDSN-433	CL-22	XNS-48	NL-46	\$247.40
912-000-173	912-000-175	MH40 MDUNR/L4-CFT	2.500	1.625	1.500	2.950	DNMG 432	IDSN-433	CL-22	XNS-48	NL-46	\$266.80

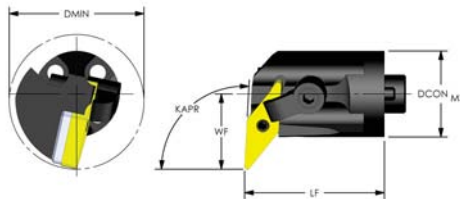

Negative 35° Diamond (KAPR: 93°)

Coolant Thru

PRODUCT # Left hand	PRODUCT # Right hand	Designation	DCON MS	LF	WF	DMIN	Insert	Shim	Clamp	Clamp Screw	Lock Pin	Price
912-000-008	912-000-009	MH16 MVUNR/L3-CFT	1.000	1.625	.875	1.435	VNMG 332	IVSN-322	CL-20	XNS-47	NL-34L	\$194.40
912-000-033	912-000-034	MH20 MVUNR/L3-CFT	1.250	1.625	1.000	1.705	VNMG 332	IVSN-322	CL-20	XNS-47	NL-34L	\$199.80
912-000-066	912-000-067	MH24 MVUNR/L3-CFT	1.500	1.625	1.125	2.000	VNMG 332	IVSN-322	CL-20	XNS-47	NL-34L	\$211.70
912-000-098	912-000-099	MH28 MVUNR/L3-CFT	1.750	1.625	1.250	2.250	VNMG 332	IVSN-322	CL-20	XNS-47	NL-34L	\$218.20
912-000-144	912-000-145	MH32 MVUNR/L3-CFT	2.000	1.625	1.375	2.500	VNMG 332	IVSN-322	CL-20	XNS-47	NL-34L	\$247.40
912-000-183	912-000-185	MH40 MVUNR/L3-CFT	2.500	1.625	1.750	3.250	VNMG 332	IVSN-322	CL-20	XNS-47	NL-34L	\$266.80
912-000-184	912-000-186	MH40 MVUNR/L4-CFT	2.500	1.625	1.750	3.250	VNMG 432	IVSN-432	CL-22	XNS-48	NL-46	\$266.80

PRODUCT #	Clamp	Price Each
968-000-016	CL-6	\$5.30
968-000-017	CL-7	\$5.30
968-000-020	CL-9	\$5.30
968-000-010	CL-12	\$5.30
968-000-011	CL-19	\$6.60
968-000-012	CL-20	\$5.30

PRODUCT #	Clamp	Price Each
968-000-013	CL-21	\$12.40
968-000-014	CL-22	\$12.60
968-000-015	CL-30	\$9.30
968-000-018	CL-84	\$28.40
968-000-019	CL-85	\$28.40

PACKAGE SIZE OF 1

PRODUCT #	Clamp Screw	Price Each
968-000-176	XNS-36	\$2.20
968-000-177	XNS-47	\$2.20
968-000-178	XNS-48	\$2.20
968-000-179	XNS-510	\$2.20
968-000-180	XNS-58	\$2.20
968-000-181	XNS-59	\$2.20

PACKAGE SIZE OF 5

PRODUCT #	Lock Pin	Price Each
968-000-097	NL-33	\$3.00
968-000-098	NL-33L	\$3.00
968-000-099	NL-34	\$3.00
968-000-100	NL-34L	\$3.00
968-000-101	NL-44	\$3.00
968-000-102	NL-46	\$2.50
968-000-103	NL-56	\$3.30
968-000-104	NL-58	\$3.00
968-000-105	NL-68	\$3.30
968-000-106	NL-68L	\$6.50

PACKAGE SIZE OF 5

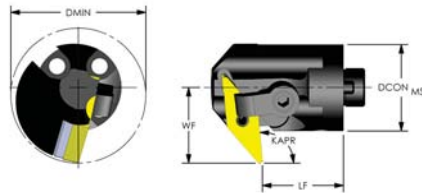

Negative 35° Diamond (KAPR: 95°)
Back Facing

Coolant Thru

PRODUCT # Left hand	PRODUCT # Right hand	Designation	DCON MS	LF	WF	DMIN	Insert	Shim	Clamp	Clamp Screw	Lock Pin	Price
912-000-010	912-000-011	MH16 MVXNR/L3-CFT	1.000	.940	.875	1.435	VNMG 332	IVSN-322	CL-20	XNS-47	NL-34L	\$194.40
912-000-035	912-000-036	MH20 MVXNR/L3-CFT	1.250	1.000	1.000	1.705	VNMG 332	IVSN-322	CL-20	XNS-47	NL-34L	\$199.80
912-000-068	912-000-069	MH24 MVXNR/L3-CFT	1.500	1.120	1.125	2.000	VNMG 332	IVSN-322	CL-20	XNS-47	NL-34L	\$211.70
912-000-100	912-000-101	MH28 MVXNR/L3-CFT	1.750	1.120	1.250	2.250	VNMG 332	IVSN-322	CL-20	XNS-47	NL-34L	\$218.20
912-000-146	912-000-147	MH32 MVXNR/L3-CFT	2.000	1.120	1.375	2.500	VNMG 332	IVSN-322	CL-20	XNS-47	NL-34L	\$247.40
912-000-187	912-000-188	MH40 MVXNR/L3-CFT	2.500	1.120	1.750	3.250	VNMG 332	IVSN-322	CL-20	XNS-47	NL-34L	\$266.80

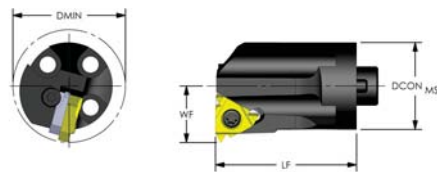

Threading / Grooving Laydown

Coolant Thru

PRODUCT #	Designation Right hand	DCON MS	LF	WF	DMIN	Insert	Insert Screw	Anvil Screw	Anvil	Price
912-000-002	MH16 LSER3-CFT	1.000	1.625	.650	1.200	3IR	SA3T	SY3T	YI3	\$206.30
912-000-023	MH20 LSER3-CFT	1.250	1.625	.770	1.450	3IR	SA3T	SY3T	YI3	\$211.70
912-000-051	MH24 LSER3-CFT	1.500	1.625	.900	1.650	3IR	SA3T	SY3T	YI3	\$222.50
912-000-085	MH28 LSER3-CFT	1.750	1.625	1.090	2.020	3IR	SA3T	SY3T	YI3	\$239.80
912-000-122	MH32 LSER3-CFT	2.000	1.625	1.281	2.400	3IR	SA3T	SY3T	YI3	\$265.70
912-000-052	MH24 LSER4-CFT	1.500	1.625	.978	1.782	4IR	SA4T	SY4T	YI4	\$222.50
912-000-084	MH28 LSER4-CFT	1.750	1.625	1.090	2.020	4IR	SA4T	SY4T	YI4	\$239.80
912-000-123	MH32 LSER4-CFT	2.000	1.625	1.281	2.400	4IR	SA4T	SY4T	YI4	\$265.70
912-000-124	MH32 LSER5-CFT	2.000	1.625	1.281	2.400	5IR	SA5T	SY5T	YI5	\$265.70
912-000-165	MH40 LSER5-CFT	2.500	1.625	1.530	2.800	5IR	SA5T	SY5T	YI5	\$289.50

PRODUCT #	Designation Left hand	DCON MS	LF	WF	DMIN	Insert	Insert Screw	Anvil Screw	Anvil	Price
912-000-001	MH16 LSEL3-CFT	1.000	1.625	.650	1.200	3IL	SA3T	SY3T	YE3	\$206.30
912-000-022	MH20 LSEL3-CFT	1.250	1.625	.770	1.450	3IL	SA3T	SY3T	YE3	\$211.70
912-000-049	MH24 LSEL3-CFT	1.500	1.625	.900	1.650	3IL	SA3T	SY3T	YE3	\$222.50
912-000-083	MH28 LSEL3-CFT	1.750	1.625	1.090	2.020	3IL	SA3T	SY3T	YE3	\$239.80
912-000-119	MH32 LSEL3-CFT	2.000	1.625	1.281	2.400	3IL	SA3T	SY3T	YE3	\$265.70
912-000-051	MH24 LSEL4-CFT	1.500	1.625	.978	1.782	4IL	SA4T	SY4T	YE4	\$206.00
912-000-086	MH28 LSEL4-CFT	1.750	1.625	1.090	2.020	4IL	SA4T	SY4T	YE4	\$222.50
912-000-120	MH32 LSEL4-CFT	2.000	1.625	1.281	2.400	4IL	SA4T	SY4T	YE4	\$265.70
912-000-121	MH32 LSEL5-CFT	2.000	1.625	1.281	2.400	5IL	SA5T	SY5T	YE5	\$265.70
912-000-164	MH40 LSEL5-CFT	2.500	1.625	1.530	2.800	5IL	SA5T	SY5T	YE5	\$289.50

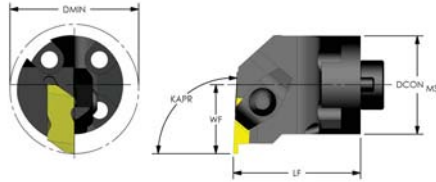

Threading / Grooving Top Notch

Coolant Thru

PRODUCT #	Designation Right Hand	DCON MS	LF	WF	DMIN	Insert	Clamp	Screw	Price
912-000-040	MH20 NER3-CFT	1.250	1.625	.875	1.750	NG 3L	CM-73	10-32	\$199.80
912-000-073	MH24 NER3-CFT	1.500	1.625	1.000	2.000	NG 3L	CM-73	10-32	\$210.60
912-000-107	MH28 NER3-CFT	1.750	1.625	1.125	2.250	NG 3L	CM-73	10-32	\$227.90
912-000-153	MH32 NER3-CFT	2.000	1.625	1.250	2.410	NG 3L	CM-73	10-32	\$253.80
912-000-108	MH28 NER4-CFT	1.750	1.625	1.250	2.500	NG 4L	CM-73	10-32	\$227.90
912-000-154	MH32 NER4-CFT	2.000	1.625	1.375	2.750	NG 4L	CM-73	10-32	\$253.80
912-000-193	MH40 NER4-CFT	2.500	1.625	1.625	3.250	NG 4L	CM-73	10-32	\$271.10
912-000-109	MH28 NER6-CFT	1.750	1.625	1.250	2.500	NG 6L	CM-121	10-32	\$227.90
912-000-155	MH32 NER6-CFT	2.000	1.625	1.375	2.750	NG 6L	CM-121	10-32	\$253.80
912-000-194	MH40 NER6-CFT	2.500	1.625	1.625	3.250	NG 6L	CM-121	10-32	\$271.10

PRODUCT #	Designation Left hand	DCON MS	LF	WF	DMIN	Insert	Clamp	Screw	Price
912-000-039	MH20 NEL3-CFT	1.250	1.625	.875	1.750	NG 3R	CM-72	10-32	\$199.80
912-000-072	MH24 NEL3-CFT	1.500	1.625	1.000	2.000	NG 3R	CM-72	10-32	\$210.60
912-000-104	MH28 NEL3-CFT	1.750	1.625	1.125	2.250	NG 3R	CM-72	10-32	\$227.90
912-000-150	MH32 NEL3-CFT	2.000	1.625	1.250	2.410	NG 3R	CM-72	10-32	\$253.80
912-000-105	MH28 NEL4-CFT	1.750	1.625	1.250	2.500	NG 4R	CM-72	10-32	\$227.90
912-000-151	MH32 NEL4-CFT	2.000	1.625	1.375	2.750	NG 4R	CM-72	10-32	\$253.80
912-000-191	MH40 NEL4-CFT	2.500	1.625	1.625	3.250	NG 4R	CM-72	10-32	\$271.10
912-000-106	MH28 NEL6-CFT	1.750	1.625	1.250	2.500	NG 6R	CM-120	10-32	\$227.90
912-000-152	MH32 NEL6-CFT	2.000	1.625	1.375	2.750	NG 6R	CM-120	10-32	\$253.80
912-000-192	MH40 NEL6-CFT	2.500	1.625	1.625	3.250	NG 6R	CM-120	10-32	\$271.10

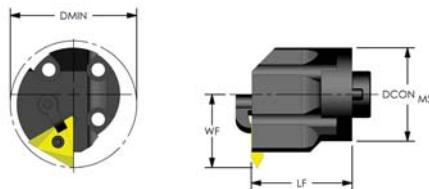

Threading / Grooving On Edge

Coolant Thru

PRODUCT # Left hand	PRODUCT # Right hand	Designation	DCON MS	LF	WF	DMIN	Insert	Clamp	Screw	Lock Pin	Price
912-000-063	912-000-064	MH24 MTHOR/L4-CFT	1.500	1.625	1.173	2.625	TNMA 43	CL-7	XNS-36	NL-44	\$210.60
912-000-095	912-000-096	MH28 MTHOR/L4-CFT	1.750	1.625	1.298	2.750	TNMA 43	CL-7	XNS-36	NL-44	\$227.90
912-000-141	912-000-142	MH32 MTHOR/L4-CFT	2.000	1.625	1.423	2.875	TNMA 43	CL-7	XNS-36	NL-44	\$253.80



In addition to our Chatter-Free bars, we offer a solid carbide or steel alternative with the same connection! These solid bars fit all heads following this page with the beginning “SH” designation.

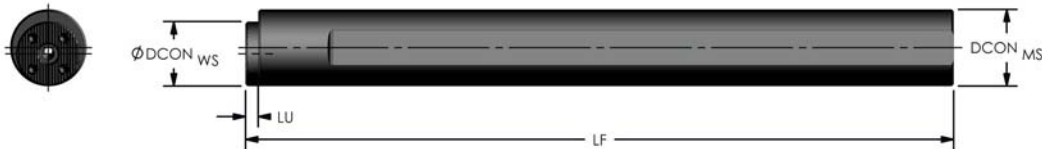

4:1 Ratio

STEEL SHANK

Coolant Thru

PRODUCT #	Designation	DCON MS	DCON WS	LU	LF	Head Bolts	Price
911-000-009	AS1000-12	1.000	25mm		12	8-32	\$351.00
911-000-010	AS1250-14	1.250	32mm		14	10-24	\$442.00
911-000-011	AS1500-14	1.500	32mm	.250	14	10-24	\$540.00
911-000-012	AS1750-16	1.750	40mm	.250	16	1/4-20	\$599.00
911-000-013	AS2000-20	2.000	40mm	.250	20	1/4-20	\$790.00
911-000-014	AS2500-12	2.500	40mm	.250	12	1/4-20	\$904.00
911-000-015	AS2500-24	2.500	40mm	.250	24	1/4-20	\$1,293.00

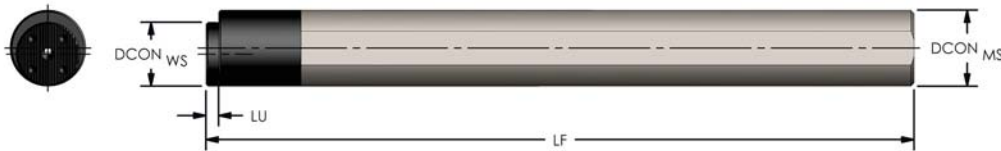

8:1 Ratio

CARBIDE SHANK

Coolant Thru

PRODUCT #	Designation	DCON MS	DCON WS	LU	LF	Head Bolts	Price
911-000-021	ES1000-12	1.000	25mm		12	8-32	\$1,200.00
911-000-022	ES1250-14	1.250	32mm		14	10-24	\$2,015.00
911-000-023	ES1500-14	1.500	32mm	.250	14	10-24	\$2,367.00
911-000-024	ES1750-16	1.750	40mm	.250	16	1/4-20	\$3,473.00
911-000-025	ES2000-20	2.000	40mm	.250	20	1/4-20	\$5,097.00



by **Ultra-Dex**

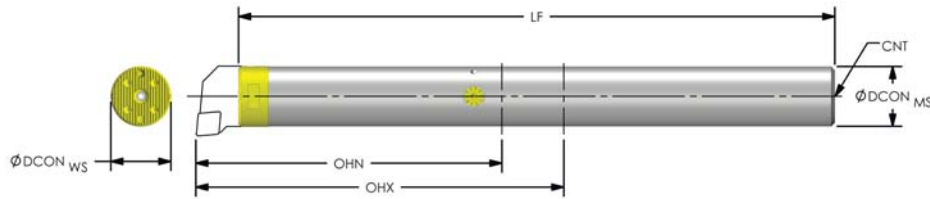

5:1 Ratio **MODULAR CHATTER-FREE BARS** **Coolant Thru**

PRODUCT #	Designation	DCON MS	DCON WS	LF	OHN	OHX	Head Bolts	CNT	Price
910-000-064	SCFT B1500-9	1.500	32mm	9	7.000	7.500	10-24 HB	1/8-27 NPT	\$1,204.40
910-000-069	SCFT B2000-12	2.000	40mm	12	7.500	10.000	1/4-20 HB	1/8-27 NPT	\$1,463.30
910-000-074	SCFT B2500-16	2.500	40mm	16	8.000	12.500	1/4-20 HB	1/8-27 NPT	\$1,990.60

7:1 Ratio

910-000-052	SCFT B1000-10	1.000	25mm	10	5.000	7.000	8-32 HB	1/8-27 NPT	\$924.60
910-000-056	SCFT B1250-12	1.250	32mm	12	6.250	8.750	10-24 HB	1/8-27 NPT	\$1,032.80
910-000-060	SCFT B1500-15	1.500	32mm	15	7.500	10.500	10-24 HB	1/8-27 NPT	\$1,204.40
910-000-065	SCFT B1750-18	1.750	40mm	18	8.7500	12.250	1/4-20 HB	1/8-27 NPT	\$1,381.20
910-000-070	SCFT B2000-20	2.000	40mm	20	10.000	14.000	1/4-20 HB	1/8-27 NPT	\$1,463.30
910-000-075	SCFT B2500-27	2.500	40mm	27	12.500	17.500	1/4-20 HB	1/4-18 NPT	\$1,990.60

10:1 Ratio

910-000-053	SCFT B1000-14	1.000	25mm	14	7.000	10.000	8-32 HB	1/8-27 NPT	\$1,854.40
910-000-057	SCFT B1250-16	1.250	32mm	16	8.750	12.500	10-24 HB	1/8-27 NPT	\$2,072.80
910-000-061	SCFT B1500-19	1.500	32mm	19	10.500	15.000	10-24 HB	1/8-27 NPT	\$2,179.90
910-000-066	SCFT B1750-23	1.750	40mm	23	12.250	17.500	1/4-20 HB	1/8-27 NPT	\$2,583.40
910-000-071	SCFT B2000-26	2.000	40mm	26	14.000	20.000	1/4-20 HB	1/8-27 NPT	\$2,828.80
910-000-076	SCFT B2500-33	2.500	40mm	33	17.500	25.000	1/4-20 HB	1/4-18 NPT	\$3,555.80

12:1 Ratio

910-000-054	SCFT B1000-16	1.000	25mm	16	10.875	12.000	8-32 HB		\$4,165.20
910-000-058	SCFT B1250-18	1.250	32mm	18	13.785	15.000	10-24 HB		\$5,158.40
910-000-062	SCFT B1500-22	1.500	32mm	22	16.375	18.000	10-24 HB		\$6,112.00
910-000-067	SCFT B1750-25	1.750	40mm	25	18.060	21.000	1/4-20 HB		\$7,472.00
910-000-072	SCFT B2000-29	2.000	40mm	29	19.375	24.000	1/4-20 HB		\$9,373.00

14:1 Ratio

910-000-055	SCFT B1000-18	1.000	25mm	18	10.875	12.000	8-32 HB		\$8,121.40
910-000-059	SCFT B1250-21	1.250	32mm	21	13.875	15.000	10-24 HB		\$9,677.20
910-000-063	SCFT B1500-25	1.500	32mm	25	16.375	18.000	10-24 HB		\$11,450.20
910-000-068	SCFT B1750-29	1.750	40mm	29	18.060	21.000	1/4-20 HB		\$13,322.10
910-000-073	SCFT B2000-33	2.000	40mm	33	19.375	24.000	1/4-20 HB		\$17,067.10

PRODUCT #	Head Bolts	Price Each
968-000-006	8-32 HB	\$2.20
968-000-002	10-24 HB	\$2.20
968-000-001	1/4-20 HB	\$2.60
968-000-004	5/16-18 HB	\$3.00

PACKAGE SIZE OF 1

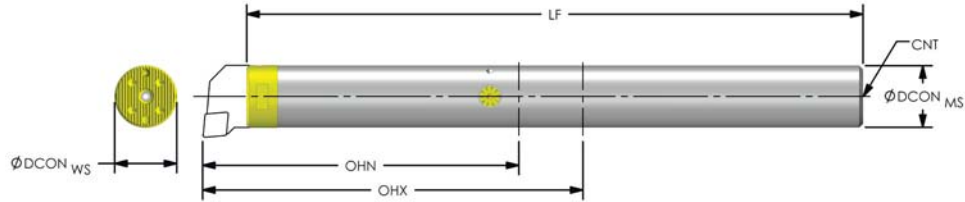

7:1 Ratio

MODULAR CHATTER-FREE BARS

Coolant Thru

PRODUCT #	Designation	DCON MS	DCON WS	LF	OHN	OHX	Head Bolts	CNT	Price
910-000-077	SCFT B25MM-250	25mm	25mm	250mm	127mm	175mm	8-32 HB	1/8-27 NPT	\$924.60
910-000-079	SCFT B32MM-320	32mm	32mm	320mm	159mm	224mm	10-24 HB	1/8-27 NPT	\$1,032.80
910-000-083	SCFT B40MM-400	40mm	40mm	400mm	190mm	280mm	1/4-20 HB	1/8-27 NPT	\$1,204.40
910-000-087	SCFT B50MM-500	50mm	40mm	500mm	254mm	350mm	1/4-20 HB	1/8-27 NPT	\$1,463.30
910-000-091	SCFT B60MM-600	60mm	40mm	600mm	320mm	420mm	1/4-20 HB	1/8-27 NPT	\$1,990.60

10:1 Ratio

910-000-078	SCFT B25MM-325	25mm	25mm	325mm	178mm	250mm	8-32 HB	1/8-27 NPT	\$1,854.40
910-000-080	SCFT B32MM-416	32mm	32mm	416mm	223mm	320mm	10-24 HB	1/8-27 NPT	\$2,072.80
910-000-084	SCFT B40MM-520	40mm	40mm	520mm	266mm	400mm	1/4-20 HB	1/8-27 NPT	\$2,179.90
910-000-088	SCFT B50MM-650	50mm	40mm	650mm	356mm	500mm	1/4-20 HB	1/8-27 NPT	\$2,828.80
910-000-092	SCFT B60MM-780	60mm	40mm	780mm	445mm	600mm	1/4-20 HB	1/8-27 NPT	\$3,555.80

12:1 Ratio

910-000-081	SCFT B32MM-480	32mm	32mm	480mm	352mm	384mm	10-24 HB		\$5,158.40
910-000-085	SCFT B40MM-600	40mm	40mm	600mm	416mm	480mm	1/4-20 HB		\$6,356.50
910-000-089	SCFT B50MM-750	50mm	40mm	750mm	492mm	600mm	1/4-20 HB		\$9,935.40

14:1 Ratio

910-000-082	SCFT B32MM-544	32mm	32mm	544mm	352mm	448mm	10-24 HB		\$9,677.20
910-000-086	SCFT B40MM-680	40mm	40mm	680mm	416mm	560mm	1/4-20 HB		\$11,450.20
910-000-090	SCFT B50MM-850	50mm	40mm	850mm	492mm	788mm	1/4-20 HB		\$17,067.10

PRODUCT #	Head Bolts	Price Each
968-000-006	8-32 HB	\$2.20
968-000-002	10-24 HB	\$2.20
968-000-001	1/4-20 HB	\$2.60
968-000-004	5/16-18 HB	\$3.00

PACKAGE SIZE OF 1

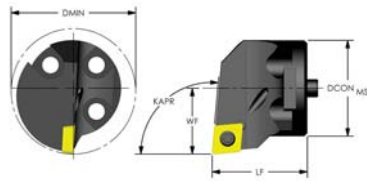

Positive 80° Diamond (KAPR:95°)

Coolant Thru

PRODUCT # Left hand	PRODUCT # Right hand	Designation	DCON MS	Coupling Size	LF	WF	DMIN	Insert	Insert Screw	Key	Price
912-000-205	912-000-206	SH16 SCLCR/L3	.984	25mm	.787	.669	1.260	CCMT 32.52	MTS-35	T-15	\$212.00
912-000-233	912-000-234	SH20 SCLCR/L3	1.260	32mm	1.260	.866	1.575	CCMT 32.52	MTS-35	T-15	\$217.00
912-000-263	912-000-264	SH24 SCLCR/L4	1.575	40mm	1.496	1.063	1.968	CCMT 432	MTS-4	T-20	\$232.00

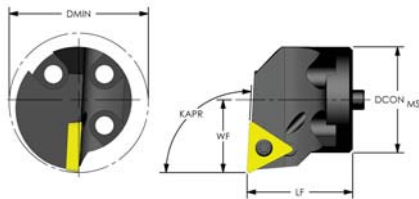

Positive Triangle (KAPR:93°)

Coolant Thru

PRODUCT # Left hand	PRODUCT # Right hand	Designation	DCON MS	Coupling Size	LF	WF	DMIN	Insert	Insert Screw	Key	Price
912-000-215	912-000-216	SH16 STUCR/L2	.984	25mm	.787	.669	1.260	TCMT 21.51	MTS-255	T-7	\$212.00
912-000-243	912-000-244	SH20 STUCR/L3	1.260	32mm	1.260	.866	1.575	TCMT 32.52	MTS-35	T-15	\$217.00
912-000-273	912-000-274	SH24 STUCR/L3	1.575	40mm	1.496	1.063	1.968	TCMT 32.52	MTS-35	T-15	\$232.00

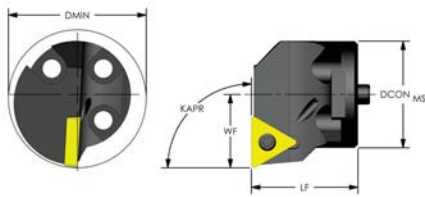

Positive Triangle (KAPR:90°)

Coolant Thru

PRODUCT # Left hand	PRODUCT # Right hand	Designation	DCON MS	Coupling Size	LF	WF	DMIN	Insert	Insert Screw	Key	Price
912-000-213	912-000-214	SH16 STFCCR/L2	.984	25mm	.787	.669	1.260	TCMT 21.51	MTS-255	T-7	\$212.00
912-000-241	912-000-242	SH20 STFCCR/L3	1.260	32mm	1.260	.866	1.575	TCMT 32.52	MTS-35	T-15	\$217.00
912-000-271	912-000-272	SH24 STFCCR/L3	1.575	40mm	1.496	1.063	1.968	TCMT 32.52	MTS-35	T-15	\$232.00

PRODUCT #	Insert Screws	Price Each
968-000-086	MTS-183	\$3.20
968-000-087	MTS-184	\$3.20
968-000-088	MTS-2	\$2.90
968-000-091	MTS-224	\$3.20
968-000-092	MTS-255	\$3.20
968-000-094	MTS-35	\$3.20
968-000-090	MTS-2.5L	\$2.90
968-000-052	ETS 4-40	\$3.20

PACKAGE SIZE OF 5

PRODUCT #	Key	Price Each
968-000-156	T-6	\$4.20
968-000-158	T-7	\$3.80
968-000-149	T-10	\$6.50
968-000-151	T-15	\$3.80
968-000-153	T-20	\$4.00

PACKAGE SIZE OF 5

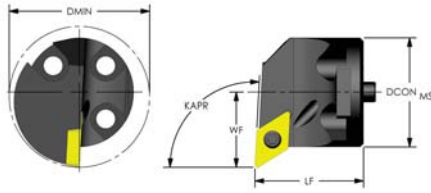

Positive 55° Diamond (KAPR: 93°) Profiling

Coolant Thru

PRODUCT # Left hand	PRODUCT # Right hand	Designation	DCON MS	Coupling Size	LF	WF	DMIN	Insert	Insert Screw	Key	Price
912-000-209	912-000-210	SH16 SDUCR/L3	.984	25mm	.787	.669	1.260	DCMT 32.52	MTS-35	T-15	\$212.00
912-000-237	912-000-238	SH20 SDUCR/L3	1.260	32mm	1.260	.866	1.575	DCMT 32.52	MTS-35	T-15	\$217.00
912-000-267	912-000-268	SH24 SDUCR/L3	1.575	40mm	1.260	1.063	1.968	DCMT 32.52	MTS-35	T-15	\$232.00

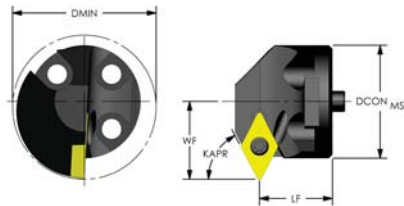

Positive 55° Diamond (KAPR: 62.5° Lead) Profiling

Coolant Thru

PRODUCT # Left hand	PRODUCT # Right hand	Designation	DCON MS	Coupling Size	LF	WF	DMIN	Insert	Insert Screw	Key	Price
912-000-207	912-000-208	SH16 SDNCR/L2	.984	25mm	.591	.709	1.299	DCMT 21.51	MTS-255	T-7	\$212.00
912-000-235	912-000-236	SH20 SDNCR/L3	1.260	32mm	.787	.866	1.575	DCMT 32.52	MTS-35	T-15	\$217.00
912-000-265	912-000-266	SH24 SDNCR/L3	1.575	40mm	.787	1.063	1.968	DCMT 32.52	MTS-35	T-15	\$232.00

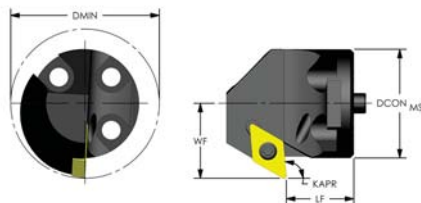

Positive 55° Diamond (5° Lead) Back Facing

Coolant Thru

PRODUCT # Left hand	PRODUCT # Right hand	Designation	DCON MS	Coupling Size	LF	WF	DMIN	Insert	Insert Screw	Key	Price
912-000-211	912-000-212	SH16 SDXCR/L2	.984	25mm	.591	.709	1.299	DCMT 21.51	MTS-255	T-7	\$212.00
912-000-239	912-000-240	SH20 SDXCR/L3	1.260	32mm	.787	.866	1.575	DCMT 32.52	MTS-35	T-15	\$217.00
912-000-269	912-000-270	SH24 SDXCR/L3	1.575	40mm	.787	1.063	1.968	DCMT 32.52	MTS-35	T-15	\$232.00

PRODUCT #	Insert Screws	Price Each
968-000-086	MTS-183	\$3.20
968-000-087	MTS-184	\$3.20
968-000-088	MTS-2	\$2.90
968-000-091	MTS-224	\$3.20
968-000-092	MTS-255	\$3.20
968-000-094	MTS-35	\$3.20
968-000-090	MTS-2.5L	\$2.90
968-000-052	ETS 4-40	\$3.20

PACKAGE SIZE OF 5

PRODUCT #	Key	Price Each
968-000-156	T-6	\$4.20
968-000-158	T-7	\$3.80
968-000-149	T-10	\$6.50
968-000-151	T-15	\$3.80
968-000-153	T-20	\$4.00

PACKAGE SIZE OF 5



by **Ultra-Dex**

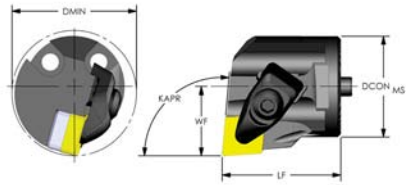

PULLBACK Clamp Negative 80° Diamond (KAPR 95° Lead)

Coolant Thru

PRODUCT # Left Hand	PRODUCT # Right Hand	Designation	DCON MS	Coupling Size	LF	WF	DMIN	Insert	Shim Seat	Shim Screw	Clamp Assy.	Price
912-000-217	912-000-218	SH20 DCLNR/L4	1.260	32mm	1.496	.866	1.575	CNMG 432	ICSN-433	PB4-SS	PB4-CA	\$268.00
912-000-245	912-000-246	SH24 DCLNR/L4	1.575	40mm	1.496	1.063	1.968	CNMG 432	ICSN-433	PB4-SS	PB4-CA	\$279.00

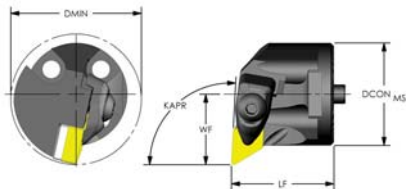

PULLBACK Clamp Negative 55° Diamond (KAPR: 93°)

Coolant Thru

PRODUCT # Left Hand	PRODUCT # Right Hand	Designation	DCON MS	Coupling Size	LF	WF	DMIN	Insert	Shim Seat	Shim Screw	Clamp Assy.	Price
912-000-219	912-000-220	SH20 DDUNR/L3	1.260	32mm	1.260	.866	1.575	DNMG 332	IDSN-322	PB3-SS	PB3-CA	\$268.00
912-000-247	912-000-248	SH24 DDUNR/L4	1.575	40mm	1.260	1.063	1.968	DNMG 432	IDSN-433	PB4-SS	PB4-CA	\$279.00

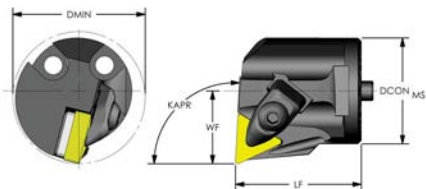

PULLBACK Clamp Negative Triangle (KAPR: 93°)

Coolant Thru

PRODUCT # Left Hand	PRODUCT # Right Hand	Designation	DCON MS	Coupling Size	LF	WF	DMIN	Insert	Shim Seat	Shim Screw	Clamp Assy.	Price
912-000-223	912-000-224	SH20 DTUNR/L3	1.260	32mm	1.496	.866	1.575	TNMG 332	ITSN-323	PB3-SS	PB3-CA	\$268.00
912-000-251	912-000-252	SH24 DTUNR/L3	1.575	40mm	1.496	1.063	1.968	TNMG 332	ITSN-323	PB3-SS	PB3-CA	\$279.00

PRODUCT #	Shim Seat	Price Each
968-000-053	ICSN-433	\$4.80
968-000-054	ICSN-533	\$5.80
968-000-055	ICSN-633	\$6.70
968-000-063	ISSN-432	\$4.70
968-000-064	ISSN-433	\$4.70
968-000-065	ISSN-533	\$5.50
968-000-066	ISSN-633	\$6.60
968-000-056	IDSN-322	\$3.80
968-000-057	IDSN-433	\$4.30
968-000-058	IDSN-533	\$6.60
968-000-067	ITSN-323	\$3.30
968-000-068	ITSN-433	\$5.30

PRODUCT #	Shim Seat	Price Each
968-000-069	ITSN-533	\$6.90
968-000-070	ITSN-636	\$9.30
968-000-071	IVSN-322	\$3.80
968-000-072	IVSN-432	\$5.10
968-000-073	IVSN-433	\$5.10
968-000-074	IWSN-322	\$4.30
968-000-075	IWSN-433	\$5.90
968-000-059	IRSN-32	\$4.20
968-000-060	IRSN-43	\$3.80
968-000-061	IRSN-53	\$6.10
968-000-062	IRSN-63	\$6.90

PACKAGE SIZE OF 10

PRODUCT #	Shim Screw	Price Each
968-000-109	PB3-SS	\$3.10
968-000-111	PB4-SS	\$3.10

PACKAGE SIZE OF 5

PRODUCT #	Clamp Assy.	Price Each
968-000-107	PB3-CA	\$20.10
968-000-110	PB4-CA	\$20.10

PACKAGE SIZE OF 1

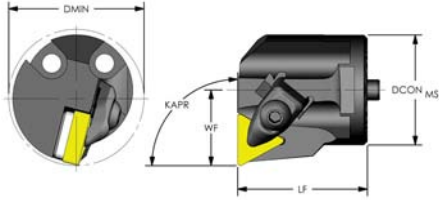

PULLBACK Clamp Negative Triangle (KAPR: 90°)

Coolant Thru

PRODUCT # Left Hand	PRODUCT # Right Hand	Designation	DCON MS	Coupling Size	LF	WF	DMIN	Insert	Shim Seat	Shim Screw	Clamp Assy.	Price
912-000-221	912-000-222	SH20 DTFNR/L3	1.260	32mm	1.496	.866	1.575	TNMG 332	ITSN-323	PB3-SS	PB3-CA	\$268.00
912-000-249	912-000-250	SH24 DTFNR/L3	1.575	40mm	1.496	1.063	1.968	TNMG 332	ITSN-323	PB3-SS	PB3-CA	\$279.00

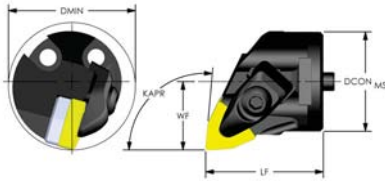

PULLBACK Clamp Negative Trigon (KAPR: 95°)

Coolant Thru

PRODUCT # Left Hand	PRODUCT # Right Hand	Designation	DCON MS	Coupling Size	LF	WF	DMIN	Insert	Shim Seat	Shim Screw	Clamp Assy.	Price
912-000-225	912-000-226	SH20 DWLNR/L4	1.260	32mm	1.496	.866	1.575	WNMG 432	IWSN-433	PB4-SS	PB4-CA	\$268.00
912-000-253	912-000-254	SH24 DWLNR/L4	1.575	40mm	1.496	1.063	1.968	WNMG 432	IWSN-433	PB4-SS	PB4-CA	\$279.00

PRODUCT #	Shim Seat	Price Each
968-000-053	ICSN-433	\$4.80
968-000-054	ICSN-533	\$5.80
968-000-055	ICSN-633	\$6.70
968-000-063	ISSN-432	\$4.70
968-000-064	ISSN-433	\$4.70
968-000-065	ISSN-533	\$5.50
968-000-066	ISSN-633	\$6.60
968-000-056	IDSN-322	\$3.80
968-000-057	IDSN-433	\$4.30
968-000-058	IDSN-533	\$6.60
968-000-067	ITSN-323	\$3.30
968-000-068	ITSN-433	\$5.30

PRODUCT #	Shim Seat	Price Each
968-000-069	ITSN-533	\$6.90
968-000-070	ITSN-636	\$9.30
968-000-071	IVSN-322	\$3.80
968-000-072	IVSN-432	\$5.10
968-000-073	IVSN-433	\$5.10
968-000-074	IWSN-322	\$4.30
968-000-075	IWSN-433	\$5.90
968-000-059	IRSN-32	\$4.20
968-000-060	IRSN-43	\$3.80
968-000-061	IRSN-53	\$6.10
968-000-062	IRSN-63	\$6.90

PACKAGE SIZE OF 10

PRODUCT #	Shim Screw	Price Each
968-000-109	PB3-SS	\$3.10
968-000-111	PB4-SS	\$3.10

PACKAGE SIZE OF 5

PRODUCT #	Clamp Assy.	Price Each
968-000-107	PB3-CA	\$20.10
968-000-110	PB4-CA	\$20.10

PACKAGE SIZE OF 1

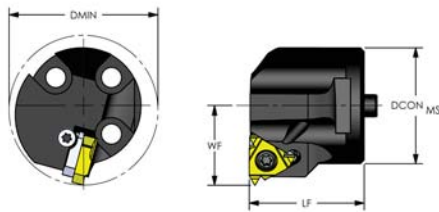

Threading / Grooving Laydown

Coolant Thru

PRODUCT #	Designation Right Hand	DCON MS	Coupling Size	LF	WF	DMIN	Insert	Insert Screw	Anvil Screw	Anvil	Price
912-000-204	SH16 LSER3	.984	25mm	.984	.669	1.260	3IR	SA3T	SY3T	YI3	\$285.00
912-000-229	SH20 LSER3	1.260	32mm	1.260	.866	1.575	3IR	SA3T	SY3T	YI3	\$313.00
912-000-257	SH24 LSER3	1.575	40mm	1.496	1.063	1.968	3IR	SA3T	SY3T	YI3	\$329.00
912-000-230	SH20 LSER4	1.260	32mm	1.260	.866	1.575	4IR	SA4T	SY4T	YI4	\$313.00
912-000-258	SH24 LSER4	1.575	40mm	1.496	1.063	1.968	4IR	SA4T	SY4T	YI4	\$329.00

PRODUCT #	Designation Left Hand	DCON MS	Coupling Size	LF	WF	DMIN	Insert	Insert Screw	Anvil Screw	Anvil	Price
912-000-203	SH16 LSEL3	.984	25mm	.984	.669	1.260	3IL	SA3T	SY3T	YE3	\$285.00
912-000-227	SH20 LSEL3	1.260	32mm	1.260	.866	1.575	3IL	SA3T	SY3T	YE3	\$313.00
912-000-255	SH24 LSEL3	1.575	40mm	1.496	1.063	1.968	3IL	SA3T	SY3T	YE3	\$329.00
912-000-228	SH20 LSEL4	1.260	32mm	1.260	.866	1.575	4IL	SA4T	SY4T	YE4	\$313.00
912-000-256	SH24 LSEL4	1.575	40mm	1.496	1.063	1.968	4IL	SA4T	SY4T	YE4	\$329.00

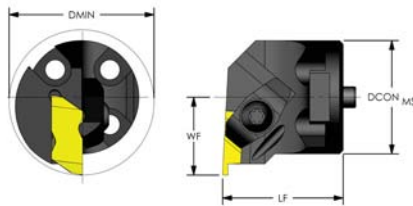

Threading / Grooving Top Notch

Coolant Thru

PRODUCT #	Designation Right Hand	D Dia.	Coupling Size	C OAL	F	Min Bore	Insert	Clamp	Screw	Price
912-000-232	SH20 NER3	1.260	32mm	1.340	.866	1.730	NG 3L	CM-73	10-32	\$302.00
912-000-261	SH24 NER3	1.575	40mm	1.575	1.102	2.210	NG 3L	CM-73	10-32	\$317.00
912-000-262	SH24 NER4	1.575	40mm	1.575	1.102	2.210	NG 4L	CM-73	10-32	\$317.00

PRODUCT #	Designation Left Hand	D Dia.	Coupling Size	C OAL	F	Min Bore	Insert	Clamp	Screw	Price
912-000-231	SH20 NEL3	1.260	32mm	1.340	.866	1.730	NG 3R	CM-72	10-32	\$302.00
912-000-259	SH24 NEL3	1.575	40mm	1.575	1.102	2.210	NG 3R	CM-72	10-32	\$317.00
912-000-260	SH24 NEL4	1.575	40mm	1.575	1.102	2.210	NG 4R	CM-72	10-32	\$317.00

PRODUCT #	Clamp	Price Each
968-000-016	CL-6	\$5.30
968-000-017	CL-7	\$5.30
968-000-020	CL-9	\$5.30
968-000-010	CL-12	\$5.30
968-000-011	CL-19	\$6.60
968-000-012	CL-20	\$5.30

PRODUCT #	Clamp	Price Each
968-000-013	CL-21	\$12.40
968-000-014	CL-22	\$12.60
968-000-015	CL-30	\$9.30
968-000-018	CL-84	\$28.40
968-000-019	CL-85	\$28.40

PACKAGE SIZE OF 1

PRODUCT #	Anvil	Price Each
968-000-185	YI3	\$20.10
968-000-182	YE3	\$20.10
968-000-187	YI4	\$31.90
968-000-186	YI3M-1.5N	\$30.80
968-000-183	YE4	\$31.90
968-000-188	YI5	\$50.60
968-000-184	YE5	\$50.60

PACKAGE SIZE OF 1

PRODUCT #	Anvil Screw	Price Each
968-000-146	SY3T	\$2.40
968-000-147	SY4T	\$3.00
968-000-148	SY5T	\$4.70

PACKAGE SIZE OF 5

PRODUCT #	Insert Screw	Price Each
968-000-124	SA3T	\$3.50
968-000-125	SA4T	\$4.70
968-000-126	SA5T	\$8.10

PACKAGE SIZE OF 5

Choosing the largest possible bar size with the shortest overhang will provide rigidity to minimize vibrations.

Make sure to allow clearance for chips.

5:1 Chatter-Free bars are recommended for grooving and threading where forces are higher than in turning.

Proper clamping of the bar is crucial to performance.
(set screws should not come in contact with the bar)



Chatter-Free bars $\phi 1.0$ " and larger have a flat located on the gold ring to indicate the insert on center line.

Overhang is measured from cutting edge to face of boring bar holder.
Bars should not be extended past the specified diameter to length ratio.
The Bars can be modified to reduce overall length .

To compensate for bar deflection due to extended overhangs, rotating the insert above center line will help.

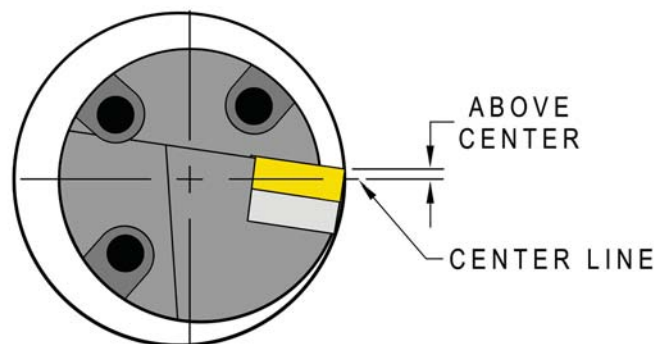

Split Collar System

To assure the best rigidity of the boring bar, the Split Collar System is the best holder. This process is achieved by locking the bar 360° on the diameter.

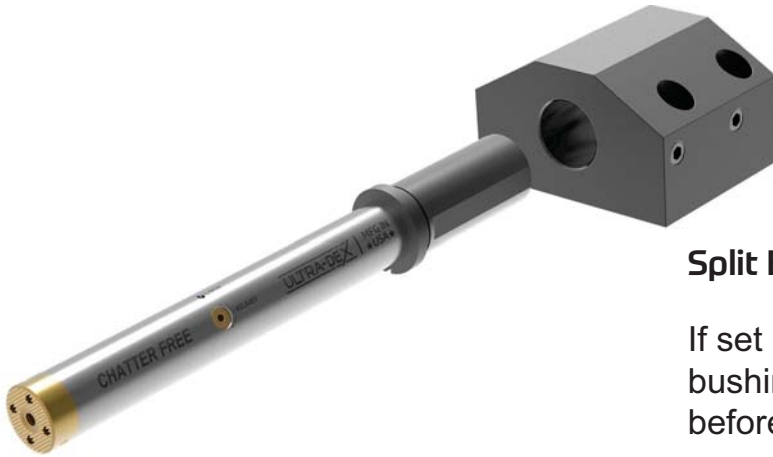

Split Bushing System

If set screws are to be used, a split bushing must be placed on the bar before placing in the machine. Set screws will contact the bushing and tighten around the bar.

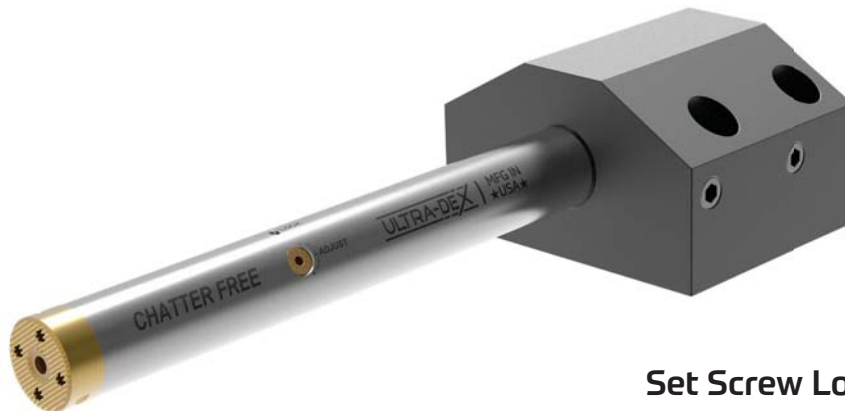

Set Screw Lock System

Do not lock in the boring bar with set screws. This creates very poor rigidity when there is one point of contact.

For Bars $\phi.75''$ and Smaller

1. Make a test cut with the bar.
2. Insert supplied T-handle wrench into the end of the bar.
3. If the pitch of the chatter was high, tighten the adjust screw 1/16 turn.(+)
4. If the pitch of the chatter was low, loosen the adjust screw 1/16turn.(-)
5. Make a test cut with the bar.
6. Repeat step 3 until the desired performance is achieved.

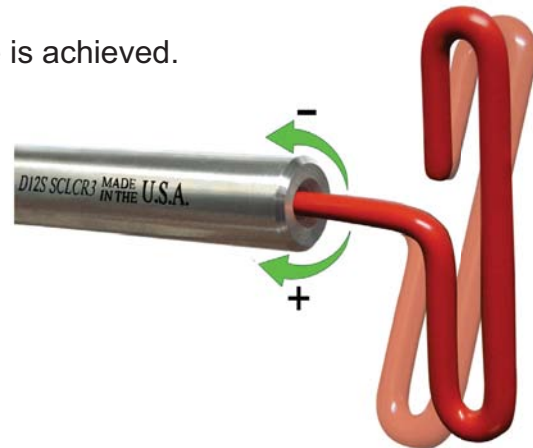

For Bars $\phi 1.0''$ and Above

1. Make a test cut with the bar.
2. Loosen lock screw two complete turns in the negative direction.
3. If the pitch of the chatter was high, tighten the adjust screw 1/2 digit.(+)
4. If the pitch of the chatter was low, loosen the adjust screw 1/2 digit.(-)
5. Make a test cut with the bar.
6. Repeat step 3 until the desired performance is achieved.
7. Tighten lock screw.DO NOT over tighten lock screw.



HANGOUT SPECS

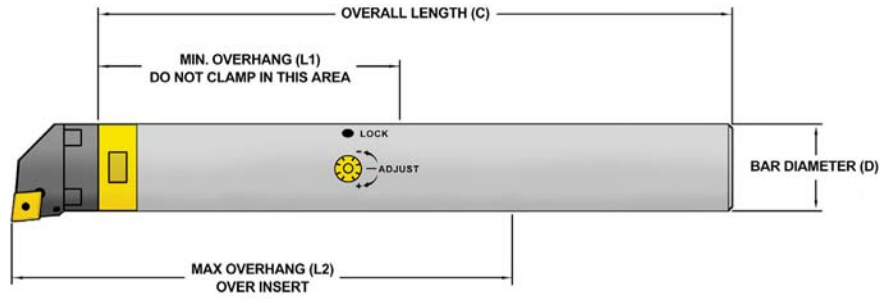

5:1 Ratio

Bar Diameter	Min Overhang (L1)	Max. Overhang (L2)	Overall Length (C)	Weight (LBS)
1.000	5.750	7.50	9.00	4.5
2.000	6.375	10.00	12.00	10.7
2.500	6.750	12.50	16.00	22.8
1.000	5.000	7.00	10.00	2.2
1.250	5.000	8.75	12.00	4.1
1.500	5.750	10.50	15.00	7.5
1.750	6.000	12.25	18.00	11.3
2.000	6.375	14.00	20.00	18.0
2.500	6.750	17.50	27.00	42.0
3.000	12.500	21.00	31.00	63.0
1.000	6.000	10.00	14.00	3.1
1.250	6.750	12.50	16.00	5.7
1.500	9.000	15.00	19.00	11.0
1.750	10.625	17.50	23.00	17.0
2.000	12.375	20.00	26.00	25.0
2.500	15.875	25.00	33.00	42.0
3.000	19.375	30.00	40.00	88.0
4.000	26.375	40.00	50.00	182.0

7:1 Ratio

10:1 Ratio

**HANGOUT SPECS
CARBIDE REINFORCED**

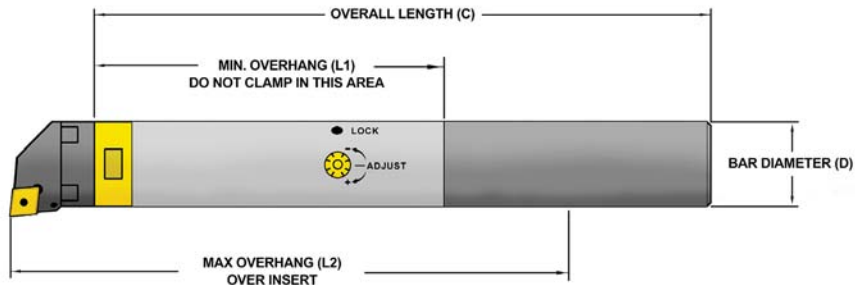

12:1 Ratio

Bar Diameter	Min Overhang (L1)	Max. Overhang (L2)	Overall Length (C)	Weight (LBS)
1.000	9.250	12.00	16.00	5.9
1.250	12.160	15.00	18.00	9.0
1.500	14.750	18.00	22.00	16.4
1.750	16.435	21.00	25.00	25.4
2.000	17.750	24.00	29.00	37.7
1.000	9.250	14.00	18.00	6.9
1.250	12.160	17.50	22.00	10.9
1.500	14.750	21.00	25.00	18.6
1.750	16.435	24.50	29.00	31.0
2.000	17.750	28.00	33.00	44.2

ULTRA-DEX[®]

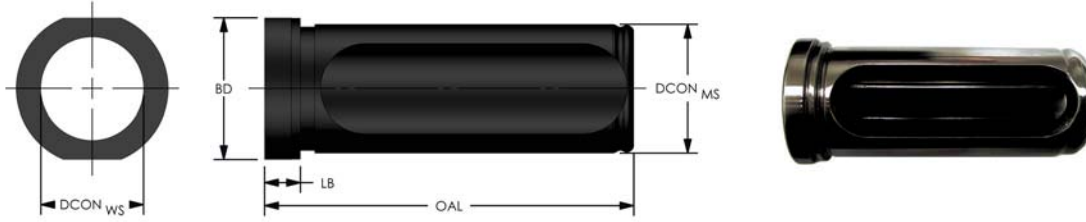

C Style

PRODUCT #	Designation	D CON MS	D CON WS	LB	OAL	Price
901-000-001	UT-12C-037	1.250	.375	3.250	2.75	\$79.00
901-000-002	UT-12C-050	1.250	0.500	3.250	2.75	\$79.00
901-000-003	UT-12C-062	1.250	.625	3.250	2.75	\$79.00
901-000-004	UT-12C-075	1.250	.750	3.250	2.75	\$79.00
901-000-005	UT-12C-100	1.250	1.000	3.250	2.75	\$79.00
901-000-011	UT-13C-037	1.500	.375	3.375	3.00	\$90.00
901-000-012	UT-13C-050	1.500	0.500	3.375	3.00	\$90.00
901-000-013	UT-13C-062	1.500	.625	3.375	3.00	\$90.00
901-000-014	UT-13C-075	1.500	.750	3.375	3.00	\$90.00
901-000-015	UT-13C-100	1.500	1.000	3.375	3.00	\$90.00
901-000-016	UT-13C-125	1.500	1.250	3.375	3.00	\$90.00

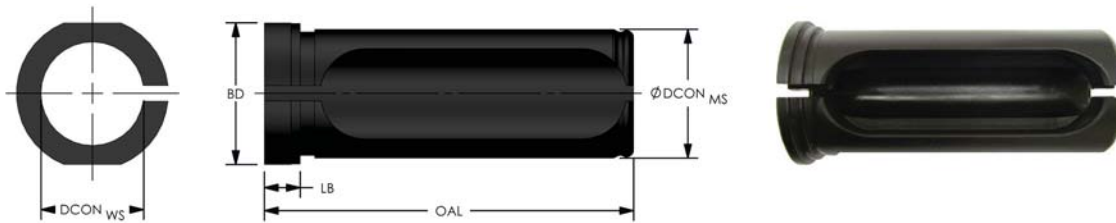

CX Style

PRODUCT #	Designation	D CON MS	D CON WS	LB	OAL	Price
901-000-006	UT-12CX-037	1.250	0.375	3.250	2.75	\$102.00
901-000-007	UT-12CX-050	1.250	0.500	3.250	2.75	\$102.00
901-000-008	UT-12CX-062	1.250	0.625	3.250	2.75	\$102.00
901-000-009	UT-12CX-075	1.250	0.750	3.250	2.75	\$102.00
901-000-010	UT-12CX-100	1.250	1.000	3.250	2.75	\$102.00
901-000-017	UT-13CX-037	1.500	0.375	3.375	3.00	\$125.00
901-000-018	UT-13CX-050	1.500	0.500	3.375	3.00	\$125.00
901-000-019	UT-13CX-062	1.500	0.625	3.375	3.00	\$125.00
901-000-020	UT-13CX-075	1.500	0.750	3.375	3.00	\$125.00
901-000-021	UT-13CX-100	1.500	1.000	3.375	3.00	\$125.00
901-000-022	UT-13CX-125	1.500	1.250	3.375	3.00	\$125.00

PRODUCT #	Designation	D CON MS	D CON WS	LB	OAL	Price
901-000-023	UT-73CX-10MM	1.500	10mm	3.375	3.00	\$139.00
901-000-024	UT-73CX-12MM	1.500	12mm	3.375	3.00	\$139.00
901-000-025	UT-73CX-16MM	1.500	16mm	3.375	3.00	\$139.00
901-000-026	UT-73CX-20MM	1.500	20mm	3.375	3.00	\$139.00
901-000-027	UT-73CX-25MM	1.500	25mm	3.375	3.00	\$139.00
901-000-028	UT-93CX-10MM	40mm	10mm	3.375	3.00	\$160.00
901-000-029	UT-93CX-12MM	40mm	12mm	3.375	3.00	\$160.00
901-000-030	UT-93CX-16MM	40mm	16mm	3.375	3.00	\$160.00
901-000-031	UT-93CX-20MM	40mm	20mm	3.375	3.00	\$160.00
901-000-032	UT-93CX-25MM	40mm	25mm	3.375	3.00	\$160.00



TECHNICAL INFORMATION

THE COMPLETE TOOL MAKING AUTHORITY™

Speeds & feeds are starting recommendations only. Factors such as machine type, fixture, tooling rigidity, available horsepower, coolant delivery method and others will affect the performance significantly.

COATINGS GUIDE

TIN

(TITANIUM NITRIDE)

- General Purpose coating for machining ferrous materials.
- Thickness: 2 - 5 microns
- Hardness HV .05: 2,300

TICN

(TITANIUM CARBON NITRIDE)

- Coating with hard, smooth finish. Offers improved wear and built up edge resistance.
- Durability for interrupted cuts
 - Low to medium cutting speeds
 - Thickness: 2 - 4 microns
 - Hardness HV .05: 3,000

TIALN

(TITANIUM ALUMINUM NITRIDE)

- High performance coating in ferrous materials.
- Heat resistance and medium hardness
- Good results in dry milling applications
- Medium to high cutting speeds
- Thickness: 2 - 4 microns
- Hardness HV .05: 2,800

ALTiN

(ALUMINUM TITANIUM NITRIDE)

- High performance coating for ferrous materials.
- High heat resistance and hardness
- Best results in dry milling applications
- Excellent at high speeds and feeds
- Thickness: 2 – 4 microns
- Hardness HV .05: 4,500

TIALN NANO

(TITANIUM ALUMINUM NITRIDE NANO)

- Extended tool life in difficult to machine steels and super alloys.
- Dry or MQL machining
- Improved chip flow due to lubricity factor.
- Reduced built up edge (BUE)
- Hardness HV .05: 3,300

HARD MILL

(HARDMILL)

- Proprietary coating blend designed specifically for extended life machining hardened materials
- Hardness HV .05: 3,300

AMORPHOUS DIAMOND

AD(AMORPHOUS DIAMOND)

- Amorphous Diamond is a smooth, hard, flexible, thin film coating
- Maintains sharper edge than CVD
- Excellent for machining graphite, carbon fiber and non-ferrous materials where machining forms a grit rather than a chip.
- Thickness: .5 - 2 microns
- Hardness HV .05: 5,000

CVD

(CRYSTALLINE DIAMOND)

- Crystalline Diamond grown directly on the cutting tool
- Excellent for machining graphite, carbon fiber, green ceramics and non-ferrous materials where machining forms a grit rather than a chip.
- Up to 50x the tool life as AD
- Thickness: 6 - 10 microns
- Hardness HV .05: 10,000

DLC

(DIAMOND LIKE COATING)

- Thin carbon based amorphous coating, best for non-ferrous materials.
- Increases tool life and ensures a more controlled wear process, while being resistant to edge build-up (BUE).
- Hardness HV .05: 2,800

PCD

PCD (POLYCRYSTALLINE DIAMOND)

- Non-ferrous applications
- Resists abrasion wear and dramatically extends the cutters tool life.
- PCD end mills run faster than conventional carbide end mills and provide better surface finish and longer tool life.
- Hardness HV .05: 10,000



Chipbreaker:

HCX : Medium to roughing applications in steel and cast iron

SCX : Medium to finishing application in steels, stainless steels, hardened steels, and super alloys

ISO	MATERIAL	HARDNESS	CHIPBREAKER	GRADE	Vc (SFM)*	Fz (INCH PER TOOTH)*
P	CARBON STEELS 1018, 1040, 1080, 1090, 10L50, 1140, 1212, 12L15, 1525, 1536	≤ 275 BHN or ≤ 28 HRC	HCX	HP470	300-800	.005 - .020
	ALLOY STEELS 4140, 4150, 4320, 5120, 5150, 8630, 86L20, 17-4 PH	≤ 375 BHN or ≤ 40 HRC			220-720	.003 - .018
M	STAINLESS STEELS (FREE MACHINING) 303, 416, 420F, 430F, 440F	≤ 275 BHN or ≤ 28 HRC	SCX	HM470	230-650	.003 - .015
	STAINLESS STEELS (DIFFICULT) 304, 304L, 316, 316L	≤ 275 BHN or ≤ 28 HRC			260-700	.003 - .015
K	GRAY IRONS Class 20, 30, 40, 50, 60, G3000, G3500	≤ 220 BHN or ≤ 19 HRC	HCX	HK430	400 - 1100	.005 - .022
	DUCTILE IRONS D&M series, 250, 300, 350, 400, 60-40-18, 65-45-12	≤ 260 BHN or ≤ 26 HRC			350 - 850	.005 - .016
H	TOOL STEELS A2, D2, H13, L2, M2, P20, S7, T15, W2	≤ 375 BHN or ≤ 55 HRC	SCX	HS470	80-280	.004 - .011
S	HR SUPER ALLOYS Inconel 718, Waspaloy, Hastelloy, Inconel 625, Stellite 31, Haynes 25, Rene 41	≤ 275 BHN or ≤ 28 HRC	SCX	HS470	60 - 250	.003 - .009
	TITANIUM 6AL-4V, ASTM 1, 2, 3, 6AL-2S	≤ 275 BHN or ≤ 28 HRC			90 - 300	.004 - .012
*LOWER Vc AND Fz = MED.- HEAVY Ap / Ae			*HIGHER Vc AND Fz = LIGHT-MED. Ap / Ae			

Recommendations:

- Keep the cutter constantly engaged, when possible, to reduce enter and exit onto the machined component
- Utilize roll technique around all corners to avoid harsh directional changes
- The width of cut, a_p , should be 30% or 70% of DC to ensure maximum efficiency and process security
- Program tool paths around interruptions and holes when possible

Speeds & feeds are starting recommendations only. Factors such as machine type, fixture, tooling rigidity, available horsepower, coolant delivery method and others will affect the performance significantly.



Chipbreaker:

HCX : Medium to roughing applications in steels and cast irons

SCX : Medium to finishing application in steels, stainless steels, hardened steels, and super alloys

LCX : Sharp cutting edge. Light finishing to medium roughing applications in non ferrous materials

ISO	MATERIAL	HARDNESS	CHIPBREAKER	GRADE	Vc (SFM)*	Fz (INCH PER TOOTH)*
P	CARBON STEELS 1018, 1040, 1080, 1090, 10L50, 1140, 1212, 12L15, 1525, 1536	≤ 275 BHN or ≤ 28 HRC	HCX	HP470	300-800	.005 - .018
	ALLOY STEELS 4140, 4150, 4320, 5120, 5150, 8630, 86L20, 17-4 PH	≤ 375 BHN or ≤ 40 HRC			220-720	.005 - .016
M	STAINLESS STEELS (FREE MACHINING) 303, 416, 420F, 430F, 440F	≤ 275 BHN or ≤ 28 HRC	SCX	HM470	230-650	.003 - .012
	STAINLESS STEELS (DIFFICULT) 304, 304L, 316, 316L	≤ 275 BHN or ≤ 28 HRC			260-700	.003 - .014
K	GRAY IRONS Class 20, 30, 40, 50, 60, G3000, G3500	≤ 220 BHN or ≤ 19 HRC	HCX	HK430	400 - 950	.005 - .020
	DUCTILE IRONS D&M series, 250, 300, 350, 400, 60-40-18, 65-45-12	≤ 260 BHN or ≤ 26 HRC			350 - 800	.005 - .016
N	NON-FERROUS Aluminum, Aluminum cast, Brass, Copper, Bronze, Non Metallic	≤ 271 BHN or ≤ 28 HRC	LCX	HK430	400 - 1100	.007 - .020
H	TOOL STEELS A2, D2, H13, L2, M2, P20, S7, T15, W2	≤ 375 BHN or ≤ 55 HRC	SCX	HS470	80-250	.004 - .011
S	HR SUPER ALLOYS Inconel 718, Waspaloy, Hastelloy, Inconel 625, Stellite 31, Haynes 25, Rene 41	≤ 275 BHN or ≤ 28 HRC	SCX	HS470	60 - 200	.003 - .008
	TITANIUM 6AL-4V, ASTM 1, 2, 3, 6AL-2S	≤ 275 BHN or ≤ 28 HRC			90 - 350	.003 - .010
*LOWER Vc AND Fz = MED.- HEAVY Ap / Ae			*HIGHER Vc AND Fz = LIGHT-MED. Ap / Ae			

Recommendations:

- Keep the cutter constantly engaged, when possible, to reduce enter and exit onto the machined component
- Utilize roll technique around all corners to avoid harsh directional changes
- The width of cut, a_e , should be 30% or 70% of DC to ensure maximum efficiency and process security
- Program tool paths around interruptions and holes when possible

Speeds & feeds are starting recommendations only. Factors such as machine type, fixture, tooling rigidity, available horsepower, coolant delivery method and others will affect the performance significantly.



Chipbreaker:

HCX : Strong cutting edge. Medium to roughing applications in steels and cast irons

SCX : Sharp cutting edge. Medium to finishing application in steels, stainless steels, hardened steels, and super alloys

CCX : Strong cutting edge for cast iron applications

LCX : Positive up sharp cutting edge. Light finishing to medium roughing applications in non ferrous materials

ISO	MATERIAL	HARDNESS	CHIPBREAKER	GRADE	Vc (SFM)*	Fz (INCH PER TOOTH)*
P	CARBON STEELS 1018, 1040, 1080, 1090, 10L50, 1140, 1212, 12L15, 1525, 1536	≤ 275 BHN or ≤ 28 HRC	HCX	HP470	230-800	.003 - .010
	ALLOY STEELS 4140, 4150, 4320, 5120, 5150, 8630, 86L20, 17-4 PH	≤ 375 BHN or ≤ 40 HRC			230-700	.003 - .008
M	STAINLESS STEELS (FREE MACHINING) 303, 416, 420F, 430F, 440F	≤ 275 BHN or ≤ 28 HRC	SCX	HM470	200-600	.003 - .009
	STAINLESS STEELS (DIFFICULT) 304, 304L, 316, 316L	≤ 275 BHN or ≤ 28 HRC			200-600	.003 - .009
K	GRAY IRONS Class 20, 30, 40, 50, 60, G3000, G3500	≤ 220 BHN or ≤ 19 HRC	CCX / HCX	HK430	400 - 950	.004 - .015
	DUCTILE IRONS D&M series, 250, 300, 350, 400, 60-40-18, 65-45-12	≤ 260 BHN or ≤ 26 HRC			300 - 700	.003 - .011
N	NON-FERROUS Aluminum, Aluminum cast, Brass, Copper, Bronze, Non Metallic	≤ 271 BHN or ≤ 28 HRC	LCX	HK430	400 - 1000	.006 - .018
H	TOOL STEELS A2, D2, H13, L2, M2, P20, S7, T15, W2	≤ 375 BHN or ≤ 55 HRC	SCX / HCX	HS470	80-250	.003 - .009
S	HR SUPER ALLOYS Inconel 718, Waspaloy, Hastelloy, Inconel 625, Stellite 31, Haynes 25, Rene 41	≤ 275 BHN or ≤ 28 HRC	SCX	HS470	60 - 200	.0025 - .007
	TITANIUM 6AL-4V, ASTM 1, 2, 3, 6AL-2S	≤ 275 BHN or ≤ 28 HRC			90 - 350	.003 - .010
*LOWER Vc AND Fz = MED.- HEAVY Ap / Ae					*HIGHER Vc AND Fz = LIGHT-MED. Ap / Ae	

Recommendations:

- Keep the cutter constantly engaged, when possible, to reduce enter and exit onto the machined component
- Utilize roll technique around all corners to avoid harsh directional changes
- The width of cut, a_p , should be 30% or 70% of DC to ensure maximum efficiency and process security
- Program tool paths around interruptions and holes when possible

Speeds & feeds are starting recommendations only. Factors such as machine type, fixture, tooling rigidity, available horsepower, coolant delivery method and others will affect the performance significantly.



Chipbreaker:

HCX : Strong cutting edge for general steels, cast irons, and hard conditions in milling application

SCX : Sharp cutting edge for general stainless steels and super alloy applications

ISO	MATERIAL	HARDNESS	CHIPBREAKER	GRADE	Vc (SFM)*	Fz (INCH PER TOOTH)*
P	CARBON STEELS 1018, 1040, 1080, 1090, 10L50, 1140, 1212, 12L15, 1525, 1536	≤ 275 BHN or ≤ 28 HRC	HCX	HP470	220 - 820	.009 - .075
	ALLOY STEELS 4140, 4150, 4320, 5120, 5150, 8630, 86L20, 17-4 PH	≤ 375 BHN or ≤ 40 HRC			220-720	.009 - .065
M	STAINLESS STEELS (FREE MACHINING) 303, 416, 420F, 430F, 440F	≤ 275 BHN or ≤ 28 HRC	SCX	HM470	230-650	.009 - .045
	STAINLESS STEELS (DIFFICULT) 304, 304L, 316, 316L	≤ 275 BHN or ≤ 28 HRC			260-700	.009 - .045
K	GRAY IRONS Class 20, 30, 40, 50, 60, G3000, G3500	≤ 220 BHN or ≤ 19 HRC	HCX	HK430	400 - 900	.009 - .063
	DUCTILE IRONS D&M series, 250, 300, 350, 400, 60-40-18, 65-45-12	≤ 260 BHN or ≤ 26 HRC			300 - 850	.009 - .055
H	TOOL STEELS A2, D2, H13, L2, M2, P20, S7, T15, W2	≤ 375 BHN or ≤ 55 HRC	SCX	HS470	100-350	.009 - .040
S	HR SUPER ALLOYS Inconel 718, Waspaloy, Hastelloy, Inconel 625, Stellite 31, Haynes 25, Rene 41	≤ 275 BHN or ≤ 28 HRC	SCX	HS470	60 - 220	.007 - .035
	TITANIUM 6AL-4V, ASTM 1, 2, 3, 6AL-2S	≤ 275 BHN or ≤ 28 HRC			90 - 400	.008 - .050

Recommendations:

- Keep the cutter constantly engaged, when possible, to reduce enter and exit onto the machined component
- Utilize roll technique around all corners to avoid harsh directional changes
- The width of cut, a_p , should be 30% or 70% of DC to ensure maximum efficiency and process security
- Program tool paths around interruptions and holes when possible

**Speeds & feeds are starting recommendations only. Factors such as machine type, fixture, tooling rigidity, available horsepower, coolant delivery method and others will affect the performance significantly.*

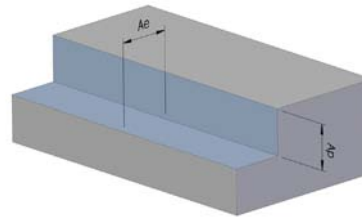

				SQUARE SHOULDER MILLING			
				Fz (INCH PER TOOTH)*		APMX	
ISO	MATERIAL	HARDNESS	Vc (SFM)*	-PF /-AL	-PM /-PR	APKT11T3	APKT1604
P	CARBON STEELS 1018, 1040, 1080, 1090, 10L50, 1140, 1212, 12L15, 1525, 1536	≤ 275 BHN or ≤ 28 HRC	550-900	0.003 - 0.009	0.003 - 0.012	0.315	0.472
	ALLOY STEELS 4140, 4150, 4320, 5120, 5150, 8630, 86L20, 17-4 PH	≤ 375 BHN or ≤ 40 HRC	450-850	0.003 - 0.0075	0.003 - 0.010	0.315	0.472
M	STAINLESS STEELS (FREE MACHINING) 303, 416, 420F, 430F, 440F	≤ 275 BHN or ≤ 28 HRC	350 - 875	0.003 - 0.009	0.003 - 0.012	0.315	0.472
	STAINLESS STEELS (DIFFICULT) 304, 304L, 316, 316L	≤ 275 BHN or ≤ 28 HRC	250 - 800	0.003 - 0.0075	0.003 - 0.010	0.315	0.472
K	GRAY IRONS Class 20, 30, 40, 50, 60, G3000, G3500	≤ 220 BHN or ≤ 19 HRC	400 - 1000	0.004 - 0.010	0.004 - 0.012	0.315	0.472
	DUCTILE IRONS D&M series, 250, 300, 350, 400, 60-40-18, 65-45-12	≤ 260 BHN or ≤ 26 HRC	300 - 800	0.004 - 0.012	0.004 - 0.012	0.315	0.472
N	NON-FERROUS Aluminum, Aluminum cast, Brass, Copper, Bronze, Non Metallic	≤ 271 BHN or ≤ 28 HRC	600-1200	0.004 - 0.014	0.004 - 0.016	0.315	0.472
H	TOOL STEELS A2, D2, H13, L2, M2, P20, S7, T15, W2	≤ 555 BHN or ≤ 55 HRC	190 - 500	0.003 - 0.007	0.003 - 0.009	0.315	0.472
S	HR SUPER ALLOYS Inconel 718, Waspaloy, Hastelloy, Inconel 625, Stellite 31, Haynes 25, Rene 41	≤ 275 BHN or ≤ 28 HRC	70-220	0.002 - 0.006	0.002 - 0.007	0.315	0.472
	TITANIUM 6AL-4V, ASTM 1, 2, 3, 6AL-2S	≤ 275 BHN or ≤ 28 HRC	230-450	0.003 - 0.0085	0.003 - 0.010	0.315	0.472

*Speeds & feeds are starting recommendations only. Factors such as machine type, fixture, tooling rigidity, available horsepower, coolant delivery method and others will affect the performance significantly.

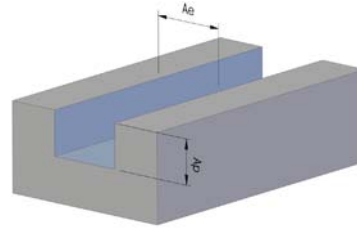

				SQUARE SLOT MILLING			
				Fz (INCH PER TOOTH)*		APMX	
ISO	MATERIAL	HARDNESS	Vc (SFM)*	-PF /-AL	-PM /-PR	APKT11T3	APKT1604
P	CARBON STEELS 1018, 1040, 1080, 1090, 10L50, 1140, 1212, 12L15, 1525, 1536	≤ 275 BHN or ≤ 28 HRC	550-900	0.003 - 0.006	0.003 - 0.010	0.315	0.472
	ALLOY STEELS 4140, 4150, 4320, 5120, 5150, 8630, 86L20, 17-4 PH	≤ 375 BHN or ≤ 40 HRC	450-850	0.003 - 0.006	0.003 - 0.0085	0.315	0.472
M	STAINLESS STEELS (FREE MACHINING) 303, 416, 420F, 430F, 440F	≤ 275 BHN or ≤ 28 HRC	350 - 875	0.003 - 0.007	0.003 - 0.010	0.315	0.472
	STAINLESS STEELS (DIFFICULT) 304, 304L, 316, 316L	≤ 275 BHN or ≤ 28 HRC	250 - 800	0.003 - 0.006	0.003 - 0.010	0.315	0.472
K	GRAY IRONS Class 20, 30, 40, 50, 60, G3000, G3500	≤ 220 BHN or ≤ 19 HRC	400 - 1000	0.004 - 0.008	0.004 - 0.010	0.315	0.472
	DUCTILE IRONS D&M series, 250, 300, 350, 400, 60-40-18, 65-45-12	≤ 260 BHN or ≤ 26 HRC	300 - 800	0.004 - 0.008	0.004 - 0.010	0.315	0.472
N	NON-FERROUS Aluminum, Aluminum cast, Brass, Copper, Bronze, Non Metallic	≤ 271 BHN or ≤ 28 HRC	600-1200	0.004 - 0.011	0.004 - 0.014	0.315	0.472
H	TOOL STEELS A2, D2, H13, L2, M2, P20, S7, T15, W2	≤ 555 BHN or ≤ 55 HRC	190 - 500	0.003 - 0.006	0.003 - 0.007	0.315	0.472
S	HR SUPER ALLOYS Inconel 718, Waspaloy, Hastelloy, Inconel 625, Stellite 31, Haynes 25, Rene 41	≤ 275 BHN or ≤ 28 HRC	70-220	0.002 - 0.006	0.002 - 0.007	0.315	0.472
	TITANIUM 6AL-4V, ASTM 1, 2, 3, 6AL-2S	≤ 275 BHN or ≤ 28 HRC	230-450	0.003 - 0.006	0.003 - 0.008	0.315	0.472

*Speeds & feeds are starting recommendations only. Factors such as machine type, fixture, tooling rigidity, available horsepower, coolant delivery method and others will affect the performance significantly.



ISO	MATERIAL	HARDNESS	GRADE	Vc (SFM)*	Fz (INCH PER TOOTH)* at 50% insert I.C. APMX**
P	CARBON STEELS 1018, 1040, 1080, 1090, 10L50, 1140, 1212, 12L15, 1525, 1536	≤ 275 BHN or ≤ 28 HRC	UD51 UD52 UD404 UD602	300-850	.006 - .018
	ALLOY STEELS 4140, 4150, 4320, 5120, 5150, 8630, 86L20, 17-4 PH	≤ 375 BHN or ≤ 40 HRC		200-700	.005 - .015
M	STAINLESS STEELS (FREE MACHINING) 303, 416, 420F, 430F, 440F	≤ 275 BHN or ≤ 28 HRC	UD32	200-650	.003 - .010
	STAINLESS STEELS (DIFFICULT) 304, 304L, 316, 316L	≤ 275 BHN or ≤ 28 HRC		260-700	.003 - .012
K	GRAY IRONS Class 20, 30, 40, 50, 60, G3000, G3500	≤ 220 BHN or ≤ 19 HRC	UD21	250-900	.005 - .020
	DUCTILE IRONS D&M series, 250, 300, 350, 400, 60-40-18, 65-45-12	≤ 260 BHN or ≤ 26 HRC		200-700	.005 - .015
N	NON-FERROUS Aluminum, Aluminum cast, Brass, Copper, Bronze, Non Metallic	≤ 271 BHN or ≤ 28 HRC	UD1 UD2	400-975	.006 - .020
H	TOOL STEELS A2, D2, H13, L2, M2, P20, S7, T15, W2	≤ 375 BHN or ≤ 55 HRC	UD32 UD404	80-400	.004 - .012
S	HR SUPER ALLOYS Inconel 718, Waspaloy, Hastelloy, Inconel 625, Stellite 31, Haynes 25, Rene 41	≤ 275 BHN or ≤ 28 HRC	UD32 UD52 UD404	40-250	.003 - .008
	TITANIUM 6AL-4V, ASTM 1, 2, 3, 6AL-2S	≤ 275 BHN or ≤ 28 HRC		100-550	.003 - .010

Recommendations:

Productivity and tooling performance is not only influenced by grade and geometry, but also by clamping the tool securely and accurately as possible.

It is recommended to use precision holders i.e. hydraulic, shrink fit

**Speeds & feeds are starting recommendations only. Factors such as machine type, fixture, tooling rigidity, available horsepower, coolant delivery method and others will affect the performance significantly.*

**** If the axial depth of cut (Ap) is less than 50% of the full radius Insert I.C., increase the feed rate (Fz) to compensate for the thinning (Hex) of the actual chip thickness.**



ISO	MATERIAL	HARDNESS	Vc (SFM)*	END MILL DIAMETER									
				1/8"	3/16"	1/4"	5/16"	3/8"	7/16"	1/2"	5/8"	3/4"	1"
P	CARBON STEELS 1018, 1040, 1080, 1090, 10L50, 1140, 1212, 12L15, 1525, 1536	≤ 275 BHN or ≤ 28 HRC	320-750	.0009 - .0017	.0011 - .0019	.0020 - .0028	.0024 - .0033	.0025 - .0038	.0025 - .0041	.0027 - .0046	.0035 - .0052	.0040 - .0066	.0042 - .0090
	ALLOY STEELS 4140, 4150, 4320, 5120, 5150, 8630, 86L20, 17-4 PH	≤ 375 BHN or ≤ 40 HRC	230-670	.0006 - .0013	.0011 - .0017	.0014 - .0022	.0017 - .0024	.0019 - .0028	.0020 - .0035	.0023 - .0040	.0030 - .0050	.0038 - .0057	.0040 - .0085
M	STAINLESS STEELS (FREE MACHINING) 303, 416, 420F, 430F, 440F	≤ 275 BHN or ≤ 28 HRC	250-600	.0004 - .0013	.0008 - .0017	.0013 - .0020	.0016 - .0023	.0020 - .0026	.0022 - .0030	.0026 -0.0034	.0032 - .0039	.0035 - .0047	.0035 - .0068
	STAINLESS STEELS (DIFFICULT) 304, 304L, 316, 316L	≤ 275 BHN or ≤ 28 HRC	180-520	.0005 - .0017	.0010 - .0020	.0013 - .0023	.0017 - .0027	.0021 - .0030	.0025 - .0035	.0028 - .0040	.0030 - .0048	.0033 - .0060	.0033 - .0078
K	GRAY IRONS Class 20, 30, 40, 50, 60, G3000, G3500	≤ 220 BHN or ≤ 19 HRC	320-830	.0007 - .0020	.0011 - .0032	.0014 - .0041	.0019 - .0052	.0022 - .0061	.0025 - .0070	.0028 - .0080	.0031 - .0086	.0032 - .0095	.0036 - .0110
	DUCTILE IRONS D&M series, 250, 300, 350, 400, 60-40-18, 65-45-12	≤ 260 BHN or ≤ 26 HRC	220-670	.0005 - .0014	.0009 - .0023	.0012 - .0032	.0016 - .0038	.0018 - .0041	.0020 - .0047	.0022 - .0053	.0024 - .0062	.0028 - .0070	.0030 - .0090
H	TOOL STEELS A2, D2, H13, L2, M2, P20, S7, T15, W2	≤ 555 BHN or ≤ 55 HRC	115-270	.0004 - .0017	.0008 - .0017	.0013 - .0020	.0016 - .0024	.0020 - .0030	.0022 - .0035	.0028 - .0045	.0032 - .0053	.0036 - .0062	.0040 - .0078
S	HR SUPER ALLOYS Inconel 718, Waspaloy, Hastelloy, Inconel 625, Stellite 31, Haynes 25, Rene 41	≤ 275 BHN or ≤ 28 HRC	70-180	.0005 - -0.0018	.0008 - .0022	.0010 - .0028	.0012 - .0032	.0015 - .0036	.0017 - .0042	.0018 - .0047	.0019 - .0050	.0022 - .0055	.0025 - .0065
	TITANIUM 6AL-4V, ASTM 1, 2, 3, 6AL-2S	≤ 275 BHN or ≤ 28 HRC	140-400	.0007 - .0013	.0011 - .0016	.0013 - .0018	.0015 - .0021	.0019 - .0026	.0022 - .0031	.0024 - .0035	.0025 - .0044	.0030 - .0053	.0031 - .0075
*LOWER Vc AND Fz APPLY TO HEAVY/ROUGHING ENGAGEMENT				*HIGHER Vc AND Fz APPLY TO LIGHT/PROFILING ENGAGEMENT									

Speeds & feeds are starting recommendations only. Factors such as machine type, fixture, tooling rigidity, available horsepower, coolant delivery method and others will affect the performance significantly.

h_{ex}

100%	1
50%	1
30%	1.091
25%	1.212
20%	1.641
15%	2.1
10%	4.375
5%	6.882



ISO	MATERIAL	HARDNESS	Vc (SFM)*		EFFECTIVE CUTTER DIAMETER (INCH)						
					≤ 1/16"	1/16"-1/8"	1/8"-1/4"	1/4"-3/8"	3/8"-1/2"	1/2"-3/4"	3/4"-1"
					Fz (INCH PER TOOTH)*						
			HSS/Cobalt	Carbide							
P	CARBON STEELS 1018, 1040, 1080, 1090, 10L50, 1140, 1212, 12L15, 1525, 1536	≤ 275 BHN or ≤ 28 HRC	80-200	220-650	.0004 - .0009	.0006 - .0015	.0010 - .0028	.0020 - .0030	.0023 - .0040	.0028 - .0060	.0032 - .0080
	ALLOY STEELS 4140, 4150, 4320, 5120, 5150, 8630, 86L20, 17-4 PH	≤ 375 BHN or ≤ 40 HRC	60-120	180-500	.0006 - .0012	.0008 - .0019	.0009 - .0022	.0010 - .0027	.0020 - .0038	.0026 - .0050	.0030 - .0065
M	STAINLESS STEELS (FREE MACHINING) 303, 416, 420F, 430F, 440F	≤ 275 BHN or ≤ 28 HRC	50-100	200-450	.0004 - .0019	.0008 - .0025	.0012 - .0030	.0016 - .0035	.0019 - .0040	.0023 - .0050	.0026 - .0065
	STAINLESS STEELS (DIFFICULT) 304, 304L, 316, 316L	≤ 275 BHN or ≤ 28 HRC	30-75	120-350	.0005 - .0013	.0009 - .0017	.0013 - .0021	.0015 - .0040	.0017 - .0048	.0021 - .0060	.0025 - .0075
K	GRAY IRONS Class 20, 30, 40, 50, 60, G3000, G3500	≤ 220 BHN or ≤ 19 HRC	60-150	250-700	.0005 - .0014	.0009 - .0023	.0012 - .0032	.0016 - .0041	.0022 - .0053	.0028 - .0090	.0030 - .0100
	DUCTILE IRONS D&M series, 250, 300, 350, 400, 60-40-18, 65-45-12	≤ 260 BHN or ≤ 26 HRC	50-90	150-450	.0003 - .0010	.0006 - .0019	.0010 - .0028	.0014 - .0038	.0020 - .0048	.0025 - .0080	.0030 - .0092
N	NON-FERROUS Aluminum, Aluminum cast, Brass, Copper, Bronze, Non Metallic	≤ 271 BHN or ≤ 28 HRC	100-400	250-950	.0003 - .0010	.0006 - .0021	.0010 - .0028	.0025 - .0040	.0028 - .0065	.0030 - .0080	.0050 - .0130
H	TOOL STEELS A2, D2, H13, L2, M2, P20, S7, T15, W2	≤ 555 BHN or ≤ 55 HRC	40-65	80-250	.0003 - .0010	.0006 - .0015	.0012 - .0021	.0015 - .0030	.0023 - .0045	.0028 - .0050	.0030 - .0065
S	HR SUPER ALLOYS Inconel 718, Waspaloy, Hastelloy, Inconel 625, Stellite 31, Haynes 25, Rene 41	≤ 275 BHN or ≤ 28 HRC	30-50	50-160	.0003 - .0007	.0005 - .0012	.0008 - .0018	.0012 - .0022	.0018 - .0035	.0020 - .0045	.0025 - .0060
	TITANIUM 6AL-4V, ASTM 1, 2, 3, 6AL-2S	≤ 275 BHN or ≤ 28 HRC	40-65	90-250	.0006 - .0014	.0008 - .0017	.0013 - .0018	.0015 - .0026	.0020 - .0035	.0025 - .0060	.0025 - .0075
* LOWER Vc AND Fz APPLY TO HEAVY/ROUGHING ENGAGEMENT					*HIGHER Vc AND Fz APPLY TO LIGHT/PROFILING ENGAGEMENT						

Speeds & feeds are starting recommendations only. Factors such as machine type, fixture, tooling rigidity, available horsepower, coolant delivery method and others will affect the performance significantly.

h_{ex}

% Radial vs Chip Thinning Multiplier	
100%	1
50%	1
30%	1.091
25%	1.212
20%	1.641
15%	2.1
10%	4.375
5%	6.882



ISO	MATERIAL	HARDNESS	GRADE	Vc (SFM)*	INDEXABLE DRILL DIAMETER (INCH)		
					0.5620"-0.7499"	0.7500" - 1.4999"	1.5000" - 2.2500"
					Fz = IPR (INCH PER REVOLUTION)*		
P	CARBON STEELS 1018, 1040, 1080, 1090, 10L50, 1140, 1212, 12L15, 1525, 1536	≤ 275 BHN or ≤ 28 HRC	HP 600	350-900	.0015-.0060	.0020-.0075	.0030-.0120
	ALLOY STEELS 4140, 4150, 4320, 5120, 5150, 8630, 86L20, 17-4 PH	≤ 375 BHN or ≤ 40 HRC		260-750	.0020-.0070	.0020-.0085	.0030-.0095
M	STAINLESS STEELS (FREE MACHINING) 303, 416, 420F, 430F, 440F	≤ 275 BHN or ≤ 28 HRC	HP 600	230-700	.0018-.0040	.0030-.0065	.0030-.0085
	STAINLESS STEELS (DIFFICULT) 304, 304L, 316, 316L	≤ 275 BHN or ≤ 28 HRC		260-750	.0018-.0040	.0030-.0065	.0030-.0085
K	GRAY IRONS Class 20, 30, 40, 50, 60, G3000, G3500	≤ 220 BHN or ≤ 19 HRC	HP 600	285-1000	.0025-.0055	.0035-.0070	.0040-.0085
	DUCTILE IRONS D&M series, 250, 300, 350, 400, 60-40-18, 65-45-12	≤ 260 BHN or ≤ 26 HRC		230-740	.0020-.0050	.0028-.0065	.0030-.0070
N	NON-FERROUS Aluminum, Aluminum cast, Brass, Copper, Bronze, Non Metallic	≤ 271 BHN or ≤ 28 HRC	HP 600	600-1150	.0020-.0075	.0030-.0090	.0045-.0115
H	TOOL STEELS A2, D2, H13, L2, M2, P20, S7, T15, W2"	≤ 375 BHN or ≤ 55 HRC	HP 600	80-275	.0018-.0065	.0020-.0075	.0030-.0080
S	HR SUPER ALLOYS Inconel 718, Waspaloy, Hastelloy, Inconel 625, Stellite 31, Haynes 25, Rene 41	≤ 275 BHN or ≤ 28 HRC	HP 600	55-270	.0016-.0032	.0020-.0055	.0025-.0060
	TITANIUM 6AL-4V, ASTM 1, 2, 3, 6AL-2S	≤ 275 BHN or ≤ 28 HRC		95-460	.0019-.0055	.0020-.0065	.0025-.008

Recommendations

Productivity and tooling performance is not only influenced by grade and geometry, but also by clamping the tool securely and accurately as possible.

- It is recommended to use precision holders i.e. hydraulic, shrink fit
- It is recommended to use internal coolant – minimum recommended pressure 145 psi

*Speeds & feeds are starting recommendations only. Factors such as machine type, fixture, tooling rigidity, available horsepower, coolant delivery method and others will affect the performance significantly.

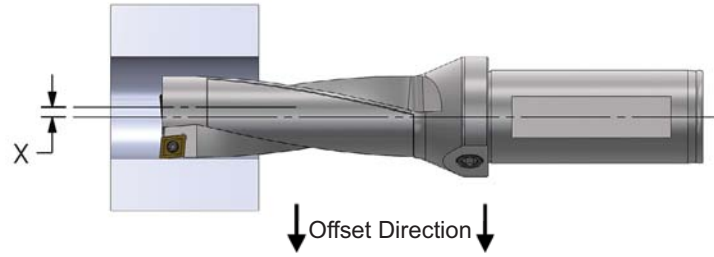

Our Drills offer the ability to offset in turning applications to help with tolerance optimization and creation of holes larger than the drill diameter.

PATRIOT

Designation	Offset (Max)
PD1-0562-3D-075	.007
PD1-0594-3D-075	.005
PD1-0609-3D-075	.005
PD1-0625-3D-075	.015
PD1-0669-3D-075	.011
PD1-0687-3D-075	.009
PD1-0709-3D-075	.007
PD1-0734-3D-100	.019
PD1-0750-3D-100	.017
PD1-0787-3D-100	.011
PD1-0812-3D-100	.009
PD1-0844-3D-100	.005
PD1-0875-3D-100	.004
PD1-0937-3D-125	.023
PD1-0984-3D-125	.019
PD1-1000-3D-125	.017
PD1-1062-3D-125	.009
PD1-1125-3D-125	.004
PD1-1181-3D-125	.035
PD1-1250-3D-125	.027
PD1-1312-3D-125	.021
PD1-1375-3D-125	.013
PD1-1437-3D-125	.008
PD1-1500-3D-150	.039
PD1-1625-3D-150	.027
PD1-1750-3D-150	.015
PD1-1875-3D-150	.051
PD1-2000-3D-150	.039
PD1-2125-3D-150	.023

REVERE *

Designation	Offset (Max)
UD-0437-2D-063	.018
UD-0468-2D-063	.016
UD-0500-2D-063	.014
UD-0531-2D-063	.023
UD-0562-2D-063	.021
UD-0593-2D-063	.019
UD-0625-2D-063	.023
UD-0656-2D-063	.021
UD-0687-2D-063	.019
UD-0719-2D-063	.017
UD-0750-2D-075	.024
UD-0781-2D-075	.022
UD-0812-2D-075	.021
UD-0844-2D-075	.019
UD-0875-2D-075	.017
UD-0906-2D-075	.015
UD-0937-2D-075	.013
UD-0968-2D-075	.011
UD-1000-2D-100	.029
UD-1031-2D-100	.027
UD-1062-2D-100	.025
UD-1094-2D-100	.023

REVERE *

Designation	Offset (Max)
UD-1125-2D-100	.021
UD-1156-2D-100	.020
UD-1187-2D-100	.018
UD-1219-2D-100	.016
UD-1250-2D-125	.035
UD-1312-2D-125	.031
UD-1343-2D-125	.029
UD-1375-2D-125	.027
UD-1437-2D-125	.023
UD-1500-2D-125	.019
UD-1562-2D-125	.015
UD-1625-2D-125	.011
UD-1687-2D-125	.008
UD-1750-2D-150	.040
UD-1812-2D-150	.036
UD-1875-2D-150	.032
UD-1937-2D-150	.028
UD-2000-2D-150	.024
UD-2125-2D-150	.017
UD-2250-2D-150	.009
UD-2375-2D-150	.001

*2XD Only



ISO	MATERIAL	HARDNESS	GRADE	Vc (SFM)*	INDEXABLE DRILL DIAMETER (INCH)		
					0.5620"-0.7499"	0.7500" - 1.4999"	1.5000" - 2.2500"
					Fz = IPR (INCH PER REVOLUTION)*		
P	CARBON STEELS 1018, 1040, 1080, 1090, 10L50, 1140, 1212, 12L15, 1525, 1536	≤ 275 BHN or ≤ 28 HRC	UD51 /UD52	300-800	.0015-.0060	.0025-.0080	.0030-.009
	ALLOY STEELS 4140, 4150, 4320, 5120, 5150, 8630, 86L20, 17-4 PH	≤ 375 BHN or ≤ 40 HRC		250-700	.0020-.0070	.0025-.0070	.0030-.0080
M	STAINLESS STEELS (FREE MACHINING) 303, 416, 420F, 430F, 440F	≤ 275 BHN or ≤ 28 HRC	UD32	230-650	.0018-.0040	.0025-.0065	.0030-.0070
	STAINLESS STEELS (DIFFICULT) 304, 304L, 316, 316L	≤ 275 BHN or ≤ 28 HRC		260-700	.0018-.0040	.0023-.0055	.0030-.0065
K	GRAY IRONS Class 20, 30, 40, 50, 60, G3000, G3500	≤ 220 BHN or ≤ 19 HRC	UD21	285-900	.0025-.0055	.0035-.0070	.0040-.0080
	DUCTILE IRONS D&M series, 250, 300, 350, 400, 60-40-18, 65-45-12	≤ 260 BHN or ≤ 26 HRC		230-700	.0020-.0050	.0028-.0055	.0030-.0060
N	NON-FERROUS Aluminum, Aluminum cast, Brass, Copper, Bronze, Non Metallic	≤ 271 BHN or ≤ 28 HRC	UD2	400-975	.0020-.0075	.0030-.0070	.0045-.0100
H	TOOL STEELS A2, D2, H13, L2, M2, P20, S7, T15, W2"	≤ 375 BHN or ≤ 55 HRC	UD32	75-200	.0018-.0065	.0020-.0065	.0030-.0070
S	HR SUPER ALLOYS Inconel 718, Waspaloy, Hastelloy, Inconel 625, Stellite 31, Haynes 25, Rene 41	≤ 275 BHN or ≤ 28 HRC	UD32 /UD52	40-200	.0016-.0032	.0020-.0050	.0020-.0050
	TITANIUM 6AL-4V, ASTM 1, 2, 3,6AL-2S	≤ 275 BHN or ≤ 28 HRC		90-350	.0019-.0055	.0020-.0050	.0020-.0065

Recommendations

Productivity and tooling performance is not only influenced by grade and geometry, but also by clamping the tool securely and accurately as possible.

- It is recommended to use precision holders i.e. hydraulic, shrink fit
- It is recommended to use internal coolant – minimum recommended pressure 145 psi

*Speeds & feeds are starting recommendations only. Factors such as machine type, fixture, tooling rigidity, available horsepower, coolant delivery method and others will affect the performance significantly.



ISO	MATERIAL	HARDNESS	Vc (SFM)*	DRILL DIAMETER (INCH)						
				≤ 1/16"	1/16"- 1/8"	1/8"- 1/4"	1/4"- 3/8"	3/8"- 1/2"	1/2"- 3/4"	3/4"- 1"
Fz = IPR(INCH PER REVOLUTION)*										
P	CARBON STEELS 1018, 1040, 1080, 1090, 10L50, 1140, 1212, 12L15, 1525, 1536	≤ 275 BHN or ≤ 28 HRC	210-510	.0008- .0030	.0030- .0055	.0040- .0085	.0050- .012	.0070- .015	.0090- .0175	.0100- .0200
	ALLOY STEELS 4140, 4150, 4320, 5120, 5150, 8630, 86L20, 17-4 PH	≤ 375 BHN or ≤ 40 HRC	170-390	.0006- .0025	.0020- .0045	.0030- .0060	.0045- .0080	.0060- .0120	.0070- .0145	.0080- .0175
M	STAINLESS STEELS (FREE MACHINING) 303, 416, 420F, 430F, 440F	≤ 275 BHN or ≤ 28 HRC	95-165	.0005- .0025	.0020- .0045	.0035- .0060	.0040- .0085	.0055- .0125	.0070- .0150	.0080- .0170
	STAINLESS STEELS (DIFFICULT) 304, 304L, 316, 316L	≤ 275 BHN or ≤ 28 HRC	80-140	.0004- .0018	.0018- .0035	.0022- .0045	.0033- .0060	.0055- .0090	.0060- .0140	.0070- .0150
K	GRAY IRONS Class 20, 30, 40, 50, 60, G3000, G3500	≤ 220 BHN or ≤ 19 HRC	190-475	.0008- .0040	.0030- .0060	.0045- .0080	.0060- .0135	.0070- .0140	.0010- .0160	.0120- .0200
	DUCTILE IRONS D&M series, 250, 300, 350, 400, 60-40- 18, 65-45-12	"≤ 260 BHN or ≤ 26 HRC"	160-310	.0006- .0030	.0028- .0035	.0040- .0070	.0055- .010	.0070- .0120	.0090- .0140	.0110- .0170
N	NON-FERROUS Aluminum, Aluminum cast, Brass, Copper, Bronze, Non Metallic	"≤ 271 BHN or ≤ 28 HRC"	350-950	.0010- .0040	.0030- .0060	.0040- .0070	.0060- .0115	.0075- .0135	.0090- .0150	.0100- .0210
H	TOOL STEELS A2, D2, H13, L2, M2, P20, S7, T15, W2	"≤ 375 BHN or ≤ 55 HRC"	55-145	.0008- .0030	.0010- .0040	.0017- .0055	.0030- .0073	.0055- .0095	.0060- .0100	.0070- .0115
S	HR SUPER ALLOYS Inconel 718, Waspaloy, Hastelloy, Inconel 625, Stellite 31, Haynes 25, Rene 41	"≤ 275 BHN or ≤ 28 HRC"	95-215	.0007- .0020	.00012- .0025	.0018- .0040	.0027- .0075	.0030- .0075	.0050- .0090	.0060- .0110
	TITANIUM 6AL-4V, ASTM 1, 2, 3, 6AL-2S	"≤ 275 BHN or ≤ 28 HRC"	70-160	.0009- .0030	.0015- .0035	.0020- .00550	.0045- .0100	.0075- .0120	.0080- .0150	.0095- .0160

Recommendations

Productivity and tooling performance is not only influenced by grade and geometry, but also by clamping the tool securely and accurately as possible.

- It is recommended to use precision holders i.e. hydraulic, shrink fit
- It is recommended to use internal coolant – minimum recommended pressure 145 psi

*Speeds & feeds are starting recommendations only. Factors such as machine type, fixture, tooling rigidity, available horsepower, coolant delivery method and others will affect the performance significantly.

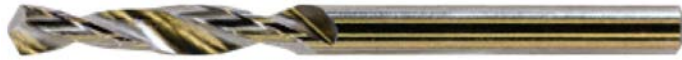

ISO	MATERIAL	HARDNESS	Vc (SFM)*		DRILL DIAMETER (INCH)						
					≤ 1/16"	1/16"- 1/8"	1/8"- 1/4"	1/4"- 3/8"	3/8" - 1/2"	1/2" - 3/4"	3/4" - 1"
					Fz = IPR (INCH PER REVOLUTION)*						
			HSS/ Cobalt	Carbide							
P	CARBON STEELS 1018, 1040, 1080, 1090, 10L50, 1140, 1212, 12L15, 1525, 1536	≤ 275 BHN or ≤ 28 HRC	70-200	150-350	.0005 - .0030	.0010 - .0050	.0020 - .0075	.0030 - .0100	.0060 - .0120	.0080 - .0140	.0100 - .0170
	ALLOY STEELS 4140, 4150, 4320, 5120, 5150, 8630, 86L20, 17-4 PH	≤ 375 BHN or ≤ 40 HRC	60-150	100-280	.0007 - .0030	.0012 - .0040	.0020 - .0060	.0040 - .0080	.0060 - .0110	.0070 - .0135	.0070 - .0155
M	STAINLESS STEELS (FREE MACHINING) 303, 416, 420F, 430F, 440F	≤ 275 BHN or ≤ 28 HRC	60-120	110-190	.0006 - .0025	.0008 - .0030	.0012 - .0060	.0025 - .0085	.0040 - .0110	.0060 - .0140	.0080 - .0170
	STAINLESS STEELS (DIFFICULT) 304, 304L, 316, 316L	≤ 275 BHN or ≤ 28 HRC	40-110	90-140	.0004 - .0018	.0006 - .0020	.0009 - .0040	.0010 - .0060	.0030 - .0080	.0040 - .0110	.0050 - .0140
K	GRAY IRONS Class 20, 30, 40, 50, 60, G3000, G3500	≤ 220 BHN or ≤ 19 HRC	60-180	140-400	.0006 - .0025	.0008 - .0030	.0012 - .0060	.0025 - .0085	.0040 - .0110	.0060 - .0140	.0080 - .0190
	DUCTILE IRONS D&M series, 250, 300, 350, 400, 60-40-18, 65-45-12	≤ 260 BHN or ≤ 26 HRC	50-90	110-280	.0006 - .0025	.0008 - .0030	.0012 - .0060	.0025 - .0085	.0040 - .0110	.0060 - .0140	.0080 - .0170
N	NON-FERROUS Aluminum, Aluminum cast, Brass, Copper, Bronze, Non Metallic	≤ 271 BHN or ≤ 28 HRC	90-300	180-500	.0003 - .0010	.0006 - .0021	.0010 - .0030	.0025 - .0040	.0028 - .0065	.0030 - .0090	.0050 - .0150
H	TOOL STEELS A2, D2, H13, L2, M2, P20, S7, T15, W2	≤ 555 BHN or ≤ 55 HRC	40-80	70-160	.0005 - .0030	.0010 - .0040	.0020 - .0055	.0040 - .0080	.0060 - .0100	.0080 - .0120	.0100 - .0140
S	HR SUPER ALLOYS Inconel 718, Waspaloy, Hastelloy, Inconel 625, Stellite 31, Haynes 25, Rene 41	≤ 275 BHN or ≤ 28 HRC	15-55	50-110	.0007 - .0020	.00012 - .0025	.0018 - .0040	.0025 - .0060	.0030 - .0075	.0040 - .0085	.0050 - .0100
	TITANIUM 6AL-4V, ASTM 1, 2, 3, 6AL-2S	≤ 275 BHN or ≤ 28 HRC	30-75	70-160	.0006 - .0025	.0008 - .0035	.0012 - .0060	.0025 - .0085	.0040 - .0100	.0060 - .0120	.0080 - .0140

Factors affecting optimized drill speeds and feeds:

- Depth of Hole
- Machinability of Material
- Coolant delivery method

Drill depths > 4X diameter require 15%-30% reduction in suggested drill feed rates.

**Speeds & feeds are starting recommendations only. Factors such as machine type, fixture, tooling rigidity, available horsepower, coolant delivery method and others will affect the performance significantly.*



by Ultra-Dex



ISO	MATERIAL	HARDNESS	GRADE	Vc (SFM)*	DIAMETER INCH (METRIC)	
					5/16" (8mm) - 1/2" (12mm)	1/2" (12mm) - 3/4" (20mm)
					Fz (INCH PER TOOTH)*	
P	CARBON STEELS 1018, 1040, 1080, 1090, 10L50, 1140, 1212, 12L15, 1525, 1536	≤ 275 BHN or ≤ 28 HRC	HP600	250-675	.0015-.0040	.0020-.0060
	ALLOY STEELS 4140, 4150, 4320, 5120, 5150, 8630, 86L20, 17-4 PH	≤ 375 BHN or ≤ 40 HRC				
M	STAINLESS STEELS (FREE MACHINING) 303, 416, 420F, 430F, 440F	≤ 275 BHN or ≤ 28 HRC	HP600	150-450	.0018-.0025	.0025-.0060
	STAINLESS STEELS (DIFFICULT) 304, 304L, 316, 316L	≤ 275 BHN or ≤ 28 HRC				
K	GRAY IRONS Class 20, 30, 40, 50, 60, G3000, G3500	≤ 220 BHN or ≤ 19 HRC	HK365	200-700	.0025-.0045	.0035-.0070
	DUCTILE IRONS D&M series, 250, 300, 350, 400, 60-40-18, 65-45-12	≤ 260 BHN or ≤ 26 HRC				
N	NON-FERROUS Aluminum, Aluminum cast, Brass, Copper, Bronze, Non Metallic	≤ 271 BHN or ≤ 28 HRC	HN300	300-750	.0020-.0060	.0030-.0090
H	TOOL STEELS A2, D2, H13, L2, M2, P20, S7, T15, W2	≤ 375 BHN or ≤ 55 HRC	HP600	60-275	.0018-.0055	.0020-.0060
S	HR SUPER ALLOYS Inconel 718, Waspaloy, Hastelloy, Inconel 625, Stellite 31, Haynes 25, Rene 41	≤ 275 BHN or ≤ 28 HRC	HP600	45-200	.0015-.0030	.0017-.0050
	TITANIUM 6AL-4V, ASTM 1, 2, 3,6AL-2S	≤ 275 BHN or ≤ 28 HRC				

Recommendations:

Productivity and tooling performance is not only influenced by grade and geometry, but also by clamping the tool securely and accurately as possible.

- It is recommended to use precision holders i.e. hydraulic, shrink fit
- It is recommended to use internal coolant – minimum recommended pressure 145 psi

*Speeds & feeds are starting recommendations only. Factors such as machine type, fixture, tooling rigidity, available horsepower, coolant delivery method and others will affect the performance significantly.



ISO	MATERIAL	HARDNESS	Vc (SFM)*	Fz (INCH PER TOOTH)*
P	CARBON STEELS 1018, 1040, 1080, 1090, 10L50, 1140, 1212, 12L15, 1525, 1536	≤ 275 BHN or ≤ 28 HRC	220-650	.0032 - .0080
	ALLOY STEELS 4140, 4150, 4320, 5120, 5150, 8630, 86L20, 17-4 PH	≤ 375 BHN or ≤ 40 HRC	180-500	.0030 - .0065
M	STAINLESS STEELS (FREE MACHINING) 303, 416, 420F, 430F, 440F	≤ 275 BHN or ≤ 28 HRC	200-450	.0026 - .0065
	STAINLESS STEELS (DIFFICULT) 304, 304L, 316, 316L	≤ 275 BHN or ≤ 28 HRC	120-350	.0025 - .0075
K	GRAY IRONS Class 20, 30, 40, 50, 60, G3000, G3500	≤ 220 BHN or ≤ 19 HRC	250-700	.0030 - .0100
	DUCTILE IRONS D&M series, 250, 300, 350, 400, 60-40-18, 65-45-12	≤ 260 BHN or ≤ 26 HRC	150-450	.0030 - .0092
N	NON-FERROUS Aluminum, Aluminum cast, Brass, Copper, Bronze, Non Metallic	≤ 271 BHN or ≤ 28 HRC	250-950	.0050 - .0130
H	TOOL STEELS A2, D2, H13, L2, M2, P20, S7, T15, W2	≤ 375 BHN or ≤ 55 HRC	80-250	.0030 - .0065
S	HR SUPER ALLOYS Inconel 718, Waspaloy, Hastelloy, Inconel 625, Stellite 31, Haynes 25, Rene 41	≤ 275 BHN or ≤ 28 HRC	50-160	.0025 - .0060
	TITANIUM 6AL-4V, ASTM 1, 2, 3,6AL-2S	≤ 275 BHN or ≤ 28 HRC	90-250	.0025 - .0075
* HIGHER Vc AND Fz APPLY TO LIGHT/FINISHING ENGAGEMENT				
* LOWER Vc AND Fz APPLY TO HEAVY/ROUGHING ENGAGEMENT				

*Speeds & feeds are starting recommendations only. Factors such as machine type, fixture, tooling rigidity, available horsepower, coolant delivery method and others will affect the performance significantly.



ISO	MATERIAL	HARDNESS	Vc (SFM)*		EFFECTIVE CUTTER DIAMETER (INCH)						
					≤ 1/16"	1/16"- 1/8"	1/8"- 1/4"	1/4"- 3/8"	3/8" - 1/2"	1/2" - 3/4"	3/4" - 1"
			HSS/ Cobalt	Carbide	Fz (INCH PER TOOTH)*						
P	CARBON STEELS 1018, 1040, 1080, 1090, 10L50, 1140, 1212, 12L15, 1525, 1536	≤ 275 BHN or ≤ 28 HRC	80-200	250-600	.0003 - .0009	.0003 - .0009	.0004 - .0011	.0005 - .0012	.0006 - .0013	.0009 - .0015	.0010 - .0030
	ALLOY STEELS 4140, 4150, 4320, 5120, 5150, 8630, 86L20, 17-4 PH"	≤ 375 BHN or ≤ 40 HRC	60-150	150-400	.0003 - .0009	.0003 - .0009	.0004 - .0011	.0005 - .0012	.0006 - .0013	.0009 - .0015	.0010 - .0030
M	STAINLESS STEELS (FREE MACHINING) 303, 416, 420F, 430F, 440F	≤ 275 BHN or ≤ 28 HRC	50-100	130-400	.0002 - .0009	.0003 - .0009	.0004 - .0012	.0005 - .0014	.0006 - .0016	.0009 - .0018	.0010 - .0022
	STAINLESS STEELS (DIFFICULT) 304, 304L, 316, 316L	≤ 275 BHN or ≤ 28 HRC	30-75	100-300	.0003 - .0008	.0003 - .0009	.0004 - .0012	.0005 - .0014	.0006 - .0016	.0009 - .0018	.0010 - .0020
K	GRAY IRONS Class 20, 30, 40, 50, 60, G3000, G3500	≤ 220 BHN or ≤ 19 HRC	60-180	200-650	.0002 - .0009	.0003 - .0010	.0004 - .0012	.0005 - .0014	.0007 - .0016	.0009 - .0018	.0010 - .0025
	DUCTILE IRONS D&M series, 250 , 300, 350, 400, 60-40-18, 65-45-12	≤ 260 BHN or ≤ 26 HRC	50-120	150-450	.0003 - .0009	.0003 - .0009	.0004 - .0011	.0005 - .0012	.0006 - .0013	.0009 - .0015	.0010 - .0030
N	NON-FERROUS Aluminum, Aluminum cast, Brass, Copper, Bronze, Non Metallic	≤ 271 BHN or ≤ 28 HRC	70-300	200-700	.0003 - .0009	.0003 - .0011	.0004 - .0013	.0005 - .0015	.0006 - .0017	.0009 - .0020	.0010 - .0035
H	TOOL STEELS A2, D2, H13, L2, M2, P20, S7, T15, W2	≤ 375 BHN or ≤ 55 HRC	30-65	80-250	.0002 - .0009	.0003 - .0009	.0004 - .0012	.0005 - .0014	.0007 - .0016	.0009 - .0018	.0010 - .0025
S	HR SUPER ALLOYS Inconel 718, Waspaloy, Hastelloy, Inconel 625, Stellite 31, Haynes 25, Rene 41	≤ 275 BHN or ≤ 28 HRC	20-50	50-90	.0002 - .0005	.0003 - .0007	.0004 - .0010	.0005 - .0011	.0006 - .0011	.0007 - .0011	.0007 - .0013
	TITANIUM 6AL-4V, ASTM 1, 2, 3,6AL-2S	≤ 275 BHN or ≤ 28 HRC	30-65	70-160	.0002 - .0007	.0003 - .0009	.0004 - .0010	.0005 - .0011	.0006 - .0012	.0007 - .0012	.0007 - .0016

*Speeds & feeds are starting recommendations only. Factors such as machine type, fixture, tooling rigidity, available horsepower, coolant delivery method and others will affect the performance significantly.



ISO	MATERIAL	HARDNESS	Vc (SFM)*		EFFECTIVE CUTTER DIAMETER (INCH)						
					≤ 1/16"	1/16"- 1/8"	1/8"- 1/4"	1/4"- 3/8"	3/8"- 1/2"	1/2"- 3/4"	3/4"- 1"
			HSS/ Cobalt	Carbide							
P	CARBON STEELS 1018, 1040, 1080, 1090, 10L50, 1140, 1212, 12L15, 1525, 1536	≤ 275 BHN or ≤ 28 HRC	80-200	200-500	.0003 - .0009	.0003 - .0009	.0004 - .0011	.0005 - .0012	.0006 - .0013	.0009 - .0015	.0010 - .0030
	ALLOY STEELS 4140, 4150, 4320, 5120, 5150, 8630, 86L20, 17-4 PH	≤ 375 BHN or ≤ 40 HRC	60-150	150-400	.0003 - .0009	.0003 - .0009	.0004 - .0011	.0005 - .0012	.0006 - .0013	.0009 - .0015	.0010 - .0030
M	STAINLESS STEELS (FREE MACHINING) 303, 416, 420F, 430F, 440F	≤ 275 BHN or ≤ 28 HRC	50-100	130-400	.0002 - .0009	.0003 - .0009	.0004 - .0012	.0005 - .0014	.0006 - .0016	.0009 - .0018	.0010 - .0022
	STAINLESS STEELS (DIFFICULT) 304, 304L, 316, 316L	≤ 275 BHN or ≤ 28 HRC	30-75	100-300	.0003 - .0008	.0003 - .0009	.0004 - .0012	.0005 - .0014	.0006 - .0016	.0009 - .0018	.0010 - .0020
K	GRAY IRONS Class 20, 30, 40, 50, 60, G3000, G3500	≤ 220 BHN or ≤ 19 HRC	60-180	200-650	.0002 - .0009	.0003 - .0010	.0004 - .0012	.0005 - .0014	.0007 - .0016	.0009 - .0018	.0010 - .0025
	DUCTILE IRONS D&M series, 250, 300, 350, 400, 60-40-18, 65-45-12	≤ 260 BHN or ≤ 26 HRC	50-120	150-450	.0003 - .0009	.0003 - .0009	.0004 - .0011	.0005 - .0012	.0006 - .0013	.0009 - .0015	.0010 - .0030
N	NON-FERROUS Aluminum, Aluminum cast, Brass, Copper, Bronze, Non Metallic	≤ 271 BHN or ≤ 28 HRC	70-300	200-700	.0003 - .0009	.0003 - .0011	.0004 - .0013	.0005 - .0015	.0006 - .0017	.0009 - .0020	.0010 - .0035
H	TOOL STEELS A2, D2, H13, L2, M2, P20, S7, T15, W2	≤ 375 BHN or ≤ 55 HRC	30-65	80-250	.0002 - .0009	.0003 - .0009	.0004 - .0012	.0005 - .0014	.0007 - .0016	.0009 - .0018	.0010 - .0025
S	HR SUPER ALLOYS Inconel 718, Waspaloy, Hastelloy, Inconel 625, Stellite 31, Haynes 25, Rene 41	≤ 275 BHN or ≤ 28 HRC	20-50	50-90	.0002 - .0005	.0003 - .0007	.0004 - .0010	.0005 - .0011	.0006 - .0011	.0007 - .0011	.0007 - .0013
	TITANIUM 6AL-4V, ASTM 1, 2, 3, 6AL-2S	≤ 275 BHN or ≤ 28 HRC	30-65	70-160	.0002 - .0007	.0003 - .0009	.0004 - .0010	.0005 - .0011	.0006 - .0012	.0007 - .0012	.0007 - .0016

Keyseat Cutter Considerations:

- Select a tool with the shortest allowable overall length to ensure the strongest tool setup possible.
- The keyseat cutter's neck diameter greatly affects its performance.
- Choose thickest neck allowable for the most optimized performance.

**Speeds & feeds are starting recommendations only. Factors such as machine type, fixture, tooling rigidity, available horsepower, coolant delivery method and others will affect the performance significantly.*



ISO	MATERIAL	HARDNESS	Vc (SFM)*		SAW DIAMETER (INCH)				
					1.00" - 3.00"	3.01" - 5.00"	5.01" - 8.00"	8.01" - 10.00"	10.01" - 12.00"
			HSS/ Cobalt	Carbide	Fz (INCH PER TOOTH)*				
P	CARBON STEELS 1018, 1040, 1080, 1090, 10L50, 1140, 1212, 12L15, 1525, 1536	≤ 275 BHN or ≤ 28 HRC	40-95	90-200	.0003 - .0009	.0003 - .0009	.0004 - .0011	.0005 - .0012	.0010 - .0020
	ALLOY STEELS 4140, 4150, 4320, 5120, 5150, 8630, 86L20, 17-4 PH	≤ 375 BHN or ≤ 40 HRC	30-70	60-150	.0003 - .0009	.0003 - .0009	.0004 - .0011	.0005 - .0012	.0007 - .0015
M	STAINLESS STEELS (FREE MACHINING) 303, 416, 420F, 430F, 440F	≤ 275 BHN or ≤ 28 HRC	60-110	80-190	.0002 - .0008	.0003 - .0008	.0004 - .0010	.0005 - .0012	.0010 - .0022
	STAINLESS STEELS (DIFFICULT) 304, 304L, 316, 316L	≤ 275 BHN or ≤ 28 HRC	30-75	40-130	.0003 - .0008	.0003 - .0008	.0004 - .0010	.0005 - .0012	.0010 - .0018
K	GRAY IRONS Class 20, 30, 40, 50, 60, G3000, G3500	≤ 220 BHN or ≤ 19 HRC	45-100	80-150	.0003 - .0009	.0003 - .0010	.0004 - .0012	.0005 - .0014	.0010 - .0020
	DUCTILE IRONS D&M series, 250, 300, 350, 400, 60-40-18, 65-45-12	≤ 260 BHN or ≤ 26 HRC	20-75	30-90	.0003 - .0009	.0003 - .0009	.0004 - .0011	.0005 - .0012	.0008 - .0016
N	NON-FERROUS Aluminum, Aluminum cast, Brass, Copper, Bronze, Non Metallic	≤ 271 BHN or ≤ 28 HRC	180-900	450-1200	.0005 - .0009	.0006 - .0011	.0006 - .0013	.0007 - .0015	.0010 - .0030
H	TOOL STEELS A2, D2, H13, L2, M2, P20, S7, T15, W2	≤ 375 BHN or ≤ 55 HRC	10-25	30-130	.0002 - .0008	.0003 - .0009	.0004 - .0010	.0005 - .0013	.0007 - .0020
S	HR SUPER ALLOYS Inconel 718, Waspaloy, Hastelloy, Inconel 625, Stellite 31, Haynes 25, Rene 41	≤ 275 BHN or ≤ 28 HRC	05-20	30-80	.0002 - .0005	.0003 - .0006	.0004 - .0010	.0005 - .0011	.0006 - .0012
	TITANIUM 6AL-4V, ASTM 1, 2, 3, 6AL-2S	≤ 275 BHN or ≤ 28 HRC	10-30	40-180	.0002 - .0007	.0003 - .0010	.0004 - .0012	.0005 - .0016	.0007 - .0020

*Speeds & feeds are starting recommendations only. Factors such as machine type, fixture, tooling rigidity, available horsepower, coolant delivery method and others will affect the performance significantly.

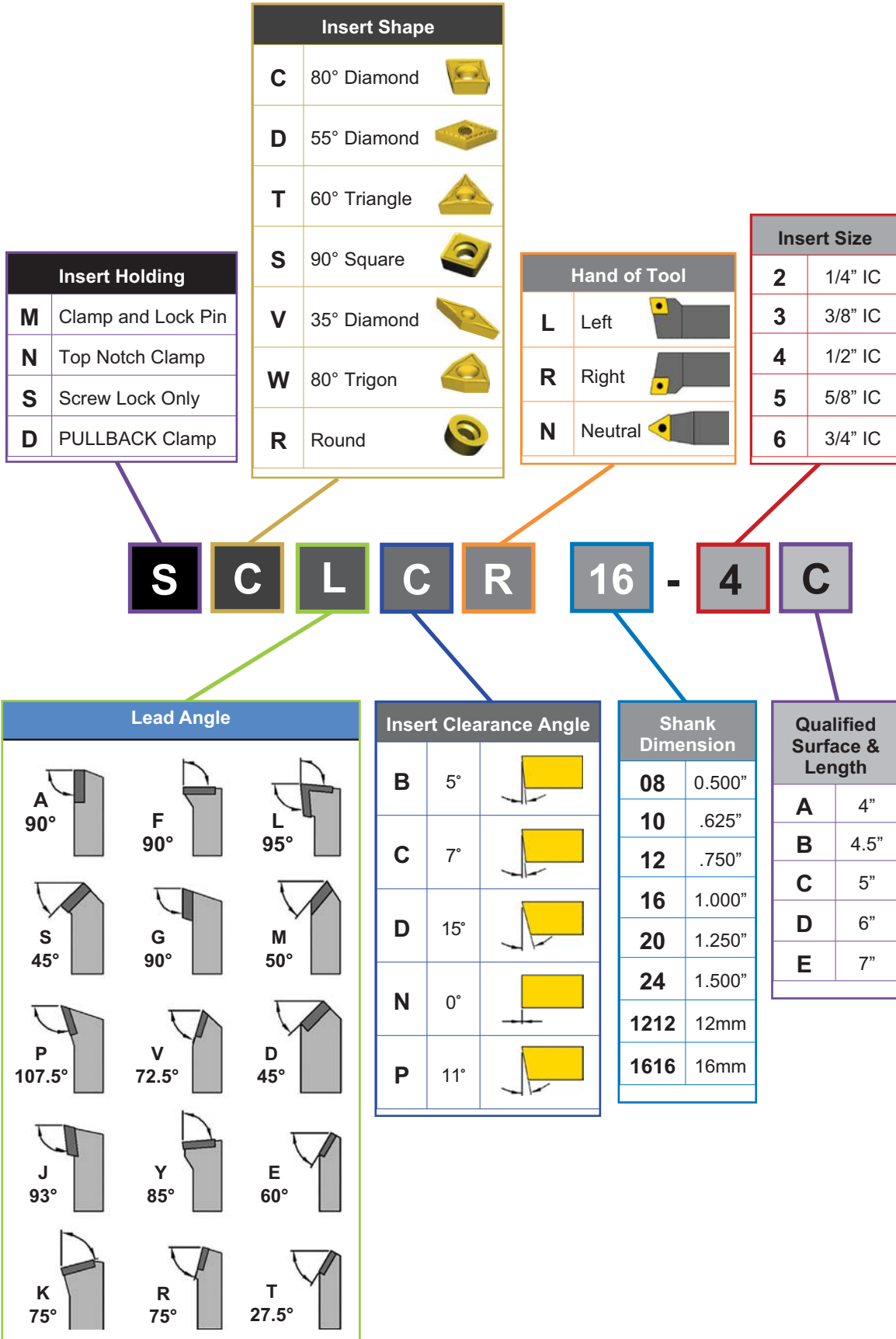

Bar Type	
A	Solid Steel Bar with Coolant
C	Carbide Bar
D	Chatter-Free with Coolant
E	Carbide Bar with Coolant
HM	Solid Heavy Metal with Coolant
J	Solid Heavy Metal
R	Carbide Reinforced Steel Bar
S	Solid Steel Bar

Bar Length	
F	3"
G	3.5"
H	4"
J	4.5"
K	5"
M	6"
Q	7"
R	8"
X	9"
S	10"
T	12"
U	14"
V	16"
W	20"

Insert Clearance Angle		
B	5°	
C	7°	
D	15°	
N	0°	
P	11°	

Alternate F Dim.	
138	.138"
167	.167"
203	.203"
281	.281"

E 10 Q S C L C R 2 -281

Bar Diameter	
02.5	.156" (5/32")
03	.187" (3/16")
03.5	.218" (7/32")
04	.250" (1/4")
05	.312" (5/16")
06	.375" (3/8")
08	0.500" (1/2")
10	.625" (5/8")
12	.750" (3/4")
16	1.000" (1")
20	1.250" (1 1/4")
24	1.500" (1 1/2")
28	1.750" (1 3/4")
32	2.000" (2")

Insert Holding	
M	Clamp and Lock Pin
N	Top Notch Clamp
S	Screw Lock Only
D	PULLBACK Clamp

Insert Shape	
C	80° Diamond
D	55° Diamond
T	60° Triangle
S	90° Square
V	35° Diamond
W	80° Trigon
R	Round

Lead Angle	
F	0°
J	-52°
K	15°
L	-5°
N	27.5°
Q	-17.5°
U	-3°
X	5°

Insert Size	
1.2	5/32" IC
1.5	3/16" IC
1.8	7/32" IC
2	1/4" IC
2.5	5/16" IC
3	3/8" IC
4	1/2" IC

Hand of Bar	
L	Left
R	Right

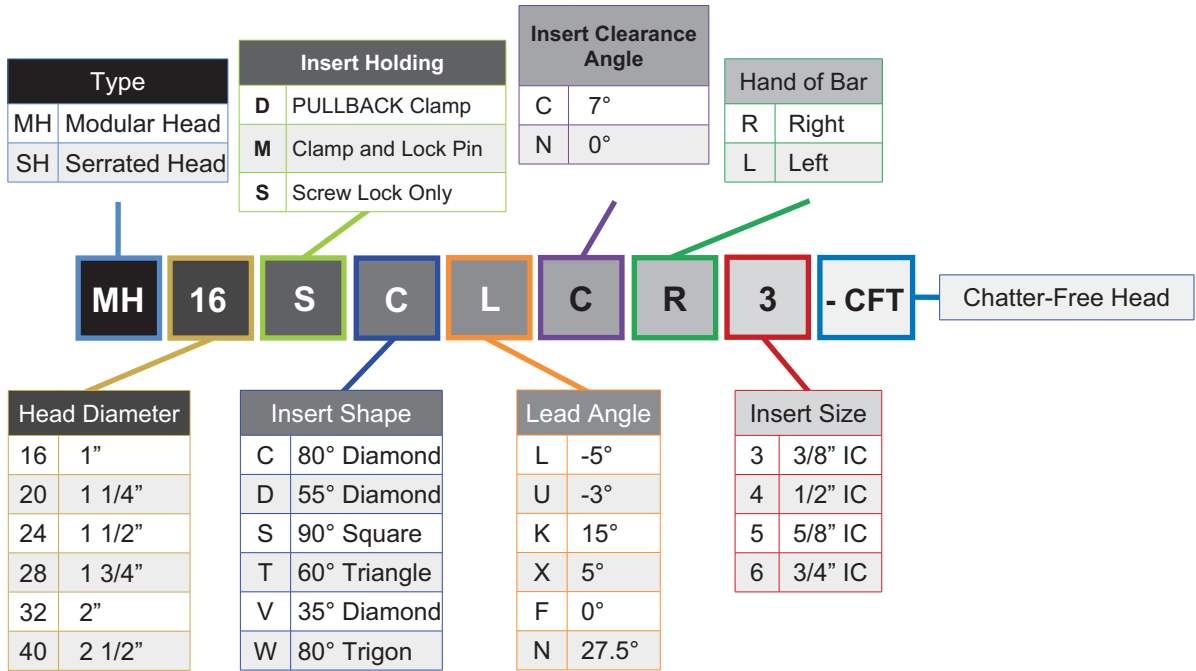

Threading / Grooving

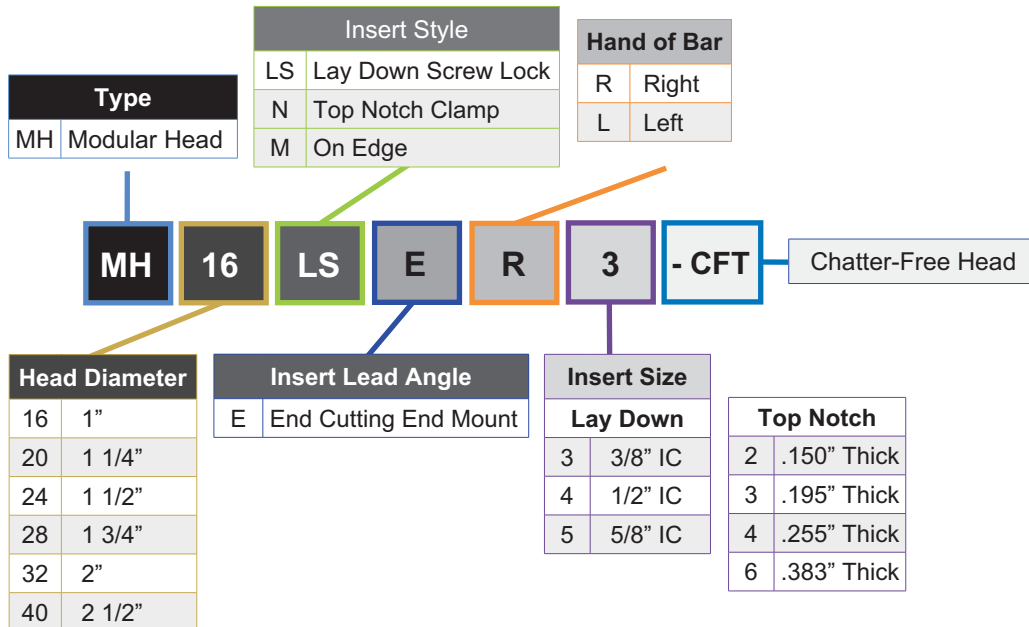

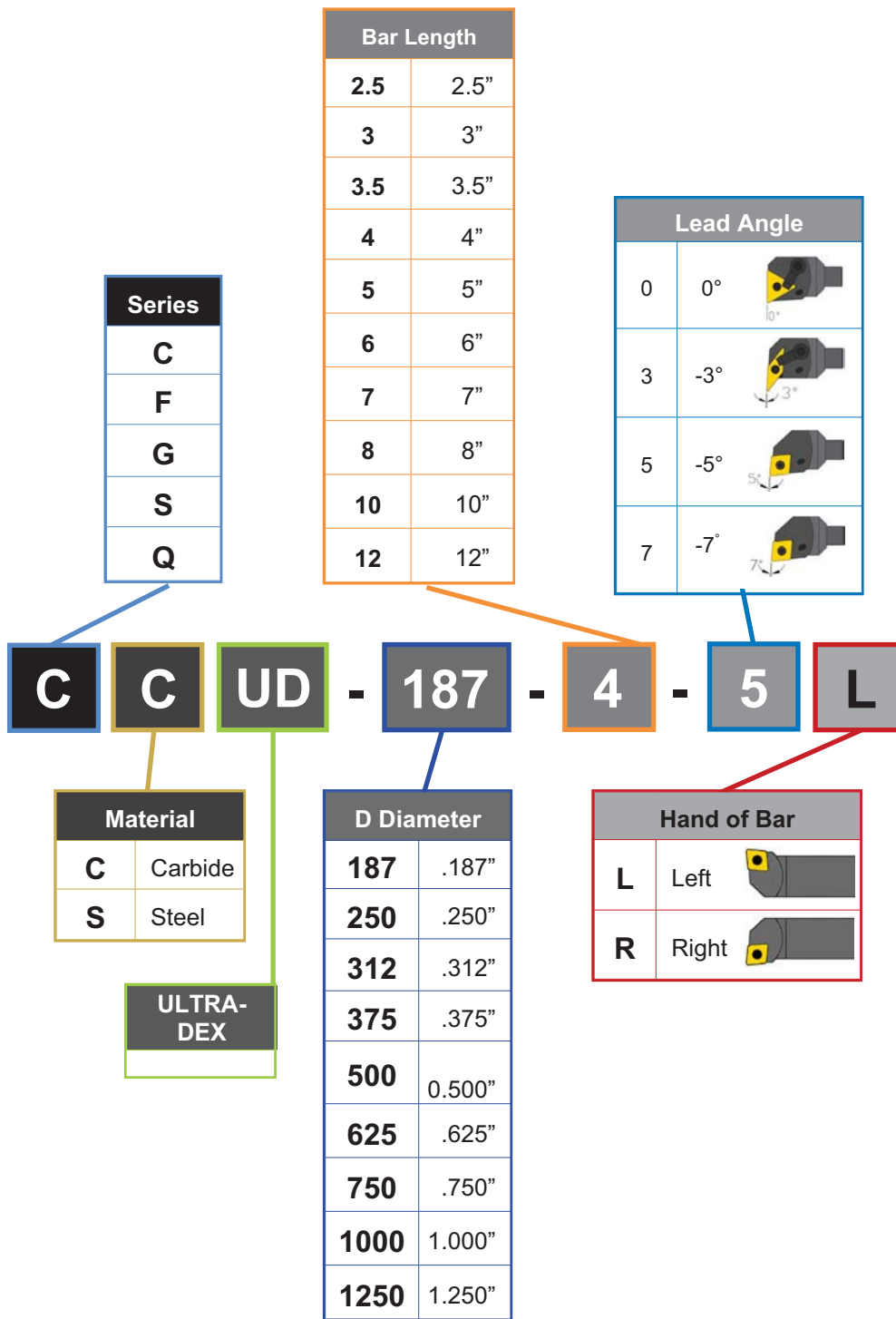

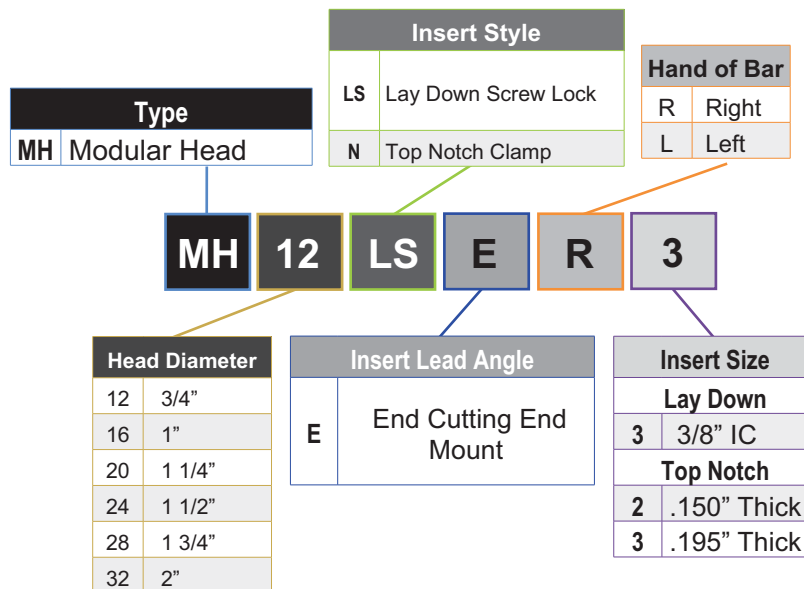
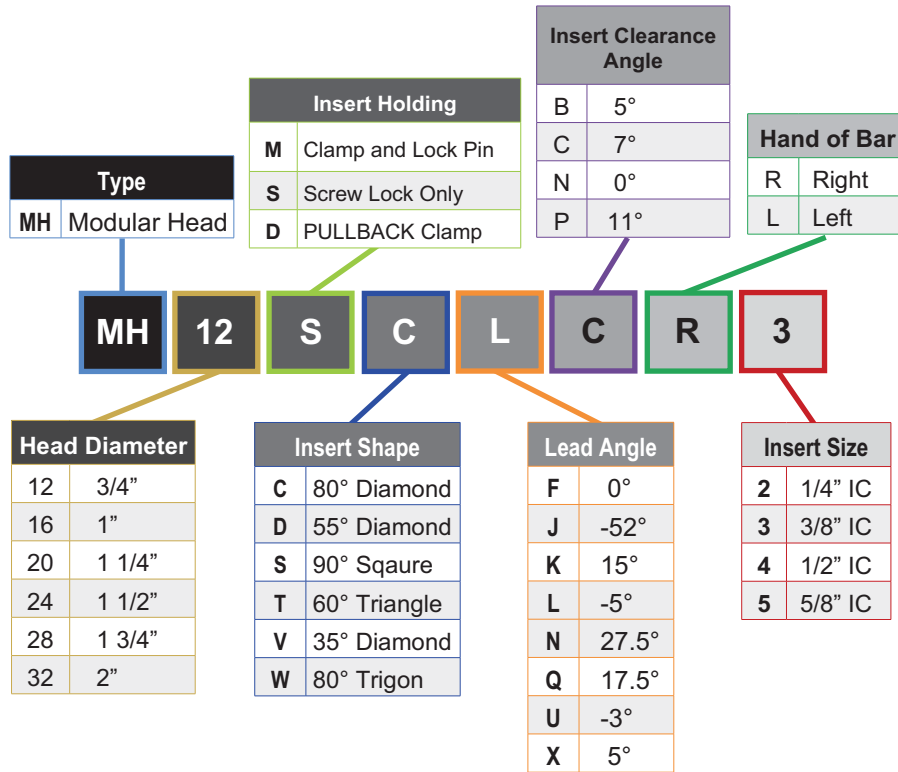

Cutting Diameter Tolerances

ARBOR TYPE CUTTERS					
Cutter Type	Specifications	Tolerance			
		Diameter	Width	Angle	Radius
Plain Milling	Up to 1" Width Over 1" – 2" Incl. Over 2"	+0.015" -0.000" +0.015" -0.000" +0.015" -0.000"	±.001" +0.010" -0.000" +0.020" -0.000"		
Side Mills	Straight Tooth Staggered Tooth Straight Tooth Saw	+0.015" -0.000" +0.015" -0.000" +0.015" -0.000"	+0.002" -0.000" ±.001" ±.001"		
Single Angle Double Angle		+0.015" -0.000" +0.015" -0.000"	+0.015" -0.000" +0.015" -0.000"	±0°10" ±0°10" on half angle	
Keyseat (1/32" oversize on diameters)	3/16" Face 1/4" Face 5/16" Face 3/8" Face and Over	±.002" ±.002" ±.002" ±.002"	-0.0002" -0.0007" -0.0003" -0.0008" -0.0004" -0.0009" -0.0005" -0.0010"		
Convex Concave Corner Rounding		+0.030" -0.000" +0.030" -0.000" +0.030" -0.000"	±.001" ±.005" ±.005"		±.001" +0.002" -0.001" +0.002" -0.001"

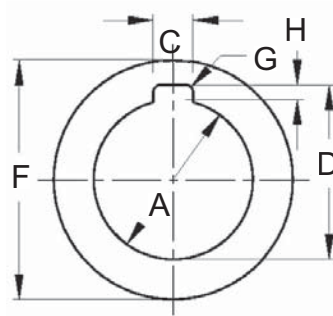

Cutter Bore "A" Inches	Nominal Size Key (Square) Inches	Dimensions - Inches						
		C		D		H Nominal	G Corner Radius	F Collar
		Max.	Min.	Max.	Min.			
1/2	3/32	.106	.099	.5678	.5578	3/64	.020	7/8
5/8	1/8	.137	.130	.7085	.6985	1/16	1/32	1
3/4	1/8	.137	.130	.8325	.8225	1/16	1/32	1-1/8
7/8	1/8	.137	.130	.9575	.9475	1/16	1/32	1-1/4
1	1/4	.262	.255	1.1140	1.1040	3/32	3/64	1-1/2
1-1/4	5/16	.325	.318	1.3950	1.3850	1/8	1/16	1-7/8
1-1/2	3/8	.410	.385	1.6760	1.6660	5/32	1/16	2-1/4
1-3/4	7/16	.473	.448	1.9580	1.9480	3/16	1/16	2-1/2
2	1/2	.535	.510	2.2080	2.1980	3/16	1/16	2-3/4
2-1/2	5/8	.660	.635	2.7430	2.7330	7/32	1/16	3-1/2
3	3/4	.785	.760	3.2750	3.2650	1/4	3/32	4
3-1/2	7/8	.910	.885	3.9000	3.8900	3/8	3/32	5
4	1	1.035	1.011	4.4000	4.3900	3/8	3/32	5-1/2
4-1/2	1-1/8	1.160	1.135	4.9630	4.9530	7/16	1/8	6
5	1-1/4	1.285	1.260	5.5250	5.5150	1/2	1/8	6-1/2

Terminology and Ordering Data

KEO® "S" Style Staggered Interlocking Cutter's consist of two pieces, each piece being a Staggered Side Milling Cutter. Unless otherwise specified, diameters of each piece held relative to each other within .001". Refer to Figures 1, 2 and 3

Total Interlocking Width (W).

The total interlocking width (W) is equal to the overall width of an interlocking cutter. The total interlock width (W) is normally equal to the width of the slot to be machined. This width is measured over the two pieces within the interlocking cutter as shown in Figure 1 and Figure 2.

Unless otherwise specified, tolerance on W Dimension is ±.001". Specify the following information when ordering:

1. Quantity of Interlocking Cutters required.
2. Diameter of Interlocking Cutters (D).
3. Interlock Width (W).
4. Hole size required.

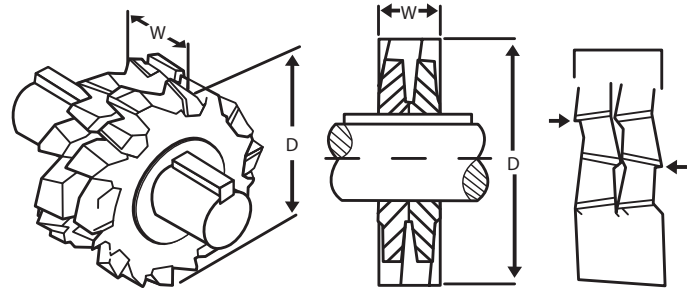

Fig. 1

Fig. 2

Fig. 3

Interlocking or overlap can be varied from as small as .010" – 3/32" or more depending upon the widths selected. Hubs may be ground in customer's plant, by a local grinding service shop or at the KEO® plants. When sharpening reduces the total interlock width, shims may be used between hubs to regain the original total interlock width.

"X" indicates Width Interlock Range that can be priced as standard in diameters listed.
All Staggered Tooth Cutters having the same number of teeth interlock.

INTERLOCK WIDTH RANGE	CUTTER DIAMETER																		
	2-1/8"	2-1/2"	2-3/4"	3"	3-1/4"	3-1/2"	3-3/4"	4"	4-1/4"	4-1/2"	5"	5-1/2"	6"	7"	8"	9"	10"	12"	
.345 – .370	X			X		X		X			X		X	X	X			X	
.370 – .401	X			X		X		X			X		X	X	X			X	
.401 – .432	X			X		X		X		X			X	X	X			X	
.432 – .464	X	X	X	X	X	X	X	X	X	X	X	X	X	X	X	X	X	X	X
.464 – .495	X	X	X	X	X	X	X	X	X	X	X	X	X	X	X	X	X	X	X
.495 – .526	X	X	X	X		X		X		X	X		X	X	X	X	X	X	X
.526 – .557	X	X	X	X		X		X		X	X		X	X	X	X	X	X	X
.557 – .588	X	X	X	X	X	X	X	X	X	X	X	X	X	X	X	X	X	X	X
.588 – .620	X	X	X	X	X	X	X	X	X	X	X	X	X	X	X	X	X	X	X
.620 – .651	X	X	X	X		X		X		X	X		X	X	X	X	X	X	X
.651 – .682	X	X	X	X		X		X		X	X		X	X	X	X	X	X	X
.682 – .713	X	X	X	X		X		X		X	X		X	X	X	X	X	X	X
.700 – .745	X	X	X	X	X	X	X	X	X	X	X	X	X	X	X	X	X	X	X
.731 – .776	X	X	X	X	X	X	X	X	X	X	X	X	X	X	X	X	X	X	X
.763 – .807	X	X	X	X		X		X		X	X		X	X	X	X	X	X	X
.794 – .838		X	X	X	X	X	X	X	X	X	X	X	X	X	X	X	X	X	X
.825 – .870		X	X	X	X	X	X	X	X	X	X	X	X	X	X	X	X	X	X
.856 – .901		X	X	X	X	X	X	X	X	X	X	X	X	X	X	X	X	X	X
.888 – .932		X	X	X	X	X	X	X	X	X	X	X	X	X	X	X	X	X	X
.930 – .995		X	X	X	X	X	X	X	X	X	X	X	X	X	X	X	X	X	X
.993 – 1.058				X	X	X	X	X	X	X	X	X	X	X	X	X	X	X	X
1.055 – 1.120				X	X	X	X	X	X	X	X	X	X	X	X	X	X	X	X
1.118 – 1.182				X	X	X	X	X	X	X	X	X	X	X	X	X	X	X	X
1.180 – 1.245				X	X	X	X	X	X	X	X	X	X	X	X	X	X	X	X
1.242 – 1.307				X	X	X	X	X	X	X	X	X	X	X	X	X	X	X	X
1.305 – 1.370				X		X		X		X	X		X	X	X	X	X	X	X
1.368 – 1.432				X		X		X		X	X		X	X	X	X	X	X	X
1.430 – 1.495				X	X	X	X	X	X	X	X	X	X	X	X	X	X	X	X
1.492 – 1.557				X	X	X	X	X	X	X	X	X	X	X	X	X	X	X	X
1.555 – 1.620				X		X		X		X	X		X	X	X	X	X	X	X
1.618 – 1.682				X		X		X		X	X		X	X	X	X	X	X	X
1.680 – 1.745				X		X		X		X	X		X	X	X	X	X	X	X
1.743 – 1.807				X		X		X		X	X		X	X	X	X	X	X	X
1.805 – 1.870				X		X		X		X	X		X	X	X	X	X	X	X
1.868 – 1.932				X		X		X		X	X		X	X	X	X	X	X	X
1.930 – 1.995				X		X		X		X	X		X	X	X	X	X	X	X
1.990 – 2.055				X		X		X		X	X		X	X	X	X	X	X	X
2.050 – 2.120				X		X		X		X	X		X	X	X	X	X	X	X
2.115 – 2.180				X		X		X		X	X		X	X	X	X	X	X	X
2.175 – 2.245				X		X		X		X	X		X	X	X	X	X	X	X
2.240 – 2.305								X					X						
2.300 – 2.370								X					X						
2.365 – 2.430								X					X						
2.425 – 2.495								X					X						

MILIMETERS TO INCHES CONVERSION CHART							
MM	INCHES	MM	INCHES	MM	INCHES	MM	INCHES
0.1	0.0039	20	0.7872	48	1.8898	76	2.9921
0.2	0.0079	21	0.8268	49	1.9291	77	3.0315
0.3	0.0118	22	0.8661	50	1.9685	78	3.0709
0.4	0.0157	23	0.9055	51	2.0079	79	3.1102
0.5	0.0197	24	0.9449	52	2.0472	80	3.1496
0.6	0.0236	25	0.9843	53	2.0866	81	3.189
0.7	0.0276	26	1.0236	54	2.126	82	3.2284
0.8	0.0315	27	1.063	55	2.1654	83	3.2677
0.9	0.0354	28	1.1024	56	2.2047	84	3.3071
1	0.0394	29	1.1417	57	2.2441	85	3.3465
2	0.0787	30	1.1811	58	2.2835	86	3.3858
3	0.1181	31	1.2205	59	2.3228	87	3.4252
4	0.1575	32	1.2598	60	2.3622	88	3.4646
5	0.1969	33	1.2992	61	2.4016	89	3.5039
6	0.2362	34	1.3386	62	2.441	90	3.5433
7	0.2756	35	1.378	63	2.4803	91	3.5827
8	0.315	36	1.4173	64	2.5197	92	3.6221
9	0.3543	37	1.4567	65	2.5591	93	3.6614
10	0.3937	38	1.4961	66	2.5984	94	3.7008
11	0.4331	39	1.5354	67	2.6378	95	3.7402
12	0.4724	40	1.5748	68	2.6772	96	3.7795
13	0.5118	41	1.6142	69	2.7165	97	3.8189
14	0.5512	42	1.6535	70	2.7559	98	3.8583
15	0.5906	43	1.6929	71	2.7953	99	3.8976
16	0.6299	44	1.7323	72	2.8347	100	3.937
17	0.6693	45	1.7717	73	2.874		
18	0.7087	46	1.811	74	2.9134		
19	0.748	47	1.8504	75	2.9528		

Surface Feet Per Minute

$$\text{SFM} = \text{RPM} \times \text{D} \times .262$$

Revolutions Per Minute

$$\text{RPM} = \frac{\text{SFM} \times 3.82}{\text{D}}$$

Inches Per Minute

$$\text{IPM} = \text{RPM} \times \text{IPT} \times \text{Z}$$

Inches Per Tooth

$$\text{IPT} = \frac{\text{IPR}}{\text{Z}}$$

Inches Per Revolution

$$\text{IPR} = \frac{\text{IPM}}{\text{RPM}}$$

Metal Removal Rate (cu. in./min.)

$$\text{MRR} = \text{RDOC} \times \text{ADOC} \times \text{IPM}$$

Inches Per Tooth
(Chip Thinning Adjustment)

$$\text{IPT}_{\text{adj}} = \frac{\text{CT} \times \text{D}}{2 \times \sqrt{(\text{D} \times \text{RDOC}) - \text{RDOC}}}$$

Feed Rate Adjustment - Inside Arc

$$\text{F}_i = \frac{\text{IPM} \times (r_i + \text{R})}{r_i}$$

Feed Rate Adjustment - Outside Arc

$$\text{F}_o = \frac{\text{IPM} \times (r_o + \text{R})}{r_o}$$

Chip Thickness

$$\text{CT} = \frac{2 \times \text{IPT} \times \sqrt{(\text{D} \times \text{RDOC}) - \text{RDOC}}}{\text{D}}$$

Ball Nose Velocity Adjustment

$$\text{V}_{\text{adj}} = \frac{\text{SFM} \times 3.82}{\text{D}_{\text{eff}}}$$

Ball Nose "Effective Diameter"

$$\text{D}_{\text{eff}} = 2 \times \sqrt{\text{ADOC} \times (\text{D} - \text{ADOC})}$$

D	Tool Cutting Diameter	r_i	Part Radius (inside arc)	RDOC	Radial Depth of Cut
Z	Number of Flutes	r_o	Part Radius (outside arc)	ADOC	Axial Depth of Cut



15 locations, 20+ application engineers, all working for you. Contact us today!

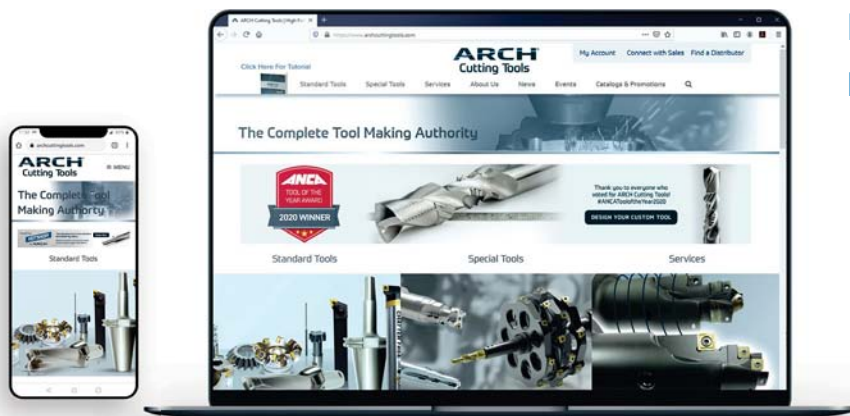

[Browse archcuttingtools.com](http://archcuttingtools.com) -
Find out more on our website

- Check inventory
- Contact our experts
- More info about us
- Keep up on news and events
- Request catalogs

Can't find what you need in our standard stocked inventory? We can create your custom tooling solution within ARCH's 350,000 square feet of manufacturing space. Here to serve you is ARCH Specials:

Standard Tools:

800-991-4225

Special Tools:

800-991-4225



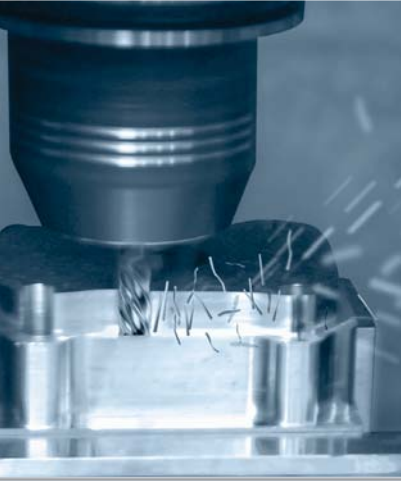

Standards / Specials / Services

ARCH[®]
Cutting Tools

ARCH Cutting Tools is your complete tool making authority. ARCH does this through blending our customer service associate's strengths with the commitment of 350,000 square feet of American manufacturing that provides the innovation to support the breadth of in-stock Standards for quick shipment at our all new Midwest campus. It is no coincidence that ARCH leads the industry in custom engineered tooling solutions, it was intentional.

THE COMPLETE TOOL MAKING AUTHORITY™

AHB
TOOLING & MACHINERY

**COMPLETE
METALWORKING
SOLUTIONS**

(800) 991-4225

www.ahbinc.com

ISO Certified

customerservice@ahbinc.com