

hard material matters

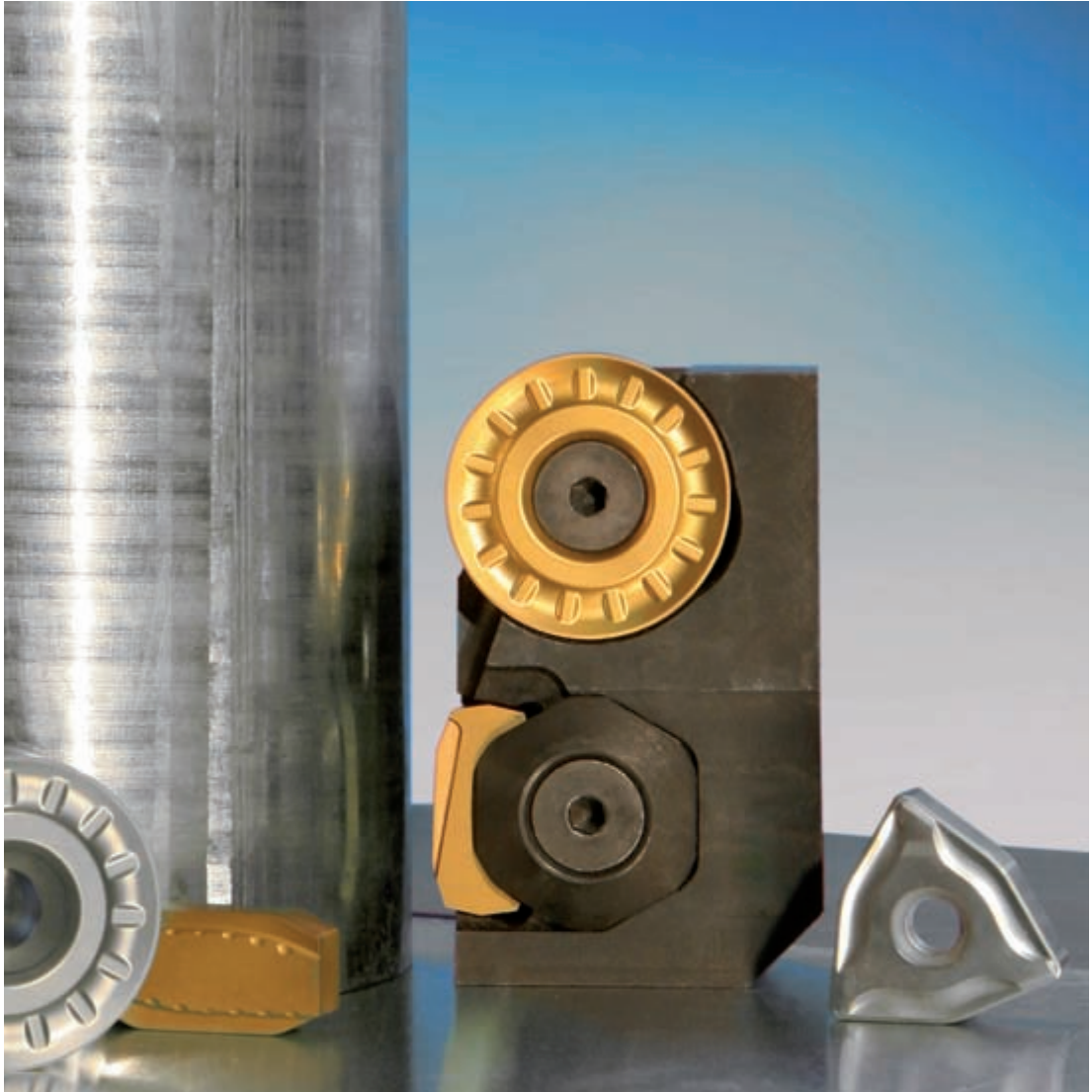

## Tools and inserts for bar peeling

**AHB** Tooling & Machinery, Inc.  
Complete Metalworking Solutions  
Roseville Saginaw & Jackson, MI

ISO Certified  
(800) 991-4225  
[www.ahbinc.com](http://www.ahbinc.com)  
[customerservice@ahbinc.com](mailto:customerservice@ahbinc.com)





# Bar peeling

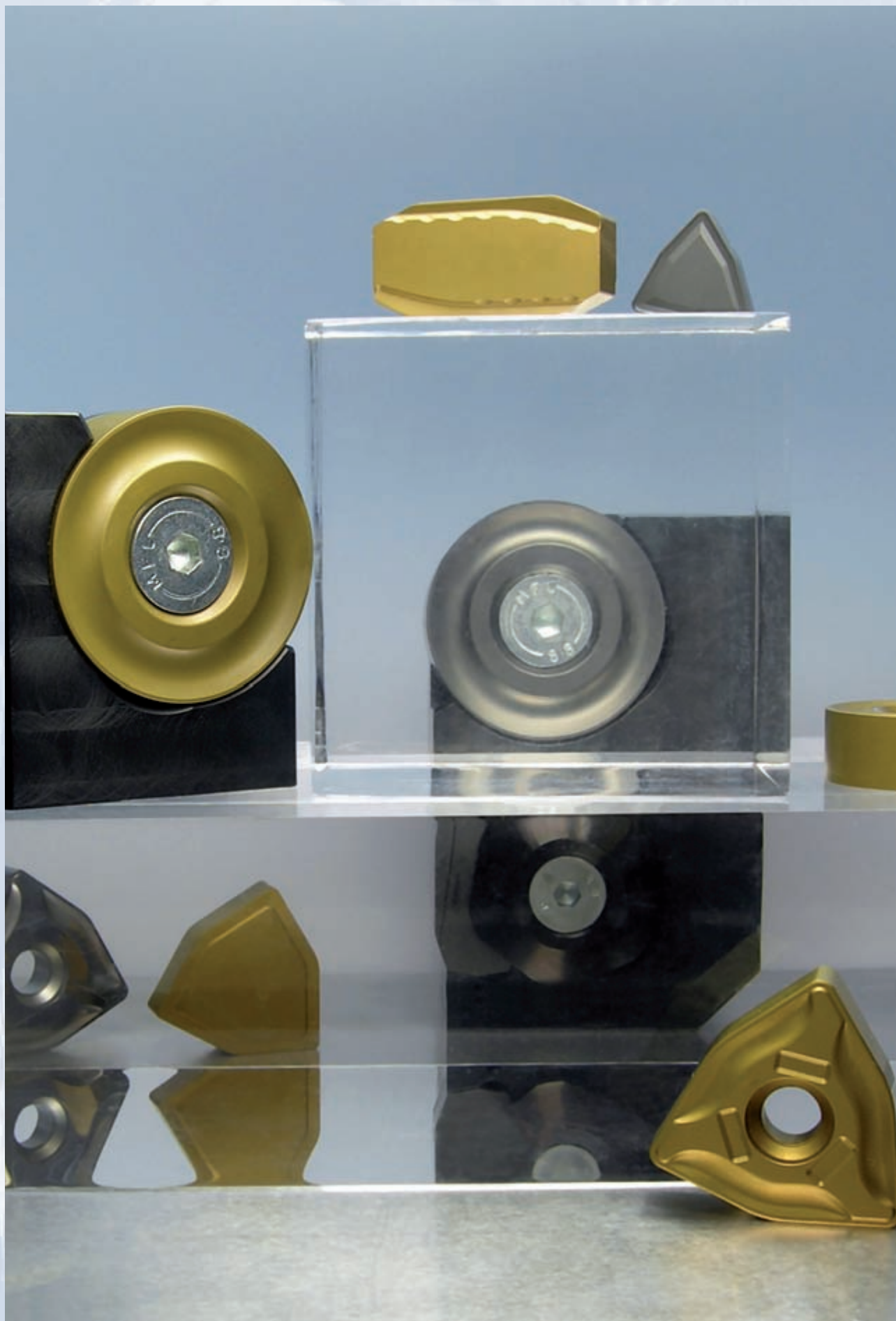



# CERATIZIT – strengths and services

## Strengths and services

- High competence in production for tungsten carbides and other hard materials like PCD, CBN, cermets ...
- Market leader in coating technology (CVD, PVD), innovative developments such as 'HYPERCOAT'
- Engineering and development
- Application and customer focused development
- Worldwide sales and production network



- Close cooperation with our customers with dedicated solutions supported by experienced application engineers on site
- Supporting machine manufacturers to achieve maximum performance
- Create tailored solutions to customers needs for all applications
- Standard range of all common spare parts
- Continuous development of cutting materials and geometries

# Benefits

## CERATIZIT – competence in bar peeling

### SUCCESS FACTORS



### Production cost savings through the application of the right insert

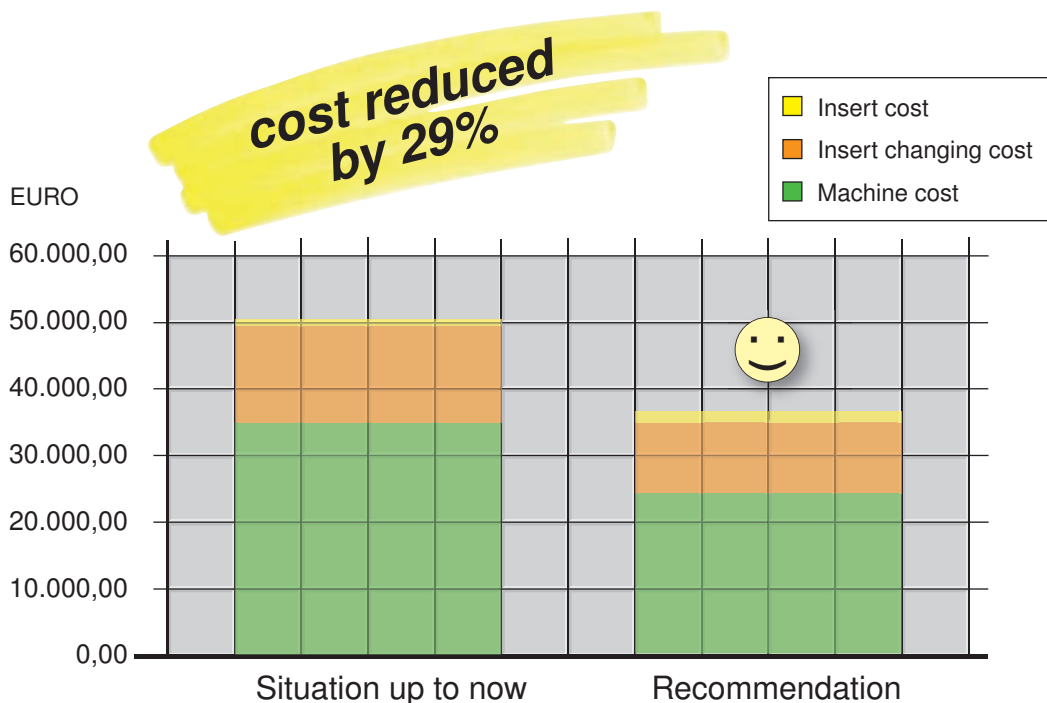

# Designation

## Designation system for bar peeling inserts

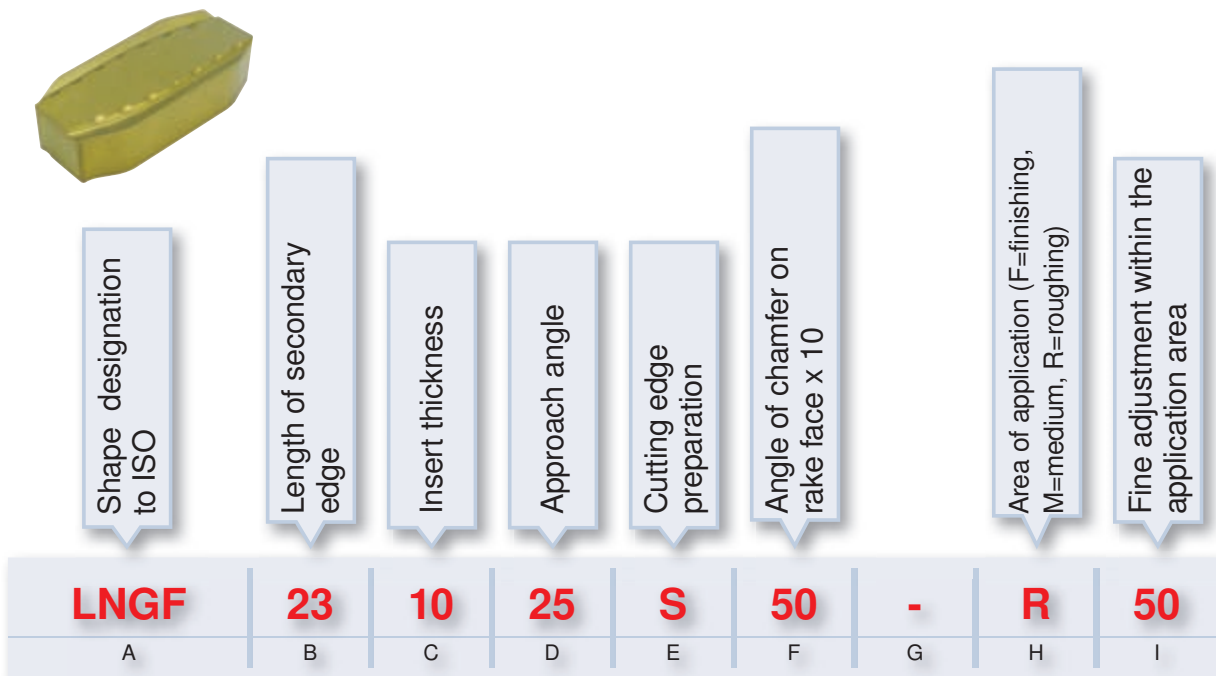

A	Description: shape + clearance angle + tolerance zone (ISO) + type (version)
B	Usable length of secondary cutting edge or diameter on round inserts
C	Insert thickness
D	Approach angle, or diameter on round inserts 00 = inch; MO = metric
E	Cutting edge (chamfered, honed ...) E = honed; T = chamfered; S = chamfered and honed; K = double chamfered and honed
F	Angle of chamfer on the secondary cutting edge in degrees (50 = 5.00°); (44 = 4°40')
G	Hyphen
H	Application range, depending on the maximum cutting depth F = finishing ≤ 1,0 mm, M = medium 1.1 - 2.9 mm, R = > 3 mm
I	Fine adjustment in the range to define the details as follows: 50 = standard for the 'long' chip groove along the complete length of the secondary edge; for example RNGH; LNGF 40 = standard for the 'short' chip groove, does not cover the complete length of the secondary edge; for example NNUX, YNUR ... Additional applications (for example chip breaker '55')

# Chamfer selection

## Overview of chamfers

Chamfer	Description	Material	Strength (Rm)
S 50	Secondary cutting edge (angle 5°)	All materials (basic hardness) e.g. machining steel, tool steel, stainless steel, Ni-based alloys	450 N/mm <sup>2</sup> – 850 N/mm <sup>2</sup>
S 42	Secondary cutting edge (angle 4°20')	All materials (tempered) e.g. tempered steel, tool steel, stainless steel, Ni-based alloys	750 N/mm <sup>2</sup> – 1200 N/mm <sup>2</sup>
P 60	Main and secondary cutting edge (angle 6°)	All materials (annealed) e.g. constructional steel, machining steel; main application of material that is susceptible to vibration and unstable machine conditions	300 N/mm <sup>2</sup> – 700 N/mm <sup>2</sup>

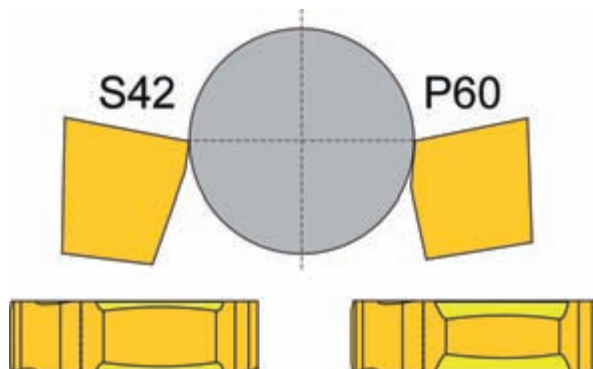
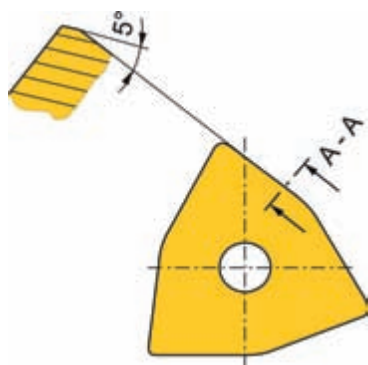

# Grade overview

Grade description	Standard designation	Cutting material	Application range										Material group							
													A	R	F	N	S	H		
			01	05	10	15	20	25	30	35	40	45	50	Steel	Stainless	Cast iron	Non ferrous metals	Heat resistant materials	Hard materials	
<b>CTC3110</b>	HC-P10	C			■	■	■							○						
	HC-K10	C			■	■	■									●				
<b>CTC1110</b>	HC-P10	C			■	■	■	■						●						
	HC-M10	C			■	■									○				○	
	HC-K15	C			■	■	■									●				
<b>CTC1115</b>	HC-P15	C			■	■	■	■						●						
	HC-M15	C			■	■									○				○	
	HC-K15	C			■	■	■									○				
<b>CTC1125</b>	HC-P25	C				■	■	■	■					●						
	HC-M25	C					■	■							○					
	HC-K20	C				■	■	■								○				
<b>CTC1130</b>	HC-P30	C					■	■	■	■				●						
	HC-M20	C					■	■							○					
	HC-K20	C				■	■	■								●				
<b>CTC1135</b>	HC-P35	C						■	■	■	■			●						
	HC-M25	C					■	■	■						○				○	
<b>CTC2135</b>	HC-P35	C						■	■	■	■			○						
	HC-M30	C					■	■	■						●				●	
<b>CTC1635</b>	HC-P35	C						■	■	■	■			●						
	HC-M30	C					■	■	■						●				○	
<b>CTC1640</b>	HC-P40	C						■	■	■	■			●						
	HC-M35	C						■	■	■	■				●				○	
<b>H216T</b>	HW-K15	W				■	■									●	●			

● Main application  
○ Extended application



# Inserts

## RNGH/RNMH



d	ap max.	Type, description	CTC3110	CTC1110	CTC1115	CTC1125	CTC1130	CTC1135	CTC1635	CTC1640	CTC2135	H216T	s	d <sub>1</sub>	Cutting edges
28	3	RNGH 280700S00-R50			●								7	9	(5)
28	3	RNGH 281000S00-R50			●						●		10	9	(5)
38	6	RNGH 381200S00-R50							●				12	12	(5)
38	6	RNGH 381200S00-R51							●	●			12	12	(5)
38	6	RNGH 381200E00-R55							●				12	12	(5)
50	9	RNMH 5018MOS00-R50							●	●			18	12,7	(5)
50	9	RNMH 5018MOE00-R55							●				18	12,7	(5)



Steel	●	●	●	●	●	○	●	●	○	●	○	○	○	○	○
Stainless	○	○	○	○	○	○	○	○	○	○	○	○	○	○	○
Cast iron	○	○	○	○	○	○	○	○	○	○	○	○	○	○	○
Non ferrous metals	○	○	○	○	○	○	○	○	○	○	○	○	○	○	○
Heat resistant	○	○	○	○	○	○	○	○	○	○	○	○	○	○	○
Hard materials	○	○	○	○	○	○	○	○	○	○	○	○	○	○	○

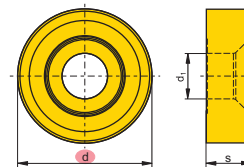

- Main application
- Extended application
- International CERATIZIT range, for present availability see price list

Ordering example: 50 pieces RNGH 280700S00-R50 CTC1115

# Inserts

## LNGF

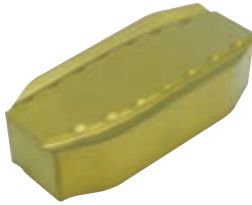

Ln	ap max.	Type, description	CTC3110	CTC1110	CTC1115	CTC1125	CTC1130	CTC1135	CTC1635	CTC1640	CTC2135	H216T	s	K	l	b	Cutting edges		
23	3	LNGF 231025S50-R50		●	●		●		●		●		10	25°	40	20	4		
23	3	LNGF 231025S42-R50			●		●						10	25°	40	20	4		
23	3	LNGF 231225S50-R50					●						12	25°	40	20	4		
23	3	LNGF 231225S42-R50					●						12	25°	40	20	4		
			Steel	●	●		●		●		○								
			Stainless		○	○		○		●		●							
			Cast iron		●	○		●											
			Non ferrous metals																
			Heat resistant		○	○					○							●	
			Hard materials																

- Main application
- Extended application
- International CERATIZIT range, for present availability see price list

Ordering example: 50 pieces LNGF 231025S50-R50 CTC1115

# Inserts

## YNUF

M50

M40

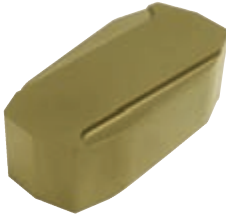

Ln	ap max.	Type, description	CTC3110	CTC1110	CTC1115	CTC1125	CTC1130	CTC1135	CTC1635	CTC1640	CTC2135	H216T	s	K	l	b	Cutting edges
17	1,5	YNUF 170820S50-M50	●	●	●	●	●				●		8	20	31	12	4
17	1,5	YNUF 170820S42-M50	●	●	●	●							8	20	31	12	4
17	1,5	YNUF 170820P60-M50				●	●						8	20	31	12	4
20	2	YNUF 201220S50-M50	●		●	●	●				●		12	20	37	18	4
20	2	YNUF 201220S42-M50	●	●	●	●							12	20	37	18	4
20	2	YNUF 201220P60-M50				●	●						12	20	37	18	4
20	2	YNUF 200920S42-M50	●			●							9	20	37	18	4
20	2	YNUF 200920S50-M50				●	●						9	20	37	18	4
27	2	YNUF 271220S50-M50			●	●	●						12	20	43	18	4
27	2	YNUF 271220S42-M50			●		●						12	20	43	18	4
27	2	YNUF 271220P60-M50				●	●						12	20	43	18	4
20	2	YNUF 201212S50-M40	●										12	20	37	18	4



Steel	○	●	●	●	●	●	●	●	●	●	○	○	○	○	○	○	○
Stainless	○	○	○	○	○	○	○	○	○	○	○	○	○	○	○	○	○
Cast iron	●	●	●	●	●	●	●	●	●	●	●	●	●	●	●	●	●
Non ferrous metals	○	○	○	○	○	○	○	○	○	○	○	○	○	○	○	○	○
Heat resistant	○	○	○	○	○	○	○	○	○	○	○	○	○	○	○	○	○
Hard materials	○	○	○	○	○	○	○	○	○	○	○	○	○	○	○	○	○

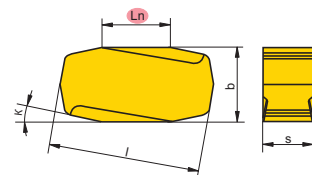

- Main application
- Extended application
- International CERATIZIT range, for present availability see price list

Ordering example: 50 pieces YNUF 170820S50-M50 CTC3110

# Inserts

## YNUR

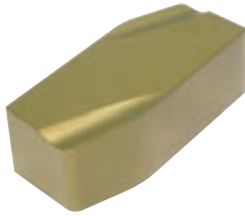

Ln	ap max.	Type, description	CTC3110	CTC1110	CTC1115	CTC1125	CTC1130	CTC1135	CTC1635	CTC1640	CTC2135	H216T	s	K	l	b	Cutting edges	
27	3	YNUR 271220P50-M40	●		●	●			●				12	20	38	18	2	
		Steel	○		●	●			●									
		Stainless			○	○			●									
		Cast iron	●		○	○												
		Non ferrous metals																
		Heat resistant			○					○								
		Hard materials																

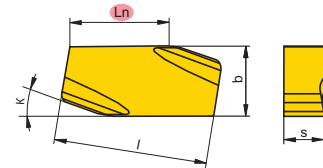

- Main application
- Extended application
- International CERATIZIT range, for present availability see price list

Ordering example: 50 pieces YNUR 271220P50-M40 CTC3110



# Inserts

## YNUX

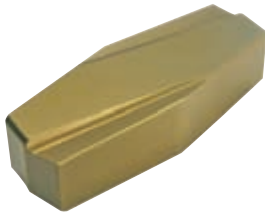

Ln	ap max.	Type, description	CTC3110	CTC1110	CTC1115	CTC1125	CTC1130	CTC1135	CTC1635	CTC1640	CTC2135	H216T	s	K	l	b	Cutting edges
10	2	YNUX 100615P50-M50				●							6	15	22	10	4



Steel						●											
Stainless						○											
Cast iron						○											
Non ferrous metals																	
Heat resistant																	
Hard materials																	

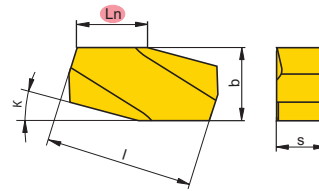

- Main application
- Extended application
- International CERATIZIT range, for present availability see price list

Ordering example: 50 pieces YNUX 100615P50-M50 CTC1125

# Inserts

## YNGX

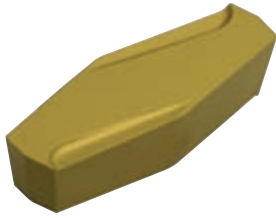

Ln	ap max.	Type, description	CTC3110	CTC1110	CTC1115	CTC1125	CTC1130	CTC1135	CTC1635	CTC1640	CTC2135	H216T	s	K	l	b	Cutting edges
15	2	YNGX 150815P50-M50			●			●					8	15	31	12	4
15	2	YNGX 150815P42-M50			●								8	15	31	12	4
15	4	YNGX 150820S50-R50	●				●						8	20	31	12	4
15	4	YNGX 150820S42-R50	●				●						8	20	31	12	4
15	4	YNGX 150820P60-R50	●				●						8	20	31	12	4



Steel	○	●	●	●	●	●	●	●	●	●	●	●	●	●	●	●	●
Stainless	○	○	○	○	○	○	○	○	○	○	○	○	○	○	○	○	○
Cast iron	●	●	●	●	●	●	●	●	●	●	●	●	●	●	●	●	●
Non ferrous metals	○	○	○	○	○	○	○	○	○	○	○	○	○	○	○	○	○
Heat resistant	○	○	○	○	○	○	○	○	○	○	○	○	○	○	○	○	○
Hard materials																	

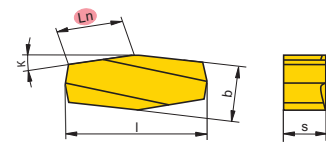

- Main application
- Extended application
- International CERATIZIT range, for present availability see price list

Ordering example: 50 pieces YNGX 150807P50-M50 CTC3110

# Inserts

## WNEU

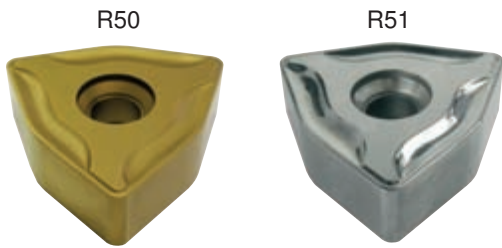

Ln	ap max.	Type, description	CTC3110	CTC1110	CTC1115	CTC1125	CTC1130	CTC1135	CTC1635	CTC1640	CTC2135	H216T	s	K	d	d <sub>i</sub>	Cutting edges
16	7	WNEU 161325S50-R50	●		●	●	●		●		●		13	25	32	9	6
16	7	WNEU 161325P50-R51										●	13	25	32	9	6
16	7	WNEU 161425S50-R50			●	●	●						14	25	32	9	6
16	7	WNEU 161425S42-R50			●								14	25	32	9	6



Steel	○	●	●	●	●	●	●	●	○	●	○	○
Stainless	○	○	○	○	○	○	○	○	○	○	○	○
Cast iron	○	○	○	○	○	○	○	○	○	○	○	○
Non ferrous metals	○	○	○	○	○	○	○	○	○	○	○	○
Heat resistant	○	○	○	○	○	○	○	○	○	○	○	○
Hard materials	○	○	○	○	○	○	○	○	○	○	○	○

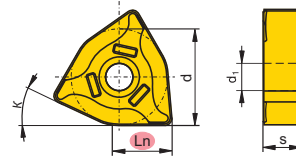

- Main application
- Extended application
- International CERATIZIT range, for present availability see price list

Ordering example: 50 pieces WNEU 161325S50-R50 CTC3110

# Inserts

## WNEF

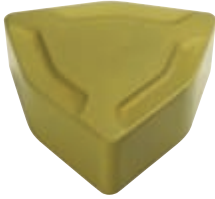

Ln	ap max.	Type, description	CTC3110	CTC1110	CTC1115	CTC1125	CTC1130	CTC1135	CTC1635	CTC1640	CTC2135	H216T	s	K	d	Cutting edges
16	7	WNEF 161325P50-R50			●	●		●					13	25	32	6
16	7	WNEF 161325P42-R50			●								13	25	32	6



	CTC3110	CTC1110	CTC1115	CTC1125	CTC1130	CTC1135	CTC1635	CTC1640	CTC2135	H216T
Steel	●	●	●	●	●	●	●	●	●	●
Stainless	○	○	○	○	○	○	○	○	○	○
Cast iron	○	○	○	○	○	○	○	○	○	○
Non ferrous metals	○	○	○	○	○	○	○	○	○	○
Heat resistant	○	○	○	○	○	○	○	○	○	○
Hard materials	○	○	○	○	○	○	○	○	○	○

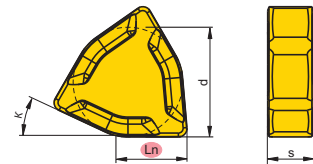

- Main application
- Extended application
- International CERATIZIT range, for present availability see price list

Ordering example: 50 pieces WNEF 161325P50-R50, CTC1115



# Inserts

## WNGG



Ln	ap max.	Type, description	CTC3110	CTC1110	CTC1115	CTC1125	CTC1130	CTC1135	CTC1635	CTC1640	CTC2135	H216T	s	K	d	d <sub>1</sub>	Cutting edges
15	2,5	WNGG 151015E00-M50				●	●	●					10	15	22	8	6
15	2,5	WNGU 151015E00-M50			●	●	●						10	15	22	8	6



Steel					●	●	●					
Stainless				○	○	○						
Cast iron				○	●							
Non ferrous metals												
Heat resistant							○					
Hard materials												

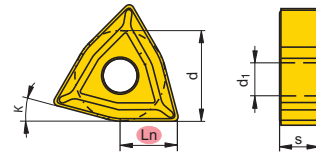

- Main application
- Extended application
- International CERATIZIT range, for present availability see price list

Ordering example: 50 pieces WNGG 151015E00-M50, CTC1125

# Inserts

## WNMF

M40

M41

R41



Ln	ap max.	Type, description	CTC3110	CTC1110	CTC1115	CTC1125	CTC1130	CTC1135	CTC1635	CTC1640	CTC2135	H216T	s	K	d	Cutting edges
11	3	WNMF 110615S50-M40	●			●							6	15	15	6
11	3	WNMF 110615S50-M41		●									6	15	15	6
15	5	WNMF 151025S50-R41	●								●		10	25	22	6



Steel	○	●	●	●	●	●	●	●	●	●	○	●				
Stainless	○	○	○	○	○	○	○	○	○	○	○	○				
Cast iron	●	●	●	●	●	●	●	●	●	●	●	●				
Non ferrous metals																
Heat resistant	○	○	○	○	○	○	○	○	○	○	○	○				
Hard materials																

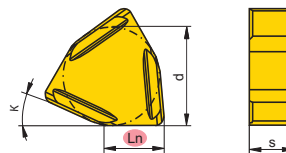

- Main application
- Extended application
- International CERATIZIT range, for present availability see price list

Ordering example: 50 pieces WNMF 110615S50-M40 CTC3110

# Inserts

## WNMF 96

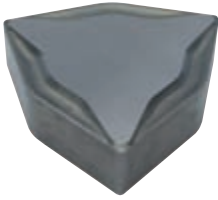

Ln	ap max.	Type, description	CTC3110	CTC1110	CTC1115	CTC1125	CTC1130	CTC1135	CTC1635	CTC1640	CTC2135	H216T	s	K	d	Cutting edges
16	8	WNMF 96-S42					●		●	●			9	30	28	6
16	8	WNMF 96-P60					●		●	●			9	30	28	6
16	8	WNMF 96-S50					●		●	●			9	30	28	6
16	8	WNMF 96-P50										●	9	30	28	6



Steel							●		●	●		
Stainless							○		●	●		
Cast iron							●		●	●		●
Non ferrous metals												●
Heat resistant									○	○		
Hard materials												

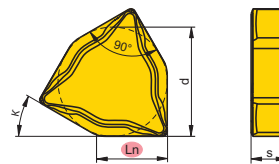

- Main application
- Extended application
- International CERATIZIT range, for present availability see price list

Ordering example: 50 pieces WNMF 96-S42 CTC1130

# Inserts

## NNUX/NNXX

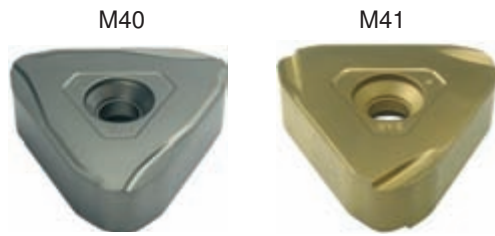

Ln	ap max.	Type, description	CTC3110	CTC1110	CTC1115	CTC1125	CTC1130	CTC1135	CTC1635	CTC1640	CTC2135	H216T	s	K	d	d <sub>1</sub>	Cutting edges
20	2,5	NNUX 201020S50-M40	●				●	●					10	20	28	7	6
20	2,5	NNUX 201020S50-M41	●										10	20	28	7	6
20	2,5	NNXX 201020S50-M40	●	●	●								10	20	28	7	6
20	2,5	NNXX 201020S42-M40	●										10	20	28	7	6
20	2,5	NNXX 201020S50-M41			●								10	20	28	7	6



Steel	○	●	●	●	●	●	●	●	●	●	●	●	●	●	●	●	●	●
Stainless	○	○	○	○	○	○	○	○	○	○	○	○	○	○	○	○	○	○
Cast iron	●	●	●	●	●	●	●	●	●	●	●	●	●	●	●	●	●	●
Non ferrous metals	○	○	○	○	○	○	○	○	○	○	○	○	○	○	○	○	○	○
Heat resistant	○	○	○	○	○	○	○	○	○	○	○	○	○	○	○	○	○	○
Hard materials																		

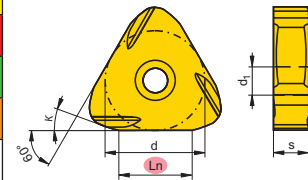

- Main application
- Extended application
- International CERATIZIT range, for present availability see price list

Ordering example: 50 pieces NNUX 201020S50-M40 CTC3110



# Inserts

## TNGT



Ln	ap max.	Type, description	CTC3110	CTC1110	CTC1115	CTC1125	CTC1130	CTC1135	CTC1635	CTC1640	CTC2135	H216T	s	K	d	d <sub>f</sub>	Cutting edges	
22	1	TNGT 220825S40-F50	●	●	●			●					8	25	19	8	3	
	Steel		○	●	●			●										
	Stainless			○	○			○										
	Cast iron		●	●	○													
	Non ferrous metals																	
	Heat resistant			○	○			○										
	Hard materials																	

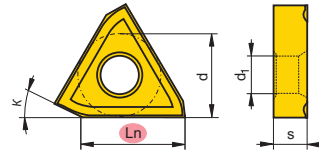

- Main application
- Extended application
- International CERATIZIT range, for present availability see price list

Ordering example: 50 pieces TNGT 220825S40-F50 CTC3110

# Tools and spare parts

In addition to a wide range of standard inserts CERATIZIT provides all spare parts which are necessary for bar peeling.

**Cutter heads with all spare parts for all common machines**

**Tool holders, with defined length and adjustable wedge**

- ▶ with integrated cartridge system
- ▶ with integrated insert seat

## Cartridges

- ▶ single cartridges
- ▶ tandem cartridges



## Spare parts

- ▶ clamps
- ▶ screws
- ▶ shims
- ▶ adjustment wedges

## Clamping parts

- ▶ locking taper
- ▶ clamping bolts

## Guide parts made of steel or carbide

- ▶ guide rolls
- ▶ guide axles
- ▶ guide wedges

# Single cartridges

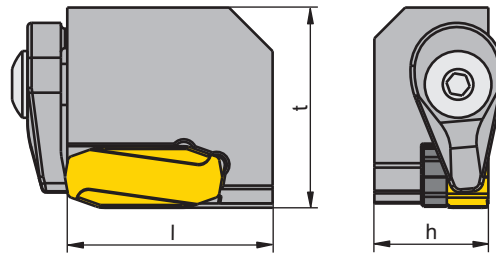
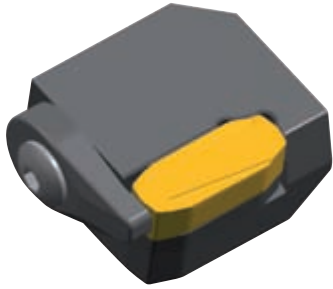

Type, description	l	t	h	Insert
CA00-YNUF17	40	39	22	YNUF 170820
CA00-YNUF20	43	39	22	YNUF 201220
CA00-YNUF27	50	39	22	YNUF 271220

Ordering example: 4 pieces CA00-YNUF17

Spare parts for cartridge	 Clamp	 Screw for clamp	 Shim	 Shim screw
CA00-YNUF17	SP-33-SK	7850300/M8x15R	10004090/HM-U YNUF1708	M4x10 ISO 10642
CA00-YNUF20	SP-33-SK	7850300/M8x15R	10004089/HM-U YNUF2012	M5x8 ISO 10642
CA00-YNUF27	SP-33-SK	7850300/M8x15R	10004088/HM-U YNUF2712	M5x8 ISO 10642

# Single cartridges

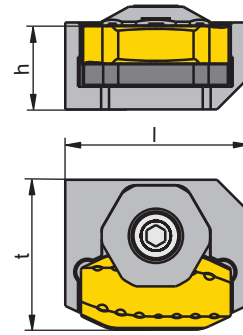
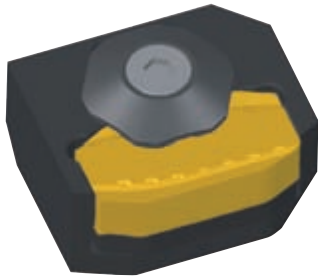

Type, description	l	t	h	Insert
CA00-LNGF2310	49	40	22	LNGF 231025
CA00-LNGF2312	49	40	22	LNGF 231225

Ordering example: 4 pieces CA00LNGF2310

Spare parts for cartridge	Clamp	Screw for clamp	Shim	Shim screw
CA00-LNGF2310	10004092-0/CF D38	M10x20 ISO 10642	10004176/HM-U LNGF 2310	M5x8 ISO 10642
CA00-LNGF2312	10004092-0/CF D38	M10x20 ISO 10642	10004177/HM-U LNGF 2312	M5x8 ISO 10642

# Single cartridges

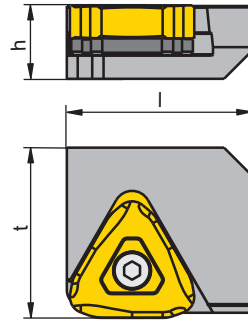
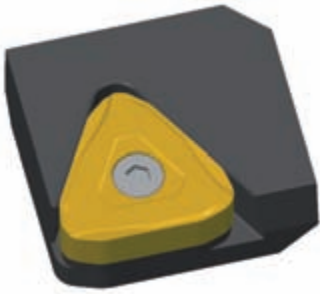

Type, description	l	t	h	Insert
CA40-NNUX20	55	45	28	NNUX 201020
CA40-NNXX20	55	58	29	NNXX 201020

Ordering example: 4 pieces CAXX-NNUX20

Spare parts for cartridge				
	Clamp	Screw for clamp	Shim	Insert clamping screw
CA40-NNUX20	–	–	10004986/HM-U NNUX 20	M6x25 ISO 10642
CA40-NNXX20	–	–	10004986/HM-U NNUX 20	M6x25 ISO 10642

# Single cartridges (on request)



Type, description	l	t	h	Insert
CAXX-WNEU1613	55	50	22	WNEU 161325
CAXX-WNEU1614	55	50	22	WNEU 161425

Ordering example: 4 pieces CAXX-WNEU1613

Spare parts for cartridge	Clamp	Screw for clamp	Shim	Insert clamping screw
CAXX-WNEU 1613	–	–	10001849/HM-U WNEU1613	8,0x20 SW5
CAXX-WNEU 1614	–	–	10004985/HM-U WNEU1614	8,0x20 SW5



# Single cartridges (on request)

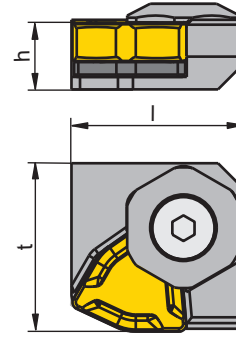
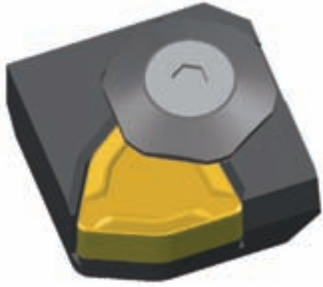

Type, description	l	t	h	Insert
CAXX-WNEF16	55	39	22	WNEF 161325

Ordering example: 4 pieces CAXX-WNEF16

Spare parts for cartridge	Clamp	Screw for clamp	Shim	Insert clamping screw
CAXX-WNEF16	10004092-0/CF D38	M10x20 ISO 10642	10001849/HM-U WNEU1613	-

# Tandem cartridges



Type, description	l	t	h	Roughing insert	$a_{p1}$ mm	Finishing insert	$a_{p2}$ mm
TCA12-RN50YN20	110	65	40	RNMH 5018MO	9	YNUF 201220	1,5
TCA10-RN50YN20	110	65	40	RNMH 5018MO	9	YNUF 201220	1,0
TCA12-RN38YN20	110	65	40	RNGH 381200	6	YNUF 201220	0,8
TCA12-RN38YN27	110	65	40	RNGH 381200	6	YNUF 271220	0,8

Ordering example: 4 pieces TCA12-RN50YN20





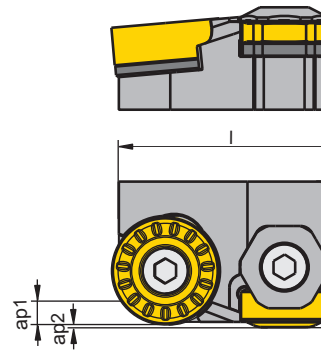

Spare parts for cartridge	 Shim	 Insert clamping screw	 Clamp	 Screw for clamp	 Shim	 Shim screw
TCA12-RN50YN20	10004093/ HSS-U RNMH50	M10x30 ISO 10642	10004092-0/ CF D38	M10x20 ISO 10642	10004089/ HM-U YNUF2012	M5x12 ISO 10642
TCA10-RN50YN20	10004093/ HSS-U RNMH50	M10x30 ISO 10642	10004092-0/ CF D38	M10x20 ISO 10642	10004089/ HM-U YNUF2012	M5x12 ISO 10642
TCA12-RN38YN20	10004459/ HSS-U RNMH38	M10x30 ISO 10642	10004092-0/ CF D38	M10x20 ISO 10642	10004089/ HM-U YNUF2012	M5x12 ISO 10642
TCA12-RN38YN27	10004459/ HSS-U RNMH38	M10x30 ISO 10642	10004092-0/ CF D38	M10x20 ISO 10642	10004088/ HM-U YNUF2712	M5x12 ISO 10642

# Tandem cartridges



Type, description	l	t	h	Roughing insert	$a_{p1}$ mm	Finishing insert	$a_{p2}$ mm
TCA12-RN50LN23	110	65	40	RNMH 5018MO	9	LNGF 231025	1,0

Ordering example: 4 pieces TCA12-RN50LN23



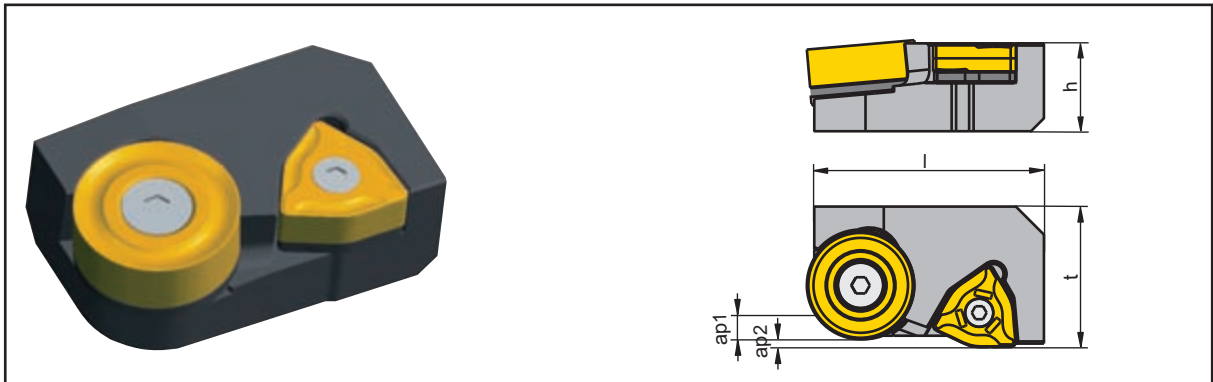

Spare parts for cartridge						
	Shim	Insert clamping screw	Clamp	Screw for clamp	Shim	Shim screw
TCA12-RN50LN23	10004093/ HSS-U RNMH50	M10x30 ISO 10642	10004092-0/ CF D38	M10x20 ISO 10642	10004176/ HM-U LNGF 2310	M5x12 ISO 10642

# Tandem cartridges



Type, description	l	t	h	Roughing insert	$a_{p1}$ mm	Finishing insert	$a_{p2}$ mm
TCA12-RN50WN16	112	65	40	RNMH 5018MO	9	WNEU 161325	3,5

Ordering example: 4 pieces TCA12-RN50WN16

Spare parts for cartridge			Clamp	Shim screw		
	Shim	Insert clamping screw			Shim	Insert clamping screw
TCA12-RN50WN16	10004093/ HSS-U RNMH50	M10x30 ISO 10642	-	-	10001849/HM-U WNEU1613	8,0x30 SW5

# Tandem cartridges

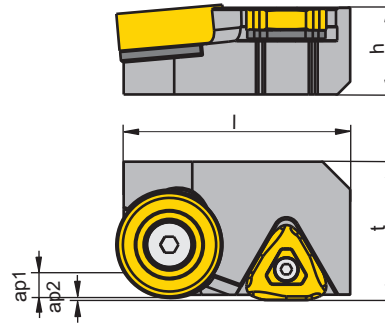
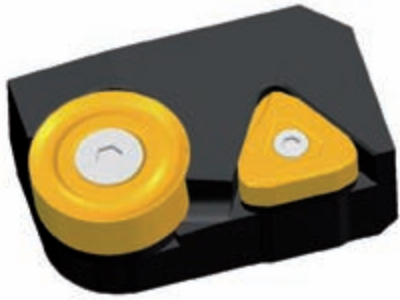

Type, description	l	t	h	Roughing insert	$a_{p1}$ mm	Finishing insert	$a_{p2}$ mm
TCA12-RN50NN20	110	65	40	RNMH 5018MO	9	NNUX 201020	1,0

Ordering example: 4 pieces TCA12-RN50NNU20

Spare parts for cartridge						
	Shim	Insert clamping screw	Clamp	Shim screw	Shim	Insert clamping screw
TCA12-RN50NNU20	10004093/ HSS-U RNMH50	M10x30 ISO 10642	-	-	10004986/ HM-U NNUX 20	M6x20 ISO 10642

# Heads, tools and spare parts (on request)

➔ CERATIZIT offers a comprehensive range of heads and tools manufactured to model or drawing for all machine types.

## Cutter heads, tools and cartridges



Cutter heads



Tool holders



Cartridges

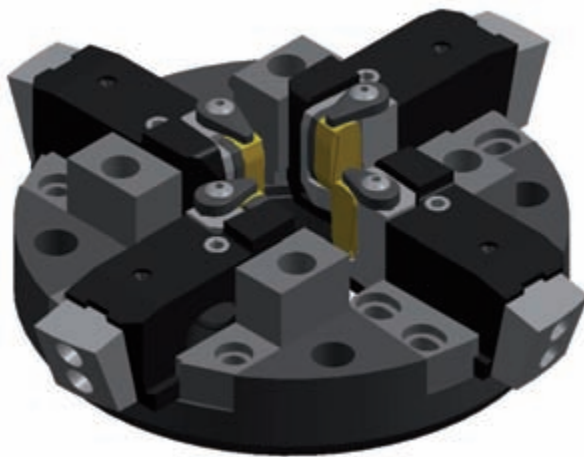

Cutter heads



Tool holders



# Heads, tools and spare parts (on request)

## Spare parts



Clamping bolts



Adjustment wedges



Locking tapers



Guide and clamping wedges

## Guide parts



Guide parts

M 12 x 1.75

26

20



Roll holders

# Machining example



**Work piece:** bar  
**Material:** alloyed steels  
**Batch:** 1200 bars  
**Criteria:** higher productivity, reduced costs with the appropriate insert

## Tooling system

	Present situation	Recommendation
<b>Insert</b>	WNGG 151015	WNEU 161325
<b>Grade</b>	CTC1135	CTC1125
<b>Costs for inserts</b>	1.130	1.700

## Cutting data

<b>Revolution n [1/min]</b>	60	64
<b>Feed rate f [mm/rev.]</b>	5,8	7,8

## Result

<b>Tool changes</b>	600	400
<b>Machining time [min/bar]</b>	17,24	12,02
<b>Costs to machine the entire batch (euro)</b>	50.612	35.738
<b>Cost saving</b>	14.874 (29%)	

# Success Stories



**Work piece:** bar  
**Material:** alloyed steel  
**Criteria:** increase productivity

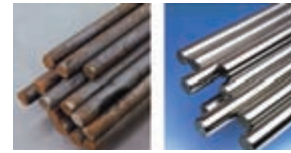

	Competitor	CERATIZIT
Insert	YNUF ...	YNUF 201220
Grade		CTC3110
Cutting speed	100 m/min	175 m/min
Feed rate	5 m/min	9 m/min

**Result with CERATIZIT: higher productivity thanks to higher cutting data**



**Work piece:** bar  
**Material:** titanium  
**Criteria:** surface quality and feed rate



	Competitor	CERATIZIT
Insert	WNEU ...	WNEU 161325
Grade	K15	H216T
Cutting speed	6,8 m/min	6,8 m/min
Feed rate	2,2 mm/rev.	2,7 mm/rev.

**Result with CERATIZIT: increase of feed rate up to 30% with improved surface quality**



**Work piece:** bar  
**Material:** stainless, tool steel, alloyed steels  
**Criteria:** one insert for all applications



	Competitor	CERATIZIT
Insert	RNGH 38...	RNGH 381200
Grade	P35 + P25	CTC1635
Cutting speed	45-100 m/min	45-100 m/min
Feed rate	12-16 mm/rev.	12-16 mm/rev.

**Result with CERATIZIT: one CERATIZIT grade is able to peel all materials (instead of two grades which were necessary with the competition). Stock reduction and more productivity due to reduced number of tool changes.**

# Trouble shooting

Problem	Possible causes	Solution
<b>Bar out of round/ irregular</b>	Inserts not on the same circumference	Adjust cartridge, check insert tolerance, use ground insert
	Bar feeds out of centre	Check position of guide rolls
	Large variety of unmachined material	Check deviations
<b>Steps on the surface (saw-teeth pattern)</b>	Secondary cutting edge of one or more inserts not parallel to axis of bar	Check and adjust the position of the secondary cutting edge
	Feed per revolution larger than length of secondary cutting edge	Reduce feed per revolution
	Incorrect clamping (dirt in insert seat)	Check and clean clamping and seat
<b>Poor chip formation</b>	Insufficient feed	Increase feed
	Incorrect chip groove	Check chip groove selection
	Insufficient coolant	Increase coolant supply
<b>Vibration marks</b>	Incorrect chamfer	Check chamfer size
	Secondary cutting edge too sharp	Use honed cutting edge
	Cutting edge is too far below centre	Check centre height
	Guide rolls or support pads incorrectly adjusted	Check and readjust
<b>Different wear patterns of inserts</b>	Tools incorrectly adjusted (one insert works at larger depth of cut than another)	Check alignment and readjust
<b>Edge chipping</b>	Incorrect edge condition	Increase chamfer width and angle
	Feed per revolution too high	Decrease feed per revolution
	Edge honing too small	Use inserts with larger honing
	Incorrect grade applied	Use tougher grade

# Formulas for bar peeling

## Cutting speed [m/min]

$$v_c = \frac{d_1 \cdot \pi \cdot n}{1000}$$

## Revolutions of spindle [rev/min]

$$n = \frac{v_c \cdot 1000}{d_1 \cdot \pi}$$

## Feed [mm/rev.]

$$f = \frac{V_f}{n}$$

## Feed rate [m/min]

$$v_f = f \cdot n$$

## Chip removal rate [cm<sup>3</sup>/min]

$$Q = a_p \cdot f \cdot v_c$$

## Calculation example:

Insert: YNUF 271220S50-M50  
CTC1130

Bar diameter: Ø 77 mm

Depth of cut ( $a_p$ ): 1 mm

Feed per rev. (f): 22 mm/rev.

Chosen cutting  
speed ( $V_c$ ): 160 m/min

## Calculation of rev. number:

$$n = \frac{160 \cdot 1000}{77 \cdot \pi} = 661 \text{ (1/min)}$$

## Calculation of feed rate:

$$v_f = 22 \cdot 661 = 14542 \text{ mm/min} \\ = 14,5 \text{ m/min}$$

## Calculation of chip removal rate:

$$Q = 1 \cdot 22 \cdot 160 = 3520 \text{ (cm}^3\text{/min)}$$



The CERATIZIT  
formula collection

Free download from [www.ceratizit.com](http://www.ceratizit.com)

# Hardness values

## Comparison table

Tensile strength N/mm <sup>2</sup>	Vickers HV	Brinell HB	Rockwell HRC	Shore C	Tensile strength N/mm <sup>2</sup>	Vickers HV	Brinell HB	Rockwell HRC	Shore C
255	80	76	—	—	880	275	261	26,4	34
270	85	80,7	—	—	900	280	268	27,1	—
285	90	85,5	—	—	915	285	271	27,8	35
305	95	90,2	—	—	930	290	276	28,5	—
320	100	95	—	—	950	295	280	29,2	36
335	105	99,8	—	—	965	300	285	29,8	37
350	110	105	—	—	995	310	295	31,0	38
370	115	109	—	—	1030	320	304	32,2	39
385	120	114	—	—	1060	330	314	33,3	40
400	125	119	—	—	1095	340	323	34,3	41
415	130	124	—	—	1125	350	333	35,5	42
430	135	128	—	—	1155	360	342	36,6	43
450	140	133	—	—	1190	370	352	37,7	44
465	145	138	—	—	1220	380	361	38,8	45
480	150	143	—	—	1255	390	371	39,8	46
495	155	147	—	—	1290	400	380	40,8	47
510	160	152	—	—	1320	410	390	41,8	48
530	165	156	—	—	1350	420	399	42,7	—
545	170	162	—	—	1385	430	409	43,6	49
560	175	166	—	—	1420	440	418	44,5	—
575	180	171	—	—	1455	450	428	45,3	51
595	185	176	—	—	1485	460	437	46,1	52
610	190	181	—	—	1520	470	447	46,9	53
625	195	185	—	—	1555	480	465	47,7	54
640	200	190	12,0	—	1595	490	466	48,4	—
660	205	195	13,0	—	1630	500	475	49,1	57
675	210	199	14,0	—	1665	510	485	49,8	58
690	215	204	15,0	—	1700	520	494	50,5	59
705	220	209	15,5	28	1740	530	504	51,1	60
720	225	214	16,0	—	1775	540	513	51,7	61
740	230	219	17,0	29	1810	550	523	52,3	62
755	235	223	18,0	—	1845	560	532	53,0	63
770	240	228	20,3	30	1880	570	542	53,6	64
785	245	233	21,3	—	1920	580	551	54,1	65
800	250	238	22,2	31	1955	590	561	54,7	66
820	255	242	23,1	32	1995	600	570	55,2	67
835	260	247	24,0	33	2030	610	580	55,7	68
850	265	252	24,8	—	2070	620	589	56,3	69
865	270	257	25,6	—	2105	630	599	56,8	70



# CERATIZIT – worldwide

## CERATIZIT – worldwide

- Production sites in the three big economic areas with a worldwide network of CERATIZIT sales and support engineers plus many CERATIZIT distribution partners guarantee customer vicinity.
- We maintain the dialogue with our customers and strive for long-term partnerships.

Find your personal distribution partner at:

[www.ceratizit.com](http://www.ceratizit.com)

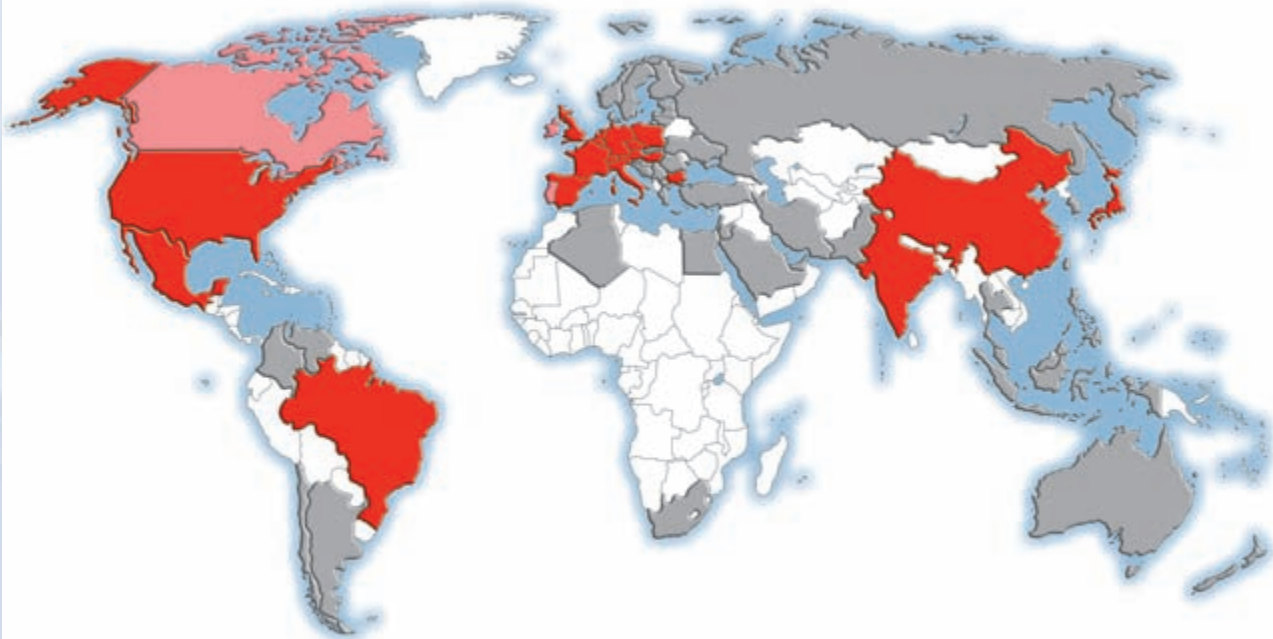

- CERATIZIT worldwide production sites and support centres
- CERATIZIT worldwide sales centres
- CERATIZIT worldwide distribution partner network

## Headquarters: CERATIZIT S.A.

Parent company in Luxembourg

CERATIZIT Luxembourg Sàrl  
Route de Holzem 101, B.P. 51  
L-8201 Mamer

Tel.: +352 312 085-1

Fax: +352 311 911

E-mail: [info@ceratizit.com](mailto:info@ceratizit.com)

[www.ceratizit.com](http://www.ceratizit.com)



174

[www.ceratizit.com](http://www.ceratizit.com) - just a click.



hard material matters



174 EN 06.08  
7000442

We reserve the right to make technical changes  
for improvement of the product.