



CUTTING SOLUTIONS FOR MAXIMUM ECONOMY

Kits for Milling and Turning



Maximum economy starts here.

CERATIZIT supports your productivity and service life goals. It's what we do. So if you're looking for better ways to get more done, go to the Product Index starting on page 40 and choose the right kit, inserts and accessories for your operation.

**SAVE
UP TO \$100
on every kit you buy!**

Each kit contains one holder and ten inserts.

All of the tools for milling and turning are right here, in more than 650 combinations, with complete technical information and all the support you need.

Call Customer Service at 800-783-2280 to order today, and be sure to have your reference number handy.

NOTE: KEEP THIS CATALOG for future reference and ordering.



CERATIZIT - A world of innovation

CERATIZIT is:

- Your reliable single source for unique solutions in cutting tools, solid rod, wear component, and wood and stone applications
- World renowned for exceptional products optimized for hard-to-machine materials and your equipment parameters
- Working to invent new solutions for the challenges of tomorrow

We consistently develop innovative solutions in carbide that increase productivity, expand technical possibilities, improve product quality and take economic feasibility to a whole new level.

Extreme tools for extreme materials.

We tailor the material properties of CERATIZIT cutting tools using a special powder metallurgical process. The result: carbide grades with outstanding wear and heat resistance under extreme conditions common with difficult-to-machine materials.

Productivity is our product.

Our business is increasing the productivity and service life of everything we touch. That's why CERATIZIT products can guarantee cost efficiency, wear resistance and reliable performance every day.

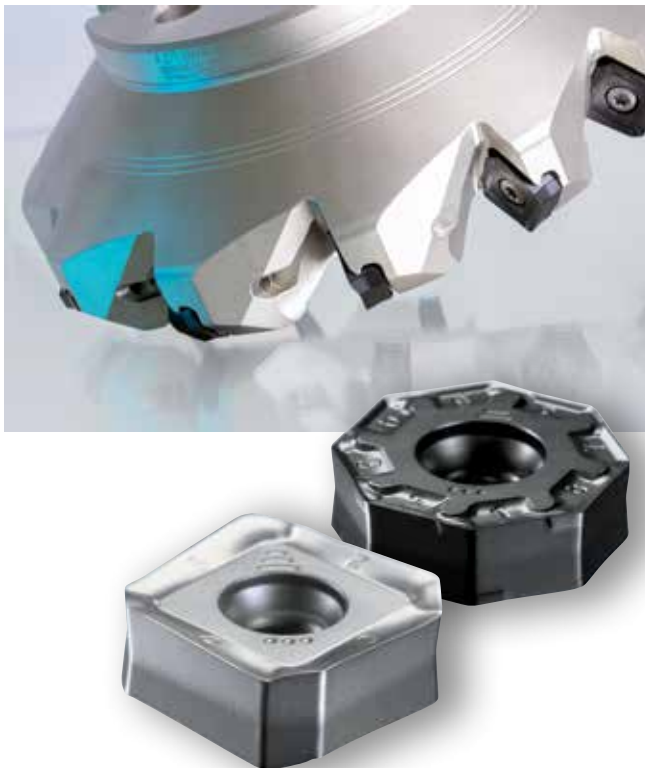

Contents

PRODUCTS	PAGE
Milling grade range	4
The CERATIZIT Designation System for cutting materials	6
Milling Cutters	8
Performance Features	9
A211/C211	9
Milling Inserts	10
Performance Features	11
A211/C211	11
A251	12
A271	12
A273	13
A274	13
AHFC	14
CHFC	14
The CERATIZIT Designation System for chip grooves	16
Technical Information - Cutting Data - Milling	17
Turning Holders	24
C Style	25
D Style	25
V Style	25
W Style	25
Turning Inserts	26
CNMG	27
DNMG	28
VNMG	29
WNMG	30
Technical Information	
Grade Overview - Turning	32
Cutting Data - Turning	34
Chip Grooves - Turning	36
Product Index / Kit Pricing	40
Milling Cutters and Inserts	41
Tool Holders - C Style	48
Tool Holders - D Style	50
Tool Holders - V Style	51
Tool Holders - W Style	52



Introduction

The new CERATIZIT grade universe



The new CERATIZIT grade universe

As one of the most competent partners when it comes to cutting tools technology, CERATIZIT continually optimises and revises the grade range for milling, drilling, turning, parting and grooving.

The universe

Within the universe, several galaxies represent the applications (milling, turning, drilling, parting and grooving). Every galaxy then consists of single solar systems. Each of these systems contains their own solutions for special requirements. Immersing ourselves deeper into the planetary systems, and taking a closer look at the planets, they reveal themselves as our unique grade coatings – the “Stars.”

The ‘STARS’

Each of the STARS is easily recognisable by the colour of its coating and shows its strengths in the machining of specific materials and in determined applications.

SILVERSTAR™

For high cutting performance in interrupted cutting actions, or with difficult-to-machine materials, SILVERSTAR™ grades are the first choice.

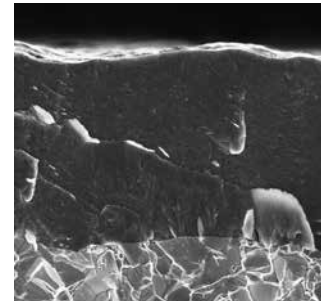

BLACKSTAR™

The BLACKSTAR™ grades are highly wear-resistant thanks to their TiN/TiCN/Al₂O₃ coatings. Due to their excellent adhesion, these coatings are particularly suitable for the machining of steel and cast iron.

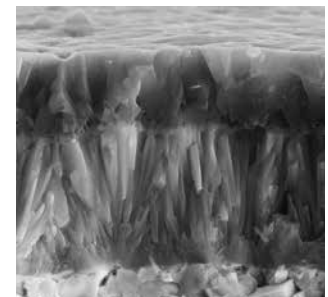



Complete range for ISO application ranges P, M, K and S

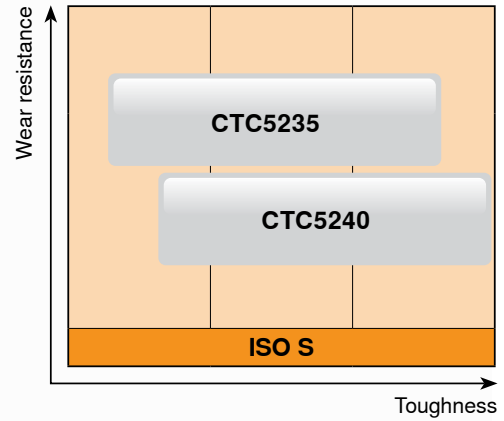
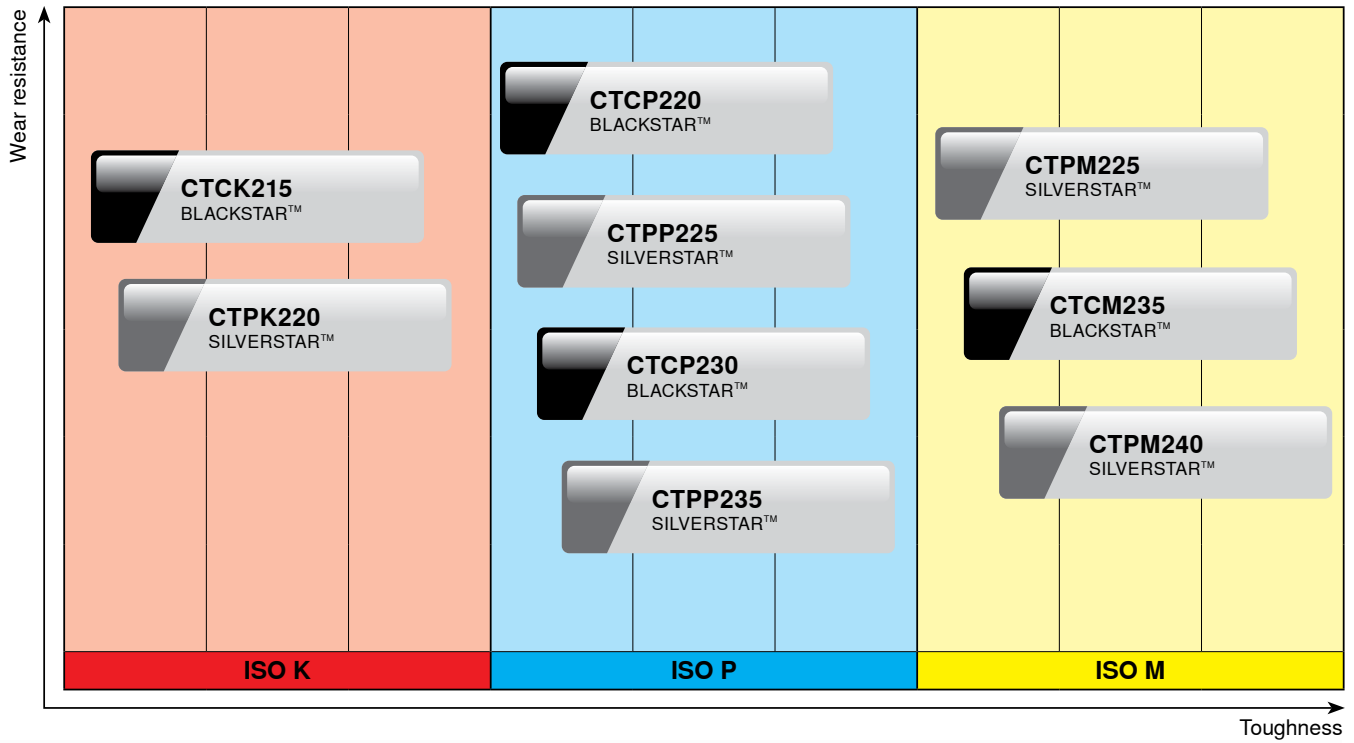



CTC P435



1 Manufacturer: CERATIZIT

2 Cutting material

W Uncoated carbide
 C CVD coated carbide
 P PVD coated carbide
 T Uncoated cermet
 E Coated cermet
 N Uncoated silicon nitride
 M Coated silicon nitride
 S Mixed ceramic
 I Sialon
 D PCD
 B CBN
 L CBN coated
 H Sintered HSS

3 Main application (material) Variant 1: number

1 Steel
 2 Stainless steel
 3 Cast iron
 4 Light and non ferrous metals, non metals
 5 Heat resistant alloys, titanium
 6 Hard materials
 7 Universal grade for a variety of applications

Main application (material) Variant 2: ISO letter

P Steel
 M Stainless steel
 K Cast iron
 N Light and non ferrous metals, non metals
 S Heat resistant alloys, titanium
 H Hard materials
 X Universal grade for a variety of applications

4 Main application (machining method)

1 Turning
 2 Milling
 3 Parting and grooving
 4 Drilling
 5 Threading
 6 Others
 7 Universal grade for a variety of applications

5 ISO 513 Application range

For example:
 05
 10
 15
 25
 35 ISO P35
 .
 .
 .



Your productivity is our passion.
Consider CERATIZIT your
resource for a universe of technical
knowledge to make your operation
more profitable.

So if you don't find what you're
looking for in this catalog, feel free
to call us with questions or technical
challenges.

Need something custom?

Call us – 800-783-2280.

Developing solutions is what
we do.





MaxiMill Cutters

MaxiMill cutters are engineered for exceptional balance, extended tool life, maximum chip-removal rates and the ultimate in milling productivity. With up to 16 cutting edges and a wide range of application-specific benefits, MaxiMill tools are in high demand around the world.





PERFORMANCE FEATURES

- ▲ Specially formulated, high-strength tool materials work longer with reliability
- ▲ State-of-the-art multilayered CVD and PVD coatings resist wear and heat, even in severe applications
- ▲ Optimized geometries for greater stability and smoother, quieter machining
- ▲ Innovative TorxPlus clamping screws keep inserts securely in place
- ▲ Advanced designs maximize performance

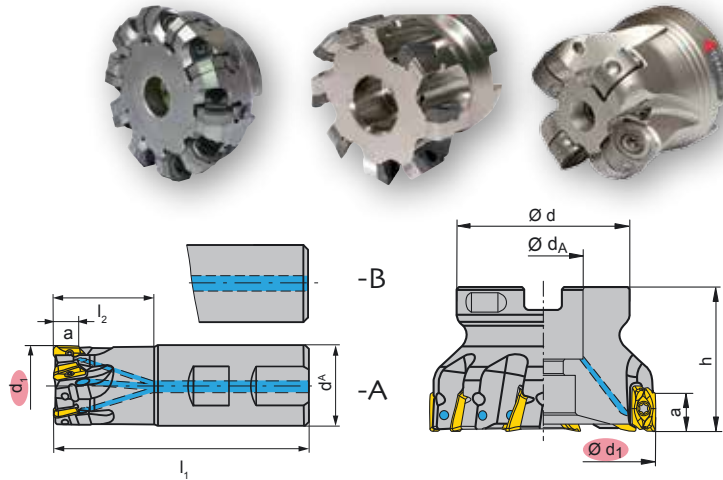

Milling Cutters - A211, C211, A251, A271, A273, A274, AHFC, CHFC

Type, description	d ₁ [inch]	h [inch]	d [inch]	l ₁ [inch]	l ₂ [inch]	d _A [inch]	a [inch]	z	n _{max} [RPM]	
A211.200.R.05-11-A075-175-EF	1.75	1.75	1.75			.750	.394	5	25,400	XD.. 11..
A211.250.R.06-11-A100-200-EF	2.00	2.25	2.25			1.000	.394	6	23,300	XD.. 11..
A211.300.R.07-11-A100-200-EF	2.00	2.25	2.25			1.000	.394	7	21,300	XD.. 11..
A211.400.R.08-11-B125-200-EF	2.00	2.75	2.75			1.250	.394	8	19,600	XD.. 11..
C211.0625.R.02-11-B-100-EF	.625			3.25	2.00	.625	.394	2	42,000	XD.. 11..
C211.0750.R.03-11-B-100-EF	.750			3.50	1.00	.750	.394	3	36,900	XD.. 11..
C211.100.R.04-11-B-125-EF	1.000			3.50	1.25	1.000	.394	4	33,200	XD.. 11..
C211.125.R.05-11-B-150-EF	1.250			3.75	1.50	1.000	.394	5	30,200	XD.. 11..
A251.150.R.05-10-A050-175-RS-EF	1.106	1.75	1.42			.500	.197	5	15,900	RP.. 10..
A251.200.R.06-10-A075-175-RS-EF	1.606	1.75	1.75			2.000	.197	6	12,700	RP.. 10..
A251.250.R.06-12-A100-200-RS-EF	2.028	2.00	2.25			1.000	.236	6	10,100	RP.. 12..
A251.300.R.07-12-RS-A100-200-EF	2.528	2.00	2.25			1.000	.236	7	7,950	RP.. 12..
A271.200.R.04-17-A075-175-EF	2.000	1.75	1.75			.750	.330	4	14,300	SA.. 17..
A271.300.R.07-17-A100-200-EF	3.000	2.00	2.25			1.000	.330	7	11,500	SA.. 17..
A271.400.R.08-17-B125-200-EF	4.000	2.00	2.75			1.250	.330	8	9,800	SA.. 17..
A271.500.R.10-17-B150-200-EF	5.000	2.00	3.75			1.500	.330	10	8,700	SA.. 17..
A273.200.R.05-06-A075-175-EF	2.400	1.75	1.75			.750	.138	5	14,800	OA/XA.. 0605..
A273.250.R.07-06-A100-200-EF	2.900	2.00	2.25			1.000	.138	7	13,000	OA/XA.. 0605..
A273.300.R.08-06-A100-200-EF	3.400	2.00	2.25			1.000	.138	8	11,800	OA/XA.. 0605..
A273.400.R.10-06-B125-200-EF	4.400	2.00	2.75			1.250	.138	10	10,100	OA/XA.. 0605..
A273.500.R.12-06-B150-200-EF	5.400	2.00	3.75			1.500	.138	12	8,900	OA/XA.. 0605..
A274.200.R.04-12-A075-175-EF	2.000	1.75	1.75			.750	.126	4	18,900	OF.. 05..
A274.250.R.05-12-A100-200-EF	2.500	2.80	2.19			1.000	.126	5	16,700	OF.. 05..
A274.300.R.06-12-A100-200-EF	3.000	2.00	2.19			1.000	.126	6	15,200	OF.. 05..
A274.400.R.07-12-A125-200-EF	4.000	2.00	2.75			1.250	.126	7	13,000	OF.. 05..
AHFC.200.R.04-12-A075-175-EF	2.00	1.75	1.75			.750	.079	4	18,800	XO.. 12..
AHFC.250.R.05-12-A100-200-EF	2.50	2.00	1.75			1.000	.079	5	16,400	XO.. 12..
AHFC.300.R.07-12-A100-200-EF	4.00	2.00	2.25			1.000	.079	7	14,000	XO.. 12..
AHFC.400.R.08-12-A125-200-EF	4.00	2.00	2.75			1.250	.079	8	12,000	XO.. 12..
CHFC.0625.R.02-06-B-150-EF	.625			3.50	1.50	.625	.031	2	18,100	XP.. 06..
CHFC.0750.R.03-06-B-200-EF	.750			4.20	2.00	.750	.031	3	14,100	XP.. 06..
CHFC.100.R.04-06-B-200-EF	1.000			4.40	2.00	1.000	.031	4	15,400	XP.. 06..
CHFC.125.R.05-06-B100-250-EF	1.250			4.90	2.50	1.000	.031	5	10,700	XP.. 06..

Save up to \$100 on every kit you buy! (Kits include one holder and ten inserts.)



Milling inserts

Get quieter machining, improved surface quality and more productivity with MaxiMill inserts. CERATIZIT inserts feature light-cutting geometries and a unique notch design for superior stability and performance. Our galaxy of grades – SILVERSTAR™, BLACKSTAR™ AND COLORSTAR™ – protects against premature wear and extreme temperatures. Your work pieces and the cutting zone have never been in better hands.





PERFORMANCE FEATURES

- ▲ Wide selection of material grades, cutting edge designs, chip grooves and radii for any application
- ▲ Light-cutting geometries and a unique notch design for greater performance
- ▲ Maximum stability in cutter for extended tool life, improved surface quality in pockets and slots
- ▲ High chip removal rates with optimized FEM chip pocket and an assortment of chip breaker designs
- ▲ Available with integrated Masterfinish edge



P					●	
M			●			
K	●					
N						
S		●				●
H						

Milling Inserts - A211/C211

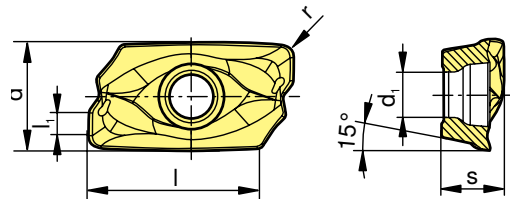

	CTCK215	CTC5235	CTCM235	CTPM240	CTPP235	CTC5240	Machining	d [inch]	l [inch]	s [inch]	l _i [inch]	r [inch]	d ₁ [inch]
XDKT 11T304SR-M50	●						Medium	.268	.417	.150	.071	.016	.110
XDKT 11T308SR-M50	●						Medium	.268	.417	.150	.055	.031	.110
XDKT 11T308SR-R50	●						Roughing	.268	.417	.150	.055	.031	.110
XDKT 11T304ER-F40		●					Finishing	.268	.417	.150	.067	.016	.110
XDKT 11T308ER-F40		●					Finishing	.268	.417	.150	.055	.031	.110
XDKT 11T308SR-F50		●					Finishing	.268	.417	.150	.055	.031	.110
XDKT 11T308SR-F50			●				Finishing	.268	.417	.150	.055	.031	.110
XDKT 11T308SR-M50			●				Medium	.268	.417	.150	.055	.031	.110
XDKT 11T308SR-R50			●				Roughing	.268	.417	.150	.055	.031	.110
XDKT 11T304SR-F50					●		Finishing	.268	.417	.150	.071	.016	.110
XDKT 11T304SR-M50					●		Medium	.268	.417	.150	.071	.016	.110
XDKT 11T304SR-R50					●		Roughing	.268	.417	.150	.071	.016	.110
XDKT 11T308SR-F50					●		Finishing	.268	.417	.150	.055	.031	.110
XDKT 11T308SR-M50					●		Medium	.268	.417	.150	.055	.031	.110
XDKT 11T308SR-R50					●		Roughing	.268	.417	.150	.055	.031	.110
XDKT 11T304ER-F40						●	Finishing	.268	.417	.150	.067	.016	.110
XDKT 11T308ER-F40						●	Finishing	.268	.417	.150	.055	.031	.110
XDKT 11T308SR-F50						●	Finishing	.268	.417	.150	.055	.031	.110

For more information or to order, call Customer Service at 800-783-2280. Have your reference number handy.



Milling inserts

P						●
M			●	●		
K	●					
N						
S	●					●
H						

	CTCK215	CTC5235	CTCM235	CTPM240	CTPP235	CTC5240
CTCK215						
CTC5235						
CTCM235						
CTPM240						
CTPP235						
CTC5240						

		Machining	d [inch]	s [inch]	d ₁ [inch]
RPHX 10T3MOSN	●	Medium	.394	.156	.134
RPHX 1204MOSN	●	Medium	.472	.187	.173
RPHX 10T3M8EN-M31	●	Medium	.394	.156	.134
RPHX 1204M8EN-M31	●	Medium	.472	.187	.173
RPHX 1204MOEN-M30	●	Medium	.472	.187	.173
RPHX 1204MOSN-F50	●	Finishing	.472	.187	.173
RPHX 10T3MOEN-M30	●	Medium	.394	.156	.134
RPHX 10T3MOSN-F50	●	Finishing	.394	.156	.134
RPHX 1204MOEN-M30	●	Medium	.472	.187	.173
RPHX 10T3MOEN-M30	●	Medium	.394	.156	.134
RPHX 10T3MOSN-M50	●	Medium	.394	.156	.134
RPHX 1204MOSN-F50	●	Finishing	.472	.187	.173
RPHX 10T3M4EN-M31	●	Medium	.394	.156	.134
RPHX 10T3M8EN-M31	●	Medium	.394	.156	.134
RPHX 1204M4EN-M31	●	Medium	.472	.187	.173
RPHX 1204M8EN-M31	●	Medium	.472	.187	.173

Milling Inserts A251

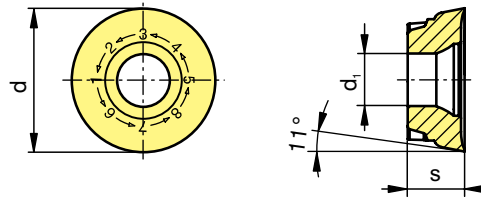

P						●
M			●			
K	●					
N						
S	●					●
H						

	CTCK215	CTC5235	CTCM235	CTPM240	CTPP235	CTC5240
CTCK215						
CTC5235						
CTCM235						
CTPM240						
CTPP235						
CTC5240						

		Machining	d [inch]	l [inch]	s [inch]	l ₁ [inch]	r [inch]	d ₁ [inch]
SAKU 1706ABSR-M50	●	Medium	.670	.670	.250	.146	.031	.228
SAKU 1706ABSR-R50	●	Roughing	.670	.670	.250	.146	.031	.228
SAKU 1706ABSR-F50	●	Finishing	.670	.670	.250	.146	.031	.228
SAKU 1706ABSR-F50	●	Finishing	.670	.670	.250	.146	.031	.228
SAKU 1706ABSR-M50	●	Medium	.670	.670	.250	.146	.031	.228
SAKU 1706ABSR-F50	●	Finishing	.670	.670	.250	.146	.031	.228
SAKU 1706ABSR-M50	●	Medium	.670	.670	.250	.146	.031	.228
SAKU 1706ABSR-F50	●	Finishing	.670	.670	.250	.146	.031	.228

Milling Inserts A271

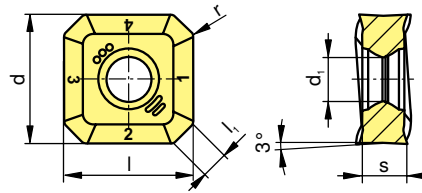



P						●
M			●			
K	●					
N						
S	●					●
H						

Milling Inserts A273

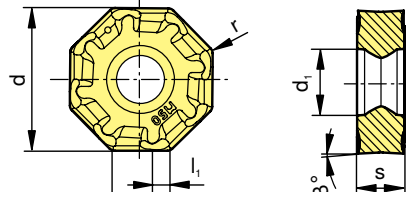

	CTCK215	CTC5235	CTCM235	CTPM240	CTPP235	CTC5240	Machining	d [inch]	l [inch]	s [inch]	l ₁ [inch]	r [inch]	d ₁ [inch]
OAKU 060508SR-M50	●						Medium	.676	.236	.219	.079	.031	.228
OAKU 060508SR-R50	●						Roughing	.676	.236	.219	.079	.031	.228
OAKU 060508ER-F40		●					Finishing	.676	.236	.219	.079	.031	.228
OAKU 060508SR-F50			●				Finishing	.676	.236	.219	.079	.031	.228
OAKU 060508SR-M50			●				Medium	.676	.236	.219	.079	.031	.228
OAKU 060508SR-F50					●		Finishing	.676	.236	.219	.079	.031	.228
OAKU 060508SR-M50					●		Medium	.676	.236	.219	.079	.031	.228
OAKU 060508ER-F40						●	Finishing	.676	.236	.219	.079	.031	.228

P						●
M			●			
K	●					
N						
S	●					●
H						

Milling Inserts A274

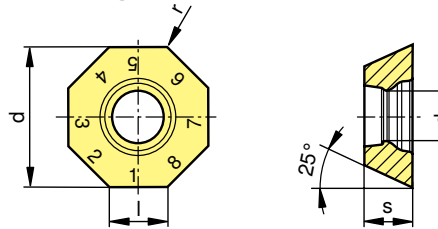

	CTCK215	CTC5235	CTCM235	CTPM240	CTPP235	CTC5240	Machining	d [inch]	l [inch]	s [inch]	r [inch]	d ₁ [inch]
OFHT 040305SN-M50	●						Medium	.375	.155	.125	.020	.132
OFHT 040305SN-F50		●					Finishing	.375	.155	.125	.020	.132
OFHT 050410SN-F50		●					Finishing	.500	.346	.187	.039	.187
OFHT 040305SN-F50			●				Finishing	.375	.155	.125	.020	.132
OFHT 050410SN-F50			●				Finishing	.500	.346	.187	.039	.187
OFHT 040305SN-F50					●		Finishing	.375	.155	.125	.020	.132
OFHT 040305SN-M50					●		Medium	.375	.155	.125	.020	.132
OFHT 050410SN-F50					●		Finishing	.500	.346	.187	.039	.187
OFHT 040305SN-F50						●	Finishing	.375	.155	.125	.020	.132

Save up to \$100 on every kit you buy! (Kits include one holder and ten inserts.)



Milling inserts

Milling Inserts AHFC

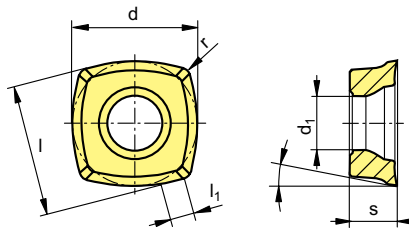

	P	M	K	N	S	H		Machining	d [inch]	l [inch]	s [inch]	l ₁ [inch]	r [inch]	d ₁ [inch]
							CTCK215	Medium	.500	.472	.187	.087	.039	.217
							CTC5235	Finishing	.500	.472	.187	.087	.039	.217
							CTCM235	Medium	.500	.472	.187	.087	.039	.217
							CTPM240	Medium	.500	.472	.187	.087	.039	.217
							CTPP235	Roughing	.500	.472	.187	.087	.039	.217
							CTC5240	Finishing	.500	.472	.187	.087	.039	.217
XOLX 120410SR-M50							CTCK215	Medium	.500	.472	.187	.087	.039	.217
XOLX 120410ER-F40							CTC5235	Finishing	.500	.472	.187	.087	.039	.217
XOLX 120410SR-M50							CTCM235	Medium	.500	.472	.187	.087	.039	.217
XOLX 120410SR-M50							CTPM240	Medium	.500	.472	.187	.087	.039	.217
XOLX 120410SR-R50							CTPP235	Roughing	.500	.472	.187	.087	.039	.217
XOLX 120410ER-F40							CTC5240	Finishing	.500	.472	.187	.087	.039	.217

Milling Inserts CHFC

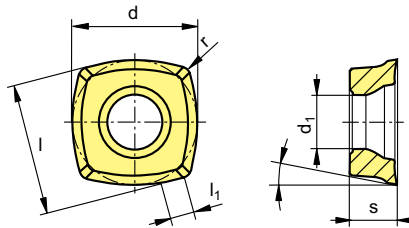

	P	M	K	N	S	H		Machining	d [inch]	l [inch]	s [inch]	l ₁ [inch]	r [inch]	d ₁ [inch]
							CTCK215	Medium	.250	.236	.108	.041	.020	.110
							CTC5235	Finishing	.250	.236	.108	.041	.020	.110
							CTCM235	Medium	.250	.236	.108	.041	.020	.110
							CTPM240	Medium	.250	.236	.108	.041	.020	.110
							CTPP235	Medium	.250	.236	.108	.041	.020	.110
							CTC5240	Finishing	.250	.236	.108	.041	.020	.110
XPLX 060305SR-M50							CTCK215	Medium	.250	.236	.108	.041	.020	.110
XPLX 060305ER-F40							CTC5235	Finishing	.250	.236	.108	.041	.020	.110
XPLX 060305SR-M50							CTCM235	Medium	.250	.236	.108	.041	.020	.110
XPLX 060305SR-M50							CTPM240	Medium	.250	.236	.108	.041	.020	.110
XPLX 060305ER-F40							CTPP235	Medium	.250	.236	.108	.041	.020	.110
XPLX 060305ER-F40							CTC5240	Finishing	.250	.236	.108	.041	.020	.110





The CERATIZIT Designation System

for chip grooves

F 50



1 Corner angle

2 Cutting edge type

Milling

Cutting data

Code	Cutting edge type		
	sharp 10 ● 20	medium 30 ●● 40	robust 50 ●●● 60
Fine machining F	27P F10 F20 	F40 	F50 M31
Medium machining M		33 33P M30 M32 29M 31 	M50 29
Rough machining R		R30 	29R R50 R60

- P Steel
- M Stainless steel
- K Cast iron
- N Non-ferrous metals
- S Difficult to machine materials
- H Hard materials



1 Main application

2 Extended application

Example:

OFHT 040305SN-M50





	V_c [sfm]	f_z [inch]	a_p [inch]	V_c [sfm]	f_z [inch]	a_p [inch]	V_c [sfm]	f_z [inch]	a_p [inch]	
MaxiMill 211-07				211-11						
	197 - 984	.002 - .004	.008 - .240	197 - 1148	.002 - .008	.008 - .380				
	130 - 722	.002 - .004	.008 - .240	130 - 820	.002 - .008	.008 - .380				
	230 - 9840	.002 - .004	.008 - .240	230 - 1148	.002 - .008	.008 - .380				
	-	-	-	656 - 9840	.004 - .100	.008 - .380				
	97 - 328	.002 - .002	.008 - .140	110 - 261	.002 - .006	.080 - .160				
	-	-	-	97 -	.002 - .006	.020 - .156				
MaxiMill 211-15				211-15K				211-20		
	238 - 1148	.002 - .014	.040 - .540	394 - 984	.002 - .014	≤ a	492 - 984	.005 - .016	≤ a	
	492 - 820	.002 - .014	.040 - .540	492 - 656	.002 - .014	≤ a	492 - 820	.005 - .014	≤ a	
	361 - 1148	.002 - .014	.040 - .540	3302 - 984	.002 - .014	≤ a	-	-	-	
	984 - 9840	.005 - .016	.040 - .540	1312 - 8200	.005 - .016	≤ a	-	-	-	
	82 - 294	.002 - .008	.004 - .300	82 - 261	.002 - .008	≤ a	82 -	.005 - .010	≤ a	
MaxiMill 251RS-08				251RS-10				251RS-12		
	589 - 1148	.004 - .014	.010 - .038	589 - 1148	.006 - .016	.020 - .059	589 - 1148	.006 - .020	.020 - .097	
	261 - 820	.002 - .006	.010 - .038	261 - 820	.002 - .008	.020 - .059	261 - 820	.004 - .012	.020 - .097	
	328 - 1148	.002 - .008	.010 - .038	328 - 1148	.002 - .008	.020 - .059	328 - 1148	.004 - .012	.020 - .097	
	< 6560	.004 - .008	.010 - .038	< 6560	.004 - .012	.020 - .059	< 6560	.004 - .016	.020 - .097	
	82 - 246	.002 - .006	.010 - .038	82 - 246	.002 - .006	.020 - .059	82 - 246	.002 - .010	.020 - .097	

The cutting data are non-binding indications for the operator. It is recommended to adapt them to the current conditions.

SUCCESS FACTORS: Milling

Ceratizit milling systems are designed for maximum performance. Features include:

- ▲ **Advanced designs:**
double-sided inserts for maximum number of edges
- ▲ **Process reliability:**
optimized chip breakers for low cutting forces
- ▲ **High productivity:**
new insert grades for maximum speeds and feeds

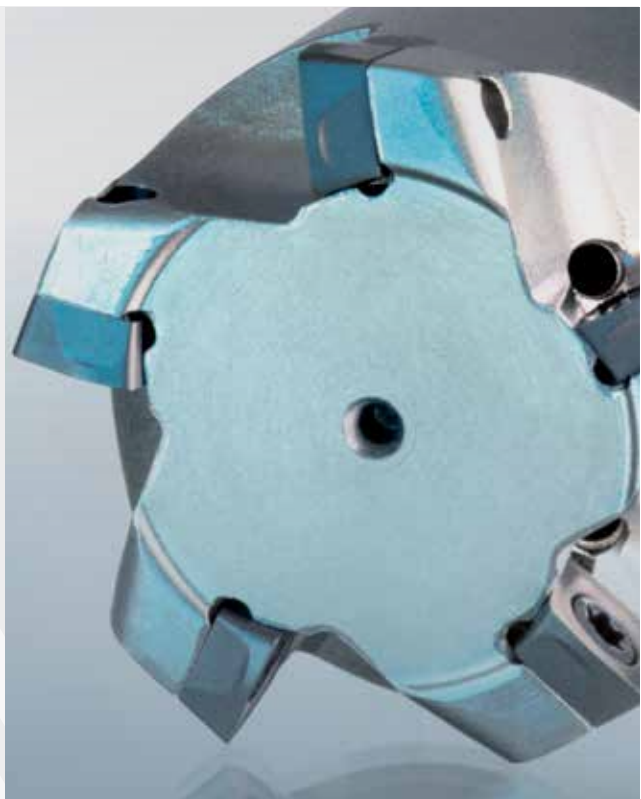



Cutting data - Milling

Tool, material

	V_c [sfm]	f_z [inch]	a_p [inch]	V_c [sfm]	f_z [inch]	a_p [inch]	V_c [sfm]	f_z [inch]	a_p [inch]
MaxiMill 251RS-16				251RS-20					
	589 - 1148	.008 - .030	.020 - .117	589 - 1148	.010 - .030	.059 - .156			
	261 - 820	.004 - .018	.020 - .117	261 - 820	.008 - .024	.059 - .156			
	328 - 1148	.004 - .018	.020 - .117	328 - 1148	.008 - .024	.059 - .156			
	< 6560	.004 - .018	.020 - .117	< 6560	.008 - .024	.059 - .156			
	82 - 246	.004 - .010	.020 - .117	82 - 246	.006 - .014	.059 - .156			
MaxiMill 271-17									
	200 - 1150	.004 - .020	.039 - .315						
	200 - 660	.004 - .014	.039 - .315						
	200 - 980	.004 - .016	.039 - .315						
	80 - 250	.004 - .010	.039 - .315						
MaxiMill 273-06 (OAKU..)									
	200 - 1150	.002 - .024	.008 - .138	330 - 1150	.002 - .024	.008 - .138			
	130 - 820	.002 - .016	.008 - .138	200 - 820	.002 - .024	.008 - .138			
	230 - 920	.002 - .016	.008 - .138	330 - 920	.002 - .024	.008 - .138			
	30 - 330	.002 - .006	.008 - .138	130 - 330	.002 - .024	.008 - .138			
MaxiMill 274-09									
	260 - 1150	.004 - .016	.004 - .150	260 - 1150	.004 - .014	.004 - .098			
	260 - 660	.002 - .014	.002 - .150	260 - 660	.002 - .010	.002 - .098			
	< 6560	.002 - .016	.002 - .150	< 6560	.002 - .016	.002 - .098			
	250 - 802	.002 - .010	.002 - .150	80 - 250	.002 - .008	.002 - .098			
MaxiMill HFC-09				HFC-12					
	330 - 920	.004 - .040	.004 - .038	330 - 920	.004 - .117	.020 - 0.78			
	460 - 850	.004 - .040	.004 - .038	460 - 850	.004 - .117	.020 - 0.78			
	360 - 750	.004 - .040	.004 - .038	360 - 750	.004 - .117	.020 - 0.78			
	80 - 250	.004 - .030	.004 - .020	80 - 250	.004 - .059	.020 - .059			

The cutting data are non-binding indications for the operator. It is recommended to adapt them to the current conditions.

Save up to \$100 on every kit you buy! (Kits include one holder and ten inserts.)



Grade designation	Standard designation		*Type of cutting material	Application range											P	M	K	N	S	H			
															Steel	Stainless	Cast iron	Non-ferrous metals	Heat-resistant	Hard materials			
	ISO	ANSI		01	05	10	15	20	25	30	35	40	45	50									
CTCP230 BLACKSTAR™	HC-P30	C6	C														●						
	HC-K25	C2	C																	●			
	HC-M25	-	C																○				
CTPP235 SILVERSTAR™	HC-P35	C5	P															●					
	HC-M30	-	P																○				
CTPM225 SILVERSTAR™	HC-M25	-	P																●				
	HC-P25	C6	P															○					
CTCM235 BLACKSTAR™	HC-M35	-	C																●				
	HC-P40	C5	C															○					
CTPM240 SILVERSTAR™	HC-M40	-	P																●				
	HC-P40	C5	P															○					
CTCK215 BLACKSTAR™	HC-K15	C3	C																		●		
CTPK220 SILVERSTAR™	HC-K20	C2	P																		●		
CTC5235	HC-S30	-	C																			●	
	HC-M35	-	C																○				
CTC5240	HC-S40	-	C																			●	
				01	05	10	15	20	25	30	35	40	45	50	● Main application ○ Extended application								



Cutting data - Milling

Tool, material

Work piece material		Type of treatment / alloy		VDI 3323 group	Hardness HB
P	Non alloyed steel	annealed	≤ 0.15 % C	1	125
		annealed	0.15 % - 0.45 % C	2	150 - 250
		tempered	≥ 0.45 % C	3	300
	Low alloyed steel	annealed		6	180
		tempered		7 / 8	250 - 300
		tempered		9	350
	High alloyed steel	annealed		10	200
		tempered		11	350
	Stainless steel	annealed	ferritic / martensitic	12	200
		tempered	martensitic	13	325
heat-treated		ferritic / martensitic	13	200	
M	Stainless steel	quenched	austenitic	14	180
		quenched	ferritic / austenitic (Duplex)	14	230 - 260
		hardened	austenitic, precipitation hardened (PH)	14	330
K	Grey cast iron		pearlitic / ferritic	15	180
			pearlitic / martensitic	16	260
	Spheroidal cast iron		ferritic	17	160
			pearlitic	18	250
	Malleable cast iron		ferritic	19	130
		pearlitic	20	230	
N	Aluminium wrought alloys	non hardened		21	60
		hardened		22	100
	Aluminium cast alloys	non hardened	< 12 % Si	23	75
		hardened	< 12 % Si	24	90
		non hardened	> 12 % Si	25	130
	Copper and copper alloys (bronze, brass)		machining alloy stock (1% Pb)	26	(110)
			brass, red bronze	27	90
			bronze	28	100
			lead-free copper and electrolytic copper	28	100
	Non-metallic materials		thermosetting plastics	29	-
		fibre-reinforced plastics	29	-	
		hard rubber	30	-	
S	Heat-resistant alloys	annealed	Fe-base	31	200
		hardened	Fe-base	32	280
		annealed	Ni or Co-base	33	250
		hardened	Ni or Co-base 30 - 58 HRC	34	(350)
		cast	Ni or Co-base 1500 - 2200 N/mm ²	35	(320)
	Titanium alloys		pure titanium	36	R _m 440*
			alpha + beta alloys	37	R _m 1050*
H	Tempered steel	hardened and tempered		38	55 HRC
		hardened and tempered		39	60 HRC
	Chilled castings	cast		40	400
	Tempered cast iron	hardened and tempered		41	55 HRC

* R_m = ultimate tensile strength, measured in MPa

The cutting data are non-binding indications for the operator. It is recommended to adapt them to the current conditions.



CTCK215		CTPK220		CTPM225		CTCP230		CTPP235	
									
v _c [sfm]	v _c [sfm]	v _c [sfm]	v _c [sfm]	v _c [sfm]	v _c [sfm]	v _c [sfm]	v _c [sfm]	v _c [sfm]	v _c [sfm]
				890	630	925	500	800	465
				760	530	825	450	700	400
				600	430	625	365	525	330
				800	560	825	450	725	400
				600	430	625	365	525	330
				460	330	460	330	400	300
				430	300	430	300	365	265
				265	200	265	200	265	200
				360	265	430	300	365	265
				265	200	300	200	265	200
				360	265	430	300	365	265
				530	500			500	365
				460	400			500	365
				400	330			430	300
1190	700	1055	630			1025	625		
725	430	560	330			525	330		
760	460	700	430			660	400		
530	330	460	300			430	265		
825	500	660	400			625	380		
700	430	560	330			525	330		



Cutting data - Milling

Tool, material

Work piece material		Type of treatment / alloy		VDI 3323 group	Hardness HB
P	Non alloyed steel	annealed	≤ 0.15 % C	1	125
		annealed	0.15 % - 0.45 % C	2	150 - 250
		tempered	≥ 0.45 % C	3	300
	Low alloyed steel	annealed		6	180
		tempered		7 / 8	250 - 300
		tempered		9	350
	High alloyed steel	annealed		10	200
		tempered		11	350
	Stainless steel	annealed	ferritic / martensitic	12	200
		tempered	martensitic	13	325
heat-treated		ferritic / martensitic	13	200	
M	Stainless steel	quenched	austenitic	14	180
		quenched	ferritic / austenitic (Duplex)	14	230 - 260
		hardened	austenitic, precipitation hardened (PH)	14	330
K	Grey cast iron		pearlitic / ferritic	15	180
			pearlitic / martensitic	16	260
	Spheroidal cast iron		ferritic	17	160
			pearlitic	18	250
	Malleable cast iron		ferritic	19	130
		pearlitic	20	230	
N	Aluminium wrought alloys	non hardened		21	60
		hardened		22	100
	Aluminium cast alloys	non hardened	< 12 % Si	23	75
		hardened	< 12 % Si	24	90
		non hardened	> 12 % Si	25	130
	Copper and copper alloys (bronze, brass)		machining alloy stock (1% Pb)	26	(110)
			brass, red bronze	27	90
			bronze	28	100
			lead-free copper and electrolytic copper	28	100
	Non-metallic materials		thermosetting plastics	29	-
		fibre-reinforced plastics	29	-	
		hard rubber	30	-	
S	Heat-resistant alloys	annealed	Fe-base	31	200
		hardened	Fe-base	32	280
		annealed	Ni or Co-base	33	250
		hardened	Ni or Co-base 30 - 58 HRC	34	(350)
		cast	Ni or Co-base 1500 - 2200 N/mm ²	35	(320)
	Titanium alloys		pure titanium	36	R _m 440*
			alpha + beta alloys	37	R _m 1050*
H	Tempered steel	hardened and tempered		38	55 HRC
		hardened and tempered		39	60 HRC
	Chilled castings	cast		40	400
	Tempered cast iron	hardened and tempered		41	55 HRC

* R_m = ultimate tensile strength, measured in MPa



Turning holders

An ideal choice for diverse applications – light roughing operations to small-part production for medical components and timepieces. Our exclusive MaxiLock D clamping system keeps inserts secured to minimize vibration and built-up edge. You get evenly distributed cutting forces, exceptional balance and uncompromisingly smooth finishes.





PERFORMANCE FEATURES

- ▲ Secure clamping of the insert under tension (e.g., copy turning)
- ▲ No tilting of the insert toward the front during heavy or interrupted cuts
- ▲ Suitable also for inserts made of various hard materials, such as ceramic, CBN or PCD
- ▲ Available in both coolant feeding and solid styles

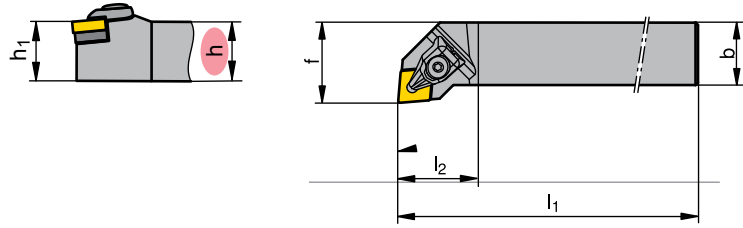

Tool Holder - C Style

Type, description	h_1 [inch]	b [inch]	l_1 [inch]	l_2 [inch]	f [inch]		
DCLNR 16-4DA-N	1.000	1.000	6.0	1.250	1.250	CN.. 43..	E01
DCLNR 16-4D-N	1.000	1.000	6.0	1.250	1.250	CN.. 43..	E01
DCLNL 16-4DA-N	1.000	1.000	6.0	1.250	1.250	CN.. 43..	E01
DCLNL 16-4D-N	1.000	1.000	6.0	1.250	1.250	CN.. 43..	E01

Tool Holder - D Style

Type, description	h_1 [inch]	b [inch]	l_1 [inch]	l_2 [inch]	f [inch]		
DDJNR 16-4DA-N	1.000	1.000	6.0	1.535	1.250	DN.. 43..	E01
DDJNR 16-4D-N	1.000	1.000	6.0	1.535	1.250	DN.. 43..	E01
DDJNL 16-4DA-N	1.000	1.000	6.0	1.535	1.250	DN.. 43..	E01
DDJNL 16-4D-N	1.000	1.000	6.0	1.535	1.250	DN.. 43..	E01

Tool Holder - V Style

Type, description	h_1 [inch]	b [inch]	l_1 [inch]	l_2 [inch]	f [inch]		
DVJNR 16-3DA-N	1.000	1.000	6.0	1.750	1.250	VN.. 33..	E01
DVJNL 16-3DA-N	1.000	1.000	6.0	1.750	1.250	VN.. 33..	E01

Tool Holder - W Style

Type, description	h_1 [inch]	b [inch]	l_1 [inch]	l_2 [inch]	f [inch]		
DWLNR 16-4DA-N	1.000	1.000	6.0	1.250	1.250	WN.. 43..	E01
DWLNR 16-4D-N	1.000	1.000	6.0	1.250	1.250	WN.. 43..	E01
DWLNL 16-4DA-N	1.000	1.000	6.0	1.250	1.250	WN.. 43..	E01
DWLNL 16-4D-N	1.000	1.000	6.0	1.250	1.250	WN.. 43..	E01



Turning inserts

From large cylinders to small medical parts, and light roughing to mirror finishes, CERATIZIT has the turning inserts to do the job better and longer. These inserts are designed for longer tool life, exceptional finish quality and versatile application. And the MaxiLock D double clamping system holds them all in place for precision tolerances and premium finishes.

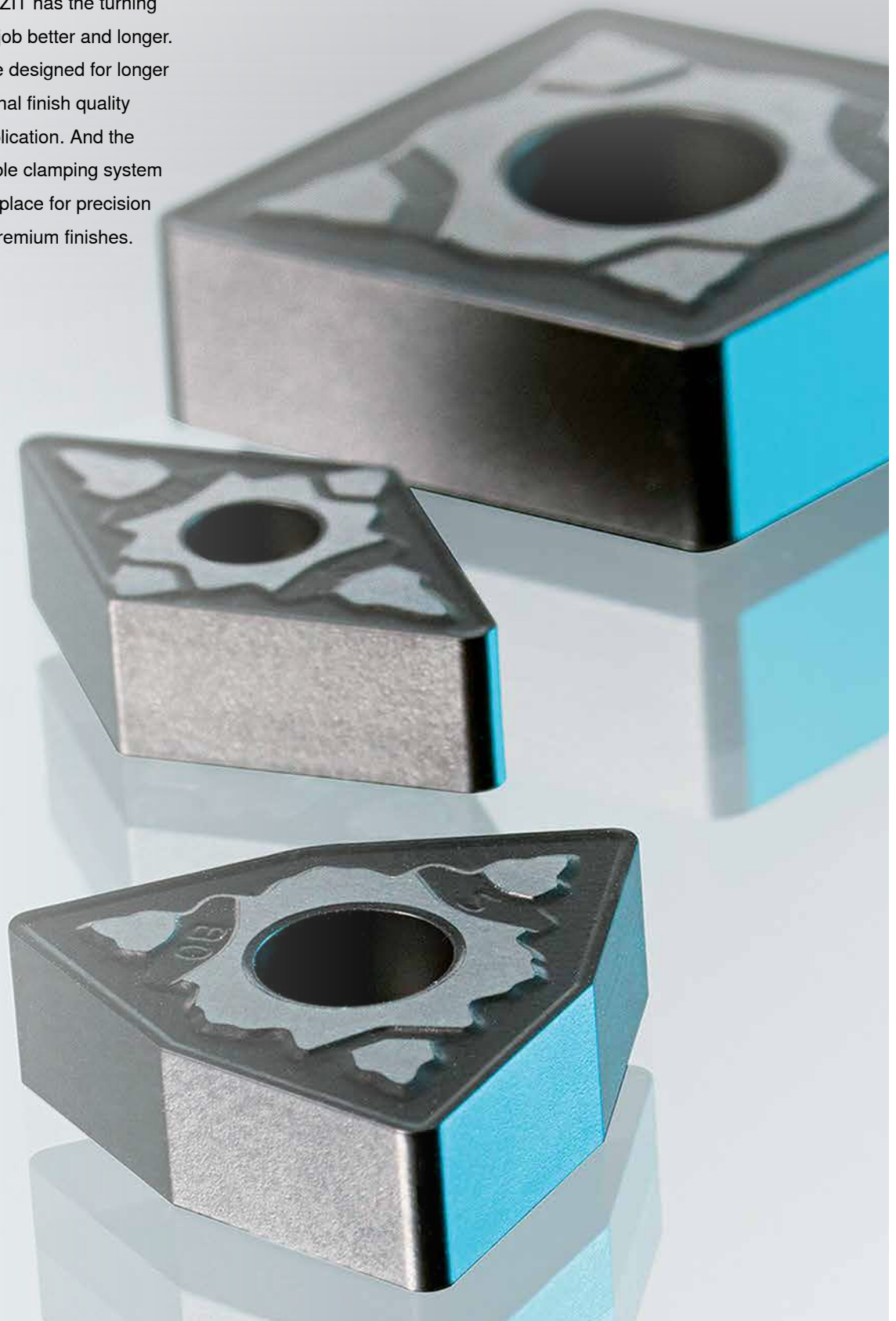



PERFORMANCE FEATURES

- ▲ Special cutting edge and chip groove designs for working in all materials, including high-tech alloys
- ▲ Engineered for smooth, reliable chip control
- ▲ High chip removal rates in large depths of cut; chip breaker designs safeguard cutting edges
- ▲ MaxiLock D double clamping system
- ▲ Excellent results at low and high cutting speeds

P						●	●
M				●	●		
K	●						
N							
S	●	●					
H							

Turning Inserts (CNMG)

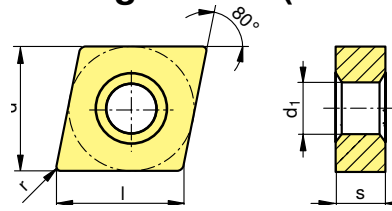

	CTCK120	CTP5110	CTP5115	CTPM125	CTP2120	CTCP115	CTCP125	Machining	d [inch]	l [inch]	s [inch]	r [inch]	d ₁ [inch]
CNMG 120408EN-M70	●							Medium Roughing	.500	.508	.187	.031	.203
CNMG 120412EN-M70	●							Medium Roughing	.500	.508	.187	.047	.203
CNMG 120408EN-F34			●					Finishing	.500	.508	.187	.031	.203
CNMG 120408EN-M34		●						Medium	.500	.508	.187	.031	.203
CNMG 120408EN-M34			●					Medium	.500	.508	.187	.031	.203
CNMG 120412EN-F34			●					Finishing	.500	.508	.187	.047	.203
CNMG 120412EN-M34		●						Medium	.500	.508	.187	.047	.203
CNMG 120412EN-M34			●					Medium	.500	.508	.187	.047	.203
CNMG 120408EN-F30				●				Finishing	.500	.508	.187	.031	.203
CNMG 120408EN-M30				●				Medium	.500	.508	.187	.031	.203
CNMG 120408EN-M42					●			Medium	.500	.508	.187	.031	.203
CNMG 120408EN-M52					●			Medium	.500	.508	.187	.031	.203
CNMG 120408EN-M60				●				Medium	.500	.508	.187	.031	.203
CNMG 120412EN-M30				●				Medium	.500	.508	.187	.047	.203
CNMG 120412EN-M52					●			Medium	.500	.508	.187	.047	.203
CNMG 120412EN-M60				●				Medium	.500	.508	.187	.047	.203
CNMG 120408EN-M50						●		Medium	.500	.508	.187	.031	.203
CNMG 120408EN-M50							●	Medium	.500	.508	.187	.031	.203
CNMG 120408EN-M70						●		Medium Roughing	.500	.508	.187	.031	.203
CNMG 120408EN-M70						●		Medium Roughing	.500	.508	.187	.031	.203
CNMG 120412EN-M50						●		Medium	.500	.508	.187	.047	.203
CNMG 120412EN-M50						●		Medium	.500	.508	.187	.047	.203
CNMG 120412EN-M70						●		Medium Roughing	.500	.508	.187	.047	.203
CNMG 120412EN-M70						●		Medium Roughing	.500	.508	.187	.047	.203



Turning Inserts

P						●	●
M						●	
K	●						
N							
S	●	●					
H							

Turning Inserts (DNMG)

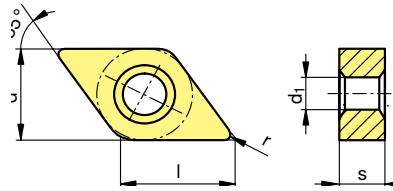

	CTCK120	CTP5110	CTP5115	CTPM125	CTP2120	CTCP115	CTCP125	Machining	d [inch]	l [inch]	s [inch]	l ₁ [inch]	r [inch]	d ₁ [inch]
DNMG 150408EN-M70	●							Medium Roughing	.500	.610	.187		.031	.203
DNMG 150412EN-M70	●							Medium Roughing	.500	.610	.178		.047	.203
DNMG 150404EN-M34		●						Medium	.500	.610	.187		.016	.203
DNMG 150408EN-M34		●						Medium	.500	.610	.178		.031	.203
DNMG 150412EN-M34		●						Medium	.500	.610	.187		.047	.203
DNMG 150404EN-M34			●					Medium	.500	.610	.178		.016	.203
DNMG 150408EN-M34			●					Medium	.500	.610	.187		.031	.203
DNMG 150412EN-M34			●					Medium	.500	.610	.178		.047	.203
DNMG 150404EN-M42					●			Medium	.500	.610	.187		.016	.203
DNMG 150404EN-M52					●			Medium	.500	.610	.178		.016	.203
DNMG 150408EN-M42					●			Medium	.500	.610	.187		.031	.203
DNMG 150408EN-M52					●			Medium	.500	.610	.178		.031	.203
DNMG 150404EN-M50						●		Medium	.500	.610	.187		.016	.203
DNMG 150408EN-M50						●		Medium	.500	.610	.178		.031	.203
DNMG 150408EN-M70						●		Medium Roughing	.500	.610	.187		.031	.203
DNMG 150412EN-M50						●		Medium	.500	.610	.178		.047	.203
DNMG 150412EN-M70						●		Medium Roughing	.500	.610	.187		.047	.203
DNMG 150404EN-M50							●	Medium	.500	.610	.178		.016	.203
DNMG 150408EN-M50							●	Medium	.500	.610	.187		.031	.203
DNMG 150408EN-M70							●	Medium Roughing	.500	.610	.178		.031	.203
DNMG 150412EN-M50							●	Medium	.500	.610	.187		.047	.203
DNMG 150412EN-M70							●	Medium Roughing	.500	.610	.178		.047	.203

Save up to \$100 on every kit you buy! (Kits include one holder and ten inserts.)



P						●	●
M	●		●				
K	●						
N							
S	●	●					
H							

Turning Inserts (VNMG)

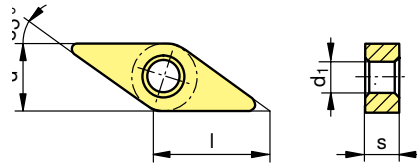

	CTCK120	CTP5110	CTP5115	CTPM125	CTP2120	CTCP115	CTCP125	Machining	d [inch]	l [inch]	s [inch]	r [inch]	d ₁ [inch]
VNMG 160408EN-M50	●							Medium	.375	.654	.187	.031	.150
VNMG 160412EN-M50	●							Medium	.375	.654	.187	.047	.150
VNMG 160408EN-M34		●						Medium	.375	.654	.187	.031	.150
VNMG 160412EN-M34		●						Medium	.375	.654	.187	.047	.150
VNMG 160408EN-M34			●					Medium	.375	.654	.187	.031	.150
VNMG 160412EN-M34			●					Medium	.375	.654	.187	.047	.150
VNMG 160404EN-M34		●						Medium	.375	.654	.187	.016	.150
VNMG 160404EN-M34			●					Medium	.375	.654	.187	.016	.150
VNMG 160404EN-F30				●				Finishing	.375	.654	.187	.016	.150
VNMG 160408EN-F30				●				Finishing	.375	.654	.187	.031	.150
VNMG 160408EN-M30				●				Medium	.375	.654	.187	.031	.150
VNMG 160404EN-M50						●		Medium	.375	.654	.187	.016	.150
VNMG 160408EN-M50						●		Medium	.375	.654	.187	.031	.150
VNMG 160412EN-M50						●		Medium	.375	.654	.187	.047	.150
VNMG 160404EN-F40							●	Finishing	.375	.654	.187	.016	.150
VNMG 160404EN-M40							●	Medium	.375	.654	.187	.016	.150
VNMG 160404EN-M50							●	Medium	.375	.654	.187	.016	.150
VNMG 160408EN-F40							●	Finishing	.375	.654	.187	.031	.150
VNMG 160408EN-M40							●	Medium	.375	.654	.187	.016	.150
VNMG 160408EN-M50							●	Medium	.375	.654	.187	.047	.150
VNMG 160412EN-M50							●	Medium	.375	.654	.187	.047	.150

SUCCESS FACTORS:

Turning

- ▲ **Chip control:**
optimized insert designs for efficient chip evacuation
- ▲ **High surface quality:**
advanced coatings for reduced built-up edge and excellent surface finish
- ▲ **Process security:**
multiple clamping systems for a broad range of applications





Turning Inserts

P						●	●
M				●	●		
K	●						
N							
S		●	●				
H							

Turning Inserts (WNMG)

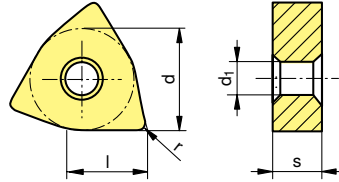

	CTCK120	CTP5110	CTP5115	CTPM125	CTP2120	CTCP115	CTCP125	Machining	d [inch]	l [inch]	s [inch]	r [inch]	d ₁ [inch]
WNMG 080408EN-M70	●							Medium Roughing	.500	.342	.187	.031	.203
WNMG 080412EN-M70	●							Medium Roughing	.500	.342	.187	.047	.203
WNMG 080408EN-F34			●					Finishing	.500	.342	.187	.031	.203
WNMG 080408EN-M34		●						Medium	.500	.342	.187	.031	.203
WNMG 080408EN-M34			●					Medium	.500	.342	.187	.031	.203
WNMG 080412EN-M34		●						Medium	.500	.342	.187	.047	.203
WNMG 080412EN-M34			●					Medium	.500	.342	.187	.047	.203
WNMG 080404EN-M42					●			Medium	.500	.342	.187	.016	.203
WNMG 080404EN-M52					●			Medium	.500	.342	.187	.016	.203
WNMG 080408EN-M42					●			Medium	.500	.342	.187	.031	.203
WNMG 080408EN-M52					●			Medium	.500	.342	.187	.031	.203
WNMG 080404EN-F30				●				Finishing	.500	.342	.187	.016	.203
WNMG 080408EN-F30				●				Finishing	.500	.342	.187	.031	.203
WNMG 080408EN-M30				●				Medium	.500	.342	.187	.031	.203
WNMG 080408EN-M60				●				Medium	.500	.342	.187	.031	.203
WNMG 080412EN-M30				●				Medium	.500	.342	.187	.047	.203
WNMG 080412EN-M60				●				Medium	.500	.342	.187	.047	.203
WNMG 080404EN-M50						●		Medium	.500	.342	.187	.016	.203
WNMG 080408EN-M50						●		Medium	.500	.342	.187	.031	.203
WNMG 080408EN-M70						●		Medium Roughing	.500	.342	.187	.031	.203
WNMG 080412EN-M50						●		Medium	.500	.342	.187	.047	.203
WNMG 080412EN-M70						●		Medium Roughing	.500	.342	.187	.047	.203
WNMG 080404EN-M50						●		Medium	.500	.342	.187	.016	.203
WNMG 080408EN-M50						●		Medium	.500	.342	.187	.031	.203
WNMG 080408EN-M70						●		Medium Roughing	.500	.342	.187	.031	.203
WNMG 080412EN-M50						●		Medium	.500	.342	.187	.047	.203
WNMG 080412EN-M70						●		Medium Roughing	.500	.342	.187	.047	.203

Turning Inserts



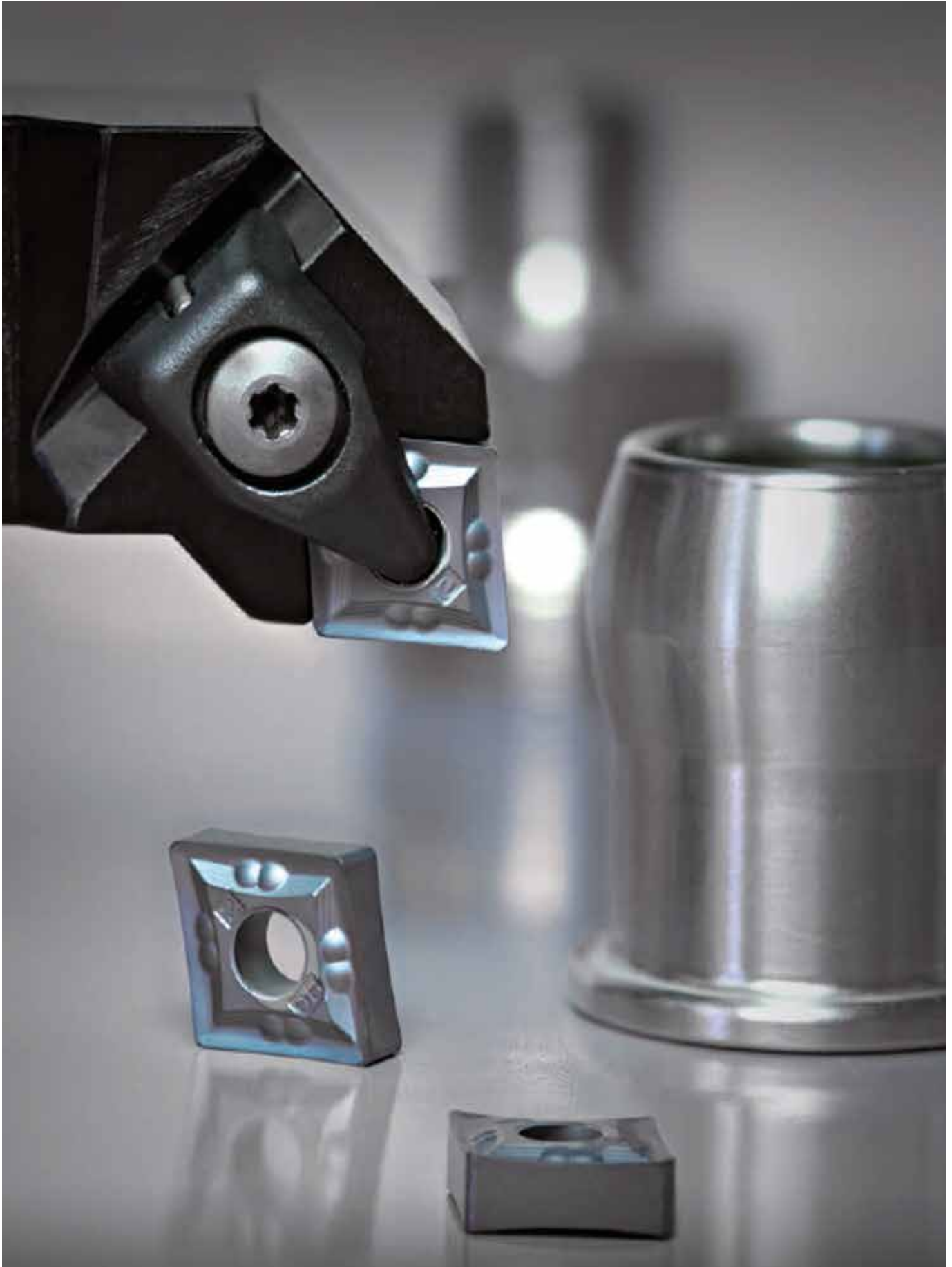



Grade designation	Standard designation		*Type of cutting material	Application range												P	M	K	N	S	H
	ISO	ANSI		01	05	10	15	20	25	30	35	40	45	50	Steel	Stainless	Cast iron	Non-ferrous metals	Heat-resistant	Hard materials	
CTCK120 BLACKSTAR™	HC-K20	C2	C													●					
	HC-P10	C8	C												○						
CTCP115 BLACKSTAR™	HC-P15	C7	C													●					
	HC-K25	C2	C													●					
	HC-M10	-	C												○						
CTCP125 BLACKSTAR™	HC-P25	C6	C													●					
	HC-K30	C1	C													●					
	HC-M20	-	C												○						
CTP2120	HC-M20	-	P													●					○
	HC-K20	-	P														○	○			
CTP5110	HC-S15	-	P																		●
	HC-M15	-	P													○					
CTP5115	HC-S15	-	P																		●
	HC-M15	-	P													○					
CTPM125 SILVERSTAR™	HC-M25	-	P													●					
	HC-P35	C5	P													●					
	HC-S25	-	P																		○

Save up to \$100 on every kit you buy! (Kits include one holder and ten inserts.)



Cutting data - Turning

Work piece material		Type of treatment / alloy		VDI 3323 group	Hardness HB
P	Non alloyed steel	annealed	≤ 0.15 % C	1	125
		annealed	0.15 % - 0.45 % C	2	150 - 250
		tempered	≥ 0.45 % C	3	300
	Low alloyed steel	annealed		6	180
		tempered		7 / 8	250 - 300
		tempered		9	350
	High alloyed steel	annealed		10	200
		tempered		11	350
	Stainless steel	annealed	ferritic / martensitic	12	200
		tempered	martensitic	13	325
heat-treated		ferritic / martensitic	13	200	
M	Stainless steel	quenched	austenitic	14	180
		quenched	ferritic / austenitic (Duplex)	14	230 - 260
		hardened	austenitic, precipitation hardened (PH)	14	330
K	Grey cast iron		pearlitic / ferritic	15	180
			pearlitic / martensitic	16	260
	Spheroidal cast iron		ferritic	17	160
			pearlitic	18	250
	Malleable cast iron		ferritic	19	130
		pearlitic	20	230	
N	Aluminium wrought alloys	non hardened		21	60
		hardened		22	100
	Aluminium cast alloys	non hardened	< 12 % Si	23	75
		hardened	< 12 % Si	24	90
		non hardened	> 12 % Si	25	130
	Copper and copper alloys (bronze, brass)		machining alloy stock (1% Pb)	26	(110)
			brass, red bronze	27	90
			bronze	28	100
			lead-free copper and electrolytic copper	28	100
	Non-metallic materials		thermosetting plastics	29	-
		fibre-reinforced plastics	29	-	
		hard rubber	30	-	
S	Heat-resistant alloys	annealed	Fe-base	31	200
		hardened	Fe-base	32	280
		annealed	Ni or Co-base	33	250
		hardened	Ni or Co-base 30 - 58 HRC	34	(350)
		cast	Ni or Co-base 1500 - 2200 N/mm ²	35	(320)
	Titanium alloys		pure titanium	36	R _m 440*
			alpha + beta alloys	37	R _m 1050*
H	Tempered steel	hardened and tempered		38	55 HRC
		hardened and tempered		39	60 HRC
	Chilled castings	cast		40	400
	Tempered cast iron	hardened and tempered		41	55 HRC

Turning

Cutting data

The cutting data are non-binding indications for the operator. It is recommended to adapt them to the current conditions.



Turning

Chip grooves





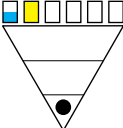

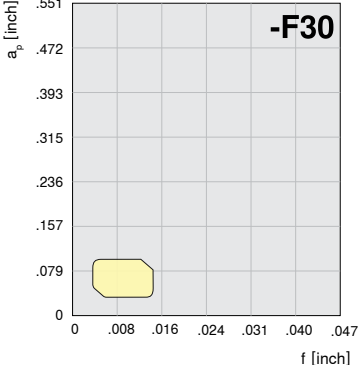



Application range:

CNMG 432EN-F30
 doc.: .031 - .098 inch
 fpr: .004 - .014 inch

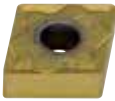
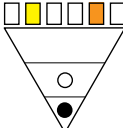
- Stainless steels
- Steel in general



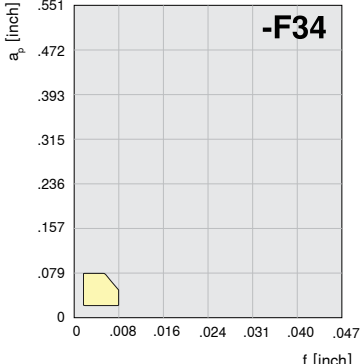



Application range:

CNMG 432EN-F34
 doc.: .031 - .118 inch
 fpr: .004 - .012 inch

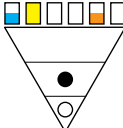
- Stainless steels
- Super alloys
- Titanium

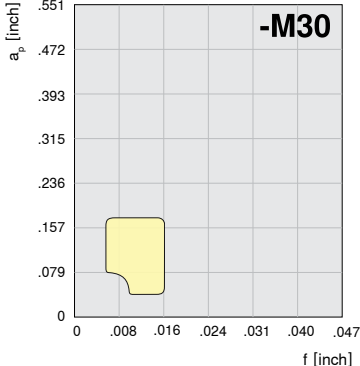

Application range:

CNMG 432EN-M30
 doc.: .039 - .171 inch
 fpr: .006 - .016 inch

- Stainless steels
- Steel in general
- Super alloys



Chip grooves - Turning

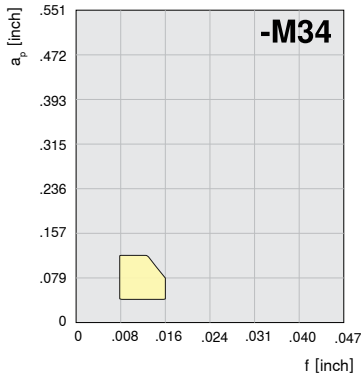
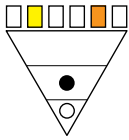

Application range:

CNMG 432EN-M34
 doc.: .031 - .118 inch
 fpr: .004 - .012 inch

- Stainless steels
- Super alloys
- Titanium

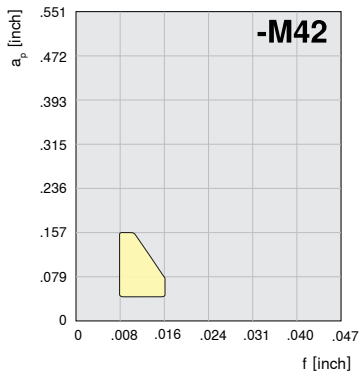
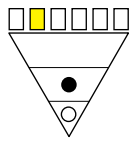

Application range:

CCMT 32.51EN-F43
 doc.: .039 - .157 inch
 fpr: .008 - .016 inch

- Stainless steels



For stainless steels

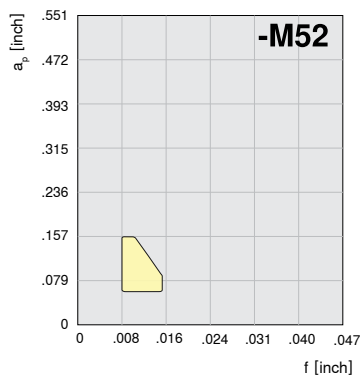
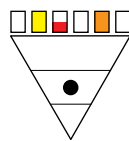

Application range:

CNMG 532EN-M52
 doc.: .059 - .157 inch
 fpr: .008 - .015 inch

- Stainless steels
- Super alloys
- Spheroidal cast iron (GGG)

Save up to \$100 on every kit you buy! (Kits include one holder and ten inserts.)



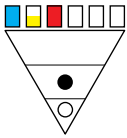

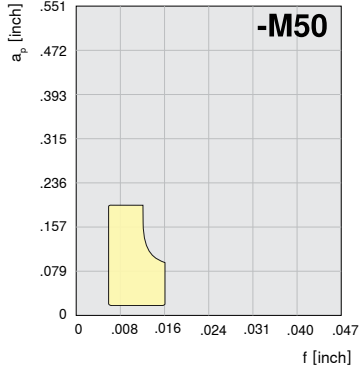



Application range:

CNMG 432EN-M34
 doc.: .020 - .197 inch
 fpr: .006 - .016 inch

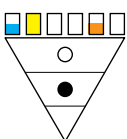
- Steel in general
- Stainless steels
- GGG



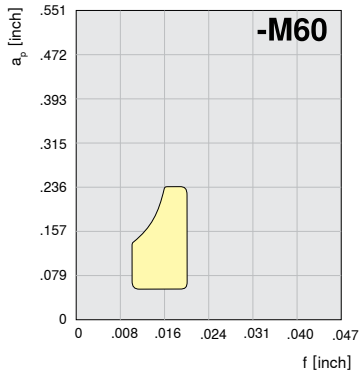



Application range:

CNMG 432EN-M60
 doc.: .060 - .236 inch
 fpr: .010 - .020 inch

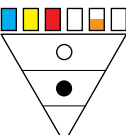
- Steel in general
- Stainless steels**
- Super alloys

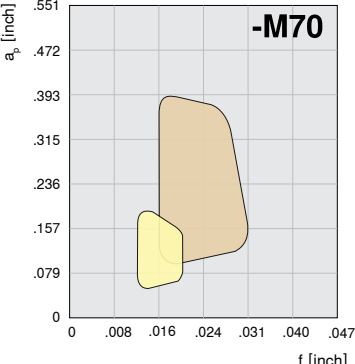

Application range:

CNMG 432EN-M70
 doc.: .059 - .197 inch
 fpr: .012 - .08 inch

CNMG 544EN-M70
 doc.: .098 - .394 inch
 fpr: .016 - .031 inch

- Steel in general**
- Stainless steels**
- Cast iron
- Bearing steel**
- Super alloys



For ordering, you'll find everything you need right here, most importantly the number for **Customer Service** –

800-783-2280

They'll be happy to take your order, answer any questions and help with anything you need.

Remember you can save up to \$100 on every kit you buy!

This is a limited-time offer, so get it while you can, from CERATIZIT, your single source for productivity solutions.





Milling Cutters



Material Number	Type, descriptions-kit	Type, description-cutter	Description-insert	Wrench	Kit Price
12021269	Kit# A211.200.001	A211.200.R.05-11-A075-175-EF	XDKT 11T304SR-M50 CTCK215	T08	\$304
12021645	Kit# A211.200.002	A211.200.R.05-11-A075-175-EF	XDKT 11T308SR-M50 CTCK215	T08	\$304
12021646	Kit# A211.200.003	A211.200.R.05-11-A075-175-EF	XDKT 11T308SR-R50 CTCK215	T08	\$304
12021649	Kit# A211.200.004	A211.200.R.05-11-A075-175-EF	XDKT 11T304ER-F40 CTC5235	T08	\$304
12021650	Kit# A211.200.005	A211.200.R.05-11-A075-175-EF	XDKT 11T308ER-F40 CTC5235	T08	\$304
12021651	Kit# A211.200.006	A211.200.R.05-11-A075-175-EF	XDKT 11T308SR-F50 CTC5235	T08	\$304
12021652	Kit# A211.200.007	A211.200.R.05-11-A075-175-EF	XDKT 11T308SR-F50 CTCM235	T08	\$304
12021653	Kit# A211.200.008	A211.200.R.05-11-A075-175-EF	XDKT 11T308SR-M50 CTCM235	T08	\$304
12021654	Kit# A211.200.009	A211.200.R.05-11-A075-175-EF	XDKT 11T308SR-R50 CTCM235	T08	\$304
12019545	Kit# A211.200.010	A211.200.R.05-11-A075-175-EF	XDKT 11T304SR-F50 CTPP235	T08	\$304
12021655	Kit# A211.200.011	A211.200.R.05-11-A075-175-EF	XDKT 11T304SR-M50 CTPP235	T08	\$304
12021656	Kit# A211.200.012	A211.200.R.05-11-A075-175-EF	XDKT 11T304SR-R50 CTPP235	T08	\$304
12021657	Kit# A211.200.013	A211.200.R.05-11-A075-175-EF	XDKT 11T308SR-F50 CTPP235	T08	\$304
12021659	Kit# A211.200.014	A211.200.R.05-11-A075-175-EF	XDKT 11T308SR-M50 CTPP235	T08	\$304
12021660	Kit# A211.200.015	A211.200.R.05-11-A075-175-EF	XDKT 11T308SR-R50 CTPP235	T08	\$304
12021661	Kit# A211.200.016	A211.200.R.05-11-A075-175-EF	XDKT 11T304ER-F40 CTC5240	T08	\$304
12021662	Kit# A211.200.017	A211.200.R.05-11-A075-175-EF	XDKT 11T308ER-F40 CTC5240	T08	\$304
12021663	Kit# A211.200.018	A211.200.R.05-11-A075-175-EF	XDKT 11T308SR-F50 CTC5240	T08	\$304
12021664	Kit# A211.250.001	A211.250.R.06-11-A100-200-EF	XDKT 11T304SR-M50 CTCK215	T08	\$342
12021665	Kit# A211.250.002	A211.250.R.06-11-A100-200-EF	XDKT 11T308SR-M50 CTCK215	T08	\$342
12021666	Kit# A211.250.003	A211.250.R.06-11-A100-200-EF	XDKT 11T308SR-R50 CTCK215	T08	\$342
12021667	Kit# A211.250.004	A211.250.R.06-11-A100-200-EF	XDKT 11T304ER-F40 CTC5235	T08	\$342
12021668	Kit# A211.250.005	A211.250.R.06-11-A100-200-EF	XDKT 11T308ER-F40 CTC5235	T08	\$342
12021669	Kit# A211.250.006	A211.250.R.06-11-A100-200-EF	XDKT 11T308SR-F50 CTC5235	T08	\$342
12021670	Kit# A211.250.007	A211.250.R.06-11-A100-200-EF	XDKT 11T308SR-F50 CTCM235	T08	\$342
12021671	Kit# A211.250.008	A211.250.R.06-11-A100-200-EF	XDKT 11T308SR-M50 CTCM235	T08	\$342
12021672	Kit# A211.250.009	A211.250.R.06-11-A100-200-EF	XDKT 11T308SR-R50 CTCM235	T08	\$342
12021673	Kit# A211.250.010	A211.250.R.06-11-A100-200-EF	XDKT 11T304SR-F50 CTPP235	T08	\$342
12021674	Kit# A211.250.011	A211.250.R.06-11-A100-200-EF	XDKT 11T304SR-M50 CTPP235	T08	\$342
12021675	Kit# A211.250.012	A211.250.R.06-11-A100-200-EF	XDKT 11T304SR-R50 CTPP235	T08	\$342
12021676	Kit# A211.250.013	A211.250.R.06-11-A100-200-EF	XDKT 11T308SR-F50 CTPP235	T08	\$342
12021677	Kit# A211.250.014	A211.250.R.06-11-A100-200-EF	XDKT 11T308SR-M50 CTPP235	T08	\$342
12021678	Kit# A211.250.015	A211.250.R.06-11-A100-200-EF	XDKT 11T308SR-R50 CTPP235	T08	\$342
12021679	Kit# A211.250.016	A211.250.R.06-11-A100-200-EF	XDKT 11T304ER-F40 CTC5240	T08	\$342
12021680	Kit# A211.250.017	A211.250.R.06-11-A100-200-EF	XDKT 11T308ER-F40 CTC5240	T08	\$342
12021681	Kit# A211.250.018	A211.250.R.06-11-A100-200-EF	XDKT 11T308SR-F50 CTC5240	T08	\$342
12021682	Kit# A211.300.001	A211.300.R.07-11-A100-200-EF	XDKT 11T304SR-M50 CTCK215	T08	\$381
12021683	Kit# A211.300.002	A211.300.R.07-11-A100-200-EF	XDKT 11T308SR-M50 CTCK215	T08	\$381
12021684	Kit# A211.300.003	A211.300.R.07-11-A100-200-EF	XDKT 11T308SR-R50 CTCK215	T08	\$381
12021685	Kit# A211.300.004	A211.300.R.07-11-A100-200-EF	XDKT 11T304ER-F40 CTC5235	T08	\$381
12021686	Kit# A211.300.005	A211.300.R.07-11-A100-200-EF	XDKT 11T308ER-F40 CTC5235	T08	\$381
12021688	Kit# A211.300.006	A211.300.R.07-11-A100-200-EF	XDKT 11T308SR-F50 CTC5235	T08	\$381
12021689	Kit# A211.300.007	A211.300.R.07-11-A100-200-EF	XDKT 11T308SR-F50 CTCM235	T08	\$381
12021690	Kit# A211.300.008	A211.300.R.07-11-A100-200-EF	XDKT 11T308SR-M50 CTCM235	T08	\$381
12021691	Kit# A211.300.009	A211.300.R.07-11-A100-200-EF	XDKT 11T308SR-R50 CTCM235	T08	\$381
12021692	Kit# A211.300.010	A211.300.R.07-11-A100-200-EF	XDKT 11T304SR-F50 CTPP235	T08	\$381
12021693	Kit# A211.300.011	A211.300.R.07-11-A100-200-EF	XDKT 11T304SR-M50 CTPP235	T08	\$381
12021694	Kit# A211.300.012	A211.300.R.07-11-A100-200-EF	XDKT 11T304SR-R50 CTPP235	T08	\$381
12021695	Kit# A211.300.013	A211.300.R.07-11-A100-200-EF	XDKT 11T308SR-F50 CTPP235	T08	\$381
12021696	Kit# A211.300.014	A211.300.R.07-11-A100-200-EF	XDKT 11T308SR-M50 CTPP235	T08	\$381

For more information or to order, call Customer Service at 800-783-2280. Have your reference number handy.



Product Index / Kit Pricing



SAVE UP TO \$100 ON MILLING CUTTERS

Material Number	Type, descriptions-kit	Type, description-cutter	Description-insert	Wrench	Kit Price
12021697	Kit# A211.300.015	A211.300.R.07-11-A100-200-EF	XDKT 11T308SR-R50 CTPP235	T08	\$381
12021698	Kit# A211.300.016	A211.300.R.07-11-A100-200-EF	XDKT 11T304ER-F40 CTC5240	T08	\$381
12021699	Kit# A211.300.017	A211.300.R.07-11-A100-200-EF	XDKT 11T308ER-F40 CTC5240	T08	\$381
12021700	Kit# A211.300.018	A211.300.R.07-11-A100-200-EF	XDKT 11T308SR-F50 CTC5240	T08	\$381
12021701	Kit# A251.150.001	A251.150.R.05-10-A050-175-RS-EF	RPHX 10T3MOSN CTCK215	T10	\$290
12021702	Kit# A251.150.002	A251.150.R.05-10-A050-175-RS-EF	RPHX 10T3M4EN-M31 CTC5240	T10	\$290
12021703	Kit# A251.150.003	A251.150.R.05-10-A050-175-RS-EF	RPHX 10T3M8EN-M31 CTC5235	T10	\$290
12021704	Kit# A251.150.004	A251.150.R.05-10-A050-175-RS-EF	RPHX 10T3M8EN-M31 CTC5240	T10	\$290
12021705	Kit# A251.150.005	A251.150.R.05-10-A050-175-RS-EF	RPHX 10T3MOEN-M30 CTPM240	T10	\$290
12021706	Kit# A251.150.006	A251.150.R.05-10-A050-175-RS-EF	RPHX 10T3MOEN-M30 CTPP235	T10	\$290
12021707	Kit# A251.150.007	A251.150.R.05-10-A050-175-RS-EF	RPHX 10T3MOSN-F50 CTPM240	T10	\$290
12021708	Kit# A251.150.008	A251.150.R.05-10-A050-175-RS-EF	RPHX 10T3MOSN-M50 CTPP235	T10	\$290
12021709	Kit# A251.150.009	A251.150.R.05-10-A050-175-RS-EF	RPHX 10T3MOSN-F50 CTCP230	T10	\$290
12021710	Kit# A251.150.010	A251.150.R.05-10-A050-175-RS-EF	RPHX 10T3MOSN-F50 CTPP235	T10	\$290
12021711	Kit# A251.150.011	A251.150.R.05-10-A050-175-RS-EF	RPHX 10T3MOSN-M50 CTC5235	T10	\$290
12021712	Kit# A251.150.012	A251.150.R.05-10-A050-175-RS-EF	RPHX 10T3MOSN-M50 CTPM240	T10	\$290
12021717	Kit# A251.200.001	A251.200.R.06-10-A075-175-RS-EF	RPHX 10T3MOSN CTCK215	T10	\$337
12021718	Kit# A251.200.002	A251.200.R.06-10-A075-175-RS-EF	RPHX 10T3M4EN-M31 CTC5240	T10	\$337
12021719	Kit# A251.200.003	A251.200.R.06-10-A075-175-RS-EF	RPHX 10T3M8EN-M31 CTC5235	T10	\$337
12021720	Kit# A251.200.004	A251.200.R.06-10-A075-175-RS-EF	RPHX 10T3M8EN-M31 CTC5240	T10	\$337
12021721	Kit# A251.200.005	A251.200.R.06-10-A075-175-RS-EF	RPHX 10T3MOEN-M30 CTPM240	T10	\$337
12021722	Kit# A251.200.006	A251.200.R.06-10-A075-175-RS-EF	RPHX 10T3MOEN-M30 CTPP235	T10	\$337
12021723	Kit# A251.200.007	A251.200.R.06-10-A075-175-RS-EF	RPHX 10T3MOSN-F50 CTPM240	T10	\$337
12021724	Kit# A251.200.008	A251.200.R.06-10-A075-175-RS-EF	RPHX 10T3MOSN-M50 CTPP235	T10	\$337
12021725	Kit# A251.200.009	A251.200.R.06-10-A075-175-RS-EF	RPHX 10T3MOSN-F50 CTCP230	T10	\$337
12021726	Kit# A251.200.010	A251.200.R.06-10-A075-175-RS-EF	RPHX 10T3MOSN-F50 CTPP235	T10	\$337
12021727	Kit# A251.200.011	A251.200.R.06-10-A075-175-RS-EF	RPHX 10T3MOSN-M50 CTC5235	T10	\$337
12021728	Kit# A251.200.012	A251.200.R.06-10-A075-175-RS-EF	RPHX 10T3MOSN-M50 CTPM240	T10	\$337
12021733	Kit# A251.250.001	A251.250.R.06-12-A100-200-RS-EF	RPHX 1204M4EN-M31 CTC5240	T15	\$383
12021734	Kit# A251.250.002	A251.250.R.06-12-A100-200-RS-EF	RPHX 1204M4EN-M31 CTC5235	T15	\$383
12021735	Kit# A251.250.003	A251.250.R.06-12-A100-200-RS-EF	RPHX 1204M4EN-M31 CTPP235	T15	\$383
12021737	Kit# A251.250.004	A251.250.R.06-12-A100-200-RS-EF	RPHX 1204M6EN-M31 CTC5240	T15	\$383
12021738	Kit# A251.250.005	A251.250.R.06-12-A100-200-RS-EF	RPHX 1204M8EN-M31 CTC5235	T15	\$383
12021739	Kit# A251.250.006	A251.250.R.06-12-A100-200-RS-EF	RPHX 1204M8EN-M31 CTC5240	T15	\$383
12021740	Kit# A251.250.007	A251.250.R.06-12-A100-200-RS-EF	RPHX 1204MOEN-M30 CTPM225	T15	\$383
12021741	Kit# A251.250.008	A251.250.R.06-12-A100-200-RS-EF	RPHX 1204MOEN-M30 CTCM235	T15	\$383
12021743	Kit# A251.250.009	A251.250.R.06-12-A100-200-RS-EF	RPHX 1204MOEN-M30 CTPM240	T15	\$383
12021744	Kit# A251.250.010	A251.250.R.06-12-A100-200-RS-EF	RPHX 1204MOSN CTCK215	T15	\$383
12021745	Kit# A251.250.011	A251.250.R.06-12-A100-200-RS-EF	RPHX 1204MOSN-F50 CTCM235	T15	\$383
12021746	Kit# A251.250.012	A251.250.R.06-12-A100-200-RS-EF	RPHX 1204MOSN-F50 CTPP235	T15	\$383
12021747	Kit# A251.250.013	A251.250.R.06-12-A100-200-RS-EF	RPHX 1204MOFN-27P H216T	T15	\$383



SAVE UP TO \$100 ON MILLING INSERTS

Material Number	Type, descriptions-kit	Type, description-cutter	Description-insert	Wrench	Kit Price
12021751	Kit# A251.300.001	A251.300.R.07-12-RS-A100-200-EF	RPHX 1204M4EN-M31 CTC5240	T15	\$424
12021752	Kit# A251.300.002	A251.300.R.07-12-RS-A100-200-EF	RPHX 1204M4EN-M31 CTC5235	T15	\$424
12021753	Kit# A251.300.003	A251.300.R.07-12-RS-A100-200-EF	RPHX 1204M4EN-M31 CTPP235	T15	\$424
12021754	Kit# A251.300.004	A251.300.R.07-12-RS-A100-200-EF	RPHX 1204M6EN-M31 CTC5240	T15	\$424
12021755	Kit# A251.300.005	A251.300.R.07-12-RS-A100-200-EF	RPHX 1204M8EN-M31 CTC5235	T15	\$424
12021756	Kit# A251.300.006	A251.300.R.07-12-RS-A100-200-EF	RPHX 1204M8EN-M31 CTC5240	T15	\$424
12021757	Kit# A251.300.007	A251.300.R.07-12-RS-A100-200-EF	RPHX 1204MOEN-M30 CTPM225	T15	\$424
12021758	Kit# A251.300.008	A251.300.R.07-12-RS-A100-200-EF	RPHX 1204MOEN-M30 CTCM235	T15	\$424
12021759	Kit# A251.300.009	A251.300.R.07-12-RS-A100-200-EF	RPHX 1204MOEN-M30 CTPM240	T15	\$424
12021760	Kit# A251.300.010	A251.300.R.07-12-RS-A100-200-EF	RPHX 1204MOSN CTCK215	T15	\$424
12021761	Kit# A251.300.011	A251.300.R.07-12-RS-A100-200-EF	RPHX 1204MOSN-F50 CTCM235	T15	\$424
12021762	Kit# A251.300.012	A251.300.R.07-12-RS-A100-200-EF	RPHX 1204MOSN-F50 CTPP235	T15	\$424
12021763	Kit# A251.300.013	A251.300.R.07-12-RS-A100-200-EF	RPHX 1204MOFN-27P H216T	T15	\$424
12021767	Kit# A271.200.001	A271.200.R.04-17-A075-175-EF	SAKU 1706ABSR-M50 CTCK215	T20	\$371
12021768	Kit# A271.200.002	A271.200.R.04-17-A075-175-EF	SAKU 1706ABSR-R50 CTCK215	T20	\$371
12021769	Kit# A271.200.003	A271.200.R.04-17-A075-175-EF	SAKU 1706ABSR-F50 CTC5235	T20	\$371
12021770	Kit# A271.200.004	A271.200.R.04-17-A075-175-EF	SAKU 1706ABSR-F50 CTCM235	T20	\$371
12021772	Kit# A271.200.005	A271.200.R.04-17-A075-175-EF	SAKU 1706ABSR-M50 CTCM235	T20	\$371
12021773	Kit# A271.200.006	A271.200.R.04-17-A075-175-EF	SAKU 1706ABSR-F50 CTPP235	T20	\$371
12021774	Kit# A271.200.007	A271.200.R.04-17-A075-175-EF	SAKU 1706ABSR-M50 CTPP235	T20	\$371
12021775	Kit# A271.200.008	A271.200.R.04-17-A075-175-EF	SAKU 1706ABSR-F50 CTC5240	T20	\$371
12021777	Kit# A271.300.001	A271.300.R.07-17-A100-200-EF	SAKU 1706ABSR-M50 CTCK215	T20	\$542
12021778	Kit# A271.300.002	A271.300.R.07-17-A100-200-EF	SAKU 1706ABSR-R50 CTCK215	T20	\$542
12021779	Kit# A271.300.003	A271.300.R.07-17-A100-200-EF	SAKU 1706ABSR-F50 CTC5235	T20	\$542
12021780	Kit# A271.300.004	A271.300.R.07-17-A100-200-EF	SAKU 1706ABSR-F50 CTCM235	T20	\$542
12021782	Kit# A271.300.005	A271.300.R.07-17-A100-200-EF	SAKU 1706ABSR-M50 CTCM235	T20	\$542
12021783	Kit# A271.300.006	A271.300.R.07-17-A100-200-EF	SAKU 1706ABSR-F50 CTPP235	T20	\$542
12021784	Kit# A271.300.007	A271.300.R.07-17-A100-200-EF	SAKU 1706ABSR-M50 CTPP235	T20	\$542
12021785	Kit# A271.300.008	A271.300.R.07-17-A100-200-EF	SAKU 1706ABSR-F50 CTC5240	T20	\$542
130916570	Kit# A271.400.001	A271.400.R.08-17-B125-200-EF	SAKU 1706ABSR-M50 CTCK215	T20	\$610
12021787	Kit# A271.400.002	A271.400.R.08-17-B125-200-EF	SAKU 1706ABSR-R50 CTCK215	T20	\$610
12021788	Kit# A271.400.003	A271.400.R.08-17-B125-200-EF	SAKU 1706ABSR-F50 CTC5235	T20	\$610
12021790	Kit# A271.400.004	A271.400.R.08-17-B125-200-EF	SAKU 1706ABSR-F50 CTCM235	T20	\$610
12021791	Kit# A271.400.005	A271.400.R.08-17-B125-200-EF	SAKU 1706ABSR-M50 CTCM235	T20	\$610
12021792	Kit# A271.400.006	A271.400.R.08-17-B125-200-EF	SAKU 1706ABSR-F50 CTPP235	T20	\$610
12021793	Kit# A271.400.007	A271.400.R.08-17-B125-200-EF	SAKU 1706ABSR-M50 CTPP235	T20	\$610
12021794	Kit# A271.400.008	A271.400.R.08-17-B125-200-EF	SAKU 1706ABSR-F50 CTC5240	T20	\$610
12021795	Kit# A271.500.001	A271.500.R.10-17-B150-200-EF	SAKU 1706ABSR-M50 CTCK215	T20	\$689
12021796	Kit# A271.500.002	A271.500.R.10-17-B150-200-EF	SAKU 1706ABSR-R50 CTCK215	T20	\$689
12021798	Kit# A271.500.003	A271.500.R.10-17-B150-200-EF	SAKU 1706ABSR-F50 CTC5235	T20	\$689
12021799	Kit# A271.500.004	A271.500.R.10-17-B150-200-EF	SAKU 1706ABSR-F50 CTCM235	T20	\$689
12021800	Kit# A271.500.005	A271.500.R.10-17-B150-200-EF	SAKU 1706ABSR-M50 CTCM235	T20	\$689

Save up to \$100 on every kit you buy! (Kits include one holder and ten inserts.)



Product Index / Kit Pricing



SAVE UP TO \$100 ON MILLING INSERTS

Material Number	Type, descriptions-kit	Type, description-cutter	Description-insert	Wrench	Kit Price
12021801	Kit# A271.500.006	A271.500.R.10-17-B150-200-EF	SAKU 1706ABSR-F50 CTPP235	T20	\$689
12021802	Kit# A271.500.007	A271.500.R.10-17-B150-200-EF	SAKU 1706ABSR-M50 CTPP235	T20	\$689
12021803	Kit# A271.500.008	A271.500.R.10-17-B150-200-EF	SAKU 1706ABSR-F50 CTC5240	T20	\$689
12021804	Kit# A273.200.001	A273.200.R.05-06-A075-175-EF	OAKU 060508SR-M50 CTCK215	T20	\$393
12021805	Kit# A273.200.002	A273.200.R.05-06-A075-175-EF	OAKU 060508SR-R50 CTCK215	T20	\$393
12021807	Kit# A273.200.003	A273.200.R.05-06-A075-175-EF	OAKU 060508ER-F40 CTC5235	T20	\$393
12021808	Kit# A273.200.004	A273.200.R.05-06-A075-175-EF	OAKU 060508SR-F50 CTCM235	T20	\$393
12021809	Kit# A273.200.005	A273.200.R.05-06-A075-175-EF	OAKU 060508SR-M50 CTCM235	T20	\$393
12021811	Kit# A273.200.006	A273.200.R.05-06-A075-175-EF	OAKU 060508SR-F50 CTPP235	T20	\$393
12021812	Kit# A273.200.007	A273.200.R.05-06-A075-175-EF	OAKU 060508SR-M50 CTPP235	T20	\$393
12021813	Kit# A273.200.008	A273.200.R.05-06-A075-175-EF	OAKU 060508ER-F40 CTC5240	T20	\$393
12021814	Kit# A273.250.001	A273.250.R.07-06-A100-200-EF	OAKU 060508SR-M50 CTCK215	T20	\$457
12021815	Kit# A273.250.002	A273.250.R.07-06-A100-200-EF	OAKU 060508SR-R50 CTCK215	T20	\$457
12021816	Kit# A273.250.003	A273.250.R.07-06-A100-200-EF	OAKU 060508ER-F40 CTC5235	T20	\$457
12021817	Kit# A273.250.004	A273.250.R.07-06-A100-200-EF	OAKU 060508SR-F50 CTCM235	T20	\$457
12021818	Kit# A273.250.005	A273.250.R.07-06-A100-200-EF	OAKU 060508SR-M50 CTCM235	T20	\$457
12021819	Kit# A273.250.006	A273.250.R.07-06-A100-200-EF	OAKU 060508SR-F50 CTPP235	T20	\$457
12021820	Kit# A273.250.007	A273.250.R.07-06-A100-200-EF	OAKU 060508SR-M50 CTPP235	T20	\$457
12021821	Kit# A273.250.008	A273.250.R.07-06-A100-200-EF	OAKU 060508ER-F40 CTC5240	T20	\$457
12021822	Kit# A273.300.001	A273.300.R.08-06-A100-200-EF	OAKU 060508SR-M50 CTCK215	T20	\$520
12021823	Kit# A273.300.002	A273.300.R.08-06-A100-200-EF	OAKU 060508SR-R50 CTCK215	T20	\$520
12021824	Kit# A273.300.003	A273.300.R.08-06-A100-200-EF	OAKU 060508ER-F40 CTC5235	T20	\$520
12021825	Kit# A273.300.004	A273.300.R.08-06-A100-200-EF	OAKU 060508SR-F50 CTCM235	T20	\$520
12021827	Kit# A273.300.005	A273.300.R.08-06-A100-200-EF	OAKU 060508SR-M50 CTCM235	T20	\$520
12021828	Kit# A273.300.006	A273.300.R.08-06-A100-200-EF	OAKU 060508SR-F50 CTPP235	T20	\$520
12021829	Kit# A273.300.007	A273.300.R.08-06-A100-200-EF	OAKU 060508SR-M50 CTPP235	T20	\$520
12021830	Kit# A273.300.008	A273.300.R.08-06-A100-200-EF	OAKU 060508ER-F40 CTC5240	T20	\$520
12021831	Kit# A273.400.001	A273.400.R.10-06-B125-200-EF	OAKU 060508SR-M50 CTCK215	T20	\$599
12021832	Kit# A273.400.002	A273.400.R.10-06-B125-200-EF	OAKU 060508SR-R50 CTCK215	T20	\$599
12021833	Kit# A273.400.003	A273.400.R.10-06-B125-200-EF	OAKU 060508ER-F40 CTC5235	T20	\$599
12021834	Kit# A273.400.004	A273.400.R.10-06-B125-200-EF	OAKU 060508SR-F50 CTCM235	T20	\$599
12021835	Kit# A273.400.005	A273.400.R.10-06-B125-200-EF	OAKU 060508SR-M50 CTCM235	T20	\$599
12021836	Kit# A273.400.006	A273.400.R.10-06-B125-200-EF	OAKU 060508SR-F50 CTPP235	T20	\$599
12021837	Kit# A273.400.007	A273.400.R.10-06-B125-200-EF	OAKU 060508SR-M50 CTPP235	T20	\$599
12021838	Kit# A273.400.008	A273.400.R.10-06-B125-200-EF	OAKU 060508ER-F40 CTC5240	T20	\$599
12021840	Kit# A274.200.001	A274.200.R.04-12-A075-175-EF	OFHT 040305SN-M50 CTCK215	T15IP	\$287
12021841	Kit# A274.200.002	A274.200.R.04-12-A075-175-EF	OFHT 040305SN-F50 CTC5235	T15IP	\$287
12021842	Kit# A274.200.003	A274.200.R.04-12-A075-175-EF	OFHT 050410SN-F50 CTC5235	T15IP	\$287
12021843	Kit# A274.200.004	A274.200.R.04-12-A075-175-EF	OFHT 040305SN-F50 CTCM235	T15IP	\$287
12021844	Kit# A274.200.005	A274.200.R.04-12-A075-175-EF	OFHT 050410SN-F50 CTCM235	T15IP	\$287
12021845	Kit# A274.200.006	A274.200.R.04-12-A075-175-EF	OFHT 040305SN-F50 CTPP235	T15IP	\$287
12021846	Kit# A274.200.007	A274.200.R.04-12-A075-175-EF	OFHT 040305SN-M50 CTPP235	T15IP	\$287
12021847	Kit# A274.200.008	A274.200.R.04-12-A075-175-EF	OFHT 050410SN-F50 CTPP235	T15IP	\$287
12021848	Kit# A274.200.009	A274.200.R.04-12-A075-175-EF	OFHT 040305SN-F50 CTC5240	T15IP	\$287
12021849	Kit# A274.250.001	A274.250.R.05-12-A100-200-EF	OFHT 040305SN-M50 CTCK215	T15IP	\$354
12021850	Kit# A274.250.002	A274.250.R.05-12-A100-200-EF	OFHT 040305SN-F50 CTC5235	T15IP	\$354
12021851	Kit# A274.250.003	A274.250.R.05-12-A100-200-EF	OFHT 050410SN-F50 CTC5235	T15IP	\$354
12021853	Kit# A274.250.004	A274.250.R.05-12-A100-200-EF	OFHT 040305SN-F50 CTCM235	T15IP	\$354
12021855	Kit# A274.250.005	A274.250.R.05-12-A100-200-EF	OFHT 050410SN-F50 CTCM235	T15IP	\$354
12021856	Kit# A274.250.006	A274.250.R.05-12-A100-200-EF	OFHT 040305SN-F50 CTPP235	T15IP	\$354

For more information or to order, call Customer Service at 800-783-2280. Have your reference number handy.



SAVE UP TO \$100 ON MILLING INSERTS

Material Number	Type, descriptions-kit	Type, description-cutter	Description-insert	Wrench	Kit Price
12021857	Kit# A274.250.007	A274.250.R.05-12-A100-200-EF	OFHT 040305SN-M50 CTPP235	T15IP	\$354
12021858	Kit# A274.250.008	A274.250.R.05-12-A100-200-EF	OFHT 050410SN-F50 CTPP235	T15IP	\$354
12021859	Kit# A274.250.009	A274.250.R.05-12-A100-200-EF	OFHT 040305SN-F50 CTC5240	T15IP	\$354
12021860	Kit# A274.300.001	A274.300.R.06-12-A100-200-EF	OFHT 040305SN-M50 CTCK215	T15IP	\$420
12021861	Kit# A274.300.002	A274.300.R.06-12-A100-200-EF	OFHT 040305SN-F50 CTC5235	T15IP	\$420
12021863	Kit# A274.300.003	A274.300.R.06-12-A100-200-EF	OFHT 050410SN-F50 CTC5235	T15IP	\$420
12021864	Kit# A274.300.004	A274.300.R.06-12-A100-200-EF	OFHT 040305SN-F50 CTCM235	T15IP	\$420
12021865	Kit# A274.300.005	A274.300.R.06-12-A100-200-EF	OFHT 050410SN-F50 CTCM235	T15IP	\$420
12021866	Kit# A274.300.006	A274.300.R.06-12-A100-200-EF	OFHT 040305SN-F50 CTPP235	T15IP	\$420
12021867	Kit# A274.300.007	A274.300.R.06-12-A100-200-EF	OFHT 040305SN-M50 CTPP235	T15IP	\$420
12021869	Kit# A274.300.008	A274.300.R.06-12-A100-200-EF	OFHT 050410SN-F50 CTPP235	T15IP	\$420
12021870	Kit# A274.300.009	A274.300.R.06-12-A100-200-EF	OFHT 040305SN-F50 CTC5240	T15IP	\$420
12021871	Kit# A274.400.001	A274.400.R.07-12-A125-200-EF	OFHT 040305SN-M50 CTCK215	T15IP	\$480
12021872	Kit# A274.400.002	A274.400.R.07-12-A125-200-EF	OFHT 040305SN-F50 CTC5235	T15IP	\$480
12021873	Kit# A274.400.003	A274.400.R.07-12-A125-200-EF	OFHT 050410SN-F50 CTC5235	T15IP	\$480
12021874	Kit# A274.400.004	A274.400.R.07-12-A125-200-EF	OFHT 040305SN-F50 CTCM235	T15IP	\$480
12021875	Kit# A274.400.005	A274.400.R.07-12-A125-200-EF	OFHT 050410SN-F50 CTCM235	T15IP	\$480
12021876	Kit# A274.400.006	A274.400.R.07-12-A125-200-EF	OFHT 040305SN-F50 CTPP235	T15IP	\$480
12021877	Kit# A274.400.007	A274.400.R.07-12-A125-200-EF	OFHT 040305SN-M50 CTPP235	T15IP	\$480
12021878	Kit# A274.400.008	A274.400.R.07-12-A125-200-EF	OFHT 050410SN-F50 CTPP235	T15IP	\$480
12021879	Kit# A274.400.009	A274.400.R.07-12-A125-200-EF	OFHT 040305SN-F50 CTC5240	T15IP	\$480
12021881	Kit# AHFC.200.001	AHFC.200.R.04-12-A075-175-EF	XOLX 120410SR-M50 CTCK215	T20	\$313
12021883	Kit# AHFC.200.002	AHFC.200.R.04-12-A075-175-EF	XOLX 120410ER-F40 CTC5235	T20	\$313
12021884	Kit# AHFC.200.003	AHFC.200.R.04-12-A075-175-EF	XOLX 120410SR-M50 CTCM235	T20	\$313
12021885	Kit# AHFC.200.004	AHFC.200.R.04-12-A075-175-EF	XOLX 120410SR-M50 CTPP235	T20	\$313
12021886	Kit# AHFC.200.005	AHFC.200.R.04-12-A075-175-EF	XOLX 120410SR-R50 CTPP235	T20	\$313
12021887	Kit# AHFC.200.006	AHFC.200.R.04-12-A075-175-EF	XOLX 120410ER-F40 CTC5240	T20	\$313
12021888	Kit# AHFC.250.001	AHFC.250.R.05-12-A100-200-EF	XOLX 120410SR-M50 CTCK215	T20	\$354
12021889	Kit# AHFC.250.002	AHFC.250.R.05-12-A100-200-EF	XOLX 120410ER-F40 CTC5235	T20	\$354
12021890	Kit# AHFC.250.003	AHFC.250.R.05-12-A100-200-EF	XOLX 120410SR-M50 CTCM235	T20	\$354
12021891	Kit# AHFC.250.004	AHFC.250.R.05-12-A100-200-EF	XOLX 120410SR-M50 CTPP235	T20	\$354
12021892	Kit# AHFC.250.005	AHFC.250.R.05-12-A100-200-EF	XOLX 120410SR-R50 CTPP235	T20	\$354
12021894	Kit# AHFC.250.006	AHFC.250.R.05-12-A100-200-EF	XOLX 120410ER-F40 CTC5240	T20	\$354
12021895	Kit# AHFC.300.001	AHFC.300.R.07-12-A100-200-EF	XOLX 120410SR-M50 CTCK215	T20	\$410
12021896	Kit# AHFC.300.002	AHFC.300.R.07-12-A100-200-EF	XOLX 120410ER-F40 CTC5235	T20	\$410
12021897	Kit# AHFC.300.003	AHFC.300.R.07-12-A100-200-EF	XOLX 120410SR-M50 CTCM235	T20	\$410
12021898	Kit# AHFC.300.004	AHFC.300.R.07-12-A100-200-EF	XOLX 120410SR-M50 CTPP235	T20	\$410
12021899	Kit# AHFC.300.005	AHFC.300.R.07-12-A100-200-EF	XOLX 120410SR-R50 CTPP235	T20	\$410
12021900	Kit# AHFC.300.006	AHFC.300.R.07-12-A100-200-EF	XOLX 120410ER-F40 CTC5240	T20	\$410
12021901	Kit# AHFC.400.001	AHFC.400.R.08-12-A125-200-EF	XOLX 120410SR-M50 CTCK215	T20	\$446
12021902	Kit# AHFC.400.002	AHFC.400.R.08-12-A125-200-EF	XOLX 120410ER-F40 CTC5235	T20	\$446
12021903	Kit# AHFC.400.003	AHFC.400.R.08-12-A125-200-EF	XOLX 120410SR-M50 CTCM235	T20	\$446
12021904	Kit# AHFC.400.004	AHFC.400.R.08-12-A125-200-EF	XOLX 120410SR-M50 CTPP235	T20	\$446
12021905	Kit# AHFC.400.005	AHFC.400.R.08-12-A125-200-EF	XOLX 120410SR-R50 CTPP235	T20	\$446
12021906	Kit# AHFC.400.006	AHFC.400.R.08-12-A125-200-EF	XOLX 120410ER-F40 CTC5240	T20	\$446
12021907	Kit# C211.100.001	C211.100.R.04-11-B-125-EF	XDKT 11T304SR-M50 CTCK215	T08IP	\$248
12021908	Kit# C211.100.002	C211.100.R.04-11-B-125-EF	XDKT 11T308SR-M50 CTCK215	T08IP	\$248
12021909	Kit# C211.100.003	C211.100.R.04-11-B-125-EF	XDKT 11T308SR-R50 CTCK215	T08IP	\$248
12021910	Kit# C211.100.004	C211.100.R.04-11-B-125-EF	XDKT 11T304ER-F40 CTC5235	T08IP	\$248
12021911	Kit# C211.100.005	C211.100.R.04-11-B-125-EF	XDKT 11T308ER-F40 CTC5235	T08IP	\$248



Product Index / Kit Pricing



SAVE UP TO \$100 ON MILLING INSERTS

Material Number	Type, descriptions-kit	Type, description-cutter	Description-insert	Wrench	Kit Price
12021912	Kit# C211.100.006	C211.100.R.04-11-B-125-EF	XDKT 11T308SR-F50 CTC5235	T08IP	\$248
12021913	Kit# C211.100.007	C211.100.R.04-11-B-125-EF	XDKT 11T308SR-F50 CTCM235	T08IP	\$248
12021914	Kit# C211.100.008	C211.100.R.04-11-B-125-EF	XDKT 11T308SR-M50 CTCM235	T08IP	\$248
12021915	Kit# C211.100.009	C211.100.R.04-11-B-125-EF	XDKT 11T308SR-R50 CTCM235	T08IP	\$248
12021916	Kit# C211.100.010	C211.100.R.04-11-B-125-EF	XDKT 11T304SR-F50 CTPP235	T08IP	\$248
12021917	Kit# C211.100.011	C211.100.R.04-11-B-125-EF	XDKT 11T304SR-M50 CTPP235	T08IP	\$248
12021918	Kit# C211.100.012	C211.100.R.04-11-B-125-EF	XDKT 11T304SR-R50 CTPP235	T08IP	\$248
12021919	Kit# C211.100.013	C211.100.R.04-11-B-125-EF	XDKT 11T308SR-F50 CTPP235	T08IP	\$248
12021920	Kit# C211.100.014	C211.100.R.04-11-B-125-EF	XDKT 11T308SR-M50 CTPP235	T08IP	\$248
12021921	Kit# C211.100.015	C211.100.R.04-11-B-125-EF	XDKT 11T308SR-R50 CTPP235	T08IP	\$248
12021922	Kit# C211.100.016	C211.100.R.04-11-B-125-EF	XDKT 11T304ER-F40 CTC5240	T08IP	\$248
12021923	Kit# C211.100.017	C211.100.R.04-11-B-125-EF	XDKT 11T308ER-F40 CTC5240	T08IP	\$248
12021924	Kit# C211.100.018	C211.100.R.04-11-B-125-EF	XDKT 11T308SR-F50 CTC5240	T08IP	\$248
12021925	Kit# C211.125.001	C211.125.R.05-11-B-150-EF	XDKT 11T304SR-M50 CTCK215	T08IP	\$270
12021926	Kit# C211.125.002	C211.125.R.05-11-B-150-EF	XDKT 11T308SR-M50 CTCK215	T08IP	\$270
12021927	Kit# C211.125.003	C211.125.R.05-11-B-150-EF	XDKT 11T308SR-R50 CTCK215	T08IP	\$270
12021928	Kit# C211.125.004	C211.125.R.05-11-B-150-EF	XDKT 11T304ER-F40 CTC5235	T08IP	\$270
12021929	Kit# C211.125.005	C211.125.R.05-11-B-150-EF	XDKT 11T308ER-F40 CTC5235	T08IP	\$270
12021930	Kit# C211.125.006	C211.125.R.05-11-B-150-EF	XDKT 11T308SR-F50 CTC5235	T08IP	\$270
12021931	Kit# C211.125.007	C211.125.R.05-11-B-150-EF	XDKT 11T308SR-F50 CTCM235	T08IP	\$270
12021932	Kit# C211.125.008	C211.125.R.05-11-B-150-EF	XDKT 11T308SR-M50 CTCM235	T08IP	\$270
12021933	Kit# C211.125.009	C211.125.R.05-11-B-150-EF	XDKT 11T308SR-R50 CTCM235	T08IP	\$270
12021935	Kit# C211.125.010	C211.125.R.05-11-B-150-EF	XDKT 11T304SR-F50 CTPP235	T08IP	\$270
12021936	Kit# C211.125.011	C211.125.R.05-11-B-150-EF	XDKT 11T304SR-M50 CTPP235	T08IP	\$270
12021937	Kit# C211.125.012	C211.125.R.05-11-B-150-EF	XDKT 11T304SR-R50 CTPP235	T08IP	\$270
12021938	Kit# C211.125.013	C211.125.R.05-11-B-150-EF	XDKT 11T308SR-F50 CTPP235	T08IP	\$270
12021939	Kit# C211.125.014	C211.125.R.05-11-B-150-EF	XDKT 11T308SR-M50 CTPP235	T08IP	\$270
12021940	Kit# C211.125.015	C211.125.R.05-11-B-150-EF	XDKT 11T308SR-R50 CTPP235	T08IP	\$270
12021941	Kit# C211.125.016	C211.125.R.05-11-B-150-EF	XDKT 11T304ER-F40 CTC5240	T08IP	\$270
12021942	Kit# C211.125.017	C211.125.R.05-11-B-150-EF	XDKT 11T308ER-F40 CTC5240	T08IP	\$270
12021943	Kit# C211.125.018	C211.125.R.05-11-B-150-EF	XDKT 11T308SR-F50 CTC5240	T08IP	\$270
12021944	Kit# C211.625.001	C211.0625.R.02-11-B-100-EF	XDKT 11T304SR-M50 CTCK215	T08IP	\$206
12021945	Kit# C211.625.002	C211.0625.R.02-11-B-100-EF	XDKT 11T308SR-M50 CTCK215	T08IP	\$206
12021946	Kit# C211.625.003	C211.0625.R.02-11-B-100-EF	XDKT 11T308SR-R50 CTCK215	T08IP	\$206
12021947	Kit# C211.625.004	C211.0625.R.02-11-B-100-EF	XDKT 11T304ER-F40 CTC5235	T08IP	\$206
12021949	Kit# C211.625.005	C211.0625.R.02-11-B-100-EF	XDKT 11T308ER-F40 CTC5235	T08IP	\$206
12021950	Kit# C211.625.006	C211.0625.R.02-11-B-100-EF	XDKT 11T308SR-F50 CTC5235	T08IP	\$206
12021951	Kit# C211.625.007	C211.0625.R.02-11-B-100-EF	XDKT 11T308SR-F50 CTCM235	T08IP	\$206
12021952	Kit# C211.625.008	C211.0625.R.02-11-B-100-EF	XDKT 11T308SR-M50 CTCM235	T08IP	\$206
12021953	Kit# C211.625.009	C211.0625.R.02-11-B-100-EF	XDKT 11T308SR-R50 CTCM235	T08IP	\$206
12021954	Kit# C211.625.010	C211.0625.R.02-11-B-100-EF	XDKT 11T304SR-F50 CTPP235	T08IP	\$206
12021955	Kit# C211.625.011	C211.0625.R.02-11-B-100-EF	XDKT 11T304SR-M50 CTPP235	T08IP	\$206
12021957	Kit# C211.625.012	C211.0625.R.02-11-B-100-EF	XDKT 11T304SR-R50 CTPP235	T08IP	\$206
12021958	Kit# C211.625.013	C211.0625.R.02-11-B-100-EF	XDKT 11T308SR-F50 CTPP235	T08IP	\$206



SAVE UP TO \$50 ON TURNING INSERTS

Material Number	Type, descriptions-kit	Type, description-cutter	Description-insert	Wrench	Kit Price
12021959	Kit# C211.625.014	C211.0625.R.02-11-B-100-EF	XDKT 11T308SR-M50 CTPP235	T08IP	\$206
12021960	Kit# C211.625.015	C211.0625.R.02-11-B-100-EF	XDKT 11T308SR-R50 CTPP235	T08IP	\$206
12021961	Kit# C211.625.016	C211.0625.R.02-11-B-100-EF	XDKT 11T304ER-F40 CTC5240	T08IP	\$206
12021963	Kit# C211.625.017	C211.0625.R.02-11-B-100-EF	XDKT 11T308ER-F40 CTC5240	T08IP	\$206
12021964	Kit# C211.625.018	C211.0625.R.02-11-B-100-EF	XDKT 11T308SR-F50 CTC5240	T08IP	\$206
12021967	Kit# C211.750.001	C211.0750.R.03-11-B-100-EF	XDKT 11T304SR-M50 CTCK215	T08IP	\$227
12021968	Kit# C211.750.002	C211.0750.R.03-11-B-100-EF	XDKT 11T308SR-M50 CTCK215	T08IP	\$227
12021969	Kit# C211.750.003	C211.0750.R.03-11-B-100-EF	XDKT 11T308SR-R50 CTCK215	T08IP	\$227
12021970	Kit# C211.750.004	C211.0750.R.03-11-B-100-EF	XDKT 11T304ER-F40 CTC5235	T08IP	\$227
12021971	Kit# C211.750.005	C211.0750.R.03-11-B-100-EF	XDKT 11T308ER-F40 CTC5235	T08IP	\$227
12021972	Kit# C211.750.006	C211.0750.R.03-11-B-100-EF	XDKT 11T308SR-F50 CTC5235	T08IP	\$227
12021973	Kit# C211.750.007	C211.0750.R.03-11-B-100-EF	XDKT 11T308SR-F50 CTCM235	T08IP	\$227
12021974	Kit# C211.750.008	C211.0750.R.03-11-B-100-EF	XDKT 11T308SR-M50 CTCM235	T08IP	\$227
12021975	Kit# C211.750.009	C211.0750.R.03-11-B-100-EF	XDKT 11T308SR-R50 CTCM235	T08IP	\$227
12021976	Kit# C211.750.010	C211.0750.R.03-11-B-100-EF	XDKT 11T304SR-F50 CTPP235	T08IP	\$227
12021977	Kit# C211.750.011	C211.0750.R.03-11-B-100-EF	XDKT 11T304SR-M50 CTPP235	T08IP	\$227
12021978	Kit# C211.750.012	C211.0750.R.03-11-B-100-EF	XDKT 11T304SR-R50 CTPP235	T08IP	\$227
12021979	Kit# C211.750.013	C211.0750.R.03-11-B-100-EF	XDKT 11T308SR-F50 CTPP235	T08IP	\$227
12021980	Kit# C211.750.014	C211.0750.R.03-11-B-100-EF	XDKT 11T308SR-M50 CTPP235	T08IP	\$227
12021981	Kit# C211.750.015	C211.0750.R.03-11-B-100-EF	XDKT 11T308SR-R50 CTPP235	T08IP	\$227
12021982	Kit# C211.750.016	C211.0750.R.03-11-B-100-EF	XDKT 11T304ER-F40 CTC5240	T08IP	\$227
12021983	Kit# C211.750.017	C211.0750.R.03-11-B-100-EF	XDKT 11T308ER-F40 CTC5240	T08IP	\$227
12021984	Kit# C211.750.018	C211.0750.R.03-11-B-100-EF	XDKT 11T308SR-F50 CTC5240	T08IP	\$227
12021985	Kit# CHFC.100.001	CHFC.100.R.04-06-B-200-EF	XPLX 060305SR-M50 CTCK215	T08	\$242
12021986	Kit# CHFC.100.002	CHFC.100.R.04-06-B-200-EF	XPLX 060305ER-F40 CTC5235	T08	\$242
12021987	Kit# CHFC.100.003	CHFC.100.R.04-06-B-200-EF	XPLX 060305SR-M50 CTPM225	T08	\$242
12021988	Kit# CHFC.100.004	CHFC.100.R.04-06-B-200-EF	XPLX 060305SR-M50 CTPP235	T08	\$242
12021989	Kit# CHFC.100.005	CHFC.100.R.04-06-B-200-EF	XPLX 060305ER-F40 CTC5240	T08	\$242
12021990	Kit# CHFC.125.001	CHFC.125.R.05-06-B100-250-EF	XPLX 060305SR-M50 CTCK215	T08	\$263
12021991	Kit# CHFC.125.002	CHFC.125.R.05-06-B100-250-EF	XPLX 060305ER-F40 CTC5235	T08	\$263
12021992	Kit# CHFC.125.003	CHFC.125.R.05-06-B100-250-EF	XPLX 060305SR-M50 CTPM225	T08	\$263
12021993	Kit# CHFC.125.004	CHFC.125.R.05-06-B100-250-EF	XPLX 060305SR-M50 CTPP235	T08	\$263
12021994	Kit# CHFC.125.005	CHFC.125.R.05-06-B100-250-EF	XPLX 060305ER-F40 CTC5240	T08	\$263
12021995	Kit# CHFC.625.001	CHFC.0625.R.02-06-B-150-EF	XPLX 060305SR-M50 CTCK215	T08	\$199
12021996	Kit# CHFC.625.002	CHFC.0625.R.02-06-B-150-EF	XPLX 060305ER-F40 CTC5235	T08	\$199
12021998	Kit# CHFC.625.003	CHFC.0625.R.02-06-B-150-EF	XPLX 060305SR-M50 CTPM225	T08	\$199
12021999	Kit# CHFC.625.004	CHFC.0625.R.02-06-B-150-EF	XPLX 060305SR-M50 CTPP235	T08	\$199
12022000	Kit# CHFC.625.005	CHFC.0625.R.02-06-B-150-EF	XPLX 060305ER-F40 CTC5240	T08	\$199
12022001	Kit# CHFC.750.001	CHFC.0750.R.03-06-B-200-EF	XPLX 060305SR-M50 CTCK215	T08	\$221
12022002	Kit# CHFC.750.002	CHFC.0750.R.03-06-B-200-EF	XPLX 060305ER-F40 CTC5235	T08	\$221
12022003	Kit# CHFC.750.003	CHFC.0750.R.03-06-B-200-EF	XPLX 060305SR-M50 CTPM225	T08	\$221
12022004	Kit# CHFC.750.004	CHFC.0750.R.03-06-B-200-EF	XPLX 060305SR-M50 CTPP235	T08	\$221
12022005	Kit# CHFC.750.005	CHFC.0750.R.03-06-B-200-EF	XPLX 060305ER-F40 CTC5240	T08	\$221

Save up to \$100 on every kit you buy! (Kits include one holder and ten inserts.)



Product Index / Kit Pricing

Tool Holders - C Style



SAVE UP TO \$50 ON C STYLE TOOL HOLDERS

Material Number	Type, descriptions-kit	Type, description-cutter	Description-insert	Wrench	Kit Price
12022006	Kit# DCLNL 16-4DA-N.001 w/Coolant	DCLNL 16-4DA-N	CNMG 120408EN-M70 CTCK120	N/A	\$84
12022007	Kit# DCLNL 16-4DA-N.002 w/Coolant	DCLNL 16-4DA-N	CNMG 120412EN-M70 CTCK120	N/A	\$84
12022008	Kit# DCLNL 16-4DA-N.003 w/Coolant	DCLNL 16-4DA-N	CNMG 120408EN-F34 CTP5115	N/A	\$84
12022009	Kit# DCLNL 16-4DA-N.004 w/Coolant	DCLNL 16-4DA-N	CNMG 120408EN-M34 CTP5110	N/A	\$84
12022010	Kit# DCLNL 16-4DA-N.005 w/Coolant	DCLNL 16-4DA-N	CNMG 120408EN-M34 CTP5115	N/A	\$84
12022011	Kit# DCLNL 16-4DA-N.006 w/Coolant	DCLNL 16-4DA-N	CNMG 120412EN-F34 CTP5115	N/A	\$84
12022012	Kit# DCLNL 16-4DA-N.007 w/Coolant	DCLNL 16-4DA-N	CNMG 120412EN-M34 CTP5110	N/A	\$84
12022013	Kit# DCLNL 16-4DA-N.008 w/Coolant	DCLNL 16-4DA-N	CNMG 120412EN-M34 CTP5115	N/A	\$84
12022014	Kit# DCLNL 16-4DA-N.009 w/Coolant	DCLNL 16-4DA-N	CNMG 120408EN-F30 CTPM125	N/A	\$84
12022015	Kit# DCLNL 16-4DA-N.010 w/Coolant	DCLNL 16-4DA-N	CNMG 120408EN-M30 CTPM125	N/A	\$84
12022016	Kit# DCLNL 16-4DA-N.011 w/Coolant	DCLNL 16-4DA-N	CNMG 120408EN-M42 CTP2120	N/A	\$84
12022017	Kit# DCLNL 16-4DA-N.012 w/Coolant	DCLNL 16-4DA-N	CNMG 120408EN-M52 CTP2120	N/A	\$84
12022018	Kit# DCLNL 16-4DA-N.013 w/Coolant	DCLNL 16-4DA-N	CNMG 120408EN-M60 CTPM125	N/A	\$84
12022019	Kit# DCLNL 16-4DA-N.014 w/Coolant	DCLNL 16-4DA-N	CNMG 120412EN-M30 CTPM125	N/A	\$84
12022020	Kit# DCLNL 16-4DA-N.015 w/Coolant	DCLNL 16-4DA-N	CNMG 120412EN-M52 CTP2120	N/A	\$84
12022021	Kit# DCLNL 16-4DA-N.016 w/Coolant	DCLNL 16-4DA-N	CNMG 120412EN-M60 CTPM125	N/A	\$84
12022022	Kit# DCLNL 16-4DA-N.017 w/Coolant	DCLNL 16-4DA-N	CNMG 120408EN-M50 CTCP115	N/A	\$84
12022023	Kit# DCLNL 16-4DA-N.018 w/Coolant	DCLNL 16-4DA-N	CNMG 120408EN-M50 CTCP125	N/A	\$84
12022024	Kit# DCLNL 16-4DA-N.019 w/Coolant	DCLNL 16-4DA-N	CNMG 120408EN-M70 CTCP115	N/A	\$84
12022025	Kit# DCLNL 16-4DA-N.020 w/Coolant	DCLNL 16-4DA-N	CNMG 120408EN-M70 CTCP125	N/A	\$84
12022026	Kit# DCLNL 16-4DA-N.021 w/Coolant	DCLNL 16-4DA-N	CNMG 120412EN-M50 CTCP115	N/A	\$84
12022027	Kit# DCLNL 16-4DA-N.022 w/Coolant	DCLNL 16-4DA-N	CNMG 120412EN-M50 CTCP125	N/A	\$84
12022029	Kit# DCLNL 16-4DA-N.023 w/Coolant	DCLNL 16-4DA-N	CNMG 120412EN-M70 CTCP115	N/A	\$84
12022030	Kit# DCLNL 16-4DA-N.024 w/Coolant	DCLNL 16-4DA-N	CNMG 120412EN-M70 CTCP125	N/A	\$84
12022031	Kit# DCLNL 16-4D-N.001	DCLNL 16-4D-N	CNMG 120408EN-M70 CTCK120	N/A	\$101
12022032	Kit# DCLNL 16-4D-N.002	DCLNL 16-4D-N	CNMG 120412EN-M70 CTCK120	N/A	\$101
12022034	Kit# DCLNL 16-4D-N.003	DCLNL 16-4D-N	CNMG 120408EN-F34 CTP5115	N/A	\$101
12022035	Kit# DCLNL 16-4D-N.004	DCLNL 16-4D-N	CNMG 120408EN-M34 CTP5110	N/A	\$101
12022036	Kit# DCLNL 16-4D-N.005	DCLNL 16-4D-N	CNMG 120408EN-M34 CTP5115	N/A	\$101
12022037	Kit# DCLNL 16-4D-N.006	DCLNL 16-4D-N	CNMG 120412EN-F34 CTP5115	N/A	\$101
12022038	Kit# DCLNL 16-4D-N.007	DCLNL 16-4D-N	CNMG 120412EN-M34 CTP5110	N/A	\$101
12022039	Kit# DCLNL 16-4D-N.008	DCLNL 16-4D-N	CNMG 120412EN-M34 CTP5115	N/A	\$101
12022040	Kit# DCLNL 16-4D-N.009	DCLNL 16-4D-N	CNMG 120408EN-F30 CTPM125	N/A	\$101
12022041	Kit# DCLNL 16-4D-N.010	DCLNL 16-4D-N	CNMG 120408EN-M30 CTPM125	N/A	\$101
12022042	Kit# DCLNL 16-4D-N.011	DCLNL 16-4D-N	CNMG 120408EN-M42 CTP2120	N/A	\$101
12022043	Kit# DCLNL 16-4D-N.012	DCLNL 16-4D-N	CNMG 120408EN-M52 CTP2120	N/A	\$101
12022044	Kit# DCLNL 16-4D-N.013	DCLNL 16-4D-N	CNMG 120408EN-M60 CTPM125	N/A	\$101
12022045	Kit# DCLNL 16-4D-N.014	DCLNL 16-4D-N	CNMG 120412EN-M30 CTPM125	N/A	\$101
12022046	Kit# DCLNL 16-4D-N.015	DCLNL 16-4D-N	CNMG 120412EN-M52 CTP2120	N/A	\$101
12022047	Kit# DCLNL 16-4D-N.016	DCLNL 16-4D-N	CNMG 120412EN-M60 CTPM125	N/A	\$101
12022048	Kit# DCLNL 16-4D-N.017	DCLNL 16-4D-N	CNMG 120408EN-M50 CTCP115	N/A	\$101
12022049	Kit# DCLNL 16-4D-N.018	DCLNL 16-4D-N	CNMG 120408EN-M50 CTCP125	N/A	\$101
12022050	Kit# DCLNL 16-4D-N.019	DCLNL 16-4D-N	CNMG 120408EN-M70 CTCP115	N/A	\$101
12022052	Kit# DCLNL 16-4D-N.020	DCLNL 16-4D-N	CNMG 120408EN-M70 CTCP125	N/A	\$101
12022053	Kit# DCLNL 16-4D-N.021	DCLNL 16-4D-N	CNMG 120412EN-M50 CTCP115	N/A	\$101
12022054	Kit# DCLNL 16-4D-N.022	DCLNL 16-4D-N	CNMG 120412EN-M50 CTCP125	N/A	\$101
12022055	Kit# DCLNL 16-4D-N.023	DCLNL 16-4D-N	CNMG 120412EN-M70 CTCP115	N/A	\$101
12022056	Kit# DCLNL 16-4D-N.024	DCLNL 16-4D-N	CNMG 120412EN-M70 CTCP125	N/A	\$101

Tool holders

Product Index / Kit Pricing

For more information or to order, call Customer Service at 800-783-2280. Have your reference number handy.



SAVE UP TO \$50 ON C STYLE TOOL HOLDERS

Material Number	Type, descriptions-kit	Type, description-cutter	Description-insert	Wrench	Kit Price
12022057	Kit# DCLNR 16-4DA-N.001 w/Coolant	DCLNR 16-4DA-N	CNMG 120408EN-M70 CTCK120	N/A	\$84
12022058	Kit# DCLNR 16-4DA-N.002 w/Coolant	DCLNR 16-4DA-N	CNMG 120412EN-M70 CTCK120	N/A	\$84
12022059	Kit# DCLNR 16-4DA-N.003 w/Coolant	DCLNR 16-4DA-N	CNMG 120408EN-F34 CTP5115	N/A	\$84
12022060	Kit# DCLNR 16-4DA-N.004 w/Coolant	DCLNR 16-4DA-N	CNMG 120408EN-M34 CTP5110	N/A	\$84
12022061	Kit# DCLNR 16-4DA-N.005 w/Coolant	DCLNR 16-4DA-N	CNMG 120408EN-M34 CTP5115	N/A	\$84
12022063	Kit# DCLNR 16-4DA-N.006 w/Coolant	DCLNR 16-4DA-N	CNMG 120412EN-F34 CTP5115	N/A	\$84
12022065	Kit# DCLNR 16-4DA-N.007 w/Coolant	DCLNR 16-4DA-N	CNMG 120412EN-M34 CTP5110	N/A	\$84
12022066	Kit# DCLNR 16-4DA-N.008 w/Coolant	DCLNR 16-4DA-N	CNMG 120412EN-M34 CTP5115	N/A	\$84
12022067	Kit# DCLNR 16-4DA-N.009 w/Coolant	DCLNR 16-4DA-N	CNMG 120408EN-F30 CTPM125	N/A	\$84
12022068	Kit# DCLNR 16-4DA-N.010 w/Coolant	DCLNR 16-4DA-N	CNMG 120408EN-M30 CTPM125	N/A	\$84
12022069	Kit# DCLNR 16-4DA-N.011 w/Coolant	DCLNR 16-4DA-N	CNMG 120408EN-M42 CTP2120	N/A	\$84
12022070	Kit# DCLNR 16-4DA-N.012 w/Coolant	DCLNR 16-4DA-N	CNMG 120408EN-M52 CTP2120	N/A	\$84
12022071	Kit# DCLNR 16-4DA-N.013 w/Coolant	DCLNR 16-4DA-N	CNMG 120408EN-M60 CTPM125	N/A	\$84
12022073	Kit# DCLNR 16-4DA-N.014 w/Coolant	DCLNR 16-4DA-N	CNMG 120412EN-M30 CTPM125	N/A	\$84
12022075	Kit# DCLNR 16-4DA-N.015 w/Coolant	DCLNR 16-4DA-N	CNMG 120412EN-M52 CTP2120	N/A	\$84
12022076	Kit# DCLNR 16-4DA-N.016 w/Coolant	DCLNR 16-4DA-N	CNMG 120412EN-M60 CTPM125	N/A	\$84
12022077	Kit# DCLNR 16-4DA-N.017 w/Coolant	DCLNR 16-4DA-N	CNMG 120408EN-M50 CTCP115	N/A	\$84
12022078	Kit# DCLNR 16-4DA-N.018 w/Coolant	DCLNR 16-4DA-N	CNMG 120408EN-M50 CTCP125	N/A	\$84
12022079	Kit# DCLNR 16-4DA-N.019 w/Coolant	DCLNR 16-4DA-N	CNMG 120408EN-M70 CTCP115	N/A	\$84
12022081	Kit# DCLNR 16-4DA-N.020 w/Coolant	DCLNR 16-4DA-N	CNMG 120408EN-M70 CTCP125	N/A	\$84
12022082	Kit# DCLNR 16-4DA-N.021 w/Coolant	DCLNR 16-4DA-N	CNMG 120412EN-M50 CTCP115	N/A	\$84
12022083	Kit# DCLNR 16-4DA-N.022 w/Coolant	DCLNR 16-4DA-N	CNMG 120412EN-M50 CTCP125	N/A	\$84
12022084	Kit# DCLNR 16-4DA-N.023 w/Coolant	DCLNR 16-4DA-N	CNMG 120412EN-M70 CTCP115	N/A	\$84
12022085	Kit# DCLNR 16-4DA-N.024 w/Coolant	DCLNR 16-4DA-N	CNMG 120412EN-M70 CTCP125	N/A	\$84
12022086	Kit# DCLNR 16-4D-N.001	DCLNR 16-4D-N	CNMG 120408EN-M70 CTCK120	N/A	\$101
12022087	Kit# DCLNR 16-4D-N.002	DCLNR 16-4D-N	CNMG 120412EN-M70 CTCK120	N/A	\$101
12022089	Kit# DCLNR 16-4D-N.003	DCLNR 16-4D-N	CNMG 120408EN-F34 CTP5115	N/A	\$101
12022090	Kit# DCLNR 16-4D-N.004	DCLNR 16-4D-N	CNMG 120408EN-M34 CTP5110	N/A	\$101
12022091	Kit# DCLNR 16-4D-N.005	DCLNR 16-4D-N	CNMG 120408EN-M34 CTP5115	N/A	\$101
12022092	Kit# DCLNR 16-4D-N.006	DCLNR 16-4D-N	CNMG 120412EN-F34 CTP5115	N/A	\$101
12022093	Kit# DCLNR 16-4D-N.007	DCLNR 16-4D-N	CNMG 120412EN-M34 CTP5110	N/A	\$101
12022094	Kit# DCLNR 16-4D-N.008	DCLNR 16-4D-N	CNMG 120412EN-M34 CTP5115	N/A	\$101
12022095	Kit# DCLNR 16-4D-N.009	DCLNR 16-4D-N	CNMG 120408EN-F30 CTPM125	N/A	\$101
12022097	Kit# DCLNR 16-4D-N.010	DCLNR 16-4D-N	CNMG 120408EN-M30 CTPM125	N/A	\$101
12022098	Kit# DCLNR 16-4D-N.011	DCLNR 16-4D-N	CNMG 120408EN-M42 CTP2120	N/A	\$101
12022099	Kit# DCLNR 16-4D-N.012	DCLNR 16-4D-N	CNMG 120408EN-M52 CTP2120	N/A	\$101
12022100	Kit# DCLNR 16-4D-N.013	DCLNR 16-4D-N	CNMG 120408EN-M60 CTPM125	N/A	\$101
12022101	Kit# DCLNR 16-4D-N.014	DCLNR 16-4D-N	CNMG 120412EN-M30 CTPM125	N/A	\$101
12022102	Kit# DCLNR 16-4D-N.015	DCLNR 16-4D-N	CNMG 120412EN-M52 CTP2120	N/A	\$101
12022103	Kit# DCLNR 16-4D-N.016	DCLNR 16-4D-N	CNMG 120412EN-M60 CTPM125	N/A	\$101
12022104	Kit# DCLNR 16-4D-N.017	DCLNR 16-4D-N	CNMG 120408EN-M50 CTCP115	N/A	\$101
12022105	Kit# DCLNR 16-4D-N.018	DCLNR 16-4D-N	CNMG 120408EN-M50 CTCP125	N/A	\$101
12022106	Kit# DCLNR 16-4D-N.019	DCLNR 16-4D-N	CNMG 120408EN-M70 CTCP115	N/A	\$101
12022107	Kit# DCLNR 16-4D-N.020	DCLNR 16-4D-N	CNMG 120408EN-M70 CTCP125	N/A	\$101
12022108	Kit# DCLNR 16-4D-N.021	DCLNR 16-4D-N	CNMG 120412EN-M50 CTCP115	N/A	\$101
12022110	Kit# DCLNR 16-4D-N.022	DCLNR 16-4D-N	CNMG 120412EN-M50 CTCP125	N/A	\$101
12022111	Kit# DCLNR 16-4D-N.023	DCLNR 16-4D-N	CNMG 120412EN-M70 CTCP115	N/A	\$101
12022112	Kit# DCLNR 16-4D-N.024	DCLNR 16-4D-N	CNMG 120412EN-M70 CTCP125	N/A	\$101



Product Index / Kit Pricing

Tool Holders - D Style



SAVE UP TO \$50 ON D STYLE TOOL HOLDERS

Material Number	Type, descriptions-kit	Type, description-cutter	Description-insert	Wrench	Kit Price
12022113	Kit# DDJNL 16-4DA-N.011 w/ coolant	DDJNL 16-4DA-N	DNMG 150404EN-M34 CTP5110	N/A	\$120
12022114	Kit# DDJNL 16-4DA-N.012 w/ coolant	DDJNL 16-4DA-N	DNMG 150408EN-M34 CTP5110	N/A	\$120
12022115	Kit# DDJNL 16-4DA-N.013 w/ coolant	DDJNL 16-4DA-N	DNMG 150412EN-M34 CTP5110	N/A	\$120
12022116	Kit# DDJNL 16-4DA-N.014 w/ coolant	DDJNL 16-4DA-N	DNMG 150404EN-M34 CTP5115	N/A	\$120
12022117	Kit# DDJNL 16-4DA-N.015 w/ coolant	DDJNL 16-4DA-N	DNMG 150408EN-M34 CTP5115	N/A	\$120
12022118	Kit# DDJNL 16-4DA-N.016 w/ coolant	DDJNL 16-4DA-N	DNMG 150412EN-M34 CTP5115	N/A	\$120
12022119	Kit# DDJNL 16-4DA-N.017 w/ coolant	DDJNL 16-4DA-N	DNMG 150404EN-M42 CTP2120	N/A	\$120
12022120	Kit# DDJNL 16-4DA-N.018 w/ coolant	DDJNL 16-4DA-N	DNMG 150404EN-M52 CTP2120	N/A	\$120
12022121	Kit# DDJNL 16-4DA-N.019 w/ coolant	DDJNL 16-4DA-N	DNMG 150408EN-M52 CTP2120	N/A	\$120
12022122	Kit# DDJNL 16-4DA-N.020 w/ coolant	DDJNL 16-4DA-N	DNMG 150404EN-M50 CTCP115	N/A	\$120
12022123	Kit# DDJNL 16-4DA-N.021 w/ coolant	DDJNL 16-4DA-N	DNMG 150408EN-M50 CTCP115	N/A	\$120
12022125	Kit# DDJNL 16-4DA-N.022 w/ coolant	DDJNL 16-4DA-N	DNMG 150408EN-M70 CTCP115	N/A	\$120
12022126	Kit# DDJNL 16-4DA-N.023 w/ coolant	DDJNL 16-4DA-N	DNMG 150412EN-M50 CTCP115	N/A	\$120
12022127	Kit# DDJNL 16-4DA-N.024 w/ coolant	DDJNL 16-4DA-N	DNMG 150412EN-M70 CTCP115	N/A	\$120
12022128	Kit# DDJNL 16-4DA-N.025 w/ coolant	DDJNL 16-4DA-N	DNMG 150404EN-M50 CTCP125	N/A	\$120
12022130	Kit# DDJNL 16-4DA-N.026 w/ coolant	DDJNL 16-4DA-N	DNMG 150408EN-M50 CTCP125	N/A	\$120
12022131	Kit# DDJNL 16-4DA-N.027 w/ coolant	DDJNL 16-4DA-N	DNMG 150408EN-M70 CTCP125	N/A	\$120
12022132	Kit# DDJNL 16-4DA-N.028 w/ coolant	DDJNL 16-4DA-N	DNMG 150412EN-M50 CTCP125	N/A	\$120
12022133	Kit# DDJNL 16-4DA-N.029 w/ coolant	DDJNL 16-4DA-N	DNMG 150412EN-M70 CTCP125	N/A	\$120
12022134	Kit# DDJNL-16-4-D.001	DDJNR 16-4D-N	DNMG 150404EN-M34 CTP5110	N/A	\$146
12022135	Kit# DDJNL-16-4-D.002	DDJNR 16-4D-N	DNMG 150408EN-M34 CTP5110	N/A	\$146
12022136	Kit# DDJNL-16-4-D.003	DDJNR 16-4D-N	DNMG 150412EN-M34 CTP5110	N/A	\$146
12022137	Kit# DDJNL-16-4-D.004	DDJNR 16-4D-N	DNMG 150404EN-M34 CTP5115	N/A	\$146
12022138	Kit# DDJNL-16-4-D.005	DDJNR 16-4D-N	DNMG 150408EN-M34 CTP5115	N/A	\$146
12022139	Kit# DDJNL-16-4-D.006	DDJNR 16-4D-N	DNMG 150412EN-M34 CTP5115	N/A	\$146
12022141	Kit# DDJNL-16-4-D.007	DDJNR 16-4D-N	DNMG 150404EN-M42 CTP2120	N/A	\$146
12022142	Kit# DDJNL-16-4-D.008	DDJNR 16-4D-N	DNMG 150404EN-M52 CTP2120	N/A	\$146
12022143	Kit# DDJNL-16-4-D.009	DDJNR 16-4D-N	DNMG 150408EN-M52 CTP2120	N/A	\$146
12022144	Kit# DDJNL-16-4-D.010	DDJNR 16-4D-N	DNMG 150404EN-M50 CTCP115	N/A	\$146
12022145	Kit# DDJNL-16-4-D.011	DDJNR 16-4D-N	DNMG 150408EN-M50 CTCP115	N/A	\$146
12022146	Kit# DDJNL-16-4-D.012	DDJNR 16-4D-N	DNMG 150408EN-M70 CTCP115	N/A	\$146
12022147	Kit# DDJNL-16-4-D.013	DDJNR 16-4D-N	DNMG 150412EN-M50 CTCP115	N/A	\$146
12022148	Kit# DDJNL-16-4-D.014	DDJNR 16-4D-N	DNMG 150412EN-M70 CTCP115	N/A	\$146
12022149	Kit# DDJNL-16-4-D.015	DDJNR 16-4D-N	DNMG 150404EN-M50 CTCP125	N/A	\$146
12022150	Kit# DDJNL-16-4-D.016	DDJNR 16-4D-N	DNMG 150408EN-M50 CTCP125	N/A	\$146
12022151	Kit# DDJNL-16-4-D.017	DDJNR 16-4D-N	DNMG 150408EN-M70 CTCP125	N/A	\$146
12022152	Kit# DDJNL-16-4-D.018	DDJNR 16-4D-N	DNMG 150412EN-M50 CTCP125	N/A	\$146
12022153	Kit# DDJNL-16-4-D.019	DDJNR 16-4D-N	DNMG 150412EN-M70 CTCP125	N/A	\$146
12022154	Kit# DDJNR 16-4DA-N.001 w/ coolant	DDJNR 16-4DA-N	DNMG 150404EN-M34 CTP5110	N/A	\$120
12022155	Kit# DDJNR 16-4DA-N.002 w/ coolant	DDJNR 16-4DA-N	DNMG 150408EN-M34 CTP5110	N/A	\$120
12022157	Kit# DDJNR 16-4DA-N.003 w/ coolant	DDJNR 16-4DA-N	DNMG 150412EN-M34 CTP5110	N/A	\$120
12022158	Kit# DDJNR 16-4DA-N.004 w/ coolant	DDJNR 16-4DA-N	DNMG 150404EN-M34 CTP5115	N/A	\$120
12022159	Kit# DDJNR 16-4DA-N.005 w/ coolant	DDJNR 16-4DA-N	DNMG 150408EN-M34 CTP5115	N/A	\$120
12022160	Kit# DDJNR 16-4DA-N.006 w/ coolant	DDJNR 16-4DA-N	DNMG 150412EN-M34 CTP5115	N/A	\$120
12022161	Kit# DDJNR 16-4DA-N.007 w/ coolant	DDJNR 16-4DA-N	DNMG 150404EN-M42 CTP2120	N/A	\$120
12022162	Kit# DDJNR 16-4DA-N.008 w/ coolant	DDJNR 16-4DA-N	DNMG 150404EN-M52 CTP2120	N/A	\$120
12022163	Kit# DDJNR 16-4DA-N.009 w/ coolant	DDJNR 16-4DA-N	DNMG 150408EN-M52 CTP2120	N/A	\$120
12022164	Kit# DDJNR 16-4DA-N.010 w/ coolant	DDJNR 16-4DA-N	DNMG 150404EN-M50 CTCP115	N/A	\$120
12022165	Kit# DDJNR 16-4DA-N.011 w/ coolant	DDJNR 16-4DA-N	DNMG 150408EN-M50 CTCP115	N/A	\$120



Material Number	Type, descriptions-kit	Type, description-cutter	Description-insert	Wrench	Kit Price
12022167	Kit# DDJNR 16-4DA-N.012 w/ coolant	DDJNR 16-4DA-N	DNMG 150408EN-M70 CTCP115	N/A	\$120
12022168	Kit# DDJNR 16-4DA-N.013 w/ coolant	DDJNR 16-4DA-N	DNMG 150412EN-M50 CTCP115	N/A	\$120
12022169	Kit# DDJNR 16-4DA-N.014 w/ coolant	DDJNR 16-4DA-N	DNMG 150412EN-M70 CTCP115	N/A	\$120
12022170	Kit# DDJNR 16-4DA-N.015 w/ coolant	DDJNR 16-4DA-N	DNMG 150404EN-M50 CTCP125	N/A	\$120
12022171	Kit# DDJNR 16-4DA-N.016 w/ coolant	DDJNR 16-4DA-N	DNMG 150408EN-M50 CTCP125	N/A	\$120
12022172	Kit# DDJNR 16-4DA-N.017 w/ coolant	DDJNR 16-4DA-N	DNMG 150408EN-M70 CTCP125	N/A	\$120
12022173	Kit# DDJNR 16-4DA-N.018 w/ coolant	DDJNR 16-4DA-N	DNMG 150412EN-M50 CTCP125	N/A	\$120
12022174	Kit# DDJNR 16-4DA-N.019 w/ coolant	DDJNR 16-4DA-N	DNMG 150412EN-M70 CTCP125	N/A	\$120
12022175	Kit# DDJNR-164-D.001	DDJNR 16-4DA-N	DNMG 150404EN-M34 CTP5110	N/A	\$146
12022177	Kit# DDJNR-164-D.002	DDJNR 16-4DA-N	DNMG 150408EN-M34 CTP5110	N/A	\$146
12022178	Kit# DDJNR-164-D.003	DDJNR 16-4DA-N	DNMG 150412EN-M34 CTP5110	N/A	\$146
12022179	Kit# DDJNR-164-D.004	DDJNR 16-4DA-N	DNMG 150404EN-M34 CTP5115	N/A	\$146
12022180	Kit# DDJNR-164-D.005	DDJNR 16-4DA-N	DNMG 150408EN-M34 CTP5115	N/A	\$146
12022181	Kit# DDJNR-164-D.006	DDJNR 16-4DA-N	DNMG 150412EN-M34 CTP5115	N/A	\$146
12022182	Kit# DDJNR-164-D.007	DDJNR 16-4DA-N	DNMG 150404EN-M42 CTP2120	N/A	\$146
12022184	Kit# DDJNR-164-D.008	DDJNR 16-4DA-N	DNMG 150404EN-M52 CTP2120	N/A	\$146
12022186	Kit# DDJNR-164-D.009	DDJNR 16-4DA-N	DNMG 150408EN-M52 CTP2120	N/A	\$146
12022187	Kit# DDJNR-164-D.010	DDJNR 16-4DA-N	DNMG 150404EN-M50 CTCP115	N/A	\$146
12022188	Kit# DDJNR-164-D.011	DDJNR 16-4DA-N	DNMG 150408EN-M50 CTCP115	N/A	\$146
12022189	Kit# DDJNR-164-D.012	DDJNR 16-4DA-N	DNMG 150408EN-M70 CTCP115	N/A	\$146
12022190	Kit# DDJNR-164-D.013	DDJNR 16-4DA-N	DNMG 150412EN-M50 CTCP115	N/A	\$146
12022191	Kit# DDJNR-164-D.014	DDJNR 16-4DA-N	DNMG 150412EN-M70 CTCP115	N/A	\$146
12022193	Kit# DDJNR-164-D.015	DDJNR 16-4DA-N	DNMG 150404EN-M50 CTCP125	N/A	\$146
12022194	Kit# DDJNR-164-D.016	DDJNR 16-4DA-N	DNMG 150408EN-M50 CTCP125	N/A	\$146
12022195	Kit# DDJNR-164-D.017	DDJNR 16-4DA-N	DNMG 150408EN-M70 CTCP125	N/A	\$146
12022196	Kit# DDJNR-164-D.018	DDJNR 16-4DA-N	DNMG 150412EN-M50 CTCP125	N/A	\$146
12022197	Kit# DDJNR-164-D.019	DDJNR 16-4DA-N	DNMG 150412EN-M70 CTCP125	N/A	\$146

Tool holders

Tool Holders - V Style



SAVE UP TO \$50 ON V STYLE TOOL HOLDERS

12022198	Kit# DVJNL 16-3DA-N.001 w/coolant	DVJNL 16-3D-N	VNMG 160408EN-M50 CTCK120	N/A	\$167
12022199	Kit# DVJNL 16-3DA-N.002 w/coolant	DVJNL 16-3D-N	VNMG 160412EN-M50 CTCK120	N/A	\$167
12022200	Kit# DVJNL 16-3DA-N.003 w/coolant	DVJNL 16-3D-N	VNMG 160408EN-M34 CTP5110	N/A	\$167
12022201	Kit# DVJNL 16-3DA-N.004 w/coolant	DVJNL 16-3D-N	VNMG 160412EN-M34 CTP5110	N/A	\$167
12022202	Kit# DVJNL 16-3DA-N.005 w/coolant	DVJNL 16-3D-N	VNMG 160408EN-M34 CTP5115	N/A	\$167
12022203	Kit# DVJNL 16-3DA-N.006 w/coolant	DVJNL 16-3D-N	VNMG 160412EN-M34 CTP5115	N/A	\$167
12022204	Kit# DVJNL 16-3DA-N.007 w/coolant	DVJNL 16-3D-N	VNMG 160404EN-M34 CTP5110	N/A	\$167
12022205	Kit# DVJNL 16-3DA-N.008 w/coolant	DVJNL 16-3D-N	VNMG 160404EN-M34 CTP5115	N/A	\$167
12022206	Kit# DVJNL 16-3DA-N.009 w/coolant	DVJNL 16-3D-N	VNMG 160404EN-F30 CTPM125	N/A	\$167
12022207	Kit# DVJNL 16-3DA-N.010 w/coolant	DVJNL 16-3D-N	VNMG 160408EN-F30 CTPM125	N/A	\$167
12022208	Kit# DVJNL 16-3DA-N.011 w/coolant	DVJNL 16-3D-N	VNMG 160408EN-M30 CTPM125	N/A	\$167
12022209	Kit# DVJNL 16-3DA-N.012 w/coolant	DVJNL 16-3D-N	VNMG 160404EN-M50 CTCP115	N/A	\$167
12022210	Kit# DVJNL 16-3DA-N.013 w/coolant	DVJNL 16-3D-N	VNMG 160408EN-M50 CTCP115	N/A	\$167
12022211	Kit# DVJNL 16-3DA-N.014 w/coolant	DVJNL 16-3D-N	VNMG 160412EN-M50 CTCP115	N/A	\$167
12022212	Kit# DVJNL 16-3DA-N.015 w/coolant	DVJNL 16-3D-N	VNMG 160404EN-F40 CTCP125	N/A	\$167
12022213	Kit# DVJNL 16-3DA-N.016 w/coolant	DVJNL 16-3D-N	VNMG 160404EN-M40 CTCP125	N/A	\$167
12022214	Kit# DVJNL 16-3DA-N.017 w/coolant	DVJNL 16-3D-N	VNMG 160404EN-M50 CTCP125	N/A	\$167
12022215	Kit# DVJNL 16-3DA-N.018 w/coolant	DVJNL 16-3D-N	VNMG 160408EN-F40 CTCP125	N/A	\$167
12022216	Kit# DVJNL 16-3DA-N.019 w/coolant	DVJNL 16-3D-N	VNMG 160408EN-M40 CTCP125	N/A	\$167
12022217	Kit# DVJNL 16-3DA-N.020 w/coolant	DVJNL 16-3D-N	VNMG 160408EN-M50 CTCP125	N/A	\$167
12022218	Kit# DVJNL 16-3DA-N.021 w/coolant	DVJNL 16-3D-N	VNMG 160412EN-M50 CTCP125	N/A	\$167

Save up to \$100 on every kit you buy! (Kits include one holder and ten inserts.)

Product Index / Kit Pricing



Product Index / Kit Pricing

Tool holders

Material Number	Type, descriptions-kit	Type, description-cutter	Description-insert	Wrench	Kit Price
12022219	Kit# DVJNR 16-3DA-N.001 w/coolant	DVJNL 16-3D-N	VNMG 160408EN-M50 CTCK120	N/A	\$167
12022220	Kit# DVJNR 16-3DA-N.002 w/coolant	DVJNL 16-3D-N	VNMG 160412EN-M50 CTCK120	N/A	\$167
12022221	Kit# DVJNR 16-3DA-N.003 w/coolant	DVJNL 16-3D-N	VNMG 160408EN-M34 CTP5110	N/A	\$167
12022222	Kit# DVJNR 16-3DA-N.004 w/coolant	DVJNL 16-3D-N	VNMG 160412EN-M34 CTP5110	N/A	\$167
12022223	Kit# DVJNR 16-3DA-N.005 w/coolant	DVJNL 16-3D-N	VNMG 160408EN-M34 CTP5115	N/A	\$167
12022224	Kit# DVJNR 16-3DA-N.006 w/coolant	DVJNL 16-3D-N	VNMG 160412EN-M34 CTP5115	N/A	\$167
12022225	Kit# DVJNR 16-3DA-N.007 w/coolant	DVJNL 16-3D-N	VNMG 160404EN-M34 CTP5110	N/A	\$167
12022226	Kit# DVJNR 16-3DA-N.008 w/coolant	DVJNL 16-3D-N	VNMG 160404EN-M34 CTP5115	N/A	\$167
12022227	Kit# DVJNR 16-3DA-N.009 w/coolant	DVJNL 16-3D-N	VNMG 160404EN-F30 CTPM125	N/A	\$167
12022228	Kit# DVJNR 16-3DA-N.010 w/coolant	DVJNL 16-3D-N	VNMG 160408EN-F30 CTPM125	N/A	\$167
12022229	Kit# DVJNR 16-3DA-N.011 w/coolant	DVJNL 16-3D-N	VNMG 160408EN-M30 CTPM125	N/A	\$167
12022230	Kit# DVJNR 16-3DA-N.012 w/coolant	DVJNL 16-3D-N	VNMG 160404EN-M50 CTCP115	N/A	\$167
12022231	Kit# DVJNR 16-3DA-N.013 w/coolant	DVJNL 16-3D-N	VNMG 160408EN-M50 CTCP115	N/A	\$167
12022232	Kit# DVJNR 16-3DA-N.014 w/coolant	DVJNL 16-3D-N	VNMG 160412EN-M50 CTCP115	N/A	\$167
12022233	Kit# DVJNR 16-3DA-N.015 w/coolant	DVJNL 16-3D-N	VNMG 160404EN-F40 CTCP125	N/A	\$167
12022234	Kit# DVJNR 16-3DA-N.016 w/coolant	DVJNL 16-3D-N	VNMG 160404EN-M40 CTCP125	N/A	\$167
12022235	Kit# DVJNR 16-3DA-N.017 w/coolant	DVJNL 16-3D-N	VNMG 160404EN-M50 CTCP125	N/A	\$167
12022236	Kit# DVJNR 16-3DA-N.018 w/coolant	DVJNL 16-3D-N	VNMG 160408EN-F40 CTCP125	N/A	\$167
12022237	Kit# DVJNR 16-3DA-N.019 w/coolant	DVJNL 16-3D-N	VNMG 160408EN-M40 CTCP125	N/A	\$167
12022238	Kit# DVJNR 16-3DA-N.020 w/coolant	DVJNL 16-3D-N	VNMG 160408EN-M50 CTCP125	N/A	\$167
12022239	Kit# DVJNR 16-3DA-N.021 w/coolant	DVJNL 16-3D-N	VNMG 160412EN-M50 CTCP125	N/A	\$167

Product Index / Kit Pricing

Tool Holders - W Style



SAVE UP TO \$50 ON W STYLE TOOL HOLDERS

12022240	Kit# DWLNL 16-4DA-N.001 w/ coolant	DWLNL 16-4DA-N	WNMG 080408EN-M70 CTCK120	N/A	\$94
12022241	Kit# DWLNL 16-4DA-N.002 w/ coolant	DWLNL 16-4DA-N	WNMG 080412EN-M70 CTCK120	N/A	\$94
12022242	Kit# DWLNL 16-4DA-N.003 w/ coolant	DWLNL 16-4DA-N	WNMG 080408EN-F34 CTP5115	N/A	\$94
12022243	Kit# DWLNL 16-4DA-N.004 w/ coolant	DWLNL 16-4DA-N	WNMG 080408EN-M34 CTP5110	N/A	\$94
12022245	Kit# DWLNL 16-4DA-N.005 w/ coolant	DWLNL 16-4DA-N	WNMG 080408EN-M34 CTP5115	N/A	\$94
12022246	Kit# DWLNL 16-4DA-N.006 w/ coolant	DWLNL 16-4DA-N	WNMG 080412EN-M34 CTP5110	N/A	\$94
12022247	Kit# DWLNL 16-4DA-N.007 w/ coolant	DWLNL 16-4DA-N	WNMG 080412EN-M34 CTP5115	N/A	\$94
12022248	Kit# DWLNL 16-4DA-N.008 w/ coolant	DWLNL 16-4DA-N	WNMG 080404EN-M42 CTP2120	N/A	\$94
12022249	Kit# DWLNL 16-4DA-N.009 w/ coolant	DWLNL 16-4DA-N	WNMG 080404EN-M52 CTP2120	N/A	\$94
12022250	Kit# DWLNL 16-4DA-N.010 w/ coolant	DWLNL 16-4DA-N	WNMG 080408EN-M42 CTP2120	N/A	\$94
12022251	Kit# DWLNL 16-4DA-N.011 w/ coolant	DWLNL 16-4DA-N	WNMG 080408EN-M52 CTP2120	N/A	\$94
12022252	Kit# DWLNL 16-4DA-N.012 w/ coolant	DWLNL 16-4DA-N	WNMG 080404EN-F30 CTPM125	N/A	\$94
12022253	Kit# DWLNL 16-4DA-N.013 w/ coolant	DWLNL 16-4DA-N	WNMG 080408EN-F30 CTPM125	N/A	\$94
12022254	Kit# DWLNL 16-4DA-N.014 w/ coolant	DWLNL 16-4DA-N	WNMG 080408EN-M30 CTPM125	N/A	\$94
12022255	Kit# DWLNL 16-4DA-N.015 w/ coolant	DWLNL 16-4DA-N	WNMG 080408EN-M60 CTPM125	N/A	\$94
12022256	Kit# DWLNL 16-4DA-N.016 w/ coolant	DWLNL 16-4DA-N	WNMG 080412EN-M30 CTPM125	N/A	\$94
12022257	Kit# DWLNL 16-4DA-N.017 w/ coolant	DWLNL 16-4DA-N	WNMG 080412EN-M60 CTPM125	N/A	\$94
12022258	Kit# DWLNL 16-4DA-N.018 w/ coolant	DWLNL 16-4DA-N	WNMG 080404EN-M50 CTCP115	N/A	\$94
12022259	Kit# DWLNL 16-4DA-N.019 w/ coolant	DWLNL 16-4DA-N	WNMG 080408EN-M50 CTCP115	N/A	\$94
12022261	Kit# DWLNL 16-4DA-N.020 w/ coolant	DWLNL 16-4DA-N	WNMG 080408EN-M70 CTCP115	N/A	\$94
12022262	Kit# DWLNL 16-4DA-N.021 w/ coolant	DWLNL 16-4DA-N	WNMG 080412EN-M50 CTCP115	N/A	\$94
12022263	Kit# DWLNL 16-4DA-N.022 w/ coolant	DWLNL 16-4DA-N	WNMG 080412EN-M70 CTCP115	N/A	\$94
12022264	Kit# DWLNL 16-4DA-N.023 w/ coolant	DWLNL 16-4DA-N	WNMG 080404EN-M50 CTCP125	N/A	\$94
12022265	Kit# DWLNL 16-4DA-N.024 w/ coolant	DWLNL 16-4DA-N	WNMG 080408EN-M50 CTCP125	N/A	\$94
12022266	Kit# DWLNL 16-4DA-N.025 w/ coolant	DWLNL 16-4DA-N	WNMG 080408EN-M70 CTCP125	N/A	\$94
12022267	Kit# DWLNL 16-4DA-N.026 w/ coolant	DWLNL 16-4DA-N	WNMG 080412EN-M50 CTCP125	N/A	\$94
12022268	Kit# DWLNL 16-4DA-N.027 w/ coolant	DWLNL 16-4DA-N	WNMG 080412EN-M70 CTCP125	N/A	\$94



Material Number	Type, descriptions-kit	Type, description-cutter	Description-insert	Wrench	Kit Price
12022269	Kit# DWLNL-164-D.001	DWLNL 16-4D-N	WNMG 080408EN-M70 CTCK120	N/A	\$113
12022270	Kit# DWLNL-164-D.002	DWLNL 16-4D-N	WNMG 080412EN-M70 CTCK120	N/A	\$113
12022271	Kit# DWLNL-164-D.003	DWLNL 16-4D-N	WNMG 080408EN-F34 CTP5115	N/A	\$113
12022272	Kit# DWLNL-164-D.004	DWLNL 16-4D-N	WNMG 080408EN-M34 CTP5110	N/A	\$113
12022273	Kit# DWLNL-164-D.005	DWLNL 16-4D-N	WNMG 080408EN-M34 CTP5115	N/A	\$113
12022274	Kit# DWLNL-164-D.006	DWLNL 16-4D-N	WNMG 080412EN-M34 CTP5110	N/A	\$113
12022275	Kit# DWLNL-164-D.007	DWLNL 16-4D-N	WNMG 080412EN-M34 CTP5115	N/A	\$113
12022276	Kit# DWLNL-164-D.008	DWLNL 16-4D-N	WNMG 080404EN-M42 CTP2120	N/A	\$113
12022277	Kit# DWLNL-164-D.009	DWLNL 16-4D-N	WNMG 080404EN-M52 CTP2120	N/A	\$113
12022278	Kit# DWLNL-164-D.010	DWLNL 16-4D-N	WNMG 080408EN-M42 CTP2120	N/A	\$113
12022279	Kit# DWLNL-164-D.011	DWLNL 16-4D-N	WNMG 080408EN-M52 CTP2120	N/A	\$113
12022280	Kit# DWLNL-164-D.012	DWLNL 16-4D-N	WNMG 080404EN-F30 CTPM125	N/A	\$113
12022281	Kit# DWLNL-164-D.013	DWLNL 16-4D-N	WNMG 080408EN-F30 CTPM125	N/A	\$113
12022282	Kit# DWLNL-164-D.014	DWLNL 16-4D-N	WNMG 080408EN-M30 CTPM125	N/A	\$113
12022283	Kit# DWLNL-164-D.015	DWLNL 16-4D-N	WNMG 080408EN-M60 CTPM125	N/A	\$113
12022284	Kit# DWLNL-164-D.016	DWLNL 16-4D-N	WNMG 080412EN-M30 CTPM125	N/A	\$113
12022286	Kit# DWLNL-164-D.017	DWLNL 16-4D-N	WNMG 080412EN-M60 CTPM125	N/A	\$113
12022287	Kit# DWLNL-164-D.018	DWLNL 16-4D-N	WNMG 080404EN-M50 CTCP115	N/A	\$113
12022288	Kit# DWLNL-164-D.019	DWLNL 16-4D-N	WNMG 080408EN-M50 CTCP115	N/A	\$113
12022289	Kit# DWLNL-164-D.020	DWLNL 16-4D-N	WNMG 080408EN-M70 CTCP115	N/A	\$113
12022290	Kit# DWLNL-164-D.021	DWLNL 16-4D-N	WNMG 080412EN-M50 CTCP115	N/A	\$113
12022291	Kit# DWLNL-164-D.022	DWLNL 16-4D-N	WNMG 080412EN-M70 CTCP115	N/A	\$113
12022292	Kit# DWLNL-164-D.023	DWLNL 16-4D-N	WNMG 080404EN-M50 CTCP125	N/A	\$113
12022293	Kit# DWLNL-164-D.024	DWLNL 16-4D-N	WNMG 080408EN-M50 CTCP125	N/A	\$113
12022294	Kit# DWLNL-164-D.025	DWLNL 16-4D-N	WNMG 080408EN-M70 CTCP125	N/A	\$113
12022295	Kit# DWLNL-164-D.026	DWLNL 16-4D-N	WNMG 080412EN-M50 CTCP125	N/A	\$113
12022296	Kit# DWLNL-164-D.027	DWLNL 16-4D-N	WNMG 080412EN-M70 CTCP125	N/A	\$113
12022297	Kit# DWLNR 16-4DA-N.001 w/ coolant	DWLNR 16-4DA-N	WNMG 080408EN-M70 CTCK120	N/A	\$94
12022298	Kit# DWLNR 16-4DA-N.002 w/ coolant	DWLNR 16-4DA-N	WNMG 080412EN-M70 CTCK120	N/A	\$94
12022299	Kit# DWLNR 16-4DA-N.003 w/ coolant	DWLNR 16-4DA-N	WNMG 080408EN-F34 CTP5115	N/A	\$94
12022300	Kit# DWLNR 16-4DA-N.004 w/ coolant	DWLNR 16-4DA-N	WNMG 080408EN-M34 CTP5110	N/A	\$94
12022301	Kit# DWLNR 16-4DA-N.005 w/ coolant	DWLNR 16-4DA-N	WNMG 080408EN-M34 CTP5115	N/A	\$94
12022302	Kit# DWLNR 16-4DA-N.006 w/ coolant	DWLNR 16-4DA-N	WNMG 080412EN-M34 CTP5110	N/A	\$94
12022303	Kit# DWLNR 16-4DA-N.007 w/ coolant	DWLNR 16-4DA-N	WNMG 080412EN-M34 CTP5115	N/A	\$94
12022304	Kit# DWLNR 16-4DA-N.008 w/ coolant	DWLNR 16-4DA-N	WNMG 080404EN-M42 CTP2120	N/A	\$94
12022305	Kit# DWLNR 16-4DA-N.009 w/ coolant	DWLNR 16-4DA-N	WNMG 080404EN-M52 CTP2120	N/A	\$94
12022306	Kit# DWLNR 16-4DA-N.010 w/ coolant	DWLNR 16-4DA-N	WNMG 080408EN-M42 CTP2120	N/A	\$94
12022307	Kit# DWLNR 16-4DA-N.011 w/ coolant	DWLNR 16-4DA-N	WNMG 080408EN-M52 CTP2120	N/A	\$94
12022308	Kit# DWLNR 16-4DA-N.012 w/ coolant	DWLNR 16-4DA-N	WNMG 080404EN-F30 CTPM125	N/A	\$94
12022309	Kit# DWLNR 16-4DA-N.013 w/ coolant	DWLNR 16-4DA-N	WNMG 080408EN-F30 CTPM125	N/A	\$94
12022310	Kit# DWLNR 16-4DA-N.014 w/ coolant	DWLNR 16-4DA-N	WNMG 080408EN-M30 CTPM125	N/A	\$94
12022311	Kit# DWLNR 16-4DA-N.015 w/ coolant	DWLNR 16-4DA-N	WNMG 080408EN-M60 CTPM125	N/A	\$94
12022312	Kit# DWLNR 16-4DA-N.016 w/ coolant	DWLNR 16-4DA-N	WNMG 080412EN-M30 CTPM125	N/A	\$94
12022313	Kit# DWLNR 16-4DA-N.017 w/ coolant	DWLNR 16-4DA-N	WNMG 080412EN-M60 CTPM125	N/A	\$94
12022315	Kit# DWLNR 16-4DA-N.018 w/ coolant	DWLNR 16-4DA-N	WNMG 080404EN-M50 CTCP115	N/A	\$94
12022316	Kit# DWLNR 16-4DA-N.019 w/ coolant	DWLNR 16-4DA-N	WNMG 080408EN-M50 CTCP115	N/A	\$94
12022317	Kit# DWLNR 16-4DA-N.020 w/ coolant	DWLNR 16-4DA-N	WNMG 080408EN-M70 CTCP115	N/A	\$94
12022318	Kit# DWLNR 16-4DA-N.021 w/ coolant	DWLNR 16-4DA-N	WNMG 080412EN-M50 CTCP115	N/A	\$94



Product Index / Kit Pricing



SAVE UP TO \$50 ON W STYLE TOOL HOLDERS

Material Number	Type, descriptions-kit	Type, description-cutter	Description-insert	Wrench	Kit Price
12022319	Kit# DWLNR 16-4DA-N.022 w/ coolant	DWLNR 16-4DA-N	WNMG 080412EN-M70 CTCP115	N/A	\$94
12022320	Kit# DWLNR 16-4DA-N.023 w/ coolant	DWLNR 16-4DA-N	WNMG 080404EN-M50 CTCP125	N/A	\$94
12022321	Kit# DWLNR 16-4DA-N.024 w/ coolant	DWLNR 16-4DA-N	WNMG 080408EN-M50 CTCP125	N/A	\$94
12022322	Kit# DWLNR 16-4DA-N.025 w/ coolant	DWLNR 16-4DA-N	WNMG 080408EN-M70 CTCP125	N/A	\$94
12022323	Kit# DWLNR 16-4DA-N.026 w/ coolant	DWLNR 16-4DA-N	WNMG 080412EN-M50 CTCP125	N/A	\$94
12022324	Kit# DWLNR 16-4DA-N.027 w/ coolant	DWLNR 16-4DA-N	WNMG 080412EN-M70 CTCP125	N/A	\$94
12022325	Kit# DWLNR-164-D.001	DWLNL 16-4D-N	WNMG 080408EN-M70 CTCK120	N/A	\$113
12022326	Kit# DWLNR-164-D.002	DWLNL 16-4D-N	WNMG 080412EN-M70 CTCK120	N/A	\$113
12022327	Kit# DWLNR-164-D.003	DWLNL 16-4D-N	WNMG 080408EN-F34 CTP5115	N/A	\$113
12022328	Kit# DWLNR-164-D.004	DWLNL 16-4D-N	WNMG 080408EN-M34 CTP5110	N/A	\$113
12022329	Kit# DWLNR-164-D.005	DWLNL 16-4D-N	WNMG 080408EN-M34 CTP5115	N/A	\$113
12022330	Kit# DWLNR-164-D.006	DWLNL 16-4D-N	WNMG 080412EN-M34 CTP5110	N/A	\$113
12022331	Kit# DWLNR-164-D.007	DWLNL 16-4D-N	WNMG 080412EN-M34 CTP5115	N/A	\$113
12022332	Kit# DWLNR-164-D.008	DWLNL 16-4D-N	WNMG 080404EN-M42 CTP2120	N/A	\$113
12022333	Kit# DWLNR-164-D.009	DWLNL 16-4D-N	WNMG 080404EN-M52 CTP2120	N/A	\$113
12022334	Kit# DWLNR-164-D.010	DWLNL 16-4D-N	WNMG 080408EN-M42 CTP2120	N/A	\$113
12022335	Kit# DWLNR-164-D.011	DWLNL 16-4D-N	WNMG 080408EN-M52 CTP2120	N/A	\$113
12022336	Kit# DWLNR-164-D.012	DWLNL 16-4D-N	WNMG 080404EN-F30 CTPM125	N/A	\$113
12022337	Kit# DWLNR-164-D.013	DWLNL 16-4D-N	WNMG 080408EN-F30 CTPM125	N/A	\$113
12022338	Kit# DWLNR-164-D.014	DWLNL 16-4D-N	WNMG 080408EN-M30 CTPM125	N/A	\$113
12022339	Kit# DWLNR-164-D.015	DWLNL 16-4D-N	WNMG 080408EN-M60 CTPM125	N/A	\$113
12022340	Kit# DWLNR-164-D.016	DWLNL 16-4D-N	WNMG 080412EN-M30 CTPM125	N/A	\$113
12022341	Kit# DWLNR-164-D.017	DWLNL 16-4D-N	WNMG 080412EN-M60 CTPM125	N/A	\$113
12022342	Kit# DWLNR-164-D.018	DWLNL 16-4D-N	WNMG 080404EN-M50 CTCP115	N/A	\$113
12022343	Kit# DWLNR-164-D.019	DWLNL 16-4D-N	WNMG 080408EN-M50 CTCP115	N/A	\$113
12022344	Kit# DWLNR-164-D.020	DWLNL 16-4D-N	WNMG 080408EN-M70 CTCP115	N/A	\$113
12022345	Kit# DWLNR-164-D.021	DWLNL 16-4D-N	WNMG 080412EN-M50 CTCP115	N/A	\$113
12022346	Kit# DWLNR-164-D.022	DWLNL 16-4D-N	WNMG 080412EN-M70 CTCP115	N/A	\$113
12022347	Kit# DWLNR-164-D.023	DWLNL 16-4D-N	WNMG 080404EN-M50 CTCP125	N/A	\$113
12022348	Kit# DWLNR-164-D.024	DWLNL 16-4D-N	WNMG 080408EN-M50 CTCP125	N/A	\$113
12022349	Kit# DWLNR-164-D.025	DWLNL 16-4D-N	WNMG 080408EN-M70 CTCP125	N/A	\$113
12022350	Kit# DWLNR-164-D.026	DWLNL 16-4D-N	WNMG 080412EN-M50 CTCP125	N/A	\$113
12022351	Kit# DWLNR-164-D.027	DWLNL 16-4D-N	WNMG 080412EN-M70 CTCP125	N/A	\$113

Tool holders

Product Index / Kit Pricing

Save up to \$100 on every kit you buy! (Kits include one holder and ten inserts.)



This is the world of CERATIZIT.

Customized solutions for every customer.

Outstanding performance under severe conditions.

Exceptional process stability and economy.

Innovations in substrate materials, advanced coatings and cutting-edge geometries.

All designed for your success.

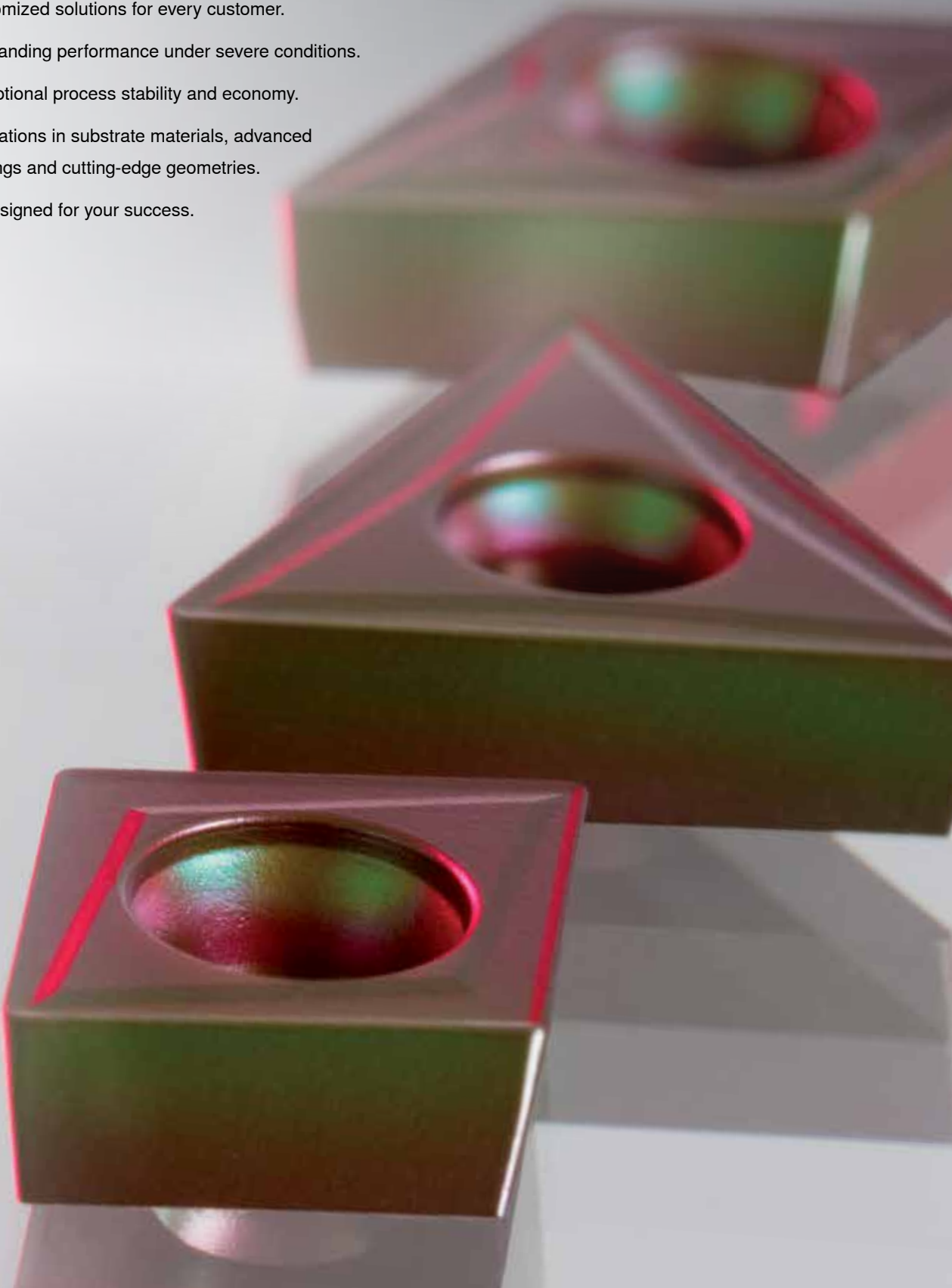

We make hard materials easier.

Cutting time. Cutting wear. Cutting tool costs.
Cutting waste. The only thing we don't cut is corners.

Cutting Solutions by CERATIZIT.

We are the solution.



Headquarters:

CE RATI ZIT S.A.

Route de Holzem 101
B.P. 51
L-8201 Mamer

T. +352 312 085-1
F. +352 311 911
E. info@ceratizit.com

Contact for further information:

CERATIZIT USA, inc.

11355 Stephens Drive USWarren,
MI 48089-1833
United States

T. +1 800 783 2280
+1 586 759 2280
F. +1 586 759 1657
E. info.usa@ceratizit.com

www.ceratizit.com

Your sales partner:

