

CMT

COLUMBIA
MARKING
TOOLS

Hand Tools

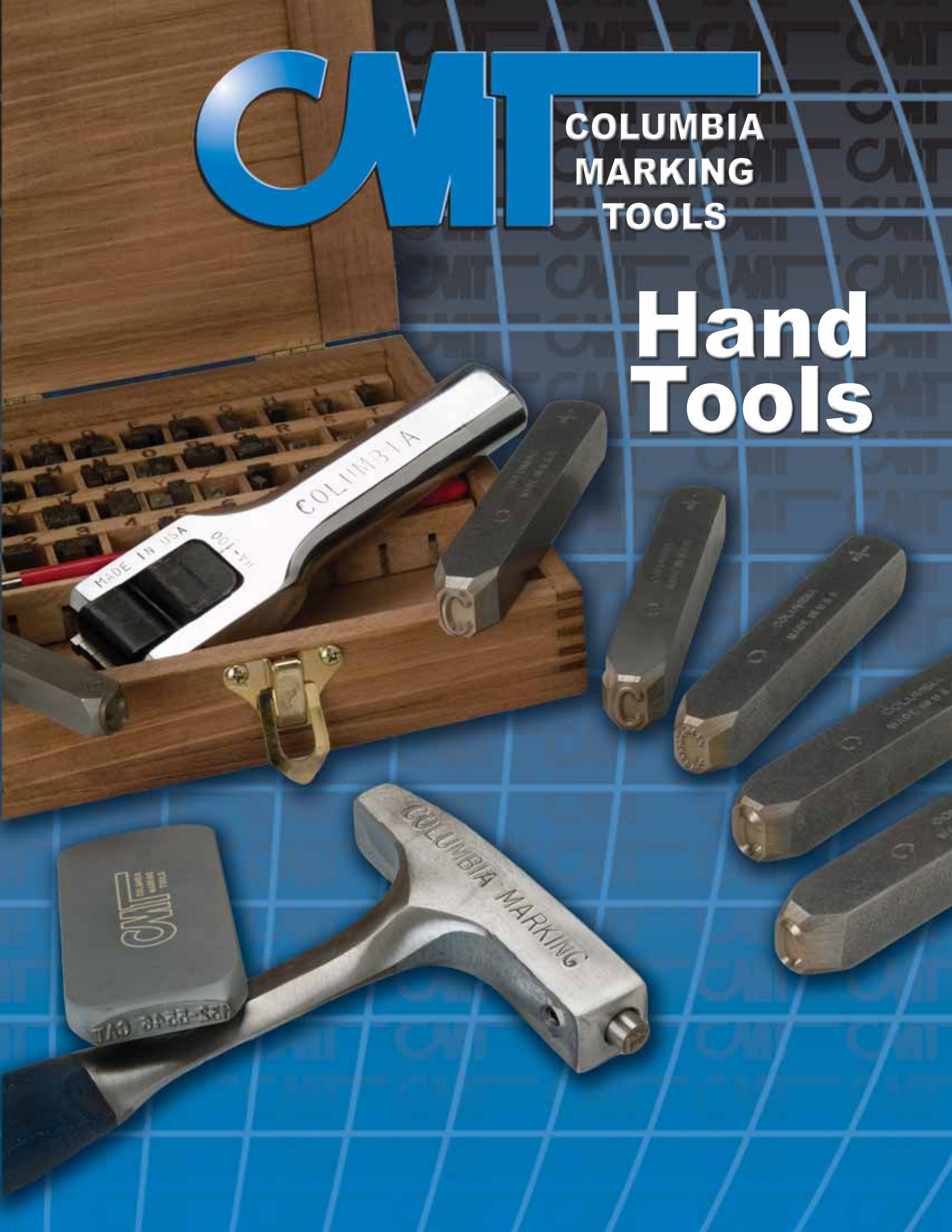

Table of Contents

Character Face Styles.....	3
Marking Pressure Data.....	4
Standard Hand Stamps.....	5
R-Buster Hand Stamps.....	6
Custom Hand Stamps.....	7
Inspector's Hammer #8.....	8
Symbols.....	9
Hand Holders: H Series.....	10
Hand Holders: HG Series.....	11
Hand Holders: R Buster Series.....	12
Numbering Heads.....	13
Press Holders.....	14
Radial Type Holders.....	15
Air Hammers (75, 85).....	16
POW-R-Mark.....	17
Steel Type and Inserts.....	18
Type Boxes.....	19

CMT uses a standard gothic font; this is similar to the Roman font used in printing, and the Arial font on the computer.

**ABCDEFGHIJKLM
NOPQRSTUVWXYZ**

0123456789

CMT can manufacture dies with any font required, including in signatures.



Over estimates of the size of the character required are quite common. The three marks to the right all have the same character size. The overall impression size will vary according to the depth of the mark; this effect must be taken into consideration whenever critical space limitations are a factor.

Standard sizes are: 1/32", 1/16", 3/32", 1/8", 5/32", 3/16", 1/4", 5/16", 3/8", and 1/2"



Columbia Marking Tools is a leading manufacturer of marking products. Our hand tools are manufactured at our Chesterfield, MI location. Columbia is ISO certified to assure the highest quality of products.

Character Face Styles

Sharp Face Characters are engraved with a sharp edge. A sharp face tool penetrates more easily than other styles.

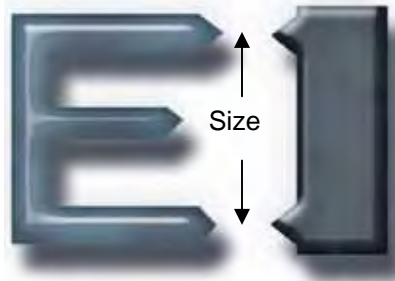

Flat Face Characters are engraved with a flat face instead of a sharp edge in order to produce a wider impression. This face is often used on brass or other non-ferrous metals. Since more material is displaced more force is required.

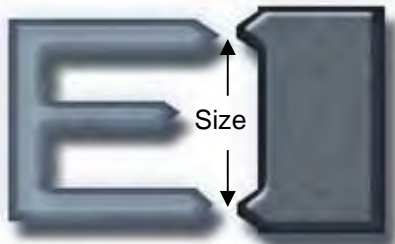

Open Face Characters have two sharp face lines to produce double line impression of an outline character. This style is used to emphasize trademarks or designs.

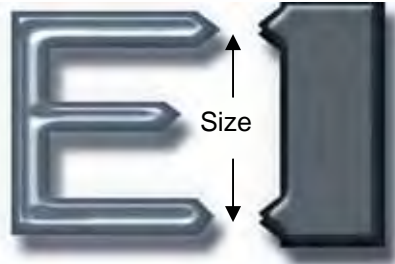

Ball Face Characters are engraved with a special rounded face for marking impressions with minimum stress at the point of marking

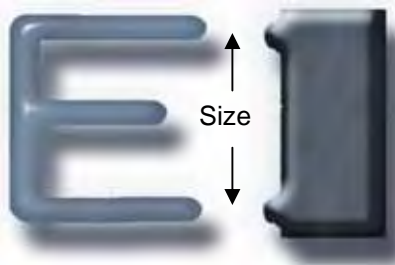

Dot Style Characters are engraved with a series of rounded dots for the lowest possible stress when marking. Recommended for high pressure fittings, aircraft and other parts where sharp tools might disrupt the molecular structure of the metal.

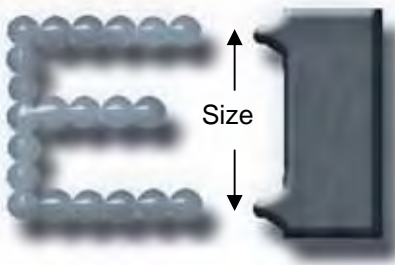

Marking Pressure



Estimated Maximum Force per Hammer Blow (in lbs)

Size of Hammer	Average machinist	Experienced Machinist	The "Big Guy"
3/4 lbs	3,000	4,000	5,000
1lbs	4,400	6,000	7,400
1 1/2lbs	6,000	8,000	10,000
2lbs	9,000	12,000	15,000
2 1/2 lbs	12,800	17,000	21,200
3lbs	22,400	30,000	37,400

As the marking application requires a greater force, through a bigger swing or hammer, you just have to ask yourself -

"Who's going to hold the stamps?"

The number of characters marked at one time is limited by:

- The character size
- The material being marked
- The size of the hammer being used

Reality Check

Marking pressure per character (see static stamping pressure chart) x number of characters = Force required.

Marking Pressure Data
Static Stamping Pressure per character

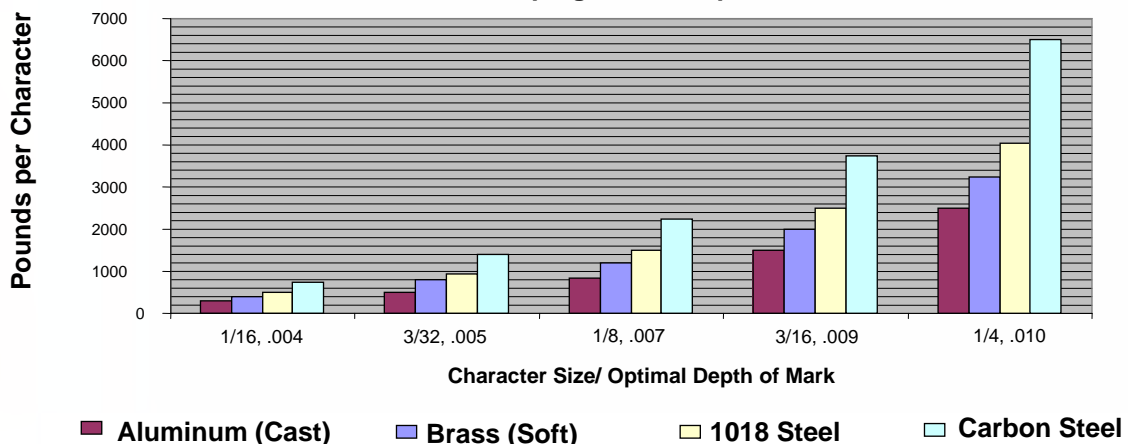

R-Buster Hand Stamps

- Twice the size of heavy duty hand stamps: **5" Long!**
- Easy gripping (no two finger pinching required)
- Double pass engraved for extra clarity
- C custom heat treat for long life
- Easy alignment of characters with tapered bevels
- Soft hammer end to reduce chipping



**All Character
Face Styles**



EDM

CMT Engraved

Multi character is our specialty!

Multi-character stamps are useful for marking repeated numbers such as part numbers.

Please specify character size and number of characters as shown below. Include description of special font, character face, or logos required.

Hand Stamp Size Chart					
Character Size	Shank Dimensions	Overall Length	Part Number	Example	
1/16	1/4	5	CMH06-	CMH06-C#-XXX Where C# is the number of characters, and XXX is the characters	
3/32	5/16	5	CMH09-		
1/8	5/16	5	CMH13-		
5/32	3/8	5	CMH16-		
3/16	3/8	5	CMH19-		
1/4	7/16	6	CMH25-		
5/16	1/2	6	CMH31-		
3/8	9/16	6 1/2	CMH38-		
1/2	3/4	7	CMH50-		

Custom Hand Stamps

- Your own special design can be easily reproduced by furnishing us with a sketch.
- Symbol marking cannot be confused with any other marking, each stands out distinctively.
- All stamps available in low stress dot style or semi ball face design.



Symbols and other special hand stamps are used for:

- Quality control in marking machine
- Inspection
- Testing operations



Logos are useful for permanently marking company information.

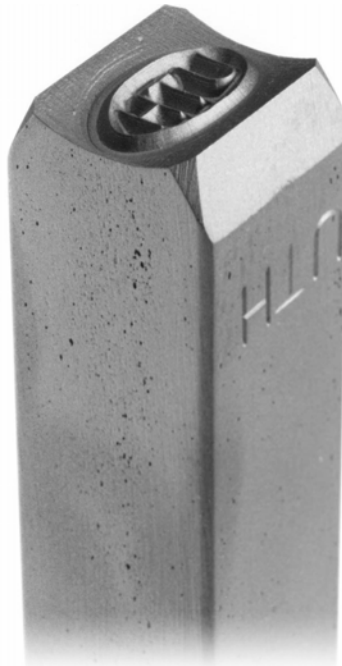

Custom hand stamps can be manufactured with:

- straight
- curved
- concave (shown right)
- convex on the letter face.

Fax or E-mail logo or artwork to 586.949.8401 or info@columbiamt.com

Inspector's Hammer #8



The quick easy choice for making an inspector's ID mark.

Columbia inspector's hammers:

- Are ideal for use in industries requiring inspection markings of their products
- Hammer and head are one piece construction
- Constructed of forged tool steel with a shock absorbing handle



Symbols

1	2	3	4	5	6	7	8	9	10
11	12	13	14	15	16	17	18	19	20
21	22	23	24	25	26	27	28	29	30
31	32	33	34	35	36	37	38	39	40
41	42	43	44	45	46	47	48	49	50
51	52	53	54	55	56	57	58	59	60
61	62	63	64	65	66	67	68	69	70
71	72	73	74	75	76	77	78	79	80
81	82	83	84	85	86	87	88	89	90
91	92	93	94	95	96	97	98	99	100

101	102	103	104	105	106	107	108	109	110
111	112	113	114	115	116	117	118	119	120
121	122	123	124	125	126	127	128	129	130
131	132	133	134	135	136	137	138	139	140
141	142	143	144	145	146	147	148	149	150
151	152	153	154	155	156	157	158	159	160
161	162	163	164	165	166	167	168	169	170
171	172	173	174	175	176	177	178	179	180
181	182	183	184	185	186	187	188	189	190
191	192	193	194	195	196	197	198	199	200

Symbols



- Symbols can be engraved on any type, insert, or hand stamp
- Specify symbol required by SYM### after the catalog number of the stamp
- Some Symbols may require a wider blank than the standard letters

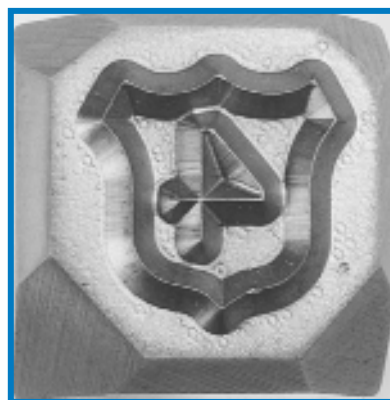

Numbers or Letters may be specified inside symbols



Hand Holders: H Series

- Recommended for the majority of marking operations requiring steel type for low volume/production marking applications with repetitive legends.
- Solid hand holder body with properly tempered non-chip head.
- Hardened replaceable stamp seat maintains uniformity even after the strongest hammer blows.

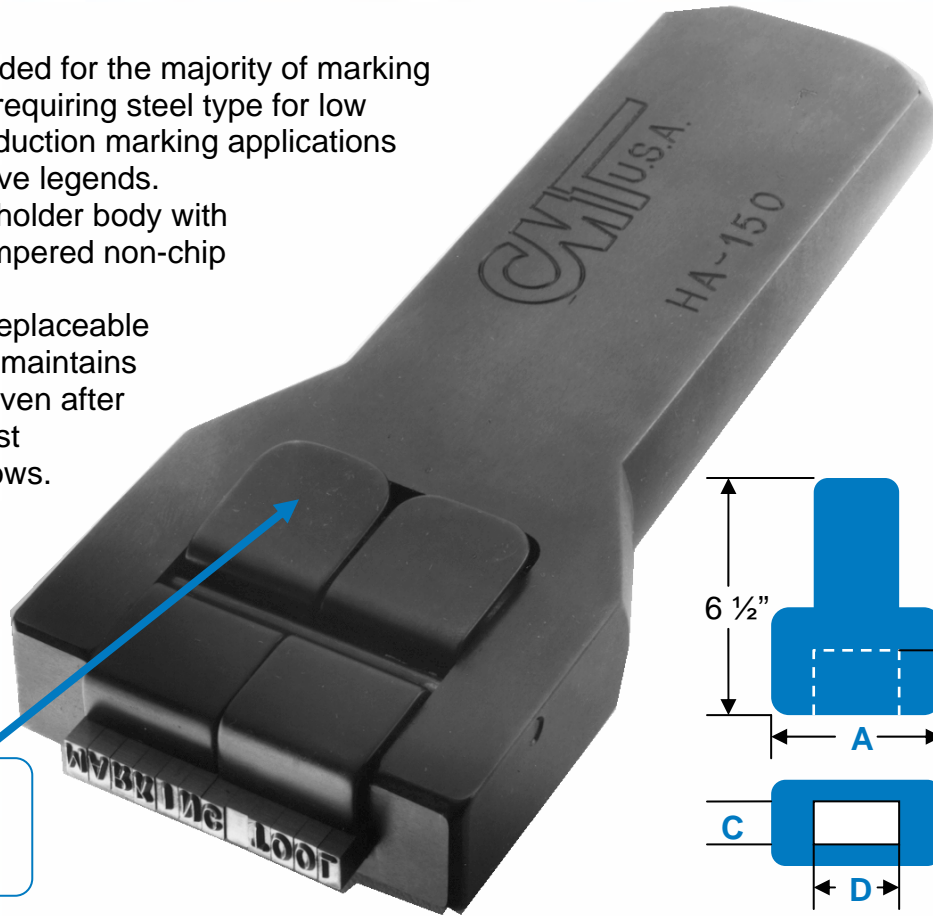

Press here to
release inserts
from clip

Catalog No.	Dimensions				CMS Style Type Capacity					
	"A"	"B"	"C"	"D"	1/16"	3/32"	1/8"	5/32"	3/16"	1/4"
HA-50	1"	3/4"	1/4"	1/2"	8	5	4			
HA-75	1 3/4"	3/4"	1/4"	3/4"	12	8	6			
HA-100	1 3/4"	3/4"	1/4"	1"	16	10*	8			
HA-150	2 1/2"	3/4"	1/4"	1 1/2"	24	16	12			
HA-200	3"	3/4"	1/4"	2"	32	21*	16			
HB-100	1 3/4"	1"	5/16"	1"				5*	5	
HB-150	2 1/2"	1"	5/16"	1 1/2"				8*	8	
HB-200	3"	1"	5/16"	2"				10*	10	
HC-100	2"	1"	3/8"	1"						4
HC-200	3"	1"	3/8"	2"						8

*Spacer required to fill out pocket

Hand Holders: HG Series

- Most economical handholder.
- Solid hand holder body with properly tempered non-chip head.
- Hardened replaceable stamp seat maintains uniformity even after the strongest hammer blows.
- HG Hand holders feature a spring clip release. This assures an accurate alignment of the characters.

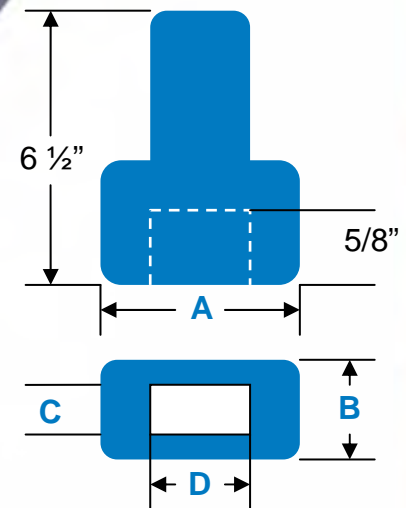
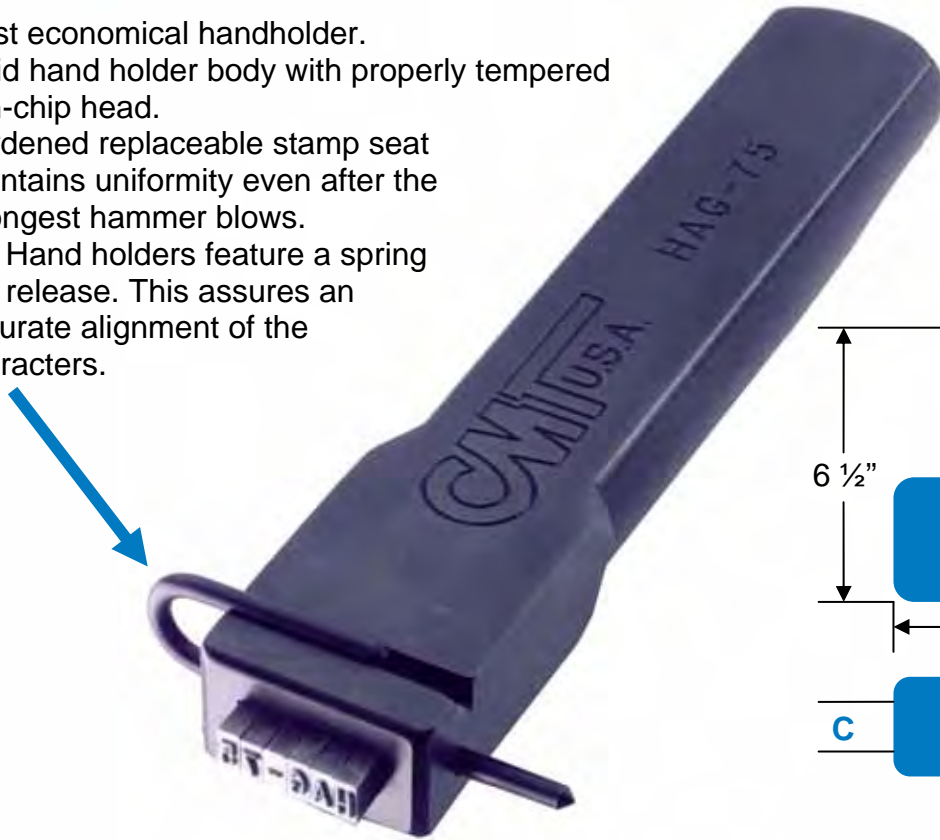

Dimensions & Type Capacity of HG Series

Catalog No.	Dimensions				CMG Style Type Capacity					
	"A"	"B"	"C"	"D"	1/16"	3/32"	1/8"	5/32"	3/16"	1/4"
HAG-50	1"	3/4"	1/4"	1/2"	8	5*	4			
HAG-75	1 1/4"	3/4"	1/4"	3/4"	12	8	6			
HAG-100	1 3/4"	3/4"	1/4"	1"	16	10*	8			
HAG-150	2 1/2"	3/4"	1/4"	1 1/2"	24	16	12			
HAG-200	3"	3/4"	1/4"	2"	32	21*	6			
HBG-100	1 3/4"	1"	5/16"	1"				5	5	
HBG-150	2 1/2"	1"	5/16"	1 1/2"				8	8	
HBG-200	3"	1"	5/16"	2"				11	11	
HCG-100	2"	1"	3/8"	1"						5
HCG-200	3"	1"	3/8"	2"						8

* Spacer required to fill pocket.

Hand Holders: R Buster Series

- Safety comes first. Large hand shield protect hand and fingers from hammer blow.
- Replaceable hammer end cap, ensures long tool life.
- Solid hand holder body with properly tempered non-chip head.
- Hardened replaceable stamp seat maintains uniformity even after the strongest hammer blows.

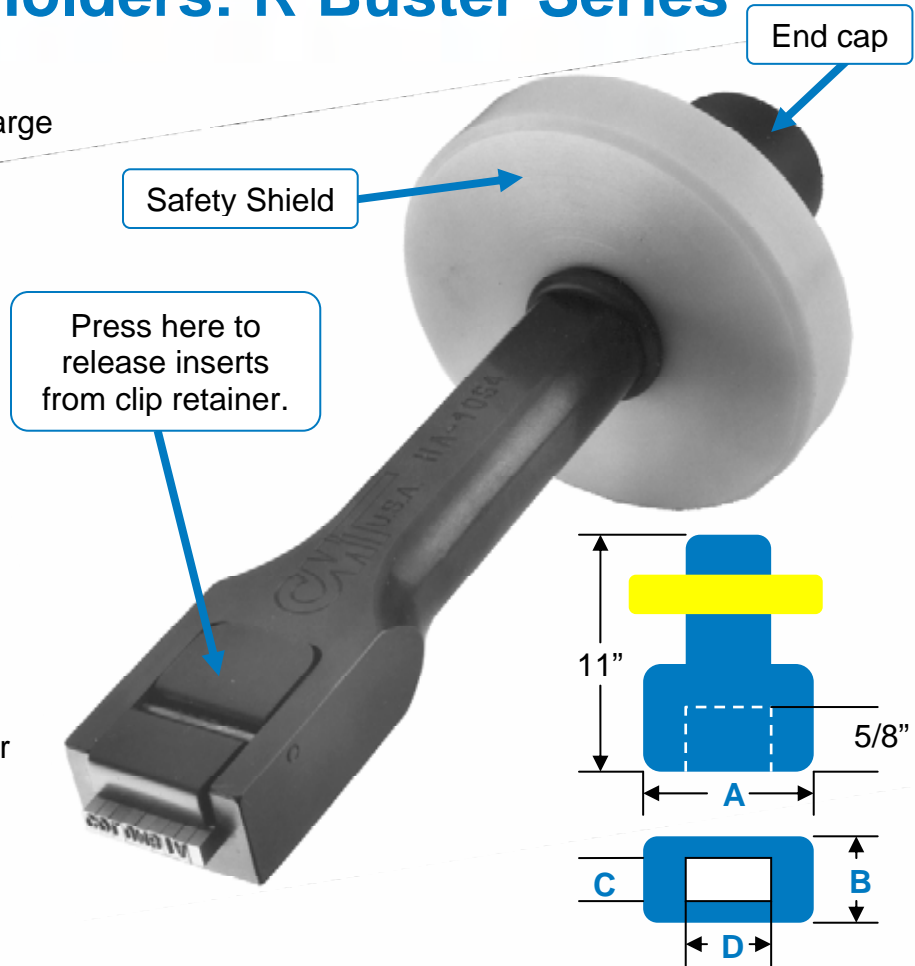

Catalog No.	Dimensions				CMS Type Capacity					
	"A"	"B"	"C"	"D"	1/16"	3/32"	1/8"	5/32"	3/16"	1/4"
HAR-50	1"	3/4"	1/4"	1/2"	8	5	4			
HAR-75	1 3/4"	3/4"	1/4"	3/4"	12	8	6			
HAR-100	1 3/4"	3/4"	1/4"	1"	16	10*	8			
HAR-150	2 1/2"	3/4"	1/4"	1 1/2"	24	16	12			
HAR-200	3"	3/4"	1/4"	2"	32	21*	16			
HBR-100	1 3/4"	1"	5/16"	1"				5*	5	
HBR-150	2 1/2"	1"	5/16"	1 1/2"				8*	8	
HBR-200	3"	1"	5/16"	2"				10*	10	
HCR-100	2"	1"	3/8"	1"						4
HCR-200	3"	1"	3/8"	2"						8

Numbering Heads



Columbia Model 30H hand held numbering head

Non-Automatic Numbering Head features:

- Character sequence changed by convenient spanner wrench
- Consistent uniform character alignment and depth
- One piece wheels
- Pawl block aids in maintaining wheel alignment
- Accurately engraved wheels for precision
- Created from high grade steel and heat treated for long life



Columbia Model 30P press shank mount numbering head

The Model 30 is available in different shanks and mounting styles:

- 30P press shank (shown above)
- 30D dovetail style mount
- 30H hand shank (shown at left)



Width of the Mark in Inches

Char. Size	Number of Wheels							
	3	4	5	6	7	8	9	10
1/32	11/64	15/64	19/64	23/24	13/32	31/64	17/32	5/8
1/16	1/4	21/64	13/32	1/2	19/32	21/32	3/4	53/64
3/32	9/32	3/8	15/32	9/16	21/32	3/4	27/32	15/16
1/8	3/8	1/2	5/8	3/4	7/8	1	1 1/8	1 1/4
5/32	15/32	5/8	25/32	15/16	1 3/32	1 1/4	13/16	1 9/16
3/16	9/16	3/4	15/16	1 1/8	1 5/16	1 5/16	1 11/16	1 7/8
1/4	21/32	7/8	1 3/32	1 3/32	1 17/32	1 3/4	1 31/32	2 3/16

Press Holders

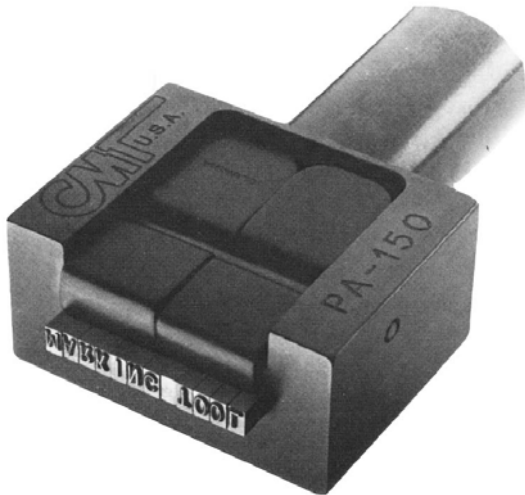

CMT Press Holders:

- Are recommended for marking on flat surfaces with CMT steel type
- When combined with CMT type fonts they create a large variety of character combinations
- Are durable and wear resistant
- Standard shank dimension is 1 1/4" diameter by 2" long

Standard shank dimension is 1 1/4" diameter by 2" long. Others available upon request.

Columbia designs and manufactures special press holders per customer request.

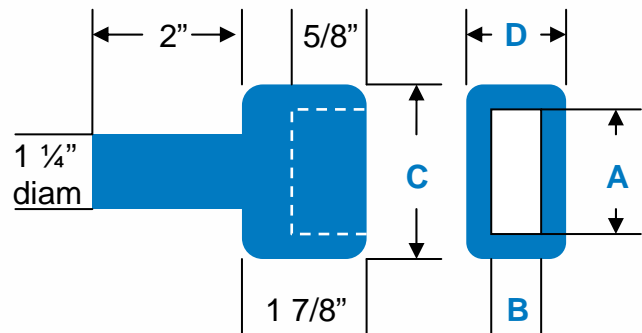

Dimensions and Type Capacity of CMT Series 'P'

Catalog No.	Dimensions				CMS Style Type Capacity							
	"A"	"B"	"C"	"D"	1/16"	3/32"	1/8"	5/32"	3/16"	1/4"	5/16"	3/8"
PA-100	1	1/4	2	1	16	10	8					
PA-250	2 1/2	1/4	3 1/2	1			20					
PB-150	1 1/2	5/16	2 1/2	1				8	8			
PB-300	3	5/16	4	1				16	16			
PC-150	1 1/2	3/8	2 1/2	1 1/4						6		
PC-300	3	3/8	4	1 1/4						12		
PD-160	1 9/16	7/16	2 1/2	1 1/4							5	
PD-280	2 13/16	7/16	4	1 1/4							9	
PE-150	1 1/2	1/2	2 1/2	1 1/4								4
PE-300	3	1/2	4	1 1/4								8

Radial Press Holder and Dies

Ideal for Marking:

- Gear blanks
- Cutter
- Pulleys
- Shafts
- Bearings
- Wheels
- Bushings

CMR Radial Type holders are designed to specific customer requirements for marking circular impressions on flat surfaces.

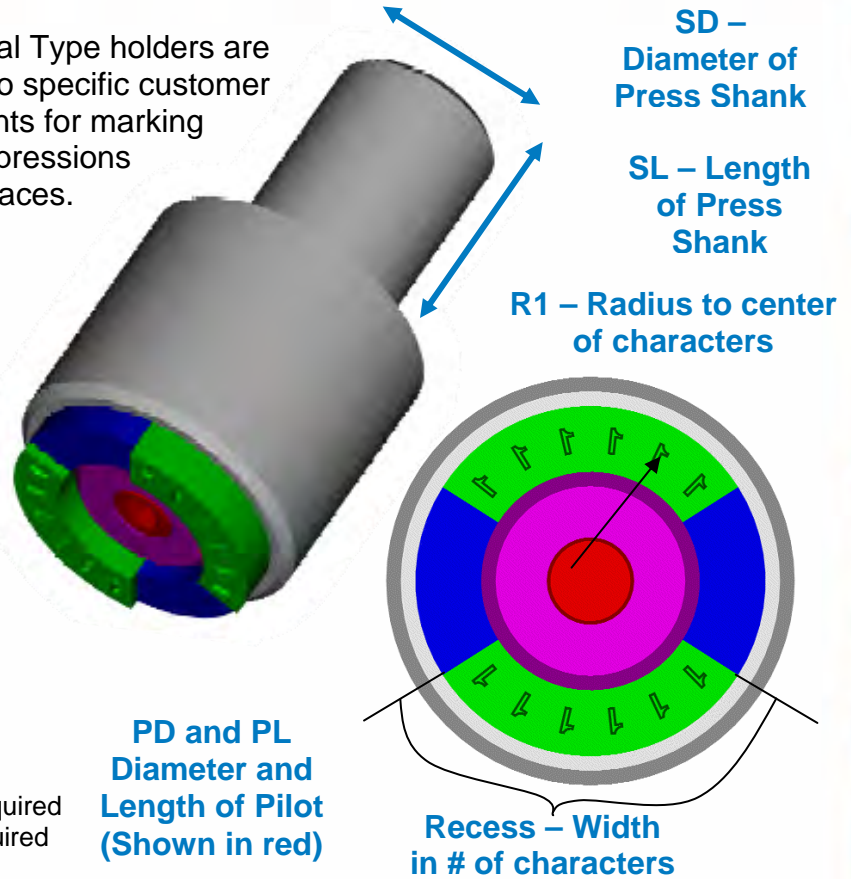

When Ordering CMR Radial Type holders Please Specify the Following Information:

1. Character Size
2. Radius to enter of character (R1)
3. Number of Recesses
4. Type Capacity of Each Recess
5. Shank Diameter (SD) & Length (SL)
6. Pilot Diameter (PD) & Length (PL) Required
7. Quantity of Letter & Figure Type Required
8. Quality of Spacers Required

To order CMR Radial Type and multi-character segment stamps use:

- Catalog number listed in the table below
- Plus actual letters, figures, or multi-character legend

IMPORTANT:
Please include part number of holder when re-ordering stamps

CMRA Style

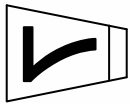

CMRB Style



Char Size	CMRA Style		CMRB Style		Blank Spacers
	Type	Logotype	Type	Logotype	
1/16	CMRA06-	LCMRA06-	CMRB06-	LCMRB06-	CMRA06-00
3/32	CMRA09-	LCMRA09-	CMRB09-	LCMRB09-	CMRA09-00
1/8	CMRA13-	LCMRA13-	CMRB13-	LCMRB13-	CMRA13-00
3/16	CMRA19-	LCMRA19-	CMRB19-	LCMRB19-	CMRA19-00
1/4	CMRA25-	LCMRA25-	CMRB25-	LCMRB25-	CMRA25-00

Air Hammer

Columbia's Air hammers:

- Use low cost CM8X round hammer inserts or CMG rectangular type
- Indents up to 1/4" characters in tool steel
- Compact, light-weight (2 1/2lbs)
- Requires only a 3/8" air hose for operation
- Only two moving parts assures long trouble-free operation

Dimensions: 8.6" x 6.5" x 2.5"

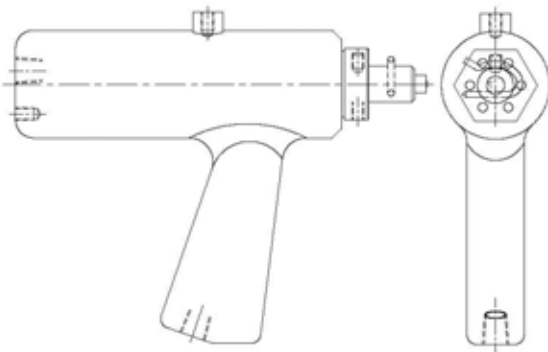

Columbia Air Hammer Model 75/85		
Model/Feature	Symbol	Example
75 Standard Power Range	75AT	
85 High Power Range	85AT	
Rod Style B (round insert)	OB	
Rod Style A (CMG type)	OA	
Rod Style AS38 (CMG type)	OAS38	

Recommended Air Hose: 3/8" I.D. min
Operating Pressure: 20 to 80psi
Max. Marking Pressure: Model 75AT is 1500lbs (at 80psi), Model 85AT is 2500lbs (at 80psi)

Stamp Capacities Rod Style "B"

- (1) Pc CM8X round insert
- Stamp Capacities Rod Style "A"**
- (4) Pc's 1/16 Char. (CMG06 Stamp Inserts)
- (2) Pc's 1/8 Char. (CMG13 Stamp Inserts)

Stamp Capacities Rod Style "AS38"

- (6) Pc's 1/16 Char. (CMG06 Stamp Inserts)
- (3) Pc's 1/8 Char. (CMG13 Stamp Inserts)

75FRL is for use with model 75, 85, and 95 hand held air hammers



Filter Regulator Lubricator and Hose

075FRL	FRL with no hose
075FRL15	FRL with 15 feet hose
075FRL20	FRL with 20 feet hose
075FRL25	FRL with 25 feet hose

Steel Type and Inserts

The process of engraving stamps and inserts that CMT uses assures for a longer stamp life. These stamps and inserts are made from select tool steel and carefully heat treated. They stand up best under high production marking conditions.



Measuring Letters & Figures

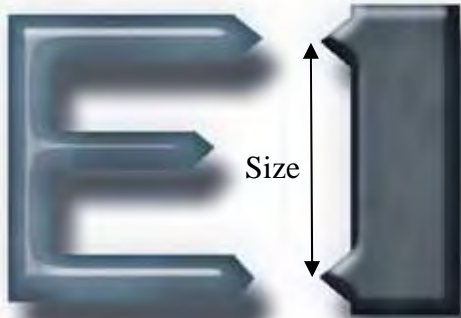

The character size is measured from the tallest part of the stamp die. When the stamp die indents into the metal the mark will be larger. The most common error is to overestimate the character size.

To order individual **LETTERS** and **FIGURES** add suffix of actual letter or figure to part number

To **BLANK SPACERS** add suffix of "-00" to part number

To order **PUNCTUATION** add suffix from table below to part number

CMG	09	-A
Style	Char Size	Letter or Figure
CMS	-13	-00
Style	Char Size	Blank Spacer
CM8X	25	-RR
Style	Char Size	Asterisk Suffix

Char Size	A	B	C	Style G Standard Groove Part Number	Style S Special Step Part Number
1/16	1/16	1/4	7/8	CMG06-	CMS06-
3/32	3/32	1/4		CMG09-	CMS09-
1/8	1/8	1/4		CMG13-	CMS13-
5/32	5/32	1/4		CMG16N-	CMS16N-
3/16	3/16	5/16		CMG19-	CMS19-
1/4	1/4	3/8		CMG25-	CMS25-

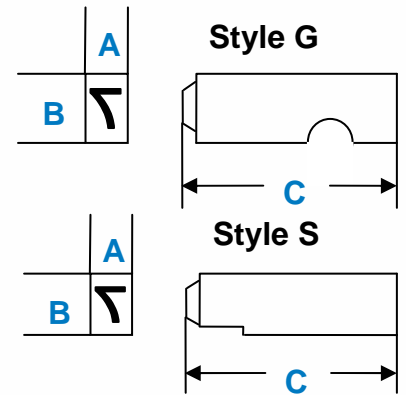

Mark	Symbol	Suffix
Dash	-	-DD
Period	.	-PP
Comma	,	-CC
Diagonal	/	-SS
Ampersand	&	-AA
Number sign	#	-TT
Multiplication	X	-MM
Equals Sign	=	-EE
Colon	:	-LL
Plus Sign	+	-UU
Asterisk	*	-RR
Percent Sign	%	-QQ
Dollar Sign	\$	-BB
At Sign	@	-ZZ

Char Size	Style 8X 3/8" Diam Part Number
1/16	CM8X06-
3/32	CM8X09-
1/8	CM8X13-
5/32	CM8X16-
3/16	CM8X19-
1/4	CM8X25-

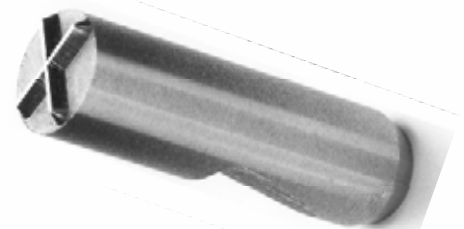
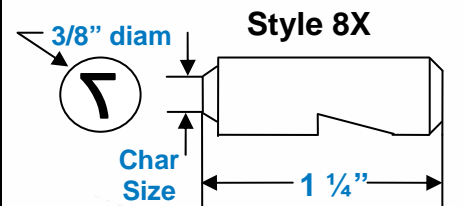

Type Boxes

Steel Type Boxes

- Built of sturdy steel
- Comes with handle and pull down latch
- Finished with rust and acid resistant enamel
- Easy organization of type
- Dimensions of type boxes: 13 1/4" x 12" x 3"



Steel Type Box	
Model #	Bins
CMT149A	8
CMT149B	12
CMT149C	16
CMT149D	20
CMT149E	21
CMT149F	24
CMT149H	13 adjustable

Wooden Type Boxes

- Sturdy wooden boxes
- Allows easy organization of type and holder
- Type Boxes for HG and H series hand holders
- Dimensions of type box #1:
2 1/4" x 7 1/2" x 7 7/8"
- Dimensions of type box #2:
2 1/2" x 9 7/8" x 9 7/8"



Wooden Type Box	
Model #	Character Size
TYPEBOX1	Type box to hold stamps with characters up to 5/32"
TYPEBOX2	Type box to hold stamps with 3/16" and larger characters

**Remember CMT for all your marking requirements.
From Hand stamps to Lasers**

CMT

COLUMBIA MARKING TOOLS



Wide Range of Products:
Impact Markers
Programmable Systems
Dot-Peen & Scribe
Laser
Numbering Heads
Roll Marking Machines
Air & Hydraulic Presses
Hot Stamping Systems & Machines
Stamping Dies & Retainers
Standard Type
Custom Marking Dies
Embossing Dies

27430 Luckino Dr
Chesterfield MI 48047

586.949.8400
586.949.8401 fax
info@columbiamt.com

www.columbiamt.com

