



Hassay Savage Company

Precision Broaches



magafor

Precision Round Tools



GMauvaisUSA™

Precision Micro Drills

2017 - 2018

IN THIS BOOK...



Hassay Savage



PRECISION BROACHES

STANDARD & CUSTOM BROACHING SOLUTIONS FOR EVERY APPLICATION

Hassay Savage has the most comprehensive program of standard broaching solutions for all applications. We offer Custom Broaching Solutions for all your broaching needs. Let us be your partner in your unique, cutting applications!

GMauvaisUSA



QUALITY MICRO DRILLS

SUPERIOR PRECISION • QUALITY • CONSISTENCY

The most consistent quality micro drill program in the world, GMauvais has a complete line of HSS-E COBALT and Solid Micro Grain Carbide MICRO Drills. Standard sizes range from .1mm to 3mm, with 1,000 line items in stock. Custom made micro drills for your special application and fast delivery is our specialty.



magafor®



UNIQUE ROUND CUTTING TOOLS

PERFORMANCE • INNOVATION • SPECIALIZATION

The world's finest Center Drill, NC Spot Drill, Countersink, Multi-V, Micro Reaming and End Mill Cutting Tools for your most challenging cutting tool applications.

We hope you enjoy using our outstanding collection of the finest cutting tools for virtually every cutting application.

Hassay Savage Company • 3 Great Programs, One Great Company!



Let us be your partner in unique cutting applications!

www.hassay-savage.com



NEW Items for 2017

www.hassay-savage.com



**Unique,
Precision
Cutting Tools!**



NEW 8760 Series Blind Hole Reamers w/Coolant

www.hassay-savage.com

What is Broaching?

Broaching is a progressive metal-cutting process which incorporates a series of roughing, semi-finishing, and finishing teeth designed to remove successive portions of stock as the tool moves through or across a workpiece in a one-pass linear operation. Each tooth is calibrated to remove only a small amount of stock appropriate to the type of material broached, which permits continuous clean chip cutting.

BROACHING ORIGINATED with the venerable blacksmith 3,000 years ago. He needed to create internal spaces within the pieces he hand-forged. The blacksmith invented **DRIFTS** in varieties of configurations to punch these shapes. Drifts were driven by hammer through the cherry-red hot metal held on the primitive anvil over the pritchel or hardy hole to form a variety of internal shapes.

MODERN BROACHING dates back to mid-nineteenth century Germany, where the drifting tool incorporated a series of uniform cutting teeth to remove material (much like a wood rasp). These **FIRST BROACHES** were short heavy hand-driven push tools. Initially, internal broaching, such as cutting keyways in pulleys and gears, accounted for the bulk of the work done, and as the power press was developed, applications for internal broaching widened.

SURFACE BROACHING evolved more slowly, but by the 1920's became critical in meeting the demands of mass production in the **AUTOMOTIVE INDUSTRY**. By the 1930s broaching processes



could supply the industry with close-tolerance square holes and multiple splines for transmission gears. The technology continued to develop into spiral spline broaching, tooth cutter bars, and broaches manufactured from **HIGH-SPEED STEEL**. By the mid-50's hydraulic, fully automatic internal and external broaching machines were in wide use, making it possible to reduce the cost of mass producing accurately finished identical parts of all shapes and sizes.



Pictured: A broaching operation using Hassay Savage push broaches.

BROACHING FIXTURES typically incorporate mechanical, hydraulic or pneumatic principles and utilize programmable controls and automatic clamping for continuous cycle indexing.

COMPUTERS increasingly play a vital role in the design and manufacturing set-up of broach toolmaking. The industry also asserts its competitive edge by taking advantage of significant technical advances in the fields of grinding, coolants, lubricants, stock materials, and heat treatment; which make it possible to produce a tougher, sharper tool at less cost and with faster turnaround.



SINCE 1969, HASSAY SAVAGE COMPANY has emerged as the leader in the development of broaching applications into many areas of manufacturing where there is need to produce precise complex shapes and forms. Forty-eight years later, we are convinced that by joining **STATE-OF-THE-ART** technologies with the **CRAFT** of broaching as it has evolved, modern broaching heads into the twenty-first century as a competitive alternative to milling, reaming and shaping in operations where critical tolerances and high production speeds of manufactured parts are required.

Broaching Processes and Tools

Classified first as **SURFACE** or **INTERNAL**, then as **STANDARD** or **SPECIAL**, each broaching tool is designed and manufactured to fit the specified print. Its length of cut, LOC, and number of teeth are set by the type of stock (i.e.- machined, cast, or forged) and amount of metal to be removed. Hassay Savage presents a comprehensive line of high-speed steel broaching tools capable of critically accurate performance in many configurations while producing extraordinarily smooth surface finishes.

Surface Broaches

Surface broaching is most commonly used in place of milling or shaping operations on surfaces of parts or components.

The tool is a simple flat bar with multiple rows of cutting teeth, usually attached by bolting or clamping onto a broach holder.

- Surfaces may be flat, concave, convex, serrated, or cam-shaped
- Can be manufactured as insert sections and configured in a broach holder, lowering costs of initial manufacturing and replacement
- Produce highly finished surfaces of complex shapes with exacting dimensions and tolerances
- Production rates can be many times faster than milling or machining processes

Applications Include:

- Flats
- Intricate Contours
- Slots
- External Gearing
- Notches
- Serrations
- Key Lock Slots
- Turbine Forms
- Connecting Rods

Standard Broaches

The strength of our business at Hassay Savage has been built upon standard broaches available from stock and **SHIPPED ON THE SAME DAY THE ORDER IS PLACED**. We are one of a very few broach manufacturers who sell standard tools from stock, which means we can satisfy our customers' needs immediately.

Our sophisticated system of market distribution (400 industrial distributors and 2 factory warehouse locations) permits product to be in the customer's plant when most needed.

Pictured:
Standard push keyway broach and guide system bushing; for 1/4 keyway for an idler mechanism

Special Broaches

The Hassay Savage design and engineering departments offer a complete line of services for production of special broaches. Our engineers can integrate the design and manufacturing process of your custom broach, while working with you to meet your product goals and increase your profit margin.

See page 34-36 for Custom Broaching Solutions.

Internal Broaches

Starting with a round drilled hole, internal broaching can mass produce practically any internal hole configuration from the simplest to the most complicated.

Pull broaches significantly remove more stock than push broaches, even where the workpiece has a thin or irregular wall, and can handle longer lengths of cut.

Faster and more economical than other machining processes.

All these derivative shapes generate internal gear splines, helical splines, and other irregular shapes.

Internal broaching solves scores of manufacturing applications that simply cannot be done any other way. For instance, there is no other way to make a precise square hole.

Applications Include:

- Tooling Fixtures
- Keyways
- Gear & Pulley Keyways
- Hole Configurations in all Geometric Shapes

Tools Include:

- Square
- Hex
- Round Helical Cut
- Straight Spline and Serration
- Involute Spline and Serration
- Combination Keyway & Bore Sizing



Hassay Savage • GMauvais • Magafor Sales Representatives & US Warehouse Locations

Hassay Savage takes great pride in providing outstanding customer service. We ship from warehouses in

Turners Falls, MA • Anaheim, CA

We provide sales and technical support services nationwide.

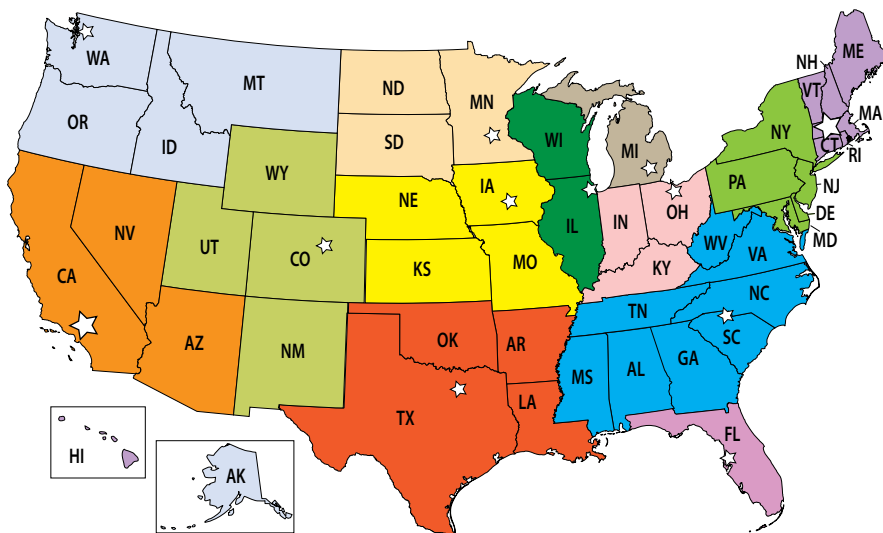

TURPIN SALES & MARKETING

330 Cold Springs Road
West Springfield, MA 01089
www.turpinsales.com
Email: dturpin@turpinsales.com
Phone: 413-733-6700
Fax: 413-747-2600
CT, MA, ME, NH, RI, VT

A J HANSON & COMPANY

203 S. Orcas Street
Seattle, WA 98108
www.ajhanson.com
Email: ajhco@ajhanson.com
Phone: 206-763-8550
Fax: 206-762-6246
WA, OR, ID, MT, AK

COAST INDUSTRIAL SALES

1630 S. Sunkist Street
Unit T
Anaheim, CA 92806
Email: coastind@pacbell.net
Phone: 714-282-6711
Fax: 714-637-1891
CA, NV, AZ

PTI, INC.

3271 South Magnolia Street
Denver, CO 80224
Email: ptidenver@msn.com
ptisaltlake@msn.com
Phone: 303-808-5311
Fax: 303-757-0092
CO, WY, UT, NM

TOM PAINE GROUP

5640 Joshua Court
Mansfield, TX 76063
www.tompainegroup.com
Email: tom@tompainegroup.com
Phone 817-296-6258
TX, OK, AR, LA

BRAASCH INDUSTRIAL SALES

9103 Vickers Crossing N.
Brooklyn Park, MN 55443
Email: reidswans@msn.com
Mobile: 612-281-7476
www.knowledgeandservice.com
MN, ND, SD

FACTORY TOOLING SOLUTIONS

1305 NW Parkridge Place
Ankeny, IA 50023
www.factorytoolingsolutions.com
Email: kbeav@msn.com
Phone: 515-249-3549
Fax: 515-965-0966
IA, NE, KS, MO

SURPLESS, DUNN & COMPANY

2150 West Lawrence Ave.
Chicago, IL 60625
www.surplesdunn.com
info@surplesdunn.com
Phone: 800-621-5117
Fax: 800-329-7301
IL, WI

CLEARWATER DIST. ADVISORS

885 N. Skokie HWY, Suite K
Lake Bluff, IL 60044
sergio.pappa@cwda-inc.com
Phone: 847-295-7371
Fax: 847-295-7373
Cell: 847-527-7662
SPECIAL DISTRIBUTION

EAGENS TOOLING SOLUTIONS

350 S. Main Street, Ste. 115
Doylestown, PA 18901
www.eagens.com
Email: meagen@eagens.com
Phone: 215-378-6404
Fax: 215-345-9480
NY, DE, MD, DC, NJ, PA, WV

RON WALLACE & ASSOCIATES

1201 Old North Main Street
Clover, SC 29710
www.rwamktg.com
Email: rwamktg@rwamktg.com
Phone: 803-222-3562
Fax: 803-222-1338
SC, VA, NC, GA, AL, TN, MS

R.A.M. SALES & MARKETING

13029 Sugar Creek Blvd
Hudson, FL 34669
www.ramsalesandmarketing.com
bob@ramsalesandmarketing.com
Phone: 727-856-6131
Fax: 727-856-6638
FL

TEK-REP GROUP, INC.

817 Eliza Court
Brunswick, OH 44212
Email: larry@tekrepgroup.com
Phone: 330-220-1116
Fax: 330-273-0121
OH, IN, KY

International Agencies:

Hassay Savage has partnered with select distributors in over 28 countries committed to our outstanding ingenuity and quality in all broaching applications. Please contact our home office for information on a Hassay Savage distributor in our growing network:

Australia, Belgium, Canada, Denmark, England, Finland, France, Germany, Greece, Holland, Ireland, Israel, Italy, Korea, Mexico, New Zealand, Russia and South Africa.



Hassay Savage Company

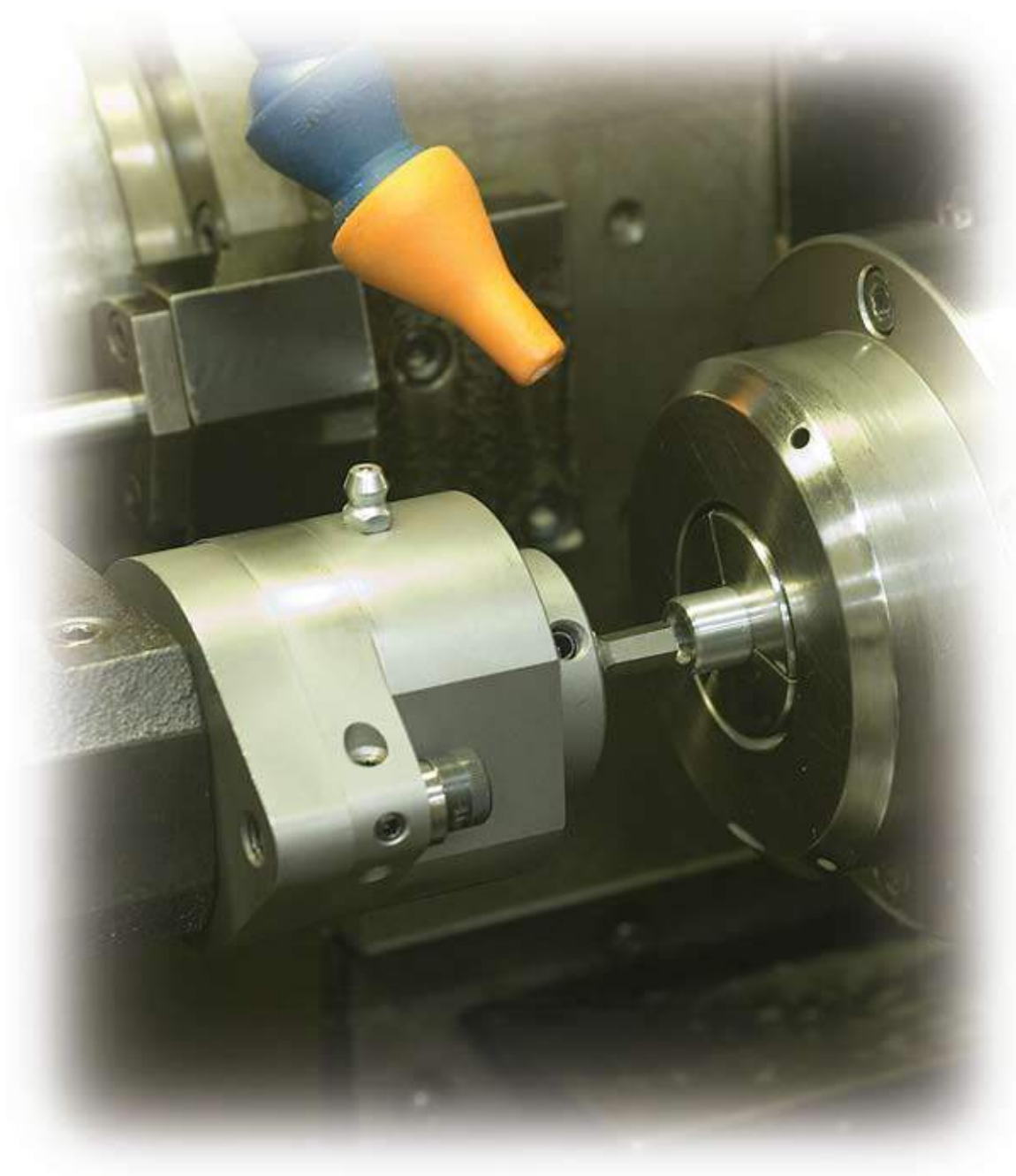

2017 - 2018

Hassay Savage



Precision Broaches for Every Application



MADE IN THE
USA



Hassay Savage

Your Total Broach Company!

Broaches For Every Application...

Medical

Orthopedic

Dental

Automotive

Firearms

Munitions

Military

Aircraft

Aerospace

Electronics

Communications

Plastics

HISTORY

Founded in 1969, Hassay Savage is a U.S. based, family owned company with designers and manufacturers of precision broaches dedicated to:

- Fine craftsmanship
- State-of-the-art design and equipment
- Computerized and process manufacturing (CNC and CAD/CAM)
- Thorough process control and process analysis (SPC)
- Dedicated tradeshow attendance



SPECIALIZATION

- Comprehensive high-speed steel broaching tools: Keyways, Squares, Hex, CNC and a variety of Unique Shapes
- Critically accurate cuts for many configurations Producing extraordinary smooth surface finishes
- World's finest push, pull and rotary broaches
- Complete breadth of line in standard broaches from stock
- Best turnaround times in the industry



PERSONALIZED SERVICE

Meet your product goals while increasing your profit margin!

We provide:

- Profit Improvement Programs (PIP)
- Cost analysis of broaching versus other machining processes
- Solutions from standard stock or custom broaches for your unique applications
- Complete turnkey design



Let us be your partner in your unique cutting applications!



Hassay Savage • GMauvais • Magafor

10 Industrial Blvd., Turners Falls, MA 01376-2251 • Phone: 413-863-9371 • Fax: 413-863-2714 • info@hassay-savage.com

TOLL FREE: 1-800-247-2024 • www.hassay-savage.com

TABLE OF CONTENTS

What is Broaching? 2
Broaching Processes and Tools 3
Sales Representatives & US Warehouse Locations 4

ORDERING

Request For Quote Form 8

KEYWAY BROACHES & SETS

Keyway Broaches Overview 9
Keyway Broach American Inch Standard Sets 10
Heavy Duty Keyway Broach Sets 11
Keyway Broach Metric Sets 12
Keyway Broach DIN Metric Sets 13
American Inch Standard Keyway Broaches 14-15
Standard Metric Keyway Broaches ISO-JS 9 16-17
Standard Metric Keyway Broaches ISO-P9 18
One Pass Keyway Broaches 18

CNC SINGLE POINT KEYWAY

Inch and Metric Shank Specifications 19

ROTARY BROACHING

Hexagonal Rotary Punch Broaches M-2 20
Hexagonal Rotary Punch Broaches M-42 21
Square Rotary Punch Broaches 22
Adjustable Rotary Broach Holders 23
Rotary Broaching Set-Up Plugs 24
Swiss Style Rotary Punch Broaches 24
Swiss Style Non-Adjustable Holders 25
Use Recommendations 26

INDEX BROACHING

Square, 2 Point Hex, 4 Point Hex, & 6 Lobe Broach Cutting ... 27-28
Quick Change Punch & Index Broach Holder Systems 28-29
Index Broach Quote Form 29

PUSH BROACHES

Inch Square & Full Square Push Broaches 30
Hexagonal Push Broaches 31

DAVIS STYLE KEYSEATING

Inch & Standard Metric Sizes 32

500 & 600 SERIES PULL TYPE

500 & 600 Series Pull Type Broaches 33

CUSTOM BROACHING SOLUTIONS

Custom & Special Broaches 34-36



KEYWAY BROACHES & SETS



CNC SINGLE POINT KEYWAY



ROTARY BROACHING



INDEX BROACHING



PUSH BROACHES



DAVIS STYLE KEYSEATING



500 & 600 SERIES PULL TYPE



CUSTOM BROACHES



Hassay Savage

24 Hour Fax: 413-863-2714 • Telephone: 1-800-247-2024

Email: info@hassay-savage.com • www.hassay-savage.com

See form on page 29 for Rotary and Index broaching applications

Request For Quote Form

Customer Information

Name _____

Title _____

Company Name _____

Street Address _____

Address line 2 _____

City _____ State _____ Zip _____

Telephone _____ FAX _____

Email _____ Country _____

Broaching Information

Size & Shape of Cut _____

Length of Cut _____ Tolerance _____

Material to be Broached _____

Pre-Broaching Condition of Hole Surface:

Pilot Hole Size _____

Hole Size (for cast holes) _____
(Include draft/fillet radii, if any)

For Keyway Broaches:

Bore Size _____ Keyway Width _____

Tolerance _____ Length of Cut _____

Depth of Keyway, measured across Bore _____

Type of Broaching Machine:

Push Pull Tonnage _____ Ram Travel _____

Daylight Opening _____

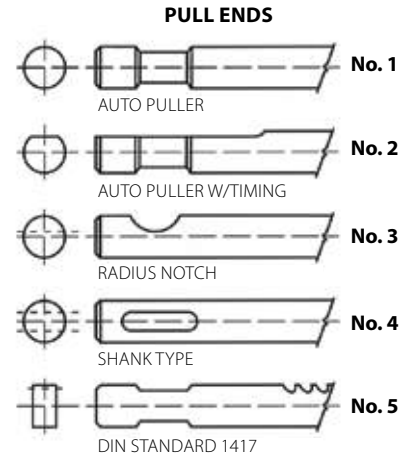

Please Provide This Information

Pull End No. _____

Size _____

Distance to 1st Tooth _____

Starting Hole Size _____

Finish Size _____

Length of Cut _____

Material _____

Remarks _____

Straight, Serration, or Involute Spline Information (Include Part Print):

Inv. Std. _____

No. of Splines _____

Diametrical Pitch _____

Pressure Angle _____

Major Dia. _____

Minor Dia. _____

Measurement Between Wires _____

Wire Size _____

Circular Tooth Thickness _____

The Hassay Savage WARRANTY

Hassay Savage Tools are warranted free from defects in material and workmanship in all cases of normal use. If under conditions of normal use a tool fails, it shall be repaired or replaced, at our option, when shipped prepaid to our factory in Turners Falls, Massachusetts 01376.

This warranty is made in lieu of all other warranties expressed or implied. This warranty does not cover tools which have been stamped for identification, experimented upon, or otherwise modified, or tools which after examination prove to have been abused, or are without flaws in material or workmanship. Government regulations require use of safety glasses and other appropriate safety equipment in the vicinity of use.

Hassay Savage Company, Inc., authorizes no other warranty by any other person or agent, nor recognizes as binding any warranty made by such person or agent on our company's behalf. We assume no further liability, except as stated herein.

Keyway Broaches Overview

HSS Keyway Broaches Are Available as Standard Items in Sizes 1/16" to 1-1/2" and 2mm to 36mm.



Keyway Broach

- Selecting a **STANDARD BROACH** from Hassay Savage is a simple process. Choose a tool, or set of tools that will produce the cut your finished part requires. Specify the EDP, size, and brief description when ordering to ensure proper delivery.
- All **STANDARD PRODUCTS** are maintained in finished goods inventory. We can ship your order the same day it is placed. Additional special widths and lengths are also available from semi-finished and finished stock, ground to your specifications with 1 week delivery.

Pressures listed in the charts are for maximum length of cut. If these lengths must be exceeded, a special Hassay Savage keyway broach can be ordered for specific length of cut and material.

Hassay Savage **VI Bushings** are available on **SPECIAL ORDER** in bore diameters of 3" - 6" for use with 7/8" - 1" keyway broaches.

- The specification charts on pages 14-18 describe the configurations, tolerances, cut lengths, and machine tonnage for each of the standard broaches we manufacture.
- Rake and relief angle geometries are CNC precision ground for efficient broaching in most mild steel materials for specified min/max LOC.
- In the event of thin pieces, pieces may be broached by stacking and nesting.
- **MODIFIED STANDARD KEYWAY BROACHES** are available within a 1 week period, for special widths and depths. This is an excellent delivery for the buyer looking for special applications for production or prototype.

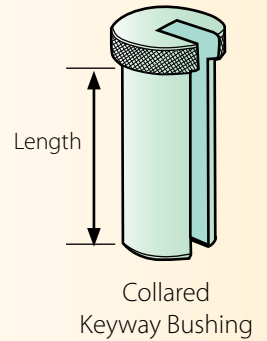

Collared Keyway Bushing

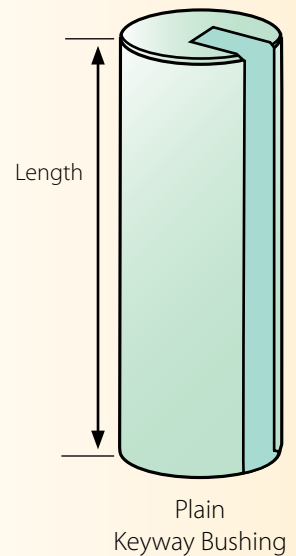

Plain Keyway Bushing



1" Keyway Broach

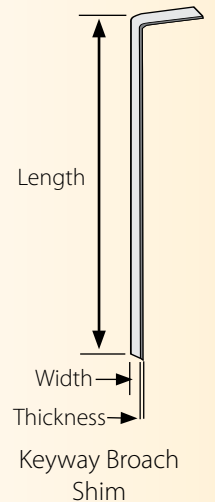
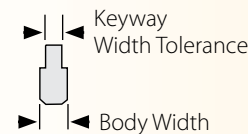
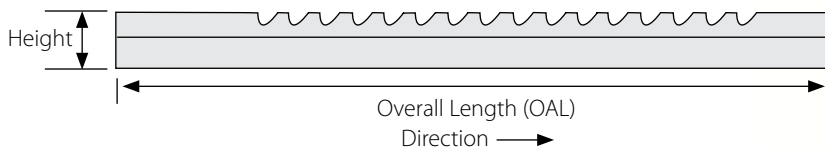

Keyway Broach Shim

See these tools at work!



www.hassay-savage.com/resource-center/product-videos

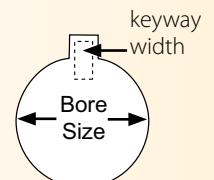

Collared Keyway Bushing

Plain Keyway Bushing

Keyway Broach Shims

Keyway Broach Sets

American Inch Standard

Keyway Range 1/16" – 3/8" with Collared Bushings in Dura Case Sets

Precision Set 1 EDP No. 15315 **DURA CASE**

3 Broaches and 5 Collared Bushings
15 Keyway Combinations *Wt. 1 lbs.*

Keyway Sizes	Broach Style	Bushing Diameters (Hole Sizes)
1/16	I	1/4, 5/16, 3/8, 7/16, 1/2
3/32	I	
1/8	I	

Standard Set C-1 EDP No. 15318 **DURA CASE**

4 Broaches and 9 Collared Bushings
18 Keyway Combinations *Wt. 8 lbs.*

Keyway Sizes	Broach Style	Bushing Diameters (Hole Sizes)
1/8	II	1/2, 5/8, 3/4, 7/8
3/16	II	
1/4	III	1, 1-1/8, 1-1/4, 1-3/8, 1-1/2
3/8	III	

Standard Set C-1A EDP No. 15319 **DURA CASE**

4 Broaches and 9 Collared Bushings
18 Keyway Combinations *Wt. 8 lbs.*

Keyway Sizes	Broach Style	Bushing Diameters (Hole Sizes)
1/8	II	9/16, 11/16, 13/16
3/16	II	
1/4	III	15/16, 1-1/16, 1-3/16, 1-5/16, 1-7/16, 1-9/16
3/8	III	

Standard Set C-2 EDP No. 15320 **DURA CASE**

3 Broaches and 9 Collared Bushings
15 Keyway Combinations *Wt. 8 lbs.*

Keyway Sizes	Broach Style	Bushing Diameters (Hole Sizes)
1/8	II	9/16, 11/16, 13/16
3/16	III	15/16, 1-1/16, 1-3/16, 1-5/16, 1-7/16, 1-9/16
1/4	III	

Standard Set C-2A EDP No. 15321 **DURA CASE**

3 Broaches and 9 Collared Bushings
14 Keyway Combinations *Wt. 8 lbs.*

Keyway Sizes	Broach Style	Bushing Diameters (Hole Sizes)
1/8	II	1/2, 5/8, 3/4, 7/8
3/16	III	1, 1-1/8, 1-1/4, 1-3/8, 1-1/2
1/4	III	

To select a standard broach from Hassay Savage, simply choose a tool, or set of tools that will produce the cut your finished part requires.

Specify the EDP, size, and brief description when ordering to ensure proper delivery.

The specification charts, on pages 14 & 15, describe the

- Dimensional Cuts,
- Configurations,
- Tolerances,
- Length of Cut, and
- Machine Tonnage

for each standard broach we manufacture.

Standard Set C-10 EDP No. 15336 **DURA CASE**

4 Broaches and 18 Collared Bushings
36 Keyway Combinations *Wt. 13 lbs.*

Keyway Sizes	Broach Style	Bushing Diameters (Hole Sizes)
1/8	II	1/2, 9/16, 5/8, 11/16, 3/4, 13/16, 7/8
3/16	II	
1/4	III	15/16, 1, 1-1/16, 1-1/8, 1-3/16, 1-1/4, 1-5/16, 1-3/8, 1-7/16, 1-1/2, 1-9/16
3/8	III	

Standard Set C-10A EDP No. 15330 **DURA CASE**

3 Broaches and 18 Collared Bushings
30 Keyway Combinations *Wt. 13 lbs.*

Keyway Sizes	Broach Style	Bushing Diameters (Hole Sizes)
1/8	II	1/2, 9/16, 5/8, 11/16, 3/4, 13/16, 7/8
3/16	III	
1/4	III	15/16, 1, 1-1/16, 1-1/8, 1-3/16, 1-1/4, 1-5/16, 1-3/8, 1-7/16, 1-1/2, 1-9/16

All broaches are CNC qualified!

**Hassay Savage
HSS Broach Sets come in
Durable Plastic Cases
(Dura Cases)
and include:**

- Broaches
- Bushings
- Shims
- Instructions

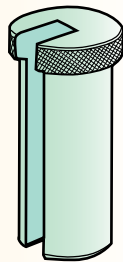

Collared
Keyway Bushing



Standard Set C-10 Dura Case

Heavy Duty Keyway Sets

American Inch Standard

Keyway Range 5/16" – 3/4" with Plain Bushings in Hardwood Cases

Standard Set 3-D

EDP No. 15024 **HARDWOOD**

4 Broaches and 8 Plain Bushings
32 Keyway Combinations *Wt. 50 lbs.*

Keyway Sizes	Broach Style	Bushing Diameters (Hole Sizes inches)
5/16	IV	1-1/2, 1-5/8, 1-3/4, 1-7/8 2, 2-1/8, 2-1/4, 2-1/2
3/8	IV	
7/16	IV	
1/2	IV	

Standard Set 3-DA

EDP No. 15124 **HARDWOOD**

4 Broaches and 8 Plain Bushings
32 Keyway Combinations *Wt. 50 lbs.*

Keyway Sizes	Broach Style	Bushing Diameters (Hole Sizes inches)
5/16	IV	1-7/16, 1-9/16, 1-11/16, 1-13/16, 1-15/16, 2-3/16, 2-7/16, 2-15/16
3/8	IV	
7/16	IV	
1/2	IV	

We are meeting the needs of today's industry. Hassay Savage broaches find use wherever precision broaching operations add to the quality and economical manufacture of identical parts.

The strength of our business has been built upon standard broaches available from stock and **SHIPPED ON THE SAME DAY THE ORDER IS PLACED.**

We are one of a very few broach manufacturers who sell standard tools from stock, which means we can satisfy our customers' needs immediately.

See these tools at work!



www.hassay-savage.com/resource-center/product-videos

Heavy Duty Set 4-E

EDP No. 15012 **HARDWOOD**

2 Broaches and 6 Plain Bushings
12 Keyway Combinations *Wt. 74 lbs.*

Keyway Sizes	Broach Style	Bushing Diameters (Hole Sizes)
5/8	V	2-3/8, 2-1/2, 2-5/8
3/4	V	2-3/4, 2-7/8, 3

Heavy Duty Set 4-F

EDP No. 15014 **HARDWOOD**

2 Broaches and 6 Plain Bushings
12 Keyway Combinations *Wt. 74 lbs.*

Keyway Sizes	Broach Style	Bushing Diameters (Hole Sizes)
5/8	V	2-5/16, 2-7/16, 2-9/16
3/4	V	2-11/16, 2-13/16, 2-15/16

Heavy Duty Set 5

EDP No. 15026 **HARDWOOD**

3 Broaches and 17 Plain Bushings
26 Keyway Combinations *Wt. 175 lbs.*

Keyway Sizes	Broach Style	Bushing Diameters (Hole Sizes)
1/2	IV	2, 2-1/16, 2-1/8, 2-3/16, 2-1/4, 2-5/16, 2-3/8, 2-7/16
5/8	V	2-1/2, 2-9/16, 2-5/8, 2-11/16, 2-3/4, 2-13/16,
3/4	V	2-7/8, 2-15/16, 3

All broaches are CNC qualified!



Standard Set 3-D Hardwood

**Hassay Savage
HSS Broach Sets in
Tongue and Grooved
Hardwood Cases
Include:**

- Broaches
- Bushings
- Shims
- Instructions

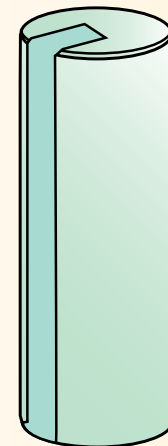

Plain Keyway Bushing

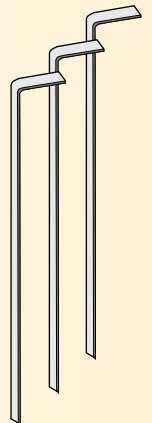

Keyway Broach Shims

Metric Keyway Broach Sets

Standard Metric

Keyway Range 2mm - 18mm

Precision Set #10

EDP No. 15410 **DURA CASE**

2 Broaches and 5 Collared Bushings
10 Keyway Combinations *Wt. 1 lbs.*

Keyway Sizes	Broach Style	Metric Bushing Diameters (Hole Sizes mm)
2mm	I	6, 7, 8, 9, 10
3mm	I	

Metric Set #40

EDP No. 15440 **DURA CASE**

6 Broaches and 18 Collared Bushings
36 Keyway Combinations *Wt. 12 lbs.*

Keyway Sizes	Broach Style	Metric Bushing Diameters (Hole Sizes mm)
2mm	I	8, 10
3mm	I	
4mm	II	12, 14, 16, 18
5mm	II	
6mm	III	18, 19, 20, 22, 24, 25, 26, 28, 30, 32, 34, 36
8mm	III	

Metric Set #18

EDP No. 15418 **DURA CASE**

4 Broaches and 9 Collared Bushings
18 Keyway Combinations *Wt. 7 lbs.*

Keyway Sizes	Broach Style	Metric Bushing Diameters (Hole Sizes mm)
4mm	II	12, 14, 16, 18
5mm	II	
6mm	III	20, 22, 24, 26, 28
8mm	III	

All standard products are maintained in finish good inventory. We can

SHIP YOUR ORDER THE SAME DAY IT IS PLACED!

Additional special widths and lengths are also available from semi-finished stock ground to your specifications with quick delivery.

The specification charts, on pages 16 & 17, describe the

- Dimensional Cuts,
- Configurations,
- Tolerances,
- Length of Cut, and
- Machine Tonnage

for each standard broach we manufacture.

Hassay Savage HSS Broach Sets in Tongue and Grooved Hardwood Cases and Plastic Dura Cases include:

- Instructions
- Broaches
- Bushings
- Shims

Metric Set #24

EDP No. 15224 **HARDWOOD**

3 Broaches and 8 Plain Bushings
24 Keyway Combinations *Wt. 36 lbs.*

Keyway Sizes	Broach Style	Metric Bushing Diameters (Hole Sizes mm)
10mm	IV	34, 36, 38, 40, 42, 44, 46, 48
12mm	IV	
14mm	IV	

Metric Set #12

EDP No. 15212 **HARDWOOD**

2 Broaches and 6 Plain Bushings
12 Keyway Combinations *Wt. 70 lbs.*

Keyway Sizes	Broach Style	Metric Bushing Diameters (Hole Sizes mm)
16mm	V	54, 56, 58, 60, 62, 64
18mm	V	

Metric Set #30

EDP No. 15230 **HARDWOOD**

3 Broaches and 16 Plain Bushings
28 Keyway Combinations *Wt. 100 lbs.*

Keyway Sizes	Broach Style	Metric Bushing Diameters (Hole Sizes mm)
14mm	IV	44, 46, 48, 50
16mm	V	52, 54, 55, 56, 58, 60, 62, 64,
18mm	V	65, 66, 68, 70

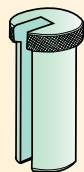

Collared Keyway Bushing



Metric Set #18



Metric Set #24

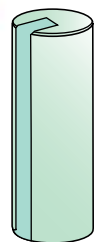

Plain Keyway Bushing

Metric Keyway Broach Sets

DIN Standard Metric

Keyway Range 2mm - 18mm

DIN is an abbreviation for the **German Institute for Standardization** (Deutsches Institut für Normung). There are currently around thirty thousand DIN Standards, covering nearly every field of technology.



DIN Standard Set #50

- **Hassay Savage Precision Quality Broaches**
- **M2 HSS Steel Keyway Broaches for long life**
- **Our most popular metric sizes all in one package**
- **Strong, light weight Dura Case goes anywhere**
- **Hardwood cases are Tongue and Grooved**

DIN Standard for Keyway

Keyway Sizes	Bushing Diameters (mm)
2mm	6-8mm
3mm	8-10mm
4mm	10-12mm
5mm	12-17mm
6mm	17-22mm
8mm	22-30mm
10mm	30-38mm
12mm	38-44mm
14mm	44-50mm
16mm	50-58mm
18mm	58-65mm
20mm	65-75mm
22mm	75-85mm
24mm	85-95mm
25mm	85-95mm



25mm Keyway Broach

DIN Standard Metric EDP No. 15410 **DURA CASE**

2 Broaches and 5 Collared Bushings
10 Keyway Combinations *Wt. 1 lbs.*

Keyway Sizes	Broach Style	Metric Bushing Diameters (Hole Sizes mm)
2mm	I	6, 7, 8, 9, 10
3mm	I	

DIN Standard Metric EDP No. 15418 **DURA CASE**

4 Broaches and 9 Collared Bushings
18 Keyway Combinations *Wt. 7 lbs.*

Keyway Sizes	Broach Style	Metric Bushing Diameters (Hole Sizes mm)
4mm	II	12, 14, 15, 16,
5mm	II	
6mm	III	18, 20, 22, 24, 25
8mm	III	



Collared Keyway Bushing

DIN Standard Metric EDP No. 15440 **DURA CASE**

6 Broaches and 13 Collared Bushings
26 Keyway Combinations *Wt. 12 lbs.*

Keyway Sizes	Broach Style	Metric Bushing Diameters (Hole Sizes mm)
2mm	I	8, 10
3mm	I	
4mm	II	12, 14, 15, 16
5mm	II	
6mm	III	18, 20, 22, 24, 25, 28, 30
8mm	III	

DIN Standard Metric EDP No. 15450 **DURA CASE**

2 Broaches and 5 Plain Bushings
10 Keyway Combinations *Wt. 13 lbs.*

Keyway Sizes	Broach Style	Metric Bushing Diameters (Hole Sizes mm)
10mm	IV	32, 35, 38, 40, 42
12mm	IV	

DIN Standard Metric EDP No. 15224 **HARDWOOD**

3 Broaches and 7 Plain Bushings
21 Keyway Combinations *Wt. 36 lbs.*

Keyway Sizes	Broach Style	Metric Bushing Diameters (Hole Sizes mm)
10mm	IV	32, 35, 38, 40, 42, 45, 50
12mm	IV	
14mm	IV	

DIN Standard Metric EDP No. 15212 **HARDWOOD**

2 Broaches and 5 Plain Bushings
10 Keyway Combinations *Wt. 70 lbs.*

Keyway Sizes	Broach Style	Metric Bushing Diameters (Hole Sizes mm)
16mm	V	52, 55, 58, 60, 65
18mm	V	



Plain Keyway Bushing

All broaches are CNC qualified!

Keyway Broaches American Inch Standard Sizes 1/16" to 3/8"

Bushings I, II, and III - Numbers 20116 - 20400 are **COLLARED Bushings**

Keyway broaches and bushings are clearly marked for bore size:

Any **I American Standard Broach** can be used with any **I American Standard Bushing**

Any **II American Standard Broach** can be used with any **II American Standard Bushing**

Any **III American Standard Broach** can be used with any **III American Standard Bushing**

In some cases American Standard CANNOT be used with Metric size Bushings and Broaches.

Please call with questions: 413-863-9371

I Broaches		Any I Broach can be used with any I Bushing					
Broach	EDP No.	Width Tolerance	Body Width x OAL (in.)	No. of shims	Length of Cut Min.	Max.	Pressure Max.L/C (lbs.)
1/16-I	10104	.0625 - .0635	1/8 x 5-1/4	0	13/64	1-1/8	270
3/32-I	10106	.0937 - .0947	1/8 x 5-1/4	0	13/64	1-1/8	810
1/8-I	10108	.1252 - .1262	1/8 x 5-1/4	1	13/64	1-1/8	720

I Shims			
Size	Thickness	Length & Width	EDP
1/8-I	.031	1-3/8 x 1/8	30108

I Bushings (Collared)		
Diameter	Length	EDP
1/4	1-1/8	20116
5/16	1-1/8	20120
3/8	1-1/8	20124
7/16	1-1/8	20128
1/2	1-1/8	20132

Keyway Broach



II Broaches		Any II Broach can be used with any II Bushing					
Broach	EDP No.	Width Tolerance	Body Width x OAL (in.)	No. of shims	Length of Cut Min.	Max.	Pressure Max.L/C (lbs.)
3/32-II	10206	.0937 - .0947	3/16 x 7	0	19/64	1-11/16	990
1/8-II	10208	.1252 - .1262	3/16 x 7	1	19/64	1-11/16	780
5/32-II	10210	.1564 - .1574	3/16 x 7	1	19/64	1-11/16	1,560
3/16-II	10212	.1877 - .1887	3/16 x 7	1	19/64	1-11/16	2,100

II Shims			
Size	Thickness	Length & Width	EDP
1/8-II	.031	1-7/8 x 3/16	30208
5/32-II	.042	1-7/8 x 3/16	30210
3/16-II	.050	1-7/8 x 3/16	30212

II Bushings (Collared)		
Diameter	Length	EDP
1/2	1-11/16	20232
9/16	1-11/16	20236
5/8	1-11/16	20240
11/16	1-11/16	20244
3/4	1-11/16	20248
13/16	1-11/16	20252
7/8	1-11/16	20256

Required shims are always supplied with each keyway broach. When ordering additional or replacement shims, specify EDP Number.

III Broaches		Any III Broach can be used with any III Bushing					
Broach	EDP No.	Width Tolerance	Body Width x OAL (in.)	No. of shims	Length of Cut Min.	Max.	Pressure Max.L/C (lbs.)
3/16-III	10312	.1877 - .1887	3/8 x 11-7/8	1	13/32	2-1/2	1,440
1/4-III	10316	.2502 - .2512	3/8 x 11-7/8	1	13/32	2-1/2	2,580
5/16-III	10320	.3127 - .3137	3/8 x 11-7/8	1	13/32	2-1/2	4,200
3/8-III	10324	.3755 - .3765	3/8 x 11-7/8	2	13/32	2-1/2	3,600

III Shims			
Size	Thickness	Length & Width	EDP
3/16-III	.050	2-7/8 x 3/8	30312
1/4-III	.062	2-7/8 x 3/8	30316
5/16-III	.078	2-7/8 x 3/8	30320
3/8-III	.062	2-7/8 x 3/8	30324

III Bushings (Collared)		
Diameter	Length	EDP
3/4	2-1/2	20348
13/16	2-1/2	20352
7/8	2-1/2	20356
15/16	2-1/2	20360
1	2-1/2	20364
1-1/16	2-1/2	20368
1-1/8	2-1/2	20372
1-3/16	2-1/2	20376
1-1/4	2-1/2	20380
1-5/16	2-1/2	20384
1-3/8	2-1/2	20388
1-7/16	2-1/2	20392
1-1/2	2-1/2	20396
1-9/16	2-1/2	20400

When ordering additional or replacement shims, specify EDP Number.

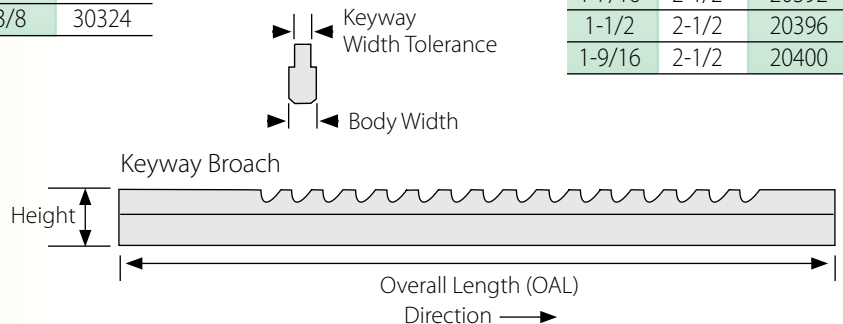
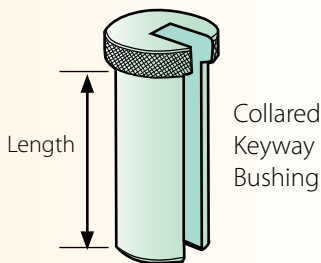
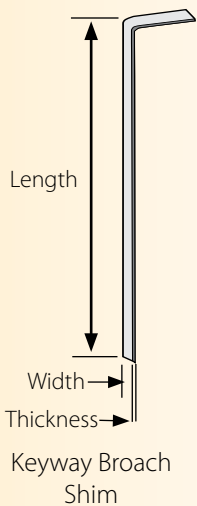

Keyway Broaches American Inch Standard Sizes 5/16" to 1-1/2"

Bushings IV and V - Numbers 21492 - 21732 are **PLAIN Bushings**

IV Broaches Any IV Broach can be used with any IV Bushing

Broach	EDP No.	Width Tolerance	Body Width x OAL (in.)	No. of shims	Length of Cut		Pressure Max.L/C (lbs.)
					Min.	Max.	
5/16-IV	10420	.3127 - .3137	9/16 x 13-7/8	1	3/4	6	9,250
3/8-IV	10424	.3755 - .3765	9/16 x 13-7/8	2	3/4	6	8,000
7/16-IV	10428	.4380 - .4390	9/16 x 13-7/8	2	3/4	6	11,750
1/2-IV	10432	.5006 - .5016	9/16 x 13-7/8	3	3/4	6	11,000
9/16-IV	10436	.5630 - .5640	9/16 x 13-7/8	3	3/4	6	11,100

IV Shims

Size	Thickness	Length & Width	EDP
5/16-IV	.078	6-1/4 x 9/16	30420
3/8-IV	.062	6-1/4 x 9/16	30424
7/16-IV	.075	6-1/4 x 9/16	30428
1/2-IV	.062	6-1/4 x 9/16	30432
9/16-IV	.062	6-1/4 x 9/16	30436

Required shims are always supplied with each keyway broach.

When ordering additional or replacement shims, specify EDP Number.

V Broaches Any V Broach can be used with any V Bushing

Broach	EDP No.	Width Tolerance	Body Width x OAL (in.)	No. of shims	Length of Cut		Pressure Max.L/C (lbs.)
					Min.	Max.	
5/8-V	10540	.6260 - .6270	3/4 x 15-1/4	4	3/4	6	11,500
3/4-V	10548	.7515 - .7525	3/4 x 15-1/4	5	3/4	6	13,500

V Shims

Size	Thickness	Length & Width	EDP
5/8-V	.062	6-3/4 x 3/4	30540
3/4-V	.062	6-3/4 x 3/4	30548

V Bushings (Plain)

Diameter	Length	EDP
2-5/16	6	21688
2-3/8	6	21692
2-7/16	6	21696
2-1/2	6	21700
2-9/16	6	21704
2-5/8	6	21708
2-11/16	6	21712
2-3/4	6	21716
2-13/16	6	21720
2-7/8	6	21724
2-15/16	6	21728
3	6	21732



IV Bushings (Plain)

Diameter	Length	EDP
1-7/16	4	21492
1-1/2	4	21496
1-9/16	4	21500
1-5/8	4	21504
1-11/16	4	21508
1-3/4	4	21512
1-13/16	5	21516
1-7/8	5	21520
1-15/16	5	21524
2	5	21528
2-1/16	5	21532
2-1/8	5	21536
2-3/16	5	21540
2-1/4	5	21544
2-5/16	5	21548
2-3/8	6	21552
2-7/16	6	21556
2-1/2	6	21560
2-9/16	6	21564
2-5/8	6	21568
2-11/16	6	21572
2-3/4	6	21576
2-13/16	6	21580
2-7/8	6	21584
2-15/16	6	21588
3	6	21592

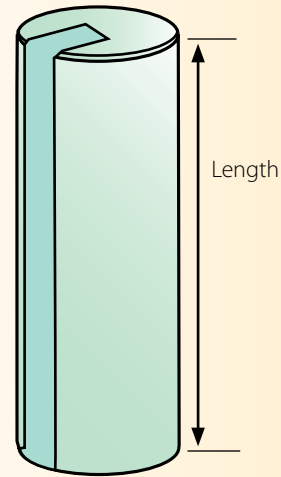

Plain Keyway Bushing

Keyway broaches and bushings are clearly marked for bore size:

Any **IV Broach** can be used with any **IV Bushing**

Any **V Broach** can be used with any **V Bushing**

VI Bushings can be Special Ordered in diameter sizes 3" - 6"

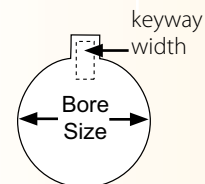

Keyway Shims correspond to broach size, not to bushing size.

VI Broaches

Broach	EDP No.	Width Tolerance	Body Width x OAL (in.)	No. of shims	Length of Cut		Pressure Max.L/C (lbs.)
					Min.	Max.	
7/8-VI	10656	.8765 - .8775	1 x 19-1/4	6	3/4	6	11,000
1-VI	10664	1.0015 - 1.0025	1 x 19-1/4	7	3/4	6	14,000

Standard Oversize Keyways

1-1/8	10666	1.1260 - 1.1270	1-1/8 x 23	8	3/4	6	15,750
1-1/4	10668	1.2510 - 1.2520	1-1/4 x 23	9	3/4	6	14,500
1-3/8	10670	1.3760 - 1.3770	1-3/8 x 23	10	3/4	6	19,250
1-1/2	10672	1.5020 - 1.5030	1-1/2 x 23	11	3/4	6	21,000

VI Shims

Size	Thickness	Length & Width	EDP
7/8-V	.062	6-3/4 x 1	30656
1-VI	.062	6-3/4 x 1	30664

Standard Oversize Keyways

1-1/8	.062	7 x 1-1/8	30740
1-1/4	.062	7 x 1-1/4	30750
1-3/8	.062	7 x 1-1/4	30760
1-1/2	.062	7 x 1-1/4	30770

Hassay Savage plain **VI Bushings** are available on **SPECIAL ORDER** in diameter sizes 3" - 6"

Metric Keyway Broaches

Standard Sizes 2mm-8mm

Bushings mm I, mm II, and mm III - Numbers 22106-22336 are **COLLARED Bushings** **ISO JS 9 Tolerance**

mm I Broaches *Any mm I Broach can be used with any mm I Bushing*

Broach	EDP No.	JS 9 Width Tolerance	Standard Millimeter Keys	Body Width x OAL (in.)	No. of shims	Length of Cut		Pressure Max.L/C (lbs.)
						Min.	Max.	
2mm-I	11102	.0782 - .0792	2mm x 2mm	1/8 x 5-1/4	0	13/64	1-1/8	510
3mm-I	11103	.1176 - .1186	3mm x 3mm	1/8 x 5-1/4	1	13/64	1-1/8	720

mm I Shims

Size	Thickness	Length & Width	EDP
3mm-I	.031	1-3/8 x 1/8	31103

Shims correspond to metric broach size, not to bushing size.

mm I Bushings

Size	Dim. In.	Length	EDP No.
6mm-I	.2362	1-1/8	22106
7mm-I	.2756	1-1/8	22107
8mm-I	.3150	1-1/8	22108
9mm-I	.3543	1-1/8	22109
10mm-I	.3937	1-1/8	22110

mm II Broaches *Any mm II Broach can be used with any mm II Bushing*

Broach	EDP No.	JS 9 Width Tolerance	Standard Millimeter Keys	Body Width x OAL (in.)	No. of shims	Length of Cut		Pressure Max.L/C (lbs.)
						Min.	Max.	
4mm-II	11204	.1569 - .1581	4mm x 4mm	1/4 x 7	1	19/64	1-11/16	1,140
5mm-II	11205	.1963 - .1975	5mm x 5mm	1/4 x 7	1	19/64	1-11/16	2,040

mm II Shims

Size	Thickness	Length & Width	EDP
4mm-II	.038	1-7/8 x 1/4	31204
5mm-II	.050	1-7/8 x 1/4	31205

Required shims are always supplied with each keyway broach.

When ordering additional or replacement shims, specify EDP Number.

mm II Bushings

Size	Dim. In.	Length	EDP No.
11mm-II	.4331	1-11/16	22211
12mm-II	.4724	1-11/16	22212
13mm-II	.5118	1-11/16	22213
14mm-II	.5512	1-11/16	22214
15mm-II	.5905	1-11/16	22215
16mm-II	.6299	1-11/16	22216
17mm-II	.6693	1-11/16	22217
18mm-II	.7087	1-11/16	22218
19mm-II	.7480	1-11/16	22219

mm III Broaches *Any mm III Broach can be used with any mm III Bushing*

Broach	EDP No.	JS 9 Width Tolerance	Standard Millimeter Keys	Body Width x OAL (in.)	No. of shims	Length of Cut		Pressure Max.L/C (lbs.)
						Min.	Max.	
5mm-III	11305	.1963 - .1975	5mm x 5mm	3/8 x 11-7/8	1	13/32	2-1/2	1,680
6mm-III	11306	.2356 - .2368	6mm x 6mm	3/8 x 11-7/8	1	13/32	2-1/2	1,890
7mm-III	11307	.2749 - .2763	7mm x 7mm	3/8 x 11-7/8	1	13/32	2-1/2	2,985
8mm-III	11308	.3143 - .3157	8mm x 8mm	3/8 x 11-7/8	1	13/32	2-1/2	3,995

mm III Shims

Size	Thickness	Length & Width	EDP
5mm-III	.047	2-7/8 x 3/8	31305
6mm-III	.062	2-7/8 x 3/8	31306
7mm-III	.062	2-7/8 x 3/8	31307
8mm-III	.078	2-7/8 x 3/8	31308

Keyway Metric Broaches and Metric Bushings are clearly marked for bore size:

Any **mm I Broach** can be used with any **mm I Bushing**,

Any **mm II Broach** can be used with any **mm II Bushing**,

Any **mm III Broach** can be used with any **mm III Bushing**,

mm III Bushings

Size	Dim. In.	Length	EDP No.
17mm-III	.6693	2-1/2	22317
18mm-III	.7087	2-1/2	22318
19mm-III	.7480	2-1/2	22319
20mm-III	.7874	2-1/2	22320
22mm-III	.8661	2-1/2	22322
24mm-III	.9449	2-1/2	22324
25mm-III	.9842	2-1/2	22325
26mm-III	1.0236	2-1/2	22326
27mm-III	1.0630	2-1/2	22327
28mm-III	1.1024	2-1/2	22328
30mm-III	1.1811	2-1/2	22330
32mm-III	1.2598	2-1/2	22332
34mm-III	1.3386	2-1/2	22334
35mm-III	1.3779	2-1/2	22335
36mm-III	1.4173	2-1/2	22336

In some cases American Standard CANNOT be used with Metric size Bushings and Broaches. Please call with questions: 413-863-9371

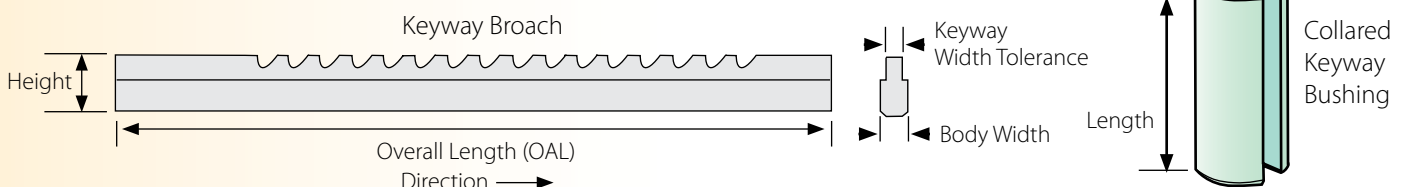

Metric Keyway Broaches

Standard Sizes 10mm-36mm

Bushings mm IV and mm V - Numbers 22432-22572 are **PLAIN Bushings**

ISO JS 9 Tolerance



mm IV Broaches

Any mm IV Broach can be used with any mm IV Bushing

Broach	EDP No.	JS 9 Width Tolerance	Standard Millimeter Keys	Body Width x OAL (in.)	No. of shims	Length of Cut Min.	Length of Cut Max.	Pressure Max.L/C (lbs.)
10mm-IV	11410	.3930 - .3944	10mm x 8mm	9/16 x 13-7/8	2	3/4	6	8,100
12mm-IV	11412	.4716 - .4732	12mm x 8mm	9/16 x 13-7/8	2	3/4	6	10,550
14mm-IV	11414	.5504 - .5520	14mm x 9mm	9/16 x 13-7/8	2	3/4	6	11,090

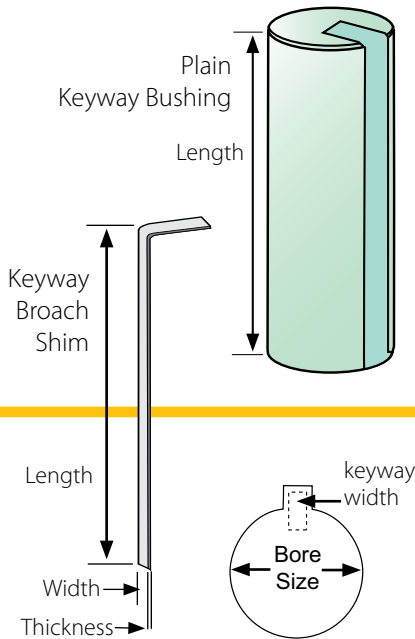

mm IV Shims

Size	Thickness	Length & Width	EDP
10mm-IV	.056	6-1/4 x 9/16	31410
12mm-IV	.056	6-1/4 x 9/16	31412
14mm-IV	.062	6-1/4 x 9/16	31414

Shims correspond to metric broach size, not to bushing size.

mm IV Bushings

Size	Dim. In.	Length	EDP No.
32mm-IV	1.2598	4	22432
34mm-IV	1.3386	4	22434
35mm-IV	1.3779	4	22435
36mm-IV	1.4173	4	22436
38mm-IV	1.4961	4	22438
40mm-IV	1.5748	4	22440
42mm-IV	1.6535	4	22442
44mm-IV	1.7323	4	22444
45mm-IV	1.7716	5	22445
46mm-IV	1.8110	5	22446
48mm-IV	1.8898	5	22448
50mm-IV	1.9685	5	22450
52mm-IV	2.0472	5	22452
54mm-IV	2.1260	5	22454
55mm-IV	2.1653	5	22455
56mm-IV	2.2047	5	22456

mm V Shims

Size	Thickness	Length & Width	EDP
16mm-V	.062	6-3/4 x 3/4	31516
18mm-V	.062	6-3/4 x 3/4	31518

mm V Bushings

Size	Dim. In.	Length	EDP No.
52mm-V	2.0472	5	22552
54mm-V	2.126	5	22554
55mm-V	2.1653	5	22555
56mm-V	2.2047	5	22556
58mm-V	2.2835	5	22558
60mm-V	2.3622	6	22560
62mm-V	2.4409	6	22562
64mm-V	2.5197	6	22564
65mm-V	2.5590	6	22565
66mm-V	2.5984	6	22566
68mm-V	2.6772	6	22568
70mm-V	2.7559	6	22570
72mm-V	2.8346	6	22572

mm V Broaches

Any mm V Broach can be used with any mm V Bushing

Broach	EDP No.	JS 9 Width Tolerance	Standard Millimeter Keys	Body Width x OAL (in.)	No. of shims	Length of Cut Min.	Length of Cut Max.	Pressure Max.L/C (lbs.)
16mm-V	11516	.6291 - .6307	16mm x 10mm	3/4 x 15-1/4	3	3/4	6	11,375
18mm-V	11518	.7079 - .7095	18mm x 11mm	3/4 x 15-1/4	3	3/4	6	12,000

Required shims are always supplied with each keyway broach.

When ordering additional or replacement shims, specify EDP Number.

mm VI Broaches

Any mm VI Broach can be used with any mm VI Bushing

Broach	EDP No.	JS 9 Width Tolerance	Standard Millimeter Keys	Body Width x OAL (in.)	No. of shims	Length of Cut Min.	Length of Cut Max.	Pressure Max.L/C (lbs.)
20mm-VI	11620	.7864 - .7884	20mm x 12mm	1 x 19-1/4	3	3/4	6	11,000
22mm-VI	11622	.8651 - .8671	22mm x 14mm	1 x 19-1/4	4	3/4	6	11,200
24mm-VI	11624	.9439 - .9459	24mm x 14mm	1 x 19-1/4	4	3/4	6	13,075
25mm-VI	11625	.9833 - .9853	25mm x 14mm	1 x 19-1/4	4	3/4	6	13,275

Standard Oversize Keyways

28mm	11628	1.1034 - 1.1014	28mm x 14mm	1-1/8 x 23	4	3/4	6	14,700
30mm	11630	1.1821 - 1.1801	30mm x 14mm	1-1/4 x 23	5	3/4	6	15,700
32mm	11632	1.2610 - 1.2586	32mm x 14mm	1-1/4 x 23	5	3/4	6'	16,790
36mm	11636	1.4185 - 1.4161	36mm x 14mm	1-7/16 x 23	5	3/4	6	18,590

mm VI Shims

Size	Thickness	Length & Width	EDP
20mm-VI	.062	6-3/4 x 1	31620
22mm-VI	.062	6-3/4 x 1	31622
24mm-VI	.062	6-3/4 x 1	31624
25mm-VI	.062	6-3/4 x 1	31625

Standard Oversize Keyways

28mm	.062	7 x 1	31628
30mm	.062	7 x 1	31630
32mm	.062	7 x 1-1/4	31632
36mm	.062	7 x 1-1/4	31636

Hassay Savage Metric VI Bushings are available on **SPECIAL ORDER**. in diameter sizes 75mm - 150mm

Metric Keyway Broaches

Standard Sizes

ISO P9 Tolerance

Optional Metric Keyway Broaches ISO P9

	Broach	EDP No.	P9 Width Tolerance	Standard Millimeter Keys	Body Width x OAL (in.)	No. of shims	Length of Cut		Pressure Max.L/C (lbs.)
							Min.	Max.	
I	2mm-I	11102P9	.0775 - .0785	2mm x 2mm	1/8 x 5-1/4	0	13/64	1-1/8	510
	3mm-I	11103P9	.1169 - .1179	3mm x 3mm	1/8 x 5-1/4	1	13/64	1-1/8	720
II	4mm-II	11204P9	.1559 - .1570	4mm x 4mm	1/4 x 7	1	19/64	1-11/16	1,140
	5mm-II	11205P9	.1953 - .1964	5mm x 5mm	1/4 x 7	1	19/64	1-11/16	2,040
III	5mm-III	11305P9	.1963 - .1973	5mm x 5mm	3/8 x 11-7/8	1	13/32	2-1/2	1,680
	6mm-III	11306P9	.2342 - .2357	6mm x 6mm	3/8 x 11-7/8	1	13/32	2-1/2	1,890
	7mm-III	11307P9	.2736 - .2750	7mm x 7mm	3/8 x 11-7/8	1	13/32	2-1/2	2,985
	8mm-III	11308P9	.3130 - .3144	8mm x 8mm	3/8 x 11-7/8	1	13/32	2-1/2	3,995
IV	10mm-IV	11410P9	.3917 - .3931	10mm x 8mm	9/16 x 13-7/8	2	3/4	6	8,100
	12mm-IV	11412P9	.4700 - .4717	12mm x 8mm	9/16 x 13-7/8	2	3/4	6	10,550
	14mm-IV	11414P9	.5488 - .5505	14mm x 9mm	9/16 x 13-7/8	2	3/4	6	11,090
V	16mm-V	11516P9	.6275 - .6292	16mm x 10mm	3/4 x 15-1/4	3	3/4	6	11,375
	18mm-V	11518P9	.7063 - .7080	18mm x 11mm	3/4 x 15-1/4	3	3/4	6	12,000
VI	20mm-VI	11620P9	.7845 - .7865	20mm x 12mm	1 x 19-1/4	3	3/4	6	11,000
	22mm-VI	11622P9	.8632 - .8652	22mm x 14mm	1 x 19-1/4	4	3/4	6	11,200
	24mm-VI	11624P9	.9420 - .9440	24mm x 14mm	1 x 19-1/4	4	3/4	6	13,075
	25mm-VI	11625P9	.9814 - .9834	25mm x 14mm	1 x 19-1/4	4	3/4	6	13,275

- Standard metric tolerances are to **ISO JS 9** and **P9**.
- Preferred metric limits fits **-ANSI B4.2-1978** (American National Standards Institute)
- Optional metric tolerances are available to **ISO P9**. The **ISO P9** option listed on this page utilizes **the same bushings and shims** as the **Standard JS 9** metric broaches listed on the previous page.
- Bushings **mm I, mm II,** and **mm III** are **COLLARED Bushings**. Bushings **mm IV** and **mm V** are **PLAIN**.
- Hassay Savage **mm VI Bushings** are available on **SPECIAL ORDER** in diameter sizes 75mm-150mm

One Pass Keyway Broaches

All One Pass Keyways Are Used With **STANDARD BUSHINGS**

One Pass Keyway Broaches American Standard

	Broach	EDP No.	Width Tolerance	Body Width x OAL (in.)	Length of Cut		Pressure Max.L/C (lbs.)
					Min.	Max.	
II	1/8-II	10208-COP**	.1252 - .1262	3/16 x 10-3/4	1/4	1-1/2	780
	5/32-II	10210-COP**	.1564 - .1574	3/16 x 10-3/4	1/4	1-1/2	1,370
	3/16-II	10212-OP*	.1877 - .1887	3/16 x 10-3/4	1/4	1-1/2	1,930
III	3/16-III	10312-COP**	.1877 - .1887	3/8 x 18-1/2	5/16	1-11/16	1,090
	1/4-III	10316-COP**	.2502 - .2512	3/8 x 18-1/2	5/16	1-11/16	1,840
	5/16-III	10320-COP**	.3127 - .3137	3/8 x 18-1/2	5/16	1-11/16	2,860
	3/8-III	10324-OP*	.3755 - .3765	3/8 x 18-1/2	5/16	1-11/16	4,030

OP* designates one-pass, no chamfer COP** designates chamfer one-pass



Collared Keyway Bushing

One Pass Metric Keyway Broaches to ISO H9 Tolerance

	Broach	EDP No.	Width Tolerance	Standard Millimeter Keys	Body Width x OAL (in.)	Length of Cut		Pressure Max.L/C (lbs.)
						Min.	Max.	
I	3mm-I	11103-OP*	.1185 - .1190	3mm x 3mm	1/8 x 8-1/2	1/4	1-1/8	780
II	4mm-II	11204-COP**	.1581 - .1585	4mm x 4mm	1/4 x 10-3/4	1/4	1-1/2	1,370
	5mm-II	11205-COP**	.1975 - .1979	5mm x 5mm	1/4 x 10-3/4	1/4	1-1/2	1,930
III	6mm-III	11306-COP**	.2372 - .2376	6mm x 6mm	3/8 x 18-1/2	5/16	1-11/16	1,090
	8mm-III	11308-COP**	.3159 - .3163	8mm x 7mm	3/8 x 18-1/2	5/16	1-11/16	1,840

OP* designates one-pass, no chamfer COP** designates chamfer one-pass

CNC Single Point Keyway Broaching

Keyway Size Ranges **1/8"-1/2"** and **4mm-12mm**

Broaching keyways on CNC machines today is as common as turning a part.

- Eliminate part handling and improve your control
- Short effective nibbling broaches that take the place of longer tools
- Quick set up on CNC machines

Save Time and Money with blind hole and through hole CNC keyway broaching with standard tools that are **off the shelf**.

- Single point nibbling cutters that are designed with two separate cutting surfaces at 180° apart.
- The one piece construction is created on a high speed tooling blank that has common size round shank with 4 ground timing flats to align the keyway for timing to the part it is broaching.
- These tools will offer long tool life, and can be easily sharpened many times for extended tool life.
- Ideally designed for either CNC lathe or CNC vertical machining centers.

For CNC lathe: mount tool directly into the turret on centerline while a setscrew-locking holder will lock into place and position.

For CNC vertical machining center: a collet will hold the tool shank and provide timing orientation.

With the spindle locked, the broach can be brought in line with pre-prepared bore diameter and chamfer lead of the part to start broaching the keyway at a speed of 10" – 30" in/min and an in-feed of .003" -.005" depth per pass, using a flood coolant for lubrication during the cut. Once the initial process is achieved, speeds can be increased to 50 - 80 IPM. The in-feeding cycle is repeated until the desired depth of the keyway is achieved. Chips can be removed from the bottom of the hole in a couple of ways:

In a **blind hole bore**, remove the chips by either:

- prior trepanning the bottom of the keyway area and allow chips to fall away.
- or pre-drill a hole from the outside to the inside of the part at the bottom of the keyway location.

With a **through hole**, you can broach right through, but do not disengage with the part, and simply de-burr the keyway upon completion.

The ADVANTAGES:

- Complete the part on one machine
- Only way to keyway a blind hole
 - Cut down on set-up time
 - Improve your process
- Become more flexible with machining
 - Manage small lot production
- Use cost effective standard tooling
 - No bushing guide required
- No hydraulic press or pull required

THINGS THAT YOU SHOULD KNOW:

- Standard tooling will come with common shank diameters.
- Keyway size and length or depth of cut will determine the shank size.
- Strength and rigidity in the set-up will give you longer tool life.
- Keyway production will achieve excellent finishes and better accuracy.
- Specials are available with expedited delivery.

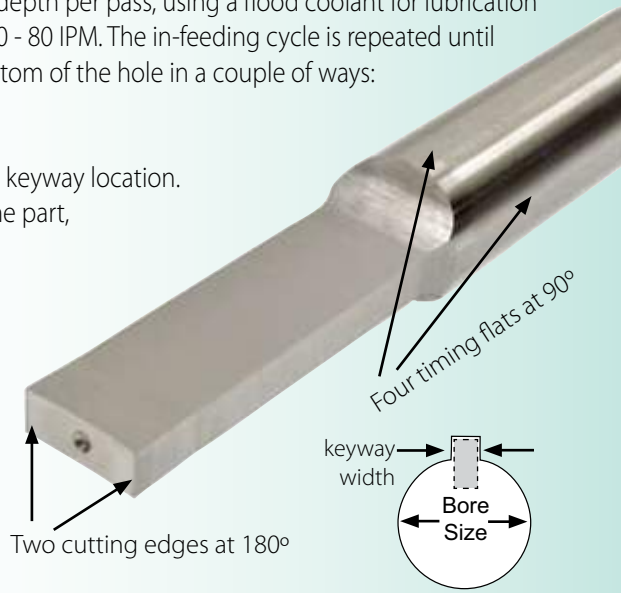

CNC Single Point Keyway Inch Shank						
Keyway Size	EDP No.	Tolerance (inches)	Shank Diameter	Overall Length	Max. LOC	Min. Bore Size
1/8	69008	0.127	5/8	3.75	1.5	7/16
4mm	69004	0.159	5/8	3.75	1.5	9/16
3/16	69012	0.189	5/8	3.75	1.5	9/16
5mm	69005	0.198	5/8	3.75	1.5	5/8
6mm	69106	0.238	3/4	4.50	2	11/16
1/4	69116	0.252	3/4	4.50	2	11/16
5/16	69120	0.314	3/4	4.50	2	3/4
8mm	69108	0.317	3/4	4.50	2	3/4
3/8	69224	0.377	1	4.50	2	1
10mm	69210	0.396	1	4.50	2	1
12mm	69212	0.474	1	4.50	2	1
1/2	69232	0.502	1	4.50	2	1

CNC Single Point Keyway Metric Shank						
Keyway Size	EDP No.	Tolerance (inches)	Shank Diameter	Overall Length	Max. LOC	Min. Bore Size
1/8	69308	0.127	16 mm	3.75	1.5	11mm
4mm	69304	0.159	16 mm	3.75	1.5	14mm
3/16	69312	0.189	16 mm	3.75	1.5	14mm
5mm	69305	0.198	16 mm	3.75	1.5	16mm
6mm	69406	0.238	20 mm	4.50	2	17mm
1/4	69416	0.252	20 mm	4.50	2	17mm
5/16	69420	0.314	20 mm	4.50	2	17mm
8mm	69408	0.317	20 mm	4.50	2	17mm
3/8	69524	0.377	25 mm	4.50	2	25mm
10mm	69510	0.396	25 mm	4.50	2	25mm
12mm	69512	0.474	25 mm	4.50	2	25mm
1/2	69532	0.502	25 mm	4.50	2	25mm

Hexagonal Rotary Punch Broaches M-2

Material: M-2 HSS For Cutting Mild Steel Applications

Rotary/Punch Broaches:

- Use in a variety of machines
- Cut polygons in blind holes
- Any type of CNC or manual turning, milling, drilling or screw machine.



Punching Versus Rotary Broaching:

Many applications can be achieved without the rotary broach holder.

For the purpose of merely punching a polygon into an existing pilot hole, these broaches have successfully been used with universal machining methods.

Hexagonal Rotary/Punch Broaches

8mm - .315 Shank Inch

EDP #	Hex Size	Across Flats +.001 / -.000	Max. Depth of Cut	Overall Length*
66002	.050	0.050	5/64	1-1/4
66004	1/16	0.063	3/32	1-1/4
66005	5/64	0.079	7/64	1-1/4
66006	3/32	0.095	9/64	1-1/4
66007	7/64	0.111	5/32	1-1/4
66008	1/8	0.127	3/16	1-1/4
66009	9/64	0.143	7/32	1-1/4
66010	5/32	0.158	1/4	1-1/4
66012	3/16	0.190	9/32	1-1/4
66014	7/32	0.221	9/32	1-1/4
66016	1/4	0.252	3/8	1-1/4
66018	9/32	0.284	3/8	1-1/4
66020	5/16	0.315	3/8	1-1/4
66022	11/32	0.346	7/16	1-1/4
66024	3/8	0.378	1/2	1-1/4
66026	13/32	0.410	1/2	1-1/4
66028	7/16	0.441	1/2	1-1/4
66030	15/32	0.472	1/2	1-1/4
66032	1/2	0.504	1/2	1-1/4

Hexagonal Rotary/Punch Broaches

8mm - .315 Shank Metric

EDP #	Hex Size	Across Flats +.001 / -.000	Max. Depth of Cut	Overall Length*
662013	1.3 mm	0.050	3/32	1-1/4
662015	1.5 mm	0.061	3/32	1-1/4
66202	2 mm	0.081	7/64	1-1/4
662025	2.5 mm	0.101	5/32	1-1/4
66203	3 mm	0.120	3/16	1-1/4
662035	3.5 mm	0.139	3/16	1-1/4
66204	4 mm	0.160	1/4	1-1/4
662045	4.5 mm	0.179	1/4	1-1/4
66205	5 mm	0.199	5/16	1-1/4
66206	6 mm	0.238	3/8	1-1/4
66207	7 mm	0.278	3/8	1-1/4
66208	8 mm	0.319	3/8	1-1/4
66209	9 mm	0.358	3/8	1-1/4
66210	10 mm	0.398	1/2	1-1/4
66211	11 mm	0.437	1/2	1-1/4
66212	12 mm	0.476	1/2	1-1/4

Hexagonal Rotary/Punch Broaches

3/4" - .750 Shank Inch

EDP #	Hex Size	Across Flats +.001 / -.000	Max. Depth of Cut	Overall Length*
66524	3/8	0.379	1/2	2-3/4
66528	7/16	0.442	1/2	2-3/4
66532	1/2	0.505	5/8	2-3/4
66536	9/16	0.567	3/4	2-3/4
66540	5/8	0.631	3/4	2-3/4
66548	3/4	0.754	7/8	2-3/4
66556	7/8	0.883	7/8	2-3/4
66564	1	1.014	7/8	2-3/4

Hexagonal Rotary/Punch Broaches

1/2" - .500 Shank Inch

EDP #	Hex Size	Across Flats +.001 / -.000	Max. Depth of Cut	Overall Length*
66106	3/32	0.095	9/64	1-3/4
66107	7/64	0.111	5/32	1-3/4
66108	1/8	0.127	3/16	1-3/4
66109	9/64	0.143	7/32	1-3/4
66110	5/32	0.158	1/4	1-3/4
66112	3/16	0.190	9/32	1-3/4
66114	7/32	0.221	9/32	1-3/4
66116	1/4	0.252	3/8	1-3/4
66118	9/32	0.284	7/16	1-3/4
66120	5/16	0.315	1/2	1-3/4
66122	11/32	0.346	9/16	1-3/4
66124	3/8	0.378	9/16	1-3/4
66126	13/32	0.410	5/8	1-3/4
66128	7/16	0.441	5/8	1-3/4
66130	15/32	0.472	5/8	1-3/4
66132	1/2	0.504	5/8	1-3/4
66136	9/16	0.567	5/8	1-3/4
66140	5/8	0.630	7/8	1-3/4
66144	11/16	0.693	7/8	1-3/4
66148	3/4	0.755	7/8	1-3/4

Hexagonal Rotary/Punch Broaches

1/2" - .500 Shank Metric

EDP #	Hex Size	Across Flats +.001 / -.000	Max. Depth of Cut	Overall Length*
66302	2mm	0.081	5/32	1-3/4
663025	2.5mm	0.101	5/32	1-3/4
66303	3mm	0.120	3/16	1-3/4
66304	4mm	0.160	1/4	1-3/4
66305	5mm	0.199	5/16	1-3/4
66306	6mm	0.239	3/8	1-3/4
66307	7mm	0.278	1/2	1-3/4
66308	8mm	0.320	1/2	1-3/4
66309	9mm	0.358	1/2	1-3/4
66310	10mm	0.398	9/16	1-3/4
66311	11mm	0.437	9/16	1-3/4
66312	12mm	0.476	5/8	1-3/4
66313	13mm	0.516	5/8	1-3/4
66314	14mm	0.556	5/8	1-3/4
66315	15mm	0.597	5/8	1-3/4
66316	16mm	0.636	5/8	1-3/4
66317	17mm	0.674	7/8	1-3/4
66318	18mm	0.714	7/8	1-3/4
66319	19mm	0.754	7/8	1-3/4

The practical forming length of rotary punch broaching is usually up to 1-1/2 times the size of the broach (measured across flats).

*Overall Tool Length Tolerances +/- .015

Hexagonal Rotary Punch Broaches M-42

Material: M-42 HSS With **8% COBALT CONTENT** For More Difficult To Machine Alloys



Broach Tool Material

These broaches are manufactured from **M-42 Cobalt High Speed Steel**. This material provides edge toughness for standard operations, and resists heat to effect better tool life in machining most metals.

For broaching materials such as ductile iron, tool steel, stainless steels, titanium alloys, or nickel-cobalt alloys, this superior grade of high speed steel with **8% COBALT CONTENT** provides significantly longer tool life with these more difficult to machine alloys.

What Is The Difference Between Rotary, Swiss, Punch & Index?

Rotary:

The tool shape is cut into the customer's part with spindle turning when using a rotary holder system.

Broaching Holder:

Serves two functions

- Holds the broach tool in a free spinning bearing
- Places the broach tool at a 1° angle relative to the centerline of the workpiece.

There are two types of commonly used holders:

Adjustable Rotary Broach Holder

Non-Adjustable Rotary Broach Holder

Swiss Style:

The tool shape is cut into the customer's part with the spindle turning when using a rotary holder system. This is typical when used on a horizontal machining center.

Punch:

The shape is cut into the customer's part with spindle locked in a stationary position, and the broach is then punched into the customer's part without a rotary holder.

Index:

A broaching process that involves a stationary spindle and a partial form of the shape that is to be generated. Once hole preparation is completed, the tool form is generated on a CNC machine by making imprints of the tool to the proper depth while the part is indexed properly to create the full form desired. **See page 27 for more details on Index Broaching.**

For more information see our
Basic Broaching Learning Modules at
www.hassay-savage.com/resource-center



Hexagonal Rotary/Punch Broaches

8mm - .315 Shank

Metric

EDP #	Hex Size	Across Flats +.001 / -.000	Max. Depth of Cut	Overall Length*
66202-M42	2mm	0.081	7/64	1-1/4
662025-M42	2.5mm	0.101	5/32	1-1/4
66203-M42	3mm	0.120	3/16	1-1/4
662035-M42	3.5mm	0.139	3/16	1-1/4
66204-M42	4mm	0.160	1/4	1-1/4
662045-M42	4.5mm	0.179	1/4	1-1/4

Hexagonal Rotary/Punch Broaches

8mm - .315 Shank

Inch

EDP #	Hex Size	Across Flats +.001 / -.000	Max. Depth of Cut	Overall Length*
66004-M42	1/16	0.063	3/32	1-1/4
66005-M42	5/64	0.079	7/64	1-1/4
66006-M42	3/32	0.095	9/64	1-1/4
66007-M42	7/64	0.111	5/32	1-1/4
66008-M42	1/8	0.127	3/16	1-1/4
66009-M42	9/64	0.143	7/32	1-1/4
66010-M42	5/32	0.158	1/4	1-1/4
66012-M42	3/16	0.190	9/32	1-1/4
66014-M42	7/32	0.221	11/32	1-1/4
66016-M42	1/4	0.252	3/8	1-1/4
66018-M42	9/32	0.284	3/8	1-1/4
66020-M42	5/16	0.315	3/8	1-1/4
66022-M42	11/32	0.346	7/16	1-1/4
66024-M42	3/8	0.378	1/2	1-1/4

Hexagonal Rotary/Punch Broaches

1/2 - .500 Shank

Inch

EDP #	Hex Size	Across Flats +.001 / -.000	Max. Depth of Cut	Overall Length*
66106-M42	3/32	0.095	9/64	1-3/4
66107-M42	7/64	0.111	5/32	1-3/4
66108-M42	1/8	0.127	3/16	1-3/4
66109-M42	9/64	0.143	7/32	1-3/4
66110-M42	5/32	0.158	1/4	1-3/4
66112-M42	3/16	0.190	9/32	1-3/4
66114-M42	7/32	0.221	9/32	1-3/4
66116-M42	1/4	0.252	3/8	1-3/4
66118-M42	9/32	0.284	7/16	1-3/4
66120-M42	5/16	0.315	1/2	1-3/4
66122-M42	11/32	0.346	9/16	1-3/4
66124-M42	3/8	0.378	9/16	1-3/4

*Overall Tool Length Tolerances +/--.015

Square Rotary Punch Broaches

Material: M-2 HSS For Mild Steel Applications. Special Materials Available For More Difficult To Machine Alloys

***Overall Tool Length Tolerances +/- .015**



Square Rotary/Punch Broaches

8mm - .315 Shank Inch Square Size

EDP #	Square Size	Across Flats +.001 / -.000	Max. Depth of Cut	Overall Length*
68004	1/16	0.063	1/8	1-1/4
68006	3/32	0.095	9/64	1-1/4
68008	1/8	0.127	3/16	1-1/4
68010	5/32	0.158	1/4	1-1/4
68012	3/16	0.190	9/32	1-1/4
68014	7/32	0.221	11/32	1-1/4
68016	1/4	0.252	3/8	1-1/4
68018	9/32	0.284	3/8	1-1/4
68020	5/16	0.315	3/8	1-1/4
68022	11/32	0.346	3/8	1-1/4
68024	3/8	0.378	3/8	1-1/4

Square Rotary/Punch Broaches

1/2" - .500 Shank Inch Square Size

EDP #	Square Size	Across Flats +.001 / -.000	Max. Depth of Cut	Overall Length*
68106	3/32	0.095	9/64	1-3/4
68108	1/8	0.127	3/16	1-3/4
68110	5/32	0.158	1/4	1-3/4
68112	3/16	0.190	9/32	1-3/4
68114	7/32	0.221	11/32	1-3/4
68116	1/4	0.252	3/8	1-3/4
68118	9/32	0.284	7/16	1-3/4
68120	5/16	0.315	1/2	1-3/4
68122	11/32	0.346	9/16	1-3/4
68124	3/8	0.378	5/8	1-3/4
68128	7/16	0.441	5/8	1-3/4
68132	1/2	0.504	5/8	1-3/4
68136	9/16	0.567	3/4	1-3/4
68140	5/8	0.630	7/8	1-3/4

Use With:

- Screw Machines
- CNC Machines
- Swiss Machines

Other Shanks, Metric,
Square, Octagon &
Spline forms Available.
Please Call

1-800-247-2024
For More Information

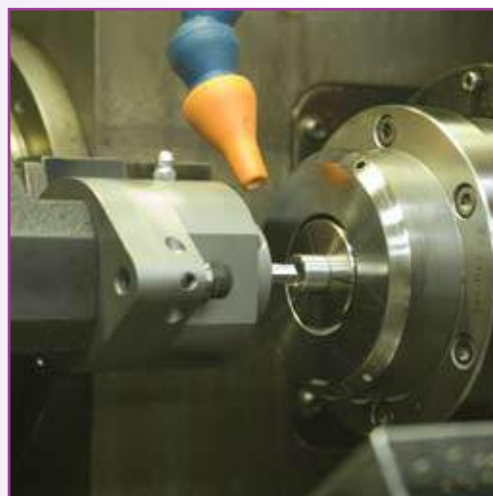

Square Rotary/Punch Broaches

3/4" - .750 Shank Inch Square Size

EDP #	Square Size	Across Flats +.001 / -.000	Max. Depth of Cut	Overall Length*
68532	1/2	0.504	5/8	2-3/4
68536	9/16	0.567	3/4	2-3/4
68540	5/8	0.630	3/4	2-3/4
68548	3/4	0.755	7/8	2-3/4

Square Rotary/Punch Broaches

1/2" - .500 Shank Metric Square Size

EDP #	Square Size	Across Flats +.001 / -.000	Max. Depth of Cut	Overall Length*
683015	1.5mm	0.0605	3/32	1-3/4
68302	2mm	0.0805	7/64	1-3/4
683025	2.5mm	0.101	5/32	1-3/4
68303	3mm	0.120	3/16	1-3/4
683035	3.5mm	0.139	3/16	1-3/4
68304	4mm	0.160	1/4	1-3/4
683045	4.5mm	0.179	1/4	1-3/4
68305	5mm	0.199	5/16	1-3/4
68306	6mm	0.238	3/8	1-3/4
68307	7mm	0.278	3/8	1-3/4
68308	8mm	0.319	3/8	1-3/4
68309	9mm	0.358	3/8	1-3/4
68310	10mm	0.398	1/2	1-3/4
68311	11mm	0.437	9/16	1-3/4
68312	12mm	0.476	5/8	1-3/4

Square Rotary/Punch Broaches

8mm - .315 Shank Metric Square Size

EDP #	Square Size	Across Flats +.001 / -.000	Max. Depth of Cut	Overall Length*
682015	1.5mm	0.0605	3/32	1-1/4
68202	2mm	0.0805	7/64	1-1/4
682025	2.5mm	0.101	5/32	1-1/4
68203	3mm	0.120	3/16	1-1/4
682035	3.5mm	0.139	3/16	1-1/4
68204	4mm	0.160	1/4	1-1/4
662045	4.5mm	0.179	1/4	1-1/4
68205	5mm	0.199	5/16	1-1/4
68206	6mm	0.238	3/8	1-1/4
68207	7mm	0.278	3/8	1-1/4
68208	8mm	0.319	3/8	1-1/4
68209	9mm	0.358	3/8	1-1/4
68210	10mm	0.398	1/2	1-1/4



The practical forming
length of a rotary/
punch broaching is
usually up to 1-1/2
times the size of the
broach (measured
across flats).

Adjustable Rotary Broach Holders

Accepts A Variety Of Shapes, Such As Internal Hex & Square Rotary Broaches

Rotary Broach Holders:

- Use on any type CNC, manual turning, milling or screw machine.

Holders and broaches are sold separately and available from stock for immediate delivery.

For optimal tool life in large production settings these broaches should be used with Rotary Broach Holders.

- The holder has an internal live spindle, which holds the cutting broach tool.
- The centerline of the cutting tool is offset at 1° from the centerline of the work piece.
- This 1° offset causes the broach to wobble creating a shearing effect as the broach is advanced into the work piece.

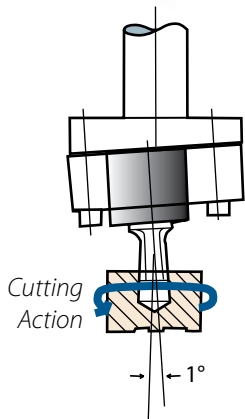

Diagram A

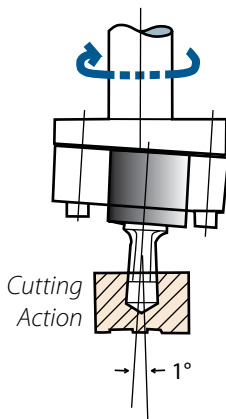

Diagram B

HEAVY DUTY Adjustable Rotary Broach Holders

Use with 3/4 - .750 Broach Shank Diameter

EDP #	Overall Length	Holder Shank Dia.	Holder Shank Length	Broach Shank Depth
P-67072HDS	7-9/16	1-1/2	3	1.25
P-67076HD	7-9/16	1-3/4	3	1.25

Diagram A - Broaching a Rotating Work Piece

In a turning or screw machine, the holder is mounted stationary while its internal live spindle and the broach rotates after contact with the rotating work piece. At the appropriate feed, the workpiece is sheared by the pressure of the broach through a wobbling type action producing the polygon shape desired.

Diagram B - Broaching a Stationary Work Piece

In a vertical milling or drilling machine, the holder is mounted into and rotates with the machine spindle while its internal live spindle along with the broach remains stationary upon contact with the stationary work piece. While the machine spindle is rotating, the broach's pressure shears the polygon shape into the work piece with a wobbling type action.

Adjustable Rotary Broach Holders

Use with 8mm - .315 Broach Shank Diameter

EDP #	Overall Length	Holder Shank Dia.	Holder Shank Length	Broach Shank Depth
P-67040	3-27/64	5/8	1-1/2	9/16
P-67048S	3-59/64	3/4	2	9/16

Adjustable Rotary Broach Holders

Use with 1/2 - .500 Broach Shank Diameter

EDP #	Overall Length	Holder Shank Dia.	Holder Shank Length	Broach Shank Depth
P-67048	4-17/32	3/4	2	.742
P-67064	4-17/32	1	2	.742
P-67068	5-17/32	1-1/4	3	.742
P-67072	5-17/32	1-1/2	3	.742

HASSAY SAVAGE ROTARY TOOL HOLDER SET-UP PROCEDURE

For Internal Rotary Holders

1. Place the Rotary Tool Holder in the Turret (Lathe) or Tool Holder (Milling) depending on the application which fits your needs.
2. Mount the Set Up Plug or Punch Broach in the spindle of the Rotary Tool Holder and take care that the Plug or Punch is bottomed out in the spindle before tightening the set screw on the Holder's Spindle.
3. Drill and Ream a hole to the proper diameter (.001 larger) for the Set Up Plug in a piece of raw material with a lead chamfer .010-.015 larger than the cross points dimension of the Punch being used. If using the Punch Broach for centering, drill and ream the hole to the diameter of the cross point's dimension.
4. Loosen the 2 cap screws 2-3 turns on the face to generate 3/16 space between the flange portion of the Holder so that it is easily movable in the cup of your hand.
5. Advance the Rotary Tool Holder with the inserted Plug or Punch to .030 away from the part while holding the holder flush against the flange.
6. By hand, insert the Plug or Punch into the reamed hole.
7. Advance the turret or tool holder until the holder and tool is fully engaged in the hole
8. With the Plug or Punch still engaged in the hole, rotate the broach by hand in the hole while tightening the 2 cap screws.
9. Retract the turret or tool holder out of the reamed hole.
10. Remove the set up plug (If using one) and replace with the Punch Broach making sure the Punch Broach is bottomed out in the holder the same as in step 2.

11. See Next Page for Set-Up Plugs!

See Live Set-Up online at www.hassay-savage.com/resource-center under Hex Rotary Broach Holder Set-Up.

Rotary Broaching Set-Up Plugs

Standard Plugs - For Hex Broach Set-Up Only

Rotary Broaching Set-Up Plugs*

8mm Shank Metric

EDP #	Size	Plug Dia. (-.001 in.)	Shank Dia. (-.0050 in.)	Depth of Plug (in.)	OAL Overall Length (in.)
67008	1/8	0.129	8mm	5/16	1-1/4
67012	3/16	0.193	8mm	5/16	1-1/4
67016	1/4	0.257	8mm	5/16	1-1/4
67020	5/16	0.321	8mm	3/8	1-1/4
67024	3/8	0.387	8mm	1/2	1-1/4
67032	1/2	0.515	8mm	1/2	1-1/4

We can also supply you with custom turned diameters for your exact drill and bore size when repeatable set-ups are required for your job on a continuous basis, for both hex and square applications.

These will all come with the standard lengths and shank diameters of: 8mm, .500 and .750.

Contact our **CUSTOMER SERVICE DEPARTMENT** at **800-247-2024** for pricing and **24 hour delivery service**.



Rotary Broaching Set-Up Plugs*

1/2 Shank American Standard Inch

EDP #	Size	Plug Dia. (-.001 in.)	Shank Dia. (-.0050 in.)	Depth of Plug (in.)	OAL Overall Length (in.)
67112	3/16	0.193	.500	5/16	1-3/4
67116	1/4	0.257	.500	5/16	1-3/4
67124	3/8	0.387	.500	5/16	1-3/4
67132	1/2	0.515	.500	1/2	1-3/4
67140	5/8	0.643	.500	1/2	1-3/4

Rotary Broaching Set-Up Plugs*

3/4 Shank American Standard Inch

EDP #	Size	Plug Dia. (-.001 in.)	Shank Dia. (-.0050 in.)	Depth of Plug (in.)	OAL Overall Length (in.)
67524	3/8	0.387	.750	1/2	2-3/4
67532	1/2	0.515	.750	1/2	2-3/4
67540	5/8	0.643	.750	3/4	2-3/4
67548	3/4	0.771	.750	3/4	2-3/4

* Stock inventories are standard diameter gauge-plugs with specifications to use in standard holders.

Swiss Style Rotary Punch Broaches - 28mm OAL

Applications with M2 and PM-M4 Materials - Medical, Dental & Aerospace

- Consistent High-Tolerance Forms for Long Production Runs!
- Superb Surface Finishes!
- Outstanding Tool Life in Stainless & Titanium!
- Special Sizes, Special Tolerances in Less Than 5 Days



Hexagonal Rotary/Punch Broaches

.315 Shank American Standard Inch

EDP # M-2*	EDP # PM-M-4*	Hex Size	Across Flats (+/- .0002)	Max Depth of Cut	OAL Overall Length
76002	77002	0.051	0.0510	5/64	28mm
76004	77004	1/16	0.0645	3/32	28mm
76005	77005	5/64	0.0801	7/64	28mm
76006	77006	3/32	0.0958	9/64	28mm
76007	77007	7/64	0.1113	5/32	28mm
76008	77008	1/8	0.1270	3/16	28mm
76009	77009	9/64	0.1426	7/32	28mm
76010	77010	5/32	0.1585	1/4	28mm
76012	77012	3/16	0.1895	9/32	28mm
76014	77014	7/32	0.2207	11/32	28mm
76016	77016	1/4	0.2520	3/8	28mm

* M-2 for use with mild steel (HSS)

* PM-M4 for use with stainless, titanium & other high alloy steel

Hexagonal Rotary/Punch Broaches

.315 Shank Metric

EDP # M-2*	EDP # PM-M-4*	Hex Size	Across Flats (+/- .0002)	Max Depth of Cut	OAL Overall Length
762015	772015	1.5mm	0.0610	3/32	28mm
76202	77202	2mm	0.0807	5/32	28mm
762025	772025	2.5mm	0.1004	5/32	28mm
76203	77203	3mm	0.1201	3/16	28mm
762035	772035	3.5mm	0.1398	3/16	28mm
76204	77204	4mm	0.1595	1/4	28mm
762045	772045	4.5mm	0.1792	1/4	28mm
76205	77205	5mm	0.1989	5/16	28mm
76206	77206	6mm	0.2382	3/8	28mm

* M-2 for use with mild steel (HSS)

* PM-M4 for use with stainless, titanium & other high alloy steel

This Swiss Style Tooling Designed for Holders on Page 25

Swiss Style Non-Adjustable Holders

High Performance Results, Quality, And Consistent Tool Life That Keeps Machines Running Longer

Swiss Style Holders

- No Center Indicating Required – Self-Centering
- Smaller Head Diameter Eliminates Interference on Tool Blocks
- Longer Shank Can Be Cut To Proper Length
- Short Head Length For Limited Back Work Space
- Built In Wobble Cutting Feature 1° Angle
- Heavy Duty Bearing Takes 2,250 lbs. Pushing Force
- Swiss Made Quality High-Precision
- Fits Most Swiss Type Tool Blocks & Gang Machines
- Excellent for Aerospace, Medical Part / Bone Screw & Dental Part Production Applications
- Recommended profile range for this holder series is 0.050" to 0.375"
- Maintenance-Free Operation

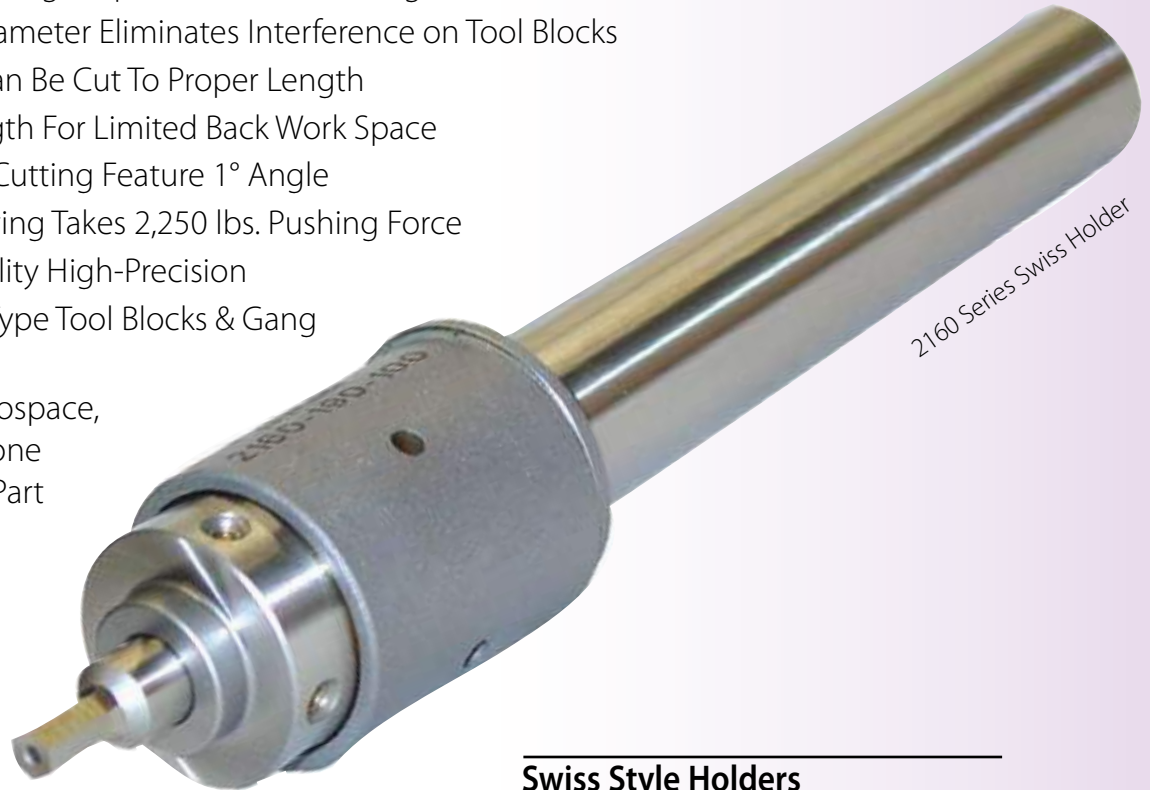

2160 Series Swiss Holder



Swiss Style Holders

Holds 8mm Shank/Max. Push Force 2,250 lbs.

EDP #	D	L	AS/Metric
HSP-2160-158-038	5/8	1-1/2	inch
HSP-2160-190-100	3/4	4	inch
HSP-2160-254-120	1	4-3/4	inch
HSP-2160-120-038	12mm	38mm	metric
HSP-2160-140-038	14mm	38mm	metric
HSP-2160-160-038	16mm	38mm	metric
HSP-2160-200-100	20mm	100mm	metric
HSP-2160-220-100	22mm	100mm	metric
HSP-2160-250-120	25mm	120mm	metric

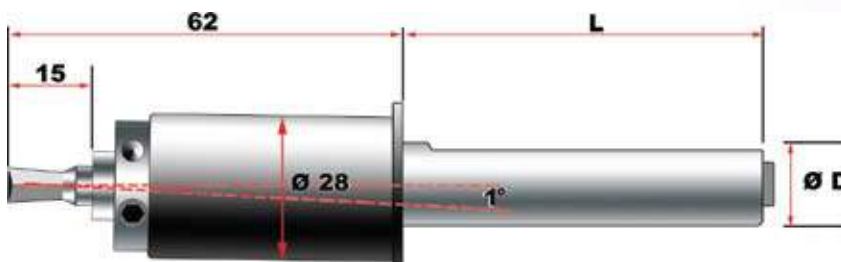

Use Recommendations

Part Preparation:

- The diameter of the pre-drilled hole should be larger than the measurement across the flats on the broach.
- Drill the hole 20% deeper than desired Depth of Cut for chip clearance.
- Countersink with a 90° lead chamfer slightly larger than the largest dimension of the broach face (distance across points) for lead of the broach.

Centering the Broach:

The most critical component in running these tools is having the broach centered as close as possible to the centerline of the work piece. Improper centering will cause uneven hole configurations, oversize holes, spiraling, and excessive cutter/holder wear.

- It is necessary to align the end of the broach tool to the centerline of the work piece diameter by means of adjusting the screws located on the sides of the holder, and the use of set-up plugs.
- Alignment instructions are included with purchase of the tool holder.

Speeds and Feeds:

Rotational speed (RPM) has a direct effect on cutting speed and tool life.

- Start at 800 RPM with a feed rate of .016 times the size of the broach in inches for a feed rate in IPR units.

Example: The feed rate for a ¼" rotary punch broach would be
 $0.016 \times .250 = .004/\text{rev.}$

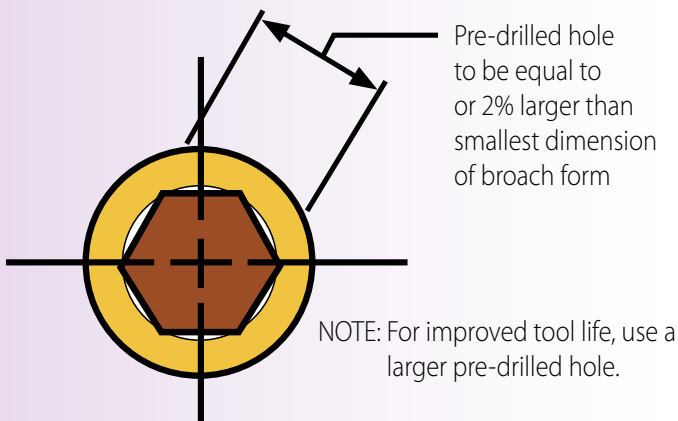

Broach Tool Material:

Broaches are customarily manufactured from M-2 high speed steel. This material provides the required edge toughness for standard operations, which do not generate enough heat to effect tool life in machining most metals. However, for broaching materials such as ductile iron, tool steel, stainless steels, titanium alloys, or nickel-cobalt alloys, a cobalt or PM-4 (powdered metal) broach would be recommended for optimal tool life. Coatings are also available.

Internal Example

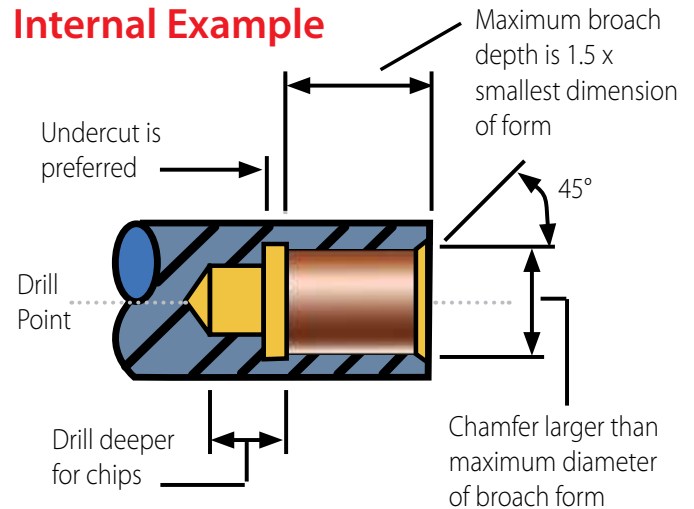

Cutting Principle

- The tool is held at a 1° angle relative to the part centerline.
- The face of the broach tool is the pivot of the 1° angle and is placed on centerline with the part.
- The cutting edge is kept on center and the rest of the tool oscillates around the part centerline with a wobble effect.
- With the faces of the tool and part are at a relative 1° angle, only the leading point of the tool is cutting and not the entire tool profile.
- The wobble effect moves the leading edge to rotate in and out of the cut like a cam.
- It shears the shape into the part with a scalloping effect as it advances forward.
- This reduces the required thrust force up to 80% when it is at the optimum feed.
- Venting can be added to broach to relieve pressure.



Vented Hex Broach

Hole Preparation Examples

Hex: B x 1.02
 = Pre-drilled hole, 2% larger
 s.c.* = B x 1.1547

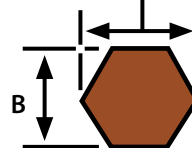

Square: B x 1.10
 = Pre-drilled hole, 10% larger
 s.c.* = B x 1.4142

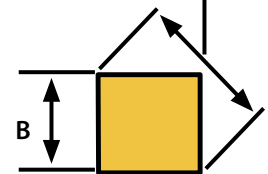

*s.c. = sharp corners

Index Broaching

An Alternative To Full Form Rotary Broaching

Index Broaching to Generate Full Polygon Forms

This broaching process involves a stationary spindle with orientation and lock capabilities. Once hole preparation is completed, then it is punched with a partial form of the shape that is to be generated. The tool form is indexed on a CNC machine by making imprints of the tool to the proper depth while the part is created to the full form desired.

Index Broaching can be performed on multiple machining applications. For instance, the **CNC machining centers** are the most common for Index Broaching:

- Lathes
- Swiss Style Machines
- Vertical Machining Centers

Typical applications include:

- Hexagonal
- Double Hexagonal
- 6 Lobe / Hexalobe
- Square
- Keyways / Slots / Splines

Required Tooling Includes:

- 90° Spot / Chamfer Tool
- Desired Pilot Drill
- Index Punch Broach



T10 -
2 Point
Hexalobe

BASIC PRINCIPLES OF THE PROCEDURE

CNC Turning Machine

The CNC Turning Center performs each of these operations on the work piece before the Index Broach makes contact with the work piece.

- Face off the work piece.
- Countersink a pilot hole for the drill bit, slightly larger than the across corner dimensions of the broach.
- Drill pilot hole approximately 2 percent larger than the size across the flats.
- Hole is now prepared for Index Broach.

Why Hassay Savage Index Broaches?

- Consistent High-Tolerance Forms for Longer Production Runs!
- Superb Surface Finishes!
- Outstanding Tool Life in Stainless & Titanium!
- Special Sizes, Special tolerances in Less Than 5 Days!
- Hassay Savage Broaches Made to $\pm .0002$ Tolerance!
- Produce bone screws to $\pm .0005$ Tolerance!
- Material specification & superior heat treating assures quality of every Index Broach!
- Cobalt Base High Speed Broach Blanks in Most Standard Sizes
In Stock for **FAST DELIVERY!**



Hex or
Square
Index Broach

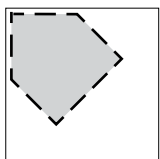

Single Point
Square Form

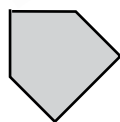

Single Point
Index Broach

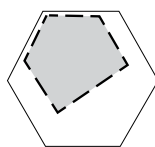

Single Point
Hex Broach

Hassay Savage Index Broaches for:

- Medical & Dental Part Manufacturing
- Aerospace / Aircraft
- Automotive
- Fasteners
- Firearms & Munitions
- Electronics
- Plastics
- Communication Systems



Index Broaching & Holders

Hex and Hexalobe

2 or 4 Point Hex Broach Cutting Process

- Hole preparation completed with chamfer & proper pilot hole size.
- Machine spindle locked
- Punch enters the work piece, cutting the work piece, then retracts.
- The machine spindle indexes 60° then locks.
- The punch enters the work piece a second time, cutting the work piece, then retracts.
- Machine spindle indexes 60° then locks.
- Punch enters for a third and final imprint.
- Drill or boring bar used to make pilot hole can re-enter cut and remove ribbons and chips formed inside the cut.

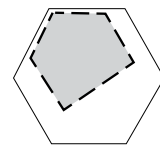

Single Point Hex Broach

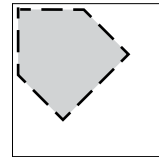

Single Point Square Form

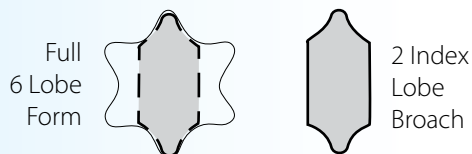
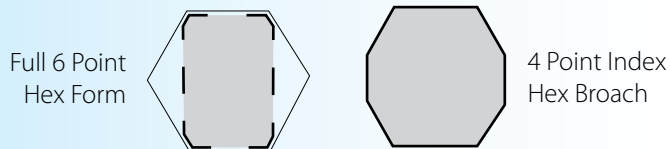
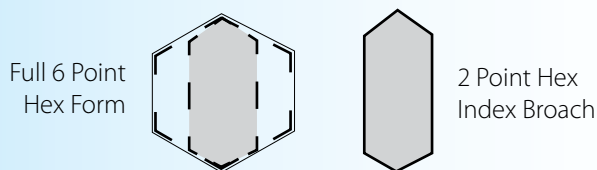

2 Point Hex Broach Cutting Procedure

is effective for broaching materials with higher tensile strength and relieves overall pressure during the process.

4 Point Hex Broach Cutting Procedure is effective for index broaching titanium and stainless steel materials to help improve better tolerances and surface finishes in the finished part.

6 Lobe Hexalobe Broach Cutting Procedures are similar procedures as 2-point or 4-point broach cutting. The process reduces overall pressure, improves tolerances and surface finishes. Ideal for automated production.

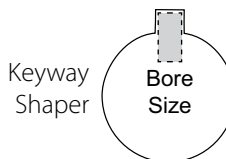

Static Index Punch Broach Holders

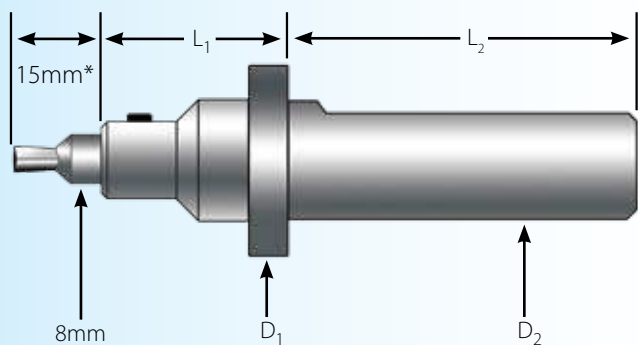

*Only applies when 8mm series broaches are used.

Punch Holders

EDP #	D1	D2	L1	L2
HSBH-158250-125-8	1.00"	.625"	1.25"	2.5"
HSBH-190250-125-8	1.00"	.750"	1.25"	2.5"
HSBH-200250-125-8	1.00"	20mm	1.25"	2.5"
HSBH-220250-125-8	1.00"	22mm	1.25"	2.5"
HSBH-254250-125-8	1.10"	1.00"	1.25"	2.5"

These Static Holders can also be used for Full Form Hex Broaches up to 1/4" / 7mm

Quick Change ER Collet Punch & Index Broach ER Holder Systems For Swiss and CNC Machining

When orientation and concentricity of an internal polygon profile is crucial, an ER holder can be used to securely hold a punch or index broach tool and accurately align the tool to center, while ensuring perfect alignment of the profile orientation. **These Quick Change Holders can be preset and reloaded in seconds.**

Punch Broach / Boring Adaptors & Nuts

EDP #	ER Size	Bore Dia.	Nut Tread
HSP-PA16-25001	ER16	.250	M19 x 1mm Nut & Locator Pin
HSP-PA16-31501	ER16	8mm	M19 x 1mm Nut & Locator Pin
HSP-PA20-25001	ER20	.250	M24 x 1mm Nut & Locator Pin
HSP-PA20-31501	ER20	8mm	M24 x 1mm Nut & Locator Pin

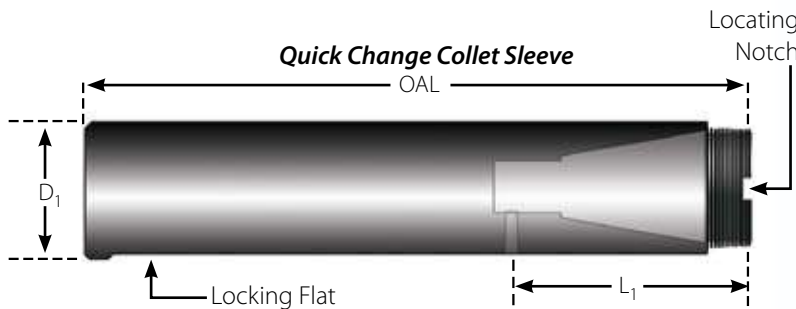
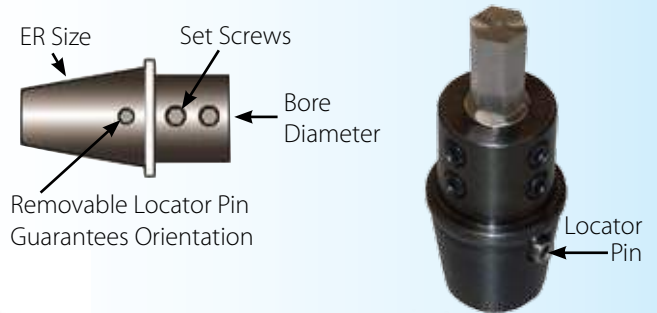

Quick Change Collet Sleeves

For SHANK ONLY Holders

EDP #	Collet	D1	L1	OAL
HSP-CS16-160500	ER16	.500	1.1	4.5
HSP-CS16-160625	ER16	.625	1.1	4.5
HSP-CS16-160750	ER16	.750	1.1	4.5
HSP-CS16-160787	ER16	20mm	28mm	71mm
HSP-CS16-160866	ER16	22mm	28mm	118mm
HSP-CS16-160984	ER16	25mm	28mm	95mm
HSP-CS16-161000	ER16	1"	1.1	4.5
HSP-CS20-200750	ER20	.750	1.2	4.5
HSP-CS20-200866	ER20	22mm	30mm	114mm
HSP-CS20-201000	ER20	1.00	1.2	4.5
HSP-CS20-201250	ER20	1.250	1.2"	4.5
HSP-CS20-201260	ER20	32mm	30mm	118mm

TO REQUEST A QUOTE PLEASE COPY AND FAX THIS PAGE TO 413-863-2714

Just Some of the Shapes You Can Broach

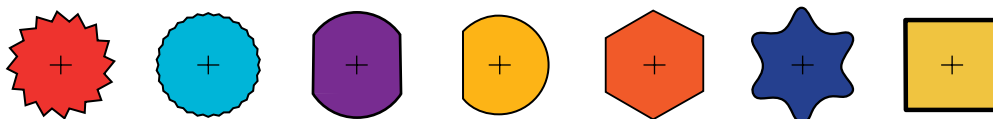

BROACH REQUIREMENTS

Size/Shape _____ Depth of Cut _____
 Tolerance +/- _____
 Desired Broach Shank Size _____
 Material to be Machined _____
 Type of Machine _____
 Type of Holder _____

CONTACT INFORMATION

Contact Name _____
 Company Name _____
 Address _____
 Phone Number _____
 Fax Number _____
 Email _____

Inch Square & Full Square Push Broaches

Designed for one pass finishing when used with • Arbor • Hydraulic Press • Vertical Broaching

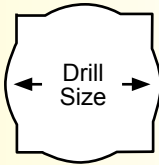

Standard Square

Inch Square Push Broaches					1/8" - 1"					Standard Inch				
Size Square	EDP No.	Tolerance	Dimension Across Corners	Pilot Diameter	Drill Size	Broach Length	Length of Cut		Pressure for Max.L/C (lbs.)					
							Min.	Max.						
1/8	13008	.1250 - .1260	.1750 - .1770	.1280	#30	4-5/8	3/16	1/2	700					
5/32	13010	.1565 - .1575	.2180 - .2200	.1585	#21	5-5/8	1/4	1/2	800					
3/16	13012	.1880 - .1890	.2620 - .2640	.1930	#10	5-1/16	1/4	5/8	1,120					
7/32	13014	.2190 - .2200	.3050 - .3070	.2275	#1	6-7/8	1/4	3/4	1,580					
1/4	13016	.2505 - .2515	.3500 - .3520	.2651	17/64	7	1/4	3/4	1,740					
9/32	13018	.2815 - .2825	.3930 - .3950	.2964	19/64	7-1/4	3/8	1	2,300					
5/16	13020	.3130 - .3140	.4370 - .4390	.3276	21/64	8-1/8	3/8	1	2,630					
11/32	13022	.3440 - .3450	.4810 - .4830	.3589	23/64	9-5/8	3/8	1-1/4	3,050					
3/8	13024	.3755 - .3765	.5230 - .5250	.3901	25/64	9-7/8	3/8	1-1/4	3,625					
13/32	13026	.4065 - .4075	.5680 - .5700	.4212	27/64	10-7/8	1/2	1-3/8	5,200					
7/16	13028	.4385 - .4395	.6110 - .6130	.4526	29/64	11-3/8	1/2	1-3/8	5,700					
15/32	13030	.4690 - .4700	.6560 - .6580	.4995	1/2	12-1/2	1/2	1-3/8	5,900					
1/2	13032	.5005 - .5015	.6970 - .6990	.5307	17/32	12-5/8	1/2	1-3/8	6,000					
9/16	13036	.5630 - .5640	.7860 - .7880	.5932	19/32	14-7/8	1/2	1-1/2	6,200					
5/8	13040	.6260 - .6270	.8710 - .8730	.6557	21/32	16-13/16	5/8	1-5/8	7,100					
11/16	13044	.6885 - .6895	.9610 - .9630	.7495	3/4	18-1/2	5/8	1-5/8	7,300					
3/4	13048	.7510 - .7520	1.0450 - 1.0470	.8120	13/16	18-7/8	5/8	1-5/8	8,600					
7/8	13056	.8765 - .8775	1.2280 - 1.0300	.9370	15/16	22-3/4	1/2	2	12,000					
1	13064	1.0020 - 1.0030	1.4030 - 1.4050	1.0932	1-3/32	24-1/2	1/2	2	12,500					

Metric Square Push Broaches					4mm- 25mm					Metric				
Size Square	EDP No.	Tolerance	Dimension Across Corners	Pilot Diameter	Drill Size	Broach Length	Length of Cut		Pressure for Max.L/C (lbs.)					
							Min.	Max.						
4mm	17001	.1580 - .1585	.2080 - .2090	.1655	4.2 mm	5-9/16	5/16	5/8	1,000					
5mm	17002	.1973 - .1983	.2645 - .2655	.2047	5.2 mm	6-7/8	3/8	3/4	1,580					
6mm	17003	.2367 - .2377	.3295 - .3300	.250	6.35 mm	7	3/8	3/4	1,740					
8mm	17004	.3155 - .3165	.4405 - .4410	.3267	8.3 mm	8-3/16	7/16	7/8	2,500					
10mm	17005	.3942 - .3952	.5435 - .5445	.4057	10.3 mm	10-7/8	1/2	1	2,800					
12mm	17006	.4729 - .4739	.6540 - .6550	.4921	12.5 mm	12-1/2	5/8	1-1/4	3,625					
14mm	17007	.5517 - .5527	.7700 - .7710	.5905	15.0 mm	14-7/8	3/4	1-1/2	6,200					
16mm	17008	.6310 - .6320	.8780 - .8790	.6693	17.0 mm	16-13/16	7/8	1-5/8	7,100					
18mm	17009	.7092 - .7102	.9880 - .9890	.7874	20.0 mm	18-1/2	7/8	1-3/4	8,200					
20mm	17010	.7879 - .7889	1.0990 - 1.1000	.8661	22.0 mm	18-7/8	7/8	1-3/4	9,500					
22mm	17011	.8666 - .8676	1.2110 - 1.2120	.9448	24.0 mm	23-1/4	7/8	1-3/4	9,700					
24mm	17012	.9454 - .9464	1.3170 - 1.3180	1.0236	26.0 mm	24-9/16	7/8	1-3/4	10,000					
25mm	17013	.9848 - .9858	1.3730 - 1.3740	1.0630	27.0 mm	24-9/16	7/8	1-3/4	10,500					

Full Square Push Broaches					3/16" - 1/2"					Standard Inch				
Size Square	EDP No.	Tolerance	Dimension Across Corners	Pilot Diameter	Drill Size	Broach Length	Length of Cut		Pressure for Max.L/C (lbs.)					
							Min.	Max.						
3/16	14012	.1880 - .1890	.2628 - .2632	.1870	3/16	6-1/4	3/16	1/2	1,200					
1/4	14016	.2505 - .2515	.3513 - .3517	.2495	1/4	8-5/8	1/4	5/8	1,600					
5/16	14020	.3120 - .3140	.4375 - .4380	.3120	5/16	10-1/4	1/4	3/4	2,300					
3/8	14024	.3755 - .3765	.5243 - .5247	.3745	3/8	12-1/4	3/8	1	3,750					
7/16	14028	.4385 - .4395	.6170 - .6180	.4370	7/16	14-7/16	3/8	1	3,950					
1/2	14032	.5005 - .5015	.6980 - .6990	.4995	1/2	14-7/16	3/8	1	5,000					

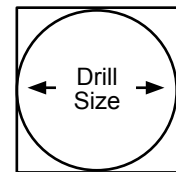

Full Square

Modified Standard Inch and Metric Tolerances are Available with Expedited Delivery!

Hexagonal Push Broaches

Hexagonal Push Broaches 1/8" - 1" Standard Inch

Size Square	EDP No.	Dimension Tolerance	Dimension Across Corners	Pilot Diameter	Drill Size	Broach Length	Length of Cut		Pressure for Max.L/C (lbs.)
							Min.	Max.	
1/8	12008	.1255 - .1260	.1450 - .1470	.1245	1/8	4-5/8	3/16	3/8	120 lbs
5/32	12010	.1565 - .1570	.1800 - .1820	.1557	5/32	5-1/2	1/4	1-1/2	340 lbs
3/16	12012	.1880 - .1890	.2145 - .2155	.1870	3/16	5-9/16	1/4	5/8	520 lbs
7/32	12014	.2190 - .2200	.2500 - .2520	.2182	7/32	6	1/4	3/4	890 lbs
1/4	12016	.2505 - .2515	.2865 - .2875	.2495	1/4	6-1/2	1/4	3/4	1,250 lbs
9/32	12018	.2815 - .2825	.3220 - .3240	.2807	9/32	7-3/4	3/8	1	1,650 lbs
5/16	12020	.3130 - .3140	.3580 - .3590	.3120	5/16	8-1/4	3/8	1	2,175 lbs
11/32	12022	.3440 - .3450	.3950 - .3970	.3432	11/32	8-1/4	3/8	1-1/4	3,500 lbs
3/8	12024	.3755 - .3765	.4300 - .4310	.3745	3/8	9	3/8	1-1/4	3,700 lbs
13/32	12026	.4065 - .4075	.4670 - .4690	.4057	13/32	10	1/2	1-3/8	4,100 lbs
7/16	12028	.4385 - .4395	.5020 - .5030	.4370	7/16	10-3/4	1/2	1-3/8	4,575 lbs
15/32	12030	.4690 - .4700	.5390 - .5410	.4682	15/32	12-3/8	1/2	1-3/8	4,700 lbs
1/2	12032	.5005 - .5015	.5740 - .5750	.4995	1/2	12-1/2	1/2	1-3/8	5,300 lbs
9/16	12036	.5630 - .5640	.6480 - .6500	.5620	9/16	14-1/4	1/2	1-1/2	6,700 lbs
5/8	12040	.6260 - .6270	.7170 - .7185	.6245	5/8	16-7/8	5/8	1-5/8	7,250 lbs
11/16	12044	.6880 - .6890	.7930 - .7950	.6870	11/16	17	5/8	1-5/8	9,300 lbs
3/4	12048	.7510 - .7520	.8610 - .8625	.7495	3/4	17-7/8	5/8	1-5/8	13,500 lbs
7/8	12056	.8755 - .8765	1.0060 - 1.0075	.8745	7/8	18-7/8	5/8	1-5/8	18,500 lbs
1	12064	1.0020 - 1.0030	1.1520 - 1.1530	.9995	1	19-7/8	5/8	1-5/8	20,050 lbs

Hexagonal Push Broaches 4mm - 25mm Metric

Size Square	EDP No.	Dimension Tolerance	Dimension Across Corners	Pilot Diameter	Drill Size	Broach Length	Length of Cut		Pressure for Max.L/C (lbs.)
							Min.	Max.	
4 mm	12104	.1580 - .1585	.1820 - .1830	.1575	4.0	5-1/2	1/4	1/2	340 lbs
5 mm	12105	.1973 - .1983	.2270 - .2280	.1968	5.0	6	1/4	3/4	890 lbs
6mm	12106	.2367 - .2377	.2730 - .2740	.2362	6.0	6-1/2	1/4	3/4	1,250 lbs
7 mm	12107	.2760 - .2770	.3180 - .3190	.2756	7.0	7-3/4	3/8	1	1,650 lbs
8mm	12108	.3155 - .3165	.3634 - .3644	.3150	8.0	8-1/4	3/8	1	2,175 lbs
10 mm	12110	.3942 - .3952	.4543 - .4553	.3937	10.0	10	1/2	1	4,100 lbs
12 mm	12112	.4729 - .4739	.5452 - .5462	.4724	12.0	12-3/8	1/2	1-3/8	4,700 lbs
14 mm	12114	.5517 - .5527	.6332 - .6342	.5512	14.0	14-1/4	1/2	1-3/8	6,700 lbs
16 mm	12116	.6310 - .6320	.7248 - .7258	.6290	16.0	16-7/8	5/8	1-1/2	7,250 lbs
18 mm	12118	.7092 - .7102	.8150 - .8160	.7087	18.0	17	5/8	1-5/8	9,400 lbs
20 mm	12120	.7879 - .7889	.9049 - .9059	.7874	20.0	17-7/8	5/8	1-5/8	14,150 lbs
22 mm	12122	.8666 - .8676	.9958 - .9968	.8661	22.0	18-7/8	5/8	1-5/8	18,500 lbs
24 mm	12124	.9454 - .9464	1.0868 - 1.0878	.9449	24.0	19-7/8	5/8	1-5/8	20,500 lbs
25 mm	12125	.9848 - .9858	1.1323 - 1.1333	.9842	25.0	19-7/8	5/8	1-5/8	22,000 lbs

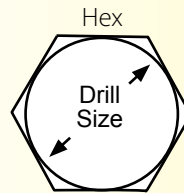

To select a **STANDARD BROACH** from Hassay Savage: **Choose** a tool, or set of tools that will produce the cut your finished part requires.

Specify

- EDP
- Size
- Brief Description

STANDARD PRODUCTS are fully maintained in finished goods inventory.

We can ship your order the same day it is placed.

Special widths and lengths are also available from semi-finished stock ground to your specifications with quick delivery.



SPECIAL SQUARE and HEXAGON BROACHES

If your application cannot be handled with the standard broaches listed, send us a sample or print of the part to be broached, and we will provide a quote.

Include the following data:

HOLE:

- Dimensions Before and After Broaching
- Tolerances
- Specify Cast, Drilled or Reamed
- Length of Cut Through Part Required

MATERIAL:

- Specifications
- Specify Bar, Cast or Forged Stock
- Rc Hardness Before Broaching

Davis Style Keyseating Broaches

KEYSEATING BROACHES

Hassay Savage HSS keyseating pull broaches are manufactured similar to the Davis AF Series cutters and are interchangeable.

- Cutter bars have 10° rake face, 5° backoff and 2° side-relief on all teeth.
- Broaches may be used on Davis model 4, 5, and 15 machines.
- Sizes range from 1/16" to 1" and 2mm to 25mm.
- For special applications contact our customer service **1-800-247-2024**

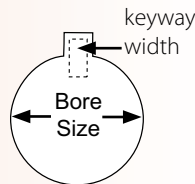

Why Hassay Savage Broaches Stand For Precision And Top Quality:

- The side relief eliminates drag in multiple-pass broaching.
- Tooth-relief, using Borazon™ wheels, improves surface finish and extends tool life.
- Precision grinding of the rake face insures consistent performance and free cutting action after several sharpenings.

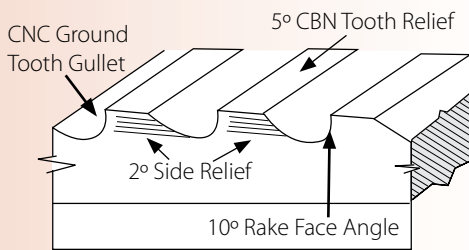

Davis Keyseat Puller Design

Keyseater Inch

1/16" - 1"

EDP No.	Broach Size	Keyway Width Tolerance (inches)	Dimensions Body Width x Height x Length	Length of Cut	
				Min.	Max.
10701	1/16	.0630 - .0640	3/16 x 3/8 x 16	5/8	1-7/8
10702	3/32	.0942 - .0952	3/16 x 7/16 x 16	5/8	1-7/8
10703	1/8	.1255 - .1265	3/16 x 7/16 x 16	5/8	1-7/8
10704	5/32	.1568 - .1578	3/16 x 1/2 x 16	5/8	1-7/8
10705	3/16	.1880 - .1890	3/16 x 9/16 x 16	5/8	1-7/8
10706	3/16	.1880 - .1890	3/16 x 3/4 x 20	5/8	3-1/8
10707	1/4	.2505 - .2515	1/4 x 3/4 x 16	5/8	1-5/8
10708	1/4	.2505 - .2515	1/4 x 3/4 x 20	5/8	3-1/8
10709	5/16	.3130 - .3140	5/16 x 7/8 x 16	1-1/16	3-3/16
10710	5/16	.3130 - .3140	5/16 x 7/8 x 20	1-1/16	5-3/16
10711	3/8	.3755 - .3765	3/8 x 7/8 x 16	1-1/16	3-3/16
10712	3/8	.3755 - .3765	3/8 x 7/8 x 20	1-1/16	5-3/16
10713	7/16	.4380 - .4390	7/16 x 1 x 16	1-1/16	3-3/16
10714	7/16	.4380 - .4390	7/16 x 1 x 20	1-1/16	5-3/16
10715	1/2	.5005 - .5015	1/2 x 1 x 20	1-1/16	5-3/16
10716	9/16	.5630 - .5640	9/16 x 1 x 20	1-1/16	5-3/16
10717	5/8	.6255 - .6265	5/8 x 1 x 20	1-1/16	5-3/16
10718	3/4	.7505 - .7515	3/4 x 1 x 20	1-1/16	5-3/16
10719	7/8	.8755 - .8765	7/8 x 1 x 20	1-1/16	5-3/16
10720	1	1.0005 - 1.0015	1 x 1 x 20	1-1/16	5-3/16

Keyseater Metric

2mm - 25mm

EDP No.	Broach Size	Keyway Width Tolerance (inches)	Dimensions Body Width x Height x Length	Length of Cut	
				Min.	Max.
11701	2 mm	.0792 - .0802	3/16 x 3/8 x 16	5/8	1-7/8
11702	3 mm	.1186 - .1196	3/16 x 7/16 x 16	5/8	1-7/8
11703	4 mm	.1580 - .1590	3/16 x 1/2 x 16	5/8	1-7/8
11704	5 mm	.1974 - .1984	5 mm x 1/2 x 16	5/8	1-7/8
11705	5 mm	.1974 - .1984	5 mm x 1/2 x 20	5/8	3-1/8
11706	6 mm	.2367 - .2377	6 mm x 5/8 x 16	5/8	1-7/8
11707	6 mm	.2367 - .2377	6 mm x 5/8 x 20	5/8	3-1/8
11708	8 mm	.3155 - .3165	8 mm x 7/8 x 16	1-1/16	3-3/16
11709	8 mm	.3155 - .3165	8 mm x 7/8 x 20	1-1/16	5-5/16
11710	10 mm	.3942 - .3952	10 mm x 7/8 x 16	1-1/16	3-3/16
11711	10 mm	.3942 - .3952	10 mm x 7/8 x 20	1-1/16	5-5/16
11712	12 mm	.4724 - .4730	12 mm x 1 x 20	1-1/16	5-5/16
11713	14 mm	.5517 - .5527	14 mm x 1 x 20	1-1/16	5-5/16
11714	16 mm	.6304 - .6314	16 mm x 1 x 20	1-1/16	5-5/16
11715	18 mm	.7092 - .7102	18 mm x 1 x 20	1-1/16	5-5/16
11716	20 mm	.7879 - .7889	20 mm x 1 x 20	1-1/16	5-5/16
11717	22 mm	.8666 - .8676	22 mm x 1 x 20	1-1/16	5-5/16
11718	24 mm	.9454 - .9464	24 mm x 1 x 20	1-1/16	5-5/16
11719	25 mm	.9848 - .9858	25 mm x 1 x 20	1-1/16	5-5/16

Tolerance considerations are based on preferred metric limits and fits ANSI B4.2-1978

Custom corner radius, size specific and full radius cutters are available with form relief upon request.

500 & 600 Series Pull Type Broaches

Hassay Savage Supplies Pull Heads For 500 And 600 Series Broaches Upon Request. Call Us For Size And Delivery.

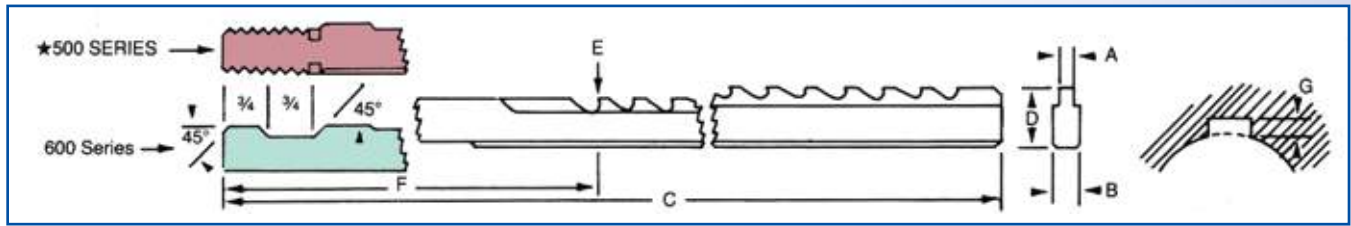

EDP No. 500 Series	EDP No. 600 Series	500 Series	600 Series	Nom. Dim.	A Decimal Dim.	Tolerance	Min. Hole Size	Min. Length Cut**	Max. Length Cut	B +.0000 -.0005	C	D ±.0005	E	F	G	No. of Cuts	Thread Size
33501	33601	501	601	1/16	.0635	+ / - .0005	3/8	3/8	1-1/4	.1552	20	.313	.271	7-3/16	.042	1	1/4 - 20
33502	33602	502	602	3/32	.0948	+ / - .0005	7/16	1/2	1-1/2	.1865	24	.367	.309	8-1/4	.058	1	5/16 - 18
33503	33603	503	603	3/32	.0948	+ / - .0005	5/8	5/8	2-1/2	.2490	33	.491	.433	10	.058	1	3/8 - 16
33504	33604	504	604	1/8	.1260	+ / - .0005	1/2	1/2	1-1/2	.2490	30	.438	.364	9	.074	1	3/8 - 16
33505	33605	505	605	1/8	.1260	+ / - .0005	7/8	5/8	2-1/2	.3115	36	.594	.520	10	.074	1	1/2 - 13
33506	33606	506	606	5/32	.1572	+ / - .0005	19/32	1/2	1-1/2	.2490	30	.525	.436	9	.089	1	3/8 - 16
33507	33607	507	607	5/32	.1572	+ / - .0005	23/32	5/8	2-1/2	.3115	33	.625	.536	10	.089	1	1/2 - 13
33508	33608	508	608	3/16	.1885	+ / - .0005	11/16	5/8	2-1/2	.3740	36	.581	.476	10	.105	1	1/2 - 13
33509	33609	509	609	3/16	.1885	+ / - .0005	15/16	11/16	3-1/2	.3740	36	.796	.691	10-11/16	.105	1	1/2 - 13
33510	33610	510	610	7/32	.2198	+ / - .0005	11/16	5/8	2-1/2	.3740	33	.557	.437	10	.120	1	1/2 - 13
33511	33611	511	611	11/32	.2198	+ / - .0005	15/16	11/16	3-1/2	.3740	42	.813	.693	11-1/16	.120	1	1/2 - 13
33512	33612	512	612	1/4	.2510	+ / - .0005	11/16	5/8	2-1/2	.3740	36	.612	.476	10	.136	1	1/2 - 13
33513	33613	513	613	1/4	.2510	+ / - .0005	1	11/16	4	.4990	45	.877	.741	11-13/16	.136	1	5/8 - 11
33514	33614	514	614	1/4	.2510	+ / - .0005	1-7/16	7/8	6	.6240	51	1.250	1.114	13-1/2	.136	1	3/4 - 10
33515	33615	515	615	9/32	.2828	+ / - .0005	7/8	11/16	4	.4990	45	.716	.564	11-5/8	.152	1	5/8 - 11
33516	33616	516	616	9/32	.2828	+ / - .0005	1-1/4	7/8	6	.4990	51	1.093	.941	13-1/2	.152	1	5/8 - 11
33517	33617	517	617	5/16	.3140	+ / - .0005	1	11/16	4	.4990	45	.908	.741	11-13/16	.167	1	5/8 - 11
33518	33618	518	618	5/16	.3140	+ / - .0005	1-5/16	7/8	6	.4990	51	1.158	.991	13-1/2	.167	1	5/8 - 11
33519	33619	519	619	3/8	.3765	+ / - .0005	1-1/16	11/16	4	.4990	45	.938	.739	11-13/16	.199	1	5/8 - 11
33520	33620	520	620	3/8	.3765	+ / - .0005	1-5/16	7/8	6	.4990	54	1.189	.990	13-1/2	.199	1	5/8 - 11
33521	33621	521	621	7/16	.4390	+ / - .0005	1-9/16	11/16	4	.6240	48	1.360	1.160	12	.230	1	3/4 - 10
33522	33622	522	622	7/16	.4390	+ / - .0005	2	1	8	.6240	48	1.611	1.496	15-5/8	.230	2	3/4 - 10
33523	33623	523	623	1/2	.5015	+ / - .0005	1-1/2	11/16	4	.6240	48	1.312	1.051	12	.261	1	3/4 - 10
33524	33624	524	624	1/2	.5015	+ / - .0005	1-1/2	1	8	.6240	48	1.377	1.246	16-1/2	.261	2	3/4 - 10
33525	33625	525	625	9/16	.5645	+ / - .0005	1-3/4	11/16	4	.6865	54	1.438	1.146	11-13/16	.292	1	1 - 8
33526	33626	526	626	9/16	.5645	+ / - .0005	1-5/8	1	8	.6865	51	1.391	1.245	16	.292	2	1 - 8
33527	33627	527	627	9/16	.5645	+ / - .0005	2-1/4	1-1/8	12	.8740	60	1.641	1.495	20	.292	2	1 - 8
33528	33628	528	628	5/8	.6270	+ / - .0005	1-7/8	11/16	4	.7490	60	1.625	1.301	12-3/16	.324	1	1 - 8
33529	33629	529	629	5/8	.6270	+ / - .0005	2-1/2	1	8	.8740	54	1.657	1.495	16-3/8	.324	2	1 - 8
33530	33630	530	630	5/8	.6270	+ / - .0005	2-1/4	1-1/8	12	.8740	57	1.657	1.495	20	.324	2	1 - 8
33531	33631	531	631	3/4	.7520	+ / - .0005	1-7/8	11/16	4	.8740	60	1.625	1.239	12-3/16	.386	1	1 - 8
33532	33632	532	632	3/4	.7520	+ / - .0005	2	1	8	.9990	60	1.688	1.495	16-3/8	.386	2	1-1/4 - 7
33533	33633	533	633	3/4	.7520	+ / - .0005	2-1/4	1-1/8	12	.9990	57	1.688	1.560	20	.386	3	1-1/4 - 7
33534	33634	534	634	7/8	.8770	+ / - .0005	2-1/4	11/16	4	1.1240	63	1.875	1.426	12-3/8	.449	1	1-1/4 - 7
33535	33635	535	635	7/8	.8770	+ / - .0005	2-1/4	1	8	1.1240	63	1.719	1.494	15-3/4	.449	2	1-1/4 - 7
33536	33636	536	636	7/8	.8770	+ / - .0005	2-1/4	1-1/8	12	1.1240	63	1.719	1.569	20	.449	3	1-1/4 - 7
33537	33637	537	637	1	1.0020	+ / - .0005	2-1/4	5/8	2-1/2	1.2490	63	1.750	1.239	10-1/2	.511	1	1-1/2 - 6
33538	33638	538	638	1	1.0020	+ / - .0005	2-1/4	7/8	6	1.2490	63	1.750	1.494	14-1/4	.511	2	1-1/2 - 6
33539	33639	539	639	1	1.0020	+ / - .0005	2-1/4	1-1/8	12	1.2490	60	1.750	1.580	20	.511	3	1-1/2 - 6

*600 Series designates notched-type shank **Minimum length of part recommended to prevent part from dropping in between teeth of broach

Custom Broaching Solutions

Save time, increase your productivity and profits with Hassay Savage Custom Broaching Solutions! Here are just a few samples of our innovative broaching solutions:

- **Broach your part right to finish tolerances**
- **Finish a shape right to specification in a CNC operation**
- **Nibble, shave, shear a geometry within a part**



Rectangle Punch
Radius Corners
with Witness Marks

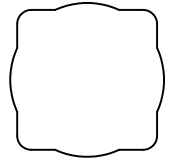

These and countless other possibilities can be obtained with the use of custom designed Hassay Savage Broaches. Whether it is to create an entire geometry or just complete an operation within a programmed, production machining operation, Hassay Savage can help you develop cost saving solutions for your production needs.

Broaching is no longer a stand alone operation. Take advantage of the full capabilities of your CNC Processing Equipment and finish your part by broaching within this process. It can be integrated into your current CNC production using custom designed broaches that can finish your parts right to specification without breaking set up or moving your part to a secondary operation. Our engineers can integrate the design and manufacturing process for your custom application and maintain total datum tolerance control of your parts.

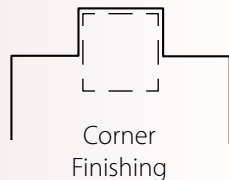
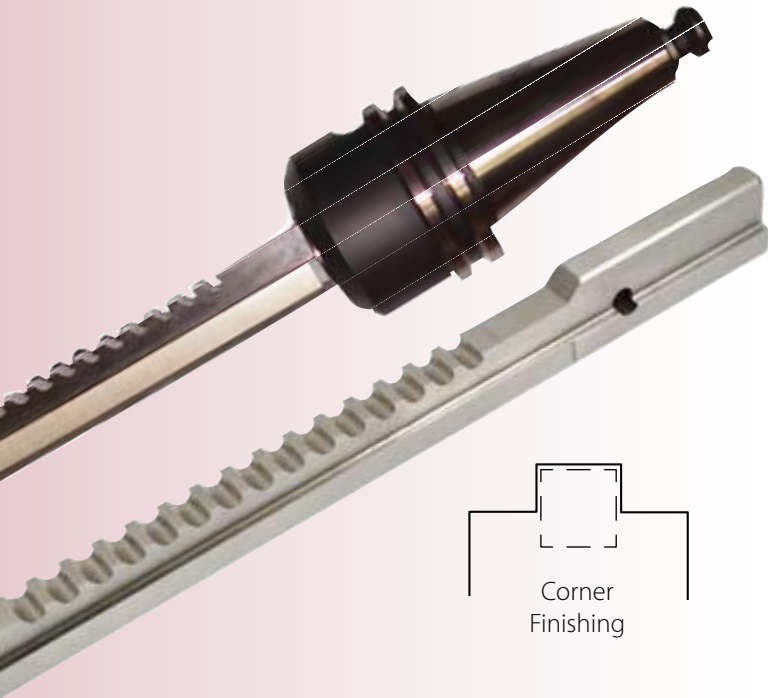

Typical Broach Applications May Include:

- Tooling Fixtures
- Gears
- Pulleys
- Keyways
- Rifling
- Special Geometric Shapes
- External Gears
- Flats
- Notches
- Serrations
- Slots
- Intricate contours
- Key Lock Slots
- Connecting Rods

We Routinely Assist The Following Industries:

- **Medical**
- **Orthopedic**
- **Dental**
- **Automotive**
- **Firearms**
- **Munitions**
- **Military**
- **Aircraft**
- **Aerospace**
- **Electronics**
- **Communications**
- **Plastics**

Selected Broaching Applications

The following list will give you an idea of the kind of first-rate special broaching that distinguishes our company world-wide.

Selected applications are:

- **Metering Valve:**

0.524" x 1.706" rectangle with 20" push broach: broached at Hassay Savage with 100% inspection for just-in-time shipments to OEM; job lot of 25,000 pieces/yr.

- **Control Vent Airframe:**

40 slots in rectangle chamber; 1.625" x 6.000"; broach was pull-type on horizontal machine; accuracy of 0.001 required throughout reference of all points; job lot of 100 units.

- **Printing guide Lever:**

19mm x 1,6mm rectangle with 610mm pull broach, bronze workpiece; limited production.

- **Wave Guide:**

1.345" x 2.848" x 36" pull broach; job lot of 500 pieces, on continuous basis.

- **Control Pin:**

Flats and radius slot; insert type slab broaches and radius slot broaching on vertical machine; high volume tumbler feed magazine.

- **Pliers:**

Set of three surface broaches to broach teeth of pliers; open clearance cut-off section; high volume run.

- **Collets:**

6 slots; 0.093 width; slotting broaches for cutting collet slots on vertical broach; high volume with a great variety of sizes using same broaches.

- **Ratchet Wrench:**

Elliptical set of holes for mechanism of ratchet; with a 2-piece construction broach for U.S. wrench manufacture.

- **Internal Spline Gear:**

22-tooth 36 spline pull broach; 24/48 diametrical pitch; 20° pressure angle; 2 million pieces per year.

- **Surgical Scissors:**

4 wide, 16 long surface broach, stainless steel workpiece; continuous medium volume.



Pictured: Custom broached parts.



Research and Development

Integration of design and manufacturing process at the prototype stage is critical!

Hassay Savage can save you time and money when our engineers are involved from the onset.

- State-of-the-art technology
- Understanding materials:
 - ferrous metals and alloys
 - non-ferrous metals
 - non-metallic materials
 - plastics and ceramics
 - wood products
- Successful broaching is knowing the capabilities of machining centers and flexible manufacturing systems
- We support partnership development

In affiliation with University Broaching Research Laboratories, we are working on:

- Expert systems for the automation of the broach design process.
- Integrated system for the automation for the near-net shape (pre-forming) manufacture of broaching tools.
- A knowledge-based system for yielding maximum allowable cutting force during broaching by creating exacting tooth geometry.
- Computer-aided process of down-loading machining programs to workstations by the actual routing process
- Procedures that reduce the cost of designing, manufacturing, and rebuilding broaches.

*The broach is an unsurpassed, unique tool that generates unique finish shapes in one pass. Broaching has a distinct advantage over other metal cutting operations because of its exacting precision, superb finish, faster production rates (as much as 5 to 10 times higher). **Wherever broaches are utilized, the result is improved quality and productivity.***

Using the Hassay Savage system gives you the best assurance in the industry!



*GMauvais***USA**TM



2017-2018



GMauvaisUSA™

A HASSAY SAVAGE COMPANY

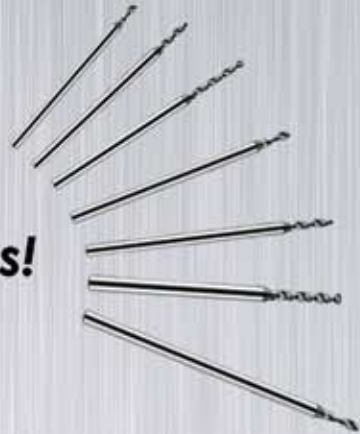

Standard MICRO Drill Solutions!



MICRO Drills
0.1mm – 3.0 mm

Division of
Hassay Savage
Company



SUPERIOR PRECISION • QUALITY • CONSISTENCY • PERFORMANCE



GMauvaisUSA™
A HASSAY SAVAGE COMPANY



Superior Micro Drills...

Since 1928 serving the Swiss Watch Industry, our factory in Annecy, France has a global reputation for superior quality and consistency in the production of high precision micro drills in μm Micron tolerances. With innovative and unique manufacturing technologies in turning, bar cutting, grinding, milling, flute grinding, sharpening and heat-treating, we produce products of the most consistent quality and reliable specifications! Our ability to control our high production operations with incredibly tight tolerances, makes us the right choice for all your micro drill needs. We offer a complete range of products in Solid Carbide and Cobalt High Speed Steel

In-process quality controls insure accurate dimensions and perfect surface finishes. Even with the strictest of quality and in-process controls, our production capabilities provide us the flexibility to offer precision, custom specification micro drill solutions for the most unique and demanding micro drill applications. Quality, precision, consistency and outstanding performance are what you can count on from GMauvaisUSA™ from every product we make!

This commitment to consistent quality and performance is relied upon by the most demanding industries. We are a key supplier to the Automotive, Aerospace, Computer / Multi-Media, Medical, Eyewear / Optics, Electronics, Connectors, Watch / Jewelry and Writing Instrument Industries where precision and performance are mandatory in daily production operations!

***Superior Precision, Quality,
Consistency & Performance***

Every Day from GMauvaisUSA™!



CONTENTS

Sales Representatives & US Warehouse Locations 4

The Anatomy of a Superior Micro Drill 40

5140 Series

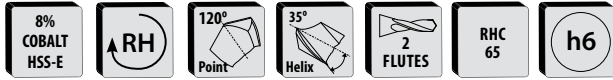

HSS-E Cobalt 8%
2-3 x D, Center Cut – Pilot – Spot Drills 120° 41

5100 Series



HSS-E Cobalt 8%
5 x D – Depth of Cut 120° 42-45

6140 Series



Solid Carbide
2-3 x D, Center – Pilot – Spot Drills 120° 46

6130 Series



Solid Carbide NEW Item for 2017
4-5 x D – Depth of Cut 120° 47-48

6120 Series



Solid Carbide
4-5 x D – Depth of Cut 120° 49-52

Advanced Precision Micro Tool Holders 52

6100 Series



Solid Carbide
5-7 x D – Depth of Cut 120° 53-55

6200 HP Series



Solid Carbide HIGH PERFORMANCE!
6-7 x D – Depth of Cut 140° 56

6220 HP Series



Solid Carbide HIGH PERFORMANCE!
12 x D – Depth of Cut 140° 57

6230 CT Series



Coolant-Thru NEW Item for 2017
15 x Depth of Cut 140° 58

1100 Series



Solid Carbide
Half Round Gun Drills 10 x Depth of Cut 120° 59

3100 Series Short



Solid Carbide
3 Flute SHORT Cross Drills 140° 60

3200 Series Long



Solid Carbide
3 Flute LONG Reamer Drills 140° 61

Speed and Feeds Chart 62

Request for Quotation Form 63



GMauvaisUSA™
A HASSAY SAVAGE COMPANY

THE ANATOMY OF A SUPERIOR MICRO DRILL

The **BIG** Picture of a Very **SMALL**, Precision Made Cutting Tool!

Superior Edge Quality & Flute Surface Finishes For **HIGH PERFORMANCE!**

Amazing Dimension Control **AT h6, h4 & h3 μm TOLERANCES!**

Extraordinary Concentricity, Circularity & Straightness **WITHIN 2 MICRONS!**

Ultra-Fine Surface Finish For **SMOOTH OPERATION!**

Consistent, Accurate Dimensions **EVERY TIME!**

Superior HSS Heat Treating & 10% Cobalt Micro Grain Carbide for **OUTSTANDING PERFORMANCE & LONG TOOL LIFE!!**

approximately 10x actual size



μm

What is a Micron?

1 micron = .001 mm = .00003937"

One Hundredth (1/100) of a Human Hair!

DRILL TERMINOLOGY

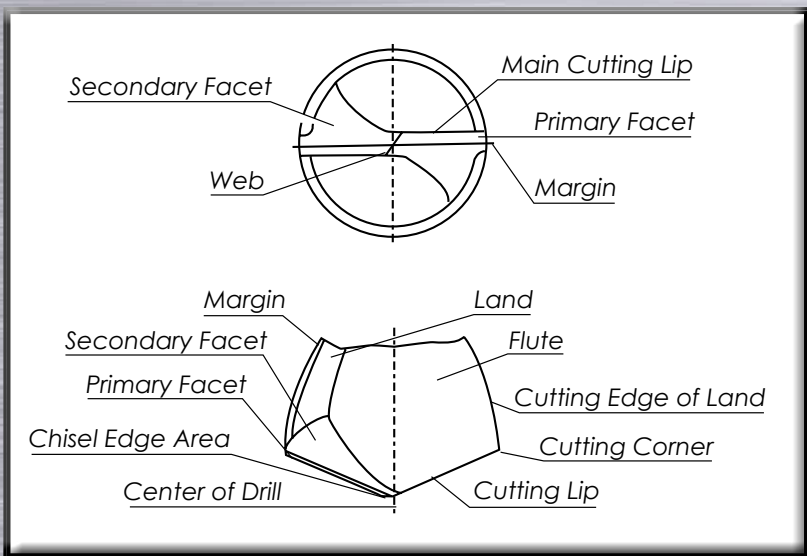

See page 4 for Sales Representative Listings

5140 Series

HSS-E Cobalt 8% 2-3 x D, Center Cut – Pilot – Spot Drills 120°

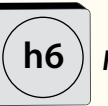
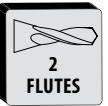
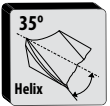
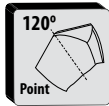

h6 + 0,000
- 0,006 mm

**FOR USE PRIOR TO USING 5100 SERIES DRILLS. CAN ALSO BE USED AS A DRILL WITH 2-3 X D DEPTH
ALL ITEMS CAN BE ORDERED AS LEFT HAND AT SAME PRICING
SPECIAL, CUSTOM SPECIFICATION ITEMS AVAILABLE**

CUSTOM SPECIFICATIONS SUCH AS:

- Helix angle of 15°, 24°, 30° or other.
- Point Angles of 90°, 110°, 130°, 140° or other.
- Special Diameters as 1,255 mm or other.
- Special Tolerances as +/- 0,001 mm or other.
- Coatings Available upon request.
- Minimum Special Order is 10 Pieces.
- Lead-Time on Specials – 3 Weeks ARO.

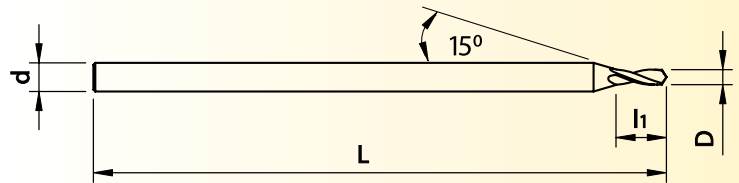

OAL 25 mm

SOLD IN 10 PIECE PACKAGES ONLY

Order Number	D flute dia. (mm)	D dec. equiv. flute dia. (inch)	Wire #	d shank dia. (mm)	l1 flute length (mm)	L overall length OAL (mm)
5140020R	0.20	0.0079	92	1.5	0.6	25
5140025R	0.25	0.0098		1.5	0.8	25
5140030R	0.30	0.0118		1.5	0.9	25
5140035R	0.35	0.0138		1.5	1	25
5140040R	0.40	0.0157		1.5	1	25
5140045R	0.45	0.0177		1.5	1.2	25
5140050R	0.50	0.0197		1.5	1.2	25
5140055R	0.55	0.0217		1.5	1.4	25
5140060R	0.60	0.0236		1.5	1.4	25
5140065R	0.65	0.0256		1.5	1.7	25
5140070R	0.70	0.0276		1.5	1.7	25
5140075R	0.75	0.0295		1.5	1.8	25
5140080R	0.80	0.0315		1.5	1.8	25
5140085R	0.85	0.0335		1.5	1.8	25
5140090R	0.90	0.0354		1.5	1.8	25
5140095R	0.95	0.0374		1.5	2	25
5140100R	1.00	0.0394		1.5	2	25
5140105R	1.05	0.0413		1.5	2.3	25
5140110R	1.10	0.0433		1.5	2.3	25
5140115R	1.15	0.0453		1.5	2.3	25
5140120R	1.20	0.0472		1.5	2.3	25
5140125R	1.25	0.0492		1.5	2.7	25
5140130R	1.30	0.0512		1.5	2.7	25
5140135R	1.35	0.0531		1.5	2.7	25
5140140R	1.40	0.0551	54	1.5	2.7	25
5140145R	1.45	0.0571		1.5	2.7	25
5140150R	1.50	0.0591		2	3	25
5140160R	1.60	0.0630	51	2	3	25

Drill Sizes 0,20 - 3,00 mm

Order Number	D flute dia. (mm)	D dec. equiv. flute dia. (inch)	Wire #	d shank dia. (mm)	l1 flute length (mm)	L overall length OAL (mm)
5140170R	1.70	0.0669		2	3.3	25
5140180R	1.80	0.0709		2	3.3	25
5140190R	1.90	0.0748		2	3.3	25
5140200R	2.00	0.0787		2	4	25
5140210R	2.10	0.0827		2.5	4	25
5140220R	2.20	0.0866		2.5	4	25
5140230R	2.30	0.0906		2.5	4.6	25
5140240R	2.40	0.0945		2.5	4.6	25
5140250R	2.50	0.0984		2.5	4.6	25
5140260R	2.60	0.1024		3	4.6	25
5140270R	2.70	0.1063		3	5.3	25
5140280R	2.80	0.1102		3	5.3	25
5140290R	2.90	0.1142		3	5.3	25
5140300R	3.00	0.1181		3	5.3	25

PILOT DRILLS

- For use prior to using 5100 series drills
- Can be used as pilot drill with 2-3 x D Depth

5100 Series HSS-E Cobalt 8%



5 x D – Depth of Cut 120°

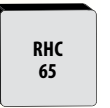
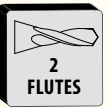
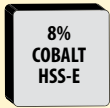

h6 + 0,000
- 0,006 mm

**FOR MATERIALS WITH LONG FORMING CHIPS, STEEL UP TO 35 RHC, COPPER, STAINLESS, TITANIUM
ALL ITEMS CAN BE ORDERED AS LEFT HAND AT SAME PRICING
SPECIAL, CUSTOM SPECIFICATION ITEMS AVAILABLE**

CUSTOM SPECIFICATIONS SUCH AS:

- Helix angle of 15°, 30°, 35° or other.
- Point Angles of 90°, 110°, 130°, 140° or other.
- Special Diameters as 1,255 mm or other.
- Special Tolerances as +/- 0,001 mm or other.
- Coatings Available upon request.
- Minimum Special Order is 10 Pieces.
- Lead-Time on Specials – 3 Weeks ARO.

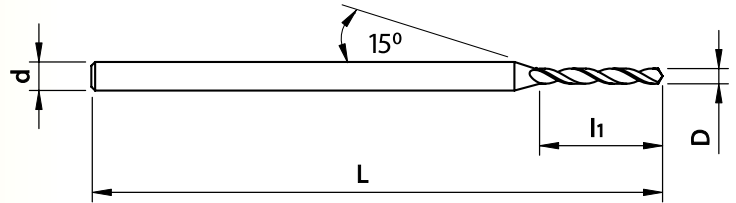

OAL Range 25 - 40 mm

SOLD IN 10 PIECE PACKAGES ONLY

Drill Sizes 0,10 - 0,65 mm

Order Number	D flute dia. (mm)	D dec. equiv. flute dia. (inch)	Wire #	d shank dia. (mm)	l1 flute length (mm)	L overall length OAL (mm)
5100010R	0.10	0.0039		1	0.7	25
5100011R	0.11	0.0043		1	0.7	25
5100012R	0.12	0.0047		1	0.7	25
5100013R	0.13	0.0051		1	1	25
5100014R	0.14	0.0055		1	1	25
5100015R	0.15	0.0059	97	1	1	25
5100016R	0.16	0.0063	96	1	1.4	25
5100017R	0.17	0.0067	95	1	1.4	25
5100018R	0.18	0.0071	94	1	1.4	25
5100019R	0.19	0.0075	93	1	1.4	25
5100020R	0.20	0.0079	92	1	1.8	25
5100021R	0.21	0.0083	91	1	1.8	25
5100022R	0.22	0.0087	90	1	1.8	25
5100023R	0.23	0.0091	89	1	1.8	25
5100024R	0.24	0.0094	88	1	1.8	25
5100025R	0.25	0.0098		1	2.2	25
5100026R	0.26	0.0102		1	2.2	25
5100027R	0.27	0.0106	86	1	2.2	25
5100028R	0.28	0.0110	85	1	2.2	25
5100029R	0.29	0.0114	84	1	2.2	25
5100030R	0.30	0.0118		1	2.2	25
5100031R	0.31	0.0122		1	2.8	25
5100032R	0.32	0.0126	82	1	2.8	25
5100033R	0.33	0.0130	81	1	2.8	25
5100034R	0.34	0.0134	80	1	2.8	25
5100035R	0.35	0.0138		1	2.8	25
5100036R	0.36	0.0142		1	2.8	25
5100037R	0.37	0.0146	79	1	2.8	25

Order Number	D flute dia. (mm)	D dec. equiv. flute dia. (inch)	Wire #	d shank dia. (mm)	l1 flute length (mm)	L overall length OAL (mm)
5100038R	0.38	0.0150		1	2.8	25
5100039R	0.39	0.0154		1	2.8	25
5100040R	0.40	0.0157		1	3.2	25
5100041R	0.41	0.0161	78	1	3.2	25
5100042R	0.42	0.0165		1	3.2	25
5100043R	0.43	0.0169		1	3.2	25
5100044R	0.44	0.0173		1	3.2	25
5100045R	0.45	0.0177		1	3.2	25
5100046R	0.46	0.0181	77	1	3.6	25
5100047R	0.47	0.0185		1	3.6	25
5100048R	0.48	0.0189		1	3.6	25
5100049R	0.49	0.0193		1	3.6	25
5100050R	0.50	0.0197		1	3.6	25
5100051R	0.51	0.0201	76	1.5	4	25
5100052R	0.52	0.0205		1.5	4	25
5100053R	0.53	0.0209	75	1.5	4	25
5100054R	0.54	0.0213		1.5	4	25
5100055R	0.55	0.0217		1.5	4	25
5100056R	0.56	0.0220		1.5	4.5	25
5100057R	0.57	0.0224	74	1.5	4.5	25
5100058R	0.58	0.0228		1.5	4.5	25
5100059R	0.59	0.0232		1.5	4.5	25
5100060R	0.60	0.0236		1.5	4.5	25
5100061R	0.61	0.0240	73	1.5	4.7	25
5100062R	0.62	0.0244		1.5	4.7	25
5100063R	0.63	0.0248	72	1.5	4.7	25
5100064R	0.64	0.0252		1.5	4.7	25
5100065R	0.65	0.0256		1.5	4.7	25

5100 Series Continued

5100 HSS-E Cobalt 8%

Drill Sizes 0,66 - 1,59 mm

Order Number	D flute dia. (mm)	D dec. equiv. flute dia. (inch)	Wire # Frac	d shank dia. (mm)	l1 flute length (mm)	L overall length OAL (mm)
5100066R	0.66	0.0260	71	1.5	4.7	25
5100067R	0.67	0.0264		1.5	4.7	25
5100068R	0.68	0.0268		1.5	5.2	25
5100069R	0.69	0.0272		1.5	5.2	25
5100070R	0.70	0.0276		1.5	5.2	25
5100071R	0.71	0.0280	70	1.5	5.2	25
5100072R	0.72	0.0283		1.5	5.2	25
5100073R	0.73	0.0287		1.5	5.2	25
5100074R	0.74	0.0291	69	1.5	5.2	25
5100075R	0.75	0.0295		1.5	5.2	25
5100076R	0.76	0.0299		1.5	5.5	25
5100077R	0.77	0.0303		1.5	5.5	25
5100078R	0.78	0.0307		1.5	5.5	25
5100079R	0.79	0.0311	68 - 1/32	1.5	5.5	25
5100080R	0.80	0.0315		1.5	5.5	25
5100081R	0.81	0.0319	67	1.5	5.5	25
5100082R	0.82	0.0323		1.5	5.5	25
5100083R	0.83	0.0327		1.5	5.5	25
5100084R	0.84	0.0331	66	1.5	5.5	25
5100085R	0.85	0.0335		1.5	5.5	25
5100086R	0.86	0.0339		1.5	6	25
5100087R	0.87	0.0343		1.5	6	25
5100088R	0.88	0.0346		1.5	6	25
5100089R	0.89	0.0350	65	1.5	6	25
5100090R	0.90	0.0354		1.5	6	25
5100091R	0.91	0.0358	64	1.5	6	25
5100092R	0.92	0.0362		1.5	6	25
5100093R	0.93	0.0366		1.5	6	25
5100094R	0.94	0.0370	63	1.5	6	25
5100095R	0.95	0.0374		1.5	6	25
5100096R	0.96	0.0378	62	1.5	6.5	25
5100097R	0.97	0.0382		1.5	6.5	25
5100098R	0.98	0.0386		1.5	6.5	25
5100099R	0.99	0.0390	61	1.5	6.5	25
5100100R	1.00	0.0394		1.5	6.5	25
5100101R	1.01	0.0398	60	1.5	6.5	25
5100102R	1.02	0.0402		1.5	6.5	25
5100103R	1.03	0.0406		1.5	6.5	25
5100104R	1.04	0.0409	59	1.5	6.5	25
5100105R	1.05	0.0413		1.5	6.5	25
5100106R	1.06	0.0417		1.5	7	25
5100107R	1.07	0.0421	58	1.5	7	25
5100108R	1.08	0.0425		1.5	7	25
5100109R	1.09	0.0429	57	1.5	7	25
5100110R	1.10	0.0433		1.5	7	25
5100111R	1.11	0.0437		1.5	7	25
5100112R	1.12	0.0441		1.5	7	25

Order Number	D flute dia. (mm)	D dec. equiv. flute dia. (inch)	Wire # Frac	d shank dia. (mm)	l1 flute length (mm)	L overall length OAL (mm)
5100113R	1.13	0.0445		1.5	7	25
5100114R	1.14	0.0449		1.5	7	25
5100115R	1.15	0.0453		1.5	7	25
5100116R	1.16	0.0457		1.5	7.5	25
5100117R	1.17	0.0461		1.5	7.5	25
5100118R	1.18	0.0465	56	1.5	7.5	25
5100119R	1.19	0.0469	3/64	1.5	7.5	25
5100120R	1.20	0.0472		1.5	7.5	25
5100121R	1.21	0.0476		1.5	7.5	25
5100122R	1.22	0.0480		1.5	7.5	25
5100123R	1.23	0.0484		1.5	7.5	25
5100124R	1.24	0.0488		1.5	7.5	25
5100125R	1.25	0.0492		1.5	7.5	25
5100126R	1.26	0.0496		1.5	7.5	25
5100127R	1.27	0.0500		1.5	7.5	25
5100128R	1.28	0.0504		1.5	7.5	25
5100129R	1.29	0.0508		1.5	7.5	25
5100130R	1.30	0.0512		1.5	7.5	25
5100131R	1.31	0.0516		1.5	8.5	25
5100132R	1.32	0.0520	55	1.5	8.5	25
5100133R	1.33	0.0524		1.5	8.5	25
5100134R	1.34	0.0528		1.5	8.5	25
5100135R	1.35	0.0531		1.5	8.5	25
5100136R	1.36	0.0535		1.5	8.5	25
5100137R	1.37	0.0539		1.5	8.5	25
5100138R	1.38	0.0543		1.5	8.5	25
5100139R	1.39	0.0547		1.5	8.5	25
5100140R	1.40	0.0551	54	1.5	8.5	25
5100141R	1.41	0.0555		1.5	8.5	25
5100142R	1.42	0.0559		1.5	8.5	25
5100143R	1.43	0.0563		1.5	8.5	25
5100144R	1.44	0.0567		1.5	8.5	25
5100145R	1.45	0.0571		1.5	8.5	25
5100146R	1.46	0.0575		1.5	8.5	25
5100147R	1.47	0.0579		1.5	8.5	25
5100148R	1.48	0.0583		1.5	8.5	25
5100149R	1.49	0.0587		1.5	8.5	25
5100150R	1.50	0.0591		2	10	35
5100151R	1.51	0.0594	53	2	10	35
5100152R	1.52	0.0598		2	10	35
5100153R	1.53	0.0602		2	10	35
5100154R	1.54	0.0606		2	10	35
5100155R	1.55	0.0610		2	10	35
5100156R	1.56	0.0614		2	10	35
5100157R	1.57	0.0618		2	10	35
5100158R	1.58	0.0622		2	10	35
5100159R	1.59	0.0626	1/16	2	10	35

SOLD IN 10 PIECE PACKAGES ONLY

5100 Series Continued

5100 HSS-E Cobalt 8%

Drill Sizes 1,60 - 2,53 mm

Order Number	D flute dia. (mm)	D dec. equiv. flute dia. (inch)	Wire # Frac	d shank dia. (mm)	l1 flute length (mm)	L overall length OAL (mm)
5100160R	1.60	0.0630		2	10	35
5100161R	1.61	0.0634	52	2	10	35
5100162R	1.62	0.0638		2	10	35
5100163R	1.63	0.0642		2	10	35
5100164R	1.64	0.0646		2	10	35
5100165R	1.65	0.0650		2	10	35
5100166R	1.66	0.0654		2	10	35
5100167R	1.67	0.0657		2	10	35
5100168R	1.68	0.0661		2	10	35
5100169R	1.69	0.0665		2	10	35
5100170R	1.70	0.0669	51	2	10	35
5100171R	1.71	0.0673		2	10	35
5100172R	1.72	0.0677		2	10	35
5100173R	1.73	0.0681		2	10	35
5100174R	1.74	0.0685		2	10	35
5100175R	1.75	0.0689		2	10	35
5100176R	1.76	0.0693		2	10	35
5100177R	1.77	0.0697		2	11	35
5100178R	1.78	0.0701	50	2	11	35
5100179R	1.79	0.0705		2	11	35
5100180R	1.80	0.0709		2	11	35
5100181R	1.81	0.0713		2	11	35
5100182R	1.82	0.0717		2	11	35
5100183R	1.83	0.0720		2	11	35
5100184R	1.84	0.0724		2	11	35
5100185R	1.85	0.0728	49	2	11	35
5100186R	1.86	0.0732		2	11	35
5100187R	1.87	0.0736		2	11	35
5100188R	1.88	0.0740		2	11	35
5100189R	1.89	0.0744		2	11	35
5100190R	1.90	0.0748		2	11	35
5100191R	1.91	0.0752		2	11	35
5100192R	1.92	0.0756		2	11	35
5100193R	1.93	0.0760	48	2	11	35
5100194R	1.94	0.0764		2	11	35
5100195R	1.95	0.0768		2	11	35
5100196R	1.96	0.0772		2	11	35
5100197R	1.97	0.0776		2	11	35
5100198R	1.98	0.0780	5/64	2	11	35
5100199R	1.99	0.0783	47	2	11	35
5100200R	2.00	0.0787		2	11	35
5100201R	2.01	0.0791		2.5	12	35
5100202R	2.02	0.0795		2.5	12	35
5100203R	2.03	0.0799		2.5	12	35
5100204R	2.04	0.0803		2.5	12	35
5100205R	2.05	0.0807		2.5	12	35
5100206R	2.06	0.0811	46	2.5	12	35

Order Number	D flute dia. (mm)	D dec. equiv. flute dia. (inch)	Wire # Frac	d shank dia. (mm)	l1 flute length (mm)	L overall length OAL (mm)
5100207R	2.07	0.0815		2.5	12	35
5100208R	2.08	0.0819	45	2.5	12	35
5100209R	2.09	0.0823		2.5	12	35
5100210R	2.10	0.0827		2.5	12	35
5100211R	2.11	0.0831		2.5	12	35
5100212R	2.12	0.0835		2.5	12	35
5100213R	2.13	0.0839		2.5	12	35
5100214R	2.14	0.0843		2.5	12	35
5100215R	2.15	0.0846		2.5	12	35
5100216R	2.16	0.0850		2.5	12	35
5100217R	2.17	0.0854		2.5	12	35
5100218R	2.18	0.0858	44	2.5	12	35
5100219R	2.19	0.0862		2.5	12	35
5100220R	2.20	0.0866		2.5	12	35
5100221R	2.21	0.0870		2.5	14	35
5100222R	2.22	0.0874		2.5	14	35
5100223R	2.23	0.0878		2.5	14	35
5100224R	2.24	0.0882		2.5	14	35
5100225R	2.25	0.0886		2.5	14	35
5100226R	2.26	0.0890	43	2.5	14	35
5100227R	2.27	0.0894		2.5	14	35
5100228R	2.28	0.0898		2.5	14	35
5100229R	2.29	0.0902		2.5	14	35
5100230R	2.30	0.0906		2.5	14	35
5100231R	2.31	0.0909		2.5	14	35
5100232R	2.32	0.0913		2.5	14	35
5100233R	2.33	0.0917		2.5	14	35
5100234R	2.34	0.0921		2.5	14	35
5100235R	2.35	0.0925		2.5	14	35
5100236R	2.36	0.0929		2.5	14	35
5100237R	2.37	0.0933		2.5	14	35
5100238R	2.38	0.0937	3/32	2.5	14	35
5100239R	2.39	0.0941		2.5	14	35
5100240R	2.40	0.0945		2.5	14	35
5100241R	2.41	0.0949		2.5	14	35
5100242R	2.42	0.0953		2.5	14	35
5100243R	2.43	0.0957		2.5	14	35
5100244R	2.44	0.0961	41	2.5	14	35
5100245R	2.45	0.0965		2.5	14	35
5100246R	2.46	0.0969		2.5	14	35
5100247R	2.47	0.0972		2.5	14	35
5100248R	2.48	0.0976		2.5	14	35
5100249R	2.49	0.0980	40	2.5	14	35
5100250R	2.50	0.0984		2.5	14	35
5100251R	2.51	0.0988		3	16	40
5100252R	2.52	0.0992		3	16	40
5100253R	2.53	0.0996	39	3	16	40

SOLD IN 10 PIECE PACKAGES ONLY

5100 Series Continued

5100 HSS-E Cobalt 8%

Order Number	D flute dia. (mm)	D dec. equiv. flute dia. (inch)	Wire # Frac	d shank dia. (mm)	l1 flute length (mm)	L overall length OAL (mm)
5100254R	2.54	0.1000		3	16	40
5100255R	2.55	0.1004		3	16	40
5100256R	2.56	0.1008		3	16	40
5100257R	2.57	0.1012		3	16	40
5100258R	2.58	0.1016	38	3	16	40
5100259R	2.59	0.1020		3	16	40
5100260R	2.60	0.1024		3	16	40
5100261R	2.61	0.1028		3	16	40
5100262R	2.62	0.1031		3	16	40
5100263R	2.63	0.1035		3	16	40
5100264R	2.64	0.1039	37	3	16	40
5100265R	2.65	0.1043		3	16	40
5100266R	2.66	0.1047		3	16	40
5100267R	2.67	0.1051		3	16	40
5100268R	2.68	0.1055		3	16	40
5100269R	2.69	0.1059		3	16	40
5100270R	2.70	0.1063	36	3	16	40
5100271R	2.71	0.1067		3	16	40
5100272R	2.72	0.1071		3	16	40
5100273R	2.73	0.1075		3	16	40
5100274R	2.74	0.1079		3	16	40
5100275R	2.75	0.1083		3	16	40
5100276R	2.76	0.1087		3	18	40
5100277R	2.77	0.1091		3	18	40

Drill Sizes 2,54 - 3,00 mm

Order Number	D flute dia. (mm)	D dec. equiv. flute dia. (inch)	Wire # Frac	d shank dia. (mm)	l1 flute length (mm)	L overall length OAL (mm)
5100278R	2.78	0.1094	7/64	3	18	40
5100279R	2.79	0.1098	35	3	18	40
5100280R	2.80	0.1102		3	18	40
5100281R	2.81	0.1106		3	18	40
5100282R	2.82	0.1110	34	3	18	40
5100283R	2.83	0.1114		3	18	40
5100284R	2.84	0.1118		3	18	40
5100285R	2.85	0.1122		3	18	40
5100286R	2.86	0.1126		3	18	40
5100287R	2.87	0.1130	33	3	18	40
5100288R	2.88	0.1134		3	18	40
5100289R	2.89	0.1138		3	18	40
5100290R	2.90	0.1142		3	18	40
5100291R	2.91	0.1146		3	18	40
5100292R	2.92	0.1150		3	18	40
5100293R	2.93	0.1154		3	18	40
5100294R	2.94	0.1157		3	18	40
5100295R	2.95	0.1161	32	3	18	40
5100296R	2.96	0.1165		3	18	40
5100297R	2.97	0.1169		3	18	40
5100298R	2.98	0.1173		3	18	40
5100299R	2.99	0.1177		3	18	40
5100300R	3.00	0.1181		3	18	40

SOLD IN 10 PIECE PACKAGES ONLY

5100 HSS-E Cobalt 8%



- For materials with long forming chips, steel up to 35 RHC, Copper, Stainless, Titanium
- Amazing dimension control at h6, h4 & h3 μ m tolerances
- Ultra-fine surface finish for smooth operation
- Superb heat treating for outstanding performance & long tool life
- Coatings available upon request

6140 Series Solid Carbide

2-3 x D, Center Cut – Pilot – Spot Drills 120°

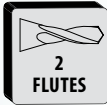

h6 + 0,000
- 0,006 mm

**FOR USE PRIOR TO USING 6120 & 6100 SERIES DRILLS. CAN ALSO BE USED AS A DRILL WITH 2-3 X D DEEP
ALL ITEMS CAN BE ORDERED AS LEFT HAND AT SAME PRICING
SPECIAL, CUSTOM SPECIFICATION ITEMS AVAILABLE**

CUSTOM SPECIFICATIONS SUCH AS:

- Helix angle of 15°, 30°, 35° or other.
- Point Angles of 90°, 110°, 130°, 140° or other.
- Special Diameters as 0,92 mm or other.
- Special Tolerances as +/- 0,001 mm or other.
- Coolant Through Drills at 3 & 4 mm shanks & 1,25 to 3 mm flute diameters.
- Coatings Available upon request.
- Minimum Special Order is 10 Pieces.
- Lead-Time on Specials – 3 Weeks ARO.

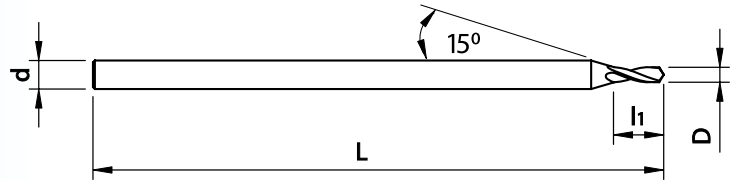

OAL Range 30 - 38 mm

SOLD IN 10 PIECE PACKAGES ONLY

Drill Sizes 0,20 - 3,00 mm

Order Number	D flute dia. (mm)	D dec. equiv. flute dia. (inch)	Wire #	d shank dia. (mm)	l1 flute length (mm)	L overall length OAL (mm)
6140020R	0.20	0.0079	92	1.5	0.9	30
6140025R	0.25	0.0098		1.5	0.9	30
6140030R	0.30	0.0118		1.5	0.9	30
6140035R	0.35	0.0138		1.5	1.2	30
6140040R	0.40	0.0157		1.5	1.5	30
6140045R	0.45	0.0177		1.5	1.5	30
6140050R	0.50	0.0197		1.5	1.9	30
6140055R	0.55	0.0217		1.5	1.9	30
6140060R	0.60	0.0236		1.5	1.9	30
6140065R	0.65	0.0256		1.5	2.1	30
6140070R	0.70	0.0276		1.5	2.4	30
6140075R	0.75	0.0295		1.5	2.4	30
6140080R	0.80	0.0315		1.5	2.6	30
6140085R	0.85	0.0335		1.5	2.6	30
6140090R	0.90	0.0354		1.5	3	30
6140095R	0.95	0.0374		1.5	3	30
6140100R	1.00	0.0394		1.5	3.4	30
6140105R	1.05	0.0413		1.5	3.4	30
6140110R	1.10	0.0433		1.5	3.8	30
6140115R	1.15	0.0453		1.5	3.8	30
6140120R	1.20	0.0472		1.5	4.2	30

Order Number	D flute dia. (mm)	D dec. equiv. flute dia. (inch)	Wire #	d shank dia. (mm)	l1 flute length (mm)	L overall length OAL (mm)
6140125R	1.25	0.0492		1.5	4.2	30
6140130R	1.30	0.0512		1.5	4.2	30
6140135R	1.35	0.0531		1.5	4.7	30
6140140R	1.40	0.0551	54	1.5	4.7	30
6140145R	1.45	0.0571		1.5	4.7	30
6140150R	1.50	0.0591		2	4.7	38
6140160R	1.60	0.0630	51	2	5.4	38
6140170R	1.70	0.0669		2	5.4	38
6140180R	1.80	0.0709		2	6.5	38
6140190R	1.90	0.0748		2	6.5	38
6140200R	2.00	0.0787		3	6.5	38
6140210R	2.10	0.0827		3	6.5	38
6140220R	2.20	0.0866		3	6.5	38
6140230R	2.30	0.0906		3	6.5	38
6140240R	2.40	0.0945		3	6.5	38
6140250R	2.50	0.0984		3	7.5	38
6140260R	2.60	0.1024		3	7.5	38
6140270R	2.70	0.1063		3	7.5	38
6140280R	2.80	0.1102		3	7.5	38
6140290R	2.90	0.1142		3	7.5	38
6140300R	3.00	0.1181		3	7.5	38

6130 Series Solid Carbide

3mm Shank Tools



4-5 x D – Depth of Cut 120°

h6 Tolerance
Reinforced Shank d 3,0 mm

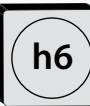
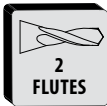
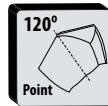

+0/-0.006mm (h6) For Uncoated Version
+0,002/-0,004mm For Coated Version

FOR SOFT, MEDIUM TO HIGH TENSILE STRENGTH STEEL, STAINLESS, TITANIUM ALLOYS & CAST IRON
ALL ITEMS CAN BE ORDERED AS LEFT HAND AT SAME PRICING
SPECIAL, CUSTOM SPECIFICATION ITEMS AVAILABLE

NEW Item for 2017

CUSTOM SPECIFICATIONS SUCH AS:

- Helix angle of 15°, 30°, 35° or other.
- Point Angles of 90°, 110°, 130°, 140° or other.
- Special Diameters as 1,255 mm or other.
- Special Tolerances as +/- 0,001 mm or other.
- Minimum Special Order is 10 Pieces.
- Lead-Time on Specials – 3 Weeks ARO.

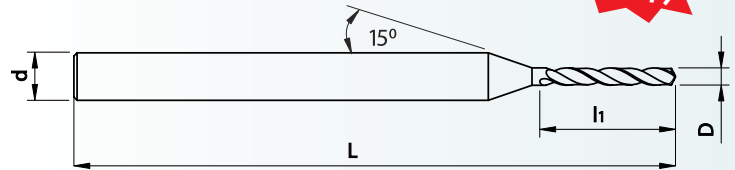

OAL Range 38 mm

SOLD IN 10 PIECE PACKAGES ONLY

Drill Sizes 0,20 - 0,88 mm

Uncoated (R) Order Number	TiAlN Coated (RC) Order Number	D flute dia. (mm)	D dec. equiv. flute dia. (inch)	Wire #	d shank dia. (mm)	l1 flute length (mm)	L overall length OAL (mm)
6130020R	6130020RC	0.20	0.0079	92	3.00	1.1	38
6130021R	6130021RC	0.21	0.0083	91	3.00	1.1	38
6130022R	6130022RC	0.22	0.0087	90	3.00	1.1	38
6130023R	6130023RC	0.23	0.0091	89	3.00	1.1	38
6130024R	6130024RC	0.24	0.0094	88	3.00	1.1	38
6130025R	6130025RC	0.25	0.0098		3.00	1.3	38
6130026R	6130026RC	0.26	0.0102		3.00	1.3	38
6130027R	6130027RC	0.27	0.0106	86	3.00	1.3	38
6130028R	6130028RC	0.28	0.0110	85	3.00	1.3	38
6130029R	6130029RC	0.29	0.0114	84	3.00	1.3	38
6130030R	6130030RC	0.30	0.0118		3.00	1.6	38
6130031R	6130031RC	0.31	0.0122		3.00	1.6	38
6130032R	6130032RC	0.32	0.0126	82	3.00	1.6	38
6130033R	6130033RC	0.33	0.0130	81	3.00	1.6	38
6130034R	6130034RC	0.34	0.0134	80	3.00	1.6	38
6130035R	6130035RC	0.35	0.0138		3.00	1.6	38
6130036R	6130036RC	0.36	0.0142		3.00	1.6	38
6130037R	6130037RC	0.37	0.0146	79	3.00	1.6	38
6130038R	6130038RC	0.38	0.0150		3.00	1.6	38
6130039R	6130039RC	0.39	0.0154		3.00	2	38
6130040R	6130040RC	0.40	0.0157		3.00	2	38
6130041R	6130041RC	0.41	0.0161	78	3.00	2	38
6130042R	6130042RC	0.42	0.0165		3.00	2	38
6130043R	6130043RC	0.43	0.0169		3.00	2	38
6130044R	6130044RC	0.44	0.0173		3.00	2	38
6130045R	6130045RC	0.45	0.0177		3.00	2	38
6130046R	6130046RC	0.46	0.0181	77	3.00	2	38
6130047R	6130047RC	0.47	0.0185		3.00	2	38
6130048R	6130048RC	0.48	0.0189		3.00	2	38
6130049R	6130049RC	0.49	0.0193		3.00	2	38
6130050R	6130050RC	0.50	0.0197		3.00	2.4	38
6130051R	6130051RC	0.51	0.0201	76	3.00	2.4	38
6130052R	6130052RC	0.52	0.0205		3.00	2.4	38
6130053R	6130053RC	0.53	0.0209	75	3.00	2.4	38
6130054R	6130054RC	0.54	0.0213		3.00	2.8	38

Uncoated (R) Order Number	TiAlN Coated (RC) Order Number	D flute dia. (mm)	D dec. equiv. flute dia. (inch)	Wire #	d shank dia. (mm)	l1 flute length (mm)	L overall length OAL (mm)
6130055R	6130055RC	0.55	0.0217		3.00	2.8	38
6130056R	6130056RC	0.56	0.0220		3.00	2.8	38
6130057R	6130057RC	0.57	0.0224	74	3.00	2.8	38
6130058R	6130058RC	0.58	0.0228		3.00	2.8	38
6130059R	6130059RC	0.59	0.0232		3.00	2.8	38
6130060R	6130060RC	0.60	0.0236		3.00	2.8	38
6130061R	6130061RC	0.61	0.0240	73	3.00	3.3	38
6130062R	6130062RC	0.62	0.0244		3.00	3.3	38
6130063R	6130063RC	0.63	0.0248	72	3.00	3.3	38
6130064R	6130064RC	0.64	0.0252		3.00	3.3	38
6130065R	6130065RC	0.65	0.0256		3.00	3.3	38
6130066R	6130066RC	0.66	0.0260	71	3.00	3.3	38
6130067R	6130067RC	0.67	0.0264		3.00	3.3	38
6130068R	6130068RC	0.68	0.0268		3.00	3.8	38
6130069R	6130069RC	0.69	0.0272		3.00	3.8	38
6130070R	6130070RC	0.70	0.0276		3.00	3.8	38
6130071R	6130071RC	0.71	0.0280	70	3.00	3.8	38
6130072R	6130072RC	0.72	0.0283		3.00	3.8	38
6130073R	6130073RC	0.73	0.0287		3.00	3.8	38
6130074R	6130074RC	0.74	0.0291	69	3.00	3.8	38
6130075R	6130075RC	0.75	0.0295		3.00	3.8	38
6130076R	6130076RC	0.76	0.0299		3.00	4.2	38
6130077R	6130077RC	0.77	0.0303		3.00	4.2	38
6130078R	6130078RC	0.78	0.0307		3.00	4.2	38
6130079R	6130079RC	0.79	0.0311	68 - 1/32	3.00	4.2	38
6130080R	6130080RC	0.80	0.0315		3.00	4.4	38
6130081R	6130081RC	0.81	0.0319	67	3.00	4.4	38
6130082R	6130082RC	0.82	0.0323		3.00	4.4	38
6130083R	6130083RC	0.83	0.0327		3.00	4.4	38
6130084R	6130084RC	0.84	0.0331	66	3.00	4.4	38
6130085R	6130085RC	0.85	0.0335		3.00	4.4	38
6130086R	6130086RC	0.86	0.0339		3.00	4.8	38
6130087R	6130087RC	0.87	0.0343		3.00	4.8	38
6130088R	6130088RC	0.88	0.0346		3.00	4.8	38

6130 Series Continued

6120 Series Solid Carbide

4-5 x D – Depth of Cut 120°

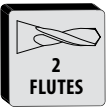
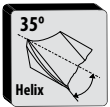
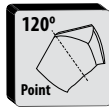

$h6 \pm 0,000$
 $- 0,006 \text{ mm}$

FOR MEDIUM TO HIGH TENSILE STRENGTH STEEL, STAINLESS, TITANIUM ALLOYS & CAST IRON
ALL ITEMS CAN BE ORDERED AS LEFT HAND AT SAME PRICING
SPECIAL, CUSTOM SPECIFICATION ITEMS AVAILABLE

CUSTOM SPECIFICATIONS SUCH AS:

- Helix angle of 15°, 24°, 30° or other.
- Point Angles of 90°, 110°, 130°, 140° or other.
- Special Diameters as 1,255 mm or other.
- Special Tolerances as +/- 0,001 mm or other.
- Coolant Through Drills at 3 & 4 mm shanks & 1,25 to 3 mm flute diameters.
- Coatings Available upon request.
- Minimum Special Order is 10 Pieces / Spec.
- Lead-Time on Specials – 3 Weeks ARO.

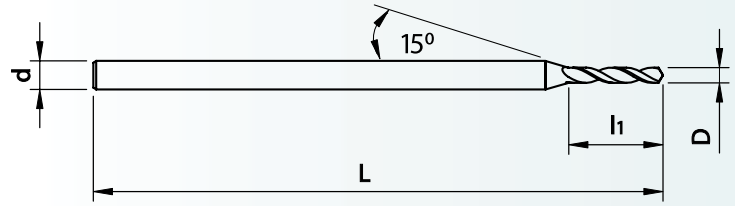

OAL Range 25 - 38 mm

SOLD IN 10 PIECE PACKAGES ONLY

Drill Sizes 0,20 - 0,71 mm

Order Number	D flute dia. (mm)	D dec. equiv. flute dia. (inch)	Wire #	d shank dia. (mm)	l1 flute length (mm)	L overall length OAL (mm)
6120020R	0.20	0.0079	92	1	1.1	25
6120021R	0.21	0.0083	91	1	1.1	25
6120022R	0.22	0.0087	90	1	1.1	25
6120023R	0.23	0.0091	89	1	1.1	25
6120024R	0.24	0.0094	88	1	1.1	25
6120025R	0.25	0.0098		1	1.3	25
6120026R	0.26	0.0102		1	1.3	25
6120027R	0.27	0.0106	86	1	1.3	25
6120028R	0.28	0.0110	85	1	1.3	25
6120029R	0.29	0.0114	84	1	1.3	25
6120030R	0.30	0.0118		1	1.6	25
6120031R	0.31	0.0122		1	1.6	25
6120032R	0.32	0.0126	82	1	1.6	25
6120033R	0.33	0.0130	81	1	1.6	25
6120034R	0.34	0.0134	80	1	1.6	25
6120035R	0.35	0.0138		1	1.6	25
6120036R	0.36	0.0142		1	1.6	25
6120037R	0.37	0.0146	79	1	1.6	25
6120038R	0.38	0.0150		1	1.6	25
6120039R	0.39	0.0154		1	2	25
6120040R	0.40	0.0157		1	2	25
6120041R	0.41	0.0161	78	1	2	25
6120042R	0.42	0.0165		1	2	25
6120043R	0.43	0.0169		1	2	25
6120044R	0.44	0.0173		1	2	25
6120045R	0.45	0.0177		1	2	25

Order Number	D flute dia. (mm)	D dec. equiv. flute dia. (inch)	Wire #	d shank dia. (mm)	l1 flute length (mm)	L overall length OAL (mm)
6120046R	0.46	0.0181	77	1	2	25
6120047R	0.47	0.0185		1	2	25
6120048R	0.48	0.0189		1	2	25
6120049R	0.49	0.0193		1	2	25
6120050R	0.50	0.0197		1	2.4	25
6120051R	0.51	0.0201	76	1	2.4	25
6120052R	0.52	0.0205		1	2.4	25
6120053R	0.53	0.0209	75	1	2.4	25
6120054R	0.54	0.0213		1	2.8	25
6120055R	0.55	0.0217		1	2.8	25
6120056R	0.56	0.0220		1	2.8	25
6120057R	0.57	0.0224	74	1	2.8	25
6120058R	0.58	0.0228		1	2.8	25
6120059R	0.59	0.0232		1	2.8	25
6120060R	0.60	0.0236		1.5	2.8	30
6120061R	0.61	0.0240	73	1.5	3.3	30
6120062R	0.62	0.0244		1.5	3.3	30
6120063R	0.63	0.0248	72	1.5	3.3	30
6120064R	0.64	0.0252		1.5	3.3	30
6120065R	0.65	0.0256		1.5	3.3	30
6120066R	0.66	0.0260	71	1.5	3.3	30
6120067R	0.67	0.0264		1.5	3.3	30
6120068R	0.68	0.0268		1.5	3.8	30
6120069R	0.69	0.0272		1.5	3.8	30
6120070R	0.70	0.0276		1.5	3.8	30
6120071R	0.71	0.0280	70	1.5	3.8	30

6120 Series Continued

6120 Series Solid Carbide

Drill Sizes 0,72 - 1,65 mm

Order Number	D flute dia. (mm)	D dec. equiv. flute dia. (inch)	Wire # Frac	d shank dia. (mm)	l1 flute length (mm)	L overall length OAL (mm)
6120072R	0.72	0.0283		1.5	3.8	30
6120073R	0.73	0.0287		1.5	3.8	30
6120074R	0.74	0.0291	69	1.5	3.8	30
6120075R	0.75	0.0295		1.5	3.8	30
6120076R	0.76	0.0299		1.5	4.2	30
6120077R	0.77	0.0303		1.5	4.2	30
6120078R	0.78	0.0307		1.5	4.2	30
6120079R	0.79	0.0311	68 - 1/32	1.5	4.2	30
6120080R	0.80	0.0315		1.5	4.4	30
6120081R	0.81	0.0319	67	1.5	4.4	30
6120082R	0.82	0.0323		1.5	4.4	30
6120083R	0.83	0.0327		1.5	4.4	30
6120084R	0.84	0.0331	66	1.5	4.4	30
6120085R	0.85	0.0335		1.5	4.4	30
6120086R	0.86	0.0339		1.5	4.8	30
6120087R	0.87	0.0343		1.5	4.8	30
6120088R	0.88	0.0346		1.5	4.8	30
6120089R	0.89	0.0350	65	1.5	4.8	30
6120090R	0.90	0.0354		1.5	4.8	30
6120091R	0.91	0.0358	64	1.5	4.8	30
6120092R	0.92	0.0362		1.5	4.8	30
6120093R	0.93	0.0366		1.5	4.8	30
6120094R	0.94	0.0370	63	1.5	4.8	30
6120095R	0.95	0.0374		1.5	4.8	30
6120096R	0.96	0.0378	62	1.5	4.8	30
6120097R	0.97	0.0382		1.5	4.8	30
6120098R	0.98	0.0386		1.5	4.8	30
6120099R	0.99	0.0390	61	1.5	4.8	30
6120100R	1.00	0.0394		1.5	4.8	30
6120101R	1.01	0.0398	60	1.5	4.8	30
6120102R	1.02	0.0402		1.5	4.8	30
6120103R	1.03	0.0406		1.5	4.8	30
6120104R	1.04	0.0409	59	1.5	4.8	30
6120105R	1.05	0.0413		1.5	4.8	30
6120106R	1.06	0.0417		1.5	4.8	30
6120107R	1.07	0.0421	58	1.5	4.8	30
6120108R	1.08	0.0425		1.5	4.8	30
6120109R	1.09	0.0429	57	1.5	4.8	30
6120110R	1.10	0.0433		1.5	5.4	30
6120111R	1.11	0.0437		1.5	5.4	30
6120112R	1.12	0.0441		1.5	5.4	30
6120113R	1.13	0.0445		1.5	5.4	30
6120114R	1.14	0.0449		1.5	5.4	30
6120115R	1.15	0.0453		1.5	5.4	30
6120116R	1.16	0.0457		1.5	5.4	30
6120117R	1.17	0.0461		1.5	5.4	30
6120118R	1.18	0.0465	56	1.5	5.4	30

Order Number	D flute dia. (mm)	D dec. equiv. flute dia. (inch)	Wire # Frac	d shank dia. (mm)	l1 flute length (mm)	L overall length OAL (mm)
6120119R	1.19	0.0469	3/64	1.5	5.4	30
6120120R	1.20	0.0472		1.5	6	30
6120121R	1.21	0.0476		1.5	6	30
6120122R	1.22	0.0480		1.5	6	30
6120123R	1.23	0.0484		1.5	6	30
6120124R	1.24	0.0488		1.5	6	30
6120125R	1.25	0.0492		1.5	6	30
6120126R	1.26	0.0496		1.5	6	30
6120127R	1.27	0.0500		1.5	6	30
6120128R	1.28	0.0504		1.5	6	30
6120129R	1.29	0.0508		1.5	6	30
6120130R	1.30	0.0512		1.5	6.7	30
6120131R	1.31	0.0516		1.5	6.7	30
6120132R	1.32	0.0520	55	1.5	6.7	30
6120133R	1.33	0.0524		1.5	6.7	30
6120134R	1.34	0.0528		1.5	6.7	30
6120135R	1.35	0.0531		1.5	6.7	30
6120136R	1.36	0.0535		1.5	6.7	30
6120137R	1.37	0.0539		1.5	6.7	30
6120138R	1.38	0.0543		1.5	6.7	30
6120139R	1.39	0.0547		1.5	6.7	30
6120140R	1.40	0.0551	54	1.5	6.7	30
6120141R	1.41	0.0555		1.5	6.7	30
6120142R	1.42	0.0559		1.5	6.7	30
6120143R	1.43	0.0563		1.5	6.7	30
6120144R	1.44	0.0567		1.5	6.7	30
6120145R	1.45	0.0571		1.5	6.7	30
6120146R	1.46	0.0575		1.5	6.7	30
6120147R	1.47	0.0579		1.5	6.7	30
6120148R	1.48	0.0583		1.5	6.7	30
6120149R	1.49	0.0587		1.5	6.7	30
6120150R	1.50	0.0591		2	7.2	38
6120151R	1.51	0.0594	53	2	7.2	38
6120152R	1.52	0.0598		2	7.2	38
6120153R	1.53	0.0602		2	7.2	38
6120154R	1.54	0.0606		2	7.2	38
6120155R	1.55	0.0610		2	7.2	38
6120156R	1.56	0.0614		2	7.2	38
6120157R	1.57	0.0618		2	7.2	38
6120158R	1.58	0.0622		2	7.2	38
6120159R	1.59	0.0626	1/16	2	7.2	38
6120160R	1.60	0.0630		2	7.2	38
6120161R	1.61	0.0634	52	2	7.2	38
6120162R	1.62	0.0638		2	7.2	38
6120163R	1.63	0.0642		2	7.2	38
6120164R	1.64	0.0646		2	7.2	38
6120165R	1.65	0.0650		2	7.2	38

SOLD IN 10 PIECE PACKAGES ONLY

6120 Series Continued

6120 Series Solid Carbide

Drill Sizes 1,66 - 2,59 mm

Order Number	D flute dia. (mm)	D dec. equiv. flute dia. (inch)	Wire # Frac	d shank dia. (mm)	l1 flute length (mm)	L overall length OAL (mm)
6120166R	1.66	0.0654		2	7.2	38
6120167R	1.67	0.0657		2	7.2	38
6120168R	1.68	0.0661		2	7.2	38
6120169R	1.69	0.0665		2	7.2	38
6120170R	1.70	0.0669	51	2	7.2	38
6120171R	1.71	0.0673		2	7.2	38
6120172R	1.72	0.0677		2	7.2	38
6120173R	1.73	0.0681		2	7.2	38
6120174R	1.74	0.0685		2	7.2	38
6120175R	1.75	0.0689		2	7.2	38
6120176R	1.76	0.0693		2	7.2	38
6120177R	1.77	0.0697		2	7.2	38
6120178R	1.78	0.0701	50	2	7.2	38
6120179R	1.79	0.0705		2	7.2	38
6120180R	1.80	0.0709		2	8.4	38
6120181R	1.81	0.0713		2	8.4	38
6120182R	1.82	0.0717		2	8.4	38
6120183R	1.83	0.0720		2	8.4	38
6120184R	1.84	0.0724		2	8.4	38
6120185R	1.85	0.0728	49	2	8.4	38
6120186R	1.86	0.0732		2	8.4	38
6120187R	1.87	0.0736		2	8.4	38
6120188R	1.88	0.0740		2	8.4	38
6120189R	1.89	0.0744		2	8.4	38
6120190R	1.90	0.0748		2	8.4	38
6120191R	1.91	0.0752		2	8.4	38
6120192R	1.92	0.0756		2	8.4	38
6120193R	1.93	0.0760	48	2	8.4	38
6120194R	1.94	0.0764		2	8.4	38
6120195R	1.95	0.0768		2	8.4	38
6120196R	1.96	0.0772		2	8.4	38
6120197R	1.97	0.0776		2	8.4	38
6120198R	1.98	0.0780	5/64	2	8.4	38
6120199R	1.99	0.0783	47	2	8.4	38
6120200R	2.00	0.0787		3	12	38
6120201R	2.01	0.0791		3	12	38
6120202R	2.02	0.0795		3	12	38
6120203R	2.03	0.0799		3	12	38
6120204R	2.04	0.0803		3	12	38
6120205R	2.05	0.0807		3	12	38
6120206R	2.06	0.0811	46	3	12	38
6120207R	2.07	0.0815		3	12	38
6120208R	2.08	0.0819	45	3	12	38
6120209R	2.09	0.0823		3	12	38
6120210R	2.10	0.0827		3	12	38
6120211R	2.11	0.0831		3	12	38
6120212R	2.12	0.0835		3	12	38

Order Number	D flute dia. (mm)	D dec. equiv. flute dia. (inch)	Wire # Frac	d shank dia. (mm)	l1 flute length (mm)	L overall length OAL (mm)
6120213R	2.13	0.0839		3	12	38
6120214R	2.14	0.0843		3	12	38
6120215R	2.15	0.0846		3	12	38
6120216R	2.16	0.0850		3	12	38
6120217R	2.17	0.0854		3	12	38
6120218R	2.18	0.0858	44	3	12	38
6120219R	2.19	0.0862		3	12	38
6120220R	2.20	0.0866		3	12	38
6120221R	2.21	0.0870		3	12	38
6120222R	2.22	0.0874		3	12	38
6120223R	2.23	0.0878		3	12	38
6120224R	2.24	0.0882		3	12	38
6120225R	2.25	0.0886		3	12	38
6120226R	2.26	0.0890	43	3	12	38
6120227R	2.27	0.0894		3	12	38
6120228R	2.28	0.0898		3	12	38
6120229R	2.29	0.0902		3	12	38
6120230R	2.30	0.0906		3	12	38
6120231R	2.31	0.0909		3	12	38
6120232R	2.32	0.0913		3	12	38
6120233R	2.33	0.0917		3	12	38
6120234R	2.34	0.0921		3	12	38
6120235R	2.35	0.0925		3	12	38
6120236R	2.36	0.0929		3	12	38
6120237R	2.37	0.0933		3	12	38
6120238R	2.38	0.0937	3/32	3	12	38
6120239R	2.39	0.0941		3	12	38
6120240R	2.40	0.0945		3	12	38
6120241R	2.41	0.0949		3	12	38
6120242R	2.42	0.0953		3	12	38
6120243R	2.43	0.0957		3	12	38
6120244R	2.44	0.0961	41	3	12	38
6120245R	2.45	0.0965		3	12	38
6120246R	2.46	0.0969		3	12	38
6120247R	2.47	0.0972		3	12	38
6120248R	2.48	0.0976		3	12	38
6120249R	2.49	0.0980	40	3	12	38
6120250R	2.50	0.0984		3	14	38
6120251R	2.51	0.0988		3	14	38
6120252R	2.52	0.0992		3	14	38
6120253R	2.53	0.0996	39	3	14	38
6120254R	2.54	0.1000		3	14	38
6120255R	2.55	0.1004		3	14	38
6120256R	2.56	0.1008		3	14	38
6120257R	2.57	0.1012		3	14	38
6120258R	2.58	0.1016	38	3	14	38
6120259R	2.59	0.1020		3	14	38

SOLD IN 10 PIECE PACKAGES ONLY

6120 Series Continued

6120 Series Solid Carbide

Drill Sizes 2,60 - 3,00 mm

Order Number	D flute dia. (mm)	D dec. equiv. flute dia. (inch)	Wire # Frac	d shank dia. (mm)	l1 flute length (mm)	L overall length OAL (mm)
6120260R	2.60	0.1024		3	14	38
6120261R	2.61	0.1028		3	14	38
6120262R	2.62	0.1031		3	14	38
6120263R	2.63	0.1035		3	14	38
6120264R	2.64	0.1039	37	3	14	38
6120265R	2.65	0.1043		3	14	38
6120266R	2.66	0.1047		3	14	38
6120267R	2.67	0.1051		3	14	38
6120268R	2.68	0.1055		3	14	38
6120269R	2.69	0.1059		3	14	38
6120270R	2.70	0.1063	36	3	14	38
6120271R	2.71	0.1067		3	14	38
6120272R	2.72	0.1071		3	14	38
6120273R	2.73	0.1075		3	14	38
6120274R	2.74	0.1079		3	14	38
6120275R	2.75	0.1083		3	14	38
6120276R	2.76	0.1087		3	14	38
6120277R	2.77	0.1091		3	14	38
6120278R	2.78	0.1094	7/64	3	14	38
6120279R	2.79	0.1098	35	3	14	38
6120280R	2.80	0.1102		3	14	38

Order Number	D flute dia. (mm)	D dec. equiv. flute dia. (inch)	Wire # Frac	d shank dia. (mm)	l1 flute length (mm)	L overall length OAL (mm)
6120281R	2.81	0.1106		3	14	38
6120282R	2.82	0.1110	34	3	14	38
6120283R	2.83	0.1114		3	14	38
6120284R	2.84	0.1118		3	14	38
6120285R	2.85	0.1122		3	14	38
6120286R	2.86	0.1126		3	14	38
6120287R	2.87	0.1130	33	3	14	38
6120288R	2.88	0.1134		3	14	38
6120289R	2.89	0.1138		3	14	38
6120290R	2.90	0.1142		3	14	38
6120291R	2.91	0.1146		3	14	38
6120292R	2.92	0.1150		3	14	38
6120293R	2.93	0.1154		3	14	38
6120294R	2.94	0.1157		3	14	38
6120295R	2.95	0.1161	32	3	14	38
6120296R	2.96	0.1165		3	14	38
6120297R	2.97	0.1169		3	14	38
6120298R	2.98	0.1173		3	14	38
6120299R	2.99	0.1177		3	14	38
6120300R	3.00	0.1181		3	14	38

SOLD IN 10 PIECE PACKAGES ONLY

Advanced Precision Micro Tool Holders

Extreme Concentricity for Micro Drills TIR < .0002"

- High performance
- Tight tolerance
- Micro parts production

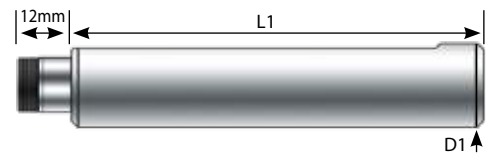

Collet Sleeves

Item No.	Description	D1	L1	OAL
HSP-CHK-127-026	CHK Collet Sleeve 1/2" Shank	.500"	26mm	38mm
HSP-CHK-190-076	CHK Collet Sleeve 3/4" Shank	.750"	76mm	90mm
HSP-CHK-254-121	CHK Collet Sleeve 1" Shank	1.00"	121mm	133mm

Note: Includes Clamping Nut & Wrench

Precision CHK Collets

Item No.	Description
HSP-CHK-1.0	1.0 mm CHK Collet
HSP-CHK-1.5	1.5 mm CHK Collet
HSP-CHK-2.0	2.0 mm CHK Collet
HSP-CHK-2.5	2.5 mm CHK Collet
HSP-CHK-3.0	3.0 mm CHK Collet
HSP-CHK-3.5	3.5 mm CHK Collet



Accessory Components

Item No.	Description
HSP-CHK - NUT	Precision CHK Collet Clamping Nut
HSP-CHK 14 mm	14 mm Flat Wrench

6100 Series

Solid Carbide 5-7 x D – Depth of Cut 120°

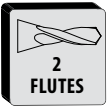
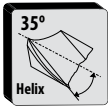
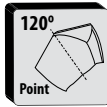

$h6 \begin{matrix} + 0,000 \\ - 0,006 \text{ mm} \end{matrix}$

FOR MEDIUM TO HIGH TENSILE STRENGTH STEEL, STAINLESS, TITANIUM ALLOYS & CAST IRON
ALL ITEMS CAN BE ORDERED AS LEFT HAND AT SAME PRICING
SPECIAL, CUSTOM SPECIFICATION ITEMS AVAILABLE

CUSTOM SPECIFICATIONS SUCH AS:

- Helix angle of 15°, 24°, 30° or other.
- Point Angles of 90°, 110°, 130°, 140° or other.
- Special Diameters as 1,255 mm or other.
- Special Tolerances as +/- 0,001 mm or other.
- Coolant Through Drills at 3 & 4 mm shanks & 1,25 to 3 mm flute diameters.
- Coatings available upon request
- Minimum Special Order is 10 Pieces / Spec.
- Lead-Time on Specials – 3 Weeks ARO.

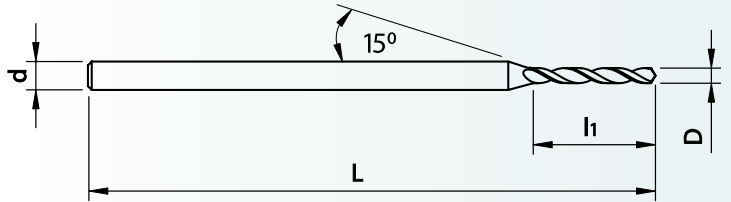

OAL Range 25 - 38 mm

SOLD IN 10 PIECE PACKAGES ONLY

Drill Sizes 0,10 - 0,61 mm

Order Number	D flute dia. (mm)	D dec. equiv. flute dia. (inch)	Wire # Frac	d shank dia. (mm)	fl flute length (mm)	L overall length OAL (mm)
6100010R	0.10	0.0039		1	0.5	25
6100011R	0.11	0.0043		1	0.5	25
6100012R	0.12	0.0047		1	0.5	25
6100013R	0.13	0.0051		1	0.6	25
6100014R	0.14	0.0055		1	0.7	25
6100015R	0.15	0.0059	97	1	1	25
6100016R	0.16	0.0063	96	1	1	25
6100017R	0.17	0.0067	95	1	1	25
6100018R	0.18	0.0071	94	1	1	25
6100019R	0.19	0.0075	93	1	1	25
6100020R	0.20	0.0079	92	1	1.8	25
6100021R	0.21	0.0083	91	1	1.8	25
6100022R	0.22	0.0087	90	1	1.8	25
6100023R	0.23	0.0091	89	1	1.8	25
6100024R	0.24	0.0094	88	1	1.8	25
6100025R	0.25	0.0098		1	2.2	25
6100026R	0.26	0.0102		1	2.2	25
6100027R	0.27	0.0106	86	1	2.2	25
6100028R	0.28	0.0110	85	1	2.2	25
6100029R	0.29	0.0114	84	1	2.2	25
6100030R	0.30	0.0118		1	2.2	25
6100031R	0.31	0.0122		1	2.8	25
6100032R	0.32	0.0126	82	1	2.8	25
6100033R	0.33	0.0130	81	1	2.8	25
6100034R	0.34	0.0134	80	1	2.8	25
6100035R	0.35	0.0138		1	2.8	25

Order Number	D flute dia. (mm)	D dec. equiv. flute dia. (inch)	Wire # Frac	d shank dia. (mm)	fl flute length (mm)	L overall length OAL (mm)
6100036R	0.36	0.0142		1	2.8	25
6100037R	0.37	0.0146	79	1	2.8	25
6100038R	0.38	0.0150		1	2.8	25
6100039R	0.39	0.0154		1	3.6	25
6100040R	0.40	0.0157		1	3.6	25
6100041R	0.41	0.0161	78	1	3.6	25
6100042R	0.42	0.0165		1	3.6	25
6100043R	0.43	0.0169		1	3.6	25
6100044R	0.44	0.0173		1	3.6	25
6100045R	0.45	0.0177		1	3.6	25
6100046R	0.46	0.0181	77	1	3.6	25
6100047R	0.47	0.0185		1	3.6	25
6100048R	0.48	0.0189		1	3.6	25
6100049R	0.49	0.0193		1	4	25
6100050R	0.50	0.0197		1	4	25
6100051R	0.51	0.0201	76	1	4	25
6100052R	0.52	0.0205		1	4	25
6100053R	0.53	0.0209	75	1	4	25
6100054R	0.54	0.0213		1	4	25
6100055R	0.55	0.0217		1	4.5	25
6100056R	0.56	0.0220		1	4.5	25
6100057R	0.57	0.0224	74	1	4.5	25
6100058R	0.58	0.0228		1	4.5	25
6100059R	0.59	0.0232		1	4.5	25
6100060R	0.60	0.0236		1.5	4.5	30
6100061R	0.61	0.0240	73	1.5	5	30

6100 Series Continued

6100 Series Solid Carbide

Drill Sizes 0,62 - 1,53 mm

Order Number	D flute dia. (mm)	D dec. equiv. flute dia. (inch)	Wire # Frac	d shank dia. (mm)	l1 flute length (mm)	L overall length OAL (mm)
6100062R	0.62	0.0244		1.5	5	30
6100063R	0.63	0.0248	72	1.5	5	30
6100064R	0.64	0.0252		1.5	5	30
6100065R	0.65	0.0256		1.5	5	30
6100066R	0.66	0.0260	71	1.5	5	30
6100067R	0.67	0.0264		1.5	5	30
6100068R	0.68	0.0268		1.5	5	30
6100069R	0.69	0.0272		1.5	5.6	30
6100070R	0.70	0.0276		1.5	5.6	30
6100071R	0.71	0.0280	70	1.5	5.6	30
6100072R	0.72	0.0283		1.5	5.6	30
6100073R	0.73	0.0287		1.5	5.6	30
6100074R	0.74	0.0291	69	1.5	5.6	30
6100075R	0.75	0.0295		1.5	5.6	30
6100076R	0.76	0.0299		1.5	6.3	30
6100077R	0.77	0.0303		1.5	6.3	30
6100078R	0.78	0.0307		1.5	6.3	30
6100079R	0.79	0.0311	68 - 1/32	1.5	6.3	30
6100080R	0.80	0.0315		1.5	6.3	30
6100081R	0.81	0.0319	67	1.5	6.3	30
6100082R	0.82	0.0323		1.5	6.3	30
6100083R	0.83	0.0327		1.5	6.3	30
6100084R	0.84	0.0331	66	1.5	6.3	30
6100085R	0.85	0.0335		1.5	6.3	30
6100086R	0.86	0.0339		1.5	7.1	30
6100087R	0.87	0.0343		1.5	7.1	30
6100088R	0.88	0.0346		1.5	7.1	30
6100089R	0.89	0.0350	65	1.5	7.1	30
6100090R	0.90	0.0354		1.5	7.1	30
6100091R	0.91	0.0358	64	1.5	7.1	30
6100092R	0.92	0.0362		1.5	7.1	30
6100093R	0.93	0.0366		1.5	7.1	30
6100094R	0.94	0.0370	63	1.5	7.1	30
6100095R	0.95	0.0374		1.5	7.1	30
6100096R	0.96	0.0378	62	1.5	8	30
6100097R	0.97	0.0382		1.5	8	30
6100098R	0.98	0.0386		1.5	8	30
6100099R	0.99	0.0390	61	1.5	8	30
6100100R	1.00	0.0394		1.5	8	30
6100101R	1.01	0.0398	60	1.5	8	30
6100102R	1.02	0.0402		1.5	8	30
6100103R	1.03	0.0406		1.5	8	30
6100104R	1.04	0.0409	59	1.5	8	30
6100105R	1.05	0.0413		1.5	8	30
6100106R	1.06	0.0417		1.5	9	30
6100107R	1.07	0.0421	58	1.5	9	30

Order Number	D flute dia. (mm)	D dec. equiv. flute dia. (inch)	Wire # Frac	d shank dia. (mm)	l1 flute length (mm)	L overall length OAL (mm)
6100108R	1.08	0.0425		1.5	9	30
6100109R	1.09	0.0429	57	1.5	9	30
6100110R	1.10	0.0433		1.5	9	30
6100111R	1.11	0.0437		1.5	9	30
6100112R	1.12	0.0441		1.5	9	30
6100113R	1.13	0.0445		1.5	9	30
6100114R	1.14	0.0449		1.5	9	30
6100115R	1.15	0.0453		1.5	9	30
6100116R	1.16	0.0457		1.5	10	30
6100117R	1.17	0.0461		1.5	10	30
6100118R	1.18	0.0465	56	1.5	10	30
6100119R	1.19	0.0469	3/64	1.5	10	30
6100120R	1.20	0.0472		1.5	10	30
6100121R	1.21	0.0476		1.5	10	30
6100122R	1.22	0.0480		1.5	10	30
6100123R	1.23	0.0484		1.5	10	30
6100124R	1.24	0.0488		1.5	10	30
6100125R	1.25	0.0492		1.5	10	30
6100126R	1.26	0.0496		1.5	10	30
6100127R	1.27	0.0500		1.5	10	30
6100128R	1.28	0.0504		1.5	10	30
6100129R	1.29	0.0508		1.5	10	30
6100130R	1.30	0.0512		1.5	10	30
6100131R	1.31	0.0516		1.5	11.2	30
6100132R	1.32	0.0520	55	1.5	11.2	30
6100133R	1.33	0.0524		1.5	11.2	30
6100134R	1.34	0.0528		1.5	11.2	30
6100135R	1.35	0.0531		1.5	11.2	30
6100136R	1.36	0.0535		1.5	11.2	30
6100137R	1.37	0.0539		1.5	11.2	30
6100138R	1.38	0.0543		1.5	11.2	30
6100139R	1.39	0.0547		1.5	11.2	30
6100140R	1.40	0.0551	54	1.5	11.2	30
6100141R	1.41	0.0555		1.5	11.2	30
6100142R	1.42	0.0559		1.5	11.2	30
6100143R	1.43	0.0563		1.5	11.2	30
6100144R	1.44	0.0567		1.5	11.2	30
6100145R	1.45	0.0571		1.5	11.2	30
6100146R	1.46	0.0575		1.5	11.2	30
6100147R	1.47	0.0579		1.5	11.2	30
6100148R	1.48	0.0583		1.5	11.2	30
6100149R	1.49	0.0587		1.5	11.2	30
6100150R	1.50	0.0591		2	12	38
6100151R	1.51	0.0594	53	2	12	38
6100152R	1.52	0.0598		2	12	38
6100153R	1.53	0.0602		2	12	38

SOLD IN 10 PIECE PACKAGES ONLY

6100 Series Continued

6100 Series Solid Carbide

Order Number	D flute dia. (mm)	D dec. equiv. flute dia. (inch)	Wire # Frac	d shank dia. (mm)	l1 flute length (mm)	L overall length OAL (mm)
6100154R	1.54	0.0606		2	12	38
6100155R	1.55	0.0610		2	12	38
6100156R	1.56	0.0614		2	12	38
6100157R	1.57	0.0618		2	12	38
6100158R	1.58	0.0622		2	12	38
6100159R	1.59	0.0626	1/16	2	12	38
6100160R	1.60	0.0630		2	12	38
6100161R	1.61	0.0634	52	2	12	38
6100162R	1.62	0.0638		2	12	38
6100163R	1.63	0.0642		2	12	38
6100164R	1.64	0.0646		2	12	38
6100165R	1.65	0.0650		2	12	38
6100166R	1.66	0.0654		2	12	38
6100167R	1.67	0.0657		2	12	38
6100168R	1.68	0.0661		2	12	38
6100169R	1.69	0.0665		2	12	38
6100170R	1.70	0.0669	51	2	12	38
6100171R	1.71	0.0673		2	12	38
6100172R	1.72	0.0677		2	12	38
6100173R	1.73	0.0681		2	12	38
6100174R	1.74	0.0685		2	12	38
6100175R	1.75	0.0689		2	12	38
6100176R	1.76	0.0693		2	12	38

SOLD IN 10 PIECE PACKAGES ONLY

Drill Sizes 1,54 - 1,99 mm

Order Number	D flute dia. (mm)	D dec. equiv. flute dia. (inch)	Wire # Frac	d shank dia. (mm)	l1 flute length (mm)	L overall length OAL (mm)
6100177R	1.77	0.0697		2	12	38
6100178R	1.78	0.0701	50	2	12	38
6100179R	1.79	0.0705		2	12	38
6100180R	1.80	0.0709		2	12	38
6100181R	1.81	0.0713		2	12	38
6100182R	1.82	0.0717		2	12	38
6100183R	1.83	0.0720		2	12	38
6100184R	1.84	0.0724		2	12	38
6100185R	1.85	0.0728	49	2	12	38
6100186R	1.86	0.0732		2	12	38
6100187R	1.87	0.0736		2	12	38
6100188R	1.88	0.0740		2	12	38
6100189R	1.89	0.0744		2	12	38
6100190R	1.90	0.0748		2	12	38
6100191R	1.91	0.0752		2	12	38
6100192R	1.92	0.0756		2	12	38
6100193R	1.93	0.0760	48	2	12	38
6100194R	1.94	0.0764		2	12	38
6100195R	1.95	0.0768		2	12	38
6100196R	1.96	0.0772		2	12	38
6100197R	1.97	0.0776		2	12	38
6100198R	1.98	0.0780	5/64	2	12	38
6100199R	1.99	0.0783	47	2	12	38

*For drill sizes 2,00 mm and larger
See our 6120 and 6200 Series*

6100 Series Solid Carbide



- For medium to high tensile strength Steel, Stainless, Titanium Alloys and Cast Iron
- Amazing dimension control at h6, h4 & h3 tolerances
- Ultra-fine surface finish for smooth operation
- Micro Grain Carbide with 10% Cobalt Content for outstanding performance & long tool life
- Coatings available upon request

6200 HP Series



Solid Carbide 6-7 x D - Depth of Cut

h4 Tolerance
HIGH PERFORMANCE!
 Reinforced Shank d 3,0 mm

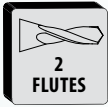
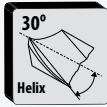
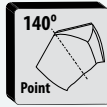

h4 + 0,000
 - 0,003 mm

HIGH PERFORMANCE DRILL, WIDE RANGE APPLICATIONS, STEELS, CAST IRON & NON-FERROUS METALS
ALL ITEMS CAN BE ORDERED AS LEFT HAND AT SAME PRICING
SPECIAL, CUSTOM SPECIFICATION ITEMS AVAILABLE

CUSTOM SPECIFICATIONS SUCH AS:

- Helix angle of 15°, 24°, 35° or other.
- Point Angles of 90°, 110°, 120°, 130° or other.
- Special Diameters as 0,92 mm or other.
- Special Tolerances as +/- 0,001 mm or other.
- Coolant Through Drills at 3 & 4 mm shanks & 1,25 to 3 mm flute diameters.
- Coatings available upon request.
- Minimum Special Order is 10 Pieces.
- Lead-Time on Specials – 3 Weeks ARO.

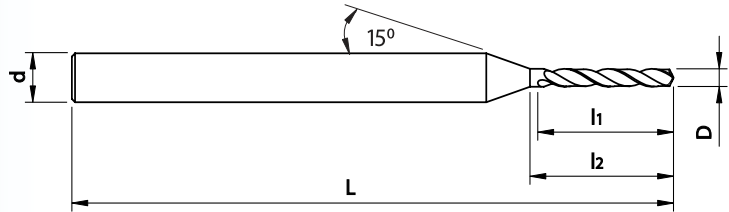

OAL 50 mm

Drill Sizes 0,50 - 3,00 mm

Order Number	D flute dia. (mm)	D dec. equiv. flute dia. (inch)	Wire #	d shank dia. (mm)	l1 flute length (mm)	l2 Dlength (mm)	L overall length OAL (mm)
6200050R	0.50	0.0197		3	3.5	4.4	50
6200055R	0.55	0.0217		3	4	5	50
6200060R	0.60	0.0236		3	4.5	5.6	50
6200065R	0.65	0.0256		3	5	6.3	50
6200070R	0.70	0.0276		3	5	6.3	50
6200075R	0.75	0.0295		3	5.5	6.9	50
6200080R	0.80	0.0315		3	5.6	7.2	50
6200085R	0.85	0.0335		3	6	7.6	50
6200090R	0.90	0.0354		3	6.5	8.1	50
6200095R	0.95	0.0374		3	6.7	8.5	50
6200100R	1.00	0.0394		3	7	8.8	50
6200105R	1.05	0.0413		3	7.5	9.4	50
6200110R	1.10	0.0433		3	8	10.1	50
6200115R	1.15	0.0453		3	8.1	10.4	50
6200120R	1.20	0.0472		3	8.5	11	50
6200125R	1.25	0.0492		3	8.9	11.3	50
6200130R	1.30	0.0512		3	9.2	11.7	50
6200135R	1.35	0.0531		3	9.6	12.2	50
6200140R	1.40	0.0551	54	3	10	12.5	50
6200145R	1.45	0.0571		3	10.5	13	50
6200150R	1.50	0.0591		3	10.5	13	50
6200155R	1.55	0.0610		3	11	13.5	50
6200160R	1.60	0.0630		3	11.5	14	50
6200165R	1.65	0.0650		3	12	15	50
6200170R	1.70	0.0669	51	3	12	15	50
6200175R	1.75	0.0689		3	12.5	15.5	50

Order Number	D flute dia. (mm)	D dec. equiv. flute dia. (inch)	Wire #	d shank dia. (mm)	l1 flute length (mm)	l2 Dlength (mm)	L overall length OAL (mm)
6200180R	1.80	0.0709		3	13	16	50
6200185R	1.85	0.0728	49	3	13	16	50
6200190R	1.90	0.0748		3	13.5	17.5	50
6200195R	1.95	0.0768		3	14	18	50
6200200R	2.00	0.0787		3	14	18	50
6200205R	2.05	0.0807		3	14.5	18.5	50
6200210R	2.10	0.0827		3	15	19	50
6200215R	2.15	0.0846		3	15	19	50
6200220R	2.20	0.0866		3	16	20	50
6200225R	2.25	0.0886		3	16	20	50
6200230R	2.30	0.0906		3	16.5	21	50
6200235R	2.35	0.0925		3	16.5	21	50
6200240R	2.40	0.0945		3	17	22	50
6200245R	2.45	0.0965		3	17.5	22.5	50
6200250R	2.50	0.0984		3	18	23	50
6200255R	2.55	0.1004		3	18	23	50
6200260R	2.60	0.1024		3	18.5	23.5	50
6200265R	2.65	0.1043		3	18.5	23.5	50
6200270R	2.70	0.1063	36	3	19	24	50
6200275R	2.75	0.1083		3	19	24	50
6200280R	2.80	0.1102		3	20	25	50
6200285R	2.85	0.1122		3	20	25	50
6200290R	2.90	0.1142		3	21	26	50
6200295R	2.95	0.1161	32	3	21	26	50
6200300R	3.00	0.1181		3	21	26	50

SOLD IN 10 PIECE PACKAGES ONLY

6220 HP Series

3mm Shank Tools



Solid Carbide 12 x D – Depth of Cut

h5 Tolerance

HIGH PERFORMANCE!

Reinforced Shank d 3,0 mm

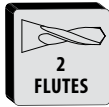
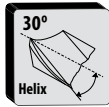
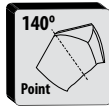

h5 + 0,000
- 0,004 mm

HIGH PERFORMANCE DRILL WITH REINFORCED SHANK AT 3,00mm
SPOT/CENTER DRILL RECOMMENDED FOR BETTER HOLE STRAIGHTNESS - WITH 6140 SERIES
FOR SOFT, MEDIUM & TENSILE STRENGTH STEELS, STAINLESS, TITANIUM, ALLOYS & CAST IRON
HIGH PERFORMANCE WITH OUTSTANDING SURFACE FINISHES WITH STRONG CORE - NO DEVIATION
ALL ITEMS CAN BE QUOTED AS LEFT HAND CUT - CONTACT US

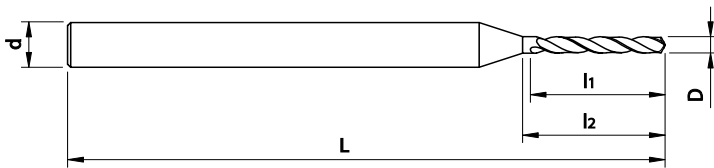

OAL Range 50 - 60 mm

CUSTOM SPECIFICATIONS SUCH AS:

- Size range from 0,5mm to 2,00mm in increments of 0,05mm.
- Intermediate sizes upon request.
- Special sizes, Point Angles and Tolerances available.
- Minimum Special Order is 10 Pieces.
- Lead-Time on Specials is 3-4 Weeks ARO

Drill Sizes 0,50 - 2,00 mm

Order Number	D flute dia. (mm)	D dec. equiv. flute dia. (inch)	Wire #	d shank dia. (mm)	l1 flute length (mm)	l2 Dlength (mm)	L overall length OAL (mm)
6220050R	0.50	0.0197		3.00	6	7.2	50
6220055R	0.55	0.0217		3.00	6.6	7.9	50
6220060R	0.60	0.0236		3.00	7.2	8.6	50
6220065R	0.65	0.0256		3.00	7.8	9.4	50
6220070R	0.70	0.0276		3.00	8.4	10.1	50
6220075R	0.75	0.0295		3.00	9	10.8	50
6220080R	0.80	0.0315		3.00	9.6	11.5	50
6220085R	0.85	0.0335		3.00	10.2	12.2	50
6220090R	0.90	0.0354		3.00	10.8	13.0	50
6220095R	0.95	0.0374		3.00	11.4	13.7	50
6220100R	1.00	0.0394		3.00	12	14.4	50
6220105R	1.05	0.0413		3.00	12.6	15.1	50
6220110R	1.10	0.0433		3.00	13.2	15.8	50
6220115R	1.15	0.0453		3.00	13.8	16.6	50
6220120R	1.20	0.0472		3.00	14.4	17.3	50
6220125R	1.25	0.0492		3.00	15	18.0	50

Order Number	D flute dia. (mm)	D dec. equiv. flute dia. (inch)	Wire #	d shank dia. (mm)	l1 flute length (mm)	l2 Dlength (mm)	L overall length OAL (mm)
6220130R	1.30	0.0512		3.00	15.6	18.7	50
6220135R	1.35	0.0531		3.00	16.2	19.4	50
6220140R	1.40	0.0551	54	3.00	16.8	20.2	50
6220145R	1.45	0.0571		3.00	17.4	20.9	50
6220150R	1.50	0.0591		3.00	18	21.6	50
6220155R	1.55	0.0610		3.00	18.6	22.3	60
6220160R	1.60	0.0630		3.00	19.2	23.0	60
6220165R	1.65	0.0650		3.00	19.8	23.8	60
6220170R	1.70	0.0669	51	3.00	20.4	24.5	60
6220175R	1.75	0.0689		3.00	21	25.2	60
6220180R	1.80	0.0709		3.00	21.6	25.9	60
6220185R	1.85	0.0728	49	3.00	22.2	26.6	60
6220190R	1.90	0.0748		3.00	22.8	27.4	60
6220195R	1.95	0.0768		3.00	23.4	28.1	60
6220200R	2.00	0.0787		3.00	24	28.8	60

SOLD IN 10 PIECE PACKAGES ONLY

6230 CT Series *3mm Shank Tools*

Coolant-Thru 15 x D - Depth of Cut

h5 Tolerance
2-Flutes Drill with
2 Helicoidal Internal Holes

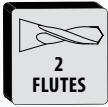
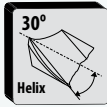
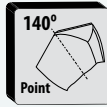

h5 + 0,000
- 0,004 mm



HIGH PERFORMANCE-COOLANT-THRU MICRO DRILLS WITH A STRONG WEB FOR MAXIMUM ALIGNMENT & ACCURACY. COOLANT-THRU TO OPTIMIZE LUBRICATION, CHIP REMOVAL & COOLING. IDEAL FOR A WIDE RANGE OF APPLICATIONS, MEDIUM & HIGH TENSILE STRENGTH STEELS, STAINLESS STEEL, TITANIUM-ALLOYS, CAST IRON. STANDARD SIZES IN 0,05MM INCREMENTS, BUT INTERMEDIATE SIZES UPON REQUEST.

CUSTOM SPECIFICATIONS SUCH AS:

- Point Angles of 90°, 110°, 120°, 130° or other.
- Special Diameters as 2,03 mm or other.
- Special Tolerances as +/- 0,001 mm or other.
- Coolant Through Drills at 3 & 4 mm shanks & 1,50 to 3 mm flute diameters.
- Minimum Special Order is 10 Pieces.
- Lead-Time on Specials – 4 Weeks ARO/6 Weeks for Coated.

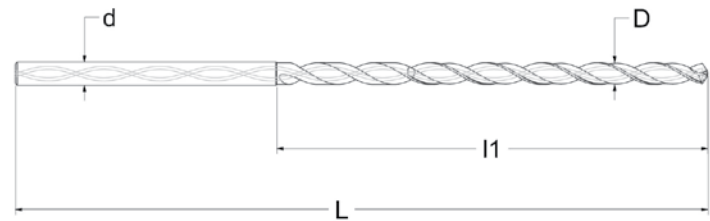

OAL 70 - 90 mm



Drill Sizes 2,05 - 3,00 mm

Order Number	Coating TiAlN order # with "RC" suffix	D flute dia. (mm)	D dec. equiv. flute dia. (inch)	Wire # Frac	d shank dia. (mm)	l1 flute length (mm)	L overall Dlength OAL (mm)
6230205R	6230205RC	2.05	0.0807		3.00	34	70
6230210R	6230210RC	2.10	0.0827		3.00	34	70
6230215R	6230215RC	2.15	0.0846		3.00	36	70
6230220R	6230220RC	2.20	0.0866		3.00	36	70
6230225R	6230225RC	2.25	0.0886		3.00	38	70
6230230R	6230230RC	2.30	0.0906		3.00	38	70
6230235R	6230235RC	2.35	0.0925		3.00	40	70
6230240R	6230240RC	2.40	0.0945		3.00	40	70
6230245R	6230245RC	2.45	0.0965		3.00	42	70
6230250R	6230250RC	2.50	0.0984		3.00	42	70
6230255R	6230255RC	2.55	0.1004		3.00	44	90
6230260R	6230260RC	2.60	0.1024		3.00	44	90
6230265R	6230265RC	2.65	0.1043		3.00	46	90
6230270R	6230270RC	2.70	0.1063		3.00	46	90
6230275R	6230275RC	2.75	0.1083	36	3.00	48	90
6230280R	6230280RC	2.80	0.1102		3.00	48	90
6230285R	6230285RC	2.85	0.1122		3.00	50	90
6230290R	6230290RC	2.90	0.1142		3.00	50	90
6230295R	6230295RC	2.95	0.1161	32	3.00	50	90
6230300R	6230300RC	3.00	0.1181		3.00	50	90

All 6230 Series Drills Sold in Single Unit Packages

FEATURES:

- For holes with depth 15 x diameter.
- Solid Tungsten Carbide Sub-micro grain with 2 helicoidal holes.
- Right-cut, point geometry for self-centering
- Standard sizes in increments of 0,05mm.
- Other diameters and lengths on request.
- Available uncoated or TiAlN coated.

BENEFITS:

- Higher drilling speed and longer tool life.
- Suitable for specific materials.
- High precision with h5 tolerances.
- Strong, no deviation, maximum alignment accuracy.
- Optimum cooling, lubrication and chip removal.
- **All 6230 Series Drills Sold in Single Unit Packages!**

1100 Series

Solid Carbide Half Round Gun Drills 10 x Depth of Cut



h5 Tolerance
h5 + 0,000
- 0,004 mm

DIRECT DRILLING, NO CENTERING REQUIRED, GOOD CHIP EVACUATION, HIGH PERFORMANCE IN BRASS CONNECTORS FOR SOFT MATERIALS, BRASS, COPPER, GOLD, SILVER & STAINLESS, TITANIUM ALLOYS
SINGLE LIP HALF ROUND FOR OUTSTANDING COOLANT FLOW & FINE SURFACE FINISHES
ALL ITEMS CAN BE ORDERED AS LEFT HAND CUT AT SAME PRICING
SPECIAL, CUSTOM SPECIFICATION ITEMS AVAILABLE

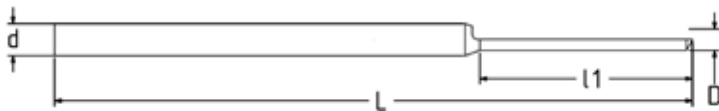

OAL Range 30 - 38 - 50 mm

CUSTOM SPECIFICATIONS SUCH AS:

- Size range from 0,20mm to 3,00mm in increments of 0,05mm.
- Intermediate sizes upon request.
- Special sizes and tolerances available.
- Minimum Special Order is 10 Pieces.
- Lead-Time on Specials is 3-4 Weeks ARO.

Drill Sizes 0,20 - 3,00 mm

Order Number	D flute dia. (mm)	D dec. equiv. flute dia. (inch)	Wire #	d shank dia. (mm)	l1 flute length (mm)	L overall length OAL (mm)
1100020R	0.20	0.0079		1.50	2.00	30
1100025R	0.25	0.0098		1.50	2.50	30
1100030R	0.30	0.0118		1.50	3.00	30
1100035R	0.35	0.0138		1.50	3.50	30
1100040R	0.40	0.0157		1.50	4.00	30
1100045R	0.45	0.0177		1.50	4.50	30
1100050R	0.50	0.0197		1.50	5.00	30
1100055R	0.55	0.0217		1.50	5.50	30
1100060R	0.60	0.0236		1.50	6.00	30
1100065R	0.65	0.0256		1.50	6.50	30
1100070R	0.70	0.0276		1.50	7.00	30
1100075R	0.75	0.0295		1.50	7.50	30
1100080R	0.80	0.0315		1.50	8.00	30
1100085R	0.85	0.0335		1.50	8.50	30
1100090R	0.90	0.0354		1.50	9.00	30
1100095R	0.95	0.0374		1.50	9.50	30
1100100R	1.00	0.0394		1.50	10.00	30
1100105R	1.05	0.0413		1.50	10.50	30
1100110R	1.10	0.0433		1.50	11.00	30
1100115R	1.15	0.0453		1.50	11.50	30
1100120R	1.20	0.0472		1.50	12.00	30
1100125R	1.25	0.0492		1.50	12.50	30
1100130R	1.30	0.0512		1.50	13.00	30
1100135R	1.35	0.0531		1.50	13.50	30

Order Number	D flute dia. (mm)	D dec. equiv. flute dia. (inch)	Wire #	d shank dia. (mm)	l1 flute length (mm)	L overall length OAL (mm)
1100140R	1.40	0.0551	54	1.50	14.00	30
1100145R	1.45	0.0571		1.50	14.50	30
1100150R	1.50	0.0591		2.00	15.00	38
1100155R	1.55	0.0610		2.00	15.5	38
1100160R	1.60	0.0630		2.00	16.00	38
1100165R	1.65	0.0650		2.00	16.50	38
1100170R	1.70	0.0669	51	2.00	17.00	38
1100175R	1.75	0.0689		2.00	17.50	38
1100180R	1.80	0.0709		2.00	18.00	38
1100185R	1.85	0.0728	49	2.00	18.50	38
1100190R	1.90	0.0748		2.00	19.00	38
1100195R	1.95	0.0768		2.00	19.50	38
1100200R	2.00	0.0787		3.00	20.00	50
1100210R	2.10	0.0827		3.00	21.00	50
1100220R	2.20	0.0866		3.00	22.00	50
1100230R	2.30	0.0906		3.00	23.00	50
1100240R	2.40	0.0945		3.00	24.00	50
1100250R	2.50	0.0984		3.00	25.00	50
1100260R	2.60	0.1024		3.00	26.00	50
1100270R	2.70	0.1063	36	3.00	27.00	50
1100280R	2.80	0.1102		3.00	28.00	50
1100290R	2.90	0.1142		3.00	29.00	50
1100300R	3.00	0.1181		3.00	30.00	50

3100 Series Short



Solid Carbide 3 Flute SHORT Cross Drills

h5 Tolerance
Reinforced Shank d 3,0 mm

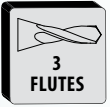
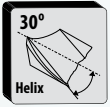
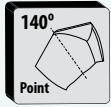

h5 + 0,000
- 0,004 mm

HIGH PERFORMANCE DRILL, 3-FLUTES FOR DRILLING & REAMING IN ONE OPERATION
FOR SOFT, MEDIUM & TENSILE STRENGTH STEELS, STAINLESS, TITANIUM, ALLOYS & CAST IRON
GOOD FOR TRANSVERSAL DRILLING WITH NO BURRS INSIDE CUT & STRONG WEB WITH NO DEVIATION
SPECIAL, CUSTOM SPECIFICATION ITEMS AVAILABLE

CUSTOM SPECIFICATIONS SUCH AS:

- Only available in right hand cut.
- Size range from 0,5mm to 3,00mm in increments of 0,05 or 0,10mm.
- Intermediate sizes upon request.
- Special sizes and tolerances available.
- Minimum Special Order is 10 Pieces.
- Lead-Time on Specials is 3-4 Weeks ARO

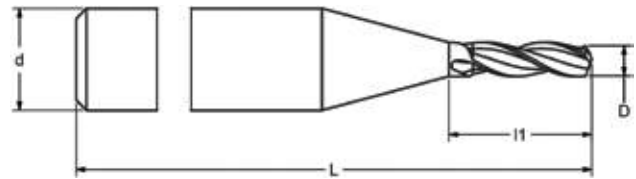

OAL 30 mm

Drill Sizes 0,50 - 1,50 mm

Order Number	D flute dia. (mm)	D dec. equiv. flute dia. (inch)	Wire #	d shank dia. (mm)	l1 flute length (mm)	L overall length OAL (mm)
3100050R	0.50	0.0197		3	3.00	30
3100055R	0.55	0.0217		3	3.00	30
3100060R	0.60	0.0236		3	3.00	30
3100065R	0.65	0.0256		3	3.00	30
3100070R	0.70	0.0276		3	3.00	30
3100075R	0.75	0.0295		3	3.50	30
3100080R	0.80	0.0315		3	3.50	30
3100085R	0.85	0.0335		3	3.50	30
3100090R	0.90	0.0354		3	3.50	30
3100095R	0.95	0.0374		3	3.50	30
3100100R	1.00	0.0394		3	3.50	30

Order Number	D flute dia. (mm)	D dec. equiv. flute dia. (inch)	Wire #	d shank dia. (mm)	l1 flute length (mm)	L overall length OAL (mm)
3100105R	1.05	0.0413		3	4.00	30
3100110R	1.10	0.0433		3	4.00	30
3100115R	1.15	0.0453		3	4.00	30
3100120R	1.20	0.0472		3	4.00	30
3100125R	1.25	0.0492		3	4.00	30
3100130R	1.30	0.0512		3	5.00	30
3100135R	1.35	0.0531		3	5.00	30
3100140R	1.40	0.0551	54	3	5.00	30
3100145R	1.45	0.0571		3	5.00	30
3100150R	1.50	0.0591		3	5.00	30

SOLD IN 10 PIECE PACKAGES ONLY

3200 Series Long Solid Carbide 3 Flute LONG Reamer Drills

h5 Tolerance
Reinforced Shank d 3,0 mm

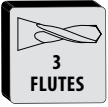
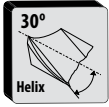
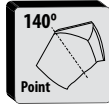

h5 + 0,000
- 0,004 mm

HIGH PERFORMANCE DRILL, 3-FLUTES FOR DRILLING & REAMING IN ONE OPERATION FOR SOFT, MEDIUM & TENSILE STRENGTH STEELS, STAINLESS, TITANIUM, ALLOYS & CAST IRON GOOD FOR TRANSVERSAL DRILLING WITH NO BURRS INSIDE CUT & STRONG WEB WITH NO DEVIATION SPECIAL, CUSTOM SPECIFICATION ITEMS AVAILABLE

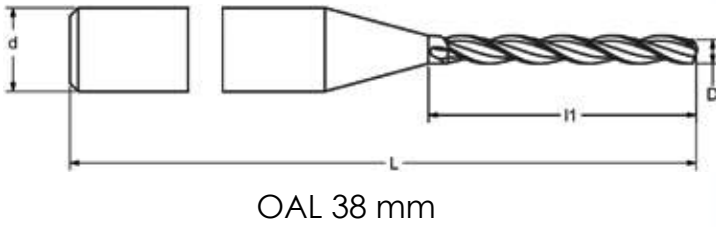

CUSTOM SPECIFICATIONS SUCH AS:

- Only available in right hand cut.
- Size range from 0,5mm to 3,00mm in increments of 0,05 or 0,10mm.
- Intermediate sizes upon request.
- Special sizes and tolerances available.
- Minimum Special Order is 10 Pieces.
- Lead-Time on Specials is 3-4 Weeks ARO.

Drill Sizes 0,50 - 3,00 mm

Order Number	D flute dia. (mm)	D dec. equiv. flute dia. (inch)	Wire #	d shank dia. (mm)	l1 flute length (mm)	L overall length OAL (mm)
3200050R	0.50	0.0197		3	6.00	38
3200055R	0.55	0.0217		3	7.00	38
3200060R	0.60	0.0236		3	7.00	38
3200065R	0.65	0.0256		3	7.00	38
3200070R	0.70	0.0276		3	9.50	38
3200075R	0.75	0.0295		3	9.50	38
3200080R	0.80	0.0315		3	9.50	38
3200085R	0.85	0.0335		3	9.50	38
3200090R	0.90	0.0354		3	9.50	38
3200095R	0.95	0.0374		3	9.50	38
3200100R	1.00	0.0394		3	9.50	38
3200105R	1.05	0.0413		3	10.50	38
3200110R	1.10	0.0433		3	10.50	38
3200115R	1.15	0.0453		3	10.50	38
3200120R	1.20	0.0472		3	10.50	38
3200125R	1.25	0.0492		3	10.50	38
3200130R	1.30	0.0512		3	10.50	38
3200135R	1.35	0.0531		3	10.50	38

Order Number	D flute dia. (mm)	D dec. equiv. flute dia. (inch)	Wire #	d shank dia. (mm)	l1 flute length (mm)	L overall length OAL (mm)
3200140R	1.40	0.0551	54	3	10.50	38
3200145R	1.45	0.0571		3	10.50	38
3200150R	1.50	0.0591		3	10.50	38
3200160R	1.60	0.0630		3	12.00	38
3200170R	1.70	0.0669	51	3	12.00	38
3200180R	1.80	0.0709		3	12.00	38
3200190R	1.90	0.0748		3	12.00	38
3200200R	2.00	0.0787		3	12.00	38
3200210R	2.10	0.0827		3	14.00	38
3200220R	2.20	0.0866		3	14.00	38
3200230R	2.30	0.0906		3	14.00	38
3200240R	2.40	0.0945		3	14.00	38
3200250R	2.50	0.0984		3	14.00	38
3200260R	2.60	0.1024		3	16.00	38
3200270R	2.70	0.1063	36	3	16.00	38
3200280R	2.80	0.1102		3	16.00	38
3200290R	2.90	0.1142		3	16.00	38
3200300R	3.00	0.1181		3	16.00	38

SOLD IN 10 PIECE PACKAGES ONLY

SPEEDS & FEEDS CHART

Cutting Speed - RPM = SFM X 97 / Drill Dia.

Feed Rate - IPM = RPM X IPR

Guidelines - Not Guaranteed

MATERIAL	DIAMETER (mm)	SPEED (SFM)	FEED RATE (IPR)
MILD & LOW CARBON STEELS	.10 - .50	40 - 80	.0002 - .0003
	.51 - .70	80 - 140	.0003 - .0004
	.71 - .99	140 - 200	.0004 - .0006
	1.00 - 2.00	140 - 200	.0006 - .0016
	2.01 - 3.00	140 - 200	.0016 - .0020
HIGH CARBON, ALLOY STEELS	.10 - .50	30 - 70	.0002 - .0003
	.51 - .70	70 - 100	.0002 - .0004
	.71 - .99	70 - 100	.0004 - .0006
	1.00 - 2.00	100 - 170	.0006 - .0016
	2.01 - 3.00	100 - 170	.0014 - .0020
STAINLESS STEELS - 300 SERIES, 17-4	.10 - .50	20 - 40	.0001 - .0002
	.51 - .70	40 - 70	.0002 - .0003
	.71 - .99	70 - 120	.0002 - .0003
	1.00 - 2.00	70 - 120	.0003 - .0010
	2.01 - 3.00	70 - 120	.0008 - .0014
STAINLESS STEELS - 400 SERIES	.10 - .50	30 - 60	.0001 - .0002
	.51 - .70	60 - 90	.0002 - .0003
	.71 - .99	90 - 140	.0003 - .0004
	1.00 - 2.00	90 - 140	.0004 - .0012
	2.01 - 3.00	90 - 140	.0010 - .0018
CAST IRON	.10 - .50	70 - 160	.0002 - .0003
	.51 - .70	160 - 200	.0003 - .0004
	.71 - .99	200 - 340	.0004 - .0008
	1.00 - 2.00	200 - 340	.0008 - .0020
	2.01 - 3.00	200 - 340	.0016 - .0026
DUCTILE IRON	.10 - .50	60 - 100	.0001 - .0002
	.51 - .70	100 - 140	.0002 - .0003
	.71 - .99	140 - 270	.0003 - .0006
	1.00 - 2.00	140 - 270	.0006 - .0016
	2.01 - 3.00	140 - 270	.0014 - .0024
ALUMINUM	.10 - .50	80 - 170	.0002 - .0003
	.51 - .70	170 - 270	.0003 - .0005
	.71 - .99	270 - 400	.0005 - .0008
	1.00 - 2.00	270 - 400	.0008 - .0024
	2.01 - 3.00	270 - 400	.0020 - .0031
HIGH ALLOYS - INCONEL, TITANIUM	.10 - .50	30 - 70	.0001 - .0002
	.51 - .70	70 - 100	.0002 - .0003
	.71 - .99	100 - 170	.0003 - .0004
	1.00 - 2.00	100 - 170	.0004 - .0012
	2.01 - 3.00	100 - 170	.0010 - .0018

REQUEST FOR QUOTATION FORM

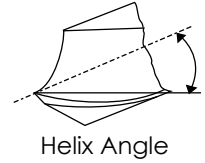
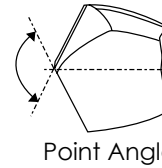
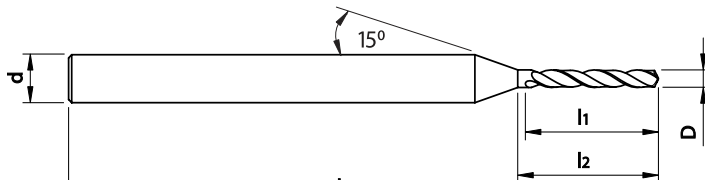

CUSTOM SPECIFICATIONS:

- | | |
|------------------------------|---|
| _____ Right or Left Cutting | _____ Helix Angle of 15°, 24°, 35° or other. |
| _____ "D" flute diameter | _____ Point Angles of 90°, 110°, 120°, 130° or other. |
| _____ "d" shank diameter | _____ Special Diameters as 0.92 mm or other. |
| _____ "l1" flute length | _____ Special Tolerances as +/- 0.001 mm or other. |
| _____ "L" overall length OAL | _____ Coolant Through Drills at 3 & 4 mm shanks & 1.25 to 3 mm flute diameters. |
| _____ Special Coating | |

Please check one:

- Solid Carbide HSS-E Cobalt %

**Supply Tool Print/Drawing if Possible • Minimum Special Order is 10 Pieces / per Specification
Lead-Time on Specials – 3 Weeks ARO • SOLD IN 10 PIECE PACKAGES ONLY**

Date: _____

Name: _____

Title: _____

Company Name: _____

Street Address: _____

Address-line 2: _____

City: _____ State: _____ Zip: _____

Telephone: _____ Fax: _____

E-mail: _____ Country: _____

GMauvaisUSA™
MICRO Drills

www.hassay-savage.com

TEL 413.863.5152 • 24 Hour FAX 413.863.2714 • info@hassay-savage.com



GMauvaisUSA™
A HASSAY SAVAGE COMPANY



Notes



magafor

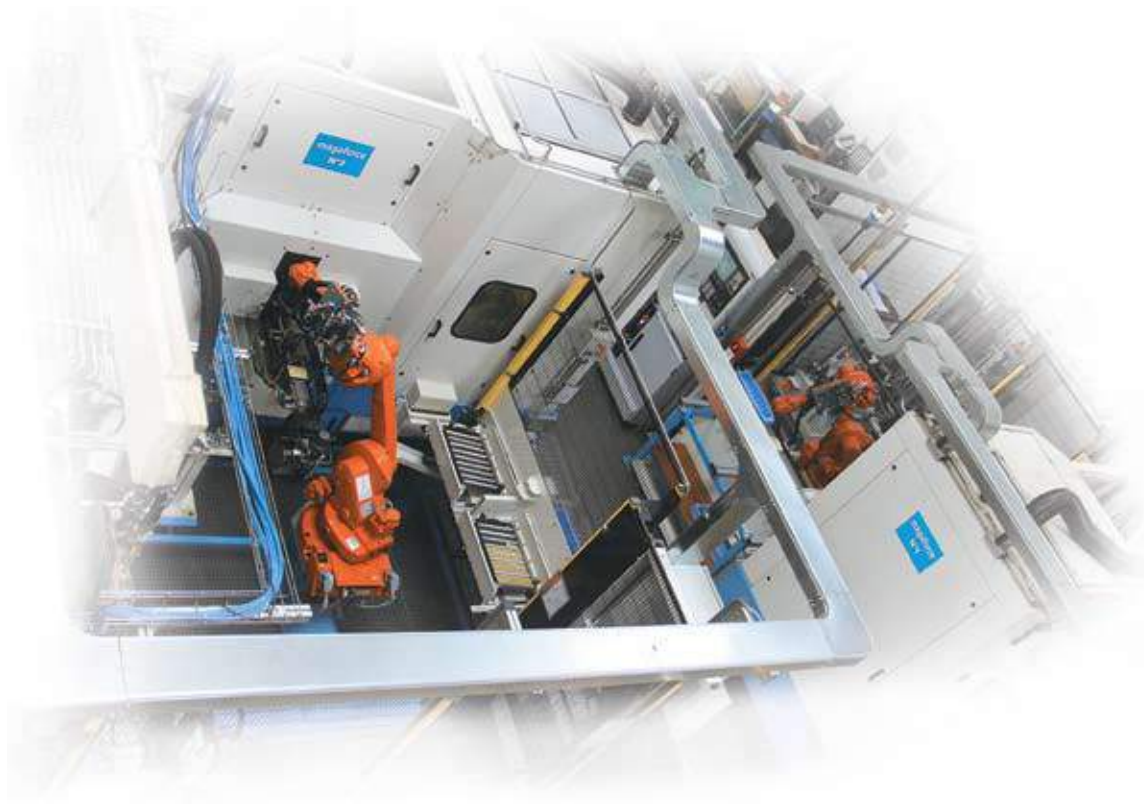

2017-2018

magafor



PERFORMANCE
PRECISION
SPECIALIZATION

magafor

Since 1937

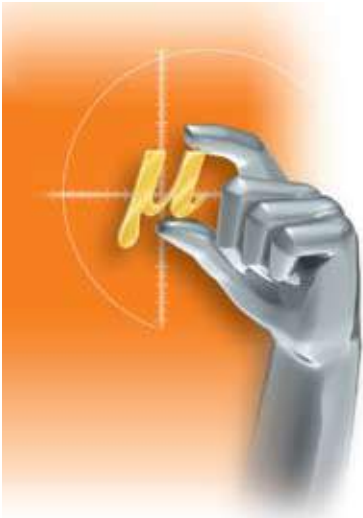

Magafor is the recognized world leader in the production of precision tools.

2001, Magafor teams with Hassay Savage Company, renowned broach manufacturer located in Massachusetts since 1969. Both companies now provide the finest tooling through established industry channels. Industrial distributors, with the support of our nationwide technical agents and stocking locations, provide consummate service to manufacturers throughout the United States.



Hassay Savage Company

Manufacturers of Precision Tools

US INVENTORY & TECHNICAL SUPPORT

At magafor we take pride in supplying the highest quality products, making them accessible, and providing exceptional customer service. We achieve our high goals in these areas with the following :

- US Warehouses on East Coast and West Coast

★ **Turners Falls, MA**

★ **Los Angeles, CA**

- 100-% US availability through local distribution in your area.

- Technical Factory Agents - **See page 4.**

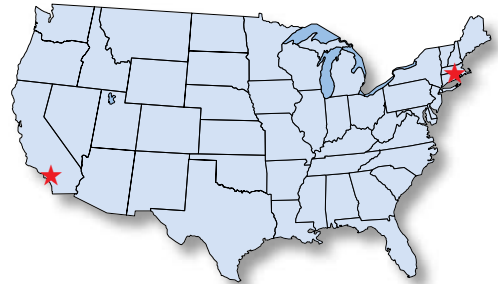

TRIAL/TEST STANDARD TOOLS FREE!!!

*We offer the most liberal trial program in the industry... We will provide you with **FREE** test tools upon your request. We are so confident that we will show you performance improvements and cost reduction that this allows us to do this free of charge.*

BLANKET ORDERS

Please know that we accept and encourage blanket orders on standard stock items, standard non-stock items, and special items. We will ensure continuous delivery with large safety stock levels at all times. We will also stock standard non-stock items in the US with an estimated usage report.

SPECIALS

magafor excels in manufacturing special tooling, and we are confident in our ability to show cost savings in most applications.

Table of Contents

Sales Representatives & US Warehouse Locations 4
 Product Series Index and Program Summary 68-69

CENTERING – SPOTTING – COMBINED MACHINING

Plain Type 60° HSS & Cobalt Center Drills 70
 ASA Carbide 60°, 82° - 90° HSS Long Center Drills..... 71
 Radius Type HSS Center Drills 72
 Bell Type HSS Center Drills 72
 Unique Bulge Style HSS Center Drills 73
 HSS, Cobalt & Carbide Metric Center Drills 74-75
 Speeds & Feeds for Center Drills & NC Spot Drills 76
 M2 HSS Short & Long NC Spotting Drills 90°, 118° & 120° 77
 Cobalt NC Spot Drills 60°, 90° & 120° and **Red'X Coated** 78
 Long Series Cobalt & Carbide NC Spot Drills 90° & 120° 78
 Carbide NC & Micro Spotting Drills 90°, 120° & 140°/ Multi-V 90° 79
 Duo-Mag = 2 Single End NC Spot Drills 80

MULTI-FUNCTION TOOLS

Micro & Multi-Function Tools "Multi-V" Carbide 40° & 60° 82
 Multi-V Carbide 90°, 100° & 120° 83
 Speeds & Feeds for Multi-V 84
 Bi-Face Chamfering Biconical Cutters 85
 Miniature Round Corner Carbide End-Mills 86

COUNTERSINKING

Countersinking & Deburring Information 87
 Metric Three Flute Countersinks Cobalt 30°, 60°, 82°, 100° & 120° 88
 Trident Hand Countersinks and Universal Auto-Lock Chuck Handles 88
 Trident Three Flute Countersinks Cobalt 90° 89
 Metric Three Flute Countersinks 90° Cobalt & Carbide – Long Series 90
 Zero Flute Deburring Tool With Hole HSS-E Cobalt 91
 Single Flute Chamfering Cutters Cobalt 92-93
 Speeds & Feeds for Deburring, Chamfering & Three Flute Countersinks... 94
 Spotweld Drills Short & Long Series Cobalt & Carbide 95

HIGH PRECISION MICRO & MINIATURE REAMERS

Reamer Information Page 96
 Reamer with Coolant for Blind Holes 97
 Carbide Micro-Reamers 98
 Carbide Miniature Reamers 99-105
 Ultra Precision Floating Reamer Holders 105
 Reamer Formulas for Speeds & Feeds 106

MICRO END-MILLS

Miniature Ball End & Square End Carbide End-Mills 1.5 x Diameter 107
 Miniature Square End With Back Clearance Carbide End-Mills 108
 Speeds & Feeds for End-Mills 108
 Standard Length Carbide End-Mills 109-110
 220° Ball End Miniature End-Mills With Back Clearance 110
 Long & Extra Long Carbide End-Mills 111

VALUE PACKED KITS & PROMOTION ITEMS 112

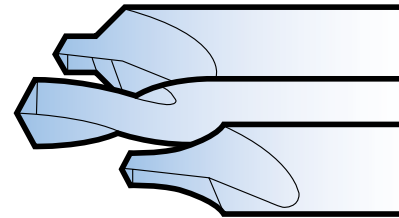

CENTERING-SPOTTING
 COMBINED MACHINING
 Pages 70-80

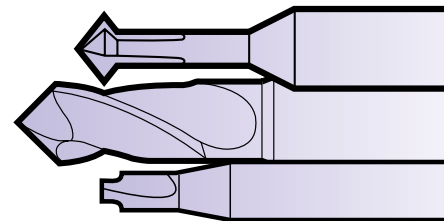

MULTI-FUNCTION TOOLS
 Pages 81-86

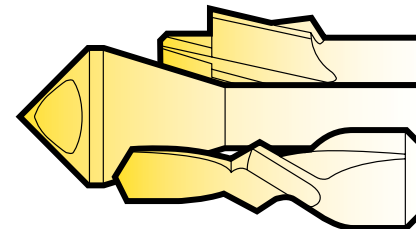

COUNTERSINKING
 Pages 87-95

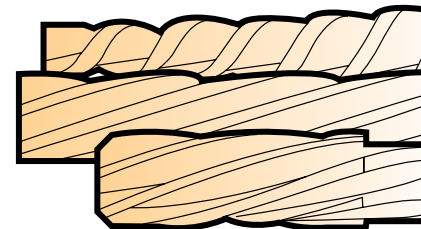

REAMING
 Pages 96-106

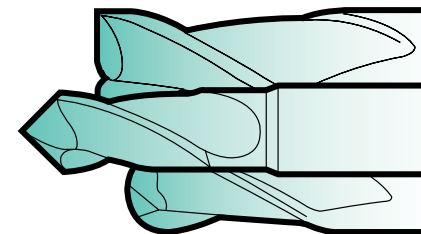

MICRO-MILLING
 Pages 107-111

EDP NUMBERING SYSTEM

EDP # 88860001810 - 1.81 mm

Solid Carbide High Precision

Micro Reamer

88860001810

Prefix **A** **B**

A = Series # - 8600

Series # 8600 refers to Solid Carbide

High Precision Micro Reamers

B = Size - 1.81 mm

Size 01810 refers to 1.81 mm

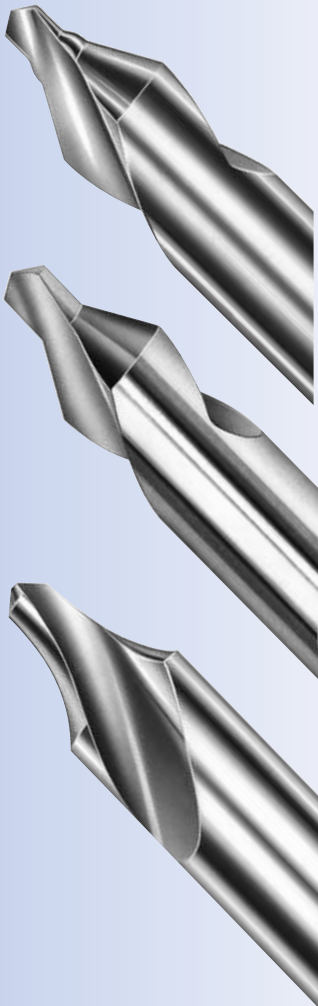

Note: Vickers Hardness Test
HV = a unit of hardness
given by the test known as
the Vickers Pyramid Number

SERIES INDEX

Code	Page	Code	Page	Code	Page	Code	Page
019	80	203	95	4834	88	8199	78
019-L	80	2901	95	4835	88	8201	95
0290	75	2903	95	4837	89	8203-H	95
0811	74	411	91	4839	88	8431	90
08115	70	412	91	4933	90	8431-H	90
0890	75	413	91	4936	90	8460	85
0895	78	414	91	8008-A	77	8460-H	85
0896	78	415	91	8008-B	77	8480	85
0910	74	421	93	8008-C	77	8480-H	85
0915	70	422	92	8008-D	77	8490	85
0919	80	423	93	8040	82	8490-H	85
0919-L	80	424	92	8088	82	8500	109, 110
0995	78	425	93	8088-H	82	8500-G	109, 110
0996	78	430	88	8090	79, 83	8500-H	109, 110
10	74	4303	90	8090-H	79, 83	8507	107
105	74	431	89	8092	82	8507-H	107
1055	70	432	88	8092-H	83	8507-D	108
11	75	433	88	8095	83	8507-DG	108
115	70	434	88	8095-H	83	8507-DH	108
125	72	435	88	8100	74	8509	111
135	72	436	90	8100-H	74	8509-G	111
145	73	437	89	8105	71	8509-H	111
154	71	438	88	8105-H	71	8510	111
155	71	439	88	8119-A	77	8510-G	111
16	75	4811	91	8119-B	77	8510-H	111
185	71	4821	93	8119-C	77	8522-H	110
191	78	4822	92	8119-D	77	8527	107
195	78	4823	93	8190-H	79	8527-H	107
196	78	4824	92	8195	79	8550	86
197	78	4825	93	8195-H	79	8550-H	86
199	78	4831	89	8196	79	8600	99-104
201	95	4832	88	8196-H	79	8610	98
202	95	4833	88	8197	78	8670	97

COATINGS

Engaged right from the start in the process aspiring to excellence, in addition to our Futura and TiN coatings, MAGAFOR offers three new "X" coatings, sprung from multi-layer nano technology.

Red'X: cobalt tool coating with higher hardness of (3700 HV) like TiAlN in a multi-layer coating. This coating can be used for dry machining. Using coolant will add lubricity.

Hard'X: carbide tool coating with a high hardness (3500 HV) this coating shows a high thermic stability and an excellent protection against heat and wear. Ideal for dry machining-high speed cut-in treated steels and dies up to 67 Rc.

Graph'X: diamond coating (8000 HV) particularly effective to machine graphite, composite materials, plastics with glass-fibers or carbon-fibers.

MATERIALS USED IN THE MANUFACTURE OF OUR TOOLS AND COATINGS

DESIGNATION

magafor	europcan	american	japanese
HSS	HSS	M2	SKH-51
HSS-E COBALT	HSS-E	M35	SKH-55
HSS-E 8% COBALT	HSS-E8	M42	SKH-59
TiN	TiN	TiN	TiN
Futura	TiAlN	TiAlN	TiAlN
Red'X	TiAlN with higher hardness (3700 HV)		
Hard'X	AlTiN	Latuma	
Graph'X	Diamond coating		
K15 CARBIDE — 6.5 - 7% Cobalt (0,006 - 0,008mm grain size)			

SPECIAL? STANDARD MAGAFOR!

SPECIALIZATION

With more than 250 product groups and over 8,000 standard products, Magafor offers the solution adapted to each of your machining applications. For example, the 0,40mm diameter micro end-mill is available in 26 different lengths and styles! Who offers more? Styles, materials and lengths vary within each specific range of tooling to offer you the widest selection.

INNOVATION

To detect the needs created by new technologies – To analyze and compare the totality of the special tools which are required of us – To compare the heavy tendencies of the market – Such are the studies undertaken by Magafor to offer a standard answer, available with specific expectations of the most demanding customers.



MINIATURE TOOLING

Forever Magafor has chosen to manufacture small tools at the feasibility limit. Naturally its production program has shown a trend towards the micro-tools.

Micro-NC Spot Drills:.....79-80

Micro End-Mills:..... 107-111

Micro-Reamers:..... 98-105

PRODUCTIVITY

The multi-purpose concept is one of the recent major evolutions for machining operations. With its multi-function tools and tools for combined machining, Magafor emphasizes this evolution. These new concepts reduce the machining times, the number of tools needed and set-up time.

Multi-Function Tools:72, 81-86

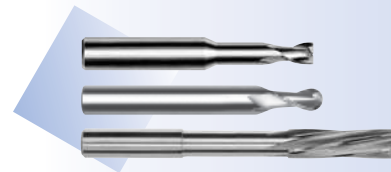

PRECISION

The miniaturization and the market requirements directed towards perfection have incited us to stock extensive series of standard items and an unrivalled range of types, forms, materials and coatings.

For Instance:

High Precision Micro Reamers available at every .0002" increment from .0078" to .0236" and every .0004 increment from .0240" to .7882"..... 98-105

Micro End-Mills available at every .0080" increment from .0020" to .2323".....107-111

magafor is the only cutting tool manufacturer member of the European Commission that has been chosen to research micro-machining.

*This research targets performance improvements of all **magafor** tools for the greatest profit margins for our customers.*





CENTERING - SPOTTING - COMBINED MACHINING

Plain Type CENTER DRILLS 60°



Inch sizes

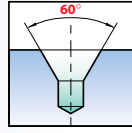

SIZE	D	d	L	I	115	M2/TIN 08115	Cobalt + 1055	M42/RedX 0915
00000	1/8	.010	1-1/4	.008 - .018	8111500A000*	800811500A0*	81105500A00*	80091500A00*
0000	1/8	.015	1-1/4	.014 - .025	8111500B000*	800811500B0*	81105500B00*	80091500B00*
000	1/8	.020	1-1/4	.020 - .032	8111500C000	800811500C0	81105500C00*	80091500C00*
00	1/8	.025	1-1/4	.028 - .040	8111500D000	800811500D0	81105500D00*	80091500D00*
0	1/8	1/32	1-1/4	.035 - .047	8111500E000	800811500E0	81105500E00*	80091500E00*
1	1/8	3/64	1-1/4	.055 - .067	81115010000	80081150100	81105501000	80091501000
2	3/16	5/64	1-7/8	.095 - .106	81115020000	80081150200	81105502000	80091502000
3	1/4	7/64	2	.130 - .154	81115030000	80081150300	81105503000	80091503000
4	5/16	1/8	2-1/8	.150 - .175	81115040000	80081150400	81105504000	80091504000
4-1/2	3/8	9/64	2-1/2	.170 - .193	81115045000	80081150450		
5	7/16	3/16	2-3/4	.230 - .256	81115050000	80081150500	81105505000	80091505000
6	1/2	7/32	3	.270 - .295	81115060000	80081150600	81105506000	80091506000
7	5/8	1/4	3-1/4	.315 - .340	81115070000	80081150700	81105507000	80091507000
8	3/4	5/16	3-1/2	.390 - .420	81115080000	80081150800	81105508000	80091508000
9	7/8	11/32	3-5/8	.430 - .460	81115090000	80081150900		
10	1	3/8	3-3/4	.475 - .500	81115100000	80081151000		

Please Note: *Single end tool



Tolerances

Tool Diameters	D	d	Angle 60° 118°
.010 - 7/64	n/a	+ .0039	
1/8 - 7/32	-.0007	+ .0047	
1/4 - 3/8	-.0009	+ .0059	- 30' ± 2°
7/16 - 5/8	-.0011	+ .0059	
3/4 - 1	-.0013	+ .0059	

Concentricity of Drill Diameter to Body is:
+/- .0005 runout

Value SETS American Standard

15 PIECES				5 PIECES	
COMPOSITION Quantity	HSS 81115000015	COMPOSITION Quantity	HSS 81115000000	COMPOSITION Quantity	Cobalt 81105500000
3 pieces each	# 1	1 piece each	# 1	1 piece each	# 1
	# 2		# 2		# 2
	# 3		# 3		# 3
	# 4		# 4		# 4
# 4-1/2	# 5		# 5		
1 piece	# 5				

Sets also available TiN coated

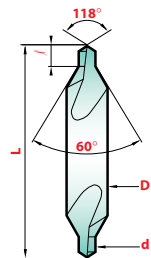

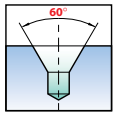

Inch sizes

Plain Type

**60°, 82° & 90° Angles
& Longs**

CENTERING

NEW
ASA Solid Carbide
60° Angle

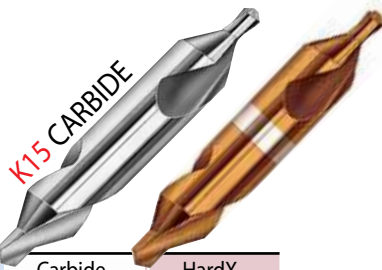

SIZE	D	d	L	I	Carbide 8105	HardX 8105-H
00	1/8	.025	1-1/4	.028 - .040	88810500D00	888105H00D0
0	1/8	1/32	1-1/4	.035 - .047	88810500E00	888105H00E0
1	1/8	3/64	1-1/4	.055 - .067	88810501000	888105H100
2	3/16	5/64	1-7/8	.095 - .106	88810502000	888105H200
3	1/4	7/64	2	.130 - .154	88810503000	888105H300
4	5/16	1/8	2-1/8	.150 - .175	88810504000	888105H400
5	7/16	3/16	2-3/4	.230 - .256	88810505000	888105H500
6	1/2	7/32	3	.270 - .295	88810506000	888105H600

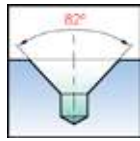
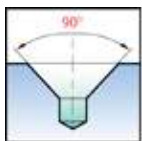
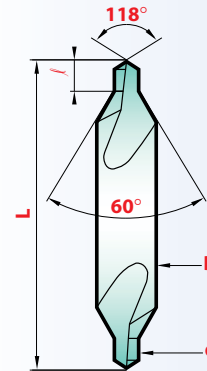

82° - 90° Angles

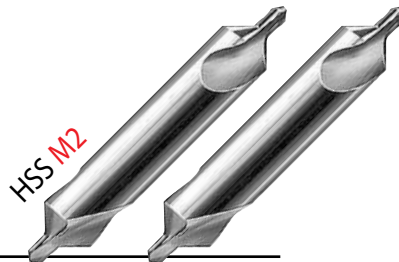

SIZE	D	d	L	I	Angle	
					82° 154	90° 155
1	1/8	3/64	1-1/4	.055 - .067	81154010000	81155010000
2	3/16	5/64	1-7/8	.095 - .106	81154020000	81155020000
3	1/4	7/64	2	.130 - .154	81154030000	81155030000
4	5/16	1/8	2-1/8	.150 - .175	81154040000	81155040000
5	7/16	3/16	2-3/4	.230 - .256	81154050000	81155050000
6	1/2	7/32	3	.270 - .295	81154060000	81155060000
7	5/8	1/4	3-1/4	.315 - .340	81154070000	81155070000
8	3/4	5/16	3-1/2	.390 - .420	81154080000	81155080000



Inch sizes

Value SETS
American Standard

5 PIECES / 4" OAL

COMPOSITION magafor 81185000000 Long

1 - 2 - 3 - 4 - 5 Long 1 piece of each



Longs

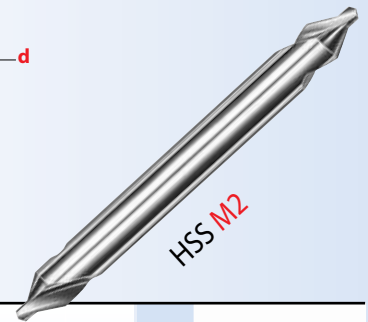

SIZE	D	d	L	185
1 x 3"	1/8	3/64	3	81185010300
1 x 4"			4	81185010400
1 x 5"			5	81185010500
1 x 6"			6	81185010600
2 x 3"	3/16	5/64	3	81185020300
2 x 4"			4	81185020400
2 x 5"			5	81185020500
2 x 6"			6	81185020600
3 x 3"	1/4	7/64	3	81185030300
3 x 4"			4	81185030400
3 x 5"			5	81185030500
3 x 6"			6	81185030600
4 x 3"	5/16	1/8	3	81185040300
4 x 4"			4	81185040400
4 x 5"			5	81185040500
4 x 6"			6	81185040600
4-1/2 x 4"	3/8	9/64	4	81185045400
4-1/2 x 5"			5	81185045500
4-1/2 x 6"			6	81185045600
5 x 4"	7/16	3/16	4	81185050400
5 x 5"			5	81185050500
5 x 6"			6	81185050600
6 x 4"	1/2	7/32	4	81185060400
6 x 5"			5	81185060500
6 x 6"			6	81185060600
7 x 5"	5/8	1/4	5	81185070500
7 x 6"			6	81185070600
8 x 6"	3/4	5/16	6	81185080600

CENTER DRILLS RADIUS TYPE Form R

magafor center drill with radius, thanks to its special profile, is more robust than the 60° center drill:

- the radius eliminates the risk of breakage,
- it provides an exact bearing,
- it serves as a protective chamfer.

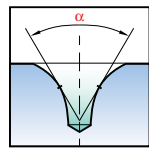
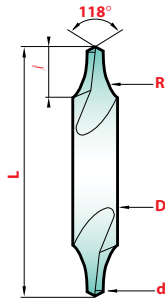

Tolerances

Tool Diameters	D	d	R max
.010 - 7/64	-0.0007	+ .0039	
1/8 - 7/32	-0.0007	+ .0047	
1/4 - 3/8	-0.0009	+ .0059	1.25 R
7/16 - 5/8	-0.0011	n/a	
3/4 - 1	-0.0013"	n/a	



Inch sizes

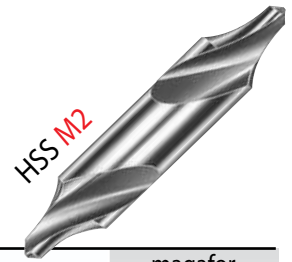

ASA #	D	d	L	R	ℓ	magafor 125
1 - R	1/8	3/64	1-1/4	.150	.125 - .150	81125010000
2 - R	3/16	5/64	1-7/8	.230	.200 - .225	81125020000
3 - R	1/4	7/64	2	.315	.270 - .300	81125030000
4 - R	5/16	1/8	2-1/8	.400	.340 - .370	81125040000
5 - R	7/16	3/16	2-3/4	.500	.480 - .510	81125050000
6 - R	1/2	7/32	3	.530	.540 - .575	81125060000
7 - R	5/8	1/4	3-1/4	.700	.660 - .700	81125070000
8 - R	3/4	5/16	3-1/2	.790	.810 - .850	81125080000

Form R SETS American Standard

5 PIECES



COMPOSITION	Quantity	81125000000
1 piece each	Radius Type	# 1-R # 2-R # 3-R # 4-R # 5-R

BELL TYPE With saved angle Form B

Center drills with protective chamfer guarantee the center obtained from any risk of blows and deformation. The splay resulting from the protective chamfer makes it easier to load parts between points on machines with automatic feed.

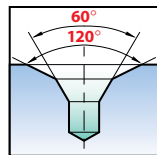
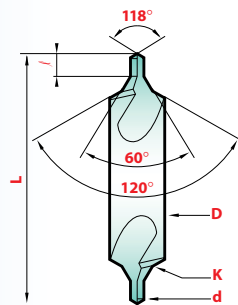

Inch sizes

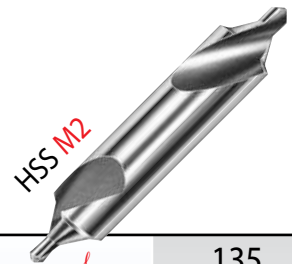

SIZE	D	d	K	L	ℓ	135
11	1/8	3/64	.100	1-1/4	.055 - .070	81135110000
12	3/16	1/16	.150	1-7/8	.070 - .090	81135120000
13	1/4	3/32	.200	2	.110 - .135	81135130000
14	5/16	7/64	.250	2-1/8	.125 - .155	81135140000
15	7/16	5/32	.350	2-3/4	.185 - .215	81135150000
16	1/2	3/16	.400	3	.230 - .260	81135160000
17	5/8	7/32	.500	3-1/4	.270 - .300	81135170000
18	3/4	1/4	.600	3-1/2	.310 - .340	81135180000
19	7/8	5/16	.700	3-5/8	.390 - .420	81135190000
20	1	3/8	.800	3-3/4	.470 - .500	81135200000

COMPOSITION	Quantity	81135000000
1 piece each	Bell Type	# 11 # 12 # 13 # 14 # 15



Tolerances

Tool Diameters	D	d	Angle
.010 - 7/64	- .0007	+ .0039	60° 118° 120°
1/8 - 7/32	- .0007	+ .0047	
1/4 - 3/8	- .0009	+ .0059	- 30' ± 2° - 4°
7/16 - 5/8	- .0011	n/a	
3/4 - 1	- .0013	n/a	

Form B SETS American Standard 5 PIECES



magafor
 "UNIQUE"
 CENTER DRILLS
 With reinforcing bulge
 Form W



Inch sizes

HSS M2



PLAIN TYPE WITH BULGE

SIZE	D	d	L	ℓ	145
1 - W	1/8	3/64	1-1/4	.055 - .067	81145010000
2 - W	3/16	5/64	1-7/8	.095 - .106	81145020000
3 - W	1/4	7/64	2	.130 - .154	81145030000
4 - W	5/16	1/8	2-1/8	.150 - .175	81145040000
5 - W	7/16	3/16	2-3/4	.230 - .256	81145050000
6 - W	1/2	7/32	3	.270 - .295	81145060000
7 - W	5/8	1/4	3-1/4	.315 - .340	81145070000
8 - W	3/4	5/16	3-1/2	.390 - .420	81145080000

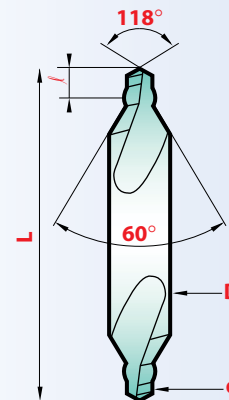
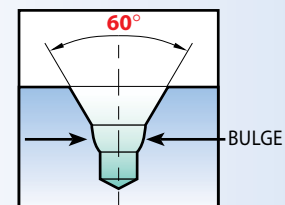

The **magafor** center drill form W is stronger than the common center drill :

- the bulge reinforces the point,
- it increases the chips removal,
- it makes the lubrication of the drill easier,
- runs at faster speeds and feeds.

Tolerances

Tool Diameters	D	d	Angle	
			60°	118°
.010 - 7/64	-.0007	+.0039		
1/8 - 7/32	-.0007	+.0047		
1/4 - 3/8	-.0009	+.0059	- 30'	± 2°
7/16 - 5/8	-.0011	n/a		
3/4 - 1	-.0013	n/a		

Form W SETS
 American Standard
 5 PIECES

COMPOSITION	Quantity	81145000000
1 piece each Bulge	# 1-W	
	# 2-W	
	# 3-W	
	# 4-W	
	# 5-W	

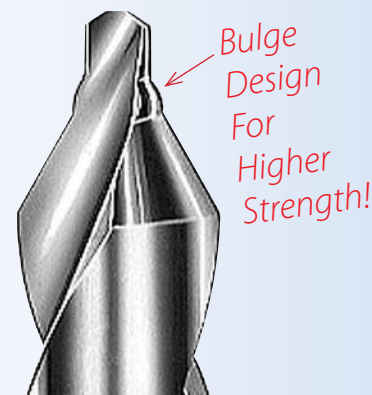

METRIC CENTER DRILLS 60° Angle



ISO • NFE 66051-A • DIN 333-A • JIS-1

In Metric

D x d	L	ℓ	magafor 10	M35/TIN 0811	cobalt 105	M42/Red'X 0910	carbide 8100	K15/Hard'X 8100-H
3,15 x 0,5*	25	0,6 - 0,9		80081103105			88810003105	888100H031505
3,15 x 0,8*	25	1,0 - 1,3		80081103108			88810003108	888100H031508
3,15 x 1,0	31	1,3 - 1,7	81100315100	80081103151	81105031510	80091003151	88810003151	888100H03151
3,15 x 1,25	31	1,6 - 2,0	81100315125	80081103125	81105031512	80091003125	88810003125	888100H0315125
3,5 x 0,75	35	1,0 - 1,3	81100350750	800811035075				
4,0 x 1,0	35	1,3 - 1,7	81100410000	80081104100			88810004100	888100H04010
4,0 x 1,6	35	2,0 - 2,6	81100416000	80081104160	81105041600	80091004160	88810004160	888100H0416
5,0 x 1,5	40	2,0 - 2,6	81100515000	80081105150			88810005150	888100H0515
5,0 x 2,0	40	2,5 - 3,1	81100520000	80081105200	81105052000	80091005200	88810005200	888100H0520
6,0 x 2,0	45	2,5 - 3,1	81100620000	80081106200			88810006200	888100H0620
6,3 x 2,5	45	3,1 - 3,8	81100632500	80081106325	81105063250	80091006325	88810006325	888100H06325
8,0 x 2,5	50	3,1 - 3,8	81100825000	80081108250			88810008250	888100H0825
8,0 x 3,0	50	3,9 - 4,6	81100830000	80081108300			88810008300	888100H0830
8,0 x 3,15	50	3,9 - 4,6	81100831500	80081108315	81105083150	80091008315	88810008315	888100H08315
10,0 x 3,0	55	3,9 - 4,6	81101030000	80081110300			88810010300	888100H1030
10,0 x 4,0	55	5,0 - 5,9	81101040000	80081110400	81105104000	80091010400	88810010400	888100H1040
12,0 x 4,0	63	5,0 - 5,9	81101240000	80081112400				
12,0 x 5,0	63	6,3 - 7,2	81101250000	80081112500			88810012500	888100H1250
12,5 x 5,0	63	6,3 - 7,2	81101255000	80081112550	81105125500	80091012550	88810012550	888100H1255
14,0 x 5,0	69	6,3 - 7,2	81101450000	80081114500				
16,0 x 6,3	71	8,0 - 8,9		80081116630			88810016630	888100H1663
20,0 x 8,0	80	10,1 - 11,1		80081120800				

* Single end

K15 CARBIDE — 6.5 - 7% Cobalt (0.006 - 0.008mm grain size)

NOTE: all metric center drills are available within 2 weeks. Call for information.



magafor



The Largest Manufacturer of Center Drills World Wide, With Over 4 Million Units Sold Annually.

Our European Catalogue Promotes 19 Pages of Combined Drills and Countersinks for World Wide Consumption.

magafor, The choice!

Material	HSS	HSS-Co	Hss-Co + TIN	HSS 8% Co	HSS 8% Co + Red'X	CARBIDE	CARBIDE + Hard'X
Hardness	63 HRC	65 HRC	65 HRC +2300 HV	67 HRC	67 HRC + 3500 HV	1800 HV	1800 HV + 3500
Use	Small Series	Production intensive		Hard and abrasive alloys		Treated steels	

METRIC CENTER DRILLS 60° Angle Form A

CENTERING



ISO • NFE 66051-A • DIN 333-A • JIS-1 In Metric

TYPE			Right hand	Left hand	With flat, right hand		
D x d	L	ℓ	11	16	P -0,1	Cobalt 0290	M35/TIN 0890
3,0 x 0,5	31	0,6 - 0,9	81110305000				
3,15 x 0,5*	25	0,6 - 0,9	81110315050	81160315050			
3,15 x 0,63*	25	0,7 - 1,0	81110315063	81160315063			
3,15 x 0,8*	25	1,0 - 1,3	81110315080	81160315080			
3,15 x 1,0	31	1,3 - 1,7	81110315100	81160315100			
3,15 x 1,25	31	1,6 - 2,0	81110315125	81160315125			
3,5 x 0,75	35	1,0 - 1,3	81110350750	81160350750			
4,0 x 1,0	35	1,3 - 1,7	81110410000	81160410000			
4,0 x 1,25	35	1,6 - 2,0	81110412500	81160412500			
4,0 x 1,6	35	2,0 - 2,6	81110416000	81160416000	3,25	80029004160	80089004160
5,0 x 1,5	40	2,0 - 2,6	81110515000	81160515000			
5,0 x 1,6	40	2,0 - 2,6	81110516000	81160516000			
5,0 x 2,0	40	2,5 - 3,1	81110520000	81160520000	4,20	80029005200	80089005200
6,0 x 2,0	45	2,5 - 3,1	81110620000	81160620000			
6,3 x 2,0	45	2,5 - 3,1	81110632000	81160632000			
6,3 x 2,5	45	3,1 - 3,8	81110632500	81160632500	5,35	80029006325	80089006325
8,0 x 2,5	50	3,1 - 3,8	81110825000	81160825000			
8,0 x 3,0	50	3,9 - 4,6	81110830000	81160830000			
8,0 x 3,15	50	3,9 - 4,6	81110831500	81160831500	6,95	80029008315	80089008315
10,0 x 3,0	55	3,9 - 4,6	81111030000	81161030000			
10,0 x 3,15	55	3,9 - 4,6	81111031500	81161031500			
10,0 x 4,0	55	5,0 - 5,9	81111040000	81161040000	8,40	80029010400	80089010400
12,0 x 4,0	63	5,0 - 5,9	81111240000	81161240000			
12,0 x 5,0	63	6,3 - 7,2	81111250000	81161250000			
12,5 x 4,0	63	5,0 - 5,9	81111254000	81161254000			
12,5 x 5,0	63	6,3 - 7,2	81111255000	81161255000	10,95	80029012550	80089012550
14,0 x 5,0	69	6,3 - 7,2	81111450000	81161450000			
16,0 x 5,0	71	6,3 - 7,2	81111650000	81161650000			
16,0 x 6,3	71	8,0 - 8,9	81111663000	81161663000	14,00	80029016630	80089016630
18,0 x 6,0	77	8,0 - 8,9	81111860000				
20,0 x 6,3	80	8,0 - 8,9	81112063000				
20,0 x 8,0	80	10,1 - 11,1	81112080000	81162080000	17,90	80029020800	
25,0 x 8,0	100	10,1 - 11,1	81112580000				
25,0 x 10,0	100	12,8 - 13,8	81112510000		22,50	80029025100	
31,5 x 10,0	125	12,8 - 13,8	81113151000				
31,5 x 12,5	125	16,5 - 17,5	81113151250				

* Single end

NOTE: all metric center drills are available within 2 weeks. Call for information.

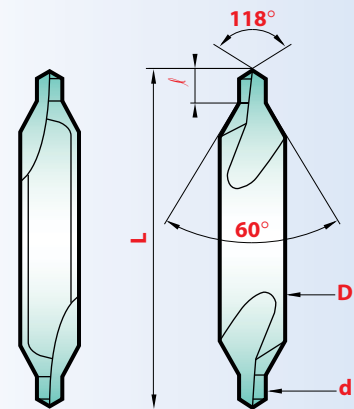
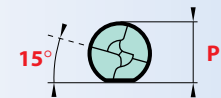
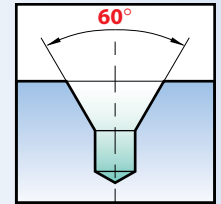

Tolerances

D	d	L	Angles	
			60°	118°
h8	k12	±1	-30'	±2°

The **magafor** center drills are particularly effective thanks to their unique ground spiral flutes. Special attention to concentricity of drill diameter to body makes us superior to others.

Form A

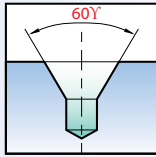

Most universal center drill.
60° angle
Standard center.
118° point

Form W

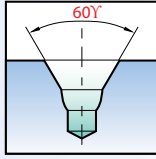

The bulge reinforces the point.
Increases chip removal.
Makes the lubrication of the drill easier.
118° point

Form R

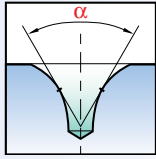

The radius eliminates the risk of breakage,
and is more robust than the 60° drill.
Provides an exact bearing surface.
Serves as a protective chamfer.
118° point

Form B

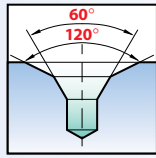

Center drill with protective chamfer
guarantees the center from any risk of blows
and deformation.
118° point



90° NC Spot Drill
By using the **magafor NC** drill of diameter
over the drilling tool, centering and
chamfering are obtained in a single operation.

120° & 140° NC Spot Drill

The preliminary hole obtained with the **magafor NC** drill corresponds to the angle at the end of the tool used in drilling and prevents it from deviating.

Performance

RECOMMENDATIONS FOR THE USE OF CENTER DRILLS AND NC SPOT DRILLS

- SFM:** Surface Feet per Minute
- RPM:** Revolutions per Minute
- IPT:** Inches per Tooth (chip load)
- IPM:** Inches per Minute
- IPR:** Inches per Revolution

Speed Formula:

$$RPM = 3.82 \times (SFM \div \text{Diameter})$$

$$\text{Feed: } IPM = IPT \times \# \text{ of Flutes} \times RPM$$

$$IPR = IPM \div RPM$$

$$SFM = RPM \times \text{Diameter} \div 3.82$$

FORMULA FOR SPEED (RPM)

Example	#1 Center Drill (.078) Cutting Soft Material: < 81 HRB
	SFM = 148 for 5/64 Ø HSS
	RPM = 3.82 x (148 ÷ .0787) = 7180
	IPM = .001 x 2 x 7180 = 14.36
	IPR = 14.36 ÷ 7180 = .002

MATERIAL	
STEEL:	< 81 HRB (B)
	< 24 Rc (C)
	24 - 32 Rc
	32 - 41 Rc
Stainless Steel/Titanium	
Inconel/Nimonic/Waspaloy	
Brass/Copper	
Copper Alloys/Bronze	
Aluminum	
Hardened Aluminum < 6% Si	
Cast Aluminum > 6% Si	
Thermoplastics	

HSS						
SFM	FEED inch/rev					
	2mm 5/64	3mm 1/8	6mm 1/4	10mm 3/8	16mm 5/8	
99 - 148	.0020	.0024	.0031	.0059	.0079	
82 - 99						
49 - 82						
33 - 49	.0012	.0016	.0024	.0039	.0059	
20 - 33						
16 - 20	.0008	.0012	.0020	.0028	.0039	
132 - 197						
99 - 132	.0020	.0028	.0035	.0059	.0079	
494 - 658	.0031	.0039	.0079	.0157	.0197	
197 - 329						
132 - 197	.0024	.0031	.0039	.0059	.0098	
329 - 428	.0031	.0035	.0079	.0138	.0157	

TIN						
SFM	FEED inch/rev					
	2mm 5/64	3mm 1/8	6mm 1/4	10mm 3/8	16mm 5/8	
197 - 296	.0031	.0035	.0047	.0098	.0118	
165 - 230						
115 - 148						
82 - 99	.0020	.0024	.0035	.0055	.0087	
39 - 53						
33 - 43	.0016	.0020	.0028	.0039	.0059	
362 - 428						
263 - 362	.0028	.0035	.0055	.0106	.0142	
1152 - 1481	.0047	.0055	.0118	.0217	.0256	
395 - 592						
263 - 395	.0031	.0039	.0059	.0118	.0157	
658 - 855	.0047	.0055	.0118	.0217	.0256	

MATERIAL	
STEEL:	< 81 HRB (B)
	< 24 Rc (C)
	24 - 32 Rc
	32 - 41 Rc
Stainless Steel/Titanium	
Inconel/Nimonic/Waspaloy	
Brass/Copper	
Copper Alloys/Bronze	
Aluminum	
Hardened Aluminum < 6% Si	
Cast Aluminum > 6% Si	
Thermoplastics	

Futura/Red'X					
SFM	FEED inch/rev				
	2mm 5/64	3mm 1/8	6mm 1/4	10mm 3/8	16mm 5/8
296 - 395	.0039	.0047	.0063	.0118	.0177
247 - 329					
165 - 214					
99 - 214	.0028	.0031	.0047	.0071	.0110
59 - 79					
49 - 66	.0020	.0024	.0039	.0055	.0079
428 - 494					
362 - 428	.0039	.0047	.0071	.0142	.0197
1645 - 2300	.0063	.0071	.0157	.0295	.0354
592 - 823					
395 - 559	.0039	.0047	.0071	.0142	.0197
987 - 1316	.0063	.0071	.0157	.0295	.0354

CARBIDE						
SFM	FEED inch/rev					
	2mm 5/64	3mm 1/8	6mm 1/4	10mm 3/8	16mm 5/8	
362 - 461	.0047	.0055	.0079	.0138	.0217	
296 - 362						
197 - 263						
115 - 165	.0035	.0039	.0055	.0087	.0094	
72 - 99						
63 - 82	.0031	.0028	.0047	.0067	.0094	
494 - 592						
428 - 494	.0047	.0055	.0087	.0173	.0240	
1974 - 2632	.0039	.0087	.0193	.0354	.0374	
658 - 987						
461 - 658	.0047	.0055	.0087	.0173	.0240	
1217 - 1579	.0079	.0087	.0193	.0354	.0374	

High Performance!
General Purpose!

M2 HSS Short & Long NC SPOTTING DRILLS

M2 HSS & TIN - Short

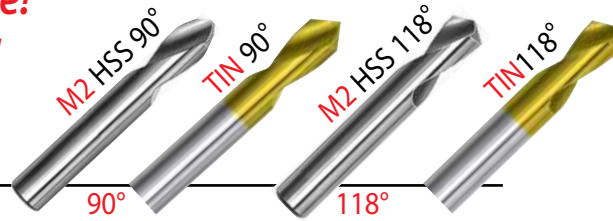

Angle					90°		118°	
D	L	f	T	M2 HSS 8119A	TIN 8008A	M2 HSS 8119B	TIN 8008B	
1/8"	1 1/4	0.380	0.012	8119A031700	8008A031700	8119B031700	8008B031700	
3/16"	1 3/8	0.500	0.020	8119A047600	8008A047600	8119B047600	8008B047600	
1/4"	1 1/2	0.640	0.025	8119A063500	8008A063500	8119B063500	8008B063500	
5/16"	1 1/2	0.640	0.031	8119A079300	8008A079300	8119B079300	8008A079300	
3/8"	2	1	0.039	8119A095200	8008A095200	8119B095200	8008B095200	
7/16"	2	1	0.043	8119A111100	8008A111100	8119B111100	8008B111100	
1/2"	2	1	0.051	8119A127000	8008A127000	8119B127000	8008B127000	
5/8"	2 1/4	1 1/8	0.063	8119A158700	8008A158700	8119B158700	8008B158700	
3/4"	2 1/4	1 1/8	0.075	8119A190500	8008A190500	8119B190500	8008B190500	
7/8"	2 1/2	1 1/4	0.088	8119A222200	8008A222200	8119B222200	8008B222200	
1"	2 1/2	1 1/4	0.100	8119A254000	8008A254000	8119B254000	8008B254000	

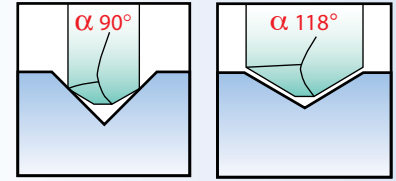

90 degree angle:

By using the **magafor NC** drill of diameter over the drilling tool, centering and chamfering are obtained in a single operation.

118 and 120 degree angle:

The preliminary hole obtained with the **magafor NC** drill corresponds to the angle at the end of the tool used in drilling and prevents it from drifting and allowing the drill point to cut first.

M2 HSS & TIN - Long Series • 3 Different Lengths

Angle					90°		120°	
D	L	f	T	M2 HSS 8119C	TIN 8008C	M2 HSS 8119D	TIN 8008D	
1/4"	2 5/8"	0.900	0.025	8119C063500	8008C063500	8119D063500	8008D063500	
1/4"	4"	0.900	0.025	8119C063504	8008C063504	8119D063504	8008D063504	
1/4"	5 1/2"	0.87	0.025	8119C0635055	8008C0635055	8119D0635055	8008D0635055	
3/8"	3 1/8"	1	0.039	8119C095200	8008C095200	8119D095200	8008D095200	
3/8"	5"	1	0.039	8119C095205	8008C095205	8119D095205	8008D095205	
3/8"	7"	1	0.039	8119C095207	8008C095207	8119D095207	8008D095207	
1/2"	3 3/4"	1 3/8	0.051	8119C127000	8008C127000	8119D127000	8008D127000	
1/2"	6"	1 3/8	0.051	8119C127006	8008C127006	8119D127006	8008D127006	
1/2"	8"	1 3/8	0.051	8119C127008	8008C127008	8119D127008	8008D127008	
5/8"	4 1/2"	1 3/8	0.063	8119C158700	8008C158700	8119D158700	8008D158700	
5/8"	8"	1 3/8	0.063	8119C158708	8008C158708	8119D158708	8008D158708	
5/8"	9"	1 3/8	0.063	8119C158709	8008C158709	8119D158709	8008D158709	
3/4"	5"	1 5/8	0.075	8119C190505	8008C190505	8119D190505	8008D190505	
3/4"	8"	1 5/8	0.075	8119C190508	8008C190508	8119D190508	8008D190508	
3/4"	10"	1 5/8	0.075	8119C190510	8008C190510	8119D190510	8008D190510	
1"	5 3/8"	1 3/4	0.100	8119C254000	8008C254000	8119D254000	8008D254000	
1"	8"	1 3/4	0.100	8119C254008	8008C254008	8119D254008	8008D254008	
1"	10"	1 3/4	0.100	8119C254010	8008C254010	8119D254010	8008D254010	

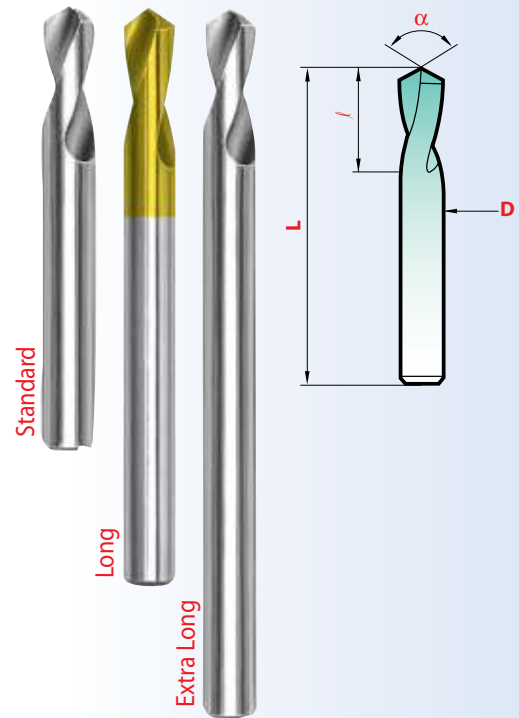

Inch sizes

M2 HSS SPOT DRILL Value SETS

4 PIECES American Standard

COMPOSITION: 1/4" x 2 5/8" - 3/8" x 3 1/8"
1/2" x 3 3/4" - 5/8" x 4 1/2"

TYPE	M2 HSS
90° Spot Drill Kit	8119C000004
120° Spot Drill Kit	8119D000004



Tolerance in inches

Diameters	Tolerance D	Angle	L
1/8" - 3/16"	0 - .0005"	± 1°	± .0395
1/4" - 3/8"	0 - .0006"		
7/16" - 5/8"	0 - .0007"		
3/4" - 1"	0 - .0008"		
1-1/4" - 1-3/4"	0 - .0010"		

COBALT NC SPOTTING DRILLS

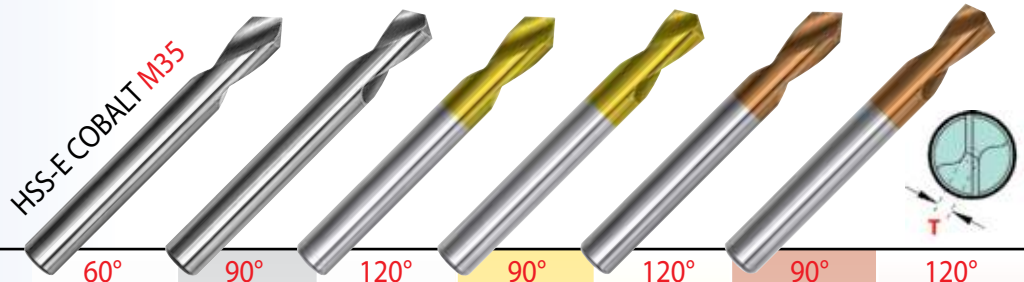

Diameter		Angle			Cobalt 191		Cobalt 195		Cobalt 196		M35/TIN 0895		M35/TIN 0896		M35/Red'X 0995*		M35/Red'X 0996*	
inch	mm	L	λ	T														
.078	2	2	.315	.008														
.118	3	2	.400	.012														
1/8		2	.400	.012														
.157	4	2-1/16	.475	.016	81191040000	81195040000	81196040000	80089504000	80089604000	80099504000	80099604000							
3/16		2-3/8	.600	.020		81195047600	81196047600	80089504760	80089604760	80099504760	80099604760							
.197	5	2-3/8	.600	.020	81191050000	81195050000	81196050000	80089505000	80089605000	80099505000	80099605000							
.236	6	2-5/8	.800	.023	81191060000	81195060000	81196060000	80089506000	80089606000	80099506000	80099606000							
1/4		2-5/8	.900	.025		81195063500	81196063500	80089506350	80089606350	80099506350	80099606350							
5/16		3-1/8	1	.031		81195079300		80089507930										
.315	8	3-1/8	1	.031	81191080000	81195080000	81196080000	80089508000	80089608000	80099508000	80099608000							
3/8		3-1/2	1	.039		81195095200	81196095200	80089509520	80089609520	80099509520	80099609520							
.394	10	3-1/2	1	.039	81191100000	81195100000	81196100000	80089510000	80089610000	80099510000	80099610000							
.472	12	4	1-1/4	.047	81191120000	81195120000	81196120000	80089512000	80089612000	80099512000	80099612000							
1/2		4	1-3/8	.051		81195127000	81196127000	80089512700	80089612700	80099512700	80099612700							
.551	14	4-1/2	1-3/8	.055		81195140000	81196140000	80089514000	80089614000	80099514000	80099614000							
5/8		4-1/2	1-3/8	.063		81195158700	81196158700	80089515870	80089615870	80099515870	80099615870							
.630	16	4-1/2	1-3/8	.063	81191160000	81195160000	81196160000	80089516000	80089616000	80099516000	80099616000							
.709	18	5-1/8	1-5/8	.071		81195180000	81196180000	80089518000	80089618000	80099518000	80099618000							
3/4		5-1/8	1-5/8	.075		81195190500	81196190500	80089519050	80089619050	80099519050	80099619050							
.787	20	5-1/8	1-5/8	.079	81191200000	81195200000	81196200000	80089520000	80089620000	80099520000	80099620000							
.984	25	5-3/8	1-3/4	.098		81195250000	81196250000	80089525000	80089625000	80099525000	80099625000							
1		5-3/8	1-3/4	.100		81195254000	81196254000	80089525400	80089625400	80099525400	80099625400							

*The Spotting Drills (0995 & 0996) with red'X coating are designed for machining abrasive hard alloys.

See these tools at work!

www.hassay-savage.com/resource-center/product-videos



Long series

Diameter		Angle			Cobalt 197		Cobalt 199		Carbide 8197		Carbide 8199	
inch	mm	L	λ	T								
.118	3	3-1/8	.400	.012	81197030000	81199030000	88819703000					
.157	4	4	.475	.016	81197040000	81199040000	88819704000	88819904000				
.197	5	4-3/4	.600	.020	81197050000	81199050000	88819705000	88819905000				
.236	6	5-1/2	.800	.023	81197060000	81199060000	88819706000	88819906000				
1/4		5-1/2	.870	.025	81197063500	81199063500	88819706350	88819906350				
.315	8	5-1/2	1	.031	81197080000	81199080000	88819708000	88819908000				
3/8		6-3/4	1	.039	81197095200	81199095200	88819709520	88819909520				
.394	10	6-3/4	1	.039	81197100000	81199100000	88819710000	88819910000				
.472	12	6-3/4	1-3/16	.047	81197120000	81199120000	88819712000	88819912000				
1/2		6-3/4	1-3/8	.051	81197127000	81199127000	88819712700	88819912700				
5/8		8	1-3/8	.063	81197158700	81199158700	88819715870	88819915870				
.630	16	8	1-3/8	.063	81197160000	81199160000	88819716000	88819916000				
3/4		8	1-5/8	.075	81197190500	81199190500	88819719050	88819919050				
.787	20	8	1-5/8	.079	81197200000	81199200000	88819720000	88819920000				
1		8	1-3/4	.100	81197254000	81199254000						

COBALT SPOT DRILL Value SETS



4 PIECES American Standard

COMPOSITION 1/4 - 3/8 - 1/2 - 5/8 - Ø

TYPE	Cobalt
90° Code	81195000004
120° Code	81196000004

Sets also available TiN and Futura coated

Hard'X coatings available with K15 CARBIDE — 6.5 - 7% Cobalt (0,006 - 0,008mm grain size)

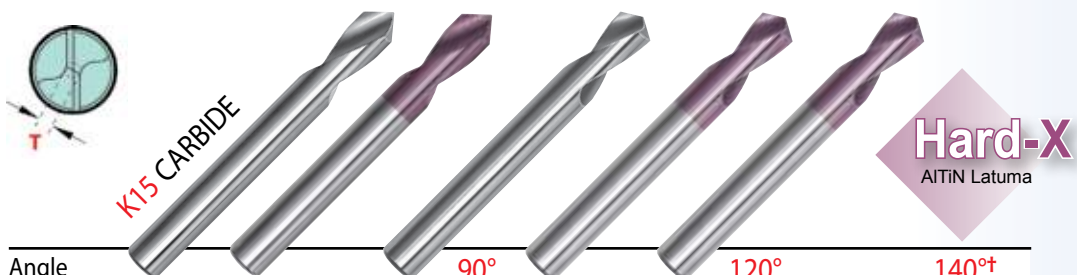

NC SPOTTING DRILLS

Angle		90°			120°			140°†
Diameter inch mm	L	ℓ	T*	Carbide 8195	K15/Hard'X 8195-H	Carbide 8196	K15/Hard'X 8196-H	K15/Hard'X 8190-H
.078	2	1-9/16	.315	.008	88819502000	888195H0200	88819602000	888196H0200
.118	3	1-3/4	.400	.012	88819503000	888195H0300	88819603000	888196H0300
.157	4	2	.475	.016	88819504000	888195H0400	88819604000	888196H0400
.197	5	2	.600	.020	88819505000	888195H0500	88819605000	888196H0500
.236	6	2	.700	.023	88819506000	888195H0600	88819606000	888196H0600
1/4	2		.700	.023	88819506350	888195H0635	88819606350	888196H0635
5/16	2-3/8		.900	.031	88819507930	888195H0793		
.315	8	2-3/8	.900	.031	88819508000	888195H0800	88819608000	888196H0800
3/8	2-3/4		.950	.039	88819509520	888195H0952	88819609520	888196H0952
.394	10	2-3/4	.950	.039	88819510000	888195H1000	88819610000	888196H1000
.472	12	2-3/4	.950	.047	88819512000	888195H1200	88819612000	888196H1200
1/2	2-3/4		.950	.051	88819512700	888195H1270	88819612700	888196H1270
.551	14	3	.950	.055	88819514000	888195H1400	88819614000	888196H1400
5/8	3-1/8		1	.063	88819515870	888195H15870	88819615870	888196H1587
.630	16	3-1/8	1	.063	88819516000	888195H1600	88819616000	888196H1600
.787	20	4	1-3/8	.079	88819520000	888195H2000	88819620000	888196H2000

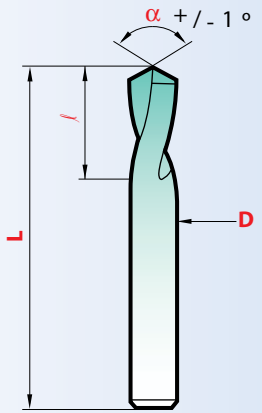

T* = web thickness of split point

†140 degree angle : for hard alloys and high performance drilling

K15 CARBIDE — 6.5 - 7% Cobalt (0.006 - 0.008mm grain size)

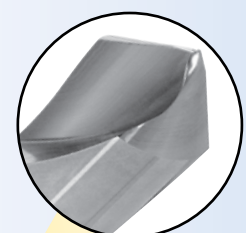

STANDARD WEB THINNING "SPLIT-POINT" FEATURE FOR HIGH SPEED CUTTING

Micro Range of Carbide MINIATURE NC SPOTTING DRILLS MULTI-V®

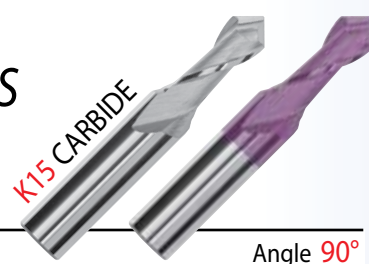

T* = web thickness of split point

STANDARD magafor Angle 90°

Diameter inch mm	L	ℓ	d2	T*	MULTI-V 8090	K15/Hard'X 8090-H	
.003	0,1	1-1/2	.008	.118	.001	88809000100	888090H0010
.007	0,2	1-1/2	.016	.118	.001	88809000200	888090H0020
.011	0,3	1-1/2	.024	.118	.001	88809000300	888090H0030
.015	0,4	1-1/2	.032	.118	.002	88809000400	888090H0040
.020	0,5	1-1/2	.040	.118	.002	88809000500	888090H0050
.024	0,6	1-1/2	.047	.118	.002	88809000600	888090H0060
.028	0,7	1-1/2	.055	.118	.003	88809000700	888090H0070
.031	0,8	1-1/2	.063	.118	.003	88809000800	888090H0080
.035	0,9	1-1/2	.071	.118	.003	88809000900	888090H0090
.039	1,0	1-1/2	.080	.118	.004	88809001000	888090H0100
.043	1,1	1-1/2	.087	.118	.004	88809001100	888090H0110
.047	1,2	1-1/2	.095	.118	.005	88809001200	888090H0120
.051	1,3	1-1/2	.102	.118	.005	88809001300	888090H0130
.055	1,4	1-1/2	.110	.118	.006	88809001400	888090H0140
.059	1,5	1-1/2	.120	.118	.006	88809001500	888090H0150
.063	1,6	1-1/2	.125	.118	.006	88809001600	888090H0160
.066	1,7	1-1/2	.134	.118	.007	88809001700	888090H0170
.071	1,8	1-1/2	.140	.118	.007	88809001800	888090H0180
.074	1,9	1-1/2	.145	.118	.008	88809001900	888090H0190
.078	2,0	1-1/2	.160	.118	.008	88809002000	888090H0200

90 degree angle :
By using the magafor NC drill of diameter over the drilling tool, centering and chamfering are obtained in a single operation.

120 and 140 degree angles :
The preliminary hole obtained with the magafor NC drill corresponds to the angle at the end of the tool used in drilling and prevents it from drifting and allowing the drill point to cut first.

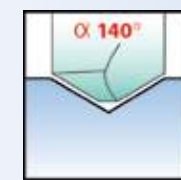
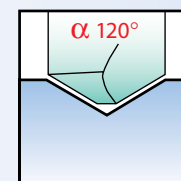
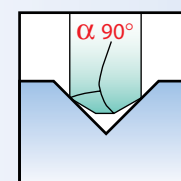

NC SPOTTING DRILLS

"The Double Ended Spot Drill"

DUO=MAG

= 2 Single End NC Spot Drills

1 Tool - 2 Points

Twice the Cutting - Same Price!

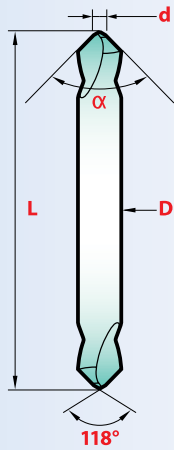

Note: The 118° sharpening angle makes tool penetration easier, while reinforcing the point. (d)

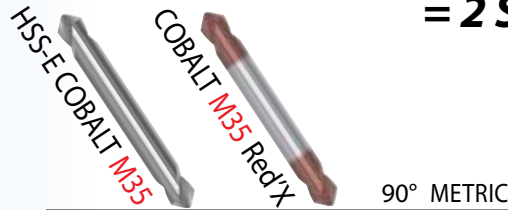

DUO=MAG		Double End NC Spot Drills	
D x d	L	Duo-Mag 019	Red'X 0919
3,0 x 0,5	40	80019030500	80091903050
4,0 x 1,0	45	80019041000	80091904100
6,0 x 2,0	55	80019062000	80091906200
8,0 x 2,5	65	80019082500	80091908250
10,0 x 3,0	75	80019103000	80091910300
12,0 x 3,5	85	80019123500	80091912350
16,0 x 4,0	90	80019164000	80091916400
20,0 x 5,0	100	80019205000	80091920500

DUO=MAG		Long Double End NC Spot Drills	
D x d	L	Duo-Mag 019L	Red'X 0919L
3,0 x 0,5	100	80019L03050	800919L3050
4,0 x 1,0	100	80019L04100	800919L0410
6,0 x 2,0	100	80019L06200	800919L0620
8,0 x 2,5	100	80019L08250	800919L0825
10,0 x 3,0	100	80019L10300	800919L1030
12,0 x 3,5	100	80019L12350	800919L1235
16,0 x 4,0	150	80019XL1640	800919XL164
20,0 x 5,0	150	80019XL2050	800919XL205

90° AMERICAN STANDARD					
DUO=MAG		Double End NC Spot Drills			
D	d	L	Duo-Mag 019	Red'X 0919	
3/16	1/16	2	80019010000	80091901000	
1/4	3/32	2	80019020000	80091902000	
3/8	9/64	3	80019030000	80091903000	
1/2	3/16	4	80019040000	80091904000	

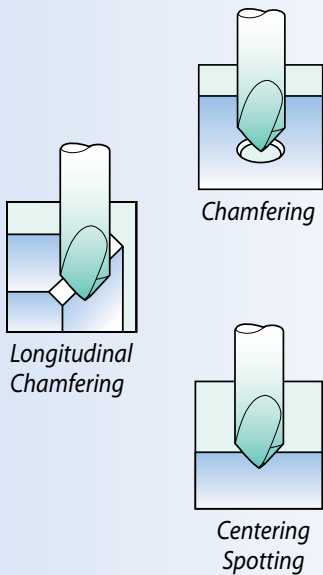

Duo Mag SETS American Standard

4 PIECE

Inch sizes

COMPOSITION Quantity	Cobalt 80019000004	COMPOSITION Quantity	Red'X 80091900004
4 piece each Duo Mag	3/16"	4 piece each Duo Mag	3/16"
	1/4"		1/4"
	3/8"		3/8"
	1/2"		1/2"



Tolerance in inches

Diameters	Tolerance D	Angle	L
.078 - .118	0 + .0002"	± 1°	± .0395
1/8 - .236	0 + .0003"		
1/4 - .394	0 + .0004"		
.472 - 1	0 + .0005"		

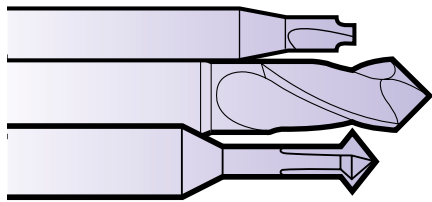

Unique, Multi-Function, Problem Solving Tools

Precision Corner Rounding with Superior Surface Finish!



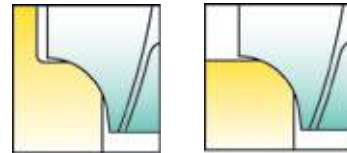

Page 86

CARBIDE MINIATURE
CORNER ROUNDING END-MILLS

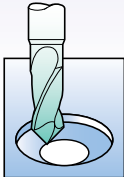
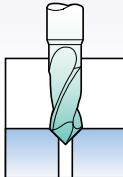
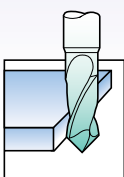
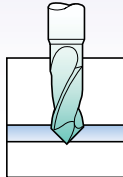
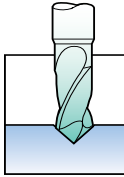
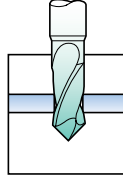
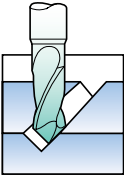
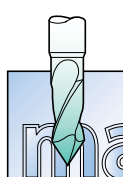
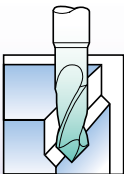

One Tool = One Holder = 10 Operations!

Page
82-83

 90° - 120° INTERPOLATION MILLING	 90° - 120° CHAMFERING	 60° - 90° - 120° CONTOURING SIDE MILLING	 60° - 90° - 120° DIRECT CHAMFERING
 90° - 120° CENTERING - SPOTTING	 90° - 120° DRILLING	 90° - 120° V - GROOVING	 40° - 60° ENGRAVING
<h1>1 MULTI-V[®]</h1> <h2>= 10 OPERATIONS</h2>		 60° - 90° - 120° LONGITUDINAL CHAMFERS	

Chamfering & Deburring in Hard to Reach Locations!



Page 85

Biface

FRONT AND BACK CHAMFERING
BICONICAL CUTTERS

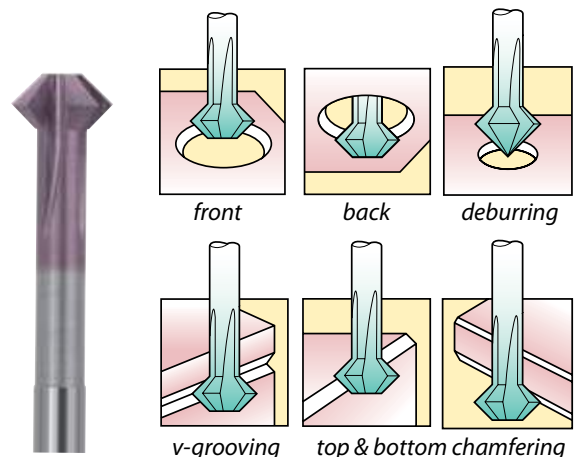

1 MULTI-V® = 10 OPERATIONS

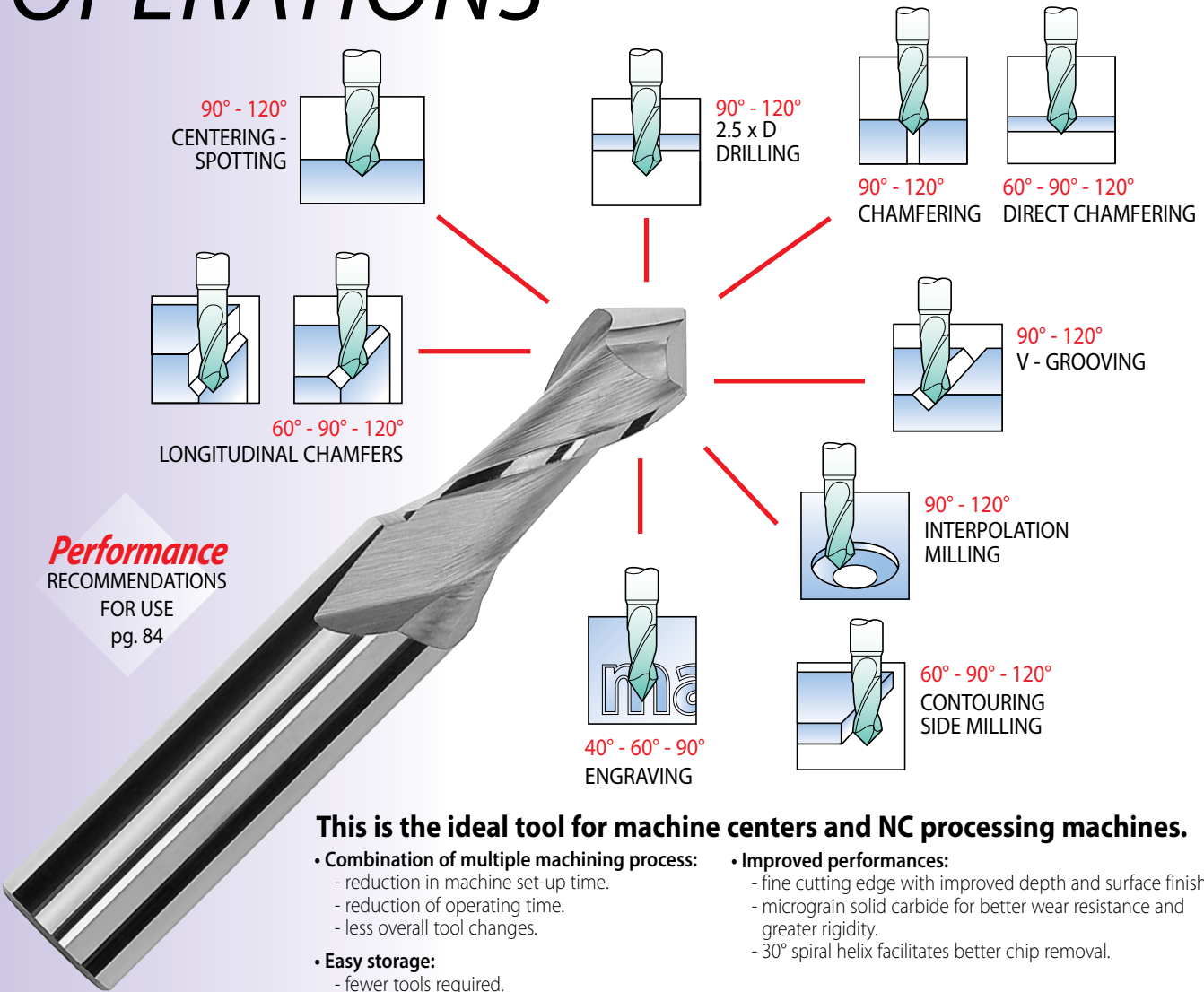

Performance
RECOMMENDATIONS
FOR USE
pg. 84

This is the ideal tool for machine centers and NC processing machines.

- **Combination of multiple machining process:**
 - reduction in machine set-up time.
 - reduction of operating time.
 - less overall tool changes.
- **Improved performances:**
 - fine cutting edge with improved depth and surface finish.
 - micrograin solid carbide for better wear resistance and greater rigidity.
 - 30° spiral helix facilitates better chip removal.
- **Easy storage:**
 - fewer tools required.
 - less tool spaces required in magazine.

METRIC
magafor



K15 CARBIDE

Angle						40°	60°	
Diameter inch	mm	L	ℓ	d2	T*	MULTI-V 8040†	MULTI-V 8088†	Hard'X 8088-H†
.020	0,5	1-1/2	.040	.118	.002	88804000500	8880880050	888088H0050
.031	0,8	1-1/2	.063	.118	.003		8880880080	888088H0080
.039	1,0	1-1/2	.080	.118	.004	88804001000	8880880100	888088H0100
.047	1,2	1-1/2	.095	.118	.005		8880880120	888088H0120
.059	1,5	1-1/2	.120	.118	.006	88804001500	8880880150	888088H0150
.070	1,8	1-1/2	.142	.118	.007		8880880180	888088H0180
.078	2,0	1-1/2	.160	.118	.008	88804002000	8880880200	888088H0200
.098	2,5	1-1/2	.195	.118	.010		8880880250	888088H0250
.118	3	2	.240	.157	.012	88804003000	8880880300	888088H0300
.157	4	2	.315	.197	.016		8880880400	888088H0400
.197	5	2	.395	.236	.020	88804005000	8880880500	888088H0500
.236	6	2-3/8	.475	.315	.023		8880880600	888088H0600
.315	8	2-3/4	.630	.394	.031		8880880800	888088H0800
.394	10	2-3/4	.710	.472	.039		8880881000	888088H1000
.472	12	2-3/4	.790	.472	.047		8880881200	888088H1200
.630	16	3-1/8	1.025	.630	.063		8880881600	888088H1600
.787	20	4	1.260	.787	.079		8880882000	888088H2000

† Angle 40° - 60° : ideal for engraving

MULTI-V = 10 OPERATIONS

STANDARD magafor							Angle 90°	
Diameter inch	mm	L	ℓ	d2	T*	MULTI-V 8090	Hard'X 8090-H	
.003	0,1	1-1/2	.008	.118	.001	88809000100	888090H0010	
.007	0,2	1-1/2	.016	.118	.001	88809000200	888090H0020	
.011	0,3	1-1/2	.024	.118	.001	88809000300	888090H0030	
.015	0,4	1-1/2	.032	.118	.002	88809000400	888090H0040	
.020	0,5	1-1/2	.040	.118	.002	88809000500	888090H0050	
.024	0,6	1-1/2	.047	.118	.002	88809000600	888090H0060	
.028	0,7	1-1/2	.055	.118	.003	88809000700	888090H0070	
.031	0,8	1-1/2	.063	.118	.003	88809000800	888090H0080	
.035	0,9	1-1/2	.071	.118	.003	88809000900	888090H0090	
.039	1,0	1-1/2	.080	.118	.004	88809001000	888090H0100	
.043	1,1	1-1/2	.087	.118	.004	88809001100	888090H0110	
.047	1,2	1-1/2	.095	.118	.005	88809001200	888090H0120	
.051	1,3	1-1/2	.102	.118	.005	88809001300	888090H0130	
.055	1,4	1-1/2	.110	.118	.006	88809001400	888090H0140	
.059	1,5	1-1/2	.120	.118	.006	88809001500	888090H0150	
.063	1,6	1-1/2	.125	.118	.006	88809001600	888090H0160	
.066	1,7	1-1/2	.134	.118	.007	88809001700	888090H0170	
.071	1,8	1-1/2	.140	.118	.007	88809001800	888090H0180	
.074	1,9	1-1/2	.145	.118	.008	88809001900	888090H0190	
.078	2,0	1-1/2	.160	.118	.008	88809002000	888090H0200	
.082	2,1	1-1/2	.165	.118	.008	88809002100	888090H0210	
.086	2,2	1-1/2	.173	.118	.009	88809002200	888090H0220	
.090	2,3	1-1/2	.181	.118	.009	88809002300	888090H0230	
.094	2,4	1-1/2	.190	.118	.009	88809002400	888090H0240	
.098	2,5	1-1/2	.195	.118	.010	88809002500	888090H0250	
.102	2,6	1-1/2	.205	.118	.010	88809002600	888090H0260	
.118	3	2	.240	.157	.012	88809003000	888090H0300	
.157	4	2	.315	.197	.016	88809004000	888090H0400	
3/16		2	.375	1/4	.020	88809004760	888090H0476	
.197	5	2	.395	.236	.020	88809005000	888090H0500	
.236	6	2-3/8	.475	.315	.023	88809006000	888090H0600	
1/4		2-3/8	.475	5/16	.025	88809006350	888090H0635	
5/16		2-3/4	.630	3/8	.031	88809007930	888090H0793	
.315	8	2-3/4	.630	.394	.031	88809008000	888090H0800	
3/8		2-3/4	.710	1/2	.039	88809009520	888090H0952	
.394	10	2-3/4	.710	.472	.039	88809010000	888090H1000	
.472	12	2-3/4	.790	.472	.047	88809012000	888090H1200	
1/2		2-3/4	.790	1/2	.051	88809012700	888090H1270	
5/8		3-1/8	1.000	5/8	.063	88809015870	888090H1587	
.630	16	3-1/8	1.025	.630	.063	88809016000	888090H1600	
.787	20	4	1.260	.787	.079	88809020000	888090H2000	

K15 CARBIDE — 6.5 - 7% Cobalt (0,006 - 0,008mm grain size)
T* = web thickness of split point

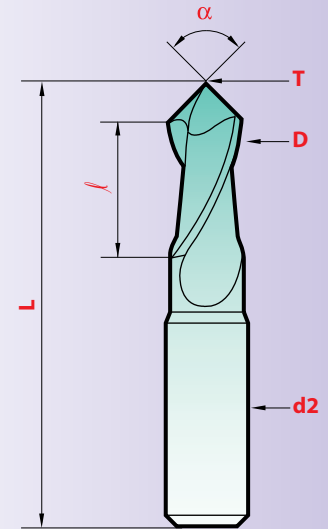

Diameters	α	d2
.003 - .118	- 0 - .0010	.118 0 - .00020
.157 - .236	- 0 - .0012	.157 - .197 0 - .00030
.250 - .394	- 0 - .0014 $\pm 1^\circ$.197 - .500 0 - .00035
.472 - .630	-.0018 - .0036	.500 - .630 0 - .00045
.787	-.0025 - .0045	.787 0 - .00050

Tolerances

METRIC magafor

Diameter		Angle					100°		120°	
inch	mm	L	ℓ	d2	T*	MULTI-V 8095+	Hard'X 8095-H+	MULTI-V 8092	Hard'X 8092-H	
.039	1,0	1-1/2	.080	.118	.004			88809201000	888092H0100	
.059	1,5	1-1/2	.120	.118	.006			88809201500	888092H0150	
.078	2,0	1-1/2	.160	.118	.008			88809202000	888092H0200	
.098	2,5	1-1/2	.195	.118	.010			88809202500	888092H0250	
.118	3	2	.240	.157	.012			88809203000	888092H0300	
.157	4	2	.315	.197	.016			88809204000	888092H0400	
.197	5	2	.395	.236	.020			88809205000	888092H0500	
.236	6	2-3/8	.475	.315	.023	88809506000	888095H0600	88809206000	888092H0600	
.315	8	2-3/4	.630	.394	.031	88809508000	888095H0800	88809208000	888092H0800	
.394	10	2-3/4	.710	.472	.039	88809510000	888095H1000	88809210000	888092H1000	
.472	12	2-3/4	.790	.472	.047	88809512000	888095H1200	88809212000	888092H1200	
.630	16	3-1/8	1.025	.630	.063	88809516000	888095H1600	88809216000	888092H1600	
.787	20	4	1.260	.787	.079			88809220000	888092H2000	

T* = web thickness of split point



Performance RECOMMENDATIONS OF USING

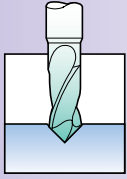

90°-120°
CENTERING - SPOTTING

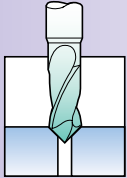

60°-90°-120°
CHAMFERING
DIRECT CHAMFERING

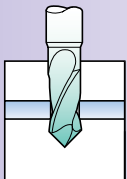

90°-120°
DRILLING

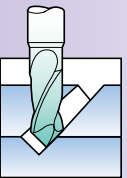

90°-120°
V - GROOVING

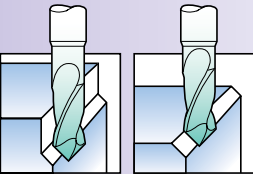

60°-90°-120°
LONGITUDINAL CHAMFERS

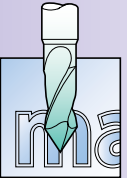

40°-60°
ENGRAVING

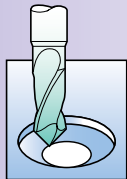

90°-120°
INTERPOLATION
MILLING

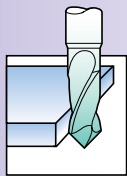

60°-90°-120°
CONTOURING
SIDE MILLING

MATERIAL	SPEED SFM	diameter			FEED inches/rev.			
		3mm-3/16"	5mm-1/4"	10mm-5/16"	12mm-1/2"	16mm-5/8"	20mm	
Steel < 81 HRB (B)	230-247	RPM	6400	4000	2500	1900	1500	1300
		IPM	12.6	12.6	13.8	14.2	14.2	14.3
Steel < 24 Rc (C)	132-197	inch/tooth	.002	.0031	.0055	.0075	.0094	.0110
		RPM	4000	2600	1600	1200	900	850
Steels 24-32 Rc Cast Iron ≤ 180 HB (Grey Cast Iron)	115-132	IPM	7.9	8.2	8.8	9.4	8.9	9.4
		inch/tooth	.002	.0031	.0055	.0075	.0094	.0110
Steels 32-41 Rc Cast Iron > 180 HB Stainless Steels	99-115	RPM	3200	2200	1400	1000	850	680
		IPM	5.7	6.1	6.6	7.1	7.4	7.5
Titanium Alloys	82-99	inch/tooth	.0018	.0028	.0047	.0071	.0087	.0110
		RPM	2800	1800	1100	800	650	550
Ni Co Alloys Inconel-Nimonic-Waspaloy	66	IPM	5.0	5.0	5.2	5.4	5.6	5.6
		inch/tooth	.0018	.0028	.0047	.0067	.0087	.0102
Copper alloys Bronze	165-395	RPM	2200	1600	900	660	500	480
		IPM	3.5	3.8	3.9	4.1	4.3	4.7
Aluminum	494	inch/tooth	.0016	.0024	.0043	.0063	.0087	.0098
		RPM	1800	1100	700	500	400	320
Thermoplastics	494	IPM	2.8	2.6	3.0	3.1	3.1	3.1
		inch/tooth	.0016	.0024	.0043	.0063	.0079	.0098
Copper alloys Bronze	165-395	RPM	5000	3500	2200	1900	1700	1400
		IPM	19.7	20.7	21.7	22.4	23.4	24.8
Aluminum	494	inch/tooth	.0039	.0059	.0098	.0118	.0138	.0177
		RPM	10000	6300	4000	3200	2500	2000
Thermoplastics	494	IPM	19.7	22.3	23.6	25.2	26.6	27.6
		inch/tooth	.0020	.0035	.0059	.0079	.0106	.0138

MATERIAL	SPEED SFM	diameter			FEED inches/rev.			
		3mm-3/16"	5mm-1/4"	10mm-5/16"	12mm-1/2"	16mm-5/8"	20mm	
Steel < 81 HRB (B)	230-247	RPM	6800	4300	2650	2000	1500	1200
		IPM	2.6	2.6	2.8	3.0	3.0	3.0
Steel < 24 Rc (C)	132-197	inch/tooth	.0002	.0003	.0006	.0007	.0010	.0012
		RPM	5400	3500	2100	1600	1200	1000
Steels 24-32 Rc Cast Iron ≤ 180 HB (Grey Cast Iron)	115-132	IPM	2.2	2.2	2.3	2.4	2.4	2.4
		inch/tooth	.0002	.0003	.0006	.0007	.0010	.0012
Steels 32-41 Rc Cast Iron > 180 HB Stainless Steels	99-115	RPM	3600	2300	1400	1000	800	630
		IPM	1.1	1.1	1.3	1.4	1.4	1.4
Titanium Alloys	82-99	inch/tooth	.0002	.0002	.0005	.0007	.0008	.0011
		RPM	3000	2000	1200	900	700	550
Ni Co Alloys Inconel-Nimonic-Waspaloy	66	IPM	1.0	1.0	1.2	1.2	1.2	1.2
		inch/tooth	.0002	.0002	.0005	.0006	.0008	.0011
Copper alloys Bronze	165-395	RPM	2200	1600	1000	760	600	400
		IPM	0.7	0.8	0.8	0.8	0.9	0.9
Aluminum	494	inch/tooth	.0002	.0002	.0004	.0005	.0007	.0011
		RPM	1800	1100	700	500	400	320
Thermoplastics	494	IPM	0.4	0.5	0.6	0.6	0.6	0.6
		inch/tooth	.0001	.0002	.0004	.0005	.0007	.0010
Copper alloys Bronze	165-395	RPM	7000	6000	3500	3200	2200	1750
		IPM	4.4	4.7	4.7	5.0	5.2	5.5
Aluminum	494	inch/tooth	.0003	.0004	.0007	.0008	.0012	.0016
		RPM	13000	8600	5300	4000	3000	2400
Thermoplastics	494	IPM	7.9	8.7	9.4	9.4	9.8	9.8
		inch/tooth	.0003	.0005	.0009	.0012	.0017	.0020
Thermoplastics	494	RPM	13000	8600	5300	4000	3000	2400
		IPM	10.2	10.2	10.4	10.6	10.6	10.6
Thermoplastics	494	inch/tooth	.0004	.0006	.0010	.0013	.0018	.0022

MATERIAL	SPEED SFM	diameter			FEED inches/rev.			
		3mm-3/16"	5mm-1/4"	10mm-5/16"	12mm-1/2"	16mm-5/8"	20mm	
Steel < 81 HRB (B)	230-247	RPM	6800	4300	2650	2000	1500	1200
		IPM	4.3	4.7	5.1	5.9	6.1	6.1
Steel < 24 Rc (C)	132-197	inch/tooth	.0003	.0006	.0010	.0016	.0020	.0026
		RPM	5400	3500	2100	1600	1200	1000
Steels < 24-32 Rc Cast Iron ≤ 180 HB (Grey Cast Iron)	115-132	IPM	3.3	3.5	4.1	4.7	4.9	4.9
		inch/tooth	.0003	.0005	.0010	.0016	.0020	.0024
Steels < 24-32 Rc Cast Iron ≤ 180 HB (Grey Cast Iron)	115-132	RPM	3600	2300	1400	1000	800	630
		IPM	2.3	2.4	2.8	3.1	3.1	3.1
Steels 32-41 Rc Cast Iron > 180 HB Stainless Steels	99-115	inch/tooth	.0003	.0005	.0010	.0016	.0020	.0024
		RPM	3000	2000	1200	900	700	550
Titanium Alloys	82-99	IPM	1.8	2.0	2.4	2.6	2.6	2.6
		inch/tooth	.0003	.0005	.0010	.0014	.0020	.0024
Ni Co Alloys Inconel-Nimonic-Waspaloy	66	RPM	2200	1600	1000	760	600	400
		IPM	1.4	1.6	2.0	2.2	2.2	2.2
Copper alloys Bronze	165-395	inch/tooth	.0003	.0005	.0010	.0014	.0018	.0028
		RPM	1800	1100	700	500	400	320
Aluminum	494	IPM	1.0	1.0	1.4	1.4	1.6	1.6
		inch/tooth	.0003	.0004	.0010	.0014	.0020	.0024
Thermoplastics	494	RPM	10000	7000	3600	2500	2300	1800
		IPM	7.9	8.3	8.5	8.9	9.1	9.2
Thermoplastics	494	inch/tooth	.0004	.0006	.0012	.0018	.0020	.0026
		RPM	13000	8600	5300	4000	3000	2400
Thermoplastics	494	IPM	8.3	8.9	12.6	14.2	11.8	12.2
		inch/tooth	.0003	.0005	.0012	.0018	.0020	.0026
Thermoplastics	494	RPM	13000	8600	5300	4000	3000	2400
		IPM	12.2	10.2	14.6	15.7	12.6	13.0
Thermoplastics	494	inch/tooth	.0005	.0006	.0014	.0020	.0020	.0028

BI-FACE ADVANTAGES

Special design = positive cut + relieving profile

- Unequalled surface finish
- Impressive performance
- Extended tools profile life

Hard-X
AlTiN Latuma

Tolerances	D	tolerance	L	α
\emptyset .040~.197	0 - .002	\pm .040	$\pm 1^\circ$	
\emptyset .236~.630	0 - .004	\pm .040	$\pm 1^\circ$	

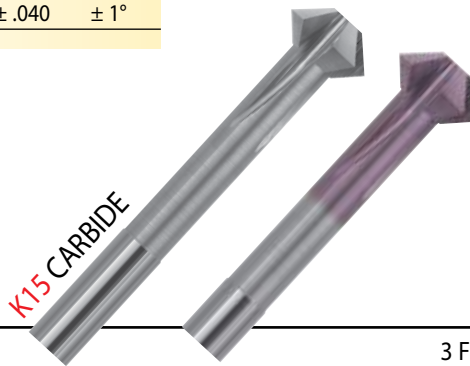

Angle 90° MINI								3 FLUTES	
Diameter	d3	T	L			Bi-face	Hard'X		
inch mm	d2 max	max	min	ℓ 2	ℓ 3	8480	8480-H		
.040 1,0	.118 .028	.012	2-3/8	.020	.197	88848001000	888480H0100		
.059 1,5	.118 .043	.018	2-3/8	.029	.236	88848001500	888480H0150		
.079 2,0	.118 .059	.024	2-3/8	.037	.315	88848002000	888480H0200		
.118 3,0	.118 .087	.035	2-3/8	.059	.394	88848003000	888480H0300		

Angle 90° STANDARD								4 FLUTES	
Diameter	d3	T	L			Bi-face	Hard'X		
inch mm	d2 max	max	min	ℓ 2	ℓ 3	8490	8490-H		
.118 3,0	.236 .087	.047	4	.051	.394	88849003000	888490H0300		
.157 4,0	.236 .114	.063	4	.069	.472	88849004000	888490H0400		
.197 5,0	.236 .134	.079	4	.091	.591	88849005000	888490H0500		
.236 6,0	.236 .154	.094	4	.114	.709	88849006000	888490H0600		
.315 8,0	.236 .193	.193	4	.118	1.339	88849008000	888490H0800		
.394 10,0	.236 .232	.232	4	.157	1.339	88849010000	888490H1000		
.472 12,0	.236 .232	.232	4	.236	1.339	88849012000	888490H1200		
.630 16,0	.394 .311	.311	4	.315	1.339	88849016000	888490H1600		

Angle 60° STANDARD								4 FLUTES	
Diameter	d3	T	L			Bi-face	Hard'X		
inch mm	d2 max	max	min	ℓ 2	ℓ 3	8460	8460-H		
.197 5,0	.236 .134	.134	4	.110	1.339	88846005000	888460H0500		
.315 8,0	.236 .193	.232	4	.213	1.339	88846008000	888460H0800		
.472 12,0	.394 .232	.232	4	.417	1.339	88846012000	888460H1200		

FRONT AND BACK CHAMFERING BICONICAL CUTTERS

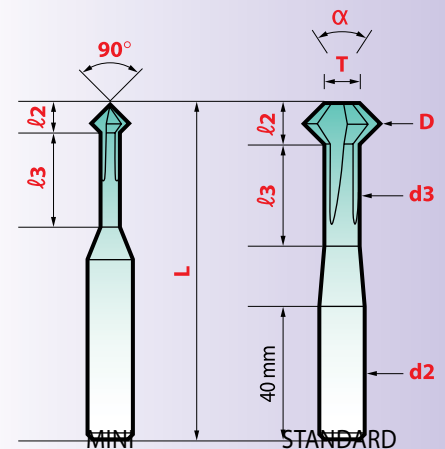
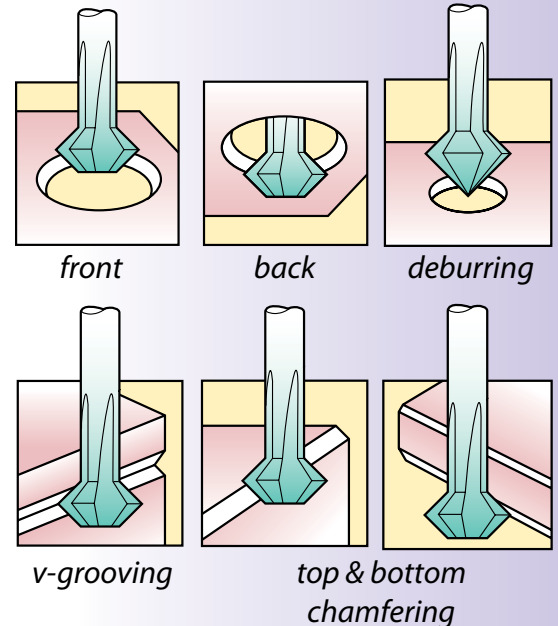

For super finish operations, **Bi-face** has a constant relieved profile. Longitudinal or interpolated work for front and back chamfering of edges and holes.

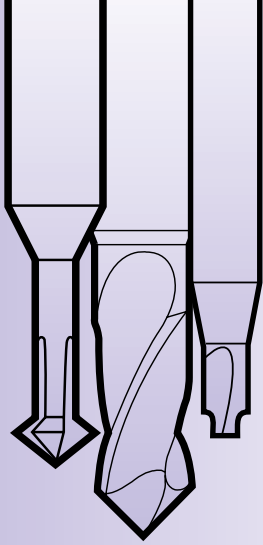

MULTI-FUNCTION TOOLS



CARBIDE MINIATURE CORNER ROUNDING END-MILLS

The radius is positioned in relation to the small \varnothing d1:-
so it is possible to machine compound forms,
small slots and holes from 0,5 mm.

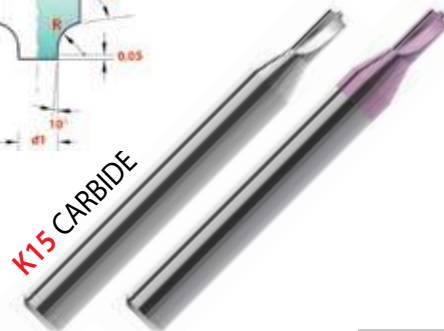
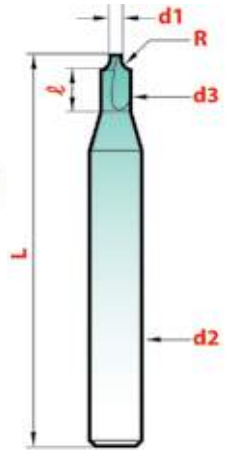
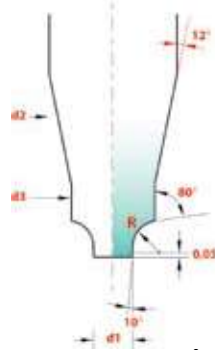
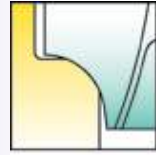

Radius		d1	d2	d3	Δx	l	L	Carbide 8550	Hard'X 8550-H
Inch	mm								
.0039	0,10	.020	.118	.031	0,35	.098	2	88855000100	888550H0010
.0059	0,15	.020	.118	.035	0,40	.098	2	88855000150	888550H0015
.0079	0,20	.020	.118	.040	0,45	.098	2	88855000200	888550H0020
.0098	0,25	.020	.118	.040	0,50	.098	2	88855000250	888550H0025
.0118	0,30	.020	.118	.047	0,55	.098	2	88855000300	888550H0030
.0157	0,40	.020	.118	.055	0,65	.098	2	88855000400	888550H0040
.0197	0,50	.020	.118	.063	0,75	.098	2	88855000500	888550H0050
.0236	0,60	.020	.118	.071	0,85	.118	2	88855000600	888550H0060
.0276	0,70	.020	.118	.083	0,95	.118	2	88855000700	888550H0070
.0295	0,75	.020	.118	.083	1,00	.118	2	88855000750	888550H0075
.0315	0,80	.031	.118	.098	1,20	.157	2	88855000800	888550H0080
.0354	0,90	.031	.118	.114	1,30	.157	2	88855000900	888550H0090
.0394	1,00	.031	.118	.114	1,40	.157	2	88855001000	888550H0100
.0492	1,25	.031	.157	.134	1,65	.157	2	88855001250	888550H0125
.0591	1,50	.059	.197	.181	2,25	.236	2	88855001500	888550H0150
.0689	1,75	.059	.236	.220	2,50	.236	2	88855001750	888550H0175
.0787	2,00	.059	.236	.220	2,75	.315	2	88855002000	888550H0200
.0886	2,25	.059	.315	.260	3,00	.394	2	88855002250	888550H0225
.0984	2,50	.059	.315	.260	3,25	.394	2	88855002500	888550H0250
.1181	3,00	.059	.315	.299	3,75	.394	2	88855003000	888550H0300
.1575	4,00	.075	.394	.394	4,95	-	2-3/16	88855004000	888550H0400
.1969	5,00	.075	.472	.472	5,95	-	2-1/2	88855005000	888550H0500

Coating is available

Tolerances

R	d1	d2	L
± .0008	± .00039	h6	± .0040

These cutters are designed for CNC machine.
They allow machining even very thin materials.
Many easy regrinds.

See these tools at work!



www.hassay-savage.com/
resource-center/product-videos

COUNTERSINKS



Hand Countersinks
Page 88

- Chamfering
- Deburring

TRIDENT THREE FLUTES

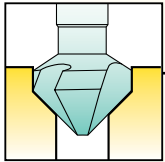

		Angle									
		30°	60°	82°	90°	100°	120°				
Page	88	Page	88	Page	89	Pages	89-90	Page	88	Page	88

- ADVANTAGES:** *Self-centering (3 flutes)*
- Designed for 82° capscrew countersinking
 - Hand using
 - Longitudinal chamfers and contouring
 - Works without vibrations

SINGLE FLUTE

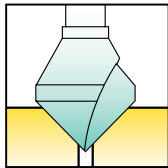

		Angle							
		60°	82°	90°	100°	120°			
Page	92	Page	92	Page	93	Page	93	Page	93

- ADVANTAGES:**
- For wood and hard plastics
 - Can drill in sheet materials
 - Easy to sharpen
 - Works without vibrations

ZERO FLUTE WITH HOLE

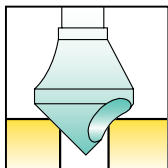

		Angle							
		60°	82°	90°	100°	120°			
Page	91	Page	91	Page	91	Page	91	Page	91

- ADVANTAGES:**
- For light metals and plastics
 - For deburring and small chamfers
 - Best surface finish
 - Works without vibrations

AUTO BODY SPOT WELD DRILL BITS

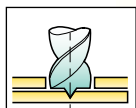

• Disconnect sheet metal spot weld

Page
95

magafor, The choice!

Material	HSS	HSS-Co	Hss-Co + TIN	HSS 8% Co	HSS 8% Co + Red'X	CARBIDE	CARBIDE + Hard'X
Hardness	63 HRC	65 HRC	65 HRC +2300 HV	67 HRC	67 HRC + 3500 HV	1800 HV	1800 HV + 3500
Use	Small Series	Production intensive		Hard and abrasive alloys		Treated steels	

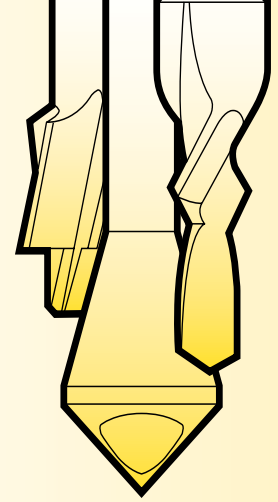

COUNTERSINKING

See these tools at work!



www.hassay-savage.com/resource-center/product-videos

TRI-DENT HAND COUNTERSINKS



METRIC		Angle	82°	90°
Diameter inch	mm	Capacity min/max	Cobalt 438	Cobalt 430
.488	12,4	.118 - .488	84438124000	84430124000
.650	16,5	.157 - .650	84438165000	84430165000
.807	20,5	.157 - .807	84438205000	84430205000
.984	25,0	.197 - .984	84438250000	84430250000
1.220	31,0	.197 - 1.220	84438310000	84430310000

UNIVERSAL AUTO-LOCK CHUCK



Ergonomic Handle Capacity 3/64 - 8 mm	magafor 84400200000
Large Handle Capacity 3/64 - 1/2	magafor 84400100000

To hold any straight shank tool, for use by hand.



3 FLUTE COUNTERSINK SETS

Angle	Cobalt	COMPOSITION / mm
60°	84432000000	10,4
	84483200000 TIN	16,5
82°	84434000000	20,5
	84483400000 TIN	25
100°	84435000000	31
120°	84433000000	

See these tools at work!

www.hassay-savage.com/resource-center/product-videos



TRI-DENT Three flute COUNTERSINKS

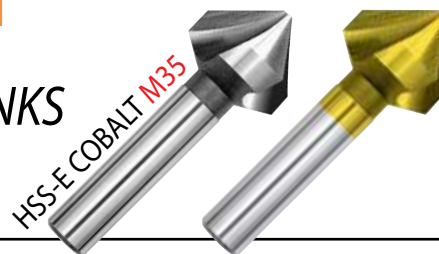

METRIC

Angle	Diameter inch	mm	Capacity min/max	d	L	Cobalt	Angle	M35/TIN
30°	.248	6,3	.079 - .248	.197	2	84439063000	30°	84483906300
	.488	12,4	.012 - .488	.315	2-1/2	84439124000		84483912400
439	.650	16,5	.157 - .650	.394	3	84439165000	4839	84483916500
	.984	25,0	.236 - .984	.394	3-1/2	84439250000		84483925000
439	.248	6,3	.051 - .248	.197	1-7/8	84432063000	4839	84483206300
	.327	8,3	.071 - .327	.236	2	84432083000		84483208300
60°	.410	10,4	.091 - .410	.236	2	84432104000	60°	84483210400
	.488	12,4	.098 - .488	.315	2-3/8	84432124000		84483212400
432	.650	16,5	.110 - .650	.394	2-1/2	84432165000	4832	84483216500
	.807	20,5	.118 - .807	.394	2-3/4	84432205000		84483220500
432	.984	25,0	.126 - .984	.394	3	84432250000	4832	84483225000
	1.22	31,0	.138 - 1.22	.472	3-1/8	84432310000		84483231000
432	.248	6,3	.051 - .248	.197	1-3/4	84434063000	4832	84483406300
	1/4	6,35	.050 - .250	1/4	1-3/4	84434063500		84483406350
432	5/16	7,94	.070 - .312	1/4	1-3/4	84434079300	4832	84483407930
	.327	8,3	.070 - .327	.236	2	84434083000		84483408300
82°	3/8	9,52	.085 - .375	1/4	2	84434095200	82°	84483409520
	.410	10,4	.087 - .410	.236	2	84434104000		84483410400
434	.488	12,4	.098 - .488	.315	2-1/4	84434124000	4834	84483412400
	1/2	12,7	.100 - .500	1/4	2	84434127000		84483412700
434	5/8	15,87	.110 - .625	3/8	2-3/8	84434158700	4834	84483415870
	.650	16,5	.110 - .650	.394	2-3/8	84434165000		84483416500
434	3/4	19,05	.120 - .750	3/8	2-3/8	84434190500	4834	84483419050
	.807	20,5	.118 - .807	.394	2-1/2	84434205000		84483420500
434	.984	25,0	.126 - .984	.394	2-11/16	84434250000	4834	84483425000
	1.00	25,4	.125 - 1.00	3/8	2-3/4	84434254000		84483425400
434	1.22	31,0	.138 - 1.22	.472	2-7/8	84434310000	4834	84483431000
	.248	6,3	.051 - .248	.197	1-3/4	84435063000		84483506300
100°	.327	8,3	.070 - .327	.236	2	84435083000	100°	84483508300
	.410	10,4	.087 - .410	.236	2	84435104000		84483510400
435	.488	12,4	.098 - .488	.315	2-3/16	84435124000	4835	84483512400
	.650	16,5	.110 - .650	.394	2-5/16	84435165000		84483516500
435	.807	20,5	.118 - .807	.394	2-7/16	84435205000	4835	84483520500
	.984	25,0	.126 - .984	.394	2-1/2	84435250000		84483525000
435	1.22	31,0	.138 - 1.22	.472	2-11/16	84435310000	4835	84483531000
	.248	6,3	.051 - .248	.197	1-3/4	84433063000		84483306300
120°	.327	8,3	.070 - .327	.236	2	84433083000	120°	84483308300
	.410	10,4	.087 - .410	.236	2	84433104000		84483310400
433	.488	12,4	.098 - .488	.315	2-1/8	84433124000	4833	84483312400
	.650	16,5	.110 - .650	.394	2-1/4	84433165000		84483316500
433	.807	20,5	.118 - .807	.394	2-5/16	84433205000	4833	84483320500
	.984	25,0	.126 - .984	.394	2-1/2	84433250000		84483325000
433	1.22	31,0	.138 - 1.22	.472	2-1/2	84433310000	4833	84483331000

TRI-DENT 90° Three flute COUNTERSINKS

90° THREE FLUTE COUNTERSINKS

Angle 90°

Diameter inch mm	Capacity min/max	d	L	Cobalt 431	M35/TIN 4831
.158 4,0	.051 - .158	.158	1-5/8	84431040000	84483104000
.170 4,3	.051 - .170	.158	1-5/8	84431043000	84483104300
.197 5,0	.051 - .197	.158	1-5/8	84431050000	84483105000
.209 5,3	.051 - .209	.197	1-3/4	84431053000	84483105300
.229 5,8	.051 - .229	.197	1-3/4	84431058000	84483105800
.236 6,0	.051 - .236	.197	1-3/4	84431060000	84483106000
.248 6,3	.051 - .248	.197	1-3/4	84431063000	84483106300
1/4 6,35	.050-.250	1/4	1-3/4	84431063500	84483106350
.276 7,0	.063 - .276	.236	2	84431070000	84483107000
.288 7,3	.063 - .288	.236	2	84431073000	84483107300
5/16 7,94	.070-.312	1/4	1-3/4	84431079300	84483107930
.315 8,0	.071 - .315	.236	2	84431080000	84483108000
.327 8,3	.071 - .327	.236	2	84431083000	84483108300
.354 9,0	.079 - .354	.236	2	84431090000	84483109000
.370 9,4	.079 - .370	.236	2	84431094000	84483109400
3/8 9,52	.085-.375	1/4	2	84431095200	84483109520
.394 10,0	.087 - .394	.236	2	84431100000	84483110000
.410 10,4	.087 - .410	.236	2	84431104000	84483110400
.453 11,5	.098 - .453	.315	2-1/4	84431115000	84483111500
.472 12,0	.098 - .472	.315	2-1/4	84431120000	84483112000
.488 12,4	.098 - .488	.315	2-1/4	84431124000	84483112400
1/2 12,70	.100-.500	1/4	2	84431127000	84483112700
.528 13,4	.098 - .528	.315	2-1/4	84431134000	84483113400
.567 14,4	.098 - .567	.315	2-1/4	84431144000	84483114400
.590 15,0	.110 - .590	.394	2-3/8	84431150000	84483115000
5/8 15,87	.110-.625	3/8	2-3/8	84431158700	84483115870
.650 16,5	.110 - .650	.394	2-3/8	84431165000	84483116500
.748 19,0	.118 - .748	.394	2-1/2	84431190000	84483119000
3/4 19,05	.120-.750	3/8	2-3/8	84431190500	84483119050
.807 20,5	.118 - .807	.394	2-1/2	84431205000	84483120500
.906 23,0	.126 - .906	.394	2-5/8	84431230000	84483123000
.984 25,0	.126 - .984	.394	2-5/8	84431250000	84483125000
1 25,40	.125-1.00	3/8	2-3/4	84431254000	84483125400
1.024 26,0	.126 - 1.024	.394	2-5/8	84431260000	84483126000
1.102 28,0	.138 - 1.102	.472	2-3/4	84431280000	84483128000
1.181 30,0	.138 - 1.181	.472	2-3/4	84431300000	84483130000
1.220 31,0	.138 - 1.220	.472	2-3/4	84431310000	84483131000

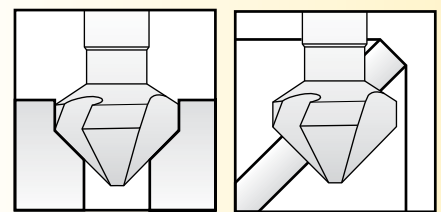
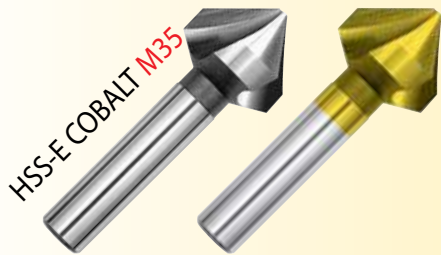

COUNTERSINK CHAMFER

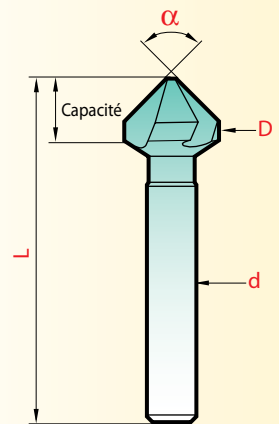

D	Angle	d	L
± 0.05	- 1°	h9	± 1mm

Tolerances

WITH 3 FLATTED SHANKS*

Diameter inch mm	Capacity min/max	d	L	Cobalt 437	TIN 4837
.488 12,4	.098 - .488	.315	2-1/4	84437124000	84483712400
.567 14,4	.098 - .567	.315	2-1/4	84437144000	84483714400
.650 16,5	.110 - .650	.394	2-3/8	84437165000	84483716500
.807 20,5	.118 - .807	.394	2-1/2	84437205000	84483720500
.984 25,0	.126 - .984	.394	2-5/8	84437250000	84483725000
1.220 31,0	.138 - 1.220	.472	2-3/4	84437310000	84483731000
1.339 34,0	.177 - 1.339	.630	4	84437340000	84483734000
1.378 35,0	.177 - 1.378	.630	4	84437350000	84483735000
1.457 37,0	.177 - 1.457	.630	4-5/8	84437370000	84483737000
1.575 40,0	.177 - 1.575	.630	4-5/8	84437400000	84483740000
1.969 50,0	.197 - 1.969	.630	5	84437500000	84483750000
2.480 63,0	.394 - 2.480	.630	5-1/2	84437630000	84483763000
3.150 80,0	.551 - 3.150	.630	6-1/2	84437800000	84483780000

* Effective holding thanks to the three flats on shank

This highly productive countersinking cutter is a much improved version of the traditional multiflute milling cutter

- grooves opened wide to allow for greater chip removal,
- high positive cut,
- constant profile relief (a great many regrinds),
- self centering countersink,
- work without vibration.

Tool dimensions are adapted to countersink the 82° and 90° capscrews. Lubrication is recommended.

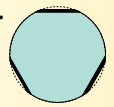

TRI-DENT 90° Three flute COUNTERSINKS

Code 4936

• Special for abrasion resistant hard alloys

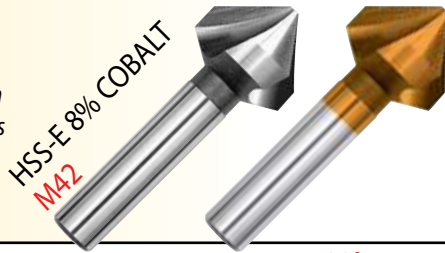

METRIC		Angle 90°					
Diameter inch mm	Capacity min/max	d	L	Cobalt + 436	M42/RedX 4936		
.248	6,3	.051 - .248	.197	1-3/4	84436063000	84493606300	
.327	8,3	.071 - .327	.236	1-3/4	84436083000	84493608300	
.410	10,4	.087 - .410	.236	1-3/4	84436104000	84493610400	
.488	12,4	.098 - .488	.315	2-1/4	84436124000	84493612400	
.650	16,5	.110 - .650	.394	2-3/8	84436165000	84493616500	
.807	20,5	.118 - .807	.394	2-1/2	84436205000	84493620500	
.984	25,0	.126 - .984	.394	2-5/8	84436250000	84493625000	
1.220	31,0	.138 - 1.220	.472	2-3/4	84436310000	84493631000	
1.969	50,0*	.197 - 1.969	.630	5	84436500000	84493650000	

* 3 flatted shanks



84483100006

HSS-E COBALT M35

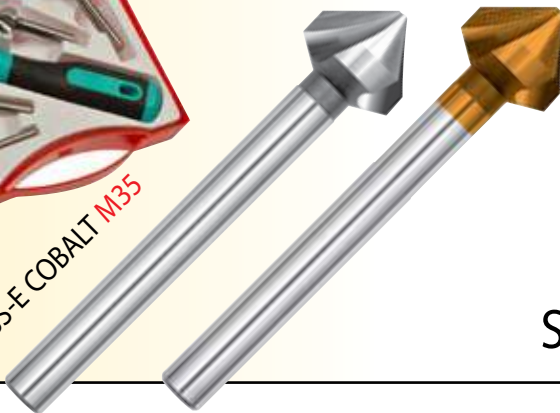

LONG SERIES

METRIC		Angle 90°						
Diameter inch mm	Capacity min/max	d	L	Cobalt 4303	M35/RedX 4933	Carbide 8431-L		
.248	6,3	.051 - .248	.236	3-5/16	84430306300	84493306300	888431L0630	
.327	8,3	.071 - .327	.315	3-3/8	84430308300	84493308300	888431L0830	
.410	10,4	.087 - .410	.394	3-1/2	84430310400	84493310400	888431L1040	
.488	12,4	.098 - .488	.394	4-1/4	84430312400	84493312400	888431L1240	
.650	16,5	.110 - .650	.630	4-7/16	84430316500	84493316500	888431L1650	
.807	20,5	.118 - .807	.630	4-1/2	84430320500	84493320500	888431L2050	
.984	25,0	.126 - .984	.788	4-11/16	84430325000	84493325000		

NOTE :

All these metric sizes are available within 2 weeks.
Call for information.

K15
SOLID CARBIDE

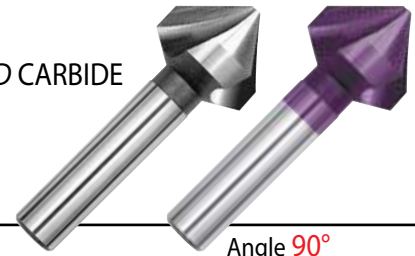

METRIC		Angle 90°					
Diameter inch mm	Capacity min/max	d	L	Carbide 8431	K15/Hard'X 8431-H		
.170	4,3	.051 - .170	.157	1-9/16	88843104300	888431H0430+	
.209	5,3	.051 - .209	.157	1-9/16	88843105300	888431H0530+	
.248	6,3	.051 - .248	.197	1-3/4	88843106300	888431H0630+	
.327	8,3	.071 - .327	.236	1-3/4	88843108300	888431H0830+	
.410	10,4	.087 - .410	.236	1-3/4	88843110400	888431H1040	
.488	12,4*	.098 - .488	.315	2-1/4	88843112400	888431H1240	
.650	16,5*	.110 - .650	.394	2-3/8	88843116500	888431H1650	
.807	20,5*	.118 - .807	.394	2-1/2	88843120500	888431H2050	
.984	25,0*	.126 - .984	.394	2-5/8	88843125000	888431H2500	
1.220	31,0*	.138 - 1.220	.472	2-3/4	88843131000	888431H3100	

* Ø 12,4 - 31,0 = 3 flatted shanks



84431000000-M

84431000000 / 84436000000

TRIDENT COUNTERSINK SETS

Angle	M35/Cobalt	COMPOSITION / mm
60°	84432000000	Ø 10,4-16,5 20,5-25-31
	84483200000	
82°	84434000000	
	84483400000	
100°	84435000000	
120°	84433000000	

3 FLUTE COUNTERSINK SETS ANGLE 90°

magafor	Diameter/COMPOSITION
84431000000-M	Ø 10 - 15 - 20,5 mm
84431000000-M-TIN	
84431000007	1/4" - 3/8" - 1/2" - 3/4"
84483100007 TIN	
84431000000	10,4 - 16,5 - 20,5 - 25,0 - 31,0 mm
84483100000 TIN	
84436000000	
84431000002	6,3 - 8,3 - 10,4 - 12,4 - 16,5 - 20,5 mm
84483100002 TIN	
84436000002	
88843100002	6,3 - 8,3 - 10,4 - 12,4 - 16,5 - 20,5 - 25 mm
84431000003 ¹	
84431000004 ¹	4,3 - 5,3 - 6,3 - 8,3 - 10,4 - 12,4 - 16,5 - 20,5 - 25 - 31 mm
88843100000	
84431000006 ²	10,4 - 16,5 - 20,5 - 25 - 31 mm carbide
84483100006 TIN ²	
84431000008 ²	6,3 - 12,4 - 16,5 - 20,5 mm
84483100008 TIN ²	
84431000008 ²	1/4" - 3/8" - 1/2" - 3/4"
84483100008 TIN ²	

¹ Set supplied with 1 auto-lock chuck handle Code 4001.

² Set supplied with 8mm auto-lock chuck handle Code 4002.

ZERO FLUTE DEBURRING TOOL With Hole

Angle 90°

TYPE	Right hand							
	#	Diameter		Capacity	d	L	Cobalt 411	M35/TIN 4811
		inch	mm	min/max				
0	1/4 ¹			5/64 - 3/16	1/4	1-3/4	84411063500	84481106350
	.394	10		5/32 - 11/32	.236	1-3/4	84411100000	84481110000
1	7/16			7/32 - 13/32	1/4	1-3/4	84411112000	84481111200
2	9/16			1/4 - 1/2	1/4	2	84411140000	84481114000
	.590	15		1/4 - 9/16	.315	2-1/4	84411150000	84481115000
	.787	20		5/16 - 11/16	.394	2-1/2	84411200000	84481120000
	3	13/16		5/16 - 11/16	1/2	2-5/8	84411204000	84481120400
	.984	25		3/8 - 7/8	.472	3	84411250000	84481125000
	1.102	28		7/16 - 1	.472	3-3/8	84411280000	84481128000
	1.181	30		1/2 - 1-1/8	.472	3-1/2	84411300000	84481130000
	4	1-3/16		1/2 - 1-1/8	1/2	3-1/2	84411301000	84481130100
	1.378	35		9/16 - 1-5/16	.630 ²	4	84411350000	84481135000
	1.575	40		5/8 - 1-1/2	.630 ²	4-5/8	84411400000	84481140000
	1.969	50		3/4 - 1-7/8	.630 ²	5	84411500000	84481150000

¹ Double end cutter

² Shanks with 3 flats for better holding

www.hassay-savage.com
/resource-center
/product-videos

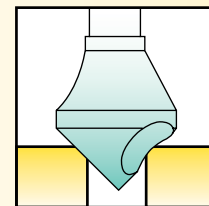

SEE THESE TOOLS AT WORK!

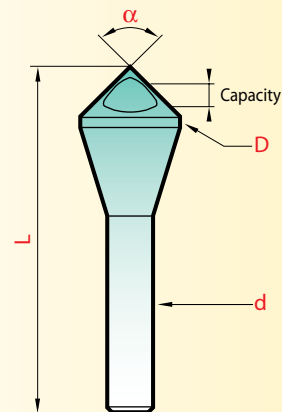

Angle	#	Diameter		Capacity	d	L	Cobalt	
		inch	mm	min/max				
60° 412	0	1/4 ¹		7/64 - 3/16	1/4	1-3/4	84412063500	
		.394	10	3/16 - 11/32	.236	2	84412100000	
	1	7/16		3/16 - 3/8	1/4	1-3/4	84412112000	
	2	9/16			9/32 - 1/2	1/4	2	84412140000
		.590	15		5/16 - 9/16	.315	2-3/8	84412150000
		.787	20		3/8 - 11/16	.394	2-7/8	84412200000
	3	13/16			3/8 - 11/16	1/2	2-5/8	84412204000
		.984	25		1/2 - 7/8	.472	3-3/8	84412250000
		1.181	30		9/16 - 1-1/8	.472	3-5/8	84412300000
	4	1-3/16			9/16 - 1-1/8	1/2	3-1/2	84412301000
	1.378	35		11/16 - 1-5/16	.630 ²	4-1/2	84412350000	
82° 414	0	1/4 ¹		5/64 - 3/16	1/4	1-3/4	84414063500	
		.394	10	5/32 - 11/32	.236	1-3/4	84414100000	
	1	7/16		7/32 - 13/32	1/4	1-3/4	84414112000	
	2	9/16			1/4 - 1/2	1/4	2	84414140000
		.590	15		1/4 - 9/16	.315	2-1/4	84414150000
		.787	20		5/16 - 11/16	.394	2-1/2	84414200000
	3	13/16			5/16 - 11/16	1/2	2-5/8	84414204000
		.984	25		3/8 - 7/8	.472	3	84414250000
		1.181	30		1/2 - 1-1/8	.472	3-1/2	84414300000
	4	1-3/16			1/2 - 1-1/8	1/2	3-1/2	84414301000
	1.378	35		9/16 - 1-5/16	.630 ²	4	84414350000	
100° 415		.394	10	5/32 - 11/32	.236	1-3/4	84415100000	
		.590	15	1/4 - 9/16	.315	2-1/8	84415150000	
		.787	20	9/32 - 11/16	.394	2-1/2	84415200000	
		.984	25	11/32 - 7/8	.472	3	84415250000	
		1.181	30	7/16 - 1-1/16	.472	3-3/8	84415300000	
	1.378	35	1/2 - 1-5/16	.630 ²	4	84415350000		
120° 413		.394	10	5/32 - 11/32	.236	1-3/4	84413100000	
		.590	15	1/4 - 9/16	.315	2	84413150000	
		.787	20	9/32 - 11/16	.394	2-3/8	84413200000	
		.984	25	11/32 - 7/8	.472	2-7/8	84413250000	
		1.181	30	7/16 - 1-1/16	.472	3-1/4	84413300000	
	1.378	35	1/2 - 1-5/16	.630 ²	3-3/4	84413350000		

¹ Double end cutter

² 3 flatted shanks



HSS-E COBALT M35



D	Angle	d	L
+0.3	-1°	h9	±1mm

Tolerances

The deburring tool "with hole" is more particularly designed for countersinking and chamfering light metals and plastics. The surface obtained is smooth and without burrs. We recommend lubricating.



SETS OF 5 ZERO FLUTE CUTTERS

Angle	magafor EDP#	COMPOSITION
60°	84412000000	Ø 10-15-20-25-30 mm
	84412000005	# 0-1-2-3-4
82°	84414000000	Ø 10-15-20-25-30 mm
	84414000005	# 0-1-2-3-4
90°	84411000000	Ø 10-15-20-25-30 mm
	84481100000-TIN	Ø 10-15-20-25-30 mm
	84411000002	Ø 10-15-20-28-35 mm
	84411000005	# 0-1-2-3-4
	84481100005-TIN	# 0-1-2-3-4
100°	84415000000	Ø 10-15-20-25-30 mm
120°	84413000000	Ø 10-15-20-25-30 mm

Single flute CHAMFERING CUTTERS

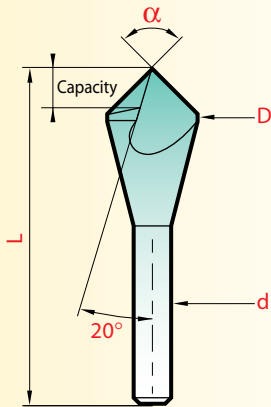
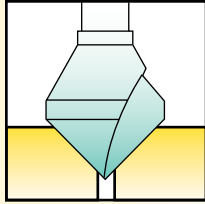

D	Angle	d	L
+0.3	-1°	h9	±1mm

Tolerances

The characteristics of the single flute chamfering cutters are similar to those of the deburring tools "with hole". They do vary on the following points :

- greater countersinking capacity, from the point to the outside diameter (up to Ø 30 mm),
- simultaneous drilling and countersinking on thin elements (laminates, aluminium, wood).

Constant finish-grind profile makes it possible to obtain many easy regrinds : a mere touch of the grinder to the tooth is sufficient. We recommend lubricating.

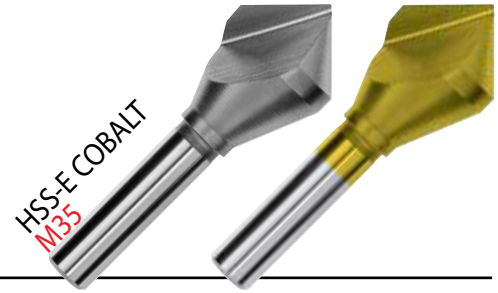

Angle	Diameter		Capacity min/max	d	L	Cobalt 422	M35/TIN 4822
	inch	mm					
60°	1/8		1/32 - 1/8	1/8	1-1/4	84422031700	84482203170
	3/16		3/64 - 3/16	3/16	1-3/8	84422047600	84482204760
	.236	6	3/64 - .236	.236	1-5/8	84422060000	84482206000
	1/4		3/64 - 1/4	1/4	1-1/2	84422063500	84482206350
	5/16		3/64 - 5/16	1/4	1-5/8	84422079300	84482207930
	3/8		3/64 - 3/8	1/4	1-3/4	84422095200	84482209520
	.394	10	3/64 - .394	.236	1-7/8	84422100000	84482210000
	.472	12	5/64 - .472	.315	2-1/8	84422120000	84482212000
	1/2		5/64 - 1/2	1/4	2	84422127000	84482212700
	.590	15	5/64 - .590	.315	2-3/8	84422150000	84482215000
	5/8		5/64 - 5/8	3/8	2-1/4	84422158700	84482215870
	3/4		5/64 - 3/4	1/2	2-5/8	84422190500	84482219050
	.787	20	5/64 - .787	.394	2-7/8	84422200000	84482220000
	7/8		7/64 - 7/8	1/2	2-3/4	84422222200	84482222220
	.984	25	1/8 - .984	.472	3-3/8	84422250000	84482225000
	1		1/8 - 1	1/2	2-3/4	84422254000	84482225400
	1.181	30	1/8 - 1.181	.472	3-5/8	84422300000	84482230000
	1-1/4		1/8 - 1-1/4	1/2	3	84422317500	84482231750

Angle	Diameter		Capacity min/max	d	L	Cobalt 424	M35/TIN 4824
	inch	mm					
82°	1/8		1/32 - 1/8	1/8	1-1/4	84424031700	84482403170
	3/16		3/64 - 3/16	3/16	1-3/8	84424047600	84482404760
	.236	6	3/64 - .236	.236	1-5/8	84424060000	84482406000
	1/4		3/64 - 1/4	1/4	1-1/2	84424063500	84482406350
	5/16		3/64 - 5/16	1/4	1-5/8	84424079300	84482407930
	3/8		3/64 - 3/8	1/4	1-3/4	84424095200	84482409520
	.394	10	3/64 - .394	.236	1-3/4	84424100000	84482410000
	.472	12	5/64 - .472	.315	2	84424120000	84482412000
	1/2		5/64 - 1/2	1/4	2	84424127000	84482412700
	.590	15	5/64 - .590	.315	2-1/4	84424150000	84482415000
	5/8		5/64 - 5/8	3/8	2-1/4	84424158700	84482415870
	3/4		5/64 - 3/4	1/2	2-5/8	84424190500	84482419050
	.787	20	5/64 - .787	.394	2-5/8	84424200000	84482420000
	7/8		7/64 - 7/8	1/2	2-3/4	84424222200	84482422220
	.984	25	1/8 - .984	.472	3	84424250000	84482425000
	1		1/8 - 1	1/2	2-3/4	84424254000	84482425400
	1.181	30	1/8 - 1.181	.472	3-1/2	84424300000	84482430000
	1-1/4		1/8 - 1-1/4	1/2	2-3/4	84424317500	84482431750

NOTE : 30 and 45 degree angles are metric standard. Call for information.

Single flute CHAMFERING CUTTERS

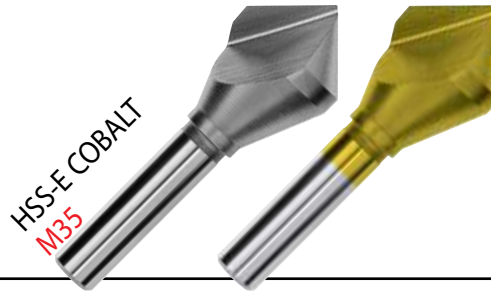

Angle	Diameter		Capacity min/max	d	L	Cobalt 421	M35/TIN 4821
	inch	mm					
90°	1/8		1/32 - 1/8	1/8	1-1/4	84421031700	84482103170
	.157	4	3/64 - .157	.157	1-1/2	84421040000	84482104000
	3/16		3/64 - 3/16	3/16	1-3/8	84421047600	84482104760
	.197	5	3/64 - .197	.197	1-1/2	84421050000	84482105000
	.236	6	3/64 - .236	.236	1-1/2	84421060000	84482106000
	1/4		3/64 - 1/4	1/4	1-1/2	84421063500	84482106350
	5/16		3/64 - 5/16	1/4	1-5/8	84421079300	84482107930
	.315	8	3/64 - .315	.236	1-1/2	84421080000	84482108000
	3/8		3/64 - 3/8	1/4	1-3/4	84421095200	84482109520
	.394	10	3/64 - .394	.236	1-3/4	84421100000	84482110000
	.472	12	5/64 - .472	.315	2	84421120000	84482112000
	1/2		5/64 - 1/2	1/4	2	84421127000	84482112700
	.590	15	5/64 - .590	.315	2-1/8	84421150000	84482115000
	5/8		5/64 - 5/8	3/8	2-1/4	84421158700	84482115870
	3/4		5/64 - 3/4	1/2	2-5/8	84421190500	84482119050
	.787	20	5/64 - .787	.394	2-5/8	84421200000	84482120000
	7/8		7/64 - 7/8	1/2	2-3/4	84421222200	84482122220
	.984	25	1/8 - .984	.472	3	84421250000	84482125000
	1		1/8 - 1	1/2	2-3/4	84421254000	84482125400
	1.181	30	1/8 - 1.181	.472	3-1/2	84421300000	84482130000
1-1/4		1/8 - 1-1/4	1/2	2-3/4	84421317500	84482131750	
1.378	35	5/32 - 1.378	.630 ¹	4	84421350000	84482135000	
1.575	40	7/32 - 1.575	.630 ¹	4-5/8	84421400000	84482140000	
2	50	15/32 - 2	.630 ¹	5	84421500000	84482150000	

¹Shank with 3 flats for better holding

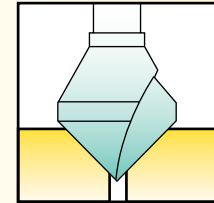

SETS OF 5 PIECES SINGLE FLUTE COUNTERSINKS METRIC

Angle	Cobalt	M35/TIN
60°	84422000000	84482200000
82°	84424000000	84482400000
90°	84421000000	84482100000
100°	84425000000	84482500000
120°	84423000000	84482300000

Angle	Diameter		Capacity min/max	d	L	Cobalt 425	M35/TIN 4825
	inch	mm					
100°	.394	10	3/64 - .394	.236	1-3/4	84425100000	84482510000
	.472	12	5/64 - .472	.315	1-7/8	84425120000	84482512000
	.590	15	5/64 - .590	.315	2-1/8	84425150000	84482515000
	.787	20	5/64 - .787	.394	2-1/2	84425200000	84482520000
	.984	25	1/8 - .984	.472	3	84425250000	84482525000
	1.181	30	1/8 - 1.181	.472	3-3/8	84425300000	84482530000

SETS OF 6 PIECE SINGLE FLUTE COUNTERSINKS

Angle	Cobalt	M35/TIN
60°	84422000006	84482200006
82°	84424000006	84482400006
90°	84421000006	84482100006

Angle	Diameter		Capacity min/max	d	L	Cobalt 423	M35/TIN 4823
	inch	mm					
120°	.394	10	3/64 - .394	.236	1-3/4	84423100000	84482310000
	.472	12	5/64 - .472	.315	1-7/8	84423120000	84482312000
	.590	15	5/64 - .590	.315	2	84423150000	84482315000
	.787	20	5/64 - .787	.394	2-3/8	84423200000	84482320000
	.984	25	1/8 - .984	.472	2-7/8	84423250000	84482325000
	1.181	30	1/8 - 1.181	.472	3-1/4	84423300000	84482330000

DEBURRING COUNTERSINKING

- Recommendation N° 1
- Recommendation N° 2

**SEE THESE TOOLS
AT WORK!**



www.hassay-savage.com
/resource-center
/product-videos

Performance CONDITIONS USING RECOMMENDATIONS

SFM = Speed : Surface Feet Per Minute

IPM = Feed : Inches Per Minute

$$RPM = \frac{SFM \times 12}{3.14 \times \text{Diameter}}$$

Example:

3/4" - .750 Diameter 3 Flute to Countersink 304 SS

$$RPM = \frac{45 \times 12}{3.14 \times .750} = \frac{540}{2.35} = 230 \text{ RPM}$$

		DEBURRING - COUNTERSINKING										CONTOURING					
MATERIAL		HSS.Co		HSS.Co		HSS.Co		HSS.8%Co		Carbure/Carbide		HSS.Co		HSS.8%Co		Carbure/Carbide	
		+TiN	+TiN	+TiN	+TiN	+TiN	+Red'X	+Hard'X	+TiN	+TiN	+Red'X	+Red'X	+Hard'X	+Hard'X			
Steel < 81 HRB (B)	SFM	115-148	115-148	115-148	115-148	55-70	55-70	112-145	112-145	128-256	128-256	55-70	55-70	112-145	112-145	128-256	128-256
	Ø10 IPM	6.5	6.5	6.5	6.5	3.4	3.4	6.5	6.5	10	10	3.4	3.4	6.5	6.5	10	10
	Ø20 IPM	3.4	3.4	3.4	3.4	1.8	1.8	3.4	3.4	5	5	1.8	1.8	3.4	3.4	5	5
Steel < 24 Rc	SFM	65-95	65-95	65-95	65-95	32-48	32-48	65-95	65-95	95-160	95-160	32-48	32-48	65-95	65-95	95-160	95-160
	Ø10 IPM	4.3	4.3	4.3	4.3	2.4	2.4	4.3	4.3	6.6	6.6	2.4	2.4	4.3	4.3	6.6	6.6
	Ø20 IPM	2	2	2	2	1.2	1.2	2	2	3.4	3.4	1.2	1.2	2	2	3.4	3.4
Steel 24 - 32 Rc	SFM	48-64	48-64	48-64	48-64	25-38	25-38	48-64	48-64	64-128	64-128	25-38	25-38	48-64	48-64	64-128	64-128
	Ø10 IPM	2	2	2	2	1.4	1.4	2	2	4	4	1.4	1.4	2	2	4	4
	Ø20 IPM	1.4	1.4	1.4	1.4	1	1	1.4	1.4	2.4	2.4	1	1	1.4	1.4	2.4	2.4
Stainless steel 32 - 41 Rc	SFM	38-48	38-48	38-48	38-48	20-32	20-32	38-48	38-48	64-128	64-128	20-32	20-32	38-48	38-48	64-128	64-128
	Ø10 IPM	1.8	1.8	1.8	1.8	1.2	1.2	1.8	1.8	4	4	1.2	1.2	1.8	1.8	4	4
	Ø20 IPM	1	1	1	1	0.6	0.6	1	1	2.4	2.4	0.6	0.6	1	1	2.4	2.4
Abrasion resistant steel	SFM							38-48	38-48	48-64	48-64			38-48	38-48	48-64	48-64
	Ø10 IPM							1.6	1.6	2	2			1.6	1.6	2	2
	Ø20 IPM							1.2	1.2	1.4	1.4			1.2	1.2	1.4	1.4
Inconel	SFM							13-20	13-20	32-38	32-38			13-20	13-20	32-38	32-38
	Ø10 IPM							0.6	0.6	1.2	1.2			0.6	0.6	1.2	1.2
	Ø20 IPM							0.3	0.3	0.6	0.6			0.3	0.3	0.6	0.6
Cast iron	SFM	64-128	64-128	64-128	64-128	48-80	48-80	64-128	64-128	128-256	128-256	48-80	48-80	64-128	64-128	128-256	128-256
	Ø10 IPM	5	5	5	5	2.8	2.8	5	5	0.3	0.3	2.8	2.8	5	5	0.3	0.3
	Ø20 IPM	3	3	3	3	1.6	1.6	3	3	6	6	1.6	1.6	3	3	6	6
Aluminium	SFM	160-190	160-190	160-190	160-190	112-145	112-145	160-190	160-190	128-320	128-320	112-145	112-145	160-190	160-190	128-320	128-320
	Ø10 IPM	10	10	10	10	7.8	7.8	10	10	13.8	13.8	7.8	7.8	10	10	13.8	13.8
	Ø20 IPM	7	7	7	7	5.2	5.2	7	7	9	9	5.2	5.2	7	7	9	9
Bronze Brass	SFM	96-128	96-128	96-128	96-128	65-95	65-95	96-128	96-128			65-95	65-95	96-128	96-128		
	Ø10 IPM	6	6	6	6	4.7	4.7	6	6			4.7	4.7	6	6		
	Ø20 IPM	4.3	4.3	4.3	4.3	3.4	3.4	4.3	4.3			3.4	3.4	4.3	4.3		
Copper	SFM	65-95	65-95	65-95	65-95	48-80	48-80	65-95	65-95	160-256	160-256	48-80	48-80	65-95	65-95	160-256	160-256
	Ø10 IPM	4.7	4.7	4.7	4.7	3.75	3.75	4.7	4.7	12	12	3.75	3.75	4.7	4.7	12	12
	Ø20 IPM	3	3	3	3	2.4	2.4	3	3	7.8	7.8	2.4	2.4	3	3	7.8	7.8
Laminated	SFM	160-320	160-320	160-320	160-320	112-224	112-224	112-224	112-224			112-224	112-224	112-224	112-224		
	Ø10 IPM	16	16	16	16	12	12	12	12			12	12	12	12		
	Ø20 IPM	12	12	12	12	7.8	7.8	7.8	7.8			7.8	7.8	7.8	7.8		
Nylon, PVC Plastics	SFM	160-320	160-320	160-320	160-320	112-224	112-224	112-224	112-224			112-224	112-224	112-224	112-224		
	Ø10 IPM	18	18	18	18	16	16	16	16			16	16	16	16		
	Ø20 IPM	13.8	13.8	13.8	13.8	12	12	12	12			12	12	12	12		

The machining of hard sheets has to be done with coated tools.

The high performance series **8203-H** is made from **Hard'X** coated carbide.

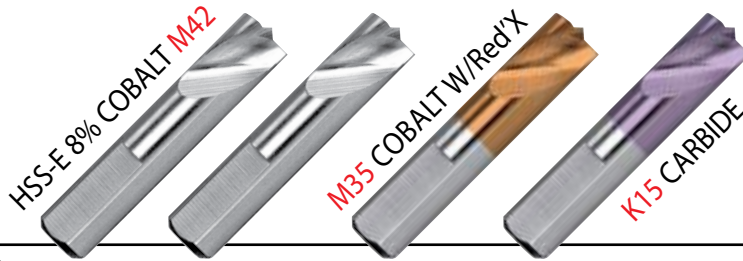

Short series

Diameter		L	ℓ	Cobalt	Cobalt	M35/Red'X	K15/Hard'X
inch	mm			202	203	2903	8203-H
.236	6	1-3/4	.590		82203060000		
5/16	8	1-1/2	.590	82202080000			
5/16	8	1-3/4	.590	82203080000	82290308000	888203H0800	

- Easy to start
- Long lasting
- Will spot and drill one panel only, without walking

These short drills are specially designed to be used with the two types of hand type pneumatic disconnecter tools :

- with swan-neck = magafor 202
- with revolver-handle = magafor 203

Flatted shanks with 60° taper for a good location in the disconnecter.



Long series

Diameter		L	ℓ	Cobalt	M35/Red'X	Brazed Carbide
inch	mm			201	2901	8201
.236	6	2-5/8	1.100	82201060000	82290106000	
.275	7	2-7/8	1.340	82201070000	82290107000	
.314	8					88820108000
5/16		3-1/8	1.450	82201080000	82290108000	
.394	10	3-1/2	1.690	82201100000	82290110000	

To be used with standard drilling machines.

K15 CARBIDE — 6.5 - 7% Cobalt (0,006 - 0,008mm grain size)

AUTO BODY DRILL BITS TO DISCONNECT SPOT WELDS

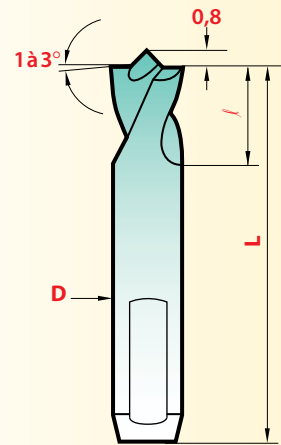
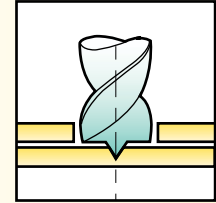

Tolerances

D	L	ℓ
h8	± 1	+1

The centering point grants perfect drilling without any drifting or walking.

Thanks to the special sharpening the first sheet will be bored without damage to the second one.

This design allows for excellent penetration, a high resistance to wear and a great many regrinds.

The carbide spotweld drills are designed to machine the new very-high elastic limit sheet metal (VHEL).



HIGH PRECISION



REAMERS

REAMERS

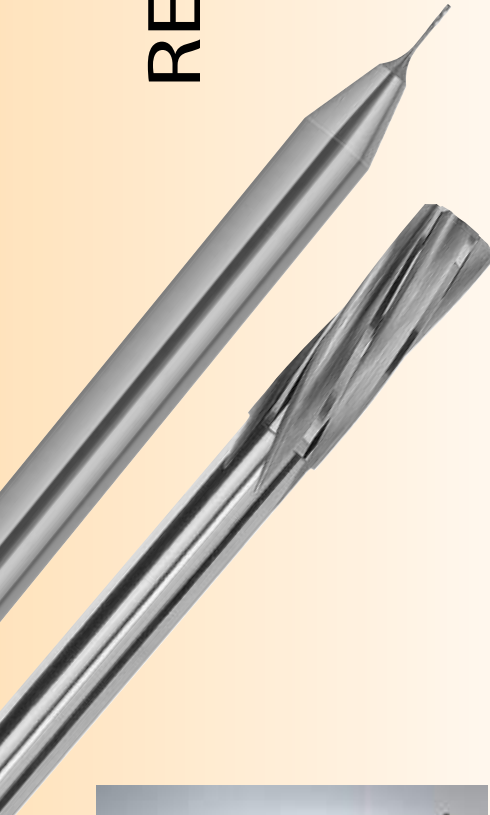

1 - HOW TO CHOOSE STANDARD INCH REAMERS

Examples	REAMING (Hole)		REAMER (Tool)	
	Ø	Tolerance	Ø	Tolerance
1	1/64" +.00006 -.00012	.01568" .01550"	EDP # 861000395 .01551"	.01559" .01551"
2	1/32" +.0001 -.0002	.03135" .03105"	EDP # 86000079 .03110"	.03122" .03110"
3	1/16" +.0004 -.0001	.0629" .0624"	EDP # 86000159 .0626"	.06272" .06260"

Example 3 explanation

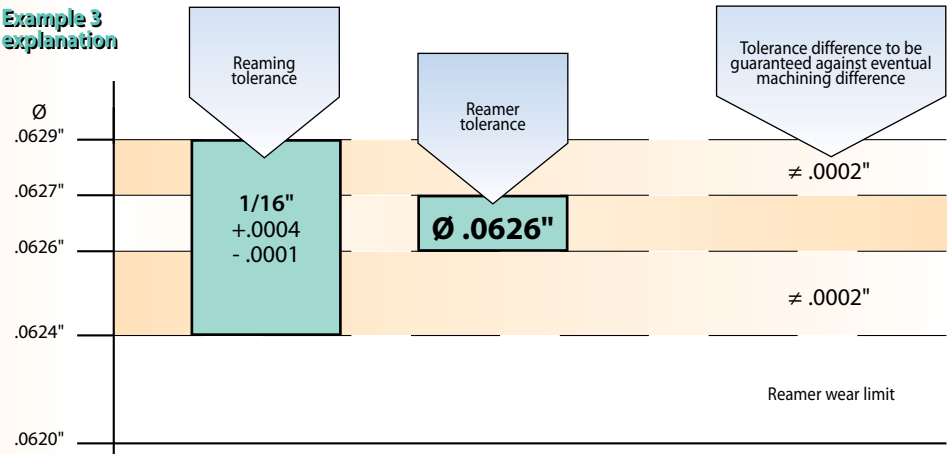

2 - HOW TO CHOOSE METRIC REAMERS

Code 8610 - 8600 : pages 91-97

Tolerance	Ø 2	Ø 3	Ø 4	Ø 5	Ø 6	Ø 8	Ø 10	Ø 12	Ø 14
D10	2,04	3,04	4,05	5,06	6,06	8,07	10,08	12,10	14,10
E 8	2,02	3,02	4,03	5,03	6,03	8,03	10,03	12,04	14,04
E 9	2,03	3,03	4,04	5,04	6,04	8,05	10,05	12,06	14,06
F 7	2,01	3,01	4,01	5,01	6,01	8,02	10,02	12,02	14,02
F 8	2,01	3,01	4,02	5,02	5,02	8,02	10,02	12,03	14,03
G 7	2,00	3,00	4,01	5,02	5,02	8,01	10,01	12,01	14,01
H 6	2,00	3,00	4,00	5,00	6,00	8,00	10,00	12,00	14,00
H 8	2,01	3,01	4,01	5,01	6,01	8,01	10,01	12,01	14,01
H 9	2,01	3,01	4,02	5,02	6,02	8,02	10,02	12,03	14,03
M 7	1,99	2,99	3,99	4,99	5,99	7,99	9,99	11,99	13,99
N 7	1,99	2,99	3,99	4,99	5,99	7,98	9,98	11,98	13,98
P 7	1,99	2,99	3,98	4,98	5,98	7,98	9,98	11,97	13,97
R 7	1,98	2,98	3,98	4,98	5,98	7,98	9,98	11,97	13,97



**NEW Item
for 2017**

8670 Series REAMERS with COOLANT for Blind Holes

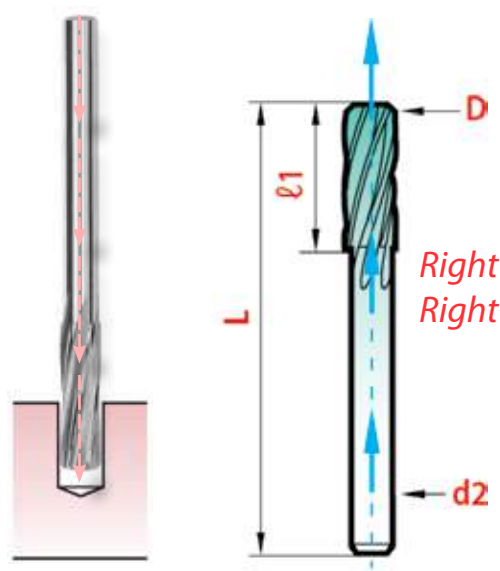

*Right Hand Spiral
Right Hand Cut for Blind Holes*

- Central oil feeding: the lubricant is fed directly into the hole to ream.
- Right hand spiral - improved removal of swarf and coolant flow.

EDP 8670 Series

#	D mm	D inch	L	ℓ1 Flute Length	Shank d2	Wire/Frac
88867003900	3.90	.1535"	2.05	0.787	0.1575	
88867004000	4.00	.1575"	2.05	0.787	0.1575	
88867004100	4.10	.1614"	2.05	0.787	0.1575	
88867004200	4.20	.1654"	2.05	0.787	0.1575	
88867004300	4.30	.1693"	2.05	0.787	0.1575	
88867004400	4.40	.1732"	2.05	0.787	0.1575	
88867004500	4.50	.1772"	2.05	0.787	0.1575	
88867004600	4.60	.1811"	2.05	0.787	0.1575	
88867004700	4.70	.1850"	2.05	0.787	0.1575	
88867004762	4.762	.1875"	2.05	0.787	0.1575	3/16"
88867004800	4.80	.1890"	2.48	0.866	0.1575	
88867004900	4.90	.1929"	2.48	0.866	0.1575	
88867005000	5.00	.1969"	2.48	0.866	0.1575	
88867005100	5.10	.2008"	2.48	0.866	0.1575	
88867005200	5.20	.2047"	2.48	0.866	0.1575	
88867005300	5.30	.2087"	2.48	0.866	0.1575	
88867005400	5.40	.2126"	2.48	0.866	0.1575	
88867005500	5.50	.2165"	2.48	0.866	0.1575	
88867005600	5.60	.2205"	2.48	0.866	0.1575	
88867005700	5.70	.2244"	2.48	0.866	0.1575	
88867005800	5.80	.2284"	2.48	0.866	0.1575	
88867005900	5.90	.2323"	2.48	0.866	0.1969	
88867006000	6.00	.2362"	2.48	0.866	0.1969	
88867006100	6.10	.2402"	2.48	0.866	0.1969	
88867006200	6.20	.2441"	2.48	0.866	0.1969	
88867006300	6.30	.2480"	2.48	0.866	0.1969	
88867006350	6.35	.2500"	2.48	0.866	0.1969	E / 1/4"
88867006400	6.40	.2520"	2.48	0.866	0.1969	
88867006500	6.50	.2559"	2.48	0.866	0.1969	
88867006600	6.60	.2598"	2.48	0.866	0.1969	
88867006700	6.70	.2638"	2.80	0.984	0.248	
88867006800	6.80	.2677"	2.80	0.984	0.248	
88867006900	6.90	.2717"	2.80	0.984	0.248	
88867007000	7.00	.2756"	2.80	0.984	0.248	
88867007100	7.10	.2795"	2.80	0.984	0.248	
88867007200	7.20	.2835"	2.80	0.984	0.248	
88867007300	7.30	.2874"	2.80	0.984	0.248	
88867007400	7.40	.2913"	2.80	0.984	0.248	
88867007500	7.50	.2956"	2.80	0.984	0.248	
88867007600	7.60	.2992"	2.80	0.984	0.248	
88867007700	7.70	.3031"	2.80	0.984	0.248	
88867007800	7.80	.3071"	2.80	0.984	0.248	
88867007900	7.90	.3110"	2.80	0.984	0.248	
88867007937	7.937	.3125"	2.80	0.984	0.248	5/16"

#	D mm	D inch	L	ℓ1 Flute Length	Shank d2	Wire/Frac
88867008000	8.00	.3150"	2.80	0.984	0.248	
88867008100	8.10	.3189"	2.80	0.984	0.248	
88867008200	8.20	.3228"	2.80	0.984	0.248	
88867008300	8.30	.3268"	2.80	0.984	0.248	
88867008400	8.40	.3307"	2.80	0.984	0.248	
88867008500	8.50	.3346"	2.80	0.984	0.248	
88867008600	8.60	.3386"	2.80	0.984	0.315	
88867008700	8.70	.3425"	2.80	0.984	0.315	
88867008800	8.80	.3465"	2.80	0.984	0.315	
88867008900	8.90	.3504"	2.80	0.984	0.315	
88867009000	9.00	.3543"	2.80	0.984	0.315	
88867009100	9.10	.3583"	2.80	0.984	0.315	
88867009200	9.20	.3543"	2.80	0.984	0.315	
88867009300	9.30	.3661"	2.80	0.984	0.315	
88867009400	9.40	.3701"	2.80	0.984	0.315	
88867009500	9.50	.3740"	2.80	0.984	0.315	
88867009525	9.525	.3750"	2.80	0.984	0.315	3/8"
88867009600	9.60	.3780"	2.80	0.984	0.315	
88867009700	9.70	.3819"	2.80	0.984	0.315	
88867009800	9.80	.3858"	2.80	0.984	0.315	
88867009900	9.90	.3897"	2.80	0.984	0.315	
88867010000	10.00	.3937"	2.80	0.984	0.315	
88867010100	10.10	.3976"	2.80	0.984	0.315	
88867010200	10.20	.4016"	2.80	0.984	0.315	
88867010300	10.30	.4055"	2.80	0.984	0.315	
88867010400	10.40	.4094"	2.80	0.984	0.315	
88867010500	10.50	.4134"	2.80	0.984	0.315	
88867010600	10.60	.4173"	2.80	0.984	0.315	
88867010700	10.70	.4213"	3.15	1.102	0.394	
88867010800	10.80	.4252"	3.15	1.102	0.394	
88867010900	10.90	.4291"	3.15	1.102	0.394	
88867011000	11.00	.4331"	3.15	1.102	0.394	
88867011100	11.10	.4370"	3.15	1.102	0.394	
88867011112	11.112	.4375"	3.15	1.102	0.394	7/16"
88867011200	11.20	.4409"	3.15	1.102	0.394	
88867011300	11.30	.4449"	3.15	1.102	0.394	
88867011400	11.40	.4488"	3.15	1.102	0.394	
88867011500	11.50	.4528"	3.15	1.102	0.394	
88867011600	11.60	.4567"	3.15	1.102	0.394	
88867011700	11.70	.4606"	3.15	1.102	0.394	
88867011800	11.80	.4646"	3.15	1.102	0.394	
88867011900	11.90	.4685"	3.15	1.102	0.394	15/32
88867012000	12.00	.4724"	3.15	1.102	0.394	
88867012700	12.70	.5000"	3.15	1.102	0.394	1/2"



HIGH PRECISION CARBIDE MICRO-REAMERS

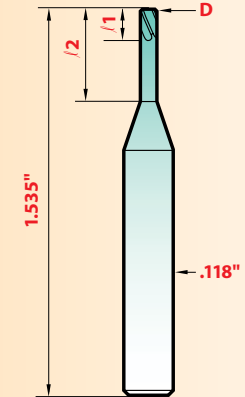

Left Hand Spiral - Right Hand Cut for Through Holes

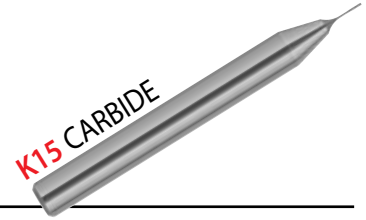

MICRO-PRECISION

D .0002" increment	/1	/2	magaforce 8610
.0079 to .0096	.036	.079	EDP # SEE BELOW
.0098 to .0116	.043	.098	
.0118 to .0136	.055	.118	
.0138 to .0156	.067	.138	
.0157 to .0195	.079	.157	
.0197 to .0234	.091	.197	

H4 TOLERANCE ± .00004"

Micro-reamers manufactured and stocked in all diameters at every .0002" increment. Their reinforced shank offers a greater stability necessary for these high precision tools.

K15 CARBIDE — 6.5 - 7% Cobalt (0,006 - 0,008mm grain size)

4 flutes, 20 degree left spiral, right hand cut.

EDP 8610				SIZE
#	mm	Decimal	Wire	
88861000200	0.200	.0079	92	
88861000205	0.205	.0081		
88861000210	0.210	.0083	91	
88861000215	0.215	.0085		
88861000220	0.220	.0087	90	
88861000225	0.225	.0089		
88861000230	0.230	.0091	89	
88861000235	0.235	.0093		
88861000240	0.240	.0094	88	
88861000245	0.245	.0096		
88861000250	0.250	.0098		
88861000255	0.255	.0100	87	
88861000260	0.260	.0102		
88861000265	0.265	.0104	86	
88861000270	0.270	.0106		
88861000275	0.275	.0108		
88861000280	0.280	.0110	85	
88861000285	0.285	.0112		
88861000290	0.290	.0114	84	
88861000295	0.295	.0116		
88861000300	0.300	.0118		
88861000305	0.305	.0120	83	
88861000310	0.310	.0122		
88861000315	0.315	.0124	82	
88861000320	0.320	.0126		
88861000325	0.325	.0128		
88861000330	0.330	.0130	81	

EDP 8610				SIZE
#	mm	Decimal	Wire	
88861000335	0.335	.0132		
88861000340	0.340	.0134	80	
88861000345	0.345	.0136		
88861000350	0.350	.0138		
88861000355	0.355	.0140		
88861000360	0.360	.0142		
88861000365	0.365	.0144	79	
88861000370	0.370	.0146		
88861000375	0.375	.0148		
88861000380	0.380	.0150		
88861000385	0.385	.0152		
88861000390	0.390	.0154		
88861000395	0.395	.0156		
88861000400	0.400	.0157		
88861000405	0.405	.0159	78	
88861000410	0.410	.0161		
88861000415	0.415	.0163		
88861000420	0.420	.0165		
88861000425	0.425	.0167		
88861000430	0.430	.0169		
88861000435	0.435	.0171		
88861000440	0.440	.0173		
88861000445	0.445	.0175		
88861000450	0.450	.0177		
88861000455	0.455	.0179	77	
88861000460	0.460	.0181		
88861000465	0.465	.0183		

EDP 8610				SIZE
#	mm	Decimal	Wire	
88861000470	0.470	.0185		
88861000475	0.475	.0187		
88861000480	0.480	.0189		
88861000485	0.485	.0191		
88861000490	0.490	.0193		
88861000495	0.495	.0195		
88861000500	0.500	.0197		
88861000505	0.505	.0199	76	
88861000510	0.510	.0201		
88861000515	0.515	.0203		
88861000520	0.520	.0205		
88861000525	0.525	.0207		
88861000530	0.530	.0209	75	
88861000535	0.535	.0211		
88861000540	0.540	.0213		
88861000545	0.545	.0215		
88861000550	0.550	.0217		
88861000555	0.555	.0219		
88861000560	0.560	.0220		
88861000565	0.565	.0222		
88861000570	0.570	.0224	74	
88861000575	0.575	.0226		
88861000580	0.580	.0228		
88861000585	0.585	.0230		
88861000590	0.590	.0232		
88861000595	0.595	.0234		

Left Hand Spiral - Right Hand Cut for Through Holes

MICRO-PRECISION

D .0004" increment	r1	r2	L	d2	magaforce 8600
.0236 to .0413	.275	.393	1.30	D	EDP # SEE BELOW
.0417 to .0610	.393	.944	1.58	D	
.0614 to .0929	.433	1.220	1.97	D	
.0933 to .1476	.590	1.500	2.25	D	
.1480 to .1673	.748	1.930	2.95	.158	
.1677 to .1870	.827	2"	3.15	.177	
.1874 to .2087	.906	2.32	3.39	.197	
.2091 to .2284	1.024	2.559	3.66	.217	
.2288 to .2638	1.102	2.795	3.98	.236	
.2642 to .2972	1.220	3.071	4.29	.276	
.2976 to .3366	1.299	3.307	4.61	.315	
.3370 to .3760	1.417	3.465	4.92	.354	
.3763 to .3957	1.496	3.819	5.236	.394	
.3961 to .4350	1.496	3.819	5.236	.394	
.4354 to .4744	1.732	4.331	5.945	.472	
.4748 to .5138	1.732	4.331	5.945	.472	
.5535 to .5890	1.969	4.409	6.378	.551	
.5929 to .7500	2.047	4.606	6.693	0.630	
.7468 to .7500	2.283	5.354	7.441	0.630	

HIGH PRECISION 8600 MINIATURE REAMERS

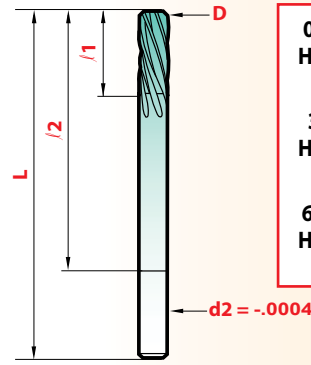

0,60 - 3,00mm
H7 TOLERANCE
0 + .00012"

3,00-6,00mm
H8 TOLERANCE
0 + .00016"

6,00-19,05mm
H9 TOLERANCE
0 + .00020"



REAMING

All reamers have a 45° chamfer lead
 Ø .0236" to .0929" = 4 flutes, Ø .0933" to .5138" = 6 flutes,
 10 degree left spiral/right hand cut for through holes.

EDP 8600				SIZE				EDP 8600				SIZE				EDP 8600				SIZE				EDP 8600				SIZE							
#	mm	Decimal	Wire	#	mm	Decimal	Wire	#	mm	Decimal	Wire	#	mm	Decimal	Wire	#	mm	Decimal	Wire	#	mm	Decimal	Wire	#	mm	Decimal	Wire	#	mm	Decimal	Wire	#	mm	Decimal	Wire
8886000600	0.60	.0236		88860000910	0.91	.0358	64	88860001220	1.22	.0480		88860001530	1.53	.0602																					
88860000610	0.61	.0240	73	88860000920	0.92	.0362		88860001230	1.23	.0484		88860001540	1.54	.0606																					
88860000620	0.62	.0244		88860000930	0.93	.0366		88860001240	1.24	.0488		88860001550	1.55	.0610																					
88860000630	0.63	.0248	72	88860000940	0.94	.0370	63	88860001250	1.25	.0492		88860001560	1.56	.0614																					
88860000640	0.64	.0252		88860000950	0.95	.0374		88860001260	1.26	.0496		88860001570	1.57	.0618																					
88860000650	0.65	.0256		88860000960	0.96	.0378	62	88860001270	1.27	.0500		88860001580	1.58	.0622																					
88860000660	0.66	.0260	71	88860000970	0.97	.0382		88860001280	1.28	.0504		88860001590	1.59	.0626																					
88860000670	0.67	.0264		88860000980	0.98	.0386		88860001290	1.29	.0508		88860001600	1.60	.0630																					
88860000680	0.68	.0268		88860000990	0.99	.0390	61	88860001300	1.30	.0512		88860001610	1.61	.0634	52																				
88860000690	0.69	.0272		88860001000	1.00	.0394		88860001310	1.31	.0516		88860001620	1.62	.0638																					
88860000700	0.70	.0276		88860001010	1.01	.0398	60	88860001320	1.32	.0520	55	88860001630	1.63	.0642																					
88860000710	0.71	.0280	70	88860001020	1.02	.0402		88860001330	1.33	.0524		88860001640	1.64	.0646																					
88860000720	0.72	.0283		88860001030	1.03	.0406		88860001340	1.34	.0528		88860001650	1.65	.0650																					
88860000730	0.73	.0287		88860001040	1.04	.0409	59	88860001350	1.35	.0531		88860001660	1.66	.0654																					
88860000740	0.74	.0291	69	88860001050	1.05	.0413		88860001360	1.36	.0535		88860001670	1.67	.0657																					
88860000750	0.75	.0295		88860001060	1.06	.0417		88860001370	1.37	.0539		88860001680	1.68	.0661																					
88860000760	0.76	.0299		88860001070	1.07	.0421	58	88860001380	1.38	.0543		88860001690	1.69	.0665																					
88860000770	0.77	.0303		88860001080	1.08	.0425		88860001390	1.39	.0547		88860001700	1.70	.0669	51																				
88860000780	0.78	.0307		88860001090	1.09	.0429	57	88860001400	1.40	.0551	54	88860001710	1.71	.0673																					
88860000790	0.79	.0311	68	88860001100	1.10	.0433		88860001410	1.41	.0555		88860001720	1.72	.0677																					
88860000800	0.80	.0315		88860001110	1.11	.0437		88860001420	1.42	.0559		88860001730	1.73	.0681																					
88860000810	0.81	.0319	67	88860001120	1.12	.0441		88860001430	1.43	.0563		88860001740	1.74	.0685																					
88860000820	0.82	.0323		88860001130	1.13	.0445		88860001440	1.44	.0567		88860001750	1.75	.0689																					
88860000830	0.83	.0327		88860001140	1.14	.0449		88860001450	1.45	.0571		88860001760	1.76	.0693																					
88860000840	0.84	.0331	66	88860001150	1.15	.0453		88860001460	1.46	.0575		88860001770	1.77	.0697																					
88860000850	0.85	.0335		88860001160	1.16	.0457		88860001470	1.47	.0579		88860001780	1.78	.0701	50																				
88860000860	0.86	.0339		88860001170	1.17	.0461		88860001480	1.48	.0583		88860001790	1.79	.0705																					
88860000870	0.87	.0343		88860001180	1.18	.0465	56	88860001490	1.49	.0587		88860001800	1.80	.0709																					
88860000880	0.88	.0346		88860001190	1.19	.0469		88860001500	1.50	.0590		88860001810	1.81	.0713																					
88860000890	0.89	.0350	65	88860001200	1.20	.0472		88860001510	1.51	.0594	53	88860001820	1.82	.0717																					
88860000900	0.90	.0354		88860001210	1.21	.0476		88860001520	1.52	.0598		88860001830	1.83	.0720																					

Note: larger sizes up to .790" Code 8600 and/or HSS-CO M35 Code 600 are available within 2 weeks. Call for information.

EDP 8600				EDP 8600				EDP 8600				EDP 8600			
			SIZE				SIZE				SIZE				SIZE
#	mm	Decimal	Wire	#	mm	Decimal	Wire	#	mm	Decimal	Wire	#	mm	Decimal	Wire
88860003670	3.67	.1445		88860004130	4.13	.1626		88860004590	4.59	.1807		88860005040	5.04	.1984	
88860003680	3.68	.1449		88860004140	4.14	.1630		88860004600	4.60	.1811		88860005050	5.05	.1988	8
88860003690	3.69	.1453		88860004150	4.15	.1634		88860004610	4.61	.1815		88860005060	5.06	.1992	
88860003700	3.70	.1457		88860004160	4.16	.1638		88860004620	4.62	.1819	14	88860005070	5.07	.1996	
88860003710	3.71	.1461		88860004170	4.17	.1642		88860004630	4.63	.1823		88860005080	5.08	.2000	
88860003720	3.72	.1465		88860004180	4.18	.1646		88860004640	4.64	.1827		88860005090	5.09	.2004	
88860003730	3.73	.1469	26	88860004190	4.19	.1650		88860004650	4.65	.1831		88860005100	5.10	.2008	7
88860003740	3.74	.1472		88860004200	4.20	.1654		88860004660	4.66	.1835		88860005110	5.11	.2012	
88860003750	3.75	.1476		88860004210	4.21	.1657		88860004670	4.67	.1839		88860005120	5.12	.2016	
88860003760	3.76	.1480		88860004220	4.22	.1661	19	88860004680	4.68	.1843		88860005130	5.13	.2020	
88860003770	3.77	.1484		88860004230	4.23	.1665		88860004690	4.69	.1846		88860005140	5.14	.2024	
88860003780	3.78	.1488		88860004240	4.24	.1669		88860004700	4.70	.1850	13	88860005150	5.15	.2028	
88860003790	3.79	.1492		88860004250	4.25	.1673		88860004710	4.71	.1854		88860005160	5.16	.2031	
88860003800	3.80	.1496	25	88860004260	4.26	.1677		88860004720	4.72	.1858		88860005170	5.17	.2035	
88860003810	3.81	.1500		88860004270	4.27	.1681		88860004730	4.73	.1862		88860005180	5.18	.2039	6
88860003820	3.82	.1504		88860004280	4.28	.1685		88860004740	4.74	.1866		88860005190	5.19	.2043	
88860003830	3.83	.1508		88860004290	4.29	.1689		88860004750	4.75	.1870		88860005200	5.20	.2047	
88860003840	3.84	.1512		88860004300	4.30	.1693	18	88860004760	4.76	.1874		88860005210	5.21	.2051	
88860003850	3.85	.1516		88860004310	4.31	.1697		88865004762	4.763	.1875		88860005220	5.22	.2055	5
88860003860	3.86	.1520	24	88860004320	4.32	.1701		88860004770	4.77	.1878		88860005230	5.23	.2059	
88860003870	3.87	.1524		88860004330	4.33	.1705		88860004780	4.78	.1882		88860005240	5.24	.2063	
88860003880	3.88	.1528		88860004340	4.34	.1709		88860004790	4.79	.1886		88860005250	5.25	.2067	
88860003890	3.89	.1531		88860004350	4.35	.1713		88860004800	4.80	.1890	12	88860005260	5.26	.2071	
88860003900	3.90	.1535		88860004360	4.36	.1717		88860004810	4.81	.1894		88860005270	5.27	.2075	
88860003910	3.91	.1539	23	88860004370	4.37	.1720		88860004820	4.82	.1898		88860005280	5.28	.2079	
88860003920	3.92	.1543		88860004380	4.38	.1724		88860004830	4.83	.1902		88860005290	5.29	.2083	
88860003930	3.93	.1547		88860004390	4.39	.1728	17	88860004840	4.84	.1906		88860005300	5.30	.2087	
88860003940	3.94	.1551		88860004400	4.40	.1732		88860004850	4.85	.1909	11	88860005310	5.31	.2091	4
88860003950	3.95	.1555		88860004410	4.41	.1736		88860004860	4.86	.1913		88860005320	5.32	.2094	
88860003960	3.96	.1559		88860004420	4.42	.1740		88860004870	4.87	.1917		88860005330	5.33	.2098	
88860003970	3.97	.1563		88860004430	4.43	.1744		88860004880	4.88	.1921		88860005340	5.34	.2102	
88860003980	3.98	.1567		88860004440	4.44	.1748		88860004890	4.89	.1925		88860005350	5.35	.2106	
88860003990	3.99	.1571	22	88860004450	4.45	.1752		88860004900	4.90	.1929		88860005360	5.36	.2110	
88860004000	4.00	.1575		88860004460	4.46	.1756		88860004910	4.91	.1933	10	88860005370	5.37	.2114	
88860004010	4.01	.1579		88860004470	4.47	.1760		88860004920	4.92	.1937		88860005380	5.38	.2118	
88860004020	4.02	.1583		88860004480	4.48	.1764		88860004930	4.93	.1941		88860005390	5.39	.2122	
88860004030	4.03	.1587		88860004490	4.49	.1768	16	88860004940	4.94	.1945		88860005400	5.40	.2126	
88860004040	4.04	.1591	21	88860004500	4.50	.1772		88860004950	4.95	.1949		88860005410	5.41	.2130	3
88860004050	4.05	.1594		88860004510	4.51	.1776		88860004960	4.96	.1953		88860005420	5.42	.2134	
88860004060	4.06	.1598		88860004520	4.52	.1780		88860004970	4.97	.1957		88860005430	5.43	.2138	
88860004070	4.07	.1602		88860004530	4.53	.1783		88860004980	4.98	.1961	9	88860005440	5.44	.2142	
88860004080	4.08	.1606		88860004540	4.54	.1787		88860004990	4.99	.1965		88860005450	5.45	.2146	
88860004090	4.09	.1610	20	88860004550	4.55	.1791		88860005000	5.00	.1969		88860005460	5.46	.2150	
88860004100	4.10	.1614		88860004560	4.56	.1795		88860005010	5.01	.1972		88860005470	5.47	.2154	
88860004110	4.11	.1618		88860004570	4.57	.1799	15	88860005020	5.02	.1976		88860005480	5.48	.2158	
88860004120	4.12	.1622		88860004580	4.58	.1803		88860005030	5.03	.1980		88860005490	5.49	.2161	

EDP 8600				EDP 8600				EDP 8600				EDP 8600			
			SIZE				SIZE				SIZE				SIZE
#	mm	Decimal	Wire	#	mm	Decimal	Wire	#	mm	Decimal	Wire	#	mm	Decimal	Wire
88860005500	5.50	.2165		88860005960	5.96	.2347		88860006420	6.42	.2528		88860006880	6.88	.2709	
88860005510	5.51	.2169		88860005970	5.97	.2350		88860006430	6.43	.2531		88860006890	6.89	.2713	
88860005520	5.52	.2173		88860005980	5.98	.2354		88860006440	6.44	.2535		88860006900	6.90	.2717	
88860005530	5.53	.2177		88860005990	5.99	.2358		88860006450	6.45	.2539		88860006910	6.91	.2720	I
88860005540	5.54	.2181		88860006000	6.00	.2362		88860006460	6.46	.2543		88860006920	6.92	.2724	
88860005550	5.55	.2185		88860006010	6.01	.2366		88860006470	6.47	.2547		88860006930	6.93	.2728	
88860005560	5.56	.2189		88860006020	6.02	.2370		88860006480	6.48	.2551		88860006940	6.94	.2732	
88860005570	5.57	.2193		88860006030	6.03	.2374		88860006490	6.49	.2555		88860006950	6.95	.2736	
88860005580	5.58	.2197		88860006040	6.04	.2378		88860006500	6.50	.2559		88860006960	6.96	.2740	
88860005590	5.59	.2201		88860006050	6.05	.2382	B	88860006510	6.51	.2563		88860006970	6.97	.2744	
88860005600	5.60	.2205		88860006060	6.06	.2386		88860006520	6.52	.2567		88860006980	6.98	.2748	
88860005610	5.61	.2209	2	88860006070	6.07	.2390		88860006530	6.53	.2571	F	88860006990	6.99	.2752	
88860005620	5.62	.2213		88860006080	6.08	.2394		88860006540	6.54	.2575		88860007000	7.00	.2756	
88860005630	5.63	.2217		88860006090	6.09	.2398		88860006550	6.55	.2579		88860007010	7.01	.2760	
88860005640	5.64	.2220		88860006100	6.10	.2402		88860006560	6.56	.2583		88860007020	7.02	.2764	
88860005650	5.65	.2224		88860006110	6.11	.2406		88860006570	6.57	.2587		88860007030	7.03	.2768	J
88860005660	5.66	.2228		88860006120	6.12	.2410		88860006580	6.58	.2591		88860007040	7.04	.2772	
88860005670	5.67	.2232		88860006130	6.13	.2413		88860006590	6.59	.2594		88860007050	7.05	.2776	
88860005680	5.68	.2236		88860006140	6.14	.2417		88860006600	6.60	.2598		88860007060	7.06	.2780	
88860005690	5.69	.2240		88860006150	6.15	.2421	C	88860006610	6.61	.2602		88860007070	7.07	.2783	
88860005700	5.70	.2244		88860006160	6.16	.2425		88860006620	6.62	.2606		88860007080	7.08	.2787	
88860005710	5.71	.2248		88860006170	6.17	.2429		88860006630	6.63	.2610	G	88860007090	7.09	.2791	
88860005720	5.72	.2252		88860006180	6.18	.2433		88860006640	6.64	.2614		88860007100	7.10	.2795	
88860005730	5.73	.2256		88860006190	6.19	.2437		88860006650	6.65	.2618		88860007110	7.11	.2799	
88860005740	5.74	.2260		88860006200	6.20	.2441		88860006660	6.66	.2622		88860007120	7.12	.2803	
88860005750	5.75	.2264		88860006210	6.21	.2445		88860006670	6.67	.2626		88860007130	7.13	.2807	
88860005760	5.76	.2268		88860006220	6.22	.2449		88860006680	6.68	.2630		88860007140	7.14	.2811	K
88860005770	5.77	.2272		88860006230	6.23	.2453		88860006690	6.69	.2634		88860007150	7.15	.2815	
88860005780	5.78	.2276		88860006240	6.24	.2457		88860006700	6.70	.2638		88860007160	7.16	.2819	
88860005790	5.79	.2280	1	88860006250	6.25	.2461	D	88860006710	6.71	.2642		88860007170	7.17	.2823	
88860005800	5.80	.2284		88860006260	6.26	.2465		88860006720	6.72	.2646		88860007180	7.18	.2827	
88860005810	5.81	.2288		88860006270	6.27	.2468		88860006730	6.73	.2650		88860007190	7.19	.2831	
88860005820	5.82	.2291		88860006280	6.28	.2472		88860006740	6.74	.2654		88860007200	7.20	.2835	
88860005830	5.83	.2295		88860006290	6.29	.2476		88860006750	6.75	.2657		88860007210	7.21	.2839	
88860005840	5.84	.2299		88860006300	6.30	.2480		88860006760	6.76	.2661	H	88860007220	7.22	.2843	
88860005850	5.85	.2303		88860006310	6.31	.2484		88860006770	6.77	.2665		88860007230	7.23	.2846	
88860005860	5.86	.2307		88860006320	6.32	.2488		88860006780	6.78	.2669		88860007240	7.24	.2850	
88860005870	5.87	.2311		88860006330	6.33	.2492		88860006790	6.79	.2673		88860007250	7.25	.2854	
88860005880	5.88	.2315		88860006340	6.34	.2496		88860006800	6.80	.2677		88860007260	7.26	.2858	
88860005890	5.89	.2319		88860006350	6.35	.2500	E	88860006810	6.81	.2681		88860007270	7.27	.2862	
88860005900	5.90	.2323		88860006360	6.36	.2504		88860006820	6.82	.2685		88860007280	7.28	.2866	
88860005910	5.91	.2327		88860006370	6.37	.2508		88860006830	6.83	.2689		88860007290	7.29	.2870	
88860005920	5.92	.2331		88860006380	6.38	.2512		88860006840	6.84	.2693		88860007300	7.30	.2874	
88860005930	5.93	.2335		88860006390	6.39	.2517		88860006850	6.85	.2697		88860007310	7.31	.2878	
88860005940	5.94	.2339	A	88860006400	6.40	.2520		88860006860	6.86	.2701		88860007320	7.32	.2882	
88860005950	5.95	.2343		88860006410	6.41	.2524		88860006870	6.87	.2705		88860007330	7.33	.2886	

HIGH PRECISION MICRO REAMERS

Over 1,108 Standard Sizes.

Starting at .0078 in .0002" increments to .0236"

In .0004" increments to .5020"

**Correct Hole Sizes
For Best Reamer Results!**

All Magafor Micro & Miniature Solid Carbide Reamers are left hand spiral – right hand cut with a 45° Lead.

Designed for through holes or holes with enough room to accommodate a small amount of waste material.

The left hand spiral acts like an Archimedean Screw, Coolant is directly led to the cutting edges for better lubrication & cooling! Chips are pushed forward with no scratches & outstanding surface finishes!

Final Hole Size to Drilled Hole Size Chart

FINAL HOLE REAMER SIZE mm / inch	Reduce Drill Hole Size By...INCH MIN / MAX	Reduce Drill Hole Size By...MM MIN / MAX
0.20 / .00787	-0.00157" / -0.00236"	-0.04mm / -0.06mm
0.30 / .01181	-0.00197" / -0.00315"	-0.05mm / -0.08mm
0.40 / .01575	-0.00197" / -0.00394"	-0.05mm / -0.10mm
0.50 / .01969	-0.00197" / -0.00472"	-0.05mm / -0.12mm
0.60 / .02362	-0.00197" / -0.00472"	-0.05mm / -0.12mm
2.00 / .07874	-0.00197" / -0.00472"	-0.05mm / -0.12mm
6.00 / .23622	-0.00591" / -0.00787"	-0.15mm / -0.20mm
10.00 / .39370	-0.00591" / -0.00787"	-0.15mm / -0.20mm
15.00 / .59055	-0.01181" / -0.01575"	-0.30mm / -0.40mm
20.00 / .78740	-0.01181" / -0.01575"	-0.30mm / -0.40mm
25.00 / .98425	-0.01181" / -0.01969"	-0.30mm / -0.50mm
15.00 / .59055	-0.01181" / -0.01575"	-0.30mm / -0.40mm
20.00 / .78740	-0.01181" / -0.01575"	-0.30mm / -0.40mm
25.00 / .98425	-0.01181" / -0.01969"	-0.30mm / -0.50mm

Ultra Precision FLOATING REAMER HOLDERS

Complete Orbital Float for True Alignment

Designed with "True Orbital Float" capability, the micro reamer holder aligns the reamer perfectly to the drilled hole enabling better size control, reduces "bell-mouthing", and increases tool life.

**True
Orbital Float!**

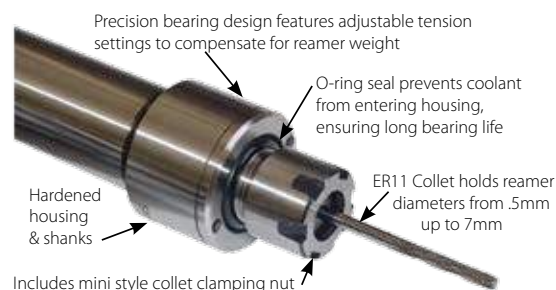

ER11 Floating Reamer Holder with Mini-Nut Assembly

Item No.	D	L
HSP-11-010-042	10mm	42
HSP-11-190-042	3/4"	2.75
HSP-11-200-042	20mm	41.5
HSP-11-220-042	22mm	41.5

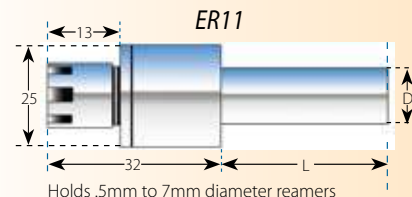

Accessory Components

Item No.	Description
HSP-04621	ER11 Mini Wrench
HSP-ER11-MNS	ER11 Mini Nut



Collet Sets

Item No.	Description
HSP-11R-S7-ISP	7pc ER11 Inch Bore Collet Set Size Range 1/16, 3/32, 1/8, 5/32, 3/16, 7/32, 1/4"
HSP-11R-S13-MSP	13pc ER11 Metric Bore Collet Set Size Range .5 - 7mm in .5mm increments
HSP-11R-S13-MUP	13pc ULTRA PRECISION Metric Bore Collet Set (.0002" TIR) Size Range .5 - 7mm in .5mm increments
HSP-11R-S13-IUP	3pc ULTRA PRECISION Inch Bore Collet Set (.0002" TIR) Size Range 1/8, 5/32, 1/2"



REAMER FORMULAS FOR SPEEDS & FEEDS

The parameters below are based on using a carbide reamer at the highest SFM

- SFM:** Surface Feet per Minute
RPM: Revolutions per Minute
IPT: Inches per Tooth (chip load)
IPM: Inches per Minute
IPR: Inches per Revolution

Speed Formula:

$$\text{RPM} = 3.82 \times (\text{SFM} \div \text{Diameter})$$

$$\text{Feed: IPM} = \text{IPT} \times \# \text{ of Flutes} \times \text{RPM}$$

$$\text{IPR} = \text{IPM} \div \text{RPM}$$

$$\text{SFM} = \text{RPM} \times \text{Diameter} \div 3.82$$

Example: using a Carbide 2mm Reamer
in Steel < 81 HRB

$$\text{RPM} = 3.82 \times (132 \div .0787) = 6407 \text{ RPM}$$

$$\text{IPM} = .0015 \times 4 \times 6407 = 38.4 \text{ IPM}$$

$$\text{IPR} = 38.4 \div 6407 = .0059 \text{ IPR}$$

See these tools at work!



www.hassay-savage.com/resource-center/product-videos

This chart has listed general reference parameters for a starting point.

Below are a couple of tips for fine-tuning the desired size.

To increase the hole diameter: Slow down the feed rate and/or decrease RPM

To decrease the hole diameter: Increase the feed rate and/or increase the RPM

MATERIAL	SPEED / SFM			Diameter mm					
	CARBIDE	COBALT		2	4	6	10	15	20
Steel < 81 HRB	82-132	49-72	IPR	.006	.006	.006	.0098	.0098	.0118
			IPM	38.4	19.2	12.8	12.3	8.2	7.7
			RPM	6400	3200	2130	1300	850	640
Steel < 24 Rc.	66-82	39-56	IPR	.0039	.0039	.0047	.0071	.0071	.0098
			IPM	14.3	8.4	6.4	5.7	3.8	3.8
			RPM	4000	2000	1300	800	500	400
Steel 24-32 Rc.	39-59	25-33	IPR	.0031	.0031	.0039	.0071	.0059	.0087
			IPM	8.6	4.3	3.4	4.1	2.3	2.4
			RPM	2800	1430	1000	600	400	280
Steel 32-41 Rc.	33-49	16-23	IPR	.0031	.0031	.0035	.0059	.0079	.0098
			IPM	7.1	3.6	2.9	2.9	2.5	2.3
			RPM	2400	1200	800	500	300	240
Stainless Steel	23-39	10-16	IPR	.0028	.0028	.0039	.0047	.0059	.0079
			IPM	5.7	2.8	2.3	1.8	1.5	1.5
			RPM	1900	950	630	400	250	240
Inconel/Waspaloy	20-33	7-10	IPR	.0028	.0028	.0039	.0047	.0059	.0079
			IPM	4.8	2.4	1.9	1.5	1.3	1.2
			RPM	1600	800	540	320	200	200
Cast Iron ≤180 HB (Grey)	99-132	20-49	IPR	.0039	.0039	.0047	.0079	.0098	.0098
			IPM	23.1	11.5	10.2	10	8.2	6.1
			RPM	6400	3200	2130	1300	850	640
Cast Iron > 180 HB	26-49	13-16	IPR	.0028	.0028	.0039	.0059	.0071	.0079
			IPM	7.1	3.6	2.9	2.9	2.3	1.9
			RPM	2400	1200	800	480	300	240
Copper	82-99	39-66	IPR	.0047	.0047	.0071	.0079	.0098	.0118
			IPM	23.1	11.5	11.5	7.5	6.1	5.8
			RPM	4800	2400	1600	960	640	480
Brass	115-132	66-99	IPR	.0079	.0079	.0087	.0118	.0138	.0157
			IPM	50	25	17.9	15.4	11.8	10
			RPM	6400	3200	2130	1300	850	640
Bronze	66-82	39-56	IPR	.0059	.0059	.0071	.0087	.0138	.0146
			IPM	21.5	11.9	9.5	7.2	7.3	5.7
			RPM	4000	2000	1320	800	530	400
Aluminum	132-197	82-115	IPR	.0059	.0059	.0071	.0098	.0118	.0138
			IPM	57.3	28.7	22.9	18.3	15.3	13.2
			RPM	9500	4800	3200	1900	1300	950
Recommended drill hole diameter:				1,90	3,90	5,85	9,80	14,70	19,70

L = 39 mm
d2 = 3mm
ℓ = 1,5 x D



d2 = .118 / 3 mm

BALL END SERIES

inch	D mm	ℓ	r	Magafor 8527	Hard'X 8527-H
.0039	0.10	.0039	.0020	88852700100	
.0059	0.15	.0079	.0030	88852700150	
.0079	0.20	.0118	.0039	88852700200	
.0098	0.25	.0138	.0049	88852700250	
.0118	0.30	.0177	.0059	88852700300	888527H0030
.0157	0.40	.0236	.0079	88852700400	888527H0040
.0197	0.50	.0295	.0098	88852700500	888527H0050
.0236	0.60	.0354	.0118	88852700600	888527H0060
.0276	0.70	.0413	.0138	88852700700	888527H0070
.0315	0.80	.0472	.0157	88852700800	888527H0080
.0354	0.90	.0531	.0177	88852700900	888527H0090
.0394	1.00	.0591	.0197	88852701000	888527H0100
.0472	1.20	.0709	.0236	88852701200	888527H0120
.0591	1.50	.0886	.0295	88852701500	888527H0150
.0787	2.00	.1181	.0394	88852702000	888527H0200

L = 39 mm
d2 = 3mm
ℓ = 1,5 x D



SQUARE END SERIES

inch	D mm	ℓ	Magafor 8507	Hard'X 8507-H
.0039	0.10	.0039	88850700100	
.0059	0.15	.0079	88850700150	
.0079	0.20	.0118	88850700200	
.0098	0.25	.0138	88850700250	
.0118	0.30	.0177	88850700300	888507H0030
.0157	0.40	.0236	88850700400	888507H0040
.0197	0.50	.0295	88850700500	888507H0050
.0236	0.60	.0354	88850700600	888507H0060
.0276	0.70	.0413	88850700700	888507H0070
.0315	0.80	.0472	88850700800	888507H0080
.0354	0.90	.0531	88850700900	888507H0090
.0394	1.00	.0591	88850701000	888507H0100
.0433	1.10	.0650	88850701100	888507H0110
.0472	1.20	.0709	88850701200	888507H0120
.0512	1.30	.0768	88850701300	888507H0130
.0551	1.40	.0827	88850701400	888507H0140
.0591	1.50	.0886	88850701500	888507H0150
.0630	1.60	.0945	88850701600	888507H0160
.0669	1.70	.1004	88850701700	888507H0170
.0709	1.80	.1063	88850701800	888507H0180
.0748	1.90	.1122	88850701900	888507H0190
.0787	2.00	.1181	88850702000	888507H0200

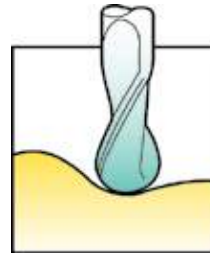

COPYING

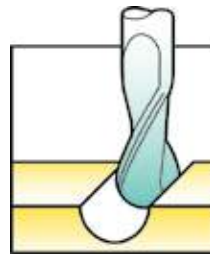

PRECISE GROOVING
R +/- 0,01mm



PRECISE GROOVING
0 - 0,01mm

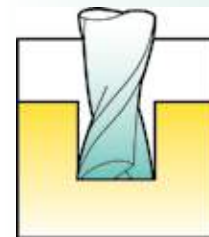

FLAT BOTTOM BORING

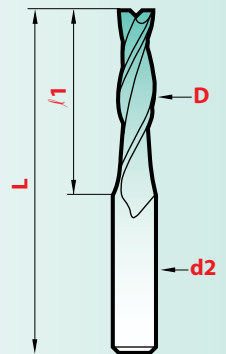
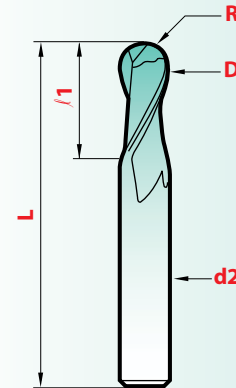

MICRO-MILLING

MICRO-MILLING

Engaged right from the start in the process aspiring to excellence, in addition to our Futura and TiN coatings, MAGAFOR offers three new "X" coatings, sprung from multi-layer nano technology.

Red'X: cobalt tool coating with higher hardness of (3700 HV) like TiAlN in a multi-layer coating. This coating can be used for dry machining. Using coolant will add lubricity.

Hard'X: carbide tool coating with a high hardness (3500 HV) this coating shows a high thermic stability and an excellent protection against heat and wear. Ideal for dry machining-high speed cut-in treated steels and dies up to 67 Rc.

MINIATURE END-MILLS WITH BACK CLEARANCE

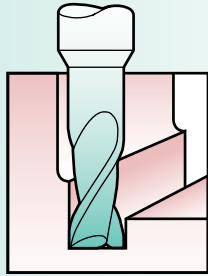

HARD TO REACH MACHINING

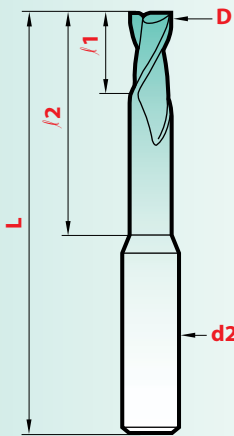

$$l = 1,5 \times D$$

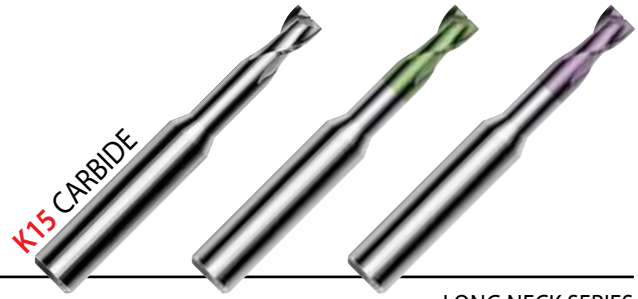

d2 = .118 / 3 mm

LONG NECK SERIES

Diameter x /2		/1	L	magaforce	K15/Graph'X	k15/Hard'X
inch	mm			8507-D	8507-DG	8507-DH
.0157 x .078	0,4 x 2	.024	1-1/2	888507D0042	888507DG0042	888507DH0042
.0197 x .078	0,5 x 2	.027	1-1/2	888507D0052	888507DG0052	888507DH0052
.0197 x .157	0,5 x 4	.027	1-1/2	888507D0054	888507DG0054	888507DH0054
.0197 x .236	0,5 x 6	.027	2-3/8	888507D0056	888507DG0056	888507DH0056
.0236 x .157	0,6 x 4	.029	1-1/2	888507D0064	888507DG0064	888507DH0064
.0276 x .157	0,7 x 4	.035	1-1/2	888507D0074	888507DG0074	888507DH0074
.0315 x .157	0,8 x 4	.041	1-1/2	888507D0084	888507DG0084	888507DH0084
.0315 x .236	0,8 x 6	.041	1-1/2	888507D0086	888507DG0086	888507DH0086
.0315 x .354	0,8 x 9	.041	2-3/8	888507D0089	888507DG0089	888507DH0089
.0354 x .236	0,9 x 6	.053	1-1/2	888507D0096	888507DG0096	888507DH0096
.0394 x .157	1,0 x 4	.059	1-1/2	888507D0140	888507DG0140	888507DH0140
.0394 x .236	1,0 x 6	.059	1-1/2	888507D0160	888507DG0160	888507DH0160
.0394 x .354	1,0 x 9	.059	1-1/2	888507D0190	888507DG0190	888507DH0190
.0394 x .472	1,0 x 12	.059	2-3/8	888507D0112	888507DG0112	888507DH0112
.0472 x .236	1,2 x 6	.071	1-1/2	888507D0126	888507DG0126	888507DH0126
.0472 x .354	1,2 x 9	.071	1-1/2	888507D0129	888507DG0129	888507DH0129
.0551 x .236	1,4 x 6	.083	1-1/2	888507D0146	888507DG0146	888507DH0146
.0551 x .354	1,4 x 9	.083	1-1/2	888507D0149	888507DG0149	888507DH0149
.0591 x .236	1,5 x 6	.089	1-1/2	888507D0156	888507DG0156	888507DH0156
.0591 x .354	1,5 x 9	.089	1-1/2	888507D0159	888507DG0159	888507DH0159
.0591 x .472	1,5 x 12	.089	2-3/8	888507D01512	888507DG01512	888507DH01512
.0709 x .354	1,8 x 9	.106	1-1/2	888507D0189	888507DG0189	888507DH0189
.0709 x .472	1,8 x 12	.106	1-1/2	888507D01812	888507DG01812	888507DH01812
.0787 x .354	2,0 x 9	.118	1-1/2	888507D0290	888507DG0290	888507DH0290
.0787 x .472	2,0 x 12	.118	1-1/2	888507D0212	888507DG0212	888507DH0212
.0787 x .590	2,0 x 15	.118	2-3/8	888507D0215	888507DG0215	888507DH0215
.0984 x .590	2,5 x 15	.148	2-3/8	888507D02515	888507DG02515	888507DH02515

/2-: tolerance - .0008 - .0020
*Call for pricing

MINIATURE END MILLS *Speeds & Feeds* **Performance** RECOMMENDATIONS OF USING

- Endmills with long neck, extra long neck, and deep machining: Reduce the speed, while maintaining the suggested feed.
- Superficial work: Increase the speed, while maintaining the suggested feed.

This chart has listed general reference parameters for a starting point.

- SFM:** Surface Feet per Minute
- RPM:** Revolutions per Minute
- IPT:** Inches per Tooth (chip load)
- IPM:** Inches per Minute
- IPR:** Inches per Revolution

Speed Formula:

$$RPM = 3.82 \times (SFM \div \text{Diameter})$$

$$\text{Feed: } IPM = IPT \times \# \text{ of Flutes} \times RPM$$

$$IPR = IPM \div RPM$$

$$SFM = RPM \times \text{Diameter} \div 3.82$$

Material	Diameter(mm)	SFM	RPM	Inch/tooth	IPM	Material	Diameter(mm)	SFM	RPM	Inch/tooth	IPM
Steels 24-40Rc	0,5	132	25615	.00004	2.0	Plastics with glass or carbon filters	0,5	263	51040	.00004	4.1
	1	132	12808	.0001	2.5		1	263	25520	.0002	10.2
	1,5	132	8538	.0001	1.7		1,5	263	17010	.0006	20.4
	2	132	6404	.0002	2.5		2	263	12760	.0008	20.4
Steel 41Rc- 45Rc	3	132	4270	.0002	1.7	3	263	8500	.0012	20.4	
	0,5	82	15920	.00004	1.3	Aluminum and other plastics	0,5	494	95860	.0002	38.3
	1	82	7960	.0001	1.6		1	658	63840	.0005	63.8
	1,5	82	5310	.0001	1.1		1,5	658	42560	.0007	60.0
2	82	3980	.0002	1.6	2		658	31920	.0009	57.5	
Steels >45Rc TiAlN coated tools only	3	82	2650	.0002	1.1	3	658	21280	.0014	60.0	
	0,5	132	25615	.00004	2.0	Copper Brass Bronze and Steels	0,5	263	51000	.0002	20.4
	1	132	12808	.0001	2.5		1	263	25520	.0005	25.5
	1,5	132	8538	.0001	1.7		1,5	263	17000	.0007	24.0
2	132	6404	.0002	2.5	2		263	12750	.0009	23.0	
	3	132	4270	.0002	1.7	<24 Rc	3	263	8500	.0014	24.0

STANDARD LENGTH MINIATURE END-MILLS

$l \approx 2-3 \times D$

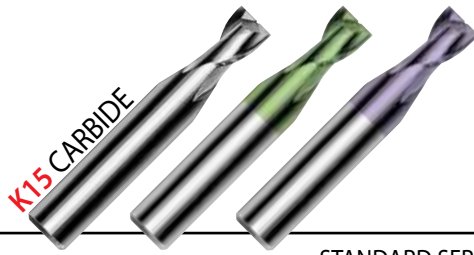

STANDARD SERIES

TOLERANCE 0 - .0004"

Diameter		r1	L	d2	magaforce	Graph'X	Hard'X
inch	mm				8500	8500-G	8500-H
.0020	0,05	.004	1-1/2	.118 3 mm	88850000050		
.0024	0,06	.005			88850000060		
.0031	0,08	.006			88850000080		
.0039	0,10	.008			88850000100		
.0047	0,12	.009			88850000120		
.0059	0,15	.012			88850000150		
.0079	0,20	.020			88850000200		
.0098	0,25	.020			88850000250		
.0118	0,30	.039			88850000300	888500G0030	888500H0030
.0138	0,35	.039			88850000350	888500G0035	888500H0035
.0157	0,40	.039			88850000400	888500G0040	888500H0040
.0177	0,45	.039			88850000450	888500G0045	888500H0045
.0197	0,50	.059			88850000500	888500G0050	888500H0050
.0216	0,55	.059			88850000550	888500G0055	888500H0055
.0236	0,60	.059			88850000600	888500G0060	888500H0060
.0256	0,65	.059			88850000650	888500G0065	888500H0065
.0276	0,70	.079			88850000700	888500G0070	888500H0070
.0295	0,75	.079			88850000750	888500G0075	888500H0075
.0315	0,80	.079	88850000800	888500G0080	888500H0080		
.0335	0,85	.079	88850000850	888500G0085	888500H0085		
.0354	0,90	.098	88850000900	888500G0090	888500H0090		
.0374	0,95	.098	88850000950	888500G0095	888500H0095		
.0394	1,00	0,12	88850001000	888500G0100	888500H0100		
.0413	1,05	0,12	88850001050	888500G0105	888500H0105		
.0433	1,10	0,12	88850001100	888500G0110	888500H0110		
.0452	1,15	0,12	88850001150	888500G0115	888500H0115		
.0472	1,20	0,16	88850001200	888500G0120	888500H0120		
.0492	1,25	0,16	88850001250	888500G0125	888500H0125		
.0512	1,30	0,16	88850001300	888500G0130	888500H0130		
.0551	1,40	0,16	88850001400	888500G0140	888500H0140		
.0591	1,50	0,16	88850001500	888500G0150	888500H0150		
.0630	1,60	0,20	88850001600	888500G0160	888500H0160		
.0669	1,70	0,20	88850001700	888500G0170	888500H0170		
.0709	1,80	0,20	88850001800	888500G0180	888500H0180		
.0748	1,90	0,20	88850001900	888500G0190	888500H0190		
.0787	2,00	0,20	88850002000	888500G0200	888500H0200		
.0827	2,10	0,24	88850002100	888500G0210	888500H0210		
.0866	2,20	0,24	88850002200	888500G0220	888500H0220		

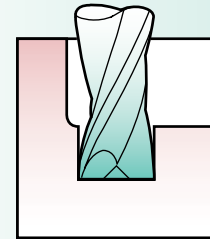

SLOTING
ENGRAVING

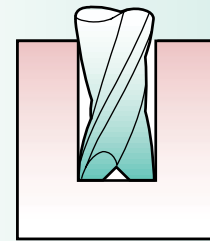

FLAT BOTTOM
BORING

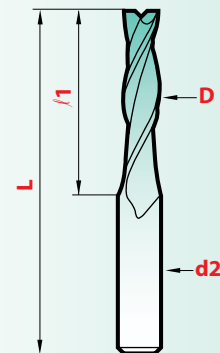

K15 CARBIDE — 6.5 - 7% Cobalt
(0,006 - 0,008mm grain size)

STANDARD LENGTH MINIATURE END-MILLS

STANDARD SERIES											
Diameter		f1	L	d2	magaforce	Graph'X	Hard'X				
inch	mm				8500	8500-G	8500-H				
.1575	4,00	0.47	2-3/16	.197 5 mm	88850004000	888500G0400	888500H0400				
.1614	4,10	0.47			88850004100	888500G0410	888500H0410				
.1654	4,20	0.47			88850004200	888500G0420	888500H0420				
.1693	4,30	0.47			88850004300	888500G0430	888500H0430				
.1732	4,40	0.47			88850004400	888500G0440	888500H0440				
.1772	4,50	0.47			88850004500	888500G0450	888500H0450				
.1811	4,60	0.47			88850004600	888500G0460	888500H0460				
.1850	4,70	0.47			88850004700	888500G0470	888500H0470				
.1890	4,80	0.47			88850004800	888500G0480	888500H0480				
.1929	4,90	0.47			88850004900	888500G0490	888500H0490				
.1969	5,00	0.55			2-3/16	.236 6 mm	88850005000	888500G0500	888500H0500		
.2008	5,10	0.55					88850005100	888500G0510	888500H0510		
.2047	5,20	0.55					88850005200	888500G0520	888500H0520		
.2087	5,30	0.55					88850005300	888500G0530	888500H0530		
.2126	5,40	0.55					88850005400	888500G0540	888500H0540		
.2165	5,50	0.55	88850005500	888500G0550			888500H0550				
.2205	5,60	0.55	88850005600	888500G0560			888500H0560				
.2244	5,70	0.55	88850005700	888500G0570			888500H0570				
.2283	5,80	0.55	88850005800	888500G0580			888500H0580				
.2323	5,90	0.55	88850005900	888500G0590			888500H0590				

$l \approx 2-3 \times D$

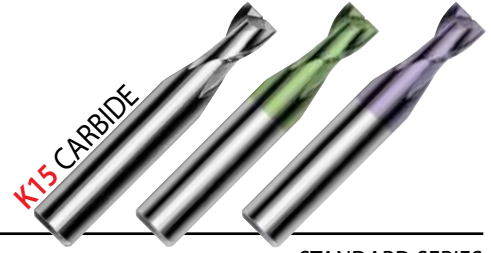

STANDARD SERIES											
Diameter		f1	L	d2	magaforce	Graph'X	Hard'X				
inch	mm				8500	8500-G	8500-H				
.0906	2,30	0.24	1-1/2	.118 3 mm	88850002300	888500G0230	888500H0230				
.0945	2,40	0.24			88850002400	888500G0240	888500H0240				
.0984	2,50	0.28			88850002500	888500G0250	888500H0250				
.1024	2,60	0.28			88850002600	888500G0260	888500H0260				
.1063	2,70	0.28			88850002700	888500G0270	888500H0270				
.1102	2,80	0.28			88850002800	888500G0280	888500H0280				
.1142	2,90	0.28			88850002900	888500G0290	888500H0290				
.1181	3,00	0.39			1-3/4	.157 4 mm	88850003000	888500G0300	888500H0300		
.1220	3,10	0.39					88850003100	888500G0310	888500H0310		
.1260	3,20	0.39					88850003200	888500G0320	888500H0320		
.1299	3,30	0.39					88850003300	888500G0330	888500H0330		
.1339	3,40	0.39					88850003400	888500G0340	888500H0340		
.1378	3,50	0.39					88850003500	888500G0350	888500H0350		
.1417	3,60	0.39					88850003600	888500G0360	888500H0360		
.1457	3,70	0.39					88850003700	888500G0370	888500H0370		
.1496	3,80	0.39	88850003800	888500G0380			888500H0380				
.1535	3,90	0.39	88850003900	888500G0390			888500H0390				

220° ball-end MINIATURE END-MILLS with back clearance

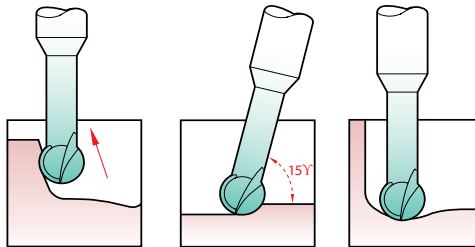

$l2 = 5 \times D$

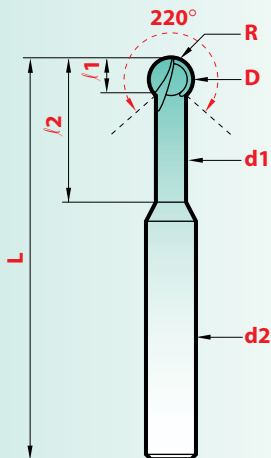
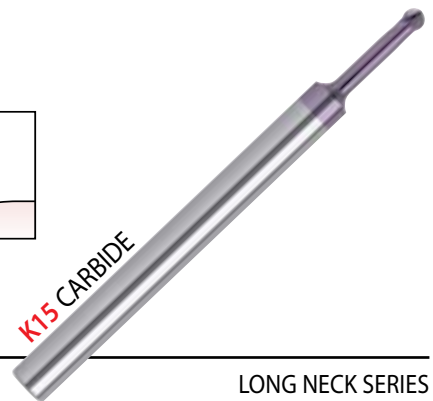

METRIC							LONG NECK SERIES	
Diameter		d1	d2	L	f1	f2	R	Hard'X
inch	mm							8522-H
.0315	0,8	0,70	3	60	0,55	4,0	0,4	888522H0080
.0394	1,0	0,85	3	60	0,70	5,0	0,5	888522H0100
.0472	1,2	1,00	3	60	0,80	6,0	0,6	888522H0120
.0590	1,5	1,30	3	60	1,00	7,5	0,75	888522H0150
.0787	2,0	1,70	3	60	1,35	10,0	1,0	888522H0200
.1180	3,0	2,60	6	75	2,00	15,0	1,5	888522H0300
.1575	4,0	3,45	6	75	2,70	20,0	2,0	888522H0400
.1969	5,0	4,30	6	75	3,40	25,0	2,5	888522H0500

*Call for pricing

LONG MINIATURE END-MILLS

TOLERANCE 0 - .0004"

L = 39 mm
l = 5 x D



K15 CARBIDE

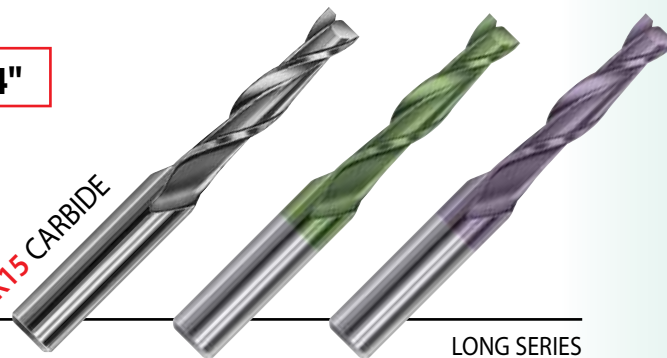

d2 = .118 / 3 mm

LONG SERIES

Diameter		l1	LONG SERIES		
inch	mm		magaforce 8509	Graph'X 8509-G	Hard'X 8509-H
.0157	0,4	.078	88850900400	888509G0040	888509H0040
.0197	0,5	.098	88850900500	888509G0050	888509H0050
.0236	0,6	.118	88850900600	888509G0060	888509H0060
.0276	0,7	.137	88850900700	888509G0070	888509H0070
.0315	0,8	.157	88850900800	888509G0080	888509H0080
.0354	0,9	.177	88850900900	888509G0090	888509H0090
.0394	1,0	.197	88850901000	888509G0100	888509H0100
.0472	1,2	.236	88850901200	888509G0120	888509H0120
.0591	1,5	.295	88850901500	888509G0150	888509H0150
.0787	2,0	.394	88850902000	888509G0200	888509H0200

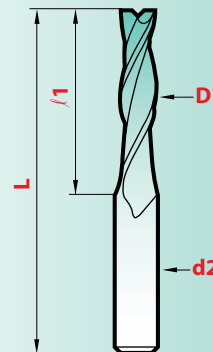

*Call for pricing

TOLERANCE 0 - .0004"

l = 8 x D



K15 CARBIDE

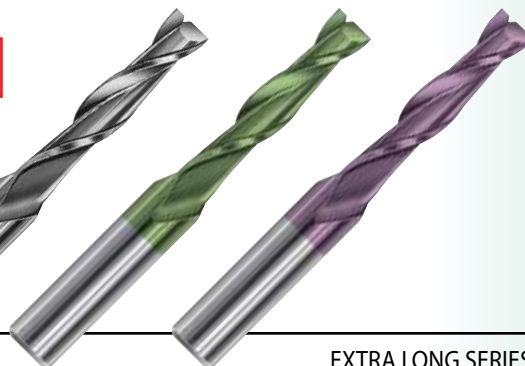

EXTRA LONG SERIES

Diameter		l1	L	d2	EXTRA LONG SERIES		
inch	mm				magaforce 8510	Graph'X 8510-G	Hard'X 8510-H
.0197	0,5	.157	1-1/2	.118 3 mm	88851000500	888510G0050	888510H0050
.0236	0,6	.197			88851000600	888510G0060	888510H0060
.0315	0,8	.236			88851000800	888510G0080	888510H0080
.0394	1,0	.315			88851001000	888510G0100	888510H0100
.0472	1,2	.354	1-3/4	.157 4 mm	88851001200	888510G0120	888510H0120
.0591	1,5	.472			88851001500	888510G0150	888510H0150
.0787	2,0	.630			88851002000	888510G0200	888510H0200
.0984	2,5	.788	2-3/8	.197 5 mm	88851002500	888510G0250	888510H0250
.1181	3,0	.945			88851003000	888510G0300	888510H0300

*Call for pricing

EXTRA-LONG MINIATURE END-MILLS

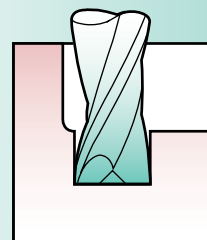

SLOTting ENGRAVING

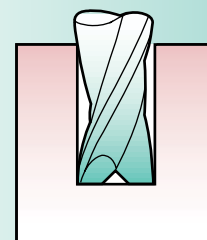

FLAT BOTTOM BORING

VALUE PACKED KITS & PROMOTION ITEMS

Versatile, Broad Application Range, Business Building!

TRIDENT 90° Three flute COUNTERSINKS

3 FLUTE COUNTERSINK SETS ANGLE 90°

magafor	COMPOSITION M35 Cobalt
84431000000-M	Ø 10 - 15 - 20,5 mm
84431000000-M-TIN	
84431000007	1/4" - 3/8" - 1/2" - 3/4"
84483100007 TIN	
84431000000	
84483100000	Ø 10,4 - 16,5 - 20,5 - 25,0 - 31,0 mm
84436000000	
84431000002	
84483100002 TIN	Ø 6,3 - 8,3 - 10,4 - 12,4 - 16,5 - 20,5 mm
84436000002	
88843100002	
84431000003 (1)	Ø 6,3 - 8,3 - 10,4 - 12,4 - 16,5 - 20,5 - 25 mm
84431000004 (1)	Ø 4,3 - 5,3 - 6,3 - 8,3 - 10,4 - 12,4 - 16,5 - 20,5 - 25 - 31
88843100000	Ø 10,4 - 16,5 - 20,5 - 25 - 31 mm
84431000006 (2)	
84483100006 TIN (2)	Ø 6,3 - 12,4 - 16,5 - 20,5 mm
84431000008 (2)	
84483100008 TIN (2)	1/4" - 3/8" - 1/2" - 3/4"

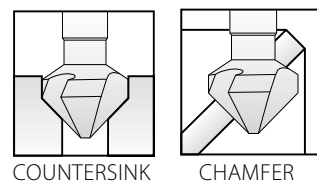

COUNTERSINK CHAMFER

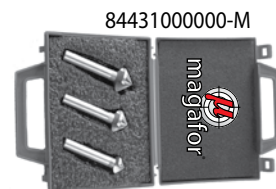

TRIDENT COUNTERSINK SETS

Angle	M35/Cobalt	COMPOSITION / mm
60°	84432000000	Ø 10,4-16,5-20,5-25-31
	84483200000	
82°	84434000000	
	84483400000	
100°	84435000000	
120°	84433000000	

(1) Set supplied with 1 auto-lock chuck handle Code 4001.

(2) Set supplied with an 8 mm auto-lock chuck handle Code 4002.

M2 HSS SPOT DRILL Value SETS

4 PIECES American Standard

COMPOSITION: 1/4" x 2 5/8" - 3/8" x 3 1/8"
1/2" x 3 3/4" - 5/8" x 4 1/2"

TYPE	M2 HSS
90° Spot Drill Kit	8119C000004
120° Spot Drill Kit	8119D000004

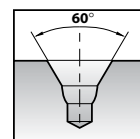

"UNIQUE" CENTER DRILLS

With reinforcing bulge

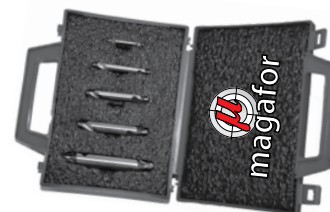

PLAIN TYPE 60° CENTER DRILLS

Sizes in inches

Value SETS American Standard 5 PIECES

81154000000	1 piece each #1, #2, #3, #4, #5
81115000000	1 piece each #1, #2, #3, #4, #5
S1055 (Cobalt)	1 piece each #1, #2, #3, #4, #5



Duo Mag SETS American Standard

4 PIECE

COMPOSITION	Cobalt
Quantity	80019000004
4 piece each Duo Mag	3/16"
	1/4"
	3/8"
	1/2"

Form W SETS

American Standard 81145000000



5 PIECES COMPOSITION	Quantity
1 piece each Bulge	# 1-W
	# 2-W
	# 3-W
	# 4-W
	# 5-W

Thank you for using our catalog.

Be sure to visit our website

www.hassay-savage.com



HS Hassay Savage **magafor** **GMauvais USA** 800-247-2021 | Search

About Our Product Lines | About Magafor Cutting Tools | Custom Broaching Solutions | Products | Resource Center | Hassay-Savage History

Micromachining?

We Do small Really Well!

Starting At **.003**

[View Our Full Product Listing](#)

HS Hassay-Savage Tech Support | **magafor** Magafor Tech Support | **GM** Find A Distributor

Featured Products

- Precision Key Way American Standard
- CNC Single Point Keyway
- Magafor Products
- GMauvais Products

Get a Quote

Name

Email

Company Name

Phone No.

SUBMIT

Quality - Performance - Value

Hassay-Savage Broaching Solutions:
Broaching solutions from standard stock items for virtually all applications or custom broaching solutions for your unique applications & requirements!

WE ARE YOUR TOTAL BROACH COMPANY!

Magafor Precision Cutting Tools:
"A program of cutting solutions!"
Magafor - truly superior quality above all others, all that you need to maximize your production & performance! The world's finest cutting tools can be delivered to you "next day" no hassle. Ultra Precision available in micro sizes. "We do small really well!"

You get it all from Hassay-Savage, Magafor and GMauvais!

Hassay-Savage - Magafor provides innovative cutting tool solutions through the most advanced state of the art broaching techniques that maximize your productivity & your profitability!

Our unique, high performance Magafor cutting tools provide solutions for your most challenging applications and can be delivered to you the next day! Hassay-Savage - Magafor has superior quality tools in an unrivaled range of products that delivers unsurpassed performance!

The website allows for easy tool selections and side-by-side comparisons that you can print and apply to your application process.

To see our tools at work and get practical "How-to" info click on resource-center/product-videos



magafor
High Precision Cutting Tools

Hassay Savage Company

Manufacturers of Precision Tools

www.hassay-savage.com

10 Industrial Blvd., Turners Falls, MA 01376-2251

Phone: 413-863-9371 • Fax: 413-863-2714

info@hassay-savage.com

TOLL FREE: 1-800-247-2024

AREA DISTRIBUTOR

