

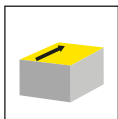

**NEUE SCHNEIDSTOFFSORTE FÜR DAS
HOCHVORSCHUB-FRÄSSYSTEM DAH8**
FÜR ERWEITERTE EINSATZGEBIETE

**NEW GRADE FOR THE DAH8
HIGH-FEED MILLING SYSTEM**
FOR EXTENDED APPLICATIONS



Planfräsen
Face milling

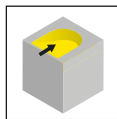

Eintauchen Rampe
Ramping

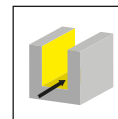

Nutfräsen
Groove milling

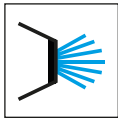

Innere Kühlmittelzufuhr
Internal cooling

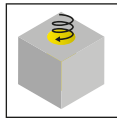

Eintauchen zirkular
Circular plunge milling

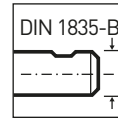

Schaftform DIN 1835-B
Shank form DIN 1835-B

Alle Abmessungen sind in mm angegeben, sofern nicht anders vermerkt.

All dimensions are in mm, unless otherwise stated.

Unsere Lieferzeiten: Einsatz für Werkstoffgruppen:

- ▲ ab Lager
- Δ 4 Wochen
- empfohlen
- o bedingt einsetzbar
- nicht geeignet

Delivery times: Use for material groups:

- ▲ on stock
- Δ 4 weeks
- recommended
- o alternative recommendation
- not suitable

Die HORN-Trennstellencodierung - wofür wird sie benötigt?

Die Trennstellencodierung stellt sicher, dass Sie immer die zueinander passenden Werkzeuge finden und wird bei Werkzeughaltern und bei Schneidplatten ausgewiesen. Wenn die Codes übereinstimmen, kann die Schneidplatte im entsprechenden Werkzeughalter verwendet werden.

Das gilt auch für unser modulares Haltersystem, hier gibt die Trennstellencodierung die Schnittstelle zwischen Grundhalter und Kassette an.

The HORN connection interface code - what is it needed for?

The connection interface code ensures that you will always find the appropriate tools and is shown on toolholders and inserts. If the codes match, the insert can be used in the corresponding toolholder.

This also applies to our modular holder system, where the connection code indicates the interface between the holder and the cassette.

HORN-Trennstellencodes und mögliche Kombinationen:

HORN connection interface codes and possible combinations:

- HIS** = Plattensitzgröße / Insert seat
- HWS** = Trennstelle Werkstückseitig / Interface workpiece side
- HMS** = Trennstelle Maschinenseitig / Interface machine side

HIS	↔	HWS
HMS	↔	HWS

Beispiel Schneidplatte

Example insert

Bestellnummer Part number	a_p	a	h	r_x	HIS	IG6B	SA4B	SC6A
DAH.82.030.S.08	1	6,8	4,5	0,8	DAH82	▲	▲	▲

Beispiel Klemmhalter

Example toolholder

Bestellnummer Part number	Z	Ds	a_p	h_2	h	d_s	d_k	l_2	b	C	d_2	HWS
DAH.82.040.A1635.05	5	40	1	33,5	35	16	33	22	8,4	5,6	16	DAH82

DER UNTERSCHIED: MEHR MÖGLICHKEITEN

THE DIFFERENCE:
MORE POSSIBILITIES

- **Ein erweitertes Spektrum an
Schneidstoffsorten**

An extended range of grades

- **Wendeschneidplatte mit speziell
auf die Anwendung abgestimmte
Hartmetallsorte inklusive Beschichtung**

Indexable insert with carbide grade
specially matched to the application,
including coating

- **Präzisionsgesinterte Wendeschneid-
platte mit 8 nutzbaren Schneidkanten**

Precision sintered insert with 8 usable
cutting edges



Abbildung = rechtsschneidend
Picture = right hand cutting version

Bestellnummer Part number	Z	Ds	ap	h ₂	h	d ₅	d _k	l ₂	b	C	d ₂	n _{max}	HWS
DAH82.040.A1635.05	5	40	1	33,5	35	16	33	22	8,4	5,6	16	14500	DAH82
DAH82.042.A1635.05	5	42	1	33,5	35	16	33	22	8,4	5,6	16	14000	DAH82
DAH82.050.A2240.06	6	50	1	38,5	40	19,5	41	24	10,4	6,3	22	13000	DAH82
DAH82.052.A2240.06	6	52	1	38,5	40	19,5	41	24	10,4	6,3	22	13000	DAH82
DAH82.063.A2240.07	7	63	1	38,5	40	19,5	49	24	10,4	6,3	22	13000	DAH82

Anbindung nach DIN 8030-A
Coupling system as per DIN 8030-A

Das Anzugsdrehmoment der Schraube 030.3070.T10P beträgt 3,0 Nm.
Torque specification of the screw 030.3070.T10P = 3,0 Nm.

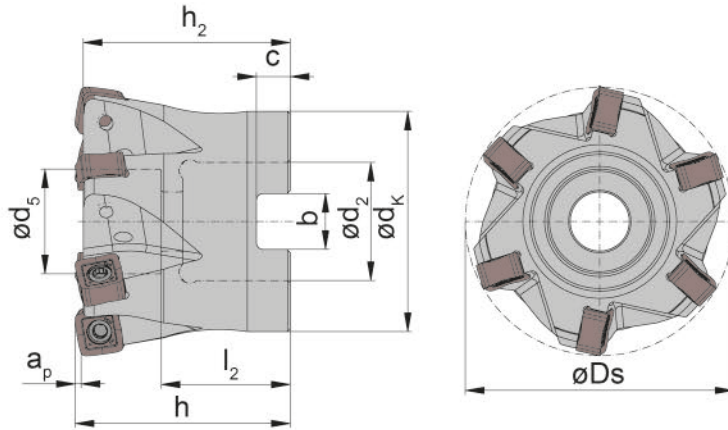
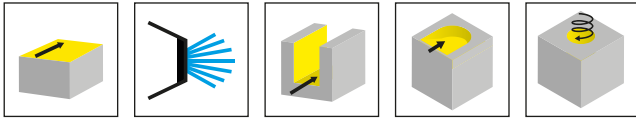
Ersatzteile

Spare Parts

Aufsteckfräser Arbor Mounted Cutter	Inbus-Schlüssel Allen Wrench	Spannschraube Clamping Screw	TORX PLUS®-Schlüssel TORX PLUS® Wrench	U-Scheibe Washer	Zylinderkopschraube Cylindrical screw
DAH82.04...	SW6,0 DIN911	030.3070.T10P	T10PL	8.4.433	8.25.912
DAH82.05.../06...	SW8,0 DIN 911	030.3070.T10P	T10PL	10.5.433	10.25.912



Abbildung = rechtsschneidend
Picture = right hand cutting version

Bestellnummer Part number	Z	Ds	l ₁	l ₂	d ₄	a _p	d ₂	SW	n _{max}	HWS	HMS
DAH82.020.M104.02	2	20	45	25	18	1	M10	15	21000	DAH82	10001
DAH82.025.M125.03	3	25	52	30	21	1	M12	17	18500	DAH82	12001
DAH82.032.M166.04	4	32	58	35	29	1	M16	24	16500	DAH82	16001
DAH82.035.M166.04	4	35	58	35	29	1	M16	24	15500	DAH82	16001
DAH82.040.M166.05	5	40	58	35	29	1	M16	24	14500	DAH82	16001

Schaftmaterial: Stahl
Material of shank: Steel

Das Anzugsdrehmoment der Schraube 030.3070.T10P beträgt 3,0 Nm.
Torque specification of the screw 030.3070.T10P = 3,0 Nm.

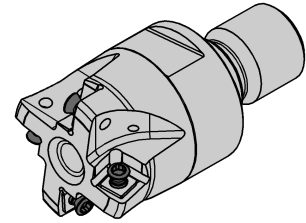
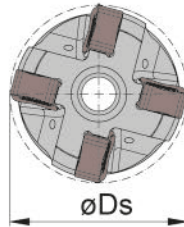
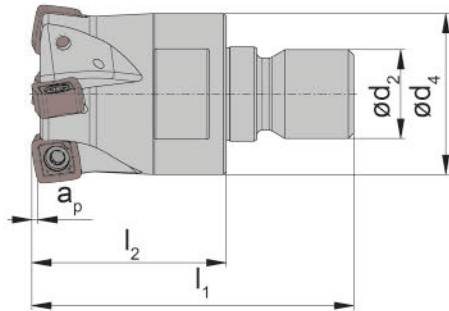
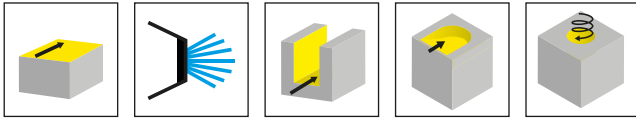
Ersatzteile
Spare Parts

Einschraubfräser Screw-in cutter	Spannschraube Clamping Screw	TORX PLUS®-Schlüssel TORX PLUS® Wrench
DAH82...	030.3070.T10P	T10PL



Abbildung = rechtsschneidend
Picture = right hand cutting version

Bestellnummer Part number	Z	Ds	d	l_1	l_3	a_p	n_{max}	HWS
DAH82.020.D204.02B	2	20	20	87	50	1	21000	DAH82
DAH82.025.D255.03B	3	25	25	101	56	1	18500	DAH82
DAH82.032.D326.04B	4	32	32	111	60	1	16500	DAH82
DAH82.035.D326.04B	4	35	32	111	60	1	15500	DAH82
DAH82.040.D326.05B	5	40	32	111	60	1	14500	DAH82

Schaftmaterial: Stahl
Material of shank: Steel

Das Anzugsdrehmoment der Schraube 030.3070.T10P beträgt 3,0 Nm.
Torque specification of the screw 030.3070.T10P = 3,0 Nm.

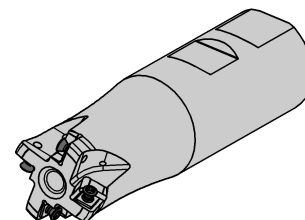
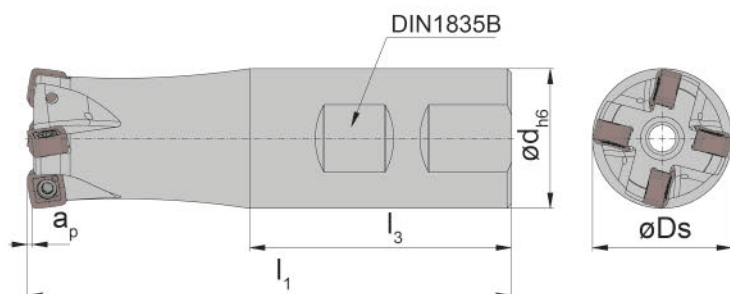
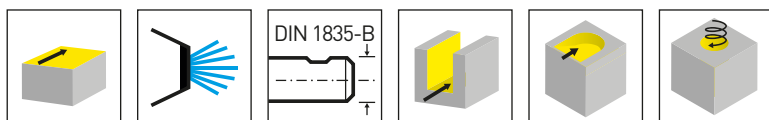
Ersatzteile
Spare Parts

Einschraubfräser Screw-in cutter	Spannschraube Clamping Screw	TORX PLUS®-Schlüssel TORX PLUS® Wrench
DAH82...	030.3070.T10P	T10PL

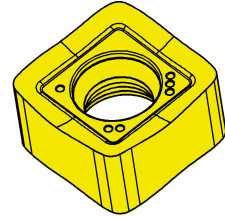
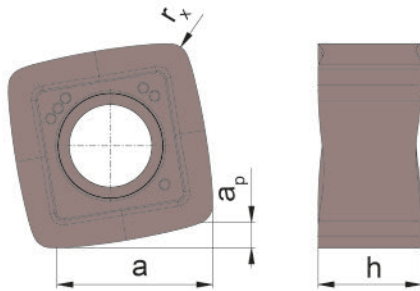
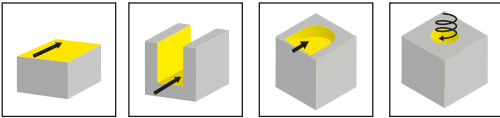

HM-Sorten
Carbide grades

▲ ab Lager
on stock

△ 4 Wochen
4 weeks

Bestellnummer Part number	a_p	a	h	r_x	HIS	IG6B	SA4B	SC6A
DAH.82.030.S.08	1	6,8	4,5	0,8	DAH82	▲	▲	▲
						P ●	●	●
						M ○	●	●
						K ○	●	●
						N ○	●	●
						S ○	-	-
						H -	-	-

positive Geometrie
positive geometry

theoretischer Eckenradius r_{th} = Programmerradius
Ist-Kontur auf Anfrage!
theoretical corner radius r_{th} = programming radius
actual outline upon request!

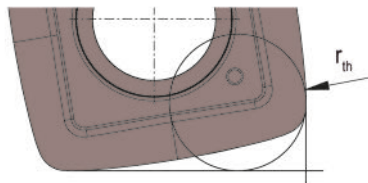



Abbildung = rechtsschneidend
Picture = right hand cutting version

Bestellnummer Part number	Z	Ds	ap	h ₂	h	d ₅	d _k	l ₂	b	C	d ₂	n _{max}	HWS
DAH84.050.A2240.04	4	50	1,5	38	40	16,5	41	25	10,4	6,3	22	8000	DAH84
DAH84.052.A2240.04	4	52	1,5	38	40	16,5	41	25	10,4	6,3	22	7500	DAH84
DAH84.063.A2240.05	5	63	1,5	38	40	19,5	49	25	10,4	6,3	22	6500	DAH84
DAH84.066.A2240.05	5	66	1,5	38	40	19,5	49	25	10,4	6,3	22	6500	DAH84
DAH84.080.A2750.06	6	80	1,5	48	50	21,5	59	28	12,4	7	27	5500	DAH84
DAH84.085.A2750.06	6	85	1,5	48	50	21,5	59	28	12,4	7	27	5500	DAH84
DAH84.100.A3250.07	7	100	1,5	48	50	30	80	33	14,4	8	32	5000	DAH84
DAH84.125.A4063.08	8	125	1,5	61	63	56	89	35	16,4	9	40	4000	DAH84

Anbindung nach DIN 8030-A
Coupling system as per DIN 8030-A

Das Anzugsdrehmoment der Schraube 030.0412.T15P beträgt 5,0 Nm.
Torque specification of the screw 030.0412.T15P = 5,0 Nm.

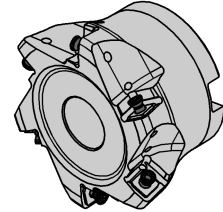
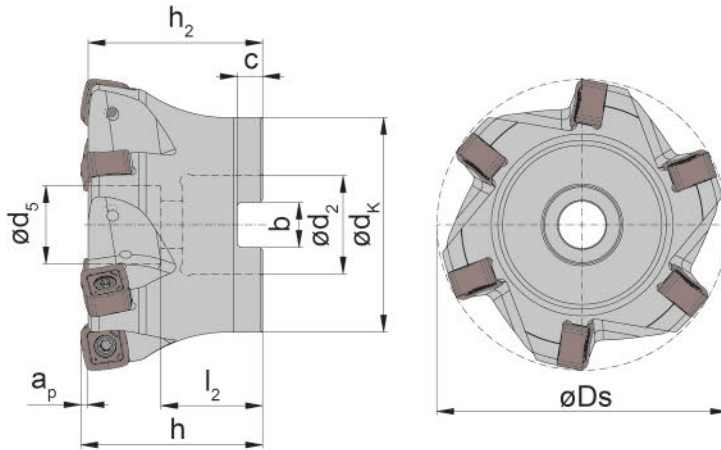
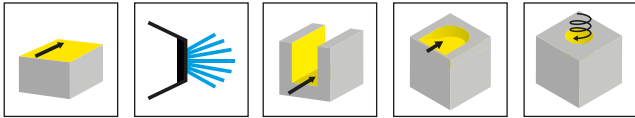
Ersatzteile

Spare Parts

Aufsteckfräser Arbor Mounted Cutter	Inbus-Schlüssel Allen Wrench	Spannschraube Clamping Screw	TORX PLUS®- Schlüssel TORX PLUS® Wrench	Zylinderkopf- schraube Cylindrical screw	Unterleg- scheibe Washer	Fräseranzugs- schraube Tightening Bolt
DAH84...04	SW8,0 DIN 911	030.0412.T15P	T15PQ	10.25.912		
DAH84...05	SW8,0 DIN 911	030.0412.T15P	T15PQ	10.25.912	10.5.433	
DAH84...06	SW10,0 DIN 911	030.0412.T15P	T15PQ	12.30.912	13.0.433	
DAH84.100.A3250.07	SW14,0 DIN 911	030.0412.T15P	T15PQ	16.35.7984	17.0.433	
DAH84.125.A4063.08		030.0412.T15P	T15PQ			20.30.6367

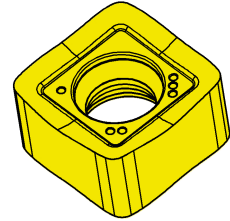
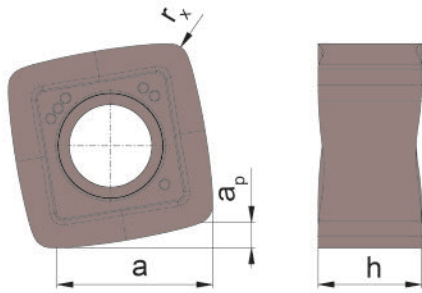
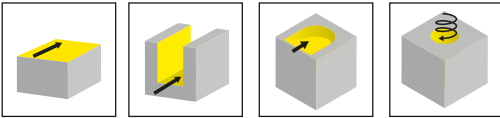

HM-Sorten
Carbide grades

▲ ab Lager
on stock

△ 4 Wochen
4 weeks

Bestellnummer Part number	a_p	a	h	r_x	HIS	IG6B	SA4B	SC6A
DAH.84.030.S.12	1,5	9,8	7	1,2	DAH84	▲	▲	▲
						P ●	●	●
						M ○	●	●
						K ○	●	●
						N ○	●	●
						S ○	-	-
						H -	-	-

positive Geometrie
positive geometry

theoretischer Eckenradius r_{th} = Programmerradius
Ist-Kontur auf Anfrage!
theoretical corner radius r_{th} = programming radius
actual outline upon request!

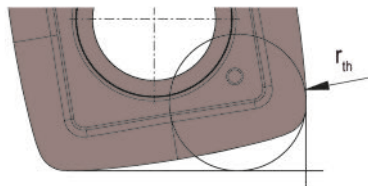

Werkstoff Material		Materialgruppe Material group	Härte (HB) Hardness Brinell	Zugfestigkeit R_m [N/mm ²] Tensile Strength	Beispiel Werkstoff Example Material	
P	unlegierter Stahl Carbon steel	~ 0,2 % C	P1.1	125	430	CK15
		~ 0,4% C geglüht annealed	P1.2	190	610	19Mn6
		~ 0,4% C vergütet quenched	P1.3	210	640	36Mn5
		~ 0,6% C geglüht annealed	P1.4	190	610	C55
		~ 0,6% C vergütet quenched	P1.5	300	1000	CK60
		Automatenstahl Free cutting steel	P1.6	220	750	9SMn28
	niedrig legierter Stahl (<5%) Alloyed steel	geglüht annealed	P2.1	180	590	100Cr6
		vergütet quenched	P2.2	280	960	14NiCr10
		vergütet quenched	P2.3	350	1250	34CrMo4
		vergütet quenched	P2.4	430	1450	55Cr3
	hochlegierter Stahl (>5%) high alloyed steel	geglüht annealed	P3.1	200	680	X10CrAl18
		gehärtet hardened	P3.2	350	1200	X210Cr2
	Stahlguss Cast steel	unlegiert unalloyed	P4.1	180	590	GE200
		legiert alloyed	P4.2	220	750	GX40CrSi28
	Sinterstahl Sintered steel	weich soft	P5.1	220	570	Sint-D39
	M	Rostfreier Stahl Stainless steel	martensitisch ferritisch martensitic ferritic	M1.1	200	680
austenitisch austenitic ferritic			M1.2	300	1000	X6CrNiMo- Ti17-12-2
austenitisch ferritisch austenitic			M1.3	230	780	X2CrNi- Mo-N17-13-3
H	Gehärtete Stähle Hardened steels	50-55 HRC	H1.1	-	-	
		55-60 HRC	H1.2	-	-	
		60-63 HRC	H1.3	-	-	
		> 63HRC	H1.4	-	-	

Werkstoff Material		Materialgruppe Material group	Härte (HB) Hardness Brinell	Zugfestigkeit R_m [N/mm ²] Tensile Strength	Beispiel Werkstoff Example Material	
K	Grauguss Grey cast iron	niedrige Festigkeit low tensile strength	K1.1	180	250	GG-25
		hohe Festigkeit high tensile strength	K1.2	250	350	GG-40
	Kugelgraphitguss Spheroidal graphite cast iron	ferritisch ferritic	K2.1	160	400	GGG-40
		perlitisch perlitic	K2.1	260	700	GGG-60
	Temperguss Malleable cast iron	ferritisch ferritic	K3.1	200	400	GTW-45
		perlitisch perlitic	K3.2	260	700	GTS-55-04
	Ausferritisches Gusseisen / ADI Ausferritic spheroidal cast iron / ADI	vergütet quenched	K4.1	260	800	
		vergütet quenched	K4.2	350	1050	
		vergütet quenched	K4.3	450	1400	
N	Al-Legierungen Al-alloys	nicht vergütbar not heat treatable	N1.1	30		AlMg1
		vergütbar heat treatable	N1.2	100	340	AlMgSi1
	Al-Guss- Legierung Al-cast-alloy	< 6% Si	N2.1	80	300	AlMgSi6
		6-10% Si	N2.2	100	320	AlSi7Mg
		10-15 % Si	N2.3	130	450	AlSi12
	Kupfer- Legierungen Copper-alloys	Reinkupfer Pure copper	N3.1	100	340	Cu
		Messing, Bronze Brass	N3.2	90	310	CuZn40Pb
		Messing bleifrei Lead-free brass	N3.3	110	430	CuZn40
		hochfest high strength	N3.4	300	1000	CuZ- n25Al5-Mn4Fe3
	Graphit Graphite		N4.1			
S	Warmfeste Legierung (Fe) Heat resistant alloy	geglüht annealed	S1.1	200	670	
		gehärtet hardened	S1.2	275	930	
	Warmfeste Legierung (Ni, Co) Heat resistant alloy	geglüht annealed	S2.1	250	840	Inconel 600
		gehärtet hardened	S2.2	350	1200	Inconel 713

Schnittdaten

Cutting Data



Schnittgeschwindigkeit vc (m/min) / Startwerte Cutting speed vc (m/min) / Start values										
	K10	TA4_	AS4_	SA4_	SD6_	SC6_	IG3_ IG6_	NE2_	HD05	PD75
		160-140	300-220	180-140	300-220	300-220	200-160			
		160-140	260-220	160-140	260-220	260-220	180-160			
		160-140	260-220	160-140	260-220	260-220	180-160			
		160-140	260-220	160-140	260-220	260-220	180-160			
		1200-500	1000-350	1200-500					3000-500	3000-500
		1200-500	1000-350	1200-500					3000-500	3000-500
	600-350	1200-500	1000-350	1200-500				3000-500	3000-500	3000-500
	600-350	1200-500		1200-500				2000-500	3000-500	3000-500
		1200-500		1200-500				1500-350	3000-500	3000-500
	230-180	1200-500		1200-500				300-220	3000-500	3000-500
	230-180	1200-500		1200-500				230-180	3000-500	3000-500
	230-180	1200-500		1200-500				240-180	3000-500	3000-500
	230-180	1200-500		1000-500				250-160	3000-500	3000-500
		30-25		70-30		80-30	80-30			
		30-25		70-30		80-30	80-30			
		30-25		70-30		80-30	80-30			
		30-25		70-30		80-30	80-30			

Werkstoff Material		Materialgruppe Material group	Härte (HB) Hardness Brinell	Zugfestigkeit R_m [N/mm ²] Tensile Strength	Beispiel Werkstoff Example Material
S	Titan	Titanlegierung α Titanium alloy α	S3.1	120	240
		Titanlegierung α - β Titanium alloy α - β	S3.2	360	1200
		Titanlegierung β Titanium alloy β	S3.3	410	1400
O	Thermoplaste Thermoplastics		01.1		
	Duroplaste Duro plaste		01.2		
	Kunststoffe glas- faserverstärkt Plastics glass fibre reinforced	GFK	01.3		
	Kunststoffe kohle- faserverstärkt Plastics carbon fibre reinforced	CKF	01.4		

Schnittdaten

Cutting Data



Schnittgeschwindigkeit vc (m/min) / Startwerte Cutting speed vc (m/min) / Start values										
	K10	TA4_	AS4_	SA4_	SD6_	SC6_	IG3_ IG6_	NE2_	HD05	PD75
		30-25		70-30		80-30	80-30			
		30-25		70-30		80-30	80-30			
		30-25		70-30		80-30	80-30			
	1500-500							500-1500		
	1500-500							500-1500		



**FINDEN SIE JETZT IHRE
PASSENDE WERKZEUGLÖSUNG.**

FIND YOUR RIGHT
TOOLING SOLUTION NOW.

horn-group.com

DEUTSCHLAND, STAMMSITZ

GERMANY, HEADQUARTERS

—

Hartmetall Werkzeugfabrik

Paul Horn GmbH

Horn-Straße 1

D-72072 Tübingen

Tel +49 7071 / 70040

Fax +49 7071 / 72893

info@de.horn-group.com

horn-group.com