

COMPLETE
METALWORKING
SOLUTIONS

(800) 991-4225

www.ahbinc.com

ISO Certified

customerservice@ahbinc.com

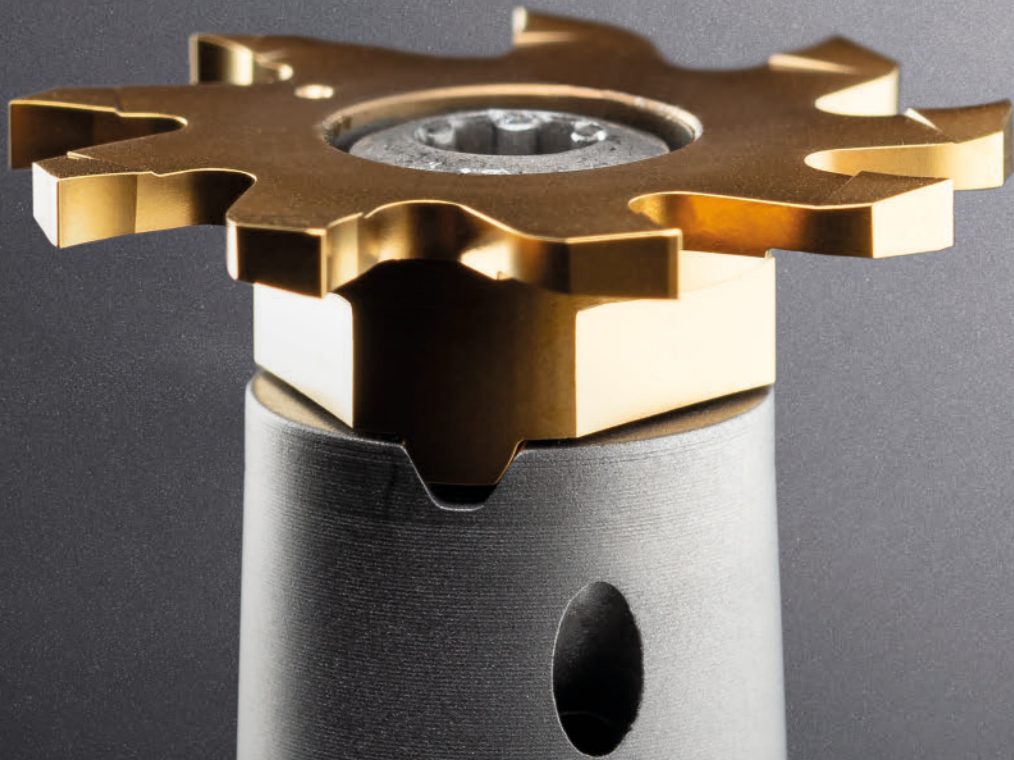

**NEUE ZIRKULARFRÄSSYSTEME
911, 913 UND 928**

9-SCHNEIDIGE ZIRKULARFRÄSPLATTEN
FÜR MEHR LEISTUNG

**NEW CIRCULAR MILLING
SYSTEMS 911, 913 AND 928**

9-EDGE CIRCULAR MILLING CUTTER
INSERTS FOR HIGHER PERFORMANCE

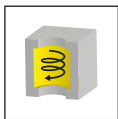

Nutfräsen zirkular
Circular groove milling

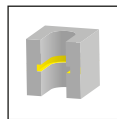

Nutfräsen innen
Internal groove milling

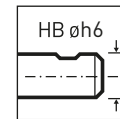

Schaftform
Shank form



Zähnezahl
Number of teeth

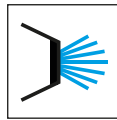

Innere Kühlmittelzufuhr
Internal coolant

Alle Abmessungen sind in mm angegeben, sofern nicht anders vermerkt.

All dimensions are in mm, unless otherwise stated.

Unsere Lieferzeiten: Einsatz für Werkstoffgruppen:

- ▲ ab Lager
- Δ 4 Wochen
- empfohlen
- o bedingt einsetzbar
- nicht geeignet

Delivery times: Use for material groups:

- ▲ on stock
- Δ 4 weeks
- recommended
- o alternative recommendation
- not suitable

Die HORN-Trennstellencodierung - wofür wird sie benötigt?

Die Trennstellencodierung stellt sicher, dass Sie immer die zueinander passenden Werkzeuge finden und wird bei Werkzeughaltern und bei Schneidplatten ausgewiesen. Wenn die Codes übereinstimmen, kann die Schneidplatte im entsprechenden Werkzeughalter verwendet werden.

Das gilt auch für unser modulares Haltersystem, hier gibt die Trennstellencodierung die Schnittstelle zwischen Grundhalter und Kassette an.

The HORN connection interface code - what is it needed for?

The connection interface code ensures that you will always find the appropriate tools and is shown on toolholders and inserts. If the codes match, the insert can be used in the corresponding toolholder.

This also applies to our modular holder system, where the connection code indicates the interface between the holder and the cassette.

HORN-Trennstellencodes und mögliche Kombinationen:

HORN connection interface codes and possible combinations:

- HIS** = Plattensitzgröße / Insert seat
- HWS** = Trennstelle Werkstückseitig / Interface workpiece side
- HMS** = Trennstelle Maschinenseitig / Interface machine side

HIS	↔	HWS
HMS	↔	HWS

Beispiel Schneidplatte

Example insert

Bestellnummer Part number	Ds	w	s	b x 45°	r	t _{max}	Z	HIS	EC55
913.0150.00	21,7	1,5	5,7	0,05	-	4,5	9	313113R	▲

Beispiel Klemmhalter

Example toolholder

Bestellnummer Part number	d	l ₁	l ₂	d ₁	Form	HWS
M313.0012.01A	12	100	-	-	A	313113R • 313113L

DER UNTERSCHIED: MEHR MÖGLICHKEITEN

THE DIFFERENCE:
MORE POSSIBILITIES

- **Kürzere Bearbeitungszeit durch höheren Vorschub**
Shorter machining time due to higher feed rate
- **Höhere Standzeit aufgrund größerer Schneidenanzahl**
Longer tool life due to larger number of cutting edges
- **Senkung der Produktionskosten**
Reduction in production costs



Abbildung = rechtsschneidend
Picture = right hand cutting version

▲ ab Lager
on stock

HM-Sorten
Carbide grades
Δ 4 Wochen
4 weeks

Bestellnummer Part number	Ds	w	s	b x 45°	r	t _{max}	Z	HIS	EG55	IG65
911.0150.00	17,7	1,5	6,1	0,05	-	3,5	9	311090R	▲	Δ
911.0200.00	17,7	2	6,1	-	0,2	3,5	9	311090R	▲	Δ
911.0250.00	17,7	2,5	6,1	-	0,2	3,5	9	311090R	▲	Δ
911.0300.00	17,7	3	6,1	-	0,2	3,5	9	311090R	▲	Δ
									P ● ●	
									M ○ ●	
									K ○ -	
									N - -	
									S - ○	
									H - -	

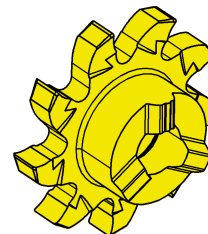
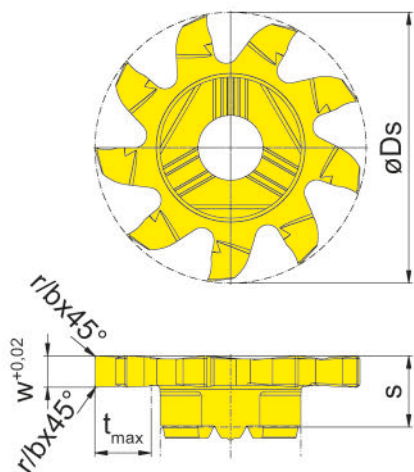
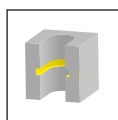
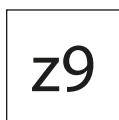
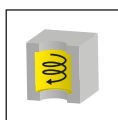

Abbildung = rechtsschneidend
Picture = right hand cutting version

▲ ab Lager
on stock

HM-Sorten
Carbide grades
Δ 4 Wochen
4 weeks

Bestellnummer Part number	Ds	w	s	b x 45°	r	t _{max}	Z	HIS	EG55	IG65
913.0150.00	21,7	1,5	5,7	0,05	-	4,5	9	313113R	▲	Δ
913.0200.00	21,7	2	5,7	-	0,2	4,5	9	313113R	▲	Δ
913.0250.00	21,7	2,5	5,7	-	0,2	4,5	9	313113R	▲	Δ
913.0300.00	21,7	3	5,7	-	0,2	4,5	9	313113R	▲	Δ
									P ● ●	
									M ○ ●	
									K ○ -	
									N - -	
									S - ○	
									H - -	

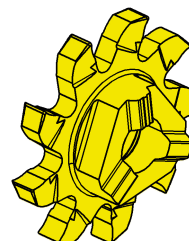
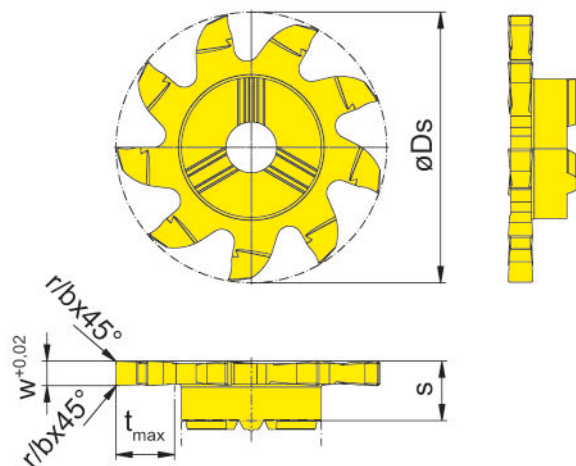
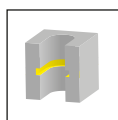
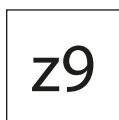
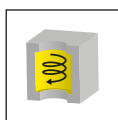

Abbildung = rechtsschneidend
Picture = right hand cutting version

▲ ab Lager
on stock

HM-Sorten
Carbide grades
△ 4 Wochen
4 weeks

Bestellnummer Part number	Ds	w	s	b x 45°	r	t _{max}	Z	HIS	EG55	IG65
928.0150.00	27,7	1,5	6,1	0,05	-	6,5	9	328143R	▲	△
928.0200.00	27,7	2	6,1	-	0,2	6,5	9	328143R	▲	△
928.0250.00	27,7	2,5	6,1	-	0,2	6,5	9	328143R	▲	△
928.0300.00	27,7	3	6,1	-	0,2	6,5	9	328143R	▲	△
									P ● ●	
									M ○ ●	
									K ○ -	
									N - -	
									S - ○	
									H - -	

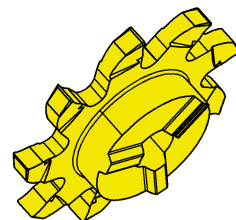
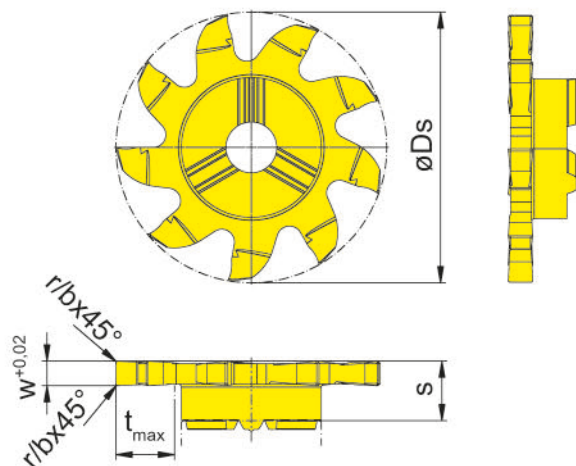
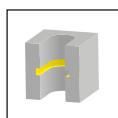
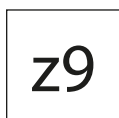
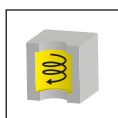
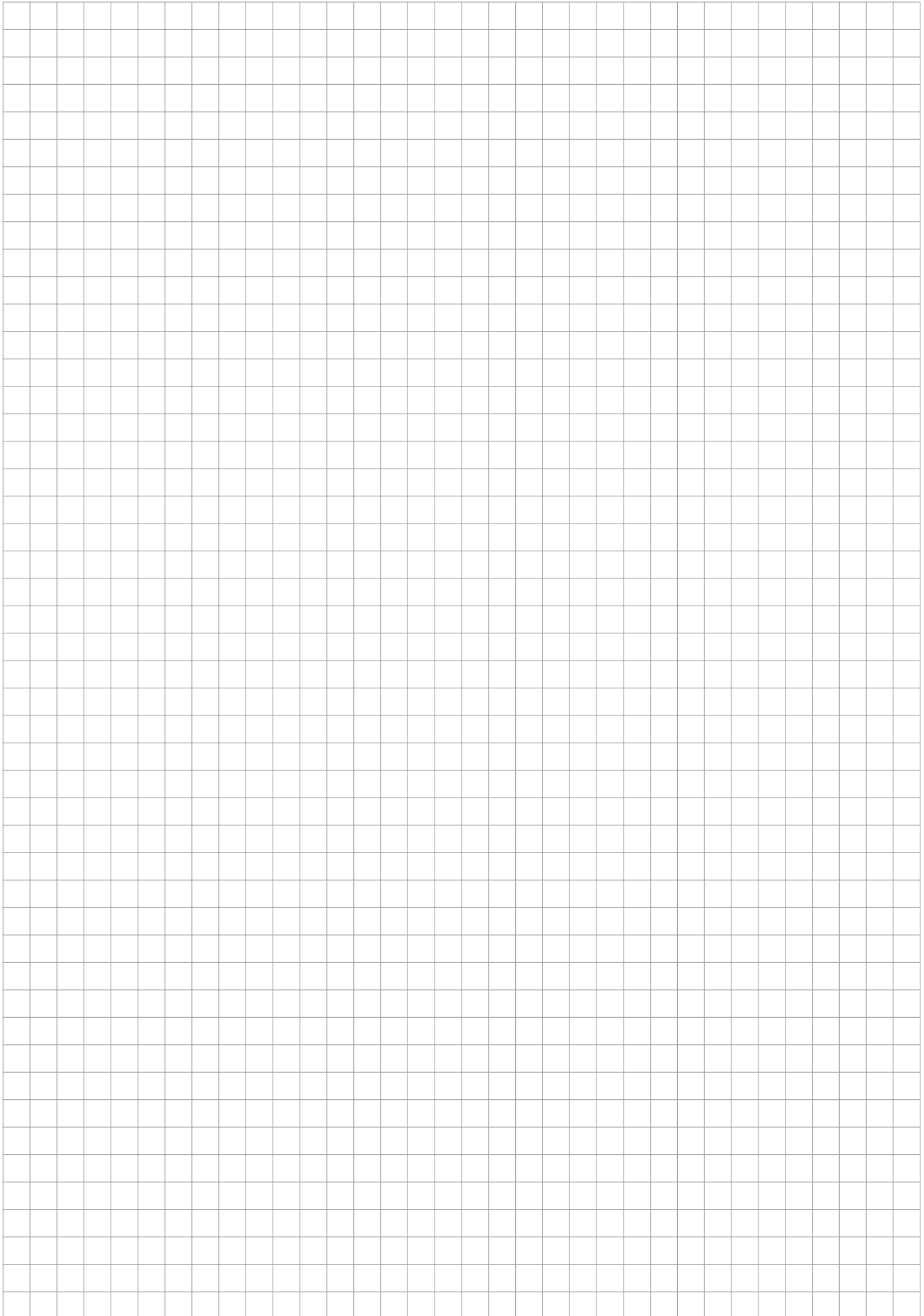



**FINDEN SIE JETZT IHRE
PASSENDE WERKZEUGLÖSUNG.**

FIND YOUR RIGHT
TOOLING SOLUTION NOW.

horn-group.com

DEUTSCHLAND, STAMMSITZ

GERMANY, HEADQUARTERS

—

Hartmetall Werkzeugfabrik

Paul Horn GmbH

Horn-Straße 1

D-72072 Tübingen

Tel +49 7071 / 70040

Fax +49 7071 / 72893

info@de.horn-group.com

horn-group.com