



[www.urma.ch](http://www.urma.ch)

# AHB

**TOOLING & MACHINERY**

**COMPLETE METALWORKING SOLUTIONS**  
(800) 991-4225  
ISO Certified

[www.ahbinc.com](http://www.ahbinc.com)  
[customerservice@ahbinc.com](mailto:customerservice@ahbinc.com)

**Innovation Is  
Our Tool**

SWISS  QUALITY

**URMA** Boring System  
Gamma – Our Basic Line

BRAND-NEW

**Ihre Vorteile mit URMA Boring System Gamma**

Advantages of Using URMA Boring System Gamma

**URMA Gamma – unsere «Basic-Line»**

- Das wirtschaftliche System
- Grosser Bereich (Ø 0.2mm – Ø 297mm)
- System-unabhängig
- Multifunktional einsetzbar dank Zylinderschaft
- Ideal auch für Drehmaschinen
- Höhere Stabilität durch optimierte Achsialabstützung
- Bewährte URMA Boring System Technologie

**URMA Gamma – our «Basic-Line»**







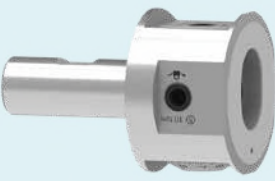

- The economical system
- Large range (Ø 0.2mm – Ø 297mm)
- System-independent
- Multifunctional usability thanks to cylindrical shank
- Optimal for lathes
- Higher stability due to optimized axial support
- Proven URMA Boring System technology

**URMA Boring System**  
MicroMax

Ø 0.2 - 40 mm

Ø 0.2 - 40 mm

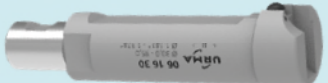
MicroMax

Standard Holders	Page 8	Page 9	Page 9	
				
		Page 10		Page 10
		Page 11		
		Page 11		Page 12
				

Ø 0.2 - 40 mm



**Feinbohrkopf 0.01 mm/ø**  
Fine Boring Head 0,01 mm/ø

**Feinbohrkopf nicht auswuchtbar**  
Non Balanceable Fine Boring Head

Gamma	Order Number	L	I	D	kg	d	MCC	Index
20	G05 56 20 038	38	50	42	0,7	20	Z16	•

d = DIN 1835-B

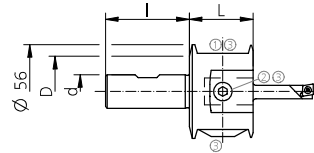

SPARE PARTS

Gamma	①	②	③	④
20	Z00 05 01	Z00 23 01	G00 02 06	G00 02 03

Ø 0.2 - 6 mm



**Bohrstangen**  
Boring Bars

**Reduzierbüchse zu Mini-Bohrstangen**  
Reducer for Mini-Boring Bars

Ø 0.2 - 6 mm

Order Number	L	MCM	MCC	Index
B105,0016,U1,01	39	Z16	B105	•

**Achtung:** Schneidrichtung beachten!  
**Attention:** Note the direction of cutting!

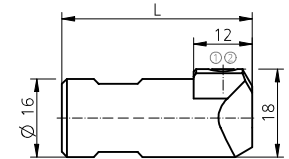

**Hartmetall-Mini-Bohrstangen**  
Carbide Mini-Boring Bars

Ø 0.2 - 6 mm

Order Number	Ø-Range	L	I	MCM	Index
L105,1802,0,02MG12	0,2 - 0,8	23	1,0	B105	•
L105,1802,0,03MG12	0,3 - 0,9	23	1,0	B105	•
L105,1803,0,07MG12	0,7 - 2,3	23	2,0	B105	•
R105,1805,1,1TN35	1,0 - 3,4	25	6,0	B105	•
R105,1809,1,2TN35	2,0 - 6,0	25	9	B105	•

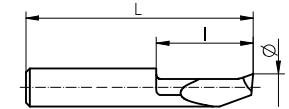

SPARE PARTS

B105..	①	②
6,075T15	G00 20 03	

Ø 5.8 - 22.5 mm



**Bohrstangen mit Hartmetallschaft für Ausdrehtiefen bis 8xD**

Boring Bars With Carbide Shank for Boring Depths up to 8xD

**Reduzierbüchsen**  
Reducers

Ø 5,8 - 22,5 mm

Order Number	L	D	d	MCM	MCC	Index
07 00 05	17	5	16	Z16	ZS5	●
07 00 06	17	6	16	Z16	ZS6	●
07 00 08	22	8	19	Z16	ZS8	●
07 00 10	25	10	22	Z16	ZS10	●
07 00 12	31	12	22	Z16	ZS12	●

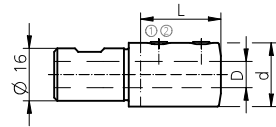

**Bohrstangen mit Hartmetallschaft**

Ø 5,8 - 22,5 mm

Boring Bars With Carbide Shanks

Order Number	Ø-Range	L	I	D	Inserts	MCM	MCC	Index
H06 05 06	5,8 - 10	65	20-40	5	WC., 0201	ZS5	WC02	●
H06 06 07	7,3 - 11	70	24-48	6	WC., 0201	ZS6	WC02	●
HW/C06 08 09	8,8 - 13	90	40-64	8	CC./CP., 0602	ZS8	CP06	●
HW/C06 10 12	11,8 - 16	105	50-80	10	CC./CP., 0602	ZS10	CP06	●
HW/C06 12 14	13,8 - 18	120	60-96	12	CC./CP., 0602	ZS12	CP06	●
HW/C06 16 16	15,8 - 20	130	100	16	CC./CP., 0602	ZS16	CP06	●
HW/C06 16 18	18,3 - 22,5	145	115	16	CC./CP., 0602	ZS16	CP06	●

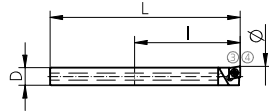

Beschreibung zu Plattenshalter mit Kombi-Plattensitz siehe Seite 12  
Description see page 12 for insert holder with combined insert pocket

SPARE PARTS

D	①	②	③	④
5-6	C00 07 01	G00 02 03	C00 20 10	G00 20 01
8-10	C00 25 03	G00 02 04	C00 20 04	G00 20 05
12	C00 07 02	G00 02 04	C00 20 01	G00 20 05
16			C00 20 01	G00 20 05

Ø 10 - 40 mm



**Bohrstangen mit Stahlschaft für Ausdrehtiefen bis 4xD**

Boring Bars With Steel Shank for Boring Depths up to 4xD

**Bohrstangen**  
Boring Bars

Ø 10 - 20 mm

Order Number	Ø-Range	L	I	D	Inserts	MCM	MCC	Index
W/C06 16 10	10 - 15	38	35	8	CC./CP., 0602..	Z16	CP06	●
W/C06 16 15	15 - 20	48	45	12,5	CC./CP., 0602..	Z16	CP06	●
W06 16 10	10 - 15	38	35	8	CC., 0602..	Z16	CC06	●
W06 16 15	15 - 20	48	45	12,5	CC., 0602..	Z16	CC06	●

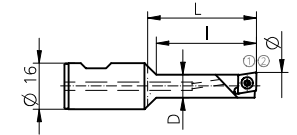

**Bohrstangen**

Ø 20 - 40 mm

Boring Bars

Order Number	Ø-Range	I	D	MCM	MCC	Index
06 16 20	20 - 25	60	17	Z16	2002	●
06 16 25	25 - 30	75	22	Z16	2002	●
06 16 30	30 - 35	75	27	Z16	2002	●
06 16 35	35 - 40	75	32	Z16	2002	●

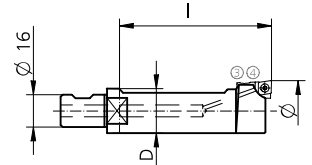

SPARE PARTS

①	②	③	④
C00 20 01	G00 20 05	C00 25 11	G00 20 07

Ø 20 - 40 mm



### Plattenhalter

Insert Holders

#### Plattenhalter

Insert Holders

Ø 20 - 40 mm

Order Number	L	Inserts	MCM	MCC	Index
W/C20 02 06	13	CC../CP..0602..	2002	CP06	•
W20 02 06	13	CC..0602..	2002	CC06	•
WW20 02 06	13	Wiper CC..0602..	2002	CC06	•

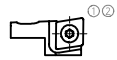

### Plattenhalter mit Kombi-Plattensitz

Insert Holder With Combined Insert Pocket

Plattenhalter der Typen W/C... und Bohrstangen HW/C06... sind so ausgelegt, dass sowohl Wendeplatten mit 7° (CCGT...) als auch mit 11° Freiwinkel (CPGT...) eingesetzt werden können. Um optimalen Sitz zu gewährleisten, empfehlen wir dringend, auf diesen Plattenhaltern Wendeplatten mit engen Umfangstoleranzen zu verwenden (geschliffene CCG... oder CPG... Platten).

Insert holders type W/C... and boring bars HW/C06... are designed to hold inserts with 7° (CCGT...) as well as 11° (CPGT...) relief angle. We highly recommend to use only precision (ground) inserts (CCG... or CPG...) on such holders to guarantee a perfect fit.

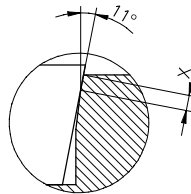
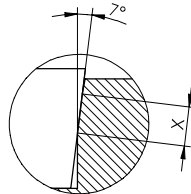

#### SPARE PARTS

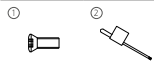

C00 20 04 G00 20 05







# URMA Boring System

## VersaMax - Type 14

Ø 19.5 - 88 mm

Ø 19.5 - 88 mm

VersaMax - Type 14

	Standard Holders	Page 19	Page 17
Double Roughing			
Offset Roughing			
			Page 18



Ø 19.5 - 88 mm

Vorteile des patentierten URMA Zweischneiderkopfes

Advantages of the Patented URMA Double Cutter Head

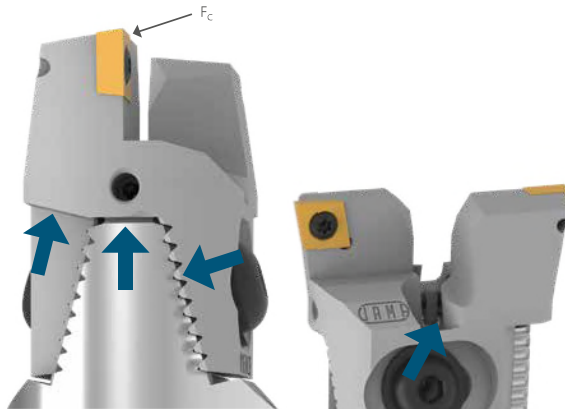

Die patentierte, gegenseitige Abstützung der Plattenhalter leitet die Schnittkräfte (F<sub>c</sub>) direkt in den Werkzeugkörper und garantiert höchste Stabilität, Zerspanungsleistung und ermöglicht:

- zweischneidiges Schruppen
- versetztes Schruppen
- individuell verstellbar
- ISO-Wendeplatten
- innere KM-Zuführung
- hohe Zuverlässigkeit
- einfache Handhabung
- nachweisbar höchste Stabilität

Patented design to direct cutting forces (F<sub>c</sub>) directly into the body and guarantee highest stability, versatility and allows:

- double cutter roughing
- offset roughing
- individual radial adjustment
- ISO-Standard inserts
- coolant through
- high reliability
- simple handling
- optimized stability

Versetztes Schruppen

Offset Roughing

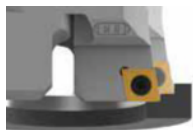

Achsal und radial versetztes Schruppen für grosse Spantiefen (für den Vorschub pro Minute darf nur mit einer Schneide gerechnet werden, Details Seite 18)

Axial and radial offset roughing for larger cutting depth (consider only one cutting edge for the feed rate per minute calculation, see page 18 for details)

Ø 19.5 - 88mm



Plattenhalter

Insert Holders

Plattenhalter 90°  
Insert Holders 90°

Gamma	Order Number	Ø-Range	kg	Inserts	MCM	MCC	Index
18	W16 01 06	19,5 - 25	0,1	CC.. 0602..	1418	CC06	●
18	W16 02 06	22,5 - 30	0,1	CC.. 0602..	1418	CC06	●
25	W16 04 06	29 - 39	0,1	CC.. 0602..	1424	CC06	●
32	W16 06 09	38 - 51	0,1	CC.. 09T3..	1432	CC09	●
42	W16 08 09	50 - 67	0,1	CC.. 09T3..	1442	CC09	●
55	W16 10 13	66 - 88	0,2	CC.. 1204..	1455	CC12	●
55	W16 10 12P	66 - 88	0,2	CN.. 1204..	1455	CN12	●

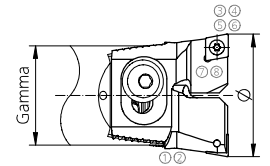

Plattenhalter 75°  
Insert Holders 75°

Gamma	Order Number	Ø-Range	kg	Inserts	MCM	MCC	Index
18	W18 02 06	22,5 - 30	0,1	CC.. 0602..	1418	CC06	●
25	W18 04 06	29 - 39	0,1	CC.. 0602..	1424	CC06	●
32	W18 06 09	38 - 51	0,1	CC.. 09T3..	1432	CC09	●
42	W18 08 09	50 - 67	0,1	CC.. 09T3..	1442	CC09	●
55	W18 10 12P	66 - 88	0,2	CN.. 1204..	1455	CN12	●

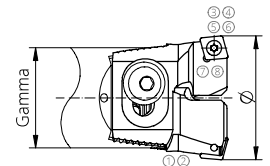

Ⓜ Im Lieferumfang nicht enthalten  
Not included in the delivery

SPARE PARTS

Gamma	①	②	③	④	⑤	⑥	⑦	⑧
18	G00 02 01	C00 02 10	C00 20 01	G00 20 05				
25	G00 02 01	C00 02 11	C00 20 01	G00 20 05				
32	G00 02 02	C00 02 12	C00 20 02	G00 20 03				
42	G00 02 03	C00 02 13	C00 20 02	G00 20 03				
55/CC12	G00 02 03	C00 02 14	C00 20 05	G00 20 03				
55/CN12	G00 02 03	C00 02 14		G00 20 03	A00 12 11	Z00 12 02	A00 02 17	A00 32 07

Ø 22.5 - 88 mm



**Plattenhalter für versetztes Schruppen**

Insert Holders for Offset Roughing

**Schneiden in Durchmesser und Höhe versetzt  
Doppelte Spantiefe**

Inserts offset in diameter and height  
Double cutting depth

**Plattenhalter 90°**

Insert Holders 90°

Gamma	Order Number	Order Number	O-Range	kg	Inserts	a <sub>p max</sub>	x	MCM	MCC	Index
18	WV16 02 06	W16 02 06	22,5 - 30	0,1	CC., 0602..	2-3	0,2	1418	CC06	●
25	WV16 04 06	W16 04 06	29 - 39	0,1	CC., 0602..	2-3	0,2	1424	CC06	●
32	WV16 06 09	W16 06 09	38 - 51	0,1	CC., 09T3..	3-4	0,2	1432	CC09	●
42	WV16 08 09	W16 08 09	50 - 67	0,2	CC., 09T3..	3-4	0,25	1442	CC09	●
55	WV16 10 12P	W16 10 12P	66 - 88	0,5	CN., 1204..	4-6	0,3	1455	CN12	●

Formula 
$$a_p = \frac{D_A - D_i}{4}$$

Ⓢ Im Lieferumfang nicht enthalten  
Not included in the delivery

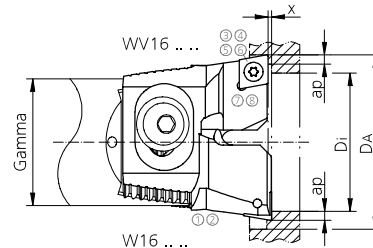

**SPARE PARTS**

Gamma	①	②	③	④	⑤	⑥	⑦	⑧
18	G00 02 01	C00 02 10	C00 20 01	G00 20 05				
25	G00 02 01	C00 02 11	C00 20 01	G00 20 05				
32	G00 02 02	C00 02 12	C00 20 02	G00 20 03				
42	G00 02 03	C00 02 13	C00 20 02	G00 20 03				
55	G00 02 03	C00 02 14	G00 20 03	A00 12 11	Z00 12 02	A00 02 17	A00 32 07	

Ø 19.5 - 88 mm



**Zweischneiderköpfe**

Double Cutter Heads

**Zweischneiderköpfe**  
Double Cutter Heads

Gamma	Order Number	O-Range	L	I	D	kg	d	MCC	Index
18	G14 18 20 100	*19,5 - 30	100	50	20	0,3	20	1418	●
25	G14 25 25 110	29 - 39	110	56	25	0,5	25	1424	●
32	G14 32 25 120	38 - 51	120	56	32	0,8	25	1432	●
40	G14 40 25 130	50 - 67	130	56	42	1,1	25	1442	●
55	G14 55 32 150	66 - 88	150	60	55	2,2	32	1455	●

d = DIN 1835-B

\* Achtung: Ø 19,5 – 20,5 max 50mm Bearbeitungslänge  
\* Attention: Ø 19,5 – 20,5 max 50 mm machining length

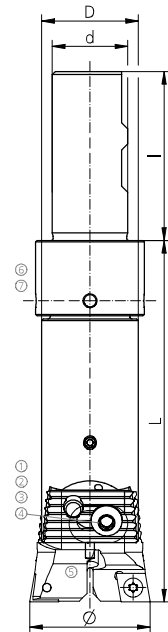

**SPARE PARTS**

Gamma	①	②	③	④	⑤	⑥	⑦
18	B00 22 01		C00 12 01	K00 02 01	G00 20 23		
25	B00 22 02		C00 12 01	K00 02 02	G00 20 24		
32	B00 22 03	G00 02 05	C00 12 08	K00 02 03		C00 14 00	G00 25 034
42	B00 22 04	G00 02 06	C00 12 04	K00 02 04		C00 14 01	G00 25 040
55	B00 22 05	G00 02 07	C00 12 05	K00 02 05		C00 14 02	G00 25 052

**URMA Boring System**  
VersaMax - Type 25

Ø 18 - 88 mm

Ø 18 - 88 mm

VersaMax - Type 25

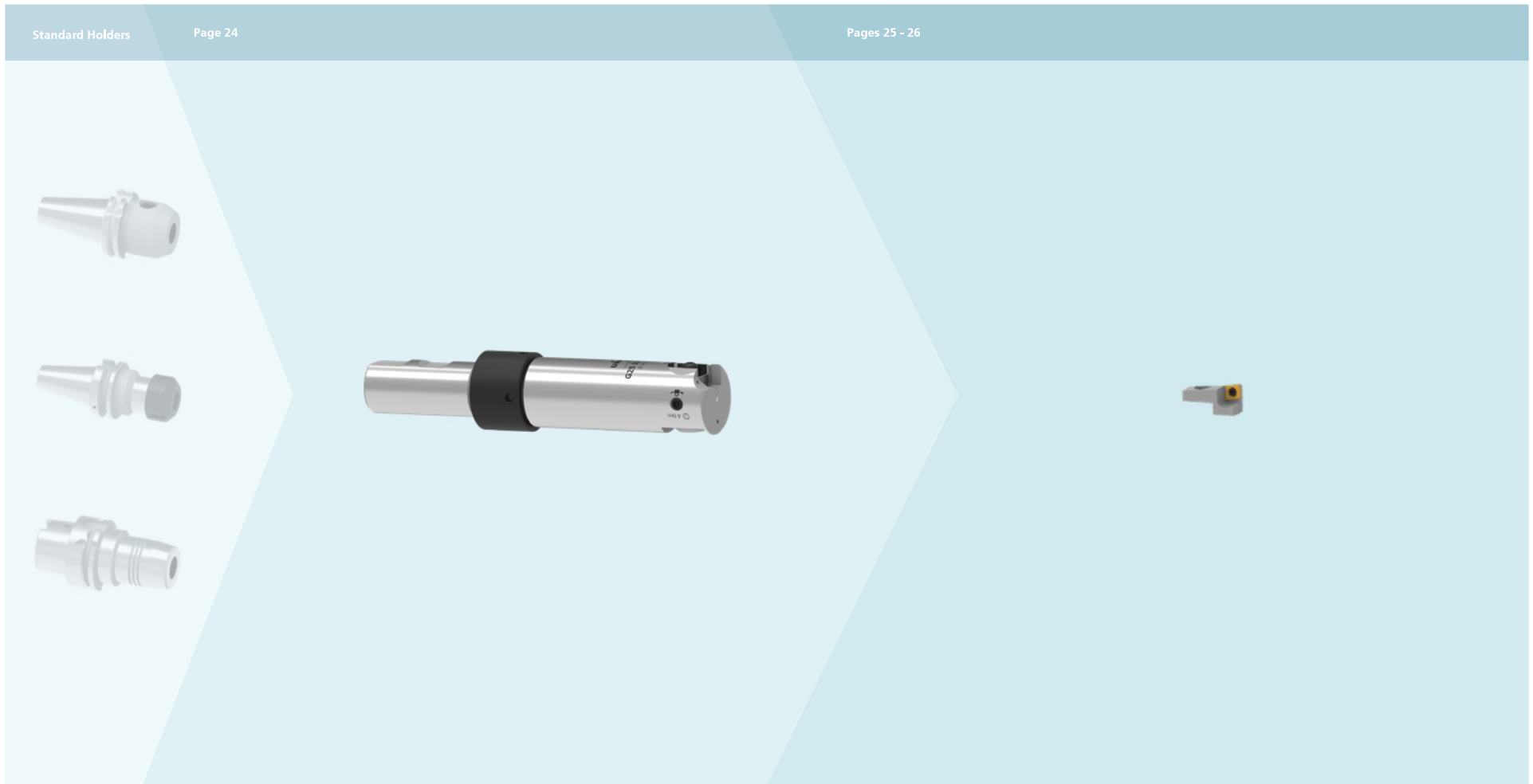

Ø 18 - 88 mm



**Feinbohrköpfe 0.01 mm/ø**  
Fine Boring Heads 0,01 mm/ø

**Feinbohrköpfe**  
Fine Boring Heads

Gamma	Order Number	Ø-Range	L	I	D	kg	d	MCC	Index
16	G25 16 16 067	18 - 22,5	67	48	16	0,2	16	2016	●
20	G25 20 20 110	22,5 - 30	100	50	20	0,3	20	2002	●
25	G25 25 25 110	29 - 39	110	56	25	0,6	25	2002	●
32	G25 32 25 120	38 - 51	120	56	32	0,9	25	2004	●
40	G25 40 25 130	50 - 67	130	56	42	1,5	25	2004	●
55	G25 55 32 150	66 - 88	150	60	55	3,0	32	2006	●

d = DIN 1835-B

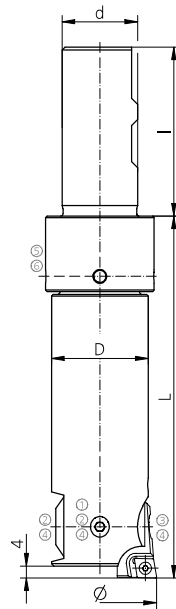

**SPARE PARTS**

Gamma	Ø-Range	①	②	③	④	⑤	⑥
16	18 - 22,5	C00 25 18		C00 25 19	G00 20 02		
20	22,5 - 30	C00 25 01		C00 25 11	G00 20 07		
25	29 - 39	C00 25 02		C00 25 11	G00 20 07		
32	38 - 51	C00 25 03	G00 02 04	C00 25 12	G00 20 03	C00 14 00	G00 25 034
40	50 - 67	C00 25 04	G00 02 04	C00 25 12	G00 20 03	C00 14 01	G00 25 040
55	66 - 88	C00 25 05	G00 02 06	C00 25 13		C00 14 02	G00 25 052

Ø 18 - 88 mm



**Feinbohr-Plattenhalter**  
Fine Boring Insert Holders

**Kombi-Plattenhalter für ISO Wendepplatten mit 7° und 11° Freiwinkel**  
Combination Insert Holders for ISO Inserts With 7° and 11° Relief Angle

Gamma	Order Number	Ø-Range	Inserts	MCM	MCC	Index
16	W/C20 16 00 06	18 - 20,5	CC../CP.. 0602..	2016	CP06	●
16	W/C20 16 01 06	20 - 22,5	CC../CP.. 0602..	2016	CP06	●
20	W/C20 02 06	22,5 - 30	CC../CP.. 0602..	2002	CP06	●
25	W/C20 02 06	29 - 39	CC../CP.. 0602..	2002	CP06	●
32	W/C20 04 06	38 - 51	CC../CP.. 0602..	2004	CP06	●
42	W/C20 04 06	50 - 67	CC../CP.. 0602..	2004	CP06	●
55	W/C20 06 06	66 - 88	CC../CP.. 0602..	2006	CP06	●

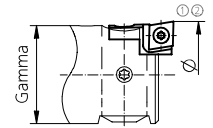

**Plattenhalter für ISO Wendepplatten mit 7° Freiwinkel**  
Insert Holders for ISO Inserts With 7° Relief Angle

Gamma	Order Number	Ø-Range	Inserts	MCM	MCC	Index
20	W20 02 06	22,5 - 30	CC.. 0602..	2002	CC06	●
25	W20 02 06	29 - 39	CC.. 0602..	2002	CC06	●
32	W20 04 06	38 - 51	CC.. 0602..	2004	CC06	●
42	W20 04 06	50 - 67	CC.. 0602..	2004	CC06	●
55	W20 06 09	66 - 88	CC.. 09T3..	2006	CC09	●

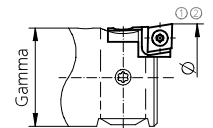

**SPARE PARTS**

Order Number	①	②
W/C20 16 00 06	C00 20 04	G00 20 05
W/C20 16 01 06	C00 20 04	G00 20 05
W/C20 06 06	C00 20 01	G00 20 05
W20 02 06	C00 20 04	G00 20 05
W20 04 06	C00 20 01	G00 20 05
W20 06 09	C00 20 37	G00 20 03

**Ø 22.5 - 88 mm**



**Feinbohr-Plattenhalter**

Fine Boring Insert Holders

**Plattenhalter 95° für Wiper Wendepplatten und 7° Freiwinkel**  
 Insert Holders 95° for Wiper Inserts With 7° Clearance Angle

Gamma	Order Number	Ø-Range	L	Inserts	MCM	MCC	Index
20	WW20 02 06	22,5 - 30	13	Wiper CC., 0602..	2002	CC06	●
25	WW20 02 06	29 - 39	13	Wiper CC., 0602..	2002	CC06	●
32	WW20 04 06	38 - 51	17	Wiper CC., 0602..	2004	CC06	●
42	WW20 04 06	50 - 67	17	Wiper CC., 0602..	2004	CC06	●
55	WW20 06 09	66 - 88	22	Wiper CC., 09T3..	2006	CC09	●

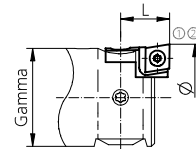

**Wiper Wendepplatten**  
 Wiper Inserts

Die Möglichkeiten von Wiper Wendepplatten (doppelter Vorschub bei gleicher Oberflächengüte oder verbesserte Oberflächengüte bei gleichem Vorschub) können nur mit Plattenhaltern mit 95° Anstellwinkel genutzt werden.

The advantages of Wiper inserts (double feed rate at equal surface quality or improved surface quality at equal feed rate) can only be used with insert holders with 95° setting angle.

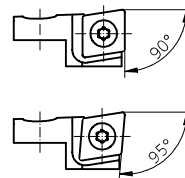

**SPARE PARTS**

Order Number	①	②
WW20 02 06	C00 20 04	G00 20 05
WW20 04 06	C00 20 01	G00 20 05
WW20 06 09	C00 20 37	G00 20 03

**URMA Boring System**  
IntraMax

Ø 49 - 297 mm

Ø 49 - 297 mm

IntraMax

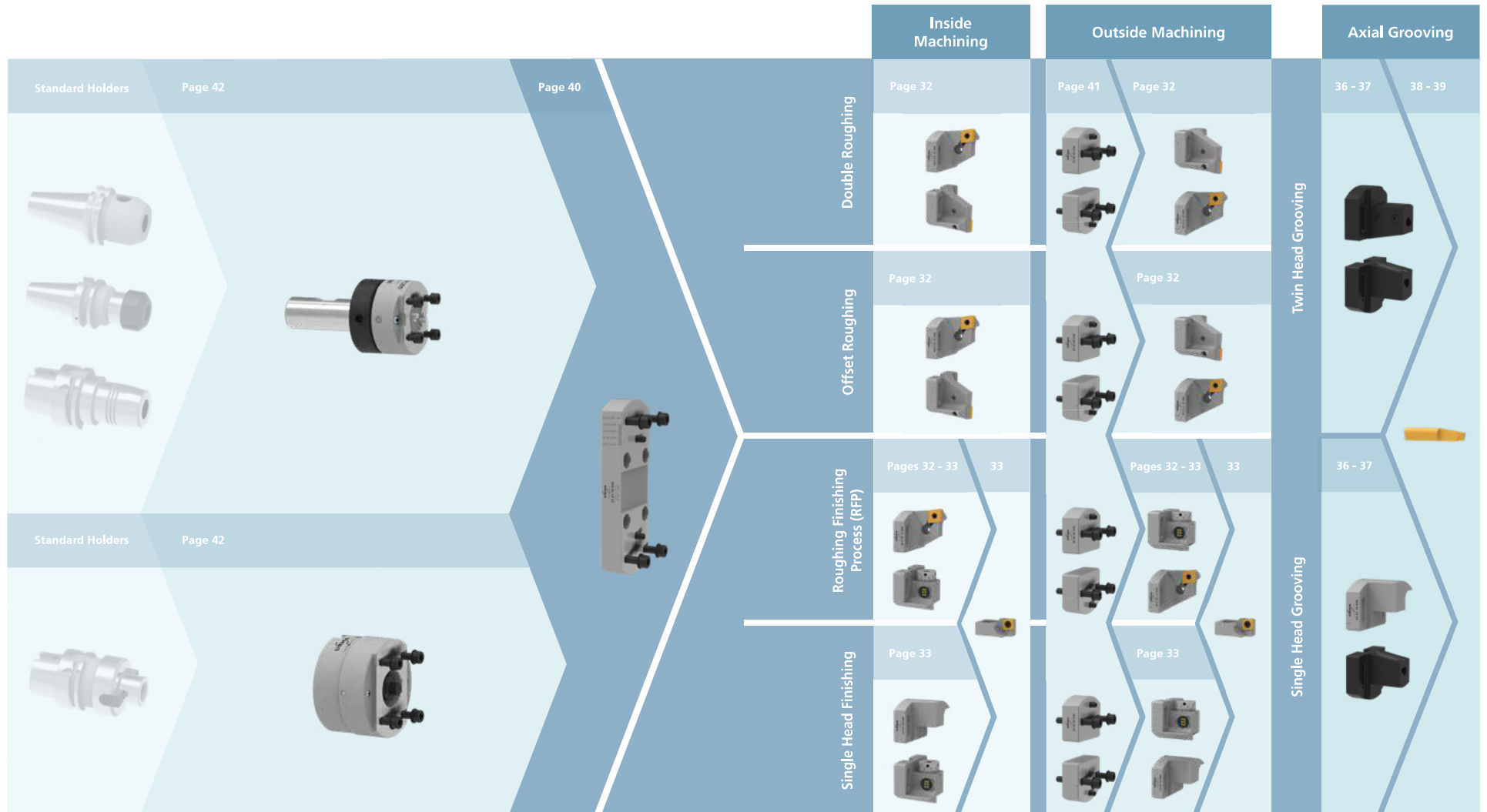



**Ø 49 - 297 mm**

**Plattenthaler Schruppen**  
Insert Holders Roughing



Für Innen- und Aussenbearbeitung  
For Internal and External Machining

**Plattenthaler**  
Insert Holders

Order Number	Ø-Range	L	kg	Inserts	MCM	MCC	Index
W17 02 09 028	49 - 88	28	0,1	CC,,_09T3,,	DK2203	CC09	•
W17 01 12 040	87 - 297	40	0,3	CN,,_1204,,	DK2201	CN12	•

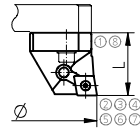

**Plattenthaler für versetztes Schruppen**  
Insert Holder for Offset Roughing

Order Number	Ø-Range	L	kg	Inserts	a <sub>p</sub>	MCM	MCC	Index
WV17 01 12 040	87 - 297	39,7	0,3	CN,,_1204,,	4 - 6	DK2201	CN12	•
W17 01 12 040	87 - 297	40	0,3	CN,,_1204,,	4 - 6	DK2201	CN12	•

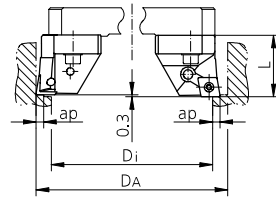

Formula 
$$a_p = \frac{D_A - D_i}{4}$$

Ⓢ Im Lieferumfang nicht enthalten  
Not included in the delivery

**SPARE PARTS**

1	2	3	4	5	6	7	8
W17 02,,	C00 02 86	C00 20 02	G00 20 03	A00 12 11	A00 02 17	A00 32 07	G00 02 01
W17 01 (WV)	C00 02 79	Z00 12 02	G00 20 03	A00 12 11	A00 02 17	A00 32 07	G00 02 02

**Ø 49 - 297 mm**

**Feinbohrköpfe**  
Fine Boring Heads



Für Innen- und Aussenbearbeitung  
For Internal and External Machining

**Feinbohrköpfe 0,005 mm/ø**  
Fine Boring Heads 0,005 mm/ø

Order Number	Ø-Range	L	I	kg	MCM	MCC	Index
23 02 10 028	49 - 88	28	10	0,15	DK2203	2012	•
23 01 30 040	87 - 297	40	18	0,4	DK2201	2010	•

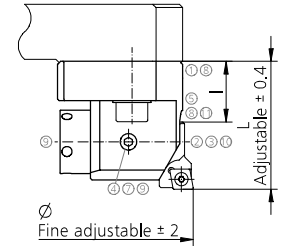

**Feinbohrplattenthaler**  
Fine Boring Insert Holders

Order Number	Ø-Range	L	Inserts	MCM	MCC	Index
WC20 12 06 000	49 - 88	18	CP,,_0602,,/CC,,_0602,,	2012	CP06	•
WC20 10 06 000	87 - 297	22	CP,,_0602,,/CC,,_0602,,	2010	CP06	•
W20 12 06 000	49 - 88	18	CC,,_0602,,	2012	CC06	•
W20 10 06 000	87 - 297	22	CC,,_0602,,	2010	CC06	•
WW20 12 06 000	49 - 88	18	Wiper CC,,_0602,,	2012	CC06	•
WW20 10 06 000	87 - 297	22	Wiper CC,,_0602,,	2010	CC06	•

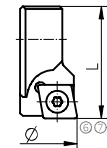

**Gegengewichte**  
Counter Weights

Order Number	Ø-Range	L	kg	MCM	Index
23 02 10 024	49 - 88	28	0,1	DK2203	•
23 01 10 036	87 - 297	40	0,3	DK2201	•

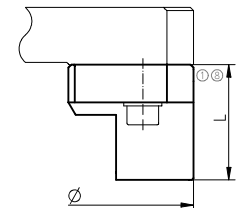

**SPARE PARTS**

Ø-Range	1	2	3	4	5	6	7	8	9	10	11
49 - 88	C00 02 86	C00 22 56	K00 02 44	C00 25 01	Z00 23 02	G00 20 07	G00 02 01	G00 02 03			
87 - 297	C00 02 79	C00 22 11	K00 02 01	C00 07 01	Z00 23 02	G00 20 07	G00 02 02	G00 02 03	G00 02 04	G00 02 01	
W,,_20						C00 20 01	G00 20 05				

Ø 49 - 297 mm

IntraMax

**Schruppen und Schlichten in einem Arbeitsgang (RFP)**

Simultaneous Single-Pass Roughing and Finishing (RFP)

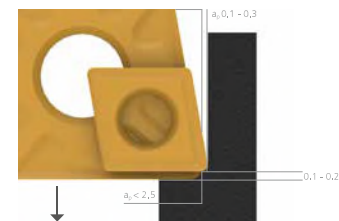

**Voreinstellung der beiden Schneiden bei RFP**  
Presetting of roughing and finishing cutting edge

Durch den Einsatz von radial und axial versetzten Schneiden kann die Bearbeitungszeit drastisch reduziert werden. Vor- und Fertigbearbeitung werden in einem einzigen Arbeitsgang erledigt.  
(RFP = Roughing-Finishing-Process)

Das Verfahren kann auf dem IntraMax angewendet werden und deckt einen Durchmesserbereich von 49 bis 297 mm ab. Empfohlene Spantiefe für den Schruppkopf ist  $a_r$  2,5 mm für Stahl.

Weitere Vorteile:

- geringere Werkzeugkosten
- kürzere Bearbeitungszeit
- hohe Oberflächenqualität
- IT7 in einem Arbeitsgang

Simultaneous single-pass roughing and finishing requires radial and axial boring head offset. Cutting time is dramatically reduced.  
(RFP = Roughing-Finishing-Process)

On IntraMax RFP can be applied and covers the entire diameter range from 49 to 297 mm. Recommended cutting depth on the roughing insert is  $a_r$  2,5 mm for steel.

Further advantages:

- reduced tooling investment
- shorter cutting time
- high surface quality
- IT7 tolerances in one pass



**IntraMax Kombination für RFP**  
IntraMax RFP combination

Ø 5 - 45 mm

Achsialeinstechen

Face Grooving



Plattenhalter

Insert Holder

Nut-Aussen

Outer Groove

Order Number	L	I	B	Type	Index
BKT105.U90K.01	24,5	17,5	28,5	R105	•

Ab Ø D<sub>min</sub> = 2x (6 mm + f<sub>Schneidplatte</sub>) sind zwei Plattenhalter gleichzeitig einsetzbar (f siehe Seiten 38 und 39). Für kleinere D<sub>min</sub> ist nur ein Plattenhalter mit Gegengewicht möglich.

From Ø D<sub>min</sub> = 2x (6 mm + f<sub>insert</sub>) two insert holders can be used simultaneously (f see pages 38 and 39). For smaller D<sub>min</sub>, only one insert holder plus counter weight can be used together.

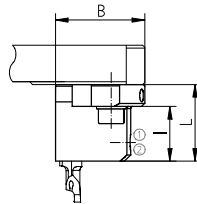

Durchmesserkonsole

Diameter Extender

Order Number	Ø-Range	Page	Insert holder	Index
1)	5 - 18	42		•
22 03 06 012	18 - 31	40	BKT105.U90K.01	•
22 03 07 012	31 - 45	40		•

- 1) Direkt über Grundaufnahme oder Zwischenkonsole (Seite 42)

Directly via basic holder or intermediate adaptor (see page 42)

Gegengewicht

Counter Weight

Order Number	L	I	B	Index
020.U00K.2040	24,5	17,5	22	•

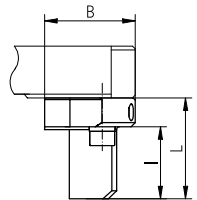

SPARE PARTS

Order Number	Ø-Range	L	I	B	Index
BKT105. ...	6,075T15	G00 20 035			

Ø 31 - 242 mm

Plattenhalter

Insert Holder

Nut-Aussen

Outer Groove

Order Number	L	I	B	Type	Index
BKT105.U90G.01 1)	36,4	24,4	39,5	R105	•
BKT110.U17G.02 2)	41	26	39,5	RA110	•

- 1) Ab Ø D<sub>min</sub> = 2x (6 mm + f<sub>Schneidplatte</sub>) sind zwei Plattenhalter gleichzeitig einsetzbar (f siehe Seiten 38 und 39). Für kleinere D<sub>min</sub> ist nur ein Plattenhalter mit Gegengewicht möglich.

From Ø D<sub>min</sub> = 2x (6 mm + f<sub>insert</sub>) two insert holders can be used simultaneously (f see pages 38 and 39). For smaller D<sub>min</sub>, only one insert holder plus counter weight can be used together.

- 2) Ab Ø D<sub>min</sub> = 2x (13,5 mm + f<sub>Schneidplatte</sub>) sind zwei Plattenhalter gleichzeitig einsetzbar (f siehe Seite 39). Für kleinere D<sub>min</sub> ist nur ein Plattenhalter mit Gegengewicht möglich.

From Ø D<sub>min</sub> = 2x (13,5 mm + f<sub>insert</sub>) two insert holders can be used simultaneously (f see page 39). For smaller D<sub>min</sub>, only one insert holder plus counter weight can be used together.

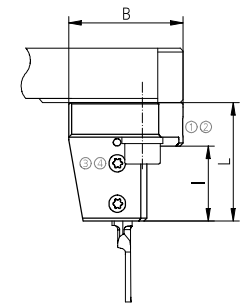

Durchmesserkonsole

Diameter Extender

Order Number	Ø-Range	Page	Insert holder	Index
1)	31 - 61	42		•
22 01 11 018	61 - 91	40		•
22 01 14 018	91 - 122	40	BKT105.U90G.01	•
22 01 17 018	122 - 152	40	BKT110.U17G.02	•
22 01 20 023	152 - 182	40		•
22 01 23 023	182 - 212	40		•
22 01 26 028	212 - 242	40		•

- 1) Direkt über Grundaufnahme oder Zwischenkonsole (Seite 42)

Directly via basic holder or intermediate adaptor (see page 42)

Gegengewicht

Counter Weight

Order Number	Ø-Range	L	kg	MCM	Index
23 01 10 036	31 - 242	40	0,3	DK2201	•

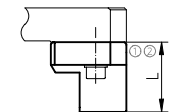

SPARE PARTS

Order Number	Ø-Range	L	I	B	Index
31 - 242	C00 02 79	G00 02 02	6,075T15	G00 20 030	



**Achsialeinstechen (System HORN-URMA)**

Face Grooving (System HORN-URMA)

**Schneidplatten Typ 105...8**  
Inserts Type 105...8

Order Number	W <sup>+0/5</sup>	f	r	L	l	t <sub>max</sub>	D <sub>min</sub>	Type	HM-Sorten Carbide grades MG12 TI25	Index
R105_0510,1,8	1,0	2,0	0,05	25	10	2,0	5,0	BKT105...	●	●
R105_0515,1,8	1,5	2,0	0,05	25	10	3,0	5,0	BKT105...	●	●
R105_0520,1,8	2,0	2,0	0,05	25	10	5,0	5,0	BKT105...	●	●
R105_0510,2,8	1,0	2,0	0,05	35	15	2,0	5,0	BKT105...	●	●
R105_0515,2,8	1,5	2,0	0,05	35	15	3,0	5,0	BKT105...	●	●
R105_0520,2,8	2,0	2,0	0,05	35	15	5,0	5,0	BKT105...	●	●
R105_0610,1,8	1,0	2,0	0,05	25	10	2,0	6,0	BKT105...	●	●
R105_0615,1,8	1,5	2,0	0,05	25	10	3,0	6,0	BKT105...	●	●
R105_0620,1,8	2,0	2,0	0,05	25	10	5,0	6,0	BKT105...	●	●
R105_0610,2,8	1,0	2,0	0,05	35	15	2,0	6,0	BKT105...	●	●
R105_0615,2,8	1,5	2,0	0,05	35	15	3,0	6,0	BKT105...	●	●
R105_0620,2,8	2,0	2,0	0,05	35	15	5,0	6,0	BKT105...	●	●
R105_0810,1,8	1,0	2,0	0,15	25	10	2,0	8,0	BKT105...	●	●
R105_0815,1,8	1,5	2,0	0,15	25	10	3,0	8,0	BKT105...	●	●
R105_0820,1,8	2,0	2,0	0,15	25	10	4,0	8,0	BKT105...	●	●
R105_0825,1,8	2,5	2,0	0,15	25	10	5,0	8,0	BKT105...	●	●
R105_0830,1,8	3,0	2,0	0,15	25	10	6,0	8,0	BKT105...	●	●
R105_0810,2,8	1,0	2,0	0,15	35	15	2,0	8,0	BKT105...	●	●
R105_0815,2,8	1,5	2,0	0,15	35	15	3,0	8,0	BKT105...	●	●
R105_0820,2,8	2,0	2,0	0,15	35	15	4,0	8,0	BKT105...	●	●
R105_0825,2,8	2,5	2,0	0,15	35	15	5,0	8,0	BKT105...	●	●
R105_0830,2,8	3,0	2,0	0,15	35	15	6,0	8,0	BKT105...	●	●

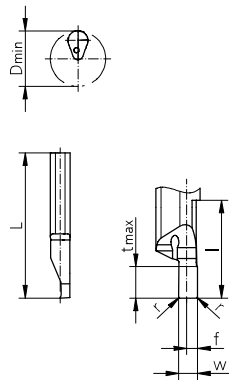

**MG12**  
Unbeschichtetes Hartmetall für tiefe Schnittgeschwindigkeiten in Stahl, Guss und NE-Metallen

**TI25**  
TiCN-beschichtetes Hartmetall für mittlere Schnittgeschwindigkeiten in Stahl und NE-Metallen

Weitere Abmessungen und Schneidprofile auf Anfrage

**MG12**  
Uncoated carbide for low cutting speed in steel, cast iron and non-ferrous metals

**TI25**  
TiCN coated carbide for medium cutting speed in steel and non-ferrous metals

Further dimensions and insert profiles upon request

**Schneidplatten Typ 105...9**  
Inserts Type 105...9

Order Number	W <sup>+0/5</sup>	f	r	L	l	t <sub>max</sub>	D <sub>min</sub>	Type	HM-Sorten Carbide grades TI25	Index
R105_0810,1,9	1,0	0,4	0,15	25	10	2,0	8,0	BKT105...	●	●
R105_0815,1,9	1,5	0,4	0,15	25	10	3,0	8,0	BKT105...	●	●
R105_0820,1,9	2,0	0,4	0,15	25	10	4,0	8,0	BKT105...	●	●
R105_0825,1,9	2,5	0,4	0,15	25	10	5,0	8,0	BKT105...	●	●
R105_0830,1,9	3,0	0,4	0,15	25	10	6,0	8,0	BKT105...	●	●

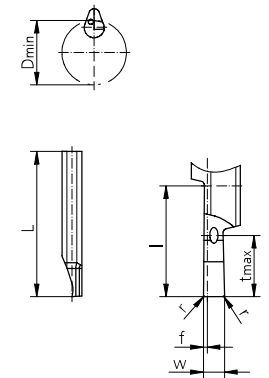

**Schneidplatten Typ A110**  
Inserts Type A110

Order Number	W <sup>+0/5</sup>	f	r	L	t <sub>max</sub>	D <sub>min</sub>	Type	HM-Sorten Carbide grades TI25	Index
RA110_2030,3,0	3,0	1,5	0,2	50	20	20 - 50*	BKT110...	●	●
RA110_2030,5,0	3,0	1,5	0,2	60	30	20 - 50*	BKT110...	●	●
RA110_5030,3,0	3,0	1,5	0,2	50	20	>50	BKT110...	●	●
RA110_5030,5,0	3,0	1,5	0,2	60	30	>50	BKT110...	●	●

\* Axialstechen ins Volle bei voller Stechtiefe nur bei D<sub>min</sub> = 20 - 50 mm möglich  
Face grooving with full width to the full depth only possible between D<sub>min</sub> = 20 - 50 mm

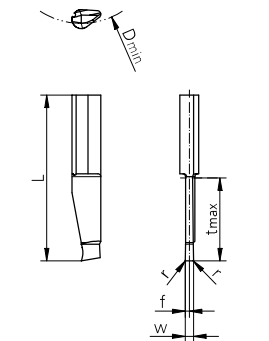

Ø 49 - 297 mm

Durchmesserkonsolen

Diameter Extenders



Durchmesserkonsolen  
Diameter Extenders

Ø 49 - 88 mm

Order Number	Ø-Range	L	I	D	kg	MCM	MCC	Index
1)	49 - 62							●
22 03 06 012	62 - 75	12	40	59	0,2	Z2203	DK2203	●
22 03 07 012	75 - 88	12	40	72	0,3	Z2203	DK2203	●

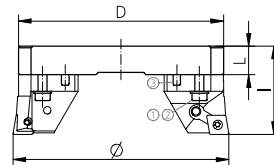

Durchmesserkonsolen

Diameter Extenders

Ø 87 - 297 mm

Order Number	Ø-Range	L	I	D	kg	MCM	MCC	Index
1)	87 - 117						DK2201	●
22 01 11 018	117 - 147	18	58	110	0,8	Z2201	DK2201	●
22 01 14 018	147 - 177	18	58	140	1	Z2201	DK2201	●
22 01 17 018	177 - 207	18	58	170	1,2	Z2201	DK2201	●
22 01 20 023	207 - 237	23	63	200	1,6	Z2201	DK2201	●
22 01 23 023	237 - 267	23	63	230	1,9	Z2201	DK2201	●
22 01 26 028	267 - 297	28	63	260	2,6	Z2201	DK2201	●

- 1) Direkt über Grundaufnahme  
Directly via basic holder

SPARE PARTS

Ø-Range	①	②	③
49 - 88	C00 22 05	K00 02 01	C00 12 08
87 - 297	C00 22 02	K00 02 20	C00 12 61

Ø 9 - 249 mm

Zwischenplatten für Aussenbearbeitung

Intermediate Adaptors for External Machining



Zwischenplatte  
Intermediate Adaptors

Ø 9 - 35 mm

Order Number	Ø-Range	D	dz	ds	L	lz	lk	kg	Diameter extender	MCM	MCC	Index
22 04 00 012	9 - 22	59	74	Ø + 56 mm	28	12	12	0,1	22 03 06 012	DK2203	DK2203	●
22 04 00 012	22 - 35	72	87	Ø + 56 mm	28	12	12	0,1	22 03 07 012	DK2203	DK2203	●

Zwischenplatte  
Intermediate Adaptors

Ø 9 - 249 mm

Order Number	Ø-Range	D	dz	ds	L	lz	lk	kg	Diameter extender	MCM	MCC	Index
22 02 00 018	9 - 39	110	125	Ø + 100 mm	40	18	18	0,25	22 01 11 018	DK2201	DK2201	●
22 02 00 018	39 - 69	140	155	Ø + 100 mm	40	18	18	0,25	22 01 14 018	DK2201	DK2201	●
22 02 00 018	69 - 99	170	185	Ø + 100 mm	40	18	18	0,25	22 01 17 018	DK2201	DK2201	●
22 02 00 018	99 - 129	200	215	Ø + 100 mm	40	18	23	0,25	22 01 20 023	DK2201	DK2201	●
22 02 00 018	129 - 159	230	245	Ø + 100 mm	40	18	23	0,25	22 01 23 023	DK2201	DK2201	●
22 02 00 018	159 - 189	260	275	Ø + 100 mm	40	18	28	0,25	22 01 26 028	DK2201	DK2201	●
22 02 00 018	189 - 219	290	305	Ø + 100 mm	40	18	28	0,25	22 01 29 028	DK2201	DK2201	●
22 02 00 018	219 - 249	320	335	Ø + 100 mm	40	18	28	0,25	22 01 32 028	DK2201	DK2201	●

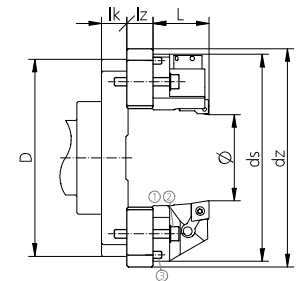

SPARE PARTS

Ø-Range	①	②	③
9 - 35	C00 22 05	K00 02 01	C00 12 08
9 - 249	C00 22 74	K00 02 20	C00 12 61

**Ø 49 - 297 mm**

**Konsolen**  
Adaptors



**Konsole mit Zylinderschaft**  
Adaptor With Cylindrical Shank

Gamma	Order Number	Ø-Range	L	l	D	d	kg	MCC	Index
20	G21 46 20 036	49 - 88	36	50	46	20	0,6	Z2203	

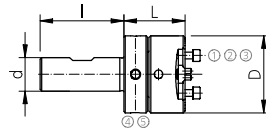

**Konsole für Aufsteckfräsdorne**  
Adaptor for Shell Mill Holder

Gamma	Order Number	Ø-Range	L	D	d	kg	MCC	Index
80	G21 80 32 052	87 - 297	52	80	32	1,8	Z2201	

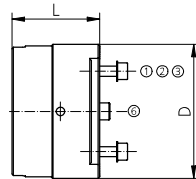

**SPARE PARTS**

Ø-Range	①	②	③	④	⑤	⑥
49 - 88	C00 22 05	K00 02 01	C00 12 08	C00 14 03	G00 25 045	Z00 21 20
87 - 297	C00 22 02	K00 02 20				

## Voreinstellen Feinbohrköpfe

Pre-Setting Fine Boring Heads

### MicroMax, VersaMax - Type 25/A25

- |   |  |
|---|--|
| 1. Blockierschraube A lösen                                 | 1. Loosen locking screw A                            |
| 2. Ausrehdurchmesser an der Mikrometerschraube B einstellen | 2. Set the boring diameter at the micrometer screw B |
| 3. Blockierschraube wieder anziehen                         | 3. Re-tighten the locking screw                      |

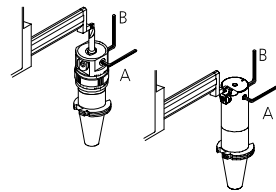

Ø 0.2 - 88 mm

## Zusammenbau von System IntraMax

Assembly of System IntraMax

### IntraMax

- |  |   |
|--|---|
| 1. Durchmesserkonsole (falls nötig) mit vier Schrauben A auf Aufnahme oder Zwischenkonsole montieren                               | 1. Mount the diameter adaptor (if needed) onto the adaptor or intermediate adaptor with four screws A                       |
| 2. Schrupp- oder Schlichtplattenhalter mit je zwei Schrauben B montieren (im Normalfall werden zwei Köpfe gleichzeitig eingesetzt) | 2. Mount the roughing or finishing insert holders with two screws B each (normally, two heads are mounted at the same time) |
| 3. Über grobskalieren an Kopf und Konsole Plattenhalter ausrichten   | 3. Align the insert holders using the coarse graduations on the head and the adaptor  |
| 4. Für die Aussenbearbeitung muss die Zwischenplatte montiert werden   | 4. For external machining, the intermediate adaptor must be mounted   |
| 5. Danach die Schrupp- oder Schlichtplattenhalter mit je zwei Schrauben C montieren  | 5. Then mount the roughing or finishing insert holders with two screws C  |

Ø 49 - 297 mm

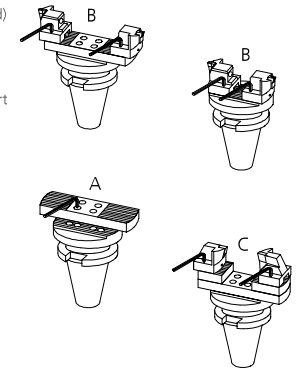

## Voreinstellen System

Pre-Setting the System

Ø 49 - 297 mm

### IntraMax

1. Ausdrehdurchmesser auf dem Voreinstellplatz mittels Skalenschraube A respektive Justierschraube D einstellen
  2. Skalenschraubenblockierung E anziehen
  3. Wenn gleichzeitig zwei Feinbohrköpfe eingesetzt werden, Feinbohrreinsatz mit Schlüssel C lösen, die Schneide mit Schlüssel B einstellen und mit Schlüssel C erneut klemmen
1. Set the boring diameter to the pre-set position using setting dial A or adjusting screw D respectively
  2. Tighten the setting dial locking device E
  3. If two fine boring heads are to be used simultaneously, loosen the fine boring insert using key C, set the blade with key B, and redamp with the key C

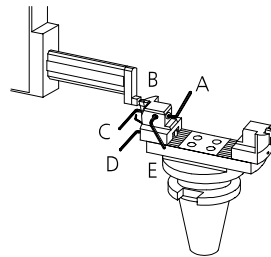

## Voreinstellen Zweischneider

Setting the Bore Diameter on a Double Cutter

Ø 19.5 - 88 mm

### VersaMax - Type 14

1. Klemmschraube A, mit montierter Spannscheibe, vorerst nur leicht anziehen
  2. Mit Justierschraube B die Schneide auf genauen Durchmesser einstellen
  3. Klemmschraube A fest anziehen
1. Gently tighten clamping screws A (spring washer must be fitted)
  2. Set the cutter to the exact diameter with the adjusting screw B
  3. Firmly tighten clamping screw A

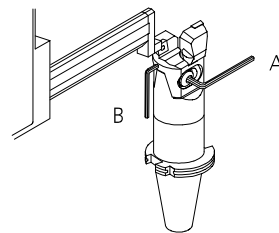

## Axialabstützmutter Gamma

Axial Support Nut Gamma

### VersaMax Type 25, VersaMax Type 14, IntraMax

1. Axialabstützmutter von Hand bis zum Anschlag Richtung Schneide schrauben
  2. Gamma-Systemwerkzeug in Weldonadapter DIN 1835-B, Spannzangen- oder Hydrodehnfutter spannen. Ein Abstand zwischen Axialabstützmutter und Futter muss vorhanden sein
  3. Axialabstützmutter mit Hakenschlüssel DIN 1810-B angemessen gegen die Stirnfläche der Aufnahme verspannen
1. Screw the axial support nut by hand against the stop towards the insert
  2. Clamp Gamma-system tool in Weldon adaptor DIN 1835-B, collet or hydro chuck. Note the gap between holder and axial support nut
  3. Tighten axial support nut with hook spanner DIN 1810-B holder with a moderate force

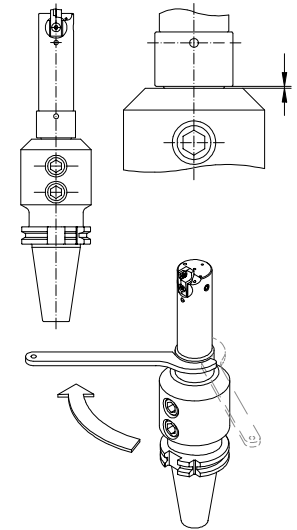





# URMA Tools

## Drilling, Boring & Reaming





**URMA AG WERKZEUGFABRIK**

Obermatt 3  
CH-5102 Rapperswil  
Switzerland  
T +41 62 889 20 20  
F +41 62 889 20 28  
info@urma.ch  
www.urma.ch

SWISS  QUALITY



Download on the  
 **App Store**



ANDROID APP ON  
 **Google play**



**Subsidiaries**

URMA GmbH  
Eisenbahnstraße 37  
D-77815 Bühl  
+49 7223 911 170  
info@urma-gmbh.de

URMA Trading (Shanghai) Co. Ltd.  
Room 511, Hua Nan Mansion  
1988 Dongfang Road  
Pudong New District  
CN-200125 Shanghai  
+86 (21) 6109 6216  
info@urmachina.com

Iraupen URMA  
Polígono Belartza  
ES-20018 Donostia-San Sebastian  
Spain  
+34 943 667 036  
info@iraupen.es

**License Manufacturer**

Command Tooling Systems, LLC  
13931 Sunfish Lake Blvd.  
Ramsey MN, 55303 USA  
+1 800 328 2197  
support@commandtool.com

Paul Horn GmbH  
Unter dem Holz 33-35  
D-72072 Tübingen  
+49 (0) 7071 7004 0  
info@phorn.de

Sumitomo Electric Ind., Ltd.  
1-1-1, Koyakita,  
Itami-shi, Hyogo 664-0016  
Japan  
+81 72 772 4535  
info@sumitomotool.com