



Cutter Series (Depth of Cut):

- 1TJ1B (90°=.13" / HF=.02")
- 1TJ1D / TJ1D (90°=.24" / HF=.04")
- 1TJ1F / TJ6F (90°=.32" / HF=.06")
- 1TJ1G / TJ_G (90°=.41" / HF=.08")
- 1TJ1J / TJ_J (90°=.54" / HF=.12")

Insert Series:

- MNHU04 / UNHU04
- MNCU06 / MNHU06 / UNHU06
- MNCU09 / MNHU09 / UNHU09
- MNHU11 / UNHU11
- MNHU14 / UNHU14

Diameter Range:

.500-4.000

Adaptions:

Cylindrical, Weldon, R8, TopOn, Chip Surfer & Face Mill

Corner Geometry:

.008, .015, .031, .039, .047, .062, .079 R, Backdraft & Hi-Feed

Materials

Iron, Steel, Stainless Steel, Aluminum, Hi-Temp Alloys, Titanium & Hard Steel

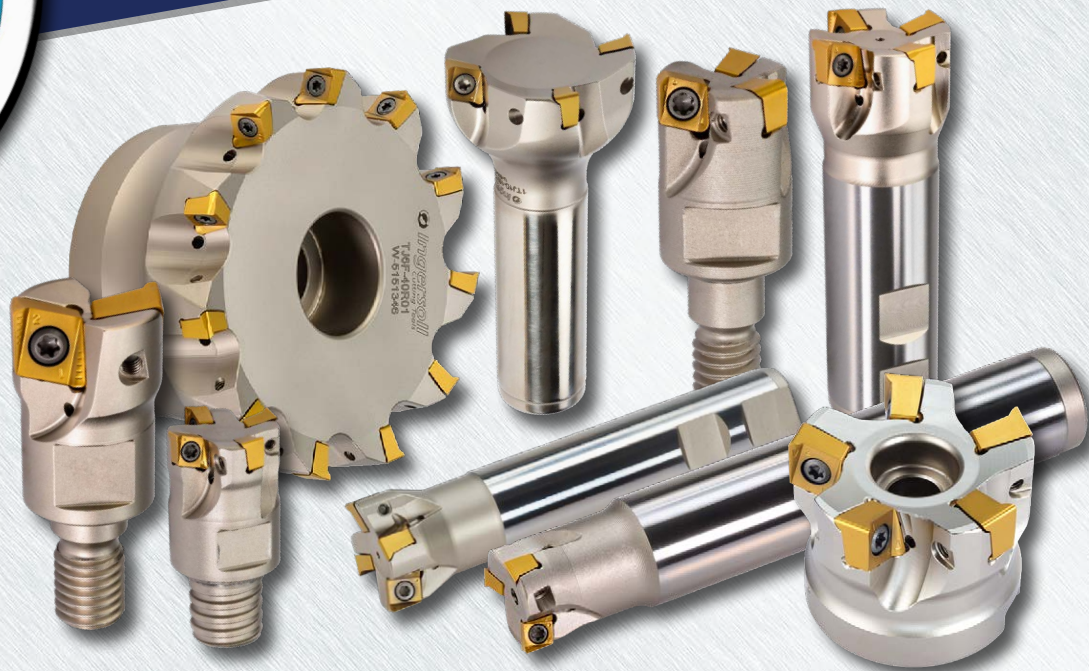

**90°, Backdraft, Hi-Feed & Hi-Ramp
Versatility with 4-Edge Economy!**

Due to the success of milling insert series MNHU06, Ingersoll is pleased to announce the addition of 4 new insert IC's. The new MNHU 04, 09, 11 & 14 inserts/cutters are designed with the same features as MNHU06 and aim to cover a wider range of sizes and applications. With all of the geometry & grade options at hand, the General Purpose, Automotive, Die/Mold, Aerospace & Miniature industries will all benefit from this product's versatility to face, shoulder, channel and ramp.

Features & Benefits:

- All inserts feature 4 cutting edges
- True 90° shoulder milling capability
- Same cutter body utilizes 90°, Backdraft & Hi-Feed inserts
- Concave face design accommodates ramping, interpolation & drill-mill functions
- Pockets designed with wide mounting area for utmost support behind the cutting edge
- Durability with thick insert & strong screw.
- Integrated wiper flats produce 32-63 Ra surface finishes
- Cutters plumbed with coolant through the tool



DIPOSDUO™ 04 SERIES 1TJ1B (WELDON SHANK)

90° END MILLS (4MM INSERT)

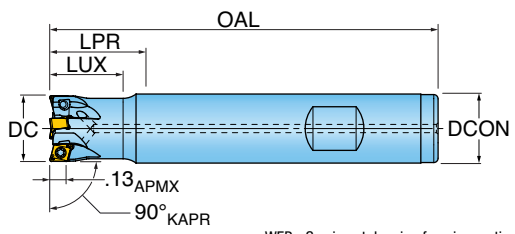

WEP - See insert drawing for wiper options.

Part Number	DC Cutting Dia.	LUX Usable Length Max.	LPR Protruding Length	OAL Overall Length	ZEFF Eff. Teeth	DCON Shank Dia.
1TJ1B-0700784R01	0.750	1.00	2.00	4.00	5	0.750
1TJ1B-10017E1R01	1.000	1.25	1.75	4.75	7	1.000
1TJ1B-12020E2R01	1.250	1.50	2.00	5.00	8	1.250
1TJ1B-15025E2R01	1.500	1.75	2.50	5.50	10	1.500

*When using Hi-Feed Insert, modify body corner to R.047.

DIPOSDUO™ 04 SERIES 1TJ1B (CYLINDRICAL SHANK)

90° END MILLS (4MM INSERT)

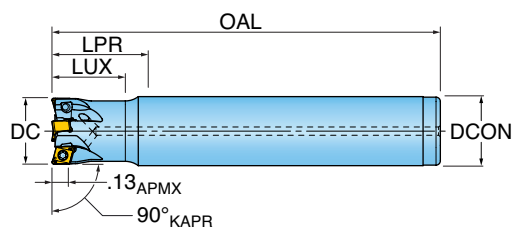

WEP - See insert drawing for wiper options.

Part Number	DC Cutting Dia.	LUX Usable Length Max.	LPR Protruding Length	OAL Overall Length	ZEFF Eff. Teeth	DCON Shank Dia.
1TJ1B-05007S4R01	0.500	0.75	1.72	3.50	3	0.500
1TJ1B-06008S6R01	0.625	0.81	2.09	4.00	4	0.625
1TJ1B-07008S7R01	0.750	0.87	3.00	5.00	5	0.750
1TJ1B-08010S8R01	0.875	1.00	3.25	5.25	6	0.875
1TJ1B-10012S1R01	1.000	1.25	2.25	5.50	7	1.000

*When using Hi-Feed Insert, modify body corner to R.047.
Designed with modification in mind. Extend usable length by turning back the neck diameter or shorten the overall length by cutting off back end.



DIPOSDUO™ 04 SERIES 1TJ1B (TOP•ON STYLE)

90° MODULAR END MILLS (4MM INSERT)

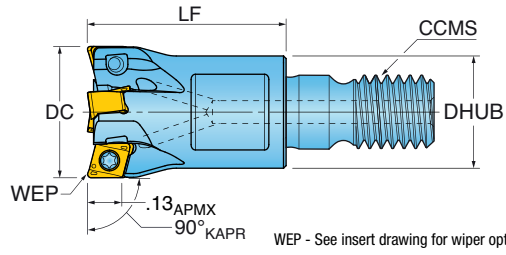

WEP - See insert drawing for wiper options.

Part Number	DC Cutting Diameter	LF Functional Length	ZEFF Effective Teeth	CCMS Connection Code	DHUB Hub Diameter
1TJ1B-05007X4R01	0.500	0.75	3	TopOn M06	0.46
1TJ1B-06008X5R01	0.625	0.88	4	TopOn M08	0.50
1TJ1B-07010X6R01	0.750	1.00	5	TopOn M10	0.69
1TJ1B-10012X7R01	1.000	1.13	7	TopOn M12	0.81

*When using Hi-Feed Insert, modify body corner to R.047.

DIPOSDUO™ 04 SERIES 1TJ1B (CHIPSURFER STYLE)

90° MODULAR END MILLS (4MM INSERT)

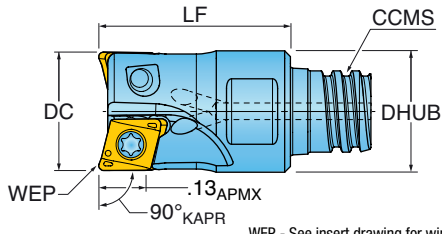

WEP - See insert drawing for wiper options.

Part Number	DC Cutting Diameter	LF Functional Length	ZEFF Effective Teeth	CCMS Connection Code	DHUB Hub Diameter
1TJ1B-05006T8R01	0.500	0.65	3	Chip Surfer T08	0.48
1TJ1B-06008TRR01	0.625	0.80	4	Chip Surfer T10	0.60
1TJ1B-07010TSR01	0.750	1.00	5	Chip Surfer T12	0.72
1TJ1B-10012TUR01	1.000	1.25	7	Chip Surfer T15	0.94

*When using Hi-Feed Insert, modify body corner to R.047.



DIPOSDUO™ 04 INSERTS

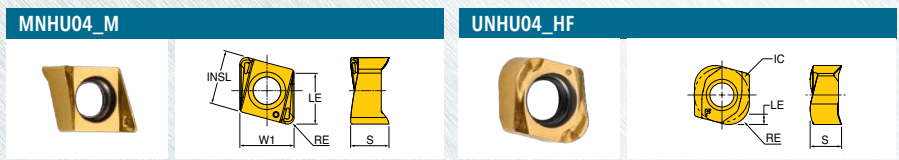

Part Number	Application	RE Corner Radius	LE Cutting Edge Eff. Length	INSL Insert Length	W1 Insert Width	S Thickness	NOI Number of Indexes	IH Insert Hand	Grade	IN2505	IN2530	IN2510
MNHU040202R-M	Multi-Purpose	0.008	0.130	0.157	0.157	0.122	4	Right		•	•	
MNHU040204R-M	Multi-Purpose	0.015	0.130	0.157	0.157	0.122	4	Right		•	•	•
MNHU040208R-M	Multi-Purpose	0.031	0.130	0.157	0.157	0.122	4	Right		•	•	

Part Number	Application	REEQ Program Radius Equivalent	LE Cutting Edge Eff. Length	INSL Insert Length	W1 Insert Width	S Thickness	NOI Number of Indexes	IH Insert Hand	Grade	IN2505	IN2504
UNHU040212R-HF	Hi-Feed	0.047	0.019	0.157	0.157	0.104	4	Right		•	•

DIPOSDUO™ 04 HARDWARE

	Screw	Driver	**OPTIONAL** Wrench	**OPTIONAL** Thin Wrench	**OPTIONAL** Torque Wrench	**OPTIONAL** Torque Driver Handle	**OPTIONAL** Preset Torque Bit	**OPTIONAL** Torque Driver Bit
1TJ1B-0700784R01	SM18-041-00	DS-TP06S-NEU	-	-	-	DS-A00-.25-S	DT-05-.25	DS-TP06B
1TJ1B-10017E1R01	SM18-041-00	DS-TP06S-NEU	-	-	-	DS-A00-.25-S	DT-05-.25	DS-TP06B
1TJ1B-12020E2R01	SM18-041-00	DS-TP06S-NEU	-	-	-	DS-A00-.25-S	DT-05-.25	DS-TP06B
1TJ1B-15025E2R01	SM18-041-00	DS-TP06S-NEU	-	-	-	DS-A00-.25-S	DT-05-.25	DS-TP06B
1TJ1B-03006R8R01	SM18-041-00	DS-TP06S-NEU	-	-	-	DS-A00-.25-S	DT-05-.25	DS-TP06B
1TJ1B-05007S4R01	SM18-041-00	DS-TP06S-NEU	-	-	-	DS-A00-.25-S	DT-05-.25	DS-TP06B
1TJ1B-06008S6R01	SM18-041-00	DS-TP06S-NEU	-	-	-	DS-A00-.25-S	DT-05-.25	DS-TP06B
1TJ1B-07008S7R01	SM18-041-00	DS-TP06S-NEU	-	-	-	DS-A00-.25-S	DT-05-.25	DS-TP06B
1TJ1B-08010S8R01	SM18-041-00	DS-TP06S-NEU	-	-	-	DS-A00-.25-S	DT-05-.25	DS-TP06B
1TJ1B-10012S1R01	SM18-041-00	DS-TP06S-NEU	-	-	-	DS-A00-.25-S	DT-05-.25	DS-TP06B
1TJ1B-05007X4R01	SM18-041-00	DS-TP06S-NEU	-	-	-	DS-A00-.25-S	DT-05-.25	DS-TP06B
1TJ1B-06008X5R01	SM18-041-00	DS-TP06S-NEU	610MM	-	-	DS-A00-.25-S	DT-05-.25	DS-TP06B
1TJ1B-07010X6R01	SM18-041-00	DS-TP06S-NEU	615MM	-	-	DS-A00-.25-S	DT-05-.25	DS-TP06B
1TJ1B-10012X7R01	SM18-041-00	DS-TP06S-NEU	617MM	-	-	DS-A00-.25-S	DT-05-.25	DS-TP06B
1TJ1B-03006T6R01	SM18-041-00	DS-TP06S-NEU	-	WS-0029	DT-90-08	DS-A00-.25-S	DT-05-.25	DS-TP06B
1TJ1B-05006T8R01	SM18-041-00	DS-TP06S-NEU	-	WS-0030	DT-130-10	DS-A00-.25-S	DT-05-.25	DS-TP06B
1TJ1B-06008TRR01	SM18-041-00	DS-TP06S-NEU	-	WS-0044	DT-250-13	DS-A00-.25-S	DT-05-.25	DS-TP06B
1TJ1B-07010TSR01	SM18-041-00	DS-TP06S-NEU	-	WS-0059	DT-250-16	DS-A00-.25-S	DT-05-.25	DS-TP06B
1TJ1B-10012TUR01	SM18-041-00	DS-TP06S-NEU	-	WS-0061	DT-350-20	DS-A00-.25-S	DT-05-.25	DS-TP06B



DIPOSDUO™ 06 SERIES 1TJ1D (WELDON SHANK)

90° END MILLS (6MM INSERT)

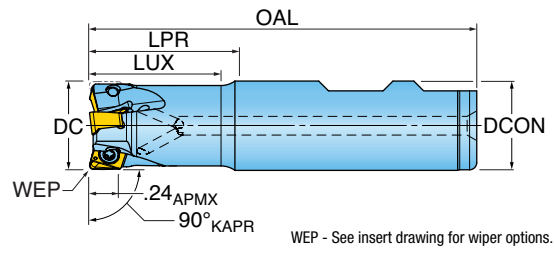

Part Number	DC Cutting Dia.	LPR Protruding Length	LUX Usable Length Max.	OAL Overall Length	ZEFF Eff. Teeth	DCON Shank Dia.
1TJ1D-0600779R01	0.625	0.75	0.72	2.66	2	0.625
1TJ1D-0701284R01	0.750	1.25	1.20	3.25	3	0.750
1TJ1D-0801284R01	0.875	1.25	1.25	3.25	3	0.750
1TJ1D-1001780R01	1.000	1.75	1.72	4.00	4	1.000
1TJ1D-1001784R01	1.000	1.75	1.72	3.75	4	0.750
1TJ1D-1201781R01	1.250	1.75	1.72	4.00	5	1.250
1TJ1D-1201784R01	1.250	1.75	1.75	3.75	5	0.750
1TJ1D-1501784R01	1.500	1.75	1.75	3.75	6	0.750
1TJ1D-1502281R01	1.500	2.25	2.25	4.50	6	1.250

*Cutter Body must be relieved for use with insert corner radii larger than R.031"; (Body R = Insert R -.02")



DIPOSDUO™ 06 SERIES 1TJ1D (CYLINDRICAL SHANK)

90° END MILLS (6MM INSERT)

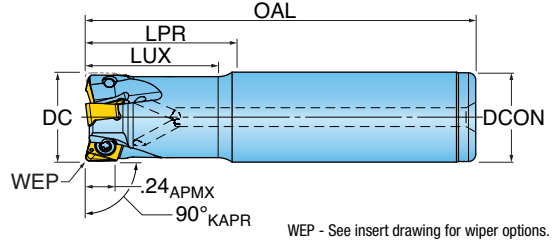

Part Number	DC Cutting Dia.	LPR Protruding Length	LUX Usable Length Max.	OAL Overall Length	ZEFF Eff. Teeth	DCON Shank Dia.
1TJ1D-06020S6R01	0.625	2.09	1.25	4.00	2	0.625
1TJ1D-07030S7R01	0.750	3.00	1.25	5.00	3	0.750
1TJ1D-10037S1R01	1.000	3.75	1.25	6.00	4	1.000
1TJ1D-12042S9R01	1.250	4.25	1.25	6.50	5	1.250
1TJ1D-15047S5R01	1.500	4.75	1.25	7.00	6	1.500

*Cutter Body must be relieved for use with insert corner radii larger than R.031"; (Body R = Insert R -.02")
Designed with modification in mind. Extend usable length by turning back the neck diameter or shorten the overall length by cutting off back end.



DIPOSDUO™ 06 SERIES 1TJ1D (KNEE MILL CYLINDRICAL STYLE)

90° END MILLS (6MM INSERT)

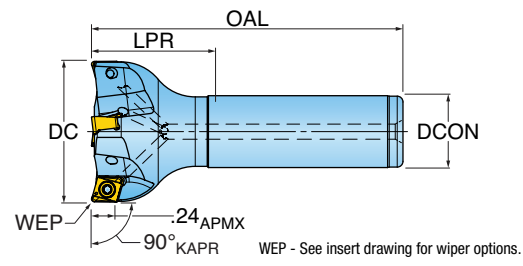

Part Number	DC Cutting Dia.	LPR Protruding Length	OAL Overall Length	ZEFF Eff. Teeth	DCON Shank Dia.
1TJ1D-10012S7R01	1.000	1.25	3.25	3	0.750
1TJ1D-15012S7R01	1.500	1.25	3.25	4	0.750
1TJ1D-20012S7R01	2.000	1.25	3.25	5	0.750

*Cutter Body must be relieved for use with insert corner radii larger than R.031"; (Body R = Insert R -.02")

Ideal on Knee mills when coupled with toolholder series R8ER.



DIPOSDUO™ 06 SERIES 1TJ1D (KNEE MILL R8 STYLE)

90° END MILLS (6MM INSERT)

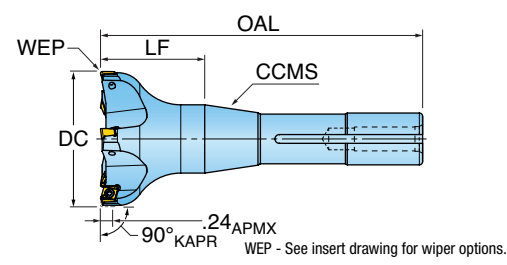

Part Number	DC Cutting Dia.	LF Functional Length	OAL Overall Length	ZEFF Eff. Teeth	CCMS Connection Code Machine Side
1TJ1D-2501940R01	2.500	1.90	5.90	5	Bridgeport R8
1TJ1D-3001940R01	3.000	1.90	5.90	5	Bridgeport R8

*Cutter Body must be relieved for use with insert corner radii larger than R.031"; (Body R = Insert R -.02")



DIPOSDUO™ 06 SERIES 1TJ1D (TOP•ON STYLE)

90° MODULAR END MILLS

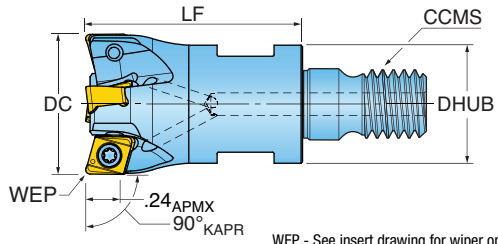

WEP - See insert drawing for wiper options.

Part Number	DC Cutting Dia.	LF Functional Length	ZEFF Eff. Teeth	CCMS Connection Code	DHUB Hub Dia.
1TJ1D-07015X6R01	0.750	1.50	3	M10	0.69
1TJ1D-10015X7R01	1.000	1.50	4	M12	0.81
1TJ1D-12017X8R01	1.250	1.75	5	M16	1.13
1TJ1D-15017X8R01	1.500	1.75	6	M16	1.13

*Cutter Body must be relieved for use with insert corner radii larger than R.031"; (Body R = Insert R -.02")

DIPOSDUO™ 06 SERIES 1TJ1D (CHIP•SURFER STYLE)

90° MODULAR END MILLS (6MM INSERT)

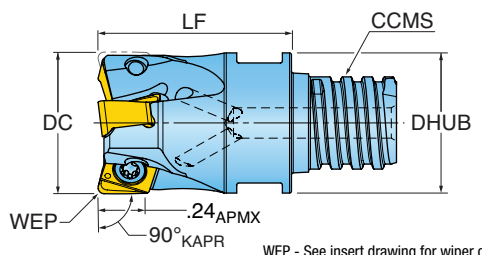

WEP - See insert drawing for wiper options.

Part Number	DC Cutting Dia.	LF Protruding Length	ZEFF Eff. Teeth	CCMS Connection Code	DHUB Hub Dia.
1TJ1D-06008TRR01	0.625	0.80	2	T10	0.61
1TJ1D-07010TSR01	0.750	1.00	3	T12	0.73
1TJ1D-10012TUR01	1.000	1.25	4	T15	0.95

*Cutter Body must be relieved for use with insert corner radii larger than R.031"; (Body R = Insert R -.02")



DIPOSDUO™ 06 SERIES TJ1D

90° FACE MILLS (6MM INSERT)

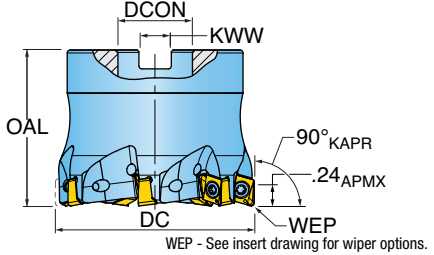

Part Number	DC Cutting Dia.	OAL Overall Length	ZEFF Eff. Teeth	DCON Bore Dia.	KWW Keyway
TJ1D-15R01	1.500	1.57	6	0.500	0.250
TJ1D-20R01	2.000	1.57	7	0.750	0.312
TJ1D-25R01	2.500	1.57	8	0.750	0.312
TJ1D-30R01	3.000	1.75	9	1.000	0.375

*Cutter Body must be relieved for use with insert corner radii larger than R.031"; (Body R = Insert R -.02")



DIPOSDUO™ 06 INSERTS

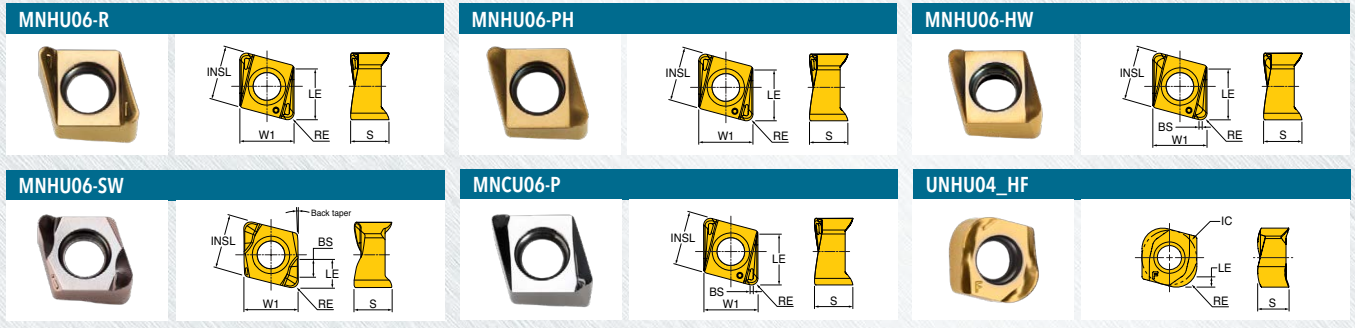

Part Number	Application	RE/BCH Corner Radius/ Chamfer	BS Wiper Length	LE Cutting Edge Length	INSL Length	W1 Width	S Thickness	NOI Number of Inserts	IH Insert Hand	Grade	IN10K	IN2035	IN2504	IN2505	IN2510	IN2530	IN615
MNHU060304R	Multi-Purpose	0.015 R	-	0.240	0.260	0.260	0.184	4	Right					•		•	
MNHU060308R	Multi-Purpose	0.031 R	-	0.230	0.260	0.260	0.184	4	Right					•	•	•	•
MNHU060312R	Multi-Purpose	0.047 R	-	0.220	0.260	0.260	0.177	4	Right					•			
MNHU060316R	Multi-Purpose	0.062 R	-	0.210	0.260	0.260	0.180	4	Right					•	•	•	•
MNHU060320R	Multi-Purpose	0.079 R	-	0.200	0.260	0.260	0.165	4	Right					•			
MNHU060304R-PH	SS/Hi-Temp/Ti	0.015 R	-	0.240	0.260	0.260	0.184	4	Right					•		•	
MNHU060308R-PH	SS/Hi-Temp/Ti	0.031 R	-	0.230	0.260	0.260	0.184	4	Right		•			•		•	
MNHU060312R-PH	SS/Hi-Temp/Ti	0.047 R	-	0.220	0.260	0.260	0.177	4	Right							•	
MNHU060316R-PH	SS/Hi-Temp/Ti	0.062 R	-	0.210	0.260	0.260	0.180	4	Right		•			•		•	
MNHU060320R-PH	SS/Hi-Temp/Ti	0.079 R	-	0.200	0.260	0.260	0.165	4	Right							•	
MNHU060304R-HW	SS/Hi-Temp/Ti - Face Wiper	0.015 R	0.039	0.240	0.260	0.260	0.184	4	Right					•			
MNHU060308R-HW	SS/Hi-Temp/Ti - Face Wiper	0.031 R	0.023	0.240	0.260	0.260	0.184	4	Right					•		•	
MNHU060310R-SW	Backdraft - Side Wiper	0.039	0.043	0.082	0.260	0.260	0.185	4	Right				•	•			
MNHU060315R-SW	Backdraft - Side Wiper	0.059	0.070	0.130	0.260	0.260	0.177	4	Right				•	•			
MNHU060320R-SW	Backdraft - Side Wiper	0.079	0.039	0.120	0.260	0.260	0.170	4	Right				•	•			
MNCU060304FR-P	Aluminum - Face Wiper	0.015 R	0.039	0.240	0.260	-	0.196	4	Right	•							
MNCU060308FR-P	Aluminum - Face Wiper	0.031 R	0.023	0.230	0.260	0.260	0.190	4	Right	•							

Part Number	Application	REQ Program Radius Equivalent	LE Cutting Edge Eff. Length	INSL Insert Length	W1 Insert Width	S Thickness	NOI Number of Indexes	IH Insert Hand	Grade	IN2504	IN2530	IN2505
UNHU060320R-HF	Hi-Feed	0.078	0.039	0.260	0.260	0.152	4	Right		•	•	•



DIPOSDUO™ 06 SERIES 1TV1D (CHIP-SURFER STYLE)

BACKDRAFT END MILLS (6MM INSERT)

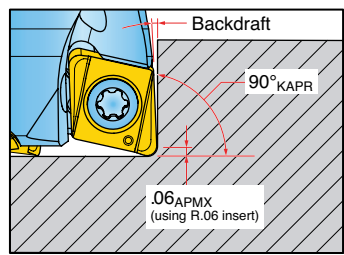
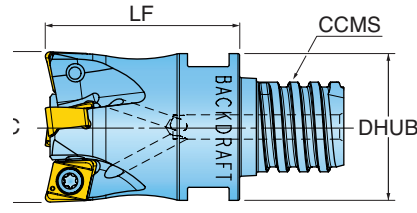

Part Number	DC Cutting Dia.	LF Protruding Length	ZEFF Eff. Teeth	CCMS Connection Code	DHUB Hub Dia.	RMPX Ramp Angle Max.	KAPR Cutting Edge Angle
1TV1D-06208TRR10	0.625	0.80	2	T10	0.60	3.0	91
1TV1D-07010TSR02	0.750	1.00	3	T12	0.72	4.7	93
1TV1D-10012TUR02	1.000	1.25	4	T15	0.95	3.9	93

*Cutter Body must be relieved for use with insert corner radii larger than R.031"; (Body R = Insert R -.02")

Notes:

- Recommend .020" maximum axial stepdown on straight wall finish applications.
- Well suited for long reach applications.

DIPOSDUO™ 06 SERIES 1TV1D INSERTS

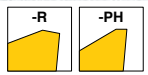

MNHU06-R

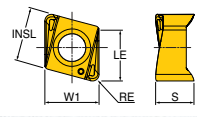

MNHU06-PH

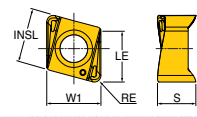

Part Number	Application	RE/BCH Corner Radius/ Chamfer	LE Cutting Edge Length	INSL Length	W1 Width	S Thickness	NOI Number of Indexes	IH Insert Hand	Grade	IN2035	IN2505	IN2510	IN2530	IN6515
MNHU060304R	Multi-Purpose	0.015 R	0.240	0.260	0.260	0.184	4	Right			•		•	
MNHU060308R	Multi-Purpose	0.031 R	0.230	0.260	0.260	0.184	4	Right			•	•	•	•
MNHU060312R	Multi-Purpose	0.047 R	0.220	0.260	0.260	0.177	4	Right			•			
MNHU060316R	Multi-Purpose	0.062 R	0.210	0.260	0.260	0.180	4	Right			•	•	•	•
MNHU060320R	Multi-Purpose	0.079 R	0.200	0.260	0.260	0.165	4	Right			•			
MNHU060304R-PH	SS/Hi-Temp/Ti	0.015 R	0.240	0.260	0.260	0.184	4	Right			•		•	
MNHU060308R-PH	SS/Hi-Temp/Ti	0.031 R	0.230	0.260	0.260	0.184	4	Right		•	•		•	
MNHU060312R-PH	SS/Hi-Temp/Ti	0.047 R	0.220	0.260	0.260	0.177	4	Right					•	
MNHU060316R-PH	SS/Hi-Temp/Ti	0.062 R	0.210	0.260	0.260	0.180	4	Right		•	•		•	
MNHU060320R-PH	SS/Hi-Temp/Ti	0.079 R	0.200	0.260	0.260	0.165	4	Right					•	



DIPOSDUO™ 06 HARDWARE

	Screw	Driver	Retention Bolt	Coolant Retention Bolt	Wrench	Torque Wrench	Torque Driver Handle	Preset Torque Bit	Torque Driver Bit
1TJ1D-06020S6R01	SM30-068-30	DS-T08W	-	-	-	-	DS-A00-.25-S	DT-11-.25	DS-T08B
1TJ1D-07030S7R01	SM30-068-30	DS-T08W	-	-	-	-	DS-A00-.25-S	DT-11-.25	DS-T08B
1TJ1D-10037S1R01	SM30-068-30	DS-T08W	-	-	-	-	DS-A00-.25-S	DT-11-.25	DS-T08B
1TJ1D-12042S9R01	SM30-068-30	DS-T08W	-	-	-	-	DS-A00-.25-S	DT-11-.25	DS-T08B
1TJ1D-15047S5R01	SM30-068-30	DS-T08W	-	-	-	-	DS-A00-.25-S	DT-11-.25	DS-T08B
1TJ1D-0600779R01	SM30-068-30	DS-T08W	-	-	-	-	DS-A00-.25-S	DT-11-.25	DS-T08B
1TJ1D-0701284R01	SM30-068-30	DS-T08W	-	-	-	-	DS-A00-.25-S	DT-11-.25	DS-T08B
1TJ1D-0801284R01	SM30-068-30	DS-T08W	-	-	-	-	DS-A00-.25-S	DT-11-.25	DS-T08B
1TJ1D-1001780R01	SM30-068-30	DS-T08W	-	-	-	-	DS-A00-.25-S	DT-11-.25	DS-T08B
1TJ1D-1001784R01	SM30-068-30	DS-T08W	-	-	-	-	DS-A00-.25-S	DT-11-.25	DS-T08B
1TJ1D-1201781R01	SM30-068-30	DS-T08W	-	-	-	-	DS-A00-.25-S	DT-11-.25	DS-T08B
1TJ1D-1201784R01	SM30-068-30	DS-T08W	-	-	-	-	DS-A00-.25-S	DT-11-.25	DS-T08B
1TJ1D-1501784R01	SM30-068-30	DS-T08W	-	-	-	-	DS-A00-.25-S	DT-11-.25	DS-T08B
1TJ1D-1502281R01	SM30-068-30	DS-T08W	-	-	-	-	DS-A00-.25-S	DT-11-.25	DS-T08B
1TJ1D-10012S7R01	SM30-068-30	DS-T08W	-	-	-	-	DS-A00-.25-S	DT-11-.25	DS-T08B
1TJ1D-15012S7R01	SM30-068-30	DS-T08W	-	-	-	-	DS-A00-.25-S	DT-11-.25	DS-T08B
1TJ1D-20012S7R01	SM30-068-30	DS-T08W	-	-	-	-	DS-A00-.25-S	DT-11-.25	DS-T08B
1TJ1D-2501940R01	SM30-068-30	DS-T08W	-	-	-	-	DS-A00-.25-S	DT-11-.25	DS-T08B
1TJ1D-3001940R01	SM30-068-30	DS-T08W	-	-	-	-	DS-A00-.25-S	DT-11-.25	DS-T08B
1TJ1D-07015X6R01	SM30-068-30	DS-T08W	-	-	615MM	-	DS-A00-.25-S	DT-11-.25	DS-T08B
1TJ1D-10015X7R01	SM30-068-30	DS-T08W	-	-	617MM	-	DS-A00-.25-S	DT-11-.25	DS-T08B
1TJ1D-12017X8R01	SM30-068-30	DS-T08W	-	-	622MM	-	DS-A00-.25-S	DT-11-.25	DS-T08B
1TJ1D-15017X8R01	SM30-068-30	DS-T08W	-	-	622MM	-	DS-A00-.25-S	DT-11-.25	DS-T08B
1TJ1D-06008TRR01	SM30-068-30	DS-T08W	-	-	WS-0044	DT-250-13	DS-A00-.25-S	DT-11-.25	DS-T08B
1TJ1D-07010TSR01	SM30-068-30	DS-T08W	-	-	WS-0059	DT-250-16	DS-A00-.25-S	DT-11-.25	DS-T08B
1TJ1D-10012TUR01	SM30-068-30	DS-T08W	-	-	WS-0061	DT-350-20	DS-A00-.25-S	DT-11-.25	DS-T08B
1TV1D-06208TRR10	SM30-068-30	DS-T08W	-	-	WS-0044	DT-250-13	DS-A00-.25-S	DT-11-.25	DS-T08B
1TV1D-07010TSR02	SM30-068-30	DS-T08W	-	-	WS-0059	DT-250-16	DS-A00-.25-S	DT-11-.25	DS-T08B
1TV1D-10012TUR02	SM30-068-30	DS-T08W	-	-	WS-0061	DT-350-20	DS-A00-.25-S	DT-11-.25	DS-T08B
TJ1D-15R01	SM30-068-30	DS-T08W	SD-04-46	-	-	-	DS-A00-.25-S	DT-11-.25	DS-T08B
TJ1D-20R01	SM30-068-30	DS-T08W	SD-06-46	SD-06-89	-	-	DS-A00-.25-S	DT-11-.25	DS-T08B
TJ1D-25R01	SM30-068-30	DS-T08W	SD-06-46	SD-06-89	-	-	DS-A00-.25-S	DT-11-.25	DS-T08B
TJ1D-30R01	SM30-068-30	DS-T08W	SD-08-46	SD-08-92	-	-	DS-A00-.25-S	DT-11-.25	DS-T08B



DIPOSDUO™ 09 SERIES 1TJ1F (WELDON SHANK)

90° END MILLS (9MM INSERT)

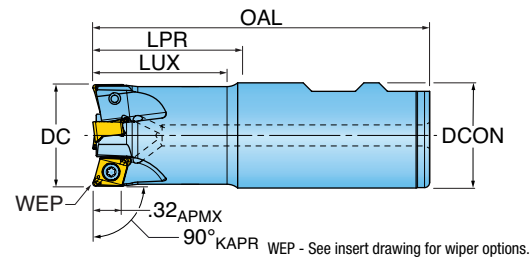

Part Number	DC Cutting Dia.	LUX Usable Length Max.	LPR Protruding Length	OAL Overall Length	ZEFF Eff. Teeth	DCON Shank Dia.
1TJ1F-1001780R01	1.000	1.72	1.75	4.00	3	1.000
1TJ1F-1201781R01	1.250	1.72	1.75	4.00	4	1.250
1TJ1F-1502281R01	1.500	2.20	2.25	4.50	5	1.250

*When using -HF insert, cutter body corner radius must be modified to R.12" for proper clearance.

DIPOSDUO™ 09 SERIES 1TJ1F (CYLINDRICAL SHANK)

90° END MILLS (9MM INSERT)

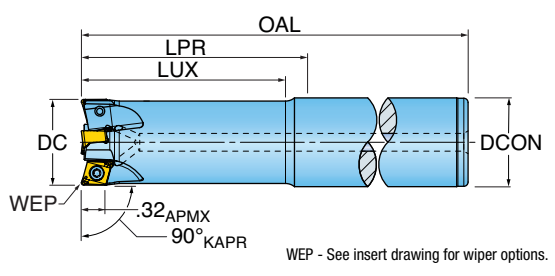

Part Number	DC Cutting Dia.	LUX Usable Length Max.	LPR Protruding Length	OAL Overall Length	ZEFF Eff. Teeth	DCON Shank Dia.
1TJ1F-1005751R01	1.000	2.40	5.75	8.00	3	1.000
1TJ1F-1207759R01	1.250	2.90	7.75	10.00	4	1.250
1TJ1F-1507355R01	1.500	2.90	7.34	10.00	5	1.500

*When using -HF insert, cutter body corner radius must be modified to R.12" for proper clearance.
Designed with modification in mind. Extend usable length by turning back the neck diameter or shorten the overall length by cutting off back end.



DIPOSDUO™ 09 SERIES 1TJ1F (TOP•ON STYLE)

90° MODULAR END MILLS (9MM INSERT)

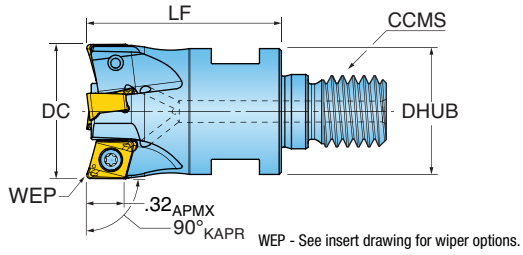

Part Number	DC Cutting Dia.	LF Functional Length	ZEFF Eff. Teeth	CCMS Connection Code	DHUB Hub Dia.
1TJ1F-10015X7R01	1.000	1.50	3	TopOn M12	0.81
1TJ1F-12017X8R01	1.250	1.75	4	TopOn M16	1.13
1TJ1F-15017X9R01	1.500	1.75	5	TopOn M16	1.13

*When using -HF insert, cutter body corner radius must be modified to R.12" for proper clearance.

DIPOSDUO™ 09 SERIES TJ6F

90° FACE MILLS (9MM INSERT)

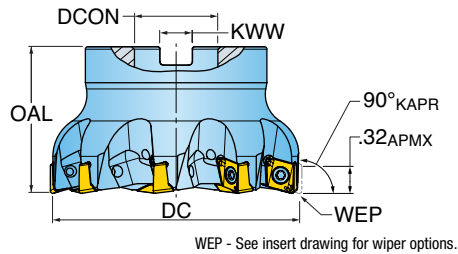

Part Number	DC Cutting Dia.	OAL Overall Length	ZEFF Eff. Teeth	DCON Bore Dia.	KWW Keyway
TJ6F-15R01	1.500	1.570	5	0.500	0.250
TJ6F-20R01	2.000	1.570	6	0.750	0.312
TJ6F-25R01	2.500	1.570	7	0.750	0.312
TJ6F-30R01	3.000	1.750	9	1.000	0.375
TJ6F-40R01	4.000	2.375	11	1.500	0.625

*When using -HF insert, cutter body corner radius must be modified to R.12" for proper clearance.



DIPOSDUO™ 09 INSERTS

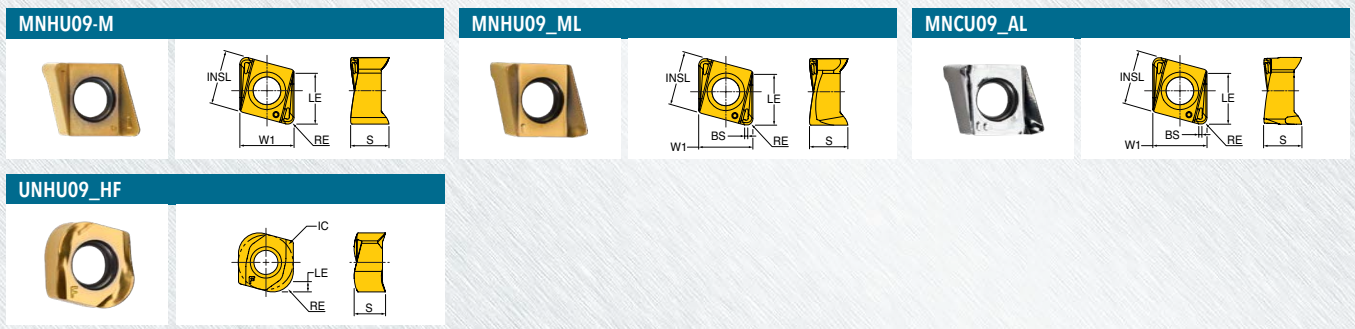

Part Number	Application	RE Corner Radius	BS Wiper Length	LE Cutting Edge Eff. Length	INSL Insert Length	W1 Insert Width	S Thickness	NOI Number of Indexes	IH Insert Hand	Grade	IN2505	IN2530	IN2510	IN2504	IN10K
MNHU090408R-M	Multi-Purpose	0.031	-	0.314	0.338	0.338	0.232	4	Right		•	•	•	•	
MNHU090416R-M	Multi-Purpose	0.062	-	0.314	0.338	0.338	0.224	4	Right		•	•	•		
MNHU090404R-ML	SS/Hi-Temp/Ti - Face Wiper	0.015	0.047	0.314	0.338	0.338	0.248	4	Right		•				
MNHU090408R-ML	SS/Hi-Temp/Ti - Face Wiper	0.031	0.031	0.314	0.338	0.338	0.248	4	Right		•	•			
MNCU090404FR-AL	Grd/Pol for Al - Face Wiper	0.015	0.047	0.314	0.338	0.338	0.248	4	Right						•
MNCU090408FR-AL	Grd/Pol for Al - Face Wiper	0.031	0.031	0.314	0.338	0.338	0.244	4	Right						•

Part Number	Application	REEO Program Radius Equivalent	LE Cutting Edge Eff. Length	INSL Insert Length	W1 Insert Width	S Thickness	NOI Number of Indexes	IH Insert Hand	Grade	IN2505
UNHU090432R-HF	Hi-Feed	0.125	0.059	0.338	0.338	0.187	4	Right		•

DIPOSDUO™ 09 HARDWARE

	Screw	Driver Handle	Torx Driver Blade	Retention Bolt	**OPTIONAL** Coolant Retention Bolt	**OPTIONAL** Wrench	**OPTIONAL** Torque Driver Handle	**OPTIONAL** Preset Torque Bit	**OPTIONAL** Torque Driver Bit
1TJ1F-1001780R01	SM35-088-10	DS-A00T	DS-T106B	-	-	-	DS-A00-.25-T	DT-30-.25	DS-T10B1
1TJ1F-1201781R01	SM35-088-10	DS-A00T	DS-T106B	-	-	-	DS-A00-.25-T	DT-30-.25	DS-T10B1
1TJ1F-1502281R01	SM35-088-10	DS-A00T	DS-T106B	-	-	-	DS-A00-.25-T	DT-30-.25	DS-T10B1
1TJ1F-1005751R01	SM35-088-10	DS-A00T	DS-T106B	-	-	-	DS-A00-.25-T	DT-30-.25	DS-T10B1
1TJ1F-1207759R01	SM35-088-10	DS-A00T	DS-T106B	-	-	-	DS-A00-.25-T	DT-30-.25	DS-T10B1
1TJ1F-1507355R01	SM35-088-10	DS-A00T	DS-T106B	-	-	-	DS-A00-.25-T	DT-30-.25	DS-T10B1
1TJ1F-10015X7R01	SM35-088-10	DS-A00T	DS-T106B	-	-	617MM	DS-A00-.25-T	DT-30-.25	DS-T10B1
1TJ1F-12017X8R01	SM35-088-10	DS-A00T	DS-T106B	-	-	622MM	DS-A00-.25-T	DT-30-.25	DS-T10B1
1TJ1F-15017X9R01	SM35-088-10	DS-A00T	DS-T106B	-	-	630MM	DS-A00-.25-T	DT-30-.25	DS-T10B1
TJ6F-15R01	SM35-088-10	DS-A00T	DS-T106B	SD-04-86	-	-	DS-A00-.25-T	DT-30-.25	DS-T10B1
TJ6F-20R01	SM35-088-10	DS-A00T	DS-T106B	SD-06-46	SD-06-89	-	DS-A00-.25-T	DT-30-.25	DS-T10B1
TJ6F-25R01	SM35-088-10	DS-A00T	DS-T106B	SD-06-46	SD-06-89	-	DS-A00-.25-T	DT-30-.25	DS-T10B1
TJ6F-30R01	SM35-088-10	DS-A00T	DS-T106B	SD-08-46	SD-08-92	-	DS-A00-.25-T	DT-30-.25	DS-T10B1
TJ6F-40R01	SM35-088-10	DS-A00T	DS-T106B	SD-12-82	SD-12-99	-	DS-A00-.25-T	DT-30-.25	DS-T10B1



DIPOSDUO™ 11 SERIES 1TJ1G (WELDON SHANK)

90° END MILLS (11MM INSERT)

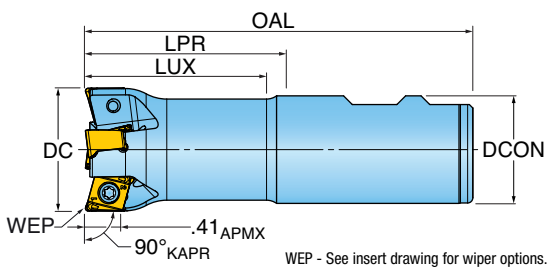

Part Number	DC Cutting Dia.	LUX Usable Length Max.	LPR Protruding Length	OAL Overall Length	ZEFF Eff. Teeth	DCON Shank Dia.
1TJ1G-1001780R01	1.000	1.72	1.75	4.00	2	1.000
1TJ1G-1202281R01	1.250	2.22	2.25	4.50	3	1.250
1TJ1G-1502281R01	1.500	2.22	2.25	4.50	4	1.250

*When using -HF insert, cutter body corner radius must be modified to R.15" for proper clearance.

DIPOSDUO™ 11 SERIES 1TJ1G (TOP•ON STYLE)

90° MODULAR END MILLS (11MM INSERT)

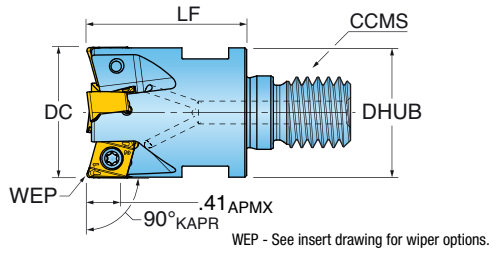

Part Number	DC Cutting Diameter	LF Functional Length	ZEFF Effective Teeth	CCMS Connection Code	DHUB Hub Diameter
1TJ1G-10015X7R01	1.000	1.50	2	TopOn M12	0.81
1TJ1G-12017X8R01	1.250	1.75	3	TopOn M16	1.13
1TJ1G-15017X9R01	1.500	1.75	4	TopOn M20	1.41

*When using -HF insert, cutter body corner radius must be modified to R.15" for proper clearance.



DIPOSDUO™ 11 SERIES TJ5G, TJ6G

90° FACE MILLS (11MM INSERT)

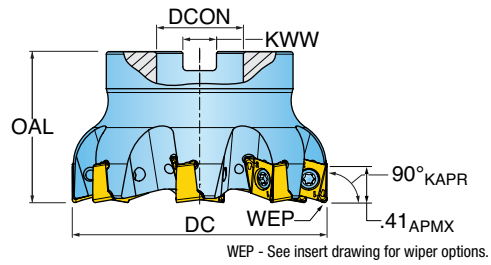

Part Number	DC Cutting Dia.	OAL Overall Length	ZEFF Eff. Teeth	DCON Bore Dia.	KWW Keyway
TJ5G-20R01	2.000	1.750	5	0.750	0.312
TJ6G-20R01	2.000	1.750	4	0.750	0.312
TJ5G-25R01	2.500	1.750	6	1.000	0.375
TJ6G-25R01	2.500	1.750	4	1.000	0.375
TJ5G-30R01	3.000	1.750	8	1.000	0.375
TJ6G-30R01	3.000	1.750	6	1.000	0.375
TJ5G-40R01	4.000	2.375	10	1.500	0.625
TJ6G-40R01	4.000	2.375	7	1.500	0.625

*When using -HF insert, cutter body corner radius must be modified to R.15" for proper clearance.

DIPOSDUO™ 11 INSERTS

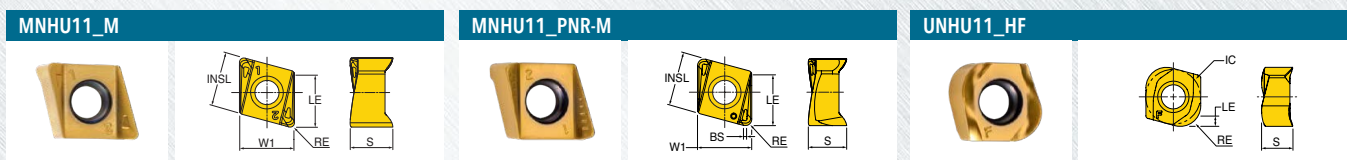









Part Number	Application	RE Corner Radius	BS Wiper Length	LE Cutting Edge Eff. Length	INSL Insert Length	W1 Insert Width	S Thickness	NOI Number of Indexes	IH Insert Hand	Grade	IN2505	IN2530	IN2510
MNHU110608R-M	Multi-Purpose	0.031	-	0.410	0.421	0.421	0.318	4	Right		•	•	•
MNHU110608PNR-M	Multi-Purpose - Integrated Wiper	0.031	0.039	0.410	0.421	0.421	0.318	4	Right		•	•	

Part Number	Application	REEO Program Radius Equivalent	LE Cutting Edge Eff. Length	INSL Insert Length	W1 Insert Width	S Thickness	NOI Number of Indexes	IH Insert Hand	Grade	IN2505
UNHU110640R-HF	Hi-Feed	0.157	0.078	0.421	0.421	0.240	4	Right		•



DIPOSDUO™ 11 HARDWARE

									
	Screw	Driver Handle	Torx Driver Blade	Retention Bolt	Coolant Retention Bolt	Wrench	Torque Driver Handle	Preset Torque Bit	Torque Driver Bit
1TJ1G-1001780R01	SM40-100-10	DS-A00T	DS-T156B	-	-	-	DS-A00-.25-T	DT-35-.25	DS-T15B1
1TJ1G-1202281R01	SM40-100-10	DS-A00T	DS-T156B	-	-	-	DS-A00-.25-T	DT-35-.25	DS-T15B1
1TJ1G-1502281R01	SM40-100-10	DS-A00T	DS-T156B	-	-	-	DS-A00-.25-T	DT-35-.25	DS-T15B1
1TJ1G-10015X7R01	SM40-100-10	DS-A00T	DS-T156B	-	-	617MM	DS-A00-.25-T	DT-35-.25	DS-T15B1
1TJ1G-12017X8R01	SM40-100-10	DS-A00T	DS-T156B	-	-	622MM	DS-A00-.25-T	DT-35-.25	DS-T15B1
1TJ1G-15017X9R01	SM40-100-10	DS-A00T	DS-T156B	-	-	630MM	DS-A00-.25-T	DT-35-.25	DS-T15B1
TJ5G-20R01	SM40-100-10	DS-A00T	DS-T156B	SD-06-46	SD-06-89	-	DS-A00-.25-T	DT-35-.25	DS-T15B1
TJ6G-20R01	SM40-100-10	DS-A00T	DS-T156B	SD-06-46	SD-06-89	-	DS-A00-.25-T	DT-35-.25	DS-T15B1
TJ5G-25R01	SM40-100-10	DS-A00T	DS-T156B	SD-08-47	SD-08-C9	-	DS-A00-.25-T	DT-35-.25	DS-T15B1
TJ6G-25R01	SM40-100-10	DS-A00T	DS-T156B	SD-08-47	SD-08-C9	-	DS-A00-.25-T	DT-35-.25	DS-T15B1
TJ5G-30R01	SM40-100-10	DS-A00T	DS-T156B	SD-08-47	SD-08-C9	-	DS-A00-.25-T	DT-35-.25	DS-T15B1
TJ6G-30R01	SM40-100-10	DS-A00T	DS-T156B	SD-08-47	SD-08-C9	-	DS-A00-.25-T	DT-35-.25	DS-T15B1
TJ5G-40R01	SM40-100-10	DS-A00T	DS-T156B	SD-12-82	SD-12-99	-	DS-A00-.25-T	DT-35-.25	DS-T15B1
TJ6G-40R01	SM40-100-10	DS-A00T	DS-T156B	SD-12-82	SD-12-99	-	DS-A00-.25-T	DT-35-.25	DS-T15B1



DIPOSDUO™ 14 SERIES 1TJ1J (WELDON SHANK)

90° END MILLS (14MM INSERT)

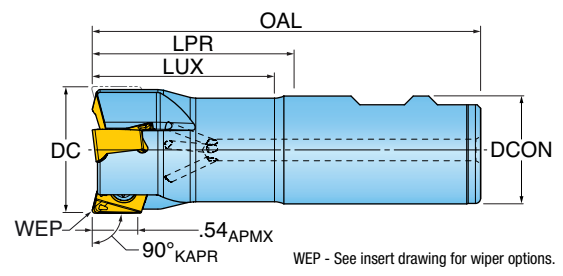

Part Number	DC Cutting Dia.	LUX Usable Length Max.	LPR Protruding Length	OAL Overall Length	ZEFF Eff. Teeth	DCON Shank Dia.
1TJ1J-1202281R01	1.250	2.22	2.25	4.50	2	1.250
1TJ1J-1502281R01	1.500	2.22	2.25	4.50	3	1.250

*When using -HF insert, cutter body corner radius must be modified to R.19" for proper clearance.

DIPOSDUO™ 14 SERIES 1TJ1J (TOP•ON STYLE)

90° MODULAR END MILLS (14MM INSERT)

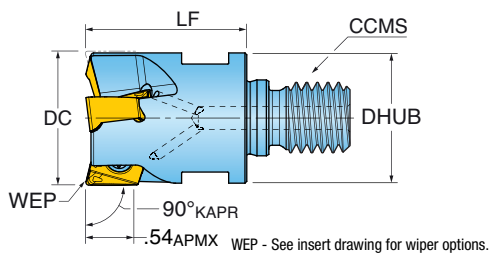

Part Number	DC Cutting Diameter	LF Functional Length	ZEFF Effective Teeth	CCMS Connection Code	DHUB Hub Diameter
1TJ1J-12017X8R01	1.250	1.75	2	TopOn M16	1.13
1TJ1J-15017X9R01	1.500	1.75	3	TopOn M20	1.41

*When using -HF insert, cutter body corner radius must be modified to R.19" for proper clearance.

DIPOSDUO™ 14 SERIES TJ5J, TJ6J

90° ROUGH & RAMP FACE MILL (14MM INSERT)

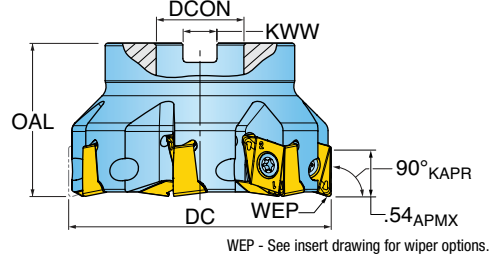

Part Number	DC Cutting Dia.	OAL Overall Length	ZEFF Eff. Teeth	DCON Bore Dia.	KWW Keyway
TJ5J-20R01	2.000	1.750	4	0.750	0.312
TJ5J-25R01	2.500	1.750	6	1.000	0.375
TJ6J-25R01	2.500	1.750	4	1.000	0.375
TJ5J-30R01	3.000	1.750	7	1.000	0.375
TJ6J-30R01	3.000	1.750	5	1.000	0.375
TJ5J-40R01	4.000	2.375	9	1.500	0.625
TJ6J-40R01	4.000	2.375	6	1.500	0.625

*When using -HF insert, cutter body corner radius must be modified to R.19" for proper clearance.

DIPOSDUO™ 14 INSERTS

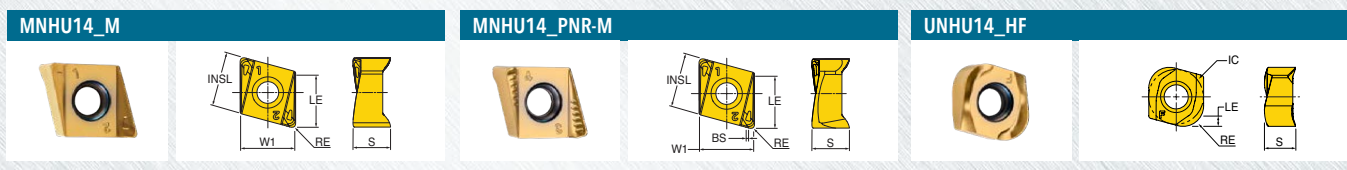









Part Number	Application	RE Corner Radius	BS Wiper Length	LE Cutting Edge Eff. Length	INSL Insert Length	W1 Insert Width	S Thickness	NOI Number of Indexes	IH Insert Hand	Grade	IN2505	IN2530	IN2510
MNHU140708R-M	Multi-Purpose	0.031	-	0.540	0.551	0.551	0.362	4	Right		•	•	•
MNHU140708PNR-M	Multi-Purpose - Integrated Wiper	0.031	0.049	0.540	0.551	0.551	0.381	4	Right		•	•	

Part Number	Application	REEO Program Radius Equivalent	LE Cutting Edge Eff. Length	INSL Insert Length	W1 Insert Width	S Thickness	NOI Number of Indexes	IH Insert Hand	Grade	IN2505
UNHU140750R-HF	Hi-Feed	0.196	0.118	0.551	0.551	0.267	4	Right		•



DIPOSDUO™ 14 HARDWARE

									
	Screw	Driver Handle	Torx Driver Blade	Retention Bolt	Coolant Retention Bolt	Wrench	Torque Driver Handle	Preset Torque Bit	Torque Driver Bit
1TJ1J-1202281R01	SM50-127-10	DS-A00T	DS-T206B	-	-	-	DS-A00-.25-T	DT-44-.25	DS-T20B1
1TJ1J-1502281R01	SM50-127-10	DS-A00T	DS-T206B	-	-	-	DS-A00-.25-T	DT-44-.25	DS-T20B1
1TJ1J-12017X8R01	SM50-127-10	DS-A00T	DS-T206B	-	-	622MM	DS-A00-.25-T	DT-44-.25	DS-T20B1
1TJ1J-15017X9R01	SM50-127-10	DS-A00T	DS-T206B	-	-	630MM	DS-A00-.25-T	DT-44-.25	DS-T20B1
TJ5J-20R01	SM50-127-10	DS-A00T	DS-T206B	SD-06-47	SD-06-A6	-	DS-A00-.25-T	DT-44-.25	DS-T20B1
TJ5J-25R01	SM50-127-10	DS-A00T	DS-T206B	SD-08-47	SD-08-C9	-	DS-A00-.25-T	DT-44-.25	DS-T20B1
TJ6J-25R01	SM50-127-10	DS-A00T	DS-T206B	SD-08-47	SD-08-C9	-	DS-A00-.25-T	DT-44-.25	DS-T20B1
TJ5J-30R01	SM50-127-10	DS-A00T	DS-T206B	SD-08-47	SD-08-C9	-	DS-A00-.25-T	DT-44-.25	DS-T20B1
TJ6J-30R01	SM50-127-10	DS-A00T	DS-T206B	SD-08-47	SD-08-C9	-	DS-A00-.25-T	DT-44-.25	DS-T20B1
TJ5J-40R01	SM50-127-10	DS-A00T	DS-T206B	SD-12-89	SD-12-99	-	DS-A00-.25-T	DT-44-.25	DS-T20B1
TJ6J-40R01	SM50-127-10	DS-A00T	DS-T206B	SD-12-89	SD-12-99	-	DS-A00-.25-T	DT-44-.25	DS-T20B1



DIPOSDUO™ 04 OPERATING GUIDELINES: 90°

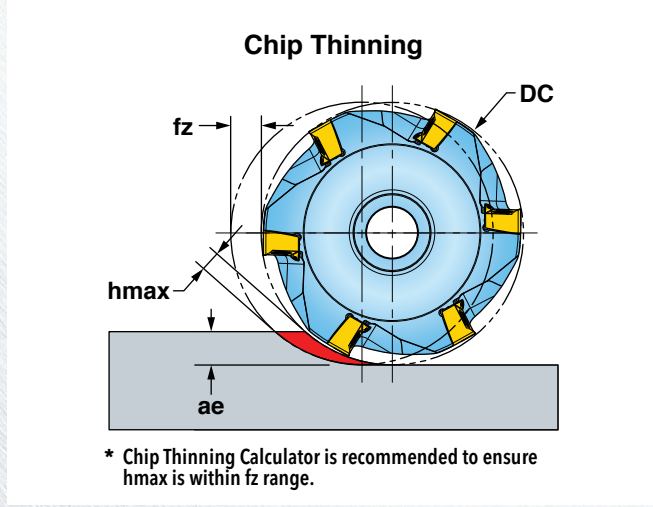

Materials				Vc Cutting Speed SFM	fz* Feed per Tooth (inch)	Harder Tougher			Coolant
ISO	Mat'l Group #VDI 3323	Type	Examples			IN2510	IN2505	IN2530	
P	1 thru 5	Non-alloy Steel	1018, A36, 1045, A572, 1070	400-1000	.002-.005	-	2	1	No
	6 thru 9	Low-alloy Steel	4140, 4340, P20, 8620, 300M	350-700					
	10, 11	High-alloy Steel	H13, A2, D2, M2, T1	300-600					
M	12 thru 13	Stainless Steel (Ferritic & Martensitic)	410, 416, 440	350-600	.002-.005	-	2	1	Yes
	14	Stainless Steel (Austenitic)	303, 304, 316, 15-5, 17-4	300-550					May not be required at high speeds
K	15 thru 16	Gray Cast Iron	CLS. 20, 30, 45	500-1000	.002-.005	1	2	-	No
	17 thru 20	Nodular Cast Iron	60-40-18, 100-70-03	400-800					
S	31 thru 35	High-Temp Alloys	Inconel, Hastelloy, Nimonic, Monel	65-200	.002-.005	-	1	2	Yes
	36 thru 37	Titanium Alloys	6Al-4V, 5Al-5Mo-5V-3Cr	85-200					
H	38 thru 39	Hardened Steel >48	A2, O1, D2	130-250	.002-.004	-	1	-	No

Note: Feed and speed recommendations are starting operating parameters. They are only guidelines from which further optimization should take place. Operating parameters are influenced by many machining variables. These variables may cause for reductions in feeds and speed or dramatic increases. Additionally, DOC and WOC may need to be revised to optimize the tools performance.



DIPOSDUO™ 04 OPERATING GUIDELINES: HI-FEED

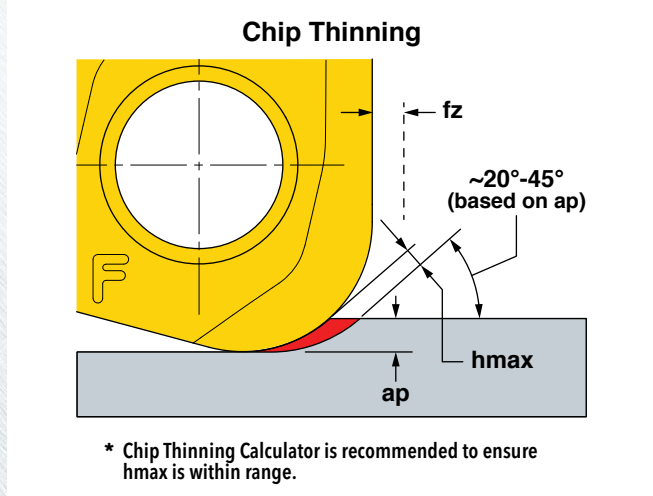

Materials				Vc Cutting Speed SFM	fz Feed/Tooth (inch)	ap Axial Depth of Cut (inch)	hmax* Chip Thick- ness Min. (inch)	Harder ... Tougher		Coolant
ISO	Mat'l Group #VDI 3323	Type	Examples					IN2505	IN2530	
P	1 thru 5	Non-alloy Steel	1018, A36, 1045, A572, 1070	400-1000	.004-.015	.008-.016	.002-.006		1	No
	6 thru 9	Low-alloy Steel	4140, 4340, P20, 8620, 300M	350-700						
	10, 11	High-alloy Steel	H13, A2, D2, M2, T1	300-600						
M	12 thru 13	Stainless Steel (Ferritic & Martensitic)	410, 416, 440	350-600	.004-.0165	.008-.016	.002-.006		1	Yes
	14	Stainless Steel (Austenitic)	303, 304, 316, 15-5, 17-4	300-550						May not be required at high speeds
K	15 thru 16	Gray Cast Iron	CLS. 20, 30, 45	500-1000	.004-.020	.008-.016	.002-.007	1	2	No
	17 thru 20	Nodular Cast Iron	60-40-18, 100-70-03	400-800						
S	31 thru 35	High-Temp Alloys	Inconel, Hastelloy, Nimonic, Monel	65-200	.004-.015	.008-.016	.002-.006		1	Yes
	36 thru 37	Titanium Alloys	6Al-4V, 5Al-5Mo-5V-3Cr	85-200						
H	38 thru 39	Hardened Steel >48	A2, O1, D2	130-250	.004-.010	.008-.012	.002-.005	1	2	No

Note: Feed and speed recommendations are starting operating parameters. They are only guidelines from which further optimization should take place. Operating parameters are influenced by many machining variables. These variables may cause for reductions in feeds and speed or dramatic increases. Additionally, DOC and WOC may need to be revised to optimize the tools performance.



DIPOSDUO™ 06 OPERATING GUIDELINES: 90°

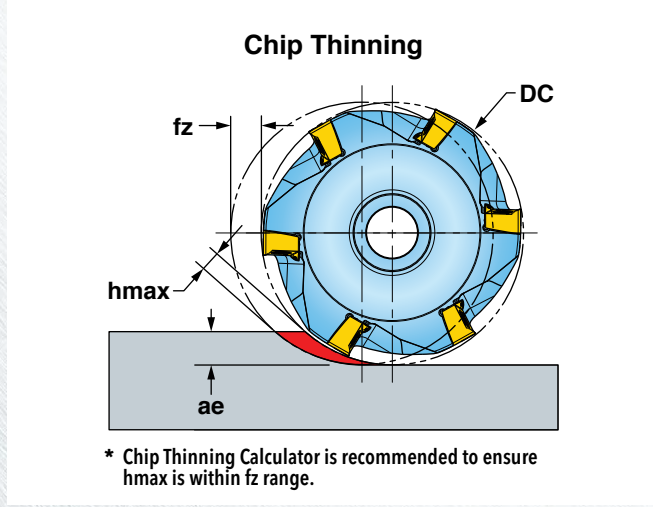

ISO	Materials			Vc Cutting Speed SFM	fz* Feed/Tooth (inch)	Harder Tougher							Coolant
	Mat'l Group #VDI 3323	Type	Examples			IN2504	IN10K	IN2510	IN6515	IN2505	IN2530	IN2035	
P	1 thru 5	Non-alloy Steel	1018, A36, 1045, A572, 1070	400-1000	.003-.006								
	6 thru 9	Low-alloy Steel	4140, 4340, P20, 8620, 300M	350-700						2	1		No
	10, 11	High-alloy Steel	H13, A2, D2, M2, T1	300-600									
M	12 thru 13	Stainless Steel (Ferritic & Martensitic)	410, 416, 440	350-600	.003-.005					2	1		Yes
	14	Stainless Steel (Austenitic)	303, 304, 316, 15-5, 17-4	300-550						3	2	1	May not be required at high speeds
K	15 thru 16	Gray Cast Iron	CLS. 20, 30, 45	500-1000	.003-.007	2		1	3				No
	17 thru 20	Nodular Cast Iron	60-40-18, 100-70-03	400-800		3		2	1				
N	21 - 30	Aluminum	7075, 6061	1000-3000	.003-.009		1						Yes
S	31 thru 35	High-Temp Alloys	Inconel, Hastelloy, Nimonic, Monel	65-200	.003-.005					2	3	1	Yes
	36 thru 37	Titanium Alloys	6Al-4V, 5Al-5Mo-5V-3Cr	85-200						3	2	1	
H	38 thru 39	Hardened Steel >48	A2, O1, D2	130-250	.003-.004	1				2			No

Note: Feed and speed recommendations are starting operating parameters. They are only guidelines from which further optimization should take place. Operating parameters are influenced by many machining variables. These variables may cause for reductions in feeds and speed or dramatic increases. Additionally, DOC and WOC may need to be revised to optimize the tools performance.



DIPOSDUO™ 06 OPERATING GUIDELINES: HI-FEED

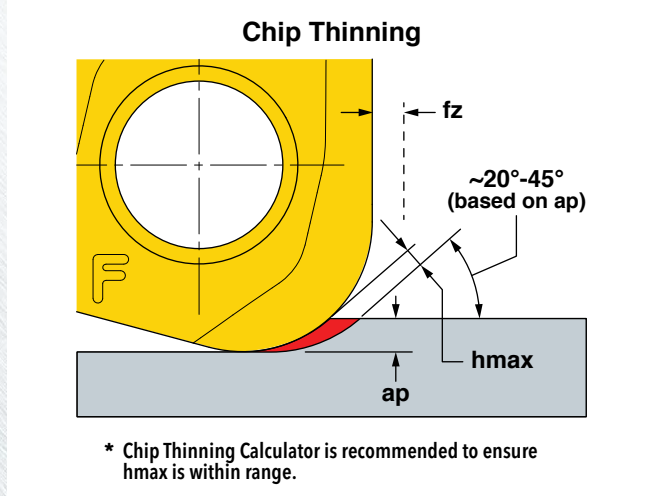

ISO	Materials			Vc Cutting Speed SFM	fz Feed/Tooth (inch)	ap Axial Depth of Cut (inch)	hmax* Chip Thick- ness Min. (inch)	Harder Tougher			Coolant
	Mat'l Group #VDI 3323	Type	Examples					IN2504	IN2505	IN2530	
P	1 thru 5	Non-alloy Steel	1018, A36, 1045, A572, 1070	400-1000	.008-.020	.008-.024	.003-.008		2	1	No
	6 thru 9	Low-alloy Steel	4140, 4340, P20, 8620, 300M	350-700							
	10, 11	High-alloy Steel	H13, A2, D2, M2, T1	300-600							
M	12 thru 13	Stainless Steel (Ferritic & Martensitic)	410, 416, 440	350-600	.008-.015	.008-.024	.003-.006	2	1	Yes	
	14	Stainless Steel (Austenitic)	303, 304, 316, 15-5, 17-4	300-550							May not be required at high speeds
K	15 thru 16	Gray Cast Iron	CLS. 20, 30, 45	500-1000	.008-.025	.008-.024	.003-.009	1	2	No	
	17 thru 20	Nodular Cast Iron	60-40-18, 100-70-03	400-800							
S	31 thru 35	High-Temp Alloys	Inconel, Hastelloy, Nimonic, Monel	65-200	.008-.015	.008-.024	.003-.006		1	2	Yes
	36 thru 37	Titanium Alloys	6Al-4V, 5Al-5Mo-5V-3Cr	85-200							
H	38 thru 39	Hardened Steel >48	A2, O1, D2	130-250	.008-.012	.008-.020	.003-.005	1	2	No	

Note: Feed and speed recommendations are starting operating parameters. They are only guidelines from which further optimization should take place. Operating parameters are influenced by many machining variables. These variables may cause for reductions in feeds and speed or dramatic increases. Additionally, DOC and WOC may need to be revised to optimize the tools performance.



DIPOSDUO™ 09 OPERATING GUIDELINES: 90°

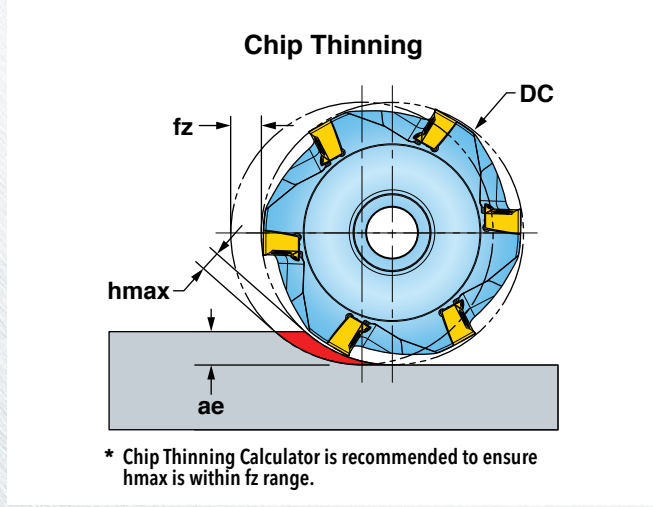

ISO	Materials			Vc Cutting Speed SFM	fz* Feed/Tooth (inch)	Harder Tougher					Coolant
	Mat'l Group #VDI 3323	Type	Examples			IN2504	IN10K	IN2510	IN2505	IN2530	
P	1 thru 5	Non-alloy Steel	1018, A36, 1045, A572, 1070	400-1000	.003-.007						No
	6 thru 9	Low-alloy Steel	4140, 4340, P20, 8620, 300M	350-700					2	1	
	10, 11	High-alloy Steel	H13, A2, D2, M2, T1	300-600							
M	12 thru 13	Stainless Steel (Ferritic & Martensitic)	410, 416, 440	350-600	.003-.006				2	1	Yes
	14	Stainless Steel (Austenitic)	303, 304, 316, 15-5, 17-4	300-550							May not be required at high speeds
K	15 thru 16	Gray Cast Iron	CLS. 20, 30, 45	500-1000	.003-.008	2		1	3		No
	17 thru 20	Nodular Cast Iron	60-40-18, 100-70-03	400-800							
N	21 - 30	Aluminum	7075, 6061	1000-3000	.003-.012		1				
S	31 thru 35	High-Temp Alloys	Inconel, Hastelloy, Nimonic, Monel	65-200	.003-.006						Yes
	36 thru 37	Titanium Alloys	6Al-4V, 5Al-5Mo-5V-3Cr	85-200					-	1	
H	38 thru 39	Hardened Steel >48	A2, O1, D2	130-250	.003-.005	1			2		No

Note: Feed and speed recommendations are starting operating parameters. They are only guidelines from which further optimization should take place. Operating parameters are influenced by many machining variables. These variables may cause for reductions in feeds and speed or dramatic increases. Additionally, DOC and WOC may need to be revised to optimize the tools performance.



DIPOSDUO™ 09 OPERATING GUIDELINES: HI-FEED

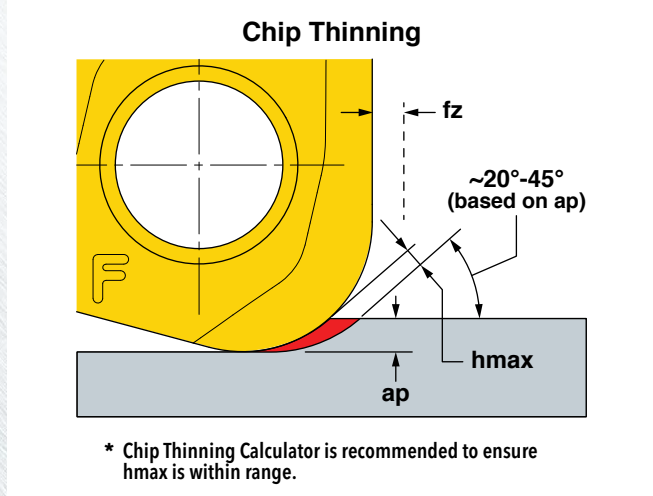

Materials				Vc Cutting Speed SFM	fz Feed/Tooth (inch)	ap Axial Depth of Cut (inch)	hmax* Chip Thickness Min. (inch)	Grade	Coolant
ISO	Mat'l Group #VDI 3323	Type	Examples					IN2505	
P	1 thru 5	Non-alloy Steel	1018, A36, 1045, A572, 1070	400-1000	.008-.025	.012-.031	.003-.010	1	No
	6 thru 9	Low-alloy Steel	4140, 4340, P20, 8620, 300M	350-700					
	10, 11	High-alloy Steel	H13, A2, D2, M2, T1	300-600					
M	12 thru 13	Stainless Steel (Ferritic & Martensitic)	410, 416, 440	350-600	.008-.020	.012-.031	.003-.008	1	Yes
	14	Stainless Steel (Austenitic)	303, 304, 316, 15-5, 17-4	300-550					May not be required at high speeds
K	15 thru 16	Gray Cast Iron	CLS. 20, 30, 45	500-1000	.008-.025	.012-.031	.003-.010	1	No
	17 thru 20	Nodular Cast Iron	60-40-18, 100-70-03	400-800					
S	31 thru 35	High-Temp Alloys	Inconel, Hastelloy, Nimonic, Monel	65-200	.008-.020	.012-.031	.003-.007	1	Yes
	36 thru 37	Titanium Alloys	6Al-4V, 5Al-5Mo-5V-3Cr	85-200					
H	38 thru 39	Hardened Steel >48	A2, O1, D2	130-250	.008-.015	.012-.025	.003-.006	1	No

Note: Feed and speed recommendations are starting operating parameters. They are only guidelines from which further optimization should take place. Operating parameters are influenced by many machining variables. These variables may cause for reductions in feeds and speed or dramatic increases. Additionally, DOC and WOC may need to be revised to optimize the tools performance.



DIPOSDUO™ 11 OPERATING GUIDELINES: 90°

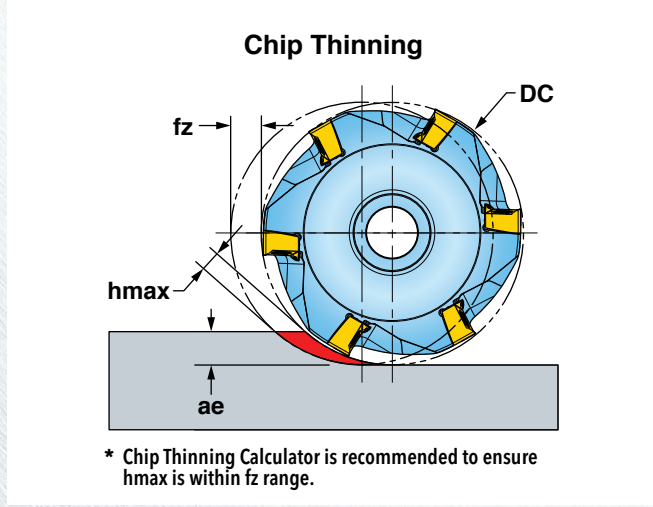

ISO	Materials			Vc Cutting Speed SFM	fz* Feed/Tooth (inch)	Harder Tougher		Coolant	
	Mat'l Group #VDI 3323	Type	Examples				IN2505		IN2530
P	1 thru 5	Non-alloy Steel	1018, A36, 1045, A572, 1070	400-1000	.003-.008			No	
	6 thru 9	Low-alloy Steel	4140, 4340, P20, 8620, 300M	350-700					
	10, 11	High-alloy Steel	H13, A2, D2, M2, T1	300-600					
M	12 thru 13	Stainless Steel (Ferritic & Martensitic)	410, 416, 440	350-600	.003-.007	2	1	Yes	
	14	Stainless Steel (Austenitic)	303, 304, 316, 15-5, 17-4	300-550				May not be required at high speeds	
K	15 thru 16	Gray Cast Iron	CLS. 20, 30, 45	500-1000	.003-.009	1	2	No	
	17 thru 20	Nodular Cast Iron	60-40-18, 100-70-03	400-800					
S	31 thru 35	High-Temp Alloys	Inconel, Hastelloy, Nimonic, Monel	65-150	.003-.006		1	2	Yes
	36 thru 37	Titanium Alloys	6Al-4V, 5Al-5Mo-5V-3Cr	85-200					
H	38 thru 39	Hardened Steel >48	A2, O1, D2	130-250	.003-.005		1		No

Note: Feed and speed recommendations are starting operating parameters. They are only guidelines from which further optimization should take place. Operating parameters are influenced by many machining variables. These variables may cause for reductions in feeds and speed or dramatic increases. Additionally, DOC and WOC may need to be revised to optimize the tools performance.



DIPOSDUO™ 11 OPERATING GUIDELINES: HI-FEED

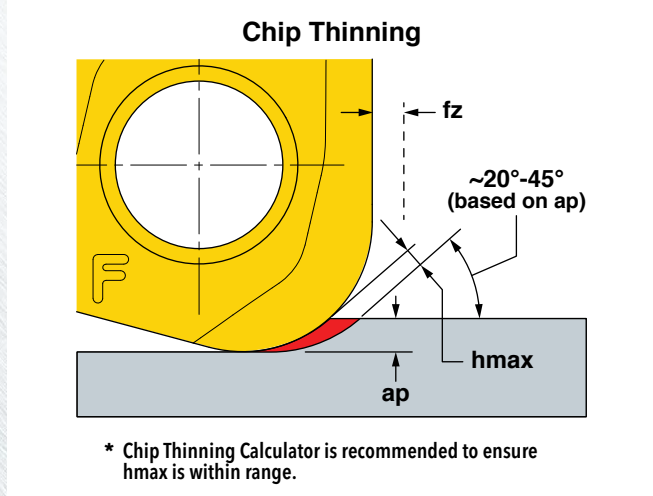

ISO	Materials			Vc Cutting Speed SFM	fz Feed/Tooth (inch)	ap Axial Depth of Cut (inch)	hmax* Chip Thickness Min. (inch)	Grade	Coolant
	Mat'l Group #VDI 3323	Type	Examples					IN2505	
P	1 thru 5	Non-alloy Steel	1018, A36, 1045, A572, 1070	400-1000	.012-.030	.012-.045	0.003-.012	1	No
	6 thru 9	Low-alloy Steel	4140, 4340, P20, 8620, 300M	350-700					
	10, 11	High-alloy Steel	H13, A2, D2, M2, T1	300-600					
M	12 thru 13	Stainless Steel (Ferritic & Martensitic)	410, 416, 440	350-600	.012-.025	.012-.045	0.003-.009	1	Yes
	14	Stainless Steel (Austenitic)	303, 304, 316, 15-5, 17-4	300-550					May not be required at high speeds
K	15 thru 16	Gray Cast Iron	CLS. 20, 30, 45	500-1000	.012-.030	.012-.045	0.003-.012	1	No
	17 thru 20	Nodular Cast Iron	60-40-18, 100-70-03	400-800					
S	31 thru 35	High-Temp Alloys	Inconel, Hastelloy, Nimonic, Monel	65-200	.012-.025	.012-.035	0.003-.008	1	Yes
	36 thru 37	Titanium Alloys	6Al-4V, 5Al-5Mo-5V-3Cr	85-200					
H	38 thru 39	Hardened Steel >48	A2, O1, D2	130-250	.012-.018	.012-.028	0.003-.006	1	No

Note: Feed and speed recommendations are starting operating parameters. They are only guidelines from which further optimization should take place. Operating parameters are influenced by many machining variables. These variables may cause for reductions in feeds and speed or dramatic increases. Additionally, DOC and WOC may need to be revised to optimize the tools performance.



DIPOSDUO™ 14 OPERATING GUIDELINES: 90°

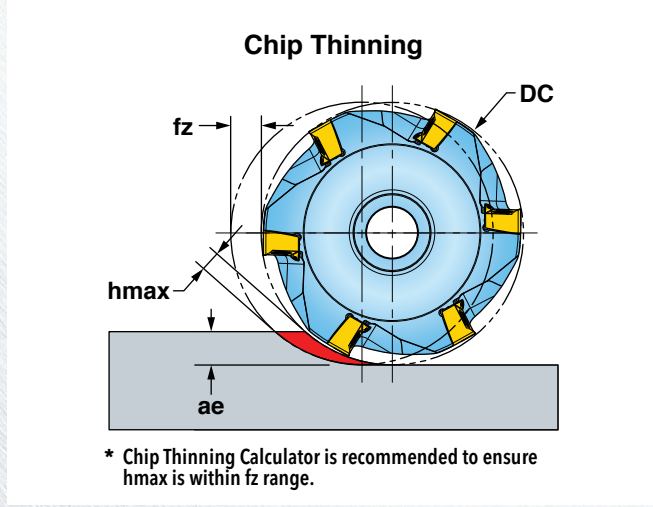

ISO	Materials			Vc Cutting Speed SFM	fz* Feed/Tooth (inch)	Harder Tougher			Coolant
	Mat'l Group #VDI 3323	Type	Examples			IN2510	IN2505	IN2530	
P	1 thru 5	Non-alloy Steel	1018, A36, 1045, A572, 1070	400-1000	.003-.008				No
	6 thru 9	Low-alloy Steel	4140, 4340, P20, 8620, 300M	350-700			2	1	
	10, 11	High-alloy Steel	H13, A2, D2, M2, T1	300-600					
M	12 thru 13	Stainless Steel (Ferritic & Martensitic)	410, 416, 440	350-600	.003-.007				Yes
	14	Stainless Steel (Austenitic)	303, 304, 316, 15-5, 17-4	300-550			2	1	May not be required at high speeds
K	15 thru 16	Gray Cast Iron	CLS. 20, 30, 45	500-1000	.003-.009				No
	17 thru 20	Nodular Cast Iron	60-40-18, 100-70-03	400-800		1	2		
S	31 thru 35	High-Temp Alloys	Inconel, Hastelloy, Nimonic, Monel	65-200	.003-.006			1	Yes
	36 thru 37	Titanium Alloys	6Al-4V, 5Al-5Mo-5V-3Cr	85-200			2	1	
H	38 thru 39	Hardened Steel >48	A2, O1, D2	130-250	.003-.005			1	No

Note: Feed and speed recommendations are starting operating parameters. They are only guidelines from which further optimization should take place. Operating parameters are influenced by many machining variables. These variables may cause for reductions in feeds and speed or dramatic increases. Additionally, DOC and WOC may need to be revised to optimize the tools performance.



DIPOSDUO™ 14 OPERATING GUIDELINES: HI-FEED

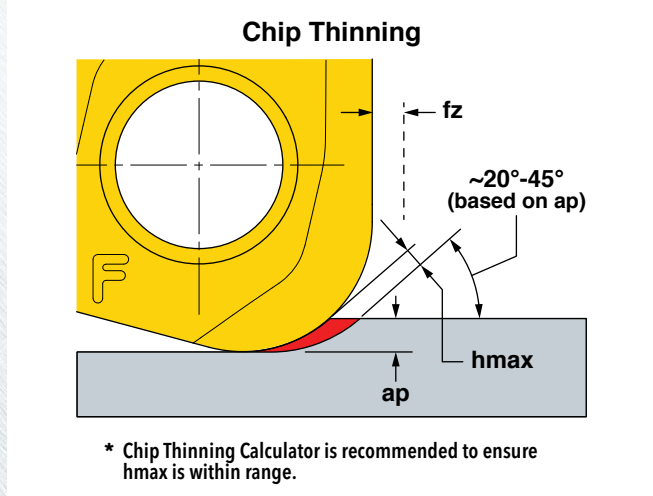

ISO	Materials			Vc Cutting Speed SFM	fz Feed/Tooth (inch)	ap Axial Depth of Cut (inch)	hmax* Chip Thickness Min. (inch)	Grade	Coolant
	Mat'l Group #VDI 3323	Type	Examples					IN2505	
P	1 thru 5	Non-alloy Steel	1018, A36, 1045, A572, 1070	400-1000	.012-.035	.012-.045	.003-.012	1	No
	6 thru 9	Low-alloy Steel	4140, 4340, P20, 8620, 300M	350-700					
	10, 11	High-alloy Steel	H13, A2, D2, M2, T1	300-600					
M	12 thru 13	Stainless Steel (Ferritic & Martensitic)	410, 416, 440	350-600	.012-.030	.012-.045	.003-.009	1	Yes
	14	Stainless Steel (Austenitic)	303, 304, 316, 15-5, 17-4	300-550					May not be required at high speeds
K	15 thru 16	Gray Cast Iron	CLS. 20, 30, 45	500-1000	.012-.035	.012-.045	.003-.012	1	No
	17 thru 20	Nodular Cast Iron	60-40-18, 100-70-03	400-800					
S	31 thru 35	High-Temp Alloys	Inconel, Hastelloy, Nimonic, Monel	65-200	.012-.025	.012-.035	.003-.008	1	Yes
	36 thru 37	Titanium Alloys	6Al-4V, 5Al-5Mo-5V-3Cr	85-200					
H	38 thru 39	Hardened Steel >48	A2, O1, D2	130-250	.012-.020	.012-.028	.003-.006	1	No

Note: Feed and speed recommendations are starting operating parameters. They are only guidelines from which further optimization should take place. Operating parameters are influenced by many machining variables. These variables may cause for reductions in feeds and speed or dramatic increases. Additionally, DOC and WOC may need to be revised to optimize the tools performance.



DIPOSDUO™ 04 RAMPING DATA USING MN_U04

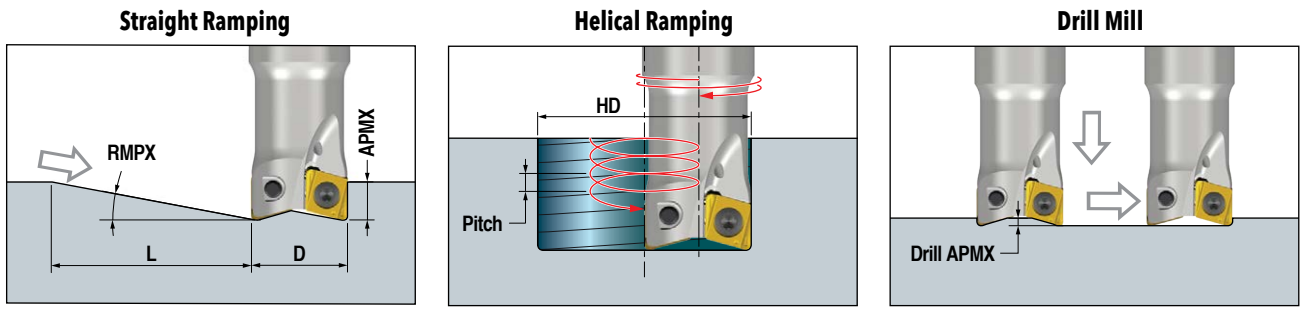

USING MN_U04 (R.008")

DC Cutter Diameter	Straight Ramp			Helical Ramp			Drill Mill
	RMPX Ramp Angle Max.	APMX Depth of Cut Max.	L Ramp Length Min.	HD Hole Dia. Min.	HD Hole Dia. Max.	Pitch Max.	Drill APMX Depth of Cut Max.
.500	5.1	0.13	1.4	0.76	1.00	0.062	0.027
						0.122	
.625	4.4	0.13	1.6	1.21	1.25	0.078	0.027
						0.118	
.750	3.3	0.13	2.2	1.26	1.50	0.082	0.023
						0.122	
.875	2.8	0.13	2.6	1.51	1.75	0.084	0.023
						0.119	
1.000	2.5	0.13	2.9	1.76	2.00	0.086	0.023
						0.114	
1.250	1.9	0.13	3.9	2.26	2.50	0.090	0.023
						0.110	
1.500	1.4	0.13	5.3	2.76	3.00	0.090	0.023
						0.106	

USING MN_U06 (R.015")

DC Cutter Diameter	Straight Ramp			Helical Ramp			Drill Mill
	RMPX Ramp Angle Max.	APMX Depth of Cut Max.	L Ramp Length Min.	HD Hole Dia. Min.	HD Hole Dia. Max.	Pitch Max.	Drill APMX Depth of Cut Max.
.500	4.7	0.13	1.5	0.76	1.00	0.059	0.023
						0.114	
.625	4.1	0.13	1.8	1.21	1.25	0.074	0.023
						0.122	
.750	3.1	0.13	2.4	1.26	1.50	0.078	0.019
						0.114	
.875	2.6	0.13	2.8	1.51	1.75	0.080	0.019
						0.110	
1.000	2.3	0.13	3.2	1.76	2.00	0.082	0.019
						0.106	
1.250	1.7	0.13	4.3	2.26	2.50	0.082	0.019
						0.102	
1.500	1.3	0.13	5.7	2.76	3.00	0.082	0.019
						0.098	



DIPOSDUO™ 04 RAMPING DATA USING MN_U04

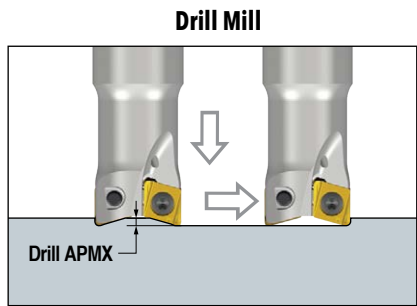
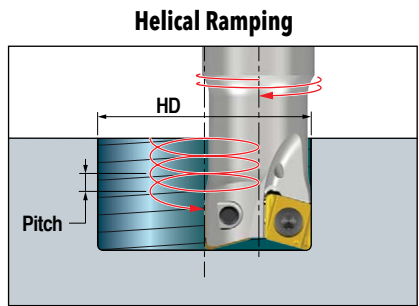
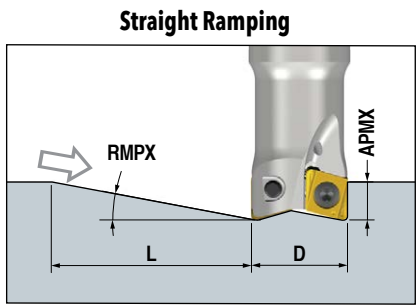

USING MN_U04 (R.031")

DC Cutter Diameter	Straight Ramp			Helical Ramp			Drill Mill
	RMPX Ramp Angle Max.	APMX Depth of Cut Max.	L Ramp Length Min.	HD Hole Dia. Min.	HD Hole Dia. Max.	Pitch Max.	Drill APMX Depth of Cut Max.
.500	3.9	0.13	1.9	0.76	1.00	0.051	0.015
						0.094	
.625	3.5	0.13	2.1	1.21	1.25	0.062	0.015
						0.102	
.750	2.6	0.13	2.8	1.26	1.50	0.066	0.012
						0.094	
.875	2.3	0.13	3.2	1.51	1.75	0.066	0.012
						0.092	
1.000	1.9	0.13	3.9	1.76	2.00	0.066	0.012
						0.090	
1.250	1.5	0.13	4.9	2.26	2.50	0.070	0.012
						0.085	
1.500	1.1	0.13	6.7	2.76	3.00	0.070	0.012
						0.082	

DIPOSDUO™ 04 RAMPING DATA USING UNHU04

Straight Ramping

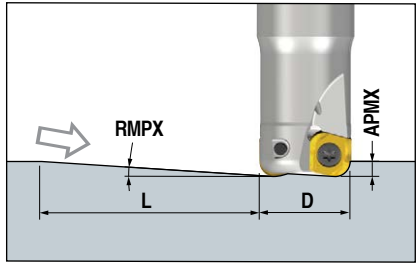

Helical Ramping

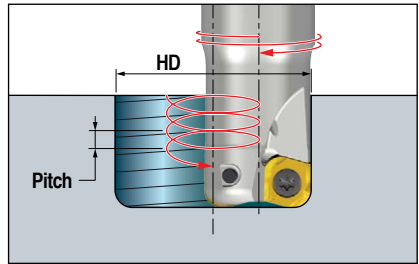

USING UNHU04 (HI-FEED)

DC Cutter Diameter	Straight Ramp			Helical Ramp		
	RMPX Ramp Angle Max.	APMX Depth of Cut Max.	L Ramp Length Min.	HD Hole Dia. Min.	HD Hole Dia. Max.	Pitch Max.
.500	2.0	0.019	0.5	0.76	1.00	0.019
						0.019
.625	1.9	0.019	0.6	1.21	1.25	0.019
						0.019
.750	2.2	0.019	0.5	1.26	1.50	0.019
						0.019
.875	2.0	0.019	0.4	1.51	1.75	0.019
						0.019
1.000	1.7	0.019	0.6	1.76	2.00	0.019
						0.019
1.250	1.3	0.019	0.9	2.26	2.50	0.019
						0.019
1.500	1.0	0.019	1.1	2.76	3.00	0.019
						0.019

DIPOSDUO™ 06 RAMPING DATA USING MN_U06

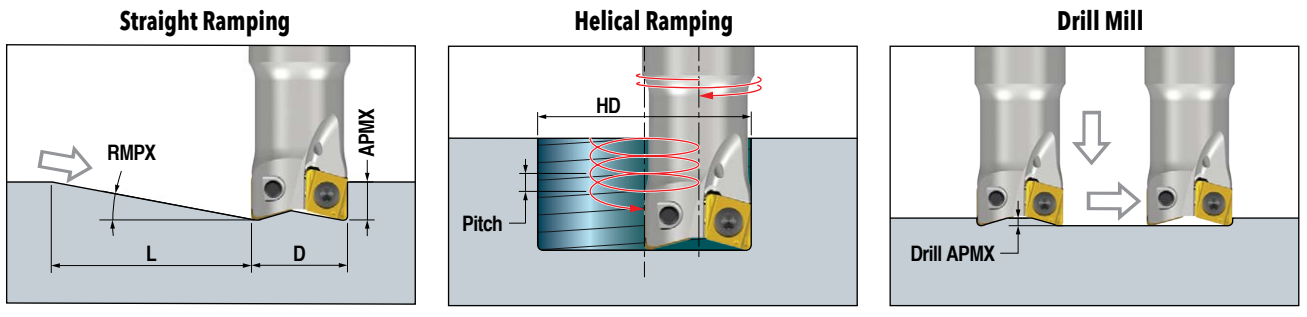

USING MN_U06 (R.015")

DC Cutter Diameter	Straight Ramp			Helical Ramp			Drill Mill
	RMPX Ramp Angle Max.	APMX Depth of Cut Max.	L Ramp Length Min.	HD Hole Dia. Min.	HD Hole Dia. Max.	Pitch Max.	Drill APMX Depth of Cut Max.
.625	2.9	0.24	4.7	0.84	1.25	0.027	0.015
						0.086	
.750	3.8	0.24	3.6	1.09	1.50	0.066	0.015
						0.137	
.875	4.0	0.24	3.4	1.34	1.75	0.078	0.015
						0.153	
1.000	3.8	0.24	3.6	1.59	2.00	0.106	0.015
						0.181	
1.250	2.8	0.24	4.9	2.09	2.50	0.110	0.015
						0.165	
1.500	2.3	0.24	5.9	2.59	3.00	0.114	0.015
						0.161	
2.000	1.6	0.24	8.5	3.59	4.00	0.118	0.015
						0.149	
2.500	1.2	0.24	11.4	4.59	5.00	0.122	0.015
						0.145	
3.000	0.8	0.24	17.0	5.59	6.00	0.128	0.015
						0.141	

DIPOSDUO™ 06 RAMPING DATA USING MN_U06

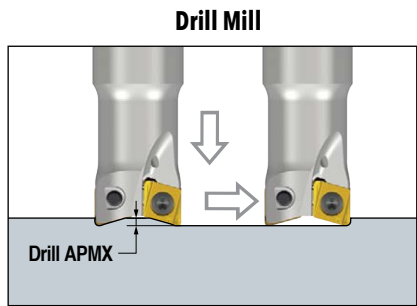
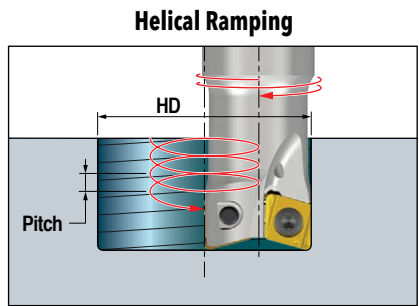
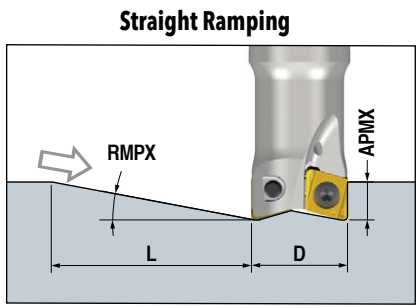

USING MN_U06 (R.031")

DC Cutter Diameter	Straight Ramp			Helical Ramp			Drill Mill
	RMPX Ramp Angle Max.	APMX Depth of Cut Max.	L Ramp Length Min.	HD Hole Dia. Min.	HD Hole Dia. Max.	Pitch Max.	Drill APMX Depth of Cut Max.
.625	2.9	0.24	4.7	0.84	1.25	0.027	0.015
						0.086	
.750	3.8	0.24	3.6	1.09	1.50	0.066	0.015
						0.137	
.875	4.0	0.24	3.4	1.34	1.75	0.078	0.015
						0.153	
1.000	4.1	0.24	3.6	1.59	2.00	0.106	0.015
						0.181	
1.250	2.8	0.24	4.9	2.09	2.50	0.110	0.015
						0.165	
1.500	2.3	0.24	5.9	2.59	3.00	0.114	0.015
						0.161	
2.000	1.6	0.24	8.5	3.59	4.00	0.118	0.015
						0.149	
2.500	1.2	0.24	11.4	4.59	5.00	0.122	0.015
						0.145	
3.000	0.8	0.24	17.0	5.59	6.00	0.128	0.015
						0.141	

DIPOSDUO™ 06 RAMPING DATA USING MN_U06

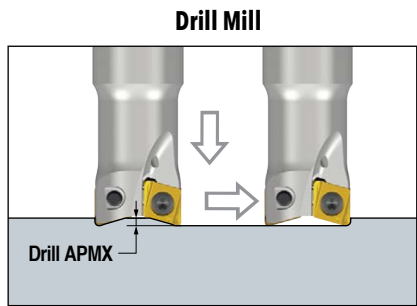
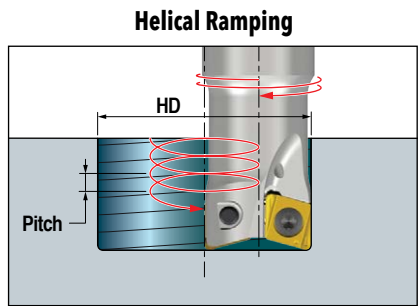
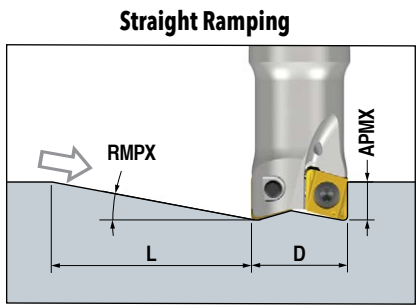

USING MN_U06 (R.039")

DC Cutter Diameter	Straight Ramp			Helical Ramp			Drill Mill
	RMPX Ramp Angle Max.	APMX Depth of Cut Max.	L Ramp Length Min.	HD Hole Dia. Min.	HD Hole Dia. Max.	Pitch Max.	Drill APMX Depth of Cut Max.
.625	2.7	0.24	5.0	0.84	1.25	0.027	0.017
						0.082	
.750	3.6	0.24	3.8	1.09	1.50	0.062	0.017
						0.133	
.875	3.8	0.24	3.6	1.34	1.75	0.074	0.017
						0.145	
1.000	4.4	0.24	3.1	1.59	2.00	0.118	0.017
						0.200	
1.250	3.1	0.24	4.4	2.09	2.50	0.122	0.017
						0.181	
1.500	2.5	0.24	5.4	2.59	3.00	0.125	0.017
						0.173	
2.000	1.8	0.24	7.6	3.59	4.00	0.129	0.017
						0.165	
2.500	1.4	0.24	9.8	4.59	5.00	0.133	0.017
						0.161	
3.000	0.9	0.24	15.2	5.59	6.00	0.139	0.017
						0.157	

DIPOSDUO™ 06 RAMPING DATA USING MN_U06

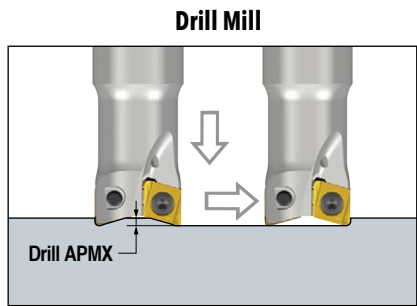
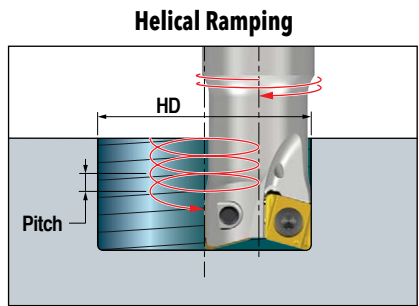
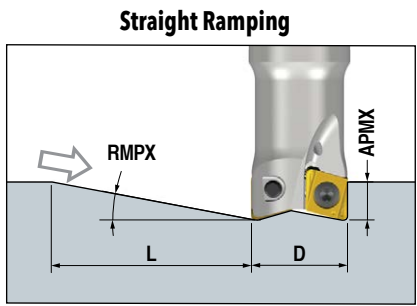

USING MN_U06 (R.047")

DC Cutter Diameter	Straight Ramp			Helical Ramp			Drill Mill
	RMPX Ramp Angle Max.	APMX Depth of Cut Max.	L Ramp Length Min.	HD Hole Dia. Min.	HD Hole Dia. Max.	Pitch Max.	Drill APMX Depth of Cut Max.
.625	3.0	0.24	4.5	0.84	1.25	0.031	0.015
						0.086	
.750	3.9	0.24	3.5	1.09	1.50	0.066	0.015
						0.141	
.875	4.1	0.24	3.3	1.34	1.75	0.078	0.015
						0.157	
1.000	4.2	0.24	3.2	1.59	2.00	0.110	0.015
						0.192	
1.250	2.9	0.24	4.7	2.09	2.50	0.114	0.015
						0.169	
1.500	2.3	0.24	5.9	2.59	3.00	0.118	0.015
						0.165	
2.000	1.7	0.24	8.0	3.59	4.00	0.122	0.015
						0.157	
2.500	1.3	0.24	10.5	4.59	5.00	0.125	0.015
						0.149	
3.000	0.9	0.24	15.2	5.59	6.00	0.129	0.015
						0.143	

DIPOSDUO™ 06 RAMPING DATA USING MN_U06

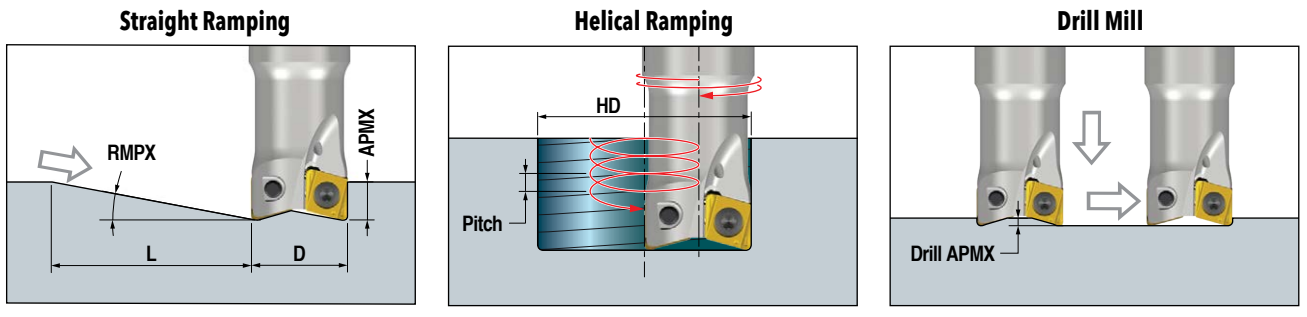

USING MN_U06 (R.062")

DC Cutter Diameter	Straight Ramp			Helical Ramp			Drill Mill
	RMPX Ramp Angle Max.	APMX Depth of Cut Max.	L Ramp Length Min.	HD Hole Dia. Min.	HD Hole Dia. Max.	Pitch Max.	Drill APMX Depth of Cut Max.
.625	2.2	0.24	6.2	0.84	1.25	0.023	0.008
						0.062	
.750	3.2	0.24	4.2	1.09	1.50	0.055	0.008
						0.118	
.875	3.4	0.24	4.0	1.34	1.75	0.066	0.008
						0.130	
1.000	3.4	0.24	4.0	1.59	2.00	0.098	0.008
						0.161	
1.250	2.5	0.24	5.4	2.09	2.50	0.102	0.008
						0.149	
1.500	2.0	0.24	6.8	2.59	3.00	0.102	0.008
						0.141	
2.000	1.5	0.24	9.1	3.59	4.00	0.110	0.008
						0.137	
2.500	1.1	0.24	12.4	4.59	5.00	0.110	0.008
						0.133	
3.000	0.5	0.24	28.6	5.59	6.00	0.112	0.008
						0.129	



DIPOSDUO™ 06 RAMPING DATA USING MN_U06

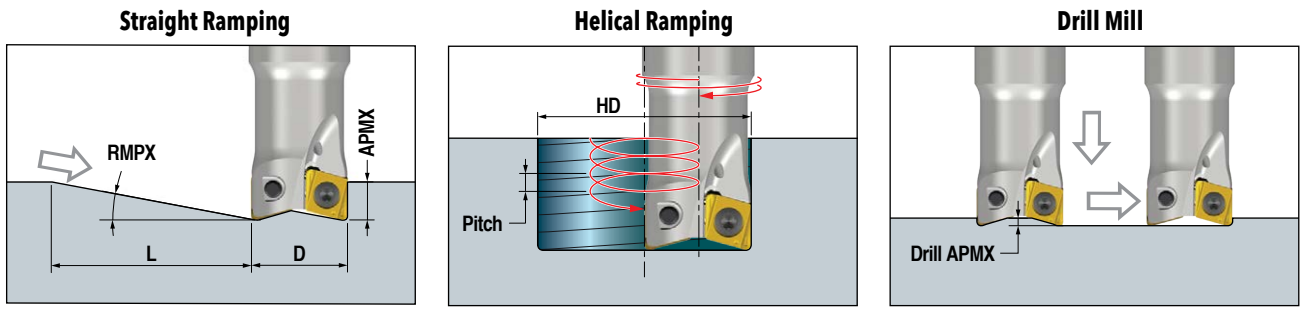

USING MN_U06 (R.079")

DC Cutter Diameter	Straight Ramp			Helical Ramp			Drill Mill
	RMPX Ramp Angle Max.	APMX Depth of Cut Max.	L Ramp Length Min.	HD Hole Dia. Min.	HD Hole Dia. Max.	Pitch Max.	Drill APMX Depth of Cut Max.
.625	0.8	0.24	17.1	0.84	1.25	0.007	0.003
						0.023	
.750	2.1	0.24	6.5	1.09	1.50	0.035	0.003
						0.078	
.875	2.3	0.24	5.9	1.34	1.75	0.043	0.003
						0.090	
1.000	3.2	0.24	4.2	1.59	2.00	0.086	0.003
						0.145	
1.250	2.2	0.24	6.2	2.09	2.50	0.090	0.003
						0.133	
1.500	1.8	0.24	7.6	2.59	3.00	0.090	0.003
						0.125	
2.000	1.3	0.24	10.5	3.59	4.00	0.094	0.003
						0.118	
2.500	1.0	0.24	13.7	4.59	5.00	0.094	0.003
						0.114	
3.000	0.4	0.24	34.3	5.59	6.00	0.096	0.003
						0.110	

DIPOSDUO™ 06 RAMPING DATA USING UNHU06

Straight Ramping

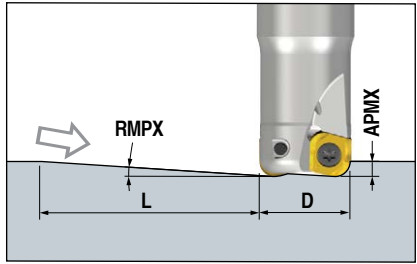

Helical Ramping

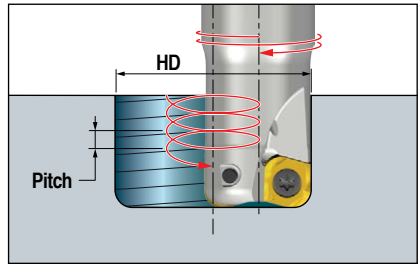

USING UNHU06 (HI-FEED)

DC Cutter Diameter	Straight Ramp			Helical Ramp		
	RMPX Ramp Angle Max.	APMX Depth of Cut Max.	L Ramp Length Min.	HD Hole Dia. Min.	HD Hole Dia. Max.	Pitch Max.
0.625	0.6	0.039	3.7	0.83		0.008
					1.25	0.019
0.750	1.7	0.039	1.3	1.08		0.027
					1.50	0.039
0.875	2.1	0.039	1.1	1.33		0.039
					1.75	0.039
1.000	2.3	0.039	1.0	1.58		0.039
					2.00	0.039
1.250	2.4	0.039	0.9	2.08		0.039
					2.50	0.039
1.500	1.8	0.039	1.2	2.58		0.039
					3.00	0.039
2.000	1.4	0.039	1.6	3.58		0.039
					4.00	0.039
2.500	1.1	0.039	2.0	4.58		0.039
					5.00	0.039
3.000	0.8	0.039	2.8	5.58		0.039
					6.00	0.039



DIPOSDUO™ 09 RAMPING DATA USING MN_U09

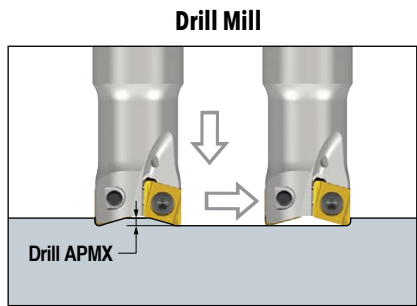
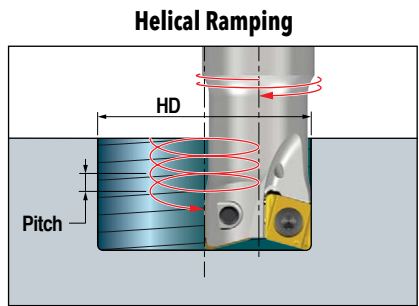
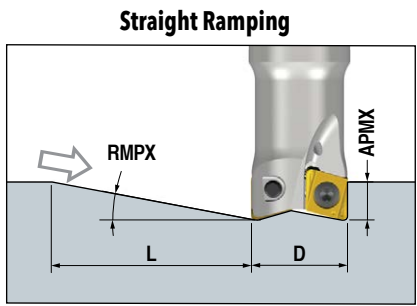

USING MN_U09 (R.015")

DC Cutter Diameter	Straight Ramp			Helical Ramp			Drill Mill
	RMPX Ramp Angle Max.	APMX Depth of Cut Max.	L Ramp Length Min.	HD Hole Dia. Min.	HD Hole Dia. Max.	Pitch Max.	Drill APMX Depth of Cut Max.
1.000	4.3	0.32	4.2	1.43	2.00	0.082 0.200	0.035
1.250	4.5	0.32	4.0	1.93	2.50	0.145 0.263	0.035
1.500	3.2	0.32	5.7	2.43	3.00	0.150 0.236	0.035
2.000	2.4	0.32	7.6	3.43	4.00	0.157 0.220	0.035
2.500	1.8	0.32	10.0	4.43	5.00	0.161 0.210	0.035
3.000	1.3	0.32	14.0	5.43	6.00	0.161 0.200	0.035
4.000	0.8	0.32	22.0	7.43	8.00	0.154 0.183	0.035

USING MN_U09 (R.031")

DC Cutter Diameter	Straight Ramp			Helical Ramp			Drill Mill
	RMPX Ramp Angle Max.	APMX Depth of Cut Max.	L Ramp Length Min.	HD Hole Dia. Min.	HD Hole Dia. Max.	Pitch Max.	Drill APMX Depth of Cut Max.
1.000	4.3	0.32	4.2	1.43	2.00	0.082 0.200	0.023
1.250	4.5	0.32	4.0	1.93	2.50	0.145 0.263	0.023
1.500	3.2	0.32	5.7	2.43	3.00	0.150 0.236	0.023
2.000	2.4	0.32	7.6	3.43	4.00	0.157 0.220	0.023
2.500	1.8	0.32	10.0	4.43	5.00	0.161 0.210	0.023
3.000	1.3	0.32	14.0	5.43	6.00	0.161 0.200	0.023
4.000	0.8	0.32	22.0	7.43	8.00	0.154 0.183	0.023



DIPOSDUO™ 09 RAMPING DATA USING MN_U09

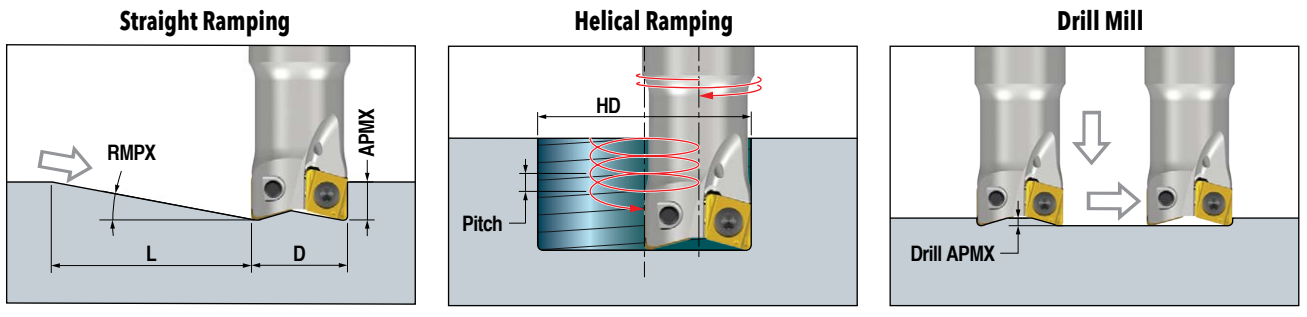

USING MN_U09 (R.062")

DC Cutter Diameter	Straight Ramp			Helical Ramp			Drill Mill
	RMPX Ramp Angle Max.	APMX Depth of Cut Max.	L Ramp Length Min.	HD Hole Dia. Min.	HD Hole Dia. Max.	Pitch Max.	Drill APMX Depth of Cut Max.
1.000	4.1	0.32	4.4	1.43	2.00	0.078	0.023
						0.180	
1.250	4.4	0.32	4.1	1.93	2.50	0.140	0.023
						0.260	
1.500	3.1	0.32	5.6	2.43	3.00	0.145	0.023
						0.228	
2.000	2.3	0.32	7.5	3.43	4.00	0.153	0.023
						0.216	
2.500	1.8	0.32	10.0	4.43	5.00	0.161	0.023
						0.208	
3.000	1.3	0.32	13.3	5.43	6.00	0.161	0.023
						0.196	
4.000	0.8	0.32	22.0	7.43	8.00	0.154	0.023
						0.183	

DIPOSDUO™ 09 RAMPING DATA USING UNHU09

Straight Ramping

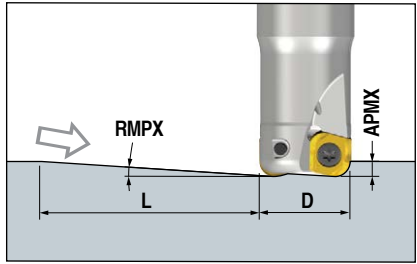

Helical Ramping

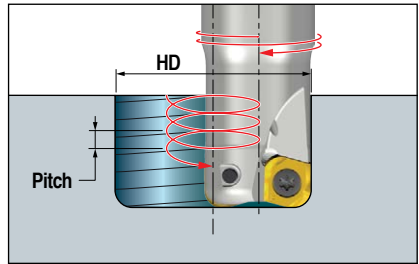

USING UNHU09 (HI-FEED)

DC Cutter Diameter	Straight Ramp			Helical Ramp		
	RMPX Ramp Angle Max.	APMX Depth of Cut Max.	L Ramp Length Min.	HD Hole Dia. Min.	HD Hole Dia. Max.	Pitch Max.
1.000	1.2	0.059	2.8	1.41		0.023
					2.00	0.059
1.250	2.4	0.059	1.4	1.91		0.059
					2.50	0.059
1.500	2.3	0.059	1.4	2.41		0.059
					3.00	0.059
2.000	1.7	0.059	1.9	3.41		0.059
					4.00	0.059
2.500	1.3	0.059	2.6	4.41		0.059
					5.00	0.059
3.000	1.0	0.059	3.3	5.41		0.059
					6.00	0.059
4.000	0.5	0.059	6.7	7.41		0.059
					8.00	0.059



DIPOSDUO™ 11 RAMPING DATA USING MN_U11

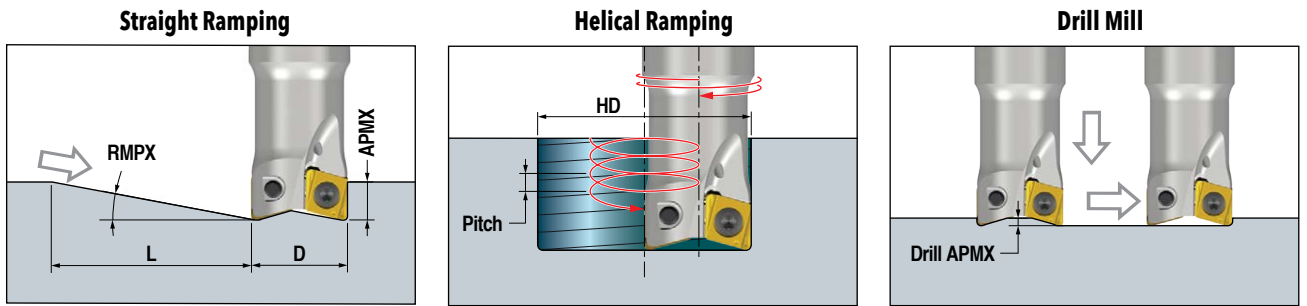

USING MN_U11 (R.031")

DC Cutter Diameter	Straight Ramp			Helical Ramp			Drill Mill
	RMPX Ramp Angle Max.	APMX Depth of Cut Max.	L Ramp Length Min.	HD Hole Dia. Min.	HD Hole Dia. Max.	Pitch Max.	Drill APMX Depth of Cut Max.
1.000	4.0	0.41	5.8	1.27	2.00	0.047 0.185	0.043
1.250	4.3	0.41	5.4	1.77	2.50	0.106 0.255	0.039
1.500	4.5	0.41	5.2	2.27	3.00	0.177 0.330	0.035
2.000	3.2	0.41	7.3	3.27	4.00	0.185 0.295	0.035
2.500	2.4	0.41	9.7	4.27	5.00	0.196 0.275	0.035
3.000	1.8	0.41	13.0	5.27	6.00	0.204 0.263	0.035
4.000	1.0	0.41	23.4	7.27	8.00	0.213 0.249	0.035

DIPOSDUO™ 11 RAMPING DATA USING UNHU11

Straight Ramping

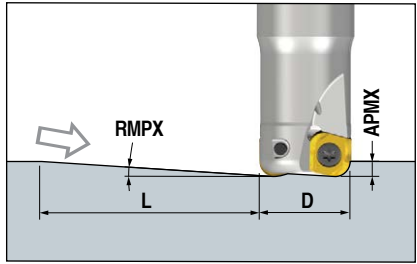

Helical Ramping

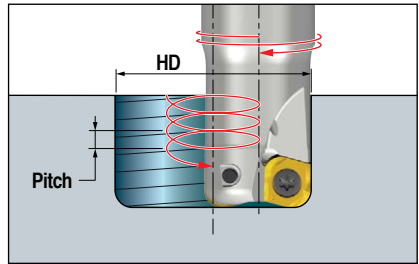

USING UNHU11 (HI-FEED)

DC Cutter Diameter	Straight Ramp			Helical Ramp		
	RMPX Ramp Angle Max.	APMX Depth of Cut Max.	L Ramp Length Min.	HD Hole Dia. Min.	HD Hole Dia. Max.	Pitch Max.
1.000	0.8	0.078	5.5	1.25		0.008
					2.00	0.035
1.250	2.0	0.078	2.2	1.75		0.047
					2.50	0.078
1.500	3.4	0.078	1.3	2.25		0.078
					3.00	0.078
2.000	2.4	0.078	1.8	3.25		0.078
					4.00	0.078
2.500	1.8	0.078	2.4	4.25		0.078
					5.00	0.078
3.000	1.3	0.078	3.4	5.25		0.078
					6.00	0.078
4.000	0.6	0.078	7.4	7.25		0.078
					8.00	0.078



DIPOSDUO™ 14 RAMPING DATA USING MN_U14

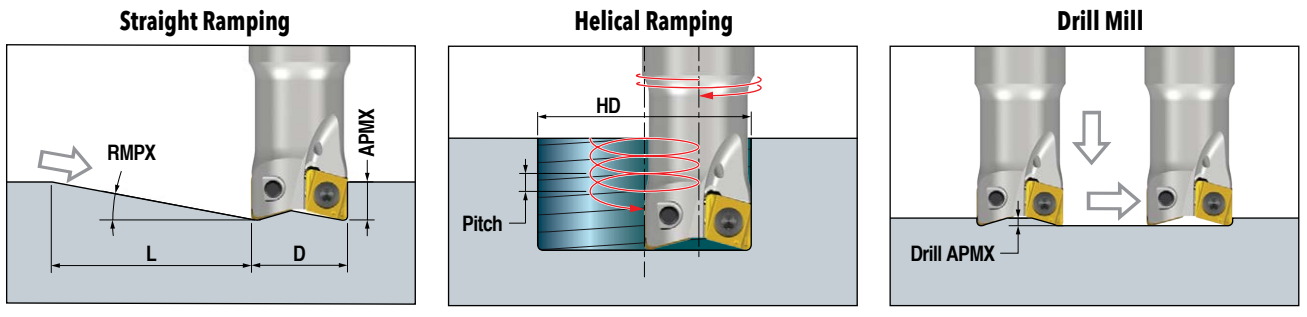

USING MN_U14 (R.031")

DC Cutter Diameter	Straight Ramp			Helical Ramp			Drill Mill
	RMPX Ramp Angle Max.	APMX Depth of Cut Max.	L Ramp Length Min.	HD Hole Dia. Min.	HD Hole Dia. Max.	Pitch Max.	Drill APMX Depth of Cut Max.
1.250	4.1	0.54	7.5	1.54		0.055	0.043
					2.50	0.240	
1.500	4.3	0.54	7.1	2.04		0.122	0.035
					3.00	0.314	
2.000	4.7	0.54	6.5	3.04		0.224	0.035
					4.00	0.437	
2.500	3.5	0.54	8.8	4.04		0.248	0.035
					5.00	0.405	
3.000	2.6	0.54	11.8	5.04		0.263	0.035
					6.00	0.381	
4.000	1.4	0.54	22.0	7.04		0.278	0.035
					8.00	0.347	



DIPOSDUO™ 14 RAMPING DATA USING UNHU14

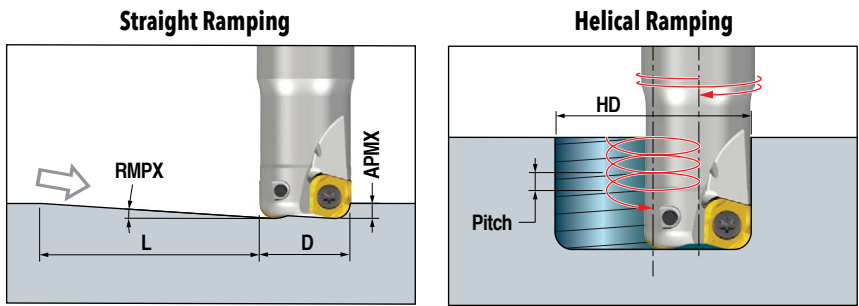

USING UNHU14 (HI-FEED)

DC Cutter Diameter	Straight Ramp			Helical Ramp		
	RMPX Ramp Angle Max.	APMX Depth of Cut Max.	L Ramp Length Min.	HD Hole Dia. Min.	HD Hole Dia. Max.	Pitch Max.
1.250	1.0	0.118	6.7	1.52		0.011
					2.50	0.059
1.500	1.8	0.118	3.7	2.02		0.051
					3.00	0.118
2.000	3.9	0.118	1.7	3.02		0.118
					4.00	0.118
2.500	2.7	0.118	2.5	4.02		0.118
					5.00	0.118
3.000	1.9	0.118	3.5	5.02		0.118
					6.00	0.118
4.000	0.7	0.118	9.6	7.02		0.118
					8.00	0.118

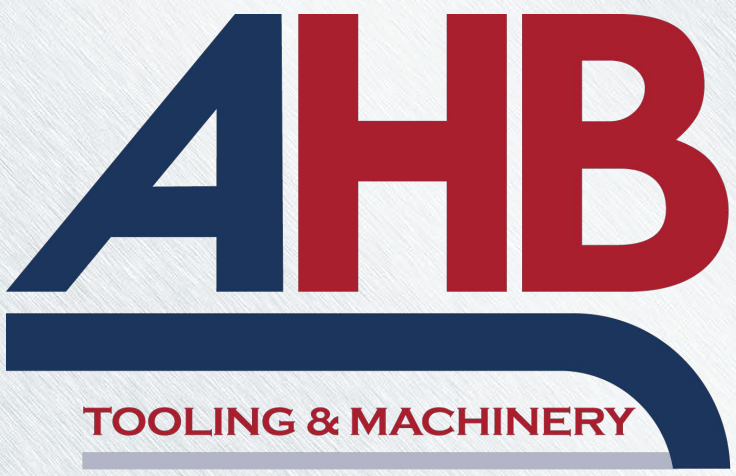

COMPLETE METALWORKING SOLUTIONS

(800) 991-4225

www.ahbinc.com

ISO Certified

customerservice@ahbinc.com