

DIPOSHEXA™

MILLING PRODUCTS

Cutter Series (Depth of Cut):

HN5D / HN6D (.11)

HN5G / HN6G (.20)

Insert Series:

HNGU06

HNGU10

Diameter Range:

1.50" - 10.00"

Lead Angle:

45°

Materials:

Cast Iron, Steel, Stainless Steel,
High-Temp Alloys, & Titanium

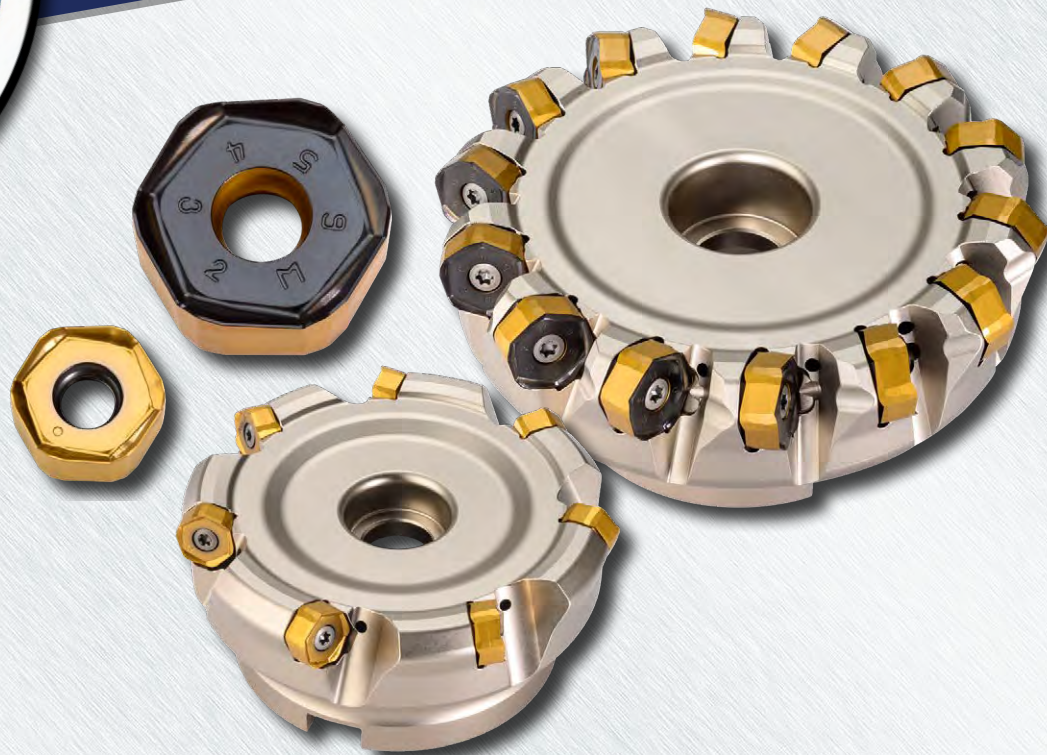

Robust 45° Face Mill with 12-Edge Economy

Ingersoll's new DiPosHexa 45° Face Mill line is designed to improve productivity in heavy machining and roughing applications. 2-Side-Technology is utilized to produce economical 12-Corner inserts that blend edge strength with an aggressive rake face for efficient chip formation and evacuation. Face pressure and heat generation is minimized with the insert's short integrated wiper length contact and the cutter's concave face design.

Features & Benefits:

- Reinforced cutting edge boasts high feed rate potential
- High radial pocket incline promotes utmost chip evacuation and fine pitch cutter design for maximized productivity
- Helical cutting edges promote smooth machining
- Unequally spaced insert placement aids to diffuse vibration
- Integrated wiper flats produce 32-63 Ra surface finishes
- Ideal for steels and iron!



COMPLETE METALWORKING SOLUTIONS

(800) 991-4225

www.ahbinc.com

ISO Certified

customerservice@ahbinc.com

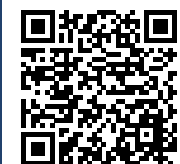

FEATURES

High incline pocket design

- Produces tightly curled chips
- Directs chips out efficiently
- Accommodates fine pitch designs

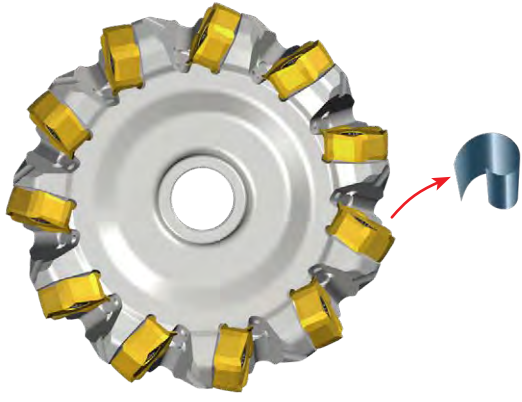

Unequal insert spacing minimizes vibration

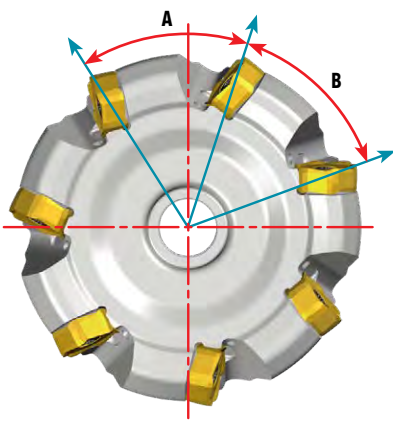

Integrated wiper flats produce 32-63 Ra surface finishes

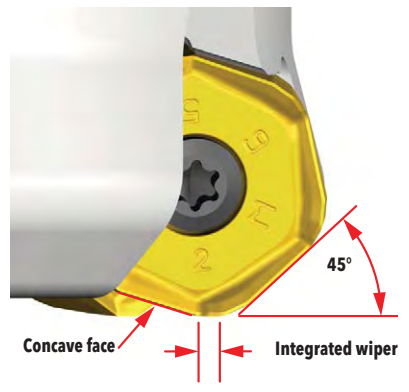



DIPOSHEXA™ 06 SERIES HN5D, HN6D

45° FACE MILL (6MM INSERT)

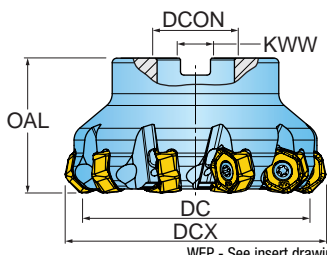
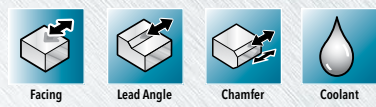

WEP - See insert drawing for wiper options.

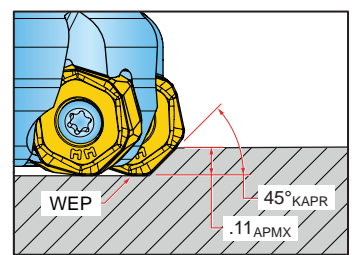

Part Number	DC Cutting Dia.	DCX Cutting Diameter Max.	OAL Overall Length	ZEFF Eff. Teeth	DCON Shank Dia.	KWW Keyway	CSP Coolant
HN6D-15R01	1.500	1.88	1.750	4	0.500	0.250	Yes
HN5D-20R01	2.000	2.38	1.750	6	0.750	0.312	Yes
HN6D-20R01	2.000	2.38	1.750	4	0.750	0.312	Yes
HN5D-25R01	2.500	2.89	1.750	7	1.000	0.375	Yes
HN6D-25R01	2.500	2.89	1.750	5	1.000	0.375	Yes
HN5D-30R01	3.000	3.39	1.750	10	1.000	0.375	Yes
HN6D-30R01	3.000	3.39	1.750	6	1.000	0.375	Yes
HN5D-40R01	4.000	4.39	2.375	12	1.500	0.625	Yes
HN6D-40R01	4.000	4.39	2.375	7	1.500	0.625	Yes
HN5D-50R01	5.000	5.39	2.375	16	1.500	0.625	Yes
HN6D-50R01	5.000	5.39	2.375	10	1.500	0.625	Yes
HN5D-60R01	6.000	6.39	2.375	20	1.500	0.625	No
HN6D-60R01	6.000	6.39	2.375	12	1.500	0.625	No

DIPOSHEXA™ 06 INSERTS

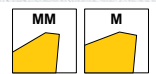

HNGU06_M

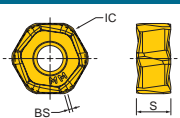

HNGU06_MM

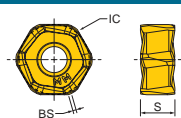

Part Number	Application	BS Wiper Length	IC Inscribed Circle Dia.	S Thickness	NOI Number of Indexes	IH Insert Hand	Grade	IN2505	IN2510	IN6537
HNGU0605ANTR-M	Medium Roughing	0.023	0.551	0.264	12	Right		•		•
HNGU0605ANTR-MM	Medium, Pos. Rake Angle	0.047	0.551	0.264	12	Right		•	•	



DIPOSHEXA™ 10 SERIES HN5G, HN6G

45° FACE MILL (10MM INSERT)

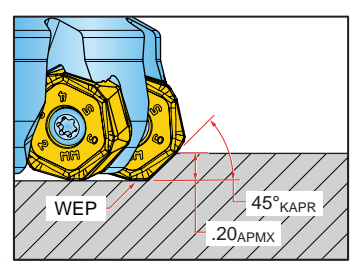
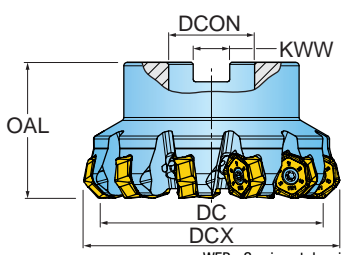
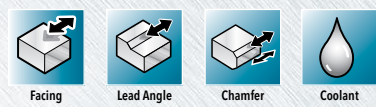

WEP - See insert drawing for wiper options.

Part Number	DC Cutting Dia.	DCX Cutting Diameter Max.	OAL Overall Length	ZEFF Eff. Teeth	DCON Shank Dia.	KWW Keyway	DBC Bolt Circle	CSP Coolant
HN5G-25R01	2.500	3.03	1.750	7	1.000	0.375	-	Yes
HN6G-25R01	2.500	3.03	1.750	5	1.000	0.375	-	Yes
HN5G-30R01	3.000	3.53	1.750	9	1.000	0.375	-	Yes
HN6G-30R01	3.000	3.53	1.750	6	1.000	0.375	-	Yes
HN5G-40R01	4.000	4.53	2.375	11	1.500	0.625	-	Yes
HN6G-40R01	4.000	4.53	2.375	7	1.500	0.625	-	Yes
HN5G-50R01	5.000	5.52	2.375	14	1.500	0.625	-	Yes
HN6G-50R01	5.000	5.52	2.375	8	1.500	0.625	-	Yes
HN5G-60R01	6.000	6.52	2.375	16	1.500	0.625	-	No
HN6G-60R01	6.000	6.52	2.375	10	1.500	0.625	-	No
HN5G-80R01	8.000	8.52	2.375	21	2.500	1.000	4.00"	No
HN6G-80R01	8.000	8.52	2.375	14	2.500	1.000	4.00"	No
HN5G-10R01	10.000	10.53	2.375	26	2.500	1.000	4.00"	No
HN6G-10R01	10.000	10.53	2.375	16	2.500	1.000	4.00"	No



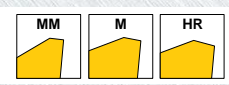





DIPOSHEXA™ 10 INSERTS



HNGU10_M		HNGU10_MM			HNGU10_HR						
Part Number	Application	BS Wiper Length	IC Inscribed Circle Dia.	S Thickness	NOI Number of Indexes	IH Insert Hand	Grade	IN2505	IN2510	IN6515	IN6537
HNGU1007ANTR-M	Medium Roughing	0.039	0.752	0.327	12	Right		•			•
HNGU1007ANTR-MM	Medium, Pos. Rake Angle	0.063	0.752	0.327	12	Right			•		
HNGU1007ANTR-HR	Heavy-Duty	0.039	0.752	0.327	12	Right				•	•



DIPOSHEXA™ 06/10 HARDWARE

								
	Screw	Driver Handle	Torx Driver Blade	Retention Bolt	**OPTIONAL** Coolant Retention Bolt	**OPTIONAL** Torque Driver Handle	**OPTIONAL** Torque Driver Bit	**OPTIONAL** Preset Torque Bit
HN6D-15R01	SM40-100-R0	DS-A00T	DS-T156B1	SD-04-48	-	DS-A00-.25-T	DS-T15B1	DT-35-.25
HN5D-20R01	SM40-100-R0	DS-A00T	DS-T156B1	SD-06-47	SD-06-A6	DS-A00-.25-T	DS-T15B1	DT-35-.25
HN6D-20R01	SM40-100-R0	DS-A00T	DS-T156B	SD-06-47	SD-06-A6	DS-A00-.25-T	DS-T15B1	DT-35-.25
HN5D-25R01	SM40-100-R0	DS-A00T	DS-T156B	SD-08-47	SD08-C9	DS-A00-.25-T	DS-T15B1	DT-35-.25
HN6D-25R01	SM40-100-R0	DS-A00T	DS-T156B	SD-08-47	SD08-C9	DS-A00-.25-T	DS-T15B1	DT-35-.25
HN5D-30R01	SM40-100-R0	DS-A00T	DS-T156B	SD-08-47	SD08-C9	DS-A00-.25-T	DS-T15B1	DT-35-.25
HN6D-30R01	SM40-100-R0	DS-A00T	DS-T156B	SD-08-47	SD08-C9	DS-A00-.25-T	DS-T15B1	DT-35-.25
HN5D-40R01	SM40-100-R0	DS-A00T	DS-T156B	SD-12-82	SD-12-99	DS-A00-.25-T	DS-T15B1	DT-35-.25
HN6D-40R01	SM40-100-R0	DS-A00T	DS-T156B	SD-12-82	SD-12-99	DS-A00-.25-T	DS-T15B1	DT-35-.25
HN5D-50R01	SM40-100-R0	DS-A00T	DS-T156B	SD-12-82	SD-12-99	DS-A00-.25-T	DS-T15B1	DT-35-.25
HN6D-50R01	SM40-100-R0	DS-A00T	DS-T156B	SD-12-82	SD-12-99	DS-A00-.25-T	DS-T15B1	DT-35-.25
HN5D-60R01	SM40-100-R0	DS-A00T	DS-T156B	SD-12-82	-	DS-A00-.25-T	DS-T15B1	DT-35-.25
HN6D-60R01	SM40-100-R0	DS-A00T	DS-T156B	SD-12-82	-	DS-A00-.25-T	DS-T15B1	DT-35-.25
HN5G-25R01	SM50-130-R0	DS-A00T	DS-T206B	SD-08-47	SD08-C9	DS-A00-.25-T	DS-T20B1	DT-44-.25
HN6G-25R01	SM50-130-R0	DS-A00T	DS-T206B	SD-08-47	SD08-C9	DS-A00-.25-T	DS-T20B1	DT-44-.25
HN5G-30R01	SM50-130-R0	DS-A00T	DS-T206B	SD-08-47	SD08-C9	DS-A00-.25-T	DS-T20B1	DT-44-.25
HN6G-30R01	SM50-130-R0	DS-A00T	DS-T206B	SD-08-47	SD08-C9	DS-A00-.25-T	DS-T20B1	DT-44-.25
HN5G-40R01	SM50-130-R0	DS-A00T	DS-T206B	SD-12-89	SD-12-99	DS-A00-.25-T	DS-T20B1	DT-44-.25
HN6G-40R01	SM50-130-R0	DS-A00T	DS-T206B	SD-12-89	SD-12-99	DS-A00-.25-T	DS-T20B1	DT-44-.25
HN5G-50R01	SM50-130-R0	DS-A00T	DS-T206B	SD-12-89	SD-12-99	DS-A00-.25-T	DS-T20B1	DT-44-.25
HN6G-50R01	SM50-130-R0	DS-A00T	DS-T206B	SD-12-89	SD-12-99	DS-A00-.25-T	DS-T20B1	DT-44-.25
HN5G-60R01	SM50-130-R0	DS-A00T	DS-T206B	SD-12-89	SD-12-99	DS-A00-.25-T	DS-T20B1	DT-44-.25
HN6G-60R01	SM50-130-R0	DS-A00T	DS-T206B	SD-12-89	SD-12-99	DS-A00-.25-T	DS-T20B1	DT-44-.25
HN5G-80R01	SM50-130-R0	DS-A00T	DS-T206B	-	-	DS-A00-.25-T	DS-T20B1	DT-44-.25
HN6G-80R01	SM50-130-R0	DS-A00T	DS-T206B	-	-	DS-A00-.25-T	DS-T20B1	DT-44-.25
HN5G-10R01	SM50-130-R0	DS-A00T	DS-T206B	-	-	DS-A00-.25-T	DS-T20B1	DT-44-.25
HN6G-10R01	SM50-130-R0	DS-A00T	DS-T206B	-	-	DS-A00-.25-T	DS-T20B1	DT-44-.25



DIPOSHEXA™ 06 OPERATING GUIDELINES

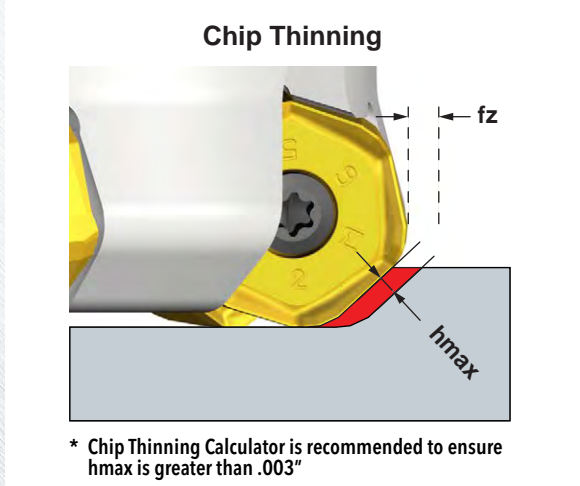

Materials				Vc Cutting Speed SFM	fz* Feed/Tooth (inch)	Harder Tougher			Coolant
ISO	Mat'l Group #VDI 3323	Type	Examples			IN2510	IN2505	IN6537	
P	1 thru 5	Non-alloy Steel	1018, A36, 1045, A572, 1070	400-1000	.005-.012		2	1	No
	6 thru 9	Low-alloy Steel	4140, 4340, P20, 8620, 300M	350-700					
	10, 11	High-alloy Steel	H13, A2, D2, M2, T1	300-600					
M	12 thru 13	Stainless Steel (Fer- ritic & Martensitic)	410, 416, 440	350-600	.005-.010		1	2	Yes
	14	Stainless Steel (Austenitic)	303, 304, 316, 15-5, 17-4	300-550					May not be required at high speeds
K	15 thru 16	Gray Cast Iron	CLS. 20, 30, 45	500-1000	.005-.013	1	2		No
	17 thru 20	Nodular Cast Iron	60-40-18, 100-70-03	400-800					
S	31 thru 35	High-Temp Alloys	Inconel, Hastelloy, Nimonic, Monel	65-120	.005-.010		1		Yes
	36 thru 37	Titanium Alloys	6Al-4V, 5Al-5Mo-5V-3Cr	85-130					

Note: Feed and speed recommendations are starting operating parameters. They are only guidelines from which further optimization should take place. Operating parameters are influenced by many machining variables. These variables may cause for reductions in feeds and speed or dramatic increases. Additionally, DOC and WOC may need to be revised to optimize the tools performance.



DIPOSHEXA™ 10 OPERATING GUIDELINES

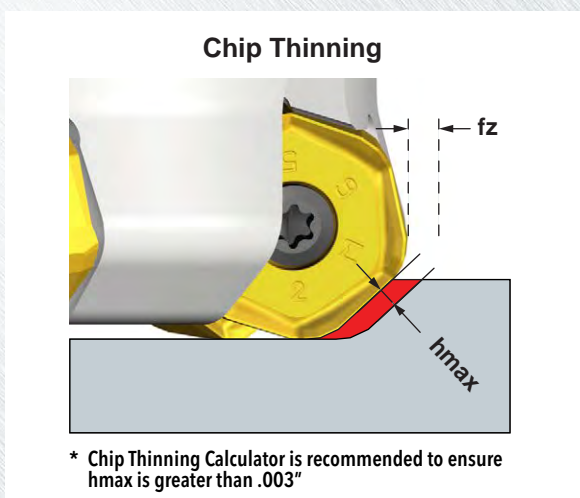

ISO	Materials			Vc Cutting Speed SFM	fz* Feed/Tooth (inch)	Harder Tougher				Coolant
	Mat'l Group #VDI 3323	Type	Examples			IN2510	IN6515	IN2505	IN6537	
P	1 thru 5	Non-alloy Steel	1018, A36, 1045, A572, 1070	400-1000	.005-.018					No
	6 thru 9	Low-alloy Steel	4140, 4340, P20, 8620, 300M	350-700				2	1	
	10, 11	High-alloy Steel	H13, A2, D2, M2, T1	300-600						
M	12 thru 13	Stainless Steel (Fer- ritic & Martensitic)	410, 416, 440	350-600	.005-.012			1	2	Yes
	14	Stainless Steel (Austenitic)	303, 304, 316, 15-5, 17-4	300-550						May not be required at high speeds
K	15 thru 16	Gray Cast Iron	CLS. 20, 30, 45	500-1000	.005-.020	1	2	3		No
	17 thru 20	Nodular Cast Iron	60-40-18, 100-70-03	400-800		2	1	3		
S	31 thru 35	High-Temp Alloys	Inconel, Hastelloy, Nimonic, Monel	65-120	.005-.012				1	Yes
	36 thru 37	Titanium Alloys	6Al-4V, 5Al-5Mo-5V-3Cr	85-130						

Note: Feed and speed recommendations are starting operating parameters. They are only guidelines from which further optimization should take place. Operating parameters are influenced by many machining variables. These variables may cause for reductions in feeds and speed or dramatic increases. Additionally, DOC and WOC may need to be revised to optimize the tools performance.



**COMPLETE
METALWORKING
SOLUTIONS**

(800) 991-4225
www.ahbinc.com
ISO Certified
customerservice@ahbinc.com