



Prices:

- **20–25%** less than comparable 1/2" IC Insert

Insert Selection:

- CNMG / DNMG / SNMG / TNMG
- 12 Grades for all Material Types
- 10 Unique Chipbreakers & Flat Top
- Coated Carbide and Uncoated Cermet

Holder Selection:

- 12 External Holder Styles (3/4" to 1" shanks)
- 6 Boring Bar Styles (5/8" to 1-1/4" shanks)
- 5 Quick Change Styles (C4)

Application Information:

- Cutting Depth Range: .005" - .177"
- Feed Rate Range: .002 - .028 ipr



Gold•Rhino™ ISO Turning Inserts

Ingersoll is pleased to launch Gold-Rhino, a series of robust smaller ISO turning inserts to meet the manufacturing industry's need to reduce machining costs and increase competitiveness.

Smaller inserts are nothing new in the ISO turning world. The difference is that Gold-Rhino inserts retain the same or similar thickness of larger IC inserts. The result is a strong, compact insert with the durability of a larger insert. When combined with a new, multi-directional clamping system in the holder and insert screw hole, these inserts provide very stable, rigid clamping, making them an ideal option even in interrupted cuts. The result is excellent performance at a price 20%-25% lower than comparable 1/2" IC inserts.

Gold-Rhino inserts feature 10 chip breakers in CNMG, DNMG, SNMG and TNMG shapes, and are available in 12 grades. This comprehensive offering of geometries and grades provides many options to improve chip-breaking, extend tool life and provide immediate cost savings in all materials.



GOLD RHINO™

SAME PERFORMANCE AT **20-25% LOWER PRICE!**

SMALL inserts with superior durability and the **SAME THICKNESS** as ISO inserts

ISO TURN
(CNMG 12)

GOLD RHINO™



Actual size of insert

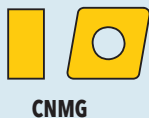

CNMG



DNMG



SNMG



TNMG

Current trends in manufacturing feature work piece components with reduced stock conditions due to improved casting and forging technology. In these cases, depths of cut in rough turning are predominantly in the range of .040"~.080" per side, rendering conventional ISO turning inserts with .500" long cutting edges inefficient due to their disproportionate size.

In the modern machining environment with high focus on cost reduction, Ingersoll is pleased to launch Gold-Rhino, a series of smaller, but robust, ISO turning inserts to meet the manufacturing industry's needs of reduced machining costs and increased competitiveness.

GOLD RHINO™

Excellent insert rigidity! Strong clamping holder!

“Next generation clamping system”

Conventional ISO clamping structure
Single directional clamping force

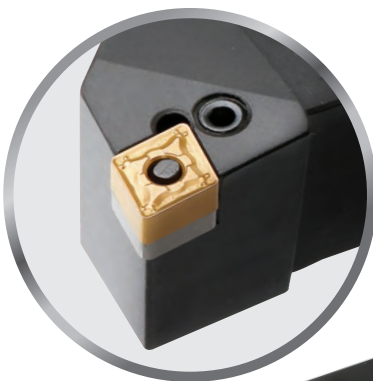
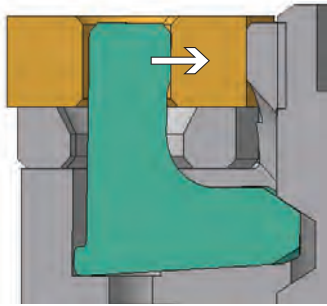

GOLD RHINO™ clamping structure
Multi-directional clamping forces

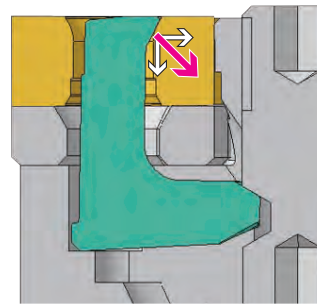

Features

- Exceptionally stable machining due to multi-directional clamping forces over the existing conventional ISO lever holder's single direction clamping force
- Excellent productivity and longer, stable tool life in high feed turning applications
- Optimal performance in interrupted cutting on weak/old machine set-ups

DETAILED PRODUCT MARKING

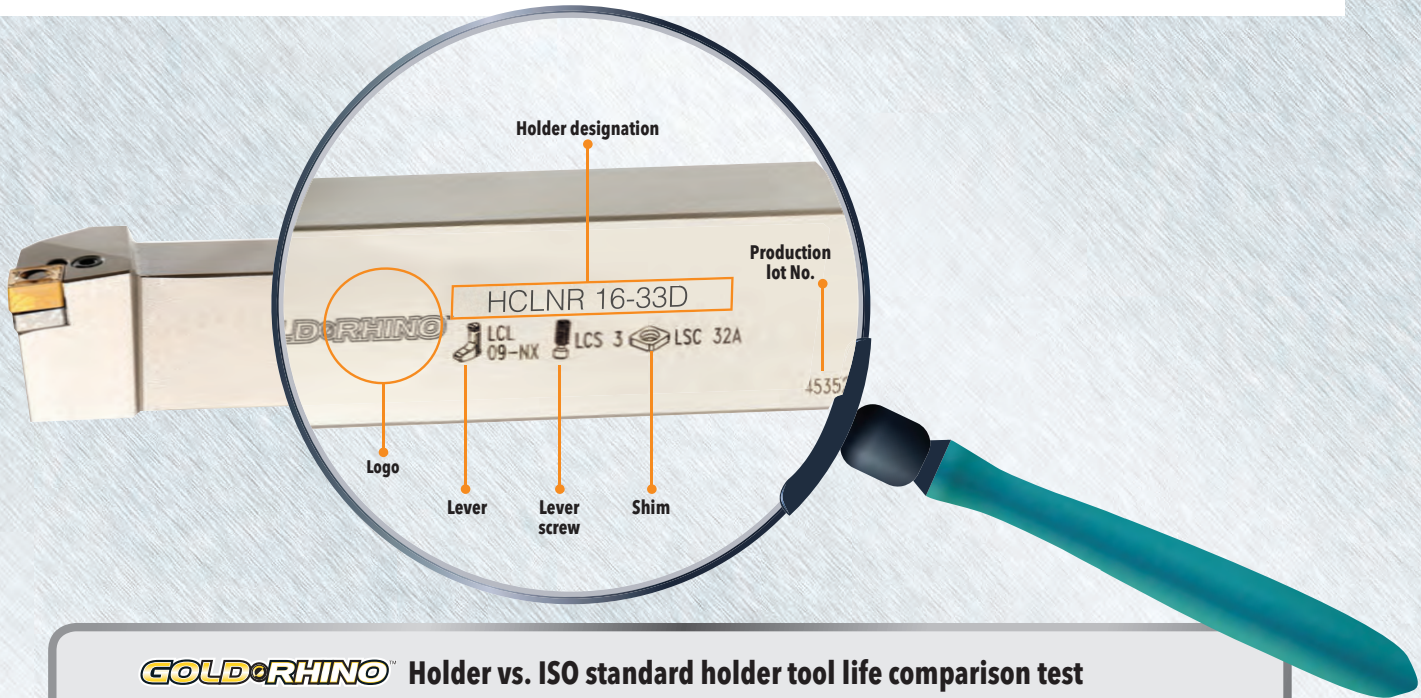

GOLD RHINO™ Holder vs. ISO standard holder tool life comparison test

Interrupted cut (Ingersoll tech center)

- Work piece: Medium carbon alloy steel
- Process: Interrupted facing
- Cutting condition: $V=330\text{sfm}$, $f=.024\text{ipr}$, $d=.160"$, Dry

Comparison test





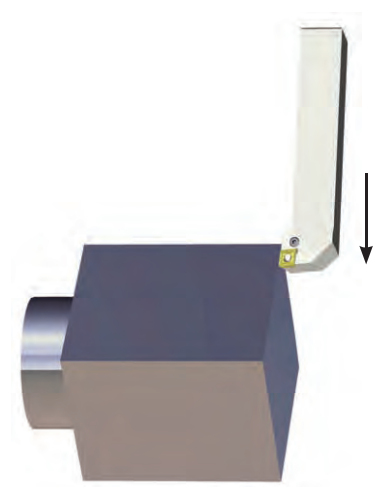
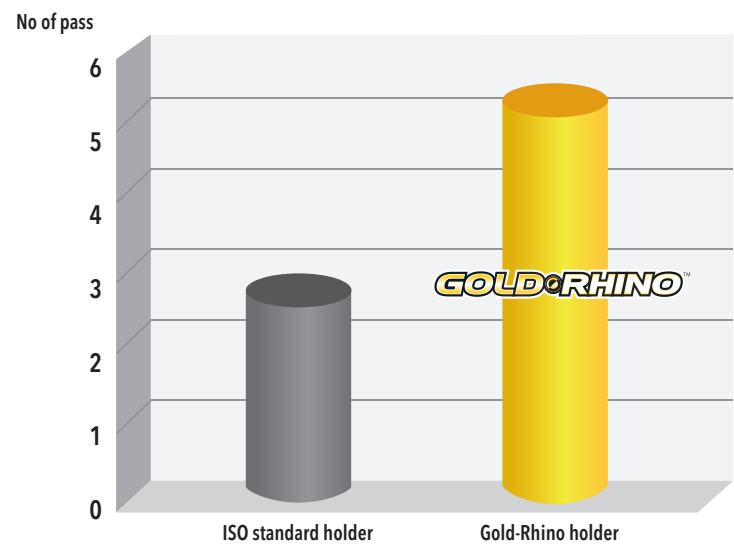



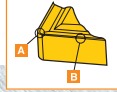



















- 1 CNMG 432 + PCLNR 2525 M12 holder (ISO standard holder)
 - 2 CNMG 332 + HCLNR 16-33D (Gold-Rhino holder)
- * Chip breaker & grade are the same

Insert life



CHIPBREAKERS



Chipbreaker		Range & Features	
FG		 	<ul style="list-style-type: none"> • For finishing and semi-finishing applications • For steel application • Low cutting forces
FM		 	<ul style="list-style-type: none"> • For steel machining • Solution for a wide range from semi-finishing to semi-medium machining
FT		 	<ul style="list-style-type: none"> • For steel machining • Strong, serrated cutting edge for excellent chip evacuation in wider depth of cut range for both profiling and step machining • Semi-finishing and medium machining • Excellent chip breaking for automotive components
PC		 	<ul style="list-style-type: none"> • For semi-finishing to medium applications • Ideal for Steel & Automotive components • Excellent chip control on medium applications
MT		 	<ul style="list-style-type: none"> • Suitable for continuous and interrupted cutting • For medium rough applications • Steel, cast iron and stainless steel • Tough rake angle for general use
EA		 	<ul style="list-style-type: none"> • For finishing applications • Exotic materials • Excellent chip control at low feeds and depths of cut
EM		 	<ul style="list-style-type: none"> • For medium applications • Stainless steel machining • Sharp land design for low cutting force
MM		 	<ul style="list-style-type: none"> • For general machining on stainless steel and steel • Positive rake angle provides excellent chip evacuation
MG-		 	<ul style="list-style-type: none"> • For medium rough applications • For general machining on cast iron • Strong rake geometry
TNGG			<ul style="list-style-type: none"> • Ground Insert • Suitable for general purpose machining • Lower cutting force and increased adhesion force • Improved dimension and finishing surface accuracy

CHIPBREAKERS

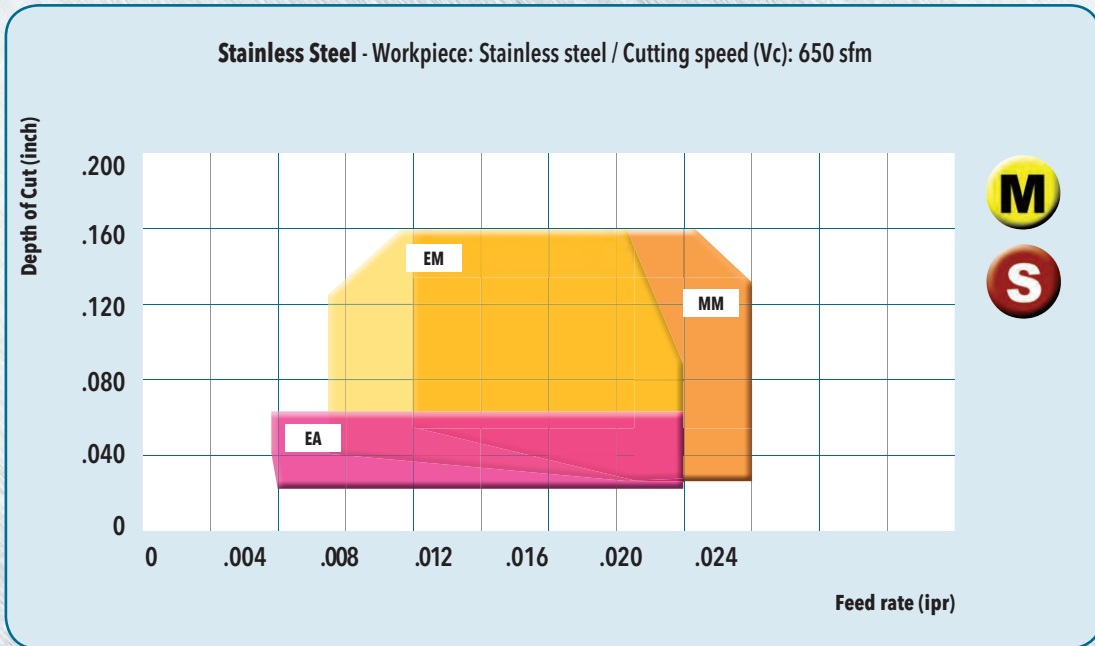
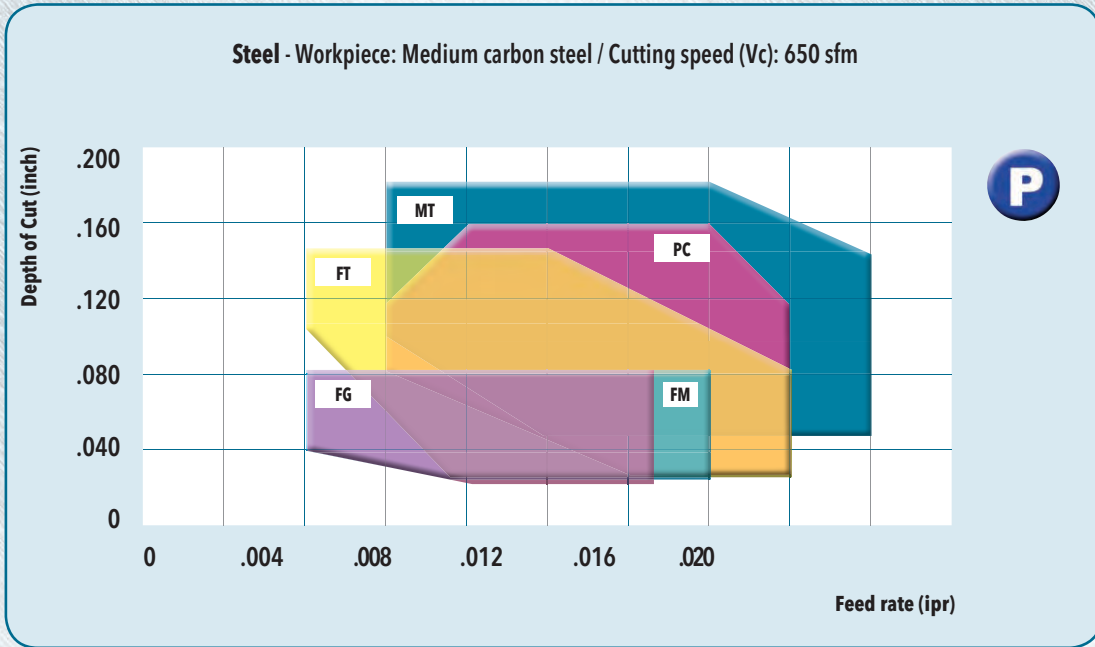

CNMG Negative 80° Rhombic Inserts

Designation	d	t	r
CNMG 331	0.375	0.187	0.016
CNMG 332	0.375	0.187	0.031
CNMG 333	0.375	0.187	0.047

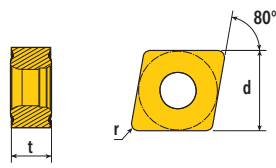





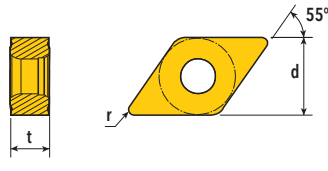

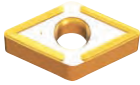

Insert	Designation		Recommended Parameters		Grade												
	ANSI	ISO	feed (ipr)	ap (inch)	CVD Coated												
					PVD Coated												
					CT3000	TT7005	TT7015	TT8115	TT8125	TT8135	TT9215	TT9225	TT9235	TT5100	TT5080	TT9080	
	CNMA332	CNMA090408	.006-.024	.039-.157		•	•										
	CNMA333	CNMA090412	.006-.028	.039-.157		•	•										
	CNMG331	CNMG090404	.004-.018	.020-.157		•	•										
	CNMG332	CNMG090408	.004-.020	.020-.157		•	•										
	CNMG333	CNMG090412	.004-.022	.020-.157		•	•										
	CNMG331EA	CNMG090404EA	.002-.012	.005-.059							•	•	•		•	•	
	CNMG332EA	CNMG090408EA	.003-.020	.006-.059							•	•	•		•	•	
	CNMG332EM	CNMG090404EM	.005-.020	.020-.157							•	•	•		•	•	
	CNMG333EM	CNMG090408EM	.006-.020	.028-.157							•	•	•		•	•	
	CNMG331FG	CNMG090404FG	.003-.012	.008-.079				•	•						•		
	CNMG332FG	CNMG090408FG	.004-.014	.020-.079				•	•						•		
	CNMG333FG	CNMG090412FG	.006-.016	.020-.079				•	•						•		
	CNMG331FM	CNMG090404FM	.003-.012	.010-.079	•			•	•	•					•		
	CNMG332FM	CNMG090408FM	.004-.014	.012-.079	•			•	•	•					•		
	CNMG333FM	CNMG090412FM	.006-.016	.014-.079	•			•	•	•					•		
	CNMG331FT	CNMG090404FT	.003-.012	.016-.138				•	•	•					•		
	CNMG332FT	CNMG090408FT	.004-.016	.020-.138				•	•	•					•		
	CNMG333FT	CNMG090412FT	.006-.020	.024-.138				•	•	•					•		
	CNMG331MM	CNMG090404MM	.006-.018	.016-.157				•	•	•	•	•	•	•	•		
	CNMG332MM	CNMG090408MM	.008-.020	.020-.157				•	•	•	•	•	•	•	•		
	CNMG333MM	CNMG090412MM	.009-.020	.028-.157				•	•	•	•	•	•	•	•		
	CNMG331MT	CNMG090404MT	.004-.014	.031-.177				•	•	•					•		
	CNMG332MT	CNMG090408MT	.006-.018	.039-.177				•	•	•					•		
	CNMG333MT	CNMG090412MT	.008-.022	.047-.177				•	•	•					•		
	CNMG331PC	CNMG090404PC	.004-.012	.016-.157				•	•	•					•		
	CNMG332PC	CNMG090408PC	.006-.016	.020-.157				•	•	•					•		
	CNMG333PC	CNMG090412PC	.007-.020	.024-.157				•	•	•					•		

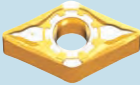
DNMG Negative 55° Rhombic Inserts

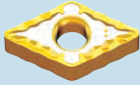
Designation	d	t	r		
DNMG 3.53.51	0.437	0.219	0.016		
DNMG 3.53.52	0.437	0.219	0.031		
DNMG 3.53.53	0.437	0.219	0.047		

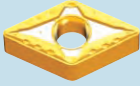







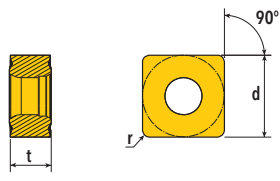
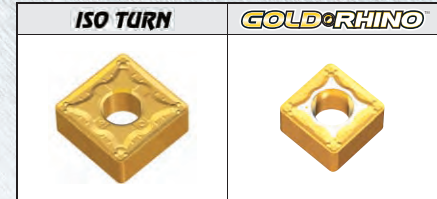

Insert	Designation		Recommended ameters		Par	Grade												
	ANSI	ISO	feed (ipr)	ap (inch)		Cermet	CVD Coated										PVD Coated	
						TT3000	TT7005	TT7015	TT8115	TT8125	TT8135	TT9215	TT9225	TT9235	TT5100	TT5080	TT9080	
	DNMG3.53.51	DNMG130504	.004-.018	.020-.157		●	●											
	DNMG3.53.52	DNMG130508	.004-.020	.020-.157		●	●											
	DNMG3.53.53	DNMG130512	.004-.022	.020-.157		●	●											
	DNMG3.53.51EA	DNMG130504EA	.002-.012	.005-.059							●	●	●		●	●		
	DNMG3.53.52EA	DNMG130508EA	.003-.016	.006-.059							●	●	●		●	●		
	DNMG3.53.52EM	DNMG130508EM	.005-.016	.020-.157							●	●	●		●	●		
	DNMG3.53.53EM	DNMG130512EM	.006-.016	.028-.157							●	●	●		●	●		
	DNMG3.53.51FG	DNMG130504FG	.003-.012	.008-.079				●	●						●			
	DNMG3.53.52FG	DNMG130508FG	.004-.014	.020-.079				●	●						●			
	DNMG3.53.53FG	DNMG130512FG	.006-.016	.020-.079				●	●						●			
	DNMG3.53.51FM	DNMG130504FM	.003-.012	.010-.079	●			●	●	●					●			
	DNMG3.53.52FM	DNMG130508FM	.004-.014	.012-.079	●			●	●	●					●			
	DNMG3.53.53FM	DNMG130512FM	.006-.016	.014-.079	●			●	●	●					●			
	DNMG3.53.51FT	DNMG130504FT	.003-.012	.010-.138				●	●	●					●			
	DNMG3.53.52FT	DNMG130508FT	.004-.016	.012-.138				●	●	●					●			
	DNMG3.53.53FT	DNMG130512FT	.006-.020	.014-.118				●	●	●					●			
	DNMG3.53.51MM	DNMG130504MM	.006-.018	.016-.177				●	●	●	●	●	●	●	●			
	DNMG3.53.52MM	DNMG130508MM	.008-.020	.020-.177				●	●	●	●	●	●	●	●			
	DNMG3.53.53MM	DNMG130512MM	.009-.020	.028-.177				●	●	●	●	●	●	●	●			
	DNMG3.53.51MT	DNMG130504MT	.004-.014	.031-.177				●	●	●					●			
	DNMG3.53.52MT	DNMG130508MT	.006-.018	.039-.177				●	●	●					●			
	DNMG3.53.53MT	DNMG130512MT	.008-.022	.047-.177				●	●	●					●			
	DNMG3.53.51PC	DNMG130504PC	.004-.012	.016-.157				●	●	●					●			
	DNMG3.53.52PC	DNMG130508PC	.006-.016	.020-.157				●	●	●					●			
	DNMG3.53.53PC	DNMG130512PC	.007-.020	.024-.157				●	●	●					●			

SNMG Negative 90° Square Inserts

Designation	d	t	r
SNMG 331	0.375	0.187	0.016
SNMG 332	0.375	0.187	0.031
SNMG 333	0.375	0.187	0.047

Insert	Designation		Recommended Parameters		Grade											
	ANSI	ISO	feed (mm/rev)	ap (mm)	Cermet		CVD Coated							PVD Coated		
					CT3000	T7005	T7015	T8115	T8125	T8135	T9215	T9225	T9235	T5100	T5080	T9080
	SNMG331	SNMG090404	.004-.018	.020-.157		●	●									
	SNMG332	SNMG090408	.004-.020	.020-.157		●	●									
	SNMG333	SNMG090412	.004-.022	.020-.157		●	●									
	SNMG331EA	SNMG090404EA	.002-.012	.005-.059							●	●	●		●	●
	SNMG332EA	SNMG090408EA	.003-.016	.006-.059							●	●	●		●	●
	SNMG332EM	SNMG090404EM	.005-.016	.020-.157							●	●	●		●	●
	SNMG333EM	SNMG090408EM	.006-.016	.028-.157							●	●	●		●	●
	SNMG331FG	SNMG090404FG	.003-.012	.008-.079				●	●						●	
	SNMG332FG	SNMG090408FG	.004-.014	.020-.079				●	●						●	
	SNMG333FG	SNMG090412FG	.006-.016	.020-.079				●	●						●	
	SNMG331FM	SNMG090404FM	.003-.012	.010-.079	●			●	●	●					●	
	SNMG332FM	SNMG090408FM	.004-.014	.012-.079	●			●	●	●					●	
	SNMG333FM	SNMG090412FM	.006-.016	.014-.079	●			●	●	●					●	
	SNMG331MM	SNMG090404MM	.006-.018	.016-.157				●	●	●	●	●	●	●	●	
	SNMG332MM	SNMG090408MM	.008-.020	.020-.157				●	●	●	●	●	●	●	●	
	SNMG333MM	SNMG090412MM	.009-.020	.028-.157				●	●	●	●	●	●	●	●	
	SNMG331MT	SNMG090404MT	.004-.014	.031-.157				●	●	●					●	
	SNMG332MT	SNMG090408MT	.006-.018	.039-.157				●	●	●					●	
	SNMG333MT	SNMG090412MT	.008-.022	.047-.157				●	●	●					●	
	SNMG331PC	SNMG090404PC	.004-.012	.016-.138				●	●	●					●	
	SNMG332PC	SNMG090408PC	.006-.016	.020-.138				●	●	●					●	
	SNMG333PC	SNMG090412PC	.007-.020	.024-.138				●	●	●					●	

TNMG Negative 60° Triangular Inserts

Designation	d	t	r
TNMG 2.531	0.313	0.187	0.016
TNMG 2.532	0.313	0.187	0.031
TNMG 2.533	0.313	0.187	0.047

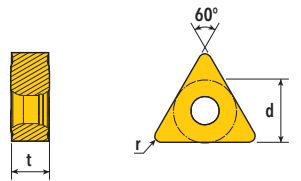

Insert	Designation		Recommended Parameters		Grade											
	ANSI	ISO	feed (mm/rev)	ap (mm)	Ct3000	CVD Coated								PVD Coated		
						T7005	T7015	T8115	T8125	T8135	T9215	T9225	T9235	T5100	T5080	T9080
	TNMG2.531	TNMG130404	.004-.018	.020-.157		●	●									
	TNMG2.532	TNMG130408	.004-.020	.020-.157		●	●									
	TNMG2.533	TNMG130412	.004-.022	.020-.157		●	●									
	TNMG2.531EA	TNMG130404EA	.002-.012	.005-.059						●	●	●		●	●	
	TNMG2.532EA	TNMG130408EA	.003-.016	.006-.059						●	●	●		●	●	
	TNMG2.531EM	TNMG130404EM	.005-.016	.020-.157						●	●	●		●	●	
	TNMG2.532EM	TNMG130408EM	.006-.016	.028-.157						●	●	●		●	●	
	TNMG2.531FG	TNMG130404FG	.003-.012	.010-.059				●	●					●		
	TNMG2.532FG	TNMG130408FG	.004-.014	.012-.059				●	●					●		
	TNMG2.533FG	TNMG130412FG	.006-.016	.014-.059				●	●					●		
	TNMG2.531FM	TNMG130404FM	.003-.012	.010-.059	●			●	●	●				●		
	TNMG2.532FM	TNMG130408FM	.004-.014	.012-.059	●			●	●	●				●		
	TNMG2.533FM	TNMG130412FM	.006-.016	.014-.059	●			●	●	●				●		
	TNMG2.531FT	TNMG130404FT	.003-.012	.010-.098				●	●	●				●		
	TNMG2.532FT	TNMG130408FT	.004-.016	.012-.098				●	●	●				●		
	TNMG2.533FT	TNMG130412FT	.006-.020	.014-.098				●	●	●				●		
	TNMG2.531MM	TNMG130404MM	.006-.018	.016-.138				●	●	●	●	●	●	●		
	TNMG2.532MM	TNMG130408MM	.008-.020	.020-.138				●	●	●	●	●	●	●		
	TNMG2.533MM	TNMG130412MM	.009-.020	.028-.138				●	●	●	●	●	●	●		
	TNMG2.531MT	TNMG130404MT	.004-.014	.031-.138				●	●	●				●		
	TNMG2.532MT	TNMG130408MT	.006-.018	.040-.138				●	●	●				●		
	TNMG2.533MT	TNMG130412MT	.008-.022	.047-.138				●	●	●				●		
	TNMG2.531PC	TNMG130404PC	.004-.012	.016-.118				●	●	●				●		
	TNMG2.532PC	TNMG130408PC	.006-.016	.020-.118				●	●	●				●		
	TNMG2.533PC	TNMG130412PC	.007-.020	.024-.118				●	●	●				●		
	TNGG2.531R/L	TNMG130404R/L	.005-.012	.039-.118	●											
	TNGG2.532R/L	TNMG130408R/L	.006-.014	.051-.118	●											

HCLNR/L HCBNR/L HCKNR/L

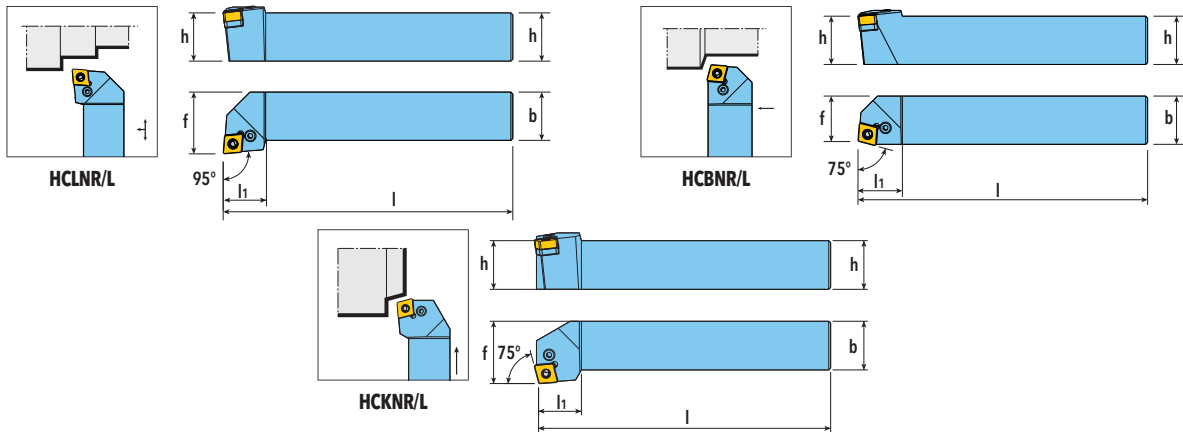

Designation	Dimensions (inch)					Insert	Components				
	h	b	l	l1	f		Lever	Screw	Seat	Seat Pin	Wrench
HCLNR/L 10-33A	0.625	0.625	4.00	0.87	0.750						
HCLNR/L 12-33B	0.750	0.750	4.50	0.87	1.000	CNMG33_	LCL09-NX	LCS3	LSC32A	LSP3A	L-W2.5
HCLNR/L 16-33D	1.000	1.000	6.00	0.87	1.250						
HCBNR/L 12-33B	0.750	0.750	4.50	0.91	0.691	CNMG33_	LCL09-NX	LCS3	LSC32A	LSP3A	L-W2.5
HCBNR/L 16-33D	1.000	1.000	6.00	0.91	0.941						
HCKNR/L 16-33D	1.000	1.000	6.00	0.87	1.250	CNMG33_	LCL09-NX	LCS3	LSC32A	LSP3A	L-W2.5

HDJNR/L HDNNR/L HDQNR/L HDUNR/L

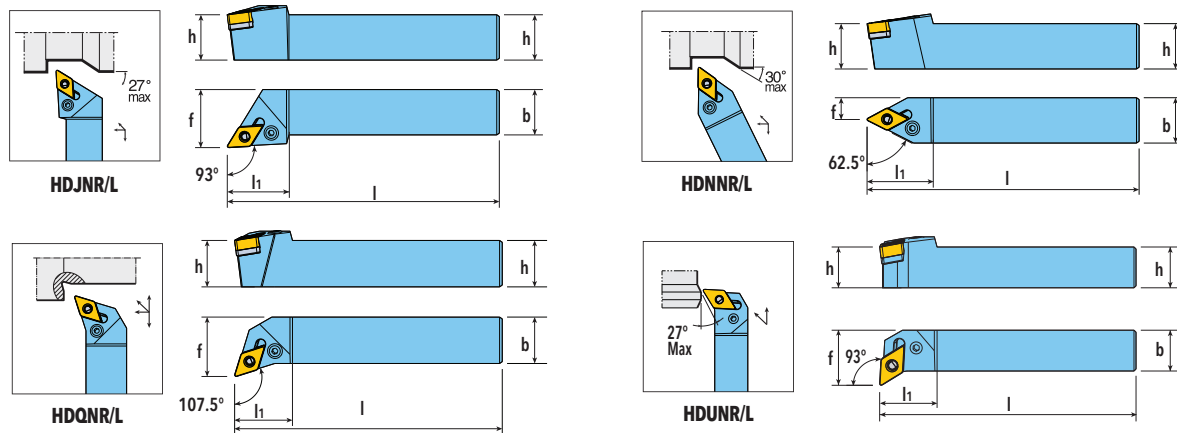

Designation	Dimensions (inch)					Insert	Components				
	h	b	l	l1	f		Lever	Screw	Seat	Seat Pin	Wrench
HDJNR/L 12-3.53.5B	0.750	0.750	4.50	1.34	1.000						
HDJNR/L 16-3.53.5D	1.000	1.000	6.00	1.34	1.250	DNMG3.53.5_	LCL11-NX	LCS4	LSD3.52	LSP4	L-W3
HDUNR/L 16-3.53.5D	1.000	1.000	6.00	1.102	1.365	DNMG3.53.5_	LCL11-NX	LCS4	LSD3.52	LSP4	L-W3
HDNNR/L 12-3.53.5B	0.750	0.750	4.50	1.44	0.375						
HDNNR/L 16-3.53.5D	1.000	1.000	6.00	1.44	0.500	DNMG3.53.5_	LCL11-NX	LCS4	LSD3.52	LSP4	L-W3
HDQNR/L 12-3.53.5B	0.750	0.750	4.50	1.22	1.000						
HDQNR/L 16-3.53.5D	1.000	1.000	6.00	1.22	1.250	DNMG3.53.5_	LCL11-NX	LCS4	LSD3.52	LSP4	L-W3

HSBNR/L HSDNN HSKNR/L HSSNR/L

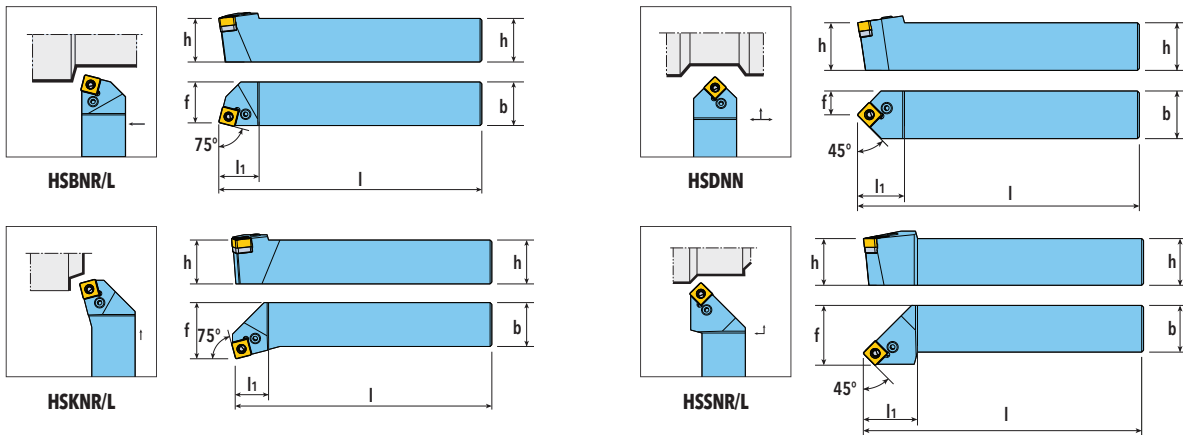

Designation	Dimensions (inch)					Insert	Components				
	h	b	l	l1	f		Lever	Screw	Seat	Seat Pin	Wrench
HSBNR/L 12-33B	0.750	0.750	4.50	0.91	0.691	SNMG33_	LCL09-NX	LCS3	LSS32A	LSP3A	L-W2.5
HSBNR/L 16-33D	1.000	1.000	6.00	0.91	0.941						
HSDNN 12-33B	0.750	0.750	4.50	0.98	0.375	SNMG33_	LCL09-NX	LCS3	LSS32A	LSP3A	L-W2.5
HSDNN 16-33D	1.000	1.000	6.00	0.98	0.500						
HSKNR/L 12-33B	0.750	0.750	4.50	0.75	1.000	SNMG33_	LCL09-NX	LCS3	LSS32A	LSP3A	L-W2.5
HSKNR/L 16-33D	1.000	1.000	6.00	0.75	1.250						
HSSNR/L 12-33B	0.750	0.750	4.50	0.85	1.000	SNMG33_	LCL09-NX	LCS3	LSS32A	LSP3A	L-W2.5
HSSNR/L 16-33D	1.000	1.000	6.00	1.14	1.250						

HTFNR/L HTGNR/L

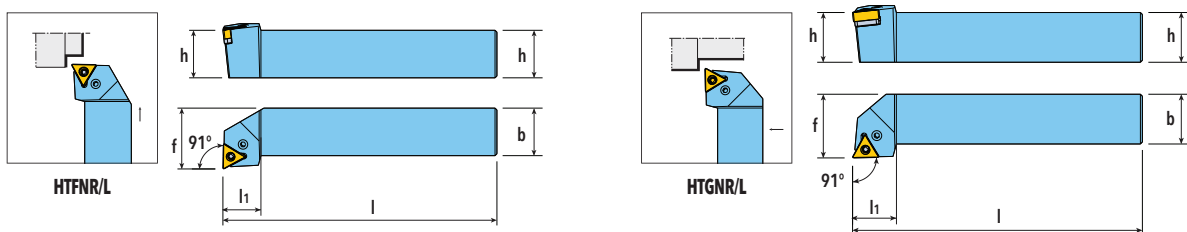

Designation	Dimensions (inch)					Insert	Components				
	h	b	l	l1	f		Lever	Screw	Seat	Seat Pin	Wrench
HTFNR/L 12-2.53B	0.750	0.750	4.50	0.79	1.000	TNMG2.53_	LCL08-NX	LCS3-NX	LST2.51.8	LSP3B	L-W2.5
HTFNR/L 16-2.53D	1.000	1.000	6.00	0.79	1.250						
HTGNR/L 10-2.53A	0.625	0.625	4.00	0.87	0.750	TNMG2.53_	LCL08-NX	LCS3-NX	LST2.51.8	LSP3B	L-W2.5
HTGNR/L 12-2.53B	0.750	0.750	4.50	0.87	1.000						
HTGNR/L 16-2.53D	1.000	1.000	6.00	0.87	1.250						

A-HCLNR/L

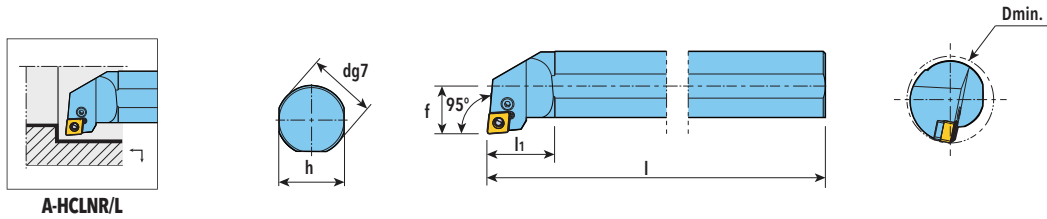

A-HCLNR/L

Designation	Dimensions (inch)						Insert	Components					
	d	h	l	l1	f	Dmin		Lever	Screw	Seat	Seat Pin	Snap Ring	Wrench
A10R-HCLNR/L-33	0.625	0.583	8.00	0.98	0.406	0.750	CNMG 33_	LCL09B-NX	LCS3B	-	-	LSR3B	L-W2
A12S-HCLNR/L-33	0.750	0.669	10.00	1.10	0.500	1.000							
A16T-HCLNR/L-33	1.000	0.921	12.00	1.22	0.640	1.250							
A20U-HCLNR/L-33	1.250	1.169	14.00	1.22	0.765	1.500							

A-HDUNR/L A-HDZNR/L

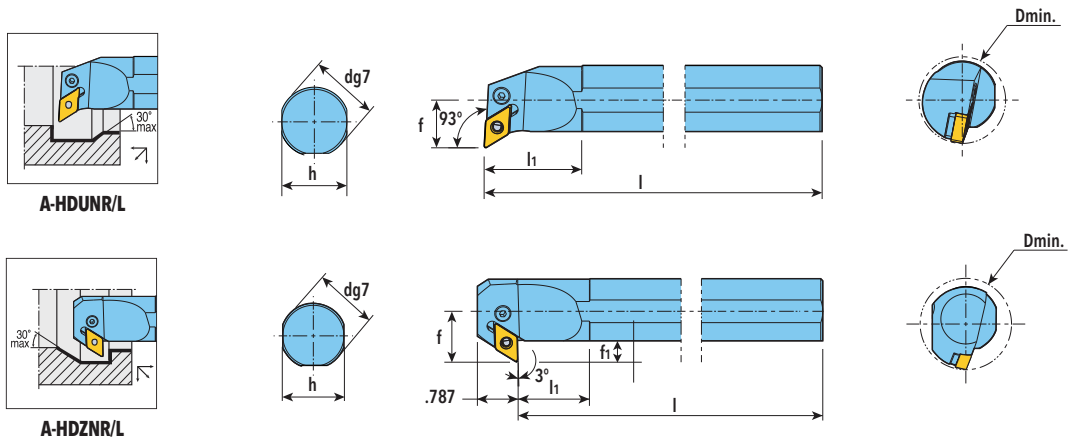

A-HDUNR/L

A-HDZNR/L

Designation	Dimensions (inch)							Insert	Components				
	d	h	l	l1	f	f1	Dmin		Lever	Screw	Seat	Seat Pin	Wrench
A20U-HDUNR/L-3.53.5	1.250	1.169	14.00	1.77	1.000	-	1.750	DNMG3.53.5_	LCL11-NX	LCS4S	LSD3.52B	LSP4	L-W3
A20U-HDZNR/L-3.53.5	1.250	1.169	14.00	1.36	1.000	0.434	1.750						

A-HSKNR/L

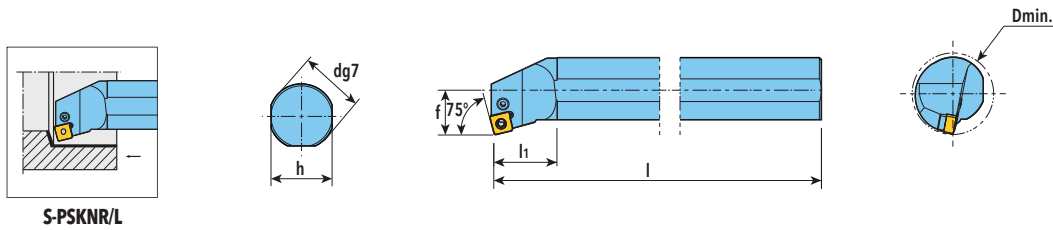

S-PSKNR/L

Designation	Dimensions (inch)						Insert	Components					
	d	h	l	l1	f	Dmin		Lever	Screw	Seat	Seat Pin	Snap Ring	Wrench
A16T-HSKNR/L-33	1.000	0.921	12.00	1.22	0.640	1.250	SNMG33_	LCL09B-NX	LCS3B	-	-	LSR3B	L-W2
A20U-HSKNR/L-33	1.250	1.169	14.00	1.22	0.765	1.500		LCL09-NX	LCS3	LSS32	LSP3A	-	L-W2.5

A-HTFNRL

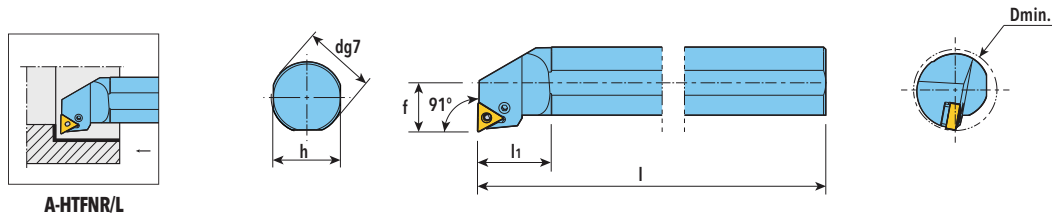

A-HTFNRL

Designation	Dimensions (inch)						Insert	Components					
	d	h	l	l1	f	Dmin		Lever	Screw	Seat	Seat Pin	Snap Ring	Wrench
A10R-HTFNRL-2.53	0.625	0.583	8.00	0.98	0.406	0.750	TNMG2.53_	LCL08B-NX	LCS3B	-	-	LSR3B	L-W2
A12S-HTFNRL-2.53	0.750	0.669	10.00	1.10	0.500	1.000							
A16T-HTFNRL-2.53	1.000	0.921	12.00	1.30	0.640	1.250							
A20U-HTFNRL-2.53	0.750	1.169	14.00	1.30	0.765	1.500							

HCLNR/L*

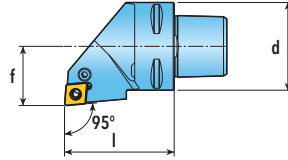
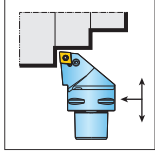

compatible with Sandvik's COROMANT CAPTO (**) system.

Designation	Dimension (mm)			Insert	Components					
	d	f	l		Lever	Screw	Shim	Shim Pin	Nozzle	Wrench
C4-HCLNR/L 27050-0904	40	27	50	CNMG 33 □	LCL 09-NX	LCS 3	LSC 32	LSP 3A	NZ 83	L-W 2.5

HDJNR/L*

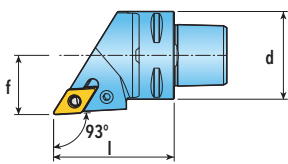
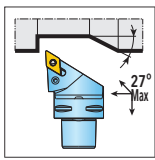

compatible with Sandvik's COROMANT CAPTO (**) system.

Designation	Dimension (mm)			Insert	Components					
	d	f	l		Lever	Screw	Shim	Shim Pin	Nozzle	Wrench
C4-HDJNR/L 27055-1305	40	27	55	DNMG 3.53.5 □	LCL 11-NX	LCS 4	LSD 3.52	LSP 4	NZ 83	L-W 3

HSSNR/L*

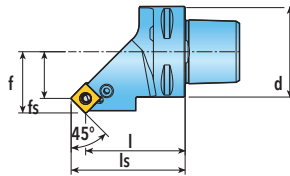
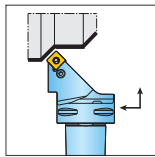

compatible with Sandvik's COROMANT CAPTO (**) system.

Designation	Dimension (mm)					Insert	Components					
	d	f	fs	l	ls		Lever	Screw	Shim	Shim Pin	Nozzle	Wrench
C4-HSSNR/L 27042-0904	40	27	20.6	44	50.3	SNMG 33 □	LCL 09-NX	LCS 3	LSS 32A	LSP 3A	NZ 83	L-W 2.5

HTGNR/L* HTJNR/L*

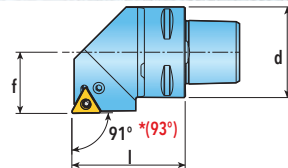
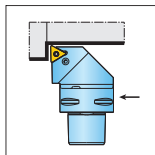

compatible with Sandvik's COROMANT CAPTO (**) system.

Designation	Dimension (mm)			Insert	Components					
	d	f	l		Lever	Screw	Shim	Shim Pin	Nozzle	Wrench
C4-HTGNR/L 27050-1304	40	27	50	TNMG 2.53 □	LCL 08-NX	LCS 3-NX	LST 2.51.8	LSP 3B	NZ 83	L-W 2.5
C4-HTJNR/L 27050-1304	40	27	50							

¹Marked : Entering angle of HTJNR/L is 93 degrees. (**) The trademark COROMANT CAPTO® is owned by Sandvik Intellectual Property AB.