



New Product Announcement

NEW-383-1 • 5/2024
Page 1/14

MILLING - INDEXABLE

Cutter Series (Depth of Cut)

1VX1F / VX_F
(90°=0.39" / Hi-Feed=0.039")

Insert Series

90°: XEVT10_AL, EL, M;
Hi-Feed: XEVT10_HF

Diameter Range

0.625-3.000"

Lead Angle

90°

Corner Radii

0.015", 0.031", 0.062", 0.125" R
2 mm, 3 mm R
Hi-Feed

Materials

- Steel
- Stainless Steel
- Cast Iron
- Non-Ferrous (Aluminum)
- Hi-Temp Alloys/Titanium

HIPOSWIN V™

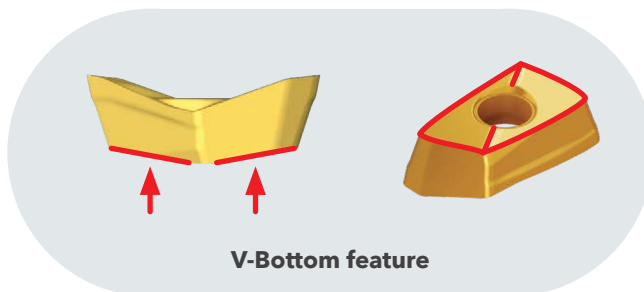
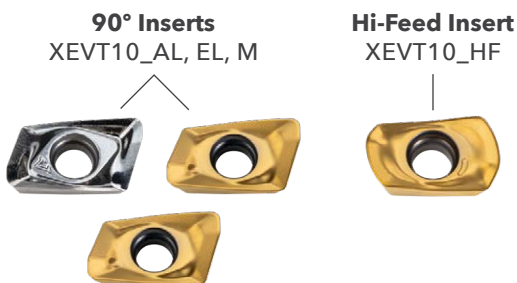

Next-Gen Shouldering Insert with V-Bottom for Strong Clamping

- » Ingersoll's newest, highest positive geometry featuring balanced cutters for high RPM - ideal for aerospace materials.
- » Steep concave face accommodates aggressive aluminum router ramp angles.
- » 90° inserts with integrated wiper flats produce 32-63 Ra deck finishes, and hi-feed inserts.

AHB

TOOLING & MACHINERY

COMPLETE METALWORKING SOLUTIONS

(800) 991-4225
ISO Certified

www.ahbinc.com
customerservice@ahbinc.com

See it in
action! »







WINSPEED™
ADVANCED MACHINING

ingersoll-imc.com

FEATURES & BENEFITS:

- Diverse geometries to maximize performance

XEVT_AL	XEVT_EL	XEVT_M	XEVT_HF
			
For shouldering aluminum & non-ferrous	For shouldering SS/hi-temp alloys & titanium	For shouldering steel & iron	For hi-feed milling

- V-bottom plus dovetail pocket design equals stability for aggressive machining

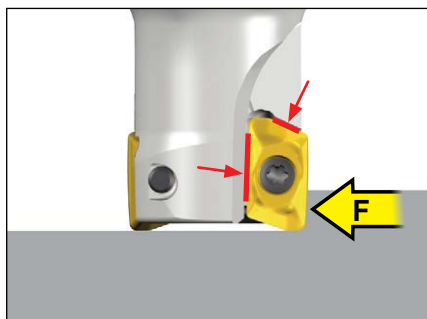
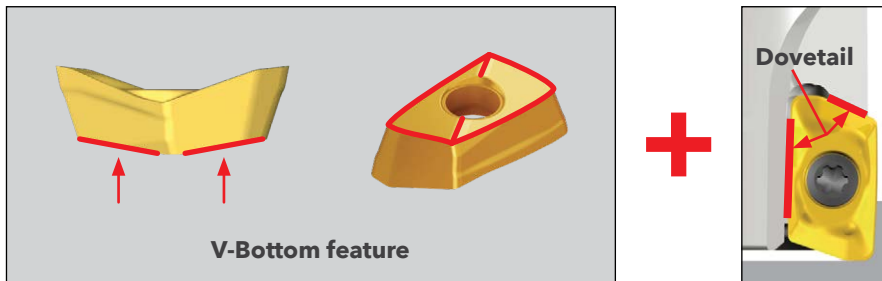

Secure when shouldering

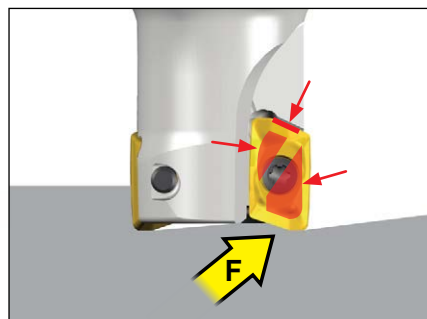

Secure when ramping

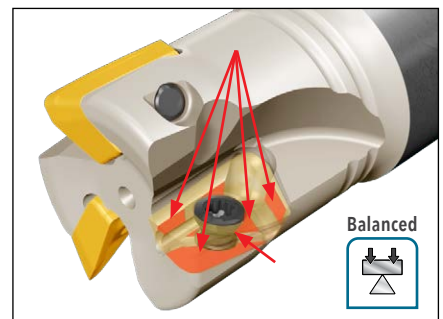



Secure on high RPM spindles

FEATURES & BENEFITS (CONT.) :

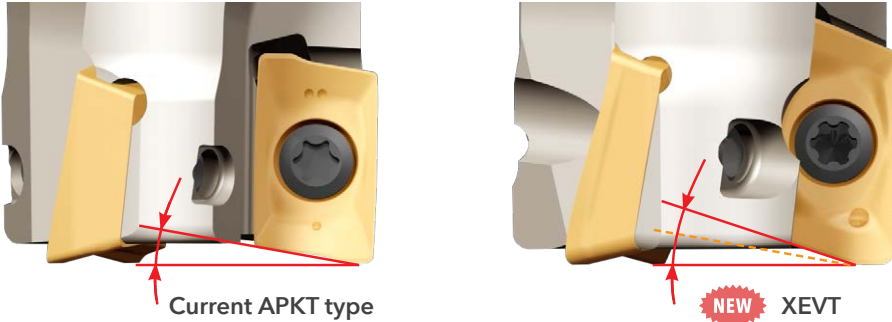
- Improved productivity via insert's higher ramping angle



Cutter Dia.	Straight ramp down max. ramping angle			
	Competitor APKT Type	NEW XEVT 	Competitor APKT Hi-Feed Type	NEW XEVT-HF 
.625	4.9°	10.9°	3.8°	7.6°
.750	3.4°	6.5°	3.0°	4.2°
1.000	1.8°	4.3°	2.1°	2.6°
1.250	2.0°	2.9°	1.6°	1.7°
1.500	1.5°	2.1°	1.2°	1.2°
2.000	1.1°	1.6°	0.9°	0.9°
3.000	0.6°	1.0°	0.4°	0.4°

- Higher axial rake enables softer entry into the part

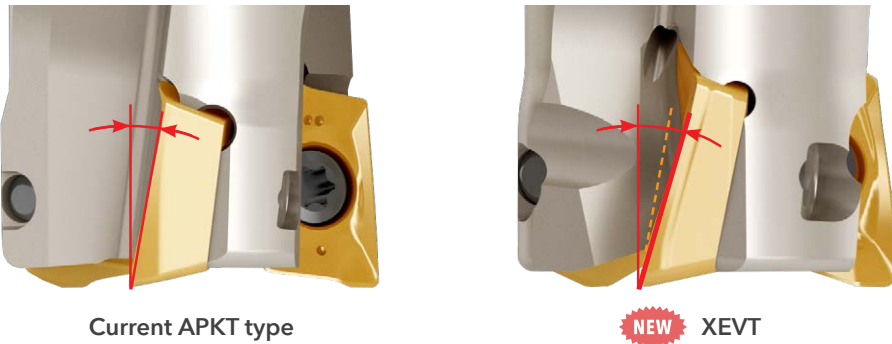

Extremely versatile and higher productivity than APKT

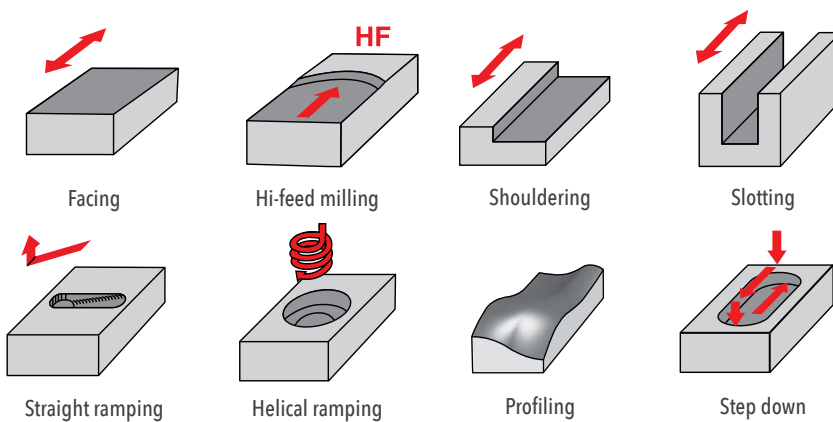

Series 1VX1F_R01

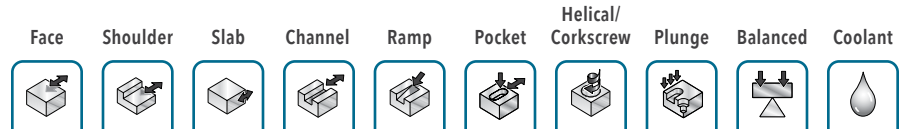

90° ROUTER - CYLINDRICAL • SMALL CORNER RADIUS

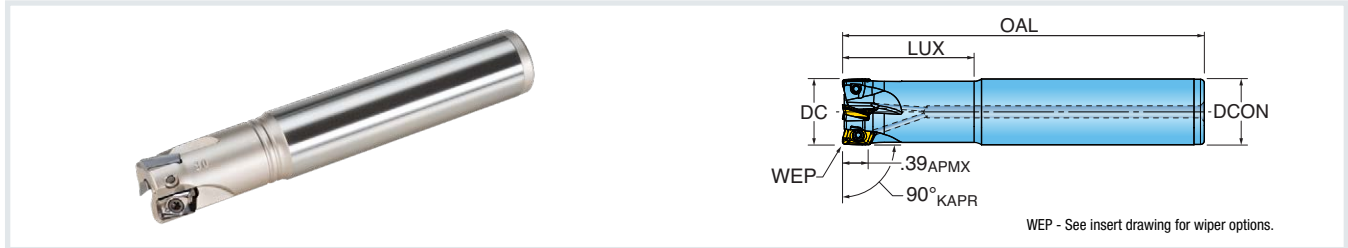

Part Number	DC Cutting Dia.	LUX Usable Length Max.	OAL Overall Length	ZEFF Eff. Teeth	DCON Shank Dia.	RPM* Maximum
1VX1F-06015S6R01	0.625	1.50	5.00	2	0.6250	40,000
1VX1F-07015S7R01	0.750	1.50	4.50	3	0.7500	39,000
1VX1F-07025S7R01	0.750	2.50	6.00	2	0.7500	39,000
1VX1F-10020S1R01	1.000	2.00	5.50	4	1.0000	37,500
1VX1F-10030S1R01	1.000	3.00	7.00	3	1.0000	37,500
1VX1F-12020S9R01	1.250	2.00	6.00	5	1.2500	36,500
1VX1F-12030S9R01	1.250	3.00	8.00	4	1.2500	36,500
1VX1F-15020S9R01	1.500	2.00	9.00	4	1.2500	36,000

Series 1VX1F_R02

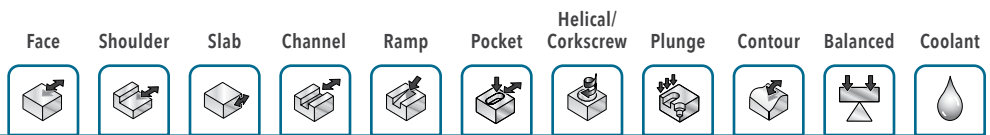

90° ROUTER - CYLINDRICAL • LARGE CORNER RADIUS / HI-FEED

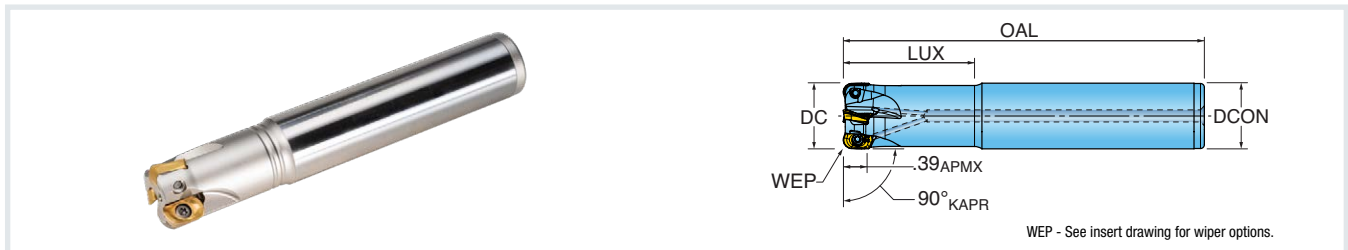

Part Number	DC Cutting Dia.	LUX Usable Length Max.	OAL Overall Length	ZEFF Eff. Teeth	DCON Shank Dia.	RPM* Maximum
1VX1F-06015S6R02	0.625	1.50	5.00	2	0.6250	40,000
1VX1F-07015S7R02	0.750	1.50	4.50	3	0.7500	39,000
1VX1F-07025S7R02	0.750	2.50	6.00	2	0.7500	39,000
1VX1F-10020S1R02	1.000	2.00	5.50	4	1.0000	37,500
1VX1F-10030S1R02	1.000	3.00	7.00	3	1.0000	37,500
1VX1F-12020S9R02	1.250	2.00	6.00	5	1.2500	36,500
1VX1F-12030S9R02	1.250	3.00	8.00	4	1.2500	36,500
1VX1F-15020S9R02	1.500	2.00	9.00	4	1.2500	36,000

*Max RPM applies to a properly balanced assembly to G2.5 (toolholder, cutter, and inserts).

Designed with modification in mind. Extend usable length by turning back the neck diameter, or shorten the overall length by cutting off the back end.

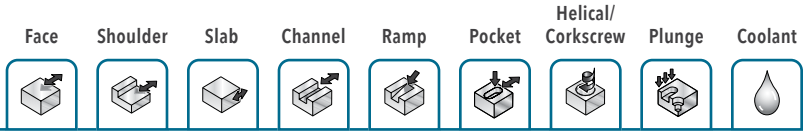

Series 1VX1F_R01

90° END MILL - WELDON • SMALL CORNER RADIUS

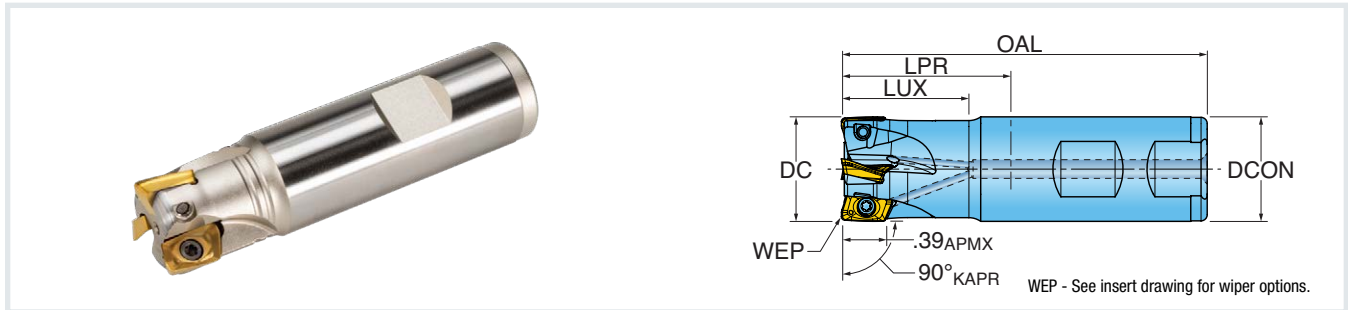

Part Number	DC Cutting Dia.	LUX Usable Length Max.	LPR Protruding Length	OAL Overall Length	ZEFF Eff. Teeth	DCON Shank Dia.
1VX1F-0601079R01	0.625	1.06	1.09	3.00	2	0.6250
1VX1F-0701284R01	0.750	1.22	1.25	3.25	3	0.7500
1VX1F-1001280R01	1.000	1.22	1.25	3.50	4	1.0000
1VX1F-1201781R01	1.250	1.72	1.75	4.00	5	1.2500
1VX1F-1502281R01	1.500	2.23	2.25	4.50	5	1.2500

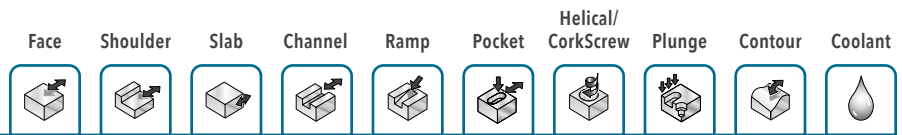

Series 1VX1F_R02

90° END MILL - WELDON • LARGE CORNER RADIUS / HI-FEED

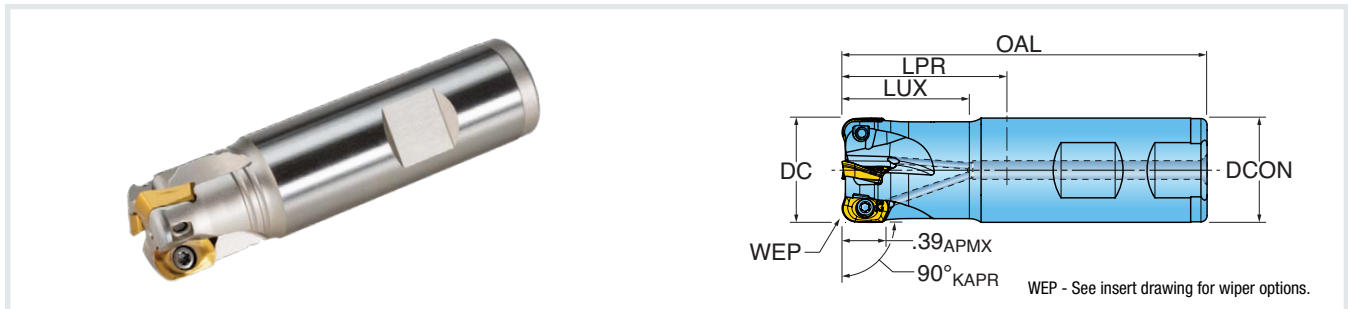

Part Number	DC Cutting Dia.	LUX Usable Length Max.	LPR Protruding Length	OAL Overall Length	ZEFF Eff. Teeth	DCON Shank Dia.
1VX1F-0601079R02	0.625	1.06	1.09	3.00	2	0.6250
1VX1F-0701284R02	0.750	1.22	1.25	3.25	3	0.7500
1VX1F-1001280R02	1.000	1.22	1.25	3.50	4	1.0000
1VX1F-1201781R02	1.250	1.72	1.75	4.00	5	1.2500
1VX1F-1502281R02	1.500	2.23	2.25	4.50	5	1.2500

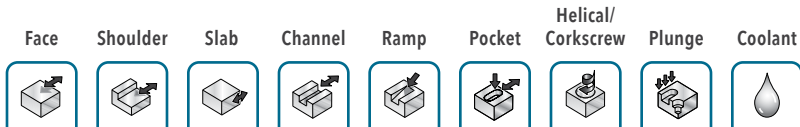

Series 1VX1F_R01

90° END MILL - TOPON • SMALL CORNER RADIUS



Part Number	DC Cutting Dia.	LF Functional Length	ZEFF Eff. Teeth	CCMS Connection Code Machine Side	DHUB Hub Dia.
1VX1F-06015X5R01	0.625	1.50	2	TopOn M08	0.50
1VX1F-07015X6R01	0.750	1.50	3	TopOn M10	0.69
1VX1F-10015X7R01	1.000	1.50	4	TopOn M12	0.81
1VX1F-12017X8R01	1.250	1.75	5	TopOn M16	1.13
1VX1F-15017X8R01	1.500	1.75	5	TopOn M16	1.13

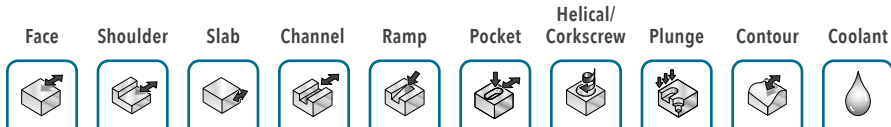

Series 1VX1F_R02

90° END MILL - TOPON • LARGE CORNER RADIUS / HI-FEED



Part Number	DC Cutting Dia.	LF Functional Length	ZEFF Eff. Teeth	CCMS Connection Code Machine Side	DHUB Hub Dia.
1VX1F-06015X5R02	0.625	1.50	2	TopOn M08	0.50
1VX1F-07015X6R02	0.750	1.50	3	TopOn M10	0.69
1VX1F-10015X7R02	1.000	1.50	4	TopOn M12	0.81
1VX1F-12017X8R02	1.250	1.75	5	TopOn M16	1.13
1VX1F-15017X8R02	1.500	1.75	5	TopOn M16	1.13

Series VX2F_R01

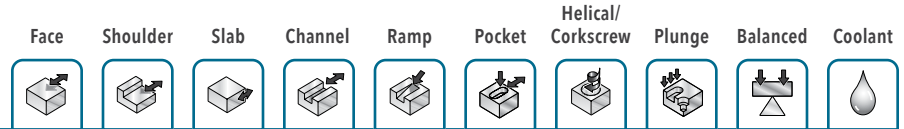

90° ROUTER - FACE MILL • SMALL CORNER RADIUS

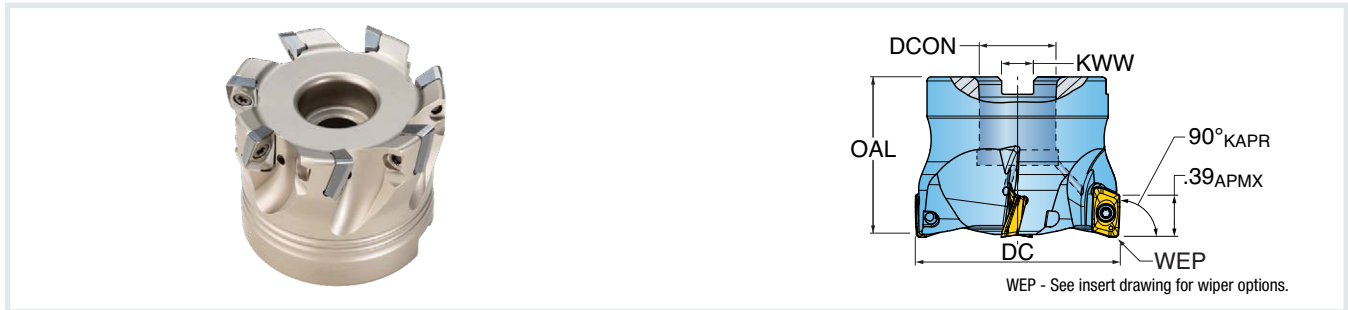

Part Number	DC Cutting Dia.	OAL Overall Length	ZEFF Eff. Teeth	DCON Bore Dia.	KWW Keyway	RPM* Maximum
VX2F-15R01	1.500	1.570	3	0.5000	0.250	36,000
VX5F-15R01	1.500	1.570	5	0.5000	0.250	36,000
VX2F-20R01	2.000	1.570	4	0.7500	0.312	35,000
VX5F-20R01	2.000	1.570	7	0.7500	0.312	35,000
VX2F-30R01	3.000	1.750	6	1.0000	0.375	28,000
VX5F-30R01	3.000	1.750	10	1.0000	0.375	28,000

Series VX2F_R02

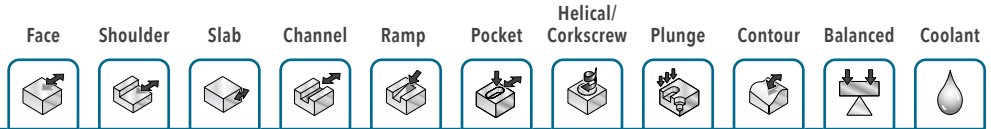

90° ROUTER - FACE MILL • LARGE CORNER RADIUS / HI-FEED

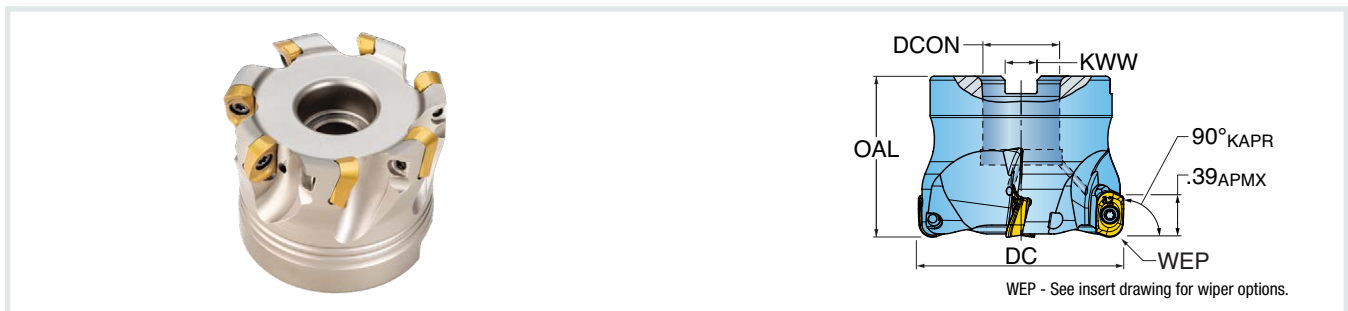

Part Number	DC Cutting Dia.	OAL Overall Length	ZEFF Eff. Teeth	DCON Bore Dia.	KWW Keyway	RPM* Maximum
VX2F-15R02	1.500	1.570	3	0.5000	0.250	36,000
VX5F-15R02	1.500	1.570	5	0.5000	0.250	36,000
VX2F-20R02	2.000	1.570	4	0.7500	0.312	35,000
VX5F-20R02	2.000	1.570	7	0.7500	0.312	35,000
VX2F-30R02	3.000	1.750	6	1.0000	0.375	28,000
VX5F-30R02	3.000	1.750	10	1.0000	0.375	28,000

*Max RPM applies to a properly balanced assembly to G2.5 (toolholder, cutter, and inserts).

Inserts

FOR SERIES 1VX1F_R01 AND VX2F_R01 • SMALL CORNER RADIUS

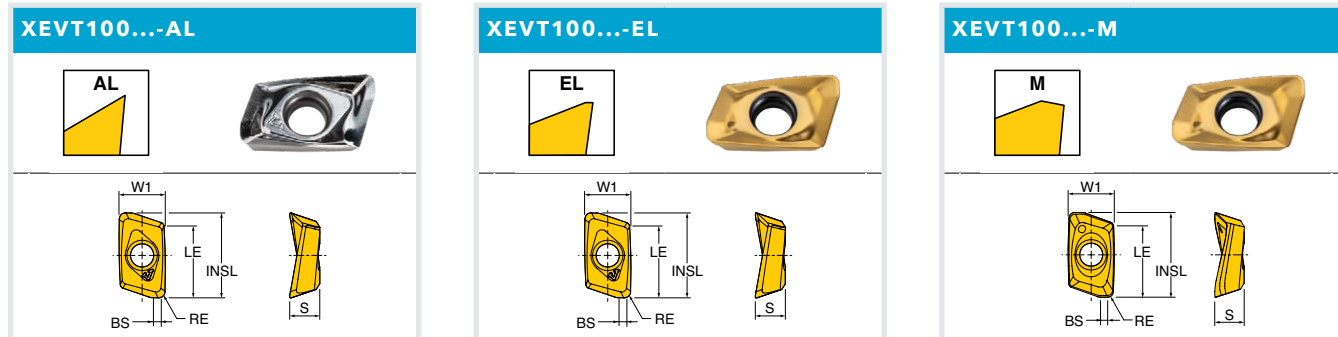

Part Number	Application	RE/BCH Corner Radius/ Chamfer	BS Wiper Length	LE Cutting Edge Length	INSL Length	W1 Width	S Thickness	NOI Number of Indexes	IH Insert Hand	Grade				
										IN10K	IN2036	IN2505	IN2510	IN2530
XEVT100404R-AL	Grd/Pol for Al	0.015	0.050	0.39	0.484	0.267	0.177	2	Right	•				
XEVT100408R-AL	Grd/Pol for Al	0.031	0.034	0.39	0.484	0.267	0.174	2	Right	•				
XEVT100416R-AL	Grd/Pol for Al	0.062	0.050	0.39	0.467	0.267	0.176	2	Right	•				
XEVT100408R-EL	SS/Hi-Temp/Ti	0.031	0.041	0.39	0.488	0.267	0.169	2	Right		•			•
XEVT100416R-EL	SS/Hi-Temp/Ti	0.062	0.025	0.39	0.479	0.267	0.169	2	Right		•			•
XEVT100408R-M	Multi-Purpose	0.031	0.039	0.39	0.488	0.267	0.169	2	Right			•	•	•
XEVT100416R-M	Multi-Purpose	0.062	0.025	0.39	0.479	0.267	0.169	2	Right			•		

FOR SERIES 1VX1F_R02 AND VX2F_R02 • LARGE CORNER RADIUS / HI-FEED

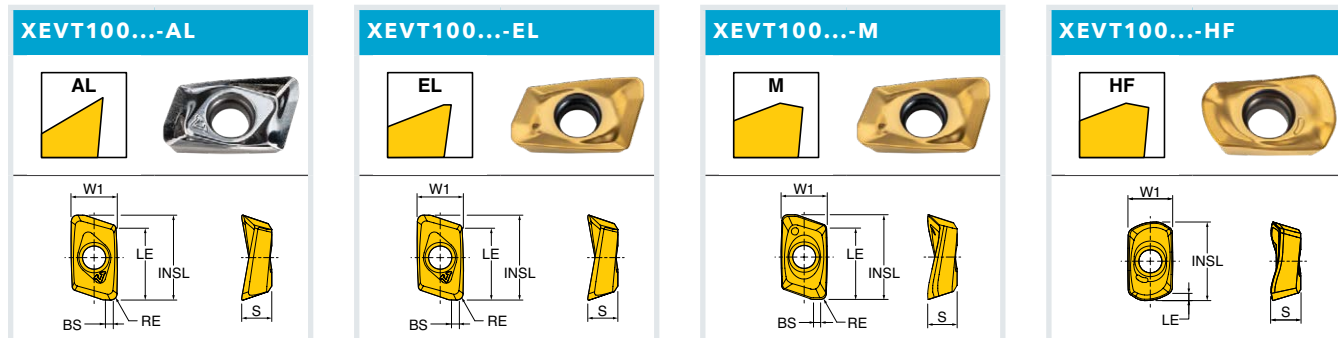







Part Number	Application	RE/BCH Corner Radius/ Chamfer	BS Wiper Length	LE Cutting Edge Length	INSL Length	W1 Width	S Thickness	NOI Number of Indexes	IH Insert Hand	Grade			
										IN10K	IN2036	IN2505	IN2530
XEVT100420R-AL	Grd/Pol for AL	0.078	0.027	0.385	0.464	0.267	0.170	2	Right	•			
XEVT100430R-AL	Grd/Pol for AL	0.118	-	0.377	0.452	0.267	0.159	2	Right	•			
XEVT100432R-AL	Grd/Pol for AL	0.125	-	0.370	0.435	0.263	0.156	2	Right	•			
XEVT100432R-EL	SS/Hi-Temp/Ti	0.125	-	0.390	0.452	0.267	0.163	2	Right		•		•
XEVT100432R-M	Multi-Purpose	0.125	-	0.390	0.452	0.267	0.163	2	Right			•	
XEVT1004TR-HF	Hi-Feed	-	-	0.039	0.457	0.259	0.172	2	Right		•	•	•

Hardware - End Mill (Shanks)







Part Number	 Screw	 Torx Driver	Optional		
			 Torque Driver Handle	 Preset Torque Adapter	 Torque Driver Bit
CYLINDRICAL					
1VX1F-06015S6R01	SM30-062-60	DS-TP08S	DS-A00-.25-S	DT-11-.25	DS-TP08B
1VX1F-07015S7R01	SM30-062-60	DS-TP08S	DS-A00-.25-S	DT-11-.25	DS-TP08B
1VX1F-07025S7R01	SM30-062-60	DS-TP08S	DS-A00-.25-S	DT-11-.25	DS-TP08B
1VX1F-10020S1R01	SM30-062-60	DS-TP08S	DS-A00-.25-S	DT-11-.25	DS-TP08B
1VX1F-10030S1R01	SM30-062-60	DS-TP08S	DS-A00-.25-S	DT-11-.25	DS-TP08B
1VX1F-12020S9R01	SM30-062-60	DS-TP08S	DS-A00-.25-S	DT-11-.25	DS-TP08B
1VX1F-12030S9R01	SM30-062-60	DS-TP08S	DS-A00-.25-S	DT-11-.25	DS-TP08B
1VX1F-15020S9R01	SM30-062-60	DS-TP08S	DS-A00-.25-S	DT-11-.25	DS-TP08B
1VX1F-06015S6R02	SM30-062-60	DS-TP08S	DS-A00-.25-S	DT-11-.25	DS-TP08B
1VX1F-07015S7R02	SM30-062-60	DS-TP08S	DS-A00-.25-S	DT-11-.25	DS-TP08B
1VX1F-07025S7R02	SM30-062-60	DS-TP08S	DS-A00-.25-S	DT-11-.25	DS-TP08B
1VX1F-10020S1R02	SM30-062-60	DS-TP08S	DS-A00-.25-S	DT-11-.25	DS-TP08B
1VX1F-10030S1R02	SM30-062-60	DS-TP08S	DS-A00-.25-S	DT-11-.25	DS-TP08B
1VX1F-12020S9R02	SM30-062-60	DS-TP08S	DS-A00-.25-S	DT-11-.25	DS-TP08B
1VX1F-12030S9R02	SM30-062-60	DS-TP08S	DS-A00-.25-S	DT-11-.25	DS-TP08B
1VX1F-15020S9R02	SM30-062-60	DS-TP08S	DS-A00-.25-S	DT-11-.25	DS-TP08B
WELDON					
1VX1F-0601079R01	SM30-062-60	DS-TP08S	DS-A00-.25-S	DT-11-.25	DS-TP08B
1VX1F-0701284R01	SM30-062-60	DS-TP08S	DS-A00-.25-S	DT-11-.25	DS-TP08B
1VX1F-1001280R01	SM30-062-60	DS-TP08S	DS-A00-.25-S	DT-11-.25	DS-TP08B
1VX1F-1201781R01	SM30-062-60	DS-TP08S	DS-A00-.25-S	DT-11-.25	DS-TP08B
1VX1F-1502281R01	SM30-062-60	DS-TP08S	DS-A00-.25-S	DT-11-.25	DS-TP08B
1VX1F-0601079R02	SM30-062-60	DS-TP08S	DS-A00-.25-S	DT-11-.25	DS-TP08B
1VX1F-0701284R02	SM30-062-60	DS-TP08S	DS-A00-.25-S	DT-11-.25	DS-TP08B
1VX1F-1001280R02	SM30-062-60	DS-TP08S	DS-A00-.25-S	DT-11-.25	DS-TP08B
1VX1F-1201781R02	SM30-062-60	DS-TP08S	DS-A00-.25-S	DT-11-.25	DS-TP08B
1VX1F-1502281R02	SM30-062-60	DS-TP08S	DS-A00-.25-S	DT-11-.25	DS-TP08B

Continued on next page

Hardware - End Mill (TopOn)

Part Number	Optional					
	 Screw	 Torx Driver	 Torque Driver Handle	 Preset Torque Adapter	 Torque Driver Bit	 TopOn Wrench
1VX1F-0601079R01	SM30-062-60	DS-TP08S	DS-A00-.25-S	DT-11-.25	DS-TP08B	610MM
1VX1F-0701284R01	SM30-062-60	DS-TP08S	DS-A00-.25-S	DT-11-.25	DS-TP08B	615MM
1VX1F-1001280R01	SM30-062-60	DS-TP08S	DS-A00-.25-S	DT-11-.25	DS-TP08B	617MM
1VX1F-1201781R01	SM30-062-60	DS-TP08S	DS-A00-.25-S	DT-11-.25	DS-TP08B	622MM
1VX1F-1502281R01	SM30-062-60	DS-TP08S	DS-A00-.25-S	DT-11-.25	DS-TP08B	622MM
1VX1F-06015X5R02	SM30-062-60	DS-TP08S	DS-A00-.25-S	DT-11-.25	DS-TP08B	610MM
1VX1F-07015X6R02	SM30-062-60	DS-TP08S	DS-A00-.25-S	DT-11-.25	DS-TP08B	615MM
1VX1F-10015X7R02	SM30-062-60	DS-TP08S	DS-A00-.25-S	DT-11-.25	DS-TP08B	617MM
1VX1F-12017X8R02	SM30-062-60	DS-TP08S	DS-A00-.25-S	DT-11-.25	DS-TP08B	622MM
1VX1F-15017X8R02	SM30-062-60	DS-TP08S	DS-A00-.25-S	DT-11-.25	DS-TP08B	622MM

Hardware - Face Mill

Part Number	Optional						
	 Screw	 Torx Driver	 Retention Bolt	 Coolant Retention Bolt	 Torque Driver Handle	 Preset Torque Adapter	 Torque Driver Bit
VX2F-15R01	SM30-062-60	DS-TP08S	SD-04-46	-	DS-A00-.25-S	DT-11-.25	DS-TP08B
VX5F-15R01	SM30-062-60	DS-TP08S	SD-04-46	-	DS-A00-.25-S	DT-11-.25	DS-TP08B
VX2F-20R01	SM30-062-60	DS-TP08S	SD-06-46	SD06-89	DS-A00-.25-S	DT-11-.25	DS-TP08B
VX5F-20R01	SM30-062-60	DS-TP08S	SD-06-46	SD06-89	DS-A00-.25-S	DT-11-.25	DS-TP08B
VX2F-30R01	SM30-062-60	DS-TP08S	SD-08-48	SD08-C9	DS-A00-.25-S	DT-11-.25	DS-TP08B
VX5F-30R01	SM30-062-60	DS-TP08S	SD-08-48	SD08-C9	DS-A00-.25-S	DT-11-.25	DS-TP08B
VX2F-15R02	SM30-062-60	DS-TP08S	SD-04-46	-	DS-A00-.25-S	DT-11-.25	DS-TP08B
VX5F-15R02	SM30-062-60	DS-TP08S	SD-04-46	-	DS-A00-.25-S	DT-11-.25	DS-TP08B
VX2F-20R02	SM30-062-60	DS-TP08S	SD-06-46	SD06-89	DS-A00-.25-S	DT-11-.25	DS-TP08B
VX5F-20R02	SM30-062-60	DS-TP08S	SD-06-46	SD06-89	DS-A00-.25-S	DT-11-.25	DS-TP08B
VX2F-30R02	SM30-062-60	DS-TP08S	SD-08-48	SD08-C9	DS-A00-.25-S	DT-11-.25	DS-TP08B
VX5F-30R02	SM30-062-60	DS-TP08S	SD-08-48	SD08-C9	DS-A00-.25-S	DT-11-.25	DS-TP08B

90° & Plunge • Operating Guidelines

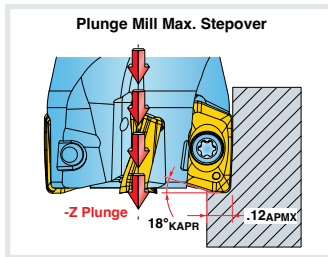

CHIP THINNING

When a_e is less than 25%,
Chip Thinning Calculator
is recommended to ensure
 h_{max} is within f_z range. ▶

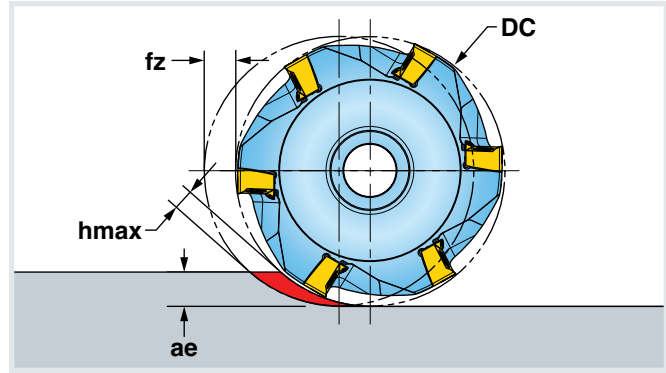

ISO	Materials			Vc Cutting Speed SFM	fz* Feed/Tooth (inch)	Harder «-----» Tougher					Coolant
	Material Group	Type	Examples			IN10K	IN2510	IN2505	IN2530	IN2036	
P	1-5	Non-Alloy Steel	1018, A36, 1045, A572, 1070	400-1000	.003-.006	-	-	2	1	-	No
	6-9	Low-Alloy Steel	4140, 4340, P20, 8620, 300M	350-700							
	10-11	Hi-Alloy Steel	H13, A2, D2, M2, T1	300-600							
M	12-13	Stainless Steel (ferritic & martensitic)	410, 416, 440	350-600	.003-.005	-	-	3	2	1	Yes
	14	Stainless Steel (austenitic)	303, 304, 316, 15-5, 17-4	300-550		May not be required at high speeds					
K	15-16	Gray Cast Iron	CLS. 20, 30, 45	500-1000	.003-.006	-	1	2	-	-	No
	17-18	Nodular Cast Iron	60-40-18, 100-70-03	400-800							
N	21-30	Aluminum	7075, 6061	1000-3000	.001-.005	1	-	-	-	-	Yes
S	31-35	Hi-Temp Alloys	Inconel, Hastelloy, Nimonic, Monel	65-150	.003-.005	-	-	2	3	1	Yes
	36-37	Titanium Alloys	6Al-4V, 5Al-5Mo-5V-3Cr	85-200		-	-	3	2	1	

Note: Feed and speed recommendations are starting operating parameters. They are only guidelines from which further optimization should take place. Operating parameters are influenced by many machining variables. These variables may cause for reductions in feeds and speed or dramatic increases. Additionally, DOC and WOC may need to be revised to optimize the tools performance.

Hi-Feed • Operating Guidelines

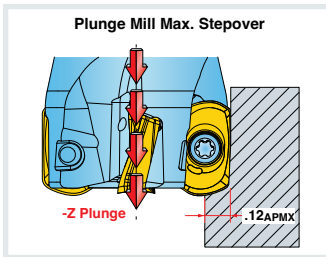

CHIP THINNING

Chip Thinning Calculator

is recommended to ensure h_{max} is within range. ▶

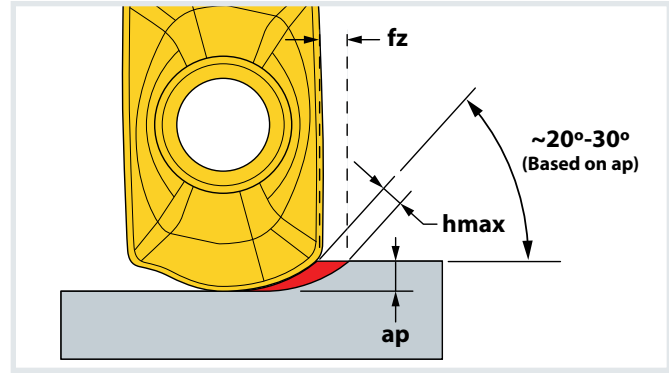

ISO	Materials			Vc Cutting Speed SFM	fz* Feed/Tooth (inch) HI-FEED	ap Recommd. (inch)	hmax* Max Chip Thickness (inch)	fz* Feed/Tooth (inch) PLUNGE	Harder «--» Tougher			Coolant
	Material Group	Type	Examples						IN2505	IN2530	IN2036	
P	1-5	Non-Alloy Steel	1018, A36, 1045, A572, 1070	400-1000	.012-.030	.008-.035	.003-.010	.003-.006	2	1	-	No
	6-9	Low-Alloy Steel	4140, 4340, P20, 8620, 300M	350-700								
	10-11	Hi-Alloy Steel	H13, A2, D2, M2, T1	300-600								
M	12-13	Stainless Steel (ferritic & martensitic)	410, 416, 440	350-600	.012-.030	.008-.035	.003-.010	.003-.005	3	2	1	Yes
	14	Stainless Steel (austenitic)	303, 304, 316, 15-5, 17-4	300-550								May not be required at high speeds
K	15-16	Gray Cast Iron	CLS. 20, 30, 45	500-1000	.012-.035	.008-.035	.003-.010	.003-.006	1	2	-	No
	17-18	Nodular Cast Iron	60-40-18, 100-70-03	400-800								
S	31-35	Hi-Temp Alloys	Inconel, Hastelloy, Nimonic, Monel	65-150	.012-.025	.008-.035	.003-.010	.003-.005	2	3	1	Yes
	36-37	Titanium Alloys	6Al-4V, 5Al-5Mo-5V-3Cr	85-200								

Note: Feed and speed recommendations are starting operating parameters. They are only guidelines from which further optimization should take place. Operating parameters are influenced by many machining variables. These variables may cause for reductions in feeds and speed or dramatic increases. Additionally, DOC and WOC may need to be revised to optimize the tools performance.

Ramp Data Using Series XEVT10 • 90°

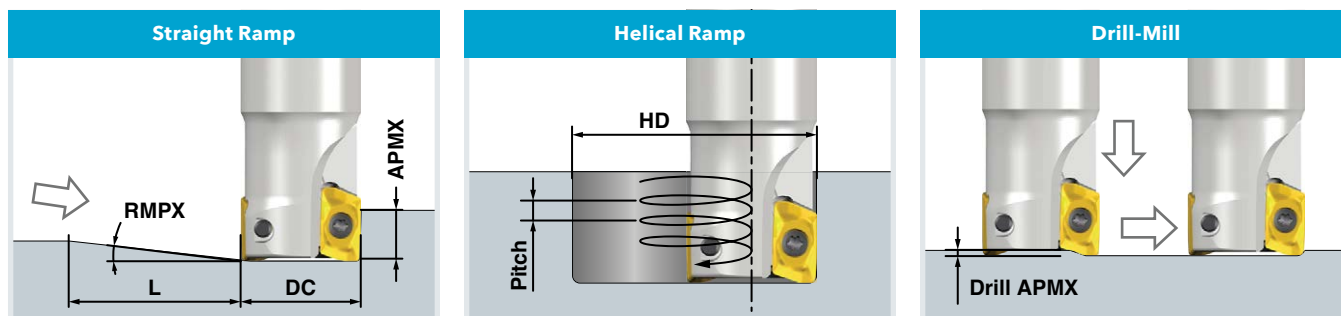

DC Cutter Diameter	Straight Ramp			Helical Ramp			Drill-Mill
	RMPX Ramp Angle Max.	APMX Depth of Cut Max.	L Ramp Length Max.	HD Hole Dia. Min.	HD Hole Dia. Max.	Pitch Max.	Drill APMX
0.625	10.9	0.39	2.0	0.78		0.094	
					1.25	0.381	0.06
0.750	6.5	0.39	3.5	1.03		0.114	
					1.50	0.283	0.08
1.000	4.3	0.39	5.2	1.53		0.122	
					2.00	0.232	0.09
1.250	2.9	0.39	7.7	2.03		0.125	
					2.50	0.200	0.07
1.500	2.1	0.39	10.7	2.53		0.125	
					3.00	0.180	0.08
2.000	1.6	0.39	14.0	3.53		0.125	
					4.00	0.170	0.09
3.000	1.0	0.39	22.3	5.53		0.120	
					6.00	0.150	0.07

Ramp Data Using Series XEVT10-HF • Hi-Feed

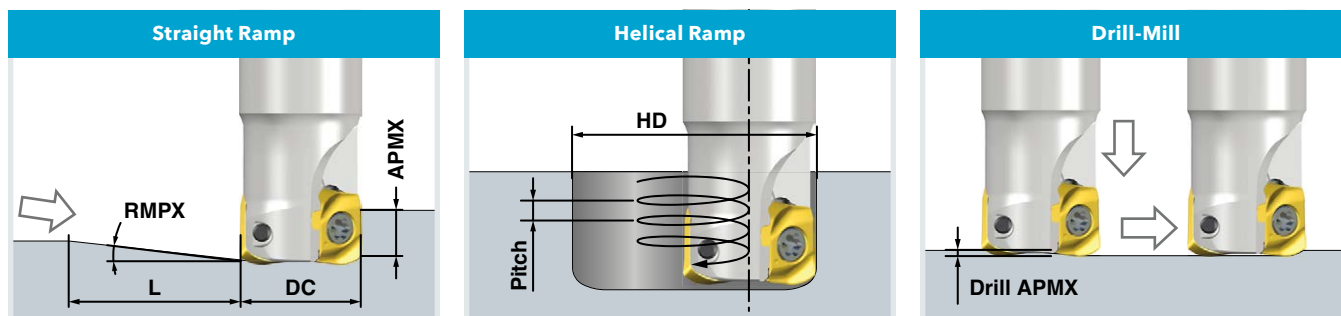

DC Cutter Diameter	Straight Ramp			Helical Ramp			Drill-Mill
	RMPX Ramp Angle Max.	APMX Depth of Cut Max.	L Ramp Length Max.	HD Hole Dia. Min.	HD Hole Dia. Max.	Pitch Max.	Drill APMX
0.625	7.6	0.03	0.2	0.80		0.075	
					1.25	0.263	0.03
0.750	4.2	0.04	0.5	1.05		0.078	
					1.50	0.180	0.04
1.000	2.6	0.05	1.1	1.55		0.075	
					2.00	0.140	0.05
1.250	1.7	0.05	1.6	2.05		0.075	
					2.50	0.120	0.05
1.500	1.2	0.05	2.3	2.55		0.075	
					3.00	0.100	0.05
2.000	0.9	0.05	3.1	3.55		0.075	
					4.00	0.095	0.05
3.000	0.4	0.05	7.1	5.55		0.075	
					6.00	0.085	0.05

Programming Technical Data	Part Number	R Program	A Overcut	B Unmachined
	XEVT1004TR-HF	0.067	0.0000	0.019
		0.075	0.0000	0.017
		0.078	0.0004	0.016
		0.100	0.0050	0.009
		0.120	0.0120	0.004

= Recommended program "R"