

### MILLING - INDEXABLE

#### Cutter Series

- 2XJ3C Shell Mills
- 2XJ3C End Mills **NEW**
- 2XJ3J Shell Mills
- 2XJ3J End Mills

#### Diameters

- 1.500"-3.000" **NEW**

#### Insert Series

- IPM313 ML (11 mm) **NEW**
- IPM425 ML (11 mm)
- IPM324 ML/MM (13 mm)
- IPM426 ML/MM (13 mm)

#### Grades

- IN2505/IN4005
- IN2530/IN4030
- IN2535/IN4035

#### Corner Radius

- .031", .062", .093", .125", .250"

#### Materials

- Steel
- Stainless Steel
- Iron
- High-Temp Alloys/Titanium

## NUMAX ILOCK™



### End Mills and Shell Mills With New, Smaller Size, Interlocking Inserts for Smooth/Reliable Operation

- » Overlapping "V-Notch" inserts that allow for smooth chip formation at high feed-rates.
- » Smaller inserts designed for lower HP machines, freer cutting conditions and larger radial depth of cut in aggressive materials.
- » Patented end station design with available corner radii inserts from .031" to .250" with no cutter body modifications needed.

# AHB

TOOLING & MACHINERY

COMPLETE METALWORKING SOLUTIONS

(800) 991-4225

www.ahbinc.com

ISO Certified

customerservice@ahbinc.com

See it in action! »



**WINSPEED™**  
ADVANCED MACHINING

ingersoll-imc.com



# Ingersoll's NuMaxILock has been expanded to include a new smaller 11mm IC size insert that creates a smaller diameter cutter and higher density Endmills & Shellmills

The new smaller 11mm IC insert allows for a smaller 1.500 diameter endmill not available in the original 13mm 2XJ3J series. With the smaller 11mm insert, Ingersoll was able to design the new 2XJ3C series to offer 1 additional flute increasing productivity in Aerospace materials like Titanium, Stainless Steel and other Hi-Temp Alloys.

Available in the new 2XJ3C series face insert, IPM425, face station inserts are designed with the ability to ramp for cutter versatility, improve overall productivity and longer tool life even under difficult machining conditions.

## Features & Benefits

---

- Tangentially mounted inserts with dovetailed seating for greater cutter reliability and insert stability
- High axial shear for smooth chip formation in both keen and landed insert geometries
- Cutter bodies are designed with through coolant/air to improve chip evacuation in tough applications
- IPM425/426 face inserts offer axial wiping flats for low Ra surface finishes
- Premium milling grades and the latest post coating treatment technology

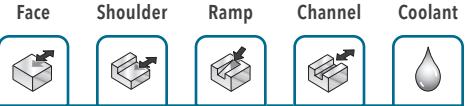

## 11 mm • Series 2XJ3C

### 90° SHELL MILL (11 MM INSERT)

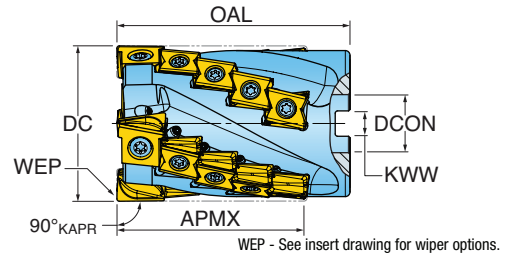

Part Number	DC Cutting Dia.	APMX Depth of Cut Max.	OAL Overall Length	ZEFF Eff. Teeth	ZEFP Eff. Teeth periphery	ZNF Face Insert Count	ZNP Periphery Insert Count	NOF Flute Count	DCON Bore Dia.	KWW Keyway	RMPX Ramp Angle Max.
2XJ3C-20023D1R01	2.000	1.670	2.350	5	5	5	15	5	0.750	0.312	0.76
2XJ3C-20027D1R01	2.000	2.060	2.750	5	5	5	20	5	0.750	0.312	0.76
2XJ3C-20030D1R01	2.000	2.450	3.000	5	5	5	25	5	0.750	0.312	0.76
2XJ3C-20035D1R01	2.000	2.840	3.500	5	5	5	30	5	0.750	0.312	0.76
2XJ3C-25030D3R01	2.500	2.450	3.000	6	6	6	30	6	1.000	0.375	0.56
2XJ3C-25035D3R01	2.500	2.840	3.500	6	6	6	36	6	1.000	0.375	0.56
2XJ3C-25040D3R01	2.500	3.230	4.000	6	6	6	42	6	1.000	0.375	0.56
2XJ3C-25045D3R01	2.500	3.620	4.500	6	6	6	48	6	1.000	0.375	0.56
2XJ3C-25050D3R01	2.500	4.000	5.000	6	6	6	54	6	1.000	0.375	0.56
2XJ3C-30050D4R01	3.000	4.000	5.000	7	7	7	63	7	1.250	0.500	0.44
2XJ3C-30035D4R01	3.000	2.840	3.500	7	7	7	42	7	1.250	0.500	0.44
2XJ3C-30040D4R01	3.000	3.230	4.000	7	7	7	49	7	1.250	0.500	0.44
2XJ3C-30045D4R01	3.000	3.620	4.500	7	7	7	56	7	1.250	0.500	0.44

\* End station insert screw tightening torque: 30-35 in\*lb. Side station insert screw tightening torque: 25-30 in\*lb.

\*\* Total number of inserts = ZNF + ZNP

## 11 mm • Series 2XJ3C

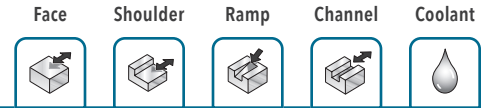

### 90° WELDON DIMPLE STYLE END MILL (11 MM INSERT)

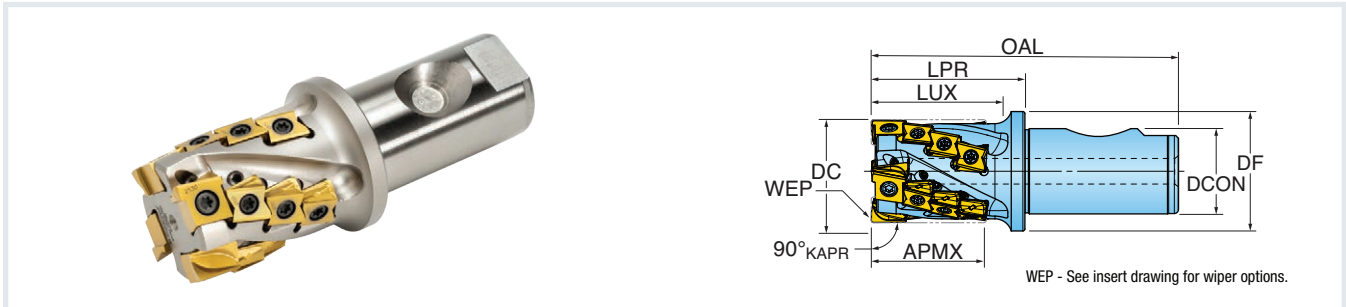

Part Number	DC Cutting Dia.	APMX Depth of Cut Max.	LUX Usable Length Max.	LPR Protruding Length	LF Funct. Length	OAL Overall Length	ZEFF Eff. Teeth	ZEFP Eff. Teeth Periphery	ZNF Face Insert Count	ZNP Periphery Insert Count	NOF Flute Count	DCON Shank Dia.	DF Flange Dia.	RMPX Ramp Angle Max.
2XJ3C-1502281R01	1.500	1.670	1.800	2.250	2.250	4.500	4	4	4	12	4	1.250	1.750	1.22
2XJ3C-1502281R02	1.500	1.670	1.800	2.250	2.250	4.500	3	3	3	9	3	1.250	1.750	1.22
2XJ3C-1502781R01	1.500	2.060	2.300	2.750	2.750	5.000	4	4	4	16	4	1.250	1.750	1.22
2XJ3C-1502781R02	1.500	2.060	2.300	2.750	2.750	5.000	3	3	3	12	3	1.250	1.750	1.22
2XJ3C-1503281R01	1.500	2.450	2.800	3.250	3.250	5.500	4	4	4	24	4	1.250	1.750	1.22
2XJ3C-1503281R02	1.500	2.450	2.800	3.250	3.250	5.500	3	3	3	15	3	1.250	1.750	1.22
2XJ3C-2002281R01	2.000	1.670	-	2.250	2.250	4.500	5	5	5	15	5	1.250	-	0.76
2XJ3C-2002781R01	2.000	2.060	-	2.750	2.750	5.000	5	5	5	20	5	1.250	-	0.76
2XJ3C-2003081R01	2.000	2.450	-	3.000	3.000	5.250	5	5	5	25	5	1.250	-	0.76

\* End station insert screw tightening torque: 30-35 in\*lb. Side station insert screw tightening torque: 25-30 in\*lb.

\*\* Total number of inserts = ZNF + ZNP

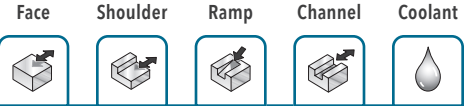

## 11 mm • Series 2XJ3C

### 90° WELDON STYLE END MILL (11 MM INSERT)

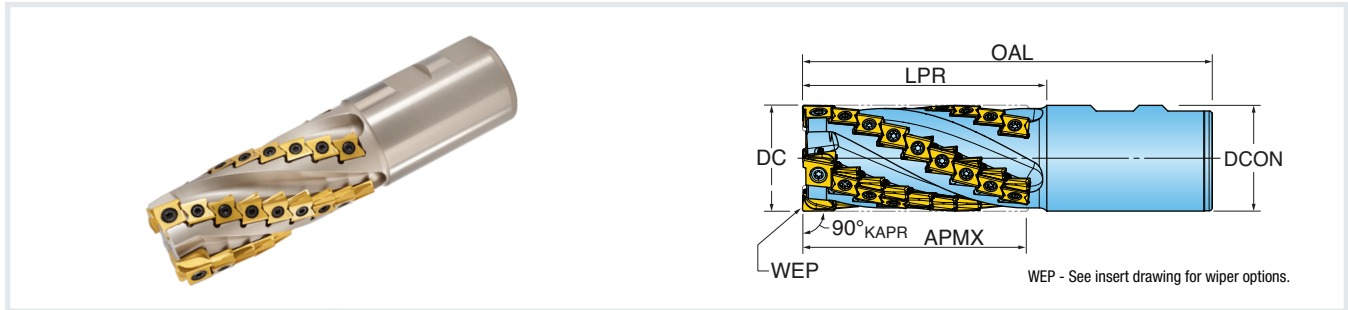

Part Number	DC Cutting Dia.	APMX Depth of Cut Max.	LPR Protruding Length	LF Funct. Length	OAL Overall Length	ZEFF Eff. Teeth	ZEFP Eff. Teeth Periphery	ZNF Face Insert Count	ZNP Periphery Insert Count	NOF Flute Count	DCON Shank Dia.	RMPX Ramp Angle Max.
2XJ3C-2004582R01	2.000	4.015	4.500	4.500	7.750	5	5	5	45	5	2.000	0.76
2XJ3C-2005082R01	2.000	4.400	5.000	5.000	8.250	5	5	5	50	5	2.000	0.76

\* End station insert screw tightening torque: 30-35 in\*lb. Side station insert screw tightening torque: 25-30 in\*lb.

\*\* Total number of inserts = ZNF + ZNP

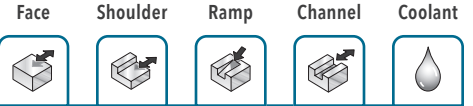

## 11 mm • Series 2XJ3C

### 90° V-FLANGE STYLE END MILL (11 MM INSERT)

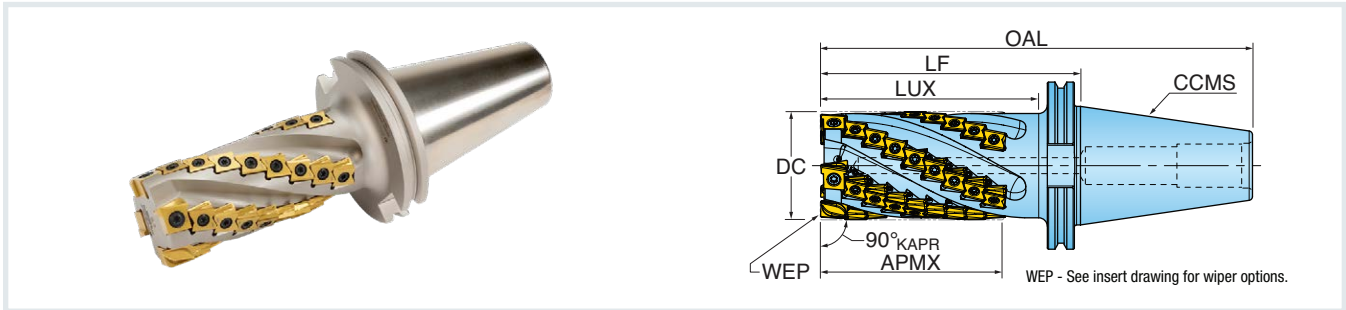

Part Number	DC Cutting Dia.	APMX Depth of Cut Max.	LUX Usable Length Max.	LF Funct. Length	OAL Overall Length	ZEFF Eff. Teeth	ZEFP Eff. Teeth Periphery	ZNF Face Insert Count	ZNP Periphery Insert Count	NOF Flute Count	CCMS Connection Code Machine Side	RMPX Ramp Angle Max.
2XJ3C-1503629R01	1.500	2.450	2.810	3.685	6.375	4	4	4	20	4	ICTC #40 .125 Draw	1.22
2XJ3C-1503629R02	1.500	2.450	2.810	3.685	6.375	3	3	3	15	3	ICTC #40 .125 Draw	1.22
2XJ3C-2006048R01	2.000	4.015	4.630	6.000	10.000	5	5	5	45	5	ICTC #50 .125 Draw	0.76
2XJ3C-2506048R01	2.500	4.010	4.630	6.000	10.000	6	6	6	54	6	ICTC #50 .125 Draw	0.56
2XJ3C-2508048R01	2.500	5.965	6.625	8.000	12.000	6	6	6	84	6	ICTC #50 .125 Draw	0.56

\* End station insert screw tightening torque: 30-35 in\*lb. Side station insert screw tightening torque: 25-30 in\*lb.

\*\* Total number of inserts = ZNF + ZNP



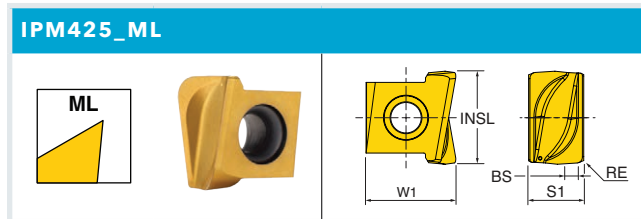
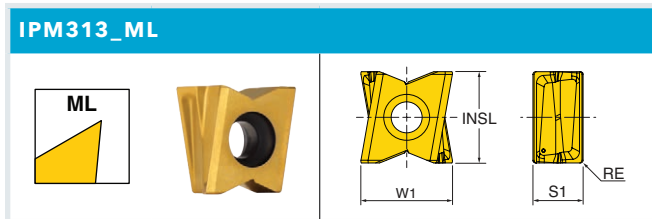



## 11 mm • Series 2XJ3C Inserts



Part Number	Application	Station	RE Corner Radius	BS Wiper Length	LE Cutting Edge Eff. Length	INSL Insert Length	W1 Insert Width	S Thick.	NOI Number of Indexes	IH Insert Hand	Grade			
											IN4030	IN2530	IN4035	IN2535
IPM313R001-ML	Multi-Purpose, Keen Edge	Periphery	0.010	-	0.423	0.433	0.433	0.236	4	Right	•	•	•	•
IPM425R001-ML	Multi-Purpose, Keen Edge	Face	0.032	0.120	0.531	0.531	0.512	0.315	2	Right	•	•	•	•
IPM425R002-ML	Multi-Purpose, Keen Edge	Face	0.062	0.090	0.531	0.531	0.508	0.315	2	Right	•	•	•	•
IPM425R003-ML	Multi-Purpose, Keen Edge	Face	0.094	0.060	0.531	0.531	0.504	0.315	2	Right	•	•	•	•
IPM425R004-ML	Multi-Purpose, Keen Edge	Face	0.125	0.029	0.531	0.531	0.499	0.315	2	Right	•	•	•	•
IPM425R009-ML	Multi-Purpose, Keen Edge	Face	0.250	0.010	0.547	0.547	0.482	0.315	2	Right	•	•	•	•



## 11 mm • Series 2XJ3C Hardware

	 Driver Bit	 Driver Handle	 Face Insert Screw	 Periphery Insert Screw	 Retention Bolt	 Coolant Hole Socket Set Screw	 Alt. Coolant Blocking Socket Set Screw
2XJ3C-1502281R01	DS-T156B	DS-A00T	SM40-143-H0	SM35-107-H0	-	SA030-01	SA030-02
2XJ3C-1502281R02	DS-T156B	DS-A00T	SM40-143-H0	SM35-107-H0	-	SA030-01	SA030-02
2XJ3C-1502781R01	DS-T156B	DS-A00T	SM40-143-H0	SM35-107-H0	-	SA030-01	SA030-02
2XJ3C-1502781R02	DS-T156B	DS-A00T	SM40-143-H0	SM35-107-H0	-	SA030-01	SA030-02
2XJ3C-1503281R01	DS-T156B	DS-A00T	SM40-143-H0	SM35-107-H0	-	SA030-01	SA030-02
2XJ3C-1503281R02	DS-T156B	DS-A00T	SM40-143-H0	SM35-107-H0	-	SA030-01	SA030-02
2XJ3C-2002281R01	DS-T156B	DS-A00T	SM40-143-H0	SM35-107-H0	-	SA030-01	SA030-02
2XJ3C-2002781R01	DS-T156B	DS-A00T	SM40-143-H0	SM35-107-H0	-	SA030-01	SA030-02
2XJ3C-2003081R01	DS-T156B	DS-A00T	SM40-143-H0	SM35-107-H0	-	SA030-01	SA030-02
2XJ3C-2004582R01	DS-T156B	DS-A00T	SM40-143-H0	SM35-107-H0	-	SA030-01	SA030-02
2XJ3C-2005082R01	DS-T156B	DS-A00T	SM40-143-H0	SM35-107-H0	-	SA030-01	SA030-02
2XJ3C-1503629R01	DS-T156B	DS-A00T	SM40-143-H0	SM35-107-H0	-	SA030-01	SA030-02
2XJ3C-1503629R02	DS-T156B	DS-A00T	SM40-143-H0	SM35-107-H0	-	SA030-01	SA030-02
2XJ3C-2006048R01	DS-T156B	DS-A00T	SM40-143-H0	SM35-107-H0	-	SA030-01	SA030-02
2XJ3C-2506048R01	DS-T156B	DS-A00T	SM40-143-H0	SM35-107-H0	-	SA030-01	SA030-02
2XJ3C-2508048R01	DS-T156B	DS-A00T	SM40-143-H0	SM35-107-H0	-	SA030-01	SA030-02
2XJ3C-20023D1R01	DS-T156B	DS-A00T	SM40-143-H0	SM35-107-H0	SD06-50	SA030-01	SA030-02
2XJ3C-20027D1R01	DS-T156B	DS-A00T	SM40-143-H0	SM35-107-H0	SD-06-A2	SA030-01	SA030-02
2XJ3C-20030D1R01	DS-T156B	DS-A00T	SM40-143-H0	SM35-107-H0	SD06-79	SA030-01	SA030-02
2XJ3C-20035D1R01	DS-T156B	DS-A00T	SM40-143-H0	SM35-107-H0	SD06-B2	SA030-01	SA030-02
2XJ3C-25030D3R01	DS-T156B	DS-A00T	SM40-143-H0	SM35-107-H0	SD08-52	SA030-01	SA030-02
2XJ3C-25035D3R01	DS-T156B	DS-A00T	SM40-143-H0	SM35-107-H0	SD08-81	SA030-01	SA030-02
2XJ3C-25040D3R01	DS-T156B	DS-A00T	SM40-143-H0	SM35-107-H0	SD08-D3	SA030-01	SA030-02
2XJ3C-25045D3R01	DS-T156B	DS-A00T	SM40-143-H0	SM35-107-H0	SD08-53	SA030-01	SA030-02
2XJ3C-25050D3R01	DS-T156B	DS-A00T	SM40-143-H0	SM35-107-H0	SD08-54	SA030-01	SA030-02
2XJ3C-30050D4R01	DS-T156B	DS-A00T	SM40-143-H0	SM35-107-H0	SD10-04	SA030-01	SA030-02
2XJ3C-30035D4R01	DS-T156B	DS-A00T	SM40-143-H0	SM35-107-H0	SD10-B7	SA030-01	SA030-02
2XJ3C-30040D4R01	DS-T156B	DS-A00T	SM40-143-H0	SM35-107-H0	SD10-B8	SA030-01	SA030-02
2XJ3C-30045D4R01	DS-T156B	DS-A00T	SM40-143-H0	SM35-107-H0	SD10-B9	SA030-01	SA030-02

\* QwikTorque optional preset torque components recommended for proper tightening screws. All components are sold separately.



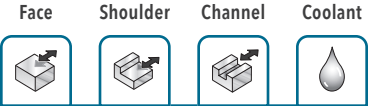

## 13 mm • Series 2XJ3J

### 90° SHELL MILL (13 MM INSERT)

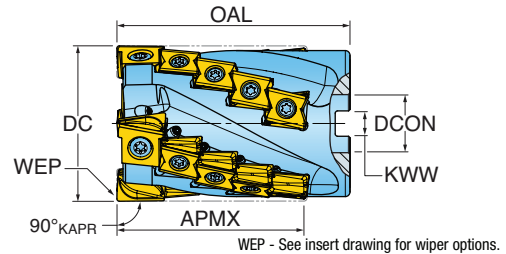

Part Number	DC Cutting Dia.	APMX Depth of Cut Max.	OAL Overall Lenth	ZEFF Eff. Teeth	ZEFP Eff. Teeth Periphery	ZNF Face Insert Count	ZNP Periphery Insert Count	NOF Flute Count	DCON Bore Dia.	KWW Keyway
2XJ3J-20023D1R01	2.000	1.512	2.35	4	4	4	8	4	0.750	0.312
2XJ3J-20027D1R01	2.000	1.971	2.75	4	4	4	12	4	0.750	0.312
2XJ3J-20027D1R02	2.000	1.512	2.75	3	3	3	6	3	0.750	0.312
2XJ3J-20030D1R01	2.000	2.430	3.00	4	4	4	16	4	0.750	0.312
2XJ3J-20035D1R01	2.000	2.889	3.50	4	4	4	20	4	0.750	0.312
2XJ3J-25035D3R02	2.500	2.886	3.50	4	4	4	20	4	1.000	0.375
2XJ3J-25030D3R01	2.500	2.431	3.00	5	5	5	20	5	1.000	0.375
2XJ3J-25035D3R01	2.500	2.886	3.50	5	5	5	25	5	1.000	0.375
2XJ3J-25035D3R02	2.500	2.886	3.50	4	4	4	20	4	1.000	0.375
2XJ3J-25040D3R01	2.500	3.348	4.00	5	5	5	30	5	1.000	0.375
2XJ3J-25045D3R01	2.500	3.806	4.50	5	5	5	35	5	1.000	0.375
2XJ3J-30037D4R01	3.000	2.890	3.75	5	5	5	25	5	1.250	0.500
2XJ3J-30037D4R02	3.000	2.890	3.75	6	6	6	30	6	1.250	0.500
2XJ3J-30042D4R01	3.000	3.348	4.25	5	5	5	30	5	1.250	0.500
2XJ3J-30050D4R01	3.000	3.807	5.00	5	5	5	35	5	1.250	0.500
2XJ3J-30050D4R02	3.000	3.807	5.00	6	6	6	42	6	1.250	0.500

\* End station insert screw tightening torque: 40-45 in\*lb. Side station insert screw tightening torque: 30-35 in\*lb.

\*\* Total number of inserts = ZNF + ZNP

## 13 mm • Series 2XJ3J

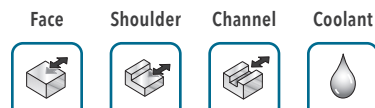

### 90° WELDON DIMPLE STYLE END MILL (13 MM INSERT)

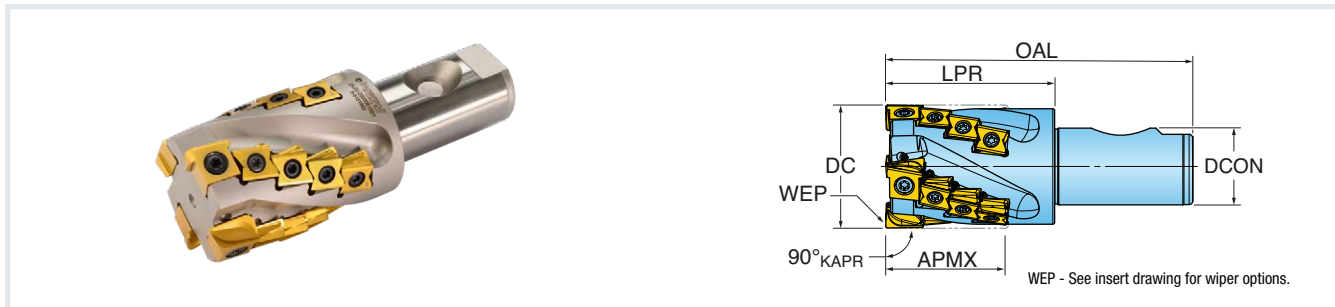

Part Number	DC Cutting Dia.	APMX Depth of Cut Max.	LUX Usable Length Max.	LPR Protruding Length	LF Funct. Length	OAL Overall Length	ZEFF Eff. Teeth	ZEFP Eff. Teeth Periphery	ZNF Face Insert Count	ZNP Periphery Insert Count	NOF Flute Count	DCON Shank Dia.
2XJ3J-2002281R01	2.000	1.510	2.250	2.250	2.250	4.500	4	4	4	8	4	1.250
2XJ3J-2002781R01	2.000	1.971	2.750	2.750	2.750	5.000	4	4	4	12	4	1.250
2XJ3J-2003081R01	2.000	2.430	3.000	3.000	3.000	5.250	4	4	4	16	4	1.250

\* End station insert screw tightening torque: 40-45 in\*lb. Side station insert screw tightening torque: 30-35 in\*lb.

\*\* Total number of inserts = ZNF + ZNP

## 13 mm • Series 2XJ3J

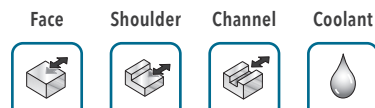

### 90° WELDON STYLE END MILL (13 MM INSERT)

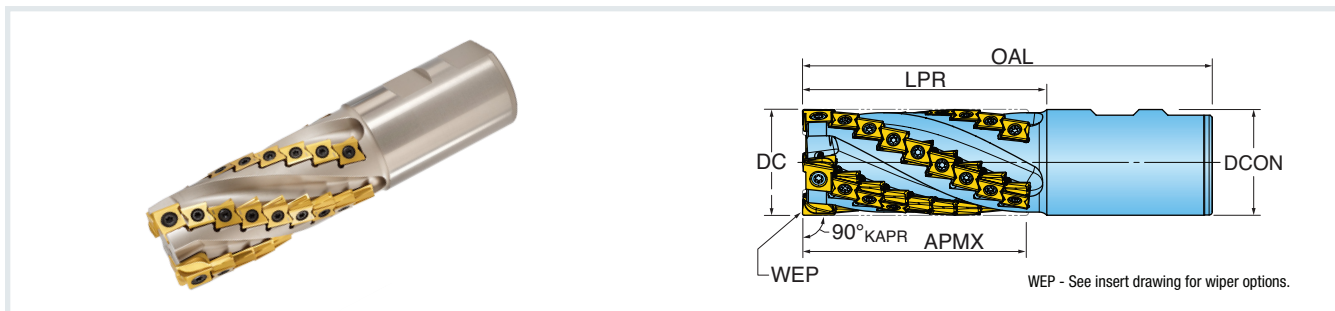

Part Number	DC Cutting Dia.	APMX Depth of Cut Max.	LUX Usable Length Max.	LPR Protruding Length	LF Funct. Length	OAL Overall Length	ZEFF Eff. Teeth	ZEFP Eff. Teeth Periphery	ZNF Face Insert Count	ZNP Periphery Insert Count	NOF Flute Count	DCON Shank Dia.
2XJ3J-2004082R01	2.000	4.262	4.650	4.650	4.650	7.750	4	4	4	32	4	2.000

\* End station insert screw tightening torque: 40-45 in\*lb. Side station insert screw tightening torque: 30-35 in\*lb.

\*\* Total number of inserts = ZNF + ZNP

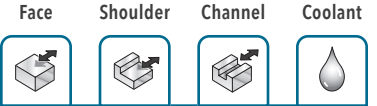

## 13 mm • Series 2XJ3J

### 90° V-FLANGE STYLE END MILL (13 MM INSERT)

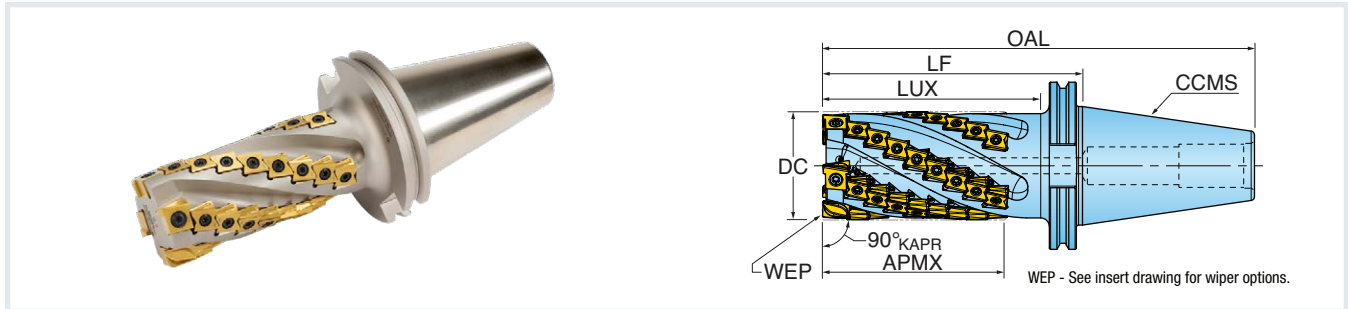

Part Number	DC Cutting Dia.	APMX Depth of Cut Max.	LUX Usable Length Max.	LF Funct. Length	OAL Overall Length	ZEFF Eff. Teeth	ZEFP Eff. Teeth Periphery	ZNF Face Insert Count	ZNP Periphery Insert Count	NOF Flute Count	CCMS Connection Code Machine Side
2XJ3J-2006048R01	2.000	4.262	4.625	6	10	4	4	4	32	4	ICTC #50 .125 Draw
2XJ3J-2006048R02	2.000	4.262	4.625	6	10	3	3	3	24	3	ICTC #50 .125 Draw
2XJ3J-2506048R01	2.500	4.262	4.625	6	10	5	5	5	40	5	ICTC #50 .125 Draw
2XJ3J-2508048R01	2.500	6.099	6.625	8	12	5	5	5	60	5	ICTC #50 .125 Draw

\* End station insert screw tightening torque: 40-45 in\*lb. Side station insert screw tightening torque: 30-35 in\*lb.





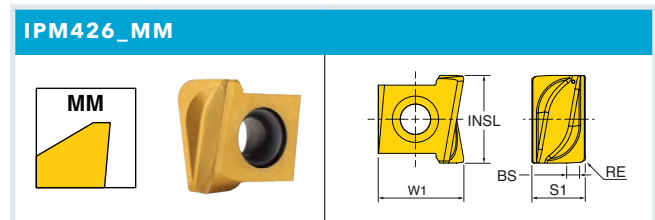
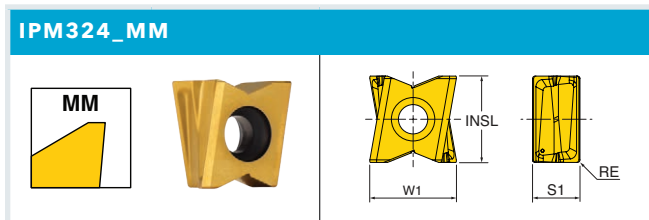
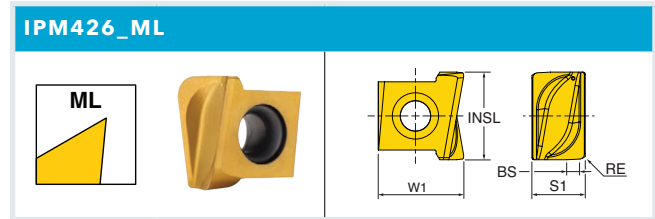
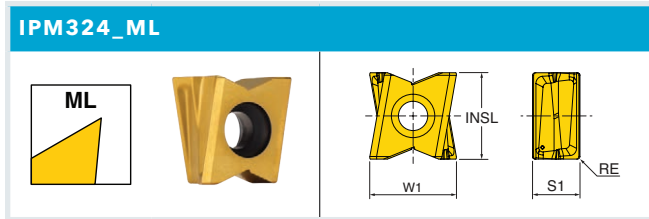



\*\* Total number of inserts = ZNF + ZNP

## 13 mm • Series 2XJ3J INSERTS



Part Number	Application	Station	RE Corner Radius	BS Wiper Length	LE Cutting Edge Eff. Length	INSL Insert Length	W1 Insert Width	S Thick.	NOI Numbers Of Indexes	IH Insert Hand	Grade					
											IN4005	IN2505	IN4030	IN2530	IN4035	IN2535
IPM324R001-ML	Multi-Purpose, Keen Edge	Periphery	0.015	.	0.482	0.512	0.514	0.281	4	Right			•	•	•	•
IPM324R001-MM	Multi-Purpose/ Heavy-Duty	Periphery	0.015	.	0.512	0.512	0.512	0.281	4	Right	•	•	•	•		
IPM426R001-ML	Multi-Purpose, Keen Edge	Face	0.030	0.103	0.617	0.617	0.595	0.375	2	Right			•	•	•	•
IPM426R001-MM	Multi-Purpose/ Heavy-Duty	Face	0.030	0.103	0.617	0.617	0.595	0.375	2	Right	•	•	•	•		
IPM426R002-ML	Multi-Purpose, Keen Edge	Face	0.060	0.103	0.620	0.620	0.594	0.375	2	Right			•	•	•	•
IPM426R002-MM	Multi-Purpose/ Heavy-Duty	Face	0.060	0.103	0.620	0.620	0.594	0.375	2	Right	•	•	•	•		
IPM426R003-ML	Multi-Purpose, Keen Edge	Face	0.090	0.103	0.623	0.623	0.586	0.375	2	Right			•	•	•	•
IPM426R003-MM	Multi-Purpose/ Heavy-Duty	Face	0.090	0.103	0.623	0.623	0.586	0.375	2	Right	•	•	•	•		
IPM426R004-ML	Multi-Purpose, Keen Edge	Face	0.125	0.104	0.626	0.626	0.585	0.375	2	Right			•	•	•	•
IPM426R004-MM	Multi-Purpose/ Heavy-Duty	Face	0.125	0.104	0.626	0.626	0.585	0.375	2	Right	•	•	•	•		

## 13 mm • Series 2XJ3J Hardware

Part Number	 Face Driver Bit	 Periphery Driver Bit	 Driver Handle	 Face Insert Screw	 Periphery Insert Screw	 Retention Bolt	 Coolant Hole Socket Set Screw	 Alt. Coolant Blocking Socket Set Screw
2XJ3J-20023D1R01	DS-T206B	DS-T156B	DS-A00T	SM50-140-10	SM40-123-H0	SD-06-50	SA030-01	SA030-02
2XJ3J-20027D1R01	DS-T206B	DS-T156B	DS-A00T	SM50-140-10	SM40-123-H0	SD-06-A2	SA030-01	SA030-02
2XJ3J-20027D1R02	DS-T206B	DS-T156B	DS-A00T	SM50-140-10	SM40-123-H0	SD-06-79	SA030-01	SA030-02
2XJ3J-20030D1R01	DS-T206B	DS-T156B	DS-A00T	SM50-140-10	SM40-123-H0	SD-06-79	SA030-01	SA030-02
2XJ3J-20035D1R01	DS-T206B	DS-T156B	DS-A00T	SM50-140-10	SM40-123-H0	SD-06-B2	SA030-01	SA030-02
2XJ3J-25030D3R01	DS-T206B	DS-T156B	DS-A00T	SM50-160-10	SM40-123-H0	SD-08-52	SA030-01	SA030-02
2XJ3J-25035D3R01	DS-T206B	DS-T156B	DS-A00T	SM50-160-10	SM40-123-H0	SD-08-81	SA030-01	SA030-02
2XJ3J-25035D3R02	DS-T206B	DS-T156B	DS-A00T	SM50-160-10	SM40-123-H0	SD-08-81	SA030-01	SA030-02
2XJ3J-25040D3R01	DS-T206B	DS-T156B	DS-A00T	SM50-160-10	SM40-123-H0	SD-08-D3	SA030-01	SA030-02
2XJ3J-25045D3R01	DS-T206B	DS-T156B	DS-A00T	SM50-160-10	SM40-123-H0	SD-08-97	SA030-01	SA030-02
2XJ3J-30037D4R01	DS-T206B	DS-T156B	DS-A00T	SM50-160-10	SM40-123-H0	SD-10-54	SA030-01	SA030-02
2XJ3J-30037D4R02	DS-T206B	DS-T156B	DS-A00T	SM50-160-10	SM40-123-H0	SD-10-54	SA030-01	SA030-02
2XJ3J-30042D4R01	DS-T206B	DS-T156B	DS-A00T	SM50-160-10	SM40-123-H0	SD-10-73	SA030-01	SA030-02
2XJ3J-30042D4R02	DS-T206B	DS-T156B	DS-A00T	SM50-160-10	SM40-123-H0	SD-10-73	SA030-01	SA030-02
2XJ3J-30050D4R01	DS-T206B	DS-T156B	DS-A00T	SM50-160-10	SM40-123-H0	SD-10-04	SA030-01	SA030-02
2XJ3J-30050D4R02	DS-T206B	DS-T156B	DS-A00T	SM50-160-10	SM40-123-H0	SD-10-04	SA030-01	SA030-02
2XJ3J-2002281R01	DS-T206B	DS-T156B	DS-A00T	SM50-160-10	SM40-123-H0	-	SA030-01	SA030-02
2XJ3J-2002781R01	DS-T206B	DS-T156B	DS-A00T	SM50-160-10	SM40-123-H0	-	SA030-01	SA030-02
2XJ3J-2003081R01	DS-T206B	DS-T156B	DS-A00T	SM50-160-10	SM40-123-H0	-	SA030-01	SA030-02
2XJ3J-2004082R01	DS-T206B	DS-T156B	DS-A00T	SM50-160-10	SM40-123-H0	-	SA030-01	SA030-02
2XJ3J-2006048R01	DS-T206B	DS-T156B	DS-A00T	SM50-160-10	SM40-123-H0	-	SA030-01	SA030-02
2XJ3J-2006048R02	DS-T206B	DS-T156B	DS-A00T	SM50-160-10	SM40-123-H0	-	SA030-01	SA030-02
2XJ3J-2506048R01	DS-T206B	DS-T156B	DS-A00T	SM50-160-10	SM40-123-H0	-	SA030-01	SA030-02
2XJ3J-2508048R01	DS-T206B	DS-T156B	DS-A00T	SM50-160-10	SM40-123-H0	-	SA030-01	SA030-02

\* QwikTorque optional preset torque components recommended for proper tightening screws. All components are sold separately.

## 11 mm • Operating Guidelines

### Ramping

Cutter Diameter	Max Ramp Angle
1.50	1.22°
2.00	0.76°
2.50	0.56°
3.00	0.44°

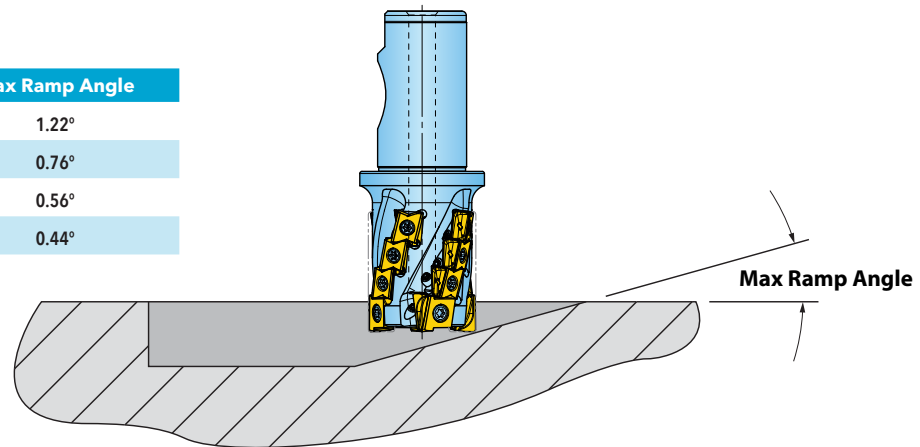

ISO	Materials			V <sub>c</sub> Cutting Speed SFM	H <sub>max</sub> Max. Chip Thickness (inch)	Harder <-----> Tougher				Coolant	Geometry 
	Material Group #VDI 3323	Type	Examples			IN4030	IN2530	IN4035	IN2535		
<b>P</b>	1-5	Non-Alloy Steel	1018, A36, 1045, A572, 1070	150-400	.004-.012	2	1	-	-	No	1
	6-9	Low-Alloy Steel	4140, 4340, P20, 8620, 300M	150-300	.004-.010	2	1	-	-	No	1
	10-11	High-Alloy Steel	H13, A2, D2, M2, T1	150-250	.004-.007	2	1	-	-	No	1
<b>M</b>	12-13	Stainless Steel (ferritic & martensitic)	410, 416, 440	150-300	.006-.010	4	3	2	1	Yes	1
	14	Stainless Steel (austenitic)	303, 304, 316, 15-5, 17-4	150-350	.004-.007	4	3	2	1	Yes	1
<b>K</b>	15-16	Gray Cast Iron	CLS. 20, 30, 45	150-400	.004-.012	1	2	-	-	Yes	1
	17-20	Nodular Cast Iron	60-40-18, 100-70-03	150-300	.004-.010	1	2	-	-	No	1
<b>N</b>	21-30	Aluminum	7075, 6061	150-700	.004-.020	1	2	-	-	Yes	1
<b>S</b>	31-35	High-Temp Alloys	Inconel, Hastelloy, Monel	50-100	.003-.006	4	3	2	1	Yes	1
	36-37	Titanium Alloys	6Al-4V, 5Al-5Mo-5V-3Cr	100-190	.002-.007	4	3	2	1	Yes	1
<b>H</b>	38-39	Hardened Steel >48	A2, 01, D2	50-150	.003-.004	2	1	-	-	No	1

Note: Feed and speed recommendations are starting operating parameters. They are only guidelines from which further optimization should take place. Operating parameters are influenced by many machining variables. These variables may cause for reductions in feeds and speed or dramatic increases. Additionally, DOC and WOC may need to be revised to optimize the tools performance.

## 13 mm • Operating Guidelines

ISO	Materials			V <sub>c</sub> Cutting Speed SFM	H <sub>max</sub> Max. Chip Thickness (inch)	Harder <-----> Tougher						Coolant	Geometry	
	Material Group #VDI 3323	Type	Examples			IN4005	IN2505	IN4030	IN2530	IN4035	IN2535		MM	ML
<b>P</b>	1-5	Non-Alloy Steel	1018, A36, 1045, A572, 1070	150-400	.004-.015	4	3	2	1	-	-	No	1	2
	6-9	Low-Alloy Steel	4140, 4340, P20, 8620, 300M	150-300	.004-.012	4	3	2	1	-	-	No	1	2
	10-11	High-Alloy Steel	H13, A2, D2, M2, T1	150-250	.004-.008	4	3	2	1	-	-	No	1	2
<b>M</b>	12-13	Stainless Steel (ferritic & martensitic)	410, 416, 440	150-300	.006-.012	-	-	4	3	2	1	Yes	1	2
	14	Stainless Steel (austenitic)	303, 304, 316, 15-5, 17-4	150-350	.004-.008	-	-	4	3	2	1	Yes	2	1
<b>K</b>	15-16	Gray Cast Iron	CLS. 20, 30, 45	150-400	.004-.015	4	3	2	1	-	-	Yes	1	2
	17-20	Nodular Cast Iron	60-40-18, 100-70-03	150-300	.004-.012	4	3	2	1	-	-	No	1	2
<b>N</b>	21-30	Aluminum	7075, 6061	150-700	.004-.025	1	2	3	4	-	-	Yes	2	1
<b>S</b>	31-35	High-Temp Alloys	Inconel, Hastelloy, Nimonic, Monel	50-100	.002-.004	-	-	-	3	2	1	Yes	2	1
	36-37	Titanium Alloys	6Al-4V, 5Al-5Mo-5V-3Cr	100-190	.002-.008	-	-	-	3	2	1	Yes	2	1
<b>H</b>	38-39	Hardened Steel >48	A2, O1, D2	50-150	.003-.005	4	3	2	1	-	-	No	1	-

Note: Feed and speed recommendations are starting operating parameters. They are only guidelines from which further optimization should take place. Operating parameters are influenced by many machining variables. These variables may cause for reductions in feeds and speed or dramatic increases. Additionally, DOC and WOC may need to be revised to optimize the tools performance.

