



TOTURN™

TURNING PRODUCTS

Chip Breaker Designations

- FLP - Finishing
- MLP - Semi-finishing to medium
- MGP - Medium
- RGP - Roughing

Insert Shapes:

- CNMG / DNMG / SNMG
- TNMG / VNMG / WNMG

Grades:

- TT8105B
- TT8115B
- TT8125B



FLP

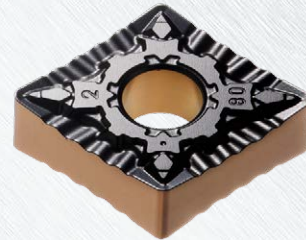

MLP



MGP



RGP

New Chip Breakers for Steel Machining: FLP, MLP, MGP, RGP

Four new ISO turning chip breakers are now available for machining of steel (ISO P). Using a new, easy-to-follow designation system, these chip breakers have been applied to our most common double-sided insert shapes.

The new chip breakers deliver optimal chip control and machining performance across a wide range of applications from finishing to roughing. All inserts feature Ingersoll's enhanced TT8115B and TT8125B CVD coating for impressive tool life in continuous or interrupted cutting. The wear-resistant grade TT8105B is also available in selected inserts.

Features & Benefits

- Excellent chip control performance from roughing to finishing
- Wider application range compared to previous chip breakers
- Improved stability and reliability for walk-away machining confidence
- New TT8105B, TT8115B and TT8125B CVD coatings provide impressive tool life

TOTURN™ CHIP BREAKERS

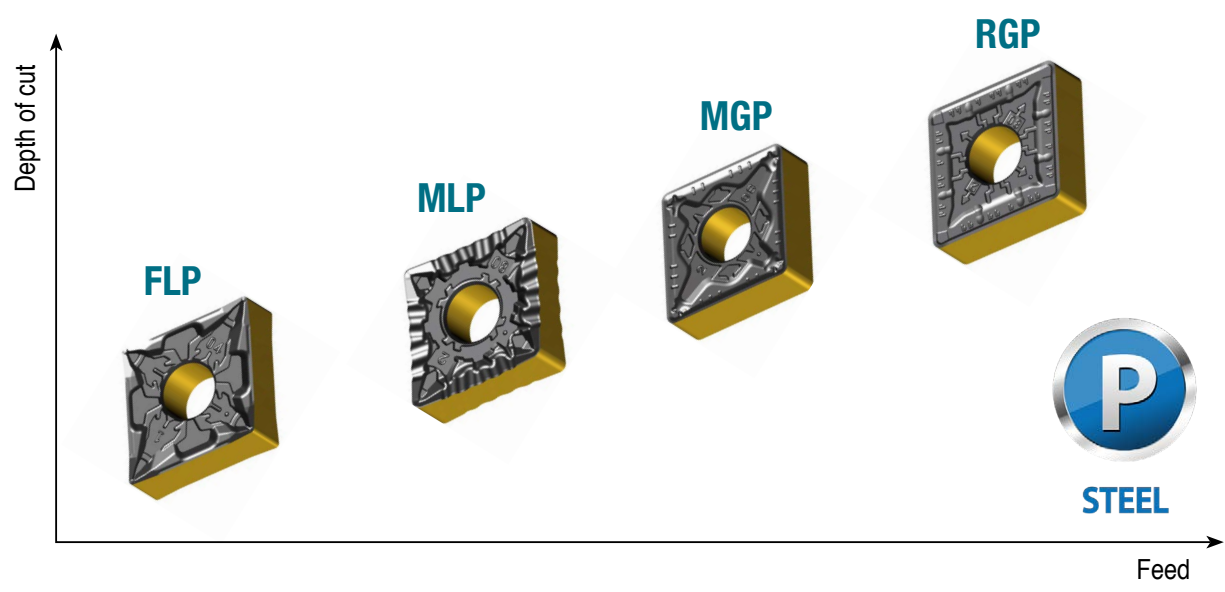

The **FLP** chip breaker (for finish machining) minimizes machining load at low depths of cut and has excellent chip control range. It also features a wide, stable supporting area providing improved dimensional accuracy.

The **MLP** chip breaker (for semi-finishing to medium machining) features a “wave edge” rake face design that provides excellent chip control on work pieces with a variable depth of cut and stable machining in a wide range of medium applications.

The **MGP** chip breaker (for medium machining) is the first choice for general machining of steels and offers a healthy range of feed rate and cutting depth parameters. It is designed with a strong cutting edge and a wide support area that promotes stable and reliable machining.

The **RGP** chip breaker (for roughing) is suitable for roughing applications due to its reinforced cutting edge and wide chip groove, and can perform reliably without chipping even in extreme interrupted machining conditions

TOTURN™ NEW CHIP BREAKER DESIGNATION

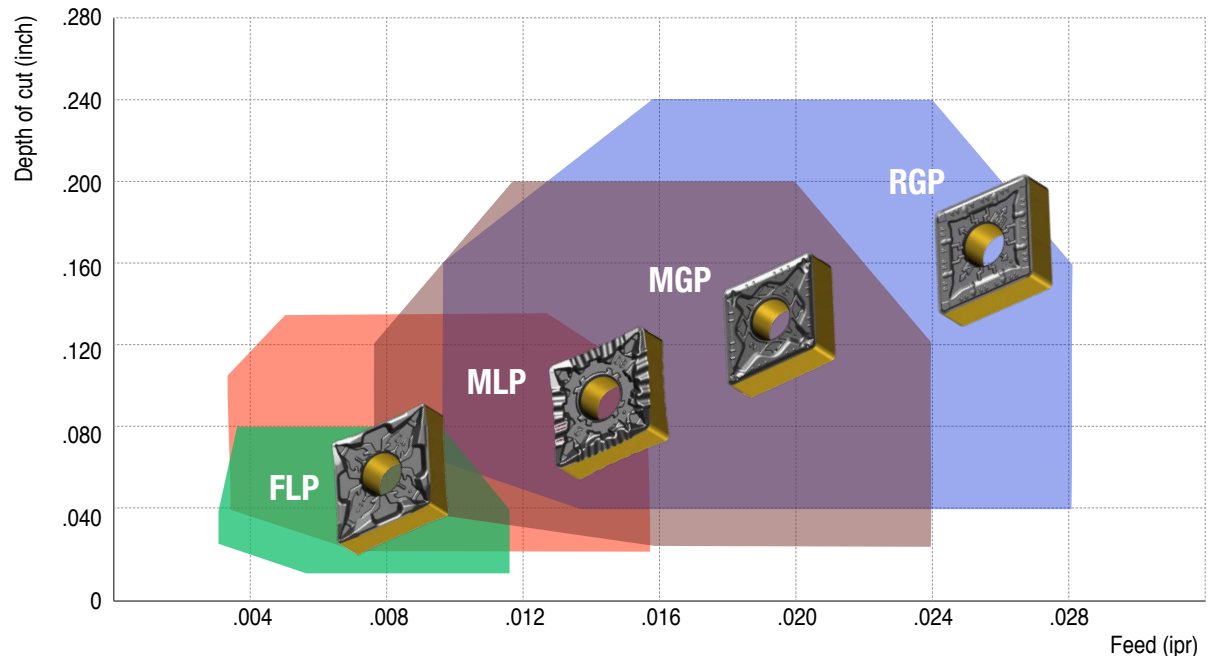
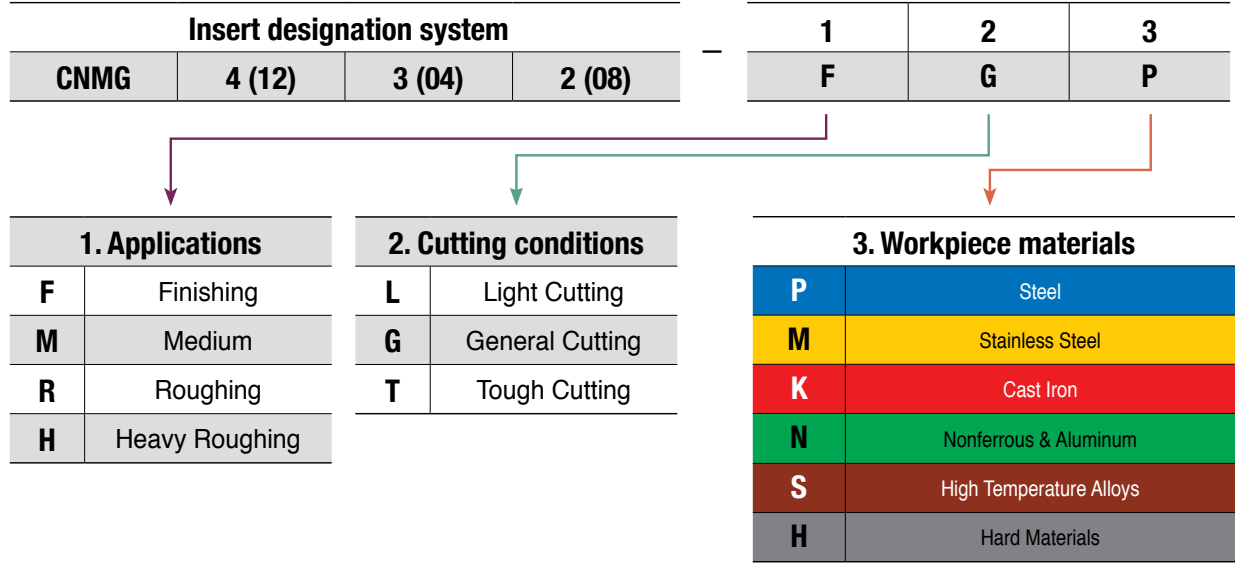

- Insert: CNMG 432 (120408)
- Cutting speed (V): 650 sfm
- Material: AISI 4140 (HB230-260)

TOTURN™ FLP CHIP BREAKER

FLP type

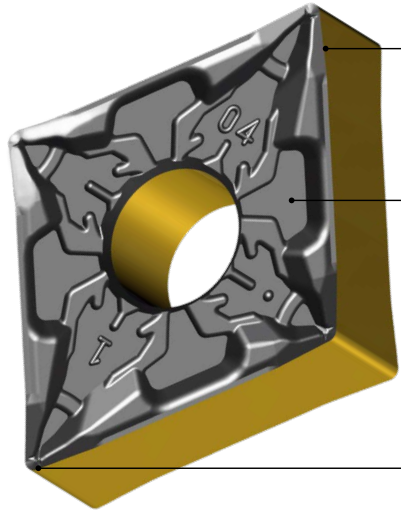
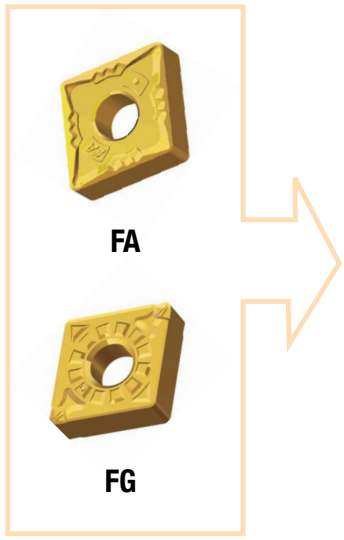

Helical edge geometry

- Low cutting forces and excellent chip control

Stable supporting area

- Wide and stable insert for support during operation

Sharp edge

- Low cutting forces
- Excellent chip control at low depths of cut

Edge geometry

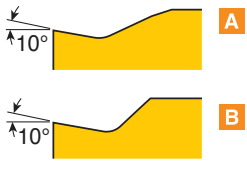
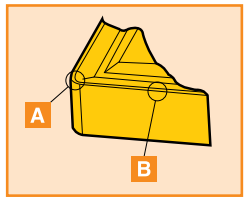

Application range

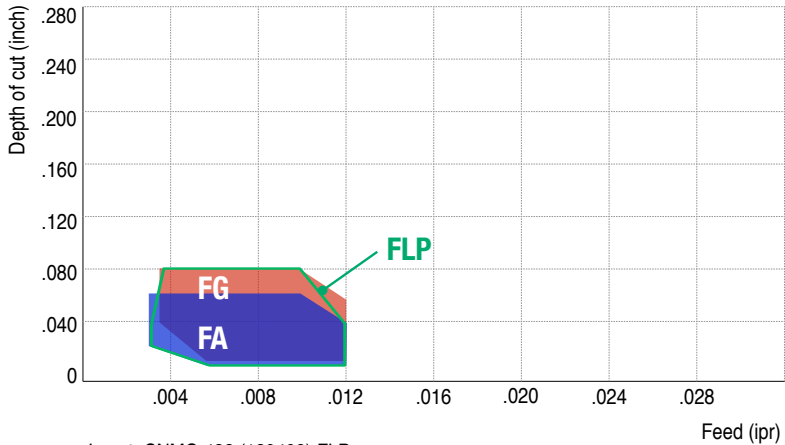

- Insert: CNMG 432 (120408) FLP
- Cutting speed (V): 650 sfm
- Material: AISI 4140 (HB230-260)

- FLP can replace FA and FG chip breakers.

TOTURN™ MLP CHIP BREAKER

MLP type

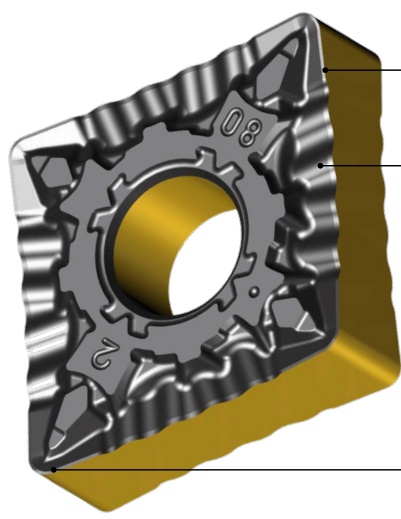
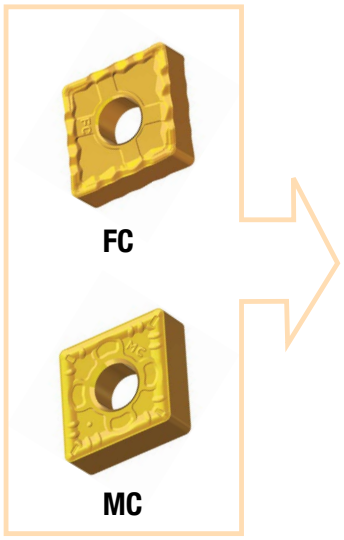

Helical edge geometry
- Low cutting forces and excellent chip control

Inclined serrated edge
- Excellent chip control and surface roughness
- Applicable to variable depths of cut

Narrow land and protrusion
- Reinforced cutting edge
- Excellent chip control at low depths of cut

Edge geometry

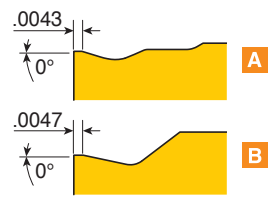
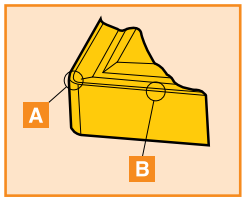

Application range

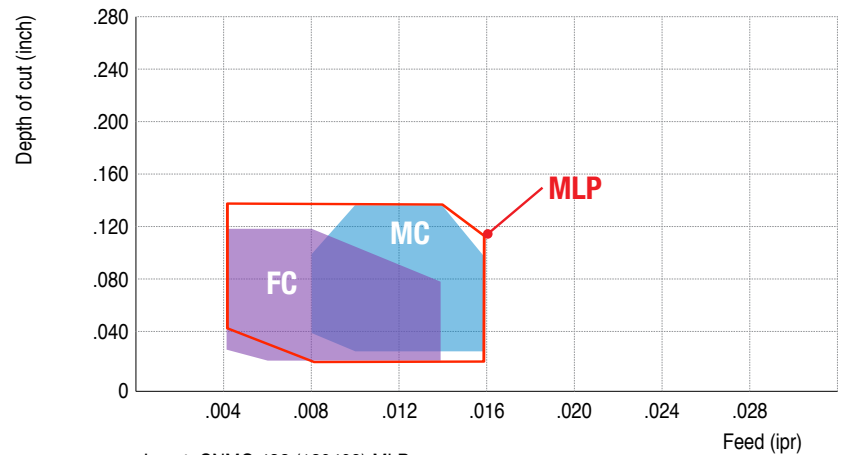

- Insert: CNMG 432 (120408) MLP
- Cutting speed (V): 650 sfm
- Material: AISI 4140 (HB230-260)

- MLP can replace FC and MC chip breakers.

TOTURN™ MGP CHIP BREAKER

MGP type

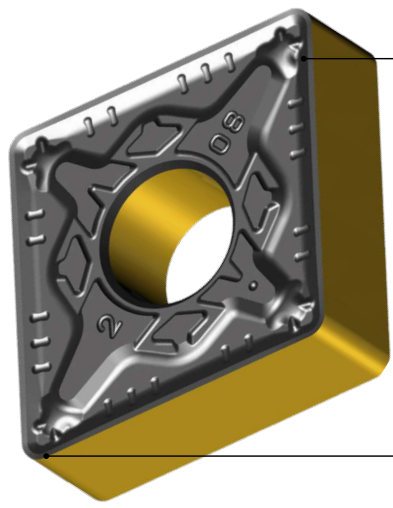
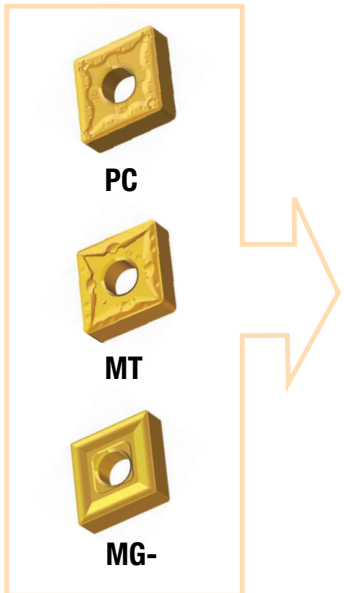

Wide groove and stable cutting edge

- Excellent chip control in deeper depths of cut
- Wide application range and low cutting load
- Stable tool life

Positive land and wide protrusion for chip control

- Excellent chip control at low depths of cut and low feed cutting conditions
- Stable cutting edge for low cutting resistance

Edge geometry

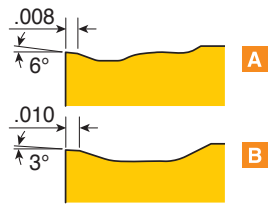
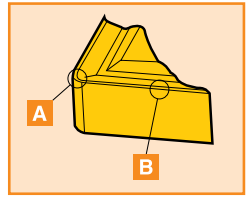

Application range

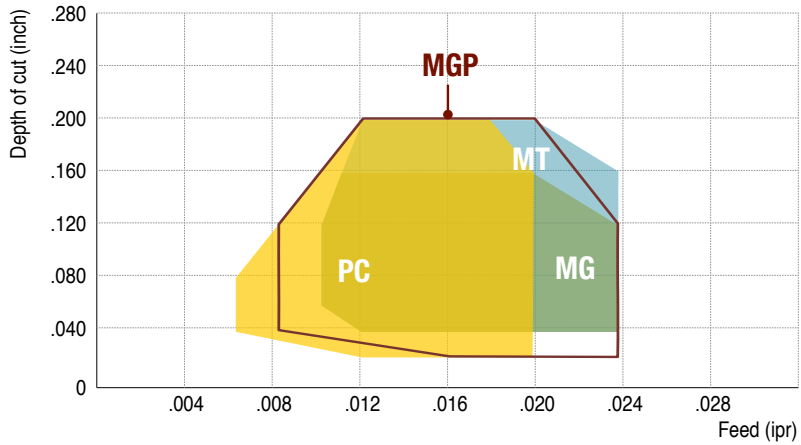

- Insert: CNMG 432 (120408) MGP
- Cutting speed (V): 650 sfm
- Material: AISI 4140 (HB230-260)

- MGP can replace PC, MT and "common" (-MG) chip breakers.

TOTURN™ MGP CHIP BREAKER

RGP type

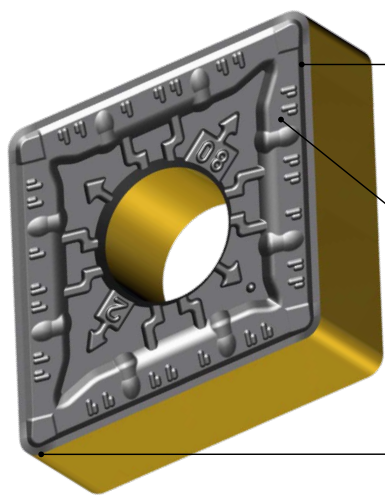
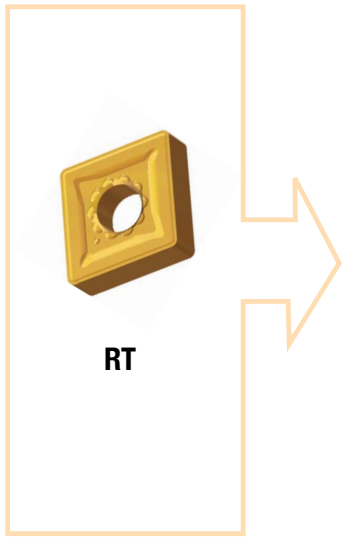

Variable land width for depth of cut

- Reinforced cutting edge
- Reduced crater wear and built-up-edge

Wide chip groove

- Reduced cutting forces for roughing applications
- Stable chip evacuation

Positive land and rectangle design at the corner

- Stable performance
- Excellent chip control at big depths of cut

Edge geometry

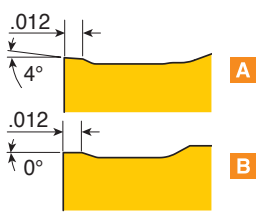
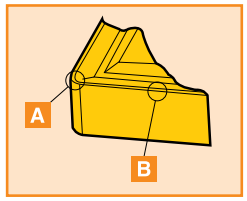

Application range

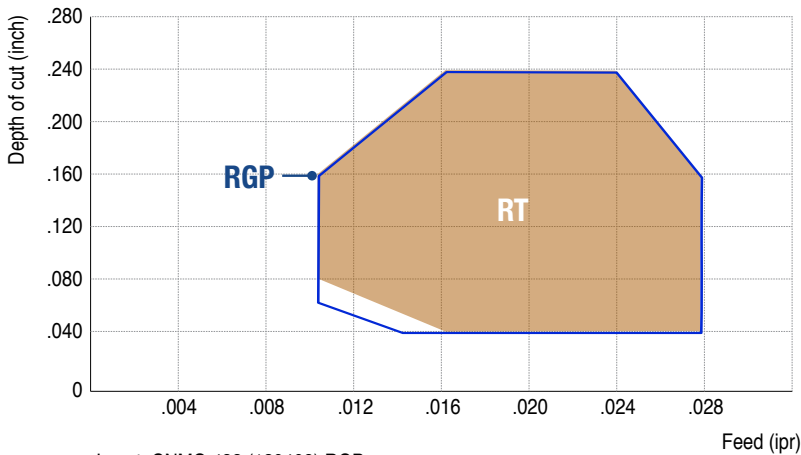

- Insert: CNMG 432 (120408) RGP
- Cutting speed (V): 650 sfm
- Material: AISI 4140 (HB230-260)

● RGP can replace RT chip breakers.



TOTURN™ CASE STUDY 1

		Competitor	Ingersoll
Workpiece material		Differential gear, Cr alloy (SCr420HVSII)	
Operation		External turning	
Insert		DNMG 432 CVD	DNMG 432 FLP TT8125
Cutting speed	V (sfm)	1180	1180
Feed	f (ipr)	.007 - .016	.007 - .016
Depth of cut	ap (inch)	.006 - .080	.006 - .080
Coolant		Wet	Wet
Tool life (pcs/corner)		180	200

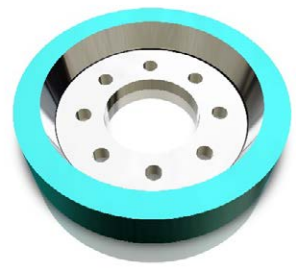
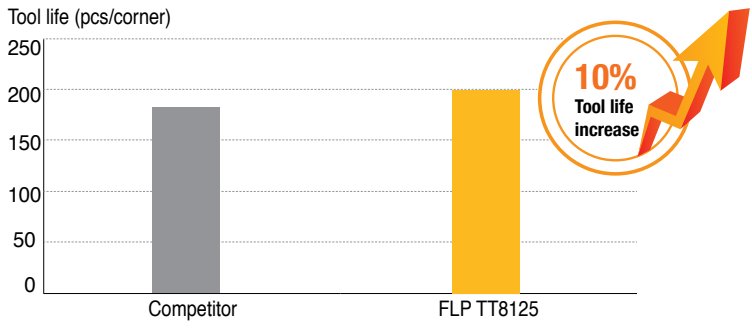

TOTURN™ CASE STUDY 2

		Competitor	Ingersoll
Workpiece material		Output hub, Cr-Mo alloy (4130)	
Operation		External turning, facing	
Insert		WNMG 333 CVD	WNMG 333 MLP TT8115
Cutting speed	V (sfm)	.980	.980
Feed	f (ipr)	.014	.014
Depth of cut	ap (inch)	.040	.040
Coolant		Wet	Wet
Tool life (pcs/corner)		100	120

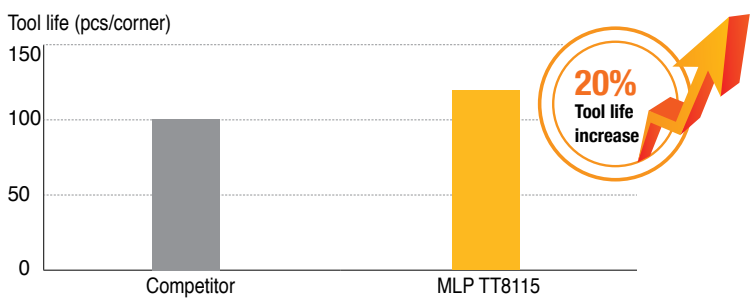



TOTURN™ CASE STUDY 3

		Competitor	Ingersoll
Workpiece material		Outer ring, Bearing steel (52100)	
Operation		External turning	
Insert		CNMG 433 CVD	CNMG 433 MGP TT8115
Cutting speed	V (sfm)	.820	.820
Feed	f (ipr)	.013	.013
Depth of cut	ap (inch)	.120	.120
Coolant		Wet	Wet
Tool life (pcs/corner)		150	400

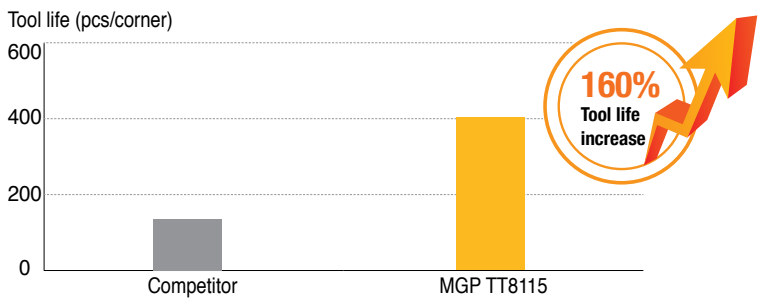

TOTURN™ CASE STUDY 4

		Competitor	Ingersoll
Workpiece material		Center bearing, 0.53% carbon steel	
Operation		External turning, facing	
Insert		CNMG 432 CVD	CNMG 432 RGP TT8125
Cutting speed	V (sfm)	.750	.750
Feed	f (ipr)	.012	.012
Depth of cut	ap (inch)	.100	.100
Coolant		Wet	Wet
Tool life (pcs/corner)		20	30

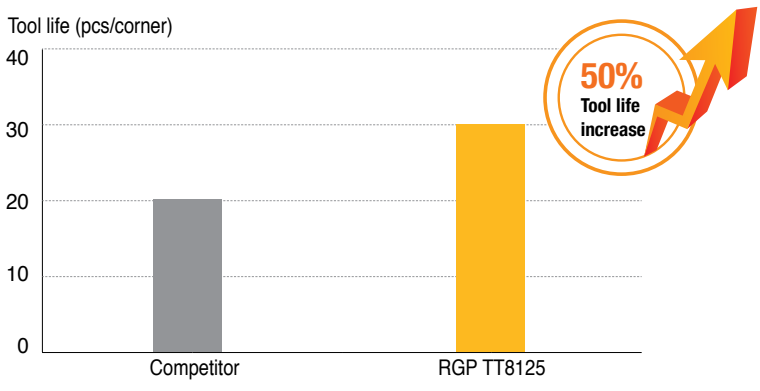



TOTURN™ CNMG INSERTS

Negative 80° rhombic inserts

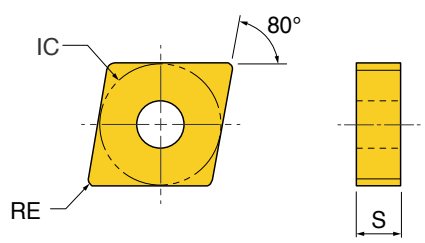

Size	Dimension (inch)		
	IC Inscribed Circle	S Thickness	RE Corner Radius
431	.500	.187	.016
432	.500	.187	.031
433	.500	.187	.047
434	.500	.187	.063
644	.750	.250	.063

Insert	Part Number	ap (inch)	Feed (ipr)	CVD coated		
				TT8105B	TT8115B	TT8125B
 Finishing	CNMG 431 (120404) FLP	.008-.040	.003-.012		●	●
	432 (120408) FLP	.012-.040	.004-.012		●	●
 Medium	CNMG 432 (120408) MLP	.020-.138	.004-.016		●	●
	433 (120412) MLP	.024-.138	.006-.020		●	●
 Medium	CNMG 432 (120408) MGP	.020-.157	.006-.022		●	●
	433 (120412) MGP	.024-.157	.007-.022		●	●
 Roughing	CNMG 432 (120408) RGP	.100-.236	.010-.028		●	●
	433 (120412) RGP	.100-.236	.010-.028		●	●
	434 (120416) RGP	.100-.236	.010-.028	●	●	●
	644 (190616) RGP	.120-.354	.012-.033		●	●



●: Standard items

TOTURN™ DNMG INSERTS

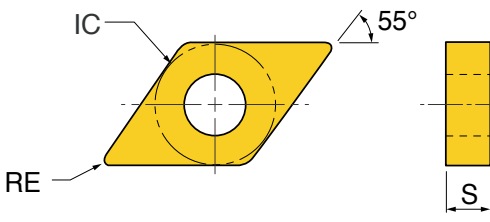
Negative 55° rhombic inserts

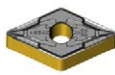

Size	Dimension (inch)		
	IC Inscribed Circle	S Thickness	RE Corner Radius
431	.500	.187	.016
441	.500	.250	.016
432	.500	.187	.031
442	.500	.250	.031
433	.500	.187	.047
443	.500	.250	.047

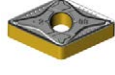
Insert	Part Number	ap (inch)	Feed (ipr)	CVD coated		
				TT8105B	TT8115B	TT8125B
 Finishing	DNMG 431 (150404) FLP	.008-.080	.003-.012		●	●
	441 (150604) FLP	.008-.080	.003-.012		●	●
	432 (150408) FLP	.012-.080	.004-.012		●	●
	442 (150608) FLP	.012-.080	.004-.012		●	●
 Medium	DNMG 432 (150408) MLP	.012-.138	.004-.016		●	●
	442 (150608) MLP	.012-.138	.004-.016		●	●
	433 (150412) MLP	.014-.138	.006-.020		●	●
	443 (150612) MLP	.014-.138	.006-.020		●	●
 Medium	DNMG 432 (150408) MGP	.020-.157	.006-.020		●	●
	442 (150608) MGP	.020-.157	.006-.020		●	●
	433 (150412) MGP	.024-.157	.007-.022		●	●
	443 (150612) MGP	.024-.157	.007-.022		●	●

●: Standard items



TOTURN™ SNMG INSERTS

Negative square inserts

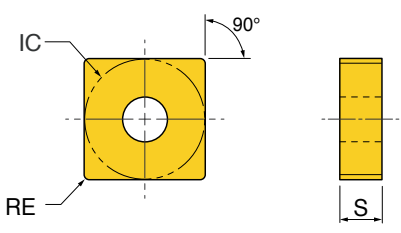

Size	Dimension (inch)		
	IC Inscribed Circle	S Thickness	RE Corner Radius
432	.500	.187	.031

Insert	Part Number	ap (inch)	Feed (ipr)	CVD coated		
				TT8105B	TT8115B	TT8125B
 Medium	SNMG 432 (120408) MGP	.020-.157	.006-.020		●	●

●: Standard items

TOTURN™ TNMG INSERTS

Negative triangular inserts

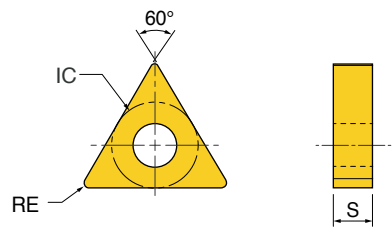

Size	Dimension (inch)		
	IC Inscribed Circle	S Thickness	RE Corner Radius
331	.375	.187	.016
332	.375	.187	.031
333	.375	.187	.047

Insert	Part Number	ap (inch)	Feed (ipr)	CVD coated		
				TT8105B	TT8115B	TT8125B
 Finishing	TNMG 331 (160404) FLP	.008-.040	.003-.012		●	●
	332 (160408) FLP	.012-.040	.004-.012		●	●
 Medium	TNMG 331 (160404) MLP	.010-.100	.003-.012		●	●
	332 (160408) MLP	.012-.100	.004-.016		●	●
	333 (160412) MLP	.014-.100	.006-.020		●	●
 Medium	TNMG 331 (160408) MGP	.020-.177	.006-.020		●	●
	332 (160412) MGP	.024-.177	.007-.022		●	●

●: Standard items

TOTURN™ VNMG INSERTS

Negative 35° rhombic inserts

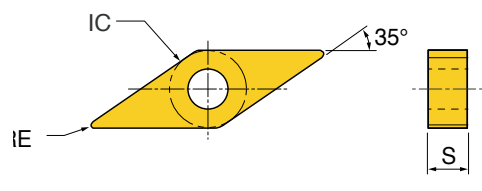

Size	Dimension (inch)		
	IC Inscribed Circle	S Thickness	RE Corner Radius
331	.375	.187	.016
332	.375	.187	.031

Insert	Part Number	ap (inch)	Feed (ipr)	CVD coated		
				TT8105B	TT8115B	TT8125B
 Finishing	VNMG 331 (160404) FLP	.008-.060	.003-.012		●	●
	332 (160408) FLP	.012-.060	.004-.012		●	●
 Medium	VNMG 332 (160408) MGP	.020-.120	.007-.014		●	●

●: Standard items



TOTURN™ WNMG INSERTS

Negative 80° trigon inserts

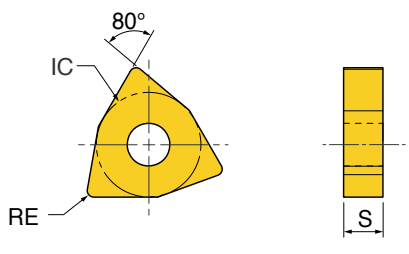

Size	Dimension (inch)		
	IC Inscribed Circle	S Thickness	RE Corner Radius
432	.500	.187	.031
433	.500	.187	.047
434	.500	.187	.063

Insert	Part Number	ap (inch)	Feed (ipr)	CVD coated		
				TT8105B	TT8115B	TT8125B
 Finishing	WNMG 432 (080408) FLP	.012-.040	.004-.012		●	●
					●	●
 Medium	WNMG 432 (080408) MLP	.020-.138	.004-.016		●	●
	433 (080412) MLP	.024-.138	.006-.020		●	●
 Medium	WNMG 432 (080408) MGP	.020-.157	.006-.022		●	●
	433 (080412) MGP	.024-.157	.007-.022		●	●
	434 (080416) MGP	.030-.157	.008-.022		●	●
 Roughing	WNMG 432 (080408) RGP	.100-.157	.010-.028		●	●
	433 (080412) RGP	.100-.157	.010-.028		●	●
	434 (080416) RGP	.100-.157	.012-.030	●	●	●

●: Standard items

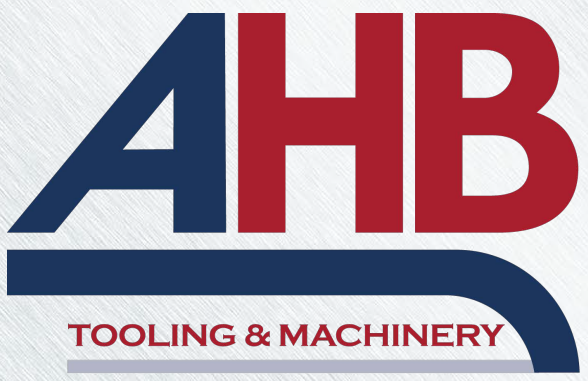

**COMPLETE
METALWORKING
SOLUTIONS**

(800) 991-4225
www.ahbinc.com
ISO Certified
customerservice@ahbinc.com