



MILLING CUTTERS

2015 - 2016 CATALOG



ARCH
GLOBAL PRECISION
« « « « LEARN MORE

**AMERICAN MANUFACTURING
SERVING THE WORLD**



MILLING CUTTERS

KEO Milling Cutters has been an industry leader in supplying the North American market with high quality milling cutters, saws and customized cutting tools for over 28 years. As outlined herein, we offer over 5,000 standard cutting tools to meet the needs of industrial customers in substantially all end markets. We design and manufacture tools with advanced geometries and tight tolerances that have a proven record of providing faster speeds and feeds, while generating consistent high quality results for our end users.

Headquartered in Athol, Massachusetts, KEO Milling Cutters is a sister company to KEO Cutters and is part of the broader ARCH Global Precision family of companies. Whether we are producing our standard catalog offering or quickly turning around a "custom" or "special" order for our customers, all tools are produced here in the U.S.A. by our highly skilled and prideful associates. We offer high speed steel, cobalt, carbide tipped and solid carbide cutting tools with several coating options that are sold through our loyal distribution customer base. We also perform re-grinding services on our tools to restore them to their original condition and allow our users to maximize their utilization and reduce their costs. Please visit our website at www.keocutters.com or call us at 800-523-5233 if you have any product inquiries or would like to locate a KEO Milling Cutters distributor near your manufacturing facility. Finally, whether you are a long time KEO Milling Cutters customer, or just now considering us as a possible future source, we want to thank you for your business and consideration of us as your source of choice for all of your milling cutter, saw blade and customized tool requirements.

**All KEO Milling Cutter products are 100%
manufactured with pride in America!**

KEO Milling Cutters — A Name You Can Trust!

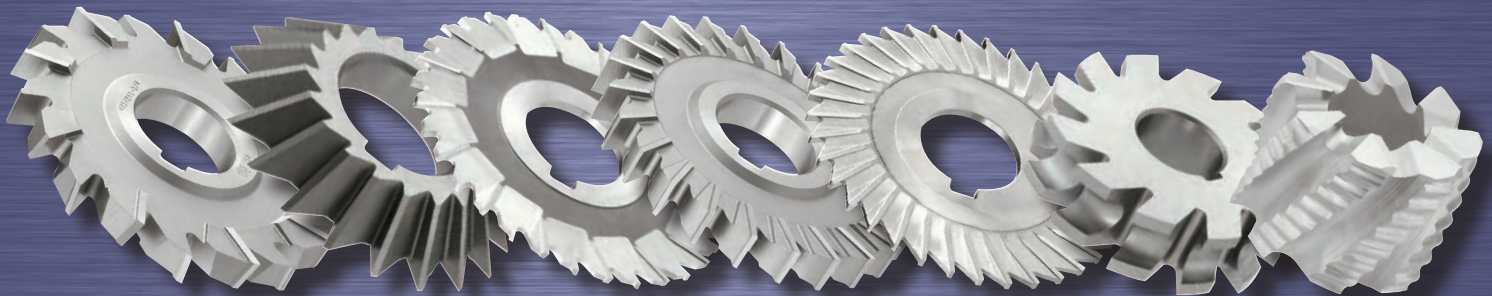

**Leader in Specials and Custom Tools
Premium Quality Products
HSS, Cobalt, Carbide-Tipped and Solid Carbide Tools
Tool Coatings: TiN, TiCN and TiALN**

**Competitive Pricing
Over 5,000 Standard Items
Exceptional Customer Service
Fax or E-mail Orders**

PHONE: 800-523-5233 | FAX: 800-955-7400 | WWW.KEOCUTTERS.COM



MADE IN U.S.A.

MILLING CUTTERS, PLAIN & SHELL MILLS, ARBOR-TYPE SLITTING SAWS

HSS Staggered Tooth Milling Cutters.....	3 – 13
HSS Straight Milling Cutters.....	14 – 22
HSS Shell Mills.....	23 – 25
HSS Slitting Saws.....	26 – 38
HSS Plain Mills.....	39 – 41
HSS Form Relieved Cutters.....	42 – 48
HSCO Staggered Tooth Milling Cutters.....	49 – 52
HSCO Straight Tooth Milling Cutters	53 – 54
HSCO Shell Mills.....	55 – 59
HSCO Slitting Saws	60 – 63

HIGH SPEED STEEL AND COBALT SHANK-TYPE CUTTERS

HSS and Cobalt Shank-Type Cutters.....	64 – 75
--	---------

TECHNICAL INFORMATION

Interlocking Set Information.....	76
Tolerances for Milling Cutters and Saws	Inside Back Cover

Warning

Cutting tools may shatter when broken. The wearing of eye protection is strongly advised in the vicinity of their use.



MILLING CUTTERS, PLAIN & SHELL MILLS, ARBOR-TYPE SLITTING SAWS













HSS STAGGERED TOOTH MILLING CUTTERS

N

PHONE: 800-523-5233 | FAX: 800-955-7400 | WWW.KEOCUTTERS.COM

**MILLING CUTTERS, PLAIN & SHELL MILLS,
ARBOR-TYPE SLITTING SAWS**



 <p>HSS Side Milling Cutter — Staggered Tooth "S" Style Diameter: 2-1/8" – 3"</p>	PAGE 4
 <p>HSS Side Milling Cutter — Staggered Tooth "S" Style Diameter: 3" – 4"</p>	PAGE 5
 <p>HSS Side Milling Cutter — Staggered Tooth "S" Style Diameter: 4" – 4-1/2"</p>	PAGE 6
 <p>HSS Side Milling Cutter — Staggered Tooth "S" Style Diameter: 4-1/2" – 5-1/2"</p>	PAGE 7
 <p>HSS Side Milling Cutter — Staggered Tooth "S" Style Diameter: 5-1/2" – 6"</p>	PAGE 8
 <p>HSS Side Milling Cutter — Staggered Tooth "S" Style Diameter: 6" – 8"</p>	PAGE 9
 <p>HSS Side Milling Cutter — Staggered Tooth "S" Style Diameter: 8" – 9"</p>	PAGE 10
 <p>HSS Side Milling Cutter — Staggered Tooth "S" Style Diameter: 9" – 10"</p>	PAGE 11
 <p>HSS Side Milling Cutter — Staggered Tooth Aluminum Cutting "A" Style</p>	PAGE 12
 <p>HSS Milling Cutter — Staggered Tooth Woodruff Keyseat "WK" Style</p>	PAGE 13



HSS STAGGERED TOOTH MILLING CUTTERS



MILLING CUTTERS, PLAIN & SHELL MILLS, ARBOR-TYPE SLITTING SAWS

HSS Side Milling Cutter — Staggered Tooth

"S" Style

- General Purpose
- Ideal for Deep Slotting
- Alternate tooth design allows excellent chip removal
- Refer to page 76 for interlocking set information



Cutter Dia	Cutter Width	Arbor Hole	Catalog Number	#T	Unc EDP	TIN Recommended		
						TiN EDP	TiCN EDP	TiAlN EDP
2-1/8	3/16	3/4	S21039	14	00004	00005	83700	84073
2-1/8	1/4	3/4	S21049	14	00008	00009	83701	84074
2-1/8	5/16	3/4	S21059	14	00012	00013	83702	84075
2-1/8	3/8	3/4	S21069	14	00016	00017	83703	84076
2-1/2	1/4	7/8	S25040	16	00020	00021	83704	84077
2-1/2	5/16	7/8	S25050	16	00030	00031	83705	84078
2-1/2	3/8	7/8	S25060	16	00040	00041	83706	84079
2-1/2	1/2	7/8	S25080	16	00050	00038	83707	84080
2-3/4	1/4	1	S27041	16	00051	00039	83708	84081
2-3/4	5/16	1	S27051	16	00052	00042	83709	84082
2-3/4	3/8	1	S27061	16	00053	00043	83710	84083
2-3/4	7/16	1	S27071	16	00054	00044	83711	84084
2-3/4	1/2	1	S27081	16	00055	00045	83712	84085
3	3/16	1	S3031	16	00060	00048	83713	84086
3	3/16	1-1/4	S3032	18	00070	00069	83714	84087
3	7/32	1	S3731	16	00080	00079	83715	84088
3	7/32	1-1/4	S3732	18	00090	00089	83716	84089
3	1/4	1	S3041	16	00100	00099	83717	84090
3	1/4	1-1/4	S3042	18	00110	00111	83718	84091
3	9/32	1	S3741	16	00120	00121	83719	84092
3	9/32	1-1/4	S3742	18	00130	00131	83720	84093
3	5/16	1	S3051	16	00140	00141	83721	84094
3	5/16	1-1/4	S3052	18	00150	00151	83722	84095
3	11/32	1	S3751	16	00160	00161	83723	84096
3	11/32	1-1/4	S3752	18	00170	00171	83724	84097
3	3/8	1	S3061	16	00180	00181	83725	84098
3	3/8	1-1/4	S3062	18	00190	00191	83726	84099
3	13/32	1	S3761	16	00200	00201	83727	84100
3	13/32	1-1/4	S3762	18	00210	00211	83728	84101
3	7/16	1	S3071	16	00220	00221	83729	84102
3	7/16	1-1/4	S3072	18	00230	00231	83730	84103
3	1/2	1	S3081	16	00240	00241	83731	84104
3	1/2	1-1/4	S3082	18	00250	00251	83732	84105
3	9/16	1	S3091	16	00260	00261	83733	84106
3	9/16	1-1/4	S3092	18	00270	00271	83734	84107
3	5/8	1	S3101	16	00280	00281	83735	84108
3	5/8	1-1/4	S3102	18	00290	00291	83736	84109
3	11/16	1	S3111	16	00300	00301	83737	84110
3	11/16	1-1/4	S3112	18	00310	00311	83738	84111
3	3/4	1	S3121	16	00320	00321	83739	84112
3	3/4	1-1/4	S3122	18	00330	00331	83740	84113
3	13/16	1	S3131	16	00340	00341	83741	84114
3	13/16	1-1/4	S3132	18	00350	00351	83742	84115
3	7/8	1	S3141	16	00360	00361	83743	84116
3	7/8	1-1/4	S3142	18	00370	00371	83744	84117
3	15/16	1	S3151	16	00380	00381	83745	84118
3	15/16	1-1/4	S3152	18	00390	00391	83746	84119

Continued on next page

MILLING CUTTERS, PLAIN & SHELL MILLS, ARBOR-TYPE SLITTING SAWS

HSS Side Milling Cutter — Staggered Tooth

"S" Style

- General Purpose
- Ideal for Deep Slotting
- Alternate tooth design allows excellent chip removal
- Refer to page 76 for interlocking set information



Cutter Dia	Cutter Width	Arbor Hole	Catalog Number	#T	Unc EDP	TiN Recommended		
						TiN EDP	TiCN EDP	TiAlN EDP
3	1	1	S3161	16	00400	00401	83747	84120
3	1	1-1/4	S3162	18	00410	00411	83748	84121
3	1-1/4	1	S3201	16	00420	00421	83749	84122
3	1-1/4	1-1/4	S3202	18	00430	00431	83750	84123
3-1/4	1/4	1-1/4	S32042	18	00435	00432	83751	84124
3-1/4	3/8	1-1/4	S32062	18	00436	00433	83752	84125
3-1/4	1/2	1-1/4	S32082	18	00437	00434	83753	84126
3-1/4	3/4	1-1/4	S32122	18	00438	00439	83754	84127
3-1/2	7/32	1	S35731	18	00440	00441	83755	84128
3-1/2	7/32	1-1/4	S35732	18	00450	00451	83756	84129
3-1/2	1/4	1	S35041	18	00460	00461	83757	84130
3-1/2	1/4	1-1/4	S35042	18	00470	00471	83758	84131
3-1/2	9/32	1	S35741	18	00480	00481	83759	84132
3-1/2	9/32	1-1/4	S35742	18	00490	00491	83760	84133
3-1/2	5/16	1	S35051	18	00500	00501	83761	84134
3-1/2	5/16	1-1/4	S35052	18	00510	00511	83762	84135
3-1/2	11/32	1	S35751	18	00520	00521	83763	84136
3-1/2	11/32	1-1/4	S35752	18	00530	00531	83764	84137
3-1/2	3/8	1	S35061	18	00540	00541	83765	84138
3-1/2	3/8	1-1/4	S35062	18	00550	00551	83766	84139
3-1/2	13/32	1	S35761	18	00560	00561	83767	84140
3-1/2	13/32	1-1/4	S35762	18	00570	00571	83768	84141
3-1/2	7/16	1	S35071	18	00580	00581	83769	84142
3-1/2	7/16	1-1/4	S35072	18	00590	00591	83770	84143
3-1/2	1/2	1	S35081	18	00600	00601	83771	84144
3-1/2	1/2	1-1/4	S35082	18	00610	00611	83772	84145
3-1/2	9/16	1	S35091	18	00620	00621	83773	84146
3-1/2	9/16	1-1/4	S35092	18	00630	00631	83774	84147
3-1/2	5/8	1	S35101	18	00640	00641	83775	84148
3-1/2	5/8	1-1/4	S35102	18	00650	00651	83776	84149
3-1/2	11/16	1	S35111	18	00660	00661	83777	84150
3-1/2	11/16	1-1/4	S35112	18	00670	00671	83778	84151
3-1/2	3/4	1	S35121	18	00680	00681	83779	84152
3-1/2	3/4	1-1/4	S35122	18	00690	00691	83780	84153
3-1/2	13/16	1	S35131	18	00700	00701	83781	84154
3-1/2	13/16	1-1/4	S35132	18	00710	00711	83782	84155
3-1/2	7/8	1	S35141	18	00720	00721	83783	84156
3-1/2	7/8	1-1/4	S35142	18	00730	00731	83784	84157
3-1/2	15/16	1	S35151	18	00740	00741	83785	84158
3-1/2	15/16	1-1/4	S35152	18	00750	00751	83786	84159
3-1/2	1	1	S35161	18	00760	00761	83787	84160
3-1/2	1	1-1/4	S35162	18	00770	00771	83788	84161
3-3/4	1/4	1-1/4	S37042	18	00775	00772	83789	84162
3-3/4	3/8	1-1/4	S37062	18	00776	00773	83790	84163
3-3/4	1/2	1-1/4	S37082	18	00777	00774	83791	84164
3-3/4	3/4	1-1/4	S37122	18	00778	00779	83792	84165
4	3/16	1	S4031	18	00786	00796	83793	84166

Continued on next page



MILLING CUTTERS

MILLING CUTTERS, PLAIN & SHELL MILLS, ARBOR-TYPE SLITTING SAWS

HSS Side Milling Cutter — Staggered Tooth

"S" Style

- General Purpose
- Ideal for Deep Slotting
- Alternate tooth design allows excellent chip removal
- Refer to page 76 for interlocking set information



Cutter Dia	Cutter Width	Arbor Hole	Catalog Number	#T	Unc EDP	TiN Recommended		
						TiN EDP	TiCN EDP	TiAlN EDP
4	3/16	1-1/4	S4032	18	00790	00798	83794	84167
4	7/32	1	S4731	18	00800	00802	83795	84168
4	7/32	1-1/4	S4732	18	00810	00812	83796	84169
4	1/4	1	S4041	18	00820	00822	83797	84170
4	1/4	1-1/4	S4042	18	00830	00832	83798	84171
4	9/32	1	S4741	18	00840	00841	83799	84172
4	9/32	1-1/4	S4742	18	00850	00851	83800	84173
4	5/16	1	S4051	18	00860	00861	83801	84174
4	5/16	1-1/4	S4052	18	00870	00871	83802	84175
4	11/32	1	S4751	18	00880	00881	83803	84176
4	11/32	1-1/4	S4752	18	00890	00891	83804	84177
4	3/8	1	S4061	18	00900	00901	83805	84178
4	3/8	1-1/4	S4062	18	00910	00911	83806	84179
4	13/32	1	S4761	18	00920	00921	83807	84180
4	13/32	1-1/4	S4762	18	00930	00931	83808	84181
4	7/16	1	S4071	18	00940	00941	83809	84182
4	7/16	1-1/4	S4072	18	00950	00951	83810	84183
4	1/2	1	S4081	18	00960	00961	83811	84184
4	1/2	1-1/4	S4082	18	00970	00971	83812	84185
4	9/16	1	S4091	18	00980	00981	83813	84186
4	9/16	1-1/4	S4092	18	00990	00991	83814	84187
4	5/8	1	S4101	18	01000	01001	83815	84188
4	5/8	1-1/4	S4102	18	01010	01011	83816	84189
4	11/16	1	S4111	18	01020	01021	83817	84190
4	11/16	1-1/4	S4112	18	01030	01031	83818	84191
4	3/4	1	S4121	18	01040	01041	83819	84192
4	3/4	1-1/4	S4122	18	01050	01051	83820	84193
4	13/16	1	S4131	18	01060	01061	83821	84194
4	13/16	1-1/4	S4132	18	01070	01071	83822	84195
4	7/8	1	S4141	18	01080	01081	83823	84196
4	7/8	1-1/4	S4142	18	01090	01091	83824	84197
4	15/16	1	S4151	18	01100	01101	83825	84198
4	15/16	1-1/4	S4152	18	01110	01111	83826	84199
4	1	1	S4161	18	01120	01121	83827	84200
4	1	1-1/4	S4162	18	01130	01131	83828	84201
4	1-1/8	1-1/4	S4182	18	01140	01141	83829	84202
4	1-1/4	1-1/4	S4202	18	01150	01151	83830	84203
4	1-3/8	1-1/4	S4222	18	01160	01161	83831	84204
4	1-1/2	1-1/4	S4242	18	01170	01171	83832	84205
4-1/4	1/4	1-1/4	S42042	18	01175	01172	83833	84206
4-1/4	3/8	1-1/4	S42062	18	01176	01173	83834	84207
4-1/4	1/2	1-1/4	S42082	18	01177	01174	83835	84208
4-1/4	3/4	1-1/4	S42122	18	01178	01179	83836	84209
4-1/2	7/32	1	S45731	18	01180	01181	83837	84210
4-1/2	7/32	1-1/4	S45732	18	01190	01191	83838	84211
4-1/2	1/4	1	S45041	18	01200	01201	83839	84212
4-1/2	1/4	1-1/4	S45042	18	01210	01211	83840	84213

Continued on next page

HSS STAGGERED TOOTH MILLING CUTTERS

MILLING CUTTERS, PLAIN & SHELL MILLS, ARBOR-TYPE SLITTING SAWS

HSS Side Milling Cutter — Staggered Tooth

"S" Style

- General Purpose
- Ideal for Deep Slotting
- Alternate tooth design allows excellent chip removal
- Refer to page 76 for interlocking set information



Cutter Dia	Cutter Width	Arbor Hole	Catalog Number	#T	Unc EDP	TiN Recommended		
						TiN EDP	TiCN EDP	TiAlN EDP
4-1/2	5/16	1	S45051	18	01220	01221	83841	84214
4-1/2	5/16	1-1/4	S45052	18	01230	01231	83842	84215
4-1/2	3/8	1	S45061	18	01240	01241	83843	84216
4-1/2	3/8	1-1/4	S45062	18	01250	01251	83844	84217
4-1/2	1/2	1	S45081	18	01260	01261	83845	84218
4-1/2	1/2	1-1/4	S45082	18	01270	01271	83846	84219
4-1/2	5/8	1	S45101	18	01280	01281	83847	84220
4-1/2	5/8	1-1/4	S45102	18	01290	01291	83848	84221
4-1/2	3/4	1	S45121	18	01300	01301	83849	84222
4-1/2	3/4	1-1/4	S45122	18	01310	01311	83850	84223
4-1/2	1	1	S45161	18	01320	01321	83851	84224
4-1/2	1	1-1/4	S45162	18	01330	01337	83852	84225
5	3/16	1	S5031	24	01340	01342	83853	84226
5	3/16	1-1/4	S5032	24	01350	01352	83854	84227
5	7/32	1	S5731	24	01360	01362	83855	84228
5	7/32	1-1/4	S5732	24	01370	01372	83856	84229
5	1/4	1	S5041	24	01380	01382	83857	84230
5	1/4	1-1/4	S5042	24	01390	01392	83858	84231
5	9/32	1	S5741	24	01400	01401	83859	84232
5	9/32	1-1/4	S5742	24	01410	01411	83860	84233
5	5/16	1	S5051	24	01420	01421	83861	84234
5	5/16	1-1/4	S5052	24	01430	01431	83862	84235
5	11/32	1	S5751	24	01440	01441	83863	84236
5	11/32	1-1/4	S5752	24	01450	01451	83864	84237
5	3/8	1	S5061	24	01460	01461	83865	84238
5	3/8	1-1/4	S5062	24	01470	01471	83866	84239
5	13/32	1	S5761	24	01480	01481	83867	84240
5	13/32	1-1/4	S5762	24	01490	01491	83868	84241
5	7/16	1	S5071	24	01500	01501	83869	84242
5	7/16	1-1/4	S5072	24	01510	01511	83870	84243
5	15/32	1	S5771	24	01520	01521	83871	84244
5	15/32	1-1/4	S5772	24	01530	01531	83872	84245
5	1/2	1	S5081	24	01540	01541	83873	84246
5	1/2	1-1/4	S5082	24	01550	01551	83874	84247
5	17/32	1-1/4	S5782	24	01560	01561	83875	84248
5	9/16	1-1/4	S5092	24	01570	01571	83876	84249
5	19/32	1-1/4	S5792	24	01580	01581	83877	84250
5	5/8	1-1/4	S5102	24	01590	01591	83878	84251
5	11/16	1-1/4	S5112	24	01600	01601	83879	84252
5	3/4	1-1/4	S5122	24	01610	01611	83880	84253
5	13/16	1-1/4	S5132	24	01620	01621	83881	84254
5	7/8	1-1/4	S5142	24	01630	01631	83882	84255
5	15/16	1-1/4	S5152	24	01640	01641	83883	84256
5	1	1-1/4	S5162	24	01650	01651	83884	84257
5-1/2	1/4	1-1/4	S55042	24	01665	01662	83885	84258
5-1/2	3/8	1-1/4	S55062	24	01666	01663	83886	84259
5-1/2	1/2	1-1/4	S55082	24	01667	01664	83887	84260

Continued on next page



MILLING CUTTERS, PLAIN & SHELL MILLS, ARBOR-TYPE SLITTING SAWS

HSS Side Milling Cutter — Staggered Tooth

"S" Style

- General Purpose
- Ideal for Deep Slotting
- Alternate tooth design allows excellent chip removal
- Refer to page 76 for interlocking set information



Cutter Dia	Cutter Width	Arbor Hole	Catalog Number	#T	Unc EDP	TiN Recommended		
						TiN EDP	TiCN EDP	TiAlN EDP
5-1/2	3/4	1-1/4	S55122	24	01668	01669	83888	84261
6	3/16	1	S6031	24	01676	01652	83889	84262
6	3/16	1-1/4	S6032	24	01678	01654	83890	84263
6	3/16	1-1/2	S6033	28	01680	01656	83891	84264
6	7/32	1	S6731	24	01690	01657	83892	84265
6	7/32	1-1/4	S6732	24	01700	01659	83893	84266
6	7/32	1-1/2	S6733	28	01710	01661	83894	84267
6	1/4	1	S6041	24	01720	01722	83895	84268
6	1/4	1-1/4	S6042	24	01730	01732	83896	84269
6	1/4	1-1/2	S6043	28	01740	01741	83897	84270
6	9/32	1	S6741	24	01750	01751	83898	84271
6	9/32	1-1/4	S6742	24	01760	01761	83899	84272
6	9/32	1-1/2	S6743	28	01770	01771	83900	84273
6	5/16	1	S6051	24	01780	01781	83901	84274
6	5/16	1-1/4	S6052	24	01790	01791	83902	84275
6	5/16	1-1/2	S6053	28	01800	01801	83903	84276
6	11/32	1	S6751	24	01810	01811	83904	84277
6	11/32	1-1/4	S6752	24	01820	01821	83905	84278
6	11/32	1-1/2	S6753	28	01830	01831	83906	84279
6	3/8	1	S6061	24	01840	01842	83907	84280
6	3/8	1-1/4	S6062	24	01850	01852	83908	84281
6	3/8	1-1/2	S6063	28	01860	01861	83909	84282
6	13/32	1	S6761	24	01870	01871	83910	84283
6	13/32	1-1/4	S6762	24	01880	01881	83911	84284
6	13/32	1-1/2	S6763	28	01890	01891	83912	84285
6	7/16	1	S6071	24	01900	01901	83913	84286
6	7/16	1-1/4	S6072	24	01910	01911	83914	84287
6	7/16	1-1/2	S6073	28	01920	01921	83915	84288
6	15/32	1	S6771	24	01930	01931	83916	84289
6	15/32	1-1/4	S6772	24	01940	01941	83917	84290
6	15/32	1-1/2	S6773	28	01950	01951	83918	84291
6	1/2	1	S6081	24	01960	01961	83919	84292
6	1/2	1-1/4	S6082	24	01970	01971	83920	84293
6	1/2	1-1/2	S6083	28	01980	01981	83921	84294
6	17/32	1-1/4	S6782	24	01990	01991	83922	84295
6	9/16	1-1/4	S6092	24	02000	02001	83923	84296
6	9/16	1-1/2	S6093	28	02010	02011	83924	84297
6	5/8	1-1/4	S6102	24	02020	02021	83925	84298
6	5/8	1-1/2	S6103	28	02030	02031	83926	84299
6	11/16	1-1/4	S6112	24	02040	02041	83927	84300
6	11/16	1-1/2	S6113	28	02050	02051	83928	84301
6	3/4	1-1/4	S6122	24	02060	02061	83929	84302
6	3/4	1-1/2	S6123	28	02070	02071	83930	84303
6	13/16	1-1/4	S6132	24	02080	02081	83931	84304
6	13/16	1-1/2	S6133	28	02090	02091	83932	84305
6	7/8	1-1/4	S6142	24	02100	02101	83933	84306
6	7/8	1-1/2	S6143	28	02110	02111	83934	84307

Continued on next page

MILLING CUTTERS, PLAIN & SHELL MILLS, ARBOR-TYPE SLITTING SAWS

HSS Side Milling Cutter — Staggered Tooth

"S" Style

- General Purpose
- Ideal for Deep Slotting
- Alternate tooth design allows excellent chip removal
- Refer to page 76 for interlocking set information



Cutter Dia	Cutter Width	Arbor Hole	Catalog Number	#T	Unc EDP	TiN Recommended		
						TiN EDP	TiCN EDP	TiAlN EDP
6	15/16	1-1/4	S6152	24	02120	02121	83935	84308
6	15/16	1-1/2	S6153	28	02130	02131	83936	84309
6	1	1-1/4	S6162	24	02140	02141	83937	84310
6	1	1-1/2	S6163	28	02150	02151	83938	84311
6	1-1/16	1-1/4	S6172	24	02160	02161	83939	84312
6	1-1/8	1-1/4	S6182	24	02170	02171	83940	84313
6	1-3/16	1-1/4	S6192	24	02180	02181	83941	84314
6	1-1/4	1-1/4	S6202	24	02190	02195	83942	84315
7	1/4	1-1/4	S7042	24	02200	02201	83943	84316
7	1/4	1-1/2	S7043	28	02210	02211	83944	84317
7	5/16	1-1/4	S7052	24	02220	02221	83945	84318
7	5/16	1-1/2	S7053	28	02230	02231	83946	84319
7	3/8	1-1/4	S7062	24	02240	02241	83947	84320
7	3/8	1-1/2	S7063	28	02250	02251	83948	84321
7	7/16	1-1/4	S7072	24	02260	02261	83949	84322
7	7/16	1-1/2	S7073	28	02270	02271	83950	84323
7	1/2	1-1/4	S7082	24	02280	02281	83951	84324
7	1/2	1-1/2	S7083	28	02290	02291	83952	84325
7	9/16	1-1/4	S7092	24	02300	02301	83953	84326
7	9/16	1-1/2	S7093	28	02310	02311	83954	84327
7	5/8	1-1/4	S7102	24	02320	02321	83955	84328
7	5/8	1-1/2	S7103	28	02330	02331	83956	84329
7	11/16	1-1/4	S7112	24	02340	02341	83957	84330
7	11/16	1-1/2	S7113	28	02350	02351	83958	84331
7	3/4	1-1/4	S7122	24	02360	02361	83959	84332
7	3/4	1-1/2	S7123	28	02370	02371	83960	84333
7	13/16	1-1/4	S7132	24	02380	02381	83961	84334
7	13/16	1-1/2	S7133	28	02390	02391	83962	84335
7	7/8	1-1/4	S7142	24	02400	02401	83963	84336
7	7/8	1-1/2	S7143	28	02410	02411	83964	84337
7	15/16	1-1/4	S7152	24	02420	02421	83965	84338
7	15/16	1-1/2	S7153	28	02430	02431	83966	84339
7	1	1-1/4	S7162	24	02440	02441	83967	84340
7	1	1-1/2	S7163	28	02450	02451	83968	84341
8	3/16	1-1/4	S8032	28	02460	02462	83969	84342
8	3/16	1-1/2	S8033	28	02470	02472	83970	84343
8	7/32	1-1/4	S8732	28	02480	02482	83971	84344
8	7/32	1-1/2	S8733	28	02490	02492	83972	84345
8	1/4	1-1/4	S8042	28	02500	02502	83973	84346
8	1/4	1-1/2	S8043	28	02510	02512	83974	84347
8	9/32	1-1/4	S8742	28	02520	02521	83975	84348
8	9/32	1-1/2	S8743	28	02530	02531	83976	84349
8	5/16	1-1/4	S8052	28	02540	02541	83977	84350
8	5/16	1-1/2	S8053	28	02550	02551	83978	84351
8	11/32	1-1/4	S8752	28	02560	02561	83979	84352
8	11/32	1-1/2	S8753	28	02570	02571	83980	84353
8	3/8	1-1/4	S8062	28	02580	02582	83981	84354

Continued on next page



MILLING CUTTERS, PLAIN & SHELL MILLS, ARBOR-TYPE SLITTING SAWS

HSS Side Milling Cutter — Staggered Tooth

"S" Style

- General Purpose
- Ideal for Deep Slotting
- Alternate tooth design allows excellent chip removal
- Refer to page 76 for interlocking set information



Cutter Dia	Cutter Width	Arbor Hole	Catalog Number	#T	Unc EDP	TiN Recommended		
						TiN EDP	TiCN EDP	TiAlN EDP
8	3/8	1-1/2	S8063	28	02590	02592	83982	84355
8	13/32	1-1/4	S8762	28	02600	02601	83983	84356
8	13/32	1-1/2	S8763	28	02610	02611	83984	84357
8	7/16	1-1/4	S8072	28	02620	02621	83985	84358
8	7/16	1-1/2	S8073	28	02630	02631	83986	84359
8	15/32	1-1/4	S8772	28	02640	02641	83987	84360
8	15/32	1-1/2	S8773	28	02650	02651	83988	84361
8	1/2	1-1/4	S8082	28	02660	02661	83989	84362
8	1/2	1-1/2	S8083	28	02670	02671	83990	84363
8	17/32	1-1/4	S8782	28	02680	02681	83991	84364
8	17/32	1-1/2	S8783	28	02690	02691	83992	84365
8	9/16	1-1/4	S8092	28	02700	02701	83993	84366
8	9/16	1-1/2	S8093	28	02710	02711	83994	84367
8	19/32	1-1/4	S8792	28	02720	02721	83995	84368
8	19/32	1-1/2	S8793	28	02730	02731	83996	84369
8	5/8	1-1/4	S8102	28	02740	02741	83997	84370
8	5/8	1-1/2	S8103	28	02750	02751	83998	84371
8	11/16	1-1/4	S8112	28	02760	02761	83999	84372
8	11/16	1-1/2	S8113	28	02770	02771	84000	84373
8	3/4	1-1/4	S8122	28	02780	02781	84001	84374
8	3/4	1-1/2	S8123	28	02790	02791	84002	84375
8	13/16	1-1/4	S8132	28	02800	02801	84003	84376
8	13/16	1-1/2	S8133	28	02810	02811	84004	84377
8	7/8	1-1/4	S8142	28	02820	02821	84005	84378
8	7/8	1-1/2	S8143	28	02830	02831	84006	84379
8	15/16	1-1/4	S8152	28	02840	02841	84007	84380
8	15/16	1-1/2	S8153	28	02850	02851	84008	84381
8	1	1-1/4	S8162	28	02860	02861	84009	84382
8	1	1-1/2	S8163	28	02870	02871	84010	84383
9	1/4	1-1/4	S9042	28	02880	02881	84011	84384
9	1/4	1-1/2	S9043	28	02890	02891	84012	84385
9	5/16	1-1/4	S9052	28	02900	02901	84013	84386
9	5/16	1-1/2	S9053	28	02910	02911	84014	84387
9	3/8	1-1/4	S9062	28	02920	02921	84015	84388
9	3/8	1-1/2	S9063	28	02930	02931	84016	84389
9	7/16	1-1/4	S9072	28	02940	02941	84017	84390
9	7/16	1-1/2	S9073	28	02950	02951	84018	84391
9	1/2	1-1/4	S9082	28	02960	02961	84019	84392
9	1/2	1-1/2	S9083	28	02970	02971	84020	84393
9	9/16	1-1/4	S9092	28	02980	02981	84021	84394
9	9/16	1-1/2	S9093	28	02990	02991	84022	84395
9	5/8	1-1/4	S9102	28	03000	03001	84023	84396
9	5/8	1-1/2	S9103	28	03010	03011	84024	84397
9	11/16	1-1/4	S9112	28	03020	03021	84025	84398
9	11/16	1-1/2	S9113	28	03030	03031	84026	84399
9	3/4	1-1/4	S9122	28	03040	03041	84027	84400
9	3/4	1-1/2	S9123	28	03050	03051	84028	84401

Continued on next page

MILLING CUTTERS, PLAIN & SHELL MILLS, ARBOR-TYPE SLITTING SAWS

HSS Side Milling Cutter — Staggered Tooth

"S" Style

- General Purpose
- Ideal for Deep Slotting
- Alternate tooth design allows excellent chip removal
- Refer to page 76 for interlocking set information



Cutter Dia	Cutter Width	Arbor Hole	Catalog Number	#T	Unc EDP	TiN Recommended		
						TiN EDP	TiCN EDP	TiAlN EDP
9	13/16	1-1/4	S9132	28	03060	03061	84029	84402
9	13/16	1-1/2	S9133	28	03070	03071	84030	84403
9	7/8	1-1/4	S9142	28	03080	03081	84031	84404
9	7/8	1-1/2	S9143	28	03090	03091	84032	84405
9	15/16	1-1/4	S9152	28	03100	03101	84033	84406
9	15/16	1-1/2	S9153	28	03110	03111	84034	84407
9	1	1-1/4	S9162	28	03120	03121	84035	84408
9	1	1-1/2	S9163	28	03130	03131	84036	84409
10	3/16	1-1/2	S10033	32	03140	03139	84037	84410
10	7/32	1-1/2	S10733	32	03150	03153	84038	84411
10	1/4	1-1/2	S10043	32	03160	03159	84039	84412
10	9/32	1-1/2	S10743	32	03170	03171	84040	84413
10	5/16	1-1/2	S10053	32	03180	03181	84041	84414
10	11/32	1-1/2	S10753	32	03190	03192	84042	84415
10	3/8	1-1/2	S10063	32	03200	03202	84043	84416
10	13/32	1-1/2	S10763	32	03210	03211	84044	84417
10	7/16	1-1/2	S10073	32	03220	03221	84045	84418
10	15/32	1-1/2	S10773	32	03230	03231	84046	84419
10	1/2	1-1/2	S10083	32	03240	03241	84047	84420
10	17/32	1-1/2	S10783	32	03250	03251	84048	84421
10	9/16	1-1/2	S10093	32	03260	03261	84049	84422
10	5/8	1-1/2	S10103	32	03270	03271	84050	84423
10	11/16	1-1/2	S10113	32	03280	03281	84051	84424
10	3/4	1-1/2	S10123	32	03290	03291	84052	84425
10	13/16	1-1/2	S10133	32	03300	03301	84053	84426
10	7/8	1-1/2	S10143	32	03310	03311	84054	84427
10	15/16	1-1/2	S10153	32	03320	03321	84055	84428
10	1	1-1/2	S10163	32	03330	03331	84056	84429

HSS Side Milling Cutter — Staggered Tooth Aluminum Cutting

"A" Style

- Coarse Pitch Design
- Ground Flutes
- Excellent for Non-Ferrous Applications
- Flutes ground on 20° helix with 15° radial rake
- Refer to page 76 for interlocking set information

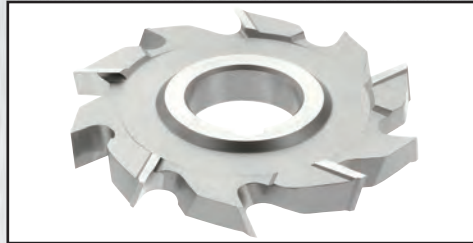

Cutter Dia	Cutter Width	Arbor Hole	Catalog Number	#T	Unc EDP	TiN Recommended		
						TiN EDP	TiCN EDP	TiAlN EDP
4	7/32	1-1/4	A4732	10	04300	04301	84447	84476
4	1/4	1-1/4	A4042	10	04310	04311	84448	84477
4	9/32	1-1/4	A4742	10	04320	04321	84449	84478
4	5/16	1-1/4	A4052	10	04330	04331	84450	84479
4	11/32	1-1/4	A4752	10	04340	04341	84451	84480
4	3/8	1-1/4	A4062	10	04350	04351	84452	84481
4	7/16	1-1/4	A4072	10	04360	04361	84453	84482
4	1/2	1-1/4	A4082	10	04370	04371	84454	84483
4	9/16	1-1/4	A4092	10	04380	04381	84455	84484
4	5/8	1-1/4	A4102	10	04390	04391	84456	84485
4	11/16	1-1/4	A4112	10	04400	04401	84457	84486
4	3/4	1-1/4	A4122	10	04410	04411	84458	84487
4	1	1-1/4	A4162	10	04420	04421	84459	84488
6	7/32	1-1/4	A6732	16	04430	04431	84460	84489
6	1/4	1-1/4	A6042	16	04440	04441	84461	84490
6	9/32	1-1/4	A6742	16	04450	04451	84462	84491
6	5/16	1-1/4	A6052	16	04460	04461	84463	84492
6	11/32	1-1/4	A6752	16	04470	04471	84464	84493
6	3/8	1-1/4	A6062	16	04480	04481	84465	84494
6	7/16	1-1/4	A6072	16	04490	04491	84466	84495
6	1/2	1-1/4	A6082	16	04500	04501	84467	84496
6	9/16	1-1/4	A6092	16	04510	04511	84468	84497
6	5/8	1-1/4	A6102	16	04520	04521	84469	84498
6	11/16	1-1/4	A6112	16	04530	04531	84470	84499
6	3/4	1-1/4	A6122	16	04540	04541	84471	84500
6	1	1-1/4	A6162	16	04545	04546	84472	84501
8	3/8	1-1/2	A8063	20	04600	04601	84473	84502
8	1/2	1-1/2	A8083	20	04620	04621	84474	84503
8	3/4	1-1/2	A8123	20	04660	04661	84475	84504

MILLING CUTTERS, PLAIN & SHELL MILLS, ARBOR-TYPE SLITTING SAWS



HSS Milling Cutter — Staggered Tooth Woodruff Keyseat

“WK” Style

- Excellent for Milling Keys
- Reduced Side Clearance to Maintain Width
- Diameters Furnished 1/32" Oversized for Resharpener
- Refer to page 76 for interlocking set information

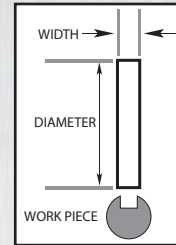

Cutter Dia	Cutter Width	Arbor Hole	Catalog Number	Old Std.	#T	Unc EDP	TiN Recommended		
							TiN EDP	TiCN EDP	TiAlN EDP
2-1/8	3/16	3/4	W666-617	26	14	10600	10601	84506	84522
2-1/8	1/4	3/4	W666-817	27	14	10610	10611	84507	84523
2-1/8	5/16	3/4	W666-1017	28	14	10620	10621	84508	84524
2-1/8	3/8	3/4	W666-1217	29	14	10630	10631	84509	84525
2-3/4	1/4	1	W666-822	R	16	10640	10641	84510	84526
2-3/4	5/16	1	W666-1022	S	16	10650	10651	84511	84527
2-3/4	3/8	1	W666-1222	T	16	10660	10661	84512	84528
2-3/4	7/16	1	W666-1422	U	16	10670	10671	84513	84529
2-3/4	1/2	1	W666-1622	V	16	10680	10681	84514	84530
3-1/2	3/8	1	W666-1228	30	18	10690	10691	84515	84531
3-1/2	7/16	1	W666-1428	31	18	10700	10701	84516	84532
3-1/2	1/2	1	W666-1628	32	18	10710	10711	84517	84533
3-1/2	9/16	1	W666-1828	33	18	10720	10721	84518	84534
3-1/2	5/8	1	W666-2028	34	18	10730	10731	84519	84535
3-1/2	11/16	1	W666-2228	35	18	10740	10741	84520	84536
3-1/2	3/4	1	W666-2428	36	18	10750	10751	84521	84537









MILLING CUTTERS, PLAIN & SHELL MILLS, ARBOR-TYPE SLITTING SAWS



HSS STRAIGHT MILLING CUTTERS

MILLING CUTTERS, PLAIN & SHELL MILLS, ARBOR-TYPE SLITTING SAWS



 <p>HSS Side Milling Cutter — Straight Tooth "B" Style Diameter: 2" – 4"</p>	PAGE 16
 <p>HSS Side Milling Cutter — Straight Tooth "B" Style Diameter: 4" – 5"</p>	PAGE 17
 <p>HSS Side Milling Cutter — Straight Tooth "B" Style Diameter: 5" – 8"</p>	PAGE 18
 <p>HSS Side Milling Cutter — Straight Tooth "B" Style Diameter: 9" – 10"</p>	PAGE 19
 <p>HSS Milling Cutter — Double Angle "DA" Style</p>	PAGE 20
 <p>HSS Milling Cutter — Right-Hand Single-Angle "FR" Style</p>	PAGE 21
 <p>HSS Milling Cutter — Left-Hand Single-Angle "FL" Style</p>	PAGE 22



HSS STRAIGHT MILLING CUTTERS



MILLING CUTTERS, PLAIN & SHELL MILLS, ARBOR-TYPE SLITTING SAWS

HSS Side Milling Cutter — Straight Tooth

"B" Style

- General Purpose
- Additional teeth for improved finish
- Excellent for thin walled parts, interrupted cuts or finish requirements

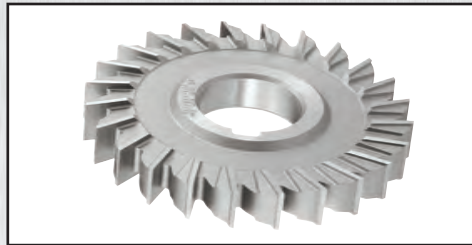

Cutter Dia	Cutter Width	Arbor Hole	Catalog Number	#T	Unc EDP	TIN Recommended		
						TiN EDP	TiCN EDP	TiAlN EDP
2	3/16	1/2	B2037	14	05000	05001	84550	84727
2	3/16	5/8	B2038	14	05010	05011	84551	84728
2	1/4	1/2	B2047	14	05020	05021	84552	84729
2	1/4	5/8	B2048	14	05030	05031	84553	84730
2	3/8	1/2	B2067	14	05040	05041	84554	84731
2	3/8	5/8	B2068	14	05050	05054	84555	84732
2-1/2	1/4	7/8	B25040	16	05060	05061	84556	84733
2-1/2	5/16	7/8	B25050	16	05070	05071	84557	84734
2-1/2	3/8	7/8	B25060	16	05080	05081	84558	84735
2-1/2	1/2	7/8	B25080	16	05090	05089	84559	84736
3	3/16	1	B3031	20	05100	05099	84560	84737
3	7/32	1	B3731	20	05110	05112	84561	84738
3	1/4	1	B3041	20	05120	05122	84562	84739
3	9/32	1	B3741	20	05130	05131	84563	84740
3	5/16	1	B3051	20	05140	05141	84564	84741
3	11/32	1	B3751	20	05150	05151	84565	84742
3	3/8	1	B3061	20	05160	05161	84566	84743
3	13/32	1	B3761	20	05170	05171	84567	84744
3	7/16	1	B3071	20	05180	05181	84568	84745
3	1/2	1	B3081	20	05190	05191	84569	84746
3	9/16	1	B3091	20	05200	05201	84570	84747
3	5/8	1	B3101	20	05210	05211	84571	84748
3	11/16	1	B3111	20	05220	05221	84572	84749
3	3/4	1	B3121	20	05230	05231	84573	84750
3	13/16	1	B3131	20	05240	05241	84574	84751
3	7/8	1	B3141	20	05250	05251	84575	84752
3	15/16	1	B3151	20	05260	05261	84576	84753
3	1	1	B3161	20	05270	05269	84577	84754
4	7/32	1	B4731	24	05281	05289	84578	84755
4	7/32	1-1/4	B4732	24	05290	05293	84579	84756
4	1/4	1	B4041	24	05300	05302	84580	84757
4	1/4	1-1/4	B4042	24	05310	05312	84581	84758
4	9/32	1	B4741	24	05320	05321	84582	84759
4	9/32	1-1/4	B4742	24	05330	05331	84583	84760
4	5/16	1	B4051	24	05340	05341	84584	84761
4	5/16	1-1/4	B4052	24	05350	05351	84585	84762
4	11/32	1	B4751	24	05360	05361	84586	84763
4	11/32	1-1/4	B4752	24	05370	05371	84587	84764
4	3/8	1	B4061	24	05380	05381	84588	84765
4	3/8	1-1/4	B4062	24	05390	05391	84589	84766
4	13/32	1	B4761	24	05400	05401	84590	84767
4	13/32	1-1/4	B4762	24	05410	05411	84591	84768
4	7/16	1	B4071	24	05420	05421	84592	84769
4	7/16	1-1/4	B4072	24	05430	05431	84593	84770
4	1/2	1	B4081	24	05440	05441	84594	84771
4	1/2	1-1/4	B4082	24	05450	05451	84595	84772

Continued on next page

MILLING CUTTERS, PLAIN & SHELL MILLS, ARBOR-TYPE SLITTING SAWS



HSS Side Milling Cutter — Straight Tooth

“B” Style

- General Purpose
- Additional teeth for improved finish
- Excellent for thin walled parts, interrupted cuts or finish requirements

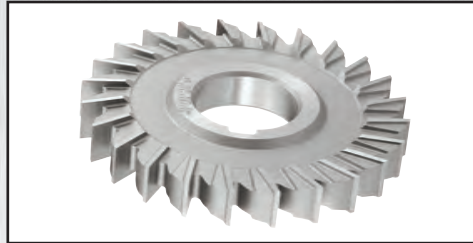

Cutter Dia	Cutter Width	Arbor Hole	Catalog Number	#T	Unc EDP	TiN Recommended		
						TiN EDP	TiCN EDP	TiAlN EDP
4	9/16	1	B4091	24	05460	05461	84596	84773
4	9/16	1-1/4	B4092	24	05470	05471	84597	84774
4	5/8	1	B4101	24	05480	05481	84598	84775
4	5/8	1-1/4	B4102	24	05490	05491	84599	84776
4	11/16	1	B4111	24	05500	05501	84600	84777
4	11/16	1-1/4	B4112	24	05510	05511	84601	84778
4	3/4	1	B4121	24	05520	05521	84602	84779
4	3/4	1-1/4	B4122	24	05530	05531	84603	84780
4	13/16	1	B4131	24	05540	05541	84604	84781
4	13/16	1-1/4	B4132	24	05550	05551	84605	84782
4	7/8	1	B4141	24	05560	05561	84606	84783
4	7/8	1-1/4	B4142	24	05570	05571	84607	84784
4	15/16	1	B4151	24	05580	05581	84608	84785
4	15/16	1-1/4	B4152	24	05590	05591	84609	84786
4	1	1	B4161	24	05600	05601	84610	84787
4	1	1-1/4	B4162	24	05610	05609	84611	84788
5	1/4	1	B5041	26	05626	05636	84612	84789
5	1/4	1-1/4	B5042	26	05630	05638	84613	84790
5	9/32	1	B5741	26	05640	05641	84614	84791
5	9/32	1-1/4	B5742	26	05650	05651	84615	84792
5	5/16	1	B5051	26	05660	05661	84616	84793
5	5/16	1-1/4	B5052	26	05670	05671	84617	84794
5	11/32	1	B5751	26	05680	05681	84618	84795
5	11/32	1-1/4	B5752	26	05690	05691	84619	84796
5	3/8	1	B5061	26	05700	05701	84620	84797
5	3/8	1-1/4	B5062	26	05710	05711	84621	84798
5	13/32	1	B5761	26	05720	05721	84622	84799
5	13/32	1-1/4	B5762	26	05730	05731	84623	84800
5	7/16	1	B5071	26	05740	05741	84624	84801
5	7/16	1-1/4	B5072	26	05750	05751	84625	84802
5	1/2	1	B5081	26	05760	05761	84626	84803
5	1/2	1-1/4	B5082	26	05770	05771	84627	84804
5	9/16	1	B5091	26	05780	05781	84628	84805
5	9/16	1-1/4	B5092	26	05790	05791	84629	84806
5	5/8	1	B5101	26	05800	05801	84630	84807
5	5/8	1-1/4	B5102	26	05810	05811	84631	84808
5	11/16	1	B5111	26	05820	05821	84632	84809
5	11/16	1-1/4	B5112	26	05830	05831	84633	84810
5	3/4	1	B5121	26	05840	05841	84634	84811
5	3/4	1-1/4	B5122	26	05850	05851	84635	84812
5	13/16	1	B5131	26	05860	05861	84636	84813
5	13/16	1-1/4	B5132	26	05870	05871	84637	84814
5	7/8	1	B5141	26	05880	05881	84638	84815
5	7/8	1-1/4	B5142	26	05890	05891	84639	84816
5	15/16	1	B5151	26	05900	05901	84640	84817
5	15/16	1-1/4	B5152	26	05910	05911	84641	84818

Continued on next page



MILLING CUTTERS, PLAIN & SHELL MILLS, ARBOR-TYPE SLITTING SAWS

HSS Side Milling Cutter — Straight Tooth

"B" Style

- General Purpose
- Additional teeth for improved finish
- Excellent for thin walled parts, interrupted cuts or finish requirements

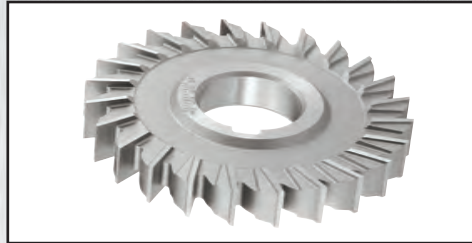

Cutter Dia	Cutter Width	Arbor Hole	Catalog Number	#T	Unc EDP	TIN Recommended		
						TiN EDP	TiCN EDP	TiAlN EDP
5	1	1	B5161	26	05920	05921	84642	84819
5	1	1-1/4	B5162	26	05930	05929	84643	84820
6	1/4	1-1/4	B6042	30	05945	05946	84644	84821
6	9/32	1-1/4	B6742	30	05950	05951	84645	84822
6	5/16	1-1/4	B6052	30	05960	05961	84646	84823
6	11/32	1-1/4	B6752	30	05965	05966	84647	84824
6	3/8	1-1/4	B6062	30	05980	05982	84648	84825
6	13/32	1-1/4	B6762	30	05990	05991	84649	84826
6	7/16	1-1/4	B6072	30	06000	06001	84650	84827
6	1/2	1	B6081	30	06010	06011	84651	84828
6	1/2	1-1/4	B6082	30	06020	06021	84652	84829
6	9/16	1-1/4	B6092	30	06030	06031	84653	84830
6	5/8	1-1/4	B6102	30	06040	06041	84654	84831
6	11/16	1-1/4	B6112	30	06050	06051	84655	84832
6	3/4	1	B6121	30	06060	06061	84656	84833
6	3/4	1-1/4	B6122	30	06070	06071	84657	84834
6	13/16	1-1/4	B6132	30	06080	06081	84658	84835
6	7/8	1-1/4	B6142	30	06090	06091	84659	84836
6	15/16	1-1/4	B6152	30	06100	06101	84660	84837
6	1	1-1/4	B6162	30	06110	06115	84661	84838
7	1/4	1-1/4	B7042	32	06120	06121	84662	84839
7	5/16	1-1/4	B7052	32	06130	06131	84663	84840
7	3/8	1-1/4	B7062	32	06140	06141	84664	84841
7	7/16	1-1/4	B7072	32	06150	06151	84665	84842
7	1/2	1-1/4	B7082	32	06160	06161	84666	84843
7	9/16	1-1/4	B7092	32	06170	06171	84667	84844
7	5/8	1-1/4	B7102	32	06180	06181	84668	84845
7	11/16	1-1/4	B7112	32	06190	06191	84669	84846
7	3/4	1-1/4	B7122	32	06200	06201	84670	84847
7	13/16	1-1/4	B7132	32	06210	06211	84671	84848
7	7/8	1-1/4	B7142	32	06220	06221	84672	84849
7	15/16	1-1/4	B7152	32	06230	06231	84673	84850
7	1	1-1/4	B7162	32	06240	06239	84674	84851
8	1/4	1-1/4	B8042	34	06250	06264	84675	84852
8	5/16	1-1/4	B8052	34	06260	06261	84676	84853
8	3/8	1-1/4	B8062	34	06270	06273	84677	84854
8	7/16	1-1/4	B8072	34	06280	06281	84678	84855
8	1/2	1-1/4	B8082	34	06290	06291	84679	84856
8	9/16	1-1/4	B8092	34	06300	06301	84680	84857
8	5/8	1-1/4	B8102	34	06310	06311	84681	84858
8	11/16	1-1/4	B8112	34	06320	06321	84682	84859
8	3/4	1-1/4	B8122	34	06330	06331	84683	84860
8	13/16	1-1/4	B8132	34	06340	06341	84684	84861
8	7/8	1-1/4	B8142	34	06350	06351	84685	84862
8	15/16	1-1/4	B8152	34	06360	06361	84686	84863
8	1	1-1/4	B8162	34	06370	06371	84687	84864

Continued on next page

MILLING CUTTERS, PLAIN & SHELL MILLS, ARBOR-TYPE SLITTING SAWS



HSS Side Milling Cutter — Straight Tooth

“B” Style

- General Purpose
- Additional teeth for improved finish
- Excellent for thin walled parts, interrupted cuts or finish requirements



Cutter Dia	Cutter Width	Arbor Hole	Catalog Number	#T	Unc EDP	TiN Recommended		
						TiN EDP	TiCN EDP	TiAlN EDP
9	1/4	1-1/4	B9042	36	06380	06381	84688	84865
9	5/16	1-1/4	B9052	36	06390	06391	84689	84866
9	3/8	1-1/4	B9062	36	06400	06401	84690	84867
9	7/16	1-1/4	B9072	36	06410	06411	84691	84868
9	1/2	1-1/4	B9082	36	06420	06421	84692	84869
9	9/16	1-1/4	B9092	36	06430	06431	84693	84870
9	5/8	1-1/4	B9102	36	06440	06441	84694	84871
9	11/16	1-1/4	B9112	36	06450	06451	84695	84872
9	3/4	1-1/4	B9122	36	06460	06461	84696	84873
9	13/16	1-1/4	B9132	36	06470	06471	84697	84874
9	7/8	1-1/4	B9142	36	06480	06481	84698	84875
9	15/16	1-1/4	B9152	36	06490	06491	84699	84876
9	1	1-1/4	B9162	36	06500	06499	84700	84877
10	1/4	1-1/2	B10043	38	06510	06513	84701	84878
10	5/16	1-1/2	B10053	38	06520	06515	84702	84879
10	3/8	1-1/2	B10063	38	06530	06532	84703	84880
10	7/16	1-1/2	B10073	38	06540	06541	84704	84881
10	1/2	1-1/2	B10083	38	06550	06551	84705	84882
10	9/16	1-1/2	B10093	38	06560	06561	84706	84883
10	5/8	1-1/2	B10103	38	06570	06571	84707	84884
10	11/16	1-1/2	B10113	38	06580	06581	84708	84885
10	3/4	1-1/2	B10123	38	06590	06591	84709	84886
10	13/16	1-1/2	B10133	38	06600	06601	84710	84887
10	7/8	1-1/2	B10143	38	06610	06611	84711	84888
10	15/16	1-1/2	B10153	38	06620	06621	84712	84889
10	1	1-1/2	B10163	38	06630	06631	84713	84890



MILLING CUTTERS, PLAIN & SHELL MILLS, ARBOR-TYPE SLITTING SAWS

HSS Milling Cutter — Double Angle

“DA” Style

- General Purpose
- Three Standard Angles
- Excellent for thin Milling Notches, Chamfers, Serrations and Angles

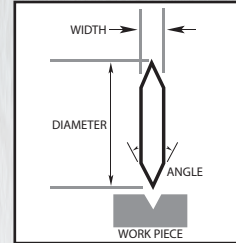

Cutter Dia	Cutter Width	Arbor Hole	Catalog Number	Incl. Angle	#T	Unc EDP	TiN Recommended		
							TiN EDP	TiCN EDP	TiAIN EDP
2-3/4	1/2	1	D45-21	45°	20	13200	13201	81655	81674
2-3/4	1/2	1	D60-21	60°	20	13210	13211	81656	81675
2-3/4	1/2	1	D90-21	90°	20	13220	13221	81657	81676
4	1/2	1-1/4	D60-42	60°	20	13230	13231	81658	81677
4	1/2	1-1/4	D90-42	90°	20	13240	13241	81659	81678
4	3/4	1-1/4	D60-43	60°	20	13250	13251	81660	81679
4	3/4	1-1/4	D90-43	90°	20	13260	13261	81661	81680
4	1	1-1/4	D60-44	60°	20	13270	13271	81662	81681
4	1	1-1/4	D90-44	90°	20	13280	13281	81663	81682
5	3/4	1-1/4	D60-53	60°	24	13290	13291	81664	81683
5	3/4	1-1/4	D90-53	90°	24	13300	13301	81665	81684
5	1	1-1/4	D60-54	60°	24	13310	13311	81666	81685
5	1	1-1/4	D90-54	90°	24	13320	13321	81667	81686
6	1	1-1/4	D60-64	60°	28	13330	13331	81668	81687
6	1	1-1/4	D90-64	90°	28	13340	13341	81669	81688
6	1-1/4	1-1/4	D60-65	60°	28	13350	13351	81670	81689
6	1-1/4	1-1/4	D90-65	90°	28	13360	13361	81671	81690
6	1-1/2	1-1/4	D60-66	60°	28	13370	13371	81672	81691
6	1-1/2	1-1/4	D90-66	90°	28	13380	13381	81673	81692

MILLING CUTTERS, PLAIN & SHELL MILLS, ARBOR-TYPE SLITTING SAWS



HSS Milling Cutter — Right-Hand Single-Angle

“FR” Style

- Available in 45° and 60°
- With cutting teeth on large diameter side

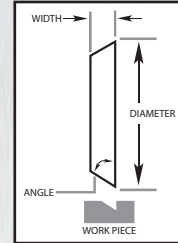

Cutter Dia	Cutter Width	Arbor Hole	Catalog Number	Incl. Angle	#T	Unc EDP	TiN Recommended		
							TiN EDP	TiCN EDP	TiAlN EDP
2-3/4	1/2	1	F45-21R	45°	20	12700	12701	81573	81593
2-3/4	1/2	1	F60-21R	60°	20	12720	12721	81574	81594
3	1/2	1-1/4	F45-32R	45°	20	12740	12741	81575	81595
3	1/2	1-1/4	F60-32R	60°	20	12760	12761	81576	81596
4	1/2	1-1/4	F45-42R	45°	20	12780	12781	81577	81597
4	1/2	1-1/4	F60-42R	60°	20	12800	12801	81578	81598
4	3/4	1-1/4	F45-43R	45°	20	12820	12821	81579	81599
4	3/4	1-1/4	F60-43R	60°	20	12840	12841	81580	81600
4	1	1-1/4	F45-44R	45°	20	12860	12861	81581	81601
4	1	1-1/4	F60-44R	60°	20	12880	12881	81582	81602
5	3/4	1-1/4	F45-53R	45°	24	12900	12901	81583	81603
5	3/4	1-1/4	F60-53R	60°	24	12920	12921	81584	81604
5	1	1-1/4	F45-54R	45°	24	12940	12941	81585	81605
5	1	1-1/4	F60-54R	60°	24	12960	12961	81586	81606
6	3/4	1-1/4	F45-63R	45°	28	12980	12981	81587	81607
6	3/4	1-1/4	F60-63R	60°	28	13000	13001	81588	81608
6	1	1-1/4	F45-64R	45°	28	13020	13021	81589	81609
6	1	1-1/4	F60-64R	60°	28	13040	13041	81590	81610
6	1-1/4	1-1/4	F45-65R	45°	28	13060	13061	81591	81611
6	1-1/4	1-1/4	F60-65R	60°	28	13080	13081	81592	81612



MILLING CUTTERS, PLAIN & SHELL MILLS, ARBOR-TYPE SLITTING SAWS

HSS Milling Cutter — Left-Hand Single-Angle

“FL” Style

- Available in 45° and 60°
- With cutting teeth on large diameter side

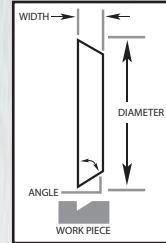

Cutter Dia	Cutter Width	Arbor Hole	Catalog Number	Incl. Angle	#T	Unc EDP	TiN Recommended		
							TiN EDP	TiCN EDP	TiAlN EDP
2-3/4	1/2	1	F45-21L	45°	20	12710	12711	81614	81634
2-3/4	1/2	1	F60-21L	60°	20	12730	12731	81615	81635
3	1/2	1-1/4	F45-32L	45°	20	12750	12751	81616	81636
3	1/2	1-1/4	F60-32L	60°	20	12770	12771	81617	81637
4	1/2	1-1/4	F45-42L	45°	20	12790	12791	81618	81638
4	1/2	1-1/4	F60-42L	60°	20	12810	12811	81619	81639
4	3/4	1-1/4	F45-43L	45°	20	12830	12831	81620	81640
4	3/4	1-1/4	F60-43L	60°	20	12850	12851	81621	81641
4	1	1-1/4	F45-44L	45°	20	12870	12871	81622	81642
4	1	1-1/4	F60-44L	60°	20	12890	12891	81623	81643
5	3/4	1-1/4	F45-53L	45°	24	12910	12911	81624	81644
5	3/4	1-1/4	F60-53L	60°	24	12930	12931	81625	81645
5	1	1-1/4	F45-54L	45°	24	12950	12951	81626	81646
5	1	1-1/4	F60-54L	60°	24	12970	12971	81627	81647
6	3/4	1-1/4	F45-63L	45°	28	12990	12991	81628	81648
6	3/4	1-1/4	F60-63L	60°	28	13010	13011	81629	81649
6	1	1-1/4	F45-64L	45°	28	13030	13031	81630	81650
6	1	1-1/4	F60-64L	60°	28	13050	13051	81631	81651
6	1-1/4	1-1/4	F45-65L	45°	28	13070	13071	81632	81652
6	1-1/4	1-1/4	F60-65L	60°	28	13090	13091	81633	81653

MILLING CUTTERS, PLAIN & SHELL MILLS,
ARBOR-TYPE SLITTING SAWS



HSS Shell End Mill — General Purpose Right-Hand Cut
SMPG



PAGE 24

HSS Shell End Mill — Right-Hand Cut Aluminum Cutting
SMAL

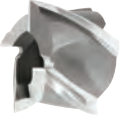

PAGE 25



HSS SHELL MILLS

HSS Shell End Mill — General Purpose Right-Hand Cut

SMGP

- Ground Flutes
- Available in Right Hand or Left Hand by special order

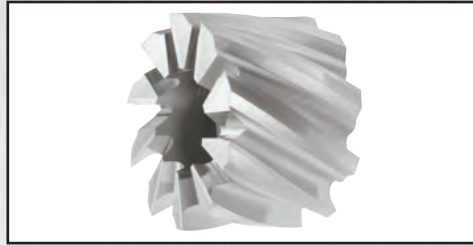

Cutter Dia	Cutter Width	Arbor Hole	Catalog Number	#T	Unc EDP	TiN Recommended		
						TiN EDP	TiCN EDP	TiAlN EDP
1-1/4	1	1/2	R1257	8	09500	09501	75486	75499
1-1/2	1-1/8	1/2	R1507	8	09510	09511	75487	75500
1-3/4	1-1/4	3/4	R1759	8	09520	09521	75488	75501
2	1-3/8	3/4	R2009	10	09530	09531	75489	75502
2-1/4	1-1/2	1	R2251	10	09540	09541	75490	75503
2-1/2	1-5/8	1	R2501	10	09550	09551	75491	75504
2-3/4	1-5/8	1	R2751	10	09560	09561	75492	75505
3	1-3/4	1-1/4	R3002	12	09570	09571	75493	75506
3-1/2	1-7/8	1-1/4	R3502	12	09580	09581	75494	75507
4	2-1/4	1-1/2	R4003	14	09590	09591	75495	75508
4-1/2	2-1/4	1-1/2	R4503	14	09600	09601	75496	75509
5	2-1/4	1-1/2	R5003	16	09610	09611	75497	75510
6	2-1/4	2	R6004	16	09620	09621	75498	75511

MILLING CUTTERS, PLAIN & SHELL MILLS, ARBOR-TYPE SLITTING SAWS

HSS Shell End Mill — Right-Hand Cut Aluminum Cutting

SMAL

- Deep Gullet Space
- Excellent for Non-Ferrous Materials
- High Rake and Polished Flutes

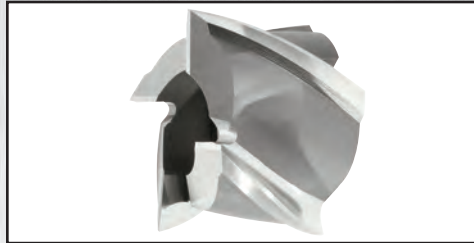

Cutter Dia	Cutter Width	Arbor Hole	Catalog Number	#T	Unc EDP	TiN Recommended		
						TiN EDP	TiCN EDP	TiAlN EDP
1-1/4	1	1/2	RA1257	4	09850	09851	19532	19540
1-1/2	1-1/8	1/2	RA1507	4	09860	09861	19533	19541
2	1-3/8	3/4	RA2009	4	09870	09871	19534	19542
2-1/2	1-5/8	1	RA2501	4	09880	09881	19535	19543
3	1-3/4	1-1/4	RA3002	6	09890	09891	19536	19544
4	2-1/4	1-1/2	RA4003	6	09900	09901	19537	19545
5	2-1/4	1-1/2	RA5003	8	09910	09911	19538	19546
6	2-1/4	2	RA6004	8	09920	09921	19539	19547



MILLING CUTTERS, PLAIN & SHELL MILLS, ARBOR-TYPE SLITTING SAWS



HSS SLITTING SAWS

**MILLING CUTTERS, PLAIN & SHELL MILLS,
ARBOR-TYPE SLITTING SAWS**



 <p>HSS Slitting Saw — Straight Side Tooth "MT" Style Diameter: 2-1/2" – 4"</p>	PAGE 28
 <p>HSS Slitting Saw — Straight Side Tooth "MT" Style Diameter: 5" – 6"</p>	PAGE 29
 <p>HSS Slitting Saw — Straight Side Tooth "MT" Style Diameter: 6" – 10"</p>	PAGE 30
 <p>HSS Slitting Saw — Staggered Tooth "MS" Style Diameter: 3" – 6"</p>	PAGE 31
 <p>HSS Slitting Saw — Staggered Tooth "MS" Style Diameter: 6" – 10"</p>	PAGE 32
 <p>HSS Slitting Saw — Concave "MC" Style</p>	PAGE 33
 <p>HSS Saw — Screw Slotting 1470 Style Diameter: 1-3/4" – 2-3/4"</p>	PAGE 34
 <p>HSS Saw — Screw Slotting 1470 Style Diameter: 2-3/4"</p>	PAGE 35
 <p>HSS Saw — Jewelers' Saws 1490 Style Diameter: 1" – 2"</p>	PAGE 36
 <p>HSS Saw — Jewelers' Saws 1490 Style Diameter: 2" – 3"</p>	PAGE 37
 <p>HSS Saw — Jewelers' Saws 1490 Style Diameter: 3" – 4"</p>	PAGE 38

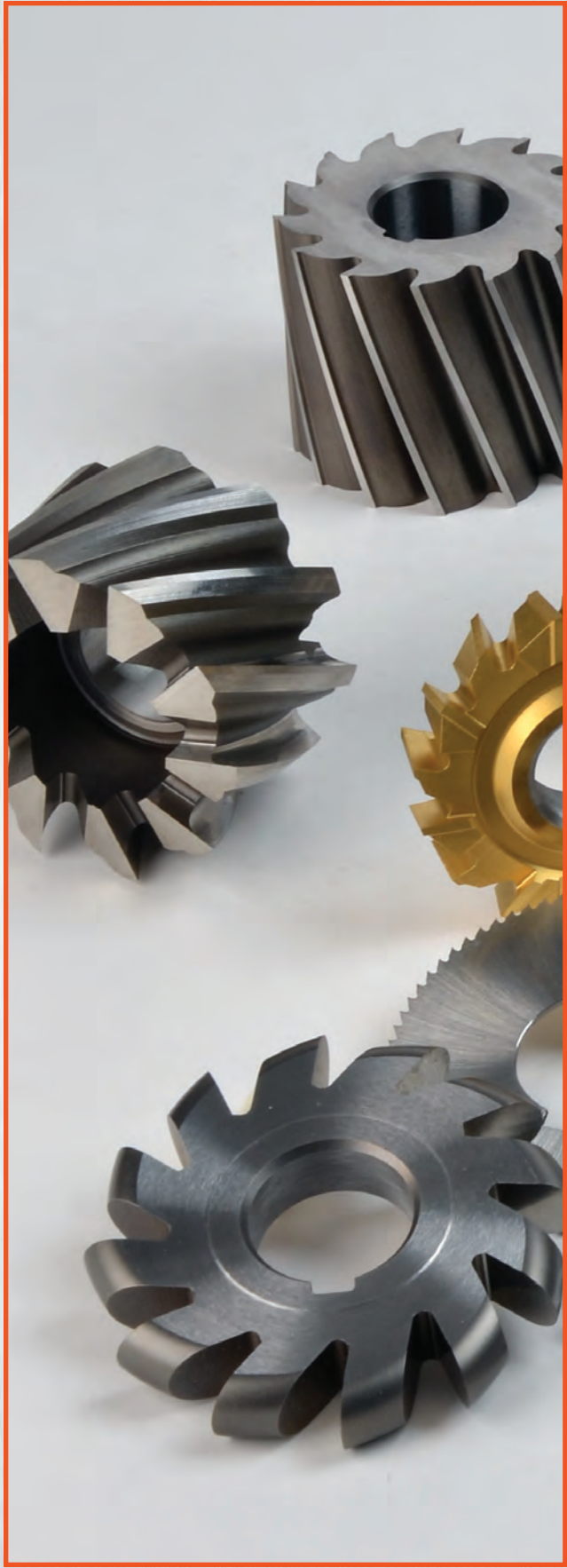

HSS SLITTING SAWS

HSS Slitting Saw — Straight Side Tooth

"MT" Style

- Excellent for Slotting and Plunging
- Fully Ground Surfaces
- Recommended for Thin Walled Parts

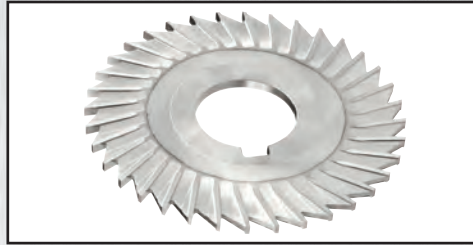

Cutter Dia	Cutter Width	Arbor Hole	Catalog Number	#T	Unc EDP	TIN Recommended		
						TiN EDP	TiCN EDP	TiAlN EDP
2-1/2	1/16	7/8	MT25010	28	08300	08301	80402	80528
2-1/2	3/32	7/8	MT25710	28	08310	08311	80403	80529
2-1/2	1/8	7/8	MT25020	28	08320	08321	80404	80530
3	1/16	1	MT3011	32	08330	08331	80405	80531
3	5/64	1	MT3511	32	08336	08337	80406	80532
3	3/32	1	MT3711	32	08340	08341	80407	80533
3	7/64	1	MT3921	32	08346	08347	80408	80534
3	1/8	1	MT3021	32	08350	08351	80409	80535
3	9/64	1	MT3521	32	08356	08357	80410	80536
3	5/32	1	MT3721	32	08360	08361	80411	80537
3	11/64	1	MT3931	32	08366	08367	80412	80538
3	3/16	1	MT3031	32	08370	08371	80413	80539
3	13/64	1	MT3531	32	08376	08377	80414	80540
3	7/32	1	MT3731	32	08380	08381	80415	80541
3	15/64	1	MT3941	32	08386	08387	80416	80542
3	1/4	1	MT3041	32	08390	08391	80417	80543
4	1/16	1	MT4011	36	08400	08401	80418	80544
4	1/16	1-1/4	MT4012	36	08410	08411	80419	80545
4	5/64	1	MT4511	36	08412	08413	80420	80546
4	5/64	1-1/4	MT4512	36	08416	08417	80421	80547
4	3/32	1	MT4711	36	08420	08421	80422	80548
4	3/32	1-1/4	MT4712	36	08430	08431	80423	80549
4	7/64	1	MT4921	36	08432	08433	80424	80550
4	7/64	1-1/4	MT4922	36	08436	08437	80425	80551
4	1/8	1	MT4021	36	08440	08441	80426	80552
4	1/8	1-1/4	MT4022	36	08450	08451	80427	80553
4	9/64	1	MT4521	36	08452	08453	80428	80554
4	9/64	1-1/4	MT4522	36	08456	08457	80429	80555
4	5/32	1	MT4721	36	08460	08461	80430	80556
4	5/32	1-1/4	MT4722	36	08470	08471	80431	80557
4	11/64	1	MT4931	36	08472	08473	80432	80558
4	11/64	1-1/4	MT4932	36	08476	08477	80433	80559
4	3/16	1	MT4031	36	08480	08481	80434	80560
4	3/16	1-1/4	MT4032	36	08490	08491	80435	80561
4	13/64	1	MT4531	36	08492	08493	80436	80562
4	13/64	1-1/4	MT4532	36	08496	08497	80437	80563
4	7/32	1	MT4731	36	08500	08501	80438	80564
4	7/32	1-1/4	MT4732	36	08510	08511	80439	80565
4	15/64	1	MT4941	36	08512	08513	80440	80566
4	15/64	1-1/4	MT4942	36	08516	08517	80441	80567
4	1/4	1	MT4041	36	08520	08521	80442	80568
4	1/4	1-1/4	MT4042	36	08530	08531	80443	80569

Continued on next page

MILLING CUTTERS, PLAIN & SHELL MILLS, ARBOR-TYPE SLITTING SAWS

HSS Slitting Saw — Straight Side Tooth

“MT” Style

- Excellent for Slotting and Plunging
- Fully Ground Surfaces
- Recommended for Thin Walled Parts

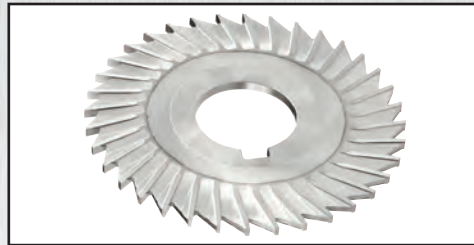

Cutter Dia	Cutter Width	Arbor Hole	Catalog Number	#T	Unc EDP	TiN Recommended		
						TiN EDP	TiCN EDP	TiAlN EDP
5	1/16	1	MT5011	40	08540	08541	80444	80570
5	1/16	1-1/4	MT5012	40	08550	08551	80445	80571
5	3/32	1	MT5711	40	08560	08561	80446	80572
5	3/32	1-1/4	MT5712	40	08570	08571	80447	80573
5	1/8	1	MT5021	40	08580	08581	80448	80574
5	1/8	1-1/4	MT5022	40	08590	08591	80449	80575
5	5/32	1	MT5721	40	08600	08601	80450	80576
5	5/32	1-1/4	MT5722	40	08610	08611	80451	80577
5	3/16	1	MT5031	40	08620	08621	80452	80578
5	3/16	1-1/4	MT5032	40	08630	08631	80453	80579
5	7/32	1	MT5731	40	08640	08641	80454	80580
5	7/32	1-1/4	MT5732	40	08650	08651	80455	80581
5	1/4	1	MT5041	40	08660	08661	80456	80582
5	1/4	1-1/4	MT5042	40	08670	08671	80457	80583
6	1/16	1	MT6011	42	08680	08681	80458	80584
6	1/16	1-1/4	MT6012	42	08690	08691	80459	80585
6	5/64	1	MT6511	42	08692	08693	80460	80586
6	5/64	1-1/4	MT6512	42	08696	08697	80461	80587
6	3/32	1	MT6711	42	08700	08701	80462	80588
6	3/32	1-1/4	MT6712	42	08710	08711	80463	80589
6	7/64	1	MT6921	42	08712	08713	80464	80590
6	7/64	1-1/4	MT6922	42	08716	08717	80465	80591
6	1/8	1	MT6021	42	08720	08721	80466	80592
6	1/8	1-1/4	MT6022	42	08730	08731	80467	80593
6	9/64	1	MT6521	42	08732	08733	80468	80594
6	9/64	1-1/4	MT6522	42	08736	08737	80469	80595
6	5/32	1	MT6721	42	08740	08741	80470	80596
6	5/32	1-1/4	MT6722	42	08750	08751	80471	80597
6	11/64	1	MT6931	42	08752	08753	80472	80598
6	11/64	1-1/4	MT6932	42	08756	08757	80473	80599
6	3/16	1	MT6031	42	08760	08761	80474	80600
6	3/16	1-1/4	MT6032	42	08770	08771	80475	80601
6	13/64	1	MT6531	42	08772	08773	80476	80602
6	13/64	1-1/4	MT6532	42	08776	08777	80477	80603
6	7/32	1	MT6731	42	08780	08781	80478	80604
6	7/32	1-1/4	MT6732	42	08790	08791	80479	80605
6	15/64	1	MT6941	42	08792	08793	80480	80606
6	15/64	1-1/4	MT6942	42	08796	08797	80481	80607
6	1/4	1	MT6041	42	08800	08801	80482	80608
6	1/4	1-1/4	MT6042	42	08810	08811	80483	80609
6	17/64	1	MT6541	42	08192	08193	80484	80610
6	17/64	1-1/4	MT6542	42	08196	08197	80485	80611

Continued on next page



MILLING CUTTERS, PLAIN & SHELL MILLS, ARBOR-TYPE SLITTING SAWS

HSS Slitting Saw — Straight Side Tooth

“MT” Style

- Excellent for Slotting and Plunging
- Fully Ground Surfaces
- Recommended for Thin Walled Parts

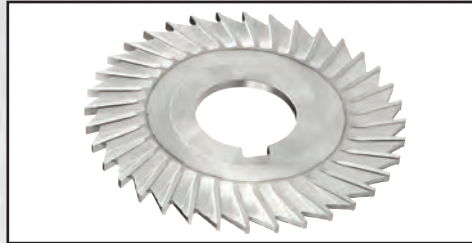

Cutter Dia	Cutter Width	Arbor Hole	Catalog Number	#T	Unc EDP	TIN Recommended		
						TiN EDP	TiCN EDP	TiAlN EDP
6	9/32	1	MT6741	42	08200	08201	80486	80612
6	9/32	1-1/4	MT6742	42	08210	08211	80487	80613
6	19/64	1	MT6951	42	08212	08213	80488	80614
6	19/64	1-1/4	MT6952	42	08216	08217	80489	80615
6	5/16	1	MT6051	42	08220	08221	80490	80616
6	5/16	1-1/4	MT6052	42	08230	08231	80491	80617
6	21/64	1	MT6551	42	08232	08233	80492	80618
6	21/64	1-1/4	MT6552	42	08236	08237	80493	80619
6	11/32	1	MT6751	42	08240	08241	80494	80620
6	11/32	1-1/4	MT6752	42	08250	08251	80495	80621
6	23/64	1	MT6961	42	08812	08813	80496	80622
6	23/64	1-1/4	MT6962	42	08816	08817	80497	80623
6	3/8	1	MT6061	42	08820	08821	80498	80624
6	3/8	1-1/4	MT6062	42	08830	08831	80499	80625
7	1/8	1	MT7021	48	08840	08841	80500	80626
7	1/8	1-1/4	MT7022	48	08850	08851	80501	80627
7	3/16	1	MT7031	48	08860	08861	80502	80628
7	3/16	1-1/4	MT7032	48	08870	08871	80503	80629
8	1/8	1	MT8021	48	08880	08881	80504	80630
8	1/8	1-1/4	MT8022	48	08890	08891	80505	80631
8	1/8	1-1/2	MT8023	48	08900	08901	80506	80632
8	5/32	1-1/4	MT8722	48	08910	08911	80507	80633
8	5/32	1-1/2	MT8723	48	08920	08921	80508	80634
8	3/16	1-1/4	MT8032	48	08930	08931	80509	80635
8	3/16	1-1/2	MT8033	48	08940	08941	80510	80636
8	7/32	1-1/4	MT8732	48	08950	08951	80511	80637
8	7/32	1-1/2	MT8733	48	08960	08961	80512	80638
8	1/4	1-1/4	MT8042	48	08970	08971	80513	80639
8	1/4	1-1/2	MT8043	48	08980	08981	80514	80640
8	3/8	1-1/4	MT8062	48	08990	08991	80515	80641
8	3/8	1-1/2	MT8063	48	09000	09001	80516	80642
10	3/16	1-1/4	MT10032	56	09010	09011	80517	80643
10	3/16	1-1/2	MT10033	56	09020	09021	80518	80644
10	7/32	1-1/4	MT10732	56	09030	09031	80519	80645
10	7/32	1-1/2	MT10733	56	09040	09041	80520	80646
10	1/4	1-1/4	MT10042	56	09050	09051	80521	80647
10	1/4	1-1/2	MT10043	56	09060	09061	80522	80648
10	3/8	1-1/4	MT10062	56	09070	09071	80523	80649
10	3/8	1-1/2	MT10063	56	09080	09081	80524	80650

MILLING CUTTERS, PLAIN & SHELL MILLS, ARBOR-TYPE SLITTING SAWS

HSS Slitting Saw — Staggered Tooth

“MS” Style

- Excellent for Deep Slotting
- Free Cutting
- Recommended for where chip packing is a problem

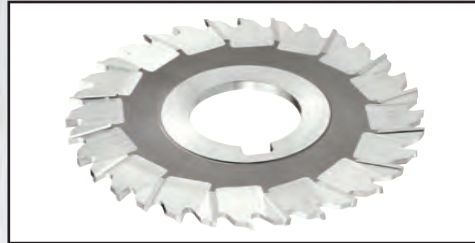

Cutter Dia	Cutter Width	Arbor Hole	Catalog Number	#T	Unc EDP	TiN Recommended		
						TiN EDP	TiCN EDP	TiAlN EDP
3	3/32	1	MS3711	28	07500	07501	80657	80726
3	1/8	1	MS3021	28	07510	07511	80658	80727
3	5/32	1	MS3721	28	07520	07521	80659	80728
3	3/16	1	MS3031	28	07530	07531	80660	80729
3	7/32	1	MS3731	28	07540	07541	80661	80730
3	1/4	1	MS3041	28	07550	07551	80662	80731
4	3/32	1	MS4711	32	07560	07561	80663	80732
4	3/32	1-1/4	MS4712	32	07570	07571	80664	80733
4	1/8	1	MS4021	32	07580	07581	80665	80734
4	1/8	1-1/4	MS4022	32	07590	07591	80666	80735
4	5/32	1	MS4721	32	07600	07601	80667	80736
4	5/32	1-1/4	MS4722	32	07610	07611	80668	80737
4	3/16	1	MS4031	32	07620	07621	80669	80738
4	3/16	1-1/4	MS4032	32	07630	07631	80670	80739
4	7/32	1	MS4731	32	07640	07641	80671	80740
4	7/32	1-1/4	MS4732	32	07650	07651	80672	80741
4	1/4	1	MS4041	32	07660	07661	80673	80742
4	1/4	1-1/4	MS4042	32	07670	07671	80674	80743
5	3/32	1	MS5711	36	07680	07681	80675	80744
5	3/32	1-1/4	MS5712	36	07690	07691	80676	80745
5	1/8	1	MS5021	36	07700	07701	80677	80746
5	1/8	1-1/4	MS5022	36	07710	07711	80678	80747
5	5/32	1	MS5721	36	07720	07721	80679	80748
5	5/32	1-1/4	MS5722	36	07730	07731	80680	80749
5	3/16	1	MS5031	36	07740	07741	80681	80750
5	3/16	1-1/4	MS5032	36	07750	07751	80682	80751
5	7/32	1	MS5731	36	07760	07761	80683	80752
5	7/32	1-1/4	MS5732	36	07770	07771	80684	80753
5	1/4	1	MS5041	36	07780	07781	80685	80754
5	1/4	1-1/4	MS5042	36	07790	07791	80686	80755
6	1/8	1	MS6021	40	07800	07801	80687	80756
6	1/8	1-1/4	MS6022	40	07810	07811	80688	80757
6	5/32	1	MS6721	40	07820	07821	80689	80758
6	5/32	1-1/4	MS6722	40	07830	07831	80690	80759
6	3/16	1	MS6031	40	07840	07841	80691	80760
6	3/16	1-1/4	MS6032	40	07850	07851	80692	80761
6	7/32	1	MS6731	40	07860	07861	80693	80762
6	7/32	1-1/4	MS6732	40	07870	07871	80694	80763
6	1/4	1	MS6041	40	07880	07881	80695	80764
6	1/4	1-1/4	MS6042	40	07890	07891	80696	80765

Continued on next page



MILLING CUTTERS, PLAIN & SHELL MILLS, ARBOR-TYPE SLITTING SAWS

HSS Slitting Saw — Staggered Tooth

"MS" Style

- Excellent for Deep Slotting
- Free Cutting
- Recommended for where chip packing is a problem

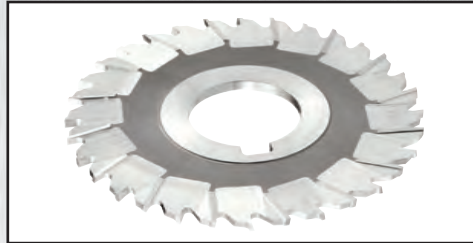

Cutter Dia	Cutter Width	Arbor Hole	Catalog Number	#T	Unc EDP	TIN Recommended		
						TiN EDP	TiCN EDP	TiAlN EDP
6	3/8	1	MS6061	40	07900	07901	80697	80766
6	3/8	1-1/4	MS6062	40	07910	07911	80698	80767
7	1/8	1	MS7021	44	07920	07921	80699	80768
7	1/8	1-1/4	MS7022	44	07930	07931	80700	80769
7	3/16	1	MS7031	44	07940	07941	80701	80770
7	3/16	1-1/4	MS7032	44	07950	07951	80702	80771
8	1/8	1-1/4	MS8022	48	07960	07961	80703	80772
8	1/8	1-1/2	MS8023	48	07970	07971	80704	80773
8	5/32	1-1/4	MS8722	48	07980	07981	80705	80774
8	5/32	1-1/2	MS8723	48	07990	07991	80706	80775
8	3/16	1-1/4	MS8032	48	08000	08001	80707	80776
8	3/16	1-1/2	MS8033	48	08010	08011	80708	80777
8	7/32	1-1/4	MS8732	48	08020	08021	80709	80778
8	7/32	1-1/2	MS8733	48	08030	08031	80710	80779
8	1/4	1-1/4	MS8042	48	08040	08041	80711	80780
8	1/4	1-1/2	MS8043	48	08050	08051	80712	80781
8	3/8	1-1/4	MS8062	48	08060	08061	80713	80782
8	3/8	1-1/2	MS8063	48	08070	08071	80714	80783
10	3/16	1-1/4	MS10032	56	08080	08081	80715	80784
10	3/16	1-1/2	MS10033	56	08090	08091	80716	80785
10	7/32	1-1/4	MS10732	56	08100	08101	80717	80786
10	7/32	1-1/2	MS10733	56	08110	08111	80718	80787
10	1/4	1-1/4	MS10042	56	08120	08121	80719	80788
10	1/4	1-1/2	MS10043	56	08130	08131	80720	80789
10	3/8	1-1/4	MS10062	56	08140	08141	80721	80790
10	3/8	1-1/2	MS10063	56	08150	08151	80722	80791

MILLING CUTTERS, PLAIN & SHELL MILLS, ARBOR-TYPE SLITTING SAWS

HSS Slitting Saw — Concave

“MC” Style

- Designed for Slitting or Cutoff Operations
- O.D. Cutting Only, No Side Teeth
- Fully Ground Surfaces
- Square Cornered with Side Concavity



Cutter Dia	Cutter Width	Arbor Hole	Catalog Number	#T	Unc EDP	TiN Recommended		
						TiN EDP	TiCN EDP	TiAlN EDP
2-1/2	1/32	7/8	MC25700	36	09200	09201	80796	80847
2-1/2	3/64	7/8	MC25910	36	09210	09211	80797	80848
2-1/2	1/16	7/8	MC25010	36	09220	09221	80798	80849
2-1/2	3/32	7/8	MC25710	36	09230	09231	80799	80850
2-1/2	1/8	7/8	MC25020	36	09240	09241	80800	80851
3	1/32	1	MC3701	36	09250	09251	80801	80852
3	3/64	1	MC3911	36	09260	09261	80802	80853
3	1/16	1	MC3011	36	09270	09271	80803	80854
3	3/32	1	MC3711	36	09280	09281	80804	80855
3	1/8	1	MC3021	36	09290	09291	80805	80856
3	5/32	1	MC3721	36	09300	09301	80806	80857
4	1/32	1	MC4701	40	09310	09311	80807	80858
4	1/32	1-1/4	MC4702	40	09314	09315	80808	80859
4	3/64	1	MC4911	40	09320	09321	80809	80860
4	3/64	1-1/4	MC4912	40	09324	09325	80810	80861
4	1/16	1	MC4011	40	09330	09331	80811	80862
4	1/16	1-1/4	MC4012	40	09334	09335	80812	80863
4	3/32	1	MC4711	40	09340	09341	80813	80864
4	3/32	1-1/4	MC4712	40	09344	09345	80814	80865
4	1/8	1	MC4021	40	09350	09351	80815	80866
4	1/8	1-1/4	MC4022	40	09354	09355	80816	80867
4	5/32	1	MC4721	40	09360	09361	80817	80868
4	5/32	1-1/4	MC4722	40	09364	09365	80818	80869
4	3/16	1	MC4031	40	09370	09371	80819	80870
4	3/16	1-1/4	MC4032	40	09374	09375	80820	80871
5	1/32	1	MC5701	44	09376	09377	80821	80872
5	1/32	1-1/4	MC5702	44	09378	09379	80822	80873
5	1/16	1	MC5011	44	09380	09381	80823	80874
5	1/16	1-1/4	MC5012	44	09384	09385	80824	80875
5	3/32	1	MC5711	44	09390	09391	80825	80876
5	3/32	1-1/4	MC5712	44	09394	09395	80826	80877
5	1/8	1	MC5021	44	09400	09401	80827	80878
5	1/8	1-1/4	MC5022	44	09410	09411	80828	80879
5	5/32	1	MC5721	44	09412	09413	80829	80880
5	5/32	1-1/4	MC5722	44	09414	09415	80830	80881
5	3/16	1	MC5031	44	09416	09417	80831	80882
5	3/16	1-1/4	MC5032	44	09418	09419	80832	80883
6	1/32	1	MC6701	48	09436	09437	80833	80884
6	1/32	1-1/4	MC6702	48	09438	09439	80834	80885
6	1/16	1	MC6011	48	09420	09421	80835	80886
6	1/16	1-1/4	MC6012	48	09424	09425	80836	80887
6	3/32	1	MC6711	48	09430	09431	80837	80888
6	3/32	1-1/4	MC6712	48	09434	09435	80838	80889
6	1/8	1	MC6021	48	09440	09441	80839	80890
6	1/8	1-1/4	MC6022	48	09450	09451	80840	80891
6	5/32	1	MC6721	48	09452	09453	80841	80892
6	5/32	1-1/4	MC6722	48	09454	09455	80842	80893
6	3/16	1	MC6031	48	09458	09459	80843	80894
6	3/16	1-1/4	MC6032	48	09460	09461	80844	80895
8	1/8	1	MC8021	58	09470	09471	80845	80896
8	1/8	1-1/4	MC8022	58	09480	09481	80846	80897



MILLING CUTTERS, PLAIN & SHELL MILLS, ARBOR-TYPE SLITTING SAWS

HSS Saw — Screw Slotting

1470

- Fully Ground Surfaces
- Recommended for Screw Heads and Shallow Slotting

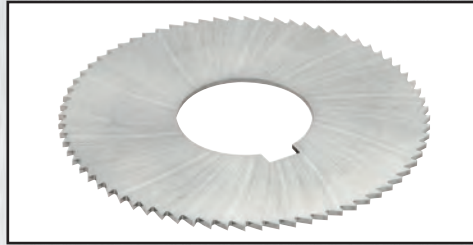

Cutter Dia	Cutter Width	Arbor Hole	#T	Unc EDP	TiN Recommended		
					TiN EDP	TiCN EDP	TiAlN EDP
1-3/4	.064	5/8	90	14700	14701	80977	81033
1-3/4	.057	5/8	90	14702	14703	80978	81034
1-3/4	.051	5/8	90	14704	14705	80979	81035
1-3/4	.045	5/8	90	14706	14707	80980	81036
1-3/4	.040	5/8	90	14708	14709	80981	81037
1-3/4	.036	5/8	90	14710	14711	80982	81038
1-3/4	.032	5/8	90	14712	14713	80983	81039
1-3/4	.028	5/8	90	14714	14715	80984	81040
1-3/4	.025	5/8	90	14716	14717	80985	81041
1-3/4	.023	5/8	90	14718	14719	80986	81042
1-3/4	.020	5/8	90	14720	14721	80987	81043
1-3/4	.018	5/8	90	14722	14723	80988	81044
1-3/4	.016	5/8	90	14724	14725	80989	81045
1-3/4	.014	5/8	90	14726	14727	80990	81046
1-3/4	.013	5/8	90	14728	14729	80991	81047
1-3/4	.010	5/8	90	14730	14731	80992	81048
2-1/4	.072	5/8	60	14732	14733	80993	81049
2-1/4	.064	5/8	60	14734	14735	80994	81050
2-1/4	.057	5/8	60	14736	14737	80995	81051
2-1/4	.051	5/8	60	14738	14739	80996	81052
2-1/4	.045	5/8	60	14740	14741	80997	81053
2-1/4	.040	5/8	60	14742	14743	80998	81054
2-1/4	.036	5/8	60	14744	14745	80999	81055
2-1/4	.032	5/8	60	14746	14747	81000	81056
2-1/4	.028	5/8	60	14748	14749	81001	81057
2-1/4	.025	5/8	60	14750	14751	81002	81058
2-1/4	.023	5/8	60	14752	14753	81003	81059
2-1/4	.020	5/8	60	14754	14755	81004	81060
2-1/4	.018	5/8	60	14756	14757	81005	81061
2-1/4	.016	5/8	60	14758	14759	81006	81062
2-1/4	.014	5/8	60	14760	14761	81007	81063
2-1/4	.013	5/8	60	14762	14763	81008	81064
2-1/4	.010	5/8	60	14764	14765	81009	81065
2-3/4	.144	1	72	14766	14767	81010	81066
2-3/4	.128	1	72	14768	14769	81011	81067
2-3/4	.114	1	72	14770	14771	81012	81068
2-3/4	.102	1	72	14772	14773	81013	81069
2-3/4	.091	1	72	14774	14775	81014	81070
2-3/4	.081	1	72	14776	14777	81015	81071
2-3/4	.072	1	72	14778	14779	81016	81072

Continued on next page

MILLING CUTTERS, PLAIN & SHELL MILLS, ARBOR-TYPE SLITTING SAWS

HSS Saw — Screw Slotting

1470

- Fully Ground Surfaces
- Recommended for Screw Heads and Shallow Slotting

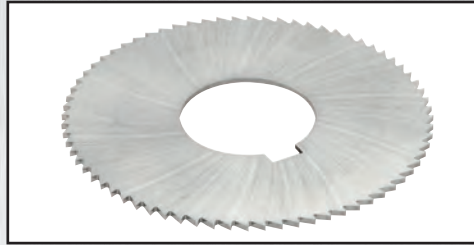

Cutter Dia	Cutter Width	Arbor Hole	#T	Unc EDP	TiN Recommended		
					TiN EDP	TiCN EDP	TiAlN EDP
2-3/4	.064	1	72	14780	14781	81017	81073
2-3/4	.057	1	72	14782	14783	81018	81074
2-3/4	.051	1	72	14784	14785	81019	81075
2-3/4	.045	1	72	14786	14787	81020	81076
2-3/4	.040	1	72	14788	14789	81021	81077
2-3/4	.036	1	72	14790	14791	81022	81078
2-3/4	.032	1	72	14792	14793	81023	81079
2-3/4	.028	1	72	14794	14795	81024	81080
2-3/4	.025	1	72	14796	14797	81025	81081
2-3/4	.023	1	72	14798	14799	81026	81082
2-3/4	.020	1	72	14800	14801	81027	81083
2-3/4	.018	1	72	14802	14803	81028	81084
2-3/4	.016	1	72	14804	14805	81029	81085
2-3/4	.014	1	72	14806	14807	81030	81086
2-3/4	.013	1	72	14808	14809	81031	81087
2-3/4	.010	1	72	14810	14811	81032	81088

HSS Saw — Jewelers' Saws

1490

- Fully Ground Surfaces
- Recommended for the Jewelry Industry



Cutter Dia	Cutter Width	Arbor Hole	#T	Unc EDP	TiN Recommended		
					TiN EDP	TiCN EDP	TiAlN EDP
1	.032	3/8	80	14900	14901	81090	81219
1	.028	3/8	80	14902	14903	81091	81220
1	.025	3/8	80	14904	14905	81092	81221
1	.023	3/8	80	14906	14907	81093	81222
1	.020	3/8	80	14908	14909	81094	81223
1	.018	3/8	80	14910	14911	81095	81224
1	.016	3/8	80	14912	14913	81096	81225
1	.014	3/8	80	14914	14915	81097	81226
1	.012	3/8	100	14916	14917	81098	81227
1	.010	3/8	100	14918	14919	81099	81228
1-1/4	.032	3/8	100	14920	14921	81100	81229
1-1/4	.028	3/8	100	14922	14923	81101	81230
1-1/4	.025	3/8	100	14924	14925	81102	81231
1-1/4	.023	3/8	100	14926	14927	81103	81232
1-1/4	.020	3/8	100	14928	14929	81104	81233
1-1/4	.018	3/8	100	14930	14931	81105	81234
1-1/4	.016	3/8	100	14932	14933	81106	81235
1-1/4	.014	3/8	100	14934	14935	81107	81236
1-1/4	.012	3/8	120	14936	14937	81108	81237
1-1/4	.010	3/8	120	14938	14939	81109	81238
1-1/2	.028	1/2	110	14940	14941	81110	81239
1-1/2	.025	1/2	110	14942	14943	81111	81240
1-1/2	.023	1/2	110	14944	14945	81112	81241
1-1/2	.020	1/2	110	14946	14947	81113	81242
1-1/2	.018	1/2	110	14948	14949	81114	81243
1-1/2	.016	1/2	110	14950	14951	81115	81244
1-1/2	.014	1/2	110	14952	14953	81116	81245
1-1/2	.012	1/2	140	14954	14955	81117	81246
1-1/2	.010	1/2	140	14956	14957	81118	81247
1-3/4	.032	1/2	130	14958	14959	81119	81248
1-3/4	.028	1/2	130	14960	14961	81120	81249
1-3/4	.025	1/2	130	14962	14963	81121	81250
1-3/4	.023	1/2	130	14964	14965	81122	81251
1-3/4	.020	1/2	130	14966	14967	81123	81252
1-3/4	.018	1/2	130	14968	14969	81124	81253
1-3/4	.016	1/2	130	14970	14971	81125	81254
1-3/4	.014	1/2	130	14972	14973	81126	81255
1-3/4	.012	1/2	160	14974	14975	81127	81256
1-3/4	.010	1/2	160	14976	14977	81128	81257
2	.057	1/2	110	14978	14979	81129	81258
2	.051	1/2	110	14980	14981	81130	81259
2	.045	1/2	110	14982	14983	81131	81260
2	.040	1/2	110	14984	14985	81132	81261
2	.035	1/2	110	14986	14987	81133	81262

Continued on next page

MILLING CUTTERS, PLAIN & SHELL MILLS, ARBOR-TYPE SLITTING SAWS



HSS Saw — Jewelers' Saws

1490

- Fully Ground Surfaces
- Recommended for the Jewelry Industry



Cutter Dia	Cutter Width	Arbor Hole	#T	Unc EDP	TiN Recommended	TiCN EDP	TiAlN EDP
					TiN EDP		
2	.032	1/2	110	14988	14989	81134	81263
2	.028	1/2	150	14990	14991	81135	81264
2	.025	1/2	150	14992	14993	81136	81265
2	.023	1/2	150	14994	14995	81137	81266
2	.020	1/2	150	14996	14997	81138	81267
2	.018	1/2	150	14998	14999	81139	81268
2	.016	1/2	150	15000	15001	81140	81269
2	.014	1/2	150	15002	15003	81141	81270
2	.012	1/2	190	15004	15005	81142	81271
2	.010	1/2	190	15006	15007	81143	81272
2-1/2	.057	1/2	140	15008	15009	81144	81273
2-1/2	.051	1/2	140	15010	15011	81145	81274
2-1/2	.045	1/2	140	15012	15013	81146	81275
2-1/2	.040	1/2	140	15014	15015	81147	81276
2-1/2	.035	1/2	140	15016	15017	81148	81277
2-1/2	.032	1/2	140	15018	15019	81149	81278
2-1/2	.028	1/2	190	15020	15021	81150	81279
2-1/2	.025	1/2	190	15022	15023	81151	81280
2-1/2	.023	1/2	190	15024	15025	81152	81281
2-1/2	.020	1/2	190	15026	15027	81153	81282
2-1/2	.018	1/2	190	15028	15029	81154	81283
2-1/2	.016	1/2	190	15030	15031	81155	81284
2-1/2	.014	1/2	190	15032	15033	81156	81285
2-1/2	.012	1/2	240	15034	15035	81157	81286
2-1/2	.010	1/2	240	15036	15037	81158	81287
3	.057	1/2	170	15038	15039	81159	81288
3	.057	1	170	15040	15041	81160	81289
3	.051	1/2	170	15042	15043	81161	81290
3	.051	1	170	15044	15045	81162	81291
3	.045	1/2	170	15046	15047	81163	81292
3	.045	1	170	15048	15049	81164	81293
3	.040	1/2	170	15050	15051	81165	81294
3	.040	1	170	15052	15053	81166	81295
3	.035	1/2	170	15054	15055	81167	81296
3	.035	1	170	15056	15057	81168	81297
3	.032	1/2	170	15058	15059	81169	81298
3	.032	1	170	15060	15061	81170	81299
3	.028	1/2	230	15062	15063	81171	81300
3	.028	1	230	15064	15065	81172	81301
3	.025	1/2	230	15066	15067	81173	81302
3	.025	1	230	15068	15069	81174	81303
3	.023	1/2	230	15070	15071	81175	81304
3	.023	1	230	15072	15073	81176	81305
3	.020	1/2	230	15074	15075	81177	81306

Continued on next page



MILLING CUTTERS, PLAIN & SHELL MILLS, ARBOR-TYPE SLITTING SAWS

HSS Saw — Jewelers' Saws

1490

- Fully Ground Surfaces
- Recommended for the Jewelry Industry



Cutter Dia	Cutter Width	Arbor Hole	#T	Unc EDP	TiN Recommended		
					TiN EDP	TiCN EDP	TiAlN EDP
3	.020	1	230	15076	15077	81178	81307
3	.018	1/2	230	15078	15079	81179	81308
3	.018	1	230	15080	15081	81180	81309
3	.016	1/2	230	15082	15083	81181	81310
3	.016	1	230	15084	15085	81182	81311
3	.014	1/2	230	15086	15087	81183	81312
3	.014	1	230	15088	15089	81184	81313
3	.012	1/2	280	15090	15091	81185	81314
3	.012	1	280	15092	15093	81186	81315
3	.010	1/2	280	15094	15095	81187	81316
3	.010	1	280	15096	15097	81188	81317
4	.057	1/2	220	15098	15099	81189	81318
4	.057	1	220	15100	15101	81190	81319
4	.051	1/2	220	15102	15103	81191	81320
4	.051	1	220	15104	15105	81192	81321
4	.045	1/2	220	15106	15107	81193	81322
4	.045	1	220	15108	15109	81194	81323
4	.040	1/2	220	15110	15111	81195	81324
4	.040	1	220	15112	15113	81196	81325
4	.035	1/2	220	15114	15115	81197	81326
4	.035	1	220	15116	15117	81198	81327
4	.032	1/2	220	15118	15119	81199	81328
4	.032	1	220	15120	15121	81200	81329
4	.028	1/2	300	15122	15123	81201	81330
4	.028	1	300	15124	15125	81202	81331
4	.025	1/2	300	15126	15127	81203	81332
4	.025	1	300	15128	15129	81204	81333
4	.023	1/2	300	15130	15131	81205	81334
4	.023	1	300	15132	15133	81206	81335
4	.020	1/2	300	15134	15135	81207	81336
4	.020	1	300	15136	15137	81208	81337
4	.018	1/2	300	15138	15139	81209	81338
4	.018	1	300	15140	15141	81210	81339
4	.016	1/2	300	15142	15143	81211	81340
4	.016	1	300	15144	15145	81212	81341
4	.014	1/2	300	15146	15147	81213	81342
4	.014	1	300	15148	15149	81214	81343
4	.012	1/2	380	15150	15151	81215	81344
4	.012	1	380	15152	15153	81216	81345
4	.010	1/2	380	15154	15155	81217	81346
4	.010	1	380	15156	15157	81218	81347

**MILLING CUTTERS, PLAIN & SHELL MILLS,
ARBOR-TYPE SLITTING SAWS**



HSS Plain Milling Cutter — Light-Duty
"LD" Style



PAGE 40

HSS Plain Milling Cutter — Left-Hand 45° Spiral Heavy-Duty
"HD" Style



PAGE 41



HSS PLAIN MILLS

HSS Plain Milling Cutter — Light-Duty

“LD” Style

- Recommended for Slab Milling
- Cutters up to 3/4" face width have straight teeth
- Cutters 3/4" face width and over have 18° left hand helix
- Right-Hand Cut, Left-Hand Helix allows for Rigidity and Improved Surface Finish

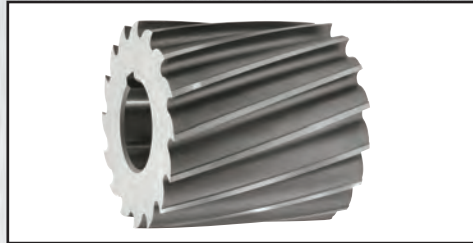

Cutter Dia	Cutter Width	Arbor Hole	Catalog Number	#T	Unc EDP	TiN Recommended		
						TiN EDP	TiCN EDP	TiAlN EDP
2-1/2	3/16	1	LD25031	16	10000	10001	81462	81500
2-1/2	1/4	1	LD25041	16	10010	10011	81463	81501
2-1/2	5/16	1	LD25051	16	10020	10021	81464	81502
2-1/2	3/8	1	LD25061	16	10030	10031	81465	81503
2-1/2	1/2	1	LD25081	16	10040	10041	81466	81504
2-1/2	5/8	1	LD25101	16	10050	10051	81467	81505
2-1/2	3/4	1	LD25121	14	10060	10061	81468	81506
2-1/2	1	1	LD25161	14	10070	10071	81469	81507
2-1/2	1-1/2	1	LD25241	14	10080	10081	81470	81508
2-1/2	2	1	LD25321	14	10090	10091	81471	81509
2-1/2	2-1/2	1	LD25401	14	10100	10101	81472	81510
2-1/2	3	1	LD25481	14	10110	10111	81473	81511
3	3/16	1	LD3031	18	10120	10121	81474	81512
3	1/4	1	LD3041	18	10130	10131	81475	81513
3	5/16	1	LD3051	18	10140	10141	81476	81514
3	3/8	1	LD3061	18	10150	10151	81477	81515
3	3/8	1-1/4	LD3062	18	10160	10161	81478	81516
3	1/2	1-1/4	LD3082	18	10170	10171	81479	81517
3	5/8	1-1/4	LD3102	18	10180	10181	81480	81518
3	3/4	1-1/4	LD3122	16	10190	10191	81481	81519
3	1	1-1/4	LD3162	16	10200	10201	81482	81520
3	1-1/4	1-1/4	LD3202	16	10210	10211	81483	81521
3	1-1/2	1-1/4	LD3242	16	10220	10221	81484	81522
3	2	1-1/4	LD3322	16	10230	10231	81485	81523
3	3	1-1/4	LD3482	16	10240	10241	81486	81524
4	1/4	1	LD4041	20	10250	10251	81487	81525
4	1/4	1-1/4	LD4042	20	10260	10261	81488	81526
4	5/16	1	LD4051	20	10270	10271	81489	81527
4	3/8	1	LD4061	20	10280	10281	81490	81528
4	3/8	1-1/4	LD4062	20	10290	10291	81491	81529
4	1/2	1-1/4	LD4082	20	10300	10301	81492	81530
4	5/8	1-1/4	LD4102	20	10310	10311	81493	81531
4	3/4	1-1/4	LD4122	20	10320	10321	81494	81532
4	1	1-1/4	LD4162	20	10330	10331	81495	81533
4	1-1/2	1-1/4	LD4242	20	10340	10341	81496	81534
4	2	1-1/4	LD4322	20	10350	10351	81497	81535
4	3	1-1/4	LD4482	20	10360	10361	81498	81536
4	4	1-1/4	LD4642	20	10370	10371	81499	81537

MILLING CUTTERS, PLAIN & SHELL MILLS, ARBOR-TYPE SLITTING SAWS

HSS Plain Milling Cutter — Left-Hand 45° Spiral Heavy-Duty

“HD” Style

- 45° Left-Hand Helix, Right-Hand Cuts
- Fewer teeth than “LD” Style making it better suited for heavy stock removal

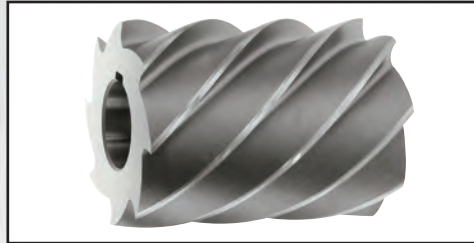

Cutter Dia	Cutter Width	Arbor Hole	Catalog Number	#T	Unc Teeth	TiN Recommended		
						TiN EDP	TiCN EDP	TiAlN EDP
2-1/2	2	1	HD25321	8	10400	10401	81550	81561
2-1/2	4	1	HD25641	8	10410	10411	81551	81562
3	2	1-1/4	HD3322	8	10420	10421	81552	81563
3	2-1/2	1-1/4	HD3402	8	10430	10431	81553	81564
3	3	1-1/4	HD3482	8	10440	10441	81554	81565
3	4	1-1/4	HD3642	8	10450	10451	81555	81566
3	6	1-1/4	HD3962	8	10460	10461	81556	81567
4	2	1-1/2	HD4323	10	10470	10471	81557	81568
4	3	1-1/2	HD4483	10	10480	10481	81558	81569
4	4	1-1/2	HD4643	10	10490	10491	81559	81570
4	6	1-1/2	HD4963	10	10500	10501	81560	81571



MILLING CUTTERS, PLAIN & SHELL MILLS, ARBOR-TYPE SLITTING SAWS



HSS FORM RELIEVED CUTTERS

**MILLING CUTTERS, PLAIN & SHELL MILLS,
ARBOR-TYPE SLITTING SAWS**



 <p>HSS Milling Cutter — Standard Diameter Convex "CVS" Style</p>	PAGE 44
 <p>HSS Milling Cutter — Large Diameter Convex "CVL" Style</p>	PAGE 45
 <p>HSS Milling Cutter — Concave "CC" Style</p>	PAGE 46
 <p>HSS Milling Cutter — Right-Hand Cutting Corner-Rounding "CR" Style</p>	PAGE 47
 <p>HSS Milling Cutter — Left-Hand Cutting Corner-Rounding "CL" Style</p>	PAGE 48



HSS FORM RELIEVED CUTTERS

HSS Milling Cutter — Standard Diameter Convex

“CVS” Style

- Produce Female Half Circle
- Form Relieved for Easy Resharpener

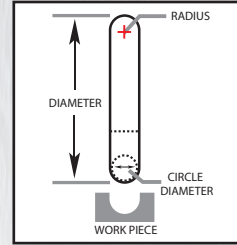

TiN
Recommended

Circle Dia	Convex Radius	Cutter Dia	Arbor Hole	Catalog Number	#T	Unc EDP	TiN EDP	TiCN EDP	TiAlN EDP
1/8	1/16	2-1/4	1	CV201	16	13500	13501	81349	81364
3/16	3/32	2-1/4	1	CV211	16	13510	13511	81350	81365
1/4	1/8	2-1/2	1	CV221	14	13520	13521	81351	81366
5/16	5/32	2-3/4	1	CV231	14	13530	13531	81352	81367
3/8	3/16	2-3/4	1	CV241	12	13540	13541	81353	81368
7/16	7/32	3	1	CV251	12	13550	13551	81354	81369
1/2	1/4	3	1	CV261	12	13560	13561	81355	81370
5/8	5/16	3-1/2	1-1/4	CV272	12	13570	13571	81356	81371
3/4	3/8	3-3/4	1-1/4	CV282	12	13580	13581	81357	81372
7/8	7/16	4	1-1/4	CV292	12	13590	13591	81358	81373
1	1/2	4-1/4	1-1/4	CV302	10	13600	13601	81359	81374
1-1/8	9/16	4-1/4	1-1/4	CV312	10	13610	13611	81360	81375
1-1/4	5/8	4-1/2	1-1/4	CV322	10	13620	13621	81361	81376
1-3/8	11/16	4-3/4	1-1/4	CV332	10	13630	13631	81362	81377
1-1/2	3/4	5	1-1/4	CV342	10	13640	13641	81363	81378

MILLING CUTTERS, PLAIN & SHELL MILLS, ARBOR-TYPE SLITTING SAWS



HSS Milling Cutter — Large Diameter Convex

“CVL” Style

- Produce Female Half Circle
- Additional Teeth
- Form Relieved for Easy Resharpenering

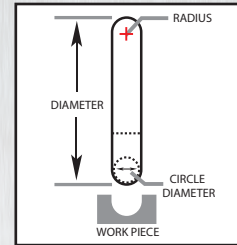
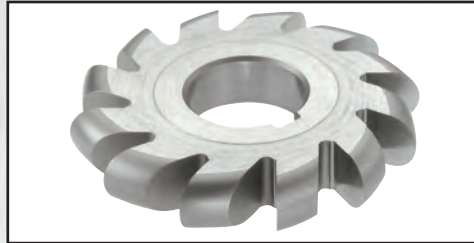

Circle Dia	Convex Radius	Cutter Dia	Arbor Hole	Catalog Number	#T	Unc EDP	TiN Recommended		
							TiN EDP	TiCN EDP	TiAlN EDP
1/8	1/16	4	1-1/4	CV4022	22	13700	13701	81380	81392
3/16	3/32	4	1-1/4	CV4032	22	13710	13711	81381	81393
1/4	1/8	4	1-1/4	CV4042	22	13720	13721	81382	81394
5/16	5/32	5	1-1/4	CV5052	18	13730	13731	81383	81395
3/8	3/16	5	1-1/4	CV5062	18	13740	13741	81384	81396
7/16	7/32	5	1-1/4	CV5072	18	13750	13751	81385	81397
1/2	1/4	5	1-1/4	CV5082	18	13760	13761	81386	81398
5/8	5/16	5	1-1/4	CV5102	18	13770	13771	81387	81399
3/4	3/8	6	1-1/4	CV6122	14	13780	13781	81388	81400
7/8	7/16	6	1-1/4	CV6142	14	13790	13791	81389	81401
1	1/2	6	1-1/4	CV6162	14	13800	13801	81390	81402
1-1/4	5/8	6	1-1/4	CV6202	14	13810	13811	81391	81403

HSS Milling Cutter — Concave

"CC" Style

- Produce Male Half Circles
- Form Relieved for Easy Resharpener

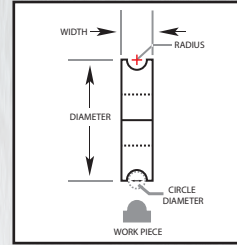
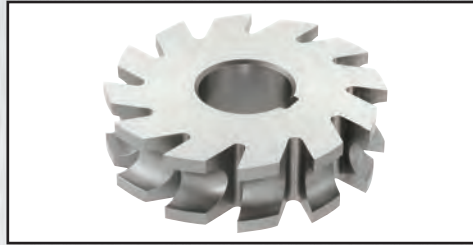

Circle Dia	Concave Radius	Cutter Dia	Cutter Width	Arbor Hole	Catalog Number	#T	Unc EDP	TiN Recommended		
								TiN EDP	TiCN EDP	TiAlN EDP
1/8	1/16	2-1/4	1/4	1	CC11	16	13900	13901	81405	81420
3/16	3/32	2-1/4	3/8	1	CC21	16	13910	13911	81406	81421
1/4	1/8	2-1/2	7/16	1	CC31	14	13920	13921	81407	81422
5/16	5/32	2-3/4	9/16	1	CC41	14	13930	13931	81408	81423
3/8	3/16	2-3/4	5/8	1	CC51	12	13940	13941	81409	81424
7/16	7/32	3	3/4	1	CC61	12	13950	13951	81410	81425
1/2	1/4	3	13/16	1	CC71	12	13960	13961	81411	81426
5/8	5/16	3-1/2	1	1-1/4	CC82	12	13970	13971	81412	81427
3/4	3/8	3-3/4	1-3/16	1-1/4	CC92	12	13980	13981	81413	81428
7/8	7/16	4	1-3/8	1-1/4	CC102	12	13990	13991	81414	81429
1	1/2	4-1/4	1-9/16	1-1/4	CC112	10	14000	14001	81415	81430
1-1/8	9/16	4-1/4	1-11/16	1-1/4	CC122	10	14010	14011	81416	81431
1-1/4	5/8	4-1/2	1-7/8	1-1/4	CC132	10	14020	14021	81417	81432
1-3/8	11/16	4-3/4	2-1/16	1-1/4	CC142	10	14030	14031	81418	81433
1-1/2	3/4	5	2-1/4	1-1/4	CC152	10	14040	14041	81419	81434

MILLING CUTTERS, PLAIN & SHELL MILLS, ARBOR-TYPE SLITTING SAWS



HSS Milling Cutter — Right-Hand Cutting Corner-Rounding

“CR” Style

- Form Relieved for Easy Resharpener
- Produces a Radius Form

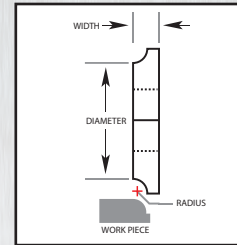

Circle Radius	Cutter Dia	Cutter Width	Arbor Hole	Catalog Number	#T	Unc EDP	TiN Recommended		
							TiN EDP	TiCN EDP	TiAlN EDP
1/8	2-1/2	1/4	1	CR631	14	14101	14103	81449	81455
1/4	3	13/32	1	CR671	12	14111	14113	81450	81456
3/8	3-3/4	9/16	1-1/4	CR692	12	14121	14123	81451	81457
1/2	4-1/4	3/4	1-1/4	CR712	10	14131	14133	81452	81458
5/8	4-1/4	15/16	1-1/4	CR732	10	14141	14143	81453	81459
3/4	4-1/2	1-1/8	1-1/4	CR752	10	14151	14153	81454	81460

HSS Milling Cutter — Left-Hand Cutting Corner-Rounding

“CL” Style

- Form Relieved for Easy Resharpener
- Produce a Radius Form

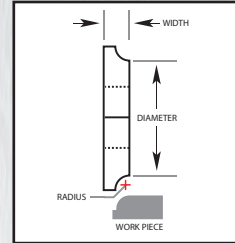

Circle Radius	Cutter Dia	Cutter Width	Arbor Hole	Catalog Number	#T	Unc EDP	TiN Recommended		
							TiN EDP	TiCN EDP	TiAlN EDP
1/8	2-1/2	1/4	1	CL431	14	14100	14102	81436	81442
1/4	3	13/32	1	CL471	12	14110	14112	81437	81443
3/8	3-3/4	9/16	1-1/4	CL492	12	14120	14122	81438	81444
1/2	4-1/4	3/4	1-1/4	CL512	10	14130	14132	81439	81445
5/8	4-1/4	15/16	1-1/4	CL532	10	14140	14142	81440	81446
3/4	4-1/2	1-1/8	1-1/4	CL552	10	14150	14152	81441	81447

MILLING CUTTERS, PLAIN & SHELL MILLS,
ARBOR-TYPE SLITTING SAWS



 <p>M42 Cobalt Side Milling Cutter — Staggered Tooth "DS" Style</p>	PAGE 50
 <p>T15 Supreme Side Milling Cutter — Staggered Tooth "NS" Style Diameter: 3" – 5"</p>	PAGE 51
 <p>T15 Supreme Side Milling Cutter — Staggered Tooth "NS" Style Diameter: 5" – 6"</p>	PAGE 52



HSCO STAGGERED TOOTH MILLING CUTTERS



MILLING CUTTERS, PLAIN & SHELL MILLS, ARBOR-TYPE SLITTING SAWS

M42 Cobalt Side Milling Cutter — Staggered Tooth

“DS” Style

- Recommended for use in Exotic Materials
- Free Cutting Design
- Long Tool Life
- Refer to page 76 for interlocking set information

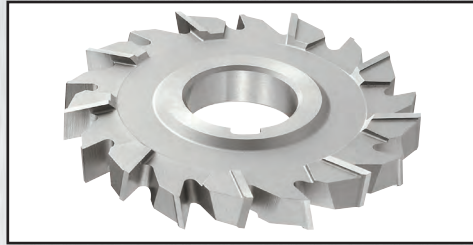

Cutter Dia	Cutter Width	Arbor Hole	Catalog Number	#T	Unc EDP	TiN Recommended		
						TiN EDP	TiCN EDP	TiAlN EDP
3	3/16	1	DS3031	16	04551	04569	80330	80348
3	1/4	1	DS3041	16	04552	04570	80331	80349
3	5/16	1	DS3051	16	04553	04571	80332	80350
3	3/8	1	DS3061	16	04554	04572	80333	80351
3	1/2	1	DS3081	16	04555	04573	80334	80352
3	1/2	1-1/4	DS3082	16	04556	04574	80335	80353
4	1/4	1	DS4041	18	04557	04575	80336	80354
4	1/4	1-1/4	DS4042	18	04558	04576	80337	80355
4	5/16	1	DS4051	18	04559	04577	80338	80356
4	5/16	1-1/4	DS4052	18	04560	04578	80339	80357
4	3/8	1-1/4	DS4062	18	04561	04579	80340	80358
4	1/2	1-1/4	DS4082	18	04562	04580	80341	80359
4	3/4	1-1/4	DS4122	18	04563	04581	80342	80360
6	1/4	1-1/4	DS6042	24	04564	04582	80343	80361
6	3/8	1-1/4	DS6062	24	04565	04583	80344	80362
6	1/2	1-1/4	DS6082	24	04566	04584	80345	80363
6	3/4	1-1/4	DS6122	24	04567	04585	80346	80364
6	1	1-1/4	DS6162	24	04568	04586	80347	80365

MILLING CUTTERS, PLAIN & SHELL MILLS, ARBOR-TYPE SLITTING SAWS

T15 Supreme Side Milling Cutter — Staggered Tooth

“NS” Style

- Recommended for Stainless and Titanium
- Resistant to High Heat and Abrasive Wear
- Free Cutting Design
- Refer to page 76 for interlocking set information



Cutter Dia	Cutter Width	Arbor Hole	Catalog Number	#T	Unc EDP	TiN Recommended		
						TiN EDP	TiCN EDP	TiAlN EDP
3	3/16	1	NS3031	18	03600	03601	84905	84966
3	7/32	1	NS3731	18	03610	03611	84906	84967
3	1/4	1	NS3041	18	03620	03621	84907	84968
3	9/32	1	NS3741	18	03630	03631	84908	84969
3	5/16	1	NS3051	18	03640	03641	84909	84970
3	11/32	1	NS3751	18	03650	03651	84910	84971
3	3/8	1	NS3061	18	03660	03661	84911	84972
3	13/32	1	NS3761	18	03670	03671	84912	84973
3	7/16	1	NS3071	18	03680	03681	84913	84974
3	15/32	1	NS3771	18	03690	03691	84914	84975
3	1/2	1	NS3081	18	03700	03701	84915	84976
4	7/32	1-1/4	NS4732	22	03710	03711	84916	84977
4	1/4	1-1/4	NS4042	22	03720	03721	84917	84978
4	9/32	1-1/4	NS4742	22	03730	03731	84918	84979
4	5/16	1-1/4	NS4052	22	03740	03741	84919	84980
4	11/32	1-1/4	NS4752	22	03750	03751	84920	84981
4	3/8	1-1/4	NS4062	22	03760	03761	84921	84982
4	13/32	1-1/4	NS4762	22	03770	03771	84922	84983
4	7/16	1-1/4	NS4072	22	03780	03781	84923	84984
4	15/32	1-1/4	NS4772	22	03790	03791	84924	84985
4	1/2	1-1/4	NS4082	22	03800	03801	84925	84986
4	9/16	1-1/4	NS4092	22	03810	03811	84926	84987
4	5/8	1-1/4	NS4102	22	03820	03821	84927	84988
4	11/16	1-1/4	NS4112	22	03830	03831	84928	84989
4	3/4	1-1/4	NS4122	22	03840	03841	84929	84990
5	7/32	1-1/4	NS5732	26	03850	03851	84930	84991
5	1/4	1-1/4	NS5042	26	03860	03861	84931	84992
5	9/32	1-1/4	NS5742	26	03870	03871	84932	84993
5	5/16	1-1/4	NS5052	26	03880	03881	84933	84994
5	11/32	1-1/4	NS5752	26	03890	03891	84934	84995
5	3/8	1-1/4	NS5062	26	03900	03901	84935	84996
5	13/32	1-1/4	NS5762	26	03910	03911	84936	84997
5	7/16	1-1/4	NS5072	26	03920	03921	84937	84998
5	15/32	1-1/4	NS5772	26	03930	03931	84938	84999
5	1/2	1-1/4	NS5082	26	03940	03941	84939	85000
5	9/16	1-1/4	NS5092	26	03950	03951	84940	85001
5	5/8	1-1/4	NS5102	26	03960	03961	84941	85002
5	11/16	1-1/4	NS5112	26	03970	03971	84942	85003
5	3/4	1-1/4	NS5122	26	03980	03981	84943	85004

Continued on next page



MILLING CUTTERS, PLAIN & SHELL MILLS, ARBOR-TYPE SLITTING SAWS

T15 Supreme Side Milling Cutter — Staggered Tooth

“NS” Style

- Recommended for Stainless and Titanium
- Resistant to High Heat and Abrasive Wear
- Free Cutting Design
- Refer to page 76 for interlocking set information



Cutter Dia	Cutter Width	Arbor Hole	Catalog Number	#T	Unc EDP	TiN Recommended		
						TiN EDP	TiCN EDP	TiAlN EDP
5	13/16	1-1/4	NS5132	26	03990	03991	84944	85005
5	7/8	1-1/4	NS5142	26	04000	04001	84945	85006
5	15/16	1-1/4	NS5152	26	04010	04011	84946	85007
5	1	1-1/4	NS5162	26	04020	04021	84947	85008
6	7/32	1-1/4	NS6732	30	04030	04031	84948	85009
6	1/4	1-1/4	NS6042	30	04040	04041	84949	85010
6	9/32	1-1/4	NS6742	30	04050	04051	84950	85011
6	5/16	1-1/4	NS6052	30	04060	04061	84951	85012
6	11/32	1-1/4	NS6752	30	04070	04071	84952	85013
6	3/8	1-1/4	NS6062	30	04080	04081	84953	85014
6	13/32	1-1/4	NS6762	30	04090	04091	84954	85015
6	7/16	1-1/4	NS6072	30	04100	04101	84955	85016
6	15/32	1-1/4	NS6772	30	04110	04111	84956	85017
6	1/2	1-1/4	NS6082	30	04120	04121	84957	85018
6	9/16	1-1/4	NS6092	30	04130	04131	84958	85019
6	5/8	1-1/4	NS6102	30	04140	04141	84959	85020
6	11/16	1-1/4	NS6112	30	04150	04151	84960	85021
6	3/4	1-1/4	NS6122	30	04160	04161	84961	85022
6	13/16	1-1/4	NS6132	30	04170	04171	84962	85023
6	7/8	1-1/4	NS6142	30	04180	04181	84963	85024
6	15/16	1-1/4	NS6152	30	04190	04191	84964	85025
6	1	1-1/4	NS6162	30	04200	04201	84965	85026

MILLING CUTTERS, PLAIN & SHELL MILLS,
ARBOR-TYPE SLITTING SAWS



M42 Cobalt Side Milling Cutter — Straight Tooth
"DB" Style



PAGE 54



HSCO STRAIGHT TOOTH MILLING CUTTERS

M42 Cobalt Side Milling Cutter — Straight Tooth

“DB” Style

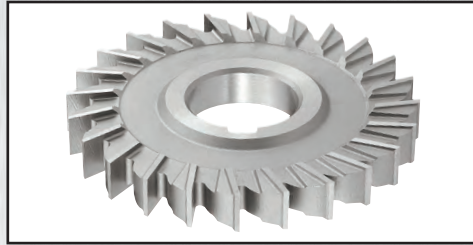

- Recommended for Exotic Materials
- Additional Teeth for Fine Finishes
- Long Tool Life
- Refer to page 76 for interlocking set information



Cutter Dia	Cutter Width	Arbor Hole	Catalog Number	#T	Unc EDP	TiN Recommended		
						TiN EDP	TiCN EDP	TiAlN EDP
3	1/4	1	DB3041	20	06970	06961	80367	80384
3	5/16	1	DB3051	20	06971	06962	80368	80385
3	3/8	1	DB3061	20	06972	06963	80369	80386
3	1/2	1	DB3081	20	06973	06964	80370	80387
4	1/4	1	DB4041	24	06974	06965	80371	80388
4	1/4	1-1/4	DB4042	24	06975	06966	80372	80389
4	5/16	1	DB4051	24	06976	06967	80373	80390
4	5/16	1-1/4	DB4052	24	06977	06968	80374	80391
4	3/8	1	DB4061	24	06978	06969	80375	80392
4	3/8	1-1/4	DB4062	24	06979	06987	80376	80393
4	1/2	1	DB4081	24	06980	06988	80377	80394
4	1/2	1-1/4	DB4082	24	06981	06989	80378	80395
4	3/4	1	DB4121	24	06982	06990	80379	80396
4	3/4	1-1/4	DB4122	24	06983	06991	80380	80397
6	1/4	1-1/4	DB6042	30	06984	06992	80381	80398
6	3/8	1-1/4	DB6062	30	06985	06993	80382	80399
6	1/2	1-1/4	DB6082	30	06986	06994	80383	80400

**MILLING CUTTERS, PLAIN & SHELL MILLS,
ARBOR-TYPE SLITTING SAWS**



 Cobalt Shell End Mill — Right-Hand Cut SMM42	PAGE 56
 T15 Supreme Cobalt Shell End Mill — Right-Hand Cut SMT15	PAGE 57
 Cobalt Roughing Shell End Mill — Right-Hand Cut Coarse-Pitch RM750	PAGE 58
 Cobalt Roughing Shell End Mill — Right-Hand Cut Fine-Pitch RP450	PAGE 59



HSCO SHELL MILLS

Cobalt Shell End Mill — Right-Hand Cut

SMM42

- Recommended for Exotic Materials
- Long Tool Life

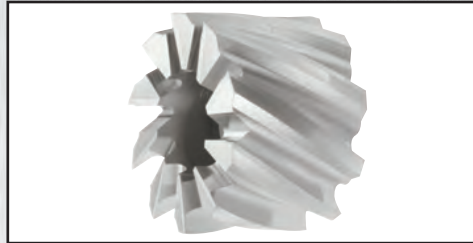

Cutter Dia	Cutter Width	Arbor Hole	Catalog Number	#T	Unc EDP	TiN Recommended		
						TiN EDP	TiCN EDP	TiAlN EDP
1-1/4	1	1/2	RD1257	8	09922	09923	19548	19560
1-1/2	1-1/8	1/2	RD1507	8	09924	09925	19549	19561
1-3/4	1-1/4	3/4	RD1759	8	09926	09927	19550	19562
2	1-3/8	3/4	RD2009	10	09991	09989	19555	19567
2-1/4	1-1/2	1	RD2251	10	09928	09929	19551	19563
2-1/2	1-5/8	1	RD2501	10	09992	09996	19556	19568
2-3/4	1-5/8	1	RD2751	10	09930	09931	19552	19564
3	1-3/4	1-1/4	RD3002	12	09993	09997	19557	19569
3-1/2	1-7/8	1-1/4	RD3502	12	09932	09933	19553	19565
4	2-1/4	1-1/2	RD4003	14	09994	09998	19558	19570
5	2-1/4	1-1/2	RD5003	16	09995	09999	19559	19571
6	2-1/4	2	RD6004	16	09936	09937	19554	19566

MILLING CUTTERS, PLAIN & SHELL MILLS, ARBOR-TYPE SLITTING SAWS

T15 Supreme Cobalt Shell End Mill — Right-Hand Cut

SMT15

- Recommended for Stainless and Titanium
- Resistant to High Heat and Abrasive Wear
- Long Tool Life

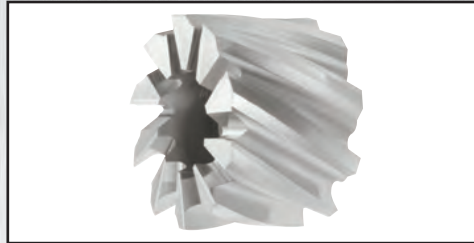

Cutter Dia	Cutter Width	Arbor Hole	Catalog Number	#T	Unc EDP	TiN Recommended		
						TiN EDP	TiCN EDP	TiAlN EDP
1-1/4	1	1/2	RS1257	8	09940	09941	19572	19578
1-1/2	1-1/8	1/2	RS1507	8	09950	09951	19573	19579
2	1-3/8	3/4	RS2009	10	09960	09961	19574	19580
2-1/2	1-5/8	1	RS2501	10	09970	09971	19575	19581
3	1-3/4	1-1/4	RS3002	12	09980	09981	19576	19582
4	2-1/4	1-1/2	RS4003	14	09990	09988	19577	19583



MILLING CUTTERS, PLAIN & SHELL MILLS, ARBOR-TYPE SLITTING SAWS

Cobalt Roughing Shell End Mill — Right-Hand Cut Coarse-Pitch

RM750

- M42 Cobalt Steel
- Form relieved style for easy resharpening
- Recommended for aggressive metal removal in most materials

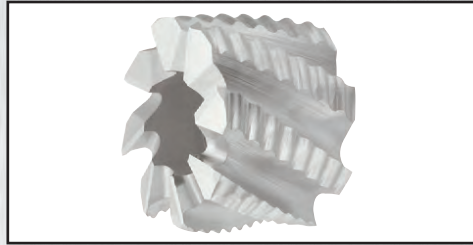

Cutter Dia	Cutter Width	Arbor Hole	Catalog Number	#T	Unc EDP	TiN Recommended		
						TiN EDP	TiCN EDP	TiAlN EDP
2	1-3/8	3/4	RM2009	8	75644	75640	79681	75538
2-1/4	1-1/2	1	RM2251	8	75654	75650	79682	75539
2-1/2	1-5/8	1	RM2501	8	75806	75800	79683	75540
2-3/4	1-5/8	1	RM2751	10	75816	75810	79684	75541
3	2	1-1/4	RM3002	10	75967	75960	79685	75542
3-1/2	1-7/8	1-1/4	RM3502	10	75977	75970	79686	75543
4	2-1/4	1-1/2	RM4003	10	75128	75120	79687	75544
4-1/2	2-1/4	1-1/2	RM4503	12	75138	75130	79688	75545
5	2-1/4	1-1/2	RM5003	12	75168	75160	79689	75546
6	2-1/4	2	RM6004	14	75178	75170	79690	75547

MILLING CUTTERS, PLAIN & SHELL MILLS, ARBOR-TYPE SLITTING SAWS

Cobalt Roughing Shell End Mill — Right-Hand Cut Fine-Pitch

RP450

- M42 Cobalt Steel
- Form relieved style for easy resharpening
- Recommended for aggressive metal removal in most materials

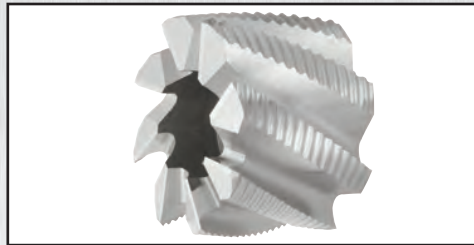

Cutter Dia	Cutter Width	Arbor Hole	#T	Unc EDP	TiN Recommended		
					TiN EDP	TiCN EDP	TiAlN EDP
2	1-3/8	3/4	8	75548	75558	75568	75578
2-1/4	1-1/2	1	8	75549	75559	75569	75579
2-1/2	1-5/8	1	8	75550	75560	75570	75580
2-3/4	1-5/8	1	10	75551	75561	75571	75581
3	2	1-1/4	10	75552	75562	75572	75582
3-1/2	1-7/8	1-1/4	10	75553	75563	75573	75583
4	2-1/4	1-1/2	10	75554	75564	75574	75584
4-1/2	2-1/4	1-1/2	12	75555	75565	75575	75585
5	2-1/4	1-1/2	12	75556	75566	75576	75586
6	2-1/4	2	14	75557	75567	75577	75587



MILLING CUTTERS, PLAIN & SHELL MILLS, ARBOR-TYPE SLITTING SAWS



HSCO SLITTING SAWS



PHONE: 800-523-5233 | FAX: 800-955-7400 | WWW.KEOCUTTERS.COM

**MILLING CUTTERS, PLAIN & SHELL MILLS,
ARBOR-TYPE SLITTING SAWS**



 <p>M42 Cobalt Slitting Saw — Straight Tooth "CMT" Style</p>	PAGE 62
 <p>M42 Cobalt Slitting Saw — Staggered Tooth "CMS" Style</p>	PAGE 63





MILLING CUTTERS, PLAIN & SHELL MILLS, ARBOR-TYPE SLITTING SAWS

M42 Cobalt Slitting Saw — Straight Tooth

“CMT” Style

- Recommended for Exotic Materials
- For use in fine finish applications
- Long Tool Life

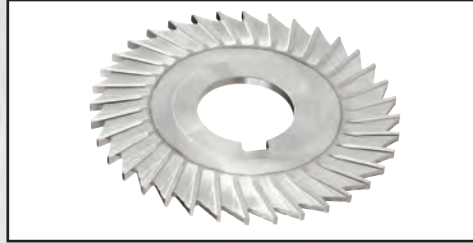

Cutter Dia	Cutter Width	Arbor Hole	Catalog Number	#T	Unc EDP	TiN Recommended		
						TiN EDP	TiCN EDP	TiAlN EDP
3	1/16	1	CMT3011	32	96330	96331	80899	80921
3	3/32	1	CMT3711	32	96340	96341	80900	80922
3	1/8	1	CMT3021	32	96350	96351	80901	80923
3	5/32	1	CMT3721	32	96360	96361	80902	80924
3	3/16	1	CMT3031	32	96370	96371	80903	80925
3	1/4	1	CMT3041	32	96390	96391	80904	80926
4	1/16	1	CMT4011	36	96400	96401	80905	80927
4	1/16	1-1/4	CMT4012	36	96410	96411	80906	80928
4	3/32	1	CMT4711	36	96420	96421	80907	80929
4	3/32	1-1/4	CMT4712	36	96430	96431	80908	80930
4	1/8	1	CMT4021	36	96440	96441	80909	80931
4	1/8	1-1/4	CMT4022	36	96450	96451	80910	80932
4	5/32	1	CMT4721	36	96460	96461	80911	80933
4	5/32	1-1/4	CMT4722	36	96470	96471	80912	80934
4	3/16	1	CMT4031	36	96480	96481	80913	80935
4	3/16	1-1/4	CMT4032	36	96490	96491	80914	80936
4	1/4	1	CMT4041	36	96520	96521	80915	80937
4	1/4	1-1/4	CMT4042	36	96530	96531	80916	80938
6	1/8	1-1/4	CMT6022	42	96830	96831	80917	80939
6	5/32	1-1/4	CMT6722	42	96850	96851	80918	80940
6	3/16	1-1/4	CMT6032	42	96870	96871	80919	80941
6	1/4	1-1/4	CMT6042	42	96910	96911	80920	80942

MILLING CUTTERS, PLAIN & SHELL MILLS, ARBOR-TYPE SLITTING SAWS

M42 Cobalt Slitting Saw — Staggered Tooth

“CMS” Style

- Recommended for Exotic Materials
- For use in Deep Slotting Applications
- Long Tool Life

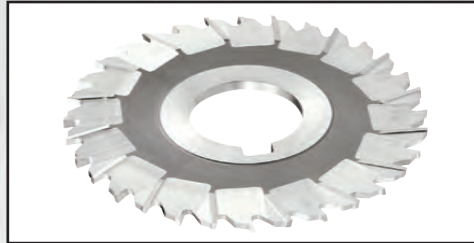

Cutter Dia	Cutter Width	Arbor Hole	Catalog Number	#T	Unc EDP	TiN Recommended		
						TiN EDP	TiCN EDP	TiAlN EDP
3	1/8	1	CMS3021	28	96940	96941	80944	80960
3	5/32	1	CMS3721	28	96950	96951	80945	80961
3	3/16	1	CMS3031	28	96960	96961	80946	80962
3	1/4	1	CMS3041	28	96970	96971	80947	80963
4	1/8	1	CMS4021	32	97000	97001	80948	80964
4	1/8	1-1/4	CMS4022	32	97010	97011	80949	80965
4	5/32	1	CMS4721	32	97020	97021	80950	80966
4	5/32	1-1/4	CMS4722	32	97030	97031	80951	80967
4	3/16	1	CMS4031	32	97040	97041	80952	80968
4	3/16	1-1/4	CMS4032	32	97050	97051	80953	80969
4	1/4	1	CMS4041	32	97060	97061	80954	80970
4	1/4	1-1/4	CMS4042	32	97070	97071	80955	80971
6	1/8	1-1/4	CMS6022	40	97200	97201	80956	80972
6	5/32	1-1/4	CMS6722	40	97210	97211	80957	80973
6	3/16	1-1/4	CMS6032	40	97220	97221	80958	80974
6	1/4	1-1/4	CMS6042	40	97230	97231	80959	80975













HIGH SPEED STEEL AND COBALT SHANK-TYPE CUTTERS



HSS AND COBALT SHANK-TYPE CUTTERS

HIGH SPEED STEEL AND COBALT SHANK-TYPE CUTTERS



T-Slot Cutter — Shank-Type TS109		PAGE 66
Cobalt T-Slot Roughing End Mill — Rougher/Finisher TS111		PAGE 67
Dovetail Cutter 45° Single-Angle — Shank-Type DT456		PAGE 68
Dovetail Cutter 60° Single-Angle — Shank-Type DT456		PAGE 68
Double-Angle — Shank-Type DA129		PAGE 69
Chamfering Cutter Single-Angle — Shank-Type CH126		PAGE 70
Concave Radius Cutter — Shank-Type CCS150		PAGE 71
Convex Radius Cutter — Shank-Type CVS130		PAGE 72
4-Flute Corner Rounding End Mill — Fractional Radius CRE124		PAGE 73
4-Flute Corner Rounding — Metric Radius CRM125		PAGE 74
4-Flute Cobalt Corner-Rounding End Mill — General Purpose CRCO126		PAGE 75



HSS AND COBALT SHANK-TYPE CUTTERS

T-Slot Cutter — Shank-Type

TS109

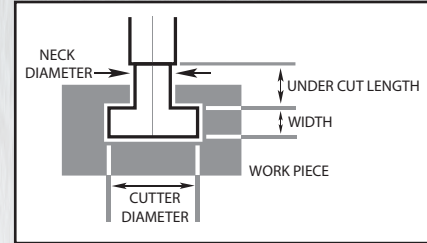
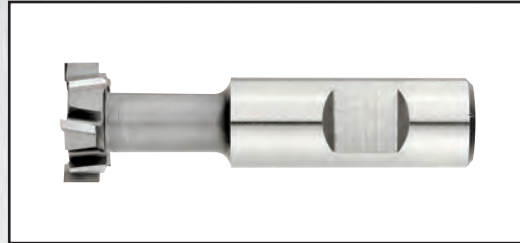

Cutter Dia	Shank Dia	Width	Neck Dia	Under Cut Length	Overall Length	Catalog Number	#T	Unc EDP	TIN Recommended		
									TiN EDP	TiCN EDP	TiAlN EDP
9/16	1/2	15/64	17/64	35/64	2-19/32	TS-1815	8	10800	10801	19332	19365
21/32	1/2	17/64	21/64	39/64	2-11/16	TS-2117	8	10810	10811	19333	19366
25/32	3/4	21/64	13/32	55/64	3-1/4	TS-2521	8	10820	10821	19334	19367
31/32	3/4	25/64	17/32	63/64	3-7/16	TS-3125	8	10830	10831	19335	19368
1	3/4	3/32	1/2	1	3-1/8	TS-3206	8	10840	10841	19336	19369
1	3/4	1/8	1/2	1	3-1/8	TS-3208	8	10850	10851	19337	19370
1	3/4	5/32	1/2	1	3-3/16	TS-3210	8	10860	10861	19338	19371
1	3/4	3/16	1/2	1	3-3/16	TS-3212	8	10870	10871	19339	19372
1	3/4	1/4	1/2	1	3-1/4	TS-3216	8	10880	10881	19340	19373
1	3/4	5/16	1/2	1	3-5/16	TS-3220	8	10890	10891	19341	19374
1	3/4	3/8	1/2	1	3-3/8	TS-3224	8	10900	10901	19342	19375
1	3/4	1/2	1/2	1	3-1/2	TS-3232	8	10910	10911	19343	19376
1-1/4	1	31/64	21/32	1-9/64	3-15/16	TS-4031	8	10920	10921	19344	19377
1-15/32	1	5/8	25/32	1-1/2	4-7/16	TS-4740	8	10930	10931	19345	19378
1-1/2	1	3/32	3/4	1-1/2	4-1/8	TS-4806	8	10940	10941	19346	19379
1-1/2	1	1/8	3/4	1-1/2	4-1/8	TS-4808	8	10950	10951	19347	19380
1-1/2	1	5/32	3/4	1-1/2	4-3/16	TS-4810	8	10960	10961	19348	19381
1-1/2	1	3/16	3/4	1-1/2	4-3/16	TS-4812	8	10970	10971	19349	19382
1-1/2	1	1/4	3/4	1-1/2	4-1/4	TS-4816	8	10980	10981	19350	19383
1-1/2	1	5/16	3/4	1-1/2	4-5/16	TS-4820	8	10990	10991	19351	19384
1-1/2	1	3/8	3/4	1-1/2	4-3/8	TS-4824	8	11000	11001	19352	19385
1-1/2	1	1/2	3/4	1-1/2	4-1/2	TS-4832	8	11010	11011	19353	19386
1-27/32	1-1/4	53/64	1-1/32	1-43/64	4-13/16	TS-5953	12	11020	11021	19354	19387
2	1-1/4	3/32	1-1/8	1-3/4	4-1/2	TS-6406	12	11030	11031	19355	19388
2	1-1/4	1/8	1-1/8	1-3/4	4-1/2	TS-6408	12	11040	11041	19356	19389
2	1-1/4	5/32	1-1/8	1-3/4	4-9/16	TS-6410	12	11050	11051	19357	19390
2	1-1/4	3/16	1-1/8	1-3/4	4-9/16	TS-6412	12	11060	11061	19358	19391
2	1-1/4	1/4	1-1/8	1-3/4	4-5/8	TS-6416	12	11070	11071	19359	19392
2	1-1/4	5/16	1-1/8	1-3/4	4-11/16	TS-6420	12	11080	11081	19360	19393
2	1-1/4	3/8	1-1/8	1-3/4	4-3/4	TS-6424	12	11090	11091	19361	19394
2	1-1/4	1/2	1-1/8	1-3/4	4-7/8	TS-6432	12	11100	11101	19362	19395
2-7/32	1-1/4	1-3/32	1-7/32	1-31/32	5-3/8	TS-7170	12	11110	11111	19363	19396
2-21/32	1-1/4	1-11/32	1-17/32	2-1/8	5-29/32	TS-8586	12	11120	11121	19364	19397
Cutter Dia	+0.000"	-0.010"			Overall Length	+/-0.060"		Helix Angle	10°	Width	+/-0.001"

HIGH SPEED STEEL AND COBALT SHANK-TYPE CUTTERS



Cobalt T-Slot Roughing End Mill — Rougher/Finisher

M42 8% Cobalt Steel

TS111

- All Materials

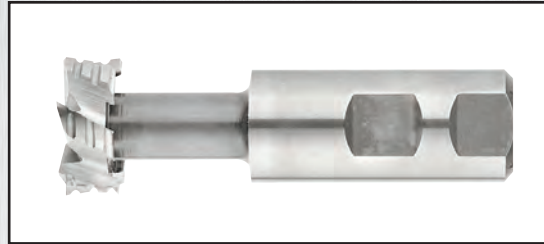

Cutter Dia	Shank Dia	Cutter Thickness	Overall Length	Bolt Size	#T	Unc EDP	TiN EDP	TiCN Recommended	
								TiCN EDP	TiAIN EDP
3/16	3/16	3/16	3-7/16	1/2	5	11135	11130	87808	16825
1/4	1/4	3/16	3-15/16	5/8	6	11145	11140	87809	16826
1-15/32	1/4	5/8	4-7/16	3/4	6	11155	11150	87810	16827
1-27/32	1-1/4	53/64	4-13/16	1	6	11165	11160	87811	16828
2-7/32	1-1/4	1-3/32	5-3/8	1-1/4	8	11175	11170	87812	16829
2-21/32	1-1/4	1-11/32	5-29/32	1-1/2	10	11185	11180	87813	16830
Flute Dia	+0.000"	-0.005"	Overall Length	+0.062"	-0.000"	Helix Angle	30°		
Length of Cut	+0.000"	-0.005"							

Dovetail Cutter 45° Single-Angle — Shank-Type

DT456

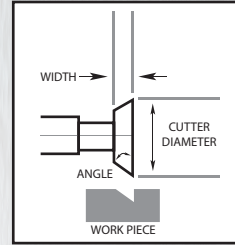
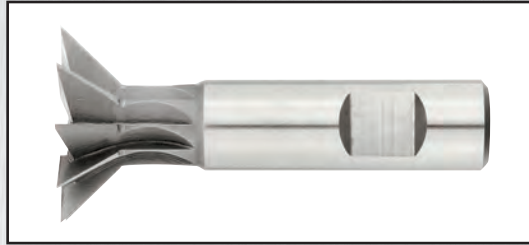

Cutter Dia	Shank Dia	Face Width	Overall Length	Angle	Catalog Number	#T	Unc EDP	TiN Recommended		
								TiN EDP	TiCN EDP	TiAlN EDP
1/2	3/8	1/8	2-1/8	45°	DT16-45	8	12500	12501	79893	29062
3/4	3/8	3/16	2-1/8	45°	DT24-45	8	12510	12511	79894	29063
1-3/8	5/8	3/8	2-7/8	45°	DT44-45	10	12520	12521	79895	29064
1-3/8	1/2	3/8	2-7/8	45°	DT44-45A	10	12530	12531	79896	29065
1-7/8	7/8	1/2	3-1/4	45°	DT60-45	12	12540	12541	79897	29066
2-1/4	1	11/16	3-3/4	45°	DT72-45	12	12550	12553	79898	29067
2-1/2	1	3/4	3-3/4	45°	DT80-45	12	12551	12554	79899	29068
Cutter Dia		+0.015"	-0.015"	Overall Length		+/-0.060"				

Dovetail Cutter 60° Single-Angle — Shank-Type

DT456

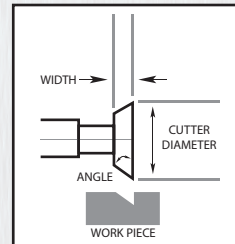
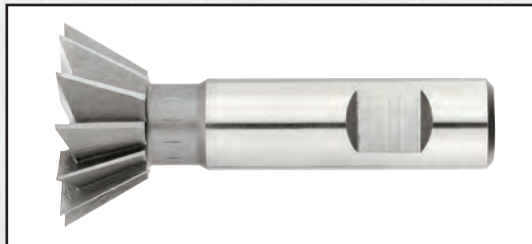

Cutter Dia	Shank Dia	Face Width	Overall Length	Angle	Catalog Number	#T	Unc EDP	TiN Recommended		
								TiN EDP	TiCN EDP	TiAlN EDP
3/8	3/8	3/16	2-1/8	60°	DT12-60	8	12560	12561	79900	29070
1/2	3/8	7/32	2-1/8	60°	DT16-60	8	12570	12571	79901	29071
3/4	3/8	5/16	2-1/8	60°	DT24-60	8	12580	12581	79902	29072
1-3/8	5/8	9/16	2-7/8	60°	DT44-60	12	12590	12591	79903	29073
1-3/8	1/2	9/16	2-7/8	60°	DT44-60A	12	12600	12601	79904	29074
1-7/8	7/8	13/16	3-1/4	60°	DT60-60	12	12610	12611	79905	29075
2-1/4	1	1-1/16	3-1/4	60°	DT72-60	12	12620	12621	79906	29076
2-1/2	1	1-1/8	3-1/4	60°	DT80-60	12	12630	12631	79907	29077
Cutter Dia		+0.015"	-0.015"	Overall Length		+/-0.060"				

HIGH SPEED STEEL AND COBALT SHANK-TYPE CUTTERS



Double-Angle — Shank-Type

DA129

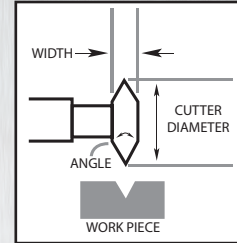
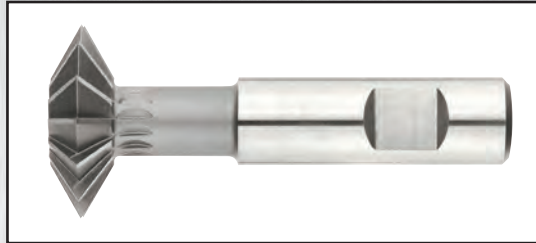

Cutter Dia	Shank Dia	Width	Overall Length	Angle	#T	Unc EDP	TiN Recommended		
							TiN EDP	TiCN EDP	TiAlN EDP
3/4	3/8	3/16	2-3/8	60°	10	72800	72970	79725	67587
1	1/2	5/16	2-27/32	60°	12	72801	72971	79726	67588
1-3/8	5/8	7/16	3-7/32	60°	14	72802	72972	79727	67589
1-1/2	5/8	1/2	3-3/8	60°	14	72803	72973	79728	67590
1-7/8	3/4	5/8	3-25/32	60°	16	72804	72974	79729	67591
2-1/4	7/8	3/4	4-5/32	60°	18	72805	72975	79730	67592
2-1/4	3/4	1/2	3-1/8	60°	16	12492	12493	79731	67593
3/4	3/8	1/4	2-7/16	90°	10	72820	72980	79732	67594
1	1/2	3/8	2-29/32	90°	12	72821	72981	79733	67595
1-3/8	5/8	1/2	3-9/32	90°	14	72822	72982	79734	67596
1-1/2	5/8	9/16	3-7/16	90°	14	72823	72983	79735	67597
1-7/8	3/4	5/8	3-25/32	90°	16	72824	72984	79736	67598
2-1/4	7/8	3/4	4-5/32	90°	18	72825	72985	79737	67599
2-1/4	3/4	1/2	3-1/8	90°	16	12490	12491	79738	67600
Cutter Dia	+0.015"	-0.000"				Overall Length	+/-0.060"		

Chamfering Cutter Single-Angle — Shank-Type

CH126

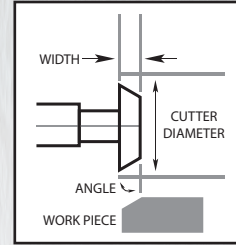
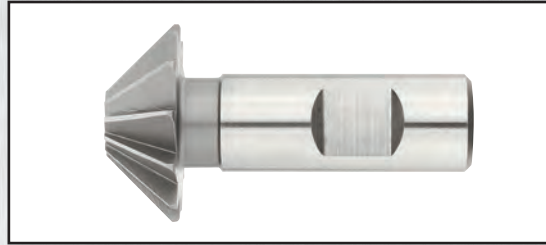

Cutter Dia	Shank Dia	Width	Overall Length	Angle	Catalog Number	#T	Unc EDP	TiN Recommended		
								TiN EDP	TiCN EDP	TiAlN EDP
1/2	3/8	1/8	2-1/8	45°	CH16-45	8	12640	12641	79647	67489
3/4	3/8	3/16	2-1/8	45°	CH24-45	8	12642	12643	79648	67490
1	1/2	5/16	2-1/2	45°	CH32-45	10	12644	12645	79649	67491
1-1/2	3/4	1/2	2-3/4	45°	CH48-45	12	12646	12647	79650	67492
1/2	3/8	7/32	2-1/8	60°	CH16-60	8	12650	12651	79651	67493
3/4	3/8	5/16	2-1/8	60°	CH24-60	8	12652	12653	79652	67494
1	1/2	7/16	2-1/2	60°	CH32-60	10	12654	12655	79653	67495
1-1/2	3/4	5/8	2-3/4	60°	CH48-60	12	12656	12657	79654	67496
Cutter Dia	+0.010"	-0.000"			Overall Length		+/-0.060"			

HIGH SPEED STEEL AND COBALT SHANK-TYPE CUTTERS



Concave Radius Cutter — Shank-Type

CCS150

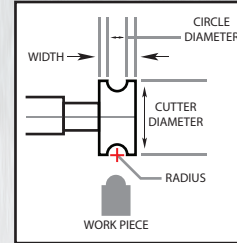
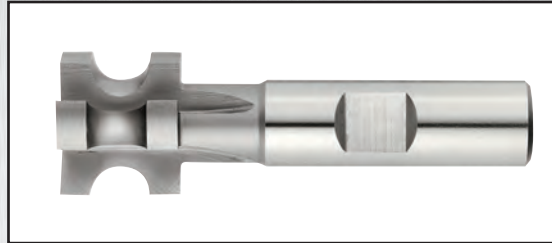

Cutter Dia	Shank Dia	Radius	Overall Length	Width	#T	Unc EDP	TiN Recommended		
							TiN EDP	TiCN EDP	TiAlN EDP
3/4	1/2	1/32	3	3/8	6	18900	18909	79908	67569
3/4	1/2	1/16	3	3/8	6	18901	18910	79909	67570
3/4	1/2	3/32	3	3/8	6	18902	18911	79910	67571
1	3/4	1/8	3-1/2	5/8	6	18903	18912	79911	67572
1	3/4	5/32	3-1/2	5/8	6	18904	18913	79912	67573
1	3/4	3/16	3-1/2	5/8	6	18905	18914	79913	67574
1-1/4	3/4	1/4	4	1	4	18906	18915	79914	67575
1-1/4	3/4	5/16	4	1	4	18907	18916	79915	67576
1-1/2	3/4	3/8	4-3/16	1-3/16	4	18908	18917	79916	67577
Cutter Dia	+0.015"	-0.000"	Overall Length			+/-0.060"			

Convex Radius Cutter — Shank-Type

CVS130

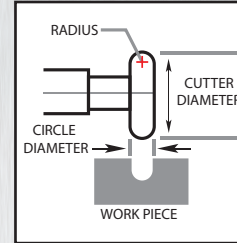

Cutter Dia	Shank Dia	Radius	Overall Length	#T	Unc EDP	TiN Recommended		
						TiN EDP	TiCN EDP	TiAlN EDP
3/4	1/2	1/32	3	6	18927	18936	79917	67578
3/4	1/2	1/16	3	6	18928	18937	79918	67579
7/8	1/2	3/32	3	6	18929	18938	79919	67580
1-1/4	3/4	1/8	3-1/2	6	18930	18939	79920	67581
1-5/16	3/4	5/32	3-1/2	6	18931	18940	79921	67582
1-3/8	3/4	3/16	3-1/2	6	18932	18941	79922	67583
1-1/2	3/4	1/4	4	6	18933	18942	79923	67584
1-5/8	3/4	5/16	4	6	18934	18943	79924	67585
1-3/4	3/4	3/8	4	6	18935	18944	79925	67586
Cutter Dia		+0.030"	-0.000"	Overall Length		+/-0.060"		

HIGH SPEED STEEL AND COBALT SHANK-TYPE CUTTERS



4-Flute Corner Rounding End Mill — Fractional Radius

CRE124

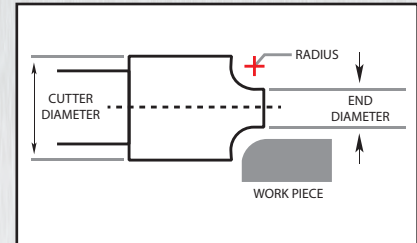
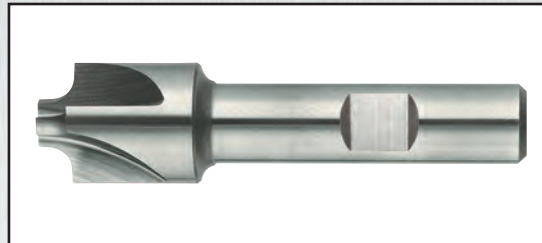

Radius	End Dia	Cutter Dia	Shank Dia	Overall Length	Catalog Number	Unc EDP	TiN Recommended		
							TiN EDP	TiCN EDP	TiAlN EDP
1/32	1/4	7/16	3/8	2-1/2	CRE-1	14190	14191	87814	14154
1/16	1/4	7/16	3/8	2-1/2	CRE-2	14200	14201	87815	14155
3/32	1/4	1/2	3/8	2-1/2	CRE-3	14210	14211	87816	14156
1/8	1/4	5/8	1/2	3	CRE-4	14220	14221	87817	14157
5/32	5/16	3/4	1/2	3	CRE-5	14230	14231	87818	14158
3/16	3/8	7/8	1/2	2-15/16	CRE-6A	14240	14241	87819	14159
3/16	3/8	7/8	3/4	3-1/8	CRE-6	14250	14251	87820	14160
1/4	3/8	1	1/2	3	CRE-8A	14260	14261	87821	14161
1/4	3/8	1	3/4	3-1/4	CRE-8	14270	14271	87822	14162
5/16	3/8	1-1/8	1/2	3-1/4	CRE-10A	14280	14281	87823	14163
5/16	3/8	1-1/8	7/8	3-1/2	CRE-10	14290	14291	87824	14164
3/8	3/8	1-1/4	1/2	3-1/2	CRE-12A	14300	14301	87825	14165
3/8	3/8	1-1/4	7/8	3-3/4	CRE-12	14310	14311	87826	14166
7/16	3/8	1-3/8	3/4	3-3/4	CRE-14A	14320	14321	87827	14167
7/16	3/8	1-3/8	1	4	CRE-14	14330	14331	87828	14168
1/2	3/8	1-1/2	3/4	3-7/8	CRE-16A	14340	14341	87829	14169
1/2	3/8	1-1/2	1	4-1/8	CRE-16	14350	14351	87830	14170
5/8	9/16	1-15/16	3/4	4	CRE-20A	14360	14361	87831	14171
5/8	9/16	1-15/16	1	4-1/4	CRE-20	14370	14371	87832	14172
3/4	5/8	2-1/4	3/4	4-1/8	CRE-24A	14380	14381	87833	14173
3/4	5/8	2-1/4	1	4-5/16	CRE-24	14390	14391	87834	14174
1	5/8	2-3/4	3/4	4-1/2	CRE-32A	14396	14397	87835	14175
1	5/8	2-3/4	1	4-3/4	CRE-32	14398	14399	87836	14176
Cutter Dia	+0.002"	-0.000"		Overall Length		+0.060"	-0.060"		
End Dia	+0.002"	-0.002"		Radius		+0.001"	-0.001"		

4-Flute Corner Rounding — Metric Radius

CRM125

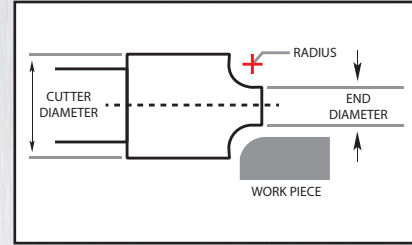
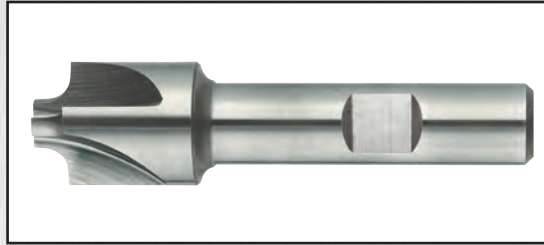

Radius	End Dia	Cutter Dia	Shank Dia	Overall Length	Catalog Number	Unc EDP	TiN Recommended		
							TiN EDP	TiCN EDP	TiAlN EDP
1mm	6mm	7/16	3/8	2-1/2	CRM1	14401	14400	87837	16202
1.5mm	6.5mm	7/16	3/8	2-1/2	CRM1.5	14403	14402	87838	16203
2mm	7mm	1/2	3/8	2-1/2	CRM2	14405	14404	87839	16204
2.5mm	6mm	1/2	3/8	2-1/2	CRM2.5	14407	14406	87840	16205
3mm	7mm	5/8	1/2	3	CRM3	14409	14408	87841	16206
3.5mm	7.5mm	3/4	1/2	3	CRM3.5	14411	14410	87842	16207
4mm	8mm	3/4	1/2	3	CRM4	14413	14412	87843	16208
4.5mm	10mm	7/8	1/2	3	CRM4.5	14415	14414	87844	16209
5mm	9mm	7/8	1/2	3	CRM5	14419	14416	87845	16210
6mm	10.5mm	1	3/4	3-1/4	CRM6	14421	14417	87846	16211
7mm	10mm	1	3/4	3-1/4	CRM7	14423	14418	87847	16212
8mm	9.5mm	1-1/8	3/4	3-1/4	CRM8	14425	14420	87848	16213
9mm	9mm	1-1/8	3/4	3-1/4	CRM9	14427	14422	87849	16214
10mm	10.5mm	1-3/8	3/4	3-3/4	CRM10	14429	14424	87850	16215
11mm	10mm	1-3/8	1	3-3/4	CRM11	14431	14426	87851	16216
12mm	11mm	1-1/2	1	4-1/8	CRM12	14433	14428	87852	16217
13mm	9mm	1-1/2	1	4-1/8	CRM13	14435	14430	87853	16218
14mm	12mm	1-5/8	1	4-1/8	CRM14	14437	14432	87854	16219
15mm	13mm	1-7/8	1	4-1/4	CRM15	14439	14434	87855	16220
16mm	14mm	2	1	4-1/4	CRM16	14441	14436	87856	16221
17mm	14mm	2-1/8	1	4-1/4	CRM17	14443	14438	87857	16222
18mm	16.5mm	2-1/4	1	4-1/4	CRM18	14445	14440	87858	16223
19mm	16mm	2-1/4	1	4-1/4	CRM19	14447	14442	87859	16224
20mm	15.5mm	2-5/16	1	4-1/4	CRM20	14449	14444	87860	16225
Cutter Dia	+0.002"	-0.000"		Overall Length		+0.060"	-0.060"		
End Dia	+0.002"	-0.002"		Radius		+0.001"	-0.001"		

HIGH SPEED STEEL AND COBALT SHANK-TYPE CUTTERS



4-Flute Cobalt Corner-Rounding End Mill — General Purpose

M42 8% Cobalt Steel — Fractional Radius

CRCO126

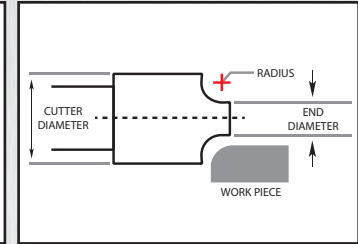
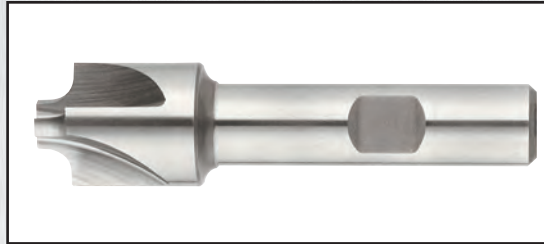

Radius	End Dia	Shank Dia	Cutter Dia	Overall Length	Unc EDP	TiN EDP	TiCN Recommended	
							TiCN EDP	TiAIN EDP
1/32	1/4	3/8	7/16	2-1/2	72750	72950	88924	29042
1/16	1/4	3/8	7/16	2-1/2	72751	72951	88925	29043
3/32	1/4	3/8	1/2	2-1/2	72752	72952	88926	29044
1/8	1/4	1/2	5/8	3	72753	72953	88927	29045
5/32	5/16	1/2	3/4	3	72754	72954	88928	29046
3/16	3/8	3/4	7/8	3-1/8	72755	72955	88929	29047
1/4	3/8	3/4	1	3-1/4	72756	72956	88930	29048
5/16	3/8	7/8	1-1/8	3-1/2	72757	72957	88931	29049
3/8	3/8	7/8	1-1/4	3-3/4	72758	72958	88932	29050
1/2	3/8	1	1-1/2	4-1/8	72759	72959	88933	29051
Cutter Dia	+0.002"	-0.000"			Overall Length	+0.060"	-0.060"	
End Dia	-0.002"	-0.002"			Radius	-0.001"	-0.001"	

Terminology and Ordering Data

KEO Milling Cutters "S" Style Staggered Interlocking Cutter's consist of two pieces, each piece being a Staggered Side Milling Cutter. Unless otherwise specified, diameters of each piece held relative to each other within .001".

Refer to Figures 1, 2 and 3

Total Interlocking Width (W).

The total interlocking width (W) is equal to the overall width of an interlocking cutter. The total interlock width (W) is normally equal to the width of the slot to be machined. This width is measured over the two pieces within the interlocking cutter as shown in Figure 1 and Figure 2. Unless otherwise specified, tolerance on W Dimension is $\pm .001"$. Specify the following information when ordering:

1. Quantity of Interlocking Cutters required.
2. Diameter of Interlocking Cutters (D).
3. Interlock Width (W).
4. Hole size required.

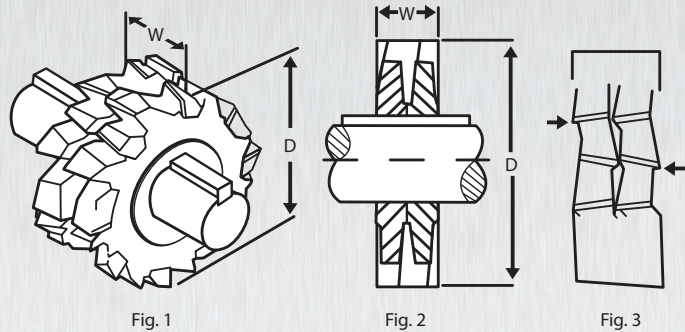

Interlocking or overlap can be varied from as small as .010" – 3/32" or more depending upon the widths selected. Hubs may be ground in customer's plant, by a local grinding service shop or at the KEO Milling Cutters plant. When sharpening reduces the total interlock width, shims may be used between hubs to regain the original total interlock width.

"X" indicates Width Interlock Range that can be priced as **STANDARD** in diameters listed.
All Staggered Tooth Cutters having the same number of teeth interlock.

INTERLOCK WIDTH RANGE	CUTTER DIAMETER																	
	2-1/8"	2-1/2"	2-3/4"	3"	3-1/4"	3-1/2"	3-3/4"	4"	4-1/4"	4-1/2"	5"	5-1/2"	6"	7"	8"	9"	10"	12"
.345 - .370	X			X		X		X			X		X	X	X		X	
.370 - .401	X			X		X		X			X		X	X	X		X	
.401 - .432	X			X		X		X			X		X	X	X		X	
.432 - .464	X	X	X	X	X	X	X	X	X	X	X	X	X	X	X	X	X	X
.464 - .495	X	X	X	X	X	X	X	X	X	X	X	X	X	X	X	X	X	X
.495 - .526	X	X	X	X	X	X	X	X	X	X	X	X	X	X	X	X	X	X
.526 - .557	X	X	X	X	X	X	X	X	X	X	X	X	X	X	X	X	X	X
.557 - .588	X	X	X	X	X	X	X	X	X	X	X	X	X	X	X	X	X	X
.588 - .620	X	X	X	X	X	X	X	X	X	X	X	X	X	X	X	X	X	X
.620 - .651	X	X	X	X	X	X	X	X	X	X	X	X	X	X	X	X	X	X
.651 - .682	X	X	X	X	X	X	X	X	X	X	X	X	X	X	X	X	X	X
.682 - .713	X	X	X	X	X	X	X	X	X	X	X	X	X	X	X	X	X	X
.700 - .745	X	X	X	X	X	X	X	X	X	X	X	X	X	X	X	X	X	X
.731 - .776	X	X	X	X	X	X	X	X	X	X	X	X	X	X	X	X	X	X
.763 - .807	X	X	X	X	X	X	X	X	X	X	X	X	X	X	X	X	X	X
.794 - .838		X	X	X	X	X	X	X	X	X	X	X	X	X	X	X	X	X
.825 - .870		X	X	X	X	X	X	X	X	X	X	X	X	X	X	X	X	X
.856 - .901		X	X	X	X	X	X	X	X	X	X	X	X	X	X	X	X	X
.888 - .932		X	X	X	X	X	X	X	X	X	X	X	X	X	X	X	X	X
.930 - .995		X	X	X	X	X	X	X	X	X	X	X	X	X	X	X	X	X
.993 - 1.058				X	X	X	X	X	X	X	X	X	X	X	X	X	X	X
1.055 - 1.120				X	X	X	X	X	X	X	X	X	X	X	X	X	X	X
1.118 - 1.182				X	X	X	X	X	X	X	X	X	X	X	X	X	X	X
1.180 - 1.245				X	X	X	X	X	X	X	X	X	X	X	X	X	X	X
1.242 - 1.307				X	X	X	X	X	X	X	X	X	X	X	X	X	X	X
1.305 - 1.370				X	X	X	X	X	X	X	X	X	X	X	X	X	X	X
1.368 - 1.432				X	X	X	X	X	X	X	X	X	X	X	X	X	X	X
1.430 - 1.495				X	X	X	X	X	X	X	X	X	X	X	X	X	X	X
1.492 - 1.557				X	X	X	X	X	X	X	X	X	X	X	X	X	X	X
1.555 - 1.620				X	X	X	X	X	X	X	X	X	X	X	X	X	X	X
1.618 - 1.682				X	X	X	X	X	X	X	X	X	X	X	X	X	X	X
1.680 - 1.745				X	X	X	X	X	X	X	X	X	X	X	X	X	X	X
1.743 - 1.807				X	X	X	X	X	X	X	X	X	X	X	X	X	X	X
1.805 - 1.870				X	X	X	X	X	X	X	X	X	X	X	X	X	X	X
1.868 - 1.932				X	X	X	X	X	X	X	X	X	X	X	X	X	X	X
1.930 - 1.995				X	X	X	X	X	X	X	X	X	X	X	X	X	X	X
1.990 - 2.055				X	X	X	X	X	X	X	X	X	X	X	X	X	X	X
2.050 - 2.120				X	X	X	X	X	X	X	X	X	X	X	X	X	X	X
2.115 - 2.180				X	X	X	X	X	X	X	X	X	X	X	X	X	X	X
2.175 - 2.245				X	X	X	X	X	X	X	X	X	X	X	X	X	X	X
2.240 - 2.305								X					X					
2.300 - 2.370								X					X					
2.365 - 2.430				X				X					X					
2.425 - 2.495				X				X					X					

TOLERANCES FOR MILLING CUTTERS AND SAWS



Cutting Diameter Tolerances

ARBOR TYPE CUTTERS					
Cutter Type	Specifications	Tolerance			
		Diameter	Width	Angle	Radius
Plain Milling	Up to 1" Width	+ .015" - .000"	± .001"		
	Over 1" – 2" Incl.	+ .015" - .000"	+ .010" - .000"		
	Over 2"	+ .015" - .000"	+ .020" - .000"		
Side Mills	Straight Tooth	+ .015" - .000"	+ .002" - .000"		
	Staggered Tooth	+ .015" - .000"	± .001"		
	Straight Tooth Saw	+ .015" - .000"	± .001"		
Single Angle Double Angle		+ .015" - .000"	+ .015" - .000"	± 10°	
		+ .015" - .000"	+ .015" - .000"	± 15°	
Keyseat (1/32" oversize on diameters)	3/16" Face	± .002"	- .0002" - .0007"		
	1/4" Face	± .002"	- .0003" - .0008"		
	5/16" Face	± .002"	- .0004" - .0009"		
	3/8" Face and Over	± .002"	- .0005" - .0010"		
Convex Concave Corner Rounding		+ .030" - .000"	± .001"		± .001"
		+ .030" - .000"	± .005"		+ .002" - .001"
		+ .030" - .000"	± .005"		+ .002" - .001"

OTHER ARCH COMPANIES



MILLING CUTTERS

KEO MILLING CUTTERS

273 Main Street • Athol, MA 01331

Toll-Free Tel. (800) 523-5233

Toll-Free Fax (800) 955-7400

WWW.KEOCUTTERS.COM

EMAIL: orders@keocutters.com



PRINTED REV. 5/15

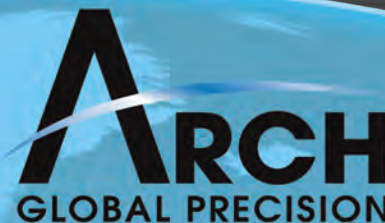

Together we can help you!

We are a family of American Made products and services guided by the goal to be your ultimate source for precision metalworking tools. The same strong and complimentary relationships between our companies exist with our customers. Working together, we provide the best products at the best prices with superior customer service.

Discover ARCH at www.archglobalprecision.com