



JCT Series

Jet Coolant-Through Holders

COMPLETE METALWORKING SOLUTIONS
(800) 991-4225
ISO Certified

www.ahbinc.com
customerservice@ahbinc.com



Excellent Chip Control and Long Tool Life with High Pressure Coolant

Large Holder Lineup for Turning, External Grooving, Cut-off and Threading

Easy Connection with High Pressure Hose and Joint

Internal Coolant Provides Longer Tool Life and Excellent Chip Control

NEW *New Inch Size Holders Now Available!*

Turning

Double-Clamp JCT

Small Parts Turning JCT

Shallow Grooving

KGBA-JCT

KGBF-JCT

Grooving / Cut-off

KGD-JCT

KTKF-JCT

Threading

KTN-JCT

Unique Coolant System for Various Machining Applications

Turning Double-Clamp-JCT Page 6

- **Three Coolant Holes**
Coolant is directed towards the rake surface for chip control and also towards the flank face of the insert to keep the cutting edge cool for longer tool life
- **Lineup**
DCLN-JCT
DDJN-JCT
DWLN-JCT

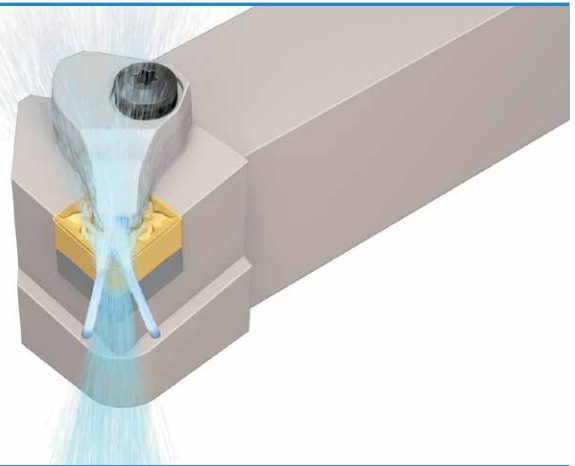

External Grooving KGBA-JCT Page 11

NEW

- **Provides Coolant towards the Rake Surface of Insert**
- **Lineup**
Edge Width: 0.031" - 0.188" / 0.33mm - 4.80mm
Maximum Depth: 0.079" - 0.197" / 0.80mm - 5.00mm

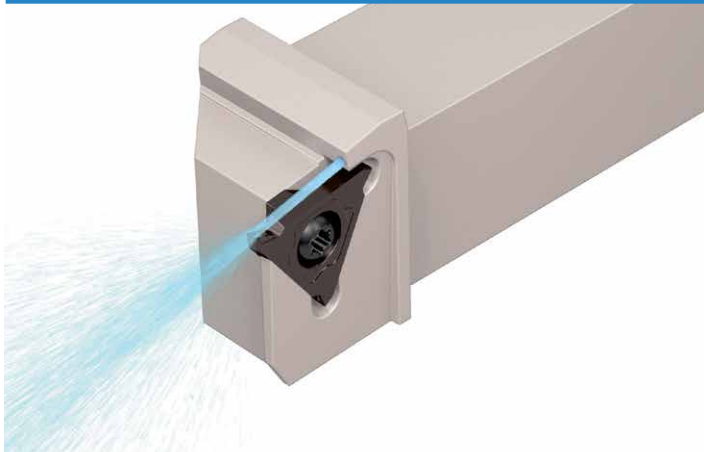

Grooving / Cut-Off KGD-JCT Page 16

- **Provides Coolant Towards the Flank and Rake Surface of Insert**
- **Lineup**
Edge Width: 0.118" - 0.197" / 3mm - 5mm
Maximum Depth: 0.787" - 1.000" / 6mm - 25mm

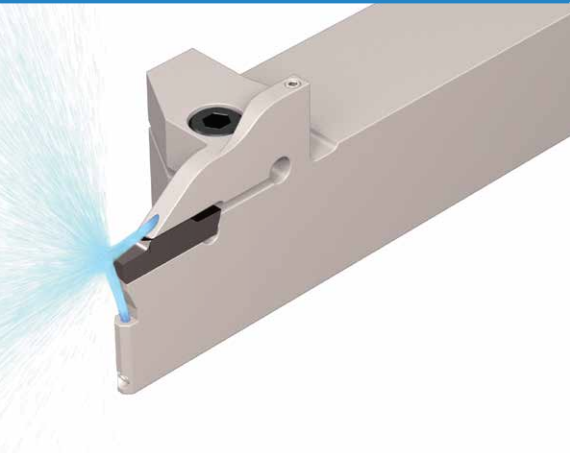

Threading KTN-JCT Page 23

- **Double Coolant Holes Reduce Defects and Lengthen Tool Life**
(Two holes toward the rake face and one hole towards the flank face of the insert)
- **Lineup**
TQ Molded Chipbreakers
When combined with KTN-JCT holders, the TQ chipbreaker improves chip control for greater productivity

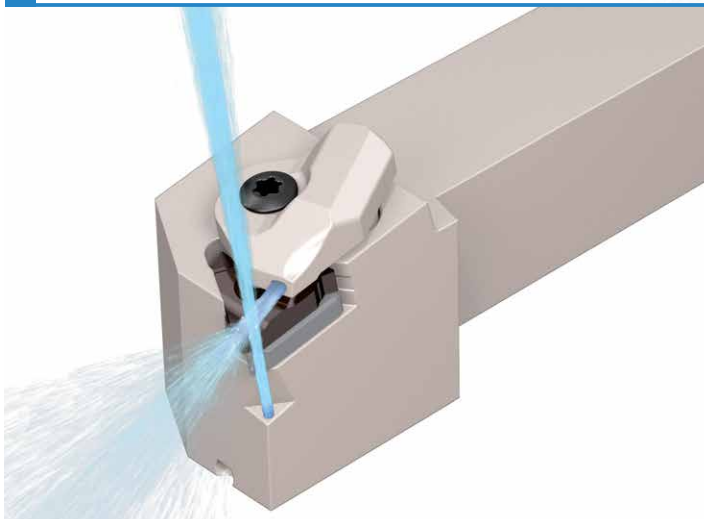

Small Parts Turning Screw-Clamp-JCT Page 32

- **Double Coolant Holes**
Double coolant holes provide coolant toward the cutting edge surface of the insert
- **Lineup**
SCLC-JCT
SDJC-JCT
SVJB-JCT
SVJP-JCT

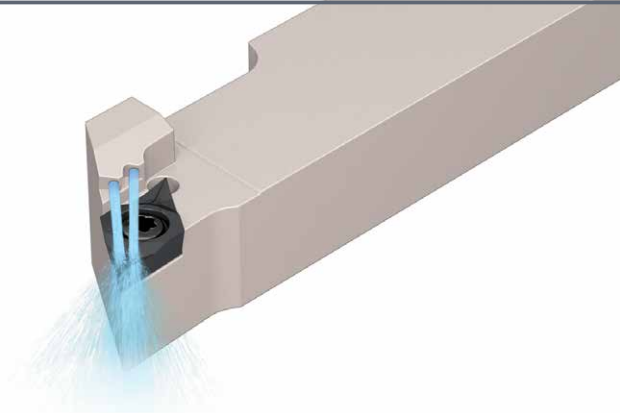

External Grooving KGBF-JCT Page 36

- **Provides Coolant towards the Rake Surface of Insert**
- **Lineup**
Edge Width: 0.25mm - 3mm
Ground Chipbreaker / GL Chipbreaker
Maximum Depth: 3mm

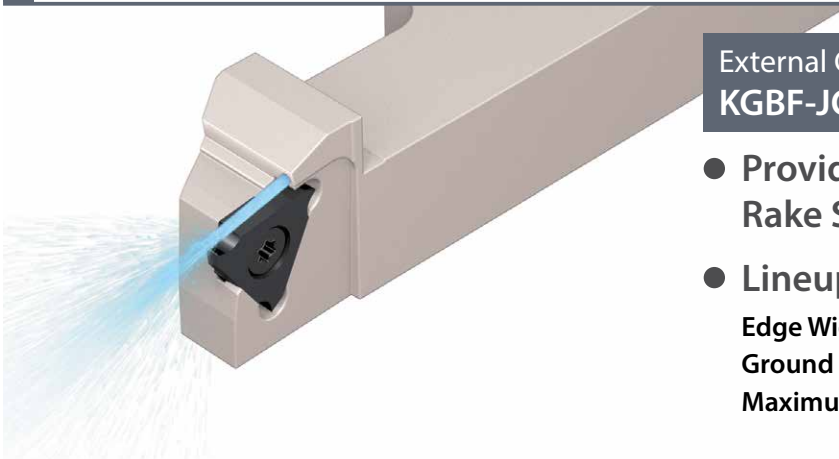

Small Diameter Grooving / Cut-Off KGD-JCT Page 18



- **Provides Coolant towards the Flank Surface of Insert**
- **Lineup**
Edge Width: 2mm - 4mm
Maximum Cut-Off Diameter: $\varnothing 24\text{mm}$ - $\varnothing 32\text{mm}$

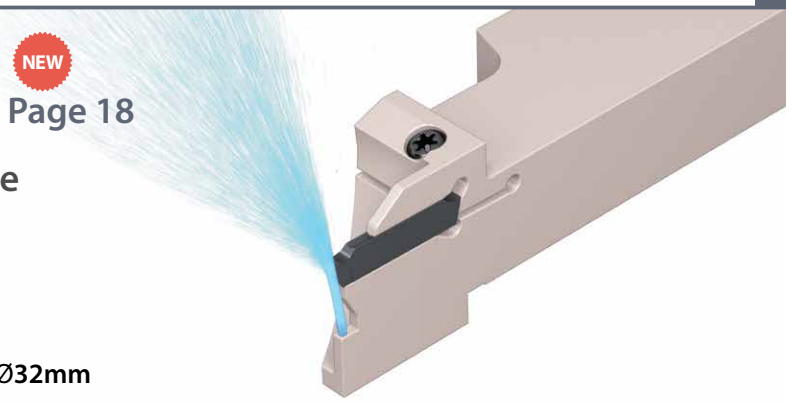

Small Diameter Cut-Off KTKF-JCT Page 40

- **Discharges Coolant in Three Directions toward Rake Surface of Insert**
(Two holes toward the rake face and one hole towards the flank face of the insert)
- **Lineup**
TKF12 Type
(Maximum Cut-Off: $\varnothing 0.197''$ - $\varnothing 0.472''$ / $\varnothing 5\text{mm}$ - $\varnothing 12\text{mm}$)
TKF16 Type
(Maximum Cut-Off: $\varnothing 0.630''$ / $\varnothing 16\text{mm}$)

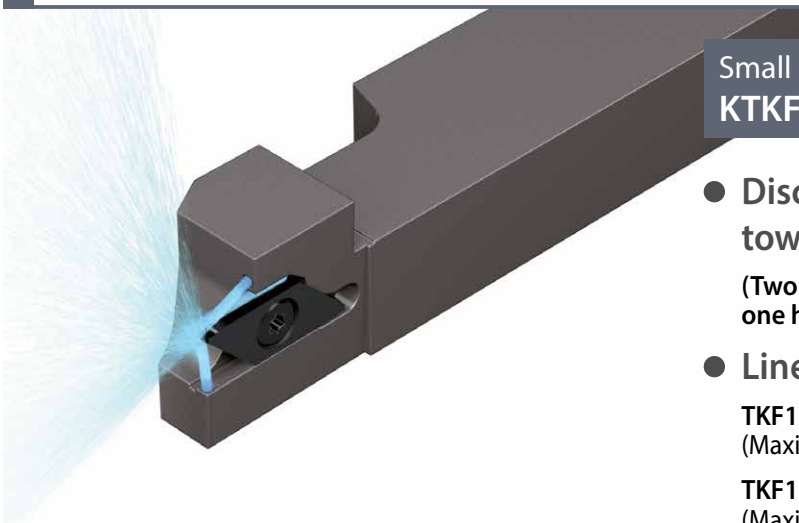

JCT Series

Coolant-Through Holders



Excellent Chip Control and Long Tool Life with High Pressure Coolant

Large Holder Lineup for Turning, External Grooving, Cut-off and Threading

Special Coolant Hole Design

Unique Coolant System for Various Machining Applications

○ : Coolant Hole



Turning: [↔ Page 6](#)
Double-Clamp-JCT



External Shallow Grooving: [↔ Page 11](#)
KGBA-JCT

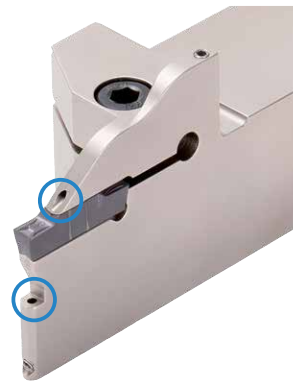

External Grooving: [↔ Page 16](#)
KGD-JCT



Threading: [↔ Page 23](#)
KTN-JCT

Advantages of Internal Coolant

Discharges Coolant towards the Cutting Edge

Internal Coolant Provides Longer Tool Life and Excellent Chip Control

Extended Tool Life

Wear Resistance Comparison (Internal Evaluation)

Internal Coolant (1,015 psi)

External Coolant (58 psi)

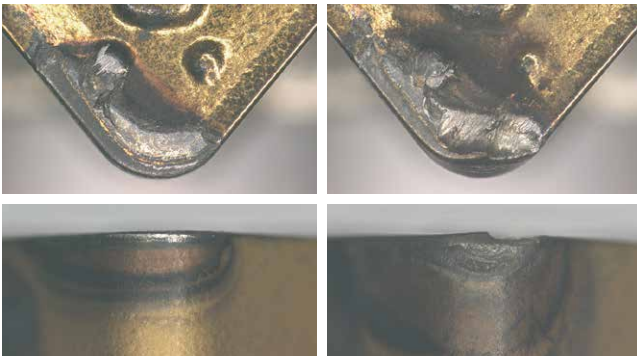

Cutting Conditions: $V_c = 820$ sfm, $f = 0.079$ ipr, D.O.C. = 0.079", Wet
CNMG432 Insert Workpiece: 4137
External Turning After Machining 42.2 min

Improved Chip Control

Chip Control Comparison (Internal Evaluation)

Internal Coolant (1,015 psi)

External Coolant (58 psi)

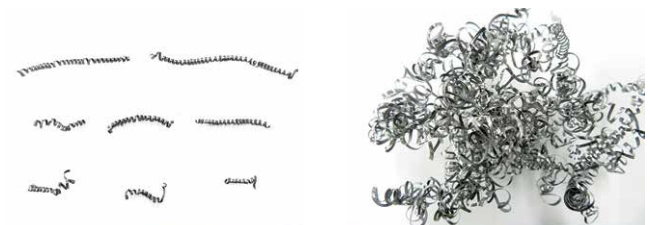

Cutting Conditions: $V_c = 660$ sfm, $f = 0.002$ ipr, D.O.C. = 0.020", Wet
DNMG432 Insert Workpiece: 4131 External Turning

Easy Coolant Connections

Easy Connection with High Pressure Hose and Joint

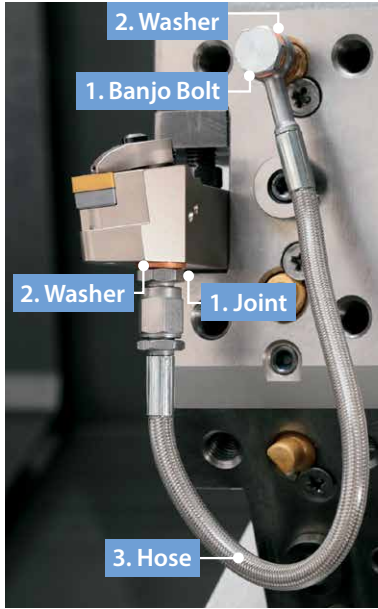

- Even without a high pressure pump, internal coolant can be used at a normal pressure
- Banjo bolt available for angled hose connection and can be used in a variety of machines

Piping Installation Guide

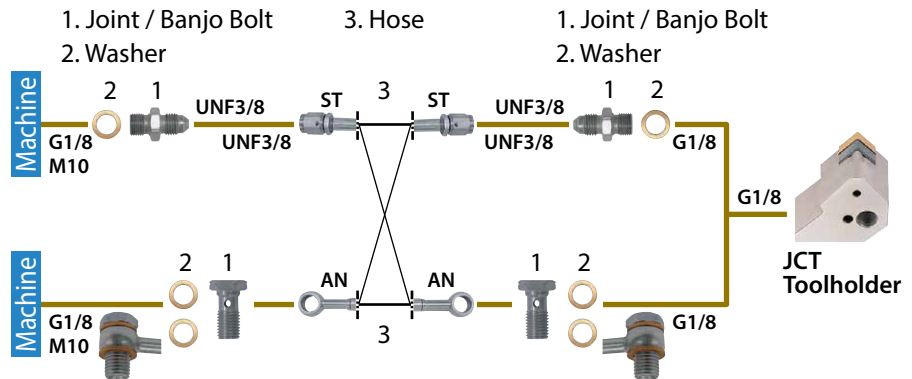

Piping Parts

Optional Piping Parts Available

Choose from parts below to match your machine specifications

1. Joint / Banjo Bolt

Pressure Resistance: up to 4,350 psi

Shape	Part Number	Stock	Thread Standard
	J-G1/8-UNF3/8	●	G1/8
	J-10X1.5-UNF3/8	●	M10X1.5
	BB-G1/8	●	G1/8
	BB-M10X1.5	●	M10X1.5

1. Joint / Banjo bolt × 2

2. Washer × 2-4

3. Hose × 1

2. Washer

Pressure Resistance: up to 4,350 psi

Shape	Part Number	Stock
	WS-10	●

* Use 2 washers for a banjo bolt

3. Hose

Pressure Resistance: up to 4,350 psi

Shape	Part Number	Stock	Thread Standard		Dimensions (mm)
					L
	HS-ST-ST-200	●	UNF3/8	UNF3/8	200
	HS-ST-ST-250	●	UNF3/8	UNF3/8	250
	HS-ST-AN-200	●	UNF3/8	-	200
	HS-ST-AN-250	●	UNF3/8	(Banjo Bolt)	250
	HS-AN-AN-200	●	-	-	200
	HS-AN-AN-250	●	(Banjo Bolt)	(Banjo Bolt)	250

Precautions

● : Standard Item

1. Make sure machine door is completely closed before use of these parts.
2. Use appropriate seal for the male thread of the piping parts and make sure the connection is secure. Use plugs to seal off unused coolant holes.
3. Connect and fasten the coolant hose firmly.
4. The use of copper washers may cause leakage but will have no effect on the performance.
5. Commercial piping parts can be used if the thread standards are the same. Check the pressure resistance before use.
6. Regularly changing the coolant filter is recommended.

Double-Clamp-JCT

Turning

Coolant-Through Holders for Turning

Discharges Coolant in Three Directions to Improve Chip Control and Lengthen Tool Life for a Wide Variety of Workpieces Including Steel, Hardened Material and Difficult-to-Cut Material

1 Superior Chip Control Performance

Special coolant-through structure designed by careful simulation and analysis technology

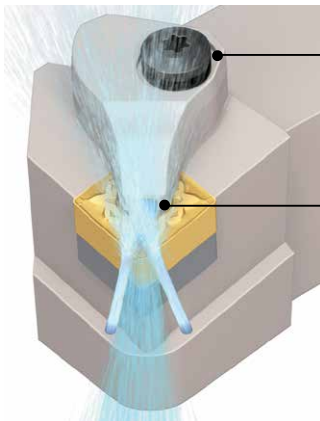

Double-Clamp

Firm insert clamp and easy to use in single operations
High-density coolant supply close to the cutting edge

Unique Nozzle Shape

Provides coolant to a wide area of the insert surface

Coolant Supply Simulation Comparison (Internal Evaluation)

Discharges a wide stream of high-density coolant towards the rake surface of the insert

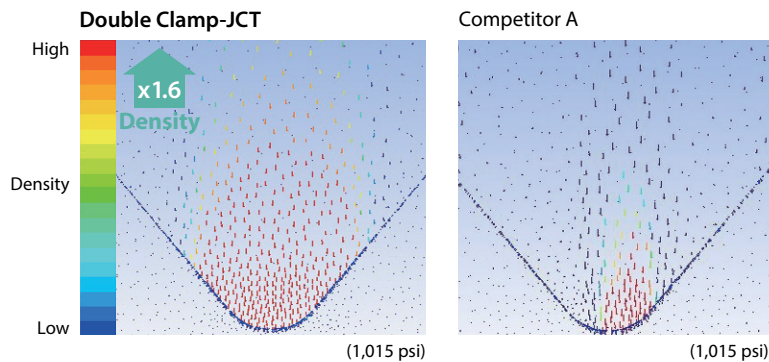
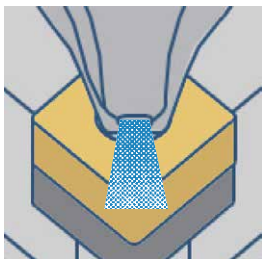

Chip Control Comparison (Internal Evaluation)

Double-Clamp JCT



Competitor A

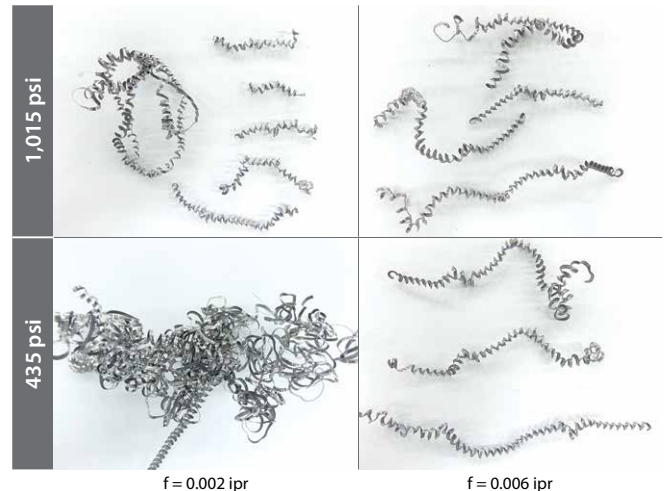

Cutting Conditions: $V_c = 490$ sfm, D.O.C. = $0.020''$, Wet, CNMG432 Insert Workpiece: 4131 External Turning

2 Longer Tool Life and High-Speed Machining

Coolant is also directed from two directions towards the flank face of the insert to ensure even cooling action

Longer tool life and high-speed machining with improved wear resistance

Discharges Coolant in Three Directions
The Cutting Edge Stays Cool

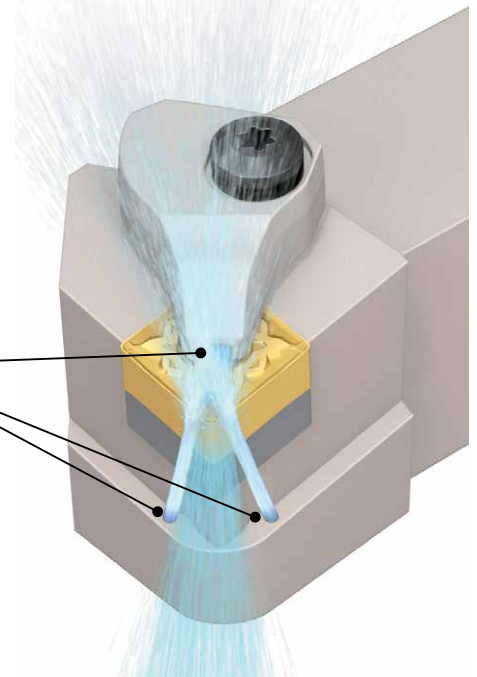

Wear Resistance Comparison (Internal Evaluation)

Alloy Steel (4137)

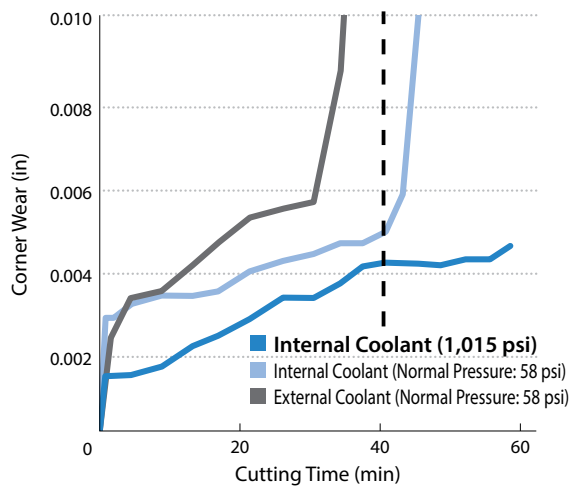

Heat-resistant Alloys (Inconel®718)

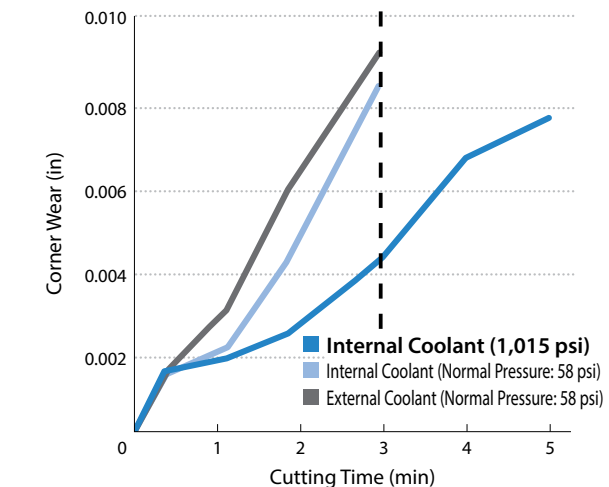

After Machining 42.2 min



Abrasion Resistance

After Machining 3 min

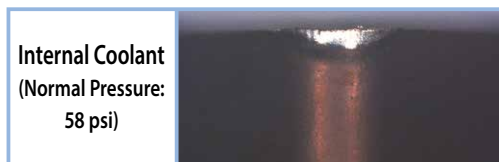
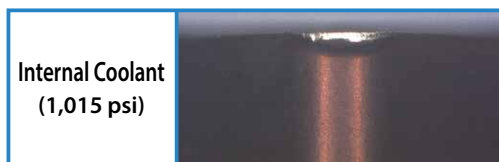

Abrasion Resistance

Cutting Conditions: $V_c = 820$ sfm, $f = 0.012$ ipr, D.O.C. = 0.079", Wet CNMG432 Insert External Turning

Cutting Conditions: $V_c = 260$ sfm, $f = 0.006$ ipr, D.O.C. = 0.020", Wet CNMG432 Insert External Turning

Using internal coolant improves wear resistance in alloy steel and heat-resistant alloys
High-pressure coolant is more effective

Wear Resistance Comparison (Internal Evaluation)

Double-Clamp JCT maintains better wear resistance than competitors

Internal Coolant (Normal Pressure: 60 psi)

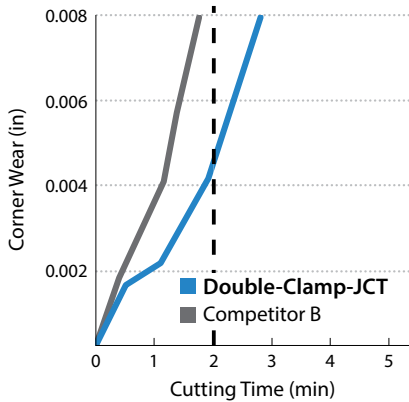

After Machining 2 min

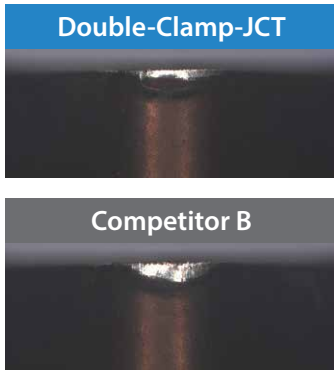

Internal Coolant (580 psi)

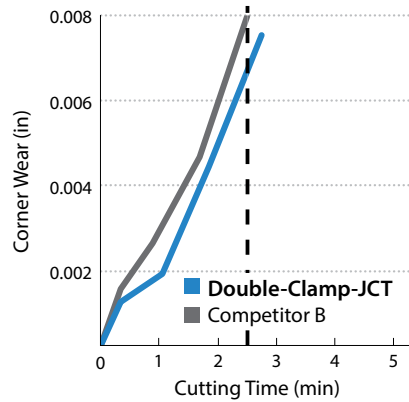

After Machining 2.5 min

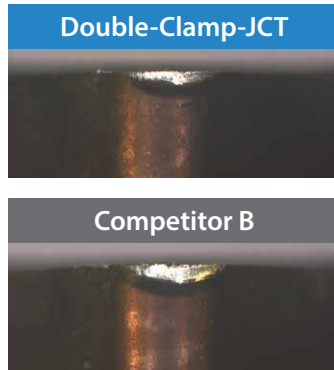

Internal Coolant (1,015 psi)

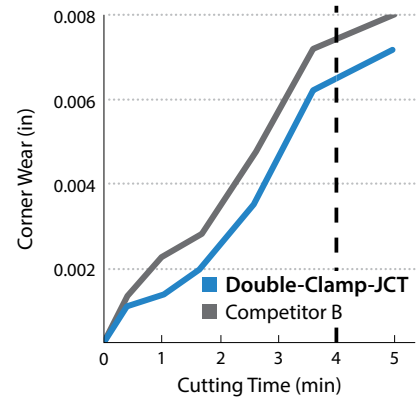

After Machining 4 min



Cutting Conditions: $V_c = 260$ sfm, $f = 0.006$ ipr, D.O.C. = 0.020° , Wet, CNMG432 Insert Workpiece: Inconel®718 (Equivalent) External Turning

Case Studies

Mechanical Parts - Carbon Steel

$V_c = 820$ sfm
D.O.C. = 0.118°
 $f = 0.014$ ipr
Wet (Water Soluble)
DCLNR2525M-12JCT
CNMG432PT Insert (CA510)

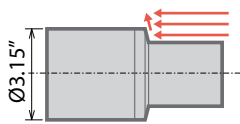

Tool Life

DCLN-JCT Toolholder
(Internal Coolant: 580 psi)

100 pcs / edge

Tool Life
↑
x1.25

Conventional Toolholder
(External Coolant)

80 pcs / edge

The DCLN-JCT internal coolant improved tool life by 1.5 times when compared to using external coolant

Shaft - 5120 (Hardened Steel Over 55HRC)

$V_c = 590$ sfm
D.O.C. = 0.004°
 $f = 0.0028$ ipr
Wet
DDJNR2525M-15JCT
DNGA432 Insert (CBN)

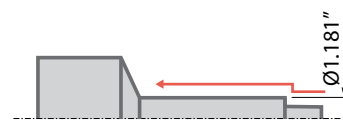

Tool Life

DDJN-JCT Toolholder
(Internal Coolant)

100 pcs / edge

Tool Life
↑
x1.4

Competitor C
(Internal Coolant)

70 pcs / edge (Unstable)

Competitor D
(External Coolant)

60 pcs / edge (Unstable)

Cutting Edge

DDJN-JCT Toolholder

Competitor C

Competitor D



The DDJN-JCT toolholder reduced sudden fracturing and defects with stable machining and maintained 1.4 times longer tool life (User Evaluation)

(User Evaluation)

Double-Clamp-JCT (Turning)

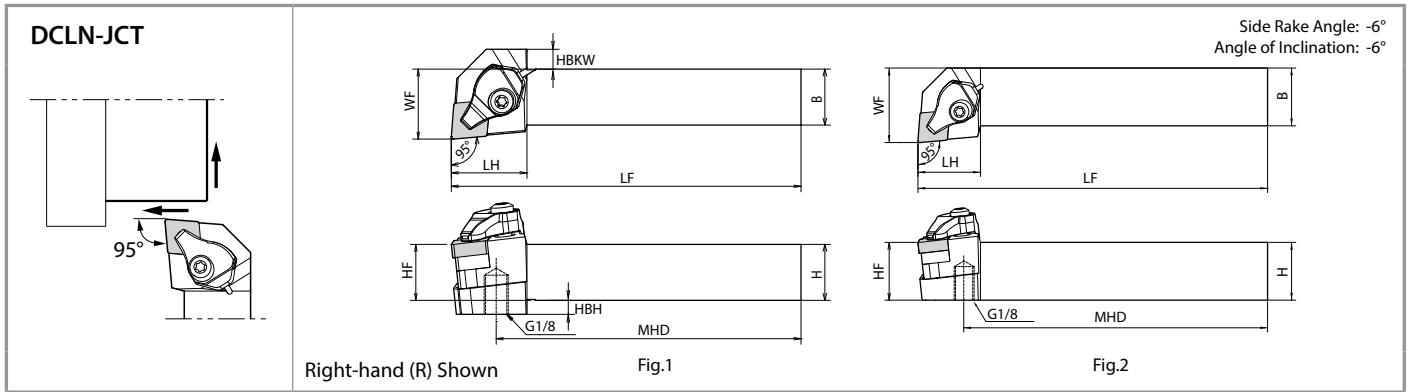

Toolholder Dimensions

Pressure Resistance: up to 4,350 psi

Part Number	Stock		Dimensions									Standard Corner-R (RE)	Drawing	Spare Parts							Applicable Inserts	
	R	L	Unit	H	HF	HBH	B	HBKW	LF	LH	WF			MHD	Clamp	Pipe Connection (*1 with O-Ring)	Screw	Spring	Wrench	Shim		Shim Screw
DCLN 12-4BJCT	●	●	inch	0.750	0.750	0.234	0.750	0.260	4.500	1.063	1.000	3.870	1/32	Fig.1	CP-3D- $\frac{1}{2}$ -JCT	FP-12	CS-3D-TR	SP-3D	FT-15	*2 DC-44 *3 DC-44-C	SB-408STR	CN..43...
16-4DJCT	●	●	inch	1.000	1.000	-	1.000	-	6.000	1.063	1.250	5.370	Fig.2									
DCLN 2020K-12JCT	●	●	mm	25	25	5	20	7	125	27	25	109	0.8	Fig.1	CP-3D- $\frac{1}{2}$ -JCT	FP-12	CS-3D-TR	SP-3D	FT-15	*2 DC-44 *3 DC-44-C	SB-408STR	
2525M-12JCT	●	●	mm	25	25	-	25	-	150	27	32	134	Fig.2									

● : Standard Item

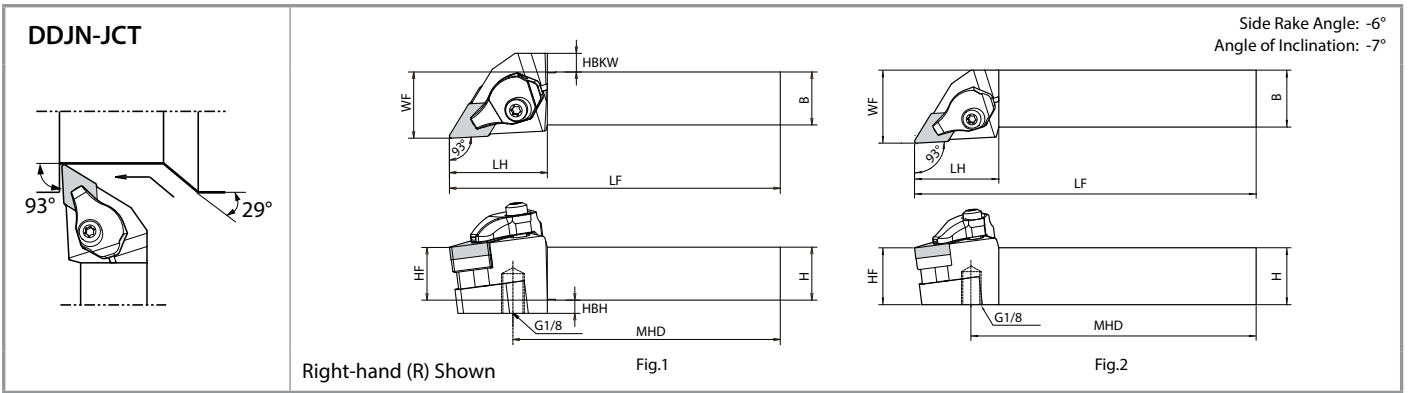

Toolholder Dimensions

Pressure Resistance: up to 4,350 psi

Part Number	Stock		Dimensions									Standard Corner-R (RE)	Drawing	Spare Parts							Applicable Inserts	
	R	L	Unit	H	HF	HBH	B	HBKW	LF	LH	WF			MHD	Clamp	Pipe Connection (*1 with O-Ring)	Screw	Spring	Wrench	Shim		Shim Screw
DDJN 12-4BJCT	●	●	inch	0.750	0.750	0.234	0.750	0.260	4.500	1.456	1.000	3.555	1/32	Fig.1	CP-3D- $\frac{1}{2}$ -JCT	FP-12	CS-3D-TR	SP-3D	FT-15	*2 DC-44 (DC-43)	SB-408STR	DN..43... (DN..44...)
16-4DJCT	●	●	inch	1.000	1.000	-	1.000	-	6.000	1.456	1.250	5.055	Fig.2									
DDJN 2020K-15JCT	●	●	mm	20	20	5	20	7	125	37	25	101	0.8	Fig.1	CP-3D- $\frac{1}{2}$ -JCT	FP-12	CS-3D-TR	SP-3D	FT-15	*2 DC-44 (DC-43)	SB-408STR	
2525M-15JCT	●	●	mm	25	25	-	25	-	150	37	32	126	Fig.2									

Shims in () are not included with the holder. Please purchase separately when a change in insert thickness is needed.

● : Standard Item

*1. O-ring (SS-035) is available to order separately

*2. When using inserts with a corner-R (RE) greater than 1/16", additional modifications to the shim are necessary in order to prevent workpiece and shim from interfering with each other.

*3. SX chipbreaker inserts require a different shim (sold separately)

See **Page 5** for piping parts

Double-Clamp-JCT (Turning)

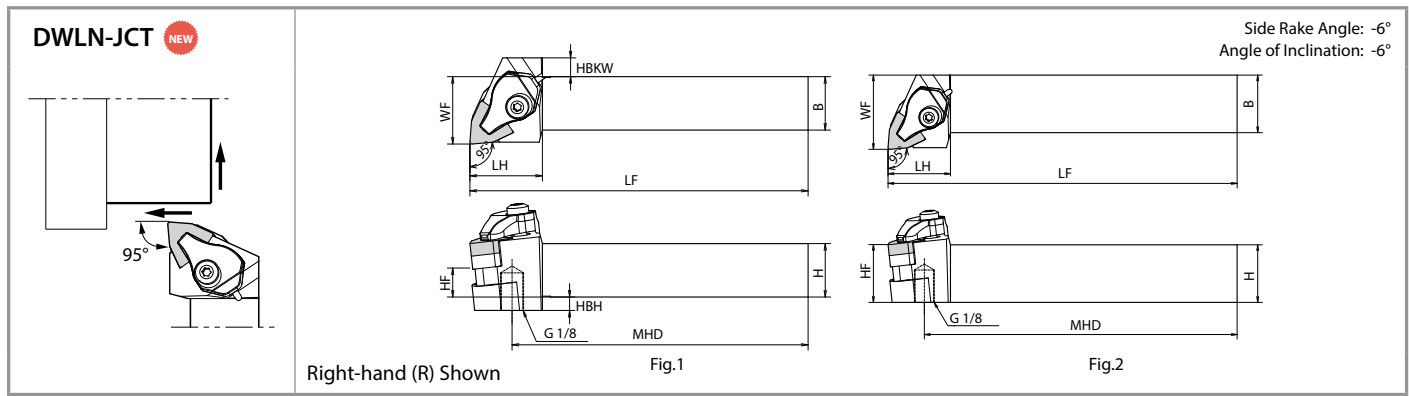

Toolholder Dimensions

Pressure Resistance: up to 4,350 psi

Part Number	Stock		Dimensions										Standard Corner-R (RE)	Drawing	Spare Parts							Applicable Inserts
	R	L	H	HF	HBH	B	HBKW	LF	LH	WF	MHD	Clamp			Pipe Connection (*1 with O-Ring)	Screw	Spring	Wrench	Shim	Shim Screw		
	Unit																					
DWLN [®] / 12-4BJCT	●	●	0.750	0.750	0.234	0.750	0.260	4.500	1.063	1.000			1/32	Fig.1	CP-3D- [®] /JCT	FP-12	CS-3D-TR	SP-3D	FT-15	DW-44	SB-4085TR	WN..43...
16-4DJCT	●	●	1.000	1.000	-	1.000	-	6.000	1.063	1.250			Fig.2									
DWLN [®] / 2020K-08JCT	●	●	20	20	5	20	7	125	27	25	109	0.8	Fig.1	CP-3D- [®] /JCT	FP-12	CS-3D-TR	SP-3D	FT-15	DW-44	SB-4085TR	WN..43...	
2525M-08JCT	●	●	25	25	-	25	-	150	27	32	134	Fig.2										

● : Standard Item

Internal Coolant Advantages (Reference)

Coolant Pressure (psi)	Tool Life	Chip Control	Advantages
Normal Pressure ~290 (Low Pressure)	Good	-	Longer tool life under 145 psi
290~1,015 (Medium Pressure)	Excellent	Good	Longer tool life and excellent chip control
1,015~2,175 (High Pressure)	Excellent	Excellent	Fine chip breaking
2,175~4,350 (Extra-high Pressure)	Excellent	Excellent	Fine chip breaking and high speed machining for heat-resistant alloys

Internal coolant under low pressure provides improved performance and stable machining

KGBA-JCT NEW

External Grooving

Coolant-Through Holders for External Shallow Grooving

KGBA-JCT can Direct Coolant Closer to the Cutting Edge from the Top of the Insert
Excellent Chip Control and Longer Tool Life

1 Excellent Chip Control

Ground Chipbreaker

Chip Control Comparison (Internal Evaluation)

Internal Coolant Provides Excellent Chip Control
High-pressure coolant is more effective

Alloy Steel (5120)

Internal Coolant	1,015 psi				
	290 psi				
	72 psi (Normal Pressure)				
External Coolant	72 psi (Normal Pressure)				
		f (ipr)	0.002	0.003	0.004

Stainless Steel (304)

Internal Coolant	1,015 psi				
	290 psi				
	72 psi (Normal Pressure)				
External Coolant	72 psi (Normal Pressure)				
		f (ipr)	0.002	0.003	0.004

Cutting Conditions: $V_c = 150$ m/min (Alloy Steel) / 100 m/min (Stainless Steel),
 $f = 0.05 \sim 0.1$ mm/rev, Groove depth = 2 mm, Wet
KGBAR2525K22-15JCT, GBA43R200-020 (PR1215)

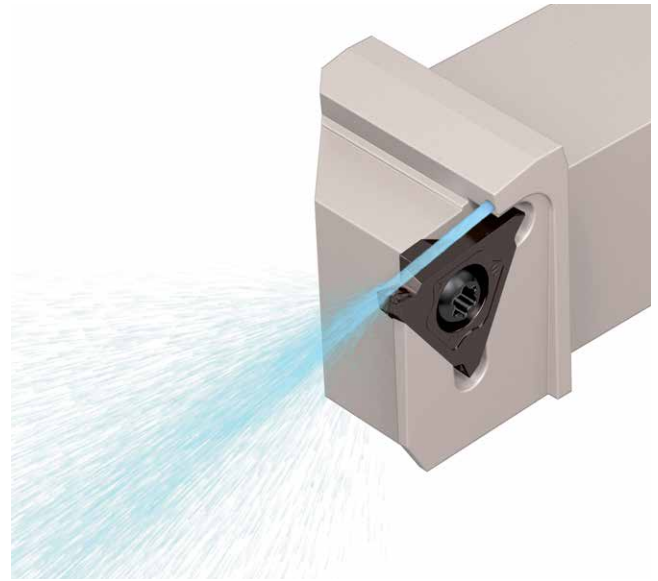

Coolant Hole

Coolant is discharged to the cutting edge
Prevents coolant stream spreading which slows the coolant flow

Coolant Direction

Sufficient coolant between the chipbreaker and the chips
Stable chip curls and sufficient cooling of the insert

2 Superior Cooling Action Improves Tool Life

Internal Coolant Provides Better
Corner Wear Resistance

Wear Resistance Comparison (Internal Evaluation)

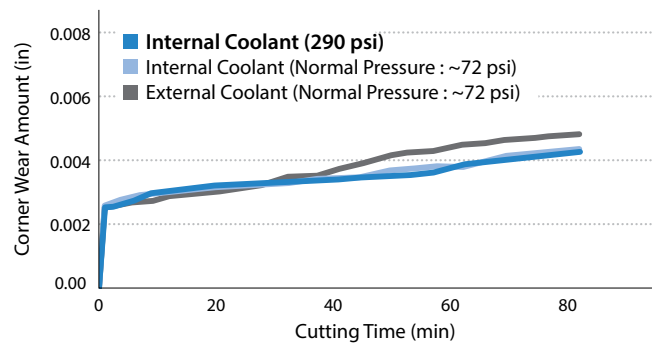

Cutting Conditions: $V_c = 150$ m/min, $f = 0.07$ mm/rev, Groove depth = 2 mm, Wet
KGBAR2525K22-15JCT, GBA43R200-020 (PR1215) Workpiece: SCM435

KGBA-JCT (Shallow Grooving)

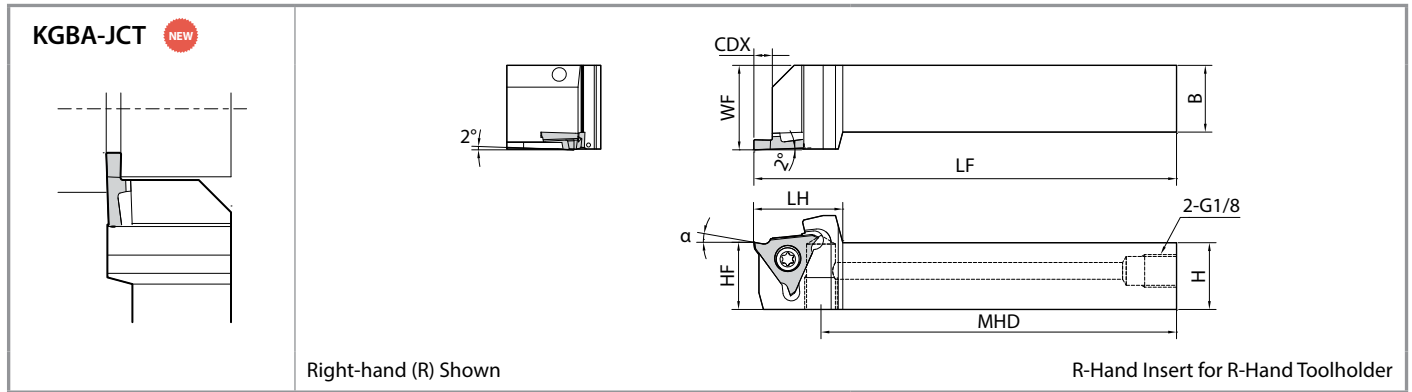

Toolholder Dimensions

Pressure Resistance: up to 4,350 psi

Part Number	Stock		Unit	Dimensions								Spare Parts				Applicable Inserts	
	R	L		H	HF	B	LF	LH	WF	CDX	MHD	Clamp Screw	Wrench	Plug			
KGBA [®] /L 2020K-16JCT	●	●	mm	20	20	20	125	24.0	25	2.5	107.5	SB-4085TR	FT-15	-	HSG1/8x8.0	GBA32 [®] /L Type	
2525K-16JCT	●	●		25	25	25			30								
2020K22-15JCT	●	●		20	20	20			25								4
2525K22-15JCT	●	●		25	25	25			30								
2020K22-25JCT	●	●		20	20	20	25	26.5	105	SB-5085TR	-	LTW-20	HSG1/8x8.0	GBA43 [®] /L Type			
2525K22-25JCT	●	●		25	25	25	30										
2020K22-35JCT	●	●		20	20	20	25										
2525K22-35JCT	●	●		25	25	25	30										

Please see P2 for piping parts.

CDX shows the distance from the toolholder to the cutting edge. For available groove depth, see "CDX" dimension of Insert.

KGBA-JCT Toolholder is Screw Clamp Type

Regarding Rake Angle after Installation of GBA (α), please see the KYOCERA general product catalog or GBA brochure

● : Standard Item

Recommended Grade for Steel

General Purpose : PR1215

(Surface Finish Oriented) : TN620

for Stable Machining : PR1625

PR1625 NEW

Cemented carbide grade with high stability and MEGACOAT NANO with excellent adhesion resistance provides high toughness and high hardness

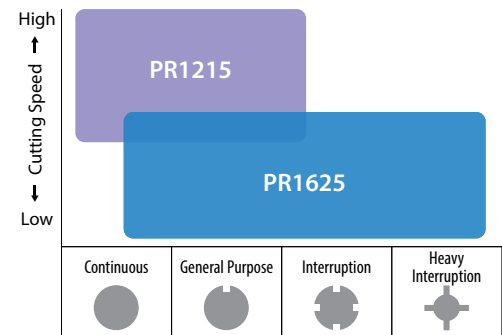

Long tool life is achieved in interrupted grooving applications like drums and shafts of transmission engine parts.

Ground Chipbreaker

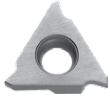
Ground Chipbreaker 	P	Carbon Steel / Alloy Steel	●	●		
	M	Stainless Steel				●
	K	Cast Iron				
	N	Non-ferrous Material				
S	Titanium Alloy					●
H	Hardened Material (~40HRC)					●
Part Number	Dimensions (in)			MEGACOAT Cement		Applicable Toolholders
	CW	CDX	RE	PV7040	PR1215	
	Edge Width (W)	Available Grooving Depth	Corner-R			
GBA32% 031N	0.031	0.079	0.002	●	●	1
	0.041	0.079	0.002	●	●	
	0.047	0.079	0.008	●	●	
	0.058	0.079	0.008	●	●	
	0.062	0.079	0.008	●	●	
	0.078	0.098	0.008	●	●	
	0.094	0.098	0.008	●	●	
GBA43% 031N	0.031	0.079	0.008	●	●	2
	0.047	0.079	0.008	●	●	
	0.062	0.138	0.008	●	●	
	0.072	0.138	0.008	●	●	
	0.078	0.138	0.008	●	●	
	0.088	0.138	0.008	●	●	
	0.094	0.157	0.012	●	●	
	0.097	0.157	0.012	●	●	
	0.105	0.157	0.012	●	●	
	0.109	0.157	0.012	●	●	
	0.110	0.157	0.012	●	●	
GBA43% 047N	0.125	0.157	0.012	●	●	3
	0.141	0.197	0.012	●	●	
	0.142	0.197	0.012	●	●	
	0.156	0.197	0.016	●	●	
	0.172	0.197	0.016	●	●	
	0.178	0.197	0.016	●	●	
	0.188	0.197	0.016	●	●	
GBA43% 078N	0.031	0.079	0.008	●	●	4
	0.047	0.079	0.008	●	●	
	0.062	0.138	0.008	●	●	
	0.072	0.138	0.008	●	●	
	0.078	0.138	0.008	●	●	
	0.088	0.138	0.008	●	●	
	0.094	0.157	0.012	●	●	

Molded Chipbreaker

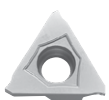
Molded MY Chipbreaker 	P	Carbon Steel / Alloy Steel	●		
	M	Stainless Steel		●	
	S	Titanium Alloy		●	
	H	Hardened Material (~40HRC)		●	
Part Number	Dimensions (in)			MEGACOAT	Applicable Toolholders
	CW	CDX	RE	PR1215	
	Edge Width (W)	Available Grooving Depth	Corner-R		
GBA43% 078MYN	0.078	0.138	0.008	●	2
	0.094	0.157	0.012	●	3
	0.125	0.157	0.012	●	
	0.156	0.197	0.016	●	4

Full-R

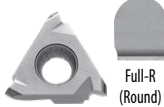
Full-R 	P	Carbon Steel / Alloy Steel	●		
	M	Stainless Steel		●	
	S	Titanium Alloy		●	
	H	Hardened Material (~40HRC)		●	
Part Number	Dimensions (in)			MEGACOAT	Applicable Toolholders
	CW	CDX	RE	PR1215	
	Edge Width (W)	Available Grooving Depth	Corner-R		
GBA32R 031R	0.062	0.079	0.031	●	1
	0.094	0.098	0.047	●	
GBA43% 031R	0.062	0.138	0.031	●	2
	0.094	0.157	0.047	●	3
	0.125	0.157	0.062	●	
GBA43% 078R	0.156	0.197	0.078	●	4
	0.188	0.197	0.094	●	

Applicable JCT Toolholders

- 1: KGBAR ...16 JCT Type
- 2: KGBA %/L ...22-15 JCT Type
- 3: KGBA %/L ...22-25 JCT Type
- 4: KGBA %/L ...22-35 JCT Type

For more details on cutting conditions, please see the KYOCERA General Product Catalog or GBA brochure

● : Standard Item ● : Right-Hand Only

Ground Chipbreaker

Ground Chipbreaker	Material		Applicable Toolholders												
	P	M	MEGACOAT Cermet			Cermet			MEGACOAT NANO			PVD Coated Carbide		Carbide	
	Carbon Steel / Alloy Steel	Stainless Steel	PV7040	TC40N	TN90	PR1625	PR1215	PR1115	PR905	PR930	KW10				
Ground Chipbreaker	K														
	N														
Ground Chipbreaker	S														
	H														
Part Number	Dimensions (mm)			Applicable Toolholders											
	CW	CDX	RE	MEGACOAT Cermet			Cermet			MEGACOAT NANO			PVD Coated Carbide		Carbide
	Edge Width (W)	Available Grooving Depth	Corner-R	PV7040	TC40N	TN90	PR1625	PR1215	PR1115	PR905	PR930	KW10			
GBA32%	033-005 ^{※1}	0.33	0.8	0.05											
	050-005 ^{※2※3}	0.50	1.0	0.05											
GBA32%	075-005	0.75	2.0	0.05											
	095-005	0.95	2.0	0.05											
GBA32%	100-005	1.00	2.0	0.05											
	110-005	1.10	2.0	0.05											
GBA32%	120-005	1.20	2.0	0.05											
	125-020	1.25	2.0	0.2											
GBA32%	130-020	1.30	2.0	0.2											
	140-020	1.40	2.5	0.2											
GBA32%	145-020 ^{※3}	1.45	2.0	0.2											
		1.45	2.5	0.2											
GBA32%	150-020 ^{※3}	1.50	2.0	0.2											
		1.50	2.5	0.2											
GBA32%	160-020	1.60	2.5	0.2											
	170-020	1.70	2.5	0.2											
GBA32%	175-020 ^{※3}	1.75	2.0	0.2											
		1.75	2.5	0.2											
GBA32%	200-020	2.00	2.5	0.2											
	225-020	2.25	2.5	0.2											
GBA32%	250-020	2.50	2.5	0.2											
	300-020	3.00	2.5	0.2											
GBA43%	125-010	1.25	2.0	0.1											
	125-020	1.25	2.0	0.2											
GBA43%	140-020	1.40	3.5	0.2											
	145-020 ^{※3}	1.45	2.0	0.2											
GBA43%		1.45	3.5	0.2											
	150-010	1.50	3.5	0.1											
GBA43%	150-020	1.50	3.5	0.2											
	170-020	1.70	3.5	0.2											
GBA43%	175-020	1.75	3.5	0.2											
	185-020	1.85	3.5	0.2											
GBA43%	200-010	2.00	3.5	0.1											
	200-020	2.00	3.5	0.2											
GBA43%	225-020	2.25	3.5	0.2											
	230-020	2.30	3.5	0.2											
GBA43%	250-010	2.50	5.0	0.1											
	250-030 ^{※3}	2.50	4.0	0.3											
GBA43%		2.50	5.0	0.3											
	265-030 ^{※3}	2.65	4.0	0.3											
GBA43%		2.65	5.0	0.3											
	280-030 ^{※3}	2.80	4.0	0.3											
GBA43%		2.80	5.0	0.3											
	300-010	3.00	5.0	0.1											
GBA43%	300-030 ^{※3}	3.00	4.0	0.3											
		3.00	5.0	0.3											
GBA43%	325-030	3.25	5.0	0.3											
	330-030 ^{※3}	3.30	4.0	0.3											
GBA43%		3.30	5.0	0.3											
	350-010	3.50	5.0	0.1											
GBA43%	350-030	3.50	5.0	0.3											
	400-010	4.00	5.0	0.1											
GBA43%	400-040	4.00	5.0	0.4											
	430-040	4.30	5.0	0.4											
GBA43%	450-040	4.50	5.0	0.4											
	480-040	4.80	5.0	0.4											

※1 : The edge width tolerance of GBA32% 033-005 : 0.33^{+0.02}

※2 : The edge width tolerance of GBA32% 050-005 : 0.50^{+0.05}

※3 : Available grooving depth is different based on grade

Ground Chipbreaker Sharp Edge	Material		Applicable Toolholders												
	P	M	MEGACOAT Cermet			Cermet			MEGACOAT NANO			PVD Coated Carbide		Carbide	
	Carbon Steel / Alloy Steel	Stainless Steel	PV7040	TC40N	TN90	PR1625	PR1215	PR1115	PR905	PR930	KW10				
Ground Chipbreaker Sharp Edge	K														
	N														
Ground Chipbreaker Sharp Edge	S														
	H														
Part Number	Dimensions (mm)			Applicable Toolholders											
	CW	CDX	RE	MEGACOAT Cermet			Cermet			MEGACOAT NANO			PVD Coated Carbide		Carbide
	Edge Width (W)	Available Grooving Depth	Corner-R	PV7040	TC40N	TN90	PR1625	PR1215	PR1115	PR905	PR930	KW10			
GBA32%	050-005F ^{※1}	0.50	1.0	0.05											
	075-005F	0.75	2.0	0.05											
GBA32%	095-005F	0.95	2.0	0.05											
	100-005F	1.00	2.0	0.05											
GBA32%	125-020F	1.25	2.0	0.2											
	145-020F	1.45	2.0	0.2											
GBA32%	150-020F	1.50	2.0	0.2											
	175-020F	1.75	2.0	0.2											
GBA32%	200-020F	2.00	2.5	0.2											
	250-020F	2.50	2.5	0.2											
GBA43%	125-020F	1.25	2.0	0.2											
	145-020F	1.45	2.0	0.2											
GBA43%	150-020F	1.50	3.5	0.2											
	175-020F	1.75	3.5	0.2											
GBA43%	185-020F	1.85	3.5	0.2											
	200-020F	2.00	3.5	0.2											
GBA43%	230-020F	2.30	3.5	0.2											
	250-030F	2.50	4.0	0.3											
GBA43%	265-030F	2.65	4.0	0.3											
	280-030F	2.80	4.0	0.3											
GBA43%	300-030F	3.00	4.0	0.3											
	330-030F	3.30	4.0	0.3											
GBA43%	350-030F	3.50	5.0	0.3											
	400-040F	4.00	5.0	0.4											
GBA43%	430-040F	4.30	5.0	0.4											
	450-040F	4.50	5.0	0.4											
GBA43%	480-040F	4.80	5.0	0.4											

※1 : The edge width tolerance of GBA32% 033-005 : 0.50^{+0.25}_{-0.00}

Applicable JCT Toolholders

- 1: KGBAR ...16 JCT Type
- 2: KGBA^{R/L} ...22-15 JCT Type
- 3: KGBA^{R/L} ...22-25 JCT Type
- 4: KGBA^{R/L} ...22-35 JCT Type

For more details on cutting conditions, please see the KYOCERA General Product Catalog or GBA brochure

● : Standard Item R : Standard Item (Right-Hand Only) L : Standard Item (Left-Hand Only)

KGBA-JCT Applicable Inserts (Metric)

Molded Chipbreaker

Molded GM Chipbreaker	P Carbon Steel / Alloy Steel		●	○	●	●	○	○			
	M Stainless Steel				●	●	○	○			
	K Cast Iron				●						
	N Non-ferrous Material										
S Titanium Alloy											
H Hardened Material (~40HRC)				●							
Part Number	Dimensions (mm)			Cermet	MEGACOAT	MEGACOAT NANO	Applicable Toolholders				
	CW	CDX	RE	TN620	PR1215	PR1625					
	Edge Width (W)	Available Grooving Depth	Corner-R								
GBA43% 140-010GM	1.40	3.5	0.1	●	●		2				
	150-020GM	1.50	3.5	0.2	●	●					
175-020GM	1.75	3.5	0.2	●	●		3				
185-020GM	1.85	3.5	0.2	●	●	●					
200-020GM	2.00	3.5	0.2	●	●	●	4				
230-020GM	2.30	3.5	0.2	●	●						
250-030GM	2.50	5.0	0.3	●	●	●	3				
265-030GM	2.65	5.0	0.3	●	●						
300-030GM	3.00	5.0	0.3	●	●	●	4				
330-030GM	3.30	5.0	0.3	●	●						
350-030GM	3.50	5.0	0.3	●	●		2				
400-040GM	4.00	5.0	0.4	●	●	●					

Molded MY Chipbreaker	P Carbon Steel / Alloy Steel		○	●	○						
	M Stainless Steel				●	○					
	K Cast Iron				●						
	N Non-ferrous Material										
S Titanium Alloy											
H Hardened Material (~40HRC)				●	○						
Part Number	Dimensions (mm)			Cermet	MEGACOAT	PVD Coated Carbide	Applicable Toolholders				
	CW	CDX	RE	TN6020	PR1215	PR930					
	Edge Width (W)	Available Grooving Depth	Corner-R								
GBA43% 175-020MY	1.75	3.5	0.2	●	●	●	2				
	185-020MY	1.85	3.5	0.2	●	●					
200-020MY	2.00	3.5	0.2	●	●	●	3				
230-020MY	2.30	3.5	0.2	●	●	●					
250-030MY ※3	2.50	4.0	0.3	Ⓜ			4				
	2.50	5.0	0.3		●	●					
265-030MY ※3	2.65	4.0	0.3	●			3				
	2.65	5.0	0.3		●	Ⓜ					
300-030MY ※3	3.00	4.0	0.3	●		●	4				
	3.00	5.0	0.3		●	●					
330-030MY ※3	3.30	4.0	0.3	Ⓜ			2				
	3.30	5.0	0.3		●	Ⓜ					
350-030MY	3.50	5.0	0.3	●	●	●	4				
400-040MY	4.00	5.0	0.4	●	●	●					

※3 : Available grooving depth is different based on grade

Full-R

Full-R	P Carbon Steel / Alloy Steel		●	○	●	●	○	○					
	M Stainless Steel				●	●	○	○					
	K Cast Iron						●	○					
	N Non-ferrous Material												
S Titanium Alloy													
H Hardened Material (~40HRC)													
Part Number	Dimensions (mm)			MEGACOAT Cermet	Cermet	MEGACOAT NANO	PVD Coated Carbide	Carbide	Applicable Toolholders				
	CW	CDX	RE	PV7040	TN620	TN90	PR1625	PR1215	PR1115	PR905	PR930	KW10	
	Edge Width (W)	Available Grooving Depth	Corner-R										
GBA32R 200-100R	2.00	2.5	1.00				●	●	1				
	300-150R	3.00	2.5	1.50			●	●					
GBA43% 100-050R	1.00	2.0	0.50	●			●	●		Ⓜ		2	
	150-075R	1.50	3.5	0.75	●	Ⓜ	●	●		Ⓜ	Ⓜ		
	200-100R	2.00	3.5	1.00	●		●	●		●			
	250-125R	2.50	4.0	1.25			●	●					
	300-150R	3.00	4.0	1.50		●	●	●		●	●		
	400-200R	4.00	5.0	2.00				●					
GBA43% 100-050RF	1.00	2.0	0.50		●							2	
	150-075RF	1.50	3.5	0.75	●								
	200-100RF	2.00	3.5	1.00	●								
	250-125RF	2.50	4.0	1.25	●								
	300-150RF	3.00	4.0	1.50	●								
	400-200RF	4.00	5.0	2.00	Ⓜ								

GBA43% ...RF: Sharp Edge Type

CBN / PCD

1-Edge (CBN / PCD)	P Carbon Steel / Alloy Steel											
	M Stainless Steel											
	K Cast Iron											
	N Non-ferrous Material											
S Titanium Alloy												
H Hardened Material (~40HRC)												
Part Number	Dimensions (mm)			CBN				PCD		Applicable Toolholders		
	CW	CDX	RE	KBN510	KBN525	KPD001	KPD010					
	Edge Width (W)	Available Grooving Depth	Corner-R									
GBA32R 125-010	1.25	2.0	0.1					1				
	150-010	1.50	2.0	0.1								
GBA43% 125-010	1.25	2.0	0.1					2				
	125-020	1.25	2.0	0.2	Ⓜ	Ⓜ						
	150-010	1.50	3.5	0.1			●				●	
	150-020	1.50	3.5	0.2	●	Ⓜ						
	200-010	2.00	3.5	0.1			●				●	
	200-020	2.00	3.5	0.2	●	●						
300-010	2.50	4.0	0.1					3				
	300-010	3.00	4.0	0.1			●				●	
	300-020	3.00	4.0	0.2		Ⓜ						

Applicable JCT Toolholders

- 1: KGBAR ...16 JCT Type
- 2: KGBA %L ...22-15 JCT Type
- 3: KGBA %L ...22-25 JCT Type
- 4: KGBA %L ...22-35 JCT Type

For more details on cutting conditions, please see the KYOCERA General Product Catalog or GBA brochure

● : Standard Item Ⓜ : Standard Item (Right-Hand Only) Ⓛ : Standard Item (Left-Hand Only)

KGD-JCT

Grooving / Cut-Off

Coolant-Through Holders for External Grooving and Cut-Off

Coolant is Directed from the Rake Surface and the Flank Face of the Insert

Improved Chip Control and Longer Tool Life for External Grooving and Cut-off

Discharges Coolant in Two Directions

Discharges coolant in two directions toward both the rake surface and the flank face of the insert

Excellent Chip Control and Long Tool Life

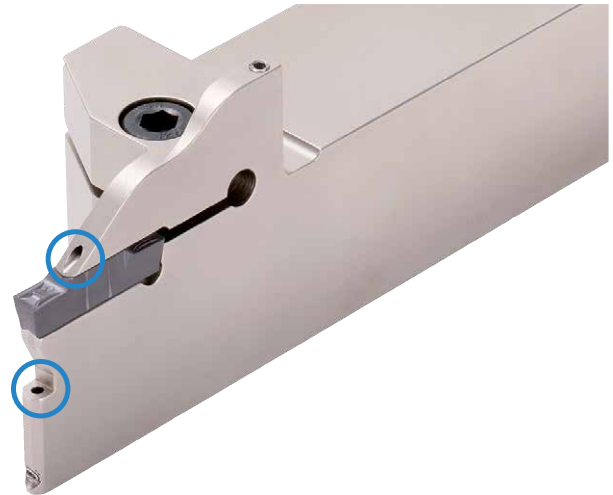

1 Superior Chip Control Performance

Coolant towards the rake face

Coolant hole position and angle improve chip control

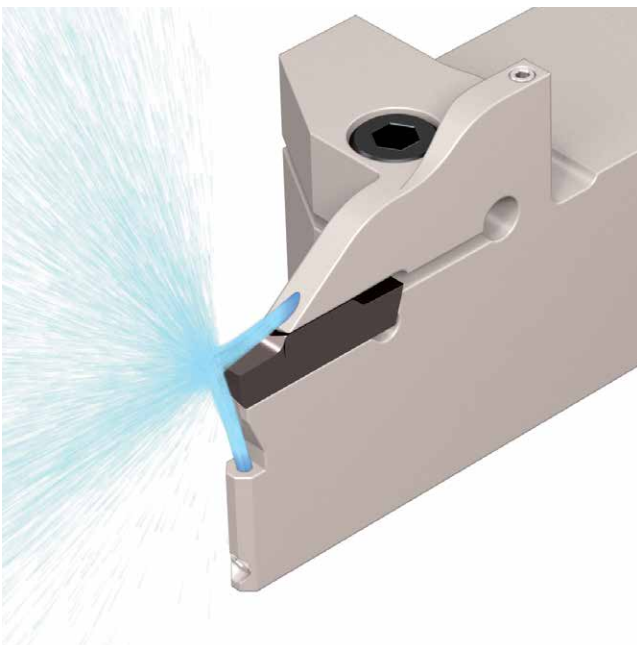

Chip Control Comparison (Internal Evaluation)

KGD-JCT showed better chip control performance even at lower feed rates
 $f = 0.002$ ipr (218 psi)



Cutting Conditions: $V_c = 490$ sfm, $f = 0.002$ ipr, $d = 0.315$ " Wet
Edge Width 4 mm (0.157") Workpiece: 4131 Grooving

2 Keeping the Cutting Edge Cool Leads to Longer Tool Life

Coolant towards the rake surface and the flank face of the insert
Directing coolant towards the cutting edge lengthens tool life

KGD-JCT

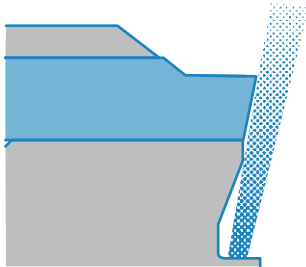

After Machining 39 min



Competitor E

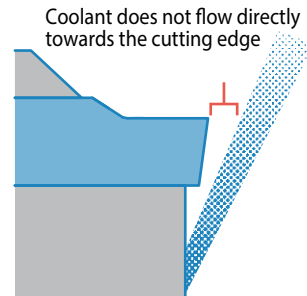

Defect

Wear Resistance Comparison (Internal Evaluation)

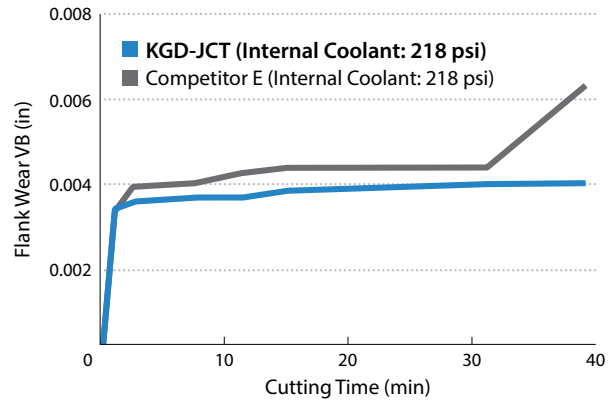

Cutting Conditions: $V_c = 590$ sfm, $f = 0.006$ ipr, $d = 0.354$ ", Wet
Edge Width 0.158" Workpiece: 4131 Grooving

KGD-JCT Minimizes Wear and Provides Longer Tool Life without Insert Fracturing

3 Large Chipbreaker Lineup for Various Machining Applications

Application Maps

External Grooving and Traversing

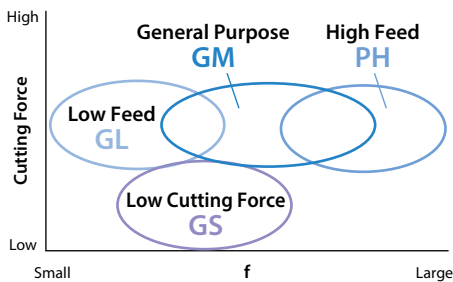

Cut-Off

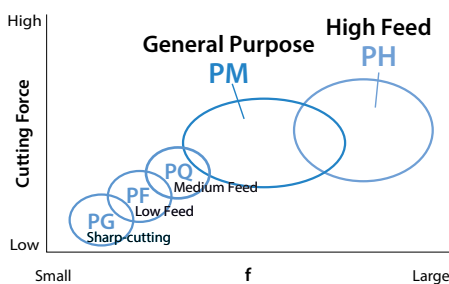

Chipbreaker Selection (External)

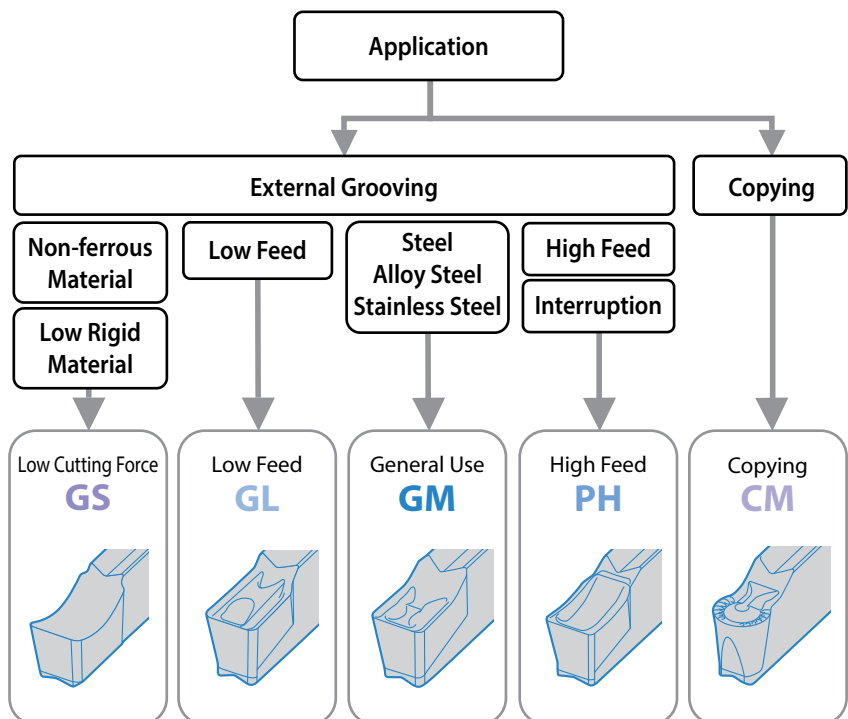

KGD-JCT for Small Parts

NEW

Small Diameter Grooving / Cut-Off

Coolant-Through Cut-Off Holders for Small Parts Machining

KGD-JCT Cut-Off Holder Lineup Expansion
Improved Tool Life Lowers Machining Costs

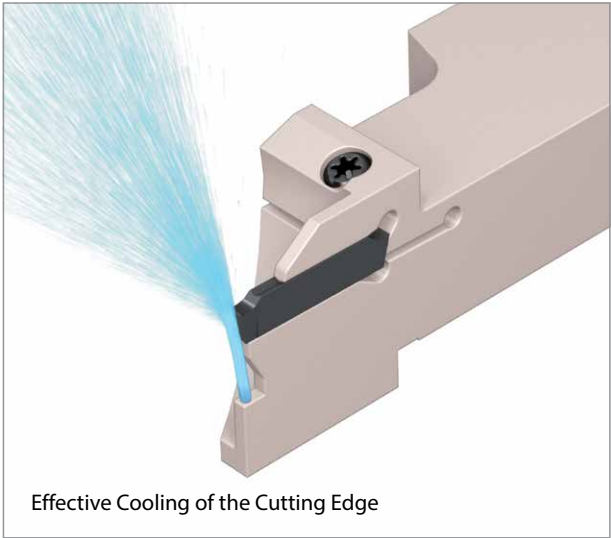

1 Optimized Coolant Hole Position

2 Discharges Coolant towards the Flank Face of the Insert

Wear Resistance Comparison
(Internal Evaluation)

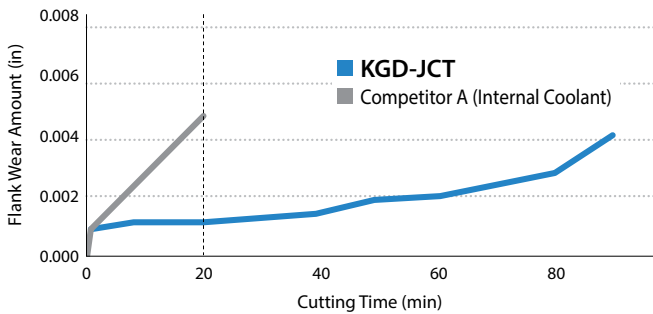

Cutting Conditions : Vc = 260 sfm, f=0.0024 ipr (at-Ø 0.079" : f = 0.0007 ipr), KGDR1625H-2JCT, GDM2020N-015PF PR1535 (Insert Width : 0.079") Workpiece : 304 (Ø0.984") Internal Coolant(218 psi) Cut-off

Coolant Discharge

KGD-JCT
Sufficient cooling towards the cutting edge

Competitor A
Coolant does not flow directly towards the cutting edge

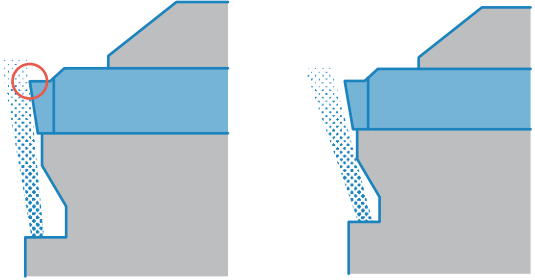

Cutting Edge (After Machining 20 min)



High density and high speeds coolant provides effective cooling of the cutting edge
Superior cooling action improves tool life

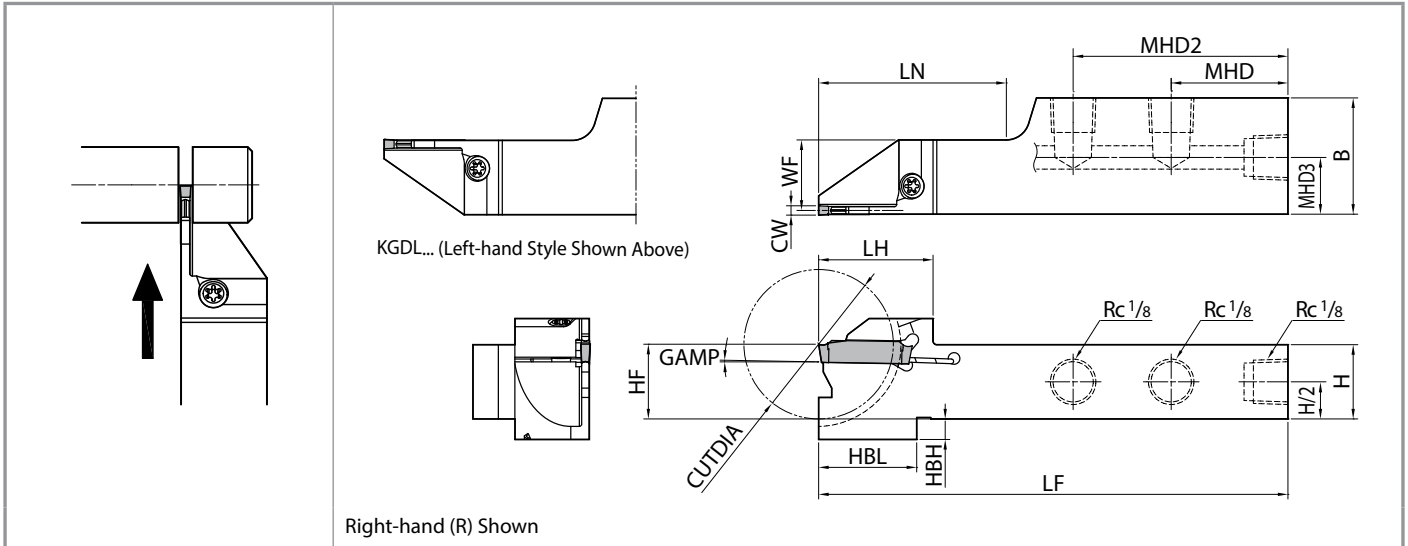

Toolholder Dimensions (Metric Size)

Part Number	Stock	Cut-Off Dia.	Dimensions (mm)											Angle	Edge Width CW (mm)		Spare Parts			Applicable Inserts Page 22
			CUTDIA	H=HF	HBH	B	LF	LH	HBL	LN	WF	MHD	MHD2		MHD3	GAMP	MIN	MAX	Clamp Screw	
KGDR 1220H-2JCT	●	24	12	8.5	20	100	19.5	21	44	11.2	35	-	8.4	1°	2.0	3.0				
KGDL 1220H-2JCT	●							21.5				7.7								
KGDR 1625H-2JCT	●	32	16	4.5	25	100	24.5	21	40	15.2	25	46	12.2	1°	2.4	3.0	SB-40120TR	LTW-15S	GP-1	GDM Type GDG Type (GDMS Type) (GDGS Type)
KGDL 1625H-2JCT	●							21				7.7								
KGDR 1220H-2.4JCT	●	24	12	8.5	20	100	19.5	21	44	11	35	-	8.4	1°	2.4	3.0				
KGDL 1220H-2.4JCT	●							21.5				7.7								
KGDR 1625H-2.4JCT	●	32	16	4.5	25	100	24.5	21	40	15	25	46	12.2	1°	3.0	4.0				
KGDL 1625H-2.4JCT	●							21				7.7								
KGDR 1220H-3JCT	●	24	12	8.5	20	100	19.5	21	44	10.8	35	-	8.6	1°	3.0	4.0				
KGDL 1220H-3JCT	●							21.5				7.7								
KGDR 1625H-3JCT	●	32	16	4.5	25	100	24.5	21	40	14.8	25	46	12.2	1°	3.0	4.0				
KGDL 1625H-3JCT	●							21				7.7								

Choose an insert with a width that falls within the MIN and MAX parameters shown in table above.
Applicable Inserts See [Page 22](#)

● : Standard Item



KGD-JCT (External Grooving / Cut-Off)

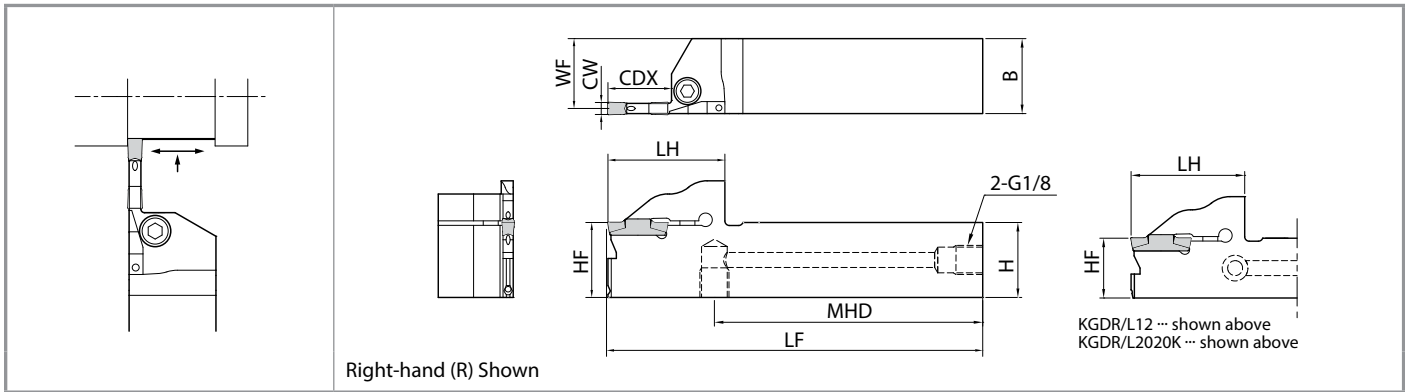

Toolholder Dimensions (Inch Size)

Pressure Resistance: up to 2,175 psi

Groove Width (in)	Max Grooving Depth (in)	Part Number	Stock		Dimensions (in)							Edge Width CW (mm)		Spare Parts		
			R	L	H=HF	B	LF	LH	WF	CDX	MHD	MIN	MAX	Clamp Screw	Wrench	Plug
0.118 (3mm)	0.787 (20mm)	KGD [®] L 12-3T20JCT	●	●	0.750	0.750	5.000	1.496	0.702	0.787 (20mm)	3.590	0.118 (3mm)	0.157 (4mm)	HH5X16	LW-4	HSG1/8X8.0
		16-3T20JCT	●	●	1.000	1.000	5.000	1.535	0.952		3.551			HH5X25	LW-4	HSG1/8X8.0
0.157 (4mm)	0.787 (20mm)	KGD [®] L 12-4T20JCT	●		0.750	0.750	5.000	1.496	0.683	0.787 (20mm)	3.590	0.157 (4mm)	0.197 (5mm)	HH5X16	LW-4	HSG1/8X8.0
		16-4T20JCT	●	●	1.000	1.000	5.000	1.535	0.933		3.551			HH5X25	LW-4	HSG1/8X8.0
	1.000 (25.4mm)	KGD [®] L 16-4T25.4JCT	●	●	1.000	1.000	5.000	1.732	0.933	1.000 (25.4mm)	3.354			HH5X25	LW-4	HSG1/8X8.0

Choose an insert with a width that falls within the MIN and MAX parameters shown in table above.
Applicable Inserts See [Page 22](#)

● : Standard Item

KGD-JCT (External Grooving / Cut-Off)

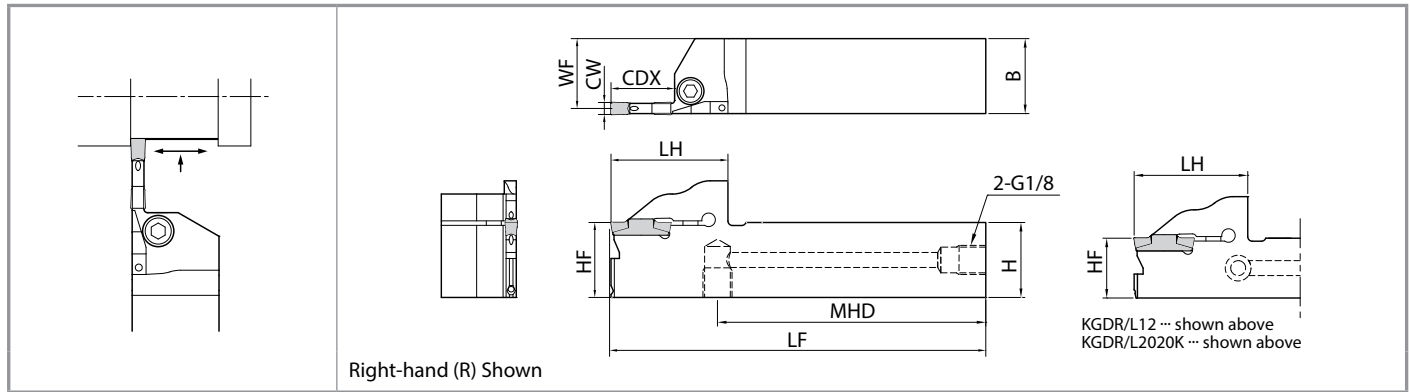

Toolholder Dimensions (Metric Size)

Pressure Resistance: up to 2,175 psi

Groove Width (mm)	Max Grooving Depth (mm)	Part Number	Stock		Dimensions (mm)							Edge Width CW (mm)		Spare Parts		
			R	L	H=HF	B	LF	LH	WF	CDX	MHD	MIN	MAX	Clamp Screw	Wrench	Plug
3	6	KGD % 2020K-3T06JCT	●	●	20	20	125	31.5	18.8	6	96.2	3.0	4.0	HH5X16	LW-4	HSG1/8X8.0
		2525K-3T06JCT	●	●	25	25			23.8					96.5		
	10	KGD % 2020K-3T10JCT	●	●	20	20		34.0	18.8	10	94.2			HH5X16		
		2525K-3T10JCT	●	●	25	25			23.8					94.5		
	20	KGD % 2020K-3T20JCT	●	●	20	20		38.0	18.8	20	90.2			HH5X16		
		2525K-3T20JCT	●	●	25	25			23.8					89.5		
4	10	KGD % 2020K-4T10JCT	●	●	20	20	125	34.0	18.3	10	94.2	4.0	5.0	HH5X16	LW-4	HSG1/8X8.0
		2525K-4T10JCT	●	●	25	25			23.3					94.5		
	20	KGD % 2020K-4T20JCT	●	●	20	20		38.0	18.3	20	90.2			HH5X16		
		2525K-4T20JCT	●	●	25	25			23.3					89.5		
	25	KGD % 2525K-4T25JCT	●	●	25	25		44.0	23.3	25	84.5			HH5X25		

Choose an insert with a width that falls within the MIN and MAX parameters shown in table above.
Applicable Inserts See [Page 22](#)

● : Standard Item

Case Studies

Ring - 5120 (Equivalent)

Vc = 525 sfm
(n = 3,200 rpm)
D.O.C. = 0.098"
f = 0.0028 ipr
Wet (Water Soluble), Normal Pressure
KGDR2020K-3T10JCT
GDM3020M-025PM PR1225

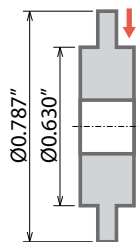

Tool Life

KGD-JCT
(Internal Coolant) **9,000 pcs / edge**

Tool Life
x1.5

Competitor H
(External Coolant) **6,000 pcs / edge**

Change to KGD-JCT (internal coolant) from Competitor H (external coolant) extended tool life by 1.5 times.

(User Evaluation)

Valve - Free Cutting Steel

Vc = 525 sfm
D.O.C. = 0.551"
f = 0.0047-0.0059 ipr
Wet (Water Soluble), Normal Pressure
KGDR2525K-3T20JCT
GDM3020M-040GM PR1535

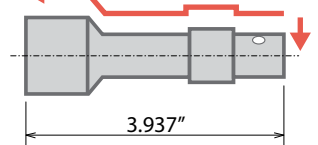

Tool Life

KGD-JCT
(Internal Coolant) **1,000 pcs / edge**

Chip Control
Surface Finish
Good Good

Competitor I
(Internal Coolant) **1,000 pcs / edge**

KGD-JCT maintained stable machining for the required number of pieces
Better chip control and surface finish

(User Evaluation)

KGD-JCT Applicable Inserts

External Grooving / Turning

Usage Classification		P	Carbon Steel / Alloy Steel		●	○	●	○	●	○		
		M	Stainless Steel				●	○	●	○		
		K	Cast Iron				●	○	●	○		
		N	Non-ferrous Material							●		
		S	Titanium Alloy				●			○		
		H	Hardened Material (~40HRC)					○				
			Hardened Material (40HRC~)									
Shape	Part Number	Dimensions (in)			RE	Cermet	MEGA COAT NANO	MEGACOAT	Carbide			
		Edge Width CW										
		inch	mm	Tolerance		TN620	TN90	PR1535	PR1225	PR1215	GW15	
External Grooving & Traversing	General Purpose	GDM 2420N-020GM	0.094	2.4	±0.0012	0.008	●	●	●	●	●	
		3020N-020GM	0.118	3		0.008	●	●	●	●	●	
		3020N-040GM				0.016	●	●	●	●	●	
		4020N-020GM	0.157	4		0.008	●	●	●	●	●	
		4020N-040GM				0.016	●	●	●	●	●	
		4020N-080GM				0.031	●	●	●	●	●	
	5020N-040GM	0.197	5	0.016	●	●	●	●	●			
	5020N-080GM			0.031	●	●	●	●	●			
	General Purpose 1-Edge	GDMs 2220N-020GM	0.087	2.2	±0.0012	0.008	●	●	●	●	●	
		3020N-040GM	0.118	3		0.016	●	●	●	●	●	
4020N-040GM		0.157	4	0.016		●	●	●	●	●		
5020N-080GM		0.197	5	0.031		●	●	●	●	●		
Low Feed	GDM 2420N-020GL	0.094	2.4	±0.0012	0.008	●	●	●	●	●		
	3020N-020GL	0.118	3		0.008	●	●	●	●	●		
	3020N-040GL	0.157	4		0.016	●	●	●	●	●		
	4020N-020GL				0.008	●	●	●	●	●		
	4020N-040GL	0.016	●		●	●	●	●	●			
5020N-040GL	0.197	5	0.016	●	●	●	●	●				
Grooving	Wiper Edge	GDG 2520N-020GS	0.098	2.5	±0.0008	0.008	●	●	●	●	●	
		3020N-020GS	0.118	3		0.008	●	●	●	●	●	
		3520N-020GS	0.138	3.5		0.008	●	●	●	●	●	
		4020N-040GS	0.157	4		0.016	●	●	●	●	●	
		5020N-040GS	0.197	5		0.016	●	●	●	●	●	
Full-R / Copying	1-Edge	GDM 3020N-150R-CM	0.118	3	±0.0012	0.059	●	●	●	●	●	
		4020N-200R-CM	0.157	4		0.079	●	●	●	●	●	
		5020N-250R-CM	0.197	5		0.098	●	●	●	●	●	
Grooving & Cut-Off (High Feed)	1-Edge	GDM 2020N-020PH	0.079	2	±0.0012	0.008		●	●	●	●	
		3020N-030PH	0.118	3		0.012		●	●	●	●	
		4020N-030PH	0.157	4			●	●	●	●	●	
		GDMS 2020N-020PH	0.079	2		0.008		●	●	●	●	
		3020N-030PH	0.118	3		0.012		●	●	●	●	
4020N-030PH	0.157	4		●	●	●	●	●				

Inserts sold in 10 piece boxes

CBN / PCD

Usage Classification		N	Non-ferrous Material				●		
		S	Titanium Alloy				●		
		H	Hardened Material (~40HRC)						
			Hardened Material (40HRC~)		●				
		-	Powdered Steel			●			
Shape	Part Number	Dimensions (in)			RE	MEGA COAT CBN	CBN	PCD	
		Edge Width CW							
		inch	mm	Tolerance		KBN05M	KBN570	KPD001	
Grooving	1-Edge	GDGS 2020N-020NB	0.079	2	±0.0012	0.008	●	●	●
		3020N-020NB	0.118	3		0.008			●
		3020N-040NB				0.016	●	●	
		4020N-020NB	0.157	4		0.008			●
		4020N-040NB				0.016	●	●	
		5020N-020NB				0.008			●
5020N-040NB	0.197	5	0.008			●			
5020N-040NB			0.016	●	●				

CBN and PCD inserts sold in 1 piece boxes

Cut-Off

Usage Classification		P	Carbon Steel / Alloy Steel		○	●	○			
		M	Stainless Steel			●	○	○		
		N	Non-ferrous Material					●	○	
Shape	Part Number	Dimensions (in)			RE	MEGA COAT NANO	MEGACOAT	DLC Coated Carbide	Carbide	
		Edge Width CW								
		inch	mm	Tolerance		PR1535	PR1225	PR1215	PDL025	GW15
Cut-Off	General Purpose	GDM 2020N-020PM	0.079	2	±0.0012	0.008	●	●	●	
		2520N-020PM	0.098	2.5		0.008	●	●	●	
		3020N-025PM	0.118	3		0.010	●	●	●	
		4020N-030PM	0.157	4		0.012	●	●	●	
	6° Lead Angle	GDM 2020R-020PM-6D	0.079	2	±0.0012	0.008	●	●	●	
		2520R-020PM-6D	0.098	2.5		0.008	●	●	●	
		3020R-025PM-6D	0.118	3		0.010	●	●	●	
	1-Edge	GDMS 2020N-020PM	0.079	2	±0.0012	0.008	●	●	●	
		3020N-025PM	0.118	3		0.010	●	●	●	
	6° Lead Angle 1-Edge	4020N-030PM	0.157	4	0.012	●	●	●		
GDMs 2020R-020PM-6D		0.079	2	±0.0012	0.008	●	●	●		
3020R-025PM-6D	0.118	3	0.010		●	●	●			
4020R-030PM-6D	0.157	4	0.012	●	●	●				
Cut-Off (Low Feed)	1-Edge	GDM 2020N-003PF	0.079	2	±0.0016	0.001	●	●		
		2020N-015PF	0.098	2.5		0.006	●	●	●	
		2520N-003PF				0.001	●	●		
		2520N-015PF	0.006	●		●	●			
		3020N-003PF	0.001	●		●				
3020N-015PF	0.006	●	●	●						
15° Lead Angle	1-Edge	GDM 2020 ^{R/L} -003PF-15D	0.079	2	±0.0016	0.001	●	●		
		2020R-015PF-15D	0.098	2.5		0.006	●	●	●	
		2520R-015PF-15D				0.001	●	●		
		3020 ^{R/L} -003PF-15D	0.001	●		●				
3020R-015PF-15D	0.006	●	●	●						
Cut-Off (Medium Feed)	1-Edge	GDM 2020N-010PQ	0.079	2	±0.0012	0.004	●	●		
		2520N-010PQ	0.098	2.5		0.004	●	●		
		3020N-010PQ	0.118	3			●	●		
15° Lead Angle	1-Edge	GDM 2020R-010PQ-15D	0.079	2	±0.0012	0.004	●	●		
		2520R-010PQ-15D	0.098	2.5		0.004	●	●		
		3020R-010PQ-15D	0.118	3			●	●		
Cut-Off (Low Cutting Force)	1-Edge	GDG 2020N-005PG	0.079	2	±0.0008	0.002	●	●	●	●
		2520N-005PG	0.098	2.5		0.002	●	●	●	●
		3020N-005PG	0.118	3			●	●	●	●
		GDG 2020R-005PG-15D	0.079	2		±0.0008	0.002	●	●	●
2520R-005PG-15D	0.098	2.5	0.002	●	●		●	●		
3020R-005PG-15D	0.118	3		●	●	●	●			

Inserts sold in 10 piece boxes

● : Standard Item

KTN-JCT

Coolant-Through Holders for Threading

Double Coolant Holes Reduce Defects and Lengthen Tool Life

Threading



1 Improved Tool Life Lowers Machining Costs

Coolant flows from the top of the clamp and provides efficient cooling of the cutting edge to prevent wear

Wear Resistance Comparison of Internal vs. External Coolant (Internal Evaluation)

Radial Infeed

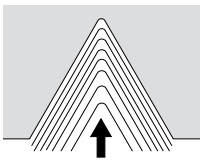

Cutting Conditions: $V_c = 490$ sfm
16ER150ISO-TQ (PR1215)
Workpiece: 4137

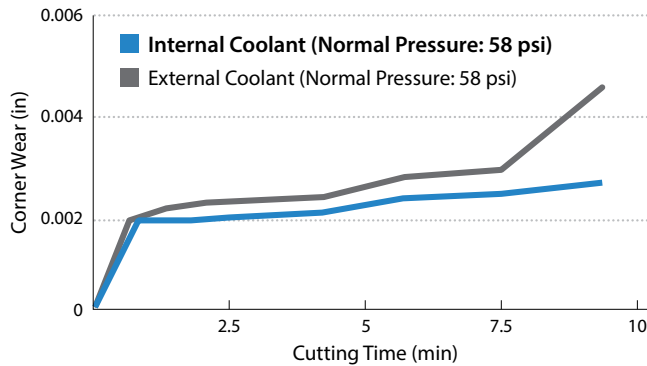

Internal Coolant (Normal Pressure: 0.4MPa)

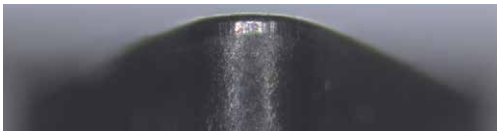

External Coolant (Normal Pressure: 0.4MPa)



Switching to the KTN-JCT with internal coolant lengthens tool life

Wear Resistance Comparison at Different Pressures (Internal Evaluation)

Radial Infeed

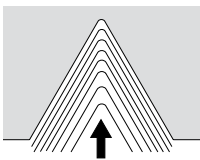

Cutting Conditions: $V_c = 490$ sfm
16ER150ISO-TQ (PR1215)
Workpiece: 4137

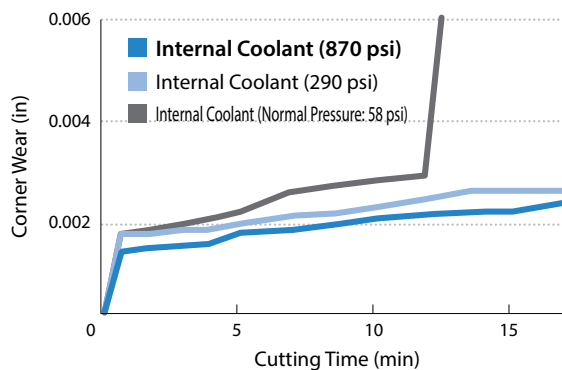

The higher the coolant pressure, the more efficient the wear resistance will be

2 Prevents Chip Recutting

Coolant from the flank face of the insert smoothly evacuates chips away from the cutting edge and reduces chip clogging

* Coolant from the flank face does not flow directly to the cutting edge.

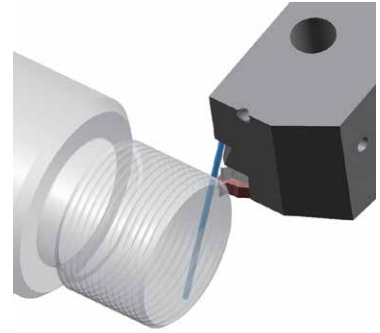

Chip Evacuation Comparison (Internal Evaluation)

Cutting Conditions: $V_c = 490$ sfm 16ER150ISO Type (PR1215) Workpiece: 4137, Radial Infeed

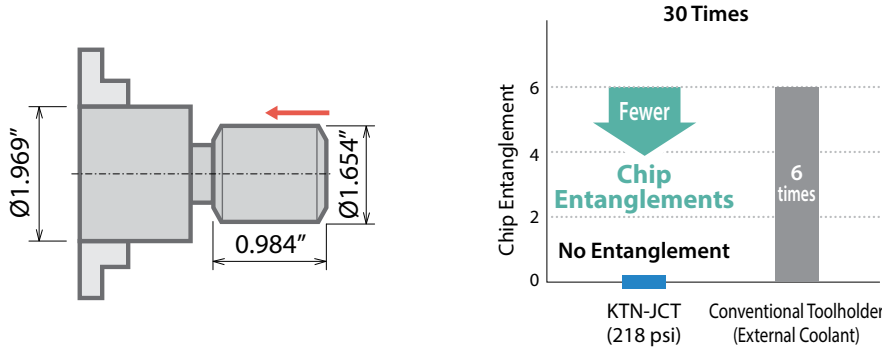

(Chip Entanglement Example)



KTN-JCT prevents chip entanglement by directing the chips downward

Internal Coolant Advantages (Reference)

Tool life is increased using internal coolant

Items	Workpiece	Advantages to Internal Coolant
Tool Life	Steel	Better Wear Resistance
	Stainless Steel	Lower Cutting Resistance
Chip Evacuation	Steel	Prevents chip entanglement with 218 psi or higher
Chip Control	Steel	Breaks chips with 870 psi or higher
	Stainless Steel	

* To prevent chip entanglement, 218 psi or higher is recommended. (Steel)

* For chip breaking, high pressure coolant is recommended. (870 psi or higher for Steel and Stainless Steel)

Case Studies

Arbor Bolt Free Cutting Steel

$n = 2,700$ rpm ($V_c = 480$ sfm)
Number of pass: 7, Radial Infeed, Wet (Water Soluble)
KTNR2020K-16-JCT, 16ER150ISO Type

Tool Life (1,250 pcs/edge)

KTN-JCT Toolholder (Internal Coolant: Normal Pressure)

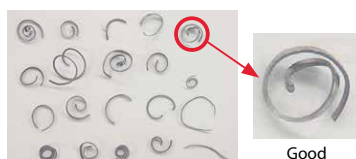

Competitor Toolholder J (External Coolant: Normal Pressure)

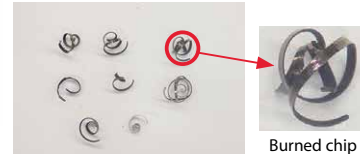

KTN-JCT could extend tool life with less wear than competitors. Also improved chip control and reduced fracturing.

(User Evaluation)

KTN-JCT (Threading)

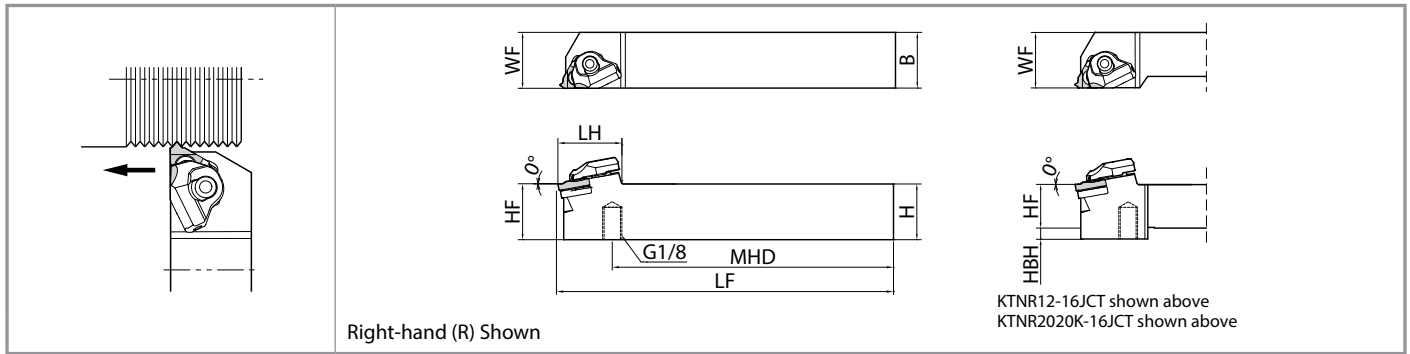

Toolholder Dimensions

Pressure Resistance: up to 2,175 psi

Part Number	Stock	Unit	Dimensions							Spare Parts					Applicable Inserts Page 26-27
			H=HF	HBH	B	WF	LF	LH	MHD	Clamp Set	Pipe Connection (*1 with O-Ring)	Wrench	Shim	Shim Screw	
KTNR 12-16JCT	●	in	0.750	0.234	0.750	0.875	5.000	1.122	4.042	CPS-5S-R-JCT	FP-12	FT-15	TN-32	SP3X8	16ER...
16-16JCT	●		1.000	-	1.000	1.000	6.000	1.122	5.042	CPS-5S-R-JCT	FP-12	FT-15	TN-32	SP3X8	16ER...
KTNR 2020K-16JCT	●	mm	20	5	20	25	125	33.3	100.7	CPS-5S-R-JCT	FP-12	FT-15	TN-32	SP3X8	16ER...
2525M-16JCT	●		25	-	25	25	150	-	125.7						

*1. O-ring (SS-035) is available to order separately
See **Page 2** for piping parts

● : Standard Item

TQ Chipbreaker

Molded Threading Chipbreaker

Improved Chip Control with Molded Chipbreaker
Combination with KTN-JCT for Greater Productivity

Stable Chip Control

Stable Chip Control with Asymmetric Chipbreaker Design

Chipbreaker Geometry

Stable chip control regardless of cutting direction

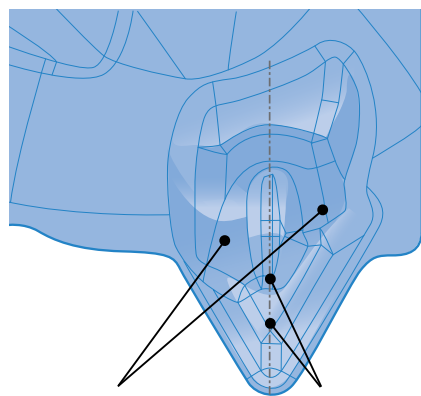

For Radial Infeed
Asymmetric dot design
controls chip-flow
direction

For Flank Infeed / Flank Compound Infeed
Breaks chips easily with
shallow breaker depth

Cutting Force Comparison (Internal Evaluation)

Radial Infeed

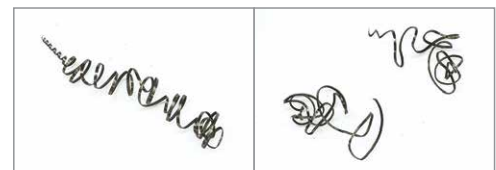
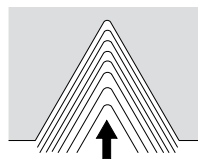

TQ Chipbreaker

Competitor K

Flank Compound Infeed

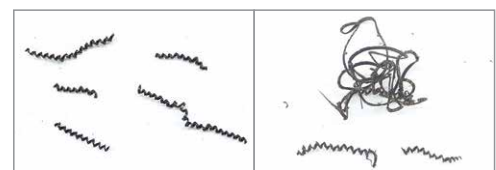
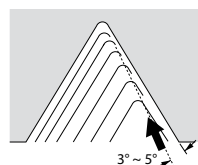

TQ Chipbreaker

Competitor K

Cutting Conditions: $V_c = 490$ sfm, D.O.C. = 0.005" (4th Pass), $L = 0.984$ " Wet, 16ER150ISO Insert
M45 x P1.5 Workpiece: 4131

Full Profile

Metric (M) 60° Full Profile

Usage Classification	P	Carbon Steel / Alloy Steel		●								
	M	Stainless Steel			●	○						
	K	Cast Iron								●		
● : 1st Choice		N	Non-ferrous Material							●		
○ : 2nd Choice												
Part Number	Applicable Thread	Pitch		Cermet	MEGACOAT / MEGACOAT NANO				PVD Coated Carbide		Carbide	
		mm	TPI		TC60	PR1215	PR1515	PR1535	PR1115	L		R
16ER	100ISO-TF	1.00								●		
	125ISO-TF	1.25								●		
	150ISO-TF	1.50								●		
	175ISO-TF	1.75								●		
	200ISO-TF	2.00								●		
	250ISO-TF	2.50								●		
	300ISO-TF	3.00								●		
16E%	050ISO	0.50								●	●	
	075ISO	0.75								●	●	
	100ISO	1.00								●	●	
	125ISO	1.25								●	●	
	150ISO	1.50								●	●	
	200ISO	2.00								●	●	
	250ISO	2.50								●	●	
16ER	100ISO-TQ	1.00			●	●	●					
	125ISO-TQ	1.25			●	●	●					
	150ISO-TQ	1.50			●	●	●					
	200ISO-TQ	2.00			●	●	●					

Unified (UN) 60° Full Profile

Usage Classification	P	Carbon Steel / Alloy Steel		●								
	M	Stainless Steel			●	○						
	K	Cast Iron								●		
● : 1st Choice		N	Non-ferrous Material							●		
○ : 2nd Choice												
Part Number	Applicable Thread	Pitch		Cermet	MEGACOAT / MEGACOAT NANO				PVD Coated Carbide		Carbide	
		mm	TPI		TC60	PR1215	PR1515	PR1535	PR1115	L		R
16ER	24UN-TF		24							●		
	20UN-TF		20							●		
	18UN-TF		18							●		
	16UN-TF		16							●		
	14UN-TF		14							●		
	13UN-TF		13							●		
	12UN-TF		12							●		
	10UN-TF		10							●		
	08UN-TF		8							●		
16ER	16UN		16	●								
16ER	24UN-TQ		24		●	●	●					
	20UN-TQ		20		●	●	●					
	18UN-TQ		18		●	●	●					
	16UN-TQ		16		●	●	●					
	14UN-TQ		14		●	●	●					
	13UN-TQ		13		●	●	●					
	12UN-TQ		12		●	●	●					
	10UN-TQ		10		●	●	●					
	08UN-TQ		8		●	●	●					

Parallel Pipe [G(PF)] Whitworth (W) 55° Full Profile

Usage Classification	P	Carbon Steel / Alloy Steel		●								
	M	Stainless Steel			●	○						
	K	Cast Iron								●		
● : 1st Choice		N	Non-ferrous Material							●		
○ : 2nd Choice												
Part Number	Applicable Thread	Pitch		Cermet	MEGACOAT / MEGACOAT NANO				PVD Coated Carbide		Carbide	
		G(PF)	W		TC60	PR1215	PR1515	PR1535	PR1115	L		R
16ER	19W-TF	19	-							●		
	16W-TF	-	16							●		
	14W-TF	14	14							●		
	11W-TF	11	11							●		
16ER	19W-TQ	19	-		●	●	●					
	14W-TQ	14	14		●	●	●					
	11W-TQ	11	11		●	●	●					

Tapered Pipe [R(PT), (BSPT)] 55° Full Profile

Usage Classification	P	Carbon Steel / Alloy Steel		●								
	M	Stainless Steel			●	○						
	K	Cast Iron								●		
● : 1st Choice		N	Non-ferrous Material							●		
○ : 2nd Choice												
Part Number	Applicable Thread	Pitch		Cermet	MEGACOAT / MEGACOAT NANO				PVD Coated Carbide		Carbide	
		mm	TPI		TC60	PR1215	PR1515	PR1535	PR1115	L		R
16ER	28BSPT-TF		28							●		
	19BSPT-TF		19							●		
	14BSPT-TF		14							●		
	11BSPT-TF		11							●		
16ER	28BSPT		28								●	
	19BSPT		19								●	
	14BSPT		14								●	
	11BSPT		11								●	
16ER	19BSPT-TQ		19		●	●	●					
	14BSPT-TQ		14		●	●	●					
	11BSPT-TQ		11		●	●	●					

American National Tapered Pipe (NPT) 60° Full Profile

Usage Classification	P	Carbon Steel / Alloy Steel		●								
	M	Stainless Steel			●	○						
	K	Cast Iron								●		
● : 1st Choice		N	Non-ferrous Material							●		
○ : 2nd Choice												
Part Number	Applicable Thread	Pitch		Cermet	MEGACOAT / MEGACOAT NANO				PVD Coated Carbide		Carbide	
		mm	TPI		TC60	PR1215	PR1515	PR1535	PR1115	L		R
16ER	19W-TF	19	-							●		
	16W-TF	-	16							●		
	11W-TF	11	11							●		

TC60 (Threading) are sold in 10 piece boxes.
Others are sold in 5 piece boxes.

16ER -TQ: With Chipbreaker
-TF: Without Chipbreaker
(TF Cutting Edge)
No Indication: Without Chipbreaker

● : Standard Item

Partial Profile

Metric (M), Unified (UN)
60° Partial Profile

Usage Classification	P	Carbon Steel / Alloy Steel		●					
	M	Stainless Steel			●	○			
	K	Cast Iron							●
○: 2nd Choice	N	Non-ferrous Material							●
Part Number	Applicable Thread	Pitch		Cermet	MEGACOAT / MEGACOAT NANO			PVD Coated Carbide	Carbide
		mm	TPI		TC60	PR1215	PR1515		
				R	R	R	R	R	R
16ER A60-TF G60-TF AG60-TF	M	0.5 ~ 1.5	48 ~ 16					●	
		1.75 ~ 3	14 ~ 8					●	
		0.5 ~ 3	48 ~ 8					●	
16ER A60 G60 AG60	UN	0.5 ~ 1.5	48 ~ 16						●
		1.75 ~ 3	14 ~ 8						●
		0.5 ~ 3	48 ~ 8						●
16ER A60-TQ G60-TQ AG60-TQ	UNF	0.5 ~ 1.5	48 ~ 16		●	●	●		
		1.75 ~ 3	14 ~ 8		●	●	●		
		0.5 ~ 3	48 ~ 8		●	●	●		

30° Trapezoidal (Tr)
30° Partial Profile

Usage Classification	P	Carbon Steel / Alloy Steel							●
	M	Stainless Steel							●
	K	Cast Iron							
○: 2nd Choice	N	Non-ferrous Material							
Part Number	Applicable Thread	Pitch		Cermet	MEGACOAT / MEGACOAT NANO			PVD Coated Carbide	Carbide
		mm	TPI		TC60	PR1215	PR1515		
				R	R	R	R	R	R
16ER 200TR 300TR	Tr	2	-						●
		3	-						●

Parallel Pipe [G(PF)], Tapered Pipe [R(PT)], (BSPT)],
Whitworth (W) 55° Partial Profile

Usage Classification	P	Carbon Steel / Alloy Steel		●						
	M	Stainless Steel			●	○				
	K	Cast Iron							●	
○: 2nd Choice	N	Non-ferrous Material							●	
Part Number	Applicable Thread	Pitch		Cermet	MEGACOAT / MEGACOAT NANO			PVD Coated Carbide	Carbide	
		G(PF) R(PT)	W		TC60	PR1215	PR1515			PR1535
				R	R	R	R	R	R	R
		TPI								
16ER A55-TF G55-TF AG55-TF	G(PF) R(PT)	28, 19	40 ~ 16						●	
		14, 11	14 ~ 8						●	
		28 ~ 11	40 ~ 8						●	
16ER A55 G55 AG55	W	28, 19	40 ~ 16						●	
		14, 11	14 ~ 8						●	
		28 ~ 11	40 ~ 8						●	

TC60 (Threading) are sold in 10 piece boxes.
Others are sold in 5 piece boxes.

16ER -TQ: With Chipbreaker
 -TF: Without Chipbreaker
 (TF Cutting Edge)
 No Indication: Without Chipbreaker

● : Standard Item



JCT Series for Small Parts

Coolant-Through Holders for Small Parts Machining

Capable of Pressure up to 2,900 psi and Improves Chip Control Performance
Large Holder Lineup for Turning, External Grooving and Cut-off

NEW *New Inch Size Holders Now Available!*

Turning Screw-Clamp-JCT

➔ Page 32



External Grooving KGBF-JCT

➔ Page 36



Cut-Off KTKF-JCT

➔ Page 40



Grooving / Cut-Off KGD-JCT

➔ Page 18

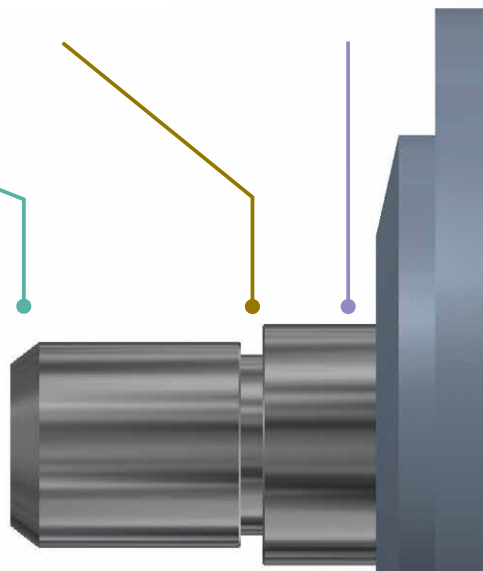

Small Parts Holder Identification System

Note: JCT-Series holders for small parts machining have rectangle shanks

See below for part number identification examples

A : Back Clamp C : Top Clamp P : Level Lock S : Screw Clamp	C : 80° Rhombic D : 55° Rhombic S : 90° Square T : 60° Triangle V : 35° Rhombic	R : Right-Hand L : Left-Hand N : Neutral	Square Shank: This number will represent the number of sixteenths of width and height. Ex. 6/16 = 3/8" Square	Rectangle Shank: the first digit represents the number of eighths of width and the second digit the number of quarters of height. Ex. Width = 6/8 = 3/4" Height = 2/4 = 1/2"	Number of 1/8ths on 1/4" IC and over.	Optional Codes Manufacturer Options (FF : Without Offset) (JCT : Jet Coolant-Through Series)					
Clamping System	Insert Shape	Hand of Tool	Shank Size	Insert Size IC	Others						
ANSI (inch)	S	C	L	C	R	62	3	FF	JCT		
ISO (metric)	S	C	L	C	R	12	20	H	09	FF	JCT
Cutting Edge System					Insert Relief Angle	Shank Height	Shank Width	Toolholder Length	Insert Size		
A 90°	B 75°	D 45°	F 90°	G 90°		Shank Height (mm)	Shank Width (mm)				
J 93°	K 75°	L 95°	N 63°	P 117.5°	B : 5° Positive C : 7° Positive N : 0° Negative P : 11° Positive			F : 80mm (85mm) H : 100mm	JX : 4.750" 120mm K : 125mm M : 150		
S 45°	T 60°	V 72.5°									

• Some back turning toolholders have Kyocera's unique descriptions

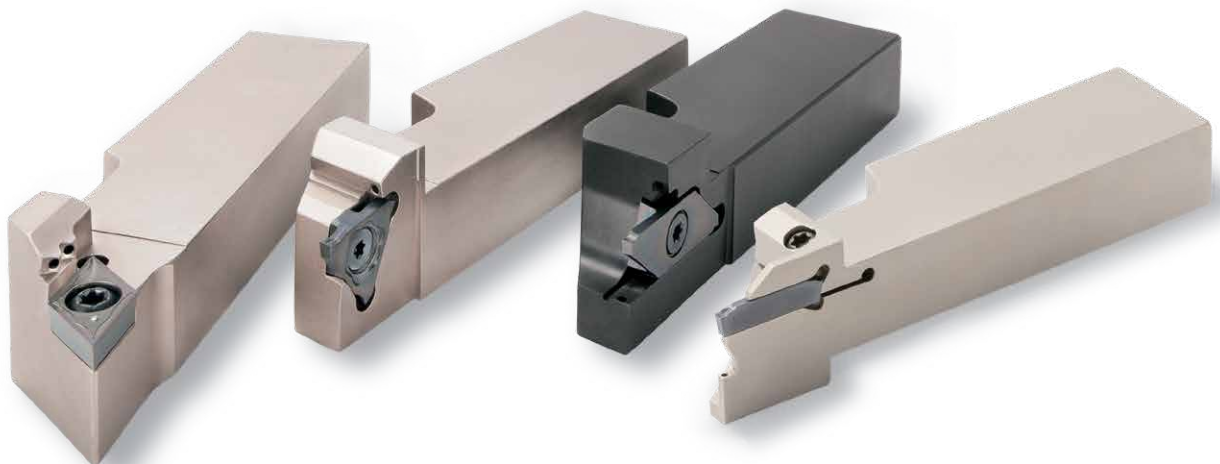

Easy Coolant Connections

Pipe parts will be required separately if internal coolant is used

Pump Pressure: up to 2,900 psi

Pump Pressure: up to 1,090 psi if couplers are used

Without Coupler (Pump Pressure: up to 2,900 psi)

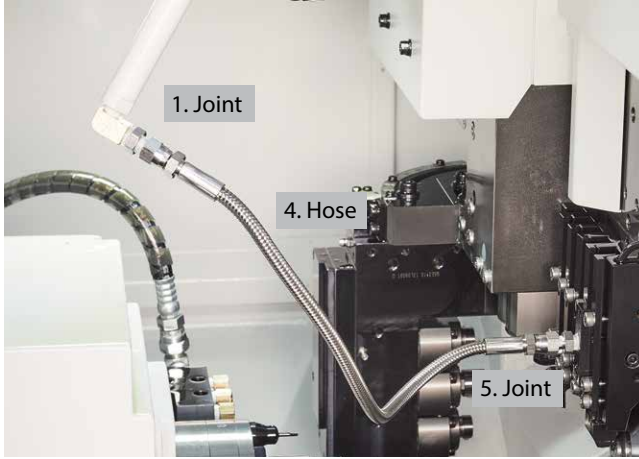

Combination Part Number (Example)

Part	Part Number
1. Joint	J-ST-R1/8-G1/8
4. Hose	HS-G1/8-G1/8-500
5. Joint	J-ST-R1/8-G1/8

Convert the thread standards on the machine's side (Rc1/4, Rc1/8, NPT1/8, etc.) to the thread standard on the hose side (G1/8) for use.

Use sealing agents such as seal tapes when installing piping parts.

With Coupler (Pump Pressure: Up to 1,090 psi)

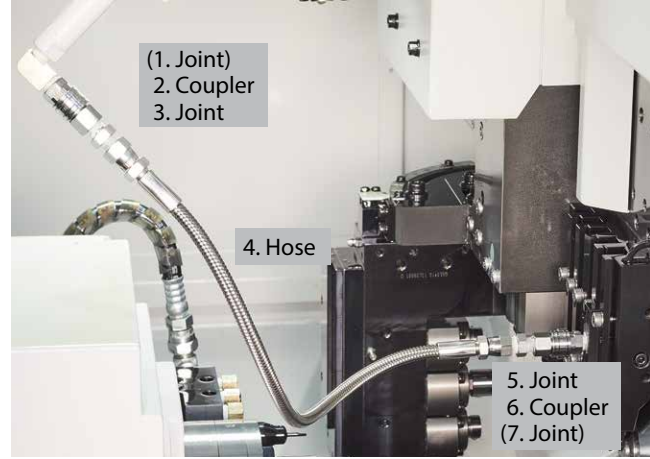

Combination Part Number (Example)

Part	Part Number
(1. Joint)	-
2. Coupler	CP-ST-R1/8, P-ST-RC1/8
3. Joint	J-ST-R1/8-G1/8
4. Hose	HS-G1/8-G1/8-500
5. Joint	J-ST-R1/8-G1/8
6. Coupler	P-ST-RC1/8, CP-ST-R1/8
(7. Joint)	-

Convert the thread standards on the machine's side (Rc1/4, Rc1/8, NPT1/8, etc.) to thread standards of the coupler (Rc1/8, etc.) or hose (G1/8) for use.

Use sealing agents such as seal tapes when installing piping parts.

Without Coupler (Pump Pressure: up to 2,900 psi)



With Coupler (Pump Pressure: up to 1,090 psi)

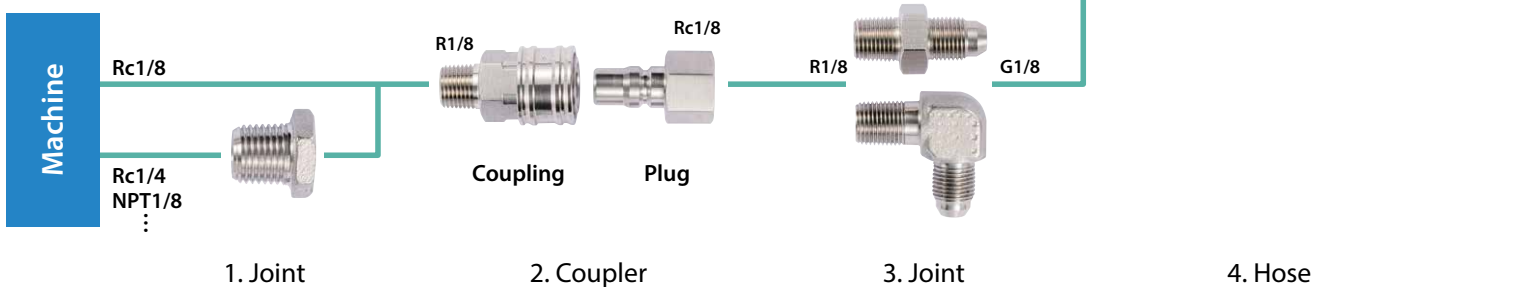

Piping Installation Parts Description

Joint (1, 3, 5, 7) Pressure Resistance: up to 2,900 psi

(Unit: mm)

Shape	Part Number	Stock	Ød1	Ød2	L	L1	L2	T1	T2
	J-ST-R1/4-G1/8	●	5.5	4.0	34	13	13	R1/4	G1/8
	J-ST-NPT1/8-G1/8	●	3.5	3.5	29	10	13	NPT1/8	G1/8
	J-ST-R1/8-G1/8	●	4.0	4.0	29	10	13	R1/8	G1/8
	J-AN-R1/8-G1/8	●	4.0	4.0	27	14	13	R1/8	G1/8
	J-ST-R1/4-RC1/8	●	-	-	17	12	-	R1/4	Rc1/8
	J-ST-NPT1/8-RC1/8	●	3.5	-	30	10	-	NPT1/8	Rc1/8
	J-ST-R1/8-RC1/8	●	3.5	-	33	13	-	R1/8	Rc1/8

Coupler (2, 6) Pressure Resistance: up to 1,090 psi (Unit: mm)

Hose (4) Pressure Resistance: up to 2,900 psi

(Unit: mm)

Shape	Part Number	Stock	Shape	Part Number	Stock	L
	CP-ST-R1/8	●		HS-G1/8-G1/8-200	●	200
				HS-G1/8-G1/8-300	●	300
HS-G1/8-G1/8-400	●	400				
HS-G1/8-G1/8-500	●	500				
HS-G1/8-G1/8-600	●	600				
HS-G1/8-G1/8-800	●	800				
	P-ST-RC1/8	●				

● : Standard Item

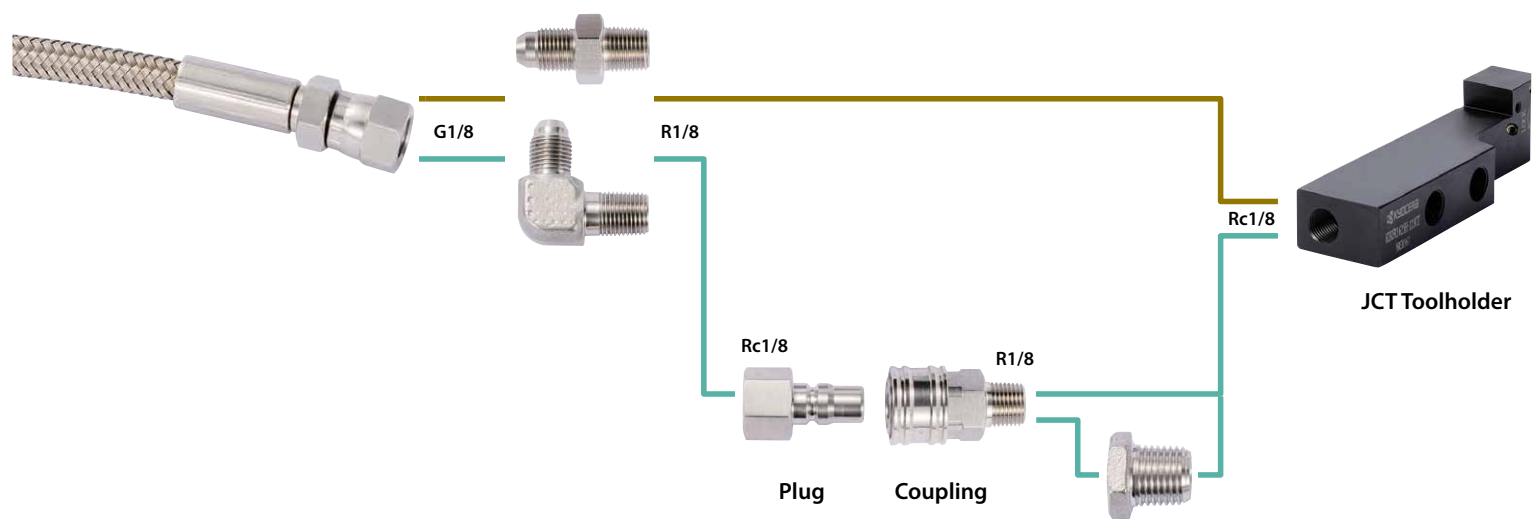

4. Hose

5. Joint

6. Coupler

7. Joint (Extension Joint)

Screw-Clamp-JCT

Small Parts
Turning

Coolant-Through Turning Holders for Small Parts Machining

Double Coolant Hole Design Delivers an Ample Supply of Coolant to the Cutting Edge
Excellent Chip Control and Longer Tool Life

1 Superior Chip Control Performance

2 Sufficient Cooling of the Cutting Edge Leads to Longer Tool Life

Double coolant hole design provides coolant to the insert cutting edge surface

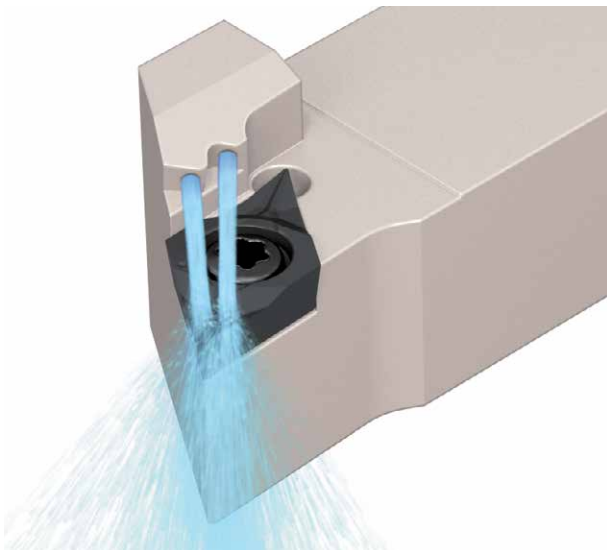

Double Coolant Holes

Provides stable chip curls
for superior chip control

The cutting edge stays cool
increasing tool life

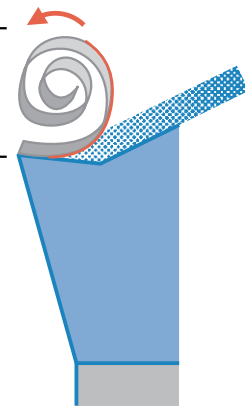

Insert cross-section

Coolant System Comparison (Internal Evaluation)

	Screw-Clamp-JCT Holder	Competitor A Holder
Coolant System	<p>Discharges coolant towards the rake surface of insert</p> <p>Chip Evacuation Direction</p>	<p>Discharges coolant down onto the chip forcing the chip into the part</p> <p>Chip Evacuation Direction</p>
Superior Chip Control	Excellent : Provides stable chip curls	Poor : Chip becomes unstable
Coolant Effects	Excellent : Ensures proper cooling of the cutting edge	Poor : Chip can cause interference with the workpiece

SDJC-JCT holder allows excellent chip control in a wide range of cutting conditions

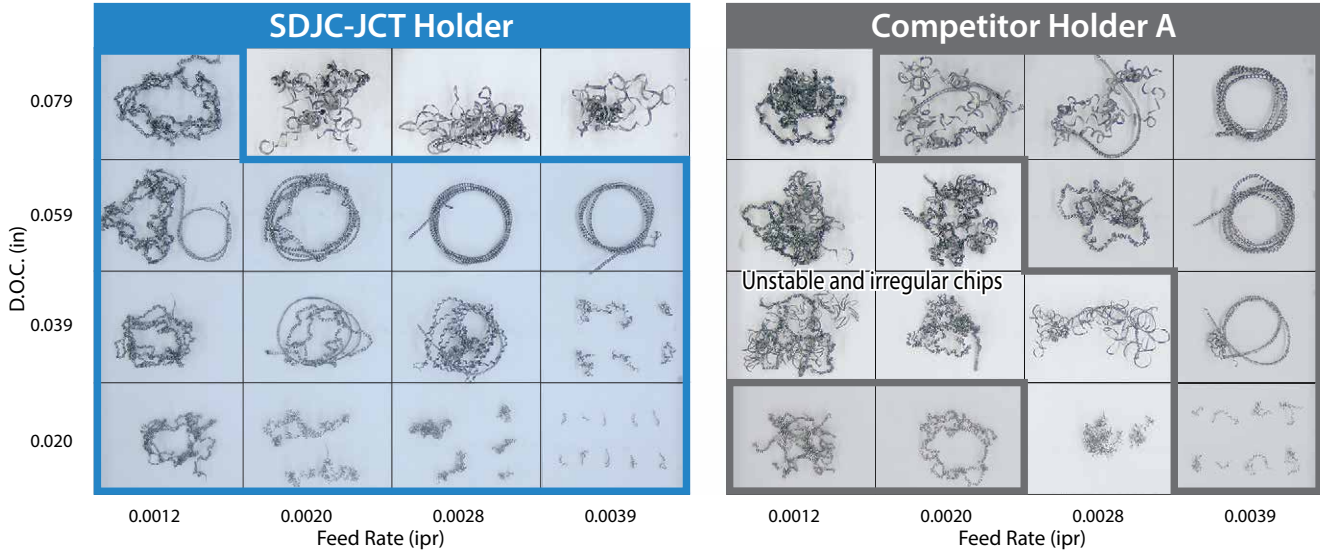

Cutting Conditions: $V_c = 260$ sfm, DCGT32505MP-CK PR1535 (Same inserts were used) Workpiece: Ti-6Al-4V External and Internal Coolant (218 psi) Turning

Great for High Pressure Coolant Wear Resistance Comparison (Internal Evaluation)

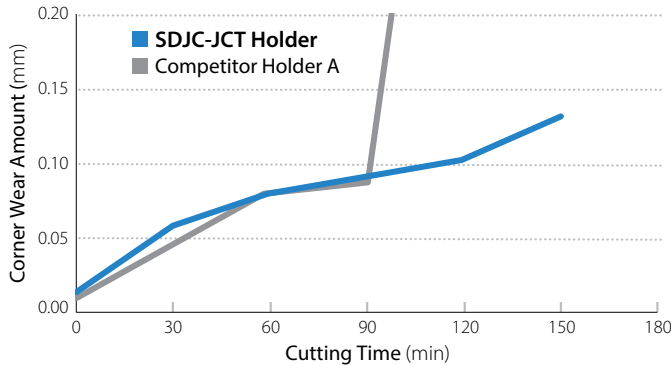

Cutting Conditions: $V_c = 660$ sfm, External Turning: D.O.C. = 0.079", $f = 0.0020$ ipr, Facing: D.O.C. = 0.008", $f = 0.0012$ ipr DCGT32505MFP-GQ PR1535 (Same inserts were used) Workpiece: 304 External and Internal Coolant (218 psi) External Turning and Facing

Cutting Edge

SDJC-JCT Holder (After Machining 150 min)



Competitor A Holder (After Machining 106 min)

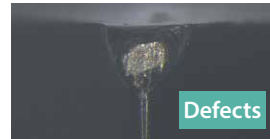

Defects

Case Studies

Pipe - Stainless Steel

$V_c = 525$ sfm
D.O.C. = 0.035" / 0.047"
 $f = 0.007$ ipr
Wet (Internal Coolant: 14MPa)
DCMT3251 Insert

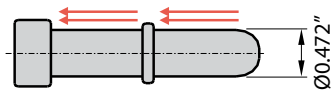

Chip Control

SDJC-JCT Holder (Internal Coolant)



Competitor Holder B (Internal Coolant)



Change to SDJC-JCT improved chip control and tool life.

(User Evaluation)

Pin - Tool Steel

$V_c = 590$ sfm
D.O.C. = 0.055"
 $f = 0.005$ ipr
Wet
DCMT3251 Insert

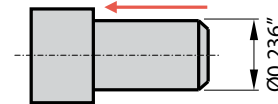

Chip Control

SDJC-JCT Holder (Internal Coolant: 360 psi)



Conventional Holder (External Coolant)



SDJC-JCT holder with internal coolant improved chip control. Reduced chip entanglement

(User Evaluation)

SCLC-JCT (Small Parts Turning)

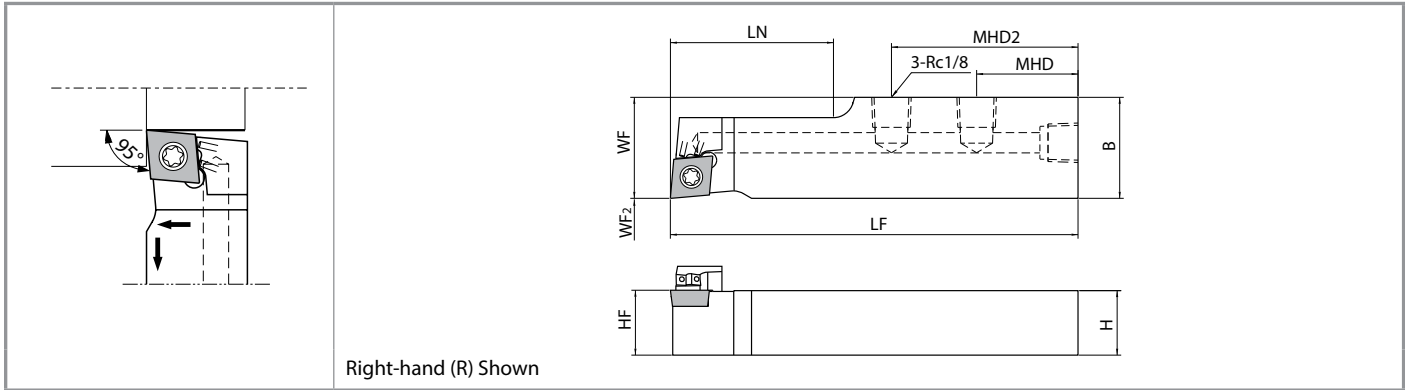

Toolholder Dimensions

Part Number	Stock		Unit	Dimensions								Standard Corner-R (RE)	Spare Parts			Applicable Inserts	
	R	L		H	HF	B	LF	LN	WF	WF ₂	MHD		MHD2	Insert Screw	Wrench		Plug
SCLCR 62-3FFJCT	●		in	0.500	0.500	0.750	4.750	1.110	0.750	0	1.378	-	0.008	SB-4085TR	FT-15	GP-1	CC..325 Sizes
82.5-3FFJCT	●			0.625	0.625	1.000	4.750	1.582	1.000		0.984	1.811					
SCLCR 1220H-09FFJCT	●		mm	12	12	20	100	28	20	0	35	-	0.2	SB-4085TR	FT-15	GP-1	
1625H-09FFJCT	●			16	16	25	100	40	25		25	46					
2025H-09FFJCT	●			20	20	25	100	40	25		25	46					

● : Standard Item

SDJC-JCT (Small Parts Turning)

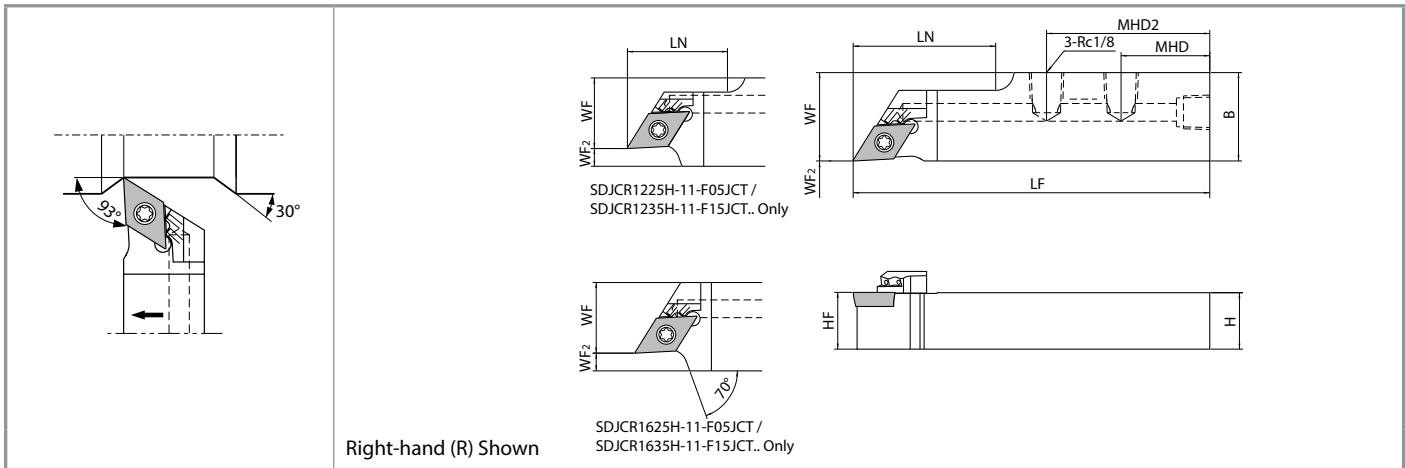

Toolholder Dimensions

Part Number	Stock		Unit	Dimensions								Standard Corner-R (RE)	Spare Parts			Applicable Inserts	
	R	L		H	HF	B	LF	LN	WF	WF ₂	MHD		MHD2	Insert Screw	Wrench		Plug
SDJCR 62-3FFJCT	●		in	0.500	0.500	0.750	4.750	1.110	0.750	0	1.378	-	0.008	SB-4085TR	FT-15	GP-1	DC..325 Sizes
82.5-3FFJCT	●			0.625	0.625	1.000	4.750	1.582	1.000		0.984	1.811					
SDJCR 1220H-11FFJCT	●		mm	12	12	20	100	28	20	0	35	-	0.2	SB-4085TR	FT-15	GP-1	
1625H-11FFJCT	●			16	16	25		40	25		25	46					
2025H-11FFJCT	●			20	20	25		40	25		25	46					
SDJCR 1225H-11-F05JCT	●		mm	12	12	25	100	28	20	5	35	-	0.2	SB-4085TR	FT-15	GP-1	
1235H-11-F15JCT	●			12	12	35		28	20	15	35	-					
SDJCR 1625H-11-F05JCT	●		mm	16	16	25	100	-	20	5	25	46	0.2	SB-4085TR	FT-15	GP-1	
1635H-11-F15JCT	●			16	16	35		-	20	15	25	46					

● : Standard Item

SVJB-JCT / SVJP-JCT (Small Parts Turning)

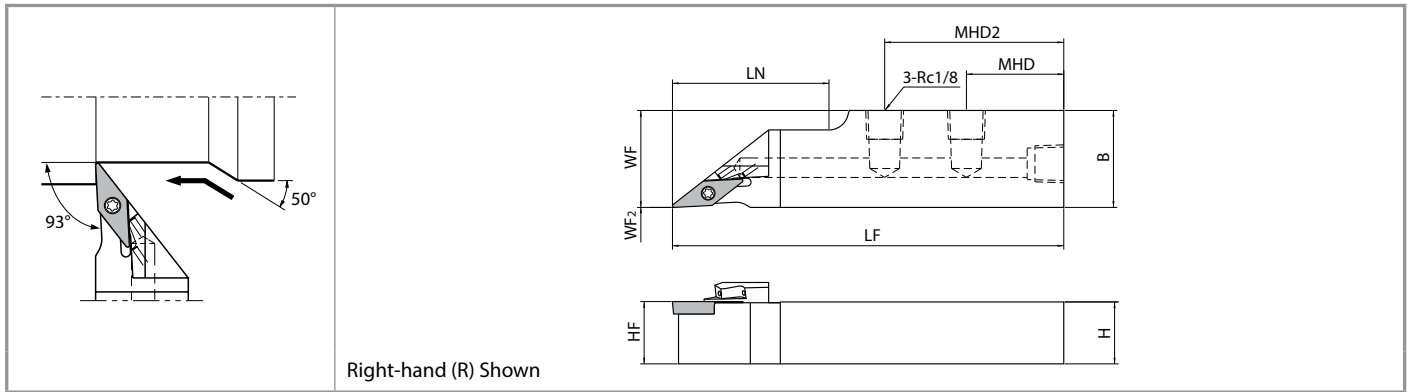

Toolholder Dimensions

Part Number	Stock		Unit	Dimensions									Standard Corner-R (RE)	Spare Parts			Applicable Inserts
	R	L		H	HF	B	LF	LN	WF	WF ₂	MHD	MHD2		Insert Screw	Wrench	Plug	
NEW SVJBR 62-2FFJCT	●		in	0.500	0.500	0.750	4.750	1.110	0.750	0	1.378	-	1/64	SB-2570TR	FT-8	GP-1	VB..22 Sizes
	●			0.625	0.625	1.000	4.750	1.110	1.000		0.984	1.811					
SVJBR 1220H-11FFJCT	●		mm	12	12	20	100	28	20	0	35	-	0.4	SB-2570TR	FT-8	GP-1	VB..22 Sizes
	●			16	16	25		40	25		25	46					
	●			20	20	25		40	25		25	46					
SVJPR 1220H-11FFJCT	●		mm	12	12	20	100	28	20	0	35	-	0.2	SB-2570TR	FT-8	GP-1	VP..22 Sizes
	●			16	16	25		40	25		25	46					
	●			20	20	25		40	25		25	46					

● : Standard Item

Chipbreaker Application Maps

Low Cutting Force Oriented

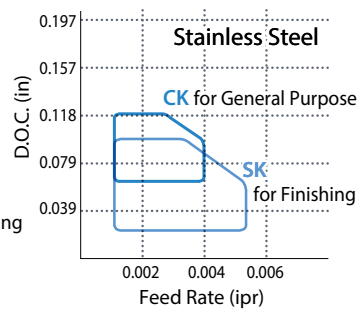
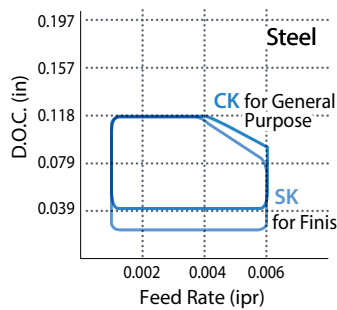

Chip Control Oriented

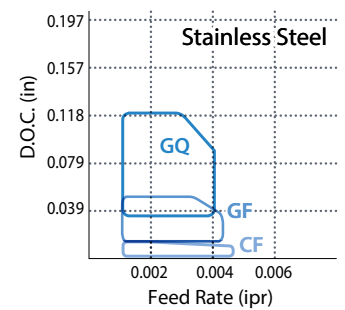
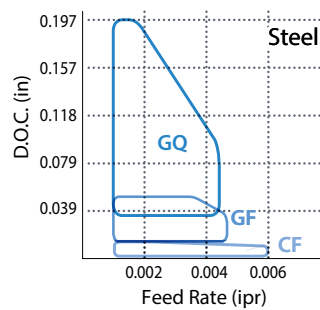

More chipbreakers are available.
For more details, see the KYOCERA general product catalog.

KGBF-JCT

External Grooving

Coolant-Through Grooving Holders for Small Parts Machining

KGBF-JCT can Direct Coolant Closer to the Cutting Edge from the Top of the Insert
Delivers Improved Chip Control and Longer Tool Life while Grooving

1 Excellent Chip Control

2 Superior Cooling Action Improves Tool Life

Discharges coolant from the top of the insert to deliver superior chip control and longer tool life



Coolant Hole

Coolant hole discharges coolant to the cutting edge and prevents coolant stream spreading which slows the coolant flow

Coolant Direction

Sufficient coolant between the chipbreaker and the chips to provide stable chip curls and sufficient cooling of the insert

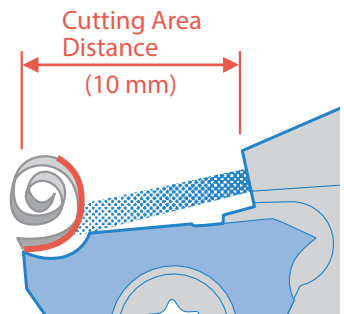

Coolant Discharge Comparison (Internal Evaluation)

KGBF-JCT can direct coolant closer to the cutting edge than competitor C

- Cutting Edge
- Coolant Hole

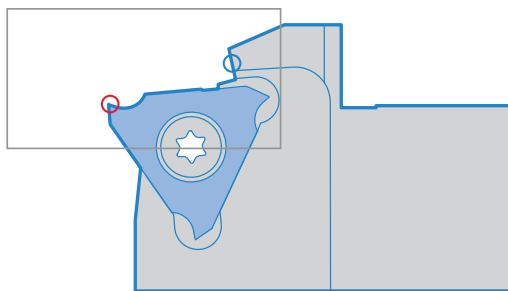

KGBF-JCT

Coolant Spread: Narrow
Coolant Density: High



(Without Insert)

Competitor C

Coolant Spread: Wide
Coolant Density: Low



(Without Insert)

Small chips and better cooling of the insert leads to longer tool life

Chip Control Comparison (Internal Evaluation)

KGBF-JCT provided much better chip control



Cutting Conditions: $V_c = 330$ sfm, D.O.C. = 0.098", GBF32R200-010 PR1535, KGBFR1625H-16FJCT
 Workpiece: Ti-6Al-4V External and Internal Coolant (218 psi) External Grooving

Wear Resistance Comparison (Internal Evaluation)

KGBF-JCT Showed Superior Wear Resistance

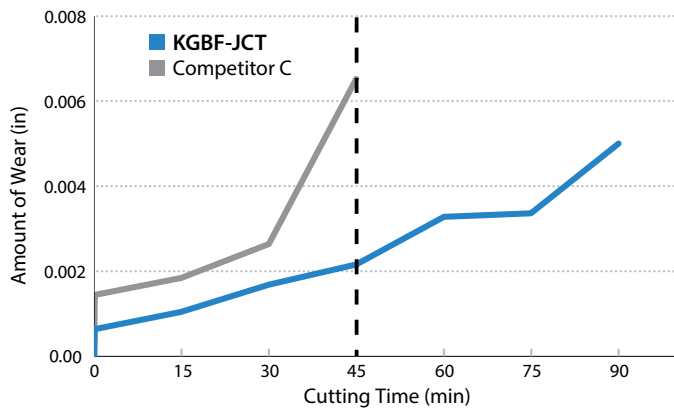

Cutting Edge

KGBF-JCT

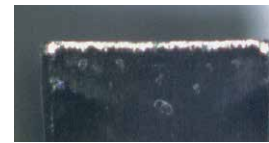

Competitor C



Cutting Conditions: $V_c = 490$ sfm, D.O.C. = 0.071", $f = 0.0024$ ipr, GBF32R100-005GL PR1535, KGBFR1625H-16FJCT
 Workpiece: 304 External and Internal Coolant (218 psi) External Grooving

Case Studies

Nozzle Parts - Stainless Steel

$V_c = 180$ sfm
 D.O.C. = 0.010"
 $f = 0.0012$ ipr
 Wet (Internal Coolant: 218 psi)

KGBFR1220H-16FJCT
 GBF32R100-005GL PR1535

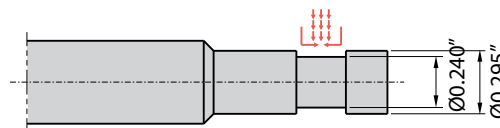

Tool Life

KGBF-JCT
 (Internal Coolant)

1,200 pcs/edge

Tool Life

x1.6

Competitor D
 (Internal Coolant)

750 pcs/edge

KGBF-JCT provided much better chip control than competitor with internal coolant and a molded chipbreaker.

The KGBF-JCT lengthened tool life by 66%

(User Evaluation)

KGBF-JCT (Small Parts Grooving)

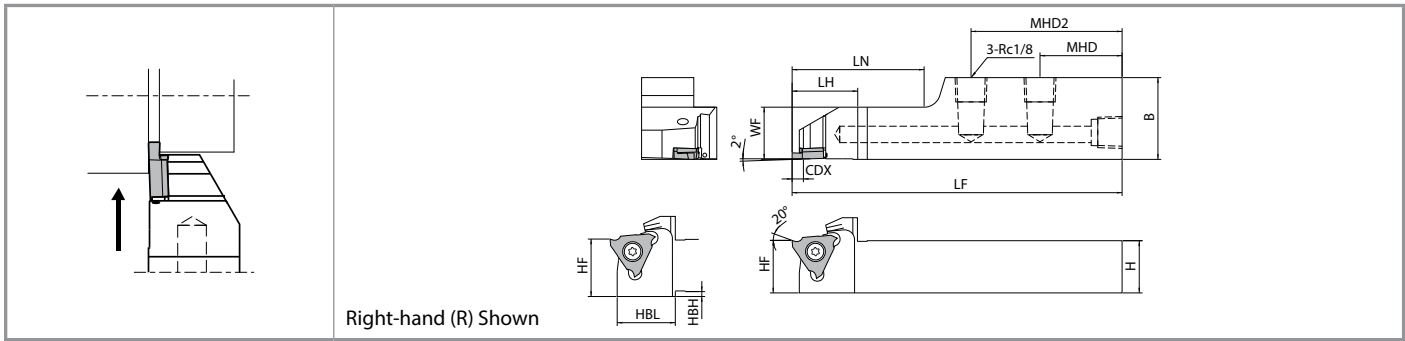

Toolholder Dimensions (Metric Size)

Part Number	Stock		Dimensions (mm)											Spare Parts		
	R	L	H=HF	HBH	B	LF	HBL	LH	LN	WF	CDX*	MHD	MHD2	Insert Screw	Wrench	Plug
KGBFR 1220H-16FJCT	●		12	1.5	20	100	20	20	28	12	3	35	-	SB-4070TRW	FT-8	GP-1
1625H-16FJCT	●		16	-	25	100	-	20	40	16	3	25	46			
2025H-16FJCT	●		20	-	25	100	-	20	40	20	3	25	46			

* Dimension CDX shows the distance from the toolholder to the cutting edge. Dimension CDX of Insert shows available grooving depth.

● : Standard Item

Caution

GBF and GBA Compatibility

- GBF will fit KGBA/KGBAS holders
Caution: The maximum groove depth for KGBA/KGBAS holders is 2.5mm
- GBA inserts will also fit KGBF-JCT holders
Caution: The rake angle after installation in the toolholder is 11°

KGBF-JCT Holder with GBF Insert Maximum Machining Diameter

- 3mm groove depth is available on workpiece diameters up to $\varnothing 51$ mm
- 2.7mm groove depth is available on workpiece diameters up to $\varnothing 100$ mm
- 2.5mm groove depth is available on workpiece diameters up to $\varnothing 200$ mm
- The workpiece will interfere with the holder at maximum cutting diameters or larger

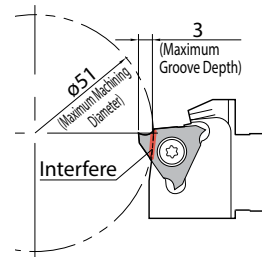

Recommended Cutting Conditions ★ 1st Recommendation ☆ 2nd Recommendation

Workpiece	Recommended Insert Grade (Cutting Speed Vc: sfm)			[1] Grooving Feed Rate (ipr) [2] Traversing Feed Rate (ipr) [3] Max D.O.C. for Traversing (in)			
	MEGACOAT	MEGACOAT NANO	Carbide	GBF32R 025 – 053	GBF32R 065 – 095	GBF32R 100 – 145	GBF32R 150 – 300
	PR1215	PR1535	GW15				
Carbon Steel	★ 260 - 590	☆ 230 - 530	-	[1] 0.0004 – 0.0020 [2] Not Recommended [3] Not Recommended	[1] 0.0008 – 0.0028 [2] Not Recommended [3] Not Recommended	[1] 0.0012 – 0.0031 [2] 0.0012 – 0.0024 [3] MAX. 0.0079	[1] 0.0012 – 0.0031 [2] 0.0012 – 0.0024 [3] MAX. 0.0079
Alloy Steel	★ 260 - 590	☆ 230 - 530	-	[1] 0.0004 – 0.0016 [2] Not Recommended [3] Not Recommended	[1] 0.0008 – 0.0024 [2] Not Recommended [3] Not Recommended	[1] 0.0012 – 0.0028 [2] 0.0008 – 0.0020 [3] MAX. 0.0079	[1] 0.0012 – 0.0028 [2] 0.0008 – 0.0020 [3] MAX. 0.0079
Stainless Steel	☆ 200 - 430	★ 160 - 390	-	[1] 0.0004 – 0.0016 [2] Not Recommended [3] Not Recommended	[1] 0.0008 – 0.0024 [2] Not Recommended [3] Not Recommended	[1] 0.0012 – 0.0028 [2] 0.0008 – 0.0020 [3] MAX. 0.0079	[1] 0.0012 – 0.0028 [2] 0.0008 – 0.0020 [3] MAX. 0.0079
Cast Iron	-	-	★ 200 - 330	[1] 0.0004 – 0.0020 [2] Not Recommended [3] Not Recommended	[1] 0.0008 – 0.0028 [2] Not Recommended [3] Not Recommended	[1] 0.0012 – 0.0031 [2] 0.0012 – 0.0024 [3] MAX. 0.0079	[1] 0.0012 – 0.0031 [2] 0.0012 – 0.0024 [3] MAX. 0.0079
Aluminum Alloy	-	-	★ 490 - 1,310	[1] 0.0004 – 0.0020 [2] Not Recommended [3] Not Recommended	[1] 0.0008 – 0.0028 [2] Not Recommended [3] Not Recommended	[1] 0.0012 – 0.0031 [2] 0.0012 – 0.0024 [3] MAX. 0.0079	[1] 0.0012 – 0.0031 [2] 0.0012 – 0.0024 [3] MAX. 0.0079
Brass	-	-	★ 490 - 980	[1] 0.0004 – 0.0016 [2] Not Recommended [3] Not Recommended	[1] 0.0008 – 0.0028 [2] Not Recommended [3] Not Recommended	[1] 0.0012 – 0.0028 [2] 0.0008 – 0.0020 [3] MAX. 0.0079	[1] 0.0012 – 0.0028 [2] 0.0008 – 0.0020 [3] MAX. 0.0079

GBF-GL

Workpiece	Recommended Insert Grade (Cutting Speed Vc: sfm)		[1] Grooving Feed Rate (ipr) [2] Traversing Feed Rate (ipr) [3] Max D.O.C. for Traversing (in)			
	MEGACOAT	MEGACOAT NANO	GBF32R 075 (GL)	GBF32R 095 – 100 (GL)	GBF32R 150 – 200 (GL)	GBF32R 300 (GL)
	PR1215	PR1535				
Carbon Steel	★ 260 - 590	☆ 230 - 530	[1] 0.0008 – 0.0028 [2] Not Recommended [3] Not Recommended	[1] 0.0012 – 0.0031 [2] 0.0012 – 0.0024 [3] MAX. 0.0079	[1] 0.0012 – 0.0031 [2] 0.0012 – 0.0024 [3] MAX. 0.0079	[1] 0.0016 – 0.0039 [2] 0.0016 – 0.0031 [3] MAX. 0.0197
Alloy Steel	★ 260 - 590	☆ 230 - 530	[1] 0.0008 – 0.0024 [2] Not Recommended [3] Not Recommended	[1] 0.0012 – 0.0028 [2] 0.0012 – 0.0024 [3] MAX. 0.0079	[1] 0.0012 – 0.0028 [2] 0.0012 – 0.0024 [3] MAX. 0.0079	[1] 0.0016 – 0.0035 [2] 0.0016 – 0.0031 [3] MAX. 0.0197
Stainless Steel	☆ 200 - 430	★ 160 - 390	[1] 0.0008 – 0.0024 [2] Not Recommended [3] Not Recommended	[1] 0.0012 – 0.0028 [2] 0.0012 – 0.0024 [3] MAX. 0.0079	[1] 0.0012 – 0.0028 [2] 0.0012 – 0.0024 [3] MAX. 0.0079	[1] 0.0016 – 0.0035 [2] 0.0016 – 0.0031 [3] MAX. 0.0197

KGBF-JCT Applicable Inserts

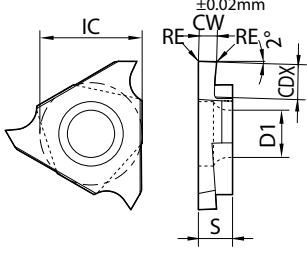
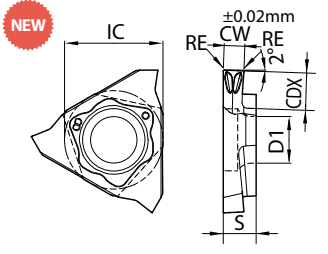
Part Number	IC	S	D1						
GBF32	9.525	3.18	4.4						
Shape	Part Number		Dimensions (mm)			MEGACOAT	MEGACOAT NANO	Carbide	
			CW	CDX	RE	PR1215	PR1535	GW15	
	GBF32R	025-005	0.25	0.60	0.05	●	●	●	
		030-005	0.30	0.80		●	●	●	
		033-005 ※1	0.33	1.00		●	●	●	
		043-005 ※2	0.43			●	●	●	
		050-005	0.50	1.20		●	●	●	
		053-005 ※3	0.53			●	●	●	
		065-005	0.65			●	●	●	
		075-005	0.75	2.00		●	●	●	
		080-005	0.80			●	●	●	
		095-005	0.95			●	●	●	
		100-005	1.00			●	●	●	
		110-005	1.10			●	●	●	
		120-005	1.20	2.70		0.10	●	●	●
		125-010	1.25				●	●	●
		130-010	1.30				●	●	●
		140-010	1.40				●	●	●
		145-010	1.45				●	●	●
		150-010	1.50				●	●	●
		165-010	1.65				●	●	●
		170-010	1.70	3.00		0.10	●	●	●
		175-010	1.75				●	●	●
		200-010	2.00				●	●	●
		225-010	2.25				●	●	●
		250-010	2.50				●	●	●
		300-010	3.00				●	●	●
	GBF32R	075-005GL	0.75	2.00	0.05	●	●		
		095-005GL	0.95			●	●		
		100-005GL	1.00			●	●		
		150-010GL	1.50	2.70	0.10	●	●		
		200-010GL	2.00	3.00		●	●		
		300-010GL	3.00			●	●		

The maximum machining diameter is Ø51 mm (Please check caution on [Page 38](#))

● : Standard Item

※1 : The edge width (CW) tolerance of GBF32R 033-005 : 0.33 $\begin{matrix} +0.015\text{mm} \\ -0.025\text{mm} \end{matrix}$

※2 : The edge width (CW) tolerance of GBF32R 043-005 : 0.43 $\begin{matrix} +0.015\text{mm} \\ -0.025\text{mm} \end{matrix}$

※3 : The edge width (CW) tolerance of GBF32R 053-005 : 0.53 $\begin{matrix} +0.015\text{mm} \\ -0.025\text{mm} \end{matrix}$

KTKF-JCT

Cut-Off

Coolant-Through Cut-Off Holders for Small Parts Machining

KTKF-JCT holders break chips evenly into small pieces with excellent chip control performance when machining difficult-to-cut material and stainless steel.

1 Excellent Chip Control Performance

The KTKF-JCT discharges coolant in two directions toward rake surface of insert and breaks chips into small pieces.

Coolant Discharge Structure Comparison

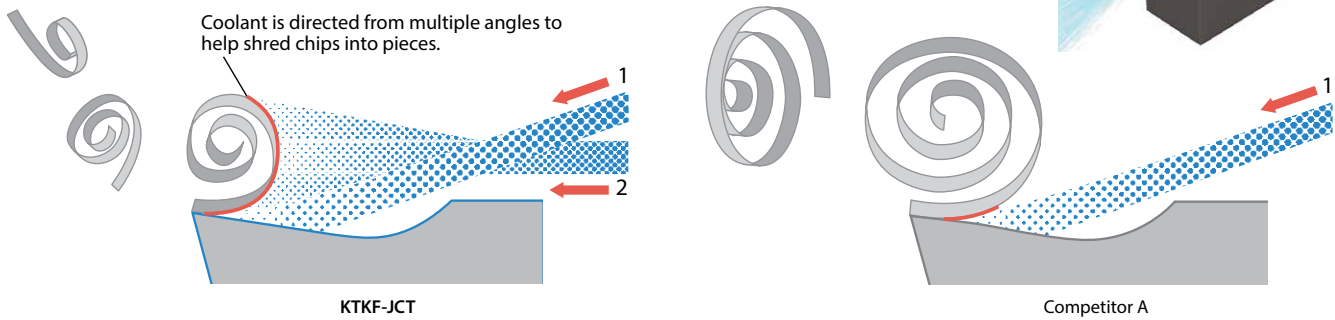

Chip Control Comparison (Internal Evaluation)

304				Ti-6Al-4V			
f (ipr)	0.0004	0.0008	0.0012	f (ipr)	0.0004	0.0008	0.0012
KTKF-JCT				KTKF-JCT			
Competitor A				Competitor A			

Cutting Conditions: $V_c = 260$ sfm, Wet (Oil-based) Coolant Pressure: 218 psi (Internal)
Workpiece: $\varnothing 0.472''$

Coolant Flow Rate Comparison (Internal Evaluation)

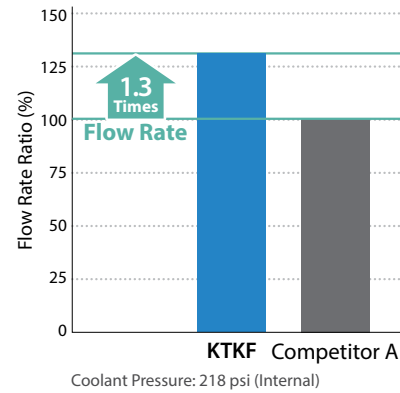

2 Superior Cooling Action Improves Tool Life

Coolant is also directed from the flank face of the insert to supply an ample amount of coolant to the tool edge area to help further suppress insert wear.

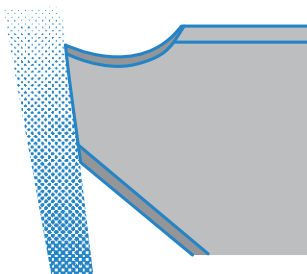

Wear Resistance Comparison (Internal Evaluation)

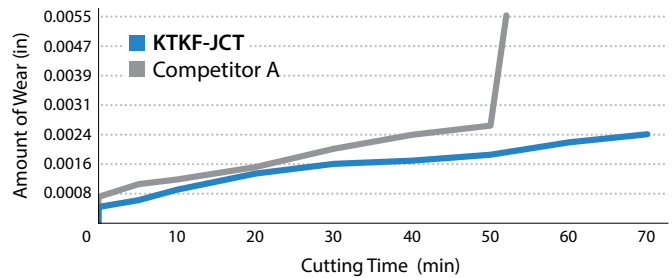

Cutting Conditions: $V_c = 330$ sfm, $f = 0.0008$ ipr, Wet (Oil-based)
Lubricating Pressure: 218 psi (Internal) Workpiece: Ti-6Al-4v $\varnothing 0.472''$

KTKF-JCT (Small Parts Cut-Off)

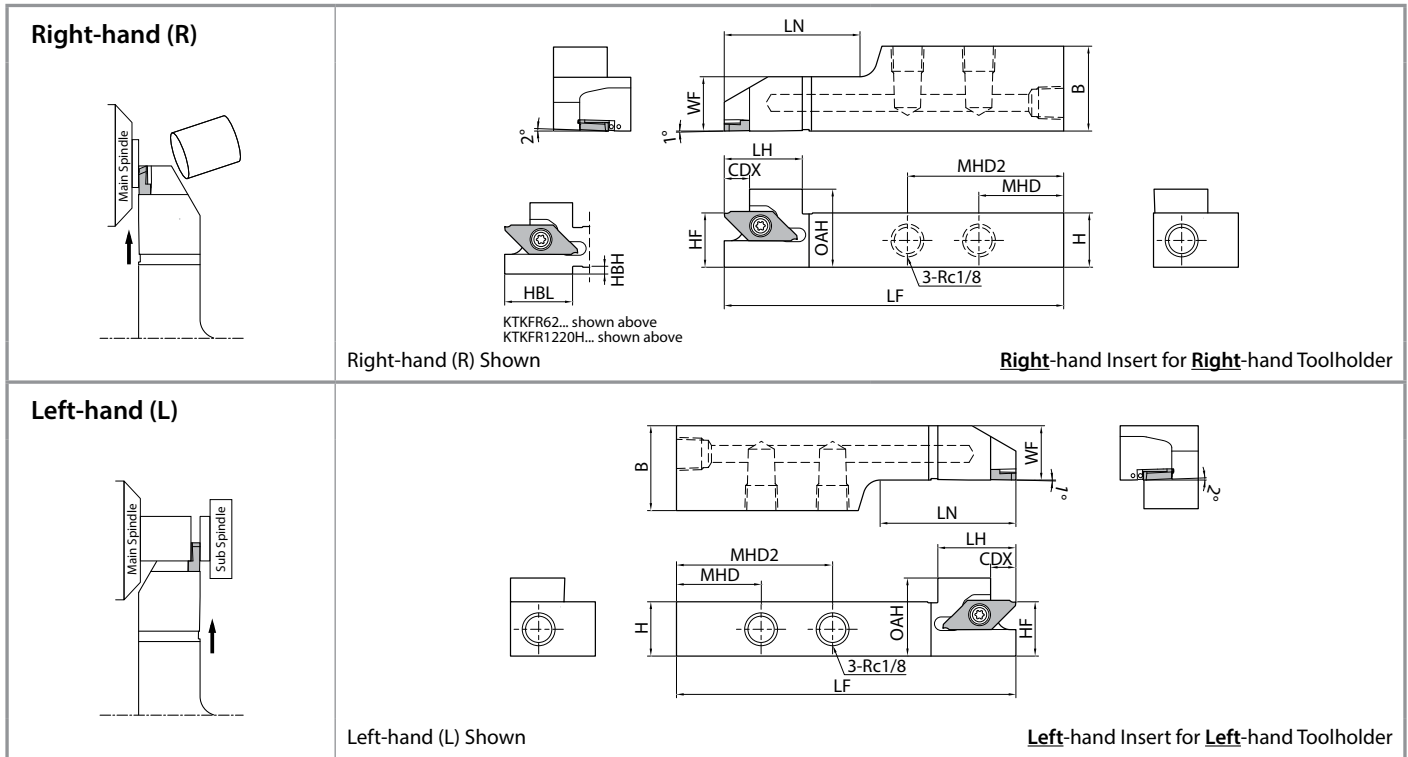









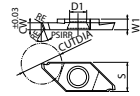

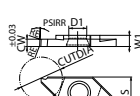

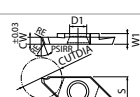

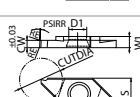

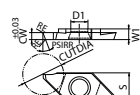

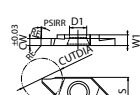

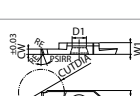

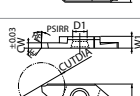
Toolholder Dimensions

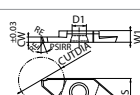
Part Number	Stock		Unit	Dimensions											Spare Parts			
	R	L		H=HF	OAH	B	LF	HBH	HBL	LH	LN	WF	CDX	MHD	MHD2	Insert Screw	Wrench	Plug
NEW KTKFR 62-12JCT	●		in	0.500	0.775	0.750	4.750	-	0.783	0.783	1.110	0.500	0.295	1.417	-	SB-4590TRWN	FT-10	GP-1
NEW 82.5-12JCT	●			0.625	0.900	1.000	4.750	-	-	0.901	1.582	0.625	0.295	0.984	1.811			
NEW KTKFR 82.5-16JCT	●			0.625	0.900	1.000	4.750	-	-	0.901	1.582	0.625	0.378	0.984	1.811			
KTKFR 1220H-12JCT	●		mm	12	19	20	100	2	20	20	28	12	7.5	35	-	SB-4590TRWN	FT-10	GP-1
KTKF ^{R/L} 1625H-12JCT	●	●		16	23	25	100	-	-	23	40	16	7.5	25	46			
2025H-12JCT	●	●		20	27													
KTKF ^{R/L} 1625H-16JCT	●	●		16	23	25	100	-	-	23	40	16	9.6	25	46			
2025H-16JCT	●	●	20	27	41											20		

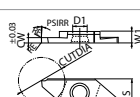
● : Standard Item

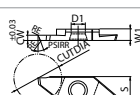
KTKF-JCT Applicable Inserts

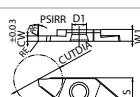
Shape		Part Number	Dimensions (in)							Angle	MEGACOAT NANO		MEGACOAT NANO		MEGACOAT		PVD Coated Carbide		DLC Coated Carbide		Uncoated Carbide						
			CW		CUTDIA	RE	W1	S	D1		PSIRR	PR1425		PR1535		PR1225		PR1025		PDL025		KW10					
			inch	mm								R	L	R	L	R	L	R	L	R	L	R	L	R	L		
 Right Lead Angle		TKF12% 050-S-16DR	0.020	0.5	0.197	0.0012	0.118	0.343	0.197	16°	●	●	●	●	●	●	●	●	●	●	●	●					
		070-S-16DR	0.028	0.7	0.315						●	●	●	●	●	●	●	●	●	●	●	●	●	●	●	●	
		100-S-16DR	0.039	1.0	0.472						●	●	●	●	●	●	●	●	●	●	●	●	●	●	●	●	●
		125-S-16DR	0.049	1.25							●	●	●	●	●	●	●	●	●	●	●	●	●	●	●	●	●
		150-S-16DR	0.059	1.5							●	●	●	●	●	●	●	●	●	●	●	●	●	●	●	●	●
		200-S-16DR	0.079	2.0							●	●	●	●	●	●	●	●	●	●	●	●	●	●	●	●	●
 0°		TKF12% 050-S	0.020	0.5	0.197	0.0012	0.118	0.343	0.197	0°	●	●	●	●	●	●	●	●	●	●	●	●					
		070-S	0.028	0.7	0.315						●	●	●	●	●	●	●	●	●	●	●	●	●	●	●		
		100-S	0.039	1.0	0.472						●	●	●	●	●	●	●	●	●	●	●	●	●	●	●	●	
		125-S	0.049	1.25							●	●	●	●	●	●	●	●	●	●	●	●	●	●	●	●	
		150-S	0.059	1.5							●	●	●	●	●	●	●	●	●	●	●	●	●	●	●	●	
		200-S	0.079	2.0							●	●	●	●	●	●	●	●	●	●	●	●	●	●	●	●	
 Right Lead Angle / Tough Edge		TKF12% 100-T-16DR	0.039	1.0	0.472	0.0031	0.118	0.343	0.197	16°	●	●	●	●	●	●	●	●	●	●	●						
		150-T-16DR	0.059	1.5							●	●	●	●	●	●	●	●	●	●	●	●	●	●	●	●	
		200-T-16DR	0.079	2.0							●	●	●	●	●	●	●	●	●	●	●	●	●	●	●	●	
 Tough Edge		TKF12% 100-T	0.039	1.0	0.472	0.0031	0.118	0.343	0.197	0°	●	●	●	●	●	●	●	●	●	●	●						
		150-T	0.059	1.5							●	●	●	●	●	●	●	●	●	●	●	●	●	●	●		
		200-T	0.079	2.0							●	●	●	●	●	●	●	●	●	●	●	●	●	●	●	●	
 Right Lead Angle / Without Chipbreaker		TKF12% 050-NB-20DR	0.020	0.5	0.197	0	0.118	0.343	0.197	20°	●	●	●	●	●	●	●	●	●	●	●						
		070-NB-20DR	0.028	0.7	0.315						●	●	●	●	●	●	●	●	●	●	●	●	●	●	●		
		100-NB-20DR	0.039	1.0	0.472						●	●	●	●	●	●	●	●	●	●	●	●	●	●	●	●	
		150-NB-20DR	0.059	1.5							●	●	●	●	●	●	●	●	●	●	●	●	●	●	●	●	
		200-NB-20DR	0.079	2.0							●	●	●	●	●	●	●	●	●	●	●	●	●	●	●	●	
 Without Chipbreaker		TKF12% 050-NB	0.020	0.5	0.197	0	0.118	0.343	0.197	0°	●	●	●	●	●	●	●	●	●	●	●						
		070-NB	0.028	0.7	0.315						●	●	●	●	●	●	●	●	●	●	●	●	●	●	●		
		100-NB	0.039	1.0	0.472						●	●	●	●	●	●	●	●	●	●	●	●	●	●	●	●	
		150-NB	0.059	1.5							●	●	●	●	●	●	●	●	●	●	●	●	●	●	●	●	
		200-NB	0.079	2.0							●	●	●	●	●	●	●	●	●	●	●	●	●	●	●	●	
 Right Lead Angle		TKF16% 150-S-16DR	0.059	1.5	0.630	0.0020	0.157	0.374	0.197	16°	●	●	●	●	●	●	●	●	●	●	●						
		200-S-16DR	0.079	2.0							●	●	●	●	●	●	●	●	●	●	●	●	●	●	●	●	
 0°		TKF16% 150-S	0.059	1.5	0.630	0.0020	0.157	0.374	0.197	0°	●	●	●	●	●	●	●	●	●	●	●						
		200-S	0.079	2.0							●	●	●	●	●	●	●	●	●	●	●	●	●	●	●	●	
 Right Lead Angle / Tough Edge		TKF16% 150-T-16DR	0.059	1.5	0.630	0.0031	0.157	0.374	0.197	16°	●	●	●	●	●	●	●	●	●	●	●						
		200-T-16DR	0.079	2.0							●	●	●	●	●	●	●	●	●	●	●	●	●	●	●	●	
 Tough Edge		TKF16% 150-T	0.059	1.5	0.630	0.0031	0.157	0.374	0.197	0°	●	●	●	●	●	●	●	●	●	●	●						
		200-T	0.079	2.0							●	●	●	●	●	●	●	●	●	●	●	●	●	●	●	●	
 Right Lead Angle / Without Chipbreaker		TKF16% 150-NB-20DR	0.059	1.5	0.630	0	0.157	0.374	0.197	20°	●	●	●	●	●	●	●	●	●	●	●						
		200-NB-20DR	0.079	2.0							●	●	●	●	●	●	●	●	●	●	●	●	●	●	●	●	
 Without Chipbreaker		TKF16% 150-NB	0.059	1.5	0.630	0	0.157	0.374	0.197	0°	●	●	●	●	●	●	●	●	●	●	●						
		200-NB	0.079	2.0							●	●	●	●	●	●	●	●	●	●	●	●	●	●	●	●	

Lead angle (front cutting edge angle: PSIRR) shows the angle when installed in the toolholder.
Machining diameter of insert (CUTDIA) indicates the machining diameter when the tool tip has proceeded to the center of workpiece

● : Standard Item

Recommended Cutting Conditions ★ 1st Recommendation ☆ 2nd Recommendation

Workpiece	Recommended Insert Grade (Vc: sfm)						TKF12						TKF16		Notes
							Edge Width W (mm)						Edge Width W (mm)		
	MEGACOAT NANO		MEGACOAT	PVD Coated Carbide	DLC Coated Carbide	Uncoated Carbide	0.5	0.7	1.0	1.25	1.5	2.0	1.5	2.0	
	PR1425	PR1535	PR1225	PR1025	PDL025	KW10	f (ipr)						f (ipr)		
Carbon Steel	★ 230 - 560 (160 - 460)	☆ 230 - 490 (160 - 390)	☆ 230 - 490 (160 - 390)	☆ 200 - 430	-	-	0.0004-0.0008	0.0004-0.0012	0.0004-0.0016 (0.0004-0.0020)	0.0004-0.0016	0.0004-0.0016 (0.0008-0.0039)	0.0004-0.0016 (0.0008-0.0039)	0.0008-0.0028 (0.0008-0.0039)	0.0008-0.0028 (0.0008-0.0039)	
Alloy Steel	★ 230 - 560 (160 - 460)	☆ 230 - 490 (160 - 390)	☆ 230 - 490 (160 - 390)	☆ 200 - 430	-	-	0.0004-0.0008	0.0004-0.0012	0.0004-0.0016 (0.0004-0.0020)	0.0004-0.0016	0.0004-0.0016 (0.0008-0.0039)	0.0004-0.0016 (0.0008-0.0039)	0.0008-0.0028 (0.0008-0.0039)	0.0008-0.0028 (0.0008-0.0039)	
Stainless Steel	☆ 200 - 460 (130 - 390)	★ 200 - 390 (130 - 330)	☆ 200 - 390 (130 - 330)	☆ 160 - 330	-	-	0.0002-0.0006	0.0004-0.0008	0.0004-0.0008 (0.0004-0.0012)	0.0004-0.0008	0.0004-0.0008 (0.0004-0.0020)	0.0004-0.0008 (0.0004-0.0020)	0.0004-0.0016 (0.0004-0.0020)	0.0004-0.0016 (0.0004-0.0020)	
Cast Iron	-	-	-	-	-	★ 160 - 330	0.0004-0.0012	0.0004-0.0016	0.0004-0.0020	0.0004-0.0020	0.0004-0.0020	0.0004-0.0020	0.0008-0.0031	0.0008-0.0031	
Aluminum	-	-	-	-	★ 660 - 1,640	☆ 660 - 1,470	0.0004-0.0012	0.0004-0.0016	0.0004-0.0020	0.0004-0.0020	0.0004-0.0020	0.0004-0.0020	0.0008-0.0031	0.0008-0.0031	
Brass	-	-	-	-	-	★ 330 - 660	0.0004-0.0012	0.0004-0.0016	0.0004-0.0024	0.0004-0.0024	0.0004-0.0024	0.0004-0.0024	0.0008-0.0039	0.0008-0.0039	

Recommendations in Parentheses () : Tough Edge Type (TKF..T.)

AH&B

TOOLING & MACHINERY

COMPLETE METALWORKING SOLUTIONS

(800) 991-4225

www.ahbinc.com

ISO Certified

customerservice@ahbinc.com



KYOCERA Precision Tools

102 Industrial Park Road
Hendersonville, NC 28792
Customer Service | 800.823.7284 - Option 1
Technical Support | 800.823.7284 - Option 2



Official Website | www.kyoceraprecisiontools.com
Distributor Website | mykpti.kyocera.com
Email | cuttingtools@kyocera.com