



COMPLETE  
METALWORKING  
SOLUTIONS

(800) 991-4225

[www.ahbinc.com](http://www.ahbinc.com)

ISO Certified

[customerservice@ahbinc.com](mailto:customerservice@ahbinc.com)

# PR005S / PR015S

for Heat-Resistant Alloy



Stable and Consistent Performance While Machining Heat-Resistant Alloy

Improved Thermal Properties Help to Reduce Sudden Fracture and Decrease Edge Wear

Improved Wear Resistance with MEGACOAT HARD Coating

Low Cutting Force and Stable Machining with Newly Developed Chipbreakers (SQ/SX/SG)





# PR005S / PR015S

for Machining Heat-Resistant Alloy

Improved Thermal Properties Help to Reduce Sudden Fracture and Edge Wear

## 1 Newly Developed Substrate Helps to Reduce Sudden Fracture and Notch Wear

Improved thermal conductivity by optimum distribution of WC coarse grains

Resists heat concentration at the cutting edge to promote stable machining

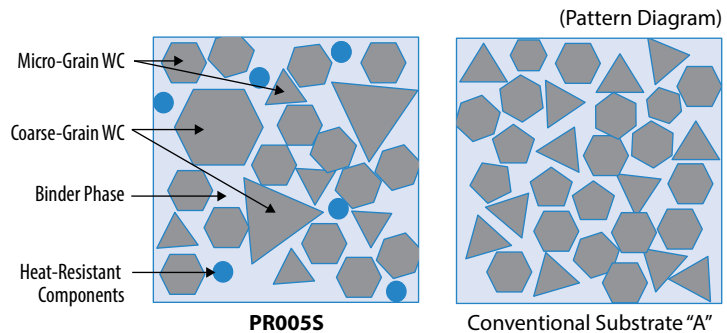

**PR005S** : Hard, Wear-resistant Grade for High-speed Machining

**PR015S** : General Purpose Grade with Excellent Wear Resistance and Stability

Fracture Resistance Comparison (Internal Evaluation)

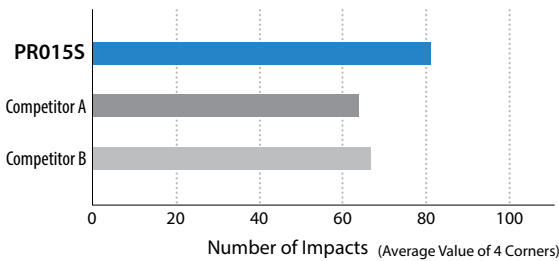

Cutting Conditions:  $V_c = 80$  sfm,  $D.O.C. = 0.039"$ ,  $f = 0.004$  ipr, Wet  
CNMG432 Type Workpiece: Nickel-based Superalloy Cylindrical Workpiece with 1 Flat Face

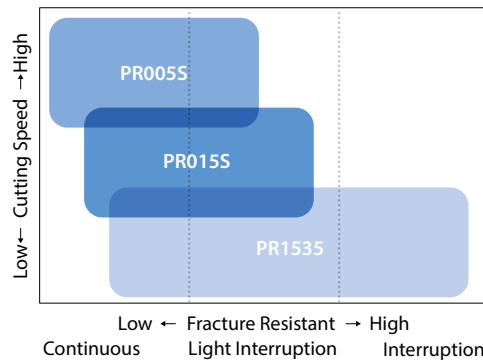

## 2 Improved Wear Resistance with MEGACOAT HARD Coating

Coating Film Property (Internal Evaluation)

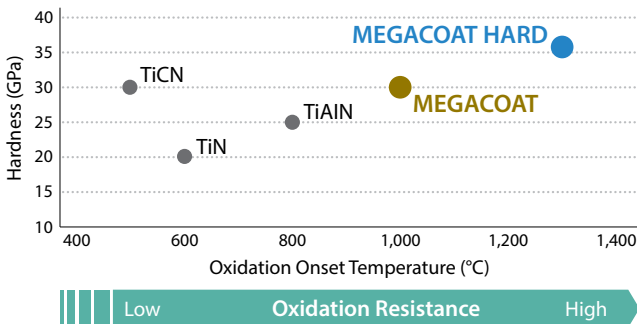

Excellent wear resistance with high-hardness resists boundary damage with improved thermal properties

Wear Resistance Comparison (Internal Evaluation)

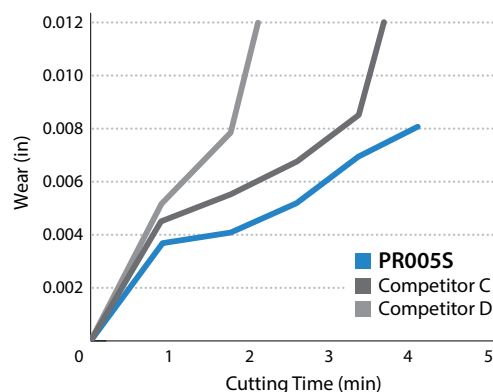

**Machining Time: 3.5 min**  
Competitor D could only reach 2.6 minutes.

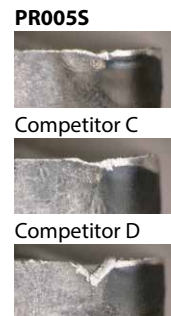

Cutting Conditions:  $V_c = 200$  sfm,  $D.O.C. = 0.039"$ ,  $f = 0.008$  ipr, Wet, CNMG432 Type  
Workpiece: Nickel-based Superalloy

# 3 New Chipbreaker Designs Improve Machining Stability

## SQ Chipbreaker for Finishing to Medium Machining

Double-sided 4-Corner Design

Extended Tool Life and Improved Efficiency for Medium-Finishing Applications in Heat-Resistant Alloys

**SQ Chipbreaker Benefits**  
 Reduced Temperature at the Cutting Edge for Extended Tool Life  
 Reduces Burring for Extended Tool Life and Efficiency Improvements



**Slant Cutting Edge**  
 Inclined in (-) Direction  
 Effective for Burr Suppression and Reducing Notching

**Special Axial Face Design Decreases Cutting Edge Temperature**  
 Optimal Design Achieved with Simulation Technology

Simulation of Edge-Temperature Comparison (Internal Evaluation)

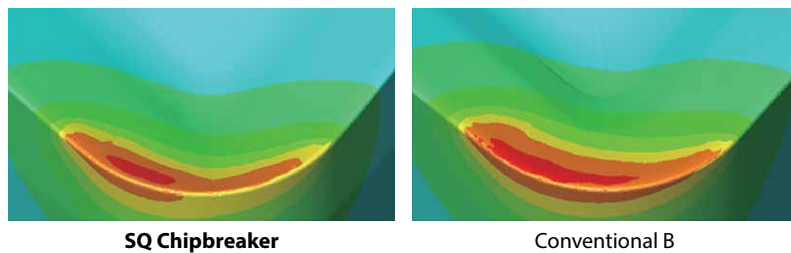

Cutting Conditions:  $V_c = 130$  sfm,  $D.O.C. = 0.039$ ",  $f = 0.006$  ipr, CNMG432 Type, Dry  
 Workpiece: Nickel-based Superalloy

The newly developed SQ chipbreaker reduces temperature at the cutting edge, thereby improving tool life and machining efficiency in semi-finishing applications.

Applicable Chipbreaker Range  
 (D.O.C. Indicates Radial Depth of Cut per Side)

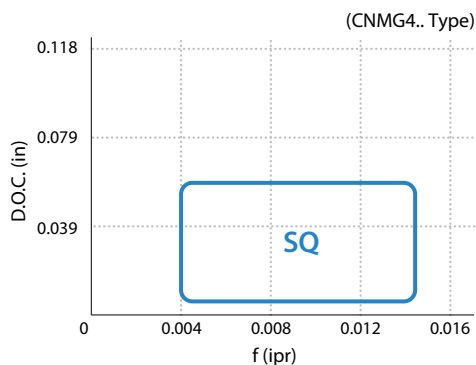

Cutting Force Comparison - Radial Force (Internal Evaluation)

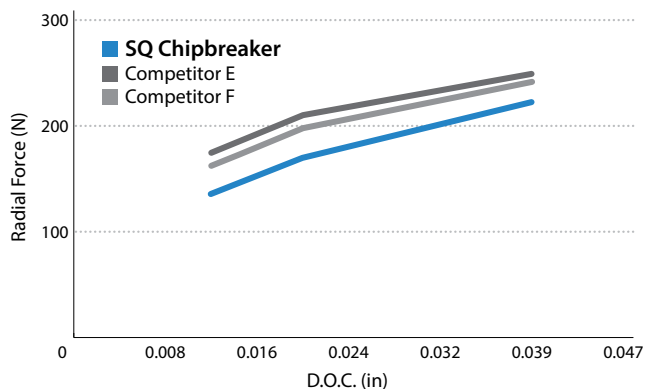

Cutting Conditions:  $V_c = 130$  sfm,  $f = 0.006$  ipr, Wet, CNMG432 Type  
 Workpiece: Nickel-based Superalloy

Wear Resistance Comparison (Internal Evaluation)

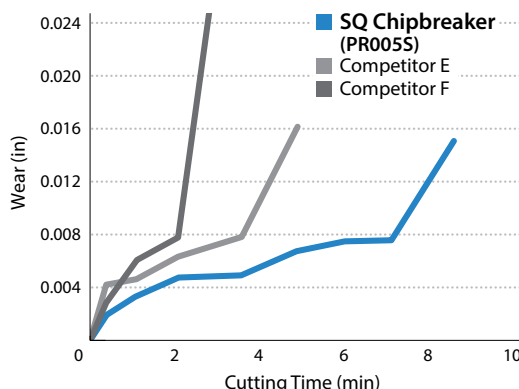

Cutting Conditions:  $V_c = 130$ ,  $D.O.C. = 0.039$ ",  $f = 0.008$  ipr, Wet, CNMG432 Type  
 Workpiece: Nickel-based Superalloy

**Machining Time: 5 min**  
 Competitor F could only reach 3.6 minutes.

**SQ Chipbreaker (PR055)**



Competitor E



Competitor F



# SX Chipbreaker for Roughing

Single-sided 2-Corner Design

Improved Efficiency for Roughing Applications in Heat-resistant Alloys

**SX Chipbreaker Benefits**

- Decreased Edge Temperature for Longer Tool Life
- Suppresses Burr Formation for Greater Depths of Cut
- Decreased Radial Forces
- Resists Edge Build-up and Improves Efficiency

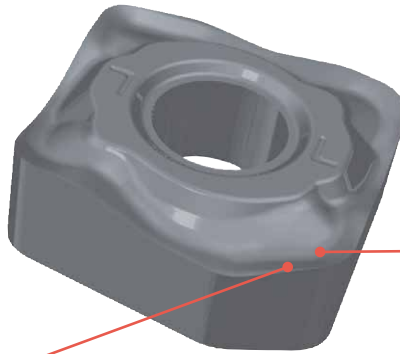

The SG chipbreaker is recommended if a double-sided 4-edge design for roughing is required

See P6 for details



**Rake Design Decreases Temperature at the Cutting Edge**

Optimal Design Achieved with CNC Simulation Technology

## Unique Cutting Edge Design (Handed Insert)

60 Degree Lead Angle (when Installed in the Toolholder)  
12 Degree Rake Angle

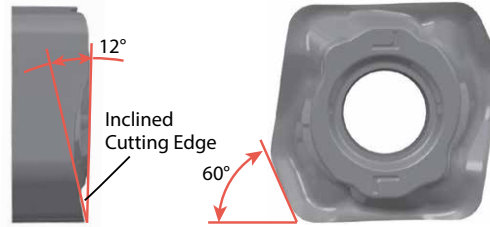

- Can be installed in standard Kyocera 80° (C type) toolholders by changing to corresponding SX shim
- Single-sided, handed insert

## Simulation of Edge-Temperature Comparison (Internal Evaluation)

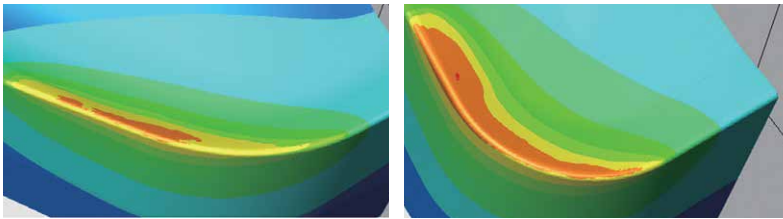

Cutting Conditions:  $V_c = 130$  sfm,  $D.O.C. = 0.079$ ",  $f = 0.010$  ipr, Dry  
CNMM43XL-SX, CNMG433 Type Workpiece: Nickel-based Superalloy

The SX Chipbreaker provides longer tool life and improved efficiency with its unique cutting edge and rake angle design

## Applicable Chipbreaker Range

(D.O.C. Indicates Radial Depth of Cut per Side)

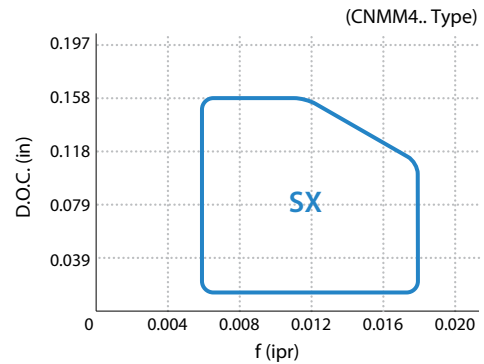

## Burr Comparison (Internal Evaluation)

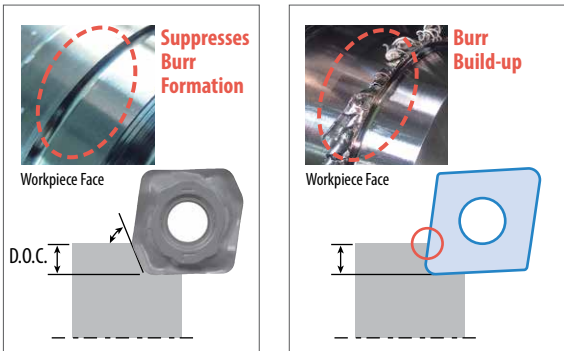

Cutting Conditions:  $V_c = 130$  sfm,  $D.O.C. = 0.079$ ",  $f = 0.010$  ipr, Wet  
CNMM43XL-SX, CNMG433 Type After Machining 9.4 min. Workpiece: Nickel-based Superalloy

Even in larger depths of cut, the SX chipbreaker is able to suppress burr build-up

Increased D.O.C capability and reduced notch wear combine to provide greater machining efficiency

## Wear Resistance Comparison (Internal Evaluation)

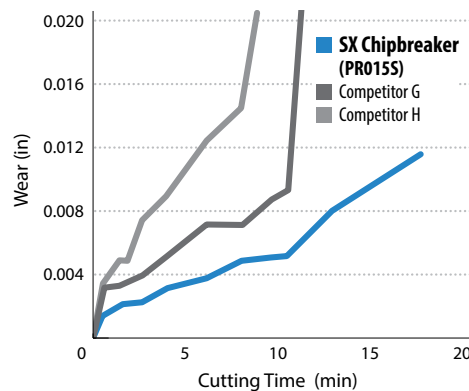

Cutting Conditions:  $V_c = 130$  sfm,  $D.O.C. = 0.079$ ",  $f = 0.010$  ipr, Wet  
CNMM43XL-SX, CNMG433 Type Workpiece: Nickel-based Superalloy

Machining Time: 5 min

**SX Chipbreaker (PR0155)**



Competitor G



Competitor H



SX Chipbreaker and PR0155 resist notching, thereby improving tool life

# Caution when Using SX Chipbreaker

## 1. Cutting Edge Height

The center of the cutting edge height of the nose is slanted by 60 degrees based on circled portions in image below

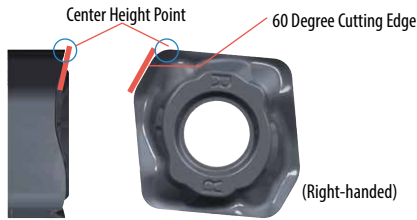

## 2. Recommended D.O.C.

Recommended depth of cut is no greater than the 60° lead angle; however, larger depths of cut are possible

Insert Part Number	Recommended D.O.C. External Turning (in)	Max. D.O.C. Facing (in)
CNMM43X%-SX	0.020 - <b>0.079</b> - 0.158	0.079
CNMM54X%-SX	0.020 - <b>0.098</b> - 0.177	0.079
CNMM64X%-SX	0.020 - <b>0.118</b> - 0.197	0.098

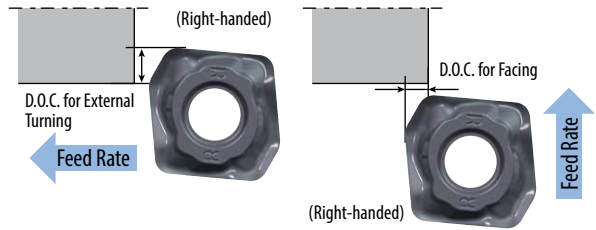

## 3. Applicable Toolholder

The SX chipbreaker insert requires a different shim than standard inserts  
No additional toolholder modifications are necessary when using the applicable Kyocera holders

Insert Part Number	Applicable Toolholder (Kyocera)	Standard Shim	Shim for SX Chipbreaker
CNMM43X%-SX	DCLN% 12-4B DCLN% 16-4D DCLN% 2020K-12 DCLN% 2525M-12	DC-44	DC-44-C
	PCLN% 12-4B PCLN% 16-4D PCLN% 2020H-12 PCLN% 2020K-12 PCLN% 2525M-12 PCLN% 3225P-12	LC-42N	LC-42N-C
CNMM54X%-SX	PCLN% 2525M-16 PCLN% 3232P-16	LC-53N	LC-53N-C
CNMM64X%-SX	PCLN% 3232P-19	LC-63	LC-63-C

Boring is Not Recommended

## 4. Unmachined Portion Varies with Insert Size

Unmachined portion is reflected below

Insert Part Number	Amount Uncut (in)	
	X	Z
CNMM43X%-SX	0.161	0.114
CNMM54X%-SX	0.189	0.130
CNMM64X%-SX	0.213	0.142



## 5. Facing

Facing is possible, but turning is recommended  
Cutting edge may drop below center in facing operations  
(Boss remains at the center of the workpiece)

Insert Part Number	Run-out Amount when Facing (in)
CNMM43X%-SX	0.030
CNMM54X%-SX	0.033
CNMM64X%-SX	0.041

The SX chipbreaker is designed for high efficiency roughing. It differs from standard inserts by the following

- Handed, single-sided, 2-corner insert
- Requires a dedicated shim
- Unmachined portion remains at corner (4. Unmachined portion varies with insert size)
- Position of insert is below the center when facing (5. Facing)

# SG Chipbreaker for Roughing

Double-sided 4-Corner Design

Improved Efficiency for Roughing Applications in Heat-resistant Alloys

**SG Chipbreaker Benefits**  
 Well-balanced axial face shape for extended tool life  
 Shallow bottom chipbreaker design for smooth chip control

## Applicable Chipbreaker Range

(D.O.C. Indicates Radial Depth of Cut per Side)

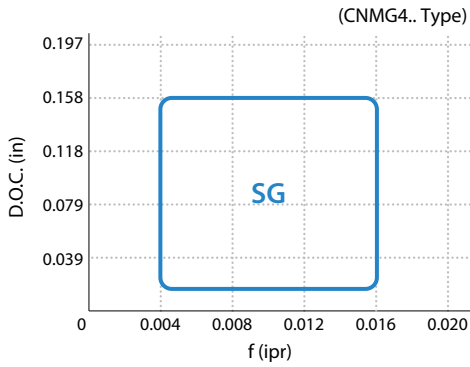

- Standard Chipbreaker**  
Stable chip control during heavy machining applications
- Well-balanced Axial Face Shape**  
High-strength land and low cutting force design

## Applicable Chipbreaker Range (D.O.C. Indicates Radial Depth of Cut per Side)

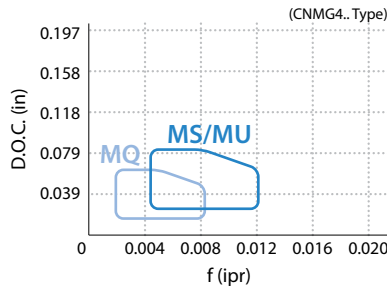
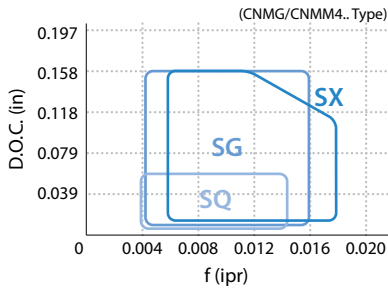













## Recommended Cutting Conditions

Workpiece	Cutting Range	Application	Recommended Chipbreaker	Recommended Grade	Min. - Recommendation - Max.		
					Vc (sfm)	D.O.C. (in)	f (ipr)
Heat-Resistant Alloys	Finishing	Continuous	MQ	PR005S	100 – 180 – 300	0.008 – 0.012 – 0.039	0.002 – 0.003 – 0.006
		Interruption		PR015S	80 – 150 – 230	0.008 – 0.020 – 0.039	0.002 – 0.004 – 0.008
	Medium	Continuous	MU	PR005S	100 – 180 – 300	0.020 – 0.039 – 0.079	0.004 – 0.006 – 0.012
				PR015S	80 – 150 – 230	0.020 – 0.039 – 0.079	0.004 – 0.006 – 0.012
		Interruption	MS	PR005S	100 – 180 – 300	0.020 – 0.039 – 0.079	0.004 – 0.006 – 0.012
				PR015S	80 – 150 – 230	0.020 – 0.039 – 0.079	0.004 – 0.006 – 0.012
		Continuous	SQ	PR005S	100 – 180 – 300	0.012 – 0.020 – 0.059	0.004 – 0.007 – 0.014
				PR015S	80 – 150 – 230	0.012 – 0.020 – 0.059	0.004 – 0.007 – 0.014
	Roughing	Continuous	SG	PR005S	100 – 180 – 300	0.020 – 0.079 – 0.158	0.004 – 0.012 – 0.016
				PR015S	80 – 150 – 230	0.020 – 0.079 – 0.158	0.004 – 0.012 – 0.016
		Interruption	SX	PR005S	100 – 180 – 300	0.020 – 0.079 – 0.158	0.006 – 0.012 – 0.018
				PR015S	80 – 150 – 230	0.020 – 0.079 – 0.158	0.006 – 0.012 – 0.018

















# Negative Inserts

Shape	Part Number	S				Heat-Resistant Alloy		MEGACOAT HARD	
		Dimensions (in)				PROSS	PRO15S	PROSS	PRO15S
		IC	Thickness	Hole	Corner-R (RE)				
	CNMG 431SQ	1/2	3/16	0.203	1/64	●	●	●	●
	432SQ				1/32	●	●	●	●
	433SQ				3/64	●	●	●	●
	CNMG 543SQ	5/8	1/4	0.250	3/64	●	●	●	●
	544SQ				1/16	●	●	●	●
CNMG 643SQ	3/4	1/4	0.313	3/64	●	●	●	●	
644SQ				1/16	●	●	●	●	
	CNMG 431MQ	1/2	3/16	0.203	1/64	●	●	●	●
	432MQ				1/32	●	●	●	●
	CNMG 431MS	1/2	3/16	0.203	1/64	●	●	●	●
	432MS				1/32	●	●	●	●
	433MS				3/64	●	●	●	●
	434MS				1/16	●	●	●	●
	CNMG 431MU	1/2	3/16	0.203	1/64	●	●	●	●
	432MU				1/32	●	●	●	●
	433MU				3/64	●	●	●	●
	CNMG 542MU	5/8	1/4	0.250	1/32	●	●	●	●
	543MU				3/64	●	●	●	●
	544MU				1/16	●	●	●	●
	CNMG 643MU				3/4	1/4	0.313	3/64	●
644MU	1/16	●	●	●				●	
	CNMG 431TK	1/2	3/16	0.203	1/64	●	●	●	●
	432TK				1/32	●	●	●	●
	CNMG 432SG	1/2	3/16	0.203	1/32	●	●	●	●
	433SG				3/64	●	●	●	●
	CNMG 543SG	5/8	1/4	0.250	3/64	●	●	●	●
	544SG				1/16	●	●	●	●
	CNMG 643SG	3/4	1/4	0.313	3/64	●	●	●	●
644SG	1/16				●	●	●	●	
	CNMM 43X <sup>°</sup> -SX*	1/2	0.174	0.203	-	●	●	●	●
	CNMM 54X <sup>°</sup> -SX*	5/8	0.235	0.250	-	●	●	●	●
	CNMM 64X <sup>°</sup> -SX*	3/4	0.233	0.313	-	●	●	●	●
	DNMG 431SQ	1/2	3/16	0.203	1/64	●	●	●	●
	432SQ				1/32	●	●	●	●
	433SQ				3/64	●	●	●	●
	DNMG 441SQ	1/2	1/4	0.203	1/64	●	●	●	●
442SQ	1/32				●	●	●	●	
DNMG 443SQ				3/64	●	●	●	●	
	DNMG 431MQ	1/2	3/16	0.203	1/64	●	●	●	●
	432MQ				1/32	●	●	●	●
	DNMG 441MQ	1/2	1/4	0.203	1/64	●	●	●	●
	442MQ				1/32	●	●	●	●
	DNMG 431MS	1/2	3/16	0.203	1/64	●	●	●	●
	432MS				1/32	●	●	●	●
	433MS				3/64	●	●	●	●
	DNMG 441MS	1/2	1/4	0.203	1/64	●	●	●	●
	442MS				1/32	●	●	●	●
DNMG 443MS				3/64	●	●	●	●	
	DNMG 431MU	1/2	3/16	0.203	1/64	●	●	●	●
	432MU				1/32	●	●	●	●
	DNMG 441MU	1/2	1/4	0.203	1/64	●	●	●	●
442MU	1/32				●	●	●	●	
	DNMG 432SG	1/2	3/16	0.203	1/32	●	●	●	●
	433SG				3/64	●	●	●	●

\*CNMM...X<sup>°</sup>-SX inserts are single-sided with 2 cutting edges.



\*CNMM...X<sup>°</sup>-SX inserts require a different shim sold separately. See page 5 for applicable shim for SX chipbreaker inserts.

Shape	Part Number	S				Heat-Resistant Alloy		MEGACOAT HARD	
		Dimensions (in)				PROSS	PRO15S	PROSS	PRO15S
		IC	Thickness	Hole	Corner-R (RE)				
	SNMG 431MQ	1/2	3/16	0.203	1/64	●	●	●	●
	432MQ				1/32	●	●	●	●
	SNMG 431MS	1/2	3/16	0.203	1/64	●	●	●	●
	432MS				1/32	●	●	●	●
	433MS				3/64	●	●	●	●
	434MS				1/16	●	●	●	●
	SNMG 643MU	3/4	1/4	0.313	3/64	●	●	●	●
	644MU				1/16	●	●	●	●
	SNMG 432SG	1/2	3/16	0.203	1/32	●	●	●	●
	433SG				3/64	●	●	●	●
	SNMG 543SG	5/8	1/4	0.250	3/64	●	●	●	●
	544SG				1/16	●	●	●	●
	SNMG 643SG	3/4	1/4	0.313	3/64	●	●	●	●
644SG	1/16				●	●	●	●	
	TNMG 331MQ	3/8	3/16	0.150	1/64	●	●	●	●
	332MQ				1/32	●	●	●	●
	TNMG 331MS	3/8	3/16	0.150	1/64	●	●	●	●
	332MS				1/32	●	●	●	●
	333MS				3/64	●	●	●	●
	TNMG 331MU	3/8	3/16	0.150	1/64	●	●	●	●
	332MU				1/32	●	●	●	●
	TNMG 332SG	3/8	3/16	0.150	1/32	●	●	●	●
	333SG				3/64	●	●	●	●
	TNMG 432SG	1/2	3/16	0.203	1/32	●	●	●	●
					3/64	●	●	●	●
	VNMG 331MQ	3/8	3/16	0.150	1/64	●	●	●	●
	332MQ				1/32	●	●	●	●
	VNMG 331MS	3/8	3/16	0.150	1/64	●	●	●	●
	332MS				1/32	●	●	●	●
	333MS				3/64	●	●	●	●
	VNMG 331MU	3/8	3/16	0.150	1/64	●	●	●	●
	332MU				1/32	●	●	●	●
	VNMG 331SG	3/8	3/16	0.150	1/64	●	●	●	●
	332SG				1/32	●	●	●	●
	WNMG 431MQ	1/2	3/16	0.203	1/64	●	●	●	●
	432MQ				1/32	●	●	●	●
	WNMG 431MS	1/2	3/16	0.203	1/64	●	●	●	●
	432MS				1/32	●	●	●	●
	433MS				3/64	●	●	●	●
	WNMG 431MU	1/2	3/16	0.203	1/64	●	●	●	●
	432MU				1/32	●	●	●	●
	WNMG 432SG	1/2	3/16	0.203	1/32	●	●	●	●
	433SG				3/64	●	●	●	●

● : Standard Stock

Inserts sold in 10 piece boxes

# Positive Inserts

<ul style="list-style-type: none"> <li>● Continuous / 1st Choice</li> <li>● Light Interruption / 1st Choice</li> </ul>		S	Heat-Resistant Alloy				●	●
Shape	Part Number	Dimensions (in)					MEGACOAT HARD	
		IC	Thickness	Hole	Corner-R (RE)	AN	PR0055	PR0155
 Finishing-Medium	CCMT 3251MQ	3/8	5/32	0.173	1/64	7°	●	●
	3252MQ				1/32		●	●
 Finishing-Medium	DCMT 21505MQ	1/4	3/32	0.173	0.008	7°	●	●
	2151MQ				1/64		●	●
	DCMT 3251MQ	3/8	5/32	0.173	1/64	7°	●	●
	3252MQ				1/32		●	●

● : Standard Stock

Inserts sold in 10 piece boxes



## KYOCERA Precision Tools

238 Marc Drive  
 Cuyahoga Falls, OH 44223  
 Customer Service | 800.823.7284 - Option 1  
 Technical Support | 800.823.7284 - Option 2



Official Website | [www.kyoceraprecisiontools.com](http://www.kyoceraprecisiontools.com)  
 Distributor Website | [portal.kyoceraprecisiontools.com](http://portal.kyoceraprecisiontools.com)  
 Email | [cuttingtools@kyocerapti.com](mailto:cuttingtools@kyocerapti.com)