



ADVANCED PRODUCT GROUP



Where **high performance** is the **standard**®

AHB Tooling & Machinery, Inc.
ISO Certified
(800) 991-4225
www.ahbinc.com
customerservice@ahbinc.com

Complete Metalworking Solutions
Roseville Saginaw & Jackson, MI

The advertisement for AHB Tooling & Machinery, Inc. features a background of an American flag. The company name 'AHB' is prominently displayed in a large, white, serif font. To the right of the name, the company's contact information is listed. Below the name, the text 'Complete Metalworking Solutions' and 'Roseville Saginaw & Jackson, MI' is written in a smaller font.

Over
300 new
sizes and
series added



Where **high performance** is the **standard**®























For more than 95 years, M.A. FORD has been at the cutting edge of tooling design and manufacturing and has developed an enviable global reputation for performance and precision in advanced solid carbide tooling, serving over 60 countries worldwide.

























Our innovative cutting geometries, materials and coating technologies are providing effective manufacturing solutions to an expanding and increasingly diverse range of industries from agriculture and construction to aerospace, power generation and automotive, to name but a few.

M.A. FORD – Where high performance is the standard.®

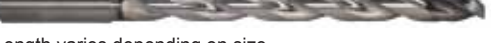

Table of Contents

Cyclone							
Series	Tool Illustration	Coolant	Length	Drill Point Angle	Helix Angle	Material Group	Page
CXDSS				140° - 142°	30°		9-12
CXDSR				140° - 142°	30°		13-16
CXDCS				140° - 142°	30°		17-20
CXDCR				140° - 142°	30°		21-24
CXDCL				140° - 142°	30°		25-28
Technical Information							62-65

Twister XD®							
Series	Tool Illustration	Coolant	Length	Drill Point Angle	Helix Angle	Material Group	Page
2XDSS				140° - 142°	30°		29-32
2XD SR				140° - 142°	30°		33-36
2XD CS				140° - 142°	30°		37-40
2XD CR				140° - 142°	30°		41-44
2XD CL				140° - 142°	30°		45-47
2XD CE	 Length varies depending on size			140° - 142°	30°		48
Technical Information							66-72





Twister® Spot Drill							
Series	Tool Illustration	Coolant	Length	Drill Point Angle	Helix Angle	Material Group	Page
200S				145°	Straight Flute		49
Technical Information							73

Table of Contents





























Twister® MD							
Series	Tool Illustration	Coolant	Length	Drill Point Angle	Helix Angle	Material Group	Page
2MDCL				140°	15°		50
Technical Information							74-75
Twister® Micro-Tuff®							
Series	Tool Illustration	Coolant	Length	Drill Point Angle	Helix Angle	Material Group	Page
305	 Length varies depending on size			135°	12°		51-56
Technical Information							76-77
Twister® HP							
Series	Tool Illustration	Coolant	Length	Drill Point Angle	Helix Angle	Material Group	Page
207CE				—	35°		57-58
Technical Information							78
Tuff-Cut® XT							
Series	Tool Illustration	Z	Length	Corner Type	Helix Angle	Material Group	Page
277		4		Square End Corner Radius	38° / 41°		81-85
277W							
277N		4		Square End Corner Radius Neck Relief	38° / 41°		86-88
278		5		Square End Corner Radius	40°		89-99
278W							
278N		5		Corner Radius Neck Relief	40°		100-101
279		4		Ball Nose	35° / 38°		102
Technical Information							142-151

Table of Contents

Tuff-Cut® XR7							
Series	Tool Illustration	Z	Length	Corner Type	Helix Angle	Material Group	Page
180		7		Square End Corner Radius	38°		103-105
180N		7		Corner Radius Neck Relief	38°		107
Technical Information							152-153











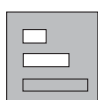



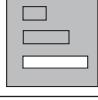

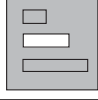

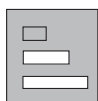





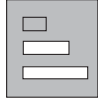

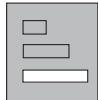





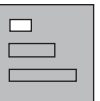

Tuff-Cut® XR							
Series	Tool Illustration	Z	Length	Corner Type	Helix Angle	Material Group	Page
177		4		Square End Corner Radius	35°/38°		108-112
177W							
177L		4		Corner Radius Neck Relief	35°/38°		113
177S		4		Square End Corner Radius Neck Relief	35°/38°		114
178		5		Square End Corner Radius	38°		115-117
178W							
178N		5		Corner Radius Neck Relief	38°		118
179		4		Ball Nose	35°/38°		119
179L		4		Ball Nose Neck Relief	35°/38°		120
Technical Information							154-161

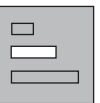
Table of Contents

Tuff-Cut® X-AL							
Series	Tool Illustration	Z	Length	Corner Type	Helix Angle	Material Group	Page
138CE		3		Square End	36°		121-122
Technical Information							162-163

Tuff-Cut® DM							
Series	Tool Illustration	Z	Length	Corner Type	Helix Angle	Material Group	Page
156		2		Neck Relief Ball Nose	20°		123-126
158		4		Neck Relief Corner Radius	35° / 38°		127
157		Multi		Square End Corner Radius	45°		128-130
Technical Information							164-173

Diamond Coated Router							
Series	Tool Illustration	End Grind	Cut	Coating	Material Group	Page	
239		Bur End Mill Safe	Up	GemX		177	
Technical Information							178

Diamond Grind Routers							
Series	Tool Illustration	End Grind	Cut	Coating	Material Group	Page	
230CE		Safe	Down	CERAedge®		179	
231CE		End Mill	Down	CERAedge®		179	
231BCE		Bur	Down	CERAedge®		179	
231DCE		Drill	Down	CERAedge®		179	
Technical Information							180



Series CXDSS	9-12
Series CXDSR.....	13-16
Series CXDCS.....	17-20
Series CXDCR.....	21-24
Series CXDCL	25-28

Twister **XD**[®] Xtreme Drilling

Series 2XDSS.....	29-32
Series 2XDSR.....	33-36
Series 2XDCS.....	37-40
Series 2XDRCR	41-44
Series 2XDCL.....	45-47
Series 2XDCE.....	48

Twister[®] Spot Drill

Series 200S	49
-------------------	----

Twister[®] MD

Series 2MDCL	50
--------------------	----

Twister[®] Micro-Tuff[®]

Series 305.....	51-56
-----------------	-------

Twister[®] HP

Series 207CE.....	57-58
-------------------	-------



HP Drills

CYCLONE

The "Perfect Storm" for High Performance Drilling

CXD ADVANCED DRILLING FEATURES AND BENEFITS

- **New lower thrust point geometry**

Reduced cutting forces allowing for heavier feed rates in most materials.
Improved performance in titanium, stainless steel, carbon steels and cast iron.

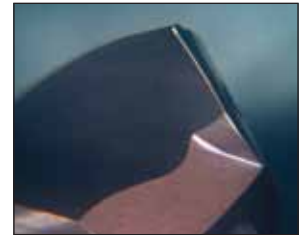

- **Enhanced double margin design**

Back margin location allows for quicker engagement in hole.
Improved hole finishes.
Improved location when drilling through cross holes.



- **ALtima® Plus AlTiN multi-layer coating**

Higher heat resistance means higher RPM capabilities.
Optimized coating structure lengthens drill life and reduces chipping and wear.

- **Enhanced surface finish technology pre and post coating**

Pre-treatment enhances coating adhesion.
Post-treatment enhances chip evacuation.

CXD CASE STUDIES

Size: .758" (19.25mm)
Work material: 1018 steel plate
Machine: Haas VF-5
Competitor: X
RPM (n): 1940
vc-SFM: 385 m/min: 117
(f) IPR: .0135 mm/Rev: .34
Hole Depth: 1.5" (38mm)
M.A. Ford® Holes Produced: 3000
Competitor X Holes Produced: 2000
Total Drill Cost Savings During Test: \$3,810

Size: 11/32"
Work material: 304 stainless steel modified
Machine: Mazak CNC lathe
Competitor: Y
RPM (n): 2228
vc-SFM: 200 m/min: 61
(f) IPR: .008 mm/Rev: .20
Hole Depth: 1.8" (45mm)
M.A. Ford® Holes Produced: 382
(ran out of parts)
Customer was very pleased with the CXD drill.
The CXD drill showed no chipping along cutting edges and flutes. The Competitor Y tool showed heavy chipping on cutting edges and flutes at same point of tool life.

ALtima® Plus Multi-Layer AlTiN Coating

M.A. Ford® 7/16" solid carbide drill
 Workpiece Material: 4140 Steel
 Coating: **M.A. Ford® ALtima® Plus**
 Competitor Coating: AlCrN

22.5%
more

	M.A. Ford® ALtima® Plus	Competitor AlCrN
Number of Holes Produced	6468	5280

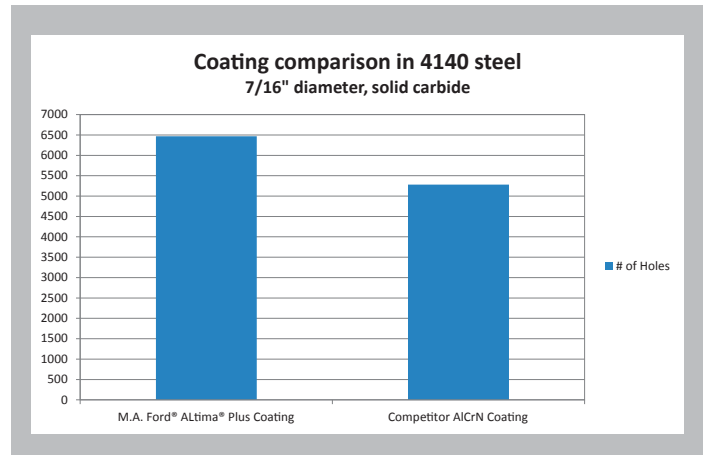

M.A. Ford® 7/16" coolant through carbide drill
 Workpiece Material: 4140 Steel
 Coating: **M.A. Ford® ALtima® Plus**
 Competitor Coating: AlCrN
 Competitor Coating: AlTiN

46%
more

	M.A. Ford® ALtima® Plus	Competitor AlCrN	Competitor AlTiN
Number of Holes Produced	1890	1556	1296

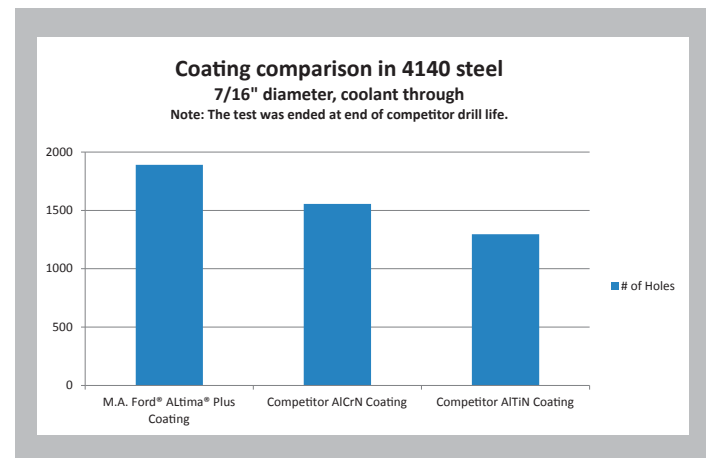

M.A. Ford® 7/16" coolant through carbide drill
 Workpiece Material: 304 Stainless Steel
 Coating: **M.A. Ford® ALtima® Plus**
 Competitor Coating: AlCrN

11%
more

	M.A. Ford® ALtima® Plus	Competitor AlCrN
Number of Holes Produced	2484	2245

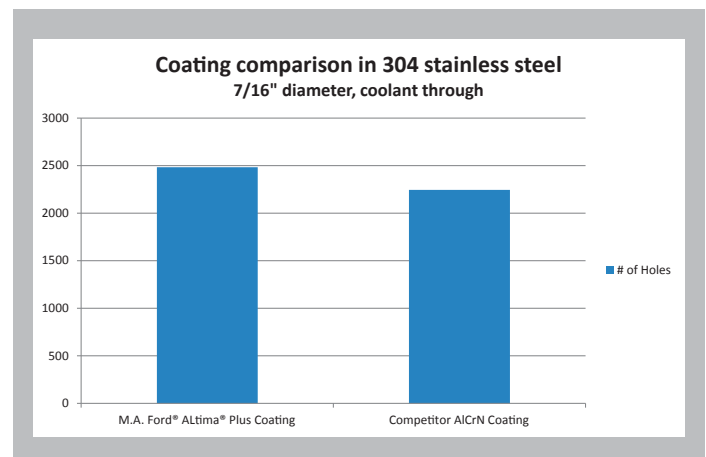

ALtima® Plus Multi-Layer AlTiN Coating

M.A. Ford® 1/4" coolant through carbide drill
 Workpiece Material: 4140 Steel
 Coating: **M.A. Ford® ALtima® Plus**
 Competitor Coating: AlTiN

	M.A. Ford® ALtima® Plus	Competitor AlTiN
Number of Holes Produced	3619	3284

10%
more

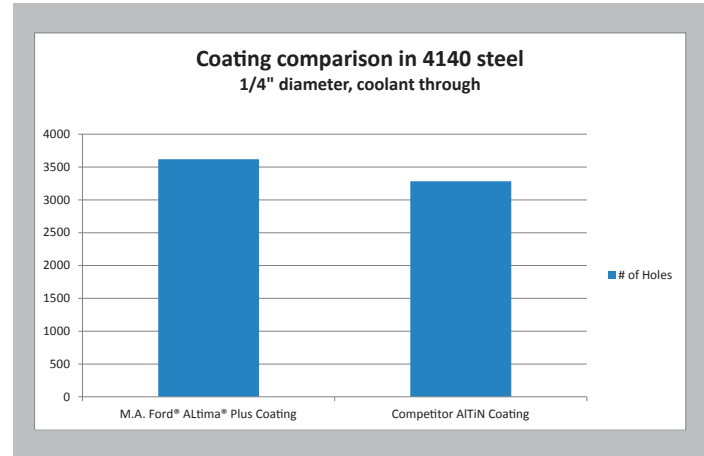

M.A. Ford® 1/4" coolant through carbide drill
 Workpiece Material: 6Al-4V Titanium
 Coating: **M.A. Ford® ALtima® Plus**
 Competitor Coating: AlTiN

	M.A. Ford® ALtima® Plus	Competitor AlTiN
Number of Holes Produced	2303	1974

17%
more

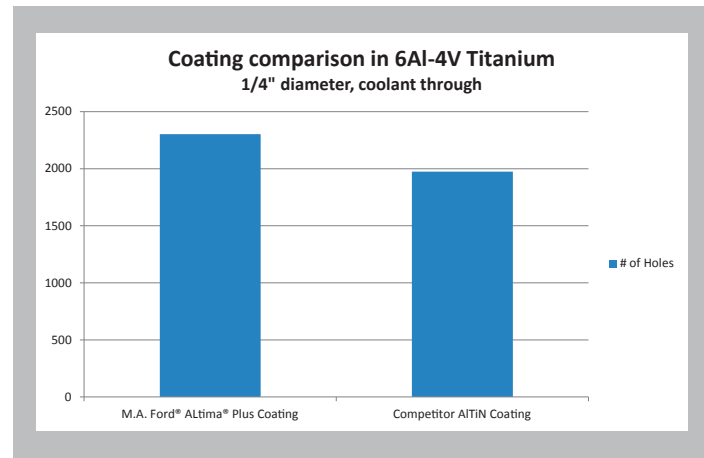

Improved Productivity • Lower Cost Per Hole

Cyclone Series CXDSS



Designed for high performance drilling in a broad range of materials.

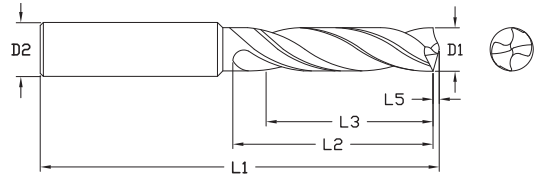

ALtima® Plus		Diameter				Shank		OAL		Flute Length		Drill Length		Point Length	
Tool No.	EDP	D1 (m7)				D2 (h6)		L1		L2 (Max.)		L3 Ref.		L5	
		Inch	Letter/ Wire	mm	Decimal	Inch	mm	Inch	mm	Inch	mm	Inch	mm	Inch	mm
CXDSS 0300AP	06615			3.0	.1181		3.0		62		20		14		0.46
CXDSS 1200AP	06616		#31		.1200	1/8		2.44		0.787		0.551		0.019	
CXDSS 0310AP	06617			3.1	.1220		4.0		62		20		14		0.48
CXDSS 1250AP	06618	1/8			.1250	1/8		2.44		0.787		0.551		0.019	
CXDSS 0320AP	06619			3.2	.1260		4.0		62		20		14		0.50
CXDSS 1285AP	06620		#30		.1285	5/32		2.44		0.787		0.551		0.020	
CXDSS 0330AP	06621			3.3	.1299		4.0		62		20		14		0.51
CXDSS 0340AP	06622			3.4	.1339		4.0		62		20		14		0.53
CXDSS 1360AP	06623		#29		.1360	5/32		2.44		0.787		0.551		0.021	
CXDSS 0350AP	06624			3.5	.1378		4.0		62		20		14		0.54
CXDSS 1406AP	06625	9/64			.1406	5/32		2.44		0.787		0.551		0.022	
CXDSS 0360AP	06626			3.6	.1417		4.0		62		20		14		0.56
CXDSS 0370AP	06627			3.7	.1457		4.0		62		20		14		0.57
CXDSS 0380AP	06628			3.8	.1496		4.0		66		24		17		0.59
CXDSS 1520AP	06629		#24		.1520	5/32		2.60		0.945		0.669		0.024	
CXDSS 0390AP	06630			3.9	.1535		4.0		66		24		17		0.60
CXDSS 1562AP	06631	5/32			.1562	5/32		2.60		0.945		0.669		0.024	
CXDSS 0400AP	06632			4.0	.1575		4.0		66		24		17		0.62
CXDSS 1590AP	06633		#21		.1590	3/16		2.60		0.945		0.669		0.025	
CXDSS 0410AP	06634			4.1	.1614		5.0		66		24		17		0.64
CXDSS 0420AP	06635			4.2	.1654		5.0		66		24		17		0.65
CXDSS 0430AP	06636			4.3	.1693		5.0		66		24		17		0.67
CXDSS 1719AP	06637	11/64			.1719	3/16		2.60		0.945		0.669		0.027	
CXDSS 0440AP	06638			4.4	.1732		5.0		66		24		17		0.68
CXDSS 0450AP	06639			4.5	.1772		5.0		66		24		17		0.70
CXDSS 0460AP	06640			4.6	.1811		5.0		66		24		17		0.71
CXDSS 0470AP	06641			4.7	.1850		5.0		66		24		17		0.73
CXDSS 1875AP	06642	3/16			.1875	3/16		2.60		1.102		0.787		0.029	
CXDSS 0480AP	06643			4.8	.1890		5.0		66		28		20		0.74
CXDSS 0490AP	06644			4.9	.1929		5.0		66		28		20		0.76
CXDSS 0500AP	06645			5.0	.1968		5.0		66		28		20		0.77
CXDSS 0510AP	06646			5.1	.2008		6.0		66		28		20		0.79
CXDSS 2031AP	06647	13/64			.2031	1/4		2.60		1.102		0.787		0.031	
CXDSS 0520AP	06648			5.2	.2047		6.0		66		28		20		0.81

Inch		
D1	Tolerance (m7)	
.0000 - .1181	+0.0008/+0.0047	
.1182 - .2362	+0.0016/+0.0063	
.2363 - .3937	+0.0024/+0.0083	
.3938 - .7087	+0.0027/+0.0098	
.7088 - .7500	+0.0031/+0.0114	

Inch		
D2	Tolerance (h6)	
.0000 - .1181	+0/-0.0024	
.1182 - .2362	+0/-0.0031	
.2363 - .3937	+0/-0.0035	
.3938 - .7087	+0/-0.0043	
.7088 - .7500	+0/-0.0051	

Metric (mm)		
D1	Tolerance (m7)	
0 - 3.0	+0.02/+0.12	
3.01 - 6.0	+0.04/+0.16	
6.01 - 10.0	+0.06/+0.21	
10.01 - 18.0	+0.07/+0.25	
18.01 - 20.0	+0.08/+0.29	

Metric (mm)		
D2	Tolerance (h6)	
0 - 3.0	+0/-0.006	
3.01 - 6.0	+0/-0.008	
6.01 - 10.0	+0/-0.009	
10.01 - 18.0	+0/-0.011	
18.01 - 20.0	+0/-0.013	



Series CXDSS Continued

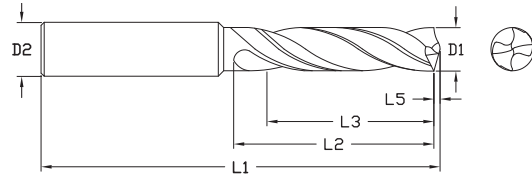
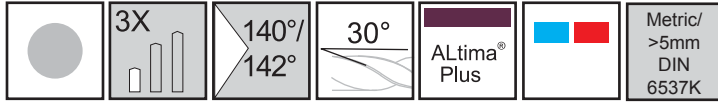

ALtima® Plus		Diameter				Shank		OAL		Flute Length		Drill Length		Point Length	
Tool No.	EDP	Inch	Letter/ Wire	mm	Decimal	Inch	mm	Inch	mm	Inch	mm	Inch	mm	Inch	mm
CXDSS 0530AP	06649			5.3	.2087		6.0		66		28		20		0.82
CXDSS 0540AP	06650			5.4	.2126		6.0		66		28		20		0.84
CXDSS 0550AP	06651			5.5	.2165		6.0		66		28		20		0.85
CXDSS2187AP	06652	7/32			.2187	1/4		2.60		1.102		0.787		0.034	
CXDSS 0560AP	07091			5.6	.2205		6.0		66		28		20		0.86
CXDSS2210AP	06653		#2		.2210	1/4		2.60		1.102		0.787		0.034	
CXDSS 0570AP	06654			5.7	.2244		6.0		66		28		20		0.88
CXDSS 0580AP	06655			5.8	.2283		6.0		66		28		20		0.90
CXDSS 0590AP	06656			5.9	.2323		6.0		66		28		20		0.91
CXDSS2344AP	06657	15/64			.2344	1/4		2.60		1.102		0.787		0.036	
CXDSS 0600AP	06658			6.0	.2362		6.0		66		28		20		0.93
CXDSS 0610AP	06659			6.1	.2402		8.0		79		34		24		0.95
CXDSS2420AP	06660		C		.2420	1/4		3.11		1.339		0.945		0.037	
CXDSS 0620AP	06661			6.2	.2441		8.0		79		34		24		0.96
CXDSS2460AP	06662		D		.2460	1/4		3.11		1.339		0.945		0.038	
CXDSS 0630AP	06663			6.3	.2480		8.0		79		34		24		0.98
CXDSS2500AP	06664	1/4			.2500	1/4		3.11		1.339		0.945		0.039	
CXDSS 0640AP	06665			6.4	.2520		8.0		79		34		24		0.99
CXDSS 0650AP	06666			6.5	.2559		8.0		79		34		24		1.01
CXDSS2570AP	06667		F		.2570	5/16		3.11		1.339		0.945		0.040	
CXDSS 0660AP	06668			6.6	.2598		8.0		79		34		24		1.03
CXDSS2610AP	06669		G		.2610	5/16		3.11		1.339		0.945		0.040	
CXDSS 0670AP	06670			6.7	.2638		8.0		79		34		24		1.04
CXDSS2656AP	06671	17/64			.2656	5/16		3.11		1.339		0.945		0.041	
CXDSS 0680AP	06672			6.8	.2677		8.0		79		34		24		1.05
CXDSS 0690AP	06673			6.9	.2717		8.0		79		34		24		1.07
CXDSS 0700AP	06674			7.0	.2756		8.0		79		34		24		1.08
CXDSS 0710AP	06675			7.1	.2795		8.0		79		41		29		1.10
CXDSS2812AP	06676	9/32			.2812	5/16		3.11		1.614		1.142		0.044	
CXDSS 0720AP	06677			7.2	.2835		8.0		79		41		29		1.12
CXDSS 0730AP	06678			7.3	.2874		8.0		79		41		29		1.13
CXDSS 0740AP	06679			7.4	.2913		8.0		79		41		29		1.15
CXDSS 0750AP	06680			7.5	.2953		8.0		79		41		29		1.16
CXDSS2969AP	06681	19/64			.2969	5/16		3.11		1.614		1.142		0.046	
CXDSS 0760AP	06682			7.6	.2992		8.0		79		41		29		1.18
CXDSS 0770AP	06683			7.7	.3031		8.0		79		41		29		1.19
CXDSS 0780AP	06684			7.8	.3071		8.0		79		41		29		1.21
CXDSS 0790AP	06685			7.9	.3110		8.0		79		41		29		1.22
CXDSS3125AP	06686	5/16			.3125	5/16		3.11		1.614		1.142		0.048	
CXDSS 0800AP	06687			8.0	.3150		8.0		79		41		29		1.24
CXDSS 0810AP	06688			8.1	.3189		10.0		89		47		35		1.26
CXDSS 0820AP	06689			8.2	.3228		10.0		89		47		35		1.27
CXDSS 0830AP	06690			8.3	.3268		10.0		89		47		35		1.29
CXDSS3281AP	06691	21/64			.3281	3/8		3.50		1.850		1.378		0.051	
CXDSS 0840AP	06692			8.4	.3307		10.0		89		47		35		1.31
CXDSS3320AP	06693		Q		.3320	3/8		3.50		1.850		1.378		0.051	
CXDSS 0850AP	06694			8.5	.3346		10.0		89		47		35		1.32
CXDSS 0860AP	06695			8.6	.3386		10.0		89		47		35		1.33

Series CXDSS Continued

ALtima® Plus		Diameter				Shank		OAL		Flute Length		Drill Length		Point Length	
		D1 (m7)				D2 (h6)		L1		L2 (Max.)		L3 Ref.		L5	
Tool No.	EDP	Inch	Letter/ Wire	mm	Decimal	Inch	mm	Inch	mm	Inch	mm	Inch	mm	Inch	mm
CXDSS 0870AP	06696			8.7	.3425		10.0		89		47		35		1.35
CXDSS3438AP	06697	11/32			.3438	3/8		3.50		1.850		1.378		0.053	
CXDSS 0880AP	06698			8.8	.3465		10.0		89		47		35		1.36
CXDSS 0890AP	06699			8.9	.3504		10.0		89		47		35		1.38
CXDSS 0900AP	06700			9.0	.3543		10.0		89		47		35		1.39
CXDSS 0910AP	06701			9.1	.3583		10.0		89		47		35		1.41
CXDSS3594AP	06702	23/64			.3594	3/8		3.50		1.850		1.378		0.056	
CXDSS 0920AP	06703			9.2	.3622		10.0		89		47		35		1.43
CXDSS 0925AP	06704			9.25	.3642		10.0		89		47		35		1.43
CXDSS 0930AP	06705			9.3	.3661		10.0		89		47		35		1.44
CXDSS 0940AP	06706			9.4	.3701		10.0		89		47		35		1.46
CXDSS 0950AP	06707			9.5	.3740		10.0		89		47		35		1.47
CXDSS3750AP	06708	3/8			.3750	3/8		3.50		1.850		1.378		0.058	
CXDSS 0960AP	06709			9.6	.3780		10.0		89		47		35		1.49
CXDSS 0970AP	06710			9.7	.3819		10.0		89		47		35		1.50
CXDSS 0980AP	06711			9.8	.3858		10.0		89		47		35		1.52
CXDSS 0990AP	06712			9.9	.3898		10.0		89		47		35		1.53
CXDSS3906AP	06713	25/64			.3906	7/16		3.50		1.850		1.378		0.061	
CXDSS 1000AP	06714			10.0	.3937		10.0		89		47		35		1.55
CXDSS 1010AP	06715			10.1	.3976		12.0		102		55		40		1.56
CXDSS 1020AP	06716			10.2	.4016		12.0		102		55		40		1.58
CXDSS 1030AP	06717			10.3	.4055		12.0		102		55		40		1.60
CXDSS4062AP	06718	13/32			.4062	7/16		4.02		2.165		1.575		0.063	
CXDSS 1040AP	06719			10.4	.4094		12.0		102		55		40		1.61
CXDSS 1050AP	06720			10.5	.4134		12.0		102		55		40		1.63
CXDSS 1060AP	06721			10.6	.4173		12.0		102		55		40		1.64
CXDSS 1070AP	06722			10.7	.4213		12.0		102		55		40		1.66
CXDSS4219AP	06723	27/64			.4219	7/16		4.02		2.165		1.575		0.065	
CXDSS 1080AP	06724			10.8	.4252		12.0		102		55		40		1.67
CXDSS 1090AP	06725			10.9	.4291		12.0		102		55		40		1.69
CXDSS 1100AP	06726			11.0	.4331		12.0		102		55		40		1.70
CXDSS 1110AP	06727			11.1	.4370		12.0		102		55		40		1.72
CXDSS4375AP	06728	7/16			.4375	7/16		4.02		2.165		1.575		0.068	
CXDSS 1120AP	06729			11.2	.4409		12.0		102		55		40		1.74
CXDSS 1130AP	06730			11.3	.4449		12.0		102		55		40		1.75
CXDSS 1140AP	06731			11.4	.4488		12.0		102		55		40		1.77
CXDSS 1150AP	06732			11.5	.4527		12.0		102		55		40		1.78
CXDSS 1160AP	06733			11.6	.4567		12.0		102		55		40		1.80
CXDSS 1170AP	06734			11.7	.4606		12.0		102		55		40		1.81
CXDSS 1180AP	06735			11.8	.4646		12.0		102		55		40		1.83
CXDSS 1190AP	06736			11.9	.4685		12.0		102		55		40		1.84
CXDSS4688AP	06737	15/32			.4688	1/2		4.02		2.165		1.575		0.073	
CXDSS 1200AP	06738			12.0	.4724		12.0		102		55		40		1.86
CXDSS 1210AP	06739			12.1	.4764		14.0		107		60		43		1.87
CXDSS4844AP	06740	31/64			.4844	1/2		4.21		2.362		1.693		0.075	
CXDSS 1250AP	06741			12.5	.4921		14.0		107		60		43		1.94
CXDSS5000AP	06742	1/2			.5000	1/2		4.21		2.362		1.693		0.077	
CXDSS 1280AP	06743			12.8	.5039		14.0		107		60		43		1.98
CXDSS 1283AP	06744			12.83	.5051		14.0		107		60		43		1.99
CXDSS 1290AP	06745			12.9	.5079		14.0		107		60		43		2.00
CXDSS 1300AP	06746			13.0	.5118		14.0		107		60		43		2.01
CXDSS5156AP	06747	33/64			.5156	9/16		4.21		2.362		1.693		0.080	
CXDSS5312AP	06748	17/32			.5312	9/16		4.21		2.362		1.693		0.082	
CXDSS 1350AP	06750			13.5	.5315		14.0		107		60		43		2.09



Series CXDSS Continued

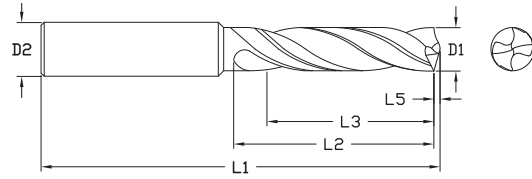
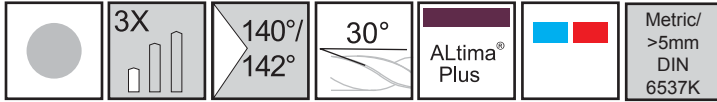

ALtima® Plus		Diameter				Shank		OAL		Flute Length		Drill Length		Point Length	
Tool No.	EDP	D1 (m7)				D2 (h6)		L1		L2 (Max.)		L3 Ref.		L5	
		Inch	Letter/ Wire	mm	Decimal	Inch	mm	Inch	mm	Inch	mm	Inch	mm	Inch	mm
CXDSS 1370AP	06751			13.7	.5394		14.0		107		60		43		2.12
CXDSS5469AP	06752	35/64			.5469	9/16		4.21		2.362		1.693		0.085	
CXDSS 1400AP	06753			14.0	.5512		14.0		107		60		43		2.17
CXDSS5625AP	06754	9/16			.5625	9/16		4.53		2.559		1.772		0.087	
CXDSS 1450AP	06755			14.5	.5709		16.0		115		65		45		2.25
CXDSS 1470AP	06756			14.7	.5787		16.0		115		65		45		2.28
CXDSS 1500AP	06757			15.0	.5905		16.0		115		65		45		2.32
CXDSS5938AP	06758	19/32			.5938	5/8		4.53		2.559		1.772		0.092	
CXDSS 1530AP	06759			15.3	.6024		16.0		115		65		45		2.37
CXDSS 1550AP	06760			15.5	.6102		16.0		115		65		45		2.40
CXDSS 1570AP	06761			15.7	.6181		16.0		115		65		45		2.43
CXDSS6250AP	06762	5/8			.6250	5/8		4.53		2.559		1.772		0.097	
CXDSS 1600AP	06763			16.0	.6299		16.0		115		65		45		2.48
CXDSS 1608AP	06764			16.08	.6331		18.0		123		73		51		2.49
CXDSS 1630AP	06765			16.3	.6417		18.0		123		73		51		2.53
CXDSS 1650AP	06766			16.5	.6496		18.0		123		73		51		2.56
CXDSS6562AP	06767	21/32			.6562	11/16		4.84		2.874		2.008		0.102	
CXDSS 1700AP	06768			17.0	.6693		18.0		123		73		51		2.63
CXDSS6875AP	06769	11/16			.6875	11/16		4.84		2.874		2.008		0.107	
CXDSS 1750AP	06770			17.5	.6890		18.0		123		73		51		2.71
CXDSS 1800AP	06771			18.0	.7087		18.0		123		73		51		2.79
CXDSS 1850AP	06772			18.5	.7283		20.0		131		79		55		2.87
CXDSS7500AP	06773	3/4			.7500	3/4		5.16		3.11		2.165		0.116	
CXDSS 1916AP	06774			19.16	.7543		20.0		131		79		55		2.97
CXDSS 1925AP	06775			19.25	.7579		20.0		131		79		55		2.98
CXDSS 1930AP	06776			19.3	.7598		20.0		131		79		55		2.99
CXDSS 1950AP	06777			19.5	.7677		20.0		131		79		55		3.02
CXDSS 2000AP	06778			20.0	.7874		20.0		131		79		55		3.10

Safety Note

Always wear the appropriate personal protective equipment such as safety glasses and protective clothing when using solid carbide or HSS cutting tools. Machines should be fully guarded. Technical data provided should be considered advisory only as variations may be necessary depending on the particular application.



Cyclone Series CXDSR

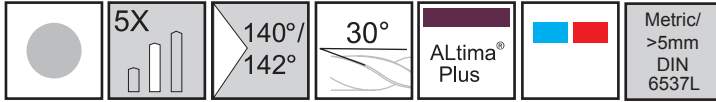

Designed for high performance drilling in a broad range of materials.

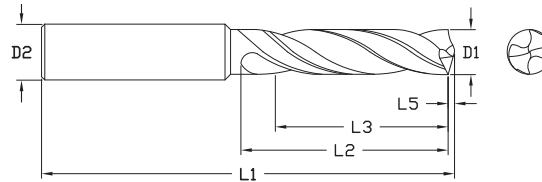

ALtima® Plus		Diameter				Shank		OAL		Flute Length		Drill Length		Point Length	
Tool No.	EDP	Inch	D1 (m7)			D2 (h6)		L1		L2 (Max.)		L3 Ref.		L5	
			Letter/ Wire	mm	Decimal	Inch	mm	Inch	mm	Inch	mm	Inch	mm	Inch	mm
CXDSR 0300AP	06467			3.0	.1181		3.0		66		28		23		0.46
CXDSR 1200AP	06468		#31		.1200	1/8		2.60		1.102		0.906		0.019	
CXDSR 0310AP	06469			3.1	.1220		4.0		66		28		23		0.48
CXDSR 1250AP	06470	1/8			.1250	1/8		2.60		1.102		0.906		0.019	
CXDSR 0320AP	06471			3.2	.1260		4.0		66		28		23		0.50
CXDSR 1285AP	06472		#30		.1285	5/32		2.60		1.102		0.906		0.020	
CXDSR 0330AP	06473			3.3	.1299		4.0		66		28		23		0.51
CXDSR 0340AP	06474			3.4	.1339		4.0		66		28		23		0.53
CXDSR 1360AP	06475		#29		.1360	5/32		2.60		1.102		0.906		0.021	
CXDSR 0350AP	06476			3.5	.1378		4.0		66		28		23		0.54
CXDSR 1406AP	06477	9/64			.1406	5/32		2.60		1.102		0.906		0.022	
CXDSR 0360AP	06478			3.6	.1417		4.0		66		28		23		0.56
CXDSR 0370AP	06479			3.7	.1457		4.0		66		28		23		0.57
CXDSR 0380AP	06480			3.8	.1496		4.0		74		36		29		0.59
CXDSR 1520AP	06481		#24		.1520	5/32		2.91		1.417		1.142		0.024	
CXDSR 0390AP	06482			3.9	.1535		4.0		74		36		29		0.60
CXDSR 1562AP	06483	5/32			.1562	5/32		2.91		1.417		1.142		0.024	
CXDSR 0400AP	06484			4.0	.1575		4.0		74		36		29		0.62
CXDSR 1590AP	06485		#21		.1590	3/16		2.91		1.417		1.142		0.025	
CXDSR 0410AP	06486			4.1	.1614		5.0		74		36		29		0.64
CXDSR 0420AP	06487			4.2	.1654		5.0		74		36		29		0.65
CXDSR 0430AP	06488			4.3	.1693		5.0		74		36		29		0.67
CXDSR 1719AP	06489	11/64			.1719	3/16		2.91		1.417		1.142		0.027	
CXDSR 0440AP	06490			4.4	.1732		5.0		74		36		29		0.68
CXDSR 0450AP	06491			4.5	.1772		5.0		74		36		29		0.70
CXDSR 0460AP	06492			4.6	.1811		5.0		74		36		29		0.71
CXDSR 0470AP	06493			4.7	.1850		5.0		74		36		29		0.73
CXDSR 1875AP	06494	3/16			.1875	3/16		3.23		1.732		1.378		0.029	
CXDSR 0480AP	06495			4.8	.1890		5.0		82		44		35		0.74
CXDSR 0490AP	06496			4.9	.1929		5.0		82		44		35		0.76
CXDSR 0500AP	06497			5.0	.1968		5.0		82		44		35		0.77
CXDSR 0510AP	06498			5.1	.2008		6.0		82		44		35		0.79
CXDSR 2031AP	06499	13/64			.2031	1/4		3.23		1.732		1.378		0.031	
CXDSR 0520AP	06500			5.2	.2047		6.0		82		44		35		0.81

Inch		
D1	Tolerance (m7)	
.0000 - .1181	+.00008/+0.00047	
.1182 - .2362	+.00016/+0.00063	
.2363 - .3937	+.00024/+0.00083	
.3938 - .7087	+.00027/+0.00098	

Inch		
D2	Tolerance (h6)	
.0000 - .1181	+0/-0.00024	
.1182 - .2362	+0/-0.00031	
.2363 - .3937	+0/-0.00035	
.3938 - .7087	+0/-0.00043	

Metric (mm)		
D1	Tolerance (m7)	
0 - 3.0	+.002/+0.012	
3.01 - 6.0	+.004/+0.016	
6.01 - 10.0	+.006/+0.021	
10.01 - 18.0	+.007/+0.025	

Metric (mm)		
D2	Tolerance (h6)	
0 - 3.0	+0/-0.006	
3.01 - 6.0	+0/-0.008	
6.01 - 10.0	+0/-0.009	
10.01 - 18.0	+0/-0.011	



Series CXDSR Continued

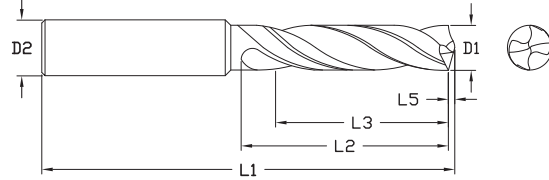
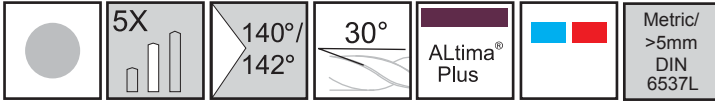

ALtima® Plus		Diameter				Shank		OAL		Flute Length		Drill Length		Point Length	
		D1 (m7)				D2 (h6)		L1		L2 (Max.)		L3 Ref.		L5	
Tool No.	EDP	Inch	Letter/ Wire	mm	Decimal	Inch	mm	Inch	mm	Inch	mm	Inch	mm	Inch	mm
CXDSR 0530AP	06501			5.3	.2087		6.0		82		44		35		0.82
CXDSR 0540AP	06502			5.4	.2126		6.0		82		44		35		0.84
CXDSR 0550AP	06503			5.5	.2165		6.0		82		44		35		0.85
CXDSR2187AP	06504	7/32			.2187	1/4		3.23		1.732		1.378		0.034	
CXDSR 0560AP	07092			5.6	.2205		6.0		82		44		35		0.86
CXDSR2210AP	06505		#2		.2210	1/4		3.23		1.732		1.378		0.034	
CXDSR 0570AP	06506			5.7	.2244		6.0		82		44		35		0.88
CXDSR 0580AP	06507			5.8	.2283		6.0		82		44		35		0.90
CXDSR 0590AP	06508			5.9	.2323		6.0		82		44		35		0.91
CXDSR2344AP	06509	15/64			.2344	1/4		3.23		1.732		1.378		0.036	
CXDSR 0600AP	06510			6.0	.2362		6.0		82		44		35		0.93
CXDSR 0610AP	06511			6.1	.2402		8.0		91		53		43		0.95
CXDSR2420AP	06512		C		.2420	1/4		3.58		2.087		1.693		0.037	
CXDSR 0620AP	06513			6.2	.2441		8.0		91		53		43		0.96
CXDSR2460AP	06514		D		.2460	1/4		3.58		2.087		1.693		0.038	
CXDSR 0630AP	06515			6.3	.2480		8.0		91		53		43		0.98
CXDSR2500AP	06516	1/4			.2500	1/4		3.58		2.087		1.693		0.039	
CXDSR 0640AP	06517			6.4	.2520		8.0		91		53		43		0.99
CXDSR 0650AP	06518			6.5	.2559		8.0		91		53		43		1.01
CXDSR2570AP	06519		F		.2570	5/16		3.58		2.087		1.693		0.040	
CXDSR 0660AP	06520			6.6	.2598		8.0		91		53		43		1.03
CXDSR2610AP	06521		G		.2610	5/16		3.58		2.087		1.693		0.040	
CXDSR 0670AP	06522			6.7	.2638		8.0		91		53		43		1.04
CXDSR2656AP	06523	17/64			.2656	5/16		3.58		2.087		1.693		0.041	
CXDSR 0680AP	06524			6.8	.2677		8.0		91		53		43		1.05
CXDSR 0690AP	06525			6.9	.2717		8.0		91		53		43		1.07
CXDSR 0700AP	06526			7.0	.2756		8.0		91		53		43		1.10
CXDSR 0710AP	06527			7.1	.2795		8.0		91		53		43		1.10
CXDSR2812AP	06528	9/32			.2812	5/16		3.58		2.087		1.693		0.044	
CXDSR 0720AP	06529			7.2	.2835		8.0		91		53		43		1.12
CXDSR 0730AP	06530			7.3	.2874		8.0		91		53		43		1.13
CXDSR 0740AP	06531			7.4	.2913		8.0		91		53		43		1.15
CXDSR 0750AP	06532			7.5	.2953		8.0		91		53		43		1.16
CXDSR2969AP	06533	19/64			.2969	5/16		3.58		2.087		1.693		0.046	
CXDSR 0760AP	06534			7.6	.2992		8.0		91		53		43		1.18
CXDSR 0770AP	06535			7.7	.3031		8.0		91		53		43		1.19
CXDSR 0780AP	06536			7.8	.3071		8.0		91		53		43		1.21
CXDSR 0790AP	06537			7.9	.3110		8.0		91		53		43		1.22
CXDSR3125AP	06538	5/16			.3125	5/16		3.58		2.087		1.693		0.048	
CXDSR 0800AP	06539			8.0	.3150		8.0		91		53		43		1.24
CXDSR 0810AP	06540			8.1	.3189		10.0		103		61		49		1.26
CXDSR 0820AP	06541			8.2	.3228		10.0		103		61		49		1.27
CXDSR 0830AP	06542			8.3	.3268		10.0		103		61		49		1.29
CXDSR3281AP	06543	21/64			.3281	3/8		4.06		2.402		1.929		0.051	



Series CXDSR Continued

ALtima® Plus		Diameter				Shank		OAL		Flute Length		Drill Length		Point Length	
		D1 (m7)				D2 (h6)		L1		L2 (Max.)		L3 Ref.		L5	
Tool No.	EDP	Inch	Letter/ Wire	mm	Decimal	Inch	mm	Inch	mm	Inch	mm	Inch	mm	Inch	mm
CXDSR 0840AP	06544			8.4	.3307		10.0		103		61		49		1.31
CXDSR3320AP	06545		Q		.3320	3/8		4.06		2.402		1.929		0.051	
CXDSR 0850AP	06546			8.5	.3346		10.0		103		61		49		1.32
CXDSR 0860AP	06547			8.6	.3386		10.0		103		61		49		1.33
CXDSR 0870AP	06548			8.7	.3425		10.0		103		61		49		1.35
CXDSR3438AP	06549	11/32			.3438	3/8		4.06		2.402		1.929		0.053	
CXDSR 0880AP	06550			8.8	.3465		10.0		103		61		49		1.36
CXDSR 0890AP	06551			8.9	.3504		10.0		103		61		49		1.38
CXDSR 0900AP	06552			9.0	.3543		10.0		103		61		49		1.39
CXDSR 0910AP	06553			9.1	.3583		10.0		103		61		49		1.41
CXDSR3594AP	06554	23/64			.3594	3/8		4.06		2.402		1.929		0.056	
CXDSR 0920AP	06555			9.2	.3622		10.0		103		61		49		1.43
CXDSR 0925AP	06556			9.3	.3642		10.0		103		61		49		1.43
CXDSR 0930AP	06557			9.3	.3661		10.0		103		61		49		1.44
CXDSR 0940AP	06558			9.4	.3701		10.0		103		61		49		1.46
CXDSR 0950AP	06559			9.5	.3740		10.0		103		61		49		1.47
CXDSR3750AP	06560	3/8			.3750	3/8		4.06		2.402		1.929		0.058	
CXDSR 0960AP	06561			9.6	.3780		10.0		103		61		49		1.49
CXDSR 0970AP	06562			9.7	.3819		10.0		103		61		49		1.50
CXDSR 0980AP	06563			9.8	.3858		10.0		103		61		49		1.52
CXDSR 0990AP	06564			9.9	.3898		10.0		103		61		49		1.53
CXDSR3906AP	06565	25/64			.3906	7/16		4.06		2.402		1.929		0.061	
CXDSR 1000AP	06566			10.0	.3937		10.0		103		61		49		1.55
CXDSR 1010AP	06567			10.1	.3976		12.0		118		71		56		1.56
CXDSR 1020AP	06568			10.2	.4016		12.0		118		71		56		1.58
CXDSR 1030AP	06569			10.3	.4055		12.0		118		71		56		1.60
CXDSR4062AP	06570	13/32			.4062	7/16		4.65		2.795		2.205		0.063	
CXDSR 1040AP	06571			10.4	.4094		12.0		118		71		56		1.61
CXDSR 1050AP	06572			10.5	.4134		12.0		118		71		56		1.63
CXDSR 1060AP	06573			10.6	.4173		12.0		118		71		56		1.64
CXDSR 1070AP	06574			10.7	.4213		12.0		118		71		56		1.66
CXDSR4219AP	06575	27/64			.4219	7/16		4.65		2.795		2.205		0.065	
CXDSR 1080AP	06576			10.8	.4252		12.0		118		71		56		1.67
CXDSR 1090AP	06577			10.9	.4291		12.0		118		71		56		1.69
CXDSR 1100AP	06578			11.0	.4331		12.0		118		71		56		1.70
CXDSR 1110AP	06579			11.1	.4370		12.0		118		71		56		1.72
CXDSR4375AP	06580	7/16			.4375	7/16		4.65		2.795		2.205		0.068	
CXDSR 1120AP	06581			11.2	.4409		12.0		118		71		56		1.74
CXDSR 1130AP	06582			11.3	.4449		12.0		118		71		56		1.75
CXDSR 1140AP	06583			11.4	.4488		12.0		118		71		56		1.77
CXDSR 1150AP	06584			11.5	.4527		12.0		118		71		56		1.78
CXDSR 1160AP	06585			11.6	.4567		12.0		118		71		56		1.80
CXDSR 1170AP	06586			11.7	.4606		12.0		118		71		56		1.81
CXDSR 1180AP	06587			11.8	.4646		12.0		118		71		56		1.83
CXDSR 1190AP	06588			11.9	.4685		12.0		118		71		56		1.84
CXDSR4688AP	06589	15/32			.4688	1/2		4.65		2.795		2.205		0.073	
CXDSR 1200AP	06590			12.0	.4724		12.0		118		71		56		1.86
CXDSR 1210AP	06591			12.1	.4764		14.0		124		77		60		1.87
CXDSR4844AP	06592	31/64			.4844	1/2		4.88		3.031		2.362		0.075	
CXDSR 1250AP	06593			12.5	.4921		14.0		124		77		60		1.94
CXDSR5000AP	06594	1/2			.5000	1/2		4.88		3.031		2.362		0.077	
CXDSR 1280AP	06595			12.8	.5039		14.0		124		77		60		1.98
CXDSR 1283AP	06596			12.83	.5051		14.0		124		77		60		1.99
CXDSR 1290AP	06597			12.9	.5079		14.0		124		77		60		2.00



Series CXDSR Continued

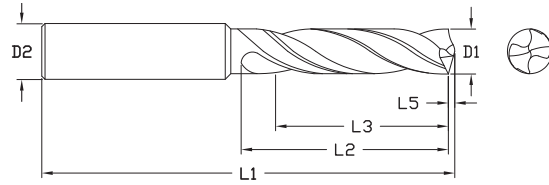
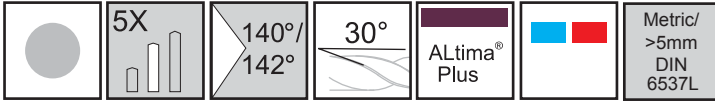

ALtima® Plus		Diameter				Shank		OAL		Flute Length		Drill Length		Point Length	
		D1 (m7)				D2 (h6)		L1		L2 (Max.)		L3 Ref.		L5	
Tool No.	EDP	Inch	Letter/ Wire	mm	Decimal	Inch	mm	Inch	mm	Inch	mm	Inch	mm	Inch	mm
CXDSR 1300AP	06598			13.0	.5118		14.0		124		77		60		2.01
CXDSR5156AP	06599	33/64			.5156	9/16		4.88		3.031		2.362		0.080	
CXDSR5312AP	06600	17/32			.5312	9/16		4.88		3.031		2.362		0.082	
CXDSR 1350AP	06601			13.5	.5315		14.0		124		77		60		2.09
CXDSR 1370AP	06602			13.7	.5394		14.0		124		77		60		2.12
CXDSR5469AP	06603	35/64			.5469	9/16		4.88		3.031		2.362		0.085	
CXDSR 1400AP	06604			14.0	.5512		14.0		124		77		60		2.17
CXDSR5625AP	06605	9/16			.5625	9/16		5.24		3.268		2.480		0.087	
CXDSR 1450AP	06606			14.5	.5709		16.0		133		83		63		2.25
CXDSR 1470AP	06607			14.7	.5787		16.0		133		83		63		2.28
CXDSR 1500AP	06608			15.0	.5905		16.0		133		83		63		2.32
CXDSR5938AP	06609	19/32			.5938	5/8		5.24		3.268		2.480		0.092	
CXDSR 1530AP	06610			15.3	.6024		16.0		133		83		63		2.37
CXDSR 1550AP	06611			15.5	.6102		16.0		133		83		63		2.40
CXDSR 1570AP	06612			15.7	.6181		16.0		133		83		63		2.43
CXDSR6250AP	06613	5/8			.6250	5/8		5.24		3.268		2.480		0.097	
CXDSR 1600AP	06614			16.0	.6299		16.0		133		83		63		2.48



Cyclone Series CXDCS

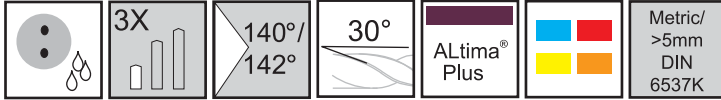

Designed for high performance drilling in a broad range of materials.

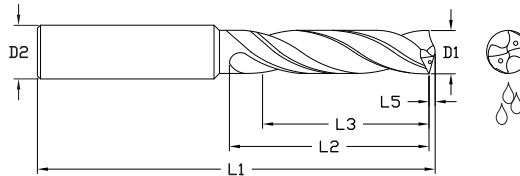

ALtima® Plus		Diameter				Shank		OAL		Flute Length		Drill Length		Point Length	
		D1 (m7)				D2 (h6)		L1		L2 (Max.)		L3 Ref.		L5	
Tool No.	EDP	Inch	Letter/ Wire	mm	Decimal	Inch	mm	Inch	mm	Inch	mm	Inch	mm	Inch	mm
CXDCS 0300AP	06779			3.0	.1181		3.0		62		20		14		0.46
CXDCS1200AP	06780		#31		.1200	1/8		2.44		0.787		0.551		0.019	
CXDCS 0310AP	06781			3.1	.1220		4.0		62		20		14		0.48
CXDCS1250AP	06782	1/8			.1250	1/8		2.44		0.787		0.551		0.019	
CXDCS 0320AP	06783			3.2	.1260		4.0		62		20		14		0.50
CXDCS1285AP	06784		#30		.1285	5/32		2.44		0.787		0.551		0.020	
CXDCS 0330AP	06785			3.3	.1299		4.0		62		20		14		0.51
CXDCS 0340AP	06786			3.4	.1339		4.0		62		20		14		0.53
CXDCS1360AP	06787		#29		.1360	5/32		2.44		0.787		0.551		0.021	
CXDCS 0350AP	06788			3.5	.1378		4.0		62		20		14		0.54
CXDCS1406AP	06789	9/64			.1406	5/32		2.44		0.787		0.551		0.022	
CXDCS 0360AP	06790			3.6	.1417		4.0		62		20		14		0.56
CXDCS 0370AP	06791			3.7	.1457		4.0		62		20		14		0.57
CXDCS 0380AP	06792			3.8	.1496		4.0		66		24		17		0.59
CXDCS1520AP	06793		#24		.1520	5/32		2.60		0.945		0.669		0.024	
CXDCS 0390AP	06794			3.9	.1535		4.0		66		24		17		0.60
CXDCS1562AP	06795	5/32			.1562	5/32		2.60		0.945		0.669		0.024	
CXDCS 0400AP	06796			4.0	.1575		4.0		66		24		17		0.62
CXDCS1590AP	06797		#21		.1590	3/16		2.60		0.945		0.669		0.025	
CXDCS 0410AP	06798			4.1	.1614		5.0		66		24		17		0.64
CXDCS 0420AP	06799			4.2	.1654		5.0		66		24		17		0.65
CXDCS 0430AP	06800			4.3	.1693		5.0		66		24		17		0.67
CXDCS1719AP	06801	11/64			.1719	3/16		2.60		0.945		0.669		0.027	
CXDCS 0440AP	06802			4.4	.1732		5.0		66		24		17		0.68
CXDCS 0450AP	06803			4.5	.1772		5.0		66		24		17		0.70
CXDCS 0460AP	06804			4.6	.1811		5.0		66		24		17		0.71
CXDCS 0470AP	06805			4.7	.1850		5.0		66		24		17		0.73
CXDCS1875AP	06806	3/16			.1875	3/16		2.60		1.102		0.787		0.029	
CXDCS 0480AP	06807			4.8	.1890		5.0		66		28		20		0.74
CXDCS 0490AP	06808			4.9	.1929		5.0		66		28		20		0.76
CXDCS 0500AP	06809			5.0	.1968		5.0		66		28		20		0.77
CXDCS 0510AP	06810			5.1	.2008		6.0		66		28		20		0.79
CXDCS2031AP	06811	13/64			.2031	1/4		2.60		1.102		0.787		0.031	
CXDCS 0520AP	06812			5.2	.2047		6.0		66		28		20		0.81

Inch		Tolerance (m7)
D1	D2	
.0000 - .1181		+0.0008/+0.00047
.1182 - .2362		+0.0016/+0.00063
.2363 - .3937		+0.0024/+0.00083
.3938 - .7087		+0.0027/+0.00098

Inch		Tolerance (h6)
D2	D1	
.0000 - .1181		+0/-0.00024
.1182 - .2362		+0/-0.00031
.2363 - .3937		+0/-0.00035
.3938 - .7087		+0/-0.00043

Metric (mm)		Tolerance (m7)
D1	D2	
0 - 3.0		+0.002/+0.012
3.01 - 6.0		+0.004/+0.016
6.01 - 10.0		+0.006/+0.021
10.01 - 18.0		+0.007/+0.025

Metric (mm)		Tolerance (h6)
D2	D1	
0 - 3.0		+0/-0.006
3.01 - 6.0		+0/-0.008
6.01 - 10.0		+0/-0.009
10.01 - 18.0		+0/-0.011



Series CXDCS Continued

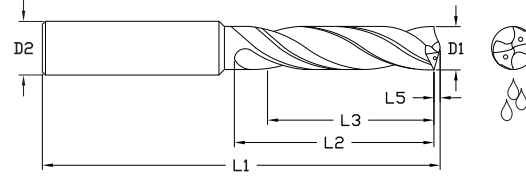
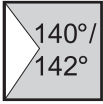
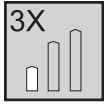

ALtima® Plus		Diameter				Shank		OAL		Flute Length		Drill Length		Point Length	
		D1 (m7)				D2 (h6)		L1		L2 (Max.)		L3 Ref.		L5	
Tool No.	EDP	Inch	Letter/ Wire	mm	Decimal	Inch	mm	Inch	mm	Inch	mm	Inch	mm	Inch	mm
CXDCS 0530AP	06813			5.3	.2087		6.0		66		28		20		0.82
CXDCS 0540AP	06814			5.4	.2126		6.0		66		28		20		0.84
CXDCS 0550AP	06815			5.5	.2165		6.0		66		28		20		0.85
CXDCS2187AP	06816	7/32			.2187	1/4		2.60		1.102		0.787		0.034	
CXDCS 0560AP	07093			5.6	.2205		6.0		66		28		20		0.86
CXDCS2210AP	06817		#2		.2210	1/4		2.60		1.102		0.787		0.034	
CXDCS 0570AP	06818			5.7	.2244		6.0		66		28		20		0.88
CXDCS 0580AP	06819			5.8	.2283		6.0		66		28		20		0.90
CXDCS 0590AP	06820			5.9	.2323		6.0		66		28		20		0.91
CXDCS2344AP	06821	15/64			.2344	1/4		2.60		1.102		0.787		0.036	
CXDCS 0600AP	06822			6.0	.2362		6.0		66		28		20		0.93
CXDCS 0610AP	06823			6.1	.2402		8.0		79		34		24		0.95
CXDCS2420AP	06824		C		.2420	1/4		3.11		1.339		0.945		0.037	
CXDCS 0620AP	06825			6.2	.2441		8.0		79		34		24		0.96
CXDCS2460AP	06826		D		.2460	1/4		3.11		1.339		0.945		0.038	
CXDCS 0630AP	06827			6.3	.2480		8.0		79		34		24		0.98
CXDCS2500AP	06828	1/4			.2500	1/4		3.11		1.339		0.945		0.039	
CXDCS 0640AP	06829			6.4	.2520		8.0		79		34		24		0.99
CXDCS 0650AP	06830			6.5	.2559		8.0		79		34		24		1.01
CXDCS2570AP	06831		F		.2570	5/16		3.11		1.339		0.945		0.040	
CXDCS 0660AP	06832			6.6	.2598		8.0		79		34		24		1.03
CXDCS2610AP	06833		G		.2610	5/16		3.11		1.339		0.945		0.040	
CXDCS 0670AP	06834			6.7	.2638		8.0		79		34		24		1.04
CXDCS2656AP	06835	17/64			.2656	5/16		3.11		1.339		0.945		0.041	
CXDCS 0680AP	06836			6.8	.2677		8.0		79		34		24		1.05
CXDCS 0690AP	06837			6.9	.2717		8.0		79		34		24		1.07
CXDCS 0700AP	06838			7.0	.2756		8.0		79		34		24		1.08
CXDCS 0710AP	06839			7.1	.2795		8.0		79		41		29		1.10
CXDCS2812AP	06840	9/32			.2812	5/16		3.11		1.614		1.142		0.044	
CXDCS 0720AP	06841			7.2	.2835		8.0		79		41		29		1.12
CXDCS 0730AP	06842			7.3	.2874		8.0		79		41		29		1.13
CXDCS 0740AP	06843			7.4	.2913		8.0		79		41		29		1.15
CXDCS 0750AP	06844			7.5	.2953		8.0		79		41		29		1.16
CXDCS2969AP	06845	19/64			.2969	5/16		3.11		1.614		1.142		0.046	
CXDCS 0760AP	06846			7.6	.2992		8.0		79		41		29		1.18
CXDCS 0770AP	06847			7.7	.3031		8.0		79		41		29		1.19
CXDCS 0780AP	06848			7.8	.3071		8.0		79		41		29		1.21
CXDCS 0790AP	06849			7.9	.3110		8.0		79		41		29		1.22
CXDCS3125AP	06850	5/16			.3125	5/16		3.11		1.614		1.142		0.048	
CXDCS 0800AP	06851			8.0	.3150		8.0		79		41		29		1.24
CXDCS 0810AP	06852			8.1	.3189		10.0		89		47		35		1.26
CXDCS 0820AP	06853			8.2	.3228		10.0		89		47		35		1.27
CXDCS 0830AP	06854			8.3	.3268		10.0		89		47		35		1.29
CXDCS3281AP	06855	21/64			.3281	3/8		3.50		1.850		1.378		0.051	
CXDCS 0840AP	06856			8.4	.3307		10.0		89		47		35		1.31
CXDCS3320AP	06857		Q		.3320	3/8		3.50		1.850		1.378		0.051	



Series CXDCS Continued

ALtima® Plus		Diameter				Shank		OAL		Flute Length		Drill Length		Point Length	
		D1 (m7)				D2 (h6)		L1		L2 (Max.)		L3 Ref.		L5	
Tool No.	EDP	Inch	Letter/ Wire	mm	Decimal	Inch	mm	Inch	mm	Inch	mm	Inch	mm	Inch	mm
CXDCS 0850AP	06858			8.5	.3346		10.0		89		47		35		1.32
CXDCS 0860AP	06859			8.6	.3386		10.0		89		47		35		1.33
CXDCS 0870AP	06860			8.7	.3425		10.0		89		47		35		1.35
CXDCS3438AP	06861	11/32			.3438	3/8		3.50		1.850		1.378		0.053	
CXDCS 0880AP	06862			8.8	.3465		10.0		89		47		35		1.36
CXDCS 0890AP	06863			8.9	.3504		10.0		89		47		35		1.38
CXDCS 0900AP	06864			9.0	.3543		10.0		89		47		35		1.39
CXDCS 0910AP	06865			9.1	.3583		10.0		89		47		35		1.41
CXDCS3594AP	06866	23/64			.3594	3/8		3.50		1.850		1.378		0.056	
CXDCS 0920AP	06867			9.2	.3622		10.0		89		47		35		1.43
CXDCS 0925AP	06868			9.25	.3642		10.0		89		47		35		1.43
CXDCS 0930AP	06869			9.3	.3661		10.0		89		47		35		1.44
CXDCS 0940AP	06870			9.4	.3701		10.0		89		47		35		1.46
CXDCS 0950AP	06871			9.5	.3740		10.0		89		47		35		1.47
CXDCS3750AP	06872	3/8			.3750	3/8		3.50		1.850		1.378		0.058	
CXDCS 0960AP	06873			9.6	.3780		10.0		89		47		35		1.49
CXDCS 0970AP	06874			9.7	.3819		10.0		89		47		35		1.50
CXDCS 0980AP	06875			9.8	.3858		10.0		89		47		35		1.52
CXDCS 0990AP	06876			9.9	.3898		10.0		89		47		35		1.53
CXDCS3906AP	06877	25/64			.3906	7/16		3.50		1.850		1.378		0.061	
CXDCS 1000AP	06878			10.0	.3937		10.0		89		47		35		1.55
CXDCS 1010AP	06879			10.1	.3976		12.0		102		55		40		1.56
CXDCS 1015AP	07095			10.15	.3996		12.0		102		55		40		1.57
CXDCS 1020AP	06880			10.2	.4016		12.0		102		55		40		1.58
CXDCS 1030AP	06881			10.3	.4055		12.0		102		55		40		1.60
CXDCS4062AP	06882	13/32			.4062	7/16		4.02		2.165		1.575		0.063	
CXDCS 1040AP	06883			10.4	.4094		12.0		102		55		40		1.61
CXDCS 1050AP	06884			10.5	.4134		12.0		102		55		40		1.63
CXDCS 1060AP	06885			10.6	.4173		12.0		102		55		40		1.64
CXDCS 1070AP	06886			10.7	.4213		12.0		102		55		40		1.66
CXDCS4219AP	06887	27/64			.4219	7/16		4.02		2.165		1.575		0.065	
CXDCS 1080AP	06888			10.8	.4252		12.0		102		55		40		1.67
CXDCS 1090AP	06889			10.9	.4291		12.0		102		55		40		1.69
CXDCS 1100AP	06890			11.0	.4331		12.0		102		55		40		1.70
CXDCS 1110AP	06891			11.1	.4370		12.0		102		55		40		1.72
CXDCS4375AP	06892	7/16			.4375	7/16		4.02		2.165		1.575		0.068	
CXDCS 1120AP	06893			11.2	.4409		12.0		102		55		40		1.74
CXDCS 1130AP	06894			11.3	.4449		12.0		102		55		40		1.75
CXDCS 1140AP	06895			11.4	.4488		12.0		102		55		40		1.77
CXDCS 1150AP	06896			11.5	.4527		12.0		102		55		40		1.78
CXDCS 1155AP	07090			11.55	.4547		12.0		102		55		40		1.79
CXDCS 1160AP	06897			11.6	.4567		12.0		102		55		40		1.80
CXDCS 1170AP	06898			11.7	.4606		12.0		102		55		40		1.81
CXDCS 1180AP	06899			11.8	.4646		12.0		102		55		40		1.83
CXDCS 1190AP	06900			11.9	.4685		12.0		102		55		40		1.84
CXDCS4688AP	06901	15/32			.4688	1/2		4.02		2.165		1.575		0.073	
CXDCS 1200AP	06902			12.0	.4724		12.0		102		55		40		1.86
CXDCS 1210AP	06903			12.1	.4764		14.0		107		60		43		1.87
CXDCS4844AP	06904	31/64			.4844	1/2		4.21		2.362		1.693		0.075	
CXDCS 1250AP	06905			12.5	.4921		14.0		107		60		43		1.94
CXDCS5000AP	06906	1/2			.5000	1/2		4.21		2.362		1.693		0.077	
CXDCS 1280AP	06907			12.8	.5039		14.0		107		60		43		1.98



Series CXDCS Continued

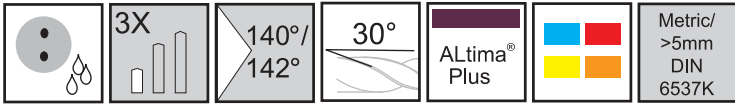
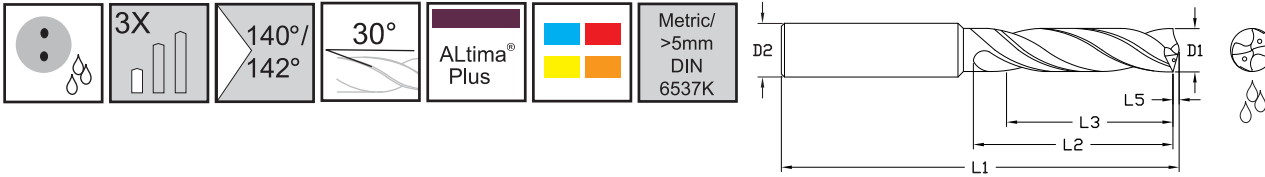

ALtima® Plus		Diameter				Shank		OAL		Flute Length		Drill Length		Point Length	
		D1 (m7)				D2 (h6)		L1		L2 (Max.)		L3 Ref.		L5	
Tool No.	EDP	Inch	Letter/ Wire	mm	Decimal	Inch	mm	Inch	mm	Inch	mm	Inch	mm	Inch	mm
CXDCS 1283AP	06908			12.83	.5051		14.0		107		60		43		1.99
CXDCS 1290AP	06909			12.9	.5079		14.0		107		60		43		2.00
CXDCS 1300AP	06910			13.0	.5118		14.0		107		60		43		2.01
CXDCS5156AP	06911	33/64			.5156	9/16		4.21		2.362		1.693		0.080	
CXDCS 1320AP	07096			13.2	.5197		14.0		107		60		43		2.06
CXDCS5312AP	07089	17/32			.5312	9/16		4.21		2.362		1.693		0.082	
CXDCS 1350AP	06912			13.5	.5315		14.0		107		60		43		2.09
CXDCS 1370AP	06913			13.7	.5394		14.0		107		60		43		2.12
CXDCS5469AP	06914	35/64			.5469	9/16		4.21		2.362		1.693		0.085	
CXDCS 1400AP	06915			14.0	.5512		14.0		107		60		43		2.17
CXDCS5625AP	06916	9/16			.5625	9/16		4.53		2.559		1.772		0.087	
CXDCS 1450AP	06917			14.5	.5709		16.0		115		65		45		2.25
CXDCS 1470AP	06918			14.7	.5787		16.0		115		65		45		2.28
CXDCS 1475AP	07097			14.75	.5807		16.0		115		65		45		2.30
CXDCS 1500AP	06919			15.0	.5905		16.0		115		65		45		2.32
CXDCS5938AP	06920	19/32			.5938	5/8		4.53		2.559		1.772		0.092	
CXDCS 1530AP	06921			15.3	.6024		16.0		115		65		45		2.37
CXDCS 1550AP	06922			15.5	.6102		16.0		115		65		45		2.40
CXDCS 1570AP	06923			15.7	.6181		16.0		115		65		45		2.43
CXDCS6250AP	06924	5/8			.6250	5/8		4.53		2.559		1.772		0.097	
CXDCS 1600AP	06925			16.0	.6299		16.0		115		65		45		2.48



Cyclone Series CXDCR

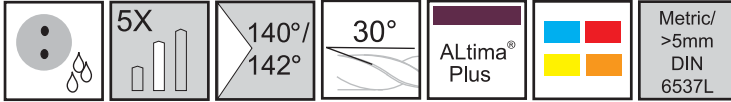

Designed for high performance drilling in a broad range of materials.

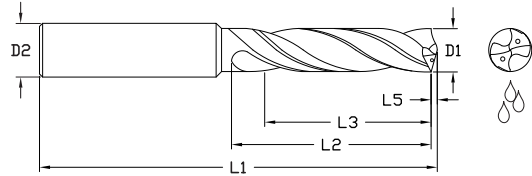

ALtima® Plus		Diameter				Shank		OAL		Flute Length		Drill Length		Point Length	
		D1 (m7)				D2 (h6)		L1		L2 (Max.)		L3 Ref.		L5	
Tool No.	EDP	Inch	Letter/ Wire	mm	Decimal	Inch	mm	Inch	mm	Inch	mm	Inch	mm	Inch	mm
CXDCR 0300AP	06926			3.0	.1181		3.0		66		28		23		0.46
CXDCR 1200AP	06927		#31		.1200	1/8		2.60		1.102		0.906		0.019	
CXDCR 0310AP	06928			3.1	.1220		4.0		66		28		23		0.48
CXDCR 1250AP	06929	1/8			.1250	1/8		2.60		1.102		0.906		0.019	
CXDCR 0320AP	06930			3.2	.1260		4.0		66		28		23		0.50
CXDCR 1285AP	06931		#30		.1285	5/32		2.60		1.102		0.906		0.020	
CXDCR 0330AP	06932			3.3	.1299		4.0		66		28		23		0.51
CXDCR 0340AP	06933			3.4	.1339		4.0		66		28		23		0.53
CXDCR 1360AP	06934		#29		.1360	5/32		2.60		1.102		0.906		0.021	
CXDCR 0350AP	06935			3.5	.1378		4.0		66		28		23		0.54
CXDCR 1406AP	06936	9/64			.1406	5/32		2.60		1.102		0.906		0.022	
CXDCR 0360AP	06937			3.6	.1417		4.0		66		28		23		0.56
CXDCR 0370AP	06938			3.7	.1457		4.0		66		28		23		0.57
CXDCR 0380AP	06939			3.8	.1496		4.0		74		36		29		0.59
CXDCR 1520AP	06940		#24		.1520	5/32		2.91		1.417		1.142		0.024	
CXDCR 0390AP	06941			3.9	.1535		4.0		74		36		29		0.60
CXDCR 1562AP	06942	5/32			.1562	5/32		2.91		1.417		1.142		0.024	
CXDCR 0400AP	06943			4.0	.1575		4.0		74		36		29		0.62
CXDCR 1590AP	06944		#21		.1590	3/16		2.91		1.417		1.142		0.025	
CXDCR 0410AP	06945			4.1	.1614		5.0		74		36		29		0.64
CXDCR 0420AP	06946			4.2	.1654		5.0		74		36		29		0.65
CXDCR 0430AP	06947			4.3	.1693		5.0		74		36		29		0.67
CXDCR 1719AP	06948	11/64			.1719	3/16		2.91		1.417		1.142		0.027	
CXDCR 0440AP	06949			4.4	.1732		5.0		74		36		29		0.68
CXDCR 0450AP	06950			4.5	.1772		5.0		74		36		29		0.70
CXDCR 0460AP	06951			4.6	.1811		5.0		74		36		29		0.71
CXDCR 0470AP	06952			4.7	.1850		5.0		74		36		29		0.73
CXDCR 1875AP	06953	3/16			.1875	3/16		3.23		1.732		1.378		0.029	
CXDCR 0480AP	06954			4.8	.1890		5.0		82		44		35		0.74
CXDCR 0490AP	06955			4.9	.1929		5.0		82		44		35		0.76
CXDCR 0500AP	06956			5.0	.1968		5.0		82		44		35		0.77
CXDCR 0510AP	06957			5.1	.2008		6.0		82		44		35		0.79
CXDCR 2031AP	06958	13/64			.2031	1/4		3.23		1.732		1.378		0.031	
CXDCR 0520AP	06959			5.2	.2047		6.0		82		44		35		0.81

Inch		Tolerance (m7)
D1	D2	
.0000 - .1181	.0000 - .1181	+0.0008/+0.0047
.1182 - .2362	.1182 - .2362	+0.0016/+0.0063
.2363 - .3937	.2363 - .3937	+0.0024/+0.0083
.3938 - .7087	.3938 - .7087	+0.0027/+0.0098
.7088 - .7500	.7088 - .7500	+0.0031/+0.0114

Inch		Tolerance (h6)
D2	D1	
.0000 - .1181	.0000 - .1181	+0/-0.0024
.1182 - .2362	.1182 - .2362	+0/-0.0031
.2363 - .3937	.2363 - .3937	+0/-0.0035
.3938 - .7087	.3938 - .7087	+0/-0.0043
.7088 - .7500	.7088 - .7500	+0/-0.0051

Metric (mm)		Tolerance (m7)
D1	D2	
0 - 3.0	0 - 3.0	+0.002/+0.012
3.01 - 6.0	3.01 - 6.0	+0.004/+0.016
6.01 - 10.0	6.01 - 10.0	+0.006/+0.021
10.01 - 18.0	10.01 - 18.0	+0.007/+0.025
18.01 - 20.0	18.01 - 20.0	+0.008/+0.029

Metric (mm)		Tolerance (h6)
D2	D1	
0 - 3.0	0 - 3.0	+0/-0.006
3.01 - 6.0	3.01 - 6.0	+0/-0.008
6.01 - 10.0	6.01 - 10.0	+0/-0.009
10.01 - 18.0	10.01 - 18.0	+0/-0.011
18.01 - 20.0	18.01 - 20.0	+0/-0.013



Series CXDCR Continued

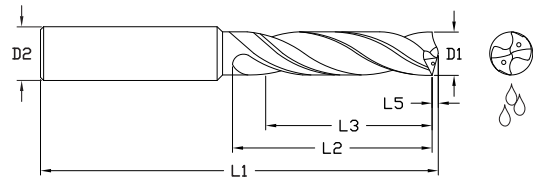
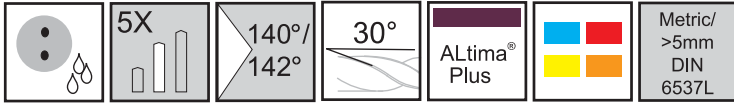

ALtima® Plus		Diameter				Shank		OAL		Flute Length		Drill Length		Point Length	
		D1 (m7)				D2 (h6)		L1		L2 (Max.)		L3 Ref.		L5	
Tool No.	EDP	Inch	Letter/ Wire	mm	Decimal	Inch	mm	Inch	mm	Inch	mm	Inch	mm	Inch	mm
CXDCR 0530AP	06960			5.3	.2087	6.0	6.0	82		44		35		0.82	
CXDCR 0540AP	06961			5.4	.2126	6.0	6.0	82		44		35		0.84	
CXDCR 0550AP	06962			5.5	.2165	6.0	6.0	82		44		35		0.85	
CXDCR2187AP	06963	7/32			.2187	1/4		3.23		1.732		1.378		0.034	
CXDCR 0560AP	07094			5.6	.2205	6.0	6.0	82		44		35		0.86	
CXDCR2210AP	06964		#2		.2210	1/4		3.23		1.732		1.378		0.034	
CXDCR 0570AP	06965			5.7	.2244	6.0	6.0	82		44		35		0.88	
CXDCR 0580AP	06966			5.8	.2283	6.0	6.0	82		44		35		0.90	
CXDCR 0590AP	06967			5.9	.2323	6.0	6.0	82		44		35		0.91	
CXDCR2344AP	06968	15/64			.2344	1/4		3.23		1.732		1.378		0.036	
CXDCR 0600AP	06969			6.0	.2362	6.0	6.0	82		44		35		0.93	
CXDCR 0610AP	06970			6.1	.2402	8.0	8.0	91		53		43		0.95	
CXDCR2420AP	06971		C		.2420	1/4		3.58		2.087		1.693		0.037	
CXDCR 0620AP	06972			6.2	.2441	8.0	8.0	91		53		43		0.96	
CXDCR2460AP	06973		D		.2460	1/4		3.58		2.087		1.693		0.038	
CXDCR 0630AP	06974			6.3	.2480	8.0	8.0	91		53		43		0.98	
CXDCR2500AP	06975	1/4			.2500	1/4		3.58		2.087		1.693		0.039	
CXDCR 0640AP	06976			6.4	.2520	8.0	8.0	91		53		43		0.99	
CXDCR 0650AP	06977			6.5	.2559	8.0	8.0	91		53		43		1.01	
CXDCR2570AP	06978		F		.2570	5/16		3.58		2.087		1.693		0.040	
CXDCR 0660AP	06979			6.6	.2598	8.0	8.0	91		53		43		1.03	
CXDCR2610AP	06980		G		.2610	5/16		3.58		2.087		1.693		0.040	
CXDCR 0670AP	06981			6.7	.2638	8.0	8.0	91		53		43		1.04	
CXDCR2656AP	06982	17/64			.2656	5/16		3.58		2.087		1.693		0.041	
CXDCR 0680AP	06983			6.8	.2677	8.0	8.0	91		53		43		1.05	
CXDCR 0690AP	06984			6.9	.2717	8.0	8.0	91		53		43		1.07	
CXDCR 0700AP	06985			7.0	.2756	8.0	8.0	91		53		43		1.08	
CXDCR 0710AP	06986			7.1	.2795	8.0	8.0	91		53		43		1.10	
CXDCR2812AP	06987	9/32			.2812	5/16		3.58		2.087		1.693		0.044	
CXDCR 0720AP	06988			7.2	.2835	8.0	8.0	91		53		43		1.12	
CXDCR 0730AP	06989			7.3	.2874	8.0	8.0	91		53		43		1.13	
CXDCR 0740AP	06990			7.4	.2913	8.0	8.0	91		53		43		1.15	
CXDCR 0750AP	06991			7.5	.2953	8.0	8.0	91		53		43		1.16	
CXDCR2969AP	06992	19/64			.2969	5/16		3.58		2.087		1.693		0.046	
CXDCR 0760AP	06993			7.6	.2992	8.0	8.0	91		53		43		1.18	
CXDCR 0770AP	06994			7.7	.3031	8.0	8.0	91		53		43		1.19	
CXDCR 0780AP	06995			7.8	.3071	8.0	8.0	91		53		43		1.21	
CXDCR 0790AP	06996			7.9	.3110	8.0	8.0	91		53		43		1.22	
CXDCR3125AP	06997	5/16			.3125	5/16		3.58		2.087		1.693		0.048	
CXDCR 0800AP	06998			8.0	.3150	8.0	8.0	91		53		43		1.24	
CXDCR 0810AP	06999			8.1	.3189	10.0	10.0	103		61		49		1.26	
CXDCR 0820AP	07000			8.2	.3228	10.0	10.0	103		61		49		1.27	
CXDCR 0830AP	07001			8.3	.3268	10.0	10.0	103		61		49		1.29	
CXDCR3281AP	07002	21/64			.3281	3/8		4.06		2.402		1.929		0.051	
CXDCR 0840AP	07003			8.4	.3307	10.0	10.0	103		61		49		1.31	
CXDCR3320AP	07004		Q		.3320	3/8		4.06		2.402		1.929		0.051	

Series CXDCR Continued

ALtima® Plus		Diameter				Shank		OAL		Flute Length		Drill Length		Point Length	
		D1 (m7)				D2 (h6)		L1		L2 (Max.)		L3 Ref.		L5	
Tool No.	EDP	Inch	Letter/ Wire	mm	Decimal	Inch	mm	Inch	mm	Inch	mm	Inch	mm	Inch	mm
CXDCR 0850AP	07005			8.5	.3346		10.0		103		61		49		1.32
CXDCR 0860AP	07006			8.6	.3386		10.0		103		61		49		1.33
CXDCR 0870AP	07007			8.7	.3425		10.0		103		61		49		1.35
CXDCR3438AP	07008	11/32			.3438	3/8		4.06		2.402		1.929		0.053	
CXDCR 0880AP	07009			8.8	.3465		10.0		103		61		49		1.36
CXDCR 0890AP	07010			8.9	.3504		10.0		103		61		49		1.38
CXDCR 0900AP	07011			9.0	.3543		10.0		103		61		49		1.39
CXDCR 0910AP	07012			9.1	.3583		10.0		103		61		49		1.41
CXDCR3594AP	07013	23/64			.3594	3/8		4.06		2.402		1.929		0.056	
CXDCR 0920AP	07014			9.2	.3622		10.0		103		61		49		1.43
CXDCR 0925AP	07015			9.25	.3642		10.0		103		61		49		1.43
CXDCR 0930AP	07016			9.3	.3661		10.0		103		61		49		1.44
CXDCR 0940AP	07017			9.4	.3701		10.0		103		61		49		1.46
CXDCR 0950AP	07018			9.5	.3740		10.0		103		61		49		1.47
CXDCR3750AP	07019	3/8			.3750	3/8		4.06		2.402		1.929		0.058	
CXDCR 0960AP	07020			9.6	.3780		10.0		103		61		49		1.49
CXDCR 0970AP	07021			9.7	.3819		10.0		103		61		49		1.50
CXDCR 0980AP	07022			9.8	.3858		10.0		103		61		49		1.52
CXDCR 0990AP	07023			9.9	.3898		10.0		103		61		49		1.53
CXDCR3906AP	07024	25/64			.3906	7/16		4.06		2.402		1.929		0.061	
CXDCR 1000AP	07025			10.0	.3937		10.0		103		61		49		1.55
CXDCR 1010AP	07026			10.1	.3976		12.0		118		71		56		1.56
CXDCR 1020AP	07027			10.2	.4016		12.0		118		71		56		1.58
CXDCR 1030AP	07028			10.3	.4055		12.0		118		71		56		1.60
CXDCR4062AP	07029	13/32			.4062	7/16		4.65		2.795		2.205		0.063	
CXDCR 1040AP	07030			10.4	.4094		12.0		118		71		56		1.61
CXDCR 1050AP	07031			10.5	.4134		12.0		118		71		56		1.63
CXDCR 1060AP	07032			10.6	.4173		12.0		118		71		56		1.64
CXDCR 1070AP	07033			10.7	.4213		12.0		118		71		56		1.66
CXDCR4219AP	07034	27/64			.4219	7/16		4.65		2.795		2.205		0.065	
CXDCR 1080AP	07035			10.8	.4252		12.0		118		71		56		1.67
CXDCR 1090AP	07036			10.9	.4291		12.0		118		71		56		1.69
CXDCR 1100AP	07037			11.0	.4331		12.0		118		71		56		1.70
CXDCR 1110AP	07038			11.1	.4370		12.0		118		71		56		1.72
CXDCR4375AP	07039	7/16			.4375	7/16		4.65		2.795		2.205		0.068	
CXDCR 1120AP	07040			11.2	.4409		12.0		118		71		56		1.74
CXDCR 1130AP	07041			11.3	.4449		12.0		118		71		56		1.75
CXDCR 1140AP	07042			11.4	.4488		12.0		118		71		56		1.77
CXDCR 1150AP	07043			11.5	.4527		12.0		118		71		56		1.78
CXDCR 1160AP	07044			11.6	.4567		12.0		118		71		56		1.80
CXDCR 1170AP	07045			11.7	.4606		12.0		118		71		56		1.81
CXDCR 1180AP	07046			11.8	.4646		12.0		118		71		56		1.83
CXDCR 1190AP	07047			11.9	.4685		12.0		118		71		56		1.84
CXDCR4688AP	07048	15/32			.4688	1/2		4.65		2.795		2.205		0.073	
CXDCR 1200AP	07049			12.0	.4724		12.0		118		71		56		1.86
CXDCR 1210AP	07050			12.1	.4764		14.0		124		77		60		1.87
CXDCR4844AP	07051	31/64			.4844	1/2		4.88		3.031		2.362		0.075	
CXDCR 1250AP	07052			12.5	.4921		14.0		124		77		60		1.94
CXDCR5000AP	07053	1/2			.5000	1/2		4.88		3.031		2.362		0.077	
CXDCR 1280AP	07054			12.8	.5039		14.0		124		77		60		1.98
CXDCR 1283AP	07055			12.83	.5051		14.0		124		77		60		1.99
CXDCR 1290AP	07056			12.9	.5079		14.0		124		77		60		2.00



Series CXDCR Continued

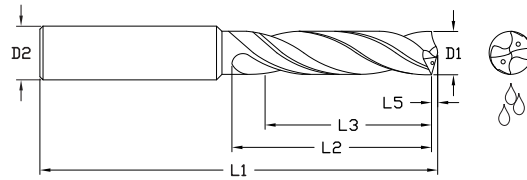
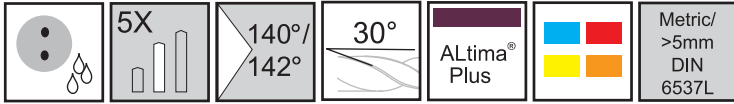

ALtima® Plus		Diameter				Shank		OAL		Flute Length		Drill Length		Point Length	
		D1 (m7)				D2 (h6)		L1		L2 (Max.)		L3 Ref.		L5	
Tool No.	EDP	Inch	Letter/ Wire	mm	Decimal	Inch	mm	Inch	mm	Inch	mm	Inch	mm	Inch	mm
CXDCR 1300AP	07057			13.0	.5118		14.0		124		77		60		2.01
CXDCR5156AP	07058	33/64			.5156	9/16		4.88		3.031		2.362		0.080	
CXDCR5312AP	07059	17/32			.5312	9/16		4.88		3.031		2.362		0.082	
CXDCR 1350AP	07060			13.5	.5315		14.0		124		77		60		2.09
CXDCR 1370AP	07061			13.7	.5394		14.0		124		77		60		2.12
CXDCR5469AP	07062	35/64			.5469	9/16		4.88		3.031		2.362		0.085	
CXDCR 1400AP	07063			14.0	.5512		14.0		124		77		60		2.17
CXDCR5625AP	07064	9/16			.5625	9/16		5.24		3.268		2.480		0.087	
CXDCR 1450AP	07065			14.5	.5709		16.0		133		83		63		2.25
CXDCR 1470AP	07066			14.7	.5787		16.0		133		83		63		2.28
CXDCR 1500AP	07067			15.0	.5905		16.0		133		83		63		2.32
CXDCR5938AP	07068	19/32			.5938	5/8		5.24		3.268		2.480		0.092	
CXDCR 1530AP	07069			15.3	.6024		16.0		133		83		63		2.37
CXDCR 1550AP	07070			15.5	.6102		16.0		133		83		63		2.40
CXDCR 1570AP	07071			15.7	.6181		16.0		133		83		63		2.43
CXDCR6250AP	07072	5/8			.6250	5/8		5.24		3.268		2.480		0.097	
CXDCR 1600AP	07073			16.0	.6299		16.0		133		83		63		2.48
CXDCR 1608AP	07074			16.08	.6331		18.0		143		93		71		2.49
CXDCR 1630AP	07075			16.3	.6417		18.0		143		93		71		2.53
CXDCR 1650AP	07076			16.5	.6496		18.0		143		93		71		2.56
CXDCR6562AP	07077	21/32			.6562	11/16		5.63		3.661		2.795		0.102	
CXDCR 1700AP	07078			17.0	.6693		18.0		143		93		71		2.63
CXDCR6875AP	07079	11/16			.6875	11/16		5.63		3.661		2.795		0.107	
CXDCR 1750AP	07080			17.5	.6890		18.0		143		93		71		2.71
CXDCR 1800AP	07081			18.0	.7087		18.0		143		93		71		2.79
CXDCR 1850AP	07082			18.5	.7283		20.0		153		101		77		2.87
CXDCR7500AP	07083	3/4			.7500	3/4		6.024		3.976		3.031		0.116	
CXDCR 1916AP	07084			19.16	.7543		20.0		153		101		77		2.97
CXDCR 1925AP	07085			19.25	.7579		20.0		153		101		77		2.98
CXDCR 1930AP	07086			19.3	.7598		20.0		153		101		77		2.99
CXDCR 1950AP	07087			19.5	.7677		20.0		153		101		77		3.02
CXDCR 2000AP	07088			20.0	.7874		20.0		153		101		77		3.10



Cyclone Series CXDCL

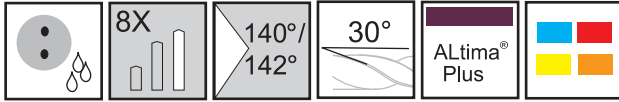

Designed for high performance drilling in a broad range of materials.

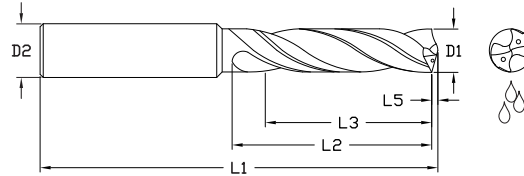

ALtima® Plus		Diameter				Shank D2 (h6)	OAL L1	Flute Length		Drill Length Ref. L3	Point Length L5
		D1 (m7)						L2	L2		
Tool No.	EDP	Inch	Letter/Wire	mm	Decimal	mm	mm	mm	mm	mm	
CXDCLM0300AP	07226			3.0	.1181	3	81	33	25	0.46	
CXDCL1200AP	07227		#31	3.05	.1200	4	92	44	33	0.48	
CXDCLM0310AP	07098			3.1	.1220	4	92	44	33	0.48	
CXDCL1250AP	07099	1/8		3.18	.1250	4	92	44	33	0.48	
CXDCLM0320AP	07100			3.2	.1260	4	92	44	33	0.50	
CXDCLM0325AP	07101			3.25	.1280	4	92	44	33	0.51	
CXDCL1285AP	07102		#30	3.26	.1285	4	92	44	33	0.51	
CXDCLM0330AP	07103			3.3	.1299	4	92	44	33	0.51	
CXDCLM0340AP	07104			3.4	.1339	4	92	44	33	0.53	
CXDCL1360AP	07105		#29	3.45	.1360	4	92	44	33	0.53	
CXDCLM0350AP	07106			3.5	.1378	4	92	44	33	0.54	
CXDCL1406AP	07107	9/64		3.57	.1406	4	92	44	33	0.56	
CXDCLM0360AP	07108			3.6	.1417	4	92	44	33	0.56	
CXDCLM0370AP	07109			3.7	.1457	4	92	44	33	0.57	
CXDCL1496AP	07110		#25	3.8	.1496	4	92	44	33	0.59	
CXDCL1520AP	07111		#24	3.86	.1520	4	92	44	33	0.60	
CXDCLM0390AP	07112			3.9	.1535	4	92	44	33	0.60	
CXDCL1562AP	07113	5/32		3.97	.1562	4	92	44	33	0.61	
CXDCLM0400AP	07114			4.0	.1575	4	92	44	33	0.62	
CXDCL1590AP	07115		#21	4.04	.1590	5	100	45	34	0.63	
CXDCLM0410AP	07116			4.1	.1614	5	100	45	34	0.64	
CXDCLM0420AP	07117			4.2	.1654	5	100	45	34	0.65	
CXDCLM0430AP	07118			4.3	.1693	5	100	45	34	0.67	
CXDCL1719AP	07119	11/64		4.37	.1719	5	100	45	34	0.68	
CXDCLM0440AP	07120			4.4	.1732	5	100	45	34	0.68	
CXDCLM0450AP	07121			4.5	.1772	5	100	45	34	0.70	
CXDCLM0460AP	07122			4.6	.1811	5	100	45	34	0.71	
CXDCLM0465AP	07123			4.65	.1831	5	100	45	34	0.72	
CXDCLM0470AP	07124			4.7	.1850	5	100	45	34	0.73	
CXDCL1875AP	07125	3/16		4.76	.1875	5	100	45	34	0.74	

Inch	
D1	Tolerance (m7)
.0000 - .1181	+0.0008/+0.0047
.1182 - .2362	+0.0016/+0.0063
.2363 - .3937	+0.0024/+0.0083
.3938 - .5000	+0.0027/+0.0098

Inch	
D2	Tolerance (h6)
.0000 - .1181	+0/-0.0024
.1182 - .2362	+0/-0.0031
.2363 - .3937	+0/-0.0035
.3938 - .5000	+0/-0.0043

Metric (mm)	
D1	Tolerance (m7)
0 - 3.0	+0.02/+0.12
3.01 - 6.0	+0.04/+0.16
6.01 - 10.0	+0.06/+0.21
10.01 - 12.7	+0.07/+0.25

Metric (mm)	
D2	Tolerance (h6)
0 - 3.0	+0/-0.006
3.01 - 6.0	+0/-0.008
6.01 - 10.0	+0/-0.009
10.01 - 12.7	+0/-0.011



Series CXDCL Continued

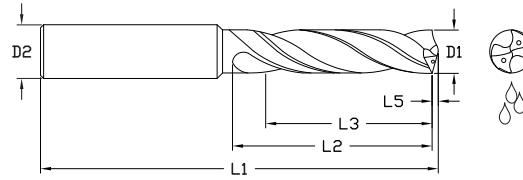
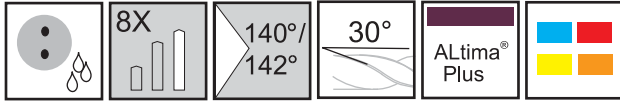

ALtima® Plus		Diameter				Shank	OAL	Flute Length	Drill Length Ref.	Point Length
		D1 (m7)				D2 (h6)	L1	L2	L3	L5
Tool No.	EDP	Inch	Letter/Wire	mm	Decimal	mm	mm	mm	mm	mm
CXDCLM0480AP	07126			4.8	.1890	5	100	50	38	0.74
CXDCLM0490AP	07127			4.9	.1929	5	100	50	38	0.76
CXDCLM0500AP	07128			5.0	.1968	5	100	50	38	0.77
CXDCLM0510AP	07129			5.1	.2008	6	100	57	43	0.79
CXDCL2031AP	07130	13/64		5.16	.2031	6	100	57	43	0.79
CXDCLM0520AP	07131			5.2	.2047	6	100	57	43	0.81
CXDCLM0530AP	07132			5.3	.2087	6	100	57	43	0.82
CXDCLM0540AP	07133			5.4	.2126	6	100	57	43	0.84
CXDCLM0550AP	07134			5.5	.2165	6	100	57	43	0.85
CXDCL2187AP	07135	7/32		5.56	.2187	6	100	57	43	0.86
CXDCLM0560AP	07136			5.6	.2205	6	100	57	43	0.86
CXDCL2210AP	07137		#2	5.61	.2210	6	100	57	43	0.86
CXDCLM0570AP	07138			5.7	.2244	6	100	57	43	0.88
CXDCLM0580AP	07139			5.8	.2283	6	100	57	43	0.90
CXDCLM0590AP	07140			5.9	.2323	6	100	57	43	0.91
CXDCL2344AP	07141	15/64		5.95	.2344	6	100	57	43	0.91
CXDCLM0600AP	07142			6.0	.2362	6	100	57	43	0.93
CXDCLM0610AP	07143			6.1	.2402	8	118	76	57	0.95
CXDCL2420AP	07144		C	6.15	.2420	8	118	76	57	0.95
CXDCLM0620AP	07145			6.2	.2441	8	118	76	57	0.96
CXDCL2460AP	07146		D	6.25	.2460	8	118	76	57	.097
CXDCLM0630AP	07147			6.3	.2480	8	118	76	57	0.98
CXDCL2500AP	07148	1/4		6.35	.2500	8	118	76	57	0.99
CXDCLM0640AP	07149			6.4	.2520	8	118	76	57	0.99
CXDCLM0650AP	07150			6.5	.2559	8	118	76	57	1.01
CXDCL2570AP	07151		F	6.53	.2570	8	118	76	57	1.03
CXDCLM0660AP	07152			6.6	.2598	8	118	76	57	1.03
CXDCL2610AP	07153		G	6.63	.2610	8	118	76	57	1.03
CXDCLM0670AP	07154			6.7	.2638	8	118	76	57	1.04
CXDCL2656AP	07155	17/64		6.75	.2656	8	118	76	57	1.04
CXDCLM0680AP	07156			6.8	.2677	8	118	76	57	1.05
CXDCLM0690AP	07157			6.9	.2717	8	118	76	57	1.07
CXDCLM0700AP	07158			7.0	.2756	8	118	76	57	1.08
CXDCLM0710AP	07159			7.1	.2795	8	118	76	57	1.10
CXDCL2812AP	07160	9/32		7.14	.2812	8	118	76	57	1.12
CXDCLM0720AP	07161			7.2	.2835	8	118	76	57	1.12
CXDCLM0730AP	07162			7.3	.2874	8	118	76	57	1.13
CXDCLM0740AP	07163			7.4	.2913	8	118	76	57	1.15

Series CXDCL Continued

ALtima® Plus		Diameter				Shank	OAL	Flute Length	Drill Length Ref.	Point Length
		D1 (m7)				D2 (h6)	L1	L2	L3	L5
Tool No.	EDP	Inch	Letter/Wire	mm	Decimal	mm	mm	mm	mm	mm
CXDCLM0750AP	07164			7.5	.2953	8	118	76	57	1.16
CXDCL2969AP	07165	19/64		7.54	.2969	8	118	76	57	1.17
CXDCLM0760AP	07166			7.6	.2992	8	118	76	57	1.18
CXDCLM0770AP	07167			7.7	.3031	8	118	76	57	1.19
CXDCLM0780AP	07168			7.8	.3071	8	118	76	57	1.21
CXDCLM0790AP	07169			7.9	.3110	8	118	76	57	1.22
CXDCL3125AP	07170	5/16		7.94	.3125	8	118	76	57	1.22
CXDCLM0800AP	07171			8.0	.3150	8	118	76	57	1.24
CXDCLM0810AP	07172			8.1	.3189	10	139	87	65	1.26
CXDCLM0820AP	07173			8.2	.3228	10	139	87	65	1.27
CXDCLM0830AP	07174			8.3	.3268	10	139	87	65	1.29
CXDCL3281AP	07175	21/64		8.33	.3281	10	139	87	65	1.30
CXDCLM0840AP	07176			8.4	.3307	10	139	87	65	1.31
CXDCL3320AP	07177		Q	8.43	.3320	10	139	87	65	1.31
CXDCLM0850AP	07178			8.5	.3346	10	139	87	65	1.32
CXDCLM0860AP	07179			8.6	.3386	10	139	87	65	1.33
CXDCLM0870AP	07180			8.7	.3425	10	139	87	65	1.35
CXDCL3438AP	07181	11/32		8.73	.3438	10	139	87	65	1.35
CXDCLM0880AP	07182			8.8	.3465	10	139	87	65	1.36
CXDCLM0890AP	07183			8.9	.3504	10	139	87	65	1.38
CXDCLM0900AP	07184			9.0	.3543	10	139	87	65	1.39
CXDCLM0910AP	07185			9.1	.3583	10	139	95	71	1.41
CXDCL3594AP	07186	23/64		9.13	.3594	10	139	95	71	1.42
CXDCLM0920AP	07187			9.2	.3622	10	139	95	71	1.43
CXDCLM0925AP	07188			9.25	.3642	10	139	95	71	1.43
CXDCLM0930AP	07189			9.3	.3661	10	139	95	71	1.44
CXDCL3680AP	07190		U	9.35	.3680	10	139	95	71	1.45
CXDCLM0940AP	07191			9.4	.3701	10	139	95	71	1.46
CXDCLM0950AP	07192			9.5	.3740	10	139	95	71	1.47
CXDCL3750AP	07193	3/8		9.52	.3750	10	139	95	71	1.47
CXDCLM0960AP	07194			9.6	.3780	10	139	95	71	1.49
CXDCLM0970AP	07195			9.7	.3819	10	139	95	71	1.50
CXDCL3858AP	07196		W	9.8	.3858	10	139	95	71	1.52
CXDCLM0990AP	07197			9.9	.3898	10	139	95	71	1.53
CXDCL3906AP	07198	25/64		9.92	.3906	10	139	95	71	1.55
CXDCLM1000AP	07199			10.0	.3937	10	139	95	71	1.55
CXDCLM1010AP	07200			10.1	.3976	12	155	106	80	1.56
CXDCLM1020AP	07201			10.2	.4016	12	155	106	80	1.58
CXDCLM1030AP	07202			10.3	.4055	12	155	106	80	1.60
CXDCL4062AP	07203	13/32		10.32	.4062	12	155	106	80	1.60
CXDCLM1040AP	07204			10.4	.4094	12	155	106	80	1.61
CXDCLM1050AP	07205			10.5	.4134	12	155	106	80	1.63
CXDCLM1060AP	07206			10.6	.4173	12	155	106	80	1.64
CXDCLM1070AP	07207			10.7	.4213	12	155	106	80	1.66
CXDCL4219AP	07208	27/64		10.72	.4219	12	155	106	80	1.65
CXDCLM1080AP	07209			10.8	.4252	12	155	106	80	1.67



Series CXDCL Continued

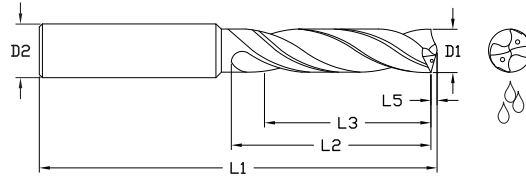
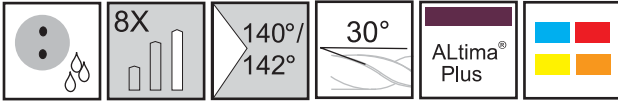

ALtima® Plus		Diameter				Shank D2 (h6)	OAL L1	Flute Length L2	Drill Length Ref.		Point Length
		D1 (m7)							L3	L5	
Tool No.	EDP	Inch	Letter/Wire	mm	Decimal	mm	mm	mm	mm	mm	
CXDCLM1090AP	07210			10.9	.4291	12	155	106	80	1.69	
CXDCLM1100AP	07211			11.0	.4331	12	155	106	80	1.70	
CXDCLM1110AP	07212			11.1	.4370	12	163	114	86	1.72	
CXDCL4375AP	07213	7/16		11.11	.4375	12	163	114	86	1.73	
CXDCLM1120AP	07214			11.2	.4409	12	163	114	86	1.74	
CXDCLM1130AP	07215			11.3	.4449	12	163	114	86	1.75	
CXDCLM1140AP	07216			11.4	.4488	12	163	114	86	1.77	
CXDCLM1150AP	07217			11.5	.4527	12	163	114	86	1.78	
CXDCLM1160AP	07218			11.6	.4567	12	163	114	86	1.80	
CXDCLM1170AP	07219			11.7	.4606	12	163	114	86	1.81	
CXDCLM1180AP	07220			11.8	.4646	12	163	114	86	1.83	
CXDCLM1190AP	07221			11.9	.4685	12	163	114	86	1.84	
CXDCL4688AP	07222	15/32		11.91	.4688	12	163	114	86	1.85	
CXDCLM1200AP	07223			12.0	.4724	12	163	114	86	1.86	
CXDCL4844AP	07224	31/64		12.3	.4844	14	182	133	100	1.91	
CXDCL5000AP	07225	1/2		12.7	.5000	14	182	133	100	1.95	

Safety Note

Always wear the appropriate personal protective equipment such as safety glasses and protective clothing when using solid carbide or HSS cutting tools. Machines should be fully guarded.



Twister XD[®] Series 2XDSS

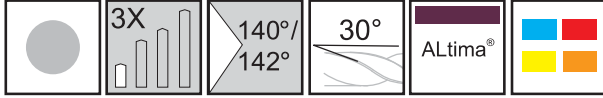

Designed for high performance drilling in a broad range of materials.

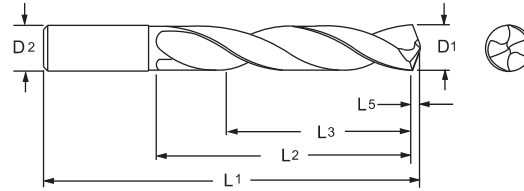

ALtima [®]		Diameter				Shank		OAL		Flute Length		Drill Length		Point Length	
		D1 (h7)				D2 (h6)		L1		L2 (Max.)		L3 Ref.		L5	
Tool No.	EDP	Inch	Letter/ Wire	mm	Decimal	Inch	mm	Inch	mm	Inch	mm	Inch	mm	Inch	mm
2XDSS0984A	22601			2.5	.0984		2.5		43		14		11		0.39
2XDSS1142A	22602			2.9	.1142		2.9		46		16		12		0.45
2XDSS1181A	02100			3.0	.1181		3.0		57		16		13		0.46
2XDSS1200A	02102		31		.1200	1/8		2.25		0.750		0.60		0.019	
2XDSS1220A	02103			3.1	.1220		4.0		63		22		18		0.48
2XDSS1250A	02104	1/8			.1250	1/8		2.25		0.750		0.60		0.019	
2XDSS1260A	02106			3.2	.1260		4.0		63		22		18		0.50
2XDSS1285A	02108		30		.1285	5/32		2.5		0.875		0.70		0.020	
2XDSS1299A	02110			3.3	.1299		4.0		63		22		18		0.51
2XDSS1339A	02112			3.4	.1339		4.0		63		22		18		0.53
2XDSS1360A	02114		29		.1360	5/32		2.5		0.875		0.70		0.021	
2XDSS1378A	02116			3.5	.1378		4.0		63		22		18		0.54
2XDSS1406A	02118	9/64			.1406	5/32		2.5		0.875		0.70		0.022	
2XDSS1417A	02119			3.6	.1417		4.0		63		22		18		0.56
2XDSS1457A	02120			3.7	.1457		4.0		63		22		18		0.57
2XDSS1496A	02122			3.8	.1496		4.0		63		22		18		0.59
2XDSS1520A	02121		24		.1520	5/32		2.5		0.875		0.70		0.024	
2XDSS1535A	02123			3.9	.1535		4.0		63		22		18		0.60
2XDSS1562A	02124	5/32			.1562	5/32		2.5		0.875		0.70		0.024	
2XDSS1575A	02126			4.0	.1575		4.0		63		22		18		0.62
2XDSS1590A	02127		21		.1590	3/16		2.5		1.000		0.80		0.025	
2XDSS1614A	04000			4.1	.1614		5.0		63		26		21		0.64
2XDSS1654A	02128			4.2	.1654		5.0		63		26		21		0.65
2XDSS1693A	02129			4.3	.1693		5.0		63		26		21		0.67
2XDSS1719A	02130	11/64			.1719	3/16		2.50		1.000		0.80		0.027	
2XDSS1732A	02131			4.4	.1732		5.0		63		26		21		0.68
2XDSS1772A	02132			4.5	.1772		5.0		63		26		21		0.70
2XDSS1811A	02134			4.6	.1811		5.0		63		26		21		0.71
2XDSS1850A	02135			4.7	.1850		5.0		63		26		21		0.73
2XDSS1875A	02136	3/16			.1875	3/16		2.50		1.000		0.80		0.029	
2XDSS1890A	02138			4.8	.1890		5.0		63		26		21		0.74
2XDSS1929A	02140			4.9	.1929		5.0		63		26		21		0.76
2XDSS1968A	02142			5.0	.1968		5.0		63		26		21		0.77
2XDSS2008A	02144			5.1	.2008		6.0		76		30		24		0.79

Inch	
D1	Tolerance (h7)
.0000 - .1181	+0/- .00039
.1182 - .2362	+0/- .00047
.2363 - .3937	+0/- .00059
.3938 - .7087	+0/- .00071
.7088 - .7500	+0/- .00083

Inch	
D2	Tolerance (h6)
.0000 - .1181	+0/- .00024
.1182 - .2362	+0/- .00031
.2363 - .3937	+0/- .00035
.3938 - .7087	+0/- .00043
.7088 - .7500	+0/- .00051

Metric (mm)	
D1	Tolerance (h7)
0 - 3.0	+0/- .010
3.01 - 6.0	+0/- .012
6.01 - 10.0	+0/- .015
10.01 - 18.0	+0/- .018
18.01 - 20.0	+0/- .021

Metric (mm)	
D2	Tolerance (h6)
0 - 3.0	+0/- .006
3.01 - 6.0	+0/- .008
6.01 - 10.0	+0/- .009
10.01 - 18.0	+0/- .011
18.01 - 20.0	+0/- .013



Series 2XDSS Continued

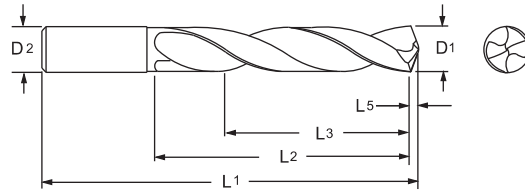
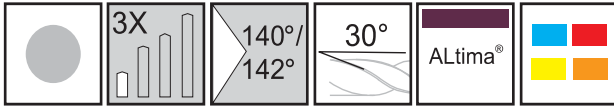

ALtima®		Diameter				Shank		OAL		Flute Length		Drill Length		Point Length	
		D1 (h7)				D2 (h6)		L1		L2 (Max.)		L3 Ref.		L5	
Tool No.	EDP	Inch	Letter/ Wire	mm	Decimal	Inch	mm	Inch	mm	Inch	mm	Inch	mm	Inch	mm
2XDSS2031A	02146	13/64			.2031	15/64		3.00		1.125		0.90		0.031	
2XDSS2047A	02148			5.2	.2047		6.0		76		30		24		0.81
2XDSS2087A	02150			5.3	.2087		6.0		76		30		24		0.82
2XDSS2126A	02152			5.4	.2126		6.0		76		30		24		0.84
2XDSS2165A	02154			5.5	.2165		6.0		76		30		24		0.85
2XDSS2187A	02156	7/32			.2187	15/64		3.00		1.125		0.90		0.034	
2XDSS2210A	02158		2		.2210	15/64		3.00		1.125		0.90		0.034	
2XDSS2244A	02160			5.7	.2244		6.0		76		30		24		0.88
2XDSS2283A	02162			5.8	.2283		6.0		76		30		24		0.90
2XDSS2323A	02164			5.9	.2323		6.0		76		30		24		0.91
2XDSS2344A	02166	15/64			.2344	15/64		3.00		1.125		0.90		0.036	
2XDSS2362A	02168			6.0	.2362		6.0		76		30		24		0.93
2XDSS2402A	02170			6.1	.2402		8.0		82		35		28		0.95
2XDSS2420A	02172		C		.2420	1/4		3.00		1.250		1.00		0.037	
2XDSS2441A	02174			6.2	.2441		8.0		82		35		28		0.96
2XDSS2460A	02176		D		.2460	1/4		3.00		1.250		1.00		0.038	
2XDSS2480A	02178			6.3	.2480		8.0		82		35		28		0.98
2XDSS2500A	02180	1/4			.2500	1/4		3.00		1.250		1.00		0.039	
2XDSS2520A	02182			6.4	.2520		8.0		82		35		28		0.99
2XDSS2559A	02184			6.5	.2559		8.0		82		35		28		1.01
2XDSS2570A	02186		F		.2570	5/16		3.25		1.375		1.10		0.040	
2XDSS2598A	02185			6.6	.2598		8.0		82		35		28		1.03
2XDSS2610A	02188		G		.2610	5/16		3.25		1.375		1.10		0.040	
2XDSS2638A	02189			6.7	.2638		8.0		82		35		28		1.04
2XDSS2656A	02190	17/64			.2656	5/16		3.25		1.375		1.10		0.041	
2XDSS2677A	02192			6.8	.2677		8.0		82		35		28		1.05
2XDSS2717A	02194			6.9	.2717		8.0		82		35		28		1.07
2XDSS2756A	02196			7.0	.2756		8.0		82		35		28		1.08
2XDSS2795A	02197			7.1	.2795		8.0		82		38		31		1.10
2XDSS2812A	02198	9/32			.2812	5/16		3.25		1.500		1.20		0.044	
2XDSS2835A	02200			7.2	.2835		8.0		82		38		31		1.12
2XDSS2874A	02201			7.3	.2874		8.0		82		38		31		1.13
2XDSS2913A	02202			7.4	.2913		8.0		82		38		31		1.15
2XDSS2953A	02204			7.5	.2953		8.0		82		38		31		1.16
2XDSS2969A	02206	19/64			.2969	5/16		3.25		1.500		1.20		0.046	
2XDSS2992A	02208			7.6	.2992		8.0		82		38		31		1.18
2XDSS3031A	02210			7.7	.3031		8.0		82		38		31		1.19
2XDSS3071A	02212			7.8	.3071		8.0		82		38		31		1.21
2XDSS3110A	02213			7.9	.3110		8.0		82		38		31		1.22
2XDSS3125A	02214	5/16			.3125	5/16		3.25		1.500		1.20		0.048	
2XDSS3150A	02216			8.0	.3150		8.0		82		38		31		1.24
2XDSS3189A	02218			8.1	.3189		10.0		89		43		35		1.26
2XDSS3228A	02220			8.2	.3228		10.0		89		43		35		1.27
2XDSS3268A	02222			8.3	.3268		10.0		89		43		35		1.29

Series 2XDSS Continued

ALtima®		Diameter				Shank		OAL		Flute Length		Drill Length		Point Length	
		D1 (h7)				D2 (h6)		L1		L2 (Max.)		L3 Ref.		L5	
Tool No.	EDP	Inch	Letter/ Wire	mm	Decimal	Inch	mm	Inch	mm	Inch	mm	Inch	mm	Inch	mm
2XDSS3281A	02224	21/64			.3281	25/64		3.50		1.687		1.35		0.051	
2XDSS3307A	02223			8.4	.3307		10.0		89		43		35		1.31
2XDSS3320A	02225		Q		.3320	25/64		3.50		1.687		1.35		0.051	
2XDSS3346A	02226			8.5	.3346		10.0		89		43		35		1.32
2XDSS3386A	02227			8.6	.3386		10.0		89		43		35		1.33
2XDSS3425A	04001			8.7	.3425		10.0		89		43		35		1.35
2XDSS3438A	02228	11/32			.3438	25/64		3.50		1.687		1.35		0.053	
2XDSS3465A	02230			8.8	.3465		10.0		89		43		35		1.36
2XDSS3504A	02232			8.9	.3504		10.0		89		43		35		1.38
2XDSS3543A	02234			9.0	.3543		10.0		89		43		35		1.39
2XDSS3583A	02235			9.1	.3583		10.0		89		43		35		1.41
2XDSS3594A	02236	23/64			.3594	25/64		3.50		1.687		1.35		0.056	
2XDSS3622A	02238			9.2	.3622		10.0		89		43		35		1.43
2XDSS3642A	02240			9.25	.3642		10.0		89		43		35		1.43
2XDSS3661A	02242			9.3	.3661		10.0		89		43		35		1.44
2XDSS3701A	02243			9.4	.3701		10.0		89		43		35		1.46
2XDSS3740A	02244			9.5	.3740		10.0		89		43		35		1.47
2XDSS3750A	02246	3/8			.3750	25/64		3.50		1.687		1.35		0.058	
2XDSS3780A	02247			9.6	.3780		10.0		89		43		35		1.49
2XDSS3819A	02248			9.7	.3819		10.0		89		43		35		1.50
2XDSS3858A	02250			9.8	.3858		10.0		89		43		35		1.52
2XDSS3898A	02251			9.9	.3898		10.0		89		43		35		1.53
2XDSS3906A	02252	25/64			.3906	25/64		3.50		1.687		1.35		0.061	
2XDSS3937A	02254			10.0	.3937		10.0		89		43		35		1.55
2XDSS3976A	02255			10.1	.3976		12.0		101		51		41		1.56
2XDSS4016A	02256			10.2	.4016		12.0		101		51		41		1.58
2XDSS4055A	02257			10.3	.4055		12.0		101		51		41		1.60
2XDSS4062A	02258	13/32			.4062	15/32		4.00		2.000		1.60		0.063	
2XDSS4094A	02259			10.4	.4094		12.0		101		51		41		1.61
2XDSS4134A	02260			10.5	.4134		12.0		101		51		41		1.63
2XDSS4173A	02261			10.6	.4173		12.0		101		51		41		1.64
2XDSS4213A	04002			10.7	.4213		12.0		101		51		41		1.66
2XDSS4219A	02262	27/64			.4219	15/32		4.00		2.00		1.60		0.065	
2XDSS4252A	02263			10.8	.4252		12.0		101		51		41		1.67
2XDSS4291A	04003			10.9	.4291		12.0		101		51		41		1.69
2XDSS4331A	02264			11.0	.4331		12.0		101		51		41		1.70
2XDSS4370A	02265			11.1	.4370		12.0		101		51		41		1.72
2XDSS4375A	02266	7/16			.4375	15/32		4.00		2.00		1.60		0.068	
2XDSS4409A	02268			11.2	.4409		12.0		101		51		41		1.74
2XDSS4449A	02269			11.3	.4449		12.0		101		51		41		1.75
2XDSS4488A	04004			11.4	.4488		12.0		101		51		41		1.77
2XDSS4527A	02270			11.5	.4527		12.0		101		51		41		1.78
2XDSS4567A	02271			11.6	.4567		12.0		101		51		41		1.80
2XDSS4606A	02272			11.7	.4606		12.0		101		51		41		1.81
2XDSS4646A	02273			11.8	.4646		12.0		101		51		41		1.83
2XDSS4685A	04005			11.9	.4685		12.0		101		51		41		1.84
2XDSS4688A	02274	15/32			.4688	15/32		4.00		2.00		1.60		0.073	
2XDSS4724A	02276			12.0	.4724		12.0		101		51		41		1.86
2XDSS4764A	02278			12.1	.4764		14.0		107		54		43		1.87
2XDSS4844A	02280	31/64			.4844	1/2		4.00		2.00		1.60		0.075	
2XDSS4921A	02282			12.5	.4921		14.0		107		54		43		1.94
2XDSS5000A	02284	1/2			.5000	1/2		4.00		2.00		1.60		0.077	



Series 2XDSS Continued

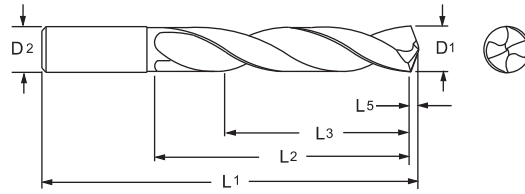
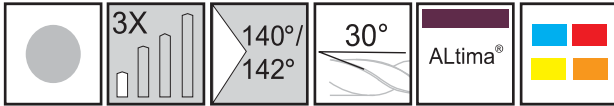

ALtima®		Diameter				Shank		OAL		Flute Length		Drill Length		Point Length	
		D1 (h7)				D2 (h6)		L1		L2 (Max.)		L3 Ref.		L5	
Tool No.	EDP	Inch	Letter/ Wire	mm	Decimal	Inch	mm	Inch	mm	Inch	mm	Inch	mm	Inch	mm
2XDSS5039A	02286			12.8	.5039		14.0		107		54		43		1.98
2XDSS5051A	02285			12.83	.5051		14.0		107		54		43		1.99
2XDSS5079A	02287			12.9	.5079		14.0		107		54		43		2.00
2XDSS5118A	02288			13.0	.5118		14.0		107		54		43		2.01
2XDSS5156A	02290	33/64			.5156	35/64		4.25		2.125		1.70		0.080	
2XDSS5312A	02291	17/32			.5312	35/64		4.25		2.125		1.70		0.082	
2XDSS5315A	02292			13.5	.5315		14.0		107		54		43		2.09
2XDSS5394A	02294			13.7	.5394		14.0		107		54		43		2.12
2XDSS5469A	02296	35/64			.5469	35/64		4.25		2.125		1.70		0.085	
2XDSS5512A	02298			14.0	.5512		14.0		107		54		43		2.17
2XDSS5625A	02300	9/16			.5625	5/8		4.625		2.375		1.90		0.087	
2XDSS5709A	02302			14.5	.5709		16.0		117		60		48		2.25
2XDSS5787A	02304			14.7	.5787		16.0		117		60		48		2.28
2XDSS5905A	02306			15.0	.5905		16.0		117		60		48		2.32
2XDSS5938A	02308	19/32			.5938	5/8		4.625		2.375		1.90		0.092	
2XDSS6024A	02309			15.3	.6024		16.0		117		60		48		2.37
2XDSS6102A	02310			15.5	.6102		16.0		117		60		48		2.40
2XDSS6181A	02312			15.7	.6181		16.0		117		60		48		2.43
2XDSS6250A	02314	5/8			.6250	5/8		4.625		2.375		1.90		0.097	
2XDSS6299A	02316			16.0	.6299		16.0		117		60		48		2.48
2XDSS6331A	02318			16.08	.6331		18.0		122		63		51		2.49
2XDSS6417A	02319			16.3	.6417		18.0		122		63		51		2.53
2XDSS6496A	02320			16.5	.6496		18.0		122		63		51		2.56
2XDSS6562A	02322	21/32			.6562	45/64		4.81		2.500		2.00		0.102	
2XDSS6693A	02324			17.0	.6693		18.0		122		63		51		2.63
2XDSS6875A	02326	11/16			.6875	45/64		4.81		2.500		2.00		0.107	
2XDSS6890A	02328			17.5	.6890		18.0		122		63		51		2.71
2XDSS7087A	02330			18.0	.7087		18.0		122		63		51		2.79
2XDSS7283A	02332			18.5	.7283		20.0		133		70		56		2.87
2XDSS7500A	02334	3/4			.7500	3/4		5.25		2.750		2.20		0.116	
2XDSS7543A	02336			19.16	.7543		20.0		133		70		56		2.97
2XDSS7579A	02338			19.25	.7579		20.0		133		70		56		2.98
2XDSS7598A	02340			19.3	.7598		20.0		133		70		56		2.99
2XDSS7677A	02342			19.5	.7677		20.0		133		70		56		3.02
2XDSS7874A	02344			20.0	.7874		20.0		133		70		56		3.10



Twister XD® Series 2XDSR

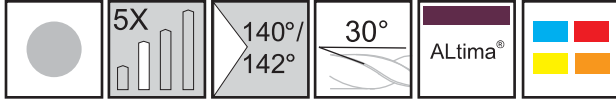

Designed for high performance drilling in a broad range of materials.

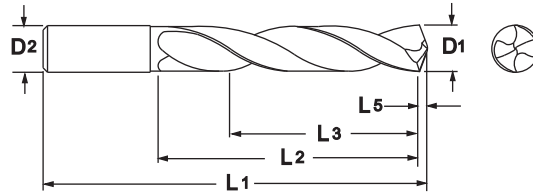

ALtima®		Diameter				Shank		OAL		Flute Length		Drill Length		Point Length	
Tool No.	EDP	D1 (h7)				D2 (h6)		L1		L2 (Max.)		L3 Ref.		L5	
		Inch	Letter/ Wire	mm	Decimal	Inch	mm	Inch	mm	Inch	mm	Inch	mm	Inch	mm
2XDSR0156A	22201	1/64			.0156	1/64		1.50		0.187		0.14		0.002	
2XDSR0197A	28001			0.5	.0197	0.50		26		6		5		0.08	
2XDSR0236A	28006			0.6	.0236	0.60		26		7		5		0.09	
2XDSR0256A	28011			0.65	.0256	0.65		26		8		6		0.10	
2XDSR0312A	22221	1/32			.0312	1/32		1.50		0.375		0.281		0.005	
2XDSR0374A	28016			0.95	.0374	0.95		32		11		8		0.15	
2XDSR0394A	28021			1.0	.0394	1.00		34		12		9		0.16	
2XDSR0413A	28026			1.05	.0413	1.05		34		12		9		0.16	
2XDSR0469A	22241	3/64			.0469	3/64		1.50		0.750		0.562		0.007	
2XDSR0492A	28031			1.25	.0492	1.25		38		16		12		0.19	
2XDSR0590A	28036			1.5	.0590	1.50		40		18		14		0.23	
2XDSR0625A	22256	1/16			.0625	1/16		1.50		0.750		0.562		0.010	
2XDSR0630A	28041			1.6	.0630	1.60		43		20		15		0.25	
2XDSR0708A	28046			1.8	.0708	1.80		46		22		17		0.28	
2XDSR0748A	28051			1.9	.0748	1.90		46		22		17		0.29	
2XDSR0781A	22276	5/64			.0781	5/64		1.75		0.875		0.656		0.012	
2XDSR0787A	28056			2.0	.0787	2.00		49		24		18		0.31	
2XDSR0807A	28058			2.05	.0807	2.05		49		24		18		0.32	
2XDSR0906A	28061			2.3	.0906	2.30		53		27		20		0.36	
2XDSR0938A	22291	3/32			.0938	3/32		2.00		1.000		0.75		0.015	
2XDSR0945A	28066			2.4	.0945	2.40		57		30		23		0.37	
2XDSR0984A	28071			2.5	.0984	2.50		57		30		23		0.39	
2XDSR1094A	22306	7/64			.1094	7/64		2.25		1.250		0.937		0.017	
2XDSR1142A	28073			2.9	.1142	2.90		61		33		25		0.45	
2XDSR1181A	02346			3.0	.1181	3.00		63		24		19		0.46	
2XDSR1200A	02348		31		.1200	1/8		2.50		1.125		0.90		0.019	
2XDSR1220A	02349			3.1	.1220	4.00		69		32		26		0.48	
2XDSR1250A	02350	1/8			.1250	1/8		2.50		1.125		0.90		0.019	
2XDSR1260A	02352			3.2	.1260	4.00		69		32		26		0.50	
2XDSR1285A	02354		30		.1285	5/32		2.75		1.260		1.000		0.020	
2XDSR1299A	02356			3.3	.1299	4.00		69		32		26		0.51	
2XDSR1339A	02358			3.4	.1339	4.00		69		32		26		0.53	
2XDSR1360A	02360		29		.1360	5/32		2.75		1.260		1.000		0.021	
2XDSR1378A	02362			3.5	.1378	4.00		69		32		26		0.54	

Inch	
D1	Tolerance (h7)
.0000 - .1181	+0/- .00039
.1182 - .2362	+0/- .00047
.2363 - .3937	+0/- .00059
.3938 - .6250	+0/- .00071

Inch	
D2	Tolerance (h6)
.0000 - .1181	+0/- .00024
.1182 - .2362	+0/- .00031
.2363 - .3937	+0/- .00035
.3938 - .6250	+0/- .00043

Metric (mm)	
D1	Tolerance (h7)
0 - 3.0	+0/- .010
3.01 - 6.0	+0/- .012
6.01 - 10.0	+0/- .015
10.01 - 16.0	+0/- .018

Metric (mm)	
D2	Tolerance (h6)
0 - 3.0	+0/- .006
3.01 - 6.0	+0/- .008
6.01 - 10.0	+0/- .009
10.01 - 16.0	+0/- .011



Series 2XDSR Continued

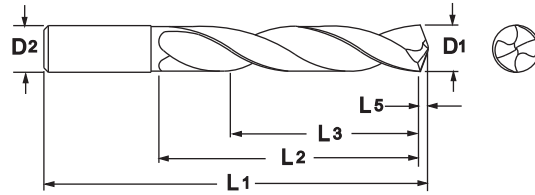
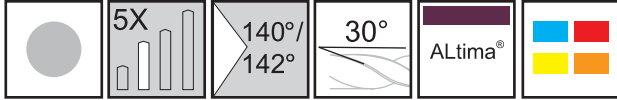

ALtima®		Diameter				Shank		OAL		Flute Length		Drill Length		Point Length	
Tool No.	EDP	D1 (h7)				D2 (h6)		L1		L2 (Max.)		L3 Ref.		L5	
		Inch	Letter/ Wire	mm	Decimal	Inch	mm	Inch	mm	Inch	mm	Inch	mm	Inch	mm
2XDSR1406A	02364	9/64			.1406	5/32		2.75		1.260		1.000		0.022	
2XDSR1417A	02365			3.6	.1417	4.00		69		32		26		0.56	
2XDSR1457A	02366			3.7	.1457	4.00		69		32		26		0.57	
2XDSR1496A	02368			3.8	.1496	4.00		69		32		26		0.59	
2XDSR1520A	02367		24		.1520	5/32		2.75		1.260		1.000		0.024	
2XDSR1535A	02369			3.9	.1535	4.00		69		32		26		0.60	
2XDSR1562A	02370	5/32			.1562	5/32		2.75		1.260		1.000		0.024	
2XDSR1575A	02372			4.0	.1575	4.00		69		32		26		0.62	
2XDSR1590A	02373		21		.1590	3/16		3.15		1.500		1.200		0.025	
2XDSR1614A	04006			4.1	.1614	5.00		80		38		30		0.64	
2XDSR1654A	02374			4.2	.1654	5.00		80		38		30		0.65	
2XDSR1693A	02375			4.3	.1693	5.00		80		38		30		0.67	
2XDSR1719A	02376	11/64			.1719	3/16		3.15		1.500		1.200		0.027	
2XDSR1732A	02377			4.4	.1732	5.00		80		38		30		0.68	
2XDSR1772A	02378			4.5	.1772	5.00		80		38		30		0.70	
2XDSR1811A	02380			4.6	.1811	5.00		80		38		30		0.71	
2XDSR1850A	02381			4.7	.1850	5.00		80		38		30		0.73	
2XDSR1875A	02382	3/16			.1875	3/16		3.15		1.500		1.200		0.029	
2XDSR1890A	02384			4.8	.1890	5.00		80		38		30		0.74	
2XDSR1929A	02386			4.9	.1929	5.00		80		38		30		0.76	
2XDSR1968A	02388			5.0	.1968	5.00		80		38		30		0.77	
2XDSR2008A	02390			5.1	.2008	6.00		82		40		32		0.79	
2XDSR2031A	02392	13/64			.2031	15/64		3.23		1.580		1.260		0.031	
2XDSR2047A	02394			5.2	.2047	6.00		82		40		32		0.81	
2XDSR2087A	02396			5.3	.2087	6.00		82		40		32		0.82	
2XDSR2126A	02398			5.4	.2126	6.00		82		40		32		0.84	
2XDSR2165A	02400			5.5	.2165	6.00		82		40		32		0.85	
2XDSR2187A	02402	7/32			.2187	15/64		3.23		1.580		1.260		0.034	
2XDSR2210A	02404		2		.2210	15/64		3.23		1.580		1.260		0.034	
2XDSR2244A	02406			5.7	.2244	6.00		82		40		32		0.88	
2XDSR2283A	02408			5.8	.2283	6.00		82		40		32		0.90	
2XDSR2323A	02410			5.9	.2323	6.00		82		40		32		0.91	
2XDSR2344A	02412	15/64			.2344	15/64		3.23		1.580		1.260		0.036	
2XDSR2362A	02414			6.0	.2362	6.00		82		40		32		0.93	
2XDSR2402A	02416			6.1	.2402	8.00		91		48		38		0.95	
2XDSR2420A	02418		C		.2420	1/4		3.25		1.740		1.390		0.037	
2XDSR2441A	02420			6.2	.2441	8.00		91		48		38		0.96	
2XDSR2460A	02422		D		.2460	1/4		3.25		1.740		1.390		0.038	
2XDSR2480A	02424			6.3	.2480	8.00		91		48		38		0.98	
2XDSR2500A	02426	1/4			.2500	1/4		3.25		1.740		1.390		0.039	
2XDSR2520A	02428			6.4	.2520	8.00		91		48		38		0.99	
2XDSR2559A	02430			6.5	.2559	8.00		91		48		38		1.01	
2XDSR2570A	02432		F		.2570	5/16		3.58		1.890		1.510		0.040	
2XDSR2598A	02433			6.6	.2598	8.00		91		48		38		1.03	
2XDSR2610A	02434		G		.2610	5/16		3.58		1.890		1.510		0.040	
2XDSR2638A	02435			6.7	.2638	8.00		91		48		38		1.04	

Series 2XDSR Continued

ALtima®		Diameter				Shank		OAL		Flute Length		Drill Length		Point Length	
		D1 (h7)				D2 (h6)		L1		L2 (Max.)		L3 Ref.		L5	
Tool No.	EDP	Inch	Letter/ Wire	mm	Decimal	Inch	mm	Inch	mm	Inch	mm	Inch	mm	Inch	mm
2XDSR2656A	02436	17/64			.2656	5/16		3.58		1.890		1.510		0.041	
2XDSR2677A	02438			6.8	.2677		8.00		91		48		38		1.05
2XDSR2717A	02440			6.9	.2717		8.00		91		48		38		1.07
2XDSR2756A	02442			7.0	.2756		8.00		91		48		38		1.08
2XDSR2795A	02443			7.1	.2795		8.00		91		48		38		1.10
2XDSR2812A	02444	9/32			.2812	5/16		3.58		1.890		1.510		0.044	
2XDSR2835A	02446			7.2	.2835		8.00		91		48		38		1.12
2XDSR2874A	02447			7.3	.2874		8.00		91		48		38		1.13
2XDSR2913A	02448			7.4	.2913		8.00		91		48		38		1.15
2XDSR2953A	02450			7.5	.2953		8.00		91		48		38		1.16
2XDSR2969A	02452	19/64			.2969	5/16		3.58		1.890		1.510		0.046	
2XDSR2992A	02454			7.6	.2992		8.00		91		48		38		1.18
2XDSR3031A	02456			7.7	.3031		8.00		91		48		38		1.19
2XDSR3071A	02458			7.8	.3071		8.00		91		48		38		1.21
2XDSR3110A	02459			7.9	.3110		8.00		91		48		38		1.22
2XDSR3125A	02460	5/16			.3125	5/16		3.58		1.890		1.510		0.048	
2XDSR3150A	02480			8.0	.3150		8.00		91		48		38		1.24
2XDSR3189A	02482			8.1	.3189		10.00		103		55		44		1.26
2XDSR3228A	02484			8.2	.3228		10.00		103		55		44		1.27
2XDSR3268A	02486			8.3	.3268		10.00		103		55		44		1.29
2XDSR3281A	02488	21/64			.3281	25/64		4.06		2.170		1.740		0.051	
2XDSR3307A	02487			8.4	.3307		10.00		103		55		44		1.31
2XDSR3320A	02489		Q		.3320	25/64		4.06		2.170		1.740		0.051	
2XDSR3346A	02490			8.5	.3346		10.00		103		55		44		1.32
2XDSR3386A	02491			8.6	.3386		10.00		103		55		44		1.33
2XDSR3425A	04007			8.7	.3425		10.00		103		55		44		1.35
2XDSR3438A	02492	11/32			.3438	25/64		4.06		2.170		1.740		0.053	
2XDSR3465A	02494			8.8	.3465		10.00		103		55		44		1.36
2XDSR3504A	02496			8.9	.3504		10.00		103		55		44		1.38
2XDSR3543A	02498			9.0	.3543		10.00		103		55		44		1.39
2XDSR3583A	02499			9.1	.3583		10.00		103		55		44		1.41
2XDSR3594A	02500	23/64			.3594	25/64		4.06		2.170		1.740		0.056	
2XDSR3622A	02502			9.2	.3622		10.00		103		55		44		1.43
2XDSR3642A	02504			9.25	.3642		10.00		103		55		44		1.43
2XDSR3661A	02506			9.3	.3661		10.00		103		55		44		1.44
2XDSR3701A	02507			9.4	.3701		10.00		103		55		44		1.46
2XDSR3740A	02508			9.5	.3740		10.00		103		55		44		1.47
2XDSR3750A	02510	3/8			.3750	25/64		4.06		2.170		1.740		0.058	
2XDSR3780A	02511			9.6	.3780		10.00		103		55		44		1.49
2XDSR3819A	02512			9.7	.3819		10.00		103		55		44		1.50
2XDSR3858A	02514			9.8	.3858		10.00		103		55		44		1.52
2XDSR3898A	02515			9.9	.3898		10.00		103		55		44		1.53
2XDSR3906A	02516	25/64			.3906	25/64		4.06		2.170		1.740		0.061	
2XDSR3937A	02518			10.0	.3937		10.00		103		55		44		1.55
2XDSR3976A	02519			10.1	.3976		12.00		120		60		48		1.56
2XDSR4016A	02520			10.2	.4016		12.00		120		60		48		1.58
2XDSR4055A	02521			10.3	.4055		12.00		120		60		48		1.60
2XDSR4062A	02522	13/32			.4062	15/32		4.72		2.360		1.890		0.063	
2XDSR4094A	02523			10.4	.4094		12.00		120		60		48		1.61
2XDSR4134A	02524			10.5	.4134		12.00		120		60		48		1.63
2XDSR4173A	02525			10.6	.4173		12.00		120		60		48		1.64
2XDSR4213A	04008			10.7	.4213		12.00		120		60		48		1.66
2XDSR4219A	02526	27/64			.4219	15/32		4.72		2.360		1.890		0.065	
2XDSR4252A	02527			10.8	.4252		12.00		120		60		48		1.67



Series 2XDSR Continued

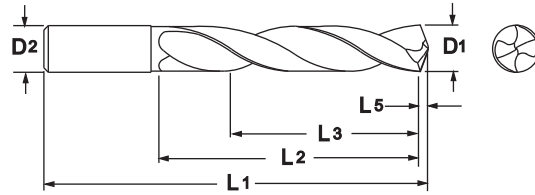
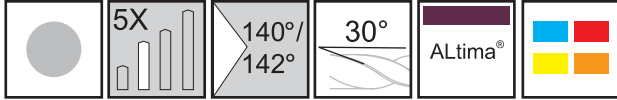

ALtima®		Diameter				Shank		OAL		Flute Length		Drill Length		Point Length	
		D1 (h7)				D2 (h6)		L1		L2 (Max.)		L3 Ref.		L5	
Tool No.	EDP	Inch	Letter/ Wire	mm	Decimal	Inch	mm	Inch	mm	Inch	mm	Inch	mm	Inch	mm
2XDSR4291A	04009			10.9	.4291		12.00		120		60		48		1.69
2XDSR4331A	02528			11.0	.4331		12.00		120		60		48		1.70
2XDSR4370A	02529			11.1	.4370		12.00		120		66		53		1.72
2XDSR4375A	02530	7/16			.4375	15/32		4.72		2.600		2.080		0.068	
2XDSR4409A	02532			11.2	.4409		12.00		120		66		53		1.74
2XDSR4449A	02533			11.3	.4449		12.00		120		66		53		1.75
2XDSR4488A	04010			11.4	.4488		12.00		120		66		53		1.77
2XDSR4527A	02534			11.5	.4527		12.00		120		66		53		1.78
2XDSR4567A	02535			11.6	.4567		12.00		120		66		53		1.80
2XDSR4606A	02536			11.7	.4606		12.00		120		66		53		1.81
2XDSR4646A	02537			11.8	.4646		12.00		120		66		53		1.83
2XDSR4685A	04011			11.9	.4685		12.00		120		66		53		1.84
2XDSR4688A	02538	15/32			.4688	15/32		4.72		2.600		2.080		0.073	
2XDSR4724A	02540			12.0	.4724		12.00		120		66		53		1.86
2XDSR4764A	02542			12.1	.4764		14.00		126		72		58		1.87
2XDSR4844A	02544	31/64			.4844	1/2		4.75		2.830		2.260		0.075	
2XDSR4921A	02546			12.5	.4921		14.00		126		72		58		1.94
2XDSR5000A	02548	1/2			.5000	1/2		4.75		2.830		2.260		0.077	
2XDSR5039A	02550			12.8	.5039		14.00		126		72		58		1.98
2XDSR5051A	02549			12.83	.5051		14.00		126		72		58		1.99
2XDSR5079A	02551			12.9	.5079		14.00		126		72		58		2.00
2XDSR5118A	02552			13.0	.5118		14.00		126		72		58		2.01
2XDSR5156A	02554	33/64			.5156	35/64		5.28		3.030		2.420		0.080	
2XDSR5312A	02555	17/32			.5312	35/64		5.28		3.030		2.420		0.082	
2XDSR5315A	02556			13.5	.5315		14.00		134		77		62		2.09
2XDSR5394A	02558			13.7	.5394		14.00		134		77		62		2.12
2XDSR5469A	02560	35/64			.5469	35/64		5.28		3.030		2.420		0.085	
2XDSR5512A	02562			14.0	.5512		14.00		134		77		62		2.17
2XDSR5625A	02564	9/16			.5625	5/8		5.51		3.150		2.520		0.087	
2XDSR5709A	02566			14.5	.5709		16.00		140		80		64		2.25
2XDSR5787A	02568			14.7	.5787		16.00		140		80		64		2.28
2XDSR5905A	02570			15.0	.5905		16.00		140		80		64		2.32
2XDSR5938A	02572	19/32			.5938	5/8		5.75		3.230		2.580		0.092	
2XDSR6024A	02573			15.3	.6024		16.00		146		82		66		2.37
2XDSR6102A	02574			15.5	.6102		16.00		146		82		66		2.40
2XDSR6181A	02576			15.7	.6181		16.00		146		82		66		2.43
2XDSR6250A	02578	5/8			.6250	5/8		5.75		3.230		2.580		0.097	
2XDSR6299A	02580			16.0	.6299		16.00		146		82		66		2.48



Twister XD® Series 2XDCS

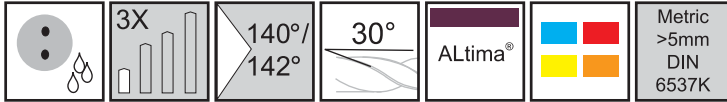

Designed for high performance drilling in a broad range of materials.

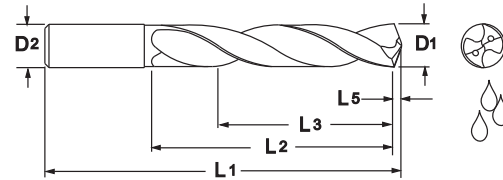

ALtima®		Diameter				Shank		OAL	Flute Length		Drill Length		Point Length		
		D1 (h7)				D2 (h6)		L1	L2 (Max.)		L3 Ref.		L5		
Tool No.	EDP	Inch	Letter/ Wire	mm	Decimal	Inch	mm	Inch	mm	Inch	mm	Inch	mm	Inch	mm
2XDCS1181A	04400			3.0	.1181		3.0		57		16		13		0.46
2XDCS1200A	04402		31		.1200	1/8		2.250		.750		.600		.019	
2XDCS1220A	04404			3.1	.1220		4.0		63		22		18		0.48
2XDCS1250A	04406	1/8			.1250	1/8		2.250		.750		.600		.019	
2XDCS1260A	04408			3.2	.1260		4.0		63		22		18		0.50
2XDCS1285A	04410		30		.1285	5/32		2.500		.875		.700		.020	
2XDCS1299A	04412			3.3	.1299		4.0		63		22		18		0.51
2XDCS1339A	04414			3.4	.1339		4.0		63		22		18		0.53
2XDCS1360A	04416		29		.1360	5/32		2.500		.875		.700		.021	
2XDCS1378A	04418			3.5	.1378		4.0		63		22		18		0.54
2XDCS1406A	04420	9/64			.1406	5/32		2.500		.875		.700		.022	
2XDCS1417A	04422			3.6	.1417		4.0		63		22		18		0.56
2XDCS1457A	04424			3.7	.1457		4.0		63		22		18		0.57
2XDCS1496A	04426			3.8	.1496		4.0		63		22		18		0.59
2XDCS1520A	04428		24		.1520	5/32		2.500		.875		.700		.024	
2XDCS1535A	04430			3.9	.1535		4.0		63		22		18		0.60
2XDCS1562A	04432	5/32			.1562	5/32		2.500		.875		.700		.024	
2XDCS1575A	04434			4.0	.1575		4.0		63		22		18		0.62
2XDCS1590A	04436		21		.1590	3/16		2.500		1.000		.800		.025	
2XDCS1614A	04438			4.1	.1614		5.0		63		26		21		0.64
2XDCS1654A	04440			4.2	.1654		5.0		63		26		21		0.65
2XDCS1693A	04442			4.3	.1693		5.0		63		26		21		0.67
2XDCS1719A	04444	11/64			.1719	3/16		2.500		1.000		.800		.027	
2XDCS1732A	04446			4.4	.1732		5.0		63		26		21		0.68
2XDCS1772A	04448			4.5	.1772		5.0		63		26		21		0.70
2XDCS1811A	04450			4.6	.1811		5.0		63		26		21		0.71
2XDCS1850A	04452			4.7	.1850		5.0		63		26		21		0.73
2XDCS1875A	04454	3/16			.1875	3/16		2.500		1.000		.800		.029	
2XDCS1890A	04456			4.8	.1890		5.0		63		26		21		0.74
2XDCS1929A	04458			4.9	.1929		5.0		63		26		21		0.76
2XDCS1968A	04460			5.0	.1968		5.0		63		26		21		0.77
2XDCS2008A	04462			5.1	.2008		6.0		66		28		20		0.79
2XDCS2031A	04464	13/64			.2031	15/64		2.598		1.102		.787		.031	
2XDCS2047A	04466			5.2	.2047		6.0		66		28		20		0.81

Inch		Inch		Metric (mm)		Metric (mm)	
D1	Tolerance (h7)	D2	Tolerance (h6)	D1	Tolerance (h7)	D2	Tolerance (h6)
.0000 - .1181	+0/-0.0039	.0000 - .1181	+0/-0.0024	0 - 3.0	+0/-0.010	0 - 3.0	+0/-0.006
.1182 - .2362	+0/-0.0047	.1182 - .2362	+0/-0.0031	3.01 - 6.0	+0/-0.012	3.01 - 6.0	+0/-0.008
.2363 - .3937	+0/-0.0059	.2363 - .3937	+0/-0.0035	6.01 - 10.0	+0/-0.015	6.01 - 10.0	+0/-0.009
.3938 - .6250	+0/-0.0071	.3938 - .6250	+0/-0.0043	10.01 - 16.0	+0/-0.018	10.01 - 16.0	+0/-0.011



Series 2XDCS Continued

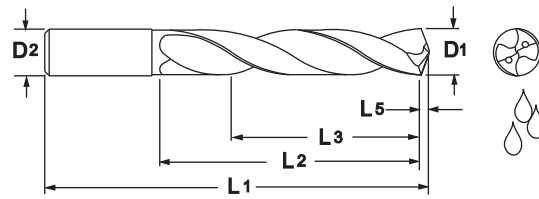
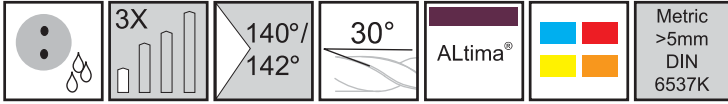

ALtima®		Diameter				Shank		OAL		Flute Length		Drill Length		Point Length	
		D1 (h7)				D2 (h6)		L1		L2 (Max.)		L3 Ref.		L5	
Tool No.	EDP	Inch	Letter/ Wire	mm	Decimal	Inch	mm	Inch	mm	Inch	mm	Inch	mm	Inch	mm
2XDCS2087A	04468			5.3	.2087		6.0		66		28		20		0.82
2XDCS2126A	04470			5.4	.2126		6.0		66		28		20		0.84
2XDCS2165A	04472			5.5	.2165		6.0		66		28		20		0.85
2XDCS2187A	04474	7/32			.2187	15/64		2.598		1.102		.787		.034	
2XDCS2210A	04476		2		.2210	15/64		2.598		1.102		.787		.034	
2XDCS2244A	04478			5.7	.2244		6.0		66		28		20		0.88
2XDCS2283A	04480			5.8	.2283		6.0		66		28		20		0.90
2XDCS2323A	04482			5.9	.2323		6.0		66		28		20		0.91
2XDCS2344A	04484	15/64			.2344	15/64		2.598		1.102		.787		.036	
2XDCS2362A	04486			6.0	.2362		6.0		66		28		20		0.93
2XDCS2402A	04488			6.1	.2402		8.0		79		34		24		0.95
2XDCS2420A	04490		C		.2420	1/4		3.110		1.339		.945		.037	
2XDCS2441A	04492			6.2	.2441		8.0		79		34		24		0.96
2XDCS2460A	04494		D		.2460	1/4		3.110		1.339		.945		.038	
2XDCS2480A	04496			6.3	.2480		8.0		79		34		24		0.98
2XDCS2500A	04498	1/4			.2500	1/4		3.110		1.339		.945		.039	
2XDCS2520A	04500			6.4	.2520		8.0		79		34		24		0.99
2XDCS2559A	04502			6.5	.2559		8.0		79		34		24		1.01
2XDCS2570A	04504		F		.2570	5/16		3.110		1.339		.945		.040	
2XDCS2598A	04506			6.6	.2598		8.0		79		34		24		1.03
2XDCS2610A	04508		G		.2610	5/16		3.110		1.339		.945		.040	
2XDCS2638A	04510			6.7	.2638		8.0		79		34		24		1.04
2XDCS2656A	04512	17/64			.2656	5/16		3.110		1.339		.945		.041	
2XDCS2677A	04514			6.8	.2677		8.0		79		34		24		1.05
2XDCS2717A	04516			6.9	.2717		8.0		79		34		24		1.07
2XDCS2756A	04518			7.0	.2756		8.0		79		34		24		1.08
2XDCS2795A	04520			7.1	.2795		8.0		79		41		29		1.10
2XDCS2812A	04522	9/32			.2812	5/16		3.110		1.614		1.142		.044	
2XDCS2835A	04524			7.2	.2835		8.0		79		41		29		1.12
2XDCS2874A	04526			7.3	.2874		8.0		79		41		29		1.13
2XDCS2913A	04528			7.4	.2913		8.0		79		41		29		1.15
2XDCS2953A	04530			7.5	.2953		8.0		79		41		29		1.16
2XDCS2969A	04532	19/64			.2969	5/16		3.110		1.614		1.142		.046	
2XDCS2992A	04534			7.6	.2992		8.0		79		41		29		1.18
2XDCS3031A	04536			7.7	.3031		8.0		79		41		29		1.19
2XDCS3071A	04538			7.8	.3071		8.0		79		41		29		1.21
2XDCS3110A	04540			7.9	.3110		8.0		79		41		29		1.22
2XDCS3125A	04542	5/16			.3125	5/16		3.110		1.614		1.142		.048	
2XDCS3150A	04544			8.0	.3150		8.0		79		41		29		1.24
2XDCS3189A	04546			8.1	.3189		10.0		89		47		35		1.26
2XDCS3228A	04548			8.2	.3228		10.0		89		47		35		1.27
2XDCS3268A	04550			8.3	.3268		10.0		89		47		35		1.29
2XDCS3281A	04552	21/64			.3281	25/64		3.504		1.850		1.378		.051	
2XDCS3307A	04554			8.4	.3307		10.0		89		47		35		1.31



Series 2XDCS Continued

ALtima®		Diameter				Shank		OAL		Flute Length		Drill Length		Point Length	
		D1 (h7)				D2 (h6)		L1		L2 (Max.)		L3 Ref.		L5	
Tool No.	EDP	Inch	Letter/ Wire	mm	Decimal	Inch	mm	Inch	mm	Inch	mm	Inch	mm	Inch	mm
2XDCS3320A	04556		Q		.3320	25/64		3.504		1.850		1.378		.051	
2XDCS3346A	04558			8.5	.3346		10.0		89		47		35		1.32
2XDCS3386A	04560			8.6	.3386		10.0		89		47		35		1.33
2XDCS3425A	04562			8.7	.3425		10.0		89		47		35		1.35
2XDCS3438A	04564	11/32			.3438	25/64		3.504		1.850		1.378		.053	
2XDCS3465A	04566			8.8	.3465		10.0		89		47		35		1.36
2XDCS3504A	04568			8.9	.3504		10.0		89		47		35		1.38
2XDCS3543A	04570			9.0	.3543		10.0		89		47		35		1.39
2XDCS3583A	04572			9.1	.3583		10.0		89		47		35		1.41
2XDCS3594A	04574	23/64			.3594	25/64		3.504		1.850		1.378		.056	
2XDCS3622A	04576			9.2	.3622		10.0		89		47		35		1.43
2XDCS3642A	04578			9.25	.3642		10.0		89		47		35		1.43
2XDCS3661A	04580			9.3	.3661		10.0		89		47		35		1.44
2XDCS3701A	04582			9.4	.3701		10.0		89		47		35		1.46
2XDCS3740A	04584			9.5	.3740		10.0		89		47		35		1.47
2XDCS3750A	04586	3/8			.3750	25/64		3.504		1.850		1.378		.058	
2XDCS3780A	04588			9.6	.3780		10.0		89		47		35		1.49
2XDCS3819A	04590			9.7	.3819		10.0		89		47		35		1.50
2XDCS3858A	04592			9.8	.3858		10.0		89		47		35		1.52
2XDCS3898A	04594			9.9	.3898		10.0		89		47		35		1.53
2XDCS3906A	04596	25/64			.3906	25/64		3.504		1.850		1.378		.061	
2XDCS3937A	04598			10.0	.3937		10.0		89		47		35		1.55
2XDCS3976A	04600			10.1	.3976		12.0		102		55		40		1.56
2XDCS4016A	04602			10.2	.4016		12.0		102		55		40		1.58
2XDCS4055A	04604			10.3	.4055		12.0		102		55		40		1.60
2XDCS4062A	04606	13/32			.4062	15/32		4.016		2.165		1.575		.063	
2XDCS4094A	04608			10.4	.4094		12.0		102		55		40		1.61
2XDCS4134A	04610			10.5	.4134		12.0		102		55		40		1.63
2XDCS4173A	04612			10.6	.4173		12.0		102		55		40		1.64
2XDCS4213A	04614			10.7	.4213		12.0		102		55		40		1.66
2XDCS4219A	04616	27/64			.4219	15/32		4.016		2.165		1.575		.065	
2XDCS4252A	04618			10.8	.4252		12.0		102		55		40		1.67
2XDCS4291A	04620			10.9	.4291		12.0		102		55		40		1.69
2XDCS4331A	04622			11.0	.4331		12.0		102		55		40		1.70
2XDCS4370A	04624			11.1	.4370		12.0		102		55		40		1.72
2XDCS4375A	04626	7/16			.4375	15/32		4.016		2.165		1.575		.068	
2XDCS4409A	04628			11.2	.4409		12.0		102		55		40		1.74
2XDCS4449A	04630			11.3	.4449		12.0		102		55		40		1.75
2XDCS4488A	04632			11.4	.4488		12.0		102		55		40		1.77
2XDCS4527A	04634			11.5	.4527		12.0		102		55		40		1.78
2XDCS4567A	04636			11.6	.4567		12.0		102		55		40		1.80
2XDCS4606A	04638			11.7	.4606		12.0		102		55		40		1.81
2XDCS4646A	04640			11.8	.4646		12.0		102		55		40		1.83
2XDCS4685A	04642			11.9	.4685		12.0		102		55		40		1.84
2XDCS4688A	04644	15/32			.4688	15/32		4.016		2.165		1.575		.073	
2XDCS4724A	04646			12.0	.4724		12.0		102		55		40		1.86
2XDCS4764A	04648			12.1	.4764		14.0		107		60		43		1.87
2XDCS4844A	04650	31/64			.4844	1/2		4.213		2.362		1.693		.075	
2XDCS4921A	04652			12.5	.4921		14.0		107		60		43		1.94
2XDCS5000A	04654	1/2			.5000	1/2		4.213		2.362		1.693		.077	
2XDCS5039A	04656			12.8	.5039		14.0		107		60		43		1.98
2XDCS5051A	04658			12.83	.5051		14.0		107		60		43		1.99



Series 2XDCS Continued

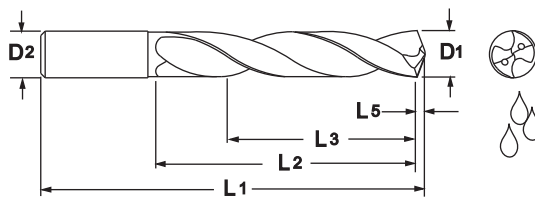
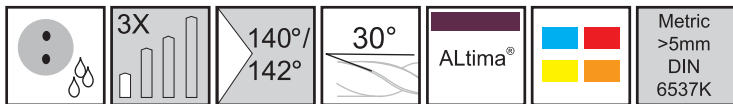

ALtima®		Diameter				Shank		OAL		Flute Length		Drill Length		Point Length	
		D1 (h7)				D2 (h6)		L1		L2 (Max.)		L3 Ref.		L5	
Tool No.	EDP	Inch	Letter/ Wire	mm	Decimal	Inch	mm	Inch	mm	Inch	mm	Inch	mm	Inch	mm
2XDCS5079A	04660			12.9	.5079		14.0		107		60		43		2.00
2XDCS5118A	04662			13.0	.5118		14.0		107		60		43		2.01
2XDCS5156A	04664	33/64			.5156	35/64		4.213		2.362		1.693		.080	
2XDCS5315A	04666			13.5	.5315		14.0		107		60		43		2.09
2XDCS5394A	04668			13.7	.5394		14.0		107		60		43		2.12
2XDCS5469A	04670	35/64			.5469	35/64		4.213		2.362		1.693		.085	
2XDCS5512A	04672			14.0	.5512		14.0		107		60		43		2.17
2XDCS5625A	04674	9/16			.5625	5/8		4.528		2.559		1.772		.087	
2XDCS5709A	04676			14.5	.5709		16.0		115		65		45		2.25
2XDCS5787A	04678			14.7	.5787		16.0		115		65		45		2.28
2XDCS5905A	04680			15.0	.5905		16.0		115		65		45		2.32
2XDCS5938A	04682	19/32			.5938	5/8		4.528		2.559		1.772		.092	
2XDCS6024A	04684			15.3	.6024		16.0		115		65		45		2.37
2XDCS6102A	04686			15.5	.6102		16.0		115		65		45		2.40
2XDCS6181A	04688			15.7	.6181		16.0		115		65		45		2.43
2XDCS6250A	04690	5/8			.6250	5/8		4.528		2.559		1.772		.097	
2XDCS6299A	04692			16.0	.6299		16.0		115		65		45		2.48

Go Green with **RED BOX**



Extend the Life of Your Cutting Tools with M.A. Ford's Reconditioning Service.

See page 178 for more information or Call 800-553-8024 or 563-391-6220



Twister XD® Series 2XDCR

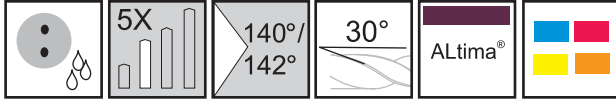

Designed for high performance drilling in a broad range of materials.

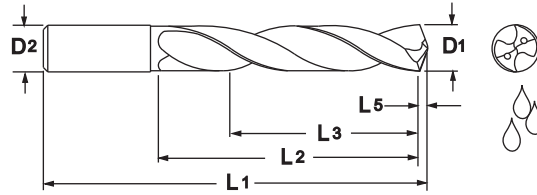

ALtima®		Diameter				Shank		OAL		Flute Length		Drill Length		Point Length	
		D1 (h7)				D2 (h6)		L1		L2 (Max.)		L3 Ref.		L5	
Tool No.	EDP	Inch	Letter/ Wire	mm	Decimal	Inch	mm	Inch	mm	Inch	mm	Inch	mm	Inch	mm
2XDCR1181A	02582			3.0	.1181		3.0		75		24		19		0.46
2XDCR1200A	02584		31		.1200	1/8		3.00		1.125		.90		0.019	
2XDCR1220A	02585			3.1	.1220		4.0		80		32		26		0.48
2XDCR1250A	02586	1/8			.1250	1/8		3.00		1.125		.90		0.019	
2XDCR1260A	02590			3.2	.1260		4.0		80		32		26		0.50
2XDCR1285A	02592		30		.1285	5/32		3.15		1.260		1.00		0.020	
2XDCR1299A	02594			3.3	.1299		4.0		80		32		26		0.51
2XDCR1339A	02596			3.4	.1339		4.0		80		32		26		0.53
2XDCR1360A	02598		29		.1360	5/32		3.15		1.2600		1.00		0.021	
2XDCR1378A	02600			3.5	.1378		4.0		80		32		26		0.54
2XDCR1406A	02602	9/64			.1406	5/32		3.15		1.260		1.00		0.022	
2XDCR1417A	02603			3.6	.1417		4.0		80		32		26		0.56
2XDCR1457A	02604			3.7	.1457		4.0		80		32		26		0.57
2XDCR1496A	02606			3.8	.1496		4.0		80		32		26		0.59
2XDCR1520A	02605		24		.1520	5/32		3.15		1.260		1.00		0.024	
2XDCR1535A	02607			3.9	.1535		4.0		80		32		26		0.60
2XDCR1562A	02608	5/32			.1562	5/32		3.15		1.260		1.00		0.024	
2XDCR1575A	02610			4.0	.1575		4.0		80		32		26		0.62
2XDCR1590A	02611		21		.1590	3/16		3.23		1.500		1.20		0.025	
2XDCR1614A	04012			4.1	.1614		5.0		82		38		30		0.64
2XDCR1654A	02612			4.2	.1654		5.0		82		38		30		0.65
2XDCR1693A	02613			4.3	.1693		5.0		82		38		30		0.67
2XDCR1719A	02614	11/64			.1719	3/16		3.23		1.500		1.20		0.027	
2XDCR1732A	02615			4.4	.1732		5.0		82		38		30		0.68
2XDCR1772A	02616			4.5	.1772		5.0		82		38		30		0.70
2XDCR1811A	02618			4.6	.1811		5.0		82		38		30		0.71
2XDCR1850A	02619			4.7	.1850		5.0		82		38		30		0.73
2XDCR1875A	02620	3/16			.1875	3/16		3.23		1.500		1.20		0.029	
2XDCR1890A	02622			4.8	.1890		5.0		82		38		30		0.74
2XDCR1929A	02624			4.9	.1929		5.0		82		38		30		0.76
2XDCR1968A	02626			5.0	.1968		5.0		82		38		30		0.77
2XDCR2008A	02628			5.1	.2008		6.0		82		40		32		0.79
2XDCR2031A	02630	13/64			.2031	15/64		3.23		1.580		1.26		0.031	
2XDCR2047A	02632			5.2	.2047		6.0		82		40		32		0.81

Inch	
D1	Tolerance (h7)
.0000 - .1181	+0/- .00039
.1182 - .2362	+0/- .00047
.2363 - .3937	+0/- .00059
.3938 - .7087	+0/- .00071
.7088 - .7500	+0/- .00083

Inch	
D2	Tolerance (h6)
.0000 - .1181	+0/- .00024
.1182 - .2362	+0/- .00031
.2363 - .3937	+0/- .00035
.3938 - .7087	+0/- .00043
.7088 - .7500	+0/- .00051

Metric (mm)	
D1	Tolerance (h7)
0 - 3.0	+0/- .010
3.01 - 6.0	+0/- .012
6.01 - 10.0	+0/- .015
10.01 - 18.0	+0/- .018
18.01 - 20.0	+0/- .021

Metric (mm)	
D2	Tolerance (h6)
0 - 3.0	+0/- .006
3.01 - 6.0	+0/- .008
6.01 - 10.0	+0/- .009
10.01 - 18.0	+0/- .011
18.01 - 20.0	+0/- .013



Series 2XDCR Continued

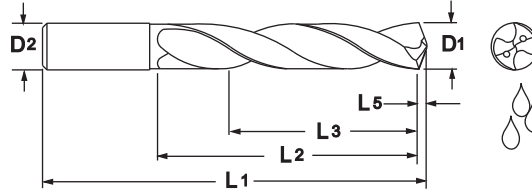
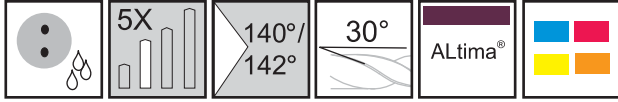

ALtima®		Diameter				Shank		OAL		Flute Length		Drill Length		Point Length	
		D1 (h7)				D2 (h6)		L1		L2 (Max.)		L3 Ref.		L5	
Tool No.	EDP	Inch	Letter/ Wire	mm	Decimal	Inch	mm	Inch	mm	Inch	mm	Inch	mm	Inch	mm
2XDCR2087A	02634			5.3	.2087		6.0		82		40		32		0.82
2XDCR2126A	02636			5.4	.2126		6.0		82		40		32		0.84
2XDCR2165A	02638			5.5	.2165		6.0		82		40		32		0.85
2XDCR2187A	02640	7/32			.2187	15/64		3.23		1.580		1.26		0.034	
2XDCR2210A	02642		2		.2210	15/64		3.23		1.580		1.26		0.034	
2XDCR2244A	02644			5.7	.2244		6.0		82		40		32		0.88
2XDCR2283A	02646			5.8	.2283		6.0		82		40		32		0.90
2XDCR2323A	02648			5.9	.2323		6.0		82		40		32		0.91
2XDCR2344A	02650	15/64			.2344	15/64		3.23		1.580		1.26		0.036	
2XDCR2362A	02652			6.0	.2362		6.0		82		40		32		0.93
2XDCR2402A	02654			6.1	.2402		8.0		91		48		38		0.95
2XDCR2420A	02656		C		.2420	1/4		3.30		1.740		1.39		0.037	
2XDCR2441A	02658			6.2	.2441		8.0		91		48		38		0.96
2XDCR2460A	02660		D		.2460	1/4		3.30		1.740		1.39		0.038	
2XDCR2480A	02662			6.3	.2480		8.0		91		48		38		0.98
2XDCR2500A	02664	1/4			.2500	1/4		3.30		1.740		1.39		0.039	
2XDCR2520A	02666			6.4	.2520		8.0		91		48		38		0.99
2XDCR2559A	02668			6.5	.2559		8.0		91		48		38		1.01
2XDCR2570A	02670		F		.2570	5/16		3.58		1.890		1.51		0.040	
2XDCR2598A	02671			6.6	.2598		8.0		91		48		38		1.03
2XDCR2610A	02672		G		.2610	5/16		3.58		1.890		1.51		0.040	
2XDCR2638A	02673			6.7	.2638		8.0		91		48		38		1.04
2XDCR2656A	02674	17/64			.2656	5/16		3.58		1.890		1.51		0.041	
2XDCR2677A	02676			6.8	.2677		8.0		91		48		38		1.05
2XDCR2717A	02678			6.9	.2717		8.0		91		48		38		1.07
2XDCR2756A	02680			7.0	.2756		8.0		91		48		38		1.08
2XDCR2795A	02681			7.1	.2795		8.0		91		48		38		1.10
2XDCR2812A	02682	9/32			.2812	5/16		3.58		1.890		1.51		0.044	
2XDCR2835A	02684			7.2	.2835		8.0		91		48		38		1.12
2XDCR2874A	02685			7.3	.2874		8.0		91		48		38		1.13
2XDCR2913A	02686			7.4	.2913		8.0		91		48		38		1.15
2XDCR2953A	02688			7.5	.2953		8.0		91		48		38		1.16
2XDCR2969A	02690	19/64			.2969	5/16		3.58		1.890		1.51		0.046	
2XDCR2992A	02692			7.6	.2992		8.0		91		48		38		1.18
2XDCR3031A	02694			7.7	.3031		8.0		91		48		38		1.19
2XDCR3071A	02696			7.8	.3071		8.0		91		48		38		1.21
2XDCR3110A	02697			7.9	.3110		8.0		91		48		38		1.22
2XDCR3125A	02698	5/16			.3125	5/16		3.58		1.890		1.51		0.048	
2XDCR3150A	02700			8.0	.3150		8.0		91		48		38		1.24
2XDCR3189A	02702			8.1	.3189	10.0		103		55		44		1.26	
2XDCR3228A	02704			8.2	.3228	10.0		103		55		44		1.27	
2XDCR3268A	02706			8.3	.3268	10.0		103		55		44		1.29	
2XDCR3281A	02708	21/64			.3281	25/64		4.06		2.170		1.74		0.051	
2XDCR3307A	02707			8.4	.3307	10.0		103		55		44		1.31	
2XDCR3320A	02709		Q		.3320	25/64		4.06		2.170		1.74		0.051	
2XDCR3346A	02710			8.5	.3346	10.0		103		55		44		1.32	



Series 2XDCR Continued

ALtima®		Diameter				Shank		OAL		Flute Length		Drill Length		Point Length	
		D1 (h7)				D2 (h6)		L1		L2 (Max.)		L3 Ref.		L5	
Tool No.	EDP	Inch	Letter/ Wire	mm	Decimal	Inch	mm	Inch	mm	Inch	mm	Inch	mm	Inch	mm
2XDCR3386A	02711			8.6	.3386		10.0		103		55		44		1.33
2XDCR3425A	04013			8.7	.3425		10.0		103		55		44		1.35
2XDCR3438A	02712	11/32			.3438	25/64		4.06		2.170		1.74		0.053	
2XDCR3465A	02714			8.8	.3465		10.0		103		55		44		1.36
2XDCR3504A	02716			8.9	.3504		10.0		103		55		44		1.38
2XDCR3543A	02718			9.0	.3543		10.0		103		55		44		1.39
2XDCR3583A	02719			9.1	.3583		10.0		103		55		44		1.41
2XDCR3594A	02720	23/64			.3594	25/64		4.06		2.170		1.74		0.056	
2XDCR3622A	02722			9.2	.3622		10.0		103		55		44		1.43
2XDCR3642A	02724			9.25	.3642		10.0		103		55		44		1.43
2XDCR3661A	02726			9.3	.3661		10.0		103		55		44		1.44
2XDCR3701A	02727			9.4	.3701		10.0		103		55		44		1.46
2XDCR3740A	02728			9.5	.3740		10.0		103		55		44		1.47
2XDCR3750A	02730	3/8			.3750	25/64		4.06		2.170		1.74		0.058	
2XDCR3780A	02731			9.6	.3780		10.0		103		55		44		1.49
2XDCR3819A	02732			9.7	.3819		10.0		103		55		44		1.50
2XDCR3858A	02734			9.8	.3858		10.0		103		55		44		1.52
2XDCR3898A	02735			9.9	.3898		10.0		103		55		44		1.53
2XDCR3906A	02736	25/64			.3906	25/64		4.06		2.170		1.74		0.061	
2XDCR3937A	02738			10.0	.3937		10.0		103		55		44		1.55
2XDCR3976A	02739			10.1	.3976		12.0		120		60		48		1.56
2XDCR4016A	02740			10.2	.4016		12.0		120		60		48		1.58
2XDCR4055A	02741			10.3	.4055		12.0		120		60		48		1.60
2XDCR4062A	02742	13/32			.4062	15/32		4.72		2.360		1.89		0.063	
2XDCR4094A	02743			10.4	.4094		12.0		120		60		48		1.61
2XDCR4134A	02744			10.5	.4134		12.0		120		60		48		1.63
2XDCR4173A	02745			10.6	.4173		12.0		120		60		48		1.64
2XDCR4213A	04014			10.7	.4213		12.0		120		60		48		1.66
2XDCR4219A	02746	27/64			.4219	15/32		4.72		2.360		1.89		0.065	
2XDCR4252A	02747			10.8	.4252		12.0		120		60		48		1.67
2XDCR4291A	04015			10.9	.4291		12.0		120		60		48		1.69
2XDCR4331A	02748			11.0	.4331		12.0		120		60		48		1.70
2XDCR4370A	02749			11.1	.4370		12.0		120		66		53		1.72
2XDCR4375A	02750	7/16			.4375	15/32		4.72		2.600		2.08		0.068	
2XDCR4409A	02752			11.2	.4409		12.0		120		66		53		1.74
2XDCR4449A	02753			11.3	.4449		12.0		120		66		53		1.75
2XDCR4488A	04016			11.4	.4488		12.0		120		66		53		1.77
2XDCR4527A	02754			11.5	.4527		12.0		120		66		53		1.78
2XDCR4567A	02755			11.6	.4567		12.0		120		66		53		1.80
2XDCR4606A	02756			11.7	.4606		12.0		120		66		53		1.81
2XDCR4646A	02757			11.8	.4646		12.0		120		66		53		1.83
2XDCR4685A	04017			11.9	.4685		12.0		120		66		53		1.84
2XDCR4688A	02758	15/32			.4688	15/32		4.72		2.600		2.08		0.073	
2XDCR4724A	02760			12.0	.4724		12.0		120		66		53		1.86
2XDCR4764A	02762			12.1	.4764		14.0		126		72		58		1.87
2XDCR4844A	02764	31/64			.4844	1/2		4.75		2.830		2.26		0.075	
2XDCR4921A	02766			12.5	.4921		14.0		126		72		58		1.94
2XDCR5000A	02768	1/2			.5000	1/2		4.75		2.830		2.26		0.077	
2XDCR5039A	02770			12.8	.5039		14.0		126		72		58		1.98
2XDCR5051A	02769			12.83	.5051		14.0		126		72		58		1.99
2XDCR5079A	02771			12.9	.5079		14.0		126		72		58		2.00
2XDCR5118A	02772			13.0	.5118		14.0		126		72		58		2.01
2XDCR5156A	02774	33/64			.5156	35/64		5.28		3.030		2.42		0.080	
2XDCR5312A	02775	17/32			.5312	35/64		5.28		3.030		2.42		0.082	



Series 2XDCR Continued

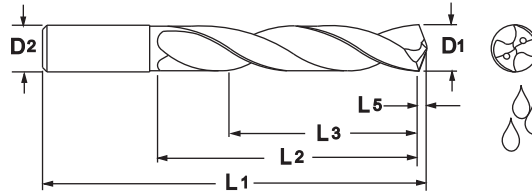
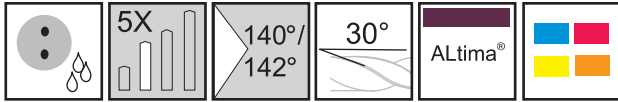

ALtima®		Diameter				Shank		OAL		Flute Length		Drill Length		Point Length	
		D1 (h7)				D2 (h6)		L1		L2 (Max.)		L3 Ref.		L5	
Tool No.	EDP	Inch	Letter/ Wire	mm	Decimal	Inch	mm	Inch	mm	Inch	mm	Inch	mm	Inch	mm
2XDCR5315A	02776			13.5	.5315		14.0		134		77		62		2.09
2XDCR5394A	02778			13.7	.5394		14.0		134		77		62		2.12
2XDCR5469A	02780	35/64			.5469	35/64		5.28		3.030		2.42		0.085	
2XDCR5512A	02782			14.0	.5512		14.0		134		77		62		2.17
2XDCR5625A	02784	9/16			.5625	5/8		5.51		3.150		2.52		0.087	
2XDCR5709A	02786			14.5	.5709		16.0		140		80		64		2.25
2XDCR5787A	02788			14.7	.5787		16.0		140		80		64		2.28
2XDCR5905A	02790			15.0	.5905		16.0		140		80		64		2.32
2XDCR5938A	02792	19/32			.5938	5/8		5.75		3.230		2.58		0.092	
2XDCR6024A	02793			15.3	.6024		16.0		146		82		66		2.37
2XDCR6102A	02794			15.5	.6102		16.0		146		82		66		2.40
2XDCR6181A	02796			15.7	.6181		16.0		146		82		66		2.43
2XDCR6250A	02798	5/8			.6250	5/8		5.75		3.230		2.58		0.097	
2XDCR6299A	02800			16.0	.6299		16.0		146		82		66		2.48
2XDCR6331A	02802			16.08	.6331		18.0		158		90		72		2.49
2XDCR6417A	02803			16.3	.6417		18.0		158		90		72		2.53
2XDCR6496A	02804			16.5	.6496		18.0		158		90		72		2.56
2XDCR6562A	02806	21/32			.6562	45/64		6.22		3.540		2.83		0.102	
2XDCR6693A	02808			17.0	.6693		18.0		158		90		72		2.63
2XDCR6875A	02810	11/16			.6875	45/64		6.22		3.740		3.00		0.107	
2XDCR6890A	02812			17.5	.6890		18.0		158		95		76		2.71
2XDCR7087A	02814			18.0	.7087		18.0		158		95		76		2.79
2XDCR7283A	02816			18.5	.7283		20.0		160		100		80		2.87
2XDCR7500A	02818	3/4			.7500	3/4		6.3		3.940		3.15		0.116	
2XDCR7543A	02820			19.16	.7543		20.0		160		100		80		2.97
2XDCR7579A	02822			19.25	.7579		20.0		160		100		80		2.98
2XDCR7598A	02824			19.3	.7598		20.0		160		100		80		2.99
2XDCR7677A	02826			19.5	.7677		20.0		160		100		80		3.02
2XDCR7874A	02828			20.0	.7874		20.0		160		100		80		3.10

Twister XD® Series 2XDCL

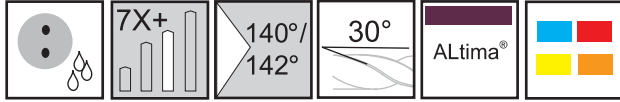

Designed for high performance drilling in a broad range of materials.

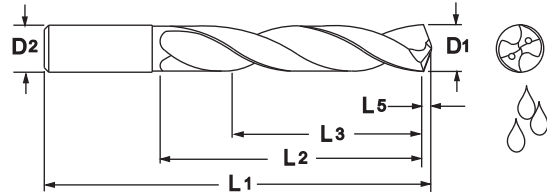

ALtima®		Diameter				Shank		OAL		Flute Length		Drill Length		Point Length	
		D1 (h7)				D2 (h6)		L1		L2 (Max.)		L3 Ref.		L5	
Tool No.	EDP	Inch	Letter/ Wire	mm	Decimal	Inch	mm	Inch	mm	Inch	mm	Inch	mm	Inch	mm
2XDCL1181A	02830			3.0	.1181		3.0		81		33		26		0.46
2XDCL1200A	02832		31		.1200	1/8		3.500		1.500		1.200		0.019	
2XDCL1220A	02833			3.1	.1220		4.0		92		44		35		0.48
2XDCL1250A	02834	1/8			.1250	1/8		3.500		1.500		1.200		0.019	
2XDCL1260A	02836			3.2	.1260		4.0		92		44		35		0.50
2XDCL1285A	02838		30		.1285	5/32		3.625		1.750		1.400		0.020	
2XDCL1299A	02840			3.3	.1299		4.0		92		44		35		0.51
2XDCL1339A	02842			3.4	.1339		4.0		92		44		35		0.53
2XDCL1360A	02844		29		.1360	5/32		3.625		1.750		1.400		0.021	
2XDCL1378A	02846			3.5	.1378		4.0		92		44		35		0.54
2XDCL1406A	02848	9/64			.1406	5/32		3.625		1.750		1.400		0.022	
2XDCL1417A	02849			3.6	.1417		4.0		92		44		35		0.56
2XDCL1457A	02850			3.7	.1457		4.0		92		44		35		0.57
2XDCL1496A	02852			3.8	.1496		4.0		92		44		35		0.59
2XDCL1520A	02851		24		.1520	5/32		3.625		1.750		1.400		0.024	
2XDCL1535A	02853			3.9	.1535		4.0		92		44		35		0.60
2XDCL1562A	02854	5/32			.1562	5/32		3.625		1.750		1.400		0.024	
2XDCL1575A	02856			4.0	.1575		4.0		92		44		35		0.62
2XDCL1590A	02857		21		.1590	3/16		3.940		1.750		1.400		0.025	
2XDCL1614A	04018			4.1	.1614		5.0		100		45		36		0.64
2XDCL1654A	02858			4.2	.1654		5.0		100		45		36		0.65
2XDCL1693A	02859			4.3	.1693		5.0		100		45		36		0.67
2XDCL1719A	02860	11/64			.1719	3/16		3.940		1.750		1.400		0.027	
2XDCL1732A	02861			4.4	.1732		5.0		100		45		36		0.68
2XDCL1772A	02862			4.5	.1772		5.0		100		45		36		0.70
2XDCL1811A	02864			4.6	.1811		5.0		100		45		36		0.71
2XDCL1850A	02865			4.7	.1850		5.0		100		45		36		0.73
2XDCL1875A	02866	3/16			.1875	3/16		3.940		1.750		1.400		0.029	
2XDCL1890A	02868			4.8	.1890		5.0		100		45		36		0.74
2XDCL1929A	02870			4.9	.1929		5.0		100		45		36		0.76
2XDCL1968A	02872			5.0	.1968		5.0		100		45		36		0.77
2XDCL2008A	02874			5.1	.2008		6.0		100		51		41		0.79
2XDCL2031A	02876	13/64			.2031	15/64		3.940		2.000		1.600		0.031	
2XDCL2047A	02878			5.2	.2047		6.0		100		51		41		0.81
2XDCL2087A	02880			5.3	.2087		6.0		100		51		41		0.82
2XDCL2126A	02882			5.4	.2126		6.0		100		51		41		0.84

Inch		Tolerance (h7)
D1	D2	
.0000 - .1181		+0/--.00039
.1182 - .2362		+0/--.00047
.2363 - .3937		+0/--.00059
.3938 - .7087		+0/--.00071

Inch		Tolerance (h6)
D2	D1	
.0000 - .1181		+0/--.00024
.1182 - .2362		+0/--.00031
.2363 - .3937		+0/--.00035
.3938 - .7087		+0/--.00043

Metric (mm)		Tolerance (h7)
D1	D2	
0 - 3.0		+0/--.010
3.01 - 6.0		+0/--.012
6.01 - 10.0		+0/--.015
10.01 - 18.0		+0/--.018

Metric (mm)		Tolerance (h6)
D2	D1	
0 - 3.0		+0/--.006
3.01 - 6.0		+0/--.008
6.01 - 10.0		+0/--.009
10.01 - 18.0		+0/--.011



Series 2XDCL Continued

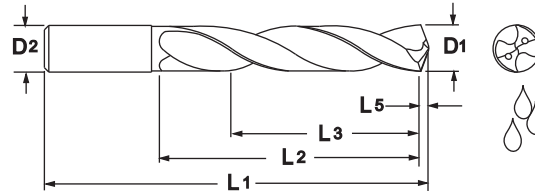
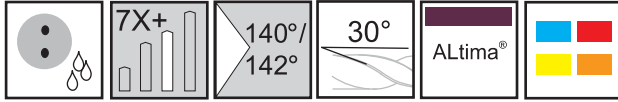

ALtima®		Diameter				Shank		OAL		Flute Length		Drill Length		Point Length	
		D1 (h7)				D2 (h6)		L1		L2 (Max.)		L3 Ref.		L5	
Tool No.	EDP	Inch	Letter/ Wire	mm	Decimal	Inch	mm	Inch	mm	Inch	mm	Inch	mm	Inch	mm
2XDCL2165A	02884			5.5	.2165		6.0		100		51		41		0.85
2XDCL2187A	02886	7/32			.2187	15/64		3.940		2.000		1.600		0.034	
2XDCL2210A	02888		2		.2210	15/64		3.940		2.000		1.60		0.034	
2XDCL2244A	02890			5.7	.2244		6.0		100		51		41		0.88
2XDCL2283A	02892			5.8	.2283		6.0		100		51		41		0.90
2XDCL2323A	02894			5.9	.2323		6.0		100		51		41		0.91
2XDCL2344A	02896	15/64			.2344	15/64		3.940		2.000		1.60		0.036	
2XDCL2362A	02898			6.0	.2362		6.0		100		51		41		0.93
2XDCL2402A	02900			6.1	.2402		8.0		109		60		48		0.95
2XDCL2420A	02902		C		.2420	1/4		4.310		2.250		1.80		0.037	
2XDCL2441A	02904			6.2	.2441		8.0		109		60		48		0.96
2XDCL2460A	02906		D		.2460	1/4		4.310		2.250		1.80		0.038	
2XDCL2480A	02908			6.3	.2480		8.0		109		60		48		0.98
2XDCL2500A	02910	1/4			.2500	1/4		4.310		2.250		1.80		0.039	
2XDCL2520A	02912			6.4	.2520		8.0		109		60		48		0.99
2XDCL2559A	02914			6.5	.2559		8.0		109		60		48		1.01
2XDCL2570A	02916		F		.2570	5/16		4.310		2.375		1.90		0.040	
2XDCL2598A	02917			6.6	.2598		8.0		109		60		48		1.03
2XDCL2610A	02918		G		.2610	5/16		4.310		2.375		1.90		0.040	
2XDCL2638A	02919			6.7	.2638		8.0		109		60		48		1.04
2XDCL2656A	02920	17/64			.2656	5/16		4.310		2.375		1.90		0.041	
2XDCL2677A	02922			6.8	.2677		8.0		109		60		48		1.05
2XDCL2717A	02924			6.9	.2717		8.0		109		60		48		1.07
2XDCL2756A	02926			7.0	.2756		8.0		109		60		48		1.08
2XDCL2795A	02927			7.1	.2795		8.0		118		70		56		1.10
2XDCL2812A	02928	9/32			.2812	5/16		4.625		2.750		2.20		0.044	
2XDCL2835A	02930			7.2	.2835		8.0		118		70		56		1.12
2XDCL2874A	02931			7.3	.2874		8.0		118		70		56		1.13
2XDCL2913A	02932			7.4	.2913		8.0		118		70		56		1.15
2XDCL2953A	02934			7.5	.2953		8.0		118		70		56		1.16
2XDCL2969A	02936	19/64			.2969	5/16		4.625		2.750		2.20		0.046	
2XDCL2992A	02938			7.6	.2992		8.0		118		70		56		1.18
2XDCL3031A	02940			7.7	.3031		8.0		118		70		56		1.19
2XDCL3071A	02942			7.8	.3071		8.0		118		70		56		1.21
2XDCL3110A	02943			7.9	.3110		8.0		118		70		56		1.22
2XDCL3125A	02944	5/16			.3125	5/16		4.625		2.750		2.20		0.048	
2XDCL3150A	02946			8.0	.3150		8.0		118		70		56		1.24
2XDCL3189A	02948			8.1	.3189		10.0		127		80		64		1.26
2XDCL3228A	02950			8.2	.3228		10.0		127		80		64		1.27
2XDCL3268A	02952			8.3	.3268		10.0		127		80		64		1.29
2XDCL3281A	02954	21/64			.3281	25/64		5.000		3.150		2.52		0.051	
2XDCL3307A	02953			8.4	.3307		10.0		127		80		64		1.31

Series 2XDCL Continued

Altima®		Diameter				Shank		OAL		Flute Length		Drill Length		Point Length	
		D1 (h7)				D2 (h6)		L1		L2 (Max.)		L3 Ref.		L5	
Tool No.	EDP	Inch	Letter/ Wire	mm	Decimal	Inch	mm	Inch	mm	Inch	mm	Inch	mm	Inch	mm
2XDCL3320A	02955		Q		.3320	25/64		5.000		3.150		2.52		0.051	
2XDCL3346A	02956			8.5	.3346		10.0		127		80		64		1.32
2XDCL3386A	02957			8.6	.3386		10.0		127		80		64		1.33
2XDCL3425A	04019			8.7	.3425		10.0		127		80		64		1.35
2XDCL3438A	02958	11/32			.3438	25/64		5.000		3.150		2.52		0.053	
2XDCL3465A	02960			8.8	.3465		10.0		127		80		64		1.36
2XDCL3504A	02962			8.9	.3504		10.0		127		80		64		1.38
2XDCL3543A	02964			9.0	.3543		10.0		127		80		64		1.39
2XDCL3583A	02965			9.1	.3583		10.0		136		85		68		1.41
2XDCL3594A	02966	23/64			.3594	25/64		5.312		3.340		2.67		0.056	
2XDCL3622A	02968			9.2	.3622		10.0		136		85		68		1.43
2XDCL3642A	02970			9.25	.3642		10.0		136		85		68		1.43
2XDCL3661A	02972			9.3	.3661		10.0		136		85		68		1.44
2XDCL3701A	02973			9.4	.3701		10.0		136		85		68		1.46
2XDCL3740A	02974			9.5	.3740		10.0		136		85		68		1.47
2XDCL3750A	02976	3/8			.3750	25/64		5.312		3.340		2.67		0.058	
2XDCL3780A	02977			9.6	.3780		10.0		136		85		68		1.49
2XDCL3819A	02978			9.7	.3819		10.0		136		85		68		1.50
2XDCL3858A	02980			9.8	.3858		10.0		136		85		68		1.52
2XDCL3898A	04024			9.9	.3898		10.0		136		85		68		1.53
2XDCL3906A	02981	25/64			.3906	25/64		5.312		3.340		2.67		0.061	
2XDCL3937A	02982			10.0	.3937		10.0		136		85		68		1.55
2XDCL3976A	04025			10.1	.3976		12.0		149		93		74		1.56
2XDCL4016A	02983			10.2	.4016		12.0		149		93		74		1.58
2XDCL4055A	04026			10.3	.4055		12.0		149		93		74		1.60
2XDCL4062A	02984	13/32			.4062	15/32		5.875		3.625		2.90		0.063	
2XDCL4094A	02979			10.4	.4094		12.0		149		93		74		1.61
2XDCL4134A	02986			10.5	.4134		12.0		149		93		74		1.63
2XDCL4173A	02985			10.6	.4173		12.0		149		93		74		1.64
2XDCL4213A	04020			10.7	.4213		12.0		149		93		74		1.66
2XDCL4219A	02987	27/64			.4219	15/32		5.875		3.625		2.90		0.065	
2XDCL4252A	96600			10.8	.4252		12.0		149		93		74		1.67
2XDCL4291A	04021			10.9	.4291		12.0		149		93		74		1.69
2XDCL4331A	02988			11.0	.4331		12.0		149		93		74		1.70
2XDCL4370A	04027			11.1	.4370		12.0		155		102		82		1.72
2XDCL4375A	02989	7/16			.4375	15/32		6.100		4.000		3.20		0.068	
2XDCL4409A	02990			11.2	.4409		12.0		155		102		82		1.74
2XDCL4449A	04028			11.3	.4449		12.0		155		102		82		1.75
2XDCL4488A	04022			11.4	.4488		12.0		155		102		82		1.77
2XDCL4527A	02991			11.5	.4527		12.0		155		102		82		1.78
2XDCL4567A	04029			11.6	.4567		12.0		155		102		82		1.80
2XDCL4606A	02992			11.7	.4606		12.0		155		102		82		1.81
2XDCL4646A	96602			11.8	.4646		12.0		155		102		82		1.83
2XDCL4685A	04023			11.9	.4685		12.0		155		102		82		1.84
2XDCL4688A	02993	15/32			.4688	15/32		6.100		4.000		3.20		0.073	
2XDCL4724A	02994			12.0	.4724		12.0		155		102		82		1.86
2XDCL4844A	02995	31/64			.4844	1/2		6.299		4.312		3.45		0.075	
2XDCL5000A	02996	1/2			.5000	1/2		6.299		4.312		3.45		0.077	



Twister XD[®] Series 2XDCE

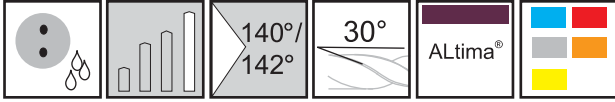

Designed to drill water lines in molds, the 2XDCE drill works exceptionally well in all deep hole drilling applications. With 2XD drilling geometry, this drill provides productivity increases and reduced cycle time by eliminating the need for a peck drilling cycle.

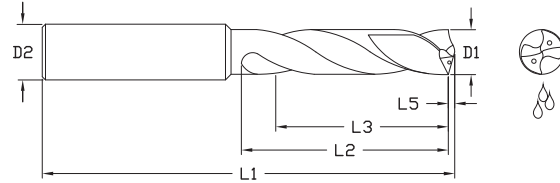

ALtima [®]		Diameter			Shank		OAL		Flute Length		Drill Length		Point Length		Fl. Length/Dia.	Dr. Length/Dia.
Tool No.	EDP	D1 (h7)			D2 (h6)		L1		L2		L3 Ref.		L5		L2/D1	L3/D1
		Inch	mm	Decimal	Inch	mm	Inch	mm	Inch	mm	Inch	mm	Inch	mm		
2XDCE1968A	04332		5.00	.1968		5.0		163		105		84		0.77	21	17
2XDCE2047A	04334		5.20	.2047		6.0		163		110		88		0.81	21	17
2XDCE2126A	04336		5.40	.2126		6.0		163		110		88		0.84	20	16
2XDCE2205A	04338		5.60	.2205		6.0		163		110		88		0.87	20	16
2XDCE2283A	04340		5.80	.2283		6.0		163		110		88		0.90	19	15
2XDCE2362A	04342		6.00	.2362		6.0		163		110		88		0.93	18	15
2XDCE2441A	04344		6.20	.2441		8.0		163		110		88		0.96	18	14
2XDCE2480A	04346		6.30	.2480		8.0		163		110		88		0.98	17	14
2XDCE2500A	04348	1/4	6.35	.2500	.3150	8.0	6.4	163	4.33	110	3.46	88	0.039	0.98	17	14
2XDCE2677A	04350		6.80	.2677		8.0		163		110		88		1.05	16	13
2XDCE2756A	04352		7.00	.2756		8.0		163		110		88		1.08	16	13
2XDCE2992A	04354		7.60	.2992		8.0		163		120		96		1.18	16	13
2XDCE3071A	04356		7.80	.3071		8.0		163		120		96		1.21	15	12
2XDCE3125A	04358	5/16	7.94	.3125	.3150	8.0	6.4	163	4.72	120	3.78	96	0.048	1.23	15	12
2XDCE3150A	04360		8.00	.3150		8.0		163		120		96		1.24	15	12
2XDCE3228A	04362		8.20	.3228		10.0		180		135		108		1.27	16	13
2XDCE3346A	04364		8.50	.3346		10.0		180		135		108		1.32	16	13
2XDCE3425A	04366		8.70	.3425		10.0		180		135		108		1.35	16	12
2XDCE3543A	04368		9.00	.3543		10.0		180		135		108		1.39	15	12
2XDCE3701A	04370		9.40	.3701		10.0		195		150		120		1.46	16	13
2XDCE3750A	04372	3/8	9.53	.3750	.3937	10.0	7.7	195	5.90	150	4.72	120	0.058	1.48	16	13
2XDCE3858A	04374		9.80	.3858		10.0		195		150		120		1.52	15	12
2XDCE3937A	04376		10.00	.3937		10.0		195		150		120		1.55	15	12
2XDCE4055A	04378		10.30	.4055		12.0		210		160		128		1.60	16	12
2XDCE4134A	04380		10.50	.4134		12.0		210		160		128		1.63	15	12
2XDCE4252A	04382		10.80	.4252		12.0		210		160		128		1.67	15	12
2XDCE4331A	04384		11.00	.4331		12.0		210		160		128		1.70	15	12
2XDCE4375A	04386	7/16	11.11	.4375	.4724	12.0	8.3	210	6.30	160	5.04	128	0.068	1.72	14	12
2XDCE4527A	04388		11.50	.4527		12.0		210		160		128		1.78	14	11
2XDCE4646A	04390		11.80	.4646		12.0		210		160		128		1.83	14	11
2XDCE4724A	04392		12.00	.4724		12.0		210		160		128		1.86	13	11
2XDCE5000A	04394	1/2	12.70	.5000	.5512	14.0	9.1	230	7.09	180	5.67	144	0.077	1.97	14	11

Inch		
D1	Tolerance (h7)	
.1968 - .2362	+0/--.00047	
.2363 - .3937	+0/--.00059	
.3938 - .5000	+0/--.00071	

Inch		
D2	Tolerance (h6)	
.1968 - .2362	+0/--.00031	
.2363 - .3937	+0/--.00035	
.3938 - .5000	+0/--.00043	

Metric (mm)		
D1	Tolerance (h7)	
5.0 - 6.0	+0/--.012	
6.01 - 10.0	+0/--.015	
10.01 - 12.0	+0/--.018	

Metric (mm)		
D2	Tolerance (h6)	
5.0 - 6.0	+0/--.008	
6.01 - 10.0	+0/--.009	
10.01 - 12.0	+0/--.011	



Twister® Spot Drill Series 200S



Spot Drills for High Performance Drills

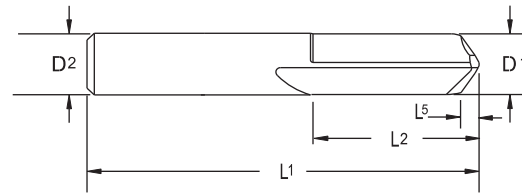

Tool No.	EDP	Diameter			Shank		OAL		Flute Length		Point Length	
		D1 (h7)			D2 (h6)		L1		L2		L5	
		Inch	mm	Decimal	Inch	mm	Inch	mm	Inch	mm	Inch	mm
200S11810A	20221		3.0	.1181		3.0		38		16		0.41
200S12500A	20230	1/8		.1250	1/8		1-1/2		5/8		0.017	
200S23620A	20431		6.0	.2362		6.0		51		19		0.83
200S25000A	20452	1/4		.2500	1/4		2		3/4		0.034	
200S31250A	20542	5/16		.3125	5/16		2-1/2		3/4		0.043	
200S31500A	20545		8.0	.3150		8.0		64		19		1.10
200S37500A	20623	3/8		.3750	3/8		2-1/2		1		0.052	
200S39370A	20647		10.0	.3937		10.0		70		25		1.38
200S47240A	20731		12.0	.4724		12.0		76		25		1.65
200S50000A	20740	1/2		.5000	1/2		3		1		0.069	
200S62500A	20782	5/8		.6250	5/8		3-1/2		1-1/4		0.086	
200S62990A	20785		16.0	.6299		16.0		89		32		2.20

Inch		Inch		Metric (mm)		Metric (mm)	
D1	Tolerance (h7)	D2	Tolerance (h6)	D1	Tolerance (h7)	D2	Tolerance (h6)
.1182 - .2362	+0/- .00047	.1182 - .2362	+0/- .00031	3.0	+0/- .010	3.0	+0/- .006
.2363 - .3937	+0/- .00059	.2363 - .3937	+0/- .00035	3.01 - 6.0	+0/- .012	3.01 - 6.0	+0/- .008
.3938 - .6250	+0/- .00071	.3938 - .6250	+0/- .00043	6.01 - 10.0	+0/- .015	6.01 - 10.0	+0/- .009
				10.01 - 16.0	+0/- .018	10.01 - 16.0	+0/- .011

 **Designed and Manufactured in the USA**



Twister® MD Series 2MDCL

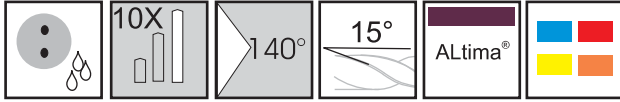

Designed for high performance drilling in a broad range of materials.



• mm sizes only

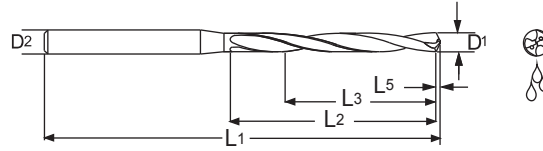

Tool No.	EDP	Diameter		Shank D2 (h6)	OAL L1	Flute Length L2	Drill Length L3 Ref.	Point Length L5
		D1 (h8)						
		mm	Decimal					
2MDCL0787A	04198	2.00	.0787	3.0	74	24	18	0.31
2MDCL0807A	04200	2.05	.0807	3.0	74	28	21	0.32
2MDCL0827A	04202	2.10	.0827	3.0	74	28	21	0.33
2MDCL0846A	04204	2.15	.0846	3.0	74	28	21	0.33
2MDCL0866A	04206	2.20	.0866	3.0	74	28	21	0.34
2MDCL0886A	04208	2.25	.0886	3.0	74	28	21	0.35
2MDCL0906A	04210	2.30	.0906	3.0	74	28	21	0.36
2MDCL0925A	04212	2.35	.0925	3.0	74	28	21	0.36
2MDCL0945A	04214	2.40	.0945	3.0	74	28	21	0.37
2MDCL0965A	04216	2.45	.0965	3.0	74	28	21	0.38
2MDCL0984A	04218	2.50	.0984	3.0	74	28	21	0.39
2MDCL1004A	04220	2.55	.1004	3.0	81	34	25.5	0.40
2MDCL1024A	04222	2.60	.1024	3.0	81	34	25.5	0.40
2MDCL1043A	04224	2.65	.1043	3.0	81	34	25.5	0.41
2MDCL1063A	04226	2.70	.1063	3.0	81	34	25.5	0.42
2MDCL1083A	04228	2.75	.1083	3.0	81	34	25.5	0.43
2MDCL1102A	04230	2.80	.1102	3.0	81	34	25.5	0.43
2MDCL1122A	04232	2.85	.1122	3.0	81	34	25.5	0.44
2MDCL1142A	04234	2.90	.1142	3.0	81	34	25.5	0.45
2MDCL1161A	04236	2.95	.1161	3.0	81	34	25.5	0.46

Inch		Inch	
D1	Tolerance (h8)	D2	Tolerance (h6)
.0787 - .1161	+0000/-0.0055	.0787 - .1161	+0000/-0.0024

Metric (mm)		Metric (mm)	
D1	Tolerance (h8)	D2	Tolerance (h6)
2.00-2.95	+0000/-0.0140	2.00-2.95	+0000/-0.0060

Inch sizes available as specials.

Twister® Micro-Tuff® Series 305

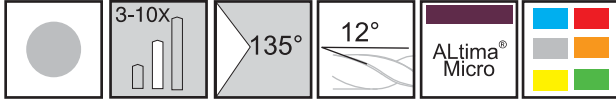

Designed for high performance drilling in a broad range of materials.



• Depth setting rings available on 1/8" shank tools.

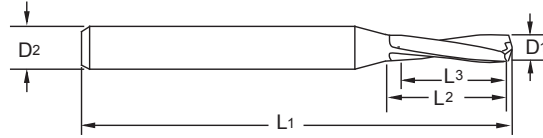

Uncoated		ALtima® Micro		Diameter			Shank		OAL		Flute Length max.*		Drill Length		
				D1			D2		L1		L2		L3 Ref.		
Tool No.	EDP	Tool No.	EDP	Inch	Letter/Wire	mm	Decimal	Inch	mm	Inch	mm	Inch	mm	Inch	mm
30500390	33999				102		0.0039	1/8		1-1/2		0.065		0.05	
305M0010	34000					0.1	0.0039		3.0		38		1.70		1.28
30500430	34001				101		0.0043	1/8		1-1/2		0.065		0.05	
305M0011	33900					0.11	0.0043		3.0		38		1.70		1.28
30500470	34002				100		0.0047	1/8		1-1/2		0.065		0.05	
305M0012	33901					0.12	0.0047		3.0		38		1.70		1.28
30500510	34003				99		0.0051	1/8		1-1/2		0.065		0.05	
305M0013	33902					0.13	0.0051		3.0		38		1.70		1.28
30500550	34004				98		0.0055	1/8		1-1/2		0.065		0.05	
305M0014	33903					0.14	0.0055		3.0		38		1.70		1.28
305M0015	34005					0.15	0.0059		3.0		38		2.50		1.88
30500600	34006						0.0060	1/8		1-1/2		0.100		0.08	
305M0016	33904					0.16	0.0063		3.0		38		2.50		1.88
30500630	34007				96		0.0063	1/8		1-1/2		0.100		0.08	
305M0017	33905					0.17	0.0067		3.0		38		2.50		1.88
30500670	34008				95		0.0067	1/8		1-1/2		0.100		0.08	
30500700	34009						0.0070	1/8		1-1/2		0.100		0.08	
305M0018	33906					0.18	0.0071		3.0		38		2.50		1.88
30500710	34010				94		0.0071	1/8		1-1/2		0.100		0.08	
305M0019	33907					0.19	0.0075		3.0		38		2.50		1.88
30500750	34011				93		0.0075	1/8		1-1/2		0.100		0.08	
305M0020	34012					0.20	0.0078		3.0		38		2.50		1.88
30500790	34013				92		0.0079	1/8		1-1/2		0.125		0.09	
30500800	34014						0.0080	1/8		1-1/2		0.125		0.09	
305M0021	33908					0.21	0.0083		3.0		38		2.50		1.88
30500830	34015				91		0.0083	1/8		1-1/2		0.125		0.09	
305M0022	33909					0.22	0.0087		3.0		38		2.50		1.88
30500870	34016				90		0.0087	1/8		1-1/2		0.125		0.09	
30500900	34017						0.0090	1/8		1-1/2		0.125		0.09	
305M0023	33910					0.23	0.0091		3.0		38		2.50		1.88

*Do not drill beyond specified flute length. Peck cycles may be utilized to achieve best tool performance.

Inch			
D1	Tolerance	D2	Tolerance
.0039-.1250	+0/-0.0003	.0039-.1250	+0/-0.0002
L1	Tolerance	L2	Tolerance
.0039-.1250	+/-0.015	.0039-.1250	+0.015/-0

Metric (mm)			
D1	Tolerance	D2	Tolerance
0.1-3.0	+0/-0.008	0.1-3.0	+0/-0.005
L1	Tolerance	L2	Tolerance
0.1-3.0	+/-0.4	0.1-3.0	+0.4/-0



Series 305 Continued

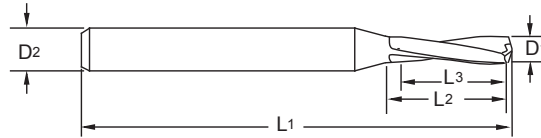
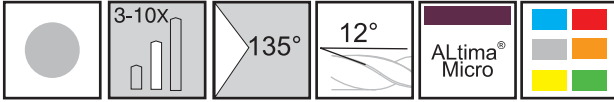

Uncoated		ALtima® Micro		Diameter			Shank		OAL		Flute Length max.*		Drill Length		
				D1			D2		L1		L2		L3 Ref.		
Tool No.	EDP	Tool No.	EDP	Inch	Letter/ Wire	mm	Deci- mal	Inch	mm	Inch	mm	Inch	mm	Inch	mm
30500910	34018				89		0.0091	1/8		1-1/2		0.125		0.09	
305M0024	33911					0.24	0.0094		3.0		38		2.50		1.88
30500950	34019				88		0.0095	1/8		1-1/2		0.125		0.09	
305M0025	34020					0.25	0.0098		3.0		38		3.20		2.40
30501000	34021				87		0.0100	1/8		1-1/2		0.150		0.11	
305M0026	33912					0.26	0.0102		3.0		38		3.20		2.40
30501050	34022				86		0.0105	1/8		1-1/2		0.150		0.11	
305M0027	33913					0.27	0.0106		3.0		38		3.20		2.40
30501100	34023				85		0.0110	1/8		1-1/2		0.150		0.11	
305M0028	33914					0.28	0.0110		3.0		38		3.20		2.40
305M0029	33915					0.29	0.0114		3.0		38		3.20		2.40
30501150	34024				84		0.0115	1/8		1-1/2		0.150		0.11	
305M0030	34025	305M0030AM	34206			0.30	0.0118		3.0		38		4.80		3.60
30501200	34026	30501200AM	34145		83		0.0120	1/8		1-1/2		0.190		0.14	
305M0031	33916					0.31	0.0122		3.0		38		4.80		3.60
30501250	34027	30501250AM	34146		82		0.0125	1/8		1-1/2		0.190		0.14	
305M0032	33917					0.32	0.0126		3.0		38		4.80		3.60
305M0033	33918					0.33	0.0130		3.0		38		4.80		3.60
30501300	34028	30501300AM	34147		81		0.0130	1/8		1-1/2		0.190		0.14	
305M0034	33919					0.34	0.0134		3.0		38		4.80		3.60
30501350	34029	30501350AM	34148		80		0.0135	1/8		1-1/2		0.190		0.14	
305M0035	34030	305M0035AM	34207			0.35	0.0138		3.0		38		4.80		3.60
305M0036	33920					0.36	0.0142		3.0		38		4.80		3.60
30501450	34031	30501450AM	34149		79		0.0145	1/8		1-1/2		0.190		0.14	
305M0037	33921					0.37	0.0146		3.0		38		4.80		3.60
305M0038	33922					0.38	0.0150		3.0		38		4.80		3.60
305M0039	33923					0.39	0.0154		3.0		38		4.80		3.60
30501560	34032	30501560AM	34150	1/64			0.0156	1/8		1-1/2		0.190		0.14	
305M0040	34033	305M0040AM	34208			0.40	0.0157		3.0		38		4.80		3.60
30501600	34034	30501600AM	34151		78		0.0160	1/8		1-1/2		0.190		0.14	
305M0041	33924					0.41	0.0161		3.0		38		6.35		4.76
305M0042	33925					0.42	0.0165		3.0		38		6.35		4.76
305M0043	33926					0.43	0.0169		3.0		38		6.35		4.76
305M0044	33927					0.44	0.0173		3.0		38		6.35		4.76
305M0045	34035	305M0045AM	34209			0.45	0.0177		3.0		38		6.35		4.76
30501800	34036	30501800AM	34152		77		0.0180	1/8		1-1/2		0.250		0.19	
305M0046	33928					0.46	0.0181		3.0		38		6.35		4.76
305M0047	33929					0.47	0.0185		3.0		38		6.35		4.76

*Do not drill beyond specified flute length. Peck cycles may be utilized to achieve best tool performance.

Series 305 Continued

Uncoated		ALtima® Micro		Diameter				Shank		OAL		Flute Length max.*		Drill Length	
				D1				D2		L1		L2		L3 Ref.	
Tool No.	EDP	Tool No.	EDP	Inch	Letter/ Wire	mm	Deci- mal	Inch	mm	Inch	mm	Inch	mm	Inch	mm
305M0048	33930					0.48	0.0189		3.0		38		6.35		4.76
305M0049	33931					0.49	0.0193		3.0		38		6.35		4.76
305M0050	34037	305M0050AM	34210			0.50	0.0197		3.0		38		6.35		4.76
30502000	34038	30502000AM	34153		76		0.0200	1/8		1-1/2		0.250		0.19	
305M0051	33932					0.51	0.0201		3.0		38		6.35		4.76
305M0052	33933					0.52	0.0205		3.0		38		6.35		4.76
305M0053	33934					0.53	0.0209		3.0		38		6.35		4.76
30502100	34039	30502100AM	34154		75		0.0210	1/8		1-1/2		0.250		0.19	
305M0054	33935					0.54	0.0213		3.0		38		6.35		4.76
305M0055	34040	305M0055AM	34211			0.55	0.0217		3.0		38		6.35		4.76
305M0056	33936					0.56	0.0220		3.0		38		6.35		4.76
305M0057	33937					0.57	0.0224		3.0		38		6.35		4.76
30502250	34041	30502250AM	34155		74		0.0225	1/8		1-1/2		0.250		0.19	
305M0058	33938					0.58	0.0228		3.0		38		6.35		4.76
305M0059	33939					0.59	0.0232		3.0		38		6.35		4.76
305M0060	34042	305M0060AM	34212			0.60	0.0236		3.0		38		6.35		4.76
30502400	34043	30502400AM	34156		73		0.0240	1/8		1-1/2		0.250		0.19	
305M0061	33940					0.61	0.0240		3.0		38		6.35		4.76
305M0062	33941					0.62	0.0244		3.0		38		6.35		4.76
305M0063	33942					0.63	0.0248		3.0		38		6.35		4.76
30502500	34044	30502500AM	34157		72		0.0250	1/8		1-1/2		0.250		0.19	
305M0064	33943					0.64	0.0252		3.0		38		6.35		4.76
305M0065	34045	305M0065AM	34213			0.65	0.0256		3.0		38		6.35		4.76
305M0066	33944					0.66	0.0260		3.0		38		8.13		6.10
30502600	34046	30502600AM	34158		71		0.0260	1/8		1-1/2		0.250		0.19	
305M0067	33945					0.67	0.0264		3.0		38		8.13		6.10
305M0068	33946					0.68	0.0268		3.0		38		8.13		6.10
305M0069	33947					0.69	0.0272		3.0		38		8.13		6.10
305M0070	34047	305M0070AM	34214			0.70	0.0276		3.0		38		8.13		6.10
305M0071	33948					0.71	0.0280		3.0		38		8.13		6.10
30502800	34048	30502800AM	34159		70		0.0280	1/8		1-1/2		0.320		0.24	
305M0072	33949					0.72	0.0283		3.0		38		8.13		6.10
305M0073	33950					0.73	0.0287		3.0		38		8.13		6.10
305M0074	33951					0.74	0.0291		3.0		38		8.13		6.10
30502920	34049	30502920AM	34160		69		0.0292	1/8		1-1/2		0.320		0.24	
305M0075	34050	305M0075AM	34215			0.75	0.0295		3.0		38		8.13		6.10
305M0076	33952					0.76	0.0299		3.0		38		10.16		7.62
305M0077	33953					0.77	0.0303		3.0		38		10.16		7.62
305M0078	33954					0.78	0.0307		3.0		38		10.16		7.62
30503100	34051	30503100AM	34161		68		0.0310	1/8		1-1/2		0.400		0.30	
305M0079	33955					0.79	0.0311		3.0		38		10.16		7.62
30503120	34052	30503120AM	34162	1/32			0.0312	1/8		1-1/2		0.400		0.30	
305M0080	34053	305M0080AM	34216			0.80	0.0315		3.0		38		10.16		7.62
305M0081	33956					0.81	0.0319		3.0		38		10.16		7.62

*Do not drill beyond specified flute length. Peck cycles may be utilized to achieve best tool performance.



Series 305 Continued

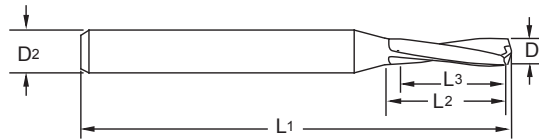
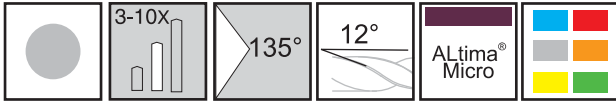

Uncoated		ALtima® Micro		Diameter			Shank		OAL		Flute Length max.*		Drill Length		
				D1			D2		L1		L2		L3 Ref.		
Tool No.	EDP	Tool No.	EDP	Inch	Letter/ Wire	mm	Deci- mal	Inch	mm	Inch	mm	Inch	mm	Inch	mm
30503200	34054	30503200AM	34163		67		0.0320	1/8		1-1/2		0.400		0.30	
305M0082	33957					0.82	0.0323		3.0		38		10.16		7.62
305M0083	33958					0.83	0.0327		3.0		38		10.16		7.62
30503300	34055	30503300AM	34164		66		0.0330	1/8		1-1/2		0.400		0.30	
305M0084	33959					0.84	0.0331		3.0		38		10.16		7.62
305M0085	34056	305M0085AM	34217			0.85	0.0335		3.0		38		10.16		7.62
305M0086	33960					0.86	0.0339		3.0		38		10.16		7.62
305M0087	33961					0.87	0.0343		3.0		38		10.16		7.62
305M0088	33962					0.88	0.0346		3.0		38		10.16		7.62
30503500	34057	30503500AM	34165		65		0.0350	1/8		1-1/2		0.400		0.30	
305M0089	33963					0.89	0.0350		3.0		38		10.16		7.62
305M0090	34058	305M0090AM	34218			0.90	0.0354		3.0		38		10.16		7.62
305M0091	33964					0.91	0.0358		3.0		38		10.16		7.62
30503600	34059	30503600AM	34166		64		0.0360	1/8		1-1/2		0.400		0.30	
305M0092	33965					0.92	0.0362		3.0		38		10.16		7.62
305M0093	33966					0.93	0.0366		3.0		38		10.16		7.62
30503700	34060	30503700AM	34167		63		0.0370	1/8		1-1/2		0.400		0.30	
305M0094	33967					0.94	0.0370		3.0		38		10.16		7.62
305M0095	34061	305M0095AM	34219			0.95	0.0374		3.0		38		10.16		7.62
305M0096	33968					0.96	0.0378		3.0		38		10.16		7.62
30503800	34062	30503800AM	34168		62		0.0380	1/8		1-1/2		0.400		0.30	
305M0097	33969					0.97	0.0382		3.0		38		10.16		7.62
305M0098	33970					0.98	0.0386		3.0		38		10.16		7.62
305M0099	33971					0.99	0.0390		3.0		38		10.16		7.62
30503900	34063	30503900AM	34169		61		0.0390	1/8		1-1/2		0.400		0.30	
305M0100	34064	305M0100AM	34220			1.00	0.0394		3.0		38		10.16		7.62
30504000	34065	30504000AM	34170		60		0.0400	1/8		1-1/2		0.400		0.30	
30504100	34066	30504100AM	34171		59		0.0410	1/8		1-1/2		0.400		0.30	
305M0105	34067	305M0105AM	34221			1.05	0.0413		3.0		38		10.16		7.62
30504200	34068	30504200AM	34172		58		0.0420	1/8		1-1/2		0.400		0.30	
30504300	34069	30504300AM	34173		57		0.0430	1/8		1-1/2		0.400		0.30	
305M0110	34070	305M0110AM	34222			1.10	0.0433		3.0		38		10.16		7.62
305M0115	34071	305M0115AM	34223			1.15	0.0452		3.0		38		10.16		7.62
30504650	34072	30504650AM	34174		56		0.0465	1/8		1-1/2		0.400		0.30	
30504690	34073	30504690AM	34175	3/64			0.0469	1/8		1-1/2		0.400		0.30	
305M0120	34074	305M0120AM	34224			1.20	0.0472		3.0		38		10.16		7.62
305M0125	34075	305M0125AM	34225			1.25	0.0492		3.0		38		10.16		7.62
305M0130	34076	305M0130AM	34226			1.30	0.0511		3.0		38		10.16		7.62

*Do not drill beyond specified flute length. Peck cycles may be utilized to achieve best tool performance.

Series 305 Continued

Uncoated		ALtima® Micro		Diameter				Shank		OAL		Flute Length max.*		Drill Length	
				D1				D2		L1		L2		L3 Ref.	
Tool No.	EDP	Tool No.	EDP	Inch	Letter/ Wire	mm	Deci- mal	Inch	mm	Inch	mm	Inch	mm	Inch	mm
30505200	34077	30505200AM	34176		55		0.0520	1/8		1-1/2		0.400		0.30	
305M0135	34078	305M0135AM	34227			1.35	0.0531		3.0		38		10.16		7.62
30505500	34079	30505500AM	34177		54		0.0550	1/8		1-1/2		0.400		0.30	
305M0140	34080	305M0140AM	34228			1.40	0.0551		3.0		38		10.16		7.62
305M0145	34081	305M0145AM	34229			1.45	0.0571		3.0		38		10.16		7.62
305M0150	34082	305M0150AM	34230			1.50	0.0590		3.0		38		10.16		7.62
30505950	34083	30505950AM	34178		53		0.0595	1/8		1-1/2		0.400		0.30	
305M0155	34084	305M0155AM	34231			1.55	0.0610		3.0		38		10.16		7.62
30506250	34085	30506250AM	34179	1/16			0.0625	1/8		1-1/2		0.480		0.36	
305M0160	34086	305M0160AM	34232			1.60	0.0630		3.0		38		12.19		9.14
30506350	34087	30506350AM	34180		52		0.0635	1/8		1-1/2		0.480		0.36	
305M0165	34088	305M0165AM	34233			1.65	0.0649		3.0		38		12.19		9.14
305M0170	34089	305M0170AM	34234			1.70	0.0669		3.0		38		12.19		9.14
30506700	34090	30506700AM	34181		51		0.0670	1/8		1-1/2		0.480		0.36	
305M0175	34091	305M0175AM	34235			1.75	0.0689		3.0		38		12.19		9.14
30507000	34092	30507000AM	34182		50		0.0700	1/8		1-1/2		0.480		0.36	
305M0180	34093	305M0180AM	34236			1.80	0.0708		3.0		38		12.19		9.14
305M0185	34094	305M0185AM	34237			1.85	0.0728		3.0		38		12.19		9.14
30507300	34095	30507300AM	34183		49		0.0730	1/8		1-1/2		0.480		0.36	
305M0190	34096	305M0190AM	34238			1.90	0.0748		3.0		38		12.19		9.14
30507600	34097	30507600AM	34184		48		0.0760	1/8		1-1/2		0.480		0.36	
305M0195	34098	305M0195AM	34239			1.95	0.0767		3.0		38		12.19		9.14
30507810	34099	30507810AM	34185	5/64			0.0781	1/8		1-1/2		0.480		0.36	
30507850	34100	30507850AM	34186		47		0.0785	1/8		1-1/2		0.480		0.36	
305M0200	34101	305M0200AM	34240			2.00	0.0787		3.0		38		12.19		9.14
305M0205	34102	305M0205AM	34241			2.05	0.0807		3.0		38		12.19		9.14
30508100	34103	30508100AM	34187		46		0.0810	1/8		1-1/2		0.480		0.36	
30508200	34104	30508200AM	34188		45		0.0820	1/8		1-1/2		0.480		0.36	
305M0210	34105	305M0210AM	34242			2.10	0.0827		3.0		38		12.19		9.14
305M0215	34106	305M0215AM	34243			2.15	0.0846		3.0		38		12.19		9.14
30508600	34107	30508600AM	34189		44		0.0860	1/8		1-1/2		0.480		0.36	
305M0220	34108	305M0220AM	34244			2.20	0.0866		3.0		38		12.19		9.14
305M0225	34109	305M0225AM	34245			2.25	0.0886		3.0		38		12.19		9.14
30508900	34110	30508900AM	34190		43		0.0890	1/8		1-1/2		0.480		0.36	
305M0230	34111	305M0230AM	34246			2.30	0.0906		3.0		38		12.19		9.14
305M0235	34112	305M0235AM	34247			2.35	0.0925		3.0		38		12.19		9.14
30509350	34113	30509350AM	34191		42		0.0935	1/8		1-1/2		0.480		0.36	
30509380	34114	30509380AM	34192	3/32			0.0938	1/8		1-1/2		0.480		0.36	
305M0240	34115	305M0240AM	34248			2.40	0.0945		3.0		38		12.19		9.14
30509600	34116	30509600AM	34193		41		0.0960	1/8		1-1/2		0.480		0.36	
305M0245	34117	305M0245AM	34249			2.45	0.0965		3.0		38		12.19		9.14
30509800	34118	30509800AM	34194		40		0.0980	1/8		1-1/2		0.480		0.36	
305M0250	34119	305M0250AM	34250			2.50	0.0984		3.0		38		12.19		9.14
30509950	34120	30509950AM	34195		39		0.0995	1/8		1-1/2		0.480		0.36	

*Do not drill beyond specified flute length. Peck cycles may be utilized to achieve best tool performance.



Series 305 Continued

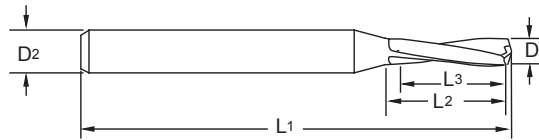
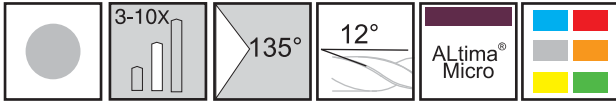

Uncoated		ALtima® Micro		Diameter				Shank		OAL		Flute Length max.*		Drill Length	
				D1				D2		L1		L2		L3 Ref.	
Tool No.	EDP	Tool No.	EDP	Inch	Letter/ Wire	mm	Deci- mal	Inch	mm	Inch	mm	Inch	mm	Inch	mm
305M0255	34121	305M0255AM	34251			2.55	0.1004		3.0		38		12.19		9.14
30510150	34122	30510150AM	34196		38		0.1015	1/8		1-1/2		0.480		0.36	
305M0260	34123	305M0260AM	34252			2.60	0.1024		3.0		38		12.19		9.14
30510400	34124	30510400AM	34197		37		0.1040	1/8		1-1/2		0.480		0.36	
305M0265	34125	305M0265AM	34253			2.65	0.1043		3.0		38		12.19		9.14
305M0270	34126	305M0270AM	34254			2.70	0.1063		3.0		38		12.19		9.14
30510650	34127	30510650AM	34198		36		0.1065	1/8		1-1/2		0.480		0.36	
305M0275	34128	305M0275AM	34255			2.75	0.1083		3.0		38		12.19		9.14
30510940	34129	30510940AM	34199	7/64			0.1094	1/8		1-1/2		0.480		0.36	
30511000	34130	30511000AM	34200		35		0.1100	1/8		1-1/2		0.480		0.36	
305M0280	34131	305M0280AM	34256			2.80	0.1102		3.0		38		12.19		9.14
30511100	34132	30511100AM	34201		34		0.1110	1/8		1-1/2		0.480		0.36	
305M0285	34133	305M0285AM	34257			2.85	0.1122		3.0		38		12.19		9.14
30511300	34134	30511300AM	34202		33		0.1130	1/8		1-1/2		0.480		0.36	
305M0290	34135	305M0290AM	34258			2.90	0.1142		3.0		38		12.19		9.14
30511600	34136	30511600AM	34203		32		0.1160	1/8		1-1/2		0.480		0.36	
305M0295	34137	305M0295AM	34259			2.95	0.1161		3.0		38		12.19		9.14
305M0300	34138	305M0300AM	34260			3.00	0.1181		3.0		38		12.19		9.14
30512000	34139	30512000AM	34204		31		0.1200	1/8		1-1/2		0.480		0.36	
30512500	34143	30512500AM	34205	1/8			0.1250	1/8		1-1/2		0.480		0.36	

*Do not drill beyond specified flute length. Peck cycles may be utilized to achieve best tool performance.

ISO 9001:2008 Certified
Made in USA



Twister® HP Series 207CE

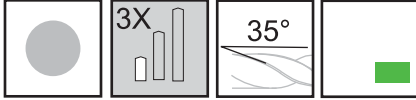

Designed for drilling Carbon Fiber Reinforced Polymer (CFRP), graphite and aramid fiber (kevlar) reinforced composite materials.

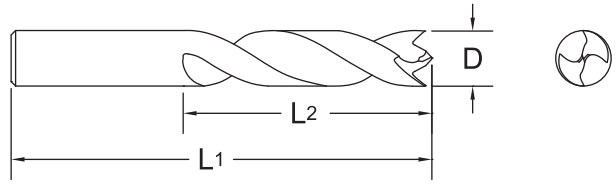

- No delamination.
- Eliminate fuzz or “fray” at exit.
- Brad and spur point.

Tool No.	EDP	Diameter				OAL		Flute Length	
		D				L1		L2	
		Inch	Wire	mm	Decimal	Inch	mm	Inch	mm
20709380CE	27005	3/32			.0938	1-3/4		1/2	
20709800CE	27014		40		.0980	1-13/16		1/2	
20710150CE	27023		38		.1015	1-13/16		1/2	
20712500CE	27068	1/8			.1250	1-7/8		5/8	
20712600CE	27071			3.20	.1260		48		16.0
20712850CE	27074		30		.1285	1-15/16		11/16	
20712990CE	27077			3.30	.1299		49		17.5
20713600CE	27083		29		.1360	1-15/16		11/16	
20714050CE	27089		28		.1405	1-15/16		11/16	
20715620CE	27122	5/32			.1562	2-1/16		3/4	
20715900CE	27131		21		.1590	2-1/8		7/8	
20716100CE	27134		20		.1610	2-1/8		7/8	
20716600CE	27143		19		.1660	2-1/8		7/8	
20718000CE	27167		15		.1800	2-3/16		15/16	
20718750CE	27179	3/16			.1875	2-3/16		15/16	
20719100CE	27188		11		.1910	2-1/4		1	
20719350CE	27194		10		.1935	2-1/4		1	
20719600CE	27197		9		.1960	2-1/4		1	
20720100CE	27209		7		.2010	2-1/4		1	
20720310CE	27212	13/64			.2031	2-1/4		1	
20720900CE	27227		4		.2090	2-3/8		1-1/16	
20721300CE	27233		3		.2130	2-3/8		1-1/16	
20721870CE	27239	7/32			.2187	2-3/8		1-1/16	
20722100CE	27245		2		.2210	2-7/16		1-1/8	
20722800CE	27251		1		.2280	2-7/16		1-1/8	
20723620CE	27266			6.00	.2362		64		32.0
20725000CE	27287	1/4	E		.2500	2-1/2		1-1/4	
20725190CE	27290			6.40	.2519		64		32.0
20725700CE	27296		F		.2570	2-5/8		1-5/16	
20726100CE	27299		G		.2610	2-5/8		1-5/16	
20726560CE	27302	17/64			.2656	2-5/8		1-5/16	
20726600CE	27305		H		.2660	2-11/16		1-3/8	
20727560CE	27311			7.00	.2756		68		35.0
20728100CE	27317		K		.2810	2-11/16		1-3/8	

Inch	
D	Tolerance
.0935-.5000	+0.0000/-0.0005

Metric (mm)	
D	Tolerance
2.40-12.00	+0.000/-0.013



Series 207CE Continued

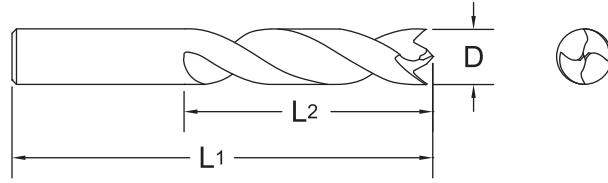
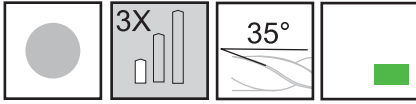

Tool No.	EDP	Diameter				OAL		Flute Length	
		D				L1		L2	
		Inch	Wire	mm	Decimal	Inch	mm	Inch	mm
20728120CE	27320	9/32			.2812	2-11/16		1-3/8	
20729000CE	27323		L		.2900	2-3/4		1-3/8	
20729500CE	27326		M		.2950	2-3/4		1-3/8	
20731250CE	27338	5/16			.3125	2-13/16		1-1/2	
20731500CE	27341			8.00	.3150		71		38.0
20737500CE	27383	3/8			.3750	3-1/8		1-5/8	
20739060CE	27392	25/64			.3906	3-1/4		1-3/4	
20740400CE	27401		Y		.4040	3-5/16		1-3/4	
20743750CE	27419	7/16			.4375	3-7/16		1-7/8	
20750000CE	27437	1/2			.5000	3-3/4		2-1/8	

M.A. FORD® **APG**

CERAedge®

Hardness that makes it the 3rd hardest material when compared to industrial diamonds.

- Toughness that is comparable to Titanium.
- Lubricity that approaches Teflon.
- Extreme heat tolerance.
- Non-reactive to Titanium.

CERAedge® Coating Properties	
Microhardness (HV)	3400
Max. Service Temperature	1100° C / 2012° F
Friction Coefficient	0.25
Coating Thickness	2-3 microns
Color	Light Gray





Technical Information CXDSS.....	62-65
Technical Information CXDSR.....	62-65
Technical Information CXDCS.....	62-65
Technical Information CXDCR	62-65
Technical Information CXDCL.....	62-65

Twister **XD**[®] Xtreme Drilling

Technical Information 2XDSS	66-69
Technical Information 2XDSR	66-69
Technical Information 2XDCS	66-69
Technical Information 2XDCR	66-69
Technical Information 2XDCL	66-69
Technical Information 2XDCE	70-72

Twister[®] Spot Drill

Technical Information 200S.....	73
---------------------------------	----

Twister[®] MD

Technical Information 2MDCL.....	74-75
----------------------------------	-------

Twister[®] Micro-Tuff[®]

Technical Information 305	76-77
---------------------------------	-------

Twister[®] HP

Technical Information 207CE	78
-----------------------------------	----



HP Drills

Twister® Drill Icon Glossary

	Solid	Workpiece Material Group
	Coolant Fed	
	Drill Length	
	Drill Point Angle	
	Helix Angle	
	Coatings	
	DIN Specs	

Cutting Calculations And Definitions			Metric	U.S.
ae	=	Width of cut, radial depth of cut	(mm)	(inch)
ap	=	Depth of cut, axial depth of cut	(mm)	(inch)
Dc	=	Cutter diameter	(mm)	(inch)
f	=	Feed per revolution	(mm/rev)	(IPR)
fz	=	Feed per tooth	(mm/tooth)	(IPT)
zn	=	Number of teeth	Number	
n	=	RPM	(rev/min)	(rev/min)
Q	=	Metal removal rate	(cm³/min)	(in³/min)
vc	=	Cutting speed	(m/min)	(SFM)
vf	=	Feed speed	(mm/min)	(IPM)
Dw	=	Working diameter	(mm)	(inch)

Formulas

Inch

RPM (n) = SFM (vc) x 3.82/Tool Diam.
 IPM (vf) = RPM (n) x IPR (f)

Conversion Inch to Metric

SFM (vc) to m/min (vc) = SFM (vc) x .3048
 IPM (vf) to mm/min (vf) = IPM (vf) x 25.4

Metric

RPM (n) = m/min (vc) x 318.057/Tool Diam.
 mm/min (vf) = RPM (n) x mm/Revolution (f).

Conversion Metric to Inch

m/min (vc) to SFM (vc) = (m/min)/.3048
 mm/min (vf) to IPM (vf) = (mm/min)/25.4

Safety Note

Always wear the appropriate personal protective equipment such as safety glasses and protective clothing when using solid carbide or HSS cutting tools. Machines should be fully guarded.

Drill Troubleshooting

Possible Solutions	Problem																																	
	Tool Deterioration										Chip Formation		Tool Life	Workpiece					Process															
	Flank wear	Margin wear	Breakage	Flaking	Creater wear	Chisel edge wear	Corner chipping	Flute chipping	Cutting edge chipping	Cutting edge wear	Point center chipping	Rake face	Scoring on tool body	Long stringy	Varied chip form	Blue/brown chips	Tool Life	Undersized hole	Oversized hole	Poor alignment	Poor surface finish	Heavy burr breakout	Retract marks	Hole location	Hole straightness	Deflection	Point Deflection	Galling	Vibration	Abnormal noise	Chip packing	No drill penetration		
Reduce feed or reduce at exit	x	x				x	x	x	x	x	x	x					x	x	x	x	x											x		
Reduce feed at entrance			x															x		x					x							x		
Consistent feed rate			x										x	x														x			x			
Increase feed	x					x			x				x				x	x																
Reduce speed	x	x			x	x			x								x	x									x		x	x				
Increase speed																				x														
Coolant mix		x	x	x				x				x					x	x		x	x											x		
Coolant increase flow	x		x			x	x	x							x		x	x		x	x											x		
Coolant filter	x		x	x				x									x	x		x	x											x		
Workpiece clamp rigid		x	x			x	x	x				x					x		x	x	x	x	x	x	x							x		
Collet accuracy			x					x											x					x	x				x					
Tool holder fit .0008			x					x											x					x	x									
Alignment			x					x											x														x	
Peck drill			x																															
Concentricity		x	x	x			x	x				x								x	x		x	x	x	x	x		x	x				
Do not extract tool during peck							x																											

Technical data provided should be considered advisory only as variations may be necessary depending on the particular application.

Coolant Pressure - Inch

Recommended Minimum Coolant Pressure

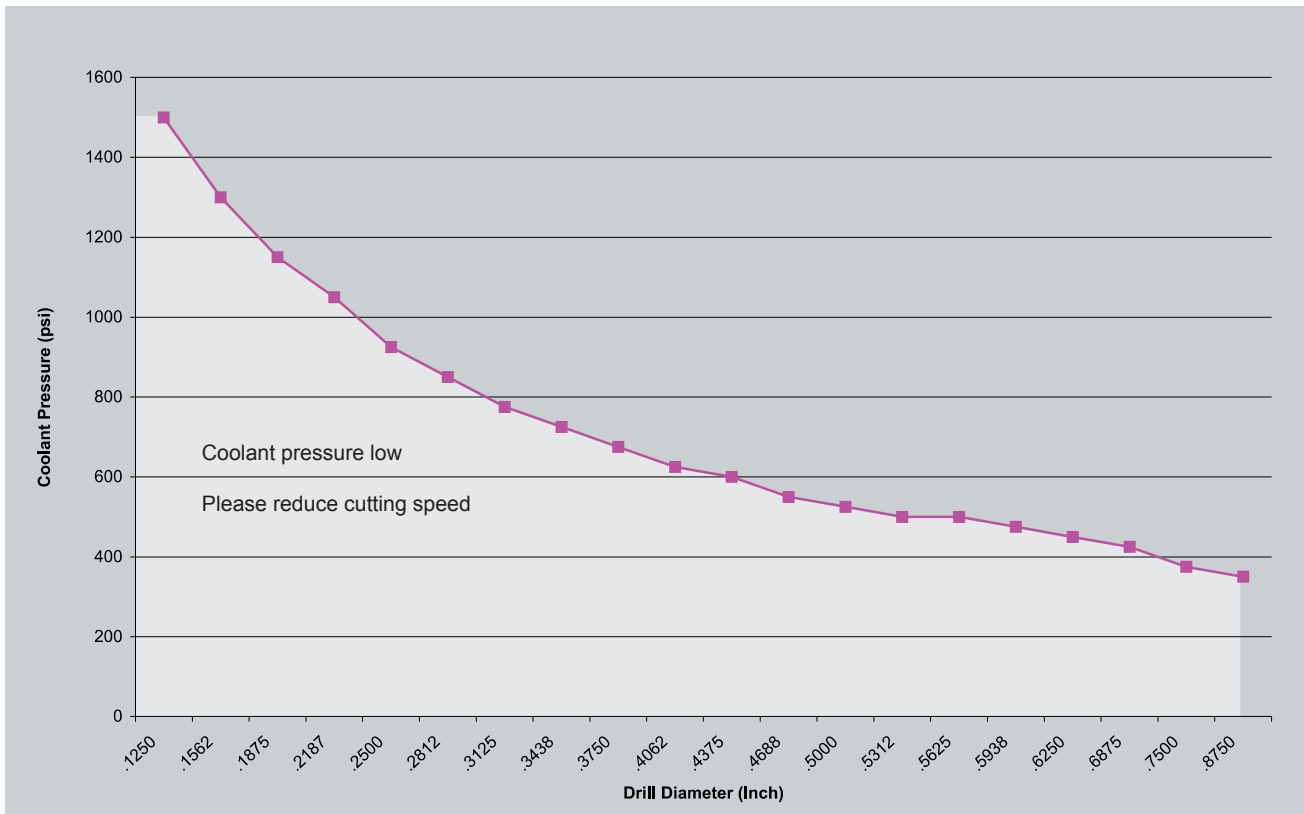

Technical Information

HP Drills

Coolant Pressure - Metric

Recommended Minimum Coolant Pressure

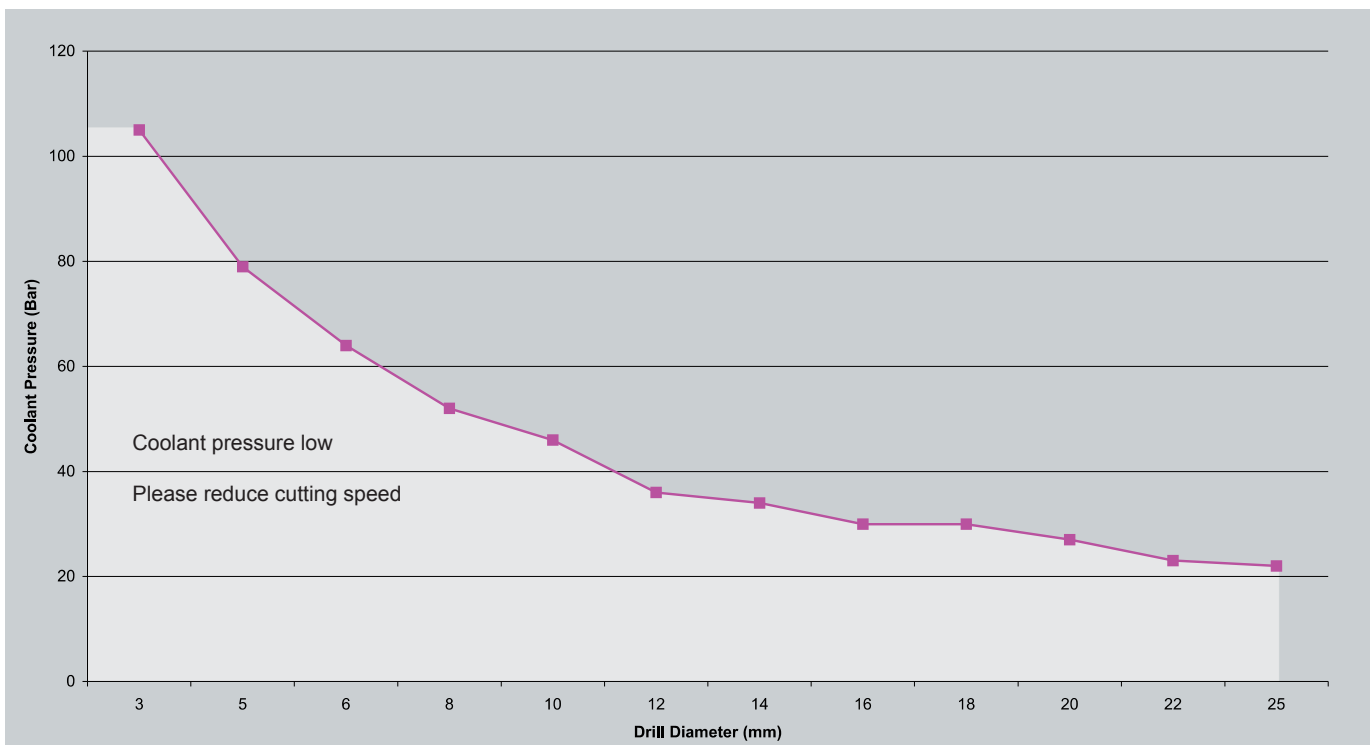

Technical data provided should be considered advisory only as variations may be necessary depending on the particular application.

Cyclone

Recommended Cutting Data CXD ≤ 1/4 - Inch

Workpiece Material Group	ISO	Hardness	Tool Series	TYPE	DEPTH	Drill Diameter				Drill Diameter			
						1/8	5/32	3/16	1/4	1/8	5/32	3/16	1/4
						vc - SFM				f - IPR			
Free Machining & Low Carbon Steels 1006, 1008, 1015, 1018, 1020, 1022, 1025, 1117, 1140, 1141, 11L08, 11L14, 1213, 12L13, 12L14, 1215, 1330	P	up to 28 Rc	CXDSS		3	390	380	370	360	.003-.005	.004-.006	.005-.007	.0055-.0080
			CXDSR		5	390	380	370	360				
			CXDSCS		3	660	650	640	630				
			CXDSCR		5	660	650	640	630				
			CXDCL		8	595	580	560	540				
Medium Carbon & High Carbon Steels, Alloy Steels & Easy to Machine Tool Steels 1030, 1035, 1040, 1045, 1050, 1052, 1055, 1060, 1085, 1095, 1541, 1551, 9255, 2515, 3135, 3415, 4130, 4137, 4140, 4150, 4320, 4340, 4520, 5015, 5115, 5120, 5132, 5140, 5155, 6150, 8620, 9262, 9840, 52100, O1, O2, O6, S2, W1 to W310	P	28 to 38 Rc	CXDSS		3	330	320	310	300	.003-.005	.004-.006	.005-.007	.0055-.008
			CXDSR		5	330	320	310	300				
			CXDSCS		3	575	550	540	500				
			CXDSCR		5	575	550	540	500				
			CXDCL		8	430	420	410	400				
Tool Steels & Die Steels O7, M1, M2, M3, M4, M7, T1, T2, T4, T5, T8, T15, A2, A3, A6, A7, H10, H11, H12, H13, H19, H21, L3, L6, L7, P2, P20, S1, S5, S7, 52100, A128, D2, D3, D4, D5, D7	P	28 to 44 Rc	CXDSS		3	200	190	190	185	.0014-.0030	.0024-.0040	.003-.005	.0035-.006
			CXDSR		5	200	190	190	185				
			CXDSCS		3	250	240	230	220				
			CXDSCR		5	250	240	230	220				
			CXDCL		8	225	220	215	205				
Stainless Steel - Easy to Machine 430F, 301, 303, 410, 416 Annealed, 420F, 430	M	up to 28 Rc	CXDSS		3	350	340	330	320	.003-.005	.004-.006	.005-.007	.0055-.008
			CXDSR		5	350	340	330	320				
			CXDSCS		3	550	500	475	450				
			CXDSCR		5	550	500	475	450				
			CXDCL		8	450	425	400	380				
Stainless Steel - Moderately Difficult 301, 302, 303 High Tensile, 304, 304L, 305, 420, 15-5PH, 17-4PH, 17-7PH	M	up to 28 Rc	CXDSS		3	140	135	130	125	.003-.005	.004-.006	.005-.007	.0055-.008
			CXDSR		5	140	135	130	125				
			CXDSCS		3	300	290	280	270				
			CXDSCR		5	300	290	280	270				
			CXDCL		8	280	270	260	250				
Stainless Steel - Difficult to Machine 302B, 304B, 309, 310, 316, 316B, 316L, 316Ti, 317, 317L, 321, PH13-8Mo, Nitronics	M	over 28 Rc	CXDSS		3	140	130	120	110	.0020-.0033	.0024-.0035	.0030-.0043	.0031-.005
			CXDSR		5	140	130	120	110				
			CXDSCS		3	265	250	240	230				
			CXDSCR		5	265	250	240	230				
			CXDCL		8	190	180	170	160				
High Temp Alloys Nimonic, Inconel, Monel, Hastelloy	S	up to 42 Rc	CXDSS		3	85	80	75	70	.0014-.0033	.0016-.0035	.002-.004	.0023-.0043
			CXDSR		5	85	80	75	70				
			CXDSCS		3	115	100	95	90				
			CXDSCR		5	115	100	95	90				
			CXDCL		8	100	100	95	95				
Titanium Alloys 6Al-4V, 5Al-2.5 Sn, 6Al-2 Sn-4Zr-6Mo, 3Al-8V-6Cr4Mo-4Zr, 10V-2Fe-3Al, 13V-11Cr-3Al	S	up to 42 Rc	CXDSS		3	130	125	120	115	.003-.004	.004-.006	.005-.007	.0055-.008
			CXDSR		5	130	125	120	115				
			CXDSCS		3	230	220	210	200				
			CXDSCR		5	230	220	210	200				
			CXDCL		8	210	190	180	170				
Cast Iron Gray CG, ASTM A48, CLASS 20, 25, 30, 35, SAE J431C, GRADES G1800, G3000, G3500, GG 10, 15, 20, 25, 30, 35, 40	K	up to 240 HB	CXDSS		3	480	470	460	430	.003-.005	.004-.006	.005-.007	.0055-.008
			CXDSR		5	480	470	460	430				
			CXDSCS		3	660	640	620	600				
			CXDSCR		5	660	640	620	600				
			CXDCL		8	500	490	480	470				
Cast Iron - Ductile & Malleable CGI 60-40-18, 65-45-12, D4018, D4512, D5506, 32510, 35108, M3210, M4504, M5503, 250, 300, 350,400,450	K	over 240 HB	CXDSS		3	280	270	260	250	.003-.005	.004-.006	.005-.007	.0055-.008
			CXDSR		5	280	270	260	250				
			CXDSCS		3	400	480	460	440				
			CXDSCR		5	400	480	460	440				
			CXDCL		8	350	340	330	320				

Technical data provided should be considered advisory only as variations may be necessary depending on the particular application.

Cyclone

Recommended Cutting Data CXD ≥ 5/16 - Inch

Workpiece Material Group	ISO	Hardness	Tool Series	TYPE	DEPTH	Drill Diameter						Drill Diameter						
						5/16	3/8	1/2	9/16	5/8	3/4	5/16	3/8	1/2	9/16	5/8	3/4	
						vc - SFM						f - IPR						
Free Machining & Low Carbon Steels 1006, 1008, 1015, 1018, 1020, 1022, 1025, 1117, 1140, 1141, 11L08, 11L14, 1213, 12L13, 12L14, 1215, 1330	P	up to 28 Rc	CXDSS		3	350	340	320	300	275	265	.006-.009	.007-.010	.008-.011	.009-.014	.010-.014	.011-.015	
			CXDSR		5	350	340	320	300	275								
			CXDSCS		3	620	600	575	550	525								
			CXDSCR		5	620	600	575	550	525	500							
			CXDCL		8	520	500	480										
Medium Carbon & High Carbon Steels, Alloy Steels & Easy to Machine Tool Steels 1030, 1035, 1040, 1045, 1050, 1052, 1055, 1060, 1085, 1095, 1541, 1551, 9255, 2515, 3135, 3415, 4130, 4137, 4140, 4150, 4320, 4340, 4520, 5015, 5115, 5120, 5132, 5140, 5155, 6150, 8620, 9262, 9840, 52100, O1, O2, O6, S2, W1 to W310	P	28 to 38 Rc	CXDSS		3	290	280	270	265	260	260	.006-.009	.007-.010	.008-.011	.009-.014	.010-.014	.011-.015	
			CXDSR		5	290	280	270	265	260								
			CXDSCS		3	475	450	425	400	325								
			CXDSCR		5	475	450	425	400	325	315							
			CXDCL		8	375	350	325										
Tool Steels & Die Steels O7, M1, M2, M3, M4, M7, T1, T2, T4, T5, T8, T15, A2, A3, A6, A7, H10, H11, H12, H13, H19, H21, L3, L6, L7, P2, P20, S1, S5, S7, 52100, A128, D2, D3, D4, D5, D7	P	28 to 44 Rc	CXDSS		3	185	180	180	175	175	170	.006-.009	.007-.010	.008-.011	.009-.014	.010-.014	.011-.015	
			CXDSR		5	185	180	180	175	175								
			CXDSCS		3	210	210	200	200	190								
			CXDSCR		5	210	210	200	200	190	190							
			CXDCL		8	200	190	190										
Stainless Steel - Easy to Machine 430F, 301, 303, 410, 416 Annealed, 420F, 430	M	up to 28 Rc	CXDSS		3	310	300	275	250	225	200	.006-.009	.007-.010	.008-.011	.009-.014	.010-.014	.011-.015	
			CXDSR		5	310	300	275	250	225								
			CXDSCS		3	400	390	380	370	330								
			CXDSCR		5	400	390	380	370	330	320							
			CXDCL		8	375	370	350										
Stainless Steel - Moderately Difficult 301, 302, 303 High Tensile, 304, 304L, 305, 420, 15-5PH, 17-4PH, 17-7PH	M	up to 28 Rc	CXDSS		3	120	115	110	105	100	95	.006-.009	.007-.010	.008-.011	.009-.014	.010-.014	.011-.015	
			CXDSR		5	120	115	110	105	100								
			CXDSCS		3	260	250	240	240	230								
			CXDSCR		5	260	250	240	240	230	220							
			CXDCL		8	240	230	220										
Stainless Steel - Difficult to Machine 302B, 304B, 309, 310, 316, 316B, 316L, 316Ti, 317, 317L, 321, PH13-8Mo, Nitronics	M	over 28 Rc	CXDSS		3	110	105	105	100	100	95	.003-.006	.005-.009	.007-.009	.008-.010	.009-.011	.009-.013	
			CXDSR		5	110	105	105	100	100								
			CXDSCS		3	220	200	190	180	170								
			CXDSCR		5	220	200	190	180	170	155							
			CXDCL		8	150	140	130										
High Temp Alloys Nimonic, Inconel, Monel, Hastelloy	S	up to 42 Rc	CXDSS		3	65	60	55	50	45	40	.003-.005	.004-.006	.005-.007	.005-.008	.006-.008	.009-.010	
			CXDSR		5	65	60	55	50	45								
			CXDSCS		3	85	85	80	80	75								
			CXDSCR		5	85	85	80	80	75	75							
			CXDCL		8	90	90	85										
Titanium Alloys 6Al-4V, 5Al-2.5 Sn, 6Al-2 Sn-4Zr-6Mo, 3Al-8V-6Cr4Mo-4Zr, 10V-2Fe-3Al, 13V-11Cr-3Al	S	up to 42 Rc	CXDSS		3	110	105	100	100	90	90	.006-.009	.007-.010	.008-.011	.008-.010	.010-.014	.011-.015	
			CXDSR		5	110	105	100	100	90								
			CXDSCS		3	190	180	170	160	150								
			CXDSCR		5	190	180	170	160	150	150							
			CXDCL		8	160	150	140										
Cast Iron - Gray CG, ASTM A48, CLASS 20, 25, 30, 35, SAE J431C, GRADES G1800, G3000, G3500, GG 10, 15, 20, 25, 30, 35, 40	K	up to 240 HB	CXDSS		3	410	400	390	370	360	350	.006-.009	.007-.010	.008-.011	.009-.014	.010-.014	.011-.015	
			CXDSR		5	410	400	390	370	360								
			CXDSCS		3	580	560	550	550	525								
			CXDSCR		5	580	560	550	550	525	500							
			CXDCL		8	460	450	440										
Cast Iron - Ductile & Malleable CGI 60-40-18, 65-45-12, D4018, D4512, D5506, 32510, 35108, M3210, M4504, M5503, 250, 300, 350, 400, 450	K	over 240 HB	CXDSS		3	240	230	220	210	200	190	.006-.009	.007-.010	.008-.011	.009-.014	.010-.014	.011-.015	
			CXDSR		5	240	230	220	210	200								
			CXDSCS		3	400	375	350	300	275								
			CXDSCR		5	400	375	350	300	275	250							
			CXDCL		8	300	270	250										

Technical data provided should be considered advisory only as variations may be necessary depending on the particular application.

Cyclone

Recommended Cutting Data CXD ≤ 6mm - Metric

Workpiece Material Group	ISO	Hardness	Tool Series	TYPE	DEPTH	Drill Diameter (mm)				Drill Diameter (mm)			
						3	4	5	6	3	4	5	6
						vc - m/min				f - mm/Rev			
Free Machining & Low Carbon Steels 1006, 1008, 1015, 1018, 1020, 1022, 1025, 1117, 1140, 1141, 11L08, 11L14, 1213, 12L13, 12L14, 1215, 1330	P	up to 28 Rc	CXDSS		3	119	116	113	110	.076-.127	.102-.152	.127-.178	.127-.203
			CXDSR		5	119	116	113	110				
			CXDSC		3	201	198	195	192	.076-.127	.102-.152	.127-.178	.127-.203
			CXDRC		5	201	198	195	192				
			CXDCL		8	181	177	171	165				
Medium Carbon & High Carbon Steels, Alloy Steels & Easy to Machine Tool Steels 1030, 1035, 1040, 1045, 1050, 1052, 1055, 1060, 1085, 1095, 1541, 1551, 9255, 2515, 3135, 3415, 4130, 4137, 4140, 4150, 4320, 4340, 4520, 5015, 5115, 5120, 5132, 5140, 5155, 6150, 8620, 9262, 9840, 52100, O1, O2, O6, S2, W1 to W310	P	28 to 38 Rc	CXDSS		3	101	98	94	91	.076-.127	.102-.152	.127-.178	.127-.203
			CXDSR		5	101	98	94	91				
			CXDSC		3	175	168	165	152	.076-.127	.102-.152	.127-.178	.127-.203
			CXDRC		5	175	168	165	152				
			CXDCL		8	131	128	125	122				
Tool Steels & Die Steels O7, M1, M2, M3, M4, M7, T1, T2, T4, T5, T8, T15, A2, A3, A6, A7, H10, H11, H12, H13, H19, H21, L3, L6, L7, P2, P20, S1, S5, S7, 52100, A128, D2, D3, D4, D5, D7	P	28 to 44 Rc	CXDSS		3	61	58	58	56	.036-.076	.061-.102	.076-.127	.089-.152
			CXDSR		5	61	58	58	56				
			CXDSC		3	76	73	70	67	.036-.076	.061-.102	.076-.127	.089-.152
			CXDRC		5	76	73	70	67				
			CXDCL		8	69	67	66	62				
Stainless Steel - Easy to Machine 430F, 301, 303, 410, 416 Annealed, 420F, 430	M	up to 28 Rc	CXDSS		3	107	104	101	98	.076-.127	.102-.152	.127-.178	.127-.203
			CXDSR		5	107	104	101	98				
			CXDSC		3	168	152	145	137	.076-.127	.102-.152	.127-.178	.127-.203
			CXDRC		5	168	152	145	137				
			CXDCL		8	137	130	122	116				
Stainless Steel - Moderately Difficult 301, 302, 303 High Tensile, 304, 304L, 305, 420, 15-5PH, 17-4PH, 17-7PH	M	up to 28 Rc	CXDSS		3	43	41	40	38	.076-.127	.102-.152	.127-.178	.127-.203
			CXDSR		5	43	41	40	38				
			CXDSC		3	91	88	85	82	.076-.127	.102-.152	.127-.178	.127-.203
			CXDRC		5	91	88	85	82				
			CXDCL		8	85	82	79	76				
Stainless Steel - Difficult to Machine 302B, 304B, 309, 310, 316, 316B, 316L, 316Ti, 317, 317L, 321, PH13-8Mo, Nitronics	M	over 28 Rc	CXDSS		3	43	40	37	34	.051-.076	.061-.089	.089-.102	.076-.127
			CXDSR		5	43	40	37	34				
			CXDSC		3	81	76	73	70	.051-.076	.061-.089	.089-.102	.076-.127
			CXDRC		5	81	76	73	70				
			CXDCL		8	58	55	52	49				
High Temp Alloys Nimonic, Inconel, Monel, Hastelloy	S	up to 42 Rc	CXDSS		3	26	24	23	21	.036-.089	.036-.089	.051-.102	.061-.127
			CXDSR		5	26	24	23	21				
			CXDSC		3	35	30	29	27	.036-.089	.036-.089	.051-.102	.061-.127
			CXDRC		5	35	30	29	27				
			CXDCL		8	30	30	29	29				
Titanium Alloys 6Al-4V, 5Al-2.5 Sn, 6Al-2 Sn-4Zr-6Mo, 3Al-8V-6Cr4Mo-4Zr, 10V-2Fe-3Al, 13V-11Cr-3Al	S	up to 42 Rc	CXDSS		3	40	38	37	35	.076-.102	.102-.152	.127-.178	.140-.229
			CXDSR		5	40	38	37	35				
			CXDSC		3	70	67	64	61	.076-.102	.102-.152	.127-.178	.140-.229
			CXDRC		5	70	67	64	61				
			CXDCL		8	64	58	55	52				
Cast Iron Gray CG, ASTM A48, CLASS 20, 25, 30, 35, SAE J431C, GRADES G1800, G3000, G3500, GG 10, 15, 20, 25, 30, 35, 40	K	up to 240 HB	CXDSS		3	146	143	140	131	.076-.127	.102-.152	.127-.178	.127-.203
			CXDSR		5	146	143	140	131				
			CXDSC		3	201	195	189	183	.076-.127	.102-.152	.127-.178	.127-.203
			CXDRC		5	201	195	189	183				
			CXDCL		8	152	149	146	143				
Cast Iron - Ductile & Malleable CGI 60-40-18, 65-45-12, D4018, D4512, D5506, 32510, 35108, M3210, M4504, M5503, 250, 300, 350, 400, 450	K	over 240 HB	CXDSS		3	85	82	79	76	.076-.127	.102-.152	.127-.178	.127-.203
			CXDSR		5	85	82	79	76				
			CXDSC		3	122	146	140	134	.076-.127	.102-.152	.127-.178	.127-.203
			CXDRC		5	122	146	140	134				
			CXDCL		8	107	104	101	98				

Technical data provided should be considered advisory only as variations may be necessary depending on the particular application.

Cyclone

Recommended Cutting Data CXD ≥ 8mm - Metric

Workpiece Material Group	ISO	Hardness	Tool Series	TYPE	DEPTH	Drill Diameter (mm)							Drill Diameter (mm)							
						8	10	12	14	16	18	20	8	10	12	14	16	18	20	
						vc - m/min							f - mm/Rev							
Free Machining & Low Carbon Steels 1006, 1008, 1015, 1018, 1020, 1022, 1025, 1117, 1140, 1141, 11L08, 11L14, 1213, 12L13, 12L14, 1215, 1330	P	up to 28 Rc	CXDSS		3	107	104	98	91	84	81	77	.16-.24	.18-.27	.21-.31	.22-.35	.25-.35	.28-.38	.30-.37	
			CXDSR		5	107	104	98	91	84	81									
			CXDSCS		3	189	183	175	168	160	152									
			CXDSCR		5	189	183	175	168	160	152	145	.16-.24	.18-.27	.21-.31	.22-.35	.25-.35	.28-.38	.30-.37	
			CXDCL		8	158	152	146												
Medium Carbon & High Carbon Steels, Alloy Steels & Easy to Machine Tool Steels 1030, 1035, 1040, 1045, 1050, 1052, 1055, 1060, 1085, 1095, 1541, 1551, 9255, 2515, 3135, 3415, 4130, 4137, 4140, 4150, 4320, 4340, 4520, 5015, 5115, 5120, 5132, 5140, 5155, 6150, 8620, 9262, 9840, 52100, O1, O2, O6, S2, W1 to W310	P	28 to 38 Rc	CXDSS		3	88	85	82	81	79	79	75	.16-.24	.18-.27	.21-.31	.22-.35	.25-.35	.28-.38	.30-.37	
			CXDSR		5	88	85	82	81	79	79									
			CXDSCS		3	145	137	130	122	99	96									
			CXDSCR		5	145	137	130	122	99	96	92	.16-.24	.18-.27	.21-.31	.22-.35	.25-.35	.28-.38	.30-.37	
			CXDCL		8	114	107	99												
Tool Steels & Die Steels O7, M1, M2, M3, M4, M7, T1, T2, T4, T5, T8, T15, A2, A3, A6, A7, H10, H11, H12, H13, H19, H21, L3, L6, L7, P2, P20, S1, S5, S7, 52100, A128, D2, D3, D4, D5, D7	P	28 to 44 Rc	CXDSS		3	56	55	55	53	53	52	49	.16-.24	.18-.27	.21-.31	.22-.35	.25-.35	.28-.38	.30-.37	
			CXDSR		5	56	55	55	53	53	52									
			CXDSCS		3	64	64	61	61	58	58									
			CXDSCR		5	64	64	61	61	58	58	55	.16-.24	.18-.27	.21-.31	.22-.35	.25-.35	.28-.38	.30-.37	
			CXDCL		8	61	58	58												
Stainless Steel - Easy to Machine 430F, 301, 303, 410, 416 Annealed, 420F, 430	M	up to 28 Rc	CXDSS		3	94	91	84	76	69	61	55	.16-.24	.18-.27	.21-.31	.22-.35	.25-.36	.28-.38	.30-.37	
			CXDSR		5	94	91	84	76	69	61									
			CXDSCS		3	122	119	116	113	101	98									
			CXDSCR		5	122	119	116	113	101	98	94	.16-.24	.18-.27	.21-.31	.22-.35	.25-.35	.28-.38	.30-.37	
			CXDCL		8	114	113	107												
Stainless Steel - Moderately Difficult 301, 302, 303 High Tensile, 304, 304L, 305, 420, 15-5PH, 17-4PH, 17-7PH	M	up to 28 Rc	CXDSS		3	37	35	34	32	30	29	28	.16-.24	.18-.27	.21-.31	.22-.35	.25-.36	.28-.38	.30-.37	
			CXDSR		5	37	35	34	32	30	29									
			CXDSCS		3	79	76	73	73	70	67									
			CXDSCR		5	79	76	73	73	70	67	64	.16-.24	.18-.27	.21-.31	.22-.35	.25-.35	.28-.38	.30-.37	
			CXDCL		8	73	70	67												
Stainless Steel - Difficult to Machine 302B, 304B, 309, 310, 316, 316B, 316L, 316Ti, 317, 317L, 321, PH13-8Mo, Nitronics	M	over 28 Rc	CXDSS		3	34	32	32	30	30	29	27	.11-.15	.13-.23	.18-.25	.21-.27	.22-.31	.25-.33	.30-.37	
			CXDSR		5	34	32	32	30	30	29									
			CXDSCS		3	67	61	58	55	52	47									
			CXDSCR		5	67	61	58	55	52	47	45	.11-.15	.13-.23	.18-.25	.21-.27	.22-.31	.25-.33	.30-.37	
			CXDCL		8	46	43	40												
High Temp Alloys Nimonic, Inconel, Monel, Hastelloy	S	up to 42 Rc	CXDSS		3	20	18	17	15	14	12	11	.08-.13	.11-.15	.12-.17	.14-.19	.16-.21	.18-.25	.17-.24	
			CXDSR		5	20	18	17	15	14	12									
			CXDSCS		3	26	26	24	24	23	23									
			CXDSCR		5	26	26	24	24	23	23	22	.09-.13	.11-.15	.12-.17	.14-.19	.16-.21	.18-.25	.17-.24	
			CXDCL		8	27	27	26												
Titanium Alloys 6Al-4V, 5Al-2.5 Sn, 6Al-2 Sn-4Zr-6Mo, 3Al-8V-6Cr4Mo-4Zr, 10V-2Fe-3Al, 13V-11Cr-3Al	S	up to 42 Rc	CXDSS		3	34	32	30	30	27	27	25	.16-.24	.18-.27	.21-.31	.22-.35	.25-.36	.28-.38	.30-.37	
			CXDSR		5	34	32	30	30	27	27									
			CXDSCS		3	55	55	52	49	46	46									
			CXDSCR		5	55	55	52	49	46	46	44	.16-.24	.18-.27	.21-.31	.22-.35	.25-.36	.28-.38	.30-.37	
			CXDCL		8	49	46	43												
Cast Iron - Gray CG, ASTM A48, CLASS 20, 25, 30, 35, SAE J431C, GRADES G1800, G3000, G3500, GG 10, 15, 20, 25, 30, 35, 40	K	up to 240 HB	CXDSS		3	125	122	119	113	110	107	102	.16-.24	.18-.27	.21-.31	.22-.35	.25-.36	.28-.38	.30-.37	
			CXDSR		5	125	122	119	113	110	107									
			CXDSCS		3	177	171	168	168	160	152									
			CXDSCR		5	177	171	168	168	160	152	145	.16-.24	.18-.27	.21-.31	.22-.35	.25-.35	.28-.38	.30-.37	
			CXDCL		8	140	137	134												
Cast Iron - Ductile & Malleable CGI 60-40-18, 65-45-12, D4018, D4512, D5506, 32510, 35108, M3210, M4504, M5503, 250, 300, 350, 400, 450	K	over 240 HB	CXDSS		3	73	70	67	64	61	58	55	.16-.24	.18-.27	.21-.31	.22-.35	.25-.36	.28-.38	.30-.37	
			CXDSR		5	73	70	67	64	61	58									
			CXDSCS		3	122	114	107	91	84	76									
			CXDSCR		5	122	114	107	91	84	76	72	.16-.24	.18-.27	.21-.31	.22-.35	.25-.35	.28-.38	.30-.37	
			CXDCL		8	91	82	76												

Technical data provided should be considered advisory only as variations may be necessary depending on the particular application.

Recommended Cutting Data X^D ≤ 1/4 - Inch

Workpiece Material Group	ISO	Hardness	Tool Series	TYPE	DEPTH	Drill Diameter						Drill Diameter					
						1/64	1/16	1/8	5/32	3/16	1/4	1/64	1/16	1/8	5/32	3/16	1/4
						vc - SFM						f - IPR					
Free Machining & Low Carbon Steels 1006, 1008, 1015, 1018, 1020, 1022, 1025, 1117, 1140, 1141, 11L08, 11L14, 1213, 12L13, 12L14, 1215, 1330	P	up to 28 Rc	2XDSS	●	3			390	380	370	360	.001-.002	.002-.003	.003-.005	.004-.006	.005-.007	.0055-.0080
			2XDSR		5	405	400	390	380	370	360						
			2XDSCS		3			660	650	640	630						
			2XDSCR		5			660	650	640	630						
			2XDCL		7+			595	580	560	540						
Medium Carbon & High Carbon Steels, Alloy Steels & Easy to Machine Tool Steels 1030, 1035, 1040, 1045, 1050, 1052, 1055, 1060, 1085, 1095, 1541, 1551, 9255, 2515, 3135, 3415, 4130, 4137, 4140, 4150, 4320, 4340, 4520, 5015, 5115, 5120, 5132, 5140, 5155, 6150, 8620, 9262, 9840, 52100, O1, O2, O6, S2, W1 to W310	P	28 to 38 Rc	2XDSS	●	3			330	320	310	300	.001-.002	.002-.003	.003-.005	.004-.006	.005-.007	.0055-.0080
			2XDSR		5	350	340	330	320	310	300						
			2XDSCS		3			575	550	540	500						
			2XDSCR		5			575	550	540	500						
			2XDCL		7+			430	420	410	400						
Tool Steels & Die Steels O7, M1, M2, M3, M4, M7, T1, T2, T4, T5, T8, T15, A2, A3, A6, A7, H10, H11, H12, H13, H19, H21, L3, L6, L7, P2, P20, S1, S5, S7, 52100, A128, D2, D3, D4, D5, D7	P	28 to 44 Rc	2XDSS	●	3			200	190	190	185	.0004-.0008	.0008-.0012	.0014-.0030	.0024-.0040	.003-.005	.0035-.0060
			2XDSR		5	210	200	200	190	190	185						
			2XDSCS		3			250	240	230	220						
			2XDSCR		5			250	240	230	220						
			2XDCL		7+			225	220	215	205						
Stainless Steel - Easy to Machine 430F, 301, 303, 410, 416 Annealed, 420F, 430	M	up to 28 Rc	2XDSS	●	3			350	340	330	320	.001-.002	.002-.003	.003-.005	.004-.006	.005-.007	.0055-.0080
			2XDSR		5	360	355	350	340	330	320						
			2XDSCS		3			550	500	475	450						
			2XDSCR		5			550	500	475	450						
			2XDCL		7+			450	425	400	380						
Stainless Steel - Moderately Difficult 301, 302, 303 High Tensile, 304, 304L, 305, 420, 15-5PH, 17-4PH, 17-7PH	M	up to 28 Rc	2XDSS	●	3			140	135	130	125	.001-.002	.002-.003	.003-.005	.004-.006	.005-.007	.0055-.0080
			2XDSR		5	150	145	140	135	130	125						
			2XDSCS		3			300	290	280	270						
			2XDSCR		5			300	290	280	270						
			2XDCL		7+			280	270	260	250						
Stainless Steel - Difficult to Machine 302B, 304B, 309, 310, 316, 316B, 316L, 316Ti, 317, 317L, 321, PH13-8Mo, Nitronics	M	over 28 Rc	2XDSS	●	3			140	130	120	110	.0004-.0012	.001-.002	.0020-.0033	.0024-.0035	.0030-.0043	.0031-.0050
			2XDSR		5	160	150	140	130	120	110						
			2XDSCS		3			265	250	240	230						
			2XDSCR		5			265	250	240	230						
			2XDCL		7+			190	180	170	160						
High Temp Alloys Nimonic, Inconel, Monel, Hastelloy	S	up to 42 Rc	2XDSS	●	3			85	80	75	70	.0004-.0012	.001-.002	.0014-.0033	.0016-.0035	.002-.004	.0023-.0043
			2XDSR		5	100	90	85	80	75	70						
			2XDSCS		3			115	100	95	90						
			2XDSCR		5			115	100	95	90						
			2XDCL		7+			100	100	95	95						
Titanium Alloys 6Al-4V, 5Al-2.5 Sn, 6Al-2 Sn-4Zr-6Mo, 3Al-8V-6Cr4Mo-4Zr, 10V-2Fe-3Al, 13V-11Cr-3Al	S	up to 42 Rc	2XDSS	●	3			130	125	120	115	.0004-.0012	.001-.002	.003-.004	.004-.006	.005-.007	.0055-.0080
			2XDSR		5	150	140	130	125	120	115						
			2XDSCS		3			230	220	210	200						
			2XDSCR		5			230	220	210	200						
			2XDCL		7+			210	190	180	170						
Cast Iron - Gray CG, ASTM A48, CLASS 20, 25, 30, 35, SAE J431C, GRADES G1800, G3000, G3500, GG 10, 15, 20, 25, 30, 35, 40	K	up to 240 HB	2XDSS	●	3			480	470	460	430	.001-.002	.002-.003	.003-.005	.004-.006	.005-.007	.0055-.0080
			2XDSR		5	500	490	480	470	460	430						
			2XDSCS		3			660	640	620	600						
			2XDSCR		5			660	640	620	600						
			2XDCL		7+			500	490	480	470						
Cast Iron Ductile & Malleable CGI 60-40-18, 65-45-12, D4018, D4512, D5506, 32510, 35108, M3210, M4504, M5503, 250, 300, 350, 400, 450	K	over 240 HB	2XDSS	●	3			280	270	260	250	.001-.002	.002-.003	.003-.005	.004-.006	.005-.007	.0055-.0080
			2XDSR		5	300	290	280	270	260	250						
			2XDSCS		3			400	480	460	440						
			2XDSCR		5			400	480	460	440						
			2XDCL		7+			350	340	330	320						

Technical data provided should be considered advisory only as variations may be necessary depending on the particular application.

Recommended Cutting Data XD ≥ 5/16 - Inch

Workpiece Material Group	ISO	Hardness	Tool Series	TYPE	DEPTH	Drill Diameter						Drill Diameter						
						5/16	3/8	1/2	9/16	5/8	3/4	5/16	3/8	1/2	9/16	5/8	3/4	
						vc - SFM						f - IPR						
Free Machining & Low Carbon Steels 1006, 1008, 1015, 1018, 1020, 1022, 1025, 1117, 1140, 1141, 11L08, 11L14, 1213, 12L13, 12L14, 1215, 1330	P	up to 28 Rc	2XDSS	●	3	350	340	320	300	275	265	.006-.009	.007-.010	.008-.011	.009-.014	.010-.014	.011-.015	
			2XDSR		5	350	340	320	300	275	265							
			2XDSCS	●	3	620	600	575	550	525	500							
			2XDSCR		5	620	600	575	550	525	500	.006-.009	.007-.010	.009-.011	.009-.014	.010-.014	.011-.015	
			2XDCL		7+	520	500	480	460	440	430							
Medium Carbon & High Carbon Steels, Alloy Steels & Easy to Machine Tool Steels 1030, 1035, 1040, 1045, 1050, 1052, 1055, 1060, 1085, 1095, 1541, 1551, 9255, 2515, 3135, 3415, 4130, 4137, 4140, 4150, 4320, 4340, 4520, 5015, 5115, 5120, 5132, 5140, 5155, 6150, 8620, 9262, 9840, 52100, O1, O2, O6, S2, W1 to W310	P	28 to 38 Rc	2XDSS	●	3	290	280	270	265	260	260	.006-.009	.007-.010	.008-.011	.009-.014	.010-.014	.011-.015	
			2XDSR		5	290	280	270	265	260	260							
			2XDSCS	●	3	475	450	425	400	325	315							
			2XDSCR		5	475	450	425	400	325	315	.006-.009	.007-.010	.009-.011	.009-.014	.010-.014	.011-.015	
			2XDCL		7+	375	350	325	315	300	280							
Tool Steels & Die Steels O7, M1, M2, M3, M4, M7, T1, T2, T4, T5, T8, T15, A2, A3, A6, A7, H10, H11, H12, H13, H19, H21, L3, L6, L7, P2, P20, S1, S5, S7, 52100, A128, D2, D3, D4, D5, D7	P	28 to 44 Rc	2XDSS	●	3	185	180	180	175	175	170	.006-.009	.007-.010	.008-.011	.009-.014	.010-.014	.011-.015	
			2XDSR		5	185	180	180	175	175	170							
			2XDSCS	●	3	210	210	200	200	190	190							
			2XDSCR		5	210	210	200	200	190	190	.006-.009	.007-.010	.009-.011	.009-.014	.010-.014	.011-.015	
			2XDCL		7+	200	190	190	180	180	170							
Stainless Steel - Easy to Machine 430F, 301, 303, 410, 416 Annealed, 420F, 430	M	up to 28 Rc	2XDSS	●	3	310	300	275	250	225	200	.006-.009	.007-.010	.008-.011	.009-.014	.010-.014	.011-.015	
			2XDSR		5	310	300	275	250	225	200							
			2XDSCS	●	3	400	390	380	370	330	320							
			2XDSCR		5	400	390	380	370	330	320	.006-.009	.007-.010	.008-.011	.009-.014	.010-.014	.011-.015	
			2XDCL		7+	375	370	350	325	310	300							
Stainless Steel - Moderately Difficult 301, 302, 303 High Tensile, 304, 304L, 305, 420, 15-5PH, 17-4PH, 17-7PH	M	up to 28 Rc	2XDSS	●	3	120	115	110	105	100	95	.006-.009	.007-.010	.008-.011	.009-.014	.010-.014	.011-.015	
			2XDSR		5	120	115	110	105	100	95							
			2XDSCS	●	3	260	250	240	240	230	220							
			2XDSCR		5	260	250	240	240	230	220	.006-.009	.007-.010	.008-.011	.009-.014	.010-.014	.011-.015	
			2XDCL		7+	240	230	220	220	200	200							
Stainless Steel - Difficult to Machine 302B, 304B, 309, 310, 316, 316B, 316L, 316Ti, 317, 317L, 321, PH13-8Mo, Nitronics	M	over 28 Rc	2XDSS	●	3	110	105	105	100	100	95	.003-.006	.005-.009	.007-.009	.008-.010	.009-.011	.009-.013	
			2XDSR		5	110	105	105	100	100	95							
			2XDSCS	●	3	220	200	190	180	170	155							
			2XDSCR		5	220	200	190	180	170	155	.003-.006	.005-.009	.007-.009	.008-.010	.009-.011	.009-.013	
			2XDCL		7+	150	140	130	130	125	125							
High Temp Alloys Nimonic, Inconel, Monel, Hastelloy	S	up to 42 Rc	2XDSS	●	3	65	60	55	50	45	40	.003-.005	.004-.006	.005-.007	.005-.008	.006-.008	.009-.010	
			2XDSR		5	65	60	55	50	45	40							
			2XDSCS	●	3	85	85	80	80	75	75							
			2XDSCR		5	85	85	80	80	75	75	.003-.005	.004-.006	.005-.007	.005-.008	.006-.008	.009-.010	
			2XDCL		7+	90	90	85	85	75	75							
Titanium Alloys 6Al-4V, 5Al-2.5 Sn, 6Al-2 Sn-4Zr-6Mo, 3Al-8V-6Cr4Mo-4Zr, 10V-2Fe-3Al, 13V-11Cr-3Al	S	up to 42 Rc	2XDSS	●	3	110	105	100	100	90	90	.006-.009	.007-.010	.008-.011	.008-.010	.010-.014	.011-.015	
			2XDSR		5	110	105	100	100	90	90							
			2XDSCS	●	3	190	180	170	160	150	150							
			2XDSCR		5	190	180	170	160	150	150	.006-.009	.007-.010	.008-.011	.008-.010	.010-.014	.011-.015	
			2XDCL		7+	160	150	140	130	120	120							
Cast Iron - Gray CG, ASTM A48, CLASS 20, 25, 30, 35, SAE J431C, GRADES G1800, G3000, G3500, GG 10, 15, 20, 25, 30, 35, 40	K	up to 240 HB	2XDSS	●	3	410	400	390	370	360	350	.006-.009	.007-.010	.008-.011	.009-.014	.010-.014	.011-.015	
			2XDSR		5	410	400	390	370	360	350							
			2XDSCS	●	3	580	560	550	550	525	500							
			2XDSCR		5	580	560	550	550	525	500	.006-.009	.007-.010	.008-.011	.009-.014	.010-.014	.011-.015	
			2XDCL		7+	460	450	440	430	410	400							
Cast Iron - Ductile & Malleable CGI 60-40-18, 65-45-12, D4018, D4512, D5506, 32510, 35108, M3210, M4504, M5503, 250, 300, 350, 400, 450	K	over 240 HB	2XDSS	●	3	240	230	220	210	200	190	.006-.009	.007-.010	.008-.011	.009-.014	.010-.014	.011-.015	
			2XDSR		5	240	230	220	210	200	190							
			2XDSCS	●	3	400	375	350	300	275	250							
			2XDSCR		5	400	375	350	300	275	250	.006-.009	.007-.010	.008-.011	.009-.014	.010-.014	.011-.015	
			2XDCL		7+	300	270	250	240	220	200	.006-.009	.007-.010	.008-.011	.009-.014	.010-.014	.011-.015	

Technical data provided should be considered advisory only as variations may be necessary depending on the particular application.

Recommended Cutting Data XD ≤ 6mm - Metric

Workpiece Material Group	ISO	Hardness	Tool Series	TYPE	DEPTH	Drill Diameter (mm)						Drill Diameter (mm)					
						0.05	1.5	3	4	5	6	0.05	1.5	3	4	5	6
						vc - m/min						f - mm/Rev					
Free Machining & Low Carbon Steels 1006, 1008, 1015, 1018, 1020, 1022, 1025, 1117, 1140, 1141, 11L08, 11L14, 1213, 12L13, 12L14, 1215, 1330	P	up to 28 Rc	2XDSS	●	3			119	116	113	110	.025-.051	.051-.076	.076-.127	.102-.152	.127-.178	.127-.203
			2XDSCR		5	123	122	119	116	113	110						
			2XDSCS	●●	3			201	198	195	192	.076-.127	.102-.152	.127-.178	.127-.203		
			2XDSCR		5			201	198	195	192						
			2XDCL		7+			181	177	171	165						
Medium Carbon & High Carbon Steels, Alloy Steels & Easy to Machine Tool Steels 1030, 1035, 1040, 1045, 1050, 1052, 1055, 1060, 1085, 1095, 1541, 1551, 9255, 2515, 3135, 3415, 4130, 4137, 4140, 4150, 4320, 4340, 4520, 5015, 5115, 5120, 5132, 5140, 5155, 6150, 8620, 9262, 9840, 52100, O1, O2, O6, S2, W1 to W310	P	28 to 38 Rc	2XDSS	●	3			101	98	94	91	.025-.051	.051-.076	.076-.127	.102-.152	.127-.178	.127-.203
			2XDSCR		5	107	104	101	98	94	91						
			2XDSCS	●●	3			175	168	165	152	.076-.127	.102-.152	.127-.178	.127-.203		
			2XDSCR		5			175	168	165	152						
			2XDCL		7+			131	128	125	122						
Tool Steels & Die Steels O7, M1, M2, M3, M4, M7, T1, T2, T4, T5, T8, T15, A2, A3, A6, A7, H10, H11, H12, H13, H19, H21, L3, L6, L7, P2, P20, S1, S5, S7, 52100, A128, D2, D3, D4, D5, D7	P	28 to 44 Rc	2XDSS	●	3			61	58	58	56	.010-.020	.020-.030	.036-.076	.061-.102	.076-.127	.089-.152
			2XDSCR		5	64	61	61	58	58	56						
			2XDSCS	●●	3			76	73	70	67	.036-.076	.061-.102	.076-.127	.089-.152		
			2XDSCR		5			76	73	70	67						
			2XDCL		7+			69	67	66	62						
Stainless Steel - Easy to Machine 430F, 301, 303, 410, 416 Annealed, 420F, 430	M	up to 28 Rc	2XDSS	●	3			107	104	101	98	.025-.051	.051-.076	.076-.127	.102-.152	.127-.178	.127-.203
			2XDSCR		5	125	120	107	104	101	98						
			2XDSCS	●●	3			168	152	145	137	.076-.127	.102-.152	.127-.178	.127-.203		
			2XDSCR		5			168	152	145	137						
			2XDCL		7+			137	130	122	116						
Stainless Steel - Moderately Difficult 301, 302, 303 High Tensile, 304, 304L, 305, 420, 15-5PH, 17-4PH, 17-7PH	M	up to 28 Rc	2XDSS	●	3			43	41	40	38	.025-.051	.051-.076	.076-.127	.102-.152	.127-.178	.127-.203
			2XDSCR		5	50	48	43	41	40	38						
			2XDSCS	●●	3			91	88	85	82	.076-.127	.102-.152	.127-.178	.127-.203		
			2XDSCR		5			91	88	85	82						
			2XDCL		7+			85	82	79	76						
Stainless Steel - Difficult to Machine 302B, 304B, 309, 310, 316, 316B, 316L, 316Ti, 317, 317L, 321, PH13-8Mo, Nitronics	M	over 28 Rc	2XDSS	●	3			43	40	37	34	.010-.030	.025-.051	.051-.076	.061-.089	.089-.102	.076-.127
			2XDSCR		5	49	46	43	40	37	34						
			2XDSCS	●●	3			81	76	73	70	.051-.076	.061-.089	.089-.102	.076-.127		
			2XDSCR		5			81	76	73	70						
			2XDCL		7+			58	55	52	49						
High Temp Alloys Nimonic, Inconel, Monel, Hastelloy	S	up to 42 Rc	2XDSS	●	3			26	24	23	21	.010-.030	.025-.051	.036-.089	.036-.089	.051-.102	.061-.127
			2XDSCR		5	30	27	26	24	23	21						
			2XDSCS	●●	3			35	30	29	27	.036-.089	.036-.089	.051-.102	.061-.127		
			2XDSCR		5			35	30	29	27						
			2XDCL		7+			30	30	29	29						
Titanium Alloys 6Al-4V, 5Al-2.5 Sn, 6Al-2 Sn-4Zr-6Mo, 3Al-8V-6Cr4Mo-4Zr, 10V-2Fe-3Al, 13V-11Cr-3Al	S	up to 42 Rc	2XDSS	●	3			40	38	37	35	.010-.030	.025-.051	.076-.102	.102-.152	.127-.178	.140-.229
			2XDSCR		5	46	43	40	38	37	35						
			2XDSCS	●●	3			70	67	64	61	.076-.102	.102-.152	.127-.178	.140-.229		
			2XDSCR		5			70	67	64	61						
			2XDCL		7+			64	58	55	52						
Cast Iron - Gray CG, ASTM A48, CLASS 20, 25, 30, 35, SAE J431C, GRADES G1800, G3000, G3500, GG 10, 15, 20, 25, 30, 35, 40	K	up to 240 HB	2XDSS	●	3			146	143	140	131	.025-.051	.051-.076	.076-.127	.102-.152	.127-.178	.127-.203
			2XDSCR		5	152	149	146	143	140	131						
			2XDSCS	●●	3			201	195	189	183	.076-.127	.102-.152	.127-.178	.127-.203		
			2XDSCR		5			201	195	189	183						
			2XDCL		7+			152	149	146	143						
Cast Iron - Ductile & Malleable CGI 60-40-18, 65-45-12, D4018, D4512, D5506, 32510, 35108, M3210, M4504, M5503, 250, 300, 350, 400, 450	K	over 240 HB	2XDSS	●	3			85	82	79	76	.025-.051	.051-.076	.076-.127	.102-.152	.127-.178	.127-.203
			2XDSCR		5	91	88	85	82	79	76						
			2XDSCS	●●	3			122	146	140	134	.076-.127	.102-.152	.127-.178	.127-.203		
			2XDSCR		5			122	146	140	134						
			2XDCL		7+			107	104	101	98						

Technical data provided should be considered advisory only as variations may be necessary depending on the particular application.

Recommended Cutting Data XD ≥ 8mm - Metric

Workpiece Material Group	ISO	Hardness	Tool Series	TYPE	DEPTH	Drill Diameter (mm)							Drill Diameter (mm)								
						8	10	12	14	16	18	20	8	10	12	14	16	18	20		
						vc - m/min							f - mm/Rev								
Free Machining & Low Carbon Steels 1006, 1008, 1015, 1018, 1020, 1022, 1025, 1117, 1140, 1141, 11L08, 11L14, 1213, 12L13, 12L14, 1215, 1330	P	up to 28 Rc	2XDSS	●	3	107	104	98	91	84	81	77	.16-.24	.18-.27	.21-.31	.22-.35	.25-.35	.28-.38	.30-.37		
			2XDSR		5	107	104	98	91	84	81	77									
			2XDSCS		●	3	189	183	175	168	160	152	145								
			2XDSCR			5	189	183	175	168	160	152	145	.16-.24	.18-.27	.21-.31	.22-.35	.25-.35	.28-.38	.30-.37	
			2XDCL			7+	158	152	146	140	134	131	125								
Medium Carbon & High Carbon Steels, Alloy Steels & Easy to Machine Tool Steels 1030, 1035, 1040, 1045, 1050, 1052, 1055, 1060, 1085, 1095, 1541, 1551, 9255, 2515, 3135, 3415, 4130, 4137, 4140, 4150, 4320, 4340, 4520, 5015, 5115, 5120, 5132, 5140, 5155, 6150, 8620, 9262, 9840, 52100, O1, O2, O6, S2, W1 to W310	P	28 to 38 Rc	2XDSS	●	3	88	85	82	81	79	79	75	.16-.24	.18-.27	.21-.31	.22-.35	.25-.35	.28-.38	.30-.37		
			2XDSR		5	88	85	82	81	79	79	75									
			2XDSCS		●	3	145	137	130	122	99	96	92								
			2XDSCR			5	145	137	130	122	99	96	92	.16-.24	.18-.27	.21-.31	.22-.35	.25-.35	.28-.38	.30-.37	
			2XDCL			7+	114	107	99	96	91	85	81								
Tool Steels & Die Steels O7, M1, M2, M3, M4, M7, T1, T2, T4, T5, T8, T15, A2, A3, A6, A7, H10, H11, H12, H13, H19, H21, L3, L6, L7, P2, P20, S1, S5, S7, 52100, A128, D2, D3, D4, D5, D7	P	28 to 44 Rc	2XDSS	●	3	56	55	55	53	53	52	49	.16-.24	.18-.27	.21-.31	.22-.35	.25-.35	.28-.38	.30-.37		
			2XDSR		5	56	55	55	53	53	52	49									
			2XDSCS		●	3	64	64	61	61	58	58	55								
			2XDSCR			5	64	64	61	61	58	58	55	.16-.24	.18-.27	.21-.31	.22-.35	.25-.35	.28-.38	.30-.37	
			2XDCL			7+	61	58	58	55	55	52	49								
Stainless Steel - Easy to Machine 430F, 301, 303, 410, 416 Annealed, 420F, 430	M	up to 28 Rc	2XDSS	●	3	94	91	84	76	69	61	55	.16-.24	.18-.27	.21-.31	.22-.35	.25-.36	.28-.38	.30-.37		
			2XDSR		5	94	91	84	76	69	61	55									
			2XDSCS		●	3	122	119	116	113	101	98	94								
			2XDSCR			5	122	119	116	113	101	98	94	.16-.24	.18-.27	.21-.31	.22-.35	.25-.35	.28-.38	.30-.37	
			2XDCL			7+	114	113	107	99	94	91	87								
Stainless Steel - Moderately Difficult 301, 302, 303 High Tensile, 304, 304L, 305, 420, 15-5PH, 17-4PH, 17-7PH	M	up to 28 Rc	2XDSS	●	3	37	35	34	32	30	29	28	.16-.24	.18-.27	.21-.31	.22-.35	.25-.36	.28-.38	.30-.37		
			2XDSR		5	37	35	34	32	30	29	28									
			2XDSCS		●	3	79	76	73	73	70	67	64								
			2XDSCR			5	79	76	73	73	70	67	64	.16-.24	.18-.27	.21-.31	.22-.35	.25-.35	.28-.38	.30-.37	
			2XDCL			7+	73	70	67	67	61	61	58								
Stainless Steel - Difficult to Machine 302B, 304B, 309, 310, 316, 316B, 316L, 316Ti, 317, 317L, 321, PH13-8Mo, Nitronics	M	over 28 Rc	2XDSS	●	3	34	32	32	30	30	29	27	.11-.15	.13-.23	.18-.25	.21-.27	.22-.31	.25-.33	.30-.37		
			2XDSR		5	34	32	32	30	30	29	27									
			2XDSCS		●	3	67	61	58	55	52	47	45								
			2XDSCR			5	67	61	58	55	52	47	45	.11-.15	.13-.23	.18-.25	.21-.27	.22-.31	.25-.33	.30-.37	
			2XDCL			7+	46	43	40	40	38	38	36								
High Temp Alloys Nimonic, Inconel, Monel, Hastelloy	S	up to 42 Rc	2XDSS	●	3	20	18	17	15	14	12	11	.08-.13	.11-.15	.12-.17	.14-.19	.16-.21	.18-.25	.17-.24		
			2XDSR		5	20	18	17	15	14	12	11									
			2XDSCS		●	3	26	26	24	24	23	23	22								
			2XDSCR			5	26	26	24	24	23	23	22	.09-.13	.11-.15	.12-.17	.14-.19	.16-.21	.18-.25	.17-.24	
			2XDCL			7+	27	27	26	26	23	23	22								
Titanium Alloys 6Al-4V, 5Al-2.5 Sn, 6Al-2 Sn-4Zr-6Mo, 3Al-8V-6Cr4Mo-4Zr, 10V-2Fe-3Al, 13V-11Cr-3Al	S	up to 42 Rc	2XDSS	●	3	34	32	30	30	27	27	25	.16-.24	.18-.27	.21-.31	.22-.35	.25-.36	.28-.38	.30-.37		
			2XDSR		5	34	32	30	30	27	27	25									
			2XDSCS		●	3	55	55	52	49	46	46	44								
			2XDSCR			5	55	55	52	49	46	46	44	.16-.24	.18-.27	.21-.31	.22-.35	.25-.36	.28-.38	.30-.37	
			2XDCL			7+	49	46	43	40	37	37	35								
Cast Iron - Gray CG, ASTM A48, CLASS 20, 25, 30, 35, SAE J431C, GRADES G1800, G3000, G3500, GG 10, 15, 20, 25, 30, 35, 40	K	up to 240 HB	2XDSS	●	3	125	122	119	113	110	107	102	.16-.24	.18-.27	.21-.31	.22-.35	.25-.36	.28-.38	.30-.37		
			2XDSR		5	125	122	119	113	110	107	102									
			2XDSCS		●	3	177	171	168	168	160	152	145								
			2XDSCR			5	177	171	168	168	160	152	145	.16-.24	.18-.27	.21-.31	.22-.35	.25-.35	.28-.38	.30-.37	
			2XDCL			7+	140	137	134	131	125	122	117								
Cast Iron - Ductile & Malleable CGI 60-40-18, 65-45-12, D4018, D4512, D5506, 32510, 35108, M3210, M4504, M5503, 250, 300, 350, 400, 450	K	over 240 HB	2XDSS	●	3	73	70	67	64	61	58	55	.16-.24	.18-.27	.21-.31	.22-.35	.25-.36	.28-.38	.30-.37		
			2XDSR		5	73	70	67	64	61	58	55									
			2XDSCS		●	3	122	114	107	91	84	76	72								
			2XDSCR			5	122	114	107	91	84	76	72	.16-.24	.18-.27	.21-.31	.22-.35	.25-.35	.28-.38	.30-.37	
			2XDCL			7+	91	82	76	73	67	61	58								

Technical data provided should be considered advisory only as variations may be necessary depending on the particular application.

Series 2XDCE Technical Information

Process For Successful Deep Hole Drilling:

1. Start by producing a 1.5 x diameter to 3 x diameter pilot hole using a coolant or non-coolant pilot drill. Typically this tool will have a point angle the same as or greater than the deep hole drill. Run this drill at 100% of the final drill speed and 1/2 the normal IPM (mm/min).
2. Retract and tool change to the final deep hole (2XDCE M.A. Ford[®] Series) drill.
3. Rapid to clearance plane and enter the pilot hole at 25% (don't exceed 400 to 500 RPM (n)) of the final speed and 1 to 2 IPM (25.4 to 50.8 mm/min). This will help with true position by eliminating drill whip. Once into the hole, turn on the coolant and advance to the material start. At this point, you can add a dwell to clear any chips that have been left from the previous drill and let the spindle get to full speed. Increase the speed and feed to final drilling parameters.
4. Drill one shot to the final hole depth or through.
5. Should you experience any squeaking you may need to retract the drill and increase your feed. Chip packing is occurring and will need to be addressed.
6. Once through the material, it may be necessary to reduce the RPM (n) to eliminate breakage of the drill due to drill whip. Then retract to the clearance plane.

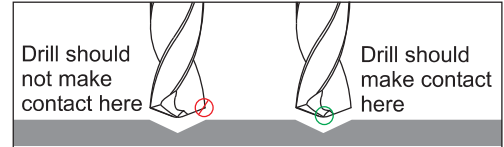

Machine Requirements

High Pressure Pump System (1,000 psi/68.9 bar)
Machine runout of .0003" (.008mm) Max.

Due to the conditions of equipment, tool holders, and conditions beyond M.A. Ford's control, your results may vary.

Should your application require more in depth discussion or a special tool, please contact M.A. Ford's Application Engineering Department at 563-391-6220/800-553-8024.









Recommended Cutting Data XD 2XDCE - Inch

Workpiece Material Group	I S O	Hardness	T Y P E	D E P T H	vc - SFM	Drill Diameter				
						3/16	1/4	5/16	3/8	1/2
						f - IPR				
Free Machining & Low Carbon Steels 1006, 1008, 1015, 1018, 1020, 1022, 1025, 1117, 1140, 1141, 11L08, 11L14, 1213, 12L13, 12L14, 1215, 1330	P	up to 28 Rc		12-25X	345	.0030	.0040	.0080	.0090	.0100
Medium Carbon & High Carbon Steels, Alloy Steels & Easy to Machine Tool Steels 1030, 1035, 1040, 1045, 1050, 1052, 1055, 1060, 1085, 1095, 1541, 1551, 9255, 2515, 3135, 3415, 4130, 4137, 4140, 4150, 4320, 4340, 4520, 5015, 5115, 5120, 5132, 5140, 5155, 6150, 8620, 9262, 9840, 52100, O1, O2, O6, S2, W1 to W310	P	28 to 35 Rc		12-25X	265	.0030	.0040	.0080	.0090	.0100
Tool Steels & Die Steels O7, M1, M2, M3, M4, M7, T1, T2, T4, T5, T8, T15, A2, A3, A6, A7, H10, H11, H12, H13, H19, H21, L3, L6, L7, P2, P20, S1, S5, S7, 52100, A128, D2, D3, D4, D5, D7	P	28 to 35 Rc		12-25X	265	.0030	.0040	.0080	.0090	.0100
Hardened Steels	H	35-45 Rc		12-25X	115	.0006	.0009	.0020	.0024	.0030
Hardened Steels		45-55 Rc			80					
Stainless Steel - Easy to Machine 430F, 301, 303, 410, 416 Annealed, 420F, 430	M	up to 28 Rc		12-25X	300	.0030	.0040	.0080	.0090	.0100
Stainless Steel - Moderately Difficult 301, 302, 303 High Tensile, 304, 304L, 305, 420, 15-5PH, 17-4PH, 17-7PH	M	up to 28 Rc		12-25X	180	.0030	.0040	.0080	.0090	.0100
Stainless Steel - Difficult to Machine 302B, 304B, 309, 310, 316, 316B, 316L, 316Ti, 317, 317L, 321, PH13-8Mo, Nitronics	M	over 28 Rc		12-25X	130	.0020	.0030	.0060	.0080	.0100
High Temp Alloys Nimonic, Inconel, Monel, Hastelloy	S	up to 42 Rc		12-25X	65-80	.0009	.0014	.0025	.0030	.0033
Titanium Alloys 6Al-4V, 5Al-2.5 Sn, 6Al-2 Sn-4Zr-6Mo, 3Al-8V-6Cr4Mo-4Zr, 10V-2Fe-3Al, 13V-11Cr-3Al	S	up to 42 Rc		12-25X	150	.0016	.0024	.0050	.0060	.0060
Cast Iron - Gray CG, ASTM A48, CLASS 20, 25, 30, 35, SAE J431C, GRADES G1800, G3000, G3500, GG 10, 15, 20, 25, 30, 35, 40	K	up to 240 HB		12-25X	400	.0030	.0050	.0080	.0090	.0100
Cast Iron - Ductile & Malleable CGI 60-40-18, 65-45-12, D4018, D4512, D5506, 32510, 35108, M3210, M4504, M5503, 250, 300, 350, 400, 450	K	over 240 HB		12-25X	265	.0030	.0050	.0080	.0090	.0100
Non-Ferrous - Al < 14% Si	N			12-25X	500	.0043	.0070	.0110	.0138	.0149
Non-Ferrous - Al > 14% Si	N			12-25X	350	.0043	.0070	.0110	.0138	.0149
Non-Ferrous - Brass	N			12-25X	400	.0030	.0040	.0110	.0130	.0140
Non-Ferrous - Cu/Cu Alloys/Magnesium	N			12-25X	300	.0030	.0040	.0110	.0130	.0140

ISO 9001:2008 Certified
Made in USA

Technical data provided should be considered advisory only as variations may be necessary depending on the particular application.

Recommended Cutting Data XD 2XDCE - Metric

Workpiece Material Group	I S O	Hardness	T Y P E	D E P T H	vc - m/min	Drill Diameter (mm)						
						5	6	7	8	9	10	12
						f - mm/Rev						
Free Machining & Low Carbon Steels 1006, 1008, 1015, 1018, 1020, 1022, 1025, 1117, 1140, 1141, 11L08, 11L14, 1213, 12L13, 12L14, 1215, 1330	P	up to 28 Rc		12-25X	105	.088	.106	.127	.193	.215	.238	.254
Medium Carbon & High Carbon Steels, Alloy Steels & Easy to Machine Tool Steels 1030, 1035, 1040, 1045, 1050, 1052, 1055, 1060, 1085, 1095, 1541, 1551, 9255, 2515, 3135, 3415, 4130, 4137, 4140, 4150, 4320, 4340, 4520, 5015, 5115, 5120, 5132, 5140, 5155, 6150, 8620, 9262, 9840, 52100, O1, O2, O6, S2, W1 to W310	P	28 to 35 Rc		12-25X	80	.088	.106	.127	.193	.215	.238	.254
Tool Steels & Die Steels O7, M1, M2, M3, M4, M7, T1, T2, T4, T5, T8, T15, A2, A3, A6, A7, H10, H11, H12, H13, H19, H21, L3, L6, L7, P2, P20, S1, S5, S7, 52100, A128, D2, D3, D4, D5, D7	P	28 to 35 Rc		12-25X	80	.088	.106	.127	.193	.215	.238	.254
Hardened Steels	H	35-45 Rc		12-25X	35	.020	.022	.027	.046	.053	.060	.066
Hardened Steels		45-55 Rc			25							
Stainless Steel - Easy to Machine 430F, 301, 303, 410, 416 Annealed, 420F, 430	M	up to 28 Rc		12-25X	90	.090	.105	.127	.193	.215	.238	.254
Stainless Steel - Moderately Difficult 301, 302, 303 High Tensile, 304, 304L, 305, 420, 15-5PH, 17-4PH, 17-7PH	M	up to 28 Rc		12-25X	55	.090	.105	.127	.193	.215	.238	.254
Stainless Steel - Difficult to Machine 302B, 304B, 309, 310, 316, 316B, 316L, 316Ti, 317, 317L, 321, PH13-8Mo, Nitronics	M	over 28 Rc		12-25X	40	.090	.105	.127	.193	.215	.238	.254
High Temp Alloys Nimonic, Inconel, Monel, Hastelloy	S	up to 42 Rc		12-25X	20-25	.030	.035	.048	.051	.071	.078	.085
Titanium Alloys 6Al-4V, 5Al-2.5 Sn, 6Al-2 Sn-4Zr-6Mo, 3Al-8V-6Cr4Mo-4Zr, 10V-2Fe-3Al, 13V-11Cr-3Al	S	up to 42 Rc		12-25X	45	.050	.060	.071	.098	.127	.140	.152
Cast Iron - Gray CG, ASTM A48, CLASS 20, 25, 30, 35, SAE J431C, GRADES G1800, G3000, G3500, GG 10, 15, 20, 25, 30, 35, 40	K	up to 240 HB		12-25X	120	.100	.120	.140	.200	.215	.240	.254
Cast Iron - Ductile & Malleable CGI 60-40-18, 65-45-12, D4018, D4512, D5506, 32510, 35108, M3210, M4504, M5503, 250, 300, 350, 400, 450	K	over 240 HB		12-25X	80	.100	.120	.140	.200	.215	.240	.254
Non-Ferrous - Al < 14% Si	N		12-25X	150	.140	.170	.195	.280	.314	.350	.378	
Non-Ferrous - Al > 14% Si	N			105	.140	.170	.195	.280	.314	.350	.378	
Non-Ferrous - Brass	N			120	.088	.106	.127	.279	.314	.350	.378	
Non-Ferrous - Cu/Cu Alloys/Magnesium	N			90	.088	.106	.127	.279	.314	.350	.378	

Safety Note

Always wear the appropriate personal protective equipment such as safety glasses and protective clothing when using solid carbide or HSS cutting tools. Machines should be fully guarded. Technical data provided should be considered advisory only as variations may be necessary depending on the particular application.

Twister® Spot Drill

Recommended Cutting Data 200S - Inch

Workpiece Material Group	I S O	Hardness	D E P T H	vc - SFM	Drill Diameter				
					1/8	1/4	3/8	1/2	5/8
					f - IPR				
Free Machining & Low Carbon Steels 1006, 1008, 1015, 1018, 1020, 1022, 1025, 1117, 1140, 1141, 11L08, 11L14, 1213, 12L13, 12L14, 1215, 1330	P	up to 28 Rc	3	330	.0015	.0030	.0040	.0050	.0060
Medium Carbon & High Carbon Steels, Alloy Steels & Easy to Machine Tool Steels 1030, 1035, 1040, 1045, 1050, 1052, 1055, 1060, 1085, 1095, 1541, 1551, 9255, 2515, 3135, 3415, 4130, 4137, 4140, 4150, 4320, 4340, 4520, 5015, 5115, 5120, 5132, 5140, 5155, 6150, 8620, 9262, 9840, 52100, O1, O2, O6, S2, W1 to W310	P	28 to 38 Rc	3	265	.0015	.0030	.0040	.0050	.0060
Tool Steels & Die Steels O7, M1, M2, M3, M4, M7, T1, T2, T4, T5, T8, T15, A2, A3, A6, A7, H10, H11, H12, H13, H19, H21, L3, L6, L7, P2, P20, S1, S5, S7, 52100, A128, D2, D3, D4, D5, D7	P	28 to 44 Rc	3	230	.0015	.0030	.0040	.0050	.0060
Hardened Steel	H	45 to 65 Rc	3	50	.0005	.0005	.0010	.0010	.0010
Stainless Steel - Moderately Difficult 301, 302, 303 High Tensile, 304, 304L, 305, 420, 15-5PH, 17-4PH, 17-7PH	M	up to 28 Rc	3	150	.0015	.0030	.0040	.0050	.0060
Stainless Steel - Difficult to Machine 302B, 304B, 309, 310, 316, 316B, 316L, 316Ti, 317, 317L, 321, PH13-8Mo, Nitronics	M	up to 28 Rc	3	100	.0010	.0020	.0025	.0030	.0040
High Temp Alloys Nimonic, Inconel, Monel, Hastelloy	S	up to 42 Rc	3	70	.0010	.0020	.0025	.0030	.0040
Titanium Alloys 6Al-4V, 5Al-2.5 Sn, 6Al-2 Sn-4Zr-6Mo, 3Al-8V-6Cr-4Mo-4Zr, 10V-2Fe-3Al, 13V-11Cr-3Al	S	up to 42 Rc	3	180	.0010	.0020	.0025	.0030	.0040
Cast Iron - Gray CG, ASTM A48, CLASS 20, 25, 30, 35, SAE J431C, GRADES G1800, G3000, G3500, GG 10, 15, 20, 25, 30, 35, 40	K	up to 240 HB	3	365	.0015	.0030	.0040	.0050	.0060
Cast Iron - Ductile & Malleable CGI 60-40-18, 65-45-12, D4018, D4512, D5506, 32510, 35108, M3210, M4504, M5503, 250, 300, 350, 400, 450	K	over 240 HB	3	265	.0015	.0030	.0040	.0050	.0060
Plastics Kevlar/Graphite	N		3	300	.0015	.0030	.0040	.0050	.0060

Recommended Cutting Data 200S - Metric

Workpiece Material Group	I S O	Hardness	D E P T H	vc - m/min	Drill Diameter (mm)					
					3	6	8	10	12	16
					f - mm/Rev					
Free Machining & Low Carbon Steels 1006, 1008, 1015, 1018, 1020, 1022, 1025, 1117, 1140, 1141, 11L08, 11L14, 1213, 12L13, 12L14, 1215, 1330	P	up to 28 Rc	3	100	.0380	.0760	.1020	.1270	.1520	.1520
Medium Carbon & High Carbon Steels, Alloy Steels & Easy to Machine Tool Steels 1030, 1035, 1040, 1045, 1050, 1052, 1055, 1060, 1085, 1095, 1541, 1551, 9255, 2515, 3135, 3415, 4130, 4137, 4140, 4150, 4320, 4340, 4520, 5015, 5115, 5120, 5132, 5140, 5155, 6150, 8620, 9262, 9840, 52100, O1, O2, O6, S2, W1 to W310	P	28 to 38 Rc	3	80	.0380	.0760	.1020	.1270	.1520	.1520
Tool Steels & Die Steels O7, M1, M2, M3, M4, M7, T1, T2, T4, T5, T8, T15, A2, A3, A6, A7, H10, H11, H12, H13, H19, H21, L3, L6, L7, P2, P20, S1, S5, S7, 52100, A128, D2, D3, D4, D5, D7	P	28 to 44 Rc	3	45	.0380	.0760	.1020	.1270	.1520	.1520
Hardened Steel	H	45 to 65 Rc	3	15	.0127	.0127	.0254	.0254	.0254	.0381
Stainless Steel - Moderately Difficult 301, 302, 303 High Tensile, 304, 304L, 305, 420, 15-5PH, 17-4PH, 17-7PH	M	up to 28 Rc	3	45	.0380	.0760	.1020	.1270	.1520	.1520
Stainless Steel - Difficult to Machine 302B, 304B, 309, 310, 316, 316B, 316L, 316Ti, 317, 317L, 321, PH13-8Mo, Nitronics	M	up to 28 Rc	3	30	.0250	.0510	.0640	.0760	.1020	.1270
High Temp Alloys Nimonic, Inconel, Monel, Hastelloy	S	up to 42 Rc	3	20	.0250	.0510	.0640	.0760	.1020	.1270
Titanium Alloys 6Al-4V, 5Al-2.5 Sn, 6Al-2 Sn-4Zr-6Mo, 3Al-8V-6Cr-4Mo-4Zr, 10V-2Fe-3Al, 13V-11Cr-3Al	S	up to 42 Rc	3	55	.0250	.0510	.0640	.0760	.1020	.1270
Cast Iron - Gray CG, ASTM A48, CLASS 20, 25, 30, 35, SAE J431C, GRADES G1800, G3000, G3500, GG 10, 15, 20, 25, 30, 35, 40	K	up to 240 HB	3	110	.0380	.0760	.1020	.1270	.1520	.1520
Cast Iron - Ductile & Malleable CGI 60-40-18, 65-45-12, D4018, D4512, D5506, 32510, 35108, M3210, M4504, M5503, 250, 300, 350, 400, 450	K	over 240 HB	3	80	.0380	.0760	.1020	.1270	.1520	.1520
Plastics Kevlar/Graphite	N		3	90	.0380	.0760	.1020	.1270	.1520	.1520

Technical data provided should be considered advisory only as variations may be necessary depending on the particular application.

Twister® MD

Recommended Cutting Data 2MDCL - Inch

Workpiece Material Group	I S O	Hardness	T Y P E	D E P T H	Drill Diameter			Drill Diameter		
					0.787	0.984	0.1142	0.0787	0.0984	0.1142
					vc - SFM			f - IPR		
Free Machining & Low Carbon Steels 1006, 1008, 1015, 1018, 1020, 1022, 1025, 1117, 1140, 1141, 11L08, 11L14, 1213, 12L13, 12L14, 1215, 1330	P	up to 28 Rc		10X	300	300	250	.0018	.0020	.0022
Medium Carbon & High Carbon Steels, Alloy Steels & Easy to Machine Tool Steels 1030, 1035, 1040, 1045, 1050, 1052, 1055, 1060, 1085, 1095, 1541, 1551, 9255, 2515, 3135, 3415, 4130, 4137, 4140, 4150, 4320, 4340, 4520, 5015, 5115, 5120, 5132, 5140, 5155, 6150, 8620, 9262, 9840, 52100, O1, O2, O6, S2, W1 to W310	P	28 to 38 Rc		10X	300	300	250	.0018	.0020	.0022
Tool Steels & Die Steels O7, M1, M2, M3, M4, M7, T1, T2, T4, T5, T8, T15, A2, A3, A6, A7, H10, H11, H12, H13, H19, H21, L3, L6, L7, P2, P20, S1, S5, S7, 52100, A128, D2, D3, D4, D5, D7	P	28 to 44 Rc		10X	250	250	200	.0018	.0020	.0022
Stainless Steel - Easy to Machine 430F, 301, 303, 410, 416 Annealed, 420F, 430	M	up to 28 Rc		10X	300	300	250	.0018	.0020	.0022
Stainless Steel - Moderately Difficult 301, 302, 303 High Tensile, 304, 304L, 305, 420, 15-5PH, 17-4PH, 17-7PH	M	up to 28 Rc		10X	230	230	200	.0018	.0020	.0022
Stainless Steel - Difficult to Machine 302B, 304B, 309, 310, 316, 316B, 316L, 316Ti, 317, 317L, 321, PH13-8Mo, Nitronics	M	over 28 Rc		10X	60	60	50	.0009	.0011	.0015
High Temp Alloys Nimonic, Inconel, Monel, Hastelloy	S	up to 42 Rc		10X	50	50	40	.0009	.0011	.0014
Titanium Alloys 6Al-4V, 5Al-2.5 Sn, 6Al-2 Sn-4Zr-6Mo, 3Al-8V-6Cr4Mo-4Zr, 10V-2Fe-3Al, 13V-11Cr-3Al	S	up to 42 Rc		10X	175	175	150	.0009	.0011	.0014
Cast Iron - Gray CG, ASTM A48, CLASS 20, 25, 30, 35, SAE J431C, GRADES G1800, G3000, G3500, GG 10, 15, 20, 25, 30, 35, 40	K	up to 240 HB		10X	325	325	300	.0018	.0020	.0022
Cast Iron - Ductile & Malleable CGI 60-40-18, 65-45-12, D4018, D4512, D5506, 32510, 35108, M3210, M4504, M5503, 250, 300, 350, 400, 450	K	over 240 HB		10X	250	250	200	.0018	.0020	.0022

M.A. Ford® recommends full retraction of the body of the drill from the hole during the peck cycle. It is recommended to leave the drill point within the hole.

For hole depths deeper than 4x the diameter, M.A. Ford® recommends using a "soft start" program that drills to .5x diameter deep at 2/3 of the speed and feed.

Machine Requirements

High Pressure Pump System (1,000 psi/68.9 bar)
Coolant filtration of 10 microns or better
Machine runout of .0004" (.01mm) Max.

Estimated Peck Depths

For hole depths up to 6X diameter No Pecks
For hole depths up to 10X diameter 0-2 Pecks
For hole depths up to 15X diameter 2-4 Pecks

Technical data provided should be considered advisory only as variations may be necessary depending on the particular application.

Twister® MD

Recommended Cutting Data 2MDCL - Metric

Workpiece Material Group	I S O	Hardness	T Y P E	D E P T H	Drill Diameter (mm)			Drill Diameter (mm)		
					2.0	2.5	2.9	2.0	2.5	2.9
					vc - m/min			f - mm/Rev		
Free Machining & Low Carbon Steels 1006, 1008, 1015, 1018, 1020, 1022, 1025, 1117, 1140, 1141, 11L08, 11L14, 1213, 12L13, 12L14, 1215, 1330	P	up to 28 Rc		10X	90	90	75	.046	.051	.056
Medium Carbon & High Carbon Steels, Alloy Steels & Easy to Machine Tool Steels 1030, 1035, 1040, 1045, 1050, 1052, 1055, 1060, 1085, 1095, 1541, 1551, 9255, 2515, 3135, 3415, 4130, 4137, 4140, 4150, 4320, 4340, 4520, 5015, 5115, 5120, 5132, 5140, 5155, 6150, 8620, 9262, 9840, 52100, O1, O2, O6, S2, W1 to W310	P	28 to 38 Rc		10X	90	90	75	.046	.051	.056
Tool Steels & Die Steels O7, M1, M2, M3, M4, M7, T1, T2, T4, T5, T8, T15, A2, A3, A6, A7, H10, H11, H12, H13, H19, H21, L3, L6, L7, P2, P20, S1, S5, S7, 52100, A128, D2, D3, D4, D5, D7	P	28 to 44 Rc		10X	60	60	53	.046	.051	.056
Stainless Steel - Easy to Machine 430F, 301, 303, 410, 416 Annealed, 420F, 430	M	up to 28 Rc		10X	90	90	75	.046	.051	.056
Stainless Steel - Moderately Difficult 301, 302, 303 High Tensile, 304, 304L, 305, 420, 15-5PH, 17-4PH, 17-7PH	M	up to 28 Rc		10X	75	75	60	.033	.038	.043
Stainless Steel - Difficult to Machine 302B, 304B, 309, 310, 316, 316B, 316L, 316Ti, 317, 317L, 321, PH13-8Mo, Nitronics	M	over 28 Rc		10X	18	18	15	.025	.027	.038
High Temp Alloys Nimonic, Inconel, Monel, Hastelloy	S	up to 42 Rc		10X	15	15	12	.025	.027	.036
Titanium Alloys 6Al-4V, 5Al-2.5 Sn, 6Al-2 Sn-4Zr-6Mo, 3Al-8V-6Cr-4Mo-4Zr, 10V-2Fe-3Al, 13V-11Cr-3Al	S	up to 42 Rc		10X	55	55	45	.025	.027	.036
Cast Iron - Gray CG, ASTM A48, CLASS 20, 25, 30, 35, SAE J431C, GRADES G1800, G3000, G3500, GG 10, 15, 20, 25, 30, 35, 40	K	up to 240 HB		10X	100	100	90	.046	.051	.065
Cast Iron - Ductile & Malleable CGI 60-40-18, 65-45-12, D4018, D4512, D5506, 32510, 35108, M3210, M4504, M5503, 250, 300, 350, 400, 450	K	over 240 HB		10X	75	75	60	.046	.051	.056

M.A. Ford® recommends full retraction of the body of the drill from the hole during the peck cycle. It is recommended to leave the drill point within the hole.

For hole depths deeper than 4x the diameter, M.A. Ford® recommends using a "soft start" program that drills to .5x diameter deep at 2/3 of the speed and feed.

Machine Requirements

High Pressure Pump System (1,000 psi/68.9 bar)
Coolant filtration of 10 microns or better
Machine runout of .0004" (.01mm) Max.

Estimated Peck Depths

For hole depths up to 6X diameter No Pecks
For hole depths up to 10X diameter 0-2 Pecks
For hole depths up to 15X diameter 2-4 Pecks

Technical data provided should be considered advisory only as variations may be necessary depending on the particular application.

Twister® Micro-Tuff®

Recommended Cutting Data 305 - Inch

Workpiece Material Group	ISO	Hardness	Tool Series	TYPE	vc - SFM	Drill Diameter				
						1/64	1/32	1/16	3/32	1/8
						f - IPR				
Free Machining & Low Carbon Steels 1006, 1008, 1015, 1018, 1020, 1022, 1025, 1117, 1140, 1141, 11L08, 11L14, 1213, 12L13, 12L14, 1215, 1330	P	up to 28 Rc	305	●	110	.0004	.0008	.0015	.0023	.0030
			305AM		150					
Medium Carbon & High Carbon Steels, Alloy Steels & Easy to Machine Tool Steels 1030, 1035, 1040, 1045, 1050, 1052, 1055, 1060, 1085, 1095, 1541, 1551, 9255, 2515, 3135, 3415, 4130, 4137, 4140, 4150, 4320, 4340, 4520, 5015, 5115, 5120, 5132, 5140, 5155, 6150, 8620, 9262, 9840, 52100, O1, O2, O6, S2, W1 to W310	P	28 to 38 Rc	305		90					
			305AM		130					
Tool Steels & Die Steels O7, M1, M2, M3, M4, M7, T1, T2, T4, T5, T8, T15, A2, A3, A6, A7, H10, H11, H12, H13, H19, H21, L3, L6, L7, P2, P20, S1, S5, S7, 52100, A128, D2, D3, D4, D5, D7	P	28 to 44 Rc	305		85					
			305AM		120					
Hardened Steels A2 / 52100	H	55 Rc	305	35						
			305AM	50						
Free Machining Stainless	M	up to 28 Rc	305	110						
			305AM	140						
Stainless Steel - Austenitic 304 / 316	M	up to 28 Rc	305	90						
			305AM	125						
Stainless Steel - Ferritic / Martensitic	M	up to 28 Rc	305	80						
			305AM	110						
Stainless Steel - Moderately Difficult 301, 302, 303 High Tensile, 304, 304L, 305, 420, 15-5PH, 17-4PH, 17-7PH	M	over 28 Rc	305	45						
			305AM	60						
Aluminum (<10% Si)	N		305	175						
			305AM							
Plastics	N		305	175						
			305AM							
Cast Iron - Gray CG, ASTM A48, CLASS 20, 25, 30, 35, SAE J431C, GRADES G1800, G3000, G3500, GG 10, 15, 20, 25, 30, 35, 40	K	up to 240 HB	305	110						
			305AM	150						
Cast Iron - Ductile & Malleable CGI 60-40-18, 65-45-12, D4018, D4512, D5506, 32510, 35108, M3210, M4504, M5503, 250, 300, 350, 400, 450	K	over 240 HB	305	110						
			305AM	150						
Titanium 6Al-4V	S	up to 40 Rc	305	50						
			305AM	70						
High Temp Alloys Inconel / Hastelloy / Waspeloy / Nickel Based Alloys-Monel	S	up to 40 Rc	305	45						
			305AM	60						

Recommended Peck Depths by Diameter*

Diameter	Peck Depth
1/64	.2 x Diameter
1/32	.3 x Diameter
1/16	.6 x Diameter
5/64	.8 x Diameter
3/32	1.0 x Diameter
1/8	1.2 x Diameter

*Peck depths can vary by material type.

Technical data provided should be considered advisory only as variations may be necessary depending on the particular application.

Twister® Micro-Tuff®

Recommended Cutting Data 305 - Metric

Workpiece Material Group	I S O	Hardness	Tool Series	T Y P E	vc - m/min	Drill Diameter (mm)										
						0.5	1	2	2.5	3						
						f - mm/Rev										
Free Machining & Low Carbon Steels 1006, 1008, 1015, 1018, 1020, 1022, 1025, 1117, 1140, 1141, 11L08, 11L14, 1213, 12L13, 12L14, 1215, 1330	P	up to 28 Rc	305	●	35	.010	.020	.040	.060	.075						
			305AM		45											
Medium Carbon & High Carbon Steels, Alloy Steels & Easy to Machine Tool Steels 1030, 1035, 1040, 1045, 1050, 1052, 1055, 1060, 1085, 1095, 1541, 1551, 9255, 2515, 3135, 3415, 4130, 4137, 4140, 4150, 4320, 4340, 4520, 5015, 5115, 5120, 5132, 5140, 5155, 6150, 8620, 9262, 9840, 52100, O1, O2, O6, S2, W1 to W310	P	28 to 38 Rc	305		25											
			305AM		40											
Tool Steels & Die Steels O7, M1, M2, M3, M4, M7, T1, T2, T4, T5, T8, T15, A2, A3, A6, A7, H10, H11, H12, H13, H19, H21, L3, L6, L7, P2, P20, S1, S5, S7, 52100, A128, D2, D3, D4, D5, D7	P	28 to 44 Rc	305		25											
			305AM		40											
Hardened Steels A2 / 52100	H	55 Rc	305	●	10	.005	.010	.020	.025	.035						
			305AM	15												
Free Machining Stainless	M	up to 28 Rc	305	●	35	.010	.020	.040	.060	.075						
			305AM		45											
Stainless Steel - Austenitic 304 / 316	M	up to 28 Rc	305		25											
			305AM		40											
Stainless Steel - Ferritic / Martensitic	M	up to 28 Rc	305		25											
			305AM		35											
Stainless Steel - Moderately Difficult 301, 302, 303 High Tensile, 304, 304L, 305, 420, 15-5PH, 17-4PH, 17-7PH	M	over 28 Rc	305	15												
			305AM	20												
Aluminum (<10% Si)	N		305	●	55	.015	.025	.050	.075	.100						
			305AM													
Plastics	N		305		55											
			305AM													
Cast Iron - Gray CG, ASTM A48, CLASS 20, 25, 30, 35, SAE J431C, GRADES G1800, G3000, G3500, GG 10, 15, 20, 25, 30, 35, 40	K	up to 240 HB	305		●						35	.010	.020	.040	.060	.075
			305AM								45					
Cast Iron - Ductile & Malleable CGI 60-40-18, 65-45-12, D4018, D4512, D5506, 32510, 35108, M3210, M4504, M5503, 250, 300, 350, 400, 450	K	over 240 HB	305	35												
			305AM	45												
Titanium 6Al-4V	S	up to 40 Rc	305	●		15	.010	.020	.040	.060	.075					
			305AM			20										
High Temp Alloys Inconel / Hastelloy / Waspeloy / Nickel Based Alloys-Monel	S		305		15											
			305AM		20											

Recommended Peck Depths by Diameter*

Diameter	Peck Depth
0.5 mm	.2 x Diameter
1.0 mm	.4 x Diameter
1.5 mm	.6 x Diameter
2.0 mm	.8 x Diameter
2.5 mm	1.0 x Diameter
3.0 mm	1.2 x Diameter

*Peck depths can vary by material type.

Technical data provided should be considered advisory only as variations may be necessary depending on the particular application.

Twister® HP

Recommended Cutting Data 207CE - Inch

Workpiece Material Group	I S O	Tool Series	T Y P E	D E P T H	Speed - (SFM) Surface Feed Per minute	Drill Diameter			
						1/8	1/4	3/8	1/2
						Feed - (IPR) Inch per Rev			
Plastics	N	207CE	●	3	330	.002	.004	.005	.006
Kevlar/Graphite	N			3	420	.002	.004	.005	.006

Recommended Cutting Data 207CE - Metric

Workpiece Material Group	I S O	Tool Series	T Y P E	D E P T H	Speed Vc- (m/min) Meters Per minute	Drill Diameter			
						3.0	6.0	10.0	12.0
						Feed - (mm/rev) millimeters per Rev			
Plastics	N	207CE	●	3	100	.05	.10	.13	.15
Kevlar/Graphite	N			3	125	.05	.10	.13	.15



Technical data provided should be considered advisory only as variations may be necessary depending on the particular application.

TuffCut®

High Performance End Mills

TuffCut® XT

Series 277.....	81-85
NEW Series 277W.....	81-85
Series 277N.....	86-88
Series 278.....	89-99 NEW SIZES
NEW Series 278W.....	89-99
Series 278N.....	100-101
Series 279.....	102

TuffCut® XR7

Series 180.....	103-105
Series 180N.....	107

TuffCut® XR

Series 177.....	108-112
NEW Series 177W.....	108-112
Series 177L.....	113
Series 177S.....	114
Series 178.....	115-117
NEW Series 178W.....	115-117
Series 178N.....	118
Series 179.....	119
Series 179L.....	120

TuffCut® X-AL

Series 138CE.....	121-122
-------------------	---------

TuffCut® DM

Series 156.....	123-126
Series 158.....	127
Series 157.....	128-130



ADVANCED TECHNOLOGY

End Mills

TuffCut®

High Performance End Mills

M.A. Ford® TuffCut® End Mills perform better and last significantly longer than competitive products, minimizing process downtime and maximizing productivity and cost efficiency. Included in our product line are high performance end mills developed for specific applications such as stainless steels and high temperature alloys, hardened steel, titanium, composite material, and aluminum and softer alloys.

New to the TuffCut® End Mill family are series 277, 277N, 278 and 278N - TuffCut® XT, and series 138CE - TuffCut® X-AL. The XT series consists of 4 & 5 flute end mills that feature improved geometries and enhanced corner protection that allows slotting at 1X diameter deep and higher feed rates over similar end mills. Coated with ALtima® Blaze, it is perfect for applications in high temperature alloys and titanium. Furthermore, we have created a standard offering of the 138 series that is coated with the new Advanced Product Group Coating CERAedge®, the 138CE series.

Benefits of M.A. Ford® End Mill products and support include:

- Thousands of end mills in stock.
- Aggressive speeds and feeds to maximize metal removal rates.
- Standard, Stub, Long and Extended Reach Lengths are available.
- Solid Carbide Tools are easy to re-sharpen for maximum life.
- ALtima®, ALtima® Plus, ALtima® 52, ALtima® Blaze, ALtima® Micro, TiN, TiCN, Fordlude, GemX and CERAedge® coatings are available. See page 188 for more information on available coatings.
- U.S. Designed and Manufactured.



ISO 9001:2008 Certified



Where High Performance is the Standard®

NEW TuffCut® XT Series 277/277W



New-Standard Offering with Weldon Shank Flats

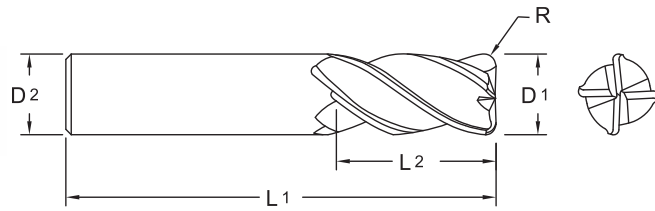

- Improved geometries.
- Enhanced corner protection.

ALtima® Blaze		ALtima® Blaze Weldon Flat		Diameter			Shank		OAL		Flute Length		Corner Radius	
Tool No.	EDP	Tool No.	EDP	D1			D2 h6		L1		L2		R	
				Inch	mm	Decimal	Inch	mm	Inch	mm	Inch	mm	Inch	mm
277 0300B	27700				3.0	.1181		6.0		57.0		8.0		
277 0300-0.25RB	27701				3.0	.1181		6.0		57.0		8.0		0.25
27712500B	18700			1/8		.1250	1/8		1-1/2		1/8			
27712502B	18701			1/8		.1250	1/8		1-1/2		1/8		.015	
27712510B	18702			1/8		.1250	1/8		1-1/2		3/8			
27712512B	18703			1/8		.1250	1/8		1-1/2		3/8		.015	
277L1250B	18704			1/8		.1250	1/8		1-1/2		1/2			
277L1252B	18705			1/8		.1250	1/8		1-1/2		1/2		.015	
277 0400B	27702				4.0	.1575		6.0		57.0		11.0		
277 0400-0.25RB	27703				4.0	.1575		6.0		57.0		11.0		0.25
27718700B	18710			3/16		.1875	3/16		2		3/16			
27718702B	18711			3/16		.1875	3/16		2		3/16		.015	
27718704B	18712			3/16		.1875	3/16		2		3/16		.030	
27718710B	18713			3/16		.1875	3/16		2		7/16			
27718712B	18714			3/16		.1875	3/16		2		7/16		.015	
27718714B	18715			3/16		.1875	3/16		2		7/16		.030	
277L1870B	18716			3/16		.1875	3/16		2-1/2		3/4			
277L1872B	18717			3/16		.1875	3/16		2-1/2		3/4		.015	
277L1874B	18718			3/16		.1875	3/16		2-1/2		3/4		.030	
277 0500B	27704				5.0	.1968		6.0		57.0		13.0		
277 0500-0.25RB	27705				5.0	.1968		6.0		57.0		13.0		0.25
277 0600B	27706				6.0	.2362		6.0		57.0		13.0		
277 0600-0.25RB	27707				6.0	.2362		6.0		57.0		13.0		0.25
27725000B	18725			1/4		.2500	1/4		2		3/8			
27725002B	18726			1/4		.2500	1/4		2		3/8		.015	
27725004B	18727			1/4		.2500	1/4		2		3/8		.030	
27725010B	18728			1/4		.2500	1/4		2-1/2		3/4			
27725012B	18729			1/4		.2500	1/4		2-1/2		3/4		.015	

Inch	
D1	Tolerance
1/8-1/4	+0.000/-0.002
>1/4-1	+0.000/-0.003

Metric (mm)	
D1	Tolerance (h10)
3.00	+0.000/-0.040
>3.00-6.00	+0.000/-0.048
>6.00-10.00	+0.000/-0.058
>10.00-18.00	+0.000/-0.070
>18.00-20.00	+0.000/-0.084

Inch	
D2	Tolerance (h6)
.1182 - .2362	+0/-0.00031
.2363 - .3937	+0/-0.00035
.3938 - .7087	+0/-0.00043
.7088 - 1.000	+0/-0.00051

Metric (mm)	
D2	Tolerance (h6)
6.0	+0/-0.008
6.01 - 10.0	+0/-0.009
10.01 - 18.0	+0/-0.011
18.01 - 20.0	+0/-0.013



Series 277/277W Continued



4
Flute

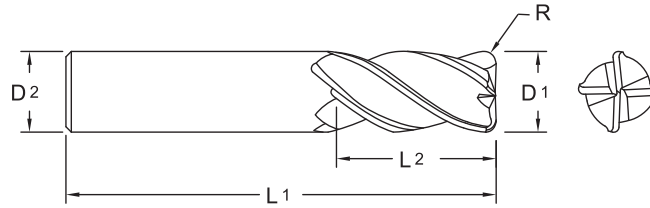

ALtima® Blaze		ALtima® Blaze Weldon Flat		Diameter			Shank		OAL		Flute Length		Corner Radius	
Tool No.	EDP	Tool No.	EDP	D1			D2 h6		L1		L2		R	
				Inch	mm	Decimal	Inch	mm	Inch	mm	Inch	mm	Inch	mm
27725014B	18730			1/4		.2500	1/4		2-1/2		3/4		.030	
277L2500B	18731			1/4		.2500	1/4		3		1-1/4			
277L2502B	18732			1/4		.2500	1/4		3		1-1/4		.015	
277L2504B	18733			1/4		.2500	1/4		3		1-1/4		.030	
277X2500B	18734			1/4		.2500	1/4		4		1-3/4			
277X2502B	18735			1/4		.2500	1/4		4		1-3/4		.015	
277X2504B	18736			1/4		.2500	1/4		4		1-3/4		.030	
27731200B	18740			5/16		.3125	5/16		2		7/16			
27731202B	18741			5/16		.3125	5/16		2		7/16		.015	
27731204B	18742			5/16		.3125	5/16		2		7/16		.030	
27731206B	18743			5/16		.3125	5/16		2		7/16		.060	
27731210B	18744			5/16		.3125	5/16		2-1/2		13/16			
27731212B	18745			5/16		.3125	5/16		2-1/2		13/16		.015	
27731214B	18746			5/16		.3125	5/16		2-1/2		13/16		.030	
27731216B	18747			5/16		.3125	5/16		2-1/2		13/16		.060	
277L3120B	18748			5/16		.3125	5/16		3		1-1/4			
277L3122B	18749			5/16		.3125	5/16		3		1-1/4		.015	
277L3124B	18750			5/16		.3125	5/16		3		1-1/4		.030	
277L3126B	18751			5/16		.3125	5/16		3		1-1/4		.060	
277X3120B	18752			5/16		.3125	5/16		4		1-3/4			
277X3122B	18753			5/16		.3125	5/16		4		1-3/4		.015	
277X3124B	18754			5/16		.3125	5/16		4		1-3/4		.030	
277X3126B	18755			5/16		.3125	5/16		4		1-3/4		.060	
277 0800B	27708				8.0	.3150		8.0		63.0		19.0		
277 0800-0.80RB	27709				8.0	.3150		8.0		63.0		19.0		0.80
27737500B	18759			3/8		.3750	3/8		2		1/2			
27737502B	18760			3/8		.3750	3/8		2		1/2		.015	
27737504B	18761			3/8		.3750	3/8		2		1/2		.030	
27737506B	18762			3/8		.3750	3/8		2		1/2		.060	
27737510B	18763			3/8		.3750	3/8		2-1/2		7/8			
27737512B	18764			3/8		.3750	3/8		2-1/2		7/8		.015	
27737514B	18765			3/8		.3750	3/8		2-1/2		7/8		.030	
27737516B	18766			3/8		.3750	3/8		2-1/2		7/8		.060	
27737520B	14498			3/8		.3750	3/8		3		1-1/4			
27737522B	14499			3/8		.3750	3/8		3		1-1/4		.015	
27737524B	14500			3/8		.3750	3/8		3		1-1/4		.030	

Series 277/277W Continued



ALtima® Blaze		ALtima® Blaze Weldon Flat		Diameter			Shank		OAL		Flute Length		Corner Radius	
Tool No.	EDP	Tool No.	EDP	D1			D2 h6		L1		L2		R	
				Inch	mm	Decimal	Inch	mm	Inch	mm	Inch	mm	Inch	mm
27737526B	14503			3/8		.3750	3/8		3		1-1/4		.060	
277L3750B	18767			3/8		.3750	3/8		4		1-1/2			
277L3752B	18768			3/8		.3750	3/8		4		1-1/2		.015	
277L3754B	18769			3/8		.3750	3/8		4		1-1/2		.030	
277L3756B	18770			3/8		.3750	3/8		4		1-1/2		.060	
277X3750B	18771			3/8		.3750	3/8		4		2-1/2			
277X3752B	18772			3/8		.3750	3/8		4		2-1/2		.015	
277X3754B	18773			3/8		.3750	3/8		4		2-1/2		.030	
277X3756B	18774			3/8		.3750	3/8		4		2-1/2		.060	
277 1000B	27710				10.0	.3937		10.0		72.0		22.0		
277 1000-0.80RB	27711				10.0	.3937		10.0		72.0		22.0		0.80
27743700B	18778			7/16		.4375	7/16		2-1/2		1/2			
27743702B	18779			7/16		.4375	7/16		2-1/2		1/2		.015	
27743704B	18780			7/16		.4375	7/16		2-1/2		1/2		.030	
27743710B	18781			7/16		.4375	7/16		2-3/4		1			
27743712B	18782			7/16		.4375	7/16		2-3/4		1		.015	
27743714B	18783			7/16		.4375	7/16		2-3/4		1		.030	
277L4370B	18784			7/16		.4375	7/16		4		2			
277L4372B	18785			7/16		.4375	7/16		4		2		.015	
277L4374B	18786			7/16		.4375	7/16		4		2		.030	
277 1200B	27712				12.0	.4724		12.0		83.0		26.0		
277 1200-0.80RB	27713				12.0	.4724		12.0		83.0		26.0		0.80
277 1200-3.00RB	27714				12.0	.4724		12.0		83.0		26.0		3.00
27750000B	18787	27750000BW	13269	1/2		.5000	1/2		2-1/2		5/8			
27750002B	18788	27750002BW	13270	1/2		.5000	1/2		2-1/2		5/8		.015	
27750004B	18789	27750004BW	13271	1/2		.5000	1/2		2-1/2		5/8		.030	
27750006B	18790	27750006BW	13272	1/2		.5000	1/2		2-1/2		5/8		.060	
27750010B	18791	27750010BW	13273	1/2		.5000	1/2		3		1			
27750012B	18792	27750012BW	13274	1/2		.5000	1/2		3		1		.015	
27750014B	18793	27750014BW	13275	1/2		.5000	1/2		3		1		.030	
27750015B	18811	27750015BW	13276	1/2		.5000	1/2		3		1		.045	
27750016B	18794	27750016BW	13277	1/2		.5000	1/2		3		1		.060	
27750017B	18795	27750017BW	13278	1/2		.5000	1/2		3		1		.090	
27750018B	18796	27750018BW	13279	1/2		.5000	1/2		3		1		.120	
27750020B	18797	27750020BW	13280	1/2		.5000	1/2		3		1-1/4			
27750022B	18798	27750022BW	13281	1/2		.5000	1/2		3		1-1/4		.015	
27750024B	18799	27750024BW	13282	1/2		.5000	1/2		3		1-1/4		.030	
27750026B	18800	27750026BW	13283	1/2		.5000	1/2		3		1-1/4		.060	
27750027B	18801	27750027BW	13284	1/2		.5000	1/2		3		1-1/4		.090	
27750028B	18802	27750028BW	13285	1/2		.5000	1/2		3		1-1/4		.120	
277L5000B	18803	277L5000BW	13286	1/2		.5000	1/2		4		2			
277L5002B	18804	277L5002BW	13287	1/2		.5000	1/2		4		2		.015	
277L5004B	18805	277L5004BW	13288	1/2		.5000	1/2		4		2		.030	
277L5006B	18806	277L5006BW	13289	1/2		.5000	1/2		4		2		.060	
277X5000B	18807	277X5000BW	13290	1/2		.5000	1/2		5		3			
277X5002B	18808	277X5002BW	13291	1/2		.5000	1/2		5		3		.015	

End Mills



Series 277/277W Continued



4
Flute

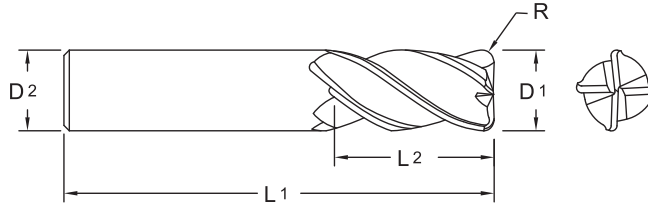

ALtima® Blaze		ALtima® Blaze Weldon Flat		Diameter			Shank		OAL	Flute Length		Corner Radius		
Tool No.	EDP	Tool No.	EDP	D1			D2 h6		L1	L2		R		
				Inch	mm	Decimal	Inch	mm	Inch	mm	Inch	mm	Inch	mm
277X5004B	18809	277X5004BW	13292	1/2		.5000	1/2		5		3		.030	
277X5006B	18810	277X5006BW	13293	1/2		.5000	1/2		5		3		.060	
27762500B	18814	27762500BW	13294	5/8		.6250	5/8		3		3/4			
27762502B	18815	27762502BW	13295	5/8		.6250	5/8		3		3/4		.015	
27762504B	18816	27762504BW	13296	5/8		.6250	5/8		3		3/4		.030	
27762506B	18817	27762506BW	13297	5/8		.6250	5/8		3		3/4		.060	
27762510B	18818	27762510BW	13298	5/8		.6250	5/8		3-1/2		1-1/4			
27762512B	18819	27762512BW	13299	5/8		.6250	5/8		3-1/2		1-1/4		.015	
27762514B	18820	27762514BW	14141	5/8		.6250	5/8		3-1/2		1-1/4		.030	
27762516B	18821	27762516BW	14142	5/8		.6250	5/8		3-1/2		1-1/4		.060	
27762517B	18822	27762517BW	14143	5/8		.6250	5/8		3-1/2		1-1/4		.090	
27762518B	18823	27762518BW	14144	5/8		.6250	5/8		3-1/2		1-1/4		.120	
277L6250B	18824	277L6250BW	14145	5/8		.6250	5/8		5		2-1/4			
277L6252B	18825	277L6252BW	14146	5/8		.6250	5/8		5		2-1/4		.015	
277L6254B	18826	277L6254BW	14147	5/8		.6250	5/8		5		2-1/4		.030	
277L6256B	18827	277L6256BW	14148	5/8		.6250	5/8		5		2-1/4		.060	
277X6250B	18828	277X6250BW	14149	5/8		.6250	5/8		6		3			
277X6252B	18829	277X6252BW	14150	5/8		.6250	5/8		6		3		.015	
277X6254B	18830	277X6254BW	14151	5/8		.6250	5/8		6		3		.030	
277X6256B	18831	277X6256BW	14152	5/8		.6250	5/8		6		3		.060	
277 1600B	27715				16.0	.6299		16.0		92.0		32.0		
277 1600-0.80RB	27716				16.0	.6299		16.0		92.0		32.0		0.80
27775000B	18832	27775000BW	14153	3/4		.7500	3/4		3		1			
27775002B	18833	27775002BW	14154	3/4		.7500	3/4		3		1		.015	
27775004B	18834	27775004BW	14155	3/4		.7500	3/4		3		1		.030	
27775006B	18835	27775006BW	14156	3/4		.7500	3/4		3		1		.060	
27775010B	18836	27775010BW	14157	3/4		.7500	3/4		4		1-5/8			
27775012B	18837	27775012BW	14158	3/4		.7500	3/4		4		1-5/8		.015	
27775014B	18838	27775014BW	14159	3/4		.7500	3/4		4		1-5/8		.030	
27775016B	18839	27775016BW	14160	3/4		.7500	3/4		4		1-5/8		.060	
27775017B	18840	27775017BW	14161	3/4		.7500	3/4		4		1-5/8		.090	
27775018B	18841	27775018BW	14162	3/4		.7500	3/4		4		1-5/8		.120	
27775019B	18842	27775019BW	14163	3/4		.7500	3/4		4		1-5/8		.190	
27775020B	18843	27775020BW	14164	3/4		.7500	3/4		4		1-5/8		.250	
277L7500B	18844	277L7500BW	14165	3/4		.7500	3/4		5		2-1/4			
277L7502B	18845	277L7502BW	14166	3/4		.7500	3/4		5		2-1/4		.015	

Series 277/277W Continued

ALtima® Blaze		ALtima® Blaze Weldon Flat		Diameter			Shank		OAL		Flute Length		Corner Radius	
Tool No.	EDP	Tool No.	EDP	D1			D2 h6		L1		L2		R	
				Inch	mm	Decimal	Inch	mm	Inch	mm	Inch	mm	Inch	mm
277L7504B	18846	277L7504BW	14167	3/4		.7500	3/4		5		2-1/4		.030	
277L7506B	18847	277L7506BW	14168	3/4		.7500	3/4		5		2-1/4		.060	
277X7500B	18848	277X7500BW	14169	3/4		.7500	3/4		6		3			
277X7502B	18849	277X7502BW	14170	3/4		.7500	3/4		6		3		.015	
277X7504B	18850	277X7504BW	14171	3/4		.7500	3/4		6		3		.030	
277X7506B	18851	277X7506BW	14172	3/4		.7500	3/4		6		3		.060	
277XX750B	18852	277XX750BW	14173	3/4		.7500	3/4		7		4-1/8			
277XX754B	18853	277XX754BW	14174	3/4		.7500	3/4		7		4-1/8		.030	
277XX756B	18854	277XX756BW	14175	3/4		.7500	3/4		7		4-1/8		.060	
277 2000B	27717				20.0	.7874		20.0		104.0		38.0		
277 2000-0.80RB	27718				20.0	.7874		20.0		104.0		38.0		0.80
27710010B	18859	27710010BW	14176	1		1.0000	1		4		1-1/2			
27710012B	18860	27710012BW	14177	1		1.0000	1		4		1-1/2		.015	
27710014B	18861	27710014BW	14178	1		1.0000	1		4		1-1/2		.030	
27710016B	18862	27710016BW	14179	1		1.0000	1		4		1-1/2		.060	
27710017B	18863	27710017BW	14180	1		1.0000	1		4		1-1/2		.090	
27710018B	18864	27710018BW	14181	1		1.0000	1		4		1-1/2		.120	
27710019B	18865	27710019BW	14182	1		1.0000	1		4		1-1/2		.190	
27710020B	18866	27710020BW	14183	1		1.0000	1		4		1-1/2		.250	
277L1000B	18867	277L1000BW	14184	1		1.0000	1		5		2-1/4			
277L1002B	18868	277L1002BW	14185	1		1.0000	1		5		2-1/4		.015	
277L1004B	18869	277L1004BW	14186	1		1.0000	1		5		2-1/4		.030	
277L1006B	18870	277L1006BW	14187	1		1.0000	1		5		2-1/4		.060	
277X1000B	18871	277X1000BW	14188	1		1.0000	1		6		3			
277X1002B	18872	277X1002BW	14189	1		1.0000	1		6		3		.015	
277X1004B	18873	277X1004BW	14190	1		1.0000	1		6		3		.030	
277X1006B	18874	277X1006BW	14191	1		1.0000	1		6		3		.060	
277XX100B	18875	277XX100BW	14192	1		1.0000	1		7		4-1/8			
277XX104B	18876	277XX104BW	14193	1		1.0000	1		7		4-1/8		.030	
277XX106B	18877	277XX106BW	14194	1		1.0000	1		7		4-1/8		.060	

4
Flute

End Mills



TECH
Page 142

TuffCut® XT Series 277N



4
Flute



- Improved geometries.
- Enhanced corner protection.

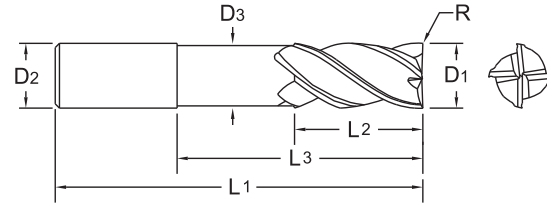

ALtima® Blaze		Diameter		Shank	Neck Diameter	OAL	Flute	Neck Length	Corner Radius	Neck/Diameter Ratio
Tool No.	EDP	D1	Decimal	D2 h6	D3	L1	L2	L3	R	L3/D1
27712500N3B	27720	1/8	.1250	1/8	.115	3	3/16	3/8		3
27712502N3B	27721	1/8	.1250	1/8	.115	3	3/16	3/8	.015	3
27712500N5B	27722	1/8	.1250	1/8	.115	3	3/16	5/8		5
27712502N5B	27723	1/8	.1250	1/8	.115	3	3/16	5/8	.015	5
27718700N3B	27724	3/16	.1875	3/16	.177	3	1/4	9/16		3
27718702N3B	27725	3/16	.1875	3/16	.177	3	1/4	9/16	.015	3
27718704N3B	27726	3/16	.1875	3/16	.177	3	1/4	9/16	.030	3
27718700N5B	27727	3/16	.1875	3/16	.177	3	1/4	15/16		5
27718702N5B	27728	3/16	.1875	3/16	.177	3	1/4	15/16	.015	5
27718704N5B	27729	3/16	.1875	3/16	.177	3	1/4	15/16	.030	5
27725000N3B	27730	1/4	.2500	1/4	.240	3	3/8	3/4		3
27725002N3B	27731	1/4	.2500	1/4	.240	3	3/8	3/4	.015	3
27725004N3B	27732	1/4	.2500	1/4	.240	3	3/8	3/4	.030	3
27725006N3B	27733	1/4	.2500	1/4	.240	3	3/8	3/4	.060	3
27725000N5B	27734	1/4	.2500	1/4	.240	4	3/8	1-1/4		5
27725002N5B	27735	1/4	.2500	1/4	.240	4	3/8	1-1/4	.015	5
27725004N5B	27736	1/4	.2500	1/4	.240	4	3/8	1-1/4	.030	5
27725006N5B	27737	1/4	.2500	1/4	.240	4	3/8	1-1/4	.060	5
27731200N3B	27738	5/16	.3125	5/16	.300	3	7/16	15/16		3
27731202N3B	27739	5/16	.3125	5/16	.300	3	7/16	15/16	.015	3
27731204N3B	27740	5/16	.3125	5/16	.300	3	7/16	15/16	.030	3
27737500N3B	27741	3/8	.3750	3/8	.360	3	1/2	1-1/8		3
27737502N3B	27742	3/8	.3750	3/8	.360	3	1/2	1-1/8	.015	3
27737504N3B	27743	3/8	.3750	3/8	.360	3	1/2	1-1/8	.030	3
27737506N3B	27744	3/8	.3750	3/8	.360	3	1/2	1-1/8	.060	3
27737500N4B	27745	3/8	.3750	3/8	.360	4	1/2	1-1/2		4
27737502N4B	27746	3/8	.3750	3/8	.360	4	1/2	1-1/2	.015	4
27737504N4B	27747	3/8	.3750	3/8	.360	4	1/2	1-1/2	.030	4
27737506N4B	27748	3/8	.3750	3/8	.360	4	1/2	1-1/2	.060	4
27737500N5B	27749	3/8	.3750	3/8	.360	4	1/2	1-7/8		5
27737502N5B	27750	3/8	.3750	3/8	.360	4	1/2	1-7/8	.015	5
27737504N5B	27751	3/8	.3750	3/8	.360	4	1/2	1-7/8	.030	5

Inch		Inch	
D1	Tolerance	D2	Tolerance (h6)
1/8-1/4	+0.000/-0.002	.1182 - .2362	+0/-0.00031
>1/4-1	+0.000/-0.003	.2363 - .3937	+0/-0.00035
		.3938 - .7087	+0/-0.00043
		.7088 - 1.000	+0/-0.00051

Series 277N Continued



ALtima® Blaze		Diameter		Shank	Neck Diameter	OAL	Flute	Neck Length	Corner Radius	Neck/Diameter Ratio
Tool No.	EDP	D1	Decimal	D2 h6	D3	L1	L2	L3	R	L3/D1
27737506N5B	27752	3/8	.3750	3/8	.360	4	1/2	1-7/8	.060	5
27750000N3B	27753	1/2	.5000	1/2	.480	4	5/8	1-1/2		3
27750002N3B	27754	1/2	.5000	1/2	.480	4	5/8	1-1/2	.015	3
27750004N3B	27755	1/2	.5000	1/2	.480	4	5/8	1-1/2	.030	3
27750006N3B	27756	1/2	.5000	1/2	.480	4	5/8	1-1/2	.060	3
27750007N3B	27757	1/2	.5000	1/2	.480	4	5/8	1-1/2	.090	3
27750008N3B	27758	1/2	.5000	1/2	.480	4	5/8	1-1/2	.120	3
27750000N4B	27759	1/2	.5000	1/2	.480	5	5/8	2		4
27750002N4B	27760	1/2	.5000	1/2	.480	5	5/8	2	.015	4
27750004N4B	27761	1/2	.5000	1/2	.480	5	5/8	2	.030	4
27750006N4B	27762	1/2	.5000	1/2	.480	5	5/8	2	.060	4
27750007N4B	27763	1/2	.5000	1/2	.480	5	5/8	2	.090	4
27750008N4B	27764	1/2	.5000	1/2	.480	5	5/8	2	.120	4
27750000N5B	27765	1/2	.5000	1/2	.480	6	5/8	2-1/2		5
27750002N5B	27766	1/2	.5000	1/2	.480	6	5/8	2-1/2	.015	5
27750004N5B	27767	1/2	.5000	1/2	.480	6	5/8	2-1/2	.030	5
27750006N5B	27768	1/2	.5000	1/2	.480	6	5/8	2-1/2	.060	5
27750007N5B	27769	1/2	.5000	1/2	.480	6	5/8	2-1/2	.090	5
27750008N5B	27770	1/2	.5000	1/2	.480	6	5/8	2-1/2	.120	5
27762500N3B	27771	5/8	.6250	5/8	.600	5	3/4	1-7/8		3
27762504N3B	27772	5/8	.6250	5/8	.600	5	3/4	1-7/8	.030	3
27762506N3B	27773	5/8	.6250	5/8	.600	5	3/4	1-7/8	.060	3
27762507N3B	27774	5/8	.6250	5/8	.600	5	3/4	1-7/8	.090	3
27762508N3B	27775	5/8	.6250	5/8	.600	5	3/4	1-7/8	.120	3
27762500N4B	27776	5/8	.6250	5/8	.600	5	3/4	2-1/2		4
27762504N4B	27777	5/8	.6250	5/8	.600	5	3/4	2-1/2	.030	4
27762506N4B	27778	5/8	.6250	5/8	.600	5	3/4	2-1/2	.060	4
27762507N4B	27779	5/8	.6250	5/8	.600	5	3/4	2-1/2	.090	4
27762508N4B	27780	5/8	.6250	5/8	.600	5	3/4	2-1/2	.120	4
27762500N5B	27781	5/8	.6250	5/8	.600	6	3/4	3-1/8		5
27762504N5B	27782	5/8	.6250	5/8	.600	6	3/4	3-1/8	.030	5
27762506N5B	27783	5/8	.6250	5/8	.600	6	3/4	3-1/8	.060	5
27762507N5B	27784	5/8	.6250	5/8	.600	6	3/4	3-1/8	.090	5
27762508N5B	27785	5/8	.6250	5/8	.600	6	3/4	3-1/8	.120	5
27775000N3B	27786	3/4	.7500	3/4	.720	5	1	2-1/4		3
27775004N3B	27787	3/4	.7500	3/4	.720	5	1	2-1/4	.030	3
27775006N3B	27788	3/4	.7500	3/4	.720	5	1	2-1/4	.060	3
27775007N3B	27789	3/4	.7500	3/4	.720	5	1	2-1/4	.090	3
27775008N3B	27790	3/4	.7500	3/4	.720	5	1	2-1/4	.120	3
27775009N3B	27791	3/4	.7500	3/4	.720	5	1	2-1/4	.190	3
27775012N3B	27792	3/4	.7500	3/4	.720	5	1	2-1/4	.250	3
27775000N4B	27793	3/4	.7500	3/4	.720	6	1	3		4
27775004N4B	27794	3/4	.7500	3/4	.720	6	1	3	.030	4
27775006N4B	27795	3/4	.7500	3/4	.720	6	1	3	.060	4
27775007N4B	27796	3/4	.7500	3/4	.720	6	1	3	.090	4
27775008N4B	27797	3/4	.7500	3/4	.720	6	1	3	.120	4

End Mills



Series 277N Continued



4
Flute

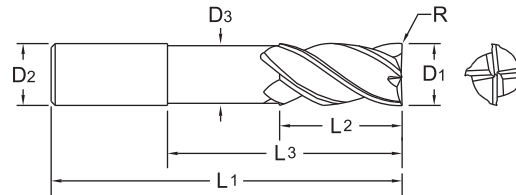

ALtima® Blaze		Diameter		Shank	Neck Diameter	OAL	Flute	Neck Length	Corner Radius	Neck/Diameter Ratio
Tool No.	EDP	D1	Decimal	D2 h6	D3	L1	L2	L3	R	L3/D1
27775009N4B	27798	3/4	.7500	3/4	.720	6	1	3	.190	4
27775012N4B	27799	3/4	.7500	3/4	.720	6	1	3	.250	4
27775000N5B	27800	3/4	.7500	3/4	.720	6	1	3-3/4		5
27775004N5B	27801	3/4	.7500	3/4	.720	6	1	3-3/4	.030	5
27775006N5B	27802	3/4	.7500	3/4	.720	6	1	3-3/4	.060	5
27775007N5B	27803	3/4	.7500	3/4	.720	6	1	3-3/4	.090	5
27775008N5B	27804	3/4	.7500	3/4	.720	6	1	3-3/4	.120	5
27775009N5B	27805	3/4	.7500	3/4	.720	6	1	3-3/4	.190	5
27775012N5B	27806	3/4	.7500	3/4	.720	6	1	3-3/4	.250	5
27710000N3B	27807	1	1.0000	1	.960	6	1-1/4	3		3
27710004N3B	27808	1	1.0000	1	.960	6	1-1/4	3	.030	3
27710006N3B	27809	1	1.0000	1	.960	6	1-1/4	3	.060	3
27710007N3B	27810	1	1.0000	1	.960	6	1-1/4	3	.090	3
27710008N3B	27811	1	1.0000	1	.960	6	1-1/4	3	.120	3
27710009N3B	27812	1	1.0000	1	.960	6	1-1/4	3	.190	3
27710012N3B	27813	1	1.0000	1	.960	6	1-1/4	3	.250	3
27710000N4B	27814	1	1.0000	1	.960	6	1-1/4	4		4
27710004N4B	27815	1	1.0000	1	.960	6	1-1/4	4	.030	4
27710006N4B	27816	1	1.0000	1	.960	6	1-1/4	4	.060	4
27710007N4B	27817	1	1.0000	1	.960	6	1-1/4	4	.090	4
27710008N4B	27818	1	1.0000	1	.960	6	1-1/4	4	.120	4
27710009N4B	27819	1	1.0000	1	.960	6	1-1/4	4	.190	4
27710012N4B	27821	1	1.0000	1	.960	6	1-1/4	4	.250	4
27710000N5B	27823	1	1.0000	1	.960	7	1-1/4	5		5
27710004N5B	27825	1	1.0000	1	.960	7	1-1/4	5	.030	5
27710006N5B	27827	1	1.0000	1	.960	7	1-1/4	5	.060	5
27710007N5B	27829	1	1.0000	1	.960	7	1-1/4	5	.090	5
27710008N5B	27831	1	1.0000	1	.960	7	1-1/4	5	.120	5
27710009N5B	27833	1	1.0000	1	.960	7	1-1/4	5	.190	5
27710012N5B	27835	1	1.0000	1	.960	7	1-1/4	5	.250	5

NEW TuffCut® XT Series 278/278W



NEW Additional sizes, lengths, corner radii, and Weldon Shank flat options

5
Flute



- Improved geometries.
- Enhanced corner protection.

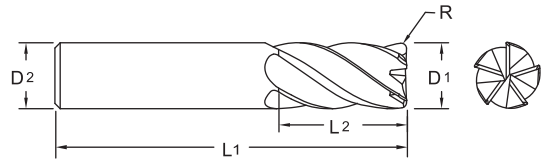

ALtima® Blaze		ALtima® Blaze Weldon Flat		Diameter		Shank	OAL	Flute Length		Corner Radius	Stock Status
Tool No.	EDP	Tool No.	EDP	D1		D2 h6	L1	L2	R		• Stocked
				Inch	Decimal	Inch	Inch	Inch	Inch		o Non-Stocked
27812500B	36992			1/8	.1250	1/8	1-1/2	1/4			•
27812502B	97002			1/8	.1250	1/8	1-1/2	1/4	.015		•
27812504B	97003			1/8	.1250	1/8	1-1/2	1/4	.030		•
27812510B	36993			1/8	.1250	1/8	1-1/2	3/8			•
27812520B	97005			1/8	.1250	1/8	1-1/2	1/2			•
27812522B	97006			1/8	.1250	1/8	1-1/2	1/2	.015		•
27812524B	97007			1/8	.1250	1/8	1-1/2	1/2	.030		•
27812530B	97009			1/8	.1250	1/8	2-1/2	3/4			o
27812532B	97010			1/8	.1250	1/8	2-1/2	3/4	.015		o
27812534B	97011			1/8	.1250	1/8	2-1/2	3/4	.030		o
27815600B	36994			5/32	.1562	3/16	2	3/16			•
27815610B	36995			5/32	.1562	3/16	2	7/16			•
27818700B	36996			3/16	.1875	3/16	2	5/16			•
27818702B	97014			3/16	.1875	3/16	2	5/16	.015		•
27818704B	97015			3/16	.1875	3/16	2	5/16	.030		•
27818710B	36997			3/16	.1875	3/16	2	7/16			•
27818720B	97017			3/16	.1875	3/16	2	9/16			•
27818722B	97018			3/16	.1875	3/16	2	9/16	.015		•
27818724B	97019			3/16	.1875	3/16	2	9/16	.030		•
27818730B	97021			3/16	.1875	3/16	2-1/2	3/4			o
27818732B	97022			3/16	.1875	3/16	2-1/2	3/4	.015		o
27818734B	97023			3/16	.1875	3/16	2-1/2	3/4	.030		o
27821800B	36998			7/32	.2187	1/4	2	1/4			•
27821810B	36999			7/32	.2187	1/4	2-1/2	7/16			•
27825000B	37000			1/4	.2500	1/4	2	3/8			•
27825002B	37001			1/4	.2500	1/4	2	3/8	.015		•
27825004B	37002			1/4	.2500	1/4	2	3/8	.030		•
27825006B	97028			1/4	.2500	1/4	2	3/8	.060		o

Inch	
D1	Tolerance
1/8-1/4	+0.000/-0.002
>1/4-1	+0.000/-0.003

Inch	
D2	Tolerance (h6)
.1182 - .2362	+0/-0.00031
.2363 - .3937	+0/-0.00035
.3938 - .7087	+0/-0.00043
.7088 - 1.000	+0/-0.00051



End Mills

Series 278/278W Continued



5
Flute

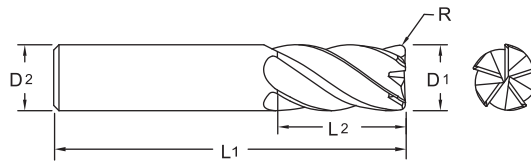

ALtima® Blaze		ALtima® Blaze Weldon Flat		Diameter		Shank	OAL	Flute Length		Corner Radius	Stock Status
Tool No.	EDP	Tool No.	EDP	Inch	Decimal	Inch	Inch	Inch	Inch	Inch	• Stocked ○ Non-Stocked
27825007B	97029			1/4	.2500	1/4	2	3/8	.090		○
27825010B	37003			1/4	.2500	1/4	2-1/2	3/4			•
27825012B	37004			1/4	.2500	1/4	2-1/2	3/4	.015		•
27825014B	37005			1/4	.2500	1/4	2-1/2	3/4	.030		•
27825016B	97052			1/4	.2500	1/4	2-1/2	3/4	.060		○
27825017B	97053			1/4	.2500	1/4	2-1/2	3/4	.090		○
278L25000B	37006			1/4	.2500	1/4	3	1-1/4			•
278L25002B	37007			1/4	.2500	1/4	3	1-1/4	.015		•
278L25004B	37008			1/4	.2500	1/4	3	1-1/4	.030		•
278L25006B	97058			1/4	.2500	1/4	3	1-1/4	.060		○
278L25007B	97059			1/4	.2500	1/4	3	1-1/4	.090		○
278X25000B	37009			1/4	.2500	1/4	4	1-3/4			•
278X25002B	37010			1/4	.2500	1/4	4	1-3/4	.015		•
278X25004B	37075			1/4	.2500	1/4	4	1-3/4	.030		•
27831200B	97061			5/16	.3125	5/16	2	7/16			○
27831202B	97062			5/16	.3125	5/16	2	7/16	.015		○
27831204B	97063			5/16	.3125	5/16	2	7/16	.030		○
27831206B	97064			5/16	.3125	5/16	2	7/16	.060		○
27831207B	97065			5/16	.3125	5/16	2	7/16	.090		○
27831210B	97067			5/16	.3125	5/16	2-1/2	13/16			○
27831212B	97068			5/16	.3125	5/16	2-1/2	13/16	.015		○
27831214B	97069			5/16	.3125	5/16	2-1/2	13/16	.030		○
27831216B	97070			5/16	.3125	5/16	2-1/2	13/16	.060		○
27831217B	97071			5/16	.3125	5/16	2-1/2	13/16	.090		○
27831220B	97073			5/16	.3125	5/16	3	1-1/4			○
27831222B	97074			5/16	.3125	5/16	3	1-1/4	.015		○
27831224B	97075			5/16	.3125	5/16	3	1-1/4	.030		○
27831226B	97076			5/16	.3125	5/16	3	1-1/4	.060		○
27831227B	97077			5/16	.3125	5/16	3	1-1/4	.090		○
27831230B	97079			5/16	.3125	5/16	4	2-1/8			○
27831232B	97080			5/16	.3125	5/16	4	2-1/8	.015		○
27831234B	97081			5/16	.3125	5/16	4	2-1/8	.030		○
27831236B	97082			5/16	.3125	5/16	4	2-1/8	.060		○
27831237B	97083			5/16	.3125	5/16	4	2-1/8	.090		○
27837500B	37013			3/8	.3750	3/8	2-1/2	1/2			•
27837502B	37014			3/8	.3750	3/8	2-1/2	1/2	.015		•

Series 278/278W Continued

ALtima® Blaze		ALtima® Blaze Weldon Flat		Diameter		Shank	OAL	Flute Length		Corner Radius	Stock Status
Tool No.	EDP	Tool No.	EDP	D1		D2 h6	L1	L2	R	• Stocked	
				Inch	Decimal	Inch	Inch	Inch	Inch	o Non-Stocked	
27837504B	37015			3/8	.3750	3/8	2-1/2	1/2	.030	•	
27837506B	97088			3/8	.3750	3/8	2-1/2	1/2	.060	o	
27837507B	97089			3/8	.3750	3/8	2-1/2	1/2	.090	o	
27837508B	97090			3/8	.3750	3/8	2-1/2	1/2	.120	o	
278375011B	97091			3/8	.3750	3/8	2-1/2	1/2	.156	o	
27837510B	37016			3/8	.3750	3/8	2-1/2	1		•	
27837512B	37017			3/8	.3750	3/8	2-1/2	1	.015	•	
27837514B	37018			3/8	.3750	3/8	2-1/2	1	.030	•	
27837516B	97136			3/8	.3750	3/8	2-1/2	1	.060	o	
27837517B	97137			3/8	.3750	3/8	2-1/2	1	.090	o	
27837518B	97138			3/8	.3750	3/8	2-1/2	1	.120	o	
278375111B	97139			3/8	.3750	3/8	2-1/2	1	.156	o	
27837520B	97141			3/8	.3750	3/8	3	1-1/4		•	
27837522B	97142			3/8	.3750	3/8	3	1-1/4	.015	•	
27837524B	97143			3/8	.3750	3/8	3	1-1/4	.030	•	
27837526B	97144			3/8	.3750	3/8	3	1-1/4	.060	•	
27837527B	97145			3/8	.3750	3/8	3	1-1/4	.090	o	
27837528B	97146			3/8	.3750	3/8	3	1-1/4	.120	o	
278375211B	97147			3/8	.3750	3/8	3	1-1/4	.156	o	
27837530B	97149			3/8	.3750	3/8	3-1/2	1-5/8		o	
27837532B	97150			3/8	.3750	3/8	3-1/2	1-5/8	.015	o	
27837534B	97151			3/8	.3750	3/8	3-1/2	1-5/8	.030	o	
27837536B	97152			3/8	.3750	3/8	3-1/2	1-5/8	.060	o	
27837537B	97153			3/8	.3750	3/8	3-1/2	1-5/8	.090	o	
27837538B	97154			3/8	.3750	3/8	3-1/2	1-5/8	.120	o	
278375311B	97155			3/8	.3750	3/8	3-1/2	1-5/8	.156	o	
27837540B	97165			3/8	.3750	3/8	6	1-5/8		o	
27837542B	97166			3/8	.3750	3/8	6	1-5/8	.015	o	
27837544B	97167			3/8	.3750	3/8	6	1-5/8	.030	o	
27837546B	97168			3/8	.3750	3/8	6	1-5/8	.060	o	
27837547B	97169			3/8	.3750	3/8	6	1-5/8	.090	o	
27837548B	97170			3/8	.3750	3/8	6	1-5/8	.120	o	
278375411B	97171			3/8	.3750	3/8	6	1-5/8	.156	o	
27837550B	97173			3/8	.3750	3/8	4	2		o	
27837552B	97174			3/8	.3750	3/8	4	2	.015	o	
27837554B	97175			3/8	.3750	3/8	4	2	.030	o	
27837556B	97176			3/8	.3750	3/8	4	2	.060	o	
27837557B	97177			3/8	.3750	3/8	4	2	.090	o	
27837558B	97178			3/8	.3750	3/8	4	2	.120	o	
278375511B	97179			3/8	.3750	3/8	4	2	.156	o	
27837560B	97181			3/8	.3750	3/8	6	2-1/2		o	
27837562B	97182			3/8	.3750	3/8	6	2-1/2	.015	o	
27837564B	97183			3/8	.3750	3/8	6	2-1/2	.030	o	
27837566B	97184			3/8	.3750	3/8	6	2-1/2	.060	o	
27837567B	97185			3/8	.3750	3/8	6	2-1/2	.090	o	
27837568B	97186			3/8	.3750	3/8	6	2-1/2	.120	o	

End Mills



Series 278/278W Continued



5
Flute

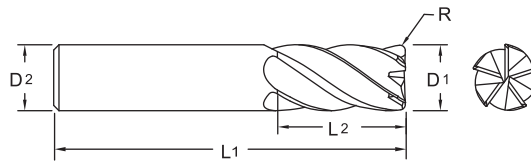

ALtima® Blaze		ALtima® Blaze Weldon Flat		Diameter		Shank	OAL	Flute Length		Corner Radius	Stock Status
Tool No.	EDP	Tool No.	EDP	Inch	Decimal	Inch	Inch	Inch	Inch	Inch	• Stocked
				D1		D2 h6	L1	L2	R	○ Non-Stocked	
278375611B	97187			3/8	.3750	3/8	6	2-1/2	.156	○	
278L37500B	37019			3/8	.3750	3/8	4	1-5/8		•	
278L37502B	37020			3/8	.3750	3/8	4	1-5/8	.015	•	
278L37504B	37076			3/8	.3750	3/8	4	1-5/8	.030	•	
278L37506B	97160			3/8	.3750	3/8	4	1-5/8	.060	○	
278L37507B	97161			3/8	.3750	3/8	4	1-5/8	.090	○	
278L37508B	97162			3/8	.3750	3/8	4	1-5/8	.120	○	
278L375011B	97163			3/8	.3750	3/8	4	1-5/8	.156	○	
278X37500B	37021			3/8	.3750	3/8	4	2-1/2		•	
278X37502B	37022			3/8	.3750	3/8	4	2-1/2	.015	•	
278X37504B	37077			3/8	.3750	3/8	4	2-1/2	.030	•	
27843700B	97189			7/16	.4375	7/16	2-1/2	5/8		○	
27843702B	97190			7/16	.4375	7/16	2-1/2	5/8	.015	○	
27843704B	97191			7/16	.4375	7/16	2-1/2	5/8	.030	○	
27843706B	97192			7/16	.4375	7/16	2-1/2	5/8	.060	○	
27843707B	97193			7/16	.4375	7/16	2-1/2	5/8	.090	○	
27843708B	97194			7/16	.4375	7/16	2-1/2	5/8	.120	○	
278437011B	97195			7/16	.4375	7/16	2-1/2	5/8	.156	○	
27843710B	97197			7/16	.4375	7/16	2-3/4	1		○	
27843712B	97198			7/16	.4375	7/16	2-3/4	1	.015	○	
27843714B	97199			7/16	.4375	7/16	2-3/4	1	.030	○	
27843716B	97200			7/16	.4375	7/16	2-3/4	1	.060	○	
27843717B	97201			7/16	.4375	7/16	2-3/4	1	.090	○	
27843718B	97202			7/16	.4375	7/16	2-3/4	1	.120	○	
278437111B	97203			7/16	.4375	7/16	2-3/4	1	.156	○	
27843720B	97205			7/16	.4375	7/16	4	2		○	
27843722B	97206			7/16	.4375	7/16	4	2	.015	○	
27843724B	97207			7/16	.4375	7/16	4	2	.030	○	
27843726B	97208			7/16	.4375	7/16	4	2	.060	○	
27843727B	97209			7/16	.4375	7/16	4	2	.090	○	
27843728B	97210			7/16	.4375	7/16	4	2	.120	○	
278437211B	97211			7/16	.4375	7/16	4	2	.156	○	
27850000B	37025	27850000BW	13528	1/2	.5000	1/2	3	5/8		•	
27850002B	37026	27850002BW	13529	1/2	.5000	1/2	3	5/8	.015	•	
27850004B	37027	27850004BW	13550	1/2	.5000	1/2	3	5/8	.030	•	
27850006B	97216			1/2	.5000	1/2	3	5/8	.060	•	



Series 278/278W Continued

ALtima® Blaze		ALtima® Blaze Weldon Flat		Diameter		Shank	OAL	Flute Length	Corner Radius	Stock Status
Tool No.	EDP	Tool No.	EDP	D1		D2 h6	L1	L2	R	• Stocked
				Inch	Decimal	Inch	Inch	Inch	Inch	o Non-Stocked
27850007B	97217			1/2	.5000	1/2	3	5/8	.090	•
27850008B	97218			1/2	.5000	1/2	3	5/8	.120	•
278500011B	97219			1/2	.5000	1/2	3	5/8	.156	o
27850009B	97220			1/2	.5000	1/2	3	5/8	.190	o
27850010B	97258			1/2	.5000	1/2	3	1		•
27850012B	97259			1/2	.5000	1/2	3	1	.015	•
27850014B	97260			1/2	.5000	1/2	3	1	.030	•
27850016B	97261			1/2	.5000	1/2	3	1	.060	•
27850017B	97262			1/2	.5000	1/2	3	1	.090	•
27850018B	97263			1/2	.5000	1/2	3	1	.120	•
278500111B	97264			1/2	.5000	1/2	3	1	.156	o
27850019B	97265			1/2	.5000	1/2	3	1	.190	o
27850020B	37028	27850020BW	13551	1/2	.5000	1/2	3	1-1/4		•
27850022B	37029	27850022BW	13579	1/2	.5000	1/2	3	1-1/4	.015	•
27850024B	37030	27850024BW	12761	1/2	.5000	1/2	3	1-1/4	.030	•
27850026B	37078	27850026BW	13584	1/2	.5000	1/2	3	1-1/4	.060	•
27850027B	97271			1/2	.5000	1/2	3	1-1/4	.090	•
27850028B	97272			1/2	.5000	1/2	3	1-1/4	.120	•
278500211B	97273			1/2	.5000	1/2	3	1-1/4	.156	o
27850029B	97274			1/2	.5000	1/2	3	1-1/4	.190	o
27850030B	97276			1/2	.5000	1/2	4	1-5/8		o
27850032B	97277			1/2	.5000	1/2	4	1-5/8	.015	o
27850034B	97278			1/2	.5000	1/2	4	1-5/8	.030	o
27850036B	97279			1/2	.5000	1/2	4	1-5/8	.060	o
27850037B	97280			1/2	.5000	1/2	4	1-5/8	.090	o
27850038B	97281			1/2	.5000	1/2	4	1-5/8	.120	o
278500311B	97282			1/2	.5000	1/2	4	1-5/8	.156	o
27850039B	97283			1/2	.5000	1/2	4	1-5/8	.190	o
27850040B	97294			1/2	.5000	1/2	4	2-1/8		o
27850042B	97295			1/2	.5000	1/2	4	2-1/8	.015	o
27850044B	97296			1/2	.5000	1/2	4	2-1/8	.030	o
27850046B	97297			1/2	.5000	1/2	4	2-1/8	.060	o
27850047B	97298			1/2	.5000	1/2	4	2-1/8	.090	o
27850048B	97299			1/2	.5000	1/2	4	2-1/8	.120	o
278500411B	97300			1/2	.5000	1/2	4	2-1/8	.156	o
27850049B	97301			1/2	.5000	1/2	4	2-1/8	.190	o
27850050B	97303			1/2	.5000	1/2	5	2-5/8		o
27850052B	97304			1/2	.5000	1/2	5	2-5/8	.015	o
27850054B	97305			1/2	.5000	1/2	5	2-5/8	.030	o
27850056B	97306			1/2	.5000	1/2	5	2-5/8	.060	o
27850057B	97307			1/2	.5000	1/2	5	2-5/8	.090	o
27850058B	97308			1/2	.5000	1/2	5	2-5/8	.120	o
278500511B	97309			1/2	.5000	1/2	5	2-5/8	.156	o
27850059B	97310			1/2	.5000	1/2	5	2-5/8	.190	o
27850060B	97285			1/2	.5000	1/2	6	1-5/8		o
27850062B	97286			1/2	.5000	1/2	6	1-5/8	.015	o



Series 278/278W Continued

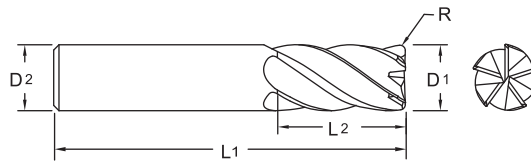

ALtima® Blaze		ALtima® Blaze Weldon Flat		Diameter		Shank	OAL	Flute Length		Corner Radius	Stock Status
Tool No.	EDP	Tool No.	EDP	Inch	Decimal	Inch	Inch	Inch	Inch	Inch	• Stocked
				D1		D2 h6	L1	L2	R	○ Non-Stocked	
27850064B	97287			1/2	.5000	1/2	6	1-5/8	.030	○	
27850066B	97288			1/2	.5000	1/2	6	1-5/8	.060	○	
27850067B	97289			1/2	.5000	1/2	6	1-5/8	.090	○	
27850068B	97290			1/2	.5000	1/2	6	1-5/8	.120	○	
278500611B	97291			1/2	.5000	1/2	6	1-5/8	.156	○	
27850069B	97292			1/2	.5000	1/2	6	1-5/8	.190	○	
27850070B	97312			1/2	.5000	1/2	6	3-1/4		○	
27850072B	97313			1/2	.5000	1/2	6	3-1/4	.015	○	
27850074B	97314			1/2	.5000	1/2	6	3-1/4	.030	○	
27850076B	97315			1/2	.5000	1/2	6	3-1/4	.060	○	
27850077B	97316			1/2	.5000	1/2	6	3-1/4	.090	○	
27850078B	97317			1/2	.5000	1/2	6	3-1/4	.120	○	
278500711B	97318			1/2	.5000	1/2	6	3-1/4	.156	○	
27850079B	97319			1/2	.5000	1/2	6	3-1/4	.190	○	
278L50000B	37031	278L50000BW	13588	1/2	.5000	1/2	4	2		•	
278L50002B	37032	278L50002BW	13589	1/2	.5000	1/2	4	2	.015	•	
278L50004B	37033	278L50004BW	13593	1/2	.5000	1/2	4	2	.030	•	
278X50000B	37034	278X50000BW	13606	1/2	.5000	1/2	5	3		•	
278X50002B	37035	278X50002BW	13607	1/2	.5000	1/2	5	3	.015	•	
278X50004B	37036	278X50004BW	13608	1/2	.5000	1/2	5	3	.030	•	
27862500B	97321			5/8	.6250	5/8	3	3/4		•	
27862502B	97322			5/8	.6250	5/8	3	3/4	.015	•	
27862504B	97323			5/8	.6250	5/8	3	3/4	.030	•	
27862506B	97324			5/8	.6250	5/8	3	3/4	.060	•	
27862507B	97325			5/8	.6250	5/8	3	3/4	.090	•	
27862508B	97326			5/8	.6250	5/8	3	3/4	.120	•	
278625011B	97327			5/8	.6250	5/8	3	3/4	.156	○	
27862509B	97328			5/8	.6250	5/8	3	3/4	.190	○	
278625012B	97329			5/8	.6250	5/8	3	3/4	.250	○	
27862510B	37039	27862510BW	13609	5/8	.6250	5/8	3-1/2	1-1/4		•	
27862512B	37040	27862512BW	13611	5/8	.6250	5/8	3-1/2	1-1/4	.015	•	
27862514B	37041	27862514BW	13612	5/8	.6250	5/8	3-1/2	1-1/4	.030	•	
27862516B	37042	27862516BW	13613	5/8	.6250	5/8	3-1/2	1-1/4	.060	•	
27862518B	37043	27862518BW	13614	5/8	.6250	5/8	3-1/2	1-1/4	.120	•	
27862520B	97361			5/8	.6250	5/8	3-1/2	1-5/8		○	
27862522B	97362			5/8	.6250	5/8	3-1/2	1-5/8	.015	○	



Series 278/278W Continued

ALtima® Blaze		ALtima® Blaze Weldon Flat		Diameter		Shank	OAL	Flute Length	Corner Radius	Stock Status
Tool No.	EDP	Tool No.	EDP	D1		D2 h6	L1	L2	R	• Stocked
				Inch	Decimal	Inch	Inch	Inch	Inch	o Non-Stocked
27862524B	97363			5/8	.6250	5/8	3-1/2	1-5/8	.030	o
27862526B	97364			5/8	.6250	5/8	3-1/2	1-5/8	.060	o
27862527B	97365			5/8	.6250	5/8	3-1/2	1-5/8	.090	o
27862528B	97366			5/8	.6250	5/8	3-1/2	1-5/8	.120	o
278625211B	97368			5/8	.6250	5/8	3-1/2	1-5/8	.156	o
27862529B	97367			5/8	.6250	5/8	3-1/2	1-5/8	.190	o
278625212B	97369			5/8	.6250	5/8	3-1/2	1-5/8	.250	o
27862530B	97371			5/8	.6250	5/8	4	2-1/8		o
27862532B	97372			5/8	.6250	5/8	4	2-1/8	.015	o
27862534B	97373			5/8	.6250	5/8	4	2-1/8	.030	o
27862536B	97374			5/8	.6250	5/8	4	2-1/8	.060	o
27862537B	97375			5/8	.6250	5/8	4	2-1/8	.090	o
27862538B	97376			5/8	.6250	5/8	4	2-1/8	.120	o
278625311B	97377			5/8	.6250	5/8	4	2-1/8	.156	o
27862539B	97378			5/8	.6250	5/8	4	2-1/8	.190	o
278625312B	97379			5/8	.6250	5/8	4	2-1/8	.250	o
27862540B	97391			5/8	.6250	5/8	5	2-5/8		o
27862542B	97392			5/8	.6250	5/8	5	2-5/8	.015	o
27862544B	97393			5/8	.6250	5/8	5	2-5/8	.030	o
27862546B	97394			5/8	.6250	5/8	5	2-5/8	.060	o
27862547B	97395			5/8	.6250	5/8	5	2-5/8	.090	o
27862548B	97396			5/8	.6250	5/8	5	2-5/8	.120	o
278625411B	97397			5/8	.6250	5/8	5	2-5/8	.156	o
27862549B	97398			5/8	.6250	5/8	5	2-5/8	.190	o
278625412B	97399			5/8	.6250	5/8	5	2-5/8	.250	o
27862550B	97381			5/8	.6250	5/8	6	2-1/8		o
27862552B	97382			5/8	.6250	5/8	6	2-1/8	.015	o
27862554B	97383			5/8	.6250	5/8	6	2-1/8	.030	o
27862556B	97384			5/8	.6250	5/8	6	2-1/8	.060	o
27862557B	97385			5/8	.6250	5/8	6	2-1/8	.090	o
27862558B	97386			5/8	.6250	5/8	6	2-1/8	.120	o
278625511B	97387			5/8	.6250	5/8	6	2-1/8	.156	o
27862559B	97388			5/8	.6250	5/8	6	2-1/8	.190	o
278625512B	97389			5/8	.6250	5/8	6	2-1/8	.250	o
27862560B	97401			5/8	.6250	5/8	6	3-1/4		o
27862562B	97402			5/8	.6250	5/8	6	3-1/4	.015	o
27862564B	97403			5/8	.6250	5/8	6	3-1/4	.030	o
27862566B	97404			5/8	.6250	5/8	6	3-1/4	.060	o
27862567B	97405			5/8	.6250	5/8	6	3-1/4	.090	o
27862568B	97406			5/8	.6250	5/8	6	3-1/4	.120	o
278625611B	97407			5/8	.6250	5/8	6	3-1/4	.156	o
27862569B	97408			5/8	.6250	5/8	6	3-1/4	.190	o
278625612B	97409			5/8	.6250	5/8	6	3-1/4	.250	o
27862570B	97411			5/8	.6250	5/8	6	4		o
27862572B	97412			5/8	.6250	5/8	6	4	.015	o
27862574B	97413			5/8	.6250	5/8	6	4	.030	o

End Mills



Series 278/278W Continued



5
Flute

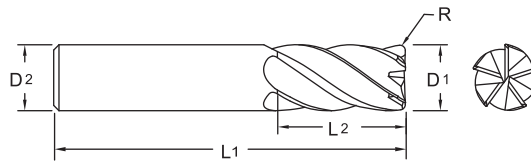

ALtima® Blaze		ALtima® Blaze Weldon Flat		Diameter		Shank	OAL	Flute Length		Corner Radius	Stock Status
Tool No.	EDP	Tool No.	EDP	Inch	Decimal	Inch	Inch	Inch	Inch	Inch	• Stocked ○ Non-Stocked
27862576B	97414			5/8	.6250	5/8	6	4	.060	o	
27862577B	97415			5/8	.6250	5/8	6	4	.090	o	
27862578B	97416			5/8	.6250	5/8	6	4	.120	o	
278625711B	97417			5/8	.6250	5/8	6	4	.156	o	
27862579B	97418			5/8	.6250	5/8	6	4	.190	o	
278625712B	97419			5/8	.6250	5/8	6	4	.250	o	
278L62500B	37044	278L62500BW	13616	5/8	.6250	5/8	5	2-1/4		•	
278L62502B	37045	278L62502BW	13617	5/8	.6250	5/8	5	2-1/4	.015	•	
278L62504B	37046	278L62504BW	13618	5/8	.6250	5/8	5	2-1/4	.030	•	
278X62500B	37047	278X62500BW	13619	5/8	.6250	5/8	6	3		•	
278X62502B	37048	278X62502BW	13621	5/8	.6250	5/8	6	3	.015	•	
278X62504B	37049	278X62504BW	13622	5/8	.6250	5/8	6	3	.030	•	
27875000B	97421			3/4	.7500	3/4	3	1		•	
27875002B	97422			3/4	.7500	3/4	3	1	.015	•	
27875004B	97423			3/4	.7500	3/4	3	1	.030	•	
27875006B	97424			3/4	.7500	3/4	3	1	.060	•	
27875007B	97425			3/4	.7500	3/4	3	1	.090	•	
27875008B	97426			3/4	.7500	3/4	3	1	.120	•	
278750011B	97427			3/4	.7500	3/4	3	1	.156	o	
27875009B	97428			3/4	.7500	3/4	3	1	.190	o	
278750012B	97429			3/4	.7500	3/4	3	1	.250	o	
27875010B	37052	27875010BW	13623	3/4	.7500	3/4	4	1-1/2		•	
27875012B	37053	27875012BW	13624	3/4	.7500	3/4	4	1-1/2	.015	•	
27875014B	37054	27875014BW	13627	3/4	.7500	3/4	4	1-1/2	.030	•	
27875016B	37055	27875016BW	13628	3/4	.7500	3/4	4	1-1/2	.060	•	
27875018B	37056	27875018BW	13629	3/4	.7500	3/4	4	1-1/2	.120	•	
27875019B	37079	27875019BW	13632	3/4	.7500	3/4	4	1 1/2	.190	•	
27875020B	97461			3/4	.7500	3/4	4	1-5/8		o	
27875022B	97462			3/4	.7500	3/4	4	1-5/8	.015	o	
27875024B	97463			3/4	.7500	3/4	4	1-5/8	.030	o	
27875026B	97464			3/4	.7500	3/4	4	1-5/8	.060	o	
27875027B	97465			3/4	.7500	3/4	4	1-5/8	.090	o	
27875028B	97466			3/4	.7500	3/4	4	1-5/8	.120	o	
278750211B	97467			3/4	.7500	3/4	4	1-5/8	.156	o	
27875029B	97468			3/4	.7500	3/4	4	1-5/8	.190	o	
278750212B	97469			3/4	.7500	3/4	4	1-5/8	.250	o	

Series 278/278W Continued

ALtima® Blaze		ALtima® Blaze Weldon Flat		Diameter		Shank	OAL	Flute Length	Corner Radius	Stock Status
Tool No.	EDP	Tool No.	EDP	D1		D2 h6	L1	L2	R	• Stocked
				Inch	Decimal	Inch	Inch	Inch	Inch	o Non-Stocked
27875030B	97471			3/4	.7500	3/4	5	2-3/8		o
27875032B	97472			3/4	.7500	3/4	5	2-3/8	.015	o
27875034B	97473			3/4	.7500	3/4	5	2-3/8	.030	o
27875036B	97474			3/4	.7500	3/4	5	2-3/8	.060	o
27875037B	97475			3/4	.7500	3/4	5	2-3/8	.090	o
27875038B	97476			3/4	.7500	3/4	5	2-3/8	.120	o
278750311B	97477			3/4	.7500	3/4	5	2-3/8	.156	o
27875039B	97478			3/4	.7500	3/4	5	2-3/8	.190	o
278750312B	97479			3/4	.7500	3/4	5	2-3/8	.250	o
27875040B	97481			3/4	.7500	3/4	6	2-3/8		o
27875042B	97482			3/4	.7500	3/4	6	2-3/8	.015	o
27875044B	97483			3/4	.7500	3/4	6	2-3/8	.030	o
27875046B	97484			3/4	.7500	3/4	6	2-3/8	.060	o
27875047B	97485			3/4	.7500	3/4	6	2-3/8	.090	o
27875048B	97486			3/4	.7500	3/4	6	2-3/8	.120	o
278750411B	97487			3/4	.7500	3/4	6	2-3/8	.156	o
27875049B	97488			3/4	.7500	3/4	6	2-3/8	.190	o
278750412B	97489			3/4	.7500	3/4	6	2-3/8	.250	o
27875050B	97491			3/4	.7500	3/4	6	3-1/4		o
27875052B	97492			3/4	.7500	3/4	6	3-1/4	.015	o
27875054B	97493			3/4	.7500	3/4	6	3-1/4	.030	o
27875056B	97494			3/4	.7500	3/4	6	3-1/4	.060	o
27875057B	97495			3/4	.7500	3/4	6	3-1/4	.090	o
27875058B	97496			3/4	.7500	3/4	6	3-1/4	.120	o
278750511B	97497			3/4	.7500	3/4	6	3-1/4	.156	o
27875059B	97498			3/4	.7500	3/4	6	3-1/4	.190	o
278750512B	97499			3/4	.7500	3/4	6	3-1/4	.250	o
27875060B	97501			3/4	.7500	3/4	7	4-1/8		o
27875062B	97502			3/4	.7500	3/4	7	4-1/8	.015	o
27875064B	97503			3/4	.7500	3/4	7	4-1/8	.030	o
27875066B	97504			3/4	.7500	3/4	7	4-1/8	.060	o
27875067B	97505			3/4	.7500	3/4	7	4-1/8	.090	o
27875068B	97506			3/4	.7500	3/4	7	4-1/8	.120	o
278750611B	97507			3/4	.7500	3/4	7	4-1/8	.156	o
27875069B	97508			3/4	.7500	3/4	7	4-1/8	.190	o
278750612B	97509			3/4	.7500	3/4	7	4-1/8	.250	o
278L75000B	37057	278L75000BW	13633	3/4	.7500	3/4	5	2-1/4		•
278L75002B	37058	278L75002BW	13634	3/4	.7500	3/4	5	2-1/4	.015	•
278L75004B	37059	278L75004BW	13636	3/4	.7500	3/4	5	2-1/4	.030	•
278X75000B	37060	278X75000BW	13637	3/4	.7500	3/4	6	3		•
278X75002B	37061	278X75002BW	13639	3/4	.7500	3/4	6	3	.015	•
278X75004B	37062	278X75004BW	13656	3/4	.7500	3/4	6	3	.030	•
27810010B	37065	27810010BW	13657	1	1.0000	1	4	1-1/2		•
27810014B	37066	27810014BW	13658	1	1.0000	1	4	1-1/2	.030	•
27810016B	37067	27810016BW	13659	1	1.0000	1	4	1-1/2	.060	•
27810018B	37068	27810018BW	13677	1	1.0000	1	4	1-1/2	.120	•

End Mills



Series 278/278W Continued



**5
Flute**

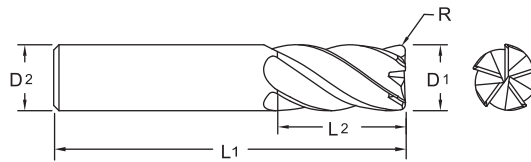

ALtima® Blaze		ALtima® Blaze Weldon Flat		Diameter		Shank	OAL	Flute Length		Corner Radius	Stock Status
Tool No.	EDP	Tool No.	EDP	Inch	Decimal	D2 h6 Inch	L1 Inch	L2 Inch	R Inch	● Stocked	○ Non-Stocked
27810019B	37080	27810019BW	14112	1	1.0000	1	4	1-1/2	.190	●	
27810020B	97555			1	1.0000	1	4	1-3/4		○	
27810022B	97556			1	1.0000	1	4	1-3/4	.015	○	
27810024B	97557			1	1.0000	1	4	1-3/4	.030	○	
27810026B	97558			1	1.0000	1	4	1-3/4	.060	○	
27810027B	97559			1	1.0000	1	4	1-3/4	.090	○	
27810028B	97560			1	1.0000	1	4	1-3/4	.120	○	
278100211B	97561			1	1.0000	1	4	1-3/4	.156	○	
27810029B	97562			1	1.0000	1	4	1-3/4	.190	○	
278100212B	97563			1	1.0000	1	4	1-3/4	.250	○	
278100213B	97564			1	1.0000	1	4	1-3/4	.375	○	
27810030B	97566			1	1.0000	1	5	2-5/8		○	
27810032B	97567			1	1.0000	1	5	2-5/8	.015	○	
27810034B	97568			1	1.0000	1	5	2-5/8	.030	○	
27810036B	97569			1	1.0000	1	5	2-5/8	.060	○	
27810037B	97570			1	1.0000	1	5	2-5/8	.090	○	
27810038B	97571			1	1.0000	1	5	2-5/8	.120	○	
278100311B	97572			1	1.0000	1	5	2-5/8	.156	○	
27810039B	97573			1	1.0000	1	5	2-5/8	.190	○	
278100312B	97574			1	1.0000	1	5	2-5/8	.250	○	
278100313B	97575			1	1.0000	1	5	2-5/8	.375	○	
27810040B	97588			1	1.0000	1	6	3-1/4		○	
27810042B	97589			1	1.0000	1	6	3-1/4	.015	○	
27810044B	97590			1	1.0000	1	6	3-1/4	.030	○	
27810046B	97591			1	1.0000	1	6	3-1/4	.060	○	
27810047B	97592			1	1.0000	1	6	3-1/4	.090	○	
27810048B	97593			1	1.0000	1	6	3-1/4	.120	○	
278100411B	97594			1	1.0000	1	6	3-1/4	.156	○	
27810049B	97595			1	1.0000	1	6	3-1/4	.190	○	
278100412B	97596			1	1.0000	1	6	3-1/4	.250	○	
278100413B	97597			1	1.0000	1	6	3-1/4	.375	○	
27810050B	97599			1	1.0000	1	7	4-1/4		○	
27810052B	97600			1	1.0000	1	7	4-1/4	.015	○	
27810054B	97601			1	1.0000	1	7	4-1/4	.030	○	
27810056B	97602			1	1.0000	1	7	4-1/4	.060	○	
27810057B	97603			1	1.0000	1	7	4-1/4	.090	○	

Series 278/278W Continued

ALtima® Blaze		ALtima® Blaze Weldon Flat		Diameter		Shank	OAL	Flute Length		Corner Radius	Stock Status
Tool No.	EDP	Tool No.	EDP	D1		D2 h6	L1	L2	R	• Stocked	
				Inch	Decimal	Inch	Inch	Inch	Inch	o Non-Stocked	
27810058B	97604			1	1.0000	1	7	4-1/4	.120	o	
278100511B	97605			1	1.0000	1	7	4-1/4	.156	o	
27810059B	97606			1	1.0000	1	7	4-1/4	.190	o	
278100512B	97607			1	1.0000	1	7	4-1/4	.250	o	
278100513B	97608			1	1.0000	1	7	4-1/4	.375	o	
278L10000B	37069	278L10000BW	14113	1	1.0000	1	5	2-1/4		•	
278L10002B	37070	278L10002BW	14114	1	1.0000	1	5	2-1/4	.015	•	
278L10004B	37071	278L10004BW	14115	1	1.0000	1	5	2-1/4	.030	•	
278X10000B	37072	278X10000BW	14116	1	1.0000	1	6	3		•	
278X10002B	37073	278X10002BW	14117	1	1.0000	1	6	3	.015	•	
278X10004B	37074	278X10004BW	14118	1	1.0000	1	6	3	.030	•	



TuffCut® XT Series 278N



5
Flute



- Improved geometries.
- Enhanced corner protection.

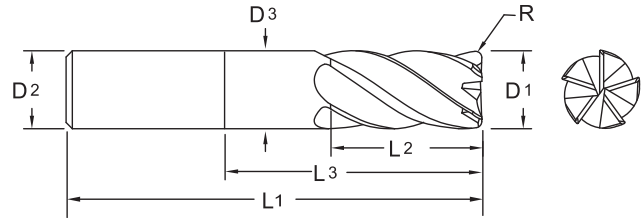

ALtima® Blaze		Diameter			Shank		Neck Diameter		OAL		Flute Length		Neck Length		Corner Radius	
		D1			D2 h6		D3		L1		L2		L3		R	
Tool No.	EDP	Inch	mm	Decimal	Inch	mm	Inch	mm	Inch	mm	Inch	mm	Inch	mm	Inch	mm
278 0300N3-0.25RB	27820		3	.1181		6		2.9		57		8		10		0.25
278 0300N3-0.5RB	27822		3	.1181		6		2.9		57		8		10		0.50
278 0400N3-0.25RB	27824		4	.1575		6		3.9		57		11		13		0.25
278 0400N3-0.5RB	27826		4	.1575		6		3.9		57		11		13		0.50
278 0500N3-0.25RB	27828		5	.1968		6		4.9		57		13		16		0.25
278 0500N3-0.5RB	27830		5	.1968		6		4.9		57		13		16		0.50
278 0600N3-0.25RB	27832		6	.2362		6		5.9		57		13		19		0.25
278 0600N3-0.5RB	27834		6	.2362		6		5.9		57		13		19		0.50
278 0600N3-1.0RB	27836		6	.2362		6		5.9		57		13		19		1.00
27825022NB	37011	1/4		.2500	1/4				4		3/4		2-1/8		0.015	
27825024NB	37012	1/4		.2500	1/4				4		3/4		2-1/8		0.030	
278 0800N3-0.25RB	27837		8	.3150		8		7.8		63		19		25		0.25
278 0800N3-0.5RB	27838		8	.3150		8		7.8		63		19		25		0.50
278 0800N3-1.0RB	27840		8	.3150		8		7.8		63		19		25		1.00
278 0800N3-2.0RB	27842		8	.3150		8		7.8		63		19		25		2.00
27837522NB	37023	3/8		.3750	3/8				4		1		2-1/8		0.015	
27837524NB	37024	3/8		.3750	3/8				4		1		2-1/8		0.030	
278 1000N3-0.5RB	27844		10	.3937		10		9.8		72		22		31		0.50
278 1000N3-1.0RB	27846		10	.3937		10		9.8		72		22		31		1.00
278 1000N3-2.0RB	27848		10	.3937		10		9.8		72		22		31		2.00
278 1200N3-0.5RB	27850		12	.4724		12		11.4		84		26		38		0.50
278 1200N3-1.0RB	27852		12	.4724		12		11.4		84		26		38		1.00
278 1200N3-1.5RB	27854		12	.4724		12		11.4		84		26		38		1.50
278 1200N3-2.5RB	27856		12	.4724		12		11.4		84		26		38		2.50
278 1200N3-3.0RB	27858		12	.4724		12		11.4		84		26		38		3.00
278 1200N3-4.0RB	27860		12	.4724		12		11.4		84		26		38		4.00
27850022NB	37037	1/2		.5000	1/2				4		1-1/4		2-1/8		0.015	
27850024NB	37038	1/2		.5000	1/2				4		1-1/4		2-1/8		0.030	

Inch	
D1	Tolerance
1/4	+0.000/-0.002
>1/4-3/4	+0.000/-0.003

Metric (mm)	
D1	Tolerance h10
3.00	+0.000/-0.040
>3.00-6.00	+0.000/-0.048
>6.00-10.00	+0.000/-0.058
>10.00-18.00	+0.000/-0.070
>18.00-25.00	+0.000/-0.084

Inch	
D2	Tolerance (h6)
.1182 - .2362	+0/-0.00031
.2363 - .3937	+0/-0.00035
.3938 - .7087	+0/-0.00043
.7088 - .7500	+0/-0.00051

Metric (mm)	
D2	Tolerance (h6)
6.0	+0/-0.008
6.01 - 10.0	+0/-0.009
10.01 - 18.0	+0/-0.011
18.01 - 25.0	+0/-0.013



ALtima® Blaze		Diameter			Shank		Neck Diameter		OAL		Flute Length		Neck Length		Corner Radius	
		D1			D2 h6		D3		L1		L2		L3		R	
Tool No.	EDP	Inch	mm	Decimal	Inch	mm	Inch	mm	Inch	mm	Inch	mm	Inch	mm	Inch	mm
27862522NB	37050	5/8		.6250	5/8				4		1-1/2		2-1/8		0.015	
27862524NB	37051	5/8		.6250	5/8				4		1-1/2		2-1/8		0.030	
278 1600N3-0.5RB	27870		16	.6299		16		15.2		100		35		50		0.50
278 1600N3-1.0RB	27872		16	.6299		16		15.2		100		35		50		1.00
278 1600N3-1.5RB	27874		16	.6299		16		15.2		100		35		50		1.50
278 1600N3-2.5RB	27876		16	.6299		16		15.2		100		35		50		2.50
278 1600N3-3.0RB	27878		16	.6299		16		15.2		100		35		50		3.00
278 1600N3-4.0RB	27880		16	.6299		16		15.2		100		35		50		4.00
278 1600N4-1.0RB	27871		16	.6299		16		15.2		117		35		65		1.00
278 1600N4-3.0RB	27873		16	.6299		16		15.2		117		35		65		3.00
278 1600N5-1.0RB	27875		16	.6299		16		15.2		133		35		82		1.00
278 1600N5-3.0RB	27877		16	.6299		16		15.2		133		35		82		3.00
27875022NB	37063	3/4		.7500	3/4				5		1-7/8		3		0.015	
27875024NB	37064	3/4		.7500	3/4				5		1-7/8		3		0.030	
278 2000N3-1.0RB	27890		20	.7874		20		19.2		112		40		62		1.00
278 2000N3-2.0RB	27906		20	.7874		20		19.2		112		40		62		2.00
278 2000N3-3.0RB	27892		20	.7874		20		19.2		112		40		62		3.00
278 2000N3-4.0RB	27894		20	.7874		20		19.2		112		40		62		4.00
278 2000N4-1.0RB	27891		20	.7874		20		19.2		133		40		82		1.00
278 2000N4-3.0RB	27893		20	.7874		20		19.2		133		40		82		3.00
278 2000N5-1.0RB	27895		20	.7874		20		19.2		152		40		102		1.00
278 2000N5-3.0RB	27897		20	.7874		20		19.2		152		40		102		3.00
278 2500N3-1.0RB	27896		25	.9843		25		24.6		127		40		77		1.00
278 2500N3-3.0RB	27898		25	.9843		25		24.6		127		40		77		3.00
278 2500N3-4.0RB	27900		25	.9843		25		24.6		127		40		77		4.00
278 2500N4-1.0RB	27899		25	.9843		25		24.6		152		40		102		1.00
278 2500N4-3.0RB	27901		25	.9843		25		24.6		152		40		102		3.00
278 2500N5-1.0RB	27902		25	.9843		25		24.6		180		40		125		1.00
278 2500N5-3.0RB	27903		25	.9843		25		24.6		180		40		125		3.00

End Mills

Safety Note
 Always wear the appropriate personal protective equipment such as safety glasses and protective clothing when using solid carbide or HSS cutting tools. Machines should be fully guarded. Technical data provided should be considered advisory only as variations may be necessary depending on the particular application.

TuffCut® XT Series 279

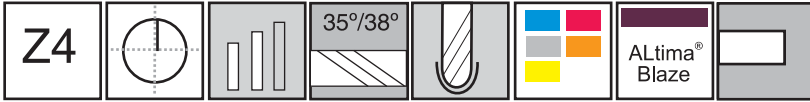

**4
Flute
Ball**



- ALtima® Blaze coated.
- Enhanced cutting edge quality.
- Variable helix and flute spacing for improved machining harmonics.

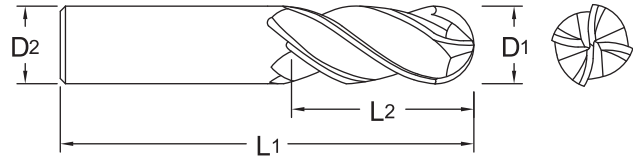

ALtima® Blaze		Diameter			Shank		OAL		Flute Length	
		Fraction	mm	Decimal	Inch	mm	Inch	mm	Inch	mm
279M0300B	27938		3	.1181		6		57		8
27912500B	27910	1/8		.1250	1/8		1-1/2		1/4	
27912510B	27912	1/8		.1250	1/8		1-1/2		3/8	
279M0400B	27940		4	.1575		6		57		11
27918700B	27914	3/16		.1875	3/16		2		3/8	
27918710B	27916	3/16		.1875	3/16		2		5/8	
279M0500B	27942		5	.1968		6		57		13
279M0600B	27944		6	.2362		6		57		13
27925000B	27918	1/4		.2500	1/4		2		3/8	
27925010B	27920	1/4		.2500	1/4		2-1/2		3/4	
27931200B	27922	5/16		.3125	5/16		2		1/2	
27931210B	27924	5/16		.3125	5/16		2-1/2		13/16	
279M0800B	27946		8	.3150		8		63		19
27937500B	27926	3/8		.3750	3/8		2		1/2	
27937510B	27928	3/8		.3750	3/8		2-1/2		7/8	
279M1000B	27948		10	.3937		10		72		22
279M1200B	27950		12	.4724		12		83		26
27950000B	27930	1/2		.5000	1/2		2-1/2		5/8	
27950010B	27932	1/2		.5000	1/2		3		1-1/4	
27962510B	27934	5/8		.6250	5/8		3-1/2		1-1/4	
279M1600B	27952		16	.6299		16		92		32
27975010B	27936	3/4		.7500	3/4		4		1-1/2	

Inch	
D1	Tolerance
1/16-1/4	+0/-0.002
> 1/4-3/4	+0/-0.003

Metric (mm)	
D1	Tolerance h10
3.00	+0/-0.040
>3.00-6.00	+0/-0.048
>6.00-10.00	+0/-0.058
>10.00-16.00	+0/-0.070

Inch	
D2	Tolerance (h6)
.1182 - .2362	+0/-0.00031
.2363 - .3937	+0/-0.00035
.3938 - .7087	+0/-0.00043
.7088 - .7500	+0/-0.00051

Metric (mm)	
D2	Tolerance (h6)
3	+0/-0.006
3.01 - 6.0	+0/-0.008
6.01 - 10.0	+0/-0.009
10.01 - 16.0	+0/-0.011



TuffCut® XR7 Series 180



40% increase in productivity over a 5 flute tool.

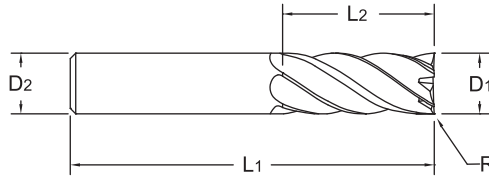

- Designed specifically for Titanium, Inconel and similar materials.
- ALtima® Blaze coating for increased performance.

ALtima® Blaze		Diameter			Shank		OAL		Flute Length		Corner Radius	
		D1			D2 h6		L1		L2		R	
Tool No.	EDP	Inch	mm	Decimal	Inch	mm	Inch	mm	Inch	mm	Inch	mm
18023600B	18936		6	.2362		6		57		13		
18023601B	18938		6	.2362		6		57		13		0.5
18025000B	18900	1/4		.2500	1/4		2		3/8			
18025002B	18901	1/4		.2500	1/4		2		3/8		.015	
18025010B	18902	1/4		.2500	1/4		2-1/2		3/4			
18025012B	18903	1/4		.2500	1/4		2-1/2		3/4		.015	
180L2500B	18904	1/4		.2500	1/4		3		1-1/4			
180X2500B	18906	1/4		.2500	1/4		4		1-3/4			
18031500B	18944		8	.3150		8		63		19		
18031501B	18946		8	.3150		8		63		19		0.5
18037500B	18908	3/8		.3750	3/8		2-1/2		1/2			
18037502B	18909	3/8		.3750	3/8		2-1/2		1/2		.015	
18037504B	18932	3/8		.3750	3/8		2-1/2		1/2		.030	
18037510B	18910	3/8		.3750	3/8		2-1/2		1			
18037512B	18911	3/8		.3750	3/8		2-1/2		1		.015	
18037514B	18934	3/8		.3750	3/8		2-1/2		1		.030	
180L3750B	18912	3/8		.3750	3/8		4		1-1/2			
180X3750B	18914	3/8		.3750	3/8		4		2-1/2			
18039300B	18940		10	.3937		10		72		22		
18039301B	18942		10	.3937		10		72		22		0.5
18047201B	18501		12	.4724		12		84		32		0.5
18047203B	18503		12	.4724		12		84		32		1.0

Inch	
D1	Tolerance
1/4-1.0	+0.00/-0.011

Metric (mm)	
D1	Tolerance
12.00-20.00	+0.00/-0.028

Inch	
D2	Tolerance (h6)
.2363 - .3937	+0/-0.00035
.3938 - .7087	+0/-0.00043
.7088 - 1.000	+0/-0.00051

Metric (mm)	
D2	Tolerance (h6)
12.00 - 18.0	+0/-0.011
18.01 - 20.0	+0/-0.013

ALtima® Blaze	
Featuring high temperature hardness and oxidation resistance that provides extreme wear resistance under all machining conditions	
Coating Properties	
Micro Hardness (HV)	3200
Max. Working Temperature	1100°C 2012°F
Friction Coefficient	0.35



End Mills

Series 180 Continued



7
Flute

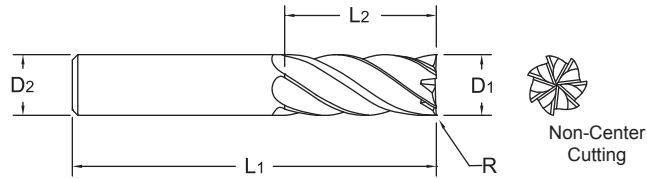

ALtima® Blaze		Diameter			Shank		OAL		Flute Length		Corner Radius	
		D1			D2 h6		L1		L2		R	
Tool No.	EDP	Inch	mm	Decimal	Inch	mm	Inch	mm	Inch	mm	Inch	mm
18047205B	18505		12	.4724		12		84		32		2.0
18047207B	18507		12	.4724		12		84		32		3.0
18047209B	18508		12	.4724		12		84		32		4.0
18050000B	18512	1/2		.5000	1/2		3		5/8			
18050002B	18515	1/2		.5000	1/2		3		5/8		.015	
18050004B	18517	1/2		.5000	1/2		3		5/8		.030	
18050006B	18519	1/2		.5000	1/2		3		5/8		.060	
18050007B	18521	1/2		.5000	1/2		3		5/8		.090	
18050008B	18523	1/2		.5000	1/2		3		5/8		.125	
18050010B	18514	1/2		.5000	1/2		3		1-1/4			
18050012B	18516	1/2		.5000	1/2		3		1-1/4		.015	
18050014B	18518	1/2		.5000	1/2		3		1-1/4		.030	
18050016B	18520	1/2		.5000	1/2		3		1-1/4		.060	
18050017B	18522	1/2		.5000	1/2		3		1-1/4		.090	
18050018B	18524	1/2		.5000	1/2		3		1-1/4		.125	
180L5000B	18916	1/2		.5000	1/2		4		2			
180X5000B	18918	1/2		.5000	1/2		5		3			
18062500B	18532	5/8		.6250	5/8		3-1/2		3/4			
18062502B	18535	5/8		.6250	5/8		3-1/2		3/4		.015	
18062504B	18537	5/8		.6250	5/8		3-1/2		3/4		.030	
18062506B	18539	5/8		.6250	5/8		3-1/2		3/4		.060	
18062507B	18541	5/8		.6250	5/8		3-1/2		3/4		.090	
18062508B	18543	5/8		.6250	5/8		3-1/2		3/4		.125	
18062510B	18534	5/8		.6250	5/8		3-1/2		1-1/4			
18062512B	18536	5/8		.6250	5/8		3-1/2		1-1/4		.015	
18062514B	18538	5/8		.6250	5/8		3-1/2		1-1/4		.030	
18062516B	18540	5/8		.6250	5/8		3-1/2		1-1/4		.060	
18062517B	18542	5/8		.6250	5/8		3-1/2		1-1/4		.090	
18062518B	18544	5/8		.6250	5/8		3-1/2		1-1/4		.125	
180L6250B	18920	5/8		.6250	5/8		5		2-1/4			
180X6250B	18922	5/8		.6250	5/8		6		3			
18062901B	18509		16	.6299		16		92		42		0.5
18062903B	18510		16	.6299		16		92		42		1.0
18062905B	18511		16	.6299		16		92		42		2.0
18062907B	18513		16	.6299		16		92		42		3.0
18062909B	18527		16	.6299		16		92		42		4.0

Series 180 Continued

ALtima® Blaze		Diameter			Shank		OAL		Flute Length		Corner Radius	
		D1			D2 h6		L1		L2		R	
Tool No.	EDP	Inch	mm	Decimal	Inch	mm	Inch	mm	Inch	mm	Inch	mm
18075000B	18570	3/4		.7500	3/4		4		1			
18075002B	18573	3/4		.7500	3/4		4		1		.015	
18075004B	18575	3/4		.7500	3/4		4		1		.030	
18075006B	18577	3/4		.7500	3/4		4		1		.060	
18075007B	18579	3/4		.7500	3/4		4		1		.090	
18075008B	18581	3/4		.7500	3/4		4		1		.125	
18075009B	18583	3/4		.7500	3/4		4		1		.190	
180750012B	18585	3/4		.7500	3/4		4		1		.250	
18075010B	18572	3/4		.7500	3/4		4		1-1/2			
18075012B	18574	3/4		.7500	3/4		4		1-1/2		.015	
18075014B	18576	3/4		.7500	3/4		4		1-1/2		.030	
18075016B	18578	3/4		.7500	3/4		4		1-1/2		.060	
18075017B	18580	3/4		.7500	3/4		4		1-1/2		.090	
18075018B	18582	3/4		.7500	3/4		4		1-1/2		.125	
18075019B	18584	3/4		.7500	3/4		4		1-1/2		.190	
180750112B	18586	3/4		.7500	3/4		4		1-1/2		.250	
180L7500B	18924	3/4		.7500	3/4		5		2-1/4			
180X7500B	18926	3/4		.7500	3/4		6		3			
18078701B	18528		20	.7874		20		102		52		0.5
18078703B	18529		20	.7874		20		102		52		1.0
18078705B	18530		20	.7874		20		102		52		2.0
18078707B	18531		20	.7874		20		102		52		3.0
18078709B	18533		20	.7874		20		102		52		4.0
18010000B	18597	1		1.0000	1		4		1			
18010002B	18599	1		1.0000	1		4		1		.015	
18010004B	18601	1		1.0000	1		4		1		.030	
18010006B	18603	1		1.0000	1		4		1		.060	
18010007B	18615	1		1.0000	1		4		1		.090	
18010008B	18607	1		1.0000	1		4		1		.125	
18010009B	18609	1		1.0000	1		4		1		.190	
180100012B	18611	1		1.0000	1		4		1		.250	
18010010B	18598	1		1.0000	1		4		1-1/2			
18010012B	18613	1		1.0000	1		4		1-1/2		.015	
18010014B	18602	1		1.0000	1		4		1-1/2		.030	
18010016B	18604	1		1.0000	1		4		1-1/2		.060	
18010017B	18606	1		1.0000	1		4		1-1/2		.090	
18010018B	18608	1		1.0000	1		4		1-1/2		.125	
18010019B	18616	1		1.0000	1		4		1-1/2		.190	
180100112B	18612	1		1.0000	1		4		1-1/2		.250	
180L1000B	18928	1		1.0000	1		5		2-1/4			
180X1000B	18930	1		1.0000	1		6		3			



End Mills



TuffCut®

High Performance End Mills

M.A. Ford® TuffCut® End Mills perform better and last significantly longer than competitive products, minimizing process downtime and maximizing productivity and cost efficiency.

Included in our product line are high performance end mills developed for specific applications such as stainless steels and high temperature alloys, hardened steel, titanium, composite material, aluminum and softer alloys.

In addition to High Performance products, M.A. Ford® carries a complete family of standard carbide end mills designed for efficient general purpose milling of all steels, cast irons and most other materials.

M.A. Ford® End Mills are ideal for tough or abrasive work. On many jobs, they can run faster than HSS or Cobalt because of their high heat resistance.

Benefits of M.A. Ford® End Mill products and support include:

- Thousands of end mills in stock.
- Over 50 different styles of end mills available.
- Aggressive speeds and feeds to maximize metal removal rates.
- Standard, Stub, Long and Extended Reach Lengths are available.
- Solid Carbide Tools are easy to re-sharpen for maximum life.
- ALtima®, ALtima® Plus, ALtima® 52, ALtima® Blaze, ALtima® Micro, Fordlude, GemX, TiN, TiCN, and CERAedge® coatings are available as well as Special Coatings upon request. See page 188 for more information on available coatings.
- U.S. Designed and Manufactured.



ADVANCED TECHNOLOGY

TuffCut® XR7 Series 180N



40% increase in productivity over a 5 flute tool.

7
Flute

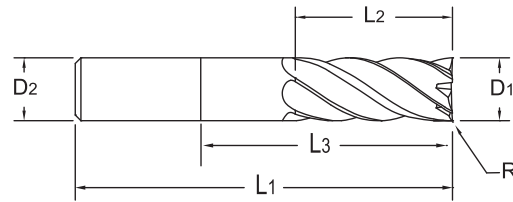

Non-Center
Cutting

- Designed specifically for Titanium, Inconel and similar materials.
- ALtima® Blaze coating for increased performance.

ALtima® Blaze		Diameter			Shank		OAL		Flute Length		Neck Length		Corner Radius	
		D1			D2 h6		L1		L2		L3		R	
Tool No.	EDP	Inch	mm	Decimal	Inch	mm	Inch	mm	Inch	mm	Inch	mm	Inch	mm
18047203NB	18500		12.0	.4724		12.0		120		30		60		1.0
18047205NB	18502		12.0	.4724		12.0		120		30		60		2.0
18047207NB	18504		12.0	.4724		12.0		120		30		60		3.0
18047209NB	18506		12.0	.4724		12.0		120		30		60		4.0
18050024NB	18526	1/2		.5000	1/2		4		1-1/4		2-1/8		.030	
18062524NB	18546	5/8		.6250	5/8		4		1-1/4		2-1/8		.030	
18062903NB	18548		16.0	.6299		16.0		150		40		80		1.0
18062905NB	18550		16.0	.6299		16.0		150		40		80		2.0
18062907NB	18552		16.0	.6299		16.0		150		40		80		3.0
18062909NB	18554		16.0	.6299		16.0		150		40		80		4.0
18075024NB	18588	3/4		.7500	3/4		5		1-7/8		3		.030	
18078713NB	18590		20.0	.7874		20.0		150		50		100		1.0
18078715NB	18592		20.0	.7874		20.0		150		50		100		2.0
18078717NB	18594		20.0	.7874		20.0		150		50		100		3.0
18078719NB	18596		20.0	.7874		20.0		150		50		100		4.0
180100205NB	18614	1		1.0000	1		6		3		4		.045	

Inch	
D1	Tolerance
1/2-1.0	+0.000/-0.0011

Metric (mm)	
D1	Tolerance
12.00-20.00	+0.000/-0.028

Inch	
D2	Tolerance (h6)
.5000 - .7087	+0/-0.00043
.7088 - 1.000	+0/-0.00051

Metric (mm)	
D2	Tolerance (h6)
12.00 - 18.0	+0/-0.011
18.01 - 20.0	+0/-0.013



Page 152

NEW TuffCut® XR Series 177/177W



Designed for EXTREME Productivity. Unique flute geometry reduces harmonics at increased feeds and speeds.

New-Standard Offering with Weldon Shank Flats

4
Flute

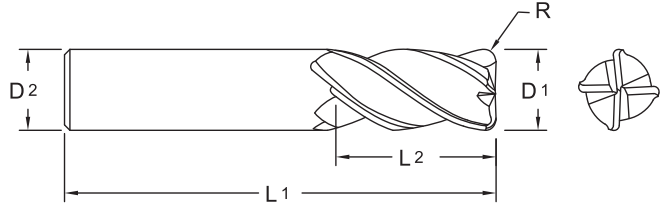

ALtima®		ALtima® Weldon Flat		Diameter			Shank		OAL		Flute Length		Corner Radius	
Tool No.	EDP	Tool No.	EDP	D1			D2 h6		L1		L2		R	
				Inch	mm	Decimal	Inch	mm	Inch	mm	Inch	mm	Inch	mm
17705900A	17680				1.5	.0591		3.0		38		3.0		
17706250A	17692			1/16		.0625	1/8		1-1/2		1/8			
17707810A	17694			5/64		.0781	1/8		1-1/2		5/32			
17707870A	17682				2.0	.0787		3.0		38		4.0		
17709370A	17696			3/32		.0937	1/8		1-1/2		3/16			
17709840A	17684				2.5	.0984		3.0		38		5.0		
17711800A	17928				3.0	.1181		6.0		57		8.0		
17711801A	17783				3.0	.1181		6.0		57		8.0		0.50
17711803A	17686				3.0	.1181		3.0		38		6.0		
17711808A	17929				3.0	.1181		6.0		57		8.0		0.25
17712500A	17700			1/8		.1250	1/8		1-1/2		1/8			
17712502A	17729			1/8		.1250	1/8		1-1/2		1/8			0.015
17712510A	17701			1/8		.1250	1/8		1-1/2		3/8			
17712512A	17730			1/8		.1250	1/8		1-1/2		3/8			0.015
17713700A	17688				3.5	.1378		6.0		57		7.0		
17715600A	17702			5/32		.1562	3/16		2		3/16			
17715602A	17731			5/32		.1562	3/16		2		3/16			0.015
17715610A	17703			5/32		.1562	3/16		2		7/16			
17715612A	17732			5/32		.1562	3/16		2		7/16			0.015
17715700A	17930				4.0	.1575		6.0		57		11.0		
17715701A	17784				4.0	.1575		6.0		57		11.0		0.50
17715708A	17931				4.0	.1575		6.0		57		11.0		0.25
17717700A	17690				4.5	.1772		6.0		57		9.0		
17718700A	17704			3/16		.1875	3/16		2		3/16			
17718702A	17733			3/16		.1875	3/16		2		3/16			0.015
17718704A	17734			3/16		.1875	3/16		2		3/16			0.030
17718710A	17705			3/16		.1875	3/16		2		7/16			
17718712A	17735			3/16		.1875	3/16		2		7/16			0.015

Inch	
D1	Tolerance
1/16-1/4	+0.00/-0.002
> 1/4-1.0	+0.00/-0.003

Metric (mm)	
D1	Tolerance h10
1.50-3.00	+0.00/-0.040
>3.00-6.00	+0.00/-0.048
>6.00-10.00	+0.00/-0.058
>10.00-18.00	+0.00/-0.070
>18.00-25.00	+0.00/-0.084

Inch	
D2	Tolerance (h6)
.1182 - .2362	+0/-0.00031
.2363 - .3937	+0/-0.00035
.3938 - .7087	+0/-0.00043
.7088 - 1.000	+0/-0.00051

Metric (mm)	
D2	Tolerance (h6)
3.0	+0/-0.006
3.01 - 6.0	+0/-0.008
6.01 - 10.0	+0/-0.009
10.01 - 18.0	+0/-0.011
18.01 - 25.0	+0/-0.013



Series 177/177W Continued

ALtima®		ALtima® Weldon Flat		Diameter			Shank		OAL		Flute Length		Corner Radius	
Tool No.	EDP	Tool No.	EDP	D1			D2 h6		L1		L2		R	
				Inch	mm	Decimal	Inch	mm	Inch	mm	Inch	mm	Inch	mm
17718714A	17736			3/16		.1875	3/16		2		7/16		0.030	
17719600A	17932				5.0	.1968		6.0		57		13.0		
17719601A	17785				5.0	.1968		6.0		57		13.0		0.50
17719608A	17933				5.0	.1968		6.0		57		13.0		0.25
17721800A	17706			7/32		.2187	1/4		2		1/4			
17721802A	17737			7/32		.2187	1/4		2		1/4		0.015	
17721804A	17738			7/32		.2187	1/4		2		1/4		0.030	
17721810A	17707			7/32		.2187	1/4		2-1/2		7/16			
17721812A	17739			7/32		.2187	1/4		2-1/2		7/16		0.015	
17721814A	17740			7/32		.2187	1/4		2-1/2		7/16		0.030	
17723600A	17934				6.0	.2362		6.0		57		13.0		
17723608A	17786				6.0	.2362		6.0		57		13.0		0.25
17723601A	17935				6.0	.2362		6.0		57		13.0		0.50
17723603A	17787				6.0	.2362		6.0		57		13.0		1.00
17723604A	17788				6.0	.2362		6.0		57		13.0		1.50
17723605A	18070				6.0	.2362		6.0		57		13.0		2.00
17725000A	17708			1/4		.2500	1/4		2		1/4			
17725002A	17741			1/4		.2500	1/4		2		1/4		0.015	
17725004A	17742			1/4		.2500	1/4		2		1/4		0.030	
17725010A	17709			1/4		.2500	1/4		2-1/2		1/2			
17725012A	17743			1/4		.2500	1/4		2-1/2		1/2		0.015	
17725014A	17744			1/4		.2500	1/4		2-1/2		1/2		0.030	
17728100A	17710			9/32		.2812	5/16		2-1/2		5/8			
17728102A	17745			9/32		.2812	5/16		2-1/2		5/8		0.015	
17728104A	17746			9/32		.2812	5/16		2-1/2		5/8		0.030	
17731200A	17711			5/16		.3125	5/16		2		5/16			
17731202A	17747			5/16		.3125	5/16		2		5/16		0.015	
17731204A	17748			5/16		.3125	5/16		2		5/16		0.030	
17731210A	17712			5/16		.3125	5/16		2-1/2		13/16			
17731212A	17749			5/16		.3125	5/16		2-1/2		13/16		0.015	
17731214A	17750			5/16		.3125	5/16		2-1/2		13/16		0.030	
17731500A	17937				8.0	.3150		8.0		63		19.0		
17731501A	17938				8.0	.3150		8.0		63		19.0		0.50
17731503A	17789				8.0	.3150		8.0		63		19.0		1.00
17731504A	17790				8.0	.3150		8.0		63		19.0		1.50
17731505A	17791				8.0	.3150		8.0		63		19.0		2.00
17731507A	18072				8.0	.3150		8.0		63		19.0		3.00
17734300A	17713			11/32		.3438	3/8		2-1/2		13/16			
17734302A	17751			11/32		.3438	3/8		2-1/2		13/16		0.015	
17734304A	17752			11/32		.3438	3/8		2-1/2		13/16		0.030	
17737500A	17714			3/8		.3750	3/8		2		3/8			
17737502A	17753			3/8		.3750	3/8		2		3/8		0.015	
17737504A	17754			3/8		.3750	3/8		2		3/8		0.030	
17737510A	17715			3/8		.3750	3/8		2-1/2		7/8			
17737512A	17755			3/8		.3750	3/8		2-1/2		7/8		0.015	
17737514A	17756			3/8		.3750	3/8		2-1/2		7/8		0.030	



End Mills



Series 177/177W Continued



4
Flute

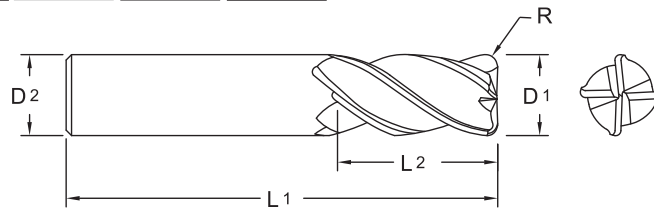

ALtima®		ALtima® Weldon Flat		Diameter			Shank		OAL		Flute Length		Corner Radius	
Tool No.	EDP	Tool No.	EDP	D1			D2 h6		L1		L2		R	
Tool No.	EDP	Tool No.	EDP	Inch	mm	Decimal	Inch	mm	Inch	mm	Inch	mm	Inch	mm
17739300A	17940				10.0	.3937		10.0		72		22.0		
17739301A	17941				10.0	.3937		10.0		72		22.0		0.50
17739303A	17792				10.0	.3937		10.0		72		22.0		1.00
17739304A	17793				10.0	.3937		10.0		72		22.0		1.50
17739305A	17794				10.0	.3937		10.0		72		22.0		2.00
17739307A	96603				10.0	.3937		10.0		72		22.0		3.00
17740600A	17716			13/32		.4062	7/16		2-3/4		15/16			
17740602A	17757			13/32		.4062	7/16		2-3/4		15/16		0.015	
17740604A	17758			13/32		.4062	7/16		2-3/4		15/16		0.030	
17743700A	17717			7/16		.4375	7/16		2-1/2		7/16			
17743702A	17759			7/16		.4375	7/16		2-1/2		7/16		0.015	
17743704A	17760			7/16		.4375	7/16		2-1/2		7/16		0.030	
17743710A	17718			7/16		.4375	7/16		2-3/4		1			
17743712A	17761			7/16		.4375	7/16		2-3/4		1		0.015	
17743714A	17762			7/16		.4375	7/16		2-3/4		1		0.030	
17746800A	17719			15/32		.4688	1/2		3		1			
17746802A	17763			15/32		.4688	1/2		3		1		0.015	
17746804A	17764			15/32		.4688	1/2		3		1		0.030	
17747200A	17943				12.0	.4724		12.0		83		26.0		
17747201A	17795				12.0	.4724		12.0		83		26.0		0.50
17747202A	17944				12.0	.4724		12.0		83		26.0		0.75
17747203A	17796				12.0	.4724		12.0		83		26.0		1.00
17747204A	17797				12.0	.4724		12.0		83		26.0		1.50
17747205A	17798				12.0	.4724		12.0		83		26.0		2.00
17747206A	18074				12.0	.4724		12.0		83		26.0		2.50
17747207A	96506				12.0	.4724		12.0		83		26.0		3.00
17747209A	18076				12.0	.4724		12.0		83		26.0		4.00
17750000A	17720	17750000AW	13166	1/2		.5000	1/2		2-1/2		1/2			
17750002A	17765	17750002AW	13167	1/2		.5000	1/2		2-1/2		1/2		0.015	
17750004A	17766	17750004AW	13168	1/2		.5000	1/2		2-1/2		1/2		0.030	
17750010A	17721	17750010AW	58038	1/2		.5000	1/2		3		1			
17750012A	17767	17750012AW	13169	1/2		.5000	1/2		3		1		0.015	



Series 177/177W Continued



ALtima®		ALtima® Weldon Flat		Diameter			Shank		OAL		Flute Length		Corner Radius	
Tool No.	EDP	Tool No.	EDP	D1			D2 h6		L1		L2		R	
				Inch	mm	Decimal	Inch	mm	Inch	mm	Inch	mm	Inch	mm
17750014A	17768	17750014AW	58039	1/2		.5000	1/2		3		1		0.030	
17750016A	17901	17750016AW	58061	1/2		.5000	1/2		3		1		0.060	
17750017A	17902	17750017AW	13170	1/2		.5000	1/2		3		1		0.090	
17750018A	17903	17750018AW	13171	1/2		.5000	1/2		3		1		0.125	
17750020A	18094	17750020AW	58056	1/2		.5000	1/2		3		1-1/4			
17750022A	18095	17750022AW	13172	1/2		.5000	1/2		3		1-1/4		.015	
17750024A	18096	17750024AW	58051	1/2		.5000	1/2		3		1-1/4		.030	
17750026A	18097	17750026AW	12610	1/2		.5000	1/2		3		1-1/4		.060	
17750027A	18098	17750027AW	13173	1/2		.5000	1/2		3		1-1/4		.090	
17750028A	18099	17750028AW	13174	1/2		.5000	1/2		3		1-1/4		.125	
17755100A	17946				14.0	.5512		14.0		83		26.0		
17755102A	17947				14.0	.5512		14.0		83		26.0		0.75
17756200A	17722			9/16		.5625	9/16		3-1/2		1-1/8			
17756202A	17769			9/16		.5625	9/16		3-1/2		1-1/8		0.015	
17756204A	17770			9/16		.5625	9/16		3-1/2		1-1/8		0.030	
17762500A	17723	17762500AW	13175	5/8		.6250	5/8		3		5/8			
17762502A	18000	17762502AW	13176	5/8		.6250	5/8		3		5/8		0.015	
17762504A	17771	17762504AW	13177	5/8		.6250	5/8		3		5/8		0.030	
17762505A	17772	17762505AW	13178	5/8		.6250	5/8		3		5/8		0.045	
17762510A	17724	17762510AW	58040	5/8		.6250	5/8		3-1/2		1-1/4			
17762512A	18001	17762512AW	13179	5/8		.6250	5/8		3-1/2		1-1/4		0.015	
17762514A	17773	17762514AW	58041	5/8		.6250	5/8		3-1/2		1-1/4		0.030	
17762515A	17774	17762515AW	13180	5/8		.6250	5/8		3-1/2		1-1/4		0.045	
17762516A	17904	17762516AW	13181	5/8		.6250	5/8		3-1/2		1-1/4		0.060	
17762517A	17905	17762517AW	13182	5/8		.6250	5/8		3-1/2		1-1/4		0.090	
17762518A	17906	17762518AW	13183	5/8		.6250	5/8		3-1/2		1-1/4		0.125	
17762900A	17950				16.0	.6299		16.0		92		32.0		
17762901A	18078				16.0	.6299		16.0		92		32.0		0.50
17762903A	17951				16.0	.6299		16.0		92		32.0		1.00
17762904A	17799				16.0	.6299		16.0		92		32.0		1.50
17762905A	17673				16.0	.6299		16.0		92		32.0		2.00
17762906A	18080				16.0	.6299		16.0		92		32.0		2.50
17762907A	17674				16.0	.6299		16.0		92		32.0		3.00
17762909A	18082				16.0	.6299		16.0		92		32.0		4.00
17770800A	17952				18.0	.7087		18.0		92		32.0		
17770803A	17953				18.0	.7087		18.0		92		32.0		1.00
17775000A	17725	17775000AW	13184	3/4		.7500	3/4		3		3/4			
17775002A	18002	17775002AW	13185	3/4		.7500	3/4		3		3/4		0.015	
17775004A	17775	17775004AW	13186	3/4		.7500	3/4		3		3/4		0.030	
17775005A	17776	17775005AW	14590	3/4		.7500	3/4		3		3/4		0.045	
17775010A	17726	17775010AW	58042	3/4		.7500	3/4		4		1-1/2			
17775012A	18003	17775012AW	13187	3/4		.7500	3/4		4		1-1/2		0.015	

End Mills



Series 177/177W Continued



4
Flute

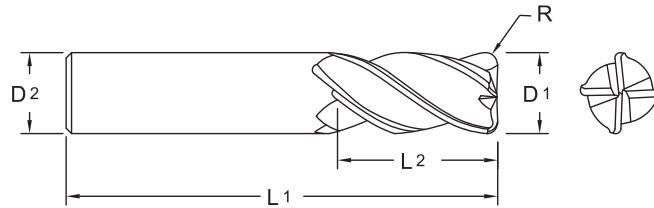

ALtima®		ALtima® Weldon Flat		Diameter			Shank		OAL		Flute Length		Corner Radius	
Tool No.	EDP	Tool No.	EDP	D1			D2 h6		L1		L2		R	
				Inch	mm	Decimal	Inch	mm	Inch	mm	Inch	mm	Inch	mm
17775014A	17777	17775014AW	58043	3/4		.7500	3/4		4		1-1/2		0.030	
17775015A	17778	17775015AW	13188	3/4		.7500	3/4		4		1-1/2		0.045	
17775016A	17907	17775016AW	58053	3/4		.7500	3/4		4		1-1/2		0.060	
17775017A	17908	17775017AW	13189	3/4		.7500	3/4		4		1-1/2		0.090	
17775018A	17909	17775018AW	13190	3/4		.7500	3/4		4		1-1/2		0.125	
17778700A	17955				20.0	.7874		20.0		104		38.0		
17778703A	17956				20.0	.7874		20.0		104		38.0		1.00
17778704A	18091				20.0	.7874		20.0		104		38.0		1.50
17778705A	18084				20.0	.7874		20.0		104		38.0		2.00
17778707A	18086				20.0	.7874		20.0		104		38.0		3.00
17778709A	18088				20.0	.7874		20.0		104		38.0		4.00
177787011A	18090				20.0	.7874		20.0		104		38.0		5.00
177787012A	18092				20.0	.7874		20.0		104		38.0		6.00
17798400A	17957				25.0	.9843		25.0		104		38.0		
17798403A	17958				25.0	.9843		25.0		104		38.0		1.00
17710000A	17727	17710000AW	13191	1		1.0000	1		4		1			
17710002A	18004	17710002AW	13192	1		1.0000	1		4		1		0.015	
17710004A	17779	17710004AW	13193	1		1.0000	1		4		1		0.030	
17710005A	17780	17710005AW	13194	1		1.0000	1		4		1		0.045	
17710010A	17728	17710010AW	58078	1		1.0000	1		4		1-1/2			
17710012A	18005	17710012AW	13195	1		1.0000	1		4		1-1/2		0.015	
17710014A	17781	17710014AW	58033	1		1.0000	1		4		1-1/2		0.030	
17710015A	17782	17710015AW	13197	1		1.0000	1		4		1-1/2		0.045	
17710016A	17910	17710016AW	13198	1		1.0000	1		4		1-1/2		0.060	
17710017A	17911	17710017AW	13199	1		1.0000	1		4		1-1/2		0.090	
17710018A	17912	17710018AW	13200	1		1.0000	1		4		1-1/2		0.125	

TuffCut® XR Series 177L

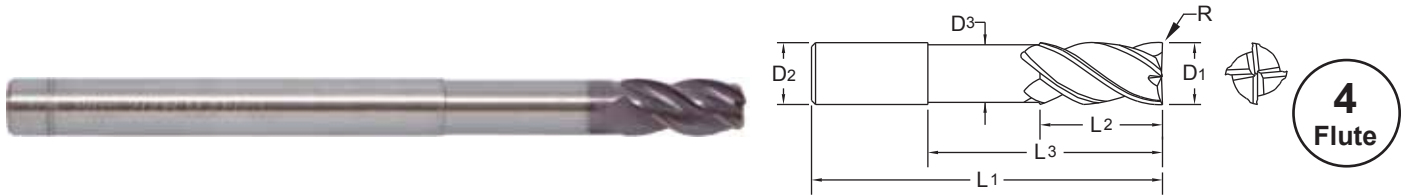

ALtima®		Diameter		Shank	Neck Dia.	OAL	Flute Length	Neck Length	Corner Radius
		D1 h10		D2 h6	D3	L1	L2	L3	R
Tool No.	EDP	mm	Decimal	mm	mm	mm	mm	mm	mm
177L2360R010N5A	18186	6	.2362	6	5.8	101	12	31	0.25
177L2360R020N5A	18183	6	.2362	6	5.8	101	12	31	0.5
177L2360R039N5A	18184	6	.2362	6	5.8	101	12	31	1.0
177L3150R020N5A	18187	8	.3150	8	7.6	101	16	41	0.5
177L3150R039N5A	18194	8	.3150	8	7.6	101	16	41	1.0
177L3150R078N5A	18195	8	.3150	8	7.6	101	16	41	2.0
177L3150R118N5A	18196	8	.3150	8	7.6	101	16	41	3.0
177L3930R020N5A	18188	10	.3937	10	9.6	127	20	51	0.5
177L3930R039N5A	18197	10	.3937	10	9.6	127	20	51	1.0
177L3930R078N5A	18198	10	.3937	10	9.6	127	20	51	2.0
177L3930R118N5A	18199	10	.3937	10	9.6	127	20	51	3.0
177L4720R020N5A	18189	12	.4724	12	11.4	152	24	62	0.5
177L4720R039N5A	18176	12	.4724	12	11.4	152	24	62	1.0
177L4720R078N5A	18177	12	.4724	12	11.4	152	24	62	2.0
177L4720R118N5A	18190	12	.4724	12	11.4	152	24	62	3.0
177L4720R157N5A	18178	12	.4724	12	11.4	152	24	62	4.0
177L6290R020N5A	18181	16	.6299	16	15.2	152	32	82	0.5
177L6290R039N5A	18191	16	.6299	16	15.2	152	32	82	1.0
177L6290R078N5A	18179	16	.6299	16	15.2	152	32	82	2.0
177L6290R118N5A	18180	16	.6299	16	15.2	152	32	82	3.0
177L7870R020N5A	18182	20	.7874	20	19.2	152	40	102	0.5
177L7870R039N5A	18192	20	.7874	20	19.2	152	40	102	1.0
177L7870R118N5A	18193	20	.7874	20	19.2	152	40	102	3.0

Inch sizes available upon request.

Metric (mm)		Metric (mm)	
D1	Tolerance h10	D2	Tolerance (h6)
6.00	+0.00/-0.048	6.0	+0/-0.008
>6.00-10.00	+0.00/-0.058	6.01 - 10.0	+0/-0.009
>10.00-18.00	+0.00/-0.070	10.01 - 18.0	+0/-0.011
>18.00-20.00	+0.00/-0.084	18.01 - 20.0	+0/-0.013



End Mills

TuffCut® XR Series 177S



4
Flute

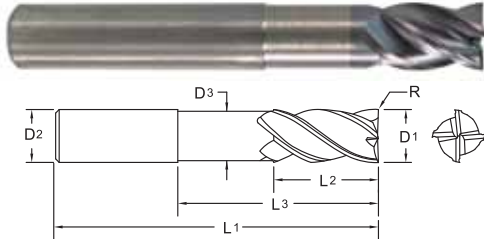

Metric (mm)	
D1	Tolerance h10
3.00	+0.00/-0.040
>3.00-6.00	+0.00/-0.048
>6.00-10.00	+0.00/-0.058
>10.00-18.00	+0.00/-0.070
>18.00-20.00	+0.00/-0.084

Metric (mm)	
D2	Tolerance (h6)
6.0	+0/-0.008
6.01 - 10.0	+0/-0.009
10.01 - 18.0	+0/-0.011
18.01 - 20.0	+0/-0.013

ALtima®		Diameter		Shank	Neck Diameter	OAL	Flute Length	Neck Length	Corner Radius	Shank
		D1 h10								
Tool No.	EDP	mm	Decimal	D2 h6	D3	L1	L2	L3	R	
177S1181A	18218	3	.1181	6	2.9	50	5	11		DIN 6535 HA
177S1181R008A	18200	3	.1181	6	2.9	50	5	11	0.20	DIN 6535 HA
177S1181AW	18254	3	.1181	6	2.9	50	5	11		DIN 6535 HB
177S1181R008AW	18236	3	.1181	6	2.9	50	5	11	0.20	DIN 6535 HB
177S1575A	18220	4	.1575	6	3.9	50	6	14		DIN 6535 HA
177S1575R008A	18202	4	.1575	6	3.9	50	6	14	0.20	DIN 6535 HA
177S1575AW	18256	4	.1575	6	3.9	50	6	14		DIN 6535 HB
177S1575R008AW	18238	4	.1575	6	3.9	50	6	14	0.20	DIN 6535 HB
177S1969A	18222	5	.1968	6	4.9	57	8	17		DIN 6535 HA
177S1969R008A	18204	5	.1968	6	4.9	57	8	17	0.20	DIN 6535 HA
177S1969AW	18258	5	.1968	6	4.9	57	8	17		DIN 6535 HB
177S1969R008AW	18240	5	.1968	6	4.9	57	8	17	0.20	DIN 6535 HB
177S2362A	18224	6	.2362	6	5.8	57	9	20		DIN 6535 HA
177S2362R012A	18206	6	.2362	6	5.8	57	9	20	0.30	DIN 6535 HA
177S2362AW	18260	6	.2362	6	5.8	57	9	20		DIN 6535 HB
177S2362R012AW	18242	6	.2362	6	5.8	57	9	20	0.30	DIN 6535 HB
177S3150A	18226	8	.3150	8	7.6	63	12	26		DIN 6535 HA
177S3150R020A	18208	8	.3150	8	7.6	63	12	26	0.50	DIN 6535 HA
177S3150AW	18262	8	.3150	8	7.6	63	12	26		DIN 6535 HB
177S3150R020AW	18244	8	.3150	8	7.6	63	12	26	0.50	DIN 6535 HB
177S3937A	18228	10	.3937	10	9.6	72	15	32		DIN 6535 HA
177S3937R020A	18210	10	.3937	10	9.6	72	15	32	0.50	DIN 6535 HA
177S3937AW	18264	10	.3937	10	9.6	72	15	32		DIN 6535 HB
177S3937R020AW	18246	10	.3937	10	9.6	72	15	32	0.50	DIN 6535 HB
177S4724A	18230	12	.4724	12	11.4	83	18	38		DIN 6535 HA
177S4724R020A	18212	12	.4724	12	11.4	83	18	38	0.50	DIN 6535 HA
177S4724AW	18266	12	.4724	12	11.4	83	18	38		DIN 6535 HB
177S4724R020AW	18248	12	.4724	12	11.4	83	18	38	0.50	DIN 6535 HB
177S6299A	18232	16	.6299	16	15.2	98	24	50		DIN 6535 HA
177S6299R039A	18214	16	.6299	16	15.2	98	24	50	1.00	DIN 6535 HA
177S6299AW	18268	16	.6299	16	15.2	98	24	50		DIN 6535 HB
177S6299R039AW	18250	16	.6299	16	15.2	98	24	50	1.00	DIN 6535 HB
177S7874A	18234	20	.7874	20	19.2	112	30	62		DIN 6535 HA
177S7874R039A	18216	20	.7874	20	19.2	112	30	62	1.00	DIN 6535 HA
177S7874AW	18270	20	.7874	20	19.2	112	30	62		DIN 6535 HB
177S7874R039AW	18252	20	.7874	20	19.2	112	30	62	1.00	DIN 6535 HB

Inch sizes available upon request.

NEW TuffCut® XR Series 178/178W



Designed for EXTREME Productivity. Gain 20% or more in productivity over four flute styles. Smooth cutting action to eliminate vibration.

5
Flute

New-Standard Offering with Weldon Shank Flats

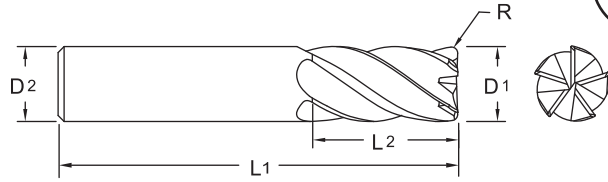

ALtima®		ALtima® Weldon Flat		Diameter			Shank		OAL		Flute Length		Corner Radius	
Tool No.	EDP	Tool No.	EDP	D1			D2 h6		L1		L2		R	
				Inch	mm	Decimal	Inch	mm	Inch	mm	Inch	mm	Inch	mm
17811800A	17959				3	.1181		6		57		8		
17811810A	17998				3	.1181		3		75		25		
17812500A	17800			1/8		.1250	1/8		1-1/2		1/8			
17812510A	17801			1/8		.1250	1/8		1-1/2		3/8			
17815600A	17802			5/32		.1562	3/16		2		3/16			
17815610A	17803			5/32		.1562	3/16		2		7/16			
17815700A	17961				4	.1575		6		57		11		
17815710A	17999				4	.1575		4		75		25		
17818700A	17804			3/16		.1875	3/16		2		3/16			
17818710A	17805			3/16		.1875	3/16		2		7/16			
17819600A	17963				5	.1968		6		57		13		
17819610A	18026				5	.1968		5		75		25		
17821800A	17806			7/32		.2187	1/4		2		1/4			
17821810A	17807			7/32		.2187	1/4		2-1/2		7/16			
17823600A	17965				6	.2362		6		57		13		
17823601A	17966				6	.2362		6		57		13		0.500
17823610A	18027				6	.2362		6		75		25		
17825000A	17808			1/4		.2500	1/4		2		3/8			
17825002A	17829			1/4		.2500	1/4		2		3/8		0.015	
17825004A	17830			1/4		.2500	1/4		2		3/8		0.030	
17825010A	17809			1/4		.2500	1/4		2-1/2		5/8			
17825012A	17831			1/4		.2500	1/4		2-1/2		5/8		0.015	
17825014A	17832			1/4		.2500	1/4		2-1/2		5/8		0.030	
17825022A	18105			1/4		.2500	1/4		2-1/2		3/4		0.015	
17828100A	17810			9/32		.2812	5/16		2-1/2		5/8			
17828102A	17835			9/32		.2812	5/16		2-1/2		5/8		0.015	
17828104A	17836			9/32		.2812	5/16		2-1/2		5/8		0.030	
17831200A	17811			5/16		.3125	5/16		2		7/16			
17831202A	17837			5/16		.3125	5/16		2		7/16		0.015	
17831204A	17838			5/16		.3125	5/16		2		7/16		0.030	

Inch	
D1	Tolerance
1/8-1/4	+0.000/-0.002
> 1/4-1.0	+0.000/-0.003

Metric (mm)	
D1	Tolerance h10
3.00	+0.000/-0.040
>3.00-6.00	+0.000/-0.048
>6.00-10.00	+0.000/-0.058
>10.00-18.00	+0.000/-0.070
>18.00-25.00	+0.000/-0.084

Inch	
D2	Tolerance (h6)
.1182 - .2362	+0/-0.00031
.2363 - .3937	+0/-0.00035
.3938 - .7087	+0/-0.00043
.7088 - 1.000	+0/-0.00051

Metric (mm)	
D2	Tolerance (h6)
3.0	+0/-0.006
3.01 - 6.0	+0/-0.008
6.01 - 10.0	+0/-0.009
10.01 - 18.0	+0/-0.011
18.01 - 25.0	+0/-0.013

Series 178/178W Continued



5
Flute

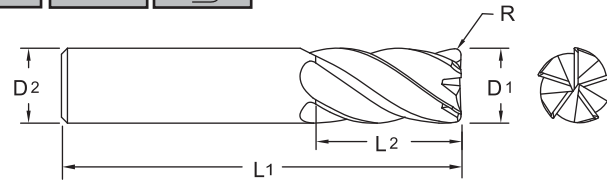

ALtima®		ALtima® Weldon Flat		Diameter			Shank		OAL		Flute Length		Corner Radius	
Tool No.	EDP	Tool No.	EDP	D1			D2 h6		L1		L2		R	
				Inch	mm	Decimal	Inch	mm	Inch	mm	Inch	mm	Inch	mm
17831210A	17812			5/16		.3125	5/16		2-1/2		13/16			
17831212A	17839			5/16		.3125	5/16		2-1/2		13/16		0.015	
17831214A	17840			5/16		.3125	5/16		2-1/2		13/16		0.030	
17831500A	17968				8	.3150		8		63		19		
17831501A	17969				8	.3150		8		63		19		0.500
17831510A	18028				8	.3150		8		75		30		
17834300A	17813			11/32		.3438	3/8		2-1/2		13/16			
17834302A	17843			11/32		.3438	3/8		2-1/2		13/16		0.015	
17834304A	17844			11/32		.3438	3/8		2-1/2		13/16		0.030	
17837500A	17814			3/8		.3750	3/8		2		1/2			
17837502A	17845			3/8		.3750	3/8		2		1/2		0.015	
17837504A	17846			3/8		.3750	3/8		2		1/2		0.030	
17837510A	17815			3/8		.3750	3/8		2-1/2		7/8			
17837512A	17847			3/8		.3750	3/8		2-1/2		7/8		0.015	
17837514A	17848			3/8		.3750	3/8		2-1/2		7/8		0.030	
17839300A	17971				10	.3937		10		72		22		
17839301A	17972				10	.3937		10		72		22		0.500
17839310A	18029				10	.3937		10		100		45		
17840600A	17816			13/32		.4062	7/16		2-3/4		7/8			
17840602A	17853			13/32		.4062	7/16		2-3/4		7/8		0.015	
17840604A	17854			13/32		.4062	7/16		2-3/4		7/8		0.030	
17843700A	17817			7/16		.4375	7/16		2-1/2		9/16			
17843702A	17855			7/16		.4375	7/16		2-1/2		9/16		0.015	
17843704A	17856			7/16		.4375	7/16		2-1/2		9/16		0.030	
17843710A	17818			7/16		.4375	7/16		2-3/4		1			
17843712A	17857			7/16		.4375	7/16		2-3/4		1		0.015	
17843714A	17858			7/16		.4375	7/16		2-3/4		1		0.030	
17846800A	17819			15/32		.4688	1/2		3		1			
17846802A	17863			15/32		.4688	1/2		3		1		0.015	
17846804A	17864			15/32		.4688	1/2		3		1		0.030	
17847200A	17974				12	.4724		12		83		26		
17847202A	17975				12	.4724		12		83		26		0.750
17847210A	18030				12	.4724		12		150		75		
17850000A	17820	17850000AW	10655	1/2		.5000	1/2		2-1/2		5/8			
17850002A	17865	17850002AW	13337	1/2		.5000	1/2		2-1/2		5/8		0.015	
17850004A	17866	17850004AW	13339	1/2		.5000	1/2		2-1/2		5/8		0.030	
17850010A	17821	17850010AW	13341	1/2		.5000	1/2		3		1			
17850012A	17867	17850012AW	13343	1/2		.5000	1/2		3		1		0.015	
17850014A	17868	17850014AW	13345	1/2		.5000	1/2		3		1		0.030	
17850015A	17869	17850015AW	13347	1/2		.5000	1/2		3		1		0.045	
17850016A	17913	17850016AW	13349	1/2		.5000	1/2		3		1		0.060	
17850017A	17914	17850017AW	13351	1/2		.5000	1/2		3		1		0.090	

Series 178/178W Continued

ALtima®		ALtima® Weldon Flat		Diameter			Shank		OAL		Flute Length		Corner Radius	
Tool No.	EDP	Tool No.	EDP	D1			D2 h6		L1		L2		R	
				Inch	mm	Decimal	Inch	mm	Inch	mm	Inch	mm	Inch	mm
17850018A	17915	17850018AW	13353	1/2		.5000	1/2		3		1		0.125	
17855100A	17977				14	.5512		14		83		26		
17855102A	17978				14	.5512		14		83		26		0.750
17856200A	17822	17856200AW	13355	9/16		.5625	9/16		3-1/2		1-1/8			
17856202A	17875	17856202AW	13357	9/16		.5625	9/16		3-1/2		1-1/8		0.015	
17856204A	17876	17856204AW	13359	9/16		.5625	9/16		3-1/2		1-1/8		0.030	
17862500A	17823	17862500AW	13361	5/8		.6250	5/8		3		3/4			
17862502A	18006	17862502AW	13363	5/8		.6250	5/8		3		3/4		0.015	
17862504A	17877	17862504AW	13365	5/8		.6250	5/8		3		3/4		0.030	
17862505A	17878	17862505AW	13367	5/8		.6250	5/8		3		3/4		0.045	
17862510A	17824	17862510AW	13369	5/8		.6250	5/8		3-1/2		1-1/4			
17862512A	18007	17862512AW	13371	5/8		.6250	5/8		3-1/2		1-1/4		0.015	
17862514A	17879	17862514AW	13373	5/8		.6250	5/8		3-1/2		1-1/4		0.030	
17862515A	17880	17862515AW	13375	5/8		.6250	5/8		3-1/2		1-1/4		0.045	
17862516A	17916	17862516AW	13377	5/8		.6250	5/8		3-1/2		1-1/4		0.060	
17862517A	17917	17862517AW	13379	5/8		.6250	5/8		3-1/2		1-1/4		0.090	
17862518A	17918	17862518AW	13381	5/8		.6250	5/8		3-1/2		1-1/4		0.125	
17862900A	17981				16	.6299		16		92		32		
17862903A	17982				16	.6299		16		92		32		1.000
17862910A	18031				16	.6299		16		150		75		
17870800A	17983				18	.7087		18		92		32		
17870803A	17984				18	.7087		18		92		32		1.000
17875000A	17825	17875000AW	10656	3/4		.7500	3/4		3		1			
17875002A	18011	17875002AW	13385	3/4		.7500	3/4		3		1		0.015	
17875004A	17887	17875004AW	13387	3/4		.7500	3/4		3		1		0.030	
17875005A	17888	17875005AW	13389	3/4		.7500	3/4		3		1		0.045	
17875010A	17826	17875010AW	13394	3/4		.7500	3/4		4		1-1/2			
17875012A	18012	17875012AW	13395	3/4		.7500	3/4		4		1-1/2		0.015	
17875014A	17889	17875014AW	13396	3/4		.7500	3/4		4		1-1/2		0.030	
17875015A	17890	17875015AW	13397	3/4		.7500	3/4		4		1-1/2		0.045	
17875016A	17919	17875016AW	13398	3/4		.7500	3/4		4		1-1/2		0.060	
17875017A	17920	17875017AW	13399	3/4		.7500	3/4		4		1-1/2		0.090	
17875018A	17921	17875018AW	13402	3/4		.7500	3/4		4		1-1/2		0.125	
17878700A	17986				20	.7874		20		104		38		
17878703A	17987				20	.7874		20		104		38		1.000
17878710A	18032				20	.7874		20		150		75		
17898400A	17988				25	.9843		25		104		38		
17898403A	17989				25	.9843		25		104		38		1.000
17810000A	17827	17810000AW	13403	1		1.0000	1		4		1			
17810010A	17828	17810010AW	13404	1		1.0000	1		4		1-1/2			
17810012A	18015	17810012AW	13405	1		1.0000	1		4		1-1/2		0.015	
17810014A	17895	17810014AW	13406	1		1.0000	1		4		1-1/2		0.030	
17810015A	17896	17810015AW	13407	1		1.0000	1		4		1-1/2		0.045	
17810016A	17922	17810016AW	13408	1		1.0000	1		4		1-1/2		0.060	
17810017A	17923	17810017AW	13420	1		1.0000	1		4		1-1/2		0.090	
17810018A	17924	17810018AW	13421	1		1.0000	1		4		1-1/2		0.125	



End Mills



TuffCut® XR Series 178N



5
Flute

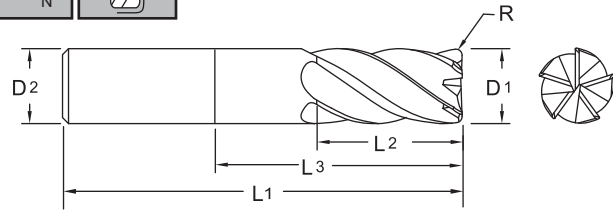

ALtima®		Diameter		Shank	OAL	Flute Length	Neck Length	Corner Radius
Tool No.	EDP	D1		D2 h6	L1	L2	L3	R
		Inch	Decimal	Inch	Inch	Inch	Inch	Inch
17825022NA	17833	1/4	.2500	1/4	4	3/4	2-1/8	0.015
17825024NA	17834	1/4	.2500	1/4	4	3/4	2-1/8	0.030
17831222NA	17841	5/16	.3125	5/16	4	1	2-1/8	0.015
17831224NA	17842	5/16	.3125	5/16	4	1	2-1/8	0.030
17837522NA	17849	3/8	.3750	3/8	4	1	2-1/8	0.015
17837524NA	17850	3/8	.3750	3/8	4	1	2-1/8	0.030
17837532NA	17851	3/8	.3750	3/8	6	1-1/4	3-3/8	0.015
17837534NA	17852	3/8	.3750	3/8	6	1-1/4	3-3/8	0.030
17843722NA	17859	7/16	.4375	7/16	4	1-1/4	2-1/8	0.015
17843724NA	17860	7/16	.4375	7/16	4	1-1/4	2-1/8	0.030
17843732NA	17861	7/16	.4375	7/16	6	1-1/2	3-3/8	0.015
17843734NA	17862	7/16	.4375	7/16	6	1-1/2	3-3/8	0.030
17850022NA	17925	1/2	.5000	1/2	4	1-1/4	2-1/8	0.015
17850024NA	17870	1/2	.5000	1/2	4	1-1/4	2-1/8	0.030
17850032NA	17871	1/2	.5000	1/2	5	1-3/8	3-1/8	0.015
17850034NA	17872	1/2	.5000	1/2	5	1-3/8	3-1/8	0.030
17850042NA	17873	1/2	.5000	1/2	6	1-1/2	4-1/8	0.015
17850044NA	17874	1/2	.5000	1/2	6	1-1/2	4-1/8	0.030
17862522NA	18008	5/8	.6250	5/8	4	1-1/2	2-1/8	0.015
17862524NA	17881	5/8	.6250	5/8	4	1-1/2	2-1/8	0.030
17862525NA	17882	5/8	.6250	5/8	4	1-1/2	2-1/8	0.045
17862532NA	18009	5/8	.6250	5/8	5	1-3/4	3-1/8	0.015
17862534NA	17883	5/8	.6250	5/8	5	1-3/4	3-1/8	0.030
17862535NA	17884	5/8	.6250	5/8	5	1-3/4	3-1/8	0.045
17862542NA	18010	5/8	.6250	5/8	6	2	4	0.015
17862544NA	17885	5/8	.6250	5/8	6	2	4	0.030
17862545NA	17886	5/8	.6250	5/8	6	2	4	0.045
17875022NA	18013	3/4	.7500	3/4	5	1-7/8	3	0.015
17875024NA	17891	3/4	.7500	3/4	5	1-7/8	3	0.030
17875025NA	17892	3/4	.7500	3/4	5	1-7/8	3	0.045
17875032NA	18014	3/4	.7500	3/4	6	2-1/4	4	0.015
17875034NA	17893	3/4	.7500	3/4	6	2-1/4	4	0.030
17875035NA	17894	3/4	.7500	3/4	6	2-1/4	4	0.045
17810022NA	18016	1	1.0000	1	5	2-1/4	3	0.015
17810024NA	17897	1	1.0000	1	5	2-1/4	3	0.030
17810025NA	17898	1	1.0000	1	5	2-1/4	3	0.045
17810032NA	18017	1	1.0000	1	6	3	4	0.015
17810034NA	17899	1	1.0000	1	6	3	4	0.030
17810035NA	17900	1	1.0000	1	6	3	4	0.045

Inch	
D1	Tolerance
1/4	+0.000/-0.002
> 1/4-1.0	+0.000/-0.003

Metric (mm)	
D1	Tolerance (h6)
.2363 - .3937	+0/-0.00035
.3938 - .7087	+0/-0.00043
.7088 - 1.000	+0/-0.00051



TuffCut® XR Series 179

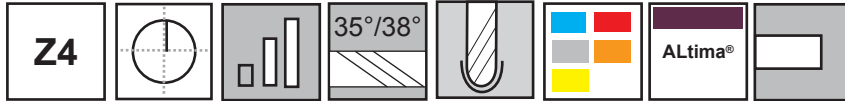

4
Flute
Ball

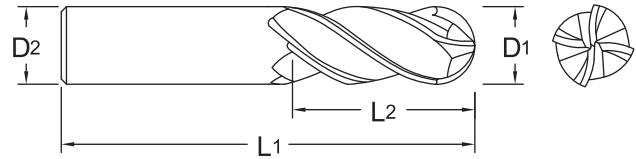

ALtima®		Diameter			Shank		OAL		Flute Length	
Tool No.	EDP	D1			D2 h6		L1		L2	
		Inch	mm	Decimal	Inch	mm	Inch	mm	Inch	mm
17905900A	18272		1.5	.0591		3		38		3.0
17906250A	18284	1/16		.0625	1/8		1-1/2		1/8	
17907810A	18286	5/64		.0781	1/8		1-1/2		5/32	
17907870A	18274		2	.0787		3		38		4.0
17909370A	18288	3/32		.0937	1/8		1-1/2		3/16	
17909840A	18276		2.5	.0984		3		38		5.0
17911800A	18018		3	.1181		6		57		8.0
17911803A	18278		3	.1181		3		38		6.0
17912500A	18034	1/8		.1250	1/8		1-1/2		1/4	
17912510A	18035	1/8		.1250	1/8		1-1/2		3/8	
17913700A	18280		3.5	.1378		6		63		7.0
17915700A	18019		4	.1575		6		57		11.0
17917700A	18282		4.5	.1772		6		63		9.0
17918700A	18038	3/16		.1875	3/16		2		3/8	
17918710A	18039	3/16		.1875	3/16		2		5/8	
17919600A	18020		5	.1968		6		57		13.0
17923600A	18021		6	.2362		6		57		13.0
17925000A	18042	1/4		.2500	1/4		2		3/8	
17925010A	18043	1/4		.2500	1/4		2-1/2		3/4	
17925020A	18063	1/4		.2500	1/4		4		1/2	
17931200A	18045	5/16		.3125	5/16		2		1/2	
17931210A	18046	5/16		.3125	5/16		2-1/2		13/16	
17931500A	18022		8	.3150		8		63		19.0
17937500A	18048	3/8		.3750	3/8		2		1/2	
17937510A	18049	3/8		.3750	3/8		2-1/2		7/8	
17937520A	18064	3/8		.3750	3/8		4		9/16	
17939300A	18023		10	.3937		10		72		22.0
17947200A	18024		12	.4724		12		83		26.0
17950000A	18054	1/2		.5000	1/2		2-1/2		5/8	
17950010A	18055	1/2		.5000	1/2		3		1-1/4	
17950020A	18065	1/2		.5000	1/2		5		5/8	
17962510A	18058	5/8		.6250	5/8		3-1/2		1-1/4	
17962520A	18066	5/8		.6250	5/8		6		3/4	
17962900A	18059		16	.6299		16		92		32.0
17975010A	18060	3/4		.7500	3/4		4		1-1/2	
17975020A	18067	3/4		.7500	3/4		6		1	
17910010A	18062	1		1.0000	1		4		1-1/2	
17910020A	18068	1		1.0000	1		6		1-1/4	

Inch	
D1	Tolerance
1/16-1/4	+0.000/-0.002
> 1/4-1.0	+0.000/-0.003

Metric (mm)	
D1	Tolerance h10
1.50-3.00	+0.000/-0.040
>3.00-6.00	+0.000/-0.048
>6.00-10.00	+0.000/-0.058
>10.00-16.00	+0.000/-0.070

Inch	
D2	Tolerance (h6)
.1182 - .2362	+0/-0.00031
.2363 - .3937	+0/-0.00035
.3938 - .7087	+0/-0.00043
.7088 - 1.000	+0/-0.00051

Metric (mm)	
D2	Tolerance (h6)
3.0	+0/-0.006
3.01 - 6.0	+0/-0.008
6.01 - 10.0	+0/-0.009
10.01 - 16.0	+0/-0.011

End Mills

TuffCut® XR Series 179L



**4
Flute
Ball**

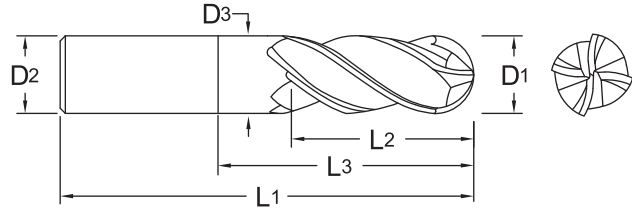

ALtima®		Diameter		Shank	Neck Dia.	OAL	Flute Length	Neck Length
Tool No.	EDP	D1 h10		D2 h6	D3	L1	L2	L3
		mm	Decimal	mm	mm	mm	mm	mm
179L1181N5A	18290	3	.1181	6	2.9	75	4.5	17
179L1575N5A	18292	4	.1575	6	3.9	75	6.0	22
179L1968N5A	18294	5	.1968	6	4.9	75	7.5	27
179L2362N5A	18296	6	.2362	6	5.8	101	9.0	32
179L3150N5A	18298	8	.3150	8	7.6	101	12.0	42
179L3937N5A	18302	10	.3937	10	9.6	127	15.0	52
179L4724N5A	18304	12	.4724	12	11.4	152	18.0	62
179L6299N5A	18306	16	.6299	16	15.2	152	24.0	82

Metric (mm)	
D1	Tolerance h10
3.00	+0.00/-0.040
>3.00-6.00	+0.00/-0.048
>6.00-10.00	+0.00/-0.058
>10.00-16.00	+0.00/-0.070

Metric (mm)	
D2	Tolerance (h6)
6.0	+0/-0.008
6.01 - 10.0	+0/-0.009
10.01 - 16.0	+0/-0.011

Inch Sizes Available upon request.



TuffCut® X-AL Series 138CE

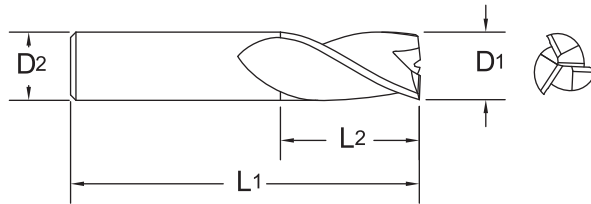
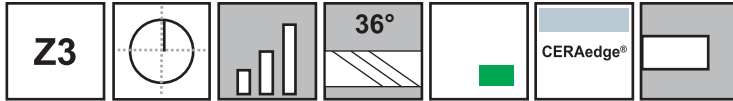

CERAedge®		Diameter			Shank		OAL		Flute Length	
		D1			D2		L1		L2	
Tool No.	EDP	Inch	mm	Decimal	Inch	mm	Inch	mm	Inch	mm
13812501CE	07988	1/8		.1250	1/8		1-1/2		1/4	
13812503CE	07990	1/8		.1250	1/8		1-1/2		3/8	
13812504CE	07992	1/8		.1250	1/8		1-1/2		1/2	
13812506CE	07994	1/8		.1250	1/8		2		3/4	
13818751CE	07996	3/16		.1875	3/16		2		3/8	
13818752CE	07998	3/16		.1875	3/16		2		1/2	
13818753CE	08000	3/16		.1875	3/16		2-1/2		5/8	
13818754CE	08002	3/16		.1875	3/16		2-1/2		3/4	
13818755CE	08004	3/16		.1875	3/16		2-1/2		1	
13823620CE	08006		6.0	.2362		6.0		58.0		13.0
13825000CE	08008	1/4		.2500	1/4		2		3/8	
13825001CE	08010	1/4		.2500	1/4		2		1/2	
13825003CE	08012	1/4		.2500	1/4		2		5/8	
13825004CE	08014	1/4		.2500	1/4		2-1/2		3/4	
13825005CE	08016	1/4		.2500	1/4		3		1	
13825007CE	08018	1/4		.2500	1/4		3		1-1/4	
13831500CE	08020		8.0	.3150		8.0		64.0		19.0
13837500CE	08022	3/8		.3750	3/8		2		1/2	
13837504CE	08024	3/8		.3750	3/8		2-1/2		3/4	
13837505CE	08026	3/8		.3750	3/8		2-1/2		1	
13837506CE	08028	3/8		.3750	3/8		3		1-1/4	
13837507CE	08030	3/8		.3750	3/8		3-1/2		1-1/2	
13837508CE	08032	3/8		.3750	3/8		4		2	
13839370CE	08034		10.0	.3937		10.0		70.0		22.0
13847240CE	08036		12.0	.4724		12.0		84.0		26.0
13850000CE	08038	1/2		.5000	1/2		3		5/8	
13850001CE	08040	1/2		.5000	1/2		3		3/4	
13850002CE	08042	1/2		.5000	1/2		3		1	

M.A. FORD® APG

CERAedge®

Hardness that makes it the 3rd hardest material when compared to industrial diamonds.

- Toughness that is comparable to Titanium.
- Lubricity that approaches Teflon.
- Extreme heat tolerance.
- Non-reactive to Titanium.

See the MA Ford Full Line catalog for the complete offering of the 138 series end mills for machining Aluminum. The offering includes 7 industry standard corner radii, stub, standard, and long length as well as necked relief styles. Contact customer service for your copy or view online at www.maford.com



Inch	
D1	Tolerance
1/8-1	+ .000/- .0005

Metric (mm)	
D1	Tolerance
6.00-20.00	+ .000/- .013

CERAedge® Coating Properties	
Microhardness (HV)	3400
Max. Service Temperature	1100° C / 2012° F
Friction Coefficient	0.25
Coating Thickness	2-3 microns
Color	Light Gray

Series 138CE Continued

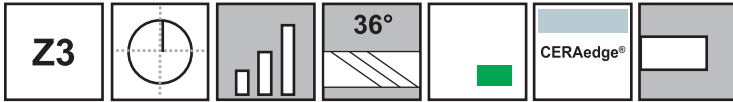

3
Flute

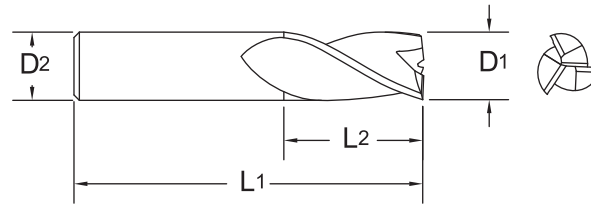

CERAedge®		Diameter			Shank		OAL		Flute Length	
		D1			D2		L1		L2	
Tool No.	EDP	Inch	mm	Decimal	Inch	mm	Inch	mm	Inch	mm
13850003CE	08044	1/2		.5000	1/2		3		1-1/4	
13850004CE	08046	1/2		.5000	1/2		4		1-1/2	
13850005CE	08048	1/2		.5000	1/2		4		2	
13850006CE	08050	1/2		.5000	1/2		4		2-1/4	
13850007CE	08052	1/2		.5000	1/2		6		2-1/2	
13855120CE	08054		14.0	.5512		14.0		84.0		26.0
13862503CE	08056	5/8		.6250	5/8		3-1/2		1-1/4	
13862504CE	08058	5/8		.6250	5/8		4		1-5/8	
13862506CE	08060	5/8		.6250	5/8		5		2-1/2	
13862507CE	08062	5/8		.6250	5/8		6		3-1/4	
13862990CE	08064		16.0	.6299		16.0		89.0		32.0
13875001CE	08066	3/4		.7500	3/4		4		1	
13875004CE	08068	3/4		.7500	3/4		4		1-5/8	
13875005CE	08070	3/4		.7500	3/4		5		2	
13875006CE	08072	3/4		.7500	3/4		5		2-1/4	
13875007CE	08074	3/4		.7500	3/4		5		2-1/2	
13875008CE	08076	3/4		.7500	3/4		6		3	
13878740CE	08078		20.0	.7874		20.0		102.0		38.0
13810002CE	08080	1		1.0000	1		4		1-1/2	
13810003CE	08082	1		1.0000	1		5		2	
13810005CE	08084	1		1.0000	1		6		3	
13810006CE	08086	1		1.0000	1		6		3-1/2	

ISO 9001:2008 Certified
Made in USA



TuffCut® DM Series 156

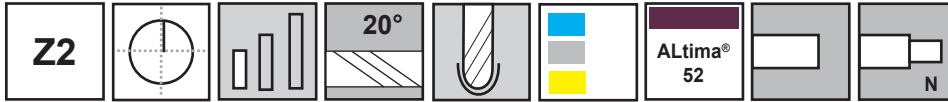

Series 156 is designed for high-productivity milling of hard and difficult to cut materials Rc 45-60. Coated with ALtima® 52 for materials Rc 52 and above.

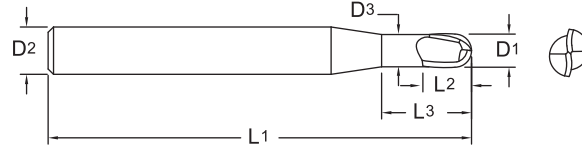

ALtima® 52		Diameter			Shank		Neck Diameter		OAL		Flute Length		Neck Length	
		D1			D2 h5		D3		L1		L2		L3	
Tool No.	EDP	Inch	mm	Decimal	Inch	mm	Inch	mm	Inch	mm	Inch	mm	Inch	mm
15601560A	15600	1/64		.0156	1/4				2-1/2		1/64			
156M0050N1A	15400		0.5	.0196		4.0		0.47		50		0.35		1
156M0050N2A	15401		0.5	.0196		4.0		0.47		50		0.35		2
156M0050N3A	15402		0.5	.0196		4.0		0.47		50		0.35		3
156M0050N4A	15403		0.5	.0196		4.0		0.47		50		0.35		4
156M0050N5A	15404		0.5	.0196		4.0		0.47		50		0.35		5
156M0050N6A	15406		0.5	.0196		4.0		0.47		50		0.35		6
15601960A	15602		0.5	.0196		6.0				63		0.50		
156M0060N2A	15409		0.6	.0236		4.0		0.57		50		0.40		2
156M0060N4A	15411		0.6	.0236		4.0		0.57		50		0.40		4
156M0060N6A	15413		0.6	.0236		4.0		0.57		50		0.40		6
156M0060N8A	15415		0.6	.0236		4.0		0.57		50		0.40		8
156M0060N10A	15417		0.6	.0236		4.0		0.57		50		0.40		10
15603120A	15604	1/32		.0312	1/4				2-1/2		1/32			
15603121A	15606	1/32		.0312	1/4		.0300		2-1/2		1/32		1/4	
15603122A	15608	1/32		.0312	1/4		.0300		2-1/2		1/32		5/16	
15603123A	15610	1/32		.0312	1/4		.0300		2-1/2		1/32		3/8	
15603124A	15612	1/32		.0312	1/4		.0300		2-1/2		1/32		1/2	
15603125A	15614	1/32		.0312	1/4		.0300		2-1/2		1/32		5/8	
156M0080N2A	15419		0.8	.0315		4.0		0.77		50		0.50		2
156M0080N4A	15420		0.8	.0315		4.0		0.77		50		0.50		4
156M0080N6A	15422		0.8	.0315		4.0		0.77		50		0.50		6
156M0080N8A	15423		0.8	.0315		4.0		0.77		50		0.50		8
156M0080N10A	15424		0.8	.0315		4.0		0.77		50		0.50		10
156M0100N2A	15425		1.0	.0394		4.0		0.96		50		0.80		2
156M0100N3A	15426		1.0	.0394		4.0		0.96		50		0.80		3
156M0100N4A	15427		1.0	.0394		4.0		0.96		50		0.80		4
156M0100N6A	15429		1.0	.0394		4.0		0.96		50		0.80		6

• Radius Tolerance +/- .0004 inch (±.010 mm)

Inch		Metric (mm)	
D1	Tolerance	D1	Tolerance
1/64-1/2	+0 /-.0005	0.50-12.00	+0 /-.015

Inch		Metric (mm)	
D2	Tolerance h5	D2	Tolerance h5
.1182-.2362	+0 /-.00020	3.01-6.00	+0 /-.005
.2363-.3937	+0 /-.00024	6.01-10.00	+0 /-.006
.3938-7087	+0 /-.00031	10.01-18.00	+0 /-.008



End Mills

Series 156 Continued

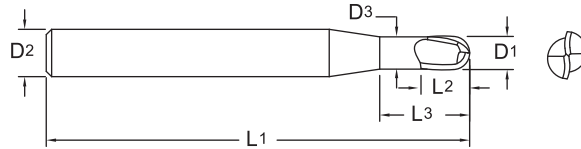
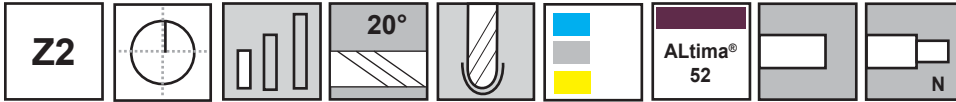

ALtima® 52		Diameter			Shank		Neck Diameter		OAL		Flute Length		Neck Length	
		D1			D2 h5		D3		L1		L2		L3	
Tool No.	EDP	Inch	mm	Decimal	Inch	mm	Inch	mm	Inch	mm	Inch	mm	Inch	mm
156M0100N10A	15431		1.0	.0394		4.0		0.96		50		0.80		10
156M0100N12A	15432		1.0	.0394		4.0		0.96		63		0.80		12
156M0100N14A	15433		1.0	.0394		4.0		0.96		63		0.80		14
156M0100N16A	15434		1.0	.0394		4.0		0.96		63		0.80		16
156M0100N18A	15435		1.0	.0394		4.0		0.96		63		0.80		18
156M0100N20A	15436		1.0	.0394		4.0		0.96		63		0.80		20
15603940A	15616		1.0	.0394		6.0				63		1.00		
15603941A	15618		1.0	.0394		6.0		0.96		63		1.00		6
15603942A	15620		1.0	.0394		6.0		0.96		63		1.00		8
15603943A	15622		1.0	.0394		6.0		0.96		63		1.00		10
15603944A	15624		1.0	.0394		6.0		0.96		63		1.00		12
15603945A	15626		1.0	.0394		6.0		0.96		63		1.00		16
156M0120N8A	15437		1.2	.0472		4.0		1.15		50		1.10		8
156M0120N12A	15438		1.2	.0472		4.0		1.15		63		1.10		12
156M0140N8A	15439		1.4	.0551		4.0		1.34		50		1.30		8
156M0140N12A	15440		1.4	.0551		4.0		1.34		63		1.30		12
156M0140N16A	15441		1.4	.0551		4.0		1.34		63		1.30		16
156M0150N4A	15442		1.5	.0591		4.0		1.44		50		1.35		4
156M0150N8A	15444		1.5	.0591		4.0		1.44		50		1.35		8
156M0150N16A	15446		1.5	.0591		4.0		1.44		63		1.35		16
156M0150N20A	15447		1.5	.0591		4.0		1.44		63		1.35		20
15605910A	15628		1.5	.0591		6.0				63		1.50		
15606250A	15630	1/16		.0625	1/4				2-1/2		1/16			
156M0160N8A	15448		1.6	.0630		4.0		1.54		50		1.40		8
156M0160N12A	15449		1.6	.0630		4.0		1.54		63		1.40		12
156M0160N16A	15450		1.6	.0630		4.0		1.54		63		1.40		16
156M0160N20A	15451		1.6	.0630		4.0		1.54		63		1.40		20
156M0180N8A	15452		1.8	.0709		4.0		1.73		50		1.60		8
156M0180N12A	15453		1.8	.0709		4.0		1.73		63		1.60		12
156M0180N16A	15454		1.8	.0709		4.0		1.73		63		1.60		16
156M0180N20A	15455		1.8	.0709		4.0		1.73		63		1.60		20
156M0200N3A	15456		2.0	.0787		4.0		1.92		50		1.70		3
156M0200N4A	15457		2.0	.0787		4.0		1.92		50		1.70		4
156M0200N6A	15458		2.0	.0787		4.0		1.92		50		1.70		6
156M0200N8A	15459		2.0	.0787		4.0		1.92		50		1.70		8
156M0200N10A	15460		2.0	.0787		4.0		1.92		50		1.70		10
156M0200N12A	15461		2.0	.0787		4.0		1.92		63		1.70		12
156M0200N16A	15463		2.0	.0787		4.0		1.92		63		1.70		16

Series 156 Continued



ALtima® 52		Diameter			Shank		Neck Diameter		OAL		Flute Length		Neck Length	
		D1			D2 h5		D3		L1		L2		L3	
Tool No.	EDP	Inch	mm	Decimal	Inch	mm	Inch	mm	Inch	mm	Inch	mm	Inch	mm
156M0200N20A	15465		2.0	.0787		4.0		1.92		63		1.70		20
156M0200N25A	15467		2.0	.0787		4.0		1.92		80		1.70		25
156M0200N30A	15468		2.0	.0787		4.0		1.92		80		1.70		30
156M0200N35A	15469		2.0	.0787		4.0		1.92		80		1.70		35
156M0200N40A	15470		2.0	.0787		4.0		1.92		80		1.70		40
15607870A	15632		2.0	.0787		6.0				63		2.00		
15607871A	15634		2.0	.0787		6.0		1.92		63		2.00		8
15607872A	15636		2.0	.0787		6.0		1.92		63		2.00		12
15607873A	15638		2.0	.0787		6.0		1.92		63		2.00		20
15609370A	15640	3/32		.0937	1/4				2-1/2		3/32			
15609371A	15642	3/32		.0937	1/4		.0898		2-1/2		3/32		5/16	
15609372A	15644	3/32		.0937	1/4		.0898		2-1/2		3/32		1/2	
15609373A	15646	3/32		.0937	1/4		.0898		2-1/2		3/32		3/4	
156M0300N8A	15471		3.0	.1181		6.0		2.90		75		2.50		8
156M0300N10A	15472		3.0	.1181		6.0		2.90		75		2.50		10
156M0300N16A	15474		3.0	.1181		6.0		2.90		75		2.50		16
156M0300N25A	15476		3.0	.1181		6.0		2.90		75		2.50		25
156M0300N30A	15477		3.0	.1181		6.0		2.90		75		2.50		30
156M0300N35A	15478		3.0	.1181		6.0		2.90		75		2.50		35
15611810A	15648		3.0	.1181		6.0				75		3.00		
15611812A	15676		3.0	.1181		6.0		2.90		75		3.00		12
15611811A	15650		3.0	.1181		6.0		2.90		75		3.00		20
15612500A	15652	1/8		.1250	1/4				3		1/8			
15612501A	15654	1/8		.1250	1/4		.1211		3		1/8		3/4	
15615620A	15656	5/32		.1562	1/4				3		5/32			
156M0400N10A	15480		4.0	.1575		6.0		3.90		75		3.00		10
156M0400N16A	15482		4.0	.1575		6.0		3.90		75		3.00		16
156M0400N25A	15484		4.0	.1575		6.0		3.90		75		3.00		25
156M0400N35A	15486		4.0	.1575		6.0		3.90		75		3.00		35
156M0400N40A	15487		4.0	.1575		6.0		3.90		75		3.00		40
156M0400N50A	15489		4.0	.1575		6.0		3.90		100		3.00		50
15615750A	15658		4.0	.1575		6.0				75		4.00		
15615751A	15678		4.0	.1575		6.0		3.90		75		4.00		12
15615752A	15679		4.0	.1575		6.0		3.90		75		4.00		20
15618750A	15659	3/16		.1875	1/4				3		3/16			
156M0500N25A	15490		5.0	.1968		6.0		4.90		75		3.50		25
156M0500N40A	15493		5.0	.1968		6.0		4.90		75		3.50		40
15619680A	15680		5.0	.1968		6.0				75		5.00		
15619681A	15681		5.0	.1968		6.0		4.90		75		5.00		12
15619682A	15682		5.0	.1968		6.0		4.90		75		5.00		25
156M0600N30A	15494		6.0	.2362		6.0		5.90		75		4.50		30
156M0600N50A	15495		6.0	.2362		6.0		5.90		100		4.50		50
15623620A	15660		6.0	.2362		6.0				75		6.00		
15623621A	15683		6.0	.2362		6.0		5.90		75		6.00		12
15623622A	15684		6.0	.2362		6.0		5.90		75		6.00		25
15625000A	15662	1/4		.2500	1/4				3		1/4			



Series 156 Continued

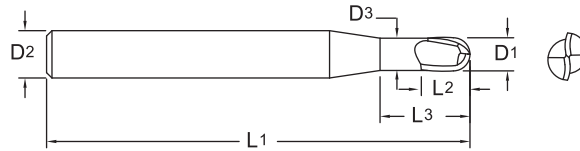
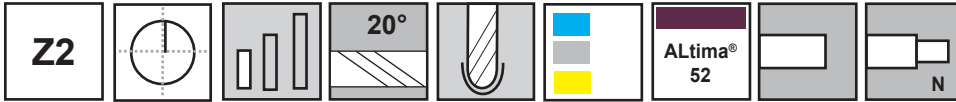

ALtima® 52		Diameter			Shank		Neck Diameter		OAL		Flute Length		Neck Length	
		D1			D2 h5		D3		L1		L2		L3	
Tool No.	EDP	Inch	mm	Decimal	Inch	mm	Inch	mm	Inch	mm	Inch	mm	Inch	mm
15631250A	15664	5/16		.3125	5/16				3-1/8		5/16			
156M0800N30A	15665		8.0	.3150		8.0		7.90		102		5.50		30
156M0800N50A	15667		8.0	.3150		8.0		7.90		102		5.50		50
15631500A	15666		8.0	.3150		8.0				80		8.00		
15637500A	15668	3/8		.3750	3/8				3-1/4		3/8			
156M1000N30A	15669		10.0	.3937		10.0		9.90		102		6.50		30
156M1000N50A	15671		10.0	.3937		10.0		9.90		102		6.50		50
15639370A	15670		10.0	.3937		10.0				82		10.00		
156M1200N30A	15673		12.0	.4724		12.0		11.90		102		7.50		30
156M1200N50A	15675		12.0	.4724		12.0		11.90		102		7.50		50
15647240A	15672		12.0	.4724		12.0				100		12.00		
15650000A	15674	1/2		.5000	1/2				4		1/2			

Go Green with RED BOX



Extend the Life of Your Cutting Tools with M.A. Ford®'s Reconditioning Service.

See page 186 for more information or Call 800-553-8024 or 563-391-6220



TuffCut® DM Series 158

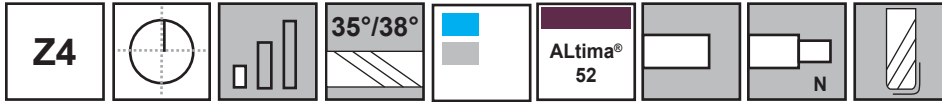

Series 158 was designed with similar TuffCut® XR geometry, but incorporates features that make it an excellent tool for die and mold steels and hard to machine materials up to 65 Rc. Coated with ALtima® 52 for materials Rc 52 and above.

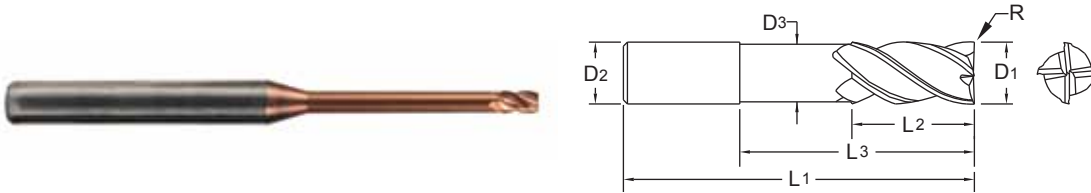

4
Flute

ALtima® 52		Diameter		Shank	Neck Diameter	OAL	Flute Length	Neck Length	Corner Radius
Tool No.	EDP	D1	D2						
		mm	Decimal	D2 h6	D3	L1	L2	L3	R
15811800N3A	15522	3	.1181	6	2.9	50	5	9	
15811800N5A	15524	3	.1181	6	2.9	50	5	15	
15811800R012N3A	15526	3	.1181	6	2.9	50	5	9	0.3
15811800R012N5A	15528	3	.1181	6	2.9	50	5	15	0.3
15811800R031N5A	15530	3	.1181	6	2.9	50	5	15	0.8
15823600N3A	15532	6	.2362	6	5.8	100	9	18	
15823600N5A	15534	6	.2362	6	5.8	100	9	30	
15823600R012N3A	15536	6	.2362	6	5.8	100	9	18	0.3
15823600R012N5A	15538	6	.2362	6	5.8	100	9	30	0.3
15823600R059N5A	15540	6	.2362	6	5.8	100	9	30	1.5
15831500N3A	15542	8	.3150	8	7.6	100	12	24	
15831500N5A	15544	8	.3150	8	7.6	100	12	40	
15831500R012N3A	15546	8	.3150	8	7.6	100	12	24	0.3
15831500R012N5A	15548	8	.3150	8	7.6	100	12	40	0.3
15831500R079N5A	15550	8	.3150	8	7.6	100	12	40	2.0
15839300N3A	15552	10	.3937	10	9.6	100	15	30	
15839300N5A	15554	10	.3937	10	9.6	100	15	50	
15839300R012N3A	15556	10	.3937	10	9.6	100	15	30	0.3
15839300R012N5A	15558	10	.3937	10	9.6	100	15	50	0.3
15839300R079N5A	15560	10	.3937	10	9.6	100	15	50	2.0
15847200N3A	15562	12	.4724	12	11.4	100	18	36	
15847200N5A	15564	12	.4724	12	11.4	130	18	60	
15847200R012N3A	15566	12	.4724	12	11.4	100	18	36	0.3
15847200R012N5A	15568	12	.4724	12	11.4	130	18	60	0.3
15847200R079N5A	15570	12	.4724	12	11.4	130	18	60	2.0
15862900N3A	15572	16	.6299	16	15.2	130	24	48	
15862900N5A	15574	16	.6299	16	15.2	150	24	80	
15862900R012N3A	15576	16	.6299	16	15.2	130	24	48	0.3
15862900R012N5A	15578	16	.6299	16	15.2	150	24	80	0.3
15862900R118N5A	15580	16	.6299	16	15.2	150	24	80	3.0
15878700N5A	15582	20	.7874	20	19.2	150	30	100	
15878700R012N5A	15584	20	.7874	20	19.2	150	30	100	0.3
15878700R118N5A	15586	20	.7874	20	19.2	150	30	100	3.0

Metric (mm)	
D1	Tolerance
3.0 - 20.0	+0/-0.02

Metric (mm)	
D2	Tolerance (h6)
3	+0/-0.006
3.01 - 6.0	+0/-0.008
6.01 - 10.0	+0/-0.009
10.01 - 18.0	+0/-0.011
18.01 - 20.0	+0/-0.013

End Mills



TuffCut® DM Series 157

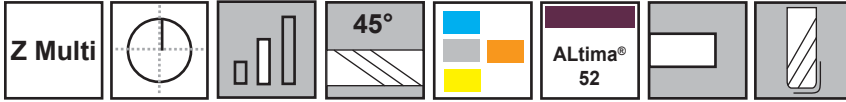

Multi-Flute designed for hardened materials Rc 50-65. Available as a Square End and in 7 standard corner radii. Coated with ALtima® 52 for materials Rc 52 and above.

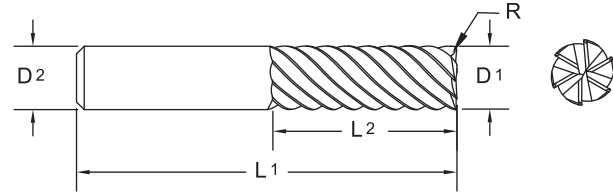

ALtima® 52		Diameter			Shank		OAL		Flute Length		Corner Radius		No. of Flutes
Tool No.	EDP	D1			D2		L1		L2		R		
		Inch	mm	Decimal	Inch	mm	Inch	mm	Inch	mm	Inch	mm	
15711810A	15700		3	.1181		6		75		10			4
15711811A	15701		3	.1181		6		75		10		0.50	4
15712500A	15702	1/8		.1250	1/4		3		3/8				4
15712501A	15703	1/8		.1250	1/4		3		3/8		0.015		4
15712502A	15704	1/8		.1250	1/4		3		3/8		0.020		4
15715620A	15705	5/32		.1562	1/4		3		15/32				4
15715621A	15706	5/32		.1562	1/4		3		15/32		0.015		4
15715622A	15707	5/32		.1562	1/4		3		15/32		0.020		4
15715750A	15708		4	.1575		6		75		12			4
15715751A	15709		4	.1575		6		75		12		0.50	4
15715752A	15710		4	.1575		6		75		12		0.75	4
15718750A	15711	3/16		.1875	1/4		3		9/16				4
15718751A	15712	3/16		.1875	1/4		3		9/16		0.015		4
15718752A	15713	3/16		.1875	1/4		3		9/16		0.020		4
15718753A	15714	3/16		.1875	1/4		3		9/16		0.030		4
15719680A	15715		5	.1968		6		90		15			4
15719681A	15716		5	.1968		6		90		15		0.50	4
15719682A	15717		5	.1968		6		90		15		0.75	4
15719683A	15718		5	.1968		6		90		15		1.00	4
15723620A	15719		6	.2362		6		90		15			6
15723621A	15720		6	.2362		6		90		15		0.50	6
15723622A	15721		6	.2362		6		90		15		0.75	6
15723623A	15722		6	.2362		6		90		15		1.00	6
15725000A	15723	1/4		.2500	1/4		3-1/2		5/8				6
15725001A	15724	1/4		.2500	1/4		3-1/2		5/8		0.015		6
15725002A	15725	1/4		.2500	1/4		3-1/2		5/8		0.020		6

Inch		Metric (mm)	
D1	Tolerance	D1	Tolerance
1/8-3/16	-.0006/- .0015	3.0	-.005/- .028
1/4-5/8	-.0008/- .0019	4.0-6.0	-.015/- .038
		8.0-16.0	-.020/- .048
		20.0-25.0	-.020/- .053



Series 157 Continued

ALtima® 52		Diameter			Shank		OAL		Flute Length		Corner Radius		No. of Flutes
		D1			D2		L1		L2		R		
Tool No.	EDP	Inch	mm	Decimal	Inch	mm	Inch	mm	Inch	mm	Inch	mm	
15725003A	15726	1/4		.2500	1/4		3-1/2		5/8		0.030		6
15725004A	15727	1/4		.2500	1/4		3-1/2		5/8		0.045		6
15731250A	15728	5/16		.3125	5/16		4		3/4				6
15731251A	15729	5/16		.3125	5/16		4		3/4		0.015		6
15731252A	15730	5/16		.3125	5/16		4		3/4		0.020		6
15731253A	15731	5/16		.3125	5/16		4		3/4		0.030		6
15731254A	15732	5/16		.3125	5/16		4		3/4		0.045		6
15731500A	15733		8	.3150		8		100		20			6
15731501A	15734		8	.3150		8		100		20		0.50	6
15731502A	15735		8	.3150		8		100		20		0.75	6
15731503A	15736		8	.3150		8		100		20		1.00	6
15731504A	15737		8	.3150		8		100		20		1.50	6
15731505A	15810		8	.3150		8		100		20		2.00	6
15737500A	15738	3/8		.3750	3/8		4		1				6
15737501A	15739	3/8		.3750	3/8		4		1		0.015		6
15737502A	15740	3/8		.3750	3/8		4		1		0.020		6
15737503A	15741	3/8		.3750	3/8		4		1		0.030		6
15737504A	15742	3/8		.3750	3/8		4		1		0.045		6
15739370A	15743		10	.3937		10		100		25			6
15739371A	15744		10	.3937		10		100		25		0.50	6
15739372A	15745		10	.3937		10		100		25		0.75	6
15739373A	15746		10	.3937		10		100		25		1.00	6
15739374A	15747		10	.3937		10		100		25		1.50	6
15739375A	15812		10	.3937		10		100		25		2.00	6
15747240A	15748		12	.4724		12		100		30			6
15747241A	15749		12	.4724		12		100		30		0.50	6
15747242A	15750		12	.4724		12		100		30		0.75	6
15747243A	15751		12	.4724		12		100		30		1.00	6
15747244A	15752		12	.4724		12		100		30		1.50	6
15747245A	15753		12	.4724		12		100		30		2.00	6
15747247A	15814		12	.4724		12		100		30		3.00	6
15750000A	15754	1/2		.5000	1/2		4		1-1/4				6
15750001A	15755	1/2		.5000	1/2		4		1-1/4		0.015		6
15750002A	15756	1/2		.5000	1/2		4		1-1/4		0.020		6
15750003A	15757	1/2		.5000	1/2		4		1-1/4		0.030		6
15750004A	15758	1/2		.5000	1/2		4		1-1/4		0.045		6
15750005A	15759	1/2		.5000	1/2		4		1-1/4		0.060		6
15762500A	15760	5/8		.6250	5/8		6		1-9/16				6
15762501A	15761	5/8		.6250	5/8		6		1-9/16		0.015		6
15762502A	15762	5/8		.6250	5/8		6		1-9/16		0.020		6
15762503A	15763	5/8		.6250	5/8		6		1-9/16		0.030		6
15762504A	15764	5/8		.6250	5/8		6		1-9/16		0.045		6
15762505A	15765	5/8		.6250	5/8		6		1-9/16		0.060		6
15762506A	15766	5/8		.6250	5/8		6		1-9/16		0.090		6



End Mills



Series 157 Continued

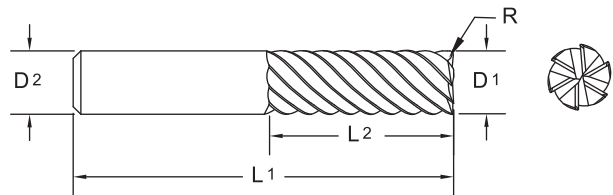
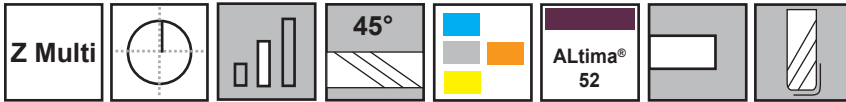

ALtima® 52		Diameter			Shank		OAL		Flute Length		Corner Radius		No. of Flutes
		D1			D2		L1		L2		R		
Tool No.	EDP	Inch	mm	Decimal	Inch	mm	Inch	mm	Inch	mm	Inch	mm	
15762990A	15767		16	.6299		16		150		40			6
15762991A	15768		16	.6299		16		150		40		0.50	6
15762992A	15769		16	.6299		16		150		40		0.75	6
15762993A	15770		16	.6299		16		150		40		1.00	6
15762994A	15771		16	.6299		16		150		40		1.50	6
15762995A	15772		16	.6299		16		150		40		2.00	6
15762996A	15773		16	.6299		16		150		40		2.50	6
15762997A	15774		16	.6299		16		150		40		3.00	6
15778740A	15783		20	.7874		20		150		45			8
15778741A	15784		20	.7874		20		150		45		0.50	8
15778742A	15785		20	.7874		20		150		45		0.75	8
15778743A	15786		20	.7874		20		150		45		1.00	8
15778744A	15787		20	.7874		20		150		45		1.50	8
15778745A	15788		20	.7874		20		150		45		2.00	8
15778746A	15789		20	.7874		20		150		45		2.50	8
15778747A	15790		20	.7874		20		150		45		3.00	8
15798430A	15791		25	.9843		25		150		50			10
15798431A	15792		25	.9843		25		150		50		0.50	10
15798432A	15793		25	.9843		25		150		50		0.75	10
15798433A	15794		25	.9843		25		150		50		1.00	10
15798434A	15795		25	.9843		25		150		50		1.50	10
15798435A	15796		25	.9843		25		150		50		2.00	10
15798436A	15797		25	.9843		25		150		50		2.50	10
15798437A	15798		25	.9843		25		150		50		3.00	10

Safety Note

Always wear the appropriate personal protective equipment such as safety glasses and protective clothing when using solid carbide or HSS cutting tools. Machines should be fully guarded.



TuffCut®

High Performance End Mills

TuffCut® XT

Tech Info Series 277 / 277N / 277W ...142-145
Tech Info Series 278 / 278N / 278W ...146-149
Tech Info Series 279150-151

TuffCut® XR7

Tech Info Series 180152-153
Tech Info Series 180N.....152-153

TuffCut® XR

Tech Info Series 177 / 177W /
177L / 177S / 179 / 179L.....154-157
Tech Info Series 178 / 178W.....158-161
Tech Info Series 178N.....158-161

TuffCut® X-AL

Tech Info Series 138CE162-163

TuffCut® DM

Tech Info Series 156164-165
Tech Info Series 158166-169
Tech Info Series 157170-173

ADVANCED TECHNOLOGY

Technical Information
End Mills



End Mill Icon Glossary



Number of Flutes



Workpiece
Material Group

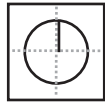

Center Cutting



Steels



Lengths



Stainless Steels

Coatings

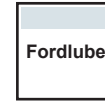
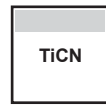

Cast Iron



Special Alloys

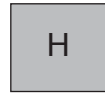

Hardened Steels
(35-65Rc)

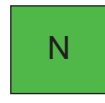

Non-Ferrous

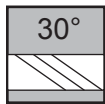

Helix Angle



Ball Nose

Coolant	Maximum
Max.	Coolant
Coolant	Minimal
MMS	Coolant

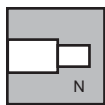

Neck Relief



Corner Radius

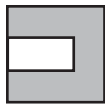

Shank

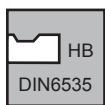

Shank/DIN

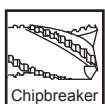

Chipbreaker

Cutting Calculations And Definitions		Metric	U.S.
ae	= Width of cut, radial depth of cut	(mm)	(inch)
ap	= Depth of cut, axial depth of cut	(mm)	(inch)
Dc	= Cutter diameter	(mm)	(inch)
f	= Feed per revolution	(mm/rev)	(IPR)
fz	= Feed per tooth	(mm/tooth)	(IPT)
zn	= Number of teeth	Number	
n	= RPM	(rev/min)	(rev/min)
Q	= Metal removal rate	(cm ³ /min)	(in ³ /min)
vc	= Cutting speed	(m/min)	(SFM)
vf	= Feed speed	(mm/min)	(IPM)
Dw	= Working diameter	(mm)	(inch)

Formulas

Inch

$$\text{RPM (n)} = \text{SFM (vc)} \times 3.82 / \text{Tool Diam.}$$

$$\text{IPM (vf)} = \text{RPM (n)} \times \text{IPR (f)}$$

Conversion Inch to Metric

$$\text{SFM (vc) to m/min (vc)} = \text{SFM (vc)} \times .3048$$

$$\text{IPM (vf) to mm/min (vf)} = \text{IPM (vf)} \times 25.4$$

Metric

$$\text{RPM (n)} = \text{m/min (vc)} \times 318.057 / \text{Tool Diam.}$$

$$\text{mm/min (vf)} = \text{RPM (n)} \times \text{mm/Revolution (f)}$$

Conversion Metric to Inch

$$\text{m/min (vc) to SFM (vc)} = (\text{m/min}) / .3048$$

$$\text{mm/min (vf) to IPM (vf)} = (\text{mm/min}) / 25.4$$

Safety Note

Always wear the appropriate personal protective equipment such as safety glasses and protective clothing when using solid carbide or HSS cutting tools. Machines should be fully guarded.

End Mill Troubleshooting

PROBLEM	POSSIBLE CAUSE	POSSIBLE SOLUTION
Excessive Flank Wear	Speed too high	Reduce the cutting speed RPM's (n).
	Improper feed speed (too slow)	Increase feed per tooth (fz).
	Hard workpiece material > 55 Rc	Try 90-100 SFM (vc) with multi-fluted tool (5 flutes+). Use ALtima® 52 hard coating.
	Recutting Chips	Change feed speed to change chip size or clear chips with coolant or air pressure.
	Milling Strategy	Ensure you are climb milling unless workpiece material has hard/abrasive outer skin or high impact tool steel like D2, then conventional milling technique is preferred for breakthrough. (see pg 136)
	Improper cutting angle	Change to correct cutting angle, tilt tool at 15 degrees.
	Too low a primary relief angle	Change to larger relief angle.
PROBLEM	POSSIBLE CAUSE	POSSIBLE SOLUTION
Excessive Corner Wear	No Corner Radius	Implementing corner radius on tool adds strength and increases tool life.
	Speed too high	Reduce the cutting speed RPM's (n).
	Tool Runout	Check tool runout in holder/spindle, <.0003" (.0076mm) desired. Hand ground flats can be suspect and common cause. Use collet, milling chuck, or shrink fit holders if possible.
	Tool Overhang	Ensure you are using shortest OAL possible, stub tool in holder. Utilize stronger necked tool for longer reaches.
PROBLEM	POSSIBLE CAUSE	POSSIBLE SOLUTION
Cutting Edge Chipping	Lack of rigidity (tool)	Use shortest end mill available, hold shank deeper in holder, investigate for tool slippage. Use short gage length holder.
	Lack of rigidity (workpiece)	Tighten workpiece fixture - a common problem.
	Feed too high	Decrease feed per tooth (fz)
	Feed too high on first pass	Decrease feed per tooth (fz) on first pass through workpiece skin or reduce radial width of cut (ae) first pass.
	Part Entry	Reduce FPT on entry - implement radius in or sweeping entrances - avoid 90° (perpendicular) entry.
	Milling Strategy	Ensure you are climb milling unless workpiece material has hard/abrasive outer skin or high impact tool steel like D2, then conventional milling technique is preferred for breakthrough. (see pg 136)
	Tool Overhang	Ensure you are using shortest OAL possible, stub tool in holder. Utilize stronger necked tool for longer reaches.
	Tool Runout	Check tool runout in holder/spindle, <.0003" (.0076mm) desired. Hand ground flats can be suspect and common cause. Use collet, milling chuck, or shrink fit holders if possible.
	Not enough rigidity of machine tool & holder	Change rigid machine tool or holder.
	Cutting Edge Prep	Ensure tool has proper edge prep for workpiece material.
	Teeth too sharp	Change to lower cutting angle, primary relief.

Technical data provided should be considered advisory only as variations may be necessary depending on the particular application.

End Mill Troubleshooting Continued

PROBLEM	POSSIBLE CAUSE	POSSIBLE SOLUTION
Breakage	Lack of rigidity (workpiece)	Tighten workpiece fixture - a common problem.
	Speed too low	Increase the cutting speed RPM's (n).
	Feed too high	Decrease feed per tooth (fz).
	Heavy depth of cut	Reduce width of cut, radial depth of cut (ae) & depth of cut, axial depth of cut (ap).
	Part Entry	Reduce FPT on entry - implement radius in or sweeping entrances - avoid 90° (perpendicular) entry.
	Milling Strategy	Review tool path and ensure there are no arbitrary moves, extreme arc of engagement increases & undesirable situations for the tool. Keep constant radial engagement. See tool path diagrams pg 136.
	Tool Overhang	Ensure you are using shortest OAL possible, stub tool in holder. Utilize stronger necked tool for longer reaches.
	Tool Runout	Check tool runout in holder/spindle, <.0003" (.0076mm) desired. Hand ground flats can be suspect and common cause. Use collet, milling chuck, or shrink fit holders if possible.
	Excessive edge wear	Recondition at earlier stage. Factory recondition service is recommended. See M.A. Ford's® Redbox reconditioning program on pg 186.
PROBLEM	POSSIBLE CAUSE	POSSIBLE SOLUTION
Built Up Edge (BUE)	Chip Welding to cutting edge	Utilize proper tool coating for workpiece material being cut. Climb mill preferred.
	Feed too low	Increase feed per tooth (fz).
	Speed too low	Increase the cutting speed RPM's (n).
	Coolant Strategy	Add coolant or readjust coolant flow, use through tool coolant if available. Check coolant mixture concentration.
PROBLEM	POSSIBLE CAUSE	POSSIBLE SOLUTION
Chip Packing	Insufficient chip room	Use end mill with fewer flutes.
	Feed too high	Decrease feed per tooth (fz).
	Heavy depth of cut	Reduce width of cut, radial depth of cut (ae) & depth of cut, axial depth of cut (ap).
	Not enough coolant	Apply more coolant to flush chips. Use air pressure or op. stop to clear chips away.
	Large heavy chip	Utilize chipbreaker style tool to cut chip size.
PROBLEM	POSSIBLE CAUSE	POSSIBLE SOLUTION
Poor Surface Finish	Feed too high	Decrease feed per tooth (fz).
	Speed too low	Increase the cutting speed RPM's (n).
	Too light width of cut	Increase width of cut, radial depth of cut (ae) to stabilize tool in cut.
	Tool Runout	Check tool runout in holder/spindle, <.0003" (.0076mm) desired. Hand ground flats can be suspect and common cause. Use collet, milling chuck, or shrink fit holders if possible.
	Built up Edge	Use Flood Coolant.
	Recutting Chips	Redirect/Evaluate coolant flush - or use fewer number of flutes.
	No end tooth concavity	Add margin (touch primary with oilstone).

Technical data provided should be considered advisory only as variations may be necessary depending on the particular application.

End Mill Troubleshooting Continued

PROBLEM	POSSIBLE CAUSE	POSSIBLE SOLUTION
Chatter/Vibration	Lack of rigidity (workpiece)	Tighten workpiece fixture - a common problem.
	Lack of rigidity (machine & holder)	Use better machine tool, holder or change condition. Ask your M.A. Ford® representative about BlueSwarf harmonic testing.
	Tool Runout	Check tool runout in holder/spindle, <.0003" (.0076mm) desired. Hand ground flats can be suspect and common cause. Use collet, milling chuck, or shrink fit holders if possible.
	Speed too high	Reduce the cutting speed RPM's (n).
	Feed too low	Increase feed per tooth (fz).
	Chip too thin	Utilize chip thinning adjustment multiplier.
	Arc of engagement violation	Use smaller tools and generate corner radii in pockets. Avoid tools that diameter matches workpiece corner radius, or rough plunge corners.
Milling Strategy	Ensure you are climb milling unless workpiece material has hard/abrasive outer skin or high impact tool steel like D2 then conventional milling technique is preferred for breakthrough.	
PROBLEM	POSSIBLE CAUSE	POSSIBLE SOLUTION
Tool Deflection	Tool Overhang	Ensure you are using shortest OAL possible, stub tool in holder. Utilize stronger necked tool for longer reaches.
	End mill Diameter	Increase diameter of end mill for higher strength to length ratio.
	Increase number of flutes	Higher number of flutes = larger core diameter = increased strength.
	Feed too high	Decrease feed per tooth (fz).
	Too high width of cut	Decrease width of cut, radial depth of cut (ae).
	Milling Strategy	Climb milling can help reduce the amount of deflection in some cases.
PROBLEM	POSSIBLE CAUSE	POSSIBLE SOLUTION
No Dimensional Accuracy (Wall Tapered)	Coolant Strategy	Add coolant or readjust coolant flow, use through tool coolant if available. Check coolant mixture concentration.
	Tool Deflection	See Tool Deflection above.
	Feed too high	Decrease feed per tooth (fz).
	Too high width of cut	Decrease width of cut, radial depth of cut (ae).
	Tool Runout	Check tool runout in holder/spindle, <.0003" (.0076mm) desired. Hand ground flats can be suspect and common cause. Use collet, milling chuck, or shrink fit holders if possible.

Technical data provided should be considered advisory only as variations may be necessary depending on the particular application.

Milling Strategy Comparison



Conventional Machining

- Reduced Axial Depths Of Cut (ap) - Normally 1 x Tool Diameter
- Higher Radial Depths Of Cut (ae) - Normally 0.5 x Tool Diameter
- Lower Spindle Speed RPM (n)
- Lower Feed Rate (vf) (inch/min or mm/min)
- Slower Machining Time
- Low Metal Removal Rate (Q - in³/min or cm³/min)

High Speed Machining (HSM)

- Increased Axial Depths Of Cut (ap) - up to 2 x Tool Diameter
- Reduced Radial Depths Of Cut (ae) - 0.1/0.2 x Tool Diameter
- Higher Spindle Speed RPM (n)
- Higher Feed Rate (vf) (inch/min or mm/min)
- Faster Machining Time
- High Metal Removal Rate (Q - in³/min or cm³/min)

Contact Your Local M.A. Ford®
Representative For More Information On The Right
Milling Strategy For Your Application.

Milling Strategy Comparison continued

Conventional

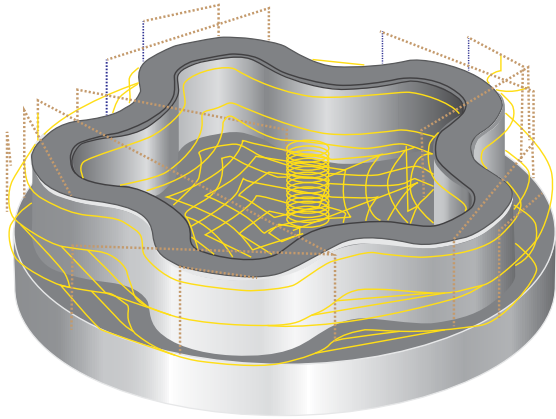

Tool Ø 12.0mm (.4724") 4 Flute

vc - 150m/min (5,905 in/min)

n - 3,975 RPM

fz - 0.06mm/z (.0024 in/z)

vf - 954mm/min (37.6 in/min)

ap - 2 x 12.0mm (.4724") 1xD

ae - 6.0mm (.2362") 0.5xD

Metal Removal Rate (MRR)

68.7 cm³/min (4.2 in³/min)

Machining Time

7 minutes 45 Seconds

High Speed

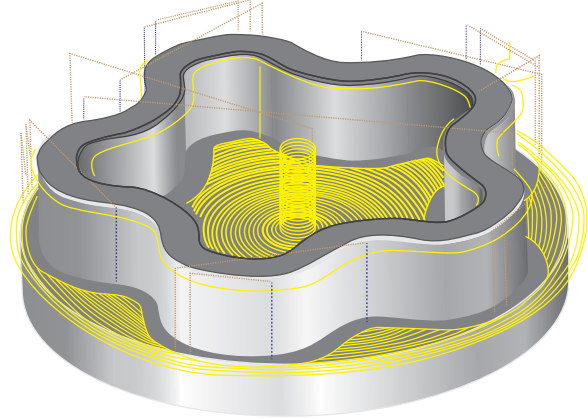

Tool Ø 12.0mm (.4724") 5 Flute

vc - 300m/min (11,811 in/min)

n - 8,000 RPM

fz - 0.15mm/z (.006 in/z)

vf - 6,000mm/min (240 in/min)

ap - 24.0mm (.945") 2xD

ae - 1.2mm (.047") 0.1xD

Metal Removal Rate (MRR)

172.8 cm³/min (10.5 in³/min)

Machining Time

3 minutes 35 Seconds

Contact Your Local M.A. Ford®
Representative For More Information On The Right
Milling Strategy For Your Application.

Radial Chip Thinning

During profile or side milling with a solid carbide end mill at 50% (a_e) radial width of cut, the chip formed is at full programmed thickness. When your radial depth of cut decreases to something less than 50%, the chip formed is not as thick. This is known as “radial chip thinning”. When less than 50% (a_e) radial depths are used, it becomes necessary to increase your feed to achieve full chip thickness. This means a higher programmed feed rate is needed to achieve the recommended chip thickness.

Programmers and Machinists have a tendency to lower feed rate due to previous experience. With the utilization of new programming methods, such as trochoidal and peel milling, manufacturers can increase productivity and tool life. These methods take advantage of much deeper (a_p) axial cuts with less (a_e) radial width of cut. With these methods, it's possible to run higher surface footages (SFM or m/min) along with these higher feed rates (IPM or mm/min) because less heat is generated at the cutting zone. Plus, you're utilizing chip thinning.

With the introduction of M.A. Ford®'s variable pitch tools, harmonics have virtually been eliminated, thus easing Programmers and Machinists fears of previous experiences. Advancements in our hard coatings enable our tools to withstand 900 degrees F, thus eliminating heat concerns. In addition, machine tools have advanced greatly to take advantage of these new methods. Use the following chart as a reference to increase feed rates by multiplying recommended feed rate by the increase feed factor, according to your (a_e) radial depth of cut as % of (D_c) cutter diameter.

(a_e) Radial Depth of Cut as to % of (D_c) Cutter Diameter	Increase Feed Factor
30%	1.10
25%	1.20
20%	1.20
15%	1.41
10%	1.80
7%	2.00
5%	2.30
3%	2.93
2%	3.60
1%	5.00

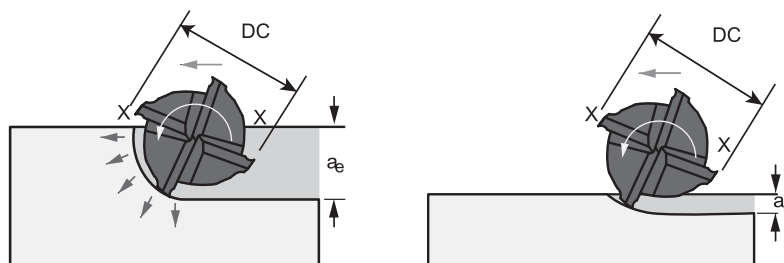

Technical data provided should be considered advisory only as variations may be necessary depending on the particular application.

Tool Engagement Angle

Sometimes referred to as “Arc of Engagement”, this is the degrees of engagement the end mill will contact the part during cut depths in the radial direction. Ideally you would like to engage the end mill at a constant engagement angle of 30-40 degrees. At this degree of engagement the tool will perform best because of acceptable loading while not exceeding deflection limits.

As the tool travels around the geometrical shape of the part features, it will encounter areas where it could exceed the acceptable engagement angle. Software manufacturers have created methods to calculate algorithms to avoid these situations. One such case would be the entry into a pocket corner. At 50% radial depth of cut (ae), the cutter runs along the pocket side with a tool engagement angle of 90 degrees. As it enters the corner, it can quickly jump to 180 degrees as shown in the example below.

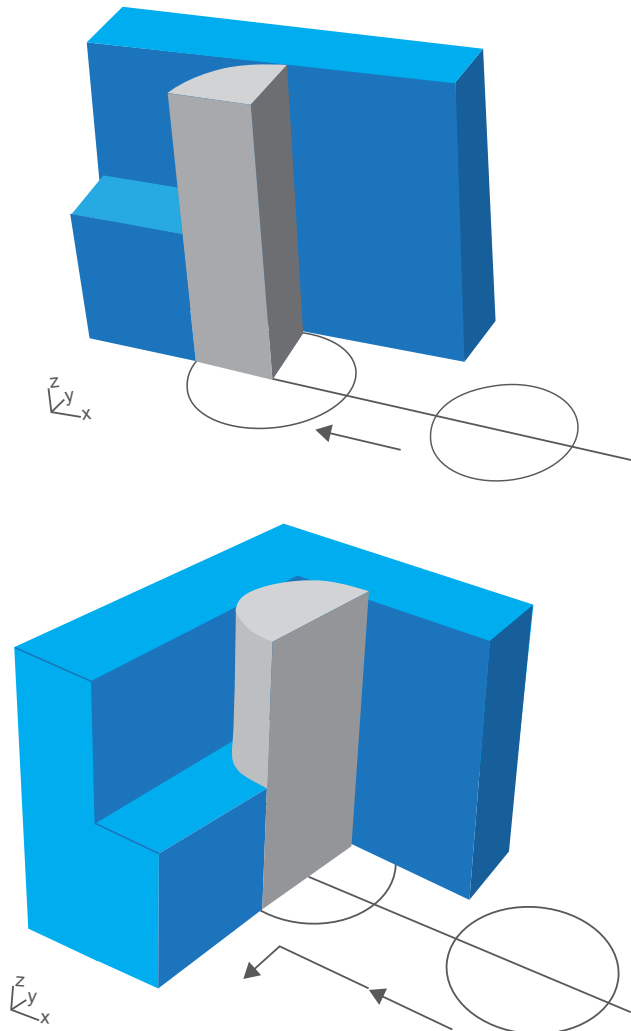

At this intersection, large engagement would cause tool chatter and even breakage. Using CAD CAM software to generate the corner avoids an abrupt stop and change of direction. It also keeps a constant arc of engagement while providing smooth chatter free cutting and long tool life.

Technical data provided should be considered advisory only as variations may be necessary depending on the particular application.

Deflection

During the machining process, high cutting forces are directed on the end mill causing it to deflect. How much the end mill deflects depends on cutting parameters, tool diameter, tool stick out, and the elasticity coefficient (PSI) of the cutting tool material. The cutting tool strength will vary from different suppliers. At M.A. Ford® we use only raw material of the highest quality and strength.

During roughing, deflection can be slightly higher than finishing. Deflection may be tolerable when roughing because at some point you will come back and finish cut your part. On larger carbide tools, deflection less than .001" (.025mm) is acceptable. However, on small micro end mills, deflection of less than .0005" (.0127mm) is acceptable.

Depending whether you are conventional milling or climb milling, deflection will be in different directions. With climb milling, deflection is in the direct opposite of the cut, but with conventional milling its direction is more parallel with the cut. This difference in direction will impart a different pattern finish on the wall of the workpiece. In climb milling, the tool engagement lines are more vertical and distinct. With conventional milling, your chip starts out thin and then gets thicker as your end mill continues through the cut; tool engagement lines are not as distinctly vertical.

M.A. Ford® has designed computer software to perform the many calculations required to determine tool deflection. All M.A. Ford® tools carry a Lot Number which can be traced back to that tool's DNA. With this information, we can plug the exact carbide TRS number into our software. How does this benefit you? We can increase cutting parameters to the point of maximum deflection, thus optimizing your operation parameters.

Please contact M.A. Ford's Tech Line (1-800-553-8024 or maftech@maford.com) with your tooling application questions.

ISO 9001:2008 Certified
Made in USA



Pocket Corners

Inside or pocket corners present a different challenge in two ways. First, if the corner radius is proportionally smaller than the related pocket size, it is necessary to use a much smaller diameter end mill to achieve the necessary radius. With a small diameter end mill there are restrictions from a cut depth standpoint; a small end mill will deflect when axial depth of cut (a_p) exceeds the end mills limits and breakage can occur.

Secondly, to rough the pocket the programmer may use a much larger end mill to remove large amounts of stock. If you plow into the rough corner with the small end mill, your tool engagement angle can cause the small end mill to deflect and chip or break. To avoid these problems, you must use one of two methods: peck milling or rest milling. Software packages again ease this procedure by maintaining low tool engagement angle.





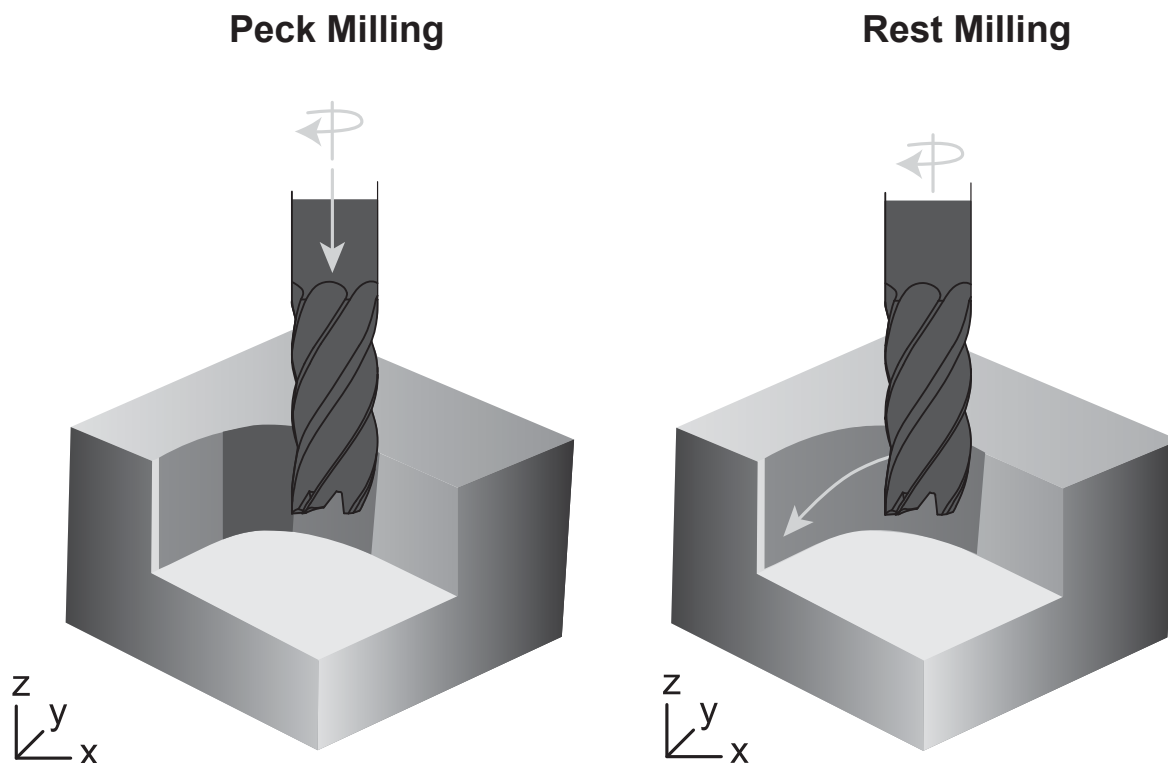

Peck milling is a series of axial plunge moves to remove much of the stock remaining in the corner. Plunging directs forces axially on the machine spindle, thus eliminating radial force and deflection. This is particularly beneficial for light duty machines.

Rest milling is a series of circular moves while traveling in the Z direction, very similar to helical milling. This removes the remaining stock much like trochoidal milling but with the addition of Z movements.



277 / 277N / 277W Recommended Cutting Data - Profile Milling

Inch

Workpiece Material Group	ISO	Hardness	Coolant				Profiling (ae)				End Mill Diameter								
			• Preferred o Possible x Not Possible				 5%	 10%	 25%	 50%	1/8*	3/16*	1/4*	5/16	3/8	1/2	5/8	3/4	1
						vc - SFM				*Profile milling at ≥ 50% ap is not recommended for diameters 1/4" and below.									
			Max.	Air	MMS					← Multiply fz by this Factor based on ae. When finishing, use the standard fz per chart below. Only add chip thinning when roughing or semi-finishing.									
											fz - in/tooth								
Low Carbon Steels 1018, 1020	P	up to 28 Rc	•	•	•	1475	1150	980	500	.0012	.0020	.0024	.0031	.0039	.0047	.0060	.0078	.0100	
Medium Carbon Steels 1140, 1145	P	28 to 38 Rc	•	•	•	1130	900	840	250	.0012	.0020	.0024	.0031	.0039	.0047	.0060	.0078	.0100	
Alloy Steels 4140, 4145	P	28 to 44 Rc	•	•	•	1035	840	765	250	.0012	.0020	.0024	.0031	.0039	.0047	.0060	.0078	.0100	
Die / Tool Steels A2, D2, H13, P20	P	28 to 44 Rc	•	•	•	900	725	615	200	.0012	.0020	.0024	.0031	.0039	.0047	.0060	.0078	.0100	
Hardened Steels A2, D2	H	45 to 50 Rc	•	o	o	610	495	325	250	.0006	0.001	.0012	.0016	.0020	.0024	.0030	.0040	.0050	
Hardened Steels A2, D2	H	50 to 55 Rc	•	o	o	510	410	280	200	.0003	.0005	.0006	.0008	.0010	.0012	.0016	.0020	.0024	
Stainless Steel - Easy to Machine 430F, 301, 303, 410, 416 Annealed, 420F, 430	M	up to 28 Rc	•	x	o	675	545	425	360	.0012	.0020	.0024	.0031	.0039	.0047	.0060	.0078	.0100	
Stainless Steel - Austenitic 301, 302, 303 High Tensile, 304, 304L, 305, 420, 15-5PH, 17-4PH, 17-7PH	M	up to 28 Rc	•	x	o	525	430	400	210	.0012	.0020	.0024	.0031	.0039	.0047	.0060	.0078	.0100	
Stainless Steel - Difficult to Machine 302B, 304B, 309, 310, 316, 316B, 316L, 316Ti, 317, 317L, 321	M	up to 28 Rc	•	x	o	410	330	295	210	.0012	.0020	.0024	.0031	.0039	.0047	.0060	.0078	.0100	
Stainless Steel - Difficult to Machine 17-4 PH, PH13-8Mo, Nitronics	M	over 28 Rc	•	x	o	525	430	395	110	.0006	.0010	.0012	.0016	.0020	.0024	.0030	.0040	.0050	
Cobalt Chrome Alloys	M	over 28 Rc	•	x	o	410	325	295	130	.0006	.0010	.0012	.0016	.0020	.0024	.0030	.0040	.0050	
Duplex (22%)	M	over 28 Rc	•	x	o	245	195	180	130	.0006	.0010	.0012	.0016	.0020	.0024	.0030	.0040	.0050	
Super Duplex (25%)	M	over 28 Rc	•	x	o	245	195	180	110	.0006	.0010	.0012	.0016	.0020	.0024	.0030	.0040	.0050	
High Temp Alloys	S	up to 42 Rc	•	x	x	180	150	130	85	.0003	.0005	.0006	.0008	.0010	.0012	.0016	.0020	.0024	
Inconel	S	up to 42 Rc	•	x	x	180	150	130	85	.0003	.0005	.0006	.0008	.0010	.0012	.0016	.0020	.0024	
Titanium Alloys 6Al-4V, 5Al-2.5 Sn, 6Al-2 Sn-4Zr-6Mo, 3Al-8V-6Cr4Mo-4Zr, 10V-2Fe-3Al, 13V-11Cr-3Al	S	up to 42 Rc	•	x	x	525	425	330	175	.0003	.0005	.0006	.0008	.0010	.0012	.0016	.0020	.0024	
Cast-Iron - Gray CG, ASTM A48, CLASS 20, 25, 30, 35, SAE J431C, GRADES G1800, G3000, G3500, GG 10, 15, 20, 25, 30, 35, 40	K	up to 240 HB	•	o	o	1625	1295	870	350	.0012	.0020	.0024	.0031	.0039	.0047	.0060	.0078	.0100	
Cast Iron - Ductile & Malleable CGI 60-40-18, 65-45-12, D4018, D4512, D5506, 32510, 35108, M3210, M4504, M5503, 250, 300, 350, 400, 450	K	over 240 HB	•	o	o	675	540	510	260	.0012	.0020	.0024	.0031	.0039	.0047	.0060	.0078	.0100	

**Spindle Maximum - Should the calculated spindle speed be more than your actual spindle maximum, use this formula:
(Calculated Feed x Spindle Maximum)/Calculated Speed**

Technical data provided should be considered advisory only as variations may be necessary depending on the particular application.

277 / 277N / 277W Recommended Cutting Data - Profile Milling

Metric

Workpiece Material Group	ISO	Hardness	Coolant ● Preferred ○ Possible x Not Possible			Profiling (ae)				End Mill Diameter (mm)							
						5%	10%	25%	50%	3*	5*	6*	8	10	12	16	20
			Max.	Air	MMS	vc- m/min				fz - mm/tooth							
			2.3	1.8	1.2	1.0	*Profile milling at ≥ 50% ap is not recommended for diameters 6mm and below.										
											← Multiply fz by this Factor based on ae. When finishing, use the standard fz per chart below. Only add chip thinning when roughing or semi-finishing.						
Low Carbon Steels 1018, 1020	P	up to 28 Rc	●	●	●	450	350	300	150	.0300	.0500	.0600	.0800	.1000	.1200	.1600	.2000
Medium Carbon Steels 1140, 1145	P	28 to 38 Rc	●	●	●	345	275	255	75	.0300	.0500	.0600	.0800	.1000	.1200	.1600	.2000
Alloy Steels 4140, 4145	P	28 to 44 Rc	●	●	●	315	255	230	75	.0300	.0500	.0600	.0800	.1000	.1200	.1600	.2000
Die / Tool Steels A2, D2, H13, P20	P	28 to 44 Rc	●	●	●	275	220	187	60	.0300	.0500	.0600	.0800	.1000	.1200	.1600	.2000
Hardened Steels A2, D2	H	45 to 50 Rc	●	○	○	185	150	100	75	.0150	.0250	.0300	.0400	.0500	.0600	.0800	.1000
Hardened Steels A2, D2	H	50 to 55 Rc	●	○	○	155	125	85	60	.0070	.0120	.0150	.0200	.0250	.0300	.0400	.0500
Stainless Steel - Easy to Machine 430F, 301, 303, 410, 416 Annealed, 420F, 430	M	up to 28 Rc	●	x	○	205	165	130	110	.0300	.0500	.0600	.0800	.1000	.1200	.1600	.2000
Stainless Steel - Austenitic 301, 302, 303 High Tensile, 304, 304L, 305, 420, 15-5PH, 17-4PH, 17-7PH	M	up to 28 Rc	●	x	○	160	130	120	65	.0300	.0500	.0600	.0800	.1000	.1200	.1600	.2000
Stainless Steel - Difficult to Machine 302B, 304B, 309, 310, 316, 316B, 316L, 316Ti, 317, 317L, 321	M	up to 28 Rc	●	x	○	125	100	90	65	.0300	.0500	.0600	.0800	.1000	.1200	.1600	.2000
Stainless Steel - Difficult to Machine 17-4 PH, PH13-8Mo, Nitronics	M	over 28 Rc	●	x	○	160	130	120	35	.0150	.0250	.0300	.0400	.0500	.0600	.0800	.1000
Cobalt Chrome Alloys	M		●	x	○	125	100	90	40	.0150	.0250	.0300	.0400	.0500	.0600	.0800	.1000
Duplex (22%)	M		●	x	○	75	60	55	40	.0150	.0250	.0300	.0400	.0500	.0600	.0800	.1000
Super Duplex (25%)	M		●	x	○	75	60	55	35	.0150	.0250	.0300	.0400	.0500	.0600	.0800	.1000
High Temp Alloys	S	up to 42 Rc	●	x	x	55	45	40	25	.0070	.0120	.0150	.0200	.0250	.0300	.0400	.0500
Inconel	S		●	x	x	55	45	40	25								
Titanium Alloys 6Al-4V, 5Al-2.5 Sn, 6Al-2 Sn-4Zr-6Mo, 3Al-8V-6Cr4Mo-4Zr, 10V-2Fe-3Al, 13V-11Cr-3Al	S	up to 42 Rc	●	x	x	160	130	100	55	.0070	.0120	.0150	.0200	.0250	.0300	.0400	.0500
Cast-Iron - Gray CG, ASTM A48, CLASS 20, 25, 30, 35, SAE J431C, GRADES G1800, G3000, G3500, GG 10, 15, 20, 25, 30, 35, 40	K	up to 240 HB	●	○	○	495	395	265	110	.0300	.0500	.0600	.0800	.1000	.1200	.1600	.2000
Cast Iron - Ductile & Malleable CGI 60-40-18, 65-45-12, D4018, D4512, D5506, 32510, 35108, M3210, M4504, M5503, 250, 300, 350, 400, 450	K	over 240 HB	●	○	○	205	165	155	80	.0300	.0500	.0600	.0800	.1000	.1200	.1600	.2000







Spindle Maximum - Should the calculated spindle speed be more than your actual spindle maximum, use this formula:

$$\text{Spindle Maximum} = \frac{\text{Calculated Feed} \times \text{Spindle Maximum}}{\text{Calculated Speed}}$$

Technical data provided should be considered advisory only as variations may be necessary depending on the particular application.

277 / 277N / 277W Recommended Cutting Data - Slotting

Inch





Workpiece Material Group	ISO	Hardness	Coolant			Slotting			End Mill Diameter								
			● Preferred ○ Possible x Not Possible						1/8*	3/16*	1/4*	5/16	3/8	1/2	5/8	3/4	1
						25%	50%	100%	*Slotting at > 25% ap is not recommended for diameters 1/4" and below.								
			Max.	Air	MMS	vc - SFM											
Low Carbon Steels 1018, 1020	P	up to 28 Rc	●	●	●	550	500	475	.0004	.0010	.0012	.0016	.0020	.0025	.0031	.0040	.0050
Medium Carbon Steels 1140, 1145	P	28 to 38 Rc	●	●	●	275	250	225	.0004	.0010	.0012	.0016	.0020	.0025	.0031	.0040	.0050
Alloy Steels 4140, 4145	P	28 to 44 Rc	●	●	●	275	250	225	.0004	.0010	.0012	.0016	.0020	.0025	.0031	.0040	.0050
Die / Tool Steels A2, D2, H13, P20	P	28 to 44 Rc	●	●	●	225	200	175	.0004	.0010	.0012	.0016	.0020	.0025	.0031	.0040	.0050
Hardened Steels A2, D2	H	45 to 50 Rc	●	○	○	275	250	225	.0003	.0005	.0006	.0008	.0010	.0012	.0016	.0020	.0024
Hardened Steels A2, D2	H	50 to 55 Rc	●	○	○	225	200	175	.0001	.0002	.0003	.0004	.0005	.0006	.0008	.0010	.0015
Stainless Steel - Easy to Machine 430F, 301, 303, 410, 416 Annealed, 420F, 430	M	up to 28 Rc	●	x	○	385	360	350	.0004	.0010	.0012	.0016	.0020	.0024	.0031	.0040	.0050
Stainless Steel - Austenitic 301, 302, 303 High Tensile, 304, 304L, 305, 420, 15-5PH, 17-4PH, 17-7PH	M	up to 28 Rc	●	x	○	225	210	200	.0004	.0010	.0012	.0016	.0020	.0024	.0031	.0040	.0050
Stainless Steel - Difficult to Machine 302B, 304B, 309, 310, 316, 316B, 316L, 316Ti, 317, 317L, 321	M	up to 28 Rc	●	x	○	225	210	200	.0004	.0010	.0012	.0016	.0020	.0024	.0031	.0040	.0050
Stainless Steel - Difficult to Machine 17-4 PH, PH13-8Mo, Nitronics	M	over 28 Rc	●	x	○	125	110	100	.0003	.0005	.0006	.0008	.0010	.0012	.0016	.0020	.0024
Cobalt Chrome Alloys	M	over 28 Rc	●	x	○	150	130	120	.0003	.0005	.0006	.0008	.0010	.0012	.0016	.0020	.0024
Duplex (22%)	M	over 28 Rc	●	x	○	150	130	120	.0003	.0005	.0006	.0008	.0010	.0012	.0016	.0020	.0024
Super Duplex (25%)	M	over 28 Rc	●	x	○	120	110	100	.0003	.0005	.0006	.0008	.0010	.0012	.0016	.0020	.0024
High Temp Alloys	S	up to 42 Rc	●	x	x	100	85	75	.0003	.0005	.0006	.0008	.0010	.0012	.0016	.0020	.0024
Inconel	S	up to 42 Rc	●	x	x	95	85	75	.0003	.0005	.0006	.0008	.0010	.0012	.0016	.0020	.0024
Titanium Alloys 6Al-4V, 5Al-2.5 Sn, 6Al-2 Sn-4Zr-6Mo, 3Al-8V-6Cr4Mo-4Zr, 10V-2Fe-3Al, 13V-11Cr-3Al	S	up to 42 Rc	●	x	x	180	175	160	.0003	.0005	.0006	.0008	.0010	.0012	.0016	.0020	.0024
Cast Iron - Gray CG, ASTM A48, CLASS 20, 25, 30, 35, SAE J431C, GRADES G1800, G3000, G3500, GG 10, 15, 20, 25, 30, 35, 40	K	up to 240 HB	●	○	○	375	350	325	.0004	.0010	.0012	.0016	.0020	.0024	.0031	.0040	.0050
Cast Iron - Ductile & Malleable CGI 60-40-18, 65-45-12, D4018, D4512, D5506, 32510, 35108, M3210, M4504, M5503, 250, 300, 350, 400, 450	K	over 240 HB	●	○	○	275	260	250	.0004	.0010	.0012	.0016	.0020	.0024	.0031	.0040	.0050

**Spindle Maximum - Should the calculated spindle speed be more than your actual spindle maximum, use this formula:
(Calculated Feed x Spindle Maximum)/Calculated Speed**

Technical data provided should be considered advisory only as variations may be necessary depending on the particular application.

277 / 277N / 277W Recommended Cutting Data - Slotting

Metric

Workpiece Material Group	ISO	Hardness	Coolant			Slotting			End Mill Diameter (mm)							
			● Preferred ○ Possible x Not Possible						3*	5*	6*	8	10	12	16	20
						25%	50%	100%	*Slotting at > 25% ap is not recommended for diameters 6mm and below.							
			Max.	Air	MMS	vc -m/min			fz - mm/tooth							
Low Carbon Steels 1018, 1020	P	up to 28 Rc	●	●	●	170	150	145	.0100	.0250	.0300	.0400	.0500	.0600	.0800	.1000
Medium Carbon Steels 1140, 1145	P	28 to 38 Rc	●	●	●	85	75	70	.0100	.0250	.0300	.0400	.0500	.0600	.0800	.1000
Alloy Steels 4140, 4145	P	28 to 44 Rc	●	●	●	85	75	70	.0100	.0250	.0300	.0400	.0500	.0600	.0800	.1000
Die / Tool Steels A2, D2, H13, P20	P	28 to 44 Rc	●	●	●	70	60	55	.0100	.0250	.0300	.0400	.0500	.0600	.0800	.1000
Hardened Steels A2, D2	H	45 to 50 Rc	●	○	○	85	75	70	.0070	.0120	.0150	.0200	.0250	.0300	.0400	.0500
Hardened Steels A2, D2	H	50 to 55 Rc	●	○	○	70	60	55	.0030	.0060	.0070	.0100	.0120	.0150	.0200	.0250
Stainless Steel - Easy to Machine 430F, 301, 303, 410, 416 Annealed, 420F, 430	M	up to 28 Rc	●	x	○	120	110	110	.0100	.0250	.0300	.0400	.0500	.0600	.0800	.1000
Stainless Steel - Austenitic 301, 302, 303 High Tensile, 304, 304L, 305, 420, 15-5PH, 17-4PH, 17-7PH	M	up to 28 Rc	●	x	○	70	65	60	.0100	.0250	.0300	.0400	.0500	.0600	.0800	.1000
Stainless Steel - Difficult to Machine 302B, 304B, 309, 310, 316, 316B, 316L, 316Ti, 317, 317L, 321	M	up to 28 Rc	●	x	○	70	65	60	.0100	.0250	.0300	.0400	.0500	.0600	.0800	.1000
Stainless Steel - Difficult to Machine 17-4 PH, PH13-8Mo, Nitronics	M	over 28 Rc	●	x	○	40	35	30	.0070	.0120	.0150	.0200	.0250	.0300	.0400	.0500
Cobalt Chrome Alloys	M	over 28 Rc	●	x	○	45	40	40	.0070	.0120	.0150	.0200	.0250	.0300	.0400	.0500
Duplex (22%)	M	over 28 Rc	●	x	○	45	40	40	.0070	.0120	.0150	.0200	.0250	.0300	.0400	.0500
Super Duplex (25%)	M	over 28 Rc	●	x	○	40	35	30	.0070	.0120	.0150	.0200	.0250	.0300	.0400	.0500
High Temp Alloys	S	up to 42 Rc	●	x	x	30	25	25	.0070	.0120	.0150	.0200	.0250	.0300	.0400	.0500
Inconel	S	up to 42 Rc	●	x	x	30	25	25	.0070	.0120	.0150	.0200	.0250	.0300	.0400	.0500
Titanium Alloys 6Al-4V, 5Al-2.5 Sn, 6Al-2 Sn-4Zr-6Mo, 3Al-8V-6Cr4Mo-4Zr, 10V-2Fe-3Al, 13V-11Cr-3Al	S	up to 42 Rc	●	x	x	55	55	50	.0070	.0120	.0150	.0200	.0250	.0300	.0400	.0500
Cast-Iron - Gray CG, ASTM A48, CLASS 20, 25, 30, 35, SAE J431C, GRADES G1800, G3000, G3500, GG 10, 15, 20, 25, 30, 35, 40	K	up to 240 HB	●	○	○	115	105	100	.0100	.0250	.0300	.0400	.0500	.0600	.0800	.1000
Cast Iron - Ductile & Malleable CGI 60-40-18, 65-45-12, D4018, D4512, D5506, 32510, 35108, M3210, M4504, M5503, 250, 300, 350, 400, 450	K	over 240 HB	●	○	○	85	80	75	.0100	.0250	.0300	.0400	.0500	.0600	.0800	.1000

Spindle Maximum - Should the calculated spindle speed be more than your actual spindle maximum, use this formula:

$$\frac{(\text{Calculated Feed} \times \text{Spindle Maximum})}{\text{Calculated Speed}}$$

Technical data provided should be considered advisory only as variations may be necessary depending on the particular application.

278 / 278N / 278W Recommended Cutting Data - Profile Milling

Inch

Workpiece Material Group	ISO	Hardness	Coolant				Profiling (ae)				End Mill Diameter								
			• Preferred o Possible x Not Possible								1/8*	3/16*	1/4*	5/16	3/8	1/2	5/8	3/4	1
							5%	10%	25%	50%	*Profile Milling at ≥ 50% ap is not recommended for diameters 1/4" and below.								
							2.3	1.8	1.2	1.0	← Multiply fz by this Factor based on ae. When finishing, use the standard fz per chart below. Only add chip thinning when roughing or semi-finishing.								
			Max.	Air	MMS	vc - SFM				fz - in/tooth									
Low Carbon Steels 1018, 1020	P	up to 28 Rc	•	•	•	1475	1150	980	500	.0012	.0020	.0024	.0031	.0039	.0047	.0060	.0078	.0100	
Medium Carbon Steels 1140, 1145	P	28 to 38 Rc	•	•	•	1130	900	830	250	.0012	.0020	.0024	.0031	.0039	.0047	.0060	.0078	.0100	
Alloy Steels 4140, 4145	P	28 to 44 Rc	•	•	•	1035	840	755	250	.0012	.0020	.0024	.0031	.0039	.0047	.0060	.0078	.0100	
Die / Tool Steels A2, D2, H13, P20	P	28 to 44 Rc	•	•	•	900	725	615	200	.0012	.0020	.0024	.0031	.0039	.0047	.0060	.0078	.0100	
Hardened Steels A2, D2	H	45 to 50 Rc	•	o	o	610	495	325	250	.0006	.0010	.0012	.0016	.0020	.0024	.0030	.0040	.0050	
Hardened Steels A2, D2	H	50 to 55 Rc	•	o	o	510	410	280	200	.0003	.0005	.0006	.0008	.0010	.0012	.0016	.0020	.0024	
Stainless Steel - Easy to Machine 430F, 301, 303, 410, 416 Annealed, 420F, 430	M	up to 28 Rc	•	x	o	675	545	425	360	.0012	.0020	.0024	.0031	.0039	.0047	.0060	.0078	.0100	
Stainless Steel - Austenitic 301, 302, 303 High Tensile, 304, 304L, 305, 420, 15-5PH, 17-4PH, 17-7PH	M	up to 28 Rc	•	x	o	525	430	400	210	.0012	.0020	.0024	.0031	.0039	.0047	.0060	.0078	.0100	
Stainless Steel - Difficult to Machine 302B, 304B, 309, 310, 316, 316B, 316L, 316Ti, 317, 317L, 321	M	up to 28 Rc	•	x	o	410	330	295	210	.0012	.0020	.0024	.0031	.0039	.0047	.0060	.0078	.0100	
Stainless Steel - Difficult to Machine 17-4 PH, PH13-8Mo, Nitronics	M	over 28 Rc	•	x	o	525	430	395	110	.0006	.0010	.0012	.0016	.0020	.0024	.0030	.0040	.0050	
Cobalt Chrome Alloys	M		•	x	o	410	325	295	130	.0006	.0010	.0012	.0016	.0020	.0024	.0030	.0040	.0050	
Duplex (22%)	M		•	x	o	245	195	180	130	.0006	.0010	.0012	.0016	.0020	.0024	.0030	.0040	.0050	
Super Duplex (25%)	M		•	x	o	245	195	180	110	.0006	.0010	.0012	.0016	.0020	.0024	.0030	.0040	.0050	
High Temp Alloys	S	up to 42 Rc	•	x	x	180	150	130	85	.0003	.0005	.0006	.0008	.0010	.0012	.0016	.0020	.0024	
Inconel	S		•	x	x	180	150	130	85	.0003	.0005	.0006	.0008	.0010	.0012	.0016	.0020	.0024	
Titanium Alloys 6Al-4V, 5Al-2.5 Sn, 6Al-2 Sn-4Zr-6Mo, 3Al-8V-6Cr4Mo-4Zr, 10V-2Fe-3Al, 13V-11Cr-3Al	S	up to 42 Rc	•	x	x	525	425	330	175	.0003	.0005	.0006	.0008	.0010	.0012	.0016	.0020	.0024	
Cast-Iron - Gray CG, ASTM A48, CLASS 20, 25, 30, 35, SAE J431C, GRADES G1800, G3000, G3500, GG 10, 15, 20, 25, 30, 35, 40	K	up to 240 HB	•	o	o	1625	1295	870	350	.0012	.0020	.0024	.0031	.0039	.0047	.0060	.0078	.0100	
Cast Iron - Ductile & Malleable CGI 60-40-18, 65-45-12, D4018, D4512, D5506, 32510, 35108, M3210, M4504, M5503, 250, 300, 350, 400, 450	K	over 240 HB	•	o	o	675	540	510	260	.0012	.0020	.0024	.0031	.0039	.0047	.0060	.0078	.0100	

Spindle Maximum - Should the calculated spindle speed be more than your actual spindle maximum, use this formula:
 (Calculated Feed x Spindle Maximum)/Calculated Speed

Technical data provided should be considered advisory only as variations may be necessary depending on the particular application.

TuffCut® XT

278 / 278N / 278W Recommended Cutting Data - Profile Milling Metric

Workpiece Material Group	ISO	Hardness	Coolant			Profiling (ae)				End Mill Diameter (mm)								
			• Preferred o Possible x Not Possible							3*	5*	6*	8	10	12	16	20	25
						2.3	1.8	1.2	1.0	*Profile Milling at ≥ 50% ap is not recommended for diameters 6mm and below.								
			Max.	Air	MMS	vc - m/min				← Multiply fz by this Factor based on ae. When finishing, use the standard fz per chart below. Only add chip thinning when roughing or semi-finishing.								
										fz - mm/tooth								
Low Carbon Steels 1018, 1020	P	up to 28 Rc	•	•	•	450	350	300	150	.0300	.0500	.0600	.0800	.1000	.1200	.1600	.2000	.2500
Medium Carbon Steels 1140, 1145	P	28 to 38 Rc	•	•	•	345	275	255	75	.0300	.0500	.0600	.0800	.1000	.1200	.1600	.2000	.2500
Alloy Steels 4140, 4145	P	28 to 44 Rc	•	•	•	315	255	230	75	.0300	.0500	.0600	.0800	.1000	.1200	.1600	.2000	.2500
Die / Tool Steels A2, D2, H13, P20	P	28 to 44 Rc	•	•	•	275	220	185	60	.0300	.0500	.0600	.0800	.1000	.1200	.1600	.2000	.2500
Hardened Steels A2, D2	H	45 to 50 Rc	•	o	o	185	150	100	75	.0150	.0250	.0300	.0400	.0500	.0600	.0800	.1000	.1250
Hardened Steels A2, D2	H	50 to 55 Rc	•	o	o	155	125	85	60	.0070	.0120	.0150	.0200	.0250	.0300	.0400	.0500	.0620
Stainless Steel - Easy to Machine 430F, 301, 303, 410, 416 Annealed, 420F, 430	M	up to 28 Rc	•	x	o	205	165	130	110	.0300	.0500	.0600	.0800	.1000	.1200	.1600	.2000	.2500
Stainless Steel - Austenitic 301, 302, 303 High Tensile, 304, 304L, 305, 420, 15-5PH, 17-4PH, 17-7PH	M	up to 28 Rc	•	x	o	160	130	120	65	.0300	.0500	.0600	.0800	.1000	.1200	.1600	.2000	.2500
Stainless Steel - Difficult to Machine 302B, 304B, 309, 310, 316, 316B, 316L, 316Ti, 317, 317L, 321	M	up to 28 Rc	•	x	o	125	100	90	65	.0300	.0500	.0600	.0800	.1000	.1200	.1600	.2000	.2500
Stainless Steel - Difficult to Machine 17-4 PH, PH13-8Mo, Nitronics	M	over 28 Rc	•	x	o	160	130	120	35	.0150	.0250	.0300	.0400	.0500	.0600	.0800	.1000	.1250
Cobalt Chrome Alloys	M		•	x	o	125	100	90	40	.0150	.0250	.0300	.0400	.0500	.0600	.0800	.1000	.1250
Duplex (22%)	M		•	x	o	75	60	55	40	.0150	.0250	.0300	.0400	.0500	.0600	.0800	.1000	.1250
Super Duplex (25%)	M		•	x	o	75	60	55	35	.0150	.0250	.0300	.0400	.0500	.0600	.0800	.1000	.1250
High Temp Alloys	S	up to 42 Rc	•	x	x	55	45	40	25									
Inconel	S		•	x	x	55	45	40	25									
Titanium Alloys 6Al-4V, 5Al-2.5 Sn, 6Al-2 Sn-4Zr-6Mo, 3Al-8V-6Cr4Mo-4Zr, 10V-2Fe-3Al, 13V-11Cr-3Al	S	up to 42 Rc	•	x	x	160	130	100	55	.0070	.0120	.0150	.0200	.0250	.0300	.0400	.0500	.0620
Cast-Iron - Gray CG, ASTM A48, CLASS 20, 25, 30, 35, SAE J431C, GRADES G1800, G3000, G3500, GG 10, 15, 20, 25, 30, 35, 40	K	up to 240 HB	•	o	o	495	395	265	110	.0300	.0500	.0600	.0800	.1000	.1200	.1600	.2000	.2500
Cast Iron - Ductile & Malleable CGI 60-40-18, 65-45-12, D4018, D4512, D5506, 32510, 35108, M3210, M4504, M5503, 250, 300, 350, 400, 450	K	over 240 HB	•	o	o	205	165	155	80	.0300	.0500	.0600	.0800	.1000	.1200	.1600	.2000	.2500







Spindle Maximum - Should the calculated spindle speed be more than your actual spindle maximum, use this formula:
(Calculated Feed x Spindle Maximum)/Calculated Speed

Technical data provided should be considered advisory only as variations may be necessary depending on the particular application.

For product information, call your local distributor

278 / 278N / 278W Recommended Cutting Data - Slotting

Inch







Workpiece Material Group	ISO	Hardness	Coolant			Slotting			End Mill Diameter								
			• Preferred o Possible x Not Possible						1/8*	3/16*	1/4*	5/16	3/8	1/2	5/8	3/4	1
						25%	50%	100%	*Slotting at > 25% ap is not recommended for diameters 1/4" and below.								
			Max.	Air	MMS	vc - SFM											
Low Carbon Steels 1018, 1020	P	up to 28 Rc	•	•	•	550	500	475	.0004	.0010	.0012	.0016	.0020	.0025	.0031	.0040	.0050
Medium Carbon Steels 1140, 1145	P	28 to 38 Rc	•	•	•	275	250	225	.0004	.0010	.0012	.0016	.0020	.0025	.0031	.0040	.0050
Alloy Steels 4140, 4145	P	28 to 44 Rc	•	•	•	275	250	225	.0004	.0010	.0012	.0016	.0020	.0025	.0031	.0040	.0050
Die / Tool Steels A2, D2, H13, P20	P	28 to 44 Rc	•	•	•	225	200	175	.0004	.0010	.0012	.0016	.0020	.0025	.0031	.0040	.0050
Hardened Steels A2, D2	H	45 to 50 Rc	•	o	o	275	250	225	.0003	.0005	.0006	.0008	.0010	.0012	.0016	.0020	.0024
Hardened Steels A2, D2	H	50 to 55 Rc	•	o	o	225	200	175	.0001	.0002	.0003	.0004	.0005	.0006	.0008	.0010	.0015
Stainless Steel - Easy to Machine 430F, 301, 303, 410, 416 Annealed, 420F, 430	M	up to 28 Rc	•	x	o	385	360	350	.0002	.0004	.0008	.0012	.0014	.0018	.0022	.0026	.0038
Stainless Steel - Austenitic 301, 302, 303 High Tensile, 304, 304L, 305, 420, 15-5PH, 17-4PH, 17-7PH	M	up to 28 Rc	•	x	o	225	210	200	.0002	.0004	.0008	.0012	.0014	.0018	.0022	.0026	.0038
Stainless Steel - Difficult to Machine 302B, 304B, 309, 310, 316, 316B, 316L, 316Ti, 317, 317L, 321	M	up to 28 Rc	•	x	o	225	210	200	.0002	.0004	.0008	.0012	.0014	.0018	.0022	.0026	.0038
Stainless Steel - Difficult to Machine 17-4 PH, PH13-8Mo, Nitronics	M	over 28 Rc	•	x	o	125	110	100	.0003	.0005	.0006	.0008	.0010	.0012	.0016	.0020	.0024
Cobalt Chrome Alloys	M		•	x	o	150	130	120	.0003	.0005	.0006	.0008	.0010	.0012	.0016	.0020	.0024
Duplex (22%)	M		•	x	o	150	130	120	.0003	.0005	.0006	.0008	.0010	.0012	.0016	.0020	.0024
Super Duplex (25%)	M		•	x	o	120	110	100	.0003	.0005	.0006	.0008	.0010	.0012	.0016	.0020	.0024
High Temp Alloys	S	up to 42 Rc	•	x	x	100	85	75	.0003	.0005	.0006	.0008	.0010	.0012	.0016	.0020	.0024
Inconel	S		•	x	x	95	85	75	.0003	.0005	.0006	.0008	.0010	.0012	.0016	.0020	.0024
Titanium Alloys 6Al-4V, 5Al-2.5 Sn, 6Al-2 Sn-4Zr-6Mo, 3Al-8V-6Cr4Mo-4Zr, 10V-2Fe-3Al, 13V-11Cr-3Al	S	up to 42 Rc	•	x	x	180	175	160	.0003	.0005	.0006	.0008	.0010	.0012	.0016	.0020	.0024
Cast-Iron - Gray CG, ASTM A48, CLASS 20, 25, 30, 35, SAE J431C, GRADES G1800, G3000, G3500, GG 10, 15, 20, 25, 30, 35, 40	K	up to 240 HB	•	o	o	375	350	325	.0004	.0010	.0012	.0016	.0020	.0024	.0031	.0040	.0050
Cast Iron - Ductile & Malleable CGI 60-40-18, 65-45-12, D4018, D4512, D5506, 32510, 35108, M3210, M4504, M5503, 250, 300, 350, 400, 450	K	over 240 HB	•	o	o	275	260	250	.0004	.0010	.0012	.0016	.0020	.0024	.0031	.0040	.0050

**Spindle Maximum - Should the calculated spindle speed be more than your actual spindle maximum, use this formula:
(Calculated Feed x Spindle Maximum)/Calculated Speed**

Technical data provided should be considered advisory only as variations may be necessary depending on the particular application.

278 / 278N / 278W Recommended Cutting Data - Slotting

Metric

Workpiece Material Group	ISO	Hardness	Coolant			Slotting			End Mill Diameter (mm)								
			● Preferred ○ Possible x Not Possible						3*	5*	6*	8	10	12	16	20	25
						25%	50%	100%	*Slotting at > 25% ap is not recommended for diameters 6mm and below.								
			Max.	Air	MMS	vc - m/min			fz - mm/tooth								
Low Carbon Steels 1018, 1020	P	up to 28 Rc	●	●	●	170	150	145	.0100	.0250	.0300	.0400	.0500	.0600	.0800	.1000	.1250
Medium Carbon Steels 1140, 1145	P	28 to 38 Rc	●	●	●	85	75	70	.0100	.0250	.0300	.0400	.0500	.0600	.0800	.1000	.1250
Alloy Steels 4140, 4145	P	28 to 44 Rc	●	●	●	85	75	70	.0100	.0250	.0300	.0400	.0500	.0600	.0800	.1000	.1250
Die / Tool Steels A2, D2, H13, P20	P	28 to 44 Rc	●	●	●	70	60	55	.0100	.0250	.0300	.0400	.0500	.0600	.0800	.1000	.1250
Hardened Steels A2, D2	H	45 to 50 Rc	●	○	○	85	75	70	.0070	.0120	.0150	.0200	.0250	.0300	.0400	.0500	.0620
Hardened Steels A2, D2	H	50 to 55 Rc	●	○	○	70	60	55	.0030	.0060	.0070	.0100	.0120	.0150	.0200	.0250	.0370
Stainless Steel - Easy to Machine 430F, 301, 303, 410, 416 Annealed, 420F, 430	M	up to 28 Rc	●	x	○	120	110	110	.0100	.0250	.0300	.0400	.0500	.0600	.0800	.1000	.1250
Stainless Steel - Austenitic 301, 302, 303 High Tensile, 304, 304L, 305, 420, 15-5PH, 17-4PH, 17-7PH	M	up to 28 Rc	●	x	○	70	65	60	.0100	.0250	.0300	.0400	.0500	.0600	.0800	.1000	.1250
Stainless Steel - Difficult to Machine 302B, 304B, 309, 310, 316, 316B, 316L, 316Ti, 317, 317L, 321	M	up to 28 Rc	●	x	○	70	65	60	.0100	.0250	.0300	.0400	.0500	.0600	.0800	.1000	.1250
Stainless Steel - Difficult to Machine 17-4 PH, PH13-8Mo, Nitronics	M	over 28 Rc	●	x	○	40	35	30	.0070	.0120	.0150	.0200	.0250	.0300	.0400	.0500	.0620
Cobalt Chrome Alloys	M		●	x	○	45	40	40	.0070	.0120	.0150	.0200	.0250	.0300	.0400	.0500	.0620
Duplex (22%)	M		●	x	○	45	40	40	.0070	.0120	.0150	.0200	.0250	.0300	.0400	.0500	.0620
Super Duplex (25%)	M		●	x	○	40	35	30	.0070	.0120	.0150	.0200	.0250	.0300	.0400	.0500	.0620
High Temp Alloys	S	up to 42 Rc	●	x	x	30	25	25	.0070	.0120	.0150	.0200	.0250	.0300	.0400	.0500	.0620
Inconel	S	up to 42 Rc	●	x	x	30	25	25	.0070	.0120	.0150	.0200	.0250	.0300	.0400	.0500	.0620
Titanium Alloys 6Al-4V, 5Al-2.5 Sn, 6Al-2 Sn-4Zr-6Mo, 3Al-8V-6Cr4Mo-4Zr, 10V-2Fe-3Al, 13V-11Cr-3Al	S	up to 42 Rc	●	x	x	55	55	50	.0070	.0120	.0150	.0200	.0250	.0300	.0400	.0500	.0620
Cast-Iron - Gray CG, ASTM A48, CLASS 20, 25, 30, 35, SAE J431C, GRADES G1800, G3000, G3500, GG 10, 15, 20, 25, 30, 35, 40	K	up to 240 HB	●	○	○	115	105	100	.0100	.0250	.0300	.0400	.0500	.0600	.0800	.1000	.1250
Cast Iron - Ductile & Malleable CGI 60-40-18, 65-45-12, D4018, D4512, D5506, 32510, 35108, M3210, M4504, M5503, 250, 300, 350, 400, 450	K	over 240 HB	●	○	○	85	80	75	.0100	.0250	.0300	.0400	.0500	.0600	.0800	.1000	.1250

Spindle Maximum - Should the calculated spindle speed be more than your actual spindle maximum, use this formula:
 (Calculated Feed x Spindle Maximum)/Calculated Speed

Technical data provided should be considered advisory only as variations may be necessary depending on the particular application.

For product information, call your local distributor

279 Recommended Cutting Data - Profiling

Inch

Semi Roughing / Roughing (25 - 48 Rc)						
Diameter	Decimal	Radius	Sfm	in/tooth Range	Max Ae	Max Ap
1/8	0.1250	0.063	820	.0008 - .0012	0.006	0.035
3/16	0.1875	0.094	1020	.0010 - .0017	0.009	0.053
1/4	0.2500	0.125	1235	.0010 - .0027	0.012	0.071
5/16	0.3125	0.156	1235	.0014 - .0032	0.016	0.094
3/8	0.3750	0.188	1235	.0018 - .0037	0.020	0.118
1/2	0.5000	0.250	1235	.0018 - .0040	0.024	0.142
5/8	0.6250	0.313	1235	.0020 - .0041	0.032	0.189
3/4	0.7500	0.375	1235	.0025 - .0045	0.038	0.225

Semi Finishing / Finishing (25 - 48 Rc)						
Diameter	Decimal	Radius	Sfm	in/tooth Range	Max Ae	Max Ap
1/8	0.125	0.063	820	.0008 - .0012	0.035	0.006
3/16	0.187	0.094	1020	.0010 - .0017	0.053	0.009
1/4	0.25	0.125	1235	.0010 - .0027	0.07	0.012
5/16	0.3125	0.156	1235	.0014 - .0032	0.094	0.016
3/8	0.375	0.188	1235	.0018 - .0037	0.118	0.02
1/2	0.5	0.25	1235	.0018 - .0040	0.141	0.024
5/8	0.625	0.312	1235	.0020 - .0041	0.188	0.031
3/4	0.75	0.375	1235	.0025 - .0045	0.225	0.0375

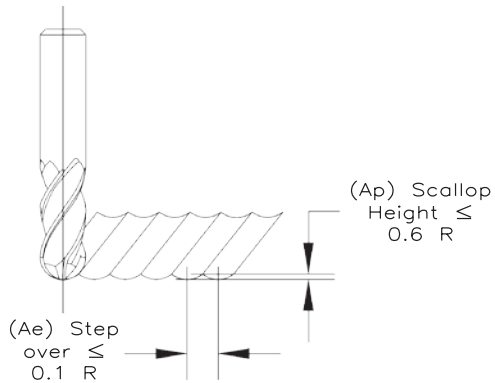

Coolant: High Pressure Air Blast

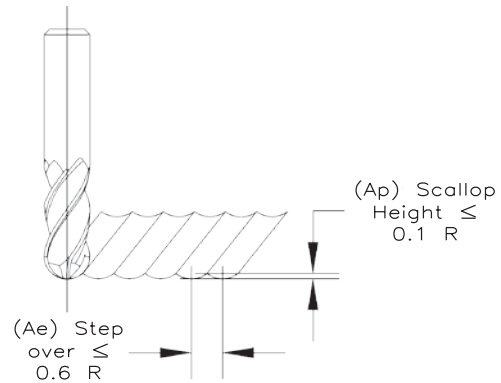

Coolant: High Pressure Air Blast

Titanium				
Diameter	Decimal	Radius	Sfm	In/tooth
1/8	0.125	0.063	500	0.0011
3/16	0.187	0.094	500	0.0015
1/4	0.25	0.125	500	0.0018
5/16	0.3125	0.156	500	0.0026
3/8	0.375	0.188	500	0.0031
1/2	0.5	0.25	500	0.0036
5/8	0.625	0.312	500	0.0039
3/4	0.75	0.375	500	0.0041

High Temp Alloys				
Diameter	Decimal	Radius	Sfm	In/tooth
1/8	0.125	0.063	150	0.0011
3/16	0.187	0.094	150	0.0015
1/4	0.25	0.125	150	0.0018
5/16	0.3125	0.156	150	0.0026
3/8	0.375	0.188	150	0.0031
1/2	0.5	0.25	150	0.0036
5/8	0.625	0.312	150	0.0039
3/4	0.75	0.375	150	0.0041

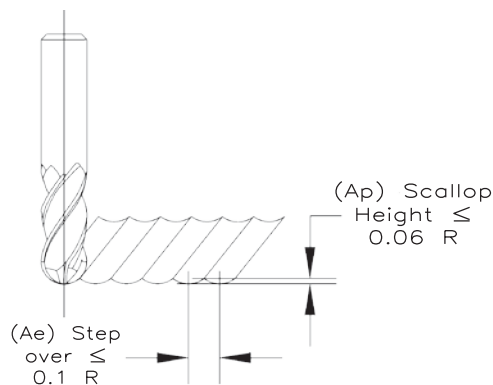

Coolant: High Pressure Air Blast

Technical data provided should be considered advisory only as variations may be necessary depending on the particular application.

TuffCut® XT

279 Recommended Cutting Data - Profiling

Metric

Semi Roughing / Roughing (25 - 48 Rc)					
Diameter	Radius	meters/min	mm/tooth range	Max	Max
				Ae	Ap
3	1.5	250	.020 - .030	0.15	0.9
4	2	290	.025 - .040	0.2	1.2
5	2.5	315	.025 - .045	0.25	1.5
6	3	375	.025 - .065	0.3	1.8
8	4	375	.035 - .080	0.4	2.4
10	5	375	.045 - .090	0.5	3
12	6	375	.045 - .100	0.6	3.6
16	8	375	.050 - .105	0.8	4.8

Semi Finishing / Finishing (25 - 48 Rc)					
Diameter	Radius	meters/min	mm/tooth range	Max	Max
				Ae	Ap
3	1.5	250	.020 - .030	0.9	0.15
4	2	290	.025 - .040	1.2	0.2
5	2.5	315	.025 - .045	1.5	0.25
6	3	375	.025 - .065	1.8	0.3
8	4	375	.035 - .080	2.4	0.4
10	5	375	.045 - .090	3	0.5
12	6	375	.045 - .100	3.6	0.6
16	8	375	.050 - .105	4.8	0.8

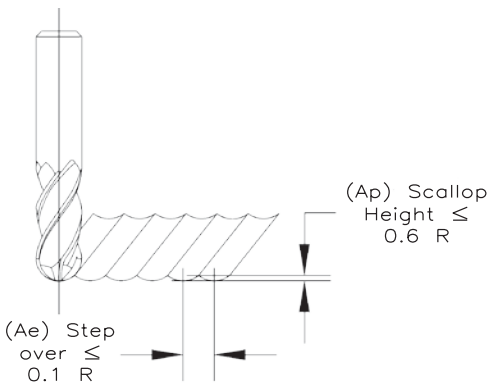

Coolant: High Pressure Air Blast

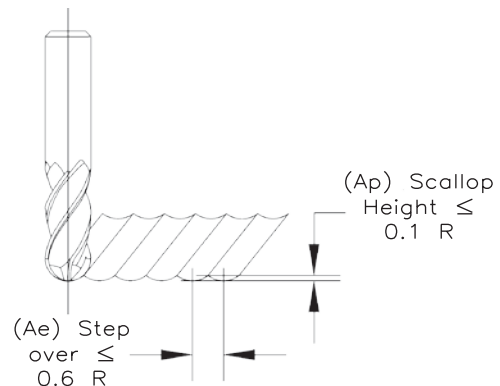

Coolant: High Pressure Air Blast

Titanium					
Diameter	Radius	meters/min	mm/tooth	Max	Max
				Ae	Ap
3	1.5	150	0.030	0.15	0.09
4	2	150	0.035	0.2	0.12
5	2.5	150	0.040	0.25	0.15
6	3	150	0.045	0.3	0.18
8	4	150	0.065	0.4	0.24
10	5	150	0.080	0.5	0.3
12	6	150	0.090	0.6	0.36
16	8	150	0.100	0.8	0.48

High Temp Alloys					
Diameter	Radius	meters/min	mm/tooth	Max	Max
				Ae	Ap
3	1.5	45	0.030	0.15	0.09
4	2	45	0.035	0.2	0.12
5	2.5	45	0.040	0.25	0.15
6	3	45	0.045	0.3	0.18
8	4	45	0.065	0.4	0.24
10	5	45	0.080	0.5	0.3
12	6	45	0.090	0.6	0.36
16	8	45	0.100	0.8	0.48

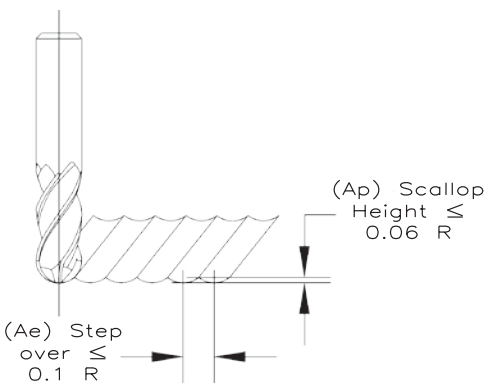

Coolant: Maximum Coolant Pressure

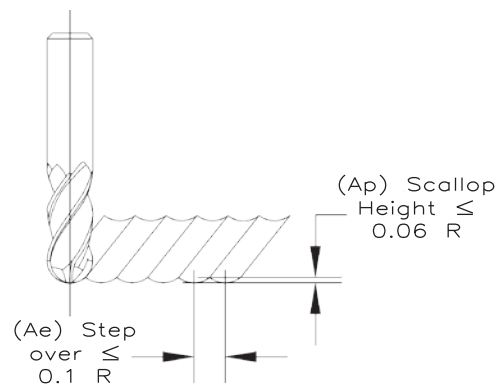

Coolant: Maximum Coolant Pressure

Technical data provided should be considered advisory only as variations may be necessary depending on the particular application.







For product information, call your local distributor

Technical Information
End Mills

TuffCut® XR7

180 / 180N Recommended Cutting Data - Profile Milling

Inch

Workpiece Material Group	ISO	Hardness	Coolant			Profiling (ae)			End Mill Diameter					
			• Preferred o Possible x Not Possible						1/4	3/8	1/2	5/8	3/4	1
						5.0	2.3	1.8	← Multiply fz by this Factor based on ae. When finishing, use the standard fz per chart below. Only add chip thinning when roughing or semi-finishing.					
			Max.	Air	MMS	vc - SFM								
Low Carbon Steels 1018, 1020	P	up to 28 Rc	•	•	•	1475	1150	980	.0024	.0039	.0047	.0060	.0078	.0100
Medium Carbon Steels 1140, 1145	P	28 to 38 Rc	•	•	•	1130	900	840	.0024	.0039	.0047	.0060	.0078	.0100
Alloy Steels 4140, 4145	P	28 to 44 Rc	•	•	•	1035	840	765	.0024	.0039	.0047	.0060	.0078	.0100
Die / Tool Steels A2, D2, H13, P20	P	28 to 44 Rc	•	•	•	900	725	615	.0024	.0039	.0047	.0060	.0078	.0100
Stainless Steel - Easy to Machine 430F, 301, 303, 410, 416 Annealed, 420F, 430	M	up to 28 Rc	•	x	o	675	545	425	.0010-.0015	.0015-.0020	.0020-.0031	.0020-.0033	.0022-.0035	.0024-.0039
Stainless Steel - Austenitic 301, 302, 303 High Tensile, 304, 304L, 305, 420, 15-5PH, 17-4PH, 17-7PH	M	up to 28 Rc	•	x	o	525	430	400	.0010-.0015	.0015-.0020	.0020-.0031	.0020-.0033	.0022-.0035	.0024-.0039
Stainless Steel - Difficult to Machine 302B, 304B, 309, 310, 316, 316B, 316L, 316Ti, 317, 317L, 321	M	up to 28 Rc	•	x	o	410	330	295	.0010-.0015	.0015-.0020	.0020-.0031	.002-.0033	.0022-.0035	.0024-.0039
Stainless Steel - Difficult to Machine 17-4 PH, PH13-8Mo, Nitronics	M	over 28 Rc	•	x	o	525	430	395	.0010-.0015	.0015-.0020	.0020-.0031	.0020-.0033	.0022-.0035	.0024-.0039
Cobalt Chrome Alloys	M		•	x	o	410	325	295	.0015	.0020	.0031	.0033	.0035	.0039
Duplex (22%)	M		•	x	o	245	325	180	.0015	.0020	.0031	.0033	.0035	.0039
Super Duplex (25%)	M		•	x	o	245	195	180	.0015	.0020	.0031	.0033	.0035	.0039
High Temp Alloys	S	up to 42 Rc	•	x	x	180	150	130	.0010-.0015	.0015-.0020	.0020-.0031	.0020-.0033	.0022-.0035	.0024-.0039
Inconel	S		•	x	x	180	150	130	.0006-.0010	.0010-.0016	.0010-.0016	.0010-.0017	.0011-.0018	.0012-.0020
Titanium Alloys 6Al-4V, 5Al-2.5 Sn, 6Al-2 Sn-4Zr-6Mo, 3Al-8V-6Cr4Mo-4Zr, 10V-2Fe-3Al, 13V-11Cr-3Al	S	up to 42 Rc	•	x	x	525	425	330	.0006-.0010	.0010-.0016	.0010-.0016	.0010-.0017	.0011-.0018	.0012-.0020
Cast-Iron - Gray CG, ASTM A48, CLASS 20, 25, 30, 35, SAE J431C, GRADES G1800, G3000, G3500, GG 10, 15, 20, 25, 30, 35, 40	K	up to 240 HB	•	o	o	1625	1295	870	.0024	.0039	.0047	.0060	.0078	.0100
Cast Iron - Ductile & Malleable CGI 60-40-18, 65-45-12, D4018, D4512, D5506, 32510, 35108, M3210, M4504, M5503, 250, 300, 350, 400, 450	K	over 240 HB	•	o	o	675	540	510	.0012	.0031	.0039	.0047	.0078	.0100
Hardened Steels	H	40-50 Rc	•	o	o	610	495	325	.0014	.0024	.0030	.0040	.0048	.0064
Hardened Steels		50-55 Rc	•	o	o	510	410	280	.0008	.0016	.0018	.0024	.0028	.0038
Hardened Steels		>55 Rc	•	o	o	330	310	280	.0006	.0010	.0015	.0018	.0021	.0028

Spindle Maximum - Should the calculated spindle speed be more than your actual spindle maximum, use this formula:



$$\frac{\text{Calculated Feed} \times \text{Spindle Maximum}}{\text{Calculated Speed}}$$

Technical data provided should be considered advisory only as variations may be necessary depending on the particular application.

TuffCut® XR7

180 / 180N Recommended Cutting Data - Profile Milling

Metric

Workpiece Material Group	ISO	Hardness	Coolant			Profiling (ae)			End Mill Diameter (mm)			
			● Preferred ○ Possible x Not Possible						12	16	18	20
			5%	10%	25%	5.0	2.3	1.8	← Multiply fz by this Factor based on ae. When finishing, use the standard fz per chart below. Only add chip thinning when roughing or semi-finishing.			
			Max.	Air	MMS	vc - m/min						
Low Carbon Steels 1018, 1020	P	up to 28 Rc	●	●	●	450	350	300	.1100	.1500	.1900	.2540
Medium Carbon Steels 1140, 1145	P	28 to 38 Rc	●	●	●	345	275	255	.1100	.1500	.1900	.2540
Alloy Steels 4140, 4145	P	28 to 44 Rc	●	●	●	315	255	230	.1100	.1500	.1900	.2540
Die / Tool Steels A2, D2, H13, P20	P	28 to 44 Rc	●	●	●	275	220	185	.1100	.1500	.1900	.2540
Stainless Steel - Easy to Machine 430F, 301, 303, 410, 416 Annealed, 420F, 430	M	up to 28 Rc	●	x	○	205	165	130	.050-.078	.050-.083	.055-.088	.060-.099
Stainless Steel - Austenitic 301, 302, 303 High Tensile, 304, 304L, 305, 420, 15-5PH, 17-4PH, 17-7PH	M	up to 28 Rc	●	x	○	160	130	120	.050-.078	.050-.083	.055-.088	.060-.099
Stainless Steel - Difficult to Machine 302B, 304B, 309, 310, 316, 316B, 316L, 316Ti, 317, 317L, 321	M	up to 28 Rc	●	x	○	125	100	90	.050-.078	.050-.083	.055-.088	.060-.099
Stainless Steel - Difficult to Machine 17-4 PH, PH13-8Mo, Nitronics	M	over 28 Rc	●	x	○	160	130	120	.050-.078	.050-.083	.055-.088	.060-.099
Cobalt Chrome Alloys	M		●	x	○	125	100	90	.0780	.0830	.0880	.0990
Duplex (22%)	M		●	x	○	75	60	55	.0780	.0830	.0880	.0990
Super Duplex (25%)	M		●	x	○	75	60	55	.0780	.0830	.0880	.0990
High Temp Alloys	S	up to 42 Rc	●	x	x	55	45	40	.025-.040	.025-.043	.027-.045	.030-.050
Inconel	S		●	x	x	55	45	40	.025-.040	.025-.043	.027-.045	.030-.050
Titanium Alloys 6Al-4V, 5Al-2.5 Sn, 6Al-2 Sn-4Zr-6Mo, 3Al-8V-6Cr4Mo-4Zr, 10V-2Fe-3Al, 13V-11Cr-3Al	S	up to 42 Rc	●	x	x	160	130	100	.050-.078	.050-.083	.055-.088	.030-.050
Cast Iron - Gray CG, ASTM A48, CLASS 20, 25, 30, 35, SAE J431C, GRADES G1800, G3000, G3500, GG 10, 15, 20, 25, 30, 35, 40	K	up to 240 HB	●	○	○	495	395	265	.1100	.1500	.1900	.2540
Cast Iron - Ductile & Malleable CGI 60-40-18, 65-45-12, D4018, D4512, D5506, 32510, 35108, M3210, M4504, M5503, 250, 300, 350, 400, 450	K	over 240 HB	●	○	○	205	165	155	.1100	.1500	.1900	.2540
Hardened Steels	H	40-50 Rc	●	○	○	185	150	100	.1016	.1168	.1310	.1524
Hardened Steels		50-55 Rc	●	○	○	155	125	85	.0610	.0762	.0857	.0889
Hardened Steels		>55 Rc	●	○	○	100	95	85	.0457	.0559	.0628	.0635

Spindle Maximum - Should the calculated spindle speed be more than your actual spindle maximum, use this formula:
 (Calculated Feed x Spindle Maximum)/Calculated Speed

Technical data provided should be considered advisory only as variations may be necessary depending on the particular application.

For product information, call your local distributor

177 / 177L / 177S / 179 / 179L / 177W Recommended Cutting Data - Profile Milling

Inch 179/179L series - If axial depth (ap) is less than the ball diameter, the speed is figured using the effective cutting diameter.

Workpiece Material Group	ISO	Hardness	Coolant				Profiling (ae)				End Mill Diameter								
			● Preferred ○ Possible x Not Possible								1/8*	3/16*	1/4*	5/16	3/8	1/2	5/8	3/4	1
			Max.	Air	MMS	vc - SFM				*Profile Milling at ≥ 50% ap is not recommended for diameters 1/4" and below. ← Multiply fz by this Factor based on ae. When finishing, use the standard fz per chart below. Only add chip thinning when roughing or semi-finishing.									
			2.3	1.8	1.2	1.0	fz - in/tooth												
Low Carbon Steels 1018, 1020	P	up to 28 Rc	●	●	●	1475	1150	980	500	.0012	.0020	.0024	.0031	.0039	.0047	.0060	.0078	.0100	
Medium Carbon Steels 1140, 1145	P	28 to 38 Rc	●	●	●	1130	900	840	250	.0012	.0020	.0024	.0031	.0039	.0047	.0060	.0078	.0100	
Alloy Steels 4140, 4145	P	28 to 44 Rc	●	●	●	1035	840	765	250	.0012	.0020	.0024	.0031	.0039	.0047	.0060	.0078	.0100	
Die / Tool Steels A2, D2, H13, P20	P	28 to 44 Rc	●	●	●	900	725	615	200	.0012	.0020	.0024	.0031	.0039	.0047	.0060	.0078	.0100	
Hardened Steels A2, D2	H	45 to 50 Rc	●	○	○	610	495	325	250	.0006	.0010	.0012	.0016	.0020	.0024	.0030	.0040	.0050	
Hardened Steels A2, D2	H	50 to 55 Rc	●	○	○	510	410	280	200	.0003	.0005	.0006	.0008	.0010	.0012	.0016	.0020	.0024	
Stainless Steel - Easy to Machine 430F, 301, 303, 410, 416 Annealed, 420F, 430	M	up to 28 Rc	●	x	○	675	545	425	360	.0012	.0020	.0024	.0031	.0039	.0047	.0060	.0078	.0100	
Stainless Steel - Austenitic 301, 302, 303 High Tensile, 304, 304L, 305, 420, 15-5PH, 17-4PH, 17-7PH	M	up to 28 Rc	●	x	○	525	430	400	210	.0012	.0020	.0024	.0031	.0039	.0047	.0060	.0078	.0100	
Stainless Steel - Difficult to Machine 302B, 304B, 309, 310, 316, 316B, 316L, 316Ti, 317, 317L, 321	M	up to 28 Rc	●	x	○	410	330	295	210	.0012	.0020	.0024	.0031	.0039	.0047	.0060	.0078	.0100	
Stainless Steel - Difficult to Machine 17-4 PH, PH13-8Mo, Nitronics	M	over 28 Rc	●	x	○	525	430	395	110	.0006	.0010	.0012	.0016	.0020	.0024	.0030	.0040	.0050	
Cobalt Chrome Alloys	M		●	x	○	410	325	295	130	.0006	.0010	.0012	.0016	.0020	.0024	.0030	.0040	.0050	
Duplex (22%)	M		●	x	○	245	195	180	130	.0006	.0010	.0012	.0016	.0020	.0024	.0030	.0040	.0050	
Super Duplex (25%)	M		●	x	○	245	195	180	110	.0006	.0010	.0012	.0016	.0020	.0024	.0030	.0040	.0050	
High Temp Alloys	S	up to 42 Rc	●	x	x	180	150	130	85	.0003	.0005	.0006	.0008	.0010	.0012	.0016	.0020	.0024	
Inconel	S	up to 42 Rc	●	x	x	180	150	130	85	.0003	.0005	.0006	.0008	.0010	.0012	.0016	.0020	.0024	
Titanium Alloys 6Al-4V, 5Al-2.5 Sn, 6Al-2 Sn-4Zr-6Mo, 3Al-8V-6Cr4Mo-4Zr, 10V-2Fe-3Al, 13V-11Cr-3Al	S	up to 42 Rc	●	x	x	525	425	330	175	.0003	.0005	.0006	.0008	.0010	.0012	.0016	.0020	.0024	
Cast-Iron - Gray CG, ASTM A48, CLASS 20, 25, 30, 35, SAE J431C, GRADES G1800, G3000, G3500, GG 10, 15, 20, 25, 30, 35, 40	K	up to 240 HB	●	○	○	1625	1295	870	350	.0012	.0020	.0024	.0031	.0039	.0047	.0060	.0078	.0100	
Cast Iron - Ductile & Malleable CGI 60-40-18, 65-45-12, D4018, D4512, D5506, 32510, 35108, M3210, M4504, M5503, 250, 300, 350, 400, 450	K	over 240 HB	●	○	○	675	540	510	260	.0012	.0020	.0024	.0031	.0039	.0047	.0060	.0078	.0100	

**Spindle Maximum - Should the calculated spindle speed be more than your actual spindle maximum, use this formula:
(Calculated Feed x Spindle Maximum)/Calculated Speed**

Technical data provided should be considered advisory only as variations may be necessary depending on the particular application.

177 / 177L / 177S / 179 / 179L / 177W Recommended Cutting Data - Profile Milling

Metric 179/179L series - If axial depth (ap) is less than the ball diameter, the speed is figured using the effective cutting diameter.







Workpiece Material Group	ISO	Hardness	Coolant			Profiling (ae)				End Mill Diameter (mm)								
			• Preferred o Possible x Not Possible							3*	5*	6*	8	10	12	16	20	25
						5%	10%	25%	50%	*Profile Milling at ≥ 50% ap is not recommended for diameters 6mm and below.								
			Max.	Air	MMS	vc - m/min				← Multiply fz by this Factor based on ae. When finishing, use the standard fz per chart below. Only add chip thinning when roughing or semi-finishing.								
										fz - mm/tooth								
Low Carbon Steels 1018, 1020	P	up to 28 Rc	•	•	•	450	350	300	150	.0300	.0500	.0600	.0800	.1000	.1200	.1600	.2000	.2500
Medium Carbon Steels 1140, 1145	P	28 to 38 Rc	•	•	•	345	275	255	75	.0300	.0500	.0600	.0800	.1000	.1200	.1600	.2000	.2500
Alloy Steels 4140, 4145	P	28 to 44 Rc	•	•	•	315	255	230	75	.0300	.0500	.0600	.0800	.1000	.1200	.1600	.2000	.2500
Die / Tool Steels A2, D2, H13, P20	P	28 to 44 Rc	•	•	•	275	220	185	60	.0300	.0500	.0600	.0800	.1000	.1200	.1600	.2000	.2500
Hardened Steels A2, D2	H	45 to 50 Rc	•	o	o	185	150	100	75	.0150	.0250	.0300	.0400	.0500	.0600	.0800	.1000	.1250
Hardened Steels A2, D2	H	50 to 55 Rc	•	o	o	155	125	85	60	.0070	.0120	.0150	.0200	.0250	.0300	.0400	.0500	.0620
Stainless Steel - Easy to Machine 430F, 301, 303, 410, 416 Annealed, 420F, 430	M	up to 28 Rc	•	x	o	205	165	130	110	.0300	.0500	.0600	.0800	.1000	.1200	.1600	.2000	.2500
Stainless Steel - Austenitic 301, 302, 303 High Tensile, 304, 304L, 305, 420, 15-5PH, 17-4PH, 17-7PH	M	up to 28 Rc	•	x	o	160	130	120	65	.0300	.0500	.0600	.0800	.1000	.1200	.1600	.2000	.2500
Stainless Steel - Difficult to Machine 302B, 304B, 309, 310, 316, 316B, 316L, 316Ti, 317, 317L, 321	M	up to 28 Rc	•	x	o	125	100	90	65	.0300	.0500	.0600	.0800	.1000	.1200	.1600	.2000	.2500
Stainless Steel - Difficult to Machine 17-4 PH, PH13-8Mo, Nitronics	M	over 28 Rc	•	x	o	160	130	120	35	.0150	.0250	.0300	.0400	.0500	.0600	.0800	.1000	.1250
Cobalt Chrome Alloys	M		•	x	o	125	100	90	40	.0150	.0250	.0300	.0400	.0500	.0600	.0800	.1000	.1250
Duplex (22%)	M		•	x	o	75	60	55	40	.0150	.0250	.0300	.0400	.0500	.0600	.0800	.1000	.1250
Super Duplex (25%)	M		•	x	o	75	60	55	35	.0150	.0250	.0300	.0400	.0500	.0600	.0800	.1000	.1250
High Temp Alloys	S	up to 42 Rc	•	x	x	55	45	40	25	.0070	.0120	.0150	.0200	.0250	.0300	.0400	.0500	.0620
Inconel	S		•	x	x	55	45	40	25	.0070	.0120	.0150	.0200	.0250	.0300	.0400	.0500	.0620
Titanium Alloys 6Al-4V, 5Al-2.5 Sn, 6Al-2 Sn-4Zr-6Mo, 3Al-8V-6Cr4Mo-4Zr, 10V-2Fe-3Al, 13V-11Cr-3Al	S	up to 42 Rc	•	x	x	160	130	100	55	.0070	.0120	.0150	.0200	.0250	.0300	.0400	.0500	.0620
Cast Iron - Gray CG, ASTM A48, CLASS 20, 25, 30, 35, SAE J431C, GRADES G1800, G3000, G3500, GG 10, 15, 20, 25, 30, 35, 40	K	up to 240 HB	•	o	o	495	395	265	110	.0300	.0500	.0600	.0800	.1000	.1200	.1600	.2000	.2500
Cast Iron - Ductile & Malleable CGI 60-40-18, 65-45-12, D4018, D4512, D5506, 32510, 35108, M3210, M4504, M5503, 250, 300, 350, 400, 450	K	over 240 HB	•	o	o	205	165	155	80	.0300	.0500	.0600	.0800	.1000	.1200	.1600	.2000	.2500

Spindle Maximum - Should the calculated spindle speed be more than your actual spindle maximum, use this formula:
 (Calculated Feed x Spindle Maximum)/Calculated Speed

Technical data provided should be considered advisory only as variations may be necessary depending on the particular application.

177 / 177L / 177S / 179 / 179L / 177W Recommended Cutting Data - Slotting

Inch 179/179L series - If axial depth (ap) is less than the ball diameter, the speed is figured using the effective cutting diameter.

Workpiece Material Group	ISO	Hardness	Coolant			Slotting			End Mill Diameter								
			● Preferred ○ Possible x Not Possible						1/8*	3/16*	1/4*	5/16	3/8	1/2	5/8	3/4	1
						25%	50%	100%	*Slotting at > 25% ap is not recommended for diameters 1/4" and below.								
			Max.	Air	MMS	vc - SFM			fz - in/tooth								
Low Carbon Steels 1018, 1020	P	up to 28 Rc	●	●	●	550	500	475	.0004	.0010	.0012	.0016	.0020	.0025	.0031	.0040	.0050
Medium Carbon Steels 1140, 1145	P	28 to 38 Rc	●	●	●	275	250	225	.0004	.0010	.0012	.0016	.0020	.0025	.0031	.0040	.0050
Alloy Steels 4140, 4145	P	28 to 44 Rc	●	●	●	275	250	225	.0004	.0010	.0012	.0016	.0020	.0025	.0031	.0040	.0050
Die / Tool Steels A2, D2, H13, P20	P	28 to 44 Rc	●	●	●	225	200	175	.0004	.0010	.0012	.0016	.0020	.0025	.0031	.0040	.0050
Hardened Steels A2, D2	H	45 to 50 Rc	●	○	○	275	250	225	.0003	.0005	.0006	.0008	.0010	.0012	.0016	.0020	.0024
Hardened Steels A2, D2	H	50 to 55 Rc	●	○	○	225	200	175	.0001	.0002	.0003	.0004	.0005	.0006	.0008	.0010	.0015
Stainless Steel - Easy to Machine 430F, 301, 303, 410, 416 Annealed, 420F, 430	M	up to 28 Rc	●	x	○	385	360	350	.0004	.0010	.0012	.0016	.0020	.0024	.0031	.0040	.0050
Stainless Steel - Austenitic 301, 302, 303 High Tensile, 304, 304L, 305, 420, 15-5PH, 17-4PH, 17-7PH	M	up to 28 Rc	●	x	○	225	210	200	.0004	.0010	.0012	.0016	.0020	.0024	.0031	.0040	.0050
Stainless Steel - Difficult to Machine 302B, 304B, 309, 310, 316, 316B, 316L, 316Ti, 317, 317L, 321	M	up to 28 Rc	●	x	○	225	210	200	.0004	.0010	.0012	.0016	.0020	.0024	.0031	.0040	.0050
Stainless Steel - Difficult to Machine 17-4 PH, PH13-8Mo, Nitronics	M	over 28 Rc	●	x	○	125	110	100	.0003	.0005	.0006	.0008	.0010	.0012	.0016	.0020	.0024
Cobalt Chrome Alloys	M	over 28 Rc	●	x	○	150	130	120	.0003	.0005	.0006	.0008	.0010	.0012	.0016	.0020	.0024
Duplex (22%)	M	over 28 Rc	●	x	○	150	130	120	.0003	.0005	.0006	.0008	.0010	.0012	.0016	.0020	.0024
Super Duplex (25%)	M	over 28 Rc	●	x	○	120	110	100	.0003	.0005	.0006	.0008	.0010	.0012	.0016	.0020	.0024
High Temp Alloys	S	up to 42 Rc	●	x	x	100	85	75	.0003	.0005	.0006	.0008	.0010	.0012	.0016	.0020	.0024
Inconel	S	up to 42 Rc	●	x	x	95	85	75	.0003	.0005	.0006	.0008	.0010	.0012	.0016	.0020	.0024
Titanium Alloys 6Al-4V, 5Al-2.5 Sn, 6Al-2 Sn-4Zr-6Mo, 3Al-8V-6Cr4Mo-4Zr, 10V-2Fe-3Al, 13V-11Cr-3Al	S	up to 42 Rc	●	x	x	180	175	160	.0003	.0005	.0006	.0008	.0010	.0012	.0016	.0020	.0024
Cast-Iron - Gray CG, ASTM A48, CLASS 20, 25, 30, 35, SAE J431C, GRADES G1800, G3000, G3500, GG 10, 15, 20, 25, 30, 35, 40	K	up to 240 HB	●	○	○	375	350	325	.0004	.0010	.0012	.0016	.0020	.0024	.0031	.0040	.0050
Cast Iron - Ductile & Malleable CGI 60-40-18, 65-45-12, D4018, D4512, D5506, 32510, 35108, M3210, M4504, M5503, 250, 300, 350, 400, 450	K	over 240 HB	●	○	○	275	260	250	.0004	.0010	.0012	.0016	.0020	.0024	.0031	.0040	.0050

Spindle Maximum - Should the calculated spindle speed be more than your actual spindle maximum, use this formula:

$$\frac{\text{Calculated Feed} \times \text{Spindle Maximum}}{\text{Calculated Speed}}$$

177 / 177L / 177S / 179 / 179L / 177W Recommended Cutting Data - Slotting

Metric 179/179L series - If axial depth (ap) is less than the ball diameter, the speed is figured using the effective cutting diameter.





Workpiece Material Group	ISO	Hardness	Coolant			Slotting			End Mill Diameter (mm)								
			● Preferred ○ Possible x Not Possible						3*	5*	6*	8	10	12	16	20	25
						25%	50%	100%	*Slotting at > 25% ap is not recommended for diameters 6mm and below.								
			Max.	Air	MMS	vc - m/min			fz - mm/tooth								
Low Carbon Steels 1018, 1020	P	up to 28 Rc	●	●	●	170	150	145	.0100	.0250	.0300	.0400	.0500	.0600	.0800	.1000	.1250
Medium Carbon Steels 1140, 1145	P	28 to 38 Rc	●	●	●	85	75	70	.0100	.0250	.0300	.0400	.0500	.0600	.0800	.1000	.1250
Alloy Steels 4140, 4145	P	28 to 44 Rc	●	●	●	85	75	70	.0100	.0250	.0300	.0400	.0500	.0600	.0800	.1000	.1250
Die / Tool Steels A2, D2, H13, P20	P	28 to 44 Rc	●	●	●	70	60	55	.0100	.0250	.0300	.0400	.0500	.0600	.0800	.1000	.1250
Hardened Steels A2, D2	H	45 to 50 Rc	●	○	○	85	75	70	.0070	.0120	.0150	.0200	.0250	.0300	.0400	.0500	.0620
Hardened Steels A2, D2	H	50 to 55 Rc	●	○	○	70	60	55	.0030	.0060	.0070	.0100	.0120	.0150	.0200	.0250	.0370
Stainless Steel - Easy to Machine 430F, 301, 303, 410, 416 Annealed, 420F, 430	M	up to 28 Rc	●	x	○	120	110	110	.0100	.0250	.0300	.0400	.0500	.0600	.0800	.1000	.1250
Stainless Steel - Austenitic 301, 302, 303 High Tensile, 304, 304L, 305, 420, 15-5PH, 17-4PH, 17-7PH	M	up to 28 Rc	●	x	○	70	65	60	.0100	.0250	.0300	.0400	.0500	.0600	.0800	.1000	.1250
Stainless Steel - Difficult to Machine 302B, 304B, 309, 310, 316, 316B, 316L, 316Ti, 317, 317L, 321	M	up to 28 Rc	●	x	○	70	65	60	.0100	.0250	.0300	.0400	.0500	.0600	.0800	.1000	.1250
Stainless Steel - Difficult to Machine 17-4 PH, PH13-8Mo, Nitronics	M	over 28 Rc	●	x	○	40	35	30	.0070	.0120	.0150	.0200	.0250	.0300	.0400	.0500	.0620
Cobalt Chrome Alloys	M		●	x	○	45	40	40	.0070	.0120	.0150	.0200	.0250	.0300	.0400	.0500	.0620
Duplex (22%)	M		●	x	○	45	40	40	.0070	.0120	.0150	.0200	.0250	.0300	.0400	.0500	.0620
Super Duplex (25%)	M		●	x	○	40	35	30	.0070	.0120	.0150	.0200	.0250	.0300	.0400	.0500	.0620
High Temp Alloys	S	up to 42 Rc	●	x	x	30	25	25	.0070	.0120	.0150	.0200	.0250	.0300	.0400	.0500	.0620
Inconel	S	up to 42 Rc	●	x	x	30	25	25	.0070	.0120	.0150	.0200	.0250	.0300	.0400	.0500	.0620
Titanium Alloys 6Al-4V, 5Al-2.5 Sn, 6Al-2 Sn-4Zr-6Mo, 3Al-8V-6Cr4Mo-4Zr, 10V-2Fe-3Al, 13V-11Cr-3Al	S	up to 42 Rc	●	x	x	55	55	50	.0070	.0120	.0150	.0200	.0250	.0300	.0400	.0500	.0620
Cast-Iron - Gray CG, ASTM A48, CLASS 20, 25, 30, 35, SAE J431C, GRADES G1800, G3000, G3500, GG 10, 15, 20, 25, 30, 35, 40	K	up to 240 HB	●	○	○	115	105	100	.0100	.0250	.0300	.0400	.0500	.0600	.0800	.1000	.1250
Cast Iron - Ductile & Malleable CGI 60-40-18, 65-45-12, D4018, D4512, D5506, 32510, 35108, M3210, M4504, M5503, 250, 300, 350, 400, 450	K	over 240 HB	●	○	○	85	80	75	.0100	.0250	.0300	.0400	.0500	.0600	.0800	.1000	.1250

Spindle Maximum - Should the calculated spindle speed be more than your actual spindle maximum, use this formula:
 (Calculated Feed x Spindle Maximum)/Calculated Speed

Technical data provided should be considered advisory only as variations may be necessary depending on the particular application.

178 / 178N / 178W Recommended Cutting Data - Profile Milling

Inch

Workpiece Material Group	ISO	Hardness	Coolant				Profiling (ae)				End Mill Diameter								
			• Preferred o Possible x Not Possible								1/8*	3/16*	1/4*	5/16	3/8	1/2	5/8	3/4	1
							5%	10%	25%	50%	*Profile Milling at ≥ 50% ap is not recommended for diameters 1/4" and below.								
							2.3	1.8	1.2	1.0	← Multiply fz by this Factor based on ae. When finishing, use the standard fz per chart below. Only add chip thinning when roughing or semi-finishing.								
			Max.	Air	MMS	vc - SFM				fz - in/tooth									
Low Carbon Steels 1018, 1020	P	up to 28 Rc	•	•	•	1475	1150	980	500	.0012	.0020	.0024	.0031	.0039	.0047	.0060	.0078	.0100	
Medium Carbon Steels 1140, 1145	P	28 to 38 Rc	•	•	•	1130	900	840	250	.0012	.0020	.0024	.0031	.0039	.0047	.0060	.0078	.0100	
Alloy Steels 4140, 4145	P	28 to 44 Rc	•	•	•	1035	840	765	250	.0012	.0020	.0024	.0031	.0039	.0047	.0060	.0078	.0100	
Die / Tool Steels A2, D2, H13, P20	P	28 to 44 Rc	•	•	•	900	725	615	200	.0012	.0020	.0024	.0031	.0039	.0047	.0060	.0078	.0100	
Hardened Steels A2, D2	H	45 to 50 Rc	•	o	o	610	495	325	250	.0006	.0010	.0012	.0016	.0020	.0024	.0030	.0040	.0050	
Hardened Steels A2, D2	H	50 to 55 Rc	•	o	o	510	410	280	200	.0003	.0005	.0006	.0008	.0010	.0012	.0016	.0020	.0024	
Stainless Steel - Easy to Machine 430F, 301, 303, 410, 416 Annealed, 420F, 430	M	up to 28 Rc	•	x	o	675	545	425	360	.0012	.0020	.0024	.0031	.0039	.0047	.0060	.0078	.0100	
Stainless Steel - Austenitic 301, 302, 303 High Tensile, 304, 304L, 305, 420, 15-5PH, 17-4PH, 17-7PH	M	up to 28 Rc	•	x	o	525	430	400	210	.0012	.0020	.0024	.0031	.0039	.0047	.0060	.0078	.0100	
Stainless Steel - Difficult to Machine 302B, 304B, 309, 310, 316, 316B, 316L, 316Ti, 317, 317L, 321	M	up to 28 Rc	•	x	o	410	330	295	210	.0012	.0020	.0024	.0031	.0039	.0047	.0060	.0078	.0100	
Stainless Steel - Difficult to Machine 17-4 PH, PH13-8Mo, Nitronics	M	over 28 Rc	•	x	o	525	430	395	110	.0006	.0010	.0012	.0016	.0020	.0024	.0030	.0040	.0050	
Cobalt Chrome Alloys	M		•	x	o	410	325	295	130	.0006	.0010	.0012	.0016	.0020	.0024	.0030	.0040	.0050	
Duplex (22%)	M		•	x	o	245	195	180	130	.0006	.0010	.0012	.0016	.0020	.0024	.0030	.0040	.0050	
Super Duplex (25%)	M		•	x	o	245	195	180	110	.0006	.0010	.0012	.0016	.0020	.0024	.0030	.0040	.0050	
High Temp Alloys	S	up to 42 Rc	•	x	x	180	150	130	85	.0003	.0005	.0006	.0008	.0010	.0012	.0016	.0020	.0024	
Inconel	S		•	x	x	180	150	130	85	.0003	.0005	.0006	.0008	.0010	.0012	.0016	.0020	.0024	
Titanium Alloys 6Al-4V, 5Al-2.5 Sn, 6Al-2 Sn-4Zr-6Mo, 3Al-8V-6Cr4Mo-4Zr, 10V-2Fe-3Al, 13V-11Cr-3Al	S	up to 42 Rc	•	x	x	525	425	330	175	.0003	.0005	.0006	.0008	.0010	.0012	.0016	.0020	.0024	
Cast-Iron - Gray CG, ASTM A48, CLASS 20, 25, 30, 35, SAE J431C, GRADES G1800, G3000, G3500, GG 10, 15, 20, 25, 30, 35, 40	K	up to 240 HB	•	o	o	1625	1295	870	350	.0012	.0020	.0024	.0031	.0039	.0047	.0060	.0078	.0100	
Cast Iron - Ductile & Malleable CGI 60-40-18, 65-45-12, D4018, D4512, D5506, 32510, 35108, M3210, M4504, M5503, 250, 300, 350, 400, 450	K	over 240 HB	•	o	o	675	540	510	260	.0012	.0020	.0024	.0031	.0039	.0047	.0060	.0078	.0100	

**Spindle Maximum - Should the calculated spindle speed be more than your actual spindle maximum, use this formula:
(Calculated Feed x Spindle Maximum)/Calculated Speed**

178 / 178N / 178W Recommended Cutting Data - Profile Milling

Metric

Workpiece Material Group	ISO	Hardness	Coolant			Profiling (ae)				End Mill Diameter (mm)								
			● Preferred ○ Possible x Not Possible							3*	5*	6*	8	10	12	16	20	25
						5%	10%	25%	50%	*Profile Milling at ≥ 50% ap is not recommended for diameters 6mm and below. ← Multiply fz by this Factor based on ae. When finishing, use the standard fz per chart below. Only add chip thinning when roughing or semi-finishing.								
						vc - m/min												
Low Carbon Steels 1018, 1020	P	up to 28 Rc	●	●	●	450	350	300	150	.0300	.0500	.0600	.0800	.1000	.1200	.1600	.2000	.2500
Medium Carbon Steels 1140, 1145	P	28 to 38 Rc	●	●	●	345	275	265	75	.0300	.0500	.0600	.0800	.1000	.1200	.1600	.2000	.2500
Alloy Steels 4140, 4145	P	28 to 44 Rc	●	●	●	315	255	230	75	.0300	.0500	.0600	.0800	.1000	.1200	.1600	.2000	.2500
Die / Tool Steels A2, D2, H13, P20	P	28 to 44 Rc	●	●	●	275	220	185	60	.0300	.0500	.0600	.0800	.1000	.1200	.1600	.2000	.2500
Hardened Steels A2, D2	H	45 to 50 Rc	●	○	○	185	150	100	75	.0150	.0250	.0300	.0400	.0500	.0600	.0800	.1000	.1250
Hardened Steels A2, D2	H	50 to 55 Rc	●	○	○	155	125	85	60	.0070	.0120	.0150	.0200	.0250	.0300	.0400	.0500	.0620
Stainless Steel - Easy to Machine 430F, 301, 303, 410, 416 Annealed, 420F, 430	M	up to 28 Rc	●	x	○	205	165	130	110	.0300	.0500	.0600	.0800	.1000	.1200	.1600	.2000	.2500
Stainless Steel - Austenitic 301, 302, 303 High Tensile, 304, 304L, 305, 420, 15-5PH, 17-4PH, 17-7PH	M	up to 28 Rc	●	x	○	160	130	120	65	.0300	.0500	.0600	.0800	.1000	.1200	.1600	.2000	.2500
Stainless Steel - Difficult to Machine 302B, 304B, 309, 310, 316, 316B, 316L, 316Ti, 317, 317L, 321	M	up to 28 Rc	●	x	○	125	100	90	65	.0300	.0500	.0600	.0800	.1000	.1200	.1600	.2000	.2500
Stainless Steel - Difficult to Machine 17-4 PH, PH13-8Mo, Nitronics	M	over 28 Rc	●	x	○	160	130	120	35	.0150	.0250	.0300	.0400	.0500	.0600	.0800	.1000	.1250
Cobalt Chrome Alloys	M		●	x	○	125	100	90	40	.0150	.0250	.0300	.0400	.0500	.0600	.0800	.1000	.1250
Duplex (22%)	M		●	x	○	75	60	55	40	.0150	.0250	.0300	.0400	.0500	.0600	.0800	.1000	.1250
Super Duplex (25%)	M		●	x	○	75	60	55	35	.0150	.0250	.0300	.0400	.0500	.0600	.0800	.1000	.1250
High Temp Alloys	S	up to 42 Rc	●	x	x	55	45	40	25	.0070	.0120	.0150	.0200	.0250	.0300	.0400	.0500	.0620
Inconel	S		●	x	x	55	45	40	25	.0070	.0120	.0150	.0200	.0250	.0300	.0400	.0500	.0620
Titanium Alloys 6Al-4V, 5Al-2.5 Sn, 6Al-2 Sn-4Zr-6Mo, 3Al-8V-6Cr4Mo-4Zr, 10V-2Fe-3Al, 13V-11Cr-3Al	S	up to 42 Rc	●	x	x	160	130	100	55	.0070	.0120	.0150	.0200	.0250	.0300	.0400	.0500	.0620
Cast Iron - Gray CG, ASTM A48, CLASS 20, 25, 30, 35, SAE J431C, GRADES G1800, G3000, G3500, GG 10, 15, 20, 25, 30, 35, 40	K	up to 240 HB	●	○	○	495	395	265	110	.0300	.0500	.0600	.0800	.1000	.1200	.1600	.2000	.2500
Cast Iron - Ductile & Malleable CGI 60-40-18, 65-45-12, D4018, D4512, D5506, 32510, 35108, M3210, M4504, M5503, 250, 300, 350, 400, 450	K	over 240 HB	●	○	○	205	165	155	80	.0300	.0500	.0600	.0800	.1000	.1200	.1600	.2000	.2500







Spindle Maximum - Should the calculated spindle speed be more than your actual spindle maximum, use this formula:

$$\frac{\text{Calculated Feed} \times \text{Spindle Maximum}}{\text{Calculated Speed}}$$

Technical data provided should be considered advisory only as variations may be necessary depending on the particular application.

178 / 178N / 178W Recommended Cutting Data - Slotting

Inch

Workpiece Material Group	ISO	Hardness	Coolant			Slotting			End Mill Diameter								
			• Preferred ○ Possible x Not Possible						1/8*	3/16*	1/4*	5/16	3/8	1/2	5/8	3/4	1
						25%	50%	100%	*Slotting at > 25% ap is not recommended for diameters 1/4" and below.								
			Max.	Air	MMS	vc - SFM			fz - in/tooth								
Low Carbon Steels 1018, 1020	P	up to 28 Rc	•	•	•	550	500	475	.0004	.0010	.0012	.0016	.0020	.0025	.0031	.0040	.0050
Medium Carbon Steels 1140, 1145	P	28 to 38 Rc	•	•	•	275	250	225	.0004	.0010	.0012	.0016	.0020	.0025	.0031	.0040	.0050
Alloy Steels 4140, 4145	P	28 to 44 Rc	•	•	•	275	250	225	.0004	.0010	.0012	.0016	.0020	.0025	.0031	.0040	.0050
Die / Tool Steels A2, D2, H13, P20	P	28 to 44 Rc	•	•	•	225	200	175	.0004	.0010	.0012	.0016	.0020	.0025	.0031	.0040	.0050
Hardened Steels A2, D2	H	45 to 50 Rc	•	○	○	275	250	225	.0003	.0005	.0006	.0008	.0010	.0012	.0016	.0020	.0024
Hardened Steels A2, D2	H	50 to 55 Rc	•	○	○	225	200	175	.0001	.0002	.0003	.0004	.0005	.0006	.0008	.0010	.0015
Stainless Steel - Easy to Machine 430F, 301, 303, 410, 416 Annealed, 420F, 430	M	up to 28 Rc	•	x	○	385	360	350	.0002	.0004	.0008	.0012	.0014	.0018	.0022	.0026	.0038
Stainless Steel - Austenitic 301, 302, 303 High Tensile, 304, 304L, 305, 420, 15-5PH, 17-4PH, 17-7PH	M	up to 28 Rc	•	x	○	225	210	200	.0002	.0004	.0008	.0012	.0014	.0018	.0022	.0026	.0038
Stainless Steel - Difficult to Machine 302B, 304B, 309, 310, 316, 316B, 316L, 316Ti, 317, 317L, 321	M	up to 28 Rc	•	x	○	225	210	200	.0002	.0004	.0008	.0012	.0014	.0018	.0022	.0026	.0038
Stainless Steel - Difficult to Machine 17-4 PH, PH13-8Mo, Nitronics	M	over 28 Rc	•	x	○	125	110	100	.0003	.0005	.0006	.0008	.0010	.0012	.0016	.0020	.0024
Cobalt Chrome Alloys	M	over 28 Rc	•	x	○	150	130	120	.0003	.0005	.0006	.0008	.0010	.0012	.0016	.0020	.0024
Duplex (22%)	M	over 28 Rc	•	x	○	150	130	120	.0003	.0005	.0006	.0008	.0010	.0012	.0016	.0020	.0024
Super Duplex (25%)	M	over 28 Rc	•	x	○	120	110	100	.0003	.0005	.0006	.0008	.0010	.0012	.0016	.0020	.0024
High Temp Alloys	S	up to 42 Rc	•	x	x	100	85	75	.0003	.0005	.0006	.0008	.0010	.0012	.0016	.0020	.0024
Inconel	S	up to 42 Rc	•	x	x	95	85	75	.0003	.0005	.0006	.0008	.0010	.0012	.0016	.0020	.0024
Titanium Alloys 6Al-4V, 5Al-2.5 Sn, 6Al-2 Sn-4Zr-6Mo, 3Al-8V-6Cr4Mo-4Zr, 10V-2Fe-3Al, 13V-11Cr-3Al	S	up to 42 Rc	•	x	x	180	175	160	.0003	.0005	.0006	.0008	.0010	.0012	.0016	.0020	.0024
Cast-Iron - Gray CG, ASTM A48, CLASS 20, 25, 30, 35, SAE J431C, GRADES G1800, G3000, G3500, GG 10, 15, 20, 25, 30, 35, 40	K	up to 240 HB	•	○	○	375	350	325	.0004	.0010	.0012	.0016	.0020	.0024	.0031	.0040	.0050
Cast Iron - Ductile & Malleable CGI 60-40-18, 65-45-12, D4018, D4512, D5506, 32510, 35108, M3210, M4504, M5503, 250, 300, 350, 400, 450	K	over 240 HB	•	○	○	275	260	250	.0004	.0010	.0012	.0016	.0020	.0024	.0031	.0040	.0050







Spindle Maximum - Should the calculated spindle speed be more than your actual spindle maximum, use this formula:

$$\frac{\text{Calculated Feed} \times \text{Spindle Maximum}}{\text{Calculated Speed}}$$

Technical data provided should be considered advisory only as variations may be necessary depending on the particular application.

178 / 178N / 178W Recommended Cutting Data - Slotting

Metric





Workpiece Material Group	ISO	Hardness	Coolant			Slotting			End Mill Diameter (mm)								
			● Preferred ○ Possible x Not Possible						3*	5*	6*	8	10	12	16	20	25
						25%	50%	100%	*Slotting at > 25% ap is not recommended for diameters 6mm and below.								
			Max.	Air	MMS	vc - m/min			fz - mm/tooth								
Low Carbon Steels 1018, 1020	P	up to 28 Rc	●	●	●	170	150	145	.0100	.0250	.0300	.0400	.0500	.0600	.0800	.1000	.1250
Medium Carbon Steels 1140, 1145	P	28 to 38 Rc	●	●	●	85	75	70	.0100	.0250	.0300	.0400	.0500	.0600	.0800	.1000	.1250
Alloy Steels 4140, 4145	P	28 to 44 Rc	●	●	●	85	75	70	.0100	.0250	.0300	.0400	.0500	.0600	.0800	.1000	.1250
Die / Tool Steels A2, D2, H13, P20	P	28 to 44 Rc	●	●	●	70	60	55	.0100	.0250	.0300	.0400	.0500	.0600	.0800	.1000	.1250
Hardened Steels A2, D2	H	45 to 50 Rc	●	○	○	85	75	70	.0070	.0120	.0150	.0200	.0250	.0300	.0400	.0500	.0620
Hardened Steels A2, D2	H	50 to 55 Rc	●	○	○	70	60	55	.0030	.0060	.0070	.0100	.0120	.0150	.0200	.0250	.0370
Stainless Steel - Easy to Machine 430F, 301, 303, 410, 416 Annealed, 420F, 430	M	up to 28 Rc	●	x	○	120	110	110	.0050	.0100	.0200	.0300	.0350	.0450	.0550	.0650	.0950
Stainless Steel - Austenitic 301, 302, 303 High Tensile, 304, 304L, 305, 420, 15-5PH, 17-4PH, 17-7PH	M	up to 28 Rc	●	x	○	70	65	60	.0050	.0100	.0200	.0300	.0350	.0450	.0550	.0650	.0950
Stainless Steel - Difficult to Machine 302B, 304B, 309, 310, 316, 316B, 316L, 316Ti, 317, 317L, 321	M	up to 28 Rc	●	x	○	70	65	60	.0050	.0100	.0200	.0300	.0350	.0450	.0550	.0650	.0950
Stainless Steel - Difficult to Machine 17-4 PH, PH13-8Mo, Nitronics	M	over 28 Rc	●	x	○	40	35	30	.0070	.0120	.0150	.0200	.0250	.0300	.0400	.0500	.0620
Cobalt Chrome Alloys	M		●	x	○	45	40	40	.0070	.0120	.0150	.0200	.0250	.0300	.0400	.0500	.0620
Duplex (22%)	M		●	x	○	45	40	40	.0070	.0120	.0150	.0200	.0250	.0300	.0400	.0500	.0620
Super Duplex (25%)	M		●	x	○	40	35	30	.0070	.0120	.0150	.0200	.0250	.0300	.0400	.0500	.0620
High Temp Alloys	S	up to 42 Rc	●	x	x	30	25	25	.0070	.0120	.0150	.0200	.0250	.0300	.0400	.0500	.0620
Inconel	S		●	x	x	30	25	25	.0070	.0120	.0150	.0200	.0250	.0300	.0400	.0500	.0620
Titanium Alloys 6Al-4V, 5Al-2.5 Sn, 6Al-2 Sn-4Zr-6Mo, 3Al-8V-6Cr4Mo-4Zr, 10V-2Fe-3Al, 13V-11Cr-3Al	S	up to 42 Rc	●	x	x	55	55	50	.0070	.0120	.0150	.0200	.0250	.0300	.0400	.0500	.0620
Cast-Iron - Gray CG, ASTM A48, CLASS 20, 25, 30, 35, SAE J431C, GRADES G1800, G3000, G3500, GG 10, 15, 20, 25, 30, 35, 40	K	up to 240 HB	●	○	○	115	105	100	.0100	.0250	.0300	.0400	.0500	.0600	.0800	.1000	.1250
Cast Iron - Ductile & Malleable CGI 60-40-18, 65-45-12, D4018, D4512, D5506, 32510, 35108, M3210, M4504, M5503, 250, 300, 350, 400, 450	K	over 240 HB	●	○	○	85	80	75	.0100	.0250	.0300	.0400	.0500	.0600	.0800	.1000	.1250

Spindle Maximum - Should the calculated spindle speed be more than your actual spindle maximum, use this formula:
 (Calculated Feed x Spindle Maximum)/Calculated Speed

Technical data provided should be considered advisory only as variations may be necessary depending on the particular application.





For product information, call your local distributor

138CE Recommended Cutting Data - Profile Milling Inch

Workpiece Material Group	ISO	Coolant Preferred	Profile Milling (ae)				End Mill Diameter								
							1/8*	3/16*	1/4*	5/16	3/8	1/2	5/8	3/4	1
			10%	20%	30%	50%	ae > .30D use < 1D ap ae < .20D use < 2D ap *Profile Milling at > 25% ap is not recommended for Diameters 1/4" and below.								
			3.8	3.1	2	1	← Multiply fz by this Factor based on ae. When finishing, use the standard fz per chart below. Only add chip thinning when roughing or semi-finishing.								
Max.	vc - SFM				fz - in/tooth										
Non-Ferrous - Aluminum / Aluminum Alloys < 10% Si	N	•	2000	1800	1200	900	.0012	.0018	.0025	.0031	.0037	.0050	.0065	.0075	.0100
Non-Ferrous - Aluminum / Aluminum Alloys > 10% Si	N	•	1500	1200	1000	800	.0012	.0018	.0025	.0031	.0037	.0050	.0065	.0075	.0100
Non-Ferrous - Brass	N	•	900	800	600	500	.0018	.0025	.0032	.0040	.0050	.0065	.0075	.0100	.0120
Non-Ferrous - Cu/Cu Alloys / Magnesium	N	•	1000	800	600	500	.0018	.0025	.0032	.0040	.0050	.0065	.0075	.0100	.0120
Non-Ferrous - Plastics	N	•	900	800	600	500	.0018	.0025	.0032	.0040	.0050	.0065	.0075	.0100	.0120

Above 20,000 RPM, Tool Balancing Required

138CE Recommended Cutting Data - Profile Milling Metric



Workpiece Material Group	ISO	Coolant Preferred	Profile Milling (ae)				End Mill Diameter (mm)					
							6*	8	10	14	16	20
			10%	20%	30%	50%	ae > .30D use < 1D ap ae < .20D use < 2D ap *Profile milling at > 25% ap is not recommended for diameters 6mm and below.					
			3.8	3.1	2	1	← Multiply fz by this Factor based on ae. When finishing, use the standard fz per chart below. Only add chip thinning when roughing or semi-finishing.					
Max.	vc - m/min				fz - mm/tooth							
Non-Ferrous - Aluminum / Aluminum Alloys < 10% Si	N	•	600	550	365	275	.0630	.0780	.0930	.1270	.1650	.1900
Non-Ferrous - Aluminum / Aluminum Alloys > 10% Si	N	•	450	365	305	250	.0630	.0780	.0930	.1270	.1650	.1900
Non-Ferrous - Brass	N	•	275	250	180	150	.0810	.1010	.1270	.1650	.1900	.2540
Non-Ferrous - Cu/Cu Alloys / Magnesium	N	•	300	250	180	150	.0810	.1010	.1270	.1650	.1900	.2540
Non-Ferrous - Plastics	N	•	275	250	180	150	.0810	.1010	.1270	.1650	.1900	.2540

Above 20,000 RPM, Tool Balancing Required

Spindle Maximum - Should the calculated spindle speed be more than your actual spindle maximum, use this formula:
 (Calculated Feed x Spindle Maximum)/Calculated Speed

TuffCut® X-AL

138CE Recommended Cutting Data - Slotting Inch

Workpiece Material Group	I S O	Coolant • Preferred	Slotting			End Mill Diameter								
						1/8*	3/16*	1/4*	5/16	3/8	1/2	5/8	3/4	1
		Max.	vc - SFM			*Slotting at > 25% ap is not recommended for diameters 1/4" and below.								
			fz - in/tooth											
Non-Ferrous - Aluminum / Aluminum Alloys < 10% Si	N	•	2000	1500	1000	.0025	.0037	.0050	.0062	.0075	.0100	.0125	.0150	.0200
Non-Ferrous - Aluminum / Aluminum Alloys > 10% Si	N	•	1500	1200	800	.0025	.0037	.0050	.0062	.0075	.0100	.0125	.0150	.0200
Non-Ferrous - Brass	N	•	600	500	400	.0025	.0037	.0050	.0062	.0075	.0100	.0125	.0150	.0200
Non-Ferrous - Cu/Cu Alloys / Magnesium	N	•	500	400	300	.0025	.0037	.0050	.0062	.0075	.0100	.0125	.0150	.0200
Non-Ferrous - Plastics	N	•	1200	1000	800	.0025	.0037	.0050	.0062	.0075	.0100	.0125	.0150	.0200

Above 20,000 RPM, Tool Balancing Required

138CE Recommended Cutting Data - Slotting Metric

Workpiece Material Group	I S O	Coolant • Preferred	Slotting			End Mill Diameter (mm)				
						6*	8	10	14	16
		Max.	vc - m/min			*Slotting at > 25% ap is not recommended for diameters 6mm and below.				
			fz - mm/tooth							
Non-Ferrous - Aluminum / Aluminum Alloys < 10% Si	N	•	600	450	300	.1200	.1600	.2000	.2800	.3200
Non-Ferrous - Aluminum / Aluminum Alloys > 10% Si	N	•	450	365	250	.1200	.1600	.2000	.2800	.3200
Non-Ferrous - Brass	N	•	180	150	120	.1200	.1600	.2000	.2800	.3200
Non-Ferrous - Cu/Cu Alloys / Magnesium	N	•	150	120	90	.1200	.1600	.2000	.2800	.3200
Non-Ferrous - Plastics	N	•	365	300	250	.1200	.1600	.2000	.2800	.3200

Above 20,000 RPM, Tool Balancing Required



Spindle Maximum - Should the calculated spindle speed be more than your actual spindle maximum, use this formula:



$$\frac{\text{Calculated Feed} \times \text{Spindle Maximum}}{\text{Calculated Speed}}$$

TuffCut® DM

156 Recommended Cutting Data - Contouring

Inch If axial depth (ap) is less than the ball diameter, the speed is figured using the effective cutting diameter.

Workpiece Material Group	ISO	Hardness	Coolant			End Mill Diameter														
			• Preferred o Possible x Not Possible			1/32		1/16		3/32		1/8		5/32		1/4				
						RPM (n)	IPM (vf)	RPM (n)	IPM (vf)	RPM (n)	IPM (vf)	RPM (n)	IPM (vf)	RPM (n)	IPM (vf)	RPM (n)	IPM (vf)			
Tool Steels & Die Steels O7, M1, M2, M3, M4, M7, T1, T2, T4, T5, T8, T15, A2, A3, A6, A7, H10, H11, H12, H13, H19, H21, L3, L6, L7, P2, P20, S1, S5, S7, 52100, A128, D2, D3, D4, D5, D7	P	28 to 44 Rc	•	•	•	30000	26.9	30000	62	25000	84	17500	95	14000	120	8750	140			
			Hardened Steels	H	40-45 Rc	•	o	o	30000	24	23500	57	22000	96	14500	90	11500	90	72500	70
			Hardened Steels		46-55 Rc	•	o	o	30000	18	23500	37	20000	35	12000	35	9600	37	6000	38
			Hardened Steels		55-60 Rc	•	o	o	30000	15	15000	15	10000	15	7000	15	5600	20	3500	18
Stainless Steel - Ferritic / Martensitic / PH	M	over 28 Rc	•	x	o	30000	26	30000	62	25000	85	17500	95	14000	120	8750	140			

Workpiece Material Group	ISO	Hardness	Coolant			End Mill Diameter								
			• Preferred o Possible x Not Possible			5/16		3/8		1/2				
						RPM (n)	IPM (vf)	RPM (n)	IPM (vf)	RPM (n)	IPM (vf)			
Tool Steels & Die Steels O7, M1, M2, M3, M4, M7, T1, T2, T4, T5, T8, T15, A2, A3, A6, A7, H10, H11, H12, H13, H19, H21, L3, L6, L7, P2, P20, S1, S5, S7, 52100, A128, D2, D3, D4, D5, D7	P	28 to 44 Rc	•	•	•	7000	168	5800	125	4300	140			
			Hardened Steels	H	40-45 Rc	•	o	o	5800	68	4800	50	3625	45
			Hardened Steels		46-55 Rc	•	o	o	4800	35	4000	30	3000	25
			Hardened Steels		55-60 Rc	•	o	o	2800	15	2300	15	1750	10
Stainless Steel - Ferritic / Martensitic / PH	M	over 28 Rc	•	x	o	7000	170	5800	125	4300	140			

Axial & Radial Depth - Roughing / Semi Finishing

30 - 40 Rc 10% of Diameter ap
 40 - 50 Rc 5% of Diameter ap
 50 - 60 Rc 4% of Diameter ap
 Radial Step Over 25%-40% of Diameter



Axial & Radial Depth - Finishing



< 40 Rc 3% of Diameter ap
 40 - 50 Rc 2% of Diameter ap
 50 - 60 Rc 1% of Diameter ap
 ae (step over) depends on finish requirement of the part.

Technical data provided should be considered advisory only as variations may be necessary depending on the particular application.

156 Recommended Cutting Data - Contouring

Metric If axial depth (ap) is less than the ball diameter, the speed is figured using the effective cutting diameter.

Workpiece Material Group	ISO	Hardness	Coolant			End Mill Diameter (mm)											
			● Preferred ○ Possible x Not Possible			0.5		1.0		1.5		2.0		3.0		4.0	
			 Max.	Air	 MMS	RPM (n)	mm/min (vf)	RPM (n)	mm/min (vf)	RPM (n)	mm/min (vf)	RPM (n)	mm/min (vf)	RPM (n)	mm/min (vf)	RPM (n)	mm/min (vf)
Tool Steels & Die Steels O7, M1, M2, M3, M4, M7, T1, T2, T4, T5, T8, T15, A2, A3, A6, A7, H10, H11, H12, H13, H19, H21, L3, L6, L7, P2, P20, S1, S5, S7, 52100, A128, D2, D3, D4, D5, D7	P	28 to 44 Rc	●	●	●	30000	508	30000	683	25000	1575	17500	2133	14000	2392	8750	3050
Hardened Steels	H	40-45 Rc	●	○	○	30000	508	30000	608	23500	1450	22000	2442	14500	2283	11500	2233
Hardened Steels		46-55 Rc	●	○	○	30000	308	30000	458	23500	942	20000	892	12000	892	9600	942
Hardened Steels		55-60 Rc	●	○	○	30000	250	30000	383	15000	383	10000	383	7000	383	5600	508
Stainless Steel - Ferritic / Martensitic / PH	M	over 28 Rc	●	x	○	30000	508	30000	683	30000	1575	25000	2133	17500	2392	14000	3050

Workpiece Material Group	ISO	Hardness	Coolant			End Mill Diameter (mm)							
			● Preferred ○ Possible x Not Possible			6.0		8.0		10.0		12.0	
			 Max.	Air	 MMS	RPM (n)	mm/min (vf)	RPM (n)	mm/min (vf)	RPM (n)	mm/min (vf)	RPM (n)	mm/min (vf)
Tool Steels & Die Steels O7, M1, M2, M3, M4, M7, T1, T2, T4, T5, T8, T15, A2, A3, A6, A7, H10, H11, H12, H13, H19, H21, L3, L6, L7, P2, P20, S1, S5, S7, 52100, A128, D2, D3, D4, D5, D7	P	28 to 44 Rc	●	●	●	7000	3558	5800	4267	4300	3175	4300	3558
Hardened Steels	H	40-45 Rc	●	○	○	7250	1775	5800	1725	4800	1292	3625	1167
Hardened Steels		46-55 Rc	●	○	○	6000	967	4800	892	4000	758	3000	633
Hardened Steels		55-60 Rc	●	○	○	3500	458	2800	383	2300	383	1750	250
Stainless Steel - Ferritic / Martensitic / PH	M	over 28 Rc	●	x	○	8750	3558	7000	4267	5800	3175	4300	3558

Axial & Radial Depth - Roughing / Semi Finishing

30 - 40 Rc 10% of Diameter ap
 40 - 50 Rc 5% of Diameter ap
 50 - 60 Rc 4% of Diameter ap
 Radial Step Over 25%-40% of Diameter

Axial & Radial Depth - Finishing

< 40 Rc 3% of Diameter ap
 40 - 50 Rc 2% of Diameter ap
 50 - 60 Rc 1% of Diameter ap
 ae (step over) depends on finish requirement of the part.

Technical data provided should be considered advisory only as variations may be necessary depending on the particular application.

158 Recommended Cutting Data - Cutting Conditions - Lower RPM (n) / High Feed (vf) Inch



Workpiece Material Group	Examples	Coolant			Tool Overhang	End Mill Diameter																
		• Preferred ○ Possible x Not Possible				.1181 X R .0315 (3.0 x R 0.8mm)				.2362 X R .059 (6.0 x R 1.5mm)				.315 X R .0787 (8.0 x R 2.0mm)				.3937 X R .0787 (10.0 x R 2.0mm)				
		Max.	Air	MMS		Axial Depth (ap)	Radial Depth (ae)	RPM (n)	IPM (vf)	Axial Depth (ap)	Radial Depth (ae)	RPM (n)	IPM (vf)	Axial Depth (ap)	Radial Depth (ae)	RPM (n)	IPM (vf)	Axial Depth (ap)	Radial Depth (ae)	RPM (n)	IPM (vf)	
Steels	P	Cast Iron/ Carbon Steels/ Alloy Steels 150-250 HB	•	•	•	5 x D	.0094	.0275	8,000	239	.0170	.0590	4,000	264	.0236	.0787	3,000	264	.0236	.1180	2,400	264
						6 X D	.0085	.0275			.0159	.0590			.0210	.0787			.0212	.1180		
						7 X D	.0078	.0275			.0147	.0590			.0196	.0787			.0196	.1180		
						8 X D	.0072	.0275			.0135	.0590			.0181	.0787			.0181	.1180		
						9 X D	.0059	.0275			.0112	.0590			.0149	.0787			.0149	.1180		
						10 X D	.0047	.0275			.0088	.0590			.0118	.0787			.0118	.1180		
Steels	P	Tool Steels 25-35 Rc	•	•	•	5 x D	.0094	.0275	7,400	200	.0170	.0590	3,700	224	.0236	.0787	2,800	225	.0236	.1180	2,200	222
						6 X D	.0085	.0275			.0159	.0590			.0210	.0787			.0212	.1180		
						7 X D	.0078	.0275			.0147	.0590			.0196	.0787			.0196	.1180		
						8 X D	.0072	.0275			.0135	.0590			.0181	.0787			.0181	.1180		
						9 X D	.0059	.0275			.0112	.0590			.0149	.0787			.0149	.1180		
						10 X D	.0047	.0275			.0088	.0590			.0118	.0787			.0118	.1180		
Hardened Steels	H	35-45 Rc H13/D2 P20/4140 8620	•	○	○	5 x D	.0094	.0275	6,900	146	.0170	.0590	3,400	160	.0236	.0787	2,600	164	.0236	.1180	2,100	165
						6 X D	.0085	.0275			.0159	.0590			.0210	.0787			.0212	.1180		
						7 X D	.0078	.0275			.0147	.0590			.0196	.0787			.0196	.1180		
						8 X D	.0072	.0275			.0135	.0590			.0181	.0787			.0181	.1180		
						9 X D	.0059	.0275			.0112	.0590			.0149	.0787			.0149	.1180		
						10 X D	.0047	.0275			.0088	.0590			.0118	.0787			.0118	.1180		
Hardened Steels	H	45 - 55 Rc H13/D2 P20/4140 8620	•	○	○	5 x D	.0066	.0275	5,300	112	.0124	.0590	2,700	127	.0165	.0787	2,000	125	.0165	.1180	1,600	125
						6 X D	.0059	.0275			.0111	.0590			.0148	.0787			.0148	.1180		
						7 X D	.0055	.0275			.0103	.0590			.0137	.0787			.0137	.1180		
						8 X D	.0050	.0275			.0095	.0590			.0126	.0787			.0126	.1180		
						9 X D	.0041	.0275			.0078	.0590			.0104	.0787			.0104	.1180		
						10 X D	.0033	.0275			.0062	.0590			.0082	.0787			.0082	.1180		
Hardened Steels	H	55-60 Rc H13/D2 P20/4140 8620	•	○	○	5 x D	.0047	.0275	5,300	45	.0088	.0590	2,700	50	.0118	.0787	2,000	50	.0118	.1180	1,600	50
						6 X D	.0042	.0275			.0079	.0590			.0106	.0787			.0106	.1180		
						7 X D	.0039	.0275			.0073	.0590			.0098	.0787			.0098	.1180		
						8 X D	.0036	.0275			.0067	.0590			.0090	.0787			.0090	.1180		
						9 X D	.0029	.0275			.0056	.0590			.0074	.0787			.0074	.1180		
						10 X D	.0023	.0275			.0044	.0590			.0059	.0787			.0059	.1180		

Technical data provided should be considered advisory only as variations may be necessary depending on the particular application.

TuffCut® DM

158 Recommended Cutting Data - Cutting Conditions - Lower RPM (n) / High Feed (vf)

Inch Continued

Workpiece Material Group	Examples	Coolant			Tool Overhang	End Mill Diameter												
		• Preferred o Possible x Not Possible				.4724 x R .0787 (12.0 x R 2.0mm)				.6299 X R .1181 (16.0 x R 3.0mm)				.7874 X R .1181 (20.0 x R 3.0mm)				
						Axial Depth (ap)	Radial Depth (ae)	RPM (n)	IPM (vf)	Axial Depth (ap)	Radial Depth (ae)	RPM (n)	IPM (vf)	Axial Depth (ap)	Radial Depth (ae)	RPM (n)	IPM (vf)	
		Max.	Air	MMS														
Steels	P	Cast Iron/ Carbon Steels/ Alloy Steels 150-250 HB	•	•	•	5 x D	.0236	.1574	2,000	250	.0354	.1968	1,500	210	.0354	.2755	1,200	172
						6 X D	.0212	.1574			.0318	.1968			.0318	.2755		
						7 X D	.0196	.1574			.0295	.1968			.0295	.2755		
						8 X D	.0181	.1574			.0271	.1968			.0271	.2755		
						9 X D	.0149	.1574			.0224	.1968			.0226	.2755		
						10 X D	.0118	.1574			.0177	.1968			.0177	.2755		
Steels	P	Tool Steels 25-35 Rc	•	•	•	5 x D	.0236	.1574	1,900	218	.0354	.1968	1,400	180	.0354	.2755	1,100	144
						6 X D	.0212	.1574			.0318	.1968			.0318	.2755		
						7 X D	.0196	.1574			.0295	.1968			.0295	.2755		
						8 X D	.0181	.1574			.0271	.1968			.0271	.2755		
						9 X D	.0149	.1574			.0224	.1968			.0226	.2755		
						10 X D	.0118	.1574			.0177	.1968			.0177	.2755		
Hardened Steels	H	35-45 Rc H13/D2 P20/4140 8620	•	o	o	5 x D	.0236	.1574	1,700	153	.0354	.1968	1,300	131	.0354	.2755	1,000	102
						6 X D	.0212	.1574			.0318	.1968			.0318	.2755		
						7 X D	.0196	.1574			.0295	.1968			.0295	.2755		
						8 X D	.0181	.1574			.0271	.1968			.0271	.2755		
						9 X D	.0149	.1574			.0224	.1968			.0226	.2755		
						10 X D	.0118	.1574			.0177	.1968			.0177	.2755		
Hardened Steels	H	45 - 55 Rc H13/D2 P20/4140 8620	•	o	o	5 x D	.0165	.1574	1,300	116	.0248	.1968	1,000	100	.0248	.2755	800	82
						6 X D	.0148	.1574			.0223	.1968			.0223	.2755		
						7 X D	.0137	.1574			.0206	.1968			.0206	.2755		
						8 X D	.0126	.1574			.0190	.1968			.0190	.2755		
						9 X D	.0104	.1574			.0157	.1968			.0157	.2755		
						10 X D	.0082	.1574			.0124	.1968			.0124	.2755		
Hardened Steels	H	55-60 Rc H13/D2 P20/4140 8620	•	o	o	5 x D	.0118	.1574	1,300	47	.0177	.1968	1,000	40	.0177	.2755	800	32
						6 X D	.0106	.1574			.0159	.1968			.0159	.2755		
						7 X D	.0098	.1574			.0147	.1968			.0147	.2755		
						8 X D	.0090	.1574			.0135	.1968			.0135	.2755		
						9 X D	.0074	.1574			.0112	.1968			.0112	.2755		
						10 X D	.0059	.1574			.0088	.1968			.0088	.2755		

Technical Information

End Mills

Technical data provided should be considered advisory only as variations may be necessary depending on the particular application.

For product information, call your local distributor

158 Recommended Cutting Data - Cutting Conditions - Lower RPM (n) / High Feed (vf) Metric

Workpiece Material Group	Examples	Coolant			Tool Over-hang	End Mill Diameter (mm)																
		• Preferred		o Possible		3.0 x R 0.8				6.0 x R 1.5				8.0 x R 2.0				10.0 x R 2.0				
		Max.	Air	MMS		Axial Depth (ap)	Radial Depth (ae)	RPM (n)	mm/min. (vf)	Axial Depth (ap)	Radial Depth (ae)	RPM (n)	mm/min. (vf)	Axial Depth (ap)	Radial Depth (ae)	RPM (n)	mm/min. (vf)	Axial Depth (ap)	Radial Depth (ae)	RPM (n)	mm/min. (vf)	
Steels	P	Cast Iron/ Carbon Steels/ Alloy Steels 150-250 HB	•	•	•	5 x D	0.24	0.7	8,000	6,080	0.45	1.5	4,000	6,700	0.60	2.0	3,000	6,700	0.60	3.0	2,400	6,700
						6 X D	0.22	0.7			0.41	1.5			0.54	2.0			0.54	3.0		
						7 X D	0.20	0.7			0.38	1.5			0.50	2.0			0.50	3.0		
						8 X D	0.18	0.7			0.35	1.5			0.46	2.0			0.46	3.0		
						9 X D	0.15	0.7			0.29	1.5			0.38	2.0			0.38	3.0		
						10 X D	0.12	0.7			0.23	1.5			0.30	2.0			0.30	3.0		
Steels	P	Tool Steels 25-35 Rc	•	•	•	5 x D	0.24	0.7	7,400	5,100	0.45	1.5	3,700	5,670	0.60	2.0	2,800	5,725	0.60	3.0	2,200	5,620
						6 X D	0.22	0.7			0.41	1.5			0.54	2.0			0.54	3.0		
						7 X D	0.20	0.7			0.38	1.5			0.50	2.0			0.50	3.0		
						8 X D	0.18	0.7			0.35	1.5			0.46	2.0			0.46	3.0		
						9 X D	0.15	0.7			0.29	1.5			0.38	2.0			0.38	3.0		
						10 X D	0.12	0.7			0.23	1.5			0.30	2.0			0.30	3.0		
Hardened Steels	H	35-45 Rc H13/D2 P20/4140 8620	•	o	o	5 x D	0.24	0.7	6,900	3,720	0.45	1.5	3,400	4,050	0.60	2.0	2,600	4,150	0.60	3.0	2,100	4,200
						6 X D	0.22	0.7			0.41	1.5			0.54	2.0			0.54	3.0		
						7 X D	0.20	0.7			0.38	1.5			0.50	2.0			0.50	3.0		
						8 X D	0.18	0.7			0.35	1.5			0.46	2.0			0.46	3.0		
						9 X D	0.15	0.7			0.29	1.5			0.38	2.0			0.38	3.0		
						10 X D	0.12	0.7			0.23	1.5			0.30	2.0			0.30	3.0		
Hardened Steels	H	45 - 55 Rc H13/D2 P20/4140 8620	•	o	o	5 x D	0.17	0.7	5,300	2,850	0.32	1.5	2,700	3,230	0.42	2.0	2,000	3,190	0.42	3.0	1,600	3,190
						6 X D	0.15	0.7			0.28	1.5			0.38	2.0			0.38	3.0		
						7 X D	0.14	0.7			0.26	1.5			0.35	2.0			0.35	3.0		
						8 X D	0.13	0.7			0.24	1.5			0.32	2.0			0.32	3.0		
						9 X D	0.11	0.7			0.20	1.5			0.27	2.0			0.27	3.0		
						10 X D	0.08	0.7			0.16	1.5			0.21	2.0			0.21	3.0		
Hardened Steels	H	55-60 Rc H13/D2 P20/4140 8620	•	o	o	5 x D	0.12	0.7	5,300	1,130	0.23	1.5	2,700	1,295	0.30	2.0	2,000	1,275	0.30	3.0	1,600	1,275
						6 X D	0.11	0.7			0.20	1.5			0.27	2.0			0.27	3.0		
						7 X D	0.10	0.7			0.19	1.5			0.25	2.0			0.25	3.0		
						8 X D	0.09	0.7			0.17	1.5			0.23	2.0			0.23	3.0		
						9 X D	0.08	0.7			0.14	1.5			0.19	2.0			0.19	3.0		
						10 X D	0.06	0.7			0.11	1.5			0.15	2.0			0.15	3.0		

Technical data provided should be considered advisory only as variations may be necessary depending on the particular application.

TuffCut® DM

158 Recommended Cutting Data - Cutting Conditions - Lower RPM (n) / High Feed (vf)

Metric Continued

Workpiece Material Group	Examples	Coolant • Preferred ○ Possible x Not Possible			Tool Overhang	End Mill Diameter (mm)												
		Max.	Air	MMS		12.0 x R 2.0				16.0 x R 3.0				20.0 x R 3.0				
						Axial Depth (ap)	Radial Depth (ae)	RPM (n)	mm/min. (vf)	Axial Depth (ap)	Radial Depth (ae)	RPM (n)	mm/min. (vf)	Axial Depth (ap)	Radial Depth (ae)	RPM (n)	mm/min. (vf)	
																		5 x D
Steels	P	Cast Iron/ Carbon Steels/ Alloy Steels 150-250 HB	•	•	•	5 x D	0.60	4.0	2,000	6,350	0.90	5.0	1,500	5,350	0.90	7.0	1,200	4,360
						6 x D	0.54	4.0			0.81	5.0			0.81	7.0		
						7 x D	0.50	4.0			0.75	5.0			0.75	7.0		
						8 x D	0.46	4.0			0.69	5.0			0.69	7.0		
						9 x D	0.38	4.0			0.57	5.0			0.57	7.0		
						10 x D	0.30	4.0			0.45	5.0			0.45	7.0		
Steels	P	Tool Steels 25-35 Rc	•	•	•	5 x D	0.60	4.0	1,900	5,530	0.90	5.0	1,400	4,580	0.90	7.0	1,100	3,650
						6 x D	0.54	4.0			0.81	5.0			0.81	7.0		
						7 x D	0.50	4.0			0.75	5.0			0.75	7.0		
						8 x D	0.46	4.0			0.69	5.0			0.69	7.0		
						9 x D	0.38	4.0			0.57	5.0			0.57	7.0		
						10 x D	0.30	4.0			0.45	5.0			0.45	7.0		
Hardened Steels	H	35-45 Rc H13/D2 P20/4140 8620	•	○	○	5 x D	0.60	4.0	1,700	3,875	0.90	5.0	1,300	3,325	0.90	7.0	1,000	2,595
						6 x D	0.54	4.0			0.81	5.0			0.81	7.0		
						7 x D	0.50	4.0			0.75	5.0			0.75	7.0		
						8 x D	0.46	4.0			0.69	5.0			0.69	7.0		
						9 x D	0.38	4.0			0.57	5.0			0.57	7.0		
						10 x D	0.30	4.0			0.45	5.0			0.45	7.0		
Hardened Steels	H	45 - 55 Rc H13/D2 P20/4140 8620	•	○	○	5 x D	0.42	4.0	1,300	2,950	0.63	5.0	1,000	2,550	0.63	7.0	800	2,070
						6 x D	0.38	4.0			0.57	5.0			0.57	7.0		
						7 x D	0.35	4.0			0.53	5.0			0.53	7.0		
						8 x D	0.32	4.0			0.48	5.0			0.48	7.0		
						9 x D	0.27	4.0			0.40	5.0			0.40	7.0		
						10 x D	0.21	4.0			0.32	5.0			0.32	7.0		
Hardened Steels	H	55-60 Rc H13/D2 P20/4140 8620	•	○	○	5 x D	0.30	4.0	1,300	1,185	0.45	5.0	1,000	1,000	0.45	7.0	800	825
						6 x D	0.27	4.0			0.41	5.0			0.41	7.0		
						7 x D	0.25	4.0			0.38	5.0			0.38	7.0		
						8 x D	0.23	4.0			0.35	5.0			0.35	7.0		
						9 x D	0.19	4.0			0.29	5.0			0.29	7.0		
						10 x D	0.15	4.0			0.23	5.0			0.23	7.0		









Technical Information

End Mills

Technical data provided should be considered advisory only as variations may be necessary depending on the particular application.









For product information, call your local distributor

157 Recommended Cutting Data - Profile Milling Inch

Workpiece Material Group	ISO	Hardness	Coolant			Profile Milling (ae)					End Mill Diameter*				
			● Preferred ○ Possible x Not Possible								1/8	1/4	3/8	1/2	5/8
						5%	10%	20%	30%	50%	*Axial depth during profile milling: OD < 1/4" .25D ap OD > 1/4" 1D ap				
			Max.	Air	MMS	2.3	1.8	1.2	1.1	1	← Multiply fz by this Factor based on ae. When finishing, use the standard fz per chart below. Only add chip thinning when roughing or semi-finishing.				
			vc - SFM					fz - in/tooth							
Free Machining & Low Carbon Steels 1006, 1008, 1015, 1018, 1020, 1022, 1025, 1117, 1140, 1141, 11L08, 11L14, 1213, 12L13, 12L14, 1215, 1330	P	up to 28 Rc	●	●	●	600	550	500	450	400	.0011	.0022	.0035	.0042	.0059
Medium Carbon & High Carbon Steels, Alloy Steels & Easy to Machine Tool Steels 1030, 1035, 1040, 1045, 1050, 1052, 1055, 1060, 1085, 1095, 1541, 1551, 9255, 2515, 3135, 3415, 4130, 4137, 4140, 4150, 4320, 4340, 4520, 5015, 5115, 5120, 5132, 5140, 5155, 6150, 8620, 9262, 9840, 52100, O1, O2, O6, S2, W1 to W310	P	28 to 38 Rc	●	●	●	600	550	500	450	400	.0011	.0022	.0035	.0042	.0059
Tool Steels & Die Steels O7, M1, M2, M3, M4, M7, T1, T2, T4, T5, T8, T15, A2, A3, A6, A7, H10, H11, H12, H13, H19, H21, L3, L6, L7, P2, P20, S1, S5, S7, 52100, A128, D2, D3, D4, D5, D7	P	28 to 44 Rc	●	●	●	550	500	450	400	375	.0011	.0020	.0033	.0040	.0055
Hardenized Steels	H	40-50 Rc	●	○	○	360	340	300	280	260	.0007	.0014	.0024	.0030	.0040
Hardenized Steels		50-55 Rc	●	○	○	360	340	300	280	260	.0004	.0008	.0016	.0018	.0024
Hardenized Steels		>55 Rc	●	○	○	320	300	280	260	240	.0003	.0006	.0010	.0015	.0018
Stainless Steel - Ferritic	M	up to 28 Rc	●	x	○	550	525	500	450	425	.0010	.0020	.0033	.0040	.0055
Stainless Steel - Martensitic	M	up to 28 Rc	●	x	○	550	525	500	450	425	.0010	.0020	.0033	.0040	.0055
Stainless Steel - PH 302B, 304B, 309, 310, 316, 316B, 316L, 316Ti, 317, 317L, 321, PH13-8Mo, Nitronics	M	over 28 Rc	●	x	○	550	525	500	450	425	.0010	.0020	.0033	.0040	.0055
High Temp Alloys Nimonic, Inconel, Monel, Hastelloy	S	up to 42 Rc	●	x	x	165	165	130	115	100	.0004	.0008	.0016	.0018	.0024
Titanium Alloys 6Al-4V, 5Al-2.5 Sn, 6Al-2 Sn-4Zr-6Mo, 3Al-8V-6Cr4Mo-4Zr, 10V-2Fe-3Al, 13V-11Cr-3Al	S	up to 42 Rc	●	x	x	400	375	350	300	250	.0004	.0008	.0016	.0018	.0024

**Spindle Maximum - Should the calculated spindle speed be more than your actual spindle maximum, use this formula:
(Calculated Feed x Spindle Maximum)/Calculated Speed**







157 Recommended Cutting Data - Profile Milling Metric

Workpiece Material Group	ISO	Hardness	Coolant			Profile Milling (ae)					End Mill Diameter (mm)*						
			• Preferred ○ Possible x Not Possible								3	6	8	10	12	16	20
						5%	10%	20%	30%	50%	*Axial depth during profile milling: OD < 6mm .25D ap OD > 6mm 1D ap						
			Max.	Air	MMS	2.3	1.8	1.2	1.1	1	← Multiply fz by this Factor based on ae. When finishing, use the standard fz per chart below. Only add chip thinning when roughing or semi-finishing.						
			vc - m/min					fz - mm/tooth									
Free Machining & Low Carbon Steels 1006, 1008, 1015, 1018, 1020, 1022, 1025, 1117, 1140, 1141, 11L08, 11L14, 1213, 12L13, 12L14, 1215, 1330	P	up to 28 Rc	•	•	•	183	168	152	137	122	.0280	.0559	.0889	.1067	.1498	.1778	.2032
Medium Carbon & High Carbon Steels, Alloy Steels & Easy to Machine Tool Steels 1030, 1035, 1040, 1045, 1050, 1052, 1055, 1060, 1085, 1095, 1541, 1551, 9255, 2515, 3135, 3415, 4130, 4137, 4140, 4150, 4320, 4340, 4520, 5015, 5115, 5120, 5132, 5140, 5155, 6150, 8620, 9262, 9840, 52100, O1, O2, O6, S2, W1 to W310	P	28 to 38 Rc	•	•	•	183	168	152	137	122	.0280	.0559	.0889	.1067	.1498	.1778	.2032
Tool Steels & Die Steels O7, M1, M2, M3, M4, M7, T1, T2, T4, T5, T8, T15, A2, A3, A6, A7, H10, H11, H12, H13, H19, H21, L3, L6, L7, P2, P20, S1, S5, S7, 52100, A128, D2, D3, D4, D5, D7	P	28 to 44 Rc	•	•	•	168	152	137	122	114	.0254	.0508	.0838	.1016	.1397	.1702	.1905
Hardened Steels	H	40-50 Rc	•	○	○	110	104	90	85	80	.0178	.0356	.0610	.0762	.1016	.1168	.1524
Hardened Steels		50-55 Rc	•	○	○	110	104	90	85	80	.0102	.0203	.0406	.0457	.0610	.0762	.0889
Hardened Steels		>55 Rc	•	○	○	100	90	85	80	75	.0076	.0152	.0254	.0381	.0457	.0559	.0635
Stainless Steel - Ferritic	M	up to 28 Rc	•	x	○	168	160	152	137	130	.0254	.0508	.0838	.1016	.1397	.1702	.1905
Stainless Steel - Martensitic	M	up to 28 Rc	•	x	○	168	160	152	137	130	.0254	.0508	.0838	.1016	.1397	.1702	.1905
Stainless Steel - PH 302B, 304B, 309, 310, 316, 316B, 316L, 316Ti, 317, 317L, 321, PH13-8Mo, Nitronics	M	over 28 Rc	•	x	○	168	160	152	137	130	.0254	.0508	.0838	.1016	.1397	.1702	.1905
High Temp Alloys Nimonic, Inconel, Monel, Hastelloy	S	up to 42 Rc	•	x	x	50	50	40	35	30	.0102	.0203	.0406	.0457	.0610	.0762	.0889
Titanium Alloys 6Al-4V, 5Al-2.5 Sn, 6Al-2 Sn-4Zr-6Mo, 3Al-8V-6Cr4Mo-4Zr, 10V-2Fe-3Al, 13V-11Cr-3Al	S	up to 42 Rc	•	x	x	122	114	107	90	75	.0102	.0203	.0406	.0457	.0610	.0762	.0889

Spindle Maximum - Should the calculated spindle speed be more than your actual spindle maximum, use this formula:
 (Calculated Feed x Spindle Maximum)/Calculated Speed

TuffCut® DM

157 Recommended Cutting Data - Slotting Inch

Workpiece Material Group	ISO	Hardness	Coolant			Slotting			End Mill Diameter				
			● Preferred ○ Possible x Not Possible						1/8	1/4	3/8	1/2	5/8
						25%	50%	100%* *Trochoidal Milling	Axial Depth (ap) during slotting: OD > 1/4" .25D ap				
			Max.	Air	MMS	vc - SFM			fz - in/tooth				
Free Machining & Low Carbon Steels 1006, 1008, 1015, 1018, 1020, 1022, 1025, 1117, 1140, 1141, 11L08, 11L14, 1213, 12L13, 12L14, 1215, 1330	P	up to 28 Rc	●	●	●	480	480	400	.0005	.0011	.0017	.0021	.0029
Medium Carbon & High Carbon Steels, Alloy Steels & Easy to Machine Tool Steels 1030, 1035, 1040, 1045, 1050, 1052, 1055, 1060, 1085, 1095, 1541, 1551, 9255, 2515, 3135, 3415, 4130, 4137, 4140, 4150, 4320, 4340, 4520, 5015, 5115, 5120, 5132, 5140, 5155, 6150, 8620, 9262, 9840, 52100, O1, O2, O6, S2, W1 to W310	P	28 to 38 Rc	●	●	●	480	480	400	.0005	.0011	.0017	.0020	.0029
Tool Steels & Die Steels O7, M1, M2, M3, M4, M7, T1, T2, T4, T5, T8, T15, A2, A3, A6, A7, H10, H11, H12, H13, H19, H21, L3, L6, L7, P2, P20, S1, S5, S7, 52100, A128, D2, D3, D4, D5, D7	P	28 to 44 Rc	●	●	●	420	420	380	.0005	.0010	.0016	.0020	.0027
Hardened Steels	H	40-50 Rc	●	○	○	350	350	300	.0003	.0006	.0012	.0015	.0020
Hardened Steels		50-55 Rc	●	○	○	180	180	150	.0002	.0004	.0008	.0009	.0012
Hardened Steels		>55 Rc	●	○	○	150	150	100	.00015	.0003	.0005	.0007	.0009
Stainless Steel - Ferritic	M	up to 28 Rc	●	x	○	420	420	400	.0005	.0010	.0016	.0020	.0027
Stainless Steel - Martensitic	M	up to 28 Rc	●	x	○	420	420	400	.0005	.0010	.0016	.0020	.0027
Stainless Steel - PH 302B, 304B, 309, 310, 316, 316B, 316L, 316Ti, 317, 317L, 321, PH13-8Mo, Nitronics	M	over 28 Rc	●	x	○	400	400	380	.0005	.0010	.0016	.0020	.0027
High Temp Alloys Nimonic, Inconel, Monel, Hastelloy	S	up to 42 Rc	●	x	x	120	120	95	.0002	.0004	.0008	.0009	.0012
Titanium Alloys 6Al-4V, 5Al-2.5 Sn, 6Al-2 Sn-4Zr-6Mo, 3Al-8V-6Cr4Mo-4Zr, 10V-2Fe-3Al, 13V-11Cr-3Al	S	up to 42 Rc	●	x	x	200	200	175	.0002	.0004	.0008	.0009	.0012







**Spindle Maximum - Should the calculated spindle speed be more than your actual spindle maximum, use this formula:
(Calculated Feed x Spindle Maximum)/Calculated Speed**

Technical data provided should be considered advisory only as variations may be necessary depending on the particular application.

TuffCut® DM

157 Recommended Cutting Data - Slotting

Metric

Workpiece Material Group	ISO	Hardness	Coolant			Slotting			End Mill Diameter (mm)						
			• Preferred ○ Possible x Not Possible						3	6	8	10	12	16	20
						25%	50%	100%* *Trochoidal Milling	Axial depth (ap) during slotting: OD > 6mm .25D ap						
			Max.	Air	MMS	vc - m/min			fz - mm/tooth						
Free Machining & Low Carbon Steels 1006, 1008, 1015, 1018, 1020, 1022, 1025, 1117, 1140, 1141, 11L08, 11L14, 1213, 12L13, 12L14, 1215, 1330	P	up to 28 Rc	•	•	•	146	146	122	.0122	.0279	.0432	.0533	.0737	.0762	.1016
Medium Carbon & High Carbon Steels, Alloy Steels & Easy to Machine Tool Steels 1030, 1035, 1040, 1045, 1050, 1052, 1055, 1060, 1085, 1095, 1541, 1551, 9255, 2515, 3135, 3415, 4130, 4137, 4140, 4150, 4320, 4340, 4520, 5015, 5115, 5120, 5132, 5140, 5155, 6150, 8620, 9262, 9840, 52100, O1, O2, O6, S2, W1 to W310	P	28 to 38 Rc	•	•	•	146	146	122	.0122	.0279	.0432	.0533	.0737	.0762	.1016
Tool Steels & Die Steels O7, M1, M2, M3, M4, M7, T1, T2, T4, T5, T8, T15, A2, A3, A6, A7, H10, H11, H12, H13, H19, H21, L3, L6, L7, P2, P20, S1, S5, S7, 52100, A128, D2, D3, D4, D5, D7	P	28 to 44 Rc	•	•	•	128	128	115	.0122	.0254	.0406	.0508	.0686	.0839	.0940
Hardened Steels	H	40-50 Rc	•	○	○	106	106	92	.0076	.0152	.0305	.0381	.0508	.0584	.0762
Hardened Steels		50-55 Rc	•	○	○	55	55	45	.0051	.0102	.0203	.0229	.0305	.0381	.0432
Hardened Steels		>55 Rc	•	○	○	45	45	30	.0038	.0076	.0127	.0178	.0229	.0279	.0305
Stainless Steel - Ferritic	M	up to 28 Rc	•	x	○	128	128	122	.0127	.0254	.0406	.0508	.0686	.0838	.0940
Stainless Steel - Martensitic	M	up to 28 Rc	•	x	○	128	128	122	.0127	.0254	.0406	.0508	.0686	.0838	.0940
Stainless Steel - PH 302B, 304B, 309, 310, 316, 316B, 316L, 316Ti, 317, 317L, 321, PH13-8Mo, Nitronics	M	over 28 Rc	•	x	○	122	122	115	.0127	.0254	.0406	.0508	.0686	.0838	.0940
High Temp Alloys Nimonic, Inconel, Monel, Hastelloy	S	up to 42 Rc	•	x	x	36	36	30	.0051	.0102	.0203	.0229	.0305	.0381	.0432
Titanium Alloys 6Al-4V, 5Al-2.5 Sn, 6Al-2 Sn-4Zr-6Mo, 3Al-8V-6Cr4Mo-4Zr, 10V-2Fe-3Al, 13V-11Cr-3Al	S	up to 42 Rc	•	x	x	60	60	55	.0051	.0102	.0203	.0229	.0305	.0381	.0432

Spindle Maximum - Should the calculated spindle speed be more than your actual spindle maximum, use this formula:

$$\frac{\text{Calculated Feed} \times \text{Spindle Maximum}}{\text{Calculated Speed}}$$



Diamond Coated Routers

The “Black Diamond”

Series 239.....177

- GemX coating
- Up cut router
- Excellent for composite materials and fiberglass applications

Diamond Grind Routers

Series 230CE & 231CE.....179

- Featuring CERAedge® coating
- Down cut routers
- Excellent for glass reinforced printed circuit boards, phenolic–epoxy and other highly abrasive materials

Routers are available with a non-cutting safe end or in three popular end-cutting styles.



M.A. Ford®'s New Diamond Coated Routers

Series 239 Coated with GemX Diamond Coating

M.A. Ford® Coating	M.A. Ford® Tool Number Designation	Microhardness (HV)	Maximum Service Temp.	Friction Coefficient
GemX	GX	10,000	600° C / 1100° F	0.10

• Benefits

- Excellent for composite materials and fiberglass applications
- Long Tool life
- Cut more linear inches
- Faster cycle times
- High routing rate
- Delivers great edge quality
- No delamination or flaking

• Features

- Rake angles specially designed to reduce cutting forces
- Cutting edges specially treated for optimized tool life
- Carbide substrate uniquely compatible to GemX coating
- GemX coating specifically designed for maximum tool life in composites

• Applications

- Trimming
- Routing
- Pocketing
- Interpolation of holes
- Low plastic content CFRP

Series 239 Case Studies

Roughing		Finishing	
Tool:	0.5" 14-Flute Router 0.5"Ø x 1" LOC x 3" OAL	Tool:	0.5" 14-Flute Router 0.5"Ø x 1" LOC x 3" OAL
Chuck:	HSK63A Haimer Shrink Fit Chuck P/N A63.140.1/2Z	Chuck:	HSK63A Haimer Shrink Fit Chuck P/N A63.140.1/2Z
Spindle Speed:	12,000 RPM	Spindle Speed:	15,000 RPM
Feed Rate:	2,500 mm/min (98in/min)	Feed Rate:	3,000 mm/min (118in/min)

Diamond Coated Routers Series 239

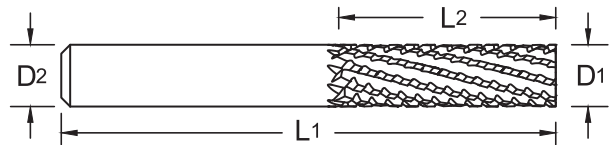

Diamond grind GemX coated



Burr End



End Mill



Safe End

Tool Number	EDP	Diameter	Shank Diameter	OAL	Flute Length	# Flutes (RHC)	End Cut
		D1	D2	L1	L2		
23912500BGX	23900	1/8	1/8	1-1/2	1/4	6	Burr
23912510EGX	23902	1/8	1/8	1-1/2	3/8	6	End Mill
23912520EGX	23904	1/8	1/8	1-1/2	1/2	8	End Mill
23918700BGX	23906	3/16	3/16	2	3/8	6	Burr
23918710EGX	23908	3/16	3/16	2	9/16	6	End Mill
23918720EGX	23910	3/16	3/16	2	3/4	8	End Mill
23925000BGX	23912	1/4	1/4	2-1/2	1/2	8	Burr
23925010BGX	23914	1/4	1/4	2-1/2	3/4	10	Burr
23925010EGX	23916	1/4	1/4	2-1/2	3/4	10	End Mill
23925020BGX	23918	1/4	1/4	3	1	10	Burr
23925020EGX	23920	1/4	1/4	3	1	10	End Mill
23925030GX	23922	1/4	1/4	4	1-1/4	12	Safe
23931200EGX	23924	5/16	5/16	2-1/2	1	10	End Mill
23937500BGX	23926	3/8	3/8	2-1/2	3/4	12	Burr
23937510BGX	23928	3/8	3/8	3	1-1/8	12	Burr
23937510EGX	23930	3/8	3/8	3	1-1/8	12	End Mill
23937520BGX	23932	3/8	3/8	4	1-1/2	12	Burr
23937520EGX	23934	3/8	3/8	4	1-1/2	12	End Mill
23937530GX	23936	3/8	3/8	4	2	12	Safe
23950000BGX	23938	1/2	1/2	3	1	14	Burr
23950000EGX	23940	1/2	1/2	3	1	14	End Mill
23950010GX	23942	1/2	1/2	4	2	16	Safe
23950010BGX	23944	1/2	1/2	4	2	16	Burr

*Stock available for desired end features with a quicker turnaround than most manufacturing suppliers!



Page 178

Diamond Coated Routers Series 239

Recommended Cutting Data - Inch

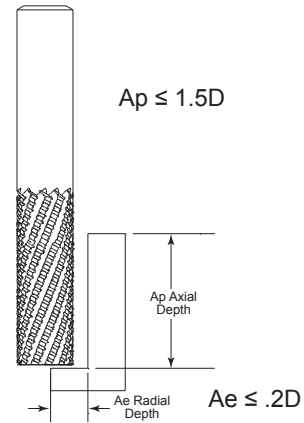
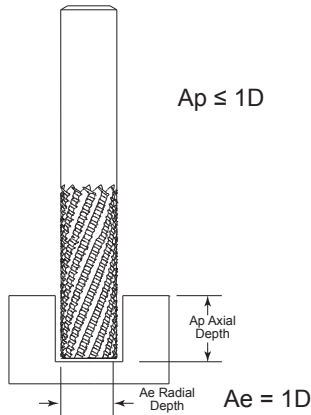

Slotting 300 (Sfm)			Slotting 600 (Sfm)		
Tool Diameter	RPM	IPM	Tool Diameter	RPM	IPM
1/8	9000	10	1/8	18000	20
3/16	6000	12	3/16	12000	25
1/4	5000	15	1/4	9000	30
5/16	4000	18	5/16	7000	35
3/8	3000	20	3/8	6000	40
1/2	2000	25	1/2	5000	50

Feed adjustment to part thickness	
$\leq 0.5D$	x 150%
0.5D - 1D	x 120%
1D - 2D	x 80%
3D-4D	x 50%

Side Milling 400 (Sfm)		
Tool Diameter	RPM	IPM
1/8	12000	20
3/16	8000	25
1/4	6000	30
5/16	5000	35
3/8	4000	40
1/2	3000	50

Side Milling 800 (Sfm)		
Tool Diameter	RPM	IPM
1/8	24000	40
3/16	16000	50
1/4	12000	60
5/16	10000	70
3/8	8000	80
1/2	6000	100

** Tool must have end grind to slot.

Note: The parameters in this table are for common material thickness of 1/4". You must use the Radial Depth (Ae) of 20% or less for Side Milling. For best surface finish conventional mill is recommended. Higher feed rates are possible but surface finish may change.

Recommended Cutting Data - Metric

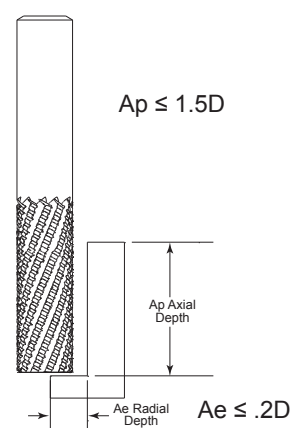
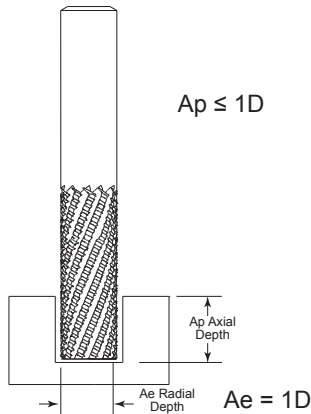

Slotting 90 (m/min)			Slotting 182 (m/min)		
Tool Diameter	RPM	mm/min	Tool Diameter	RPM	mm/min
3	9000	254	3	18000	508
5	6000	304	5	12000	635
6	5000	381	6	9000	762
8	4000	457	8	7000	889
10	3000	508	10	6000	1016
12	2000	635	12	5000	1270

Feed adjustment to part thickness	
$\leq 0.5D$	x 150%
0.5D - 1D	x 120%
1D - 2D	x 80%
3D-4D	x 50%

Side Milling 120(m/min)		
Tool Diameter	RPM	mm/min
3	12000	508
5	8000	635
6	6000	762
8	5000	889
10	4000	1016
12	3000	1270

Side Milling 240 (m/min)		
Tool Diameter	RPM	mm/min
3	24000	1016
5	16000	1270
6	12000	1524
8	10000	1778
10	8000	2032
12	6000	2540

** Tool must have end grind to slot.

Note: The parameters in this table are for common material thickness of 6mm. You must use the Radial Depth (Ae) of 20% or less for Side Milling. For best surface finish conventional mill is recommended. Higher feed rates are possible but surface finish may change.

Technical data provided should be considered advisory only as variations may be necessary depending on the particular application.

CERAedge® Coated Routers

Series 230CE/231CE

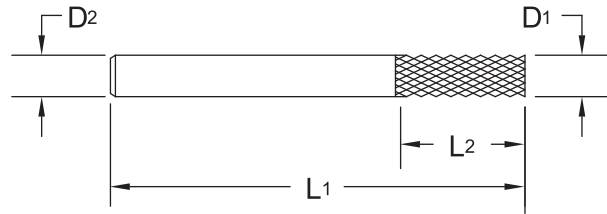

Diamond Grind

- Designed for routing of glass-reinforced printed circuit boards, phenolic-epoxy, composites and other highly abrasive materials.
- Ultra fine micrograin carbide.

Series 230CE

Down Cut
Safe End



Series 231CE

Down Cut
End Mill Type Point



Series 231BCE

Down Cut
Bur End Point



Series 231DCE

Down Cut
Drill Point



Series 230CE		Series 231CE		Diameter			Shank		OAL		Flute Length	
Tool No.	EDP	Tool No.	EDP	D1			D2		L1		L2	
				Inch	mm	Decimal	Inch	mm	Inch	mm	Inch	mm
23011810CE	90839	23111810CE	91047		3.0	.1181		3.0		38		12.5
23012500CE	90845	23112500CE	91071	1/8		.1250	1/8		1-1/2		1/2	
23018750CE	90847	23118750CE	91082	3/16		.1875	3/16		2		5/8	
23019680CE	90850	23119680CE	91094		5.0	.1968		5.0		51		16.0
23023620CE	90853	23123620CE	91106		6.0	.2362		6.0		51		19.0
23025010CE	90859	23125010CE	91130	1/4		.2500	1/4		2-1/2		3/4	

Series 231BCE		Series 231DCE		Diameter			Shank		OAL		Flute Length	
Tool No.	EDP	Tool No.	EDP	D1			D2		L1		L2	
				Inch	mm	Decimal	Inch	mm	Inch	mm	Inch	mm
23111810BCE	91050	23111810DCE	91053		3.0	.1181		3.0		38		12.5
23112500BCE	91074	23112500DCE	91077	1/8		.1250	1/8		1-1/2		1/2	
23118750BCE	91085	23118750DCE	91088	3/16		.1875	3/16		2		5/8	
23119680BCE	91097	23119680DCE	91100		5.0	.1968		5.0		51		16.0
23123620BCE	91109	23123620DCE	91112		6.0	.2362		6.0		51		19.0
23125010BCE	91133	23125010DCE	91136	1/4		.2500	1/4		2-1/2		3/4	

Routers are available with color coded depth setting rings upon request for 1/8" shanks.



Page 180

CERAedge® Coated Routers

Diamond Grind Routers

Series 230CE / 231CE

Series 231BCE / 231DCE

Recommended Cutting Data - Inch

Slotting 300 (Sfm)			Slotting 600 (Sfm)		
Tool Diameter	RPM	IPM	Tool Diameter	RPM	IPM
1/32	36000	29	1/32	73000	58
3/64	24000	24	3/64	48000	48
1/16	18000	27	1/16	36000	54
3/32	12000	24	3/32	24000	48
1/8	9100	22	1/8	18000	45
3/16	6100	18	3/16	12000	36
1/4	4500	16	1/4	9000	32
5/16	3600	14	5/16	7000	28

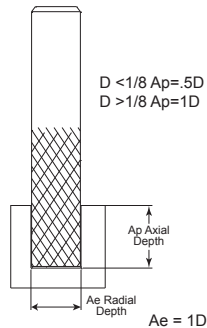

Side Milling 400 (Sfm)			Side Milling 900 (Sfm)		
Tool Diameter	RPM	IPM	Tool Diameter	RPM	IPM
1/32	48000	39	1/32	90000	72
3/64	32000	32	3/64	73000	73
1/16	24000	36	1/16	55000	83
3/32	16000	32	3/32	36000	72
1/8	12000	30	1/8	27000	68
3/16	8100	24	3/16	18000	54
1/4	6100	21	1/4	13000	46
5/16	4800	19	5/16	11000	44

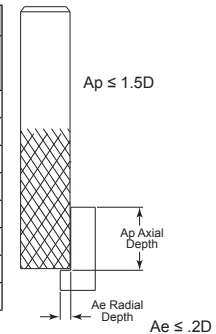

** Tool must have end grind in order to slot.

Note: The parameters in this table are for common material thickness of 1/4". You must use the Radial Depth (Ae) of 20% or less for Side Milling. For best surface finish conventional mill is recommended. Higher feed rates are possible but surface finish may change.

Recommended Cutting Data - Metric

Slotting 90 (m/min)			Slotting 182 (m/min)		
Tool Diameter	RPM	mm/min	Tool Diameter	RPM	mm/min
0.8	35000	141	0.8	72000	289
1	28000	226	1	57000	463
1.2	23000	306	1.2	48000	627
1.5	18000	376	1.5	38000	771
1.6	17000	388	1.6	36000	795
2	14000	423	2	28000	868
2.4	11000	447	2.4	24000	916
3	9400	480	3	19000	984
5	5600	395	5	11000	810
6	4700	423	6	9600	868
8	3500	353	8	7200	723

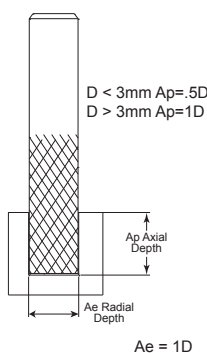

Side Milling 120(m/min)			Side Milling 240 (m/min)		
Tool Diameter	RPM	mm/min	Tool Diameter	RPM	mm/min
0.8	47000	190	0.8	95000	381
1	38000	305	1	76000	610
1.2	31000	413	1.2	63000	826
1.5	25000	508	1.5	50000	1017
1.6	23000	524	1.6	47000	1049
2	19000	572	2	38000	1145
2.4	15000	604	2.4	31000	1208
3	12000	648	3	25000	1297
5	7600	534	5	15000	1068
6	6300	572	6	12000	1145
8	4700	477	8	9500	954

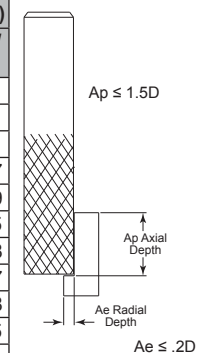

** Tool must have end grind in order to slot.

Note: The parameters in this table are for common material thickness of 6mm. You must use the Radial Depth (Ae) of 20% or less for Side Milling. For best surface finish conventional mill is recommended. Higher feed rates are possible but surface finish may change.

ISO 9001:2008 Certified
Made in USA

Safety Note

Always wear the appropriate personal protective equipment such as safety glasses and protective clothing when using solid carbide or HSS cutting tools. Machines should be fully guarded.

Technical data provided should be considered advisory only as variations may be necessary depending on the particular application.



ADVANCED PRODUCT GROUP

CERAedge[®]





CUSTOM Tool Division

Engineering & Manufacturing Excellence

The M.A. Ford® Custom Tool Division focuses on meeting the growing need for unique and increasingly complex special cutting tools. By partnering with select machine tool users the Custom Tool Division develops and supplies custom engineered carbide tools of unmatched quality which meet or exceed their productivity, delivery and utilized cost expectations. Custom tools are proven to increase speeds and feeds, save setup and handling time which in turn leads to faster run times, more efficient manufacturing and most importantly, **INCREASED PROFITS.**

To support your productivity improvement efforts, we offer the following services:

- Technical assistance in prototype custom tool design.
- Re-engineering of existing custom tooling to optimize tool performance.
- Tool manufacturing lead times which meet or exceed your delivery requirements.
- Immediate response to quotation request.
- Readily available technical phone support.
- Field representative support service.
- Emergency tool service.
- Custom tools of the highest quality.

Meeting the growing need for unique and increasingly complex high performance custom cutting tools in today's industry

We offer application development, design and manufacturing expertise in the following product classifications:

All tools in either Solid or Coolant Thru Configurations

- High Performance Drills and Step Drills
- Rockbit Drills (Flat Bottom - 150°)
- G-Drills and Step G-Drills
- Step Reamers
- Reamers
- Coolant Thru Specials
- Firearms Reamers (Chamber - Barrel - Muzzle - Throat)
- Custom End Mills
- Custom Form Tools

Call us today to increase your
productivity and profits with
Custom Tooling

Stop Guessing. Start Knowing.

The BlueSwarf Dashboard™ is a revolutionary new product that dramatically improves the performance of milling using the science of machining dynamics. Dashboards™ control the dynamic frequencies and vibrations that limit milling operations and generate chatter.



EXPERT ANALYSIS - BlueSwarf Dashboards™ are a system of patented and proven services that begin with onsite measurements of your milling tools by M.A. Ford® and analysis by our staff of Ph.D.-level engineers. Interactive Dashboards™ are delivered for first time right and fully optimized machining.

- Eliminate Chatter
- Increase Metal Removal Rates
- Increase Tool Life
- Improve surface finishes
- Faster Set-Ups
- Reduce Energy Consumption

Fully interactive BlueSwarf Dashboards™ allow users, without extensive knowledge of chatter theory or mechanical vibrations, to take full advantage of the available improvements in process efficiency. BlueSwarf Dashboards™ allow process planners and programmers to select high-efficiency milling parameters for maximized material removal rates in a science-based pre-process manner, rather than relying on trial and error testing.

For more information on BlueSwarf Harmonics Analysis contact your local
M.A. Ford® Representative.

M.A. Ford® is an Authorized and Certified BlueSwarf Service Provider.

ISO 9001:2008 Certified

Made in USA



See something you would like to try?

Complete this form to request your FREE tool!*

Company Information:	
Company Name:	End User:
Requested By:	Contact Name:
Address:	Ship to Address:
City, State, Zip:	City, State, Zip:
Phone:	Phone: Ship Via:
Fax:	Fax:
e-mail Address:	e-mail Address:

M.A. Ford® Sales Rep.: _____

M.A. Ford® Trial Tool Requested:

Qty/Tool # _____

Qty/Tool # _____

Comments: _____

Additional Information:			
Application Description:			
Machine Type	Horizontal <input type="checkbox"/>	Vertical <input type="checkbox"/>	Other <input type="checkbox"/>
RPM		Horsepower	
Condition	Good <input type="checkbox"/>	Fair <input type="checkbox"/>	Poor <input type="checkbox"/>
Material:		Hardness	
Coolant?	Yes <input type="checkbox"/>	No <input type="checkbox"/>	Type

Current Tooling Appraisal:	
Current Tool:	
Mfg.	Part #
Feed Rate:	
RPM:	
Width/Depth of Cut:	
Hole Depth:	
No. Holes Produced:	
No. Parts Produced:	
Production Rate:	

*All requests subject to approval. An M.A. Ford® representative will contact you to discuss your application.

RED BOX

Factory Reconditioning Service

Extend the life of your cutting tools with M.A. Ford®'s
Factory Reconditioning / Recoating Service.



SAVE

and

Go Green

with



**Drills
End Mills
Countersinks
Burs**

Simplified Pricing Structure.

No Minimum Order Value.

Original Coatings.

M.A. Ford® Quality Workmanship.

Tools Reground to Factory Specifications.

Quick Turnaround.

RETURN • RECONDITION • REDUCE COST

QUALITY



The M.A. Ford® Quality Policy is:

- Know our customers.
- Know their requirements.
- Make continual improvements in satisfying those requirements.

These are the responsibilities of every individual who works at M.A. Ford®.

Steve Morency, CEO



Coatings

ALtima®

Aluminum Titanium Nitride (AlTiN). ALtima® is the original high performance coating. This coating allows tools to be run at higher speeds and feeds in a wide array of materials. Also, it allows the option of running tools dry due to the high oxidation temperature of the coating.

ALtima® Plus

This Aluminum Titanium Nitride (AlTiN) multi-layer coating has optimized coating structure, with pre and post treatment of the coating for optimized high performance drilling in any ferrous material.

ALtima® 52

Aluminum Titanium Nitride (AlTiN). ALtima® 52 is specially designed for milling hardened steels 52 Rc and above. It has very high hardness and the oxidation temperature of the coating makes this the absolute best choice for hardened steel milling. ALtima® 52 is designed to allow for dry machining.

ALtima® Blaze

Aluminum Chromium Nitride (AlCrN). ALtima® Blaze is designed to allow higher material removal rates. This coating has a higher oxidation temperature than a typical TiAlN coating. It has shown very good results in nickel alloys, titanium, and other difficult to machine materials. Tools coated with ALtima® Blaze can be used in dry machining.

ALtima® Micro

An ultra thin, nano structured, TiAlN coating developed specifically for micro tool applications.

Fordlube

Titanium DiBoride (TiB₂) is a unique coating with low Aluminum affinity, smooth surface finish and high hardness. It is ideal for Aluminum and Magnesium alloys as it prevents build-up on cutting edge, provides superior chip flow along with extended wear resistance.

GemX

A CVD diamond coating for composites and aluminum that offers the maximum hardness and wear resistance of any of our coatings.

TiN

Titanium Nitride (TiN). TiN coating has shown good results in low carbon steels and many iron-based applications. It is a very popular coating used in the industry today.

TiCN

Titanium Carbonitride (TiCN). TiCN is a multi-layer coating. Because of the multi-layer composition, TiCN is tougher than TiN, even though TiCN is harder. The added toughness of the TiCN coating makes it a good choice for mechanically stressed edges like in end mill applications. The higher hardness makes TiCN a good choice for abrasive applications where higher wear resistance is required.

CERAedge®

CERAedge® is a unique coating that provides excellent performance in titanium, aluminium, and composites.

Special Coatings

Upon request, M.A. Ford® can provide any commercially available coating. Any standard M.A. Ford® cutting tool can be provided with coating if requested.

Coating Properties

M.A. Ford® Coating	M.A. Ford® Tool Number Designation	Microhardness (HV)	Maximum Service Temp.	Friction Coefficient
ALtima®	A	3100	1100° C / 2012° F	0.42
ALtima® Plus	AP	3200	1100° C / 2012° F	0.25
ALtima® 52	A	3600	1200° C / 2192° F	0.40
ALtima® Blaze	B	3200	1100° C / 2012° F	0.35
ALtima® Micro	AM	3300	900° C / 1652° F	0.30-0.35
Fordlube	F	4000	700° C / 1292° F	0.30
GemX	GX	10000	600° C / 1100° F	0.10
TiN	T	2300	600° C / 1112° F	0.40
TiCN	C	3000	400° C / 752° F	0.40
CERAedge®	CE	3400	1100° C / 2012° F	0.25

CERAedge®

Ceramic Coating with Extreme Properties

- Hardness that makes it the 3rd hardest material when compared to industrial diamonds.
- Toughness that is comparable to Titanium.
- Lubricity that approaches Teflon.
- Extreme heat tolerance.
- Non-reactive to Titanium.

Coating Properties

M.A. Ford® Coating	Microhardness (HV)	Maximum Service Temp.	Friction Coefficient	Coating Thickness	Color
CERAedge®	3400	1100° C / 2012° F	.25	2-3 Microns	Light Gray

CERAedge® Applications

Titanium-clad composite material:

Hardness and lubricity ideal for composites
 Toughness that allows excellent machining of
 Titanium CERAedge® is perfect for machining of
 Titanium-clad composites!

Aluminum and high silicon aluminum materials:

Hardness and lubricity extend tool life by increasing
 wear and resistance.









See Standard Offering of these Products with CERAedge® coating		See Page
138CE	Series End Mills	121
207CE	Brad and Spur Point Drill	57
230CE	Safe End Diamond Grind Router	179
231CE	End Mill End Diamond Grind Router	179
231BCE	Bur End Diamond Grind Router	179
231DCE	Drill Point Diamond Grind Router	179

Test Data

Material Machined: 6061 Aluminum Extrusion
 M.A. Ford® Tool: 138 Series, 3 Flute End Mill, 1/2" (12.7mm) OD
 RPM: 22,000 RPM
 IPM: 300 (7,620 mm/minute)









	Competitor's Lubricious Coating	M.A. Ford® CERAedge® Coated
Parts Produced/Tool	5	42
Linear Inches/Tool (Linear m/tool)	10,690 (272)	92,976 (2,360)

Material Conversion Chart

								
	USA	France	Brazil	German W-nr	German DIN	UK	Spain	Japan JIS
FREE MACHINING STEEL	12L13	S250Pb		1.0718	9SMnPb28		F.2112 -	
	1108	10F1		1.0721	10S20	210M15	F.2121 -	
	11L08	10PbF2		1.0722	10SPb20		F.2122 -	
	1215	S300	1215	1.0723	15S20	210A15	F.210F.	
	12L14	S300Pb		1.0736	9SMn36	240M07 EN 1B	F.2113-	
				1.0737	9MnPb36		F.2114 -	
LOW CARBON STEEL	1010	AF34C10/XC10	1010	1.0301	C10	045M10		
	1015	AF37C12/XC18	1015	1.0401	C15	080M15;040A15	F.111	
	1020	AF42C20/XC25	1020	1.0402	C22	055M15 EN2C	F.112	
	1025	AF50C30		1.0406	C25	070M26	F.221	
	1212			1.0711	9S20	220M07		
	1213	S250	1213	1.0715	9SMn28	230M07	F.2111 -	
	1010	XC10	1010	1.1121	Ck10	040A10	F.1510 -	
	1022/1518	20M5		1.1133	20Mn5	120M19	F.1515 -	
	1015	XC15 / C15E	1015	1.1141	Ck15	080M15 EN 32C	F.1511 -	
	1020/1023	XC25 / C22E	1020	1.1151	Ck22	050A20	F.1120 -	
	1025	XC25 / C25E		1.1158	Ck25	070M26	F.1120 -	
	A350-LF5	15N6 / 15Ni6		1.5622	14Ni6		F.2641 -	
	3310/9314	12NC15		1.5752	14NiCr14	655M13/A12 EN 36A		
MEDIUM CARBON STEEL	1035	AF55C35 /XC38	1035	1.0501	C35	060A35	F.113	
	1045	AF65C45 /C45	1045	1.0503	C45	080M46	F.114	
	1040	AF60C40 C40	1040	1.0511	C40		F.114.A	
	1055	C55	1055	1.0535	C55	070M55		
	1060	AF70C55 / C60	1060	1.0601	C60	080A62 EN 43D	F.115	
	1140	35MF6	1140	1.0726	35S20	212M36 EN 8M	F.210G.	
	1146	45MF4		1.0727	45S20	212M44		
	9255	51S7		1.0903	51Si7	250A53 EN 45	F.1450 -	
	9255	55S7	9254	1.0904	55Si7		F.1440-	
	9260	60S7		1.0909	60Si7	250A58	F.1441 -	
	9262	60SC7		1.0961	60SiCr7	250A61	F.1442 -	
	1330/1536	35M5 / 30Mn5		1.1165/66	30Mn5/34Mn5	120M36/150M28	F.1203	
	1335	40M5 / 36Mn5	1541	1.1167	36Mn5	150M36 EN 15	F.1203 -	
	1330	20M5 / 28Mn6	1330	1.117	28Mn6	150M28 EN 14A		
	1035	XC32 / C35R	1035	1.118	Cm35	080M36	F.1135 -	
	1040	XC42H1 / C40E	1040	1.1186	Ck40	060A40/080A40		S 40 C
	1045	XC42H1 / C45/XC45	1045	1.1191	Ck45	080M46/060A47	F.1140 -	S 45 C
	1045	XC42H1 /C45R	1045	1.1201	Cm45	080M46	F.1145 -	
	1055	XC55H1 / C55E	1055	1.1203	Ck55	060A57/070M55	F.1150 -	S55C
	1050	XC48H1 / C50E	1050	1.1206	Ck50	080M50		
1050	XC48H1TS	1050	1.1213	Cf53	060A52			
1060	XC60 / C60E/2C60	1060	1.1221	Ck60	060A62	F.511/F.512	S58C	
1070	XC68	1070	1.1231	Ck67	060A67			
ALLOY STEEL	1080/1078/1086	XC75 / C75E/XC90	1074	1.1248/1269	Ck75	060A78	F.513/514/515	
	1095	XC100	1095	1.1274	Ck101	060A96		
	4135/4142	34CD4 /42CD4		1.233	35CrMo4/47CrMo4	708A37/M40		SCM435TK
	3135/3140	35NC6		1.571/5711	36NiCr6/40NiCr6	640A35/M40 EN111A		
	8620/8720	20NCD2	8620	1.6523/43	21NiCrMo2	805M20/A20 EN 362	F.1522 -	SNCM220(H)
	8740	40NCD2	8640	1.6546	40NiCrMo22	311-Type7	F.1204 -	SNCM240
		18NCD6		1.6587	17CrNiMo8	820A16	F.1560 -	
	5132	32C4 / 34Cr4		1.7033	34Cr4	530A32 EN18B	F.8221 /F.224	SCR430(H)
	5135	38C4 / 37Cr4	5135	1.7034	37Cr4	530A36	F.1201 -	
	5140	42C4 / 41Cr4	5140	1.7035	41Cr4	530M40/A40 EN 18	F.1202 -	SCR440(H)
	5140	42C4TS	5140	1.7045	42Cr4	530A40	F.1202 -	SCR440
	5115	16MC5	5115	1.7131	16MnCr5	527M17	F.1515 -	
	5155	55C3		1.7176	55Cr3	527A60 EN 48	F.1431 -	SUP9(A)
	4130	25CD4 / 25CrMo4	4130	1.7218	25CrMo4	1717CDS110	F.8330 -	SCM420/430
	4135/4137	35CD4 / 34CrMo4		1.722	34CrMo4	708A37 EN 19B	F.8231 -	
	4140/4142	42CD4 / 42CrMo4	4140	1.7225	42CrMo4	708M40 EN 19A	F.8232 -	
	4150	50CrMo4	4150	1.7228	50CrMo4	708A47		
6150	50CV4 / 51CrV4	6151	1.8159	50CrV4	735A50 EN 47	F.1430 -		

Technical data provided should be considered advisory only as variations may be necessary depending on the particular application.

Material Conversion Chart









								
	USA	France	Brazil	German W-nr	German DIN	UK	Spain	Japan JIS
HIGH STRENGTH ALLOY STEEL	A355Cl.D	30CAD6.12		1.8507	34CrAlMo5	905M31	F.1741 -	
	A355Cl.A	40CAD6.12		1.8509	41CrAlMo7	905M39 EN 41B	F.1740 -	
		18NC13		1.5755	31NiCr14	653M31	F.123	
	9840	40NCD3		1.6511	36CrNiMo4	816M40 EN 110	F.1280	
	4340		4340	1.6562	40NiCrMo73	817M40		SNCM 447
		30CND8		1.658	30CrNiMo8	823M30		
	4340	35NCD6	4340	1.6582	34CrNiMo8	817M40 EN 24	F.1272	SNCM 447
		35NCD14		1.6746	32NiCrMo145	830M31	F.1262	
		35NCD16		1.6747	30NiCrMo166	835M30	F.1260	
	30CD12		1.8515	31CrMoV139	722M24 EN 40B	F.1712		
			1.8523	39CrMoV139	897M39 EN 40C			
STRUCTURAL STEEL	A570 (36)	E24-2NE / S235JRG2	A36	1.0038	RS137-2	4360-40C		STKM 12A
	A570 (40)	E28-2 / S275JR		1.0044	St44-2	4360-43A/B	A 430B	SM 400 A,B,C
	A570 (50)	A50-2 / E295		1.005	St50-2	4360-50B		SS490
		A60-2 / E335-A70-2/E360		1.006/007	St60-2/St70-2	4360-55E		
	A284/A573/A611	E24-3;-4 / S235J2G3		1.0116	St37-3	4360-40C/D-1449-37C	A360 C;D	
	A366/1012/A619	DC01		1.033/0333	St12/13	1449 -2/3/4CR	AP 00/02	
	A620	DC04		1.0338	St14	1449 1CR; 2CR	AP 04	
	A516Gr.65;-55;	A37CP;AP / P235GH		1.0345	H I	1501Gr.161-360/400	A 37 RC I;RA II	
		A42CP;AP / P265GH		1.0425	H II	161-400;	A42 RC I	
	A537	A52CP;AP / P335GH		1.0473	19Mn6		A 47 RB II	
	A516 (70)	A48CP;AP / P295GH		1.0481	17Mn4		A 47 RC I; RA II	
		E36-3/4 / S355J2G3		1.057	St52-3	4360-50B;50C;50D	A 510 C;D	
	A204 (A)	15D3 / 15Mo3		1.5415	15Mo3	1501-240	F.2601 -	
	4520			1.5423	16Mo5	1503-245-420	F.2602 -	
	A350-LF3	12Ni14 / 12Ni14		1.5637	10Ni14	1501-503-690	F.152	
	3115	10NC6		1.5713	13NiCr6			
	3415	14NC11		1.5732	14NiCr10		F.1540	
	A182-F11;F12	15CD3.05		1.7335	13CrMo44	620Gr.27;31	F.2631	
	A387 (12)	15CD4.5		1.7337	16CrMo44	620Gr.27		
	A182F22	10CrMo9-10		1.738	10CrMo910	622Gr.31;45	TU.H	
A633Gr.E	E420RIFP / S420N		1.8902	StE420	4360-55E	AE 420 KG		
A633Gr.E	E460RIFP / S460N		1.8905	StE460		AE 460 KG		
HIGH TEMPERATURE ALLOYS	330	Z12NCS37.18		1.4864	X12NiCrSi3616	NA17	F.3313	
				1.4865	G-X40NiCrSi3818	330C40		
	B163	Z8NC3221		1.4876	X10NiCrAlTi3320	NA15(H)	F.3545	
	4544/SB127/164	NU30		2.436	NiCu30Fe	3072-76/NA13		
	4676			2.4375	NiCu30Al	3072-76/NA18/3146		
	5388 C	NC 17 DWY		2.4602	NiCr17Mo17FeW			
		NC 20 T		2.463	Ni-Cr20Ti	HR5/203-4/703-B		
		NC 20 TA		2.4631	NiCr20TiAl	HR 401HR601/736B		
		NCKD 20 ATV		2.4634	NiCo20Cr15MoAlTi	HR 3/5007		
	687	NCKD 20 AT		2.4636	NiCo15Cr15MoAlTi			
		NCK 20 D		2.465	NiCr20Co19MoTi	HR 10		
	5660C	Z8 NCDT 42		2.4662	NiCr15MoTi			
	5536E	Nc 22 FeD		2.4665	NiCr22Fe18Mo	HR 6/204		
		NC 19 FeNb		2.4668	NiCr19Fe19NbMo	HR 8		
	5542G	NC 15 Fe TNb		2.4669	NiCr16FeTi	HR 505		
	5391A	NC 13 AD		2.467	G-NiCr13Al6MoNb	HC 203		
		NK 15 CAT		2.4674	NiCo15Cr10MoAlTi	HC 204		
	5540	NC 15 Fe		2.4816	NiCr15Fe	3072-76		
	5581	NC 22 FeDNB		2.4856	NiCr22Mo9Nb			
		NC 21 FeDU		2.4858	NiCr21Mo	3072-76		
	NC 19 KDT		2.4973	NiCr19Co11MoTi				
684	NCK 19 DAT		2.4983	NiCr18Co18MoAlTi				
TITANIUM TITANIUM ALLOYS		T-35		3.7024/25	Ti 99.8	TA.1	Ti-PO1	
		T-U2		3.7124	TiCu2	TA.21-24/52-55/58	Ti-P11	
		T-A6ZD		3.7154	TiAl6Zr5Mo0.5Si0.2	TA.43/44	Ti-P67	
		T-A4DE		3.7184	TiAl4Mo4Sn2Si0.5	TA.45-51/57	Ti-P68	
	4941/42/51/4902	T-40		3.7034/35	Ti 99.7	TA.2/3/4/5	Ti-PO2	
	4901/21	T-60		3.7064/65	Ti99.5	TA.6/7/8/9	Ti-PO4	
	491128/35/54/65/67	T-A6V		3.7164/65	TiAl6V4	TA.10-13/28/56	Ti-P63	
	4900	T-50				DTD 5023/5283		

Material Conversion Chart

Technical data provided should be considered advisory only as variations may be necessary depending on the particular application.









For product information, call your local distributor

Material Conversion Chart

								
	USA	France	Brazil	German W-nr	German DIN	UK	Spain	Japan JIS
STAINLESS STEELS	410S	Z3014		1.4001	X7Cr14	403S17	F.8401	
	405	Z6CA13 / Z6CrAl13		1.4002	X6CrAl13	405S17	F.3111	
	416	Z12CF13 / Z12CrS13		1.4005	X12CrS13	416S21	F.3411	SUS 416
	410/CA-15	Z12C13 / Z12Cr13	410	1.4006	X10Cr13	410S21 ENEN 56A	F.3401	SUS 410
	430	Z8C17 / Z6Cr17		1.4016	X6Cr17	430S15 EN 60	F.3113	SUS 430
	420	Z20C13 / Z20Cr13	420	1.4021	X20Cr13	420S37	F.3402	SUS 420
		Z40C14 / Z40Cr14		1.4034	X46Cr13	420S45 EN 56D	F.3405	
	431	Z15CN16.02		1.4057	X20CrNi172	431S29 EN 57	F.3427	
	430F	Z10CF17		1.4104	X12CrMoS17		F.3117	
	434	Z8CD17.01		1.4113	X6CrMo17	434S17		
	440C	Z100CD17		1.4125	X105CrMo17			
	304/304H	Z6CN18.09	304	1.4301	X5CrNi1810	304S15 EN 58E	F.3451	SUS304
	308: 305	Z8CN18.12		1.4303	X5CrNi1812	305S19	F.3513	
	303	Z10CNF18.09	303	1.4305	X10CrNiS189	303S21 EN 58M	F.3508	SUS303
	304L	Z2CN18.10/Z3CN19.10M		1.4306	G-X2CrNi189/1911	304S12/S11/C12	F.3503	SCS19
	CF-8	Z6CN18.10M		1.4308	G-X6CrNi189	304C15		
	301	Z12CN17.07	302	1.431	X12CrNi177	301S21	F.3517	
	304LN	Z2CN18.10Az		1.4311	X2CrNiN1810	304S62		
		Z10CN18.9M		1.4312	G-X10CrNi188	302C25		
	CA6-NM	Z4CND13.4M		1.4313	G-X5CrNi134	425C11		
	316/316L	Z6CND17.11	316	1.4401	X5CrNiMo17122	316S16/S31 EN 58J	F.3543	SUS316
	316L	Z2CND 18.13	316L	1.4404	X2CrNiMo17132	316S11/S12	F.3533	SUS316 L
	316LN	Z2CND 17.12Az		1.4406	2CrNiMoN17122	316S61		SUS316LN
	CF-8M			1.4408	G-X6CrNiMo1810	316C16	F.8414	
	316LN	Z2CND17.13Az		1.4429	X2CrNiMo17133	316S62		SUS316LN
	316L	Z2CND17.13		1.4435	X2CrNiMo18143	316S11/S12	F.3533	SUS316LN
	316	Z6CND17.12		1.4436	X5CrNiMo17133	316S16	F.3534	SUS316
	317L	Z2CND19.15		1.4438	X2CrNiMo18164	317S12		SUS317L
	329		329 (DUPLEx)	1.446	X8CrNiMo275		F.3309	SUS329
	XM8/430Ti	Z8CT17		1.451	X6CrTi17		F.3114	
	409	Z6CT12		1.4512	X5CrTi12	409S19		
	321	Z6CNT18.10	321	1.4541	X6CrNiTi1810	321S12/S31 EN 58B	F.3523	SUS321
	630	Z6CNU17.04		1.4542	X5CrNiCuNb1714			SUS630
	347	Z6CNCNb18.10		1.455	X6CrNiNb1810	347S17/S31 EN 58F	F.3552	SUS347
	316Ti	Z6CNDT17.12		1.4571	X6CrNiMoTi17122	320S31/S17 EN 58J	F.3552	
	316Ti			1.4573	X10CrNiMoTi1812	320S33		
	316Cb	Z6CNDNb17.12/19.13		1.458	X6CrNiMoNb17122	318S17		
	HNV3	Z45CS9		1.4718	X45CrSi93	401S45 EN52	F.3220	
		Z10C13		1.4724	X10CrAl13	403S17	F.13152	
		Z40CSD10		1.4731	X40CrSiMo102		F.3221	
	430	Z10CAS18		1.4742	X10CrAl18	430S15	F.3153	SUS430
	HNV6	Z80CSN20.02		1.4747	X80CrNiSi20	443S65 EN 59	F.3222	
	446	Z10CAS24		1.4762	X10CrAl24		F.3154	SUH446
	309	Z15CNS20.12		1.4828	X15CrNiSi2012	309S24		
	309S	Z15CN24.13		1.4833	X7CrNi2314	309S24		
	314/310	Z15CNS25.20	314	1.4841	X15CrNiSi2520		F.3310	
	310S	Z12CN25.20	310	1.4845	X12CrNi2521	310S24	F.331	
	HK			1.4848	G-X40CrNiSi2520	310C40	F.8452	
	EV8	Z52CMN21.09		1.4871	X53CrMnNiN219	349S54	F.3217	
		Z35CNWS14.14		1.4873	X45CrNiW189	331S40	F.3211	
321	T6CNT18.12(B)		1.4878	X12CrNiTi189	321S20	F.3523	SUS321	
A353	Z8N9		1.5662	X8Ni9	1501-509;510	F.2645		
2515	Z18N5		1.568	12Ni19				

Technical data provided should be considered advisory only as variations may be necessary depending on the particular application.

Material Conversion Chart









								
	USA	France	Brazil	German W-nr	German DIN	UK	Spain	Japan JIS
TOOL STEELS	A532IBNiCr-LC			0.962	G-X260NiCr42	Grade2A		
	A532IANiCr-HC			0.9625	G-X330NiCr42	Grade2B		
	A532IDNi-HiCr			0.963	G-X300CrNiSi952	Grade2C,D,E		
	A532IID20%CrMo-LC			0.9645	G-X260CrMoNi2021	Grade3C		
	A532IIIA25%Cr			0.965	G-X260Cr27	Grade3D		
	A532IIIA25%Cr			0.9655	G-X300CrMo271	Grade3E		
	W108	Y190;Y180		1.1525	C80W1			
	W110	Y1105		1.1545	C105W1			SK3
	W112	Y2120		1.1663	C125W			
	W1			1.175/.1625	C75W/C80W1	BW1A/BW1B	F.5123	
	L3	Y100C6	52100	1.2067	100Cr6	BL3	F.5230	
	D3	Z200C12	420 (1.2083)	1.208	X210Cr12	BD3	F.5212	
	L2			1.221	115CrV3			
	H11	Z38CDV5	H11	1.2343	X38CrMoV51	BH11	F.5317	
	H13	Z40CDV5	H13	1.2344	X40CrMoV51	BH13	F.5318	SKD61
	A2	Z100CDV5	A2	1.2363	X100CrMoV51	BA2	F.5227	SKD12
	H10	32DCV28	H10	1.2365	X32CrMoV33	BH10	F.5313	
	D2	Z160CDV12	D2	1.2379	X155CrVMo121	BD2		
		105WC13		1.2419	105WCr6		F.5233	
			D6 (VC131)	1.2436	X210CrW12		F.5213	
	O1		O1 (VND)	1.251	100MnCrW4	BO1	F.5220	SKS 31
	S1		S1 (VW3)	1.2542	45WCrV7	BS1	F.5241	
		55WC20		1.255	60WCrV7			
	H21	Z30WCV9	H20/H21	1.2581	X30WCrV93	BH21	F.5323	SKD5
				1.2601	X165CrMoV12		F.5211	
	H12	Z35CWDV5	H12	1.2606	X37CrMoW51	BH12		
	L6	55NCDV7	(VMO)	1.2713	55NiCrMoV6		F.528	
	W210	Y1105V		1.2833	100V1	BW2		
	2	90MV8		1.2842	90MnCrV8	BO2		
	T15			1.3202	S12-1-4-5	BT15	F.5563	
		Z130WKCDV10-10-04-03		1.3207	S10-4-3-10		F.553	
		Z85WDCVCV06-05-05-04-02	M35	1.3243	S6-5-2-5		F.5613	
	M41	Z110WKCDV07-05-04-04-02		1.3246	S7-4-2-5		F.5613	
	M42	Z110DKCWW09-08-04-02-01	M42	1.3247	S2-10-1-8	BT42	F.5615	
	M33/M34			1.3249	S2-9-2-8	BM34	F.5611	
	T4	Z80WKCV18-05-04-01		1.3255	S18-1-2-5	BT4	F.5530	
	T5			1.3265	S18-1-2-10	BT5	F.5540	
	M3	Z90WDCV06-05-04-03		1.3342	SC6-5-2			
	M2	Z85WDCV06-05-04-02	M2	1.3343	S6-5-2	BM2	F.5603	
	M3Class2	Z130WDCV06-05-04-04	M3:2	1.3344	S6-5-3		F.5605	
	H41/M1	Z85DCVW08-04-02-01		1.3346	S2-9-1	BM1		
	M7	Z100DCVW09-04-02-02	M7	1.3348	S2-9-2		F.5607	
	T1	Z80WCV18-04-01		1.3355	S18-0-1	BT1	F.5520	
	A128(A)	Z120M12 / Z120Mn12		1.3401	X120Mn12		F.82551	
	52100	100C6	52100	1.3505	100Cr6	534A99	F.1310	
HARDENED STEEL								
CAST ALUMINIUM	319,2	A-S5U		3.2151	G-AISI6Cu4	LM4/LM22	L-2660	
	380,1	A-S9U3		3.2161	G-AISI8Cu3	LM24	L-2630	
		A-S4G		3.2341	G-AISI5Mg	DTD716B		
	A356.2	A-S7G0,3		3.2371	G-AISI7Mg	2L99/LM25		
		A7-S10G		3.2373	G-AISI9Mg			
	A360	A-S10G		3.2381	G-AISI10Mg	LM9	L-2560	
	413,1	A-S12U		3.2583	G-AISI12Cu	LM20	L-2530	
	514,1	A-G6		3.3561	G-ALMg5	LM5		
	A413	A-S13		3.3581	G-AISI12	LM6	L-2520	
	520	A-G10-Y4		3.3591	G-ALMg10	LM10	L-2310	
	390				AISI17Cu4			
	393				AISI18-25CuNiMg	LM28/LM29		

Material Conversion Chart

Technical data provided should be considered advisory only as variations may be necessary depending on the particular application.

For product information, call your local distributor

Material Conversion Chart

								
	USA	France	Brazil	German W-nr	German DIN	UK	Spain	Japan JIS
WROUGHT ALUMINIUM	1200	A4		3.0205	Al99	1C	L-3001	
	1050A	A5		3.0255	Al99,5	1B	L-3051	
	1350A	A5/L		3.0257	E-Al	1E	L-3052	
	1080A	A8		3.0285	Al99,8	1A	L-3081	
	1199	A99		3.0385	Al99,98R	1		
	3004	A-M1G		3.0526	AlMnMg1	N4	L-3820	
	2014	A-U4SG		3.1255	AlCuSiMn	H15	L-3130	
	2117	A-U2G		3.1305	AlCu2,5Mg0,5	3L86/HR13	L-3180	
	2017A	A-U4G		3.1325	AlCuMg1	H14	L-3120	
	2024	A-U4G1		3.1355	AlCuMg2	2L98	L3140	
	2003	A-U4Pb		3.1645	AlCuMgPb		L-3121	
	2011	A-U5PbBi		3.1655	AlCuBiPb	FC1	L-3182	
	6101B			3.2305	E-AlMgSi	91E	L-3431	
	6463	A85-GS		3.2307	Al99,85MgSl	BTR6		
	6181	A-SGMO,7		3.2315	Al-Si1 Mg	H30	L-3451	
	6060			3.3206	AlMGSi0,5	H9	L-3441	
	6101C	A-GS/L		3.3207	E-AlMgSi0,5	BTRE6		
	5005A	A-G0,6		3.3315	AlMg1	N41	L-3350	
	5050B	A-G1,5		3.3316	AlMg1,5	3L44	L-3380	
	5052	A-G2,5C		3.3523	AlMg2,5	N5Mg3,5	L-3360	
	5251	A-G2M		3.3525	AlMg2Mn0,3	N4		
	5754	A-G3M		3.3535	AlMg3		L-3390	
	5454	A-G2,5MC		3.3537	AlMg2,7Mn	N51		
	5083	5083		3.3547	AlMg4,5Mn	N8	L-3321	
5056A			3.3555	AlMg5	N6	L-3320		
7020	A-Z5G		3.4335	AlZn4,5Mg1	H17	L-3741		
7075	A-Z5GU		3.4365	AlZnMgCu1,5	2L95	L-3710		
SG / NODULAR CAST IRON	60-40-18	FGS-400-12		0.704	GGG-40	420/12		
		FGS370-17		0.7043	GGG-40.3	370/17		
	65-45-12	FGS500-7		0.705	GGG-50	500/7		FDC500
	80-55-06	FGS 600-3		0.706	GGG-60	600/3		
	100-70-03	FGS 700-2		0.707	GGG-70	700/2		FDC700
	120-90-02	FGS 800-2		0.708	GGG-80	800/2		
		MB 35-7		0.8035	GTW-35-04	W 340/3		
		MB 40-10		0.804	GTW-40-05	W 410/4		
				0.8045	GTW-45-07			
	32 510	MN 35-10		0.8135	GTS-35-10	B 340/12		
		MP 50-5		0.8145	GTS-45-06	P 440/7		
	MP 60-3		0.8155	GTS-55-04	P 540/5			
			0.8165	GTS 65-02				
70 003	MP 70-2		0.817	GTS 70-02	P 690/2			
GREY / WHITE CAST IRON	A48-40B	Ft25D / FGL250		0.6025	GG25	Grade 260	FG 25	
	A48-20B	Ft10D / FGL100		0.601	GG10		FG 10	
	A48-25B	Ft15D / FGL150		0.6015	GG15	Grade 150	FG 15	
	A48-30B	Ft20D / FGL200		0.602	GG20	Grade 220	FG20	
	A48-45B	Ft30D / FGL300		0.603	GG30	Grade 300	FG 30	
	A48-50B	Ft35D / FGL350		0.6035	GG35	Grade 350	FG35	
A48-60B	Ft40D / FGL400		0.604	GG40	Grade 400			
BRONZE ALUMINIUM- BRONZE TIN BRONZE	C 60 800	CuAl6		2.0918	CuAl5As			
	C 61 000	CuAl8		2.092	CuAl8			
	C 61 400	CuAl7Fe2		2.0932	CuAl8Fe3	CA 106		
	C 62 300	CuAl9Fe3Mn2		2.0936	CuAl10Fe3Mn2	CA 105		
	C 95 200	CuAl9Fe3		2.094	CuAl10Fe	AB 1		
	B 505	CuAl9Fe3		2.094	G-FeAlBzF50	AB 1		
		CuAl9Mn2		2.096	CuAl9Mn2			
	C 63 200	CuAl9Ni5Fe3Mn		2.0966	CuAl10Ni5Fe4	CA 104		
	C 95 800	CuAl9Ni5Fe		2.097	G-NiAlBzF50	AB 2		
		CuAl11Ni5Fe5		2.0978	CuAl11Ni6Fe5			
C 94100	CuPb20Sn5		2.1188	G-CuPb20Sn	LB5			

Technical data provided should be considered advisory only as variations may be necessary depending on the particular application.

Material Conversion Chart

								
	USA	France	Brazil	German W-nr	German DIN	UK	Spain	Japan JIS
BRASS	C 21000/34500	CuZn5		2.022/2.032	CuZn5	CZ 125/101		
	C 85700	CuZn40-Y30		2.034	G-CuZn37Pb	PCB 3		
	C 28000/38500	CuZn40/44Pb2		2.036/2.041	CuZn40/44Pb2	CZ 109/CZ130		
	C 68700	CuZn22Al2		2.046	CuZn20Al2	CZ 110		
	C 44300			2.047	CuZn28Sn1	CZ 111		
	C 46400			2.053	CuZn38Sn1	CZ 112		
	C 67400			2.055	CuZn40Al2	CZ 114		
	C 86400			2.0591	G-CuZn38Al	PCB1, DCB 3		
	C 86400	CuZn40-Y30		2.0592	G-CuZn35Al1	HTB 1		
	C 86300			2.0598	G-CuZn25Al5	HTB 3		
	C 90500			2.105	G-CuSn10Zn	G1		
	C 90800	CuSn12		2.1052	G-CuSn12	Pb2		
	C 91700			2.106	G-CuSn12Ni	CT2		
	C 90250			2.1086	G-CuSn10	CT1		
	C 93200	CuSn7Pb6Zn4		2.109	G-CuSn7ZnPb			
	C 92410			2.1093	G-CuSn6ZnNi	LG4		
C 83600	CuPb5Sn5Zn5		2.1096	G-CuSn5ZnPb/RG5	LG2			
C 93700	CuPb10Sn10		2.1176	G-CuPb10Sn	LB2			
C 93800			2.1182	G-CuPb15Sn	LB1			
COPPER COPPER/NICKEL ALLOYS	C 96200			2.0815	G-CuNi10			
	C 71300	CiNi25		2.083	CuNi25	CN 105		
	C 96400			2.0835	G-CuNi30	CN 2		
	C 72150	CuNi44		2.0842	CuNi44Mn1			
	C 70600	CuNi10Fe1Mn		2.0872	CuNi10Fe1Mn	CN 102		
	C 71500	CuNi30Mn1Fe		2.0882	CuNi30Mn1Fe	CN 107		
	C 17000	CuBe1,7		2.1245	CuBe1,7	CB 101		
	C 17200	CuBe1,9		2.1247	CuBe2			
	C 17500			2.1285	CuCo2Be	C 112		
	C 71640	CuNi30Fe2Mn2			CuNi30Fe2Mn2	CN 108		
	OF	Cu-c1/C2		2.004	OF-Cu	Cu-OF C 103/110		
	C 11000	Cu-a1/A2		2.006	E-Cu57	Cu-ETP-2 C 101		
	C 11000	Cu-a1		2.0065	E-Cu58	Cu-ETP-2 C 101		
	C 1200	Cu-b2		2.0076	SW-Cu			
	C 12200	Cu-b1		2.009	SF-Cu	Cu-DHP C 106		

Technical data provided should be considered advisory only as variations may be necessary depending on the particular application.



**Corporate
Headquarters**

Davenport, Iowa



Manufacturing

Vero Beach, Florida

Leeds, UK

Nanjing, China



Sales Offices

Derby, UK

Hong Kong

Maharashtra, India

Worldwide Distribution World Class Service

Centrally located in Davenport, Iowa, with national and international distribution through an extensive network of distributors and manufacturer's representatives, M.A. Ford® responds effectively to customer tooling needs. Our extensive line of standard products are on the shelf for immediate shipping and technical support is just a phone call away.

Visit www.mafood.com for your local M.A. Ford® representative.

Where **high performance** is the **standard**®

ISO 9001:2008 Certified



Made in USA





Where **high performance** is the **standard**®

Also available:

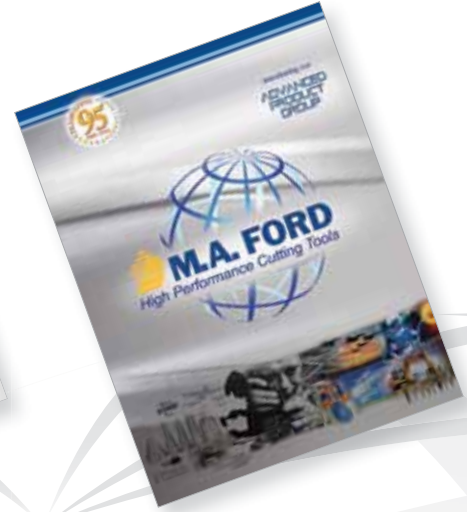

AHB Tooling & Machinery, Inc.
ISO Certified
(800) 991-4225
www.ahbinc.com
customerservice@ahbinc.com

Complete Metalworking Solutions
Roseville Saginaw & Jackson, MI

M.A. Ford® Asia-Pacific, Ltd.

Unit 2501, 25/F
148 Electric Road
North Point
Hong Kong
Ph: + 852-2167-7150
Fax: +852-2167-8150
sales@mafordap.com

M.A. Ford Europe Ltd.

Unit 38, Royal Scot Road
Pride Park, Derby
DE24 8AJ UK
Tel: +44(0) 1332 267960
Fax: +44(0) 1332 267969
sales@mafordeurope.com
www.mafordeurope.com

M.A. Ford® Asia-Pacific Ltd. (India)

412A, Arcadia
Hiranandani Estate,
Thane (W) - 400607
Maharashtra, India
Ph: +91 22 41237421
Fax: +91 22 41233387
sales@mafordin.com