

# TR4D

High Feed Radius Mill

*Chip Breaker Style Inserts  
added*

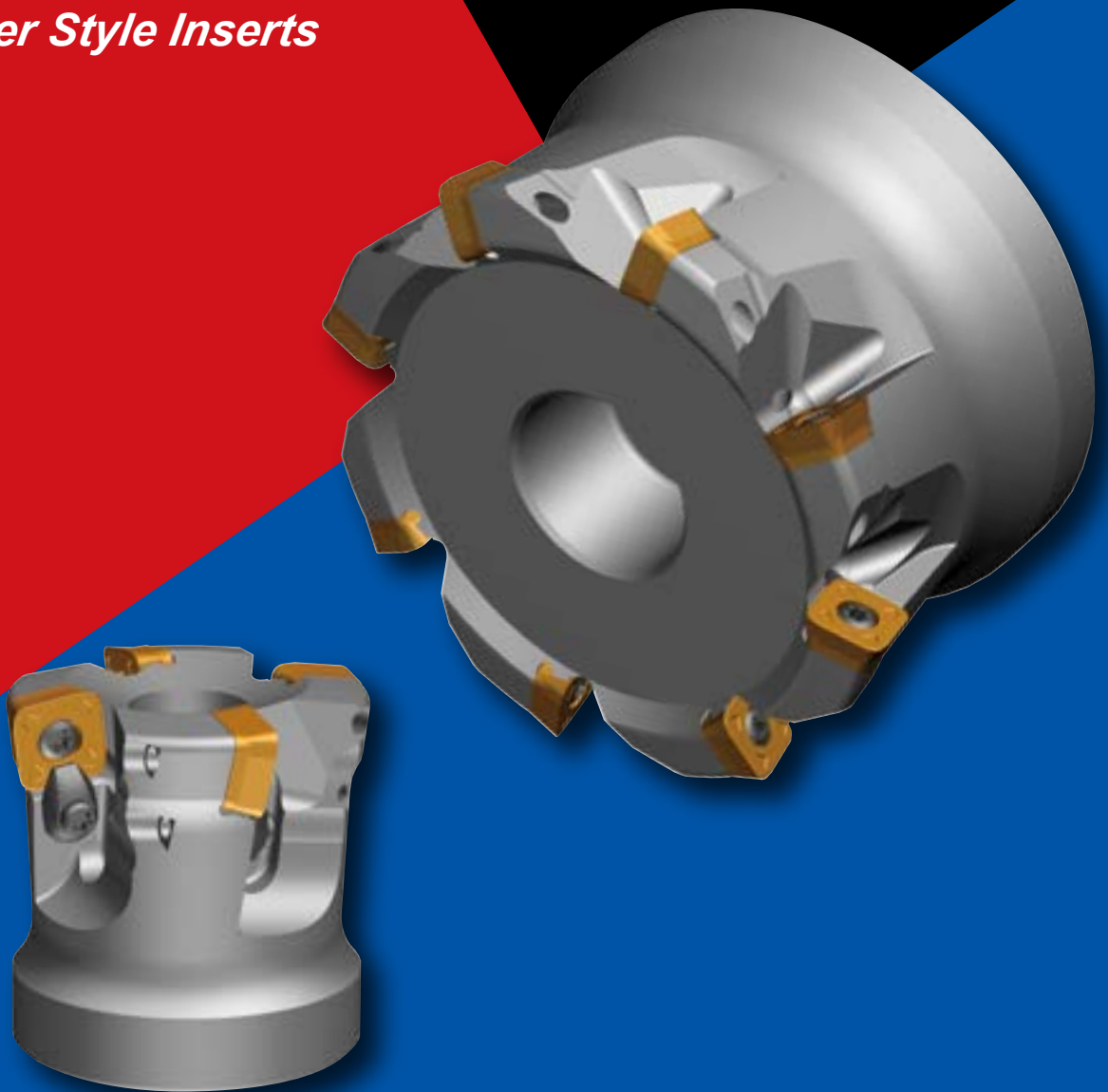



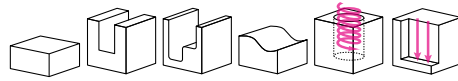
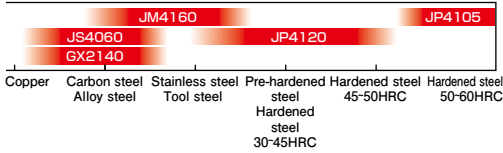

**MOLDINO Tool Engineering, Ltd.**

# Technology

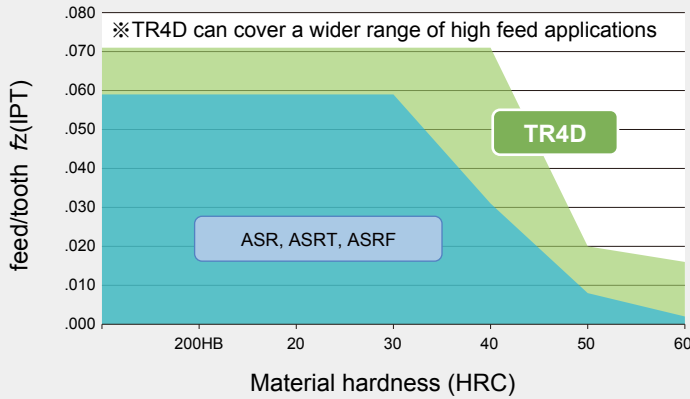

## Features 01 Pocket Stability



	Conventional	TR4D type
<b>Cross-sectional area</b>	 100%	 <b>110%</b>
<b>Constraint area</b>	 100%	 <b>135%</b>

● Increased cross-sectional and constraint areas have added insert strength for high-load cutting applications.

## Features 02 Insert Options

Insert Options - 3 geometries & 5 insert grades cover various applications.

SDNW120520TR	SDNW120520TR-P	SDMT120520TR <b>NEW</b>
		
The recommended default insert offers superior cutting edge strength. Ideal for general high-feed cutting.	Recommended for relatively continuous (uninterrupted) cutting with short overhangs. Ideal for pre-hardened steel (P20 and P21 materials).	Breaker type insert. Ideal for rough machining with low-rigidity work materials and low-horsepower M/C.

### Comparison of cutting force

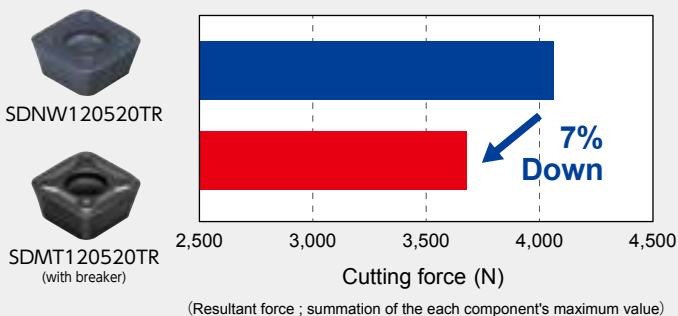

### Cutting Conditions

Work Material	Pre-hardened steel (32HRC)
Tool	DCX = 2.480 inch (63mm)
Insert Model	SDNW120520TR : JP4120 SDMT120520TR : JP4120
Cutting Speed	$v_c = 492$ SFM (150m/min)
Feed per tooth	$f_z = .059$ IPT (1.5mm/t)
Cutting depth	$a_p \times a_e = .039 \times 1.654$ inch (1.0x42mm)
Overhang	7.874 inch (200mm)
Air-blow	Single edge cutting

Line up includes:

- Inch and metric shell mill coupling
- Additional insert clamps are available for coarse pitch cutters when extreme rigidity is needed.
- Multiple pitch options including a variable pitch design to reduce vibration.



- 1 Max feed per tooth:  $f_z = .079$  IPT (2.0mm/tooth)

It is necessary to adjust the feed rate according to machining situation

- 2 For best milling performance, recommend max cutting depth  $a_p = .047$  inch (1.2mm)
- 3 Number of corners: 4 corners (single-side)

Economical multi-corner

- 4 Advantages of single sided inserts compared to double sided inserts.

- 1) Large chip pocket for chip evacuation    2) Optimized rake angle reduces chip jamming    3) Higher clamping security than a 2 sided insert.  
4) All corners can be fully used up    5) Large ramping angle

## AJ Coating Series

New AJ coating is now applied to all 4100 series inserts. AJ coating features High Al(Aluminum) content AlTiN PVD coating technology that delivers both improved heat resistance and coating adhesion. To further increase performance, 4100 series inserts have a special surface treatment that reduces friction and minimizes welding.

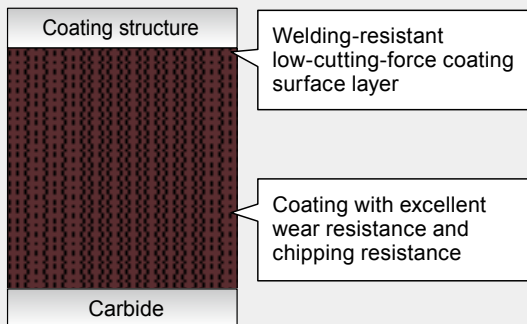

PVD Technology

Grade for machining high-hardness materials

JP4105

- Employs an ultra-fine cemented carbide substrate along with the new "AJ Coating" to improve wear resistance.
- Excellent wear resistance when machining high hardness materials of 50HRC or higher.

PVD Technology

Grade for machining pre-hardened or hardened materials

JP4120

Highly versatile with excellent cutting performance on pre-hardened steel or hardened steel. (30-50 HRC).

PVD Technology

Grade for machining stainless-steel materials

JM4160

JM4160 features a tough substrate to handle demanding stainless materials topped with AJ coating engineered specially for stainless materials.

## GX Coating Series

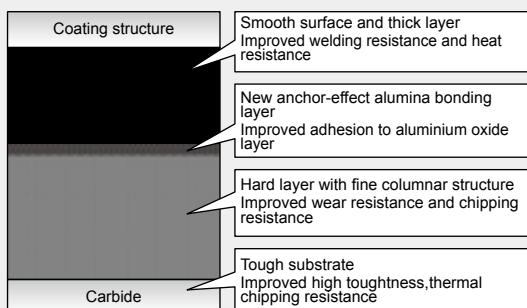

CVD Technology

General purpose for steel

GX2140

- Smooth surfaced  $\alpha$ -Al<sub>2</sub>O<sub>3</sub> layer with improved chipping / welding resistance reduces sudden chipping of cutting edge.
- Machining efficiency is improved for high speed, and high feed rate roughing by using the hard layer with fine columnar structure.
- Dry cutting of materials less than 35 HRC.
- For continuous and light interrupted cutting.

# Line up

## Shell Mill type

## (I)TR4D4○○○B(M)-○

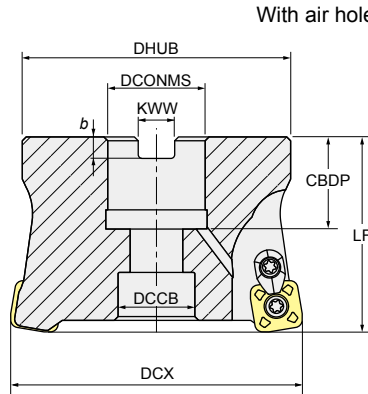
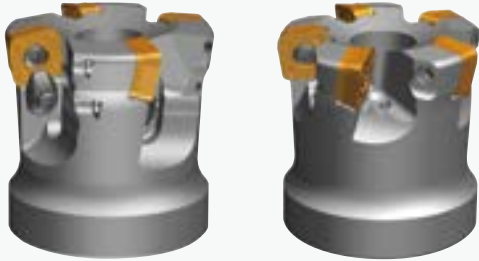

Fig.1 with clamp piece set

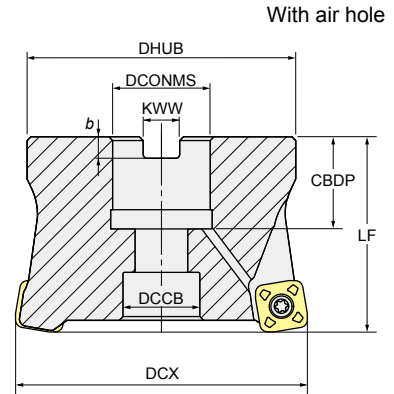

Fig.2 Multi-flutes (no clamp piece set)

## Inch



Order No.	Stock	# of Flutes	Dimensions (inch)								Insert	Fig.
			DCX	DHUB	LF	CBDP	KWW	b	DCONMS	DCCB		
ITR4D4032B-4	●	4	2.000	1.875	2.000	.748	.313	.187	.750	.630	SDNW120520TR SDNW120520TR-P SDMT120520TR	Fig.1
ITR4D4032B-5	●	5	2.000	1.875	2.000	.748	.313	.187	.750	.630		Fig.2
ITR4D4040B-4	●	4	2.500	2.375	2.000	.945	.375	.219	1.000	.787		Fig.1
ITR4D4040B-6	●	6	2.500	2.375	2.000	.945	.375	.219	1.000	.787		Fig.2
ITR4D4048B-5	●	5	3.000	2.750	2.000	.945	.375	.219	1.000	.787		Fig.1
ITR4D4048B-7	●	7	3.000	2.750	2.000	.945	.375	.219	1.000	.787		Fig.2
ITR4D4048B-7-1.25	●	7	3.000	2.875	2.500	1.260	.500	.281	1.250	1.024		Fig.2
ITR4D4064B-6	●	6	4.000	3.813	2.500	1.181	.625	.375	1.500	1.181		Fig.1
ITR4D4064B-8	●	8	4.000	3.813	2.500	1.181	.625	.375	1.500	1.181	Fig.2	

## Metric

Order No.	Stock	# of Flutes	Dimensions (mm)								Insert	Fig.
			DCX	DHUB	LF	CBDP	KWW	b	DCONMS	DCCB		
TR4D4050BM-3	●	3	50	47	50	20	10.4	6.3	22	17	SDNW120520TR SDNW120520TR-P SDMT120520TR	Fig.1
TR4D4050BM-4	●	4	50	47	50	20	10.4	6.3	22	17		Fig.1
TR4D4063BM-4	●	4	63	60	50	20	10.4	6.3	22	17		Fig.1
TR4D4063BM-5	●	5	63	60	50	20	10.4	6.3	22	17		Fig.1
TR4D4080BM-5	●	5	80	76	70	22	12.4	7	27	20		Fig.1
TR4D4100BM-6	●	6	100	96	70	25.5	14.4	8	32	26		Fig.1

## Parts

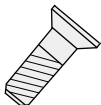
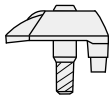
The clamp screw is a consumable part. Clamp screw replacement is dependent on use. We recommend replacing screw at signs of wear on screw seat chamfer.

Parts	Insert Screw	Clamp Piece Set	Wrench	Screw Anti-Seizure Agent
Shape				
Order No.	262-141	CM3.5-141	105-T15	P37

● : Inventory maintained in US

# Insert

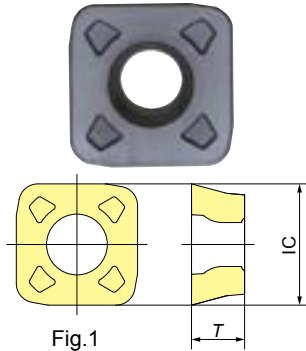

Fig.1

**SDNW120520TR**

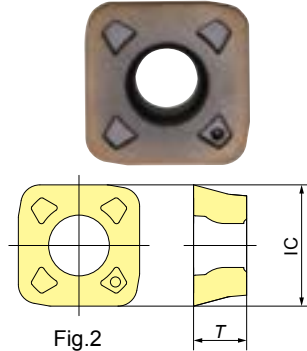

Fig.2

**SDNW120520TR-P**

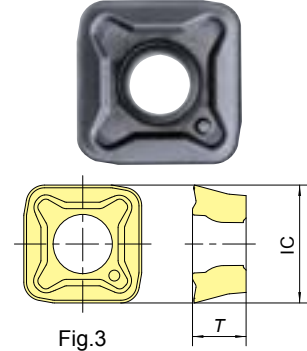

Fig.3

**SDMT120520TR**

<b>P</b>	Carbon steel													■ : General cutting, First recommendation □ : General cutting, Second recommendation
<b>M</b>	Stainless Steel													
<b>K</b>	Cast Iron/Ductile Cast Iron													
<b>H</b>	Hardened steel													
Item Code	Tolerance Class	AJ-Coated			JS-Coated		GX-Coated	Dimensions (mm)		Dimensions (inch)		Shape		
		JP4105	JP4120	JM4160	JS4045	JS4060	GX2140	IC	T	IC	T			
SDNW120520TR	N	●	●	●	△	●	●	12.7	5.56	.500	.219	Fig.1		
SDNW120520TR-P			●	●								Fig.2		
SDMT120520TR	M	●*1	●*1			●	●					5.76		

※ 1 : Can be used to process the precipitation hardened stainless steel.

[Note] Please note that the GX coating and JS coating do not cause a reaction in conductive touch sensors.

## Grade map for less than 35HRC

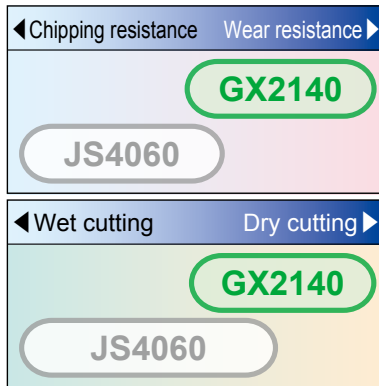

## Grade map for work material

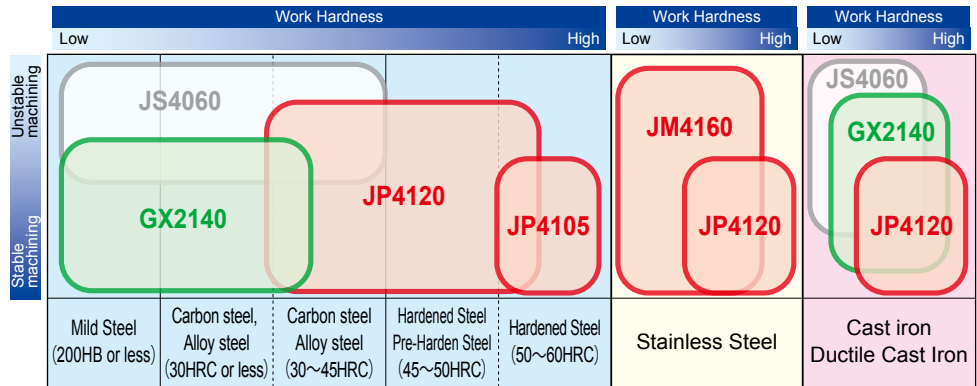

# Recommended Cutting Conditions

Inch

Face Milling, Side Milling

Red indicates primary recommended insert grade.

Work Material	Insert Grade	Cutter Dia.	φ 2.000(4NT)				φ 2.000(5NT)				φ 2.500(4NT)				φ 2.500(6NT)								
			<3Dc		3~5Dc	5~7Dc	>7Dc	<3Dc		3~5Dc	5~7Dc	>7Dc	<3Dc		3~5Dc	5~7Dc	>7Dc	<3Dc		3~5Dc	5~7Dc	>7Dc	
			General	High Speed				General	High Speed				General	High Speed				General	High Speed				
General Structural Steel (200HB or less)	GX2140 JS4060	n (min <sup>-1</sup> )	940	1,250	940	810	690	940	1,250	940	810	690	750	1,000	750	650	550	750	1,000	750	650	550	
		vc (SFM)	492	654	492	424	361	492	654	492	424	361	491	654	491	425	360	491	654	491	425	360	
		vf (IPM)	270	400	270	230	200	330	490	330	290	240	210	320	210	180	160	320	470	320	280	230	
		fz (IPT)	.071	.079	.071	.071	.071	.071	.079	.071	.071	.071	.071	.079	.079	.071	.071	.071	.071	.079	.071	.071	.071
		ap (inch)	.039	.039	.039	.031	.031	.039	.039	.039	.031	.031	.039	.039	.039	.031	.031	.031	.039	.039	.039	.031	.031
		ae (inch)	1.600	1.600	1.600	1.600	1.600	1.600	1.600	1.600	1.600	1.600	2.000	2.000	2.000	2.000	2.000	2.000	2.000	2.000	2.000	2.000	2.000
		Q (inch <sup>3</sup> /min)	16.8	25.0	16.8	11.4	9.9	20.6	30.6	20.6	14.4	11.9	16.4	25.0	16.4	11.2	9.9	25.0	36.7	25.0	17.4	14.3	
Carbon Steel Alloy Steel (<35HRC)	GX2140 JS4060	n (min <sup>-1</sup> )	940	1,250	940	810	690	940	1,250	940	810	690	750	1,000	750	650	550	750	1,000	750	650	550	
		vc (SFM)	492	654	492	424	361	492	654	492	424	361	491	654	491	425	360	491	654	491	425	360	
		vf (IPM)	270	400	270	230	200	330	490	330	290	240	210	320	210	180	160	320	470	320	280	230	
		fz (IPT)	.071	.079	.071	.071	.071	.071	.079	.071	.071	.071	.071	.079	.079	.071	.071	.071	.071	.079	.071	.071	.071
		ap (inch)	.039	.039	.039	.031	.031	.039	.039	.039	.031	.031	.039	.039	.039	.031	.031	.031	.039	.039	.039	.031	.031
		ae (inch)	1.600	1.600	1.600	1.600	1.600	1.600	1.600	1.600	1.600	1.600	2.000	2.000	2.000	2.000	2.000	2.000	2.000	2.000	2.000	2.000	2.000
		Q (inch <sup>3</sup> /min)	16.8	25.0	16.8	11.4	9.9	20.6	30.6	20.6	14.4	11.9	16.4	25.0	16.4	11.2	9.9	25.0	36.7	25.0	17.4	14.3	
Carbon Steel Alloy Steel (35~45HRC)	JP4120 JS4060	n (min <sup>-1</sup> )	810	940	810	690	560	810	940	810	690	560	650	750	650	550	450	650	750	650	550	450	
		vc (SFM)	424	492	424	361	293	424	492	424	361	293	425	491	425	360	295	425	491	425	360	295	
		vf (IPM)	230	300	230	170	140	290	370	290	220	180	180	240	180	140	110	280	360	280	210	170	
		fz (IPT)	.071	.079	.071	.063	.063	.071	.079	.071	.063	.063	.071	.079	.071	.063	.063	.071	.079	.071	.063	.063	
		ap (inch)	.039	.039	.039	.031	.031	.039	.039	.039	.031	.031	.039	.039	.039	.031	.031	.031	.039	.039	.039	.031	.031
		ae (inch)	1.600	1.600	1.600	1.600	1.600	1.600	1.600	1.600	1.600	1.600	2.000	2.000	2.000	2.000	2.000	2.000	2.000	2.000	2.000	2.000	2.000
		Q (inch <sup>3</sup> /min)	14.4	18.7	14.4	8.4	6.9	18.1	23.1	18.1	10.9	8.9	14.0	18.7	14.0	8.7	6.8	21.8	28.1	21.8	13.0	10.5	
300 series Stainless Steel (WET)	JM4160	n (min <sup>-1</sup> )	630	-	630	530	440	630	-	630	530	440	500	-	500	430	350	500	-	500	430	350	
		vc (SFM)	330	-	330	278	230	330	-	330	278	230	327	-	327	281	229	327	-	327	281	229	
		vf (IPM)	100	-	100	80	70	120	-	120	100	90	80	-	80	70	50	120	-	120	100	80	
		fz (IPT)	.039	-	.039	.039	.039	.039	-	.039	.039	.039	.039	-	.039	.039	.039	.039	-	.039	.039	.039	
		ap (inch)	.039	-	.039	.031	.031	.039	-	.039	.031	.031	.039	-	.039	.031	.031	.039	-	.039	.031	.031	
		ae (inch)	1.600	-	1.600	1.600	1.600	1.600	-	1.600	1.600	1.600	2.000	-	2.000	2.000	2.000	2.000	-	2.000	2.000	2.000	
		Q (inch <sup>3</sup> /min)	6.2	-	6.2	4.0	3.5	7.5	-	7.5	5.0	4.5	6.2	-	6.2	4.3	3.1	9.4	-	9.4	6.2	5.0	
Precipitation Hardening Stainless Steel (WET)	JM4160 JP4120	n (min <sup>-1</sup> )	560	-	560	500	440	560	-	560	500	440	450	-	450	400	350	450	-	450	400	350	
		vc (SFM)	293	-	293	262	230	293	-	293	262	230	295	-	295	262	229	295	-	295	262	229	
		vf (IPM)	70	-	70	60	50	90	-	90	80	70	60	-	60	50	40	80	-	80	70	70	
		fz (IPT)	.031	-	.031	.031	.031	.031	-	.031	.031	.031	.031	-	.031	.031	.031	.031	-	.031	.031	.031	
		ap (inch)	.039	-	.039	.031	.031	.039	-	.039	.031	.031	.039	-	.039	.031	.031	.039	-	.039	.031	.031	
		ae (inch)	1.600	-	1.600	1.600	1.600	1.600	-	1.600	1.600	1.600	2.000	-	2.000	2.000	2.000	2.000	-	2.000	2.000	2.000	
		Q (inch <sup>3</sup> /min)	4.4	-	4.4	3.0	2.5	5.6	-	5.6	4.0	3.5	4.7	-	4.7	3.1	2.5	6.2	-	6.2	4.3	4.3	
Cast Iron Ductile Cast Iron	GX2140 JS4060 JP4120	n (min <sup>-1</sup> )	940	1,250	940	810	690	940	1,250	940	810	690	750	1,000	750	650	550	750	1,000	750	650	550	
		vc (SFM)	492	654	492	424	361	492	654	492	424	361	491	654	491	425	360	491	654	491	425	360	
		vf (IPM)	300	400	300	260	220	370	490	370	320	270	240	320	240	210	170	360	470	360	310	260	
		fz (IPT)	.079	.079	.079	.079	.079	.079	.079	.079	.079	.079	.079	.079	.079	.079	.079	.079	.079	.079	.079	.079	
		ap (inch)	.039	.039	.039	.031	.031	.039	.039	.039	.031	.031	.039	.039	.039	.031	.031	.031	.039	.039	.039	.031	.031
		ae (inch)	1.600	1.600	1.600	1.600	1.600	1.600	1.600	1.600	1.600	1.600	2.000	2.000	2.000	2.000	2.000	2.000	2.000	2.000	2.000	2.000	
		Q (inch <sup>3</sup> /min)	18.7	25.0	18.7	12.9	10.9	23.1	30.6	23.1	15.9	13.4	18.7	25.0	18.7	13.0	10.5	28.1	36.7	28.1	19.2	16.1	
Hardened Steel (45~50HRC)	JP4120 JP4105	n (min <sup>-1</sup> )	500	560	500	440	380	500	560	500	440	380	400	450	400	350	300	400	450	400	350	300	
		vc (SFM)	262	293	262	230	199	262	293	262	230	199	262	295	262	229	196	262	295	262	229	196	
		vf (IPM)	40	70	40	40	30	50	90	50	40	40	30	60	30	30	20	50	80	50	40	40	
		fz (IPT)	.020	.031	.020	.020	.020	.020	.031	.020	.020	.020	.020	.020	.031	.020	.020	.020	.020	.031	.020	.020	
		ap (inch)	.031	.031	.031	.024	.024	.031	.031	.031	.024	.024	.024	.031	.031	.031	.024	.024	.024	.031	.031	.031	
		ae (inch)	1.600	1.600	1.600	1.600	1.600	1.600	1.600	1.600	1.600	1.600	2.000	2.000	2.000	2.000	2.000	2.000	2.000	2.000	2.000	2.000	
		Q (inch <sup>3</sup> /min)	2.0	3.5	2.0	1.5	1.2	2.5	4.5	2.5	1.5	1.5	1.9	3.7	1.9	1.4	1.0	3.1	5.0	3.1	1.9	1.9	
Hardened Steel (50~60HRC)	JP4105 JP4120	n (min <sup>-1</sup> )	500	560	500	440	380	500	560	500	440	380	400	450	400	350	300	400	450	400	350	300	
		vc (SFM)	262	293	262	230	199	262	293	262	230	199	262	295	262	229	196	262	295	262	229	196	
		vf (IPM)	30	50	30	30	20	40	70	40	40	30	40	30	30	20	20	40	60	40	30	30	
		fz (IPT)	.016	.024	.016	.016	.016	.016	.024	.016	.016	.016	.016	.016	.024	.016	.016	.016	.016	.024	.016	.016	
		ap (inch)	.031	.031	.031	.024	.024	.031	.031	.031	.024	.024	.024	.031	.031	.031	.024	.024	.031	.031	.031	.024	
		ae (inch)	1.600	1.600	1.600	1.600	1.600	1.600	1.600	1.600	1.600	1.600	2.000	2.000	2.000	2.000	2.000	2.000	2.000	2.000	2.000	2.000	
		Q (inch <sup>3</sup> /min)	1.5	2.5	1.5	1.2	.8	2.0	3.5	2.0	1.5	1.2	1.9	2.5	1.9	1.0	1.0	2.5	3.7	2.5	1.4	1.4	

## Standard Cutting Conditions for plunging

Red indicates primary recommended insert grade.

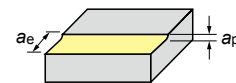

Work Material	Insert Grade	Cutter Dia.	φ 3.000(5NT)				φ 3.000(7NT)				φ 4.000(6NT)				φ 4.000(8NT)							
			Overhang Ratio		<3Dc	3~5Dc	5~7Dc	>7Dc	<3Dc		3~5Dc	5~7Dc	>7Dc	<3Dc		3~5Dc	5~7Dc	>7Dc				
			General	High Speed					General	High Speed				General	High Speed				General	High Speed		
General Structural Steel (200HB or less)	GX2140 JS4060	n (min <sup>-1</sup> )	630	840	630	540	460	630	840	630	540	460	470	630	470	410	340	470	630	470	410	340
		vc (SFM)	495	660	495	424	361	495	660	495	424	361	492	660	492	429	356	492	660	492	429	356
		vf (IPM)	220	330	220	190	160	310	460	310	270	230	200	300	200	170	140	270	400	270	230	190
		fz (IPT)	.071	.079	.071	.071	.071	.071	.079	.071	.071	.071	.071	.079	.071	.071	.071	.071	.079	.071	.071	.071
		ap (inch)	.039	.039	.039	.031	.031	.039	.039	.039	.031	.031	.039	.039	.039	.031	.031	.039	.039	.039	.031	.031
		ae (inch)	2.400	2.400	2.400	2.400	2.400	2.400	2.400	2.400	2.400	2.400	3.200	3.200	3.200	3.200	3.200	3.200	3.200	3.200	3.200	3.200
		Q (inch <sup>3</sup> /min)	20.6	30.9	20.6	14.1	11.9	29.0	43.1	29.0	20.1	17.1	25.0	37.4	25.0	16.9	13.9	33.7	49.9	33.7	22.8	18.8
Carbon Steel Alloy Steel (<35HRC)	GX2140 JS4060	n (min <sup>-1</sup> )	630	840	630	540	460	630	840	630	540	460	470	630	470	410	340	470	630	470	410	340
		vc (SFM)	495	660	495	424	361	495	660	495	424	361	492	660	492	429	356	492	660	492	429	356
		vf (IPM)	220	330	220	190	160	310	460	310	270	230	200	300	200	170	140	270	400	270	230	190
		fz (IPT)	.071	.079	.071	.071	.071	.071	.079	.071	.071	.071	.071	.079	.071	.071	.071	.071	.079	.071	.071	.071
		ap (inch)	.039	.039	.039	.031	.031	.039	.039	.039	.031	.031	.039	.039	.039	.031	.031	.039	.039	.039	.031	.031
		ae (inch)	2.400	2.400	2.400	2.400	2.400	2.400	2.400	2.400	2.400	2.400	3.200	3.200	3.200	3.200	3.200	3.200	3.200	3.200	3.200	3.200
		Q (inch <sup>3</sup> /min)	20.6	30.9	20.6	14.1	11.9	29.0	43.1	29.0	20.1	17.1	25.0	37.4	25.0	16.9	13.9	33.7	49.9	33.7	22.8	18.8
Carbon Steel Alloy Steel (35~45HRC)	JP4120 JS4060	n (min <sup>-1</sup> )	540	630	540	460	380	540	630	540	460	380	410	470	410	340	280	410	470	410	340	280
		vc (SFM)	424	495	424	361	298	424	495	424	361	298	429	492	429	356	293	429	492	429	356	293
		vf (IPM)	190	250	190	140	120	270	350	270	200	170	170	220	170	130	110	230	300	230	170	140
		fz (IPT)	.071	.079	.071	.063	.063	.071	.079	.071	.063	.063	.071	.079	.071	.063	.063	.071	.079	.071	.063	.063
		ap (inch)	.039	.039	.039	.031	.031	.039	.039	.039	.031	.031	.039	.039	.039	.031	.031	.039	.039	.039	.031	.031
		ae (inch)	2.400	2.400	2.400	2.400	2.400	2.400	2.400	2.400	2.400	2.400	3.200	3.200	3.200	3.200	3.200	3.200	3.200	3.200	3.200	3.200
		Q (inch <sup>3</sup> /min)	17.8	23.4	17.8	10.4	8.9	25.3	32.8	25.3	14.9	12.6	21.2	27.5	21.2	12.9	10.9	28.7	37.4	28.7	16.9	13.9
300 series Stainless Steel (WET)	JM4160	n (min <sup>-1</sup> )	420	-	420	360	290	420	-	420	360	290	310	-	310	270	220	310	-	310	270	220
		vc (SFM)	330	-	330	283	228	330	-	330	283	228	325	-	325	283	230	325	-	325	283	230
		vf (IPM)	80	-	80	70	60	110	-	110	100	80	70	-	70	60	50	100	-	100	80	70
		fz (IPT)	.039	-	.039	.039	.039	.039	-	.039	.039	.039	.039	-	.039	.039	.039	.039	-	.039	.039	.039
		ap (inch)	.039	-	.039	.031	.031	.039	-	.039	.031	.031	.039	-	.039	.031	.031	.039	-	.039	.031	.031
		ae (inch)	2.400	-	2.400	2.400	2.400	2.400	-	2.400	2.400	2.400	3.200	-	3.200	3.200	3.200	3.200	-	3.200	3.200	3.200
		Q (inch <sup>3</sup> /min)	7.5	-	7.5	5.2	4.5	10.3	-	10.3	7.4	6.0	8.7	-	8.7	6.0	5.0	12.5	-	12.5	7.9	6.9
Precipitation Hardening Stainless Steel (WET)	JM4160 JP4120	n (min <sup>-1</sup> )	380	-	380	330	290	380	-	380	330	290	280	-	280	250	220	280	-	280	250	220
		vc (SFM)	298	-	298	259	228	298	-	298	259	228	293	-	293	262	230	293	-	293	262	230
		vf (IPM)	60	-	60	50	40	80	-	80	70	60	50	-	50	50	40	70	-	70	60	50
		fz (IPT)	.031	-	.031	.031	.031	.031	-	.031	.031	.031	.031	-	.031	.031	.031	.031	-	.031	.031	.031
		ap (inch)	.039	-	.039	.031	.031	.039	-	.039	.031	.031	.039	-	.039	.031	.031	.039	-	.039	.031	.031
		ae (inch)	2.400	-	2.400	2.400	2.400	2.400	-	2.400	2.400	2.400	3.200	-	3.200	3.200	3.200	3.200	-	3.200	3.200	3.200
		Q (inch <sup>3</sup> /min)	5.6	-	5.6	3.7	3.0	7.5	-	7.5	5.2	4.5	6.2	-	6.2	5.0	4.0	8.7	-	8.7	6.0	5.0
Cast Iron Ductile Cast Iron	GX2140 JS4060 JP4120	n (min <sup>-1</sup> )	630	840	630	540	460	630	840	630	540	460	470	630	470	410	340	470	630	470	410	340
		vc (SFM)	495	660	495	424	361	495	660	495	424	361	492	660	492	429	356	492	660	492	429	356
		vf (IPM)	250	330	250	210	180	350	460	350	300	250	220	300	220	190	160	300	400	300	260	210
		fz (IPT)	.079	.079	.079	.079	.079	.079	.079	.079	.079	.079	.079	.079	.079	.079	.079	.079	.079	.079	.079	.079
		ap (inch)	.039	.039	.039	.031	.031	.039	.039	.039	.031	.031	.039	.039	.039	.031	.031	.039	.039	.039	.031	.031
		ae (inch)	2.400	2.400	2.400	2.400	2.400	2.400	2.400	2.400	2.400	2.400	3.200	3.200	3.200	3.200	3.200	3.200	3.200	3.200	3.200	3.200
		Q (inch <sup>3</sup> /min)	23.4	30.9	23.4	15.6	13.4	32.8	43.1	32.8	22.3	18.6	27.5	37.4	27.5	18.8	15.9	37.4	49.9	37.4	25.8	20.8
Hardened Steel (45~50HRC)	JP4120 JP4105	n (min <sup>-1</sup> )	330	380	330	290	250	330	380	330	290	250	250	280	250	220	190	250	280	250	220	190
		vc (SFM)	259	298	259	228	196	259	298	259	228	196	262	293	262	230	199	262	293	262	230	199
		vf (IPM)	30	60	30	30	30	50	80	50	40	40	30	50	30	30	20	40	70	40	40	30
		fz (IPT)	.020	.031	.020	.020	.020	.020	.031	.020	.020	.020	.020	.031	.020	.020	.020	.020	.031	.020	.020	.020
		ap (inch)	.031	.031	.031	.024	.024	.031	.031	.031	.024	.024	.031	.031	.031	.024	.024	.031	.031	.031	.024	.024
		ae (inch)	2.400	2.400	2.400	2.400	2.400	2.400	2.400	2.400	2.400	2.400	3.200	3.200	3.200	3.200	3.200	3.200	3.200	3.200	3.200	3.200
		Q (inch <sup>3</sup> /min)	2.2	4.5	2.2	1.7	1.7	3.7	6.0	3.7	2.3	2.3	3.0	5.0	3.0	2.3	1.5	4.0	6.9	4.0	3.1	2.3
Hardened Steel (50~60HRC)	JP4105 JP4120	n (min <sup>-1</sup> )	330	380	330	290	250	330	380	330	290	250	250	280	250	220	190	250	280	250	220	190
		vc (SFM)	259	298	259	228	196	259	298	259	228	196	262	293	262	230	199	262	293	262	230	199
		vf (IPM)	30	50	30	20	20	40	60	40	30	30	20	40	20	20	20	30	50	30	30	20
		fz (IPT)	.016	.024	.016	.016	.016	.016	.024	.016	.016	.016	.016	.024	.016	.016	.016	.016	.024	.016	.016	.016
		ap (inch)	.031	.031	.031	.024	.024	.031	.031	.031	.024	.024	.031	.031	.031	.024	.024	.031	.031	.031	.024	.024
		ae (inch)	2.400	2.400	2.400	2.400	2.400	2.400	2.400	2.400	2.400	2.400	3.200	3.200	3.200	3.200	3.200	3.200	3.200	3.200	3.200	3.200
		Q (inch <sup>3</sup> /min)	2.2	3.7	2.2	1.2	1.2	3.0	4.5	3.0	1.7	1.7	2.0	4.0	2.0	1.5	1.5	3.0	5.0	3.0	2.3	1.5

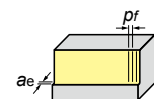

Work Material	Insert Grade	Cutter Dia.	φ 3.000(5NT)				φ 3.000(7NT)				φ 4.000(6NT)				φ 4.000(8NT)			
			Overhang Ratio		<3Dc	3~5Dc	5~7Dc	>7Dc	<3Dc	3~5Dc	5~7Dc	>7Dc	<3Dc	3~5Dc	5~7Dc	>7Dc	<3Dc	3~5Dc
Cast Iron Ductile Cast Iron	JP4120 GX2140 JS4060	n (min <sup>-1</sup> )	840	840	710	630	840	840	710	630	630	630	530	470	630	630	530	470
		vc (SFM)	660	660	558	495	660	660	558	495	660	660	555	492	660	660	555	492
		vf (IPM)	30	30	20	20	50	50	30	30	30	30	20	20	40	40	30	20
		fz (IPT)	.008	.008	.006	.006	.008	.008	.006	.006	.008	.008	.006	.006	.008	.008	.006	.006
		pr (inch)	≤0.5Dc				≤0.5Dc				≤0.5Dc				≤0.5Dc			
		ae (inch)	≤.354				≤.354				≤.354				≤.354			

- [Note]**

# Recommended Cutting Conditions

## Metric

### Face Milling, Side Milling

Red indicates primary recommended insert grade.

Work Material	Insert Grade	Cutter Dia.	φ 1.969 inch (50mm) (3NT)					φ 1.969 inch (50mm) (4NT)					φ 2.480 inch (63mm) (4NT)					
			Overhang Ratio	<3Dc		3~5Dc	5~7Dc	>7Dc	<3Dc		3~5Dc	5~7Dc	>7Dc	<3Dc		3~5Dc	5~7Dc	>7Dc
				General	High Speed				General	High Speed				General	High Speed			
General Structural Steel (200HB or less)	GX2140 JS4060	n (min <sup>-1</sup> )	950	1,270	950	830	700	950	1,270	950	830	700	760	1,010	760	660	560	
		vc (SFM)	492	656	492	426	361	492	656	492	426	361	492	656	492	426	361	
		vf (IPM)	202	300	202	176	149	269	400	269	235	198	215	318	215	187	159	
		fz (IPT)	.071	.079	.071	.071	.071	.071	.079	.071	.071	.071	.071	.071	.079	.071	.071	.071
		ap (inch)	.039	.039	.039	.031	.031	.039	.039	.039	.031	.031	.039	.039	.039	.031	.031	
		ae (inch)	1.575	1.575	1.575	1.575	1.575	1.575	1.575	1.575	1.575	1.575	1.575	1.969	1.969	1.969	1.969	1.969
		Q (inch <sup>3</sup> /min)	8.1	12.0	8.1	5.6	4.8	10.8	16.0	10.8	7.5	6.3	10.8	15.9	10.8	7.5	6.3	
Carbon Steel Alloy Steel (<35HRC)	GX2140 JS4060	n (min <sup>-1</sup> )	950	1,270	950	830	700	950	1,270	950	830	700	760	1,010	760	660	560	
		vc (SFM)	492	656	492	426	361	492	656	492	426	361	492	656	492	426	361	
		vf (IPM)	202	300	202	176	149	269	400	269	235	198	215	318	215	187	159	
		fz (IPT)	.071	.079	.071	.071	.071	.071	.079	.071	.071	.071	.071	.079	.071	.071	.071	
		ap (inch)	.039	.039	.039	.031	.031	.039	.039	.039	.031	.031	.039	.039	.039	.031	.031	
		ae (inch)	1.575	1.575	1.575	1.575	1.575	1.575	1.575	1.575	1.575	1.575	1.575	1.969	1.969	1.969	1.969	1.969
		Q (inch <sup>3</sup> /min)	8.1	12.0	8.1	5.6	4.8	10.8	16.0	10.8	7.5	6.3	10.8	15.9	10.8	7.5	6.3	
Carbon Steel Alloy Steel (35~45HRC)	JP4120 JS4060	n (min <sup>-1</sup> )	830	950	830	700	570	830	950	830	700	570	660	760	660	560	450	
		vc (SFM)	426	492	426	361	295	426	492	426	361	295	426	492	426	361	295	
		vf (IPM)	176	224	176	132	108	235	299	235	176	144	187	239	187	141	113	
		fz (IPT)	.071	.079	.071	.063	.063	.071	.079	.071	.063	.063	.071	.079	.071	.063	.063	
		ap (inch)	.039	.039	.039	.031	.031	.039	.039	.039	.031	.031	.039	.039	.039	.031	.031	
		ae (inch)	1.575	1.575	1.575	1.575	1.575	1.575	1.575	1.575	1.575	1.575	1.575	1.969	1.969	1.969	1.969	1.969
		Q (inch <sup>3</sup> /min)	7.0	9.0	7.0	4.3	3.5	9.4	12.0	9.4	5.6	4.6	9.4	12.0	9.4	5.6	4.5	
300 series Stainless Steel (WET)	JM4160	n (min <sup>-1</sup> )	640	-	640	540	450	640	-	640	540	450	510	-	510	430	350	
		vc (SFM)	328	-	328	279	230	328	-	328	279	230	328	-	328	279	230	
		vf (IPM)	76	-	76	64	53	101	-	101	85	71	80	-	80	68	55	
		fz (IPT)	.039	-	.039	.039	.039	.039	-	.039	.039	.039	.039	-	.039	.039	.039	
		ap (inch)	.039	-	.039	.031	.031	.039	-	.039	.031	.031	.039	-	.039	.031	.031	
		ae (inch)	1.575	-	1.575	1.575	1.575	1.575	-	1.575	1.575	1.575	1.969	-	1.969	1.969	1.969	
		Q (inch <sup>3</sup> /min)	3.0	-	3.0	2.0	1.7	4.0	-	4.0	2.7	2.3	4.0	-	4.0	2.7	2.2	
Precipitation Hardening Stainless Steel (WET)	JM4160 JP4120	n (min <sup>-1</sup> )	570	-	570	510	450	570	-	570	510	450	450	-	450	400	350	
		vc (SFM)	295	-	295	262	230	295	-	295	262	230	295	-	295	262	230	
		vf (IPM)	54	-	54	48	43	72	-	72	64	57	57	-	57	50	44	
		fz (IPT)	.031	-	.031	.031	.031	.031	-	.031	.031	.031	.031	-	.031	.031	.031	
		ap (inch)	.039	-	.039	.031	.031	.039	-	.039	.031	.031	.039	-	.039	.031	.031	
		ae (inch)	1.575	-	1.575	1.575	1.575	1.575	-	1.575	1.575	1.575	1.969	-	1.969	1.969	1.969	
		Q (inch <sup>3</sup> /min)	2.2	-	2.2	1.5	1.4	2.9	-	2.9	2.0	1.8	2.8	-	2.8	2.0	1.8	
Cast Iron Ductile Cast Iron	GX2140 JS4060 JP4120	n (min <sup>-1</sup> )	950	1,270	950	830	700	950	1,270	950	830	700	760	1,010	760	660	560	
		vc (SFM)	492	656	492	426	361	492	656	492	426	361	492	656	492	426	361	
		vf (IPM)	224	300	224	196	165	299	400	299	261	220	239	318	239	208	176	
		fz (IPT)	.079	.079	.079	.079	.079	.079	.079	.079	.079	.079	.079	.079	.079	.079	.079	
		ap (inch)	.039	.039	.039	.031	.031	.039	.039	.039	.031	.031	.039	.039	.039	.031	.031	
		ae (inch)	1.575	1.575	1.575	1.575	1.575	1.575	1.575	1.575	1.575	1.575	1.575	1.969	1.969	1.969	1.969	
		Q (inch <sup>3</sup> /min)	9.0	12.0	9.0	6.3	5.3	12.0	16.0	12.0	8.3	7.0	12.0	15.9	12.0	8.3	7.0	
Hardened Steel (45~50HRC)	JP4120 JP4105	n (min <sup>-1</sup> )	510	570	510	450	380	510	570	510	450	380	400	450	400	350	300	
		vc (SFM)	262	295	262	230	197	262	295	262	230	197	262	295	262	230	197	
		vf (IPM)	30	54	30	27	22	40	72	40	35	30	31	57	31	28	24	
		fz (IPT)	.020	.031	.020	.020	.020	.020	.031	.020	.020	.020	.020	.031	.020	.020	.020	
		ap (inch)	.031	.031	.031	.024	.024	.031	.031	.031	.024	.024	.031	.031	.031	.031	.024	.024
		ae (inch)	1.575	1.575	1.575	1.575	1.575	1.575	1.575	1.575	1.575	1.575	1.575	1.969	1.969	1.969	1.969	1.969
		Q (inch <sup>3</sup> /min)	1.0	1.7	1.0	.6	.6	1.3	2.3	1.3	.9	.7	1.3	2.3	1.3	.8	.7	
Hardened Steel (50~60HRC)	JP4105 JP4120	n (min <sup>-1</sup> )	510	570	510	450	380	510	570	510	450	380	400	450	400	350	300	
		vc (SFM)	262	295	262	230	197	262	295	262	230	197	262	295	262	230	197	
		vf (IPM)	24	41	24	21	18	32	54	32	28	24	25	43	25	22	19	
		fz (IPT)	.016	.024	.016	.016	.016	.016	.024	.016	.016	.016	.016	.024	.016	.016	.016	
		ap (inch)	.031	.031	.031	.024	.024	.031	.031	.031	.024	.024	.031	.031	.031	.031	.024	.024
		ae (inch)	1.575	1.575	1.575	1.575	1.575	1.575	1.575	1.575	1.575	1.575	1.575	1.969	1.969	1.969	1.969	1.969
		Q (inch <sup>3</sup> /min)	.8	1.3	.8	.5	.4	1.0	1.7	1.0	.7	.6	1.0	1.7	1.0	.7	.6	

### Standard Cutting Conditions for plunging

Red indicates primary recommended insert grade.

Work Material	Insert Grade	Cutter Dia.	φ 1.969 inch (50 mm) (3NT)				φ 1.969 inch (50mm) (4NT)				φ 2.480 inch (63mm) (4NT)			
			Overhang Ratio	<3Dc	3~5Dc	5~7Dc	>7Dc	<3Dc	3~5Dc	5~7Dc	>7Dc	<3Dc	3~5Dc	5~7Dc
Cast Iron Ductile Cast Iron	JP4120 GX2140 JS4060	n (min <sup>-1</sup> )	1,270	1,270	1,080	950	1,270	1,270	1,080	950	1,010	1,010	860	760
		vc (SFM)	656	656	558	492	656	656	558	492	656	656	558	492
		vf (IPM)	30	30	19	17	40	40	26	22	32	32	20	18
		fz (IPT)	.008	.008	.006	.006	.008	.008	.006	.006	.008	.008	.006	.006
		pr (inch)	≤0.5Dc				≤0.5Dc				≤0.5Dc			
		ae (inch)	≤.354				≤.354				≤.354			

**[Note]** ① This table provides general guidelines for cutting conditions; in actual machining conditions adjust the parameters according to your actual machine and work-piece conditions. In particular, when performing shoulder milling in combination with slotting or machining of cutting widths close to slots, etc., chattering vibrations may occur, which can lead to trouble. Therefore, please consider the following when adjusting the conditions:

- Reduce rotation speed and table feed rate by 50 to 70%
- Reduce cutting depth ap by 50 to 70%
- Reduce cutting width ae by 50 to 70%

② Please note that the GX coating and JS coating do not cause a reaction in conductive touch sensors.

③ JP4105 is for the high-hardness steels. It is not suitable for Non-heat-treated steel material.



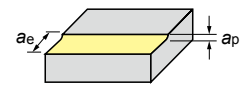

Work Material	Insert Grade	Cutter Dia.	φ 2.480 inch (63mm) (5NT)					φ 3.150 inch (80mm) (5NT)					φ 3.937 inch (100mm) (6NT)				
			Overhang Ratio		3~5Dc	5~7Dc	>7Dc	<3Dc		3~5Dc	5~7Dc	>7Dc	<3Dc		3~5Dc	5~7Dc	>7Dc
			General	High Speed				General	High Speed				General	High Speed			
General Structural Steel (200HB or less)	GX2140 JS4060	n (min <sup>-1</sup> )	760	1,010	760	660	560	600	800	600	520	440	480	640	480	410	350
		vc (SFM)	492	656	492	426	361	492	656	492	426	361	492	656	492	426	361
		vf (IPM)	269	398	269	234	198	213	315	213	184	156	204	302	204	174	149
		fz (IPT)	.071	.079	.071	.071	.071	.071	.079	.071	.071	.071	.071	.079	.071	.071	.071
		ap (inch)	.039	.039	.039	.031	.031	.039	.039	.039	.031	.031	.039	.039	.039	.031	.031
		ae (inch)	1.969	1.969	1.969	1.969	1.969	2.520	2.520	2.520	2.520	2.520	3.150	3.150	3.150	3.150	3.150
		Q (inch <sup>3</sup> /min)	13.5	19.9	13.5	9.4	8.0	13.6	20.2	13.6	9.4	8.0	16.3	24.2	16.3	11.2	9.5
Carbon Steel Alloy Steel (<35HRC)	GX2140 JS4060	n (min <sup>-1</sup> )	760	1,010	760	660	560	600	800	600	520	440	480	640	480	410	350
		vc (SFM)	492	656	492	426	361	492	656	492	426	361	492	656	492	426	361
		vf (IPM)	269	398	269	234	198	213	315	213	184	156	204	302	204	174	149
		fz (IPT)	.071	.079	.071	.071	.071	.071	.079	.071	.071	.071	.071	.079	.071	.071	.071
		ap (inch)	.039	.039	.039	.031	.031	.039	.039	.039	.031	.031	.039	.039	.039	.031	.031
		ae (inch)	1.969	1.969	1.969	1.969	1.969	2.520	2.520	2.520	2.520	2.520	3.150	3.150	3.150	3.150	3.150
		Q (inch <sup>3</sup> /min)	13.5	19.9	13.5	9.4	8.0	13.6	20.2	13.6	9.4	8.0	16.3	24.2	16.3	11.2	9.5
Carbon Steel Alloy Steel (35~45HRC)	JP4120 JS4060	n (min <sup>-1</sup> )	660	760	660	560	450	520	600	520	440	360	410	480	410	350	290
		vc (SFM)	426	492	426	361	295	426	492	426	361	295	426	492	426	361	295
		vf (IPM)	234	299	234	176	142	184	236	184	139	113	174	227	174	132	109
		fz (IPT)	.071	.079	.071	.063	.063	.071	.079	.071	.063	.063	.071	.079	.071	.063	.063
		ap (inch)	.039	.039	.039	.031	.031	.039	.039	.039	.031	.031	.039	.039	.039	.031	.031
		ae (inch)	1.969	1.969	1.969	1.969	1.969	2.520	2.520	2.520	2.520	2.520	3.150	3.150	3.150	3.150	3.150
		Q (inch <sup>3</sup> /min)	11.7	15.0	11.7	7.0	5.7	11.8	15.1	11.8	7.1	5.8	13.9	18.2	13.9	8.5	7.0
300 series Stainless Steel (WET)	JM4160	n (min <sup>-1</sup> )	510	-	510	430	350	400	-	400	340	280	320	-	320	270	220
		vc (SFM)	328	-	328	279	230	328	-	328	279	230	328	-	328	279	230
		vf (IPM)	100	-	100	85	69	79	-	79	67	55	76	-	76	64	52
		fz (IPT)	.039	-	.039	.039	.039	.039	-	.039	.039	.039	.039	-	.039	.039	.039
		ap (inch)	.039	-	.039	.031	.031	.039	-	.039	.031	.031	.039	-	.039	.031	.031
		ae (inch)	1.969	-	1.969	1.969	1.969	2.520	-	2.520	2.520	2.520	3.150	-	3.150	3.150	3.150
		Q (inch <sup>3</sup> /min)	5.0	-	5.0	3.4	2.8	5.0	-	5.0	3.4	2.8	6.1	-	6.1	4.1	3.3
Precipitation Hardening Stainless Steel (WET)	JM4160 JP4120	n (min <sup>-1</sup> )	450	-	450	400	350	360	-	360	320	280	290	-	290	250	220
		vc (SFM)	295	-	295	262	230	295	-	295	262	230	295	-	295	262	230
		vf (IPM)	71	-	71	63	55	57	-	57	50	44	55	-	55	47	42
		fz (IPT)	.031	-	.031	.031	.031	.031	-	.031	.031	.031	.031	-	.031	.031	.031
		ap (inch)	.039	-	.039	.031	.031	.039	-	.039	.031	.031	.039	-	.039	.031	.031
		ae (inch)	1.969	-	1.969	1.969	1.969	2.520	-	2.520	2.520	2.520	3.150	-	3.150	3.150	3.150
		Q (inch <sup>3</sup> /min)	3.5	-	3.5	2.5	2.2	3.6	-	3.6	2.6	2.2	4.4	-	4.4	3.0	2.7
Cast Iron Ductile Cast Iron	GX2140 JS4060 JP4120	n (min <sup>-1</sup> )	760	1,010	760	660	560	600	800	600	520	440	480	640	480	410	350
		vc (SFM)	492	656	492	426	361	492	656	492	426	361	492	656	492	426	361
		vf (IPM)	299	398	299	260	220	236	315	236	205	173	227	302	227	194	165
		fz (IPT)	.079	.079	.079	.079	.079	.079	.079	.079	.079	.079	.079	.079	.079	.079	.079
		ap (inch)	.039	.039	.039	.031	.031	.039	.039	.039	.031	.031	.039	.039	.039	.031	.031
		ae (inch)	1.969	1.969	1.969	1.969	1.969	2.520	2.520	2.520	2.520	2.520	3.150	3.150	3.150	3.150	3.150
		Q (inch <sup>3</sup> /min)	15.0	19.9	15.0	10.4	8.8	15.1	20.2	15.1	10.5	8.9	18.2	24.2	18.2	12.4	10.6
Hardened Steel (45~50HRC)	JP4120 JP4105	n (min <sup>-1</sup> )	400	450	400	350	300	320	360	320	280	240	250	290	250	220	190
		vc (SFM)	262	295	262	230	197	262	295	262	230	197	262	295	262	230	197
		vf (IPM)	39	71	39	35	30	31	57	31	28	24	30	55	30	26	22
		fz (IPT)	.020	.031	.020	.020	.020	.020	.031	.020	.020	.020	.020	.031	.020	.020	.020
		ap (inch)	.031	.031	.031	.024	.024	.031	.031	.031	.024	.024	.031	.031	.031	.024	.024
		ae (inch)	1.969	1.969	1.969	1.969	1.969	2.520	2.520	2.520	2.520	2.520	3.150	3.150	3.150	3.150	3.150
		Q (inch <sup>3</sup> /min)	1.6	2.8	1.6	1.0	.9	1.6	2.9	1.6	1.1	.9	1.9	3.5	1.9	1.3	1.1
Hardened Steel (50~60HRC)	JP4105 JP4120	n (min <sup>-1</sup> )	400	450	400	350	300	320	360	320	280	240	250	290	250	220	190
		vc (SFM)	262	295	262	230	197	262	295	262	230	197	262	295	262	230	197
		vf (IPM)	31	53	31	28	24	25	43	25	22	19	24	41	24	21	18
		fz (IPT)	.016	.024	.016	.016	.016	.016	.024	.016	.016	.016	.016	.024	.016	.016	.016
		ap (inch)	.031	.031	.031	.024	.024	.031	.031	.031	.024	.024	.031	.031	.031	.024	.024
		ae (inch)	1.969	1.969	1.969	1.969	1.969	2.520	2.520	2.520	2.520	2.520	3.150	3.150	3.150	3.150	3.150
		Q (inch <sup>3</sup> /min)	1.3	2.1	1.3	.8	.7	1.3	2.2	1.3	.9	.7	1.5	2.6	1.5	1.0	.9

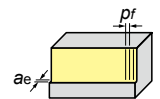

Work Material	Insert Grade	Cutter Dia.	φ 2.480 inch (63mm) (5NT)				φ 3.150 inch (80mm) (5NT)				φ 3.937 inch (100mm) (6NT)						
			Overhang Ratio		3~5Dc	5~7Dc	>7Dc	<3Dc		3~5Dc	5~7Dc	>7Dc	<3Dc		3~5Dc	5~7Dc	>7Dc
			General	High Speed				General	High Speed				General	High Speed			
Cast Iron Ductile Cast Iron	JP4120 GX2140 JS4060	n (min <sup>-1</sup> )	1,010	1,010	860	760	800	800	680	600	640	640	540	480			
		vc (SFM)	656	656	558	492	656	656	558	492	656	656	558	492			
		vf (IPM)	40	40	26	22	31	31	20	18	30	30	19	17			
		fz (IPT)	.008	.008	.006	.006	.008	.008	.006	.006	.008	.008	.006	.006			
		pr (inch)	≤ 0.5Dc				≤ 0.5Dc				≤ 0.5Dc						
		ae (inch)	≤ 354				≤ 354				≤ 354						

- [Note] ④ For strongly interrupted cutting, when unsupported length is long, or for wet cutting, JM4160 is recommended.  
 ⑤ To prevent tool damage due to chip clogging, always use a chip removal method such as an air blower, etc.  
 ⑥ Since there is a danger of the removed chips flying out and causing injury to workers, fire, or damage to eyes, during use be sure to cover the work area with a safety cover and have workers wear protective equipment such as glasses, etc. to make the work area safe.  
 ⑦ Perform insert replacement at an early stage to prevent chipping due to excessive use.  
 ⑧ The following equation can be used to determine the metal removal rate per unit time Q;  

$$Q(\text{inch}^3/\text{min}) = a_p(\text{inch}) \times a_e(\text{inch}) \times v_f(\text{IPM}) / 1000$$

# Precautions for use

## Programming guidance

In CAM, define the tool shape as .118 inch (R3.0mm) radius shape.

Corner R Definition in CAM inch (mm)	Remains inch (mm)	Maximum cutting depth inch (mm)
.118 (R3.0)	.039 (1.0)	.047 (1.2)

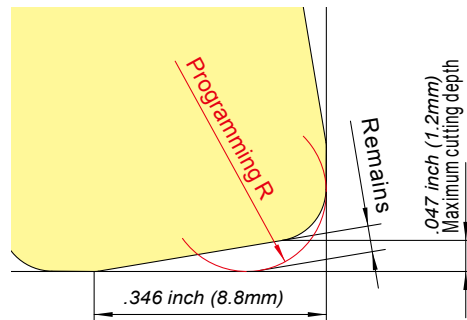

## Maximum ramp angle and helical hole diameter

Since the cutting flute does not extend to the center of the cutter, there are limitations on the maximum ramp angle. However, it is possible to helical mill without a pilot hole as shown in below table.

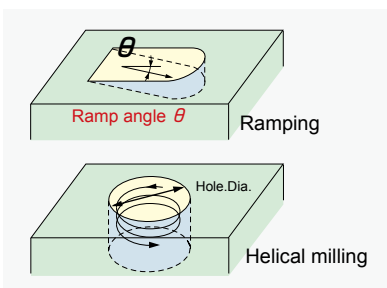

Tool Diameter	2.000 inch or 50mm	2.500 inch or 63mm	3.000 inch or 80mm	4.000 inch or 100mm
Max ramp angle $\theta$	3°	2°	1.7°	1°
Hole Dia. (inch)	3.228~3.780	4.252~4.803	5.591~6.142	7.165~7.717
Hole Dia. (mm)	82~96	108~122	142~156	182~196

**[Note]** ① Please set the ramp angle within the above range on table. we recommend to use less than 1°. Pilot hole is necessary if the hole diameter is larger than that range.  
 ② For hole diameters outside the ranges listed above, a pilot hole should be drilled before milling.  
 ③ For helical cutting, please set the "ap" to around 50% of recommended cutting condition.  
 ④ It is recommended that the tool be used while performing sufficient chip removal and checking that there are no abnormal vibrations.

## Attention for the corner change

Turn the insert counterclockwise upon corner change.



## High Feed Tools Lineup

Application Matrix: Rough Machining										
Type	Feature				Holder		Insert		Programming R inch (mm)	Max cutting depth inch (mm)
	Economical (No. of corners)	High accuracy (Less uncut remnants)	Supports for high-hardened steel	Efficiency (No. of Flutes)	Tool dia. Upper (inch) Lower (mm)	No. of corners	Shape	Inscribed circle code		
TD4N	⊙	⊙	~50HRC	⊙ High efficiency multiflutes	.625 ~1.500 16~42	4		06	.079 (2.0)	.039 (1.0)
ASR MULTI	○	○	~62HRC	⊙ High efficiency multiflutes	.625~2.500 16~66	2		06 12	.079 (2.0)	.059 (1.5)
ASRF-mini	⊙	○	~62HRC	○ General	.750~2.500 20~63	4		07	.079 (2.0)	.047 (1.2)
ASR	○	○	~60HRC	○ General	.750~4.000 20~100	2		08 ~ 15	.118 (3.0)	.079 (2.0)
IASRT	○	○	~62HRC	○ General	2.000~5.000	3		09 ~ 15	.118 (3.0)	.079 (2.0)
IASRF	⊙	○	~60HRC	○ General	1.250~4.000	4		12	.177 (4.5)	.079 (2.0)
TR4D	⊙	○	~60HRC	⊙ High efficiency multiflutes	2.000~4.000 50~100	4		12	.118 (3.0)	.047 (1.2)

※ For details of tool specifications, please check on catalog or website ([www.moldino.com/en-US/](http://www.moldino.com/en-US/))

# Field Data

No.	User name	Work (mold type / parts)	Competitor	Tools & cutting conditions	Evaluation
1	Company A	Plastic mold (for automotive bumper) Pre-hardened steel (42HRC)	—	<p><b>【Tools】</b> TR4D4100B-6 (φ3.937 inch -6 flutes) SDNW120520TR-P: JP4120</p> <p><b>【Cutting conditions】</b> vc:351 SFM (107m/min) , fz:.071 IPT (1.8mm/t) OH:16.063 inch (408mm) (4D) ap×ae = .039 x 2.559 inch (1.0 x 65mm)</p> <p><b>【Tools】</b> TR4D4080B-5 (φ3.150 inch -5 flutes) SDNW120520TR-P: JP4120</p> <p><b>【Cutting conditions】</b> vc:328 SFM (100m/min), fz:.067 IPT (1.7mm/t) OH:16.063 inch (408mm) ap×ae = .039 x 2.047 inch (1.0 x 52 mm)</p>	Achieved high efficiency stable cutting with long projection
2	Company B	Shear blade SCM440 (47 ~ 48HRC)	Competitor G 3 corner High-feed tools	<p><b>【Tools】</b> TR4D4063BM-5 (φ2.480 inch -5 flutes) SDNW120520TR: JP4120</p> <p>vc:390 SFM (119m/min) fz:.031 IPT (0.8mm/t) ap×ae = .039 x 1.732 (1.0 x 44mm)</p>	1.5 times longer tool life against competitors
3	Company C	Forging dies (for crank shaft) H13 (46 ~ 48HRC)	Competitor Y 4 corner High-feed tools	<p><b>【Tools】</b> TR4D4100B-6 (φ3.937 inch -6 flutes) SDNW120520TR :JP4120</p> <p><b>【Cutting conditions】</b> vc:331 SFM (101m/min) fz:.017 IPT (0.42mm/t) ap×ae = .059 x 2.756 inch (1.5 x 70mm)</p>	Achieved stable cutting with 1.2 times efficiency It was well received since small and curled cutting chips were generated
4	Company D	Lens mold 4140(A)	Competitor J 3 corner High-feed tools	<p><b>【Tools】</b> TR4D4063BM-5 (φ2.480 inch -5 flutes) SDNW120520TR: JP4120</p> <p><b>【Cutting conditions】</b> vc:430 SFM (131m/min) fz:.047 IPT (1.2mm/t) ap×ae = .043 ~ .071 x 1.968 Inch (1.1 ~ 1.8 x 50mm)</p>	Achieved stable cutting with 1.6 times efficiency It was well received since machining noise and cutting chips are small

The diagrams and table data are examples of test results, and are not guaranteed values.  
“MOLDINO” is registered trademarks of MOLDINO Tool Engineering, Ltd.



## Safety Considerations

### 1. Handling

- (1) When removing tool from packaging, be careful not to drop the tool on your foot or fingers.
- (2) When actually setting the inserts, be careful not to touch the cutting flute directly with your bare hands.

### 2. Mounting

- (1) When preparing to use, be sure that the insert is firmly screwed in the pocket and cutter is properly mounted on the tool holder.
- (2) If abnormal chattering occurs during use, stop the machine immediately, identify the cause of the chatter and take corrective action.

### 3. Usage

- (1) Before use confirm all dimensions, verify work material and programmed tool rotation.
- (2) The numerical values in the standard cutting conditions table should be used as criteria when starting new work. The cutting conditions should be adjusted as appropriate when the cutting depth is large, the rigidity of the machine being used is low, or according to the conditions of the work material.
- (3) Inserts are made of hard material and may break and be expelled from cutter at high speeds. Since there is a danger of injury to workers from chip evacuation, insert breakage or fire safety precautions must be observed at all times. Including, but not limited to: safety glasses, machine enclosures or other means to create a safe environment for work. If you have questions on safety, contact your supervisor.
  - Do not use where there is a risk of fire or explosion.
  - Do not use non-water-soluble cutting oils. Such oils may result in fire.
- (4) Do not use the tool for any purpose other than that for which it is intended, and do not modify it.

### **California Office [Headquarters]**

3535 Hyland Avenue, Suite 200  
Costa Mesa, CA 92626  
Customer Service: 800.523.0800  
Technical Service: 800.486.2341

### **Detroit Office [MOLDINO Products Customer Service]**

41700 Gardenbrook Road, Suite 120 Novi, MI 48375  
Customer Service: 833.924.3100  
Main: 248.308.2620  
Fax: 248.308.2627  
Email: rfqHTdiv@mmus.com (MOLDINO Product & Technical Inquiry)

### **Toronto Office [Canada Branch]**

3535 Laird Road  
Units 15 & 16  
Mississauga, Ontario, Canada L5L 5Y7  
Main: 905.814.0240  
Fax: 905.814.0245

### **MMC Metal de Mexico, S.A. DE C.V.**

Av. La Cañada No.16,  
Parque Industrial Bernardo  
Quintana, El Marques,  
Queretaro C.P. 76246 MEXICO  
Main: +52.442.221.61.36  
Fax: +52.442.221.61.34

### **Chicago Office [Engineering]**

300 N. Martingale Road, Suite 500  
Schaumburg, IL 60173  
Main: 847.252.6300  
Fax: 847.519.1732

### **North Carolina-MTEC [Marketing & Technical Center]**

105 Corporate Center Drive, Suite A  
 Mooresville, NC 28117  
Main: 980.312.3100  
Fax: 704.746.9292

**DISTRIBUTED BY:**



**COMPLETE  
METALWORKING  
SOLUTIONS**

**(800) 991-4225**

[www.ahbinc.com](http://www.ahbinc.com)

ISO Certified

[customerservice@ahbinc.com](mailto:customerservice@ahbinc.com)

**MOLDINO Tool Engineering, Ltd.**

[www.moldino.com/en-US/](http://www.moldino.com/en-US/)

(Manufacturer)

2021 1st Edition

NO. H1901A-3

Tools Specifications subject to change without notice.