

NTK CUTTING TOOLS

SWISS TOOLING 6100



App for iOS
Available on the
App Store

App for ANDROID
ANDROID APP ON
Google play

WATCH ON
YouTube

NTKCUTTINGTOOLS.com
youtube.com/NTKCUTTINGTOOLS

NTK TECHNOLOGY

HIGH TEMPERATURE ALLOYS



GRAY/DUCTILE CAST IRON



HARDENED STEELS

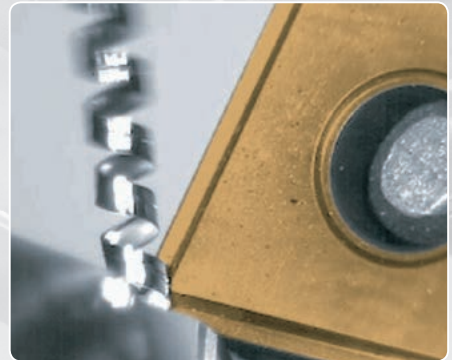

MILL ROLLS



GROOVING

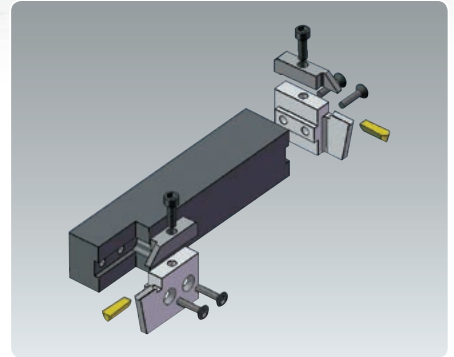

BEARING PRODUCTION

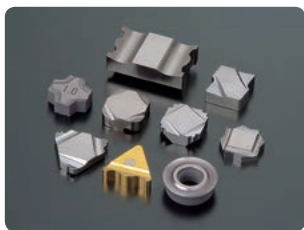

STEEL MACHINING

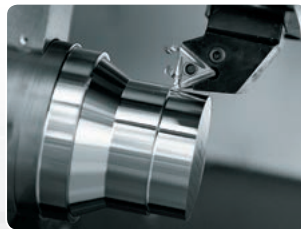
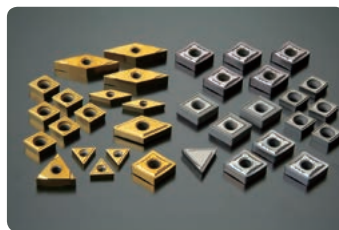

HIGH SPEED MACHINING OF ALUMINUM



NTK General Catalog

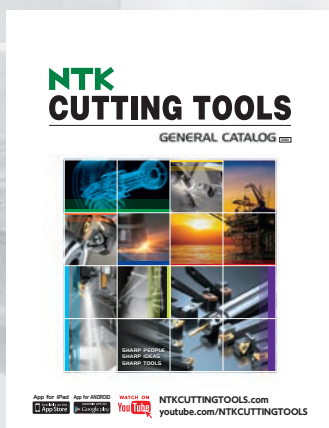

Downloadable version online /
Hard copy upon request

NTKCUTTINGTOOLS.com



youtube.com/NTKCUTTINGTOOLS



App for iPad / iPhone



App for ANDROID

Guidelines for Catalog

- This catalog lists products as of April 2015.
- Please note that specifications of the products listed in this catalog may be changed without notice due to continuous research & development and product improvements.
- This catalog contains the major features and relevant information on all of our products. Please contact our sales representatives or dealers if more detailed information is needed.
- Stock Status Symbols
 - : Standard stock available for Right-Hand, Left-Hand and neutral products
 - R : Stock available only in Right-Hand
 - L : Stock available only in Left-Hand
 - : 1-2 weeks delivery
 - Ⓜ : 1-2 weeks delivery only in Right-Hand
 - Ⓛ : 1-2 weeks delivery only in Left-Hand
 - : While stock lasts
 - No symbol : Not stocked
- Please note that this catalog was prepared based on products intended mainly for sale in North and South America.

■ Standard

1) Holder Type	Package quantity	Notes
Turning holder	1 pc/case	
Milling cutter	1 pc/case	
2) Spare parts	Package quantity	Notes
Screw	10 pcs/case	Clamp screw, Clamp bolt, Double screw, Button screw
Seat	10 pcs/case	Shim seat
Clamp	10 pcs/case	Clamp
Wrench and cutter parts (such as cartridges)	5 pcs/case	Wrench, bit, cutter product
Handle, Hose	1 pc/case	Handle with magnet, handle and bit
3) Insert Type	Package quantity	Notes
CBN	1 pc/case	B23, B30, B36, B40, B52, B5K, B6K
PCD	1 pc/case	PD1, PD2
CTPW insert for cut-off	5 pcs/case	CTPW series
STICK DUO Solid carbide bar	1 pc/case	SHFS, SHFB, SBFS, SBFB, SBB, SBG, SBT, SSP
All others	10 pcs/case	

*Packaging may vary depending on the product size.

For more information, please contact your nearest dealer or our sales office.

New Product Information		N1 to N11
NEW PRODUCTS		
"SPLASH Series" Coolant through toolholders	N2	NTK Unique Tooling
"STICK DUO SPLASH" Coolant through sleeves for ID boring with adjustable overhang mechanism ...	N4	Tooling for Swiss-type Lathes
"TBP / TBPA-BM" 3D molded chipbreaker for Back turning	N6	Front Turning
"GTMH-GX" 3D molded chipbreaker for Grooving	N7	Back Turning
"YL Chipbreaker" New chipbreaker for Front turning	N8	Cut-off
"SHAPER DUO" New concept tool for making Hexagon/Square socket	N9	Grooving / Side-Turning
"VBGT Tooling" YL chipbreaker and coolant through tool holders for Swiss machine ...	N10	Threading
"Groove Duo" Grooving and side-turning tools with highly rigid design	N11	ID Tooling
NTK Unique Tooling		
"Thread Whirling" Can form Multi-lead thread with single pass	O2	Shaper
"SPLASH series" Coolant through toolholders.....	O3	Indexable End mill
Quick change coolant components	O10	Information
"Y-axis Toolholders" Chip control by gravity	O11	Index
"Mogul Bar" High rigidity boring bars with coolant through system	O16	
"DS-ACH Toolholders" Adjust centerline height simply with a wrench ...	O17	
"DS Toolholders" Utilize drill sleeve posts	O18	
"DS Sleeve" Prevents coolant and chips from damaging live tool stations ...	O26	
"CSV Series" Best tool for up to .200" diameter material.....	O27	
"CTPS Series" Best fit for Radial-style tool station	O31	
"WP Series" Wiper insert with ISO style	O33	
"UL Chipbreaker" 6 corner insert for Swiss machines	O34	
"Shifted Toolholders" Designed for extended guide-bushing	O35	
"SATURN DUO" Face turning/grooving tools	O35	
		Z1 to Z4





Features

- Evacuates chips away from the cutting edge
- Reduces cutting tool temperature and helps keep the edge sharp
- Y-axis toolholders are available
- Improves part tolerance by steady coolant supply to the edge

Square Shank Toolholders

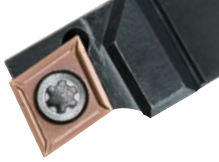

Front Turning

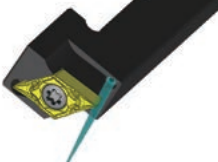
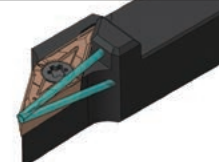
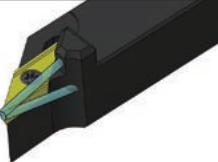
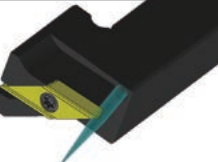
Insert	CC.. insert	DC.. insert	
	SCLC-OH	SDJC-OH	Y-SDJC-OH
Holder			
Insert	VB.. insert	VC.. insert	
	SVJB-OH	SDJC-OH	Y-SDJC-OH
Holder			

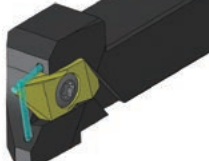
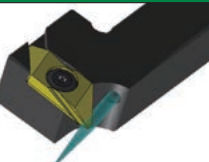
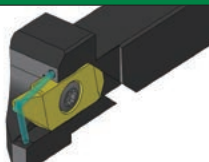

Back Turning

Insert	TBP insert
	TBP-OH
Holder	
Insert	TBP insert
	Y-TBP-OH
Holder	
Insert	TBPA insert
	CTPA-OH
Holder	

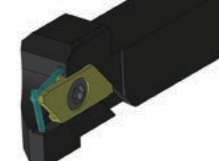
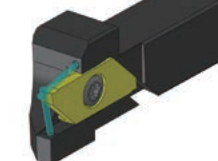
Cut Off

Insert	CTP insert	CTPA insert
	CTP-OH	CTPA-OH
Holder		

Grooving / Side Turning

Insert	GTM.. insert	GTPA.. insert	
	GTT-OH	Y-GTT-OH	Y-GTPA-OH
Holder			

ID Tooling Toolholders

STICK DUO Series with Adjustable Overhang Mechanism

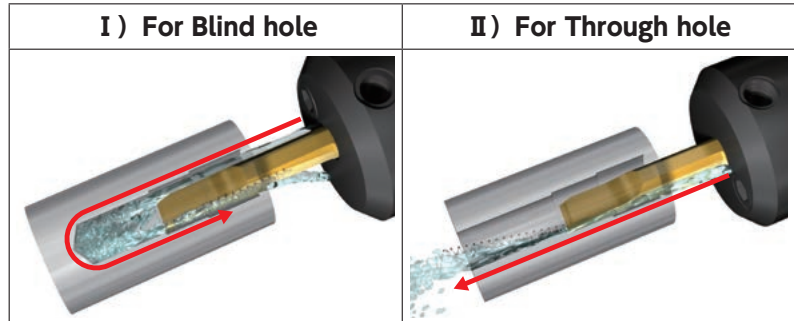
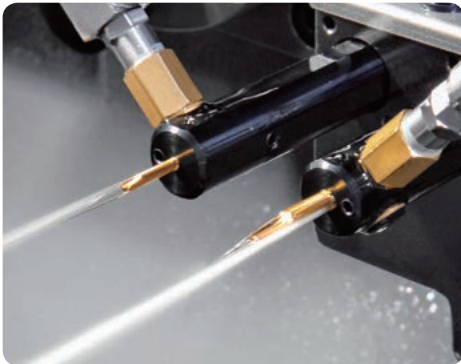

Features

- Good chip control evacuation in ID machining
- Three way coolant connection
- Can choose 2-way coolant direct
- Adjustable overhang length

Mogul Bar Series

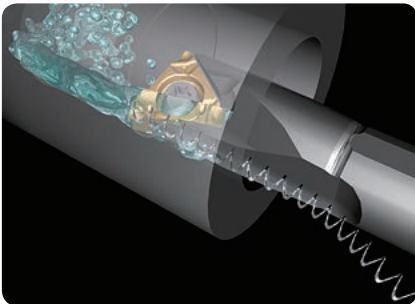

Features

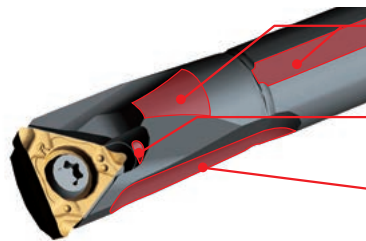

- Highly rigid design reduces vibration and chatter
- Internal coolant helps chip evacuation
- Large clearance for improved chip evacuation

Quick-Change Coolant Components

③ Conversion / Extension Joint

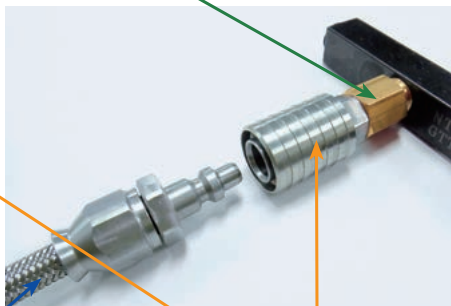
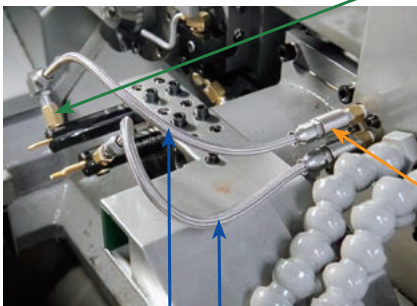

- Up to 2900psi
- High quality flexible stainless steel braided hose
- Reduce machine down time

① Plug-in Style Flexible Hose

② Quick Change Coupling

NEW

STICK DUO SPLASH

New Products

- Coolant through sleeves for ID Boring with Adjustable Overhang Mechanism -

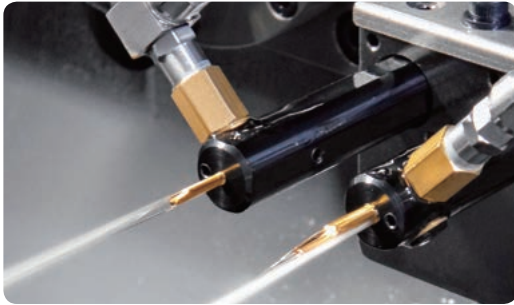

■ No chip problems

STICK DUO SPLASH	External coolant
No chip inside hole	Chip packed
Material : 4140 Insert bar : SHFS040R005S Hole depth : .590" (15mm) Pilot hole : $\phi .201" \times 1.102" L (\phi 5.1 \times 28.0 \text{mm} L)$ Coolant Pressure : 725psi(5MPa)	

■ Can choose 2-way coolant direct

I) For Blind hole	II) For Through hole
Just rotated 180 degrees	

■ 3-way coolant connection

② Rear Connection (Rc 1/8)

③ Sealed end for closed unit

Adjustable overhang length (Hyper system)

① Front Connection (M6 x 1.0)

① Front Connection example



② Rear Connection example

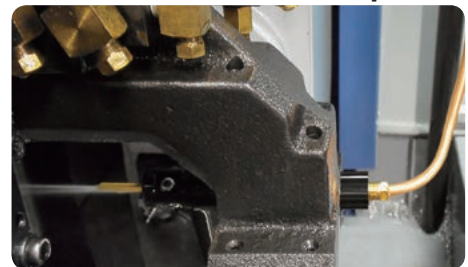

Quick-change Coolant Components

③ Conversion / Extension Joint

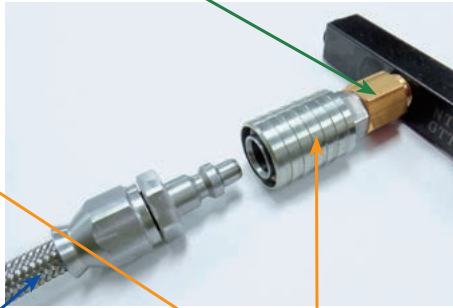
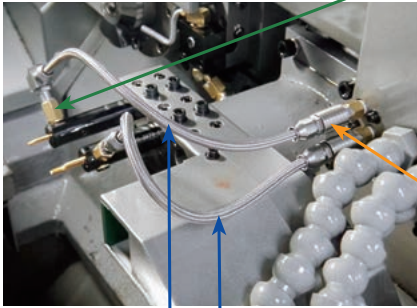

- Up to 2900psi
- High quality flexible stainless steel braided hose
- Reduce machine downtime

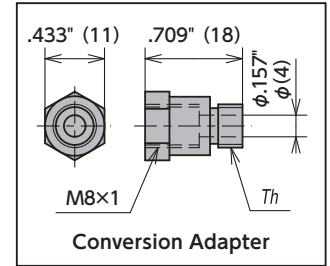

① Plug-in Style Flexible Hose

② Quick Change Coupling

① Plug-in Style Flexible Hose

Straight style

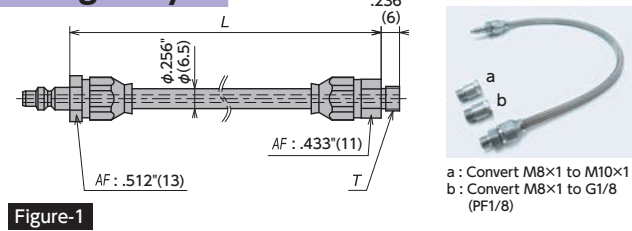

Figure-1

L-style

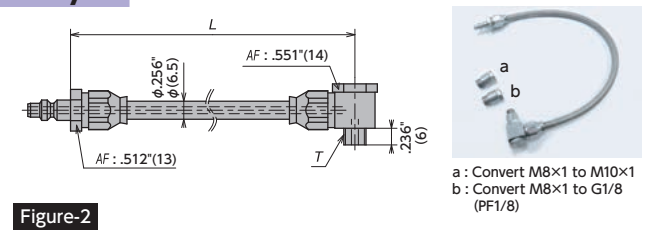
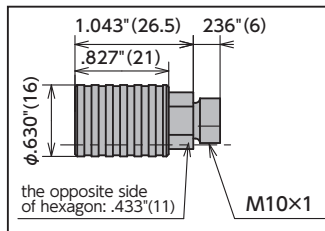

Figure-2

Item Number	Figure	Stock	L		T	Comes with
			(Inch)	(mm)		
HOSE-ST-1/8NPT-4IN	1	●	4.000	101.6	NPT1/8	—
HOSE-ST-1/8NPT-6IN	1	●	6.000	152.4	NPT1/8	—
HOSE-ST-1/8NPT-10IN	1	●	10.000	254.0	NPT1/8	—
HOSE-ST-M8*1	1	●	11.811	300.0	M8 × 1	Conversion Adapter a and b
HOSE-AN-M8*1	2	●	11.890	302.0	M8 × 1	Conversion Adapter a and b

② Quick Change Coupling



Item Number	Stock	Comes with
COUP-M10*1	●	Seal Plug

③ Conversion / Extension Joint

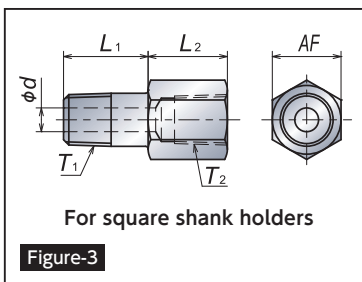

Figure-3

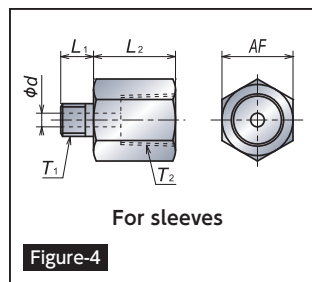

Figure-4

Item Number	Figure	Stock	T ₁ (mm)	T ₂ (mm)	L ₁ (mm)	L ₂ (mm)	AF (mm)	d (mm)
SCJ-M6-RC1/8-L	3	○	M6 × 1	Rc1/8 (PT1/8)	16	15	13	2.5
SCJ-NPT1/8-M10-L	3	●	NPT1/8	M10 × 1	16	12	13	4.5
SCJ-R1/8-M10-L	3	○	R1/8 (PT1/8)	M10 × 1	16	12	13	4.5
SCJ-R1/8-RC1/8-L	3	○	R1/8 (PT1/8)	Rc1/8 (PT1/8)	16	15	13	4.5
SCJ-R1/8-NPT1/8-L	3	●	R1/8 (PT1/8)	NPT1/8	16	15	13	4.5
SCJ-M6-M10	4	○	M6 × 1	M10 × 1	6	15	12	2.5
SCJ-M6-RC1/8	4	○	M6 × 1	Rc1/8 (PT1/8)	6	15	13	2.5
SCJ-M6-NPT1/8	4	●	M6 × 1	NPT1/8	6	15	13	2.5
SCJ-M8-RC1/8	4	○	M8 × 1	Rc1/8 (PT1/8)	6	15	13	3.5
SCJ-R1/8-M10	4	○	R1/8 (PT1/8)	M10 × 1	10	15	12	4.5
SCJ-R1/8-NPT1/8	4	●	R1/8 (PT1/8)	NPT1/8	10	15	13	4.5

● : Stock ○ : 1-2 week delivery 🔵 : Coolant through

3D Molded Chipbreakers

NEW

TBP / TBPA-BM for Back turnings



Features

- "Single Pass Back Turning" offers excellent surface finishes
- Up-right type insert and screw clamping provides high rigidity
- Wiper flat on cutting edge offers stable surface finishes even under high feed cutting conditions

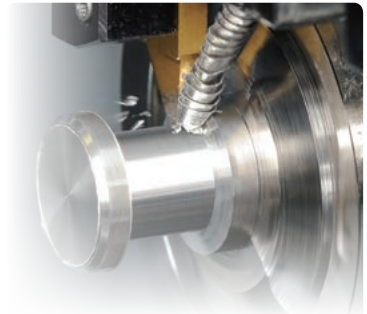

New BM chipbreaker

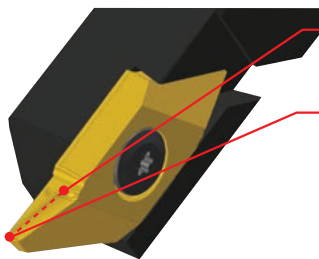

- Prevents the rough end face from hitting the chip
- Wiper flat on cutting edge offers excellent surface finishes

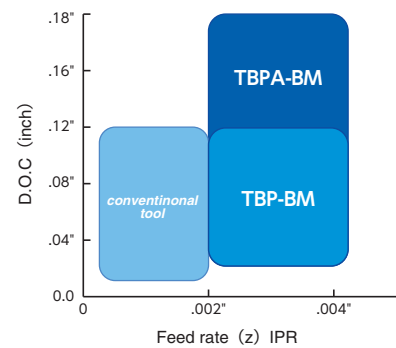

Superior Surface Finish

1Pass	BM chipbreaker		Competitor's tool	
	End face	OD	End face	OD
	Excellent surface		Rough surface	

Material : 304 SS (φ.630") , 260 SFM , Feed X : .0008 IPR , Feed Z : .0031 IPR , .118"DOC , WET

Excellent Chip Control

Feed rate (IPR)	BM chipbreaker		Competitor	
	.002"	.003"	.002"	.003"
.020"				
.120"				

Material : 304 SS (φ.630") , 260 SFM , WET

NEW

GTMH-GX Chipbreaker for Grooving / Side Turning



New Products

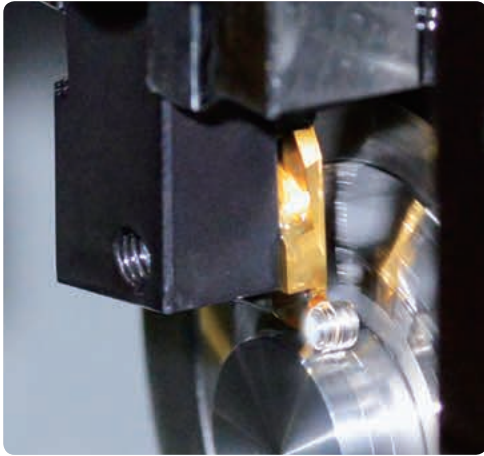

Features

- Can solve either problems of chips remaining in the grooves or bird's nest of chips
- Good surface finishes on groove side faces
- UP to .078" DOC side turning capability

Typical Grooving Problems

- Chips remain at the bottom of groove
- Bird's nest of chips



Excellent Chip Control

• Chipbreakers



Groove width .059"~



Groove width ~.039"

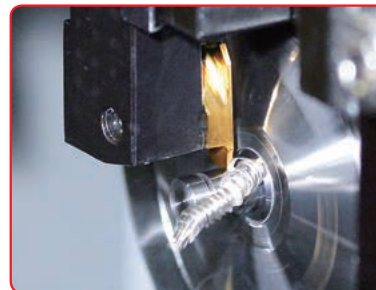

GX chipbreaker can solve these problems

• Grooving

DOC	Feed rate (IPR)		
	.0004"	.0011"	.0020"
GX chipbreaker			
Competitor's chipbreaker			

Material : 304 SS (φ.630"), 260 SFM, .059", DOC

Best Solution for Chip Control

Now available in Coolant through toolholders

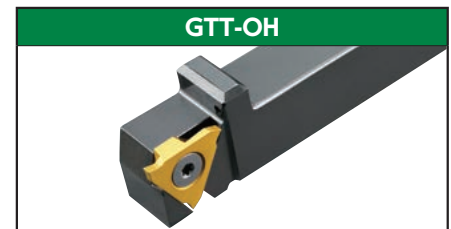

• Side Turning

DOC	Feed rate (IPR)			
	.0004"	.0011"	.0020"	.0031"
.010"				
.020"				
.030"				

Material : 304 SS (φ.630"), 260 SFM, .030" width insert

NEW

Front Turning Chipbreaker Quartet

New Products

NEW

YL Chipbreaker

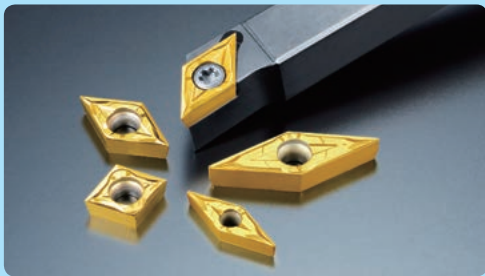

- Great combination of sharpness and toughness
- Covers extremely wide range
- Excellent chip control

WATCH ON YouTube

CL Chipbreaker

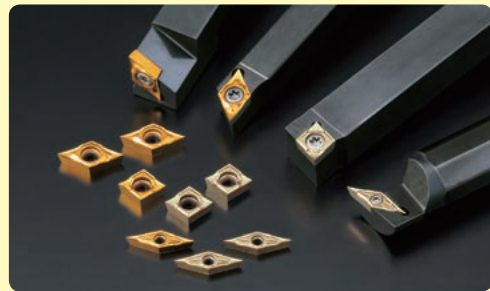

- Sharpest molded Chipbreaker
- Excellent chip control
- Less tool pressure

WATCH ON YouTube

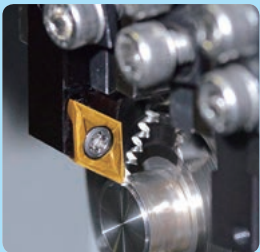

AM3 Chipbreaker



- All purpose chipbreaker
- Sharp edge with toughness

AMX Chipbreaker

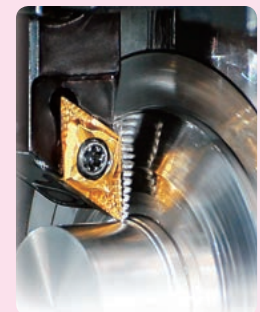

- Designed for very light depth of cut
- Exceptional sharpness

WATCH ON YouTube

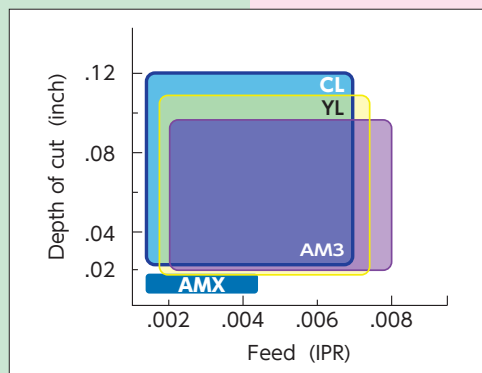
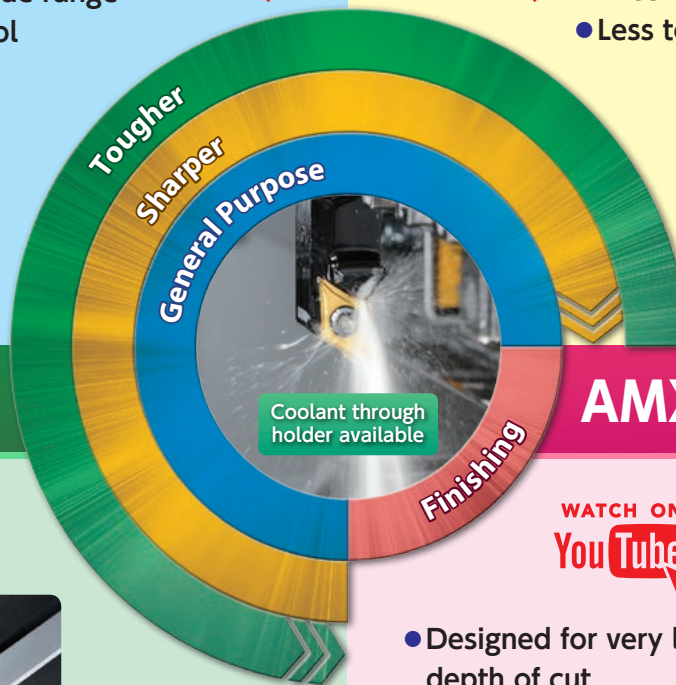

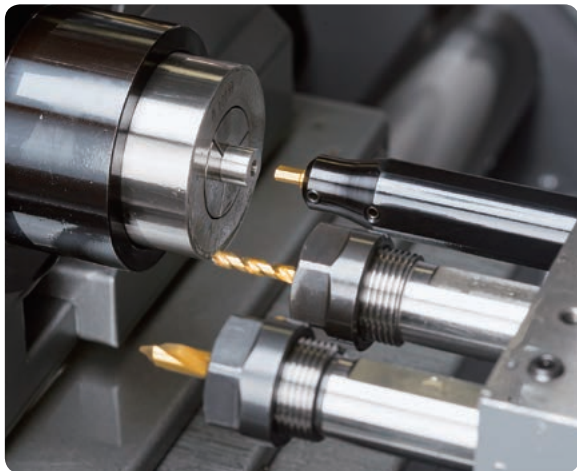

Hexagon Socket

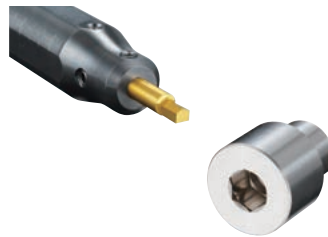

Square Socket

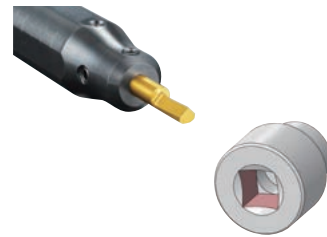

- Perfect fit for back spindle of Swiss machine
- Achieves good corner edge sharpness
- Less tool pressure than Rotary-Broaching
- Easy to adjust for correct dimension
- Economical two-sided insert bar

Comparison Chart of HEX Socket Machining

	Tool Pressure	Cycle Time	Pliability	Tool Cost	
Shaper Duo 	◎	△ * Can be off-set by over-wrapping operation	○	◎	<ul style="list-style-type: none"> ● Less tool pressure-especially on small diameter parts ● One size can cover several socket sizes
Broach Tool	△	○	×	△	<ul style="list-style-type: none"> ● Need to have tools for each socket size

Process Chart

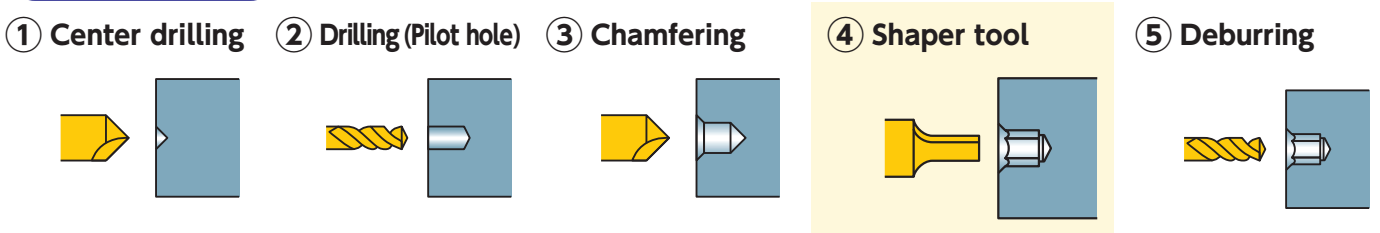

SHAPER DUO Process Chart

HEX Standard	Tool	Pilot bore Dia. (mm)	Total DOC /side (mm)	Number of passes			Estimated cycle time *		
				Total pass /side	Roughing pass 0.025mm	Finishing pass 0.010mm	ISO 2936 standard depth of Hex hole (mm)	Whole process ①-⑤	Process④ Shaper
HEX 1.5	SSP020N1130H	1.5	0.116	6	5	1	2	39 sec	14 sec
HEX 2.0	SSP020N1430H	2.0	0.155	7	6	1	2.5	44 sec	16 sec
HEX 2.5	SSP030N1940H	2.5	0.193	9	8	1	3	50 sec	20 sec
HEX 3.0	SSP030N1940H	3.0	0.232	10	9	1	3.5	55 sec	23 sec
HEX 4.0	SSP040N2450H	4.0	0.309	13	12	1	5	73 sec	33 sec
HEX 5.0	SSP050N3260H	5.0	0.387	17	16	1	6	90 sec	46 sec
HEX 6.0	SSP060N42120H	6.0	0.464	20	19	1	8	117 sec	63 sec
HEX 8.0	SSP080N62160H	8.0	0.619	26	25	1	10	155 sec	92 sec

*Pilot bore diameter is same as AF
*Using Carbide drill

*Shaper cutting conditions

Feed : 3000 mm/min
DOC : 0.025 mm (Roughing), 0.010 mm (Finishing)

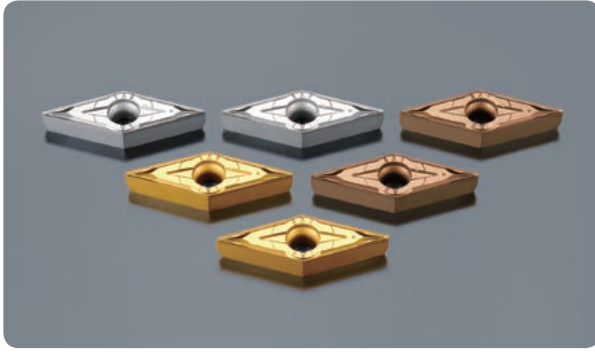

Features

- NTK developed the "VB" style chipbreaker with a unique combination of both sharpness and toughness
- Excellent chip control and covers a wide range of cutting conditions
- "G" tolerance inserts provide great surface finishes and stable part tolerances

Wide Chip Control Range

304SS (ϕ .630") 260SFM		Feed (IPR)		
		.002"	.003"	.005"
Depth of cut (inch)	.118"			
	.079"			
	.039"			
	.020"			

Coolant Through Toolholders Available



- Evacuates chips away from the cutting edge
- Reduces cutting tool temperature and keeps edge sharp even large depth of cut conditions
- Improves part tolerance by steady coolant supply to the edge

* Left-hand holders (SVJBL) are designed for Right-hand machines



Features

- Grooving and side turning tools with highly rigid design
- 3D design chipbreakers result in less tool pressure and excellent chip control

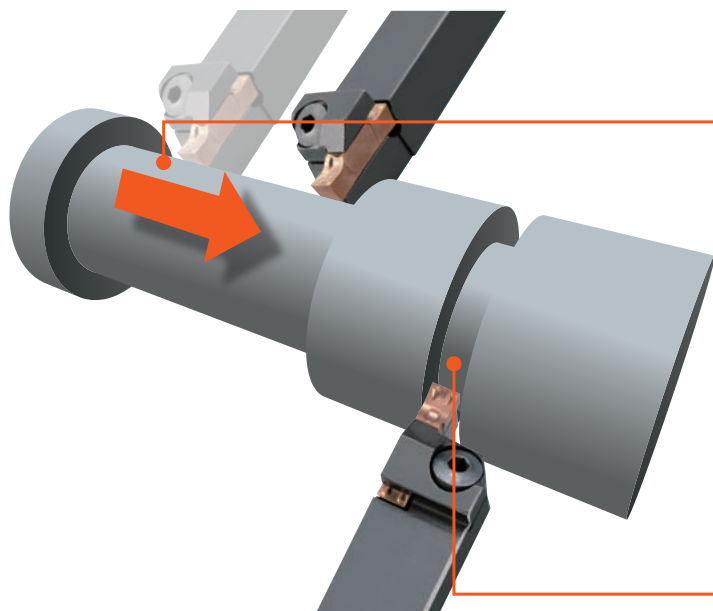

Side-turning

	NTK:GW chipbreaker	Competitor
Chip		
Surface finish		

Material : 4135, 5005FM, .004IPR, .040DOC

Grooving

	NTK:GW chipbreaker	Competitor
Chip		
Surface finish		

Material : 4135, 5005FM, .004IPR, .275DOC

Chipbreaker

For Grooving / Side-turning

Less tool pressure

GW

GV

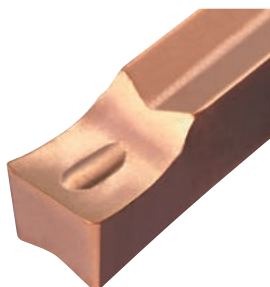
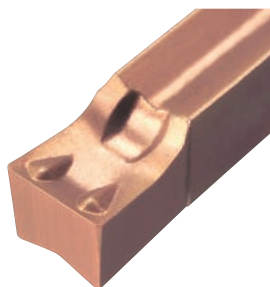

- Excellent chip control
- Good sharpness
- Side turning capability

- Superior sharp edge

Tool pressure comparison when grooving

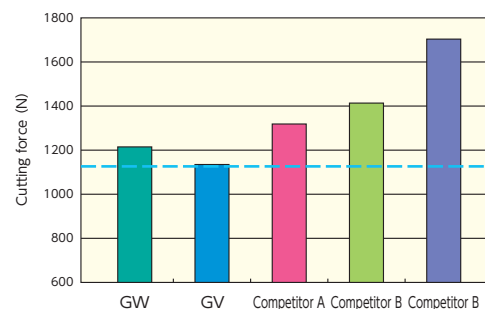



Multi-lead thread machining capability

Thread Whirling

→O2 [WATCH ON YouTube](#)



Coolant through toolholders

Splash Series / Quick-Charge Coolant Components

→O3 [WATCH ON YouTube](#) **NEW**

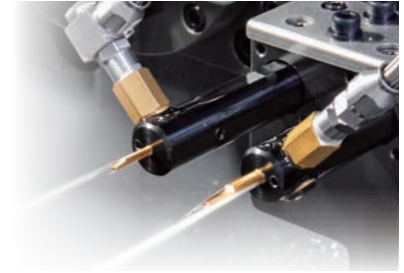

Chip controlled by gravity

Y-axis Toolholders

→O11 [WATCH ON YouTube](#)



High rigidity boring bars

Mogul Bar

→O16 [WATCH ON YouTube](#)



Interchangeable tools

CSV / CTPS Series

→O27 · O31

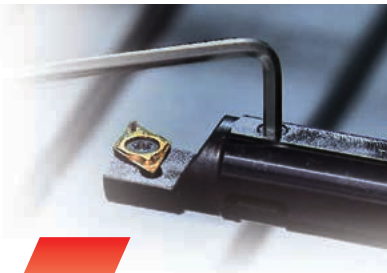

Tools for sub-spindle machining

DS-ACH / DS Toolholders / DS Sleeves

→O17 · O26 [WATCH ON YouTube](#)



Wiper inserts with ISO style

WP Series

→O33 [WATCH ON YouTube](#)



6 corner insert for Swiss machines

UL Chipbreaker

→O34 [WATCH ON YouTube](#)



Toolholders for extended guide-bushing

Shifted Toolholders

→O35 [WATCH ON YouTube](#)



Face turning / grooving tools

Saturn DUO

→O35 [WATCH ON YouTube](#)

Thread Whirling

Features

WATCH ON
YouTube





- NTK's unique patented design technology makes precise and correct inserts possible the first time, *without any redesign or remanufacture even if it is a multiple-lead thread*
- The sharper cutting edges produce a better surface finish and longer tool life than competitor's inserts

NTK Unique Tooling

Form Double-lead or Multiple-lead with Single Pass

Patented

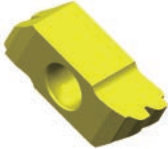
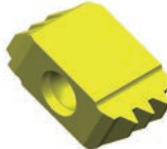
	Double-lead threads	Triple-lead threads
Work	Bone screw	Worm gear
Work material	Ti-6Al-4V ELI	brass
Work appearance		
Insert appearance		
Major Dia.	φ .157" (4.0mm)	φ .278" (7.0mm)
Minor Dia.	φ .094" (2.4mm)	φ .185" (4.7mm)
Lead [Pitch×No. of Lead]	.135" (3.42mm) [.067"×2(1.71mm×2)]	.193" (4.9mm) [.064"×3(1.63mm×3)]

- Can reduce cycle time by more than half
- NTK can achieve what other competitors cannot

Double-lead Bone Screw Process Example

- 1 1st thread whirl at taper part
- 2 Rotate the bar 180° and whirl the 2nd thread on same part as 1
- 3 Thread whirl whole straight part
- 4 Thread whirl at very last part to get two-exits, after back of bar has been backed up a half lead (one pitch) and rotated 180°

Information →U16

SPLASH Series

Coolant through toolholders

WATCH ON
YouTube

Coolant through toolholders

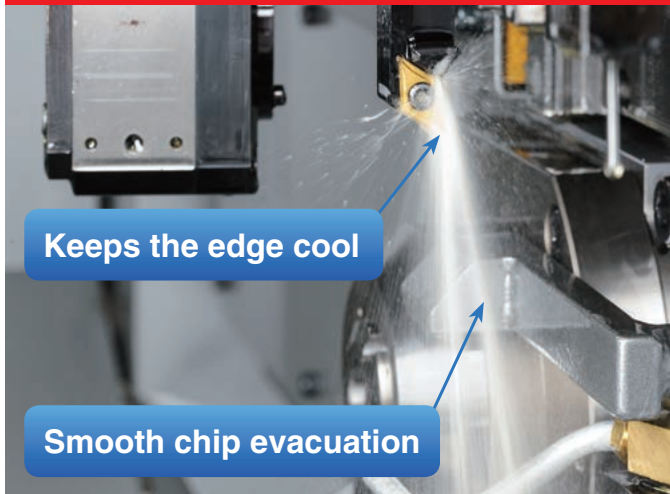

STICK DUO SPLASH

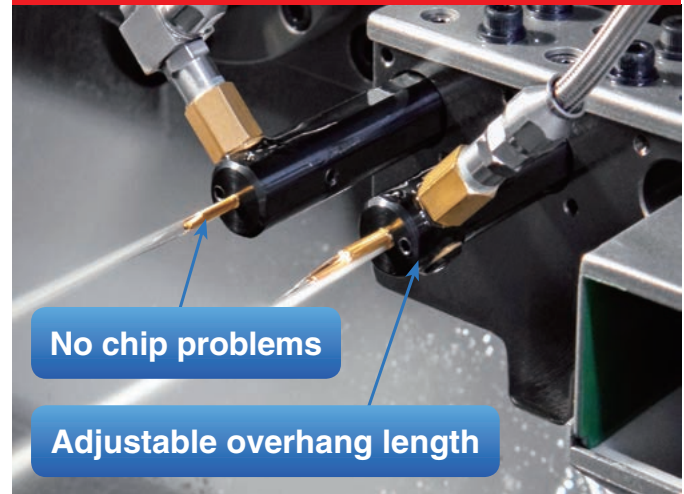

→V8

Full line-up

Front turning

<p>SCLC-OH</p> <p>NEW</p>	<p>SDJC-OH</p> <p>NEW</p>	<p>SVJB-OH</p> <p>NEW</p>	<p>SVJC-OH</p> <p>NEW</p>	<p>Y-SDJC-OH</p> <p>NEW</p>	<p>Y-SVJC-OH</p> <p>NEW</p>
----------------------------------	----------------------------------	----------------------------------	----------------------------------	------------------------------------	------------------------------------

Back turning / Grooving / Side turning

<p>TBP-OH</p> <p>NEW</p>	<p>CTPA-OH</p> <p>NEW</p>	<p>GTT-OH</p> <p>NEW</p>	<p>Y-TBP-OH</p> <p>NEW</p>	<p>Y-GTT-OH</p> <p>NEW</p>	<p>Y-GTPA-OH</p> <p>NEW</p>
---------------------------------	----------------------------------	---------------------------------	-----------------------------------	-----------------------------------	------------------------------------

Cut-off

<p>CTP-OH</p> <p>NEW</p>	<p>CTPA-OH</p> <p>NEW</p>
---------------------------------	----------------------------------

Perfect solution for chip control
- Y-axis holder with coolant through -

Front Turning Toolholders I

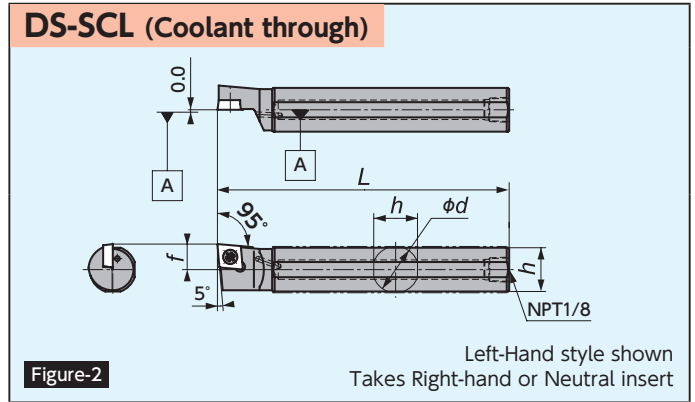
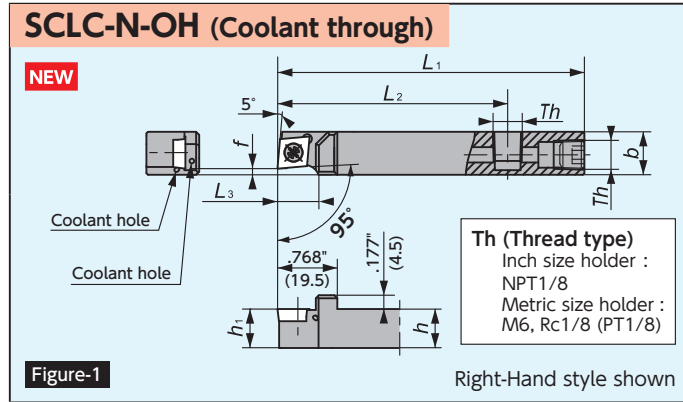

Gage Insert	Item Number	Figure	Stock		h		b		h ₁		L ₁		f		L ₂		L ₃		Th	Clamp Screw	Wrench
			R	L	(Inch)	(mm)	(Inch)	(mm)	(Inch)	(mm)	(Inch)	(mm)	(Inch)	(mm)	(Inch)	(mm)	(Inch)	(mm)			
CC..21.5..	SCLC%1082H-F079-OH	1	●	●	1/2	.551 14	.551 14	.551 14	1/2	3.937 100	.079 2	2.953 75	.472 12	NPT1/8	LRIS-2.5 x 7	CLR-155					
	SCLC%1083H-F079-OH	1	●	●	1/2	.551 14	.551 14	.551 14	1/2	3.937 100	.079 2	2.953 75	.472 12	NPT1/8	LRIS-4 x 10	LLR-255					
	SCLC%1103H-F079-OH	1	■	■	5/8	5/8	5/8	5/8	5/8	3.937 100	.079 2	2.953 75	.472 12	NPT1/8	LRIS-4 x 10	LLR-255					
	SCLC%1103HL-F079-OH	1	●	●	5/8	5/8	5/8	5/8	5/8	3.937 100	.079 2	2.953 75	.697 17.7	NPT1/8	LRIS-4 x 10	LLR-255					
CC..32.5..	SCLC%11014F09N-F02OH	1	○	○	.394 10	.551 14	.394 10	.394 10	3.150 80	.079 2.0	2.165 55	.472 12	M6 x 1	LRIS-4 x 10	LLR-255						
	SCLC%11214H09N-F02OH	1	○	○	.472 12	.551 14	.472 12	.472 12	3.937 100	.079 2.0	2.953 75	.472 12	Rc1/8(PT1/8)	LRIS-4 x 10	LLR-255						
	SCLC%11616H09N-F02OH	1	○	○	.630 16	.630 16	.630 16	.630 16	3.937 100	.079 2.0	2.953 75	.697 17.7	Rc1/8(PT1/8)	LRIS-4 x 10	LLR-255						

Gage Insert	Item Number	Figure	Stock		D _s		h		b		L ₁		f		Clamp Screw	Wrench
			R	L	(Inch)	(mm)	(Inch)	(mm)	(Inch)	(mm)	(Inch)	(mm)	(Inch)	(mm)		
CC..32.5..	DS-SCLL19-09-004	2	●	●	3/4	19.050	.709 18	.709 18	.709 18	4.724 120	.413 10.5	12.0	.472 12.0	LRIS-4 x 8	LLR-255-20 x 65	
	DS-SCLL22-09-005	2	●	●	.866	22.000	.827 21	.827 21	.827 21	4.724 120	.472 12.0	12.0	.472 12.0	LRIS-4 x 8	LLR-255-20 x 65	

Inserts → Q12

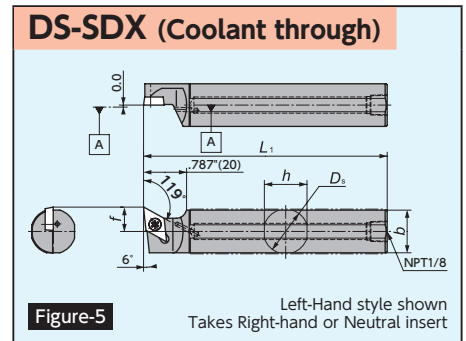
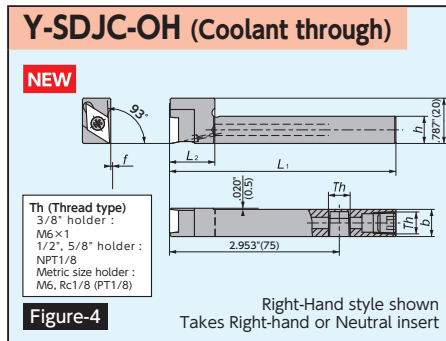
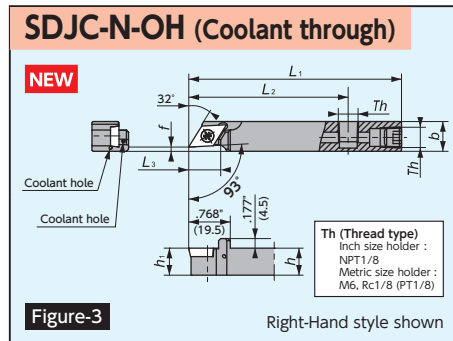

Gage Insert	Item Number	Figure	Stock		h		b		h ₁		L ₁		f		L ₂		L ₃		Th	Clamp Screw	Wrench
			R	L	(Inch)	(mm)	(Inch)	(mm)	(Inch)	(mm)	(Inch)	(mm)	(Inch)	(mm)	(Inch)	(mm)					
			N																		
DC..21.5../DC..21.5..WP	SDJC%1082H-F079-OH	3	●	●	1/2	.551 14	.551 14	.551 14	1/2	3.937 100	.079 2	2.953 75	.630 16	NPT1/8	LRIS-2.5 x 7	CLR-155					
	SDJC%1083H-F079-OH	3	●	●	1/2	.551 14	.551 14	.551 14	1/2	3.937 100	.079 2	2.953 75	.630 16	NPT1/8	LRIS-4 x 10	LLR-255					
	SDJC%1103H-F079-OH	3	■	■	5/8	5/8	5/8	5/8	5/8	3.937 100	.079 2	2.953 75	.630 16	NPT1/8	LRIS-4 x 10	LLR-255					
DC..32.5..	SDJC%1103HL-F079-OH	3	●	●	5/8	5/8	5/8	5/8	5/8	3.937 100	.079 2	2.953 75	.724 18.4	NPT1/8	LRIS-4 x 10	LLR-255					
DC..32.5..WP	SDJC%11014F11N-F02OH	3	○	○	.392 10	.551 14	.394 10	.394 10	3.150 80	.079 2	2.165 55	.630 16	M6 x 1	LRIS-4 x 10	LLR-255						
	SDJC%11214H11N-F02OH	3	●	●	.472 12	.551 14	.472 12	.472 12	3.937 100	.079 2	2.953 75	.630 16	Rc1/8(PT1/8)	LRIS-4 x 10	LLR-255						
	SDJC%11616H11N-F02OH	3	○	○	.630 16	.630 16	.630 16	.630 16	3.937 100	.079 2	2.953 75	.724 18.4	Rc1/8(PT1/8)	LRIS-4 x 10	LLR-255						
DC..21.5..	Y-SDJCR062H-IN-OH	4	●	●	3/8	3/8	3/8	3/8	3.937 100	0 0	.984 25		M6 x 1	LRIS-2.5 x 7	CLR-155						
DC..21.5..WP	Y-SDJCR082H-IN-OH	4	●	●	1/2	1/2	1/2	1/2	3.937 100	0 0	.984 25		NPT1/8	LRIS-2.5 x 7	CLR-155						
	Y-SDJCR083H-IN-OH	4	●	●	1/2	1/2	1/2	1/2	3.937 100	0 0	.984 25		NPT1/8	LRIS-4 x 10	LLR-255-20 x 65						
DC..32.5..	Y-SDJCR103H-IN-OH	4	●	●	5/8	5/8	5/8	5/8	3.937 100	0 0	.984 25		NPT1/8	LRIS-4 x 10	LLR-255-20 x 65						
DC..32.5..WP	Y-SDJCR1212H115-OH	4	●	●	.472 12.0	.472 12.0	.472 12.0	.472 12.0	3.937 100	0 0	.787 20		Rc1/8(PT1/8)	LRIS-4 x 10	LLR-255-20 x 65						
	Y-SDJCR1616H11-OH	4	○	○	.630 16.0	.630 16.0	.630 16.0	.630 16.0	3.937 100	0 0	.984 25		Rc1/8(PT1/8)	LRIS-4 x 10	LLR-255-20 x 65						

Gage Insert	Item Number	Figure	Stock		D _s		h		b		L ₁		f		Clamp Screw	Wrench
			R	L	(Inch)	(mm)	(Inch)	(mm)	(Inch)	(mm)	(Inch)	(mm)	(Inch)	(mm)		
DC..32.5..	DS-SDX%122-11-006	5	●	●	.866	22.000	.827 21.0	.827 21.0	.827 21.0	4.724 120	.472 12.0	12.0	.472 12.0	LRIS-4 x 10	LLR-255-20 x 65	

● : Stock ○ : 1-2 week delivery ■ : While stock lasts 🔵 : Coolant through

Inserts → Q20

Cutting condition → Q4

Front Turning Toolholders II

SVJB-OH (Coolant through)

NEW

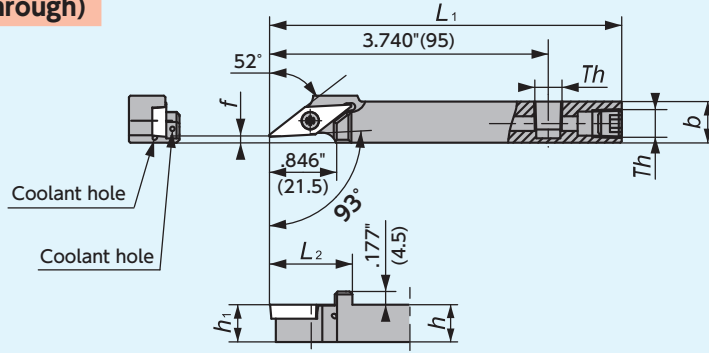

Th (Thread type)
 Inch size holder : NPT1/8
 Metric size holder: Rc1/8 (PT1/8)

Figure-1

• Left-Hand coolant through holders are designed for Right-Hand machines.

VBGT33

Gage Insert	Item Number	Figure	Stock		h		b		h ₁		L ₁		f		g		Th	Clamp Screw	Wrench
			R	L	(Inch)	(mm)	(Inch)	(mm)	(Inch)	(mm)	(Inch)	(mm)	(Inch)	(mm)	(Inch)	(mm)			
 VBGT33..	SVJB%L083C-F079-OH	1	●	●	1/2	.551 14	1/2	4.724 120	.079 2	.079 2	NPT1/8	LRIS-4 × 10	LLR-25S						
	SVJB%L103C-F079-OH	1	●	●	5/8	5/8	5/8	4.724 120	.079 2	0 0	NPT1/8	LRIS-4 × 10	LLR-25S						
	SVJB%L1214-X16N-F02OH	1	●	●	.472 12	.551 14	.472 12	4.724 120	.079 2	.079 2	Rc1/8(PT1/8)	LRIS-4 × 10	LLR-25S						
	SVJB%L1616-X16N-F02OH	1	●	●	.630 16	.630 16	.630 16	4.724 120	.079 2	0 0	Rc1/8(PT1/8)	LRIS-4 × 10	LLR-25S						

• Left-Hand coolant through holders are designed for Right-Hand machines.

Inserts → Q24

SVJC-OH (Coolant through)

NEW

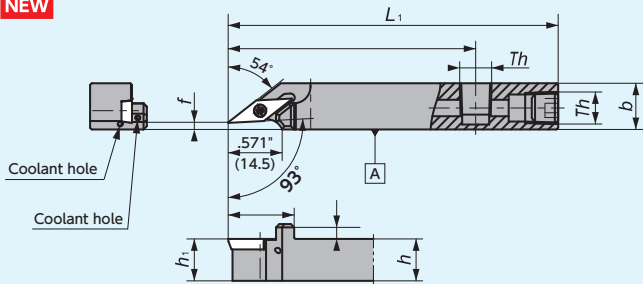

Th (Thread type)
 Inch size holder: NPT1/8

Figure-2

Right-Hand style shown

Y-SVJCR-OH (Coolant through)

NEW

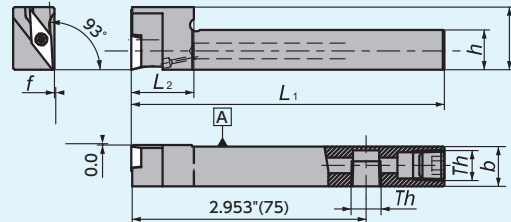

Th (Thread type)
 Inch size holder: NPT1/8

Figure-3

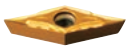
Gage Insert	Item Number	Figure	Stock		h		b		h ₁		L ₁		f		Th	Clamp Screw	Wrench
			R	L	(Inch)	(mm)	(Inch)	(mm)	(Inch)	(mm)	(Inch)	(mm)	(Inch)	(mm)			
 VC..22..	SVJC%L-082H-F079-OH	2	●	●	1/2	.551 14	1/2	3.937 100	.079 2.0	.079 2.0	NPT1/8	LRIS-2.5 × 7	CLR-15S				
	SVJC%L-102H-F079-OH	2	●	●	5/8	5/8	5/8	3.937 100	.079 2.0	.079 2.0	NPT1/8	LRIS-2.5 × 7	CLR-15S				
	Y-SVJCR082SHS-IN-OH	3	●	●	1/2	1/2	1/2	3.937 100	0.0 0.0	.787 20	NPT1/8	LRIS-2.5 × 7	CLR-15S				
	Y-SVJCR102H-IN-OH	3	●	●	5/8	5/8	5/8	3.937 100	0.0 0.0	.984 25	NPT1/8	LRIS-2.5 × 7	CLR-15S				

Inserts → Q24

Cutting condition → Q4

Back Turning Toolholders

TBP-OH (Coolant through)

Screw accessible from both sides

NEW

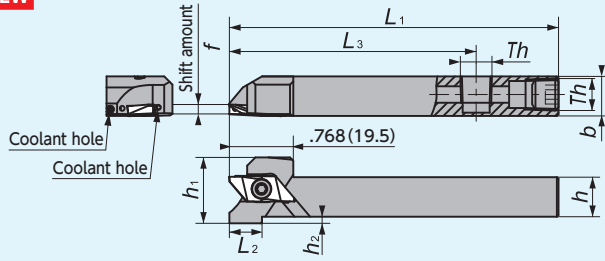

Th (Thread type)
 3/8" holder : M6×1
 1/2", 5/8" holder : NPT1/8
 Metric size holder : Rc1/8 (PT1/8)

Figure-1

Right-Hand style shown

Y-TBP-OH (Coolant through)

Screw accessible from both sides

NEW

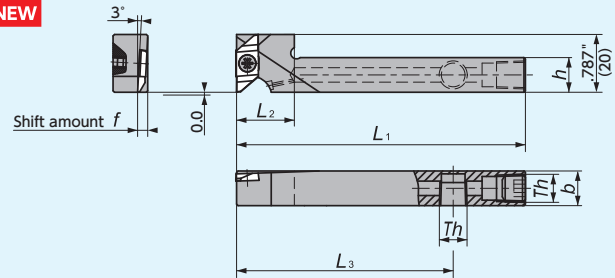

Th (Thread type)
 Inch size holder : NPT1/8
 Metric size holder : M6, Rc1/8 (PT1/8)

Figure-2

Right-Hand style shown
 Takes Right-hand Insert

TBP

Gage Insert	Item Number	Figure	Stock		h (Inch) (mm)	b (Inch) (mm)	h ₁ (Inch) (mm)	L ₁ (Inch) (mm)	f (Inch) (mm)	L ₂ (Inch) (mm)	h ₂ (Inch) (mm)	L ₃ (Inch) (mm)	Th	Clamp Screw	Wrench	
			R	L												
	TBP%06-IN-OH	1	●	●	3/8	.472 12	3/8	3.937 100	.138 3.5	.748 19	.176 4.475	2.953 75	M6 × 1	LRIS-4 × 10PW	CLR-15S	
	TBP%08-IN-OH	1	●	●	1/2	1/2	1/2	3.937 100	.138 3.5	.394 10	.051 1.3	2.953 75	NPT1/8	LRIS-4 × 12PW	CLR-15S	
	TBP%10-IN-OH	1	●	●	5/8	5/8	5/8	3.937 100	.138 3.5	0 0	0 0	2.953 75	NPT1/8	LRIS-4 × 12PW	CLR-15S	
	TBP%1012H-OH	1	○	○	.394 10	.472 12	.394 10	3.937 100	.138 3.5	.748 19	.176 4.475	2.953 75	M6 × 1	LRIS-4 × 10PW	CLR-15S	
	TBP%12H-OH	1	●	●	.472 12	.472 12	.472 12	3.937 100	.138 3.5	.394 10	.051 1.3	2.953 75	Rc1/8(PT1/8)	LRIS-4 × 12PW	CLR-15S	
	TBP%16H-OH	1	○	○	.630 16	.630 16	.630 16	3.937 100	.138 3.5	0 0	0 0	2.953 75	Rc1/8(PT1/8)	LRIS-4 × 12PW	CLR-15S	
	Y-TBP%08H-IN-OH	2	●	●	1/2	1/2	—	3.937 100	.138 3.5	.984 25	—	—	2.953 75	NPT1/8	LRIS-4 × 12PW	CLR-15S
	Y-TBP%12HS-OH	2	●	●	.472 12	.472 12	—	3.937 100	.138 3.5	.787 20	—	—	2.953 75	Rc1/8(PT1/8)	LRIS-4 × 12PW	CLR-15S
	Y-TBP%16H-OH	2	○	○	.630 16	.630 16	—	3.937 100	.138 3.5	.984 25	—	—	2.953 75	Rc1/8(PT1/8)	LRIS-4 × 12PW	CLR-15S

Inserts →R9

CTPA-OH / TBPA-OH

Screw accessible from both sides

NEW

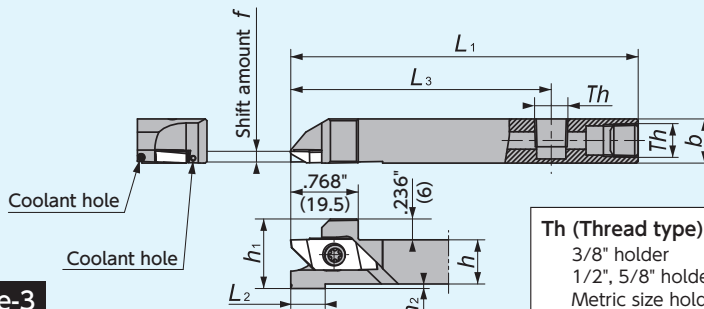

Th (Thread type)
 3/8" holder : M6×1
 1/2", 5/8" holder : NPT1/8
 Metric size holder : Rc1/8 (PT1/8)

Figure-3

Right-Hand style shown

Max Bar Dia at Max DOC

CTPA-OH

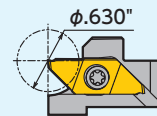

TBPA-OH

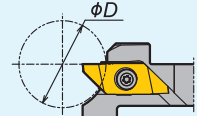

CTPA (Compatible with TBPA & CTPA Inserts)

Gage Insert	Item Number	Figure	Stock		Max. Bar Dia. ϕD (Inch) (mm)	h (Inch) (mm)	h ₁ (Inch) (mm)	b (Inch) (mm)	L ₁ (Inch) (mm)	h ₂ (Inch) (mm)	L ₂ (Inch) (mm)	L ₃ (Inch) (mm)	Th	f (Inch) (mm)	Clamp Screw	Wrench
			R	L												
	CTPA%06H-IN-OH	3	●	●	.630 16	3/8	3/8	3/8	3.937 100	.176 4.475	.787 20	2.165 55	M6 × 1	.134 3.4	LRIS-4 × 10PW	CLR-15S
	CTPA%08H-IN-OH	3	●	●	.630 16	1/2	1/2	1/2	3.937 100	.051 1.3	.394 10	2.953 75	NPT1/8	.134 3.4	LRIS-4 × 12PW	CLR-15S
	CTPA%10H-IN-OH	3	●	●	.630 16	5/8	5/8	5/8	3.937 100	0 0	0 0	2.953 75	NPT1/8	.134 3.4	LRIS-4 × 12PW	CLR-15S
	CTPA%12H-OH	2	●	●	.630 16	.472 12	.472 12	.472 12	3.937 100	.079 2	.768 19.5	.394 10	Rc1/8(PT1/8)	.134 3.4	LRIS-4 × 12PW	CLR-15S
	CTPA%16H-OH	2	○	○	.630 16	.630 16	.630 16	.630 16	3.937 100	0 0	.768 19.5	0 0	Rc1/8(PT1/8)	.134 3.4	LRIS-4 × 12PW	CLR-15S

TBPA (Optimized for TBPA Inserts)

Gage Insert	Item Number	Figure	Stock		Max. Bar Dia. ϕD (Inch) (mm)	h (Inch) (mm)	h ₁ (Inch) (mm)	b (Inch) (mm)	L ₁ (Inch) (mm)	h ₂ (Inch) (mm)	L ₂ (Inch) (mm)	L ₃ (Inch) (mm)	Th	f (Inch) (mm)	Clamp Screw	Wrench
			R	L												
	TBPA%12H-OH*	2	○	○	.984 25	.472 12	.472 12	.472 12	3.937 100	.157 4	.768 19.5	.394 10	Rc1/8(PT1/8)	.134 3.4	LRIS-4X12PW	CLR-15S
	TBPA%16H-OH*	2	○	○	1.378 35	.630 16	.630 16	.630 16	3.937 100	.079 2	.768 19.5	.394 10	Rc1/8(PT1/8)	.134 3.4	LRIS-4X12PW	CLR-15S
	TBPA%20H-OH*	2	○	○	1.969 50	.787 20	.787 20	.787 20	3.937 100	0 0	.768 19.5	0 0	Rc1/8(PT1/8)	.134 3.4	LRIS-4X12PW	CLR-15S

* To be released in June 2015.

● : Stock ○ : 1-2 week delivery 💧 : Coolant through

Inserts →R11

Cutting condition →R3

Back Turning / Grooving / Side Turning Toolholders

NTK Unique Tooling

GTT-OH (Coolant through)

Screw accessible from both sides

NEW

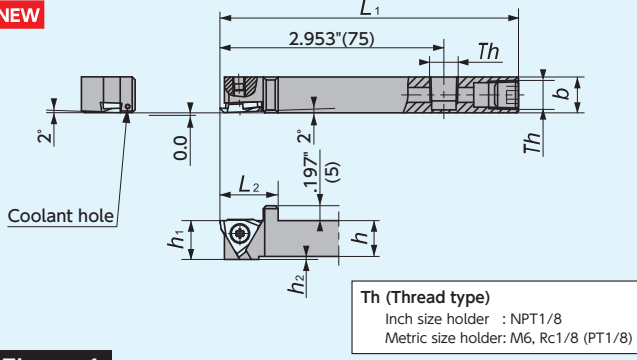

Figure-1

Right-Hand style shown

Y-GTT-OH (Coolant through)

Screw accessible from both sides

NEW

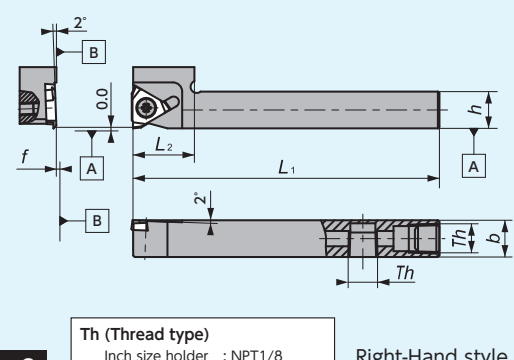

Figure-2

Right-Hand style shown
Takes Right-hand Insert

GTT

Gage Insert	Item Number	Figure	Stock		h (Inch) (mm)	b (Inch) (mm)	h ₁ (Inch) (mm)	L ₁ (Inch) (mm)	f (Inch) (mm)	L ₂ (Inch) (mm)	a _r (Inch) (mm)	h ₂ (Inch) (mm)	Th	Clamp Screw	Wrench	
			R	L												
TBMH32.. GTM.32.. TMG32	GTT%{08HA-IN-OH	1	●		1/2	1/2	1/2	3.937 100	.000 0	.768 19.5	.071 1.8	.039 1	NPT1/8	LR-S-4x10PW	CLR-15S	
	GTT%{08HB-IN-OH	1	●		1/2	1/2	1/2	3.937 100	.000 0	.768 19.5	.106 2.7	.039 1	NPT1/8	LR-S-4x10PW	CLR-15S	
	GTT%{10HA-IN-OH	1	●		5/8	5/8	5/8	3.937 100	.000 0	.768 19.5	.071 1.8	.000 0	NPT1/8	LR-S-4x10PW	CLR-15S	
	GTT%{10HB-IN-OH	1	●		5/8	5/8	5/8	3.937 100	.000 0	.768 19.5	.106 2.7	.000 0	NPT1/8	LR-S-4x10PW	CLR-15S	
	GTT%{1012H00-OH	1	○		.394 10	.472 12	.394 10	3.937 100	.000 0	.768 19.5	.071 1.8	.039 1	M6 x 1	LR-S-4x10PW	CLR-15S	
	GTT%{12H00-OH	1	●		.472 12	.472 12	.472 12	3.937 100	.000 0	.768 19.5	.071 1.8	.039 1	Rc1/8 (PT1/8)	LR-S-4x10PW	CLR-15S	
	GTT%{16H00-OH	1	○		.630 16	.630 16	.630 16	3.937 100	.000 0	.768 19.5	.071 1.8	0 0	Rc1/8 (PT1/8)	LR-S-4x10PW	CLR-15S	
	Y-GTT%{08H-IN-OH	2	●		1/2	1/2	— —	3.937 100	.000 0	.984 25.0	.063 1.6	— —	— —	NPT1/8	LR-S-4x10PW	CLR-15S
	Y-GTT%{12H00S-OH	2	●		.472 12	.472 12	— —	3.937 100	.000 0	.787 20.0	.063 1.6	— —	— —	Rc1/8 (PT1/8)	LR-S-4x10PW	CLR-15S
Y-GTT%{16H00-OH	2	○		.630 16	.472 16	— —	3.937 100	.000 0	.984 25.0	.063 1.6	— —	— —	Rc1/8 (PT1/8)	LR-S-4x10PW	CLR-15S	

Inserts TBMH **➔R19**
 Inserts GTM. **➔T12**

Y-GTPA-OH (Coolant through)

Screw Accessible from both sides

NEW

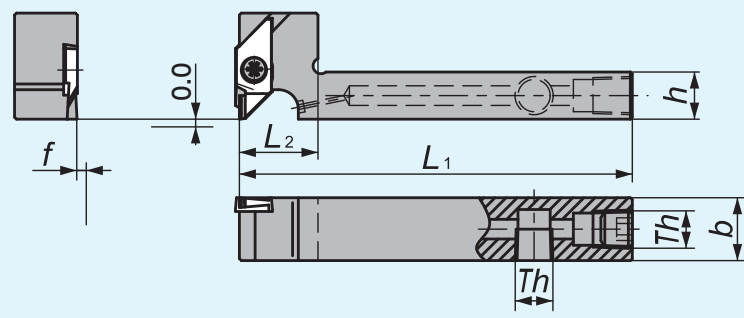

Th (Thread type)
 Metric size holder: Rc1/8 (PT1/8)

Figure-3

Right-Hand style shown

GTPA

Gage Insert	Item Number	Figure	Stock		h (Inch) (mm)	b (Inch) (mm)	h ₁ (Inch) (mm)	L ₁ (Inch) (mm)	f (Inch) (mm)	L ₂ (Inch) (mm)	Th	Clamp Screw	Wrench
			R	L									
GTPA	Y-GTPA%{1216HS-OH	3	○		.472 12	.630 16	— —	2.756 70	.004 0.1	.787 20	Rc1/8(PT1/8)	LRIS-4 x 12PW	CLR-15S
	Y-GTPA%{1216H-OH	3	○		.630 16	.630 16	— —	2.756 70	.004 0.1	.984 25	Rc1/8(PT1/8)	LRIS-4 x 12PW	CLR-15S

Inserts **➔T24**

Cut-off Toolholders

CTP-OH (Coolant through)

Screw Accessible from both sides

NEW

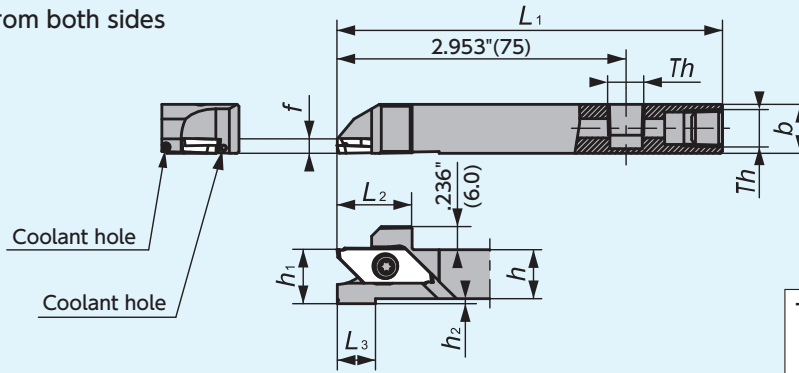

Th (Thread type)
 3/8" holder : M6×1
 1/2", 5/8" holder : NPT1/8
 Metric size holder: Rc1/8 (PT1/8)

Figure-1 ● Left-Hand holders are designed for Right-Hand machines Right-Hand style shown

CTP

Gage Insert	Item Number	Figure	Stock		Max. Cut-off Dia. ϕD^*		h		h_1		b		L_1		h_2		L_2		L_3		Th	f		Clamp Screw	Wrench
			R	L	(Inch)	(mm)	(Inch)	(mm)	(Inch)	(mm)	(Inch)	(mm)	(Inch)	(mm)	(Inch)	(mm)	(Inch)	(mm)	(Inch)	(mm)		(Inch)	(mm)		
	CTP% ϕ 06H-IN-OH	1	●	●	.472	12	3/8	.472	12	3/8	3.937	100	.176	4.475	.768	19.5	.748	19	M6 × 1	0.0	0.0	LR15-4×10PW	CLR-15S		
	CTP% ϕ 08H-IN-OH	1	●	●	.472	12	1/2	1/2	1/2	3.937	100	.051	1.3	.768	19.5	.394	10	NPT1/8	0.0	0.0	LR15-4×12PW	CLR-15S			
	CTP% ϕ 1012H-OH	1	○	○	.472	12	.394	10	.472	12	.394	10	3.937	100	.176	4.475	.768	19.5	.748	19	M6 × 1	0.0	0.0	LR15-4×12PW	CLR-15S
	CTP% ϕ 12H-OH	1	●	●	.472	12	.472	12	.472	12	.472	12	3.937	100	.051	1.3	.768	19.5	.394	10	Rc1/8(PT1/8)	0.0	0.0	LR15-4×12PW	CLR-15S
	CTP% ϕ 16H-OH	1	○	○	.472	12	.630	16	.630	16	.630	16	3.937	100	0	0	.768	19.5	—	—	Rc1/8(PT1/8)	0.0	0.0	LR15-4×12PW	CLR-15S

● Left-Hand coolant through holders are designed for Right-Hand machines. * Would be changed by insert
Inserts →S10·S12

CTPA-OH / TBPA-OH

Screw Accessible from both sides

NEW

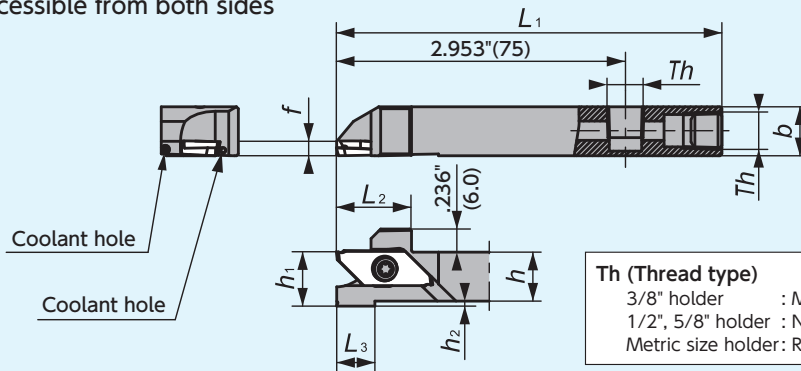

Max Bar Dia at Max DOC

CTPA-OH

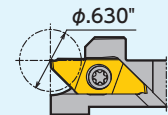

TBPA-OH

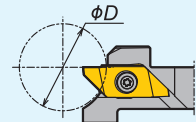

Th (Thread type)
 3/8" holder : M6×1
 1/2", 5/8" holder : NPT1/8
 Metric size holder: Rc1/8 (PT1/8)

Figure-2 ● Left-Hand holders are designed for Right-Hand machines Right-Hand style shown

CTPA (Compatible with TBPA & CTPA Inserts)

Gage Insert	Item Number	Figure	Stock		Max. Cut-off Dia. ϕD^*		h		h_1		b		L_1		h_2		L_2		L_3		Th	f		Clamp Screw	Wrench
			R	L	(Inch)	(mm)	(Inch)	(mm)	(Inch)	(mm)	(Inch)	(mm)	(Inch)	(mm)	(Inch)	(mm)	(Inch)	(mm)	(Inch)	(mm)					
	CTPA% ϕ 06H-IN-OH	2	●	●	.630	16	3/8	.472	12	3/8	3.937	100	.176	4.475	.768	19.5	.787	20	M6 × 1	0.0	0.0	LR15-4×10PW	CLR-15S		
	CTPA% ϕ 08H-IN-OH	2	●	●	.630	16	1/2	1/2	1/2	3.937	100	.051	1.3	.768	19.5	.394	10	NPT1/8	0.0	0.0	LR15-4×12PW	CLR-15S			
	CTPA% ϕ 10H-IN-OH	2	●	●	.630	16	5/8	5/8	5/8	3.937	100	0	0	.768	19.5	—	—	NPT1/8	0.0	0.0	LR15-4×12PW	CLR-15S			
	CTPA% ϕ 12H-OH	2	●	●	.630	16	.472	12	.472	12	.472	12	3.937	100	.079	2	.768	19.5	.394	10	Rc1/8(PT1/8)	0.0	0.0	LR15-4×12PW	CLR-15S
	CTPA% ϕ 16H-OH	2	○	○	.630	16	.630	16	.630	16	.630	16	3.937	100	0	0	.768	19.5	0	0	Rc1/8(PT1/8)	0.0	0.0	LR15-4×12PW	CLR-15S

● Left-Hand coolant through holders are designed for Right-Hand machines. * Would be changed by insert

● : Stock ○ : 1-2 week delivery 💧 : Coolant through

Inserts →S10·S12

Cutting condition →S5

ID Tooling - STICK DUO SPLASH -

HY-NBH-OH (Coolant through)

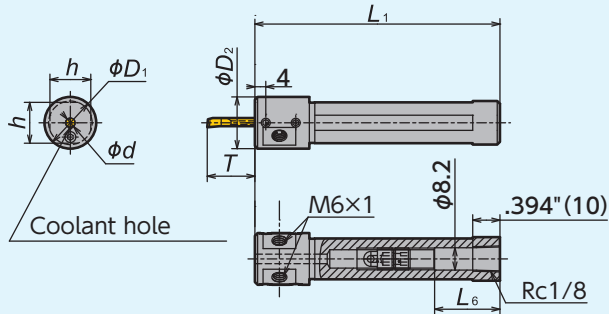

Figure-1

HY-NBH-OH (Coolant through)

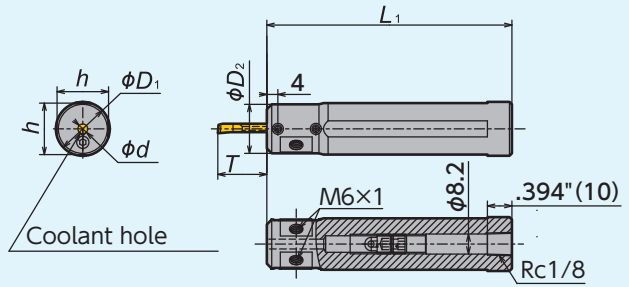
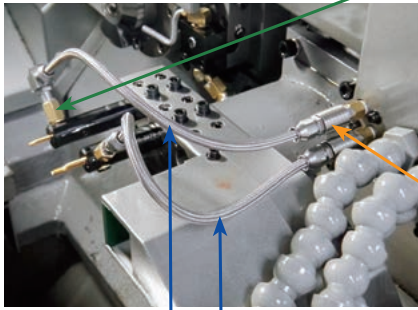

Figure-2

Item Number	Stock	Figure	ϕd		ϕD_1		ϕD_2	h	L_1	Overhang Length of Bar T				
			(Inch)	(mm)	(Inch)	(mm)				Min.		Max.		
											(Inch)	(mm)	(Inch)	(mm)
HY-NBH02016G-OH	●	1	.079	2	.630	16	19	15	90	.197	5.0	.709	18.0	
HY-NBH02516G-OH	●	1	.098	2.5	.630	16	19	15	90	.248	6.3	.768	19.5	
HY-NBH03016G-OH	●	1	.118	3	.630	16	19	15	90	.295	7.5	.827	21.0	
HY-NBH03516G-OH	●	1	.138	3.5	.630	16	19	15	90	.346	8.8	.965	24.5	
HY-NBH04016G-OH	●	1	.157	4	.630	16	19	15	90	.394	10.0	1.102	28.0	
HY-NBH05016G-OH	●	1	.197	5	.630	16	19	15	90	.492	12.5	1.378	35.0	
HY-NBH02019J-OH	●	2	.079	2	3/4	19.05	19.05	18	110	.197	5.0	.709	18.0	
HY-NBH02519J-OH	●	2	.098	2.5	3/4	19.05	19.05	18	110	.248	6.3	.768	19.5	
HY-NBH03019J-OH	●	2	.118	3	3/4	19.05	19.05	18	110	.295	7.5	.827	21.0	
HY-NBH03519J-OH	●	2	.138	3.5	3/4	19.05	19.05	18	110	.346	8.8	.965	24.5	
HY-NBH04019J-OH	●	2	.157	4	3/4	19.05	19.05	18	110	.394	10.0	1.102	28.0	
HY-NBH05019J-OH	●	2	.197	5	3/4	19.05	19.05	18	110	.492	12.5	1.378	35.0	
HY-NBH02020J-OH	●	2	.079	2	.787	20	20	19	110	.197	5.0	.709	18.0	
HY-NBH02520J-OH	●	2	.098	2.5	.787	20	20	19	110	.248	6.3	.768	19.5	
HY-NBH03020J-OH	●	2	.118	3	.787	20	20	19	110	.295	7.5	.827	21.0	
HY-NBH03520J-OH	●	2	.138	3.5	.787	20	20	19	110	.346	8.8	.965	24.5	
HY-NBH04020J-OH	●	2	.157	4	.787	20	20	19	110	.394	10.0	1.102	28.0	
HY-NBH05020J-OH	●	2	.197	5	.787	20	20	19	110	.492	12.5	1.378	35.0	
HY-NBH02022X-OH	●	2	.079	2	.866	22	20	21	120	.197	5.0	.709	18.0	
HY-NBH02522X-OH	●	2	.098	2.5	.866	22	20	21	120	.248	6.3	.768	19.5	
HY-NBH03022X-OH	●	2	.118	3	.866	22	20	21	120	.295	7.5	.827	21.0	
HY-NBH03522X-OH	●	2	.138	3.5	.866	22	20	21	120	.346	8.8	.965	24.5	
HY-NBH04022X-OH	●	2	.157	4	.866	22	20	21	120	.394	10.0	1.102	28.0	
HY-NBH05022X-OH	●	2	.197	5	.866	22	20	21	120	.492	12.5	1.378	35.0	
HY-NBH02025.0K-OH	●	2	.079	2	.984	25.0	20	24	125	.197	5.0	.709	18.0	
HY-NBH02525.0K-OH	●	2	.098	2.5	.984	25.0	20	24	125	.248	6.3	.768	19.5	
HY-NBH03025.0K-OH	●	2	.118	3	.984	25.0	20	24	125	.295	7.5	.827	21.0	
HY-NBH03525.0K-OH	●	2	.138	3.5	.984	25.0	20	24	125	.346	8.8	.965	24.5	
HY-NBH04025.0K-OH	●	2	.157	4	.984	25.0	20	24	125	.394	10.0	1.102	28.0	
HY-NBH05025.0K-OH	●	2	.197	5	.984	25.0	20	24	125	.492	12.5	1.378	35.0	
HY-NBH02025.4K-OH	●	2	.079	2	1	25.4	20	24	125	.197	5.0	.709	18.0	
HY-NBH02525.4K-OH	●	2	.098	2.5	1	25.4	20	24	125	.248	6.3	.768	19.5	
HY-NBH03025.4K-OH	●	2	.118	3	1	25.4	20	24	125	.295	7.5	.827	21.0	
HY-NBH03525.4K-OH	●	2	.138	3.5	1	25.4	20	24	125	.346	8.8	.965	24.5	
HY-NBH04025.4K-OH	●	2	.157	4	1	25.4	20	24	125	.394	10.0	1.102	28.0	
HY-NBH05025.4K-OH	●	2	.197	5	1	25.4	20	24	125	.492	12.5	1.378	35.0	

Quick-change Coolant Components

③ Conversion / Extension Joint



① Plug-in Style Flexible Hose

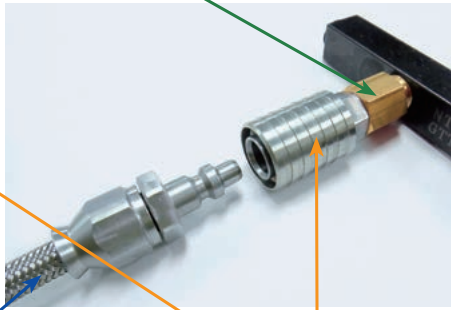

② Quick Change Coupling

- Up to 2900psi
- High quality flexible stainless steel braided hose
- Reduce machine downtime

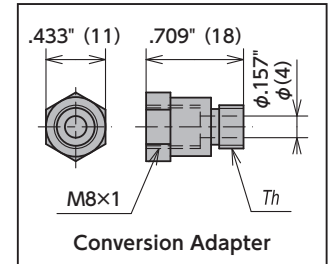

NTK Unique Tooling

① Plug-in Style Flexible Hose

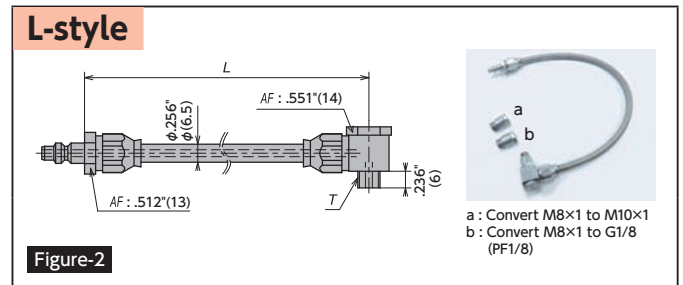
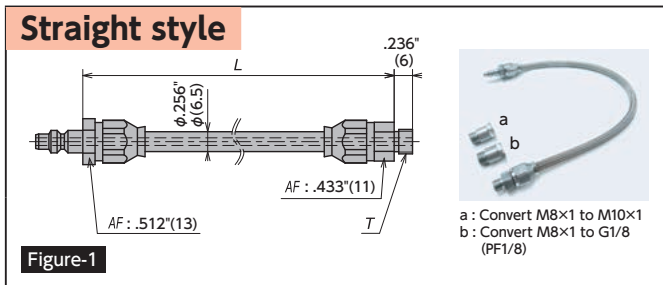

Item Number	Figure	Stock	L		T	Comes with
			(Inch)	(mm)		
HOSE-ST-1/8NPT-4IN	1	●	4.000	101.6	NPT1/8	—
HOSE-ST-1/8NPT-6IN	1	●	6.000	152.4	NPT1/8	—
HOSE-ST-1/8NPT-10IN	1	●	10.000	254.0	NPT1/8	—
HOSE-ST-M8*1	1	●	11.811	300.0	M8 × 1	Conversion Adapter a and b
HOSE-AN-M8*1	2	●	11.890	302.0	M8 × 1	Conversion Adapter a and b

② Quick Change Coupling

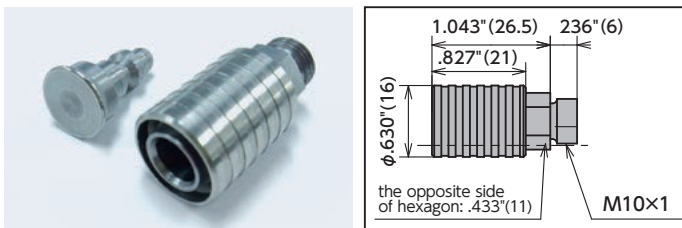

Item Number	Stock	Comes with
COUP-M10*1	●	Seal Plug

③ Conversion / Extension Joint

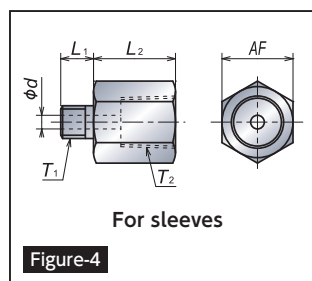
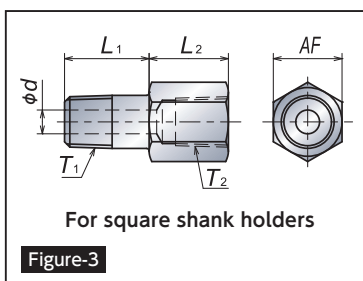

Item Number	Figure	Stock	T ₁ (mm)	T ₂ (mm)	L ₁ (mm)	L ₂ (mm)	AF (mm)	d (mm)
SCJ-M6-RC1/8-L	3	○	M6 × 1	Rc1/8 (PT1/8)	16	15	13	2.5
SCJ-NPT1/8-M10-L	3	●	NPT1/8	M10 × 1	16	12	13	4.5
SCJ-R1/8-M10-L	3	○	R1/8 (PT1/8)	M10 × 1	16	12	13	4.5
SCJ-R1/8-RC1/8-L	3	○	R1/8 (PT1/8)	Rc1/8 (PT1/8)	16	15	13	4.5
SCJ-R1/8-NPT1/8-L	3	●	R1/8 (PT1/8)	NPT1/8	16	15	13	4.5
SCJ-M6-M10	4	○	M6 × 1	M10 × 1	6	15	12	2.5
SCJ-M6-RC1/8	4	○	M6 × 1	Rc1/8 (PT1/8)	6	15	13	2.5
SCJ-M6-NPT1/8	4	●	M6 × 1	NPT1/8	6	15	13	2.5
SCJ-M8-RC1/8	4	○	M8 × 1	Rc1/8 (PT1/8)	6	15	13	3.5
SCJ-R1/8-M10	4	○	R1/8 (PT1/8)	M10 × 1	10	15	12	4.5
SCJ-R1/8-NPT1/8	4	●	R1/8 (PT1/8)	NPT1/8	10	15	13	4.5

● : Stock ○ : 1-2 week delivery 🔵 : Coolant through

Y-axis Toolholders

Chip control by gravity

WATCH ON
YouTube

Features

- Chip drops down to the bed of the machine due to gravity, and chip control problem is solved
- Now available coolant through holders
- Front turning, grooving, and back turning operations can be performed by utilizing Y-axis control

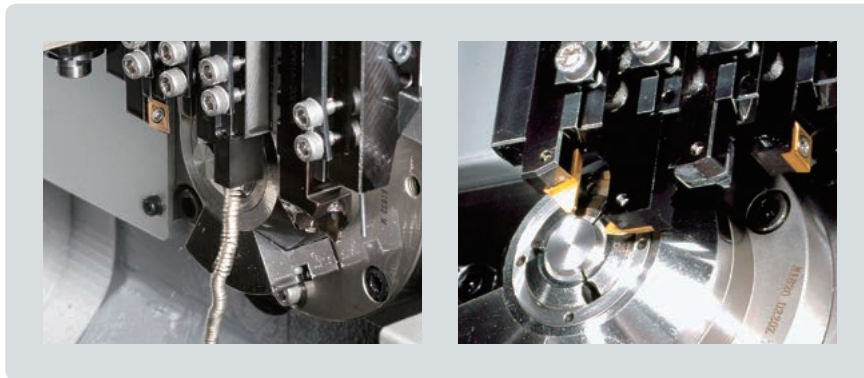

- Perfect solution for chip problems
- Less wear, more stable dimensions

Programming guidance

Regular Toolholder					Y-axis Toolholder			
① T300				Select tool	① T300			
② G0	X .450	Z .000	T3	Position tool	② G0	Y .450	Z .000	T3
③					③	X .000		
④ G1	X .300		F .003	Move to OD to cut	④ G1	Y .300		F .003
⑤		Z .200	F .002	Cut .200" length	⑤		Z .200	F .002
⑥	X .400			Cut face	⑥	Y .450		
⑦ G0	X .450				⑦ G0	X .450		

Cut by X-axis

Cut by Y-axis

Note: Need Y-offset for holder shank size.

Machinable OD Dimensions

*Machinable ODs with Y-GTTR type grooving toolholders are shown as an example (The dimensions apply to other Y-axis toolholders as well)

Y-axis Holder Overhang	Tool Layout	Situation	Overhang Amount (L)		
			.787 (20mm)	.866 (22mm)	.984 (25mm)
.787 (20mm)		D1 Max machinable OD with Holder A	No limitation	No limitation	No limitation
		D2 Max machinable OD with Holder B	.512 (13mm)	.512 (13mm)	.512 (13mm)
		D3 Max machinable OD with Holder C	No limitation	No limitation	No limitation
.984 (25mm)		D1 Max machinable OD with Holder A	1.496 (38mm)	2.283 (58mm)	No limitation
		D2 Max machinable OD with Holder B	.587 (14.9mm)	.535 (13.6mm)	.512 (13mm)
		D3 Max machinable OD with Holder C	1.496 (38mm)	2.283 (58mm)	No limitation
1.181 (30mm)		D1 Max machinable OD with Holder A	1.055 (26.8mm)	1.142 (29mm)	1.516 (38.5mm)
		D2 Max machinable OD with Holder B	.811 (20.6mm)	.705 (17.9mm)	.587 (14.9mm)
		D3 Max machinable OD with Holder C	1.299 (33mm) 1.055 (26.8mm) for TBP style	1.457 (37mm) 1.142 (29mm) for TBP style	2.028 (51.5mm) 1.516 (38.5mm) for TBP style

Important Notes for Using Y-axis Toolholders

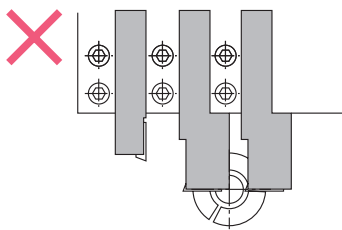

To avoid interference, two Y-axis toolholders should not be installed next to each other

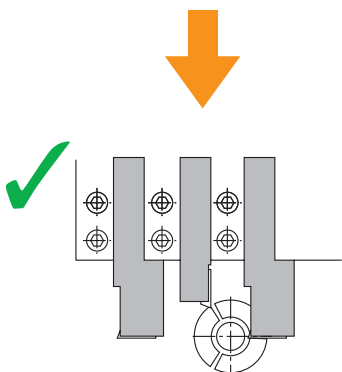

Install a standard toolholder between the two Y-axis toolholders

For tool change, determine a retraction point based on the overhang of the Y-axis toolholder

- Example: Tool change from No.2 to No.4

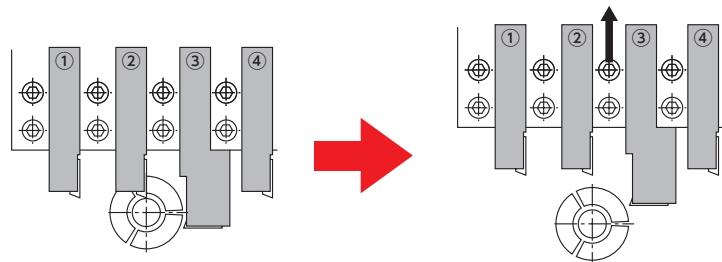

Retract the tool station based on the cutting edge location on the Y-axis toolholder

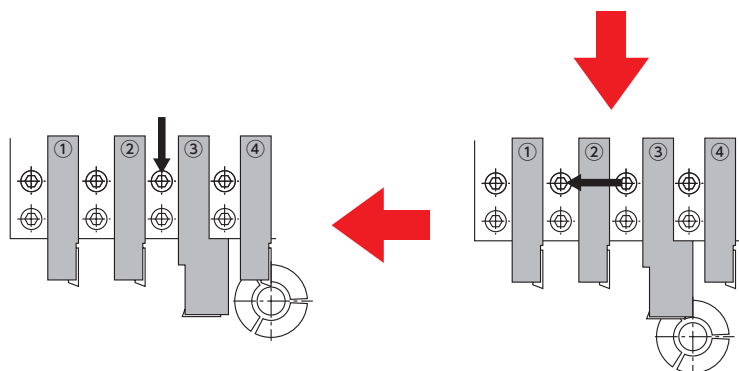

Front Turning

DC.. Series - Toolholders

Y-SDJC-OH (Coolant through)

NEW

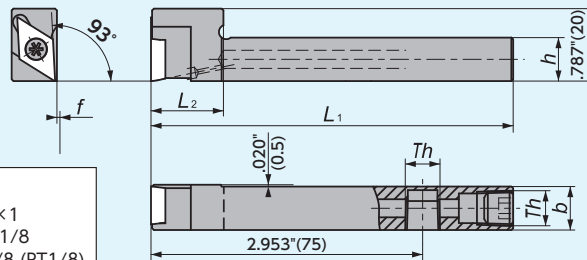

Th (Thread type)
 3/8" holder : M6×1
 1/2", 5/8" holder : NPT1/8
 Metric size holder: Rc1/8 (PT1/8)

Figure-1

Right-Hand style shown
 Takes Right-hand or Neutral insert

Y-SDJC

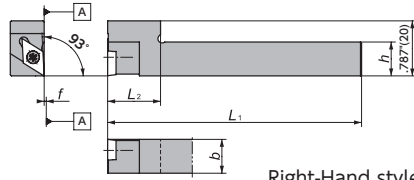

Figure-2

Right-Hand style shown
 Takes Right-hand or Neutral insert

Y-SDNC

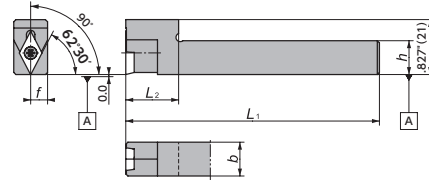

Figure-3

Takes Right-hand or Neutral insert

Gage Insert	Item Number	Figure	Stock		h	b	L ₁	f	L ₂	Th	Clamp Screw	Wrench
			R	L								
DC..21.5..	Y-SDJCR062H-IN-OH	1	●		3/8	3/8	3.937 100	0 0	.984 25	M6 × 1	LRIS-2.5 × 7	CLR-15S
DC..21.5..WP	Y-SDJCR082H-IN-OH	1	●		1/2	1/2	3.937 100	0 0	.984 25	NPT1/8	LRIS-2.5 × 7	CLR-15S
DC..32.5..	Y-SDJCR083H-IN-OH	1	●		1/2	1/2	3.937 100	0 0	.984 25	NPT1/8	LRIS-4 × 10	LLR-25S-20 × 65
	Y-SDJCR103H-IN-OH	1	●		5/8	5/8	3.937 100	0 0	.984 25	NPT1/8	LRIS-4 × 10	LLR-25S-20 × 65
	Y-SDJCR1212H11S-OH	1	●		.472 12.0	.472 12.0	3.937 100	0 0	.787 20	Rc1/8(PT1/8)	LRIS-4 × 10	LLR-25S-20 × 65
	Y-SDJCR1616H11-OH	1	○		.630 16.0	.630 16.0	3.937 100	0 0	.984 25	Rc1/8(PT1/8)	LRIS-4 × 10	LLR-25S-20 × 65
DC..21.5..	Y-SDJCR062-IN	2	●		3/8	3/8	4.724 120	0 0	.984 25	—	LRIS-2.5 × 7	CLR-15S
	Y-SDJCR082-IN	2	●		1/2	1/2	4.724 120	0 0	.984 25	—	LRIS-2.5 × 7	CLR-15S
	Y-SDJCR10-07S	2	○		.394 10.0	.394 10	4.724 120	0 0	.787 20	—	LRIS-2.5 × 7	CLR-15S
	Y-SDJCR12-07S	2	○		.472 12.0	.472 12	4.724 120	0 0	.787 20	—	LRIS-2.5 × 7	CLR-15S
DC..32.5..	Y-SDJCR083-IN	2	●		1/2	1/2	4.724 120	0 0	.984 25	—	LRIS-4 × 10	LLR-25S-20 × 65
	Y-SDJCR103-IN	2	●		5/8	5/8	4.724 120	0 0	.984 25	—	LRIS-4 × 10	LLR-25S-20 × 65
	Y-SDJCR12-11S	2	○		.472 12.0	.630 16	4.724 120	0 0	.787 20	—	LRIS-4 × 10	LLR-25S-20 × 65
	Y-SDJCR16-11S	2	○		.630 16.0	.630 16	4.724 120	0 0	.787 20	—	LRIS-4 × 10	LLR-25S-20 × 65
DC..32.5..	Y-SDNCN083-IN	3	●		1/2	1/2	4.724 120	1/4 6.35	.984 25	—	LRIS-4 × 10	LLR-25S-20 × 65
	Y-SDNCN12-11S	3	○		.472 12.0	.472 12	4.724 120	.236 6.0	.787 20	—	LRIS-4 × 10	LLR-25S-20 × 65
	Y-SDNCN16-11S	3	○		.630 16.0	.630 16	4.724 120	.315 8.0	.787 20	—	LRIS-4 × 10	LLR-25S-20 × 65

Inserts → **Q20**

VC.. Series - Toolholders

Y-SVJCR-OH (Coolant through)

NEW

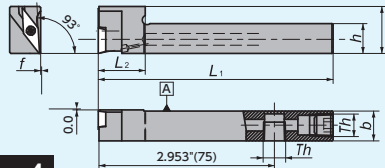

Figure-4

Th (Thread type)
 Inch size holder:
 NPT1/8

Y-SVJCR

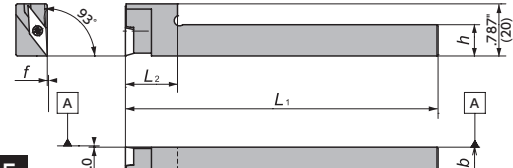

Figure-5

Gage Insert	Item Number	Figure	Stock		h	b	L ₁	f	L ₂	Th	Clamp Screw	Wrench
			R	L								
VC..22..	Y-SVJCR082SHS-IN-OH	4	●		1/2	1/2	3.937 100	0.0 0.0	.787 20	NPT1/8	LRIS-2.5 × 7	CLR-15S
	Y-SVJCR102H-IN-OH	4	●		5/8	5/8	3.937 100	0.0 0.0	.984 25	NPT1/8	LRIS-2.5 × 7	CLR-15S
VC..22..	Y-SVJCR062-IN	5	●		3/8	3/8	4.724 120	0.0 0.0	.787 20	—	LRIS-2.5 × 7	CLR-15S
	Y-SVJCR082-IN	5	●		1/2	1/2	4.724 120	0.0 0.0	.787 20	—	LRIS-2.5 × 7	CLR-15S
	Y-SVJCR102-IN	5	●		5/8	5/8	4.724 120	0.0 0.0	.984 25	—	LRIS-2.5 × 7	CLR-15S

Inserts → **Q29**

Back Turning

TBP Series - Toolholders

Y-TBP-OH (Coolant through)

Screw accessible from both sides

NEW

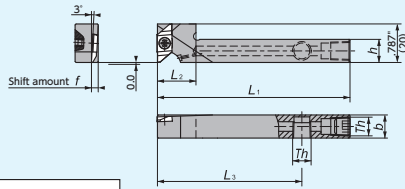

Figure-1

Th (Thread type)
Inch size holder : NPT1/8
Metric size holder: M6, Rc1/8 (PT1/8)

Right-Hand style shown
Takes Right-hand Insert

Y-TBP

Screw accessible from both sides

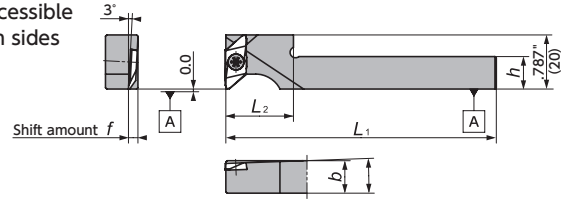

Figure-2

Right-Hand style shown
Takes Right-hand Insert

TBP

Gage Insert	Item Number	Figure	Stock		h (Inch) (mm)	b (Inch) (mm)	h ₁ (Inch) (mm)	L ₁ (Inch) (mm)	f (Inch) (mm)	L ₂ (Inch) (mm)	h ₂ (Inch) (mm)	L ₃ (Inch) (mm)	Th	Clamp Screw	Wrench
			R	L											
	Y-TBP%108H-IN-OH	1	●		1/2	1/2	—	3.937 100	.138 3.5	.984 25	—	2.953 75	NPT1/8	LRIS-4 x 12PW	CLR-155
	Y-TBP%112HS-OH	1	●		.472 12	.472 12	—	3.937 100	.138 3.5	.787 20	—	2.953 75	Rc1/8(PT1/8)	LRIS-4 x 12PW	CLR-155
	Y-TBP%116H-OH	1	○		.630 16	.630 16	—	3.937 100	.138 3.5	.984 25	—	2.953 75	Rc1/8(PT1/8)	LRIS-4 x 12PW	CLR-155
	Y-TBP%106-IN	2	●		3/8	3/8	—	2.756 70	.138 3.5	.984 25	—	—	—	LRIS-4 x 10PW	CLR-155
	Y-TBP%108-IN	2	●		1/2	1/2	—	2.756 70	.138 3.5	.984 25	—	—	—	LRIS-4 x 12PW	CLR-155
	Y-TBP%110-IN	2	●		5/8	5/8	—	2.756 70	.138 3.5	.984 25	—	—	—	LRIS-4 x 12PW	CLR-155
	Y-TBP%110S	2	○		.394 10	.394 10	—	4.724 120	.138 3.5	.787 20	—	—	—	LRIS-4 x 10PW	CLR-155
Y-TBP%112S	2	○		.472 12	.472 12	—	4.724 120	.138 3.5	.787 20	—	—	—	LRIS-4 x 12PW	CLR-155	

Inserts →R9

TBPA (CTPA) Series - Toolholders

Y-CTPA

Screw accessible from both sides

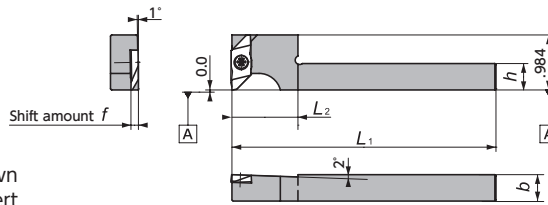
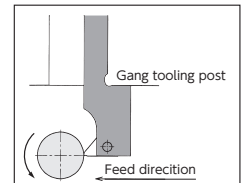

Figure-3

Right-Hand style shown
Takes Right-hand Insert



CTPA

Gage Insert	Item Number	Figure	Stock		h (Inch) (mm)	b (Inch) (mm)	h ₁ (Inch) (mm)	L ₁ (Inch) (mm)	f (Inch) (mm)	L ₂ (Inch) (mm)	h ₂ (Inch) (mm)	L ₃ (Inch) (mm)	Th	Clamp Screw	Wrench
			R	L											
	Y-CTPA%108L-IN	3	●		1/2	1/2	—	4.724 120	1.34 34	—	—	—	—	LRIS-4 x 12PW	CLR-155

Inserts →R11

TBDP Series - Toolholders

Y-TBDP

NEW

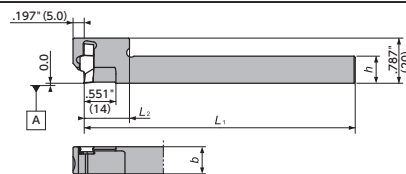
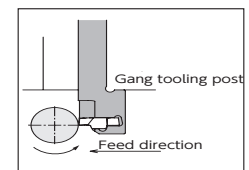

Figure-4

Right-Hand style shown



TBDP

Gage Insert	Item Number	Figure	Stock		h (Inch) (mm)	b (Inch) (mm)	h ₁ (Inch) (mm)	L ₁ (Inch) (mm)	f (Inch) (mm)	L ₂ (Inch) (mm)	L ₃ (Inch) (mm)	h ₂ (Inch) (mm)	Clamp Screw	Wrench
			R	L										
	Y-TBDPR12S	4	○		.472 12	.472 12	—	4.724 120	.081 2.05	.787 20	.197 5	—	LRIS-4 x 12	LLR-255

● : Stock ○ : 1-2 week delivery ● : Coolant through

Inserts →R12

Cutting condition →R3

Grooving / Side turning / Back turning

GTT Series

Y-GTT-OH (Coolant through)

Screw accessible from both sides

NEW

Th (Thread type)
Inch size holder : NPT1/8
Metric size holder: M6, Rc1/8 (PT1/8)

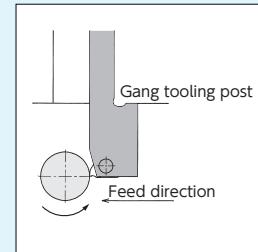
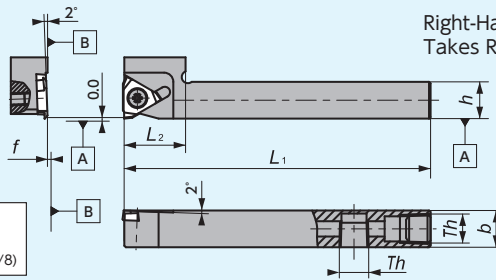

Figure-1

Y-GTT

Screw accessible from both sides

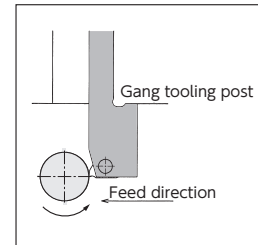
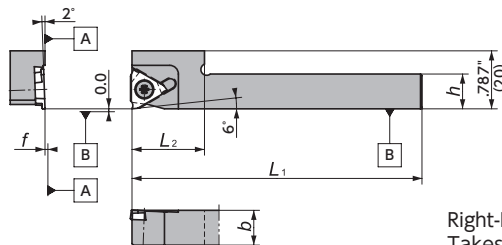

Figure-2

GTT

Gage Insert	Item Number	Figure	Stock		h		b		h ₁		L ₁		f		L ₂		a _r		h ₂		Th	Clamp Screw	Wrench
			R	L	(Inch)	(mm)	(Inch)	(mm)	(Inch)	(mm)	(Inch)	(mm)	(Inch)	(mm)	(Inch)	(mm)	(Inch)	(mm)					
TBMH32.. GTM.32.. TMG32	Y-GTT%108H-IN-OH	1	●		1/2		1/2				3.937	100	.000	0	.984	25.0	.063	1.6			NPT1/8	LR-5-4x10PW	CLR-155
	Y-GTT%112H005-OH	1	●		.472	12	.472	12			3.937	100	.000	0	.787	20.0	.063	1.6			Rc1/8(PT1/8)	LR-5-4x10PW	CLR-155
	Y-GTT%116H00-OH	1	○		.630	16	.472	16			3.937	100	.000	0	.984	25.0	.063	1.6			Rc1/8(PT1/8)	LR-5-4x10PW	CLR-155
	Y-GTTR%106-IN	2	●		3/8		3/8				4.724	120	.000	0	.984	25.0	.063	1.6				LR-5-4x10PW	CLR-155
	Y-GTTR%108-IN	2	●		1/2		1/2				4.724	120	.000	0	.984	25.0	.063	1.6				LR-5-4x10PW	CLR-155
	Y-GTTR%110-IN	2	●		5/8		5/8				4.724	120	.000	0	.984	25.0	.063	1.6				LR-5-4x10PW	CLR-155
	Y-GTT%110S	2	○		.394	10	.394	10			4.724	120	.000	0	.787	20.0	.063	1.6				LR-5-4x10PW	CLR-155
	Y-GTT%112S	2	○		.472	12	.472	12			4.724	120	.000	0	.787	20.0	.063	1.6				LR-5-4x10PW	CLR-155

Inserts GTM..32 ➔T12

Inserts TBMH32.. ➔R19

Multi-functional Grooving for non-ferrous material

GTPA Series - Inserts

Y-GTPA-OH (Coolant through)

Screw Accessible from both sides

NEW

Th (Thread type)
Metric size holder:
Rc1/8 (PT1/8)

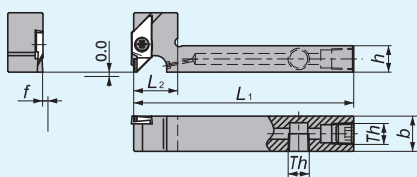

Figure-1

Right-Hand style shown

Y-GTPA

Screw Accessible from both sides

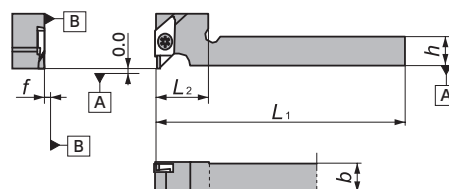

Figure-2

Right-Hand style shown

GTPA

Gage Insert	Item Number	Figure	Stock		h		b		h ₁		L ₁		f		L ₂		Th	Clamp Screw	Wrench
			R	L	(Inch)	(mm)	(Inch)	(mm)	(Inch)	(mm)	(Inch)	(mm)	(Inch)	(mm)	(Inch)	(mm)			
GTPA	Y-GTPA%11216HS-OH	1	○		.472	12	.630	16			2.756	70	.004	0.1	.787	20	Rc1/8(PT1/8)	LRIS-4 x 12PW	CLR-155
	Y-GTPA%11216H-OH	1	○		.630	16	.630	16			2.756	70	.004	0.1	.984	25	Rc1/8(PT1/8)	LRIS-4 x 12PW	CLR-155
	Y-GTPA%11216	2	○		.472	12	.630	16			4.724	120	.004	0.1	.787	20		LRIS-4 x 12PW	CLR-155

Inserts ➔T24

Mogul Bar

High rigidity boring bars

WATCH ON
YouTube

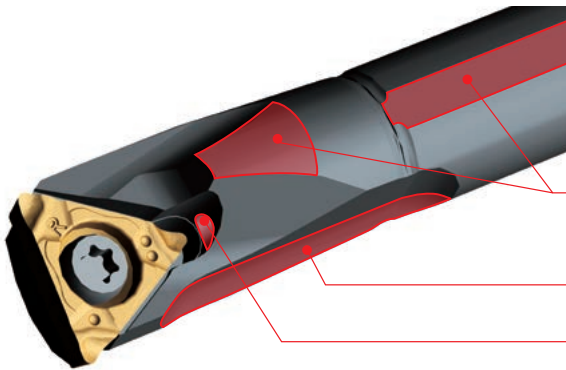

Features

- High rigidity + Minimal flat widths
Reduce vibration
- Large clearance for improved chip evacuation
- All MogulBar boring bars are coolant through

NTK Unique Tooling

Recommended amount of overhang

Steel Shank $L/D \leq 5$

Carbide Shank $L/D \leq 7$

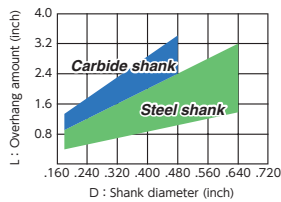

L : Overhang
D : Shank diameter

[Cutting condition example]

Work materials: Alloy steel, stainless
260 SFM, .002 - .004 IPR, .004" - .020" DOC WET

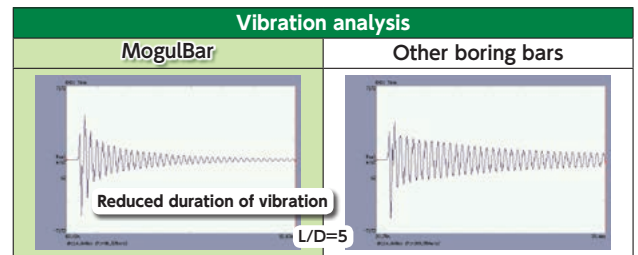

Note: Assuming a 100N load is applied. An equal amount of force was applied to both bars for vibration analysis.
Boring bar used in above analysis: S08H-STUPR09D10-OH

F Chipbreakers - Evacuate chips BACKWARD







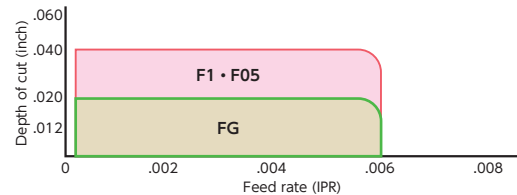

- F chipbreakers allow chips to evacuate backward
- Combination of the F-chipbreakers and MogulBar delivers the best performance



Recommended Cutting Condition Range



F Chipbreakers - Features

	DOC (inch)	Feed (IPR)	
		.002	.004
FG Chipbreaker <ul style="list-style-type: none"> • Best for finishing • Works for small DOC (.020" or less) • High rake angle 	.004		
	.012		
F1/F05 Chipbreakers <ul style="list-style-type: none"> • Cover wide condition range • Ground chipbreaker 	.020		
	Note: Right-hand inserts with FG and F1 chipbreakers should be used with right-hand holders		[Cutting condition example] 4140 Carbon Steel Diameter : ϕ .472" 260 SFM Depth of Bore : .787" Wet Holder : S10K-STUPR11D12-OH Insert : TPGH221

DS-ACH Toolholders



Features

- Adjust centerline height simply with a wrench

1 Adjust centerline height easily

Patented

- Eliminate center boss on end faces
- Provide constant OD dimension
- Adjust easily in machine

1 Turn a screw clockwise

2 Adjustment wedge goes down

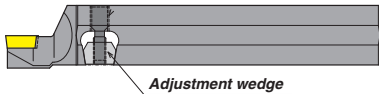

3 Insert edge moves up

Range of centerline height adjustment
0 - .008"

2 Optimized design reduces vibration

Improved chatter resistance.

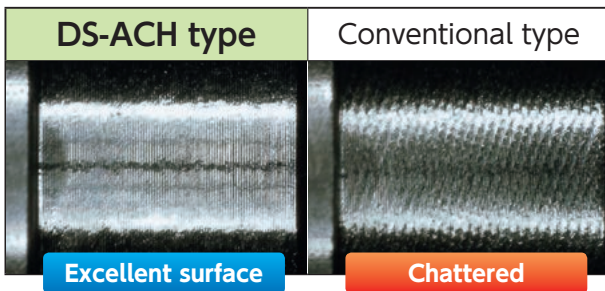

Tested cutting conditions (304 SS)

Work material : 304 SS
Holder : DS-SDUL19-11-ACH
Insert : DCGT32.508MCL TM4
Cutting condition : 250 SFM .002 IPR .079" DOC WET

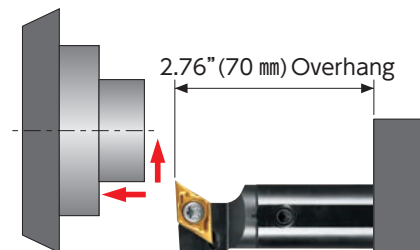

How to use

Insert moves in an upward direction only. (Loosen wedge screw before making any adjustment)

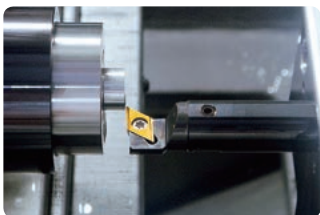

① Install the holder slightly below centerline. Then take a facing test cut.



② Measure the diameter of the centerboss.



③ Raise the center height by one half of the diameter of the boss. Adjustment references are available in the tool case.



④ Re-machine the end face.

*Adjustment instructions are supplied in the tool case

DS Toolholders

For making the most of vacant drill sleeves

DS / DS-ACH Toolholders

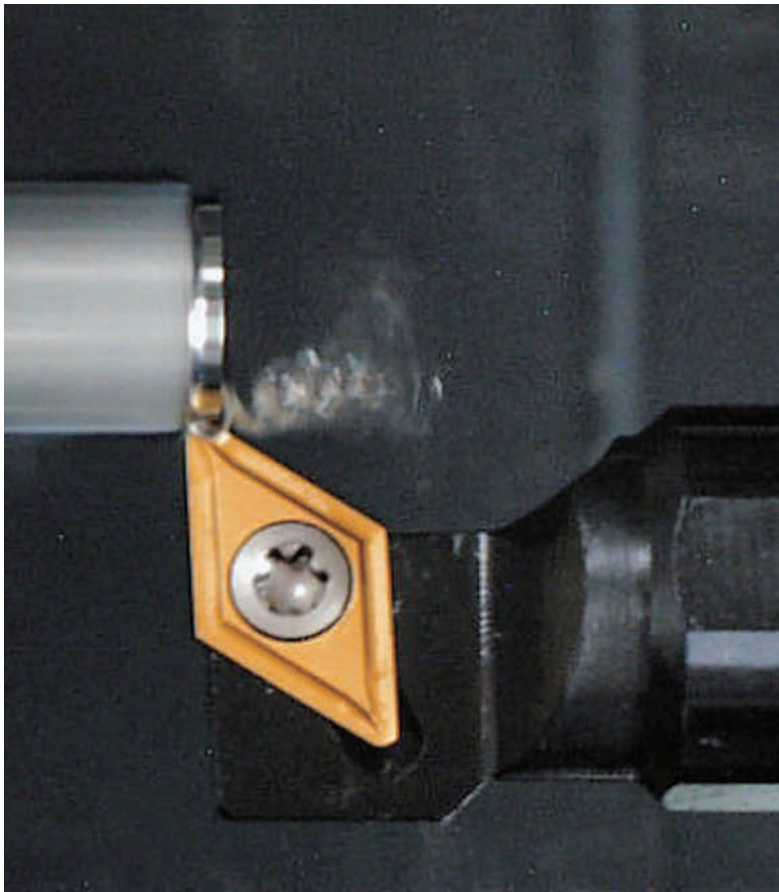

Are you satisfied with the number of tool positions in your machine?
NTK DS type toolholder is useful when additional tool positions are required

Front turning, Back turning, Grooving, Threading, and Small boring which fit into the machines' vacant drill sleeves

DS Series toolholders can be used with both Swiss or non-Swiss type CNC lathes

Features

- More turning tools without any hassle
- Available for Front turning, Back turning, Grooving, Threading, Micro-boring, and interchangeable tooling
- Available shank size range: from .511"(14mm) to 1"(25.4mm)

Front Turning

CC.. Series - Toolholders

DS-SCLL-ACH (Adjustable centerline height)

(Parts)

Shank	Wedge	Screw for Wedge
φ .630" (16)	ACH-W18 (5805601)	WS060415-003 (5795539)
φ 3/4" (19.05)		
φ .787" (20)	ACH-W24 (5805619)	WS060419-004 (5799226)
φ .866" (22)		
φ 1" (25.4)		

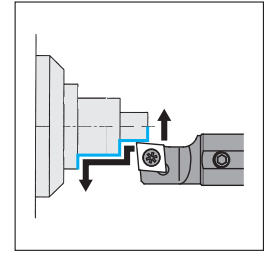
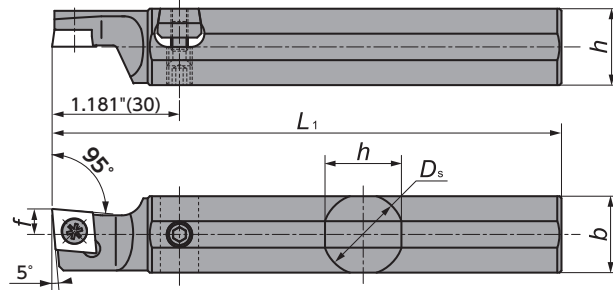

Figure-1

Left-Hand style shown
Takes Right-hand or Neutral insert

DS-SCL

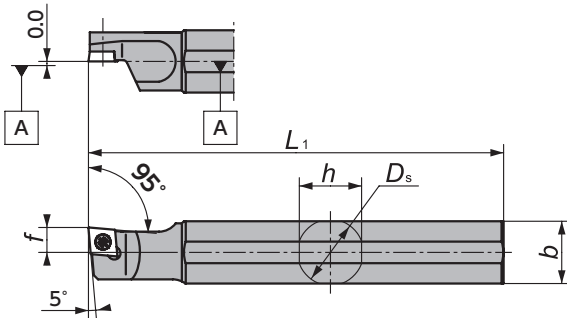

Figure-2

DS-SCL (Coolant through)

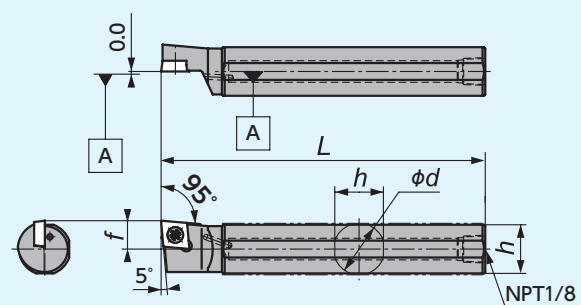

Figure-3

Left-Hand style shown
Takes Right-hand or Neutral insert

DS-SCL (Takes right-hand or neutral insert)

Gage Insert	Item Number	Figure	Stock		D_s		h		b		L_1		f		Clamp Screw	Wrench
			R	L	(Inch)	(mm)	(Inch)	(mm)	(Inch)	(mm)	(Inch)	(mm)	(Inch)	(mm)		
CC..21.5..	DS-SCL%14F-06	2	○	○	.551	14.000	.512	13	.512	13	3.150	80	.236	6.0	LRIS-2.5 × 7	CLR-15S
	DS-SCL%15H-06	2	○	○	5/8	15.875	.591	15	.591	15	3.937	100	.236	6.0	LRIS-2.5 × 7	CLR-15S
	DS-SCL%16F-06	2	○	○	.630	16.000	.591	15	.591	15	3.150	80	.236	6.0	LRIS-2.5 × 7	CLR-15S
	DS-SCL%19-06	2	●	○	3/4	19.050	.709	18	.709	18	4.724	120	.236	6.0	LRIS-2.5 × 7	CLR-15S
	DS-SCL%20X-06	2	○	○	.787	20.000	.748	19	.748	19	3.740	95	.236	6.0	LRIS-2.5 × 7	CLR-15S
	DS-SCL%20-06	2	○	○	.787	20.000	.748	19	.748	19	4.724	120	.236	6.0	LRIS-2.5 × 7	CLR-15S
	DS-SCL%22-06	2	○	○	.866	22.000	.827	21	.827	21	4.724	120	.236	6.0	LRIS-2.5 × 7	CLR-15S
	DS-SCL%25-06MET	2	○	○	.984	25.000	.945	24	.945	24	4.724	120	.236	6.0	LRIS-2.5 × 7	CLR-15S
DS-SCL%25-06	2	○	○	1	25.400	.945	24	.945	24	5.906	150	.236	6.0	LRIS-2.5 × 7	CLR-15S	
CC..32.5..	DS-SCL%14F-09	2	○	○	.551	14.000	.512	13	.512	13	3.150	80	.236	6.0	LRIS-4 × 8	LLR-25S-20 × 65
	DS-SCL%15H-09	2	○	○	5/8	15.875	.591	15	.591	15	3.937	100	.236	6.0	LRIS-4 × 8	LLR-25S-20 × 65
	DS-SCL%16F-09	2	○	○	.630	16.000	.591	15	.591	15	3.150	80	.236	6.0	LRIS-4 × 8	LLR-25S-20 × 65
	DS-SCL%19GX-09	2	○	○	3/4	19.050	.709	18	.709	18	3.346	85	.236	6.0	LRIS-4 × 8	LLR-25S-20 × 65
	DS-SCL%19-09	2	○	○	3/4	19.050	.709	18	.709	18	4.724	120	.236	6.0	LRIS-4 × 8	LLR-25S-20 × 65
	DS-SCL%19-09-004	3	○	○	3/4	19.050	.709	18	.709	18	4.724	120	.413	10.5	LRIS-4 × 8	LLR-25S-20 × 65
	DS-SCL%20X-09	2	○	○	.787	20.000	.748	19	.748	19	3.740	95	.236	6.0	LRIS-4 × 8	LLR-25S-20 × 65
	DS-SCL%20-09	2	○	○	.787	20.000	.748	19	.748	19	4.724	120	.236	6.0	LRIS-4 × 8	LLR-25S-20 × 65
	DS-SCL%22-09	2	○	○	.866	22.000	.827	21	.827	21	4.724	120	.236	6.0	LRIS-4 × 8	LLR-25S-20 × 65
	DS-SCL%22-09-005	3	○	○	.866	22.000	.827	21	.827	21	4.724	120	.472	12.0	LRIS-4 × 8	LLR-25S-20 × 65
	DS-SCL%25-09MET	2	○	○	.984	25.000	.945	24	.945	24	4.724	120	.236	6.0	LRIS-4 × 8	LLR-25S-20 × 65
	DS-SCL%25-09	2	○	○	1	25.400	.945	24	.945	24	5.906	150	.236	6.0	LRIS-4 × 8	LLR-25S-20 × 65
	DS-SCL%16F-09-ACH	1	○	○	.630	16.000	.610	15.5	.610	15.5	3.150	80	.236	6.0	LRIS-4 × 8	LLR-25S-20 × 65
	DS-SCL%19-09-ACH	1	○	○	3/4	19.050	.709	18.0	.709	18.0	4.724	120	.236	6.0	LRIS-4 × 8	LLR-25S-20 × 65
	DS-SCL%20-09-ACH	1	○	○	.787	20.000	.748	19.0	.748	19.0	4.724	120	.236	6.0	LRIS-4 × 8	LLR-25S-20 × 65
	DS-SCL%22-09-ACH	1	○	○	.866	22.000	.827	21.0	.827	21.0	4.724	120	.236	6.0	LRIS-4 × 8	LLR-25S-20 × 65
	DS-SCL%25-09MET-ACH	1	○	○	.984	25.000	.945	24.0	.945	24.0	4.724	120	.236	6.0	LRIS-4 × 8	LLR-25S-20 × 65
DS-SCL%25-09-ACH	1	○	○	1	25.400	.945	24.0	.945	24.0	5.906	150	.236	6.0	LRIS-4 × 8	LLR-25S-20 × 65	

Inserts → Q12

DC.. Series - Toolholders

DS-SDU-ACH (Adjustable centerline height)

(Parts)

Shank	Wedge	Screw for Wedge
φ .630" (16)	ACH-W18 (5805601)	WS060415-003 (5795539)
φ 3/4" (19.05)		
φ .787" (20)	ACH-W24 (5805619)	WS060419-004 (5799226)
φ .866" (22)		
φ 1" (25.4)		

Figure-1

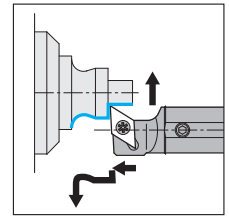
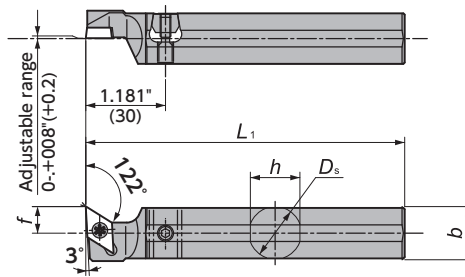

Left-Hand style shown
Takes Right-hand or Neutral insert

DS-SDU

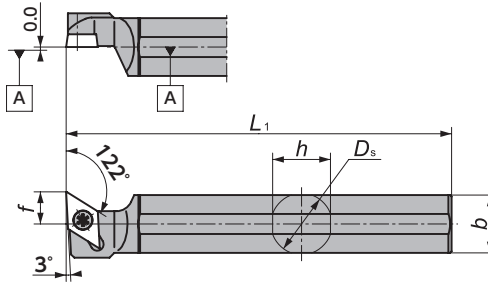
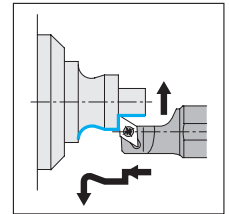

Figure-2



Left-Hand style shown
Takes Right-hand or Neutral insert

DS-SDX / DS-SDX (Coolant through)

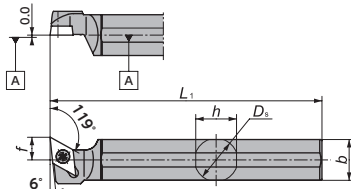

Figure-3

DS-SDXL22-11-006 (Coolant through)

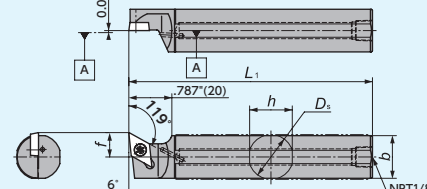
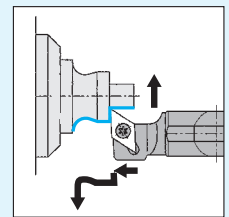

Figure-4



Left-Hand style shown
Takes Right-hand or Neutral insert

Gage Insert	Item Number	Figure	Stock		D_s		h		b		L_1		f		Clamp Screw	Wrench
			R	L	(Inch)	(mm)	(Inch)	(mm)	(Inch)	(mm)	(Inch)	(mm)	(Inch)	(mm)		
DC..21.5.. DC..21.5..WP	DS-SDU%14F-07	2	○	○	.551	14.000	.512	13.0	.512	13.0	3.150	80	.236	6.0	LRIS-2.5 × 7	CLR-15S
	DS-SDU%15H-07	2	○	○	.5/8	15.875	.591	15.0	.591	15.0	3.937	100	.236	6.0	LRIS-2.5 × 7	CLR-15S
	DS-SDU%16F-07	2	○	○	.630	16.000	.591	15.0	.591	15.0	3.150	80	.236	6.0	LRIS-2.5 × 7	CLR-15S
	DS-SDU%16X-07	2	○	○	.630	16.000	.591	15.0	.591	15.0	3.740	95	.236	6.0	LRIS-2.5 × 7	CLR-15S
	DS-SDU%19-07	2	○	○	3/4	19.050	.709	18.0	.709	18.0	4.724	120	.236	6.0	LRIS-2.5 × 7	CLR-15S
	DS-SDU%20X-07	2	○	○	.787	20.000	.748	19.0	.748	19.0	3.740	95	.236	6.0	LRIS-2.5 × 7	CLR-15S
	DS-SDU%20-07	2	●	○	.787	20.000	.748	19.0	.748	19.0	4.724	120	.236	6.0	LRIS-2.5 × 7	CLR-15S
	DS-SDU%22-07	2	●	○	.866	22.000	.827	21.0	.827	21.0	4.724	120	.236	6.0	LRIS-2.5 × 7	CLR-15S
DC..32.5.. DC..32.5..WP	DS-SDU%14F-11	2	○	○	.551	14.000	.512	13.0	.512	13.0	3.150	80	.394	10.0	LRIS-4 × 10	LLR-25S-20 × 65
	DS-SDU%16F-11	2	○	○	.630	16.000	.591	15.0	.591	15.0	3.150	80	.394	10.0	LRIS-4 × 10	LLR-25S-20 × 65
	DS-SDU%19-11	2	●	○	3/4	19.050	.709	18.0	.709	18.0	4.724	120	.394	10.0	LRIS-4 × 10	LLR-25S-20 × 65
	DS-SDU%19-11SPL	2	○	○	3/4	19.050	.709	18.0	.709	18.0	6.300	160	.394	10.0	LRIS-4 × 10	LLR-25S-20 × 65
	DS-SDU%20X-11	2	○	○	.787	20.000	.748	19.0	.748	19.0	3.740	95	.394	10.0	LRIS-4 × 10	LLR-25S-20 × 65
	DS-SDU%20-11	2	●	○	.787	20.000	.748	19.0	.748	19.0	4.724	120	.394	10.0	LRIS-4 × 10	LLR-25S-20 × 65
	DS-SDU%22-11	2	●	○	.866	22.000	.827	21.0	.827	21.0	4.724	120	.394	10.0	LRIS-4 × 10	LLR-25S-20 × 65
	DS-SDU%23-11-007	2	○	○	.906	23.000	.866	22.0	.866	22.0	2.756	70	.394	10.0	LRIS-4 × 10	LLR-25S-20 × 65
	DS-SDU%25-11MET	2	●	○	.984	25.000	.945	24.0	.945	24.0	4.724	120	.394	10.0	LRIS-4 × 10	LLR-25S-20 × 65
	DS-SDU%25-11	2	●	○	1	25.400	.945	24.0	.945	24.0	5.906	150	.394	10.0	LRIS-4 × 10	LLR-25S-20 × 65
	DS-SDU%25-11SPL	2	○	○	1	25.400	.945	24.0	.945	24.0	5.906	150	.492	12.5	LRIS-4 × 10	LLR-25S-20 × 65
	DS-SDU%16F-11-ACH	1	●	○	.630	16.000	.610	15.5	.610	15.5	3.150	80	.394	10.0	LRIS-4 × 10	LLR-25S-20 × 65
	DS-SDU%19-11-ACH	1	●	○	3/4	19.050	.709	18.0	.709	18.0	4.724	120	.394	10.0	LRIS-4 × 10	LLR-25S-20 × 65
	DS-SDU%20-11-ACH	1	●	○	.787	20.000	.748	19.0	.748	19.0	4.724	120	.394	10.0	LRIS-4 × 10	LLR-25S-20 × 65
	DS-SDU%22-11-ACH	1	●	○	.866	22.000	.827	21.0	.827	21.0	4.724	120	.394	10.0	LRIS-4 × 10	LLR-25S-20 × 65
	DS-SDU%25-11MET-ACH	1	●	○	.984	25.000	.945	24.0	.945	24.0	4.724	120	.394	10.0	LRIS-4 × 10	LLR-25S-20 × 65
	DS-SDU%25-11-ACH	1	●	○	1	25.400	.945	24.0	.945	24.0	5.906	150	.394	10.0	LRIS-4 × 10	LLR-25S-20 × 65
	DS-SDX%22-11-006	4	●	○	.866	22.000	.827	21.0	.827	21.0	4.724	120	.472	12.0	LRIS-4 × 10	LLR-25S-20 × 65
	DS-SDX%19-11	3	○	○	3/4	19.050	.709	18.0	.709	18.0	4.724	120	.394	10.0	LRIS-4 × 10	LLR-25S-20 × 65
	DS-SDX%20X-11	3	○	○	.787	20.000	.748	19.0	.748	19.0	3.740	95	.394	10.0	LRIS-4 × 10	LLR-25S-20 × 65
DS-SDX%20-11	3	○	○	.787	20.000	.748	19.0	.748	19.0	4.724	120	.394	10.0	LRIS-4 × 10	LLR-25S-20 × 65	
DS-SDX%25-11MET	3	○	○	.984	25.000	.945	24.0	.945	24.0	4.724	120	.394	10.0	LRIS-4 × 10	LLR-25S-20 × 65	

Inserts → Q20

● : Stock ○ : 1-2 week delivery ● : Coolant through

Cutting condition → Q4

VC.. Series - Toolholders

DS-SVX

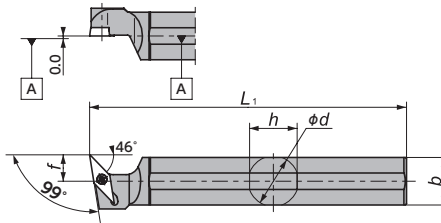

Figure-1

Gage Insert	Item Number	Figure	Stock		ϕd		h		b		L_1		f		Clamp Screw	Wrench
			R	L	(Inch)	(mm)	(Inch)	(mm)	(Inch)	(mm)	(Inch)	(mm)	(Inch)	(mm)		
VC..22..	DS-SVX%14F-11	1	○	○	.551	14.000	.512	13	.512	13	3.150	80	.394	10.0	LRIS-2.5 × 7	CLR-15S
	DS-SVX%15H-11	1	○	○	5/8	15.875	.591	15	.591	15	3.937	100	.394	10.0	LRIS-2.5 × 7	CLR-15S
	DS-SVX%16F-11	1	●	○	.630	16.000	.591	15	.591	15	3.150	80	.394	10.0	LRIS-2.5 × 7	CLR-15S
	DS-SVX%19-11	1	●	○	3/4	19.050	.709	18	.709	18	4.724	120	.394	10.0	LRIS-2.5 × 7	CLR-15S
	DS-SVX%19-11SPL	1	○	○	3/4	19.050	.709	18	.709	18	6.299	160	.433	11.0	LRIS-2.5 × 7	CLR-15S
	DS-SVX%20X-11	1	○	○	.787	20.000	.748	19	.748	19	3.740	95	.394	10.0	LRIS-2.5 × 7	CLR-15S
	DS-SVX%20-11	1	●	○	.787	20.000	.748	19	.748	19	4.724	120	.394	10.0	LRIS-2.5 × 7	CLR-15S
	DS-SVX%22-11	1	●	○	.866	22.000	.827	21	.827	21	4.724	120	.394	10.0	LRIS-2.5 × 7	CLR-15S
DS-SVX%25-11	1	●	○	1	25.400	.945	24	.945	24	5.906	150	.394	10.0	LRIS-2.5 × 7	CLR-15S	

Inserts → Q29

VP..08 Series - Toolholders

DS-SVXP

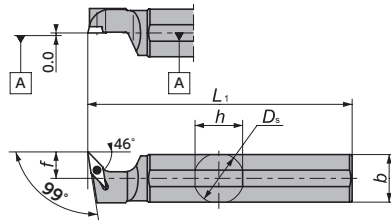
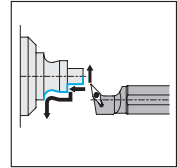

Figure-2



Left-Hand style shown
Takes Right-hand or Neutral insert

Gage Insert	Item Number	Figure	Stock		D_s		h		b		L_1		f		Clamp Screw	Wrench
			R	L	(Inch)	(mm)	(Inch)	(mm)	(Inch)	(mm)	(Inch)	(mm)	(Inch)	(mm)		
VP..0802	DS-SVXP%19-08	2	○	○	3/4	19.050	.709	18	.709	18	4.724	120	.394	10	LRIS-2 × 6	CLR-13S
	DS-SVXP%20-08	2	○	○	.787	20.000	.748	19	.748	19	4.724	120	.394	10	LRIS-2 × 6	CLR-13S
	DS-SVXP%22-08	2	○	○	.866	22.000	.827	21	.827	21	4.724	120	.394	10	LRIS-2 × 6	CLR-13S
	DS-SVXP%25-08	2	○	○	1	25.400	.945	24	.945	24	5.906	150	.394	10	LRIS-2 × 6	CLR-13S

Inserts → Q30

VP..22 Series - Toolholders

DS-SVVP-ACH (Adjustable centerline height)

(Parts)

Shank	Wedge	Screw for Wedge
$\phi .630^{\circ}$ (16)	ACH-W18 (5805601)	WS060415-003 (5795539)
$\phi 3/4^{\circ}$ (19.05)		
$\phi .787^{\circ}$ (20)	ACH-W24 (5805619)	WS060419-004 (5799226)
$\phi .866^{\circ}$ (22)		
$\phi 1^{\circ}$ (25.4)		

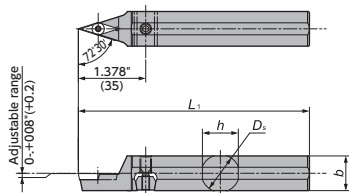

Figure-3

DS-SVVP

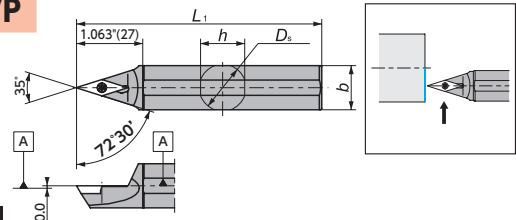



Figure-4

Gage Insert	Item Number	Figure	Stock	D_s		h		b		L_1		Clamp Screw	Wrench
				(Inch)	(mm)	(Inch)	(mm)	(Inch)	(mm)	(Inch)	(mm)		
	DS-SVVPN19-11	4	○	3/4	19.050	.709	18.0	.709	18	4.724	120	LRIS-2.5 × 7	CLR-15S
	DS-SVVPN22-11	4	○	.866	22.000	.827	21.0	.827	21	4.724	120	LRIS-2.5 × 7	CLR-15S
	DS-SVVPN16-11-ACH	3	●	.630	16.000	.610	15.5	.610	15	4.724	120	LRIS-2.5 × 7	CLR-15S
	DS-SVVPN19-11-ACH	3	●	3/4	19.050	.709	18.0	.709	18	4.724	120	LRIS-2.5 × 7	CLR-15S
	DS-SVVPN20-11-ACH	3	●	.787	20.000	.748	19.0	.748	19	4.724	120	LRIS-2.5 × 7	CLR-15S
	DS-SVVPN22-11-ACH	3	●	.866	22.000	.827	21.0	.827	21	4.724	120	LRIS-2.5 × 7	CLR-15S
	DS-SVVPN25-11-ACH	3	●	1	25.400	.945	24.0	.945	24	5.906	150	LRIS-2.5 × 7	CLR-15S

Inserts → Q31

TN.. Series - Toolholders

DS-PTX-ACH (Adjustable centerline height)

(Parts)		
Shank	Wedge	Screw for Wedge
φ.630" (16)	ACH-W18 (5805601)	WS060415-003 (5795539)
φ.3/4" (19.05)		
φ.787" (20)		
φ.866" (22)	ACH-W24 (5805619)	WS060419-004 (5799226)
φ.1" (25.4)		

Figure-1

Shim	Clamp Pin	Spring
-	LCL33N	-

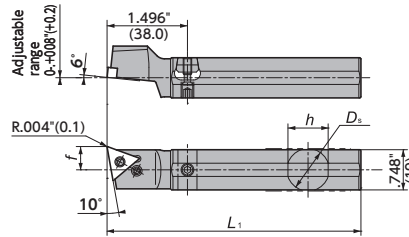

Left-Hand style shown
Takes Right-hand or Neutral insert.

DS-PTX

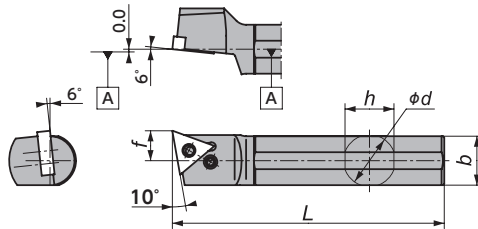
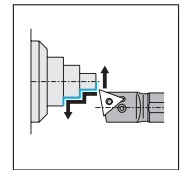

Figure-2

Shim	Clamp Pin	Spring
-	LCL33N	-

Left-Hand style shown
Takes Right-hand or Neutral insert.



DS-PTX / DS-PTX-ACH



Gage Insert	Item Number	Figure	Stock		D_s (Inch) (mm)	h (Inch) (mm)	b (Inch) (mm)	L_1 (Inch) (mm)	f (Inch) (mm)	Clamp Screw	Wrench
			R	L							
TN...33..	DS-PTX [®] 19-33	2	○	○	3/4 19.050	.709 18.0	.709 18	4.724 120	.433 11.0	LCS33	LW-2
	DS-PTX [®] 20-33	2	○	○	.787 20.000	.748 19.0	.748 19	4.724 120	.433 11.0	LCS33	LW-2
	DS-PTX [®] 22-33	2	○	○	.866 22.000	.827 21.0	.827 21	4.724 120	.472 12.0	LCS33	LW-2
	DS-PTX [®] 25M-33	2	○	○	1 25.400	.945 24.0	.945 24	5.906 150	.512 13.0	LCS33	LW-2
TN...33..	DS-PTX [®] 16-33-ACH	1	●	○	.630 16.000	.610 15.5	.591 15	4.724 120	.433 11.0	LCS33	LW-2
	DS-PTX [®] 19-33-ACH	1	●	○	3/4 19.050	.709 18.0	.709 18	4.724 120	.433 11.0	LCS33	LW-2
	DS-PTX [®] 20-33-ACH	1	●	○	.787 20.000	.748 19.0	.748 19	4.724 120	.433 11.0	LCS33	LW-2
	DS-PTX [®] 22-33-ACH	1	●	○	.866 22.000	.827 21.0	.827 21	4.724 120	.472 12.0	LCS33	LW-2
	DS-PTX [®] 25-33MET-ACH	1	●	○	1 25.000	.945 24.0	.945 24	4.724 120	.512 13.0	LCS33	LW-2
	DS-PTX [®] 25-33-ACH	1	●	○	1 25.400	.945 24.0	.945 24	5.906 150	.512 13.0	LCS33	LW-2

Inserts → Q36

Cutting condition → Q4

Back Turning

TBP.. Series - Toolholders

DS-TBP

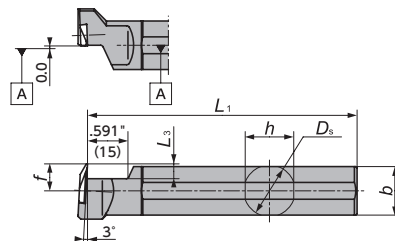
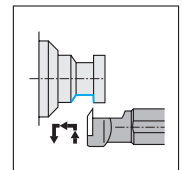

Figure-1

Left-Hand style shown
Takes Right-hand Insert



DS-TBP (Takes right-hand inserts)

Gage Insert	Item Number	Figure	Stock		D_s (Inch) (mm)	h (Inch) (mm)	b (Inch) (mm)	L_1 (Inch) (mm)	f (Inch) (mm)	L_3 (Inch) (mm)	Clamp Screw	Wrench
			R	L								
TBP..FR..	DS-TBP [®] 19	1	○	○	3/4 19.050	.709 18	.709 18	4.724 120	.433 11.0	.217 5.5	LRIS-4 × 10	LLR-25S-20×65
	DS-TBP [®] 20	1	○	○	.787 20.000	.748 19	.748 19	4.724 120	.433 11.0	.217 5.5	LRIS-4 × 10	LLR-25S-20×65
	DS-TBP [®] 25	1	○	○	1.00 25.400	.945 24	.945 24	5.906 150	.512 13.0	.217 5.5	LRIS-4 × 10	LLR-25S-20×65

Inserts → R9

Cutting condition → R3

● : Stock ○ : 1-2 week delivery

Grooving / Side Turning / Back Turning

GTT.. Series - Toolholders

DS-GTT

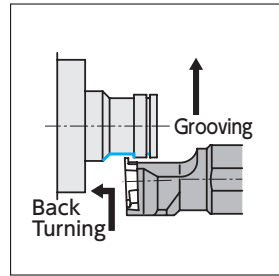
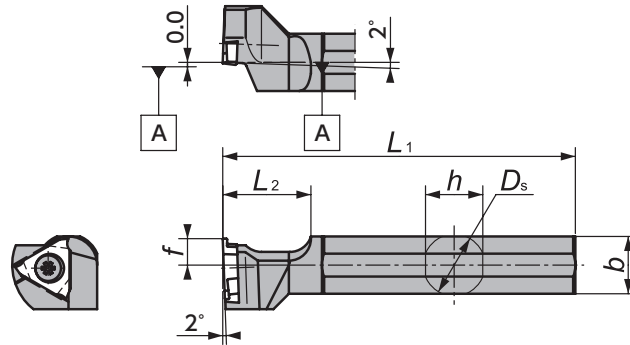



Figure-1

Left-Hand style shown
Takes Right-hand Insert

DS-GTT

Gage Insert	Item Number	Figure	Stock		D_s		h		b		L_1		f		L_2		Clamp Screw	Wrench
			R	L	(Inch)	(mm)	(Inch)	(mm)	(Inch)	(mm)	(Inch)	(mm)	(Inch)	(mm)	(Inch)	(mm)		
 TBMH32.. GTM.32 TMG32	DS-GTT $\frac{1}{4}$ 14F	1	○	○	.551	14.000	.512	13	.512	13	3.150	80	.236	6	.787	20	LR-S-4 × 9	RLR-20S
	DS-GTT $\frac{1}{4}$ 15H	1	○	○	.518	15.875	.591	15	.591	15	3.937	100	.236	6	.787	20	LR-S-4 × 9	RLR-20S
	DS-GTT $\frac{1}{4}$ 16X	1	●	○	.630	16.000	.591	15	.591	15	3.740	95	.236	6	.787	20	LR-S-4 × 9	RLR-20S
	DS-GTT $\frac{1}{4}$ 19	1	●	○	3/4	19.050	.709	18	.709	18	4.724	120	.236	6	.787	20	LR-S-4 × 9	RLR-20S
	DS-GTT $\frac{1}{4}$ 20	1	●	○	.787	20.000	.748	19	.748	19	4.724	120	.236	6	.787	20	LR-S-4 × 9	RLR-20S
	DS-GTT $\frac{1}{4}$ 22	1	●	○	.866	22.000	.827	21	.827	21	4.724	120	.236	6	.787	20	LR-S-4 × 9	RLR-20S
	DS-GTT $\frac{1}{4}$ 25	1	●	○	1	25.400	.945	24	.945	24	4.724	120	.394	10	.787	20	LR-S-4 × 9	RLR-20S

Inserts GTM.32 →T12

Inserts TBMH32.. →R19

Face Grooving

FGV.. Series - Toolholders

DS-FGV

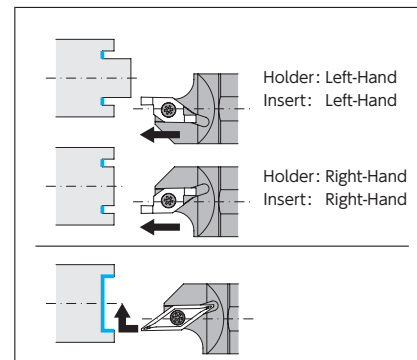
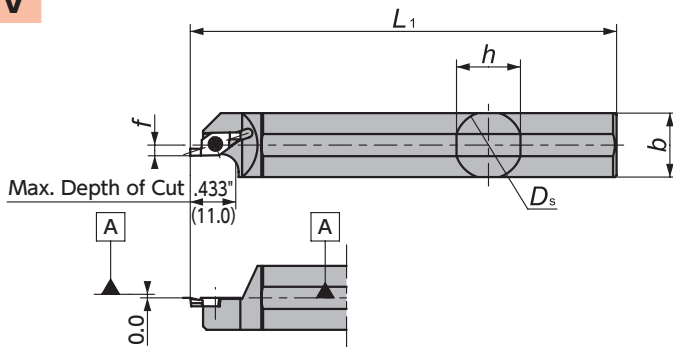



Figure-1

Right-Hand with FGV style shown

DS-FGV

Gage Insert	Item Number	Figure	Stock		D_s		h		b		L_1		f		Clamp Screw	Wrench
			R	L	(Inch)	(mm)	(Inch)	(mm)	(Inch)	(mm)	(Inch)	(mm)	(Inch)	(mm)		
 FGV FBV	DS-FGV $\frac{1}{4}$ 16-012	1	○	○	.630	16	.591	15	.591	15	3.150	80	.118	3.0	LRIS-2.5 × 7	CLR-15S
	DS-FGV $\frac{1}{4}$ 19	1	○	○	3/4	19.05	.709	18	.709	18	4.724	120	.118	3.0	LRIS-2.5 × 7	CLR-15S
	DS-FGV $\frac{1}{4}$ 20	1	○	○	.787	20	.748	19	.748	19	4.724	120	.118	3.0	LRIS-2.5 × 7	CLR-15S
	DS-FGV $\frac{1}{4}$ 22	1	○	○	.866	22	.827	21	.827	21	4.724	120	.118	3.0	LRIS-2.5 × 7	CLR-15S
	DS-FGV $\frac{1}{4}$ 25	1	○	○	1	25.4	.965	24.5	.965	24.5	4.724	120	.118	3.0	LRIS-2.5 × 7	CLR-15S

Inserts →T23

Cutting condition →T4 · T21

Threading

TTP.. Series - Toolholders

DS-TTP

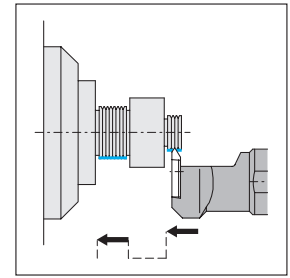
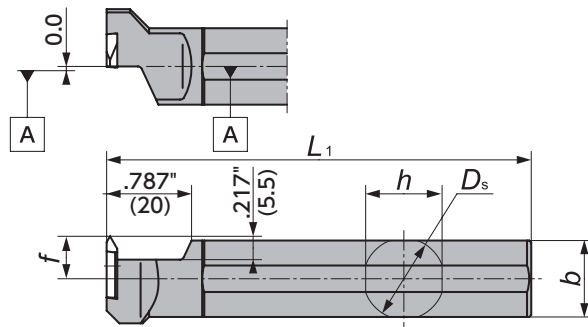



Figure-1

Left-Hand style shown
Takes Right-Hand insert.

DS-TTP

Gage Insert	Item Number	Figure	Stock		D_s		h		b		L_1		f		Clamp Screw	Wrench
			R	L	(Inch)	(mm)	(Inch)	(mm)	(Inch)	(mm)	(Inch)	(mm)	(Inch)	(mm)		
 TTP..	DS-TTP $\frac{1}{2}$ 16F	1	○	○	.630	16.00	.591	15	.591	15	3.150	80	.394	10.0	LRIS-4 × 10	LLR-25S-20 × 65
	DS-TTP $\frac{1}{2}$ 19	1	●	○	3/4	19.05	.709	18	.709	18	4.724	120	.394	10.0	LRIS-4 × 10	LLR-25S-20 × 65
	DS-TTP $\frac{1}{2}$ 20	1	●	○	.787	20.00	.748	19	.748	19	4.724	120	.394	10.0	LRIS-4 × 10	LLR-25S-20 × 65
	DS-TTP $\frac{1}{2}$ 22	1	●	○	.866	22.00	.827	21	.827	21	4.724	120	.394	10.0	LRIS-4 × 10	LLR-25S-20 × 65
	DS-TTP $\frac{1}{2}$ 25	1	●	○	1	25.40	.945	24	.945	24	5.906	150	.394	10.0	LRIS-4 × 10	LLR-25S-20 × 65

Inserts →U11

STTN.. Series - Toolholders

DS-STT

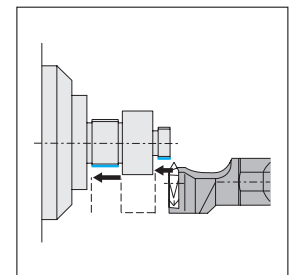
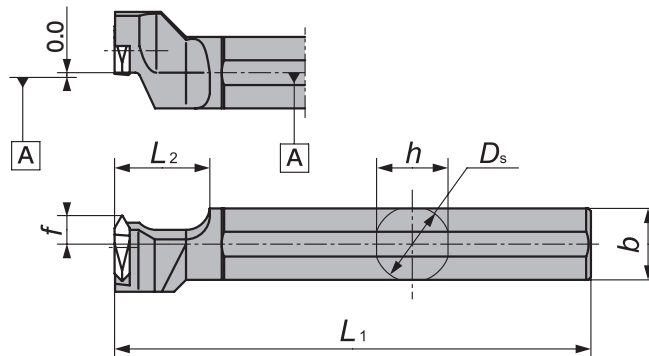



Figure-2

Left-Hand style shown
Takes Right-Hand insert.

DS-STT $\frac{1}{2}$

Gage Insert	Item Number	Figure	Stock		D_s		h		b		L_1		f		Clamp Screw	Wrench
			R	L	(Inch)	(mm)	(Inch)	(mm)	(Inch)	(mm)	(Inch)	(mm)	(Inch)	(mm)		
 TTMH3260	DS-STT $\frac{1}{2}$ 14F	2	○	○	.551	14.000	.512	13	.512	13	3.150	80	.236	6.0	LR-5-4 × 9	RLR-20S
	DS-STT $\frac{1}{2}$ 15H	2	○	○	5/8	15.875	.591	15	.591	15	3.937	100	.236	6.0	LR-5-4 × 9	RLR-20S
	DS-STT $\frac{1}{2}$ 16X*	2	○	○	.630	16.000	.591	15	.591	15	3.346	85	.236	6.0	LR-5-4 × 9	RLR-20S

Inserts →U14

● : Stock ○ : 1-2 week delivery

Cutting condition →U4

ID Boring

LBM.. Series - Toolholders

DS-LBMB

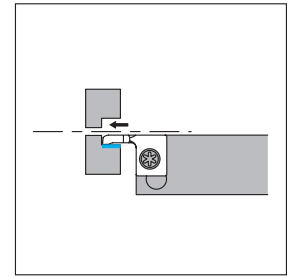
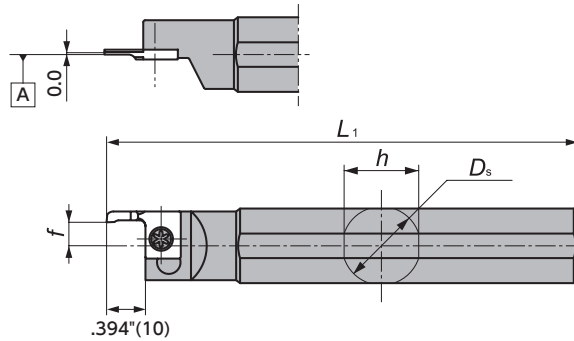



Figure-1

Left-Hand style shown

LBMAR / CH-TTPL

Gage Insert	Item Number	Figure	Stock	D _s		h		b		h ₁		L ₁		f		Clamp Screw	Wrench
				(Inch)	(mm)	(Inch)	(mm)	(Inch)	(mm)	(Inch)	(mm)	(Inch)	(mm)	(Inch)	(mm)		
 Long type	DS-LBMBL14F	1	○	.551	14.000	.512	13	.512	13	—	—	3.150	80 *1	*3	*3	LRIS-4 × 10PW	CLR-15S
	DS-LBMBL15H	1	○	5/8	15.875	.591	15	.591	15	—	—	3.937	100 *1	*3	*3	LRIS-4 × 10PW	CLR-15S
	DS-LBMBL16X	1	●	.630	16.000	.591	15	.591	15	—	—	3.740	95 *1	*2	*2	LRIS-4 × 10PW	CLR-15S
	DS-LBMBL19	1	●	3/4	19.050	.709	18	.709	18	—	—	4.724	120 *1	*2	*2	LRIS-4 × 10PW	CLR-15S
	DS-LBMBL20	1	●	.787	20.000	.748	19	.748	19	—	—	4.724	120 *1	*2	*2	LRIS-4 × 10PW	CLR-15S
	DS-LBMBL22	1	●	.866	22.000	.827	21	.827	21	—	—	4.724	120 *1	*2	*2	LRIS-4 × 10PW	CLR-15S
	DS-LBMBL25-MET	1	○	.984	25.000	.945	24	.945	24	—	—	4.724	120 *1	*2	*2	LRIS-4 × 10PW	CLR-15S
	DS-LBMBL25	1	○	1	25.400	.945	24	.945	24	—	—	5.906	150 *1	*2	*2	LRIS-4 × 10PW	CLR-15S

Inserts →V7

Cutting condition →V4

Interchangeable Tooling

CSV.. Series - Toolholders

DS-CSVL

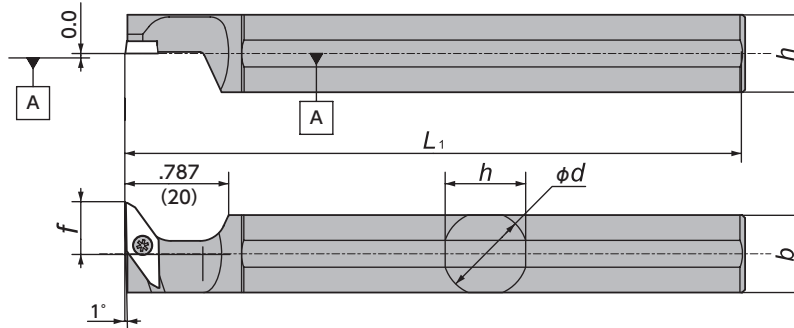



Figure-1

Left-Hand style shown
Takes right-hand inserts

DS-CSVL (Takes right-hand insert)

Gage Insert	Item Number	Figure	Stock		D _s		h		b		L ₁		f		Clamp Screw	Wrench
			R	L	(Inch)	(mm)	(Inch)	(mm)	(Inch)	(mm)	(Inch)	(mm)	(Inch)	(mm)		
 CSV..11FR..	DS-CSVL15	1	●		5/8	15.875	.591	15	.591	15	4.724	120	.394	10	LRIS-2.5 × 7	CLR-15S

Inserts →O29

DS Sleeve

Features

- Prevents coolant and chips from damaging live tool stations
- Accepts DS Series holders to perform various back working
- Designed exclusively for 22mm(.886") and 34mm(1.339") round shank stations
- Compatible with 16mm(.630") / 22mm(.886") round shank DS Series holders

WATCH ON
YouTube



First Recommendation for Turning

✗

Coolant and chips sneak in.

When DS holders are used directly in live tool stations, coolant and chips sneak in from the flat of holders to damage the live stations

✓

How it works

Stop coolant and chips from damaging live tool stations.

By using the DS Sleeve, you can use the DS Series holders without any worry about damaging live stations

For Back 4-spindle unit

■ SS-DSU-SK

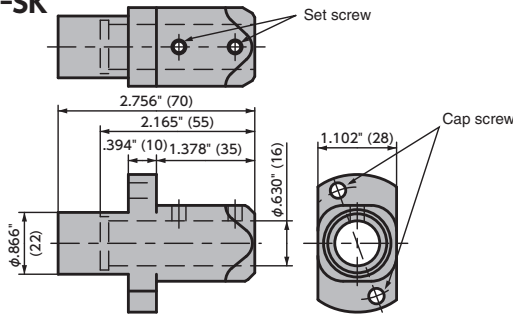

■ SS-DSU-L23

For DS-ACH series

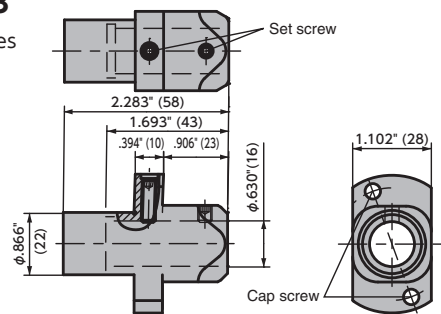

For Back 8-spindle unit

■ SS-DSU-B8L23

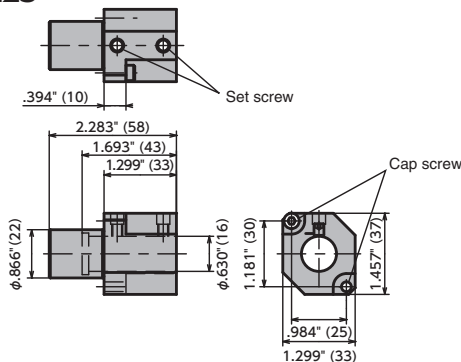

■ SS-DSU-B8D34

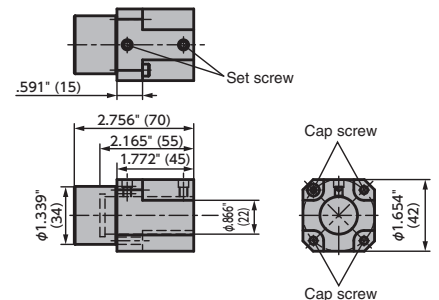

Item number	Stock	Spare parts				Coment
		Cap screw	Wrench	Set screw	Wrench	
SS-DSU-SK	●	CS0515	LW-4	SS0506	LW-2.5	
SS-DSU-L23	●	CS0515	LW-4	SS0506 SS0515	LW-2.5	For DS-ACH Series
SS-DSU-B8L23	●	CS0415	LW-3	SS0506	LW-2.5	Can take DS-ACH Series
SS-DSU-B8D34*	●	CS0506	LW-3	SS0506	LW-2.5	

● : Stock ○ : 1-2 week delivery

*To be released in July 2015.



CSV Series

Tooling for small diameter parts

Best tool for up to .200" diameter material



Features

- Very up- sharp edge with mirror finish provides superior precise machining
- Interchangeable tool : All the inserts can use the same toolholder
- Specially designed edge shape for small diameter machining

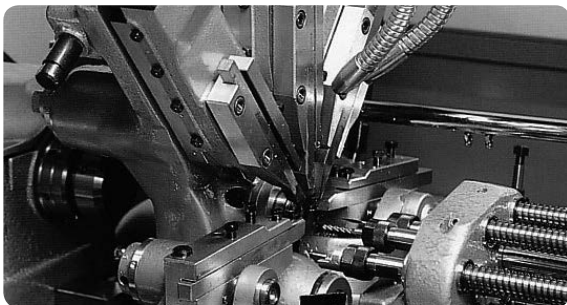
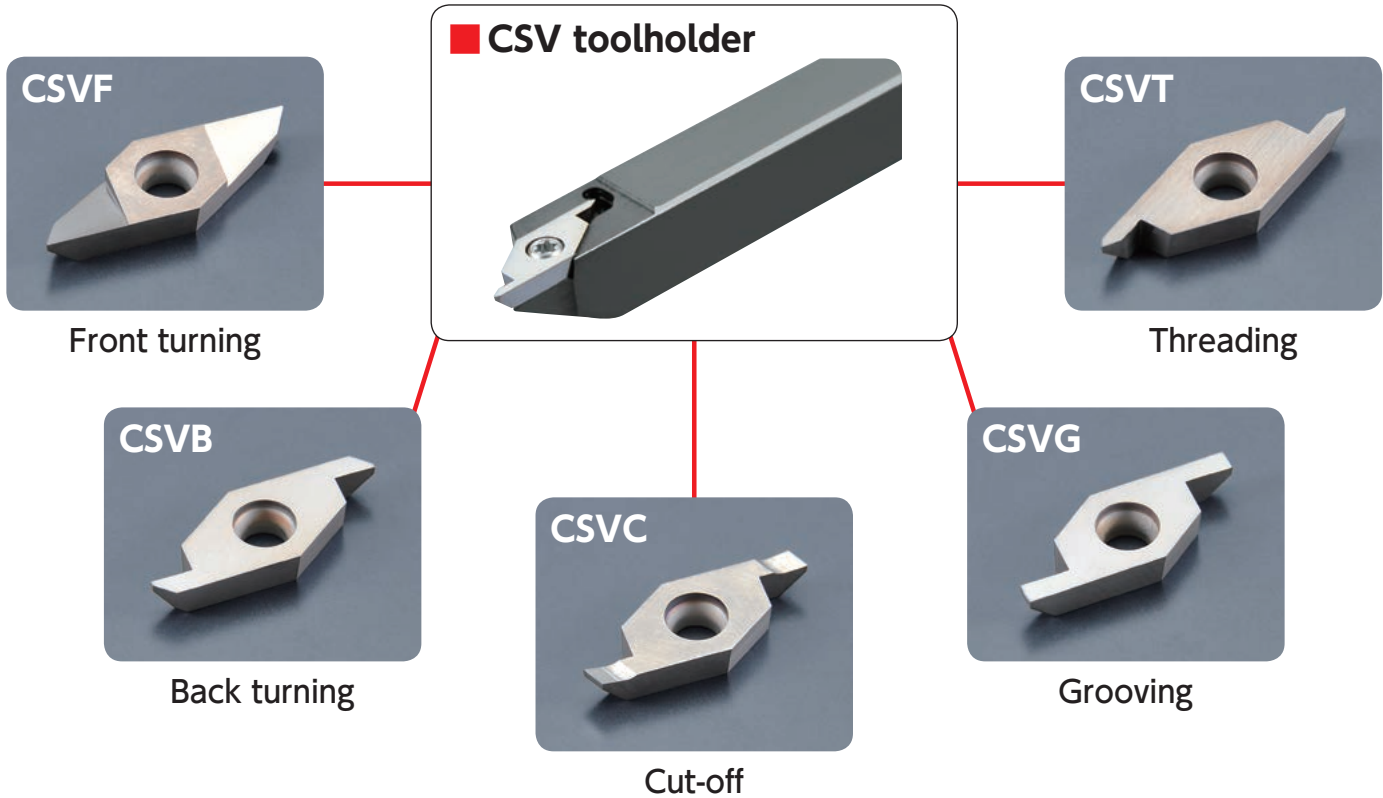

- Holders for Cam-style machine also available

CSV Series - Toolholders

Best for up to .200" diameter material

CSV-NC

For Gang-style machine

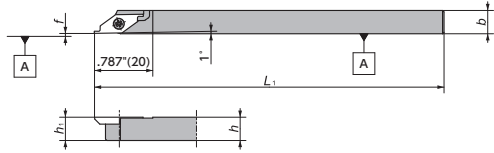

Figure-1

Right-Hand style shown

CSV

For Cam-style machine

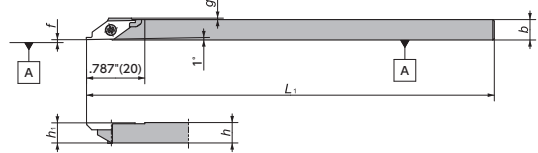

Figure-2

Right-Hand style shown

DS-CSVL

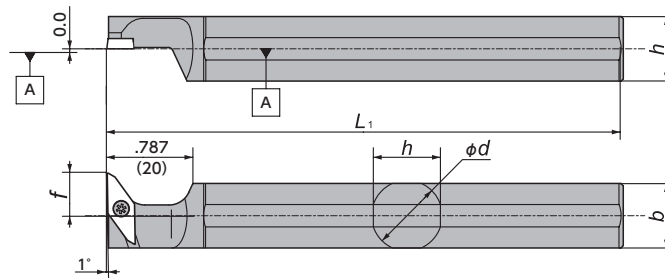



Figure-3

Left-Hand style shown
Takes right-hand inserts

CSV Series - Toolholders

CSV^{R/L} / CSV^{R/L}-NC

Gage Insert	Item Number	Figure	Stock		h		b		h ₁		L ₁		f		g		Clamp Screw	Wrench
			R	L	(Inch)	(mm)	(Inch)	(mm)	(Inch)	(mm)	(Inch)	(mm)	(Inch)	(mm)	(Inch)	(mm)		
	CSV ^{R/L} 06-IN-NC	1	●	●	3/8	8	3/8	8	3/8	8	4.724	120	.004	0.1	0.0	0.0	LRIS-2.5 × 7	CLR-15S
	CSV ^{R/L} 08-IN-NC	1	●	●	1/2	12	1/2	12	1/2	12	4.724	120	.004	0.1	0.0	0.0	LRIS-2.5 × 7	CLR-15S
	CSV ^{R/L} 08NC	1	○	○	.315	8	.315	8	.315	8	4.724	120	.004	0.1	0.0	0.0	LRIS-2.5 × 7	CLR-15S
	CSV ^{R/L} 08NC-F	1	○	○	.315	8	.315	8	.315	8	4.724	120	0-.004	0.0-0.1	0.0	0.0	LRIS-2.5 × 7	CLR-15S
	CSV ^{R/L} 10GXNC	1	○	○	.394	10	.394	10	.394	10	3.346	85	.004	0.1	0.0	0.0	LRIS-2.5 × 7	CLR-15S
	CSV ^{R/L} 10NC	1	○	○	.394	10	.394	10	.394	10	4.724	120	.004	0.1	0.0	0.0	LRIS-2.5 × 7	CLR-15S
	CSV ^{R/L} 12NC	1	●	●	.472	12	.472	12	.472	12	4.724	120	.004	0.1	0.0	0.0	LRIS-2.5 × 7	CLR-15S
	CSV ^{R/L} 07GX	2	○	○	.275	7	.275	7	.275	7	3.346	85	.004	0.1	.020	0.5	LRIS-2.5 × 7	CLR-15S
	CSV ^{R/L} 07	2	○	●	.275	7	.275	7	.275	7	5.512	140	.004	0.1	.020	0.5	LRIS-2.5 × 7	CLR-15S
	CSV ^{R/L} 08GX	2	○	○	.315	8	.315	8	.315	8	3.346	85	.004	0.1	0.0	0.0	LRIS-2.5 × 7	CLR-15S
	CSV ^{R/L} 08	2	●	●	.315	8	.315	8	.315	8	5.512	140	.004	0.1	0.0	0.0	LRIS-2.5 × 7	CLR-15S
	CSV ^{R/L} 095	2	○	○	.374	9.5	.374	9.5	.374	9.5	5.512	140	.004	0.1	0.0	0.0	LRIS-2.5 × 7	CLR-15S
	CSV ^{R/L} 10	2	●	○	.394	10	.394	10	.394	10	5.512	140	.004	0.1	0.0	0.0	LRIS-2.5 × 7	CLR-15S
	CSV ^{R/L} 12GX	2	○	○	.472	12	.472	12	.472	12	3.346	85	.004	0.1	0.0	0.0	LRIS-2.5 × 7	CLR-15S
	CSV ^{R/L} 12	2	●	●	.472	12	.472	12	.472	12	5.512	140	.004	0.1	0.0	0.0	LRIS-2.5 × 7	CLR-15S

DS-CSVL (Takes right-hand insert)

Gage Insert	Item Number	Figure	Stock		D _s		h		b		L ₁		f		Clamp Screw	Wrench
			R	L	(Inch)	(mm)	(Inch)	(mm)	(Inch)	(mm)	(Inch)	(mm)	(Inch)	(mm)		
	DS-CSVL15	3	●		5/8	15.875	.591	15	.591	15	4.724	120	.394	10	LRIS-2.5 × 7	CLR-15S

CSV Series - Inserts

Front turning

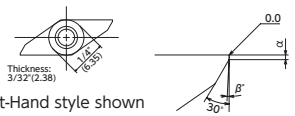
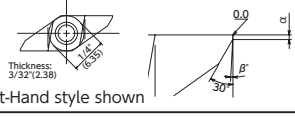
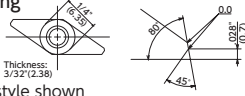

■ CSVF Mirror finish

Shape	Item Number	Chip-breaker	Max Depth of Cut		Edge Geometry ($\alpha \times \beta^\circ$)		Coated Carbide					
			(Inch)	(mm)	(Inch)	(mm)	DT4		VM1		ZM3	
							R	L	R	L	R	L
 Right-Hand style shown	CSVF11F%LV	No	—	—	.012 × 5°	0.3 × 5°			○	○		
	CSVF11F%LV-A	No	—	—	.012 × 2°	0.3 × 2°			○			
	CSVF11F%LV-M	No	—	—	.006 × 2°	0.15 × 2°	●	●	●	○		
	CSVF11F%LV-C	No	—	—	.006 × 5°	0.15 × 5°			○			
 Right-Hand style shown	CSVF11F%VB	Yes	.118	3	.012 × 5°	0.3 × 5°			●	○		
	CSVF11F%VB-A	Yes	.118	3	.012 × 2°	0.3 × 2°			○			
	CSVF11F%VB-M	Yes	.118	3	.006 × 2°	0.15 × 2°	●	●	●	○		
	CSVF11F%VB-C	Yes	.118	3	.006 × 5°	0.15 × 5°			○			
 For Profiling Left-Hand style shown	CSVF11F%VX	No	—	—							○	

Note: All angles shown are obtained when insert is set in the holder

Back turning

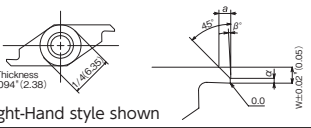
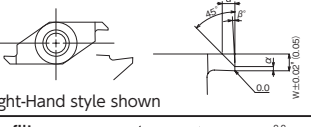
■ CSVB Mirror finish

Shape	Item Number	Chip-breaker	Length of Blade		Max Depth of Cut		W		Edge Geometry ($\alpha \times \beta^\circ$)		Coated Carbide					
			(Inch)	(mm)	(Inch)	(mm)	(Inch)	(mm)	(Inch)	(mm)	DT4		VM1		ZM3	
											R	L	R	L	R	L
 Right-Hand style shown	CSVB11F%LV	No	.028	0.7	.079	2.0	.039	1.00	.012 × 5°	0.3 × 5°			○	○		
	CSVB11F%LV-A	No	.028	0.7	.079	2.0	.039	1.00	.012 × 2°	0.3 × 2°			○			
	CSVB11F%LV-M	No	.028	0.7	.079	2.0	.039	1.00	.006 × 2°	0.15 × 2°	●	●	○	○		
	CSVB11F%LV-C	No	.028	0.7	.079	2.0	.039	1.00	.006 × 5°	0.15 × 5°			○			
	CSVB11F%LV12	No	.031	0.8	.079	2.0	.047	1.20	.012 × 5°	0.3 × 5°			○			
	CSVB11F%LV14	No	.039	1.0	.079	2.0	.055	1.40	.012 × 5°	0.3 × 5°			○			
 Right-Hand style shown	CSVB11F%VB	Yes	.028	0.7	.079	2.0	.039	1.00	.012 × 5°	0.3 × 5°			○			
	CSVB11F%VB-A	Yes	.028	0.7	.079	2.0	.039	1.00	.012 × 2°	0.3 × 2°			○			
	CSVB11F%VB-M	Yes	.028	0.7	.079	2.0	.039	1.00	.006 × 2°	0.15 × 2°	●	●	○	○		
	CSVB11F%VB-C	Yes	.028	0.7	.079	2.0	.039	1.00	.006 × 5°	0.15 × 5°			○			
	CSVB11F%VB12	Yes	.031	0.8	.079	2.0	.047	1.20	.012 × 2°	0.3 × 5°			○			
	CSVB11F%VB14	Yes	.039	1.0	.079	2.0	.055	1.40	.012 × 2°	0.3 × 5°			○			
 Profiling Left-Hand style shown	CSVB11F%VX	No	—	—	—	—	—	—							○	

Note: All angles shown are obtained when insert is set in the holder

Cut-off

■ CSVC Mirror finish

Shape	Item Number	Chip-breaker	Max. Cut-off Dia. ϕD		w		L		r_ϵ		VM1	
			(Inch)	(mm)	(Inch)	(mm)	(Inch)	(mm)	(Inch)	(mm)	R	L
 Right-Hand style shown	CSVC11F%V06	No	.118	3.0	.024	0.6	.079	2.0	0	0.0	○	
	CSVC11F%V07	No	.157	4.0	.028	0.7	.098	2.5	0	0.0	●	●
	CSVC11F%V08	No	.157	4.0	.031	0.8	.098	2.5	0	0.0	○	○
	CSVC11F%V09	No	.157	4.0	.035	0.9	.098	2.5	0	0.0	○	○
	CSVC11F%V10	No	.197	5.0	.039	1.0	.118	3.0	0	0.0	●	●
	CSVC11F%V13	No	.197	5.0	.051	1.3	.118	3.0	0	0.0	○	○
	CSVC11F%V15	No	.197	5.0	.059	1.5	.118	3.0	0	0.0	○	○
 Right-Hand style shown	CSVC11F%VB06	Yes	.118	3.0	.024	0.6	.079	2.0	0	0.0	○	
	CSVC11F%VB07	Yes	.157	4.0	.028	0.7	.098	2.5	0	0.0	●	
	CSVC11F%VB08	Yes	.157	4.0	.031	0.8	.098	2.5	0	0.0	○	
	CSVC11F%VB09	Yes	.157	4.0	.035	0.9	.098	2.5	0	0.0	○	
	CSVC11F%VB10	Yes	.197	5.0	.039	1.0	.118	3.0	0	0.0	●	
	CSVC11F%VB13	Yes	.197	5.0	.051	1.3	.118	3.0	0	0.0	○	
	CSVC11F%VB15	Yes	.197	5.0	.059	1.5	.118	3.0	0	0.0	○	

Note: All angles shown are obtained when insert is set in the holder

Grooving

■ CSVG **Mirror finish**

Shape	Item Number	Chip-breaker	Groove Width <i>W</i>		Max Depth of Cut		<i>L</i>		<i>r_ε</i>		Coated Carbide	
			(Inch)	(mm)	(Inch)	(mm)	(Inch)	(mm)	(Inch)	(mm)	VM1	
											R	L
<p>Thickness: .094" (2.38)</p> <p>1/4" (6.35)</p> <p>W +.001" (0.03)</p> <p>0.0</p> <p>Right-Hand style shown</p>	CSVG11F ^R V025 M	No	.010	0.25	.006	0.15	.020	0.50	0.0	0.0	●	
	CSVG11F ^R V030 M	No	.012	0.30	.006	0.15	.020	0.50	0.0	0.0	●	
	CSVG11F ^R V035 M	No	.014	0.35	.006	0.15	.020	0.50	0.0	0.0	●	
	CSVG11F ^R V040 M	No	.016	0.40	.006	0.15	.020	0.50	0.0	0.0	●	
	CSVG11F ^R V045 M	No	.018	0.45	.018	0.45	.039	1.00	0.0	0.0	●	
	CSVG11F ^R V050 M	No	.020	0.50	.018	0.45	.039	1.00	0.0	0.0	●	
	CSVG11F ^R V055 M	No	.022	0.55	.018	0.45	.039	1.00	0.0	0.0	●	
	CSVG11F ^R V060 M	No	.024	0.60	.018	0.45	.039	1.00	0.0	0.0	●	
	CSVG11F ^R V065 M	No	.026	0.65	.018	0.45	.039	1.00	0.0	0.0	●	
	CSVG11F ^R V070 M	No	.028	0.70	.018	0.45	.039	1.00	0.0	0.0	●	
	CSVG11F ^R V075 M	No	.030	0.75	.050	1.40	.079	2.00	0.0	0.0	●	○
	CSVG11F ^R V080 M	No	.031	0.80	.050	1.40	.079	2.00	0.0	0.0	●	
	CSVG11F ^R V085 M	No	.033	0.85	.050	1.40	.079	2.00	0.0	0.0	●	
	CSVG11F ^R V090 M	No	.035	0.90	.050	1.40	.079	2.00	0.0	0.0	●	
	CSVG11F ^R V095 M	No	.037	0.95	.050	1.40	.079	2.00	0.0	0.0	●	○
	CSVG11F ^R V100 M	No	.039	1.00	.050	1.40	.079	2.00	0.0	0.0	●	
	CSVG11F ^R V110 M	No	.043	1.10	.102	2.60	.102	2.60	0.0	0.0	●	
	CSVG11F ^R V120 M	No	.047	1.20	.102	2.60	.102	2.60	0.0	0.0	●	○
	CSVG11F ^R V130 M	No	.051	1.30	.102	2.60	.102	2.60	0.0	0.0	●	
	CSVG11F ^R V140 M	No	.055	1.40	.102	2.60	.102	2.60	0.0	0.0	●	
CSVG11F ^R V150 M	No	.059	1.50	.102	2.60	.102	2.60	0.0	0.0	●		

NTK Unique Tooling

Threading

■ CSVT **Mirror finish**

Shape	Item Number	Chip-breaker	<i>r_ε</i>		Pitch		Coated Carbide	
			(TPI)	(mm)	(TPI)	(mm)	VM1	
							R	L
(A type) <p>thickness: .094" (2.38)</p> <p>Right-Hand style shown</p>	CSVT11F ^R P60-035A M	No	-R.001	R0.03 MAX	127 - 51	0.2 - 0.5	●	●
(B type) <p>thickness: .094" (2.38)</p> <p>Right-Hand style shown</p>	CSVT11F ^R P60-035B M	No	-R.001	R0.03 MAX	127 - 51	0.2 - 0.5	●	●

Note: All angles shown are obtained when insert is set in the holder

● : Stock ○ : 1-2 week delivery **M** : Mirror finish

CTPS Series

Tooling for Radial-style tool station

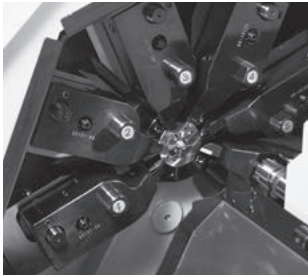

Features

- Best fit for Radial-style tool station.
- Interchangeable tools

CTPS Series

SVACR1010X11N
(Designed for Radial-style tool station)



Front turning

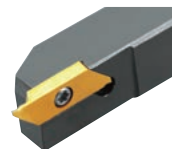

Back turning



Cut-off



Grooving

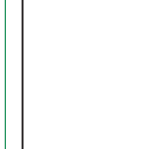

Threading

CTPS Series - Toolholders

CTPS

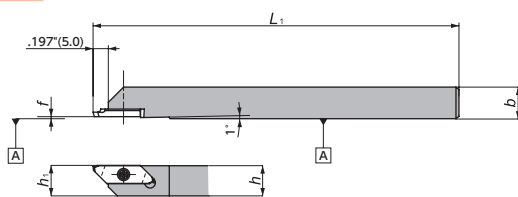

Figure-1

Right-Hand style shown

CTPSR-SUB

Max. Cut-off Dia. .157" (4.0mm)

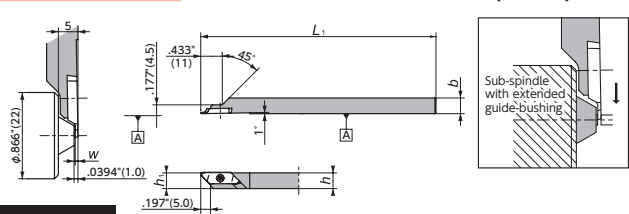



Figure-2

Right-Hand style shown



CTPS / CTPSR

Gage Insert	Item Number	Figure	Stock		Max. Cut-off Dia. ϕD		h		b		h_1		L_1		f		Clamp Screw	Wrench
			R	L	(Inch)	(mm)	(Inch)	(mm)	(Inch)	(mm)	(Inch)	(mm)	(Inch)	(mm)	(Inch)	(mm)		
	CTPSR06-IN	1	●		.394	10.0	3/8	3/8	3/8	4.724	120	0	0.0	LRIS-2.5 × 7	CLR-15S			
	CTPSR08-IN	1	●		.394	10.0	1/2	1/2	1/2	4.724	120	0	0.0	LRIS-2.5 × 7	CLR-15S			
	CTPSR10	1	○		.394	10.0	.394	10	.394	10	4.724	120	0	0.0	LRIS-2.5 × 7	CLR-15S		
	CTPSR12	1	○		.394	10.0	.472	12	.472	12	4.724	120	0	0.0	LRIS-2.5 × 7	CLR-15S		
CTPS-001	CTPSR08-SUB04	2	○		.157	4.0	.315	8	.315	8	4.724	120	—	LRIS-2.5 × 5	CLR-15S			

CTPS Series - Inserts

Back turning

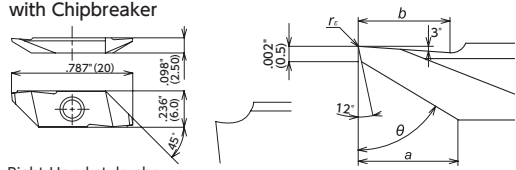
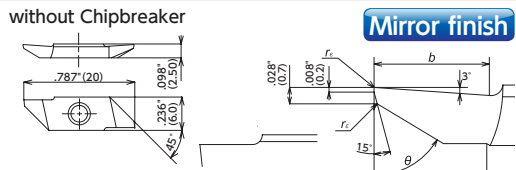

TBPS

Shape	Item Number	Chip-breaker	Length of Blade a		Max Depth of Cut b		θ	r_ϵ		Coated Carbide	
			(Inch)	(mm)	(Inch)	(mm)		(Inch)	(mm)	VM1	ZM3
with Chipbreaker  Right-Hand style shown	TBPS60FR00	Yes	.122	3.1	.138	3.5	60°	0.0	0.0	○	○
	TBPS60FR10	Yes	.122	3.1	.138	3.5	60°	.004	0.1	○	○
without Chipbreaker  Right-Hand style shown	TBPS60FRV 	No	.189	4.8	.189	4.8	60°	0.0	0.0	○	○

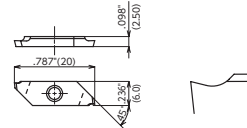
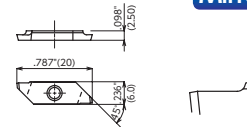

Note: All angles shown are obtained when insert is set in the holder

Cut-off

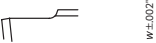
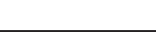
CTPS

Shape	Item Number	Chip-breaker	Max. Cut-off Dia.		w		L	θ	r_e		Coated Carbide				
			ϕD												
			(Inch)	(mm)	(Inch)	(mm)			(Inch)	(mm)	(Inch)	(mm)	VM1	ZM3	R
 <p>Right-Hand style shown</p>	CTPS12FR	Yes	.157	4.0	.047	1.2	.138	3.5	16°	.002	0.05	○	○	●	○
	CTPS15FR	Yes	.197	5.0	.059	1.5	.157	4.0	16°	.002	0.05	○	○	●	○
	CTPS18FR	Yes	.335	8.5	.071	1.8	.217	5.5	16°	.002	0.05	○	○	●	○
	CTPS20FR	Yes	.394	10.0	.079	2.0	.236	6.0	16°	.002	0.05	○	○	○	○
 <p>Right-Hand style shown</p>	CTPS12FRV 	No	.157	4.0	.047	1.2	.138	3.5	20°	0	0.0	●	○	○	○
	CTPS15FRV 	No	.197	5.0	.059	1.5	.157	4.0	20°	0	0.0	○	○	○	○
	CTPS18FRV 	No	.335	8.5	.071	1.8	.217	5.5	20°	0	0.0	○	○	○	○
	CTPS20FRV 	No	.394	10.0	.079	2.0	.236	6.0	20°	0	0.0	○	○	○	○

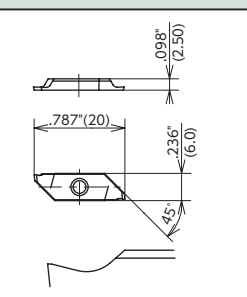
CTPS-001

Shape	Item Number	Chip-breaker	Max. Cut-off Dia.		w		θ	r_e		Coated Carbide	
			ϕD							ZM3	
			(Inch)	(mm)	(Inch)	(mm)		(Inch)	(mm)	R	L
 <p>Right-Hand style shown</p>	CTPS07FRN-001	Yes	.157	4.0	.028	0.7	0°	.002	0.05	○	○
	CTPS07FR-001	Yes	.157	4.0	.028	0.7	16°	.002	0.05	○	○
	CTPS07FRV-001 	No	.157	4.0	.028	0.7	20°	0	0.0	○	○

Grooving

GTPS

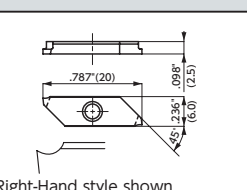
Shape	Item Number	Groove Width w		Max Depth of Cut		r_e		L		Coated Carbide	
		(Inch)	(mm)	(Inch)	(mm)	(Inch)	(mm)	(Inch)	(mm)	VM1	ZM3
 <p>Right-Hand style shown ☆ θ shows the angle when the holder is set.</p>	GTGS075FR	.030	0.75	.039	1.0	0.0	0.0	.059	1.5	○	○
	GTGS095FR	.037	0.95	.059	1.5	0.0	0.0	.079	2.0	○	○
	GTGS100FR	.039	1.00	.059	1.5	0.0	0.0	.079	2.0	○	○
	GTGS120FR	.047	1.20	.098	2.5	0.0	0.0	.118	3.0	○	○
	GTGS150FR	.059	1.50	.098	2.5	0.0	0.0	.118	3.0	○	○
	GTGS200FR	.079	2.00	.098	2.5	0.0	0.0	.118	3.0	○	○

Threading

TTPS - Threading

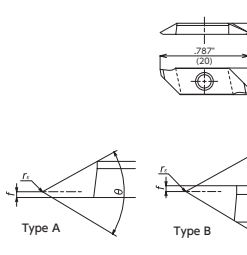
Shape	Item Number	Type	θ	f		r_e		Pitch		Coated Carbide	
				(Inch)	(mm)	(Inch)	(mm)	(TPI)	(mm)	VM1	ZM3
 <p>Right-Hand style shown</p>	TTPS60FR4A	A	60°	.016	0.4	.002	(0.05)	127 - 34	0.2 - 0.75	○	○
	TTPS60FR4B	B	60°	.016	0.4	.002	(0.05)	127 - 34	0.2 - 0.75	○	○
	TTPS60FR8A	A	60°	.031	0.8	R.002	(0.05)	63 - 21	0.4 - 1.25	○	○
	TTPS60FR8B	B	60°	.031	0.8	R.002	(0.05)	63 - 21	0.4 - 1.25	○	○
	TTPS60FR-N	N	60°	.049	1.25	R.004	(0.1)	25 - 17	1.0 - 1.5	○	○

Note: All angles shown are obtained when insert is set in the holder **032**

UL Chipbreaker

6 corner insert for Swiss machines

WATCH ON
YouTube

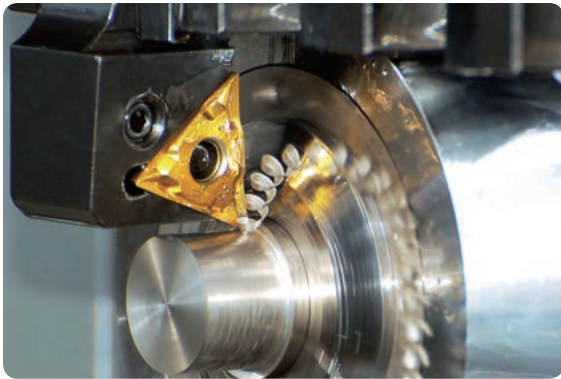

Features

- First negative style insert designed for Swiss machines
- Less tool pressure and good chip control

NTK Unique Tooling

Reduce Cost in Swiss Machining

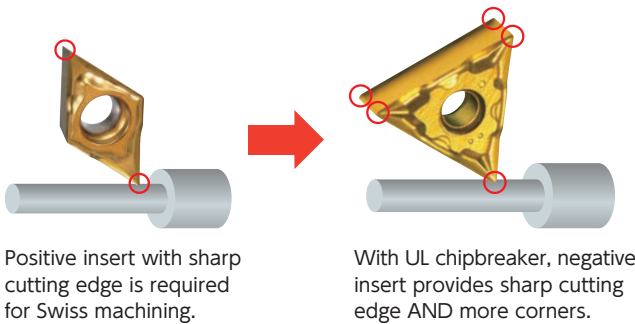

Cuts Like Positive Inserts

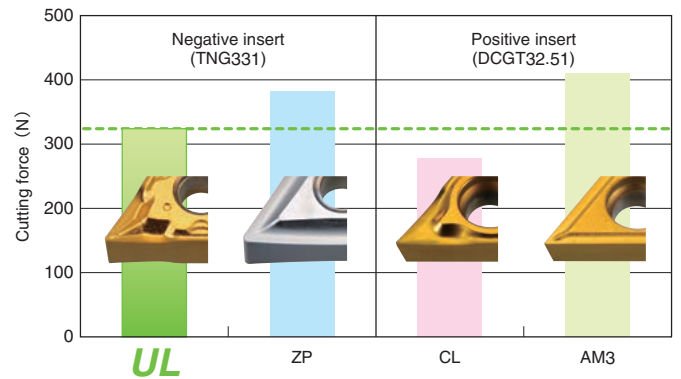

Covers a Wide Range of Cutting Conditions with Good Chip Control

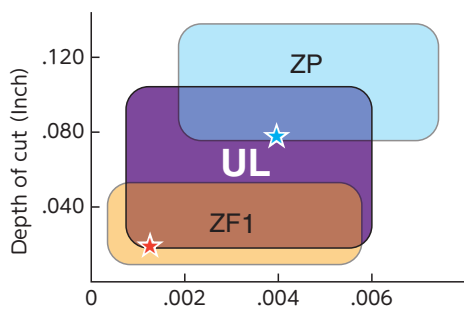

《304 SS》 260 SFM WET

★ .001 IPR .020" DOC

★ .004 IPR .079" DOC

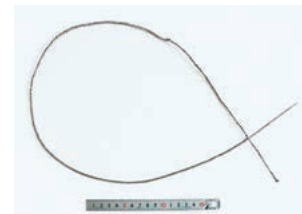
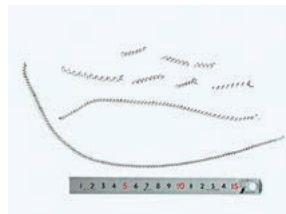

Toolholders for Swiss Machines



Available in ACH (Adjustable centerline height) toolholder

Holders → Q34
Inserts → Q36

Shifted Toolholders

Toolholders for extended guide-bushing



Two Major Features



1. Eliminate shims for turning holders when extended guide bushing is used (especially in thread whirling)
2. Performs finish cut without retracting roughed section (bar) from guide bushing

● Feature 1

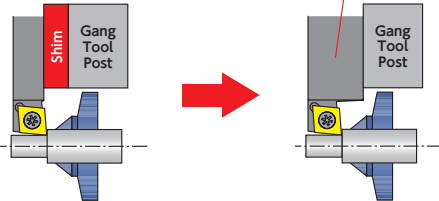

No shims required during thread whirling operation with an extended guide bushing

● Feature 2

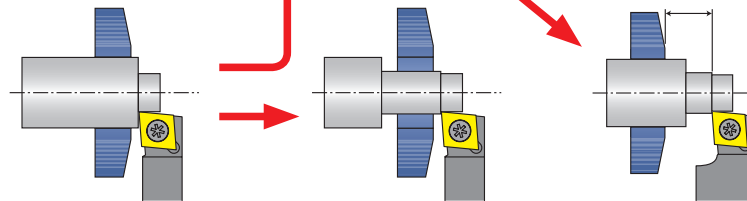

Typical turning

With Conventional Holders: Roughed bar comes out when retracted for finish turn

With Shifted Holders: Finish turn can be done without retracting the roughed bar

SATURN DUO

Face turning / grooving tools



Features

- FGV type for face grooving and FBV type for face machining
- Economical double-corner specification
- Improved tool rigidity by optimizing the overhang and holder shape
- Selection includes : gang-type, front-gang-type and sleeve holder type

FGV type for face grooving

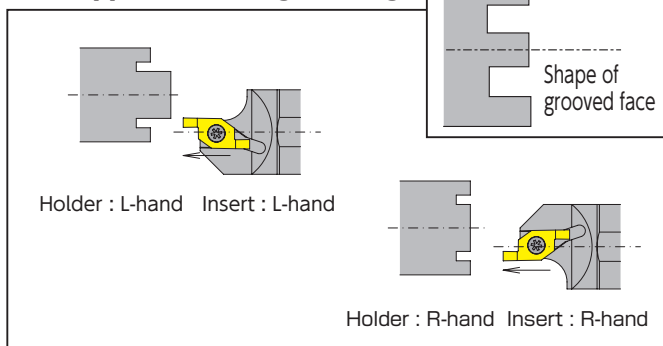

Target work shape

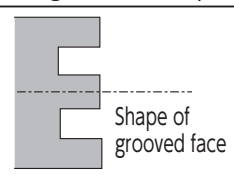

FBV type for face machining

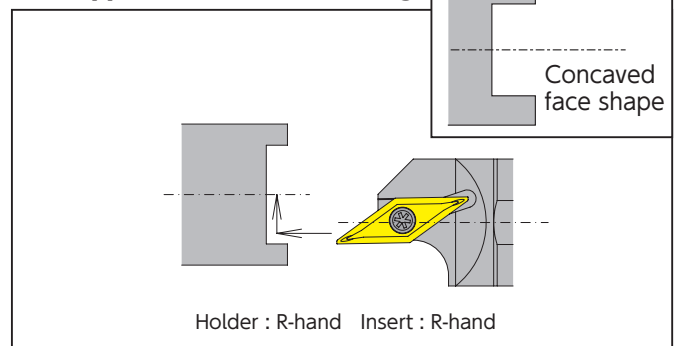

Target work shape

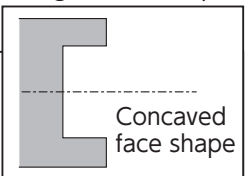

- Grooving possible under a wide range of cutting conditions due to strengthened rigidity of both insert and holder
- Minimum machining diameter of $\phi .236"$, and groove width of $.039"$
- Left-hand types available for machining work with a boss

- Further improved face machining efficiency
- Minimum machining diameter of $\phi .315"$

➡T20

P



Tooling for Swiss-type Lathes

- Tooling P2
- Grade Introduction P5
- Recommended Insert Grade
and Cutting Conditions P17
- Chipbreaker Introduction P21

Tooling example for a small CNC automatic lathe (gang type)

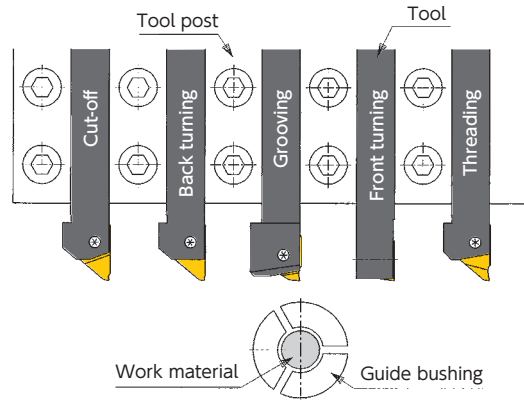
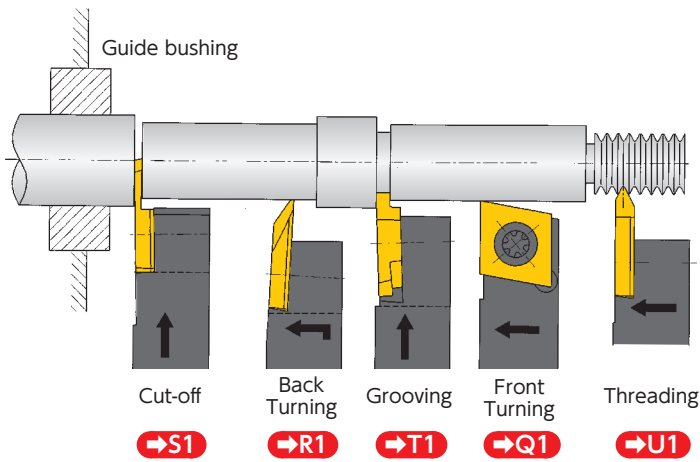

Tooling for gang type tool post

Tooling example for a small CNC automatic lathe (turret type)

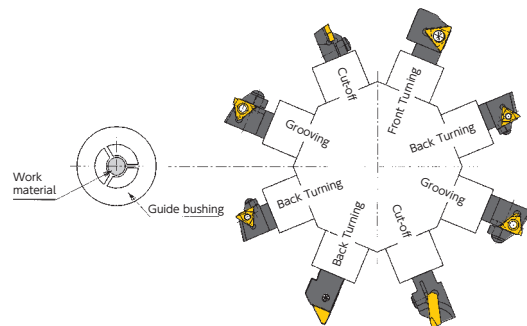
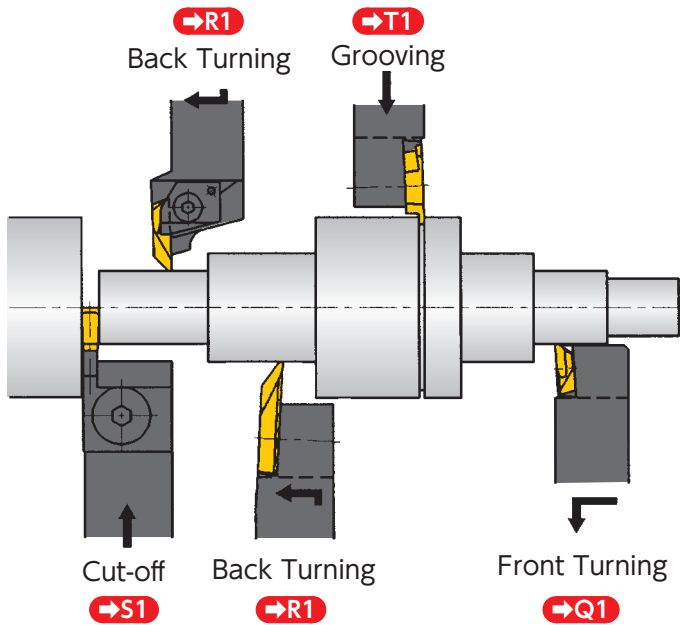

Tooling for turret type tool post

Tooling example for a small CNC automatic lathe (horizontal gang style)

■ Front Turning

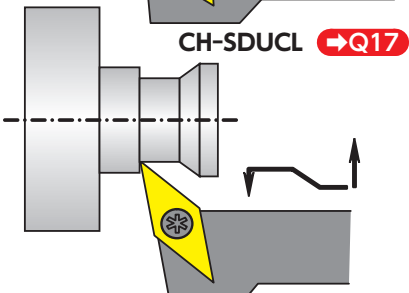
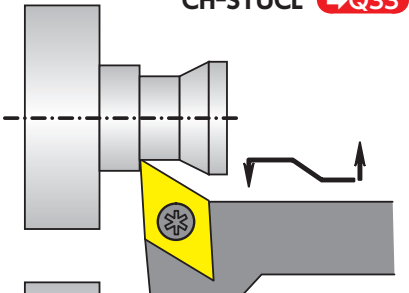
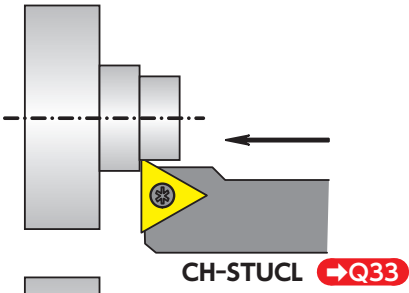

■ back Turning

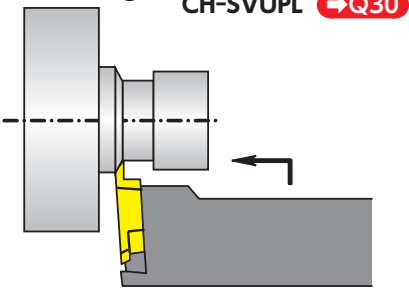

■ Grooving

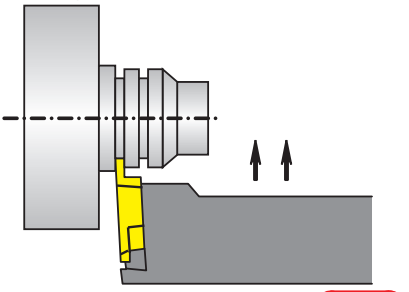

■ ID Boring

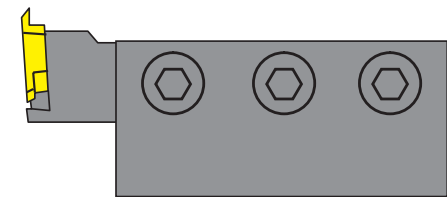
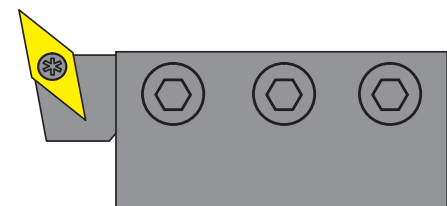
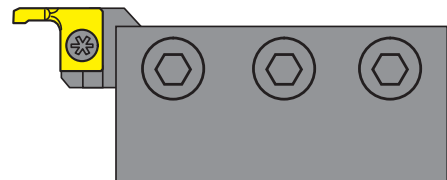
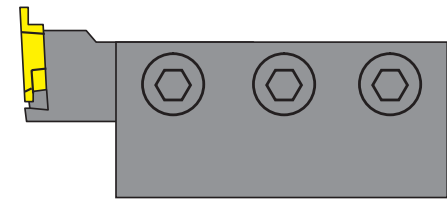
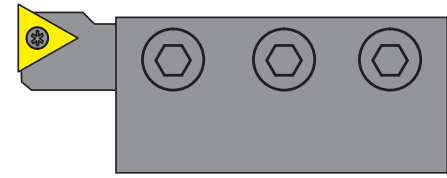
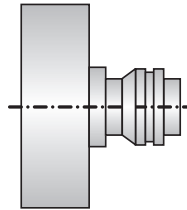
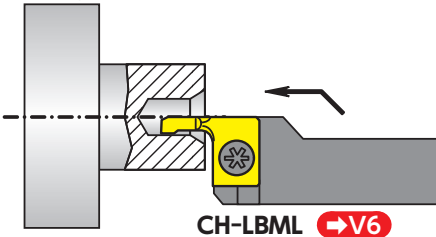

Micro-grain Carbide and PVD/CVD-coated Carbide

Micro-grain Carbide and PVD/CVD-coated Carbide



Excellence in precision machining and machining of hard-to-cut materials

These material grades use WC micro-grain carbide, the hard layer of which is granulated to a micro size $1\mu\text{m}$ as the substrate. Furthermore, the substrate is coated by the PVD method with TiN, TiCN, and/or TiAlN. The end results are materials that are suitable for precision machining and machining of difficult-to-cut materials. Inserts in these grades are tougher and harder than carbide and come with precision sharp cutting edges. They even have superior toughness and sharper cutting edges than ultra micro-grain carbide grades, with excellent wear resistance and thermal crack resistance.

The result of intensive research and development for improving carbide grades

The NTK carbide grade series shows very stable performance under a wide range of conditions. NTK uses micro-grain carbide well balanced between wear resistance and toughness, as substrate.

Carbide grade

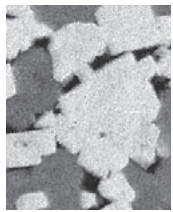

General carbide structure

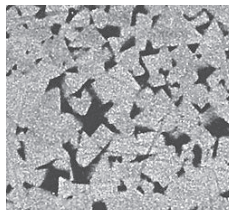

Micro-grain carbide structure

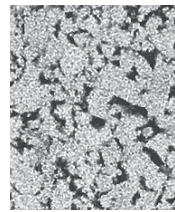

Super micro-grain carbide structure

Features Superior cutting performance

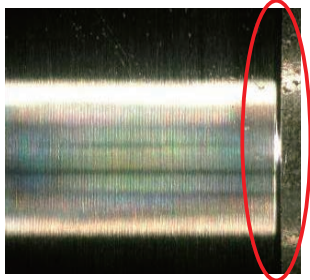

No burrs

Machined with our insert with a sharp cutting edge

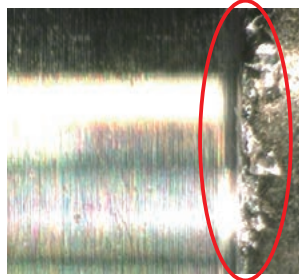

Burrs

Machined with a competitor's product with a honed cutting edge

Relentless pursuit of better cutting performance

NTK takes pride in its carbide grade series for their outstanding cutting performance as a result of grinding ultra sharp cutting edges. This outstanding cutting performance benefits in better burr control, lower tool pressure, stabilized dimensions and improved work hardening control.

Features Precise analysis on insert wear patterns

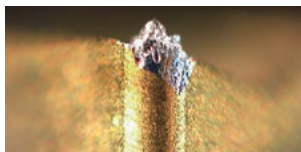

Build-up edge



Chipping / fracture





Flank wear



Wear on rake

Continuous research on insert tool life

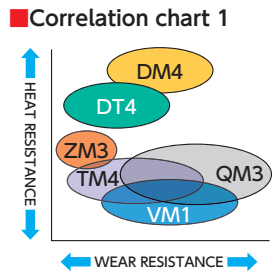
Damage to insert cutting edges varies depending on the machining process and the work material. There are various types of coatings that reduce such damages to prolong the tool life. NTK carbide series offers a variety of coated insert grades which have been developed to improve their resistance characteristics, including wear, fracture, adhesion, oxidation and the likes, by utilizing our state-of-the-art technologies.

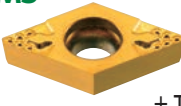
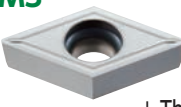
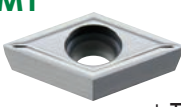
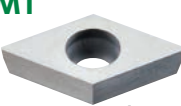
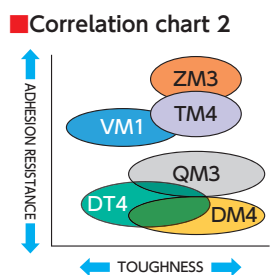
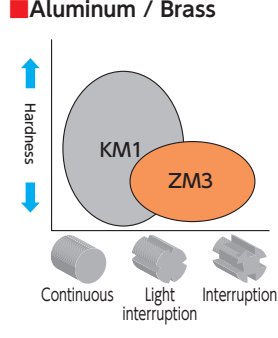
	Grade / Coating	Applications / Features	Physical properties*					Applications map	
			Density g/cm ³	Hardness HRA	Bending strength MPa	Young's modulus GPa	Thermal expansion coefficient X10 ⁻⁶ /K		Thermal conductivity W/m · K
PVD coated	DM4  Micro-grain carbide + Thick TiN-TiCN-TiAlN coat	P M S H • Best oxidation resistance enable high temperature machining	14.4	91.0	3000	580	5.8	63	 <p>■ Correlation chart 1</p> <p>HEAT RESISTANCE ↑</p> <p>WEAR RESISTANCE ↔</p>
	DT4  Micro-grain carbide + Thin TiN-TiCN-TiAlN coat	P M S H • Excellent oxidation resistance for Swiss-type lathes	14.4	91.0	3000	580	5.8	63	
	TM4  Micro-grain carbide + Thin TiN-TiCN-TiN coat	P M N S • Best combination of wear resistance and toughness and adhesion resistance for Swiss-type lathes	14.4	91.0	3000	580	5.8	63	
	ZM3  Micro-grain carbide + Thick TiN coat	P M N • Best Adhesion resistance enables high accuracy machining	14.4	91.0	3000	580	5.8	63	
	QM3  Micro-grain carbide + Thick TiCN coat	P M S H • Best wear resistance enable stable machining	14.4	91.0	3000	580	5.8	63	
	VM1  Micro-grain carbide + Thin TiCN coat	P M N • Best edge sharpness and good wear resistance	14.8	92.0	2500	640	5.7	84	
Uncoated	KM1  Micro-grain carbide	P M N • Best for non-ferrous material with mirror finish	14.8	92.0	2500	640	5.7	84	 <p>■ Correlation chart 2</p> <p>ADHESION RESISTANCE ↑</p> <p>TOUGHNESS ↔</p>
									 <p>■ Aluminum / Brass</p> <p>Hardness ↑</p> <p>Continuous Light Interruption</p>

*For products with coating, the values of the base material are indicated.

QM3

Superb wear resistance and fracture resistance in interrupted cutting !

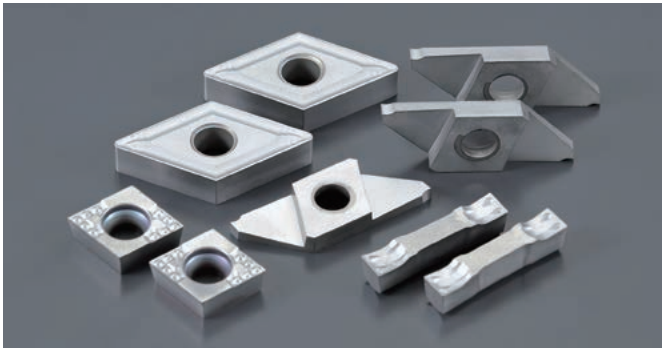

Features

- Excellent toughness and wear resistance for wide speed range
- Stable interrupted machining of steel

Spindle		
4135		
330 SFM		
.0012 IPR		
.008" DOC		
WET		
NTK : QM3	600 pcs	
Competitor's PVD-coated carbide	300 pcs	
Best for	Optimized for	Excellent in
<ul style="list-style-type: none"> ● Carbon steels ● Stainless steels ● Alloy steels ● Heat resistant alloys 	Swiss-type lathes Conventional lathes	Wear resistance

NEW DT4

Excellent heat resistance for Swiss-type lathes !

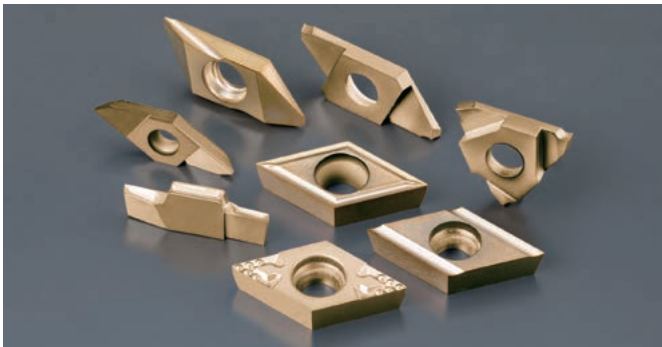

Features

- Excellent oxidation resistance for Swiss-type lathes

Pin		
440 CSS		
260 SFM		
.002 IPR		
.039" DOC		
WET		
NTK : DT4	1100 pcs	
Competitor's PVD-coated carbide	800 pcs	
Best for	Optimized for	Excellent in
<ul style="list-style-type: none"> ● Titanium alloys ● Stainless steels ● Alloy steels ● Carbon steels ● Heat resistant alloys 	Swiss-type lathes	Oxidation Heat resistance

NEW DM4

Excellent oxidation resistance !

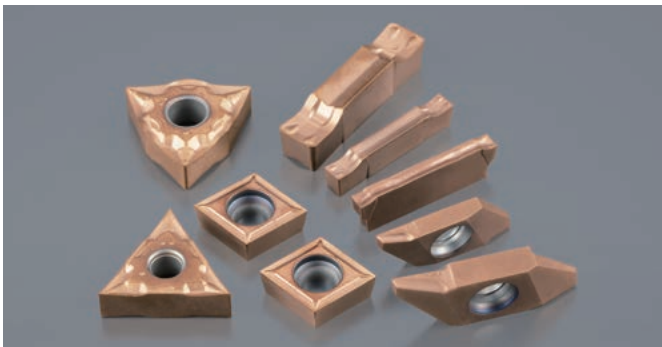

Features

- Best oxidation resistance for high temperature machining
- Optimized for Conventional / Swiss-type lathes

Case		
Inco 718		
130 SFM		
.001 IPR		
.008" DOC		
WET		
NTK : DM4	110 pcs	
Competitor's PVD-coated carbide	90 pcs	
Best for	Optimized for	Excellent in
<ul style="list-style-type: none"> ● Titanium alloys ● Stainless steels ● Alloy steels ● Carbon steels ● Heat resistant alloys 	Conventional lathes Swiss-type lathes	Oxidation Heat resistance

TM4 Next generation standard insert grade for Swiss-type lathes !



Features

- Excellent dimensional stability and tool life thanks to triple titanium layers with excellent adherence to insert substrate

Automobile parts		
304 SS		
260 SFM		
.0008 IPR		
.047" DOC		
WET		
NTK : TM4	950 pcs	
Competitor's PVD-coated carbide	500 pcs	
Best for	Optimized for	Excellent in
<ul style="list-style-type: none"> ● Carbon steels ● Stainless steels ● Alloy steels 	Swiss-type lathes	Balance

VM1 High precision machining of small diameter parts !

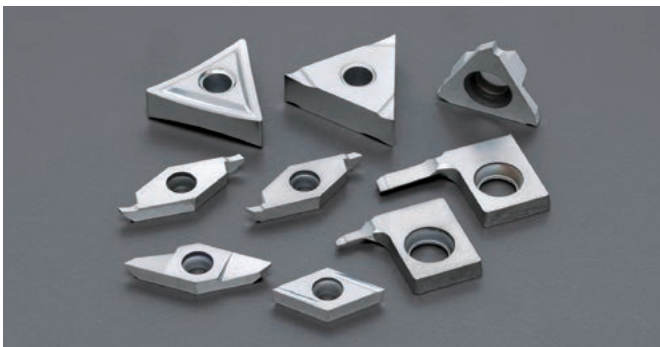

Features

- Especially for machining free cutting steels (SUM materials)
- For high-precision machining with longer tool life even in the high-speed machining range

Plug		
12L14		
460 SFM		
.0006 IPR		
.004" DOC		
WET		
NTK : VM1	800-1000 pcs	
Competitor's PVD-coated carbide	150 pcs	
Best for	Optimized for	Excellent in
<ul style="list-style-type: none"> ● Carbon steels ● Stainless steels ● Alloy steels 	Swiss-type lathes	Edge sharpness

ZM3 The best selling grade for automatic lathes !

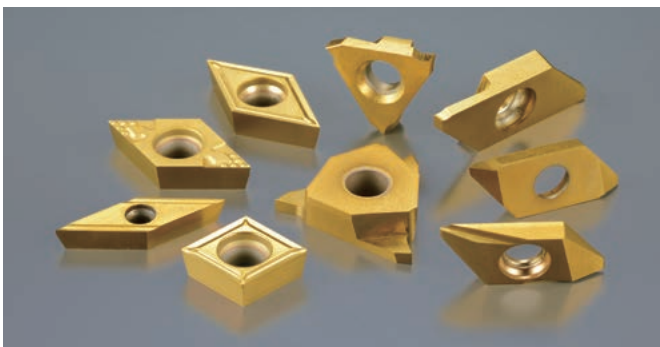

Features

- Stabilizes machining dimensions thanks to the coating being firmly adhered to the substrate
- A wide range of cutting tools in various sizes available for automatic lathes

Case		
1010		
330 SFM		
.0047 IPR		
.012"-.015" DOC		
WET		
NTK : ZM3	6000 pcs	
Competitor's PVD-coated carbide	150 pcs	
Best for	Optimized for	Excellent in
<ul style="list-style-type: none"> ● Carbon steels ● Stainless steels ● Alloy steels ● Non-ferrous materials 	Swiss-type lathes Conventional lathes	Adhesion resistance

Tooling for Swiss-type Lathes

[Carbide]

KM1

Longer tool life even for machining hard-to-cut materials !



Features

- **Very sharp cutting edges with uncoated Micro-grain carbide**
- **Excellent adhesion resistance because of mirror-finish**
- **A wide range of cutting tools in various types available for Swiss-type lathes**

Spool machining		
5056 (Aluminium)		
300 ~ 560 SFM		
.0016 IPR		
.02"-.20" DOC		
WET		
NTK : KM1	300 pcs	
Competitor's PVD-coated carbide	200 pcs	
Best for	Optimized for	Excellent in
<ul style="list-style-type: none"> ● Aluminium ● Plastic ● Non-ferrous materials 	Swiss-type lathes	Edge sharpness

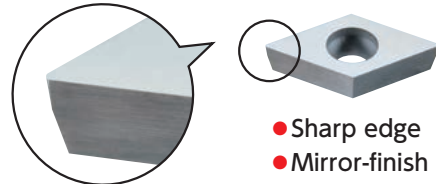

PVD Coatings

QM3/Q15

Q-Coat

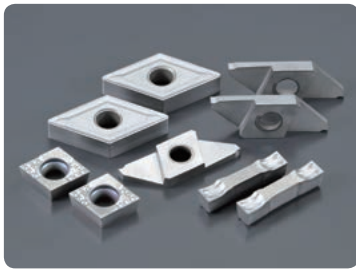

Best wear resistance

- stainless steel
- Carbon steel
- Alloy steel

TM4

TM-Coat

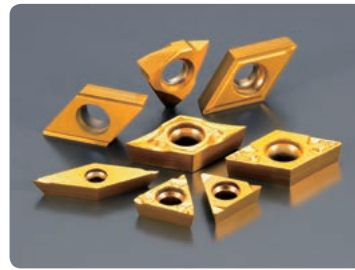

Best balance of wear resistance and adhesion resistance

- For small part machining in general

DM4

DM-Coat



Best heat resistance

- Heat resistant alloy
- Stainless steel
- Hardened material

DT4

DT-Coat



Best balance of heat resistance and sharp edges

- Titanium alloy
- Heat resistant alloy
- Stainless steel
- Hardened material

VM1

V-Coat

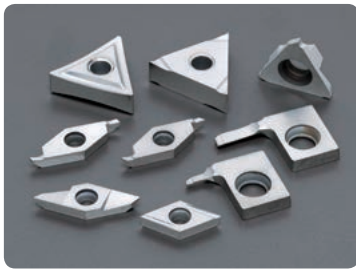

Best edge sharpness

- Titanium alloy
- Non-ferrous material
- Stainless steel
- Plastic

ZM3/C7Z

Z-Coat



Best adhesion resistance

- General purpose machining

Coating Specifications

	Q-Coat	TM-Coat	DM-Coat	DT-Coat	V-Coat	Z-Coat
Thickness	Thick	Thin	Thick	Thin	Thin	Thick
Wear Resistance	◎	○	○	○	○	
Heat Resistance			◎	◎		○
Adhesion Resistance		○				◎
Edge Sharpness		○		○	◎	
Composition	TiCN	Multilayer	Multilayer	Multilayer	TiCN	TiN

◎1st choice ○2nd choice

Cermet / PVD-coated Cermet

Cermet series

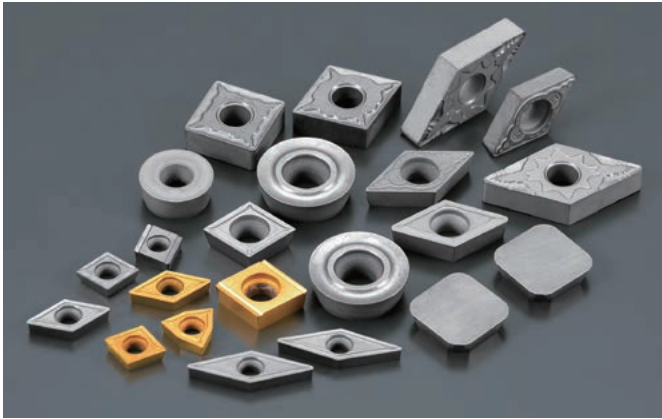

Cermet is a cutting tool material composed mainly of TiC (Titanium Carbide) and TiN (Titanium Nitride). The name, cermet, is derived from the words CERAMIC and METAL (representing carbide). As the name suggests, cutting performance is also in the mid-range of ceramic's and carbide's. The advantages of this material grade are high-quality and excellent surface finishes can be achieved with elevated cutting speeds. Cermets provide extended tool life.

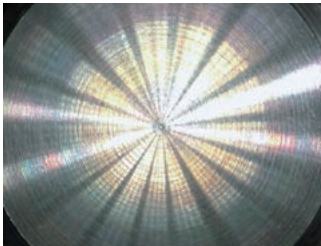

Surface finished with cermet

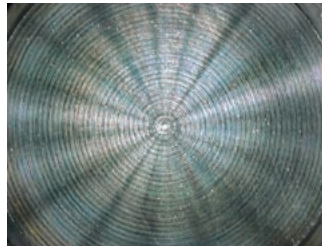

Surface finished with carbide

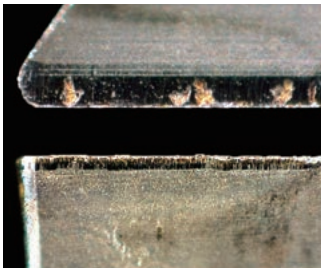

Cermet

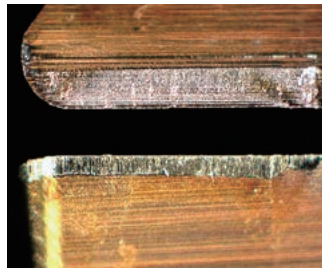

Carbide

PVD-coated cermet series



PVD TiN or TiCN coated cermet grades bring improved wear resistance. Since the coating layer does not contain any binder components, the coating maximizes the wear resistance of the titanium which delivers excellent performance and the tool life.

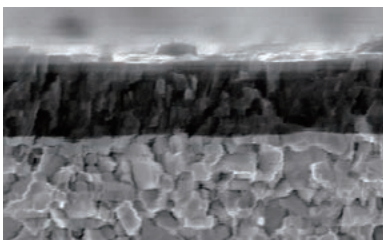

Smooth coating layer offers excellent adhesion resistance

Outstanding coating bonding with substrate

Features

High quality surface finish





The main components, TiC and TiN, have good BUE resistance as they have low affinity with work materials. Thus, machining with cermets brings high quality surface finish over extended periods of time.

High speed cutting

The main components, TiC and TiN, are more resistant to wear and oxidation at high temperature than WC (tungsten carbide), which is the main component of carbide tools. Because of excellent wear and oxidation resistance, cermet grades are less reactive with work materials and make stable high speed machining possible.

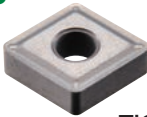
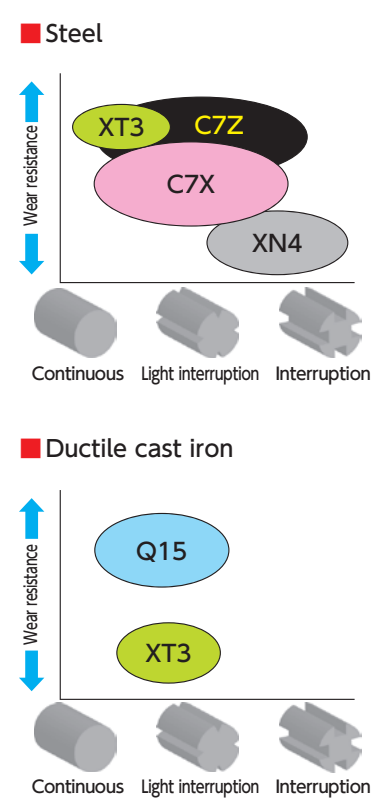
Features

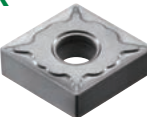
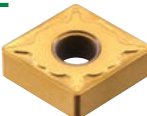
PVD coating with superb hardness and surface smoothness provide excellent wear resistance and adhesion resistance.

Grade / Coating	Applications / Features	Physical properties*						Applications and ceramic property map
		Density g/cm ³	Hardness HRA	Bending strength MPa	Young's modulus GPa	Thermal expansion coefficient X10 ⁻⁶ /K	Thermal conductivity W/m · K	
XT3  TiC+TiN base	P M K N • Well balanced between wear resistance and toughness	6.3	92.5	1,700	450	8.4	21	
Q15  TiC+TiN base+TiCN coat	P M K • Superior wear resistance and toughness	6.3	92.5	1,700	450	8.4	21	
C7X  TiCN base	P M K N • Good combination of heat resistance and toughness	7.0	91.5	1,800	440	8.2	31	
C7Z  TiCN base + TiN coat	P M K N • Perfect combination of heat resistance and toughness	7.0	91.5	1,800	440	8.2	31	
XN4  TiN base	P M • Excellent toughness	5.9	91.5	1,900	450	8.9	42	

*For coated grades, the values of the base material are indicated.

■ Applications

Material	General steel Carbon steel , Alloy steel					Stainless steel Stainless steel , Cast steel					Cast iron Gray cast iron , Ductile cast iron			
	Finish ← → Rough					Finish ← → Rough					Finish ← → Rough			
Range	P01	P10	P20	P30	P40	M01	M10	M20	M30	M40	K01	K10	K20	K30
Cermets	XT3		C7X			XT3					XT3			
						C7X								
											XN4			
PVD Coated cermets	Q15					Q15					Q15			
	C7Z					C7Z								

Tooling for Swiss-type Lathes

[Cermet]

XT3

Well balanced combination of wear resistance and toughness !

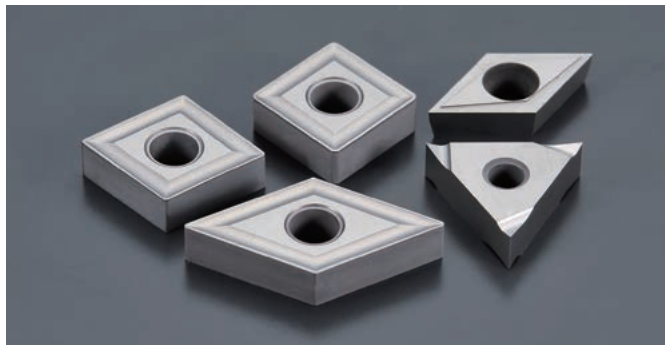

Features

- Well-balanced combination of wear resistance and toughness
- Covers a wide range of steel cutting, from medium cutting to finishing of steel

Crank shaft	
1049	
250 SFM	
.002 IPR	
.001" DOC	
WET	
NTK : XT3	100 pcs
Competitor's cermet	60 pcs

Best for

- Carbon steels
- Stainless steels
- Alloy steels
- Cast iron

Optimized for

Conventional lathes

Excellent in

Wear resistance

Q15

Coated cermet for high-speed finishing of ductile cast iron !

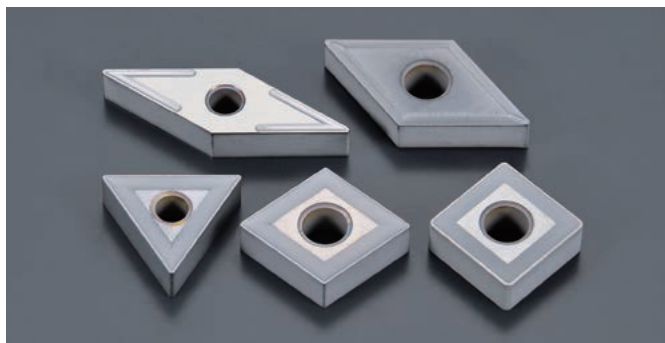

Features

- Further improved wear resistance and toughness from the TiCN-based coating
- The recommended grade for high-speed finishing of ductile cast iron

Differential case	
Ductile cast iron	
525 SFM	
.004 IPR	
.008" DOC	
WET	
NTK : Q15	35 pcs
Competitor's cermet	20 pcs

Best for

- Carbon steels
- Stainless steels
- Alloy steels
- Cast iron
- Ductile cast iron

Optimized for

Conventional lathes

Excellent in

Wear resistance

C7X High-strength cermet grade that offers remarkable machining stability !

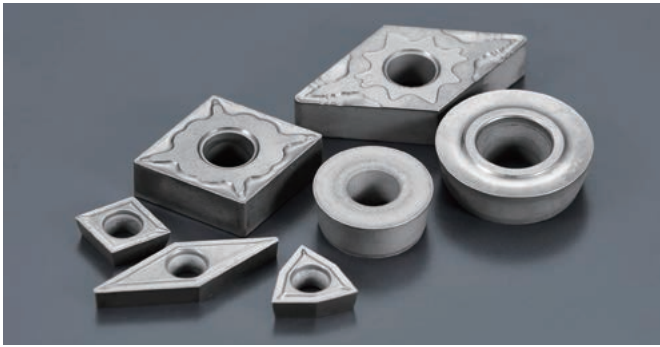

Features

- Overcomes the traditional weakness of conventional cermet grades with improved thermal shock resistance
- Excellent grade for grooving and bearing machining

AT clutch		
SS		
800 SFM		
.0008-.0016 IPR		
.060" DOC		
WET		
NTK : C7X	200 pcs	
Competitor's cermet	100 pcs	
Best for	Optimized for	Excellent in
<ul style="list-style-type: none"> • Carbon steels • Stainless steels • Alloy steels • Cast iron 	Swiss-type lathes Conventional lathes	Balance

C7Z Combining the advantages of thermal shock resistance and fracture resistance !

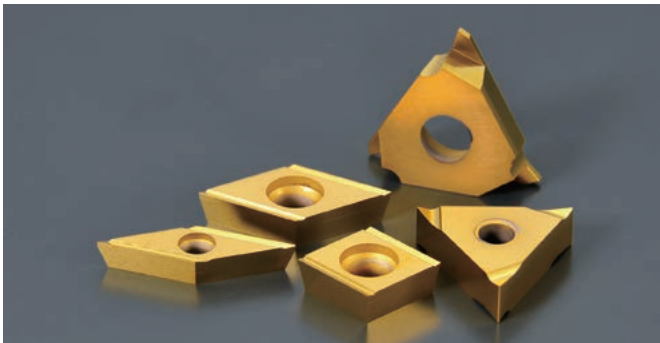

Features

- Further improvement in wear resistance and thermal shock resistance with a TiN-based coating
- Excellent performance in grooving and bearing machining
- The most recommended grade for high-speed machining of steel

Spring		
SS		
430 SFM		
.002 IPR		
.012" DOC		
WET		
NTK : C7Z	1600 pcs	
Competitor's cermet	1200 pcs	
Best for	Optimized for	Excellent in
<ul style="list-style-type: none"> • Carbon steels • Stainless steels • Alloy steels • Cast iron 	Swiss-type lathes Conventional lathes	Balance

XN4 Toughest cermet grade with excellent fracture resistance !

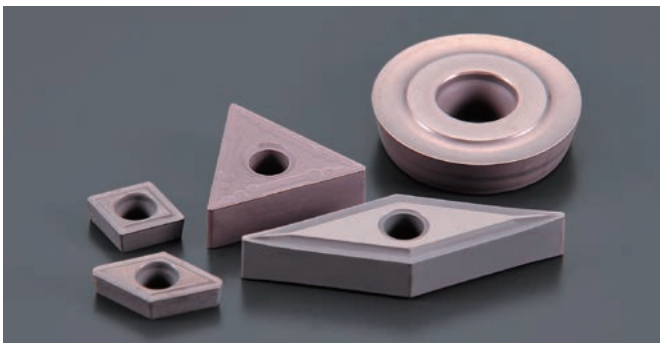

Features

- Allows for stable machining with longer tool life thanks to its excellent fracture resistance

Gear		
5120H		
360 SFM		
.004 IPR		
WET		
WET		
NTK : XN4	300 pcs	
Competitor's cermet	200 pcs	
Best for	Optimized for	Excellent in
<ul style="list-style-type: none"> • Carbon steels • Stainless steels • Alloy steels 	Conventional lathes	Toughness

Tooling for Swiss-type Lathes

[Cermet]

EZCUBE

Excellent performance with superb versatility at a low price !

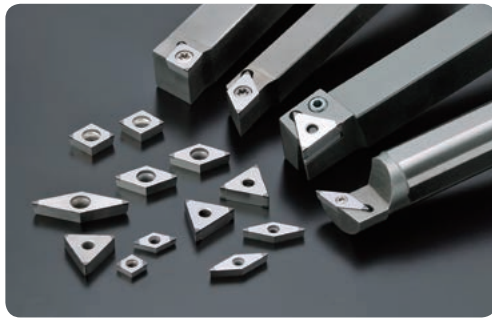

CBN (Cubic Boron Nitride)

Features

- Seven grades available to cover a variety of work materials
- A wide selection in geometries
- Multiple corners on both insert sides contributes to cost reduction

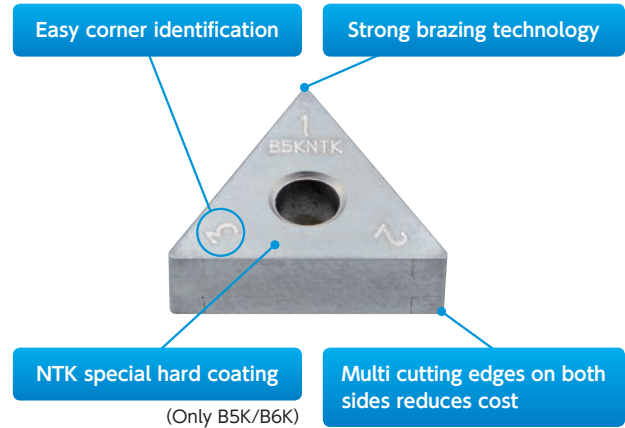

● NTKEZCUBE / EZ CUBE

Material grade	Main binder	CBN content	Major application
B23	Ti-base	90%	High-speed semi roughing of cast iron/sintered alloys
B30	Ti-base	95%	High-speed finishing of cast iron
B6K/B36	TiCN-base	65%	semi-interrupted to interrupted machining of hardened materials
B40	TiN-base	65%	Interrupted machining of highly hardened materials
B5K/B52	TiC-base	50%	Finishing of ductile cast iron and continuous machining of highly hardened materials

B23

Features

- Excellent wear resistance thanks to high CBN content
- Ideal for roughing cast iron and machining sintered materials

[Recommended cutting conditions]

Work material	Application	Purpose	Cutting speed (SFM)	Feed (IPR)	Depth of cut (inch)	DRY	WET
Cast iron	Turning	Rough Semi finish	1300-3300	.004-.020	.008-.080	○	●
Sintered alloy	Turning	Rough-Finish	150-1000	.001-.008	.002-.020	●	●

Brake rotor	
Gray cast iron	
820 SFM	
.0079 IPR	
.079" DOC	
WET	
NTK : B23	
Competitor's CBN	70 pcs

B30

Features

- Excellent wear resistance thanks to high CBN content
- Designed for finishing cast iron

[Recommended cutting conditions]

Work material	Application	Purpose	Cutting speed (SFM)	Feed (IPR)	Depth of cut (inch)	DRY	WET
Cast iron	Turning	Semi finish Finish	1300-3300	.004-.020	.008-.080	○	●

Cylinder block	
Cast iron	
2600 SFM	
.012 IPR	
.004" DOC	
WET	
NTK : B30	
Competitor's CBN	500 pcs

NEW B6K/B36

Features

- **Excellent combination of wear resistance and toughness due to special TiCN binders**
- **Best for semi-interrupted cutting of hardened materials**

[Recommended cutting conditions]

Work material	Application	Purpose	Cutting speed (SFM)	Feed (IPR)	Depth of cut (inch)	DRY	WET
Hardened material	Turning (Light interrupted)	Rough-Finish	130-800	.002-.008	.004-.040	●	●

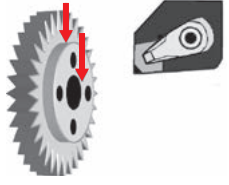
Gear (HRC61-65)	
5120H	
430 SFM	
.006 IPR	
.004" DOC	
DRY	
NTK : B36	50 pcs
Competitor's CBN	20 pcs

B40

Features

- **Exceptional toughness thanks to special TiN binders**
- **Designed for severely interrupted cutting of hardened materials**

[Recommended cutting conditions]

Work material	Application	Purpose	Cutting speed (SFM)	Feed (IPR)	Depth of cut (inch)	DRY	WET
Hardened material	Turning (Heavy interrupted)	Rough-Finish	100-500	.002-.008	.004-.040	●	○

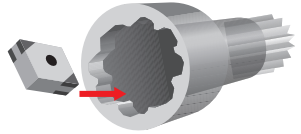
Universal joint (HRC62)	
1055	
360 SFM	
.0055 IPR	
.0059" DOC	
DRY	
NTK : B40	2300 pcs
Competitor's CBN	1500 pcs

NEW B5K/B52

Features

- **Excellent wear resistance due to optimum CBN content with special TiC binders**
- **Ideal for finishing ductile cast iron and continuous cuts for finishing hardened materials**

[Recommended cutting conditions]

Work material	Application	Purpose	Cutting speed (SFM)	Feed (IPR)	Depth of cut (inch)	DRY	WET
Ductile cast iron	Turning	Finish	300-1600	.004-.016	.012-.080	○	●
Hardened material	Turning (Continuous)	Rough-Finish	300-1000	.004-.020	.004-.040	○	●

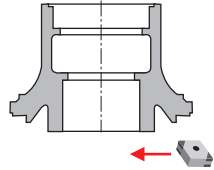
Hub	
Ductile cast iron	
1150-1130 SFM	
.003 IPR	
.0079" DOC	
WET	
NTK : B52	60 pcs
Competitor's CBN	30 pcs

Tooling for Swiss-type Lathes

PCD (Polycrystalline Diamond)

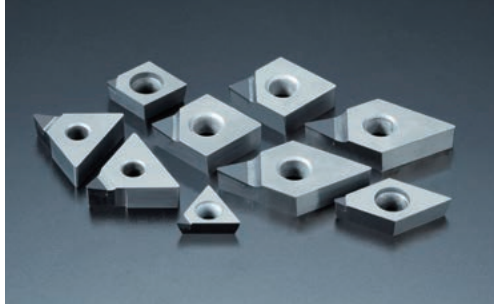
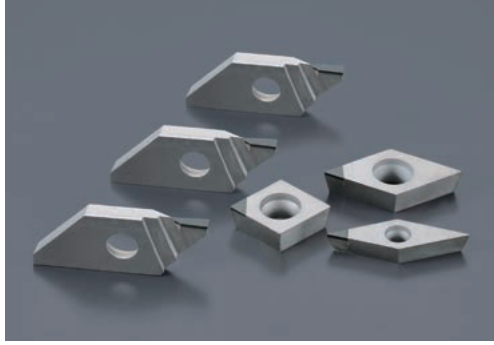

Features

- **Faster cutting speeds than carbide**
- **Recommended for cutting aluminum and copper alloys thanks to its excellent adhesion resistance**
- **Incorporates a very sharp cutting edge**
- **Available for general turning and cut-off in addition to the inserts for milling cutters**

[Recommended cutting conditions]

Work material	Application	Purpose	Cutting speed (SFM)	Feed (IPR/IPT)	Depth of cut (inch)	DRY	WET
Aluminum alloy Non-ferrous material	Turning	Rough-Finish	-6500	-.006	-.200		●
	Milling	Rough-Finish	-25000	-.008	-.200		●

Tooling for Swiss-type Lathes

[CBN / PCD]

PD1

Features

- **Sharp cutting edges**
- **Enables high precision and stable machining by controlling the potential for built-up edge**

Spool		
①Rough	②Finish	
A6061	A6061	
660 SFM	660 SFM	
.004 IPR	.002 IPR	
.200 DOC	.008 DOC	
①NTK : PD1		30,000 pcs
②NTK : PD1		30,000 pcs

NEW PD2

Features

- **Super micro grain PCD maintains sharp cutting edges with increased chipping resistance**
- **Good chip control due to the high rake angle on the insert**

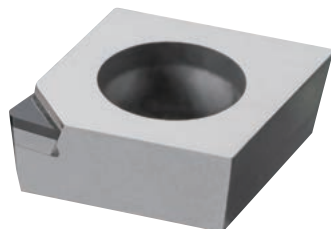

Spool		
A6061		
560 SFM		
.002 IPR		
.006 DOC		
NTK : PD2		15,000 pcs
Competitor's PCD		10,000 pcs

Recommended Insert Grade and Cutting Conditions

Front Turning

CSVF / CC.. / DC.. / VC.. / VB.. / TN.. / TF

Work Material		High Temperature Alloys	Titanium Alloys	Cobalt Chrome Alloys	Stainless Steels		Alloy Steels	Carbon Steels	
					Hard to cut	Free cutting			
Common Name		Inconel Hastelloy MP35N	Ti-6Al-4V	ASTM F-75	304 316 17-4PH	303 430F	5120 4137	1045 1046	
Grade	1st choice	DT4			DT4	TM4	QM3		
	2nd choice	TM4 / QM3			QM3 / VM1	QM3	TM4 / DT4 / C7Z(X)		
Cutting Speed (SFM)		75 125 225	100 200 275		130 230 330	150 300 600	Carbide C7Z(X)	150 300 500 400 500 800	
Recommended Chipbreaker Feed Rate (IPR)	≤.004 DOC	AMX KHG .0004 .0008 .0012				AMX KHG .0004 .0012 .0016			
	.004 to .060 DOC	CL S AM3 .0008 .0016 .0024				CL AM3 AZ7 ZR S U/U1 UL .0008 .0020 .0032			
	≥ .060 DOC	CL S AM3 .0008 .0015 .0025				CL AM3 ZP .0012 .0024 .0040			

Back Turning

CSVB

Work Material		High Temperature Alloys	Titanium Alloys	Cobalt Chrome Alloys	Stainless Steels		Alloy Steels	Carbon Steels
					Hard to cut	Free cutting		
Common Name		Inconel Hastelloy MP35N	Ti-6Al-4V	ASTM F-75	304 316 17-4PH	303 430F	5120 4137	1045 1046
Grade	1st choice	DT4						VM1
	2nd choice	VM1						DT4
Cutting Speed (SFM)		75 125 225	100 200 275			100 200 300		
Feed Rate (IPR)	X Direction	.0004 .0008 .0012						
	Z Direction	.0004 .0012 .0016						

TBDP / TBMH / TBP / TBPA / TBVC

Work Material		High Temperature Alloys	Titanium Alloys	Cobalt Chrome Alloys	Stainless Steels		Alloy Steels	Carbon Steels
					Hard to cut	Free cutting		
Common Name		Inconel Hastelloy MP35N	Ti-6Al-4V	ASTM F-75	304 316 17-4PH	303 430F	5120 4137	1045 1046
Grade	1st choice	DT4			DT4 / QM3	TM4	QM3	
	2nd choice	TM4 / QM3			VM1	QM3	TM4 / DT4 / C7Z(X)	
Cutting Speed (SFM)		75 125 225	100 200 275			150 300 500		
Feed Rate (IPR)	X Direction	.0004 .0008 .0012				.0004 .0008 .0016		
	Z Direction	.0008 .0016 .0024				.0008 .0016 .0031		

TB32 / TB43

Work Material		High Temperature Alloys	Titanium Alloys	Cobalt Chrome Alloys	Stainless Steels		Alloy Steels	Carbon Steels
					Hard to cut	Free cutting		
Common Name		Inconel Hastelloy MP35N	Ti-6Al-4V	ASTM F-75	304 316 17-4PH	303 430F	5120 4137	1045 1046
Grade	1st choice	ZM3						ZM3
	2nd choice	ZM3						Z15
Cutting Speed (SFM)		50 100 150				ZM3 150 300 425 Z15 400 600 800		
Feed Rate (IPR)	X Direction	.0004 .0012 .0020				.0004 .0012 .0020		
	Z Direction	.0016 .0020 .0031				.0016 .0031 .0059		

Tooling for Swiss-type Lathes

[Recommended cutting conditions]

Recommended Insert Grade and Cutting Conditions

Cut Off

CSV T

Work Material		High Temperature Alloys	Titanium Alloys	Cobalt Chrome Alloys	Stainless Steels		Alloy Steels	Carbon Steels
					Hard to cut	Free cutting		
Common Name		Inconel Hastelloy MP35N	Ti-6Al-4V	ASTM F-75	304 316 17-4PH	303 430F	5120 4137	1045 1046
Grade	1st choice	DT4					VM1	
	2nd choice	VM1					DT4	
Cutting Speed (SFM)		100 160 230			100 200 300			
Feed Rate (IPR)		.0004 .0008 .0012			.0004 .0012 .0020			

CTP / CTPA / CTPS / CTPW

Work Material		High Temperature Alloys	Titanium Alloys	Cobalt Chrome Alloys	Stainless Steels		Alloy Steels	Carbon Steels
					Hard to cut	Free cutting		
Common Name		Inconel Hastelloy MP35N	Ti-6Al-4V	ASTM F-75	304 316 17-4PH	303 430F	5120 4137	1045 1046
Grade	1st choice	DT4				TM4	QM3	
	2nd choice	TM4			QM3 / VM1	QM3	TM4 / DT4 / C7Z(X)	
Cutting Speed (SFM)		100 160 230			100 200 300			
Feed Rate (IPR)		.0008 .0012 .0020			.0008 .0016 .0024			

CTDP / CTV

Work Material		High Temperature Alloys	Titanium Alloys	Cobalt Chrome Alloys	Stainless Steels		Alloy Steels	Carbon Steels
					Hard to cut	Free cutting		
Common Name		Inconel Hastelloy MP35N	Ti-6Al-4V	ASTM F-75	304 316 17-4PH	303 430F	5120 4137	1045 1046
Grade	1st choice	DM4				TM4	QM3	
	2nd choice	TM4 / QM3				QM3	TM4 / DM4	
Cutting Speed (SFM)		100 160 230			100 200 300			
Feed Rate (IPR)		.0012 .0020 .0031			.0016 .0031 .0047			

Grooving

CSV / GTG / GTMH / GTMT / GTMX / SBG

Work Material	High Temperature Alloys	Titanium Alloys	Cobalt Chrome Alloys	Stainless Steels		Alloy Steels	Carbon Steels
				Hard to cut	Free cutting		
Common Name	Inconel Hastelloy MP35N	Ti-6Al-4V	ASTM F-75	304 316 17-4PH	303 430F	5120 4137	1045 1046
Grade	1st choice	DT4		DM4 / DT4	TM4	QM3	
	2nd choice	TM4 / QM3		QM3 / VM1	QM3	TM4 / DT4 / C7Z(X)	
Cutting Speed (SFM)		75 125 225	100 200 275	130 230 330	150 300 600	Carbide C7Z(X)	150 300 500 400 500 800
Feed Rate (IPR) A. Grooving B. Side turning*	Width .010-.020	A. .0002 - .0012					
		B. .0001 - .0002					
	.020-.040	A. .0008 - .0024					A. .0008 - .0028
		B. .0002 - .0004					B. .0002 - .0004
	.040-.080	A. .0012 - .0028					A. .0012 - .0031
		B. .0008 - .0020					B. .0012 - .0024
	> .080	A. .0012 - .0079					
		B. .0012 - .0024					

*When side turning, Max. DOC is under .0079". Under .016" width side turning impossible

GVW / Groove Duo

Work Material	High Temperature Alloys	Titanium Alloys	Cobalt Chrome Alloys	Stainless Steels		Alloy Steels	Carbon Steels
				Hard to cut	Free cutting		
Common Name	Inconel Hastelloy MP35N	Ti-6Al-4V	ASTM F-75	304 316 17-4PH	303 430F	5120 4137	1045 1046
Grade	1st choice	QM3					
	2nd choice	QM3					
Cutting Speed (SFM)		75 125 225	100 200 275	130 230 330	150 300 600	150 300 500	
Feed Rate (IPR) A. Grooving B. Side turning*	Width .118-.157	A. .0020 - .0059					
		A. .0039 - .0079				A. .0039 - .0098	
	.157-.197	B. .0059 - .0118					
		A. .0059 - .0138					
> .197	A. .0059 - .0138						

*Max DOC is 80% of width

GTPA

Work Material	Aluminum Alloy	
Common Name	ASTM 5056 ASTM 6061	
Grade	1st choice	PD1
	2nd choice	KM1
Cutting Speed (SFM)		PD1 330 650 1000 KM1 160 330 650
Feed Rate (IPR) A. Grooving B. Side turning	A. .0020 - .0079	
	B. .0039 - .0079	

Recommended Insert Grade and Cutting Conditions

Threading

Work Material		High Temperature Alloys	Titanium Alloys	Cobalt Chrome Alloys	Stainless Steels		Alloy Steels	Carbon Steels
					Hard to cut	Free cutting		
Common Name		Inconel Hastelloy MP35N	Ti-6Al-4V	ASTM F-75	304 316 17-4PH	303 430F	5120 4137	1045 1046
Grade	1st choice	VM1		VM1 / ZM3		QM3		
	2nd choice	ZM3		QM3		VM1 / ZM3		
Cutting Speed (SFM)		75 125 225	100 200 275	130 230 330	150 300 600	150 300 500		

*Unless your machine is equipped with high speed threading program, please set the feed rate to 80 IPM or lower to prevent making incomplete threads

ID Boring







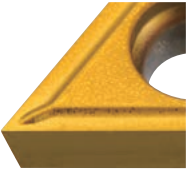
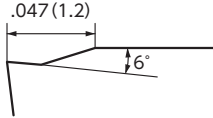
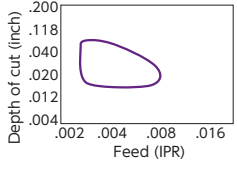

diameter ≤ .240" (LBM / STICK DUO)

Work Material		High Temperature Alloys	Titanium Alloys	Cobalt Chrome Alloys	Stainless Steels		Alloy Steels	Carbon Steels
					Hard to cut	Free cutting		
Common Name		Inconel Hastelloy MP35N	Ti-6Al-4V	ASTM F-75	304 316 17-4PH	303 430F	5120 4137	1045 1046
Grade	1st choice	TM4					VM1 / TM4	
	2nd choice	VM1 / ZM3					ZM3	
Cutting Speed (SFM)		60 160 230			100 200 300			
Feed Rate (IPR)		.0004 .0012 .0020						
Depth Of Cut (DOC)		.0020 .0031 .0039						

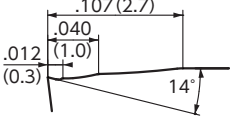
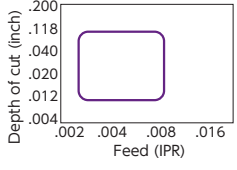
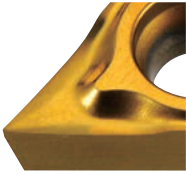
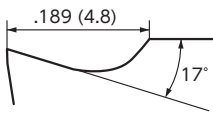
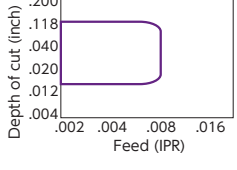
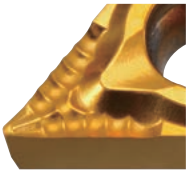
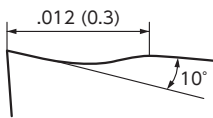
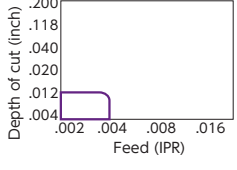
diameter > .240"

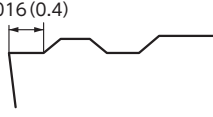
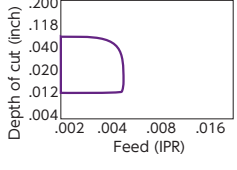
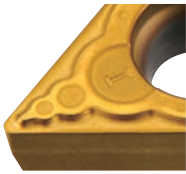

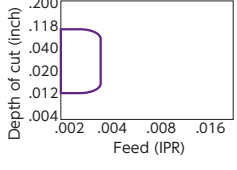
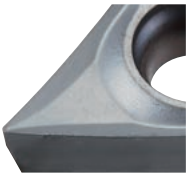

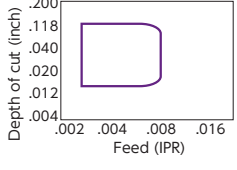

Work Material		High Temperature Alloys	Titanium Alloys	Cobalt Chrome Alloys	Stainless Steels		Alloy Steels	Carbon Steels
					Hard to cut	Free cutting		
Common Name		Inconel Hastelloy MP35N	Ti-6Al-4V	ASTM F-75	304 316 17-4PH	303 430F	5120 4137	1045 1046
Grade	1st choice	DT4		DT4	TM4	QM3		
	2nd choice	TM4		QM3 / TM4	QM3	TM4 / DT4 / C7Z(X)		
Cutting Speed (SFM)		150 230 330		130 230 330	150 300 600	Carbide C7Z(X)	150 300 500 400 500 800	
Feed Rate (IPR)		.0008 .0024 .0047						
Depth Of Cut (DOC)		.0039 .0197 .0787						

Molded Chipbreakers for Positive Inserts

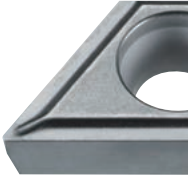
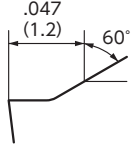
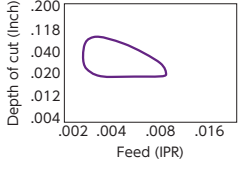

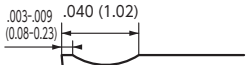
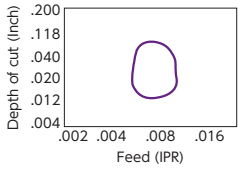

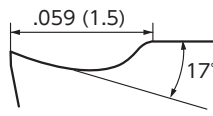
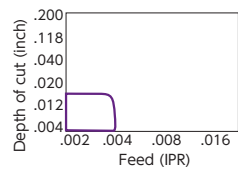
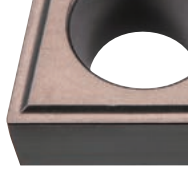
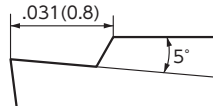
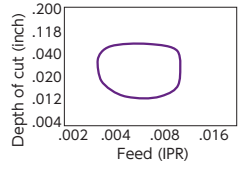
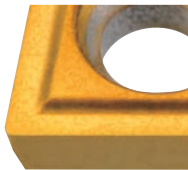
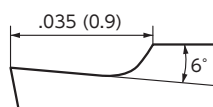
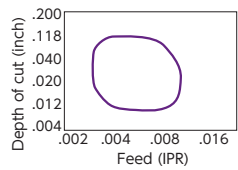

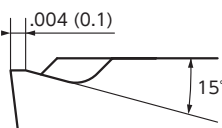
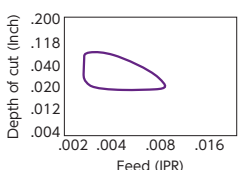
Name	Chipbreaker Geometry	Features	Chip Control Range
AM3	  <p>DCGT32.508 shown</p> <p>➔N8</p>	<ul style="list-style-type: none"> ● All purpose chipbreaker ● Sharp edge with toughness 	
YL	  <p>DCGT11T302MYL</p> <p>WATCH ON YouTube ➔N8</p>	<ul style="list-style-type: none"> ● Great combination of sharpness and toughness ● Covers extremely wide range ● Excellent chip control 	
CL	  <p>DCGT32.508M shown</p> <p>WATCH ON YouTube ➔N8</p>	<ul style="list-style-type: none"> ● Sharpest molded Chipbreaker ● Excellent chip control ● Less tool pressure 	
AMX	  <p>DCGT32.508M shown</p> <p>WATCH ON YouTube ➔N8</p>	<ul style="list-style-type: none"> ● Designed for very light depth of cut ● Good sharpness 	
AZ7	  <p>DCGT32.508M shown</p> <p>WATCH ON YouTube</p>	<ul style="list-style-type: none"> ● Excellent chip control at light feed and light depth of cut 	
ZR	  <p>DCMT32.508 shown</p>	<ul style="list-style-type: none"> ● Covers a wide depth of cut range under high-speed and low-feed conditions 	
1L	  <p>DCGT32.508 shown</p>	<ul style="list-style-type: none"> ● Double-positive design with low tool pressure ● Tough cutting edge and excellent performance in combination with QM3 	

Chipbreakers for Positive Inserts

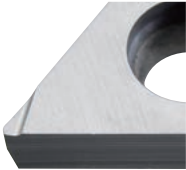
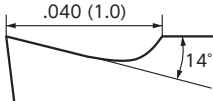
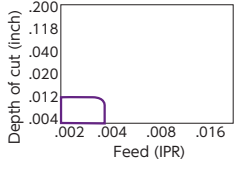
Molded Chipbreakers for Positive Inserts (continued)

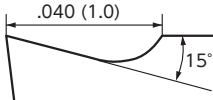
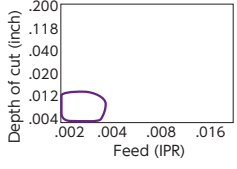
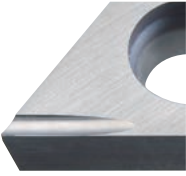
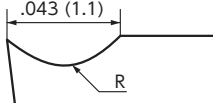
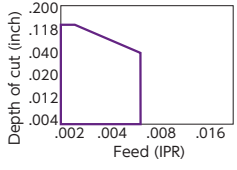
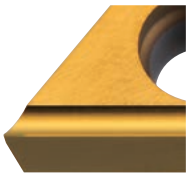
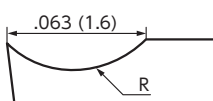
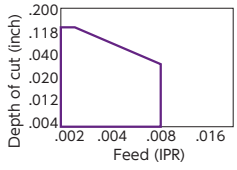
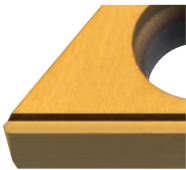
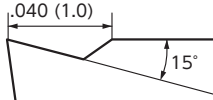
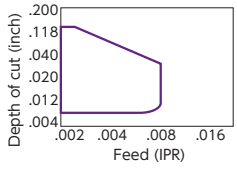
Name	Chipbreaker Geometry		Features	Chip Control Range
AF3		 DCGT32.508 shown	<ul style="list-style-type: none"> ● Good chip control 	
GA		 VBGT332 shown	<ul style="list-style-type: none"> ● Sharp and tough cutting edge 	
FG	 →O16	 TPGH221 shown	<ul style="list-style-type: none"> ● Exclusively designed for ID boring ● Evacuates chips BACKWARD at light depth of cut ● Sharp cutting edge with high rake angle 	
AF1		 CCGT32.508 shown	<ul style="list-style-type: none"> ● Produces remarkable surfaces in semi-finishing of steels 	
AM5		 CPGH21.508 shown	<ul style="list-style-type: none"> ● Chipbreaker for boring ● Provides both good cutting performance and chip control 	
QB		 WCGT5208 shown	<ul style="list-style-type: none"> ● Sharp and tough cutting edge 	

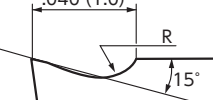
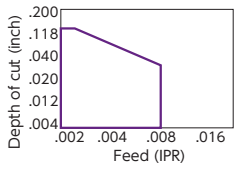
Ground Chipbreakers for Positive Inserts

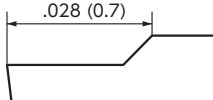
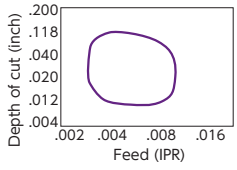









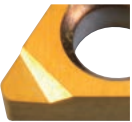

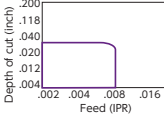

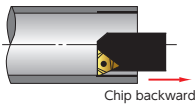
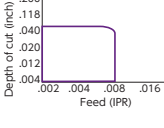

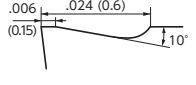
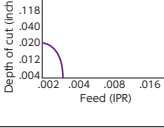
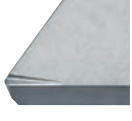
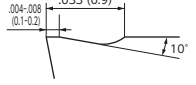
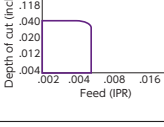

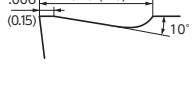
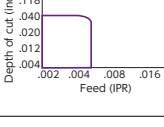
Name	Chipbreaker Geometry		Features	Chip Control Range
KHG		 DCET32.508 shown	<ul style="list-style-type: none"> ● Excellent chip control on finishing cuts ● For super high-precision machining <p>* Precision tolerance in corner radius: ±.0004"</p>	
K		 TPGHP7308 shown	<ul style="list-style-type: none"> ● Superb chip control on finishing applications ● Sharp cutting edge with the high rake angle 	
UHG		 DCET32.504M shown	<ul style="list-style-type: none"> ● Sharp cutting edge ● Covers wide cutting condition range <p>* Precision tolerance in corner radius: ±.0004"</p>	
U/U1		 DCGT32.508 shown	<ul style="list-style-type: none"> ● Sharp cutting edge prevents materials from work hardening 	
S		 DCGT320.508 shown	<ul style="list-style-type: none"> ● Standard ground chipbreaker with wide cutting condition coverage ● Sharp cutting edge with excellent chip control 	
AT		 DCGT32.508 shown	<ul style="list-style-type: none"> ● Excellent adhesion resistance with dimensional stability ● Best for small diameter parts and for machining low carbon steels 	
FM		 DCGT32.508 shown	<ul style="list-style-type: none"> ● Full-peripheral ground chipbreaker 	

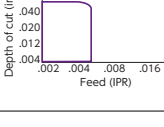
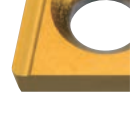
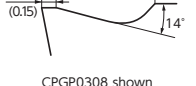
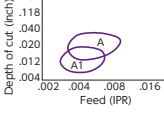
Chipbreakers for Positive Inserts



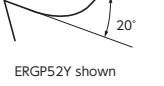
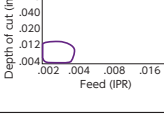

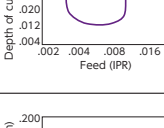

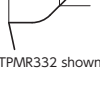
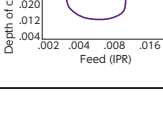



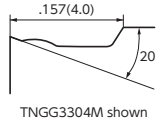
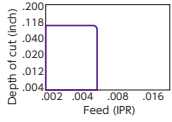

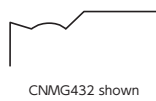
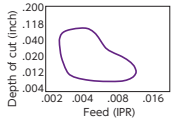

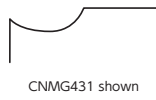
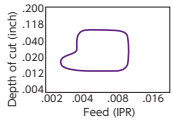

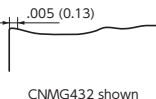
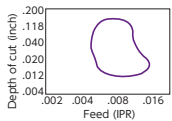
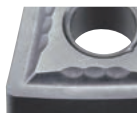

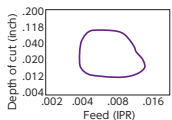
Ground Chipbreakers for Positive Inserts (continued)

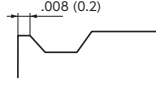
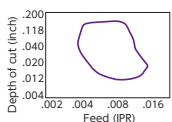
Tooling for Swiss-type Lathes

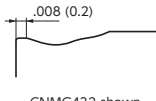
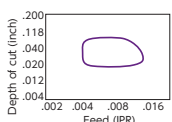
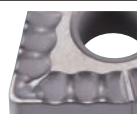
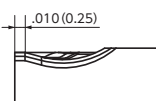
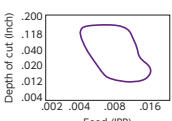
[Ground Chipbreakers for Positive Inserts]

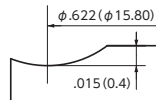
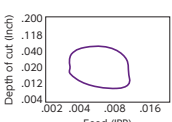

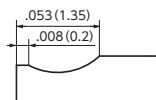
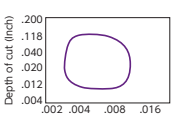

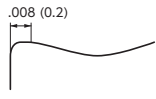
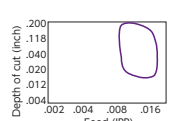

Name	Chipbreaker Geometry		Features	Chip Control Range
F05		 TPGP5208 shown	<ul style="list-style-type: none"> ● Exclusively designed for ID boring ● Evacuates chips BACKWARD ● Excellent choice for blind hole machining 	
F1		 TPGP2208 shown	 Chip backward	
B1		 TCGP5208 shown		
P1		 TPGR321R shown	<ul style="list-style-type: none"> ● Stable cutting when boring thanks to sharp and tough cutting edge 	
B2		 TPGP7308 shown		
B3		 TPGP6308 shown		
A		 CPGP0308 shown	<ul style="list-style-type: none"> ● Tough cutting edge and good chip control 	
A1		 CPGP8308 shown	<ul style="list-style-type: none"> ● General-purpose ID chipbreaker 	
A2		 ERGP52Y shown	<ul style="list-style-type: none"> ● Control chips at light feed and light depth of cut ● Sharp cutting edge due to large rake angle 	
A283		 TPMR221 shown		
A305		 TPMR332 shown	<ul style="list-style-type: none"> ● Breaks chip into small pieces 	

Molded Chipbreakers for Negative Inserts

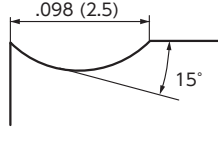
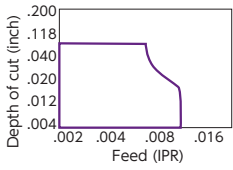
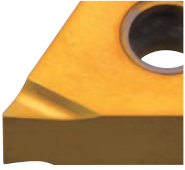
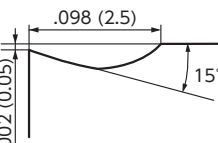
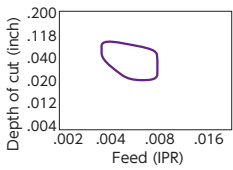
Name	Chipbreaker Geometry		Features	Chip Control Range
UL			<ul style="list-style-type: none"> ● Negative insert with a positive insert's chipbreaker ● Reduced burr ● Improved microfinish ● Superb advantage in cost per corner over positive inserts 	
ZF1			<ul style="list-style-type: none"> ● Produce small curled chips on finishing cuts 	
WM			<ul style="list-style-type: none"> ● Remarkable chip control in the low feed range 	
ZW1			<ul style="list-style-type: none"> ● Versatile chipbreaker with remarkable chip control performance in a wide range of conditions 	
ZP			<ul style="list-style-type: none"> ● Double-positive rake and sharp cutting edge ● Low tool pressure even at heavy depth of cut 	
Z5			<ul style="list-style-type: none"> ● Very tough insert ● Designed for machining with heavy interruption 	
WV			<ul style="list-style-type: none"> ● Offers the advantages of both a tough cutting edge and chip control 	
WR			<ul style="list-style-type: none"> ● Designed for cermet ● Covers wide range of conditions 	
R1			<ul style="list-style-type: none"> ● Sharp cutting edge ● Good chip control 	
GE			<ul style="list-style-type: none"> ● Sharp and tough cutting edge 	
G			<ul style="list-style-type: none"> ● Tough chipbreaker for roughing with exceptional stability 	

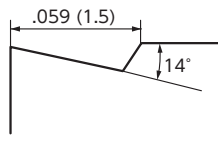
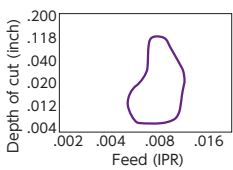
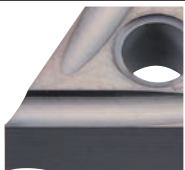
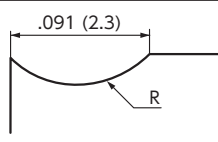
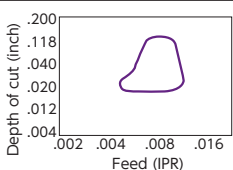
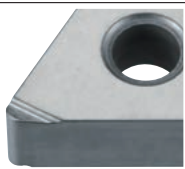
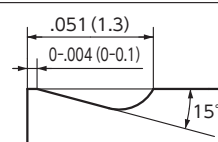
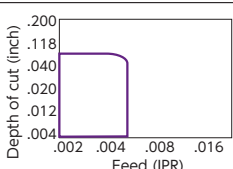
Chipbreakers for Negative Inserts

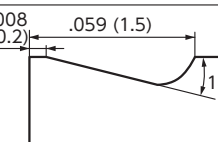
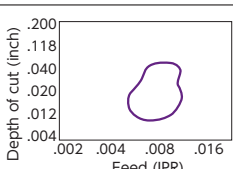
Ground Chipbreakers for Negative Inserts

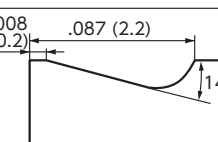
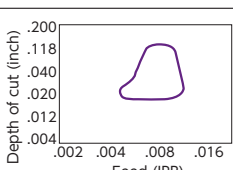
Name	Chipbreaker Geometry		Features	Chip Control Range
DA		 TNGG3304 shown	<ul style="list-style-type: none"> ● Excellent chip control and sharp cutting edge 	
D1		 TNEG3308 shown		
N1		 TNGG3308 shown	<ul style="list-style-type: none"> ● Double-positive design with the large rake angle ● Excellent chip control 	
U2		 TNGG3308 shown	<ul style="list-style-type: none"> ● Reduced burr and work hardening due to high rake design 	
L2		 TNGG332R shown		
B		 TNGG331 shown	<ul style="list-style-type: none"> ● General-purpose chipbreaker with excellent toughness and chip control 	
C		 TNGG3308 shown		

Flat Top with Mirror Finish

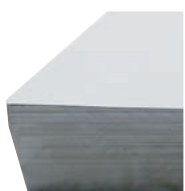
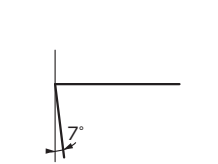
Name	Chipbreaker Geometry		Features	Chip Control Range
V P H			<ul style="list-style-type: none"> ● Very up-sharp edge with mirror finish V: Mirror finish on Top and Flank side with R0 nose radius P: Mirror finish on Top and Flank side H: Mirror finish on Top side 	—

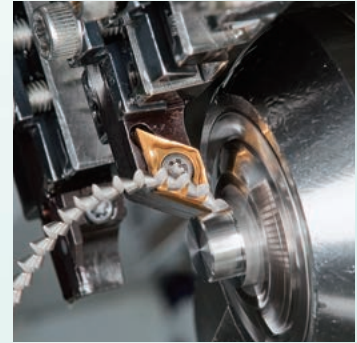

General Turning / Front Turning

- **Front Turning Tools** Q2
- **Recommended Cutting Conditions**..... Q4
- **General Information** Q4
- **ANSI / ISO Insert Nomenclature** Q6
- **Tool List** Q8
 - CSV Series Q8
 - CC.. Series..... Q10
 - DC.. Series Q16
 - VB.. Series..... Q24
 - VC.. Series Q25
 - VP.. Series..... Q30
 - TFT Series Q32
 - TC.. Series..... Q33
 - TN.. Series..... Q34
 - CN.. Series Q37
 - DN.. Series Q38

NTK General / Front Turning Tools - Product Lines

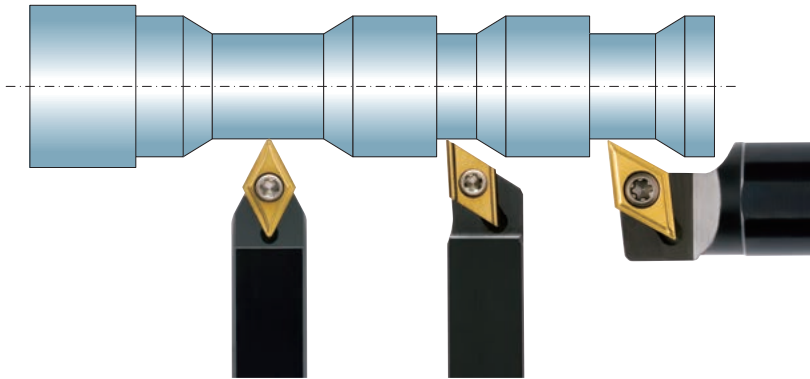

Insert	CSVF →Q9	
	CSV	DS-CSV
Holder	 91° →Q8	 91° →Q8

Insert	CC..21/32.5.. →Q12					
	SCAC	SCLC	SCLC-OH	SCLC-F	DS-SCLL	DS-SCLL-ACH
Holder	 91° →Q10	 95° →Q10	 95° →Q10 Coolant through	 95° →Q10 Shifted	 95° →Q10	 95° →Q10 DS-ACH

Insert	DC..21/32.5..			DC..21/32.5..WP.. →Q20		
	SDJC	SDJC-OH	SDJC-F	Y-SDJC	Y-SDJC-OH	CH-SDUC
Holder	 93° →Q16	 93° →Q16 Coolant through	 93° →Q16 Shifted	 93° →Q18 Y-axis	 93° →Q18 Y-axis w/ Coolant through	 93° →Q17

Insert	DC..21/32.5..WP.. →Q20		DC..21/32.5.. →Q20				
	DS-SDUL	DS-SDUL-ACH	SDXC	DS-SDX	SDQC	SDNC	Y-SDNC
Holder	 93° →Q19	 93° →Q19 DS-ACH	 96° →Q16	 96° →Q19	 107°30' →Q16	 62°30' →Q16	 62°30' →Q18 Y-axis

Insert	VB..33 →Q24	VC..22..-WP					VC..22.. →Q29
Holder	SVJB-OH NEW 93° →Q24 Coolant through	SVAC 91° →Q26	SVJC 93° →Q26	SVJC-OH NEW 93° →Q26 Coolant through	SVJC-F 93° →Q26 Shifted	Y-SVJC 93° →Q28 Y-axis	Y-SVJC-OH NEW 93° →Q28 Y-axis w/ Coolant through

Insert	VC..22.. →Q29				VCGT21.5.. →Q25	VCGT13030.. →Q25
Holder	SVXC 99° →Q26	DS-SVXC 99° →Q28	SVQC 117°30' →Q27	SVVCN 72°30' →Q27	SVAC-1L 91° →Q25	SVAC-W 91° →Q25

Insert	VP..08020.. →Q30			VP..22.. →Q31		
Holder	SVQP 117°30' →Q30	CH-SVUP 93° →Q30	DS-SVXP 99° →Q30	SVXP 99° →Q31	DS-SVVPN 72°30' →Q31	DS-SVVPN-ACH 72°30' →Q31 DS-ACH







Insert	TF33.. →Q32	TC..73../..21..-WP		TC..73../..21.. →Q33
Holder	TFT 93° →Q32	STAC 91° →Q33	CH-STUC 93° →Q33	

Insert	TN..33.. →Q36				CN..43.. →Q37	DN..43.. →Q38
Holder	PTXN 100° →Q34	DS-PTX 100° →Q34	DS-PTX-ACH 100° →Q34 DS-ACH	PTAN 91° →Q34	PTLN 95° →Q34	PCLN 95° →Q37
						PDJN 93° →Q38

Recommended Insert Grade and Cutting Conditions

Front Turning

CSVF / CC.. / DC.. / VC.. / VB.. / TN.. / TF

Work Material		High Temperature Alloys	Titanium Alloys	Cobalt Chrome Alloys	Stainless Steels		Alloy Steels	Carbon Steels
					Hard to cut	Free cutting		
Common Name		Inconel Hastelloy MP35N	Ti-6Al-4V	ASTM F-75	304 316 17-4PH	303 430F	5120 4137	1045 1046
Grade	1st choice	DT4			DT4	TM4	QM3	
	2nd choice	TM4 / QM3			QM3 / VM1	QM3	TM4 / DT4 / C7Z(X)	
Cutting Speed (SFM)		75 125 225	100 200 275		130 230 330	150 300 600	Carbide C7Z(X)	150 300 500 400 500 800
Recommended Chipbreaker Feed Rate (IPR)	≤.004 DOC	AMX KHG 			AMX KHG 			
		.0004 .0008 .0012			.0004 .0012 .0016			
	.004 to .060 DOC	CL YL AM3 S 			CL YL AM3 AZ7 S U/U1 UL 			
		.0008 .0016 .0024			.0008 .0020 .0032			
	≥ .060 DOC	CL YL AM3 S 			CL YL AM3 ZP 			
		.0008 .0015 .0025			.0012 .0024 .0040			

General Turning Inserts Explained

Advantage for each geometry

CC.. Style (80°)

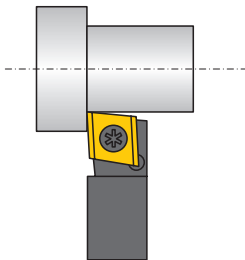

- Increased toughness. Cutting edge is close to insert pocket.
- Not applicable to undercut

DC.. Style (55°)

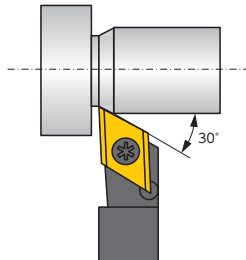

- Versatile geometry. Toughness of CC.. with flexibility of VC..
- Up to 30 deg. undercuts

VB / VC / VP Style (35°)

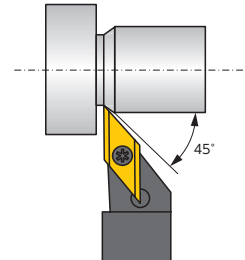

- Wide coverage in work geometry.
- Up to 45 deg. undercuts

Chip Control and Finish

SCLCR →Q10

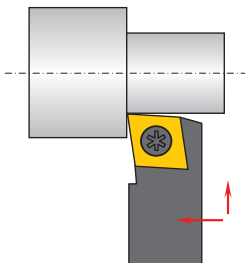

Rigid clamping
High dimensional repeatability

SDJCR →Q16

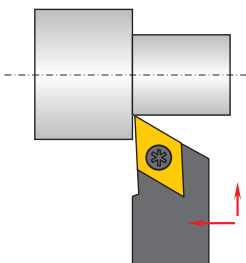

Increased room for chip evacuation
Prevent chips from scratching works

SDNCN →Q16

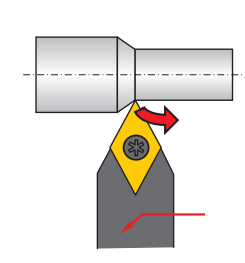

Chips flow away from the work

Surface Finish in General Turning by Inserts with Wiper Flat

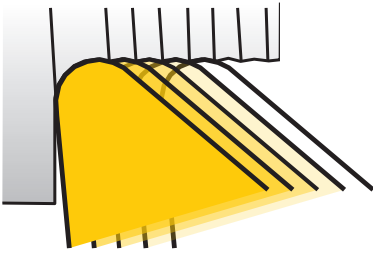

Slower feed rates create better finishes but sacrifices cycle time, chip control, and tool life.

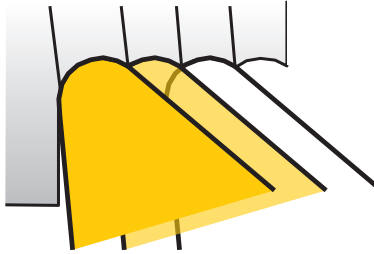

Fast feed rates improve chip control but produce a bad surface finish.

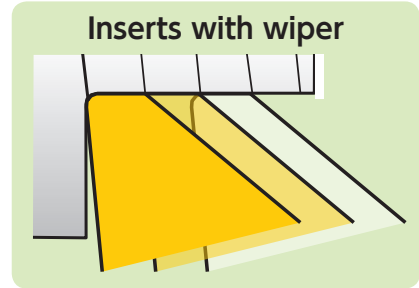

Inserts with a wiper flat creates good chip control and surface finish.

Wiper Flat Insert - WP series

DCGT.. -WP (TFD) →Q20·Q22



for SDJC toolholders

TCGT.. -WP (TFT) →Q33



for STAC toolholders

VCGT.. -WP (TFV) →Q29



for SVAC toolholders

Roughing and Finishing Long Work on Swiss Lathes

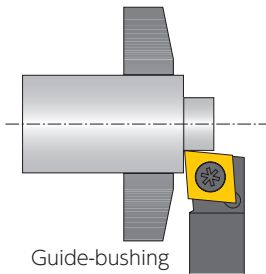

Guide-bushing

Single pass machining is common in Swiss front turning operations.

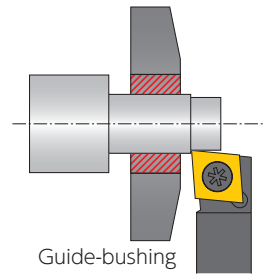

Guide-bushing

Conventional toolholders are not suitable for roughing or finishing of long parts. The guide-bushing cannot hold machined bar stock.

Shifted Holders

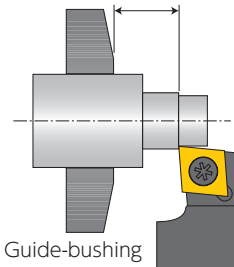

Guide-bushing

Shifted Holders make a finishing process possible without worrying about the bar stock coming out of the guide-bushing.

Coolant flows effectively which improves chip control thanks to the increased room between the tools and guide-bushing.

SCLC-N-F →Q10

SDJC-N-F →Q16

SVJC-N-F →Q26

Combination of Grooving Tool and DS Holders

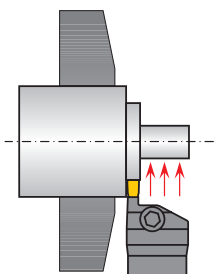

Rough with grooving tool for good chip control

GTWP Holders →T9

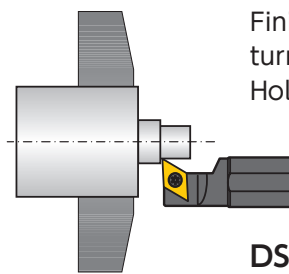

Finish by using general turning inserts with DS Holders

DS Holders

ANSI / ISO Insert Nomenclature

1 Shape

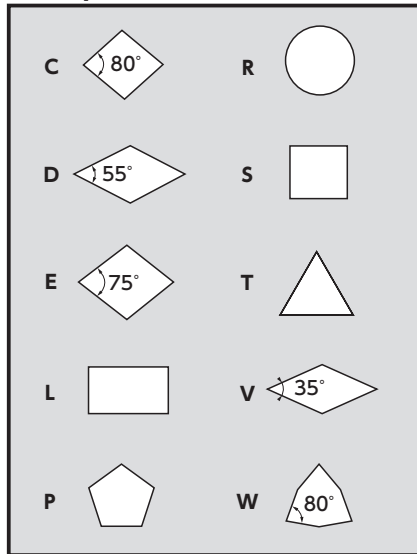

3 Tolerance Class

Diagram showing tolerance class symbols C, S, and T, and dimensions d, m, and s.

Symbol	d (inch)	m (inch)	s (inch)
A	±.0010	±.0002	±.0010
F	±.0050	±.0002	±.0010
C	±.0010	±.0005	±.0010
H	±.0050	±.0005	±.0010
E	±.0010	±.0010	±.0010
G	±.0010	±.0010	±.0050
J	±.0020	±.0020	±.0050
K	±.002 ~ ±.005	±.0005	±.0010
L	±.002 ~ ±.005	±.0010	±.0010
M	±.002 ~ ±.005	±.003 ~ ±.007	±.0050
N	±.002 ~ ±.005	±.003 ~ ±.007	±.0010
U	±.003 ~ ±.010	±.005 ~ ±.015	±.0050

C S T		M tolerance	
Inscribed Circle		d (inch)	m (inch)
1/4		±.002	±.003
3/8		±.002	±.003
1/2		±.003	±.005
5/8		±.004	±.006
3/4		±.004	±.006
1		±.005	±.007

D K		M tolerance	
Inscribed Circle		d (inch)	m (inch)
1/4		±.002	±.004
3/8		±.002	±.004
1/2		±.003	±.006
5/8		±.004	±.006
3/4		±.004	±.007

Inch

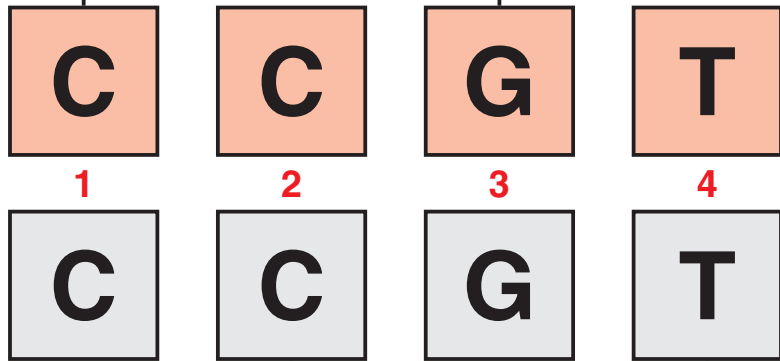

2 Clearances

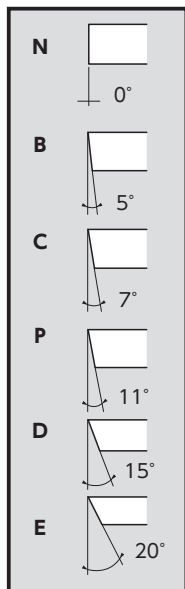

4 Type

Type	Symbol	Type	Symbol
	N (E)		H
	F		B
	R		T
	A		W
	G		
	M		
Special design	X		

6 Thickness

Thickness S(inch)	Inch	Metric
3/32	1.5	02
1/8	2	03
5/32	2.5	T3
3/16	3	04
1/4	4	06
5/16	5	07
3/8	6	09
1/2	8	12

5 Cutting Edge Length

Inch		Metric						
Inscribed Circle								
1/4	2	06	07	06	11	11	04	
3/8	3	09	11	09	16	16	06	
1/2	4	12	15	12	22	22	08	
5/8	5	16	19	15	27	27	10	
3/4	6	19	23	19	33	33	13	
1	8	25	31	25	44	44	17	

7 Nose Radius

Corner Radius	Inch	Metric
	.001	01
	.003	04M
	.004	04
	.007	08M
	.008	08
	.015	1M
	.016 (1/64)	1
	.031 (1/32)	2

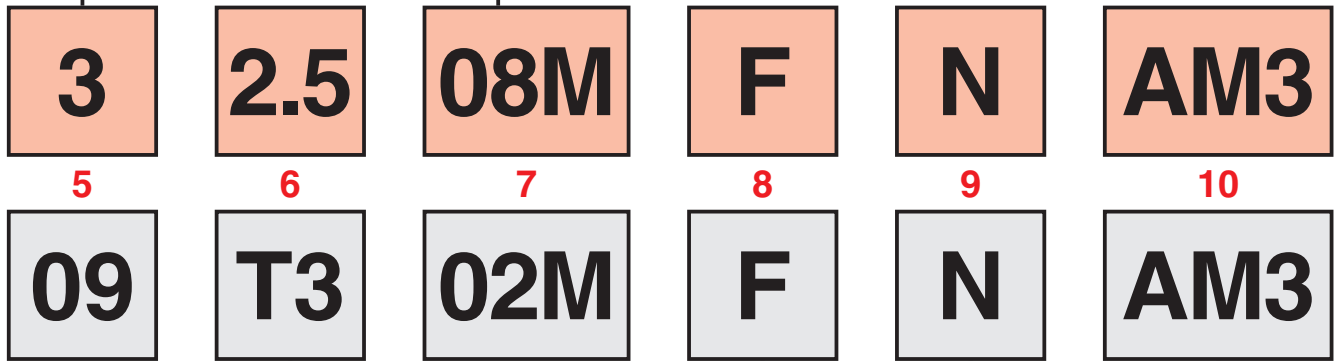

8 Edge Sharpness

F	Up-sharp edge (without any edge preparation)
(Blank)	Non up-sharp edge

9 Hand of Chipbreaker

N	Neutral*
R	Right-hand
L	Left-hand

* Omitted when edge is not "up-sharp"

10 Type of Chipbreaker

See page C8 to C13 for chipbreaker information

11 Wiper insert

"-WP" after chipbreaker

Front Turning

CSV Series

Best for up to .200" diameter material

CSV-NC

For Gang-style machine

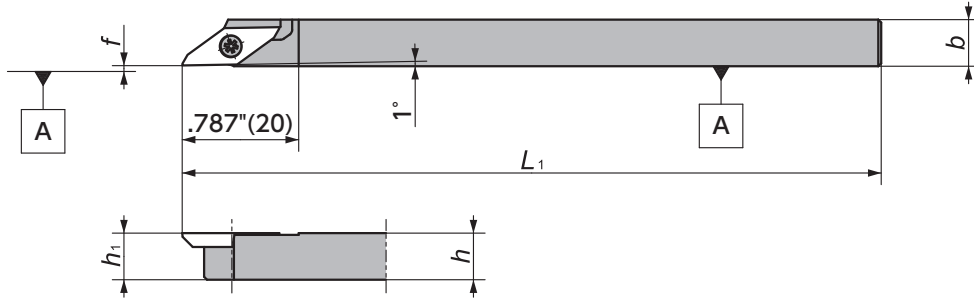

Figure-1

Right-Hand style shown

CSV

For Cam-style machine

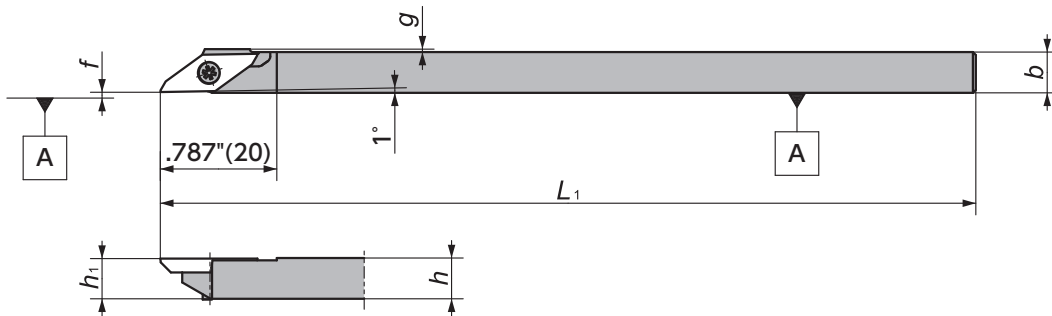

Figure-2

Right-Hand style shown

DS-CSVL

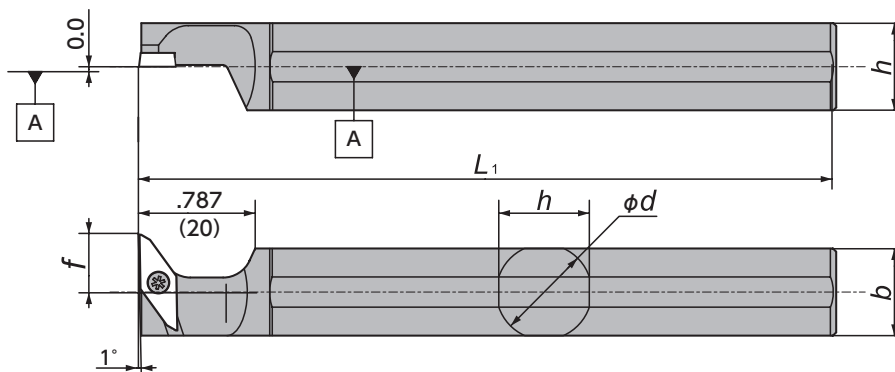



Figure-3

Left-Hand style shown
Takes Right-hand insert

CSV Series - Toolholders

CSV_{R/L} / CSV_{R/L}-NC

Gage Insert	Item Number	Figure	Stock		h		b		h_1		L_1		f		g		Clamp Screw	Wrench
			R	L	(Inch)	(mm)	(Inch)	(mm)	(Inch)	(mm)	(Inch)	(mm)	(Inch)	(mm)	(Inch)	(mm)		
 CSV..11..	CSV _{R/L} 06-IN-NC	1	●	●	3/8		3/8		3/8		4.724	120	.004	0.1	—	—	LRIS-2.5 × 7	CLR-15S
	CSV _{R/L} 08-IN-NC	1	●	●	1/2		1/2		1/2		4.724	120	.004	0.1	—	—	LRIS-2.5 × 7	CLR-15S
	CSV _{R/L} 08NC	1	○	○	.315	8	.315	8	.315	8	4.724	120	.004	0.1	—	—	LRIS-2.5 × 7	CLR-15S
	CSV _{R/L} 08NC-F	1	○	○	.315	8	.315	8	.315	8	4.724	120	0-.004	0.0-0.1	—	—	LRIS-2.5 × 7	CLR-15S
	CSV _{R/L} 10GXNC	1	○	○	.394	10	.394	10	.394	10	3.346	85	.004	0.1	—	—	LRIS-2.5 × 7	CLR-15S
	CSV _{R/L} 10NC	1	○	○	.394	10	.394	10	.394	10	4.724	120	.004	0.1	—	—	LRIS-2.5 × 7	CLR-15S
	CSV _{R/L} 12NC	1	●	●	.472	12	.472	12	.472	12	4.724	120	.004	0.1	—	—	LRIS-2.5 × 7	CLR-15S
	CSV _{R/L} 07GX	2	○	○	.275	7	.275	7	.275	7	3.346	85	.004	0.1	.020	0.5	LRIS-2.5 × 7	CLR-15S
	CSV _{R/L} 07	2	○	●	.275	7	.275	7	.275	7	5.512	140	.004	0.1	.020	0.5	LRIS-2.5 × 7	CLR-15S
	CSV _{R/L} 08GX	2	○	○	.315	8	.315	8	.315	8	3.346	85	.004	0.1	0.0	0.0	LRIS-2.5 × 7	CLR-15S
	CSV _{R/L} 08	2	●	●	.315	8	.315	8	.315	8	5.512	140	.004	0.1	0.0	0.0	LRIS-2.5 × 7	CLR-15S
	CSV _{R/L} 095	2	○	○	.374	9.5	.374	9.5	.374	9.5	5.512	140	.004	0.1	0.0	0.0	LRIS-2.5 × 7	CLR-15S
	CSV _{R/L} 10	2	●	○	.394	10	.394	10	.394	10	5.512	140	.004	0.1	0.0	0.0	LRIS-2.5 × 7	CLR-15S
	CSV _{R/L} 12GX	2	○	○	.472	12	.472	12	.472	12	3.346	85	.004	0.1	0.0	0.0	LRIS-2.5 × 7	CLR-15S
CSV _{R/L} 12	2	●	●	.472	12	.472	12	.472	12	5.512	140	.004	0.1	0.0	0.0	LRIS-2.5 × 7	CLR-15S	

DS-CSVL (Takes right-hand insert)

Gage Insert	Item Number	Figure	Stock		D_s		h		b		L_1		f		Clamp Screw	Wrench
			R	L	(Inch)	(mm)	(Inch)	(mm)	(Inch)	(mm)	(Inch)	(mm)	(Inch)	(mm)		
 CSV..11FR..	DS-CSVL15	3	●		5/8	15.875	.591	15	.591	15	4.724	120	.394	10	LRIS-2.5 × 7	CLR-15S

CSV Series - Inserts

CSVF - Front Turning Mirror finish

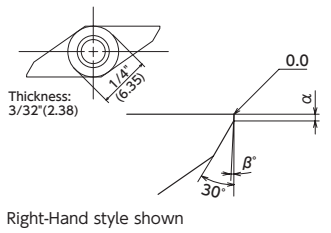
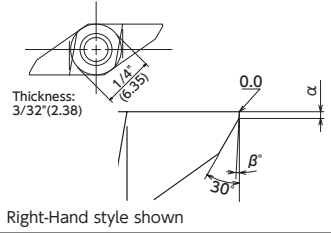
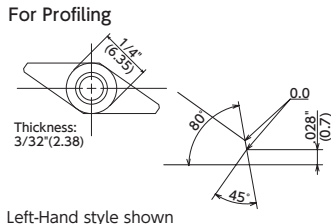
Shape	Item Number	Chip-breaker	Max Depth of Cut		Edge Geometry ($\alpha \times \beta^\circ$)		Coated Carbide					
			(Inch)	(mm)	(Inch)	(mm)	DT4		VM1		ZM3	
							R	L	R	L	R	L
 <p>Thickness: 3/32" (2.38)</p> <p>Right-Hand style shown</p>	CSVF11F _{R/L} V M	No	—	—	.012 × 5°	0.3 × 5°			○	○		
	CSVF11F _{R/L} V-A M		—	—	.012 × 2°	0.3 × 2°			○			
	CSVF11F _{R/L} V-M M		—	—	.006 × 2°	0.15 × 2°	●		●	●	○	
	CSVF11F _{R/L} V-C M		—	—	.006 × 5°	0.15 × 5°			○			
 <p>Thickness: 3/32" (2.38)</p> <p>Right-Hand style shown</p>	CSVF11F _{R/L} VB M	Yes	.118	3	.012 × 5°	0.3 × 5°			●	○		
	CSVF11F _{R/L} VB-A M		.118	3	.012 × 2°	0.3 × 2°			○			
	CSVF11F _{R/L} VB-M M		.118	3	.006 × 2°	0.15 × 2°	●		●	●	○	
	CSVF11F _{R/L} VB-C M		.118	3	.006 × 5°	0.15 × 5°			○			
 <p>Thickness: 3/32" (2.38)</p> <p>Left-Hand style shown</p>	CSVF11F _{R/L} VX M	No	—	—						○		

Note: All angles shown are obtained when insert is set in the holder

● : Stock

○ : 1-2 week delivery

M : Mirror finish

CSV series →Q27

Cutting condition →Q4

Toolholders for CC.. Inserts

SCAC-N

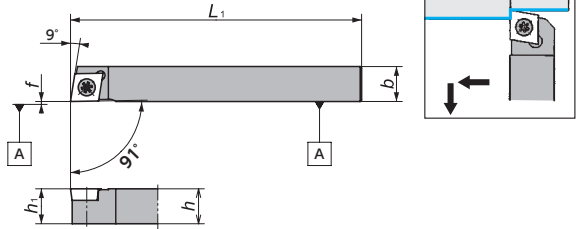

Figure-1

Right-Hand style shown

SCLC-N

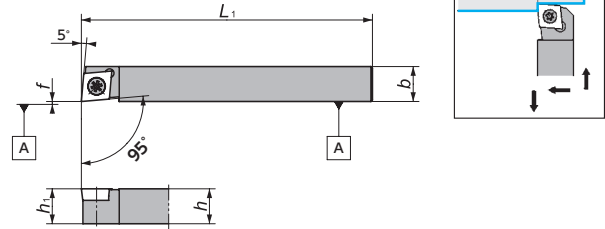

Figure-2

Right-Hand style shown

SCLC-N-OH (Coolant through)

NEW

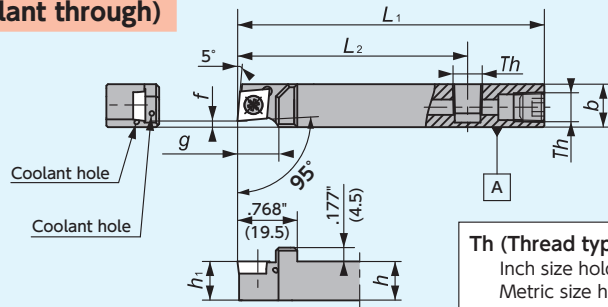
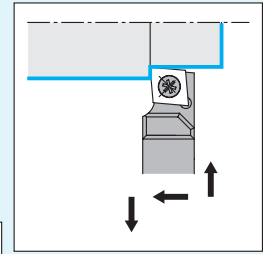

Figure-3

Th (Thread type)
 Inch size holder : NPT1/8
 Metric size holder: M6, Rc1/8 (PT1/8)



Right-Hand style shown

SCLC-N-F (Shifted)

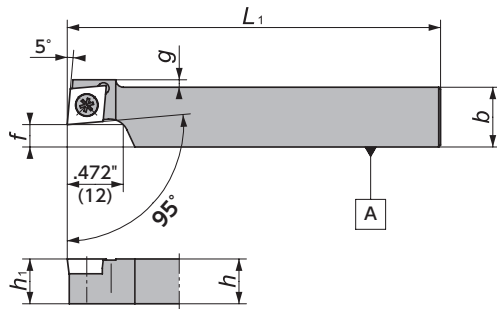
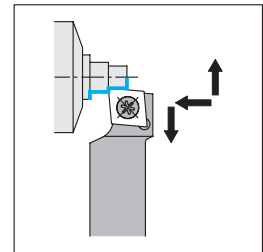

Figure-4



Right-Hand style shown

DS-SCL

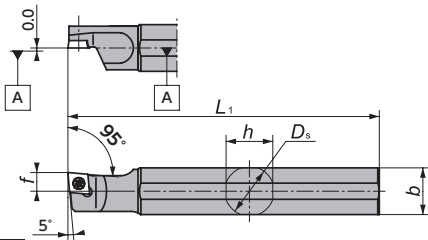

Figure-5

DS-SCL (Coolant through)

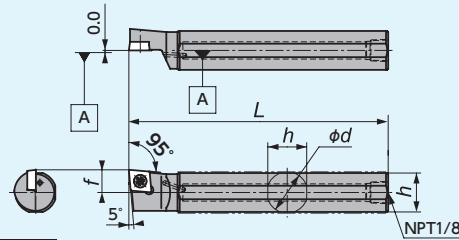
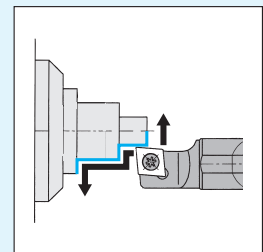

Figure-6



Left-Hand style shown
 Takes Right-hand or Neutral insert

DS-SCLL-ACH (Adjustable centerline height)

(Parts)

Shank	Wedge	Screw for Wedge
φ .630" (16)	ACH-W18 (5805601)	WS060415-003 (5795539)
φ 3/4" (19.05)		
φ .787" (20)		
φ .866" (22)	ACH-W24 (5805619)	WS060419-004 (5799226)
φ 1" (25.4)		

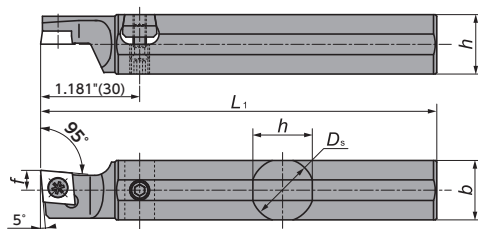
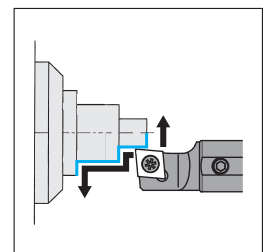

Figure-7



Left-Hand style shown
 Takes Right-hand or Neutral insert

CC.. Series - Toolholders



SCAC

Gage Insert	Item Number	Figure	Stock		h		b		h_1		L_1		f		g		Clamp Screw	Wrench
			R	L	(Inch)	(mm)	(Inch)	(mm)	(Inch)	(mm)	(Inch)	(mm)	(Inch)	(mm)	(Inch)	(mm)		
CC..21.5..	SCAC%062C	1	■	■	3/8		3/8		3/8		4.724	120	0.0	0.0	-	-	LRIS-2.5 × 7	CLR-15S
	SCAC%082C	1	■	■	1/2		1/2		1/2		4.724	120	0.0	0.0	-	-	LRIS-2.5 × 7	CLR-15S
	SCAC%0808X06N	1	○	○	.315	8	.315	8	.315	8	4.724	120	0.0	0.0	-	-	LRIS-2.5 × 7	CLR-15S
	SCAC%1010X06N	1	○	○	.394	10	.394	10	.394	10	4.724	120	0.0	0.0	-	-	LRIS-2.5 × 7	CLR-15S
CC..32.5..	SCAC%083C	1	■	■	1/2		1/2		1/2		4.724	120	0.0	0.0	-	-	LRIS-4 × 10	LLR-25S
	SCAC%103C	1	■	■	5/8		5/8		5/8		4.724	120	0.0	0.0	-	-	LRIS-4 × 10	LLR-25S
	SCAC%1212GX09N	1	○	○	.472	12	.472	12	.472	12	3.346	85	0.0	0.0	-	-	LRIS-4 × 10	LLR-25S
	SCAC%1212X09N	1	○	○	.472	12	.472	12	.472	12	4.724	120	0.0	0.0	-	-	LRIS-4 × 10	LLR-25S

SCLC

Gage Insert	Item Number	Figure	Stock		h		b		h_1		L_1		f		L_2		g		Th	Clamp Screw	Wrench	
			R	L	(Inch)	(mm)	(Inch)	(mm)	(Inch)	(mm)	(Inch)	(mm)	(Inch)	(mm)	(Inch)	(mm)	(Inch)	(mm)				
CC..21.5..	SCLC%062C	2	●	●	3/8		3/8		3/8		4.724	120	0.0	0.0	-	-	-	-	LRIS-2.5 × 7	CLR-15S		
	SCLC%082C	2	●	●	1/2		1/2		1/2		4.724	120	0.0	0.0	-	-	-	-	LRIS-2.5 × 7	CLR-15S		
	SCLC%0808X06N	2	○	○	.315	8	.315	8	.315	8	4.724	120	0.0	0.0	-	-	-	-	LRIS-2.5 × 7	CLR-15S		
	SCLC%1010X06N	2	○	○	.394	10	.394	10	.394	10	4.724	120	0.0	0.0	-	-	-	-	LRIS-2.5 × 7	CLR-15S		
CC..32.5..	SCLC%083C	2	●	●	1/2		1/2		1/2		4.724	120	0.0	0.0	-	-	-	-	LRIS-4 × 10	LLR-25S		
	SCLC%103C	2	●	●	5/8		5/8		5/8		4.724	120	0.0	0.0	-	-	-	-	LRIS-4 × 10	LLR-25S		
	SCLC%1010H09N	2	○	○	.394	10	.394	10	.394	10	3.937	100	0.0	0.0	-	-	-	-	LRIS-4 × 10	LLR-25S		
	SCLC%1010X09N	2	○	○	.394	10	.394	10	.394	10	4.724	120	0.0	0.0	-	-	-	-	LRIS-4 × 10	LLR-25S		
CC..32.5..	SCLC%1212GX09N	2	○	○	.472	12	.472	12	.472	12	3.346	85	0.0	0.0	-	-	-	-	LRIS-4 × 10	LLR-25S		
	SCLC%1212X09N	2	●	●	.472	12	.472	12	.472	12	4.724	120	0.0	0.0	-	-	-	-	LRIS-4 × 10	LLR-25S		
	SCLC%1616X09N	2	○	○	.630	16	.630	16	.630	16	4.724	120	0.0	0.0	-	-	-	-	LRIS-4 × 10	LLR-25S		
	CC..21.5..	SCLC%082H-F079-OH	3	●	●	1/2		.551	14	1/2		3.937	100	.079	2	2.953	75	.472	12	NPT1/8	LRIS-2.5 × 7	CLR-15S
	CC..32.5..	SCLC%083H-F079-OH	3	●	●	1/2		.551	14	1/2		3.937	100	.079	2	2.953	75	.472	12	NPT1/8	LRIS-4 × 10	LLR-25S
		SCLC%103H-F079-OH	3	■	■	5/8		5/8		5/8		3.937	100	.079	2	2.953	75	.472	12	NPT1/8	LRIS-4 × 10	LLR-25S
		SCLC%103HL-F079-OH	3	●	●	5/8		5/8		5/8		3.937	100	.079	2	2.953	75	.697	17.7	NPT1/8	LRIS-4 × 10	LLR-25S
		SCLC%1014F09N-F02OH	3	○	○	.394	10	.551	14	.394	10	3.150	80	.079	2.0	2.165	55	.472	12	M6 × 1	LRIS-4 × 10	LLR-25S
		SCLC%1214H09N-F02OH	3	○	○	.472	12	.551	14	.472	12	3.937	100	.079	2.0	2.953	75	.472	12	Rc1/8(PT1/8)	LRIS-4 × 10	LLR-25S
		SCLC%1616H09N-F02OH	3	○	○	.630	16	.630	16	.630	16	3.937	100	.079	2.0	2.953	75	.697	17.7	Rc1/8(PT1/8)	LRIS-4 × 10	LLR-25S
		SCLC%083C-F250	4	●	●	1/2		.984	25	1/2		4.724	120	1/4		-	-	0	0	-	LRIS-4 × 10	LLR-25S
		SCLC%083C-F500	4	●	●	1/2		.984	25	1/2		4.724	120	1/2		-	-	0	0	-	LRIS-4 × 10	LLR-25S
SCLC%1015X09N-F05		4	○	○	.394	10	.591	15	.394	10	4.724	120	.197	5	-	-	.079	2	-	LRIS-4 × 10	LLR-25S	
SCLC%1020X09N-F10		4	○	○	.394	10	.787	20	.394	10	4.724	120	.394	10	-	-	.079	2	-	LRIS-4 × 10	LLR-25S	
SCLC%1218X09N-F06	4	●	●	.472	12	.709	18	.472	12	4.724	120	.236	6	-	-	0	0	-	LRIS-4 × 10	LLR-25S		
SCLC%1224X09N-F12	4	●	●	.472	12	.945	24	.472	12	4.724	120	.472	12	-	-	0	0	-	LRIS-4 × 10	LLR-25S		









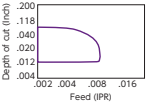

DS-SCL (Takes right-hand or neutral insert)

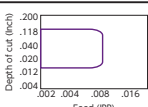
Gage Insert	Item Number	Figure	Stock		D_s		h		b		L_1		f		Clamp Screw	Wrench
			R	L	(Inch)	(mm)	(Inch)	(mm)	(Inch)	(mm)	(Inch)	(mm)	(Inch)	(mm)		
CC..21.5..	DS-SCL%14F-06	5	○	○	.551	14.000	.512	13	.512	13	3.150	80	.236	6.0	LRIS-2.5 × 7	CLR-15S
	DS-SCL%15H-06	5	○	○	5/8	15.875	.591	15	.591	15	3.937	100	.236	6.0	LRIS-2.5 × 7	CLR-15S
	DS-SCL%16F-06	5	○	○	.630	16.000	.591	15	.591	15	3.150	80	.236	6.0	LRIS-2.5 × 7	CLR-15S
	DS-SCL%19-06	5	●	●	3/4	19.050	.709	18	.709	18	4.724	120	.236	6.0	LRIS-2.5 × 7	CLR-15S
	DS-SCL%20X-06	5	○	○	.787	20.000	.748	19	.748	19	3.740	95	.236	6.0	LRIS-2.5 × 7	CLR-15S
	DS-SCL%20-06	5	●	●	.787	20.000	.748	19	.748	19	4.724	120	.236	6.0	LRIS-2.5 × 7	CLR-15S
	DS-SCL%22-06	5	○	○	.866	22.000	.827	21	.827	21	4.724	120	.236	6.0	LRIS-2.5 × 7	CLR-15S
	DS-SCL%25-06MET	5	●	●	.984	25.000	.945	24	.945	24	4.724	120	.236	6.0	LRIS-2.5 × 7	CLR-15S
	DS-SCL%25-06	5	●	●	1	25.400	.945	24	.945	24	5.906	150	.236	6.0	LRIS-2.5 × 7	CLR-15S
	CC..32.5..	DS-SCL%14F-09	5	○	○	.551	14.000	.512	13	.512	13	3.150	80	.236	6.0	LRIS-4 × 8
DS-SCL%15H-09		5	○	○	5/8	15.875	.591	15	.591	15	3.937	100	.236	6.0	LRIS-4 × 8	LLR-25S-20 × 65
DS-SCL%16F-09		5	○	○	.630	16.000	.591	15	.591	15	3.150	80	.236	6.0	LRIS-4 × 8	LLR-25S-20 × 65
DS-SCL%19GX-09		5	○	○	3/4	19.050	.709	18	.709	18	3.346	85	.236	6.0	LRIS-4 × 8	LLR-25S-20 × 65
DS-SCL%19-09		5	●	●	3/4	19.050	.709	18	.709	18	4.724	120	.236	6.0	LRIS-4 × 8	LLR-25S-20 × 65
DS-SCLL19-09-004		6	●	●	3/4	19.050	.709	18	.709	18	4.724	120	.413	10.5	LRIS-4 × 8	LLR-25S-20 × 65
DS-SCL%20X-09		5	○	○	.787	20.000	.748	19	.748	19	3.740	95	.236	6.0	LRIS-4 × 8	LLR-25S-20 × 65
DS-SCL%20-09		5	●	●	.787	20.000	.748	19	.748	19	4.724	120	.236	6.0	LRIS-4 × 8	LLR-25S-20 × 65
DS-SCL%22-09		5	●	●	.866	22.000	.827	21	.827	21	4.724	120	.236	6.0	LRIS-4 × 8	LLR-25S-20 × 65
DS-SCLL22-09-005		6	●	●	.866	22.000	.827	21	.827	21	4.724	120	.472	12.0	LRIS-4 × 8	LLR-25S-20 × 65
DS-SCL%25-09MET		5	○	○	.984	25.000	.945	24	.945	24	4.724	120	.236	6.0	LRIS-4 × 8	LLR-25S-20 × 65
DS-SCL%25-09		5	●	●	1	25.400	.945	24	.945	24	5.906	150	.236	6.0	LRIS-4 × 8	LLR-25S-20 × 65
DS-SCL%16F-09-ACH		7	●	●	.630	16.000	.610	15.5	.610	15.5	3.150	80	.236	6.0	LRIS-4 × 8	LLR-25S-20 × 65
DS-SCL%19-09-ACH		7	●	●	3/4	19.050	.709	18.0	.709	18.0	4.724	120	.236	6.0	LRIS-4 × 8	LLR-25S-20 × 65
DS-SCL%20-09-ACH		7	●	●	.787	20.000	.748	19.0	.748	19.0	4.724	120	.236	6.0	LRIS-4 × 8	LLR-25S-20 × 65
DS-SCL%22-09-ACH		7	●	●	.866	22.000	.827	21.0	.827	21.0	4.724	120	.236	6.0	LRIS-4 × 8	LLR-25S-20 × 65
DS-SCL%25-09MET-ACH		7	●	●	.984	25.000	.945	24.0	.945	24.0	4.724	120	.236	6.0	LRIS-4 × 8	LLR-25S-20 × 65
DS-SCL%25-09-ACH		7	●	●	1	25.400	.945	24.0	.945	24.0	5.906	150	.236	6.0	LRIS-4 × 8	LLR-25S-20 × 65

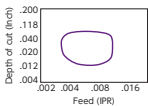
● : Stock ○ : 1-2 week delivery ■ : While stock lasts 🔵 : Coolant through

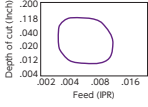
Inserts → Q12

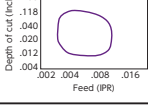
Cutting condition → Q4

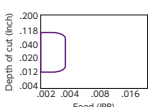
Shape	Item Number	ISO Item Number	IC	R	Carbide							Cermet					Depth of cut (inch) Feed (IPR)
					PVD Coated							PVD Coated					
					QM3	DT4	DM4	TM4	VM1	ZM3	KM1	XT3	C7X	XN4	Q15	C7Z	
	CCGT 21.501 FNAZ7*	CCGT 060200 AZ7	1/4	.001	○												
	CCGT 21.504M FNAZ7*	CCGT 060201M AZ7	1/4	.003	○												
	CCGT 21.508M FNAZ7*	CCGT 060202M AZ7	1/4	.007	○												
	CCGT 32.501 FNAZ7*	CCGT 09T300 AZ7	3/8	.001	●	○		○									
	CCGT 32.504M FNAZ7*	CCGT 09T301M AZ7	3/8	.003	●	○		○									
	CCGT 32.508M FNAZ7*	CCGT 09T302M AZ7	3/8	.007	●	○		○									
	CCGT 32.51M FNAZ7*	CCGT 09T304M AZ7	3/8	.015	●	○		○									
	CCGT 21.508 FN1L	CCGT 060202 FN1L	1/4	.008	○												
	CCGT 32.51 FN1L	CCGT 09T304 FN1L	3/8	.016	○												
	CCGT 21.504 AF1	CCGT 060201 ENBAF1	1/4	.004								●					
	CCGT 21.508 AF1	CCGT 060202 ENBAF1	1/4	.008								●					
	CCGT 21.51 AF1	CCGT 060204 ENBAF1	1/4	.016								●					
	CCGT 21.51 FNAF1	CCGT 060204 FNAF1	1/4	.016								●					
	CCGT 21.52 AF1	CCGT 060208 ENBAF1	1/4	.031								●					
	CCGT 32.508 AF1	CCGT 09T302 ENBAF1	3/8	.008								○					
	CCGT 32.508 FNAF1	CCGT 09T302 FNAF1	3/8	.008								●					
	CCGT 32.51 FNAF1	CCGT 09T304 FNAF1	3/8	.016								●					
	CCGT 32.51 AF1	CCGT 09T304 ENBAF1	3/8	.016								○					
	CCGT 32.52 FNAF1	CCGT 09T308 FNAF1	3/8	.031								●					
	CCGT 32.52 AF1	CCGT 09T308 ENBAF1	3/8	.031								○					
	CCMT 21.51 AM5	CCMT 060204 ENBAM5	1/4	.016									○				
	CCMT 32.51 AM5	CCMT 09T304 ENBAM5	3/8	.016									○				
	CCMT 32.52 AM5	CCMT 09T308 ENBAM5	3/8	.031									○				
	CCGT 21.508 ENBFM	CCGT 060202 ENBFM	1/4	.008								○					
	CCGT 21.51 ENBFM	CCGT 060204 ENBFM	1/4	.016								○					
	CCMT 21.508 ENBZR	CCMT 060202 ENBZR	1/4	.008									○				
	CCMT 21.51 ENBZR	CCMT 060204 ENBZR	1/4	.016									○				
	CCMT 32.508 ENBZR	CCMT 09T302 ENBZR	3/8	.008									○				
	CCMT 32.51 ENBZR	CCMT 09T304 ENBZR	3/8	.016									○				
	CCMT 32.52 ENBZR	CCMT 09T308 ENBZR	3/8	.031									○				



* To be replaced by version which has 0.2mm higher edge.

● : Stock ○ : 1-2 week delivery

Holders → **Q10**
 Cutting condition → **Q4**
 Chipbreaker → **P21**

Front Turning

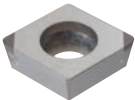
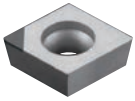
CC.. inserts - CBN / PCD

				Steel	P												
				Stainless Steel	M												
				Cast Iron	K	●	●					●	●				
				Non-Ferrous Material	N											●	●
				Heat Resistant Alloy	S												
				Hardened Material	H	●	●	●	●	●							
Shape	Item Number	ISO Item Number	Edge Prep.	IC	R	No. of edge	Length of edge	CBN (Brazed)						PCD			
								Coated		Coated				PD1	PD2		
								B5K	B52	B6K	B36	B40	B23	B30			
	CCGW 21.51 PD	CCGW 060204 PD	S0415	1/4	.016	2	.091		●								
	CCGW 32.508 PD	CCGW 09T302 PD	S0415	3/8	.008	2	.091		●								
	CCGW 32.508 PD	CCGW 09T302 PD	S0635	3/8	.008	2	.091					●					
	CCGW 32.51 PD	CCGW 09T304 PD	S0415	3/8	.016	2	.091		●								
	CCGW 32.51 PD	CCGW 09T304 PD	S0635	3/8	.016	2	.091						●				
	CCGW 32.52 PD	CCGW 09T308 PD	S0415	3/8	.031	2	.087		●								
	CCMW 32.504	CCMW 09T301	None	3/8	.004	1	—									○	
	CCMW 32.508	CCMW 09T302	None	3/8	.008	1	—									○	
	CCMW 32.51	CCMW 09T304	None	3/8	.016	1	—									○	
	CCMW 32.52	CCMW 09T308	None	3/8	.031	1	—									○	
 with chipbreaker	CCMT 32.508 PF	CCMT 09T302PF	None	3/8	.008	1	—										●
	CCMT 32.51 PF	CCMT 09T304PF	None	3/8	.016	1	—										●

Front Turning

● : Stock ○ : 1-2 week delivery ■ : While stock lasts
 R : Stock (Right-hand only) L : Stock (Left-hand only)
 ® : 1-2 week delivery (Right-hand only) ℒ : 1-2 week delivery (Left-hand only) M : Mirror finish

Holders → Q10
 Cutting condition → Q4
 Chipbreaker → P21

Toolholders for DC.. Inserts

SDJC-N

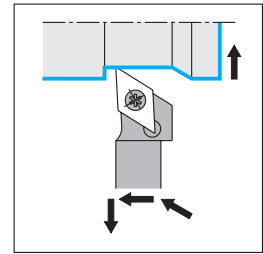
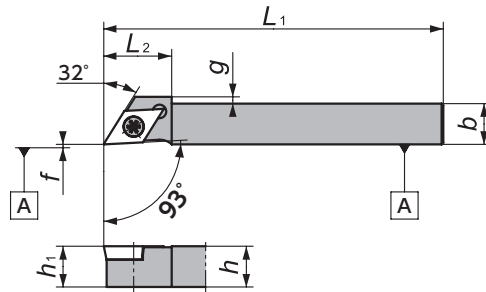

Right-Hand style shown

Figure-1

SDJC-N-OH (Coolant through)

NEW

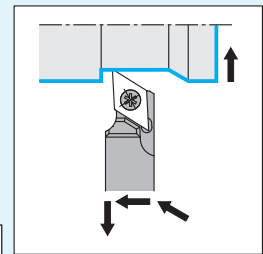
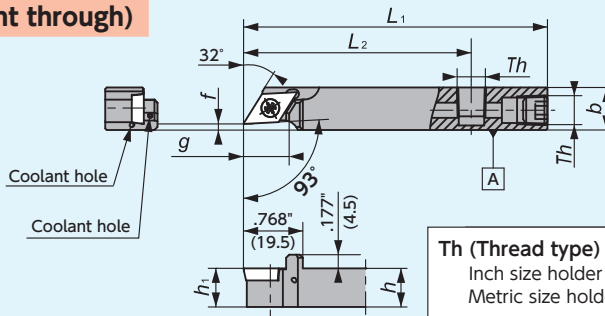

Right-Hand style shown

Figure-2

SDJC-N-F (Shifted)

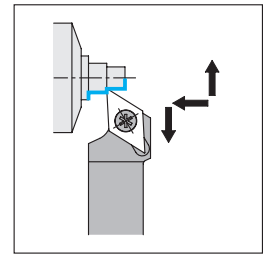
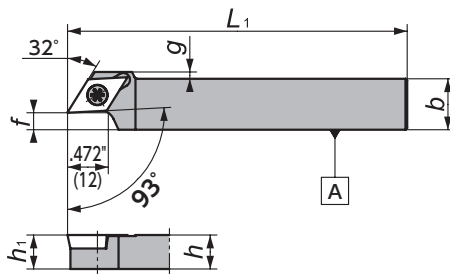

Right-Hand style shown

Figure-3

SDXC-N

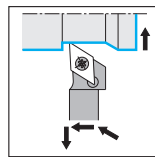
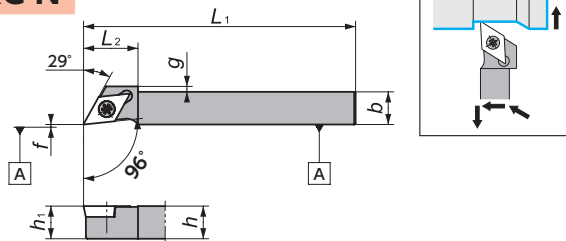

Right-Hand style shown

Figure-4

SDQC

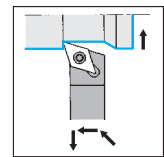
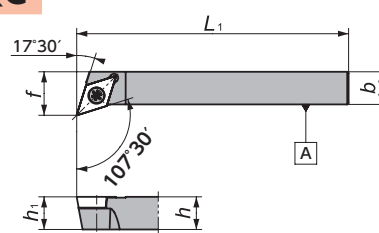

Right-Hand style shown

Figure-5

SDNC

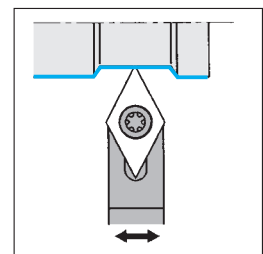
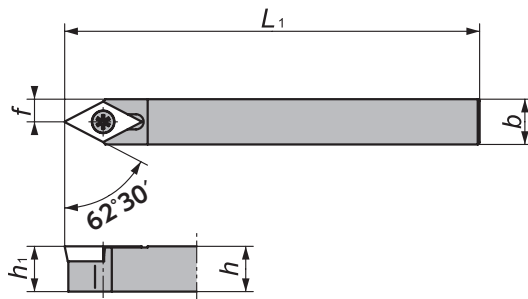

Right-Hand style shown

Figure-6

CH-SDUC

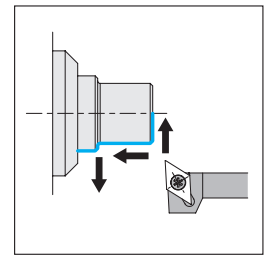
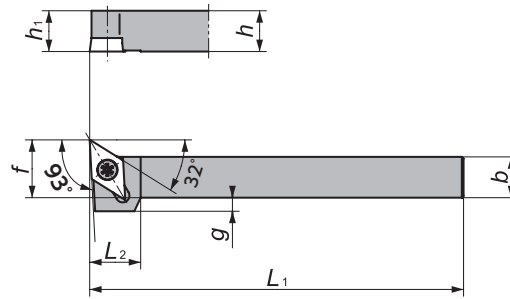

Left-Hand style shown
Takes Right-hand or Neutral insert

Figure-7

DC.. Series - Toolholders I



Gage Insert	Item Number	Figure	Stock		h	b	h ₁	L ₁	f	L ₂	g	Th	Clamp Screw	Wrench
			R	L										
			N		(Inch) (mm)	(Inch) (mm)	(Inch) (mm)	(Inch) (mm)	(Inch) (mm)	(Inch) (mm)	(Inch) (mm)			
DC..21.5.. DC..21.5..WP	SDJC%062C	1	●	●	3/8	3/8	3/8	4.724 120	0 0	- -	- -	-	LRIS-2.5 × 7	CLR-155
	SDJC%082C	1	●	●	1/2	1/2	1/2	4.724 120	0 0	- -	- -	-	LRIS-2.5 × 7	CLR-155
	SDJC%0808X07N	1	○	○	.315 8	.315 8	.315 8	4.724 120	0 0	- -	- -	-	LRIS-2.5 × 7	CLR-155
	SDJC%1010GX07N	1	○	○	.394 10	.394 10	.394 10	3.346 85	0 0	- -	- -	-	LRIS-2.5 × 7	CLR-155
DC..32.5.. DC..32.5..WP	SDJC%1010X07N	1	○	○	.394 10	.394 10	.394 10	4.724 120	0 0	- -	- -	-	LRIS-2.5 × 7	CLR-155
	SDJC%-083C	1	●	●	1/2	1/2	1/2	4.724 120	0 0	- -	- -	-	LRIS-4 × 10	LLR-255
	SDJC%-103C	1	●	●	5/8	5/8	5/8	4.724 120	0 0	- -	- -	-	LRIS-4 × 10	LLR-255
	SDJC%1010H11N	1	○	○	.394 10	.394 10	.394 10	3.937 100	0 0	.748 19	.079 2	-	LRIS-4 × 10	LLR-255
	SDJC%1010X11N	1	○	○	.394 10	.394 10	.394 10	4.724 120	0 0	.748 19	.079 2	-	LRIS-4 × 10	LLR-255
	SDJC%1210X11N	1	○	○	.394 10	.472 12	.394 10	4.724 120	0 0	- -	- -	-	LRIS-4 × 10	LLR-255
	SDJC%1212GX11N	1	○	○	.472 12	.472 12	.472 12	3.346 85	0 0	- -	- -	-	LRIS-4 × 10	LLR-255
	SDJC%1216GX11N	1	○	○	.472 12	.630 16	.472 12	3.346 85	0 0	- -	- -	-	LRIS-4 × 10	LLR-255
	SDJC%1212X11N	1	●	●	.472 12	.472 12	.472 12	4.724 120	0 0	- -	- -	-	LRIS-4 × 10	LLR-255
	SDJC%1616X11N	1	○	○	.630 16	.630 16	.630 16	4.724 120	0 0	- -	- -	-	LRIS-4 × 10	LLR-255
DC..21.5../DC..21.5..WP	SDJC%082H-F079-OH	2	●	●	1/2	.551 14	1/2	3.937 100	.079 2	2.953 75	.630 16	NPT1/8	LRIS-2.5 × 7	CLR-155
DC..32.5.. DC..32.5..WP	SDJC%083H-F079-OH	2	●	●	1/2	.551 14	1/2	3.937 100	.079 2	2.953 75	.630 16	NPT1/8	LRIS-4 × 10	LLR-255
	SDJC%103H-F079-OH	2	●	●	5/8	5/8	5/8	3.937 100	.079 2	2.953 75	.630 16	NPT1/8	LRIS-4 × 10	LLR-255
	SDJC%103HL-F079-OH	2	●	●	5/8	5/8	5/8	3.937 100	.079 2	2.953 75	.724 18.4	NPT1/8	LRIS-4 × 10	LLR-255
	SDJC%1014F11N-F02OH	2	○	○	.392 10	.551 14	.394 10	3.150 80	.079 2	2.165 55	.630 16	M6 × 1	LRIS-4 × 10	LLR-255
	SDJC%1214H11N-F02OH	2	●	●	.472 12	.551 14	.472 12	3.937 100	.079 2	2.953 75	.630 16	Rc1/8(PT1/8)	LRIS-4 × 10	LLR-255
	SDJC%1616H11N-F02OH	2	○	○	.630 16	.630 16	.630 16	3.937 100	.079 2	2.953 75	.724 18.4	Rc1/8(PT1/8)	LRIS-4 × 10	LLR-255
DC..21.5.. DC..21.5..WP	SDJC%1015X07N-F05	3	○	○	.394 10	.591 15	.394 10	4.724 120	.197 5	- -	- -	-	LRIS-2.5 × 7	CLR-155
	SDJC%1020X07N-F10	3	○	○	.394 10	.787 20	.394 10	4.724 120	.394 10	- -	- -	-	LRIS-2.5 × 7	CLR-155
DC..32.5.. DC..32.5..WP	SDJC%083C-F250	3	●	●	1/2	.728 18.5	1/2	4.724 120	0 0	- -	- -	-	LRIS-4 × 10	LLR-255
	SDJC%083C-F500	3	●	●	1/2	1	1/2	4.724 120	0 0	- -	- -	-	LRIS-4 × 10	LLR-255
	SDJC%1015X11N-F05	3	○	○	.394 10	.591 15	.394 10	4.724 120	.197 5	.748 19	.079 2	-	LRIS-4 × 10	LLR-255
	SDJC%1020X11N-F10	3	○	○	.394 10	.787 20	.394 10	4.724 120	.394 10	.748 19	.079 2	-	LRIS-4 × 10	LLR-255
	SDJC%1218X11N-F06	3	●	●	.472 12	.709 18	.472 12	4.724 120	.236 6	- -	- -	-	LRIS-4 × 10	LLR-255
	SDJC%1224X11N-F12	3	●	●	.472 12	.945 24	.472 12	4.724 120	.472 12	- -	- -	-	LRIS-4 × 10	LLR-255
	DC..32.5..	SDXC%1010X11N	4	○	○	.394 10	.394 10	.394 10	4.724 120	0 0	.787 20	.118 3	-	LRIS-4 × 10
SDXC%1016X11N		4	○	○	.394 10	.630 16	.394 10	4.724 120	0 0	- -	- -	-	LRIS-4 × 10	LLR-255
SDXC%1212X11N		4	○	○	.472 12	.472 12	.472 12	4.724 120	0 0	.787 20	.039 1	-	LRIS-4 × 10	LLR-255
SDXC%1216X11N		4	○	○	.472 12	.630 16	.472 12	4.724 120	0 0	- -	- -	-	LRIS-4 × 10	LLR-255
SDXC%1616X11N		4	○	○	.630 16	.630 16	.630 16	4.724 120	0 0	- -	- -	-	LRIS-4 × 10	LLR-255
DC..21.5..	SDQC%10-X07	5	○	○	.394 10	.394 10	.394 10	4.724 120	.472 12	- -	- -	-	LRIS-2.5 × 7	CLR-155
	SDQC%12-X11	5	○	○	.472 12	.472 12	.472 12	4.724 120	.630 16	- -	- -	-	LRIS-4 × 10	LLR-255
	SDQC%16-X11	5	○	○	.630 16	.630 16	.630 16	4.724 120	.787 20	- -	- -	-	LRIS-4 × 10	LLR-255
DC..21.5..	SDQC%120-X11	5	○	○	.787 20	.787 20	.787 20	4.724 120	.984 25	- -	- -	-	LRIS-4 × 10	LLR-255
	SDNCN-062	6	●	●	3/8	3/8	3/8	2.5 63.5	3/16	- -	- -	-	LRIS-2.5 × 7	CLR-155
	SDNCN-082	6	●	●	1/2	1/2	1/2	3.5 88.9	1/4	- -	- -	-	LRIS-2.5 × 7	CLR-155
DC..21.5..	SDNCN08-X07	6	○	○	.315 8	.315 8	.315 8	4.724 120	.157 4	- -	- -	-	LRIS-2.5 × 7	CLR-155
	SDNCN10-X07	6	○	○	.394 10	.394 10	.394 10	4.724 120	.197 5	- -	- -	-	LRIS-2.5 × 7	CLR-155
	SDNCN-083	6	●	●	1/2	1/2	1/2	3.937 100	1/4	- -	- -	-	LRIS-4 × 10	LLR-255
DC..32.5..	SDNCN-103	6	●	●	5/8	5/8	5/8	3.937 100	5/16	- -	- -	-	LRIS-4 × 10	LLR-255
	SDNCN12-X11	6	○	○	.472 12	.472 12	.472 12	4.724 120	.236 6	- -	- -	-	LRIS-4 × 10	LLR-255
	SDNCN16-X11	6	○	○	.630 16	.630 16	.630 16	4.724 120	.315 8	- -	- -	-	LRIS-4 × 10	LLR-255
	SDNCN20-X11	6	○	○	.787 20	.787 20	.787 20	4.724 120	.394 10	- -	- -	-	LRIS-4 × 10	LLR-255
DC..32.5.. DC..32.5..WP	CH-SDUC%1010H11	7	○	○	.394 10	.394 10	.394 10	3.937 100	.591 15	.591 15	.236 6	-	LRIS-4 × 10PW	CLR-155
	CH-SDUC%1212H11	7	○	○	.472 12	.472 12	.472 12	3.937 100	.669 17	.591 15	.157 4	-	LRIS-4 × 10PW	CLR-155

● : Stock

○ : 1-2 week delivery

💧 : Coolant through

Inserts → Q20

Cutting condition → Q4

Y-Axis Holders for DC.. Inserts

Y-SDJC

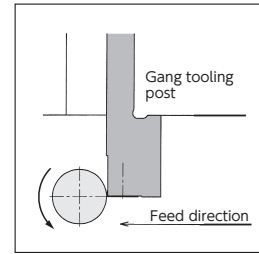
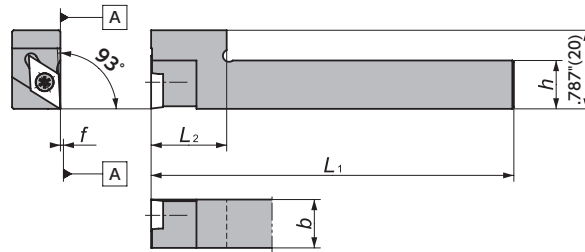

Right-Hand style shown
Takes Right-hand or Neutral insert

Figure-1

Y-SDJC-OH (Coolant through)

NEW

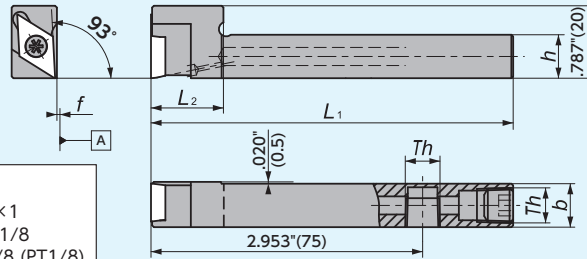

Th (Thread type)
3/8" holder : M6×1
1/2", 5/8" holder : NPT1/8
Metric size holder: Rc1/8 (PT1/8)

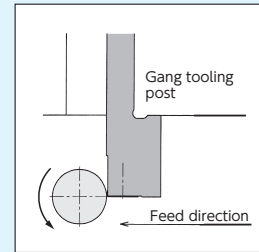

Right-Hand style shown
Takes Right-hand or Neutral insert

Figure-2

Y-SDNC

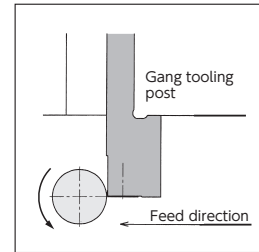
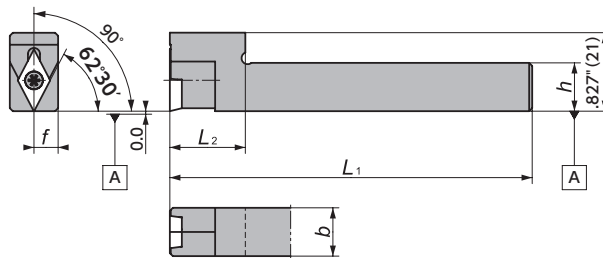

Takes Right-hand or Neutral insert

Figure-3

DC.. Series - Toolholders II

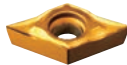

Gage Insert	Item Number	Figure	Stock		h		b		L ₁		f		L ₂		Th	Clamp Screw	Wrench
			R	L	(Inch)	(mm)	(Inch)	(mm)	(Inch)	(mm)	(Inch)	(mm)	(Inch)	(mm)			
			N														
DC..21.5.. DC..21.5..WP	Y-SDJCR062-IN	1	●		3/8	3/8	4.724	120	0	0	.984	25	—	LRIS-2.5 × 7	CLR-155		
	Y-SDJCR082-IN	1	●		1/2	1/2	4.724	120	0	0	.984	25	—	LRIS-2.5 × 7	CLR-155		
	Y-SDJCR10-075	1	○		.394	10.0	.394	10	4.724	120	0	0	.787	20	—	LRIS-2.5 × 7	CLR-155
	Y-SDJCR12-075	1	○		.472	12.0	.472	12	4.724	120	0	0	.787	20	—	LRIS-2.5 × 7	CLR-155
DC..32.5.. DC..32.5..WP	Y-SDJCR083-IN	1	●		1/2	1/2	4.724	120	0	0	.984	25	—	LRIS-4 × 10	LLR-255-20 × 65		
	Y-SDJCR103-IN	1	●		5/8	5/8	4.724	120	0	0	.984	25	—	LRIS-4 × 10	LLR-255-20 × 65		
	Y-SDJCR12-115	1	○		.472	12.0	.630	16	4.724	120	0	0	.787	20	—	LRIS-4 × 10	LLR-255-20 × 65
	Y-SDJCR16-115	1	○		.630	16.0	.630	16	4.724	120	0	0	.787	20	—	LRIS-4 × 10	LLR-255-20 × 65
DC..21.5.. DC..21.5..WP	Y-SDJCR062H-IN-OH	2	●		3/8	3/8	3.937	100	0	0	.984	25	M6 × 1	LRIS-2.5 × 7	CLR-155		
	Y-SDJCR082H-IN-OH	2	●		1/2	1/2	3.937	100	0	0	.984	25	NPT1/8	LRIS-2.5 × 7	CLR-155		
DC..32.5.. DC..32.5..WP	Y-SDJCR083H-IN-OH	2	●		1/2	1/2	3.937	100	0	0	.984	25	NPT1/8	LRIS-4 × 10	LLR-255-20 × 65		
	Y-SDJCR103H-IN-OH	2	●		5/8	5/8	3.937	100	0	0	.984	25	NPT1/8	LRIS-4 × 10	LLR-255-20 × 65		
	Y-SDJCR1212H115-OH	2	●		.472	12.0	.472	12.0	3.937	100	0	0	.787	20	Rc1/8(PT1/8)	LRIS-4 × 10	LLR-255-20 × 65
	Y-SDJCR1616H11-OH	2	○		.630	16.0	.630	16.0	3.937	100	0	0	.984	25	Rc1/8(PT1/8)	LRIS-4 × 10	LLR-255-20 × 65
DC..32.5..	Y-SDNCN083-IN	3	●		1/2	1/2	4.724	120	1/4	6.35	.984	25	—	LRIS-4 × 10	LLR-255-20 × 65		
	Y-SDNCN12-115	3	○		.472	12.0	.472	12	4.724	120	.236	6.0	.787	20	—	LRIS-4 × 10	LLR-255-20 × 65
	Y-SDNCN16-115	3	○		.630	16.0	.630	16	4.724	120	.315	8.0	.787	20	—	LRIS-4 × 10	LLR-255-20 × 65

DS Toolholders for DC.. Inserts

DS-SDU

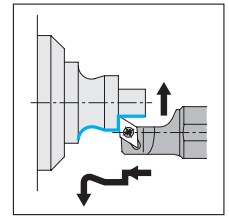
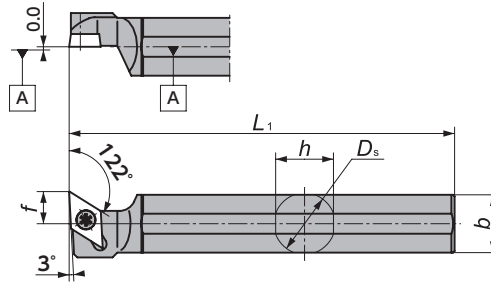

Left-Hand style shown
Takes Right-hand or Neutral insert

Figure-4

DS-SDU-ACH (Adjustable centerline height)

(Parts)

Shank	Wedge	Screw for Wedge
φ.630" (16)	ACH-W18 (5805601)	WS060415-003 (5795539)
φ.787" (20)		
φ.866" (22)	ACH-W24 (5805619)	WS060419-004 (5799226)
φ.1" (25.4)		

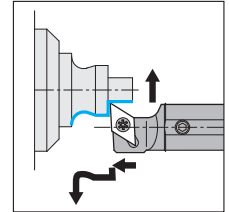
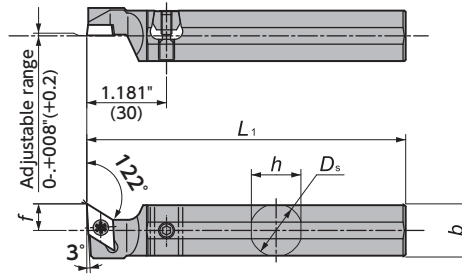

Left-Hand style shown
Takes Right-hand or Neutral insert

Figure-5

DS-SDX / DS-SDX (Coolant through)

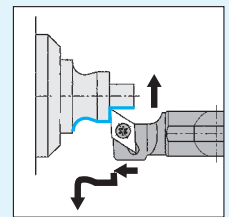
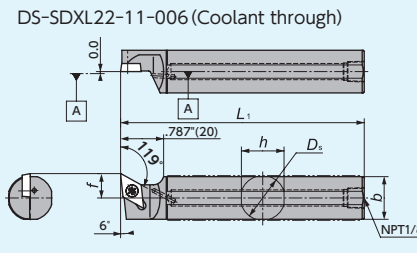
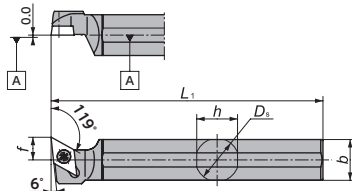

Left-Hand style shown
Takes Right-hand or Neutral insert

Figure-6

DC.. Series - Toolholders III



Gage Insert	Item Number	Figure	Stock		D_s		h		b		L_1		f	Clamp Screw	Wrench	
			R	L	(Inch)	(mm)	(Inch)	(mm)	(Inch)	(mm)	(Inch)	(mm)				
DC..21.5.. DC..21.5..WP	DS-SDU%14F-07	4	○	○	.551	14.000	.512	13.0	.512	13.0	3.150	80	.236	6.0	LRIS-2.5 × 7	CLR-15S
	DS-SDU%15H-07	4	○	○	5/8	15.875	.591	15.0	.591	15.0	3.937	100	.236	6.0	LRIS-2.5 × 7	CLR-15S
	DS-SDU%16F-07	4	○	○	.630	16.000	.591	15.0	.591	15.0	3.150	80	.236	6.0	LRIS-2.5 × 7	CLR-15S
	DS-SDU%16X-07	4	○	○	.630	16.000	.591	15.0	.591	15.0	3.740	95	.236	6.0	LRIS-2.5 × 7	CLR-15S
	DS-SDU%19-07	4	○	○	3/4	19.050	.709	18.0	.709	18.0	4.724	120	.236	6.0	LRIS-2.5 × 7	CLR-15S
	DS-SDU%20X-07	4	○	○	.787	20.000	.748	19.0	.748	19.0	3.740	95	.236	6.0	LRIS-2.5 × 7	CLR-15S
	DS-SDU%20-07	4	○	●	.787	20.000	.748	19.0	.748	19.0	4.724	120	.236	6.0	LRIS-2.5 × 7	CLR-15S
	DS-SDU%22-07	4	○	●	.866	22.000	.827	21.0	.827	21.0	4.724	120	.236	6.0	LRIS-2.5 × 7	CLR-15S
DC..32.5.. DC..32.5..WP	DS-SDU%14F-11	4	○	○	.551	14.000	.512	13.0	.512	13.0	3.150	80	.394	10.0	LRIS-4 × 10	LLR-25S-20 × 65
	DS-SDU%16F-11	4	○	○	.630	16.000	.591	15.0	.591	15.0	3.150	80	.394	10.0	LRIS-4 × 10	LLR-25S-20 × 65
	DS-SDU%19-11	4	○	●	3/4	19.050	.709	18.0	.709	18.0	4.724	120	.394	10.0	LRIS-4 × 10	LLR-25S-20 × 65
	DS-SDU%19-11SPL	4	○	○	3/4	19.050	.709	18.0	.709	18.0	6.300	160	.394	10.0	LRIS-4 × 10	LLR-25S-20 × 65
	DS-SDU%20X-11	4	○	○	.787	20.000	.748	19.0	.748	19.0	3.740	95	.394	10.0	LRIS-4 × 10	LLR-25S-20 × 65
	DS-SDU%20-11	4	○	●	.787	20.000	.748	19.0	.748	19.0	4.724	120	.394	10.0	LRIS-4 × 10	LLR-25S-20 × 65
	DS-SDU%22-11	4	○	●	.866	22.000	.827	21.0	.827	21.0	4.724	120	.394	10.0	LRIS-4 × 10	LLR-25S-20 × 65
	DS-SDU%23-11-007	4	○	○	.906	23.000	.866	22.0	.866	22.0	2.756	70	.394	10.0	LRIS-4 × 10	LLR-25S-20 × 65
	DS-SDU%25-11MET	4	○	●	.984	25.000	.945	24.0	.945	24.0	4.724	120	.394	10.0	LRIS-4 × 10	LLR-25S-20 × 65
	DS-SDU%25-11	4	○	●	1	25.400	.945	24.0	.945	24.0	5.906	150	.394	10.0	LRIS-4 × 10	LLR-25S-20 × 65
	DS-SDU%25-11SPL	4	○	○	1	25.400	.945	24.0	.945	24.0	5.906	150	.492	12.5	LRIS-4 × 10	LLR-25S-20 × 65
	DS-SDU%16F-11-ACH	5	○	●	.630	16.000	.610	15.5	.610	15.5	3.150	80	.394	10.0	LRIS-4 × 10	LLR-25S-20 × 65
	DS-SDU%19-11-ACH	5	○	●	3/4	19.050	.709	18.0	.709	18.0	4.724	120	.394	10.0	LRIS-4 × 10	LLR-25S-20 × 65
	DS-SDU%20-11-ACH	5	○	●	.787	20.000	.748	19.0	.748	19.0	4.724	120	.394	10.0	LRIS-4 × 10	LLR-25S-20 × 65
	DS-SDU%22-11-ACH	5	○	●	.866	22.000	.827	21.0	.827	21.0	4.724	120	.394	10.0	LRIS-4 × 10	LLR-25S-20 × 65
	DS-SDU%25-11MET-ACH	1	○	○	.984	25.000	.945	24.0	.945	24.0	4.724	120	.394	10.0	LRIS-4 × 10	LLR-25S-20 × 65
	DS-SDU%25-11-ACH	5	○	●	1	25.400	.945	24.0	.945	24.0	5.906	150	.394	10.0	LRIS-4 × 10	LLR-25S-20 × 65
	DS-SDX%22-11-006	6	○	●	.866	22.000	.827	21.0	.827	21.0	4.724	120	.472	12.0	LRIS-4 × 10	LLR-25S-20 × 65
DS-SDX%19-11	6	○	○	3/4	19.050	.709	18.0	.709	18.0	4.724	120	.394	10.0	LRIS-4 × 10	LLR-25S-20 × 65	
DS-SDX%20X-11	6	○	○	.787	20.000	.748	19.0	.748	19.0	3.740	95	.394	10.0	LRIS-4 × 10	LLR-25S-20 × 65	
DS-SDX%20-11	6	○	○	.787	20.000	.748	19.0	.748	19.0	4.724	120	.394	10.0	LRIS-4 × 10	LLR-25S-20 × 65	
DS-SDX%25-11MET	6	○	○	.984	25.000	.945	24.0	.945	24.0	4.724	120	.394	10.0	LRIS-4 × 10	LLR-25S-20 × 65	

● : Stock

○ : 1-2 week delivery

● : Coolant through

Inserts → Q20

Cutting condition → Q4

Front Turning

DC.. inserts - Carbide / Cermet

(inch)	IC	T
DC..21.5	1/4	3/32
DC..32.5	3/8	5/32

[Molded Chipbreakers]

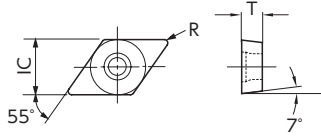

Material	P	M	K	N	S	H	Q	T	X	C	Z
Steel	●	●	●	●	●	●	●	●	●	●	●
Stainless Steel	●	●	●	●	●	●	●	●	●	●	●
Cast Iron	●	●	●	●	●	●	●	●	●	●	●
Non-Ferrous Material	●	●	●	●	●	●	●	●	●	●	●
Heat Resistant Alloy	●	●	●	●	●	●	●	●	●	●	●
Hardened Material	●	●	●	●	●	●	●	●	●	●	●

● : 1st Choice
● : Alternate choice

Shape	Item Number	ISO Item Number	IC	R	Carbide							Cermet							
					PVD Coated							PVD Coated							
					QM3	DT4	DM4	TM4	VM1	ZM3	KM1	XT3	C7X	XN4	Q15	C7Z			
	DCGT 21.501 FNAM3	DCGT 070200 FNAM3	1/4	.001	●	●													
	DCGT 21.504M FNAM3	DCGT 070201 MFNAM3	1/4	.003	●	●													
	DCGT 21.504 FNAM3	DCGT 070201 FNAM3	1/4	.004															
	DCGT 21.504 FNAM3	DCGT 070201 FNXAM3	1/4	.004															
	DCGT 21.508M FNAM3	DCGT 070202 MFNAM3	1/4	.007	●	●													
	DCGT 21.508 AM3	DCGT 070202 ENBAM3	1/4	.008															
	DCGT 21.508 FNAM3	DCGT 070202 FNAM3	1/4	.008															
	DCGT 21.508 FNAM3	DCGT 070202 FNXAM3	1/4	.008															
	DCGT 21.51M FNAM3	DCGT 070204 MFNAM3	1/4	.015	●	●													
	DCGT 21.51 AM3	DCGT 070204 ENBAM3	1/4	.016															
	DCGT 21.51 FNAM3	DCGT 070204 FNAM3	1/4	.016															
	DCGT 21.51 FNAM3	DCGT 070204 FNXAM3	1/4	.016															
	DCGT 32.501 FNAM3	DCGT 11T300 FNAM3	3/8	.001	●	●													
	DCGT 32.504M FNAM3	DCGT 11T301 MFNAM3	3/8	.003	●	●													
	DCGT 32.504 FNAM3	DCGT 11T301 FNXAM3	3/8	.004															
	DCGT 32.508M FNAM3	DCGT 11T302 MFNAM3	3/8	.007	●	●													
	DCGT 32.508 AM3	DCGT 11T302 ENBAM3	3/8	.008															
	DCGT 32.508 FNAM3	DCGT 11T302 FNAM3	3/8	.008	●	●													
	DCGT 32.508 FNAM3	DCGT 11T302 FNXAM3	3/8	.008															
	DCGT 32.51M FNAM3	DCGT 11T304 MFNAM3	3/8	.015	●	●													
DCGT 32.51 FNAM3	DCGT 11T304 FNAM3	3/8	.016	●	●														
DCGT 32.51 FNAM3	DCGT 11T304 FNXAM3	3/8	.016																
DCGT 32.52 FNAM3	DCGT 11T308 FNAM3	3/8	.031	●	●														
DCGT 32.52 AM3	DCGT 11T308 ENBAM3	3/8	.031																
DCGT 32.52 FNAM3	DCGT 11T308 FNXAM3	3/8	.031																
DCMT 21.508 AM3	DCMT 070202 ENBAM3	1/4	.008																
DCMT 21.508 FNAM3	DCMT 070202 FNAM3	1/4	.008																
DCMT 21.51 AM3	DCMT 070204 ENBAM3	1/4	.016																
DCMT 21.51 FNAM3	DCMT 070204 FNAM3	1/4	.016																
DCMT 21.52 AM3	DCMT 070208 ENBAM3	1/4	.031																
DCMT 32.508 AM3	DCMT 11T302 ENBAM3	3/8	.008																
DCMT 32.508 FNAM3	DCMT 11T302 FNAM3	3/8	.008																
DCMT 32.51 AM3	DCMT 11T304 ENBAM3	3/8	.016																
DCMT 32.51 FNAM3	DCMT 11T304 FNAM3	3/8	.016																
DCMT 32.52 AM3	DCMT 11T308 ENBAM3	3/8	.031																
DCMT 32.52 FNAM3	DCMT 11T308 FNAM3	3/8	.031																
DCMT 32.53 AM3	DCMT 11T312 ENBAM3	3/8	.047																
NEW 	DCGT 32.502 AM3-WP*	TFD 11FR05AM3	3/8	.002		●													
	DCGT 32.506 AM3-WP*	TFD 11FR15AM3	3/8	.006		●													
NEW 	DCGT 32.504M YL	DCGT 11T301M YL	3/8	.005			●	○											
	DCGT 32.508M YL	DCGT 11T302M YL	3/8	.007			●	○											
	DCGT 32.51M YL	DCGT 11T304M YL	3/8	.015			●	○											
	DCGT 21.504M CL	DCGT 070201M CL	1/4	.003		●	○	○											
	DCGT 21.508M CL	DCGT 070202M CL	1/4	.007		●	○	○											
	DCGT 21.51M CL	DCGT 070204M CL	1/4	.015		●	○	○											
	DCGT 32.504M CL	DCGT 11T301M CL	3/8	.003		●	○	○											
	DCGT 32.508M CL	DCGT 11T302M CL	3/8	.007		●	○	○											
	DCGT 32.51M CL	DCGT 11T304M CL	3/8	.015		●	○	○											

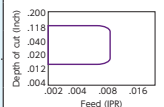
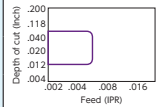
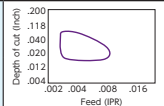
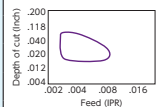

Front Turning

Shape	Item Number	ISO Item Number	IC	R	Carbide							Cermet					Graph	
					PVD Coated							KM1	XT3	C7X	XN4	PVD Coated		
					QM3	DT4	DM4	TM4	VM1	ZM3	Q15					C7Z		
	DCGT 21.504M AMX	DCGT 070201M AMX	1/4	.003				●										
	DCGT 21.508M AMX	DCGT 070202M AMX	1/4	.007				●										
	DCGT 32.504M AMX	DCGT 11T301M AMX	3/8	.003			●	●										
	DCGT 32.508M AMX	DCGT 11T302M AMX	3/8	.007			●	●										
	DCGT 32.51M AMX	DCGT 11T304M AMX	3/8	.015			●	●										
DCGT 21.501 FNAZ7**	DCGT 070200 AZ7	1/4	.001	○														
DCGT 21.504M FNAZ7**	DCGT 070201M AZ7	1/4	.003	○														
DCGT 21.508M FNAZ7**	DCGT 070202M AZ7	1/4	.007	○														
DCGT 32.501 FNAZ7**	DCGT 11T300 AZ7	3/8	.001	●	○		○		○									
DCGT 32.504M FNAZ7**	DCGT 11T301M AZ7	3/8	.003	●	○		○		○									
DCGT 32.508M FNAZ7**	DCGT 11T302M AZ7	3/8	.007	●	○		○		○									
DCGT 32.51M FNAZ7**	DCGT 11T304M AZ7	3/8	.015	●	○		○		○									
DCGT 32.52 FNAZ7**	DCGT 11T308 AZ7	3/8	.031	●	○		○		○									
	DCGT 21.51 FN1L	DCGT 070204 FN1L	1/4	.016	○													
	DCGT 32.508 FN1L	DCGT 11T302 FN1L	3/8	.008	○													
	DCGT 32.51 FN1L	DCGT 11T304 FN1L	3/8	.016	○													
	DCGT 32.508 AF3	DCGT 11T302 ENBAF3	3/8	.008								●						
	DCGT 32.51 AF3	DCGT 11T304 ENBAF3	3/8	.016								●						
	DCGT 32.508 FM	DCGT 11T302 ENBFM	3/8	.008								○						
	DCGT 32.51 FM	DCGT 11T304 ENBFM	3/8	.016								○						
	DCGT 32.52 FM	DCGT 11T308 ENBFM	3/8	.031								●						
	DCMT 21.508 ENBZR	DCMT 070202 ENBZR	1/4	.008									○					
	DCMT 21.51 ENBZR	DCMT 070204 ENBZR	1/4	.016									○					
	DCMT 32.508 ENBZR	DCMT 11T302 ENBZR	3/8	.008									○					
	DCMT 32.51 ENBZR	DCMT 11T304 ENBZR	3/8	.016									○					
	DCMT 32.52 ENBZR	DCMT 11T308 ENBZR	3/8	.031									○					

**To be replaced by version which has 0.2mm higher edge.

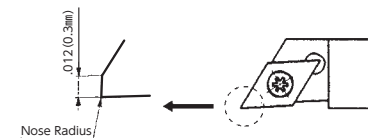



* Note: NTK WP style inserts have a wiper facet design.
 The insert has a 0.3mm (.012") flat on the cutting edge when the insert is set into the toolholder.
 The flat on the cutting edge ensures a superior surface finish when feed rates are increased.
 WP style inserts can be used in toolholders: SDJC, CH-SDUC and DS-SDUL.

● : Stock ○ : 1-2 week delivery

Holders → **Q16-19**
 Cutting condition → **Q4**
 Chipbreaker → **P21**

Front Turning

Shape	Item Number	ISO Item Number	IC	R	Carbide							Cermets					
					PVD Coated							PVD Coated					
					QM3	DT4	DM4	TM4	VM1	ZM3	KM1	XT3	C7X	XN4	Q15	C7Z	
	DCGW 21.500 V	DCGW 07020 V	1/4	0					○								
	DCGW 21.501 FN	DCGW 070200 FN	1/4	.001						○							
	DCGW 21.501 H	DCGW 070200 H	1/4	.001							●						
	DCGW 21.504 FN	DCGW 070201 FN	1/4	.004						○							
	DCGW 21.504 H	DCGW 070201 H	1/4	.004							●						
	DCGW 21.508 H	DCGW 070202 H	1/4	.008							○						
	DCGW 32.500 V	DCGW 11T30 V	3/8	0					○								
	DCGW 32.501 FN	DCGW 11T300 FN	3/8	.001						○							
	DCGW 32.501 H	DCGW 11T300 H	3/8	.001							○						
	DCGW 32.504 FN	DCGW 11T301 FN	3/8	.004						○							
DCGW 32.504 H	DCGW 11T301 H	3/8	.004							○							
DCGW 32.508 H	DCGW 11T302 H	3/8	.008							○							
 wiper insert	DCGW 21.502RH-WP*	TFD 07FR05H	1/4	.002							○						
	DCGW 32.502RH-WP*	TFD 11FR05H	3/8	.006							○						

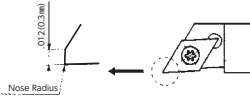

*Note: NTK WP style inserts have a wiper facet design. The insert has a 0.3mm (.012") flat on the cutting edge when the insert is set into the toolholder. The flat on the cutting edge ensures a superior surface finish when feed rates are increased. WP style inserts can be used in toolholders: SDJC, CH-SDUC and D5-SDUL.

DC.. Inserts - CBN / PCD

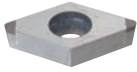
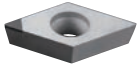
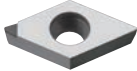
Shape	Item Number	ISO Item Number	Edge Prep.	IC	R	No. of edge	Length of edge	CBN (Brazed)							PCD		
								Coated		Coated					PCD		
								B5K	B52	B6K	B36	B40	B23	B30	PD1	PD2	
	DCGW 21.508 PD	DCGW 070202 PD	S0415	1/4	.008	2	.094		●								
	DCGW 21.51 PD	DCGW 070204 PD	S0415	1/4	.016	2	.087		●								
	DCGW 21.51 PD	DCGW 070204 PD	S0635	1/4	.016	2	.087					●					
	DCGW 21.52 PD	DCGW 070208 PD	S0415	1/4	.031	2	.075		●								
	DCGW 32.508 PD	DCGW 11T302 PD	S0415	3/8	.008	2	.094	●	●								
	DCGW 32.508 PD	DCGW 11T302 PD	S0635	3/8	.008	2	.094					●					
	DCGW 32.51 PD	DCGW 11T304 PD	S0415	3/8	.016	2	.087	●	●								
	DCGW 32.51 PD	DCGW 11T304 PD	S0635	3/8	.016	2	.087					●					
	DCGW 32.52 PD	DCGW 11T308 PD	S0415	3/8	.031	2	.075		●								
DCGW 32.52 PD	DCGW 11T308 PD	S0635	3/8	.031	2	.075					●						
	DCMW 32.504	DCMW 11T301	None	3/8	.004	1	-									○	
	DCMW 32.508	DCMW 11T302	None	3/8	.008	1	-									○	
	DCMW 32.51	DCMW 11T304	None	3/8	.016	1	-									○	
	DCMW 32.52	DCMW 11T308	None	3/8	.031	1	-									○	
 with chipbreaker	DCMT 32.508 PF	DCMT 11T302 PF	None	3/8	.008	1	-										●
	DCMT 32.51 PM	DCMT 11T304 PF	None	3/8	.016	1	-										●

● : Stock ○ : 1-2 week delivery
 R : Stock (Right-hand only) L : Stock (Left-hand only)
 ® : 1-2 week delivery (Right-hand only) ℒ : 1-2 week delivery (Left-hand only) M : Mirror finish
 Holders → Q16-19
 Cutting condition → Q4
 Chipbreaker → P21

Toolholders for VC.. Inserts

SVAC-N-1L

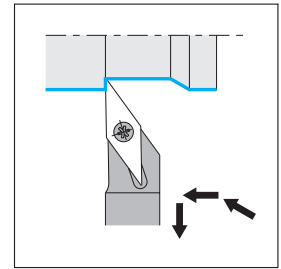
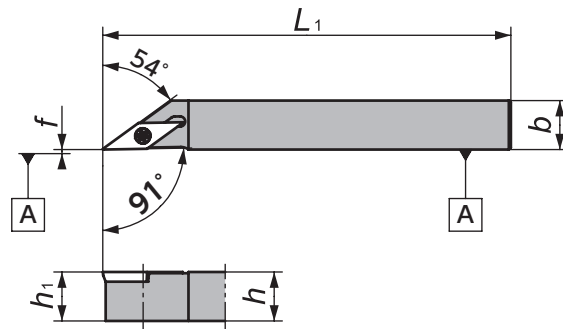



Figure-1

Right-Hand style shown

SVAC-N

Gage Insert	Item Number	Figure	Stock		h		b		h ₁		L ₁		f		Clamp Screw	Wrench
			R	L	(Inch)	(mm)	(Inch)	(mm)	(Inch)	(mm)	(Inch)	(mm)	(Inch)	(mm)		
	SVAC ^{1/4} 1010X11N-1L	1	○	○	.394	10	.394	10	.394	10	4.724	120	0.0	0.0	LRIS-2.5 × 7	CLR-155
	SVAC ^{1/4} 1212X11N-1L	1	○	○	.472	12	.472	12	.472	12	4.724	120	0.0	0.0	LRIS-2.5 × 7	RLR-205

SVAC-N

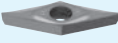
Shape	Item Number	ISO Item Number	IC		T		R		Coated Carbide			
			(Inch)	(mm)	(Inch)	(mm)	(Inch)	(mm)	QM3	DT4	DM4	TM4
	VCGT21.508MCL	VCGT110202MCL	1/4	6.35	1/8	3.175	.007	0.18		○	○	○
	VCGT21.508FN1L	VCGT110202FN1L	1/4	6.35	1/8	3.175	.008	0.2	○			

SVAC-NW

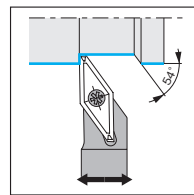
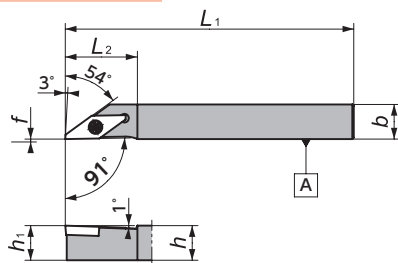

Figure-2

Right-Hand style shown

SVAC-W

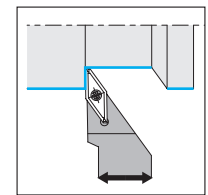
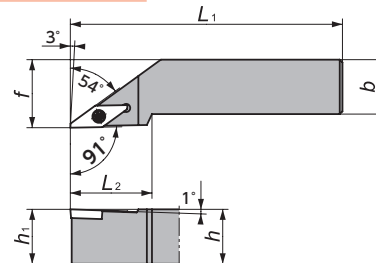



Figure-3

Right-Hand style shown

SVAC^{1/4}

Gage Insert	Item Number	Figure	Stock		h		b		h ₁		L ₁		f		L ₂		Clamp Screw	Wrench
			R	L	(Inch)	(mm)	(Inch)	(mm)	(Inch)	(mm)	(Inch)	(mm)	(Inch)	(mm)	(Inch)	(mm)		
	SVAC ^{1/4} 1010L13NW	2	○	○	.394	10	.394	10	.394	10	5.512	140	0.0	0.0	.984	25	LRIS-3 × 8	RLR-205
	SVAC ^{1/4} 1212L13NW	2	○	○	.472	12	.472	12	.472	12	5.512	140	0.0	0.0	.984	25	LRIS-3 × 8	RLR-205
	SVAC ^{1/4} 1616M13NW	2	○	○	.630	16	.630	16	.630	16	5.512	140	0.0	0.0	.984	25	LRIS-3 × 8	RLR-205
	SVAC ^{1/4} 2020M13W	3	○		.787	20	.787	20	.787	20	5.906	150	.984	25.0	1.181	30	LRIS-3 × 8	RLR-205

SVAC^{1/4}

Shape	Item Number	ISO Item Number	IC		T		R		Coated Carbide			
			(Inch)	(mm)	(Inch)	(mm)	(Inch)	(mm)	QM3	DT4	DM4	TM4
	VCGT130300F ^{1/2} 2M	VCGT130300F ^{1/2} 2M	.313	7.95	1/8	3.175	.001	0.02		○		
	VCGT130301F ^{1/2} 2M	VCGT130301F ^{1/2} 2M	.313	7.95	1/8	3.175	.004	0.1		○		

● : Stock

○ : 1-2 week delivery

💧 : Coolant through

Cutting condition ➡ Q4

Chipbreaker ➡ P21

Toolholders for VC.. Inserts

SVAC-N

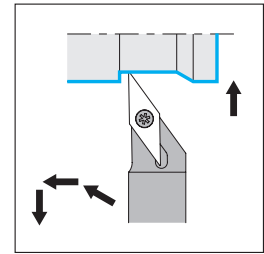
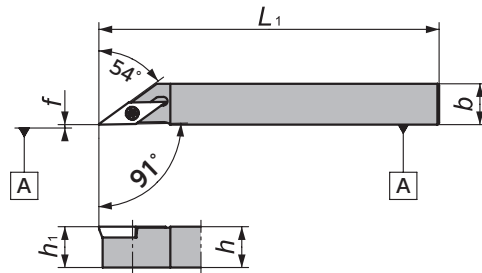

Right-Hand style shown

Figure-1

SVJC

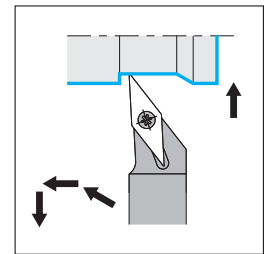
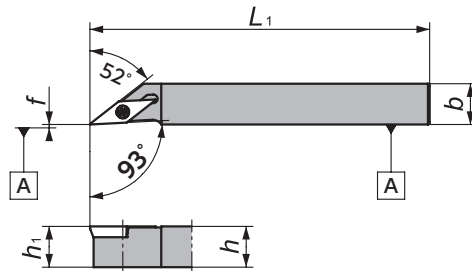

Right-Hand style shown

Figure-2

SVJC-OH (Coolant through)

NEW

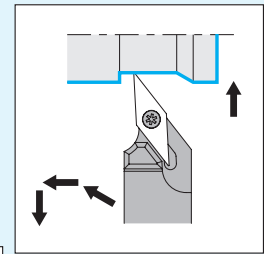
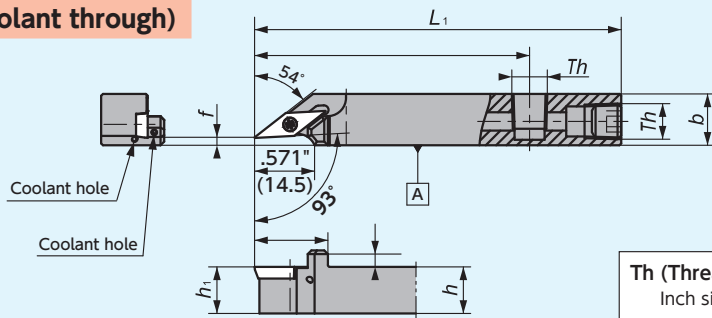

Right-Hand style shown

Figure-3

Th (Thread type)
Inch size holder: NPT1/8

SVJC-F (Shifted)

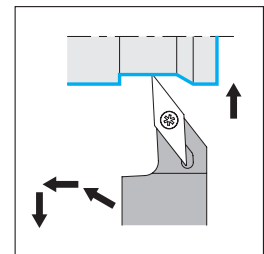
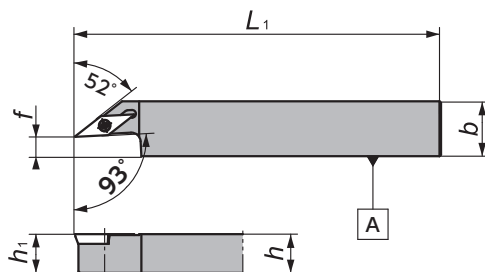

Right-Hand style shown

Figure-4

SVXC-N

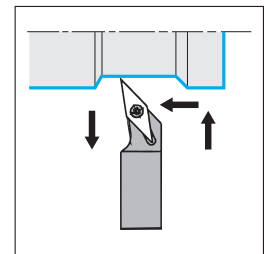
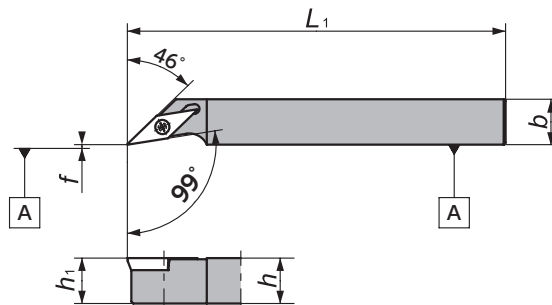

Right-Hand style shown

Figure-5

SVQC

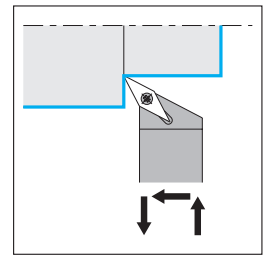
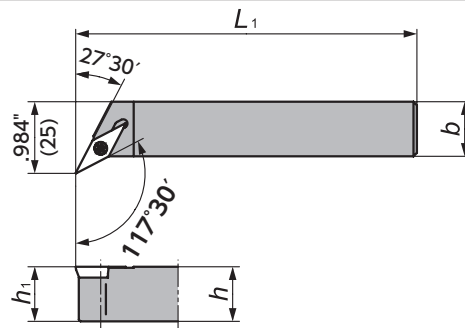

Right-Hand style shown

Figure-6

SVVC-N

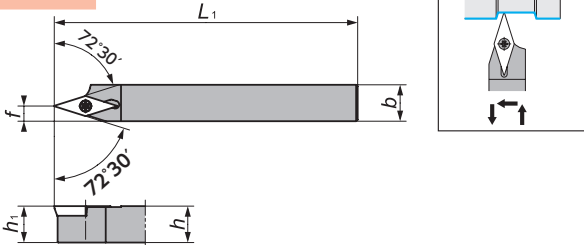

Right-Hand style shown

Figure-7

SVVC-N

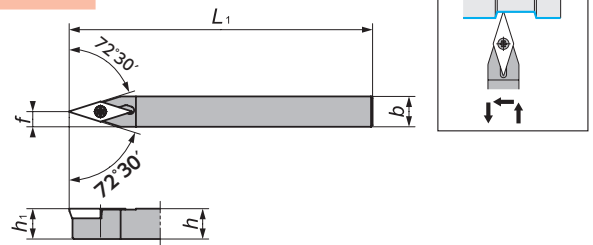

Figure-8

VC.. Series - Toolholders I



Gage Insert	Item Number	Figure	Stock		h		b		h ₁		L ₁		f		Th	Clamp Screw	Wrench
			R	L	(Inch)	(mm)	(Inch)	(mm)	(Inch)	(mm)	(Inch)	(mm)	(Inch)	(mm)			
VC..22 VC..22-WP	SVAC%10808X11N	1	●	●	.315	8	.315	8	.315	8	4.724	120	0.0	0.0	—	LRIS-2.5 × 7	CLR-15S
	SVAC%11010X11N	1	○	○	.394	10	.394	10	.394	10	4.724	120	0.0	0.0	—	LRIS-2.5 × 7	CLR-15S
	SVAC%11212X11N	1	○	○	.472	12	.472	12	.472	12	4.724	120	0.0	0.0	—	LRIS-2.5 × 7	CLR-15S
	SVAC%11616X11N	1	○	○	.630	16	.630	16	.630	16	4.724	120	0.0	0.0	—	LRIS-2.5 × 7	CLR-15S
VC..22	SVJC%1-062C	4	●	●	3/8		3/8		3/8		4.724	120	0.0	0.0	—	LRIS-2.5 × 7	CLR-15S
	SVJC%1-082C	4	●	●	1/2		1/2		1/2		4.724	120	0.0	0.0	—	LRIS-2.5 × 7	CLR-15S
	SVJC%1-102C	4	●	●	5/8		5/8		5/8		4.724	120	0.0	0.0	—	LRIS-2.5 × 7	CLR-15S
	SVJC%10808H11N	2	○	○	.315	8	.315	8	.315	8	3.937	100	0.0	0.0	—	LRIS-2.5 × 7	CLR-15S
	SVJC%11010X11N	2	○	○	.394	10	.394	10	.394	10	4.724	120	0.0	0.0	—	LRIS-2.5 × 7	CLR-15S
	SVJC%11212X11N	2	●	○	.472	12	.472	12	.472	12	4.724	120	0.0	0.0	—	LRIS-2.5 × 7	CLR-15S
	SVJC%11616X11N	2	○	○	.630	16	.630	16	.630	16	4.724	120	0.0	0.0	—	LRIS-2.5 × 7	CLR-15S
VC..22	SVJC%1-082H-F079-OH	3	●	●	1/2		.551	14	1/2		3.937	100	.079	2.0	NPT1/8	LRIS-2.5 × 7	CLR-15S
	SVJC%1-102H-F079-OH	3	●	●	5/8		5/8		5/8		3.937	100	.079	2.0	NPT1/8	LRIS-2.5 × 7	CLR-15S
VC..22	SVJC%1-082C-F250	4	●	●	1/2		1/2		.709	18	4.724	120	1/4		—	LRIS-2.5 × 7	CLR-15S
	SVJC%1-082C-F500	4	●	●	1/2		1/2		.984	25	4.724	120	1/2		—	LRIS-2.5 × 7	CLR-15S
VC..22	SVXC%11210X11N	5	○	○	.394	10	.472	12	.394	10	4.724	120	0.0	0.0	—	LRIS-2.5 × 7	CLR-15S
	SVXC%11212X11N	5	○	○	.472	12	.472	12	.472	12	4.724	120	0.0	0.0	—	LRIS-2.5 × 7	CLR-15S
VC..22	SVQC%120-X11	6	○	○	.787	20	.787	20	.787	20	4.724	120	—	—	—	LRIS-2.5 × 7	CLR-15S
VC..22	SVVC%11212X11N	7	●	●	.472	12	.472	12	.472	12	4.724	120	.197	5	—	LRIS-2.5 × 7	CLR-15S
	SVVC%11616X11N	7	○	○	.630	16	.630	16	.630	16	4.724	120	.197	5	—	LRIS-2.5 × 7	CLR-15S
	SVVCN0808H11N	8	○	○	.315	8	.315	8	.315	8	3.937	100	.157	4	—	LRIS-2.5 × 7	CLR-15S
	SVVCN1010X11N	8	○	○	.394	10	.394	10	.394	10	4.724	120	.197	5	—	LRIS-2.5 × 7	CLR-15S
	SVVCN20-X11	8	○	○	.787	20	.787	20	.787	20	4.724	120	.394	10	—	LRIS-2.5 × 7	CLR-15S

● : Stock

○ : 1-2 week delivery

💧 : Coolant through

Inserts → Q29

Cutting condition → Q4

Y-axis Toolholders for VC.. Inserts

Y-SVJCR

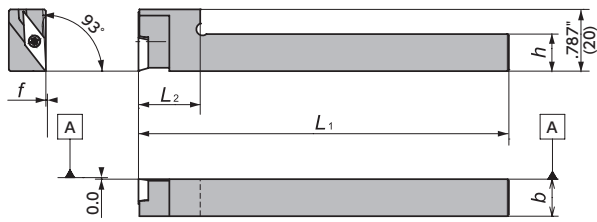

Figure-1

Right-Hand style shown
Takes Right-hand or Neutral insert

Y-SVJCR-OH (Coolant through)

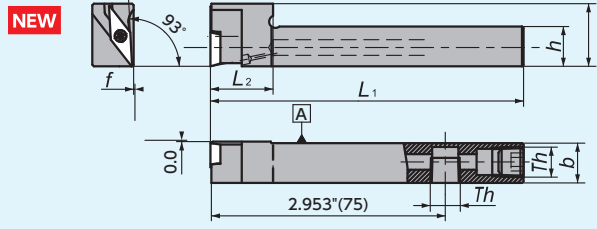

Figure-2

Th (Thread type)
Inch size holder: NPT1/8
Right-Hand style shown
Takes Right-hand or Neutral insert

VC.. Series - Toolholders II



Gage Insert	Item Number	Figure	Stock		h		b		L ₁		f		L ₂		Th	Clamp Screw	Wrench
			R	L	(Inch)	(mm)	(Inch)	(mm)	(Inch)	(mm)	(Inch)	(mm)	(Inch)	(mm)			
VC..22..	Y-SVJCR062-IN	1	●		3/8	3/8	4.724	120	0.0	0.0	.787	20	—	LRIS-2.5 × 7	CLR-15S		
	Y-SVJCR082-IN	1	●		1/2	1/2	4.724	120	0.0	0.0	.787	20	—	LRIS-2.5 × 7	CLR-15S		
	Y-SVJCR102-IN	1	●		5/8	5/8	4.724	120	0.0	0.0	.984	25	—	LRIS-2.5 × 7	CLR-15S		
VC..22..	Y-SVJCR082SH5-IN-OH	2	●		1/2	1/2	3.937	100	0.0	0.0	.787	20	NPT1/8	LRIS-2.5 × 7	CLR-15S		
	Y-SVJCR102H-IN-OH	2	●		5/8	5/8	3.937	100	0.0	0.0	.984	25	NPT1/8	LRIS-2.5 × 7	CLR-15S		

DS Toolholders for VC.. Inserts

DS-SVX

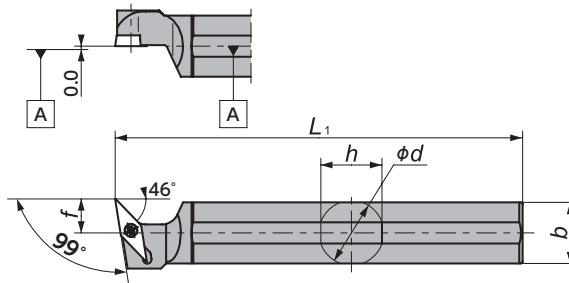

Figure-3

Left-Hand style shown
Takes Right-hand or Neutral insert

VC.. Series - Toolholders III



Gage Insert	Item Number	Figure	Stock		φ d		h		b		L ₁		f		Clamp Screw	Wrench
			R	L	(Inch)	(mm)	(Inch)	(mm)	(Inch)	(mm)	(Inch)	(mm)	(Inch)	(mm)		
VC..22..	DS-SVX $\frac{1}{4}$ 14F-11	3	○		.551	14.000	.512	13	.512	13	3.150	80	.394	10.0	LRIS-2.5 × 7	CLR-15S
	DS-SVX $\frac{1}{4}$ 15H-11	3	○		5/8	15.875	.591	15	.591	15	3.937	100	.394	10.0	LRIS-2.5 × 7	CLR-15S
	DS-SVX $\frac{1}{4}$ 16F-11	3	●		.630	16.000	.591	15	.591	15	3.150	80	.394	10.0	LRIS-2.5 × 7	CLR-15S
	DS-SVX $\frac{1}{4}$ 19-11	3	●		3/4	19.050	.709	18	.709	18	4.724	120	.394	10.0	LRIS-2.5 × 7	CLR-15S
	DS-SVX $\frac{1}{4}$ 19-11SPL	3	○		3/4	19.050	.709	18	.709	18	6.299	160	.433	11.0	LRIS-2.5 × 7	CLR-15S
	DS-SVX $\frac{1}{4}$ 20X-11	3	○		.787	20.000	.748	19	.748	19	3.740	95	.394	10.0	LRIS-2.5 × 7	CLR-15S
	DS-SVX $\frac{1}{4}$ 20-11	3	●		.787	20.000	.748	19	.748	19	4.724	120	.394	10.0	LRIS-2.5 × 7	CLR-15S
	DS-SVX $\frac{1}{4}$ 22-11	3	●		.866	22.000	.827	21	.827	21	4.724	120	.394	10.0	LRIS-2.5 × 7	CLR-15S
	DS-SVX $\frac{1}{4}$ 25-11	3	●		1	25.400	.945	24	.945	24	5.906	150	.394	10.0	LRIS-2.5 × 7	CLR-15S

● : Stock ○ : 1-2 week delivery ■ : While stock lasts R : Stock (Right-hand only) L : Stock (Left-hand only) Cutting condition →Q4
 ® : 1-2 week delivery (Right-hand only) Ⓛ : 1-2 week delivery (Left-hand only) M : Mirror finish Coolant through Chipbreaker →P21

VC.. Inserts - Carbide / Cermet

(inch)	IC	T
VC..22	1/4	1/8

Shape	Item Number	ISO Item Number	IC	R	Carbide						Cermet										
					PVD Coated						PVD Coated										
					QM3	DT4	DM4	TM4	VM1	ZM3	KM1	XT3	C7X	XN4	Q15		C7Z				
	VCGT 2201 FNAM3	VCGT 110300 FNAM3	1/4	.001	●	●	●	●	●	●	●	●	●	●	●	●	●	●	●	●	
	VCGT 2204M FNAM3	VCGT 110301M FNAM3	1/4	.003	●	●	○	○	○	○	○	○	○	○	○	○	○	○	○	○	
	VCGT 2204 FNAM3	VCGT 110301 FNAM3	1/4	.004	●	●	○	○	○	○	○	○	○	○	○	○	○	○	○	○	
	VCGT 2208M FNAM3	VCGT 110302M FNAM3	1/4	.007	●	●	○	○	○	○	○	○	○	○	○	○	○	○	○	○	
	VCGT 2208 FNAM3	VCGT 110302 FNAM3	1/4	.008	●	●	○	○	○	○	○	○	○	○	○	○	○	○	○	○	
	VCGT 2208 FNAM3	VCGT 110302 FNXAM3	1/4	.008	●	●	○	○	○	○	○	○	○	○	○	○	○	○	○	○	
	VCGT 221M FNAM3	VCGT 110304M FNAM3	1/4	.015	●	●	○	○	○	○	○	○	○	○	○	○	○	○	○	○	
	VCGT 221 FNAM3	VCGT 110304 FNAM3	1/4	.016	●	●	○	○	○	○	○	○	○	○	○	○	○	○	○	○	
	VCMT 2208 FNAM3	VCGT 110302 FNAM3	1/4	.008	○	○	○	○	○	○	○	○	○	○	○	○	○	○	○	○	
	VCMT 221 FNAM3	VCGT 110304 FNAM3	1/4	.016	○	○	○	○	○	○	○	○	○	○	○	○	○	○	○	○	
NEW	VCGT 2204M YL	VCGT 110301M YL	1/4	.003	○	○	○	○	○	○	○	○	○	○	○	○	○	○	○	○	
	VCGT 2208M YL	VCGT 110302M YL	1/4	.007	○	○	○	○	○	○	○	○	○	○	○	○	○	○	○	○	
	VCGT 221M YL	VCGT 110304M YL	1/4	.015	○	○	○	○	○	○	○	○	○	○	○	○	○	○	○	○	
	VCGT 2204M CL	VCGT 110301M CL	1/4	.003	○	○	○	○	○	○	○	○	○	○	○	○	○	○	○	○	
	VCGT 2208M CL	VCGT 110302M CL	1/4	.007	○	○	○	○	○	○	○	○	○	○	○	○	○	○	○	○	
	VCGT 2201 FNAZ7**	VCGT 110300 AZ7	1/4	.001	●	●	○	○	○	○	○	○	○	○	○	○	○	○	○	○	
	VCGT 2204M FNAZ7**	VCGT 110301M AZ7	1/4	.003	●	●	○	○	○	○	○	○	○	○	○	○	○	○	○	○	
	VCGT 2208M FNAZ7**	VCGT 110302M AZ7	1/4	.007	●	●	○	○	○	○	○	○	○	○	○	○	○	○	○	○	
	VCGT 221M FNAZ7**	VCGT 110304M AZ7	1/4	.015	●	●	○	○	○	○	○	○	○	○	○	○	○	○	○	○	
	VCMT 2204 T $\frac{1}{2}$ AS	VCMT 110301 T $\frac{1}{2}$ AS	1/4	.004	○	○	○	○	○	○	○	○	○	○	○	○	○	○	○	○	
	VCMT 2208 T $\frac{1}{2}$ AS	VCMT 110302 T $\frac{1}{2}$ AS	1/4	.008	○	○	○	○	○	○	○	○	○	○	○	○	○	○	○	○	
	VCMT 221 T $\frac{1}{2}$ AS	VCMT 110304 T $\frac{1}{2}$ AS	1/4	.016	○	○	○	○	○	○	○	○	○	○	○	○	○	○	○	○	
wiper insert	VCGT 2202 $\frac{1}{2}$ S-WP*	TFV 11F $\frac{1}{2}$ 05SX	1/4	.002	○	○	○	○	○	○	○	○	○	○	○	○	○	○	○	○	
	VCGT 2204 $\frac{1}{2}$ S-WP*	TFV 11F $\frac{1}{2}$ 10SX	1/4	.004	○	○	○	○	○	○	○	○	○	○	○	○	○	○	○	○	
	VCGT 2201 $\frac{1}{2}$ U	VCGT 110300 $\frac{1}{2}$ U	1/4	.001	○	○	○	○	○	○	○	○	○	○	○	○	○	○	○	○	
	VCGT 2204M $\frac{1}{2}$ U	VCGT 110301M $\frac{1}{2}$ U	1/4	.003	○	○	○	○	○	○	○	○	○	○	○	○	○	○	○	○	
	VCGT 2204 $\frac{1}{2}$ U	VCGT 110301 $\frac{1}{2}$ U	1/4	.004	○	○	○	○	○	○	○	○	○	○	○	○	○	○	○	○	
	VCGT 2208M $\frac{1}{2}$ U	VCGT 110302M $\frac{1}{2}$ U	1/4	.007	○	○	○	○	○	○	○	○	○	○	○	○	○	○	○	○	
	VCGT 2208 $\frac{1}{2}$ U	VCGT 110302 $\frac{1}{2}$ U	1/4	.008	○	○	○	○	○	○	○	○	○	○	○	○	○	○	○	○	
wiper insert	VCGT 2202 $\frac{1}{2}$ U-WP*	TFV 11F $\frac{1}{2}$ 05U	1/4	.002	○	○	○	○	○	○	○	○	○	○	○	○	○	○	○	○	
	VCGT 2204 $\frac{1}{2}$ U-WP*	TFV 11F $\frac{1}{2}$ 10U	1/4	.004	○	○	○	○	○	○	○	○	○	○	○	○	○	○	○	○	
	VCET 2203 $\frac{1}{2}$ UHG	VCET 1103008 $\frac{1}{2}$ UHG	1/4	.003	○	○	○	○	○	○	○	○	○	○	○	○	○	○	○	○	
	VCGW 2201 H	VCGW 110300 H	1/4	.001	○	○	○	○	○	○	○	○	○	○	○	○	○	○	○	○	
	VCGW 2204 H	VCGW 110301 H	1/4	.004	○	○	○	○	○	○	○	○	○	○	○	○	○	○	○	○	
	VCGW 2208 H	VCGW 110302 H	1/4	.008	○	○	○	○	○	○	○	○	○	○	○	○	○	○	○	○	

**To be replaced by version which has 0.2mm higher edge.



*Note: NTK WP style inserts have a wiper facet design.
 The insert has a 0.2mm (.008") flat on the cutting edge when the insert is set into the toolholder.
 The flat on the cutting edge ensures a superior surface finish when feed rates are increased.
 WP style inserts can be used in toolholders: SVAC

Shape	Item Number	ISO Item Number	Edge Prep.	IC	R	No. of edge	Length of edge	CBN (Brazed)						PCD				
								Coated		Coated		Coated		B30	PD1		PD2	
								B5K	B52	B6K	B36	B40	B23					
	VCGW 221 PD	VCGW 110304 PD	S0415	1/4	.016	2	.098	○	○	○	○	○	○	○	○	○	○	
	VCGW 221 PD	VCGW 110304 PD	S0635	1/4	.016	2	.098	○	○	○	○	○	○	○	○	○	○	
	VCGW 222 PD	VCGW 110308 PD	S0415	1/4	.031	2	.063	○	○	○	○	○	○	○	○	○	○	
	VCGW 222 PD	VCGW 110308 PD	S0635	1/4	.031	2	.063	○	○	○	○	○	○	○	○	○	○	
	VCMW 2204	VCMW 110301	None	1/4	.004	1	—	○	○	○	○	○	○	○	○	○	○	
	VCMW 2208	VCMW 110302	None	1/4	.008	1	—	○	○	○	○	○	○	○	○	○	○	
	VCMW 221	VCMW 110304	None	1/4	.016	1	—	○	○	○	○	○	○	○	○	○	○	

Front Turning

Toolholders VP..08 Inserts

SVQP-N

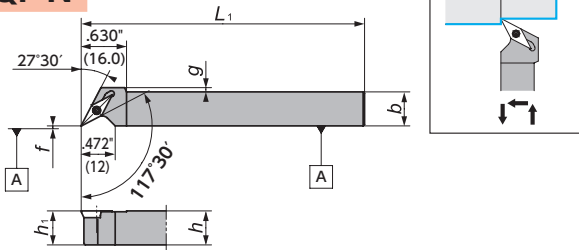

Figure-1

Right-Hand style shown

CH-SVUP

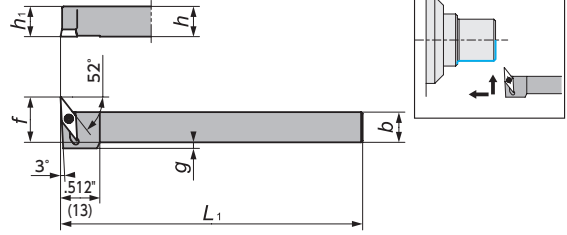

Figure-2

Left-Hand style shown
Takes Right-hand or Neutral insert

DS-SVXP

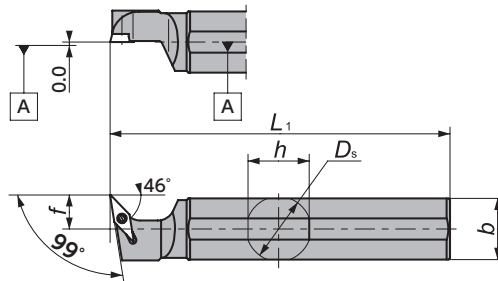

Figure-3

Left-Hand style shown
Takes Right-hand or Neutral insert

Gage Insert	Item Number	Figure	Stock		h		b		h ₁		L ₁		f		g		Clamp Screw	Wrench
			R	L	(Inch)	(mm)	(Inch)	(mm)	(Inch)	(mm)	(Inch)	(mm)	(Inch)	(mm)	(Inch)	(mm)		
VP..0802	SVQP ^{1/2} 1010X08N	1	○	○	.394	10	.394	10	.394	10	4.724	120	0.0	0.0	.138	3.5	LRIS-2 × 6	CLR-13S
	SVQP ^{1/2} 1212X08N	1	○	○	.472	12	.472	12	.394	10	4.724	120	0.0	0.0	.059	1.5	LRIS-2 × 6	CLR-13S
	SVQP ^{1/2} 1616X08N	1	○	○	.630	16	.630	16	.394	10	4.724	120	0.0	0.0	0	0	LRIS-2 × 6	CLR-13S
	CH-SVUP ^{1/2} 1010H08	2	○	○	.394	10	.394	10	.394	10	3.937	100	.591	15	.079	2	LRIS-2 × 6	CLR-13S
	CH-SVUP ^{1/2} 1212H08	2	○	○	.472	12	.472	12	.472	12	3.937	100	.669	17	0	0	LRIS-2 × 6	CLR-13S

Gage Insert	Item Number	Figure	Stock		D _s		h		b		L ₁		f		Clamp Screw	Wrench
			R	L	(Inch)	(mm)	(Inch)	(mm)	(Inch)	(mm)	(Inch)	(mm)	(Inch)	(mm)		
VP..0802	DS-SVXP ^{1/2} 19-08	3	○	○	3/4	19.050	.709	18	.709	18	4.724	120	.394	10	LRIS-2 × 6	CLR-13S
	DS-SVXP ^{1/2} 20-08	3	○	○	.787	20.000	.748	19	.748	19	4.724	120	.394	10	LRIS-2 × 6	CLR-13S
	DS-SVXP ^{1/2} 22-08	3	○	○	.866	22.000	.827	21	.827	21	4.724	120	.394	10	LRIS-2 × 6	CLR-13S
	DS-SVXP ^{1/2} 25-08	3	○	○	1	25.400	.945	24	.945	24	5.906	150	.394	10	LRIS-2 × 6	CLR-13S

VP.. Inserts - Carbide / Cermet

(inch)	IC	T
VP..08	3/16	3/32

Shape	Item Number	ISO Item Number	IC	R	Carbide								Cermet					
					PVD Coated								PVD Coated					
					QM3	DT4	DM4	TM4	VM1	ZM3	KM1	XT3	C7X	XN4	Q15	C7Z		
	VPET 0802005 ^{1/2} KHG	VPET 0802005 ^{1/2} KHG	.187	.002	●	●	●	●	●	●	●	●	●	●	●	●	●	●
	VPET 0802008 ^{1/2} KHG	VPET 0802008 ^{1/2} KHG	.187	.003	●	●	●	●	●	●	●	●	●	●	●	●	●	●
	VPET 0802018 ^{1/2} KHG	VPET 0802018 ^{1/2} KHG	.187	.007	●	●	●	●	●	●	●	●	●	●	●	●	●	●
	VPET 080202 ^{1/2} KHG	VPET 080202 ^{1/2} KHG	.187	.008	●	●	●	●	●	●	●	●	●	●	●	●	●	●
	VPET 0802008 ^{1/2} UHG	VPET 0802008 ^{1/2} UHG	.187	.003	●	●	●	●	●	●	●	●	●	●	●	●	●	●

● : 1st Choice
● : Alternate choice

Toolholders for VP..22 Inserts

SVXP-N

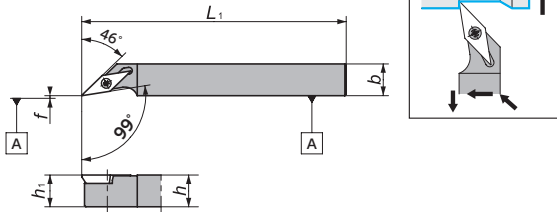

Figure-1

Right-Hand style shown

DS-SVVP

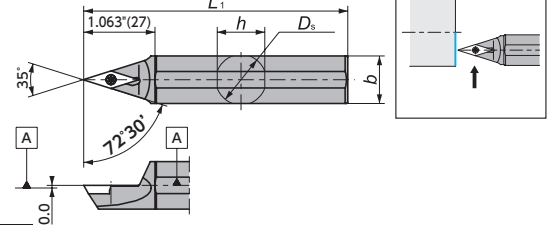

Figure-2

DS-SVVP-ACH (Adjustable centerline height)

<Parts>

Shank	Wedge	Screw for Wedge
φ .630" (16)	ACH-W18 (5805601)	WS060415-003 (5795539)
φ 3/4" (19.05)		
φ .787" (20)		
φ .866" (22)	ACH-W24 (5805619)	WS060419-004 (5799226)
φ 1" (25.4)		

Figure-3

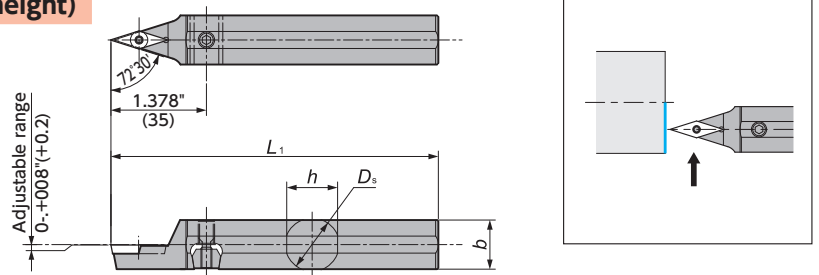

Gage Insert	Item Number	Figure	Stock		h		b		h ₁		L ₁		f		Clamp Screw	Wrench
			R	L	(Inch)	(mm)	(Inch)	(mm)	(Inch)	(mm)	(Inch)	(mm)	(Inch)	(mm)		
VP..22	SVXP $\frac{1}{2}$ 1012X11N	1	○	○	.394	10	.472	12	.394	10	4.724	120	0.0	0.0	LRIS-2.5 × 7	CLR-15S
	SVXP $\frac{1}{2}$ 1212X11N	1	○	○	.472	12	.472	12	.472	12	4.724	120	0.0	0.0	LRIS-2.5 × 7	CLR-15S

Gage Insert	Item Number	Figure	Stock Neutral	D _s		h		b		L ₁		Clamp Screw	Wrench
				(Inch)	(mm)	(Inch)	(mm)	(Inch)	(mm)	(Inch)	(mm)		
VP..22	DS-SVVPN19-11	2	○	3/4	19.050	.709	18.0	.709	18	4.724	120	LRIS-2.5 × 7	CLR-15S
	DS-SVVPN22-11	2	○	.866	22.00	.827	21.0	.827	21	4.724	120	LRIS-2.5 × 7	CLR-15S
	DS-SVVPN16-11-ACH	3	●	.630	16.000	.610	15.5	.610	15	4.724	120	LRIS-2.5 × 7	CLR-15S
	DS-SVVPN19-11-ACH	3	●	3/4	19.050	.709	18.0	.709	18	4.724	120	LRIS-2.5 × 7	CLR-15S
	DS-SVVPN20-11-ACH	3	●	.787	20.000	.748	19.0	.748	19	4.724	120	LRIS-2.5 × 7	CLR-15S
	DS-SVVPN22-11-ACH	3	●	.866	22.000	.827	21.0	.827	21	4.724	120	LRIS-2.5 × 7	CLR-15S
	DS-SVVPN25-11-ACH	3	●	1	25.400	.945	24.0	.945	24	5.906	150	LRIS-2.5 × 7	CLR-15S

VP.. Inserts - Carbide / Cermet

(inch)	IC	T
VP..22	1/4	1/8

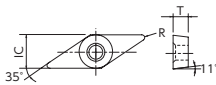

VP__

	Steel	P	●	●	●	●	●	●	●	●	●	●	●	●	●	●	●	●	●	●	●
Stainless Steel	M	●	●	●	●	●	●	●	●	●	●	●	●	●	●	●	●	●	●	●	●
Cast Iron	K	●	●	●	●	●	●	●	●	●	●	●	●	●	●	●	●	●	●	●	●
Non-Ferrous Material	N	●	●	●	●	●	●	●	●	●	●	●	●	●	●	●	●	●	●	●	●
Heat Resistant Alloy	S	●	●	●	●	●	●	●	●	●	●	●	●	●	●	●	●	●	●	●	●
Hardened Material	H	●	●	●	●	●	●	●	●	●	●	●	●	●	●	●	●	●	●	●	●

● : 1st Choice
● : Alternate choice

Shape	Item Number	ISO Item Number	IC	R	Carbide							Cermet									
					PVD Coated							PVD Coated									
					QM3	DT4	DM4	TM4	VM1	ZM3	KM1	XT3	C7X	XN4	Q15	C7Z					
VPET 2202	VPET 2202 $\frac{1}{4}$ KHG	VPET 1103005 $\frac{1}{4}$ KHG	1/4	.002					Ⓜ	Ⓜ											
	VPET 2203 $\frac{1}{4}$ KHG	VPET 1103008 $\frac{1}{4}$ KHG	1/4	.003					Ⓜ	Ⓜ											
	VPET 2207 $\frac{1}{4}$ KHG	VPET 1103018 $\frac{1}{4}$ KHG	1/4	.007					Ⓜ	Ⓜ											
	VPET 2208 $\frac{1}{4}$ KHG	VPET 110302 $\frac{1}{4}$ KHG	1/4	.008					Ⓜ	Ⓜ											
VPGT 2201	VPGT 2201 FNAM3	VPGT 110300 FNAM3	1/4	.001		●															
	VPGT 2204M FNAM3	VPGT 110301M FNAM3	1/4	.003	●	●															
	VPGT 2208M FNAM3	VPGT 110302M FNAM3	1/4	.007	●	●															

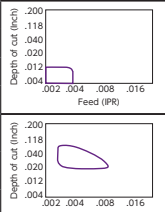

● : Stock ○ : 1-2 week delivery Ⓜ : 1-2 week delivery (Right-hand only) Ⓛ : 1-2 week delivery (Left-hand only)

Cutting condition → Q4
Chipbreaker → P21

Front Turning

Toolholders for TFT series

TFT

Screw accessible from both sides

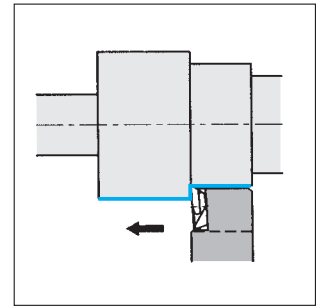
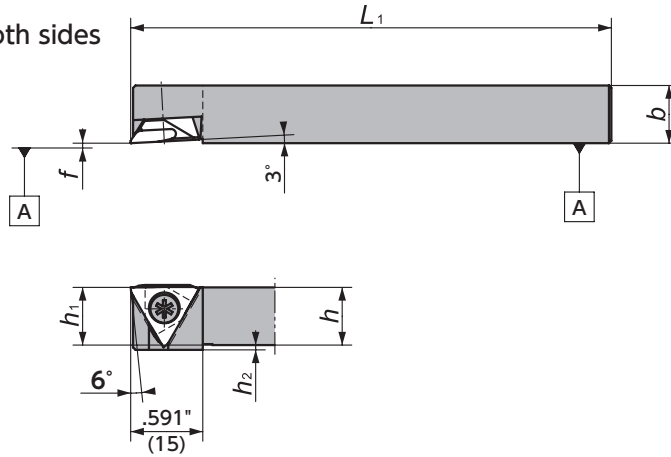

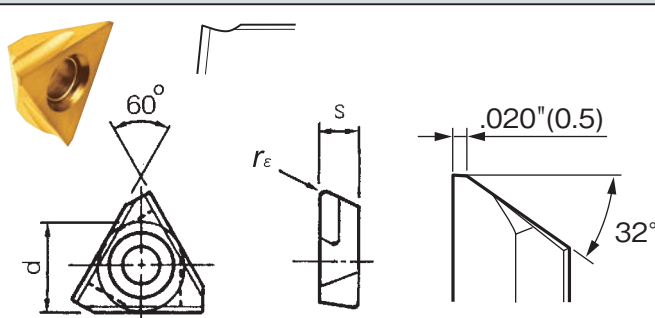

Figure-1

Right-Hand style shown

Gage Insert	Item Number	Figure	Stock		h		b		h_1		L_1		f		h_2		Clamp Screw	Wrench
			R	L	(Inch)	(mm)	(Inch)	(mm)	(Inch)	(mm)	(Inch)	(mm)	(Inch)	(mm)	(Inch)	(mm)		
 TF33	TFT%06-IN	1	●		3/8	3/8	3/8	3/8	3/8	3/8	4.724	120	0.0	0.0	.118	3	LR-S-4 × 10PW	CLR-15S
	TFT%08-IN	1	●		1/2	1/2	1/2	1/2	1/2	1/2	4.724	120	0.0	0.0	.039	1	LR-S-4 × 10PW	CLR-15S
	TFT%10	1	○		.394	10	.394	10	.394	10	4.724	120	0.0	0.0	.118	3	LR-S-4 × 10PW	CLR-15S
	TFT%12	1	○		.472	12	.472	12	.472	12	4.724	120	0.0	0.0	.039	1	LR-S-4 × 10PW	CLR-15S
	TFT%16	1	○		.630	16	.630	16	.630	16	4.724	120	0.0	0.0	0.0	0	LR-S-4 × 10PW	CLR-15S
	TFT%20	1	○		.787	20	.787	20	.787	20	4.724	120	0.0	0.0	0.0	0	LR-S-4 × 10PW	CLR-15S

TFT Series - Inserts

Shape	Item Number	d		s		r_ϵ		ZM3	
		(Inch)	(mm)	(Inch)	(mm)	(Inch)	(mm)	R	L
 <p>Right-Hand style shown</p> <p>Note: Up to .157*(4.0mm) D.O.C. All angles shown are obtained when insert is set in the holder.</p>	TF3300%	3/8	9.525	3/16	4.76	0	0	●	
	TF3305%	3/8	9.525	3/16	4.76	.002	0.05	●	
	TF3315%	3/8	9.525	3/16	4.76	.006	0.15	●	
	TF3320%	3/8	9.525	3/16	4.76	.008	0.2	○	

Toolholders for TC.. Inserts

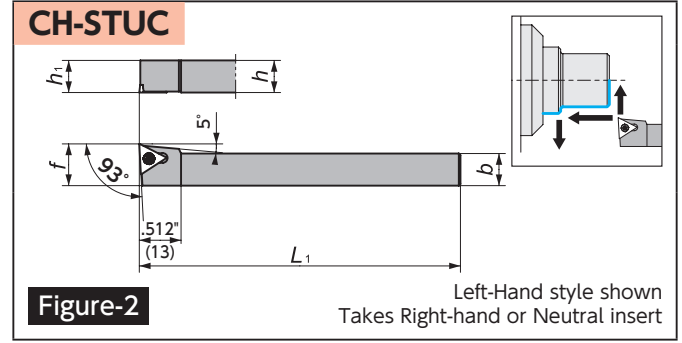
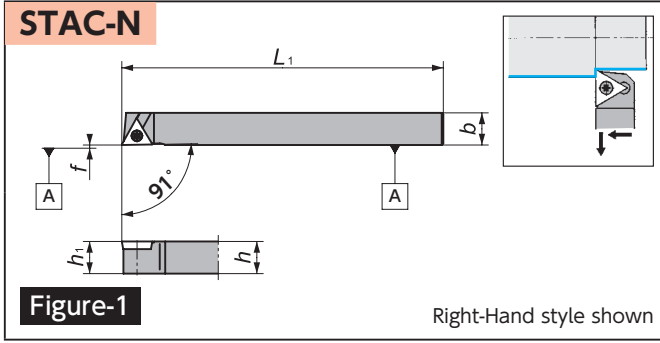

Gage Insert	Item Number	Figure	Stock		h		b		h ₁		L ₁		f		Clamp Screw	Wrench
			R	L	(Inch)	(mm)	(Inch)	(mm)	(Inch)	(mm)	(Inch)	(mm)	(Inch)	(mm)		
TC..73..	STAC%0808X09N	1	○		.315	8	.315	8	.315	8	4.724	120	0.0	0.0	LRIS-2.2 × 6	CLR-13S
	STAC%1010X09N	1	○	○	.394	10	.394	10	.394	10	4.724	120	0.0	0.0	LRIS-2.2 × 6	CLR-13S
TC..21.5..	STAC%1212X11N	1	○	○	.472	12	.472	12	.472	12	4.724	120	0.0	0.0	LRIS-2.5 × 7	CLR-15S
TC..73..	CH-STUC%1010H09	2	○	○	.394	10	.394	10	.394	10	3.937	100	.512	13	LRIS-2.2 × 6	CLR-13S
	CH-STUC%1212H09	2	○	○	.472	12	.472	12	.472	12	3.937	100	.591	15	LRIS-2.2 × 6	CLR-13S

TC.. Inserts - Carbide / Cermet

Shape	Item Number	ISO Item Number	IC	R	Carbide							Cermet					Depth of cut (inch) Feed (IPR)			
					PVD Coated							PVD Coated								
					QM3	DT4	DM4	TM4	VM1	ZM3	KM1	XT3	C7X	XN4	Q15	C7Z				
	TCGT 21.508 FNAM3	TCGT 110202 FNXAM3	1/4	.008															○	
	TCGT 7304 R/4 S	TCGT 090201 R/4 S	7/32	.004						Ⓡ	Ⓡ								Ⓡ	
	TCGT 7308 R/4 S	TCGT 090202 R/4 S	7/32	.008						Ⓡ	Ⓡ								Ⓡ	
	TCGT 21.504 R/4 S	TCGT 110201 R/4 S	1/4	.004						Ⓡ	Ⓡ								Ⓡ	
	TCGT 7302 R/4 S-WP*	TFT 09F R/4.05	7/32	.002						Ⓡ	Ⓡ								Ⓡ	
	TCGT 7306 R/4 S-WP*	TFT 09F R/4.15	7/32	.006						Ⓡ	Ⓡ								Ⓡ	
	TCGT 21.502 R/4 S-WP*	TFT 11F R/4.05	1/4	.002						Ⓡ	Ⓡ								Ⓡ	
	TCGT 21.506 R/4 S-WP*	TFT 11F R/4.15	1/4	.006						Ⓡ	Ⓡ								Ⓡ	
	TCGT 7304 R/4 U	TCGT 090201 R/4 U	7/32	.004						Ⓡ	Ⓡ								Ⓡ	
	TCGT 7308 R/4 U	TCGT 090202 R/4 U	7/32	.008						Ⓡ	Ⓡ								Ⓡ	
	TCGT 7302 R/4 U-WP*	TFT 09F R/4.05U	7/32	.002						Ⓡ	Ⓡ								Ⓡ	
	TCGT 7306 R/4 U-WP*	TFT 09F R/4.15U	7/32	.006						Ⓡ	Ⓡ								Ⓡ	
	TCGT 21.502 R/4 U1-WP*	TFT 11F R/4.05U1	1/4	.002						Ⓡ	Ⓡ								Ⓡ	
	TCGT 21.506 R/4 U1-WP*	TFT 11F R/4.15U1	1/4	.006						Ⓡ	Ⓡ								Ⓡ	
	TCGW 7301 FN	TCGW 090200 FN	7/32	.001						○	○								○	
	TCGW 7304 FN	TCGW 090201 FN	7/32	.004						○	○								○	
	TCGW 21.501 FN	TCGW 110200 FN	1/4	.001						○	○								○	
	TCGW 21.504 FN	TCGW 110201 FN	1/4	.004						○	○								○	



* Note: NTK WP style inserts have a wiper facet design. The insert has a 0.3mm (.012") flat on the cutting edge when the insert is set into the toolholder. The flat on the cutting edge ensures a superior surface finish when feed rates are increased. WP style inserts can be used in toolholders: STAC

● : Stock ○ : 1-2 week delivery Ⓡ : 1-2 week delivery (Right-hand only) Ⓛ : 1-2 week delivery (Left-hand only)

Cutting condition → **Q4**
Chipbreaker → **P21**

Toolholders for TN.. Inserts

PTXN-N

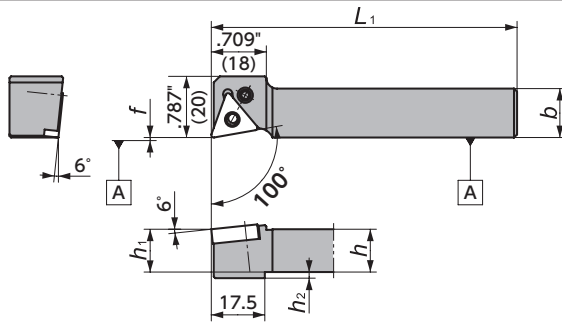

Shim	Clamp Pin	Spring
—	LCL33N	—

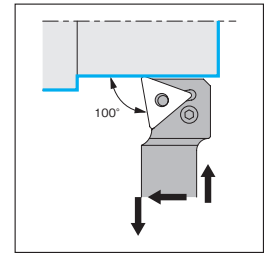

Right-Hand style shown

Figure-1

PTAN-N

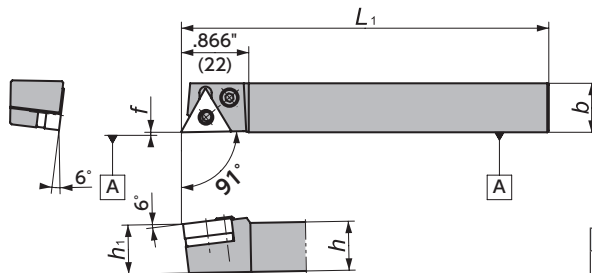

Shim	Clamp Pin	Spring
LST317	LCL3	LSP3

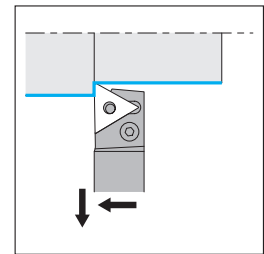

Right-Hand style shown

Figure-2

PTLN

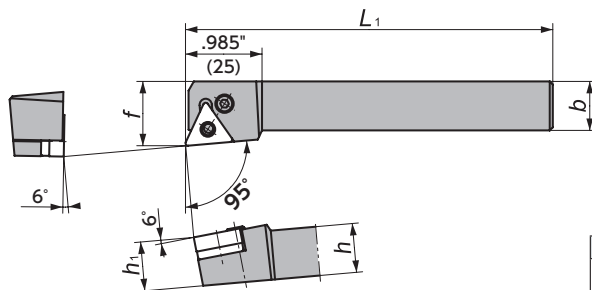

Shim	Clamp Pin	Spring
LST317	LCL3	LSP3

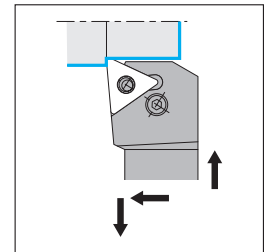

Right-Hand style shown

Figure-3

DS-PTX

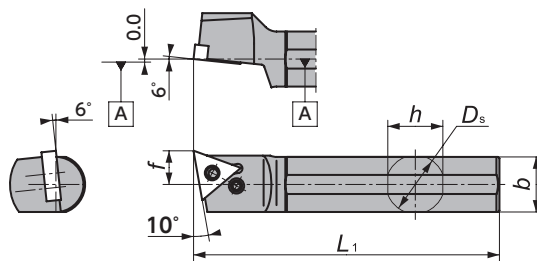

Shim	Clamp Pin	Spring
—	LCL33N	—

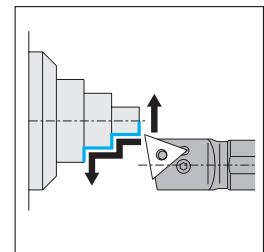

Left-Hand style shown
Takes Right-hand or Neutral insert

Figure-4

DS-PTX-ACH (Adjustable centerline height)

<Parts>

Shank	Wedge	Screw for Wedge
φ .630" (16)	ACH-W18 (5805601)	WS060415-003 (5795539)
φ 3/4" (19.05)		
φ .787" (20)		
φ .866" (22)	ACH-W24 (5805619)	WS060419-004 (5799226)
φ 1" (25.4)		

Shim	Clamp Pin	Spring
—	LCL33N	—

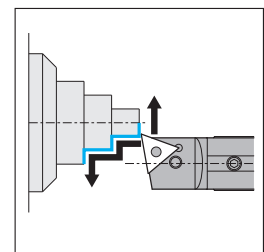
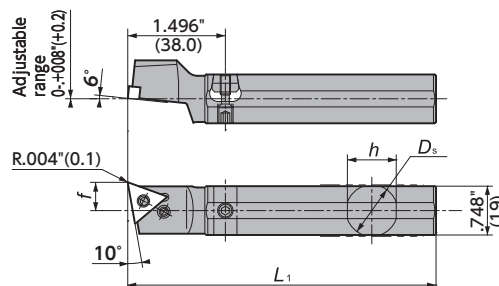

Left-Hand style shown
Takes Right-hand or Neutral insert

Figure-5

TN.. Series - Toolholders



PTXN-N / PTAN-N / PTLN

Gage Insert	Item Number	Figure	Stock		h		b		h_1		L_1		h_2		f		Clamp Screw	Wrench
			R	L	(Inch)	(mm)	(Inch)	(mm)	(Inch)	(mm)	(Inch)	(mm)	(Inch)	(mm)	(Inch)	(mm)		
TN..33..	PTXN%063C	1	●		3/8	5/8	3/8	5/8	3/8	5/8	4.724	120	.097	2.475	0.0	0.0	LCS33	LW-2
	PTXN%083C	1	●		1/2	5/8	1/2	5/8	1/2	5/8	4.724	120	—	—	0.0	0.0	LCS33	LW-2
	PTXN%103C	1	●		5/8	5/8	5/8	5/8	5/8	5/8	4.724	120	—	—	0.0	0.0	LCS33	LW-2
TN..33..	PTXN%1016X33N	1	○		.394	10.0	.630	16	.394	10	4.724	120	.079	2	0.0	0.0	LCS33	LW-2
	PTXN%1216X33N	1	●		.472	12.0	.630	16	.472	12	4.724	120	—	—	0.0	0.0	LCS33	LW-2
	PTXN%1616X33N	1	○		.630	16.0	.630	16	.630	16	4.724	120	—	—	0.0	0.0	LCS33	LW-2
	PTXN%2020X33N	1	○		.787	20.0	.787	20	.787	20	4.724	120	—	—	0.0	0.0	LCS33	LW-2
TN..33..	PTAN%1616X33N	2	○		.630	16.0	.630	16	.630	16	4.724	120	—	—	0.0	0.0	LCS3	LW-2.5
TN..33..	PTLN%2020L33	3	○	○	.787	20.0	.787	20	.787	20	5.512	140	—	—	.984	25	LCS3	LW-2.5



DS-PTX / DS-PTX-ACH

Gage Insert	Item Number	Figure	Stock		D_s		h		b		L_1		f		Clamp Screw	Wrench
			R	L	(Inch)	(mm)	(Inch)	(mm)	(Inch)	(mm)	(Inch)	(mm)	(Inch)	(mm)		
TN..33..	DS-PTX%19-33	4		○	3/4	19.050	.709	18.0	.709	18	4.724	120	.433	11.0	LCS33	LW-2
	DS-PTX%20-33	4		○	.787	20.000	.748	19.0	.748	19	4.724	120	.433	11.0	LCS33	LW-2
	DS-PTX%22-33	4		○	.866	22.000	.827	21.0	.827	21	4.724	120	.472	12.0	LCS33	LW-2
	DS-PTX%25M-33	4		○	1	25.400	.945	24.0	.945	24	5.906	150	.512	13.0	LCS33	LW-2
TN..33..	DS-PTX%16-33-ACH	5		●	.630	16.000	.610	15.5	.591	15	4.724	120	.433	11.0	LCS33	LW-2
	DS-PTX%19-33-ACH	5		●	3/4	19.050	.709	18.0	.709	18	4.724	120	.433	11.0	LCS33	LW-2
	DS-PTX%20-33-ACH	5		●	.787	20.000	.748	19.0	.748	19	4.724	120	.433	11.0	LCS33	LW-2
	DS-PTX%22-33-ACH	5		●	.866	22.000	.827	21.0	.827	21	4.724	120	.472	12.0	LCS33	LW-2
	DS-PTX%25-33MET-ACH	1		●	1	25.000	.945	24.0	.945	24	4.724	120	.512	13.0	LCS33	LW-2
	DS-PTX%25-33-ACH	5		●	1	25.400	.945	24.0	.945	24	5.906	150	.512	13.0	LCS33	LW-2

Note: All angles shown are obtained when insert is set in the holder

● : Stock ○ : 1-2 week delivery

Inserts [→Q36](#)
Cutting condition [→Q4](#)

Front Turning

Front Turning

Toolholders for DN.. Inserts

PDJN-N

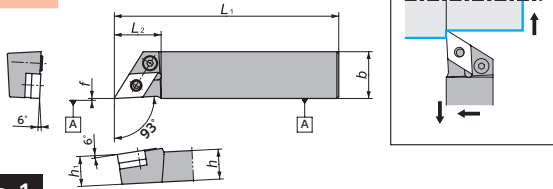

Figure-1

Right-Hand style shown

PDJN

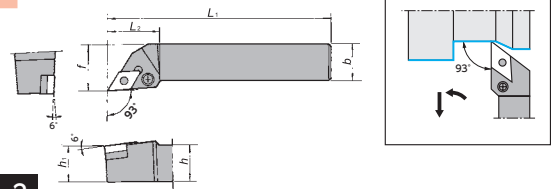
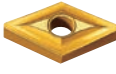

Figure-2

Right-Hand style shown



Gage Insert	Item Number	Figure	Stock		h (Inch) (mm)	b (Inch) (mm)	h ₁ (Inch) (mm)	L ₁ (Inch) (mm)	f (Inch) (mm)	L ₂ (Inch) (mm)	Shim	Clamp Pin	Clamp Screw	Spring	Wrench
			R	L											
 DN..43..	PDJN%{1625X43N	1	○		.630 16	.984 25	.630 16	4.724 120	0.0 0.0	.984 25	LSD42	LCL4	LCS4CA	LSP4	LW-3
	PDJN%{2020K43	2	○	○	.787 20	.787 20	.787 20	4.921 125	.984 25	1.260 32	LSD42	LCL4	LCS4	LSP4	LW-3
	PDJN%{2525M43	2	○		.984 25	.984 25	.984 25	5.906 150	1.260 32	1.260 32	LSD42	LCL4	LCS4	LSP4	LW-3



Note: All angles shown are obtained when insert is set in the holder

DN.. Inserts

[Molded Chipbreakers]

(inch)	IC	T
DN..43	1/2	3/16

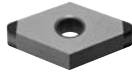
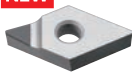
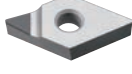
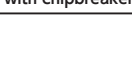
Shape	Item Number	ISO Item Number	IC	R	Material										Depth of cut (inch)	Feed (IPR)												
					Steel	Stainless Steel	Cast Iron	Non-Ferrous Material	Heat Resistant Alloy	Hardened Material	Carbide						Cermets											
					P	M	K	N	S	H	Q	T	M	V			Z	K	X	C	X	Q	C					
	DNGG 431 FNZP	DNGG 150404 FNZP	1/2	.016	●	●	●	●	●	●	●	●	●	●	●	●	●	●	●	●	●	●	●	●	●	●	●	
	DNGG 432 FNZP	DNGG 150408 FNZP	1/2	.031	●	●	●	●	●	●	●	●	●	●	●	●	●	●	●	●	●	●	●	●	●	●	●	
	DNGG 4304 FNZF1 DNGG 4308 FNZF1 DNGG 431 FNZF1 DNGG 432 FNZF1	DNGG 150401 FNZF1 DNGG 150402 FNZF1 DNGG 150404 FNZF1 DNGG 150408 FNZF1	1/2 1/2 1/2 1/2	.004 .008 .016 .031	●	●	●	●	●	●	●	●	●	●	●	●	●	●	●	●	●	●	●	●	●	●	●	●

Shape	Item Number	ISO Item Number	Edge Prep.	IC	R	No. of edge	Length of edge	Material										PCD									
								Steel	Stainless Steel	Cast Iron	Non-Ferrous Material	Heat Resistant Alloy	Hardened Material	CBN (Brazed)													
								P	M	K	N	S	H	B5K	B52	B6K	B36	B40	B23	B30	PD1	PD2					
	DNGA 4308 PQ	DNGA 150402 PQ	S0415	1/2	.008	4	.094	●	●	●	●	●	●	●	●	●	●	●	●	●	●	●	●	●	●	●	●
	DNGA 4308 PQ	DNGA 150402 PQ	S0635	1/2	.008	4	.094	●	●	●	●	●	●	●	●	●	●	●	●	●	●	●	●	●	●	●	●
	DNGA 431 PQ	DNGA 150404 PQ	S0415	1/2	.016	4	.087	●	●	●	●	●	●	●	●	●	●	●	●	●	●	●	●	●	●	●	●
	DNGA 431 PQ	DNGA 150404 PQ	S0525	1/2	.016	4	.087	●	●	●	●	●	●	●	●	●	●	●	●	●	●	●	●	●	●	●	●
	DNGA 431 PQ	DNGA 150404 PQ	S0635	1/2	.016	4	.087	●	●	●	●	●	●	●	●	●	●	●	●	●	●	●	●	●	●	●	●
	DNGA 432 PQ	DNGA 150408 PQ	S0415	1/2	.031	4	.075	●	●	●	●	●	●	●	●	●	●	●	●	●	●	●	●	●	●	●	●
	DNGA 432 PQ	DNGA 150408 PQ	S0420	1/2	.031	4	.075	●	●	●	●	●	●	●	●	●	●	●	●	●	●	●	●	●	●	●	●
	DNGA 432 PQ	DNGA 150408 PQ	T0420	1/2	.031	4	.075	●	●	●	●	●	●	●	●	●	●	●	●	●	●	●	●	●	●	●	●
	DNGA 432 PQ	DNGA 150408 PQ	S0525	1/2	.031	4	.075	●	●	●	●	●	●	●	●	●	●	●	●	●	●	●	●	●	●	●	●
	DNGA 432 PQ	DNGA 150408 PQ	S0635	1/2	.031	4	.075	●	●	●	●	●	●	●	●	●	●	●	●	●	●	●	●	●	●	●	●
	DNGA 433 PQ	DNGA 150412 PQ	S0415	1/2	.047	4	.102	●	●	●	●	●	●	●	●	●	●	●	●	●	●	●	●	●	●	●	●
	DNGA 433 PQ	DNGA 150412 PQ	S0420	1/2	.047	4	.102	●	●	●	●	●	●	●	●	●	●	●	●	●	●	●	●	●	●	●	●
DNGA 433 PQ	DNGA 150412 PQ	T0420	1/2	.047	4	.102	●	●	●	●	●	●	●	●	●	●	●	●	●	●	●	●	●	●	●	●	
DNGA 433 PQ	DNGA 150412 PQ	S0525	1/2	.047	4	.087	●	●	●	●	●	●	●	●	●	●	●	●	●	●	●	●	●	●	●	●	
DNGA 433 PQ	DNGA 150412 PQ	S0635	1/2	.047	4	.102	●	●	●	●	●	●	●	●	●	●	●	●	●	●	●	●	●	●	●	●	
	DNGA 4308 PQ	DNGA 150402 PQ	S0415	1/2	.008	4	.094	●	●	●	●	●	●	●	●	●	●	●	●	●	●	●	●	●	●	●	●
NEW 	DNGA 4308 PQ	DNGA 150402 PQ	S0635	1/2	.008	4	.094	●	●	●	●	●	●	●	●	●	●	●	●	●	●	●	●	●	●	●	●
NEW 	DNGA 4308 PQ	DNGA 150402 PQ	S0525	1/2	.016	4	.087	●	●	●	●	●	●	●	●	●	●	●	●	●	●	●	●	●	●	●	●
NEW 	DNGA 4308 PQ	DNGA 150402 PQ	S0635	1/2	.016	4	.087	●	●	●	●	●	●	●	●	●	●	●	●	●	●	●	●	●	●	●	●
NEW 	DNGA 4308 PQ	DNGA 150402 PQ	S0420	1/2	.031	4	.075	●	●	●	●	●	●	●	●	●	●	●	●	●	●	●	●	●	●	●	●
NEW 	DNGA 4308 PQ	DNGA 150402 PQ	T0420	1/2	.031	4	.075	●	●	●	●	●	●	●	●	●	●	●	●	●	●	●	●	●	●	●	●
NEW 	DNGA 4308 PQ	DNGA 150402 PQ	S0525	1/2	.031	4	.075	●	●	●	●	●	●	●	●	●	●	●	●	●	●	●	●	●	●	●	●
NEW 	DNGA 4308 PQ	DNGA 150402 PQ	S0635	1/2	.031	4	.075	●	●	●	●	●	●	●	●	●	●	●	●	●	●	●	●	●	●	●	●
NEW 	DNGA 4308 PQ	DNGA 150412 PQ	S0415	1/2	.047	4	.102	●	●	●	●	●	●	●	●	●	●	●	●	●	●	●	●	●	●	●	●
NEW 	DNGA 4308 PQ	DNGA 150412 PQ	S0420	1/2	.047	4	.102	●	●	●	●	●	●	●	●	●	●	●	●	●	●	●	●	●	●	●	●
NEW 	DNGA 4308 PQ	DNGA 150412 PQ	T0420	1/2	.047	4	.102	●	●	●	●	●	●	●	●	●	●	●	●	●	●	●	●	●	●	●	●
NEW 	DNGA 4308 PQ	DNGA 150412 PQ	S0525	1/2	.047	4	.087	●	●	●	●	●	●	●	●	●	●	●	●	●	●	●	●	●	●	●	●
NEW 	DNGA 4308 PQ	DNGA 150412 PQ	S0635	1/2	.047	4	.102	●	●	●	●	●	●	●	●	●	●	●	●	●	●	●	●	●	●	●	●
NEW 	DNGA 4308 PQ	DNGA 150404 PF	none	1/2	.016	1	-	●	●	●	●	●	●	●	●	●	●	●	●	●	●	●	●	●	●	●	●
NEW 	DNGA 4308 PQ	DNGA 150408 PF	none	1/2	.031	1	-	●	●	●	●	●	●	●	●	●	●	●	●	●	●	●	●	●	●	●	●

Cutting condition →Q4 Chipbreaker →P24

R





Back Turning



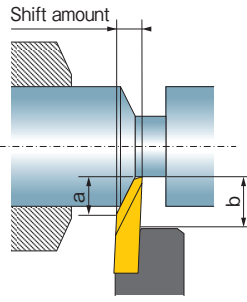
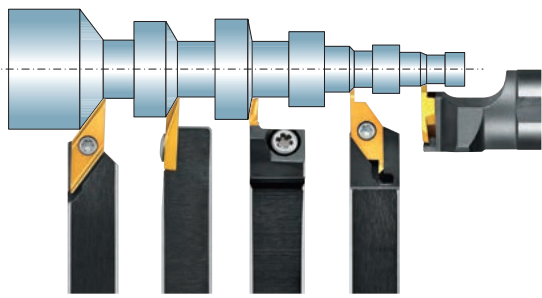



- **Back Turning Tools** R2
- **Recommended Cutting conditions**..... R3
- **General Information** R4
- **Tool list** R6
 - CSV Series R6
 - CTPS Series R7
 - TBP Series R8
 - TBPA Series R10
 - TBDP Series R12
 - SVAC Series R13
 - TBVC Series R14
 - TB Series R16
 - TBMH Series R18





NTK Back Turning Tools - Product Lines







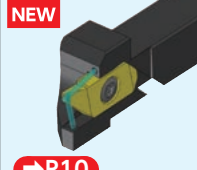

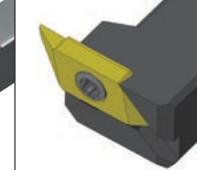
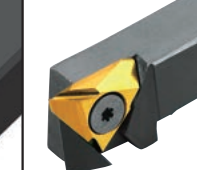

a: Length of Blade
b: Max Depth of Cut

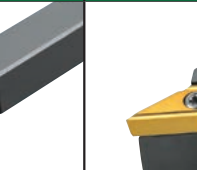
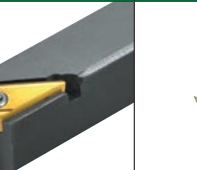
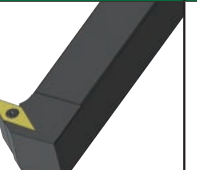
Insert	CSVB →R6	
	CSV-NC	DS-CSV
Holder	 →R6	 →R6
a	~.039" (~1.0mm)	
b	~.079" (~2.0mm)	
Shift amount	.043"-.055" (1.1-1.5mm)	

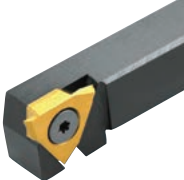
Insert	CTPS →R7		TBP →R9			
	CTPS	TBP	TBP-OH	Y-TBP	Y-TBP-OH	DS-TBP
Holder	 →R7	 →R8	 →R8 NEW Coolant through	 →R8	 →R8 NEW Y-axis w/ Coolant through	 →R9
a	~.189" (~4.8mm)			~.189" (~4.8mm)		
b	~.189" (~4.8mm)			~.209" (~5.3mm)		
Shift amount	.094" (2.4mm)			.138" (3.5mm)		

Insert	TBPA →R11				TB →R17	
	CTPA	CTPA-OH	TBPA-OH	Y-CTPA	CH-TBPA	TB
Holder	 →R10	 →R10 NEW Coolant through	 →R10 NEW Coolant through	 →R10	 →R10	 →R16
a			~.248" (~6.3mm)			~.157" (~4.0mm)
b			~.268" (~6.8mm)			~.335" (~8.8mm)
Shift amount			.134" (3.4mm)			.157" (4.0mm)

Insert	TBDP →R12		VC..22 →R15		VCGT1303 →R13
	TBDP	Y-TBDP	TBVC →R14	CH-SVXCL	SVAC-W
Holder	 →R12	 →R12 NEW Y-axis	 →R14	 →R14	 →R13 91°
a	.138" (3.5mm)		.315" (8.0mm)	—	—
b	~.204" (~5.0mm)		.315" (8.0mm)	—	—
Shift amount	.081" (2.05mm)		.295"/.394" (7.5/10mm)	.394" (10mm)	—

Insert	TBMH →R19					
Holder	GTT	GTT-OH	Y-GTT	Y-GTT-OH	DS-GTT	CH-GTT
						
	→R18	NEW →R18 Coolant through	→R18 Y-axis	NEW →R18 Y-axis w/ Coolant through	→R18	→R18
a	~.051" (~1.3mm)					
b	~.106" (~2.7mm)					
Shift amount	.039"/.059" (1.0/1.5mm)					

Recommended Cutting conditions

■ Back Turning

CSVB

Work Material	High Temperature Alloys	Titanium Alloys	Cobalt Chrome Alloys	Stainless Steels		Alloy Steels	Carbon Steels
	Inconel Hastelloy MP35N	Ti-6Al-4V	ASTM F-75	Hard to cut 304 316 17-4PH	Free cutting 303 430F	5120 4137	1045 1046
Grade	1st choice	DT4				VM1	
	2nd choice	VM1				DT4	
Cutting Speed (SFM)	75 125 225	100 200 275			100 200 300		
Feed Rate (IPR)	X Direction	.0004 .0008 .0012					
	Z Direction	.0004 .0012 .0016					

TBDP / TBMH / TBP / TBPA / TBVC

Work Material	High Temperature Alloys	Titanium Alloys	Cobalt Chrome Alloys	Stainless Steels		Alloy Steels	Carbon Steels
	Inconel Hastelloy MP35N	Ti-6Al-4V	ASTM F-75	Hard to cut 304 316 17-4PH	Free cutting 303 430F	5120 4137	1045 1046
Grade	1st choice	DT4		DT4 / QM3	TM4	QM3	
	2nd choice	TM4 / QM3		VM1	QM3	TM4 / DT4 / C7Z(X)	
Cutting Speed (SFM)	75 125 225	100 200 275			150 300 500		
Feed Rate (IPR)	X Direction	.0004 .0008 .0012				.0004 .0008 .0016	
	Z Direction	.0008 .0016 .0024				.0008 .0016 .0031	

TB32 / TB43

Work Material	High Temperature Alloys	Titanium Alloys	Cobalt Chrome Alloys	Stainless Steels		Alloy Steels	Carbon Steels	
	Inconel Hastelloy MP35N	Ti-6Al-4V	ASTM F-75	Hard to cut 304 316 17-4PH	Free cutting 303 430F	5120 4137	1045 1046	
Grade	1st choice	ZM3					ZM3	
	2nd choice	ZM3					Z15	
Cutting Speed (SFM)	50 100 150			ZM3 150 300 425 Z15 400 600 800				
Feed Rate (IPR)	X Direction	.0004 .0012 .0020				.0004 .0012 .0020		
	Z Direction	.0016 .0020 .0031				.0016 .0031 .0059		

Back Turning

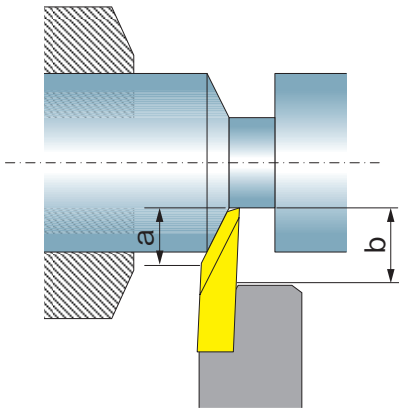

Recommended max. depth of cut for each pass

(Multiply this ratio by the length of blade (a) to obtain the max. depth of cut for each pass)

Grade Work material	PVD Coated Carbide QM3·DT4·DM4·TM4·VM1·ZM3	Cermet XT3 · XN4
Steel	.028" (0.7mm)	.020" (0.5mm)
Stainless Steel	.024" (0.6mm)	.016" (0.4mm)
Non-ferrous material	.035" (0.9mm)	.031" (0.8mm)
Plastic	.035" (0.9mm)	.035" (0.9mm)

a : Length of Blade b : Max. Depth of Cut

Back Turning

When the length of blade (a) is not long enough

Back turning can be performed multiple times until the total depth of cut reaches (b).

End face	
NTK BM-chipbreaker	Competitor
Excellent surface	Rough surface

When experiencing rough finish on shoulder

Turning the shoulder twice can improve the finish.
This problem can be solved by using TBP-BM, TBPA-BM, TBDP inserts without increasing the number of passes

TBP-BM, TBPA-BM, TBDP come with NTK's uniquely designed molded chipbreaker providing single pass machining. These inserts can provide excellent surface finish.

TBP-BM ➡R9
TBPA-BM ➡R11
TBDP ➡R12

Finishing cut

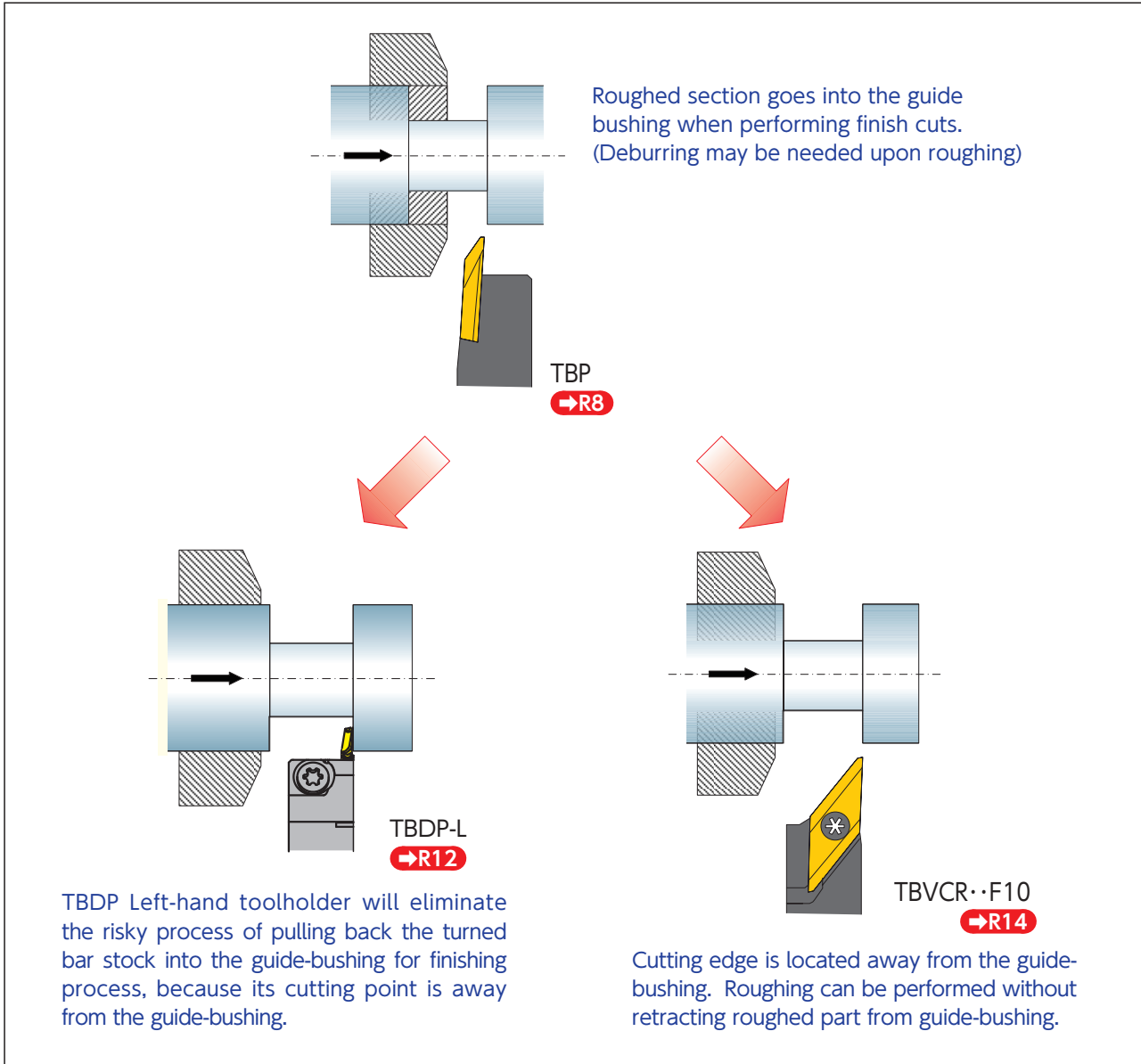

Back Turning

Undercut

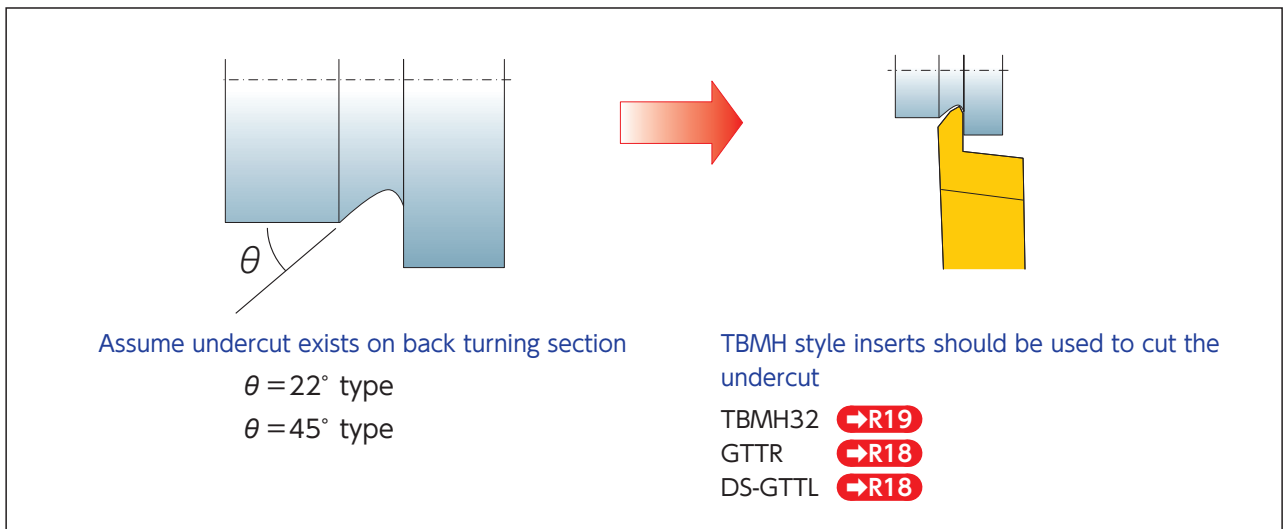

CSV Series

Best for up to .200" diameter material

CSV-NC For Gang-style machine

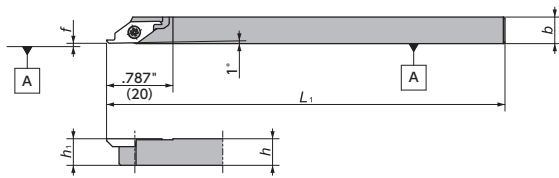

Figure-1

Right-Hand style shown

CSV For Cam-style machine

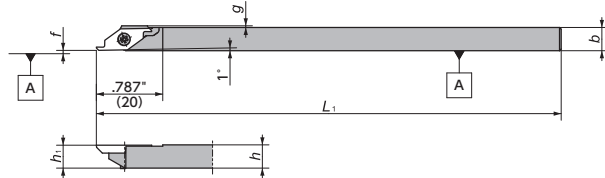

Figure-2

Right-Hand style shown

DS-CSVL

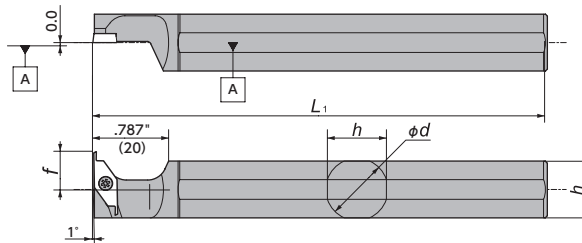



Figure-3

Left-Hand style shown
Takes Right-hand insert

CSV^R/_L / CSV^R/_L-NC

Gage Insert	Item Number	Figure	Stock		h (Inch) (mm)	b (Inch) (mm)	h ₁ (Inch) (mm)	L ₁ (Inch) (mm)	f (Inch) (mm)	g (Inch) (mm)	Clamp Screw	Wrench
			R	L								
	CSV ^R / _L 06-IN-NC	1	●	●	3/8	3/8	3/8	4.724 120	.004 0.1	0.0 0.0	LRIS-2.5 × 7	CLR-15S
	CSV ^R / _L 08-IN-NC	1	●	●	1/2	1/2	1/2	4.724 120	.004 0.1	0.0 0.0	LRIS-2.5 × 7	CLR-15S
	CSV ^R / _L 08NC	1	○	○	.315 8	.315 8	.315 8	4.724 120	.004 0.1	0.0 0.0	LRIS-2.5 × 7	CLR-15S
	CSV ^R / _L 08NC-F	1	○	○	.315 8	.315 8	.315 8	4.724 120	0-.004 0.0-0.1	0.0 0.0	LRIS-2.5 × 7	CLR-15S
	CSV ^R / _L 10GXNC	1	○	○	.394 10	.394 10	.394 10	3.346 85	.004 0.1	0.0 0.0	LRIS-2.5 × 7	CLR-15S
	CSV ^R / _L 10NC	1	○	○	.394 10	.394 10	.394 10	4.724 120	.004 0.1	0.0 0.0	LRIS-2.5 × 7	CLR-15S
	CSV ^R / _L 12NC	1	○	○	.472 12	.472 12	.472 12	4.724 120	.004 0.1	0.0 0.0	LRIS-2.5 × 7	CLR-15S
	CSV ^R / _L 07GX	2	○	○	.275 7	.275 7	.275 7	3.346 85	.004 0.1	.020 0.5	LRIS-2.5 × 7	CLR-15S
	CSV ^R / _L 07	2	○	●	.275 7	.275 7	.275 7	5.512 140	.004 0.1	.020 0.5	LRIS-2.5 × 7	CLR-15S
	CSV ^R / _L 08GX	2	○	○	.315 8	.315 8	.315 8	3.346 85	.004 0.1	0.0 0.0	LRIS-2.5 × 7	CLR-15S
	CSV ^R / _L 08	2	○	●	.315 8	.315 8	.315 8	5.512 140	.004 0.1	0.0 0.0	LRIS-2.5 × 7	CLR-15S
	CSV ^R / _L 095	2	○	○	.374 9.5	.374 9.5	.374 9.5	5.512 140	.004 0.1	0.0 0.0	LRIS-2.5 × 7	CLR-15S
	CSV ^R / _L 10	2	○	○	.394 10	.394 10	.394 10	5.512 140	.004 0.1	0.0 0.0	LRIS-2.5 × 7	CLR-15S
	CSV ^R / _L 12GX	2	○	○	.472 12	.472 12	.472 12	3.346 85	.004 0.1	0.0 0.0	LRIS-2.5 × 7	CLR-15S
CSV ^R / _L 12	2	○	●	.472 12	.472 12	.472 12	5.512 140	.004 0.1	0.0 0.0	LRIS-2.5 × 7	CLR-15S	

DS-CSVL (Takes right-hand insert)

Gage Insert	Item Number	Figure	Stock		D _s (Inch) (mm)	h (Inch) (mm)	b (Inch) (mm)	L ₁ (Inch) (mm)	f (Inch) (mm)	Clamp Screw	Wrench
			R	L							
	DS-CSVL15	3	●		5/8 15.875	.591 15	.591 15	4.724 120	.394 10	LRIS-2.5 × 7	CLR-15S

CSVB - Back Turning

Mirror finish

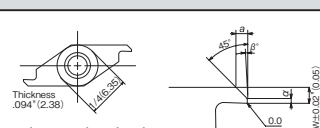
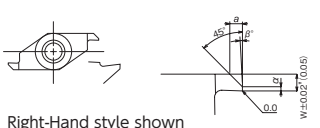
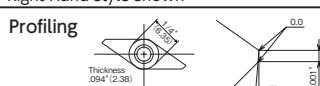
Shape	Item Number	Chip-breaker	Length of Blade		Max Depth of Cut		W		Edge Geometry (α × β°)		Coated Carbide					
			(Inch) (mm)		(Inch) (mm)		(Inch) (mm)		(Inch) (mm)		DT4		VM1		ZM3	
			R	L	R	L	R	L	R	L	R	L	R	L		
 <p>Right-Hand style shown</p>	CSVB11F ^R / _L V	No	.028 0.7	.079 2.0	.039 1.00	.012 × 5°	0.3 × 5°									
	CSVB11F ^R / _L V-A	No	.028 0.7	.079 2.0	.039 1.00	.012 × 2°	0.3 × 2°									
	CSVB11F ^R / _L V-M	No	.028 0.7	.079 2.0	.039 1.00	.006 × 2°	0.15 × 2°	●	●	○	○					
	CSVB11F ^R / _L V-C	No	.028 0.7	.079 2.0	.039 1.00	.006 × 5°	0.15 × 5°									
	CSVB11F ^R / _L V12	No	.031 0.8	.079 2.0	.047 1.20	.012 × 5°	0.3 × 5°									
	CSVB11F ^R / _L V14	No	.039 1.0	.079 2.0	.055 1.40	.012 × 5°	0.3 × 5°									
 <p>Right-Hand style shown</p>	CSVB11F ^R / _L VB	Yes	.028 0.7	.079 2.0	.039 1.00	.012 × 5°	0.3 × 5°									
	CSVB11F ^R / _L VB-A	Yes	.028 0.7	.079 2.0	.039 1.00	.012 × 2°	0.3 × 2°									
	CSVB11F ^R / _L VB-M	Yes	.028 0.7	.079 2.0	.039 1.00	.006 × 2°	0.15 × 2°	●	●	○	○					
	CSVB11F ^R / _L VB-C	Yes	.028 0.7	.079 2.0	.039 1.00	.006 × 5°	0.15 × 5°									
	CSVB11F ^R / _L VB12	Yes	.031 0.8	.079 2.0	.047 1.20	.012 × 2°	0.3 × 5°									
	CSVB11F ^R / _L VB14	Yes	.039 1.0	.079 2.0	.055 1.40	.012 × 2°	0.3 × 5°									
<p>Profiling</p>  <p>Left-Hand style shown</p>	CSVB11F ^R / _L VX	No	-	-	-	-	-	-	-	-						

Note: All angles shown are obtained when insert is set in the holder

CTPS Series

CTPS

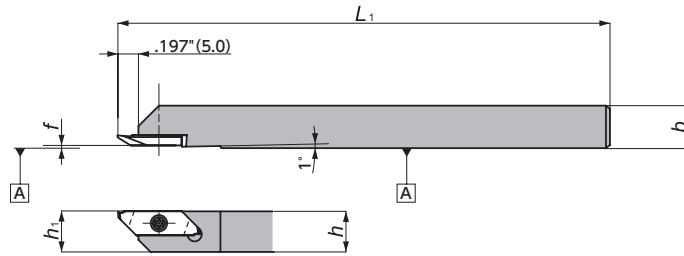



Figure-1

Right-Hand style shown

CTPS Series - Toolholders

CTPS

Gage Insert	Item Number	Figure	Stock	h (Inch) (mm)	b (Inch) (mm)	h_1 (Inch) (mm)	L_1 (Inch) (mm)	f (Inch) (mm)	Clamp Screw	Wrench
	CTPSR06-IN	1	●	3/8	3/8	3/8	4.724 120	0.0 0.0	LRIS-2.5 × 7	CLR-15S
	CTPSR08-IN	1	●	1/2	1/2	1/2	4.724 120	0.0 0.0	LRIS-2.5 × 7	CLR-15S
	CTPSR10	1	○	.394 10	.394 10	.394 10	4.724 120	0.0 0.0	LRIS-2.5 × 7	CLR-15S
	CTPSR12	1	○	.472 12	.472 12	.472 12	4.724 120	0.0 0.0	LRIS-2.5 × 7	CLR-15S

Back Turning

TBPS Series - Inserts

TBPS - Back Turning

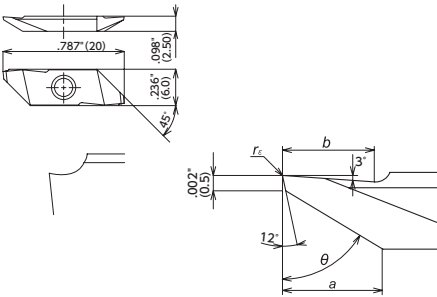
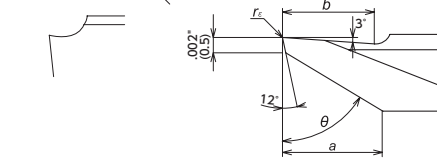
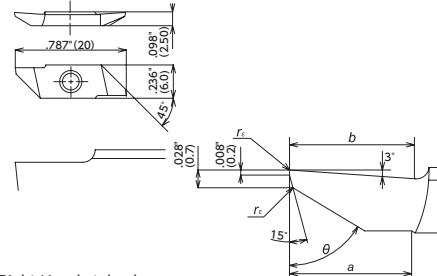
Shape	Item Number	Chip-breaker	Length of Blade a		Max Depth of Cut b		θ	r_c		Coated Carbide	
			(Inch)	(mm)	(Inch)	(mm)		(Inch)	(mm)	VM1	ZM3
with Chipbreaker 	TBPS60FR00	Yes	.122	3.1	.138	3.5	60°	0.0 0.0	○	○	
Right-Hand style shown 	TBPS60FR10	Yes	.122	3.1	.138	3.5	60°	.004 0.1	○	○	
without Chipbreaker Mirror finish 	TBPS60FRV ^M	No	.189	4.8	.189	4.8	60°	0.0 0.0	○	○	
Right-Hand style shown											

Note: All angles shown are obtained when insert is set in the holder

● : Stock

○ : 1-2 week delivery

^M : Mirror finish

CTPS series **→O31**

Cutting condition **→R3**

TBP Series

TBP

Screw accessible from both sides

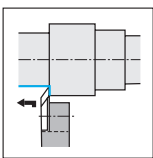
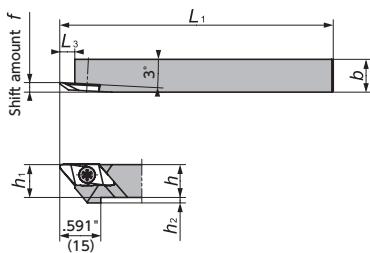

Figure-1

Right-Hand style shown

TBP-OH (Coolant through)

Screw accessible from both sides

NEW

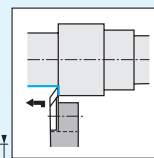
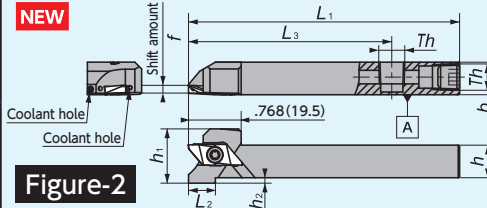

Figure-2

Th (Thread type)
 3/8" holder : M6×1
 1/2", 5/8" holder : NPT1/8
 Metric size holder : Rc1/8 (PT1/8)

Right-Hand style shown

Y-TBP

Screw accessible from both sides

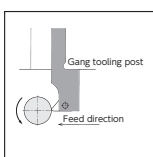
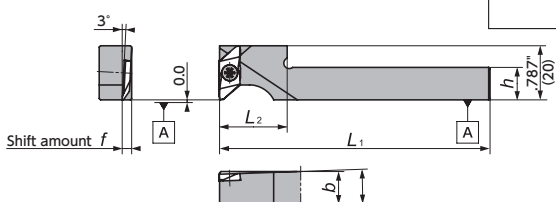

Figure-3

Right-Hand style shown
 Takes Right-hand Insert

Y-TBP-OH (Coolant through)

Screw accessible from both sides

NEW

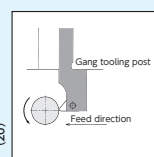
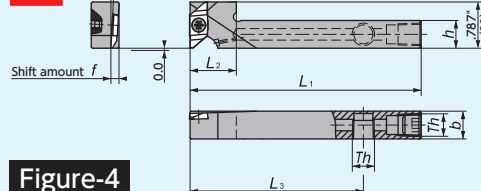



Figure-4

Th (Thread type)
 Inch size holder : NPT1/8
 Metric size holder: M6, Rc1/8 (PT1/8)

Right-Hand style shown
 Takes Right-hand Insert

TBP Series - Toolholders

TBP

Gage Insert	Item Number	Figure	Stock		h (Inch) (mm)	b (Inch) (mm)	h ₁ (Inch) (mm)	L ₁ (Inch) (mm)	f (Inch) (mm)	L ₂ (Inch) (mm)	h ₂ (Inch) (mm)	L ₃ (Inch) (mm)	Th	Clamp Screw	Wrench		
			R	L													
	TBP $\frac{1}{8}$ 06-IN	1	●		3/8	3/8	3/8	4.724 120	.138 3.5	—	—	.079 2	.217 5.5	—	LRIS-4 × 10PW	CLR-15S	
	TBP $\frac{1}{8}$ 08-IN	1	●		1/2	1/2	1/2	4.724 120	.138 3.5	—	—	0 0	.217 5.5	—	LRIS-4 × 12PW	CLR-15S	
	TBP $\frac{1}{8}$ 10-IN	1	●		5/8	5/8	5/8	4.724 120	.138 3.5	—	—	0 0	.217 5.5	—	LRIS-4 × 12PW	CLR-15S	
	TBP $\frac{1}{8}$ 08	1	○	○	.315 8	.394 10	.315 8	4.724 120	.138 3.5	—	—	.157 4	.217 5.5	—	LRIS-4 × 10PW	CLR-15S	
	TBP $\frac{1}{8}$ 10H	1	○	○	.394 10	.394 10	.394 10	3.937 100	.138 3.5	—	—	.394 2	.217 5.5	—	LRIS-4 × 10PW	CLR-15S	
	TBP $\frac{1}{8}$ 10	1	○	○	.394 10	.394 10	.394 10	4.724 120	.138 3.5	—	—	.394 2	.217 5.5	—	LRIS-4 × 10PW	CLR-15S	
	TBP $\frac{1}{8}$ 12GX	1	○	○	.472 12	.472 12	.472 12	3.346 85	.138 3.5	—	—	0 0	.217 5.5	—	LRIS-4 × 12PW	CLR-15S	
	TBP $\frac{1}{8}$ 12	1	●	○	.472 12	.472 12	.472 12	4.724 120	.138 3.5	—	—	0 0	.217 5.5	—	LRIS-4 × 12PW	CLR-15S	
	TBP $\frac{1}{8}$ 13	1	○	○	.512 13	.512 13	.512 13	4.724 120	.138 3.5	—	—	0 0	.217 5.5	—	LRIS-4 × 12PW	CLR-15S	
	TBP $\frac{1}{8}$ 16H	1	○	○	.630 16	.630 16	.630 16	3.937 100	.138 3.5	—	—	0 0	.217 5.5	—	LRIS-4 × 12PW	CLR-15S	
	TBP $\frac{1}{8}$ 16	1	○	○	.630 16	.630 16	.630 16	4.724 120	.138 3.5	—	—	0 0	.217 5.5	—	LRIS-4 × 12PW	CLR-15S	
	TBP $\frac{1}{8}$ 06-IN-OH	2	●		3/8	.472 12	3/8	3.937 100	.138 3.5	.748 19	.176 4.475	2.953 75		M6 × 1	LRIS-4 × 10PW	CLR-15S	
	TBP $\frac{1}{8}$ 08-IN-OH	2	●		1/2	1/2	1/2	3.937 100	.138 3.5	.394 10	.051 1.3	2.953 75		NPT1/8	LRIS-4 × 12PW	CLR-15S	
	TBP $\frac{1}{8}$ 10-IN-OH	2	●		5/8	5/8	5/8	3.937 100	.138 3.5	0 0	0 0	2.953 75		NPT1/8	LRIS-4 × 12PW	CLR-15S	
	TBP $\frac{1}{8}$ 1012H-OH	2	○	○	.394 10	.472 12	.394 10	3.937 100	.138 3.5	.748 19	.176 4.475	2.953 75		M6 × 1	LRIS-4 × 10PW	CLR-15S	
	TBP $\frac{1}{8}$ 12H-OH	2	●		.472 12	.472 12	.472 12	3.937 100	.138 3.5	.394 10	.051 1.3	2.953 75		Rc1/8(PT1/8)	LRIS-4 × 12PW	CLR-15S	
	TBP $\frac{1}{8}$ 16H-OH	2	○	○	.630 16	.630 16	.630 16	3.937 100	.138 3.5	0 0	0 0	2.953 75		Rc1/8(PT1/8)	LRIS-4 × 12PW	CLR-15S	
	Y-TBP $\frac{1}{8}$ 06-IN	3	●		3/8	3/8	—	2.756 70	.138 3.5	.984 25	—	—	—	—	—	LRIS-4 × 10PW	CLR-15S
	Y-TBP $\frac{1}{8}$ 08-IN	3	●		1/2	1/2	—	2.756 70	.138 3.5	.984 25	—	—	—	—	—	LRIS-4 × 12PW	CLR-15S
	Y-TBP $\frac{1}{8}$ 10-IN	3	●		5/8	5/8	—	2.756 70	.138 3.5	.984 25	—	—	—	—	—	LRIS-4 × 12PW	CLR-15S
Y-TBP $\frac{1}{8}$ 10S	3	○	○	.394 10	.394 10	—	4.724 120	.138 3.5	.787 20	—	—	—	—	—	LRIS-4 × 10PW	CLR-15S	
Y-TBP $\frac{1}{8}$ 12S	3	○	○	.472 12	.472 12	—	4.724 120	.138 3.5	.787 20	—	—	—	—	—	LRIS-4 × 12PW	CLR-15S	
Y-TBP $\frac{1}{8}$ 08H-IN-OH	4	●		1/2	1/2	—	3.937 100	.138 3.5	.984 25	—	—	2.953 75		NPT1/8	LRIS-4 × 12PW	CLR-15S	
Y-TBP $\frac{1}{8}$ 12HS-OH	4	●		.472 12	.472 12	—	3.937 100	.138 3.5	.787 20	—	—	2.953 75		Rc1/8(PT1/8)	LRIS-4 × 12PW	CLR-15S	
Y-TBP $\frac{1}{8}$ 16H-OH	4	○	○	.630 16	.630 16	—	3.937 100	.138 3.5	.984 25	—	—	2.953 75		Rc1/8(PT1/8)	LRIS-4 × 12PW	CLR-15S	

TBPA (CTPA Series) *Can use same holder with CTPA inserts.

CTPA

Screw accessible from both sides

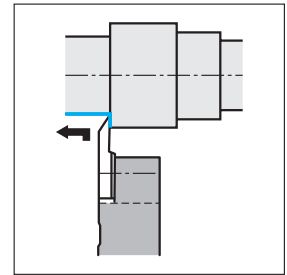
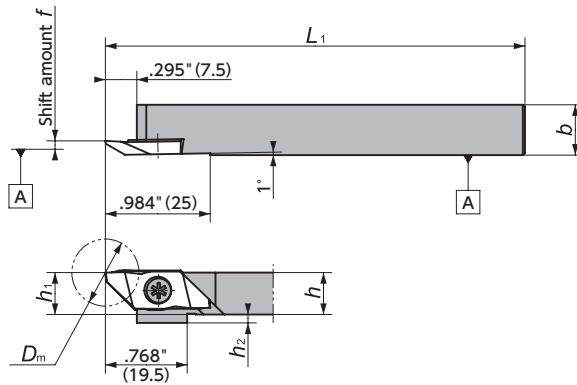

Right-Hand style shown

Figure-1

CTPA-OH / TBPA-OH

Screw accessible from both sides

NEW

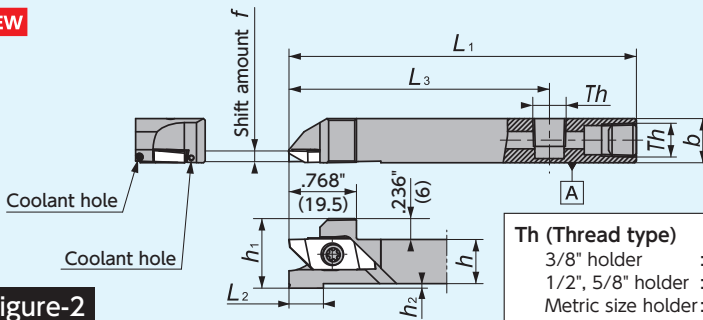

Th (Thread type)
 3/8" holder : M6×1
 1/2", 5/8" holder : NPT1/8
 Metric size holder: Rc1/8 (PT1/8)

Max Bar Dia at Max DOC

CTPA-OH

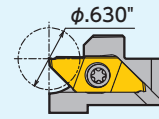

TBPA-OH

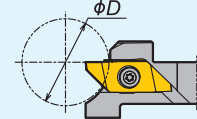

Right-Hand style shown

Figure-2

Y-CTPA

Screw accessible from both sides

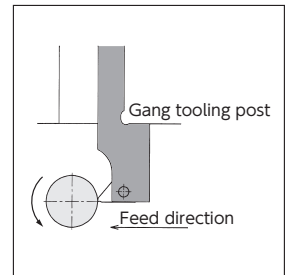
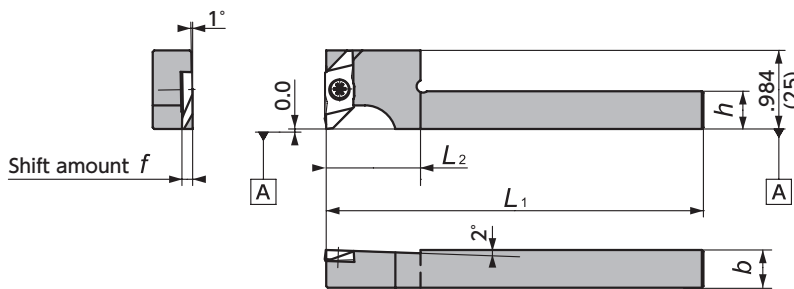

Right-Hand style shown
Takes Right-hand Insert

Figure-3

CH-TBPA

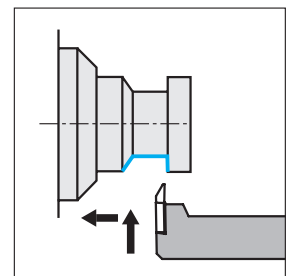
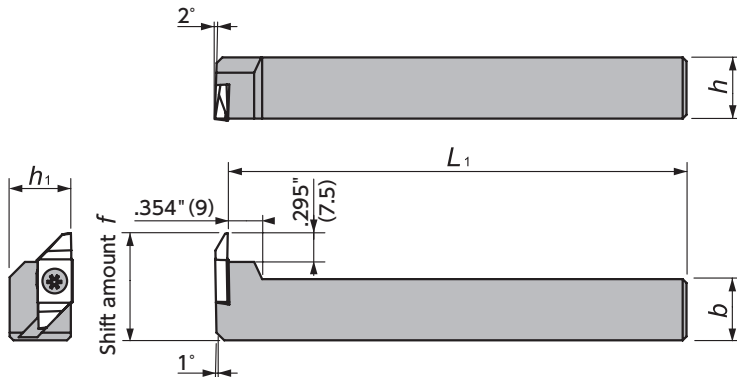

Left-Hand style shown
Takes Right-hand Insert

Figure-4

TBPA (CTPA) Series - Toolholders

CTPA (Compatible with TBPA & CTPA Inserts)

Gage Insert	Item Number	Figure	Stock		Max. Bar Dia. ϕD		h		h_1		b		L_1		h_2		L_2		L_3		Th	f		Clamp Screw	Wrench			
			R	L	(Inch)	(mm)	(Inch)	(mm)	(Inch)	(mm)	(Inch)	(mm)	(Inch)	(mm)	(Inch)	(mm)	(Inch)	(mm)	(Inch)	(mm)		(Inch)	(mm)					
TBPA..	CTPA% ϕ 06-IN	1	●	●	—	—	3/8	3/8	3/8	3/8	4.724	120	0	0	—	—	—	—	—	—	—	.134	3.4	LRIS-4×10PW	CLR-15S			
	CTPA% ϕ 08-IN	1	●	●	—	—	1/2	1/2	1/2	1/2	4.724	120	0	0	—	—	—	—	—	—	—	.134	3.4	LRIS-4×12PW	CLR-15S			
	CTPA% ϕ 10-IN	1	●	●	—	—	5/8	5/8	5/8	5/8	4.724	120	0	0	—	—	—	—	—	—	—	.134	3.4	LRIS-4×12PW	CLR-15S			
	CTPA% ϕ 10	1	○	○	—	—	.394	10	.394	10	.394	10	4.724	120	.790	2	—	—	—	—	—	—	.134	3.4	LRIS-4×10PW	CLR-15S		
	CTPA% ϕ 12	1	●	●	—	—	.472	12	.472	12	.472	12	4.724	120	0	0	—	—	—	—	—	—	.134	3.4	LRIS-4×12PW	CLR-15S		
	CTPA% ϕ 16	1	○	○	—	—	.630	16	.630	16	.630	16	4.724	120	0	0	—	—	—	—	—	—	.134	3.4	LRIS-4×12PW	CLR-15S		
	CTPA% ϕ 20F	1	○	○	—	—	.787	20	.787	20	.787	20	3.150	80	0	0	—	—	—	—	—	—	.134	3.4	LRIS-4×10	LLR-15S		
	CTPA% ϕ 06H-IN-OH	2	●	●	.630	16	3/8	3/8	3/8	3/8	3.937	100	.176	4.475	.787	20	2.165	55	M6×1	—	—	—	.134	3.4	LRIS-4×10PW	CLR-15S		
	CTPA% ϕ 08H-IN-OH	2	●	●	.630	16	1/2	1/2	1/2	1/2	3.937	100	.051	1.3	.394	10	2.953	75	NPT1/8	—	—	—	.134	3.4	LRIS-4×12PW	CLR-15S		
	CTPA% ϕ 10H-IN-OH	2	●	●	.630	16	5/8	5/8	5/8	5/8	3.937	100	0	0	0	0	2.953	75	NPT1/8	—	—	—	.134	3.4	LRIS-4×12PW	CLR-15S		
	CTPA% ϕ 12H-OH	2	●	●	.630	16	.472	12	.472	12	.472	12	3.937	100	.079	2	.768	19.5	.394	10	Rc1/8(PT1/8)	—	—	—	.134	3.4	LRIS-4×12PW	CLR-15S
	CTPA% ϕ 16H-OH	2	○	○	.630	16	.630	16	.630	16	.630	16	3.937	100	0	0	.768	19.5	0	0	Rc1/8(PT1/8)	—	—	—	.134	3.4	LRIS-4×12PW	CLR-15S
	Y-CTPA% ϕ 08L-IN	3	●	—	—	—	1/2	—	—	1/2	4.724	120	—	—	—	—	—	—	—	—	—	—	1.34	34	LRIS-4×12PW	CLR-15S		
	CH-TBPAL16	4	○	—	—	—	.630	16	.630	16	.630	16	4.724	120	—	—	—	—	—	—	—	—	1.102	28	LRIS-4×10	LLR-15S		
CH-TBPAL20	4	○	—	—	—	.787	20	.787	20	.787	20	4.724	120	—	—	—	—	—	—	—	—	1.260	32	LRIS-4×10	LLR-15S			

TBPA (Optimized for TBPA Inserts)

Gage Insert	Item Number	Figure	Stock		Max. Bar Dia. ϕD		h		h_1		b		L_1		h_2		L_2		L_3		Th	f		Clamp Screw	Wrench
			R	L	(Inch)	(mm)	(Inch)	(mm)	(Inch)	(mm)	(Inch)	(mm)	(Inch)	(mm)	(Inch)	(mm)	(Inch)	(mm)	(Inch)	(mm)					
TBPA..	TBPA% ϕ 12H-OH*	2	○	○	.984	25	.472	12	.472	12	.472	12	3.937	100	.157	4	.768	19.5	.394	10	Rc1/8(PT1/8)	.134	3.4	LRIS-4X12PW	CLR-15S
	TBPA% ϕ 16H-OH*	2	○	○	1.378	35	.630	16	.630	16	.630	16	3.937	100	.079	2	.768	19.5	.394	10	Rc1/8(PT1/8)	.134	3.4	LRIS-4X12PW	CLR-15S
	TBPA% ϕ 20H-OH*	2	○	○	1.969	50	.787	20	.787	20	.787	20	3.937	100	0	0	.768	19.5	0	0	Rc1/8(PT1/8)	.134	3.4	LRIS-4X12PW	CLR-15S

*To be released in June 2015.

TBPA Series - Inserts

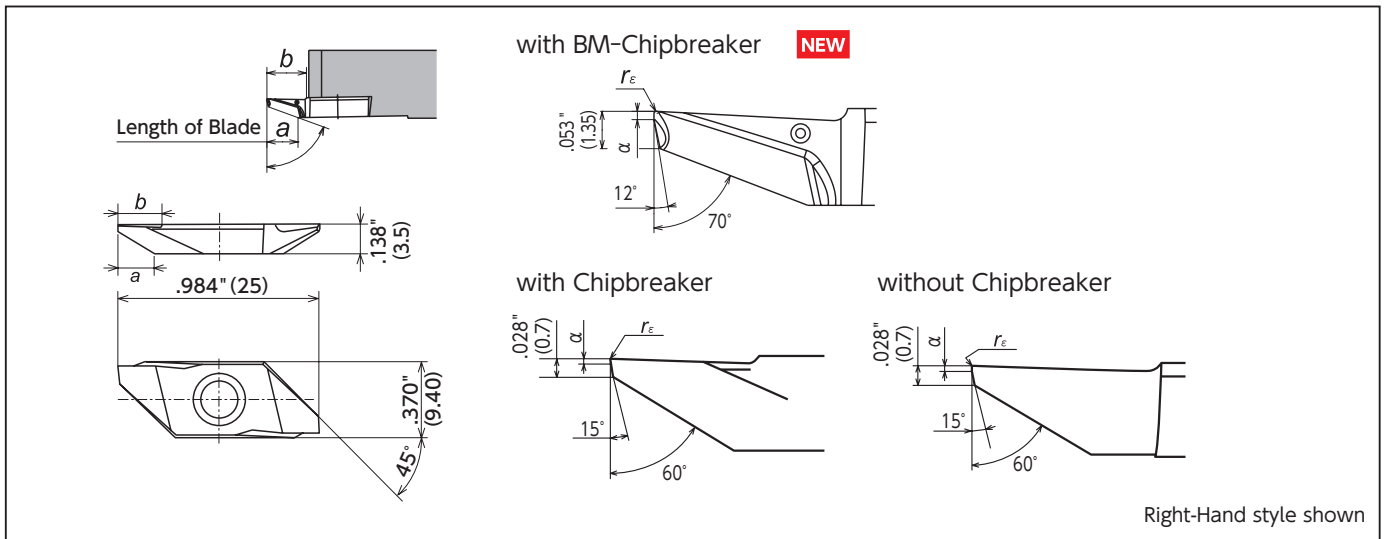

TBPA - Back Turning

Item Number	Chip-breaker	Length of Blade a		Max Depth of Cut b		α		r_ϵ		Coated Carbide													
		(Inch)	(mm)	(Inch)	(mm)	(Inch)	(mm)	(Inch)	(mm)	QM3		DT4		DM4		TM4		VM1		ZM3			
		R	L	R	L	R	L	R	L	R	L	R	L	R	L	R	L	R	L	R	L		
TBPA70F% ϕ 05-BM	Yes-BM	.217	5.5	.256	6.5	.012	0.3	.002	0.05					●		○							
TBPA70F% ϕ 10M-BM	Yes-BM	.217	5.5	.256	6.5	.012	0.3	.003	0.08					●		○							
TBPA70F% ϕ 20M-BM	Yes-BM	.217	5.5	.256	6.5	.012	0.3	.007	0.18					●		○							
TBPA60F% ϕ 10M	Yes	.177	4.5	.209	5.3	.012	0.3	.000	0.00	●		○							○		●	○	
TBPA60F% ϕ 10M	Yes	.177	4.5	.209	5.3	.012	0.3	.003	0.08														
TBPA60F% ϕ 10M	Yes	.177	4.5	.209	5.3	.012	0.3	.003	0.08			●											
TBPA60F% ϕ 10M	Yes	.177	4.5	.209	5.3	.012	0.3	.004	0.10												○	○	
TBPA60F% ϕ 10M	Yes	.177	4.5	.209	5.3	.012	0.3	.007	0.18			●											
TBPA60F% ϕ 10M	No	.248	6.3	.268	6.8	.008	0.2	.000	0.00												○	○	○

● : Stock ○ : 1-2 week delivery ● : Coolant through M : Mirror finish

Cutting condition → R3

TBDP (Back Duo) Series

TBDP

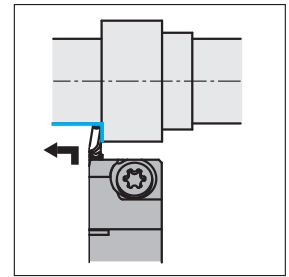
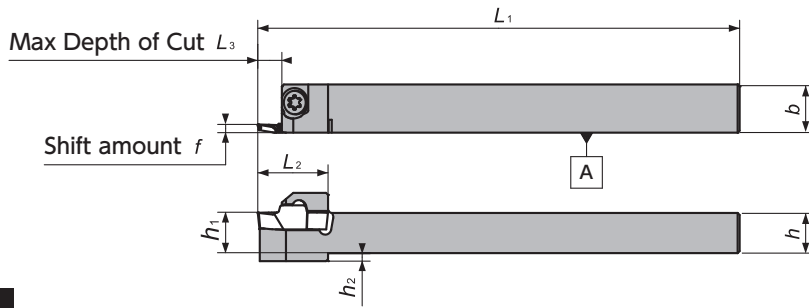

Right-Hand style shown

Figure-1

Y-TBDP

NEW

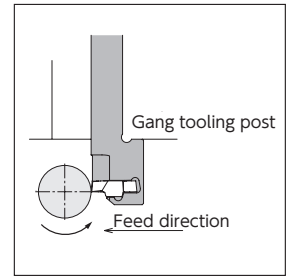
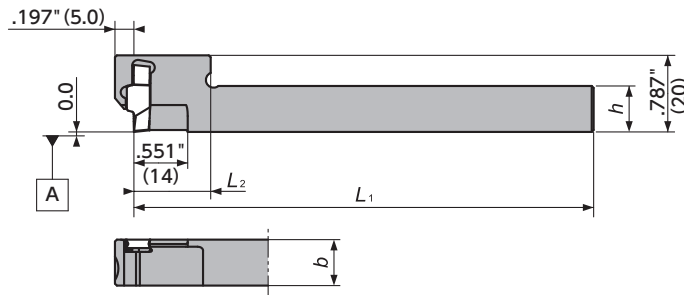

Right-Hand style shown

Figure-2

TBDP Series - Toolholders

TBDP

Gage Insert	Item Number	Figure	Stock		h (Inch) (mm)	b (Inch) (mm)	h ₁ (Inch) (mm)	L ₁ (Inch) (mm)	f (Inch) (mm)	L ₂ (Inch) (mm)	L ₃ (Inch) (mm)	h ₂ (Inch) (mm)	Clamp Screw	Wrench
			R	L										
	TBDP $\frac{1}{8}$ IN	1	●		3/8	.472 12	3/8	4.724 120	.081 2.05	.571 14.5	.118 3	.079 2	LRIS-4 × 12	LLR-25S
	TBDP $\frac{1}{4}$ IN	1	●		1/2	1/2	1/2	4.724 120	.081 2.05	.689 17.5	.197 5	0 0	LRIS-4 × 12	LLR-25S
	TBDP $\frac{3}{8}$ IN	1	●		5/8	5/8	5/8	4.724 120	.081 2.05	.768 19.5	.197 5	0 0	LRIS-4 × 12	LLR-25S
	TBDP $\frac{1}{2}$ IN	1	○		.394 10	.472 12	.394 10	3.937 100	.081 2.05	.591 15	.118 3	.079 2	LRIS-4 × 12	LLR-25S
	TBDP $\frac{3}{4}$ IN	1	○	○	.394 10	.472 12	.394 10	4.724 120	.081 2.05	.591 15	.118 3	.079 2	LRIS-4 × 12	LLR-25S
	TBDP $\frac{1}{2}$ IN	1	○	○	.472 12	.472 12	.472 12	4.724 120	.081 2.05	.709 18	.197 5	0 0	LRIS-4 × 12	LLR-25S
	TBDP $\frac{3}{4}$ IN	1	○	○	.630 16	.630 16	.630 16	4.724 120	.081 2.05	.768 19.5	.197 5	0 0	LRIS-4 × 12	LLR-25S
	TBDP $\frac{1}{2}$ IN	1	○	○	.787 20	.787 20	.787 20	4.724 120	.081 2.05	.768 19.5	.197 5	0 0	LRIS-4 × 12	LLR-25S
	Y-TBDP $\frac{1}{2}$ IN	2	○		.472 12	.472 12	— —	4.724 120	.081 2.05	.787 20	.197 5	— —	— —	LRIS-4 × 12

TBDP Series - Inserts

TBDP

Shape	Item Number	Length of Blade a		θ	r_ϵ		Coated Carbide		
		(Inch)	(mm)		(Inch)	(mm)	QM3	DM4	TM4
	TBDP22005R	.138	3.5	80	.002	0.05	●	○	●
	TBDP2201MR	.138	3.5	80	.003	0.08	●	○	●
	TBDP2202MR	.138	3.5	80	.007	0.18	●	○	●

SVAC Series

SVAC-NW

Double-edge tool

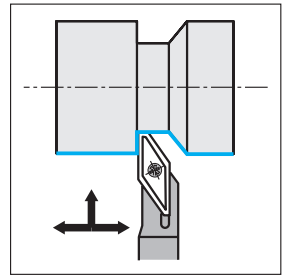
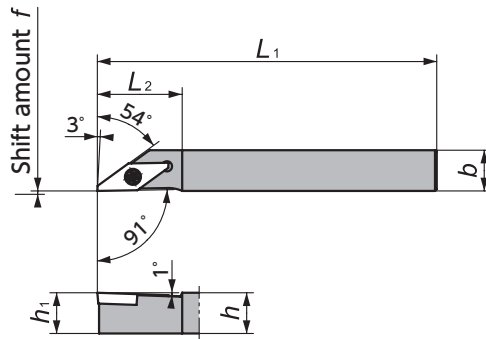

Right-Hand style shown

Figure-1

SVAC-W

Double-edge tool

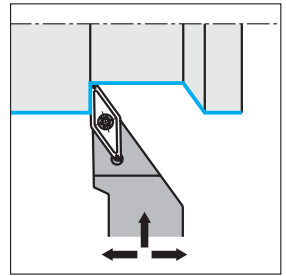
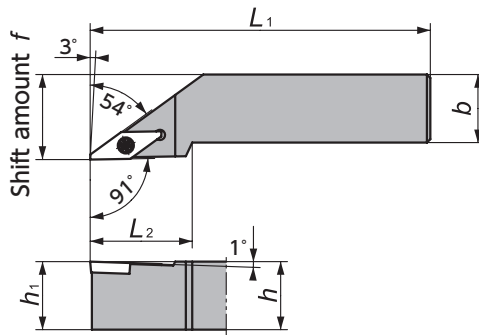

Right-Hand style shown

Figure-2

SVAC Series - Toolholders

SVAC

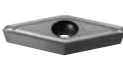
Gage Insert	Item Number	Figure	Stock		h		b		h_1		L_1		f		L_2		Clamp Screw	Wrench
			R	L	(Inch)	(mm)	(Inch)	(mm)	(Inch)	(mm)	(Inch)	(mm)	(Inch)	(mm)	(Inch)	(mm)		
	SVAC%1010L13NW	1	○	○	.394	10	.394	10	.394	10	5.512	140	0.0	0.0	.984	25	LR15-3 × 8	RLR-20S
	SVAC%1212L13NW	1	○	○	.472	12	.472	12	.472	12	5.512	140	0.0	0.0	.984	25	LR15-3 × 8	RLR-20S
	SVAC%1616M13NW	1	○	○	.630	16	.630	16	.630	16	5.906	150	0.0	0.0	.984	25	LR15-3 × 8	RLR-20S
	SVAC%2020M13W	2	○		.787	20	.787	20	.787	20	5.906	150	.984	25.0	1.181	30	LR15-3 × 8	RLR-20S

SVAC Series - Inserts

VCGT1303

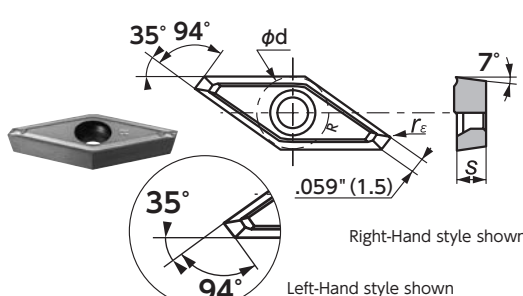
Shape	Item Number	d		s		r_ϵ		Coated Carbide	
		(Inch)	(mm)	(Inch)	(mm)	(Inch)	(mm)	QM3	
		R	L	R	L	R	L		
 <p>Right-Hand style shown</p> <p>Left-Hand style shown</p>	VCGT1303%01F2M	.313	7.94	.125	3.18	.004	0.1	○	○

● : Stock ○ : 1-2 week delivery

Cutting condition → R3

Back Turning

TBVC Series

TBVC

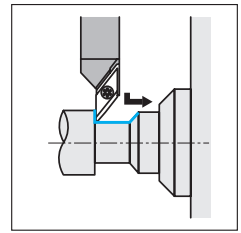
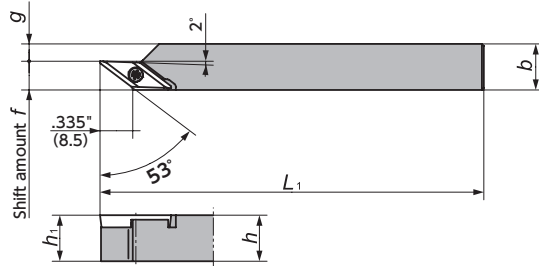

Right-Hand style shown
For non - ferrous material

Figure-1

TBVC-F10

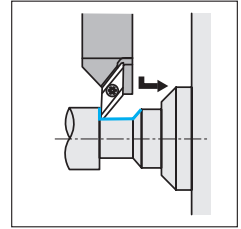
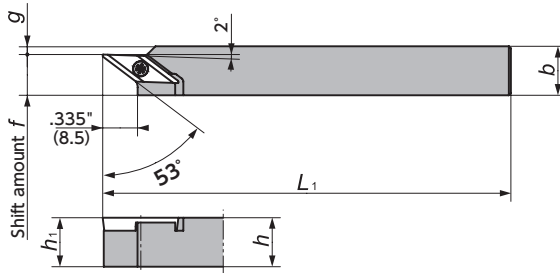

Right-Hand style shown

Figure-2

CH-SVXCL

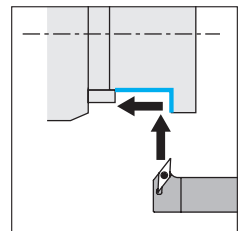
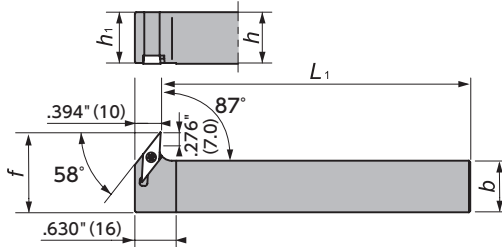

Left-Hand style shown
Takes Right-hand or Neutral chip breaker

Figure-3

TBVC Series - Toolholders

Gage Insert	Item Number	Figure	Stock		h		b		h ₁		L ₁		f		g		Clamp Screw	Wrench
			R	L	(Inch)	(mm)	(Inch)	(mm)	(Inch)	(mm)	(Inch)	(mm)	(Inch)	(mm)	(Inch)	(mm)		
	TBVC%110	1	○	○	.394	10	.394	10	.394	10	4.724	120	.295	7.5	.098	2.5	LRIS-2.5 × 7	CLR-15S
	TBVC%112	1	○	○	.472	12	.472	12	.472	12	4.724	120	.295	7.5	.098	4.5	LRIS-2.5 × 7	CLR-15S
	TBVC%116	1	○	○	.630	16	.630	16	.630	16	4.724	120	.295	7.5	.098	8.5	LRIS-2.5 × 7	CLR-15S
	TBVC%108-F10-IN	2	●	○	1/2	12	1/2	12	1/2	12	4.724	120	.394	10	0	0	LRIS-2.5 × 7	CLR-15S
	TBVC%110-F10	2	○	○	.394	10	.394	10	.394	10	4.724	120	.394	10	0	0	LRIS-2.5 × 7	CLR-15S
	TBVC%112GX-F10	2	○	○	.472	12	.472	12	.472	12	3.346	85	.394	10	.079	2	LRIS-2.5 × 7	CLR-15S
	TBVC%112-F10	2	●	○	.472	12	.472	12	.472	12	4.724	120	.394	10	.079	2	LRIS-2.5 × 7	CLR-15S
	TBVC%116H-F10	2	○	○	.630	16	.630	16	.630	16	3.150	100	.394	10	.234	6	LRIS-2.5 × 7	CLR-15S
	TBVC%116-F10	2	●	○	.630	16	.630	16	.630	16	4.724	120	.394	10	.234	6	LRIS-2.5 × 7	CLR-15S
	TBVC%120F-F10	2	○	○	.787	20	.787	20	.787	20	3.150	80	.394	10	.394	10	LRIS-2.5 × 7	CLR-15S
CH-SVXC%1616 × 11	3	○	○	.630	16	.630	16	.787	20	4.724	120	1.063	27	—	—	LRIS-2.5 × 7	CLR-15S	
CH-SVXC%2020 × 11	3	○	○	.630	16	.630	16	.787	20	4.724	120	1.220	31	—	—	LRIS-2.5 × 7	CLR-15S	

TBVC Series - Inserts

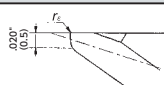
Shape	Item Number	d		s		r _e		Coated Carbide			
		(Inch)	(mm)	(Inch)	(mm)	(Inch)	(mm)	VM1		ZM3	
		R	L	R	L	R	L	R	L		
	TBVC11F%05U	1/4	6.35	1/8	3.18	.002	0.05			●	
	TBVC11F%10U	1/4	6.35	1/8	3.18	.004	0.10	●		●	
	TBVC11F%10S	1/4	6.35	1/8	3.18	.004	0.10			●	

● : Stock ○ : 1-2 week delivery

Cutting condition → R3

TB Series

TBT Screw accessible from both sides

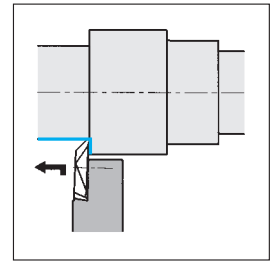
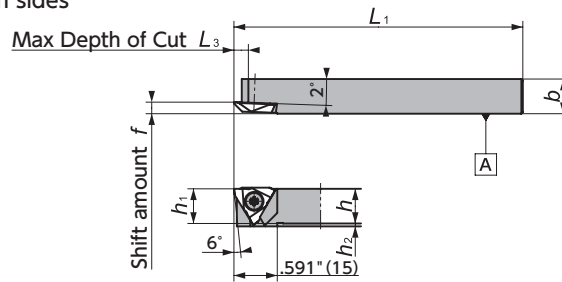

Right-Hand style shown

Figure-1

TB-N

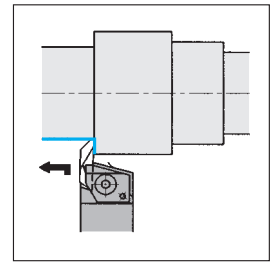
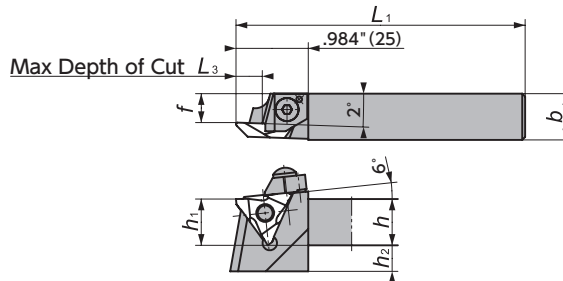

Right-Hand style shown

Figure-2

TB-F

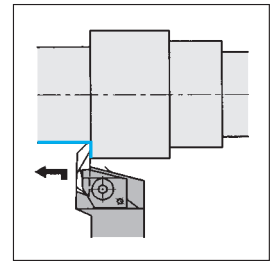
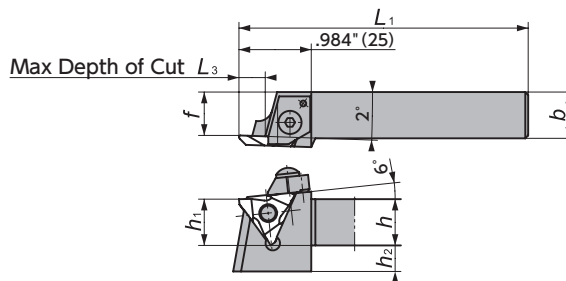



Right-Hand style shown

Figure-3

TB Series - Toolholders

TB

Gage Insert	Item Number	Figure	Stock		h (Inch) (mm)	b (Inch) (mm)	h ₁ (Inch) (mm)	L ₁ (Inch) (mm)	h ₂ (Inch) (mm)	f (Inch) (mm)	L ₃ (Inch) (mm)	Clamp Screw	Wrench
			R	L									
 TB32	TBT%06-IN	1	●		3/8	3/8	3/8	4.724 120	.118 3	.157 4	.197 5.0	LR-S-4 × 10PW	CLR-15S
	TBT%08-IN	1	●		1/2	1/2	1/2	4.724 120	.039 1	.157 4	.197 5.0	LR-S-4 × 10PW	CLR-15S
	TBT%08F	1	○	○	.315 8	.315 8	.315 8	3.150 80	.157 5	.157 4	.197 5.0	LR-S-4 × 10PW	CLR-15S
	TBT%08K	1	○	○	.315 8	.315 8	.315 8	4.724 120	.157 5	.157 4	.197 5.0	LR-S-4 × 10PW	CLR-15S
	TBT%10F	1	○	○	.394 10	.394 10	.394 10	3.150 80	.118 3	.157 4	.197 5.0	LR-S-4 × 10PW	CLR-15S
	TBT%10K	1	○	○	.394 10	.394 10	.394 10	4.724 120	.118 3	.157 4	.197 5.0	LR-S-4 × 10PW	CLR-15S
	TBT%12F	1	○	○	.472 12	.472 12	.472 12	3.150 80	.039 1	.157 4	.197 5.0	LR-S-4 × 10PW	CLR-15S
TBT%12K	1	○	○	.472 12	.472 12	.472 12	4.724 120	.039 1	.157 4	.197 5.0	LR-S-4 × 10PW	CLR-15S	
TB42	TB%16N-42	2	○		.630 16	.630 16	.630 16	3.071 78	.354 9	.453 11.5	.354 9.0	—	LW-2.5
 TB43	TB%16NS	2	○		.630 16	.630 16	.630 16	3.071 78	.354 9	.394 10	.197 5.0	—	LW-2.5
	TB%16N	2	○	○	.630 16	.630 16	.630 16	3.071 78	.354 9	.394 10	.354 9.0	—	LW-2.5
	TB%16N-H	2	○		.630 16	.630 16	.630 16	3.937 100	.354 9	.394 10	.354 9.0	—	LW-2.5
	TB%16N-K	2	○		.630 16	.630 16	.630 16	4.921 125	.354 9	.394 10	.354 9.0	—	LW-2.5
	TB%20N	2	○	○	.787 20	.787 20	.787 20	3.937 100	.157 5	.394 10	.354 9.0	—	LW-2.5
	TB%25N	2	○	○	.984 25	.984 25	.984 25	5.906 150	0 0	.394 10	.354 9.0	—	LW-2.5
	TB%16FS	3	○		.630 16	.630 16	.630 16	3.937 100	.354 9	.591 15	.197 5.0	—	LW-2.5
	TB%16F	3	○		.630 16	.630 16	.630 16	3.937 100	.354 9	.591 15	.354 9.0	—	LW-2.5
	TB%20FS	3	○		.787 20	.787 20	.787 20	3.937 100	.157 5	.787 20	.197 5.0	—	LW-2.5
TB%20F	3	○		.787 20	.787 20	.787 20	3.937 100	.157 5	.787 20	.354 9.0	—	LW-2.5	
TB%25F	3	○		.984 25	.984 25	.984 25	5.906 150	0 0	.984 25	.354 9.0	—	LW-2.5	

TB32 • 42 • 43 - Inserts

TB32 • 42 • 43

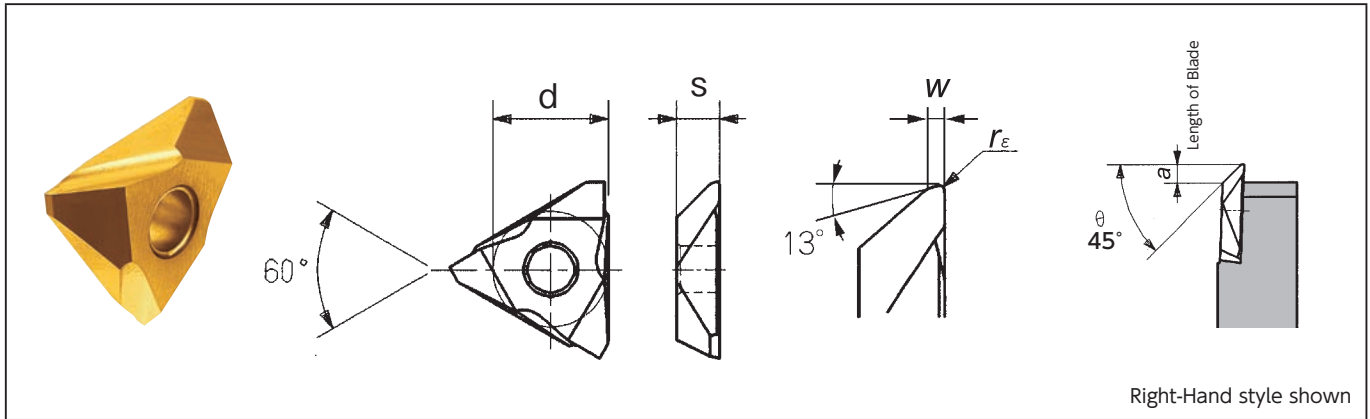

Item Number	Chip-breaker	a		θ	r_E		w		d		s		Coated Carbide		Cermet		Coated Cermet	
		(Inch)	(mm)		(Inch)	(mm)	(Inch)	(mm)	(Inch)	(mm)	(Inch)	(mm)	ZM3		XT3		Z15	
		R	L		R	L	R	L	R	L	R	L	R	L	R	L		
TB3200%	Yes	.106	2.7	45°	0	0.00	.020	0.5	3/8	9.525	1/8	3.18	●					
TB3205%	Yes	.106	2.7	45°	.002	0.05	.020	0.5	3/8	9.525	1/8	3.18	●	○	●			
TB3210%	Yes	.106	2.7	45°	.004	0.10	.020	0.5	3/8	9.525	1/8	3.18				○		
TB3215%	Yes	.106	2.7	45°	.006	0.15	.020	0.5	3/8	9.525	1/8	3.18	●	○	●	○	○	
TB3220%	Yes	.106	2.7	45°	.008	0.20	.020	0.5	3/8	9.525	1/8	3.18	○					
TB4215%	Yes	.091	2.3	45°	.006	0.15	.040	1.0	1/2	12.70	1/8	3.18	○					
TB4300%	Yes	.157	4.0	45°	0	0.00	.040	1.0	1/2	12.70	3/16	4.76						
TB4305%	Yes	.157	4.0	45°	.002	0.05	.040	1.0	1/2	12.70	3/16	4.76	●		○			
TB4315%	Yes	.157	4.0	45°	.006	0.15	.040	1.0	1/2	12.70	3/16	4.76	●		○	○	○	
TB4340%	Yes	.154	3.9	45°	.016	0.40	.040	1.0	1/2	12.70	3/16	4.76	●		○	○	○	

Note: All angles shown are obtained when insert is set in the holder

● : Stock

○ : 1-2 week delivery

Cutting condition **→R3**

GTT Series

GTT Screw accessible from both sides

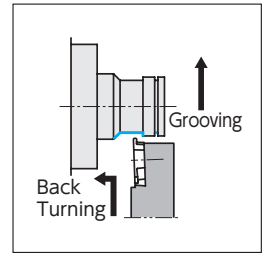
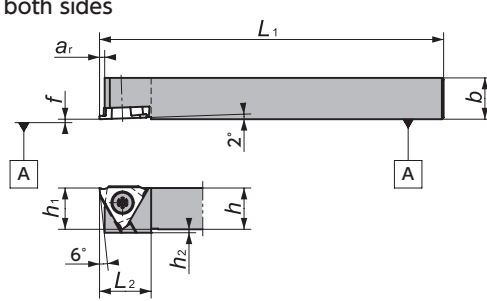

Figure-1

Right-Hand style shown

GTT-OH (Coolant through)

Screw accessible from both sides

NEW

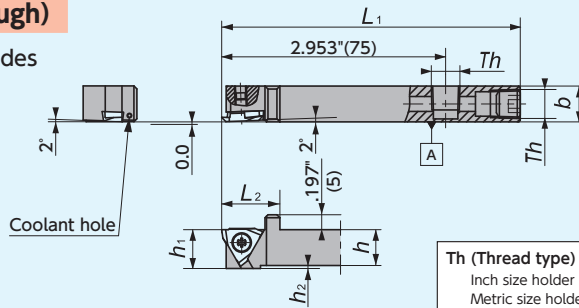

Th (Thread type)
Inch size holder : NPT1/8
Metric size holder: M6, Rc1/8 (PT1/8)

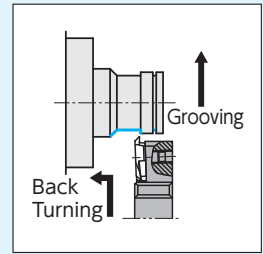

Figure-2

Right-Hand style shown

Y-GTT

Screw accessible from both sides

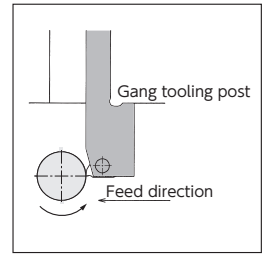
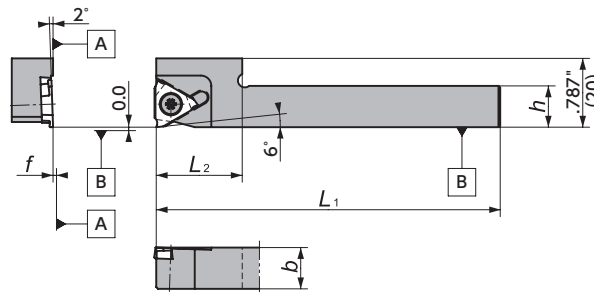

Figure-3

Right-Hand style shown
Takes Right-hand Insert

Y-GTT-OH (Coolant through)

Screw accessible from both sides

NEW

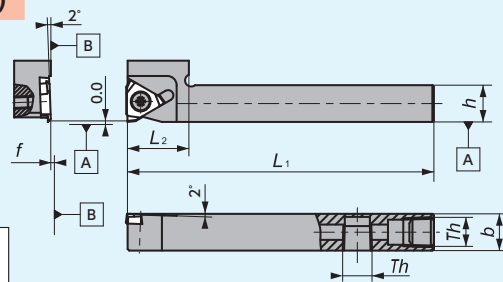

Th (Thread type)
Inch size holder : NPT1/8
Metric size holder: Rc1/8 (PT1/8)

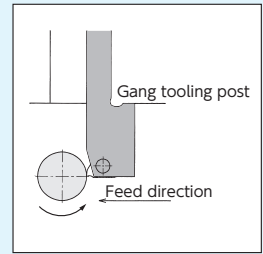

Figure-4

Right-Hand style shown
Takes Right-hand Insert

CH-GTT

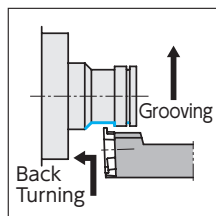
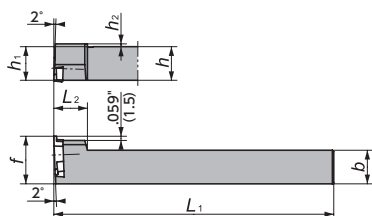

Figure-5

Left-Hand style shown
Takes Right-hand Insert

DS-GTT

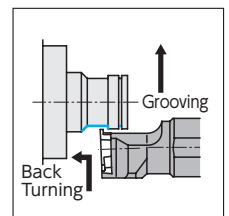
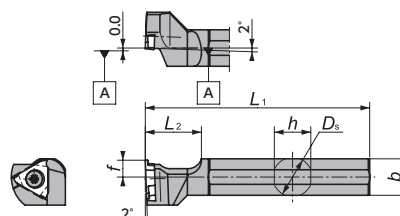



Figure-6

Left-Hand style shown
Takes Right-hand Insert

GTT

Gage Insert	Item Number	Figure	Stock		h (Inch) (mm)	b (Inch) (mm)	h ₁ (Inch) (mm)	L ₁ (Inch) (mm)	f (Inch) (mm)	L ₂ (Inch) (mm)	a _r (Inch) (mm)	h ₂ (Inch) (mm)	Th	Clamp Screw	Wrench	
			R	L												
 TBMH32..	GTT%06A-IN	1	●	●	3/8	3/8	3/8	4.724 120	.000 0	.591 15.0	.071 1.8	.118 3	—	LR-5-4×10PW	CLR-15S	
	GTT%06B-IN	1	●	●	3/8	3/8	3/8	4.724 120	.000 0	.591 15.0	.106 2.7	.118 3	—	LR-5-4×10PW	CLR-15S	
	GTT%08A-IN	1	●	●	1/2	1/2	1/2	4.724 120	.000 0	.591 15.0	.071 1.8	.039 1	—	LR-5-4×10PW	CLR-15S	
	GTT%08B-IN	1	●	●	1/2	1/2	1/2	4.724 120	.000 0	.591 15.0	.106 2.7	.039 1	—	LR-5-4×10PW	CLR-15S	
	GTT%10A-IN	1	●	●	5/8	5/8	5/8	4.724 120	.000 0	.591 15.0	.071 1.8	.000 0	—	LR-5-4×10PW	CLR-15S	
	GTT%10B-IN	1	●	●	5/8	5/8	5/8	4.724 120	.000 0	.591 15.0	.106 2.7	.000 0	—	LR-5-4×10PW	CLR-15S	
	GTT%12A-IN	1	●	●	3/4	3/4	3/4	4.724 120	.000 0	.591 15.0	.071 1.8	.000 0	—	LR-5-4×10PW	CLR-15S	
	GTT%12B-IN	1	●	●	3/4	3/4	3/4	4.724 120	.000 0	.591 15.0	.106 2.7	.000 0	—	LR-5-4×10PW	CLR-15S	
	GTT%08F00	1	○	○	.315 8	.315 8	.315 8	3.150 80	.000 0	.591 15.0	.071 1.8	.157 5	—	R:LR-5-4×10PW L:LR-5-4×5.8	CLR-15S	
	GTT%0810F00	1	○	○	.315 8	.394 10	.315 8	3.150 80	.000 0	.591 15.0	.071 1.8	.157 5	—	LR-5-4×10PW	CLR-15S	
	GTT%08K00	1	○	○	.315 8	.315 8	.315 8	4.724 120	.000 0	.591 15.0	.071 1.8	.157 5	—	R:LR-5-4×10PW L:LR-5-4×5.8	CLR-15S	
	GTT%0810K00	1	○	○	.315 8	.394 10	.315 8	4.724 120	.000 0	.591 15.0	.071 1.8	.157 5	—	LR-5-4×10PW	CLR-15S	
	GTT%10F00	1	○	○	.394 10	.394 10	.394 10	3.150 80	.000 0	.591 15.0	.071 1.8	.118 3	—	LR-5-4×10PW	CLR-15S	
	GTT%10K00	1	○	○	.394 10	.394 10	.394 10	4.724 120	.000 0	.591 15.0	.071 1.8	.118 3	—	LR-5-4×10PW	CLR-15S	
	GTT%12F00	1	○	○	.472 12	.472 12	.472 12	3.150 80	.000 0	.591 15.0	.071 1.8	.040 1	—	LR-5-4×10PW	CLR-15S	
	GTT%12K00	1	●	●	.472 12	.472 12	.472 12	4.724 120	.000 0	.591 15.0	.071 1.8	.040 1	—	LR-5-4×10PW	CLR-15S	
	GTT%16H00	1	○	○	.630 16	.630 16	.630 16	3.937 100	.000 0	.591 15.0	.071 1.8	.000 0	—	LR-5-4×10PW	CLR-15S	
	GTT%16K00	1	○	○	.630 16	.630 16	.630 16	4.724 120	.000 0	.591 15.0	.071 1.8	.000 0	—	LR-5-4×10PW	CLR-15S	
	GTT%20K00	1	○	○	.787 20	.787 20	.787 20	4.921 125	.000 0	.591 15.0	.106 2.7	.000 0	—	LR-5-4×10PW	CLR-15S	
	GTT%25M00	1	○	○	.984 25	.984 25	.984 25	5.906 150	.000 0	.591 15.0	.106 2.7	.000 0	—	LR-5-4×10PW	CLR-15S	
	GTT%10F15	1	○	○	.394 10	.394 10	.394 10	3.150 80	.000 0	.591 15.0	.106 2.7	.118 3	—	LR-5-4×10PW	CLR-15S	
	GTT%10K15	1	○	○	.394 10	.394 10	.394 10	4.724 120	.000 0	.591 15.0	.106 2.7	.118 3	—	LR-5-4×10PW	CLR-15S	
	GTT%12F15	1	○	○	.472 12	.472 12	.472 12	3.150 80	.000 0	.591 15.0	.106 2.7	.040 1	—	LR-5-4×10PW	CLR-15S	
	GTT%12K15	1	○	○	.472 12	.472 12	.472 12	4.724 120	.000 0	.591 15.0	.106 2.7	.040 1	—	LR-5-4×10PW	CLR-15S	
	GTT%16H15	1	○	○	.630 16	.630 16	.630 16	3.937 100	.000 0	.591 15.0	.106 2.7	.000 0	—	LR-5-4×10PW	CLR-15S	
	GTT%16K15	1	●	●	.630 16	.630 16	.630 16	4.724 120	.000 0	.591 15.0	.106 2.7	.000 0	—	LR-5-4×10PW	CLR-15S	
	GTT%10F25	1	○	○	.394 10	.394 10	.394 10	3.150 80	.000 0	.591 15.0	.106 2.7	.118 3	—	LR-5-4×10PW	CLR-15S	
	GTT%10K25	1	○	○	.394 10	.394 10	.394 10	4.724 120	.000 0	.591 15.0	.106 2.7	.118 3	—	LR-5-4×10PW	CLR-15S	
	GTT%12F25	1	○	○	.472 12	.472 12	.472 12	3.150 80	.000 0	.591 15.0	.106 2.7	.040 1	—	LR-5-4×10PW	CLR-15S	
	GTT%12K25	1	○	○	.472 12	.472 12	.472 12	4.724 120	.000 0	.591 15.0	.106 2.7	.040 1	—	LR-5-4×10PW	CLR-15S	
	GTT%16H25	1	○	○	.630 16	.630 16	.630 16	3.937 100	.000 0	.591 15.0	.106 2.7	.000 0	—	LR-5-4×10PW	CLR-15S	
	GTT%16K25	1	○	○	.630 16	.630 16	.630 16	4.724 120	.000 0	.591 15.0	.106 2.7	.000 0	—	LR-5-4×10PW	CLR-15S	
	GTT%08HA-IN-OH	2	●	●	1/2	1/2	1/2	3.937 100	.000 0	.768 19.5	.071 1.8	.039 1	NPT1/8	LR-5-4×10PW	CLR-15S	
	GTT%08HB-IN-OH	2	●	●	1/2	1/2	1/2	3.937 100	.000 0	.768 19.5	.106 2.7	.039 1	NPT1/8	LR-5-4×10PW	CLR-15S	
	GTT%10HA-IN-OH	2	●	●	5/8	5/8	5/8	3.937 100	.000 0	.768 19.5	.071 1.8	.000 0	NPT1/8	LR-5-4×10PW	CLR-15S	
	GTT%10HB-IN-OH	2	●	●	5/8	5/8	5/8	3.937 100	.000 0	.768 19.5	.106 2.7	.000 0	NPT1/8	LR-5-4×10PW	CLR-15S	
	GTT%1012H00-OH	2	○	○	.394 10	.472 12	.394 10	3.937 100	.000 0	.768 19.5	.071 1.8	.039 1	M6 × 1	LR-5-4×10PW	CLR-15S	
	GTT%12H00-OH	2	●	●	.472 12	.472 12	.472 12	3.937 100	.000 0	.768 19.5	.071 1.8	.039 1	Rc1/8(PT1/8)	LR-5-4×10PW	CLR-15S	
	GTT%16H00-OH	2	○	○	.630 16	.630 16	.630 16	3.937 100	.000 0	.768 19.5	.071 1.8	0 0	Rc1/8(PT1/8)	LR-5-4×10PW	CLR-15S	
	Y-GTTR%06-IN	3	●	●	3/8	3/8	—	4.724 120	.000 0	.984 25.0	.063 1.6	—	—	—	LR-5-4×10PW	CLR-15S
	Y-GTTR%08-IN	3	●	●	1/2	1/2	—	4.724 120	.000 0	.984 25.0	.063 1.6	—	—	—	LR-5-4×10PW	CLR-15S
	Y-GTTR%10-IN	3	●	●	5/8	5/8	—	4.724 120	.000 0	.984 25.0	.063 1.6	—	—	—	LR-5-4×10PW	CLR-15S
	Y-GTT%10S	3	○	○	.394 10	.394 10	—	4.724 120	.000 0	.787 20.0	.063 1.6	—	—	—	LR-5-4×10PW	CLR-15S
	Y-GTT%12S	3	○	○	.472 12	.472 12	—	4.724 120	.000 0	.787 20.0	.063 1.6	—	—	—	LR-5-4×10PW	CLR-15S
	Y-GTT%08H-IN-OH	4	●	●	1/2	1/2	—	3.937 100	.000 0	.984 25.0	.063 1.6	—	—	NPT1/8	LR-5-4×10PW	CLR-15S
Y-GTT%12H00S-OH	4	●	●	.472 12	.472 12	—	3.937 100	.000 0	.787 20.0	.063 1.6	—	—	Rc1/8(PT1/8)	LR-5-4×10PW	CLR-15S	
Y-GTT%16H00-OH	4	○	○	.630 16	.472 16	—	3.937 100	.000 0	.984 25.0	.063 1.6	—	—	Rc1/8(PT1/8)	LR-5-4×10PW	CLR-15S	
CH-GTT%10H00	5	○	○	.394 10	.394 10	.394 10.0	4.724 120	.591 15	.472 12.0	.059 1.5	.118 3	—	—	LR-5-4×10PW	CLR-15S	
CH-GTT%12H00	5	○	○	.472 12	.472 12	.472 12.0	4.724 120	.669 17	.472 12.0	.059 1.5	.040 1	—	—	LR-5-4×10PW	CLR-15S	

DS-GTT

Gage Insert	Item Number	Figure	Stock		D _s (Inch) (mm)	h (Inch) (mm)	b (Inch) (mm)	L ₁ (Inch) (mm)	f (Inch) (mm)	L ₂ (Inch) (mm)	Clamp Screw	Wrench
			R	L								
 TBMH32..	DS-GTT%14F	6	○	○	.551 14.000	.512 13	.512 13	3.150 80	.236 6	.787 20	LR-5-4 × 9	RLR-20S
	DS-GTT%15H	6	○	○	.518 15.875	.591 15	.591 15	3.937 100	.236 6	.787 20	LR-5-4 × 9	RLR-20S
	DS-GTT%16X	6	●	●	.630 16.000	.591 15	.591 15	3.740 95	.236 6	.787 20	LR-5-4 × 9	RLR-20S
	DS-GTT%19	6	●	●	3/4 19.050	.709 18	.709 18	4.724 120	.236 6	.787 20	LR-5-4 × 9	RLR-20S
	DS-GTT%20	6	●	●	.787 20.000	.748 19	.748 19	4.724 120	.236 6	.787 20	LR-5-4 × 9	RLR-20S
	DS-GTT%22	6	●	●	.866 22.000	.827 21	.827 21	4.724 120	.236 6	.787 20	LR-5-4 × 9	RLR-20S
	DS-GTT%25	6	●	●	1 25.400	.945 24	.945 24	4.724 120	.394 10	.787 20	LR-5-4 × 9	RLR-20S

GTT Series - Inserts

TBMH32

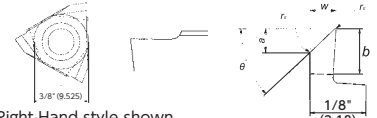
Shape	Item Number	Chip-breaker	Length of Blade a		Max Depth of Cut b		w	θ	r _e		Coated Carbide		
			(Inch)	(mm)	(Inch)	(mm)			(Inch)	(mm)	ZM3		
			R	L	R	L							
 Right-Hand style shown	TBMH32100%05-22	Yes	.012	0.3	.071	1.8	.039	1.0	22°	.002	0.05	●	
	TBMH32100%05-45	Yes	.035	0.9	.071	1.8	.039	1.0	45°	.002	0.05	●	
	TBMH32150%05-22	Yes	.020	0.5	.106	2.7	.059	1.5	22°	.002	0.05	●	
	TBMH32150%05-45	Yes	.051	1.3	.102	2.6	.059	1.5	45°	.002	0.05	●	

Note: All angles shown are obtained when insert is set in the holder

MEMO

S



Cut-off / Parting



- **Cut-off Tooling** S2
- **Cut-off Tool Selection Guide** S4
- **Recommended Cutting Conditions** S5
- **Tool List** S6
 - CSV Series (Up to dia. .197") S6
 - CTPS Series (Up to dia. .394") S7
 - CTP Series (Up to dia. .472") S8
 - CTPA Series (Up to dia. .630") S8
 - CTPW Series (Up to dia. .787") S8
 - CTDP Series (Up to dia. 1.339") S14
 - CTV-S Series (Up to dia. .787") S15
 - CTV Series (Up to dia. 1.772") S16

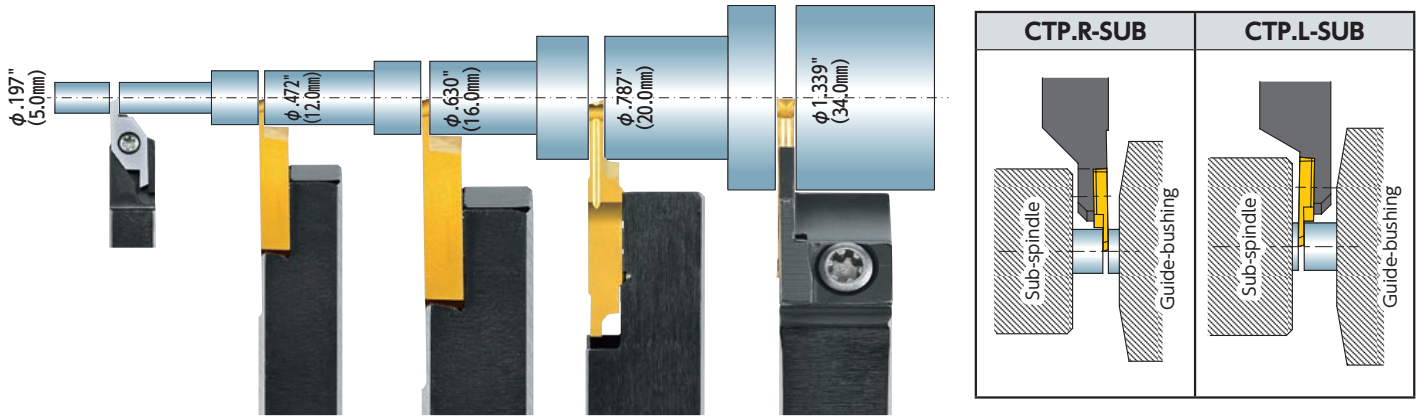

NTK Cut-off Tools - Product Lines

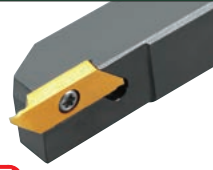

NTK offers a variety of cut-off tools with as narrow a width as .020" (0.5mm)
 NTK cut-off tools are specialized for small part applications



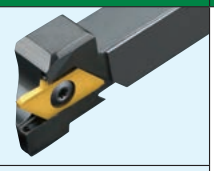



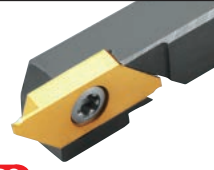
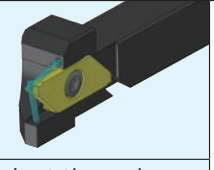

Cut-off

Insert	CSV →S6	CTPS →S7	CTPS-001 →S7
Holder	CSV-NC  →S6	CTPS  →S7	CTPSR-SUB  →S7
Max Cut-off Diameter	~φ.197" (~5.0mm)	~φ.394" (~10.0mm)	~φ.157" (~4.0mm)
Blade width	.024" - .059" (0.6 - 1.5mm)	.047" - .079" (1.2 - 2.0mm)	.028" (0.7mm)

Insert	CTP →S10 · S12			
Holder	CTP  →S8	CTP-OH  NEW →S8 Coolant through	CTPR-SUB  →S8	CTPL-SUB  →S8
Max Cut-off Diameter	~φ.472" (~12.0mm)			
Blade width	.020" - .079" (0.5 - 2.0mm)			

Insert	CTPA →S10 · S12			
Holder	CTPA  →S8	CTPA-OH  NEW →S8 Coolant through	CTPAR-SUB  →S8	CTPAL-SUB  →S8
Max Cut-off Diameter	~φ.630" (~16.0mm)			
Blade width	.028" - .118" (0.7 - 3.0mm)			

Insert	CTPW →S10·S12	CTDP →S14
Holder	 →S8	 →S14
Max Cut-off Diameter	~φ .787" (~20.0mm)	~φ 1.339" (~34.0mm)
Blade width	.098" (2.5mm)	.079"·.098" (2.0·2.5mm)

Insert	CTV-S →S15		CTV →S17		
	CTV-K2	CTVN-K2	CTV-S	CTV-M (B)	CTV-X
Holder	 →S15	 →S15	 →S16	 →S16	 →S16
Max Cut-off Diameter	~φ .787" (~20.0mm)		~φ 1.378" (~35.0mm)	~φ 1.772" (~45.0mm)	~1.378" (~35.0mm)
Blade width	.087" - .098" (2.2 - 2.5mm)		.098"·.118" (2.5·3.0mm)	.098"·.118" (2.5·3.0mm)	.118" (3.0mm)

■ CTP/CTPA/CTPS/CTPW selection guide : Right hand? Or Left hand?

Right-hand recommended

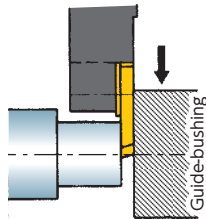

R-hand Toolholder using a R-hand insert with lead angle

Left-hand recommended

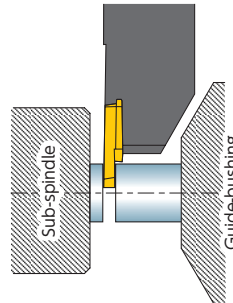

L-hand Toolholder with a non-lead angle insert when the bar stock is held by sub-spindle

■ CTP/CTPA-SUB selection guide Right hand? Or Left hand?

Right-hand recommended

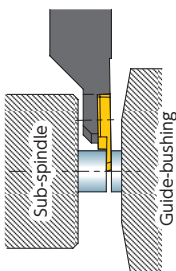

R-hand Toolholder with R-hand insert with lead angle for longer parts or small diameter part. When part length is too short for sub-spindle to hold, use L-hand with slower speed.

Left-hand recommended

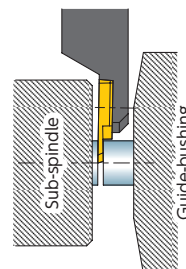

L-hand with L-hand insert with lead angle for short part

More information →S4

Cut-off Tool Selection Guide

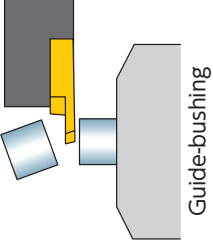
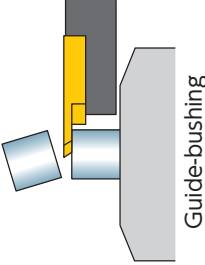
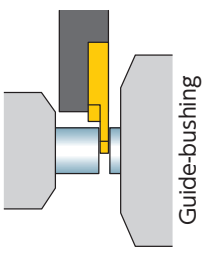
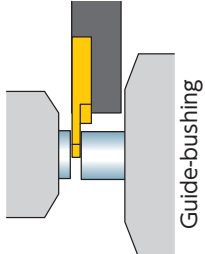
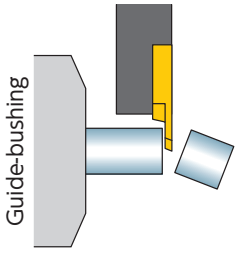
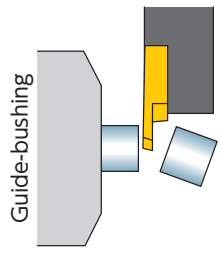
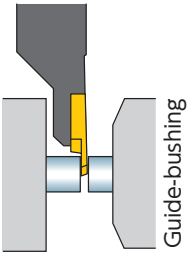
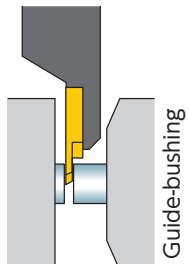
Right-hand combination		Left-hand combination	
FR, FRFT, FRV Style		FLK, FLKFT, FLKV Style	
 <p>FRFT: Flat top FRV : Flat top with mirror finish</p>	<ul style="list-style-type: none"> ● Common geometry in cut-off ● Lead angle minimizes center-boss ● End face is likely to get scratched from chip control because of lead angle and chip-breaker configuration ● Good for small diameter machining as it cuts near guide-bushing 	 <p>FLKFT: Flat top FLKV : Flat top with mirror finish</p>	<ul style="list-style-type: none"> ● Can cut-off closer to the sub-spindle ● Less burrs with hollow work ● Sub-spindle should hold the work
FRN, FRS,FRNV Style		FLN, FLS Style	
 <p>FRS : Flat top FRNV: Flat top with mirror finish</p>	<ul style="list-style-type: none"> ● Good for small diameter machining as it cuts near guide-bushing ● 1st recommendation when sub-spindle holds the part ● No lead angle helps to prevent scratches on both faces 	 <p>FLS: Flat top</p>	<ul style="list-style-type: none"> ● Recommended when required to cut-off close to the sub-spindle due to short part length ● Good for big diameter part ● No lead angle helps to prevent scratches on both faces ● Sub-spindle should hold the work
FRK Style		FL, FLV Style	
	<ul style="list-style-type: none"> ● Used with inverse spindle rotation ● Short part length and using sub-spindle ● Less burrs with hollow work 	 <p>FLV: Flat top with mirror finish</p>	<ul style="list-style-type: none"> ● Used with inverse spindle rotation ● Without sub-spindle ● Less burrs with hollow work
CTP. R-SUB		CTP. L-SUB	
	<ul style="list-style-type: none"> ● Recommended when cut-off point is close to guide-bushing for small and thin parts ● When the part length is short, extended sub-spindle guide-bushing is generally used 		<ul style="list-style-type: none"> ● Recommended when required to cut-off close to the sub-spindle especially with small diameters ● Can cut much closer to the sub-spindle than the other left-handed tool holders ● Sub-spindle should hold the work

Recommended Cutting Conditions

Cut-off

CSV T

Work Material		High Temperature Alloys	Titanium Alloys	Cobalt Chrome Alloys	Stainless Steels		Alloy Steels	Carbon Steels
					Hard to cut	Free cutting		
Common Name		Inconel Hastelloy MP35N	Ti-6Al-4V	ASTM F-75	304 316 17-4PH	303 430F	5120 4137	1045 1046
Grade	1st choice	DT4					VM1	
	2nd choice	VM1					DT4	
Cutting Speed (SFM)		100 160 230			100 200 300			
Feed Rate (IPR)		.0004 .0008 .0012			.0004 .0012 .0020			





CTP / CTPA / CTPS / CTPW

Work Material		High Temperature Alloys	Titanium Alloys	Cobalt Chrome Alloys	Stainless Steels		Alloy Steels	Carbon Steels
					Hard to cut	Free cutting		
Common Name		Inconel Hastelloy MP35N	Ti-6Al-4V	ASTM F-75	304 316 17-4PH	303 430F	5120 4137	1045 1046
Grade	1st choice	DT4				TM4	QM3	
	2nd choice	TM4			QM3 / VM1	QM3	TM4 / DT4 / C7Z(X)	
Cutting Speed (SFM)		100 160 230			100 200 300			
Feed Rate (IPR)		.0008 .0012 .0020			.0008 .0016 .0024			

CTDP / CTV

Work Material		High Temperature Alloys	Titanium Alloys	Cobalt Chrome Alloys	Stainless Steels		Alloy Steels	Carbon Steels
					Hard to cut	Free cutting		
Common Name		Inconel Hastelloy MP35N	Ti-6Al-4V	ASTM F-75	304 316 17-4PH	303 430F	5120 4137	1045 1046
Grade	1st choice	DM4				TM4	QM3	
	2nd choice	TM4 / QM3				QM3	TM4 / DM4	
Cutting Speed (SFM)		100 160 230			100 200 300			
Feed Rate (IPR)		.0012 .0020 .0031			.0016 .0031 .0047			

1st Recommendation style for Cut-off Diameter

Cut-off diameter (φ)	Style	Code	Image
.197"	CSV style	→S6	
.197"-.472"	CTP style	→S8	
.472"-.630"	CTPA style	→S8	
	CTDP style	→S14	
.630"-	CTDP style	→S14	

CSV Series

Best for up to .200" diameter material

CSV-NC For Gang-style machine

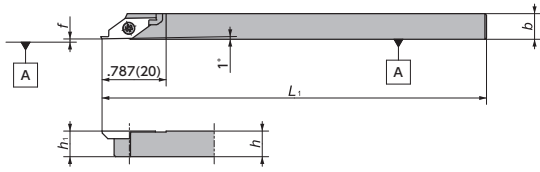

Figure-1

Right-Hand style shown

CSV For Cam-style machine

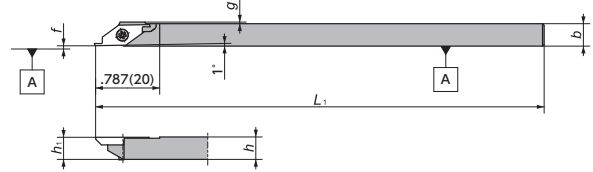



Figure-2

Right-Hand style shown

CSV Series - Toolholders

CSV_{R/L} / CSV_{R/L}-NC

Gage Insert	Item Number	Figure	Stock		h		b		h ₁		L ₁		f		g		Clamp Screw	Wrench
			R	L	(Inch)	(mm)	(Inch)	(mm)	(Inch)	(mm)	(Inch)	(mm)	(Inch)	(mm)	(Inch)	(mm)		
	CSV _{R/L} 06-IN-NC	1	●	●	3/8	3/8	3/8	3/8	4.724	120	.004	0.1	0.0	0.0	LRIS-2.5 × 7	CLR-15S		
	CSV _{R/L} 08-IN-NC	1	●	●	1/2	1/2	1/2	1/2	4.724	120	.004	0.1	0.0	0.0	LRIS-2.5 × 7	CLR-15S		
	CSV _{R/L} 08NC	1	○	○	.315	8	.315	8	.315	8	4.724	120	.004	0.1	0.0	0.0	LRIS-2.5 × 7	CLR-15S
	CSV _{R/L} 08NC-F	1	○	○	.315	8	.315	8	.315	8	4.724	120	0-.004	0.0-0.1	0.0	0.0	LRIS-2.5 × 7	CLR-15S
	CSV _{R/L} 10GXNC	1	○	○	.394	10	.394	10	.394	10	3.346	85	.004	0.1	0.0	0.0	LRIS-2.5 × 7	CLR-15S
	CSV _{R/L} 10NC	1	○	○	.394	10	.394	10	.394	10	4.724	120	.004	0.1	0.0	0.0	LRIS-2.5 × 7	CLR-15S
	CSV _{R/L} 12NC	1	○	○	.472	12	.472	12	.472	12	4.724	120	.004	0.1	0.0	0.0	LRIS-2.5 × 7	CLR-15S
	CSV _{R/L} 07GX	2	○	○	.275	7	.275	7	.275	7	3.346	85	.004	0.1	.020	0.5	LRIS-2.5 × 7	CLR-15S
	CSV _{R/L} 07	2	○	●	.275	7	.275	7	.275	7	5.512	140	.004	0.1	.020	0.5	LRIS-2.5 × 7	CLR-15S
	CSV _{R/L} 08GX	2	○	○	.315	8	.315	8	.315	8	3.346	85	.004	0.1	0.0	0.0	LRIS-2.5 × 7	CLR-15S
	CSV _{R/L} 08	2	○	●	.315	8	.315	8	.315	8	5.512	140	.004	0.1	0.0	0.0	LRIS-2.5 × 7	CLR-15S
	CSV _{R/L} 095	2	○	○	.374	9.5	.374	9.5	.374	9.5	5.512	140	.004	0.1	0.0	0.0	LRIS-2.5 × 7	CLR-15S
	CSV _{R/L} 10	2	○	○	.394	10	.394	10	.394	10	5.512	140	.004	0.1	0.0	0.0	LRIS-2.5 × 7	CLR-15S
	CSV _{R/L} 12GX	2	○	○	.472	12	.472	12	.472	12	3.346	85	.004	0.1	0.0	0.0	LRIS-2.5 × 7	CLR-15S
CSV _{R/L} 12	2	○	●	.472	12	.472	12	.472	12	5.512	140	.004	0.1	0.0	0.0	LRIS-2.5 × 7	CLR-15S	

CSV Series - Inserts

CSV_C - Cut-off Mirror finish

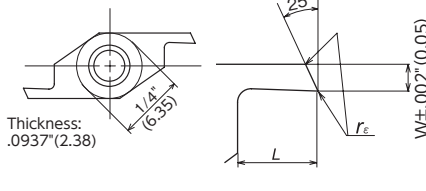
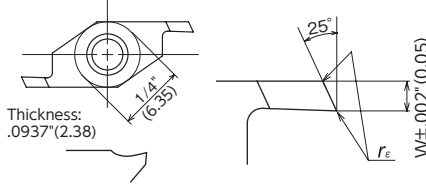
Shape	Item Number	Chip-breaker	Max. Cut-off Dia. ϕD		w		L		r_e		VM1	
			(Inch)	(mm)	(Inch)	(mm)	(Inch)	(mm)	(Inch)	(mm)	R	L
 <p>Thickness: .0937(2.38)</p> <p>Right-Hand style shown</p>	CSV11F _{R/L} V06 M	No	.118	3.0	.024	0.6	.079	2.0	0	0.0	○	○
	CSV11F _{R/L} V07 M	No	.157	4.0	.028	0.7	.098	2.5	0	0.0	●	●
	CSV11F _{R/L} V08 M	No	.157	4.0	.031	0.8	.098	2.5	0	0.0	○	○
	CSV11F _{R/L} V09 M	No	.157	4.0	.035	0.9	.098	2.5	0	0.0	○	○
	CSV11F _{R/L} V10 M	No	.197	5.0	.039	1.0	.118	3.0	0	0.0	●	●
	CSV11F _{R/L} V13 M	No	.197	5.0	.051	1.3	.118	3.0	0	0.0	●	○
 <p>Thickness: .0937(2.38)</p> <p>Right-Hand style shown</p>	CSV11F _{R/L} VB06 M	Yes	.118	3.0	.024	0.6	.079	2.0	0	0.0	○	○
	CSV11F _{R/L} VB07 M	Yes	.157	4.0	.028	0.7	.098	2.5	0	0.0	●	○
	CSV11F _{R/L} VB08 M	Yes	.157	4.0	.031	0.8	.098	2.5	0	0.0	○	○
	CSV11F _{R/L} VB09 M	Yes	.157	4.0	.035	0.9	.098	2.5	0	0.0	○	○
	CSV11F _{R/L} VB10 M	Yes	.197	5.0	.039	1.0	.118	3.0	0	0.0	●	○
	CSV11F _{R/L} VB13 M	Yes	.197	5.0	.051	1.3	.118	3.0	0	0.0	○	○
CSV11F _{R/L} VB15 M	Yes	.197	5.0	.059	1.5	.118	3.0	0	0.0	○	○	

Note: All angles shown are obtained when insert is set in the holder

CTPS Series

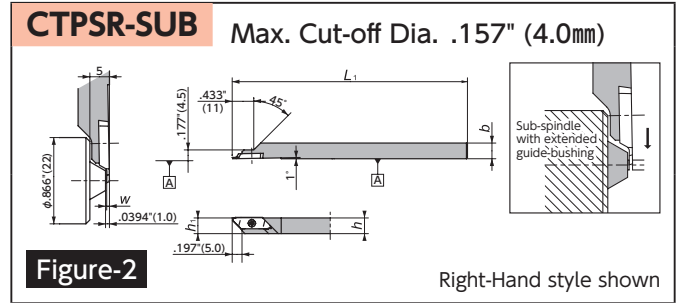
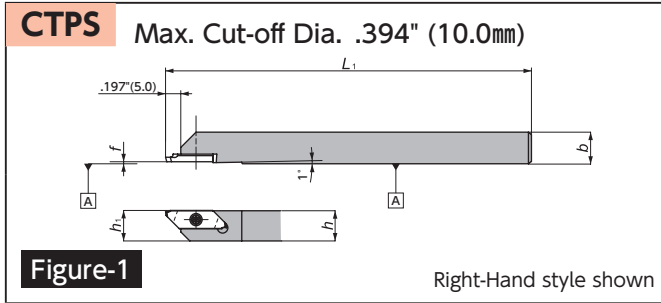

CTPS Series - Toolholders

CTPS / CTPSR

Gage Insert	Item Number	Figure	Stock		Max. Cut-off Dia. ϕD		h		b		h_1		L_1		f		Clamp Screw	Wrench
			R	L	(Inch)	(mm)	(Inch)	(mm)	(Inch)	(mm)	(Inch)	(mm)	(Inch)	(mm)	(Inch)	(mm)		
	CTPSR06-IN	1	●	●	.394	10.0	3/8	3/8	3/8	3/8	4.724	120	0	0.0	LRIS-2.5 × 7	CLR-15S		
	CTPSR08-IN	1	●	●	.394	10.0	1/2	1/2	1/2	1/2	4.724	120	0	0.0	LRIS-2.5 × 7	CLR-15S		
	CTPSR10	1	○	○	.394	10.0	.394	10	.394	10	.394	10	0	0.0	LRIS-2.5 × 7	CLR-15S		
	CTPSR12	1	○	○	.394	10.0	.472	12	.472	12	.472	12	0	0.0	LRIS-2.5 × 7	CLR-15S		
CTPS-001	CTPSR08-SUB04	2	○	○	.157	4.0	.315	8	.315	8	.315	8	4.724	120	—	LRIS-2.5 × 5	CLR-15S	

CTPS Series - Inserts

CTPS - Cut-off

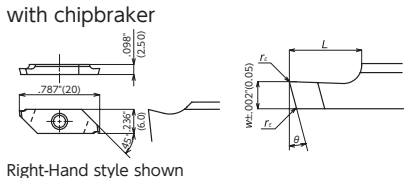
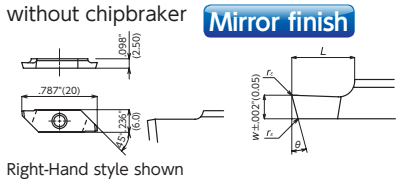
Shape	Item Number	Chip-breaker	Max. Cut-off Dia. ϕD		w		L		θ	r_ϵ		Coated Carbide			
			(Inch)	(mm)	(Inch)	(mm)	(Inch)	(mm)		(Inch)	(mm)	VM1		ZM3	
			R	L	R	L	R	L		R	L				
 <p>with chipbraker</p> <p>Right-Hand style shown</p>	CTPS12FR	Yes	.157	4.0	.047	1.2	.138	3.5	16°	.002	0.05	○	○	●	○
	CTPS15FR	Yes	.197	5.0	.059	1.5	.157	4.0	16°	.002	0.05	○	○	●	○
	CTPS18FR	Yes	.335	8.5	.071	1.8	.217	5.5	16°	.002	0.05	○	○	●	○
	CTPS20FR	Yes	.394	10.0	.079	2.0	.236	6.0	16°	.002	0.05	○	○	○	○
 <p>without chipbraker</p> <p>Mirror finish</p> <p>Right-Hand style shown</p>	CTPS12FRV (M)	No	.157	4.0	.047	1.2	.138	3.5	20°	0	0.0	●	○	○	○
	CTPS15FRV (M)	No	.197	5.0	.059	1.5	.157	4.0	20°	0	0.0	○	○	○	○
	CTPS18FRV (M)	No	.335	8.5	.071	1.8	.217	5.5	20°	0	0.0	○	○	○	○
	CTPS20FRV (M)	No	.394	10.0	.079	2.0	.236	6.0	20°	0	0.0	○	○	○	○

Note: All angles shown are obtained when insert is set in the holder

CTPS-001 - Cut-off

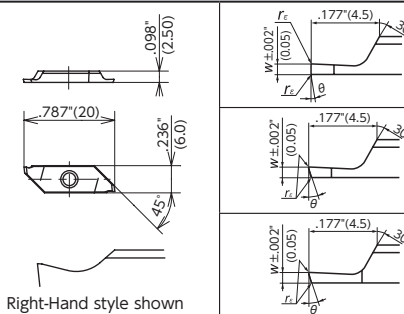
Shape	Item Number	Chip-breaker	Max. Cut-off Dia. ϕD		w	θ	r_ϵ		Coated Carbide		
			(Inch)	(mm)			(Inch)	(mm)	ZM3		
			R	L			R	L			
 <p>Right-Hand style shown</p>	CTPS07FRN-001	Yes	.157	4.0	.028	0.7	0°	.002	0.05	○	○
	CTPS07FR-001	Yes	.157	4.0	.028	0.7	16°	.002	0.05	○	○
	CTPS07FRV-001 (M)	No	.157	4.0	.028	0.7	20°	0	0.0	○	○

Note: All angles shown are obtained when insert is set in the holder

● : Stock

○ : 1-2 week delivery

(M) : Mirror finish

CTPS series → O31

Cutting condition → S5

CTP / CTPA / CTPW - Toolholders

CTP / CTPA

Screw Accessible from both sides

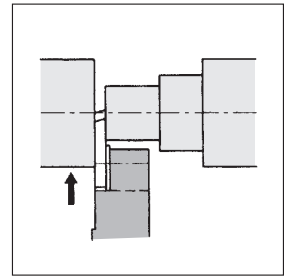
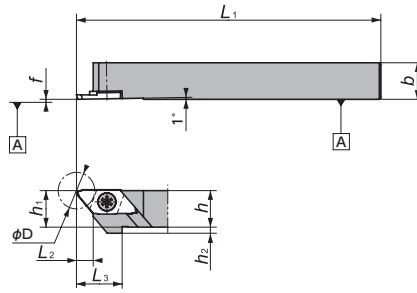

Right-Hand style shown

Figure-1

CTP-OH / CTPA-OH (Coolant through)

Screw Accessible from both sides

NEW

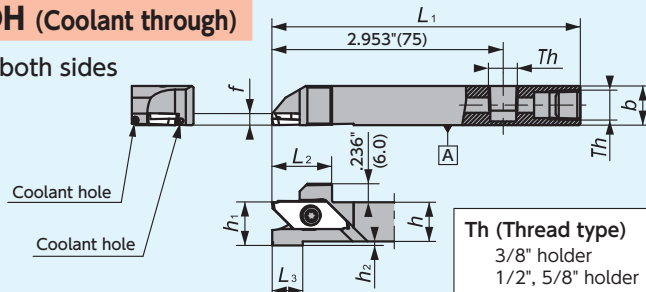

Th (Thread type)

3/8" holder : M6 x 1

1/2", 5/8" holder : NPT1/8

Metric size holder : Rc1/8 (PT1/8)

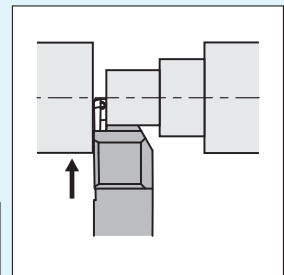

Right-Hand style shown

Figure-2

• Left-Hand holders are designed for Right-Hand machines

CTPW

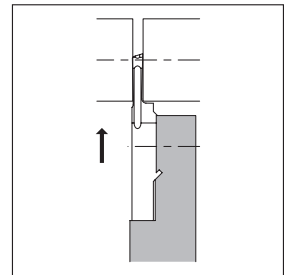
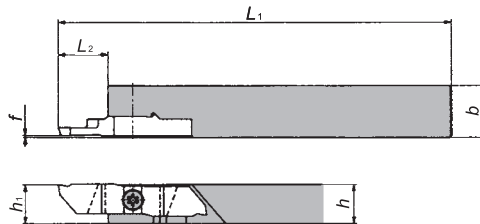

Right-Hand style shown

Figure-3

CTPR-SUB / CTPAR-SUB

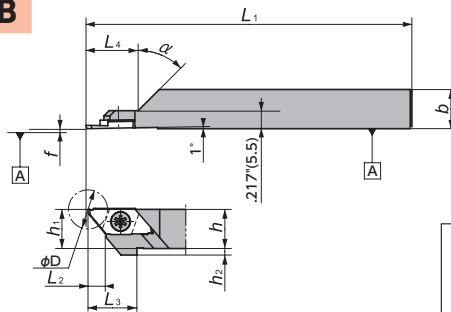

phi Ds

CTPR-SUB: phi 1.18" (phi 30mm)

CTPAR-SUB: phi 1.42" (phi 36mm)

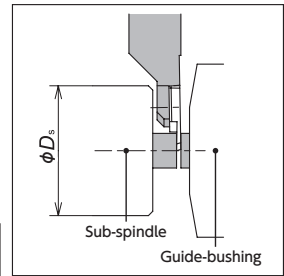

Sub-spindle
Guide-bushing

Figure-4

CTPL-SUB / CTPAL-SUB

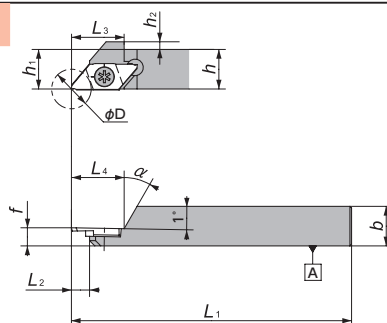

phi Ds

CTPL-SUB: phi 1.18" (phi 30mm)

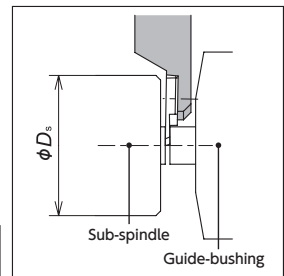

CTPAL-SUB: phi 1.42" (phi 36mm)



Sub-spindle
Guide-bushing

Figure-5



CTP / CTPA / CTPW

Gage Insert	Item Number	Figure	Stock		Max. Cut-off Dia. ϕD^*		h	h_1	b	L_1	h_2	L_2	L_3	Th	f	Clamp Screw	Wrench
			R	L	(Inch)	(mm)											
	CTP%06-IN	1	●	●	.472	12	3/8	3/8	3/8	4.724 120	.079 2	.217 5.5	.591 15	—	0.0 0.0	LRIS-4×10PW	CLR-15S
	CTP%08-IN	1	●	●	.472	12	1/2	1/2	1/2	4.724 120	0 0	.217 5.5	.591 15	—	0.0 0.0	LRIS-4×12PW	CLR-15S
	CTP%10-IN	1	●	●	.472	12	5/8	5/8	5/8	4.724 120	0 0	.217 5.5	.591 15	—	0.0 0.0	LRIS-4×12PW	CLR-15S
	CTP%108	1	●	●	.472	12	.315 8	.315 8	.394 10	4.724 120	.157 4	.217 5.5	.591 15	—	0.0 0.0	LRIS-4×10PW	CLR-15S
	CTP%10H	1	○	○	.472	12	.394 10	.394 10	.394 10	3.937 100	.079 2	.217 5.5	.591 15	—	0.0 0.0	LRIS-4×10PW	CLR-15S
	CTP%110	1	○	○	.472	12	.394 10	.394 10	.394 10	4.724 120	.079 2	.217 5.5	.591 15	—	0.0 0.0	LRIS-4×10PW	CLR-15S
	CTP%112GX	1	○	○	.472	12	.472 12	.472 12	.472 12	3.346 85	0 0	.217 5.5	.591 15	—	0.0 0.0	LRIS-4×12PW	CLR-15S
	CTP%112	1	○	○	.472	12	.472 12	.472 12	.472 12	4.724 120	0 0	.217 5.5	.591 15	—	0.0 0.0	LRIS-4×12PW	CLR-15S
	CTP%113	1	○	○	.472	12	.519 13	.519 13	.519 13	4.724 120	0 0	.217 5.5	.591 15	—	0.0 0.0	LRIS-4×12PW	CLR-15S
	CTP%116H	1	○	○	.472	12	.630 16	.630 16	.630 16	3.937 100	0 0	.217 5.5	.591 15	—	0.0 0.0	LRIS-4×12PW	CLR-15S
	CTP%116	1	○	○	.472	12	.630 16	.630 16	.630 16	4.724 120	0 0	.217 5.5	.591 15	—	0.0 0.0	LRIS-4×12PW	CLR-15S
	CTP%06H-IN-OH	2	●	●	.472	12	3/8	.472 12	3/8	3.937 100	.176 4.475	.768 19.5	.748 19	M6 × 1	0.0 0.0	LRIS-4×10PW	CLR-15S
	CTP%08H-IN-OH	2	●	●	.472	12	1/2	1/2	1/2	3.937 100	.051 1.3	.768 19.5	.394 10	NPT1/8	0.0 0.0	LRIS-4×12PW	CLR-15S
	CTP%1012H-OH	2	○	○	.472	12	.394 10	.472 12	.394 10	3.937 100	.176 4.475	.768 19.5	.748 19	M6 × 1	0.0 0.0	LRIS-4×12PW	CLR-15S
CTP%112H-OH	2	●	●	.472	12	.472 12	.472 12	.472 12	3.937 100	.051 1.3	.768 19.5	.394 10	Rc1/8(PT1/8)	0.0 0.0	LRIS-4×12PW	CLR-15S	
CTP%116H-OH	2	○	○	.472	12	.630 16	.630 16	.630 16	3.937 100	0 0	.768 19.5	—	—	0.0 0.0	LRIS-4×12PW	CLR-15S	
	CTPA%06-IN	1	●	●	.630	16	3/8	3/8	3/8	4.724 120	.079 2	.295 7.5	.768 19.5	—	0.0 0.0	LRIS-4×10PW	CLR-15S
	CTPA%08-IN	1	●	●	.630	16	1/2	1/2	1/2	4.724 120	0 0	.295 7.5	.768 19.5	—	0.0 0.0	LRIS-4×12PW	CLR-15S
	CTPA%10-IN	1	●	●	.630	16	5/8	5/8	5/8	4.724 120	0 0	.295 7.5	.768 19.5	—	0.0 0.0	LRIS-4×12PW	CLR-15S
	CTPA%110	1	○	○	.630	16	.394 10	.394 10	.394 10	4.724 120	.079 2	.295 7.5	.768 19.5	—	0.0 0.0	LRIS-4×10PW	CLR-15S
	CTPA%112	1	○	○	.630	16	.472 12	.472 12	.472 12	4.724 120	0 0	.295 7.5	.768 19.5	—	0.0 0.0	LRIS-4×12PW	CLR-15S
	CTPA%116	1	○	○	.630	16	.630 16	.630 16	.630 16	4.724 120	0 0	.295 7.5	.768 19.5	—	0.0 0.0	LRIS-4×12PW	CLR-15S
	CTPA%120F	1	○	○	.630	16	.787 20	.787 20	.787 20	3.150 80	0 0	.295 7.5	.768 19.5	—	0.0 0.0	LRIS-4×10PW	LLR-25S
	CTPA%06H-IN-OH	2	●	●	.630	16	3/8	.472 12	3/8	3.937 100	.176 4.475	.768 19.5	.787 20	M6 × 1	0.0 0.0	LRIS-4×10PW	CLR-15S
	CTPA%08H-IN-OH	2	●	●	.630	16	1/2	1/2	1/2	3.937 100	.051 1.3	.768 19.5	.394 10	NPT1/8	0.0 0.0	LRIS-4×12PW	CLR-15S
	CTPA%10H-IN-OH	2	●	●	.630	16	5/8	5/8	5/8	3.937 100	0 0	.768 19.5	—	—	0.0 0.0	LRIS-4×12PW	CLR-15S
	CTPW%08-IN	3	●	●	.787	20	1/2	.498	.630 16	4.724 120	—	.591 15	—	—	0.0 0.0	LRIS-4×10	LLR-25S
	CTPW%10-IN	3	●	●	.787	20	5/8	.623	.630 16	4.724 120	—	.591 15	—	—	0.0 0.0	LRIS-4×10	LLR-25S
	CTPW%10A	3	○	○	.787	20	.394 10	.392 9.95	.630 16	4.724 120	—	.591 15	—	—	0.0 0.0	LRIS-4×10	LLR-25S
	CTPW%110	3	○	○	.787	20	.394 10	.392 9.95	.472 12	4.724 120	—	.591 15	—	—	0.0 0.0	LRIS-4×10	LLR-25S
	CTPW%112A	3	○	○	.787	20	.472 12	.470 11.95	.630 16	4.724 120	—	.591 15	—	—	0.0 0.0	LRIS-4×10	LLR-25S
	CTPW%112	3	○	○	.787	20	.472 12	.470 11.95	.472 12	4.724 120	—	.591 15	—	—	0.0 0.0	LRIS-4×10	LLR-25S
	CTPW%116	3	○	○	.787	20	.630 16	.628 15.95	.630 16	4.724 120	—	.591 15	—	—	0.0 0.0	LRIS-4×10	LLR-25S
	CTPW%120	3	○	○	.787	20	.787 20	.785 19.95	.787 20	4.724 120	—	.591 15	—	—	0.0 0.0	LRIS-4×10	LLR-25S

● Left-Hand coolant through holders are designed for Right-Hand machines



* Would be changed by insert

CTPR-SUB / CTPAR-SUB

Gage Insert	Item Number	Figure	Stock		Max. Cut-off Dia. ϕD^*		h	h_1	b	L_1	h_2	L_2	L_3	L_4	α	f	Clamp Screw	Wrench
			R	L	(Inch)	(mm)												
	CTPR06-IN-SUB	4	●	●	.472	12	3/8	3/8	3/8	4.724 120	.079 2	.217 5.5	.591 15	.630 16	45°	.217 5.5	LRIS-4×5	LLR-25S
	CTPR08-IN-SUB	4	●	●	.472	12	1/2	1/2	1/2	4.724 120	0 0	.217 5.5	.591 15	.630 16	45°	.217 5.5	LRIS-4×5	LLR-25S
	CTPR10-IN-SUB	4	●	●	.472	12	5/8	5/8	5/8	4.724 120	0 0	.217 5.5	.591 15	.630 16	45°	.217 5.5	LRIS-4×5	LLR-25S
	CTPR08-SUB	4	○	○	.472	12	.315 8	.315 8	.315 8	4.724 120	.157 4	.217 5.5	.591 15	.630 16	45°	.217 5.5	LRIS-4×5	LLR-25S
	CTPR08J-SUB	4	○	○	.472	12	.315 8	.315 8	.315 8	4.331 110	.157 4	.217 5.5	.591 15	.630 16	45°	.217 5.5	LRIS-4×5	LLR-25S
	CTPR10F-SUB	4	○	○	.472	12	.394 10	.394 10	.394 10	3.150 80	.079 2	.217 5.5	.591 15	.630 16	45°	.217 5.5	LRIS-4×5	LLR-25S
	CTPR10KX-SUB	4	○	○	.472	12	.394 10	.394 10	.394 10	4.724 120	.079 2	.217 5.5	.591 15	.630 16	45°	.217 5.5	LRIS-4×5	LLR-25S
	CTPR12GX-SUB	4	○	○	.472	12	.472 12	.472 12	.472 12	3.346 85	0 0	.217 5.5	.591 15	.630 16	45°	.217 5.5	LRIS-4×5	LLR-25S
	CTPR12-SUB	4	○	○	.472	12	.472 12	.472 12	.472 12	4.724 120	0 0	.217 5.5	.591 15	.630 16	45°	.217 5.5	LRIS-4×5	LLR-25S
		CTPAR06-IN-SUB	4	●	●	.630	16	3/8	3/8	3/8	4.724 120	.079 2	.295 7.5	.768 19.5	.787 20	25°	.217 5.5	LRIS-4×5
CTPAR08-IN-SUB		4	●	●	.630	16	1/2	1/2	1/2	4.724 120	0 0	.295 7.5	.768 19.5	.787 20	25°	.217 5.5	LRIS-4×5	LLR-25S
CTPAR10-IN-SUB		4	●	●	.630	16	5/8	5/8	5/8	4.724 120	0 0	.295 7.5	.768 19.5	.787 20	25°	.217 5.5	LRIS-4×5	LLR-25S
CTPAR10GX-SUB		4	○	○	.630	16	.394 10	.394 10	.394 10	3.346 85	.079 2	.787 20	.768 19.5	.787 20	25°	0 0.0	LRIS-4×5	LLR-25S
CTPAR12GX-SUB		4	○	○	.630	16	.472 12	.472 12	.472 12	3.346 85	0 0	.787 20	.768 19.5	.787 20	25°	0 0.0	LRIS-4×5	LLR-25S
CTPAR12KX-SUB		4	○	○	.630	16	.472 12	.472 12	.472 12	4.724 120	0 0	.787 20	.768 19.5	.787 20	25°	0 0.0	LRIS-4×5	LLR-25S

* Would be changed by insert

CTPL-SUB / CTPAL-SUB

Gage Insert	Item number	Figure	Stock		Max. Cut-off Dia. ϕD^*		h	h_1	b	L_1	h_2	L_2	L_3	L_4	α	f	Clamp screw	Wrench
			L	R	(Inch)	(mm)												
	CTPL08-SUB	5	○	○	.472	12	.315 8	.315 8	.394 10	4.724 120	.157 4	.217 5.5	.591 15	.630 16	30°	.217 5.5	LRIS-4×5	LLR-25S
	CTPL08J-SUB	5	○	○	.472	12	.315 8	.315 8	.315 8	4.331 110	.157 4	.217 5.5	.591 15	.630 16	30°	.217 5.5	LRIS-4×5	LLR-25S
	CTPL10GX-SUB	5	○	○	.472	12	.394 10	.394 10	.394 10	3.346 85	.079 2	.217 5.5	.591 15	.630 16	30°	.217 5.5	LRIS-4×5	LLR-25S
	CTPL12GX-SUB	5	○	○	.472	12	.472 12	.472 12	.472 12	3.346 85	0 0	.217 5.5	.591 15	.630 16	30°	.217 5.5	LRIS-4×5	LLR-25S
	CTPAL06-IN-SUB	5	●	●	.630	16	3/8	3/8	3/8	4.724 120	.079 2	.295 7.5	.768 19.5	.787 20	30°	.295 7.5	LRIS-4×5	LLR-25S
	CTPAL08-IN-SUB	5	●	●	.630	16	1/2	1/2	1/2	4.724 120	0 0	.295 7.5	.768 19.5	.787 20	30°	.295 7.5	LRIS-4×5	LLR-25S
	CTPAL10-IN-SUB	5	●	●	.630	16	5/8	5/8	5/8	4.724 120	0 0	.295 7.5	.768 19.5	.787 20	30°	.295 7.5	LRIS	

CTP / CTPA / CTPW Inserts (Right-Hand)

Two-sided insert

CTP / CTPX / CTP-X

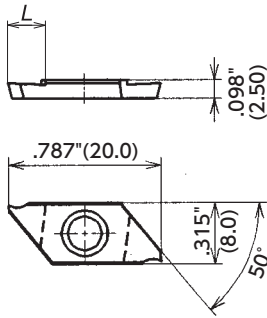

Right-Hand style shown

CTPA / CTPAX

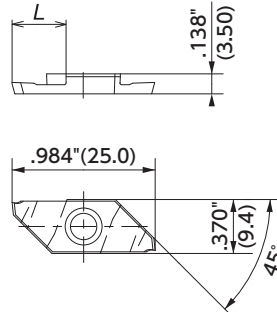

Right-Hand style shown

CTPW

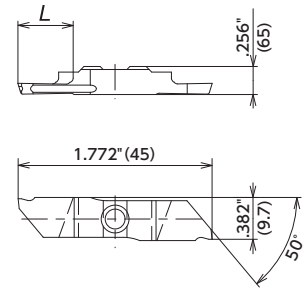

Right-Hand style shown

FR

Shape	Item Number	Figure	Chip-breaker	Max. Cut-off Dia. ϕD		w		L		θ	r_{e1}		Coated Carbide				Carbide	PCD
				(Inch)	(mm)	(Inch)	(mm)	(Inch)	(mm)		(Inch)	(mm)	QM3	DT4	VM1	ZM3	KM1	PD1
Figure-1	CTP05FR-SH	1	Yes	.197	5.0	.020	0.5	.110	2.8	15°	.001	0.03				●		
	CTP07FR	1	Yes	.315	8.0	.028	0.7	.177	4.5	16°	.002	0.05				●		
	CTP10FR-SH	1	Yes	.275	7.0	.039	1.0	.161	4.1	15°	.002	0.05		○		○		
	CTP10FR	1	Yes	.472	12.0	.039	1.0	.264	6.7	16°	.002	0.05		●	●	●		
	CTP10FRFT	3	No	.472	12.0	.039	1.0	.264	6.7	16°	.002	0.05	●					
Figure-2	CTP10FRV ^M	2	No	.472	12.0	.039	1.0	.264	6.7	20°	0.0	0.0		○	●	●	○	
	CTP15FR	1	Yes	.472	12.0	.059	1.5	.264	6.7	16°	.002	0.05			●	●		
	CTPX15FR	1	Yes	.472	12.0	.059	1.5	.264	6.7	16°	.002	0.05	●	●		○		
	CTP15FRX	1	Yes	.472	12.0	.059	1.5	.264	6.7	16°	.002	0.05				○		
Figure-3	CTP15FRV ^M	2	No	.472	12.0	.059	1.5	.264	6.7	20°	0.0	0.0			●	●	○	
	CTP20FR	1	Yes	.472	12.0	.079	2.0	.264	6.7	16°	.002	0.05			●	●		
	CTPX20FR	1	Yes	.472	12.0	.079	2.0	.264	6.7	16°	.002	0.05	●	●		○		
	CTP20FRX	1	Yes	.472	12.0	.079	2.0	.264	6.7	16°	.002	0.05				○		
Figure-4	CTP20FRV ^M	2	No	.472	12.0	.079	2.0	.264	6.7	20°	0.0	0.0			●	●	○	
	CTPA07FR	1	Yes	.315	8.0	.028	0.7	.177	4.5	16°	.002	0.05				●		
	CTPA10FR	1	Yes	.472	12.0	.039	1.0	.264	6.7	16°	.002	0.05	●		●	●		
	CTPA10FRFT	3	No	.472	12.0	.039	1.0	.264	6.7	20°	.002	0.05	●					
	CTPA15FR	1	Yes	.630	16.0	.059	1.5	.362	9.2	16°	.002	0.05	●	●	●	●		
Figure-5	CTPA15FRFT	3	No	.630	16.0	.059	1.5	.362	9.2	20°	.002	0.05	●					
	CTPA20FR	1	Yes	.630	16.0	.079	2.0	.362	9.2	16°	.002	0.05	●	●	●	●		
	CTPA20FRV ^M	2	No	.630	16.0	.079	2.0	.362	9.2	20°	0.0	0.0			○		○	
	CTPW25FR	4	Yes	.787	20.0	.098	2.5	.472	12	17°	.002	0.05				●		
	CTPW25FRP ^M	5	No	.787	20.0	.098	2.5	.472	12	17°	.002	0.05				○		

FRN

Shape	Item Number	Figure	Chip-breaker	Max. Cut-off Dia. ϕD		w		L		θ	$r_{\epsilon 1}$		Coated Carbide				Carbide	PCD
				(Inch)	(mm)	(Inch)	(mm)	(Inch)	(mm)		(Inch)	(mm)	QM3	DT4	VM1	ZM3	KM1	PD1
Figure-1 	CTP05FRN-SH	1	Yes	.197	5.0	.020	0.5	.110	2.8	0°	.001	0.03				●		
	CTP10FRN-SH	1	Yes	.275	7.0	.039	1.0	.161	4.1	0°	.002	0.05		○		○		
	CTP10FRN	1	Yes	.472	12.0	.039	1.0	.264	6.7	0°	.002	0.05		●		●		
	CTP15FRN	1	Yes	.472	12.0	.059	1.5	.264	6.7	0°	.002	0.05			●	●		
	CTPX15FRN	1	Yes	.472	12.0	.059	1.5	.264	6.7	0°	.002	0.05	●	●				
Figure-2 	CTP15FRNX	1	Yes	.472	12.0	.059	1.5	.264	6.7	0°	.002	0.05				○		
	CTP15FRNV M	2	No	.472	12.0	.059	1.5	.264	6.7	0°	0.0	0.0					○	
	CTP20FRN	1	Yes	.472	12.0	.079	2.0	.264	6.7	0°	.002	0.05			●	●		
	CTPX20FRN	1	Yes	.472	12.0	.079	2.0	.264	6.7	0°	.002	0.05	●	●				
	CTP20FRNX	1	Yes	.472	12.0	.079	2.0	.264	6.7	0°	.002	0.05				○		
Figure-3 	CTP20FRNV M	2	No	.472	12.0	.079	2.0	.264	6.7	0°	0.0	0.0					○	
	CTPA07FRN	1	Yes	.315	8.0	.028	0.7	.177	4.5	0°	.002	0.05				●		
	CTPA10FRN	1	Yes	.472	12.0	.039	1.0	.264	6.7	0°	.002	0.05	●			●		
	CTPA10FRS M	2	No	.472	16.0	.039	1.0	.362	9.2	0°	.002	0.05	●					
	CTPA15FRN	1	Yes	.630	16.0	.059	1.5	.362	9.2	0°	.002	0.05	●	●	●	●		
Figure-4 	CTPA15FRS M	2	No	.630	16.0	.059	1.5	.362	9.2	0°	.002	0.05	●					
	CTPA20FRN	1	Yes	.630	16.0	.079	2.0	.362	9.2	0°	.002	0.05	●	●	●	●		
	CTPA20FRS M	2	No	.630	16.0	.079	2.0	.362	9.2	0°	.002	0.05	●			○		
	CTPA20FRNV M	2	No	.630	16.0	.079	2.0	.362	9.2	0°	0.0	0.0					○	
	CTPA20FRN-P	3	Yes	.630	16.0	.079	2.0	.362	9.2	0°	.004	0.1						○
Figure-5 	CTPA30FRN	1	Yes	.630	16.0	.118	3.0	.362	9.2	0°	.002	0.05	○					
	CTPW25FRN	4	Yes	.787	20.0	.098	2.5	.472	12	0°	.002	0.05				●		
	CTPW25FRNV M	5	No	.787	20.0	.098	2.5	.472	12	0°	0.0	0.0				●		

Cut-off

FRK

Shape	Item Number	Figure	Chip-breaker	Max. Cut-off Dia. ϕD		w		L		θ	$r_{\epsilon 1}$		Coated Carbide				Carbide	PCD
				(Inch)	(mm)	(Inch)	(mm)	(Inch)	(mm)		(Inch)	(mm)	QM3	DT4	VM1	ZM3	KM1	PD1
Figure-1 	CTP10FRK	1	Yes	.433	11.0	.039	1.0	.264	6.7	16°	.002	0.05				○		
	CTP15FRK	1	Yes	.433	11.0	.059	1.5	.264	6.7	16°	.002	0.05				○		
	CTP20FRK	1	Yes	.433	11.0	.079	2.0	.264	6.7	16°	.002	0.05				○		

Note: All angles shown are obtained when insert is set in the holder.

Holders **→S8**

Tool selection guide **→S4**

Cutting condition **→S5**

● : Stock

○ : 1-2 week delivery

M : Mirror finish

CTP / CTPA / CTPW Inserts (Left-Hand)

Two-sided insert

CTP / CTPX / CTP-X

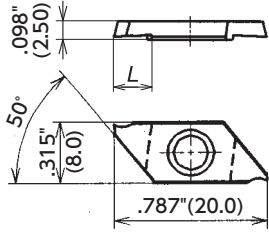

Left-Hand style shown

CTPA / CTPAX

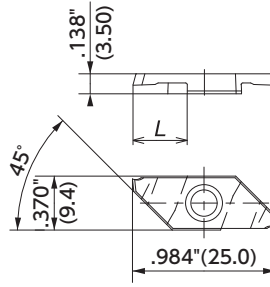

Left-Hand style shown

CTPW

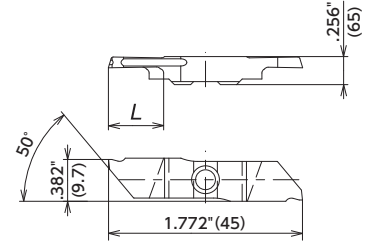

Left-Hand style shown

FLK

Shape	Item Number	Figure	Chip-breaker	Max. Cut-off Dia. ϕD		W		L		θ	r_{e1}		Coated Carbide				Carbide	PCD
				(Inch)	(mm)	(Inch)	(mm)	(Inch)	(mm)		(Inch)	(mm)	QM3	DT4	VM1	ZM3	KM1	PD1
Figure-1 	CTP05FLK-SH	1	Yes	.197	5.0	.020	0.5	.110	2.8	17°	.001	0.03				●		
	CTP10FLK-SH	1	Yes	.275	7.0	.039	1.0	.161	4.1	17°	.002	0.05		○		○		
	CTP10FLK	1	Yes	.433	11.0	.039	1.0	.264	6.7	16°	.002	0.05		●	○	●		
	CTP10FLK-211	1	Yes	.472	12.0	.039	1.0	.295	7.5	16°	.002	0.05			●			
	CTP15FLK	1	Yes	.433	11.0	.059	1.5	.264	6.7	16°	.002	0.05			○	●		
	CTP15FLKB	1	Yes	.433	11.0	.059	1.5	.264	6.7	16°	.002	0.05				○		
	CTPX15FLK	1	Yes	.433	11.0	.059	1.5	.264	6.7	16°	.002	0.05	●	●				
	CTP15FLKV ^M	2	No	.433	11.0	.059	1.5	.264	6.7	20°	0.0	0.0				●		○
Figure-2 Flat top 	CTP20FLK	1	Yes	.433	11.0	.079	2.0	.264	6.7	16°	.002	0.05			○	●		
	CTPX20FLK	1	Yes	.433	11.0	.079	2.0	.264	6.7	16°	.002	0.05	●	●				
	CTPA07FLK	1	Yes	.256	6.5	.028	0.7	.177	4.5	16°	.002	0.05				●		
	CTPA10FLK	1	Yes	.433	11.0	.039	1.0	.264	6.7	16°	.002	0.05	●			●	●	
Figure-3 	CTPA10FLKFD	1	Yes	.630	16.0	.039	1.0	.362	9.2	16°	.002	0.05				○		
	CTPA10FLKFT	2	No	.630	16.0	.039	1.0	.311	7.9	16°	.0	0.0	●					
	CTPA15FLK	1	Yes	.571	14.5	.059	1.5	.362	9.2	16°	.002	0.05	●	●	●	●		
	CTPA15FLKFT	2	No	.630	16.0	.059	1.5	.394	10.0	16°	0.0	0.0	●					
	CTPA15FLKV ^M	2	No	.571	14.5	.059	1.5	.362	9.2	20°	0.0	0.0	●					
	CTPA20FLK	1	Yes	.571	14.5	.079	2.0	.362	9.2	16°	.002	0.05	●	●	●	●		
	CTPA20FLKV ^M	2	No	.571	14.5	.079	2.0	.362	9.2	20°	0.0	0.0			○		○	
	CTPW25FLK	3	Yes	.787	20.0	.098	2.5	.472	12	17°	.002	0.05				●		

Note: All angles shown are obtained when insert is set in the holder

FLN

Shape	Item Number	Figure	Chip-breaker	Max. Cut-off Dia. ϕD		w		L		θ	$r_{\epsilon 1}$		Coated Carbide				Carbide	PCD
				(Inch)	(mm)	(Inch)	(mm)	(Inch)	(mm)		(Inch)	(mm)	QM3	DT4	VM1	ZM3	KM1	PD1
Figure-1 	CTP05FLN-SH	1	Yes	.197	5.0	.020	0.5	.110	2.8	0°	.001	0.03				●		
	CTP10FLN-SH	1	Yes	.275	7.0	.039	1.0	.161	4.1	0°	.002	0.05		○		○		
	CTP10FLN	1	Yes	.472	12.0	.039	1.0	.264	6.7	0°	.002	0.05		●		●		
	CTP15FLN	1	Yes	.472	12.0	.059	1.5	.264	6.7	0°	.002	0.05			○	●		
	CTPX15FLN	1	Yes	.472	12.0	.059	1.5	.264	6.7	0°	.002	0.05	●	●				
Figure-2 Flat top 	CTP15FLNV	2	No	.472	12.0	.059	1.5	.264	6.7	0°	0.0	0.0					○	
	CTP20FLN	1	Yes	.472	12.0	.079	2.0	.264	6.7	0°	.002	0.05			○	●		
	CTPX20FLN	1	Yes	.472	12.0	.079	2.0	.264	6.7	0°	.002	0.05	●	●				
	CTP20FLNV	2	No	.472	12.0	.079	2.0	.264	6.7	0°	0.0	0.0					○	
Figure-3 PCD tipped 	CTPA10FLN	1	Yes	.472	12.0	.039	1.0	.264	6.7	0°	.002	0.05	●		○	●		
	CTPA10FLND	1	Yes	.630	16.0	.039	1.0	.362	9.2	0°	.002	0.05				○		
	CTPA10FLS M	2	No	.630	16.0	.039	1.0	.362	9.2	0°	.002	0.05	●					
	CTPA15FLN	1	Yes	.630	16.0	.059	1.5	.362	9.2	0°	.002	0.05	●	●	○	●		
Figure-4 	CTPA15FLS M	2	No	.630	16.0	.059	1.5	.362	9.2	0°	.002	0.05	●					
	CTPA20FLN	1	Yes	.630	16.0	.079	2.0	.362	9.2	0°	.002	0.05	●	●	○	●		
	CTPA20FLS M	2	No	.630	16.0	.079	2.0	.362	9.2	0°	.002	0.05	●			○		
	CTPA20FLNV M	2	No	.630	16.0	.079	2.0	.362	9.2	0°	0.0	0.0					○	
Figure-5 Flat top 	CTPA20FLN-P	3	Yes	.630	16.0	.079	2.0	.362	9.2	0°	.004	0.1						○
	CTPA30FLN	1	Yes	.630	16.0	.118	3.0	.362	9.2	0°	.002	0.05	○					
	CTPW25FLN	4	Yes	.787	20.0	.098	2.5	.472	12	0°	.002	0.05				●		
	CTPW25FLNV M	5	No	.787	20.0	.098	2.5	.472	12	0°	0.0	0.0				●		

Cut-off

FL

Shape	Item Number	Figure	Chip-breaker	Max. Cut-off Dia. ϕD		w		L		θ	$r_{\epsilon 1}$		Coated Carbide				Carbide	PCD
				(Inch)	(mm)	(Inch)	(mm)	(Inch)	(mm)		(Inch)	(mm)	QM3	DT4	VM1	ZM3	KM1	PD1
Figure-1 	CTP07FL	1	Yes	.315	8.0	.028	0.7	.177	4.5	16°	.002	0.05				●		
	CTP10FL	1	Yes	.472	12.0	.039	1.0	.264	6.7	16°	.002	0.05				●		
	CTP10FLV M	2	No	.472	12.0	.039	1.0	.264	6.7	20°	0.0	0.0			○	○		
	CTP15FL	1	Yes	.472	12.0	.059	1.5	.264	6.7	16°	.002	0.05				○		
Figure-2 Flat top 	CTPX15FL	1	Yes	.472	12.0	.059	1.5	.264	6.7	16°	.002	0.05		●				
	CTP15FLV M	2	No	.472	12.0	.059	1.5	.264	6.7	20°	0.0	0.0			○	○		
	CTP20FL	1	Yes	.472	12.0	.079	2.0	.264	6.7	16°	.002	0.05				●		
Figure-3 	CTPX20FL	1	Yes	.472	12.0	.079	2.0	.264	6.7	16°	.002	0.05		●				
	CTP20FLV M	2	No	.472	12.0	.079	2.0	.264	6.7	20°	0.0	0.0			○	○		
	CTPA07FL	1	Yes	.315	8.0	.028	0.7	.177	4.5	16°	.002	0.05				○		
	CTPA10FL	1	Yes	.472	12.0	.039	1.0	.264	6.7	16°	.002	0.05				○		
Figure-4 Flat top 	CTPA15FL	1	Yes	.630	16.0	.059	1.5	.362	9.2	16°	.002	0.05		●		○		
	CTPA20FL	1	Yes	.630	16.0	.079	2.0	.362	9.2	16°	.002	0.05		●	○	○		
	CTPA20FLV M	2	No	.630	16.0	.079	2.0	.362	9.2	20°	0.0	0.0			○			
	CTPW25FL	3	Yes	.787	20.0	.098	2.5	.472	12	17°	.002	0.05				○		
	CTPW25FLP M	4	No	.787	20.0	.098	2.5	.472	12	17°	.002	0.05				○		

● : Stock ○ : 1-2 week delivery **M** : Mirror finish

Holders **S8**

Tool selection guide **S4**

Cutting Condition **S5**

CTDP (Cut Duo) Series

Max. Cut-off Dia. - ϕ .787"(20.0mm), - ϕ 1"(25.4mm), ϕ 1.260"(32.0mm), - ϕ 1.339"(34.0mm)

CTDP

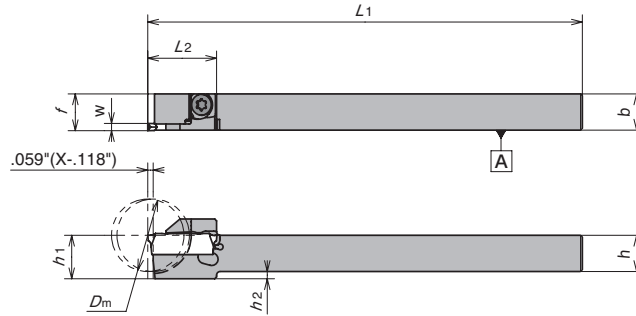

Right-Hand style shown

CTDP Series - Toolholders

CTDP

Gage Insert	Item Number	Stock		Max. Cut-off Dia. D_m		w		h		b		h_1		L_1		h_2		L_2		f		Clamp Screw	Wrench
		R	L	(Inch)	(mm)	(Inch)	(mm)	(Inch)	(mm)	(Inch)	(mm)	(Inch)	(mm)	(Inch)	(mm)	(Inch)	(mm)	(Inch)	(mm)				
CTDP20	CTDP $\frac{1}{4}$ 06-IN-20D20	●	●	.787	20.0	.079	2.0	3/8		.394	10	3/8		4.729	120	.019	0.5	.748	19.0	.400	10.150	LRIS-4 × 12	LLR-25S
	CTDP $\frac{1}{4}$ 08-IN-20D25	●	●	.984	25.0	.079	2.0	1/2		1/2		1/2		4.729	120	0	0	.866	22.0	.506	12.850	LRIS-4 × 12	LLR-25S
	CTDP $\frac{1}{4}$ 10-IN-20D32	●	●	1.260	32.0	.079	2.0	5/8		5/8		5/8		4.729	120	0	0	1.083	27.5	.631	16.025	LRIS-5 × 10	LLR-28S
	CTDP $\frac{1}{4}$ 12-IN-20D32	●	●	1.260	32.0	.079	2.0	3/4		3/4		3/4		4.729	120	0	0	1.083	27.5	.756	19.200	LRIS-5 × 10	LLR-28S
	CTDP $\frac{1}{4}$ 10-20D20	○	○	.787	20.0	.079	2.0	.394	10	.394	10	.394	10	4.724	120	.079	2	.748	19.0	.400	10.15	LRIS-4 × 12	LLR-25S
	CTDP $\frac{1}{4}$ 12-20D20	○	○	.787	20.0	.079	2.0	.472	12	.472	12	.472	12	4.724	120	0	0	.748	19.0	.478	12.15	LRIS-4 × 12	LLR-25S
	CTDP $\frac{1}{4}$ 12-20D25	●	○	1.000	25.4	.079	2.0	.472	12	.472	12	.472	12	4.724	120	0	0	.866	22.0	.478	12.15	LRIS-4 × 12	LLR-25S
	CTDP $\frac{1}{4}$ 16-20D25	●	○	1.000	25.4	.079	2.0	.630	16	.630	16	.630	16	4.724	120	0	0	.866	22.0	.636	16.15	LRIS-4 × 12	LLR-25S
	CTDP $\frac{1}{4}$ 16-20D32A	○	○	1.260	32.0	.079	2.0	.630	16	.630	16	.630	16	4.724	120	0	0	1.083	27.5	.636	16.15	LRIS5 × 10	LLR-28S
	CTDP $\frac{1}{4}$ 2012-20D32A	○	○	1.260	32.0	.079	2.0	.787	20	.472	12	.787	20	4.724	120	0	0	1.161	29.5	.478	12.15	LRIS5 × 10	LLR-28S
CTDP $\frac{1}{4}$ 20-20D32A	○	○	1.260	32.0	.079	2.0	.787	20	.787	20	.787	20	4.724	120	0	0	1.161	29.5	.793	20.15	LRIS5 × 10	LLR-28S	
CTDP25	CTDP $\frac{1}{4}$ 16-25D34A	●	○	1.339	34.0	.098	2.5	.630	16	.630	16	.630	16	4.724	120	0	0	1.122	28.5	.636	16.15	CS0516LSH	LW-3
	CTDP $\frac{1}{4}$ 2012-25D34A	○	○	1.339	34.0	.098	2.5	.787	20	.472	12	.787	20	4.724	120	0	0	1.161	29.5	.478	12.15	CS0516LSH	LW-3
	CTDP $\frac{1}{4}$ 20-25D34A	○	○	1.339	34.0	.098	2.5	.787	20	.787	20	.787	20	4.724	120	0	0	1.161	29.5	.793	20.15	CS0516LSH	LW-3

CTDP Series - Inserts

CTDP

Shape	Item Number	w		L		θ	r_ϵ		Coated Carbide		
		(Inch)	(mm)	(Inch)	(mm)		(Inch)	(mm)	QM3	DM4	TM4
 Two-sided	CTDP20N	.079	2.0	.752	19.1	0°	.002	0.05	●	●	○
	CTDP20N02	.079	2.0	.752	19.1	0°	.008	0.2	●	●	○
	CTDP20R6	.079	2.0	.752	19.1	6°	.002	0.05	●	●	○
	CTDP20R15	.079	2.0	.752	19.1	15°	.002	0.05	●	●	○
	CTDP25N	.098	2.5	.835	21.2	0°	.002	0.05	●	●	○
	CTDP25N02	.098	2.5	.835	21.2	0°	.008	0.2	●	●	○
	CTDP25R6	.098	2.5	.835	21.2	6°	.002	0.05	●	●	○
	CTDP25R15	.098	2.5	.835	21.2	15°	.002	0.05	●	●	○

CTV Series

Max. Cut-off Dia. - $\phi .787"$ (20.0mm)

CTV-K2

Screw Accessible from both sides

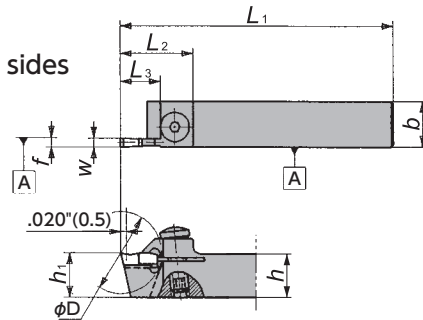
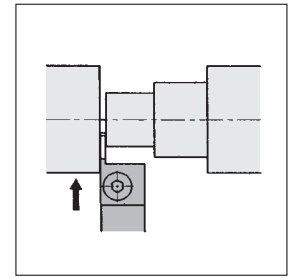

Figure-1



Right-Hand style shown

CTVN-K2

Screw Accessible from both sides

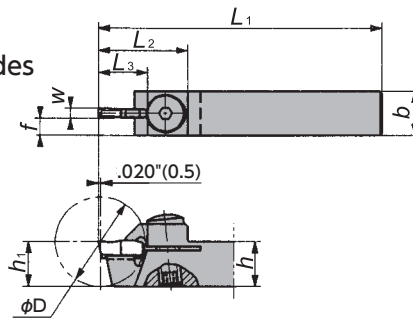
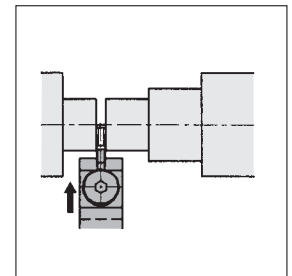

Figure-2



CTV Series - Toolholders

CTV

Gage Insert	Item Number	Figure	Stock		Max. Cut-off Dia. ϕD	w		h		b		h_1		L_1		L_2		L_3		f		Clamp Screw	Wrench
			R	L		(Inch)	(mm)	(Inch)	(mm)	(Inch)	(mm)	(Inch)	(mm)	(Inch)	(mm)	(Inch)	(mm)	(Inch)	(mm)				
	CTV $\frac{1}{2}$ 10K2	1	○	○	.787 20.0	.087(.098)	2.2(2.5)	.394 10	.394 10	.394 10	4.724 120	.787 20.0	.433 11	0.0 0.0	AOS-5 × 16	LW-2.5S							
	CTV $\frac{1}{2}$ 12GX2	1	○	○	.787 20.0	.087(.098)	2.2(2.5)	.472 12	.472 12	.472 12	3.346 85	.787 20.0	.433 11	0.0 0.0	AOS-5 × 16	LW-2.5S							
	CTV $\frac{1}{2}$ 12K2	1	○	○	.787 20.0	.087(.098)	2.2(2.5)	.472 12	.472 12	.472 12	4.724 120	.787 20.0	.433 11	0.0 0.0	AOS-5 × 16	LW-2.5S							
	CTVN10K2	2	○	○	.787 20.0	.087(.098)	2.2(2.5)	.394 10	.394 10	.394 10	4.724 120	.768 19.5	.433 11	.154 3.9	AOS-5 × 16	LW-2.5S							
	CTVN12K2	2	○	○	.787 20.0	.087(.098)	2.2(2.5)	.472 12	.472 12	.472 12	4.724 120	.768 19.5	.433 11	.193 4.9	AOS-5 × 16	LW-2.5S							

Note: f shows when takes CTV22.. insert

CTV Series - Inserts

CTV-S

Shape	Item Number	w		L		θ	r_ϵ		Coated Carbide
		(Inch)	(mm)	(Inch)	(mm)		(Inch)	(mm)	ZM3
 Single-sided 90° 157° (4.0) ±.002(0.05) 12° CTV..N.S CTV..R.S CTV..L.S	CTV22N05S	.087	2.2	.394	10	0°	.002	0.05	○
	CTV22N10S	.087	2.2	.394	10	0°	.004	0.10	○
	CTV25N05S	.098	2.5	.394	10	0°	.002	0.05	○
	CTV25N10S	.098	2.5	.394	10	0°	.004	0.10	○
	CTV22R05S	.087	2.2	.394	10	17°	.002	0.05	○
	CTV22R10S	.087	2.2	.394	10	17°	.004	0.10	○
	CTV25R05S	.098	2.5	.394	10	17°	.002	0.05	○
	CTV25R10S	.098	2.5	.394	10	17°	.004	0.10	○
	CTV22L05S	.087	2.2	.394	10	17°	.002	0.05	○
	CTV22L10S	.087	2.2	.394	10	17°	.004	0.10	○
	CTV25L05S	.098	2.5	.394	10	17°	.002	0.05	○
	CTV25L10S	.098	2.5	.394	10	17°	.004	0.10	○

● : Stock

○ : 1-2 week delivery

Cutting condition **→S5**

CTV Series

Max. Cut-off Dia. - ϕ 1.772"(45.0mm)

CTV (-S)

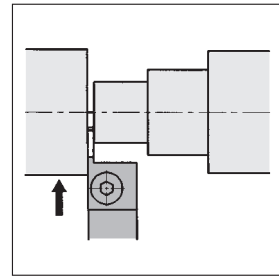
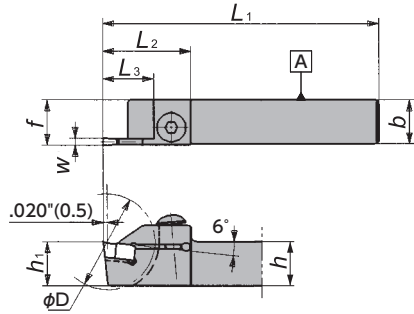

Right-Hand style shown

Figure-1

CTV-X

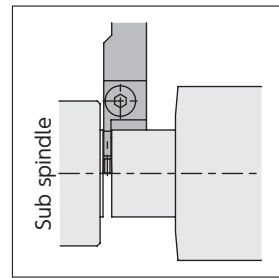
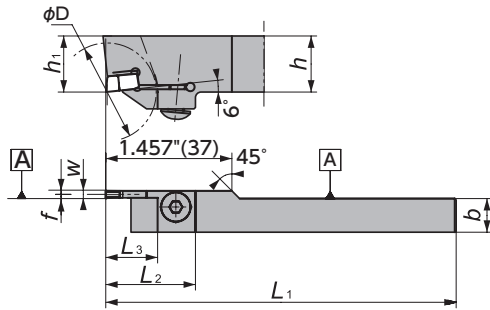

Left-Hand style shown

Figure-2

CTV-M (B)

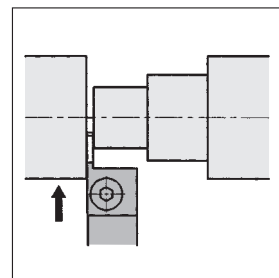
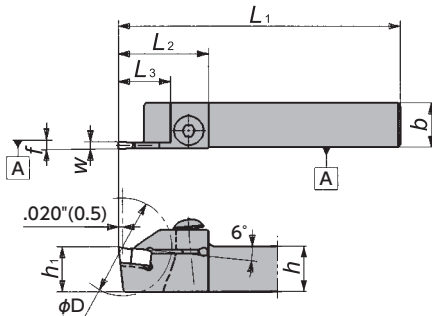

Right-Hand style shown

Figure-3

CTV Series - Toolholders



CTV

Gage Insert	Item Number	Figure	Stock		Max. Cut-off Dia. D_m		w		h		b		h_1		L_1		L_2		L_3		f		Clamp Screw	Wrench
			R	L	(Inch)	(mm)	(Inch)	(mm)	(Inch)	(mm)	(Inch)	(mm)	(Inch)	(mm)	(Inch)	(mm)	(Inch)	(mm)	(Inch)	(mm)				
CTV25	CTV%08B	1	●		.900	22.9	.098	2.5	1/2	1/2	1/2	4.5	114	.945	24	.480	12.2	.520	13.2	BS0620	LW-4			
	CTV%16K25	1	●	●	1.378	35.0	.098	2.5	.630	16	.630	16	.630	16	4.921	125	1.260	32	.728	18.5	.650	16.5	BS0620	LW-4
	CTV%16K25S	1	○		.906	23.0	.098	2.5	.630	16	.630	16	.630	16	4.921	125	.945	24	.480	12.2	.650	16.5	BS0620	LW-4
	CTV%16-25M	3	○		1.102	28.0	.098	2.5	.630	16	.630	16	.630	16	4.724	120	1.004	25.5	.591	15	.020	0.5	BS0520	LW-3
	CTV%20K25	1	●	○	1.378	35.0	.098	2.5	.787	20	.787	20	.787	20	4.921	125	1.260	32	.728	18.5	.807	20.5	BS0620	LW-4
	CTV%20K25S	1	○		.906	23.0	.098	2.5	.787	20	.787	20	.787	20	4.921	125	.945	24	.480	12.2	.807	20.5	BS0620	LW-4
	CTV%20-25M	3	○		1.102	28.0	.098	2.5	.787	20	.787	20	.787	20	4.724	120	1.004	25.5	.591	15	.020	0.5	BS0520	LW-3
	CTV%1913L25	1	○	○	1.378	35.0	.098	2.5	.748	19	.512	13	.748	19	5.512	140	1.260	32	.728	18.5	.512	13.0	BS0620	LW-4
CTV30	CTV%16K30	1	○	○	1.378	35.0	.118	3.0	.630	16	.630	16	.630	16	4.921	125	1.260	32	.728	18.5	.650	16.5	BS0620	LW-4
	CTV%16K30S	1	○		.906	23.0	.118	3.0	.630	16	.630	16	.630	16	4.921	125	.945	24	.480	12.2	.650	16.5	BS0620	LW-4
	CTV%16-30M	3	○		1.102	28.0	.118	3.0	.630	16	.630	16	.630	16	4.724	120	1.004	25.5	.591	15	.020	0.5	BS0520	LW-3
	CTV%20K30	1	○	○	1.378	35.0	.118	3.0	.787	20	.787	20	.787	20	4.921	125	1.260	32	.728	18.5	.807	20.5	BS0620	LW-4
	CTV%20K30S	1	○		.906	23.0	.118	3.0	.787	20	.787	20	.787	20	4.921	125	.945	24	.480	12.2	.807	20.5	BS0620	LW-4
	CTV%20-30M	3	○		1.102	28.0	.118	3.0	.787	20	.787	20	.787	20	4.724	120	1.004	25.5	.591	15	.020	0.5	BS0520	LW-3
	CTV%25-30B	3	○	○	1.772	45.0	.118	3.0	.984	25	.984	25	.984	25	5.906	150	1.358	34.5	.925	23.5	.020	0.5	BS0625	LW-4
	CTV%1913L30	1	○	○	1.378	35.0	.118	3.0	.748	19	.512	13	.748	19	5.512	140	1.260	32	.728	18.5	.512	13.0	BS0620	LW-4
	CTVL2012K30X-1	2	○	○	1.378	35.0	.118	3.0	.787	20	.472	12	.787	20	4.921	125	1.260	32	.728	18.5	.118	3.0	BS0620	LW-4

CTV Series - Inserts

CTV

Shape	Item Number	W		L		θ	r_ϵ		Coated Carbide	
		(Inch)	(mm)	(Inch)	(mm)		(Inch)	(mm)	QM3	ZM3
<p>Single-sided</p>	CTV25N	.098	2.5	.472	12	0°	.008	0.20		○
	CTV30N	.118	3.0	.472	12	0°	.008	0.20	○	○
	CTV25R	.098	2.5	.472	12	8°	.008	0.20		●
	CTV30R	.118	3.0	.472	12	8°	.008	0.20		○
	CTV30L	.118	3.0	.472	12	8°	.008	0.20		○
<p>Single-sided</p>	CTV30N038	.118	3.0	.472	12	0°	.008	0.20		○
<p>Single-sided</p>	CTV25R00A	.098	2.5	.472	12	8°	.002 MAX.	0.05 max.		●
	CTV30R00A	.118	3.0	.472	12	8°	.002 MAX.	0.05 max.		○
	CTV25R00B	.098	2.5	.472	12	17°	.002 MAX.	0.05 max.		●
	CTV30R00B	.118	3.0	.472	12	17°	.002 MAX.	0.05 max.		○

Cut-off

● : Stock

○ : 1-2 week delivery

Cutting condition → S5

MEMO

T

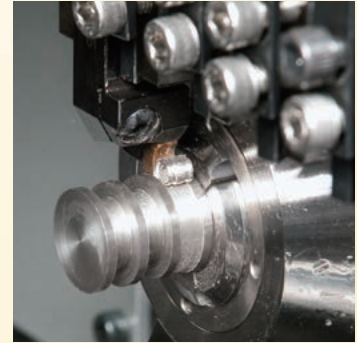







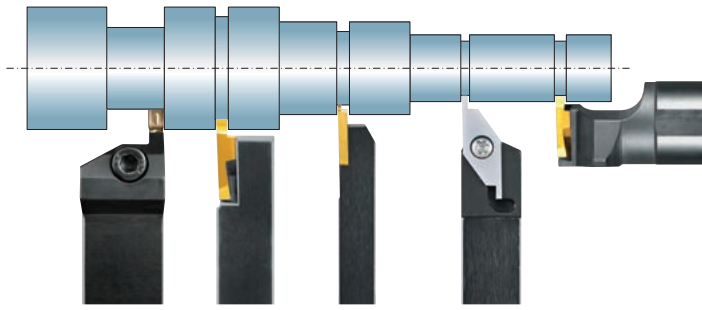

Grooving / Side Turning





- Grooving Tools T2
- Recommended Cutting Condition ... T4
- General Information T5
- Tool List T6
 - CSV Series T6
 - CTPS Series T8
 - GTW Series (GROOVE DUO) T9
 - GTM.32 Series..... T10
 - TWG Series T17
 - GTM.43 Series..... T18
 - SATURN DUO Series (Face grooving) T20
 - GTPA Series T24

NTK Grooving / Side Turning Tools - Product Lines





Insert	CSVG →T7		GTPS →T8
	CSV	DS-CSV	CTPS
Holder	 →T6	 →T6	 →T8
Blade width	.010" - .059" (0.25 - 1.50mm)		.030" - .079" (0.75 - 2.0mm)
Depth of cut	~.102" (~2.59mm)		~.098" (~2.50mm)

Insert	GTMH32 / GTMX32 / GTM32 / TMG32 →T12					
	GTT	GTT-OH NEW	Y-GTT	Y-GTT-OH NEW	DS-GTT	CH-GTT
Holder	 →T10	 →T10 Coolant through	 →T10 Y-axis	 →T10 Y-axis w/ Coolant through	 →T10	 →T10
Blade width	.012" - .118" (0.3 - 3.0mm)					
Depth of cut	~.106" (~2.69mm)					

Insert	GWP →T9	GTM43 / GTMA43 / GTMT43 →T19		TWG →T17
	GTWP NEW	NGTN	NGTB	TWG
Holder	 →T9	 →T18	 →T18	 →T17
Blade width	.118" - .236" (3.0 - 5.9mm)	.039" - .216" (1.0 - 5.49mm)		.079" - .118" (2.0 - 3.0mm)
Depth of cut	~.354" (~9.0mm)	.177" (4.50mm)		~.118" (~3.0mm)

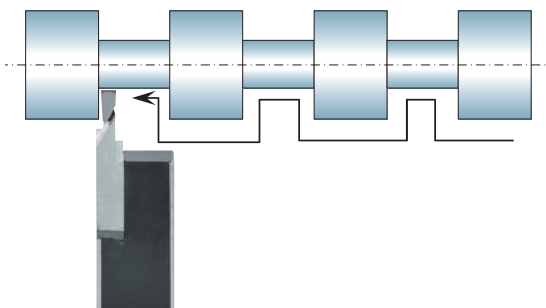
■ Multifunctional Grooving for non-ferrous material

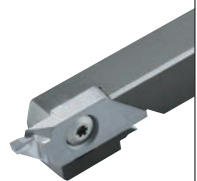

Insert	GTPA →T24		
	GTPA	Y-GTPA	Y-GTPA-OH NEW
Holder	 →T24	 →T24 Y-axis	 →T24 Y-axis w/ Coolant through
Blade width	.079" - .098" (2.0 - 2.50mm)		
Depth of cut	~.236" (~6.0mm)		

■ Face Grooving

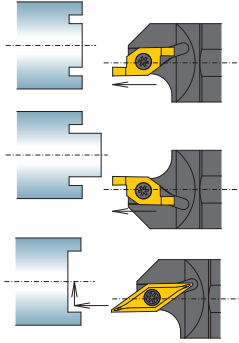

Insert	FGV →T23	FBV →T23	
Holder	FGV →T22	DS-FGV →T22	CH-FGV →T22
Blade width	.039" - .079" (1.0mm - 2.0mm)		
Depth of cut	~.118" (~3.0mm)	FGV: ~.118" (~3.0mm) FBV: ~.157" (~4.0mm)	

■ ID Grooving

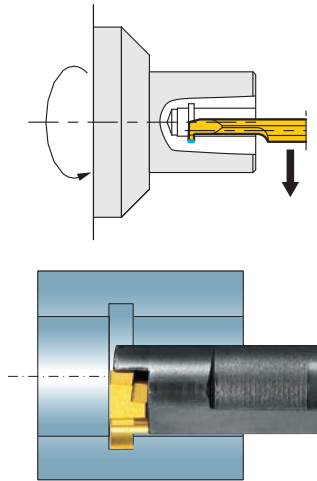

Insert	SBG →V18	GTG →V19
Holder	NBH →V14	S-BG / BG →V19
Blade width	.020" - .079" (0.5 - 2.0mm)	.020" - .079" (0.5 - 2.0mm)
Depth of cut	~.079" (~2.0mm)	~.118" (~3.0mm)

■ ID Face Grooving

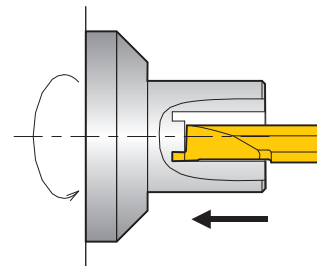

Insert	SFG →V18
Holder	NBH →V14
Blade width	.039" - .118" (1.0 - 3.0mm)
Depth of cut	~.110" (~2.79mm)

Recommended Cutting Conditions

Grooving

CSV / GTPS / GTG / GTMH / GTMT / GTMX / TMG / SBG

Work Material		High Temperature Alloys	Titanium Alloys	Cobalt Chrome Alloys	Stainless Steels		Alloy Steels	Carbon Steels
					Hard to cut	Free cutting		
Common Name		Inconel Hastelloy MP35N	Ti-6Al-4V	ASTM F-75	304 316 17-4PH	303 430F	5120 4137	1045 1046
Grade	1st choice	DT4			DM4 / DT4	TM4	QM3	
	2nd choice	TM4 / QM3			QM3 / VM1	QM3	TM4 / DT4 / C7Z(X)	
Cutting Speed (SFM)		75 125 225	100 200 275	130 230 330	150 300 600	Carbide C7Z(X)	150 300 500 400 500 800	
Feed Rate (IPR) A. Grooving B. Side turning*	Width .010-.020	A. .0002 - .0012						
		B. .0001 - .0002						
	.020-.040	A. .0008 - .0024						A. .0008 - .0028
		B. .0002 - .0004						B. .0002 - .0004
	.040-.080	A. .0012 - .0028						A. .0012 - .0031
B. .0008 - .0020						B. .0012 - .0024		
> .080	A. .0012 - .0079							
	B. .0012 - .0024							

*When side turning, Max. DOC is under .0079". Under .016" width side turning impossible

GVP / GWP / TWG

Work Material		High Temperature Alloys	Titanium Alloys	Cobalt Chrome Alloys	Stainless Steels		Alloy Steels	Carbon Steels
					Hard to cut	Free cutting		
Common Name		Inconel Hastelloy MP35N	Ti-6Al-4V	ASTM F-75	304 316 17-4PH	303 430F	5120 4137	1045 1046
Grade	1st choice	QM3						
	2nd choice	QM3						
Cutting Speed (SFM)		75 125 225	100 200 275	130 230 330	150 300 600	150 300 500		
Feed Rate (IPR) A. Grooving B. Side turning*	Width .118-.157	A. .0020 - .0059						
	.157-.197	A. .0039 - .0079					A. .0039 - .0098	
							B. .0059 - .0118	
> .197	A. .0059 - .0138							

*Max DOC is 80% of width

GTPA

Work Material		Aluminum Alloy
Common Name		ASTM 5056 ASTM 6061
Grade	1st choice	PD1
	2nd choice	KM1
Cutting Speed (SFM)		PD1 330 650 1000 KM1 160 330 650
Feed Rate (IPR) A. Grooving B. Side turning		A. .0020 - .0079 B. .0039 - .0079

OD Grooving

NTK GTMT / GTMH series can be used for uneven diameter grooving thanks to the 2 degree slanted insert mounting on the toolholder

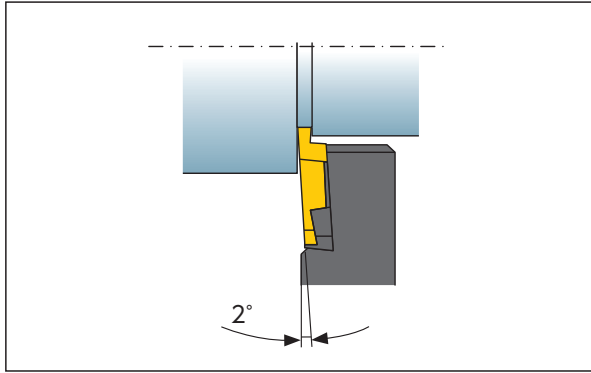

Chamfering and radius machining can be done after the rough grooving process at the center of the groove

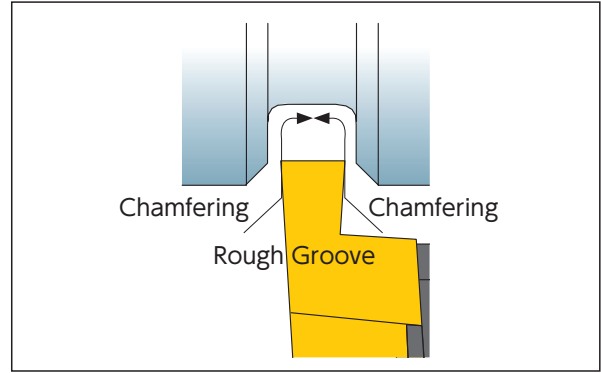

Side Turning

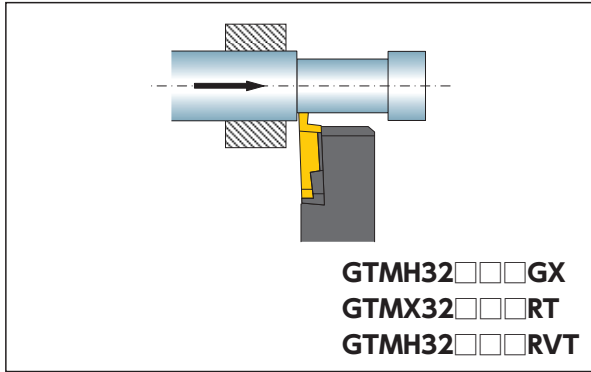

Full Radius

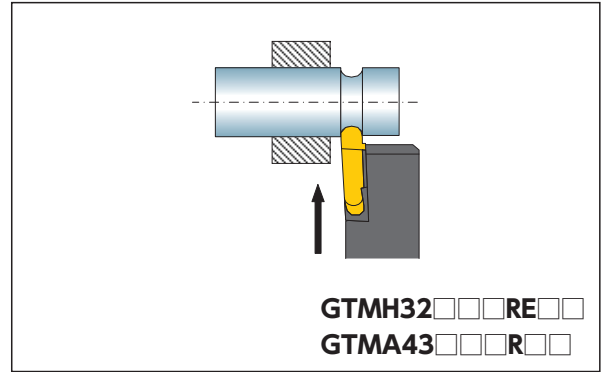

Rough Plunging for OD Turning

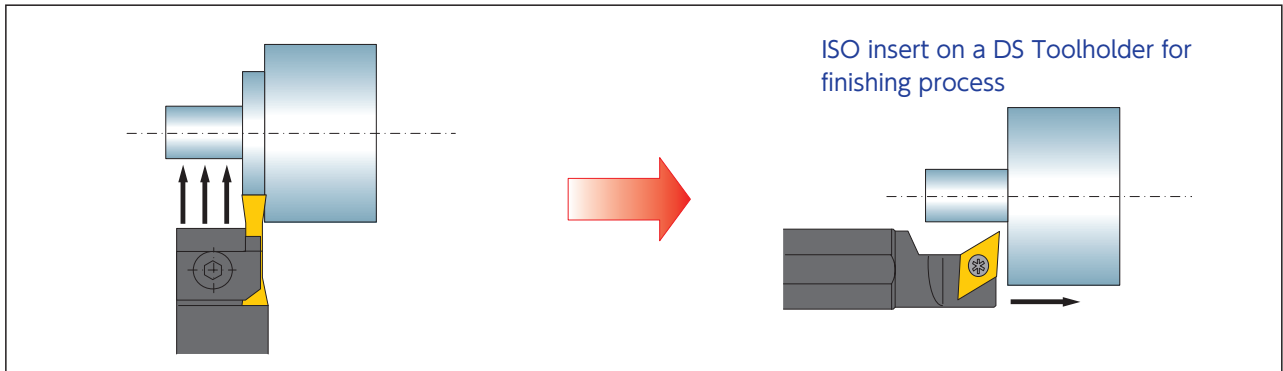

Spool Grooving

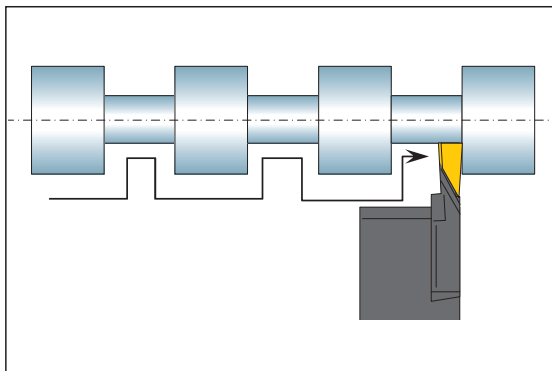

ID Grooving

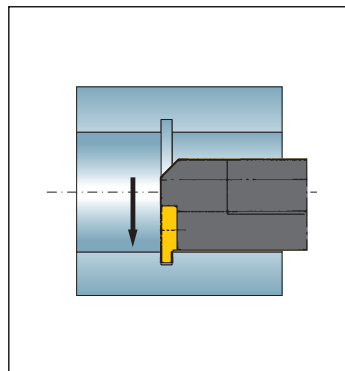

Face Grooving

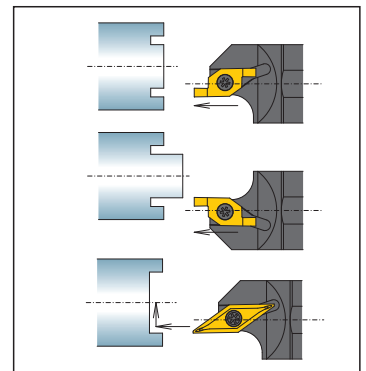

CSV Series

Best for up to .200" diameter material

CSV-NC

For Gang-style machine

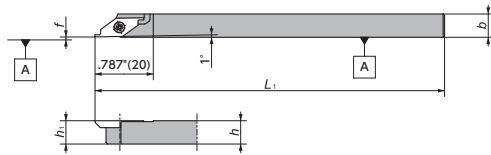

Figure-1

Right-Hand style shown

CSV

For Cam-style machine

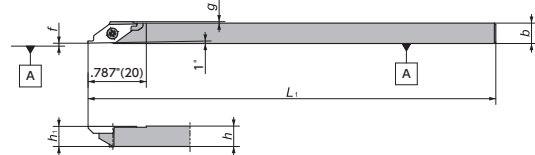

Figure-2

Right-Hand style shown

DS-CSVL

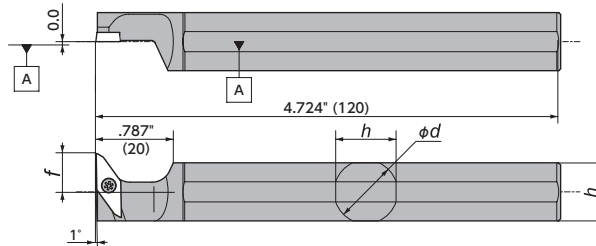



Figure-3

Left-Hand style shown
Takes Right-hand insert

CSV Series - Toolholders

CSV^R/_L / CSV^R/_L-NC

Gage Insert	Item Number	Figure	Stock		h		b		h_1		L_1		f		g		Clamp Screw	Wrench
			R	L	(Inch)	(mm)	(Inch)	(mm)	(Inch)	(mm)	(Inch)	(mm)	(Inch)	(mm)	(Inch)	(mm)		
 CSV..11..	CSV ^R / _L 06-IN-NC	1	●	●	3/8	3/8	3/8	3/8	3/8	3/8	4.724	120	.004	0.1	0.0	0.0	LRIS-2.5 × 7	CLR-15S
	CSV ^R / _L 08-IN-NC	1	●	●	1/2	1/2	1/2	1/2	1/2	1/2	4.724	120	.004	0.1	0.0	0.0	LRIS-2.5 × 7	CLR-15S
	CSV ^R / _L 08NC	1	○	○	.315	8	.315	8	.315	8	4.724	120	.004	0.1	0.0	0.0	LRIS-2.5 × 7	CLR-15S
	CSV ^R / _L 08NC-F	1	○	○	.315	8	.315	8	.315	8	4.724	120	0-.004	0.0-0.1	0.0	0.0	LRIS-2.5 × 7	CLR-15S
	CSV ^R / _L 10GXNC	1	○	○	.394	10	.394	10	.394	10	3.346	85	.004	0.1	0.0	0.0	LRIS-2.5 × 7	CLR-15S
	CSV ^R / _L 10NC	1	○	○	.394	10	.394	10	.394	10	4.724	120	.004	0.1	0.0	0.0	LRIS-2.5 × 7	CLR-15S
	CSV ^R / _L 12NC	1	●	●	.472	12	.472	12	.472	12	4.724	120	.004	0.1	0.0	0.0	LRIS-2.5 × 7	CLR-15S
	CSV ^R / _L 07GX	2	○	○	.275	7	.275	7	.275	7	3.346	85	.004	0.1	.020	0.5	LRIS-2.5 × 7	CLR-15S
	CSV ^R / _L 07	2	○	●	.275	7	.275	7	.275	7	5.512	140	.004	0.1	.020	0.5	LRIS-2.5 × 7	CLR-15S
	CSV ^R / _L 08GX	2	○	○	.315	8	.315	8	.315	8	3.346	85	.004	0.1	0.0	0.0	LRIS-2.5 × 7	CLR-15S
	CSV ^R / _L 08	2	●	●	.315	8	.315	8	.315	8	5.512	140	.004	0.1	0.0	0.0	LRIS-2.5 × 7	CLR-15S
	CSV ^R / _L 095	2	○	○	.374	9.5	.374	9.5	.374	9.5	5.512	140	.004	0.1	0.0	0.0	LRIS-2.5 × 7	CLR-15S
	CSV ^R / _L 10	2	●	○	.394	10	.394	10	.394	10	5.512	140	.004	0.1	0.0	0.0	LRIS-2.5 × 7	CLR-15S
	CSV ^R / _L 12GX	2	○	○	.472	12	.472	12	.472	12	3.346	85	.004	0.1	0.0	0.0	LRIS-2.5 × 7	CLR-15S
CSV ^R / _L 12	2	●	●	.472	12	.472	12	.472	12	5.512	140	.004	0.1	0.0	0.0	LRIS-2.5 × 7	CLR-15S	

DS-CSVL (Takes right-hand insert)

Gage Insert	Item Number	Figure	Stock		D_s		h		b		L_1		f		Clamp Screw	Wrench
			R	L	(Inch)	(mm)	(Inch)	(mm)	(Inch)	(mm)	(Inch)	(mm)	(Inch)	(mm)		
 CSV..11FR..	DS-CSVL15	3	●		5/8	15.875	.591	15	.591	15	4.724	120	.394	10	LRIS-2.5 × 7	CLR-15S

CSV Series - Inserts

■ CSVG - Grooving **Mirror finish**

Shape	Item Number	Chip-breaker	Groove Width <i>W</i>		Max Depth of Cut		<i>L</i>		<i>r_ε</i>		Coated Carbide	
			(Inch)	(mm)	(Inch)	(mm)	(Inch)	(mm)	(Inch)	(mm)	VM1	
											R	L
<p>Thickness: .094"(2.38)</p> <p>1/4" (6.35)</p> <p>L</p> <p>0.0</p> <p>W+.001" (0.03)</p> <p>Right-Hand style shown</p>	CSVG11F ^R /V025 M	No	.010	0.25	.006	0.15	.020	0.50	0.0	0.0	●	
	CSVG11F ^R /V030 M	No	.012	0.30	.006	0.15	.020	0.50	0.0	0.0	●	
	CSVG11F ^R /V035 M	No	.014	0.35	.006	0.15	.020	0.50	0.0	0.0	●	
	CSVG11F ^R /V040 M	No	.016	0.40	.006	0.15	.020	0.50	0.0	0.0	●	
	CSVG11F ^R /V045 M	No	.018	0.45	.018	0.45	.039	1.00	0.0	0.0	●	
	CSVG11F ^R /V050 M	No	.020	0.50	.018	0.45	.039	1.00	0.0	0.0	●	
	CSVG11F ^R /V055 M	No	.022	0.55	.018	0.45	.039	1.00	0.0	0.0	●	
	CSVG11F ^R /V060 M	No	.024	0.60	.018	0.45	.039	1.00	0.0	0.0	●	
	CSVG11F ^R /V065 M	No	.026	0.65	.018	0.45	.039	1.00	0.0	0.0	●	
	CSVG11F ^R /V070 M	No	.028	0.70	.018	0.45	.039	1.00	0.0	0.0	●	
	CSVG11F ^R /V075 M	No	.030	0.75	.050	1.40	.079	2.00	0.0	0.0	●	○
	CSVG11F ^R /V080 M	No	.031	0.80	.050	1.40	.079	2.00	0.0	0.0	●	
	CSVG11F ^R /V085 M	No	.033	0.85	.050	1.40	.079	2.00	0.0	0.0	●	
	CSVG11F ^R /V090 M	No	.035	0.90	.050	1.40	.079	2.00	0.0	0.0	●	
	CSVG11F ^R /V095 M	No	.037	0.95	.050	1.40	.079	2.00	0.0	0.0	●	○
	CSVG11F ^R /V100 M	No	.039	1.00	.050	1.40	.079	2.00	0.0	0.0	●	
	CSVG11F ^R /V110 M	No	.043	1.10	.102	2.60	.102	2.60	0.0	0.0	●	
	CSVG11F ^R /V120 M	No	.047	1.20	.102	2.60	.102	2.60	0.0	0.0	●	○
CSVG11F ^R /V130 M	No	.051	1.30	.102	2.60	.102	2.60	0.0	0.0	●		
CSVG11F ^R /V140 M	No	.055	1.40	.102	2.60	.102	2.60	0.0	0.0	●		
CSVG11F ^R /V150 M	No	.059	1.50	.102	2.60	.102	2.60	0.0	0.0	●		

Grooving / Side-Turning

● : Stock

○ : 1-2 week delivery

M : Mirror finish

CSV series **→O27**

Cutting condition **→T4**

CTPS Series

CTPS

For Cam-style machine

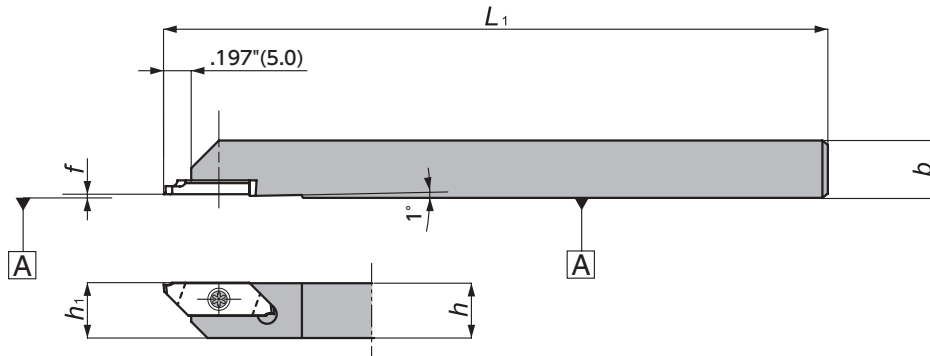

Right-Hand style shown

CTPS - Toolholders

CTPS

Gage Insert	Item Number	Figure	Stock	Groove Width Range w (Inch) (mm)	h (Inch) (mm)	b (Inch) (mm)	h_1 (Inch) (mm)	L_1 (Inch) (mm)	f (Inch) (mm)	Clamp Screw	Wrench
 GTPS	CTPSR06-IN	1	●	.030-.079 0.75-2.00	3/8	3/8	3/8	4.724 120	0 0.0	LRIS-2.5 x 7	CLR-15S
	CTPSR08-IN	1	●	.030-.079 0.75-2.00	1/2	1/2	1/2	4.724 120	0 0.0	LRIS-2.5 x 7	CLR-15S
	CTPSR10	1	○	.030-.079 0.75-2.00	.394 10	.394 10	.394 10	4.724 120	0 0.0	LRIS-2.5 x 7	CLR-15S
	CTPSRR12	1	○	.030-.079 0.75-2.00	.472 12	.472 12	.472 12	4.724 120	0 0.0	LRIS-2.5 x 7	CLR-15S

CTPS Series - Inserts

CTPS - Grooving

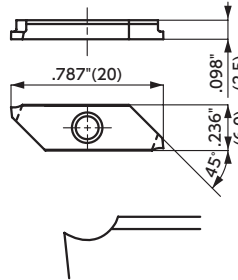
Shape	Item Number	Groove Width w		Max Depth of Cut		r_ϵ		L		Coated Carbide	
		(Inch)	(mm)	(Inch)	(mm)	(Inch)	(mm)	(Inch)	(mm)	VM1	ZM3
 <p>Right-Hand style shown ☆ θ shows the angle when the holder is set.</p>	GTPS075FR	.030	0.75	.039	1.0	0.0	0.0	.059	1.5	○	○
	GTPS095FR	.037	0.95	.059	1.5	0.0	0.0	.079	2.0	○	○
	GTPS100FR	.039	1.00	.059	1.5	0.0	0.0	.079	2.0	○	○
	GTPS120FR	.047	1.20	.098	2.5	0.0	0.0	.118	3.0	○	○
	GTPS150FR	.059	1.50	.098	2.5	0.0	0.0	.118	3.0	○	○
	GTPS200FR	.079	2.00	.098	2.5	0.0	0.0	.118	3.0	○	○

● : Stock ○ : 1-2 week delivery

CTPS series **→O31**

Cutting condition **→T4**

GTW (GROOVE DUO) Series

GTWP

Side Turning Capable
For Swiss Machine

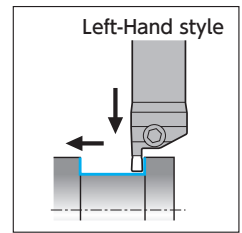
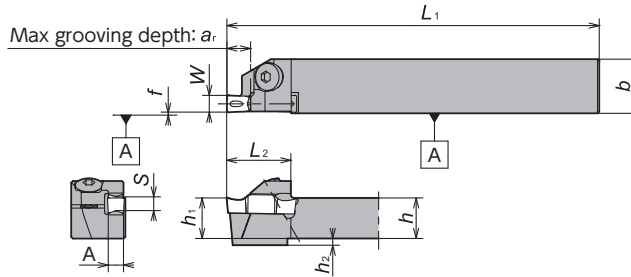

Right-Hand style shown

Figure-1

GTW Series - Toolholders



GWP

Gage Insert	Item Number	Figure	Stock		Groove Width W	a _r	h	b	h ₁	L ₁	h ₂	f	L ₂	A	Seat Size S	Clamp Screw	Wrench
			R	L													
GWP ○ 300	GTWP%08-IN3D07	1	●		.118 3	.275 7	1/2	.630 16	1/2	4.724 120	0 0	.012 0.3	.748 19	.102 2.6	D	AOB-5 × 14	LW-3S
	GTWP%10-IN3D09	1	●		.118 3	.354 9	5/8	.630 16	5/8	4.724 120	0 0	.012 0.3	.866 22	.102 2.6	D	AOB-5 × 16	LW-3S
	GTWP%1016-3D07	1	○		.118 3	.275 7	.394 10	.630 16	.472 12	4.724 120	.079 2	.012 0.3	.748 19	.102 2.6	D	AOB-5 × 14	LW-3S
	GTWP%1216-3D07	1	●		.118 3	.275 7	.472 12	.630 16	.472 12	4.724 120	0 0	.012 0.3	.768 19.5	.102 2.6	D	AOB-5 × 16	LW-3S
GWP ○ 400	GTWP%1616-3D09	1	○		.118 3	.354 9	.630 16	.630 16	.630 16	4.724 120	0 0	.012 0.3	.866 22	.102 2.6	D	AOB-5 × 16	LW-3S
	GTWP%08-IN4E07	1	●		.157 4	.275 7	1/2	.630 16	1/2	4.724 120	0 0	.012 0.3	.748 19	.138 3.5	E	AOB-5 × 14	LW-3S
	GTWP%10-IN4E09	1	●		.157 4	.354 9	5/8	.630 16	5/8	4.724 120	0 0	.012 0.3	.866 22	.138 3.5	E	AOB-5 × 16	LW-3S
	GTWP%1016-4E07	1	○		.157 4	.275 7	.394 10	.630 16	.472 12	4.724 120	.079 2	.012 0.3	.748 19	.138 3.5	E	AOB-5 × 14	LW-3S
GWP ○ 500	GTWP%1216-4E07	1	●		.157 4	.275 7	.472 12	.630 16	.472 12	4.724 120	0 0	.012 0.3	.768 19.5	.138 3.5	E	AOB-5 × 16	LW-3S
	GTWP%1616-4E09	1	○		.157 4	.354 9	.630 16	.630 16	.630 16	4.724 120	0 0	.012 0.3	.866 22	.138 3.5	E	AOB-5 × 16	LW-3S
	GTWP%1016-5F07	1	○		.197 5	.275 7	.394 10	.630 16	.472 12	4.724 120	.079 2	.012 0.3	.748 19	.177 4.5	F	AOB-5 × 14	LW-3S
GWP ○ 600	GTWP%1216-5F07	1	○		.197 5	.275 7	.472 12	.630 16	.472 12	4.724 120	0 0	.012 0.3	.768 19.5	.177 4.5	F	AOB-5 × 16	LW-3S
	GTWP%1616-5F09	1	○		.197 5	.354 9	.630 16	.630 16	.630 16	4.724 120	0 0	.012 0.3	.866 22	.177 4.5	F	AOB-5 × 16	LW-3S
	GTWP%1020-6G07	1	○		.236 6	.275 7	.394 10	.787 20	.394 10	4.724 120	.079 2	.012 0.3	.866 22	.209 5.3	G	AOB-5 × 14	LW-3S
GWP ○ 600	GTWP%1220-6G07	1	○		.236 6	.275 7	.472 12	.787 20	.472 12	4.724 120	0 0	.012 0.3	.886 22.5	.209 5.3	G	AOB-5 × 16	LW-3S
	GTWP%1620-6G09	1	○		.236 6	.354 9	.630 16	.787 20	.630 16	4.724 120	0 0	.012 0.3	.984 25	.209 5.3	G	AOB-5 × 16	LW-3S

GTW Series - Inserts

Shape	Item Number	w		r _e	M	L	Seat Size S	Coated Carbide DM4
		Groove Width (Inch) (mm)	Width Tolerance (Inch) (mm)					
<p>GWPG: Outside ground GWPM: Full-molded</p> <ul style="list-style-type: none"> ● Excellent chip control ● Best for side turning 	GWPG300N02D-GW	.118 3.0	.001 ± 0.025	.008 0.2	.098 2.5	.811 20.6	D	●
	GWPG300N04D-GW	.118 3.0	.001 ± 0.025	.016 0.4	.098 2.5	.811 20.6	D	●
	GWPG400N02E-GW	.157 4.0	.001 ± 0.025	.008 0.2	.134 3.4	.811 20.6	E	●
	GWPG400N04E-GW	.157 4.0	.001 ± 0.025	.016 0.4	.134 3.4	.811 20.6	E	●
	GWPG400N08E-GW	.157 4.0	.001 ± 0.025	.031 0.8	.134 3.4	.811 20.6	E	●
	GWPG500N02F-GW	.197 5.0	.001 ± 0.025	.008 0.2	.169 4.3	.811 20.6	F	○
	GWPG500N04F-GW	.197 5.0	.001 ± 0.025	.016 0.4	.169 4.3	.811 20.6	F	○
	GWPG500N08F-GW	.197 5.0	.001 ± 0.025	.031 0.8	.169 4.3	.811 20.6	F	○
	GWPG600N02G-GW	.236 6.0	.001 ± 0.025	.008 0.2	.205 5.2	1.008 25.6	G	○
	GWPG600N04G-GW	.236 6.0	.001 ± 0.025	.016 0.4	.205 5.2	1.008 25.6	G	○
	GWPG600N08G-GW	.236 6.0	.001 ± 0.025	.031 0.8	.205 5.2	1.008 25.6	G	○
	<ul style="list-style-type: none"> ● Less tool pressure design 	GWPM300N04D-GW	.118 3.0	.002 ± 0.05	.016 0.4	.098 2.5	.811 20.6	D
GWPM400N04E-GW		.157 4.0	.002 ± 0.05	.016 0.4	.134 3.4	.811 20.6	E	○
GWPM500N04F-GW		.197 5.0	.002 ± 0.05	.016 0.4	.169 4.3	.811 20.6	F	○
GWPM600N04G-GW		.236 6.0	.002 ± 0.05	.016 0.4	.205 5.2	1.008 25.6	G	○
GWPG300N02D-GV		.118 3.0	.001 ± 0.025	.008 0.2	.205 2.5	.811 20.6	D	●
GWPG300N04D-GV		.118 3.0	.001 ± 0.025	.016 0.4	.205 2.5	.811 20.6	D	●
GWPG400N02E-GV		.157 4.0	.001 ± 0.025	.008 0.2	.169 4.3	.811 20.6	E	●
GWPG400N04E-GV		.157 4.0	.001 ± 0.025	.016 0.4	.169 4.3	.811 20.6	E	●
GWPG500N02F-GV		.197 5.0	.001 ± 0.025	.008 0.2	.169 4.3	.811 20.6	F	○
GWPG500N04F-GV		.197 5.0	.001 ± 0.025	.016 0.4	.169 4.3	.811 20.6	F	○
GWPG600N02G-GV		.236 6.0	.001 ± 0.025	.008 0.2	.169 4.3	1.008 25.6	G	○
GWPG600N04G-GV		.236 6.0	.001 ± 0.025	.016 0.4	.169 4.3	1.008 25.6	G	○

Grooving / Side-Turning

GTT Series

GTT

Screw accessible from both sides

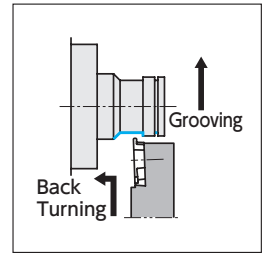
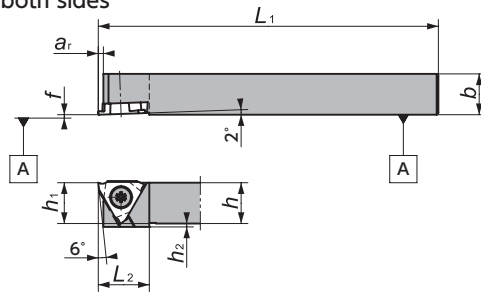

Right-Hand style shown

Figure-1

GTT-OH (Coolant through)

Screw accessible from both sides

NEW

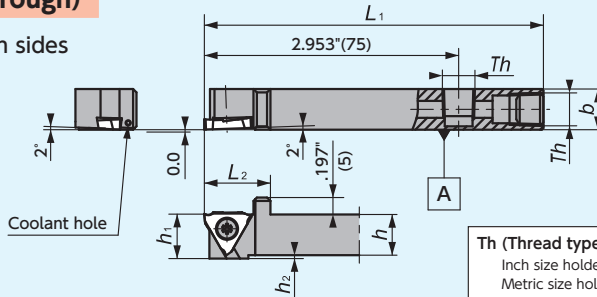

Th (Thread type)
Inch size holder : NPT1/8
Metric size holder: M6, Rc1/8 (PT1/8)

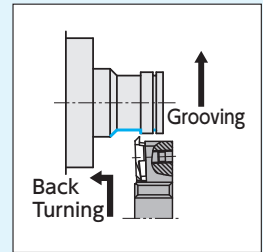

Right-Hand style shown

Figure-2

Y-GTT

Screw accessible from both sides

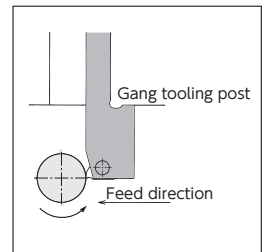
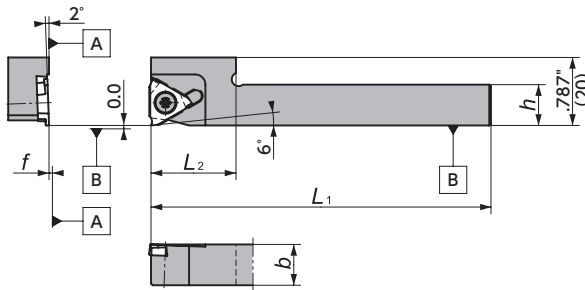

Right-Hand style shown
Takes Right-hand Insert

Figure-3

Y-GTT-OH (Coolant through)

Screw accessible from both sides

NEW

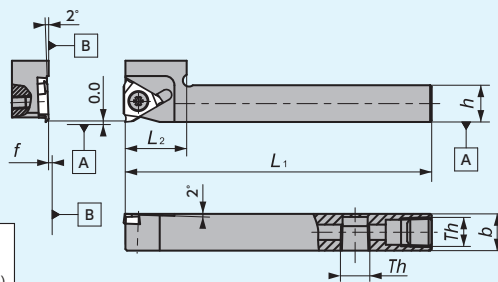

Th (Thread type)
Inch size holder : NPT1/8
Metric size holder: M6, Rc1/8 (PT1/8)

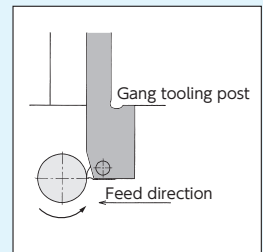

Right-Hand style shown
Takes Right-hand Insert

Figure-4

CH-GTT

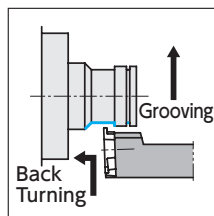
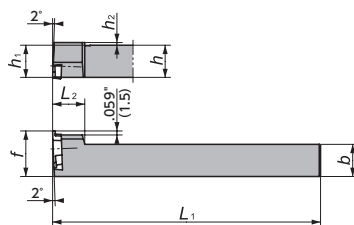

Left-Hand style shown
Takes Right-hand Insert

Figure-5

DS-GTT

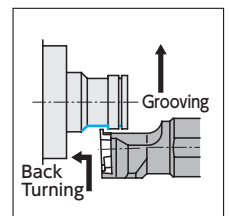
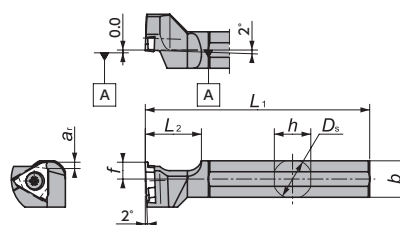

Left-Hand style shown
Takes Right-hand Insert

Figure-6

● : Stock ○ : 1-2 week delivery

💧 : Coolant through

Inserts → T12

Cutting condition → T4

GTT

Gage Insert	Item Number	Figure	Stock		Groove Width <i>W</i>		<i>h</i>	<i>b</i>	<i>h</i> ₁	<i>L</i> ₁	<i>f</i>	<i>L</i> ₂	<i>a</i> _r	<i>h</i> ₂	<i>Th</i>	Clamp Screw	Wrench								
			R	L	(Inch)	(mm)	(Inch)	(mm)	(Inch)	(mm)	(Inch)	(mm)	(Inch)	(mm)				(Inch)	(mm)						
	GTT%106A-IN	1	●	●	.012-.125	0.30-3.17	3/8	3/8	3/8	4.724	120	.000	0	.591	15.0	.071	1.8	.118	3	—	LR-5-4×10PW	CLR-15S			
	GTT%106B-IN	1	●	●	.057-.125	1.45-3.17	3/8	3/8	3/8	4.724	120	.000	0	.591	15.0	.106	2.7	.118	3	—	LR-5-4×10PW	CLR-15S			
	GTT%108A-IN	1	●	●	.012-.125	0.30-3.17	1/2	1/2	1/2	4.724	120	.000	0	.591	15.0	.071	1.8	.039	1	—	LR-5-4×10PW	CLR-15S			
	GTT%108B-IN	1	●	●	.057-.125	1.45-3.17	1/2	1/2	1/2	4.724	120	.000	0	.591	15.0	.106	2.7	.039	1	—	LR-5-4×10PW	CLR-15S			
	GTT%110A-IN	1	●	●	.012-.125	0.30-3.17	5/8	5/8	5/8	4.724	120	.000	0	.591	15.0	.071	1.8	.000	0	—	LR-5-4×10PW	CLR-15S			
	GTT%110B-IN	1	●	●	.057-.125	1.45-3.17	5/8	5/8	5/8	4.724	120	.000	0	.591	15.0	.106	2.7	.000	0	—	LR-5-4×10PW	CLR-15S			
	GTT%112A-IN	1	●	●	.012-.125	0.30-3.17	3/4	3/4	3/4	4.724	120	.000	0	.591	15.0	.071	1.8	.000	0	—	LR-5-4×10PW	CLR-15S			
	GTT%112B-IN	1	●	●	.057-.125	1.45-3.17	3/4	3/4	3/4	4.724	120	.000	0	.591	15.0	.106	2.7	.000	0	—	LR-5-4×10PW	CLR-15S			
	GTT%108F00	1	○	○	.012-.125	0.30-3.17	.315	8	.315	8	.315	8	3.150	80	.000	0	.591	15.0	.071	1.8	.157	5	—	R:LR-5-4×10PW L:LR-5-4×5.8	CLR-15S
	GTT%10810F00	1	○	○	.012-.125	0.30-3.17	.315	8	.394	10	.315	8	3.150	80	.000	0	.591	15.0	.071	1.8	.157	5	—	LR-5-4×10PW	CLR-15S
	GTT%108K00	1	○	○	.012-.125	0.30-3.17	.315	8	.315	8	.315	8	4.724	120	.000	0	.591	15.0	.071	1.8	.157	5	—	R:LR-5-4×10PW L:LR-5-4×5.8	CLR-15S
	GTT%10810K00	1	○	○	.012-.125	0.30-3.17	.315	8	.394	10	.315	8	4.724	120	.000	0	.591	15.0	.071	1.8	.157	5	—	LR-5-4×10PW	CLR-15S
	GTT%110F00	1	○	○	.012-.125	0.30-3.17	.394	10	.394	10	.394	10	3.150	80	.000	0	.591	15.0	.071	1.8	.118	3	—	LR-5-4×10PW	CLR-15S
	GTT%110K00	1	○	○	.012-.125	0.30-3.17	.394	10	.394	10	.394	10	4.724	120	.000	0	.591	15.0	.071	1.8	.118	3	—	LR-5-4×10PW	CLR-15S
	GTT%112F00	1	○	○	.012-.125	0.30-3.17	.472	12	.472	12	.472	12	3.150	80	.000	0	.591	15.0	.071	1.8	.040	1	—	LR-5-4×10PW	CLR-15S
	GTT%112K00	1	●	○	.012-.125	0.30-3.17	.472	12	.472	12	.472	12	4.724	120	.000	0	.591	15.0	.071	1.8	.040	1	—	LR-5-4×10PW	CLR-15S
	GTT%116H00	1	○	○	.012-.125	0.30-3.17	.630	16	.630	16	.630	16	3.937	100	.000	0	.591	15.0	.071	1.8	.000	0	—	LR-5-4×10PW	CLR-15S
	GTT%116K00	1	○	○	.012-.125	0.30-3.17	.630	16	.630	16	.630	16	4.724	120	.000	0	.591	15.0	.071	1.8	.000	0	—	LR-5-4×10PW	CLR-15S
	GTT%120K00	1	○	○	.012-.125	0.30-3.17	.787	20	.787	20	.787	20	4.921	125	.000	0	.591	15.0	.106	2.7	.000	0	—	LR-5-4×10PW	CLR-15S
	GTT%125M00	1	○	○	.012-.125	0.30-3.17	.984	25	.984	25	.984	25	5.906	150	.000	0	.591	15.0	.106	2.7	.000	0	—	LR-5-4×10PW	CLR-15S
	GTT%110F15	1	○	○	.057-.125	1.45-3.17	.394	10	.394	10	.394	10	3.150	80	.000	0	.591	15.0	.106	2.7	.118	3	—	LR-5-4×10PW	CLR-15S
	GTT%110K15	1	○	○	.057-.125	1.45-3.17	.394	10	.394	10	.394	10	4.724	120	.000	0	.591	15.0	.106	2.7	.118	3	—	LR-5-4×10PW	CLR-15S
	GTT%112F15	1	○	○	.057-.125	1.45-3.17	.472	12	.472	12	.472	12	3.150	80	.000	0	.591	15.0	.106	2.7	.040	1	—	LR-5-4×10PW	CLR-15S
	GTT%112K15	1	○	○	.057-.125	1.45-3.17	.472	12	.472	12	.472	12	4.724	120	.000	0	.591	15.0	.106	2.7	.040	1	—	LR-5-4×10PW	CLR-15S
	GTT%116H15	1	○	○	.057-.125	1.45-3.17	.630	16	.630	16	.630	16	3.937	100	.000	0	.591	15.0	.106	2.7	.000	0	—	LR-5-4×10PW	CLR-15S
	GTT%116K15	1	●	○	.057-.125	1.45-3.17	.630	16	.630	16	.630	16	4.724	120	.000	0	.591	15.0	.106	2.7	.000	0	—	LR-5-4×10PW	CLR-15S
	GTT%110F25	1	○	○	.098-.125	2.50-3.17	.394	10	.394	10	.394	10	3.150	80	.000	0	.591	15.0	.106	2.7	.118	3	—	LR-5-4×10PW	CLR-15S
	GTT%110K25	1	○	○	.098-.125	2.50-3.17	.394	10	.394	10	.394	10	4.724	120	.000	0	.591	15.0	.106	2.7	.118	3	—	LR-5-4×10PW	CLR-15S
	GTT%112F25	1	○	○	.098-.125	2.50-3.17	.472	12	.472	12	.472	12	3.150	80	.000	0	.591	15.0	.106	2.7	.040	1	—	LR-5-4×10PW	CLR-15S
	GTT%112K25	1	○	○	.098-.125	2.50-3.17	.472	12	.472	12	.472	12	4.724	120	.000	0	.591	15.0	.106	2.7	.040	1	—	LR-5-4×10PW	CLR-15S
	GTT%116H25	1	○	○	.098-.125	2.50-3.17	.630	16	.630	16	.630	16	3.937	100	.000	0	.591	15.0	.106	2.7	.000	0	—	LR-5-4×10PW	CLR-15S
	GTT%116K25	1	○	○	.098-.125	2.50-3.17	.630	16	.630	16	.630	16	4.724	120	.000	0	.591	15.0	.106	2.7	.000	0	—	LR-5-4×10PW	CLR-15S
	GTT%108HA-IN-OH	2	●	●	.012-.125	0.30-3.17	1/2	1/2	1/2	3.937	100	.000	0	.768	19.5	.071	1.8	.039	1	NPT1/8	LR-5-4×10PW	CLR-15S			
	GTT%108HB-IN-OH	2	●	●	.057-.125	1.45-3.17	1/2	1/2	1/2	3.937	100	.000	0	.768	19.5	.106	2.7	.039	1	NPT1/8	LR-5-4×10PW	CLR-15S			
	GTT%110HA-IN-OH	2	●	●	.012-.125	0.30-3.17	5/8	5/8	5/8	3.937	100	.000	0	.768	19.5	.071	1.8	.000	0	NPT1/8	LR-5-4×10PW	CLR-15S			
	GTT%110HB-IN-OH	2	●	●	.057-.125	1.45-3.17	5/8	5/8	5/8	3.937	100	.000	0	.768	19.5	.106	2.7	.000	0	NPT1/8	LR-5-4×10PW	CLR-15S			
	GTT%11012H00-OH	2	○	○	.012-.125	0.30-3.17	.394	10	.472	12	.394	10	3.937	100	.000	0	.768	19.5	.071	1.8	.039	1	M6 × 1	LR-5-4×10PW	CLR-15S
	GTT%112H00-OH	2	●	○	.012-.125	0.30-3.17	.472	12	.472	12	.472	12	3.937	100	.000	0	.768	19.5	.071	1.8	.039	1	Rc1/8 (PT1/8)	LR-5-4×10PW	CLR-15S
	GTT%116H00-OH	2	○	○	.012-.125	0.30-3.17	.630	16	.630	16	.630	16	3.937	100	.000	0	.768	19.5	.071	1.8	0	0	Rc1/8 (PT1/8)	LR-5-4×10PW	CLR-15S
	Y-GTTR%106-IN	3	●	○	.012-.125	0.30-3.17	3/8	3/8	—	—	—	—	4.724	120	.000	0	.984	25.0	.063	1.6	—	—	—	LR-5-4×10PW	CLR-15S
	Y-GTTR%108-IN	3	●	○	.012-.125	0.30-3.17	1/2	1/2	—	—	—	—	4.724	120	.000	0	.984	25.0	.063	1.6	—	—	—	LR-5-4×10PW	CLR-15S
	Y-GTTR%110-IN	3	●	○	.012-.125	0.30-3.17	5/8	5/8	—	—	—	—	4.724	120	.000	0	.984	25.0	.063	1.6	—	—	—	LR-5-4×10PW	CLR-15S
	Y-GTT%110S	3	○	○	.012-.125	0.30-3.17	.394	10	.394	10	—	—	4.724	120	.000	0	.787	20.0	.063	1.6	—	—	—	LR-5-4×10PW	CLR-15S
	Y-GTT%112S	3	○	○	.012-.125	0.30-3.17	.472	12	.472	12	—	—	4.724	120	.000	0	.787	20.0	.063	1.6	—	—	—	LR-5-4×10PW	CLR-15S
	Y-GTT%108H-IN-OH	4	●	○	.012-.125	0.30-3.17	1/2	1/2	—	—	—	—	3.937	100	.000	0	.984	25.0	.063	1.6	—	—	NTP1/8	LR-5-4×10PW	CLR-15S
	Y-GTT%112H00S-OH	4	●	○	.012-.125	0.30-3.17	.472	12	.472	12	—	—	3.937	100	.000	0	.787	20.0	.063	1.6	—	—	Rc1/8 (PT1/8)	LR-5-4×10PW	CLR-15S
	Y-GTT%116H00-OH	4	○	○	.012-.125	0.30-3.17	.630	16	.472	16	—	—	3.937	100	.000	0	.984	25.0	.063	1.6	—	—	Rc1/8 (PT1/8)	LR-5-4×10PW	CLR-15S
	CH-GTT%110H00	5	○	○	.012-.125	0.30-3.17	.394	10	.394	10	.394	10.0	4.724	120	.591	15	.472	12.0	.059	1.5	.118	3	—	LR-5-4×10PW	CLR-15S
	CH-GTT%112H00	5	○	○	.012-.125	0.30-3.17	.472	12	.472	12	.472	12.0	4.724	120	.669	17	.472	12.0	.059	1.5	.040	1	—	LR-5-4×10PW	CLR-15S



GTM...32
TMG32

Grooving /
Side-Turning

DS-GTT

Gage Insert	Item Number	Figure	Stock		<i>D</i> _s		<i>h</i>	<i>b</i>	<i>L</i> ₁	<i>f</i>	<i>L</i> ₂	Clamp Screw	Wrench					
			R	L	(Inch)	(mm)	(Inch)	(mm)	(Inch)	(mm)	(Inch)			(mm)				
	DS-GTT%114F	6	○	○	.551	14.000	.512	13	.512	13	3.150	80	.236	6	.787	20	LR-5-4 × 9	RLR-20S
	DS-GTT%115H	6	○	○	.518	15.875	.591	15	.591	15	3.937	100	.236	6	.787	20	LR-5-4 × 9	RLR-20S
	DS-GTT%116X	6	●	○	.630	16.000	.591	15	.591	15	3.740	95	.236	6	.787	20	LR-5-4 × 9	RLR-20S
	DS-GTT%119	6	●	○	3/4	19.050	.709	18	.709	18	4.724	120	.236	6	.787	20	LR-5-4 × 9	RLR-20S
	DS-GTT%120	6	●	○	.787	20.000	.748	19	.748	19	4.724	120	.236	6	.787	20	LR-5-4 × 9	RLR-20S
	DS-GTT%122	6	●	○	.866	22.000	.827	21	.827									

NEW GTMH-GX Chipbreaker for Grooving / Side Turning

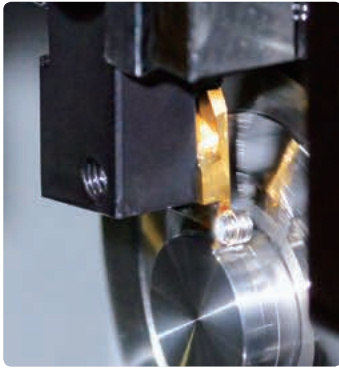

Features

- Can solve either problems of chips remaining in the grooves or bird's nest of chips
- Good surface finishes on groove side faces
- UP to .078" DOC side turning capability

Excellent Chip Control

• Grooving

	Feed rate (IPR)	.0004"	.0011"	.0020"
	DOC			
Material : 304 SS ($\phi .630$), 260 SFM, .059", DOC				

• Side Turning

	Feed rate (IPR)	.0004"	.0011"	.0020"	.0031"
	DOC				
	.010"				
	.020"				
Material : 304 SS ($\phi .630$), 260 SFM, .030" width insert					

Best Solution for Chip Control

Now available in Coolant through toolholders



GTMH32.. Inserts - Carbide

■ GTMH32-GX

Shape	Item Number	Groove Width W		Max Depth of Cut				L		r_e		Coated Carbide			
		(Inch)	(mm)	Grooving		Side turning		(Inch)	(mm)	(Inch)	(mm)	DM4		TM4	
				(Inch)	(mm)	(Inch)	(mm)					R	L	R	L
Side Turning Capable NEW 	GTMH32075RGX	.030	0.75	.106	2.7	.030	0.75	.079	2.0	.002	0.05	●		○	
	GTMH32095RGX	.037	0.95	.106	2.7	.059	1.50	.079	2.0	.002	0.05	●		○	
	GTMH32100RGX	.039	1.00	.106	2.7	.059	1.50	.079	2.0	.002	0.05	●		○	
	GTMH32100RGX01	.039	1.00	.106	2.7	.059	1.50	.079	2.0	.004	0.1	●		○	
	GTMH32150RGX	.059	1.50	.106	2.7	.079	2.00	.118	3.0	.002	0.05	●		○	
	GTMH32150RGX01	.059	1.50	.106	2.7	.079	2.00	.118	3.0	.004	0.1	●		○	
	GTMH32150RGX02	.059	1.50	.106	2.7	.079	2.00	.118	3.0	.008	0.2	●		○	
	GTMH32200RGX	.079	2.00	.106	2.7	.079	2.00	.118	3.0	.002	0.05	●		○	
	GTMH32200RGX01	.079	2.00	.106	2.7	.079	2.00	.118	3.0	.004	0.1	●		○	
	GTMH32200RGX02	.079	2.00	.106	2.7	.079	2.00	.118	3.0	.008	0.2	●		○	
	GTMH32300RGX	.118	3.00	.106	2.7	.079	2.00	.118	3.0	.002	0.05	●		○	
	GTMH32300RGX02	.118	3.00	.106	2.7	.079	2.00	.118	3.0	.008	0.2	●		○	

GTMX32

Shape	Item Number	Groove Width W		Max Depth of Cut Grooving		L		r _ε		Coated Carbide			
		(Inch)	(mm)	(Inch)	(mm)	(Inch)	(mm)	(Inch)	(mm)	QM3		DT4	
										R	L	R	L
	GTMX32030%T	.012	0.30	.010	0.25	.024	0.6	.002	0.05	●	□	○	
	GTMX32033%T	.013	0.33	.010	0.25	.024	0.6	.002	0.05	●	■		
	GTMX32043%T	.017	0.43	.035	0.9	.047	1.2	.002	0.05	●	□	○	
	GTMX32050%T	.020	0.50	.035	0.9	.047	1.2	.002	0.05	●	■	○	
	GTMX32053%T	.021	0.53	.035	0.9	.047	1.2	.002	0.05	●	□		
	GTMX32065%T	.026	0.65	.035	0.9	.047	1.2	.002	0.05	●	□	○	
	GTMX32075%T	.030	0.75	.063	1.6	.079	2.0	.002	0.05	●	●	○	○
	GTMX32080%T	.031	0.80	.063	1.6	.079	2.0	.002	0.05	●	■	○	
	GTMX32095%T	.037	0.95	.063	1.6	.079	2.0	.002	0.05	○	○	○	○
	GTMX32100%T	.039	1.00	.063	1.6	.079	2.0	.002	0.05	●	□		
	GTMX32100%T01	.039	1.00	.063	1.6	.079	2.0	.004	0.1	●	□	○	
	GTMX32110%T	.043	1.10	.063	1.6	.079	2.0	.002	0.05	○	□		
	GTMX32120%T	.047	1.20	.063	1.6	.079	2.0	.002	0.05	●	□	○	
	GTMX32120%T01	.047	1.20	.063	1.6	.079	2.0	.004	0.1	●	□	○	
	GTMX32125%T	.049	1.25	.063	1.6	.079	2.0	.002	0.05	●	■		
	GTMX32130%T	.051	1.30	.063	1.6	.079	2.0	.002	0.05	○	□	○	
	GTMX32140%T	.055	1.40	.063	1.6	.079	2.0	.002	0.05	○	□	○	
	GTMX32145%T	.057	1.45	.106	2.7	.118	3.0	.002	0.05	○	□		
	GTMX32150%T	.059	1.50	.106	2.7	.118	3.0	.002	0.05	●	●	○	○
	GTMX32150%T01	.059	1.50	.106	2.7	.118	3.0	.004	0.1	●	□	○	
	GTMX32150%T02	.059	1.50	.106	2.7	.118	3.0	.008	0.2	●	■		
	GTMX32160%T	.063	1.60	.106	2.7	.118	3.0	.002	0.05	●	□		
	GTMX32175%T	.069	1.75	.106	2.7	.118	3.0	.002	0.05	○	●	○	
	GTMX32180%T	.071	1.80	.106	2.7	.118	3.0	.002	0.05	○	□	○	
	GTMX32200%T	.079	2.00	.106	2.7	.118	3.0	.002	0.05	●	●	○	○
	GTMX32200%T01	.079	2.00	.106	2.7	.118	3.0	.004	0.1	○	○	○	○
	GTMX32200%T02	.079	2.00	.106	2.7	.118	3.0	.008	0.2	●	■		
	GTMX32250%T	.098	2.50	.106	2.7	.118	3.0	.002	0.05	●	○	○	○
GTMX32250%T01	.098	2.50	.106	2.7	.118	3.0	.004	0.1	○		○		
GTMX32250%T02	.098	2.50	.106	2.7	.118	3.0	.008	0.2	○		○		
GTMX32300%T	.118	3.00	.106	2.7	.118	3.0	.002	0.05	●	■	○		
GTMX32300%T02	.118	3.00	.106	2.7	.118	3.0	.008	0.2	●		○		

Right-Hand style shown

Grooving / Side-Turning

GTMH32 - VT Mirror finish

Shape	Item Number	Groove Width W		Max Depth of Cut Grooving		L		r _ε		Coated Carbide	
		(Inch)	(mm)	(Inch)	(mm)	(Inch)	(mm)	(Inch)	(mm)	VM1	
										R	L
	GTMH32033%VT M	.013	0.33	.010	0.25	.024	0.6	0.0	0.0	●	
	GTMH32043%VT M	.017	0.43	.035	0.9	.047	1.2	0.0	0.0	●	
	GTMH32053%VT M	.021	0.53	.063	1.6	.079	2.0	0.0	0.0	●	
	GTMH32065%VT M	.026	0.65	.063	1.6	.079	2.0	0.0	0.0	●	
	GTMH32075%VT M	.030	0.75	.063	1.6	.079	2.0	0.0	0.0	●	
	GTMH32080%VT M	.031	0.80	.063	1.6	.079	2.0	0.0	0.0	○	
	GTMH32085%VT M	.033	0.85	.063	1.6	.079	2.0	0.0	0.0	○	
	GTMH32095%VT M	.037	0.95	.063	1.6	.079	2.0	0.0	0.0	○	
	GTMH32100%VT M	.039	1.00	.063	1.6	.079	2.0	0.0	0.0	●	
	GTMH32110%VT M	.043	1.10	.063	1.6	.079	2.0	0.0	0.0	○	
	GTMH32120%VT M	.047	1.20	.063	1.6	.079	2.0	0.0	0.0	○	
	GTMH32130%VT M	.051	1.30	.063	1.6	.079	2.0	0.0	0.0	○	
	GTMH32140%VT M	.055	1.40	.063	1.6	.079	2.0	0.0	0.0	○	
	GTMH32150%VT M	.059	1.50	.106	2.7	.118	3.0	0.0	0.0	●	
	GTMH32200%VT M	.079	2.00	.106	2.7	.118	3.0	0.0	0.0	●	

Right-Hand style shown

Side turning instruction for GTMH-GX / GTMX-T / GTMH-VT

- ① To perform side turning with an insert whose groove width is greater than .017" set side turning feed rate to .001 IPR or smaller.
- ② When performing side turning with an insert whose groove width is greater than .017" and the feed rate is over .001 IPR (.004 IPR max), it is likely that chips will damage grooved sides. In this case, please perform grooving in two or more passes to make room for chips before performing side turning.

● : Stock ○ : 1-2 week delivery ■, □ : While stock lasts M : Mirror finish Holders → T10 Cutting condition → T4

Grooving / Side-Turning

GTMH32 - E

Shape	Item Number	Groove width W		Max Depth of Cut		L		r_ϵ		Coated Carbide	
		(Inch)	(mm)	(Inch)	(mm)	(Inch)	(mm)	(Inch)	(mm)	ZM3	
										R	L
	GTMH32033% $\frac{1}{2}$ E	.013	0.33	.012	0.3	.024	0.6	.001	0.03	○	○
	GTMH32043% $\frac{1}{2}$ E	.017	0.43	.035	0.9	.047	1.2	.001	0.03	●	○
	GTMH32053% $\frac{1}{2}$ E	.021	0.53	.035	0.9	.047	1.2	.002	0.05	○	○
	GTMH32075% $\frac{1}{2}$ E	.030	0.75	.063	1.6	.079	2.0	.002	0.05	○	○
	GTMH32077% $\frac{1}{2}$ E	.030	0.77	.063	1.6	.079	2.0	.002	0.05	○	○
	GTMH32095% $\frac{1}{2}$ E	.037	0.95	.063	1.6	.079	2.0	.002	0.05	○	○
	GTMH32097% $\frac{1}{2}$ E	.038	0.97	.063	1.6	.079	2.0	.002	0.05	○	○
	GTMH32100% $\frac{1}{2}$ E	.039	1.00	.063	1.6	.079	2.0	.002	0.05	○	○
	GTMH32100% $\frac{1}{2}$ E01	.039	1.00	.063	1.6	.079	2.0	.004	0.1	○	○
	GTMH32120% $\frac{1}{2}$ E	.047	1.20	.063	1.6	.079	2.0	.002	0.05	●	○
	GTMH32120% $\frac{1}{2}$ E01	.047	1.20	.063	1.6	.079	2.0	.004	0.1	○	○
	GTMH32125% $\frac{1}{2}$ E	.049	1.25	.063	1.6	.079	2.0	.002	0.05	○	○
	GTMH32140% $\frac{1}{2}$ E	.055	1.40	.063	1.6	.079	2.0	.002	0.05	○	○
	GTMH32145% $\frac{1}{2}$ E	.057	1.45	.063	1.6	.079	2.0	.002	0.05	○	○
	GTMH32150% $\frac{1}{2}$ E	.059	1.50	.106	2.7	.118	3.0	.002	0.05	○	○
	GTMH32150% $\frac{1}{2}$ E01	.059	1.50	.106	2.7	.118	3.0	.004	0.1	○	○
	GTMH32175% $\frac{1}{2}$ E	.069	1.75	.106	2.7	.118	3.0	.002	0.05	○	○
	GTMH32180% $\frac{1}{2}$ E	.071	1.80	.106	2.7	.118	3.0	.002	0.05	○	○
GTMH32200% $\frac{1}{2}$ E	.079	2.00	.106	2.7	.118	3.0	.002	0.05	○	○	
GTMH32200% $\frac{1}{2}$ E01	.079	2.00	.106	2.7	.118	3.0	.004	0.1	○	○	
GTMH32225% $\frac{1}{2}$ E	.089	2.25	.106	2.7	.118	3.0	.002	0.05	○	○	
GTMH32250% $\frac{1}{2}$ E	.098	2.50	.106	2.7	.118	3.0	.002	0.05	○	○	
GTMH32275% $\frac{1}{2}$ E	.108	2.75	.106	2.7	.118	3.0	.002	0.05	○	○	
GTMH32300% $\frac{1}{2}$ E	.118	3.00	.106	2.7	.118	3.0	.002	0.05	○	○	

Right-Hand style shown

GTMH32 (Full radius style)

Shape	Item Number	Groove Width W		Max Depth of Cut		L		r_ϵ		Coated Carbide			
		(Inch)	(mm)	(Inch)	(mm)	(Inch)	(mm)	(Inch)	(mm)	QM3		ZM3	
										R	L	R	L
	GTMH32050% $\frac{1}{2}$ E025	.020	0.50	.035	0.9	.047	1.2	.010	0.25	●	●		
	GTMH32070% $\frac{1}{2}$ E035	.028	0.70	.063	1.6	.079	2.0	.014	0.35	●	●		
	GTMH32100% $\frac{1}{2}$ E05	.039	1.00	.063	1.6	.079	2.0	.020	0.50	●	●		
	GTMH32150% $\frac{1}{2}$ E075	.059	1.50	.106	2.7	.118	3.0	.030	0.75	●			
	GTMH32200% $\frac{1}{2}$ E10	.079	2.00	.106	2.7	.118	3.0	.039	1.00	●	○		
	GTMH32300% $\frac{1}{2}$ E15	.118	3.00	.106	2.7	.118	3.0	.059	1.50	●	○		

Right-Hand style shown

● : Stock

○ : 1-2 week delivery

■, □ : While stock lasts

Ⓜ : Mirror finish

Holders → T10

Cutting condition → T4

TMG32-E

Shape	Item Number	Groove Width W		Max Depth of Cut		L		r_ϵ		Coated Carbide	
		(Inch)	(mm)	(Inch)	(mm)	(Inch)	(mm)	(Inch)	(mm)	ZM3	
										R	L
<p>Right-Hand style shown</p>	TMG32031% $\frac{1}{4}$ E01	.031	0.79	.063	1.6	.079	2.0	.004	0.1	●	■
	TMG32039% $\frac{1}{4}$ E01	.039	1.00	.063	1.6	.079	2.0	.004	0.1	●	●
	TMG32049% $\frac{1}{4}$ E01	.049	1.25	.063	1.6	.079	2.0	.004	0.1	●	■
	TMG32062% $\frac{1}{4}$ E02	.062	1.57	.106	2.7	.118	3.0	.008	0.2	●	□
	TMG32079% $\frac{1}{4}$ E02	.079	2.00	.106	2.7	.118	3.0	.008	0.2	●	□
	TMG32094% $\frac{1}{4}$ E02	.094	2.39	.106	2.7	.118	3.0	.008	0.2	●	□
	TMG32125% $\frac{1}{4}$ E02	.125	3.18	.106	2.7	.118	3.0	.008	0.2	●	□

GTMH • X32 (Flat top chipbreaker)

Shape	Item Number	Groove Width W		Max Depth of Cut		L		r_ϵ		Carbide	
		(Inch)	(mm)	(Inch)	(mm)	(Inch)	(mm)	(Inch)	(mm)	KM1	
										R	L
<p>Mirror finish</p> <p>Right-Hand style shown</p>	GTMH32100% $\frac{1}{4}$ SSH M	.039	1.00	.063	1.6	.079	2.0	.002	0.05	○	
	GTMH32150% $\frac{1}{4}$ SSH M	.059	1.50	.106	2.7	.118	3.0	.002	0.05	○	
	GTMH32200% $\frac{1}{4}$ SSH M	.079	2.00	.106	2.7	.118	3.0	.002	0.05	○	

Shape	Item Number	Groove Width W		Max Depth of Cut		L		r_ϵ		Coated Carbide	
		(Inch)	(mm)	(Inch)	(mm)	(Inch)	(mm)	(Inch)	(mm)	ZM3	
										R	L
<p>Right-Hand style shown</p>	GTMX32100% $\frac{1}{4}$ SS	.039	1.00	.063	1.6	.079	2.0	.002	0.05	○	
	GTMX32150% $\frac{1}{4}$ SS	.059	1.50	.106	2.7	.118	3.0	.002	0.05	○	
	GTMX32200% $\frac{1}{4}$ SS	.079	2.00	.106	2.7	.118	3.0	.002	0.05	○	
<p>Right-Hand style shown</p>	GTMX32100% $\frac{1}{4}$ LS	.039	1.00	.063	1.6	.079	2.0	.002	0.05	○	
	GTMX32150% $\frac{1}{4}$ LS	.059	1.50	.106	2.7	.118	3.0	.002	0.05	○	
	GTMX32200% $\frac{1}{4}$ LS	.079	2.00	.106	2.7	.118	3.0	.002	0.05	○	

GTMX32 (90 Degree V-style)

Shape	Item Number	Max Depth of Cut		Edge Geometry	r_ϵ		L		Coated Carbide	
		(Inch)	(mm)		(Inch)	(mm)	(Inch)	(mm)	TM4	
									R	L
<p>Right-Hand style shown</p>	GTMX32V90% $\frac{1}{4}$ 005	.020	0.5	90°	.002	0.05	.020	0.5	○	
	GTMX32V90% $\frac{1}{4}$ 010	.028	0.7	90°	.004	0.1	.040	1.0	○	

GTMH32.. Inserts - Cermet

GTMH32-J

Shape	Item Number	Groove Width w		Max Depth of Cut		L		r_ϵ		Coated Cermet	
		(Inch)	(mm)	(Inch)	(mm)	(Inch)	(mm)	(Inch)	(mm)	C7Z	
										R	L
	GTMH32075%J005	.030	0.75	.063	1.6	.079	2.0	.002	0.05	○	○
	GTMH32080%J005	.031	0.80	.063	1.6	.079	2.0	.002	0.05	○	○
	GTMH32095%J005	.037	0.95	.063	1.6	.079	2.0	.002	0.05	○	○
	GTMH32100%J005	.039	1.00	.063	1.6	.079	2.0	.002	0.05	○	○
	GTMH32115%J005	.045	1.15	.063	1.6	.079	2.0	.002	0.05	○	○
	GTMH32120%J01	.047	1.20	.063	1.6	.079	2.0	.004	0.1	○	○
	GTMH32125%J01	.049	1.25	.063	1.6	.079	2.0	.004	0.1	○	○
	GTMH32145%J01	.057	1.45	.106	2.7	.118	3.0	.004	0.1	○	○
	GTMH32150%J01	.059	1.50	.106	2.7	.118	3.0	.004	0.1	○	○
	GTMH32150%J	.059	1.50	.106	2.7	.118	3.0	.008	0.2	○	○
	GTMH32160%J01	.063	1.60	.106	2.7	.118	3.0	.004	0.1	○	○
	GTMH32175%J01	.069	1.75	.106	2.7	.118	3.0	.004	0.1	○	○
	GTMH32180%J01	.071	1.80	.106	2.7	.118	3.0	.004	0.1	○	○
	GTMH32200%J01	.079	2.00	.106	2.7	.118	3.0	.004	0.1	○	○
	GTMH32200%J	.079	2.00	.106	2.7	.118	3.0	.008	0.2	○	○
	GTMH32250%J01	.098	2.50	.106	2.7	.118	3.0	.004	0.1	○	○
GTMH32250%J	.098	2.50	.106	2.7	.118	3.0	.008	0.2	○	○	
GTMH32300%J	.118	3.00	.106	2.7	.118	3.0	.008	0.2	○	○	

Right-Hand style shown

GTM32 (Molded Chipbreaker)

Shape	Item Number	Groove Width w		Max Depth of Cut		L		r_ϵ		Cermet	
		(Inch)	(mm)	(Inch)	(mm)	(Inch)	(mm)	(Inch)	(mm)	XN4	
										R	L
	GTM32100%01	.039	1.00	.063	1.6	.079	2.0	.004	0.1	○	○
	GTM32100%L	.039	1.00	.063	1.6	.079	2.0	.008	0.2	○	○
	GTM32145%L	.057	1.45	.106	2.7	.118	3.0	.008	0.2	○	○
	GTM32150%L	.059	1.50	.106	2.7	.118	3.0	.008	0.2	○	○
	GTM32200%L	.079	2.00	.106	2.7	.118	3.0	.008	0.2	○	○
	GTM32230%L	.091	2.30	.106	2.7	.118	3.0	.008	0.2	○	○
	GTM32250%L	.098	2.50	.106	2.7	.118	3.0	.008	0.2	○	○
	GTM32300%L	.118	3.00	.106	2.7	.118	3.0	.008	0.2	○	○

Right-Hand style shown

TWG Series

TWG

Side Turning Capable
Up to .059"(1.5mm) doc.

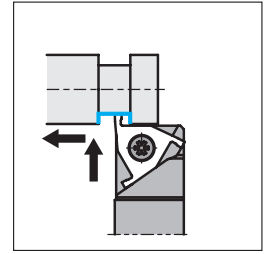
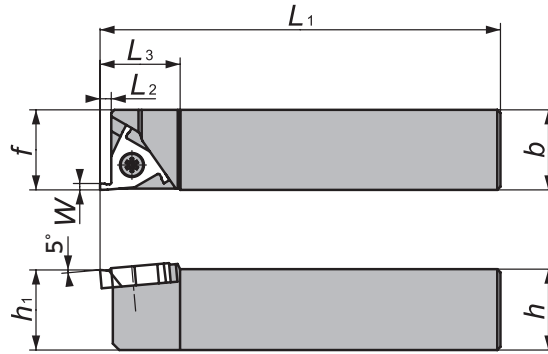



Figure-1

Right-Hand style shown

TWG Series - Toolholders

TWG

Gage Insert	Item Number	Figure	Stock		h		b		h_1		L_1		f		L_2		L_3		Clamp Screw	Wrench
			R	L	(Inch)	(mm)	(Inch)	(mm)	(Inch)	(mm)	(Inch)	(mm)	(Inch)	(mm)	(Inch)	(mm)	(Inch)	(mm)		
	TWG2012X	1	○		.472	12	.787	20	.472	12	4.724	120	.787	20	.138	3.5	.984	25	FSS25-5.0 × 10	RLR-20S
	TWG2016X	1	○		.630	16	.787	20	.630	16	4.724	120	.787	20	.138	3.5	.984	25	FSS10-5.0 × 14	LLR-20S
	TWG¾2020K	1	○	○	.787	20	.787	20	.787	20	4.921	125	.787	20	.138	3.5	.984	25	FSS10-5.0 × 14	RLR-20S
	TWG¾2525K	1	○	○	.984	25	.984	25	.984	25	4.921	125	.984	25	.138	3.5	.984	25	FSS10-5.0 × 14	RLR-20S

TWG Series - Inserts

TWG

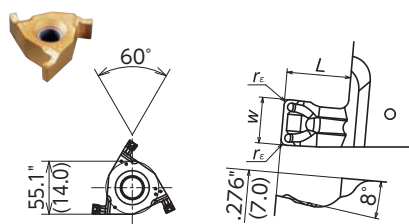
Shape	Item Number	Groove Width w		Max Depth of Cut		L		r_ϵ		Coated Carbide	
		(Inch)	(mm)	(Inch)	(mm)	(Inch)	(mm)	(Inch)	(mm)	TM1	
										R	L
 <p>Right-Hand style shown</p>	TWG20¾005	.079	2.0	.118	3.0	.138	3.5	.002	0.05	○	○
	TWG20¾020	.079	2.0	.118	3.0	.138	3.5	.008	0.2	○	○
	TWG25¾010	.098	2.5	.118	3.0	.138	3.5	.004	0.1	○	○
	TWG25¾030	.098	2.5	.118	3.0	.138	3.5	.012	0.3	○	○
	TWG30¾010	.118	3.0	.118	3.0	.138	3.5	.004	0.1	○	○
	TWG30¾030	.118	3.0	.118	3.0	.138	3.5	.012	0.3	○	○

○ : 1-2 week delivery

Cutting condition **→T4**

GTM.43 Series - Toolholders

NGTN

No-Offset

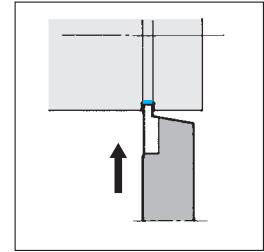
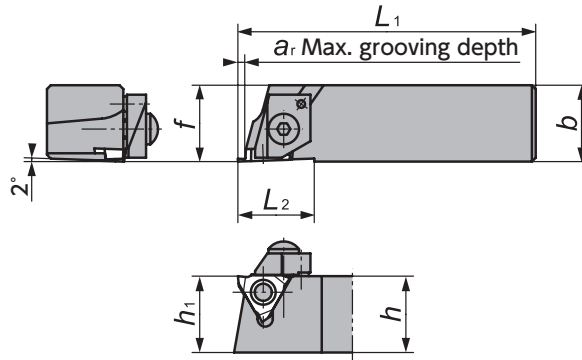

(Parts)

Clamp	Spring
CPR/L5S	ASG-5

Figure-1

Right-Hand style shown

NGTB

With Offset

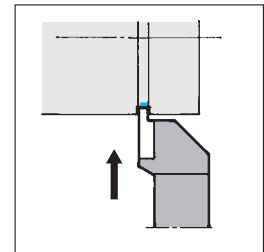
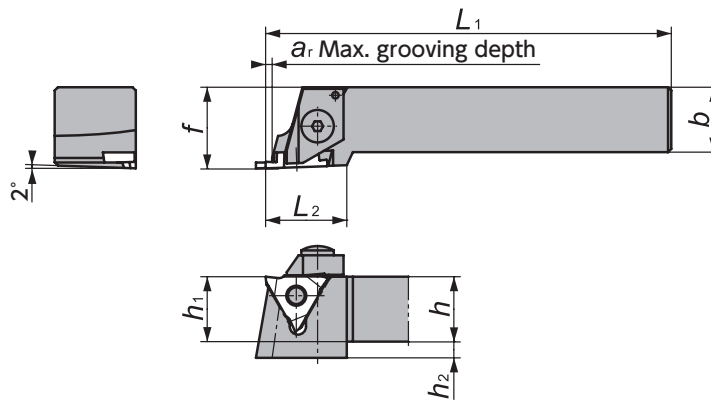

(Parts)

Clamp	Spring
CPR/L5	ASG-5
CPR/L6	ASG-6

Figure-2

Right-Hand style shown

GTM.43 Series - Toolholders

NGTN / NTGB

Gage Insert	Item Number	Figure	Stock		Groove Width Range		a_r	h	b	h_1	L_1	f	L_2	h_2	Clamp Screw	Wrench
			R	L	(Inch)	(mm)										
 GTM43 GTMA43 GTMT43	NGTN%161643-20	1	○	○	.079-.137	2.00-3.49	.177 4.5	.630 16	.630 16	.630 16	3.071 78	.630 16	.787 20	.354 9	AOS-5 × 20	LW-2.5
	NGTN%161643-35	1	○	○	.138-.217	3.50-5.50	.177 4.5	.630 16	.630 16	.630 16	3.071 78	.630 16	.787 20	.354 9	AOS-5 × 20	LW-2.5
	NGTB%161643-00S	2	○	○	.039-.098	1.00-2.49	.118 3.0	.630 16	.630 16	.630 16	3.150 100	.787 20	.984 25	.354 9	AOS-5 × 25	LW-2.5
	NGTB%161643-20S	2	○	○	.079-.137	2.00-3.49	.177 4.5	.630 16	.630 16	.630 16	3.150 100	.787 20	.984 25	.354 9	AOS-5 × 25	LW-2.5
	NGTB%161643-35S	2	○	○	.138-.217	3.50-5.50	.177 4.5	.630 16	.630 16	.630 16	3.150 100	.787 20	.984 25	.354 9	AOS-5 × 25	LW-2.5

GTMA43.. Inserts - Carbide / Cermet

GTMT43 / GTMA43

Shape	Item Number	Groove Width <i>W</i>		Max Depth of Cut		<i>L</i>		<i>r_e</i>		<i>S</i>		Coated Carbide			
		(Inch)	(mm)	(Inch)	(mm)	(Inch)	(mm)	(Inch)	(mm)	(Inch)	(mm)	QM3		DM4	
												R	L	R	L
	GTMT43145%L	.057	1.45	.118	3.0	.138	3.5	.008	0.2	.187	4.76	○	○	○	○
	GTMT43150%L	.059	1.50	.118	3.0	.138	3.5	.008	0.2	.187	4.76	○	○	○	○
	GTMT43175%L	.069	1.75	.118	3.0	.138	3.5	.008	0.2	.187	4.76	○	○	○	○
	GTMT43185%L	.073	1.85	.118	3.0	.138	3.5	.008	0.2	.187	4.76	○	○	○	○
	GTMT43200%L	.079	2.00	.118	3.0	.138	3.5	.008	0.2	.187	4.76	○	○	○	○
	GTMT43230%L	.091	2.30	.118	3.0	.138	3.5	.008	0.2	.187	4.76	○	○	○	○
	GTMT43250%L	.098	2.50	.169	4.3	.217	5.5	.012	0.3	.187	4.76	○	○	○	○
	GTMT43265%L	.104	2.65	.169	4.3	.217	5.5	.012	0.3	.187	4.76	○	○	○	○
	GTMT43280%L	.110	2.80	.169	4.3	.217	5.5	.012	0.3	.187	4.76	○	○	○	○
	GTMT43300%L	.118	3.00	.169	4.3	.217	5.5	.012	0.3	.187	4.76	○	○	○	○
	GTMT43330%L	.130	3.30	.169	4.3	.217	5.5	.012	0.3	.187	4.76	○	○	○	○
	GTMT43350%L	.138	3.50	.169	4.3	.217	5.5	.012	0.3	.187	4.76	○	○	○	○
	GTMT43400%L	.157	4.00	.169	4.3	.217	5.5	.016	0.4	.187	4.76	○	○	○	○
	GTMT43450%L	.177	4.50	.169	4.3	.217	5.5	.016	0.4	.187	4.76	○	○	○	○
	GTMT43500%L	.197	5.00	.169	4.3	.217	5.5	.016	0.4	.227	5.76	○	○	○	○
GTMT43550%L	.217	5.50	.169	4.3	.217	5.5	.016	0.4	.227	5.76	○	○	○	○	

GTMA43 / GTMA43 / GTM43

Shape	Item Number	Groove Width <i>W</i>		Max Depth of Cut		<i>L</i>		<i>r_e</i>		Coated Cermet		Cermet	
		(Inch)	(mm)	(Inch)	(mm)	(Inch)	(mm)	(Inch)	(mm)	C7Z		XN4	
										R	L	R	L
	GTMA43100%J01	.039	1.00	.063	1.6	.079	2.0	.004	0.1	○	○		
	GTMA43125%J01	.049	1.25	.063	1.6	.079	2.0	.004	0.1	○	○		
	GTMA43145%J01	.057	1.45	.118	3.0	.138	3.5	.004	0.1	○	○		
	GTMA43150%J	.059	1.50	.118	3.0	.138	3.5	.008	0.2	○	○		
	GTMA43175%J	.069	1.75	.118	3.0	.138	3.5	.008	0.2	○	○		
	GTMA43185%J	.073	1.85	.118	3.0	.138	3.5	.008	0.2	○	○		
	GTMA43200%J	.079	2.00	.118	3.0	.138	3.5	.008	0.2	○	○		
	GTMA43230%J	.091	2.30	.118	3.0	.138	3.5	.008	0.2	○	○		
	GTMA43250%J03	.098	2.50	.177	4.5	.217	5.5	.012	0.3	○	○		
	GTMA43265%J03	.104	2.65	.177	4.5	.217	5.5	.012	0.3	○	○		
	GTMA43280%J03	.110	2.80	.177	4.5	.217	5.5	.012	0.3	○	○		
	GTMA43300%J03	.118	3.00	.177	4.5	.217	5.5	.012	0.3	○	○		
	GTMA43330%J03	.130	3.30	.177	4.5	.217	5.5	.012	0.3	○	○		
GTMA43350%J03	.138	3.50	.177	4.5	.217	5.5	.012	0.3	○	○			
GTMA43400%J04	.157	4.00	.177	4.5	.217	5.5	.016	0.4	○	○			
GTMA43450%J04	.177	4.50	.177	4.5	.217	5.5	.016	0.4	○	○			
	GTM43200%L	.079	2.00	.118	3.0	.138	3.5	.008	0.2			○	○
	GTM43230%L	.091	2.30	.118	3.0	.138	3.5	.008	0.2			○	○
	GTM43250%L	.098	2.50	.165	4.2	.217	5.5	.008	0.2			○	○
	GTM43265%L	.104	2.65	.165	4.2	.217	5.5	.008	0.2			○	○
	GTM43300%L	.118	3.00	.165	4.2	.217	5.5	.008	0.2			○	○
	GTM43330%L	.130	3.30	.165	4.2	.217	5.5	.008	0.2			○	○
	GTM43350%L	.138	3.50	.165	4.2	.217	5.5	.008	0.2			○	○
	GTM43400%L	.157	4.00	.165	4.2	.217	5.5	.008	0.2			○	○
GTM43450%L	.177	4.50	.165	4.2	.217	5.5	.008	0.2			○	○	

GTMA43 (Full Radius style)

Shape	Item Number	Groove Width <i>W</i>		Max Depth of Cut		<i>L</i>		<i>r_e</i>		Coated Carbide		Coated Cermet	
		(Inch)	(mm)	(Inch)	(mm)	(Inch)	(mm)	(Inch)	(mm)	QM3		C7Z	
										R	L	R	L
	GTMA43200%L10R	.079	2.00	.118	3.0	.138	3.5	.039	1.0	○			
	GTMA43300%L15R	.118	3.00	.177	4.5	.217	5.5	.059	1.5	○			
	GTMA43400%L20R	.157	4.00	.177	4.5	.217	5.5	.787	2.0	○			
	GTMA43100%LJ05R	.039	1.00	.063	1.6	.079	2.0	.020	0.50			○	
	GTMA43150%LJ075R	.059	1.50	.118	3.0	.138	3.5	.030	0.75			○	
	GTMA43200%LJ10R	.079	2.00	.118	3.0	.138	3.5	.039	1.00			○	
	GTMA43250%LJ125R	.098	2.50	.157	4.0	.217	5.5	.049	1.25			○	
GTMA43300%LJ15R	.118	3.00	.157	4.0	.217	5.5	.059	1.50			○		

○ : 1-2 week delivery

Cutting condition → T4

Grooving / Side-Turning

SATURN DUO

Face grooving tool

WATCH ON
YouTube



Features

- FGV type for face grooving and FBV type for face machining
- Economical double-corner specification
- Improved tool rigidity by optimizing the overhang and holder shape
- Gang-type, front-gang-type and sleeve holder types available

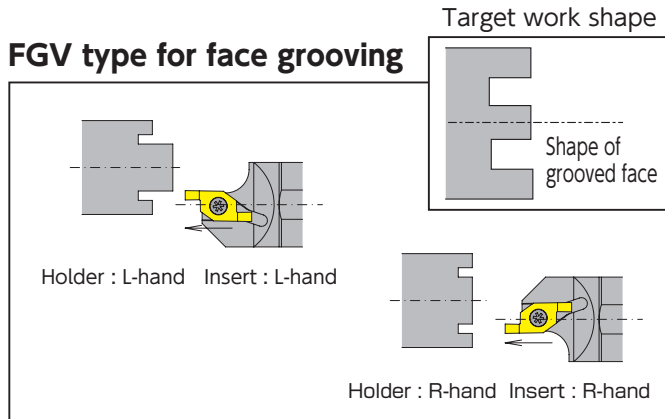

- Grooving is possible under a wide range of cutting conditions due to strengthened rigidity of both insert and holder
- Minimum machining diameter of $\phi .236"$, and groove width of $.039"$
- Left-hand types available for machining work with a boss

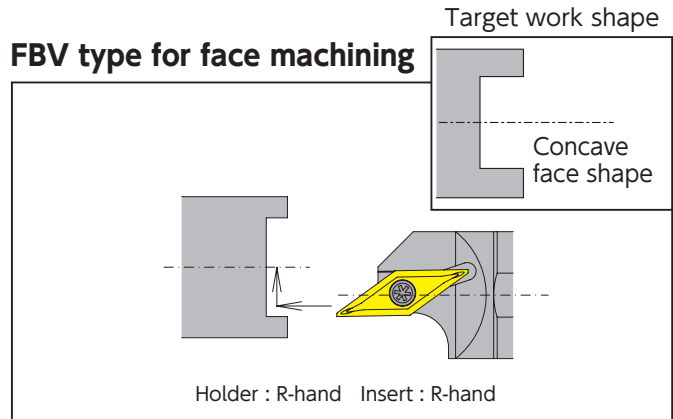

- Further improved face machining efficiency
- Minimum machining diameter of $\phi .315"$

Recommended Cutting Condition for FGV Style Tooling (for Face Grooving)

		Steel (Carbon Steel, Alloy Steel)	Stainless Steel (Excluding 303 SS)	Free Cutting Steel (Including 303 SS)	Non-ferrous Metals (Brass, Aluminum, Copper)
Speed (SFM)		160 (100 - 330)	130 (100 - 330)	200 (100 - 330)	260 (160 - 390)
Feed Rate (IPR)	Groove Depth (Inch)	.039	.0008 (.0004-.002)	.0008 (.0004-.002)	.002 (.0004-.0025)
		.059	.0008 (.0004-.002)	.0004 (.0002-.001)	.001 (.0004-.002)
		.079	.0004 (.0002-.001)	.0004 (.0002-.001)	.0008 (.0004-.002)

☆Tips for Successful Face Grooving

- ① Run multiple passes if turning wider grooves.
Make sure to groove from outer diameter to inner diameter to avoid any interference.
- ② If lines appear on the boss section, slow down feed rate when retracting the tool.
- ③ If scratch appears at the end of the boss, slow down the feed rate.
- ④ If groove surface looks torn, either slow down feed rate or increase speed.
- ⑤ If groove bottom looks torn with a speed and feed condition, increase the speed.

☆Note

Side turning cannot be performed with FGV style tooling

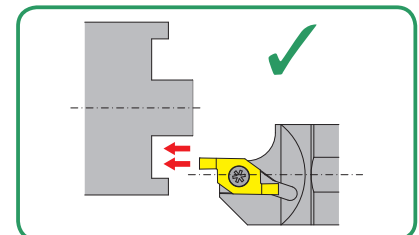
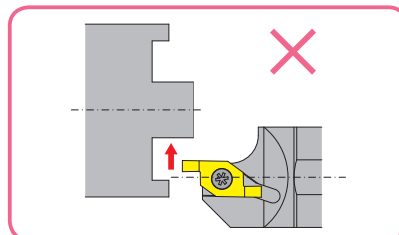

Recommended Cutting Conditions for FBV Style Tooling (for Face Grooving)

Minimum machining diameter: ϕ .315" (8mm) WET

			Steel (Carbon Steel, Alloy Steel)	Stainless Steel (Excluding 303 SS)	Free Cutting Steel (Including 303 SS)	Non-ferrous Metals (Brass, Aluminum, Copper)
Speed (SFM)			160 (100 - 330)	130 (100 - 330)	200 (100 - 330)	260 (160 - 390)
Feed Rate (IPR)	Groove Depth (Inch)	.039	.001 (.0004-.002)	.0008 (.0004-.002)	.002 (.0004-.0025)	.002 (.0004-.0025)
		.059	.0008 (.0004-.002)	.0004 (.0002-.001)	.001 (.0004-.002)	.001 (.0004-.002)
		.079	.0004 (.0002-.001)	.0004 (.0002-.001)	.0008 (.0004-.002)	.0008 (.0004-.002)

* When machining difficult materials where chip control is problematic (such as 304SS), it is recommended that the machining be carried out in several stages.

☆Machining process

- For materials with good machinability, it is possible to machine up to .157" (4mm) deep at a low feed rate in a single pass for both longitudinal feed and cross feed.

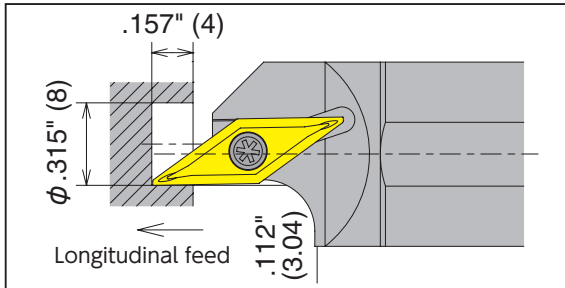

Cutting in Z direction : Longitudinal feed

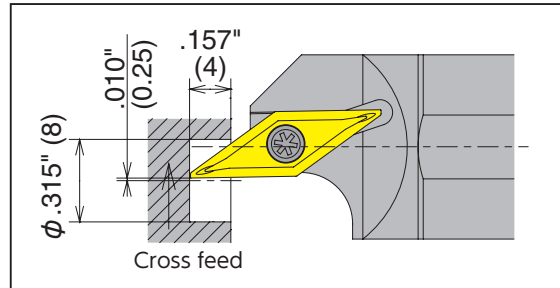

Cutting in X direction : Cross feed

☆Useful tips for machining

When burrs occur on ID surface, it is recommended to perform the cut in 2 passes, one for roughing and one for finishing as shown in the following procedure:

☆Example of 2-pass machining: Leave .008" (0.2mm) on roughing then run a finish cut

1 Longitudinal feed (roughing)

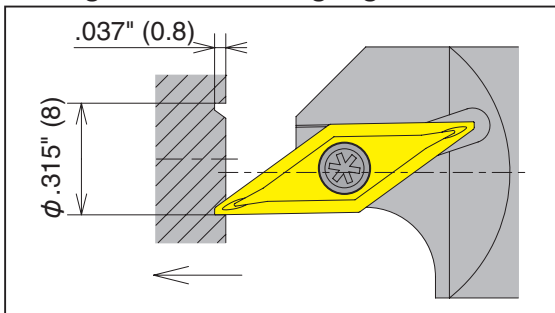

2 Longitudinal feed (finishing)

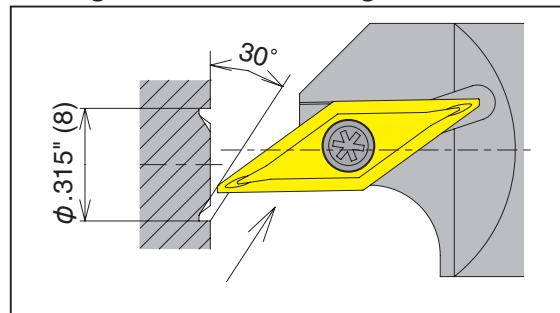

3 Slant machining (roughing)

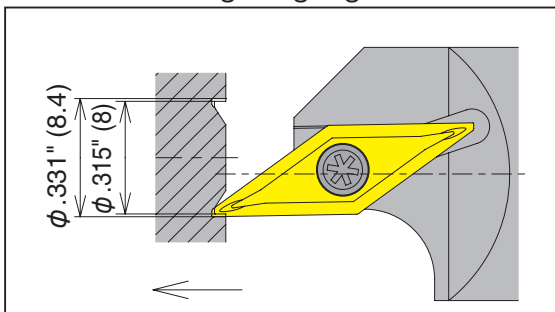

4 Cross feed (finishing)

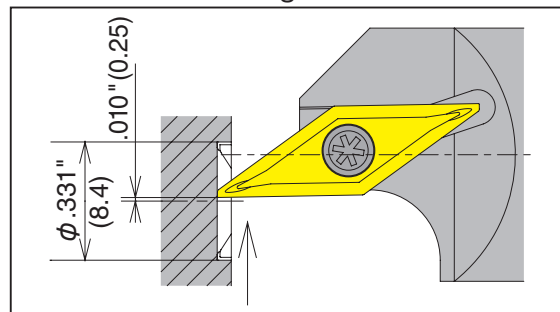

FGV Series

FGV

For Gang-style machine

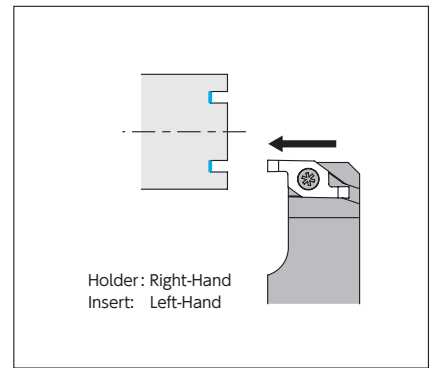
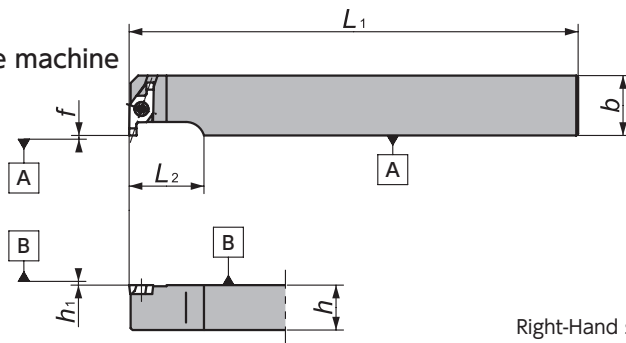

Figure-1

Right-Hand style shown
Takes Left-Hand insert

CH-FGV

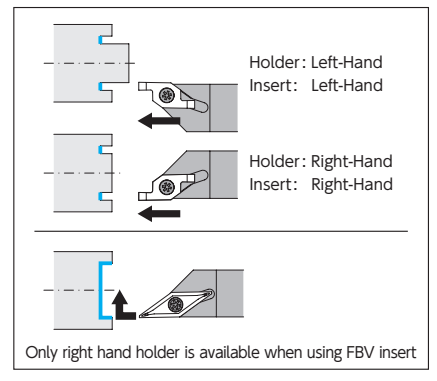
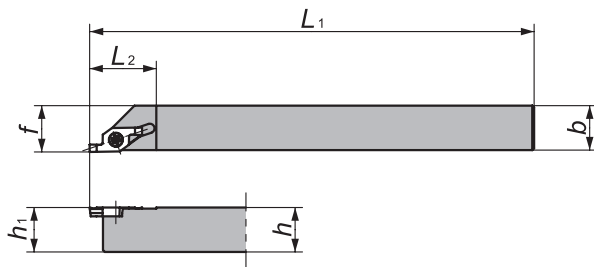

Figure-2

Right-Hand style shown

DS-FGV

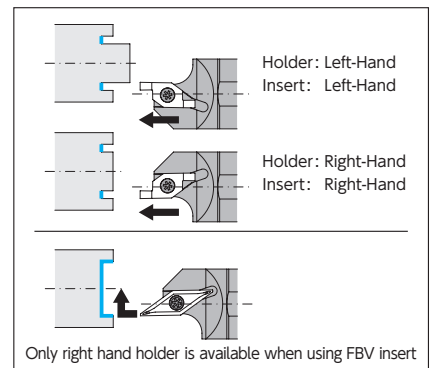
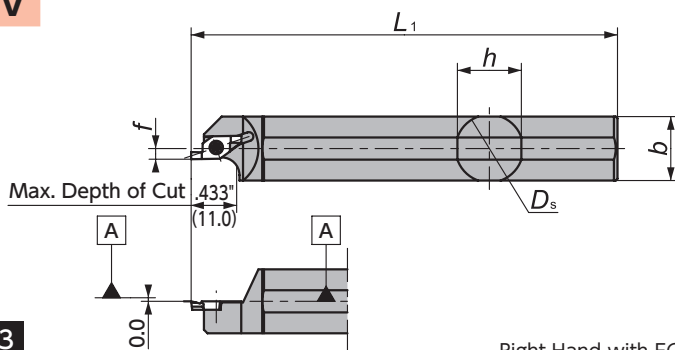

Figure-3

Right-Hand with FGV style shown

FGV - Toolholders

FGV

Gage Insert	Item Number	Figure	Stock		h		b		h_1		L_1		f		L_2		Clamp Screw	Wrench
			R	L	(Inch)	(mm)	(Inch)	(mm)	(Inch)	(mm)	(Inch)	(mm)	(Inch)	(mm)	(Inch)	(mm)		
FGV...L	FGV%1016	1	○		.413	10	.630	16	0	0.0	4.724	120	0	0.0	.787	20	LRIS-2.5 × 7	CLR-15S
	FGV%1216	1	○		.472	12	.630	16	0	0.0	4.724	120	0	0.0	.787	20	LRIS-2.5 × 7	CLR-15S
	FGV%1616	1	○		.630	16	.630	16	0	0.0	4.724	120	0	0.0	.787	20	LRIS-2.5 × 7	CLR-15S
FGV FBV	CH-FGV%1010	2	○	○	.413	10	.394	10	.394	10	4.724	120	.413	10.5	.709	18	LRIS-2.5 × 7	CLR-15S
	CH-FGV%1212	2	○	○	.472	12	.472	12	.472	12	4.724	120	.492	12.5	.709	18	LRIS-2.5 × 7	CLR-15S
	CH-FGV%1616	2	○	○	.630	16	.630	16	.630	16	4.724	120	.650	16.5	.709	18	LRIS-2.5 × 7	CLR-15S



DS-FGV

Gage Insert	Item Number	Figure	Stock		D_s		h		b		L_1		f		Clamp Screw	Wrench
			R	L	(Inch)	(mm)	(Inch)	(mm)	(Inch)	(mm)	(Inch)	(mm)	(Inch)	(mm)		
FGV FBV	DS-FGV%16-012	3	○	○	.630	16	.591	15	.591	15	3.150	80	.118	3.0	LRIS-2.5 × 7	CLR-15S
	DS-FGV%19	3	○	○	3/4	19.05	.709	18	.709	18	4.724	120	.118	3.0	LRIS-2.5 × 7	CLR-15S
	DS-FGV%20	3	○	○	.787	20	.748	19	.748	19	4.724	120	.118	3.0	LRIS-2.5 × 7	CLR-15S
	DS-FGV%22	3	○	○	.866	22	.827	21	.827	21	4.724	120	.118	3.0	LRIS-2.5 × 7	CLR-15S
	DS-FGV%25	3	○	○	1	25.4	.965	24.5	.965	24.5	4.724	120	.118	3.0	LRIS-2.5 × 7	CLR-15S

FGV - Inserts

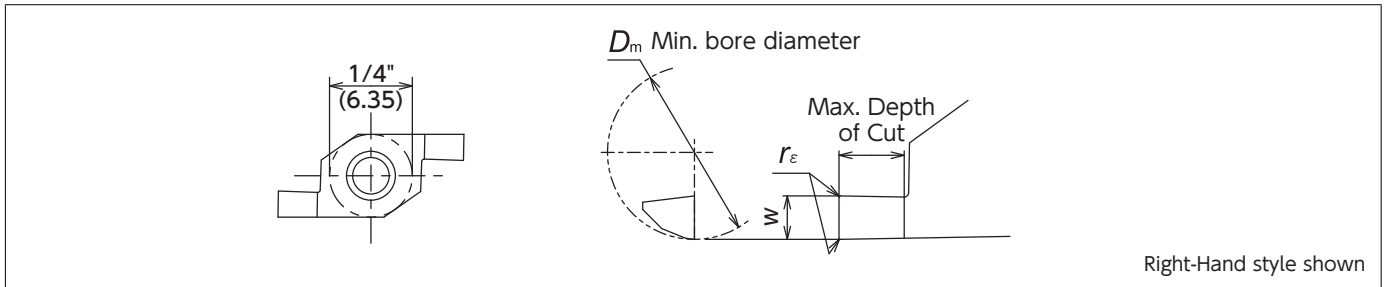
FGV





Shape	Item Number	Groove Width w		Min. Bore Diameter		Max Depth of Cut		Thickness		r_{ϵ}		Coated Carbide	
		(Inch)	(mm)	(Inch)	(mm)	(Inch)	(mm)	(Inch)	(mm)	(Inch)	(mm)	TM4	
												R	L
 Right-Hand style shown	FGV100RB00D6	.039	1.0	.236	6.0	.059	1.5	3/32	2.38	.000	0.00	○	
	FGV100RB05D6	.039	1.0	.236	6.0	.059	1.5	3/32	2.38	.002	0.05	○	
	FGV150RB00D6	.059	1.5	.236	6.0	.079	2.0	3/32	2.38	.000	0.00	○	
	FGV150RB05D6	.059	1.5	.236	6.0	.079	2.0	3/32	2.38	.002	0.05	○	
	FGV200RB00D6	.079	2.0	.236	6.0	.118	3.0	3/32	2.38	.000	0.00	○	
	FGV200RB05D6	.079	2.0	.236	6.0	.118	3.0	3/32	2.38	.002	0.05	○	
 Left-Hand style shown	FGV100LB00D6	.039	1.0	.236	6.0	.059	1.5	3/32	2.38	.000	0.00		○
	FGV100LB05D6	.039	1.0	.236	6.0	.059	1.5	3/32	2.38	.002	0.05		○
	FGV150LB00D6	.059	1.5	.236	6.0	.079	2.0	3/32	2.38	.000	0.00		○
	FGV150LB05D6	.059	1.5	.236	6.0	.079	2.0	3/32	2.38	.002	0.05		○
	FGV200LB00D6	.079	2.0	.236	6.0	.118	3.0	3/32	2.38	.000	0.00		○
	FGV200LB05D6	.079	2.0	.236	6.0	.118	3.0	3/32	2.38	.002	0.05		○

Grooving / Side-Turning

FBV - Inserts

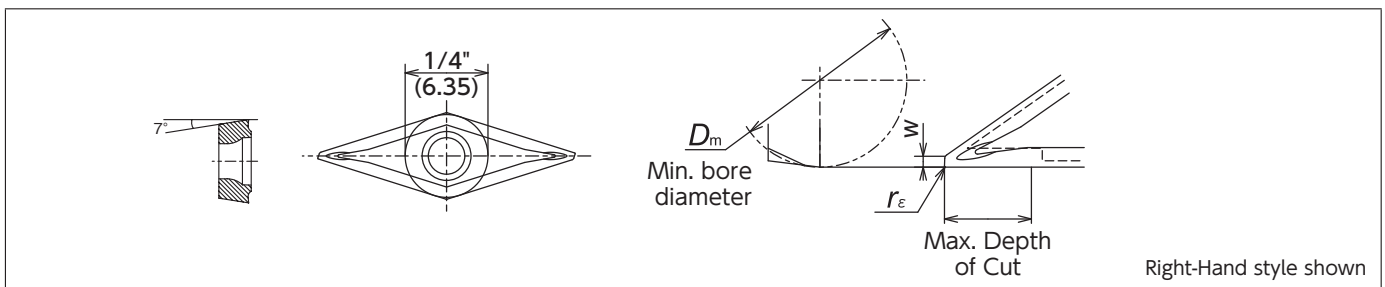
FBV



Shape	Item Number	Groove Width w		Min. Bore Diameter		Max Depth of Cut		Thickness		r_{ϵ}		Coated Carbide	
		(Inch)	(mm)	(Inch)	(mm)	(Inch)	(mm)	(Inch)	(mm)	(Inch)	(mm)	R	L
 Right-Hand style shown	FBV40%105D8AM3	.020	0.5	.315	8.0	.157	4.0	.102	2.58	.002	0.05	○	
	FBV40%115D8AM3	.020	0.5	.315	8.0	.157	4.0	.102	2.58	.006	0.15	○	

Note: Only CH-FGVR and DS-FGVR can take FBV Right hand insert.

○ : 1-2 week delivery

Cutting condition **T20**

GTPA Series

Best tool for Aluminum Spool Machining

GTPA

Screw Accessible from both sides

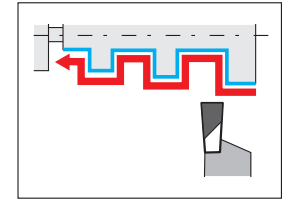
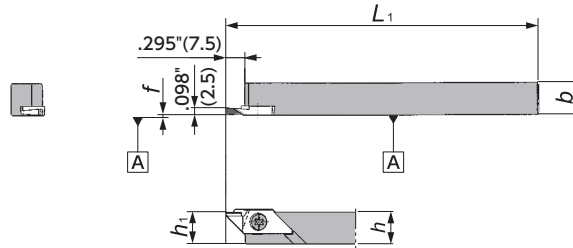

Right-Hand style shown

Figure-1

Y-GTPA

Screw Accessible from both sides

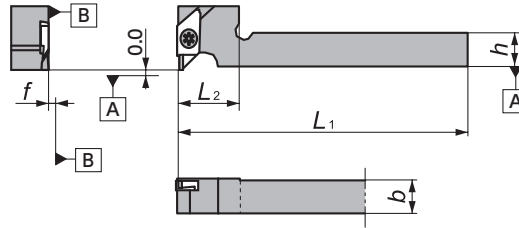

Right-Hand style shown

Figure-2

Y-GTPA-OH (Coolant through)

Screw Accessible from both sides

NEW

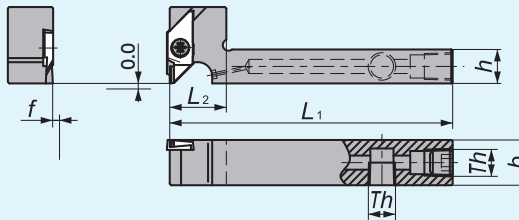

Th (Thread type)
Metric size holder: Rc1/8 (PT1/8)

Right-Hand style shown

Figure-3

GTPA - Toolholders

GTPA

Gage Insert	Item Number	Figure	Stock		h		b		h ₁		L ₁		f		L ₂		Th	Clamp Screw	Wrench
			R	L	(Inch)	(mm)	(Inch)	(mm)	(Inch)	(mm)	(Inch)	(mm)	(Inch)	(mm)	(Inch)	(mm)			
	GTPA [®] 1010	1	○	○	.394	10	.394	10	.394	10	4.724	120	.004	0.1	—	—	—	LRIS-4 × 10PW	CLR-15S
	GTPA [®] 1212	1	○	○	.472	12	.472	12	.472	12	4.724	120	.004	0.1	—	—	—	LRIS-4 × 10PW	CLR-15S
	GTPA [®] 1616	1	○	○	.630	16	.630	16	.630	16	4.724	120	.004	0.1	—	—	—	LRIS-4 × 12PW	CLR-15S
	Y-GTPA [®] 1216	2	○	○	.472	12	.630	16	—	—	4.724	120	.004	0.1	.787	20	—	LRIS-4 × 12PW	CLR-15S
	Y-GTPA [®] 1216HS-OH	3	○	○	.472	12	.630	16	—	—	2.756	70	.004	0.1	.787	20	Rc1/8(PT1/8)	LRIS-4 × 12PW	CLR-15S
Y-GTPA [®] 1216H-OH	3	○	○	.630	16	.630	16	—	—	2.756	70	.004	0.1	.984	25	Rc1/8(PT1/8)	LRIS-4 × 12PW	CLR-15S	

GTPA Series - Inserts

GTPA

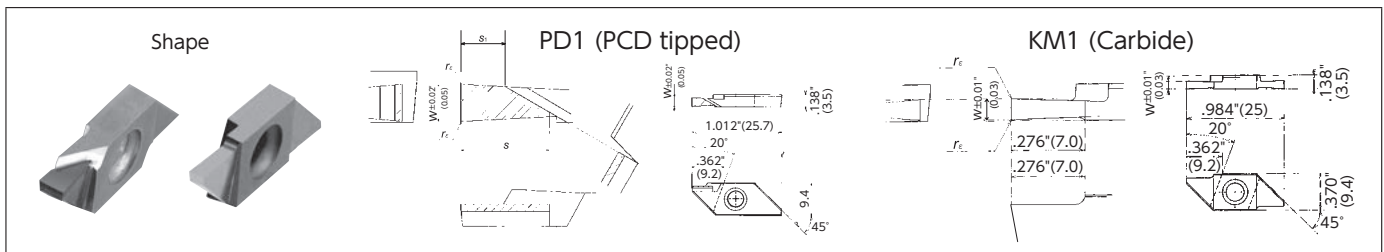

Item Number	Groove Width w		Max Depth of Cut		s		s ₁		r _ε		Coated Carbide	PCD
	(Inch)	(mm)	(Inch)	(mm)	(Inch)	(mm)	(Inch)	(mm)	(Inch)	(mm)		
GTPA20FRN01-082	.079	2.0	.118	3.0	.157	4.0	.079	2.0	-.004	-0.1		○
GTPA20FRN01	.079	2.0	.197	5.0	.236	6.0	.157	4.0	-.004	-0.1		○
GTPA20FRN01	.079	2.0	.236	6.0	—	—	—	—	-.004	-0.1	○	
GTPA25FRN01-081	.098	2.5	.118	3.0	.157	4.0	.024	1.0	-.004	-0.1		○
GTPA25FRN01	.098	2.5	.197	5.0	.236	6.0	.118	3.0	-.004	-0.1		○
GTPA25FRN01	.098	2.5	.236	6.0	—	—	—	—	-.004	-0.1	○	

○ : 1-2 week delivery

⦿ : Coolant through

Cutting condition → T4

U





Threading



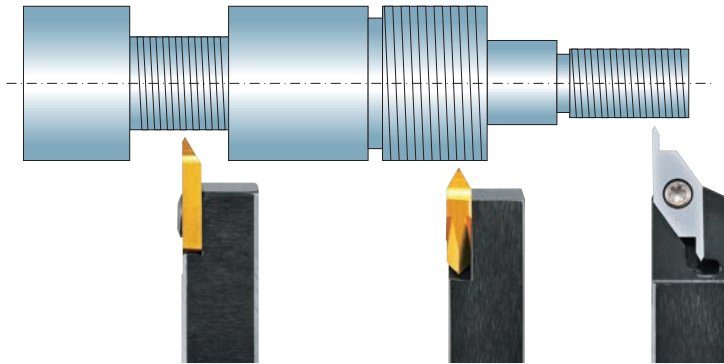

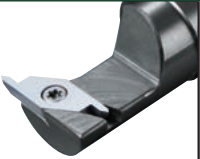

- **Threading Tools** **U2**
- **Recommended Cutting Conditions**..... **U4**
- **General Information** **U5**
- **Tool List** **U6**
 - CSV series.....U6
 - TTPS seriesU8
 - TTP series U10
 - TTMH series U14
 - Thread Whirling U16

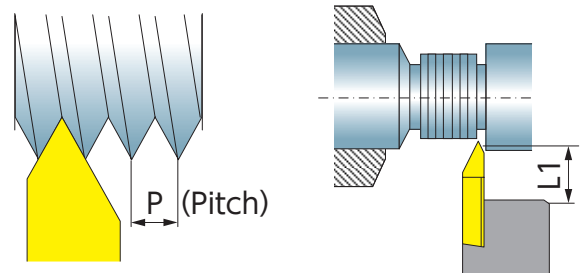
NTK Threading Tools - Product Lines

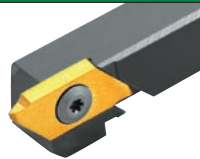



Insert	CSV		TTPS
		→U6	→U8
	CSV	DS-CSV	CTPS
Holder			
	→U6	→U6	→U8
Profile	60°		60°
Pitch	127 - 51 TPI (0.2 - 0.5mm)		127 - 17 TPI (0.2 - 1.5mm)
L1	.118" (3.0mm)		.197" (5.0mm)

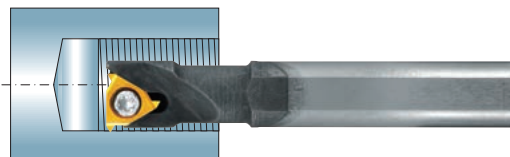

Insert	TTP			TTMH32		
			→U11			→U14
	TTP	DS-TTP	CH-TTP	STTN	DS-STT	NTTB
Holder						
	→U10	→U10	→U10	→U14	→U14	→U14
Profile	60° / 55°			60°		
Pitch	127 - 13 TPI (0.2 - 2.0mm)			31 - 9 TPI (0.8 - 3.0mm)		
L1	.217" (5.5mm)			.157" (4.0mm)	.118" (3.0mm)	.157" (4.0mm)



Insert	SBT	TMN
	→V20	→V22
	NBH	TGC / HN
Holder		
	→V9	→V22
Profile	60°	60°
Pitch	51 - 15 TPI (0.5 - 1.75mm)	63 - 34 TPI (0.4 - 0.75mm)
L1	.024" - .071" (0.6 - 1.8mm)	.028" - .039" (0.7 - 1.0mm)

Tools and Thread Standards

Thread Type		ISO Metric	American Unified	Whitworth	Parallel Pipe	American Tapered Pipe	Tapered Pipe
		M	UNC UNE	W	G(PF)	NPT	R(PT)
Profile	60°	60°	55°	55°	60°	55°	
Tool		Pitch	mm	TPI	TPI	TPI	TPI
External Thread	 CSV	0.2 - 0.5	80 - 56	—	—	—	—
	 TTPS	0.2 - 1.5	80 - 18	—	—	(18)	—
	 TTP	0.2 - 2.0	80 - 13	40/24/20/18/16	(28/19)	(18/14)	(28/19)
	 TTMH	0.8 - 3.0	24 - 9	—	—	18/14/11.5	—
Internal Thread	 SBT	0.5 - 1.75	36 - 16	—	—	(18)	—
	 TGC/HN	0.4 - 0.75	56 - 36	—	—	—	—

(Please check Radius [Flat] shape over inserts)

Recommended Cutting Conditions

Threading

Work Material		High Temperature Alloys	Titanium Alloys	Cobalt Chrome Alloys	Stainless Steels		Alloy Steels	Carbon Steels
					Hard to cut	Free cutting		
Common Name		Inconel Hastelloy MP35N	Ti-6Al-4V	ASTM F-75	304 316 17-4PH	303 430F	5120 4137	1045 1046
Grade	1st choice	VM1		VM1 / ZM3		QM3		
	2nd choice	ZM3		QM3		VM1 / ZM3		
Cutting Speed (SFM)		75 125 225	100 200 275	130 230 330	150 300 600	150 300 500		

*Unless your machine is equipped with high speed threading program, please set the feed rate to 80 IPM or lower to prevent making incomplete threads

Recommended Depth of Cut (DOC) for Each Pass

TTP, TTPS, TTMH, TTMA, CSVT

Thread Type		Pitch (mm)	Total DOC (mm)	Number of pass	1	2	3	4	5	6	7	8	9	10	
Metric (60°)	Male thread	0.20	0.20	4	0.08	0.06	0.04	0.02							
		0.25	0.24	4	0.10	0.08	0.04	0.02							
		0.30	0.28	5	0.08	0.07	0.07	0.04	0.02						
		0.35	0.32	5	0.10	0.09	0.07	0.04	0.02						
		0.40	0.35	5	0.12	0.10	0.07	0.04	0.02						
		0.45	0.39	5	0.16	0.10	0.07	0.04	0.02						
		0.50	0.33	5	0.10	0.10	0.07	0.04	0.02						
		0.60	0.40	6	0.10	0.10	0.08	0.06	0.04	0.02					
		0.70	0.48	6	0.10	0.10	0.10	0.10	0.06	0.02					
		0.75	0.52	7	0.10	0.10	0.10	0.08	0.07	0.05	0.02				
		0.80	0.56	7	0.10	0.10	0.10	0.10	0.08	0.06	0.02				
		1.00	0.71	8	0.15	0.15	0.12	0.10	0.08	0.06	0.03	0.02			
		1.25	0.90	9	0.20	0.18	0.13	0.10	0.10	0.07	0.05	0.05	0.02		
1.50	1.09	10	0.22	0.20	0.15	0.12	0.10	0.10	0.08	0.05	0.05	0.02			

Thread Type		Pitch (TPI)	Total DOC (inch)	Number of pass	1	2	3	4	5	6	7	8	9	10	
American Unified	Male thread	80	.008	4	.003	.003	.002	.001							
		72	.009	4	.004	.003	.002	.001							
		64	.011	5	.003	.003	.002	.002	.001						
		56	.012	5	.004	.003	.002	.002	.001						
		48	.015	5	.005	.004	.003	.002	.001						
		44	.016	6	.005	.004	.003	.002	.002	.001					
		40	.018	6	.005	.004	.004	.003	.002	.001					
		36	.020	6	.005	.005	.004	.003	.002	.001					
		32	.022	7	.005	.005	.004	.003	.002	.002	.001				
		28	.025	7	.006	.005	.004	.004	.003	.002	.001				
		24	.030	8	.007	.006	.005	.004	.003	.002	.002	.001			
		20	.033	9	.007	.006	.005	.004	.003	.003	.002	.002	.001		
		18	.038	9	.008	.007	.006	.005	.004	.003	.002	.002	.001		
		16	.036	9	.007	.007	.006	.005	.004	.003	.002	.002	.001		
		14	.043	10	.008	.008	.007	.006	.005	.003	.002	.002	.002	.001	

■ Cutting Conditions for STICK DUO

For 600 - 1500 RPM Recommended Depth of Cut (DOC) for Each Pass

Metric Thread		Number of Pass																				
Pitch (mm)	Total DOC (mm)	1	2	3	4	5	6	7	8	9	10	11	12	13	14	15	16	17	18	19	20	21
0.5	0.3	0.06	0.05	0.05	0.04	0.04	0.03	0.02	0.01	—	—	—	—	—	—	—	—	—	—	—	—	—
0.7	0.43	0.06	0.06	0.06	0.05	0.05	0.05	0.04	0.03	0.02	0.01	—	—	—	—	—	—	—	—	—	—	—
0.75	0.46	0.06	0.06	0.06	0.05	0.05	0.04	0.04	0.04	0.03	0.02	0.01	—	—	—	—	—	—	—	—	—	—
0.8	0.49	0.06	0.06	0.06	0.05	0.05	0.04	0.04	0.04	0.03	0.03	0.02	0.01	—	—	—	—	—	—	—	—	—
1.0	0.62	0.07	0.07	0.06	0.06	0.05	0.05	0.05	0.04	0.04	0.04	0.03	0.03	0.02	0.01	—	—	—	—	—	—	—
1.25	0.76	0.07	0.07	0.07	0.07	0.07	0.06	0.06	0.06	0.05	0.05	0.04	0.03	0.02	0.01	—	—	—	—	—	—	—
1.5	0.92	0.07	0.07	0.07	0.07	0.07	0.07	0.06	0.06	0.06	0.05	0.05	0.04	0.03	0.04	0.03	0.03	0.02	0.01	—	—	—
1.75	1.09	0.07	0.07	0.07	0.07	0.07	0.07	0.06	0.06	0.06	0.06	0.05	0.05	0.05	0.05	0.04	0.04	0.03	0.03	0.02	0.01	—

UNF Thread		Number of Pass																			
Pitch (TPI)	Total DOC (inch)	1	2	3	4	5	6	7	8	9	10	11	12	13	14	15	16	17	18	19	
36	.017	.002	.002	.002	.002	.002	.002	.001	.001	.0008	.0004	—	—	—	—	—	—	—	—	—	—
32	.019	.002	.002	.002	.002	.002	.001	.001	.001	.001	.0008	.0004	—	—	—	—	—	—	—	—	—
28	.022	.003	.002	.002	.002	.002	.002	.001	.001	.001	.001	.001	.0008	.0004	—	—	—	—	—	—	—
24	.026	.003	.002	.002	.002	.002	.002	.002	.002	.001	.001	.001	.001	.0008	.0004	—	—	—	—	—	—
20	.031	.003	.003	.003	.003	.002	.002	.002	.002	.002	.002	.001	.001	.001	.001	.0008	.0004	—	—	—	—
18	.034	.003	.003	.003	.003	.003	.002	.002	.002	.002	.002	.002	.002	.001	.001	.001	.0008	.0004	—	—	—
16	.039	.003	.003	.003	.003	.003	.003	.003	.002	.002	.002	.002	.002	.002	.001	.001	.001	.001	.0008	.0004	—

■ Infeed Threading Method

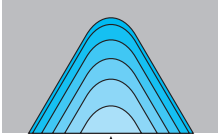
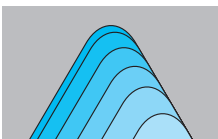
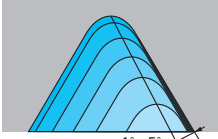
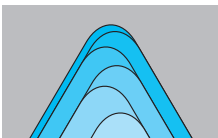
	Features	
	Advantage	Disadvantage
 <p>Radial Infeed</p>	<ul style="list-style-type: none"> ● Most popular and easiest method ● Easy to change parameter ● Uniform wear on both sides of insert 	<ul style="list-style-type: none"> ● Chip evacuation ● Vibration due to higher cutting force ● Ineffective for large pitch threading
 <p>Flank Infeed</p>	<ul style="list-style-type: none"> ● 2nd most popular and easy method ● Effective for larger pitch and gummy material thanks to lower cutting force ● Excellent chip evacuation 	<ul style="list-style-type: none"> ● Larger flank wear on right side of the insert ● Difficult to change cutting depth per cut
 <p>Modified Flank Infeed</p>	<ul style="list-style-type: none"> ● Reduce flank wear on right side ● Effective for larger pitch and gummy material thanks to lower cutting force ● Excellent chip evacuation 	<ul style="list-style-type: none"> ● Difficult to program ● Difficult to change cutting depth per cut
 <p>Incremental Infeed</p>	<ul style="list-style-type: none"> ● Uniform flank wear ● Effective for larger pitch and gummy material thanks to lower cutting force 	<ul style="list-style-type: none"> ● Difficult to program ● Difficult to change cutting depth per cut ● Chip evacuation

CSV Series

Best for up to .200" diameter material

CSV-NC For Gang-style machine

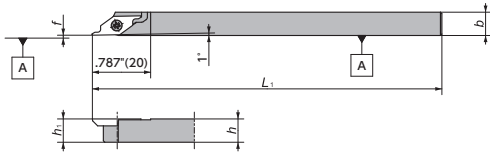

Figure-1

Right-Hand style shown

CSV For Cam-style machine

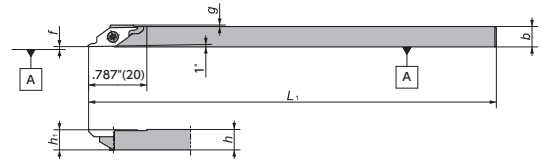

Figure-2

Right-Hand style shown

DS-CSVL

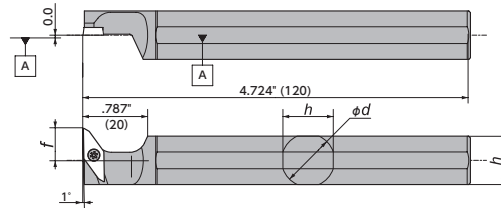



Figure-3

Left-Hand style shown
Takes Right-hand insert

CSV_{R/L} / CSV_{R/L}-NC

Gage Insert	Item Number	Figure	Stock		h		b		h_1		L_1		f		g		Clamp Screw	Wrench
			R	L	(Inch)	(mm)	(Inch)	(mm)	(Inch)	(mm)	(Inch)	(mm)	(Inch)	(mm)	(Inch)	(mm)		
 CSV..11..	CSV _{R/L} 06-IN-NC	1	●	●	3/8	3/8	3/8	3/8	3/8	3/8	4.724	120	.004	0.1	—	—	LRIS-2.5 × 7	CLR-15S
	CSV _{R/L} 08-IN-NC	1	●	●	1/2	1/2	1/2	1/2	1/2	1/2	4.724	120	.004	0.1	—	—	LRIS-2.5 × 7	CLR-15S
	CSV _{R/L} 08NC	1	○	○	.315	8	.315	8	.315	8	4.724	120	.004	0.1	—	—	LRIS-2.5 × 7	CLR-15S
	CSV _{R/L} 08NC-F	1	○	○	.315	8	.315	8	.315	8	4.724	120	0-.004	0.0-0.1	—	—	LRIS-2.5 × 7	CLR-15S
	CSV _{R/L} 10GXNC	1	○	○	.394	10	.394	10	.394	10	3.346	85	.004	0.1	—	—	LRIS-2.5 × 7	CLR-15S
	CSV _{R/L} 10NC	1	○	○	.394	10	.394	10	.394	10	4.724	120	.004	0.1	—	—	LRIS-2.5 × 7	CLR-15S
	CSV _{R/L} 12NC	1	○	○	.472	12	.472	12	.472	12	4.724	120	.004	0.1	—	—	LRIS-2.5 × 7	CLR-15S
	CSV _{R/L} 07GX	2	○	○	.275	7	.275	7	.275	7	3.346	85	.004	0.1	.020	0.5	LRIS-2.5 × 7	CLR-15S
	CSV _{R/L} 07	2	○	●	.275	7	.275	7	.275	7	5.512	140	.004	0.1	.020	0.5	LRIS-2.5 × 7	CLR-15S
	CSV _{R/L} 08GX	2	○	○	.315	8	.315	8	.315	8	3.346	85	.004	0.1	0.0	0.0	LRIS-2.5 × 7	CLR-15S
	CSV _{R/L} 08	2	○	●	.315	8	.315	8	.315	8	5.512	140	.004	0.1	0.0	0.0	LRIS-2.5 × 7	CLR-15S
	CSV _{R/L} 095	2	○	○	.374	9.5	.374	9.5	.374	9.5	5.512	140	.004	0.1	0.0	0.0	LRIS-2.5 × 7	CLR-15S
	CSV _{R/L} 10	2	○	●	.394	10	.394	10	.394	10	5.512	140	.004	0.1	0.0	0.0	LRIS-2.5 × 7	CLR-15S
	CSV _{R/L} 12GX	2	○	○	.472	12	.472	12	.472	12	3.346	85	.004	0.1	0.0	0.0	LRIS-2.5 × 7	CLR-15S
CSV _{R/L} 12	2	○	●	.472	12	.472	12	.472	12	5.512	140	.004	0.1	0.0	0.0	LRIS-2.5 × 7	CLR-15S	

DS-CSVL (Takes right-hand insert)

Gage Insert	Item Number	Figure	Stock		D_s		h		b		L_1		f		Clamp Screw	Wrench
			R	L	(Inch)	(mm)	(Inch)	(mm)	(Inch)	(mm)	(Inch)	(mm)	(Inch)	(mm)		
 CSV..11FR..	DS-CSVL15	3	●		5/8	15.875	.591	15	.591	15	4.724	120	.394	10	LRIS-2.5 × 7	CLR-15S

CSV_T - Threading

Mirror finish

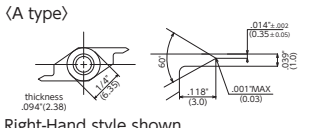
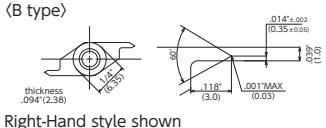
Shape	Item Number	Chip-breaker	r_e		Pitch		Coated Carbide	
			(TPI)	(mm)	(TPI)	(mm)	VM1	
							R	L
(A type)  Right-Hand style shown	CSVT11F _{R/L} P60-035A	No	-R.001	R0.03 MAX	127 - 51	0.2 - 0.5	●	●
(B type)  Right-Hand style shown	CSVT11F _{R/L} P60-035B	No	-R.001	R0.03 MAX	127 - 51	0.2 - 0.5	●	●

Note: All angles shown are obtained when insert is set in the holder

CSVT Style



Unified Standard (UN, UNF, UNC) Threads

	Thread Type		Pitch			Applicable Inserts
	#1	#2	(TPI)	(inch)	(mm)	
Coarse		No.1-64 UNC	64	.016	0.3969	CSVT11F $\frac{P}{60}$ -035A CSVT11F $\frac{P}{60}$ -035B
	No.2-56 UNC		56	.018	0.4536	
Fine	No.0-80 UNF		80	.013	0.3175	
		No.1-72 UNF	72	.014	0.3528	
	No.2-64 UNF		64	.016	0.3969	
		No.3-56 UNF	56	.018	0.4536	

Metric (M) Threads / Fine and Coarse

	Pitch (mm)				
	0.50	0.40	0.35	0.25	0.20
M1				Coarse	Fine
M2		Coarse		Fine	
M3	Coarse		Fine		
M4	Fine				
M5					

Recommended Depth of Cut (DOC) for Each Pass (mm)

TTP, TTPS, TTMH, TTMA, CSVT

Thread Type		Pitch (mm)	Total DOC (mm)	Number of pass	1	2	3	4	5	6	7	8	9	10
Metric (60°)	Male thread	0.20	0.20	4	0.08	0.06	0.04	0.02						
		0.25	0.24	4	0.10	0.08	0.04	0.02						
		0.30	0.28	5	0.08	0.07	0.07	0.04	0.02					
		0.35	0.32	5	0.10	0.09	0.07	0.04	0.02					
		0.40	0.35	5	0.12	0.10	0.07	0.04	0.02					
		0.45	0.39	5	0.16	0.10	0.07	0.04	0.02					
		0.50	0.33	5	0.10	0.10	0.07	0.04	0.02					
		0.60	0.40	6	0.10	0.10	0.08	0.06	0.04	0.02				
		0.70	0.48	6	0.10	0.10	0.10	0.10	0.06	0.02				
		0.75	0.52	7	0.10	0.10	0.10	0.08	0.07	0.05	0.02			
		0.80	0.56	7	0.10	0.10	0.10	0.10	0.08	0.06	0.02			
		1.00	0.71	8	0.15	0.15	0.12	0.10	0.08	0.06	0.03	0.02		
		1.25	0.90	9	0.20	0.18	0.13	0.10	0.10	0.07	0.05	0.05	0.02	
1.50	1.09	10	0.22	0.20	0.15	0.12	0.10	0.10	0.08	0.05	0.05	0.02		

● : Stock

○ : 1-2 week delivery

M : Mirror finish

CSV series **→O27**

Cutting condition **→U4**

CTPS Series

CTPS

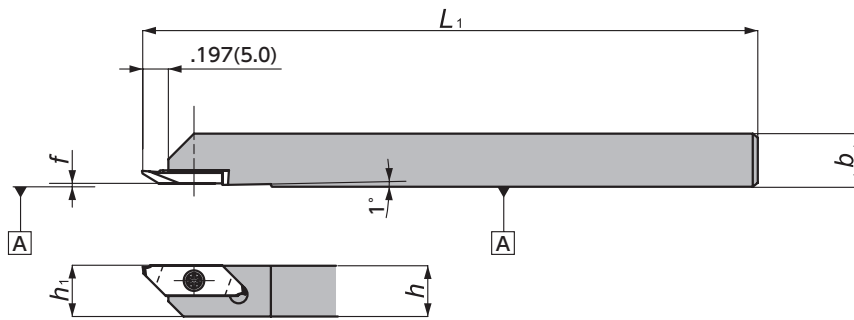



Figure-1

Right-Hand style shown



CTPS Series - Toolholders

CTPS (Takes right-hand inserts)

Gage Insert	Item Number	Figure	Stock		h		b		h_1		L_1		f		Clamp Screw	Wrench
			R	L	(Inch)	(mm)	(Inch)	(mm)	(Inch)	(mm)	(Inch)	(mm)	(Inch)	(mm)		
 TTPS	CTPSR06-IN	1	●		3/8	3/8	3/8	3/8	4.724	120	0.0	0.0	LRIS-2.5 × 7	CLR-15S		
	CTPSR08-IN	1	●		1/2	1/2	1/2	1/2	4.724	120	0.0	0.0	LRIS-2.5 × 7	CLR-15S		
	CTPSR10	1	○		.394	10	.394	10	.394	10	4.724	120	0.0	0.0	LRIS-2.5 × 7	CLR-15S
	CTPSR12	1	○		.472	12	.472	12	.472	12	4.724	120	0.0	0.0	LRIS-2.5 × 7	CLR-15S

CTPS Series - Inserts

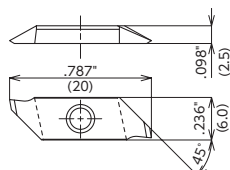
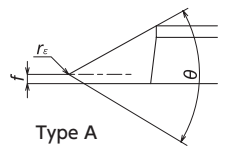
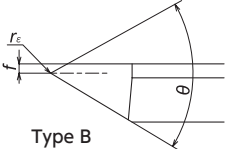
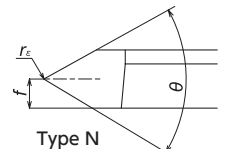
TTPS - Threading

Shape	Item Number	Type	θ	f		r_ϵ		Pitch		Coated Carbide	
				(Inch)	(mm)	(Inch)	(mm)	(TPI)	(mm)	VM1	ZM3
 Type A	TTPS60FR4A	A	60°	.016	0.4	.002 MAX Flat	(0.05) MAX Flat	127 - 34	0.2 - 0.75	○	○
 Type A	TTPS60FR4B	B	60°	.016	0.4	.002 MAX Flat	(0.05) MAX Flat	127 - 34	0.2 - 0.75	○	○
 Type B	TTPS60FR8A	A	60°	.031	0.8	R.002	(0.05)	63 - 21	0.4 - 1.25	○	○
 Type B	TTPS60FR8B	B	60°	.031	0.8	R.002	(0.05)	63 - 21	0.4 - 1.25	○	○
 Type N	TTPS60FR-N	N	60°	.049	1.25	R.004	(0.1)	25 - 17	1.0 - 1.5	○	○

Right-Hand style shown

Note: All angles shown are obtained when insert is set in the holder

TTPS Style

Unified Standard (UN, UNF, UNC) Threads

	Thread Type		Pitch		Applicable Inserts	
	#1	#2	(TPI)	(mm)		
Coarse		No.1-64 UNC	64	0.397	TTPS60FR4A (B)	
	No.2-56 UNC		56	0.454	TTPS60FR4A (B) TTPS60FR8A (B)	
		No.3-48 UNC	48	0.529		
	No.4-40 UNC		40	0.635		
	No.5-40 UNC		40	0.635		
		No.6-32 UNC		32	0.794	TTPS60FR4A (B) TTPS60FR8A (B)
	No.8-32 UNC		32	0.794		
	No.10-24 UNC		24	1.058	TTPS60FR4A (B) TTPS60FR8A (B) TTPS60FR-N	
		No.12-24 UNC	24	1.058		
		1/4-20 UNC		20	1.270	TTPS60FR-N
	5/16-18 UNC		18	1.411		
Fine	No.0-80 UNF		80	0.318	TTPS60FR4A (B)	
		No.1-72 UNF	72	0.353		
	No.2-64 UNF		64	0.397		
		No.3-56 UNF	56	0.454	TTPS60FR4A (B) TTPS60FR8A (B)	
	No.4-48 UNF		48	0.529		
	No.5-44 UNF		44	0.577		
	No.6-40 UNF		40	0.635		
	No.8-36 UNF		36	0.706	TTPS60FR8A (B)	
	No.10-32 UNF		32	0.794		
		No.12-28 UNF	28	0.907	TTPS60FR8A (B)	
		1/4-28 UNF	28	0.907		
		5/16-24 UNF	24	1.058	TTPS60FR8A (B) TTPS60FR-N	
		3/8-24 UNF	24	1.058		
		7/16-20 UNF	20	1.270		
		1/2-20 UNF	20	1.270	TTPS60FR-N	
		9/16-18 UNF	18	1.411		
	5/8-18 UNF	18	1.411			

Metric (M) Threads / Fine and Coarse

Thread Type			Pitch (mm)										
#1	#2	#3	1.50	1.25	1.00	0.80	0.75	0.70	0.50	0.40	0.35	0.25	0.20
M1												Coarse	Fine
M2										Coarse		Fine	
M3									Coarse		Fine		
M4								Coarse	Fine				
M5						Coarse							
M6					Coarse								
M7	M7												
M8				Coarse				Fine					
M9		M9											
M10			Coarse	Fine									
M11		M11											
M12													
M13		M14		Fine									
M14													
M15		M15											
M16													
M17		M17											
M18													
M19		M18											
M20													
M21		M22											
M22													
M23													
M24													
M25		M25											
M26		M26											
M27													
M28		M27											
M29													
M30													
M31													
M32													
M33													
M34													
M35													
M36													
M37													
M38													
M39													
M40													
M41													
M42													
M43													
M44													
M45													
M46													
M47													
M48													
M49													
M50													
M51													
M52													
M53													
M54													
M55													
M56													
M57													
M58													
M59													
M60													
M61													
M62													
M63													
M64													
M65													
M66													
M67													
M68													
M69													
M70													
M71													
M72													
M73													
M74													
M75													
M76													
M77													
M78													
M79													
M80													
M81													
M82													
M83													
M84													
M85													
M86													
M87													
M88													
M89													
M90													
M91													
M92													
M93													
M94													
M95													
M96													
M97													
M98													
M99													
M100													

Covered Thread Pitch Range

Inserts	Pitch	
	(TPI)	(mm)
TTPS60FR4A (B)	127 - 34	0.2 - 0.75
TTPS60FR8A (B)	63 - 21	0.4 - 1.25
TTPS60FR-N	25 - 17	1.0 - 1.5

● : Stock

○ : 1-2 week delivery

CTPS series → O31

Cutting condition → U4

TTP Series

TTP

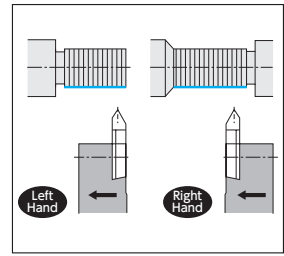
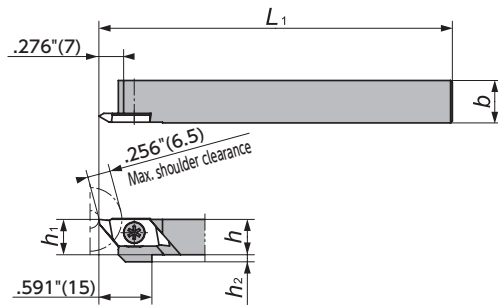

Right-Hand style shown

Figure-1

CH-TTP

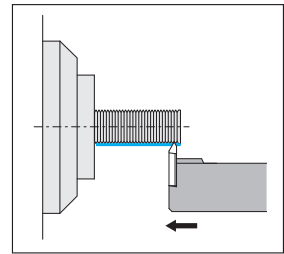
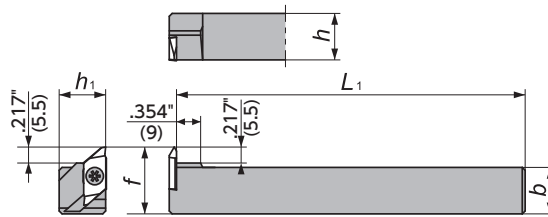

Left-Hand style shown
Takes Right-hand insert

Figure-2

DS-TTP

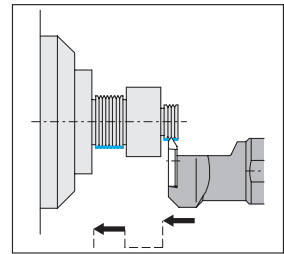
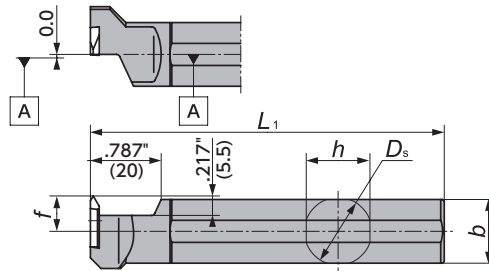

Left-Hand style shown
Takes Right-hand insert

Figure-3

TTP $\frac{1}{4}$ / CH-TTPL

Gage Insert	Item Number	Figure	Stock		h		b		h ₁		L ₁		f		h ₂		Clamp Screw	Wrench
			R	L	(Inch)	(mm)	(Inch)	(mm)	(Inch)	(mm)	(Inch)	(mm)	(Inch)	(mm)	(Inch)	(mm)		
 TTP.. TTP..FR	TTP $\frac{1}{4}$ 06-IN	1	●	●	3/8	3/8	3/8	3/8	3/8	3/8	4.724	120	—	—	.079	2	LRIS-4 × 10PW	CLR-15S
	TTP $\frac{1}{4}$ 08-IN	1	●	●	1/2	1/2	1/2	1/2	1/2	1/2	4.724	120	—	—	0	0	LRIS-4 × 10PW	CLR-15S
	TTP $\frac{1}{4}$ 10-IN	1	●	●	5/8	5/8	5/8	5/8	5/8	5/8	4.724	120	—	—	0	0	LRIS-4 × 12PW	CLR-15S
	TTP $\frac{1}{4}$ 08	1	○	○	.315	8	.394	10	.315	8	4.724	120	—	—	.157	4	LRIS-4 × 12PW	CLR-15S
	TTP $\frac{1}{4}$ 10	1	○	○	.394	10	.394	10	.394	10	4.724	120	—	—	.079	2	LRIS-4 × 12PW	CLR-15S
	TTP $\frac{1}{4}$ 12GX	1	○	○	.472	12	.472	12	.472	12	3.346	85	—	—	0	0	LRIS-4 × 12PW	CLR-15S
	TTP $\frac{1}{4}$ 12	1	●	●	.472	12	.472	12	.472	12	4.724	120	—	—	0	0	LRIS-2.5 × 7	CLR-15S
	TTP $\frac{1}{4}$ 16H	1	○	○	.630	16	.630	16	.630	16	3.937	100	—	—	0	0	LRIS-2.5 × 7	CLR-15S
	TTP $\frac{1}{4}$ 16	1	○	○	.630	16	.630	16	.630	16	4.724	120	—	—	0	0	LRIS-2.5 × 7	CLR-15S
	TTP $\frac{1}{4}$ 20F	1	○	○	.787	20	.787	20	.787	20	3.150	80	—	—	0	0	LRIS-2.5 × 7	CLR-15S
CH-TTPL16	2	○	○	.630	16	.630	16	.630	16	4.724	120	.906	23	—	—	LRIS-4 × 10	LLR-25S	
CH-TTPL20	2	○	○	.787	20	.787	20	.787	20	4.724	120	1.063	27	—	—	LRIS-4 × 10	LLR-25S	

DS-TTP

Gage Insert	Item Number	Figure	Stock		D _s		h		b		L ₁		f		Clamp Screw	Wrench
			R	L	(Inch)	(mm)	(Inch)	(mm)	(Inch)	(mm)	(Inch)	(mm)	(Inch)	(mm)		
 TTP..	DS-TTP $\frac{1}{4}$ 16F	3	○	○	.630	16.00	.591	15	.591	15	3.150	80	.394	10.0	LRIS-4 × 10	LLR-25S-20 × 65
	DS-TTP $\frac{1}{4}$ 19	3	●	●	3/4	19.05	.709	18	.709	18	4.724	120	.394	10.0	LRIS-4 × 10	LLR-25S-20 × 65
	DS-TTP $\frac{1}{4}$ 20	3	●	●	.787	20.00	.748	19	.748	19	4.724	120	.394	10.0	LRIS-4 × 10	LLR-25S-20 × 65
	DS-TTP $\frac{1}{4}$ 22	3	●	●	.866	22.00	.827	21	.827	21	4.724	120	.394	10.0	LRIS-4 × 10	LLR-25S-20 × 65
	DS-TTP $\frac{1}{4}$ 25	3	●	●	1	25.40	.945	24	.945	24	5.906	150	.394	10.0	LRIS-4 × 10	LLR-25S-20 × 65

TTP Series - Inserts

TTP - Threading

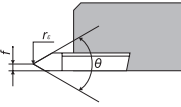
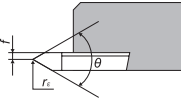
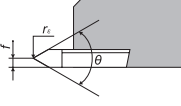
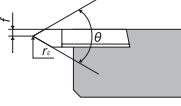
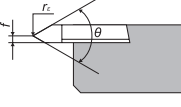
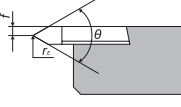
Shape	Item Number	θ	f		r_ϵ		Pitch		Coated Carbide		Carbide			
			(Inch)	(mm)	(Inch)	(mm)	(TPI)	(mm)	QM3		KM1			
									R	L	R	L	R	L
Right-Hand	A type 	TTP60FR2A	60°	.008	0.2	(.002) MAX Flat	(0.05) MAX Flat	127 - 63	0.2 - 0.4			○		
		TTP60FR4A	60°	.016	0.4	(.002) MAX Flat	(0.05) MAX Flat	127 - 34	0.2 - 0.75	●		●		
		TTP60FR4AS \mathcal{M}	60°	.016	0.4	(.002) MAX Flat	(0.05) MAX Flat	127 - 34	0.2 - 0.75					○
		TTP60FR8A	60°	.031	0.8	(R.002)	(R0.05)	63 - 21	0.4 - 1.25	●		●		
		TTP60FR8AS \mathcal{M}	60°	.031	0.8	(R.002)	(R0.05)	63 - 21	0.4 - 1.25					○
		TTP55FR8A	55°	.031	0.8	(R.002)	(R0.05)	48 - 16	-			●		
	B type 	TTP60FR2B	60°	.008	0.2	(.002) MAX Flat	(0.05) MAX Flat	127 - 63	0.2 - 0.4			○		
		TTP60FR4B	60°	.016	0.4	(.002) MAX Flat	(0.05) MAX Flat	127 - 34	0.2 - 0.75	●		●		
		TTP60FR4BS \mathcal{M}	60°	.016	0.4	(.002) MAX Flat	(0.05) MAX Flat	127 - 34	0.2 - 0.75					○
		TTP60FR8B	60°	.031	0.8	(R.002)	(R0.05)	63 - 21	0.4 - 1.25	●		●		
		TTP60FR8BS \mathcal{M}	60°	.031	0.8	(R.002)	(R0.05)	63 - 21	0.4 - 1.25					○
		TTP55FR8B	55°	.031	0.8	(R.002)	(R0.05)	48 - 16	-			●		
	N type 	TTP60FR-N	60°	.049	1.25	(R.004)	(R0.1)	25 - 17	1.0 - 1.5	●		●		
		TTP60FR-NS \mathcal{M}	60°	.049	1.25	(R.004)	(R0.1)	25 - 17	1.0 - 1.5					○
		TTP60FR-N02	60°	.049	1.25	(R.008)	(R0.2)	16 - 13	1.5 - 2.0	●		○		
Left-Hand	A type 	TTP60FL2A	60°	.008	0.2	(.002) MAX Flat	(0.05) MAX Flat	127 - 63	0.2 - 0.4			○		
		TTP60FL4A	60°	.016	0.4	(.002) MAX Flat	(0.05) MAX Flat	127 - 34	0.2 - 0.75		●	●		
		TTP60FL4AS \mathcal{M}	60°	.016	0.4	(.002) MAX Flat	(0.05) MAX Flat	127 - 34	0.2 - 0.75					○
		TTP60FL8A	60°	.031	0.8	(R.002)	(R0.05)	63 - 21	0.4 - 1.25		●	●		
		TTP60FL8AS \mathcal{M}	60°	.031	0.8	(R.002)	(R0.05)	63 - 21	0.4 - 1.25					○
		TTP55FL8A	55°	.031	0.8	(R.002)	(R0.05)	48 - 16	-				●	
	B type 	TTP60FL2B	60°	.008	0.2	(.002) MAX Flat	(0.05) MAX Flat	127 - 63	0.2 - 0.4			○		
		TTP60FL4B	60°	.016	0.4	(.002) MAX Flat	(0.05) MAX Flat	127 - 34	0.2 - 0.75		●	●		
		TTP60FL4BS \mathcal{M}	60°	.016	0.4	(.002) MAX Flat	(0.05) MAX Flat	127 - 34	0.2 - 0.75					○
		TTP60FL8B	60°	.031	0.8	(R.002)	(R0.05)	63 - 21	0.4 - 1.25		○	●		
		TTP60FL8BS \mathcal{M}	60°	.031	0.8	(R.002)	(R0.05)	63 - 21	0.4 - 1.25					○
		TTP55FL8B	55°	.031	0.8	(R.002)	(R0.05)	48 - 16	-				●	
	N type 	TTP60FL-N	60°	.049	1.25	(R.004)	(R0.1)	25 - 17	1.0 - 1.5		●	●		
		TTP60FL-NS \mathcal{M}	60°	.049	1.25	(R.004)	(R0.1)	25 - 17	1.0 - 1.5					○
		TTP60FL-N02	60°	.049	1.25	(R.008)	(R0.2)	16 - 13	1.5 - 2.0		●		○	

Right Hand Toolholders

Left Hand Toolholders

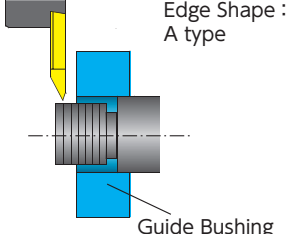
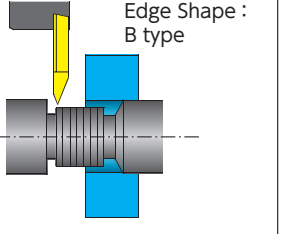
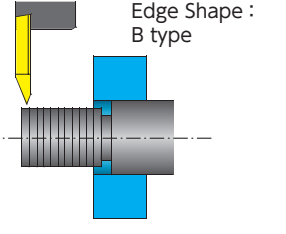
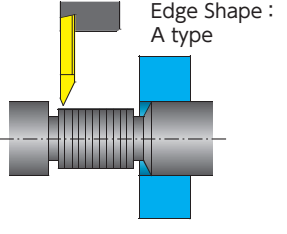
 <p>Edge Shape : A type</p>		 <p>Edge Shape : B type</p>		 <p>Edge Shape : B type</p>		 <p>Edge Shape : A type</p>	
Toolholder	TTPR	Toolholder	TTPR	Toolholder	TTPL	Toolholder	TTPL
Insert	TTP..FR..A	Insert	TTP..FR..B	Insert	TTP..FL..B	Insert	TTP..FL..A

● : Stock ○ : 1-2 week delivery

\mathcal{M} : Mirror finish

Cutting condition \rightarrow U4

Threading

TTP Style



Unified Standard (UN, UNF, UNC) Threads

	Thread Type		Pitch		Applicable Inserts
			(TPI)	(mm)	
Coarse (UNC)		No.1-64 UNC	64	0.3969	TTP60F $\frac{3}{4}$ -2A (B) TTP60F $\frac{3}{4}$ -4A, AS (B, BS)
		No.2-56 UNC	56	0.4536	TTP60F $\frac{3}{4}$ -4A, AS (B, BS) TTP60F $\frac{3}{4}$ -8A, AS (B, BS)
		No.3-48 UNC	48	0.5292	
		No.4-40 UNC	40	0.6350	
		No.5-40 UNC	40	0.6350	TTP60F $\frac{3}{4}$ -8A, AS (B, BS)
		No.6-32 UNC	32	0.7938	
		No.8-32 UNC	32	0.7938	TTP60F $\frac{3}{4}$ -8A, AS (B, BS) TTP60F $\frac{3}{4}$ -N(S)
		No.10-24 UNC	24	1.0583	
		No.12-24 UNC	24	1.0583	TTP60F $\frac{3}{4}$ -N(S)
		$\frac{1}{4}$ -20 UNC	20	1.2700	
		$\frac{5}{16}$ -18 UNC	18	1.4111	TTP60F $\frac{3}{4}$ -N02
		$\frac{3}{8}$ -16 UNC	16	1.5875	
		$\frac{7}{16}$ -14 UNC	14	1.8143	TTP60F $\frac{3}{4}$ -N02
		$\frac{1}{2}$ -13 UNC	13	1.9538	
Fine (UNF)		No.0-80 UNF	80	0.3175	TTP60F $\frac{3}{4}$ -2A (B) TTP60F $\frac{3}{4}$ -4A, AS (B, BS)
		No.1-72 UNF	72	0.3528	
		No.2-64 UNF	64	0.3969	
		No.3-56 UNF	56	0.4536	TTP60F $\frac{3}{4}$ -4A, AS (B, BS) TTP60F $\frac{3}{4}$ -8A, AS (B, BS)
		No.4-48 UNF	48	0.5292	
		No.5-44 UNF	44	0.5773	
		No.6-40 UNF	40	0.6350	
		No.8-36 UNF	36	0.7056	TTP60F $\frac{3}{4}$ -8A, AS (B, BS) TTP60F $\frac{3}{4}$ -N(S)
		No.10-32 UNF	32	0.7938	
		No.12-28 UNF	28	0.9071	TTP60F $\frac{3}{4}$ -N(S)
		$\frac{1}{4}$ -28 UNF	28	0.9071	
		$\frac{5}{16}$ -24 UNF	24	1.0583	TTP60F $\frac{3}{4}$ -N02
		$\frac{3}{8}$ -24 UNF	24	1.0583	
		$\frac{7}{16}$ -20 UNF	20	1.2700	TTP60F $\frac{3}{4}$ -N(S)
		$\frac{1}{2}$ -20 UNF	20	1.2700	
		$\frac{9}{16}$ -18 UNF	18	1.4111	TTP60F $\frac{3}{4}$ -N02
		$\frac{5}{8}$ -18 UNF	18	1.4111	
	$\frac{3}{4}$ -16 UNF	16	1.5875	TTP60F $\frac{3}{4}$ -N02	
	$\frac{7}{8}$ -14 UNF	14	1.8143		

■ Metric (M) Threads / Fine and Coarse

Thread Type		Pitch (mm)												
		2.00	1.50	1.25	1.00	0.80	0.75	0.70	0.50	0.40	0.35	0.25	0.20	
M1													Coarse	Fine
M2													Coarse	Fine
M3													Coarse	Fine
M4													Coarse	Fine
M5													Coarse	Fine
M6													Coarse	Fine
M7	M7												Coarse	Fine
M8													Coarse	Fine
M9	M9												Coarse	Fine
M10													Coarse	Fine
M11													Coarse	Fine
M12													Coarse	Fine
M14	M14												Coarse	Fine
M15													Coarse	Fine
M16													Coarse	Fine
M17													Coarse	Fine
M18													Coarse	Fine
M20													Coarse	Fine
M22													Coarse	Fine
M24													Coarse	Fine
M25													Coarse	Fine
M26													Coarse	Fine
M27													Coarse	Fine
M28													Coarse	Fine
M30													Coarse	Fine
M32													Coarse	Fine

Covered Thread Pitch Range		
Inserts	Pitch	
	(TPI)	(mm)
TTP60F ^R 2A (B)	127 - 63	0.2 - 0.4
TTP60F ^R 4A, AS (B, BS)	127 - 34	0.2 - 0.75
TTP60F ^R 8A, AS (B, BS)	63 - 21	0.4 - 1.25
TTP60F ^R L-N (S)	25 - 17	1.0 - 1.5
TTP60F ^R L-N02	16 - 13	1.5 - 2.0

TTP60F^R L-N02 can be used up to M150 when the pitch is 2.0 mm

■ Whitworth

Applicable Insert	Thread Type	Pitch	
		(TPI)	(mm)
TTP55F ^R 8A (B)	W 1/8	40	0.63
	W 3/16	24	1.06
	W 1/4	20	1.27
	W 5/16	18	1.41
	W 3/8	16	1.54

STTN Series

STTN

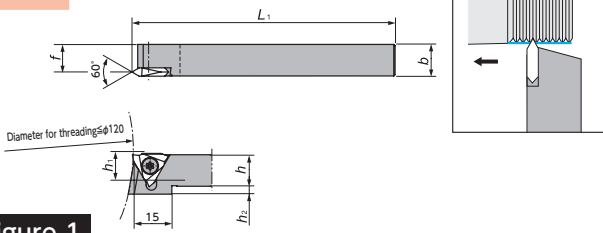

Figure-1

Right-Hand style shown

NTTB

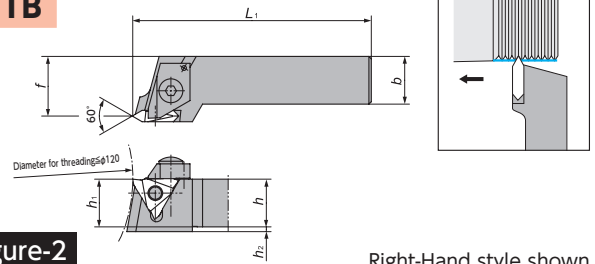

Figure-2

Right-Hand style shown

DS-STT

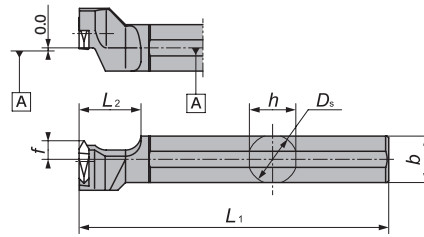

Figure-3

Left-Hand style shown
Takes Right-hand insert

STTN^{R/L} / NTTB^{R/L}

Gage Insert	Item Number	Figure	Stock		h		b		h_1		L_1		f		h_2		Clamp Screw	Wrench
			R	L	(Inch)	(mm)	(Inch)	(mm)	(Inch)	(mm)	(Inch)	(mm)	(Inch)	(mm)	(Inch)	(mm)		
TTMH3260	STTN ^{R/L} 101032	1	○		.394	10	.394	10	.394	10	3.150	80	.335	8.5	.197	5.0	LR-S-4 × 9	RLR-20S
	STTN ^{R/L} 121232	1	○		.472	12	.472	12	.472	12	3.150	80	.413	10.5	.197	5.0	LR-S-4 × 9	RLR-20S
	STTN ^{R/L} 121232-K	1	○		.472	12	.472	12	.472	12	4.912	125	.413	10.5	.197	5.0	LR-S-4 × 9	RLR-20S
	NTTB ^{R/L} 161632	2	○		.630	16	.630	16	.630	16	4.724	120	.787	20.0	.157	4.0	—	LW-2.5
	NTTB ^{R/L} 202032	2	○		.787	20	.787	20	.787	20	5.512	140	.984	25.0	0.0	0.0	—	LW-2.5

DS-STT^{R/L}

Gage Insert	Item Number	Figure	Stock		D_s		h		b		L_1		f		Clamp Screw	Wrench
			R	L	(Inch)	(mm)	(Inch)	(mm)	(Inch)	(mm)	(Inch)	(mm)	(Inch)	(mm)		
TTMH3260	DS-STT ^{R/L} 14F	3	○		.551	14.000	.512	13	.512	13	3.150	80	.236	6.0	LR-S-4 × 9	RLR-20S
	DS-STT ^{R/L} 15H	3	○		5/8	15.875	.591	15	.591	15	3.937	100	.236	6.0	LR-S-4 × 9	RLR-20S
	DS-STT ^{R/L} 16X*	3	○		.630	16.000	.591	15	.591	15	3.346	85	.236	6.0	LR-S-4 × 9	RLR-20S

STTN Series - Inserts

TTMH

Shape	Item Number	d		s		r_e		Pitch		Coated Carbide		Coated Cermet	
		(Inch)	(mm)	(Inch)	(mm)	(Inch)	(mm)	(Inch)	(mm)	ZM3		C7X	
										R	L	R	L
	TTMH3260R010	3/8	9.525	1/8	3.18	.004	0.10	31 - 9	0.8 - 3.0	○		○	
	TTMH3260R015	3/8	9.525	1/8	3.18	.006	0.15	25 - 9	1.0 - 3.0	○		○	
	TTMH3260R020	3/8	9.525	1/8	3.18	.008	0.20	16 - 9	1.5 - 3.0	○			
	TTMH3260R025	3/8	9.525	1/8	3.18	.010	0.25	14 - 9	1.75 - 3.0			○	

Right-Hand style shown

TTMH Style



Unified Standard (UN, UNF, UNC) Threads

	Thread Type		Pitch		Applicable Inserts
	#1	#2	(TPI)	(mm)	
Coarse (UNC)	No.10-24 UNC		24	1.0583	TTMH3260R010 TTMH3260R015
		No.12-24 UNC	24	1.0583	
	1/4-20 UNC		20	1.2700	
	5/16-18 UNC		18	1.4111	
					TTMH3260R010,R015 TTMH3260R020
	3/8-16 UNC		16	1.5875	
	7/16-14 UNC		14	1.8143	TTMH3260R010,R015 TTMH3260R020,R025
	1/2-13 UNC		13	1.9538	
	9/16-12 UNC		12	2.1167	
	5/8-11 UNC		11	2.3091	
3/4-10 UNC		10	2.5400		
7/8-9 UNC		9	2.8222		
Fine (UNF)		No.12-28 UNF	28	0.9071	TTMH3260R010
	1/4-28 UNF		28	0.9071	TTMH3260R010 TTMH3260R015
	5/16-24 UNF		24	1.0583	
	3/8-24 UNF		24	1.0583	
	7/16-20 UNF		20	1.2700	
	1/2-20 UNF		20	1.2700	TTMH3260R010,R015 TTMH3260R020
	9/16-18 UNF		18	1.4111	
	5/8-18 UNF		18	1.4111	
	3/4-16 UNF		16	1.5875	TTMH3260R010,R015 TTMH3260R020,R025
	7/8-14 UNF		14	1.8143	
	1-12 UNF		12	2.1167	
	1 1/8-12 UNF		12	2.1167	
	1 1/4-12 UNF		12	2.1167	
	1 3/8-12 UNF		12	2.1167	
1 1/2-12 UNF		12	2.1167		

Metric (M) Threads / Fine and Coarse

Thread Type			Pitch (mm)							
#1	#2	#3	3.00	2.50	2.00	1.75	1.50	1.25	1.00	0.80
M5										Coarse
M6									Coarse	
	M7								Fine	
M8		M9						Coarse	Fine	
M10		M11					Coarse	Fine	Fine	
M12		M14			Coarse			Fine	Fine	
		M15			Coarse				Fine	
M16		M17							Fine	
	M18			Coarse	Fine				Fine	
M20		M22							Fine	
M24			Coarse						Fine	
		M25							Fine	
		M26							Fine	
	M27		Coarse						Fine	
		M28							Fine	
M30		M32	Fine						Fine	
		M33	Fine						Fine	
		M35	Fine						Fine	
M36			Fine						Fine	
		M38							Fine	
	M39		Fine						Fine	
		M40							Fine	

Covered Thread Pitch Range

Inserts	Pitch	
	(TPI)	(mm)
TTMH3260R010	31 - 9	0.8 - 3.0
TTMH3260R015	25 - 9	1.0 - 3.0
TTMH3260R020	16 - 9	1.5 - 3.0
TTMH3260R025	14 - 9	1.75 - 3.0

● : Stock ○ : 1-2 week delivery

Cutting condition → U4

Thread Whirling



Features



- NTK's unique patented design technology makes precise and correct inserts possible the first time, *without any redesign or remanufacture even if it is a multiple-lead thread*
- The sharper cutting edges produce a better surface finish and longer tool life than competitor's inserts

Form Double-lead or Multiple-lead with Single Pass

Patented

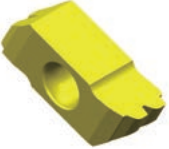
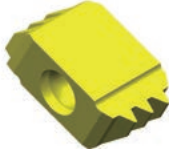
	Double-lead threads	Triple-lead threads
Work	Bone screw	Worm gear
Work material	Ti-6Al-4V ELI	brass
Work appearance		
Insert appearance		
Major Dia.	φ.157"(4.0mm)	φ.278"(7.0mm)
Minor Dia.	φ.094"(2.4mm)	φ.185"(4.7mm)
Lead [Pitch×No. of Lead]	.135"(3.42mm) [.067"×2(1.71mm×2)]	.193"(4.9mm) [.064"×3(1.63mm×3)]

- Can reduce cycle time by more than half
- NTK can achieve what other competitors cannot

Double-lead Bone Screw Process Example

- 1 1st thread whirl at taper part
- 2 Rotate the bar 180° and whirl the 2nd thread on same part as 1
- 3 Thread whirl whole straight part
- 4 Thread whirl at very last part to get two-exits, after back of bar has been backed up a half lead (one pitch) and rotated 180°

Special Item Capability

- Even though almost all bone screw shapes are special, NTK thread whirling inserts can make the correct shape of thread the first time, without any redesign and remanufacture
- Inserts will be delivered in 5 weeks after the order is received
- Within a 3 week time period, expedite delivery is available with an expedite fee
- Basically NTK thread whirling inserts are ground with topping and coated

Recommended Cutting Conditions

No. of teeth		9	6	4	
Conditions					
Main spindle	RPM	10 - 40	10 - 25	7 - 15	Faster RPM reduces machining time
	F	5400 - 14400	3600 - 9000	2500 - 5400	
Whirling cutter	RPM	1500 - 4000			
Feed Rate		Same as thread-lead			
Bar stock	φ	~φ .400" *		~φ .200"	* For cutter with φ 12mm ID
Work Material		Ti-6Al-4V ELI / 316SS / Titanium			

- Formula for calculating thread whirling process time

$$T \text{ (Seconds)} = \frac{60 \times \text{Thread length}}{\text{Main spindle rpm} \times \text{Feed rate (Thread lead)}}$$

Ex.) Double lead / 2" length / .100" lead (2×.050" pitch) / 30 rpm

$$T \text{ (Seconds)} = \frac{60 \times 2}{30 \times .100"} = 40 \text{ Seconds}$$

Applicable Thread Geometry (Approximated)

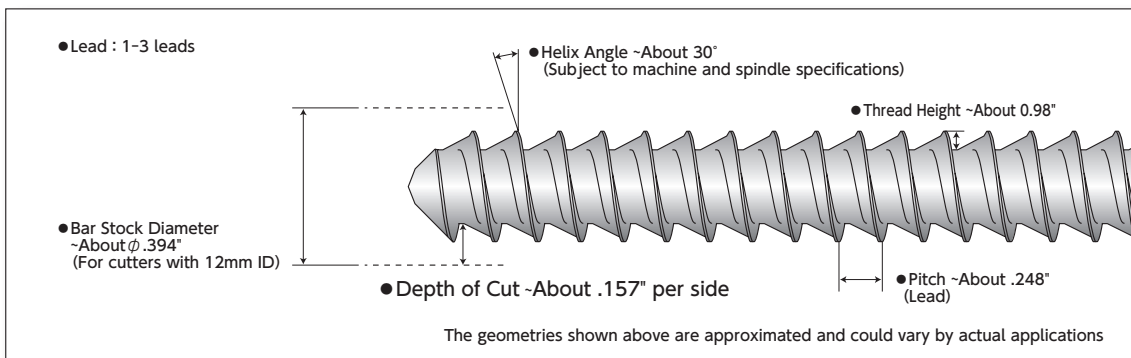

Thread Whirling System

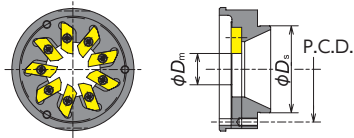

Type 1

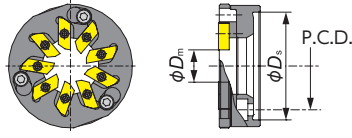

Type 2
Quick-change

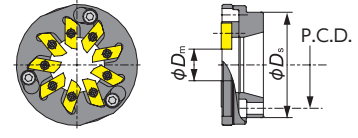

Type 3
Quick-change

Machine make	Model	Location	Spindle make	Spindle model	Helix angle	NTK Thread whirling system	Stock	No. of tooth	ϕD_m (mm)	Type	ϕD_s	P.C.D.	Mount adapter screw								
CITIZEN	M ₄ 32-VIII	Gang	CITIZEN	BTW-4000	0° - 15°	TWC9C0746HP1	●	9	$\phi 12$	1	$\phi 46$	$\phi 35$	M3								
	L20E/L20X	Gang		BTW-3000	0° - 15°	TWC9C1040HP1 TWC6C1040HP1 TWC9C1040HP1-D16	●	9	$\phi 12$	1	$\phi 33$	$\phi 40$	M3 (Provided with spindle)								
	A20	Gang		BTW-2000	±25°		●	6	$\phi 12$												
	M ₄ 32			0° - 25°	●		9	$\phi 16$													
	C32			±25°																	
	L20			+20° - -25°																	
	M20			±25°																	
	M ₃ 32																				
	C12/16	Gang		CITIZEN	LTR0170	±15°	TWC9C1037P2	●	9	$\phi 12$	2	$\phi 37$	$\phi 30.5$	CS0310(M3)							
	M12/16	Turret			LTR0168																
	M12/16 III		MSW105																		
	M20/32 III		KSW110																		
	L20	Gang	CITIZEN	LTR0183	±15°	TWC9J1040P2	●	9	$\phi 12$	2	$\phi 40$	$\phi 32.5$	H-M4 × 12								
	M20/32	Turret		LTR0169																	
K16	Attachment	PCM	GSW-101	±15°	TWC6P1620HP1-D9	●	6	$\phi 9$	1	$\phi 32$	$\phi 26$	M4 (Provided with spindle)									
L20	Gang		LSW-101-L20	±10°	TWC9P1340P2	●	9	$\phi 12$	2	$\phi 40$	$\phi 32.5$	M4 (Provided with spindle)									
M12/16	Turret		MSW-101																		
M20/M32			KSW-101																		
STAR	ECAS-12/20	Attachment	STAR	54178	±10°	TWC9S1640P2	●	9	$\phi 12$	3	$\phi 40$	$\phi 33$	CS04148S(M4)								
	SB-12R/16R/20R			0M171	-20° - 0°																
	SR-20J/20R III			68172	-20° - 0°																
	SR-20R IV/SR-32J/SW-20																				
	ECAS-20T/ST-20	Turret		59172	±20°																
	ECAS-32T			58171	±10°																
	ST-38			43156	±20°																
	SV-12			45172	±10°																
	SV-20			42173	±10°																
	SV-32			43172	±10°																
	SV-38R			43156	±20°																
SV-12R II	Attachment	10159	±20°	TWC4S1433HP1*	●	4	$\phi 8$	7	$\phi 33$	$\phi 27$	CS0310(M3)										
TSUGAMI	BH20/BH38	Turret	TSUGAMI	3263-Y481	±10°	TWC9TS2252P2	●	9	$\phi 12$	3	$\phi 52$	$\phi 42$	CS0515(M5)								
	BS20	Attachment		3214-Y1371	±10°	TWC9TS20550P2	●	9	$\phi 16$	3	$\phi 50$	$\phi 40$	CS0515(M5)								
	SS20/SS26/SS32 B0265/B0266 - II B0325/B0326 - II	Attachment		3268-Y450	0° - 10°	TWC9TS2244HP1	●	9	$\phi 12$	4	$\phi 52$	$\phi 44$	CS0520(M5)								
				3268-Y451																	
				3281-Y450	0° - 20°	TWC9TS1944HP1	●	9	$\phi 12$	4	$\phi 52$	$\phi 44$	CS0520(M5)								
	S205/S206			3281-Y451																	
	B0123/B0124/B0125/ B0126 - II / III B0203/B0204/B0205/ B0205/B0206 - II / III	Attachment		3220-Y6540	0° - 25°	TWC9TS1644HP1	●	9	$\phi 12$	4	$\phi 52$	$\phi 44$	CS0515(M5)								
				3220-Y6541																	
					0° - 30°	TWC9TS1044HP1	●	9	$\phi 12$	4	$\phi 52$	$\phi 44$	CS0515(M5)								
	SS20/SS26/SS32			3268-Y271	0° - 10°	TWC9TS1952P2BK	●	9	$\phi 12$	4	$\phi 52$	$\phi 38$	CS0515(M5)								
			0° - 20°	TWC9TS1652P2BK	●	9	$\phi 12$	4	$\phi 52$	$\phi 38$	CS0515(M5)										
SS207/SS267/SS327	-	Using B-axis		0° - 15°	TWC4TS3010HP1	●	4	$\phi 7$	5	$\phi 10$	For single-corner inserts only										

* To be released in June 2015.

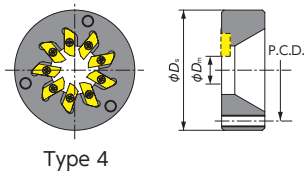

Type 4

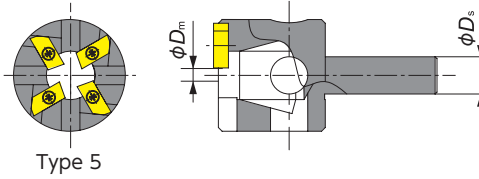

Type 5

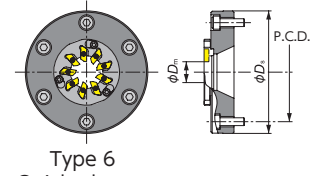

Type 6
Quick-change

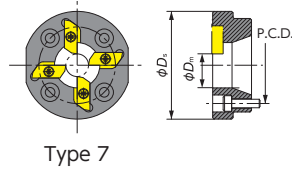

Type 7

Machine make	Model	Location	Spindle make	Spindle model	Helix angle	NTK Thread whirling system	Stock	No. of tooth	ϕD_m (mm)	Type	ϕD_s	P.C.D.	Mount adapter screw
TORNOS	DECO 10/10a	Attachment	TORNOS	224-1900	$\pm 15^\circ$	TWC6TO11542HP1	●	6	$\phi 12$	4	$\phi 42$	$\phi 32$	CS0410(M4)
	Evo DECO 10/10			242-1900									
	DECO 13a/13e			226-1900	$\pm 15^\circ$	TWC9TO10540P2	●	9	$\phi 12$	3	$\phi 40$	$\phi 31$	CS0410(M4)
	Evo DECO 16/10			243-1900									
	Swiss ST26			246-1900									
	DECO 20a			223-1900									
	DECO 26a			225-1900	$\pm 25^\circ$	TWC9TO12050P2-D18	●	9	$\phi 18$	3	$\phi 50$	$\phi 40$	CS0410(M4)
	Sigma 20			234-2750									
Sigma 32	236-2750												
HASEGAWA	JS-1W	—	HASEGAWA	—	$0^\circ - 20^\circ$	TWC9HA22594P2	●	9	$\phi 16$	6	$\phi 94$	$\phi 76$	CS0620(M6)

■ Spare Insert Holder (Cartridge)

Item number	No. of tooth	ϕD_m (mm)	Compatible cutters
TWC6HP2	6	12	For Type 2 and Type 3*
TWC9HP2	9	12	For Type 2 and Type 3*
TWC9HP2-D16	9	16	For TWC9TS20550P2 and Type 6

Note: Insert holder comes with insert screws and wrench
 Insert holder mounting screw is not included
 *Cannot be used for TWC9TS20550P2, TWC9TO12050P2-D18 and TWC9HA22594P2

■ Spare Parts

Description		Item number
Insert Screw	For 4mm thick inserts	FSI17-2.2×6.0
	For 6.5mm thick inserts	FSI24-2.2×7.9
Wrench		T-07
Insert Holder Mounting Screw		CS0309-TW

NTK's Unique Attachment System

NTK's whirling insert holder can be attached and detached without removing mounting screws



① Loosen the Mounting Screws

② Rotate the Insert Holder 10 degrees

③ Detach the Insert Holder without removing the Mounting Screws

● : Stock

○ : 1-2 week delivery

Basic Insert Grade

ZM3

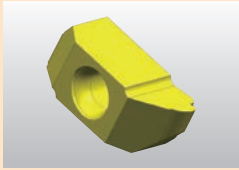

- ZM3 is our basic grade for NTK thread whirling
- ZM3 offers excellent surface finish
- NTK can make inserts with other coatings to meet customers demands

NTK Experiences and Solutions Example

For absolute flat on OD

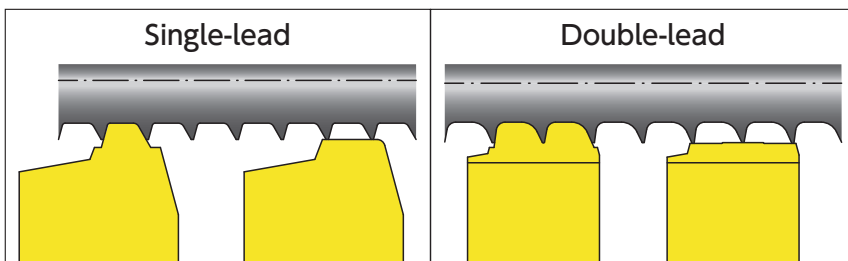

- Two insert combination brings absolute flat on OD to meet the drawing

For tiny thread

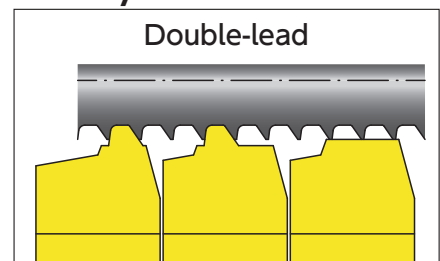

- NTK's Thread Whirling system can machine small diameter multi-lead screws to spec, with lower tool pressure, by using several types of specially designed and accurately ground inserts on the cutter.

Standard Thread Whirling Inserts (two-sided) for ISO Style Threads

(Note: Must use Thread whirling cutters with 12mm ϕ Dm dimension. See page U18-19 to find ϕ Dm for each cutter.)

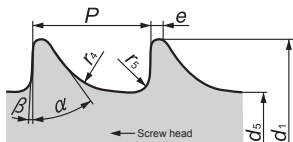

ISO5835 HA

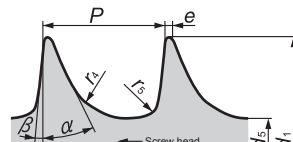

ISO5835 HB

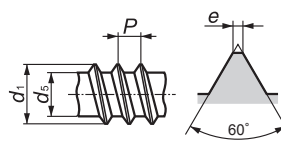

ISO9268 HC

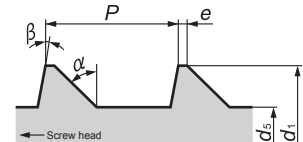



ISO9268 HD

Item number	ISO Standard	d_1	d_5	P	e	r_4	r_5	α	β	Metric dimensions		
										Supposition material Dia.	Coated Carbide ZM3	
TW5835-HA1.5-D12	ISO5835	1.5 ⁰ _{0.15}	1.1 ⁰ _{0.1}	0.5	0.1	0.3	0.1	35°	3°	ϕ 8	○	
TW5835-HA2.0-D12		2.0 ⁰ _{0.15}	1.3 ⁰ _{0.1}	0.6	0.1	0.4	0.1	35°	3°		○	
TW5835-HA2.7-D12		2.7 ⁰ _{0.15}	1.9 ⁰ _{0.15}	1	0.1	0.6	0.2	35°	3°		○	
TW5835-HA3.5-D12		3.5 ⁰ _{0.15}	2.4 ⁰ _{0.15}	1.25	0.1	0.8	0.2	35°	3°		○	
TW5835-HA4.0-D12		4.0 ⁰ _{0.15}	2.9 ⁰ _{0.15}	1.5	0.1	0.8	0.2	35°	3°		○	
TW5835-HA4.5-D12		4.5 ⁰ _{0.15}	3.0 ⁰ _{0.15}	1.75	0.1	1	0.3	35°	3°		○	
TW5835-HA5.0-D12		5.0 ⁰ _{0.15}	3.5 ⁰ _{0.15}	1.75	0.1	1	0.3	35°	3°		ϕ 10	○
TW5835-HB4.0-D12	ISO5835	4.0 ⁰ _{0.15}	1.9 ⁰ _{0.15}	1.75	0.1	0.8	0.3	25°	5°	ϕ 8	○	
TW5835-HB6.5-D12		6.5 ⁰ _{0.15}	3.0 ⁰ _{0.15}	2.75	0.2	1.2	0.8	25°	5°	ϕ 10	○	
TW9268-HC2.9-D12	ISO9268	2.79 to 2.9	2.03 to 2.18	1.06	0.1max	—	—	—	—	ϕ 8	○	
TW9268-HC3.5-D12		3.43 to 3.53	2.51 to 2.64	1.27	0.1max	—	—	—	—		○	
TW9268-HC3.9-D12		3.78 to 3.91	2.77 to 2.92	1.27	0.1max	—	—	—	—		○	
TW9268-HC4.2-D12		4.09 to 4.22	2.95 to 3.25	1.27	0.1max	—	—	—	—		○	
TW9268-HD4.0-D12		4.0±0.03	2.92±0.03	1.59	0.1	—	—	—	45°		10°	○
TW9268-HD4.5-D12		4.5±0.03	2.92±0.03	2.18	0.1	—	—	—	45°		10°	○

● : Stock ○ : 1-2 week delivery

Application Examples

Double-lead Bone Screw			
Work Material : Ti-6Al-4v ELI			
Bar Stock Dia.	φ.375	Number of start	2
Major Dia.	φ.157	Helix Angle	28.5°
Minor Dia.	φ.098	Hand of thread	Right
Cutting condition			
Main Spindle Speed (rpm)	15	Speed of whirling cutter (rpm)	3,500
Lead = Feed (IPR)	.217	Result	OK
NTK Thread Whirling	Dramatically improved productivity		
Competitor's Thread Whirling		<i>Cannot complete with single pass. Requires feeding stock multiple times and two passes for threading each time.</i>	
NTK thread whirling succeeded in double lead screw machining when one of the major thread whirling suppliers has failed many times.			

Double-lead Bone Screw			
Work Material : Ti-6Al-4v ELI			
Bar Stock Dia.	φ.250	Number of start	2
Major Dia.	φ.118	Helix Angle	15.4°
Minor Dia.	φ.083	Hand of thread	Right
Cutting condition			
Main Spindle Speed (rpm)	11	Speed of whirling cutter (rpm)	2,200
Lead = Feed (IPR)	.087	Result	OK
NTK Thread Whirling	Dramatically improved productivity		
Competitor's Thread Whirling		<i>Cannot complete with single pass. Requires feeding stock multiple times and two passes for threading each time.</i>	
Customer was concerned with stock rigidity and long cycle time. NTK applied three geometry inserts to achieve single pass machining, in dramatically short time. The up-sharp cutting edges and low cutting pressure produced "excellent" surface finish.			

Single-lead Bone Screw			
Work Material : Ti-6Al-4v ELI			
Bar Stock Dia.	φ.197	Number of start	1
Major Dia.	φ.091	Helix Angle	5.3°
Minor Dia.	φ.067	Hand of thread	Right
Cutting condition			
Main Spindle Speed (rpm)	30	Speed of whirling cutter (rpm)	3,100
Pitch = Feed (IPR)	.023	Result	OK
NTK Thread Whirling	2200 pcs		
This thread is up to 1.26" length with a small pitch. Cycle time could be increased with a single-point threading tool. NTK's inserts, designed for lower tool pressure, ran 2,200 pcs/corner at 30 rpm of bar stock (F10,800). It only took 110 seconds to finish a 1.26" length thread.			

Double-lead Bone Screw			
Work Material : Ti-6Al-4v ELI			
Bar Stock Dia.	φ.350	Number of start	2
Major Dia.	φ.180	Helix Angle	23.0°
Minor Dia.	φ.120	Hand of thread	Right
Cutting condition			
Main Spindle Speed (rpm)	12	Speed of whirling cutter (rpm)	2,500
Lead = Feed (IPR)	.200	Result	OK
NTK Thread Whirling	Dramatically improved productivity		
Competitor's Thread Whirling		<i>Cannot complete with single pass. Requires feeding stock multiple times and two passes for threading each time.</i>	
The customer could not get perfect double lead thread form in single pass from other manufacturers. NTK got perfect thread form with a single pass on first trial saving cycle time.			

Single-lead Bone Screw			
Work Material : 316SS			
Bar Stock Dia.	φ.315	Number of start	1
Major Dia.	φ.138	Helix Angle	7.5°
Minor Dia.	φ.098	Hand of thread	Right
Cutting condition			
Main Spindle Speed (rpm)	23	Speed of whirling cutter (rpm)	2,000
Pitch = Feed (IPR)	.049	Result	OK
NTK Thread Whirling	2600 pcs		
Competitor's Thread Whirling		1000 pcs	
Some thread whirling manufacturers offer 6-teeth or 12-teeth systems, too many teeth cause chip packing issues and more tool pressure. Fewer teeth means greater cycle time. NTK concluded that 9-teeth is the best configuration. Our customers can run 1.5 times faster and get longer tool life.			

Triple-lead Worm Gear			
Work Material : Brass			
Bar Stock Dia.	φ.315	Number of start	3
Major Dia.	φ.276	Helix Angle	14.6°
Minor Dia.	φ.185	Hand of thread	Left
Cutting condition			
Main Spindle Speed (rpm)	20	Speed of whirling cutter (rpm)	3,500
Lead = Feed (IPR)	.189	Result	OK
Multi-lead threads, common in the Worm Gear industry are made by a forming or cutting process. The large helix angle is difficult to machine with single-point threading. NTK now makes thread whirling inserts for multi-lead threads. Cycle time is reduced with a one pass process and thread form dimensions are stable with the low tool pressure.			

MEMO

V



ID Tooling

- **ID Tooling Tools V2**
- **Recommended Cutting Conditions..... V4**
- **Tools list V6**
 - LBM SeriesV6
 - STICK DUO SPLASHV8
 - STICK DUO HYPER V10
 - STICK DUO V14
 - ID Back Turning Tools V17
 - ID Grooving Tools V18
 - ID Threading Tools V20
 - Mogul Bar Series V23
- **Chipbreakers for Mogul Bar ... V32**

NTK ID Tooling - Product Lines

ID Boring

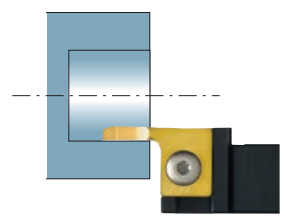

Insert	LBM →V7		
	LBMA	DS-LBMB	CH-LBM
Holder	 →V6	 →V6	 →V6
Min. Bore Dia.	ϕ.039" (1.0mm)		

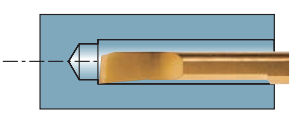



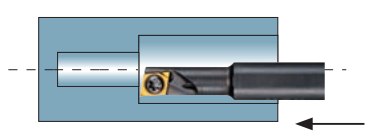

Insert	SHFS • SHFB • SBFS • SBFB →V12 • 16		
	HY-NBH-OH	HY-NBH	NBH
Holder	NEW →V9 STICK DUO HYPER with Coolant through	 →V11 STICK DUO HYPER	 →V14
Min. Bore Dia.	ϕ.079" (2.0mm)		

	Holder	Insert		
		HY-NBH-OH STICK DUO HYPER with Coolant through	HY-NBH STICK DUO HYPER	NBH STICK DUO
"S" chip breaker Sharp cutting edge	SHFS-S High Precision Insert	Best fit	Best fit	2nd OPT.
	SBFS-S	2nd OPT.	2nd OPT.	Best fit
"F" chip breaker Evacuates chips BACKWARD	SHFB-F High Precision Insert	Best fit	Best fit	2nd OPT.
	SBFB-F	2nd OPT.	2nd OPT.	Best fit
"H" Flat type Mirror finish edge	SHFS-H High Precision Insert	Best fit	Best fit	2nd OPT.
	SBFS-H	2nd OPT.	2nd OPT.	Best fit
Back turning	SBB	2nd OPT.	2nd OPT.	Best fit
Grooving	SBG	2nd OPT.	2nd OPT.	Best fit
Threading	SBT	2nd OPT.	2nd OPT.	Best fit

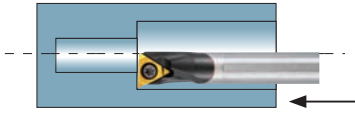





Insert	MBL →V23		ERGP →V24	
	C-MBR (Carbide shank)	S-MBR (Steel shank)	C-SEXR (Carbide shank)	S-SEXR (Steel shank)
Holder	 →V23 Coolant through	 →V23 Coolant through	 →V24 Coolant through	 →V24 Coolant through
Min. Bore Dia.	ϕ.197" (5.0mm)		ϕ.236" (6.0mm)	

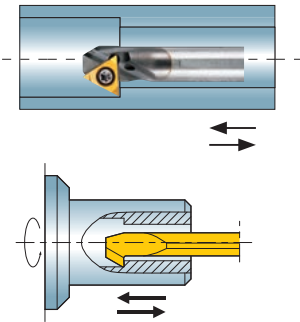

Insert	CC/CP →V25·26		TC/TP →V30	
	C-SCLC/P (Carbide shank)	S-SCLC/P (Steel shank)	C-STUC/P (Carbide shank)	S-STUC/P (Steel shank)
Holder				
	Coolant through →V25·26	Coolant through →V25·26	→V30 Coolant through	→V30 Coolant through
Min. Bore Dia.	φ .276" (7.0mm)		φ .315" (8.0mm)	



■ ID Back Turning



Insert	NEW SBB →V17		TC/TP →V30
	HY-NBH-OH		NBH
Holder			
	NEW →V9 Coolant through	→V14	→V30
Min. Bore Dia.	φ .118" (3.0mm)		φ .394" (10mm)

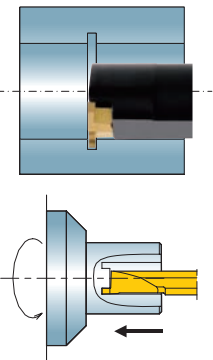

■ ID Grooving

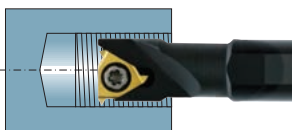

Insert	SBG →V18	SFG →V18	GTG →V19
	HY-NBH-OH	NBH	NBH
Holder			
	NEW →V9 Coolant through	→V14	→V14
Min. Bore Dia.	φ .118" (3.0mm)	φ .118" (3.0mm)	φ .394" (10mm)

■ ID Threading



Insert	SBT →V20		TMN →V22
	HY-NBH-OH		NBH
Holder			
	NEW →V9 Coolant through	→V14	→V22
Min. Bore Dia.	φ .118" (3.0mm)		φ .315" (8.0mm)

Recommended Cutting Conditions

■ ID Boring

diameter ≤ .240"

Work Material	High Temperature Alloys	Titanium Alloys	Cobalt Chrome Alloys	Stainless Steels		Alloy Steels	Carbon Steels
				Hard to cut	Free cutting		
Common Name	Inconel Hastelloy MP35N	Ti-6Al-4V	ASTM F-75	304 316 17-4PH	303 430F	5120 4137	1045 1046
Grade	1st choice	TM4				VM1 / TM4	
	2nd choice	VM1 / ZM3				ZM3	
Cutting Speed (SFM)	60 160 230				100 200 300		
Feed Rate (IPR)	.0004 .0012 .0020						
Depth Of Cut (DOC)	.0020 .0031 .0039						

diameter > .240"

Work Material	High Temperature Alloys	Titanium Alloys	Cobalt Chrome Alloys	Stainless Steels		Alloy Steels	Carbon Steels
				Hard to cut	Free cutting		
Common Name	Inconel Hastelloy MP35N	Ti-6Al-4V	ASTM F-75	304 316 17-4PH	303 430F	5120 4137	1045 1046
Grade	1st choice	DT4		DT4	TM4	QM3	
	2nd choice	TM4		QM3 / TM4	QM3	TM4 / DT4 / C7Z(X)	
Cutting Speed (SFM)	150 230 330			130 230 330	150 300 600	Carbide C7Z(X)	150 300 500 400 500 800
Feed Rate (IPR)	.0008 .0024 .0047						
Depth Of Cut (DOC)	.0039 .0197 .0787						

■ Through hole

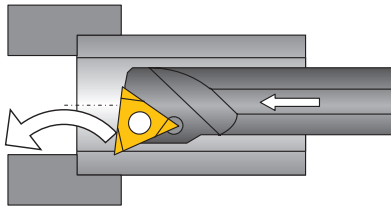

For chip control : chips can be evacuated forward

■ Blind hole

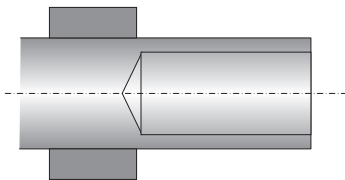

Blind hole due to bar stock

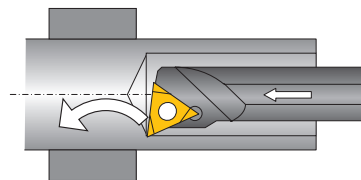

Typical inserts direct flow chips forward. Then packed chips damage and break cutting edge

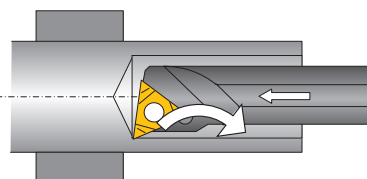

F05, F1, and FG chipbreakers will direct chips backwards and eliminate chipping on inserts

*Note: Use right-hand inserts with F05, F1 and FG chipbreaker for right-hand boring bars

ID Grooving

GTG / SBG

Work Material		High Temperature Alloys	Titanium Alloys	Cobalt Chrome Alloys	Stainless Steels		Alloy Steels	Carbon Steels	
					Hard to cut	Free cutting			
Common Name		Inconel Hastelloy MP35N	Ti-6Al-4V	ASTM F-75	304 316 17-4PH	303 430F	5120 4137	1045 1046	
Grade	1st choice	DT4			DM4 / DT4	TM4	QM3		
	2nd choice	TM4 / QM3			QM3 / VM1	QM3	TM4 / DT4 / C7Z(X)		
Cutting Speed (SFM)		75 125 225	100 200 275		130 230 330	150 300 600	Carbide C7Z(X)	150 300 500 400 500 800	
Feed Rate (IPR) A. Grooving B. Side turning*	Width .010-.020	A. .0002 - .0012							
		B. .0001 - .0002							
	.020-.040	A. .0008 - .0024						A. .0008 - .0028	
		B. .0002 - .0004						B. .0002 - .0004	
	.040-.080	A. .0012 - .0028						A. .0012 - .0031	
B. .0008 - .0020						B. .0012 - .0024			
> .080	A. .0012 - .0079								
	B. .0012 - .0024								

*When side turning, Max. DOC is under .0079". Under .016" width side turning impossible

ID Threading

● Threading

For 600 - 1500 RPM Recommended Depth of Cut (DOC) for Each Pass

UNF Thread		Number of Pass																		
Pitch (TPI)	Total DOC (inch)	1	2	3	4	5	6	7	8	9	10	11	12	13	14	15	16	17	18	19
36	0.43	.002	.002	.002	.002	.002	.002	.001	.001	.0008	.0004	—	—	—	—	—	—	—	—	—
32	0.49	.002	.002	.002	.002	.002	.001	.001	.001	.001	.0008	.0004	—	—	—	—	—	—	—	—
28	0.56	.003	.002	.002	.002	.002	.002	.001	.001	.001	.001	.001	.0008	.0004	—	—	—	—	—	—
24	0.66	.003	.002	.002	.002	.002	.002	.002	.002	.001	.001	.001	.001	.0008	.0004	—	—	—	—	—
20	0.78	.003	.003	.003	.003	.002	.002	.002	.002	.002	.002	.001	.001	.001	.001	.0008	.0004	—	—	—
18	0.87	.003	.003	.003	.003	.003	.002	.002	.002	.002	.002	.002	.002	.001	.001	.001	.0008	.0004	—	—
16	0.98	.003	.003	.003	.003	.003	.003	.003	.002	.002	.002	.002	.002	.002	.001	.001	.001	.001	.0008	.0004

Metric Thread		Number of Pass																				
Pitch (mm)	Total DOC (mm)	1	2	3	4	5	6	7	8	9	10	11	12	13	14	15	16	17	18	19	20	21
0.5	0.3	0.06	0.05	0.05	0.04	0.04	0.03	0.02	0.01	—	—	—	—	—	—	—	—	—	—	—	—	—
0.7	0.43	0.06	0.06	0.06	0.05	0.05	0.05	0.04	0.03	0.02	0.01	—	—	—	—	—	—	—	—	—	—	—
0.75	0.46	0.06	0.06	0.06	0.05	0.05	0.04	0.04	0.04	0.03	0.02	0.01	—	—	—	—	—	—	—	—	—	—
0.8	0.49	0.06	0.06	0.06	0.05	0.05	0.04	0.04	0.04	0.03	0.03	0.02	0.01	—	—	—	—	—	—	—	—	—
1.0	0.62	0.07	0.07	0.06	0.06	0.05	0.05	0.05	0.04	0.04	0.04	0.03	0.03	0.02	0.01	—	—	—	—	—	—	—
1.25	0.76	0.07	0.07	0.07	0.07	0.07	0.06	0.06	0.06	0.05	0.05	0.04	0.03	0.03	0.02	0.01	—	—	—	—	—	—
1.5	0.92	0.07	0.07	0.07	0.07	0.07	0.07	0.06	0.06	0.06	0.05	0.05	0.05	0.04	0.04	0.03	0.03	0.02	0.01	—	—	—
1.75	1.09	0.07	0.07	0.07	0.07	0.07	0.07	0.06	0.06	0.06	0.06	0.06	0.05	0.05	0.05	0.04	0.04	0.03	0.03	0.02	0.01	—

LBM Series

Minimum bore diameter $\phi .039"$ (1.0mm) - $\phi .118"$ (3.0mm)

LBMA / LBMA-S

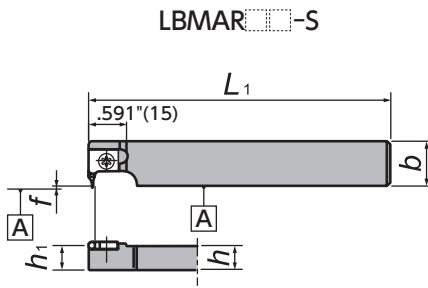

Figure-1

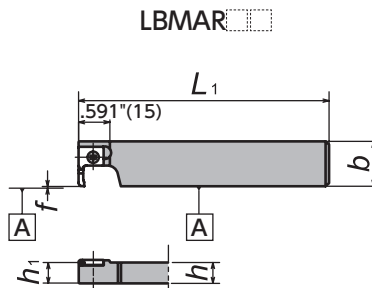

Figure-2

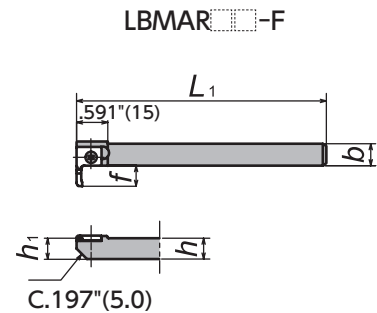

Figure-3

Right-Hand style shown

DS-LBMB

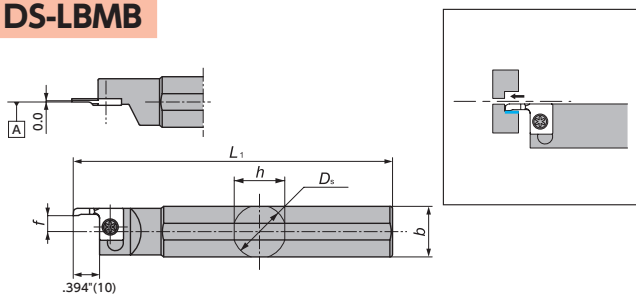

Figure-4

Left-Hand style shown

CH-LBM

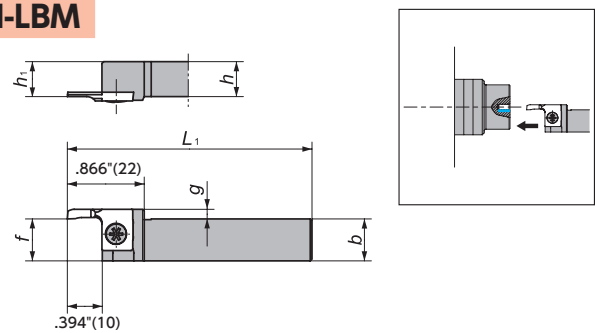

Figure-5

Left-Hand style shown

LBMAR / CH-TTPL

Gage Insert	Item Number	Figure	Stock	D_s		h		b		h_1		L_1		f		Clamp Screw	Wrench
				(Inch)	(mm)	(Inch)	(mm)	(Inch)	(mm)	(Inch)	(mm)	(Inch)	(mm)	(Inch)	(mm)		
Short type	LBMAR10SGX	1	○	—	—	.394	10	.709	18	.394	10	3.346	85	0	0.0	LRIS-4 × 10PW	CLR-15S
	LBMAR10S	1	○	—	—	.394	10	.709	18	.394	10	4.724	120	0	0.0	LRIS-4 × 10PW	CLR-15S
	LBMAR12S	1	○	—	—	.472	12	.709	18	.472	12	4.724	120	0	0.0	LRIS-4 × 12PW	CLR-15S
Long type	LBMAR06-IN	2	●	—	—	3/8	3/8	3/8	3/8	4.724	120	0	0.0	LRIS-4 × 10PW	CLR-15S		
	LBMAR08-IN	2	●	—	—	1/2	1/2	1/2	1/2	4.724	120	0	0.0	LRIS-4 × 12PW	CLR-15S		
	LBMAR10-IN	2	●	—	—	5/8	5/8	5/8	5/8	4.724	120	0	0.0	LRIS-4 × 12PW	CLR-15S		
	LBMAR08	2	○	—	—	.315	8	.846	21.5	.315	8	4.724	120	0	0.0	LRIS-4 × 10	LLR-25S
	LBMAR10	2	○	—	—	.394	10	.846	21.5	.394	10	4.724	120	0	0.0	LRIS-4 × 10PW	CLR-15S
	LBMAR12	2	○	—	—	.472	12	.846	21.5	.472	12	4.724	120	0	0.0	LRIS-4 × 10PW	CLR-15S
	LBMAR16	2	○	—	—	.630	16	.846	21.5	.630	16	4.724	120	0	0.0	LRIS-4 × 12PW	CLR-15S
Long type	LBMAR10-F	3	○	—	—	.394	10	.394	10.0	.394	10	4.724	120	.394	10.0	LRIS-4 × 12PW	CLR-15S
Long type	DS-LBMBL14F	4	○	.551	14.000	.512	13	.512	13	—	—	3.150	80 *1	*3	*3	LRIS-4 × 10PW	CLR-15S
	DS-LBMBL15H	4	○	5/8	15.875	.591	15	.591	15	—	—	3.937	100 *1	*3	*3	LRIS-4 × 10PW	CLR-15S
	DS-LBMBL16X	4	●	.630	16.000	.591	15	.591	15	—	—	3.740	95 *1	*2	*2	LRIS-4 × 10PW	CLR-15S
	DS-LBMBL19	4	●	3/4	19.050	.709	18	.709	18	—	—	4.724	120 *1	*2	*2	LRIS-4 × 10PW	CLR-15S
	DS-LBMBL20	4	●	.787	20.000	.748	19	.748	19	—	—	4.724	120 *1	*2	*2	LRIS-4 × 10PW	CLR-15S
	DS-LBMBL22	4	●	.866	22.000	.827	21	.827	21	—	—	4.724	120 *1	*2	*2	LRIS-4 × 10PW	CLR-15S
	DS-LBMBL25-MET	4	○	.984	25.000	.945	24	.945	24	—	—	4.724	120 *1	*2	*2	LRIS-4 × 10PW	CLR-15S
	DS-LBMBL25	4	○	1	25.400	.945	24	.945	24	—	—	5.906	150 *1	*2	*2	LRIS-4 × 10PW	CLR-15S
Short type	CH-LBML1012H	5	○	—	—	.394	10	.472	12	.394	10	3.937	100	*3	*3	LRIS-4 × 10PW	CLR-15S
	CH-LBML1212H	5	○	—	—	.472	12	.472	12	.472	12	3.937	100	*3	*3	LRIS-4 × 10PW	CLR-15S

LBM Series - Toolholders

LBMD-S

Short type

Mirror finish

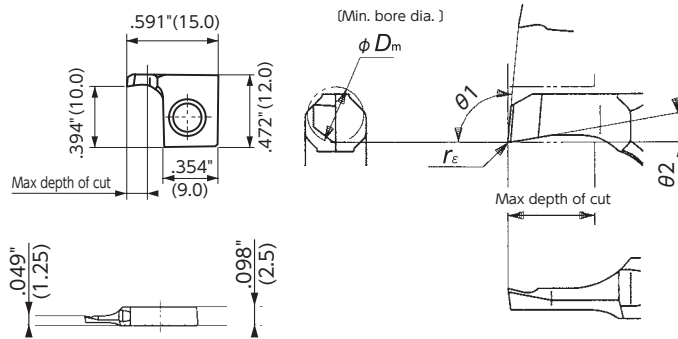

LBMD2335FLPB05S shown

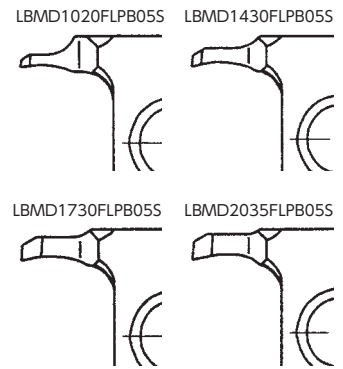

DS-LBMB

Long type

Mirror finish

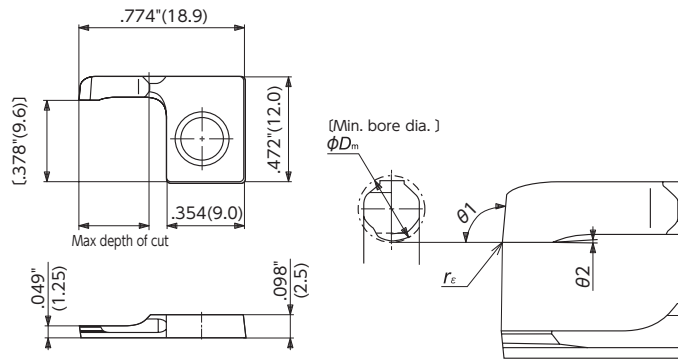

Min. bore diameter ϕ .118" (3.0) shown

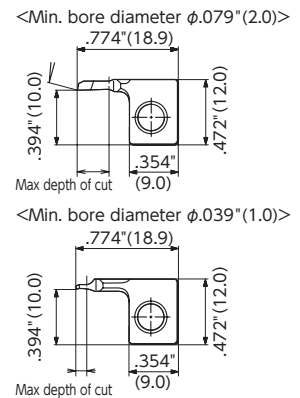

LBM Mirror finish

Insert type	Item Number	Chip-breaker	Min. Bore Dia.		Max. Depth		$\theta 1$	$\theta 2$	r_{ϵ}		Coated Carbide	
			(Inch)	(mm)	(Inch)	(mm)			(Inch)	(mm)	VM1	ZM3
Short type	LBMD1020FLVBS	Yes	.039	1.0	.079	2.0	95°	10°	.000	0.00	○	
	LBMD1020FLPB05S	Yes	.039	1.0	.079	2.0	95°	10°	.002	0.05	○	
	LBMD1430FLVBS	Yes	.055	1.4	.118	3.0	95°	10°	.000	0.00	○	
	LBMD1430FLPB05S	Yes	.055	1.4	.118	3.0	95°	10°	.002	0.05	●	
	LBMD1730FLVBS	Yes	.067	1.7	.118	3.0	95°	10°	.000	0.00	○	
	LBMD1730FLPB05S	Yes	.067	1.7	.118	3.0	95°	10°	.002	0.05	○	
	LBMD2035FLVBS	Yes	.079	2.0	.138	3.5	95°	10°	.000	0.00	○	
	LBMD2035FLPB05S	Yes	.079	2.0	.138	3.5	95°	10°	.002	0.05	○	
	LBMD2335FLVBS	Yes	.091	2.3	.138	3.5	95°	10°	.000	0.00	○	
LBMD2335FLPB05S	Yes	.091	2.3	.138	3.5	95°	10°	.002	0.05	●		
Long type	LBMD1020FLVB	Yes	.039	1.0	.079	2.0	95°	10°	.000	0.00	●	
	LBMD1020FLPB05	Yes	.039	1.0	.079	2.0	95°	10°	.002	0.05	●	
	LBMD2060FLVB	Yes	.079	2.0	.236	6.0	95°	10°	.000	0.00	●	
	LBMD2060FLPB05	Yes	.079	2.0	.236	6.0	95°	10°	.002	0.05	●	
	LBME2060FLV	No	.079	2.0	.236	6.0	105°	2°	.000	0.00	○	
	LBME2060FLP05	No	.079	2.0	.236	6.0	105°	2°	.002	0.05	○	
	LBME2060FLVB	Yes	.079	2.0	.236	6.0	105°	2°	.000	0.00	○	
	LBME2060FLPB05	Yes	.079	2.0	.236	6.0	105°	2°	.002	0.05	○	
	LBMC3080FLV	No	.118	3.0	.315	8.0	95°	2°	.000	0.00	○	○
	LBMC3080FLP05	No	.118	3.0	.315	8.0	95°	2°	.002	0.05	○	○
	LBMC3080FLVB	Yes	.118	3.0	.315	8.0	90°	2°	.000	0.00	●	
	LBMC3080FLPB05	Yes	.118	3.0	.315	8.0	90°	2°	.002	0.05	●	
	LBMC3080FLVB	Yes	.118	3.0	.315	8.0	95°	2°	.000	0.00	○	○
LBMC3080FLPB05	Yes	.118	3.0	.315	8.0	95°	2°	.002	0.05	○	○	

● : Stock

○ : 1-2 week delivery

Ⓜ : Mirror finish



Cutting condition \rightarrow V4

STICK DUO SPLASH

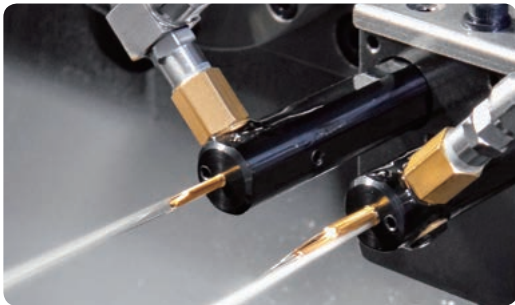

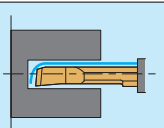
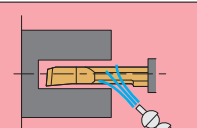
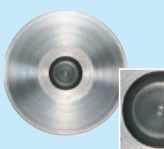

- Coolant through sleeves for ID Boring with Adjustable Overhang Mechanism -

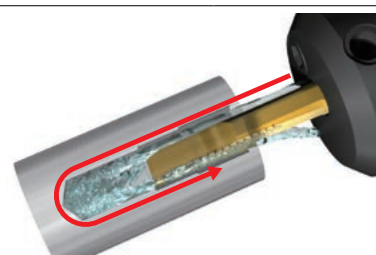
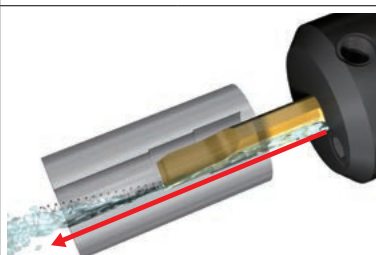

■ No chip problems

STICK DUO SPLASH	External coolant
	
	
<i>No chip inside hole</i>	<i>Chip packed</i>
Material : 4140 Insert bar : SHFS040R005S Hole depth : .590" (15mm) Pilot hole : $\phi .201" \times 1.102" L (\phi 5.1 \times 28.0 \text{mm} L)$ Coolant Pressure : 725psi (5MPa)	

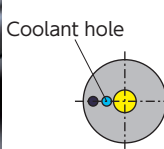
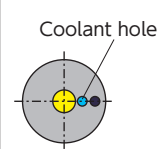
■ Can choose 2-way coolant direct

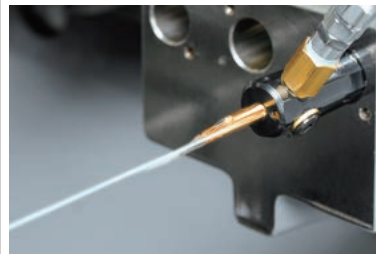
I) For Blind hole	II) For Through hole
	
	
	
	
Just rotated 180 degrees	

■ 3-way coolant connection

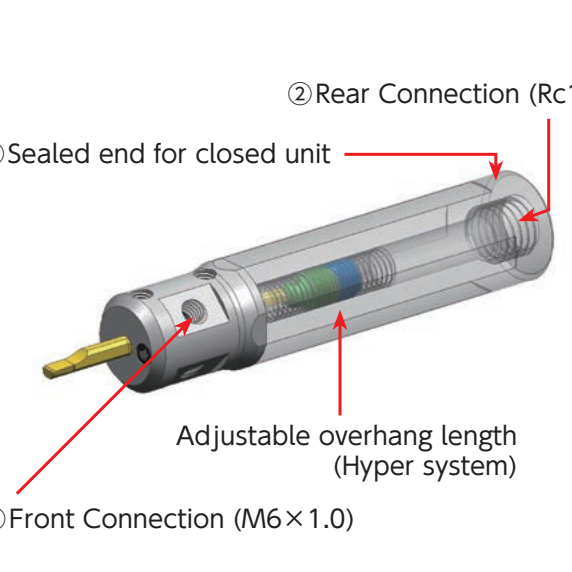

① Front Connection example



② Rear Connection example

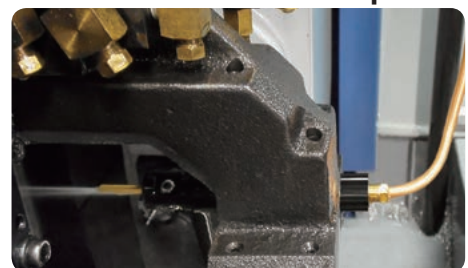

SPLASH DUO - Stick Duo Hyper with Coolant through -

HY-NBH-OH (Coolant through)

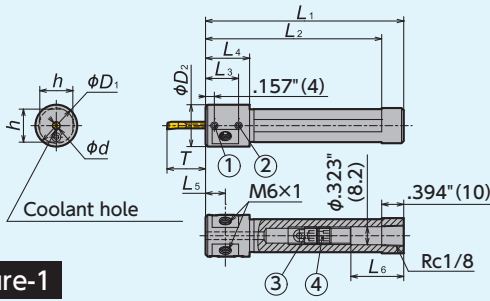

Figure-1

HY-NBH-OH (Coolant through)

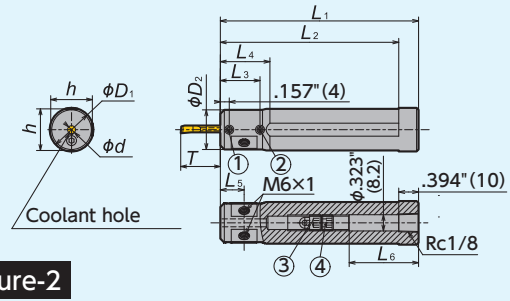

Figure-2

Item Number	Stock	Figure	ϕd		ϕD_1		ϕD_2	h	L_1	L_2	L_3	L_4	L_5	L_6	Overhang Length of Bar T			
			(Inch)	(mm)	(Inch)	(mm)									(mm)	(mm)	(Inch)	(mm)
HY-NBH02016G-OH	●	1	.079	2	.630	16	19	15	90	80	15	19	9.5	29	.197	5.0	.709	18.0
HY-NBH02516G-OH	●	1	.098	2.5	.630	16	19	15	90	80	15	19	9.5	30	.248	6.3	.768	19.5
HY-NBH03016G-OH	●	1	.118	3	.630	16	19	15	90	80	15	19	9.5	31	.295	7.5	.827	21.0
HY-NBH03516G-OH	●	1	.138	3.5	.630	16	19	15	90	80	15	19	9.5	23	.346	8.8	.965	24.5
HY-NBH04016G-OH	●	1	.157	4	.630	16	19	15	90	80	20	24	12	23	.394	10.0	1.102	28.0
HY-NBH05016G-OH	●	1	.197	5	.630	16	19	15	90	80	20	24	12	16	.492	12.5	1.378	35.0
HY-NBH02019J-OH	●	2	.079	2	3/4	19.05	19.05	18	110	100	15	—	9.5	49	.197	5.0	.709	18.0
HY-NBH02519J-OH	●	2	.098	2.5	3/4	19.05	19.05	18	110	100	15	—	9.5	50	.248	6.3	.768	19.5
HY-NBH03019J-OH	●	2	.118	3	3/4	19.05	19.05	18	110	100	15	—	9.5	51	.295	7.5	.827	21.0
HY-NBH03519J-OH	●	2	.138	3.5	3/4	19.05	19.05	18	110	100	15	—	9.5	43	.346	8.8	.965	24.5
HY-NBH04019J-OH	●	2	.157	4	3/4	19.05	19.05	18	110	100	20	—	12	43	.394	10.0	1.102	28.0
HY-NBH05019J-OH	●	2	.197	5	3/4	19.05	19.05	18	110	100	20	—	12	36	.492	12.5	1.378	35.0
HY-NBH02020J-OH	●	2	.079	2	.787	20	20	19	110	100	15	—	9.5	49	.197	5.0	.709	18.0
HY-NBH02520J-OH	●	2	.098	2.5	.787	20	20	19	110	100	15	—	9.5	50	.248	6.3	.768	19.5
HY-NBH03020J-OH	●	2	.118	3	.787	20	20	19	110	100	15	—	9.5	51	.295	7.5	.827	21.0
HY-NBH03520J-OH	●	2	.138	3.5	.787	20	20	19	110	100	15	—	9.5	43	.346	8.8	.965	24.5
HY-NBH04020J-OH	●	2	.157	4	.787	20	20	19	110	100	20	—	12	43	.394	10.0	1.102	28.0
HY-NBH05020J-OH	●	2	.197	5	.787	20	20	19	110	100	20	—	12	36	.492	12.5	1.378	35.0
HY-NBH02022X-OH	●	2	.079	2	.866	22	20	21	120	110	15	25	9.5	59	.197	5.0	.709	18.0
HY-NBH02522X-OH	●	2	.098	2.5	.866	22	20	21	120	110	15	25	9.5	60	.248	6.3	.768	19.5
HY-NBH03022X-OH	●	2	.118	3	.866	22	20	21	120	110	15	25	9.5	61	.295	7.5	.827	21.0
HY-NBH03522X-OH	●	2	.138	3.5	.866	22	20	21	120	110	15	25	9.5	53	.346	8.8	.965	24.5
HY-NBH04022X-OH	●	2	.157	4	.866	22	20	21	120	110	20	25	12	53	.394	10.0	1.102	28.0
HY-NBH05022X-OH	●	2	.197	5	.866	22	20	21	120	110	20	25	12	46	.492	12.5	1.378	35.0
HY-NBH02025.0K-OH	●	2	.079	2	.984	25.0	20	24	125	115	15	25	9.5	64	.197	5.0	.709	18.0
HY-NBH02525.0K-OH	●	2	.098	2.5	.984	25.0	20	24	125	115	15	25	9.5	65	.248	6.3	.768	19.5
HY-NBH03025.0K-OH	●	2	.118	3	.984	25.0	20	24	125	115	15	25	9.5	66	.295	7.5	.827	21.0
HY-NBH03525.0K-OH	●	2	.138	3.5	.984	25.0	20	24	125	115	15	25	9.5	58	.346	8.8	.965	24.5
HY-NBH04025.0K-OH	●	2	.157	4	.984	25.0	20	24	125	115	20	25	12	58	.394	10.0	1.102	28.0
HY-NBH05025.0K-OH	●	2	.197	5	.984	25.0	20	24	125	115	20	25	12	51	.492	12.5	1.378	35.0
HY-NBH02025.4K-OH	●	2	.079	2	1	25.4	20	24	125	115	15	25	9.5	64	.197	5.0	.709	18.0
HY-NBH02525.4K-OH	●	2	.098	2.5	1	25.4	20	24	125	115	15	25	9.5	65	.248	6.3	.768	19.5
HY-NBH03025.4K-OH	●	2	.118	3	1	25.4	20	24	125	115	15	25	9.5	66	.295	7.5	.827	21.0
HY-NBH03525.4K-OH	●	2	.138	3.5	1	25.4	20	24	125	115	15	25	9.5	58	.346	8.8	.965	24.5
HY-NBH04025.4K-OH	●	2	.157	4	1	25.4	20	24	125	115	20	25	12	58	.394	10.0	1.102	28.0
HY-NBH05025.4K-OH	●	2	.197	5	1	25.4	20	24	125	115	20	25	12	51	.492	12.5	1.378	35.0

Parts for SPLASH DUO

Item Number	Clamp Screw		Overhang Adjustment		
	①	②	③	④	⑤
HY-NBH ... -OH	SS04045FS	SS0406F	SS0811R-OH	SS0806F-OH (Through hole)	SS0806F
	M6 Screw		Wrench		
	⑥		for ①②	for ③④⑤	for ⑥
	SS0606SC		LW-2	LW-4×104	LW-3

● : Stock

💧 : Coolant through

Insert bars → V12

ID Tooling

STICK DUO HYPER

- Sleeves for ID Boring with Adjustable Overhang Mechanism -



■ Can Index boring bars like inserts

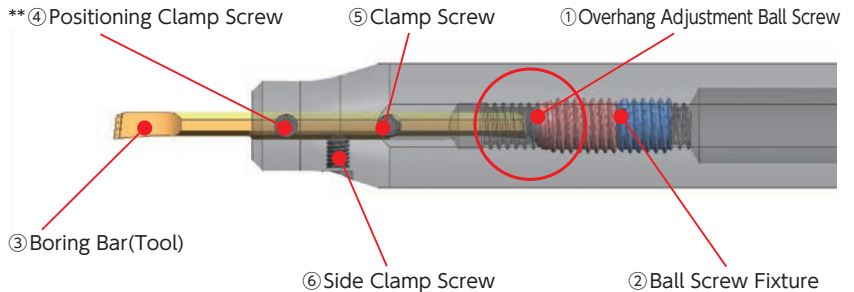

■ Installation Procedure for STICK DUO Hyper

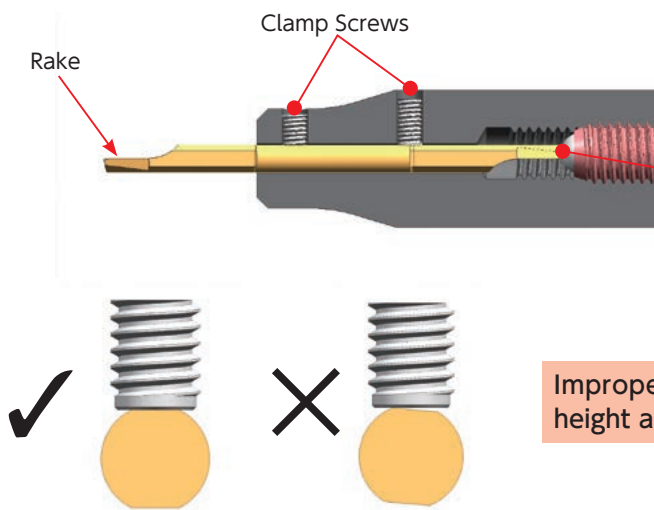

Caution: Improper installation dramatically increases the chance of chipping cutting edge

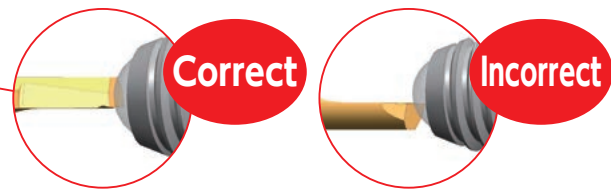

Improper clamping of boring bar causes unstable centerline height and offset

① Position the overhang adjustment ball screw to determine overhang amount

② Slide the ball screw fixture to secure the ball screw location

③ Insert a boring bar (tool)

Note: Make sure to insert the boring bar correctly so that the rake faces is toward the side where the clamp screws are located

④ Secure the boring bar by tightening the positioning clamp screw ▶ Recommended Clamping Torque: 17.7 lb in

** Make sure to clamp the boring bar so that flat surface of the bar makes proper contacts with clamp screws

⑤ Secure the boring bar by tightening the remaining clamp screws ▶ Recommended Clamping Torque: 17.7 lb in

⑥ Even if 4 and 5 cannot be performed due to tool clearance and layout, the tool can be used by only securing the side clamp screw

Once the initial setup is complete, repeat the above procedures 3 thru 5 for each index

■ When the tool is installed upside down

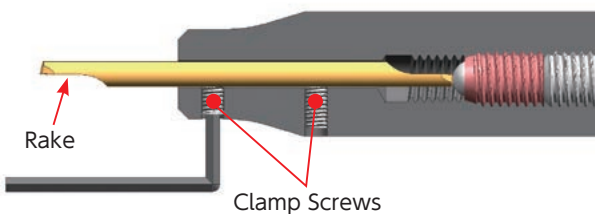

Toolholder must be installed so that clamp screws and rake of the tool face toward the same side

STICK DUO HYPER

HY-NBH

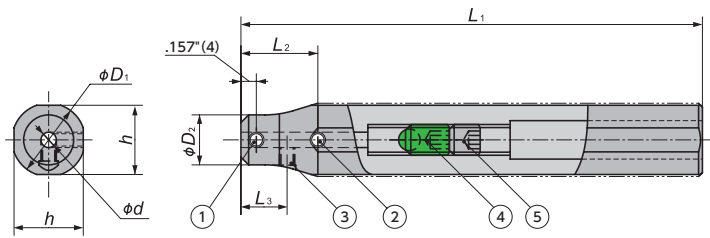

Please refer to ϕd to find correct-size inserts (bars)

Item Number	Stock	ϕd		ϕD_1		ϕD_2	h	L_1	L_2	L_3	Clamp Screws		
		(Inch)	(mm)	(Inch)	(mm)						①	②	③
HY-NBH02016H	○	.079	2.0	.630	16	11	15	100	15	9.5	SS04045FS	SS0406F	SS0404F
HY-NBH02516H	○	.098	2.5	.630	16	11.5	15	100	15	9.5	SS04045FS	SS0406F	SS0404F
HY-NBH03016H	○	.118	3.0	.630	16	12	15	100	15	9.5	SS04045FS	SS0406F	SS0404F
HY-NBH03516H	○	.138	3.5	.630	16	12.5	15	100	20	12	SS04045FS	SS0404F	SS0404F
HY-NBH04016H	○	.157	4.0	.630	16	13	15	100	20	12	SS04045FS	SS0404F	SS0404F
HY-NBH05016H	○	.197	5.0	.630	16	14	15	100	20	12	SS04045FS	SS0404F	SS0404F
HY-NBH02019K	●	.079	2.0	3/4	19.05	11	18	125	15	9.5	SS04045FS	SS0406F	SS0404F
HY-NBH02519K	●	.098	2.5	3/4	19.05	11.5	18	125	15	9.5	SS04045FS	SS0406F	SS0404F
HY-NBH03019K	●	.118	3.0	3/4	19.05	12	18	125	15	9.5	SS04045FS	SS0406F	SS0404F
HY-NBH03519K	●	.138	3.5	3/4	19.05	12.5	18	125	20	12	SS04045FS	SS0406F	SS0404F
HY-NBH04019K	●	.157	4.0	3/4	19.05	13	18	125	20	12	SS04045FS	SS0406F	SS0404F
HY-NBH05019K	●	.197	5.0	3/4	19.05	14	18	125	20	12	SS04045FS	SS0406F	SS0404F
HY-NBH02020K	○	.079	2.0	.787	20	11	19	125	15	9.5	SS04045FS	SS0406F	SS0404F
HY-NBH02520K	○	.098	2.5	.787	20	11.5	19	125	15	9.5	SS04045FS	SS0406F	SS0404F
HY-NBH03020K	○	.118	3.0	.787	20	12	19	125	15	9.5	SS04045FS	SS0406F	SS0404F
HY-NBH03520K	○	.138	3.5	.787	20	12.5	19	125	20	12	SS04045FS	SS0406F	SS0404F
HY-NBH04020K	○	.157	4.0	.787	20	13	19	125	20	12	SS04045FS	SS0406F	SS0404F
HY-NBH05020K	○	.197	5.0	.787	20	14	19	125	20	12	SS04045FS	SS0406F	SS0404F
HY-NBH02022K	●	.079	2.0	.866	22	11	21	125	15	9.5	SS04045FS	SS0406F	SS0404F
HY-NBH02522K	●	.098	2.5	.866	22	11.5	21	125	15	9.5	SS04045FS	SS0406F	SS0404F
HY-NBH03022K	●	.118	3.0	.866	22	12	21	125	15	9.5	SS04045FS	SS0406F	SS0404F
HY-NBH03522K	●	.138	3.5	.866	22	12.5	21	125	20	12	SS04045FS	SS0406F	SS0404F
HY-NBH04022K	●	.157	4.0	.866	22	13	21	125	20	12	SS04045FS	SS0406F	SS0404F
HY-NBH05022K	●	.197	5.0	.866	22	14	21	125	20	12	SS04045FS	SS0406F	SS0404F
HY-NBH02025K-MET	○	.079	2.0	.984	25	11	24	125	15	9.5	SS04045FS	SS0406F	SS0404F
HY-NBH02525K-MET	○	.098	2.5	.984	25	11.5	24	125	15	9.5	SS04045FS	SS0406F	SS0404F
HY-NBH03025K-MET	○	.118	3.0	.984	25	12	24	125	15	9.5	SS04045FS	SS0406F	SS0404F
HY-NBH03525K-MET	○	.138	3.5	.984	25	12.5	24	125	20	12	SS04045FS	SS0406F	SS0404F
HY-NBH04025K-MET	○	.157	4.0	.984	25	13	24	125	20	12	SS04045FS	SS0406F	SS0404F
HY-NBH05025K-MET	○	.197	5.0	.984	25	14	24	125	20	12	SS04045FS	SS0406F	SS0404F
HY-NBH02025K	●	.079	2.0	1	25.4	11	24	125	15	9.5	SS04045FS	SS0406F	SS0404F
HY-NBH02525K	●	.098	2.5	1	25.4	11.5	24	125	15	9.5	SS04045FS	SS0406F	SS0404F
HY-NBH03025K	●	.118	3.0	1	25.4	12	24	125	15	9.5	SS04045FS	SS0406F	SS0404F
HY-NBH03525K	●	.138	3.5	1	25.4	12.5	24	125	20	12	SS04045FS	SS0406F	SS0404F
HY-NBH04025K	●	.157	4.0	1	25.4	13	24	125	20	12	SS04045FS	SS0406F	SS0404F
HY-NBH05025K	●	.197	5.0	1	25.4	14	24	125	20	12	SS04045FS	SS0406F	SS0404F

■ Spare Parts

Item Number	Overhang Adjustment		Wrench	
	④	⑤	for ①②③	for ④⑤
HY-NBH ... K	SS0812R	SS0808F	LW-2	LW-4×104

● : Stock ○ : 1-2 week delivery

Insert bars → V12

ID Tooling

Bars for STICK DUO SPLASH/STICK DUO HYPER

SHFS-S type (for ID Boring) Minimum Bore Diameter .087" (2.2mm)

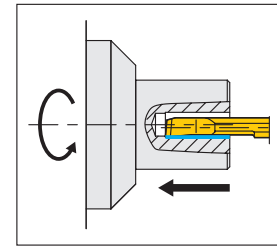
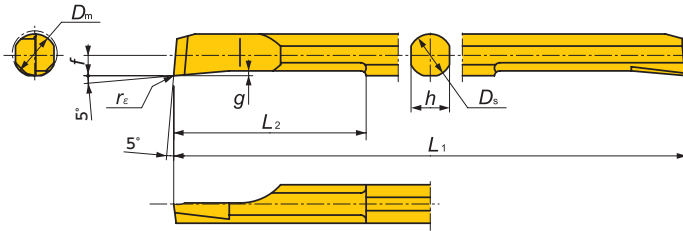
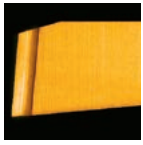

Item Number	D_s		Min Bore Dia. D_m		L_1	L_2	f	h	g	r_e		Chipbreaker	Coated Carbide TM4
	(Inch)	(mm)	(Inch)	(mm)						(Inch)	(mm)		
SHFS020R005S	.079	2	.087	2.2	50	10	0.9	1.8	0.25	.002	0.05	Type S	●
SHFS025R005S	.098	2.5	.106	2.7	50	12.5	1.15	2.3	0.30	.002	0.05	Type S	●
SHFS025R015S	.098	2.5	.106	2.7	50	12.5	1.15	2.3	0.30	.006	0.15	Type S	●
SHFS030R005S	.118	3	.126	3.2	50	15	1.4	2.7	0.40	.002	0.05	Type S	●
SHFS030R015S	.118	3	.126	3.2	50	15	1.4	2.7	0.40	.006	0.15	Type S	●
SHFS035R005S	.138	3.5	.146	3.7	60	17.5	1.65	3.2	0.40	.002	0.05	Type S	●
SHFS035R015S	.138	3.5	.146	3.7	60	17.5	1.65	3.2	0.40	.006	0.15	Type S	●
SHFS040R005S	.157	4	.165	4.2	60	20	1.9	3.6	0.45	.002	0.05	Type S	●
SHFS040R015S	.157	4	.165	4.2	60	20	1.9	3.6	0.45	.006	0.15	Type S	●
SHFS050R005S	.197	5	.205	5.2	70	25	2.4	4.5	0.50	.002	0.05	Type S	●
SHFS050R015S	.197	5	.205	5.2	70	25	2.4	4.5	0.50	.006	0.15	Type S	●

S.FS-S type

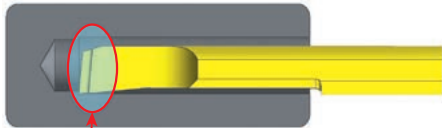

Chipbreaker for sharp cutting

S.FB-F type

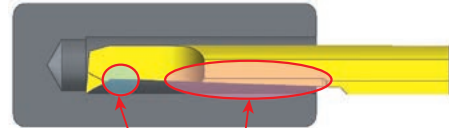

Back taper
Wide area of chip pocket

SHFB-F type (for ID Boring) Minimum Bore Diameter .087" (2.2mm)

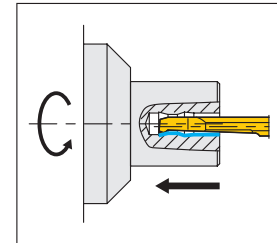
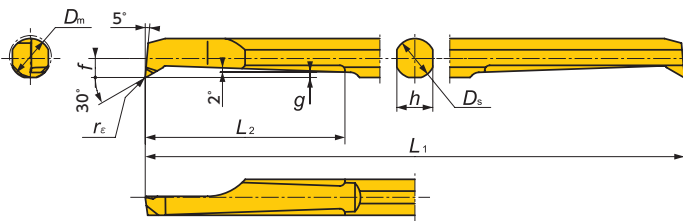

Evacuate chips backward

Item Number	D_s		Min Bore Dia. D_m		L_1	L_2	f	h	g	r_e		Chipbreaker	Coated Carbide TM4
	(Inch)	(mm)	(Inch)	(mm)						(Inch)	(mm)		
SHFB020R005F	.087	2	.087	2.2	50	8	0.95	1.8	0.25	.002	0.05	Type F	●
SHFB025R005F	.098	2.5	.106	2.7	50	12.5	1.2	2.3	0.30	.002	0.05	Type F	●
SHFB025R015F	.098	2.5	.106	2.7	50	12.5	1.2	2.3	0.30	.006	0.15	Type F	●
SHFB030R005F	.118	3	.126	3.2	50	15	1.4	2.7	0.45	.002	0.05	Type F	●
SHFB030R015F	.118	3	.126	3.2	50	15	1.4	2.7	0.45	.006	0.15	Type F	●
SHFB035R005F	.138	3.5	.146	3.7	60	17.5	1.65	3.2	0.50	.002	0.05	Type F	●
SHFB035R015F	.138	3.5	.146	3.7	60	17.5	1.65	3.2	0.50	.006	0.15	Type F	●
SHFB040R005F	.157	4	.165	4.2	60	20	1.9	3.6	0.50	.002	0.05	Type F	●
SHFB040R015F	.157	4	.165	4.2	60	20	1.9	3.6	0.50	.006	0.15	Type F	●
SHFB050R005F	.197	5	.205	5.2	70	25	2.4	4.5	0.70	.002	0.05	Type F	●
SHFB050R015F	.197	5	.205	5.2	70	25	2.4	4.5	0.70	.006	0.15	Type F	●

SHFS-H type (for ID Boring)

Minimum Bore Diameter .087" (2.2mm)

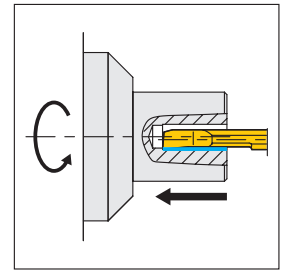
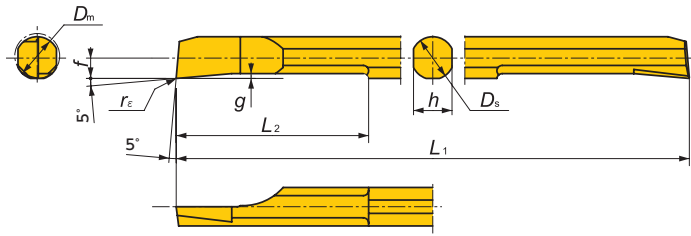

Mirror finish

Item Number	D_s		Min Bore Dia. D_m		L_1	L_2	f	h	g	r_e		Chipbreaker	Coated Carbide
	(Inch)	(mm)	(Inch)	(mm)						(Inch)	(mm)		TM4
SHFS020R005H M	.079	2	.087	2.2	50	10	0.9	1.8	0.25	.002	0.05	None	●
SHFS025R005H M	.098	2.5	.106	2.7	50	12.5	1.15	2.3	0.30	.002	0.05	None	●
SHFS025R015H M	.098	2.5	.106	2.7	50	12.5	1.15	2.3	0.30	.006	0.15	None	●
SHFS030R005H M	.118	3	.126	3.2	50	15	1.4	2.7	0.40	.002	0.05	None	●
SHFS030R015H M	.118	3	.126	3.2	50	15	1.4	2.7	0.40	.006	0.15	None	●
SHFS035R005H M	.138	3.5	.146	3.7	60	17.5	1.65	3.2	0.40	.002	0.05	None	●
SHFS035R015H M	.138	3.5	.146	3.7	60	17.5	1.65	3.2	0.40	.006	0.15	None	●
SHFS040R005H M	.157	4	.165	4.2	60	20	1.9	3.6	0.45	.002	0.05	None	●
SHFS040R015H M	.157	4	.165	4.2	60	20	1.9	3.6	0.45	.006	0.15	None	●
SHFS050R005H M	.197	5	.205	5.2	70	25	2.4	4.5	0.50	.002	0.05	None	●
SHFS050R015H M	.197	5	.205	5.2	70	25	2.4	4.5	0.50	.006	0.15	None	●

Tolerance of SHFS-S/SHFB-F/SHFS-H bars

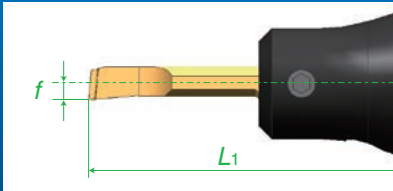

Offset f : $\pm .0006''$
Tool Length L_1 : $\pm .0008''$

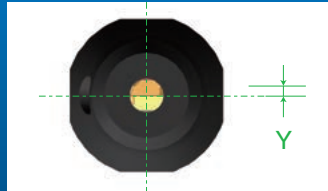

Centerline Y : $+ .002'' / - .000''$

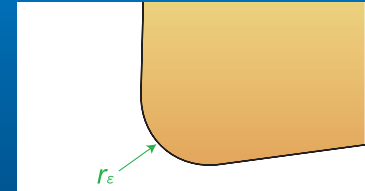

Corner r_e : $\pm .0006''$

Repeatability of (STICK DUO SPLASH / STICK DUO Hyper) with (SHFS / SHFB) bars

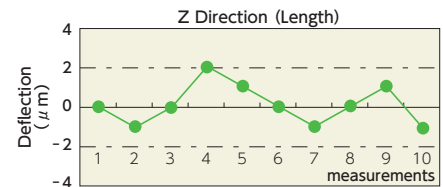
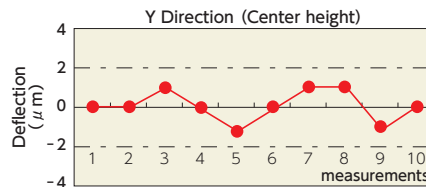
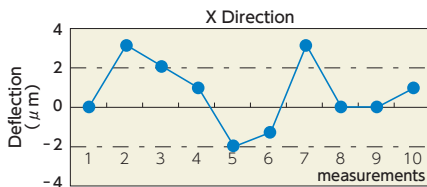

● : Stock

○ : 1-2 week delivery

M : Mirror finish

Sleeves ➡ V9 · 11

Cutting condition ➡ V4

STICK DUO - Sleeves for ID machining -

NBH

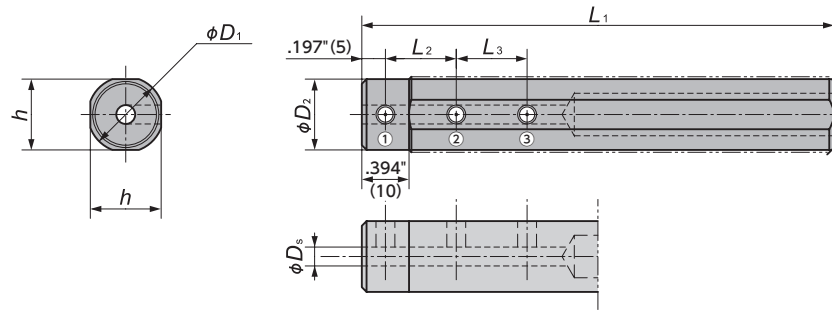

Item number	Stock	ϕD_s		ϕD_1		ϕD_2	h	L_1	L_2	L_3	Clamp screw			Wrench
		(Inch)	(mm)	(Inch)	(mm)						①	②	③	
NBH02015H	○	.079	2.0	5/8		15	15	100	10	—	SS0406F	SS0406F	—	LW-2
NBH02515H	○	.098	2.5	5/8		15	15	100	10	—	SS0406F	SS0406F	—	LW-2
NBH03015H	○	.118	3.0	5/8		15	15	100	10	10	SS0404F	SS0404F	SS0404F	LW-2
NBH03515H	○	.138	3.5	5/8		15	15	100	10	10	SS0404F	SS0404F	SS0404F	LW-2
NBH04015H	○	.157	4.0	5/8		15	15	100	15	15	SS0404F	SS0404F	SS0404F	LW-2
NBH04515H	○	.177	4.5	5/8		15	15	100	15	15	SS0404F	SS0404F	SS0404F	LW-2
NBH05015H	○	.197	5.0	5/8		15	15	100	15	15	SS0404F	SS0404F	SS0404F	LW-2
NBH06015H	○	.236	6.0	5/8		15	15	100	20	20	SS0404F	SS0404F	SS0404F	LW-2
NBH08015H	○	.315	8.0	5/8		15	15	100	20	20	SS0403F	SS0403F	SS0403F	LW-2
NBH02016H	○	.079	2.0	.630	16	15	15	100	10	—	SS0406F	SS0406F	—	LW-2
NBH02516H	○	.098	2.5	.630	16	15	15	100	10	—	SS0406F	SS0406F	—	LW-2
NBH03016H	○	.118	3.0	.630	16	15	15	100	10	10	SS0404F	SS0404F	SS0404F	LW-2
NBH03516H	○	.138	3.5	.630	16	15	15	100	10	10	SS0404F	SS0404F	SS0404F	LW-2
NBH04016H	○	.157	4.0	.630	16	15	15	100	15	15	SS0404F	SS0404F	SS0404F	LW-2
NBH04516H	○	.177	4.5	.630	16	15	15	100	15	15	SS0404F	SS0404F	SS0404F	LW-2
NBH05016H	○	.197	5.0	.630	16	15	15	100	15	15	SS0404F	SS0404F	SS0404F	LW-2
NBH06016H	○	.236	6.0	.630	16	15	15	100	20	20	SS0404F	SS0404F	SS0404F	LW-2
NBH07016H	○	.276	7.0	.630	16	15	15	100	20	20	SS0403F	SS0404F	SS0404F	LW-2
NBH08016H	○	.315	8.0	.630	16	15	15	100	20	20	SS0403F	SS0403F	SS0403F	LW-2
NBH02019K	○	.079	2.0	3/4		18	18	125	10	—	SS0408F	SS0408F	—	LW-2
NBH02519K	○	.098	2.5	3/4		18	18	125	10	—	SS0408F	SS0408F	—	LW-2
NBH03019K	○	.118	3.0	3/4		18	18	125	10	10	SS0406F	SS0406F	SS0406F	LW-2
NBH03519K	○	.138	3.5	3/4		18	18	125	10	10	SS0406F	SS0406F	SS0406F	LW-2
NBH04019K	○	.157	4.0	3/4		18	18	125	15	15	SS0406F	SS0406F	SS0406F	LW-2
NBH04519K	○	.177	4.5	3/4		18	18	125	15	15	SS0406F	SS0406F	SS0406F	LW-2
NBH05019K	○	.197	5.0	3/4		18	18	125	15	15	SS0406F	SS0406F	SS0406F	LW-2
NBH06019K	○	.236	6.0	3/4		18	18	125	20	20	SS0406F	SS0406F	SS0406F	LW-2
NBH07019K	○	.276	7.0	3/4		18	18	125	20	20	SS0404F	SS0404F	SS0404F	LW-2
NBH08019K	○	.315	8.0	3/4		18	18	125	20	20	SS0404F	SS0404F	SS0404F	LW-2
NBH10019K	○	.394	10.0	3/4		18	18	125	20	20	SS0403F	SS0404F	SS0404F	LW-2

NBH

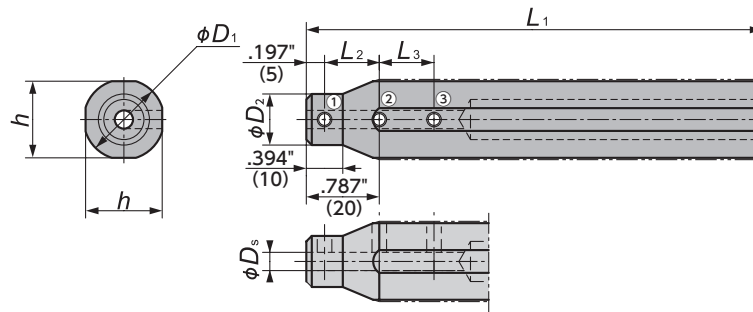

Item number	Stock	ϕD_s		ϕD_1		ϕD_2	h_1	L_1	L_2	L_3	Clamp screw			Wrench
		(Inch)	(mm)	(Inch)	(mm)						①	②	③	
NBH02020K	○	.079	2.0	.787	20	11	19	125	10	—	SS0404F	SS0404F	—	LW-2
NBH02520K	○	.098	2.5	.787	20	11	19	125	10	—	SS0404F	SS0404F	—	LW-2
NBH03020K	○	.118	3.0	.787	20	12	19	125	10	10	SS0404F	SS0404F	SS0406F	LW-2
NBH03520K	○	.138	3.5	.787	20	12	19	125	10	10	SS0404F	SS0404F	SS0406F	LW-2
NBH04020K	○	.157	4.0	.787	20	13	19	125	15	15	SS0404F	SS0406F	SS0406F	LW-2
NBH04520K	○	.177	4.5	.787	20	13	19	125	15	15	SS0404F	SS0406F	SS0406F	LW-2
NBH05020K	○	.197	5.0	.787	20	14	19	125	15	15	SS0404F	SS0406F	SS0406F	LW-2
NBH06020K	○	.236	6.0	.787	20	15	19	125	20	20	SS0404F	SS0406F	SS0406F	LW-2
NBH07020K	○	.276	7.0	.787	20	16	19	125	20	20	SS0404F	SS0406F	SS0406F	LW-2
NBH08020K	○	.315	8.0	.787	20	17	19	125	20	20	SS0404F	SS0404F	SS0404F	LW-2
NBH10020K	○	.394	10.0	.787	20	19	19	125	20	20	SS0404F	SS0404F	SS0404F	LW-2
NBH02022K	○	.079	2.0	.866	22	11	21	125	10	—	SS0404F	SS0406F	—	LW-2
NBH02522K	○	.098	2.5	.866	22	11	21	125	10	—	SS0404F	SS0406F	—	LW-2
NBH03022K	○	.118	3.0	.866	22	12	21	125	10	10	SS0404F	SS0406F	SS0408F	LW-2
NBH03522K	○	.138	3.5	.866	22	12	21	125	10	10	SS0404F	SS0406F	SS0406F	LW-2
NBH04022K	○	.157	4.0	.866	22	13	21	125	15	15	SS0404F	SS0406F	SS0406F	LW-2
NBH04522K	○	.177	4.5	.866	22	13	21	125	15	15	SS0404F	SS0406F	SS0406F	LW-2
NBH05022K	○	.197	5.0	.866	22	14	21	125	15	15	SS0404F	SS0406F	SS0406F	LW-2
NBH06022K	○	.236	6.0	.866	22	15	21	125	20	20	SS0404F	SS0406F	SS0406F	LW-2
NBH07022K	○	.276	7.0	.866	22	16	21	125	20	20	SS0404F	SS0406F	SS0406F	LW-2
NBH08022K	○	.315	8.0	.866	22	17	21	125	20	20	SS0404F	SS0406F	SS0406F	LW-2
NBH10022K	○	.394	10.0	.866	22	19	21	125	20	20	SS0404F	SS0404F	SS0404F	LW-2
NBH12022K	○	.472	12.0	.866	22	21	21	125	25	25	SS0404F	SS0404F	SS0404F	LW-2
NBH02023K	○	.079	2.0	.906	23	11	21	125	10	—	SS0404F	SS0406F	—	LW-2
NBH02523K	○	.098	2.5	.906	23	11	21	125	10	—	SS0404F	SS0406F	—	LW-2
NBH03023K	○	.118	3.0	.906	23	12	21	125	10	10	SS0404F	SS0406F	SS0408F	LW-2
NBH03523K	○	.138	3.5	.906	23	12	21	125	10	10	SS0404F	SS0406F	SS0406F	LW-2
NBH04023K	○	.157	4.0	.906	23	13	21	125	15	15	SS0404F	SS0406F	SS0406F	LW-2
NBH04523K	○	.177	4.5	.906	23	13	21	125	15	15	SS0404F	SS0406F	SS0406F	LW-2
NBH05023K	○	.197	5.0	.906	23	14	21	125	15	15	SS0404F	SS0406F	SS0406F	LW-2
NBH06023K	○	.236	6.0	.906	23	15	21	125	20	20	SS0404F	SS0406F	SS0406F	LW-2
NBH08023K	○	.315	8.0	.906	23	17	21	125	20	20	SS0404F	SS0406F	SS0406F	LW-2
NBH10023K	○	.394	10.0	.906	23	19	21	125	20	20	SS0404F	SS0404F	SS0404F	LW-2
NBH12023K	○	.472	12.0	.906	23	21	21	125	25	25	SS0404F	SS0404F	SS0404F	LW-2
NBH02025K-MET	○	.079	2.0	.984	25	11	24	125	10	—	SS0404F	SS0406F	—	LW-2
NBH02525K-MET	○	.098	2.5	.984	25	11	24	125	10	—	SS0404F	SS0406F	—	LW-2
NBH03025K-MET	○	.118	3.0	.984	25	12	24	125	10	10	SS0404F	SS0406F	SS0408F	LW-2
NBH03525K-MET	○	.138	3.5	.984	25	12	24	125	10	10	SS0404F	SS0406F	SS0408F	LW-2
NBH04025K-MET	○	.157	4.0	.984	25	13	24	125	15	15	SS0404F	SS0408F	SS0408F	LW-2
NBH04525K-MET	○	.177	4.5	.984	25	13	24	125	15	15	SS0404F	SS0408F	SS0408F	LW-2
NBH05025K-MET	○	.197	5.0	.984	25	14	24	125	15	15	SS0404F	SS0408F	SS0408F	LW-2
NBH06025K-MET	○	.236	6.0	.984	25	15	24	125	20	20	SS0404F	SS0408F	SS0408F	LW-2
NBH07025K-MET	○	.276	7.0	.984	25	16	24	125	20	20	SS0404F	SS0408F	SS0408F	LW-2
NBH08025K-MET	○	.315	8.0	.984	25	17	24	125	20	20	SS0404F	SS0406F	SS0406F	LW-2
NBH10025K-MET	○	.394	10.0	.984	25	19	24	125	20	20	SS0404F	SS0406F	SS0406F	LW-2
NBH12025K-MET	○	.472	12.0	.984	25	21	24	125	25	25	SS0404F	SS0404F	SS0404F	LW-2
NBH02025K	○	.079	2.0	1	25.4	11	24	125	10	—	SS0404F	SS0406F	—	LW-2
NBH02525K	○	.098	2.5	1	25.4	11	24	125	10	—	SS0404F	SS0406F	—	LW-2
NBH03025K	○	.118	3.0	1	25.4	12	24	125	10	10	SS0404F	SS0406F	SS0408F	LW-2
NBH03525K	○	.138	3.5	1	25.4	12	24	125	10	10	SS0404F	SS0406F	SS0408F	LW-2
NBH04025K	○	.157	4.0	1	25.4	13	24	125	15	15	SS0404F	SS0408F	SS0408F	LW-2
NBH04525K	○	.177	4.5	1	25.4	13	24	125	15	15	SS0404F	SS0408F	SS0408F	LW-2
NBH05025K	○	.197	5.0	1	25.4	14	24	125	15	15	SS0404F	SS0408F	SS0408F	LW-2
NBH06025K	○	.236	6.0	1	25.4	15	24	125	20	20	SS0404F	SS0408F	SS0408F	LW-2
NBH07025K	○	.276	7.0	1	25.4	16	24	125	20	20	SS0404F	SS0408F	SS0408F	LW-2
NBH08025K	○	.315	8.0	1	25.4	17	24	125	20	20	SS0404F	SS0406F	SS0406F	LW-2
NBH10025K	○	.394	10.0	1	25.4	19	24	125	20	20	SS0404F	SS0406F	SS0406F	LW-2
NBH12025K	○	.472	12.0	1	25.4	21	24	125	25	25	SS0404F	SS0404F	SS0404F	LW-2

○ : 1-2 week delivery

Insert bars **V16**

SBFS-S type (for ID Boring) Minimum Bore Diameter .087" (2.2mm)

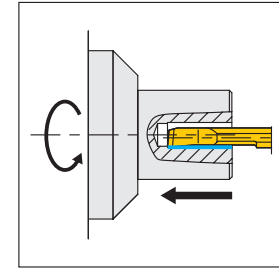
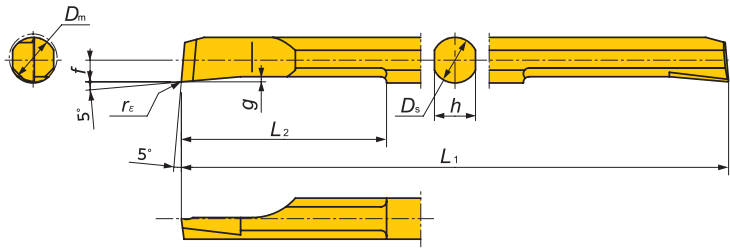
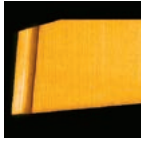

Item Number	Ds		Min Bore Dia. Dm		L1	L2	f	h	g	rε		Chipbreaker	Coated Carbide	
	(Inch)	(mm)	(Inch)	(mm)						(Inch)	(mm)		DT4	ZM3
SBFS020R005S	.079	2	.087	2.2	50	10	0.9	1.8	0.25	.002	0.05	Type S	○	○
SBFS025R005S	.098	2.5	.106	2.7	50	12.5	1.15	2.3	0.30	.002	0.05	Type S	○	○
SBFS025R015S	.098	2.5	.106	2.7	50	12.5	1.15	2.3	0.30	.006	0.15	Type S	○	○
SBFS030R005S	.118	3	.126	3.2	50	15	1.4	2.7	0.40	.002	0.05	Type S	○	○
SBFS030R015S	.118	3	.126	3.2	50	15	1.4	2.7	0.40	.006	0.15	Type S	○	○
SBFS035R005S	.138	3.5	.146	3.7	60	17.5	1.65	3.2	0.40	.002	0.05	Type S	○	○
SBFS035R015S	.138	3.5	.146	3.7	60	17.5	1.65	3.2	0.40	.006	0.15	Type S	○	○
SBFS040R005S	.157	4	.165	4.2	60	20	1.9	3.6	0.45	.002	0.05	Type S	○	○
SBFS040R015S	.157	4	.165	4.2	60	20	1.9	3.6	0.45	.006	0.15	Type S	○	○
SBFS050R005S	.197	5	.205	5.2	70	25	2.4	4.5	0.50	.002	0.05	Type S	○	○
SBFS050R015S	.197	5	.205	5.2	70	25	2.4	4.5	0.50	.006	0.15	Type S	○	○
SBFS060R005S	.236	6	.244	6.2	80	30	2.9	5.4	0.60	.002	0.05	Type S	○	○
SBFS060R015S	.236	6	.244	6.2	80	30	2.9	5.4	0.60	.006	0.15	Type S	○	○

SBFB-F type (for ID Boring) Minimum Bore Diameter .087" (2.2mm)

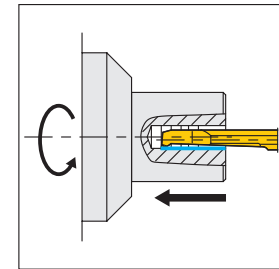
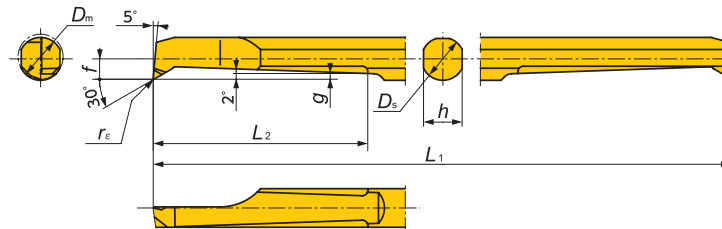
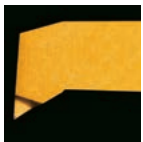

Evacuate chips backward

Item Number	Ds		Min Bore Dia. Dm		L1	L2	f	h	g	rε		Chipbreaker	Coated Carbide	
	(Inch)	(mm)	(Inch)	(mm)						(Inch)	(mm)		DT4	ZM3
SBFB020R005F	.087	2	.087	2.2	50	8	0.95	1.8	0.25	.002	0.05	Type F	○	○
SBFB025R005F	.098	2.5	.106	2.7	50	12.5	1.2	2.3	0.30	.002	0.05	Type F	○	○
SBFB025R015F	.098	2.5	.106	2.7	50	12.5	1.2	2.3	0.30	.006	0.15	Type F	○	○
SBFB030R005F	.118	3	.126	3.2	50	15	1.4	2.7	0.45	.002	0.05	Type F	○	○
SBFB030R015F	.118	3	.126	3.2	50	15	1.4	2.7	0.45	.006	0.15	Type F	○	○
SBFB035R005F	.138	3.5	.146	3.7	60	17.5	1.65	3.2	0.50	.002	0.05	Type F	○	○
SBFB035R015F	.138	3.5	.146	3.7	60	17.5	1.65	3.2	0.50	.006	0.15	Type F	○	○
SBFB040R005F	.157	4	.165	4.2	60	20	1.9	3.6	0.50	.002	0.05	Type F	○	○
SBFB040R015F	.157	4	.165	4.2	60	20	1.9	3.6	0.50	.006	0.15	Type F	○	○
SBFB050R005F	.197	5	.205	5.2	70	25	2.4	4.5	0.70	.002	0.05	Type F	○	○
SBFB050R015F	.197	5	.205	5.2	70	25	2.4	4.5	0.70	.006	0.15	Type F	○	○
SBFB060R005F	.236	6	.244	6.2	80	30	2.9	5.4	0.90	.002	0.05	Type F	○	○
SBFB060R015F	.236	6	.244	6.2	80	30	2.9	5.4	0.90	.006	0.15	Type F	○	○

SBFS-H type (for ID Boring) Minimum Bore Diameter .087" (2.2mm)

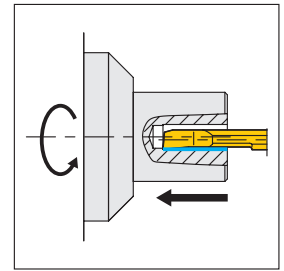
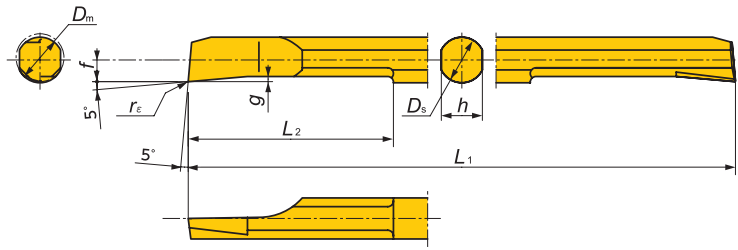

Mirror finish

Item Number	D _s		Min Bore Dia. D _m		L ₁	L ₂	f	h	g	r _e		Chipbreaker	Coated Carbide	
	(Inch)	(mm)	(Inch)	(mm)						(Inch)	(mm)		DT4	ZM3
SBFS020R005H M	.079	2	.087	2.2	50	10	0.9	1.8	0.25	.002	0.05	None		○
SBFS025R005H M	.098	2.5	.106	2.7	50	12.5	1.15	2.3	0.30	.002	0.05	None		○
SBFS025R015H M	.098	2.5	.106	2.7	50	12.5	1.15	2.3	0.30	.006	0.15	None		○
SBFS030R005H M	.118	3	.126	3.2	50	15	1.4	2.7	0.40	.002	0.05	None		○
SBFS030R015H M	.118	3	.126	3.2	50	15	1.4	2.7	0.40	.006	0.15	None		○
SBFS035R005H M	.138	3.5	.146	3.7	60	17.5	1.65	3.2	0.40	.002	0.05	None		○
SBFS035R015H M	.138	3.5	.146	3.7	60	17.5	1.65	3.2	0.40	.006	0.15	None		○
SBFS040R005H M	.157	4	.165	4.2	60	20	1.9	3.6	0.45	.002	0.05	None		○
SBFS040R015H M	.157	4	.165	4.2	60	20	1.9	3.6	0.45	.006	0.15	None		○
SBFS050R005H M	.197	5	.205	5.2	70	25	2.4	4.5	0.50	.002	0.05	None		○
SBFS050R015H M	.197	5	.205	5.2	70	25	2.4	4.5	0.50	.006	0.15	None		○
SBFS060R005H M	.236	6	.244	6.2	80	30	2.9	5.4	0.60	.002	0.05	None		○
SBFS060R015H M	.236	6	.244	6.2	80	30	2.9	5.4	0.60	.006	0.15	None		○
SBFS080R005H M	.315	8	.323	8.2	80	30	3.9	7.3	0.80	.002	0.05	None		○
SBFS080R015H M	.315	8	.323	8.2	80	30	3.9	7.3	0.80	.006	0.15	None		○

SBB Series ID Back turning

SBB-S type (for ID Back turning)

Minimum Bore Diameter .118" (3.0mm)

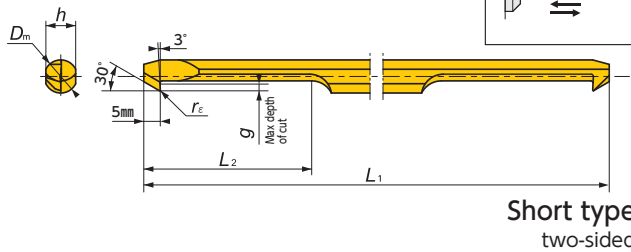

SBB type (for ID Back turning)

Minimum Bore Diameter .118" (3.0mm)

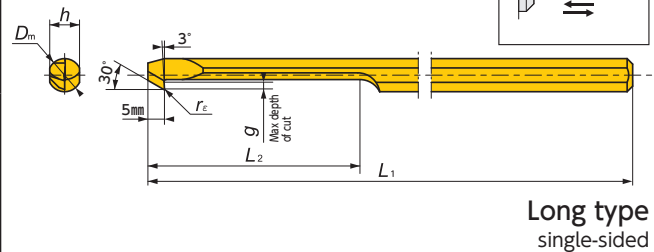

	Item Number	D _s		Min Bore Dia. D _m		L ₁	L ₂	f	h	g	r _e		Chipbreaker	No. of edge	Coated Carbide
		(Inch)	(mm)	(Inch)	(mm)						(Inch)	(mm)			ZM3
Short Type	SBB030RB005-S	.118	3	.118	3	50	15	1.3	2.7	0.5	.002	0.05	Yes	2	○
	SBB030RB010-S	.118	3	.118	3	50	15	1.3	2.7	0.5	.004	0.1	Yes	2	○
	SBB040RB005-S	.157	4	.157	4	60	18	1.8	3.6	0.8	.002	0.05	Yes	2	○
	SBB040RB015-S	.157	4	.157	4	60	18	1.8	3.6	0.8	.006	0.15	Yes	2	○
Long Type	SBB030RB005	.118	3	.118	3	50	19	1.3	2.7	0.5	.002	0.05	Yes	1	○
	SBB030RB010	.118	3	.118	3	50	19	1.3	2.7	0.5	.004	0.1	Yes	1	○
	SBB040RB005	.157	4	.157	4	60	24	1.8	3.6	0.8	.002	0.05	Yes	1	○
	SBB040RB015	.157	4	.157	4	60	24	1.8	3.6	0.8	.006	0.15	Yes	1	○

○ : 1-2 week delivery

M : Mirror finish

Sleeves → V9 · 11 · 14

Cutting condition → V4

SBG / SFG Series

ID Grooving

SBG (for ID Grooving)

Minimum Bore Diameter .118" (3.0mm)

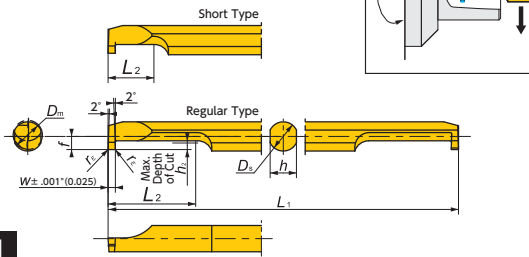

Figure-1

SFG (for ID Face Grooving)

Minimum Bore Diameter .236" (6.0mm)

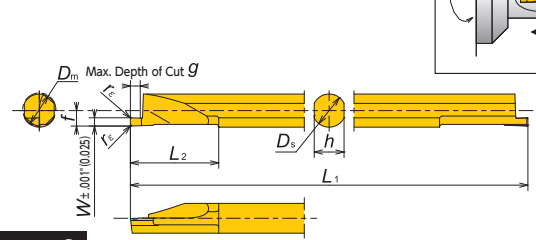

Figure-2

SBG

Item Number	Groove width <i>W</i>		Min Bore Dia. <i>D_m</i>		<i>D_s</i>		<i>L₁</i>	<i>L₂</i>	<i>f</i>	<i>h</i>	<i>h₂</i>	<i>r_ε</i>		Chip-breaker	Coated Carbide
	(Inch)	(mm)	(Inch)	(mm)	(Inch)	(mm)						(Inch)	(mm)		ZM3
SBG030050RB	.020	0.50	.118	3	.118	3	50	9	1.3	2.7	0.8	.002	0.05	Yes	●
SBG030075RB	.030	0.75	.118	3	.118	3	50	9	1.3	2.7	0.8	.002	0.05	Yes	●
SBG030100RB	.039	1.00	.118	3	.118	3	50	9	1.3	2.7	0.8	.002	0.05	Yes	●
SBG040050RB	.020	0.50	.157	4	.157	4	60	12	1.8	3.6	1.0	.002	0.05	Yes	●
SBG040075RB	.030	0.75	.157	4	.157	4	60	12	1.8	3.6	1.0	.002	0.05	Yes	●
SBG040100RB	.039	1.00	.157	4	.157	4	60	12	1.8	3.6	1.0	.002	0.05	Yes	●
SBG050050RB	.020	0.50	.197	5	.197	5	70	20	2.3	4.5	1.2	.002	0.05	Yes	●
SBG050100RB	.039	1.00	.197	5	.197	5	70	20	2.3	4.5	1.2	.002	0.05	Yes	●
SBG050150RB	.059	1.50	.197	5	.197	5	70	20	2.3	4.5	1.2	.002	0.05	Yes	●
SBG060100RB	.039	1.00	.236	6	.236	6	80	20	2.8	5.4	1.8	.002	0.05	Yes	●
SBG060150RB	.059	1.50	.236	6	.236	6	80	20	2.8	5.4	1.8	.002	0.05	Yes	●
SBG060200RB	.079	2.00	.236	6	.236	6	80	20	2.8	5.4	1.8	.002	0.05	Yes	●
SBG080100RB	.039	1.00	.315	8	.315	8	80	20	3.8	7.3	2.2	.002	0.05	Yes	●
SBG080150RB	.059	1.50	.315	8	.315	8	80	20	3.8	7.3	2.2	.002	0.05	Yes	●
SBG080200RB	.079	2.00	.315	8	.315	8	80	20	3.8	7.3	2.2	.002	0.05	Yes	●
SBG030050RB-S	.020	0.50	.118	3	.118	3	50	4.5	1.3	2.7	0.8	.002	0.05	Yes	○
SBG030075RB-S	.030	0.75	.118	3	.118	3	50	4.5	1.3	2.7	0.8	.002	0.05	Yes	○
SBG030100RB-S	.039	1.00	.118	3	.118	3	50	4.5	1.3	2.7	0.8	.002	0.05	Yes	○
SBG030150RB-S	.059	1.50	.118	3	.118	3	50	4.5	1.3	2.7	0.8	.002	0.05	Yes	○
SBG040050RB-S	.020	0.50	.157	4	.157	4	60	6	1.8	3.6	1.0	.002	0.05	Yes	○
SBG040075RB-S	.030	0.75	.157	4	.157	4	60	6	1.8	3.6	1.0	.002	0.05	Yes	○
SBG040100RB-S	.039	1.00	.157	4	.157	4	60	6	1.8	3.6	1.0	.002	0.05	Yes	○
SBG040150RB-S	.059	1.50	.157	4	.157	4	60	6	1.8	3.6	1.0	.002	0.05	Yes	○
SBG050050RB-S	.020	0.50	.197	5	.197	5	70	7.5	2.3	4.5	1.2	.002	0.05	Yes	○
SBG050100RB-S	.039	1.00	.197	5	.197	5	70	7.5	2.3	4.5	1.2	.002	0.05	Yes	○
SBG050150RB-S	.059	1.50	.197	5	.197	5	70	7.5	2.3	4.5	1.2	.002	0.05	Yes	○
SBG050200RB-S	.079	2.00	.197	5	.197	5	70	7.5	2.3	4.5	1.2	.002	0.05	Yes	○
SBG060100RB-S	.039	1.00	.236	6	.236	6	80	7.5	2.8	5.4	1.8	.002	0.05	Yes	○
SBG060150RB-S	.059	1.50	.236	6	.236	6	80	7.5	2.8	5.4	1.8	.002	0.05	Yes	○
SBG060200RB-S	.079	2.00	.236	6	.236	6	80	7.5	2.8	5.4	1.8	.002	0.05	Yes	○
SBG080100RB-S	.039	1.00	.315	8	.315	8	80	8.5	3.8	7.3	2.2	.002	0.05	Yes	○
SBG080150RB-S	.059	1.50	.315	8	.315	8	80	8.5	3.8	7.3	2.2	.002	0.05	Yes	○
SBG080200RB-S	.079	2.00	.315	8	.315	8	80	8.5	3.8	7.3	2.2	.002	0.05	Yes	○

SFG

Item Number	Groove width <i>W</i>		Min Bore Dia. <i>D_m</i>		<i>D_s</i>		<i>L₁</i>	<i>L₂</i>	<i>f</i>	<i>h</i>	<i>g</i>	<i>r_ε</i>		Chip-breaker	Coated Carbide
	(Inch)	(mm)	(Inch)	(mm)	(Inch)	(mm)						(Inch)	(mm)		TM4
SFG060R100B	.039	1.00	.236	6	.236	6	80	16.0	2.8	5.4	1.5	.002	0.05	Yes	○
SFG060R150B	.059	1.50	.236	6	.236	6	80	16.0	2.8	5.4	2.5	.002	0.05	Yes	○
SFG060R200B	.079	2.00	.236	6	.236	6	80	16.0	2.8	5.4	3.0	.002	0.05	Yes	○
SFG080R100B	.039	1.00	.315	8	.315	8	80	16.0	3.8	7.3	1.5	.002	0.05	Yes	○
SFG080R150B	.059	1.50	.315	8	.315	8	80	16.0	3.8	7.3	2.5	.002	0.05	Yes	○
SFG080R200B	.079	2.00	.315	8	.315	8	80	16.0	3.8	7.3	3.0	.002	0.05	Yes	○
SFG080R300B	.118	3.00	.315	8	.315	8	80	16.0	3.8	7.3	3.0	.002	0.05	Yes	○

BG Series - Toolholders

S-BG (Takes Left-Hand Insert)

Minimum Bore Diameter .394"(10.0mm)

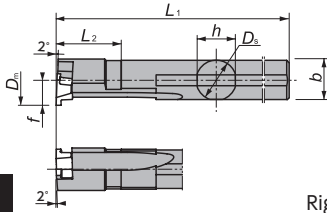

Figure-1

Right-Hand style shown

BG (Takes Left-Hand Insert)

Minimum Bore Diameter .394"(10.0mm)

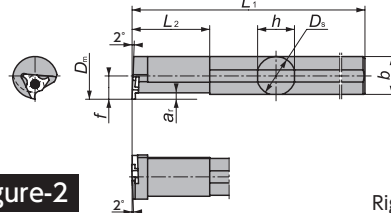

Figure-2

Right-Hand style shown

S08H-BG / S10K-BG / BG

Gage Insert	Item Number	Figure	Stock		Min. Bore Dia. D_m	Max. Depth Of Cut. a_r	D_s	h	b	L_1	f	L_2	Groove width covered w		Clamp Screw	Wrench
			R	L									(Inch)	(mm)		
GTG10	S08H-BG $\frac{1}{2}$ 10D10	1	○	○	.394 10	.039 1.0	.315 8	.303 7.7	.309 7.85	4.724 120	.197 5.0	.787 20	.020-079	0.50-2.00	LR-S-25 x 6.8	CLR-15S
	S10K-BG $\frac{1}{2}$ 10D12	1	○	○	.472 12	.039 1.0	.394 10	.378 9.6	.386 9.8	4.724 120	.236 6.0	.984 25	.020-079	0.50-2.00	LR-S-25 x 6.8	CLR-15S
GTG10	BG $\frac{1}{2}$ 08-00S	2	○	○	.394 10	.039 1.0	.315 8	.276 7.0	.295 7.5	4.921 125	.197 5.0	.787 20	.020-079	0.50-2.00	LR-S-25 x 6.8	CLR-15S
	BG $\frac{1}{2}$ 08-10S	2	○	○	.394 10	.039 1.0	.315 8	.276 7.0	.295 7.5	4.921 125	.197 5.0	.787 20	.039-079	1.00-2.00	LR-S-25 x 6.8	CLR-15S
	BG $\frac{1}{2}$ 10-00S	2	○	○	.472 12	.079 2.0	.394 10	.354 9.0	.374 9.5	5.906 150	.236 6.0	.984 25	.020-079	0.50-2.00	LR-S-25 x 6.8	CLR-15S
	BG $\frac{1}{2}$ 10-10S	2	○	○	.472 12	.079 2.0	.394 10	.354 9.0	.374 9.5	5.906 150	.236 6.0	.984 25	.039-079	1.00-2.00	LR-S-25 x 6.8	CLR-15S
GTG14	BG $\frac{1}{2}$ 12-00S	2	○	○	.551 14	.079 2.0	.472 12	.433 11.0	.453 11.5	7.087 180	.276 7.0	1.181 30	.039-079	1.00-2.00	LR-S-3 x 7.8	RRL-20S
	BG $\frac{1}{2}$ 12-12S	2	○	○	.551 14	.079 2.0	.472 12	.433 11.0	.453 11.5	7.087 180	.276 7.0	1.181 30	.057-079	1.45-2.00	LR-S-3 x 7.8	RRL-20S
	BG $\frac{1}{2}$ 14-00S	2	○	○	.630 16	.118 3.0	.551 14	.512 13.0	.531 13.5	7.087 180	.315 8.0	1.378 35	.039-079	1.00-2.00	LR-S-3 x 7.8	RRL-20S
	BG $\frac{1}{2}$ 14-12S	2	○	○	.630 16	.118 3.0	.551 14	.512 13.0	.531 13.5	7.087 180	.315 8.0	1.378 35	.057-079	1.45-2.00	LR-S-3 x 7.8	RRL-20S
GTG20	BG $\frac{1}{2}$ 16	2	○	○	.787 20	.118 3.0	.630 16	.591 15.0	.610 15.5	7.874 200	.394 10.0	1.575 40	.059-079	1.50-2.00	LR-S-3 x 7.8	RRL-20S
	BG $\frac{1}{2}$ 20	2	○	○	.984 25	.118 3.0	.787 20	.748 19.0	.768 19.5	7.874 200	.472 12.0	1.575 40	.059-079	1.50-2.00	LR-S-3 x 7.8	RRL-20S

BG Series - Inserts

GTG

Shape	Item Number	Groove width w		Max. Depth Of Cut. a_r		L		r_ϵ		d		Coated Carbide			Coated Cermet	
		(Inch)	(mm)	(Inch)	(mm)	(Inch)	(mm)	(Inch)	(mm)	(Inch)	(mm)	QM3	TM4	ZM3	C7X	
<p>Left-Hand style shown</p>	GTG10050FL005	0.020	0.50	.039	1.0	.047	1.2	.002	0.05	.219	5.56		○			
	GTG10075FL005	0.030	0.75	.039	1.0	.047	1.2	.002	0.05	.219	5.56		○			
	GTG10100FL005	0.039	1.00	.039	1.0	.047	1.2	.002	0.05	.219	5.56		○			
	GTG10150FL005	0.059	1.50	.039	1.0	.047	1.2	.002	0.05	.219	5.56		○			
	GTG10200FL005	0.079	2.00	.039	1.0	.047	1.2	.002	0.05	.219	5.56		○			
	GTG10050FL00	0.020	0.50	.039	1.0	.047	1.2	.002	0.05	.219	5.56			○		
	GTG10065FL00	0.026	0.65	.039	1.0	.047	1.2	.002	0.05	.219	5.56			○		
	GTG10075FL00	0.030	0.75	.039	1.0	.047	1.2	.002	0.05	.219	5.56			○		
	GTG10100FL00	0.039	1.00	.039	1.0	.047	1.2	.002	0.05	.219	5.56			○		
	GTG10125L	0.049	1.25	.039	1.0	.047	1.2	.008	0.2	.219	5.56				○	
	GTG10150FL00	0.059	1.50	.039	1.0	.047	1.2	.002	0.05	.219	5.56			○		
	GTG10200FL01	0.079	2.00	.039	1.0	.047	1.2	.004	0.1	.219	5.56			○		
	GTG14100FL00	0.039	1.00	.079	2.0	.087	2.2	.002	0.05	.313	7.94			○		
	GTG14145L	0.057	1.45	.079	2.0	.087	2.2	.008	0.2	.313	7.94				○	
	GTG14150FL00	0.059	1.50	.079	2.0	.087	2.2	.002	0.05	.313	7.94			○		
	GTG14175L	0.069	1.75	.079	2.0	.087	2.2	.008	0.2	.313	7.94				○	
	GTG14200FL01	0.079	2.00	.079	2.0	.087	2.2	.004	0.1	.313	7.94			○		
	GTG20150FL	0.059	1.50	.118	3.0	.126	3.2	.008	0.2	.375	9.525	○				○
	GTG20175L	0.069	1.75	.118	3.0	.126	3.2	.008	0.2	.375	9.525					○
	GTG20200L	0.079	2.00	.118	3.0	.126	3.2	.008	0.2	.375	9.525					○
GTG20200FL	0.079	2.00	.118	3.0	.126	3.2	.008	0.2	.375	9.525	○					

● : Stock

○ : 1-2 week delivery

Cutting condition V5

SBT Series

ID Threading

SBT Minimum Bore Diameter .098" (2.5mm) ~

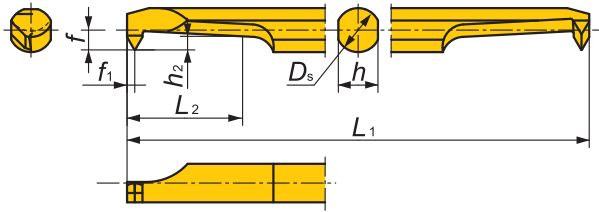

Figure-1

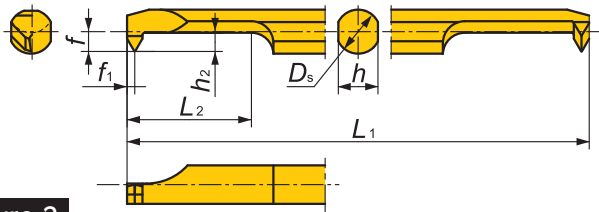
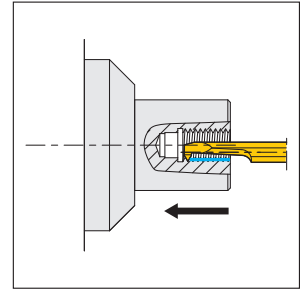
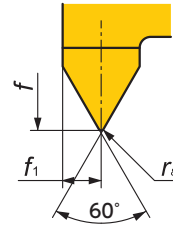

Figure-2



Right-Hand style shown

SBT Insert dimension

Item Number	Figure	Chip-breaker	Min. Bore Dia. D_m		D_s		L_2		h_2		L_1		f		f_1		h		r_e		Coated Carbide ZM3
			(Inch)	(mm)	(Inch)	(mm)	(Inch)	(mm)	(Inch)	(mm)	(Inch)	(mm)	(Inch)	(mm)	(Inch)	(mm)	(Inch)	(mm)	(Inch)	(mm)	
SBT025M3R	1	No	.098	2.5	.098	2.5	.213	5.4	.024	0.6	1.969	50	.043	1.10	.016	0.40	.091	2.3	.002 MAX Flat	0.05 MAX Flat	●
SBT030M4R	1	No	.118	3.0	.118	3.0	.295	7.5	.031	0.8	1.969	50	.051	1.30	.020	0.50	.028	2.7	.002 MAX Flat	0.05 MAX Flat	●
SBT030M4RB	1	Yes	.118	3.0	.118	3.0	.295	7.5	.031	0.8	1.969	50	.051	1.30	.020	0.50	.028	2.7	.002 MAX Flat	0.05 MAX Flat	●
SBT035M5RB	1	Yes	.138	3.5	.138	3.5	.335	8.5	.039	1.0	2.362	60	.061	1.55	.022	0.55	.013	3.2	.002 MAX Flat	0.05 MAX Flat	●
SBT040M6RB	1	Yes	.157	4.0	.157	4.0	.413	10.5	.047	1.2	2.362	60	.071	1.80	.028	0.70	.142	3.6	R.002	R0.05	●
SBT050M8RB	2	Yes	.197	5.0	.197	5.0	.622	15.8	.059	1.5	2.756	70	.091	2.30	.031	0.80	.117	4.5	R.002	R0.05	●
SBT060M10RB	2	Yes	.236	6.0	.236	6.0	.724	18.4	.071	1.8	3.150	80	.110	2.80	.037	0.95	.213	5.4	R.002	R0.05	●

SBT Applicable Thread

Item Number	Figure	Chip-breaker	Min. Bore Dia. D_m		Thread Type				Recommended Thread Type	
			(Inch)	(mm)	Metric Thread		UNF Thread		Metric Thread	UNF Thread
SBT025M3R	1	No	.098	2.5	M3	0.5	—	—	M3 × 0.5	—
SBT030M4R	1	No	.118	3.0	M4-	0.5-0.8	No.8-32UNC-	36-32	M4 × 0.7	No.8-32UNC
SBT030M4RB	1	Yes	.118	3.0	M4-	0.5-0.8	No.8-32UNC-	36-32	M4 × 0.7	No.8-32UNC
SBT035M5RB	1	Yes	.138	3.5	M4.5-	0.5-1.0	No.10-24UNC-	32-24	M5 × 0.8	No.10-24UNC No.12-24UNC
SBT040M6RB	1	Yes	.157	4.0	M5.5-	0.75-1.25	No.12-24UNC-	28-20	M6 × 1.0	1/4-20UNC
SBT050M8RB	2	Yes	.197	5.0	M7-	0.75-1.5	1/4-28UNF-	28-18	M8 × 1.25	5/16-18UNC
SBT060M10RB	2	Yes	.236	6.0	M8-	0.75-1.75	5/16-24UNF-	28-16	M10 × 1.5	3/8-16UNC

● : Stock

○ : 1-2 week delivery

Sleeves → V9 · 11 · 14

Unified Standard

	Thread Type		Pilot hole(mm)	Pitch		Applicable Inserts
	#1	#2		TPI	(mm)	
Coarse	No.8-32UNC	—	φ3.42	32	0.7938	SBT030M4R(B)
	No.10-24UNC	—	φ3.83	24	1.0583	SBT035M5RB
	—	No.12-24UNC	φ4.47	24	1.0583	
	1/4-20UNC	—	φ5.12	20	1.2700	SBT040M6RB
	5/16-18UNC	—	φ6.57	18	1.4111	SBT050M8RB
Fine	3/8-16UNC	—	φ7.98	16	1.5875	SBT060M10RB
	No.8-36UNF	—	φ3.51	36	0.7056	SBT030M4RB
	No.10-32UNF	—	φ4.07	32	0.7938	SBT035M5RB
	—	No.12-28UNF	φ4.61	28	0.9071	SBT040M6RB
	1/4-28UNF	—	φ5.47	28	0.9071	
	5/16-24UNF	—	φ6.91	24	1.0583	SBT050M8RB
	3/8-24UNF	—	φ8.51	24	1.0583	SBT060M10RB
	7/16-20UNF	—	φ9.88	20	1.2700	
	1/2-20UNF	—	φ11.47	20	1.2700	
	9/16-18UNF	—	φ12.9	18	1.4111	
5/8-18UNF	—	φ14.5	18	1.4111		
3/4-16UNF	—	φ17.5	16	1.5875		

ISO Metric

Thread Type			Pitch (mm)								
#1	#2	#3	2.0	1.75	1.5	1.25	1.0	0.8	0.75	0.7	0.5
M3											Coarse
M4										Coarse	Fine
	M4.5								Coarse		
M5								Coarse			
		M5.5									
M6							Coarse				
	M7									Fine	
M8							Coarse				
		M9								Fine	
M10							Coarse				
		M11								Fine	
M12							Coarse				
	M14		Coarse							Fine	
		M15									

Cutting Conditions

Threading

For 600 - 1500 RPM Recommended Depth of Cut (DOC) for Each Pass

Metric Thread		Number of Pass																				
Pitch (mm)	Total DOC (mm)	1	2	3	4	5	6	7	8	9	10	11	12	13	14	15	16	17	18	19	20	21
0.5	0.3	0.06	0.05	0.05	0.04	0.04	0.03	0.02	0.01	—	—	—	—	—	—	—	—	—	—	—	—	—
0.7	0.43	0.06	0.06	0.06	0.05	0.05	0.05	0.04	0.03	0.02	0.01	—	—	—	—	—	—	—	—	—	—	—
0.75	0.46	0.06	0.06	0.06	0.05	0.05	0.04	0.04	0.04	0.03	0.02	0.01	—	—	—	—	—	—	—	—	—	—
0.8	0.49	0.06	0.06	0.06	0.05	0.05	0.04	0.04	0.04	0.03	0.03	0.02	0.01	—	—	—	—	—	—	—	—	—
1.0	0.62	0.07	0.07	0.06	0.06	0.05	0.05	0.05	0.04	0.04	0.04	0.03	0.03	0.02	0.01	—	—	—	—	—	—	—
1.25	0.76	0.07	0.07	0.07	0.07	0.07	0.06	0.06	0.06	0.05	0.05	0.04	0.03	0.03	0.02	0.01	—	—	—	—	—	—
1.5	0.92	0.07	0.07	0.07	0.07	0.07	0.07	0.06	0.06	0.06	0.05	0.05	0.05	0.04	0.04	0.03	0.03	0.02	0.01	—	—	—
1.75	1.09	0.07	0.07	0.07	0.07	0.07	0.07	0.06	0.06	0.06	0.06	0.06	0.05	0.05	0.05	0.05	0.04	0.04	0.03	0.03	0.02	0.01

UNF Thread		Number of Pass																			
Pitch (TPI)	Total DOC (inch)	1	2	3	4	5	6	7	8	9	10	11	12	13	14	15	16	17	18	19	
36	.017	.002	.002	.002	.002	.002	.002	.001	.001	.0008	.0004	—	—	—	—	—	—	—	—	—	—
32	.019	.002	.002	.002	.002	.002	.001	.001	.001	.001	.0008	.0004	—	—	—	—	—	—	—	—	—
28	.022	.003	.002	.002	.002	.002	.002	.001	.001	.001	.001	.001	.0008	.0004	—	—	—	—	—	—	—
24	.026	.003	.002	.002	.002	.002	.002	.002	.002	.001	.001	.001	.001	.0008	.0004	—	—	—	—	—	—
20	.031	.003	.003	.003	.003	.002	.002	.002	.002	.002	.002	.001	.001	.001	.001	.0008	.0004	—	—	—	—
18	.034	.003	.003	.003	.003	.003	.002	.002	.002	.002	.002	.002	.002	.001	.001	.001	.0008	.0004	—	—	—
16	.039	.003	.003	.003	.003	.003	.003	.003	.002	.002	.002	.002	.002	.002	.001	.001	.001	.001	.001	.0008	.0004

TMN Series

TGC Minimum Bore Diameter .315" (80mm) ~

Carbide shank

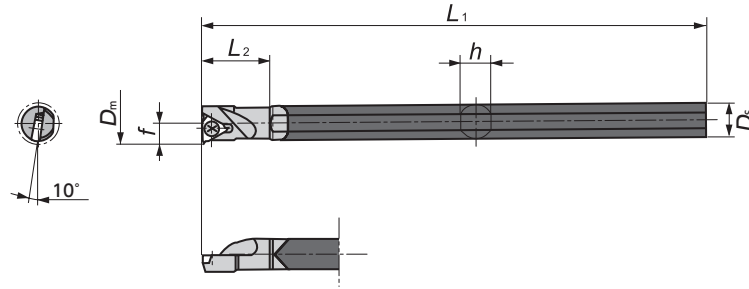

Figure-1

Right-Hand style shown

HN Minimum Bore Diameter .315" (80mm) ~

Steel shank

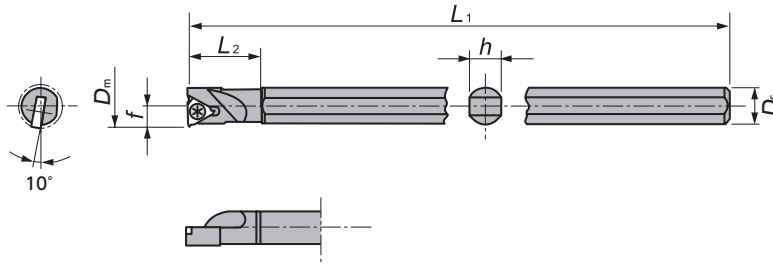

Figure-2

Right-Hand style shown

TMN Series - Toolholders



TGC/HN

Gage Insert	Item Number	Figure	Stock	Min. Machining Dia. D_n (Inch) (mm)	D_s (Inch) (mm)	h (Inch) (mm)	L_1 (Inch) (mm)	f (Inch) (mm)	L_2 (Inch) (mm)	Clamp Screw	Wrench
TMN..06..	TGC10T06H161R	1	○	.315 8	.236 6	.217 5.5	3.937 100	.150 3.8	.512 13.0	LR-S-2 × 4.4	CLR-13S
TMN..08..	TGC10T08K162R	1	○	.394 10	.315 8	.276 7.0	4.921 125	.185 4.7	.669 17.0	LR-S-2 × 5.5	CLR-13S
TMN..09..	TGC10T10M163R	1	○	.472 12	.394 10	.354 9.0	5.906 150	.236 6.0	.787 20.0	LRIS-2.2 × 6	CLR-13S
TMN..06..	HN59Z-0028	2	○	.315 8	.236 6	.217 5.5	3.937 100	.150 3.8	.512 13.0	LR-S-2 × 4.4	CLR-13S
TMN..08..	HN59Z-0029	2	○	.394 10	.315 8	.276 7.0	4.921 125	.185 4.7	.669 17.0	LR-S-2 × 5.5	CLR-13S
TMN..09..	HN59Z-0030	2	○	.472 12	.236 10	.354 9.0	5.906 150	.236 6.0	.787 20.0	LRIS-2.2 × 6	CLR-13S

TMN Series - Inserts

TMN

Shape	Item Number	ϕd		s		r_e		Recommended Pitch		Pitch		Coated Carbide
		(Inch)	(mm)	(Inch)	(mm)	(Inch)	(mm)	(TPI)	(mm)	(TPI)	(mm)	ZM3
<p>Right-hand type shown</p>	TMN06FR03	.156	3.97	.063	1.59	.001	.003	51	0.5	63-34	0.4-0.75	○
	TMN08FR03	.187	4.76	.094	2.38	.001	.003	51	0.5	63-34	0.4-0.75	○
	TMN09FR03	.219	5.56	.094	2.38	.001	.003	51	0.5	63-34	0.4-0.75	○

Cutting condition → V5

Mogul Bar for 75° Diamond (MBL style)

Minimum Bore Diameter .197"(5.0mm)

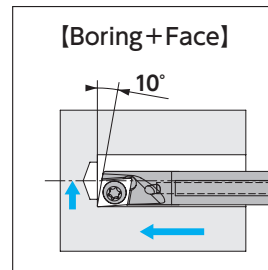
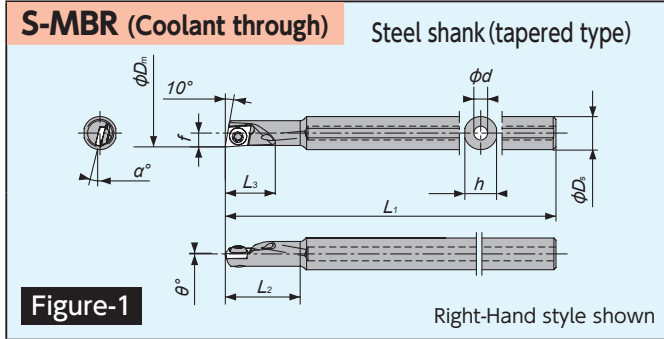

F1 chipbreakers evacuates chips BACKWARD (S-STUC style shown)

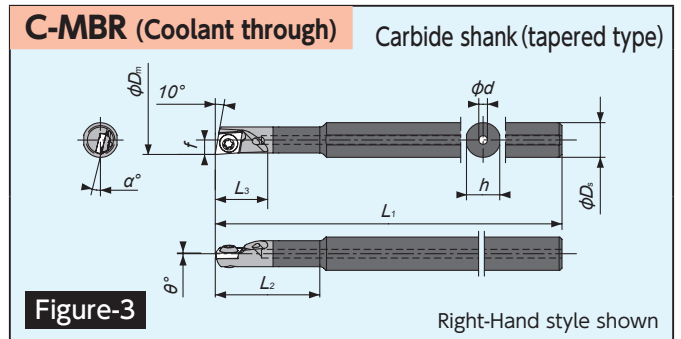
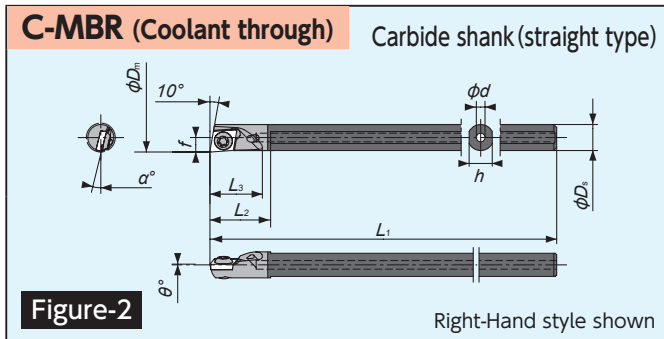

MBL style - Toolholders

Gage Insert	Item number*	Figure	Stock	ϕD_s		Min. bore Dia. ϕD_m		h	L_1	f	L_2	L_3	L_4	ϕd	θ	α	Std. corner radius r_e		Clamp screw	Wrench
				(inch)	(mm)	(inch)	(mm)	(mm)	(mm)	(mm)	(mm)	(mm)	(mm)	(mm)	(inch)	(mm)				
 MBL	S06F-MBRD05-OH	1	●	.236	6.0	.197	5.0	5.7	80	2.5	13.5	9	-	2.5	0°	-13°	.0059	0.15	LR-S-2 × 3.5	CLR-13S
	C045F-MBRD05-OH	2	●	.177	4.5	.197	5.0	4.0	80	2.5	10.5	9	-	1.5	0°	-13°	.0059	0.15	LR-S-2 × 3.5	CLR-13S
	C06F-MBRD05-OH	3	●	.236	6.0	.197	5.0	5.7	80	2.5	18	9	-	1.5	0°	-13°	.0059	0.15	LR-S-2 × 3.5	CLR-13S

* "S" denotes steel shank, "C" denotes carbide shank

MBL style - Insert

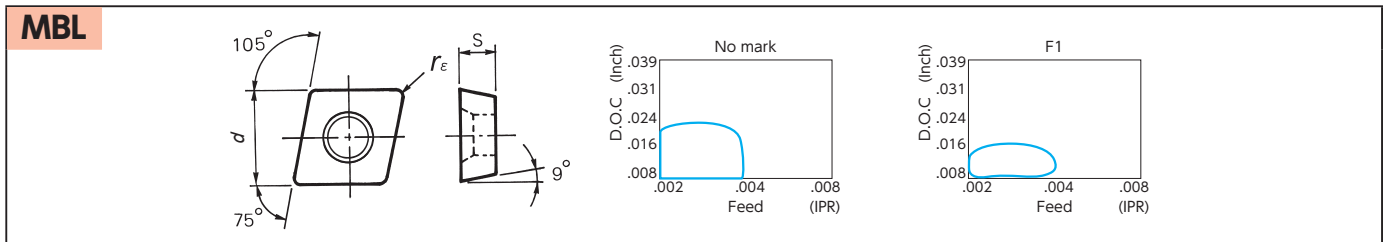

	Item Number	d		s		r_e		Coated Carbide	
		(Inch)	(mm)	(Inch)	(mm)	(Inch)	(mm)	TM4	ZM3
 L-hand shown	MBL 005 FL	.142	3.6	.039	1.0	.002	0.05	●	○
	MBL 015 FL	.142	3.6	.039	1.0	.006	0.15	●	○
 R-hand shown	MBL 005 FR F1	.142	3.6	.039	1.0	.002	0.05	●	○
	MBL 015 FR F1	.142	3.6	.039	1.0	.006	0.15	●	○

*For F1 chipbreaker, right-hand inserts fit to right-hand toolholder

Note: F1 chipbreaker evacuates chips BACKWARD

● : Stock ○ : 1-2 week delivery : Coolant through

Cutting condition

ID Tooling

Mogul Bar for 75° Diamond (ERGP style)

Minimum Bore Diameter .236"(6.0mm)

S-SEXR (Coolant through) Steel shank (tapered type)

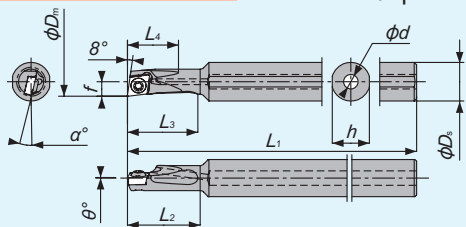
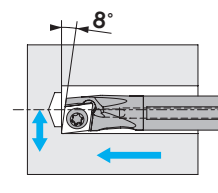

Figure-1

Right-Hand style shown

[Boring + Face]



F1 chipbreakers evacuates chips BACKWARD (S-STUC style shown)

C-SEXR (Coolant through) Carbide shank (straight type)

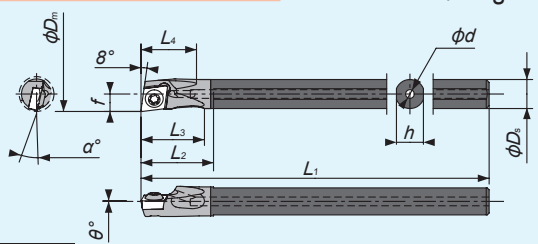

Figure-2

Right-Hand style shown

C-SEXR (Coolant through) Carbide shank (tapered type)

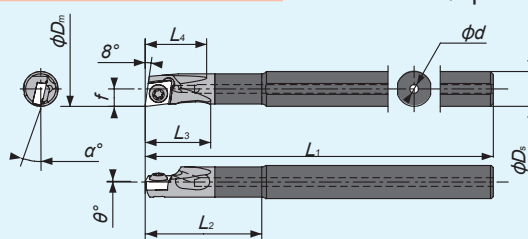

Figure-3

Right-Hand style shown

ERGP style - Toolholders

Gage Insert	Item number*	Figure	Stock		ϕD_s		Min. bore Dia. ϕD_m		h	L_1	f	L_2	L_3	L_4	ϕd	θ	α	Std. corner radius r_e		Clamp screw	Wrench
			R	L	(inch)	(mm)	(inch)	(mm)	(mm)	(mm)	(mm)	(mm)	(mm)	(mm)	(inch)	(mm)					
	S08G-SEXR 5/32 3D06-OH	1	●		.315	8.0	.236	6.0	7.7	90	3.0	15	15	10	3.0	0°	-13°	.008	0.2	LR-S-2 x 3.7	CLR-13S
	C05G-SEXR 5/32 3D06-OH	2	●	○	.197	5.0	.236	6.0	4.0	90	3.0	12.5	11	10	1.5	0°	-13°	.008	0.2	LR-S-2 x 3.7	CLR-13S
	C06G-SEXR 5/32 3D06-OH	3	●	○	.236	6.0	.236	6.0	5.7	90	3.0	20	11	10	1.5	0°	-13°	.008	0.2	LR-S-2 x 3.7	CLR-13S

* "S" denotes steel shank, "C" denotes carbide shank

ERGP style - Insert

ERGP

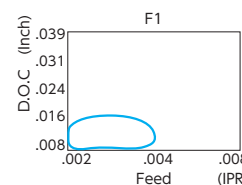
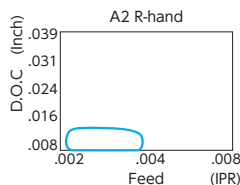
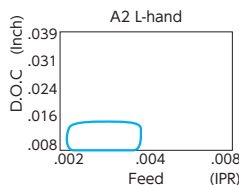
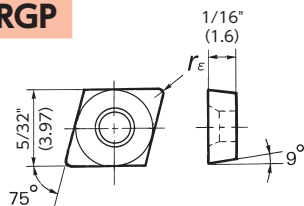

● Right-Hand style shown

ERGP

	Item Number	ISO Item Number	IC		Thickness		r_e		Coated Carbide				Cermet					
			(Inch)	(mm)	(Inch)	(mm)	(Inch)	(mm)	TM4		VM1		XT3		C7X			
			R	L	R	L	R	L	R	L	R	L	R	L	R	L		
	ERGP 52Y- F 5/32 A2	ERGHT 30102 FR A2	5/32	3.97	1/16	1.6	.008	0.2	R	L	R	L	R	L	R	L	R	L
	ERGP 521- F 5/32 A2	ERGHT 30104 FR A2	5/32	3.97	1/16	1.6	.016	0.4	R					L				
	ERGP 5204 FR-- F1	ERGHT 30101 FR F1	5/32	3.97	1/16	1.6	.004	0.1	R									
	ERGP 52Y- FR-- F1	ERGHT 30102 FR F1	5/32	3.97	1/16	1.6	.008	0.2	R									
	ERGP 521- FR-- F1	ERGHT 30104 FR F1	5/32	3.97	1/16	1.6	.016	0.4	R									

*For F1 chipbreaker, right-hand inserts fit to right-hand toolholder

● : Stock ○ : 1-2 week delivery

R : Stock (Right-hand only)

L : Stock (Left-hand only)

Ⓡ : 1-2 week delivery (Right-hand only)

Ⓛ : 1-2 week delivery (Left-hand only)

💧 : Coolant through

Cutting condition → V4

Note: F1 chipbreaker evacuates chips BACKWARD

Mogul Bar for 80° Diamond (CP style)

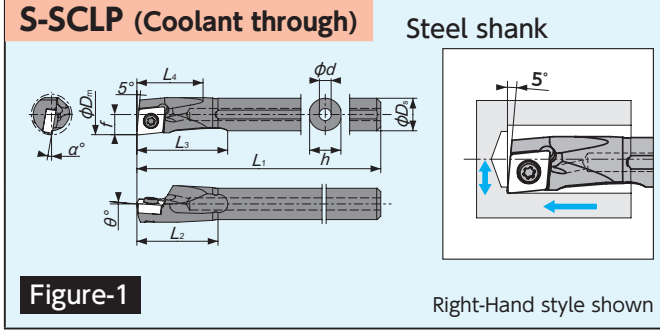

Minimum Bore Diameter .276" (7.0mm)

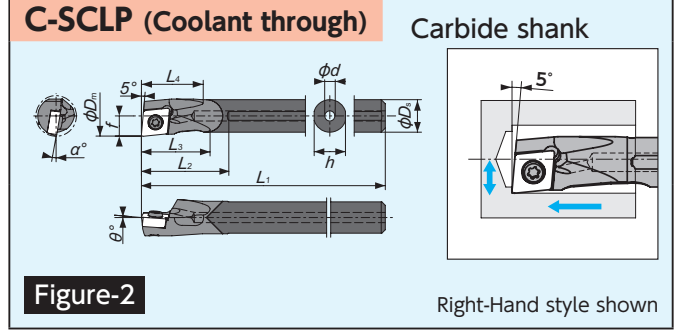

CP style - Toolholders



Gage Insert	Item number*	Figure	Stock		ϕD_s		Min. bore Dia. ϕD_m		h	L_1	f	L_2	L_3	L_4	ϕd	θ	α	Std. corner radius r_ϵ		Clamp screw	Wrench
			R	L	(inch)	(mm)	(inch)	(mm)										(inch)	(mm)		
CP..62..	S06F-SCLP $\frac{R}{L}$ 04D07-OH	1	●		.236	6.0	.276	7.0	5.75	80	3.5	14	17.0	12.0	2.5	+5°	-9°	.008	0.2	LR-5-2 × 3.7	CLR-13S
	S07G-SCLP $\frac{R}{L}$ 04D08-OH	1	●		.276	7.0	.315	8.0	6.75	90	4.0	16	19.5	13.5	3.0	+5°	-7°	.008	0.2	LR-5-2 × 3.7	CLR-13S
CP..21.5..	S08H-SCLP $\frac{R}{L}$ 06D10-OH	1	●		.315	8.0	.394	10.0	7.7	100	5.0	20	22.0	16.0	3.0	+5°	-10°	.016	0.4	LR-5-2.5 × 6	CLR-15S
CP..62..	C06H-SCLP $\frac{R}{L}$ 04D07-OH	2	●	○	.236	6.0	.276	7.0	5.75	100	3.5	15.5	11.5	12.0	2.0	+5°	-9°	.008	0.2	LR-5-2 × 3.7	CLR-13S
	C07J-SCLP $\frac{R}{L}$ 04D08-OH	2	●	○	.276	7.0	.315	8.0	6.75	110	4.0	17.5	13.0	13.5	2.0	+5°	-7°	.008	0.2	LR-5-2 × 3.7	CLR-13S
CP..21.5..	C08K-SCLP $\frac{R}{L}$ 06D10-OH	2	●	○	.315	8.0	.394	10.0	7.7	125	5.0	21.5	16.5	15.0	2.5	+5°	-10°	.016	0.4	LR-5-2.5 × 6	CLR-15S

* "S" denotes steel shank, "C" denotes carbide shank

CP style - Insert - Carbide/Cermet

80 degree Diamond Positive type (CP..)

	(inch)	IC	T
CP..21.5	1/4	3/32	
CP..32.5	3/8	5/32	

Shape	Item Number	ISO Item Number	IC	R	Carbide							Cermet					Depth of cut (inch)	Feed (IPR)		
					PVD Coated							PVD Coated								
					QM3	DT4	DM4	TM4	VM1	ZM3	KM1	XT3	C7X	XN4	Q15	C7Z				
	CPGT 21.504 FNAM3	CPGT 060201 FNXAM3	1/4	.004																
	CPGT 21.508 FNAM3	CPGT 060202 FNXAM3	1/4	.008																
	CPGT 21.51 FNAM3	CPGT 060204 FNXAM3	1/4	.016																
	CPGH 21.504 AM5	CPGH 060201 ENBAM5	1/4	.004																
	CPGH 21.508 AM5	CPGH 060202 ENBAM5	1/4	.008																
	CPGH 21.508 FNAM5	CPGH 060202 FNXAM5	1/4	.008																
	CPGH 21.51 AM5	CPGH 060204 ENBAM5	1/4	.016																
	CPGH 21.51 FNAM5	CPGH 060204 FNXAM5	1/4	.016																
	CPGP 6208 F $\frac{R}{L}$ A1	CPGH 040102 F $\frac{R}{L}$ A1	.187	.008																
	CPGP 621 F $\frac{R}{L}$ A1	CPGH 040104 F $\frac{R}{L}$ A1	.187	.016																
	CPGP 21.508 F $\frac{R}{L}$ A	CPGH 060202 F $\frac{R}{L}$ A	1/4	.008																
	CPGP 21.51 F $\frac{R}{L}$ A	CPGH 060204 F $\frac{R}{L}$ A	1/4	.016																
	CPGP 6208 T $\frac{R}{L}$ A1	CPGH 040102 T $\frac{R}{L}$ A1	.187	.008																
	CPGP 621 T $\frac{R}{L}$ A1	CPGH 040104 T $\frac{R}{L}$ A1	.187	.016																
	CPGP 21.508 T $\frac{R}{L}$ A	CPGH 060202 T $\frac{R}{L}$ A	1/4	.008																
CPGP 21.51 T $\frac{R}{L}$ A	CPGH 060204 T $\frac{R}{L}$ A	1/4	.016																	
	CPGP 6204 F $\frac{R}{L}$ F1	CPGH 040101 F $\frac{R}{L}$ F1	.187	.004																
	CPGP 6208 F $\frac{R}{L}$ F1	CPGH 040102 F $\frac{R}{L}$ F1	.187	.008																
	CPGP 621 F $\frac{R}{L}$ F1	CPGH 040104 F $\frac{R}{L}$ F1	.187	.016																
	CPGP 21.504 F $\frac{R}{L}$ F1	CPGH 060201 F $\frac{R}{L}$ F1	1/4	.004																
	CPGP 21.508 F $\frac{R}{L}$ F1	CPGH 060202 F $\frac{R}{L}$ F1	1/4	.008																
	CPGP 21.51 F $\frac{R}{L}$ F1	CPGH 060204 F $\frac{R}{L}$ F1	1/4	.016																
	CPGP 6208 $\frac{R}{L}$ S	CPGH 040102 $\frac{R}{L}$ S	.187	.008																
	CPGP 621 $\frac{R}{L}$ S	CPGH 040104 $\frac{R}{L}$ S	.187	.016																
	CPGP 21.508 $\frac{R}{L}$ S	CPGH 060202 $\frac{R}{L}$ S	1/4	.008																
	CPGP 21.51 $\frac{R}{L}$ S	CPGH 060204 $\frac{R}{L}$ S	1/4	.016																

*For F1 chipbreaker, right-hand inserts fit to right-hand toolholder
Note: F1 chipbreaker evacuates chips BACKWARD

Mogul Bar for 80° Diamond ("CC" style)

Minimum Bore Diameter .394"(10mm)

S-SCLC (Coolant through)

Steel shank

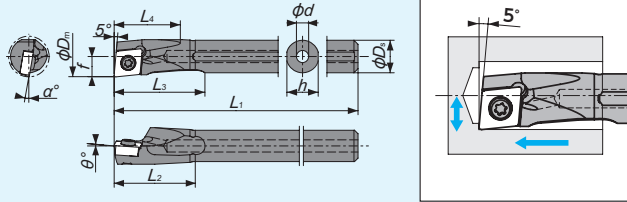

Figure-1

Right-Hand style shown

C-SCLC (Coolant through)

Carbide shank

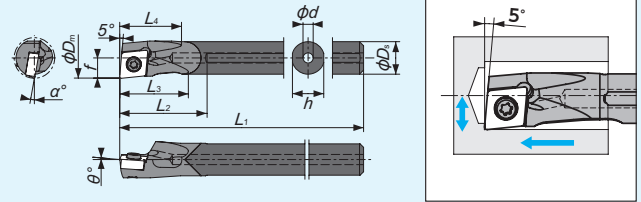

Figure-2

Right-Hand style shown

"CC" style - Toolholders



Gage Insert	Item number*	Figure	Stock		ϕD_s		Min. bore Dia. ϕD_m		h	L ₁	f	L ₂	L ₃	L ₄	ϕd	θ	α	Std. corner radius		Clamp screw	Wrench
			R	L	(inch)	(mm)	(inch)	(mm)										(inch)	(mm)		
CC..21.5..	S08H-SCLC%{06D10-OH	1	●		.315	8.0	.394	10.0	7.7	100	5.0	20.0	22.0	16.0	3.0	0°	-13°	.016	0.4	LRIS-2.5 × 5	CLR-15S
	S10K-SCLC%{06D12-OH	1	●		.394	10.0	.472	12.0	9.6	125	6.0	24.0	27.5	20.0	3.5	0°	-11°	.016	0.4	LRIS-2.5 × 5	CLR-15S
	S12M-SCLC%{06D14-OH	1	●		.472	12.0	.551	14.0	11.5	150	7.0	28.0	32.5	23.0	4.0	0°	-9°	.016	0.4	LRIS-2.5 × 5	CLR-15S
CC..32.5..	S16Q-SCLC%{09D18-OH	1	●		.630	16.0	.709	18.0	15.4	180	9.0	36.0	42.5	30.0	5.0	0°	-10°	.016	0.4	LRIS-4 × 8	LLR-25S
CC..21.5..	C08K-SCLC%{06D10-OH	2	●		.315	8.0	.394	10.0	7.7	125	5.0	21.5	16.5	15.0	2.5	0°	-13°	.016	0.4	LRIS-2.5 × 5	CLR-15S
	C10M-SCLC%{06D12-OH	2	●	○	.394	10.0	.472	12.0	9.6	150	6.0	25.0	20.0	19.5	2.5	0°	-11°	.016	0.4	LRIS-2.5 × 5	CLR-15S
	C12M-SCLC%{06D14-OH	2	●		.472	12.0	.551	14.0	11.5	150	7.0	29.0	23.5	22.5	3.0	0°	-9°	.016	0.4	LRIS-2.5 × 5	CLR-15S

* "S" denotes steel shank, "C" denotes carbide shank

CC.. inserts - CBN / PCD

80° Diamond Positive type(CC..)

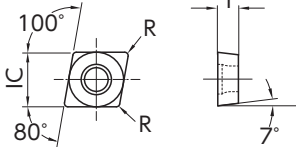

Shape	Item Number	ISO Item Number	Edge Prep.	IC	R	No. of edge	Length of edge	CBN (Brazed)							PCD			
								Coated		Coated					PD1	PD2		
								B5K	B52	B6K	B36	B40	B23	B30				
	CCGW 21.51 PD	CCGW 060204 PD	S0415	1/4	.016	2	.091		●									
	CCGW 32.508 PD	CCGW 09T302 PD	S0415	3/8	.008	2	.091		●									
	CCGW 32.508 PD	CCGW 09T302 PD	S0635	3/8	.008	2	.091											
	CCGW 32.51 PD	CCGW 09T304 PD	S0415	3/8	.016	2	.091		●									
	CCGW 32.51 PD	CCGW 09T304 PD	S0635	3/8	.016	2	.091											
	CCGW 32.52 PD	CCGW 09T308 PD	S0415	3/8	.031	2	.087		●									
	CCMW 32.504	CCMW 09T301	None	3/8	.004	1	—											○
	CCMW 32.508	CCMW 09T302	None	3/8	.008	1	—											○
	CCMW 32.51	CCMW 09T304	None	3/8	.016	1	—											○
	CCMW 32.52	CCMW 09T308	None	3/8	.031	1	—											○
	CCMT 32.508 PF	CCMT 09T302PF	None	3/8	.008	1	—											●
	CCMT 32.51 PF	CCMT 09T304PF	None	3/8	.016	1	—											●

● : Stock ○ : 1-2 week delivery

R : Stock (Right-hand only)

L : Stock (Left-hand only)

Ⓡ : 1-2 week delivery (Right-hand only)

Ⓛ : 1-2 week delivery (Left-hand only)

💧 : Coolant through

Cutting condition → V4

CC.. inserts - Carbide / Cermet

(inch)	IC	T
CC..21.5	1/4	3/32
CC..32.5	3/8	5/32

Shape	Item Number	ISO Item Number	IC	R	Material Compatibility												
					Steel	P	Stainless Steel	M	Cast Iron	K	Non-Ferrous Material	N	Heat Resistant Alloy	S	Hardened Material	H	
					Carbide					Cermet							
					PVD Coated					PVD Coated							
					QM3	DT4	DM4	TM4	VM1	ZM3	KM1	XT3	C7X	XN4	Q15	C7Z	
	CCGT 21.501 FNAM3	CCGT 060200 FNAM3	1/4	.001	●	●	●	●	●	●	●	●	●	●	●	●	
	CCGT 21.504M FNAM3	CCGT 060201M FNAM3	1/4	.003	●	●	●	●	●	●	●	●	●	●	●	●	
	CCGT 21.504 FNAM3	CCGT 060201 FNXAM3	1/4	.004								●	●	●	●	●	
	CCGT 21.508M FNAM3	CCGT 060202M FNAM3	1/4	.007	●	●							●	●	●	●	
	CCGT 21.508 FNAM3	CCGT 060202 FNAM3	1/4	.008					○	○							
	CCGT 21.508 FNXAM3	CCGT 060202 FNXAM3	1/4	.008								●	●	●	●	●	
	CCGT 21.51M FNAM3	CCGT 060204M FNAM3	1/4	.015	●	●							●	●	●	●	
	CCGT 21.51 FNAM3	CCGT 060204 FNAM3	1/4	.016						○			●	●	●	●	
		CCGT 32.501 FNAM3	CCGT 09T300 FNAM3	3/8	.001	●	●		○	○							
		CCGT 32.504M FNAM3	CCGT 09T301M FNAM3	3/8	.003	●	●		○	○							
		CCGT 32.504 FNAM3	CCGT 09T301 FNXAM3	3/8	.004								●	●	●	●	●
		CCGT 32.508M FNAM3	CCGT 09T302M FNAM3	3/8	.007	●	●		○	○							
		CCGT 32.508 FNAM3	CCGT 09T302 FNAM3	3/8	.008	●	●			○	○						
		CCGT 32.508 FNXAM3	CCGT 09T302 FNXAM3	3/8	.008								●	●	●	●	●
		CCGT 32.51M FNAM3	CCGT 09T304M FNAM3	3/8	.015	●	●		○	○	○						
		CCGT 32.51 FNAM3	CCGT 09T304 FNAM3	3/8	.016	●	●			○	○						
		CCGT 32.51 FNXAM3	CCGT 09T304 FNXAM3	3/8	.016								●	●	●	●	●
		CCGT 32.52 FNAM3	CCGT 09T308 FNAM3	3/8	.031	●	●										
	CCGT 32.52 FNXAM3	CCGT 09T308 FNXAM3	3/8	.031								●	●	●	●	●	
	NEW	CCMT 21.508 FNAM3	CCMT 060202 FNAM3	1/4	.008			○									
		CCMT 21.508 AM3	CCMT 060202 ENBAM3	1/4	.008								○			○	
		CCMT 21.51 FNAM3	CCMT 060204 FNAM3	1/4	.016			○									
		CCMT 21.51 AM3	CCMT 060204 ENBAM3	1/4	.016								●			○	
		CCMT 32.508 AM3	CCMT 09T302 ENBAM3	3/8	.008								○			○	
		CCMT 32.51 FNAM3	CCMT 09T304 FNAM3	3/8	.016			○									
		CCMT 32.51 AM3	CCMT 09T304 ENBAM3	3/8	.016								●			○	
		CCMT 32.52 FNAM3	CCMT 09T308 FNAM3	3/8	.031			○									
	CCMT 32.52 AM3	CCMT 09T308 ENBAM3	3/8	.031								●			○		
	CCMT 32.53 AM3	CCMT 09T312 ENBAM3	3/8	.047								○			○		
		CCGT 32.504M YL	CCGT 09T301M YL	3/8	.003			●	○								
		CCGT 32.508M YL	CCGT 09T302M YL	3/8	.007			●	○								
		CCGT 32.51M YL	CCGT 09T304M YL	3/8	.015			●	○								
	CCGT 21.504M CL	CCGT 060201M CL	1/4	.003	●	●	●										
	CCGT 21.508M CL	CCGT 060202M CL	1/4	.007	●	●	●										
	CCGT 32.504M CL	CCGT 09T301M CL	3/8	.003	●	●	●										
	CCGT 32.508M CL	CCGT 09T302M CL	3/8	.007	●	●	●										
	CCGT 32.51M CL	CCGT 09T304M CL	3/8	.015	●	●	●										

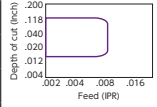
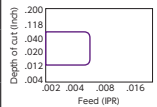
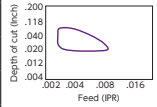

Mogul Bar for 60° Triangle (TC/TP style)

S-STUC (P) (Coolant through)

Steel shank

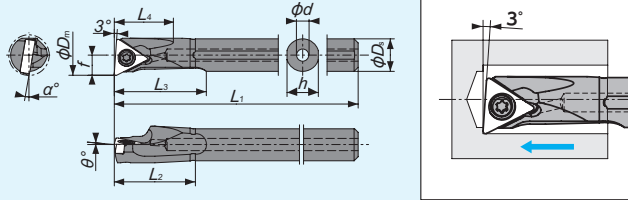

Figure-3

Right-Hand style shown

Minimum Bore Diameter .315"(8.0mm)

C-STUC (P) (Coolant through)

Carbide shank

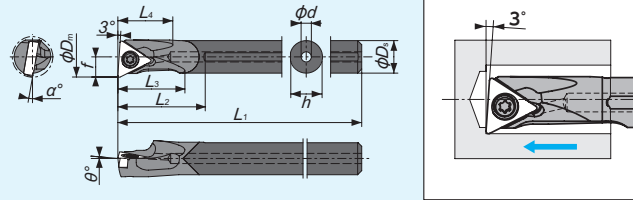

Figure-4

Right-Hand style shown

TC/TP style - Toolholders



GageInsert	Item number*	Figure	Stock		φ D _s (inch) (mm)	Min. bore Dia. φ D _m (inch) (mm)	h	L ₁	f	L ₂	L ₃	L ₄	φ d	θ	α	Std. corner radius r _e		Clamp screw	Wrench
			R	L												(inch)	(mm)		
TC..52..	S07G-STUC%{06D08-OH	3	●		.276 7.0	.315 8.0	6.75	90	4.0	16	19.5	12.5	2.5	0°	-11°	.008	0.2	LR-5-2 × 4.4	CLR-13S
TP..73..	S08H-STUP%{09D10-OH	3	●		.315 8.0	.394 10.0	7.7	100	5.0	20	22.5	14.5	3.0	+5°	-10°	.016	0.4	LR-5-2.5 × 4.8	CLR-15S
TP..22..	S10K-STUP%{11D12-OH	3	●		.394 10.0	.472 12.0	9.6	125	6.0	24	27.5	18.5	3.5	+5°	-7.5°	.016	0.4	LR-5-3 × 5.8	RLR-20S
	S12M-STUP%{11D14-OH	3	●		.472 12.0	.551 14.0	11.5	150	7.0	28	32.5	22.0	4.0	+5°	-5°	.016	0.4	LR-5-3 × 5.8	RLR-20S
	S16Q-STUP%{11D18-OH	3	●		.630 16.0	.709 18.0	15.4	180	9.0	32	42.5	28.5	5.0	+5°	-3°	.016	0.4	LR-5-3 × 5.8	RLR-20S
TC..52..	C07J-STUC%{06D08-OH	4	●	○	.276 7.0	.315 8.0	6.75	110	4.0	17.5	13.0	12.5	2.0	0°	-11°	.008	0.2	LR-5-2 × 4.4	CLR-13S
TP..73..	C08K-STUP%{09D10-OH	4	●	○	.315 8.0	.394 10.0	7.7	125	5.0	21.5	16.5	14.5	2.5	+5°	-10°	.016	0.4	LR-5-2.5 × 4.8	CLR-15S
TP..22..	C10M-STUP%{11D12-OH	4	●	○	.394 10.0	.472 12.0	9.6	150	6.0	25.0	20.0	17.5	2.5	+5°	-7.5°	.016	0.4	LR-5-3 × 5.8	RLR-20S
	C12M-STUP%{11D14-OH	4	●	○	.472 12.0	.551 14.0	11.5	150	7.0	29.0	23.0	21.5	3.0	+5°	-5°	.016	0.4	LR-5-3 × 5.8	RLR-20S
	C16Q-STUP%{11D18-OH	4	●	○	.630 16.0	.709 18.0	15.4	180	9.0	37.0	29.0	28.0	4.0	+5°	-3°	.016	0.4	LR-5-3 × 5.8	RLR-20S

* "S" denotes steel shank, "C" denotes carbide shank

C-STZP (C) (Coolant through)

Minimum Bore Diameter .394"(10mm) Carbide shank

NEW

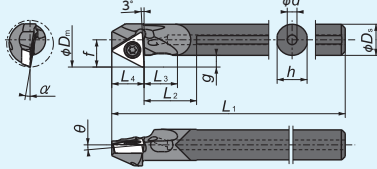

● Use right-hand inserts for machining backward
Use left-hand inserts for machining forward

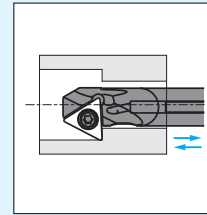

Insert	Item number*	Stock	φ D _s		Min. bore Dia. φ D _m	Max. shoulder height g	h	L ₁	f	L ₂	L ₃	L ₄	φ d	θ	α	Std. corner radius r _e		Clamp screw	Wrench
			R	L												(inch)	(mm)		
TC..52..	C06H-STZCR06D10-OH	○	.236	6	.394 10	.098 2.5	5.75	100	5.5	10.5	6	6	2.0	0°	-10°	.008	0.2	LR-5-2 × 4	CLR-13S
TP..73..	C08K-STZPR09D12-OH	○	.315	8	.472 12	.118 3	7.7	125	7	13.5	8.5	8.3	2.5	+5°	-10°	.016	0.4	LR-5-2.5 × 4.8	CLR-15S
	C10M-STZPR09D14-OH	○	.394	10	.551 14	.118 3	9.6	150	8	18.5	12	8.3	2.5	+5°	-7°	.118	0.4	LR-5-2.5 × 4.8	CLR-15S
TP..22..	C12M-STZPR11D17.5-OH	○	.472	12	.689 17.5	.177 4.5	11.5	150	10.5	22	14.5	9.6	3.0	+5°	-5°	.117	0.4	LR-5-3 × 5.8	RLR-20S

TPG CBN / PCD

(inch)	IC	T
TP.. 22	1/4	1/8

Shape	Item Number	ISO Item Number	Edge Prep.	IC	R	No. of edge	Length of edge	CBN (Brazed)						PCD				
								B5K	B52	B6K	B36	B40	B23	B30	PD1	PD2		
	TPGW 2208 PT	TPGW 110302 PT	S0415	1/4	.008	3	.087											
	TPGW 221 PT	TPGW 110304 PT	S0415	1/4	.016	3	.079											
	TPGW 221 PT	TPGW 110304 PT	T0615	1/4	.016	3	.079											
	TPGW 221 PT	TPGW 110304 PT	S0635	1/4	.016	3	.079											
	TPGW 222 PT	TPGW 110308 PT	S0415	1/4	.031	3	.067											
	TPGW 222 PT	TPGW 110308 PT	S0635	1/4	.031	3	.067											
NEW	TPMT 7308 PF	TPMT 090202 PF	None	7/32	.008	1	—											
	TPMT 731 PF	TPMT 090204 PF	None	7/32	.016	1	—											
	TPMT 2208 PF	TPMT 110302 PF	None	1/4	.008	1	—											
	TPMT 221 PF	TPMT 110304 PF	None	1/4	.016	1	—											

60° Triangle Positive type Carbide / Cermet (TC..52)

						(inch)		IC	T								
						TC..52		5/32	1/16								
		Steel	P	●	●	●	●	●	●								
		Stainless Steel	M	●	●	●	●	●	●								
		Cast Iron	K	●	●	●	●	●	●								
		Non-Ferrous Material	N	●	●	●	●	●	●								
		Heat Resistant Alloy	S	●	●	●	●	●	●								
		Hardened Material	H	●	●	●	●	●	●								
Shape	Item Number	ISO Item Number	IC	R	Carbide						Cermet						
					PVD Coated						PVD Coated						
					QM3	DT4	DM4	TM4	VM1	ZM3	KM1	XT3	CTX	XN4	Q15	C7Z	
	TCGH 5204 T $\frac{R}{L}$ B1 TCGH 5208 F $\frac{R}{L}$ B1 TCGH 5208 T $\frac{R}{L}$ B1 TCGH 521 F $\frac{R}{L}$ B1 TCGH 521 T $\frac{R}{L}$ B1	TCGH 060101 T $\frac{R}{L}$ B1 TCGH 060102 F $\frac{R}{L}$ B1 TCGH 060102 T $\frac{R}{L}$ B1 TCGH 060104 F $\frac{R}{L}$ B1 TCGH 060104 T $\frac{R}{L}$ B1	5/32	.004 .008 .008 .016 .016				L				L					
	TCGP 5204 F $\frac{R}{L}$ F05 TCGP 5208 F $\frac{R}{L}$ F05 TCGP 5208 T $\frac{R}{L}$ F05 TCGP 521 F $\frac{R}{L}$ F05 TCGP 521 T $\frac{R}{L}$ F05	TCGH 060101 F $\frac{R}{L}$ F05 TCGH 060102 F $\frac{R}{L}$ F05 TCGH 060102 T $\frac{R}{L}$ F05 TCGH 060104 F $\frac{R}{L}$ F05 TCGH 060104 T $\frac{R}{L}$ F05	5/32	.004 .008 .008 .016 .016				R	L	R	R						
	TCGH 5208 F $\frac{R}{L}$ K TCGH 521 F $\frac{R}{L}$ K	TCGH 060102 F $\frac{R}{L}$ K TCGH 060104 F $\frac{R}{L}$ K	5/32	.008 .016				L									
	TCGD 52Y TCGD 521	TCGB 060102 TN TCGB 060104 TN	5/32	.008 .016								○					

60° Triangle Positive type Carbide / Cermet (TP..)

						(inch)		IC	T								
						TP..22		1/4	1/8								
		Steel	P	●	●	●	●	●	●								
		Stainless Steel	M	●	●	●	●	●	●								
		Cast Iron	K	●	●	●	●	●	●								
		Non-Ferrous Material	N	●	●	●	●	●	●								
		Heat Resistant Alloy	S	●	●	●	●	●	●								
		Hardened Material	H	●	●	●	●	●	●								
Shape	Item Number	ISO Item Number	IC	R	Carbide						Cermet						
					PVD Coated						PVD Coated						
					QM3	DT4	DM4	TM4	VM1	ZM3	KM1	XT3	CTX	XN4	Q15	C7Z	
	TPGH 7308 F $\frac{R}{L}$ B2 TPGH 731 F $\frac{R}{L}$ B2 TPGH 731 T $\frac{R}{L}$ B2 TPGH 732 T $\frac{R}{L}$ B2	TPGH 090202 F $\frac{R}{L}$ B2 TPGH 090204 F $\frac{R}{L}$ B2 TPGH 090204 T $\frac{R}{L}$ B2 TPGH 090208 F $\frac{R}{L}$ B2	7/32	.008 .016 .016 .031				L		L		R	L				
	TPGH 2204 T $\frac{R}{L}$ B3 TPGH 221 T $\frac{R}{L}$ B3 TPGH 222 T $\frac{R}{L}$ B3	TPGH 110301 T $\frac{R}{L}$ B3 TPGH 110304 T $\frac{R}{L}$ B3 TPGH 110308 T $\frac{R}{L}$ B3	1/4	.004 .016 .031								L					
	TPGH 7304 F $\frac{R}{L}$ F1 TPGH 7308 F $\frac{R}{L}$ F1 TPGH 731 F $\frac{R}{L}$ F1 TPGH 732 F $\frac{R}{L}$ F1	TPGH 090201 F $\frac{R}{L}$ F1 TPGH 090202 F $\frac{R}{L}$ F1 TPGH 090204 F $\frac{R}{L}$ F1 TPGH 090208 F $\frac{R}{L}$ F1	7/32	.004 .008 .016 .031				R		R	R						
	TPGH 2208 F $\frac{R}{L}$ F1 TPGH 221 F $\frac{R}{L}$ F1 TPGH 222 F $\frac{R}{L}$ F1	TPGH 110302 F $\frac{R}{L}$ F1 TPGH 110304 F $\frac{R}{L}$ F1 TPGH 110308 F $\frac{R}{L}$ F1	1/4	.008 .016 .031				R		R	R						
	TPGP 7308 T $\frac{R}{L}$ F1 TPGP 731 T $\frac{R}{L}$ F1	TPGH 090202 T $\frac{R}{L}$ F1 TPGHP 090204 T $\frac{R}{L}$ F1	7/32	.008 .016								R			R		
	TPGP 2208 T $\frac{R}{L}$ F1 TPGP 221 T $\frac{R}{L}$ F1 TPGP 222 T $\frac{R}{L}$ F1	TPGH 110302 T $\frac{R}{L}$ F1 TPGH 110304 T $\frac{R}{L}$ F1 TPGH 110308 T $\frac{R}{L}$ F1	1/4	.008 .016 .031								R			R		
	TPGP 7308 T $\frac{R}{L}$ FG TPGP 731 T $\frac{R}{L}$ FG	TPGH 090202 T $\frac{R}{L}$ FG TPGH 090204 T $\frac{R}{L}$ FG	7/32	.008 .016				R							R		
	TPGH 2208 T $\frac{R}{L}$ FG TPGH 221 T $\frac{R}{L}$ FG	TPGH 110302 T $\frac{R}{L}$ FG TPGH 110304 T $\frac{R}{L}$ FG	1/4	.008 .016				R							R		
	TPGP 7308 F $\frac{R}{L}$ K TPGP 7318 F $\frac{R}{L}$ K TPGP 7328 F $\frac{R}{L}$ K	TPGH 090202 F $\frac{R}{L}$ K TPGH 090204 F $\frac{R}{L}$ K TPGH 090208 F $\frac{R}{L}$ K	1/4	.008 .016 .031				L		L							

● : Stock ○ : 1-2 week delivery
 R : Stock (Right-hand only) L : Stock (Left-hand only)
 ⊙ : 1-2 week delivery (Right-hand only) ⊙ : 1-2 week delivery (Left-hand only)

*For F05, F1 and FG chipbreaker, right-hand inserts fit to right-hand toolholder
 Note: F05, F1 and FG chipbreaker evacuates chips BACKWARD

Cutting condition **→V4**

Chipbreakers for Mogul Bar

Molded Chipbreakers

Name	Chipbreaker Geometry	Features	ER Style	CC Style	CP Style	TC Style	TP Style
FG		● Evacuate chips BACKWARD at light depth of cut	—	—	—	—	
AM3		● Great combination of sharp edge and chip control	—			—	—
YL		● Great combination of sharpness and toughness ● Covers extremely wide range ● Excellent chip control	—		—	—	—
CL		● Double-positive geometry ● Sharp edge and low tool pressure ● Very wide chip control range	—		—	—	—
AZ7		● Excellent chip control at light feed and light depth of cut	—		—	—	—
ZR		● Covers a wide range of depth of cut under high-speed and low-feed conditions	—		—	—	—
AM5		● Provides both good cutting performance and chip control	—			—	—

Ground Chipbreakers

Name	Chipbreaker Geometry	Features	ER Style	CC Style	CP Style	TC Style	TP Style
F05 • F1		● Exclusively designed for ID boring ● Evacuate chips BACKWARD					
S		● Sharp cutting edge with excellent chip control	—			—	—
U • U1		● Sharp cutting edge prevents work materials from work hardening	—		—	—	—
KHG		● Excellent chip control on finishing cuts ● For super high-precision machining	—		—	—	—
K		● Superb chip control on finishing applications	—	—	—		—
A • A1		● Tough cutting edge and good chip control ● General-purpose ID chipbreaker	—	—		—	—
A2		● Sharp cutting edge due to large rake angle		—	—	—	—
B1•B2•B3		● Stable cutting in boring thanks to sharp and tough cutting edge	—	—	—		

Boring on CNC Swiss-Type Lathes

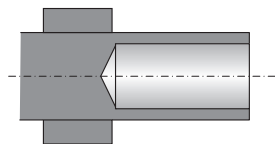

Blind hole due to bar stock

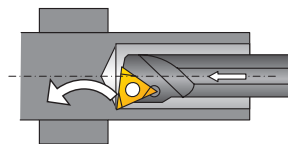

Typical inserts direct chips forward
Then packed chips damage and break cutting edges

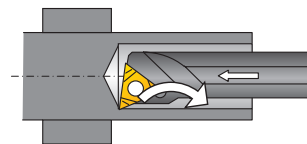

FG, F1 and F05 chipbreakers direct chips backward and prevent cutting edges from breaking

Note: Use right-hand inserts with FG, F1 and F05 chipbreakers for right-hand boring bars

W



Shaper

SHAPER DUO

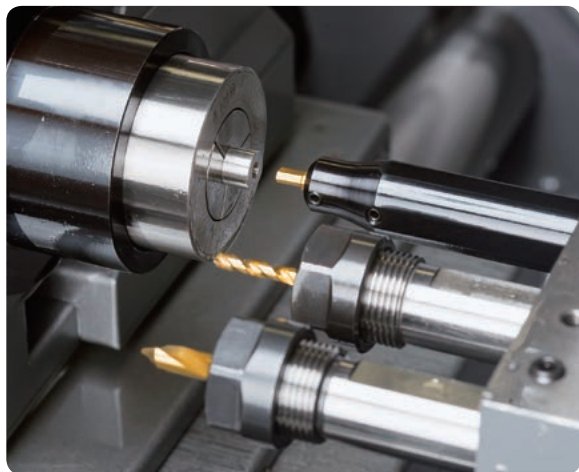

Hexagon Socket



Square Socket



WATCH ON
YouTube

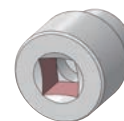

- Perfect fit for back spindle of Swiss machine
- Achieves good corner edge sharpness
- Less tool pressure than Rotary-Broaching
- Easy to adjust for correct dimension
- Economical double-ended insert bar

Insert Bar -Hexagon-

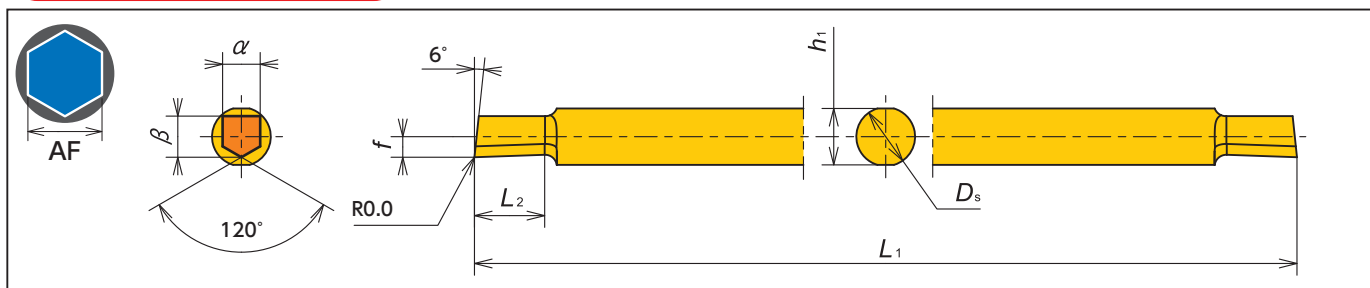

Item Number	Base AF (mm)	HEX Standard size range (mm)	AF range		D_s (mm)	L_1 (mm)	L_2 (mm)	h_1 (mm)	α (mm)	β (mm)	f (mm)	Coated Carbide
			(Inch)	(mm)								TM4
SSP020N1130H	HEX 1.5	HEX 1.5 - 2.0	.055 - .078	1.4 - 2.0	ϕ 2	50	3.0	1.8	1.1	0.8	0.40	●
SSP020N1430H	HEX 2.0	HEX 2.0 - 2.5	.075 - .102	1.9 - 2.6	ϕ 2	50	3.0	1.8	1.4	1.1	0.55	●
SSP030N1940H	HEX 3.0	HEX 2.5 - 3.5	.095 - .141	2.4 - 3.6	ϕ 3	50	4.0	2.8	1.9	1.6	0.8	●
SSP040N2450H	HEX 4.0	HEX 3.5 - 4.5	.134 - .181	3.4 - 4.6	ϕ 4	60	5.0	3.8	2.4	2.6	1.3	●
SSP050N3260H	HEX 5.0	HEX 4.5 - 6.0	.174 - .244	4.4 - 6.2	ϕ 5	70	6.0	4.8	3.2	3.4	1.70	●
SSP060N42120H	HEX 6.0	HEX 6.0 - 8.0	.233 - .322	5.9 - 8.2	ϕ 6	80	12.0	5.6	4.2	4.0	2.00	●
SSP080N62160H	HEX 8.0	HEX 8.0 - 12.0	.311 - .480	7.9 - 12.2	ϕ 8	80	16.0	7.6	6.2	4.7	2.35	●

Insert Bar -Square-

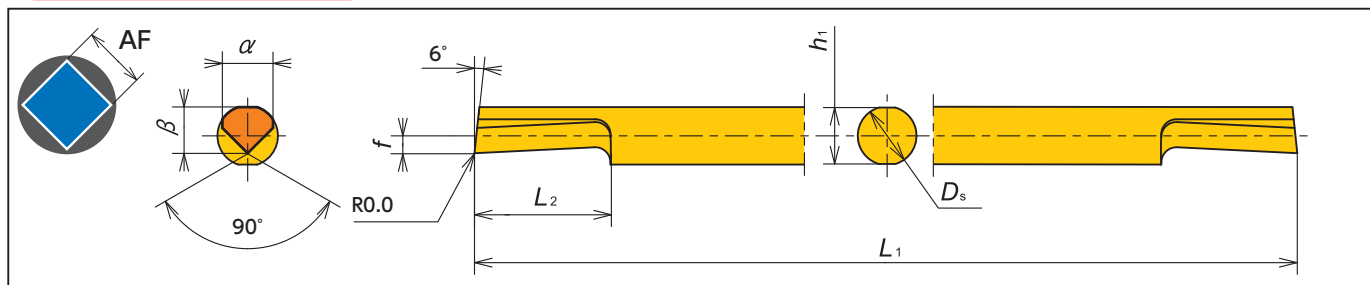

Item Number	Base AF (mm)	AF range		D_s (mm)	L_1 (mm)	L_2 (mm)	h_1 (mm)	α (mm)	β (mm)	f (mm)	Coated Carbide
		(Inch)	(mm)								TM4
SSP020N1740S	2.0	.075 - .090	1.9 - 2.3	ϕ 2.0	50	4.0	1.8	1.70	1.60	0.70	○
SSP025N1940S	2.5	.087 - .102	2.2 - 2.6	ϕ 2.5	50	4.0	2.3	1.95	1.80	0.65	○
SSP030N2260S	3.0	.099 - .118	2.5 - 3.0	ϕ 3.0	50	6.0	2.8	2.20	2.05	0.65	○
SSP035N2760S	3.5	.115 - .145	2.9 - 3.7	ϕ 3.5	60	6.0	3.3	2.70	2.25	0.60	○
SSP040N3380S	4.0	.142 - .181	3.6 - 4.6	ϕ 4.0	60	8.0	3.8	3.35	3.05	1.15	○
SSP050N39100S	5.0	.178 - .212	4.5 - 5.4	ϕ 5.0	70	10.0	4.8	3.90	3.95	1.55	○
SSP060N47120S	6.0	.209 - .259	5.3 - 6.6	ϕ 6.0	80	12.0	5.6	4.75	4.50	1.70	○
SSP080N58160S	8.0	.256 - .318	6.5 - 8.1	ϕ 8.0	80	16.0	7.6	5.80	5.50	1.70	○

● : Stock

○ : 1-2 week delivery

Sleeves → W7-10

Comparison Chart of HEX Socket Machining

	Tool Pressure	Cycle Time	Pliability	Tool Cost	
Shaper Duo 	◎	△ * Can be off-set by over-wrapping operation	○	◎	<ul style="list-style-type: none"> ● Less tool pressure-especially on small diameter parts ● One size can cover several socket sizes
Broach Tool	△	○	×	△	<ul style="list-style-type: none"> ● Need to have tools for each socket size

Process Chart

① Center drilling

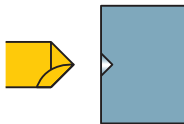

Select a pilot hole drill which is bigger dia. than AF.

② Drilling (Pilot hole)

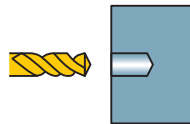

Select a drill with same dia. as AF and machine a bit deeper because burrs may cause chipping on shaper insert

③ Chamfering

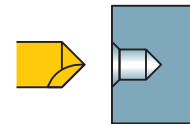

Chamfer with the same pilot hole drill as ① (Chamfer can be done at same time as ①).

④ Shaper tool

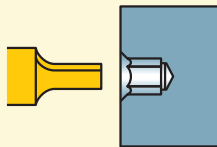

Machine HEX portion rotating 60 degrees 6 times

⑤ Deburring

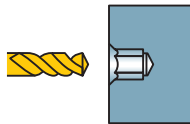

Finish and deburr with the same drill as in process②
 ☆Reduce cutting conditions due to heavy interruption

SHAPER DUO Process Chart

HEX Standard	Tool	Pilot bore Dia. (mm)	Total DOC /side (mm)	Number of passes			Estimated cycle time *		
				Total pass /side	Roughing pass 0.025mm	Finishing pass 0.010mm	ISO 2936 standard depth of Hex hole (mm)	Whole process ①-⑤	Process④ Shaper
HEX 1.5	SSP020N1130H	1.5	0.116	6	5	1	2	39 sec	14 sec
HEX 2.0	SSP020N1430H	2.0	0.155	7	6	1	2.5	44 sec	16 sec
HEX 2.5	SSP030N1940H	2.5	0.193	9	8	1	3	50 sec	20 sec
HEX 3.0	SSP030N1940H	3.0	0.232	10	9	1	3.5	55 sec	23 sec
HEX 4.0	SSP040N2450H	4.0	0.309	13	12	1	5	73 sec	33 sec
HEX 5.0	SSP050N3260H	5.0	0.387	17	16	1	6	90 sec	46 sec
HEX 6.0	SSP060N42120H	6.0	0.464	20	19	1	8	117 sec	63 sec
HEX 8.0	SSP080N62160H	8.0	0.619	26	25	1	10	155 sec	92 sec

*Pilot bore diameter is same as AF
 *Using Carbide drill

*Shaper cutting conditions

Feed : 3000 mm/min
 DOC : 0.025 mm (Roughing), 0.010 mm (Finishing)

Recommended Cutting Conditions

Feed : 3000 mm/min (120 IPM)
 DOC : Roughing ... 0.025 mm (.0010") + Finishing ... 0.010 mm (.0004")

Program Example → W5

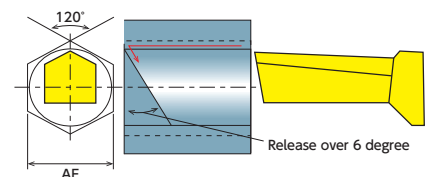

Shaper

SHAPER DUO Set-up Instruction - Hexagonal

Outside machine

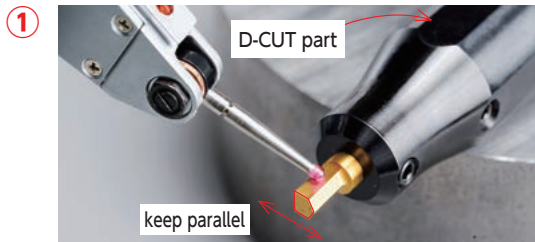

- Set the insert bar in the sleeve and check the parallelism of the flat portion of the sleeve and the insert bar.
- Minimize the overhang of the insert.

Inside machine



- Set the sleeve into the tool post and make sure the sleeve is set parallel.
- Minimize sleeve overhang.

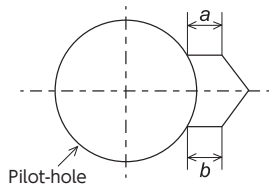
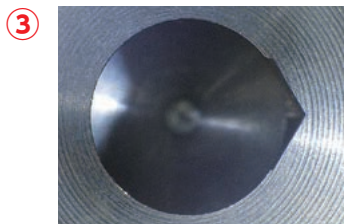

- Machine one angle a bit wider than the drilled hole.
*Increase the number of machining passes because the insert may get chipped with increased depth of cut. (0.025mm×5pass is recommended)
No chamfering process is required for measuring purpose.
- Measure the length of both [a] and [b] with comparator or magnifier.
- Adjust centerline height by rotating the sleeve until you get the same length for [a] and [b].(The difference should be less than .0008")
*If the straight is not seen with increased passes, please reset the insert and the sleeve.
Please make sure both the insert and the sleeve are set up correctly.

4 Machine Hexagonal shape

- Run full HEX machining program.



SHAPER DUO Programming Code Examples from Machine Builders in Metric

Note : The codes and numbers may vary by machine type. Please contact the machine builder for details.
 Programming code example for HEX 3.0mm. **AF : 3.0mm, Depth : 2.7mm, Pilot drill diameter : 3.0mm**

CITIZEN

Main Program Sequence

```
M25
M78 S0 .....I
Shaper T****
G50 U1.6 .....II
G0 X2.9 Z-2.0 T** .....III
M98 P2100 L14 .....IV
M98 P2200 .....V
```

```
M78 S60 .....I
G0 X2.9 Z-2.0
M98 P2100 L14
M98 P2200 } <a>
```

Repeat <a> program sequence 4 more times to complete the cuts at S120, S180, S240, S300 (represents 120°, 180°, 240°, 300°).

```
M20
G0 Z-10.0
G50 U-2.0
G0 U0 W0 T0
M1
```

STAR

Main Program Sequence

```
M25
Shaper T****
G50 U1.6 .....II
M8
G0 X2.9 Z-2.0 C0 T** .....I, III
M98 P2100 L14 .....IV
M98 P2200 .....V
```

```
G0 C60.0 .....I
G0 X2.9 Z-2.0
M98 P2100 L14
M98 P2200 } <a>
```

Repeat <a> program sequence 4 more times to complete the cuts at C120.0, C180.0, C240.0, C300.0 (represents 120°, 180°, 240°, 300°).

```
G0 Z-2.0
G50 U-2.0
G0 T0
G28 W0
M1
```

TSUGAMI

Main Program Sequence

```
M105
M150
G28 H0 .....I
M182
Shaper T****
G50 U1.6 .....II
G0 X2.9 Z2.0 T** .....III
M98 P2100 L14 .....IV
M98 P2200 .....V
M183
```

```
G0 C60 .....I
M182
G0 X2.9 Z2.0
M98 P2100 L14
M98 P2200
M183 } <a>
```

Repeat <a> program sequence 4 more times to complete the cuts at C120, C180, C240, C300 (represents 120°, 180°, 240°, 300°).

```
M151
G0 Z10.0
G50 U2.0
G0 U0 W0 T0
M1
```

Sub-Program Sequence #1 for Roughing

```
N2100
G4 U0.02 .....A
G98 G1 Z2.7 F3000 .....B
G4 U0.02
U-0.2 W-0.018 .....C
G4 U0.02
G0 Z-2.0
G4 U0.02
U0.25 .....D
M99
```

Sub-Program Sequence #1 for Roughing

```
O2100
G4 U0.02 .....A
G98 G1 Z2.7 F3000 .....B
G4 U0.02
U-0.2 W-0.018 .....C
G4 U0.02
G0 Z-2.0
G4 U0.02
U0.25 .....D
M99
```

Sub-Program Sequence #1 for Roughing

```
O2100
G4 U0.02 .....A
G98 G1 Z-2.7 F3000 .....B
G4 U0.02
U-0.2 W0.018 .....C
G4 U0.02
G0 Z2.0
G4 U0.02
U0.25 .....D
M99
```

Sub-Program Sequence #2 for Finishing

```
N2200
G98 G1 X3.61 Z-2.0 F1000 .....E
G4 U0.02
Z2.7 F3000
G4 U0.02
U-0.2 W-0.018
G4 U0.02
G0 Z-2.0
M99
```

Sub-Program Sequence #2 for Finishing

```
O2200
G98 G1 X3.61 Z-2.0 F1000 .....E
G4 U0.02
Z2.7 F3000
G4 U0.02
U-0.2 W-0.018
G4 U0.02
G0 Z-2.0
M99
```

Sub-Program Sequence #2 for Finishing

```
O2200
G98 G1 X3.61 Z2.0 F1000 .....E
G4 U0.02
Z-2.7 F3000
G4 U0.02
U-0.2 W0.018
G4 U0.02
G0 Z2.0
M99
```

- I. Index the sub-spindle 6 times in 60 degree increments.
- II. Specify the coordinate system shift command (in X axis direction) for the tool. [2 x f, where f is tool dimension located in catalog].
 - A positive direction shift is recommended for easier programming.
- III. Execute the positioning of the tool.
 - X position should be 0.1 mm less than pilot drill diameter.
 - Z position should be off-set 2.0 mm from material to achieve program feed rate.
- IV. Go to the Sub-Program #1.
 - Sequence runs 14 times. First cutting point X2.9 and final cutting point X3.6, with 0.05 DOC (for diameter) each time. (3.6 - 2.9 / 0.05 = 14 times)

- A. Specify dwell time. This allows the program and machine to stay synchronized.
- B. Cut into part 2.7mm. F3000 is recommended feed to be used for most materials; including Titanium Alloy and Stainless Steel.
- C. This code backs off the tool with an angle greater than 6 degrees (10 degrees used in example).
- D. Return the X position + 0.05mm (the DOC for diameter).
- V. Go to the Sub-Program #2, for finishing sequence.
 - E. Finishing operation with 0.01mm DOC (X 3.61) is recommended for better surface finish.

SHAPER DUO Trouble Shooting

■ Problem: Step on sides

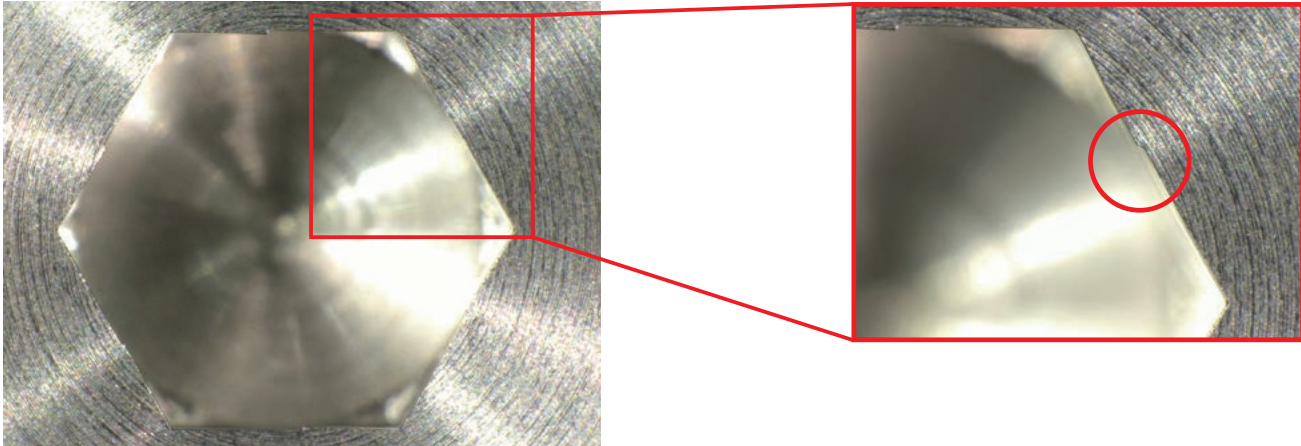

Cause: Incorrect tool set-up
(Center-line shift)

Solution: Machine one angle and make sure both [a] and [b] lengths are identical, rotating the sleeve if necessary

■ Problem: Wall dented

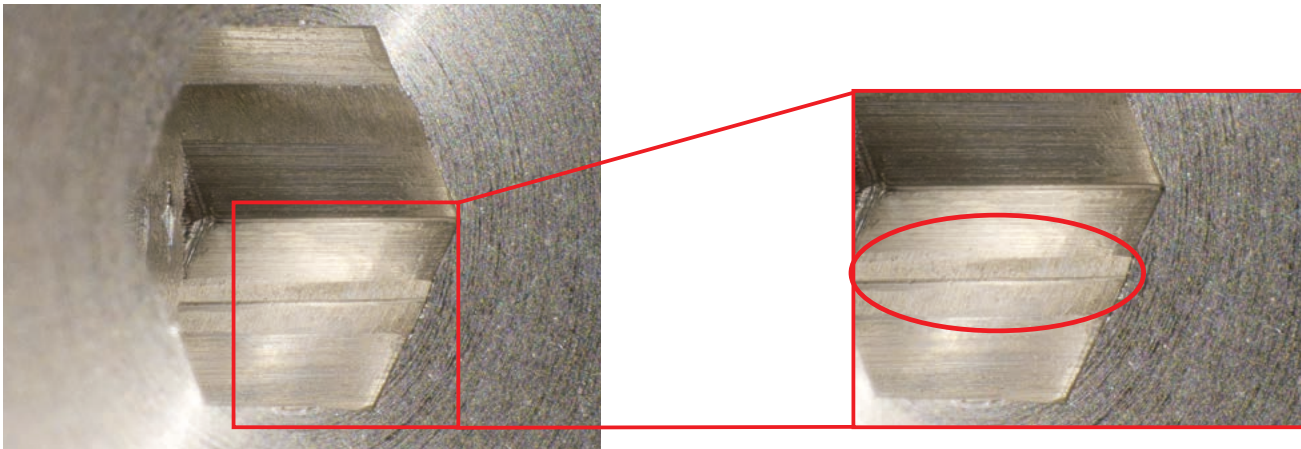

Cause: Pilot hole remaining

Solution: Need pilot hole tool's offset

■ Problem: Wall tapered

Solution: ● Smaller depth of cut
● Less tool overhang

■ Problem: Chuck is slipping / Insert Chipped

Solution: ● Run at 3000 mm/min (120 IPM) feed rate
● Smaller depth of cut

- 3000 mm/min (120 IPM) feed rate can cover most materials including Titanium alloy and Stainless steel.
- Too slow or too fast of a feed rate may cause excessive tool pressure for the Work piece and Tool.

SPLASH DUO - Stick Duo Hyper with Coolant through -

HY-NBH-OH (Coolant through)

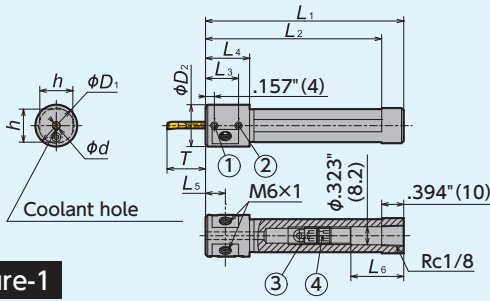

Figure-1

HY-NBH-OH (Coolant through)

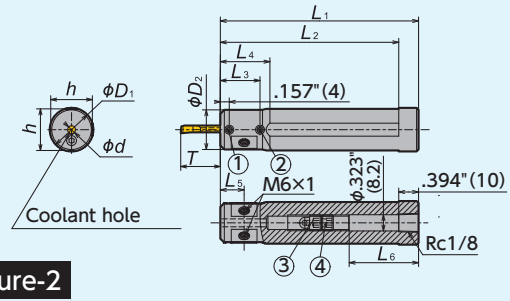

Figure-2

Item Number	Stock	Figure	ϕd		ϕD_1		ϕD_2	h	L_1	L_2	L_3	L_4	L_5	L_6	Overhang Length of Bar T			
			(Inch)	(mm)	(Inch)	(mm)									(mm)	(mm)	(mm)	(mm)
HY-NBH02016G-OH	●	1	.079	2	.630	16	19	15	90	80	15	19	9.5	29	.197	5.0	.709	18.0
HY-NBH02516G-OH	●	1	.098	2.5	.630	16	19	15	90	80	15	19	9.5	30	.248	6.3	.768	19.5
HY-NBH03016G-OH	●	1	.118	3	.630	16	19	15	90	80	15	19	9.5	31	.295	7.5	.827	21.0
HY-NBH03516G-OH	●	1	.138	3.5	.630	16	19	15	90	80	15	19	9.5	23	.346	8.8	.965	24.5
HY-NBH04016G-OH	●	1	.157	4	.630	16	19	15	90	80	20	24	12	23	.394	10.0	1.102	28.0
HY-NBH05016G-OH	●	1	.197	5	.630	16	19	15	90	80	20	24	12	16	.492	12.5	1.378	35.0
HY-NBH02019J-OH	●	2	.079	2	3/4	19.05	19.05	18	110	100	15	—	9.5	49	.197	5.0	.709	18.0
HY-NBH02519J-OH	●	2	.098	2.5	3/4	19.05	19.05	18	110	100	15	—	9.5	50	.248	6.3	.768	19.5
HY-NBH03019J-OH	●	2	.118	3	3/4	19.05	19.05	18	110	100	15	—	9.5	51	.295	7.5	.827	21.0
HY-NBH03519J-OH	●	2	.138	3.5	3/4	19.05	19.05	18	110	100	15	—	9.5	43	.346	8.8	.965	24.5
HY-NBH04019J-OH	●	2	.157	4	3/4	19.05	19.05	18	110	100	20	—	12	43	.394	10.0	1.102	28.0
HY-NBH05019J-OH	●	2	.197	5	3/4	19.05	19.05	18	110	100	20	—	12	36	.492	12.5	1.378	35.0
HY-NBH02020J-OH	●	2	.079	2	.787	20	20	19	110	100	15	—	9.5	49	.197	5.0	.709	18.0
HY-NBH02520J-OH	●	2	.098	2.5	.787	20	20	19	110	100	15	—	9.5	50	.248	6.3	.768	19.5
HY-NBH03020J-OH	●	2	.118	3	.787	20	20	19	110	100	15	—	9.5	51	.295	7.5	.827	21.0
HY-NBH03520J-OH	●	2	.138	3.5	.787	20	20	19	110	100	15	—	9.5	43	.346	8.8	.965	24.5
HY-NBH04020J-OH	●	2	.157	4	.787	20	20	19	110	100	20	—	12	43	.394	10.0	1.102	28.0
HY-NBH05020J-OH	●	2	.197	5	.787	20	20	19	110	100	20	—	12	36	.492	12.5	1.378	35.0
HY-NBH02022X-OH	●	2	.079	2	.866	22	20	21	120	110	15	25	9.5	59	.197	5.0	.709	18.0
HY-NBH02522X-OH	●	2	.098	2.5	.866	22	20	21	120	110	15	25	9.5	60	.248	6.3	.768	19.5
HY-NBH03022X-OH	●	2	.118	3	.866	22	20	21	120	110	15	25	9.5	61	.295	7.5	.827	21.0
HY-NBH03522X-OH	●	2	.138	3.5	.866	22	20	21	120	110	15	25	9.5	53	.346	8.8	.965	24.5
HY-NBH04022X-OH	●	2	.157	4	.866	22	20	21	120	110	20	25	12	53	.394	10.0	1.102	28.0
HY-NBH05022X-OH	●	2	.197	5	.866	22	20	21	120	110	20	25	12	46	.492	12.5	1.378	35.0
HY-NBH02025.0K-OH	●	2	.079	2	.984	25.0	20	24	125	115	15	25	9.5	64	.197	5.0	.709	18.0
HY-NBH02525.0K-OH	●	2	.098	2.5	.984	25.0	20	24	125	115	15	25	9.5	65	.248	6.3	.768	19.5
HY-NBH03025.0K-OH	●	2	.118	3	.984	25.0	20	24	125	115	15	25	9.5	66	.295	7.5	.827	21.0
HY-NBH03525.0K-OH	●	2	.138	3.5	.984	25.0	20	24	125	115	15	25	9.5	58	.346	8.8	.965	24.5
HY-NBH04025.0K-OH	●	2	.157	4	.984	25.0	20	24	125	115	20	25	12	58	.394	10.0	1.102	28.0
HY-NBH05025.0K-OH	●	2	.197	5	.984	25.0	20	24	125	115	20	25	12	51	.492	12.5	1.378	35.0
HY-NBH02025.4K-OH	●	2	.079	2	1	25.4	20	24	125	115	15	25	9.5	64	.197	5.0	.709	18.0
HY-NBH02525.4K-OH	●	2	.098	2.5	1	25.4	20	24	125	115	15	25	9.5	65	.248	6.3	.768	19.5
HY-NBH03025.4K-OH	●	2	.118	3	1	25.4	20	24	125	115	15	25	9.5	66	.295	7.5	.827	21.0
HY-NBH03525.4K-OH	●	2	.138	3.5	1	25.4	20	24	125	115	15	25	9.5	58	.346	8.8	.965	24.5
HY-NBH04025.4K-OH	●	2	.157	4	1	25.4	20	24	125	115	20	25	12	58	.394	10.0	1.102	28.0
HY-NBH05025.4K-OH	●	2	.197	5	1	25.4	20	24	125	115	20	25	12	51	.492	12.5	1.378	35.0

Parts for SPLASH DUO

Item Number	Clamp Screw		Overhang Adjustment		
	①	②	③	④	⑤
HY-NBH ... -OH	SS04045FS	SS0406F	SS0811R-OH	SS0806F-OH (Through hole)	SS0806F
	M6 Screw		Wrench		
	⑥		for ①②	for ③④⑤	for ⑥
	SS0606SC	LW-2	LW-4×104	LW-3	

● : Stock ● : Coolant through

STICK DUO HYPER

HY-NBH

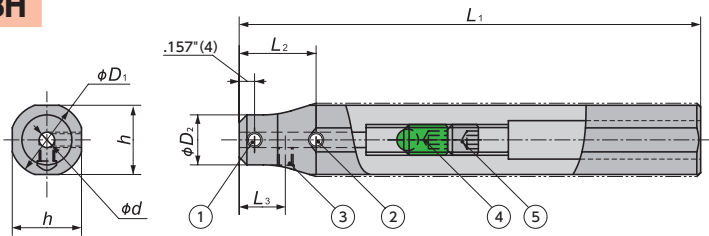

Spare Parts

Item Number	Overhang Adjustment		Wrench	
	④	⑤	for ①②③	for ④⑤
HY-NBH ... K	SS0812R	SS0808F	LW-2	LW-4×104

Please refer to ϕd to find correct-size inserts (bars)

Item Number	Stock	ϕd		ϕD_1		ϕD_2	h	L_1	L_2	L_3	Clamp Screws		
		(Inch)	(mm)	(Inch)	(mm)						①	②	③
HY-NBH02016H	○	.079	2.0	.630	16	11	15	100	15	9.5	SS04045FS	SS0406F	SS0404F
HY-NBH02516H	○	.098	2.5	.630	16	11.5	15	100	15	9.5	SS04045FS	SS0406F	SS0404F
HY-NBH03016H	○	.118	3.0	.630	16	12	15	100	15	9.5	SS04045FS	SS0406F	SS0404F
HY-NBH03516H	○	.138	3.5	.630	16	12.5	15	100	20	12	SS04045FS	SS0404F	SS0404F
HY-NBH04016H	○	.157	4.0	.630	16	13	15	100	20	12	SS04045FS	SS0404F	SS0404F
HY-NBH05016H	○	.197	5.0	.630	16	14	15	100	20	12	SS04045FS	SS0404F	SS0404F
HY-NBH02019K	●	.079	2.0	3/4	19.05	11	18	125	15	9.5	SS04045FS	SS0406F	SS0404F
HY-NBH02519K	●	.098	2.5	3/4	19.05	11.5	18	125	15	9.5	SS04045FS	SS0406F	SS0404F
HY-NBH03019K	●	.118	3.0	3/4	19.05	12	18	125	15	9.5	SS04045FS	SS0406F	SS0404F
HY-NBH03519K	●	.138	3.5	3/4	19.05	12.5	18	125	20	12	SS04045FS	SS0406F	SS0404F
HY-NBH04019K	●	.157	4.0	3/4	19.05	13	18	125	20	12	SS04045FS	SS0406F	SS0404F
HY-NBH05019K	●	.197	5.0	3/4	19.05	14	18	125	20	12	SS04045FS	SS0406F	SS0404F
HY-NBH02020K	○	.079	2.0	.787	20	11	19	125	15	9.5	SS04045FS	SS0406F	SS0404F
HY-NBH02520K	○	.098	2.5	.787	20	11.5	19	125	15	9.5	SS04045FS	SS0406F	SS0404F
HY-NBH03020K	○	.118	3.0	.787	20	12	19	125	15	9.5	SS04045FS	SS0406F	SS0404F
HY-NBH03520K	○	.138	3.5	.787	20	12.5	19	125	20	12	SS04045FS	SS0406F	SS0404F
HY-NBH04020K	○	.157	4.0	.787	20	13	19	125	20	12	SS04045FS	SS0406F	SS0404F
HY-NBH05020K	○	.197	5.0	.787	20	14	19	125	20	12	SS04045FS	SS0406F	SS0404F
HY-NBH02022K	●	.079	2.0	.866	22	11	21	125	15	9.5	SS04045FS	SS0406F	SS0404F
HY-NBH02522K	●	.098	2.5	.866	22	11.5	21	125	15	9.5	SS04045FS	SS0406F	SS0404F
HY-NBH03022K	●	.118	3.0	.866	22	12	21	125	15	9.5	SS04045FS	SS0406F	SS0404F
HY-NBH03522K	●	.138	3.5	.866	22	12.5	21	125	20	12	SS04045FS	SS0406F	SS0404F
HY-NBH04022K	●	.157	4.0	.866	22	13	21	125	20	12	SS04045FS	SS0406F	SS0404F
HY-NBH05022K	●	.197	5.0	.866	22	14	21	125	20	12	SS04045FS	SS0406F	SS0404F
HY-NBH02025K-MET	○	.079	2.0	.984	25	11	24	125	15	9.5	SS04045FS	SS0406F	SS0404F
HY-NBH02525K-MET	○	.098	2.5	.984	25	11.5	24	125	15	9.5	SS04045FS	SS0406F	SS0404F
HY-NBH03025K-MET	○	.118	3.0	.984	25	12	24	125	15	9.5	SS04045FS	SS0406F	SS0404F
HY-NBH03525K-MET	○	.138	3.5	.984	25	12.5	24	125	20	12	SS04045FS	SS0406F	SS0404F
HY-NBH04025K-MET	○	.157	4.0	.984	25	13	24	125	20	12	SS04045FS	SS0406F	SS0404F
HY-NBH05025K-MET	○	.197	5.0	.984	25	14	24	125	20	12	SS04045FS	SS0406F	SS0404F
HY-NBH02025K	●	.079	2.0	1	25.4	11	24	125	15	9.5	SS04045FS	SS0406F	SS0404F
HY-NBH02525K	●	.098	2.5	1	25.4	11.5	24	125	15	9.5	SS04045FS	SS0406F	SS0404F
HY-NBH03025K	●	.118	3.0	1	25.4	12	24	125	15	9.5	SS04045FS	SS0406F	SS0404F
HY-NBH03525K	●	.138	3.5	1	25.4	12.5	24	125	20	12	SS04045FS	SS0406F	SS0404F
HY-NBH04025K	●	.157	4.0	1	25.4	13	24	125	20	12	SS04045FS	SS0406F	SS0404F
HY-NBH05025K	●	.197	5.0	1	25.4	14	24	125	20	12	SS04045FS	SS0406F	SS0404F

Precaution for Shaper duo with STICK DUO HYPER sleeve

● Set insert in this position



Hexagon



Square

● To avoid insert chipping don't set insert in this position



Hexagon



Square

● : Stock

○ : 1-2 week delivery

💧 : Coolant through

Insert bars **➡W2**

Cutting condition **➡W3**

STICK DUO - Sleeves for ID machining -

NBH

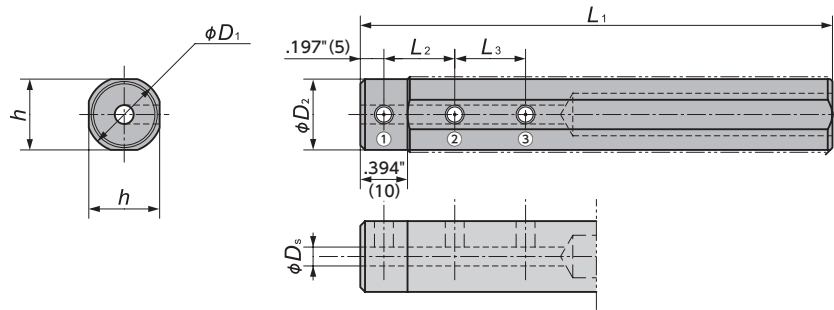

Item number	Stock	ϕD_s		ϕD_1		ϕD_2	h	L_1	L_2	L_3	Clamp screw			Wrench
		(Inch)	(mm)	(Inch)	(mm)						①	②	③	
NBH02015H	○	.079	2.0	5/8		15	15	100	10	—	SS0406F	SS0406F	—	LW-2
NBH02515H	○	.098	2.5	5/8		15	15	100	10	—	SS0406F	SS0406F	—	LW-2
NBH03015H	○	.118	3.0	5/8		15	15	100	10	10	SS0404F	SS0404F	SS0404F	LW-2
NBH03515H	○	.138	3.5	5/8		15	15	100	10	10	SS0404F	SS0404F	SS0404F	LW-2
NBH04015H	○	.157	4.0	5/8		15	15	100	15	15	SS0404F	SS0404F	SS0404F	LW-2
NBH04515H	○	.177	4.5	5/8		15	15	100	15	15	SS0404F	SS0404F	SS0404F	LW-2
NBH05015H	○	.197	5.0	5/8		15	15	100	15	15	SS0404F	SS0404F	SS0404F	LW-2
NBH06015H	○	.236	6.0	5/8		15	15	100	20	20	SS0404F	SS0404F	SS0404F	LW-2
NBH08015H	○	.315	8.0	5/8		15	15	100	20	20	SS0403F	SS0403F	SS0403F	LW-2
NBH02016H	○	.079	2.0	.630	16	15	15	100	10	—	SS0406F	SS0406F	—	LW-2
NBH02516H	○	.098	2.5	.630	16	15	15	100	10	—	SS0406F	SS0406F	—	LW-2
NBH03016H	○	.118	3.0	.630	16	15	15	100	10	10	SS0404F	SS0404F	SS0404F	LW-2
NBH03516H	○	.138	3.5	.630	16	15	15	100	10	10	SS0404F	SS0404F	SS0404F	LW-2
NBH04016H	○	.157	4.0	.630	16	15	15	100	15	15	SS0404F	SS0404F	SS0404F	LW-2
NBH04516H	○	.177	4.5	.630	16	15	15	100	15	15	SS0404F	SS0404F	SS0404F	LW-2
NBH05016H	○	.197	5.0	.630	16	15	15	100	15	15	SS0404F	SS0404F	SS0404F	LW-2
NBH06016H	○	.236	6.0	.630	16	15	15	100	20	20	SS0404F	SS0404F	SS0404F	LW-2
NBH07016H	○	.276	7.0	.630	16	15	15	100	20	20	SS0403F	SS0404F	SS0404F	LW-2
NBH08016H	○	.315	8.0	.630	16	15	15	100	20	20	SS0403F	SS0403F	SS0403F	LW-2
NBH02019K	○	.079	2.0	3/4		18	18	125	10	—	SS0408F	SS0408F	—	LW-2
NBH02519K	○	.098	2.5	3/4		18	18	125	10	—	SS0408F	SS0408F	—	LW-2
NBH03019K	○	.118	3.0	3/4		18	18	125	10	10	SS0406F	SS0406F	SS0406F	LW-2
NBH03519K	○	.138	3.5	3/4		18	18	125	10	10	SS0406F	SS0406F	SS0406F	LW-2
NBH04019K	○	.157	4.0	3/4		18	18	125	15	15	SS0406F	SS0406F	SS0406F	LW-2
NBH04519K	○	.177	4.5	3/4		18	18	125	15	15	SS0406F	SS0406F	SS0406F	LW-2
NBH05019K	○	.197	5.0	3/4		18	18	125	15	15	SS0406F	SS0406F	SS0406F	LW-2
NBH06019K	○	.236	6.0	3/4		18	18	125	20	20	SS0406F	SS0406F	SS0406F	LW-2
NBH07019K	○	.276	7.0	3/4		18	18	125	20	20	SS0404F	SS0404F	SS0404F	LW-2
NBH08019K	○	.315	8.0	3/4		18	18	125	20	20	SS0404F	SS0404F	SS0404F	LW-2
NBH10019K	○	.394	10.0	3/4		18	18	125	20	20	SS0403F	SS0404F	SS0404F	LW-2

NBH

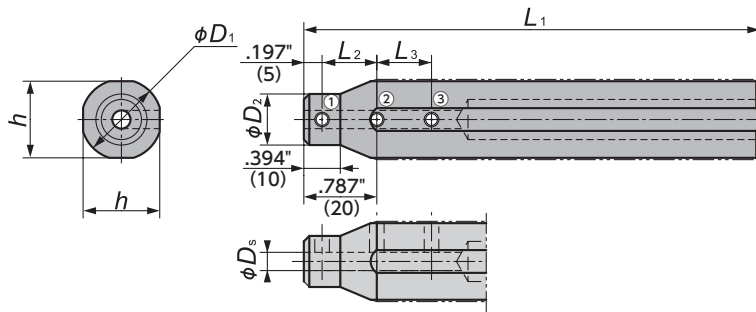

Item number	Stock	ϕD_s		ϕD_1		ϕD_2	h_1	L_1	L_2	L_3	Clamp screw			Wrench
		(Inch)	(mm)	(Inch)	(mm)						①	②	③	
NBH02020K	○	.079	2.0	.787	20	11	19	125	10	—	SS0404F	SS0404F	—	LW-2
NBH02520K	○	.098	2.5	.787	20	11	19	125	10	—	SS0404F	SS0404F	—	LW-2
NBH03020K	○	.118	3.0	.787	20	12	19	125	10	10	SS0404F	SS0404F	SS0406F	LW-2
NBH03520K	○	.138	3.5	.787	20	12	19	125	10	10	SS0404F	SS0404F	SS0406F	LW-2
NBH04020K	○	.157	4.0	.787	20	13	19	125	15	15	SS0404F	SS0406F	SS0406F	LW-2
NBH04520K	○	.177	4.5	.787	20	13	19	125	15	15	SS0404F	SS0406F	SS0406F	LW-2
NBH05020K	○	.197	5.0	.787	20	14	19	125	15	15	SS0404F	SS0406F	SS0406F	LW-2
NBH06020K	○	.236	6.0	.787	20	15	19	125	20	20	SS0404F	SS0406F	SS0406F	LW-2
NBH07020K	○	.276	7.0	.787	20	16	19	125	20	20	SS0404F	SS0406F	SS0406F	LW-2
NBH08020K	○	.315	8.0	.787	20	17	19	125	20	20	SS0404F	SS0404F	SS0404F	LW-2
NBH10020K	○	.394	10.0	.787	20	19	19	125	20	20	SS0404F	SS0404F	SS0404F	LW-2
NBH02022K	○	.079	2.0	.866	22	11	21	125	10	—	SS0404F	SS0406F	—	LW-2
NBH02522K	○	.098	2.5	.866	22	11	21	125	10	—	SS0404F	SS0406F	—	LW-2
NBH03022K	○	.118	3.0	.866	22	12	21	125	10	10	SS0404F	SS0406F	SS0408F	LW-2
NBH03522K	○	.138	3.5	.866	22	12	21	125	10	10	SS0404F	SS0406F	SS0406F	LW-2
NBH04022K	○	.157	4.0	.866	22	13	21	125	15	15	SS0404F	SS0406F	SS0406F	LW-2
NBH04522K	○	.177	4.5	.866	22	13	21	125	15	15	SS0404F	SS0406F	SS0406F	LW-2
NBH05022K	○	.197	5.0	.866	22	14	21	125	15	15	SS0404F	SS0406F	SS0406F	LW-2
NBH06022K	○	.236	6.0	.866	22	15	21	125	20	20	SS0404F	SS0406F	SS0406F	LW-2
NBH07022K	○	.276	7.0	.866	22	16	21	125	20	20	SS0404F	SS0406F	SS0406F	LW-2
NBH08022K	○	.315	8.0	.866	22	17	21	125	20	20	SS0404F	SS0406F	SS0406F	LW-2
NBH10022K	○	.394	10.0	.866	22	19	21	125	20	20	SS0404F	SS0404F	SS0404F	LW-2
NBH12022K	○	.472	12.0	.866	22	21	21	125	25	25	SS0404F	SS0404F	SS0404F	LW-2
NBH02023K	○	.079	2.0	.906	23	11	21	125	10	—	SS0404F	SS0406F	—	LW-2
NBH02523K	○	.098	2.5	.906	23	11	21	125	10	—	SS0404F	SS0406F	—	LW-2
NBH03023K	○	.118	3.0	.906	23	12	21	125	10	10	SS0404F	SS0406F	SS0408F	LW-2
NBH03523K	○	.138	3.5	.906	23	12	21	125	10	10	SS0404F	SS0406F	SS0406F	LW-2
NBH04023K	○	.157	4.0	.906	23	13	21	125	15	15	SS0404F	SS0406F	SS0406F	LW-2
NBH04523K	○	.177	4.5	.906	23	13	21	125	15	15	SS0404F	SS0406F	SS0406F	LW-2
NBH05023K	○	.197	5.0	.906	23	14	21	125	15	15	SS0404F	SS0406F	SS0406F	LW-2
NBH06023K	○	.236	6.0	.906	23	15	21	125	20	20	SS0404F	SS0406F	SS0406F	LW-2
NBH08023K	○	.315	8.0	.906	23	17	21	125	20	20	SS0404F	SS0406F	SS0406F	LW-2
NBH10023K	○	.394	10.0	.906	23	19	21	125	20	20	SS0404F	SS0404F	SS0404F	LW-2
NBH12023K	○	.472	12.0	.906	23	21	21	125	25	25	SS0404F	SS0404F	SS0404F	LW-2
NBH02025K-MET	○	.079	2.0	.984	25	11	24	125	10	—	SS0404F	SS0406F	—	LW-2
NBH02525K-MET	○	.098	2.5	.984	25	11	24	125	10	—	SS0404F	SS0406F	—	LW-2
NBH03025K-MET	○	.118	3.0	.984	25	12	24	125	10	10	SS0404F	SS0406F	SS0408F	LW-2
NBH03525K-MET	○	.138	3.5	.984	25	12	24	125	10	10	SS0404F	SS0406F	SS0408F	LW-2
NBH04025K-MET	○	.157	4.0	.984	25	13	24	125	15	15	SS0404F	SS0408F	SS0408F	LW-2
NBH04525K-MET	○	.177	4.5	.984	25	13	24	125	15	15	SS0404F	SS0408F	SS0408F	LW-2
NBH05025K-MET	○	.197	5.0	.984	25	14	24	125	15	15	SS0404F	SS0408F	SS0408F	LW-2
NBH06025K-MET	○	.236	6.0	.984	25	15	24	125	20	20	SS0404F	SS0408F	SS0408F	LW-2
NBH07025K-MET	○	.276	7.0	.984	25	16	24	125	20	20	SS0404F	SS0408F	SS0408F	LW-2
NBH08025K-MET	○	.315	8.0	.984	25	17	24	125	20	20	SS0404F	SS0406F	SS0406F	LW-2
NBH10025K-MET	○	.394	10.0	.984	25	19	24	125	20	20	SS0404F	SS0406F	SS0406F	LW-2
NBH12025K-MET	○	.472	12.0	.984	25	21	24	125	25	25	SS0404F	SS0404F	SS0404F	LW-2
NBH02025K	○	.079	2.0	1	25.4	11	24	125	10	—	SS0404F	SS0406F	—	LW-2
NBH02525K	○	.098	2.5	1	25.4	11	24	125	10	—	SS0404F	SS0406F	—	LW-2
NBH03025K	○	.118	3.0	1	25.4	12	24	125	10	10	SS0404F	SS0406F	SS0408F	LW-2
NBH03525K	○	.138	3.5	1	25.4	12	24	125	10	10	SS0404F	SS0406F	SS0408F	LW-2
NBH04025K	○	.157	4.0	1	25.4	13	24	125	15	15	SS0404F	SS0408F	SS0408F	LW-2
NBH04525K	○	.177	4.5	1	25.4	13	24	125	15	15	SS0404F	SS0408F	SS0408F	LW-2
NBH05025K	○	.197	5.0	1	25.4	14	24	125	15	15	SS0404F	SS0408F	SS0408F	LW-2
NBH06025K	○	.236	6.0	1	25.4	15	24	125	20	20	SS0404F	SS0408F	SS0408F	LW-2
NBH07025K	○	.276	7.0	1	25.4	16	24	125	20	20	SS0404F	SS0408F	SS0408F	LW-2
NBH08025K	○	.315	8.0	1	25.4	17	24	125	20	20	SS0404F	SS0406F	SS0406F	LW-2
NBH10025K	○	.394	10.0	1	25.4	19	24	125	20	20	SS0404F	SS0406F	SS0406F	LW-2
NBH12025K	○	.472	12.0	1	25.4	21	24	125	25	25	SS0404F	SS0404F	SS0404F	LW-2

● : Stock ○ : 1-2 week delivery

Insert bars →W2

Cutting condition →W3

X

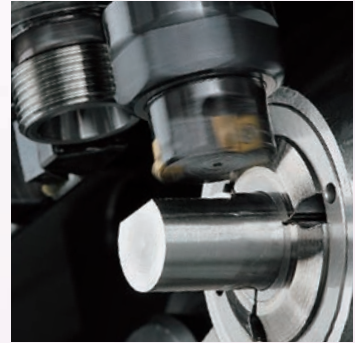

Indexable End Mills

Small Diameter Indexable End Mills

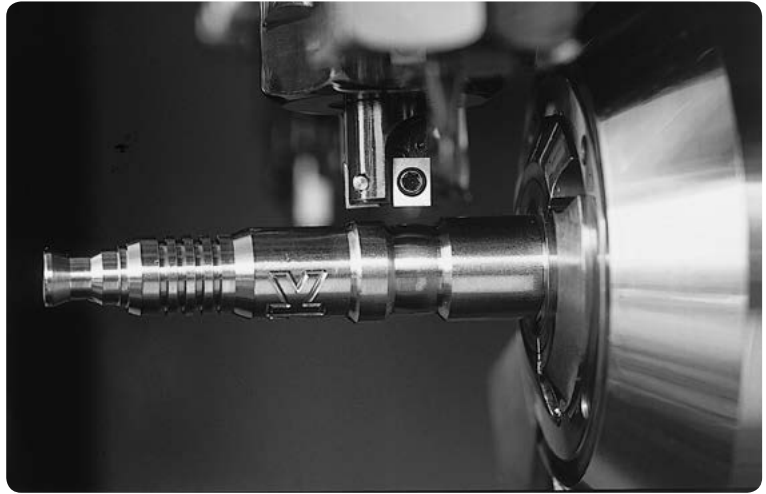

Features

- Attach .787"(20mm) end mills in ER16 collet
- Just change inserts to index. No need to make any adjustments
- High quality surface finish, as low as 1um (Rz) when wiper inserts are used
- Corner radius as small as .002"
- In addition to D cut, ramp machining can be performed*

*A combination of single-blade type endmills and inserts with center blade is required

[Recommended Cutting Conditions]

Work Material	Speed SFM	Axial feed IPR	Traverse feed IPR	Depth of cut Inch	Width of cut
Steel	260 - 400	~.001	~.002	~.118	~50% of cutter diameter
Stainless Steel	130 - 200	~.0008	~.0015	~.079	~50% of cutter diameter

Application Example

Application Example-1

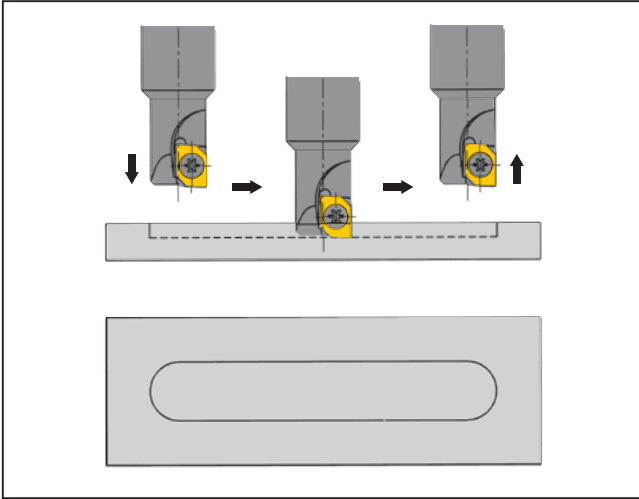

- A single tooth endmill equipped with a center cutting edge insert can be used for both plunge and side cut operations.

Application Example-2

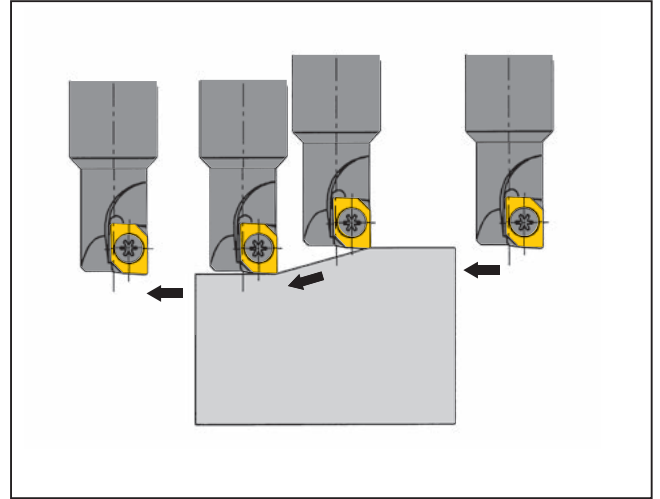

- A single tooth endmill equipped with a center cutting edge insert can be used for slope milling operations.

Insert

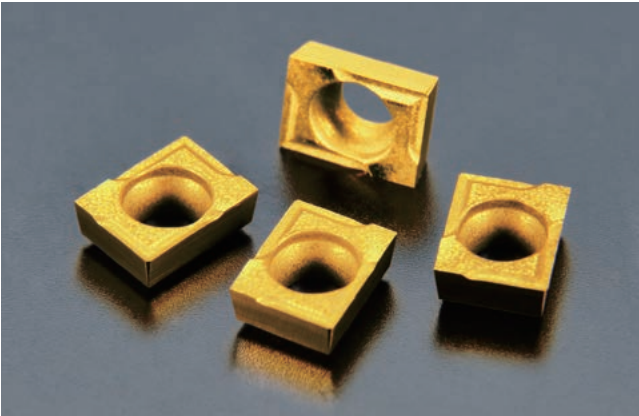

Wiper

- Excellent surface finish obtained with new wiper insert

Chipbreaker

- Less tool pressure with chipbreaker

45°

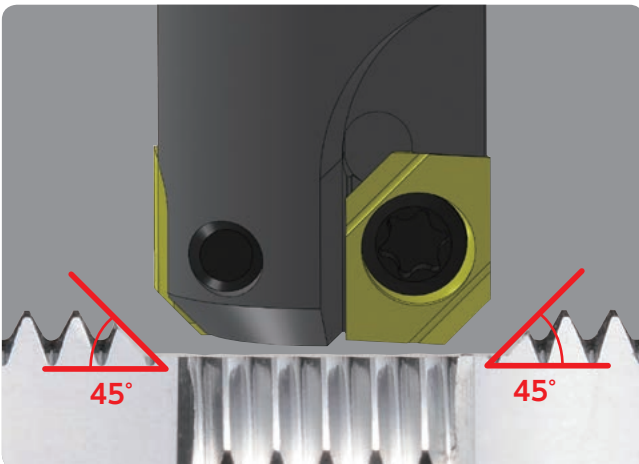

Chamfered surface finish insert	
S45C	
310 SFM	
.0056 IPR	
.039 DOC	
WET	
NTK : QM3 C45 type	700 pcs
Competitor's solid endmill	500 pcs

REZ Series

REZ

<D cutting = lead angle 90 type end milling tool>

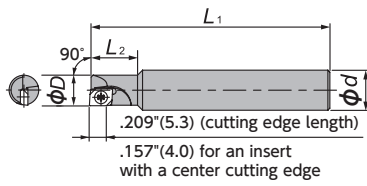

Figure-1

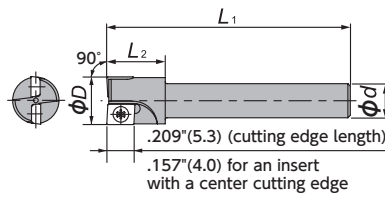

Figure-2

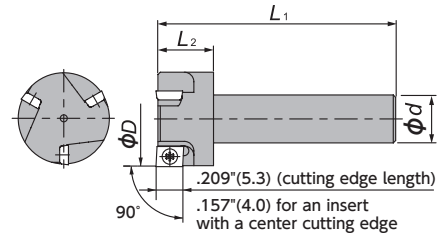

Figure-3

<D cutting = lead angle 45 type end milling tool>

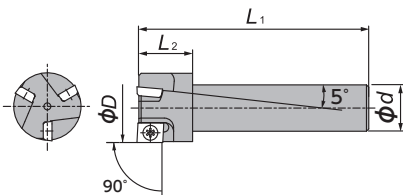

Figure-4 Right-Hand style shown

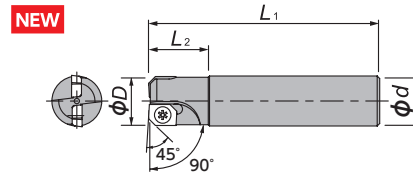

Figure-5

REZ Series - Toolholders



REZ

Gage Insert	Item Number	Figure	Stock		No. of teeth	ϕD		ϕd		L_1		L_2		Clamp Screw	Wrench
			R	L		(Inch)	(mm)	(Inch)	(mm)	(Inch)	(mm)	(Inch)	(mm)		
CZH04..CFR...	REZ080C1R212	1	○		1	.315	8	.394	10	2.362	60	.472	12	FS102-2.2 × 4.0	T-07
CZH05..CFR...	REZ100C1R218	1	○		1	.394	10	.394	10	2.953	75	.472	12	FS102-2.2 × 4.3	T-07
CZH04..CFR...	REZ100B2R329	2	○		2	.394	10	.197	5	1.575	40	.394	10	FS102-2.2 × 4.3	T-07
	REZ100C2R133	2	○		2	.394	10	.236	6	1.969	50	.472	12	FS102-2.2 × 4.3	T-07
	REZ100C2R132	2	○		2	.394	10	.276	7	1.969	50	.472	12	FS102-2.2 × 4.3	T-07
	REZ100C2R141	2	●		2	.394	10	.394	10	1.969	50	.472	12	FS102-2.2 × 4.3	T-07
	REZ120C2R141	2	○		2	.472	12	.394	10	1.969	50	.472	12	FS102-2.2 × 4.3	T-07
	REZ140C2R141	2	○		2	.551	14	.394	10	1.969	50	.472	12	FS102-2.2 × 4.3	T-07
	REZ150B3R330	3	○		3	.591	15	.197	5	1.575	40	.394	10	FS102-2.2 × 4.3	T-07
	REZ200M3R319	3	○		3	.787	20	.276	7	1.969	50	.472	12	FS102-2.2 × 4.3	T-07
	REZ200M3R320	3	●		3	.787	20	.394	10	1.969	50	.472	12	FS102-2.2 × 4.3	T-07
	REZ200C3R403	4	●		3	.787	20	.394	10	1.969	50	.472	12	FS102-2.2 × 4.3	T-07
CZH0400CFR-C45	REZ100C2R466	5	○		2	.394	10	.276	7	1.969	50	.472	12	FS102-2.2 × 4.3	T-07
CZH04..CFR...	REZ100C2R461	5	●		2	.394	10	.394	10	1.969	50	.472	12	FS102-2.2 × 4.3	T-07

CZH Series - Inserts

NEW

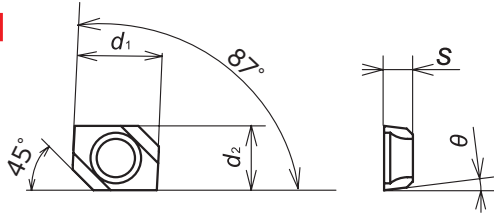

Figure-1 Chipbreaker with wiper

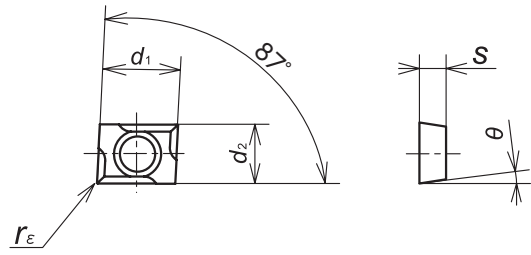

Figure-2 Chipbreaker

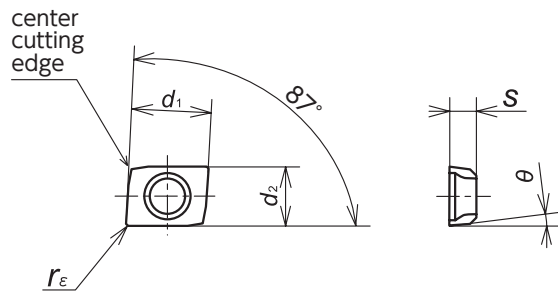

Figure-3 Center cutting edge without wiper

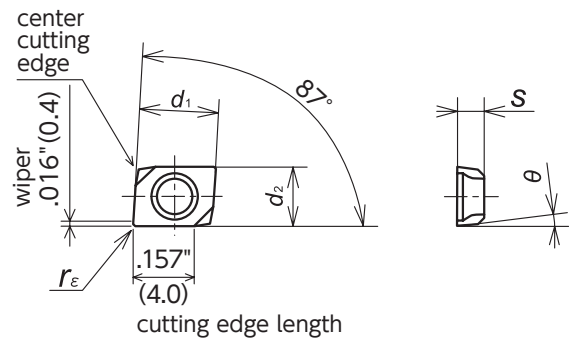

Figure-4 Center cutting edge with wiper

CZH

Item Number	Figure	Chip-breaker	Center Blade	Wiper	d_1		d_2		s		θ	C or r_e		Coated Carbide				
					(Inch)	(mm)	(Inch)	(mm)	(Inch)	(mm)		(Inch)	(mm)	QM3	DT4	DM4	TM4	ZM3
CZH0400CFR-C45*	1	Yes	No	Yes	.219	5.56	.165	4.20	.074	1.88	7°	C.053	C1.35	○	●			
CZH04005CFR-BL	2	Yes	No	No	.219	5.56	.165	4.20	.074	1.88	7°	.002	0.05			●	○	
CZH0402CFR-BL	2	Yes	No	No	.219	5.56	.165	4.20	.074	1.88	7°	.008	0.2			●	○	
CZH04005CFR-070	3	No	Yes	No	.219	5.56	.165	4.20	.074	1.88	7°	.002	0.05		●			●
CZH0402CFR-070	3	No	Yes	No	.219	5.56	.165	4.20	.074	1.88	7°	.008	0.2		●			○
CZH04005CFR-140	4	No	Yes	Yes	.219	5.56	.165	4.20	.074	1.88	7°	.002	0.05		●			●
CZH0402CFR-140	4	No	Yes	Yes	.219	5.56	.165	4.20	.074	1.88	7°	.008	0.2		●			●
CZH05005CFR-141	4	No	Yes	Yes	.208	5.28	.219	5.56	.086	2.18	10°	.002	0.05					○
CZH0502CFR-141	4	No	Yes	Yes	.208	5.28	.219	5.56	.086	2.18	10°	.008	0.2					○

*Must be used with REZ100C2R461/466Cutters

● : Stock ○ : 1-2 week delivery

Cutting condition → X2

MEMO

Y



Information

- **Grade Comparison Chart** Y2
- **Turning Tool Terminology** Y4
- **Milling Cutter Terminology** Y5
- **Calculation Formula for Turning** Y6
- **Troubleshooting for Turning** Y8
- **Calculation Formula for Milling Processes**... Y10
- **Troubleshooting for Milling** Y12
- **Surface Roughness Standards** Y14
- **Spare Parts - Wrenches** Y16
- **Clamp Screws and Wrenches** Y17
- **Material Cross Reference Chart** Y18
- **Ni-based Heat Resistant Alloys** Y20
- **Co-based Heat Resistant Alloys** Y24
- **Swiss Machine List** Y26
- **Hardness Comparison Chart** Y30

Grade Comparison Chart

* Italic type = Coated insert

● BIDE MICS / Ceramics

	NTK	GREENLEAF	HERTEL	INDEXABLE	ISCAR	KENNAMETAL	KYOCERA	NEWCOMER	ROMAY	SANDVIK	SPK	SSANGYONG	SUMIOTOMO	TAEGUTECH	TUNGALOY	VALENITE	
Cast iron [K]	HC1 HW2	GEM19	AC5	I50	IN11		KA30	NP5200	CC10			SZ200 SZ300		AW20 AB120			
	HC2 HC5 HC6	GEM7	MC2	I100	IN22 IN23	K090 KY1615	A65 A66N PT600M	NP5000	CC20 CC30	CC620 CC650	SH2	ST100 ST300 ST500 SD200 TC300 TA300	NB90S	AB30	LX11 LX21 CX710	Q32	
	SX6 SP9	CSN100 CSN200		MW30 MW43	IS8 IS80	KYK25 KYK35 KY3000 KY3400 KY3500	CS7050 KS6000 KS6050		CC510 CC513 CC514 CC514SC CC516 CC516SC	CC6190 CC1690	SL506 SL508 SL554C SL808 SL550C SL654 SL854C	SN26 SN300 SN400 SN600 SN500 SN600 SN700 SN800	SN2000K SN2100K NS260 NS260C	AS10 SC10 AS500	FX105	VPQ130 VPQ135	
Heat resistant alloy [S]	JX1																
	WA1	WG300 WG600			IW7	KY4300			CC600	CC670		SW400 SW500 SW700	WX2000	TC430			
	SX5 SX7 SX9			MW37		KYS25 KYS30 KY2100 KY1525 KY1540	CF1		CC5477	CC6060 CC6065		SN900		AS20			
Hardened material [H]	HC4 ZC4 HC5 HC7 ZC7	GEN7		I100	IN22	KY4400	A65 KT66 A66N PT600M		CC30SC	CC6050				NB90S	AB20	LX11	Q35 VPZ215 VPZ205
	WA1	WG300 WG600			IW7	KYS25 KY4300				CC670		SW400 SW500 SW700					

● Cermet

	NTK	DIJET	HITACHI	ISCAR	KENNAMETAL	KYOCERA	mitsubishi	SANDVIK	SECO	SSANGYONG	SUMIOTOMO	TAEGUTECH	TUNGALOY
Steel [P]	XT3 Q15 C7X C7Z XN4	LN10 CX50 CX75 CX90 CX99 NIT NAT SUZ	CH350 CZ25 CH550 CH7030 CZ1025	IC20N IC520N IC530N IC75T IC30N	KT315 KTP10	TN30 PV30 TN6010 PV7010 TN60 TN6020 PV7020 PV7025 TN90	AP25N NX2525 NX3035 VP45N	CT5015 GC1525	CM C15M	TX510 TX515 TX520 TX530	T110A T1200A T2000Z T3000Z	PV3010 PV3030 CT3000 CT5000	NS520 G7530 G7730 NS730 NS740
Stainless steel [M]	XT3 Q15 C7X C7Z XN4	LN10 CX50 CX75 CX90 CX99 NIT NAT SUZ	CH350 CH550 CH7030 CZ1025	IC20N IC520N IC530N IC30N	KT315 KTP10	TN60 TN6020 PV7020 PV7025 TN90	NX2525 AP25N NX3035	GC1525	CM C15M	TX510 TX515 TX520 TX530	T2000Z	PV3010 PV3030 CT3000 CT5000	NS520 NS530 G7730 NS740
Cast iron [K]	T15 Q15	LN10 NIT	CH350		KT315 KTP10	TN30 PV30 PV7005 TN60 TN6010 PV7005 PV7010	AP25N NX2525	CT5015		TX510 TX515 TX520 TX530	T110A T1200A	PV3010 PV3030 CT3000 CT5000	NS520 NS530 NS730 G7730

● Non coated carbide

	NTK	DIJET	GREENLEAF	HITACHI	INDEXABLE	ISCAR	KENNAMETAL	KYOCERA	mitsubishi	ROMAY	SANDVIK	SECO	SUMIOTOMO	TAEGUTECH	TUNGALOY	WALTER
Steel [P]	KM1	SRT DX30 DX35 SR30	G60 G20M	WS10 EX35 EX40 EX45	C19 C17 C16 C15	IC70 IC50M IC54	KU10	PW30	UTi20T			S10M S25M S60M	ST10P ST20E ST30E A30	CT3000	UX30 TX40	
Cast iron [K]	KM1	KG03 KG1 KG10 KT9 CR1 KG20 KG30 LF12	G02	WH02 WH05 WH10 WH20D	Cl65 Cl2 Cl3 Cl1 Cl4	IC04 IC20 IC10 IC28	K68 K313	KW10 GW15 GW25	HTi05T HTi10T UTi20T	R600	H10 H13A	890 883 HX	G10E	UF1	TH03 KS05F G1F TH10 G2 G2F KS15F KS20 G3	WSN10 WK1

● PVD coated carbide

	NTK	DIJET	GREENLEAF	HITACHI	INDEXABLE	ISCAR	KENAMETAL	KYOCERA	MITSUBISHI	SANDVIK	SECO	SUMIOTOMO	TAEGUTECH	TUNGALOY	WALTER
Steel P	VM1 ZM3 QM3 TM4 DT4 DM4	JC5003 JC5030 JC5015 JC5040	G915 G920 G925	CY15 CY150 IP2000 CY250 CY9020 HC844 IP3000	CI29 CI25A	IC507 IC807 IC907 IC908 IC328 IC928 IC3028	KC5510 KC5010 KCU10 KCU25 KC5025 KC5525	PR915 PR1005 PR930 PR1025 PR1115 PR1215 PR1225	VP10MF VP10RT VP15TF VP20MF VP20RT	GC1125 GC1525	CP200 CP250 CP500	ACZ150 ACZ310 AC520U ACZ330 ACZ350 AC530U	TT1040 TT7220 TT8010 TT8020 TT9030 TT9080	AH710 AH725 AH730 SH730 GH330 AH120 AH740 AH130 GH130 AH140	WSM30 WXP43 WXM33 WXP20
Stainless steel M	VM1 ZM3 QM3 TM4 DT4 DM4	JC5003 JC5015 JC5030 JC5040	G915 G920 G925	IP050S IP100S CY250 CY9020	CI29 CI24 CI23	IC507 IC520 IC907 IC308 IC908 IC3028 IC1008 IC1028 IC3028 IC928	KCU10 KCU25 KC5010 KC5025 KC5510 KC5525	PR915 PR1025 PR1215 PR1225 PR930 PR1125	VP10MF VP10RT VP15TF VP20MF VP20RT	GC15 GC1005 GC1105 GC1115 GC1525 GC2035	TS2000 CP200 TS2500 CP500	EH510Z ACZ150 AC510U EH520Z ACZ310 AC520U ACZ330 ACZ350 AC530U	TT1040 TT5080 TT7010 TT7080 TT7220 TT8010 TT8020	AH710 AH725 AH730 GH330 SH730 GH730 AH120 AH130 GH130 AH140	WXN10 WXP43 WXM33 WXP20 WXM20
Cast iron K	QM3 DM4	JC5003 JC5015		CY100H CY10H CY9020		IC910 IC507 IC908 IC508	KCU10 KCU25 KC5010 KC5025 KC5510 KC5525	PR905 PR1215	VP10RT VP15TF VP20RT		TS2000 CP200 DTS2500 CP250 CP500	EH10Z EH510Z AC510U EH20Z ACZ310 AC520U AC530U	TT1040 TT6080 TT7010 TT7080	AH110 GH110 AH120 GH130	

● CVD coated carbide

	NTK	DIJET	GREENLEAF	HITACHI	INDEXABLE	ISCAR	KENAMETAL	KYOCERA	MITSUBISHI	ROMAY	SANDVIK	SECO	SUMIOTOMO	TAEGUTECH	TUNGALOY	WALTER
Cast iron K	CP1	JC105V JC605X JC605W JC050W JC110V JC610 JC215V	GA5022 GA5023	HG3305 HG3315 HX3505 HX3515 GM8015 HG8010 GM8020 GM8025 GM25	CIN2 CIT3 CIT6 CINX CIX	IC428 IC9007 IC9150 IC418 IC428 IC9015 IC9007	KCP05 KCK05 KCP10 KCK15 KCP25 KCK20 KCP30	CA4010 CA4505 CA5505 CA4115 CA4515 CA4120	UC5105 UC5115 UC6110 UE6110	R100 R200 R500	GC3005 GC3205 GC3210 GC3215 GC4215	TK1000 TH1000 TK2000 MK1500 TX150 TP200 TP2500	AC300G AC410K AC700G ACK200 DAC820P AC420K ACK200	TT6300 TT6800 TT7005 TT7015	T5105 T5115 T1115 T5125	WPP01 WPP10 WPP20

● BIDEKICS/CBN

	NTK	DIJET	HITACHI	INDEXABLE	ISCAR	KENAMETAL	KYOCERA	MITSUBISHI	SANDVIK	SECO	SPK	SSANGYONG	SUMIOTOMO	TAEGUTECH	TUNGALOY	WALTER
Cast iron K	B23 B30 B99	JBN795 JBN330	BH200 BH250	CBN90 CBN95 CBN100	IB50 IB85 IB55	KB5630 KB1630 KB1345 KB9610 KB9640	<i>KBN60M KBN900</i>	MB710 MB5015 MB730 MB5140 BC5030	CB7525 CB7925	<i>CBN050C CBN300P</i> CBN20 CBN200 CBN300 CBN350	WBN115 WBN105 WBN100 WBN120 WBN750	SBN1600	BN700 BNS800 BN600 BN500	TB730 TB650 KB90 KB90A TB670	BX930 BX90S BX870 BX470 BX480 BX950 BXC90	
Heat resistant alloy S	JP2			CBN80		KB5630 KB1630 KB1340		MB730		CBN170			BN700	TB730 KB90	BX950	
Hardened material H	B52 B36 B40 B5K B6K	JBN300 JBN245	BH200 BH250	CBN45 CBN50 CBN60 CBN70	IB50 IB55	KB1610 KBN525 KBN10C KBN25C KBN05M KBN10M KBN25M KBN30M KBN35N KBN900	<i>MBC010 MB810 BC8020 MB8025 MB825 MB835</i>	CB7015 CB20 CB50 CB7025 CB7525	<i>CBN050C CBN10 CBN100 CBN150 CBN170 CBN200 CBN160P CBN350 CBN300P</i>		SBN2000	BNX10 BNX20 BN250 BNX25 BN300 BNC150 BNC80 DBNC200 BNC300	KB50 TB650 TB610 TB670	BX310 <i>BXM10</i> BX330 BX360 <i>BXC50</i> BX380 BX380 <i>BXM20</i>	WLB30 WLB50	

● PCD

	NTK	DIJET	INDEXABLE	ISCAR	KENAMETAL	KYOCERA	MITSUBISHI	SANDVIK	SECO	SSANGYONG	SUMIOTOMO	TAEGUTECH	TUNGALOY	WALTER
Non-ferrous material N	PD1 PD2	JDA30 JDA735 JDA40 JDA745 JDA10 JDA715	PCD3 PCD-F PCD-UF	ID5	KD1400 KD1405 KD1425	KPD001 KPD010 KPD230	MD205 MD220 MD230	CD10	PD10 PD20 PD30	SPD100 SPD200 SPD300	DA1000 DA2200 DA150 DA200 DA90	KP100 KP300 KP500	DX180 DX160 DX140 DX110 DX120	WCD10

(Note) This chart is based on published data and not authorized by each manufacturer

Turning Tool Terminology

Toolholder part names

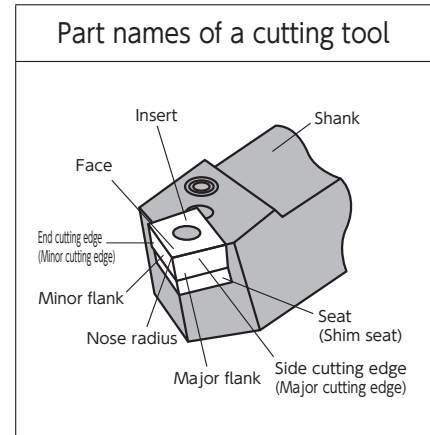
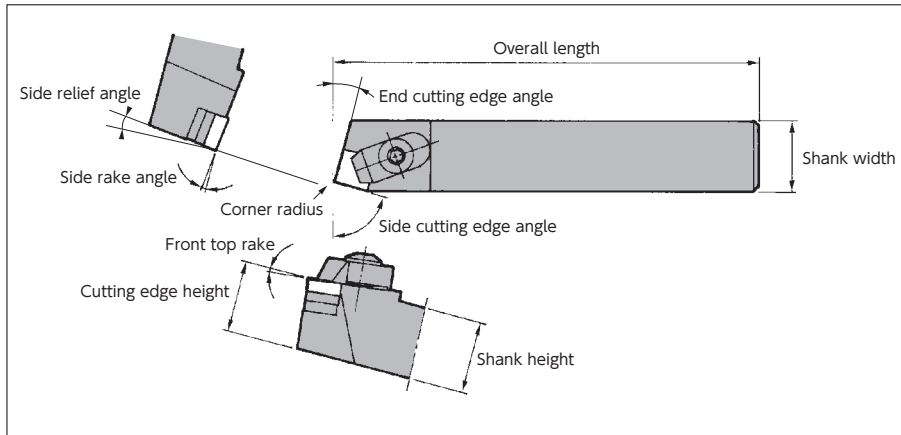

Holder rigidity

Toolholder deflection

$$\delta = \frac{4 \times F \times L^3}{E \times b \times h^3} = \frac{4 \times k_c \times f \times L^3}{E \times b \times h^3}$$

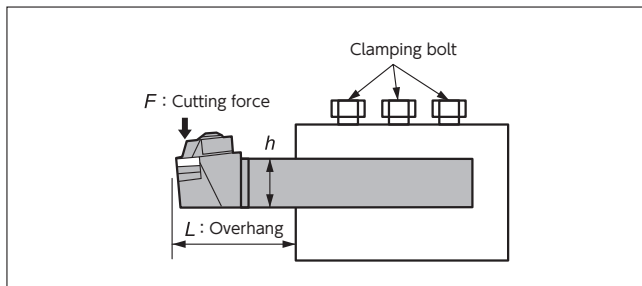

Symbol	Term	Unit
δ	Deflection amount	mm
b	Shank width	mm
h	Shank height	mm
E	Young's modulus	N/mm ²
a_p	Depth of cut	mm
f	Feed amount	mm/rev
k_c	Specific cutting force	N/mm ²
L	Overhang	mm
F	Cutting force	N

$$(F = k_c \times a_p \times f)$$

Boring bar deflection

$$\delta = \frac{64 \times F \times L^3}{3 \times E \times \pi \times D^4} = \frac{64 \times k_c \times a_p \times f \times L^3}{3 \times E \times \pi \times D^4}$$

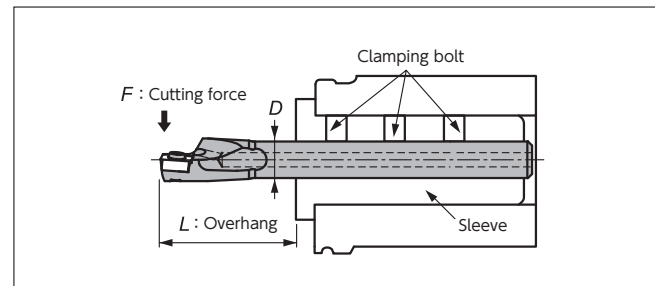

Symbol	Term	Unit
δ	Deflection amount	mm
D	Shank diameter	mm
E	Young's modulus	N/mm ²
a_p	Depth of cut	mm
f	Feed amount	mm/rev
k_c	Specific cutting force	N/mm ²
L	Overhang	mm
F	Cutting force	N

$$(F = k_c \times a_p \times f)$$

An important factor in improving the rigidity of a toolholder is to ensure the overhang of the tool shank is as short as possible.

■ Milling Cutter Terminology

● Milling cutter terminology

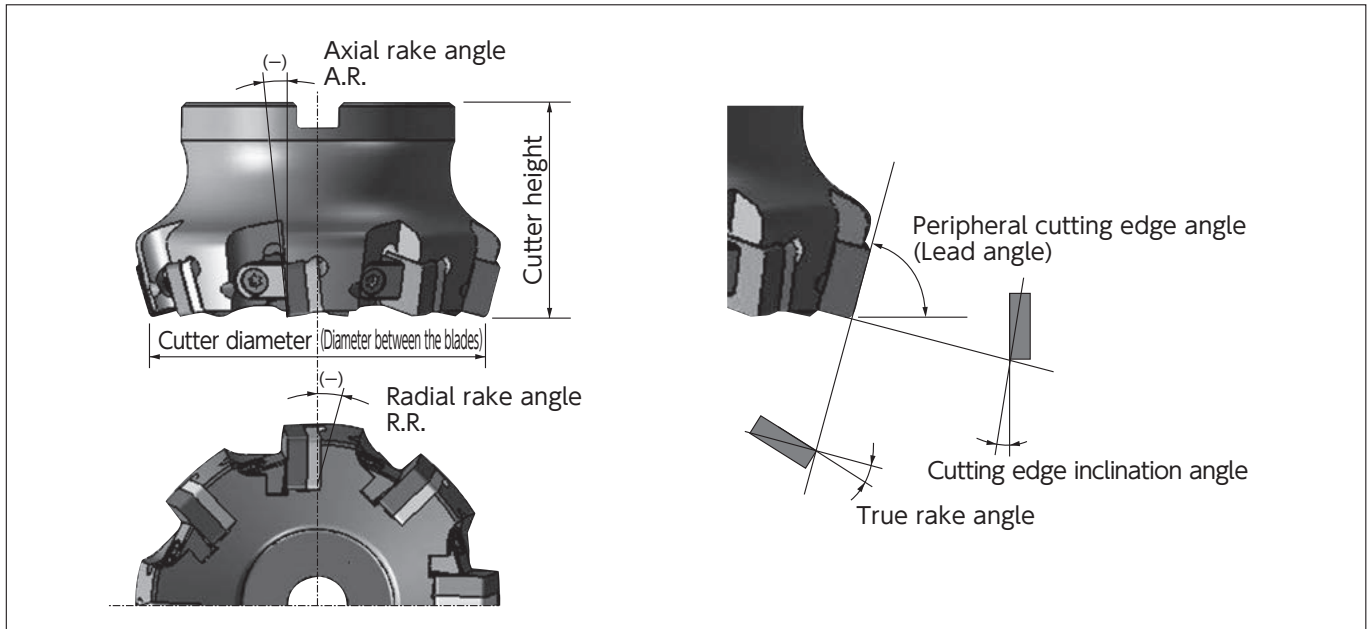

● Functions of each cutting edge angle

Name	Function	Effects
Radial rake angle: R.R.	Controls the direction of chip evacuation and cutting force	Negative (-): Excels in chip control performance
Axial rake angle: A.R.	Controls the direction of chip evacuation and cutting force	Positive (+): Excels in cutting performance and BUE resistance
Lead angle	Controls the thickness and evacuation direction of chips	Larger lead angles decrease the thickness of chips and relieves cutting load
True rake angle	Actual rake angle	Larger angles excel in cutting performance and BUE resistance, but lower the cutting edge strength Smaller angles increase the cutting edge strength but lower the BUE resistance
Cutting edge tilt angle	Controls the direction of chip evacuation	Larger angles excel in chip control performance and relieve cutting load, but lower the strength of the insert corner

● Functions of each angle

《Lead angle》: Relationship of this angle and chip thickness

Lead angle : 45 degrees	
Lead angle : 75 degrees	
Lead angle : 90 degrees	

《Rake angle》: Combinations and characteristics

Combinations of the angles for basic cutting edge shapes	(+) Axial rake angle : positive	(-) Axial rake angle : negative	(+) Axial rake angle : positive
Radial rake angle (R.R.)	Positive (+)	Negative (-)	Negative (-)
Axial rake angle (A.R.)	Positive (+)	Negative (-)	Positive (+)
Insert specification	Positive (single side used)	Negative (both sides used)	Positive (single side used)
Work material	Steel	●	●
	Cast iron	—	●
	Aluminum alloy	●	—

Calculation Formula for Turning

Calculating the cutting speed

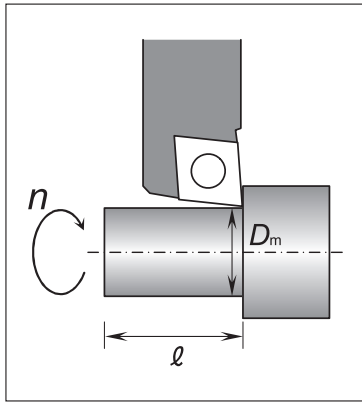

Calculating the cutting speed from the rotation speed

$$v_c = \frac{\pi \times D_m \times n}{12}$$

(SFM)

v_c : Cutting speed (SFM)
 D_m : Machining diameter (inch)
 n : Spindle speed (rpm)
 π : Pi (.1236")

Calculating the revolution speed from the cutting speed

$$n = \frac{12 \times v_c}{\pi \times D_m}$$

(rpm)

Example : Obtaining a cutting speed for machining a work piece of 2" diameter at the spindle speed of 1,000 min⁻¹:

$$v_c = \frac{\pi \times 2 \times 1000}{12} = \underline{523 \text{ (SFM)}}$$

Calculating the cutting time

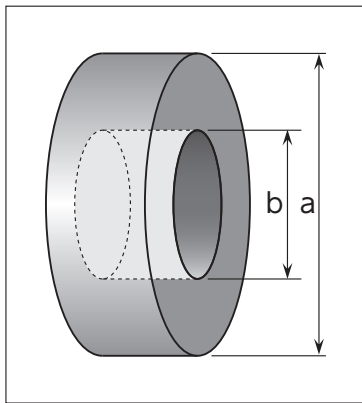

Calculating the cutting time for OD (ID) machining

$$T = \frac{l}{f \times n}$$

(min)

T : Cutting time (min)
 l : Cutting length (inch)
 f : Feed rate (IPR)
 n : Spindle speed (rpm)

Calculating the cutting time for facing

$$T = \frac{\pi \times (a^2 - b^2)}{4000 \times v_c \times f}$$

(min)

T : Cutting time (min)
 v_c : Cutting speed (m/min)
 f : Feed amount (mm/rev)
 π : Pi (3.14)

Example : Obtaining a cutting time for machining of work to be cut 4" long at the spindle speed of 1,000 rpm and at a feed rate of .004IPR:

$$T = \frac{4}{.004 \times 1000} = \underline{1 \text{ (min)}}$$

Calculating the theoretical surface roughness

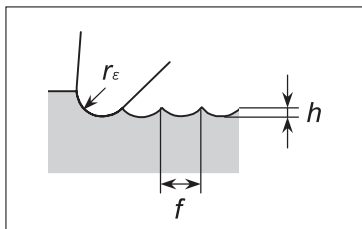

$$h = \frac{f^2}{8 r_\epsilon} \times 1000^2$$

(μinch)

h : Theoretical surface roughness (μinch)
 f : Feed amount (IPR)
 r_ϵ : Corner radius (inch)

Example : Obtaining the theoretical surface roughness when machining with an insert having .031 corner nose radius at a feed rate of 0.004 IPR:

$$h = \frac{.004^2}{8 \times .031} \times 1000^2 = \underline{64.51 \text{ (μinch)}}$$

[Guidelines for actually finished surface roughness]
 Steel type work: Theoretical surface roughness × 1.5 to 3
 Cast iron type work: Theoretical surface roughness × 3 to 5

● Calculating the cutting force

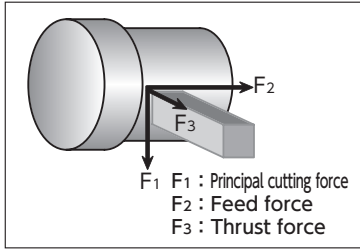

$$F = k_c \times a_p \times f$$

(N)

F : Cutting force (N)
 k_c : Specific cutting force (N/mm³) *See the table below.
 a_p : Depth of cut (mm)
 f : Feed amount (mm/rev)

Example : Calculating the cutting force for grey cast iron cut at the feed rate of 0.2 mm/rev and with a depth of cut of 3 mm:

$$F = 1800 \times 3 \times 0.2 = \underline{1080 \text{ (N)}}$$

● Calculating the power required

$$P_c = \frac{v_c \times f \times a_p \times k_c}{60 \times 10^3 \times \eta}$$

(kW)

P_c : Required power (kW)
 v_c : Cutting speed (m/min)
 f : Feed amount (mm/rev)
 a_p : Depth of cut (mm)
 k_c : Specific cutting force (N/mm³) *See the table below.
 η : Mechanical efficiency (0.7~0.8)

Example : Calculating the cutting power for the machining of grey cast iron at a cutting speed of 700 m/min, feed rate of 0.4 mm/rev, and with a depth of cut of 2 mm (with 0.8 set as the mechanical efficiency):

$$P_c = \frac{700 \times 0.4 \times 2 \times 1400}{60 \times 10^3 \times 0.8} = \underline{16.33 \text{ (kW)}}$$

● Specific cutting force

Work material	Tensile strength or hardness	Specific cutting force (N/mm ³) " k_c " to cutting feed rate (mm/rev)					
		0.1mm/rev	0.2mm/rev	0.3mm/rev	0.4mm/rev	0.6mm/rev	
Soft steel	520	3,610	3,100	2,720	2,500	2,280	
Medium steel	620	3,080	2,700	2,570	2,450	2,300	
Hard steel	720	4,500	3,600	6,250	2,950	2,640	
Tool steel	SKD	670	3,040	2,800	2,630	2,500	2,400
		770	3,150	2,850	2,620	2,450	2,340
Cr-Mo steel	SCM	600	3,610	3,200	2,880	2,700	2,500
		730	4,500	3,900	3,400	3,150	2,850
Alloy steel	SNCM	900	3,070	2,650	2,350	2,200	1,980
		HB350	3,310	2,900	2,580	2,400	2,200
Gray cast iron	FC	HB200	2,110	1,800	1,600	1,400	1,330

● Calculating the volume of chips produced

$$Q = v_c \times f \times a_p$$

(cm³/min)

Q : Volume of evacuated chips (cm³/min)
 v_c : Cutting speed (m/min)
 a_p : Depth of cut (mm)
 f : Feed amount (mm/rev)

Example : Obtaining the volume of chips evacuated per minute for machining at a cutting speed of 700 m/min, feed of 0.4 mm/rev, and a depth of cut of 2mm

$$Q = 700 \times 0.4 \times 2 = \underline{560 \text{ (cm}^3\text{/min)}}$$

Troubleshooting for Turning

Type of problem		Possible cause	Material/grade selection				Cutting conditions				Tool shape				Machine/installation				
			Change to a harder material/grade	Change to a tougher material/grade	Change to a material/grade more resistant to thermal shock	Change to a material/grade more resistant to deposition	Cutting speed	Feed rate	Depth of cut	Coolant		Review the type of chipbreaker	Rake angle	Nose radius of the insert	Side cutting edge angle	Cutting edge strength, honing	Improve the accuracy of insert	Improve the rigidity of the holder	
										Use non-water-soluble type	Review dry or wet operation								Decrease
Short tool life	Excessive insert wear	Unsuitable tool material/grade	●																
		Unsuitable cutting edge shape									●	→	→	→	→				
		Improper cutting conditions					↘	↗			Wet								
	Fracture/chipping of the cutting edge	Unsuitable tool material/grade		●															
		Improper cutting conditions						↘	↘										
		Insufficient cutting edge strength										●	→		→				
		Thermal shock			●		↘	↘	↘	●	Dry								
		Built-up edge				●	↗	↗		●	Wet								
Insufficient toughness															●	●	●	●	
Poor dimensional accuracy	Variation in dimensions during cutting	Improper accuracy of insert														●			
		Clearance/relief of the work/tool										●	→	→	→	→	●	●	●
	Need for offsetting during cutting	Increased flank wear	●											→					
		Built-up edge				●	↗												
		Improper cutting conditions					↘	↗											
Poor surface finish	Poor surface roughness	Deposition					↗			●	Wet								
		Unsuitable cutting edge shape									●	→							
		Chatter					↘	↘	↘							●	●	●	●
Heat	Deterioration in tool life/accuracy due to excessive heat generation	Improper cutting conditions					↘	↘	↘										
		Unsuitable cutting edge shape									●	→		→					
Burring, chipping, scuffing	Burring	Boundary wear	●																
		Improper cutting conditions					↘	↕			Wet								
		Unsuitable cutting edge shape										●	→	→	→	→			
	Chipping	Improper cutting conditions						↘	↘										
		Unsuitable cutting edge shape										●	→	→	→	→			
		Vibration															●	●	●
	Scuffing	Unsuitable tool material/grade				●													
		Improper cutting conditions					↗				●	Wet							
Unsuitable cutting edge shape											●	→		→					
Vibration																●	●	●	●
Chip control	Elongated chips	Improper cutting conditions					↘	↗	↗		Wet								
		Chipbreaker's effective chip control range										●							
		Unsuitable cutting edge shape											→	→					

Troubleshooting Case Studies: Turning

	Case/Symptom	Possible causes	Corrective measures
Insert	VB wear	<ul style="list-style-type: none"> ●The material / grade is too soft ●Cutting speed is too high ●Relief angle is too small 	<ul style="list-style-type: none"> ●Use a coated grade ●Choose a material/grade highly resistant to wear ●Decrease the cutting speed
	Wear on face	<ul style="list-style-type: none"> ●High temperature causes chemical reactions between the insert material and chips 	<ul style="list-style-type: none"> ●Use a coated grade ●Decrease both of the cutting speed and feed rate ●Widen the rake angle
	Notching wear	<ul style="list-style-type: none"> ●The work surface is too hard ●Boundary area has been oxidized ●Burr, caused by chips in the sheared form, have been cut 	<ul style="list-style-type: none"> ●Widen the side cutting edge angle ●Make the nose radius larger so that cutting is performed within the radius ●Use a round insert
	Chipping/ fracture	<ul style="list-style-type: none"> ●Feed rate is too high ●Chips have become trapped ●Chatter resulting in vibration 	<ul style="list-style-type: none"> ●Enlarge the honed edge ●Make the nose radius larger ●Narrow the rake angle to secure the cutting edge strength
	Flaking	<ul style="list-style-type: none"> ●This is due to compressive forces being applied to the cutting edge from elastic deformation in the area being cut ●This occurs when deposited/adhered material is peeled off 	<ul style="list-style-type: none"> ●Change the cutting conditions by checking the cutting edge ●Choose a material/grade highly resistant to fracture ●Increase the coolant rate and pressure ●Improve the run-out of the main spindle of the machine
	Plastic deformation	<ul style="list-style-type: none"> ●High cutting force and excessive heat is applied to the cutting edge 	<ul style="list-style-type: none"> ●Choose a material/grade highly resistant to wear ●Decrease both of the cutting speed and feed rate ●Make the nose radius larger ●Use coolant
	Built-up edge	<ul style="list-style-type: none"> ●This occurs because the cutting temperature is lower than the recrystallization temperature of the work material 	<ul style="list-style-type: none"> ●Increase the cutting speed ●Use coolant with excellent lubrication performance ●Change to a grade with less affinity to the work material
	Deposition	<ul style="list-style-type: none"> ●The deposition is caused to the face by a chemical reactions of the work material due to heat generation 	<ul style="list-style-type: none"> ●Increase the cutting speed ●Widen the relief angle ●Hone the face with a mirror-like-surface finish ●Change to a grade with less affinity to the work material
	Clamping crack	<ul style="list-style-type: none"> ●The insert was clamped under improper seating conditions 	<ul style="list-style-type: none"> ●Clean the clamping areas and install the insert in the recommended way ●Tighten to the specified torque
Work piece	Chipping	<ul style="list-style-type: none"> ●The feed rate is too high ●An unsuitable insert was selected 	<ul style="list-style-type: none"> ●Decrease the feed rate ●Use a smaller edge preparation ●Change to a grade highly resistant to boundary wear ●Change the cutting edge angle of the holder
	Burring	<ul style="list-style-type: none"> ●The feed rate is incorrect ●The shape of insert is not suitable 	<ul style="list-style-type: none"> ●Decrease the feed rate ●Use a smaller edge preparation
	Chatter mark	<ul style="list-style-type: none"> ●The cutting force is too great ●The rigidity of the work piece and cutting tool is insufficient 	<ul style="list-style-type: none"> ●Decrease the feed rate ●Use a smaller edge preparation ●Ensure tool overhang is minimised ●Change the cutting edge angle of the holder
	Gouging	<ul style="list-style-type: none"> ●Vibration of the cutting edge due to deposition/built-up edge 	<ul style="list-style-type: none"> ●Increase the cutting speed ●Use cutting oil excellent in lubrication performance ●Change to a grade with less affinity to the work material

■ Calculation Formula for Milling Processes

● Calculating the cutting speed

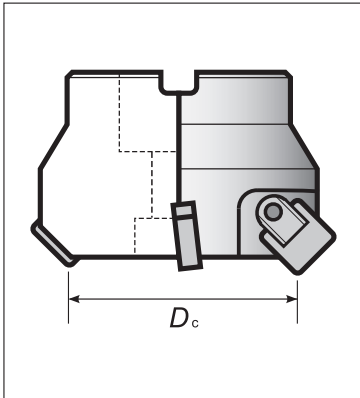

Calculating the cutting speed from the rotation speed

$$v_c = \frac{\pi \times D_c \times n}{12}$$

(SFM)

v_c : Cutting speed (SFM)
 D_c : Cutter diameter (inch)
 n : Spindle speed (rpm)
 π : Pi (3.14)

Calculating the revolution speed from the cutting speed

$$n = \frac{12 \times v_c}{\pi \times D_c}$$

(rpm)

Example : Obtaining the cutting speed for machining with an 8" diameter cutter at the Spindle speed of 1,000 rpm:

$$v_c = \frac{\pi \times 8 \times 1000}{12} = \underline{2093 \text{ (SFM)}}$$

● Calculating the feeding speed and feed rate

Calculating the feed rate per blade

$$f_z = \frac{v_f}{z \times n}$$

(IPT)

f_z : Inch amount per tooth (IPT)
 v_f : Table feed (inch/min)
 z : Number of tooth
 n : Spindle speed (rpm)

Calculating the feeding speed per minute

$$v_f = f_z \times z \times n$$

(inch/min)

Example : Obtaining the feed rate for milling with a 10-teeth cutter at the .008IPT and the revolution speed of 1,000 rpm

$$v_f = .008 \times 10 \times 1000 = \underline{80 \text{ (inch/min)}}$$

● Calculating the machining time

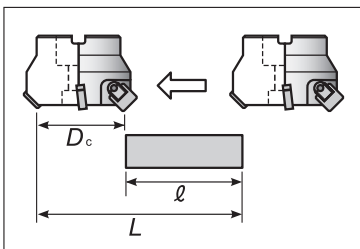

$$T = \frac{L}{v_f}$$

(min)

T : Cutting time (min)
 L : Total length of table feed
 ($\ell + D_c$)
 v_f : Table feed (inch/min)

Example : Obtaining the machining time for milling 8" on a work piece fed at the rate of 40 inch/min:

$$T = \frac{8}{40} = \underline{0.2 \text{ (min)}}$$

● Calculating the cutting power

$$P_c = \frac{a_e \times a_p \times v_f \times k_c}{60 \times 10^6 \times \eta}$$

(kW)

P_c : Required power (kW)

a_e : Cutting length (mm)

a_p : Depth of cut (mm)

v_f : Feed rate (mm/min)

k_c : Specific cutting force (N/mm³) *See the table below.

η : Mechanical efficiency (0.7~0.8)

Example : Calculating the power required to machine gray cast iron for a length of 150 mm, at a feed rate of 1,100 mm/min, and with a depth of cut of 3 mm (with 0.8 set as the mechanical efficiency and 0.2 mm as the feed per tooth/blade)

$$P_c = \frac{150 \times 3 \times 1100 \times 1400}{60 \times 10^6 \times 0.8} = \underline{14.44 \text{ (kW)}}$$

● Specific cutting force

Work material		Tensile strength or hardness	Specific cutting force (N/mm ³) “ k_c ” to cutting feed amount (mm/rev)				
			0.1mm/t	0.2mm/t	0.3mm/t	0.4mm/t	0.6mm/t
Soft steel		520	2,200	1,950	1,820	1,700	1,580
Medium steel		620	1,980	1,800	1,730	1,600	1,570
Hard steel		720	2,520	2,200	2,040	1,850	1,740
Tool steel	SKD	670	1,980	1,800	1,730	1,700	1,600
		770	2,030	2,030	1,800	1,750	1,700
Cr-Mo steel	SCM	600	2,180	2,000	1,860	1,800	1,670
		730	2,540	2,250	2,140	2,000	1,800
Alloy steel	SNCM	900	2,000	1,800	1,680	1,600	1,500
		HB350	2,100	1,900	1,760	1,700	1,530
Gray cast iron	FC	HB200	1,750	1,400	1,240	1,050	970
Aluminum alloy	AC,ADC	160	580	480	400	350	320

※For power required for NTK HCC, please refer to page P31.

● Calculating the volume of evacuated chips

$$Q = a_e \times a_p \times v_f$$

(cm³/min)

Q : Volume of evacuated chips (cm³/min)

a_e : Cutting length (mm)

a_p : Depth of cut (mm)

v_f : Feed rate (mm/min)



Example : Obtaining the volume of chips evacuated per minute for machining at a cutting speed of 700 m/min, feed rate of 0.4 mm/rev, and with a 2 mm depth of cut:

$$Q = 150 \times 3 \times 1100 = \underline{495 \text{ (cm}^3\text{/min)}}$$

Troubleshooting for Milling

Type of problem		Possible cause	Material/grade selection				Cutting conditions						Tool shape								
			Change to a harder material/grade	Change to a tougher material/grade	Change to a material/grade more resistant to thermal shock	Change to a material/grade more resistant to deposition	Cutting speed Decrease ↙ Increase ↘	Feed rate Increase ↘	Depth of cut Increase ↘	Review cutter diameter and cutting width	Review tool path	Coolant		Relief angle of insert Decrease ↙ Increase ↘	Nose radius of cutting edge Increase ↘	Cutting edge strength, honing Increase ↘	Number of teeth/blades	Enlarge the chip pocket	Check the wiper shape	Improve accuracy of cutting edge run-out	Improve rigidity of tool
												Wet	Dry								
Damaged or broken cutting edge of the insert	Increased flank wear	Improper cutting conditions					↘						●								
		Unsuitable cutting edge shape	●											↘	↘			●			
	Increased wear on face	Improper cutting conditions					↘	↘	↘				●								
		Unsuitable cutting edge shape	●											↘	↘	↘					
	Fracture/chipping on cutting edge	Improper cutting conditions						↘	↘		●								●	●	
		Unsuitable cutting edge shape		●										↘	↘	↘			●	●	
	Thermal shock	Improper cutting conditions					↘	↘	↘								●				
		Unsuitable cutting edge shape			●									↘		↘					
Built-up edge	Improper cutting conditions					↘	↘									●					
	Unsuitable cutting edge shape				●								↘		↘						
Machining accuracy	Poor surface finish	Improper cutting conditions					↘	↘	↘				●								
		Unsuitable cutting edge shape	●			●									↘	↘		●	●		
	Burring	Improper cutting conditions						↕	↘	●	●										
		Unsuitable cutting edge shape												↘	↘	↘		●			
	Chipping	Improper cutting conditions						↘	↘		●										
		Unsuitable cutting edge shape												↘	↘	↘	↘		●		
Poor flatness and parallelism	Improper cutting conditions						↘	↘				●		↘	↘	↘		●	●		
Others	Increased chatter/vibration	Improper cutting conditions					↘	↘	↘	●	●										
		Improper cutting conditions					↘	↘		●			●								
	Poor chip evacuation	Unsuitable tool/blade edge shape												↘			↘	●			

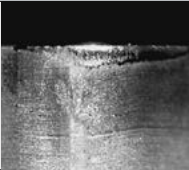
Troubleshooting Case Studies: Milling

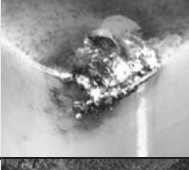
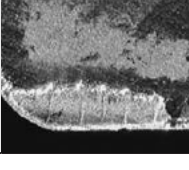
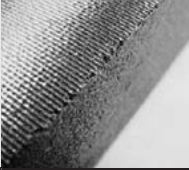
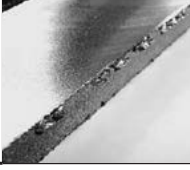
	Case/Symptom	Possible causes	Corrective measures
Insert	VB wear 	<ul style="list-style-type: none"> ●Cutting speed is too high. ●Feed rate is too low. ●The shape of the insert is not suitable. ●The material / grade of the insert is not suitable. 	<ul style="list-style-type: none"> ●Decrease the cutting speed. ●Increase the feed rate. ●Make the nose radius larger. ●Change to a grade highly resistant to boundary wear.
	Notching wear 	<ul style="list-style-type: none"> ●The material / grade of the inserts is not suitable. ●The shape of the cutter is not suitable ●The shape of insert is not suitable. 	<ul style="list-style-type: none"> ●Change to a grade highly resistant to boundary wear. ●Widen the rake angle. ●Change the Insert shape to a different one.
	Chipping / fracture 	<ul style="list-style-type: none"> ●The cutting speed is incorrect. ●The shape of the cutter is not suitable ●The shape of insert is not suitable. 	<ul style="list-style-type: none"> ●Decrease the feed rate and depth of cut in order to reduce the cutting force. ●Use a smaller edge preparation. ●Prepare the cutting edge to give it a round honing. ●Change to a grade highly resistant to fracture.
	Thermal crack 	<ul style="list-style-type: none"> ●The cutting conditions are incorrect ●The material / grade of insert is not suitable 	<ul style="list-style-type: none"> ●Decrease the cutting speed. ●Change to dry cutting from wet cutting. ●Use a material / grade highly resistant to thermal shock
Work piece	Chipping 	<ul style="list-style-type: none"> ●The feed rate is too high. ●An unsuitable insert is selected. ●The shape of the cutter is not suitable. 	<ul style="list-style-type: none"> ●Decrease the feed rate. ●Use a smaller edge preparation ●Change to a grade highly resistant to boundary wear. ●Set the lead angle at 45 degrees.
	Burring 	<ul style="list-style-type: none"> ●The feed rate is incorrect. ●The shape of insert is not suitable. ●The shape of the cutter is not suitable. 	<ul style="list-style-type: none"> ●Adjust the feed rate. ●Use a smaller edge preparation. ●Make the lead angle narrower.

Surface Roughness Standards

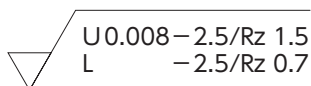
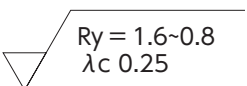
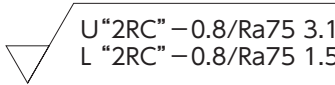
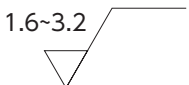
		JIS B0601 (2001) ISO 4287 (1997) / ISO 1302 (2002)	JIS B0601 (1994) JIS B0031 (1982)	
Cross-section curve		No filter, digital signal	No filter, digital signal	
	Evaluation length	Shape length	—	
	Maximum height	Pt	—	
	10-point average roughness	—	—	
Roughness curve		Phase correction, band $\lambda_s - \lambda_c$	Phase correction, short wavelength λ_c	
	Evaluation length	Determine individually for each standard length λ_c .	Average for λ_n , calculated for each standard length λ_c	
	Maximum height	Maximum height Rz	Maximum height Ry	
	Set standard length based on height parameters Rz, Rmax, and Ry.	0.25mm	0.1~0.5 μ m	0.1~0.5 μ m
		0.8mm	0.5~10 μ m	0.5~10 μ m
		2.5mm	10~50 μ m	10~50 μ m
	Dimension indicated in drawing		 U 0.008 - 2.5/Rz 1.5 L - 2.5/Rz 0.7	 Ry = 1.6~0.8 λ_c 0.25
	10-point average roughness		Rz_{JIS}	Rz
	Center line average roughness		Ra₇₅	Ra75
	Arithmetic average roughness		Arithmetic average roughness Ra	Arithmetic average roughness Ra
	Set standard length based on height parameters Rz, Rmax, and Ry.	0.25mm	0.1~0.5 μ m	0.1~0.5 μ m
0.8mm		0.5~10 μ m	0.5~10 μ m	
2.5mm		10~50 μ m	10~50 μ m	
Dimension indicated in drawing		 U "2RC" - 0.8/Ra75 3.1 L "2RC" - 0.8/Ra75 1.5	 1.6~3.2	

Theoretical surface roughness

The theoretical surface roughness for lathe machining is the minimum value which can be obtained under the set machining conditions, and can be expressed by the following formula.

$$h_{(\mu\text{m})} = \frac{f^2}{8 r_\epsilon} \times 1000$$

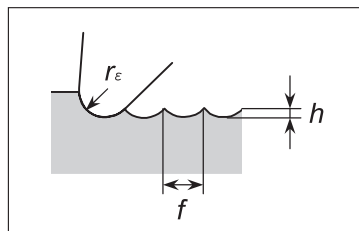

h : Theoretical surface roughness (μm)

f : Feed amount (mm/rev)

r_ϵ : Nose radius (mm)

Actual surface roughness

- When machining steel: Theoretical surface roughness x 1.5-3
- When machining cast iron: Theoretical surface roughness x 3-5

Surface finish improvement measures

- Increase the nose radius.
- Use a wiper insert.
- Adjust the cutting speed and/or feed amount.
- Change the material and/or shape of the insert







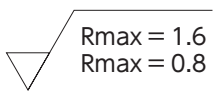
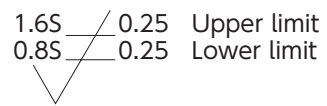

Relationship with triangle symbols

Arithmetic average roughness Ra (μm)	Maximum height Rz (μm)	10-point average roughness Rz _{JIS} (μm)	※ (Triangle symbol)
0.025	0.1	0.1	
0.05	0.2	0.2	
0.1	0.4	0.4	
0.2	0.8	0.8	
0.4	1.6	1.6	▽▽▽
0.8	3.2	3.2	
1.6	6.3	6.3	
3.2	12.5	12.5	▽▽
6.3	25	25	
12.5	50	50	▽
25	100	100	

• Examples of reading

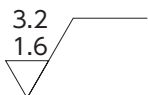
- When Ra = 1.6 μm → 1.6 μm Ra
- When Rz = 6.3 μm → 6.3 μm Rz
- When Rz_{JIS} = 6.3 μm → 6.3 μm Rz_{JIS}

※ The finishing symbols (triangle symbol ▽ and symbol -) are no longer used in JIS pursuant to the 1994 revision.

JIS B0601 (1982) JIS B0031 (1982)	JIS B0601 (1970) JIS B0031 (1970)	JIS B0601 (1970)
No filter, analog signal	No filter, analog signal	No filter, analog signal
One standard length	One standard length	One standard length
Rmax	Rmax (S indication)	Hmax (S)
Rz	Rz (Z indication)	—
2RC, short wavelength cut-off λc	2RC, short wavelength cut-off λc	—
One measured length $\geq 3\lambda c$	One measured length $\geq 3\lambda c$	—
—	—	—
0.8 μm or less	0.8 μm or less	Select from 0.3, 1, 3, 5 and 10mm
0.8~6.3 μm	0.8~6.3 μm	Select from 0.3, 1, 3, 5 and 10mm
6.3~25 μm	6.3~25 μm	Select from 0.3, 1, 3, 5 and 10mm
	Surface symbol or triangle symbol	Triangle symbol
		0.8S or less 
		1.5S~6S 
		12S~25S 
		35S or higher 
—	—	—
Ra	Ra ("a" indication)	—
—	—	—
—	—	—
Ra shall be 12.5 μm or less.	λc shall be 0.8 mm.	—
12.5~100 μm	—	—
	Surface symbol or triangle symbol	—
	0.2a or less 	
	0.4a~1.6a 	
	3.2a~6.3a 	
	12.5a to 25a or more 	

● Obtaining the surface roughness

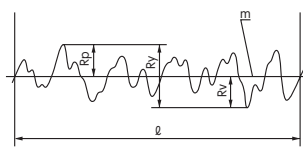
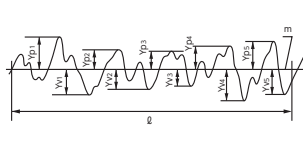
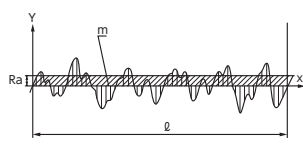





Type	New symbol	Old symbol	Calculation	Obtaining method (example)
	JIS B0601:01	JIS B0601:94		
Max. height (Peak)	Rz	Ry	$Rz = Rp + Rv$	
Average roughness of 10 points	Rz _{JIS}	Rz	$Rz_{JIS} = \frac{(Yp1 + Yp2 + Yp3 + Yp4 + Yp5) + (Yv1 + Yv2 + Yv3 + Yv4 + Yv5)}{5}$	
Arithmetic average of roughness	Ra	Ra	$Ra = \frac{1}{l} \int_0^l \{f(x)\}$	

● Conditions for measuring R parameters

Non-cyclic wave form (random wave form)		Settings for measuring	
Range of Ra (μm)	Range of Rz (μm)	Reference length $\varnothing r$ (mm) = cut-off λc (mm)	Evaluated length $\varnothing n$ (mm) = $\varnothing r \times 5$
0.006 < Ra \leq 0.2	0.025 < Rz \leq 0.1	0.08	0.4
0.02 < Ra \leq 0.1	0.1 < Rz \leq 0.5	0.25	1.25
0.1 < Ra \leq 2	0.5 < Rz \leq 10	0.8	4
2 < Ra \leq 10	10 < Rz \leq 50	2.5	12.5
10 < Ra \leq 80	50 < Rz \leq 200	8	40

Spare Parts - Wrenches

Standard Items

Item Number	Appearance
CLR-13S (Formerly RLR-13S)	
CLR-15S (Formerly RLR-15S)	
RLR-20S	
LLR-25S	
LLR-25S-20*65	
LLR-28S	





Optional Items

<LLR Type>

Item Number	Appearance
LLR-13S	
LLR-15S	
LLR-20S	

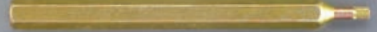
<Driver type wrench for increased adaptability>

Item Number	Magnetic Driver Handle
XX2815-04	

Item Number	Replaceable Bits
HLR-13S	
HLR-15S	
HLR-20S	
HLR-25S	

<Driver type wrench kits>

Item Number	Contents
XX2815-04-13S	XX2815-04 with HLR-25S (HLR-13S)
XX2815-04-15S	XX2815-04 with HLR-25S (HLR-15S)
XX2815-04-20S	XX2815-04 with HLR-25S (HLR-20S)
XX2815-04-25S	XX2815-04 with HLR-25S (HLR-25S)



Clamp Screws and Wrenches

Clamp Screw			Dimension (mm)				Standard Wrench			
Appearance	Order Code	Item Number	a	b	c	θ (°)	Order Code	Item Number		
	5704739	LR-S-2×3.5	M2×P0.4	3.1	3.5	82	5681994	CLR-13S		
	5907704	LR-S-2×3.7	M2×P0.4	3.1	3.7	82				
	5907712	LR-S-2×4.4	M2×P0.4	3.1	4.4	82				
	5907720	LR-S-2×5.5	M2×P0.4	3.0	5.5	90				
	5907738	LR-S-2.5×4.8	M2.5×P0.45	3.6	4.8	82				
	5704747	LR-S-2.5×5.5	M2.5×P0.45	3.6	5.5	82	5681978	CLR-15S		
	5907746	LR-S-2.5×6	M2.5×P0.45	3.5	6.0	90				
	5907753	LR-S-2.5×6.8	M2.5×P0.45	3.5	6.8	90				
	5773619	LR-S-3×5.8	M3×P0.5	4.1	5.8	90				
	5907761	LR-S-3×6.2	M3×P0.5	5.2	6.2	82				
	5907779	LR-S-3×7.8	M3×P0.5	4.0	7.8	90	5485164	RLR-20S		
	5907787	LR-S-4×5.8	M4×P0.7	5.8	6.0	82				
	5907795	LR-S-4×9	M4×P0.7	5.8	9.0	82				
	5116991	LR-S-4×10PW	M4×P0.7	5.8	10.0	90			5681978	CLR-15S
		5534029	LRIS-2×6	M2×P0.4	2.6	6.0			60	5681994
5907803		LRIS-2.2×6	M2.2×P0.45	3.15	6.0	60				
5989181		LRIS-2.5×5	M2.5×P0.45	3.6	5.0	60	5681978	CLR-15S		
5907811		LRIS-2.5×7	M2.5×P0.45	3.6	7.0	60				
5907829		LRIS-3×6	M3×P0.5	4.0	6.0	60	5485164	RLR-20S		
5428156		LRIS-3×8	M3×P0.5	4.2	8.0	60				
5477328		LRIS-4×5	M4×P0.7	5.85	5.0	60	5364930 5794698	LLR-25S LLR-25S-20*65		
5907837		LRIS-4×6	M4×P0.7	5.85	6.0	60				
5977566		LRIS-4×8	M4×P0.7	5.85	8.0	60				
5907845		LRIS-4×10	M4×P0.7	5.85	10.0	60				
5684105	LRIS-4×12	M4×P0.7	5.85	12.0	60	5364948	LLR-28S			
5907852	LRIS-5×10	M5×P0.8	7.0	9.5	60					
5116983	LRIS-4×10PW	M4×P0.7	5.7	10.0	60	5681978	CLR-15S			
5090576	LRIS-4×12PW	M4×P0.7	5.7	12.0	60					

Attention: When tightening screws

- Make sure the wrench tip and wrench hole are neither deformed nor stripped
- Engage the wrench straight to screw hole

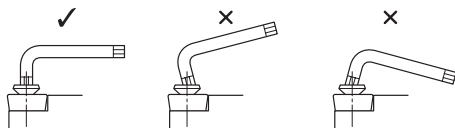

- Do not apply more torque than the recommended amount (as shown to the right)

Note: Wrenches and bits come in a pack of five
Clamp screws come in a pack of ten

Recommended Tightening Torque

Item Number	Recommended Tightening Torque (in-lbs)
CLR LLR HLR 13S	6.2 (0.7N·m)
CLR LLR HLR 15S	12.4 (1.4N·m)
RLR LLR HLR 20S	26.6 (3.0N·m)
LLR HLR 25S	44.3 (5.0N·m)
LLR HLR 28S	62.0 (7.0N·m)

Material Cross Reference Chart

ISO	Country	U.S.A.	Japan	Germany	ISO	Country	U.S.A.	Japan	Germany	
	Standard	AISI / SAE	JIS	DIN		Standard	AISI / SAE	JIS	DIN	
Stainless steel [M]	Stainless Steel (Ferrite/Martensitic)				Cast iron [K]	Malleable cast iron				
	403		SUS403	X6Cr13		—		FCMB310	—	
				X7Cr14		32510		FCMW330	EN-GJMB350-10	
	416		SUS416	X12CrS13		40010		FCMW370	EN-GJMB450-6	
	430		SUS430	X6Cr17		50005		FCMW490	EN-GJMB550-4	
	410		SUS410	X10Cr13		70003		FCMP540		
			SUS420J2	X46Cr13		A220-70003		FCMP590	EN-GJMB650-2	
	405			X6CrAL13		A220-80002		FCMP690	EN-GJMB700-2	
	420			X20Cr13		Gray cast iron				
	431		SUS431	X19CrNi17-2		No 20 B		FC100	EN-GJL-100	
	430F		SUS430F	X14CrMoS17		No 25 B		FC150	EN-GJL-150	
	434		SUS434	X6CrMoS17-2		No 30 B		FC200	EN-GJL-200	
	CA6-		SCS5	X3CrNiMo13-4		No 35 B		FD250	EN-GJL-250	
	405		SUS405	X10CrAL13		No 40 B		—	—	
	HNV6		SUH4	X85CrMoV18-2		No 45 B		FC300	EN-GJL-300	
	446		SUH446	X10CrAL2-4		No 50 B		FC350	EN-GJL-350	
	EV8		SUH35,SUH36	X53CrMnNiN21-9		No 55 B		—	EN-JLZ	
	S44400			X1CrMoTi18-2		A436 Type 2		—	GGL-NiCr20-2	
				X20CrMoV12-1		Ductile cast iron				
	630			X5CrNiCuNb16-4		60-40-18		FCD400	EN-GJL-400-15	
	Stainless Steel (Austenitic)					—		—	EN-GJL-400-18-LT	
	304L			X2CrNi19-11		80-55-06		FCD500	EN-GJL-500-7	
	304		SUS304	X5CrNi18-10		A43D2		—	EN-GJSA-500	
	303		SUS303	X8CrNiS18-9		—		FCD600	EN-GJS-600-3	
			SUS304L			100-70-03		FCD700	EN-GJS-700-2	
	304L		SCS19	X2CrNi19-11		Nonferrous material [N]	SC64D	C4BS	G-AISI9MGWA	
	301		SUS301	X9CrNi18-8			GD-AISI12	AC4A	G-ALMG5	
	304LN		SUS304LN	X2CrNi18-10			356.1	A5052		
	316		SUS316	X5CrNiMo17-2-2			A413.0	A6061	GD-AISI12	
	316LN		SUS316LN	X2CrNiMoN17-13-3			A380.1	A7075	GD-AISI8Cu3	
	316L			X2CrNiMoN17-12-2			A413.1	ADC12	G-AISI12(Cu)	
	316L		SCS16	X2CrNiMo18-14-3			A413.2		G-AISI12	
			SUS316L				A360.2		G-AISI10Mg(Cu)	
	317L		SUS317L	X2CrNiMo18-15-4			Heat-resistant alloy			
	UNS			X1NiCrMoCu25-20-5			330		SUH330	X12NiCrSi36 16
	V 0890A							SCH15	G-X40NiCrSi36-18	
	321		SUS321	X6CrNiTi18-10		5390A				
	347		SUS347	X10CrNiNb18-10		5666			NiCr22Mo9Nb	
	316Ti			X6CrNiMoTi17-12-2					NiCr20Ti	
	318			X10CrNiMoNb 18-12		5660			NiFe35Cr14MoTi	
	309		SUH309	X15CrNiSi20-12		5391			S-NiCr13A16MoNb	
	310S		SUH310	X8CrNi25-21		5383			NiCr19Fe19NbMo	
308		SCS17	X2CrNiMoN17-11-2	4676			NiCu30AL3Ti			
17-7PH			X7CrNiAL 17-7				NiCr20TiAk			
N08028			X1NiCrMoCu31-27-4	AMS 5399			NiCr19Co11MoTi			
Stainless Steel (Austenitic/Ferrite)				AMS 5544			NiCr19Fe19NbMo			
S31500			X2CrNiN23-4	AMS 5397			NiCo15Cr10MoAl			
S32900			X8CrNiMo27-5	5537C			CoCr20W15Ni			
S32304			X2CrNiN23-4	AMS 5772			CoCr22W14Ni			
S31803			X2CrNiMoN22-53	Titanium alloy						
Hardened material [H]	5130H		SCr430H	34Cr4	AMS R54520		TiAl5Sn2.5			
	5135H		SCr435H	37Cr4	AMS R56400		TiAl6V4			
	4135H		SCM435H	34CrMo4	AMS R56401		TiAl6V4ELI			
	4140H		SCM440H	42CrMo4			TiAl4Mo4Sn4Si0.5			

ISO	Country	U.S.A.	Japan	Germany	ISO	Country	U.S.A.	Japan	Germany
	Standard	AISI/SAE	JIS	DIN		Standard	AISI/SAE	JIS	DIN
Steel P	Carbon steel				Steel P	A573-81	SM400A;B;C SM490A;B;C;YA;YB	S275J2G3 S355J2G3+C2	
	A570.36	STKM12A;C	S235JRG2	5120		5120	DS355J2G3		
	1115		GC16E	9255		9255	55Si7		
	A573-8165		S235J2G3	9262		9262	S340MGC		
	1015		C15	52100		SUJ2	100Cr6		
	1020		C22	ASTM		ASTM	16Mo3		
	1213	SUM22	11SMn30	4520		4520	16Mo5		
	12L13	SUM22L	11SMnPb30	ASTM		ASTM	14Ni6		
			10SPb20	8620		8620	21NiCrMo2		
	1215		11SMn37	8740		8740	40NiCrMo22		
	12L14		11SMnPb37				17CrNiMo6		
	1015	S15C	Ck15E	5015		5015	15Cr3		
	1025	S25C	Ck25E	5140		5140	42Cr4		
	A572-60		S380N	5155		5155	55Cr3		
	A572-60		17MnV7				SCM415(H)		
	1035		C35	8740		8740	15CrMo5		
	1045		C45	5015		5015	40NiCrMo8-4		
	1040		35S20	ASTMA182		ASTMA182	15Cr3		
	1039		40Mn4	ASTMA182		ASTMA182	13CrMo5		
	1335	SMn438(H)	36Mn5				13CrMo4-5		
	1330	SCMn1	28Mn6				14MoV63		
	1035	S35C	C35G				31CrMo12		
	1045	S45C	C45E				39CrMoV13		
	1050	S50C	C53G				41CrS4		
	1055		C55	L1		L1	22Mo4		
	1060		C60E	8620		8620	50CoMo4		
	1055	S55C	C55E				16MnCr5		
	1060	S58C	C60E				31NiCrMo14		
	1095		C101E	L6		L6	50NiCr13		
	W1	SK3	C101u	3135		3135	36NiCr6		
	W210	SUP4	C105W1	3415		3415	14NiCr10		
	Alloy steel					3415;3310	3415;3310	14NiCr14	
	ASTMA353		X8Ni9	9255		9255			
	2515		12Ni19	9840		9840		36CrNiMo4	
			14NiCrMo13	4340		4340		34CrNiMo6	
	D3	SKD1	X210Cr12	5132		5132	SCr430(H)	34Cr4	
				5140		5140	SCr440(H)	41Cr4	
				5115		5115		16MnCr5	
	H13	SKD61	X40CrMo134	4130		4130	SCM420;SCM430	25CrMo4	
				4137;4135		4137;4135	SCM432;SCCRM3	34CrMo4	
	A2	SKD12	X100CrMoV51	4140;4142		4140;4142	SCM440	41CrMo4	
		SKD2	X210CrW12	4140		4140	SCM440(H)	42CrMo4	
	S1		45WCrV7					32CrMo12	
	H21	SKD5	X30WCrV93	6150		6150	SUP10	51CrV4	
			X30WCrV9					41CrMo7	
		X165CrMoV12	L3	L3		100Cr6			
HW3	SUH1	X45GrSi93			SKS31	105WCr6			
D3	SUH3	S6-5-2	L6	L6	SKS2,SKS3				
M2	SKH51	S6-5-2	Cast steel			55NiCrMoV6			
M35	SKH55	S6-5-2-5			SEMnH1				
M7		S6-9-2			SCMnH/1	G-X120Mn12			
HNV3		X210Cr12G							

Ni-based Heat Resistant Alloys

Material Specifications Cross-Reference List-Aerospace Material Designation

Commercial designation	Hardness Brinell HB		Nominal composition Approximate content in %										
	Ann.	Aged	Ni	Cr	Co	Fe	Mo	C	Mn	Si	Al	Ti	Others
Astroloy*	—	—	56.9	15.0	15.0	—	5.25	0.06	—	—	4.0	3.5	0.05
GMR 235*	—	—	63.3	15.5	—	10.0	5.2	0.15	0.25	0.6	3.0	2.0	0.06
GMR 235D	—	—	63.0	15.5	—	4.5	5.0	0.15	0.1	0.3	3.5	2.5	0.05
Hastalloy B*	140	—	64.3	0.6	1.25	5.5	28.0	0.1	0.8	0.7	—	—	—
Hastalloy C*	200	—	54.1	16.0	1.25	5.75	17.0	0.07	0.8	0.7	—	—	4.0
Hastalloy N*	—	—	72.2	7.0	0.25	3.0	16.5	0.06	0.4	0.25	0.5	—	0.21
Hastalloy W*	—	—	62.7	5.0	1.25	5.5	24.5	0.06	0.5	0.5	—	—	—
Hastalloy X*	160	—	47.1	22.0	1.5	18.5	9.0	0.1	0.6	0.6	—	—	0.6
Hastelloy R235*	—	—	61.0	15.0	2.5	10.0	5.5	0.15	0.25	0.6	3.0	2.0	—
Haynes 75	—	—	73.7	20.0	—	5.0	—	0.12	—	—	0.25	0.4	0.5
Haynes 80A	—	—	70.9	20.0	2.0	3.0	—	0.1	—	—	1.5	2.5	—
Haynes 263	—	25	51.4	20.0	20.0	—	6.0	0.06	—	—	1.0	1.5	—
Haynes 600	—	—	75.9	16.0	—	8.0	—	0.08	—	—	—	—	—
Haynes 625	—	—	61.4	21.0	—	5.0	9.0	0.1	—	—	—	—	3.5
Haynes 718	—	43	53.5	18.0	—	19.0	3.0	0.08	—	—	0.5	0.9	5.0
Haynes X-750	—	37	74.9	16.0	—	7.0	—	0.08	—	—	0.8	0.25	1.0
IN-100*	—	—	61.6	10.0	15.0	—	3.0	0.18	1.2	0.5	5.5	4.75	—
Incoloy 804*	—	—	41.0	29.5	—	26.0	—	0.1	1.0	0.75	0.25	0.6	0.5
Incoloy 825*	180	—	42.0	21.0	—	30.0	3.0	0.04	—	—	—	1.0	2.0
Incoloy 901*	180	300	44.3	12.5	—	34.0	6.0	0.05	0.24	0.12	0.15	2.7	0.15
Incoloy 903*	—	380	39.0	—	15.0	41.0	—	0.02	—	—	0.7	1.4	3.0
Inconel 600*	170	—	75.0	15.5	—	8.0	—	0.05	—	—	—	—	—
Inconel 601*	150	—	60.0	23.0	—	14.0	—	0.05	—	—	1.4	—	—
Inconel 604*	180	—	74.4	15.8	—	7.2	—	0.04	0.2	0.2	—	—	0.1
Inconel 625*	180	—	61.0	21.5	—	2.5	9.0	0.04	0.5	0.5	0.4	0.4	3.6
Inconel 700*	—	350	46.0	15.0	23.5	0.7	3.75	0.12	0.1	0.3	3.0	2.2	—
Inconel 702*	—	—	79.6	15.6	—	0.35	—	0.04	0.05	0.2	3.0	0.7	—
Inconel 706*	—	—	42.0	16.0	—	40.0	—	0.03	0.2	0.3	0.4	1.75	—
Inconel 713*	—	—	75.0	12.5	—	—	4.2	0.12	—	—	6.1	0.8	—
Inconel 718*	180	380	52.5	19.0	—	19.0	3.0	0.04	0.35	0.35	0.9	0.9	0.1
Inconel 722*	—	380	74.8	15.0	—	6.5	—	0.04	0.55	0.2	0.6	2.4	—
Inconel 751*	—	—	70.0	15.5	—	7.0	—	0.1	1.0	0.5	1.5	2.6	0.5
Inconel 781	—	—	70.0	16.0	—	8.0	—	0.07	2.25	0.15	0.1	3.0	0.2
Inconel X-750*	—	390	73.0	15.5	—	7.0	—	0.04	0.35	0.35	0.7	2.5	—
Jessop G39*	130	—	67.5	19.5	—	5.0	3.0	0.5	—	—	—	—	4.5
Jessop G64*	220	—	60.7	11.0	—	2.0	3.0	0.15	—	—	6.0	—	4.0
Jessop G81*	—	300	79.3	20.0	13.0	—	—	0.05	—	—	1.3	2.3	—
Jethete M-252*	—	320	55.3	20.0	10.0	—	10.0	0.15	0.5	0.5	1.0	2.6	—
MAR-M 200*	—	—	69.4	9.0	10.0	—	—	0.15	—	—	5.0	2.0	13.5
MAR-M 246*	—	270	59.5	9.0	10.0	0.2	2.5	0.15	—	—	5.5	1.5	11.5
MAR-M 421*	—	—	62.3	15.5	10.0	—	1.7	0.15	—	—	4.3	1.75	5.3
MAR-M 432*	—	—	52.3	15.5	20.0	—	—	0.15	—	—	2.8	4.3	5.0
Monel 400*	110	—	65.0	—	—	1.5	—	0.12	1.0	—	—	—	32.0
Monel K-500*	120	290	64.0	—	—	1.0	—	0.13	0.8	—	2.8	0.6	30.0

* These alloys can be hardened by an aging process

USA		UK	France	Germany		Others
SAE	AMS	BS	AFNOR	Werkst.-Nr	DIN1706	
—	—	—	—	—	—	—
—	—	—	—	—	—	AISI:686
—	—	—	—	—	NiCr16MoAl	—
5396A	5396	—	ND37FeV	2.48	S-NiMo30	N10001
5388C	5388	—	—	2.4602	NiCr17Mo17FeW	N10002
5771	5607	—	—	—	—	N10003
—	5786	—	—	—	—	N10004
5390A	5390	—	NC22FeD	2.4603	—	N06002
—	—	—	—	—	—	—
—	—	—	—	—	—	—
—	—	—	—	—	—	—
—	5872	—	—	—	—	—
—	—	—	—	—	—	—
—	—	—	—	—	—	—
—	5596/5597	—	—	—	—	—
—	5542/5593	—	NC15TNbA	—	—	—
—	5397	—	—	LW2.4674	NiCo15Cr10MoAlTi	N13100
—	—	—	—	—	—	—
—	—	3072-76	NC21FeDU	2.4858	NiCr21Mo	N08825
—	5660	—	ZSNCDT42	LW2.4662	NiFe35Cr14MoTi	N09901
—	—	—	—	—	—	—
5540	5580	3072-76	NC15Fe	2.4816	NiCr15Fe	N06600
—	5715	—	—	2.4851	NiCr23Fe	N06601
—	—	—	—	—	—	—
—	5666	—	NC22FeDNB	2.4856	NiCr22Mo9Nb	N06625
—	—	—	NK27CADT	—	NiCo29Cr15MoAlTi	—
—	5550	—	—	—	—	N07702
—	5702	—	—	—	—	N09707
—	5391	3146-3	NC12AD	LW2.4670	S-NiCr13Al6MoNb	—
5383	5589	HR8	NC19FeNB	LW24668	NiCr19Fe19NbMo	N07713
—	5541	—	NC16FeTi	—	NiCr16FeTi	N07722
—	—	—	—	—	—	N07751
—	—	—	—	—	—	—
5542G	5582	—	NC16FeTNb	2.4669	NiCr16FeTi	N07750
—	—	—	—	—	NiCr20MoW	—
—	—	—	—	—	NiCr11AlWNb	—
—	—	—	—	—	NiCr20Co18Ti	—
—	5551	—	—	2.4916	S-NiCr19Co	N07252
—	—	—	—	—	NiW13Co10Cr9AlTi	—
—	—	—	—	2.4675	NiCo10W10Cr9AlTi	—
—	—	—	—	—	NiCr16Co10WAlTi	—
—	—	—	—	—	NiCo20Cr16WAlTi	—
4544	4574	3072-76	NU30	2.436	NiCu30Fe	N04400
4676	—	3072-76	—	2.4375	NiCu30Al	N05500

Ni-based Heat Resistant Alloys

Material Specifications Cross-Reference List-Aerospace Material Designation

Commercial designation	Hardness Brinell HB		Nominal composition Approximate content in %										
	Ann.	Aged	Ni	Cr	Co	Fe	Mo	C	Mn	Si	Al	Ti	Others
Monel R-405*	110	—	66.0	—	—	1.2	—	0.15	1.0	—	—	—	31.06
Nimocast 80*	—	—	69.9	20.0	2.0	5.0	—	0.1	—	—	1.0	2.0	—
Nimocast 90*	—	—	52.9	20.0	18.0	5.0	—	0.1	—	—	1.5	2.5	—
Nimocast 713	—	—	72.6	13.4	—	—	4.5	0.12	—	—	6.2	1.0	2.3
Nimocast 842	—	—	57.7	22.0	10.0	—	10.0	0.3	—	—	—	—	—
Nimocast PD16	—	—	43.8	16.5	—	34.0	3.3	0.06	—	—	1.2	1.2	—
Nimocast PE10	—	—	56.4	20.0	—	—	6.0	—	—	—	—	—	9.0
Nimocast PK24	—	—	61.1	9.5	15.0	—	3.0	0.17	—	—	5.5	4.7	1.0
Nimonic 75*	170	—	75.0	19.5	—	4.0	—	0.12	—	—	—	0.4	—
Nimonic 80A*	—	350	75.0	19.5	—	—	—	0.08	—	—	1.4	2.4	—
Nimonic 90*	—	346	59.0	19.5	16.5	—	—	0.08	—	—	1.5	2.5	—
Nimonic 95	—	—	49.9	19.5	—	5.0	—	0.11	—	1.0	2.0	3.5	—
Nimonic 105*	—	320	53.0	15.0	20.0	—	5.0	0.12	—	—	4.7	1.2	—
Nimonic 115*	—	350	59.0	14.2	13.2	—	4.0	0.16	—	—	5.0	4.0	—
Nimonic 242	—	—	58.0	21.5	10.0	—	10.5	—	—	—	—	—	—
Nimonic 263/C263*	—	275	51.5	20.2	20.0	—	6.0	0.06	—	—	0.5	2.0	—
Nimonic 901*	—	350	44.0	12.5	—	35.0	5.7	0.04	—	—	0.3	2.9	—
Nimonic PE13	—	—	49.0	21.8	1.5	18.5	9.0	0.1	0.5	0.5	—	—	0.6
Nimonic PE16*	—	250	43.5	16.5	—	34.0	3.3	0.06	—	—	1.2	1.2	—
Nimonic PK25	—	—	49.9	19.0	19.5	—	4.0	0.08	0.8	0.8	2.9	2.9	—
Nimonic PK31	—	—	53.8	20.0	14.0	—	4.5	—	—	—	0.4	2.3	5.0
Nimonic PK33*	—	350	55.9	18.0	14.0	0.5	7.0	0.05	0.25	0.25	2.1	2.2	—
R-235*	—	—	63.3	15.0	1.2	10.0	5.5	0.12	0.1	0.3	2.0	2.5	—
Refractaloy 26	—	—	38.0	19.0	20.0	16.0	3.2	0.03	0.8	1.0	0.2	2.75	—
Rene 41	—	—	53.1	19.0	11.0	1.8	10.0	0.09	0.3	0.3	1.5	3.1	—
Rene 63	—	—	54.4	14.0	15.0	0.5	6.0	0.05	0.1	0.2	3.8	2.5	3.5
Rene 77	—	—	57.6	15.0	15.0	0.4	4.2	0.17	0.1	0.1	4.3	3.3	—
Rene 80	—	—	61.0	14.0	9.5	—	4.0	0.15	—	—	—	4.0	8.0
Rene 95	—	—	64.5	14.0	8.0	—	3.5	0.15	—	—	—	2.5	3.5
Rene 100	—	—	60.6	10.0	15.0	—	3.0	0.18	—	—	5.5	4.7	—
Rene 125	—	—	60.0	8.9	10.0	—	2.0	0.1	—	—	4.7	2.5	7.0
TRW 1800	—	—	70.0	13.0	—	—	—	0.1	—	—	6.0	0.06	10.5
TRW V1 A	—	—	70.5	6.0	7.5	—	2.0	0.13	—	—	5.4	1.0	6.3
Udimet 500*	—	—	51.7	19.0	19.0	—	4.0	0.1	0.1	0.1	3.0	3.0	—
Udimet 630	—	—	51.0	17.0	—	17.5	3.0	0.04	—	—	0.6	1.1	4.1
Udimet 700	—	—	54.6	15.0	17.5	—	—	0.1	—	—	4.4	3.4	—
Udimet 710	—	—	55.0	18.0	15.0	0.5	1.5	0.07	—	—	2.5	5.0	1.5
Udimet 718*	180	380	52.5	18.0	—	18.0	3.0	0.05	—	—	0.6	0.1	5.2
Waspaloy*	—	HRC35-42	56.9	19.8	13.5	0.8	4.45	0.07	0.1	0.1	1.4	3.0	—

* These alloys can be hardened by an aging process

USA		UK	France	Germany		Others
SAE	AMS	BS	AFNOR	Werkst.-Nr	DIN1706	
4674	7234	—	—	—	—	N04405
—	—	3146	—	—	—	—
—	—	—	—	—	—	—
—	—	—	—	—	—	—
5391A	—	HC203	NC13AD	2.467	S-NiCr13Al6MoNb	—
—	5397	HC204	NK15CAT	LW2.4674	—	—
—	—	—	—	—	NiFe33Cr17Mo	—
—	—	3146	—	—	—	—
—	—	HR5,203-4	NC20T	2.463	NiCr20Ti	—
—	—	Hr401,601	NC20TA	2.4631	NiCr20TiAk	N07080
—	—	Hr2,202	Nc20ATV	2.4632	NiCr20Co18Ti	N07090
—	—	—	—	—	—	—
—	—	HR3	NCKD20ATV	2.4634	NiCo20C15MoAlTi	—
—	—	HR4	NCK15ATD	2.4636	NiCo15Cr15MoAlTi	—
—	—	—	—	—	—	—
—	—	HR10	NCK20D	2.465	NiCr15Co19MoTi	—
5660C	5661A	—	ZSNCDT42	2.4662	NiCr15MoTi	—
5536E	5754E	HR6,204	NC22FeD	2.4665	NiCr22Fe18Mo	—
—	—	HR207	NW11AC	—	NiFe33Cr17Mo	—
5751A	5753	—	NKOD20ATU	2.4666	NiCr18CoMo	—
—	—	—	—	—	—	—
—	—	—	NC19KDUV	—	NiCr20Co16MoTi	—
—	—	—	—	—	—	—
—	—	—	Z6NKCDT38	—	—	—
—	5399	—	NC19KDT	2.4973	NiCr19Co11MoTi	N07041
—	—	—	—	—	—	—
—	—	—	—	—	—	—
—	—	—	—	—	—	—
—	—	—	NC14K8	—	—	—
—	—	—	—	—	NiCo15Cr10MoAlTi	—
—	—	—	—	—	—	—
—	—	—	—	—	—	—
—	—	—	—	—	NiTa9Co8W6CrAl	—
—	5751	—	NCK19DAT	2.4983	NiCr18Co18MoTi	N07500
—	—	—	—	2.4668	NiCr19NbMo	—
—	—	—	NCKD20AT	2.4636	NiCo15CrMoAlTi	—
—	—	—	NC18TDA	—	—	—
5383	5589	HR8	NC19FeN	LW2.4668	NiCr19Fe19NbMo	N07718
—	5544	—	NC20K14	LW2.4668	NiCr19Fe19NbMo	N07001

Co-based Heat Resistant Alloys

Material Specifications Cross-Reference List-Aerospace Material Designation

Commercial designation	Hardness Brinell HB		Nominal composition Approximate content in %										
	Ann.	Aged	Ni	Cr	Co	Fe	Mo	W	Mn	Si	Al	Ti	Others
Air Resist 13	—	—	1.0	—	79.6	2.5	—	11.0	—	—	3.5	—	4.12
Air Resist 213	—	—	—	19.0	65.8	—	—	4.7	—	—	3.5	—	6.68
Altemp S 816	—	—	20.0	20.0	47.6	—	4.0	4.0	—	—	—	—	0.4
FSX 414	—	—	10.0	29.0	52.8	1.0	—	7.0	—	—	—	—	0.25
Haynes 25*	—	—	10.0	20.0	49.0	3.0	—	15.0	1.5	0.5	—	—	0.1
Haynes 36	—	—	10.0	18.5	52.8	2.0	—	14.5	1.2	0.6	—	—	0.4
Haynes 151	—	—	—	20.0	65.6	—	—	12.8	0.5	0.5	—	0.15	0.47
Haynes 188*	—	—	22.0	22.0	38.0	2.5	—	14.0	1.0	0.4	—	—	0.1
HS 6*	—	—	2.5	28.0	60.5	3.0	—	5.0	—	—	—	—	1.0
HS 21*	—	—	3.0	27.0	62.6	2.0	5.0	—	0.6	0.6	—	—	0.25
HS 25	—	—	10.0	20.0	48.4	3.0	—	15.0	1.5	2.0	—	—	0.1
HS 30	—	—	16.0	24.0	51.4	1.0	6.0	—	0.6	0.6	—	—	0.4
HS 31	—	—	10.0	25.0	53.8	1.5	—	8.0	0.6	0.8	—	—	0.4
HS 36	—	—	10.0	18.0	53.1	2.0	—	15.0	1.5	—	—	—	0.4
J 1570*	—	—	28.0	19.0	39.0	2.0	—	7.0△	—	—	—	—	—
J 1650	—	—	27.0	19.0	38.0	—	—	12.0	—	—	—	—	0.2
Jessop 832	—	—	12.0	19.0	44.0	17.0	2.0	—	0.8	0.3	—	—	3.5
Jessop 834	—	—	12.0	19.0	42.0	20.0	2.0	—	—	—	—	—	6.5
Jessop 865	—	—	10.5	25.5	53.0	2.0	—	7.5	0.6	0.6	—	—	0.45
Jessop 875	—	—	—	21.0	66.0	—	—	11.0	—	—	—	—	2.45
Jessop 887	—	—	10.0	20.0	50.0	3.0	—	15.0	0.5	1.5	—	—	0.1
Jessop X-40	—	—	10.5	25.5	53.0	1.5	—	7.5	0.75	0.75	—	—	0.5
Jessop X-45	—	—	10.5	25.5	54.7	2.0	—	7.0	—	—	—	—	0.25
Jessop X-50	—	—	20.5	25.5	40.3	4.0	—	12.0	—	—	—	—	0.75
Jessop X-63	—	—	10.0	25.0	57.6	1.0	6.0	—	—	—	—	—	0.45
Jetalloy 209	—	—	10.0	20.0	52.0	1.0	—	15.0	—	—	—	2.0	0.02
L-251	—	—	10.0	19.0	56.0	1.0	—	14.0	—	—	—	—	0.4
L-605	—	—	10.0	20.0	51.0	1.6	—	15.0	1.5	0.6	—	—	0.1
M 203	—	—	25.0	20.0	38.0	1.6	—	12.0	0.8	1.0	0.7	2.0	1.67
M 204	—	—	25.0	18.0	42.0	1.6	—	12.0	—	—	—	—	1.27
M 205	—	—	25.0	18.0	40.0	1.6	—	12.0	—	—	2.7	—	1.67
MAR-M 302	—	—	—	21.5	57.0	0.75	—	10.0	0.1	0.2	—	—	10.0
MAR-M 322	—	—	—	21.5	60.0	0.75	—	9.0	0.1	0.1	—	0.75	7.7
MAR-M 509	—	—	10.0	23.0	55.0	—	—	7.0	0.05	0.05	—	0.2	4.6
MAR-M 905	—	—	20.0	20.0	55.0	—	—	—	—	—	—	0.5	7.65
MAR-M 918	—	—	20.0	20.0	52.0	0.4	—	—	0.1	0.1	—	0.5	7.65
Refractaloy 70	—	—	20.0	21.0	46.0	0.5	8.0	4.0	—	—	—	—	0.08
V-36	—	—	20.0	25.0	43.2	2.4	4.0	2.0	0.6	0.5	—	—	2.29
WL-52	—	—	0.5	21.0	62.6	2.0	—	11.0	0.25	0.25	—	—	2.45

* These alloys can be hardened by an aging process

USA		UK	France	Germany		Others
SAE	AMS	BS	AFNOR	Werkst.-Nr	DIN1706	
—	—	—	—	—	—	—
—	—	—	—	—	—	—
—	(5534)	—	—	LW2.4989	CoCr20Ni20W	—
—	—	—	—	—	—	—
5537C	5759	—	KC20WN	LW2.4964	CoCr20W15Ni	—
—	—	—	—	—	CoCr19W14NiB	—
—	—	—	—	—	CoCr20W13	—
—	5772	—	KC22WN	—	CoCr22W14Ni	—
—	5373	—	—	—	—	R30006
—	5385	3531	—	—	CoCr29Mo	R30021
—	5759	—	KC20WN	LW2.4964	CoCr20W15Ni	—
5380	—	—	—	—	CoCr25NiW	R30030
5382	—	3146	—	LW2.4670	CoCr25NiW	R30031
—	—	—	—	—	CoCr19W14NiB	—
—	—	—	—	—	—	—
—	—	—	—	—	—	—
—	—	—	—	—	CoCr19Fe16NiMoVNb	—
—	—	—	—	—	CoCr19Fe20NiMoVNb	—
—	—	—	—	—	CoCr25NiW	—
—	—	—	—	—	CoCr21W11Nb	—
—	—	—	—	—	CoCr20W15Ni	—
—	5382	3156-2	—	LW2.4670	CoCr25NiW	—
—	—	—	—	—	—	—
—	—	—	—	—	—	—
—	—	—	—	—	—	—
—	—	—	—	—	—	—
—	—	—	—	—	—	—
—	5759	—	—	2.4964	CoCr20W15Ni	R30605
—	—	—	—	—	—	—
—	—	—	—	—	—	—
—	—	—	—	—	—	—
—	—	—	—	—	CoCrW10TaZrB	—
—	—	—	—	—	CoCr22W9TaZrNb	—
—	—	3146-3	—	—	CoCr24Ni10WTaZrB	—
—	—	—	—	—	—	—
—	—	—	—	—	CoCr20Ni20Ta	—
—	—	—	—	—	—	—
—	—	—	—	—	CoCr25NiMoWNb	—
—	—	—	—	—	CoCr12MoW	—

Swiss Machine List

Citizen/Cincom

Machine Model	Gang Station					Turret Station						Sleeve Station		Hand	Max cutting dia mm
	Inch		Metric		Number of tools	Inch		Metric		Number of tools		Inch	Metric		
	h×b	L	h×b	L		h×b	L	h×b	L	Turret	Station	"	mm		
A12	□3/8	4.75	□10	100	5			—	—	—	—	φ3/4	φ20	R	φ12
A16	□3/8	4.75	□10	100	5			—	—	—	—	φ3/4	φ20	R	φ16
A20	□1/2	4	□12(□13)	120	5-7			—	—	—	—	φ1		R	φ20
A25	□1/2	4	□12(□13)	120	5/6			—	—	—	—	φ1		R	φ25
A32	□5/8	4.75	□16	150	6			—	—	—	—	φ1		R	φ32
B12, B12E	□3/8	4.75	□10	100	5			—	—	—	—	φ3/4	φ20	R	φ12
B16E	□3/8	4.75	□10	10	5			—	—	—	—	φ3/4	φ20	R	φ16
B20	□1/2	4.75	□12(□13)	120	6			—	—	—	—	φ3/4	φ20	R	φ20
BL12	□3/8	4.75	□10	60-120	5			—	—	—	—	φ3/4	φ20	R	φ12
BL20			□12(□13)	120	7			—	—	—	—	φ3/4	φ20	R	φ20
BL25			□12(□13)	120	7			—	—	—	—	φ3/4	φ20	R	φ25
C12	□3/8	4.75	□10	120	6			—	—	—	—	φ3/4		R	φ12
C16	□3/8	4.75	□10	120	6			—	—	—	—	φ3/4		R	φ16
C32	□5/8	4.75	□16	130	5			—	—	—	—	φ1		R	φ32
E32			—	—	—			□16(19×13)	90	2	10/Turret	φ1		R	φ32
F10			—	—	—			□10	60	1	10	φ3/4		R	φ10
F12			—	—	—			□10	60	1	10	φ3/4		R	φ12
F16			—	—	—			□10	60	1	10	φ3/4		R	φ16
F20			—	—	—			□16(19×13)	90	1	10	φ1		R	φ20
F25			—	—	—			□16(19×13)	90	1	10	φ1		R	φ25
FL25			—	—	—			□16	90	1	12		φ16	R	φ25
FL42			—	—	—			□16	90	1	12		φ16	R	φ42
G10			—	—	—			□10	60	1	8	—	—	R	φ10
G16			—	—	—			□10	60	1	8	—	—	R	φ16
G32			—	—	—			□16(19×13)	90	1	10	—	—	R	φ32
K12, K12E	□3/8		□10	100	7			—	—	—	—		φ20	R	φ12
K16, K16E	□3/8		□12	100	6			—	—	—	—		φ20	R	φ16
L10			□8	100-130	5			—	—	—	—	φ5/8		R	φ10
L12	□3/8	4	□10	100	6			—	—	—	—	φ3/4	φ20	R	φ12
L16, L16E			□12(□10)	130	7			—	—	—	—	φ3/4		R	φ16
L20, L20E	□1/2	4.75	□12	130	7			—	—	—	—	φ3/4		R	φ20
L25	□5/8	4.75	□16	130	5			—	—	—	—	φ1		R	φ25
L32	□5/8	4.75	□16	130	5			—	—	—	—	φ1		R	φ32
M ₂ 12, M ₃ 12	□3/8		□10	120	5			□10	60	1	10	φ3/4		R	φ12
M ₂ 16, M ₃ 16, M ₄ 16	□3/8		□10	120	5			□10	60	1	10	φ3/4		R	φ16
M ₂ 20, M ₃ 20	□5/8	4.75	□12	130	5	□3/4		□16	90	1	10	φ1		R	φ20
M ₂ 32, M ₃ 32, M ₄ 32	□5/8	4.75	□16	130	5	□3/4		□16	90	1	10	φ1		R	φ32
M20	□1/2	4	□13(□12)	150	5	□1/2		□10	60	1	10	φ3/4		R	φ20
MSL12			□10	120	—			—	—	—	—	—	—	R	φ12
R04			□8	120	7			—	—	—	—	φ5/8		R	φ4
R07			□8	120	5			—	—	—	—	φ5/8		R	φ7
RL02			□16	60-150	Max 6			—	—	—	—		φ16/φ20	L	φ20
RL21			□10(□12)	90	—			—	—	—	—	φ3/4		R	φ20

STAR

Machine Model	Gang Station					Turret Station						Sleeve Station		Hand	DS-Sleeve item number	Max cutting dia
	Inch		Metric		Number of tools	Inch		Metric		Number of tools		Inch	Metric			
	h×b	L	h×b	L		h×b	L	h×b	L	Turret	Station	"	mm			mm
ECAS-12			□10	95-150	6								φ22	R	SS-DSU-L23 SS-DSU-SK	φ13
ECAS-20			□12(16)	80-144	6								φ22	R	SS-DSU-L23 SS-DSU-SK	φ20
ECAS-20T								□12(16)	80	3	8/Turret		φ22	R	SS-DSU-B8D34	φ20
ECAS-32T			□16	80-120	4			□16	60-78	2	10/Turret		φ22/32	R	SS-DSU-SK	φ32
JNC-10								□8	65	1	6		-	L	—	φ10
JNC-16								□10	80	1	6		-	L	—	φ16
JNC-25/32								□16	78-120	1	10		φ22	R	—	φ25/φ32
KJR-16B/25B								□16	78	1	12/16		φ22	R	—	φ16/φ25
KNC-16/20								□16	68	1	16		φ22	R	—	φ16/φ20
KNC-25II/32II								□16	78	1	20		φ22/32	R	—	φ25/φ32
RNC-10/16			□10	80-120	5								φ22	R	—	φ10/φ16
RNC-16II/16BII			□10	80-120	5								φ22	R	—	φ16
SA-16R			□10	95-120	6								φ22	R	—	φ16
SB-12II/12R/16II	□1/2 (3/8)		□12(10)	95-130	6(7)								φ22	R	SS-DSU-L23 SS-DSU-SK	φ12/φ13/φ16
SB-16/16R	□1/2 (3/8)		□12(10)	95-130	6(7)								φ22	R	SS-DSU-L23 SS-DSU-SK	φ16
SB-20/20R	□1/2 (3/8)		□12(10)	95-130	6(7)								φ22	R	SS-DSU-L23 SS-DSU-SK	φ20
SC-20			□12	95-130	6								φ22	R	—	φ20
SE-12/12B, 16/16B			□10	95-120	5								φ22	R	—	φ13/φ16
SF-25								□16	73-98	1	10		φ22/32	R	—	φ25
SG-42								□16(20)	84-88	1	10		φ22/32	R	—	φ42
SH-12/16			□10	95-120	5								φ22	R	—	φ13/φ16
SH-7			□8	95-120	5								φ22	R	—	φ7
SI-12/12C			□10	80-130	6								φ22	R	—	φ13
SR-10J	□5/16		□8	67-110	6								φ22	R	SS-DSU-L23 SS-DSU-SK	φ10
SR-16/20			□12	95-120	5								φ22	R	—	φ16/φ20
SR-20J	□1/2		□12	100-135	6								φ22	R	SS-DSU-L23 SS-DSU-SK	φ20
SR-20R/20RII/20RIII			□12	100-135	6								φ22	R	SS-DSU-L23 SS-DSU-SK	φ20
SR-20RIV	□1/2		□12	100-130	7								φ22	R	SS-DSU-B8L23	φ20
SR-25J/32J	□5/8		□16	95-155	6								φ22/32	R	SS-DSU-L23 SS-DSU-SK	φ25/φ32
SR-32			□16	100-135	6								φ22	R	—	φ32
SST-16			□12	95-115	5								φ22	R	—	φ16
ST-20								□12(16)	70-78	3	8/Turret		φ22	R	—	φ20
ST-38								□16(20)	85	3	10/Turret		φ22/32	R	—	φ38
SV-12/20			□12	95-135	4			□12	70-78	1	8		φ22	R	—	φ13/φ20
	□1/2		□12/□16	95-135	5			□16	65-70	1	8					
SV-32			□16	95-135	4			□16	80-88	1	10		φ22/32	R	—	φ32
SV-32J/32JII			□16	95-135	4			□16	65-70	1	8		φ22/32	R	—	φ32
SV-38R			□16+□20 (Cut off)	95-135	5			□16(20)	84-88	1	10		φ22/32	R	SS-DSU-B8D34	φ38
SW-12RII			□10	80-115	6								φ16	R	SS-DSU-B8L23	φ13
SW-20	□1/2 (5/8)		□12(16)	80-144	6								φ22	R	SS-DSU-B8L23	φ20
SW-7			□8	80-120	4								—	R	—	φ7

Machine Model	Gang Station					Turret Station						Sleeve Station		Hand	Max cutting dia
	Inch		Metric		Number of tools	Inch		Metric		Number of tools		Inch	Metric		
	h×b	L	h×b	L		h×b	L	h x b	L	Turret	Station	"	mm		mm
P013H/P014H			□8	100-120	6			—	—	—	—		φ16	R	φ1
P033H/P034H			□8	100-120	6			—	—	—	—		φ16	R	φ3
B007-III	—	—	□7(□8/□10)	85	8			—	—	—	—		φ25	R	φ7
B073-II	—	—	□8	85	9			—	—	—	—		φ20	R	φ7
B074/B07-V	—	—	□8	85	9			—	—	—	—		φ20	R	φ7
B0123/B0124/B0125/B0126	—	—	□12	85	9			—	—	—	—		φ20	R	φ12
B012F/B012-V/BE12-V	—	—	□12	85	9			—	—	—	—		φ20	R	φ12
B016MF	—	—	□12	85	9			—	—	—	—		φ20	R	φ16
B018-III	—	—	□12	85	9			—	—	—	—		φ20	R	φ18
B0203/B0204/B0205/B025-II/B0205-III/B0206-II	—	—	□12	85	9			—	—	—	—		φ20	R	φ20
B020F/B020-V/BE20-V	—	—	□12	85	9			—	—	—	—		φ20	R	φ20
B026-V	—	—	□12(□16)	85	6			—	—	—	—		φ25	R	φ26
B0265-II/B0266-II	—	—	□16	100	12			—	—	—	—		φ25	R	φ26
B0325-II/B0326-II	—	—	□16	100	12			—	—	—	—		φ25	R	φ32
B0385/B0385L	—	—	□16	125	8			—	—	—	—		φ32	R	φ38
B038T	—	—	□16	125	3			□20	125	1	8		φ25/φ32	R	φ38
BA20-III			□12	85	6			—	—	—	—		φ25	R	φ20
BA26-III			□12(□16)	85	6			—	—	—	—		φ25	R	φ26
BC18	□1/2		□12	85	10			—	—	—	—		φ25	R	φ18
BC25	□1/2		□12	85	10			—	—	—	—		φ10/φ25	R	φ25
BE18	□1/2		□12	85	9			—	—	—	—		φ20	R	φ18
BH20/BH20Z	□1/2		□12	85	4			□12	85	1	12		φ25/φ32	R	φ20
BH38	□5/8		□16	125	7			□20	125	1	12		φ25/φ32	R	φ38
BM07			□8	85	9			—	—	—	—		φ20	R	φ7
BM163/BM164/BM165	□1/2		□12	85	9			—	—	—	—		φ20	R	φ16
BM20-V	□1/2		□12	85	9			—	—	—	—		φ20	R	φ20
BN12-III			□12	85	7			—	—	—	—		φ20	R	φ12
BN20-III			□12(□16)	85	7			—	—	—	—		φ20	R	φ20
BS12-V	□1/2		□12	85	8(12)			—	—	—	—		φ20/φ25	R	φ12
BS18-III	□1/2		□12	85	7(10)			—	—	—	—		φ14/φ25	R	φ18
BS20-V	□1/2		□12	85	8(12)			—	—	—	—		φ20/φ25	R	φ20
BS26(ABC)-V	□5/8		□16	100	7(10)			—	—	—	—		φ16/φ25	R	φ26
BS32C-V	□5/8		□16	100	6			—	—	—	—		φ16/φ25	R	φ32
BU12			□12	85	4			□12	80	1	8		φ20	R	φ51
BU20			□12	85	4			□12	80	1	8		φ20	R	φ20
BU26			□16	100	7			□20	80	1	8		φ20/φ32	R	φ26
BU38	□1/2		□16	100	7			□20	80	1	8		φ20/φ32	R	φ38
BW07-III	□1/2		□12	85	7			—	—	—	—		φ20	R	φ7
BW12-III	□1/2		□12	85	7			—	—	—	—		φ20	R	φ12
BW20-III	□1/2		□12(□16)	85	7			—	—	—	—		φ20	R	φ20
C004-III			□13	60-100	6-8			—	—	—	—		-φ10	R/L	φ120
C150	—	—	□10	60-100	4-6			—	—	—	—		-φ8	R/L	φ80
C180	—	—	□12	60-100	4-6			—	—	—	—		-φ10	R/L	φ120
C220	—	—	□13	60-100	6-8			—	—	—	—		-φ10	R/L	φ120
C300-III	—	—	□16	100-130	6-10			—	—	—	—		-φ14	R/L	φ170
CH154			□12	60-100	-16			—	—	—	—		-φ10	R/L	φ15
M34J			—	—	—			□20	125	1	12		φ20/φ32	R	φ34
M42J/M42D/M42SD			—	—	—			□20	125	1	12		φ25/φ32	R	φ42
M50SY-III			—	—	—			□20	100	1	12		φ32	R	φ51
M50J			—	—	—			□20	100	1	12		φ20/φ32	R	φ51
MB25			—	—	—			□20	80	2	8/Turret		φ20/φ32	R	φ25
MB35-III			—	—	—			□20	80	2	8/Turret		φ20/φ32	R	φ35
MB38-III			—	—	—			□20	80	2	8/Turret		φ20/φ32	R*	φ38
MB50-III			—	—	—			□20	80	2	8/Turret		φ20/φ32	R	φ50
MU26			—	—	—			□20	80	2	8/Turret		φ20/φ32	R	φ26
MU38			—	—	—			□20	80	2	8/Turret		φ20/φ32	R	φ38
NU50-III			—	—	—			□20	100	1	12		φ20/φ32	R	φ51
B020M-II/SS20M/SS20M-5AX			□10*	46	—			BT15 spindle			24		φ20	R	φ20
S205/S206	□1/2		□12(□16)	100	8			—	—	—	—		φ20/φ22	R	φ20
SS20	□1/2		□16	100	8			—	—	—	—		φ20/φ22	R	φ20
SS207/SS207-5AX	□1/2		□12(□16)	100	8			—	—	—	—		φ20/φ22	R	φ20
SS26	□5/8		□16	100	7			—	—	—	—		φ20/φ22	R	φ26
SS267/SS267-5AX	□5/8		□16	100	8			—	—	—	—		φ25	R	φ26
SS32/SS32L	□5/8		□16	100	7			—	—	—	—		φ20/φ22	R	φ32
SS327/SS327-5AX	□5/8		□16	100	8			—	—	—	—		φ25	R	φ32
TMB2			—	—	—			□20	125	1	16		φ32	R	φ51
TMU1			—	—	—			□20	125	1	16		φ32	R	φ38
TMA8-IV/TMA8J			□20*	100	—			KM40 spindle			30			R	φ220
M06J			—	—	—			□25	150	1	8		φ32/φ40	R	φ260
M06SY			—	—	—			□25	150	1	12		φ32/φ40	R	φ260
M06JC			—	—	—			□20	125	1	8		φ32/φ40	R	φ260
M08J			—	—	—			□25	150	1	8		φ32/φ40	R	φ280
M08SY/M08D/M08SD			—	—	—			□25	150	1	12		φ32/φ40	R	φ280

● TORNOS

Machine Model	Gang Station				Number of tools	Sleeve Station		Hand	Max cutting dia
	Inch		Metric			Inch	Metric		mm
	h×b	L	h×b	L		"	mm		
EvoDECO 10/10	□5/16		□8		8		φ 20/ φ 25	R	φ 10
EvoDECO 10/8	□5/16		□8		8		φ 20/ φ 25	R	φ 10
EvoDECO 16/10	□1/2		□12		10		φ 20/ φ 25	R	φ 16
EvoDECO 16/8	□1/2		□12		10		φ 20/ φ 25	R	φ 16
EvoDECO 20	□5/8		□16		10		φ 20/ φ 25	R	φ 25.4
EvoDECO 32	□5/8		□16		10		φ 20/ φ 25	R	φ 32
Swiss ST 26	□1/2		□12		17		φ 20/ φ 22/ φ 25	R	φ 25.4
Sigma 20/6	□5/8		□16		14	φ 1	φ 20	R	φ 25.4
Sigma 32/6	□5/8		□16		14	φ 1.26	φ 32	R	φ 32
SwissNano	□5/16		□8		7		φ 12/ φ 16	R	φ 4
Delta 12/4	□1/2*		□12	85	5		φ 20	R	φ 12
Delta 12/5	□1/2*		□12	85	5		φ 20	R	φ 12
Delta 20/4	□1/2*		□12	85	5		φ 20	R	φ 20
Delta 20/5	□1/2*		□12	85	5		φ 20	R	φ 20
Delta 38/5B			□20	125	8		φ 25/ φ 32	R	φ 38
Delta 38/5BL			□20	125	8		φ 25/ φ 32	R	φ 38
Gamma 20/5			□16	100	8		φ 20/ φ 22	R	φ 20
Gamma 20/6			□16	100	8		φ 20/ φ 22	R	φ 20
CT20	□1/2		□12	100	5			R	φ 20

*Except cut off must be 12mm

● NOMURA

Machine Model	Gang Station				Number of tools	Sleeve Station		Hand	Max cutting dia
	Inch		Metric			Inch	Metric		mm
	h×b	L	h×b	L		"	mm		
NS-P1053A			□9.5	130	5	—	—	R	φ 10
NN-10C			□10	130	6		φ 17	R	φ 10
NN-10E			□10	130	6		φ 16	R	φ 10
NN-10C2			□10	130	6		φ 17	R	φ 10
NN-10CS			□10	130	6		φ 17	R	φ 10
NN-10CS(No live tools)			□10	130	5		φ 17	R	φ 10
NN-10SII			□10	130	5		φ 23	R	φ 10
NN-10T			□10	130	7		φ 23	R	φ 10
NN-10SB5			□10	130	5		φ 23	R	φ 16
NN-16SB5			□10	130	5		φ 23	R	φ 16
NN-16SB6 Type1	□1/2	5.12	□12.7	130	5		φ 17(φ 22)	R	φ 16
NN-16SB6 Type2	□1/2	5.12	□12.7	130	5		φ 17(φ 22)	R	φ 16
NN-16SB6 Type2.5	□1/2	5.12	□12.7	130	5		φ 17(φ 22)	R	φ 16
NN-16SB6 Type3	□1/2	5.12	□12.7	130	5		φ 17(φ 22)	R	φ 16
NN-16HIII			□12	130	6		φ 23	R	φ 16
NN-20HIII			□12	130	6		φ 23	R	φ 20
NN-16UIII			□12	130	5		φ 23	R	φ 16
NN-20UIII			□12	130	5		φ 23	R	φ 20
NN-20CS	□1/2	5.12	□12.7	130	5(6)		φ 22	R	φ 20(φ 25)
NN-20U5	□1/2	5.12	□12.7	130	5(6)		φ 22	R	φ 20(φ 25)
NN-16UB5			□12	130	5		φ 23	R	φ 16
NN-20UB5			□12	130	5		φ 23	R	φ 20
NN-20UB7			□12	130	6		φ 23	R	φ 20
NN-20UB8	□1/2	5.12	□12.7	130	5(6)		φ 22	R	φ 20(φ 25)
NN-20YB			□12	130	8		φ 23	R	φ 20
NN-25YB/32YB			□16	130	8		φ 23/ φ 32	R	φ 25
NN-32YB2			□16	130	5		φ 22/ φ 32	R	φ 32
NN-16J	□1/2	5.12	□12.7	130	6		φ 23	R	φ 16
NN-20J	□1/2	5.12	□12.7	130	6		φ 23	R	φ 20
NN-20J2	□1/2	5.12	□12.7	130	6		φ 22	R	φ 20

Hardness Comparison Chart

Vickers Hardness (HV)	Rockwell hardness			Brinell hardness, 10 mm balls, 3000 kgf load	Tungsten carbide ball	Shore hardness	Tensile strength Kgf/mm ² [N/m ²] Approximate value MPa (1)
	Scale A Load: 60 kgf brale indenter (HRA)	Scale C Load: 150 kgf brale indenter (HRC)	Scale B Load: 100 kgf Diameter 1/16" indenter (HRB)				
2200	(95.1)	—	—	—	—	—	
2100	(94.6)	—	—	—	—	—	
2000	94.2	—	—	—	—	—	
1900	93.7	(80.5)	—	—	—	—	
1800	93.2	(79.2)	—	—	—	—	
1700	92.7	(77.9)	—	—	—	—	
1600	91.8	(76.6)	—	—	—	—	
1500	91.0	(75.3)	—	—	—	—	
1450	90.4	(74.6)	—	—	—	—	
1400	90.0	74.0	—	—	—	—	
1350	89.6	73.4	—	—	—	—	
1300	89.1	72.7	—	—	—	—	
1250	88.6	72.1	—	—	—	—	
1200	88.1	71.5	—	—	—	—	
1150	87.6	70.9	—	—	—	—	
1100	87.1	70.3	—	—	—	—	
1050	86.6	69.6	—	—	—	—	
1000	86.2	68.9	—	—	—	—	
940	85.6	68.0	—	—	97		
920	85.3	67.5	—	—	96		
900	85.0	67.0	—	—	95		
880	84.7	66.4	—	(767)	93		
860	84.4	65.9	—	(757)	92		
840	84.1	65.3	—	(745)	91		
820	83.8	64.7	—	(733)	90		
800	83.4	64.0	—	(722)	88		
780	83.0	63.3	—	(710)	87		
760	82.6	62.5	—	(698)	86		
740	82.2	61.8	—	(684)	84		
720	81.8	61.0	—	(670)	83		
700	81.3	60.1	—	(656)	81		
690	81.1	59.7	—	(647)	—		
680	80.8	59.2	—	(638)	80		
670	80.6	58.8	—	630	—		
660	80.3	58.3	—	620	79		
650	80.0	57.8	—	611	—		
640	79.8	57.3	—	601	77		
630	79.5	56.8	—	591	—		
620	79.2	56.3	—	582	75		
610	78.9	55.7	—	573	—		
600	78.6	55.2	—	564	74		
590	78.4	54.7	—	554	—		
580	78.0	54.1	—	545	72		
570	77.8	53.6	—	535	—		
560	77.4	53.0	—	525	71		
550	77.0	52.3	—	517	—		
540	76.7	51.7	—	507	69		
530	76.4	51.1	—	497	—		
520	76.1	50.5	—	488	67		
510	75.7	49.8	—	479	—		
500	75.3	49.1	—	471	66		

Vickers Hardness (HV)	Rockwell hardness			Brinell hardness, 10 mm balls, 3000 kgf load	Tungsten carbide ball	Shore hardness	Tensile strength Kgf/mm ² [N/m ²] Approximate value MPa (1)
	Scale A Load: 60 kgf brale indenter (HRA)	Scale C Load: 150 kgf brale indenter (HRC)	Scale B Load: 100 kgf Diameter 1/16" indenter (HRB)				
490	74.9	48.4	—	460	—	—	
480	74.5	47.7	—	452	64		
470	74.1	46.9	—	442	—		
460	73.6	46.1	—	433	62		
450	73.3	45.3	—	425	—		
440	72.8	44.5	—	415	59		
430	72.3	43.6	—	405	—		
420	71.8	42.7	—	397	57		
410	71.4	41.8	—	388	—		
400	70.8	40.8	—	379	55		
390	70.3	39.8	—	369	—		
380	69.8	38.8	(110.0)	360	52		
370	69.2	37.7	—	350	—		
360	68.7	36.6	(109.0)	341	50		
350	68.1	35.5	—	331	—		
340	67.6	34.4	(108.0)	322	47		
330	67.0	33.3	—	313	—		
320	66.4	32.2	(107.0)	303	45		
310	65.8	31.0	—	294	—		
300	65.2	29.8	(105.5)	284	42		
295	64.8	29.2	—	280	—		
290	64.5	28.5	104.5	275	41		
285	64.2	27.8	—	270	—		
280	63.8	27.0	103.5	265	40		
275	63.5	26.4	—	261	—		
270	63.1	25.6	102.0	256	38		
265	62.7	24.8	—	252	—		
260	62.4	24.0	101.0	247	37	825	
255	62.0	23.1	—	243	—	805	
250	61.6	22.2	99.5	238	36	795	
245	61.2	21.3	—	233	—	780	
240	60.7	20.3	98.1	228	34	765	
230	—	18.0	96.7	219	33	730	
220	—	15.7	95.0	209	32	695	
210	—	13.4	93.4	200	30	670	
200	—	(11.0)	91.5	190	29	635	
190	—	(8.5)	89.5	181	28	605	
180	—	(6.0)	87.1	171	26	580	
170	—	(3.0)	85.0	162	25	545	
160	—	(0.0)	81.7	152	24	515	
150	—	—	78.7	143	22	490	
140	—	—	75.0	133	21	455	
130	—	—	71.2	124	20	425	
120	—	—	66.7	114	—	390	
110	—	—	52.3	105	—	—	
100	—	—	56.2	95	—	—	
95	—	—	52.0	90	—	—	
90	—	—	48.0	86	—	—	
85	—	—	41.0	81	—	—	

(1) 1 MPa = 1 N/mm²

(2) This table is an excerpt from the JIS Iron and Steel Handbook

(3) Values in parentheses in the above table are not usually used

Z

Index

Item number	Description	Page number
BG	Toolholder	V19
C045-MBR	Toolholder	V23
C05G-SEXR	Toolholder	V24
C06F-MBR	Toolholder	V23
C06G-SEXR	Toolholder	V24
C06H-SCLP	Toolholder	V25
C06H-STZ	Toolholder	V30
C07J-SCLP	Toolholder	V25
C07J-STUC	Toolholder	V30
C08K-SCLC	Toolholder	V26
C08K-SCLP	Toolholder	V25
C08K-STUP	Toolholder	V30
C08K-STZ	Toolholder	V30
C10M-SCLC	Toolholder	V26
C10M-STUP	Toolholder	V30
C10M-STZ	Toolholder	V30
C12M-SCLC	Toolholder	V26
C12M-STUP	Toolholder	V30
C12M-STZ	Toolholder	V30
C16Q-STUP	Toolholder	V30
CCET	Insert	Q14, V29
CCGT	Insert	Q12, Q13, Q14, V27, V28, V29
CCGW	Insert	Q14, Q15, V26, V29
CCMT	Insert	Q12, Q13, Q14, Q15, V26, V27, V28, V29
CCMW	Insert	Q15, V26
CH-FGV	Toolholder	T22
CH-GTT	Toolholder	R18, T10
CH-LBM	Toolholder	V6
CH-SDUC	Toolholder	Q17
CH-STUC	Toolholder	Q33
CH-SVUP	Toolholder	Q30
CH-SVXC	Toolholder	R14
CH-TBPA	Toolholder	R10
CH-TTP	Toolholder	U10
CLR-13S	Wrench	Y16
CLR-15S	Wrench	Y16
CNGA	Insert	Q37
CNGG	Insert	Q37
CNMA	Insert	Q37
CNMP	Insert	Q37
CNMX	Insert	Q37
COUP-M10*1	Parts	N5, O10
CPGH	Insert	V25
CPGP	Insert	V25
CPGT	Insert	V25
CSV	Toolholder	O28, Q8, R6, S6, T6, U6
CSVB	Insert	O29, R6
CSVC	Insert	O29, S6
CSVF	Insert	O29, Q9
CSVG	Insert	O30, T7
CSVT	Insert	O30, U6
CTDP%	Toolholder	S14
CTDP	Insert	S14
CTP%	Toolholder	O8, S8

Item number	Description	Page number
CTP	Insert	S10, S11, S12, S13
CTPA%	Toolholder	O6, O8, R10, S8
CTPA	Insert	S10, S11, S12, S13
CTPS	Toolholder	O31, R7, S7, T8, U8
CTPS	Insert	O32, S7
CTPW%	Toolholder	S8
CTPW	Insert	S10, S11, S12, S13
CTV%	Toolholder	S15, S16
CTV	Insert	S15, S17
CZH	Insert	X4
DCET	Insert	Q22
DCGT	Insert	O33, Q20, Q21, Q22, Q23
DCGW	Insert	Q23
DCMT	Insert	Q20, Q21, Q22, Q23
DCMW	Insert	Q23
DNGA	Insert	Q38
DNGG	Insert	Q38
DNMA	Insert	Q38
DNMX	Insert	Q38
DS-CSVL	Toolholder	O25, O28, Q8, R6, T6, U6
DS-FGV%	Toolholder	O23, T22
DS-GTT	Toolholder	O23, R18, T10
DS-LBMB	Toolholder	O25, V6
DS-PTX	Toolholder	O22, Q34
DS-SCL	Toolholder	O4, O19, Q10
DS-SDU	Toolholder	O19, Q19
DS-SDX	Toolholder	O4, O19, Q19
DS-STT	Toolholder	O24, U14
DS-SVVP	Toolholder	O21, Q31
DS-SVX	Toolholder	O21, Q28
DS-SVXP	Toolholder	O21, Q30
DS-TBP	Toolholder	O22, R9
DS-TTP	Toolholder	O24, U10
ERGP	Insert	V24
FBV	Insert	T23
FGV	Toolholder	T22
FGV	Insert	T23
FSI	Parts	U19
GTG	Insert	V19
GTM	Insert	T16, T19
GTMMA	Insert	T19
GTMH	Insert	T12, T13, T14, T15, T16
GTMNT	Insert	T19
GTMX	Insert	T13, T15
GTPA	Toolholder	T24
GTPA	Insert	T24
GTPS	Insert	O32, T8
GTT	Toolholder	O7, R18, T10
GTWP	Toolholder	T9
GWPG	Insert	T9
GWPM	Insert	T9
HLR-13S	Bit	Y16
HLR-15S	Bit	Y16
HLR-20S	Bit	Y16

Item number	Description	Page number
HLR-25S	Bit	Y16
HN59Z	Toolholder	V22
HOSE-AN	Hose	N5, O10
HOSE-ST	Hose	N5, O10
HY-NBH	Toolholder	O9, V9, V11, W7, W8
LBM	Insert	V7
LBMA	Toolholder	V6
LBMC	Insert	V7
LBMD	Insert	V7
LBME	Insert	V7
LLR-25S	Wrench	Y16
LLR-25S-20*65	Parts	Y16
LLR-28S	Parts	Y16
LRIS	Parts	Y17
LR-S	Parts	Y17
MBL	Insert	V23
NBH	Toolholder	V14, V15, W9, W10
NGTB	Toolholder	T18
NGTN	Toolholder	T18
NTTB	Toolholder	U14
PCLN	Toolholder	Q37
PDJN	Toolholder	Q38
PTAN	Toolholder	Q34
PTLN	Toolholder	Q34
PTXN	Toolholder	Q34
REZ	Cutter	X4
RLR-20S	Wrench	Y16
S06F-MBR	Toolholder	V23
S06F-SCLP	Toolholder	V25
S07G-SCLP	Toolholder	V25
S07G-STUC	Toolholder	V30
S08G-SEXR	Toolholder	V24
S08H-BG	Toolholder	V19
S08H-SCLC	Toolholder	V26
S08H-SCLP	Toolholder	V25
S08H-STUP	Toolholder	V30
S10K-BG	Toolholder	V19
S10K-SCLC	Toolholder	V26
S10K-STUP	Toolholder	V30
S12M-SCLC	Toolholder	V26
S12M-STUP	Toolholder	V30
S16Q-SCLC	Toolholder	V26
S16Q-STUP	Toolholder	V30
SBB	Insert	V17
SBFB	Insert	V16
SBFS	Insert	V16, V17
SBG	Insert	V18
SBT	Insert	V20
SCAC	Toolholder	Q10
SCJ	Parts	N5, O10
SCLC%	Toolholder	O4, Q10
SDJC%	Toolholder	O4, Q16
SDNCN	Toolholder	Q16
SDQC	Toolholder	Q16

Item number	Description	Page number
SDXC	Toolholder	Q16
SFG	Insert	V18
SHFB	Insert	V12
SHFS	Insert	V12, V13
SS04	Parts	V9
SS06	Parts	V9
SS08	Parts	V9
SS-DSU	DS Sleeve	O26
SSP	Insert	W2
STAC	Toolholder	Q33
STTN	Toolholder	U14
SVAC%	Toolholder	Q25, Q26, R13
SVJB	Toolholder	O5, Q24
SVJC	Toolholder	O5, Q26
SVQC	Toolholder	Q27
SVQP	Toolholder	Q30
SVVC	Toolholder	Q27
SVXC	Toolholder	Q26
SVXP%	Toolholder	Q31
TB	Toolholder	R16
TB	Insert	R17
TBDP	Toolholder	R12
TBDP%	Insert	R12
TBMH	Insert	R19
TBP	Toolholder	O6, R8
TBP	Insert	R9, R9
TBPA	Toolholder	O6, R10
TBPA	Insert	R11
TBPS	Insert	O31, R7
TBT	Toolholder	R16
TBVC	Toolholder	R14
TBVC	Insert	R14
TCGD	Insert	V31
TCGH	Insert	V31
TCGP	Insert	V31
TCGT	Insert	O33, Q33
TCGW	Insert	Q33
TF	Insert	Q32
TFT	Toolholder	Q32
TGC	Toolholder	V22
TMG	Insert	T15
TMN	Insert	V22
TNGA	Insert	Q36
TNGG	Insert	Q36
TNMA	Insert	Q36
TNMX	Insert	Q36
TPGH	Insert	V31
TPGP	Insert	V31
TPGW	Insert	V30
TPMT	Insert	V30
TTMH	Insert	U14
TTP%	Toolholder	U10
TTP	Insert	U11
TTPS	Insert	O32, U8

Item number	Description	Page number
TW5835	Insert	U20
TW9268	Insert	U20
TWC	TW CUTTER	U18, U19
TWG	Toolholder	T17
TWG	Insert	T17
VBGT	Insert	Q24
VBGW	Insert	Q24
VCET	Insert	Q29, R15
VCGT	Insert	O33, Q25, Q29, Q31, R13, R15
VCGW	Insert	Q29, R15
VCMT	Insert	Q29
VCMW	Insert	Q29, R15
VPET	Insert	Q30, Q31
VPGT	Insert	Q31
XX2815	Wrench	Y16
Y-CTPA	Toolholder	O14, R10
Y-GTPA	Toolholder	O7, O15, T24
Y-GTT	Toolholder	O7, O15, R18, T10
Y-SDJC	Toolholder	O4, O13, Q18
Y-SDNC	Toolholder	O13, Q18
Y-SVJC	Toolholder	O5, O13, Q28
Y-TBDP	Toolholder	O14, R12
Y-TBP	Toolholder	O6, O14, R8

MEMO

MEMO

Metalcutting Safety

Applicable Products	Possible Risks	Safety Measures
General Cutting Tools	⊙Contact with a sharp cutting edge with bare hands may result in injury.	*Use protective gear such as protective gloves when taking the tool out of packaging and installing into the machine.
	⊙Misuse or using under inappropriate conditions may cause the cutting tool to break and/or shatter into pieces, resulting in personal injury.	*Use protective equipment, machine guarding and/or protective glasses. *Use within the range of recommended conditions. Please refer to the instruction manual and catalog.
	⊙Sudden increase in cutting resistance due to sudden impact load or excessive wear may cause the cutting tool to break and/or shatter into pieces, resulting in personal injury.	*Use protective gear such as protective gloves when taking the tool out of packaging and installing into the machine.
	⊙High-temperature chips may be produced and long chips may be ejected, resulting in injury and/or burns.	*Use protective equipment, machine guarding and/or protective glasses. *Before removing chips, always stop the machine. Wear protective gloves and use proper equipment for chip removal.
	⊙The tool and material/work being cut can become very hot. Touching them immediately after use may cause burns.	*Use protective gear such as protective gloves.
	⊙Sparks, heat generation due to breakage and/or chips during cutting may cause fire.	*Do not use the machine and tools in locations where there are risks of ignition or explosion. *When using water-insoluble cutting oil, fire prevention measures must be implemented.
	⊙Out of balance machine set ups when used at a high-speed, may cause insert breakage due to excess vibration or chatter, resulting in injury.	*Use protective equipment, machine guarding and/or protective glasses. *Perform a trial-run beforehand to make sure the setup is stable, free of chatter, vibration and abnormal noise.
Throw-Away Type Tools (With indexable insert)	⊙Touching burrs and flashes on machined work may result in personal injury.	*Use adequate hand protection.
	⊙Inappropriately clamped inserts and/or components may become detached from the machine during cutting, resulting in injury.	*Before installing the insert, clean the seating surface and clamping components so that they are free of debris. *Use the wrench supplied to install the insert and check that the insert and components are securely clamped. Do not use any inserts or components other than the items specified.
	⊙Excessively tightening with a device such as a pipe extension may cause the insert and/or components to break or detach due to over clamping.	*Do not use tightening devices such as pipe extensions to obtain further torque. Always use the supplied wrench.
Cutters and Rotational Tools	⊙At high speeds, inserts and/or components may lose clamping pressure due to the loosening effect of centrifugal force. This is very dangerous. Always ensure secure clamping systems and check regularly.	*Use within the range of recommended conditions. Please refer to the instruction manual and catalog.
	⊙As cutters have sharp cutting edges, contact with bare hands may result in injury.	*Use protective equipment such as protective gloves.
Braze Inserts / Tools	⊙Imbalance or excessive rotation may cause the tool to break due to vibration or chatter, resulting in potential injury.	*Use at a rotational speed within the recommended conditions. *To prevent excessive rotation and vibration due to worn bearings, regularly check the machine rotor/rotating parts for the accuracy and balance and adjust as required.
	⊙Inserts may break or become, detached due to incorrect brazing.	*Use protective equipment such as machine guards and/or protective glasses. Additional guarding around the chuck and drill may be advisable.
Others	⊙It is not advisable to use brazed inserts repeatedly as the braze may progressively weaken.	*Do not use brazed inserts repeatedly as the strength of such inserts is lowered.
	⊙Use only for the original and intended purpose. Using outside recommended parameters is very dangerous, causing damages to machines and/or tools.	*Always use and operate as specified, observing the required safety rules and conditions.

North and South America



NTK CUTTING TOOLS USA
a division of NGK SPARK PLUGS (U.S.A), INC.



46929 Magellan Drive,
Wixom, MI 48393, U.S.A.
Tel.; +1-248-668-0100
Fax; +1-248-668-0200
www.ntkcuttingtools.com



NTK CUTTING TOOLS MEXICO
a division of Bujias NGK de México, S.A. DE C.V.



Carretera Lago de Guadalupe,
Km. 27.5, S/N, Bodega 3-A,
Col. San Pedro Barrientos,
Tlalneapantla, Estado de
México, C.P. 54010
Tel.; +52-55-5317-5872
Fax; +52-55-5317-5876
www.ntkcuttingtools.com/mx/



NTK CUTTING TOOLS BRAZIL
a division of NGK DO BRASIL LTDA.



Rodovia Professor Alfredo
Rolim de Moura(SP-88),
km.61, s/n, Bairro Cocuera,
Caixa Postal 2540,
CEP 08780-970,
Mogi das Cruzes-SP, Brasil
Tel.; +55-11-4793-8265
Fax ;+55-11-4793-8270
www.ntkcuttingtools.com/br/



JAPAN / Head office



NTK CUTTING TOOLS JAPAN
a division of NGK SPARK PLUG CO.,LTD.



2808,Iwasaki, Komaki,
Aichi
485-8510, Japan
Tel.; +81-568-76-1538
Fax; +81-568-76-1288
www.ntkcuttingtools.com/jp/

EUROPE



NTK CUTTING TOOLS EUROPE
a division of NGK SPARK PLUG EUROPE GmbH



Harkortstr41, 40880
Ratingen, Germany
Tel.; +49 2102 974-350
Fax; +49 2102 974-399
www.ntk-cutting-tools.com



NTK CUTTING TOOLS UK
a division of NGK SPARK PLUGS (U.K), LTD.



Maylands Avenue,
Hemel Hempstead Herts.
HP2 4SD, U.K.
Tel.; +44 1442-281-000
Fax; +44 1442-281-080
www.ntkcuttingtools.co.uk

ASIA



NTK CUTTING TOOLS THAILAND
a division of NGK SPARK PLUGS (THAILAND) CO.,LTD.



700/864 Moo1,
Panthong sub-district,
Panthong District,
Chonburi 20160,
Thailand
Tel.; +66-38-185-306
Fax; +66-38-185-316



NTK CUTTING TOOLS INDONESIA
a division of P.T. NGK Busi Indonesia



Jl. Raya
Jakarta-Bogor,
Km 26, 6 Ciracas,
Pasar Rebo,
Jakarta Timur,
Indonesia
Tel. : +62-21-8710974
Fax : +62-21-8710965



NTK CUTTING TOOLS CHINA
a division of NGK Spark Plug (Shanghai) Co., Ltd.



No.736
Songsheng Road
Songjiang Industrial Zone,
Shanghai 201613,The People's
Republic of China
Tel.; +86-21-63857652
Fax; +86-21-63853690
www.ntkcuttingtools.com/cn/



NTK CUTTING TOOLS KOREA
a division of NTK TECHNICAL CERAMICS KOREA CO.,LTD.



680-14 Kojan-Dong,
Namdong-ku Incheon,
Korea
Tel.; +82-32-815-6763
Fax; +82-32-815-6762
www.kntktool.co.kr

NGK | **NTK**
SPARK PLUGS | TECHNICAL CERAMICS

NGK SPARK PLUGS (USA), INC.

NTK Cutting Tools USA

a division of NGK SPARK PLUGS (U.S.A), INC.
46929 Magellan Drive, Wixom, MI 48393, U.S.A.
Phone: 248-668-0100 Fax: 248-668-0200
Toll Free: 866-900-9800

www.ntkcuttingtools.com
www.youtube.com/ntkcuttingtools



DISTRIBUTED BY

