

CATALOG &
TECHNICAL
GUIDE



SOLID ROUND TOOLING



COMPLETE
METALWORKING
SOLUTIONS

(800) 991-4225
www.ahbinc.com
ISO Certified
customerservice@ahbinc.com



Niagara Cutter
A SECO TOOLS COMPANY



YOUR SOLID TOOLING & TECHNOLOGY EXPERTS

A TEST FOR OURSELVES & A PROMISE TO OUR CUSTOMERS

Niagara Cutter understands product consistency, quality, and maximum levels of performance are paramount to our customers. These fundamentals begin in our dedicated R&D, Engineering, and test facilities. The knowledge gained through these resources serve as a framework to educate not only ourselves, but also allow us to assist our customers in becoming competent and practical experts. Extensive product development and educational initiatives support Niagara Cutter's continuous achievement in exceeding industry expectations. Always striving for excellence and embracing the needs of our customer guarantee that the promise we make is the promise we keep... to provide the highest value cutting tools in the world.

INNOVATION | TECHNOLOGY | QUALITY | SERVICE



Niagara Cutter
A SECO TOOLS COMPANY

TECHNICAL INFO

END MILL FAMILY SUMMARY	11-12
PRODUCT CODE KEYS.....	13-14
WORKPIECE MATERIAL CLASSIFICATION.....	15
MILLING OPERATIONS	16

STABILIZER™ 2.0 & STABILIZER™

STABILIZER™ 2.0 - STEELS, ALLOY STEELS, COPPER ALLOYS & CAST IRON

STABILIZER™ 2.0 INTRODUCTION	17
6 TIPS HIGH PERFORMANCE MACHINING	18
STS430.2 - 4 Flute Square - Slotting / Pocketing / Profiling	19-20
STS430M.2 - Metric 4 Flute Square - Slotting / Pocketing / Profiling.....	21
STR430.2 - 4 Flute with Radius - Slotting / Pocketing / Profiling	22-24
STR430M.2 - Metric 4 Flute Radius - Slotting / Pocketing / Profiling	25
STB430.2 - 4 Flute Ball End - Slotting / Pocketing / Profiling.....	26
STB430M.2 - Metric 4 Flute Ball End - Slotting / Pocketing / Profiling	26
STRN430.2 - 4 Flute Neck Style with Radius - Slotting / Pocketing / Profiling.....	27
STBN430.2 - 4 Flute Neck Style Ball End - Slotting / Pocketing / Profiling	27

STABILIZER™ 2.0 - STAINLESS STEELS, STEELS OVER 42 RC, TITANIUM & INCONEL

STR440.2 - 4 Flute with Radius - Slotting / Pocketing / Profiling	28-30
STR440M.2 - Metric 4 Flute with Radius - Slotting / Pocketing / Profiling.....	31
STB440.2 - 4 Flute Ball End - Slotting / Pocketing / Profiling.....	32
STB440M.2 - Metric 4 Flute Ball End - Slotting / Pocketing / Profiling	32
STRN440.2 - 4 Flute Neck Style with Radius - Slotting / Pocketing / Profiling.....	33
STBN440.2 - 4 Flute Neck Style Ball End - Slotting / Pocketing / Profiling	33

STABILIZER™ 5 FLUTE - STAINLESS, TITANIUM, HIGH TEMPERATURE ALLOYS, CARBON, ALLOY & TOOL STEELS

STABILIZER™ 5 FLUTE INTRODUCTION	34
4 TIPS FOR HIGH PERFORMANCE VERSATILITY.....	35
STS540 - 5 Flute - Profiling	36
STS540M - Metric 5 Flute - Profiling.....	36
STR540 - 5 Flute with Radius - Profiling	37-38
STR540M - Metric 5 Flute with Radius - Profiling.....	39
STSN540 - 5 Flute Square Neck Style - Profiling	40
STRN540 - 5 Flute with Radius Neck Style - Profiling	41-42
STRCS540 - 5 Flute with Radius & Chip Splitter Neck Style - Profiling.....	43

CUTTING DATA - STABILIZER™ 2.0 & STABILIZER™ 5 FLUTE

STS430.2 / STR430.2 / STB430.2.....	44
STS430M.2 / STR430M.2 / STB430M.2	45
STRN430.2 / STBN430.2	46
STR440.2 / STB440.2.....	47
STR440M.2 / STB440M.2	48
STRN440.2 / STBN440.2	49
STS540 / STR540.....	50-53
STSN540 / STRN540	50-55

STS540M / STR540M	56-59
STRCS540.....	60

MULTI FLUTE - ELITE S SERIES SOLID CARBIDE HIGH PERFORMANCE

STEELS, STAINLESS, CAST IRON, TITANIUM & HIGH TEMP ALLOYS

MULTI FLUTE INTRODUCTION	61
6 TIPS FOR OPTIMIZED ROUGHING	62
S638 - 6 Flute Square - Profiling	63-64
S638R - 6 Flute with Radius - Profiling	63-64
SN638 - 6 Flute Neck Style - Profiling	65
SN638R - 6 Flute Neck Style With Radius - Profiling	65
SB638 - 6 Flute Ball End - Profiling / Copy Milling	66
SBN638 - 6 Flute Neck Style Ball End - Profiling / Copy Milling	66
SCS638 - 6 Flute Square with Chip Splitter - Profiling	67
SCS638R - 6 Flute with Radius & Chip Splitter - Profiling	67
S738 - 7 Flute with Corner Chamfer - Profiling	68
S738R - 7 Flute with Radius - Profiling	68
SCS738R - 7 Flute with Radius & Chip Splitter - Profiling	69
S938 - 9 Flute with Corner Chamfer - Profiling	70-71
S938R - 9 Flute with Radius - Profiling	70-71
SCS938R - 9 Flute with Radius and Chip Splitter - Profiling	71

CUTTING DATA - MULTI FLUTE

S638 / S638R / SN638 / SN638R	72-74
SB638 / SBN638	74-76
SCS638 / SCS638R	77
S738 / S738R / S938 / S938R	78-79
SCS738R / SCS938R	80

ELITE A SERIES SOLID CARBIDE HIGH PERFORMANCE

ALUMINUM & NON-FERROUS MATERIALS

AN230 & AN335 PRODUCT INTRODUCTION	81
4 TIPS FOR THE AN230 & AN335	82
AN230 - 2 Flute Square Neck Style - Slotting / Pocketing / Profiling	83
AN230R - 2 Flute Radius Neck Style - Slotting / Pocketing / Profiling	84
AN335 - 3 Flute Square Neck Style - Slotting / Pocketing / Profiling	85
AN335R - 3 Flute Radius Neck Style - Slotting / Pocketing / Profiling	86
AN340 - 3 Flute Radius Neck Style - Slotting / Pocketing / Profiling	87
ACS540 / ACS540R - 5 Flute Square & Corner Radius with Chip Splitter – Slotting / Profiling	88
A245 & A345 PRODUCT INTRODUCTION	89
A245 - 2 Flute Square - Slotting / Pocketing	90-91
AB245 - 2 Flute Ball End - Slotting / Pocketing	92
A345 - 3 Flute Square - Slotting / Pocketing / Profiling	93-94
A345M - Metric 3 Flute Square - Slotting / Pocketing / Profiling	95
A345R - 3 Flute with Radius - Slotting / Pocketing / Profiling	96-97
AN345 - 3 Flute Square Neck Style - Slotting / Pocketing / Profiling	98

AN345R - 3 Flute Radius Neck Style - Slotting / Pocketing / Profiling	99
AR330 - 3 Flute Coarse-Pitch Rougher - Slotting / Pocketing / Profiling	100

CUTTING DATA - ELITE A SERIES

AN230 / AN230R	101
AN335 / AN335R	102
A245 / AB245	103
A345 / A345R	103-104
A345M	104-105
AN345 / AN345R	105-106
AN340	106
AR330	107
AN335 / AN335R	108
ACS540 / ACS540R	109

ELITE S SERIES SOLID CARBIDE HIGH PERFORMANCE

STEEL, STAINLESS, TITANIUM & HIGH TEMP ALLOYS

NS240R LONG FLUTE FINISHER INTRODUCTION	110
NS240R - 2 Flute Long Flute Finisher - Profiling	111
S335 - 3 Flute Radius - Slotting / Pocketing	112
SB335 - 3 Flute Ball End - Slotting / Pocketing	113
SN335 - 3 Flute Radius Neck Style - Slotting / Pocketing	114
S545 - 5 Flute Square - Profiling	115-117
S545R - 5 Flute with Radius - Profiling	118-120
S645M - Metric 6 Flute Square - Profiling	121
SR420 - 4 Flute Fine-Pitch Rougher - Slotting / Pocketing / Profiling	122
SR420M - Metric 4 Flute Fine-Pitch Rougher - Slotting / Pocketing / Profiling	122
SR545 - 5 Flute Fine-Pitch Rougher - Slotting / Pocketing / Profiling	123

CUTTING DATA - ELITE S SERIES

NS240R	124
S335	125-126
SB335	127-128
SN335	129-130
S545 / S545R	131
SR420	132
SR545	133
S645M	134
SR420M	135-136

SN200R / 400R / 500R

HIGH FEED FOR STEELS, HARDENED STAINLESS STEELS, CAST IRON, TITANIUM & HIGH TEMP ALLOYS

SN200R/400R/500R INTRODUCTION	137
HOW DOES HIGH FEED MILLING WORK?	138
SN200R - 2 Flute High Feed - Facing / Slotting / Plunging	139

SN400R - 4 Flute High Feed - Facing / Slotting	140
SN500R - 5 Flute High Feed - Facing / Slotting	141

CUTTING DATA - SN200R / 400R / 500R

SN200R / SN400R / SN500R	141-145
---------------------------------------	---------

MZN410R / 510R

HIGH FEED FOR STEELS, HARDENED STEELS, CAST IRON & HIGH TEMP ALLOYS

MBZ & MZN INTRODUCTION	146
6 TIPS FOR HARD MILLING	147
MZN410R - 4 Flute High Feed - Slotting / Profiling	148
MZN510R - 5 Flute High Feed - Slotting / Profiling	148
MZN410RM - 4 Flute Metric High Feed - Slotting / Profiling	148
MZN510RM - 5 Flute Metric High Feed - Slotting / Profiling	148

CUTTING DATA - MZN410R / 510R

MZN410R / MZN510R	149-151
MZN410RM / MZN510RM	152-155

MOLD AND DIE

MB215 - 2 Flute Ball End - Profiling	156
MB215M - Metric 2 Flute Ball End - Profiling	156
MBZ215 - 2 Flute Ball End - Profiling	156
MBZ215M - 2 Flute Ball End - Profiling	157
MZ645 - 6 Flute - Profiling	158
MZ645R - 6 Flute with Radius - Profiling	158

CUTTING DATA - MOLD AND DIE

MBZ215	159
MBZ215M	160-162
MB215	163
MB215M	163
MBZ215	164
MZ645	164
MZ645R	164

CVD DIAMOND COATED

CARBON FIBER, COMPOSITE APPLICATIONS, GRAPHITE & GREEN CERAMICS

CVD DIAMOND COATED INTRODUCTION	165
DIA230 - 2 Flute - Slotting / Profiling	166
DIAB230 - 2 Flute Ball End - Slotting / Profiling	167
DIAB230M - Metric 2 Flute Ball End - Slotting / Profiling	167

DIA430 - 4 Flute - Slotting / Profiling	168
DIA430M - Metric 4 Flute - Slotting / Profiling	168
DIACR430 - 4 Flute with Radius - Slotting / Profiling	169
DIAL430 - 4 Flute Long Length - Slotting / Profiling	169
DIAB430 - 4 Flute Ball End - Slotting / Profiling	170
DIALB430 - 4 Flute Long Length Ball End - Slotting / Profiling	170
DIAXRB430 - 4 Flute Neck Style Ball End - Slotting / Profiling	171
DIAXSB430 - 4 Flute Neck Style Stub Length Ball End - Slotting / Profiling	171
DIAXRR430 - 4 Flute Neck Style with Radius - Slotting / Profiling	171

COMPRESSION CUTTERS - CARBON FIBER, COMPOSITE APPLICATIONS, GRAPHITE & GREEN CERAMICS

DIACC - Coarse-Pitch Compression Cutter - Slotting / Profiling	172
DIACC - Fine-Pitch Compression Cutter - Profiling	172

ROUTER BURRS - CARBON FIBER, COMPOSITE APPLICATIONS, GRAPHITE & GREEN CERAMICS

DIAMOND COATED INTRODUCTION	173
DIAEPB - Coarse-Pitch Burr with End Mill Point - Slotting / Profiling	173
DIAEPB - Fine-Pitch Burr with End Mill Point - Profiling	173
DIABEB - Coarse-Pitch Fiber Router Burr with Burr End - Slotting / Profiling	174
DIABEB - Fine-Pitch Fiber Router Burr with Burr End - Profiling	174
DIAPPB - Coarse-Pitch Burr with Plunge Point - Slotting / Profiling	175
DIAPPB - Fine-Pitch Burr with Plunge Point - Profiling	175

CUTTING DATA - CVD DIAMOND COATED

DIA230 / DIAB230	176-177
DIA230M / DIAB230M	178-179
DIA430 / DIACR430 / DIAB430	180-181
DIAXSB430 / DIAL430 / DIALB430 / DIAXRR430 / DIAXRB430	182-183
DIA430M	184-185
DIACC COARSE / FINE PITCH	186-187
DIAEPB / DIAPPB / DIABEB COARSE PITCH	188-189
DIAEPB / DIAPPB / DIABEB FINE PITCH	190

GENERAL PURPOSE SOLID CARBIDE

2 FLUTE

C230 - 2 Flute Square - Slotting / Pocketing	191-193
C230R - 2 Flute with Radius - Slotting / Pocketing	194
CB230 - 2 Flute Ball End - Slotting / Pocketing	195-197
CD230 - 2 Flute Double End - Slotting / Pocketing	198
CSD230 - 2 Flute Double End Stub Length - Slotting / Pocketing	199
CSDB230 - 2 Flute Double End Stub Length Ball End - Slotting / Pocketing	200
CNC230 - 2 Flute NC Tolerance - Slotting / Pocketing	201

3 FLUTE

C330 - 3 Flute Square - Slotting / Pocketing	202
---	-----

C360 - 3 Flute - Profiling	203
---	-----

4 FLUTE

C430 - 4 Flute Square - Slotting ½D / Pocketing / Profiling	204-209
C430M - Metric 4 Flute Square - Slotting ½D / Pocketing / Profiling	209
C430R - 4 Flute with Radius - Slotting ½D / Pocketing / Profiling	210-211
CB430 - 4 Flute Ball End - Slotting ½D / Pocketing / Profiling	212-213
CB430M - Metric 4 Flute Ball End - Slotting ½D / Pocketing / Profiling	214
CD430 - 4 Flute Double End - Slotting ½D / Pocketing / Profiling	215
CSD430 - 4 Flute Double End Stub Length - Slotting ½D / Pocketing / Profiling	216
CSDB430 - 4 Flute Double End Stub Length Ball End - Slotting ½D / Pocketing / Profiling	217

CUTTING DATA - GENERAL PURPOSE SOLID CARBIDE

C230 / C230R / CNC230 / CD230 / CSD230	218-219
CB230 / CSDB230	220-221
C330	222-223
C360	224
C430 / C430R / CNC430 / CD430 / CSD430	225-226
CB430 / CSDB430	227-228
C430M	229-230
CB430M	231-232

CHAMFER END MILLS

CM260 - 2 Flute 60° Chamfer	233
CM290 - 2 Flute 90° Chamfer	233
CM460 - 4 Flute 60° Chamfer	234
CM490 - 4 Flute 90° Chamfer	234

CUTTING DATA - CHAMFER END MILLS

CM260 / CM290	235-236
CM460 / CM490	237-238

VARIABLE FACE PROFILE

STAINLESS STEELS & TITANIUM

VARIABLE FACE PROFILE INTRODUCTION	239
VFP435 - 4 Flute with Chamfer - Slotting / Pocketing / Profiling	240
VFP635 - 6 Flute with Chamfer - Slotting / Pocketing / Profiling	240
VFP435SB - 4 Flute Short Block with Chamfer - Slotting / Pocketing / Profiling	241
VFP635SB - 6 Flute Short Block with Chamfer - Slotting / Pocketing / Profiling	241
VFP435SB / VFP435SBR - 4 Flute Short Block with Chamfer or Radius - Coated - Slotting / Pocketing / Profiling	242
VFP635SB / VFP635SBR - 6 Flute Short Block with Chamfer or Radius - Coated - Slotting / Pocketing / Profiling	242

GENERAL PURPOSE COBALT

2 FLUTE FINISHERS

SP205 - 2 Flute - Slotting / Pocketing	243
---	-----

4 OR MORE FLUTE FINISHERS

SPC408 - Multi Flute Center Cutting - Profiling.....	244-247
SPB540 - Multi-Flute Ball End - Profiling.....	247

3 FLUTE ROUGHERS

RTM713 - 3 Flute Coarse-Pitch Rougher - Slotting / Profiling	248
RHC752 - 3 Flute Coarse-Pitch Rougher for Aluminum - Slotting / Profiling	249

4 OR MORE FLUTE ROUGHERS

REM710 - Multi-Flute Coarse-Pitch Rougher - Slotting / Profiling.....	250-252
REC700 - Multi-Flute Coarse-Pitch Center-Cutting Rougher - Slotting / Profiling.....	253-254
EXR350 - Multi-Flute Fine-Pitch Rougher PM HSCO - Slotting / Pocketing / Profiling.....	255
REM445 - Multi-Flute Fine-Pitch Rougher - Slotting / Profiling.....	255-257
REC448 - Multi-Flute Fine-Pitch Center-Cutting Rougher - Slotting / Profiling.....	258

CUTTING DATA - GENERAL PURPOSE COBALT

SP205	259-260
SPC408 / SPB540	261-263
RTM713	264
RHC752	265
REM710 / REC700 / RMB700	266-267
EXR350	268-269
REM445 / REC448 / RMB449	270-271
VFP435 / VFP635 / VFP435SB / VFP635SB / VFP435SBR / VFP635SBR	272

THREAD MILLS

NTM100UN - UN Thread Mills	273
NTM120UN - UN Thread Mill.....	274
NTM160UN - UN Thread Mills	275
NTM400MI - Metric Thread / Inch Shank Thread Mills.....	276
NTM200NPT - NPT Thread Mills.....	277
NTM300NPTF - NPTF Thread Mills	277

CUTTING DATA AND TECHNICAL INFORMATION - THREAD MILLS

THREAD MILLS	278-279
THREAD MILLS TECHNICAL INFO	280-282

HTA COATED

HTA INTRODUCTION.....	283
S545 / S545R	284
MULTI-FLUTE S638 / S738 / S938	285-288
STABILIZER™ 2.0 STS430.2 / STR430.2 / STR440.2	288-290
STABILIZER™ 2.0 STB440.2.....	290
STABILIZER 5-FLUTE STS540 / STR430.....	277

CUTTING DATA - HTA COATED

S545 / S545R HTA	293-294
S638 / S638R / SB638 HTA.....	295-296
S738 HTA	297
S938 HTA	298
SB638 HTA.....	299
SCS638R HTA	300
SCS738R HTA	300
SCS938R HTA	301
STS540 / STR540 HTA.....	302-303
STS430.2 / STR430.2 HTA.....	304
STB440.2 / STR440.2 HTA.....	305-306

TECHNICAL INFO

TOOL SELECTION GUIDE	307-311
END MILL DESIGN.....	312
CLIMB MILLING VS. CONVENTIONAL MILLING	313
MILLING CONSIDERATIONS IN STEEL, ALUMINUM & STAINLESS STEEL	313
TOOLHOLDER CONSIDERATIONS.....	314
TROUBLESHOOTING GUIDE.....	315-316
WHEN IS IT TIME TO CHANGE AN END MILL?	316
MILLING CALCULATIONS.....	317-318
END MILL TOLERANCES	319-320
SAFETY INFORMATION WARNING.....	321
DECLARATION OF CONFORMITY	322

EXPLORE OUR TOOLS ON SECOTOOLS.COM

Find the perfect tool for your application by searching Niagara Cutter's comprehensive product offering.

Discover new products and search a library of product flyers, articles, videos, and technical information all at your fingertips. Product search is quick and easy allowing you to filter by attribute to find the perfect tool for your specific needs in seconds. Your cutting solution awaits!

Search for tools by attributes or browse by product family.

View the site anywhere with our mobile-friendly design.

Explore a host of brochures, videos, articles, and technical information.



GET TOOLING GUIDANCE ANYWHERE SECO ASSISTANT APP

Seco Assistant App streamlines the daily machining experience. With easy-to-navigate practical tools, it puts the information you really need at your fingertips, including:

- Find and calculate cutting data in seconds
- Get product information by scanning barcodes, QR-codes, or by text-search
- Synchronize and share your favorite products
- Access product information, and other functionalities offline

Download the free app from the App Store or Google Play today!

WANT TO MAKE A PURCHASE? SECOLOCATOR.COM

Quickly and easily connect with local authorized distributors across North America. Find nearby distributors by zip, by name, or click "search distributors near me" to let your GPS do the hard work. Available in the US, Canada and Mexico.

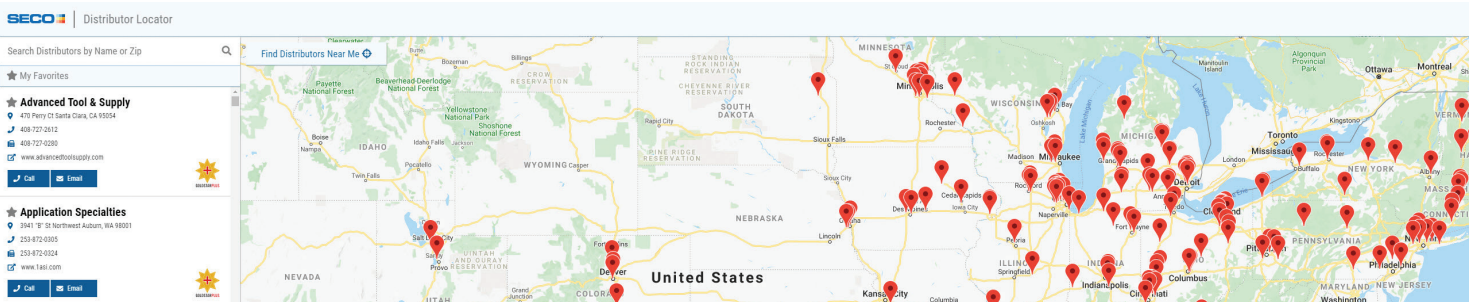



APPLICATION ENGINEERING

At Niagara Cutter, we are dedicated to a process of constant improvement and take pride in our record of significant innovation and industry advancements.

Our truly innovative and comprehensive systems approach to world-class products starts with listening and learning. Then, between initial concept and final product there is application engineering, prototype development, exhaustive product testing and critical analysis before culminating in a product that does not just perform, but outperforms that which previously existed.



MANUFACTURING TECHNOLOGY

Niagara Cutter continues to invest heavily in automated processes, but in the final analysis these machines are only as capable as their programming and maintenance allows. The final products are only as consistent as the parameters set by Niagara's machinists. It is in these areas where no machine can match the human contribution.

Niagara Cutter aggressively pursues continuous improvement in its automated operations and its people. Therefore, the perfect operation between man and machine at Niagara Cutter results in a company that is far greater than the sum of its parts in achieving consistency and accuracy.

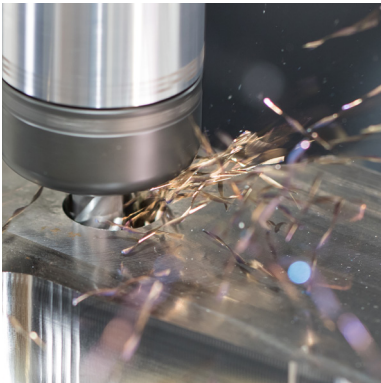

PRODUCTS - HIGH PERFORMANCE CUTTING TOOL SOLUTIONS

Niagara Cutter offers many product styles, including end mills, thread mills, and special cutting tools to customer blueprints. With multiple material substrates (cobalt, tungsten carbide), tool geometries and PVD and CVD coatings, we provide a complete product range to meet your cutting tool requirements.

Our job is not just to produce premium cutting tools, but to produce premium cutting tools specific to your application and for absolute optimum performance. We do this by asking the critical questions and quickly responding with the most effective solution.



HIGH PERFORMANCE STABILIZER™ AND STABILIZER 2.0 SERIES - Page 17

The Stabilizer 2.0 family of end mills raises the bar in high performance milling by incorporating a patented continuously varying asymmetrical geometry which helps create a smooth chatter free milling condition. This configuration, along with a specially engineered flute shape, allow for feed rates twice that of the previous Stabilizer.

Simplify tool selection and part programming with the newly expanded ST540 family of 5-flute end mills from Seco. Gain part processing versatility with the ability to handle slot milling, side mill roughing, side mill finishing and face milling applications as well as in traditional and high-performance optimized roughing, pocketing and ramping in all major material families – all with a single product family.



ELITE A & S SERIES - Page 61

Our Elite series of end mills feature specific geometries for ferrous or nonferrous materials, available in 0.125 - 1.25” diameters.

The S638, S738 and S938 multi flute end mills are designed for Optimized and Peripheral Roughing and Finishing applications in Stainless Steel, Titanium and high temperature alloys.

The A series is designed for aluminum and non ferrous materials and is available with two or three flutes in a variety of configurations. The S series provides high performance machining in steel, stainless steel and high temperature alloys with three, four, five, six, seven and nine flutes.



HIGH FEED & MOLD & DIE - Page 137

The Mold & Die range offers geometries for hard milling of steels up to 65Rc.

The SN200R, SN400R and SN500R cover a broad range of applications and materials. These end mills direct radial cutting pressure up into spindle for increased metal removal rates in deep pockets and long reach applications.

The MZN and MBZ family of end mills are designed to maximize productivity in hardened steels and superalloys. These end mills feature optimized substrate, geometry and coating to offer superior performance and process reliability.



GENERAL PURPOSE C SERIES - Page 191

The C series end mills with two, three, or four flutes are available in square, corner radius or ball end, uncoated or with TiAlN as standard. This broad range of end mills is typical for job shop environments where one tool can handle a variety of applications.



CHAMFER MILLS - Page 233

Chamfer mills are available to produce either a 60° or 90° chamfer. Both styles are available with two or four flutes.



COBALT - Page 243

General purpose M42 cobalt roughers and finishers are available in a wide variety of sizes in both center cutting and non center cutting geometries.

The VFP geometry is designed specifically for high metal removal rates in stainless steel and titanium alloys.

Our EXCEL end mills are a revolutionary solution that combines superior geometry, high grade cobalt substrate and wear resistant PVD coatings to handle difficult milling applications.



THREAD MILLS - Page 273

Thread milling is a versatile and cost effective solution, especially if you are machining a variety of parts and materials on the same machine. Niagara Cutter offers a broad range of solid carbide thread mills to meet your requirements.

One thread mill can produce, regardless of diameter, thread forms of the same pitch. Thread forms produced can be internal or external, right-hand or left-hand. Plus, milled threads produce excellent form, finish, and dimensional accuracy, even in difficult to machine materials.



HTA COATING - Page 283

HTA (High Temperature Alloys) coating is a newly developed proprietary PVD coating for the Niagara Cutter product range. Combining this new coating with a premium carbide substrate and high-performance geometries provides customers with increased tool life and process reliability, when milling materials such as High Temperature Alloys.

Popular sizes from the series S545, S545R, S638, S638R, S738, S738R, S938, S938R, SB638, SCS638, SCS638R, SCS738R, SCS938R, STR430.2, STS430.2, STR440.2, STB440.2, STS540, STR540 are offered HTA coated.

END MILL PRODUCT CODE KEY

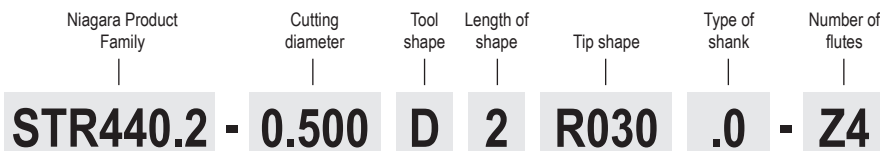

PRODUCT LABEL



PRODUCT RANGE

Example:
ST = STABILIZER
 For all products, see catalog.

CUTTING DIAMETER

Metric = 3 digit code (in case of 4 digit code: xx.xx mm)
 Imperial = a decimal followed by a 3 digit code
 For example: (050 = metric, 5 mm)
 (.500 = imperial, 1/2 inch)

TOOL SHAPE

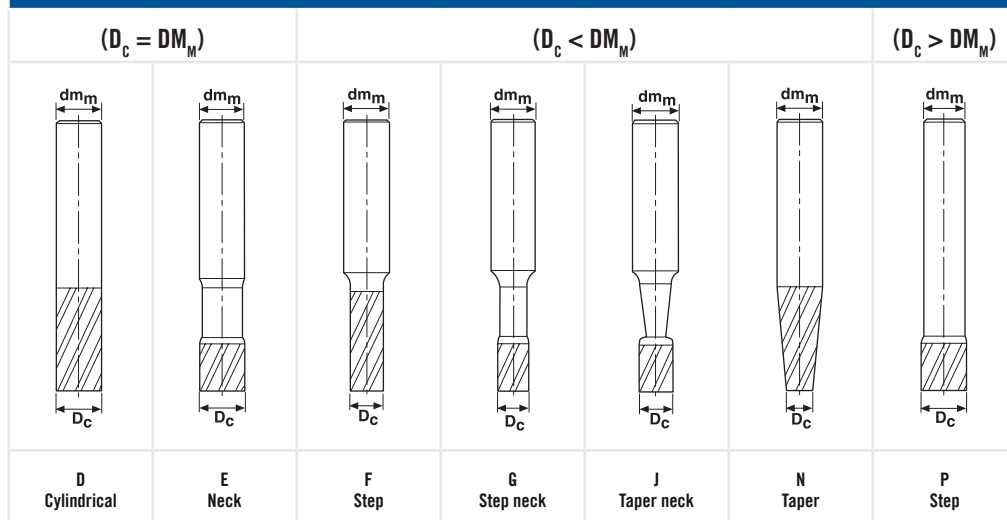

LENGTH OF SHAPE

- STUB = 1
- S = 2
- M = 3
- L = 4
- LR1 = 5
- LR2 = 6
- LR3 = 7
- LR4 = 8
- LR5 = 9

TYPE OF SHANK

Indicates the shank types that are available.
 .0 = Cylindrical
 .3 = Weldon
 .5 = Whistle Notch
 .9 = Safe-Lock

TIP SHAPE

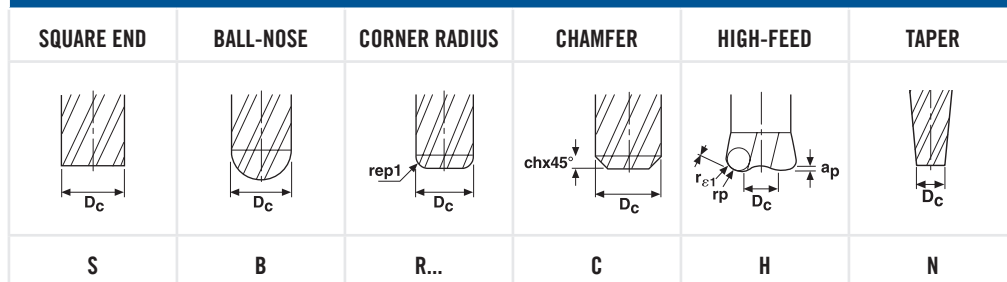

Size of radius for convex and concave radius tipped products

000 = For metric products the tip shape is shown by a three-digit figure.
 By dividing this figure by 100 you will get the actual corner radius size in millimeters.

.000 = For inch products the tip shape is shown by a dot, followed by a three-digit figure.
 This figure actually shows the size of the corner radius in inch (e.g. R.100 would indicate a radius of 0.100 Inch).

NUMBER OF FLUTES

This figure indicates the number of flutes in the cutter.
 For example;
 Z2 = 2 flutes, Z6 = 6 flutes

COATING	DESCRIPTION
AlCrN	AlCrN
AlTiN	AlTiN
ANF	ZrN
CVDDIA	Diamond CVD
HTA	TiAlSiN
TiAlN	TiAlN
TiCN	TiCN
	Uncoated

THREAD MILLING PRODUCT CODE KEY

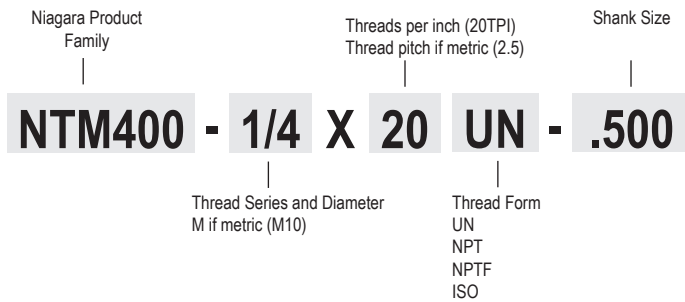

FORMULA

a_e = Width of cut/radial depth of cut
 a_p = Depth of cut/axial depth of cut
 f = Feed per revolution
 f_z = Feed per tooth
 n = Rev/min RPM
 v_c = Surface footage/min
 v_f = Table travel (in/min)
 z_n = Number of teeth

SYMBOL KEY

TOOL MATERIAL - SUBSTRATE

SOLID CARBIDE	PREMIUM PARTICLE METAL 8.5% COBALT	M42 8% COBALT
---------------	---------------------------------------	------------------

TOOL END SHAPE

SQUARE END	BALL END	CHAMFER 60°	CHAMFER 90°
CHAMFER 45°	RADIUS	HIGH FEED	

HELIX ANGLE

HELIX 0°	HELIX 10°	HELIX 15°	HELIX 20°
HELIX 30°	HELIX 35°	HELIX 36°	HELIX 37°
HELIX 38°	HELIX 40°	HELIX 45°	HELIX 60°
HELIX VARIABLE			

END TEETH

CENTER CUTTING	NON CENTER CUTTING
----------------	--------------------

ROUGHING PROFILES

CHIPBREAKER	COARSE PITCH	FINE PITCH	TRUNCATED
CHIPSPLITTER			

SECO MATERIAL GROUP (SMG)

STEEL, FERRITIC AND MARTENSITIC STAINLESS STEEL

ISO	SMG NO.	REPRESENTATIVE MATERIAL	DESCRIPTION	BHN	$k_{c1.1} \times 1000$ lbf/in ²	m_c
P	1	1010	Very soft carbon steels Purely ferritic steels	< 135	196	0.21
	2	1140	Free-cutting steels	120 < 210	218	0.22
	3	1045	Structural steels. Ordinary carbon steels with low to medium carbon content (<0,5%C)	135 < 165	218	0.25
	4	4140	Carbon steels with high carbon content (>0,5%C) Medium hard steels for toughening. Ordinary low-alloy steels Ferritic and martensitic stainless steels	165 < 210	247	0.24
	5	4340	Normal tool steels Harder steels for toughening Martensitic stainless steels	210 < 270	276	0.24
	6	D2	Difficult tool steels High-alloy steels with high hardness Martensitic stainless steels	270 < 360	290	0.24
H	7	A128 Grade A	Difficult high-strength steels with 42 to 56 HRC hardness Hardened steels from material group 3-6 Martensitic stainless steels	> 360	421	0.22

FREE-CUTTING, AUSTENITIC AND DUPLEX STAINLESS STEEL

M	8	304	Easy-cutting stainless steels Free-cutting stainless steels Calcium-treated stainless steels		254	0.22
	9	316	Moderately difficult stainless steels Austenitic and duplex stainless steels		276	0.2
	10	310	Difficult stainless steels Austenitic and duplex stainless steels		297	0.2
	11	330	Very difficult stainless steels Austenitic and duplex stainless steels		312	0.2

CAST IRON

K	12	60-40-18	Medium hard cast iron Grey cast iron		167	0.22
	13	A536 80-55-06	Low-alloy cast iron Malleable cast iron Nodular cast iron		178	0.25
	14	A536 100-70-03	Moderately difficult alloy cast iron Moderately difficult malleable cast iron Nodular cast iron		196	0.28
	15	A536 120-90-02	Difficult high-alloy cast iron Difficult malleable cast iron Nodular cast iron		213	0.3

OTHER MATERIALS

N	16	A380	Aluminum alloys: Low Si		101	0.25
	17	B390.0	Aluminum alloys: High Si		101	0.27
	18	CA937	Copper alloys			
S	19	Disalloy	Fe-based superalloys			
	20	Stellite 21	Co-based superalloys		377	0.24
	21	Inconel 718 (bar, forge, ring)	Ni-based superalloys		479	0.24
	22	Ti 6Al-4V (annealed)	Titanium alloys		210	0.23

$k_{c1.1}$ -values with 0 degree effective cutting rake angle. For other rake angles, reduce the $k_{c1.1}$ -value by 1% for every degree increase in the cutting rake angle and vice versa. Keep in mind that the BHN-value is only an aid in the selection of the material group when the material has been worked by rolling, drawing, heat treatment or other methods that increase the strength of the material.

BASIC MILLING OPERATIONS

FACE MILLING

Operation where the tool is in engagement with less than 180° arc of contact.

Tool engagement:
Small a_p and large a_e .

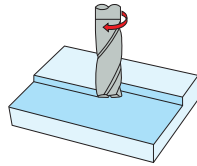

SLOT MILLING

Operation where the full diameter is in engagement, a_e is equal to D_c and a_p up to 1½ times D_c depending on the machining strategy in use.

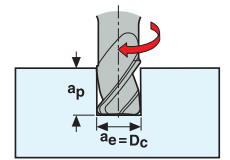

SIDE MILLING

Operation where the side of the tool is in engagement, a_p is large and a_e is small.

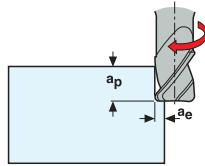

COPY MILLING

Operation where the radius is in engagement. a_p and a_e are both small.

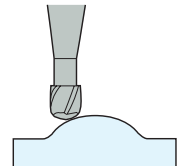

ADVANCED MILLING OPERATIONS

RAMPING

Opening up a pocket by making a Z axis at an angle.

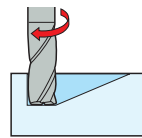

HELICAL INTERPOLATION RAMPING

Opening a pocket by making a circular movement with the tool slightly less than 2 x D while ramping in Z axis.

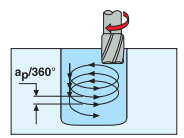

TROCHOIDAL

Opening a slot by using side milling, making a partial circular movement in X- or Y-axis. (changing slot milling into side milling).

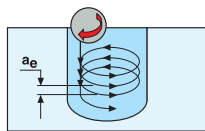

PUSH-PULL

Machining a 3D form by making a down and up copying movement following the profile of the form.

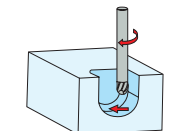

PLUNGE MILLING

Opening up a deep slot by using drilling (Z) axis.

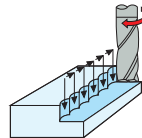

Z-LEVELING

Machining a surface by making a small drilling or ramping in Z axis then opening the pocket with X and Y movements.

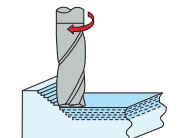

DRILLING

Making a hole with movement in Z axis.

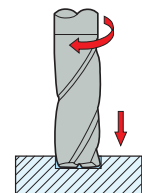

OPTIMIZED ROUGHING

Well defined tool paths with constant arc of contact for reliable roughing of simple & complex shapes.

The large axial depths (a_p) & small radial depths (a_e) of cut combined with high feeds per tooth (f_z) and cutting speeds (V_c) results in high productivity.

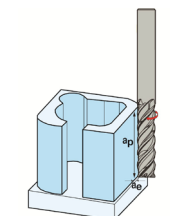

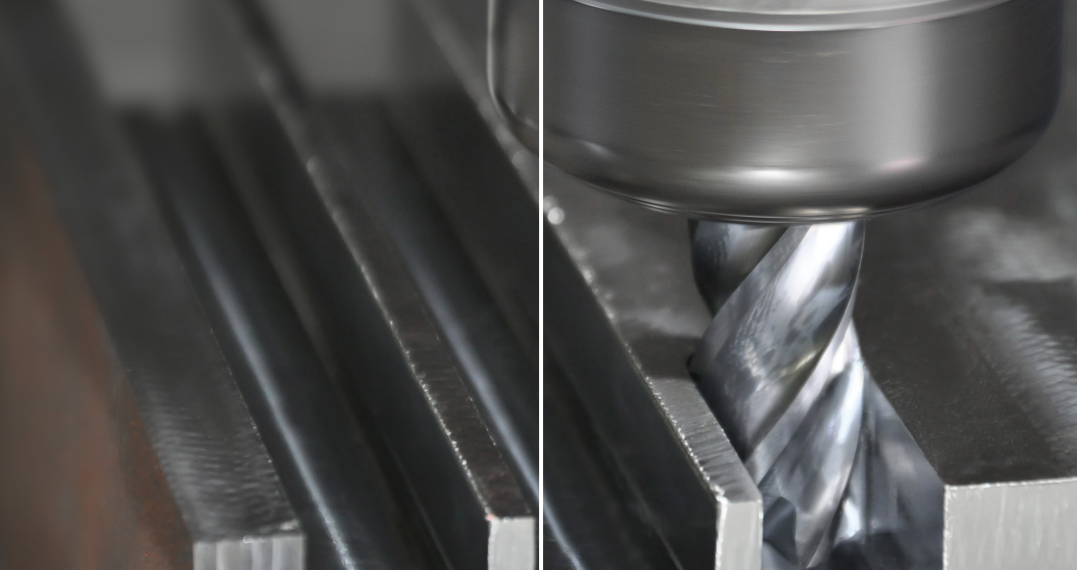

NIAGARA CUTTER™

HIGH PERFORMANCE SOLID CARBIDE END MILLS

DOUBLE YOUR FEED RATES STABILIZER™ 2.0

Raise the bar in your high performance milling operations with the Stabilizer 2.0 family of end mills. A patented, continuously varying asymmetrical geometry helps create a smooth chatter free milling condition. This configuration, along with a specially engineered flute shape, allow for feed rates twice that of the previous Stabilizer.

RANGE OVERVIEW

- Square, radius, and ball nose options
- Cylindrical shank with weldon option on inch product
- Diameters from 1/8" - 1" and 3 mm - 25 mm
- 1 x D, 2 x D, and 3 x D length versions available

STS430.2 / STR430.2 - 4-FLUTE, SQUARE END AND RADIUS

- .125" – 1.000" diameters, up to 3xD flute length

STB430.2 - 4-FLUTE, BALL NOSE

- .125" – 1.000" diameters, 2xD flute length

STRN430.2 / STBN430.2 - 4-FLUTE, RADIUS AND BALL NOSE NECKED OPTION

- .250" – 1.000" diameters, 2xD flute length and 3xD reach length

STS430M.2 / STR430M.2 - 4-FLUTE, SQUARE END AND RADIUS

- 3 – 25mm diameters, up to 3xD flute length

STB430M.2 - 4-FLUTE, BALL NOSE

- 3 – 25mm diameters, up to 3xD flute length

STR440.2 - 4-FLUTE, RADIUS

- .125" – 1.000" diameters, up to 3xD flute length

STB440.2 - 4-FLUTE, BALL NOSE

- .125" – 1.000" diameters, 2xD flute length

STRN440.2 / STBN440.2 - 4-FLUTE, RADIUS AND BALL NOSE NECKED OPTION

- .250" – 1.000" diameters, 2xD flute length and 3xD reach length

STR440M.2 / STB440M.2 - 4-FLUTE, SQUARE END AND RADIUS

- 3 – 25mm diameters, up to 3xD flute length

MATERIAL GROUPS (430 SERIES)

Steel 1-6

Cast Iron 12-15

MATERIAL GROUPS (440 SERIES)

Stainless Steel 8-11

Superalloys 19-22

INDUSTRY TARGETS

- General Engineering
- Aerospace
- Medical



6 TIPS

HIGH PERFORMANCE MACHINING

High performance machining (HPM) with the Stabilizer 2.0 can be highly effective in many 2D applications including slot milling, pocket milling and side milling. Higher metal removal rates can be achieved by increased feed rates and step overs pushing 50%+ of the cutter diameter compared to conventional machining strategies. Achieving the best possible results requires using these few common practices.

1. UNDERSTANDING THE NEED FOR INCREASED CUTTING PRESSURE

Due to the advanced flute geometry of the new Stabilizer 2.0, large step-overs need to be incorporated into the milling strategy in order to stabilize the tool while in cut. As a rule of thumb, a minimum of 20% of the diameter of the tool should be utilized. If the part and/or machine configuration does not allow for this large of a step-over, then the recommended catalog feed rate should be doubled to increase cutting pressure. Failure to "load" the tool may cause premature wear and a loss in productivity.

2. USE STRONG, SECURE TOOLHOLDERS & FIXTURING

The heavy cutting pressure of the Stabilizer 2.0 demands secure tool holders and fixturing. Utilizing an anti-pull-out system is the first choice when high performance milling is applied. Side lock holders, milling chucks and shrinkfit holders with anti-pull-out systems will help ensure that the tools are secure and provide optimal run-out of less than 0.0004". Some high precision collet systems and heavy-duty reinforced hydraulic chucks are a second option. However, the pull-out cannot be forgotten. Rigid fixturing and clamping will help ensure that the work piece stays fastened to the machining table.

3. LIMITING FACTORS OF MACHINE TOOLS

Knowing machine tool limitations and horse power consumption rates prior to implementing HPM strategies is crucial for success. These methods consume higher levels of horsepower and torque compared to standard milling strategies, this can push machine tools past their limits causing catastrophic failures. Using greater than a ½" diameter end mill in a CAT40 or similar size taper machine tool while utilizing HPM strategies could be problematic. Knowing your machine's limits is always the best option.

4. NOT ALL STAINLESS STEELS ARE CREATED EQUAL

To ensure optimal success, careful consideration must be taken when machining common pH hardened stainless steels such as 13-8, 15-5 and 17-4. When heat treated to a range of 32-42 HRC, these materials have a machining characteristic like common tool steel. The ST430.2 is designed for steel machining applications and may be a better option than the ST440.2 which is the first choice tool for stainless steel applications. Utilizing the recommended cutting parameters for the ST440.2 while using the ST430.2, is a safe common practice.

5. VERSATILE STABILIZER 2.0

If you wanted to choose one Stabilizer 2.0 series as an all-around tool for machining both steel and stainless steels, the ST440.2 series is the answer. Feed rates in steel are lower than the ST430.2 series due to reduced chip spacing (higher helix angle = less chip spacing). On average, the fpt of the ST440.2 series is 25% of the max feed rate in steel compared to the ST430.2 series.

EXAMPLE: fpt in 4140 for a 1.00" OD ST430.2 is 0.005", fpt for a 1.00" OD ST440.2 will only be 0.00375"

6. RECOMMENDED CUTTING PARAMETERS

Through meticulous research and years of first-hand experience, we have developed specific recommended cutting parameters. Cutting data is optimized for each tool's design, specifications and material groups. These configurations should always be used as a starting point and then modified from there depending on the application.

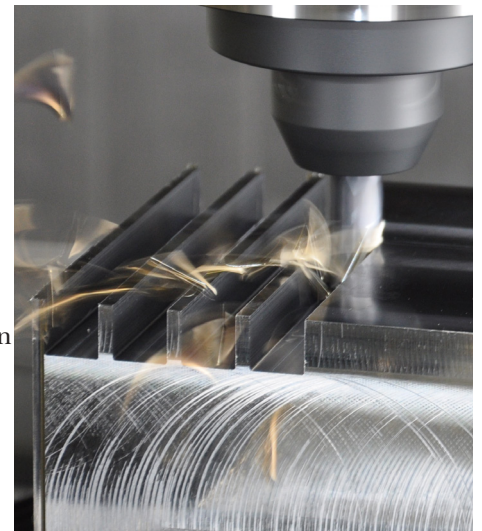

STABILIZER™ 2.0-STS430.2

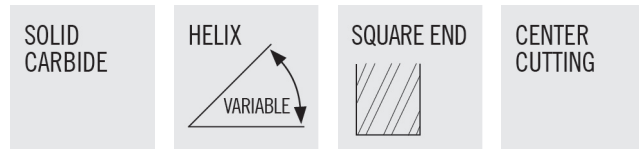

- US Patent # 6,991,409
- Eccentric Primary Relief
- Continuous Varying Asymmetrical Flute Geometry
- Weldon flat on shank sizes 3/8" and larger (optional)
- Ideal for profiling and slotting in steels, alloy steels, copper alloys, and cast iron

ITEM NUMBER	DESCRIPTION	FLUTE DIA.	SHANK DIA.	LENGTH OF CUT	OVERALL LENGTH	FLUTES	COATING	SHANK TYPE
N09696	STS430.2-0.125-D1-S.0-Z4	1/8	1/8	1/8	1-1/2	4	ALTiN	CYLINDRICAL
N09697	STS430.2-0.125-D2-S.0-Z4	1/8	1/8	1/4	1-1/2	4	ALTiN	CYLINDRICAL
N09698	STS430.2-0.125-D3-S.0-Z4	1/8	1/8	3/8	1-1/2	4	ALTiN	CYLINDRICAL
N09699	STS430.2-0.156-F1-S.0-Z4	5/32	3/16	5/32	2	4	ALTiN	CYLINDRICAL
N09702	STS430.2-0.156-F2-S.0-Z4	5/32	3/16	5/16	2	4	ALTiN	CYLINDRICAL
N09703	STS430.2-0.156-F3-S.0-Z4	5/32	3/16	15/32	2	4	ALTiN	CYLINDRICAL
N09704	STS430.2-0.188-D1-S.0-Z4	3/16	3/16	3/16	2	4	ALTiN	CYLINDRICAL
N09705	STS430.2-0.188-D2-S.0-Z4	3/16	3/16	3/8	2	4	ALTiN	CYLINDRICAL
N09706	STS430.2-0.188-D3-S.0-Z4	3/16	3/16	9/16	2	4	ALTiN	CYLINDRICAL
N09707	STS430.2-0.219-F1-S.0-Z4	7/32	1/4	7/32	2	4	ALTiN	CYLINDRICAL
N09708	STS430.2-0.219-F2-S.0-Z4	7/32	1/4	7/16	2-1/2	4	ALTiN	CYLINDRICAL
N09709	STS430.2-0.219-F3-S.0-Z4	7/32	1/4	21/32	2-1/2	4	ALTiN	CYLINDRICAL
N09712	STS430.2-0.250-D1-S.0-Z4	1/4	1/4	1/4	2	4	ALTiN	CYLINDRICAL
N09713	STS430.2-0.250-D2-S.0-Z4	1/4	1/4	1/2	2-1/2	4	ALTiN	CYLINDRICAL
N09714	STS430.2-0.250-D3-S.0-Z4	1/4	1/4	3/4	2-1/2	4	ALTiN	CYLINDRICAL
N09715	STS430.2-0.281-F1-S.0-Z4	9/32	5/16	9/32	2	4	ALTiN	CYLINDRICAL
N09716	STS430.2-0.281-F2-S.0-Z4	9/32	5/16	9/16	2-1/2	4	ALTiN	CYLINDRICAL
N09717	STS430.2-0.281-F3-S.0-Z4	9/32	5/16	27/32	2-1/2	4	ALTiN	CYLINDRICAL
N09718	STS430.2-0.313-D1-S.0-Z4	5/16	5/16	5/16	2	4	ALTiN	CYLINDRICAL
N09719	STS430.2-0.313-D2-S.0-Z4	5/16	5/16	5/8	2-1/2	4	ALTiN	CYLINDRICAL
N09722	STS430.2-0.313-D3-S.0-Z4	5/16	5/16	15/16	2-1/2	4	ALTiN	CYLINDRICAL
N09723	STS430.2-0.375-D1-S.0-Z4	3/8	3/8	3/8	2	4	ALTiN	CYLINDRICAL
N09724	STS430.2-0.375-D1-S.3-Z4	3/8	3/8	3/8	2	4	ALTiN	WELDON
N09725	STS430.2-0.375-D2-S.0-Z4	3/8	3/8	3/4	2-1/2	4	ALTiN	CYLINDRICAL
N09726	STS430.2-0.375-D2-S.3-Z4	3/8	3/8	3/4	2-1/2	4	ALTiN	WELDON
N09727	STS430.2-0.375-D3-S.0-Z4	3/8	3/8	1-1/8	3	4	ALTiN	CYLINDRICAL
N09728	STS430.2-0.375-D3-S.3-Z4	3/8	3/8	1-1/8	3	4	ALTiN	WELDON
N09729	STS430.2-0.438-D1-S.0-Z4	7/16	7/16	7/16	2-3/4	4	ALTiN	CYLINDRICAL
N09732	STS430.2-0.438-D1-S.3-Z4	7/16	7/16	7/16	2-3/4	4	ALTiN	WELDON
N09733	STS430.2-0.438-D2-S.0-Z4	7/16	7/16	7/8	2-3/4	4	ALTiN	CYLINDRICAL
N09734	STS430.2-0.438-D2-S.3-Z4	7/16	7/16	7/8	2-3/4	4	ALTiN	WELDON
N09735	STS430.2-0.438-D3-S.0-Z4	7/16	7/16	1-5/16	4	4	ALTiN	CYLINDRICAL
N09736	STS430.2-0.438-D3-S.3-Z4	7/16	7/16	1-5/16	4	4	ALTiN	WELDON
N09737	STS430.2-0.500-D1-S.0-Z4	1/2	1/2	1/2	2-1/2	4	ALTiN	CYLINDRICAL
N09738	STS430.2-0.500-D1-S.3-Z4	1/2	1/2	1/2	2-1/2	4	ALTiN	WELDON
N09739	STS430.2-0.500-D2-S.0-Z4	1/2	1/2	1	3	4	ALTiN	CYLINDRICAL
N09742	STS430.2-0.500-D2-S.3-Z4	1/2	1/2	1	3	4	ALTiN	WELDON
N09743	STS430.2-0.500-D3-S.0-Z4	1/2	1/2	1-1/4	3	4	ALTiN	CYLINDRICAL
N09744	STS430.2-0.500-D3-S.3-Z4	1/2	1/2	1-1/4	3	4	ALTiN	WELDON

STABILIZER™ 2.0-STS430.2 (CONT.)

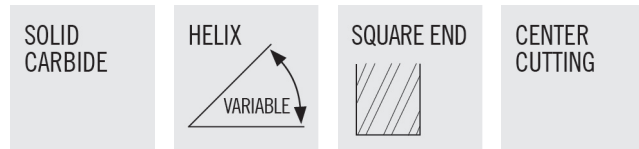

- US Patent # 6,991,409
- Eccentric Primary Relief
- Continuous Varying Asymmetrical Flute Geometry
- Ideal for profiling and slotting in steels, alloy steels, copper alloys, and cast iron

ITEM NUMBER	DESCRIPTION	FLUTE DIA.	SHANK DIA.	LENGTH OF CUT	OVERALL LENGTH	FLUTES	COATING	SHANK TYPE
N09745	STS430.2-0.500-D4-S.0-Z4	1/2	1/2	1-1/2	4	4	ALTIN	CYLINDRICAL
N09746	STS430.2-0.500-D4-S.3-Z4	1/2	1/2	1-1/2	4	4	ALTIN	WELDON
N09747	STS430.2-0.625-D1-S.0-Z4	5/8	5/8	5/8	3	4	ALTIN	CYLINDRICAL
N09748	STS430.2-0.625-D1-S.3-Z4	5/8	5/8	5/8	3	4	ALTIN	WELDON
N09749	STS430.2-0.625-D2-S.0-Z4	5/8	5/8	1-1/4	3-1/2	4	ALTIN	CYLINDRICAL
N09752	STS430.2-0.625-D2-S.3-Z4	5/8	5/8	1-1/4	3-1/2	4	ALTIN	WELDON
N09753	STS430.2-0.625-D3-S.0-Z4	5/8	5/8	1-7/8	4	4	ALTIN	CYLINDRICAL
N09754	STS430.2-0.625-D3-S.3-Z4	5/8	5/8	1-7/8	4	4	ALTIN	WELDON
N09755	STS430.2-0.750-D1-S.0-Z4	3/4	3/4	3/4	3	4	ALTIN	CYLINDRICAL
N09756	STS430.2-0.750-D1-S.3-Z4	3/4	3/4	3/4	3	4	ALTIN	WELDON
N09757	STS430.2-0.750-D2-S.0-Z4	3/4	3/4	1-1/2	4	4	ALTIN	CYLINDRICAL
N09758	STS430.2-0.750-D2-S.3-Z4	3/4	3/4	1-1/2	4	4	ALTIN	WELDON
N09759	STS430.2-0.750-D3-S.0-Z4	3/4	3/4	2-1/4	5	4	ALTIN	CYLINDRICAL
N09762	STS430.2-0.750-D3-S.3-Z4	3/4	3/4	2-1/4	5	4	ALTIN	WELDON
N09763	STS430.2-0.875-D1-S.0-Z4	7/8	7/8	7/8	4	4	ALTIN	CYLINDRICAL
N09764	STS430.2-0.875-D1-S.3-Z4	7/8	7/8	7/8	4	4	ALTIN	WELDON
N09765	STS430.2-0.875-D2-S.0-Z4	7/8	7/8	1-3/4	4	4	ALTIN	CYLINDRICAL
N09766	STS430.2-0.875-D2-S.3-Z4	7/8	7/8	1-3/4	4	4	ALTIN	WELDON
N09767	STS430.2-0.875-D3-S.0-Z4	7/8	7/8	2-5/8	5	4	ALTIN	CYLINDRICAL
N09768	STS430.2-0.875-D3-S.3-Z4	7/8	7/8	2-5/8	5	4	ALTIN	WELDON
N09769	STS430.2-1.000-D1-S.0-Z4	1	1	1	4	4	ALTIN	CYLINDRICAL
N09772	STS430.2-1.000-D1-S.3-Z4	1	1	1	4	4	ALTIN	WELDON
N09773	STS430.2-1.000-D2-S.0-Z4	1	1	2	5	4	ALTIN	CYLINDRICAL
N09774	STS430.2-1.000-D2-S.3-Z4	1	1	2	5	4	ALTIN	WELDON
N09775	STS430.2-1.000-D3-S.0-Z4	1	1	3	6	4	ALTIN	CYLINDRICAL
N09776	STS430.2-1.000-D3-S.3-Z4	1	1	3	6	4	ALTIN	WELDON

STABILIZER™ 2.0-STS430M.2

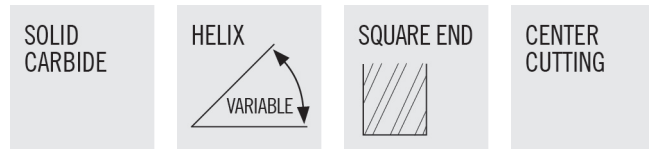

- US Patent # 6,991,409
- Eccentric Primary Relief
- Continuous Varying Asymmetrical Flute Geometry
- Ideal for profiling and slotting in steels, alloy steels, copper alloys, and cast iron

ITEM NUMBER	DESCRIPTION	FLUTE DIA.	SHANK DIA.	LENGTH OF CUT	OVERALL LENGTH	FLUTES	COATING	SHANK TYPE
N09538	STS430M.2-030-F2-S.0-Z4	3	6	6	58	4	ALTIN	CYLINDRICAL
N09539	STS430M.2-030-F3-S.0-Z4	3	6	9	58	4	ALTIN	CYLINDRICAL
N09542	STS430M.2-040-F2-S.0-Z4	4	6	8	58	4	ALTIN	CYLINDRICAL
N09543	STS430M.2-040-F3-S.0-Z4	4	6	12	58	4	ALTIN	CYLINDRICAL
N09544	STS430M.2-050-F2-S.0-Z4	5	6	10	58	4	ALTIN	CYLINDRICAL
N09545	STS430M.2-050-F3-S.0-Z4	5	6	15	58	4	ALTIN	CYLINDRICAL
N09546	STS430M.2-060-D2-S.0-Z4	6	6	12	58	4	ALTIN	CYLINDRICAL
N09547	STS430M.2-060-D3-S.0-Z4	6	6	18	58	4	ALTIN	CYLINDRICAL
N09548	STS430M.2-080-D2-S.0-Z4	8	8	16	64	4	ALTIN	CYLINDRICAL
N09549	STS430M.2-080-D3-S.0-Z4	8	8	24	64	4	ALTIN	CYLINDRICAL
N09552	STS430M.2-100-D2-S.0-Z4	10	10	20	73	4	ALTIN	CYLINDRICAL
N09553	STS430M.2-100-D3-S.0-Z4	10	10	30	73	4	ALTIN	CYLINDRICAL
N09554	STS430M.2-120-D2-S.0-Z4	12	12	24	84	4	ALTIN	CYLINDRICAL
N09555	STS430M.2-120-D3-S.0-Z4	12	12	36	84	4	ALTIN	CYLINDRICAL
N09556	STS430M.2-160-D2-S.0-Z4	16	16	32	93	4	ALTIN	CYLINDRICAL
N09557	STS430M.2-160-D3-S.0-Z4	16	16	48	93	4	ALTIN	CYLINDRICAL
N09558	STS430M.2-200-D2-S.0-Z4	20	20	40	105	4	ALTIN	CYLINDRICAL
N09559	STS430M.2-200-D3-S.0-Z4	20	20	60	125	4	ALTIN	CYLINDRICAL
N09562	STS430M.2-250-D2-S.0-Z4	25	25	50	115	4	ALTIN	CYLINDRICAL
N09563	STS430M.2-250-D3-S.0-Z4	25	25	75	147	4	ALTIN	CYLINDRICAL

STABILIZER™ 2.0-STR430.2

SOLID
CARBIDE

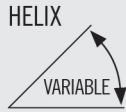

CENTER
CUTTING



- US Patent # 6,991,409
- Eccentric Primary Relief
- Continuous Varying Asymmetrical Flute Geometry
- Ideal for profiling and slotting in steels, alloy steels, copper alloys, and cast iron

ITEM NUMBER	DESCRIPTION	FLUTE DIA.	SHANK DIA.	LENGTH OF CUT	OVERALL LENGTH	FLUTES	COATING	RADIUS	SHANK TYPE
N09777	STR430.2-0.125-D1-R010.0-Z4	1/8	1/8	1/8	1-1/2	4	ALTIN	0.010	CYLINDRICAL
N09778	STR430.2-0.125-D2-R010.0-Z4	1/8	1/8	1/4	1-1/2	4	ALTIN	0.010	CYLINDRICAL
N09779	STR430.2-0.125-D3-R010.0-Z4	1/8	1/8	3/8	1-1/2	4	ALTIN	0.010	CYLINDRICAL
N09782	STR430.2-0.156-F1-R010.0-Z4	5/32	3/16	5/32	2	4	ALTIN	0.010	CYLINDRICAL
N09783	STR430.2-0.156-F2-R010.0-Z4	5/32	3/16	5/16	2	4	ALTIN	0.010	CYLINDRICAL
N09784	STR430.2-0.156-F3-R010.0-Z4	5/32	3/16	15/32	2	4	ALTIN	0.010	CYLINDRICAL
N09785	STR430.2-0.188-D1-R010.0-Z4	3/16	3/16	3/16	2	4	ALTIN	0.010	CYLINDRICAL
N09786	STR430.2-0.188-D2-R010.0-Z4	3/16	3/16	3/8	2	4	ALTIN	0.010	CYLINDRICAL
N09787	STR430.2-0.188-D3-R010.0-Z4	3/16	3/16	9/16	2	4	ALTIN	0.010	CYLINDRICAL
N09788	STR430.2-0.219-F1-R020.0-Z4	7/32	1/4	7/32	2	4	ALTIN	0.020	CYLINDRICAL
N09789	STR430.2-0.219-F2-R020.0-Z4	7/32	1/4	7/16	2-1/2	4	ALTIN	0.020	CYLINDRICAL
N09792	STR430.2-0.219-F3-R020.0-Z4	7/32	1/4	21/32	2-1/2	4	ALTIN	0.020	CYLINDRICAL
N09793	STR430.2-0.250-D1-R020.0-Z4	1/4	1/4	1/4	2	4	ALTIN	0.020	CYLINDRICAL
N09794	STR430.2-0.250-D2-R020.0-Z4	1/4	1/4	1/2	2-1/2	4	ALTIN	0.020	CYLINDRICAL
N09795	STR430.2-0.250-D3-R020.0-Z4	1/4	1/4	3/4	2-1/2	4	ALTIN	0.020	CYLINDRICAL
N09796	STR430.2-0.281-F1-R020.0-Z4	9/32	5/16	9/32	2	4	ALTIN	0.020	CYLINDRICAL
N09797	STR430.2-0.281-F2-R020.0-Z4	9/32	5/16	9/16	2-1/2	4	ALTIN	0.020	CYLINDRICAL
N09798	STR430.2-0.281-F3-R020.0-Z4	9/32	5/16	27/32	2-1/2	4	ALTIN	0.020	CYLINDRICAL
N09799	STR430.2-0.313-D1-R020.0-Z4	5/16	5/16	5/16	2	4	ALTIN	0.020	CYLINDRICAL
N09802	STR430.2-0.313-D2-R020.0-Z4	5/16	5/16	5/8	2-1/2	4	ALTIN	0.020	CYLINDRICAL
N09803	STR430.2-0.313-D3-R020.0-Z4	5/16	5/16	15/16	2-1/2	4	ALTIN	0.020	CYLINDRICAL
N09804	STR430.2-0.375-D1-R020.0-Z4	3/8	3/8	3/8	2	4	ALTIN	0.020	CYLINDRICAL
N09805	STR430.2-0.375-D1-R020.3-Z4	3/8	3/8	3/8	2	4	ALTIN	0.020	WELDON
N09806	STR430.2-0.375-D2-R020.0-Z4	3/8	3/8	3/4	2-1/2	4	ALTIN	0.020	CYLINDRICAL
N09807	STR430.2-0.375-D2-R020.3-Z4	3/8	3/8	3/4	2-1/2	4	ALTIN	0.020	WELDON
N09808	STR430.2-0.375-D3-R020.0-Z4	3/8	3/8	1-1/8	3	4	ALTIN	0.020	CYLINDRICAL
N09809	STR430.2-0.375-D3-R020.3-Z4	3/8	3/8	1-1/8	3	4	ALTIN	0.020	WELDON
N09812	STR430.2-0.438-F1-R020.0-Z4	7/16	7/16	7/16	2-3/4	4	ALTIN	0.020	CYLINDRICAL
N09813	STR430.2-0.438-F1-R020.3-Z4	7/16	7/16	7/16	2-3/4	4	ALTIN	0.020	WELDON
N09814	STR430.2-0.438-F2-R020.0-Z4	7/16	7/16	7/8	2-3/4	4	ALTIN	0.020	CYLINDRICAL
N09815	STR430.2-0.438-F2-R020.3-Z4	7/16	7/16	7/8	2-3/4	4	ALTIN	0.020	WELDON
N09816	STR430.2-0.438-F3-R020.0-Z4	7/16	7/16	1-5/16	4	4	ALTIN	0.020	CYLINDRICAL
N09817	STR430.2-0.438-F3-R020.3-Z4	7/16	7/16	1-5/16	4	4	ALTIN	0.020	WELDON
N09818	STR430.2-0.500-D1-R030.0-Z4	1/2	1/2	1/2	2-1/2	4	ALTIN	0.030	CYLINDRICAL
N09819	STR430.2-0.500-D1-R030.3-Z4	1/2	1/2	1/2	2-1/2	4	ALTIN	0.030	WELDON
N09844	STR430.2-0.500-D2-R030.0-Z4	1/2	1/2	1	3	4	ALTIN	0.030	CYLINDRICAL
N09845	STR430.2-0.500-D2-R030.3-Z4	1/2	1/2	1	3	4	ALTIN	0.030	WELDON
03212567	STR430.2-0.500-D2-R060.0-Z4	1/2	1/2	1	3	4	ALTIN	0.060	CYLINDRICAL
03212568	STR430.2-0.500-D2-R060.3-Z4	1/2	1/2	1	3	4	ALTIN	0.060	WELDON
03212569	STR430.2-0.500-D2-R120.0-Z4	1/2	1/2	1	3	4	ALTIN	0.120	CYLINDRICAL
03212570	STR430.2-0.500-D2-R120.3-Z4	1/2	1/2	1	3	4	ALTIN	0.120	WELDON

STABILIZER™ 2.0-STR430.2 (CONT.)

SOLID CARBIDE

HELIX

RADIUS

CENTER CUTTING



- US Patent # 6,991,409
- Eccentric Primary Relief
- Continuous Varying Asymmetrical Flute Geometry
- Ideal for profiling and slotting in steels, alloy steels, copper alloys, and cast iron

ITEM NUMBER	DESCRIPTION	FLUTE DIA.	SHANK DIA.	LENGTH OF CUT	OVERALL LENGTH	FLUTES	COATING	RADIUS	SHANK TYPE
N09846	STR430.2-0.500-D3-R030.0-Z4	1/2	1/2	1-1/4	3	4	ALTIN	0.030	CYLINDRICAL
N09847	STR430.2-0.500-D3-R030.3-Z4	1/2	1/2	1-1/4	3	4	ALTIN	0.030	WELDON
03212571	STR430.2-0.500-D3-R060.0-Z4	1/2	1/2	1-1/4	3	4	ALTIN	0.060	CYLINDRICAL
03212572	STR430.2-0.500-D3-R060.3-Z4	1/2	1/2	1-1/4	3	4	ALTIN	0.060	WELDON
03212573	STR430.2-0.500-D3-R120.0-Z4	1/2	1/2	1-1/4	3	4	ALTIN	0.120	CYLINDRICAL
03212574	STR430.2-0.500-D3-R120.3-Z4	1/2	1/2	1-1/4	3	4	ALTIN	0.120	WELDON
N09848	STR430.2-0.500-D4-R030.0-Z4	1/2	1/2	1-1/2	4	4	ALTIN	0.030	CYLINDRICAL
N09849	STR430.2-0.500-D4-R030.3-Z4	1/2	1/2	1-1/2	4	4	ALTIN	0.030	WELDON
03212575	STR430.2-0.500-D4-R060.0-Z4	1/2	1/2	1-1/2	4	4	ALTIN	0.060	CYLINDRICAL
03212576	STR430.2-0.500-D4-R060.3-Z4	1/2	1/2	1-1/2	4	4	ALTIN	0.060	WELDON
03212577	STR430.2-0.500-D4-R120.0-Z4	1/2	1/2	1-1/2	4	4	ALTIN	0.120	CYLINDRICAL
03212578	STR430.2-0.500-D4-R120.3-Z4	1/2	1/2	1-1/2	4	4	ALTIN	0.120	WELDON
N09852	STR430.2-0.625-D1-R030.0-Z4	5/8	5/8	5/8	3	4	ALTIN	0.030	CYLINDRICAL
N09853	STR430.2-0.625-D1-R030.3-Z4	5/8	5/8	5/8	3	4	ALTIN	0.030	WELDON
N09854	STR430.2-0.625-D2-R030.0-Z4	5/8	5/8	1-1/4	3-1/2	4	ALTIN	0.030	CYLINDRICAL
N09855	STR430.2-0.625-D2-R030.3-Z4	5/8	5/8	1-1/4	3-1/2	4	ALTIN	0.030	WELDON
03212579	STR430.2-0.625-D2-R060.0-Z4	5/8	5/8	1-1/4	3-1/2	4	ALTIN	0.060	CYLINDRICAL
03212580	STR430.2-0.625-D2-R060.3-Z4	5/8	5/8	1-1/4	3-1/2	4	ALTIN	0.060	WELDON
03212581	STR430.2-0.625-D2-R090.0-Z4	5/8	5/8	1-1/4	3-1/2	4	ALTIN	0.090	CYLINDRICAL
03212582	STR430.2-0.625-D2-R090.3-Z4	5/8	5/8	1-1/4	3-1/2	4	ALTIN	0.090	WELDON
03212583	STR430.2-0.625-D2-R120.0-Z4	5/8	5/8	1-1/4	3-1/2	4	ALTIN	0.120	CYLINDRICAL
03212584	STR430.2-0.625-D2-R120.3-Z4	5/8	5/8	1-1/4	3-1/2	4	ALTIN	0.120	WELDON
N09856	STR430.2-0.625-D3-R030.0-Z4	5/8	5/8	1-7/8	4	4	ALTIN	0.030	CYLINDRICAL
N09857	STR430.2-0.625-D3-R030.3-Z4	5/8	5/8	1-7/8	4	4	ALTIN	0.030	WELDON
03212585	STR430.2-0.625-D3-R060.0-Z4	5/8	5/8	1-7/8	4	4	ALTIN	0.060	CYLINDRICAL
03212586	STR430.2-0.625-D3-R060.3-Z4	5/8	5/8	1-7/8	4	4	ALTIN	0.060	WELDON
03212587	STR430.2-0.625-D3-R090.0-Z4	5/8	5/8	1-7/8	4	4	ALTIN	0.090	CYLINDRICAL
03212588	STR430.2-0.625-D3-R090.3-Z4	5/8	5/8	1-7/8	4	4	ALTIN	0.090	WELDON
03212589	STR430.2-0.625-D3-R120.0-Z4	5/8	5/8	1-7/8	4	4	ALTIN	0.120	CYLINDRICAL
03212590	STR430.2-0.625-D3-R120.3-Z4	5/8	5/8	1-7/8	4	4	ALTIN	0.120	WELDON
N09858	STR430.2-0.750-D1-R030.0-Z4	3/4	3/4	3/4	3	4	ALTIN	0.030	CYLINDRICAL
N09859	STR430.2-0.750-D1-R030.3-Z4	3/4	3/4	3/4	3	4	ALTIN	0.030	WELDON
N09862	STR430.2-0.750-D2-R030.0-Z4	3/4	3/4	1-1/2	4	4	ALTIN	0.030	CYLINDRICAL
N09863	STR430.2-0.750-D2-R030.3-Z4	3/4	3/4	1-1/2	4	4	ALTIN	0.030	WELDON
03212591	STR430.2-0.750-D2-R060.0-Z4	3/4	3/4	1-1/2	4	4	ALTIN	0.060	CYLINDRICAL
03212592	STR430.2-0.750-D2-R060.3-Z4	3/4	3/4	1-1/2	4	4	ALTIN	0.060	WELDON
03212593	STR430.2-0.750-D2-R090.0-Z4	3/4	3/4	1-1/2	4	4	ALTIN	0.090	CYLINDRICAL
03212594	STR430.2-0.750-D2-R090.3-Z4	3/4	3/4	1-1/2	4	4	ALTIN	0.090	WELDON
03212595	STR430.2-0.750-D2-R120.0-Z4	3/4	3/4	1-1/2	4	4	ALTIN	0.120	CYLINDRICAL
03212596	STR430.2-0.750-D2-R120.3-Z4	3/4	3/4	1-1/2	4	4	ALTIN	0.120	WELDON
03212597	STR430.2-0.750-D2-R250.0-Z4	3/4	3/4	1-1/2	4	4	ALTIN	0.250	CYLINDRICAL

STABILIZER™ 2.0-STR430.2 (CONT.)

SOLID CARBIDE

HELIX

 VARIABLE

RADIUS

CENTER CUTTING



- US Patent # 6,991,409
- Eccentric Primary Relief
- Continuous Varying Asymmetrical Flute Geometry
- Ideal for profiling and slotting in steels, alloy steels, copper alloys, and cast iron

ITEM NUMBER	DESCRIPTION	FLUTE DIA.	SHANK DIA.	LENGTH OF CUT	OVERALL LENGTH	FLUTES	COATING	RADIUS	SHANK TYPE
03212598	STR430.2-0.750-D2-R250.3-Z4	3/4	3/4	1-1/2	4	4	ALTIN	0.250	WELDON
N09864	STR430.2-0.750-D3-R030.0-Z4	3/4	3/4	2-1/4	5	4	ALTIN	0.030	CYLINDRICAL
N09865	STR430.2-0.750-D3-R030.3-Z4	3/4	3/4	2-1/4	5	4	ALTIN	0.030	WELDON
03212599	STR430.2-0.750-D3-R060.0-Z4	3/4	3/4	2-1/4	5	4	ALTIN	0.060	CYLINDRICAL
03212600	STR430.2-0.750-D3-R060.3-Z4	3/4	3/4	2-1/4	5	4	ALTIN	0.060	WELDON
03212601	STR430.2-0.750-D3-R090.0-Z4	3/4	3/4	2-1/4	5	4	ALTIN	0.090	CYLINDRICAL
03212602	STR430.2-0.750-D3-R090.3-Z4	3/4	3/4	2-1/4	5	4	ALTIN	0.090	WELDON
03212603	STR430.2-0.750-D3-R120.0-Z4	3/4	3/4	2-1/4	5	4	ALTIN	0.120	CYLINDRICAL
03212604	STR430.2-0.750-D3-R120.3-Z4	3/4	3/4	2-1/4	5	4	ALTIN	0.120	WELDON
03212606	STR430.2-0.750-D3-R250.0-Z4	3/4	3/4	2-1/4	5	4	ALTIN	0.250	CYLINDRICAL
03212607	STR430.2-0.750-D3-R250.3-Z4	3/4	3/4	2-1/4	5	4	ALTIN	0.250	WELDON
N09866	STR430.2-0.875-D1-R030.0-Z4	7/8	7/8	7/8	4	4	ALTIN	0.030	CYLINDRICAL
N09867	STR430.2-0.875-D1-R030.3-Z4	7/8	7/8	7/8	4	4	ALTIN	0.030	WELDON
N09868	STR430.2-0.875-D2-R030.0-Z4	7/8	7/8	1-3/4	4	4	ALTIN	0.030	CYLINDRICAL
N09869	STR430.2-0.875-D2-R030.3-Z4	7/8	7/8	1-3/4	4	4	ALTIN	0.030	WELDON
N09872	STR430.2-0.875-D3-R030.0-Z4	7/8	7/8	2-5/8	5	4	ALTIN	0.030	CYLINDRICAL
N09873	STR430.2-0.875-D3-R030.3-Z4	7/8	7/8	2-5/8	5	4	ALTIN	0.030	WELDON
N09874	STR430.2-1.000-D1-R030.0-Z4	1	1	1	4	4	ALTIN	0.030	CYLINDRICAL
N09875	STR430.2-1.000-D1-R030.3-Z4	1	1	1	4	4	ALTIN	0.030	WELDON
N09876	STR430.2-1.000-D2-R030.0-Z4	1	1	2	5	4	ALTIN	0.030	CYLINDRICAL
N09877	STR430.2-1.000-D2-R030.3-Z4	1	1	2	5	4	ALTIN	0.030	WELDON
N09878	STR430.2-1.000-D3-R030.0-Z4	1	1	3	6	4	ALTIN	0.030	CYLINDRICAL
N09879	STR430.2-1.000-D3-R030.3-Z4	1	1	3	6	4	ALTIN	0.030	WELDON

STABILIZER™ 2.0-STR430M.2

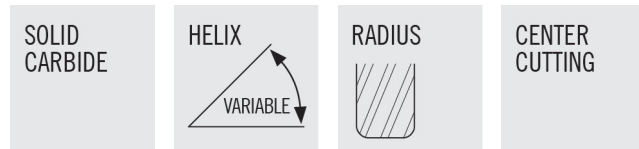



- US Patent # 6,991,409
- Eccentric Primary Relief
- Continuous Varying Asymmetrical Flute Geometry
- Ideal for profiling and slotting in steels, alloy steels, copper alloys, and cast iron

ITEM NUMBER	DESCRIPTION	FLUTE DIA.	SHANK DIA.	LENGTH OF CUT	OVERALL LENGTH	FLUTES	COATING	RADIUS	SHANK TYPE
N09564	STR430M.2-030-F2-R025.0-Z4	3	6	6	58	4	ALTIN	0.25mm	CYLINDRICAL
N09565	STR430M.2-030-F3-R025.0-Z4	3	6	9	58	4	ALTIN	0.25mm	CYLINDRICAL
N09566	STR430M.2-040-F2-R025.0-Z4	4	6	8	58	4	ALTIN	0.25mm	CYLINDRICAL
N09567	STR430M.2-040-F3-R025.0-Z4	4	6	12	58	4	ALTIN	0.25mm	CYLINDRICAL
N09568	STR430M.2-050-F2-R025.0-Z4	5	6	10	58	4	ALTIN	0.25mm	CYLINDRICAL
N09569	STR430M.2-050-F3-R025.0-Z4	5	6	15	58	4	ALTIN	0.25mm	CYLINDRICAL
N09582	STR430M.2-060-D2-R050.0-Z4	6	6	12	58	4	ALTIN	0.50mm	CYLINDRICAL
N09583	STR430M.2-060-D3-R050.0-Z4	6	6	18	58	4	ALTIN	0.50mm	CYLINDRICAL
N09584	STR430M.2-080-D2-R050.0-Z4	8	8	16	64	4	ALTIN	0.50mm	CYLINDRICAL
N09585	STR430M.2-080-D3-R050.0-Z4	8	8	24	64	4	ALTIN	0.50mm	CYLINDRICAL
N09586	STR430M.2-100-D2-R050.0-Z4	10	10	20	73	4	ALTIN	0.50mm	CYLINDRICAL
N09587	STR430M.2-100-D3-R050.0-Z4	10	10	30	73	4	ALTIN	0.50mm	CYLINDRICAL
N09588	STR430M.2-120-D2-R075.0-Z4	12	12	24	84	4	ALTIN	0.75mm	CYLINDRICAL
N09589	STR430M.2-120-D3-R075.0-Z4	12	12	36	84	4	ALTIN	0.75mm	CYLINDRICAL
N09602	STR430M.2-160-D2-R075.0-Z4	16	16	32	93	4	ALTIN	0.75mm	CYLINDRICAL
N09603	STR430M.2-160-D3-R075.0-Z4	16	16	48	93	4	ALTIN	0.75mm	CYLINDRICAL
N09604	STR430M.2-200-D2-R075.0-Z4	20	20	40	105	4	ALTIN	0.75mm	CYLINDRICAL
N09605	STR430M.2-200-D3-R075.0-Z4	20	20	60	125	4	ALTIN	0.75mm	CYLINDRICAL
N09606	STR430M.2-250-D2-R075.0-Z4	25	25	50	115	4	ALTIN	0.75mm	CYLINDRICAL
N09607	STR430M.2-250-D3-R075.0-Z4	25	25	75	147	4	ALTIN	0.75mm	CYLINDRICAL

STABILIZER™ 2.0-STB430.2 & STB430M.2

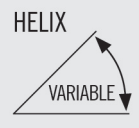
SOLID CARBIDE





CENTER CUTTING



- US Patent # 6,991,409
- Eccentric Primary Relief
- Continuous Varying Asymmetrical Flute Geometry
- Ideal for profiling and slotting in steels, alloy steels, copper alloys, and cast iron

ITEM NUMBER	DESCRIPTION	FLUTE DIA.	SHANK DIA.	LENGTH OF CUT	OVERALL LENGTH	FLUTES	COATING	SHANK TYPE
INCH - STB430.2								
N09369	STB430.2-0.125-D2-B.0-Z4	1/8	1/8	1/4	1-1/2	4	ALTIN	CYLINDRICAL
N09373	STB430.2-0.188-D2-B.0-Z4	3/16	3/16	3/8	2	4	ALTIN	CYLINDRICAL
N09383	STB430.2-0.250-D2-B.0-Z4	1/4	1/4	1/2	2-1/2	4	ALTIN	CYLINDRICAL
N09386	STB430.2-0.313-D2-B.0-Z4	5/16	5/16	5/8	2-1/2	4	ALTIN	CYLINDRICAL
N09387	STB430.2-0.375-D2-B.0-Z4	3/8	3/8	3/4	2-1/2	4	ALTIN	CYLINDRICAL
N09389	STB430.2-0.375-D2-B.3-Z4	3/8	3/8	3/4	2-1/2	4	ALTIN	WELDON
N09393	STB430.2-0.438-D2-B.0-Z4	7/16	7/16	7/8	2-3/4	4	ALTIN	CYLINDRICAL
N09396	STB430.2-0.438-D2-B.3-Z4	7/16	7/16	7/8	2-3/4	4	ALTIN	WELDON
N09397	STB430.2-0.500-D2-B.0-Z4	1/2	1/2	1	3	4	ALTIN	CYLINDRICAL
N09398	STB430.2-0.500-D2-B.3-Z4	1/2	1/2	1	3	4	ALTIN	WELDON
N09399	STB430.2-0.625-D2-B.0-Z4	5/8	5/8	1-1/4	3-1/2	4	ALTIN	CYLINDRICAL
N09402	STB430.2-0.625-D2-B.3-Z4	5/8	5/8	1-1/4	3-1/2	4	ALTIN	WELDON
N09403	STB430.2-0.750-D2-B.0-Z4	3/4	3/4	1-1/2	4	4	ALTIN	CYLINDRICAL
N09404	STB430.2-0.750-D2-B.3-Z4	3/4	3/4	1-1/2	4	4	ALTIN	WELDON
N09405	STB430.2-1.000-D2-B.0-Z4	1	1	2	5	4	ALTIN	CYLINDRICAL
N09406	STB430.2-1.000-D2-B.3-Z4	1	1	2	5	4	ALTIN	WELDON
METRIC - STB430M.2								
N09608	STB430M.2-030-F2-B.0-Z4	3mm	6mm	6mm	58mm	4	ALTIN	CYLINDRICAL
N09609	STB430M.2-030-F3-B.0-Z4	3mm	6mm	9mm	58mm	4	ALTIN	CYLINDRICAL
N09612	STB430M.2-040-F2-B.0-Z4	4mm	6mm	8mm	58mm	4	ALTIN	CYLINDRICAL
N09613	STB430M.2-040-F3-B.0-Z4	4mm	6mm	12mm	58mm	4	ALTIN	CYLINDRICAL
N09614	STB430M.2-050-F2-B.0-Z4	5mm	6mm	10mm	58mm	4	ALTIN	CYLINDRICAL
N09615	STB430M.2-050-F3-B.0-Z4	5mm	6mm	15mm	58mm	4	ALTIN	CYLINDRICAL
N09616	STB430M.2-060-D2-B.0-Z4	6mm	6mm	12mm	58mm	4	ALTIN	CYLINDRICAL
N09617	STB430M.2-060-D3-B.0-Z4	6mm	6mm	18mm	58mm	4	ALTIN	CYLINDRICAL
N09618	STB430M.2-080-D2-B.0-Z4	8mm	8mm	16mm	64mm	4	ALTIN	CYLINDRICAL
N09622	STB430M.2-080-D3-B.0-Z4	8mm	8mm	24mm	64mm	4	ALTIN	CYLINDRICAL
N09623	STB430M.2-100-D2-B.0-Z4	10mm	10mm	20mm	73mm	4	ALTIN	CYLINDRICAL
N09624	STB430M.2-100-D3-B.0-Z4	10mm	10mm	30mm	73mm	4	ALTIN	CYLINDRICAL
N09626	STB430M.2-120-D2-B.0-Z4	12mm	12mm	24mm	84mm	4	ALTIN	CYLINDRICAL
N09627	STB430M.2-120-D3-B.0-Z4	12mm	12mm	36mm	84mm	4	ALTIN	CYLINDRICAL
N09628	STB430M.2-160-D2-B.0-Z4	16mm	16mm	32mm	93mm	4	ALTIN	CYLINDRICAL
N09631	STB430M.2-160-D3-B.0-Z4	16mm	16mm	48mm	93mm	4	ALTIN	CYLINDRICAL
N09632	STB430M.2-200-D2-B.0-Z4	20mm	20mm	40mm	105mm	4	ALTIN	CYLINDRICAL
N09633	STB430M.2-200-D3-B.0-Z4	20mm	20mm	60mm	125mm	4	ALTIN	CYLINDRICAL
N09634	STB430M.2-250-D2-B.0-Z4	25mm	25mm	50mm	115mm	4	ALTIN	CYLINDRICAL
N09635	STB430M.2-250-D3-B.0-Z4	25mm	25mm	75mm	147mm	4	ALTIN	CYLINDRICAL

STABILIZER™ 2.0-STRN430.2

SOLID CARBIDE

HELIX

RADIUS

CENTER CUTTING



- US Patent # 6,991,409
- Eccentric Primary Relief
- Continuous Varying Asymmetrical Flute Geometry
- Ideal for profiling and slotting in steels, alloy steels, copper alloys, and cast iron

ITEM NUMBER	DESCRIPTION	FLUTE DIA.	SHANK DIA.	LENGTH OF CUT	OVERALL LENGTH	NECK DIA.	REACH	FLUTES	COATING	RADIUS	SHANK TYPE
N09447	STRN430.2-0.250-E2-R020.0-Z4	1/4	1/4	1/2	2-1/2	0.240	3/4	4	ALTIN	0.020	CYLINDRICAL
N09448	STRN430.2-0.313-E2-R020.0-Z4	5/16	5/16	5/8	3	0.300	15/16	4	ALTIN	0.020	CYLINDRICAL
N09449	STRN430.2-0.375-E2-R020.0-Z4	3/8	3/8	3/4	3	0.360	1-1/8	4	ALTIN	0.020	CYLINDRICAL
N09456	STRN430.2-0.375-E2-R020.3-Z4	3/8	3/8	3/4	3	0.360	1-1/8	4	ALTIN	0.020	WELDON
N09457	STRN430.2-0.438-E2-R020.0-Z4	7/16	7/16	7/8	4	0.420	1-5/16	4	ALTIN	0.020	CYLINDRICAL
N09462	STRN430.2-0.438-E2-R020.3-Z4	7/16	7/16	7/8	4	0.420	1-5/16	4	ALTIN	0.020	WELDON
N09463	STRN430.2-0.500-E2-R030.0-Z4	1/2	1/2	1	3	0.480	1-1/2	4	ALTIN	0.030	CYLINDRICAL
N09464	STRN430.2-0.500-E2-R030.3-Z4	1/2	1/2	1	3	0.480	1-1/2	4	ALTIN	0.030	WELDON
N09465	STRN430.2-0.625-E2-R030.0-Z4	5/8	5/8	1-1/4	3-1/2	0.600	1-7/8	4	ALTIN	0.030	CYLINDRICAL
N09466	STRN430.2-0.625-E2-R030.3-Z4	5/8	5/8	1-1/4	3-1/2	0.600	1-7/8	4	ALTIN	0.030	WELDON
N09467	STRN430.2-0.750-E2-R030.0-Z4	3/4	3/4	1-1/2	4	0.720	2-1/4	4	ALTIN	0.030	CYLINDRICAL
N09468	STRN430.2-0.750-E2-R030.3-Z4	3/4	3/4	1-1/2	4	0.720	2-1/4	4	ALTIN	0.030	WELDON
N09469	STRN430.2-1.000-E2-R030.0-Z4	1	1	2	5	0.960	3	4	ALTIN	0.030	CYLINDRICAL
N09472	STRN430.2-1.000-E2-R030.3-Z4	1	1	2	5	0.960	3	4	ALTIN	0.030	WELDON

STABILIZER™ 2.0-STBN430.2

SOLID CARBIDE

HELIX

BALL END

CENTER CUTTING



ITEM NUMBER	DESCRIPTION	FLUTE DIA.	SHANK DIA.	LENGTH OF CUT	OVERALL LENGTH	NECK DIA.	REACH	FLUTES	COATING	SHANK TYPE
N09473	STBN430.2-0.250-E2-B.0-Z4	1/4	1/4	1/2	2-1/2	0.240	3/4	4	ALTIN	CYLINDRICAL
N09474	STBN430.2-0.313-E2-B.0-Z4	5/16	5/16	5/8	3	0.300	15/16	4	ALTIN	CYLINDRICAL
N09475	STBN430.2-0.375-E2-B.0-Z4	3/8	3/8	3/4	3	0.360	1-1/8	4	ALTIN	CYLINDRICAL
N09476	STBN430.2-0.375-E2-B.3-Z4	3/8	3/8	3/4	3	0.360	1-1/8	4	ALTIN	WELDON
N09477	STBN430.2-0.438-E2-B.0-Z4	7/16	7/16	7/8	4	0.420	1-5/16	4	ALTIN	CYLINDRICAL
N09478	STBN430.2-0.438-E2-B.3-Z4	7/16	7/16	7/8	4	0.420	1-5/16	4	ALTIN	WELDON
N09479	STBN430.2-0.500-E2-B.0-Z4	1/2	1/2	1	3	0.480	1-1/2	4	ALTIN	CYLINDRICAL
N09493	STBN430.2-0.500-E2-B.3-Z4	1/2	1/2	1	3	0.480	1-1/2	4	ALTIN	WELDON
N09494	STBN430.2-0.625-E2-B.0-Z4	5/8	5/8	1-1/4	3-1/2	0.600	1-7/8	4	ALTIN	CYLINDRICAL
N09495	STBN430.2-0.625-E2-B.3-Z4	5/8	5/8	1-1/4	3-1/2	0.600	1-7/8	4	ALTIN	WELDON
N09496	STBN430.2-0.750-E2-B.0-Z4	3/4	3/4	1-1/2	4	0.720	2-1/4	4	ALTIN	CYLINDRICAL
N09497	STBN430.2-0.750-E2-B.3-Z4	3/4	3/4	1-1/2	4	0.720	2-1/4	4	ALTIN	WELDON
N09499	STBN430.2-1.000-E2-B.0-Z4	1	1	2	5	0.960	3	4	ALTIN	CYLINDRICAL
N09502	STBN430.2-1.000-E2-B.3-Z4	1	1	2	5	0.960	3	4	ALTIN	WELDON

STABILIZER™ 2.0-STR440.2

SOLID
CARBIDE

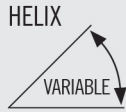

CENTER
CUTTING



- US Patent # 6,991,409
- Eccentric Primary Relief
- Continuous Varying Asymmetrical Flute Geometry
- Ideal for profiling and slotting in stainless steels, steels over 42 Rc, titanium, and inconel

ITEM NUMBER	DESCRIPTION	FLUTE DIA.	SHANK DIA.	LENGTH OF CUT	OVERALL LENGTH	FLUTES	COATING	RADIUS	SHANK TYPE
N09882	STR440.2-0.125-D1-R010.0-Z4	1/8	1/8	1/8	1-1/2	4	ALTIN	0.010	CYLINDRICAL
N09883	STR440.2-0.125-D2-R010.0-Z4	1/8	1/8	1/4	1-1/2	4	ALTIN	0.010	CYLINDRICAL
N09884	STR440.2-0.125-D3-R010.0-Z4	1/8	1/8	3/8	1-1/2	4	ALTIN	0.010	CYLINDRICAL
N09885	STR440.2-0.156-D1-R010.0-Z4	5/32	3/16	5/32	2	4	ALTIN	0.010	CYLINDRICAL
N09886	STR440.2-0.156-F2-R010.0-Z4	5/32	3/16	5/16	2	4	ALTIN	0.010	CYLINDRICAL
N09887	STR440.2-0.156-F3-R010.0-Z4	5/32	3/16	15/32	2	4	ALTIN	0.010	CYLINDRICAL
N09888	STR440.2-0.188-D1-R010.0-Z4	3/16	3/16	3/16	2	4	ALTIN	0.010	CYLINDRICAL
N09889	STR440.2-0.188-D2-R010.0-Z4	3/16	3/16	3/8	2	4	ALTIN	0.010	CYLINDRICAL
N09892	STR440.2-0.188-D3-R010.0-Z4	3/16	3/16	9/16	2	4	ALTIN	0.010	CYLINDRICAL
N09893	STR440.2-0.219-F1-R020.0-Z4	7/32	1/4	7/32	2	4	ALTIN	0.020	CYLINDRICAL
N09894	STR440.2-0.219-F2-R020.0-Z4	7/32	1/4	7/16	2-1/2	4	ALTIN	0.020	CYLINDRICAL
N09895	STR440.2-0.219-F3-R020.0-Z4	7/32	1/4	21/32	2-1/2	4	ALTIN	0.020	CYLINDRICAL
N09896	STR440.2-0.250-D1-R020.0-Z4	1/4	1/4	1/4	2	4	ALTIN	0.020	CYLINDRICAL
N09897	STR440.2-0.250-D2-R020.0-Z4	1/4	1/4	1/2	2-1/2	4	ALTIN	0.020	CYLINDRICAL
N09898	STR440.2-0.250-D3-R020.0-Z4	1/4	1/4	3/4	2-1/2	4	ALTIN	0.020	CYLINDRICAL
N09899	STR440.2-0.281-F1-R020.0-Z4	9/32	5/16	9/32	2	4	ALTIN	0.020	CYLINDRICAL
N09902	STR440.2-0.281-F2-R020.0-Z4	9/32	5/16	9/16	2-1/2	4	ALTIN	0.020	CYLINDRICAL
N09903	STR440.2-0.281-F3-R020.0-Z4	9/32	5/16	27/32	2-1/2	4	ALTIN	0.020	CYLINDRICAL
N09904	STR440.2-0.313-D1-R020.0-Z4	5/16	5/16	5/16	2	4	ALTIN	0.020	CYLINDRICAL
N09905	STR440.2-0.313-D2-R020.0-Z4	5/16	5/16	5/8	2-1/2	4	ALTIN	0.020	CYLINDRICAL
N09906	STR440.2-0.313-D3-R020.0-Z4	5/16	5/16	15/16	2-1/2	4	ALTIN	0.020	CYLINDRICAL
N09907	STR440.2-0.375-D1-R020.0-Z4	3/8	3/8	3/8	2	4	ALTIN	0.020	CYLINDRICAL
N09908	STR440.2-0.375-D1-R020.3-Z4	3/8	3/8	3/8	2	4	ALTIN	0.020	WELDON
N09909	STR440.2-0.375-D2-R020.0-Z4	3/8	3/8	3/4	2-1/2	4	ALTIN	0.020	CYLINDRICAL
N09912	STR440.2-0.375-D2-R020.3-Z4	3/8	3/8	3/4	2-1/2	4	ALTIN	0.020	WELDON
N09913	STR440.2-0.375-D3-R020.0-Z4	3/8	3/8	1-1/8	3	4	ALTIN	0.020	CYLINDRICAL
N09914	STR440.2-0.375-D3-R020.3-Z4	3/8	3/8	1-1/8	3	4	ALTIN	0.020	WELDON
N09915	STR440.2-0.438-D1-R020.0-Z4	7/16	7/16	7/16	2-3/4	4	ALTIN	0.020	CYLINDRICAL
N09916	STR440.2-0.438-D1-R020.3-Z4	7/16	7/16	7/16	2-3/4	4	ALTIN	0.020	WELDON
N09917	STR440.2-0.438-D2-R020.0-Z4	7/16	7/16	7/8	2-3/4	4	ALTIN	0.020	CYLINDRICAL
N09919	STR440.2-0.438-D2-R020.3-Z4	7/16	7/16	7/8	2-3/4	4	ALTIN	0.020	WELDON
N09934	STR440.2-0.438-D3-R020.0-Z4	7/16	7/16	1-5/16	4	4	ALTIN	0.020	CYLINDRICAL
N09935	STR440.2-0.438-D3-R020.3-Z4	7/16	7/16	1-5/16	4	4	ALTIN	0.020	WELDON
N09939	STR440.2-0.500-D1-R030.0-Z4	1/2	1/2	1/2	2-1/2	4	ALTIN	0.030	CYLINDRICAL
N09942	STR440.2-0.500-D1-R030.3-Z4	1/2	1/2	1/2	2-1/2	4	ALTIN	0.030	WELDON
N09943	STR440.2-0.500-D1-R060.0-Z4	1/2	1/2	1/2	2-1/2	4	ALTIN	0.060	CYLINDRICAL
N09944	STR440.2-0.500-D1-R060.3-Z4	1/2	1/2	1/2	2-1/2	4	ALTIN	0.060	WELDON
N09945	STR440.2-0.500-D1-R120.0-Z4	1/2	1/2	1/2	2-1/2	4	ALTIN	0.120	CYLINDRICAL
N09946	STR440.2-0.500-D1-R120.3-Z4	1/2	1/2	1/2	2-1/2	4	ALTIN	0.120	WELDON
N09947	STR440.2-0.500-D2-R030.0-Z4	1/2	1/2	1	3	4	ALTIN	0.030	CYLINDRICAL
N09948	STR440.2-0.500-D2-R030.3-Z4	1/2	1/2	1	3	4	ALTIN	0.030	WELDON
N09949	STR440.2-0.500-D3-R030.0-Z4	1/2	1/2	1-1/4	3	4	ALTIN	0.030	CYLINDRICAL

STABILIZER™ 2.0-STR440.2 (CONT.)

SOLID
CARBIDE

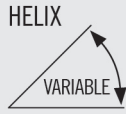

CENTER
CUTTING



- US Patent # 6,991,409
- Eccentric Primary Relief
- Continuous Varying Asymmetrical Flute Geometry
- Ideal for profiling and slotting in stainless steels, steels over 42 Rc, titanium, and inconel

ITEM NUMBER	DESCRIPTION	FLUTE DIA.	SHANK DIA.	LENGTH OF CUT	OVERALL LENGTH	FLUTES	COATING	RADIUS	SHANK TYPE
N09952	STR440.2-0.500-D3-R030.3-Z4	1/2	1/2	1-1/4	3	4	ALTIM	0.030	WELDON
N09953	STR440.2-0.500-D2-R060.0-Z4	1/2	1/2	1	3	4	ALTIM	0.060	CYLINDRICAL
N09954	STR440.2-0.500-D2-R060.3-Z4	1/2	1/2	1	3	4	ALTIM	0.060	WELDON
N09955	STR440.2-0.500-D2-R120.0-Z4	1/2	1/2	1	3	4	ALTIM	0.120	CYLINDRICAL
N09956	STR440.2-0.500-D2-R120.3-Z4	1/2	1/2	1	3	4	ALTIM	0.120	WELDON
N09957	STR440.2-0.500-D4-R030.0-Z4	1/2	1/2	1-1/2	4	4	ALTIM	0.030	CYLINDRICAL
N09958	STR440.2-0.500-D4-R030.3-Z4	1/2	1/2	1-1/2	4	4	ALTIM	0.030	WELDON
N09959	STR440.2-0.500-D3-R060.0-Z4	1/2	1/2	1-1/2	4	4	ALTIM	0.060	CYLINDRICAL
N09962	STR440.2-0.500-D3-R060.3-Z4	1/2	1/2	1-1/2	4	4	ALTIM	0.060	WELDON
N09963	STR440.2-0.500-D3-R120.0-Z4	1/2	1/2	1-1/2	4	4	ALTIM	0.120	CYLINDRICAL
N09964	STR440.2-0.500-D3-R120.3-Z4	1/2	1/2	1-1/2	4	4	ALTIM	0.120	WELDON
N09965	STR440.2-0.625-D1-R030.0-Z4	5/8	5/8	5/8	3	4	ALTIM	0.030	CYLINDRICAL
N09966	STR440.2-0.625-D1-R030.3-Z4	5/8	5/8	5/8	3	4	ALTIM	0.030	WELDON
N09967	STR440.2-0.625-D1-R060.0-Z4	5/8	5/8	5/8	3	4	ALTIM	0.060	CYLINDRICAL
N09968	STR440.2-0.625-D1-R060.3-Z4	5/8	5/8	5/8	3	4	ALTIM	0.060	WELDON
N09969	STR440.2-0.625-D1-R120.0-Z4	5/8	5/8	5/8	3	4	ALTIM	0.120	CYLINDRICAL
N09972	STR440.2-0.625-D1-R120.3-Z4	5/8	5/8	5/8	3	4	ALTIM	0.120	WELDON
N09973	STR440.2-0.625-D2-R030.0-Z4	5/8	5/8	1-1/4	3-1/2	4	ALTIM	0.030	CYLINDRICAL
N09974	STR440.2-0.625-D2-R030.3-Z4	5/8	5/8	1-1/4	3-1/2	4	ALTIM	0.030	WELDON
N09975	STR440.2-0.625-D2-R060.0-Z4	5/8	5/8	1-1/4	3-1/2	4	ALTIM	0.060	CYLINDRICAL
N09976	STR440.2-0.625-D2-R060.3-Z4	5/8	5/8	1-1/4	3-1/2	4	ALTIM	0.060	WELDON
N09977	STR440.2-0.625-D2-R120.0-Z4	5/8	5/8	1-1/4	3-1/2	4	ALTIM	0.120	CYLINDRICAL
N09978	STR440.2-0.625-D2-R120.3-Z4	5/8	5/8	1-1/4	3-1/2	4	ALTIM	0.120	WELDON
N09979	STR440.2-0.625-D3-R030.0-Z4	5/8	5/8	1-7/8	4	4	ALTIM	0.030	CYLINDRICAL
N09982	STR440.2-0.625-D3-R030.3-Z4	5/8	5/8	1-7/8	4	4	ALTIM	0.030	WELDON
N09983	STR440.2-0.625-D3-R060.0-Z4	5/8	5/8	1-7/8	4	4	ALTIM	0.060	CYLINDRICAL
N09984	STR440.2-0.625-D3-R060.3-Z4	5/8	5/8	1-7/8	4	4	ALTIM	0.060	WELDON
N00328	STR440.2-0.625-D3-R120.0-Z4	5/8	5/8	1-7/8	4	4	ALTIM	0.120	CYLINDRICAL
N00329	STR440.2-0.625-D3-R120.3-Z4	5/8	5/8	1-7/8	4	4	ALTIM	0.120	WELDON
N00332	STR440.2-0.750-D1-R030.0-Z4	3/4	3/4	3/4	3	4	ALTIM	0.030	CYLINDRICAL
N00333	STR440.2-0.750-D1-R030.3-Z4	3/4	3/4	3/4	3	4	ALTIM	0.030	WELDON
N00334	STR440.2-0.750-D1-R060.0-Z4	3/4	3/4	3/4	3	4	ALTIM	0.060	CYLINDRICAL
N00335	STR440.2-0.750-D1-R060.3-Z4	3/4	3/4	3/4	3	4	ALTIM	0.060	WELDON
N00336	STR440.2-0.750-D1-R120.0-Z4	3/4	3/4	3/4	3	4	ALTIM	0.120	CYLINDRICAL
N00337	STR440.2-0.750-D1-R120.3-Z4	3/4	3/4	3/4	4	4	ALTIM	0.120	WELDON
N00338	STR440.2-0.750-D2-R030.0-Z4	3/4	3/4	1-1/2	4	4	ALTIM	0.030	CYLINDRICAL
N00339	STR440.2-0.750-D2-R030.3-Z4	3/4	3/4	1-1/2	4	4	ALTIM	0.030	WELDON
N00342	STR440.2-0.750-D2-R060.0-Z4	3/4	3/4	1-1/2	4	4	ALTIM	0.060	CYLINDRICAL
N00343	STR440.2-0.750-D2-R060.3-Z4	3/4	3/4	1-1/2	4	4	ALTIM	0.060	WELDON
N00344	STR440.2-0.750-D2-R120.0-Z4	3/4	3/4	1-1/2	4	4	ALTIM	0.120	CYLINDRICAL
N00345	STR440.2-0.750-D2-R120.3-Z4	3/4	3/4	1-1/2	4	4	ALTIM	0.120	WELDON
N00346	STR440.2-0.750-D3-R030.0-Z4	3/4	3/4	2-1/4	5	4	ALTIM	0.030	CYLINDRICAL

STABILIZER™ 2.0-STR440.2 (CONT.)

SOLID CARBIDE

HELIX

RADIUS

CENTER CUTTING



- US Patent # 6,991,409
- Eccentric Primary Relief
- Continuous Varying Asymmetrical Flute Geometry
- Ideal for profiling and slotting in stainless steels, steels over 42 Rc, titanium, and inconel

ITEM NUMBER	DESCRIPTION	FLUTE DIA.	SHANK DIA.	LENGTH OF CUT	OVERALL LENGTH	FLUTES	COATING	RADIUS	SHANK TYPE
N00347	STR440.2-0.750-D3-R030.3-Z4	3/4	3/4	2-1/4	5	4	ALTIN	0.030	WELDON
N00348	STR440.2-0.750-D3-R060.0-Z4	3/4	3/4	2-1/4	5	4	ALTIN	0.060	CYLINDRICAL
N00349	STR440.2-0.750-D3-R060.3-Z4	3/4	3/4	2-1/4	5	4	ALTIN	0.060	WELDON
N00352	STR440.2-0.750-D3-R120.0-Z4	3/4	3/4	2-1/4	5	4	ALTIN	0.120	CYLINDRICAL
N00353	STR440.2-0.750-D3-R120.3-Z4	3/4	3/4	2-1/4	5	4	ALTIN	0.120	WELDON
N00354	STR440.2-1.000-D1-R030.0-Z4	1	1	1	4	4	ALTIN	0.030	CYLINDRICAL
N00355	STR440.2-1.000-D1-R030.3-Z4	1	1	1	4	4	ALTIN	0.030	WELDON
N09327	STR440.2-1.000-D1-R060.0-Z4	1	1	1	4	4	ALTIN	0.060	CYLINDRICAL
N09329	STR440.2-1.000-D1-R060.3-Z4	1	1	1	4	4	ALTIN	0.060	WELDON
N09333	STR440.2-1.000-D1-R120.0-Z4	1	1	1	4	4	ALTIN	0.120	CYLINDRICAL
N09336	STR440.2-1.000-D1-R120.3-Z4	1	1	1	4	4	ALTIN	0.120	WELDON
N09337	STR440.2-1.000-D2-R030.0-Z4	1	1	2	5	4	ALTIN	0.030	CYLINDRICAL
N09339	STR440.2-1.000-D2-R030.3-Z4	1	1	2	5	4	ALTIN	0.030	WELDON
N09343	STR440.2-1.000-D2-R060.0-Z4	1	1	2	5	4	ALTIN	0.060	CYLINDRICAL
N09346	STR440.2-1.000-D2-R060.3-Z4	1	1	2	5	4	ALTIN	0.060	WELDON
N09347	STR440.2-1.000-D2-R120.0-Z4	1	1	2	5	4	ALTIN	0.120	CYLINDRICAL
N09349	STR440.2-1.000-D2-R120.3-Z4	1	1	2	5	4	ALTIN	0.120	WELDON
N09356	STR440.2-1.000-D3-R030.0-Z4	1	1	3	6	4	ALTIN	0.030	CYLINDRICAL
N09357	STR440.2-1.000-D3-R030.3-Z4	1	1	3	6	4	ALTIN	0.030	WELDON
N09359	STR440.2-1.000-D3-R060.0-Z4	1	1	3	6	4	ALTIN	0.060	CYLINDRICAL
N09363	STR440.2-1.000-D3-R060.3-Z4	1	1	3	6	4	ALTIN	0.060	WELDON
N09366	STR440.2-1.000-D3-R120.0-Z4	1	1	3	6	4	ALTIN	0.120	CYLINDRICAL
N09367	STR440.2-1.000-D3-R120.3-Z4	1	1	3	6	4	ALTIN	0.120	WELDON

STABILIZER™ 2.0-STR440M.2

SOLID CARBIDE

HELIX

RADIUS

CENTER CUTTING



- US Patent # 6,991,409
- Eccentric Primary Relief
- Continuous Varying Asymmetrical Flute Geometry
- Ideal for profiling and slotting in stainless steels, steels over 42 Rc, titanium, and inconel

ITEM NUMBER	DESCRIPTION	FLUTE DIA.	SHANK DIA.	LENGTH OF CUT	OVERALL LENGTH	FLUTES	COATING	RADIUS	SHANK TYPE
N09636	STR440M.2-030-F2-R025.0-Z4	3	6	6	58	4	ALTIN	0.25	CYLINDRICAL
N09637	STR440M.2-030-F3-R025.0-Z4	3	6	9	58	4	ALTIN	0.25	CYLINDRICAL
N09645	STR440M.2-040-F2-R025.0-Z4	4	6	8	58	4	ALTIN	0.25	CYLINDRICAL
N09646	STR440M.2-040-F3-R025.0-Z4	4	6	12	58	4	ALTIN	0.25	CYLINDRICAL
N09647	STR440M.2-050-F2-R025.0-Z4	5	6	10	58	4	ALTIN	0.25	CYLINDRICAL
N09648	STR440M.2-050-F3-R025.0-Z4	5	6	15	58	4	ALTIN	0.25	CYLINDRICAL
N09649	STR440M.2-060-D2-R050.0-Z4	6	6	12	58	4	ALTIN	0.50	CYLINDRICAL
N09650	STR440M.2-060-D3-R050.0-Z4	6	6	18	58	4	ALTIN	0.50	CYLINDRICAL
N09651	STR440M.2-080-D2-R050.0-Z4	8	8	16	64	4	ALTIN	0.50	CYLINDRICAL
N09652	STR440M.2-080-D3-R050.0-Z4	8	8	24	64	4	ALTIN	0.50	CYLINDRICAL
N09653	STR440M.2-100-D2-R050.0-Z4	10	10	20	73	4	ALTIN	0.50	CYLINDRICAL
N09654	STR440M.2-100-D3-R050.0-Z4	10	10	30	73	4	ALTIN	0.50	CYLINDRICAL
N09655	STR440M.2-120-D2-R075.0-Z4	12	12	24	84	4	ALTIN	0.75	CYLINDRICAL
N09665	STR440M.2-120-D3-R075.0-Z4	12	12	36	84	4	ALTIN	0.75	CYLINDRICAL
N09667	STR440M.2-160-D2-R075.0-Z4	16	16	32	93	4	ALTIN	0.75	CYLINDRICAL
N09668	STR440M.2-160-D3-R075.0-Z4	16	16	48	93	4	ALTIN	0.75	CYLINDRICAL
N09670	STR440M.2-200-D2-R075.0-Z4	20	20	40	105	4	ALTIN	0.75	CYLINDRICAL
N09671	STR440M.2-200-D3-R075.0-Z4	20	20	60	125	4	ALTIN	0.75	CYLINDRICAL
N09672	STR440M.2-250-D2-R075.0-Z4	25	25	50	115	4	ALTIN	0.75	CYLINDRICAL
N09673	STR440M.2-250-D3-R075.0-Z4	25	25	75	147	4	ALTIN	0.75	CYLINDRICAL

STABILIZER™ 2.0-STB440.2 & STB440M.2

SOLID CARBIDE

CENTER CUTTING



- US Patent # 6,991,409
- Eccentric Primary Relief
- Continuous Varying Asymmetrical Flute Geometry
- Ideal for profiling and slotting in stainless steels, steels over 42 Rc, titanium, and inconel

ITEM NUMBER	DESCRIPTION	FLUTE DIA.	SHANK DIA.	LENGTH OF CUT	OVERALL LENGTH	FLUTES	COATING	SHANK TYPE
INCH - STB440.2								
N09407	STB440.2-0.125-D2-B.0-Z4	1/8	1/8	1/4	1-1/2	4	ALTIN	CYLINDRICAL
N09408	STB440.2-0.188-D2-B.0-Z4	3/16	3/16	3/8	2	4	ALTIN	CYLINDRICAL
N09409	STB440.2-0.250-D2-B.0-Z4	1/4	1/4	1/2	2-1/2	4	ALTIN	CYLINDRICAL
N09422	STB440.2-0.313-D2-B.0-Z4	5/16	5/16	5/8	2-1/2	4	ALTIN	CYLINDRICAL
N09423	STB440.2-0.375-D2-B.0-Z4	3/8	3/8	3/4	2-1/2	4	ALTIN	CYLINDRICAL
N09426	STB440.2-0.375-D2-B.3-Z4	3/8	3/8	3/4	2-1/2	4	ALTIN	WELDON
N09427	STB440.2-0.438-D2-B.0-Z4	7/16	7/16	7/8	2-3/4	4	ALTIN	CYLINDRICAL
N09428	STB440.2-0.438-D2-B.3-Z4	7/16	7/16	7/8	2-3/4	4	ALTIN	WELDON
N09429	STB440.2-0.500-D2-B.0-Z4	1/2	1/2	1	3	4	ALTIN	CYLINDRICAL
N09432	STB440.2-0.500-D2-B.3-Z4	1/2	1/2	1	3	4	ALTIN	WELDON
N09433	STB440.2-0.625-D2-B.0-Z4	5/8	5/8	1-1/4	3-1/2	4	ALTIN	CYLINDRICAL
N09442	STB440.2-0.625-D2-B.3-Z4	5/8	5/8	1-1/4	3-1/2	4	ALTIN	WELDON
N09443	STB440.2-0.750-D2-B.0-Z4	3/4	3/4	1-1/2	4	4	ALTIN	CYLINDRICAL
N09444	STB440.2-0.750-D2-B.3-Z4	3/4	3/4	1-1/2	4	4	ALTIN	WELDON
N09445	STB440.2-1.000-D2-B.0-Z4	1	1	2	5	4	ALTIN	CYLINDRICAL
N09446	STB440.2-1.000-D2-B.3-Z4	1	1	2	5	4	ALTIN	WELDON
METRIC - STB440M.2								
N09674	STB440M.2-030-F2-B.0-Z4	3mm	6mm	6mm	58mm	4	ALTIN	CYLINDRICAL
N09675	STB440M.2-030-F3-B.0-Z4	3mm	6mm	9mm	58mm	4	ALTIN	CYLINDRICAL
N09676	STB440M.2-040-F2-B.0-Z4	4mm	6mm	8mm	58mm	4	ALTIN	CYLINDRICAL
N09677	STB440M.2-040-F3-B.0-Z4	4mm	6mm	12mm	58mm	4	ALTIN	CYLINDRICAL
N09679	STB440M.2-050-F2-B.0-Z4	5mm	6mm	10mm	58mm	4	ALTIN	CYLINDRICAL
N09680	STB440M.2-050-F3-B.0-Z4	5mm	6mm	15mm	58mm	4	ALTIN	CYLINDRICAL
N09682	STB440M.2-060-D2-B.0-Z4	6mm	6mm	12mm	58mm	4	ALTIN	CYLINDRICAL
N09683	STB440M.2-060-D3-B.0-Z4	6mm	6mm	18mm	58mm	4	ALTIN	CYLINDRICAL
N09684	STB440M.2-080-D2-B.0-Z4	8mm	8mm	16mm	64mm	4	ALTIN	CYLINDRICAL
N09685	STB440M.2-080-D3-B.0-Z4	8mm	8mm	24mm	64mm	4	ALTIN	CYLINDRICAL
N09686	STB440M.2-100-D2-B.0-Z4	10mm	10mm	20mm	73mm	4	ALTIN	CYLINDRICAL
N09687	STB440M.2-100-D3-B.0-Z4	10mm	10mm	30mm	73mm	4	ALTIN	CYLINDRICAL
N09688	STB440M.2-120-D2-B.0-Z4	12mm	12mm	24mm	84mm	4	ALTIN	CYLINDRICAL
N09689	STB440M.2-120-D3-B.0-Z4	12mm	12mm	36mm	84mm	4	ALTIN	CYLINDRICAL
N09690	STB440M.2-160-D2-B.0-Z4	16mm	16mm	32mm	93mm	4	ALTIN	CYLINDRICAL
N09691	STB440M.2-160-D3-B.0-Z4	16mm	16mm	48mm	93mm	4	ALTIN	CYLINDRICAL
N09692	STB440M.2-200-D2-B.0-Z4	20mm	20mm	40mm	105mm	4	ALTIN	CYLINDRICAL
N09693	STB440M.2-200-D3-B.0-Z4	20mm	20mm	60mm	125mm	4	ALTIN	CYLINDRICAL
N09694	STB440M.2-250-D2-B.0-Z4	25mm	25mm	50mm	115mm	4	ALTIN	CYLINDRICAL
N09695	STB440M.2-250-D3-B.0-Z4	25mm	25mm	75mm	147mm	4	ALTIN	CYLINDRICAL

STABILIZER™ 2.0-STRN440.2

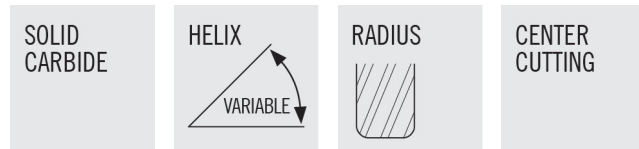

- US Patent # 6,991,409
- Eccentric Primary Relief
- Continuous Varying Asymmetrical Flute Geometry
- Ideal for profiling and slotting in stainless steels, steels over 42 Rc, titanium, and inconel

ITEM NUMBER	DESCRIPTION	FLUTE DIA.	SHANK DIA.	LENGTH OF CUT	OVERALL LENGTH	NECK DIA.	REACH	FLUTES	COATING	RADIUS	SHANK TYPE
N09503	STRN440.2-0.250-E2-R020.0-Z4	1/4	1/4	1/2	2-1/2	0.240	3/4	4	ALTIN	0.020	CYLINDRICAL
N09504	STRN440.2-0.313-E2-R020.0-Z4	5/16	5/16	5/8	3	0.300	15/16	4	ALTIN	0.020	CYLINDRICAL
N09505	STRN440.2-0.375-E2-R020.0-Z4	3/8	3/8	3/4	3	0.360	1-1/8	4	ALTIN	0.020	CYLINDRICAL
N09506	STRN440.2-0.375-E2-R020.3-Z4	3/8	3/8	3/4	3	0.360	1-1/8	4	ALTIN	0.020	WELDON
N09507	STRN440.2-0.438-E2-R020.0-Z4	7/16	7/16	7/8	4	0.420	1-5/16	4	ALTIN	0.020	CYLINDRICAL
N09508	STRN440.2-0.438-E2-R020.3-Z4	7/16	7/16	7/8	4	0.420	1-5/16	4	ALTIN	0.020	WELDON
N09509	STRN440.2-0.500-E2-R030.0-Z4	1/2	1/2	1	3	0.480	1-1/2	4	ALTIN	0.030	CYLINDRICAL
N09512	STRN440.2-0.500-E2-R030.3-Z4	1/2	1/2	1	3	0.480	1-1/2	4	ALTIN	0.030	WELDON
N09513	STRN440.2-0.625-E2-R030.0-Z4	5/8	5/8	1-1/4	3-1/2	0.600	1-7/8	4	ALTIN	0.030	CYLINDRICAL
N09515	STRN440.2-0.625-E2-R030.3-Z4	5/8	5/8	1-1/4	3-1/2	0.600	1-7/8	4	ALTIN	0.030	WELDON
N09516	STRN440.2-0.750-E2-R030.0-Z4	3/4	3/4	1-1/2	4	0.720	2-1/4	4	ALTIN	0.030	CYLINDRICAL
N09517	STRN440.2-0.750-E2-R030.3-Z4	3/4	3/4	1-1/2	4	0.720	2-1/4	4	ALTIN	0.030	WELDON
N09518	STRN440.2-1.000-E2-R030.0-Z4	1	1	2	5	0.960	3	4	ALTIN	0.030	CYLINDRICAL
N09519	STRN440.2-1.000-E2-R030.3-Z4	1	1	2	5	0.960	3	4	ALTIN	0.030	WELDON

STABILIZER™ 2.0-STBN440.2

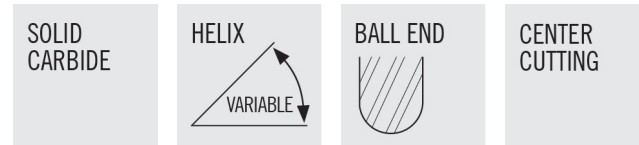

ITEM NUMBER	DESCRIPTION	FLUTE DIA.	SHANK DIA.	LENGTH OF CUT	OVERALL LENGTH	NECK DIA.	REACH	FLUTES	COATING	SHANK TYPE
N09522	STBN440.2-0.250-E2-B.0-Z4	1/4	1/4	1/2	2-1/2	0.240	3/4	4	ALTIN	CYLINDRICAL
N09523	STBN440.2-0.313-E2-B.0-Z4	5/16	5/16	5/8	3	0.300	15/16	4	ALTIN	CYLINDRICAL
N09524	STBN440.2-0.375-E2-B.0-Z4	3/8	3/8	3/4	3	0.360	1-1/8	4	ALTIN	CYLINDRICAL
N09525	STBN440.2-0.375-E2-B.3-Z4	3/8	3/8	3/4	3	0.360	1-1/8	4	ALTIN	WELDON
N09526	STBN440.2-0.438-E2-B.0-Z4	7/16	7/16	7/8	4	0.420	1-5/16	4	ALTIN	CYLINDRICAL
N09527	STBN440.2-0.438-E2-B.3-Z4	7/16	7/16	7/8	4	0.420	1-5/16	4	ALTIN	WELDON
N09528	STBN440.2-0.500-E2-B.0-Z4	1/2	1/2	1	3	0.480	1-1/2	4	ALTIN	CYLINDRICAL
N09529	STBN440.2-0.500-E2-B.3-Z4	1/2	1/2	1	3	0.480	1-1/2	4	ALTIN	WELDON
N09532	STBN440.2-0.625-E2-B.0-Z4	5/8	5/8	1-1/4	3-1/2	0.600	1-7/8	4	ALTIN	CYLINDRICAL
N09533	STBN440.2-0.625-E2-B.3-Z4	5/8	5/8	1-1/4	3-1/2	0.600	1-7/8	4	ALTIN	WELDON
N09534	STBN440.2-0.750-E2-B.0-Z4	3/4	3/4	1-1/2	4	0.720	2-1/4	4	ALTIN	CYLINDRICAL
N09535	STBN440.2-0.750-E2-B.3-Z4	3/4	3/4	1-1/2	4	0.720	2-1/4	4	ALTIN	WELDON
N09536	STBN440.2-1.000-E2-B.0-Z4	1	1	2	5	0.960	3	4	ALTIN	CYLINDRICAL
N09537	STBN440.2-1.000-E2-B.3-Z4	1	1	2	5	0.960	3	4	ALTIN	WELDON

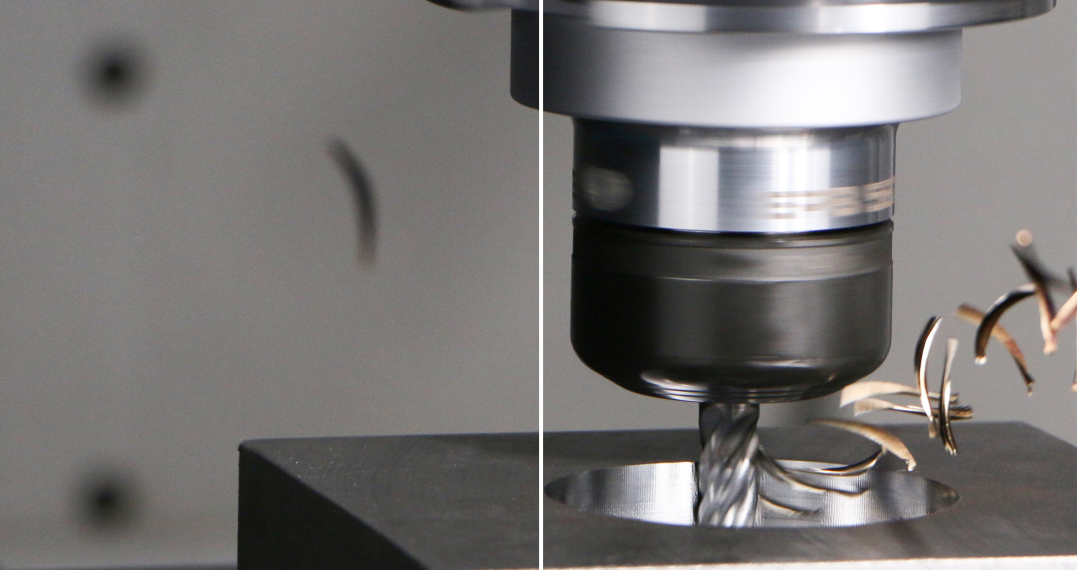

GET A TOOLROOM WORTH OF PRODUCTIVITY AND VERSATILITY IN ONE END MILL

STABILIZER™ 5-FLUTE

Simplify tool selection and part programming with the new Niagara Cutter multi-purpose ST540 family of 5-flute end mills. Gain part processing versatility with the ability to handle slot milling, side mill roughing, side mill finishing and face milling applications as well as in traditional and high-performance optimized roughing, pocketing and ramping – all with a single product family. Reduce your tool inventory with the universal ST540 family and work equally effective in all materials such as steel, cast iron, stainless steels and superalloys.

RANGE OVERVIEW

STS540 / STR540 - 5-FLUTE, SQUARE & RADIUS

- .125” – 1.000” diameters (and 6mm-16mm), up to 4xD flute length

STRN540 - 5-FLUTE, NECKED SERIES

- .250” – 1.000” diameters, up to 2xD flute length and 8xD reach length

STRCS540 - 5-FLUTE, CHIP SPLITTER SERIES

- .250” – .750” diameters, up to 3.2xD flute length

YOUR BENEFITS

- More aggressive full slotting and large radial stepover cuts made possible by the 5-flute design’s efficient chip evacuation
- Maintain optimal cutting speeds and achieve high-quality surfaces with the superior harmonics and chatter reduction of variable geometry
- Superior tool life, wear resistance and edge strength thanks to AlCrN coating, eccentric radial relief and asymmetrical cutting edges
- Maximize material removal in long-tool applications and prevent long chips from nesting and causing downtime or ruining surface finishes with extended reach configurations and a new advanced chip splitter

MATERIAL GROUPS
Steel 1-6
Stainless Steel 8-11
Cast Iron 12-15
Superalloys 19-22

Bridge the gap between the Stabilizer™ 2.0 and the S638, S738, S938 Multi Flute product family

INDUSTRY TARGETS

- Aerospace
- Automotive
- General Engineering
- Medical

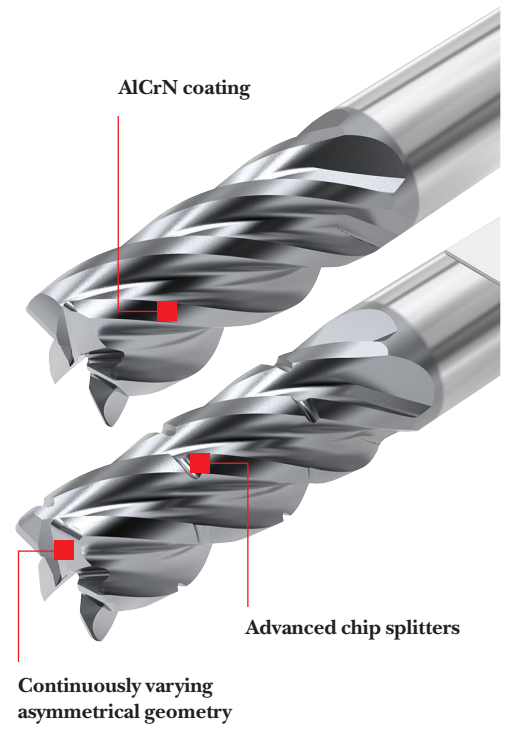

4 TIPS

FOR HIGH-PERFORMANCE VERSATILITY

The right 5-Flute end mill offers a unique balance of versatility and performance across a variety of high performance applications, materials, and setups. Subpar machines with limited horsepower, fixture rigidity, spindle type, CNC controller lookahead and programming styles can wreak havoc on more specialized high-performance end mills. 5-Flutes rough, finish, even optimize rough without requiring the finer tuning or optimal setups of its 4 or 6-flute counterparts.

1. BEING STUCK IN THE MIDDLE CAN BE A GOOD THING

4-flute end mills designed for heavy roughing applications typically struggle to perform when it comes to light radial stepovers less than 20% of the diameter of the tool. This means that finishing cuts are almost always out of the question. On the other side of the spectrum, multi-flute end mills with 6 flutes or more excel in optimized roughing and side mill finishing applications, typically taking less than 15% of the diameter radial stepovers. However, these end mills lack the chip spacing for heavy slotting and side milling cuts. The 5-flute ST540 Stabilizer™ falls right in the middle because it takes both roughing and finishing cuts with ease as well as slot milling, helical ramping and face milling cuts. If you are looking for one tool for all square shoulder milling applications, the 5-flute ST540 Stabilizer is the tool for you.

2. VERSATILITY + PERFORMANCE = COST SAVINGS

We are all looking for ways to reduce machining costs. In the fast-paced world of manufacturing, more and more machine shops are having to machine wider ranges of materials utilizing multiple square shoulder milling strategies. This poses a unique challenge for machine shops because not all end mills and materials are created equal. Some end mills are designed for only certain materials and others only work well in certain types of milling applications. Trying to have the right tool for every application and material can cause tooling costs to increase and fluctuate rapidly. Utilizing the ST540 product family helps reduce tooling costs and increase consistent performance due to its unique ability to work in all material types regardless of machining strategy.

3. BALANCE IS KEY TO SUCCESS

Looking to find balance in your manufacturing processes? Utilizing the 5-flute ST540 Stabilizer product family is a great way to balance tooling cost, performance and versatility. Material type, machining strategy, machine setup and fixture rigidity all play a vital role in the machining process. The variable flute geometry coupled with varied helix angles and edge prep ensure consistent performance and reliable tool life. The break-up of chatter and harmonics results in less cutting edge failure due to micro chipping.

4. THE "BEST" ISN'T ALWAYS THE BEST

When choosing the proper end mill for your machining process, sometimes using the best of the best may not be the best choice. Most end mills designed for high-performance machining strategies require high amounts of horsepower, torque and rigidity. End mills specialized for advanced side milling strategies require newer CNC machining centers with advanced controls to keep up with rapidly changing feed rates and high spindle speeds.

If your machining centers lack any one of these requirements using a more versatile 5-flute geometry like the ST540 can offer high-performance solutions in less than optimal machining conditions. A tough carbide substrate coupled with an advanced coating and edge prep ensure that the ST540 product family maintains consistent quality by protecting the cutting edges from irregular machining conditions.



STABILIZER™-STS540 & STS540M

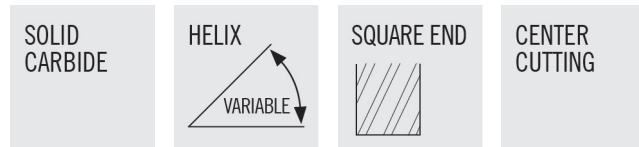

- Asymmetrical cutting edges
- US Patent # 6,991,409
- Ideal for profiling, high speed and trochoidal milling, stainless, titanium, high temperature alloys, carbon, alloy and tool steels
- Eccentric radial relief

ITEM NUMBER	DESCRIPTION	FLUTE DIA.	SHANK DIA.	LENGTH OF CUT	OVERALL LENGTH	FLUTES	COATING	SHANK TYPE
IMPERIAL - STS540								
03257826	STS540-0.125-D2-S.0-Z5	1/8	1/8	1/4	1-1/2	5	ALCRN	CYLINDRICAL
03257828	STS540-0.125-D4-S.0-Z5	1/8	1/8	1/2	1-1/2	5	ALCRN	CYLINDRICAL
03257830	STS540-0.156-F2-S.0-Z5	5/32	3/16	5/16	2	5	ALCRN	CYLINDRICAL
03257832	STS540-0.156-F4-S.0-Z5	5/32	3/16	9/16	2	5	ALCRN	CYLINDRICAL
03257834	STS540-0.188-D2-S.0-Z5	3/16	3/16	5/16	2	5	ALCRN	CYLINDRICAL
03257836	STS540-0.188-D3-S.0-Z5	3/16	3/16	9/16	2	5	ALCRN	CYLINDRICAL
03257838	STS540-0.219-F2-S.0-Z5	7/32	1/4	3/8	2	5	ALCRN	CYLINDRICAL
03257840	STS540-0.219-F3-S.0-Z5	7/32	1/4	3/4	2-1/2	5	ALCRN	CYLINDRICAL
03257842	STS540-0.250-D1-S.0-Z5	1/4	1/4	3/8	2	5	ALCRN	CYLINDRICAL
N68625	STS540-0.250-D3-S.0-Z5	1/4	1/4	3/4	2-1/2	5	ALCRN	CYLINDRICAL
N68626	STS540-0.313-D2-S.0-Z5	5/16	5/16	3/4	2-1/2	5	ALCRN	CYLINDRICAL
03257857	STS540-0.375-D1-S.0-Z5	3/8	3/8	1/2	2-1/2	5	ALCRN	CYLINDRICAL
N68627	STS540-0.375-D2-S.0-Z5	3/8	3/8	7/8	2-1/2	5	ALCRN	CYLINDRICAL
03257880	STS540-0.500-D1-S.0-Z5	1/2	1/2	5/8	3	5	ALCRN	CYLINDRICAL
03257881	STS540-0.500-D1-S.3-Z5	1/2	1/2	5/8	3	5	ALCRN	WELDON
03257889	STS540-0.500-D2-S.0-Z5	1/2	1/2	1	3	5	ALCRN	CYLINDRICAL
03257890	STS540-0.500-D2-S.3-Z5	1/2	1/2	1	3	5	ALCRN	WELDON
N68628	STS540-0.500-D3-S.0-Z5	1/2	1/2	1-1/4	3	5	ALCRN	CYLINDRICAL
03257919	STS540-0.625-D1-S.0-Z5	5/8	5/8	3/4	3	5	ALCRN	CYLINDRICAL
03257920	STS540-0.625-D1-S.3-Z5	5/8	5/8	3/4	3	5	ALCRN	WELDON
N68629	STS540-0.625-D2-S.0-Z5	5/8	5/8	1-1/4	3-1/2	5	ALCRN	CYLINDRICAL
03257927	STS540-0.625-D4-S.0-Z5	5/8	5/8	1-5/8	3-1/2	5	ALCRN	CYLINDRICAL
03257929	STS540-0.625-D5-S.0-Z5	5/8	5/8	2-1/8	4	5	ALCRN	CYLINDRICAL
03257940	STS540-0.750-D1-S.0-Z5	3/4	3/4	7/8	3	5	ALCRN	CYLINDRICAL
N68630	STS540-0.750-D2-S.0-Z5	3/4	3/4	1-1/2	4	5	ALCRN	CYLINDRICAL
METRIC - STS540M								
N68699	STS540M-060-D2-S.0-Z5	6	6	12	58	5	ALTIN	CYLINDRICAL
N68700	STS540M-080-D2-S.0-Z5	8	8	16	64	5	ALTIN	CYLINDRICAL
N68701	STS540M-100-D2-S.0-Z5	10	10	20	73	5	ALTIN	CYLINDRICAL
N68702	STS540M-120-D2-S.0-Z5	12	12	24	84	5	ALTIN	CYLINDRICAL

STABILIZER™-STR540

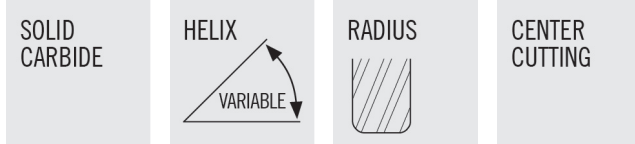

- Asymmetrical flute geometry
- US Patent # 6,991,409
- Ideal for profiling, high speed and trochoidal milling, stainless, titanium, high temperature alloys, carbon, alloy and tool steels
- Eccentric radial relief

ITEM NUMBER	DESCRIPTION	FLUTE DIA.	SHANK DIA.	LENGTH OF CUT	OVERALL LENGTH	FLUTES	COATING	RADIUS	SHANK TYPE
03257827	STR540-0.125-D2-R010.0-Z5	1/8	1/8	1/4	1-1/2	5	ALCRN	0.010	CYLINDRICAL
03257829	STR540-0.125-D4-R010.0-Z5	1/8	1/8	1/2	1-1/2	5	ALCRN	0.010	CYLINDRICAL
03257831	STR540-0.156-F2-R010.0-Z5	5/32	3/16	5/16	2	5	ALCRN	0.010	CYLINDRICAL
03257833	STR540-0.156-F4-R010.0-Z5	5/32	3/16	9/16	2	5	ALCRN	0.010	CYLINDRICAL
03257835	STR540-0.188-D2-R010.0-Z5	3/16	3/16	5/16	2	5	ALCRN	0.010	CYLINDRICAL
03257837	STR540-0.188-D3-R010.0-Z5	3/16	3/16	9/16	2	5	ALCRN	0.010	CYLINDRICAL
03257839	STR540-0.219-F2-R010.0-Z5	7/32	1/4	3/8	2	5	ALCRN	0.010	CYLINDRICAL
03257841	STR540-0.219-F3-R010.0-Z5	7/32	1/4	3/4	2-1/2	5	ALCRN	0.010	CYLINDRICAL
03257843	STR540-0.250-D1-R015.0-Z5	1/4	1/4	3/8	2	5	ALCRN	0.015	CYLINDRICAL
03257844	STR540-0.250-D1-R030.0-Z5	1/4	1/4	3/8	2	5	ALCRN	0.030	CYLINDRICAL
03257845	STR540-0.250-D1-R045.0-Z5	1/4	1/4	3/8	2	5	ALCRN	0.045	CYLINDRICAL
N68632	STR540-0.250-D3-R015.0-Z5	1/4	1/4	3/4	2-1/2	5	ALCRN	0.015	CYLINDRICAL
N68639	STR540-0.250-D3-R030.0-Z5	1/4	1/4	3/4	2-1/2	5	ALCRN	0.030	CYLINDRICAL
N68646	STR540-0.250-D3-R045.0-Z5	1/4	1/4	3/4	2-1/2	5	ALCRN	0.045	CYLINDRICAL
03257846	STR540-0.250-D4-R015.0-Z5	1/4	1/4	1	3	5	ALCRN	0.015	CYLINDRICAL
N68633	STR540-0.313-D2-R015.0-Z5	5/16	5/16	3/4	2-1/2	5	ALCRN	0.015	CYLINDRICAL
03257858	STR540-0.375-D1-R015.0-Z5	3/8	3/8	1/2	2-1/2	5	ALCRN	0.015	CYLINDRICAL
03257859	STR540-0.375-D1-R030.0-Z5	3/8	3/8	1/2	2-1/2	5	ALCRN	0.030	CYLINDRICAL
03257860	STR540-0.375-D1-R045.0-Z5	3/8	3/8	1/2	2-1/2	5	ALCRN	0.045	CYLINDRICAL
N68634	STR540-0.375-D2-R015.0-Z5	3/8	3/8	7/8	2-1/2	5	ALCRN	0.015	CYLINDRICAL
N68641	STR540-0.375-D2-R030.0-Z5	3/8	3/8	7/8	2-1/2	5	ALCRN	0.030	CYLINDRICAL
N68648	STR540-0.375-D2-R045.0-Z5	3/8	3/8	7/8	2-1/2	5	ALCRN	0.045	CYLINDRICAL
03257861	STR540-0.375-D2-R060.0-Z5	3/8	3/8	7/8	2-1/2	5	ALCRN	0.060	CYLINDRICAL
03257862	STR540-0.375-D3-R030.0-Z5	3/8	3/8	1-1/4	3	5	ALCRN	0.030	CYLINDRICAL
03257863	STR540-0.375-D4-R030.0-Z5	3/8	3/8	1-1/2	4	5	ALCRN	0.030	CYLINDRICAL
03257882	STR540-0.500-D1-R015.0-Z5	1/2	1/2	5/8	3	5	ALCRN	0.015	CYLINDRICAL
03257883	STR540-0.500-D1-R030.0-Z5	1/2	1/2	5/8	3	5	ALCRN	0.030	CYLINDRICAL
03257884	STR540-0.500-D1-R030.3-Z5	1/2	1/2	5/8	3	5	ALCRN	0.030	WELDON
03257885	STR540-0.500-D1-R045.0-Z5	1/2	1/2	5/8	3	5	ALCRN	0.045	CYLINDRICAL
03257886	STR540-0.500-D1-R060.0-Z5	1/2	1/2	5/8	3	5	ALCRN	0.060	CYLINDRICAL
03257887	STR540-0.500-D1-R060.3-Z5	1/2	1/2	5/8	3	5	ALCRN	0.060	WELDON
03257888	STR540-0.500-D1-R120.0-Z5	1/2	1/2	5/8	3	5	ALCRN	0.120	CYLINDRICAL
03257891	STR540-0.500-D2-R015.0-Z5	1/2	1/2	1	3	5	ALCRN	0.015	CYLINDRICAL
03257892	STR540-0.500-D2-R030.0-Z5	1/2	1/2	1	3	5	ALCRN	0.030	CYLINDRICAL
03257893	STR540-0.500-D2-R030.3-Z5	1/2	1/2	1	3	5	ALCRN	0.030	WELDON
03257894	STR540-0.500-D2-R060.0-Z5	1/2	1/2	1	3	5	ALCRN	0.060	CYLINDRICAL
03257895	STR540-0.500-D2-R060.3-Z5	1/2	1/2	1	3	5	ALCRN	0.060	WELDON

STABILIZER™-STR540 (CONT.)

SOLID
CARBIDE

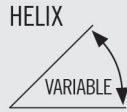

CENTER
CUTTING

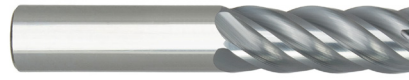



- Asymmetrical flute geometry
- US Patent # 6,991,409
- Ideal for profiling, high speed and trochoidal milling, stainless, titanium, high temperature alloys, carbon, alloy and tool steels
- Eccentric radial relief

ITEM NUMBER	DESCRIPTION	FLUTE DIA.	SHANK DIA.	LENGTH OF CUT	OVERALL LENGTH	FLUTES	COATING	RADIUS	SHANK TYPE
IMPERIAL - STR540									
N68635	STR540-0.500-D3-R015.0-Z5	1/2	1/2	1-1/4	3	5	ALCRN	0.015	CYLINDRICAL
N68642	STR540-0.500-D3-R030.0-Z5	1/2	1/2	1-1/4	3	5	ALCRN	0.030	CYLINDRICAL
N68649	STR540-0.500-D3-R045.0-Z5	1/2	1/2	1-1/4	3	5	ALCRN	0.045	CYLINDRICAL
N68653	STR540-0.500-D3-R060.0-Z5	1/2	1/2	1-1/4	3	5	ALCRN	0.060	CYLINDRICAL
N68657	STR540-0.500-D3-R090.0-Z5	1/2	1/2	1-1/4	3	5	ALCRN	0.090	CYLINDRICAL
N68661	STR540-0.500-D3-R125.0-Z5	1/2	1/2	1-1/4	3	5	ALCRN	0.125	CYLINDRICAL
03257896	STR540-0.500-D4-R030.0-Z5	1/2	1/2	1-5/8	4	5	ALCRN	0.030	CYLINDRICAL
03257897	STR540-0.500-D4-R030.3-Z5	1/2	1/2	1-5/8	4	5	ALCRN	0.030	WELDON
03257898	STR540-0.500-D5-R030.0-Z5	1/2	1/2	2	4	5	ALCRN	0.030	CYLINDRICAL
03257899	STR540-0.500-D5-R030.3-Z5	1/2	1/2	2	4	5	ALCRN	0.030	WELDON
03257921	STR540-0.625-D1-R015.0-Z5	5/8	5/8	3/4	3	5	ALCRN	0.015	CYLINDRICAL
03257922	STR540-0.625-D1-R030.0-Z5	5/8	5/8	3/4	3	5	ALCRN	0.030	CYLINDRICAL
03257923	STR540-0.625-D1-R030.3-Z5	5/8	5/8	3/4	3	5	ALCRN	0.030	WELDON
03257924	STR540-0.625-D1-R060.0-Z5	5/8	5/8	3/4	3	5	ALCRN	0.060	CYLINDRICAL
03257925	STR540-0.625-D1-R060.3-Z5	5/8	5/8	3/4	3	5	ALCRN	0.060	WELDON
03257926	STR540-0.625-D1-R120.0-Z5	5/8	5/8	3/4	3	5	ALCRN	0.120	CYLINDRICAL
N68636	STR540-0.625-D2-R015.0-Z5	5/8	5/8	1-1/4	3-1/2	5	ALCRN	0.015	CYLINDRICAL
N68643	STR540-0.625-D2-R030.0-Z5	5/8	5/8	1-1/4	3-1/2	5	ALCRN	0.030	CYLINDRICAL
N68650	STR540-0.625-D2-R045.0-Z5	5/8	5/8	1-1/4	3-1/2	5	ALCRN	0.045	CYLINDRICAL
N68654	STR540-0.625-D2-R060.0-Z5	5/8	5/8	1-1/4	3-1/2	5	ALCRN	0.060	CYLINDRICAL
N68658	STR540-0.625-D2-R090.0-Z5	5/8	5/8	1-1/4	3-1/2	5	ALCRN	0.090	CYLINDRICAL
N68662	STR540-0.625-D2-R125.0-Z5	5/8	5/8	1-1/4	3-1/2	5	ALCRN	0.125	CYLINDRICAL
03257928	STR540-0.625-D4-R030.3-Z5	5/8	5/8	1-5/8	3-1/2	5	ALCRN	0.030	WELDON
03257930	STR540-0.625-D5-R030.3-Z5	5/8	5/8	2-1/8	4	5	ALCRN	0.030	WELDON
03257941	STR540-0.750-D1-R030.0-Z5	3/4	3/4	7/8	3	5	ALCRN	0.030	CYLINDRICAL
03257942	STR540-0.750-D1-R060.0-Z5	3/4	3/4	7/8	3	5	ALCRN	0.060	CYLINDRICAL
03257943	STR540-0.750-D1-R120.0-Z5	3/4	3/4	7/8	3	5	ALCRN	0.120	CYLINDRICAL
N68644	STR540-0.750-D2-R030.0-Z5	3/4	3/4	1-1/2	4	5	ALCRN	0.030	CYLINDRICAL
N68655	STR540-0.750-D2-R060.0-Z5	3/4	3/4	1-1/2	4	5	ALCRN	0.060	CYLINDRICAL
N68659	STR540-0.750-D2-R090.0-Z5	3/4	3/4	1-1/2	4	5	ALCRN	0.090	CYLINDRICAL
N68663	STR540-0.750-D2-R125.0-Z5	3/4	3/4	1-1/2	4	5	ALCRN	0.125	CYLINDRICAL
03257944	STR540-0.750-D3-R030.0-Z5	3/4	3/4	1-5/8	4	5	ALCRN	0.030	CYLINDRICAL
03257945	STR540-0.750-D3-R030.3-Z5	3/4	3/4	1-5/8	4	5	ALCRN	0.030	WELDON
03257946	STR540-0.750-D4-R030.0-Z5	3/4	3/4	2-1/4	5	5	ALCRN	0.030	CYLINDRICAL
03257947	STR540-0.750-D5-R030.0-Z5	3/4	3/4	2-3/4	5	5	ALCRN	0.030	CYLINDRICAL
N68638	STR540-1.000-D2-R015.0-Z5	1	1	1-3/4	4	5	ALCRN	0.015	CYLINDRICAL
N68645	STR540-1.000-D2-R030.0-Z5	1	1	1-3/4	4	5	ALCRN	0.030	CYLINDRICAL
N68656	STR540-1.000-D2-R060.0-Z5	1	1	1-3/4	4	5	ALCRN	0.060	CYLINDRICAL

STABILIZER™-STR540M

SOLID
CARBIDE

HELIX

RADIUS

CENTER
CUTTING

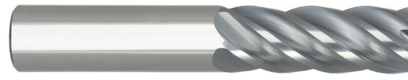

- Asymmetrical flute geometry
- US Patent # 6,991,409
- Ideal for profiling, high speed and trochoidal milling, stainless, titanium, high temperature alloys, carbon, alloy and tool steels
- Eccentric radial relief

ITEM NUMBER	DESCRIPTION	FLUTE DIA.	SHANK DIA.	LENGTH OF CUT	OVERALL LENGTH	FLUTES	COATING	RADIUS	SHANK TYPE
METRIC - STR540M									
N68717	STR540M-060-D2-R050.0-Z5	6	6	12	58	5	ALTIN	0.50	CYLINDRICAL
N68718	STR540M-080-D2-R050.0-Z5	8	8	16	64	5	ALTIN	0.50	CYLINDRICAL
N68719	STR540M-100-D2-R050.0-Z5	10	10	20	73	5	ALTIN	0.50	CYLINDRICAL
N68720	STR540M-120-D2-R075.0-Z5	12	12	24	84	5	ALTIN	0.75	CYLINDRICAL
N68722	STR540M-160-D2-R075.0-Z5	16	16	32	93	5	ALTIN	0.75	CYLINDRICAL

STABILIZER™-STSN540

SOLID
CARBIDE

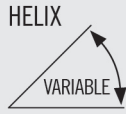

CENTER
CUTTING



- Asymmetrical cutting edges
- US Patent # 6,991,409
- Ideal for profiling, high speed and trochoidal milling, stainless, titanium, high temperature alloys, carbon, alloy and tool steels
- Eccentric radial relief

ITEM NUMBER	DESCRIPTION	FLUTE DIA.	SHANK DIA.	LENGTH OF CUT	OVERALL LENGTH	NECK DIA.	REACH	FLUTES	COATING	SHANK TYPE
03257848	STSN540-0.250-E4-S.0-Z5	1/4	1/4	1/2	3	0.240	1	5	ALCRN	CYLINDRICAL
03257851	STSN540-0.250-E5-S.0-Z5	1/4	1/4	1/2	4	0.240	1-1/4	5	ALCRN	CYLINDRICAL
03257854	STSN540-0.250-E8-S.0-Z5	1/4	1/4	1/2	4	0.240	2-1/8	5	ALCRN	CYLINDRICAL
03257865	STSN540-0.375-E4-S.0-Z5	3/8	3/8	3/4	3	0.360	1-1/2	5	ALCRN	CYLINDRICAL
03257870	STSN540-0.375-E5-S.0-Z5	3/8	3/8	1/2	4	0.360	2-1/8	5	ALCRN	CYLINDRICAL
03257875	STSN540-0.375-E8-S.0-Z5	3/8	3/8	1/2	6	0.360	3-1/8	5	ALCRN	CYLINDRICAL
03257904	STSN540-0.500-E4-S.0-Z5	1/2	1/2	1	4	0.480	2	5	ALCRN	CYLINDRICAL
03257909	STSN540-0.500-E6-S.0-Z5	1/2	1/2	5/8	5	0.480	3-1/8	5	ALCRN	CYLINDRICAL
03257914	STSN540-0.500-E8-S.0-Z5	1/2	1/2	5/8	6	0.480	4-1/8	5	ALCRN	CYLINDRICAL
03257934	STSN540-0.625-E4-S.0-Z5	5/8	5/8	1-1/4	5	0.600	2-1/2	5	ALCRN	CYLINDRICAL
03257937	STSN540-0.625-E5-S.0-Z5	5/8	5/8	3/4	6	0.600	3-3/8	5	ALCRN	CYLINDRICAL
03257951	STSN540-0.750-E3-S.0-Z5	3/4	3/4	1-1/8	5	0.720	2-1/2	5	ALCRN	CYLINDRICAL
03257955	STSN540-0.750-E4-S.0-Z5	3/4	3/4	1-1/2	5	0.720	3	5	ALCRN	CYLINDRICAL
03257959	STSN540-0.750-E5-S.0-Z5	3/4	3/4	1-1/8	6	0.720	4-1/8	5	ALCRN	CYLINDRICAL

STABILIZER™ - STRN540

SOLID
CARBIDE

HELIX



RADIUS



CENTER
CUTTING



- Asymmetrical cutting edges
- US Patent # 6,991,409
- Ideal for profiling, high speed and trochoidal milling, stainless, titanium, high temperature alloys, carbon, alloy and tool steels
- Eccentric radial relief

ITEM NUMBER	DESCRIPTION	FLUTE DIA.	SHANK DIA.	LENGTH OF CUT	OVERALL LENGTH	NECK DIA.	REACH	FLUTES	COATING	RADIUS	SHANK TYPE
03257849	STRN540-0.250-E4-R015.0-Z5	1/4	1/4	1/2	3	0.240	1	5	ALCRN	0.015	CYLINDRICAL
03257850	STRN540-0.250-E4-R030.0-Z5	1/4	1/4	1/2	3	0.240	1	5	ALCRN	0.030	CYLINDRICAL
03257852	STRN540-0.250-E5-R015.0-Z5	1/4	1/4	1/2	4	0.240	1-1/4	5	ALCRN	0.015	CYLINDRICAL
03257853	STRN540-0.250-E5-R030.0-Z5	1/4	1/4	1/2	4	0.240	1-1/4	5	ALCRN	0.030	CYLINDRICAL
03257855	STRN540-0.250-E8-R015.0-Z5	1/4	1/4	1/2	4	0.240	2-1/8	5	ALCRN	0.015	CYLINDRICAL
03257856	STRN540-0.250-E8-R030.0-Z5	1/4	1/4	1/2	4	0.240	2-1/8	5	ALCRN	0.030	CYLINDRICAL
03257866	STRN540-0.375-E4-R015.0-Z5	3/8	3/8	3/4	3	0.360	1-1/2	5	ALCRN	0.015	CYLINDRICAL
03257867	STRN540-0.375-E4-R030.0-Z5	3/8	3/8	3/4	3	0.360	1-1/2	5	ALCRN	0.030	CYLINDRICAL
03257868	STRN540-0.375-E4-R045.0-Z5	3/8	3/8	3/4	3	0.360	1-1/2	5	ALCRN	0.045	CYLINDRICAL
03257869	STRN540-0.375-E4-R060.0-Z5	3/8	3/8	3/4	3	0.360	1-1/2	5	ALCRN	0.060	CYLINDRICAL
03257871	STRN540-0.375-E5-R015.0-Z5	3/8	3/8	1/2	4	0.360	2-1/8	5	ALCRN	0.015	CYLINDRICAL
03257872	STRN540-0.375-E5-R030.0-Z5	3/8	3/8	1/2	4	0.360	2-1/8	5	ALCRN	0.030	CYLINDRICAL
03257873	STRN540-0.375-E5-R045.0-Z5	3/8	3/8	1/2	4	0.360	2-1/8	5	ALCRN	0.045	CYLINDRICAL
03257874	STRN540-0.375-E5-R060.0-Z5	3/8	3/8	1/2	4	0.360	2-1/8	5	ALCRN	0.060	CYLINDRICAL
03257876	STRN540-0.375-E8-R015.0-Z5	3/8	3/8	1/2	6	0.360	3-1/8	5	ALCRN	0.015	CYLINDRICAL
03257877	STRN540-0.375-E8-R030.0-Z5	3/8	3/8	1/2	6	0.360	3-1/8	5	ALCRN	0.030	CYLINDRICAL
03257878	STRN540-0.375-E8-R045.0-Z5	3/8	3/8	1/2	6	0.360	3-1/8	5	ALCRN	0.045	CYLINDRICAL
03257879	STRN540-0.375-E8-R060.0-Z5	3/8	3/8	1/2	6	0.360	3-1/8	5	ALCRN	0.060	CYLINDRICAL
03257910	STRN540-0.500-E6-R015.0-Z5	1/2	1/2	5/8	5	0.480	3-1/8	5	ALCRN	0.015	CYLINDRICAL
03257911	STRN540-0.500-E6-R030.0-Z5	1/2	1/2	5/8	5	0.480	3-1/8	5	ALCRN	0.030	CYLINDRICAL
03257912	STRN540-0.500-E6-R060.0-Z5	1/2	1/2	5/8	5	0.480	3-1/8	5	ALCRN	0.060	CYLINDRICAL
03257913	STRN540-0.500-E6-R120.0-Z5	1/2	1/2	5/8	5	0.480	3-1/8	5	ALCRN	0.120	CYLINDRICAL
03257915	STRN540-0.500-E8-R015.0-Z5	1/2	1/2	5/8	6	0.480	4-1/8	5	ALCRN	0.015	CYLINDRICAL
03257916	STRN540-0.500-E8-R030.0-Z5	1/2	1/2	5/8	6	0.480	4-1/8	5	ALCRN	0.030	CYLINDRICAL
03257917	STRN540-0.500-E8-R060.0-Z5	1/2	1/2	5/8	6	0.480	4-1/8	5	ALCRN	0.060	CYLINDRICAL
03257918	STRN540-0.500-E8-R120.0-Z5	1/2	1/2	5/8	6	0.480	4-1/8	5	ALCRN	0.120	CYLINDRICAL
03257905	STRN540-0.500-E4-R015.0-Z5	1/2	1/2	1	4	0.480	2	5	ALCRN	0.015	CYLINDRICAL
03257906	STRN540-0.500-E4-R030.0-Z5	1/2	1/2	1	4	0.480	2	5	ALCRN	0.030	CYLINDRICAL
03257907	STRN540-0.500-E4-R060.0-Z5	1/2	1/2	1	4	0.480	2	5	ALCRN	0.060	CYLINDRICAL
03257908	STRN540-0.500-E4-R120.0-Z5	1/2	1/2	1	4	0.480	2	5	ALCRN	0.120	CYLINDRICAL
03257938	STRN540-0.625-E5-R030.0-Z5	5/8	5/8	3/4	6	0.600	3-3/8	5	ALCRN	0.030	CYLINDRICAL
03257939	STRN540-0.625-E5-R060.0-Z5	5/8	5/8	3/4	6	0.600	3-3/8	5	ALCRN	0.060	CYLINDRICAL
03257935	STRN540-0.625-E4-R030.0-Z5	5/8	5/8	1-1/4	5	0.600	2-1/2	5	ALCRN	0.030	CYLINDRICAL
03257936	STRN540-0.625-E4-R060.0-Z5	5/8	5/8	1-1/4	5	0.600	2-1/2	5	ALCRN	0.060	CYLINDRICAL
03257952	STRN540-0.750-E3-R030.0-Z5	3/4	3/4	1-1/8	5	0.720	2-1/2	5	ALCRN	0.030	CYLINDRICAL
03257953	STRN540-0.750-E3-R060.0-Z5	3/4	3/4	1-1/8	5	0.720	2-1/2	5	ALCRN	0.060	CYLINDRICAL
03257954	STRN540-0.750-E3-R120.0-Z5	3/4	3/4	1-1/8	5	0.720	2-1/2	5	ALCRN	0.120	CYLINDRICAL
03257960	STRN540-0.750-E5-R030.0-Z5	3/4	3/4	1-1/8	6	0.720	4-1/8	5	ALCRN	0.030	CYLINDRICAL
03257961	STRN540-0.750-E5-R060.0-Z5	3/4	3/4	1-1/8	6	0.720	4-1/8	5	ALCRN	0.060	CYLINDRICAL
03257962	STRN540-0.750-E5-R120.0-Z5	3/4	3/4	1-1/8	6	0.720	4-1/8	5	ALCRN	0.120	CYLINDRICAL

STABILIZER™ - STRN540 (CONT.)

SOLID CARBIDE

HELIX

RADIUS

CENTER CUTTING



- Asymmetrical cutting edges
- US Patent # 6,991,409
- Ideal for profiling, high speed and trochoidal milling, stainless, titanium, high temperature alloys, carbon, alloy and tool steels
- Eccentric radial relief

ITEM NUMBER	DESCRIPTION	FLUTE DIA.	SHANK DIA.	LENGTH OF CUT	OVERALL LENGTH	NECK DIA.	REACH	FLUTES	COATING	RADIUS	SHANK TYPE
03257956	STRN540-0.750-E4-R030.0-Z5	3/4	3/4	1-1/2	5	0.720	3	5	ALCRN	0.030	CYLINDRICAL
03257957	STRN540-0.750-E4-R060.0-Z5	3/4	3/4	1-1/2	5	0.720	3	5	ALCRN	0.060	CYLINDRICAL
03257958	STRN540-0.750-E4-R120.0-Z5	3/4	3/4	1-1/2	5	0.720	3	5	ALCRN	0.120	CYLINDRICAL
03257963	STRN540-1.000-E3-R030.0-Z5	1	1	1-1/4	6	0.960	3-1/2	5	ALCRN	0.030	CYLINDRICAL
03257964	STRN540-1.000-E3-R060.0-Z5	1	1	1-1/4	6	0.960	3-1/2	5	ALCRN	0.060	CYLINDRICAL
03257965	STRN540-1.000-E3-R120.0-Z5	1	1	1-1/4	6	0.960	3-1/2	5	ALCRN	0.120	CYLINDRICAL

STABILIZER™ - STRCS540

SOLID CARBIDE	HELIX VARIABLE	RADIUS	CENTER CUTTING	CHIPSPLITTER
---------------	-------------------	--------	----------------	--------------



- Asymmetrical cutting edges
- US Patent # 6,991,409
- Ideal for profiling, high speed and trochoidal milling, stainless, titanium, high temperature alloys, carbon, alloy and tool steels
- Eccentric radial relief

ITEM NUMBER	DESCRIPTION	FLUTE DIA.	SHANK DIA.	LENGTH OF CUT	OVERALL LENGTH	FLUTES	COATING	RADIUS	SHANK TYPE
03257847	STRCS540-0.250-D3-R015.0-Z5	1/4	1/4	3/4	2-1/2	5	ALCRN	0.015	CYLINDRICAL
03257864	STRCS540-0.375-D3-R030.0-Z5	3/8	3/8	1-1/4	3	5	ALCRN	0.030	CYLINDRICAL
03257900	STRCS540-0.500-D3-R030.0-Z5	1/2	1/2	1-1/4	3	5	ALCRN	0.030	CYLINDRICAL
03257901	STRCS540-0.500-D3-R030.3-Z5	1/2	1/2	1-1/4	3	5	ALCRN	0.030	WELDON
03257902	STRCS540-0.500-D4-R030.0-Z5	1/2	1/2	1-5/8	4	5	ALCRN	0.030	CYLINDRICAL
03257903	STRCS540-0.500-D4-R030.3-Z5	1/2	1/2	1-5/8	4	5	ALCRN	0.030	WELDON
03257931	STRCS540-0.625-D3-R030.0-Z5	5/8	5/8	1-3/8	3-1/2	5	ALCRN	0.030	CYLINDRICAL
03257932	STRCS540-0.625-D5-R030.0-Z5	5/8	5/8	2-1/8	4	5	ALCRN	0.030	CYLINDRICAL
03257933	STRCS540-0.625-D5-R030.3-Z5	5/8	5/8	2-1/8	4	5	ALCRN	0.030	WELDON
03257948	STRCS540-0.750-D3-R030.0-Z5	3/4	3/4	1-5/8	4	5	ALCRN	0.030	CYLINDRICAL
03257949	STRCS540-0.750-D3-R030.3-Z5	3/4	3/4	1-5/8	4	5	ALCRN	0.030	WELDON
03257950	STRCS540-0.750-D4-R030.0-Z5	3/4	3/4	2-1/4	5	5	ALCRN	0.030	CYLINDRICAL

STS430.2, STR430.2, STB430.2 - SLOTTING - INCH - START VALUES

ISO GROUP	SMG	a _p x Dc (max)	a _e x Dc (max)	v _c (sf / min)		SLOTTING													
						Zn = 4													
						1/8	5/32	3/16	7/32	1/4	9/32	5/16	3/8	7/16	1/2	5/8	3/4	7/8	1
P	E 1 - 2	1.00	1.00	425	n [min-1]	12988	10390	8659	7422	6494	5772	5195	4329	3711	3247	2598	2165	1855	1624
					fz [in]	0.0008	0.0010	0.0012	0.0014	0.0016	0.0018	0.0020	0.0024	0.0028	0.0032	0.0039	0.0047	0.0055	0.0063
					vf [in/min]	41	41	41	41	41	41	41	41	41	41	41	41	41	41
	E 3 - 4	1.00	1.00	400	n [min-1]	12224	9779	8149	6985	6112	5433	4890	4075	3493	3056	2445	2037	1746	1528
					fz [in]	0.0007	0.0009	0.0011	0.0012	0.0014	0.0016	0.0018	0.0021	0.0025	0.0029	0.0036	0.0043	0.0050	0.0057
					vf [in/min]	35	35	35	35	35	35	35	35	35	35	35	35	35	35
	E 5 - 6	1.00	1.00	350	n [min-1]	10696	8557	7131	6112	5348	4754	4278	3565	3056	2674	2139	1783	1528	1337
					fz [in]	0.0006	0.0008	0.0009	0.0011	0.0013	0.0014	0.0016	0.0019	0.0022	0.0025	0.0031	0.0038	0.0044	0.0050
					vf [in/min]	27	27	27	27	27	27	27	27	27	27	27	27	27	27
K	E 12 - 13	1.00	1.00	350	n [min-1]	10696	8557	7131	6112	5348	4754	4278	3565	3056	2674	2139	1783	1528	1337
					fz [in]	0.0007	0.0009	0.0010	0.0012	0.0014	0.0015	0.0017	0.0021	0.0024	0.0028	0.0034	0.0041	0.0048	0.0055
					vf [in/min]	29	29	29	29	29	29	29	29	29	29	29	29	29	29
	E 14 - 15	1.00	1.00	325	n [min-1]	9932	7946	6621	5675	4966	4414	3973	3311	2838	2483	1986	1655	1419	1242
					fz [in]	0.0006	0.0007	0.0008	0.0010	0.0011	0.0013	0.0014	0.0017	0.0020	0.0023	0.0028	0.0034	0.0039	0.0045
					vf [in/min]	22	22	22	22	22	22	22	22	22	22	22	22	22	22

STS430.2, STR430.2, STB430.2 - SIDE MILLING/ROUGHING - INCH - START VALUES

ISO GROUP	SMG	a _p x Dc (max)	a _e x Dc (max)	v _c (sf / min)		SIDE MILLING - ROUGHING													
						Zn = 4													
						1/8	5/32	3/16	7/32	1/4	9/32	5/16	3/8	7/16	1/2	5/8	3/4	7/8	1
P	E 1 - 2	1.50	0.25	425	n [min-1]	12988	10390	8659	7422	6494	5772	5195	4329	3711	3247	2598	2165	1855	1624
					fz [in]	0.0009	0.0011	0.0013	0.0015	0.0018	0.0020	0.0022	0.0026	0.0031	0.0035	0.0044	0.0053	0.0061	0.0070
					vf [in/min]	45	45	45	45	45	45	45	45	45	45	45	45	45	45
	E 3 - 4	1.50	0.25	400	n [min-1]	12224	9779	8149	6985	6112	5433	4890	4075	3493	3056	2445	2037	1746	1528
					fz [in]	0.0008	0.0010	0.0012	0.0014	0.0016	0.0018	0.0020	0.0024	0.0028	0.0032	0.0040	0.0048	0.0056	0.0064
					vf [in/min]	39	39	39	39	39	39	39	39	39	39	39	39	39	39
	E 5 - 6	1.00	0.25	350	n [min-1]	10696	8557	7131	6112	5348	4754	4278	3565	3056	2674	2139	1783	1528	1337
					fz [in]	0.0008	0.0009	0.0011	0.0013	0.0015	0.0017	0.0019	0.0023	0.0026	0.0030	0.0038	0.0045	0.0053	0.0060
					vf [in/min]	32	32	32	32	32	32	32	32	32	32	32	32	32	32
K	E 12 - 13	1.50	0.25	350	n [min-1]	10696	8557	7131	6112	5348	4754	4278	3565	3056	2674	2139	1783	1528	1337
					fz [in]	0.0008	0.0009	0.0011	0.0013	0.0015	0.0017	0.0019	0.0023	0.0026	0.0030	0.0038	0.0045	0.0053	0.0060
					vf [in/min]	32	32	32	32	32	32	32	32	32	32	32	32	32	32
	E 14 - 15	1.00	0.25	325	n [min-1]	9932	7946	6621	5675	4966	4414	3973	3311	2838	2483	1986	1655	1419	1242
					fz [in]	0.0006	0.0008	0.0009	0.0011	0.0013	0.0014	0.0016	0.0019	0.0022	0.0025	0.0031	0.0038	0.0044	0.0050
					vf [in/min]	25	25	25	25	25	25	25	25	25	25	25	25	25	25

SMG = Seco Material Group
 n [min-1] = RPM
 v_c (sf/min) = Surface feet/min

fz [in] = Feed/tooth
 a_p/D_c = % of diameter
 vf [in/min] = Feed rate
 a_e/D_c = % of diameter

A = Air D = Dry E = Emulsion (flood coolant) M = Mist
 All cutting data are start values. All cutting data is in inch values.
 Please reference the Workpiece Material Classification chart located on page 15.

STS430M.2, STR430M.2, STB430M.2 - SLOTTING - METRIC - START VALUES

ISO GROUP	SMG	$a_p \times D_c$ (max)	$a_e \times D_c$ (max)	V_c (sf / min)	SLOTTING											
						$Z_n = 4$										
						3	4	5	6	8	10	12	14	16	20	25
P	E 1 - 2	1.00	1.00	425 325 - 525	n [min-1]	13790	10350	8280	6900	5170	4140	3450	2960	2590	2070	1660
					fz [in]	0.0007	0.0010	0.0012	0.0015	0.0020	0.0025	0.0030	0.0035	0.0040	0.0050	0.0062
					vf [in/min]	41	41	41	41	41	41	41	41	41	41	41
	E 3 - 4	1.00	1.00	400 350 - 450	n [min-1]	12940	9710	7770	6470	4850	3880	3240	2770	2430	1940	1550
					fz [in]	0.0007	0.0009	0.0011	0.0013	0.0018	0.0022	0.0027	0.0031	0.0036	0.0045	0.0056
					vf [in/min]	35	35	35	35	35	35	35	35	35	35	35
	E 5 - 6	1.00	1.00	350 330 - 370	n [min-1]	11350	8510	6810	5680	4260	3410	2840	2430	2130	1700	1360
					fz [in]	0.0006	0.0008	0.0010	0.0012	0.0016	0.0020	0.0024	0.0028	0.0031	0.0039	0.0049
					vf [in/min]	27	27	27	27	27	27	27	27	27	27	27
K	E 12 - 13	1.00	1.00	350 280 - 420	n [min-1]	11350	8510	6810	5680	4260	3410	2840	2430	2130	1700	1360
					fz [in]	0.0006	0.0009	0.0011	0.0013	0.0017	0.0022	0.0026	0.0030	0.0035	0.0043	0.0054
					vf [in/min]	29	29	29	29	29	29	29	29	29	29	29
	E 14 - 15	1.00	1.00	325 275 - 375	n [min-1]	10500	7880	6300	5250	3940	3150	2630	2250	1970	1580	1260
					fz [in]	0.0005	0.0007	0.0009	0.0011	0.0014	0.0018	0.0021	0.0025	0.0028	0.0035	0.0044
					vf [in/min]	22	22	22	22	22	22	22	22	22	22	22

STS430M.2, STR430M.2, STB430M.2 - SIDE MILLING/ROUGHING - METRIC - START VALUES

ISO GROUP	SMG	$a_p \times D_c$ (max)	$a_e \times D_c$ (max)	V_c (sf / min)	SIDE MILLING - ROUGHING											
						$Z_n = 4$										
						3	4	5	6	8	10	12	14	16	20	25
P	E 1 - 2	1.50	0.25	425 325 - 525	n [min-1]	13790	10350	8280	6900	5170	4140	3450	2960	2590	2070	1660
					fz [in]	0.0008	0.0011	0.0014	0.0017	0.0022	0.0028	0.0033	0.0039	0.0044	0.0055	0.0069
					vf [in/min]	46	46	46	46	46	46	46	46	46	46	46
	E 3 - 4	1.50	0.25	400 350 - 450	n [min-1]	12940	9710	7770	6470	4850	3880	3240	2770	2430	1940	1550
					fz [in]	0.0008	0.0010	0.0013	0.0015	0.0020	0.0025	0.0030	0.0035	0.0040	0.0050	0.0063
					vf [in/min]	39	39	39	39	39	39	39	39	39	39	39
	E 5 - 6	1.00	0.25	350 330 - 370	n [min-1]	11350	8510	6810	5680	4260	3410	2840	2430	2130	1700	1360
					fz [in]	0.0007	0.0009	0.0012	0.0014	0.0019	0.0024	0.0028	0.0033	0.0038	0.0047	0.0059
					vf [in/min]	32	32	32	32	32	32	32	32	32	32	32
K	E 12 - 13	1.50	0.25	350 280 - 420	n [min-1]	11350	8510	6810	5680	4260	3410	2840	2430	2130	1700	1360
					fz [in]	0.0007	0.0009	0.0012	0.0014	0.0019	0.0024	0.0028	0.0033	0.0038	0.0047	0.0059
					vf [in/min]	32	32	32	32	32	32	32	32	32	32	32
	E 14 - 15	1.00	0.25	325 275 - 375	n [min-1]	10500	7880	6300	5250	3940	3150	2630	2250	1970	1580	1260
					fz [in]	0.0006	0.0008	0.0010	0.0012	0.0016	0.0020	0.0024	0.0028	0.0031	0.0039	0.0049
					vf [in/min]	25	25	25	25	25	25	25	25	25	25	25

SMG = Seco Material Group
 n [min-1] = RPM
 V_c (sf/min) = Surface feet/min

fz [in] = Feed/tooth
 a_p/D_c = % of diameter
 vf [in/min] = Feed rate
 a_e/D_c = % of diameter

A = Air D = Dry E = Emulsion (flood coolant) M = Mist
 All cutting data are start values. All cutting data is in inch values.
 Please reference the Workpiece Material Classification chart located on page 15.

STRN430.2, STBN430.2 - SLOTTING - INCH - START VALUES

ISO GROUP	SMG	$a_p \times D_c$ (max)	$a_e \times D_c$ (max)	v_c (sf / min)	SLOTTING								
						$Z_n = 4$							
						1/4	5/16	3/8	7/16	1/2	5/8	3/4	1
P	E 1 - 2	0.50	1.00	425	n [min-1]	6494	5195	4329	3711	3247	2598	2165	1624
					fz [in]	0.0008	0.0009	0.0011	0.0013	0.0015	0.0019	0.0023	0.0030
					vf [in/min]	19	19	19	19	19	19	19	19
	E 3 - 4	0.50	1.00	400	n [min-1]	6112	4890	4075	3493	3056	2445	2037	1528
					fz [in]	0.0006	0.0008	0.0009	0.0011	0.0013	0.0016	0.0019	0.0025
					vf [in/min]	15	15	15	15	15	15	15	15
	E 5 - 6	0.50	1.00	350	n [min-1]	5348	4278	3565	3056	2674	2139	1783	1337
					fz [in]	0.0006	0.0007	0.0009	0.0010	0.0012	0.0014	0.0017	0.0023
					vf [in/min]	12	12	12	12	12	12	12	12
K	E 12 - 13	0.50	1.00	350	n [min-1]	5348	4278	3565	3056	2674	2139	1783	1337
					fz [in]	0.0010	0.0013	0.0015	0.0018	0.0020	0.0025	0.0030	0.0040
					vf [in/min]	21	21	21	21	21	21	21	21
	E 14 - 15	0.50	1.00	325	n [min-1]	4966	3973	3311	2838	2483	1986	1655	1242
					fz [in]	0.0008	0.0009	0.0011	0.0013	0.0015	0.0019	0.0023	0.0030
					vf [in/min]	15	15	15	15	15	15	15	15

STRN430.2, STBN430.2 - SIDE MILLING ROUGHING - INCH - START VALUES

ISO GROUP	SMG	$a_p \times D_c$ (max)	$a_e \times D_c$ (max)	v_c (sf / min)	SIDE MILLING - ROUGHING								
						$Z_n = 4$							
						1/4	5/16	3/8	7/16	1/2	5/8	3/4	1
P	E 1 - 2	1.00	0.25	425	n [min-1]	6494	5195	4329	3711	3247	2598	2165	1624
					fz [in]	0.0009	0.0011	0.0013	0.0015	0.0018	0.0022	0.0026	0.0035
					vf [in/min]	23	23	23	23	23	23	23	23
	E 3 - 4	1.00	0.25	400	n [min-1]	6112	4890	4075	3493	3056	2445	2037	1528
					fz [in]	0.0008	0.0009	0.0011	0.0013	0.0015	0.0019	0.0023	0.0030
					vf [in/min]	18	18	18	18	18	18	18	18
	E 5 - 6	1.00	0.25	350	n [min-1]	5348	4278	3565	3056	2674	2139	1783	1337
					fz [in]	0.0007	0.0009	0.0011	0.0012	0.0014	0.0018	0.0021	0.0028
					vf [in/min]	15	15	15	15	15	15	15	15
K	E 12 - 13	1.00	0.25	350	n [min-1]	5348	4278	3565	3056	2674	2139	1783	1337
					fz [in]	0.0011	0.0014	0.0017	0.0020	0.0023	0.0028	0.0034	0.0045
					vf [in/min]	24	24	24	24	24	24	24	24
	E 14 - 15	1.00	0.25	325	n [min-1]	4966	3973	3311	2838	2483	1986	1655	1242
					fz [in]	0.0009	0.0011	0.0013	0.0015	0.0018	0.0022	0.0026	0.0035
					vf [in/min]	17	17	17	17	17	17	17	17

SMG = Seco Material Group
 n [min-1] = RPM
 v_c (sf/min) = Surface feet/min

fz [in] = Feed/tooth
 a_p/D_c = % of diameter
 vf [in/min] = Feed rate
 a_e/D_c = % of diameter

A = Air D = Dry E = Emulsion (flood coolant) M = Mist
 All cutting data are start values. All cutting data is in inch values.
 Please reference the Workpiece Material Classification chart located on page 15.

STR440.2 - STB440.2 - SLOTTING - INCH - START VALUES

ISO GROUP	SMG	a _p x D _c (max)	a _e x D _c (max)	v _c (sf / min)		SLOTTING												
						Zn = 4												
						1/8	5/32	3/16	7/32	1/4	9/32	5/16	3/8	7/16	1/2	5/8	3/4	1
M	E 8 - 9	1.00	1.00	370	n [min-1]	11307	9046	7538	6461	5654	5025	4523	3769	3231	2827	2261	1885	1413
					fz [in]	0.0008	0.0009	0.0011	0.0013	0.0015	0.0017	0.0019	0.0023	0.0026	0.0030	0.0038	0.0045	0.0060
					vf [in/min]	34	34	34	34	34	34	34	34	34	34	34	34	34
	E 10 - 11	1.00	1.00	300	n [min-1]	9168	7334	6112	5239	4584	4075	3667	3056	2619	2292	1834	1528	1146
					fz [in]	0.0008	0.0009	0.0011	0.0013	0.0015	0.0017	0.0019	0.0023	0.0026	0.0030	0.0038	0.0045	0.0060
					vf [in/min]	27	27	27	27	27	27	27	27	27	27	27	27	27
S	E 19	1.00	1.00	90	n [min-1]	2750	2200	1834	1572	1375	1222	1100	917	786	688	550	458	344
					fz [in]	0.0004	0.0005	0.0006	0.0007	0.0008	0.0009	0.0010	0.0012	0.0014	0.0016	0.0020	0.0024	0.0032
					vf [in/min]	4	4	4	4	4	4	4	4	4	4	4	4	4
	E 20	1.00	1.00	90	n [min-1]	2750	2200	1834	1572	1375	1222	1100	917	786	688	550	458	344
					fz [in]	0.0004	0.0005	0.0006	0.0007	0.0008	0.0009	0.0010	0.0012	0.0014	0.0016	0.0020	0.0024	0.0032
					vf [in/min]	4	4	4	4	4	4	4	4	4	4	4	4	4
	E 21	1.00	1.00	90	n [min-1]	2750	2200	1834	1572	1375	1222	1100	917	786	688	550	458	344
					fz [in]	0.0004	0.0005	0.0006	0.0007	0.0008	0.0009	0.0010	0.0012	0.0014	0.0016	0.0020	0.0024	0.0032
					vf [in/min]	4	4	4	4	4	4	4	4	4	4	4	4	4
	E 22	1.00	1.00	185	n [min-1]	5654	4523	3769	3231	2827	2513	2261	1885	1615	1413	1131	942	707
					fz [in]	0.0006	0.0008	0.0009	0.0011	0.0013	0.0014	0.0016	0.0019	0.0022	0.0025	0.0031	0.0038	0.0050
					vf [in/min]	14	14	14	14	14	14	14	14	14	14	14	14	14

STR440.2 - STB440.2 - SIDE MILLING/ROUGHING - INCH - START VALUES

ISO GROUP	SMG	a _p x D _c (max)	a _e x D _c (max)	v _c (sf / min)		SIDE MILLING - ROUGHING												
						Zn = 4												
						1/8	5/32	3/16	7/32	1/4	9/32	5/16	3/8	7/16	1/2	5/8	3/4	1
H	E 7	1.00	0.15	150	n [min-1]	4584	3667	3056	2619	2292	2037	1834	1528	1310	1146	917	764	573
					fz [in]	0.0003	0.0004	0.0004	0.0005	0.0006	0.0006	0.0007	0.0009	0.0010	0.0012	0.0014	0.0017	0.0023
					vf [in/min]	5	5	5	5	5	5	5	5	5	5	5	5	5
M	E 8 - 9	1.00	0.25	370	n [min-1]	11307	9046	7538	6461	5654	5025	4523	3769	3231	2827	2261	1885	1413
					fz [in]	0.0008	0.0009	0.0011	0.0013	0.0015	0.0017	0.0019	0.0023	0.0026	0.0030	0.0038	0.0045	0.0060
					vf [in/min]	33.9	33.9	33.9	33.9	33.9	33.9	33.9	33.9	33.9	33.9	33.9	33.9	33.9
	E 10 - 11	1.00	0.25	300	n [min-1]	9168	7334	6112	5239	4584	4075	3667	3056	2619	2292	1834	1528	1146
					fz [in]	0.0008	0.0009	0.0011	0.0013	0.0015	0.0017	0.0019	0.0023	0.0026	0.0030	0.0038	0.0045	0.0060
					vf [in/min]	27	27	27	27	27	27	27	27	27	27	27	27	27
S	E 19	1.00	0.15	90	n [min-1]	2750	2200	1834	1572	1375	1222	1100	917	786	688	550	458	344
					fz [in]	0.0005	0.0006	0.0008	0.0009	0.0010	0.0011	0.0013	0.0015	0.0018	0.0020	0.0025	0.0030	0.0040
					vf [in/min]	5	5	5	5	5	5	5	5	5	5	5	5	5
	E 20	1.00	0.15	90	n [min-1]	2750	2200	1834	1572	1375	1222	1100	917	786	688	550	458	344
					fz [in]	0.0005	0.0006	0.0008	0.0009	0.0010	0.0011	0.0013	0.0015	0.0018	0.0020	0.0025	0.0030	0.0040
					vf [in/min]	5	5	5	5	5	5	5	5	5	5	5	5	5
	E 21	1.00	0.15	90	n [min-1]	2750	2200	1834	1572	1375	1222	1100	917	786	688	550	458	344
					fz [in]	0.0005	0.0006	0.0008	0.0009	0.0010	0.0011	0.0013	0.0015	0.0018	0.0020	0.0025	0.0030	0.0040
					vf [in/min]	5	5	5	5	5	5	5	5	5	5	5	5	5
	E 22	1.00	0.25	185	n [min-1]	5654	4523	3769	3231	2827	2513	2261	1885	1615	1413	1131	942	707
					fz [in]	0.0008	0.0009	0.0011	0.0013	0.0015	0.0017	0.0019	0.0023	0.0026	0.0030	0.0038	0.0045	0.0060
					vf [in/min]	17	17	17	17	17	17	17	17	17	17	17	17	17

SMG = Seco Material Group
 n [min-1] = RPM
 v_c (sf/min) = Surface feet/min

fz [in] = Feed/tooth
 a_p/D_c = % of diameter
 vf [in/min] = Feed rate
 a_e/D_c = % of diameter

A = Air D = Dry E = Emulsion (flood coolant) M = Mist
 All cutting data are start values. All cutting data is in inch values.
 Please reference the Workpiece Material Classification chart located on page 15.

STR440M.2 - STB440M.2 - SLOTTING - METRIC - START VALUES

ISO GROUP	SMG	$a_p \times D_c$ (max)	$a_e \times D_c$ (max)	v_c (sf / min)	SLOTTING												
						$Z_n = 4$											
						3	4	5	6	8	10	12	14	16	20	25	
M	E 8 - 9	1.00	1.00	370	n [min-1]	11990	8990	7190	5990	4500	3600	3000	2570	2250	1800	1440	
					fz [in]	0.0007	0.0009	0.0012	0.0014	0.0019	0.0024	0.0028	0.0033	0.0038	0.0047	0.0059	
					vf [in/min]	34	34	34	34	34	34	34	34	34	34	34	34
	E 10 - 11	1.00	1.00	300	n [min-1]	9660	7240	5790	4830	3620	2900	2410	2070	1810	1450	1160	
					fz [in]	0.0007	0.0009	0.0012	0.0014	0.0019	0.0024	0.0028	0.0033	0.0038	0.0047	0.0059	
					vf [in/min]	27	27	27	27	27	27	27	27	27	27	27	27
S	E 19	1.00	1.00	90	n [min-1]	2860	2150	1720	1430	1070	860	720	610	540	430	340	
					fz [in]	0.0004	0.0005	0.0006	0.0008	0.0010	0.0013	0.0015	0.0018	0.0020	0.0025	0.0031	
					vf [in/min]	4	4	4	4	4	4	4	4	4	4	4	4
	E 20	1.00	1.00	90	n [min-1]	2860	2150	1720	1430	1070	860	720	610	540	430	340	
					fz [in]	0.0004	0.0005	0.0006	0.0008	0.0010	0.0013	0.0015	0.0018	0.0020	0.0025	0.0031	
					vf [in/min]	4	4	4	4	4	4	4	4	4	4	4	4
	E 21	1.00	1.00	90	n [min-1]	2860	2150	1720	1430	1070	860	720	610	540	430	340	
					fz [in]	0.0004	0.0005	0.0006	0.0008	0.0010	0.0013	0.0015	0.0018	0.0020	0.0025	0.0031	
					vf [in/min]	4	4	4	4	4	4	4	4	4	4	4	4
	E 22	1.00	1.00	185	n [min-1]	5940	4460	3570	2970	2230	1780	1490	1270	1110	890	710	
					fz [in]	0.0006	0.0008	0.0010	0.0012	0.0016	0.0020	0.0024	0.0028	0.0031	0.0039	0.0049	
					vf [in/min]	14	14	14	14	14	14	14	14	14	14	14	14

STR440M.2 - STB440M.2 - SIDE MILLING/ROUGHING - METRIC - START VALUES

ISO GROUP	SMG	$a_p \times D_c$ (max)	$a_e \times D_c$ (max)	v_c (sf / min)	SIDE MILLING - ROUGHING												
						$Z_n = 4$											
						3	4	5	6	8	10	12	14	16	20	25	
H	E 7	1.00	0.15	150	n [min-1]	4880	3660	2930	2440	1830	1460	1220	1050	920	730	590	
					fz [in]	0.0003	0.0004	0.0005	0.0005	0.0007	0.0009	0.0011	0.0013	0.0014	0.0018	0.0023	
					vf [in/min]	5	5	5	5	5	5	5	5	5	5	5	5
M	E 8 - 9	1.00	0.25	370	n [min-1]	11990	8990	7190	5990	4500	3600	3000	2570	2250	1800	1440	
					fz [in]	0.0007	0.0009	0.0012	0.0014	0.0019	0.0024	0.0028	0.0033	0.0038	0.0047	0.0059	
					vf [in/min]	34	34	34	34	34	34	34	34	34	34	34	34
	E 10 - 11	1.00	0.25	300	n [min-1]	9660	7240	5790	4830	3620	2900	2410	2070	1810	1450	1160	
					fz [in]	0.0007	0.0009	0.0012	0.0014	0.0019	0.0024	0.0028	0.0033	0.0038	0.0047	0.0059	
					vf [in/min]	27	27	27	27	27	27	27	27	27	27	27	27
S	E 19	1.00	0.15	90	n [min-1]	2860	2150	1720	1430	1070	860	720	610	540	430	340	
					fz [in]	0.0005	0.0006	0.0008	0.0009	0.0013	0.0016	0.0019	0.0022	0.0025	0.0031	0.0039	
					vf [in/min]	5	5	5	5	5	5	5	5	5	5	5	
	E 20	1.00	0.15	90	n [min-1]	2860	2150	1720	1430	1070	860	720	610	540	430	340	
					fz [in]	0.0005	0.0006	0.0008	0.0009	0.0013	0.0016	0.0019	0.0022	0.0025	0.0031	0.0039	
					vf [in/min]	5	5	5	5	5	5	5	5	5	5	5	
	E 21	1.00	0.15	90	n [min-1]	2860	2150	1720	1430	1070	860	720	610	540	430	340	
					fz [in]	0.0005	0.0006	0.0008	0.0009	0.0013	0.0016	0.0019	0.0022	0.0025	0.0031	0.0039	
					vf [in/min]	5	5	5	5	5	5	5	5	5	5	5	
	E 22	1.00	0.25	185	n [min-1]	5940	4460	3570	2970	2230	1780	1490	1270	1110	890	710	
					fz [in]	0.0007	0.0009	0.0012	0.0014	0.0019	0.0024	0.0028	0.0033	0.0038	0.0047	0.0059	
					vf [in/min]	17	17	17	17	17	17	17	17	17	17	17	17

SMG = Seco Material Group
 n [min-1] = RPM
 v_c (sf/min) = Surface feet/min

fz [in] = Feed/tooth
 a_p/D_c = % of diameter
 vf [in/min] = Feed rate
 a_e/D_c = % of diameter

A = Air D = Dry E = Emulsion (flood coolant) M = Mist
 All cutting data are start values. All cutting data is in inch values.
 Please reference the Workpiece Material Classification chart located on page 15.

STRN440.2 - STBN440.2 - SLOTTING - INCH - START VALUES

ISO GROUP	SMG	a _p x D _c (max)	a _e x D _c (max)	v _c (sf / min)		SLOTTING							
						Zn = 4							
						1/4	5/16	3/8	7/16	1/2	5/8	3/4	1
M	E 8 - 9	0.50	1.00	370	n [min-1]	5654	4523	3769	3231	2827	2261	1885	1413
					fz [in]	0.0008	0.0009	0.0011	0.0013	0.0015	0.0019	0.0023	0.0030
					340 - 400	vf [in/min]	17	17	17	17	17	17	17
	E 10 - 11	0.50	1.00	300	n [min-1]	4584	3667	3056	2619	2292	1834	1528	1146
					fz [in]	0.0008	0.0009	0.0011	0.0013	0.0015	0.0019	0.0023	0.0030
					270 - 330	vf [in/min]	14	14	14	14	14	14	14
S	E 19	0.50	1.00	90	n [min-1]	1375	1100	917	786	688	550	458	344
					fz [in]	0.0004	0.0005	0.0006	0.0007	0.0008	0.0009	0.0011	0.0015
					70 - 110	vf [in/min]	2	2	2	2	2	2	2
	E 20	0.50	1.00	90	n [min-1]	1375	1100	917	786	688	550	458	344
					fz [in]	0.0004	0.0005	0.0006	0.0007	0.0008	0.0009	0.0011	0.0015
					70 - 110	vf [in/min]	2	2	2	2	2	2	2
	E 21	0.50	1.00	90	n [min-1]	1375	1100	917	786	688	550	458	344
					fz [in]	0.0004	0.0005	0.0006	0.0007	0.0008	0.0009	0.0011	0.0015
					70 - 110	vf [in/min]	2	2	2	2	2	2	2
	E 22	0.50	1.00	185	n [min-1]	2827	2261	1885	1615	1413	1131	942	707
					fz [in]	0.0006	0.0008	0.0009	0.0011	0.0012	0.0015	0.0018	0.0024
					165 - 205	vf [in/min]	7	7	7	7	7	7	7

STRN440.2 - STBN440.2 - SIDE MILLING/ROUGHING - INCH - START VALUES

ISO GROUP	SMG	a _p x D _c (max)	a _e x D _c (max)	v _c (sf / min)		SIDE MILLING - ROUGHING							
						Zn = 4							
						1/4	5/16	3/8	7/16	1/2	5/8	3/4	1
H	E 7	1.00	0.15	150	n [min-1]	2292	1834	1528	1310	1146	917	764	573
					fz [in]	0.0003	0.0004	0.0005	0.0006	0.0006	0.0008	0.0010	0.0013
					120 - 180	vf [in/min]	3	3	3	3	3	3	3
M	E 8 - 9	1.00	0.25	370	n [min-1]	5654	4523	3769	3231	2827	2261	1885	1413
					fz [in]	0.0008	0.0010	0.0012	0.0014	0.0016	0.0020	0.0024	0.0032
					340 - 400	vf [in/min]	18	18	18	18	18	18	18
	E 10 - 11	1.00	0.25	300	n [min-1]	4584	3667	3056	2619	2292	1834	1528	1146
					fz [in]	0.0008	0.0010	0.0012	0.0014	0.0016	0.0020	0.0024	0.0032
					270 - 330	vf [in/min]	15	15	15	15	15	15	15
S	E 19	1.00	0.15	90	n [min-1]	1375	1100	917	786	688	550	458	344
					fz [in]	0.0005	0.0006	0.0008	0.0009	0.0010	0.0013	0.0015	0.0020
					70 - 110	vf [in/min]	3	3	3	3	3	3	3
	E 20	1.00	0.15	90	n [min-1]	1375	1100	917	786	688	550	458	344
					fz [in]	0.0005	0.0006	0.0008	0.0009	0.0010	0.0013	0.0015	0.0020
					70 - 110	vf [in/min]	3	3	3	3	3	3	3
	E 21	1.00	0.15	90	n [min-1]	1375	1100	917	786	688	550	458	344
					fz [in]	0.0005	0.0006	0.0008	0.0009	0.0010	0.0013	0.0015	0.0020
					70 - 110	vf [in/min]	3	3	3	3	3	3	3
	E 22	1.00	0.25	185	n [min-1]	2827	2261	1885	1615	1413	1131	942	707
					fz [in]	0.0007	0.0008	0.0010	0.0011	0.0013	0.0016	0.0020	0.0026
					165 - 205	vf [in/min]	7	7	7	7	7	7	7

SMG = Seco Material Group
 n [min-1] = RPM
 v_c (sf/min) = Surface feet/min

fz [in] = Feed/tooth
 a_p/D_c = % of diameter
 vf [in/min] = Feed rate
 a_e/D_c = % of diameter

A = Air D = Dry E = Emulsion (flood coolant) M = Mist
 All cutting data are start values. All cutting data is in inch values.
 Please reference the Workpiece Material Classification chart located on page 15.

STS540, STR540, STSN540, STRN540 - SLOTTING - INCH - UP TO 4 X DIAMETER REACH LENGTH - START VALUES

ISO GROUP	SMG	a _p x D _c	a _e x D _c	v _c (sf / min)		SLOTTING										
						Zn = 5										
						1/8	5/32	3/16	7/32	1/4	5/16	3/8	1/2	5/8	3/4	1
P	E 1 - 2	1.00	1.00	425	n (min-1)	12988	10390	8659	7422	6494	5195	4329	3247	2598	2165	1624
					fz (in)	0.0006	0.0007	0.00084	0.0010	0.0011	0.0014	0.0017	0.0023	0.0028	0.0034	0.0045
					vf (in/min)	37	37	37	37	37	37	37	37	37	37	37
	A / E 3 - 4	1.00	1.00	400	n (min-1)	12224	9779	8149	6985	6112	4890	4075	3056	2445	2037	1528
					fz (in)	0.0005	0.0006	0.00075	0.0009	0.0010	0.0013	0.0015	0.0020	0.0025	0.0030	0.0040
					vf (in/min)	31	31	31	31	31	31	31	31	31	31	31
	A / E 5 - 6	1.00	1.00	350	n (min-1)	10696	8557	7131	6112	5348	4278	3565	2674	2139	1783	1337
					fz (in)	0.0004	0.0005	0.00066	0.0008	0.0009	0.0011	0.0013	0.0018	0.0022	0.0026	0.0035
					vf (in/min)	23	23	23	23	23	23	23	23	23	23	23
H	M / A 7 (48-56 HRc)	0.50	1.00	275	n (min-1)	8404	6723	5603	4802	4202	3362	2801	2101	1681	1401	1051
					fz (in)	0.00025	0.0003	0.00038	0.0004	0.0005	0.0006	0.0008	0.0010	0.0013	0.0015	0.0020
					vf (in/min)	11	11	11	11	11	11	11	11	11	11	11
M	E 8 - 9	0.50	1.00	325	n (min-1)	9932	7946	6621	5675	4966	3973	3311	2483	1986	1655	1242
					fz (in)	0.0003	0.0004	0.00047	0.0005	0.0006	0.0008	0.0009	0.0013	0.0016	0.0019	0.0025
					vf (in/min)	16	16	16	16	16	16	16	16	16	16	16
	A / E 10 - 11	0.50	1.00	275	n (min-1)	8404	6723	5603	4802	4202	3362	2801	2101	1681	1401	1051
					fz (in)	0.0003	0.0003	0.0004	0.0004	0.0005	0.0006	0.0008	0.0010	0.0013	0.0015	0.0020
					vf (in/min)	11	11	11	11	11	11	11	11	11	11	11
K	E 12 - 13	1.00	1.00	400	n (min-1)	12224	9779	8149	6985	6112	4890	4075	3056	2445	2037	1528
					fz (in)	0.0006	0.0007	0.0008	0.0010	0.0011	0.0014	0.0017	0.0023	0.0028	0.0034	0.0045
					vf (in/min)	34	34	34	34	34	34	34	34	34	34	34
	E 14 - 15	0.50	1.00	325	n (min-1)	9932	7946	6621	5675	4966	3973	3311	2483	1986	1655	1242
					fz (in)	0.00038	0.0005	0.00056	0.0007	0.0008	0.0009	0.0011	0.0015	0.0019	0.0023	0.0030
					vf (in/min)	19	19	19	19	19	19	19	19	19	19	19
S	E 19	0.50	1.00	90	n (min-1)	2750	2200	1834	1572	1375	1100	917	688	550	458	344
					fz (in)	0.00028	0.0003	0.00041	0.0005	0.0006	0.0007	0.0008	0.0011	0.0014	0.0017	0.0022
					vf (in/min)	4	4	4	4	4	4	4	4	4	4	4
	E 20	0.25	1.00	75	n (min-1)	2292	1834	1528	1310	1146	917	764	573	458	382	287
					fz (in)	0.00025	0.00031	0.00038	0.0004	0.0005	0.0006	0.0008	0.0010	0.0013	0.0015	0.0020
					vf (in/min)	3	3	3	3	3	3	3	3	3	3	3
	E 21	0.25	1.00	65	n (min-1)	1986	1589	1324	1135	993	795	662	497	397	331	248
					fz (in)	0.00025	0.00031	0.00038	0.0004	0.0005	0.0006	0.0008	0.0010	0.0013	0.0015	0.0020
					vf (in/min)	2	2	2	2	2	2	2	2	2	2	2
	E 22	0.50	1.00	170	n (min-1)	5195	4156	3463	2969	2598	2078	1732	1299	1039	866	649
					fz (in)	0.0004	0.0005	0.0006	0.0007	0.0008	0.0009	0.0011	0.0015	0.0019	0.0023	0.0030
					vf (in/min)	10	10	10	10	10	10	10	10	10	10	10

SMG = Seco Material Group
 n [min-1] = RPM
 v_c (sf/min) = Surface feet/min

fz [in] = Feed/tooth
 a_p/D_c = % of diameter
 vf [in/min] = Feed rate
 a_e/D_c = % of diameter

A = Air D = Dry E = Emulsion (flood coolant) M = Mist
 All cutting data are start values. All cutting data is in inch values.
 Please reference the Workpiece Material Classification chart located on page 15.

STS540, STR540, STSN540, STRN540 - SIDE MILLING LIGHT ROUGHING - INCH - UP TO 4 X DIAMETER REACH LENGTH - START VALUES

ISO GROUP	SMG	a _p x D _c	a _e x D _c	v _c (sf / min)		SIDE MILLING - LIGHT ROUGHING										
						Zn = 5										
						1/8	5/32	3/16	7/32	1/4	5/16	3/8	1/2	5/8	3/4	1
P	E 1 - 2	2.00	0.15	600	n [min-1]	18336	14669	12224	10478	9168	7334	6112	4584	3667	3056	2292
					fz [in]	0.0010	0.0013	0.0015	0.0018	0.0020	0.0025	0.0030	0.0040	0.0050	0.0060	0.0080
					vf [in/min]	92	92	92	92	92	92	92	92	92	92	92
	A / E 3 - 4	2.00	0.15	550	n [min-1]	16808	13446	11205	9605	8404	6723	5603	4202	3362	2801	2101
					fz [in]	0.0010	0.0013	0.0015	0.0018	0.0020	0.0025	0.0030	0.0040	0.0050	0.0060	0.0080
					vf [in/min]	84	84	84	84	84	84	84	84	84	84	84
A / E 5 - 6	2.00	0.12	450	n [min-1]	13752	11002	9168	7858	6876	5501	4584	3438	2750	2292	1719	
				fz [in]	0.0008	0.0010	0.0012	0.0014	0.0016	0.0020	0.0024	0.0033	0.0041	0.0049	0.0065	
				vf [in/min]	56	56	56	56	56	56	56	56	56	56	56	
H	M / A 7 (48-56 HRc)	2.00	0.08	200	n [min-1]	6112	4890	4075	3493	3056	2445	2037	1528	1222	1019	764
					fz [in]	0.0006	0.0007	0.0008	0.0010	0.0011	0.0014	0.0017	0.0023	0.0028	0.0034	0.0045
					vf [in/min]	17	17	17	17	17	17	17	17	17	17	17
M	E 8 - 9	2.00	0.15	510	n [min-1]	15586	12468	10390	8906	7793	6234	5195	3896	3117	2598	1948
					fz [in]	0.0009	0.0012	0.0014	0.0016	0.0019	0.0023	0.0028	0.0038	0.0047	0.0056	0.0075
					vf [in/min]	73	73	73	73	73	73	73	73	73	73	73
	A / E 10 - 11	2.00	0.12	480	n [min-1]	14669	11735	9779	8382	7334	5868	4890	3667	2934	2445	1834
					fz [in]	0.0008	0.0010	0.0012	0.0014	0.0016	0.0020	0.0024	0.0033	0.0041	0.0049	0.0065
					vf [in/min]	60	60	60	60	60	60	60	60	60	60	60
K	E 12 - 13	2.00	0.12	420	n [min-1]	12835	10268	8557	7334	6418	5134	4278	3209	2567	2139	1604
					fz [in]	0.0009	0.0011	0.0013	0.0015	0.0018	0.0022	0.0026	0.0035	0.0044	0.0053	0.0070
	E 14 - 15	2.00	0.12	360	n [min-1]	11002	8801	7334	6287	5501	4401	3667	2750	2200	1834	1375
					fz [in]	0.0006	0.0008	0.0009	0.0011	0.0013	0.0016	0.0019	0.0025	0.0031	0.0038	0.0050
S	E 19	2.00	0.12	130	n [min-1]	3973	3178	2649	2270	1986	1589	1324	993	795	662	497
					fz [in]	0.0006	0.0008	0.0009	0.0011	0.0013	0.0016	0.0019	0.0025	0.0031	0.0038	0.0050
					vf [in/min]	12	12	12	12	12	12	12	12	12	12	12
					n [min-1]	3056	2445	2037	1746	1528	1222	1019	764	611	509	382
	E 20	2.00	0.10	100	fz [in]	0.0006	0.0007	0.0008	0.0010	0.0011	0.0014	0.0017	0.0023	0.0028	0.0034	0.0045
					vf [in/min]	9	9	9	9	9	9	9	9	9	9	9
					n [min-1]	2598	2078	1732	1484	1299	1039	866	649	520	433	325
					fz [in]	0.0006	0.0007	0.0008	0.0010	0.0011	0.0014	0.0017	0.0023	0.0028	0.0034	0.0045
	E 21	2.00	0.10	85	vf [in/min]	7	7	7	7	7	7	7	7	7	7	7
					n [min-1]	7029	5623	4686	4016	3514	2812	2343	1757	1406	1171	879
					fz [in]	0.0008	0.0010	0.0012	0.0014	0.0016	0.0020	0.0024	0.0033	0.0041	0.0049	0.0065
					vf [in/min]	29	29	29	29	29	29	29	29	29	29	29
E 22	2.00	0.15	230	n [min-1]	7029	5623	4686	4016	3514	2812	2343	1757	1406	1171	879	
				fz [in]	0.0008	0.0010	0.0012	0.0014	0.0016	0.0020	0.0024	0.0033	0.0041	0.0049	0.0065	
				vf [in/min]	29	29	29	29	29	29	29	29	29	29	29	
				n [min-1]	7029	5623	4686	4016	3514	2812	2343	1757	1406	1171	879	

SMG = Seco Material Group
 n [min-1] = RPM
 v_c (sf/min) = Surface feet/min

fz [in] = Feed/tooth
 a_p/D_c = % of diameter
 vf [in/min] = Feed rate
 a_e/D_c = % of diameter

A = Air D = Dry E = Emulsion (flood coolant) M = Mist
 All cutting data are start values. All cutting data is in inch values.
 Please reference the Workpiece Material Classification chart located on page 15.

STS540, STR540, STSN540, STRN540 - SIDE MILLING HEAVY ROUGHING - INCH - UP TO 4 X DIAMETER REACH LENGTH - START VALUES

		SIDE MILLING - HEAVY ROUGHING															
ISO GROUP	SMG	a _p x D _c	a _e x D _c	v _c (sf / min)		Zn = 5											
						1/8	5/32	3/16	7/32	1/4	5/16	3/8	1/2	5/8	3/4	1	
P	E 1 - 2	2.00	0.40	510	n [min-1]	15586	12468	10390	8906	7793	6234	5195	3896	3117	2598	1948	
					fz [in]	0.0009	0.0011	0.0013	0.0015	0.0018	0.0022	0.0026	0.0035	0.0044	0.0053	0.0070	
					vf [in/min]	68	68	68	68	68	68	68	68	68	68	68	68
	A / E 3 - 4	2.00	0.40	460	n [min-1]	14058	11246	9372	8033	7029	5623	4686	3514	2812	2343	1757	
					fz [in]	0.0009	0.0011	0.0013	0.0015	0.0018	0.0022	0.0026	0.0035	0.0044	0.0053	0.0070	
					vf [in/min]	62	62	62	62	62	62	62	62	62	62	62	62
A / E 5 - 6	2.00	0.30	380	n [min-1]	11613	9290	7742	6636	5806	4645	3871	2903	2323	1935	1452		
				fz [in]	0.0008	0.0009	0.0011	0.0013	0.0015	0.0019	0.0023	0.0030	0.0038	0.0045	0.0060		
				vf [in/min]	44	44	44	44	44	44	44	44	44	44	44	44	44
H	M / A 7 (48-56 HRC)	2.00	0.15	150	n [min-1]	4584	3667	3056	2619	2292	1834	1528	1146	917	764	573	
					fz [in]	0.0004	0.0005	0.0007	0.0008	0.0009	0.0011	0.0013	0.0018	0.0022	0.0026	0.0035	
					vf [in/min]	10	10	10	10	10	10	10	10	10	10	10	10
M	E 8 - 9	2.00	0.30	430	n [min-1]	13141	10513	8761	7509	6570	5256	4380	3285	2628	2190	1643	
					fz [in]	0.0006	0.0007	0.0008	0.0010	0.0011	0.0014	0.0017	0.0023	0.0028	0.0034	0.0045	
					vf [in/min]	37	37	37	37	37	37	37	37	37	37	37	37
	A / E 10 - 11	2.00	0.25	400	n [min-1]	12224	9779	8149	6985	6112	4890	4075	3056	2445	2037	1528	
					fz [in]	0.0005	0.0006	0.0008	0.0009	0.0010	0.0013	0.0015	0.0020	0.0025	0.0030	0.0040	
					vf [in/min]	31	31	31	31	31	31	31	31	31	31	31	31
K	E 12 - 13	2.00	0.30	350	n [min-1]	10696	8557	7131	6112	5348	4278	3565	2674	2139	1783	1337	
					fz [in]	0.0008	0.0010	0.0012	0.0014	0.0016	0.0020	0.0024	0.0033	0.0041	0.0049	0.0065	
					vf [in/min]	43	43	43	43	43	43	43	43	43	43	43	43
	E 14 - 15	2.00	0.25	300	n [min-1]	9168	7334	6112	5239	4584	3667	3056	2292	1834	1528	1146	
					fz [in]	0.0006	0.0008	0.0009	0.0011	0.0013	0.0016	0.0019	0.0025	0.0031	0.0038	0.0050	
					vf [in/min]	29	29	29	29	29	29	29	29	29	29	29	29
S	E 19	2.00	0.20	110	n [min-1]	3362	2689	2241	1921	1681	1345	1121	840	672	560	420	
					fz [in]	0.0006	0.0007	0.0008	0.0010	0.0011	0.0014	0.0017	0.0022	0.0028	0.0033	0.0044	
					vf [in/min]	9	9	9	9	9	9	9	9	9	9	9	9
					n [min-1]	2598	2078	1732	1484	1299	1039	866	649	520	433	325	
	E 20	2.00	0.20	85	fz [in]	0.0004	0.0005	0.0007	0.0008	0.0009	0.0011	0.0013	0.0018	0.0022	0.0026	0.0035	
					vf [in/min]	6	6	6	6	6	6	6	6	6	6	6	
					n [min-1]	2139	1711	1426	1222	1070	856	713	535	428	357	267	
					fz [in]	0.0004	0.0005	0.0007	0.0008	0.0009	0.0011	0.0013	0.0018	0.0022	0.0026	0.0035	
	E 21	2.00	0.20	70	vf [in/min]	5	5	5	5	5	5	5	5	5	5	5	
					n [min-1]	5806	4645	3871	3318	2903	2323	1935	1452	1161	968	726	
					fz [in]	0.0008	0.0010	0.0012	0.0014	0.0016	0.0020	0.0024	0.0033	0.0041	0.0049	0.0065	
					vf [in/min]	24	24	24	24	24	24	24	24	24	24	24	24

SMG = Seco Material Group
 n [min-1] = RPM
 v_c (sf/min) = Surface feet/min

fz [in] = Feed/tooth
 a_p/D_c = % of diameter
 vf [in/min] = Feed rate
 a_e/D_c = % of diameter

A = Air D = Dry E = Emulsion (flood coolant) M = Mist
 All cutting data are start values. All cutting data is in inch values.
 Please reference the Workpiece Material Classification chart located on page 15.

CUTTING DATA - 5 FLUTE STABILIZER

STS540, STR540, STSN540, STRN540 - SIDE MILLING FINISHING - INCH - UP TO 4 X DIAMETER REACH LENGTH - START VALUES

ISO GROUP	SMG	a _p x D _c	a _e x D _c	v _c (sf / min)	SIDE MILLING - FINISHING											
					Zn = 5											
					1/8	5/32	3/16	7/32	1/4	5/16	3/8	1/2	5/8	3/4	1	
P	E 1 - 2	2.00	0.02	750	n [min-1]	22920	18336	15280	13097	11460	9168	7640	5730	4584	3820	2865
					fz [in]	0.0006	0.0008	0.0009	0.0011	0.0013	0.0016	0.0019	0.0025	0.0031	0.0038	0.0050
					vf [in/min]	72	72	72	72	72	72	72	72	72	72	72
	A / E 3 - 4	2.00	0.02	680	n [min-1]	20781	16625	13854	11875	10390	8312	6927	5195	4156	3463	2598
					fz [in]	0.0006	0.0008	0.0009	0.0011	0.0013	0.0016	0.0019	0.0025	0.0031	0.0038	0.0050
					vf [in/min]	65	65	65	65	65	65	65	65	65	65	65
A / E 5 - 6	2.00	0.02	560	n [min-1]	17114	13691	11409	9779	8557	6845	5705	4278	3423	2852	2139	
				fz [in]	0.0006	0.0008	0.0009	0.0011	0.0013	0.0016	0.0019	0.0025	0.0031	0.0038	0.0050	
				vf [in/min]	53	53	53	53	53	53	53	53	53	53	53	53
H	M / A 7 (48-56 HRC)	2.00	0.02	250	n [min-1]	7640	6112	5093	4366	3820	3056	2547	1910	1528	1273	955
					fz [in]	0.0005	0.0006	0.0008	0.0009	0.0010	0.0013	0.0015	0.0020	0.0025	0.0030	0.0040
					vf [in/min]	19	19	19	19	19	19	19	19	19	19	19
M	E 8 - 9	2.00	0.02	630	n [min-1]	19253	15402	12835	11002	9626	7701	6418	4813	3851	3209	2407
					fz [in]	0.0006	0.0008	0.0009	0.0011	0.0013	0.0016	0.0019	0.0025	0.0031	0.0038	0.0050
					vf [in/min]	60	60	60	60	60	60	60	60	60	60	60
	A / E 10 - 11	2.00	0.02	600	n [min-1]	18336	14669	12224	10478	9168	7334	6112	4584	3667	3056	2292
					fz [in]	0.0006	0.0008	0.0009	0.0011	0.0013	0.0016	0.0019	0.0025	0.0031	0.0038	0.0050
					vf [in/min]	57	57	57	57	57	57	57	57	57	57	57
K	E 12 - 13	2.00	0.02	520	n [min-1]	15891	12713	10594	9081	7946	6356	5297	3973	3178	2649	1986
					fz [in]	0.0006	0.0008	0.0009	0.0011	0.0013	0.0016	0.0019	0.0025	0.0031	0.0038	0.0050
					vf [in/min]	50	50	50	50	50	50	50	50	50	50	50
	E 14 - 15	2.00	0.02	450	n [min-1]	13752	11002	9168	7858	6876	5501	4584	3438	2750	2292	1719
					fz [in]	0.0005	0.0006	0.0008	0.0009	0.0010	0.0013	0.0015	0.0020	0.0025	0.0030	0.0040
					vf [in/min]	34	34	34	34	34	34	34	34	34	34	34
S	E 19	2.00	0.02	160	n [min-1]	4890	3912	3260	2794	2445	1956	1630	1222	978	815	611
					fz [in]	0.0005	0.0006	0.0008	0.0009	0.0010	0.0013	0.0015	0.0020	0.0025	0.0030	0.0040
					vf [in/min]	12	12	12	12	12	12	12	12	12	12	12
	E 20	2.00	0.02	125	n [min-1]	3820	3056	2547	2183	1910	1528	1273	955	764	637	478
					fz [in]	0.0005	0.0006	0.0008	0.0009	0.0010	0.0013	0.0015	0.0020	0.0025	0.0030	0.0040
					vf [in/min]	10	10	10	10	10	10	10	10	10	10	10
	E 21	2.00	0.02	100	n [min-1]	3056	2445	2037	1746	1528	1222	1019	764	611	509	382
					fz [in]	0.0005	0.0006	0.0008	0.0009	0.0010	0.0013	0.0015	0.0020	0.0025	0.0030	0.0040
					vf [in/min]	8	8	8	8	8	8	8	8	8	8	8
	E 22	2.00	0.02	270	n [min-1]	8251	6601	5501	4715	4126	3300	2750	2063	1650	1375	1031
					fz [in]	0.0006	0.0008	0.0009	0.0011	0.0013	0.0016	0.0019	0.0025	0.0031	0.0038	0.0050
					vf [in/min]	26	26	26	26	26	26	26	26	26	26	26

SMG = Seco Material Group
 n [min-1] = RPM
 v_c (sf/min) = Surface feet/min

fz [in] = Feed/tooth
 a_p/D_c = % of diameter
 vf [in/min] = Feed rate
 a_e/D_c = % of diameter

A = Air D = Dry E = Emulsion (flood coolant) M = Mist
 All cutting data are start values. All cutting data is in inch values.
 Please reference the Workpiece Material Classification chart located on page 15.

STSN540, STRN540 - SIDE MILLING FINISHING - INCH - OVER 4 X DIAMETER REACH LENGTH - START VALUES

ISO GROUP	SMG	$a_p \times D_c$	$a_e \times D_c$	v_c (sf / min)		Zn = 5					
						1/4	3/8	1/2	5/8	3/4	1
P	E 1 - 2	1.00	0.01	750	n [min-1]	11460	7640	5730	4584	3820	2865
					fz [in]	0.0013	0.0019	0.0025	0.0031	0.0038	0.0050
					vf [in/min]	72	72	72	72	72	72
	A / E 3 - 4	1.00	0.01	680	n [min-1]	10390	6927	5195	4156	3463	2598
					fz [in]	0.0013	0.0019	0.0025	0.0031	0.0038	0.0050
					vf [in/min]	65	65	65	65	65	65
	A / E 5 - 6	1.00	0.01	560	n [min-1]	8557	5705	4278	3423	2852	2139
					fz [in]	0.0013	0.0019	0.0025	0.0031	0.0038	0.0050
					vf [in/min]	53	53	53	53	53	53
H	M / A 7 (48-56 HRC)	1.00	0.01	250	n [min-1]	3820	2547	1910	1528	1273	955
					fz [in]	0.0010	0.0015	0.0020	0.0025	0.0030	0.0040
					vf [in/min]	19	19	19	19	19	19
M	E 8 - 9	1.00	0.01	630	n [min-1]	9626	6418	4813	3851	3209	2407
					fz [in]	0.0013	0.0019	0.0025	0.0031	0.0038	0.0050
					vf [in/min]	60	60	60	60	60	60
	A / E 10 - 11	1.00	0.01	600	n [min-1]	9168	6112	4584	3667	3056	2292
					fz [in]	0.0013	0.0019	0.0025	0.0031	0.0038	0.0050
					vf [in/min]	57	57	57	57	57	57
K	E 12 - 13	1.00	0.01	525	n [min-1]	8022	5348	4011	3209	2674	2006
					fz [in]	0.0013	0.0019	0.0025	0.0031	0.0038	0.0050
					vf [in/min]	50	50	50	50	50	50
	E 14 - 15	1.00	0.01	450	n [min-1]	6876	4584	3438	2750	2292	1719
					fz [in]	0.0010	0.0015	0.0020	0.0025	0.0030	0.0040
					vf [in/min]	34	34	34	34	34	34
S	E 19	1.00	0.01	160	n [min-1]	2445	1630	1222	978	815	611
					fz [in]	0.0010	0.0015	0.0020	0.0025	0.0030	0.0040
					vf [in/min]	12	12	12	12	12	12
	E 20	1.00	0.01	125	n [min-1]	1910	1273	955	764	637	478
					fz [in]	0.0010	0.0015	0.0020	0.0025	0.0030	0.0040
					vf [in/min]	10	10	10	10	10	10
	E 21	1.00	0.01	105	n [min-1]	1604	1070	802	642	535	401
					fz [in]	0.0010	0.0015	0.0020	0.0025	0.0030	0.0040
					vf [in/min]	8	8	8	8	8	8
	E 22	1.00	0.01	290	n [min-1]	4431	2954	2216	1772	1477	1108
					fz [in]	0.0013	0.0019	0.0025	0.0031	0.0038	0.0050
					vf [in/min]	28	28	28	28	28	28

SMG = Seco Material Group
 n [min-1] = RPM
 v_c (sf/min) = Surface feet/min

fz [in] = Feed/tooth
 a_p/D_c = % of diameter
 a_e/D_c = % of diameter
 vf [in/min] = Feed rate

A = Air D = Dry E = Emulsion (flood coolant) M = Mist
 All cutting data are start values. All cutting data is in inch values.
 Please reference the Workpiece Material Classification chart located on page 15.

CUTTING DATA - 5 FLUTE STABILIZER

STSN540, STRN540 - SIDE MILLING LIGHT ROUGHING - INCH - OVER 4 X DIAMETER REACH LENGTH - START VALUES

ISO GROUP	SMG	$a_p \times D_c$	$a_e \times D_c$	v_c (sf / min)		SIDE MILLING - LIGHT ROUGHING					
						Zn = 5					
						1/4	3/8	1/2	5/8	3/4	1
P	E 1 - 2	0.50	0.10	600	n [min-1]	9168	6112	4584	3667	3056	2292
					fz [in]	0.0015	0.0023	0.0030	0.0038	0.0045	0.0060
					vf [in/min]	69	69	69	69	69	69
	A / E 3 - 4	0.50	0.10	550	n [min-1]	8404	5603	4202	3362	2801	2101
					fz [in]	0.0015	0.0023	0.0030	0.0038	0.0045	0.0060
					vf [in/min]	63	63	63	63	63	63
	A / E 5 - 6	0.50	0.08	450	n [min-1]	6876	4584	3438	2750	2292	1719
					fz [in]	0.0011	0.0017	0.0023	0.0028	0.0034	0.0045
					vf [in/min]	39	39	39	39	39	39
H	M / A 7 (48-56 HRC)	0.50	0.05	200	n [min-1]	3056	2037	1528	1222	1019	764
					fz [in]	0.0009	0.0013	0.0018	0.0022	0.0026	0.0035
					vf [in/min]	13	13	13	13	13	13
M	E 8 - 9	0.50	0.10	510	n [min-1]	7793	5195	3896	3117	2598	1948
					fz [in]	0.0014	0.0021	0.0028	0.0034	0.0041	0.0055
					vf [in/min]	54	54	54	54	54	54
	A / E 10 - 11	0.50	0.08	480	n [min-1]	7334	4890	3667	2934	2445	1834
					fz [in]	0.0013	0.0019	0.0025	0.0031	0.0038	0.0050
					vf [in/min]	46	46	46	46	46	46
K	E 12 - 13	0.50	0.08	420	n [min-1]	6418	4278	3209	2567	2139	1604
					fz [in]	0.0013	0.0019	0.0025	0.0031	0.0038	0.0050
					vf [in/min]	40	40	40	40	40	40
	E 14 - 15	0.50	0.08	360	n [min-1]	5501	3667	2750	2200	1834	1375
					fz [in]	0.0010	0.0015	0.0020	0.0025	0.0030	0.0040
					vf [in/min]	28	28	28	28	28	28
S	E 19	0.50	0.08	130	n [min-1]	1986	1324	993	795	662	497
					fz [in]	0.0010	0.0015	0.0020	0.0025	0.0030	0.0040
					vf [in/min]	10	10	10	10	10	10
	E 20	0.50	0.06	100	n [min-1]	1528	1019	764	611	509	382
					fz [in]	0.0009	0.0013	0.0018	0.0022	0.0026	0.0035
					vf [in/min]	7	7	7	7	7	7
	E 21	0.50	0.06	85	n [min-1]	1299	866	649	520	433	325
					fz [in]	0.0009	0.0013	0.0018	0.0022	0.0026	0.0035
					vf [in/min]	6	6	6	6	6	6
	E 22	0.50	0.10	230	n [min-1]	3514	2343	1757	1406	1171	879
					fz [in]	0.0013	0.0019	0.0025	0.0031	0.0038	0.0050
					vf [in/min]	22	22	22	22	22	22

SMG = Seco Material Group
 n [min-1] = RPM
 v_c (sf/min) = Surface feet/min

fz [in] = Feed/tooth
 a_p/D_c = % of diameter
 a_e/D_c = % of diameter
 v_f [in/min] = Feed rate

A = Air D = Dry E = Emulsion (flood coolant) M = Mist
 All cutting data are start values. All cutting data is in inch values.
 Please reference the Workpiece Material Classification chart located on page 15.

STS540M, STR540M - SLOTTING - METRIC - START VALUES

ISO GROUP	SMG	$a_p \times D_c$	$a_e \times D_c$	v_c (sf / min)	SLOTTING									
										$Z_n = 5$				
					6	8	10	12	16					
P	E 1 - 2	1.00	1.00	425	n (min-1)	6873	5155	4124	3436	2577				
					fz (in)	0.0011	0.0014	0.0018	0.0021	0.0028				
					vf (in/min)	37	37	37	37	37				
	A / E 3 - 4	1.00	1.00	400	n (min-1)	6469	4851	3881	3234	2426				
					fz (in)	0.0009	0.0013	0.0016	0.0019	0.0025				
					vf (in/min)	31	31	31	31	31				
A / E 5 - 6	1.00	1.00	350	n (min-1)	5660	4245	3396	2830	2122					
				fz (in)	0.0008	0.0011	0.0014	0.0017	0.0022					
				vf (in/min)	23	23	23	23	23					
H	M / A 7 (48-56 HRc)	0.50	1.00	275	n (min-1)	4447	3335	2668	2224	1668				
					fz (in)	0.0005	0.0006	0.0008	0.0009	0.0013				
					vf (in/min)	11	11	11	11	11				
M	E 8 - 9	0.50	1.00	325	n (min-1)	5256	3942	3153	2628	1971				
					fz (in)	0.0006	0.0008	0.0010	0.0012	0.0016				
					vf (in/min)	16	16	16	16	16				
	A / E 10 - 11	0.50	1.00	275	n (min-1)	4447	3335	2668	2224	1668				
					fz (in)	0.0005	0.0006	0.0008	0.0009	0.0013				
					vf (in/min)	11	11	11	11	11				
K	E 12 - 13	1.00	1.00	400	n (min-1)	6469	4851	3881	3234	2426				
					fz (in)	0.0011	0.0014	0.0018	0.0021	0.0028				
					vf (in/min)	34	34	34	34	34				
	E 14 - 15	0.50	1.00	325	n (min-1)	5256	3942	3153	2628	1971				
					fz (in)	0.0007	0.0009	0.0012	0.0014	0.0019				
					vf (in/min)	19	19	19	19	19				
S	E 19	0.50	1.00	90	n (min-1)	1455	1092	873	728	546				
					fz (in)	0.0005	0.0007	0.0009	0.0010	0.0014				
	E 20	0.25	1.00	75	n (min-1)	1213	910	728	606	455				
					fz (in)	0.0005	0.0006	0.0008	0.0009	0.0013				
	E 21	0.25	1.00	65	n (min-1)	1051	788	631	526	394				
					fz (in)	0.0005	0.0006	0.0008	0.0009	0.0013				
	E 22	0.50	1.00	170	n (min-1)	2749	2062	1649	1375	1031				
					fz (in)	0.0007	0.0009	0.0012	0.0014	0.0019				
					128		213	vf (in/min)	10	10	10	10	10	

SMG = Seco Material Group
 n [min-1] = RPM
 v_c (sf/min) = Surface feet/min

fz [in] = Feed/tooth
 a_p/D_c = % of diameter
 a_e/D_c = % of diameter
 vf [in/min] = Feed rate

A = Air D = Dry E = Emulsion (flood coolant) M = Mist
 All cutting data are start values. All cutting data is in inch values.
 Please reference the Workpiece Material Classification chart located on page 15.

STS540M, STR540M - SIDE MILLING LIGHT ROUGHING - METRIC - START VALUES

SIDE MILLING - LIGHT ROUGHING											
ISO GROUP	SMG	$a_p \times D_c$	$a_e \times D_c$	v_c (sf / min)		$Zn = 5$					
						6	8	10	12	16	
P	E 1 - 2	2.00	0.15	600	n [min-1]	9703	7277	5822	4851	3639	
					fz [in]	0.0019	0.0025	0.0031	0.0038	0.0050	
					vf [in/min]	92	92	92	92	92	
	A / E 3 - 4	2.00	0.15	550	n [min-1]	8894	6671	5337	4447	3335	
					fz [in]	0.0019	0.0025	0.0031	0.0038	0.0050	
					vf [in/min]	84	84	84	84	84	
A / E 5 - 6	2.00	0.12	450	n [min-1]	7277	5458	4366	3639	2729		
				fz [in]	0.0015	0.0020	0.0026	0.0031	0.0041		
				vf [in/min]	56	56	56	56	56		
H	M / A 7 (48-56 HRc)	2.00	0.08	200	n [min-1]	3234	2426	1941	1617	1213	
					fz [in]	0.0011	0.0014	0.0018	0.0021	0.0028	
					vf [in/min]	17	17	17	17	17	
M	E 8 - 9	2.00	0.15	510	n [min-1]	8247	6186	4948	4124	3093	
					fz [in]	0.0018	0.0024	0.0030	0.0035	0.0047	
					vf [in/min]	73	73	73	73	73	
	A / E 10 - 11	2.00	0.12	480	n [min-1]	7762	5822	4657	3881	2911	
					fz [in]	0.0015	0.0020	0.0026	0.0031	0.0041	
					vf [in/min]	60	60	60	60	60	
K	E 12 - 13	2.00	0.12	420	n [min-1]	6792	5094	4075	3396	2547	
					fz [in]	0.0017	0.0022	0.0028	0.0033	0.0044	
					vf [in/min]	56	56	56	56	56	
	E 14 - 15	2.00	0.12	360	n [min-1]	5822	4366	3493	2911	2183	
					fz [in]	0.0012	0.0016	0.0020	0.0024	0.0031	
					vf [in/min]	34	34	34	34	34	
S	E 19	2.00	0.12	130	n [min-1]	2102	1577	1261	1051	788	
					fz [in]	0.0012	0.0016	0.0020	0.0024	0.0031	
	E 20	2.00	0.10	100	n [min-1]	1617	1213	970	809	606	
					fz [in]	0.0011	0.0014	0.0018	0.0021	0.0028	
	E 21	2.00	0.10	85	n [min-1]	1375	1031	825	687	515	
					fz [in]	0.0011	0.0014	0.0018	0.0021	0.0028	
	E 22	2.00	0.15	230	n [min-1]	3719	2790	2232	1860	1395	
					fz [in]	0.0015	0.0020	0.0026	0.0031	0.0041	
					173 - 288	vf [in/min]	29	29	29	29	29

SMG = Seco Material Group
 n [min-1] = RPM
 v_c (sf/min) = Surface feet/min

fz [in] = Feed/tooth
 a_p/D_c = % of diameter
 v_f [in/min] = Feed rate
 a_e/D_c = % of diameter

A = Air D = Dry E = Emulsion (flood coolant) M = Mist
 All cutting data are start values. All cutting data is in inch values.
 Please reference the Workpiece Material Classification chart located on page 15.

STS540M, STR540M - SIDE MILLING HEAVY ROUGHING - METRIC - START VALUES

ISO GROUP	SMG	$a_p \times D_c$	$a_e \times D_c$	v_c (sf / min)	SIDE MILLING - HEAVY ROUGHING						
					$Z_n = 5$						
					6	8	10	12	16		
P	E 1 - 2	2.00	0.40	510 383 - 638	n [min-1]	8247	6186	4948	4124	3093	
					fz [in]	0.0017	0.0022	0.0028	0.0033	0.0044	
					vf [in/min]	68	68	68	68	68	
	A / E 3 - 4	2.00	0.40	460 345 - 575	n [min-1]	7439	5579	4463	3719	2790	
					fz [in]	0.0017	0.0022	0.0028	0.0033	0.0044	
					vf [in/min]	62	62	62	62	62	
A / E 5 - 6	2.00	0.30	380 285 - 475	n [min-1]	6145	4609	3687	3073	2304		
				fz [in]	0.0014	0.0019	0.0024	0.0028	0.0038		
				vf [in/min]	44	44	44	44	44		
H	M / A 7 (48-56 HRc)	2.00	0.15	150 113 - 188	n [min-1]	2426	1819	1455	1213	910	
					fz [in]	0.0008	0.0011	0.0014	0.0017	0.0022	
					vf [in/min]	10	10	10	10	10	
M	E 8 - 9	2.00	0.30	430 323 - 538	n [min-1]	6954	5215	4172	3477	2608	
					fz [in]	0.0011	0.0014	0.0018	0.0021	0.0028	
					vf [in/min]	37	37	37	37	37	
	A / E 10 - 11	2.00	0.25	400 250 - 500	n [min-1]	6469	4851	3881	3234	2426	
					fz [in]	0.0009	0.0013	0.0016	0.0019	0.0025	
					vf [in/min]	31	31	31	31	31	
K	E 12 - 13	2.00	0.30	350 263 - 438	n [min-1]	5660	4245	3396	2830	2122	
					fz [in]	0.0015	0.0020	0.0026	0.0031	0.0041	
					vf [in/min]	43	43	43	43	43	
	E 14 - 15	2.00	0.25	300 225 - 375	n [min-1]	4851	3639	2911	2426	1819	
					fz [in]	0.0012	0.0016	0.0020	0.0024	0.0031	
					vf [in/min]	29	29	29	29	29	
S	E 19	2.00	0.20	110 83 - 138	n [min-1]	1779	1334	1067	889	667	
					fz [in]	0.0010	0.0014	0.0017	0.0021	0.0028	
	E 20	2.00	0.20	85 64 - 106	n [min-1]	1375	1031	825	687	515	
					fz [in]	0.0008	0.0011	0.0014	0.0017	0.0022	
	E 21	2.00	0.20	70 53 - 88	n [min-1]	1132	849	679	566	424	
					fz [in]	0.0008	0.0011	0.0014	0.0017	0.0022	
	E 22	2.00	0.40	190 143 - 238	n [min-1]	3073	2304	1844	1536	1152	
					fz [in]	0.0015	0.0020	0.0026	0.0031	0.0041	
						vf [in/min]	24	24	24	24	24

SMG = Seco Material Group
 n [min-1] = RPM
 v_c (sf/min) = Surface feet/min

fz [in] = Feed/tooth
 a_p/D_c = % of diameter
 v_f [in/min] = Feed rate
 a_e/D_c = % of diameter

A = Air D = Dry E = Emulsion (flood coolant) M = Mist
 All cutting data are start values. All cutting data is in inch values.
 Please reference the Workpiece Material Classification chart located on page 15.

STS540M, STR540M - SIDE MILLING FINISHING - METRIC - START VALUES

ISO GROUP	SMG	$a_p \times D_c$	$a_e \times D_c$	v_c (sf / min)	SIDE MILLING - FINISHING						
					$Z_n = 5$						
					6	8	10	12	16		
P	E 1 - 2	2.00	0.02	750	n [min-1]	12129	9096	7277	6064	4548	
					fz [in]	0.0012	0.0016	0.0020	0.0024	0.0031	
					vf [in/min]	72	72	72	72	72	
	A / E 3 - 4	2.00	0.02	680	n [min-1]	10997	8247	6598	5498	4124	
					fz [in]	0.0012	0.0016	0.0020	0.0024	0.0031	
					vf [in/min]	65	65	65	65	65	
A / E 5 - 6	2.00	0.02	560	n [min-1]	9056	6792	5434	4528	3396		
				fz [in]	0.0012	0.0016	0.0020	0.0024	0.0031		
				vf [in/min]	53	53	53	53	53		
H	M / A 7 (48-56 HRC)	2.00	0.02	250	n [min-1]	4043	3032	2426	2021	1516	
					fz [in]	0.0009	0.0013	0.0016	0.0019	0.0025	
					vf [in/min]	19	19	19	19	19	
M	E 8 - 9	2.00	0.02	630	n [min-1]	10188	7641	6113	5094	3820	
					fz [in]	0.0012	0.0016	0.0020	0.0024	0.0031	
					vf [in/min]	60	60	60	60	60	
	A / E 10 - 11	2.00	0.02	600	n [min-1]	9703	7277	5822	4851	3639	
					fz [in]	0.0012	0.0016	0.0020	0.0024	0.0031	
					vf [in/min]	57	57	57	57	57	
K	E 12 - 13	2.00	0.02	520	n [min-1]	8409	6307	5045	4205	3153	
					fz [in]	0.0012	0.0016	0.0020	0.0024	0.0031	
					vf [in/min]	50	50	50	50	50	
	E 14 - 15	2.00	0.02	450	n [min-1]	7277	5458	4366	3639	2729	
					fz [in]	0.0009	0.0013	0.0016	0.0019	0.0025	
					vf [in/min]	34	34	34	34	34	
S	E 19	2.00	0.02	160	n [min-1]	2587	1941	1552	1294	970	
					fz [in]	0.0009	0.0013	0.0016	0.0019	0.0025	
	E 20	2.00	0.02	125	n [min-1]	2021	1516	1213	1011	758	
					fz [in]	0.0009	0.0013	0.0016	0.0019	0.0025	
	E 21	2.00	0.02	100	n [min-1]	1617	1213	970	809	606	
					fz [in]	0.0009	0.0013	0.0016	0.0019	0.0025	
	E 22	2.00	0.02	270	n [min-1]	4366	3275	2620	2183	1637	
					fz [in]	0.0012	0.0016	0.0020	0.0024	0.0031	
					203 - 338	vf [in/min]	26	26	26	26	26

SMG = Seco Material Group
 n [min-1] = RPM
 v_c (sf/min) = Surface feet/min

fz [in] = Feed/tooth
 a_p/D_c = % of diameter
 v_f [in/min] = Feed rate
 a_e/D_c = % of diameter

A = Air D = Dry E = Emulsion (flood coolant) M = Mist
 All cutting data are start values. All cutting data is in inch values.
 Please reference the Workpiece Material Classification chart located on page 15.

STRCS540 - SIDE MILLING SEMI ROUGHING - INCH - START VALUES

ISO GROUP	SMG	$a_p \times D_c$	$a_e \times D_c$	v_c (sf / min)		Zn = 5					
						1/4	3/8	1/2	5/8	3/4	1
P	E 1 - 2	3.00	0.10	700	n [min-1]	10696	7131	5348	4278	3565	2674
					fz [in]	0.0020	0.0030	0.0040	0.0050	0.0060	0.0080
					vf [in/min]	107	107	107	107	107	107
	A / E 3 - 4	3.00	0.10	645	n [min-1]	9856	6570	4928	3942	3285	2464
					fz [in]	0.0020	0.0030	0.0040	0.0050	0.0060	0.0080
					vf [in/min]	99	99	99	99	99	99
	A / E 5 - 6	3.00	0.08	525	n [min-1]	8022	5348	4011	3209	2674	2006
					fz [in]	0.0016	0.0024	0.0033	0.0041	0.0049	0.0065
					vf [in/min]	65	65	65	65	65	65
H	M / A 7 (48-56 HRC)	3.00	0.04	220	n [min-1]	3362	2241	1681	1345	1121	840
					fz [in]	0.0010	0.0015	0.0020	0.0025	0.0030	0.0040
					vf [in/min]	17	17	17	17	17	17
M	E 8 - 9	3.00	0.10	600	n [min-1]	9168	6112	4584	3667	3056	2292
					fz [in]	0.0019	0.0028	0.0038	0.0047	0.0056	0.0075
					vf [in/min]	86	86	86	86	86	86
	A / E 10 - 11	3.00	0.08	565	n [min-1]	8633	5755	4317	3453	2878	2158
					fz [in]	0.0016	0.0024	0.0033	0.0041	0.0049	0.0065
					vf [in/min]	70	70	70	70	70	70
K	E 12 - 13	3.00	0.08	495	n [min-1]	7564	5042	3782	3025	2521	1891
					fz [in]	0.0018	0.0026	0.0035	0.0044	0.0053	0.0070
					vf [in/min]	66	66	66	66	66	66
	E 14 - 15	3.00	0.08	430	n [min-1]	6570	4380	3285	2628	2190	1643
					fz [in]	0.0013	0.0019	0.0025	0.0031	0.0038	0.0050
					vf [in/min]	41	41	41	41	41	41
S	E 19	3.00	0.06	150	n [min-1]	2292	1528	1146	917	764	573
					fz [in]	0.0013	0.0019	0.0025	0.0031	0.0038	0.0050
					vf [in/min]	14	14	14	14	14	14
	E 20	3.00	0.05	120	n [min-1]	1834	1222	917	733	611	458
					fz [in]	0.0012	0.0017	0.0023	0.0029	0.0035	0.0046
					vf [in/min]	11	11	11	11	11	11
	E 21	3.00	0.05	100	n [min-1]	1528	1019	764	611	509	382
					fz [in]	0.0012	0.0017	0.0023	0.0029	0.0035	0.0046
					vf [in/min]	9	9	9	9	9	9
	E 22	3.00	0.08	270	n [min-1]	4126	2750	2063	1650	1375	1031
					fz [in]	0.0016	0.0024	0.0033	0.0041	0.0049	0.0065
					vf [in/min]	34	34	34	34	34	34

SMG = Seco Material Group
 n [min-1] = RPM
 v_c (sf/min) = Surface feet/min

fz [in] = Feed/tooth
 a_p/D_c = % of diameter
 vf [in/min] = Feed rate
 a_e/D_c = % of diameter

A = Air D = Dry E = Emulsion (flood coolant) M = Mist
 All cutting data are start values. All cutting data is in inch values.
 Please reference the Workpiece Material Classification chart located on page 15.

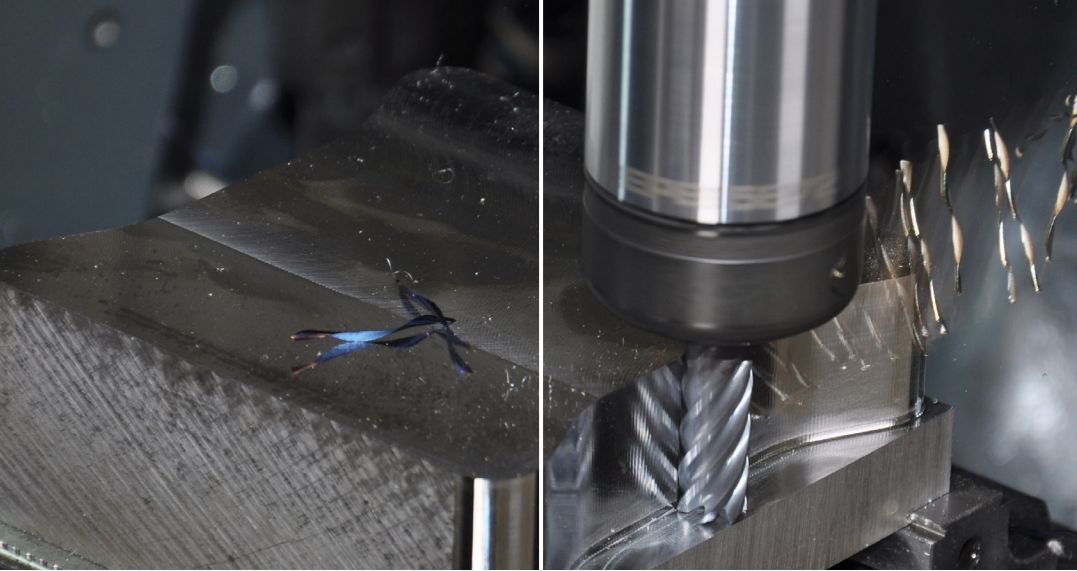

NIAGARA CUTTER™

HIGH PERFORMANCE SOLID CARBIDE END MILLS

ACHIEVE EFFICIENT OPTIMIZED ROUGHING MULTI FLUTE

Reducing cycle times, increasing throughput and extending tool life have never been easier with the Niagara Cutter™ Multi Flute family of end mills. This product series now offers smaller diameters down to 1/8", necked versions with extended reaches and even a new ball nose option for those demanding 3D applications that require optimal performance and tool life. The most unique addition to these products is the advanced chip splitter design. This innovative engineering allows for unsurpassed chip control in applications requiring depths of cut up to 3 times the diameter of the tool.

RANGE OVERVIEW

S638/S638R - Square & Radius

- 1 - 2.5 x Dc flute length (Dc 0.125" - 1.000")
- Cylindrical shank, square corner and radius (0.010", 0.015", 0.030", 0.060", 0.090", 0.120", 0.190", & 0.250")

SN638/SN638R - Necked Series

- 2 - 2.5 x Dc flute length and 4 x D reach length (Dc 0.375" - 1.000")
- Cylindrical shank, square corner and radius (0.015", 0.030", 0.060", 0.090", 0.120" & 0.250")

SB638/SBN638 - Ball Nose Series

- 1 - 2.5 x Dc flute length (Dc 0.250" - 1.000")
- Necked version - 1 x Dc flute length and 3 x Dc reach length
- Cylindrical shank

S738/S738R - Chamfer & Radius

- 1 - 5.0 x Dc flute length (Dc 0.250" - 1.000")
- Cylindrical shank, corner chamfer and radius (0.015", 0.030" & 0.060")

S938/S938R - Chamfer & Radius

- 1.5 - 4.0 x Dc flute length (Dc 0.625" - 1.000")
- Cylindrical shank, corner chamfer and radius (0.030", 0.060", 0.090" & 0.120")

SCS638/SCS638R, SCS738R, SCS938R - Advanced Chip Splitters

- 2.5 - 5.0 x Dc flute length (Dc 0.250" - 1.000")
- Cylindrical shank, square corner and radius (0.015", 0.030", 0.060", 0.120", & 0.250")

MATERIAL GROUPS
Steel 1-6
Stainless Steel 8-11
Cast Iron 12-15
Superalloys 19-22

YOUR BENEFITS

- Increased chip evacuation in deep pocket applications
- AlTiN coating increases tool life
- Smoother cutting for an improved surface finish
- High heat abrasion resistance
- Stronger cutting edge



6 TIPS

OPTIMIZED ROUGHING

Optimized roughing can be highly effective for machining part features such as pockets with challenging corners as well as any straight walls two times the diameter of your end mill and require long axial depths of cuts. This strategy enables you to machine pockets three to four times faster than conventional methods while also dramatically extending the life of your tools. Achieving the best possible results with today's optimized roughing strategy does require adhering to a few specific guidelines.

1. CHOOSE AN APPROPRIATE STEPOVER

Optimized roughing typically employs end mills with 5- to 9-flutes. End mills with fewer flutes have more space for chip formation, thus can utilize larger step-overs. Although the step-over of tools with fewer flutes can be higher, the traverse rate of the tool will decrease because of the fewer flutes. Therefore, a balance must be struck where the optimum step-over and feed rate are utilized for each type of tool. The cutting data in this brochure has been specified based on extensive testing and experience and should serve as a good starting point for your application.

2. USE STRONG, SECURE TOOLHOLDERS & FIXTURING

High-precision holders are crucial when optimized roughing to achieve maximum tool life. Run-out needs to be kept to less than 0.0004" to maximize tool life. This type of precision can be achieved by most shrink fit holders, milling chucks, high precision collet chucks and select manufacturer's end mill holders. A precise holder ensures the accuracy of the process, whereas a less secure holder will cause undesirable levels of vibration while optimized roughing at high feed rates.

3. MAKE SURE YOUR MACHINE IS CAPABLE OF PERFORMING

Machine tools used for optimized roughing not only need to be able to achieve extremely high feed rates, but also need to be able to process thousands of lines of code in a matter of seconds. This requires advanced look-ahead capabilities and processing systems found in newer machine tools. Rigidity throughout the machine tool from the spindle bearings all the way through to the ball screws ensures smooth cutting, consistent tool life and unsurpassed part quality.

4. CHOOSE A SUITABLE PROGRAMMING METHOD

It is nearly impossible to program an optimized roughing strategy manually. Many companies provide state-of-the-art programming software. Careful consideration must be made when choosing the right software or software add on. Not all software is created equal. For example, a programming software designed only for complex 3D high speed milling may not be able to perform the complex radial moves inside of tight corners to maintain a consistent angle of engagement. This is one of the many keys to successful optimized roughing strategies.

5. SELECT THE RIGHT DEPTH OF CUT

Take advantage of the full flute length of the tool selected for the specific application. Maximizing depth of cuts above 2 times the diameter of the tool is common when optimized roughing. Smaller radial step-overs make such depths of the cut possible. A larger step-over would increase the amount of heat in the cut, which in-turn will have a negative effect on tool life and performance. Therefore, rpm and feed rates must be reduced. A cut that is too deep, over 3 x D for instance, can create cutting pressures greater than what the tool can bear and possibly cause deflection. In this circumstance, chip splitters can minimize radial cutting pressure reducing deflection and aiding in chip control.

6. FOLLOW RECOMMENDED CUTTING PARAMETERS

After meticulous research and years of firsthand experience, we have developed specific recommended cutting parameters. Always to be used as a starting point, cutting data is optimized per tool design, specifications and material groups. Modifications can be made depending on the application.





MULTI FLUTE-S638 & S638R



- Eccentric O.D. relief creating a stronger cutting edge
- Variable indexing to reduce harmonics providing smoother cutting and improved surface finish
- Designed for peripheral roughing and finishing for stainless steel, titanium, and high temperature alloys
- Excellent in high speed milling and optimized roughing techniques
- Designed for increased radial depths as compared to the S738 and S938

ITEM NUMBER	DESCRIPTION	DIMENSIONS IN INCH				NUMBER OF FLUTES	COATING	RADIUS
		FLUTE DIA. (DC)	SHANK DIA. (DMM)	LOC (APMX)	OVERALL LENGTH (OAL)			
10072629	S638-0.125-F2-S.0-Z6	1/8	1/4	3/16	2	6	AITN	-
03115930	S638-0.125-F3-S.0-Z6	1/8	1/4	5/16	2	6	AITN	-
10072631	S638-0.188-F2-S.0-Z6	3/16	1/4	5/16	2	6	AITN	-
03115932	S638-0.188-F3-S.0-Z6	3/16	1/4	1/2	2	6	AITN	-
10072633	S638-0.250-D2-S.0-Z6	1/4	1/4	3/8	2	6	AITN	-
03115934	S638-0.250-D3-S.0-Z6	1/4	1/4	5/8	2	6	AITN	-
10072636	S638-0.313-D1-S.0-Z6	5/16	5/16	7/16	2	6	AITN	-
03115940	S638-0.313-D2-S.0-Z6	5/16	5/16	3/4	2	6	AITN	-
10072639	S638-0.375-D2-S.0-Z6	3/8	3/8	1/2	2	6	AITN	-
03007642	S638-0.375-D1-S.0-Z6	3/8	3/8	1	2-1/2	6	AITN	-
10072642	S638-0.500-D2-S.0-Z6	1/2	1/2	5/8	3	6	AITN	-
10072645	S638-0.500-D3-S.0-Z6	1/2	1/2	1	3	6	AITN	-
03007645	S638-0.500-D1-S.0-Z6	1/2	1/2	1-1/4	3	6	AITN	-
10072648	S638-0.625-D2-S.0-Z6	5/8	5/8	3/4	3	6	AITN	-
10072650	S638-0.625-D3-S.0-Z6	5/8	5/8	1-1/4	3-1/2	6	AITN	-
03007651	S638-0.625-D1-S.0-Z6	5/8	5/8	1-5/8	3-1/2	6	AITN	-
10072652	S638-0.750-D2-S.0-Z6	3/4	3/4	1	3	6	AITN	-
03007658	S638-0.750-D1-S.0-Z6	3/4	3/4	1-3/4	4	6	AITN	-
03007664	S638-1.000-D1-S.0-Z6	1	1	2	5	6	AITN	-
10072630	S638R-0.125-F2-R010.0-Z6	1/8	1/4	3/16	2	6	AITN	0.010
03115931	S638R-0.125-F3-R010.0-Z6	1/8	1/4	5/16	2	6	AITN	0.010
10072632	S638R-0.188-F2-R010.0-Z6	3/16	1/4	5/16	2	6	AITN	0.010
03115933	S638R-0.188-F3-R010.0-Z6	3/16	1/4	1/2	2	6	AITN	0.010
10072634	S638R-0.250-D2-R015.0-Z6	1/4	1/4	3/8	2	6	AITN	0.015
10072635	S638R-0.250-D2-R030.0-Z6	1/4	1/4	3/8	2	6	AITN	0.030
03115935	S638R-0.250-D3-R015.0-Z6	1/4	1/4	5/8	2	6	AITN	0.015
03115936	S638R-0.250-D3-R030.0-Z6	1/4	1/4	5/8	2	6	AITN	0.030
10072637	S638R-0.313-D1-R015.0-Z6	5/16	5/16	7/16	2	6	AITN	0.015
10072638	S638R-0.313-D1-R030.0-Z6	5/16	5/16	7/16	2	6	AITN	0.030
03115941	S638R-0.313-D2-R015.0-Z6	5/16	5/16	3/4	2	6	AITN	0.015
03115942	S638R-0.313-D2-R030.0-Z6	5/16	5/16	3/4	2	6	AITN	0.030
10072640	S638R-0.375-D2-R015.0-Z6	3/8	3/8	1/2	2	6	AITN	0.015
10072641	S638R-0.375-D2-R030.0-Z6	3/8	3/8	1/2	2	6	AITN	0.030
03007643	S638R-0.375-D1-R015.0-Z6	3/8	3/8	1	2-1/2	6	AITN	0.015
03007644	S638R-0.375-D1-R030.0-Z6	3/8	3/8	1	2-1/2	6	AITN	0.030
10072643	S638R-0.500-D2-R015.0-Z6	1/2	1/2	5/8	3	6	AITN	0.015
10072644	S638R-0.500-D2-R030.0-Z6	1/2	1/2	5/8	3	6	AITN	0.030
10072646	S638R-0.500-D3-R015.0-Z6	1/2	1/2	1	3	6	AITN	0.015
10072647	S638R-0.500-D3-R030.0-Z6	1/2	1/2	1	3	6	AITN	0.030
03007646	S638R-0.500-D1-R015.0-Z6	1/2	1/2	1-1/4	3	6	AITN	0.015
03007647	S638R-0.500-D1-R030.0-Z6	1/2	1/2	1-1/4	3	6	AITN	0.030

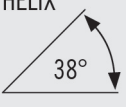
MULTI FLUTE-S638 & S638R (CONT.)

SOLID CARBIDE	HELIX 	SQUARE END 	RADIUS 	CENTER CUTTING
---------------	--	---	---	----------------



- Eccentric O.D. relief creating a stronger cutting edge
- Variable indexing to reduce harmonics providing smoother cutting and improved surface finish
- Designed for peripheral roughing and finishing for stainless steel, titanium, and high temperature alloys
- Excellent in high speed milling and optimized roughing techniques
- Designed for increased radial depths as compared to the S738 and S938

ITEM NUMBER	DESCRIPTION	DIMENSIONS IN INCH				NUMBER OF FLUTES	COATING	RADIUS
		FLUTE DIA. (DC)	SHANK DIA. (DMM)	LOC (APMX)	OVERALL LENGTH (OAL)			
03007648	S638R-0.500-D1-R060.0-Z6	1/2	1/2	1-1/4	3	6	AITN	0.060
03007649	S638R-0.500-D1-R090.0-Z6	1/2	1/2	1-1/4	3	6	AITN	0.090
03007650	S638R-0.500-D1-R120.0-Z6	1/2	1/2	1-1/4	3	6	AITN	0.120
10072649	S638R-0.625-D2-R030.0-Z6	5/8	5/8	3/4	3	6	AITN	0.030
10072651	S638R-0.625-D3-R030.0-Z6	5/8	5/8	1-1/4	3-1/2	6	AITN	0.030
03007652	S638R-0.625-D1-R015.0-Z6	5/8	5/8	1-5/8	3-1/2	6	AITN	0.015
03007654	S638R-0.625-D1-R030.0-Z6	5/8	5/8	1-5/8	3-1/2	6	AITN	0.030
03007655	S638R-0.625-D1-R060.0-Z6	5/8	5/8	1-5/8	3-1/2	6	AITN	0.060
03007656	S638R-0.625-D1-R090.0-Z6	5/8	5/8	1-5/8	3-1/2	6	AITN	0.090
03007657	S638R-0.625-D1-R120.0-Z6	5/8	5/8	1-5/8	3-1/2	6	AITN	0.120
10072653	S638R-0.750-D2-R030.0-Z6	3/4	3/4	1	3	6	AITN	0.030
10072654	S638R-0.750-D2-R060.0-Z6	3/4	3/4	1	3	6	AITN	0.060
03007659	S638R-0.750-D1-R030.0-Z6	3/4	3/4	1-3/4	4	6	AITN	0.030
03007660	S638R-0.750-D1-R060.0-Z6	3/4	3/4	1-3/4	4	6	AITN	0.060
03007661	S638R-0.750-D1-R090.0-Z6	3/4	3/4	1-3/4	4	6	AITN	0.090
03007662	S638R-0.750-D1-R120.0-Z6	3/4	3/4	1-3/4	4	6	AITN	0.120
03007663	S638R-0.750-D1-R190.0-Z6	3/4	3/4	1-3/4	4	6	AITN	0.190
03007665	S638R-1.000-D1-R030.0-Z6	1	1	2	5	6	AITN	0.030
03007666	S638R-1.000-D1-R060.0-Z6	1	1	2	5	6	AITN	0.060
03007667	S638R-1.000-D1-R090.0-Z6	1	1	2	5	6	AITN	0.090
03007668	S638R-1.000-D1-R120.0-Z6	1	1	2	5	6	AITN	0.120
03007669	S638R-1.000-D1-R190.0-Z6	1	1	2	5	6	AITN	0.190
03007670	S638R-1.000-D1-R250.0-Z6	1	1	2	5	6	AITN	0.250

MULTI FLUTE-SN638 & SN638R

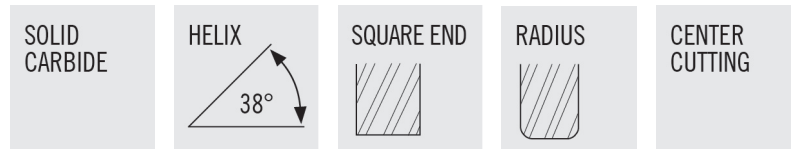

- Eccentric O.D. relief creating a stronger cutting edge
- Variable indexing to reduce harmonics providing smoother cutting and improved surface finish
- Designed for peripheral roughing and finishing for stainless steel, titanium, and high temperature alloys
- Excellent in high speed milling and optimized roughing techniques

ITEM NUMBER	DESCRIPTION	DIMENSIONS IN INCH						NUMBER OF FLUTES	COATING	RADIUS
		FLUTE DIA. (DC)	SHANK DIA. (DMM)	LOC (APMX)	OVERALL LENGTH (OAL)	NECK DIA.	REACH			
03115949	SN638-0.375-E3-S.0-Z6	3/8	3/8	1	3	0.360	1.500	6	AITiN	-
03115958	SN638-0.500-E2-S.0-Z6	1/2	1/2	1-1/8	4	0.480	2.000	6	AITiN	-
03115970	SN638-0.625-E2-S.0-Z6	5/8	5/8	1-3/8	5	0.600	2.500	6	AITiN	-
03115982	SN638-0.750-E2-S.0-Z6	3/4	3/4	1-3/4	6	0.720	3	6	AITiN	-
03115950	SN638R-0.375-E3-R015.0-Z6	3/8	3/8	1	3	0.360	1.500	6	AITiN	0.015
03115951	SN638R-0.375-E3-R030.0-Z6	3/8	3/8	1	3	0.360	1.500	6	AITiN	0.030
03115959	SN638R-0.500-E2-R030.0-Z6	1/2	1/2	1-1/8	4	0.480	2.000	6	AITiN	0.030
03115960	SN638R-0.500-E2-R060.0-Z6	1/2	1/2	1-1/8	4	0.480	2.000	6	AITiN	0.060
03115961	SN638R-0.500-E2-R120.0-Z6	1/2	1/2	1-1/8	4	0.480	2.000	6	AITiN	0.120
03115971	SN638R-0.625-E2-R015.0-Z6	5/8	5/8	1-3/8	5	0.600	2.500	6	AITiN	0.015
03115972	SN638R-0.625-E2-R030.0-Z6	5/8	5/8	1-3/8	5	0.600	2.500	6	AITiN	0.030
03115973	SN638R-0.625-E2-R060.0-Z6	5/8	5/8	1-3/8	5	0.600	2.500	6	AITiN	0.060
03115983	SN638R-0.750-E2-R030.0-Z6	3/4	3/4	1-3/4	6	0.720	3	6	AITiN	0.030
03115984	SN638R-0.750-E2-R060.0-Z6	3/4	3/4	1-3/4	6	0.720	3	6	AITiN	0.060
03115985	SN638R-0.750-E2-R120.0-Z6	3/4	3/4	1-3/4	6	0.720	3	6	AITiN	0.120
03115993	SN638R-1.000-E2-R030.0-Z6	1	1	2-1/4	7	0.960	4.125	6	AITiN	0.030
03115994	SN638R-1.000-E2-R060.0-Z6	1	1	2-1/4	7	0.960	4.125	6	AITiN	0.060
03115995	SN638R-1.000-E2-R090.0-Z6	1	1	2-1/4	7	0.960	4.125	6	AITiN	0.090
03115996	SN638R-1.000-E2-R120.0-Z6	1	1	2-1/4	7	0.960	4.125	6	AITiN	0.120
03115997	SN638R-1.000-E2-R250.0-Z6	1	1	2-1/4	7	0.960	4.125	6	AITiN	0.250

MULTI FLUTE-SB638

SOLID CARBIDE



CENTER CUTTING



- Eccentric O.D. relief creating a stronger cutting edge
- Variable indexing to reduce harmonics providing smoother cutting and improved surface finish
- Designed for peripheral roughing and finishing for stainless steel, titanium, and high temperature alloys
- Excellent in high speed milling and optimized roughing techniques

ITEM NUMBER	DESCRIPTION	DIMENSIONS IN INCH				NUMBER OF FLUTES	COATING	RADIUS
		FLUTE DIA. (DC)	SHANK DIA. (DMM)	LOC (APMX)	OVERALL LENGTH (OAL)			
03115937	SB638-0.250-D1-B.0-Z6	1/4	1/4	1/4	2	6	AITiN	-
03115938	SB638-0.250-D3-B.0-Z6	1/4	1/4	5/8	2	6	AITiN	-
03115943	SB638-0.313-D1-B.0-Z6	5/16	5/16	5/16	2	6	AITiN	-
03115944	SB638-0.313-D2-B.0-Z6	5/16	5/16	3/4	2	6	AITiN	-
03115946	SB638-0.375-D1-B.0-Z6	3/8	3/8	3/8	2	6	AITiN	-
03115947	SB638-0.375-D3-B.0-Z6	3/8	3/8	1	2-1/2	6	AITiN	-
03115955	SB638-0.500-D1-B.0-Z6	1/2	1/2	1/2	2-1/2	6	AITiN	-
03115956	SB638-0.500-D3-B.0-Z6	1/2	1/2	1-1/4	3	6	AITiN	-
03115967	SB638-0.625-D1-B.0-Z6	5/8	5/8	5/8	3	6	AITiN	-
03115968	SB638-0.625-D3-B.0-Z6	5/8	5/8	1-5/8	4	6	AITiN	-
03115979	SB638-0.750-D1-B.0-Z6	3/4	3/4	3/4	3	6	AITiN	-
03115980	SB638-0.750-D2-B.0-Z6	3/4	3/4	1-3/4	4	6	AITiN	-
03115990	SB638-1.000-D1-B.0-Z6	1	1	1	4	6	AITiN	-
03115991	SB638-1.000-D2-B.0-Z6	1	1	2	5	6	AITiN	-

DISCOUNT CODE D43

MULTI FLUTE-SBN638

SOLID CARBIDE



CENTER CUTTING



- Eccentric O.D. relief creating a stronger cutting edge
- Variable indexing to reduce harmonics providing smoother cutting and improved surface finish
- Designed for peripheral roughing and finishing for stainless steel, titanium, and high temperature alloys
- Excellent in high speed milling and optimized roughing techniques

ITEM NUMBER	DESCRIPTION	DIMENSIONS IN INCH						NUMBER OF FLUTES	COATING	RADIUS
		FLUTE DIA. (DC)	SHANK DIA. (DMM)	LOC (APMX)	OVERALL LENGTH (OAL)	NECK DIA.	REACH			
03115939	SBN638-0.250-E1-B.0-Z6	1/4	1/4	1/4	2	0.240	0.750	6	AITiN	-
03115945	SBN638-0.313-E1-B.0-Z6	5/16	5/16	5/16	2-1/2	0.300	1.000	6	AITiN	-
03115948	SBN638-0.375-E1-B.0-Z6	3/8	3/8	3/8	2-1/2	0.360	1.250	6	AITiN	-
03115957	SBN638-0.500-E1-B.0-Z6	1/2	1/2	1/2	3	0.480	1.500	6	AITiN	-
03115969	SBN638-0.625-E1-B.0-Z6	5/8	5/8	5/8	4	0.600	1.875	6	AITiN	-
03115981	SBN638-0.750-E1-B.0-Z6	3/4	3/4	3/4	5	0.720	2.250	6	AITiN	-
03115992	SBN638-1.000-E1-B.0-Z6	1	1	1	6	0.960	3.000	6	AITiN	-

DISCOUNT CODE D43

MULTI FLUTE-SCS638 & SCS638R

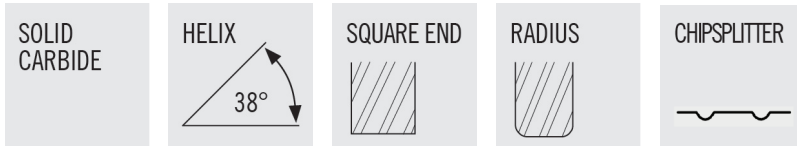

- Eccentric O.D. relief creating a stronger cutting edge
- Variable indexing to reduce harmonics providing smoother cutting and improved surface finish
- Designed for peripheral roughing and finishing for stainless steel, titanium, and high temperature alloys
- Excellent in high speed milling and optimized roughing techniques
- Designed for increased radial depths as compared to the SCS738 and SCS938
- Advanced chip splitter design for increased chip control and management

ITEM NUMBER	DESCRIPTION	DIMENSIONS IN INCH						NUMBER OF FLUTES	COATING	RADIUS
		FLUTE DIA. (DC)	SHANK DIA. (DMM)	LOC (APMX)	OVERALL LENGTH (OAL)	NECK DIA.	REACH			
03115952	SCS638-0.375-D3-S-0-Z6	3/8	3/8	1-1/4	3	-	-	6	AITIN	-
03115962	SCS638-0.500-D3-S-0-Z6	1/2	1/2	1-5/8	4	-	-	6	AITIN	-
03115974	SCS638-0.625-D3-S-0-Z6	5/8	5/8	2	4	-	-	6	AITIN	-
03115986	SCS638-0.750-D3-S-0-Z6	3/4	3/4	2-1/2	5	-	-	6	AITIN	-
03115953	SCS638R-0.375-D3-R015.0-Z6	3/8	3/8	1-1/4	3	-	-	6	AITIN	0.015
03115954	SCS638R-0.375-D3-R030.0-Z6	3/8	3/8	1-1/4	3	-	-	6	AITIN	0.030
03115963	SCS638R-0.500-D3-R015.0-Z6	1/2	1/2	1-5/8	4	-	-	6	AITIN	0.015
03115964	SCS638R-0.500-D3-R030.0-Z6	1/2	1/2	1-5/8	4	-	-	6	AITIN	0.030
03115965	SCS638R-0.500-D3-R060.0-Z6	1/2	1/2	1-5/8	4	-	-	6	AITIN	0.060
03115966	SCS638R-0.500-D3-R120.0-Z6	1/2	1/2	1-5/8	4	-	-	6	AITIN	0.120
03115975	SCS638R-0.625-D3-R015.0-Z6	5/8	5/8	2	4	-	-	6	AITIN	0.015
03115976	SCS638R-0.625-D3-R030.0-Z6	5/8	5/8	2	4	-	-	6	AITIN	0.030
03115977	SCS638R-0.625-D3-R060.0-Z6	5/8	5/8	2	4	-	-	6	AITIN	0.060
03115978	SCS638R-0.625-D3-R120.0-Z6	5/8	5/8	2	4	-	-	6	AITIN	0.120
03115987	SCS638R-0.750-D3-R030.0-Z6	3/4	3/4	2-1/2	5	-	-	6	AITIN	0.030
03115988	SCS638R-0.750-D3-R060.0-Z6	3/4	3/4	2-1/2	5	-	-	6	AITIN	0.060
03115989	SCS638R-0.750-D3-R120.0-Z6	3/4	3/4	2-1/2	5	-	-	6	AITIN	0.120
03115998	SCS638R-1.000-D3-R030.0-Z6	1	1	3-1/8	6	-	-	6	AITIN	0.030
03115999	SCS638R-1.000-D3-R120.0-Z6	1	1	3-1/8	6	-	-	6	AITIN	0.120
03116000	SCS638R-1.000-D3-R250.0-Z6	1	1	3-1/8	6	-	-	6	AITIN	0.250

DISCOUNT CODE D43

MULTI FLUTE-S738 & S738R

SOLID CARBIDE

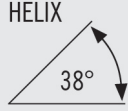

RADIUS



CHAMFER

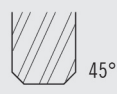

NON CENTER CUTTING



- Eccentric O.D. relief creating a stronger cutting edge
- Variable indexing to reduce harmonics providing smoother cutting and improved surface finish
- Designed for peripheral roughing and finishing for stainless steel, titanium, and high temperature alloys
- Excellent in high speed milling and optimized roughing techniques

ITEM NUMBER	DESCRIPTION	DIMENSIONS IN INCH				NUMBER OF FLUTES	COATING	CHAMFER	RADIUS
		FLUTE DIA. (DC)	SHANK DIA. (DMM)	LOC (APMX)	OVERALL LENGTH (OAL)				
17002312	S738-0.250-D2-C003.0-Z7	1/4	1/4	3/8	2	7	AlTiN	0.003	-
17002315	S738-0.250-D3-C003.0-Z7	1/4	1/4	3/4	2-1/2	7	AlTiN	0.003	-
17002318	S738-0.250-D5-C003.0-Z7	1/4	1/4	1-1/4	3	7	AlTiN	0.003	-
17002321	S738-0.375-D1-C005.0-Z7	3/8	3/8	1/2	2-1/2	7	AlTiN	0.005	-
17002324	S738-0.375-D3-C005.0-Z7	3/8	3/8	1	3	7	AlTiN	0.005	-
17002327	S738-0.375-D4-C005.0-Z7	3/8	3/8	1-1/2	3-1/2	7	AlTiN	0.005	-
17002330	S738-0.500-D2-C006.0-Z7	1/2	1/2	3/4	3	7	AlTiN	0.006	-
17002334	S738-0.500-D3-C006.0-Z7	1/2	1/2	1-1/4	3	7	AlTiN	0.006	-
17002338	S738-0.500-D4-C006.0-Z7	1/2	1/2	2	4	7	AlTiN	0.006	-
10072656	S738-0.625-D2-C008.0-Z7	5/8	5/8	1-1/4	4	7	AlTiN	0.008	-
10072662	S738-0.750-D2-C010.0-Z7	3/4	3/4	1-5/8	4	7	AlTiN	0.010	-
17002313	S738R-0.250-D2-R015.0-Z7	1/4	1/4	3/8	2	7	AlTiN	-	0.015
17002314	S738R-0.250-D2-R030.0-Z7	1/4	1/4	3/8	2	7	AlTiN	-	0.030
17002316	S738R-0.250-D3-R015.0-Z7	1/4	1/4	3/4	2-1/2	7	AlTiN	-	0.015
17002317	S738R-0.250-D3-R030.0-Z7	1/4	1/4	3/4	2-1/2	7	AlTiN	-	0.030
17002319	S738R-0.250-D5-R015.0-Z7	1/4	1/4	1-1/4	3	7	AlTiN	-	0.015
17002320	S738R-0.250-D5-R030.0-Z7	1/4	1/4	1-1/4	3	7	AlTiN	-	0.030
17002322	S738R-0.375-D1-R015.0-Z7	3/8	3/8	1/2	2-1/2	7	AlTiN	-	0.015
17002323	S738R-0.375-D1-R030.0-Z7	3/8	3/8	1/2	2-1/2	7	AlTiN	-	0.030
17002325	S738R-0.375-D3-R015.0-Z7	3/8	3/8	1	3	7	AlTiN	-	0.015
17002326	S738R-0.375-D3-R030.0-Z7	3/8	3/8	1	3	7	AlTiN	-	0.030
17002328	S738R-0.375-D4-R015.0-Z7	3/8	3/8	1-1/2	3-1/2	7	AlTiN	-	0.015
17002329	S738R-0.375-D4-R030.0-Z7	3/8	3/8	1-1/2	3-1/2	7	AlTiN	-	0.030
17002331	S738R-0.500-D2-R015.0-Z7	1/2	1/2	3/4	3	7	AlTiN	-	0.015
17002332	S738R-0.500-D2-R030.0-Z7	1/2	1/2	3/4	3	7	AlTiN	-	0.030
17002333	S738R-0.500-D2-R060.0-Z7	1/2	1/2	3/4	3	7	AlTiN	-	0.060
17002335	S738R-0.500-D3-R015.0-Z7	1/2	1/2	1-1/4	3	7	AlTiN	-	0.015
17002336	S738R-0.500-D3-R030.0-Z7	1/2	1/2	1-1/4	3	7	AlTiN	-	0.030
17002337	S738R-0.500-D3-R060.0-Z7	1/2	1/2	1-1/4	3	7	AlTiN	-	0.060
17002339	S738R-0.500-D4-R015.0-Z7	1/2	1/2	2	4	7	AlTiN	-	0.015
17002340	S738R-0.500-D4-R030.0-Z7	1/2	1/2	2	4	7	AlTiN	-	0.030
17002341	S738R-0.500-D4-R060.0-Z7	1/2	1/2	2	4	7	AlTiN	-	0.060
10072655	S738R-0.625-D1-R030.0-Z7	5/8	5/8	3/4	3	7	AlTiN	-	0.030
10072657	S738R-0.625-D2-R015.0-Z7	5/8	5/8	1-1/4	4	7	AlTiN	-	0.015
10072658	S738R-0.625-D2-R030.0-Z7	5/8	5/8	1-1/4	4	7	AlTiN	-	0.030
10072659	S738R-0.625-D2-R060.0-Z7	5/8	5/8	1-1/4	4	7	AlTiN	-	0.060
10072660	S738R-0.625-D3-R030.0-Z7	5/8	5/8	1-5/8	4	7	AlTiN	-	0.030
10072661	S738R-0.750-D1-R030.0-Z7	3/4	3/4	1	4	7	AlTiN	-	0.030
10072663	S738R-0.750-D2-R030.0-Z7	3/4	3/4	1-5/8	4	7	AlTiN	-	0.030
10072664	S738R-0.750-D3-R030.0-Z7	3/4	3/4	2-1/4	5	7	AlTiN	-	0.030
10072665	S738R-0.750-D3-R060.0-Z7	3/4	3/4	2-1/4	5	7	AlTiN	-	0.060
10072666	S738R-1.000-D3-R030.0-Z7	1	1	3-1/4	6	7	AlTiN	-	0.030

MULTI FLUTE-SCS738R



- Eccentric O.D. relief creating a stronger cutting edge
- Variable indexing to reduce harmonics providing smoother cutting and improved surface finish
- Designed for peripheral roughing and finishing for stainless steel, titanium, and high temperature alloys
- Excellent in high speed milling and optimized roughing techniques
- Advanced chip splitter design for increased chip control and management

ITEM NUMBER	DESCRIPTION	DIMENSIONS IN INCH				NUMBER OF FLUTES	COATING	CHAMFER	RADIUS
		FLUTE DIA. (DC)	SHANK DIA. (DMM)	LOC (APMX)	OVERALL LENGTH (OAL)				
03116001	SCS738R-0.250-D3-R015.0-Z7	1/4	1/4	3/4	2-1/2	7	AlTiN	-	0.015
03116002	SCS738R-0.250-D5-R015.0-Z7	1/4	1/4	1-1/4	3	7	AlTiN	-	0.015
03116003	SCS738R-0.375-D3-R015.0-Z7	3/8	3/8	1	3	7	AlTiN	-	0.015
03116004	SCS738R-0.375-D4-R015.0-Z7	3/8	3/8	1-1/2	3-1/2	7	AlTiN	-	0.015
03116005	SCS738R-0.500-D3-R030.0-Z7	1/2	1/2	1-1/4	3	7	AlTiN	-	0.030
03116006	SCS738R-0.500-D4-R030.0-Z7	1/2	1/2	2	4	7	AlTiN	-	0.030
10072627	SCS738R-0.625-D4-R030.0-Z7	5/8	5/8	2-1/2	5	7	AlTiN	-	0.030
10072628	SCS738R-0.750-D3-R030.0-Z7	3/4	3/4	3-1/4	6	7	AlTiN	-	0.030

MULTI FLUTE-S938 & S938R

SOLID CARBIDE

HELIX

RADIUS

CHAMFER

NON CENTER CUTTING



- Eccentric O.D. relief creating a stronger cutting edge
- Variable indexing to reduce harmonics providing smoother cutting and improved surface finish
- Designed for peripheral roughing and finishing for stainless steel, titanium, and high temperature alloys
- Excellent in high speed milling and optimized roughing techniques

ITEM NUMBER	DESCRIPTION	DIMENSIONS IN INCH				NUMBER OF FLUTES	COATING	CHAMFER	RADIUS
		FLUTE DIA. (DC)	SHANK DIA. (DMM)	LOC (APMX)	OVERALL LENGTH (OAL)				
17002342	S938-0.625-D1-C008.0-Z9	5/8	5/8	3/4	3	9	AlTiN	0.008	-
17002347	S938-0.625-D3-C008.0-Z9	5/8	5/8	1-5/8	4	9	AlTiN	0.008	-
17002352	S938-0.625-D4-C008.0-Z9	5/8	5/8	2-1/2	5	9	AlTiN	0.008	-
17002357	S938-0.750-D2-C010.0-Z9	3/4	3/4	1-5/8	4	9	AlTiN	0.010	-
17002362	S938-0.750-D3-C010.0-Z9	3/4	3/4	2-1/4	5	9	AlTiN	0.010	-
17002367	S938-0.750-D4-C010.0-Z9	3/4	3/4	3-1/4	6	9	AlTiN	0.010	-
17002372	S938-1.000-D2-C012.0-Z9	1	1	2	5	9	AlTiN	0.012	-
17002377	S938-1.000-D3-C012.0-Z9	1	1	3-1/4	6	9	AlTiN	0.012	-
17002382	S938-1.000-D4-C012.0-Z9	1	1	4-1/8	7	9	AlTiN	0.012	-
17002343	S938R-0.625-D1-R030.0-Z9	5/8	5/8	3/4	3	9	AlTiN	-	0.030
17002344	S938R-0.625-D1-R060.0-Z9	5/8	5/8	3/4	3	9	AlTiN	-	0.060
17002345	S938R-0.625-D1-R090.0-Z9	5/8	5/8	3/4	3	9	AlTiN	-	0.090
17002346	S938R-0.625-D1-R120.0-Z9	5/8	5/8	3/4	3	9	AlTiN	-	0.120
17002348	S938R-0.625-D3-R030.0-Z9	5/8	5/8	1-5/8	4	9	AlTiN	-	0.030
17002349	S938R-0.625-D3-R060.0-Z9	5/8	5/8	1-5/8	4	9	AlTiN	-	0.060
17002350	S938R-0.625-D3-R090.0-Z9	5/8	5/8	1-5/8	4	9	AlTiN	-	0.090
17002351	S938R-0.625-D3-R120.0-Z9	5/8	5/8	1-5/8	4	9	AlTiN	-	0.120
17002353	S938R-0.625-D4-R030.0-Z9	5/8	5/8	2-1/2	5	9	AlTiN	-	0.030
17002354	S938R-0.625-D4-R060.0-Z9	5/8	5/8	2-1/2	5	9	AlTiN	-	0.060
17002355	S938R-0.625-D4-R090.0-Z9	5/8	5/8	2-1/2	5	9	AlTiN	-	0.090
17002356	S938R-0.625-D4-R120.0-Z9	5/8	5/8	2-1/2	5	9	AlTiN	-	0.120
17002358	S938R-0.750-D2-R030.0-Z9	3/4	3/4	1-5/8	4	9	AlTiN	-	0.030
17002359	S938R-0.750-D2-R060.0-Z9	3/4	3/4	1-5/8	4	9	AlTiN	-	0.060
17002360	S938R-0.750-D2-R090.0-Z9	3/4	3/4	1-5/8	4	9	AlTiN	-	0.090
17002361	S938R-0.750-D2-R120.0-Z9	3/4	3/4	1-5/8	4	9	AlTiN	-	0.120
17002363	S938R-0.750-D3-R030.0-Z9	3/4	3/4	2-1/4	5	9	AlTiN	-	0.030
17002364	S938R-0.750-D3-R060.0-Z9	3/4	3/4	2-1/4	5	9	AlTiN	-	0.060
17002365	S938R-0.750-D3-R090.0-Z9	3/4	3/4	2-1/4	5	9	AlTiN	-	0.090
17002366	S938R-0.750-D3-R120.0-Z9	3/4	3/4	2-1/4	5	9	AlTiN	-	0.120
17002368	S938R-0.750-D4-R030.0-Z9	3/4	3/4	3-1/4	6	9	AlTiN	-	0.030
17002369	S938R-0.750-D4-R060.0-Z9	3/4	3/4	3-1/4	6	9	AlTiN	-	0.060
17002370	S938R-0.750-D4-R090.0-Z9	3/4	3/4	3-1/4	6	9	AlTiN	-	0.090
17002371	S938R-0.750-D4-R120.0-Z9	3/4	3/4	3-1/4	6	9	AlTiN	-	0.120
17002373	S938R-1.000-D2-R030.0-Z9	1	1	2	5	9	AlTiN	-	0.030
17002374	S938R-1.000-D2-R060.0-Z9	1	1	2	5	9	AlTiN	-	0.060
17002375	S938R-1.000-D2-R090.0-Z9	1	1	2	5	9	AlTiN	-	0.090
17002376	S938R-1.000-D2-R120.0-Z9	1	1	2	5	9	AlTiN	-	0.120
17002378	S938R-1.000-D3-R030.0-Z9	1	1	3-1/4	6	9	AlTiN	-	0.030
17002379	S938R-1.000-D3-R060.0-Z9	1	1	3-1/4	6	9	AlTiN	-	0.060
17002380	S938R-1.000-D3-R090.0-Z9	1	1	3-1/4	6	9	AlTiN	-	0.090

MULTI FLUTE-S938 & S938R (CONT.)

SOLID CARBIDE	HELIX 38°	CHAMFER 45°	RADIUS	NON CENTER CUTTING
---------------	--------------	----------------	--------	--------------------



- Eccentric O.D. relief creating a stronger cutting edge
- Variable indexing to reduce harmonics providing smoother cutting and improved surface finish
- Designed for peripheral roughing and finishing for stainless steel, titanium, and high temperature alloys
- Excellent in high speed milling and optimized roughing techniques

ITEM NUMBER	DESCRIPTION	DIMENSIONS IN INCH				NUMBER OF FLUTES	COATING	CHAMFER	RADIUS
		FLUTE DIA. (DC)	SHANK DIA. (DMM)	LOC (APMX)	OVERALL LENGTH (OAL)				
17002381	S938R-1.000-D3-R120.0-Z9	1	1	3-1/4	6	9	AlTiN	-	0.120
17002383	S938R-1.000-D4-R030.0-Z9	1	1	4-1/8	7	9	AlTiN	-	0.030
17002384	S938R-1.000-D4-R060.0-Z9	1	1	4-1/8	7	9	AlTiN	-	0.060
17002385	S938R-1.000-D4-R090.0-Z9	1	1	4-1/8	7	9	AlTiN	-	0.090
17002386	S938R-1.000-D4-R120.0-Z9	1	1	4-1/8	7	9	AlTiN	-	0.120

DISCOUNT CODE D43

MULTI FLUTE-SCS938R

SOLID CARBIDE	HELIX 38°	RADIUS	NON CENTER CUTTING	CHIPSPLITTER
---------------	--------------	--------	--------------------	--------------



- Eccentric O.D. relief creating a stronger cutting edge
- Variable indexing to reduce harmonics providing smoother cutting and improved surface finish
- Designed for peripheral roughing and finishing for stainless steel, titanium, and high temperature alloys
- Excellent in high speed milling and optimized roughing techniques
- Advanced chip splitter design for increased chip control and management

ITEM NUMBER	DESCRIPTION	DIMENSIONS IN INCH				NUMBER OF FLUTES	COATING	CHAMFER	RADIUS
		FLUTE DIA. (DC)	SHANK DIA. (DMM)	LOC (APMX)	OVERALL LENGTH (OAL)				
03116007	SCS938R-0.625-D3-R030.0-Z9	5/8	5/8	1-5/8	4	9	AlTiN	-	0.030
03116008	SCS938R-0.625-D4-R030.0-Z9	5/8	5/8	2-1/2	5	9	AlTiN	-	0.030
03116009	SCS938R-0.750-D3-R030.0-Z9	3/4	3/4	2-1/4	5	9	AlTiN	-	0.030
03116010	SCS938R-0.750-D4-R030.0-Z9	3/4	3/4	3-1/4	6	9	AlTiN	-	0.030
03116011	SCS938R-1.000-D3-R030.0-Z9	1	1	3-1/4	6	9	AlTiN	-	0.030
03116012	SCS938R-1.000-D4-R030.0-Z9	1	1	4-1/8	7	9	AlTiN	-	0.030

DISCOUNT CODE D43

DISCOUNT CODE D43

S638 / S638R / SB638 / SBN638 - START VALUES

SIDE MILLING - ROUGHING														
ISO GROUP	SMG	$a_p \times D_c$ (max)	$a_e \times D_c$ (max)	v_c (sf / min)		$Z_n = 6$								
						1/8	3/16	1/4	5/16	3/8	1/2	5/8	3/4	1
P	E 1 - 2	2.00	0.12	700	n (min-1)	21392	14261	10696	8557	7131	5348	4278	3565	2674
					fz (in)	0.0010	0.0015	0.0020	0.0025	0.0030	0.0040	0.0050	0.0060	0.0080
					vf (in/min)	128	128	128	128	128	128	128	128	128
	E 3 - 4	2.00	0.12	645	n (min-1)	19711	13141	9856	7884	6570	4928	3942	3285	2464
					fz (in)	0.0010	0.0015	0.0020	0.0025	0.0030	0.0040	0.0050	0.0060	0.0080
					vf (in/min)	118	118	118	118	118	118	118	118	118
	E 5 - 6	2.00	0.10	525	n (min-1)	16044	10696	8022	6418	5348	4011	3209	2674	2006
					fz (in)	0.0008	0.0012	0.0016	0.0020	0.0024	0.0033	0.0041	0.0049	0.0065
					vf (in/min)	78	78	78	78	78	78	78	78	78
M	E 8 - 9	2.00	0.12	600	n (min-1)	18336	12224	9168	7334	6112	4584	3667	3056	2292
					fz (in)	0.0009	0.0014	0.0019	0.0023	0.0028	0.0038	0.0047	0.0056	0.0075
					vf (in/min)	103	103	103	103	103	103	103	103	103
	E 10 - 11	2.00	0.10	565	n (min-1)	17266	11511	8633	6907	5755	4317	3453	2878	2158
					fz (in)	0.0008	0.0012	0.0016	0.0020	0.0024	0.0033	0.0041	0.0049	0.0065
					vf (in/min)	84	84	84	84	84	84	84	84	84
K	E 12 - 13	2.00	0.10	495	n (min-1)	15127	10085	7564	6051	5042	3782	3025	2521	1891
					fz (in)	0.0009	0.0013	0.0018	0.0022	0.0026	0.0035	0.0044	0.0053	0.0070
					vf (in/min)	79	79	79	79	79	79	79	79	79
	E 14 - 15	2.00	0.10	430	n (min-1)	13141	8761	6570	5256	4380	3285	2628	2190	1643
					fz (in)	0.0006	0.0009	0.0013	0.0016	0.0019	0.0025	0.0031	0.0038	0.0050
S	E 19	2.00	0.07	150	n (min-1)	4584	3056	2292	1834	1528	1146	917	764	573
					fz (in)	0.0006	0.0009	0.0013	0.0016	0.0019	0.0025	0.0031	0.0038	0.0050
					vf (in/min)	17	17	17	17	17	17	17	17	17
	E 20	2.00	0.06	120	n (min-1)	3667	2445	1834	1467	1222	917	733	611	458
					fz (in)	0.0006	0.0008	0.0011	0.0014	0.0017	0.0023	0.0028	0.0034	0.0045
					vf (in/min)	12	12	12	12	12	12	12	12	12
	E 21	2.00	0.06	100	n (min-1)	3056	2037	1528	1222	1019	764	611	509	382
					fz (in)	0.0006	0.0008	0.0011	0.0014	0.0017	0.0023	0.0028	0.0034	0.0045
					vf (in/min)	10	10	10	10	10	10	10	10	10
	E 22	2.00	0.10	270	n (min-1)	8251	5501	4126	3300	2750	2063	1650	1375	1031
					fz (in)	0.0008	0.0012	0.0016	0.0020	0.0024	0.0033	0.0041	0.0049	0.0065
					vf (in/min)	40	40	40	40	40	40	40	40	40

NOTE: Optimized roughing is an excellent strategy for achieving quality parts and extending tool life, but requires use of the right equipment and cutting parameters. If you are having problems implementing the approach or want to learn more about how to use the strategy to process a part, contact the Technical Support Team at 1-800-TEC-TEAM (1-800-832-8326).

SMG = Seco Material Group
 n [min-1] = RPM
 v_c (sf/min) = Surface feet/min

fz [in] = Feed/tooth
 a_p/D_c = % of diameter

vf [in/min] = Feed rate
 a_e/D_c = % of diameter

A = Air D = Dry E = Emulsion (flood coolant) M = Mist
 All cutting data are start values. All cutting data is in inch values.
 Please reference the Workpiece Material Classification chart located on page 15.

SN638 / SN638R - START VALUES

SIDE MILLING - ROUGHING										
ISO GROUP	SMG	$a_p \times D_c$ (max)	$a_e \times D_c$ (max)	v_c (sf / min)		$Z_n = 6$				
						3/8	1/2	5/8	3/4	1
P	E 1 - 2	2.00	0.08	700	n (min-1)	7131	5348	4278	3565	2674
					fz (in)	0.0030	0.0040	0.0050	0.0060	0.0080
					v_f (in/min)	128	128	128	128	128
	E 3 - 4	2.00	0.08	645	n (min-1)	6570	4928	3942	3285	2464
					fz (in)	0.0030	0.0040	0.0050	0.0060	0.0080
					v_f (in/min)	118	118	118	118	118
	E 5 - 6	2.00	0.07	525	n (min-1)	5348	4011	3209	2674	2006
					fz (in)	0.0024	0.0033	0.0041	0.0049	0.0065
					v_f (in/min)	78	78	78	78	78
M	E 8 - 9	2.00	0.08	600	n (min-1)	6112	4584	3667	3056	2292
					fz (in)	0.0028	0.0038	0.0047	0.0056	0.0075
					v_f (in/min)	103	103	103	103	103
	E 10 - 11	2.00	0.07	565	n (min-1)	5755	4317	3453	2878	2158
					fz (in)	0.0024	0.0033	0.0041	0.0049	0.0065
					v_f (in/min)	84	84	84	84	84
K	E 12 - 13	2.00	0.07	495	n (min-1)	5042	3782	3025	2521	1891
					fz (in)	0.0026	0.0035	0.0044	0.0053	0.0070
					v_f (in/min)	79	79	79	79	79
	E 14 - 15	2.00	0.07	430	n (min-1)	4380	3285	2628	2190	1643
fz (in)	0.0019	0.0025	0.0031	0.0038	0.0050					
v_f (in/min)	49	49	49	49	49					
S	E 19	2.00	0.05	150	n (min-1)	1528	1146	917	764	573
					fz (in)	0.0019	0.0025	0.0031	0.0038	0.0050
					v_f (in/min)	17	17	17	17	17
	E 20	2.00	0.04	120	n (min-1)	1222	917	733	611	458
					fz (in)	0.0017	0.0023	0.0029	0.0035	0.0046
					v_f (in/min)	13	13	13	13	13
	E 21	2.00	0.04	100	n (min-1)	1019	764	611	509	382
					fz (in)	0.0017	0.0023	0.0029	0.0035	0.0046
					v_f (in/min)	11	11	11	11	11
	E 22	2.00	0.07	270	n (min-1)	2750	2063	1650	1375	1031
fz (in)					0.0024	0.0033	0.0041	0.0049	0.0065	
v_f (in/min)					40	40	40	40	40	

SMG = Seco Material Group
 n [min-1] = RPM
 v_c (sf/min) = Surface feet/min

fz [in] = Feed/tooth
 a_p/D_c = % of diameter
 v_f [in/min] = Feed rate
 a_e/D_c = % of diameter

A = Air D = Dry E = Emulsion (flood coolant) M = Mist
 All cutting data are start values. All cutting data is in inch values.
 Please reference the Workpiece Material Classification chart located on page 15.

S638 / S638R / SN638 / SN638R / SB638 / SBN638 - START VALUES

SIDE MILLING - FINISHING														
ISO GROUP	SMG	$a_p \times D_c$ (max)	$a_e \times D_c$ (max)	v_c (sf / min)		$Z_n = 6$								
						1/8	3/16	1/4	5/16	3/8	1/2	5/8	3/4	1
P	E 1 - 2	2.00	0.02	805	n (min-1)	24601	16401	12300	9840	8200	6150	4920	4100	3075
					fz (in)	0.0006	0.0009	0.0013	0.0016	0.0019	0.0025	0.0031	0.0038	0.0050
					604 - 1006	vf (in/min)	92	92	92	92	92	92	92	92
	E 3 - 4	2.00	0.02	740	n (min-1)	22614	15076	11307	9046	7538	5654	4523	3769	2827
					fz (in)	0.0006	0.0009	0.0013	0.0016	0.0019	0.0025	0.0031	0.0038	0.0050
					555 - 925	vf (in/min)	85	85	85	85	85	85	85	85
	E 5 - 6	2.00	0.02	605	n (min-1)	18489	12326	9244	7396	6163	4622	3698	3081	2311
					fz (in)	0.0006	0.0009	0.0013	0.0016	0.0019	0.0025	0.0031	0.0038	0.0050
					454 - 756	vf (in/min)	69	69	69	69	69	69	69	69
M	E 8 - 9	2.00	0.02	690	n (min-1)	21086	14058	10543	8435	7029	5272	4217	3514	2636
					fz (in)	0.0006	0.0009	0.0013	0.0016	0.0019	0.0025	0.0031	0.0038	0.0050
					518 - 863	vf (in/min)	79	79	79	79	79	79	79	79
	E 10 - 11	2.00	0.02	650	n (min-1)	19864	13243	9932	7946	6621	4966	3973	3311	2483
					fz (in)	0.0006	0.0009	0.0013	0.0016	0.0019	0.0025	0.0031	0.0038	0.0050
					488 - 813	vf (in/min)	74	74	74	74	74	74	74	74
K	E 12 - 13	2.00	0.02	570	n (min-1)	17419	11613	8710	6968	5806	4355	3484	2903	2177
					fz (in)	0.0006	0.0009	0.0013	0.0016	0.0019	0.0025	0.0031	0.0038	0.0050
					428 - 713	vf (in/min)	65	65	65	65	65	65	65	65
	E 14 - 15	2.00	0.02	495	n (min-1)	15127	10085	7564	6051	5042	3782	3025	2521	1891
					fz (in)	0.0005	0.0008	0.0010	0.0013	0.0015	0.0020	0.0025	0.0030	0.0040
					371 - 619	vf (in/min)	45	45	45	45	45	45	45	45
S	E 19	2.00	0.02	175	n (min-1)	5348	3565	2674	2139	1783	1337	1070	891	669
					fz (in)	0.0005	0.0008	0.0010	0.0013	0.0015	0.0020	0.0025	0.0030	0.0040
					131 - 219	vf (in/min)	16	16	16	16	16	16	16	16
	E 20	2.00	0.02	140	n (min-1)	4278	2852	2139	1711	1426	1070	856	713	535
					fz (in)	0.0005	0.0008	0.0010	0.0013	0.0015	0.0020	0.0025	0.0030	0.0040
					105 - 175	vf (in/min)	13	13	13	13	13	13	13	13
	E 21	2.00	0.02	115	n (min-1)	3514	2343	1757	1406	1171	879	703	586	439
					fz (in)	0.0005	0.0008	0.0010	0.0013	0.0015	0.0020	0.0025	0.0030	0.0040
					86 - 144	vf (in/min)	11	11	11	11	11	11	11	11
	E 22	2.00	0.02	310	n (min-1)	9474	6316	4737	3789	3158	2368	1895	1579	1184
					fz (in)	0.0006	0.0009	0.0013	0.0016	0.0019	0.0025	0.0031	0.0038	0.0050
					233 - 388	vf (in/min)	36	36	36	36	36	36	36	36

SMG = Seco Material Group
 n [min-1] = RPM
 v_c (sf/min) = Surface feet/min

fz [in] = Feed/tooth
 a_p/D_c = % of diameter

vf [in/min] = Feed rate
 a_e/D_c = % of diameter

A = Air D = Dry E = Emulsion (flood coolant) M = Mist
 All cutting data are start values. All cutting data is in inch values.
 Please reference the Workpiece Material Classification chart located on page 15.

SB638 / SBN638 - START VALUES

COPY MILLING - ROUGHING

ISO GROUP	SMG	$a_p \times D_c$ (max)	$a_e \times D_c$ (max)	v_c (sf / min)		$Z_n = 6$								
						1/4	5/16	3/8	1/2	5/8	3/4	1		
P	E 1 - 2	0.050	0.050	950	-	1188	n (min-1)	14516	11613	9677	7258	5806	4839	3629
							fz (in)	0.0033	0.0041	0.0049	0.0065	0.0081	0.0098	0.0130
				713	-	1188	vf (in/min)	283	283	283	283	283	283	283
	E 3 - 4	0.050	0.050	820	-	1025	n (min-1)	12530	10024	8353	6265	5012	4177	3132
							fz (in)	0.0030	0.0038	0.0045	0.0060	0.0075	0.0090	0.0120
				615	-	1025	vf (in/min)	226	226	226	226	226	226	226
	E 5 - 6	0.040	0.040	705	-	881	n (min-1)	10772	8618	7182	5386	4309	3591	2693
							fz (in)	0.0030	0.0038	0.0045	0.0060	0.0075	0.0090	0.0120
				529	-	881	vf (in/min)	194	194	194	194	194	194	194
M	E 8 - 9	0.050	0.050	360	-	450	n (min-1)	5501	4401	3667	2750	2200	1834	1375
							fz (in)	0.0030	0.0038	0.0045	0.0060	0.0075	0.0090	0.0120
				270	-	450	vf (in/min)	99	99	99	99	99	99	99
	E 10 - 11	0.040	0.040	230	-	288	n (min-1)	3514	2812	2343	1757	1406	1171	879
							fz (in)	0.0030	0.0038	0.0045	0.0060	0.0075	0.0090	0.0120
				173	-	288	vf (in/min)	63	63	63	63	63	63	63
K	E 12 - 13	0.050	0.050	900	-	1125	n (min-1)	13752	11002	9168	6876	5501	4584	3438
							fz (in)	0.0028	0.0034	0.0041	0.0055	0.0069	0.0083	0.0110
				675	-	1125	vf (in/min)	227	227	227	227	227	227	227
	E 14 - 15	0.050	0.050	740	-	925	n (min-1)	11307	9046	7538	5654	4523	3769	2827
							fz (in)	0.0025	0.0031	0.0038	0.0050	0.0063	0.0075	0.0100
				555	-	925	vf (in/min)	170	170	170	170	170	170	170
S	E 19	0.045	0.045	295	-	369	n (min-1)	4508	3606	3005	2254	1803	1503	1127
							fz (in)	0.0025	0.0031	0.0038	0.0050	0.0063	0.0075	0.0100
				221	-	369	vf (in/min)	68	68	68	68	68	68	68
	E 20	0.040	0.040	295	-	369	n (min-1)	4508	3606	3005	2254	1803	1503	1127
							fz (in)	0.0025	0.0031	0.0038	0.0050	0.0063	0.0075	0.0100
				221	-	369	vf (in/min)	68	68	68	68	68	68	68
	E 21	0.035	0.035	145	-	181	n (min-1)	2216	1772	1477	1108	886	739	554
							fz (in)	0.0020	0.0025	0.0030	0.0040	0.0050	0.0060	0.0080
	E 22	0.050	0.050	295	-	369	n (min-1)	4508	3606	3005	2254	1803	1503	1127
							fz (in)	0.0025	0.0031	0.0038	0.0050	0.0063	0.0075	0.0100
221				-	369	vf (in/min)	68	68	68	68	68	68	68	68

SMG = Seco Material Group
 n [min-1] = RPM
 v_c (sf/min) = Surface feet/min

fz [in] = Feed/tooth
 a_p/D_c = % of diameter

vf [in/min] = Feed rate
 a_e/D_c = % of diameter

A = Air D = Dry E = Emulsion (flood coolant) M = Mist
 All cutting data are start values. All cutting data is in inch values.
 Please reference the Workpiece Material Classification chart located on page 15.

SB638 / SBN638 - START VALUES

COPY MILLING - FINISHING													
ISO GROUP	SMG	$a_p \times D_c$ (max)	$a_e \times D_c$ (max)	v_c (sf / min)		$Z_n = 6$							
						1/8	3/16	1/4	5/16	3/8	3/4	1	
P	E 1 - 2	0.02	0.02	1045	n (min-1)	15968	12774	10645	7984	6387	5323	3992	
						fz (in)	0.0026	0.0033	0.0039	0.0052	0.0065	0.0078	0.0104
						vf (in/min)	249	249	249	249	249	249	249
	E 3 - 4	0.02	0.02	900	n (min-1)	13752	11002	9168	6876	5501	4584	3438	
						fz (in)	0.0024	0.0030	0.0036	0.0048	0.0060	0.0072	0.0096
						vf (in/min)	198	198	198	198	198	198	198
	E 5 - 6	0.02	0.02	775	n (min-1)	11842	9474	7895	5921	4737	3947	2961	
						fz (in)	0.0024	0.0030	0.0036	0.0048	0.0060	0.0072	0.0096
						vf (in/min)	171	171	171	171	171	171	171
M	E 8 - 9	0.02	0.02	395	n (min-1)	6036	4828	4024	3018	2414	2012	1509	
						fz (in)	0.0024	0.0030	0.0036	0.0048	0.0060	0.0072	0.0096
						vf (in/min)	87	87	87	87	87	87	87
	E 10 - 11	0.02	0.02	250	n (min-1)	3820	3056	2547	1910	1528	1273	955	
						fz (in)	0.0024	0.0030	0.0036	0.0048	0.0060	0.0072	0.0096
						vf (in/min)	55	55	55	55	55	55	55
K	E 12 - 13	0.02	0.02	990	n (min-1)	15127	12102	10085	7564	6051	5042	3782	
						fz (in)	0.0022	0.0028	0.0033	0.0044	0.0055	0.0066	0.0088
						vf (in/min)	200	200	200	200	200	200	200
	E 14 - 15	0.02	0.02	815	n (min-1)	12453	9963	8302	6227	4981	4151	3113	
						fz (in)	0.0020	0.0025	0.0030	0.0040	0.0050	0.0060	0.0080
						vf (in/min)	149	149	149	149	149	149	149
S	E 19	0.02	0.02	325	n (min-1)	4966	3973	3311	2483	1986	1655	1242	
						fz (in)	0.0020	0.0025	0.0030	0.0040	0.0050	0.0060	0.0080
						vf (in/min)	60	60	60	60	60	60	60
	E 20	0.02	0.02	325	n (min-1)	4966	3973	3311	2483	1986	1655	1242	
						fz (in)	0.0020	0.0025	0.0030	0.0040	0.0050	0.0060	0.0080
						vf (in/min)	60	60	60	60	60	60	60
	E 21	0.02	0.02	160	n (min-1)	2445	1956	1630	1222	978	815	611	
						fz (in)	0.0016	0.0020	0.0024	0.0032	0.0040	0.0048	0.0064
	E 22	0.02	0.02	325	n (min-1)	4966	3973	3311	2483	1986	1655	1242	
						fz (in)	0.0020	0.0025	0.0030	0.0040	0.0050	0.0060	0.0080
vf (in/min)						60	60	60	60	60	60	60	

SMG = Seco Material Group
 n (min-1) = RPM
 fz (in) = Feed/tooth
 vf (in/min) = Feed rate
 v_c (sf/min) = Surface feet/min
 $a_p \times D_c$ = % of diameter
 $a_e \times D_c$ = % of diameter
 All cutting data are start values
 All cutting data is in inch values

SMG = Seco Material Group
 n [min-1] = RPM
 v_c (sf/min) = Surface feet/min
 fz [in] = Feed/tooth
 a_p/D_c = % of diameter
 vf [in/min] = Feed rate
 a_e/D_c = % of diameter

A = Air D = Dry E = Emulsion (flood coolant) M = Mist
 All cutting data are start values. All cutting data is in inch values.
 Please reference the Workpiece Material Classification chart located on page 15.

SCS638 / SCS638R - CHIP SPLITTERS - START VALUES

SIDE MILLING - SEMI ROUGHING										
ISO GROUP	SMG	a _p x D _c (max)	a _e x D _c (max)	v _c (sf / min)		Z _n = 6				
						3/8	1/2	5/8	3/4	1
P	E 1 - 2	3.00	0.08	700	n (min-1)	7131	5348	4278	3565	2674
					fz (in)	0.0030	0.0040	0.0050	0.0060	0.0080
					vf (in/min)	128	128	128	128	128
	E 3 - 4	3.00	0.08	645	n (min-1)	6570	4928	3942	3285	2464
					fz (in)	0.0030	0.0040	0.0050	0.0060	0.0080
					vf (in/min)	118	118	118	118	118
	E 5 - 6	3.00	0.07	525	n (min-1)	5348	4011	3209	2674	2006
					fz (in)	0.0024	0.0033	0.0041	0.0049	0.0065
					vf (in/min)	78	78	78	78	78
M	E 8 - 9	3.00	0.08	600	n (min-1)	6112	4584	3667	3056	2292
					fz (in)	0.0028	0.0038	0.0047	0.0056	0.0075
					vf (in/min)	103	103	103	103	103
	E 10 - 11	3.00	0.07	565	n (min-1)	5755	4317	3453	2878	2158
					fz (in)	0.0024	0.0033	0.0041	0.0049	0.0065
					vf (in/min)	84	84	84	84	84
K	E 12 - 13	3.00	0.07	495	n (min-1)	5042	3782	3025	2521	1891
					fz (in)	0.0026	0.0035	0.0044	0.0053	0.0070
	E 14 - 15	3.00	0.07	430	n (min-1)	4380	3285	2628	2190	1643
					fz (in)	0.0019	0.0025	0.0031	0.0038	0.0050
S	E 19	3.00	0.05	150	n (min-1)	1528	1146	917	764	573
					fz (in)	0.0019	0.0025	0.0031	0.0038	0.0050
					vf (in/min)	17	17	17	17	17
	E 20	3.00	0.04	120	n (min-1)	1222	917	733	611	458
					fz (in)	0.0017	0.0023	0.0029	0.0035	0.0046
					vf (in/min)	13	13	13	13	13
	E 21	3.00	0.04	100	n (min-1)	1019	764	611	509	382
					fz (in)	0.0017	0.0023	0.0029	0.0035	0.0046
	E 22	3.00	0.07	270	n (min-1)	2750	2063	1650	1375	1031
					fz (in)	0.0024	0.0033	0.0041	0.0049	0.0065
vf (in/min)					40	40	40	40	40	

SMG = Seco Material Group
 n [min-1] = RPM
 v_c (sf/min) = Surface feet/min

fz [in] = Feed/tooth
 a_p/D_c = % of diameter

vf [in/min] = Feed rate
 a_e/D_c = % of diameter

A = Air D = Dry E = Emulsion (flood coolant) M = Mist
 All cutting data are start values. All cutting data is in inch values.
 Please reference the Workpiece Material Classification chart located on page 15.

S738 / S738R - START VALUES

SIDE MILLING - ROUGHING												
ISO GROUP	SMG	$a_p \times D_c$ (max)	$a_e \times D_c$ (max)	v_c (sf / min)		$Z_n=7$						
						1/4	3/8	1/2	5/8	3/4	1	
P	E 1 - 2	2.00	0.09	800	n [min-1]	12224	8149	6112	4890	4075	3056	
						fz [in]	0.0025	0.0038	0.0050	0.0063	0.0075	0.0100
							vf [in/min]	214	214	214	214	214
	E 3 - 4	2.00	0.09	740	n [min-1]	11307		7538	5654	4523	3769	2827
						fz [in]	0.0025	0.0038	0.0050	0.0063	0.0075	0.0100
							vf [in/min]	198	198	198	198	198
	E 5 - 6	2.00	0.07	605	n [min-1]	9244		6163	4622	3698	3081	2311
						fz [in]	0.0020	0.0030	0.0040	0.0050	0.0060	0.0080
							vf [in/min]	129	129	129	129	129
M	E 8 - 9	2.00	0.09	680	n [min-1]	10390		6927	5195	4156	3463	2598
						fz [in]	0.0020	0.0030	0.0040	0.0050	0.0060	0.0080
							vf [in/min]	145	145	145	145	145
	E 10 - 11	2.00	0.08	630	n [min-1]	9626		6418	4813	3851	3209	2407
						fz [in]	0.0018	0.0026	0.0035	0.0044	0.0053	0.0070
							vf [in/min]	118	118	118	118	118
K	E 12 - 13	2.00	0.08	550	n [min-1]	8404		5603	4202	3362	2801	2101
						fz [in]	0.0020	0.0030	0.0040	0.0050	0.0060	0.0080
							vf [in/min]	118	118	118	118	118
	E 14 - 15	2.00	0.07	490	n [min-1]	7487		4991	3744	2995	2496	1872
						fz [in]	0.0018	0.0026	0.0035	0.0044	0.0053	0.0070
							vf [in/min]	92	92	92	92	92
S	E 19	2.00	0.05	170	n [min-1]	2598		1732	1299	1039	866	649
						fz [in]	0.0015	0.0023	0.0030	0.0038	0.0045	0.0060
							vf [in/min]	27	27	27	27	27
	E 20	2.00	0.05	135	n [min-1]	2063		1375	1031	825	688	516
						fz [in]	0.0014	0.0021	0.0028	0.0034	0.0041	0.0055
							vf [in/min]	20	20	20	20	20
	E 21	2.00	0.05	115	n [min-1]	1757		1171	879	703	586	439
						fz [in]	0.0014	0.0021	0.0028	0.0034	0.0041	0.0055
							vf [in/min]	17	17	17	17	17
	E 22	2.00	0.05	310	n [min-1]	4737		3158	2368	1895	1579	1184
fz [in]						0.0015	0.0023	0.0030	0.0038	0.0045	0.0060	
						vf [in/min]	50	50	50	50	50	50
										233	-	388

SMG = Seco Material Group
 n [min-1] = RPM
 v_c (sf/min) = Surface feet/min

fz [in] = Feed/tooth
 a_p/D_c = % of diameter
 a_e/D_c = % of diameter
 vf [in/min] = Feed rate
 a_p/D_c = % of diameter

A = Air D = Dry E = Emulsion (flood coolant) M = Mist
 All cutting data are start values. All cutting data is in inch values.
 Please reference the Workpiece Material Classification chart located on page 15.

S738 / S738R - START VALUES

SIDE MILLING - FINISHING												
ISO GROUP	SMG	$a_p \times D_c$ (max)	$a_e \times D_c$ (max)	v_c (sf / min)		$Z_n=7$						
						1/4	3/8	1/2	5/8	3/4	1	
P	E 1 - 2	2.00	0.02	920	n [min-1]	14058	9372	7029	5623	4686	3514	
						fz [in]	0.0013	0.0019	0.0025	0.0031	0.0038	0.0050
						690 - 1150	vf [in/min]	123	123	123	123	123
	E 3 - 4	2.00	0.02	850	n [min-1]	12988	8659	6494	5195	4329	3247	
						fz [in]	0.0013	0.0019	0.0025	0.0031	0.0038	0.0050
						638 - 1063	vf [in/min]	114	114	114	114	114
	E 5 - 6	2.00	0.02	700	n [min-1]	10696	7131	5348	4278	3565	2674	
						fz [in]	0.0013	0.0019	0.0025	0.0031	0.0038	0.0050
						525 - 875	vf [in/min]	94	94	94	94	94
M	E 8 - 9	2.00	0.02	780	n [min-1]	11918	7946	5959	4767	3973	2980	
						fz [in]	0.0013	0.0019	0.0025	0.0031	0.0038	0.0050
						585 - 975	vf [in/min]	104	104	104	104	104
	E 10 - 11	2.00	0.02	725	n [min-1]	11078	7385	5539	4431	3693	2770	
						fz [in]	0.0013	0.0019	0.0025	0.0031	0.0038	0.0050
						544 - 906	vf [in/min]	97	97	97	97	97
K	E 12 - 13	2.00	0.02	630	n [min-1]	9626	6418	4813	3851	3209	2407	
						fz [in]	0.0013	0.0019	0.0025	0.0031	0.0038	0.0050
						473 - 788	vf [in/min]	84	84	84	84	84
	E 14 - 15	2.00	0.02	565	n [min-1]	8633	5755	4317	3453	2878	2158	
						fz [in]	0.0010	0.0015	0.0020	0.0025	0.0030	0.0040
						424 - 706	vf [in/min]	60	60	60	60	60
S	E 19	2.00	0.02	195	n [min-1]	2980	1986	1490	1192	993	745	
						fz [in]	0.0010	0.0015	0.0020	0.0025	0.0030	0.0040
						146 - 244	vf [in/min]	21	21	21	21	21
	E 20	2.00	0.02	155	n [min-1]	2368	1579	1184	947	789	592	
						fz [in]	0.0010	0.0015	0.0020	0.0025	0.0030	0.0040
						116 - 194	vf [in/min]	17	17	17	17	17
	E 21	2.00	0.02	130	n [min-1]	1986	1324	993	795	662	497	
						fz [in]	0.0010	0.0015	0.0020	0.0025	0.0030	0.0040
						98 - 163	vf [in/min]	14	14	14	14	14
	E 22	2.00	0.02	360	n [min-1]	5501	3667	2750	2200	1834	1375	
fz [in]						0.0013	0.0019	0.0025	0.0031	0.0038	0.0050	
270 - 450						vf [in/min]	48	48	48	48	48	48

SMG = Seco Material Group
 n [min-1] = RPM
 v_c (sf/min) = Surface feet/min

fz [in] = Feed/tooth
 a_p/D_c = % of diameter
 a_e/D_c = % of diameter
 v_f [in/min] = Feed rate

A = Air D = Dry E = Emulsion (flood coolant) M = Mist
 All cutting data are start values. All cutting data is in inch values.
 Please reference the Workpiece Material Classification chart located on page 15.

SCS738R - CHIP SPLITTERS - START VALUES

SIDE MILLING - SEMI ROUGHING												
ISO GROUP	SMG	$a_p \times D_c$ (max)	$a_e \times D_c$ (max)	v_c (sf / min)				$Z_n=7$				
								1/4	3/8	1/2	5/8	3/4
P	E 1 - 2	3.00	0.06	800			n (min-1)	12224	8149	6112	4890	4075
							fz (in)	0.0025	0.0038	0.0050	0.0063	0.0075
				600 - 1000			vf (in/min)	214	214	214	214	214
	E 3 - 4	3.00	0.06				740			n (min-1)	11307	7538
				fz (in)	0.0025	0.0038				0.0050	0.0063	0.0075
				555 - 925			vf (in/min)	198	198	198	198	198
	E 5 - 6	3.00	0.05				605			n (min-1)	9244	6163
				fz (in)	0.0020	0.0030				0.0040	0.0050	0.0060
				454 - 756			vf (in/min)	129	129	129	129	129
E 8 - 9	3.00	0.06	680				n (min-1)	10390	6927	5195	4156	3463
						fz (in)	0.0020	0.0030	0.0040	0.0050	0.0060	
			510 - 850			vf (in/min)	145	145	145	145	145	
E 10 - 11	3.00	0.05				630			n (min-1)	9626	6418	4813
			fz (in)	0.0018	0.0026				0.0035	0.0044	0.0053	
			473 - 788			vf (in/min)	118	118	118	118	118	
E 12 - 13	3.00	0.06				550			n (min-1)	8404	5603	4202
			fz (in)	0.0020	0.0030				0.0040	0.0050	0.0060	
			413 - 688			vf (in/min)	118	118	118	118	118	
E 14 - 15	3.00	0.05				490			n (min-1)	7487	4991	3744
			fz (in)	0.0018	0.0026				0.0035	0.0044	0.0053	
			368 - 613			vf (in/min)	92	92	92	92	92	
E 19	3.00	0.04				170			n (min-1)	2598	1732	1299
			fz (in)	0.0015	0.0023				0.0030	0.0038	0.0045	
			128 - 213			vf (in/min)	27	27	27	27	27	
E 20	3.00	0.04				135			n (min-1)	2063	1375	1031
			fz (in)	0.0014	0.0021				0.0028	0.0034	0.0041	
			101 - 169			vf (in/min)	20	20	20	20	20	
E 21	3.00	0.04				115			n (min-1)	1757	1171	879
			fz (in)	0.0014	0.0021				0.0028	0.0034	0.0041	
			86 - 144			vf (in/min)	17	17	17	17	17	
E 22	3.00	0.05				310			n (min-1)	4737	3158	2368
			fz (in)	0.0015	0.0023				0.0030	0.0038	0.0045	
			233 - 388			vf (in/min)	50	50	50	50	50	

NOTE: Optimized roughing is an excellent strategy for achieving quality parts and extending tool life, but requires use of the right equipment and cutting parameters. If you are having problems implementing the approach or want to learn more about how to use the strategy to process a part, contact the Technical Support Team at 1-800-TEC-TEAM (1-800-832-8326).

SMG = Seco Material Group
 n [min-1] = RPM
 v_c (sf/min) = Surface feet/min

fz [in] = Feed/tooth
 a_p/D_c = % of diameter

vf [in/min] = Feed rate
 a_e/D_c = % of diameter

A = Air D = Dry E = Emulsion (flood coolant) M = Mist
 All cutting data are start values. All cutting data is in inch values.
 Please reference the Workpiece Material Classification chart located on page 15.

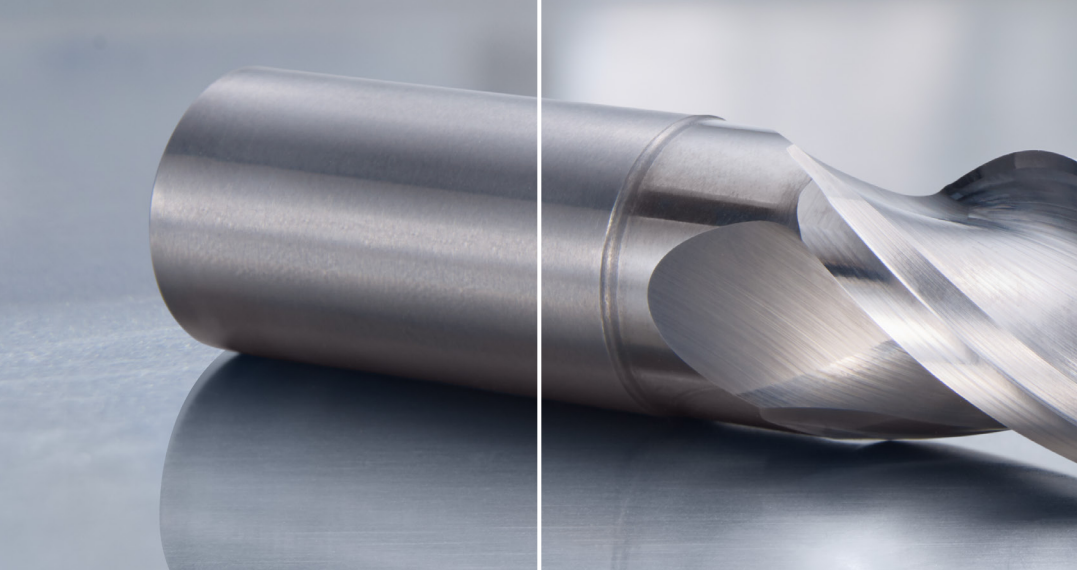

**NIAGARA
CUTTER™**

**ELITE A
SERIES HIGH
PERFORMANCE**

**REACH PEAK METAL REMOVAL RATES IN
HIGH-VELOCITY ALUMINUM MILLING**

AN230 & AN335

Achieve exceptional material removal rates for aerospace slotting and profiling applications in aluminum with the high-performance AN230 and AN335 solid carbide end mills from Niagara Cutter™. Designed to minimize deflection and vibrations with its advanced geometry, these end mills can keep up with any high-velocity spindle without sacrificing surface finish or tool life.

MATERIAL GROUPS
Non-ferrous 16-17

For modern machine tools equipped with spindles capable of 16,000 rpm or more, avoiding vibrations is critical to securing processes and preventing damage to the spindle. For the highest level of process security, the AN230 and AN335 end mills can spend days in cut with ease thanks to innovative engineering.

These end mills have been optimized with K-lands that enable reduced frictional forces and contact with the chip as well as smoother cutting thanks to the avoidance of material adhesion. Axial coolant holes in the 3-flute configuration further improve performance and chip control.

KEY BENEFITS

- Push your machine to its limits without sacrificing surface finish, tool life or process security
- Increase chip evacuation and reduce friction and heat with specially designed axial coolant holes
- Avoid deflection and chatter with advanced tool geometry
- Get customized tool designs according to your specific needs

RANGE OVERVIEW

- 94 uncoated inch end mills (AN230/AN230R) (AN335/AN335R)
- 0.5", 0.75", 1.00" diameter sizes
- Standard square corner and aerospace radii options

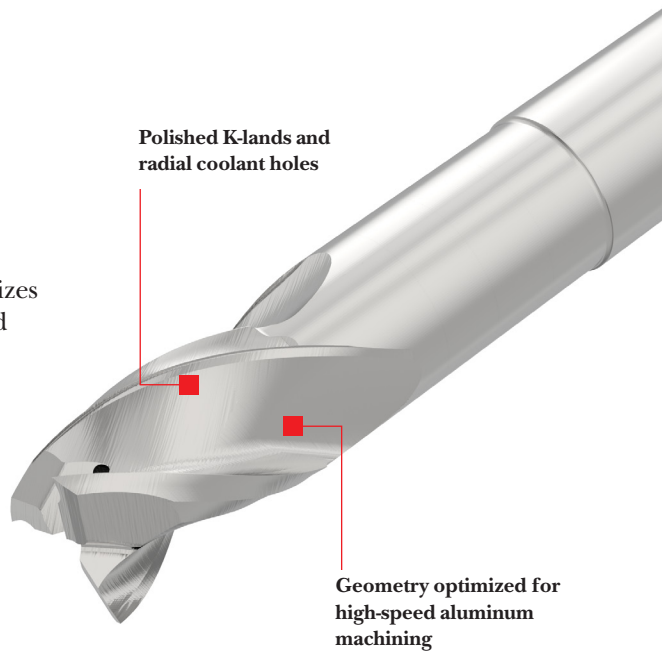

4 THINGS TO KNOW

TO GET THE MOST OUT OF ALUMINUM MILLING WITH THE AN230 AND AN335

1. WHY WAS THIS PRODUCT DEVELOPED?

The Niagara Cutter AN230 and AN335 are designed for high speed / high velocity aluminum milling applications. These two series of end mills meet the design requirements established by industry leading CNC machine tool builders to be run in milling machines utilizing 80kw and 120kw spindles. The flexibility of the AN230 and AN335 can also be used in mid-range to high performance milling machines found in many Aerospace machine shops.

2. WHAT CAN NIAGARA CUTTER OFFER?

A consistent and reliable high level of performance for each and every tool, standard or special. This is delivered from the engineered flute shape, to polishing of the K-land to provide a strong and homogenous cutting edge.

AN230 & AN335 offers:

- Square end and standard Aerospace corner radius sizes
- Unequal flute spacing to eliminate harmonics
- Polished Rake Face K-Land to reduce friction and chip to flute contact
- Stabilization land to eliminate harmonics
- Available in multiple reach lengths to accommodate shallow and deep pockets
- Shank lengths optimized for shrink fit toolholder clamping depths
- Internal Y coolant channels available as standards on the AN335 series

3. APPLICATION AREAS

High velocity slotting and profiling milling aluminum up to 1 x diameter depth of cut. High pressure flood coolant and thru the spindle coolant (AN335) is recommended to ensure proper chip evacuation. Balanced tool holder assemblies are highly recommended per the machine tool builder requirements.

4. INDUSTRY REQUIREMENTS AND NEEDS

- 80 kw and up for AN230 geometry
- 120kw spindles for AN335 geometry
- High rpm applications require balanced toolholder assemblies
- High precision holders that ensure minimal run-out as well as good clamping and transmittable torque are highly recommended when high velocity milling, such as:
 - Heavy duty reinforced Shrinkfit holders
 - Power Milling chucks
 - High precision collet chucks
 - Weldon holders
- Anti-pullout protection such as Haimer Safe-Lock or weldon
- Programming “lead in” and “lead outs” to ensure smooth transitions into and exiting the workpiece



AN230

SOLID CARBIDE

HELIX

SQUARE END

CENTER CUTTING



- Polished K-land to increase cutting edge strength
- Form ground flute shape
- Eccentric primary relief
- Ideal for high volume material removal in aluminum and non-ferrous materials

ITEM NUMBER	DESCRIPTION	FLUTE DIA.	SHANK DIA.	LENGTH OF CUT	OVERALL LENGTH	NECK DIA.	REACH	FLUTES	SHANK TYPE
03302585	AN230-0.500-E2-S.0-Z2	1/2	1/2	3/4	3	0.470	1-1/4	2	CYLINDRICAL
03302588	AN230-0.500-E3-S.0-Z2	1/2	1/2	3/4	3-1/2	0.470	1-3/4	2	CYLINDRICAL
03302591	AN230-0.500-E4-S.0-Z2	1/2	1/2	3/4	4	0.470	2-1/4	2	CYLINDRICAL
03302594	AN230-0.500-E5-S.0-Z2	1/2	1/2	3/4	4-1/2	0.470	2-3/4	2	CYLINDRICAL
03302597	AN230-0.750-E2-S.0-Z2	3/4	3/4	1	4	0.720	2-1/8	2	CYLINDRICAL
03302602	AN230-0.750-E3-S.0-Z2	3/4	3/4	1	4-1/2	0.720	2-5/8	2	CYLINDRICAL
03302607	AN230-0.750-E4-S.0-Z2	3/4	3/4	1	5	0.720	3-1/8	2	CYLINDRICAL
03302612	AN230-0.750-E5-S.0-Z2	3/4	3/4	1	5-1/2	0.720	3-5/8	2	CYLINDRICAL
03302617	AN230-1.000-E2-S.0-Z2	1	1	1-1/4	4	0.960	2-1/8	2	CYLINDRICAL
03302622	AN230-1.000-E3-S.0-Z2	1	1	1-1/4	4-1/2	0.960	2-5/8	2	CYLINDRICAL
03302627	AN230-1.000-E4-S.0-Z2	1	1	1-1/4	5	0.960	3-1/8	2	CYLINDRICAL

AN230R

SOLID CARBIDE

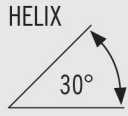

CENTER CUTTING



- Polished K-land to increase cutting edge strength
- Form ground flute shape
- Eccentric primary relief
- Ideal for high volume material removal in aluminum and non-ferrous materials
- With corner radius for strength

ITEM NUMBER	DESCRIPTION	FLUTE DIA.	SHANK DIA.	LENGTH OF CUT	OVERALL LENGTH	NECK DIA	REACH	FLUTES	RADIUS	SHANK TYPE
03302586	AN230R-0.500-E2-R030.0-Z2	1/2	1/2	3/4	3	0.470	1-1/4	2	0.030	CYLINDRICAL
03302587	AN230R-0.500-E2-R060.0-Z2	1/2	1/2	3/4	3	0.470	1-1/4	2	0.060	CYLINDRICAL
03302589	AN230R-0.500-E3-R030.0-Z2	1/2	1/2	3/4	3-1/2	0.470	1-3/4	2	0.030	CYLINDRICAL
03302590	AN230R-0.500-E3-R060.0-Z2	1/2	1/2	3/4	3-1/2	0.470	1-3/4	2	0.060	CYLINDRICAL
03302592	AN230R-0.500-E4-R030.0-Z2	1/2	1/2	3/4	4	0.470	2-1/4	2	0.030	CYLINDRICAL
03302593	AN230R-0.500-E4-R060.0-Z2	1/2	1/2	3/4	4	0.470	2-1/4	2	0.060	CYLINDRICAL
03302595	AN230R-0.500-E5-R030.0-Z2	1/2	1/2	3/4	4-1/2	0.470	2-3/4	2	0.030	CYLINDRICAL
03302596	AN230R-0.500-E5-R060.0-Z2	1/2	1/2	3/4	4-1/2	0.470	2-3/4	2	0.060	CYLINDRICAL
03302598	AN230R-0.750-E2-R030.0-Z2	3/4	3/4	1	4	0.720	2-1/8	2	0.030	CYLINDRICAL
03302599	AN230R-0.750-E2-R060.0-Z2	3/4	3/4	1	4	0.720	2-1/8	2	0.060	CYLINDRICAL
03302600	AN230R-0.750-E2-R090.0-Z2	3/4	3/4	1	4	0.720	2-1/8	2	0.090	CYLINDRICAL
03302601	AN230R-0.750-E2-R120.0-Z2	3/4	3/4	1	4	0.720	2-1/8	2	0.120	CYLINDRICAL
03302603	AN230R-0.750-E3-R030.0-Z2	3/4	3/4	1	4-1/2	0.720	2-5/8	2	0.030	CYLINDRICAL
03302604	AN230R-0.750-E3-R060.0-Z2	3/4	3/4	1	4-1/2	0.720	2-5/8	2	0.060	CYLINDRICAL
03302605	AN230R-0.750-E3-R090.0-Z2	3/4	3/4	1	4-1/2	0.720	2-5/8	2	0.090	CYLINDRICAL
03302606	AN230R-0.750-E3-R120.0-Z2	3/4	3/4	1	4-1/2	0.720	2-5/8	2	0.120	CYLINDRICAL
03302608	AN230R-0.750-E4-R030.0-Z2	3/4	3/4	1	5	0.720	3-1/8	2	0.030	CYLINDRICAL
03302609	AN230R-0.750-E4-R060.0-Z2	3/4	3/4	1	5	0.720	3-1/8	2	0.060	CYLINDRICAL
03302610	AN230R-0.750-E4-R090.0-Z2	3/4	3/4	1	5	0.720	3-1/8	2	0.090	CYLINDRICAL
03302611	AN230R-0.750-E4-R120.0-Z2	3/4	3/4	1	5	0.720	3-1/8	2	0.120	CYLINDRICAL
03302613	AN230R-0.750-E5-R030.0-Z2	3/4	3/4	1	5-1/2	0.720	3-5/8	2	0.030	CYLINDRICAL
03302614	AN230R-0.750-E5-R060.0-Z2	3/4	3/4	1	5-1/2	0.720	3-5/8	2	0.060	CYLINDRICAL
03302615	AN230R-0.750-E5-R090.0-Z2	3/4	3/4	1	5-1/2	0.720	3-5/8	2	0.090	CYLINDRICAL
03302616	AN230R-0.750-E5-R120.0-Z2	3/4	3/4	1	5-1/2	0.720	3-5/8	2	0.120	CYLINDRICAL
03302618	AN230R-1.000-E2-R030.0-Z2	1	1	1-1/4	4	0.960	2-1/8	2	0.030	CYLINDRICAL
03302619	AN230R-1.000-E2-R060.0-Z2	1	1	1-1/4	4	0.960	2-1/8	2	0.060	CYLINDRICAL
03302620	AN230R-1.000-E2-R090.0-Z2	1	1	1-1/4	4	0.960	2-1/8	2	0.090	CYLINDRICAL
03302621	AN230R-1.000-E2-R120.0-Z2	1	1	1-1/4	4	0.960	2-1/8	2	0.120	CYLINDRICAL
03302623	AN230R-1.000-E3-R030.0-Z2	1	1	1-1/4	4-1/2	0.960	2-5/8	2	0.030	CYLINDRICAL
03302624	AN230R-1.000-E3-R060.0-Z2	1	1	1-1/4	4-1/2	0.960	2-5/8	2	0.060	CYLINDRICAL
03302625	AN230R-1.000-E3-R090.0-Z2	1	1	1-1/4	4-1/2	0.960	2-5/8	2	0.090	CYLINDRICAL
03302626	AN230R-1.000-E3-R120.0-Z2	1	1	1-1/4	4-1/2	0.960	2-5/8	2	0.120	CYLINDRICAL
03302628	AN230R-1.000-E4-R030.0-Z2	1	1	1-1/4	5	0.960	3-1/8	2	0.030	CYLINDRICAL
03302629	AN230R-1.000-E4-R060.0-Z2	1	1	1-1/4	5	0.960	3-1/8	2	0.060	CYLINDRICAL
03302630	AN230R-1.000-E4-R090.0-Z2	1	1	1-1/4	5	0.960	3-1/8	2	0.090	CYLINDRICAL
03302631	AN230R-1.000-E4-R120.0-Z2	1	1	1-1/4	5	0.960	3-1/8	2	0.120	CYLINDRICAL

AN335

SOLID
CARBIDE

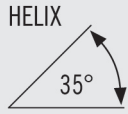

CENTER
CUTTING

COOLANT
THROUGH



- Polished K-land to increase cutting edge strength
- Form ground flute shape
- Eccentric primary relief
- Ideal for high volume material removal in aluminum and non-ferrous materials
- Y-Channel coolant through

ITEM NUMBER	DESCRIPTION	FLUTE DIA.	SHANK DIA.	LENGTH OF CUT	OVERALL LENGTH	NECK DIA.	REACH	FLUTES	SHANK TYPE
03302634	AN335-0.500-E2-S.0-Z3A	1/2	1/2	3/4	3	0.470	1-1/4	3	CYLINDRICAL
03302637	AN335-0.500-E3-S.0-Z3A	1/2	1/2	3/4	3-1/2	0.470	1-3/4	3	CYLINDRICAL
03302640	AN335-0.500-E4-S.0-Z3A	1/2	1/2	3/4	4	0.470	2-1/4	3	CYLINDRICAL
03302643	AN335-0.500-E5-S.0-Z3A	1/2	1/2	3/4	4-1/2	0.470	2-3/4	3	CYLINDRICAL
03302646	AN335-0.750-E2-S.0-Z3A	3/4	3/4	1	4	0.720	2-1/8	3	CYLINDRICAL
03302651	AN335-0.750-E3-S.0-Z3A	3/4	3/4	1	4-1/2	0.720	2-5/8	3	CYLINDRICAL
03302656	AN335-0.750-E4-S.0-Z3A	3/4	3/4	1	5	0.720	3-1/8	3	CYLINDRICAL
03302662	AN335-0.750-E5-S.0-Z3A	3/4	3/4	1	5-1/2	0.720	3-5/8	3	CYLINDRICAL
03302667	AN335-1.000-E2-S.0-Z3A	1	1	1-1/4	4	0.960	2-1/8	3	CYLINDRICAL
03302672	AN335-1.000-E3-S.0-Z3A	1	1	1-1/4	4-1/2	0.960	2-5/8	3	CYLINDRICAL
03302677	AN335-1.000-E4-S.0-Z3A	1	1	1-1/4	5	0.960	3-1/8	3	CYLINDRICAL

AN335R

SOLID
CARBIDE

HELIX

RADIUS

CENTER
CUTTING

COOLANT
THROUGH



- Polished K-land to increase cutting edge strength
- Form ground flute shape
- Eccentric primary relief
- Ideal for high volume material removal in aluminum and non-ferrous materials
- With corner radius for strength
- Y-Channel coolant through

ITEM NUMBER	DESCRIPTION	FLUTE DIA.	SHANK DIA.	LENGTH OF CUT	OVERALL LENGTH	NECK DIA.	REACH	FLUTES	RADIUS	SHANK TYPE
03302635	AN335R-0.500-E2-R030.0-Z3A	1/2	1/2	3/4	3	0.470	1-1/4	3	0.030	CYLINDRICAL
03302636	AN335R-0.500-E2-R060.0-Z3A	1/2	1/2	3/4	3	0.470	1-1/4	3	0.060	CYLINDRICAL
03302638	AN335R-0.500-E3-R030.0-Z3A	1/2	1/2	3/4	3-1/2	0.470	1-3/4	3	0.030	CYLINDRICAL
03302639	AN335R-0.500-E3-R060.0-Z3A	1/2	1/2	3/4	3-1/2	0.470	1-3/4	3	0.060	CYLINDRICAL
03302641	AN335R-0.500-E4-R030.0-Z3A	1/2	1/2	3/4	4	0.470	2-1/4	3	0.030	CYLINDRICAL
03302642	AN335R-0.500-E4-R060.0-Z3A	1/2	1/2	3/4	4	0.470	2-1/4	3	0.060	CYLINDRICAL
03302644	AN335R-0.500-E5-R030.0-Z3A	1/2	1/2	3/4	4-1/2	0.470	2-3/4	3	0.030	CYLINDRICAL
03302645	AN335R-0.500-E5-R060.0-Z3A	1/2	1/2	3/4	4-1/2	0.470	2-3/4	3	0.060	CYLINDRICAL
03302647	AN335R-0.750-E2-R030.0-Z3A	3/4	3/4	1	4	0.720	2-1/8	3	0.030	CYLINDRICAL
03302648	AN335R-0.750-E2-R060.0-Z3A	3/4	3/4	1	4	0.720	2-1/8	3	0.060	CYLINDRICAL
03302649	AN335R-0.750-E2-R090.0-Z3A	3/4	3/4	1	4	0.720	2-1/8	3	0.090	CYLINDRICAL
03302650	AN335R-0.750-E2-R120.0-Z3A	3/4	3/4	1	4	0.720	2-1/8	3	0.120	CYLINDRICAL
03302652	AN335R-0.750-E3-R030.0-Z3A	3/4	3/4	1	4-1/2	0.720	2-5/8	3	0.030	CYLINDRICAL
03302653	AN335R-0.750-E3-R060.0-Z3A	3/4	3/4	1	4-1/2	0.720	2-5/8	3	0.060	CYLINDRICAL
03302654	AN335R-0.750-E3-R090.0-Z3A	3/4	3/4	1	4-1/2	0.720	2-5/8	3	0.090	CYLINDRICAL
03302655	AN335R-0.750-E3-R120.0-Z3A	3/4	3/4	1	4-1/2	0.720	2-5/8	3	0.120	CYLINDRICAL
03302657	AN335R-0.750-E4-R030.0-Z3A	3/4	3/4	1	5	0.720	3-1/8	3	0.030	CYLINDRICAL
03302658	AN335R-0.750-E4-R060.0-Z3A	3/4	3/4	1	5	0.720	3-1/8	3	0.060	CYLINDRICAL
03302659	AN335R-0.750-E4-R090.0-Z3A	3/4	3/4	1	5	0.720	3-1/8	3	0.090	CYLINDRICAL
03302660	AN335R-0.750-E4-R120.0-Z3A	3/4	3/4	1	5	0.720	3-1/8	3	0.120	CYLINDRICAL
03302663	AN335R-0.750-E5-R030.0-Z3A	3/4	3/4	1	5-1/2	0.720	3-5/8	3	0.030	CYLINDRICAL
03302664	AN335R-0.750-E5-R060.0-Z3A	3/4	3/4	1	5-1/2	0.720	3-5/8	3	0.060	CYLINDRICAL
03302665	AN335R-0.750-E5-R090.0-Z3A	3/4	3/4	1	5-1/2	0.720	3-5/8	3	0.090	CYLINDRICAL
03302666	AN335R-0.750-E5-R120.0-Z3A	3/4	3/4	1	5-1/2	0.720	3-5/8	3	0.120	CYLINDRICAL
03302668	AN335R-1.000-E2-R030.0-Z3A	1	1	1-1/4	4	0.960	2-1/8	3	0.030	CYLINDRICAL
03302669	AN335R-1.000-E2-R060.0-Z3A	1	1	1-1/4	4	0.960	2-1/8	3	0.060	CYLINDRICAL
03302670	AN335R-1.000-E2-R090.0-Z3A	1	1	1-1/4	4	0.960	2-1/8	3	0.090	CYLINDRICAL
03302671	AN335R-1.000-E2-R120.0-Z3A	1	1	1-1/4	4	0.960	2-1/8	3	0.120	CYLINDRICAL
03302673	AN335R-1.000-E3-R030.0-Z3A	1	1	1-1/4	4-1/2	0.960	2-5/8	3	0.030	CYLINDRICAL
03302674	AN335R-1.000-E3-R060.0-Z3A	1	1	1-1/4	4-1/2	0.960	2-5/8	3	0.060	CYLINDRICAL
03302675	AN335R-1.000-E3-R090.0-Z3A	1	1	1-1/4	4-1/2	0.960	2-5/8	3	0.090	CYLINDRICAL
03302676	AN335R-1.000-E3-R120.0-Z3A	1	1	1-1/4	4-1/2	0.960	2-5/8	3	0.120	CYLINDRICAL
03302678	AN335R-1.000-E4-R030.0-Z3A	1	1	1-1/4	5	0.960	3-1/8	3	0.030	CYLINDRICAL
03302679	AN335R-1.000-E4-R060.0-Z3A	1	1	1-1/4	5	0.960	3-1/8	3	0.060	CYLINDRICAL
03302680	AN335R-1.000-E4-R090.0-Z3A	1	1	1-1/4	5	0.960	3-1/8	3	0.090	CYLINDRICAL
03302681	AN335R-1.000-E4-R120.0-Z3A	1	1	1-1/4	5	0.960	3-1/8	3	0.120	CYLINDRICAL

AN340

SOLID CARBIDE

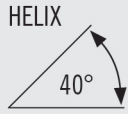

CENTER CUTTING



- Cylindrical land to eliminate chatter
- Form ground flute shape
- Eccentric primary relief
- Ideal for high volume material removal in aluminum and non-ferrous materials
- With corner radius for strength
- Wiper flat to improve floor finish on the workpiece

ITEM NUMBER	DESCRIPTION	FLUTE DIA.	SHANK DIA.	LENGTH OF CUT	OVERALL LENGTH	NECK DIA.	REACH	FLUTES	COATING	RADIUS	SHANK TYPE
N57881	AN340-0.188-E1-R010.0-Z3	3/16	3/16	1/4	2	0.178	9/16	3	UNCOATED	0.010	CYLINDRICAL
N57910	AN340-0.188-E1-R010.0-Z3	3/16	3/16	1/4	2	0.178	9/16	3	TICN	0.010	CYLINDRICAL
N57882	AN340-0.188-E2-R010.0-Z3	3/16	3/16	1/4	3	0.178	1-9/16	3	UNCOATED	0.010	CYLINDRICAL
N57911	AN340-0.188-E2-R010.0-Z3	3/16	3/16	1/4	3	0.178	1-9/16	3	TICN	0.010	CYLINDRICAL
N57884	AN340-0.250-E1-R010.0-Z3	1/4	1/4	5/16	2-1/2	0.240	3/4	3	UNCOATED	0.010	CYLINDRICAL
N57913	AN340-0.250-E1-R010.0-Z3	1/4	1/4	5/16	2-1/2	0.240	3/4	3	TICN	0.010	CYLINDRICAL
N57885	AN340-0.250-E2-R010.0-Z3	1/4	1/4	5/16	3-1/4	0.240	1-3/4	3	UNCOATED	0.010	CYLINDRICAL
N57914	AN340-0.250-E2-R010.0-Z3	1/4	1/4	5/16	3-1/4	0.240	1-3/4	3	TICN	0.010	CYLINDRICAL
N57888	AN340-0.375-E1-R015.0-Z3	3/8	3/8	1/2	2-1/2	0.360	7/8	3	UNCOATED	0.015	CYLINDRICAL
N57917	AN340-0.375-E1-R015.0-Z3	3/8	3/8	1/2	2-1/2	0.360	7/8	3	TICN	0.015	CYLINDRICAL
N57889	AN340-0.375-E2-R015.0-Z3	3/8	3/8	1/2	3	0.360	1-3/8	3	UNCOATED	0.015	CYLINDRICAL
N57918	AN340-0.375-E2-R015.0-Z3	3/8	3/8	1/2	3	0.360	1-3/8	3	TICN	0.015	CYLINDRICAL
N57890	AN340-0.375-E3-R015.0-Z3	3/8	3/8	1/2	4	0.360	2-3/8	3	UNCOATED	0.015	CYLINDRICAL
N57919	AN340-0.375-E3-R015.0-Z3	3/8	3/8	1/2	4	0.360	2-3/8	3	TICN	0.015	CYLINDRICAL
N57893	AN340-0.500-E1-R020.0-Z3	1/2	1/2	5/8	3	0.480	1-1/8	3	UNCOATED	0.020	CYLINDRICAL
N57922	AN340-0.500-E1-R020.0-Z3	1/2	1/2	5/8	3	0.480	1-1/8	3	TICN	0.020	CYLINDRICAL
N57894	AN340-0.500-E2-R020.0-Z3	1/2	1/2	5/8	4	0.480	2-1/8	3	UNCOATED	0.020	CYLINDRICAL
N57923	AN340-0.500-E2-R020.0-Z3	1/2	1/2	5/8	4	0.480	2-1/8	3	TICN	0.020	CYLINDRICAL
N57895	AN340-0.500-E3-R020.0-Z3	1/2	1/2	5/8	5	0.480	3-1/8	3	UNCOATED	0.020	CYLINDRICAL
N57924	AN340-0.500-E3-R020.0-Z3	1/2	1/2	5/8	5	0.480	3-1/8	3	TICN	0.020	CYLINDRICAL
N57897	AN340-0.625-E1-R025.0-Z3	5/8	5/8	3/4	3-1/2	0.600	1-1/2	3	UNCOATED	0.025	CYLINDRICAL
N57926	AN340-0.625-E1-R025.0-Z3	5/8	5/8	3/4	3-1/2	0.600	1-1/2	3	TICN	0.025	CYLINDRICAL
N57901	AN340-0.750-E1-R030.0-Z3	3/4	3/4	1	4	0.720	1-7/8	3	UNCOATED	0.030	CYLINDRICAL
N57930	AN340-0.750-E1-R030.0-Z3	3/4	3/4	1	4	0.720	1-7/8	3	TICN	0.030	CYLINDRICAL
N57902	AN340-0.750-E2-R030.0-Z3	3/4	3/4	1	5	0.720	2-7/8	3	UNCOATED	0.030	CYLINDRICAL
N57931	AN340-0.750-E2-R030.0-Z3	3/4	3/4	1	5	0.720	2-7/8	3	TICN	0.030	CYLINDRICAL
N57903	AN340-0.750-E3-R030.0-Z3	3/4	3/4	1	6	0.720	3-7/8	3	UNCOATED	0.030	CYLINDRICAL
N57932	AN340-0.750-E3-R030.0-Z3	3/4	3/4	1	6	0.720	3-7/8	3	TICN	0.030	CYLINDRICAL
N57906	AN340-1.000-E1-R040.0-Z3	1	1	1-1/4	4	0.960	1-5/8	3	UNCOATED	0.040	CYLINDRICAL
N57935	AN340-1.000-E1-R040.0-Z3	1	1	1-1/4	4	0.960	1-5/8	3	TICN	0.040	CYLINDRICAL

ACS540 / ACS540R



- Engineered for ISO-N aerospace aluminum alloys and non-ferrous materials
- 5 flutes for increased feedrates in optimized roughing and finishing toolpaths
- Asymmetrical geometry minimizes chatter and harmonics yielding increased metal removal rates
- Form ground proprietary flute shape maximizes chip load per tooth and evacuation
- Internal coolant hole for increased chip flushing and chip management
- Advanced staggered chip splitter design for increased chip control and reduced cutting forces
- ANF PVD coating reduces friction and built-up edge improving workpiece surface finish and increased tool life

ITEM NUMBER	DESCRIPTION	DIMENSIONS IN INCH				FLUTES	COATING	RADIUS	SHANK TYPE
		FLUTE DIA.	SHANK DIA.	LOC	OAL				
10134849	ACS540-0.375-D2-S.0-Z5	3/8	3/8	3/4	2 1/2	5	UNCOATED	-	CYLINDRICAL
10135014	ACS540R-0.375-D2-R015.0-Z5	3/8	3/8	3/4	2 1/2	5	ANF	0.015	CYLINDRICAL
10135015	ACS540R-0.375-D2-R030.0-Z5	3/8	3/8	3/4	2 1/2	5	ANF	0.030	CYLINDRICAL
10135016	ACS540R-0.375-D2-R060.0-Z5	3/8	3/8	3/4	2 1/2	5	ANF	0.060	CYLINDRICAL
10134850	ACS540-0.375-D3-S.0-Z5	3/8	3/8	1 1/8	3	5	UNCOATED	-	CYLINDRICAL
10135017	ACS540R-0.375-D3-R015.0-Z5	3/8	3/8	1 1/8	3	5	ANF	0.015	CYLINDRICAL
10135018	ACS540R-0.375-D3-R030.0-Z5	3/8	3/8	1 1/8	3	5	ANF	0.030	CYLINDRICAL
10135019	ACS540R-0.375-D3-R060.0-Z5	3/8	3/8	1 1/8	3	5	ANF	0.060	CYLINDRICAL
10134851	ACS540-0.500-D2-S.0-Z5	1/2	1/2	1	3	5	UNCOATED	-	CYLINDRICAL
10135020	ACS540R-0.500-D2-R015.0-Z5	1/2	1/2	1	3	5	ANF	0.015	CYLINDRICAL
10135021	ACS540R-0.500-D2-R030.0-Z5	1/2	1/2	1	3	5	ANF	0.030	CYLINDRICAL
10135022	ACS540R-0.500-D2-R060.0-Z5	1/2	1/2	1	3	5	ANF	0.060	CYLINDRICAL
10134852	ACS540-0.500-D3-S.0-Z5	1/2	1/2	1 1/2	3 1/2	5	UNCOATED	-	CYLINDRICAL
10135023	ACS540R-0.500-D3-R015.0-Z5	1/2	1/2	1 1/2	3 1/2	5	ANF	0.015	CYLINDRICAL
10135024	ACS540R-0.500-D3-R030.0-Z5	1/2	1/2	1 1/2	3 1/2	5	ANF	0.030	CYLINDRICAL
10135025	ACS540R-0.500-D3-R060.0-Z5	1/2	1/2	1 1/2	3 1/2	5	ANF	0.060	CYLINDRICAL
10134853	ACS540-0.750-D2-S.0-Z5	3/4	3/4	1 1/2	4	5	UNCOATED	-	CYLINDRICAL
10135026	ACS540R-0.750-D2-R030.0-Z5	3/4	3/4	1 1/2	4	5	ANF	0.030	CYLINDRICAL
10135028	ACS540R-0.750-D2-R060.0-Z5	3/4	3/4	1 1/2	4	5	ANF	0.060	CYLINDRICAL
10135029	ACS540R-0.750-D2-R090.0-Z5	3/4	3/4	1 1/2	4	5	ANF	0.090	CYLINDRICAL
10135030	ACS540R-0.750-D2-R120.0-Z5	3/4	3/4	1 1/2	4	5	ANF	0.120	CYLINDRICAL
10134854	ACS540-0.750-D3-S.0-Z5	3/4	3/4	2 1/4	5	5	UNCOATED	-	CYLINDRICAL
10135031	ACS540R-0.750-D3-R030.0-Z5	3/4	3/4	2 1/4	5	5	ANF	0.030	CYLINDRICAL
10135032	ACS540R-0.750-D3-R060.0-Z5	3/4	3/4	2 1/4	5	5	ANF	0.060	CYLINDRICAL
10135033	ACS540R-0.750-D3-R090.0-Z5	3/4	3/4	2 1/4	5	5	ANF	0.090	CYLINDRICAL
10135034	ACS540R-0.750-D3-R120.0-Z5	3/4	3/4	2 1/4	5	5	ANF	0.120	CYLINDRICAL

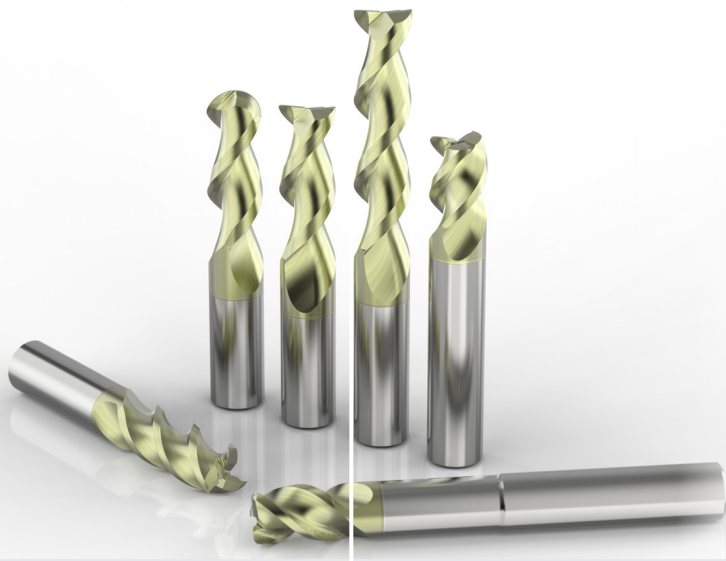

**NIAGARA
CUTTER™**

**ELITE A
SERIES HIGH
PERFORMANCE**

ACHIEVE OPTIMAL METAL REMOVAL RATES AND TOOL LIFE IN ISO-N MACHINING

A245 & A345

Machining non-ferrous materials like aluminum, brass, copper, and other ISO-N materials allows manufacturers to push their machines to the limit and achieve the highest metal removal rates (MRR). Push past those limits and achieve higher MRR in ISO-N materials – even with older and less rigid machines – with the upgraded family of A245/A345 solid carbide end mills from Niagara Cutter™. Re-engineered tool geometry coupled with a new proprietary PVD coating developed by Niagara Cutter result in a minimum of 20% less power consumption, yielding improved cutting efficiency for superior surface finishes and exceptional tool life.

Machining aluminum and other gummy ISO-N materials efficiently requires tools that can handle aggressive speeds and feeds and minimize built-up edge, even in less stable machining environments. The existing A245/A345 product line helps to address these issues with a cylindrical margin that minimizes chatter and vibration for superior surface finishes. Now, these products feature a polished K-land and optimized flute shape to control chip formation and reduce friction. Paired with a new proprietary Niagara Cutter ANF (aluminum non-ferrous) PVD coating with the smoothness needed to minimize built-up edge. As a result, manufacturers can reduce cutting forces and power consumption for truly exceptional MRR in ISO-N materials.

RANGE OVERVIEW

Inch & metric range expansion encompassing select existing Niagara Cutter geometries with and without ANF PVD coating:

2-flute configurations

- A245 square corner end mill
- AB245 ball end mil

3-flute configurations

- A345 square corner end mill
- A345R corner radius end mill
- A345M metric square corner end mill (ANF coated only)
- AN345 reduced neck square corner end mill
- AN345R reduced neck corner radius end mill (ANF coated only)

5-flute configurations

- ACS540 square corner end mill
- ACS540R corner radius end mill

SECO MATERIAL GROUPS

Non-Ferrous N16-N17

INDUSTRY TARGETS

- Aerospace
- Medical
- General Engineering

KEY BENEFITS

- Reduced power consumption
- Increased cutting efficiency
- Improved chip evacuation
- Superior workpiece surface finish
- Increased tool life
- Boosted process stability

A245

SOLID
CARBIDE

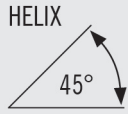

CENTER
CUTTING



- Cylindrical land to eliminate chatter
- Form ground flute shape
- Polished K-Land
- Wiper flat on end teeth
- ANF coating reduces friction and built up material

ITEM NUMBER	DESCRIPTION	DIMENSIONS IN INCH				FLUTES	COATING	SHANK TYPE
		FLUTE DIA.	SHANK DIA.	LOC	OAL			
17002948	A245-0.125-D2-S.0-Z2	1/8	1/8	1/4	1-1/2	2	-	CYLINDRICAL
10022702	A245-0.125-D2-S.0-Z2	1/8	1/8	1/4	1-1/2	2	ANF	CYLINDRICAL
17002949	A245-0.125-D3-S.0-Z2	1/8	1/8	3/8	1-1/2	2	-	CYLINDRICAL
10022703	A245-0.125-D3-S.0-Z2	1/8	1/8	3/8	1-1/2	2	ANF	CYLINDRICAL
17002950	A245-0.156-F2-S.0-Z2	5/32	3/16	5/16	2	2	-	CYLINDRICAL
10022704	A245-0.156-F2-S.0-Z2	5/32	3/16	5/16	2	2	ANF	CYLINDRICAL
17002951	A245-0.156-F3-S.0-Z2	5/32	3/16	1/2	2	2	-	CYLINDRICAL
10022705	A245-0.156-F3-S.0-Z2	5/32	3/16	1/2	2	2	ANF	CYLINDRICAL
17002952	A245-0.188-D2-S.0-Z2	3/16	3/16	5/16	2	2	-	CYLINDRICAL
10022706	A245-0.188-D2-S.0-Z2	3/16	3/16	5/16	2	2	ANF	CYLINDRICAL
17002953	A245-0.188-D3-S.0-Z2	3/16	3/16	9/16	2	2	-	CYLINDRICAL
10022707	A245-0.188-D3-S.0-Z2	3/16	3/16	9/16	2	2	ANF	CYLINDRICAL
17002955	A245-0.219-F3-S.0-Z2	7/32	1/4	3/4	2-1/2	2	-	CYLINDRICAL
10022708	A245-0.219-F3-S.0-Z2	7/32	1/4	3/4	2-1/2	2	ANF	CYLINDRICAL
17002956	A245-0.250-D2-S.0-Z2	1/4	1/4	3/8	2-1/2	2	-	CYLINDRICAL
10022709	A245-0.250-D2-S.0-Z2	1/4	1/4	3/8	2-1/2	2	ANF	CYLINDRICAL
17002957	A245-0.250-D3-S.0-Z2	1/4	1/4	3/4	2-1/2	2	-	CYLINDRICAL
10022710	A245-0.250-D3-S.0-Z2	1/4	1/4	3/4	2-1/2	2	ANF	CYLINDRICAL
17002958	A245-0.250-D5-S.0-Z2	1/4	1/4	1-1/4	4	2	-	CYLINDRICAL
10022711	A245-0.250-D5-S.0-Z2	1/4	1/4	1-1/4	4	2	ANF	CYLINDRICAL
17002961	A245-0.313-D1-S.0-Z2	5/16	5/16	7/16	2-1/2	2	-	CYLINDRICAL
10022712	A245-0.313-D1-S.0-Z2	5/16	5/16	7/16	2-1/2	2	ANF	CYLINDRICAL
17002962	A245-0.313-D3-S.0-Z2	5/16	5/16	13/16	2-1/2	2	-	CYLINDRICAL
10022713	A245-0.313-D3-S.0-Z2	5/16	5/16	13/16	2-1/2	2	ANF	CYLINDRICAL
17002963	A245-0.313-D4-S.0-Z2	5/16	5/16	1-1/4	3-1/2	2	-	CYLINDRICAL
10022714	A245-0.313-D4-S.0-Z2	5/16	5/16	1-1/4	3-1/2	2	ANF	CYLINDRICAL
17002967	A245-0.375-D1-S.0-Z2	3/8	3/8	1/2	2-1/2	2	-	CYLINDRICAL
10022715	A245-0.375-D1-S.0-Z2	3/8	3/8	1/2	2-1/2	2	ANF	CYLINDRICAL
17002968	A245-0.375-D3-S.0-Z2	3/8	3/8	1	2-1/2	2	-	CYLINDRICAL
10022716	A245-0.375-D3-S.0-Z2	3/8	3/8	1	2-1/2	2	ANF	CYLINDRICAL
17002969	A245-0.375-D4-S.0-Z2	3/8	3/8	1-1/2	4	2	-	CYLINDRICAL
10022717	A245-0.375-D4-S.0-Z2	3/8	3/8	1-1/2	4	2	ANF	CYLINDRICAL
17002976	A245-0.500-D1-S.0-Z2	1/2	1/2	5/8	3	2	-	CYLINDRICAL
10022718	A245-0.500-D1-S.0-Z2	1/2	1/2	5/8	3	2	ANF	CYLINDRICAL
17002977	A245-0.500-D3-S.0-Z2	1/2	1/2	1-1/4	3	2	-	CYLINDRICAL
10022719	A245-0.500-D3-S.0-Z2	1/2	1/2	1-1/4	3	2	ANF	CYLINDRICAL
17002978	A245-0.500-D4-S.0-Z2	1/2	1/2	2	4	2	-	CYLINDRICAL
10022720	A245-0.500-D4-S.0-Z2	1/2	1/2	2	4	2	ANF	CYLINDRICAL

A245 (CONT.)

SOLID CARBIDE

HELIX

SQUARE END

CENTER CUTTING



- Cylindrical land to eliminate chatter
- Form ground flute shape
- Polished K-Land
- Wiper flat on end teeth
- ANF coating reduces friction and built up material

ITEM NUMBER	DESCRIPTION	DIMENSIONS IN INCH				FLUTES	COATING	SHANK TYPE
		FLUTE DIA.	SHANK DIA.	LOC	OAL			
17002979	A245-0.500-D6-S.0-Z2	1/2	1/2	3-1/8	6	2	-	CYLINDRICAL
10022721	A245-0.500-D6-S.0-Z2	1/2	1/2	3-1/8	6	2	ANF	CYLINDRICAL
17002981	A245-0.625-D3-S.0-Z2	5/8	5/8	1-5/8	3-1/2	2	-	CYLINDRICAL
10022722	A245-0.625-D3-S.0-Z2	5/8	5/8	1-5/8	3-1/2	2	ANF	CYLINDRICAL
17002982	A245-0.625-D4-S.0-Z2	5/8	5/8	2-1/2	5	2	-	CYLINDRICAL
10022723	A245-0.625-D4-S.0-Z2	5/8	5/8	2-1/2	5	2	ANF	CYLINDRICAL
17002983	A245-0.625-D6-S.0-Z2	5/8	5/8	3-3/4	6	2	-	CYLINDRICAL
10022724	A245-0.625-D6-S.0-Z2	5/8	5/8	3-3/4	6	2	ANF	CYLINDRICAL
17002984	A245-0.750-D1-S.0-Z2	3/4	3/4	1	3	2	-	CYLINDRICAL
10022725	A245-0.750-D1-S.0-Z2	3/4	3/4	1	3	2	ANF	CYLINDRICAL
17002985	A245-0.750-D2-S.0-Z2	3/4	3/4	1-5/8	4	2	-	CYLINDRICAL
10022726	A245-0.750-D2-S.0-Z2	3/4	3/4	1-5/8	4	2	ANF	CYLINDRICAL
17002986	A245-0.750-D3-S.0-Z2	3/4	3/4	2-1/4	5	2	-	CYLINDRICAL
10022727	A245-0.750-D3-S.0-Z2	3/4	3/4	2-1/4	5	2	ANF	CYLINDRICAL
17002987	A245-0.750-D4-S.0-Z2	3/4	3/4	3-1/4	6	2	-	CYLINDRICAL
10022728	A245-0.750-D4-S.0-Z2	3/4	3/4	3-1/4	6	2	ANF	CYLINDRICAL
17002988	A245-0.750-D5-S.0-Z2	3/4	3/4	4	6-1/2	2	-	CYLINDRICAL
10022729	A245-0.750-D5-S.0-Z2	3/4	3/4	4	6-1/2	2	ANF	CYLINDRICAL
17002990	A245-1.000-D2-S.0-Z2	1	1	2	5	2	-	CYLINDRICAL
10022730	A245-1.000-D2-S.0-Z2	1	1	2	5	2	ANF	CYLINDRICAL
17002992	A245-1.000-D4-S.0-Z2	1	1	3-1/4	6	2	-	CYLINDRICAL
10022731	A245-1.000-D4-S.0-Z2	1	1	3-1/4	6	2	ANF	CYLINDRICAL

AB245

SOLID CARBIDE

HELIX

BALL END

CENTER CUTTING



- Cylindrical land to eliminate chatter
- Form ground flute shape
- Polished K-Land
- ANF coating reduces friction and built up material

ITEM NUMBER	DESCRIPTION	DIMENSIONS IN INCH				FLUTES	COATING	SHANK TYPE
		FLUTE DIA.	SHANK DIA.	LOC	OAL			
17003632	AB245-0.250-D2-B.0-Z2	1/4	1/4	3/8	2-1/2	2	-	CYLINDRICAL
10022732	AB245-0.250-D2-B.0-Z2	1/4	1/4	3/8	2-1/2	2	ANF	CYLINDRICAL
17003633	AB245-0.250-D3-B.0-Z2	1/4	1/4	3/4	2-1/2	2	-	CYLINDRICAL
10022733	AB245-0.250-D3-B.0-Z2	1/4	1/4	3/4	2-1/2	2	ANF	CYLINDRICAL
17003635	AB245-0.313-D3-B.0-Z2	5/16	5/16	13/16	2-1/2	2	-	CYLINDRICAL
10022734	AB245-0.313-D3-B.0-Z2	5/16	5/16	13/16	2-1/2	2	ANF	CYLINDRICAL
17003636	AB245-0.375-D1-B.0-Z2	3/8	3/8	1/2	2-1/2	2	-	CYLINDRICAL
10022735	AB245-0.375-D1-B.0-Z2	3/8	3/8	1/2	2-1/2	2	ANF	CYLINDRICAL
17003637	AB245-0.375-D3-B.0-Z2	3/8	3/8	1	2-1/2	2	-	CYLINDRICAL
10022736	AB245-0.375-D3-B.0-Z2	3/8	3/8	1	2-1/2	2	ANF	CYLINDRICAL
17003640	AB245-0.500-D1-B.0-Z2	1/2	1/2	5/8	3	2	-	CYLINDRICAL
10022737	AB245-0.500-D1-B.0-Z2	1/2	1/2	5/8	3	2	ANF	CYLINDRICAL
17003641	AB245-0.500-D3-B.0-Z2	1/2	1/2	1-1/4	3	2	-	CYLINDRICAL
10022738	AB245-0.500-D3-B.0-Z2	1/2	1/2	1-1/4	3	2	ANF	CYLINDRICAL
17003645	AB245-0.750-D2-B.0-Z2	3/4	3/4	1-5/8	4	2	-	CYLINDRICAL
10022739	AB245-0.750-D2-B.0-Z2	3/4	3/4	1-5/8	4	2	ANF	CYLINDRICAL

A345

SOLID
CARBIDE

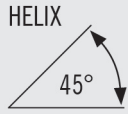

CENTER
CUTTING



- Cylindrical land to eliminate chatter
- Form ground flute shape
- Polished K-Land
- Wiper flat on end teeth
- ANF coating reduces friction and built up material

ITEM NUMBER	DESCRIPTION	DIMENSIONS IN INCH				FLUTES	COATING	SHANK TYPE
		FLUTE DIA.	SHANK DIA.	LOC	OAL			
17003132	A345-0.125-D2-S.0-Z3	1/8	1/8	1/4	1-1/2	3	-	CYLINDRICAL
10023001	A345-0.125-D2-S.0-Z3	1/8	1/8	1/4	1-1/2	3	ANF	CYLINDRICAL
17003133	A345-0.125-D3-S.0-Z3	1/8	1/8	3/8	1-1/2	3	-	CYLINDRICAL
10023002	A345-0.125-D3-S.0-Z3	1/8	1/8	3/8	1-1/2	3	ANF	CYLINDRICAL
17003134	A345-0.156-F2-S.0-Z3	5/32	3/16	5/16	2	3	-	CYLINDRICAL
10023003	A345-0.156-F2-S.0-Z3	5/32	3/16	5/16	2	3	ANF	CYLINDRICAL
17003135	A345-0.156-F3-S.0-Z3	5/32	3/16	1/2	2	3	-	CYLINDRICAL
10023004	A345-0.156-F3-S.0-Z3	5/32	3/16	1/2	2	3	ANF	CYLINDRICAL
17003136	A345-0.188-D2-S.0-Z3	3/16	3/16	5/16	2	3	-	CYLINDRICAL
10023005	A345-0.188-D2-S.0-Z3	3/16	3/16	5/16	2	3	ANF	CYLINDRICAL
17003137	A345-0.188-D3-S.0-Z3	3/16	3/16	9/16	2	3	-	CYLINDRICAL
10023006	A345-0.188-D3-S.0-Z3	3/16	3/16	9/16	2	3	ANF	CYLINDRICAL
17003139	A345-0.219-F3-S.0-Z3	7/32	1/4	3/4	2-1/2	3	-	CYLINDRICAL
10023007	A345-0.219-F3-S.0-Z3	7/32	1/4	3/4	2-1/2	3	ANF	CYLINDRICAL
17003140	A345-0.250-D2-S.0-Z3	1/4	1/4	3/8	2-1/2	3	-	CYLINDRICAL
10023008	A345-0.250-D2-S.0-Z3	1/4	1/4	3/8	2-1/2	3	ANF	CYLINDRICAL
17003141	A345-0.250-D3-S.0-Z3	1/4	1/4	3/4	2-1/2	3	-	CYLINDRICAL
10023009	A345-0.250-D3-S.0-Z3	1/4	1/4	3/4	2-1/2	3	ANF	CYLINDRICAL
17003142	A345-0.250-D5-S.0-Z3	1/4	1/4	1-1/4	4	3	-	CYLINDRICAL
10023010	A345-0.250-D5-S.0-Z3	1/4	1/4	1-1/4	4	3	ANF	CYLINDRICAL
17003145	A345-0.313-D1-S.0-Z3	5/16	5/16	7/16	2-1/2	3	-	CYLINDRICAL
10023011	A345-0.313-D1-S.0-Z3	5/16	5/16	7/16	2-1/2	3	ANF	CYLINDRICAL
17003146	A345-0.313-D3-S.0-Z3	5/16	5/16	13/16	2-1/2	3	-	CYLINDRICAL
10023012	A345-0.313-D3-S.0-Z3	5/16	5/16	13/16	2-1/2	3	ANF	CYLINDRICAL
17003147	A345-0.313-D4-S.0-Z3	5/16	5/16	1-1/4	3-1/2	3	-	CYLINDRICAL
10023013	A345-0.313-D4-S.0-Z3	5/16	5/16	1-1/4	3-1/2	3	ANF	CYLINDRICAL
17003148	A345-0.313-D7-S.0-Z3	5/16	5/16	2-1/4	4	3	-	CYLINDRICAL
10023014	A345-0.313-D7-S.0-Z3	5/16	5/16	2-1/4	4	3	ANF	CYLINDRICAL
17003151	A345-0.375-D1-S.0-Z3	3/8	3/8	1/2	2-1/2	3	-	CYLINDRICAL
10023015	A345-0.375-D1-S.0-Z3	3/8	3/8	1/2	2-1/2	3	ANF	CYLINDRICAL
17003152	A345-0.375-D3-S.0-Z3	3/8	3/8	1	2-1/2	3	-	CYLINDRICAL
10023016	A345-0.375-D3-S.0-Z3	3/8	3/8	1	2-1/2	3	ANF	CYLINDRICAL
17003153	A345-0.375-D4-S.0-Z3	3/8	3/8	1-1/2	4	3	-	CYLINDRICAL
10023017	A345-0.375-D4-S.0-Z3	3/8	3/8	1-1/2	4	3	ANF	CYLINDRICAL
17003157	A345-0.438-D2-S.0-Z3	7/16	7/16	1	2-3/4	3	-	CYLINDRICAL
10023018	A345-0.438-D2-S.0-Z3	7/16	7/16	1	2-3/4	3	ANF	CYLINDRICAL
17003160	A345-0.500-D1-S.0-Z3	1/2	1/2	5/8	3	3	-	CYLINDRICAL

A345 (CONT.)

SOLID CARBIDE

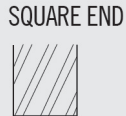
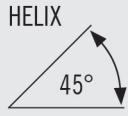

CENTER CUTTING



- Cylindrical land to eliminate chatter
- Form ground flute shape
- Polished K-Land
- Wiper flat on end teeth
- ANF coating reduces friction and built up material

ITEM NUMBER	DESCRIPTION	DIMENSIONS IN INCH				FLUTES	COATING	SHANK TYPE
		FLUTE DIA.	SHANK DIA.	LOC	OAL			
10023019	A345-0.500-D1-S.0-Z3	1/2	1/2	5/8	3	3	ANF	CYLINDRICAL
17003161	A345-0.500-D3-S.0-Z3	1/2	1/2	1-1/4	3	3	-	CYLINDRICAL
10023020	A345-0.500-D3-S.0-Z3	1/2	1/2	1-1/4	3	3	ANF	CYLINDRICAL
17003162	A345-0.500-D4-S.0-Z3	1/2	1/2	2	4	3	-	CYLINDRICAL
10023021	A345-0.500-D4-S.0-Z3	1/2	1/2	2	4	3	ANF	CYLINDRICAL
17003163	A345-0.500-D6-S.0-Z3	1/2	1/2	3-1/8	6	3	-	CYLINDRICAL
10023022	A345-0.500-D6-S.0-Z3	1/2	1/2	3-1/8	6	3	ANF	CYLINDRICAL
17003164	A345-0.625-D1-S.0-Z3	5/8	5/8	3/4	3	3	-	CYLINDRICAL
10023023	A345-0.625-D1-S.0-Z3	5/8	5/8	3/4	3	3	ANF	CYLINDRICAL
17003165	A345-0.625-D3-S.0-Z3	5/8	5/8	1-5/8	3-1/2	3	-	CYLINDRICAL
10023024	A345-0.625-D3-S.0-Z3	5/8	5/8	1-5/8	3-1/2	3	ANF	CYLINDRICAL
17003166	A345-0.625-D4-S.0-Z3	5/8	5/8	2-1/2	5	3	-	CYLINDRICAL
10023025	A345-0.625-D4-S.0-Z3	5/8	5/8	2-1/2	5	3	ANF	CYLINDRICAL
17003168	A345-0.750-D1-S.0-Z3	3/4	3/4	1	3	3	-	CYLINDRICAL
10023026	A345-0.750-D1-S.0-Z3	3/4	3/4	1	3	3	ANF	CYLINDRICAL
17003169	A345-0.750-D2-S.0-Z3	3/4	3/4	1-5/8	4	3	-	CYLINDRICAL
10023027	A345-0.750-D2-S.0-Z3	3/4	3/4	1-5/8	4	3	ANF	CYLINDRICAL
17003170	A345-0.750-D3-S.0-Z3	3/4	3/4	2-1/4	5	3	-	CYLINDRICAL
10023028	A345-0.750-D3-S.0-Z3	3/4	3/4	2-1/4	5	3	ANF	CYLINDRICAL
17003171	A345-0.750-D4-S.0-Z3	3/4	3/4	3-1/4	6	3	-	CYLINDRICAL
10023029	A345-0.750-D4-S.0-Z3	3/4	3/4	3-1/4	6	3	ANF	CYLINDRICAL
17003172	A345-0.750-D5-S.0-Z3	3/4	3/4	4	6-1/2	3	-	CYLINDRICAL
10023030	A345-0.750-D5-S.0-Z3	3/4	3/4	4	6-1/2	3	ANF	CYLINDRICAL
17003173	A345-1.000-D1-S.0-Z3	1	1	1-1/4	4	3	-	CYLINDRICAL
10023031	A345-1.000-D1-S.0-Z3	1	1	1-1/4	4	3	ANF	CYLINDRICAL
17003174	A345-1.000-D2-S.0-Z3	1	1	2	5	3	-	CYLINDRICAL
10023032	A345-1.000-D2-S.0-Z3	1	1	2	5	3	ANF	CYLINDRICAL
17003175	A345-1.000-D3-S.0-Z3	1	1	2-5/8	6	3	-	CYLINDRICAL
10023033	A345-1.000-D3-S.0-Z3	1	1	2-5/8	6	3	ANF	CYLINDRICAL
17003176	A345-1.000-D4-S.0-Z3	1	1	3-1/4	6	3	-	CYLINDRICAL
10023034	A345-1.000-D4-S.0-Z3	1	1	3-1/4	6	3	ANF	CYLINDRICAL
17003177	A345-1.000-D5-S.0-Z3	1	1	4-1/8	7	3	-	CYLINDRICAL
10023035	A345-1.000-D5-S.0-Z3	1	1	4-1/8	7	3	ANF	CYLINDRICAL

A345M

SOLID CARBIDE

HELIX

SQUARE END

CENTER CUTTING



- Cylindrical land to eliminate chatter
- Form ground flute shape
- Polished K-Land
- Wiper flat on end teeth
- ANF coating reduces friction and built up material

ITEM NUMBER	DESCRIPTION	DIMENSIONS IN METRIC				FLUTES	COATING	SHANK TYPE
		FLUTE DIA.	SHANK DIA.	LOC	OAL			
10023168	A345M-030-D4-S.0-Z3	3	3	12	39	3	ANF	CYLINDRICAL
10023169	A345M-040-D3-S.0-Z3	4	4	12	51	3	ANF	CYLINDRICAL
10023170	A345M-050-D3-S.0-Z3	5	5	14	51	3	ANF	CYLINDRICAL
10023171	A345M-060-D3-S.0-Z3	6	6	16	58	3	ANF	CYLINDRICAL
10023172	A345M-080-D2-S.0-Z3	8	8	20	64	3	ANF	CYLINDRICAL
10023173	A345M-100-D2-S.0-Z3	10	10	22	73	3	ANF	CYLINDRICAL
10023174	A345M-120-D3-S.0-Z3	12	12	32	84	3	ANF	CYLINDRICAL
10023175	A345M-160-D2-S.0-Z3	16	16	36	93	3	ANF	CYLINDRICAL
10023176	A345M-200-D3-S.0-Z3	20	20	50	105	3	ANF	CYLINDRICAL

A345R

SOLID CARBIDE

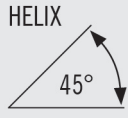

CENTER CUTTING



- Cylindrical land to eliminate chatter
- Form ground flute shape
- Polished K-Land
- Wiper flat on end teeth
- ANF coating reduces friction and built up material

ITEM NUMBER	DESCRIPTION	DIMENSIONS IN INCH				FLUTES	COATING	RADIUS	SHANK TYPE
		FLUTE DIA.	SHANK DIA.	LOC	OAL				
10023036	A345R-0.125-D3-R010.0-Z3	1/8	1/8	3/8	1-1/2	3	ANF	0.010	CYLINDRICAL
10023037	A345R-0.125-D3-R020.0-Z3	1/8	1/8	3/8	1-1/2	3	ANF	0.020	CYLINDRICAL
10023038	A345R-0.125-D3-R030.0-Z3	1/8	1/8	3/8	1-1/2	3	ANF	0.030	CYLINDRICAL
10023039	A345R-0.156-F3-R010.0-Z3	5/32	3/16	1/2	2	3	ANF	0.010	CYLINDRICAL
10023040	A345R-0.156-F3-R020.0-Z3	5/32	3/16	1/2	2	3	ANF	0.020	CYLINDRICAL
10023041	A345R-0.156-F3-R030.0-Z3	5/32	3/16	1/2	2	3	ANF	0.030	CYLINDRICAL
10023042	A345R-0.188-D3-R010.0-Z3	3/16	3/16	9/16	2	3	ANF	0.010	CYLINDRICAL
10023043	A345R-0.188-D3-R020.0-Z3	3/16	3/16	9/16	2	3	ANF	0.020	CYLINDRICAL
10023044	A345R-0.188-D3-R030.0-Z3	3/16	3/16	9/16	2	3	ANF	0.030	CYLINDRICAL
10023045	A345R-0.219-F3-R010.0-Z3	7/32	1/4	3/4	2-1/2	3	ANF	0.010	CYLINDRICAL
10023046	A345R-0.219-F3-R020.0-Z3	7/32	1/4	3/4	2-1/2	3	ANF	0.020	CYLINDRICAL
10023047	A345R-0.219-F3-R030.0-Z3	7/32	1/4	3/4	2-1/2	3	ANF	0.030	CYLINDRICAL
10023048	A345R-0.250-D3-R010.0-Z3	1/4	1/4	3/4	2-1/2	3	ANF	0.010	CYLINDRICAL
10023049	A345R-0.250-D3-R020.0-Z3	1/4	1/4	3/4	2-1/2	3	ANF	0.020	CYLINDRICAL
10023050	A345R-0.250-D3-R030.0-Z3	1/4	1/4	3/4	2-1/2	3	ANF	0.030	CYLINDRICAL
10023051	A345R-0.250-D3-R045.0-Z3	1/4	1/4	3/4	2-1/2	3	ANF	0.045	CYLINDRICAL
10023052	A345R-0.250-D3-R060.0-Z3	1/4	1/4	3/4	2-1/2	3	ANF	0.060	CYLINDRICAL
10023053	A345R-0.375-D3-R010.0-Z3	3/8	3/8	1	2-1/2	3	ANF	0.010	CYLINDRICAL
10023054	A345R-0.375-D3-R020.0-Z3	3/8	3/8	1	2-1/2	3	ANF	0.020	CYLINDRICAL
10023055	A345R-0.375-D3-R030.0-Z3	3/8	3/8	1	2-1/2	3	ANF	0.030	CYLINDRICAL
10023056	A345R-0.375-D3-R045.0-Z3	3/8	3/8	1	2-1/2	3	ANF	0.045	CYLINDRICAL
10023057	A345R-0.375-D3-R060.0-Z3	3/8	3/8	1	2-1/2	3	ANF	0.060	CYLINDRICAL
10023058	A345R-0.500-D1-R010.0-Z3	1/2	1/2	5/8	3	3	ANF	0.010	CYLINDRICAL
10023059	A345R-0.500-D1-R020.0-Z3	1/2	1/2	5/8	3	3	ANF	0.020	CYLINDRICAL
10023060	A345R-0.500-D1-R030.0-Z3	1/2	1/2	5/8	3	3	ANF	0.030	CYLINDRICAL
10023061	A345R-0.500-D1-R045.0-Z3	1/2	1/2	5/8	3	3	ANF	0.045	CYLINDRICAL
10023062	A345R-0.500-D1-R060.0-Z3	1/2	1/2	5/8	3	3	ANF	0.060	CYLINDRICAL
10023063	A345R-0.500-D1-R090.0-Z3	1/2	1/2	5/8	3	3	ANF	0.090	CYLINDRICAL
10023064	A345R-0.500-D1-R125.0-Z3	1/2	1/2	5/8	3	3	ANF	0.125	CYLINDRICAL
10023065	A345R-0.500-D3-R010.0-Z3	1/2	1/2	1-1/4	3	3	ANF	0.010	CYLINDRICAL
10023066	A345R-0.500-D3-R020.0-Z3	1/2	1/2	1-1/4	3	3	ANF	0.020	CYLINDRICAL
10023067	A345R-0.500-D3-R030.0-Z3	1/2	1/2	1-1/4	3	3	ANF	0.030	CYLINDRICAL
10023068	A345R-0.500-D3-R045.0-Z3	1/2	1/2	1-1/4	3	3	ANF	0.045	CYLINDRICAL
10023069	A345R-0.500-D3-R060.0-Z3	1/2	1/2	1-1/4	3	3	ANF	0.060	CYLINDRICAL
10023070	A345R-0.500-D3-R090.0-Z3	1/2	1/2	1-1/4	3	3	ANF	0.090	CYLINDRICAL
10023071	A345R-0.500-D3-R125.0-Z3	1/2	1/2	1-1/4	3	3	ANF	0.125	CYLINDRICAL
10023072	A345R-0.500-D4-R010.0-Z3	1/2	1/2	2	4	3	ANF	0.010	CYLINDRICAL
10023073	A345R-0.500-D4-R020.0-Z3	1/2	1/2	2	4	3	ANF	0.020	CYLINDRICAL

A345R (CONT.)

SOLID CARBIDE

HELIX

45°

RADIUS

CENTER CUTTING



- Cylindrical land to eliminate chatter
- Form ground flute shape
- Polished K-Land
- Wiper flat on end teeth
- ANF coating reduces friction and built up material

ITEM NUMBER	DESCRIPTION	DIMENSIONS IN INCH				FLUTES	COATING	RADIUS	SHANK TYPE
		FLUTE DIA.	SHANK DIA.	LOC	OAL				
10023074	A345R-0.500-D4-R030.0-Z3	1/2	1/2	2	4	3	ANF	0.030	CYLINDRICAL
10023075	A345R-0.500-D4-R045.0-Z3	1/2	1/2	2	4	3	ANF	0.045	CYLINDRICAL
10023076	A345R-0.500-D4-R060.0-Z3	1/2	1/2	2	4	3	ANF	0.060	CYLINDRICAL
10023077	A345R-0.500-D4-R090.0-Z3	1/2	1/2	2	4	3	ANF	0.090	CYLINDRICAL
10023078	A345R-0.500-D4-R125.0-Z3	1/2	1/2	2	4	3	ANF	0.125	CYLINDRICAL
10023079	A345R-0.625-D3-R010.0-Z3	5/8	5/8	1-5/8	3-1/2	3	ANF	0.010	CYLINDRICAL
10023080	A345R-0.625-D3-R020.0-Z3	5/8	5/8	1-5/8	3-1/2	3	ANF	0.020	CYLINDRICAL
10023081	A345R-0.625-D3-R030.0-Z3	5/8	5/8	1-5/8	3-1/2	3	ANF	0.030	CYLINDRICAL
10023082	A345R-0.625-D3-R045.0-Z3	5/8	5/8	1-5/8	3-1/2	3	ANF	0.045	CYLINDRICAL
10023083	A345R-0.625-D3-R060.0-Z3	5/8	5/8	1-5/8	3-1/2	3	ANF	0.060	CYLINDRICAL
10023084	A345R-0.625-D3-R090.0-Z3	5/8	5/8	1-5/8	3-1/2	3	ANF	0.090	CYLINDRICAL
10023085	A345R-0.625-D3-R125.0-Z3	5/8	5/8	1-5/8	3-1/2	3	ANF	0.125	CYLINDRICAL
10023086	A345R-0.750-D1-R010.0-Z3	3/4	3/4	1	3	3	ANF	0.010	CYLINDRICAL
10023087	A345R-0.750-D1-R020.0-Z3	3/4	3/4	1	3	3	ANF	0.020	CYLINDRICAL
10023088	A345R-0.750-D1-R030.0-Z3	3/4	3/4	1	3	3	ANF	0.030	CYLINDRICAL
10023089	A345R-0.750-D1-R045.0-Z3	3/4	3/4	1	3	3	ANF	0.045	CYLINDRICAL
10023090	A345R-0.750-D1-R060.0-Z3	3/4	3/4	1	3	3	ANF	0.060	CYLINDRICAL
10023091	A345R-0.750-D1-R090.0-Z3	3/4	3/4	1	3	3	ANF	0.090	CYLINDRICAL
10023092	A345R-0.750-D1-R125.0-Z3	3/4	3/4	1	3	3	ANF	0.125	CYLINDRICAL
10023093	A345R-0.750-D1-R190.0-Z3	3/4	3/4	1	3	3	ANF	0.190	CYLINDRICAL
10023094	A345R-0.750-D3-R010.0-Z3	3/4	3/4	2-1/4	5	3	ANF	0.010	CYLINDRICAL
10023095	A345R-0.750-D3-R020.0-Z3	3/4	3/4	2-1/4	5	3	ANF	0.020	CYLINDRICAL
10023096	A345R-0.750-D3-R030.0-Z3	3/4	3/4	2-1/4	5	3	ANF	0.030	CYLINDRICAL
10023097	A345R-0.750-D3-R045.0-Z3	3/4	3/4	2-1/4	5	3	ANF	0.045	CYLINDRICAL
10023098	A345R-0.750-D3-R060.0-Z3	3/4	3/4	2-1/4	5	3	ANF	0.060	CYLINDRICAL
10023099	A345R-0.750-D3-R090.0-Z3	3/4	3/4	2-1/4	5	3	ANF	0.090	CYLINDRICAL
10023100	A345R-0.750-D3-R125.0-Z3	3/4	3/4	2-1/4	5	3	ANF	0.125	CYLINDRICAL
10023101	A345R-0.750-D3-R190.0-Z3	3/4	3/4	2-1/4	5	3	ANF	0.190	CYLINDRICAL
10023102	A345R-1.000-D3-R010.0-Z3	1	1	2-5/8	6	3	ANF	0.010	CYLINDRICAL
10023103	A345R-1.000-D3-R020.0-Z3	1	1	2-5/8	6	3	ANF	0.020	CYLINDRICAL
10023104	A345R-1.000-D3-R030.0-Z3	1	1	2-5/8	6	3	ANF	0.030	CYLINDRICAL
10023105	A345R-1.000-D3-R045.0-Z3	1	1	2-5/8	6	3	ANF	0.045	CYLINDRICAL
10023106	A345R-1.000-D3-R060.0-Z3	1	1	2-5/8	6	3	ANF	0.060	CYLINDRICAL
10023107	A345R-1.000-D3-R090.0-Z3	1	1	2-5/8	6	3	ANF	0.090	CYLINDRICAL
10023108	A345R-1.000-D3-R125.0-Z3	1	1	2-5/8	6	3	ANF	0.125	CYLINDRICAL
10023109	A345R-1.000-D3-R190.0-Z3	1	1	2-5/8	6	3	ANF	0.190	CYLINDRICAL

AN345

SOLID CARBIDE

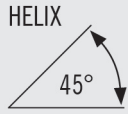

CENTER CUTTING



- Cylindrical land to eliminate chatter
- Form ground flute shape
- Polished K-Land
- Wiper flat on end teeth
- ANF coating reduces friction and built up material

ITEM NUMBER	DESCRIPTION	DIMENSIONS IN INCH						FLUTES	COATING	SHANK TYPE
		FLUTE DIA.	SHANK DIA.	LOC	OAL	DN	LN			
17000012	AN345-0.250-E2-S.0-Z3	1/4	1/4	3/8	4	0.240	2-1/8	3	-	CYLINDRICAL
10023110	AN345-0.250-E2-S.0-Z3	1/4	1/4	3/8	4	0.240	2-1/8	3	ANF	CYLINDRICAL
17002222	AN345-0.250-E3-S.0-Z3	1/4	1/4	1/2	3	0.240	1	3	-	CYLINDRICAL
10023111	AN345-0.250-E3-S.0-Z3	1/4	1/4	1/2	3	0.240	1	3	ANF	CYLINDRICAL
17002223	AN345-0.250-E4-S.0-Z3	1/4	1/4	1/2	4	0.240	1-1/2	3	-	CYLINDRICAL
10023112	AN345-0.250-E4-S.0-Z3	1/4	1/4	1/2	4	0.240	1-1/2	3	ANF	CYLINDRICAL
17000013	AN345-0.313-E1-S.0-Z3	5/16	5/16	7/16	4	0.300	2-1/8	3	-	CYLINDRICAL
10023113	AN345-0.313-E1-S.0-Z3	5/16	5/16	7/16	4	0.300	2-1/8	3	ANF	CYLINDRICAL
17000014	AN345-0.375-E1-S.0-Z3	3/8	3/8	3/8	2-1/2	0.360	1-1/8	3	-	CYLINDRICAL
10023114	AN345-0.375-E1-S.0-Z3	3/8	3/8	3/8	2-1/2	0.360	1-1/8	3	ANF	CYLINDRICAL
17000015	AN345-0.375-E2-S.0-Z3	3/8	3/8	1/2	4	0.360	2-1/8	3	-	CYLINDRICAL
10023115	AN345-0.375-E2-S.0-Z3	3/8	3/8	1/2	4	0.360	2-1/8	3	ANF	CYLINDRICAL
17000016	AN345-0.375-E3-S.0-Z3	3/8	3/8	1/2	6	0.360	4-1/8	3	-	CYLINDRICAL
10023116	AN345-0.375-E3-S.0-Z3	3/8	3/8	1/2	6	0.360	4-1/8	3	ANF	CYLINDRICAL
17002224	AN345-0.375-E4-S.0-Z3	3/8	3/8	3/4	4	0.360	2	3	-	CYLINDRICAL
10023118	AN345-0.375-E4-S.0-Z3	3/8	3/8	3/4	4	0.360	2	3	ANF	CYLINDRICAL
17002225	AN345-0.375-E5-S.0-Z3	3/8	3/8	3/4	5	0.360	3	3	-	CYLINDRICAL
10023119	AN345-0.375-E5-S.0-Z3	3/8	3/8	3/4	5	0.360	3	3	ANF	CYLINDRICAL
17000018	AN345-0.500-E2-S.0-Z3	1/2	1/2	5/8	4	0.480	2-1/8	3	-	CYLINDRICAL
10023120	AN345-0.500-E2-S.0-Z3	1/2	1/2	5/8	4	0.480	2-1/8	3	ANF	CYLINDRICAL
17002226	AN345-0.500-E4-S.0-Z3	1/2	1/2	5/8	5	0.480	3	3	-	CYLINDRICAL
10023121	AN345-0.500-E4-S.0-Z3	1/2	1/2	5/8	5	0.480	3	3	ANF	CYLINDRICAL
17000019	AN345-0.500-E3-S.0-Z3	1/2	1/2	5/8	6	0.480	4-1/8	3	-	CYLINDRICAL
10023122	AN345-0.500-E3-S.0-Z3	1/2	1/2	5/8	6	0.480	4-1/8	3	ANF	CYLINDRICAL
17000021	AN345-0.625-E2-S.0-Z3	5/8	5/8	3/4	6	0.600	4	3	-	CYLINDRICAL
10023123	AN345-0.625-E2-S.0-Z3	5/8	5/8	3/4	6	0.600	4	3	ANF	CYLINDRICAL
17000024	AN345-0.750-E3-S.0-Z3	3/4	3/4	1	6	0.720	3-1/2	3	-	CYLINDRICAL
10023124	AN345-0.750-E3-S.0-Z3	3/4	3/4	1	6	0.720	3-1/2	3	ANF	CYLINDRICAL
17000025	AN345-0.750-E4-S.0-Z3	3/4	3/4	1	7	0.720	4-1/8	3	-	CYLINDRICAL
10023125	AN345-0.750-E4-S.0-Z3	3/4	3/4	1	7	0.720	4-1/8	3	ANF	CYLINDRICAL
17000027	AN345-1.000-E2-S.0-Z3	1	1	1-1/4	6	0.960	3-1/2	3	-	CYLINDRICAL
10023126	AN345-1.000-E2-S.0-Z3	1	1	1-1/4	6	0.960	3-1/2	3	ANF	CYLINDRICAL

AN345R

SOLID CARBIDE



CENTER CUTTING



- Cylindrical land to eliminate chatter
- Form ground flute shape
- Polished K-Land
- Wiper flat on end teeth
- ANF coating reduces friction and built up material

ITEM NUMBER	DESCRIPTION	DIMENSIONS IN INCH						FLUTES	COATING	RADIUS	SHANK TYPE
		FLUTE DIA.	SHANK DIA.	LOC	OAL	DN	LN				
10023127	AN345R-0.250-E2-R010.0-Z3	1/4	1/4	3/8	4	0.240	2-1/8	3	ANF	0.010	CYLINDRICAL
10023128	AN345R-0.250-E2-R020.0-Z3	1/4	1/4	3/8	4	0.240	2-1/8	3	ANF	0.020	CYLINDRICAL
10023129	AN345R-0.250-E2-R030.0-Z3	1/4	1/4	3/8	4	0.240	2-1/8	3	ANF	0.030	CYLINDRICAL
10023130	AN345R-0.250-E2-R060.0-Z3	1/4	1/4	3/8	4	0.240	2-1/8	3	ANF	0.060	CYLINDRICAL
10023131	AN345R-0.250-E4-R010.0-Z3	1/4	1/4	1/2	4	0.240	1-1/2	3	ANF	0.010	CYLINDRICAL
10023132	AN345R-0.250-E4-R020.0-Z3	1/4	1/4	1/2	4	0.240	1-1/2	3	ANF	0.020	CYLINDRICAL
10023133	AN345R-0.250-E4-R030.0-Z3	1/4	1/4	1/2	4	0.240	1-1/2	3	ANF	0.030	CYLINDRICAL
10023134	AN345R-0.250-E4-R060.0-Z3	1/4	1/4	1/2	4	0.240	1-1/2	3	ANF	0.060	CYLINDRICAL
10023135	AN345R-0.375-E2-R010.0-Z3	3/8	3/8	1/2	4	0.360	2-1/8	3	ANF	0.010	CYLINDRICAL
10023136	AN345R-0.375-E2-R030.0-Z3	3/8	3/8	1/2	4	0.360	2-1/8	3	ANF	0.030	CYLINDRICAL
10023137	AN345R-0.375-E2-R060.0-Z3	3/8	3/8	1/2	4	0.360	2-1/8	3	ANF	0.060	CYLINDRICAL
10023138	AN345R-0.375-E3-R010.0-Z3	3/8	3/8	1/2	6	0.360	4-1/8	3	ANF	0.010	CYLINDRICAL
10023139	AN345R-0.375-E3-R030.0-Z3	3/8	3/8	1/2	6	0.360	4-1/8	3	ANF	0.030	CYLINDRICAL
10023140	AN345R-0.375-E3-R060.0-Z3	3/8	3/8	1/2	6	0.360	4-1/8	3	ANF	0.060	CYLINDRICAL
10023141	AN345R-0.375-E4-R010.0-Z3	3/8	3/8	3/4	4	0.360	2	3	ANF	0.010	CYLINDRICAL
10023142	AN345R-0.375-E4-R030.0-Z3	3/8	3/8	3/4	4	0.360	2	3	ANF	0.030	CYLINDRICAL
10023143	AN345R-0.375-E4-R060.0-Z3	3/8	3/8	3/4	4	0.360	2	3	ANF	0.060	CYLINDRICAL
10023144	AN345R-0.375-E5-R010.0-Z3	3/8	3/8	3/4	5	0.360	3	3	ANF	0.010	CYLINDRICAL
10023145	AN345R-0.375-E5-R030.0-Z3	3/8	3/8	3/4	5	0.360	3	3	ANF	0.030	CYLINDRICAL
10023146	AN345R-0.375-E5-R060.0-Z3	3/8	3/8	3/4	5	0.360	3	3	ANF	0.060	CYLINDRICAL
10023147	AN345R-0.500-E2-R010.0-Z3	1/2	1/2	5/8	4	0.480	2-1/8	3	ANF	0.010	CYLINDRICAL
10023148	AN345R-0.500-E2-R030.0-Z3	1/2	1/2	5/8	4	0.480	2-1/8	3	ANF	0.030	CYLINDRICAL
10023149	AN345R-0.500-E2-R060.0-Z3	1/2	1/2	5/8	4	0.480	2-1/8	3	ANF	0.060	CYLINDRICAL
10023150	AN345R-0.500-E2-R090.0-Z3	1/2	1/2	5/8	4	0.480	2-1/8	3	ANF	0.090	CYLINDRICAL
10023151	AN345R-0.500-E2-R125.0-Z3	1/2	1/2	5/8	4	0.480	2-1/8	3	ANF	0.125	CYLINDRICAL
10023152	AN345R-0.500-E3-R010.0-Z3	1/2	1/2	5/8	5	0.480	3	3	ANF	0.010	CYLINDRICAL
10023153	AN345R-0.500-E3-R030.0-Z3	1/2	1/2	5/8	5	0.480	3	3	ANF	0.030	CYLINDRICAL
10023154	AN345R-0.500-E3-R060.0-Z3	1/2	1/2	5/8	5	0.480	3	3	ANF	0.060	CYLINDRICAL
10023155	AN345R-0.500-E3-R090.0-Z3	1/2	1/2	5/8	5	0.480	3	3	ANF	0.090	CYLINDRICAL
10023156	AN345R-0.500-E3-R125.0-Z3	1/2	1/2	5/8	5	0.480	3	3	ANF	0.125	CYLINDRICAL
10023157	AN345R-0.500-E4-R010.0-Z3	1/2	1/2	5/8	6	0.480	4-1/8	3	ANF	0.010	CYLINDRICAL
10023158	AN345R-0.500-E4-R030.0-Z3	1/2	1/2	5/8	6	0.480	4-1/8	3	ANF	0.030	CYLINDRICAL
10023159	AN345R-0.500-E4-R060.0-Z3	1/2	1/2	5/8	6	0.480	4-1/8	3	ANF	0.060	CYLINDRICAL
10023160	AN345R-0.500-E4-R090.0-Z3	1/2	1/2	5/8	6	0.480	4-1/8	3	ANF	0.090	CYLINDRICAL
10023161	AN345R-0.500-E4-R125.0-Z3	1/2	1/2	5/8	6	0.480	4-1/8	3	ANF	0.125	CYLINDRICAL
10023162	AN345R-0.750-E3-R010.0-Z3	3/4	3/4	1	6	0.720	3-1/2	3	ANF	0.010	CYLINDRICAL
10023163	AN345R-0.750-E3-R020.0-Z3	3/4	3/4	1	6	0.720	3-1/2	3	ANF	0.020	CYLINDRICAL
10023164	AN345R-0.750-E3-R030.0-Z3	3/4	3/4	1	6	0.720	3-1/2	3	ANF	0.030	CYLINDRICAL
10023165	AN345R-0.750-E3-R060.0-Z3	3/4	3/4	1	6	0.720	3-1/2	3	ANF	0.060	CYLINDRICAL
10023166	AN345R-0.750-E3-R090.0-Z3	3/4	3/4	1	6	0.720	3-1/2	3	ANF	0.090	CYLINDRICAL
10023167	AN345R-0.750-E3-R125.0-Z3	3/4	3/4	1	6	0.720	3-1/2	3	ANF	0.125	CYLINDRICAL

AR330

SOLID
CARBIDE

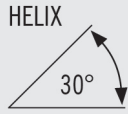

CENTER
CUTTING

COARSE
PITCH



- Form ground flute shape
- Ideal for aluminum and non-ferrous materials
- Reduced radial pressure

ITEM NUMBER	DESCRIPTION	FLUTE DIA.	SHANK DIA.	LENGTH OF CUT	OVERALL LENGTH	FLUTES	COATING	CHAMFER	SHANK TYPE
N76195	AR330-0.250-D3-C020.0-Z3	1/4	1/4	3/4	2-1/2	3	UNCOATED	0.020	CYLINDRICAL
N76227	AR330-0.250-D3-C020.0-Z3	1/4	1/4	3/4	2-1/2	3	TICN	0.020	CYLINDRICAL
N76198	AR330-0.375-D1-C020.0-Z3	3/8	3/8	1/2	2	3	UNCOATED	0.020	CYLINDRICAL
N76230	AR330-0.375-D1-C020.0-Z3	3/8	3/8	1/2	2	3	TICN	0.020	CYLINDRICAL
N76199	AR330-0.375-D3-C020.0-Z3	3/8	3/8	1	2-1/2	3	UNCOATED	0.020	CYLINDRICAL
N76231	AR330-0.375-D3-C020.0-Z3	3/8	3/8	1	2-1/2	3	TICN	0.020	CYLINDRICAL
N76203	AR330-0.500-D3-C025.0-Z3	1/2	1/2	1-1/4	3	3	UNCOATED	0.025	CYLINDRICAL
N76235	AR330-0.500-D3-C025.0-Z3	1/2	1/2	1-1/4	3	3	TICN	0.025	CYLINDRICAL
N76205	AR330-0.625-D3-C025.0-Z3	5/8	5/8	1-5/8	3-1/2	3	UNCOATED	0.025	CYLINDRICAL
N76237	AR330-0.625-D3-C025.0-Z3	5/8	5/8	1-5/8	3-1/2	3	TICN	0.025	CYLINDRICAL
N76206	AR330-0.750-D1-C025.0-Z3	3/4	3/4	1	3	3	UNCOATED	0.025	CYLINDRICAL
N76238	AR330-0.750-D1-C025.0-Z3	3/4	3/4	1	3	3	TICN	0.025	CYLINDRICAL
N76207	AR330-0.750-D2-C025.0-Z3	3/4	3/4	1-5/8	4	3	UNCOATED	0.025	CYLINDRICAL
N76239	AR330-0.750-D2-C025.0-Z3	3/4	3/4	1-5/8	4	3	TICN	0.025	CYLINDRICAL
N76209	AR330-1.000-D2-C025.0-Z3	1	1	2	5	3	UNCOATED	0.025	CYLINDRICAL
N76241	AR330-1.000-D2-C025.0-Z3	1	1	2	5	3	TICN	0.025	CYLINDRICAL

AN230 / AN230R E2 LENGTH - START VALUES

SLOT MILLING								
ISO GROUP	SMG	$a_p \times D_c$ (max)	$a_e \times D_c$ (max)	v_c (sf / min)				
						1/2	3/4	1
N	E 16 Alum (Si<9%)	1.00	1.00	3300	n (min-1)	25212	16808	12606
					fz (in)	0.0041	0.0061	0.0081
					v_f (in/min)	205	205	205
	E 17 Alum (9%<Si<16%)	0.80	1.00	2700	n (min-1)	20628	13752	10314
					fz (in)	0.0032	0.0047	0.0063
					v_f (in/min)	130	130	130
			1350	-	4050			

AN230 / AN230R E2 LENGTH - START VALUES

SIDE MILLING - ROUGHING								
ISO GROUP	SMG	$a_p \times D_c$ (max)	$a_e \times D_c$ (max)	v_c (sf / min)				
						1/2	3/4	1
N	E 16 Alum (Si<9%)	1.30	0.25	4000	n (min-1)	30560	20373	15280
					fz (in)	0.0059	0.0088	0.0118
					v_f (in/min)	360	360	360
	E 17 Alum (9%<Si<16%)	1.30	0.25	3300	n (min-1)	25212	16808	12606
					fz (in)	0.0044	0.0065	0.0087
					v_f (in/min)	220	220	220
			1650	-	4950			

AN230 / AN230R E2 LENGTH - START VALUES

SIDE MILLING - FINISHING								
ISO GROUP	SMG	$a_p \times D_c$ (max)	$a_e \times D_c$ (max)	v_c (sf / min)				
						1/2	3/4	1
N	E 16 Alum (Si<9%)	1.00	0.02	5000	n (min-1)	38200	25467	19100
					fz (in)	0.0025	0.0037	0.0050
					v_f (in/min)	190	190	190
	E 17 Alum (9%<Si<16%)	1.00	0.02	4100	n (min-1)	31324	20883	15662
					fz (in)	0.0025	0.0037	0.0050
					v_f (in/min)	155	155	155
			2050	-	6150			

SMG = Seco Material Group
 n (min-1) = RPM
 fz (in) = Feed/tooth
 v_f (in/min) = Feed rate
 v_c (sf/min) = Surface feet/min
 $a_p \times D_c$ = % of diameter
 $a_e \times D_c$ = % of diameter
 All cutting data are start values
 All cutting data is in inch values

SMG = Seco Material Group
 n [min-1] = RPM
 v_c (sf/min) = Surface feet/min

fz [in] = Feed/tooth
 a_p/D_c = % of diameter
 v_f [in/min] = Feed rate
 a_e/D_c = % of diameter

A = Air D = Dry E = Emulsion (flood coolant) M = Mist
 All cutting data are start values. All cutting data is in inch values.
 Please reference the Workpiece Material Classification chart located on page 15.

AN335 / AN335R E2 LENGTH - START VALUES

SLOT MILLING								
ISO GROUP	SMG	$a_p \times D_c$ (max)	$a_e \times D_c$ (max)	v_c (sf / min)				
						1/2	3/4	1
N	E 16 Alum (Si<9%)	0.50	1.00	3300	n (min-1)	25212	16808	12606
					fz (in)	0.0032	0.0049	0.0065
					v_f (in/min)	245	245	245
	E 17 Alum (9%<Si<16%)	0.40	1.00	2700	n (min-1)	20628	13752	10314
					fz (in)	0.0024	0.0036	0.0049
					v_f (in/min)	150	150	150
				1350	-	4050		

AN335 / AN335R E2 LENGTH - START VALUES

SIDE MILLING - ROUGHING								
ISO GROUP	SMG	$a_p \times D_c$ (max)	$a_e \times D_c$ (max)	v_c (sf / min)				
						1/2	3/4	1
N	E 16 Alum (Si<9%)	1.30	0.25	4000	n (min-1)	30560	20373	15280
					fz (in)	0.0044	0.0065	0.0087
					v_f (in/min)	400	400	400
	E 17 Alum (9%<Si<16%)	1.20	0.25	3300	n (min-1)	25212	16808	12606
					fz (in)	0.0033	0.0050	0.0066
					v_f (in/min)	250	250	250
				1650	-	4950		

AN335 / AN335R E2 LENGTH - START VALUES

SIDE MILLING - FINISHING								
ISO GROUP	SMG	$a_p \times D_c$ (max)	$a_e \times D_c$ (max)	v_c (sf / min)				
						1/2	3/4	1
N	E 16 Alum (Si<9%)	1.00	0.02	5000	n (min-1)	38200	25467	19100
					fz (in)	0.0025	0.0037	0.0050
					v_f (in/min)	190	190	190
	E 17 Alum (9%<Si<16%)	1.00	0.02	4100	(min-1)	31324	20883	15662
					fz (in)	0.0025	0.0037	0.0050
					v_f (in/min)	155	155	155
				2050	-	6150		

SMG = Seco Material Group
 n (min-1) = RPM
 fz (in) = Feed/tooth
 v_f (in/min) = Feed rate
 v_c (sf/min) = Surface feet/min
 $a_p \times D_c$ = % of diameter
 $a_e \times D_c$ = % of diameter
 All cutting data are start values
 All cutting data is in inch values

SMG = Seco Material Group
 n [min-1] = RPM
 v_c (sf/min) = Surface feet/min

fz [in] = Feed/tooth
 a_p/D_c = % of diameter
 v_f [in/min] = Feed rate
 a_e/D_c = % of diameter

A = Air D = Dry E = Emulsion (flood coolant) M = Mist
 All cutting data are start values. All cutting data is in inch values.
 Please reference the Workpiece Material Classification chart located on page 15.

CUTTING DATA - ELITE A SERIES HIGH PERFORMANCE

A245 / AB245

		SLOTTING														
ISO GROUP	SMG	a _p x Dc (max)	a _e x Dc (max)	v _c (sf / min)		Z _n = 2										
						1/8	5/32	3/16	7/32	1/4	5/16	3/8	1/2	5/8	3/4	1
N	E 16	1.00	1300	1300	n [min-1]	39728	31833	26485	22702	19864	15891	13243	9932	7933	6621	4966
					fz [in]	0.0020	0.0025	0.0030	0.0035	0.0040	0.0050	0.0060	0.0080	0.0100	0.0120	0.0160
					vf [in/min]	159	159	159	159	159	159	159	159	159	159	159
	E 17	1.00	900	900	n [min-1]	27504	22038	18336	15717	13752	11002	9168	6876	5492	4584	3438
					fz [in]	0.0016	0.0020	0.0024	0.0028	0.0033	0.0041	0.0049	0.0065	0.0081	0.0098	0.0130
					vf [in/min]	89	89	89	89	89	89	89	89	89	89	89
				- 1125	vf [in/min]	89	89	89	89	89	89	89	89	89	89	89

A245 / AB245

		SIDE MILLING - ROUGHING														
ISO GROUP	SMG	a _p x Dc (max)	a _e x Dc (max)	v _c (sf / min)		Z _n = 2										
						1/8	5/32	3/16	7/32	1/4	5/16	3/8	1/2	5/8	3/4	1
N	E 16	2.00	0.50	1300	n [min-1]	39728	31782	26485	22702	19864	15891	13243	9932	7933	6621	4966
					fz [in]	0.0025	0.0031	0.0038	0.0044	0.0050	0.0063	0.0075	0.0100	0.0125	0.0150	0.0200
					vf [in/min]	199	199	199	199	199	199	199	199	199	199	199
	E 17	1.50	0.50	900	n [min-1]	27504	22003	18336	15717	13752	11002	9168	6876	5492	4584	3438
					fz [in]	0.0020	0.0025	0.0030	0.0035	0.0040	0.0050	0.0060	0.0080	0.0100	0.0120	0.0160
					vf [in/min]	110	110	110	110	110	110	110	110	110	110	110
				675 - 1125	vf [in/min]	110	110	110	110	110	110	110	110	110	110	

A245 / AB245

		SIDE MILLING - FINISHING														
ISO GROUP	SMG	a _p x Dc (max)	a _e x Dc (max)	v _c (sf / min)		Z _n = 2										
						1/8	5/32	3/16	7/32	1/4	5/16	3/8	1/2	5/8	3/4	1
N	E 16	MAX	0.02	1600	n [min-1]	48896	39117	32597	27941	24448	19558	16299	12224	9764	8149	6112
					fz [in]	0.0009	0.0011	0.0013	0.0015	0.0018	0.0022	0.0026	0.0035	0.0044	0.0053	0.0070
					vf [in/min]	86	86	86	86	86	86	86	86	86	86	86
	E 17	MAX	0.02	1100	n [min-1]	33616	26893	22411	19209	16808	13446	11205	8404	6712	5603	4202
					fz [in]	0.0009	0.0011	0.0013	0.0015	0.0018	0.0022	0.0026	0.0035	0.0044	0.0053	0.0070
					vf [in/min]	59	59	59	59	59	59	59	59	59	59	59
				825 - 1375	vf [in/min]	59	59	59	59	59	59	59	59	59	59	

A345 / A345R

		SLOTTING															
ISO GROUP	SMG	a _p x Dc (max)	a _e x Dc (max)	v _c (sf / min)		Z _n = 3											
						1/8	5/32	3/16	7/32	1/4	5/16	3/8	7/16	1/2	5/8	3/4	1
N	E 16	1.00	1.00	1300	n [min-1]	39728	31782	26485	22702	19864	15891	13243	11351	9932	7933	6621	4966
					fz [in]	0.0018	0.0022	0.0026	0.0031	0.0035	0.0044	0.0053	0.0061	0.0070	0.0088	0.0105	0.0140
					vf [in/min]	209	209	209	209	209	209	209	209	209	209	209	209
	E 17	1.00	1.00	900	n [min-1]	27504	22003	18336	15717	13752	11002	9168	7858	6876	5492	4584	3438
					fz [in]	0.0015	0.0019	0.0023	0.0026	0.0030	0.0038	0.0045	0.0053	0.0060	0.0075	0.0090	0.0120
					vf [in/min]	124	124	124	124	124	124	124	124	124	124	124	124
				675 - 1125	vf [in/min]	124	124	124	124	124	124	124	124	124	124	124	

SMG = Seco Material Group
 n [min-1] = RPM
 v_c (sf/min) = Surface feet/min

fz [in] = Feed/tooth
 a_p/D_c = % of diameter
 vf [in/min] = Feed rate
 a_e/D_c = % of diameter

A = Air D = Dry E = Emulsion (flood coolant) M = Mist
 All cutting data are start values. All cutting data is in inch values.
 Please reference the Workpiece Material Classification chart located on page 15.

A345 / A345R

SIDE MILLING - ROUGHING																	
ISO GROUP	SMG	a _p x Dc (max)	a _e x Dc (max)	v _c (sf / min)		Z _n = 3											
						1/8	5/32	3/16	7/32	1/4	5/16	3/8	7/16	1/2	5/8	3/4	1
N	E 16	2.00	0.40	1300	n [min-1]	39728	31782	26485	22702	19864	15891	13243	11351	9932	7933	6621	4966
					fz [in]	0.0023	0.0028	0.0034	0.0039	0.0045	0.0056	0.0068	0.0079	0.0090	0.0113	0.0135	0.0180
					vf [in/min]	268	268	268	268	268	268	268	268	268	268	268	268
	E 17	1.50	0.40	900	n [min-1]	27504	22003	18336	15717	13752	11002	9168	7858	6876	5492	4584	3438
					fz [in]	0.0020	0.0025	0.0030	0.0035	0.0040	0.0050	0.0060	0.0070	0.0080	0.0100	0.0120	0.0160
					vf [in/min]	165	165	165	165	165	165	165	165	165	165	165	165

A345 / A345R

SIDE MILLING - FINISHING																	
ISO GROUP	SMG	a _p x Dc (max)	a _e x Dc (max)	v _c (sf / min)		Z _n = 3											
						1/8	5/32	3/16	7/32	1/4	5/16	3/8	7/16	1/2	5/8	3/4	1
N	E 16	MAX	0.02	1600	n [min-1]	48896	39117	32597	27941	24448	19558	16299	13970	12224	9764	8149	6112
					fz [in]	0.0009	0.0011	0.0013	0.0015	0.0018	0.0022	0.0026	0.0031	0.0035	0.0044	0.0053	0.0070
					vf [in/min]	128	128	128	128	128	128	128	128	128	128	128	128
	E 17	MAX	0.02	1100	n [min-1]	33616	26893	22411	19209	16808	13446	11205	9605	8404	6712	5603	4202
					fz [in]	0.0009	0.0011	0.0013	0.0015	0.0018	0.0022	0.0026	0.0031	0.0035	0.0044	0.0053	0.0070
					vf [in/min]	88	88	88	88	88	88	88	88	88	88	88	88

A345M

SLOTING																	
ISO GROUP	SMG	a _p x Dc (max)	a _e x Dc (max)	v _c (sf / min)		Z _n = 3											
						3	4	5	6	8	10	12	16	20			
N	E 16	1.00	1.00	1300	n [min-1]	42045	31534	25227	21023	15767	12614	10511	7884	6307			
					fz [in]	0.0017	0.0022	0.0028	0.0033	0.0044	0.0055	0.0066	0.0088	0.0110			
					vf [in/min]	209	209	209	209	209	209	209	209	209	209		
	E 17	1.00	1.00	900	n [min-1]	29108	21831	17465	14554	10916	8733	7277	5458	4366			
					fz [in]	0.0014	0.0019	0.0024	0.0028	0.0038	0.0047	0.0057	0.0076	0.0094			
					vf [in/min]	124	124	124	124	124	124	124	124	124	124		

A345M

SIDE MILLING - ROUGHING																	
ISO GROUP	SMG	a _p x Dc (max)	a _e x Dc (max)	v _c (sf / min)		Z _n = 3											
						3	4	5	6	8	10	12	16	20			
N	E 16	2.00	0.40	1300	n [min-1]	42045	31534	25227	21023	15767	12614	10511	7884	6307			
					fz [in]	0.0021	0.0028	0.0035	0.0043	0.0057	0.0071	0.0085	0.0113	0.0142			
					vf [in/min]	268	268	268	268	268	268	268	268	268	268		
	E 17	1.50	0.40	900	n [min-1]	29108	21831	17465	14554	10916	8733	7277	5458	4366			
					fz [in]	0.0019	0.0025	0.0031	0.0038	0.0050	0.0063	0.0076	0.0101	0.0126			
					vf [in/min]	165	165	165	165	165	165	165	165	165	165		

CUTTING DATA - ELITE A SERIES HIGH PERFORMANCE

A345M

SIDE MILLING - FINISHING															
ISO GROUP	SMG	a _p x D _c (max)	a _e x D _c (max)	v _c (sf / min)		Z _n = 3									
						3	4	5	6	8	10	12	16	20	
N	E 16	MAX	0.02	1600	n [min-1]	51748	38811	31049	25874	19406	15524	12937	9703	7762	
						fz [in]	0.0008	0.0011	0.0014	0.0017	0.0022	0.0028	0.0033	0.0044	0.0055
							vf [in/min]	128	128	128	128	128	128	128	128
	E 17	MAX	0.02	1100	n [min-1]	35577		26683	21346	17788	13341	10673	8894	6671	5337
						fz [in]	0.0008	0.0011	0.0014	0.0017	0.0022	0.0028	0.0033	0.0044	0.0055
							vf [in/min]	88	88	88	88	88	88	88	88
			825 - 1375												

AN345 / AN345R

SLOTING														
ISO GROUP	SMG	a _p x D _c (max)	a _e x D _c (max)	v _c (sf / min)		Z _n = 3								
						1/4	5/16	3/8	1/2	5/8	3/4	1		
N	E 16	0.50	1.00	800	n [min-1]	12224	9779	8149	6112	4882	4075	3056		
						fz [in]	0.0019	0.0024	0.0029	0.0039	0.0048	0.0058	0.0077	
							vf [in/min]	71	71	71	71	71	71	71
	E 17	0.50	1.00	640	n [min-1]	9779		7823	6519	4890	3905	3260	2445	
						fz [in]	0.0015	0.0019	0.0023	0.0031	0.0038	0.0046	0.0061	
							vf [in/min]	45	45	45	45	45	45	45
			480 - 800											

AN345 / AN345R

SIDE MILLING - ROUGHING														
ISO GROUP	SMG	a _p x D _c (max)	a _e x D _c (max)	v _c (sf / min)		Z _n = 3								
						1/4	5/16	3/8	1/2	5/8	3/4	1		
N	E 16	2.00	0.40	800	n [min-1]	12224	9779	8149	6112	4882	4075	3056		
						fz [in]	0.0030	0.0038	0.0045	0.0060	0.0075	0.0090	0.0120	
							vf [in/min]	110	110	110	110	110	110	110
	E 17	1.50	0.40	640	n [min-1]	9779		7823	6519	4890	3905	3260	2445	
						fz [in]	0.0025	0.0031	0.0038	0.0050	0.0063	0.0075	0.0100	
							vf [in/min]	73	73	73	73	73	73	73
			480 - 800											

AN345 / AN345R

SIDE MILLING - FINISHING														
ISO GROUP	SMG	a _p x D _c (max)	a _e x D _c (max)	v _c (sf / min)		Z _n = 3								
						1/4	5/16	3/8	1/2	5/8	3/4	1		
N	E 16	MAX	0.02	1000	n [min-1]	15280	12224	10187	7640	6102	5093	3820		
						fz [in]	0.0018	0.0022	0.0026	0.0035	0.0044	0.0053	0.0070	
							vf [in/min]	80	80	80	80	80	80	80
	E 17	MAX	0.02	800	n [min-1]	12224		9779	8149	6112	4882	4075	3056	
						fz [in]	0.0018	0.0022	0.0026	0.0035	0.0044	0.0053	0.0070	
							vf [in/min]	64	64	64	64	64	64	64
			600 - 1000											

SMG = Seco Material Group
 n [min-1] = RPM
 v_c (sf/min) = Surface feet/min

fz [in] = Feed/tooth
 a_p/D_c = % of diameter
 vf [in/min] = Feed rate
 a_e/D_c = % of diameter

A = Air D = Dry E = Emulsion (flood coolant) M = Mist
 All cutting data are start values. All cutting data is in inch values.
 Please reference the Workpiece Material Classification chart located on page 15.

A345M - START VALUES

		SLOTTING															
ISO GROUP	SMG	$a_p \times D_c$ (max)	$a_e \times D_c$ (max)	V_c (sf / min)		$Z_n = 3$											
						3	4	5	6	8	10	12	14	16	20	25	
N	E 16	0.5	1.00	1000	n (min-1)	32343	24257	19406	16171	12129	9703	8086	6931	6064	4851	3881	
						fz (in)	0.0011	0.0015	0.0019	0.0023	0.0030	0.0038	0.0045	0.0053	0.0060	0.0076	0.0094
						vf (in/min)	110	110	110	110	110	110	110	110	110	110	110
	E 17	0.5	1.00	800	n (min-1)	25874	19406	15524	12937	9703	7762	6469	5544	4851	3881	3105	
						fz (in)	0.0009	0.0012	0.0015	0.0018	0.0024	0.0030	0.0036	0.0042	0.0049	0.0061	0.0076
						vf (in/min)	71	71	71	71	71	71	71	71	71	71	71

		SIDE MILLING - ROUGHING															
N	E 16	2.0	0.40	1000	n (min-1)	32343	24257	19406	16171	12129	9703	8086	6931	6064	4851	3881	
						fz (in)	0.0014	0.0019	0.0024	0.0028	0.0038	0.0047	0.0057	0.0066	0.0076	0.0094	0.0118
						vf (in/min)	138	138	138	138	138	138	138	138	138	138	138
	E 17	1.5	0.40	800	n (min-1)	25874	19406	15524	12937	9703	7762	6469	5544	4851	3881	3105	
						fz (in)	0.0011	0.0015	0.0019	0.0023	0.0030	0.0038	0.0045	0.0053	0.0060	0.0076	0.0094
						vf (in/min)	88	88	88	88	88	88	88	88	88	88	88

AN340 - START VALUES

		SLOTTING											
ISO GROUP	SMG	$a_p \times D_c$ (max)	$a_e \times D_c$ (max)	V_c (sf / min)		$Z_n = 3$							
						1/8	1/4	3/8	1/2	5/8	3/4	1	
N	E 16	1.0	1.00	1200	n (rev/min)	36672	18336	12224	9168	7334	6112	4584	
						fz (in)	0.0019	0.0038	0.0056	0.0075	0.0094	0.0113	0.0150
						vf (in/min)	206	206	206	206	206	206	206
	E 17	1.0	1.00	1000	n (rev/min)	30560	15280	10187	7640	6112	5093	3820	
						fz (in)	0.0019	0.0038	0.0056	0.0075	0.0094	0.0113	0.0150
						vf (in/min)	172	172	172	172	172	172	172

		SIDE MILLING - ROUGHING											
N	E 16	1.0	0.25	1200	n (rev/min)	36672	18336	12224	9168	7334	6112	4584	
						fz (in)	0.0028	0.0056	0.0084	0.0113	0.0141	0.0169	0.0225
						vf (in/min)	309	309	309	309	309	309	309
	E 17	1.0	0.25	1000	n (rev/min)	30560	15280	10187	7640	6112	5093	3820	
						fz (in)	0.0028	0.0056	0.0084	0.0113	0.0141	0.0169	0.0225
						vf (in/min)	258	258	258	258	258	258	258

SMG = Seco Material Group
 n [min-1] = RPM
 V_c (sf/min) = Surface feet/min

fz [in] = Feed/tooth
 a_p/D_c = % of diameter
 vf [in/min] = Feed rate
 a_e/D_c = % of diameter

A = Air D = Dry E = Emulsion (flood coolant) M = Mist
 All cutting data are start values. All cutting data is in inch values.
 Please reference the Workpiece Material Classification chart located on page 15.

AR330 - START VALUES

		SLOTTING										
ISO GROUP	SMG	$a_p \times D_c$ (max)	$a_e \times D_c$ (max)	v_c (sf / min)		$Z_n = 3$						
						1/8	1/4	3/8	1/2	5/8	3/4	1
N	E 16	1.00	1.00	800	n (rev/min)	24448	12224	8149	6112	4890	4075	3056
					f_z (in)	0.0008	0.0015	0.0023	0.0030	0.0038	0.0045	0.0060
					v_f (in/min)	55	55	55	55	55	55	55
	E 17	1.00	1.00	800	n (rev/min)	24448	12224	8149	6112	4890	4075	3056
					f_z (in)	0.0008	0.0015	0.0023	0.0030	0.0038	0.0045	0.0060
					v_f (in/min)	55	55	55	55	55	55	55

		SIDE MILLING - ROUGHING										
N	E 16	1.00	0.25	1100	n (rev/min)	33616	16808	11205	8404	6723	5603	4202
					f_z (in)	0.0011	0.0021	0.0032	0.0042	0.0053	0.0063	0.0084
					v_f (in/min)	106	106	106	106	106	106	106
	E 17	1.00	0.25	1100	n (rev/min)	33616	16808	11205	8404	6723	5603	4202
					f_z (in)	0.0011	0.0021	0.0032	0.0042	0.0053	0.0063	0.0084
					v_f (in/min)	106	106	106	106	106	106	106

SMG = Seco Material Group
 n [min-1] = RPM
 v_c (sf/min) = Surface feet/min

f_z [in] = Feed/tooth
 a_p/D_c = % of diameter
 v_f [in/min] = Feed rate
 a_e/D_c = % of diameter

A = Air D = Dry E = Emulsion (flood coolant) M = Mist
 All cutting data are start values. All cutting data is in inch values.
 Please reference the Workpiece Material Classification chart located on page 15.

AN335 / AN335R

SLOT MILLING									
ISO GROUP	SMG	$a_p \times D_c$ (max)	$a_e \times D_c$ (max)	V_c (sf / min)			$Z_n = 3$		
							1/2	3/4	1
N	E 16 Alum (Si<9%)	0.50	1.00	3300		n (min-1)	25212	16808	12606
						fz (in)	0.0032	0.0049	0.0065
				1650	-	4950	vf (in/min)	245	245
	E 17 Alum (9%<Si<16%)	0.40	1.00	2700		n (min-1)	20628	13752	10314
						fz (in)	0.0024	0.0036	0.0049
				1350	-	4050	vf (in/min)	150	150

AN335 / AN335R

SIDE MILLING - ROUGHING									
ISO GROUP	SMG	$a_p \times D_c$ (max)	$a_e \times D_c$ (max)	V_c (sf / min)			$Z_n = 3$		
							1/2	3/4	1
N	E 16 Alum (Si<9%)	1.30	0.25	4000		n (min-1)	30560	20373	15280
						fz (in)	0.0044	0.0065	0.0087
				2000	-	6000	vf (in/min)	400	400
	E 17 Alum (9%<Si<16%)	1.20	0.25	3300		n (min-1)	25212	16808	12606
						fz (in)	0.0033	0.0050	0.0066
				1650	-	4950	vf (in/min)	250	250

AN335 / AN335R

SIDE MILLING - FINISHING									
ISO GROUP	SMG	$a_p \times D_c$ (max)	$a_e \times D_c$ (max)	V_c (sf / min)			$Z_n = 3$		
							1/2	3/4	1
N	E 16 Alum (Si<9%)	1.00	0.02	5000		n (min-1)	38200	25467	19100
						fz (in)	0.0025	0.0037	0.0050
				2500	-	7500	vf (in/min)	190	190
	E 17 Alum (9%<Si<16%)	1.00	0.02	4100		(min-1)	31324	20883	15662
						fz (in)	0.0025	0.0037	0.0050
				2050	-	6150	vf (in/min)	155	155

ACS540 / ACS540R

SIDE MILLING - FINISHING									
ISO GROUP	SMG	$a_p \times D_c$ (max)	$a_e \times D_c$ (max)	v_c (sf / min)			$Z_n = 5$		
							3/8	1/2	3/4
N	E 16	MAX	0.02	1450		n (min-1)	14771	11078	7385
				1088 - 1813		fz (in)	0.0019	0.0025	0.0038
						vf (in/min)	138	138	138
	E 17	MAX	0.02	1100		n (min-1)	11205	8404	5603
				825 - 1375		fz (in)	0.0017	0.0023	0.0034
						vf (in/min)	95	95	95

ACS540 / ACS540R

SIDE MILLING - ROUGHING									
ISO GROUP	SMG	$a_p \times D_c$ (max)	$a_e \times D_c$ (max)	v_c (sf / min)			$Z_n = 5$		
							3/8	1/2	3/4
N	E 16	2.00	0.30	1300		n (min-1)	13243	9932	6621
				975 - 1625		fz (in)	0.0034	0.0045	0.0068
						vf (in/min)	223	223	223
	E 17	2.00	0.30	900		n (min-1)	9168	6876	4584
				675 - 1125		fz (in)	0.0023	0.0030	0.0045
						vf (in/min)	103	103	103

ACS540 / ACS540R

SIDE MILLING - ROUGHING									
ISO GROUP	SMG	$a_p \times D_c$ (max)	$a_e \times D_c$ (max)	v_c (sf / min)			$Z_n = 5$		
							3/8	1/2	3/4
N	E 16	3.00	0.30	840		n (min-1)	8556	6417	4278
				630 - 1050		fz (in)	0.0026	0.0035	0.0053
						vf (in/min)	111	112	113
	E 17	3.00	0.30	581		n (min-1)	5923	4443	2962
				436 - 727		fz (in)	0.0023	0.0030	0.0045
						vf (in/min)	68	67	67

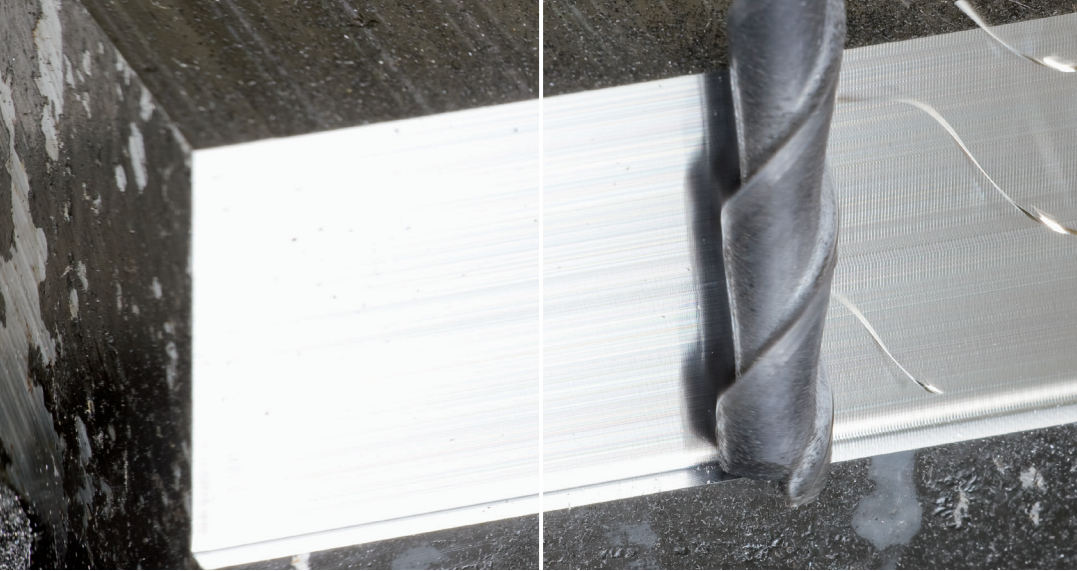

ONE PASS, HIGH PRECISION FINISHING NS240R LONG FLUTE FINISHER

The Niagara NS240R long flute finisher is a geometry for optimized performance in general machining. The NS240R allows one pass machining in square shoulder milling applications, thus reducing cycle time. These end mills are designed especially to produce high tolerance straight walls in deep pockets and to provide excellent surface quality.

The Niagara long flute finishers are offered with a 5xD depth of cut as standard, ranging in diameters from 1/4" to 1 1/4" with various radii available.

The NS240R is effective in most materials but excels in stainless steel and titanium. A typical application for this end mill is in the manufacture of aerospace structural parts made from titanium and aluminum.

PRODUCT OVERVIEW

- NS240R stabilized edge design gives improved surface quality
- Increased core diameter for more stability
- Defined back taper along cutting length to compensate for tool deflection
- Polished AlTiN coating gives increased tool life

YOUR BENEFITS

- Optimized finishing
- Vibration free machining
- High surface quality
- Correct workpiece dimensions in a single pass
- High process stability
- Aerospace corner radii available on some diameters

INCREASED CORE DIAMETER

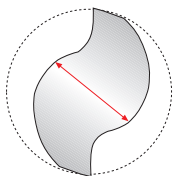

Typical two flute core diameter

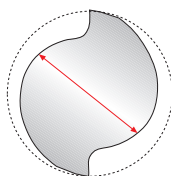

NS240R core diameter

The enlarged core diameter provides better cutter stability and less tool deflection during machining.

MATERIAL GROUPS

Steel 1-6
Stainless Steel 8-11
Cast Iron 12-15
Non-ferrous 16-18
Superalloys 19-22

COMMON APPLICATION AREAS

- Aerospace: wing parts, body and floor panels, engine casings, brackets

NS240R APPLICATION EXAMPLE

Material	Titanium	
Spindle	BT50	
Cutter	NS240R	
Diameter	1 1/4"	
Cutting data	v_c	165 sf/min
	n	497 rev/min
	f_z	.012"
	v_f	12 ipm
	a_e	.012"
	a_p	5.5"
	h_m	.0011"
	Q	.50 in ³ /min
	R_a	0.51 μ m

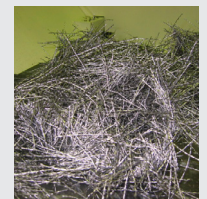
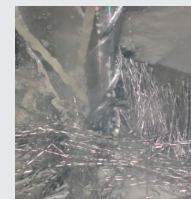

NS240R

SOLID
CARBIDE

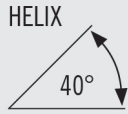

RADIUS



CENTER
CUTTING



- Rigid design to minimize tool deflection
- Designed for peripheral finish milling of aerospace parts requiring long axial engagement in materials such as titanium, stainless steels, and superalloys.

ITEM NUMBER	DESCRIPTION	FLUTE DIA.	SHANK DIA.	LENGTH OF CUT	OVERALL LENGTH	FLUTES	COATING	RADIUS	SHANK TYPE
N00291	NS240R-0.250-D1-R010.0-Z2	1/4	1/4	1-1/4	3	2	AlTiN	0.010	CYLINDRICAL
N00292	NS240R-0.313-D1-R010.0-Z2	5/16	5/16	1-1/2	3-1/2	2	AlTiN	0.010	CYLINDRICAL
N00293	NS240R-0.375-D1-R010.0-Z2	3/8	3/8	1-7/8	4	2	AlTiN	0.010	CYLINDRICAL
N00294	NS240R-0.500-D1-R010.0-Z2	1/2	1/2	2-1/2	5	2	AlTiN	0.010	CYLINDRICAL
N00295	NS240R-0.625-D1-R015.0-Z2	5/8	5/8	3-1/8	6	2	AlTiN	0.015	CYLINDRICAL
N00296	NS240R-0.750-D1-R015.0-Z2	3/4	3/4	3-3/4	7	2	AlTiN	0.015	CYLINDRICAL
N00297	NS240R-0.750-D1-R120.0-Z2	3/4	3/4	3-3/4	7	2	AlTiN	0.120	CYLINDRICAL
N00298	NS240R-0.750-D1-R250.0-Z2	3/4	3/4	3-3/4	7	2	AlTiN	0.250	CYLINDRICAL
N00299	NS240R-1.000-D1-R015.0-Z2	1	1	5	8	2	AlTiN	0.015	CYLINDRICAL
N00300	NS240R-1.000-D1-R120.0-Z2	1	1	5	8	2	AlTiN	0.120	CYLINDRICAL
N00301	NS240R-1.000-D1-R250.0-Z2	1	1	5	8	2	AlTiN	0.250	CYLINDRICAL
N00302	NS240R-1.250-D1-R015.0-Z2	1-1/4	1-1/4	6-1/4	9-1/2	2	AlTiN	0.015	CYLINDRICAL
N00303	NS240R-1.250-D1-R120.0-Z2	1-1/4	1-1/4	6-1/4	9-1/2	2	AlTiN	0.120	CYLINDRICAL
N00304	NS240R-1.250-D1-R250.0-Z2	1-1/4	1-1/4	6-1/4	9-1/2	2	AlTiN	0.250	CYLINDRICAL

DUE TO THE LONG AXIAL ENGAGEMENT THE LENGTH OF CHIP CAN BE DIFFICULT TO EVACUATE. GOOD COOLANT VOLUME, VELOCITY, AND DIRECTION IS REQUIRED TO FLUSH THE LONG CHIPS AWAY FROM THE CUTTING ZONE TO AVOID RE-CUTTING OF CHIPS.

S335

SOLID
CARBIDE



CENTER
CUTTING



- Ideal for slotting in steel, stainless steel, titanium, and high temperature alloys
- Large area for chip evacuation

ITEM NUMBER	DESCRIPTION	FLUTE DIA.	SHANK DIA.	LENGTH OF CUT	OVERALL LENGTH	FLUTES	COATING	RADIUS	SHANK TYPE
N61802	S335-0.125-D2-R010.0-Z3	1/8	1/8	1/4	1-1/2	3	AlTiN	0.010	CYLINDRICAL
N61803	S335-0.125-D4-R010.0-Z3	1/8	1/8	1/2	1-1/2	3	AlTiN	0.010	CYLINDRICAL
N61804	S335-0.156-F2-R010.0-Z3	5/32	3/16	5/16	2	3	AlTiN	0.010	CYLINDRICAL
N61805	S335-0.156-F4-R010.0-Z3	5/32	3/16	9/16	2	3	AlTiN	0.010	CYLINDRICAL
N61806	S335-0.188-D2-R010.0-Z3	3/16	3/16	5/16	2	3	AlTiN	0.010	CYLINDRICAL
N61807	S335-0.188-D3-R010.0-Z3	3/16	3/16	9/16	2	3	AlTiN	0.010	CYLINDRICAL
N61808	S335-0.219-F2-R020.0-Z3	7/32	1/4	3/8	2	3	AlTiN	0.020	CYLINDRICAL
N61809	S335-0.219-F3-R020.0-Z3	7/32	1/4	3/4	2-1/2	3	AlTiN	0.020	CYLINDRICAL
N61810	S335-0.250-D2-R020.0-Z3	1/4	1/4	3/8	2	3	AlTiN	0.020	CYLINDRICAL
N61811	S335-0.250-D3-R020.0-Z3	1/4	1/4	3/4	2-1/2	3	AlTiN	0.020	CYLINDRICAL
N61812	S335-0.281-F2-R020.0-Z3	9/32	5/16	7/16	2	3	AlTiN	0.020	CYLINDRICAL
N61813	S335-0.281-F3-R020.0-Z3	9/32	5/16	13/16	2-1/2	3	AlTiN	0.020	CYLINDRICAL
N61814	S335-0.313-D1-R020.0-Z3	5/16	5/16	7/16	2	3	AlTiN	0.020	CYLINDRICAL
N61815	S335-0.313-D3-R020.0-Z3	5/16	5/16	13/16	2-1/2	3	AlTiN	0.020	CYLINDRICAL
N61818	S335-0.375-D1-R020.3-Z3	3/8	3/8	1/2	2	3	AlTiN	0.020	WELDON
N61819	S335-0.375-D3-R020.3-Z3	3/8	3/8	1	2-1/2	3	AlTiN	0.020	WELDON
N61820	S335-0.438-D1-R020.3-Z3	7/16	7/16	9/16	2-1/2	3	AlTiN	0.020	WELDON
N61821	S335-0.438-D2-R020.3-Z3	7/16	7/16	1	2-3/4	3	AlTiN	0.020	WELDON
N61822	S335-0.500-D1-R030.3-Z3	1/2	1/2	5/8	2-1/2	3	AlTiN	0.030	WELDON
N61823	S335-0.500-D3-R030.3-Z3	1/2	1/2	1-1/4	3	3	AlTiN	0.030	WELDON
N61824	S335-0.625-D1-R030.3-Z3	5/8	5/8	3/4	3	3	AlTiN	0.030	WELDON
N61825	S335-0.625-D3-R030.3-Z3	5/8	5/8	1-5/8	3-1/2	3	AlTiN	0.030	WELDON
N61826	S335-0.750-D1-R030.3-Z3	3/4	3/4	1	3	3	AlTiN	0.030	WELDON
N61827	S335-0.750-D2-R030.3-Z3	3/4	3/4	1-5/8	4	3	AlTiN	0.030	WELDON
N61828	S335-1.000-D1-R030.3-Z3	1	1	1-1/4	4	3	AlTiN	0.030	WELDON
N61829	S335-1.000-D2-R030.3-Z3	1	1	2	5	3	AlTiN	0.030	WELDON

SB335

SOLID
CARBIDE



CENTER
CUTTING



- Ideal for slotting in steel, stainless steel, titanium and high temperature alloys
- Large area for chip evacuation

ITEM NUMBER	DESCRIPTION	FLUTE DIA.	SHANK DIA.	LENGTH OF CUT	OVERALL LENGTH	FLUTES	COATING	SHANK TYPE
N66218	SB335-0.125-D2-B.0-Z3	1/8	1/8	1/4	1-1/2	3	AITIN	CYLINDRICAL
N66219	SB335-0.125-D4-B.0-Z3	1/8	1/8	1/2	1-1/2	3	AITIN	CYLINDRICAL
N66220	SB335-0.156-F2-B.0-Z3	5/32	3/16	5/16	2	3	AITIN	CYLINDRICAL
N66221	SB335-0.156-F4-B.0-Z3	5/32	3/16	9/16	2	3	AITIN	CYLINDRICAL
N66222	SB335-0.188-D2-B.0-Z3	3/16	3/16	5/16	2	3	AITIN	CYLINDRICAL
N66223	SB335-0.188-D3-B.0-Z3	3/16	3/16	9/16	2	3	AITIN	CYLINDRICAL
N66224	SB335-0.219-F2-B.0-Z3	7/32	1/4	3/8	2	3	AITIN	CYLINDRICAL
N66225	SB335-0.219-F3-B.0-Z3	7/32	1/4	3/4	2-1/2	3	AITIN	CYLINDRICAL
N66226	SB335-0.250-D2-B.0-Z3	1/4	1/4	3/8	2	3	AITIN	CYLINDRICAL
N66227	SB335-0.250-D3-B.0-Z3	1/4	1/4	3/4	2-1/2	3	AITIN	CYLINDRICAL
N66228	SB335-0.281-F2-B.0-Z3	9/32	5/16	7/16	2	3	AITIN	CYLINDRICAL
N66229	SB335-0.281-F3-B.0-Z3	9/32	5/16	13/16	2-1/2	3	AITIN	CYLINDRICAL
N66230	SB335-0.313-D1-B.0-Z3	5/16	5/16	7/16	2	3	AITIN	CYLINDRICAL
N66231	SB335-0.313-D3-B.0-Z3	5/16	5/16	13/16	2-1/2	3	AITIN	CYLINDRICAL
N66232	SB335-0.344-F1-B.3-Z3	11/32	3/8	1/2	2	3	AITIN	WELDON
N66233	SB335-0.344-F3-B.3-Z3	11/32	3/8	1	2-1/2	3	AITIN	WELDON
N66234	SB335-0.375-D1-B.3-Z3	3/8	3/8	1/2	2	3	AITIN	WELDON
N66235	SB335-0.375-D3-B.3-Z3	3/8	3/8	1	2-1/2	3	AITIN	WELDON
N66236	SB335-0.438-D1-B.3-Z3	7/16	7/16	9/16	2-1/2	3	AITIN	WELDON
N66237	SB335-0.438-D2-B.3-Z3	7/16	7/16	1	2-3/4	3	AITIN	WELDON
N66238	SB335-0.500-D1-B.3-Z3	1/2	1/2	5/8	2-1/2	3	AITIN	WELDON
N66239	SB335-0.500-D3-B.3-Z3	1/2	1/2	1-1/4	3	3	AITIN	WELDON
N66241	SB335-0.625-D3-B.3-Z3	5/8	5/8	1-5/8	3-1/2	3	AITIN	WELDON
N66243	SB335-0.750-D2-B.3-Z3	3/4	3/4	1-5/8	4	3	AITIN	WELDON
N66245	SB335-1.000-D2-B.3-Z3	1	1	2	5	3	AITIN	WELDON

SN335

SOLID
CARBIDE

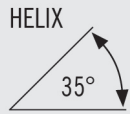

CENTER
CUTTING



- Ideal for slotting, pocketing and long reach peripheral milling in steel, stainless steel, titanium, and exotic alloys

ITEM NUMBER	DESCRIPTION	FLUTE DIA.	SHANK DIA.	LENGTH OF CUT	OVERALL LENGTH	NECK DIA	REACH	FLUTES	COATING	RADIUS	SHANK TYPE
N18648	SN335-0.250-E2-R020.0-Z3	1/4	1/4	3/8	4	0.240	2-1/8	3	AlTiN	0.020	CYLINDRICAL
N18650	SN335-0.375-E1-R020.3-Z3	3/8	3/8	1/2	4	0.360	2-1/8	3	AlTiN	0.020	WELDON
N18651	SN335-0.375-E2-R020.3-Z3	3/8	3/8	1/2	6	0.360	3-3/8	3	AlTiN	0.020	WELDON
N18654	SN335-0.500-E1-R030.3-Z3	1/2	1/2	5/8	4	0.480	2-1/8	3	AlTiN	0.030	WELDON
N18655	SN335-0.500-E2-R030.3-Z3	1/2	1/2	5/8	5	0.480	3-1/8	3	AlTiN	0.030	WELDON
N18656	SN335-0.500-E3-R030.3-Z3	1/2	1/2	5/8	6	0.480	4-1/8	3	AlTiN	0.030	WELDON

S545

SOLID
CARBIDE

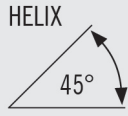

CENTER
CUTTING



- Eccentric primary relief
- Ideal for peripheral finish milling in steel, stainless steel, titanium and high temperature alloys

ITEM NUMBER	DESCRIPTION	FLUTE DIA.	SHANK DIA.	LENGTH OF CUT	OVERALL LENGTH	FLUTES	COATING	SHANK TYPE
N61830	S545-0.125-D2-S.0-Z5	1/8	1/8	1/4	1-1/2	5	UNCOATED	CYLINDRICAL
N61983	S545-0.125-D2-S.0-Z5	1/8	1/8	1/4	1-1/2	5	AITIN	CYLINDRICAL
N61831	S545-0.125-D4-S.0-Z5	1/8	1/8	1/2	1-1/2	5	UNCOATED	CYLINDRICAL
N61984	S545-0.125-D4-S.0-Z5	1/8	1/8	1/2	1-1/2	5	AITIN	CYLINDRICAL
N61832	S545-0.156-F2-S.0-Z5	5/32	3/16	5/16	2	5	UNCOATED	CYLINDRICAL
N61985	S545-0.156-F2-S.0-Z5	5/32	3/16	5/16	2	5	AITIN	CYLINDRICAL
N61833	S545-0.156-F4-S.0-Z5	5/32	3/16	9/16	2	5	UNCOATED	CYLINDRICAL
N61986	S545-0.156-F4-S.0-Z5	5/32	3/16	9/16	2	5	AITIN	CYLINDRICAL
N61834	S545-0.188-D2-S.0-Z5	3/16	3/16	5/16	2	5	UNCOATED	CYLINDRICAL
N61987	S545-0.188-D2-S.0-Z5	3/16	3/16	5/16	2	5	AITIN	CYLINDRICAL
N61835	S545-0.188-D3-S.0-Z5	3/16	3/16	9/16	2	5	UNCOATED	CYLINDRICAL
N61988	S545-0.188-D3-S.0-Z5	3/16	3/16	9/16	2	5	AITIN	CYLINDRICAL
N61836	S545-0.219-F2-S.0-Z5	7/32	1/4	3/8	2	5	UNCOATED	CYLINDRICAL
N61989	S545-0.219-F2-S.0-Z5	7/32	1/4	3/8	2	5	AITIN	CYLINDRICAL
N61837	S545-0.219-F3-S.0-Z5	7/32	1/4	3/4	2-1/2	5	UNCOATED	CYLINDRICAL
N61990	S545-0.219-F3-S.0-Z5	7/32	1/4	3/4	2-1/2	5	AITIN	CYLINDRICAL
N61838	S545-0.250-D2-S.0-Z5	1/4	1/4	3/8	2	5	UNCOATED	CYLINDRICAL
N61991	S545-0.250-D2-S.0-Z5	1/4	1/4	3/8	2	5	AITIN	CYLINDRICAL
N61839	S545-0.250-D3-S.0-Z5	1/4	1/4	3/4	2-1/2	5	UNCOATED	CYLINDRICAL
N61992	S545-0.250-D3-S.0-Z5	1/4	1/4	3/4	2-1/2	5	AITIN	CYLINDRICAL
N61840	S545-0.250-D5-S.0-Z5	1/4	1/4	1-1/4	4	5	UNCOATED	CYLINDRICAL
N61993	S545-0.250-D5-S.0-Z5	1/4	1/4	1-1/4	4	5	AITIN	CYLINDRICAL
N61842	S545-0.281-F3-S.0-Z5	9/32	5/16	13/16	2-1/2	5	UNCOATED	CYLINDRICAL
N61995	S545-0.281-F3-S.0-Z5	9/32	5/16	13/16	2-1/2	5	AITIN	CYLINDRICAL
N61843	S545-0.313-D1-S.0-Z5	5/16	5/16	7/16	2	5	UNCOATED	CYLINDRICAL
N61996	S545-0.313-D1-S.0-Z5	5/16	5/16	7/16	2	5	AITIN	CYLINDRICAL
N61844	S545-0.313-D3-S.0-Z5	5/16	5/16	13/16	2-1/2	5	UNCOATED	CYLINDRICAL
N61997	S545-0.313-D3-S.0-Z5	5/16	5/16	13/16	2-1/2	5	AITIN	CYLINDRICAL
N61845	S545-0.313-D4-S.0-Z5	5/16	5/16	1-1/4	4	5	UNCOATED	CYLINDRICAL
N61998	S545-0.313-D4-S.0-Z5	5/16	5/16	1-1/4	4	5	AITIN	CYLINDRICAL
N61846	S545-0.313-D7-S.0-Z5	5/16	5/16	2-1/8	4	5	UNCOATED	CYLINDRICAL
N61999	S545-0.313-D7-S.0-Z5	5/16	5/16	2-1/8	4	5	AITIN	CYLINDRICAL
N61849	S545-0.375-D1-S.0-Z5	3/8	3/8	1/2	2	5	UNCOATED	CYLINDRICAL
N62002	S545-0.375-D1-S.0-Z5	3/8	3/8	1/2	2	5	AITIN	CYLINDRICAL
N61850	S545-0.375-D3-S.0-Z5	3/8	3/8	1	2-1/2	5	UNCOATED	CYLINDRICAL
N62003	S545-0.375-D3-S.0-Z5	3/8	3/8	1	2-1/2	5	AITIN	CYLINDRICAL
N61851	S545-0.375-D4-S.0-Z5	3/8	3/8	1-1/2	4	5	UNCOATED	CYLINDRICAL
N62004	S545-0.375-D4-S.0-Z5	3/8	3/8	1-1/2	4	5	AITIN	CYLINDRICAL
N61852	S545-0.375-D7-S.0-Z5	3/8	3/8	2-1/2	6	5	UNCOATED	CYLINDRICAL
N62005	S545-0.375-D7-S.0-Z5	3/8	3/8	2-1/2	6	5	AITIN	CYLINDRICAL

S545 (CONT.)

SOLID CARBIDE

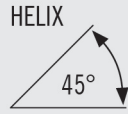

CENTER CUTTING



- Eccentric primary relief
- Ideal for peripheral finish milling in steel, stainless steel, titanium and high temperature alloys

ITEM NUMBER	DESCRIPTION	FLUTE DIA.	SHANK DIA.	LENGTH OF CUT	OVERALL LENGTH	FLUTES	COATING	SHANK TYPE
N61855	S545-0.438-D1-S.0-Z5	7/16	7/16	9/16	2-1/2	5	UNCOATED	CYLINDRICAL
N62008	S545-0.438-D1-S.0-Z5	7/16	7/16	9/16	2-1/2	5	AITIN	CYLINDRICAL
N61856	S545-0.438-D2-S.0-Z5	7/16	7/16	1	2-3/4	5	UNCOATED	CYLINDRICAL
N62009	S545-0.438-D2-S.0-Z5	7/16	7/16	1	2-3/4	5	AITIN	CYLINDRICAL
N61857	S545-0.438-D5-S.0-Z5	7/16	7/16	2	4	5	UNCOATED	CYLINDRICAL
N62010	S545-0.438-D5-S.0-Z5	7/16	7/16	2	4	5	AITIN	CYLINDRICAL
N61860	S545-0.500-D1-S.0-Z5	1/2	1/2	5/8	2-1/2	5	UNCOATED	CYLINDRICAL
N62013	S545-0.500-D1-S.0-Z5	1/2	1/2	5/8	2-1/2	5	AITIN	CYLINDRICAL
N61861	S545-0.500-D3-S.0-Z5	1/2	1/2	1-1/4	3	5	UNCOATED	CYLINDRICAL
N62014	S545-0.500-D3-S.0-Z5	1/2	1/2	1-1/4	3	5	AITIN	CYLINDRICAL
N61862	S545-0.500-D4-S.0-Z5	1/2	1/2	2	4	5	UNCOATED	CYLINDRICAL
N62015	S545-0.500-D4-S.0-Z5	1/2	1/2	2	4	5	AITIN	CYLINDRICAL
N61863	S545-0.500-D6-S.0-Z5	1/2	1/2	3-1/8	6	5	UNCOATED	CYLINDRICAL
N62016	S545-0.500-D6-S.0-Z5	1/2	1/2	3-1/8	6	5	AITIN	CYLINDRICAL
N55330	S545-0.563-D3-S.0-Z5	9/16	9/16	1-1/2	3-1/2	5	UNCOATED	CYLINDRICAL
N55333	S545-0.563-D3-S.0-Z5	9/16	9/16	1-1/2	3-1/2	5	AITIN	CYLINDRICAL
N61864	S545-0.625-D1-S.0-Z5	5/8	5/8	3/4	3	5	UNCOATED	CYLINDRICAL
N62017	S545-0.625-D1-S.0-Z5	5/8	5/8	3/4	3	5	AITIN	CYLINDRICAL
N61865	S545-0.625-D3-S.0-Z5	5/8	5/8	1-5/8	3-1/2	5	UNCOATED	CYLINDRICAL
N62018	S545-0.625-D3-S.0-Z5	5/8	5/8	1-5/8	3-1/2	5	AITIN	CYLINDRICAL
N61866	S545-0.625-D4-S.0-Z5	5/8	5/8	2-1/2	5	5	UNCOATED	CYLINDRICAL
N62019	S545-0.625-D4-S.0-Z5	5/8	5/8	2-1/2	5	5	AITIN	CYLINDRICAL
N61867	S545-0.625-D6-S.0-Z5	5/8	5/8	4	6	5	UNCOATED	CYLINDRICAL
N62020	S545-0.625-D6-S.0-Z5	5/8	5/8	4	6	5	AITIN	CYLINDRICAL
N61868	S545-0.750-D1-S.0-Z5	3/4	3/4	1	3	5	UNCOATED	CYLINDRICAL
N62021	S545-0.750-D1-S.0-Z5	3/4	3/4	1	3	5	AITIN	CYLINDRICAL
N61869	S545-0.750-D2-S.0-Z5	3/4	3/4	1-5/8	4	5	UNCOATED	CYLINDRICAL
N62022	S545-0.750-D2-S.0-Z5	3/4	3/4	1-5/8	4	5	AITIN	CYLINDRICAL
INCH - S545 (CONT.)								
N61870	S545-0.750-D3-S.0-Z5	3/4	3/4	2-1/4	5	5	UNCOATED	CYLINDRICAL
N62023	S545-0.750-D3-S.0-Z5	3/4	3/4	2-1/4	5	5	AITIN	CYLINDRICAL
N61871	S545-0.750-D4-S.0-Z5	3/4	3/4	3-1/4	6	5	UNCOATED	CYLINDRICAL
N62024	S545-0.750-D4-S.0-Z5	3/4	3/4	3-1/4	6	5	AITIN	CYLINDRICAL
N61872	S545-0.750-D5-S.0-Z5	3/4	3/4	4	6	5	UNCOATED	CYLINDRICAL
N62025	S545-0.750-D5-S.0-Z5	3/4	3/4	4	6	5	AITIN	CYLINDRICAL
N61873	S545-1.000-D1-S.0-Z5	1	1	1-1/4	4	5	UNCOATED	CYLINDRICAL
N62026	S545-1.000-D1-S.0-Z5	1	1	1-1/4	4	5	AITIN	CYLINDRICAL
N61874	S545-1.000-D2-S.0-Z5	1	1	2	4	5	UNCOATED	CYLINDRICAL
N62027	S545-1.000-D2-S.0-Z5	1	1	2	4	5	AITIN	CYLINDRICAL
N61875	S545-1.000-D3-S.0-Z5	1	1	2-5/8	6	5	UNCOATED	CYLINDRICAL

S545 (CONT.)

SOLID
CARBIDE

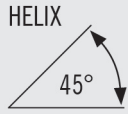

CENTER
CUTTING



- Eccentric primary relief
- Ideal for peripheral finish milling in steel, stainless steel, titanium and high temperature alloys

ITEM NUMBER	DESCRIPTION	FLUTE DIA.	SHANK DIA.	LENGTH OF CUT	OVERALL LENGTH	FLUTES	COATING	SHANK TYPE
N62028	S545-1.000-D3-S.0-Z5	1	1	2-5/8	6	5	AITIN	CYLINDRICAL
N61876	S545-1.000-D4-S.0-Z5	1	1	3-1/4	6	5	UNCOATED	CYLINDRICAL
N62029	S545-1.000-D4-S.0-Z5	1	1	3-1/4	6	5	AITIN	CYLINDRICAL
N61877	S545-1.000-D5-S.0-Z5	1	1	4-1/8	7	5	UNCOATED	CYLINDRICAL
N62030	S545-1.000-D5-S.0-Z5	1	1	4-1/8	7	5	AITIN	CYLINDRICAL
N61878	S545-1.250-D2-S.0-Z7	1-1/4	1-1/4	2	4-1/2	7	UNCOATED	CYLINDRICAL
N62031	S545-1.250-D2-S.0-Z7	1-1/4	1-1/4	2	4-1/2	7	AITIN	CYLINDRICAL
N61879	S545-1.250-D3-S.0-Z7	1-1/4	1-1/4	3-1/4	6	7	UNCOATED	CYLINDRICAL
N62032	S545-1.250-D3-S.0-Z7	1-1/4	1-1/4	3-1/4	6	7	AITIN	CYLINDRICAL
N61880	S545-1.250-D4-S.0-Z7	1-1/4	1-1/4	5	7-1/2	7	UNCOATED	CYLINDRICAL
N62033	S545-1.250-D4-S.0-Z7	1-1/4	1-1/4	5	7-1/2	7	AITIN	CYLINDRICAL

S545R

SOLID
CARBIDE

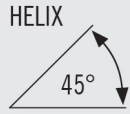

RADIUS



CENTER
CUTTING



- Eccentric primary relief
- Ideal for peripheral finish milling in steel, stainless steel, titanium and high temperature alloys

ITEM NUMBER	DESCRIPTION	FLUTE DIA.	SHANK DIA.	LENGTH OF CUT	OVERALL LENGTH	FLUTES	COATING	RADIUS	SHANK TYPE
N90927	S545R-0.125-D2-R015.0-Z5	1/8	1/8	1/4	1-1/2	5	AITiN	0.015	CYLINDRICAL
N90928	S545R-0.125-D2-R020.0-Z5	1/8	1/8	1/4	1-1/2	5	AITiN	0.020	CYLINDRICAL
N90929	S545R-0.125-D4-R015.0-Z5	1/8	1/8	1/2	1-1/2	5	AITiN	0.015	CYLINDRICAL
N90930	S545R-0.125-D4-R020.0-Z5	1/8	1/8	1/2	1-1/2	5	AITiN	0.020	CYLINDRICAL
N90931	S545R-0.188-D2-R015.0-Z5	3/16	3/16	5/16	2	5	AITiN	0.015	CYLINDRICAL
N90932	S545R-0.188-D2-R020.0-Z5	3/16	3/16	5/16	2	5	AITiN	0.020	CYLINDRICAL
N90908	S545R-0.188-D3-R015.0-Z5	3/16	3/16	9/16	2	5	AITiN	0.015	CYLINDRICAL
N90933	S545R-0.188-D3-R020.0-Z5	3/16	3/16	9/16	2	5	AITiN	0.020	CYLINDRICAL
N90935	S545R-0.250-D2-R015.0-Z5	1/4	1/4	3/8	2	5	AITiN	0.015	CYLINDRICAL
N90936	S545R-0.250-D2-R020.0-Z5	1/4	1/4	3/8	2	5	AITiN	0.020	CYLINDRICAL
N90937	S545R-0.250-D2-R030.0-Z5	1/4	1/4	3/8	2	5	AITiN	0.030	CYLINDRICAL
N90938	S545R-0.250-D2-R045.0-Z5	1/4	1/4	3/8	2	5	AITiN	0.045	CYLINDRICAL
N90926	S545R-0.250-D3-R015.0-Z5	1/4	1/4	3/4	2-1/2	5	AITiN	0.015	CYLINDRICAL
N90940	S545R-0.250-D3-R020.0-Z5	1/4	1/4	3/4	2-1/2	5	AITiN	0.020	CYLINDRICAL
N90934	S545R-0.250-D3-R030.0-Z5	1/4	1/4	3/4	2-1/2	5	AITiN	0.030	CYLINDRICAL
N90941	S545R-0.250-D3-R045.0-Z5	1/4	1/4	3/4	2-1/2	5	AITiN	0.045	CYLINDRICAL
N90943	S545R-0.313-D1-R015.0-Z5	5/16	5/16	7/16	2	5	AITiN	0.015	CYLINDRICAL
N90945	S545R-0.313-D1-R030.0-Z5	5/16	5/16	7/16	2	5	AITiN	0.030	CYLINDRICAL
N90944	S545R-0.313-D1-R020.0-Z5	5/16	5/16	7/16	2	5	AITiN	0.020	CYLINDRICAL
N90946	S545R-0.313-D1-R045.0-Z5	5/16	5/16	7/16	2	5	AITiN	0.045	CYLINDRICAL
N90947	S545R-0.313-D3-R015.0-Z5	5/16	5/16	13/16	2-1/2	5	AITiN	0.015	CYLINDRICAL
N90948	S545R-0.313-D3-R020.0-Z5	5/16	5/16	13/16	2-1/2	5	AITiN	0.020	CYLINDRICAL
N90939	S545R-0.313-D3-R030.0-Z5	5/16	5/16	13/16	2-1/2	5	AITiN	0.030	CYLINDRICAL
N90949	S545R-0.313-D3-R045.0-Z5	5/16	5/16	13/16	2-1/2	5	AITiN	0.045	CYLINDRICAL
N90950	S545R-0.375-D1-R015.0-Z5	3/8	3/8	1/2	2	5	AITiN	0.015	CYLINDRICAL
N90952	S545R-0.375-D1-R020.0-Z5	3/8	3/8	1/2	2	5	AITiN	0.020	CYLINDRICAL
N90953	S545R-0.375-D1-R030.0-Z5	3/8	3/8	1/2	2	5	AITiN	0.030	CYLINDRICAL
N90954	S545R-0.375-D1-R045.0-Z5	3/8	3/8	1/2	2	5	AITiN	0.045	CYLINDRICAL
N90955	S545R-0.375-D1-R060.0-Z5	3/8	3/8	1/2	2	5	AITiN	0.060	CYLINDRICAL
N90956	S545R-0.375-D3-R015.0-Z5	3/8	3/8	1	2-1/2	5	AITiN	0.015	CYLINDRICAL
N90957	S545R-0.375-D3-R020.0-Z5	3/8	3/8	1	2-1/2	5	AITiN	0.020	CYLINDRICAL
N90958	S545R-0.375-D3-R030.0-Z5	3/8	3/8	1	2-1/2	5	AITiN	0.030	CYLINDRICAL
N90942	S545R-0.375-D3-R045.0-Z5	3/8	3/8	1	2-1/2	5	AITiN	0.045	CYLINDRICAL
N90960	S545R-0.438-D1-R015.0-Z5	7/16	7/16	9/16	2-1/2	5	AITiN	0.015	CYLINDRICAL
N90961	S545R-0.438-D1-R020.0-Z5	7/16	7/16	9/16	2-1/2	5	AITiN	0.020	CYLINDRICAL
N90962	S545R-0.438-D1-R030.0-Z5	7/16	7/16	9/16	2-1/2	5	AITiN	0.030	CYLINDRICAL
N90963	S545R-0.438-D1-R045.0-Z5	7/16	7/16	9/16	2-1/2	5	AITiN	0.045	CYLINDRICAL
N90964	S545R-0.438-D1-R060.0-Z5	7/16	7/16	9/16	2-1/2	5	AITiN	0.060	CYLINDRICAL
N90965	S545R-0.438-D1-R090.0-Z5	7/16	7/16	9/16	2-1/2	5	AITiN	0.090	CYLINDRICAL
N90967	S545R-0.438-D1-R125.0-Z5	7/16	7/16	9/16	2-1/2	5	AITiN	0.125	CYLINDRICAL
N90951	S545R-0.438-D2-R015.0-Z5	7/16	7/16	1	2-3/4	5	AITiN	0.015	CYLINDRICAL
N90972	S545R-0.438-D2-R020.0-Z5	7/16	7/16	1	2-3/4	5	AITiN	0.020	CYLINDRICAL

S545R (CONT.)

SOLID CARBIDE

HELIX

RADIUS



CENTER CUTTING



- Eccentric primary relief
- Ideal for peripheral finish milling in steel, stainless steel, titanium and high temperature alloys

ITEM NUMBER	DESCRIPTION	FLUTE DIA.	SHANK DIA.	LENGTH OF CUT	OVERALL LENGTH	FLUTES	COATING	RADIUS	SHANK TYPE
N90973	S545R-0.438-D2-R030.0-Z5	7/16	7/16	1	2-3/4	5	AITIN	0.030	CYLINDRICAL
N90976	S545R-0.438-D2-R045.0-Z5	7/16	7/16	1	2-3/4	5	AITIN	0.045	CYLINDRICAL
N90977	S545R-0.438-D2-R060.0-Z5	7/16	7/16	1	2-3/4	5	AITIN	0.060	CYLINDRICAL
N90978	S545R-0.438-D2-R090.0-Z5	7/16	7/16	1	2-3/4	5	AITIN	0.090	CYLINDRICAL
N90979	S545R-0.438-D2-R125.0-Z5	7/16	7/16	1	2-3/4	5	AITIN	0.125	CYLINDRICAL
N90982	S545R-0.500-D1-R015.0-Z5	1/2	1/2	5/8	2-1/2	5	AITIN	0.015	CYLINDRICAL
N90987	S545R-0.500-D1-R020.0-Z5	1/2	1/2	5/8	2-1/2	5	AITIN	0.020	CYLINDRICAL
N91004	S545R-0.500-D1-R030.0-Z5	1/2	1/2	5/8	2-1/2	5	AITIN	0.030	CYLINDRICAL
N91008	S545R-0.500-D1-R045.0-Z5	1/2	1/2	5/8	2-1/2	5	AITIN	0.045	CYLINDRICAL
N91009	S545R-0.500-D1-R060.0-Z5	1/2	1/2	5/8	2-1/2	5	AITIN	0.060	CYLINDRICAL
N91010	S545R-0.500-D1-R090.0-Z5	1/2	1/2	5/8	2-1/2	5	AITIN	0.090	CYLINDRICAL
N91011	S545R-0.500-D1-R125.0-Z5	1/2	1/2	5/8	2-1/2	5	AITIN	0.125	CYLINDRICAL
N90959	S545R-0.500-D3-R015.0-Z5	1/2	1/2	1-1/4	3	5	AITIN	0.015	CYLINDRICAL
N91012	S545R-0.500-D3-R020.0-Z5	1/2	1/2	1-1/4	3	5	AITIN	0.020	CYLINDRICAL
N91013	S545R-0.500-D3-R030.0-Z5	1/2	1/2	1-1/4	3	5	AITIN	0.030	CYLINDRICAL
N91015	S545R-0.500-D3-R045.0-Z5	1/2	1/2	1-1/4	3	5	AITIN	0.045	CYLINDRICAL
N91017	S545R-0.500-D3-R060.0-Z5	1/2	1/2	1-1/4	3	5	AITIN	0.060	CYLINDRICAL
N91019	S545R-0.500-D3-R090.0-Z5	1/2	1/2	1-1/4	3	5	AITIN	0.090	CYLINDRICAL
N91021	S545R-0.500-D3-R125.0-Z5	1/2	1/2	1-1/4	3	5	AITIN	0.125	CYLINDRICAL
N91042	S545R-0.625-D1-R015.0-Z5	5/8	5/8	3/4	3	5	AITIN	0.015	CYLINDRICAL
N91051	S545R-0.625-D1-R020.0-Z5	5/8	5/8	3/4	3	5	AITIN	0.020	CYLINDRICAL
N91060	S545R-0.625-D1-R030.0-Z5	5/8	5/8	3/4	3	5	AITIN	0.030	CYLINDRICAL
N91075	S545R-0.625-D1-R045.0-Z5	5/8	5/8	3/4	3	5	AITIN	0.045	CYLINDRICAL
N91076	S545R-0.625-D1-R060.0-Z5	5/8	5/8	3/4	3	5	AITIN	0.060	CYLINDRICAL
N91077	S545R-0.625-D1-R090.0-Z5	5/8	5/8	3/4	3	5	AITIN	0.090	CYLINDRICAL
N91078	S545R-0.625-D1-R125.0-Z5	5/8	5/8	3/4	3	5	AITIN	0.125	CYLINDRICAL
N90980	S545R-0.625-D3-R015.0-Z5	5/8	5/8	1-5/8	3-1/2	5	AITIN	0.015	CYLINDRICAL
N91079	S545R-0.625-D3-R020.0-Z5	5/8	5/8	1-5/8	3-1/2	5	AITIN	0.020	CYLINDRICAL
N91084	S545R-0.625-D3-R030.0-Z5	5/8	5/8	1-5/8	3-1/2	5	AITIN	0.030	CYLINDRICAL
N91086	S545R-0.625-D3-R045.0-Z5	5/8	5/8	1-5/8	3-1/2	5	AITIN	0.045	CYLINDRICAL
N91090	S545R-0.625-D3-R060.0-Z5	5/8	5/8	1-5/8	3-1/2	5	AITIN	0.060	CYLINDRICAL
N91091	S545R-0.625-D3-R090.0-Z5	5/8	5/8	1-5/8	3-1/2	5	AITIN	0.090	CYLINDRICAL
N91093	S545R-0.625-D3-R125.0-Z5	5/8	5/8	1-5/8	3-1/2	5	AITIN	0.125	CYLINDRICAL
N91095	S545R-0.750-D1-R015.0-Z5	3/4	3/4	1	3	5	AITIN	0.015	CYLINDRICAL
N91096	S545R-0.750-D1-R020.0-Z5	3/4	3/4	1	3	5	AITIN	0.020	CYLINDRICAL
N91097	S545R-0.750-D1-R030.0-Z5	3/4	3/4	1	3	5	AITIN	0.030	CYLINDRICAL
N91098	S545R-0.750-D1-R045.0-Z5	3/4	3/4	1	3	5	AITIN	0.045	CYLINDRICAL
N91099	S545R-0.750-D1-R060.0-Z5	3/4	3/4	1	3	5	AITIN	0.060	CYLINDRICAL
N91102	S545R-0.750-D1-R090.0-Z5	3/4	3/4	1	3	5	AITIN	0.090	CYLINDRICAL
N91103	S545R-0.750-D1-R125.0-Z5	3/4	3/4	1	3	5	AITIN	0.125	CYLINDRICAL
N91104	S545R-0.750-D1-R190.0-Z5	3/4	3/4	1	3	5	AITIN	0.190	CYLINDRICAL
N91039	S545R-0.750-D2-R015.0-Z5	3/4	3/4	1-5/8	4	5	AITIN	0.015	CYLINDRICAL

S545R (CONT.)

SOLID CARBIDE	 <p>HELIX 45°</p>	 <p>RADIUS</p>	CENTER CUTTING
---------------	--	---	----------------



- Eccentric primary relief
- Ideal for peripheral finish milling in steel, stainless steel, titanium and high temperature alloys

ITEM NUMBER	DESCRIPTION	FLUTE DIA.	SHANK DIA.	LENGTH OF CUT	OVERALL LENGTH	FLUTES	COATING	RADIUS	SHANK TYPE
N91105	S545R-0.750-D2-R020.0-Z5	3/4	3/4	1-5/8	4	5	AlTiN	0.020	CYLINDRICAL
N91107	S545R-0.750-D2-R030.0-Z5	3/4	3/4	1-5/8	4	5	AlTiN	0.030	CYLINDRICAL
N91108	S545R-0.750-D2-R045.0-Z5	3/4	3/4	1-5/8	4	5	AlTiN	0.045	CYLINDRICAL
N91110	S545R-0.750-D2-R060.0-Z5	3/4	3/4	1-5/8	4	5	AlTiN	0.060	CYLINDRICAL
N91111	S545R-0.750-D2-R090.0-Z5	3/4	3/4	1-5/8	4	5	AlTiN	0.090	CYLINDRICAL
N91116	S545R-0.750-D2-R125.0-Z5	3/4	3/4	1-5/8	4	5	AlTiN	0.125	CYLINDRICAL
N91117	S545R-0.750-D2-R190.0-Z5	3/4	3/4	1-5/8	4	5	AlTiN	0.190	CYLINDRICAL
N91133	S545R-1.000-D1-R015.0-Z5	1	1	1-1/4	4	5	AlTiN	0.015	CYLINDRICAL
N91094	S545R-1.000-D2-R015.0-Z5	1	1	2	4	5	AlTiN	0.015	CYLINDRICAL
N91148	S545R-1.000-D2-R030.0-Z5	1	1	2	4	5	AlTiN	0.030	CYLINDRICAL
N91149	S545R-1.000-D2-R045.0-Z5	1	1	2	4	5	AlTiN	0.045	CYLINDRICAL
N91152	S545R-1.000-D2-R060.0-Z5	1	1	2	4	5	AlTiN	0.060	CYLINDRICAL
N91155	S545R-1.000-D2-R090.0-Z5	1	1	2	4	5	AlTiN	0.090	CYLINDRICAL
N91158	S545R-1.000-D2-R125.0-Z5	1	1	2	4	5	AlTiN	0.125	CYLINDRICAL
N91163	S545R-1.000-D2-R190.0-Z5	1	1	2	4	5	AlTiN	0.190	CYLINDRICAL

S645M

SOLID
CARBIDE

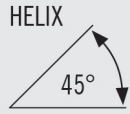

CENTER
CUTTING



- Eccentric primary relief
- Ideal for peripheral finish milling in steel, stainless steel, titanium and high temperature alloys

ITEM NUMBER	DESCRIPTION	FLUTE DIA.	SHANK DIA.	LENGTH OF CUT	OVERALL LENGTH	FLUTES	COATING	SHANK TYPE
N47858	S645M-030-D4-S.0-Z6	3	3	12	38	6	AlTiN	CYLINDRICAL
N47860	S645M-040-D2-S.0-Z6	4	4	6	50	6	AlTiN	CYLINDRICAL
N47862	S645M-040-D3-S.0-Z6	4	4	12	50	6	AlTiN	CYLINDRICAL
N47864	S645M-050-D3-S.0-Z6	5	5	14	50	6	AlTiN	CYLINDRICAL
N47866	S645M-060-D1-S.0-Z6	6	6	8	51	6	AlTiN	CYLINDRICAL
N47868	S645M-060-D3-S.0-Z6	6	6	16	58	6	AlTiN	CYLINDRICAL
N47870	S645M-080-D1-S.0-Z6	8	8	10	59	6	AlTiN	CYLINDRICAL
N47872	S645M-080-D2-S.0-Z6	8	8	20	64	6	AlTiN	CYLINDRICAL
N47874	S645M-100-D1-S.0-Z6	10	10	11	67	6	AlTiN	CYLINDRICAL
N47876	S645M-100-D2-S.0-Z6	10	10	22	73	6	AlTiN	CYLINDRICAL
N47880	S645M-120-D3-S.0-Z6	12	12	32	84	6	AlTiN	CYLINDRICAL
N47886	S645M-160-D1-S.0-Z6	16	16	16	83	6	AlTiN	CYLINDRICAL
N47888	S645M-160-D2-S.0-Z6	16	16	36	89	6	AlTiN	CYLINDRICAL
N47894	S645M-200-D2-S.0-Z6	20	20	38	101	6	AlTiN	CYLINDRICAL
N47896	S645M-200-D3-S.0-Z6	20	20	50	104	6	AlTiN	CYLINDRICAL

SR420 & SR420M

SOLID CARBIDE

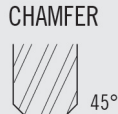

CENTER CUTTING



- Fine-pitch knuckle form
- Designed for steels, stainless steel, and cast iron

ITEM NUMBER	DESCRIPTION	FLUTE DIA.	SHANK DIA.	LENGTH OF CUT	OVERALL LENGTH	FLUTES	COATING	CHAMFER	SHANK TYPE
INCH - SR420									
N76130	SR420-0.250-D2-C020.0-Z4	1/4	1/4	3/8	2	4	UNCOATED	0.020	CYLINDRICAL
N76178	SR420-0.250-D2-C020.0-Z4	1/4	1/4	3/8	2	4	AlTiN	0.020	CYLINDRICAL
N76131	SR420-0.250-D3-C020.0-Z4	1/4	1/4	3/4	2-1/2	4	UNCOATED	0.020	CYLINDRICAL
N76179	SR420-0.250-D3-C020.0-Z4	1/4	1/4	3/4	2-1/2	4	AlTiN	0.020	CYLINDRICAL
N76132	SR420-0.313-D1-C020.0-Z4	5/16	5/16	7/16	2	4	UNCOATED	0.020	CYLINDRICAL
N76180	SR420-0.313-D1-C020.0-Z4	5/16	5/16	7/16	2	4	AlTiN	0.020	CYLINDRICAL
N76133	SR420-0.313-D3-C020.0-Z4	5/16	5/16	13/16	2-1/2	4	UNCOATED	0.020	CYLINDRICAL
N76181	SR420-0.313-D3-C020.0-Z4	5/16	5/16	13/16	2-1/2	4	AlTiN	0.020	CYLINDRICAL
N76134	SR420-0.375-D1-C020.3-Z4	3/8	3/8	1/2	2	4	UNCOATED	0.020	WELDON
N76182	SR420-0.375-D1-C020.3-Z4	3/8	3/8	1/2	2	4	AlTiN	0.020	WELDON
N76135	SR420-0.375-D3-C020.3-Z4	3/8	3/8	1	2-1/2	4	UNCOATED	0.020	WELDON
N76183	SR420-0.375-D3-C020.3-Z4	3/8	3/8	1	2-1/2	4	AlTiN	0.020	WELDON
N76136	SR420-0.438-D1-C020.3-Z4	7/16	7/16	9/16	2-1/2	4	UNCOATED	0.020	WELDON
N76184	SR420-0.438-D1-C020.3-Z4	7/16	7/16	9/16	2-1/2	4	AlTiN	0.020	WELDON
N76137	SR420-0.438-D2-C020.3-Z4	7/16	7/16	1	2-3/4	4	UNCOATED	0.020	WELDON
N76185	SR420-0.438-D2-C020.3-Z4	7/16	7/16	1	2-3/4	4	AlTiN	0.020	WELDON
N76138	SR420-0.500-D1-C025.3-Z4	1/2	1/2	5/8	2-1/2	4	UNCOATED	0.025	WELDON
N76186	SR420-0.500-D1-C025.3-Z4	1/2	1/2	5/8	2-1/2	4	AlTiN	0.025	WELDON
N76139	SR420-0.500-D3-C025.3-Z4	1/2	1/2	1-1/4	3	4	UNCOATED	0.025	WELDON
N76187	SR420-0.500-D3-C025.3-Z4	1/2	1/2	1-1/4	3	4	AlTiN	0.025	WELDON
N76140	SR420-0.625-D1-C025.3-Z4	5/8	5/8	3/4	3	4	UNCOATED	0.025	WELDON
N76188	SR420-0.625-D1-C025.3-Z4	5/8	5/8	3/4	3	4	AlTiN	0.025	WELDON
N76141	SR420-0.625-D3-C025.3-Z4	5/8	5/8	1-5/8	3-1/2	4	UNCOATED	0.025	WELDON
N76189	SR420-0.625-D3-C025.3-Z4	5/8	5/8	1-5/8	3-1/2	4	AlTiN	0.025	WELDON
N76142	SR420-0.750-D1-C025.3-Z4	3/4	3/4	1	3	4	UNCOATED	0.025	WELDON
N76190	SR420-0.750-D1-C025.3-Z4	3/4	3/4	1	3	4	AlTiN	0.025	WELDON
N76143	SR420-0.750-D2-C025.3-Z4	3/4	3/4	1-5/8	4	4	UNCOATED	0.025	WELDON
N76191	SR420-0.750-D2-C025.3-Z4	3/4	3/4	1-5/8	4	4	AlTiN	0.025	WELDON
N76144	SR420-1.000-D1-C025.3-Z5	1	1	1-1/4	4	5	UNCOATED	0.025	WELDON
N76192	SR420-1.000-D1-C025.3-Z5	1	1	1-1/4	4	5	AlTiN	0.025	WELDON
N76145	SR420-1.000-D2-C025.3-Z5	1	1	2	5	5	UNCOATED	0.025	WELDON
N76193	SR420-1.000-D2-C025.3-Z5	1	1	2	5	5	AlTiN	0.025	WELDON
METRIC - SR420M									
N47902	SR420M-060-D3-C050.0-Z4	6	6	16	58	4	AlTiN	0.50	CYLINDRICAL
N47904	SR420M-080-D2-C050.0-Z4	8	8	20	64	4	AlTiN	0.50	CYLINDRICAL
N47906	SR420M-100-D2-C050.0-Z4	10	10	22	73	4	AlTiN	0.50	CYLINDRICAL
N47907	SR420M-120-D1-C100.0-Z4	12	12	12	74	4	AlTiN	1.00	CYLINDRICAL
N47908	SR420M-120-D3-C100.0-Z4	12	12	32	84	4	AlTiN	1.00	CYLINDRICAL
N47910	SR420M-140-D2-C100.0-Z4	14	14	32	84	4	AlTiN	1.00	CYLINDRICAL
N47912	SR420M-160-D2-C100.0-Z4	16	16	36	93	4	AlTiN	1.00	CYLINDRICAL
N47916	SR420M-200-D3-C100.0-Z4	20	20	50	105	4	AlTiN	1.00	CYLINDRICAL

SR545

SOLID CARBIDE

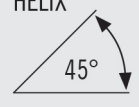
HELIX

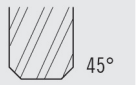
CHAMFER

CENTER CUTTING



- Fine-pitch knuckle profile
- Designed for peripheral milling (25% of tool diameter maximum) Stainless, High Temp Alloys, Titanium
- High shearing action to reduce radial deflection
- Fine pitch knuckle design

ITEM NUMBER	DESCRIPTION	FLUTE DIA.	SHANK DIA.	LENGTH OF CUT	OVERALL LENGTH	FLUTES	COATING	CHAMFER	SHANK TYPE
N99092	SR545-0.375-D1-C020.0-Z5	3/8	3/8	1/2	2	5	AITIN	0.020	CYLINDRICAL
N99093	SR545-0.375-D3-C020.0-Z5	3/8	3/8	1	2-1/2	5	AITIN	0.020	CYLINDRICAL
N99096	SR545-0.500-D1-C025.0-Z5	1/2	1/2	5/8	2-1/2	5	AITIN	0.025	CYLINDRICAL
N99097	SR545-0.500-D3-C025.0-Z5	1/2	1/2	1-1/4	3	5	AITIN	0.025	CYLINDRICAL
N99057	SR545-0.625-D3-C025.0-Z5	5/8	5/8	1-5/8	3-1/2	5	UNCOATED	0.025	CYLINDRICAL
N99099	SR545-0.625-D3-C025.0-Z5	5/8	5/8	1-5/8	3-1/2	5	AITIN	0.025	CYLINDRICAL
N99100	SR545-0.750-D1-C025.0-Z5	3/4	3/4	1	3	5	AITIN	0.025	CYLINDRICAL
N99101	SR545-0.750-D2-C025.0-Z5	3/4	3/4	1-5/8	4	5	AITIN	0.025	CYLINDRICAL
N99103	SR545-1.000-D2-C025.0-Z5	1	1	2	4	5	AITIN	0.025	CYLINDRICAL

CUTTING DATA - ELITE S SERIES HIGH PERFORMANCE



NS240R - START VALUES

SIDE MILLING - FINISHING

ISO GROUP	SMG	a _p x Dc (max)	a _e x Dc (max)	V _f (sf / min)	n (rev/min)	Z _η = 2							
						1/4	5/16	3/8	1/2	5/8	3/4	1	1 1/4
P	E / M / A 1 - 2	5	0.02	660	n (rev/min)	10080	8070	6720	5040	4030	3360	2520	2020
					f _z (in)	0.0025	0.0031	0.0038	0.0050	0.0063	0.0075	0.0100	0.0125
					V _f (in/min)	50	50	50	50	50	50	50	50
	E / M / A 3 - 4	5	0.02	590	n (rev/min)	9020	7210	6010	4510	3610	3010	2250	1800
					f _z (in)	0.0025	0.0031	0.0038	0.0050	0.0063	0.0075	0.0100	0.0125
					V _f (in/min)	45	45	45	45	45	45	45	45
	E / M / A 5 - 6	5	0.02	520	n (rev/min)	7950	6360	5300	3970	3180	2650	1990	1590
					f _z (in)	0.0025	0.0031	0.0038	0.0050	0.0063	0.0075	0.0100	0.0125
					V _f (in/min)	40	40	40	40	40	40	40	40
M	E / M / A 8 - 9	5	0.02	330	n (rev/min)	5040	4030	3360	2520	2020	1680	1260	1010
					f _z (in)	0.0025	0.0031	0.0038	0.0050	0.0063	0.0075	0.0100	0.0125
					V _f (in/min)	25	25	25	25	25	25	25	25
	E / M / A 10 - 11	5	0.02	260	n (rev/min)	3970	3180	2650	1990	1590	1320	990	790
					f _z (in)	0.0025	0.0031	0.0038	0.0050	0.0063	0.0075	0.0100	0.0125
					V _f (in/min)	20	20	20	20	20	20	20	20
K	E 12 - 13	5	0.02	390	n (rev/min)	5960	4770	3970	2980	2380	1990	1490	1190
					f _z (in)	0.0025	0.0031	0.0038	0.0050	0.0063	0.0075	0.0100	0.0125
					V _f (in/min)	30	30	30	30	30	30	30	30
	E 14 - 15	5	0.02	330	n (rev/min)	5040	4030	3360	2520	2020	1680	1260	1010
					f _z (in)	0.0025	0.0031	0.0038	0.0050	0.0063	0.0075	0.0100	0.0125
					V _f (in/min)	25	25	25	25	25	25	25	25
N	E / M / A 16	5	0.02	2620	n (rev/min)	40030	32030	26690	20020	16010	13340	10010	8010
					f _z (in)	0.0025	0.0031	0.0038	0.0050	0.0063	0.0075	0.0100	0.0125
					V _f (in/min)	200	200	200	200	200	200	200	200
	E / M / A 17	5	0.02	2620	n (rev/min)	40030	32030	26690	20020	16010	13340	10010	8010
					f _z (in)	0.0025	0.0031	0.0038	0.0050	0.0063	0.0075	0.0100	0.0125
					V _f (in/min)	200	200	200	200	200	200	200	200
	E / M / A 18	5	0.02	1310	n (rev/min)	20020	16010	13340	10010	8010	6670	5000	4000
					f _z (in)	0.0025	0.0031	0.0038	0.0050	0.0063	0.0075	0.0100	0.0125
					V _f (in/min)	100	100	100	100	100	100	100	100
S	E / M / A 19	5	0.02	160	n (rev/min)	2440	1960	1630	1220	980	810	610	490
					f _z (in)	0.0018	0.0022	0.0026	0.0035	0.0044	0.0053	0.0070	0.0088
					V _f (in/min)	9	9	9	9	9	9	9	9
	E / M / A 20	5	0.02	160	n (rev/min)	2440	1960	1630	1220	980	810	610	490
					f _z (in)	0.0018	0.0022	0.0026	0.0035	0.0044	0.0053	0.0070	0.0088
					V _f (in/min)	9	9	9	9	9	9	9	9
	E / M / A 21	5	0.02	130	n (rev/min)	1990	1590	1320	990	790	660	500	400
					f _z (in)	0.0018	0.0022	0.0026	0.0035	0.0044	0.0053	0.0070	0.0088
V _f (in/min)					7	7	7	7	7	7	7	7	
E / M / A 22	5	0.02	330	n (rev/min)	5040	4030	3360	2520	2020	1680	1260	1010	
				f _z (in)	0.0025	0.0031	0.0038	0.0050	0.0063	0.0075	0.0100	0.0125	
				V _f (in/min)	25	25	25	25	25	25	25	25	
GR	A / D GRAPHITE	5	0.02	3280	n (rev/min)	50120	40090	33410	25060	20050	16710	12530	10020
					f _z (in)	0.0025	0.0031	0.0038	0.0050	0.0063	0.0075	0.0100	0.0125
					V _f (in/min)	251	251	251	251	251	251	251	251
TS	A / D PLASTIC (SOFT)	5	0.02	3280	n (rev/min)	50120	40090	33410	25060	20050	16710	12530	10020
					f _z (in)	0.0025	0.0031	0.0038	0.0050	0.0063	0.0075	0.0100	0.0125
					V _f (in/min)	251	251	251	251	251	251	251	251
TP	A / D PLASTIC (HARD)	5	0.02	1970	n (rev/min)	30100	24080	20070	15050	12040	10030	7530	6020
					f _z (in)	0.0025	0.0031	0.0038	0.0050	0.0063	0.0075	0.0100	0.0125
					V _f (in/min)	151	151	151	151	151	151	151	151

SMG = Seco Material Group
 n [min-1] = RPM
 V_c (sf/min) = Surface feet/min

f_z [in] = Feed/tooth
 a_p/D_c = % of diameter
 v_f [in/min] = Feed rate
 a_e/D_c = % of diameter

A = Air D = Dry E = Emulsion (flood coolant) M = Mist
 All cutting data are start values. All cutting data is in inch values.
 Please reference the Workpiece Material Classification chart located on page 15.

S335 - START VALUES

		SLOTTING											
ISO GROUP	SMG	$a_p \times D_c$ (max)	$a_e \times D_c$ (max)	v_c (sf / min)		$Z_n = 3$							
						1/16	1/8	1/4	3/8	1/2	5/8	3/4	1
P	E 1 - 2	1.0	1.00	395	n (rev/min)	24142	12071	6036	4024	3018	2414	2012	1509
					f_z (in)	0.0003	0.0005	0.0010	0.0015	0.0020	0.0025	0.0030	0.0040
					v_f (in/min)	18	18	18	18	18	18	18	18
	E 3 - 4	1.0	1.00	330	n (rev/min)	20170	10085	5042	3362	2521	2017	1681	1261
					f_z (in)	0.0003	0.0005	0.0010	0.0015	0.0020	0.0025	0.0030	0.0040
					v_f (in/min)	15	15	15	15	15	15	15	15
	E 5 - 6	1.0	1.00	260	n (rev/min)	15891	7946	3973	2649	1986	1589	1324	993
					f_z (in)	0.0002	0.0004	0.0008	0.0012	0.0016	0.0020	0.0024	0.0032
					v_f (in/min)	10	10	10	10	10	10	10	10
M	E 8 - 9	1.0	1.00	260	n (rev/min)	15891	7946	3973	2649	1986	1589	1324	993
					f_z (in)	0.0002	0.0003	0.0007	0.0010	0.0013	0.0016	0.0020	0.0026
					v_f (in/min)	8	8	8	8	8	8	8	8
	E 10 - 11	1.0	1.00	230	n (rev/min)	14058	7029	3514	2343	1757	1406	1171	879
					f_z (in)	0.0002	0.0003	0.0007	0.0010	0.0013	0.0016	0.0020	0.0026
					v_f (in/min)	7	7	7	7	7	7	7	7
K	E 12 - 13	1.0	1.00	385	n (rev/min)	23531	11766	5883	3922	2941	2353	1961	1471
					f_z (in)	0.0003	0.0006	0.0011	0.0017	0.0023	0.0028	0.0034	0.0045
					v_f (in/min)	20	20	20	20	20	20	20	20
	E 14 - 15	1.0	1.00	340	n (rev/min)	20781	10390	5195	3463	2598	2078	1732	1299
					f_z (in)	0.0003	0.0006	0.0011	0.0017	0.0023	0.0028	0.0034	0.0045
					v_f (in/min)	18	18	18	18	18	18	18	18
S	E 19	1.0	1.00	110	n (rev/min)	6723	3362	1681	1121	840	672	560	420
					f_z (in)	0.0001	0.0002	0.0005	0.0007	0.0009	0.0011	0.0014	0.0018
					v_f (in/min)	2	2	2	2	2	2	2	2
	E 20	1.0	1.00	110	n (rev/min)	6723	3362	1681	1121	840	672	560	420
					f_z (in)	0.0001	0.0002	0.0005	0.0007	0.0009	0.0011	0.0014	0.0018
					v_f (in/min)	2	2	2	2	2	2	2	2
	E 21	1.0	1.00	70	n (rev/min)	4278	2139	1070	713	535	428	357	267
					f_z (in)	0.0001	0.0002	0.0004	0.0006	0.0008	0.0009	0.0011	0.0015
					v_f (in/min)	1	1	1	1	1	1	1	1
	E 22	1.0	1.00	180	n (rev/min)	11002	5501	2750	1834	1375	1100	917	688
f_z (in)					0.0001	0.0003	0.0006	0.0009	0.0011	0.0014	0.0017	0.0023	
v_f (in/min)					5	5	5	5	5	5	5	5	

SMG = Seco Material Group
 n [min-1] = RPM
 v_c (sf/min) = Surface feet/min

f_z [in] = Feed/tooth
 a_p/D_c = % of diameter
 v_f [in/min] = Feed rate
 a_e/D_c = % of diameter

A = Air D = Dry E = Emulsion (flood coolant) M = Mist
 All cutting data are start values. All cutting data is in inch values.
 Please reference the Workpiece Material Classification chart located on page 15.

S335 - START VALUES

SIDE MILLING - ROUGHING

ISO GROUP	SMG	$a_p \times D_c$ (max)	$a_e \times D_c$ (max)	V_c (sf / min)		$Z_n = 3$							
						1/16	1/8	1/4	3/8	1/2	5/8	3/4	1
P	E 1 - 2	1.0	0.20	525	n (rev/min)	32088	16044	8022	5348	4011	3209	2674	2006
					f_z (in)	0.0001	0.0002	0.0005	0.0007	0.0009	0.0011	0.0014	0.0018
					v_f (in/min)	11	11	11	11	11	11	11	11
	E 3 - 4	1.0	0.20	460	n (rev/min)	28115	14058	7029	4686	3514	2812	2343	1757
					f_z (in)	0.0001	0.0002	0.0005	0.0007	0.0009	0.0011	0.0014	0.0018
					v_f (in/min)	10	10	10	10	10	10	10	10
	E 5 - 6	1.0	0.20	330	n (rev/min)	20170	10085	5042	3362	2521	2017	1681	1261
					f_z (in)	0.0001	0.0002	0.0005	0.0007	0.0009	0.0011	0.0014	0.0018
					v_f (in/min)	7	7	7	7	7	7	7	7
M	E 8 - 9	1.0	0.20	280	n (rev/min)	17114	8557	4278	2852	2139	1711	1426	1070
					f_z (in)	0.0001	0.0002	0.0004	0.0006	0.0008	0.0011	0.0013	0.0017
					v_f (in/min)	5	5	5	5	5	5	5	5
	E 10 - 11	1.0	0.20	250	n (rev/min)	15280	7640	3820	2547	1910	1528	1273	955
					f_z (in)	0.0001	0.0002	0.0004	0.0006	0.0008	0.0011	0.0013	0.0017
					v_f (in/min)	5	5	5	5	5	5	5	5
K	E 12 - 13	1.0	0.20	340	n (rev/min)	20781	10390	5195	3463	2598	2078	1732	1299
					f_z (in)	0.0001	0.0002	0.0005	0.0007	0.0009	0.0011	0.0014	0.0018
					v_f (in/min)	7	7	7	7	7	7	7	7
	E 14 - 15	1.0	0.20	440	n (rev/min)	26893	13446	6723	4482	3362	2689	2241	1681
					f_z (in)	0.0001	0.0002	0.0005	0.0007	0.0009	0.0011	0.0014	0.0018
					v_f (in/min)	9	9	9	9	9	9	9	9
S	E 19	0.5	0.20	120	n (rev/min)	7334	3667	1834	1222	917	733	611	458
					f_z (in)	0.0001	0.0002	0.0005	0.0007	0.0009	0.0011	0.0014	0.0018
					v_f (in/min)	3	3	3	3	3	3	3	3
	E 20	0.5	0.20	120	n (rev/min)	7334	3667	1834	1222	917	733	611	458
					f_z (in)	0.0001	0.0002	0.0005	0.0007	0.0009	0.0011	0.0014	0.0018
					v_f (in/min)	3	3	3	3	3	3	3	3
	E 21	0.5	0.20	80	n (rev/min)	4890	2445	1222	815	611	489	407	306
					f_z (in)	0.0001	0.0002	0.0004	0.0006	0.0008	0.0009	0.0011	0.0015
					v_f (in/min)	1	1	1	1	1	1	1	1
	E 22	0.5	0.20	220	n (rev/min)	13446	6723	3362	2241	1681	1345	1121	840
					f_z (in)	0.0001	0.0003	0.0006	0.0009	0.0011	0.0014	0.0017	0.0023
					v_f (in/min)	6	6	6	6	6	6	6	6

SMG = Seco Material Group
 n [min-1] = RPM
 V_c (sf/min) = Surface feet/min

f_z [in] = Feed/tooth
 a_p/D_c = % of diameter
 v_f [in/min] = Feed rate
 a_e/D_c = % of diameter

A = Air D = Dry E = Emulsion (flood coolant) M = Mist
 All cutting data are start values. All cutting data is in inch values.
 Please reference the Workpiece Material Classification chart located on page 15.

CUTTING DATA - ELITE S SERIES HIGH PERFORMANCE

SB335 - START VALUES

SLOTTING													
ISO GROUP	SMG	$a_p \times D_c$ (max)	$a_e \times D_c$ (max)	V_c (sf / min)		$Z_n = 3$							
						1/16	1/8	1/4	3/8	1/2	5/8	3/4	1
P	E 1 - 2	1.0	0.75	315	n (rev/min)	19253	9626	4813	3209	2407	1925	1604	1203
					f_z (in)	0.0003	0.0005	0.0010	0.0015	0.0020	0.0025	0.0030	0.0040
					v_f (in/min)	14	14	14	14	14	14	14	14
	E 3 - 4	1.0	0.75	264	n (rev/min)	16136	8068	4034	2689	2017	1614	1345	1008
					f_z (in)	0.0003	0.0005	0.0010	0.0015	0.0020	0.0025	0.0030	0.0040
					v_f (in/min)	12	12	12	12	12	12	12	12
	E 5 - 6	1.0	0.75	208	n (rev/min)	12713	6356	3178	2119	1589	1271	1059	795
					f_z (in)	0.0002	0.0004	0.0008	0.0012	0.0016	0.0020	0.0024	0.0032
					v_f (in/min)	8	8	8	8	8	8	8	8
M	E 8 - 9	1.0	0.75	208	n (rev/min)	12713	6356	3178	2119	1589	1271	1059	795
					f_z (in)	0.0002	0.0003	0.0007	0.0010	0.0013	0.0016	0.0020	0.0026
					v_f (in/min)	6	6	6	6	6	6	6	6
	E 10 - 11	1.0	0.75	185	n (rev/min)	11307	5654	2827	1885	1413	1131	942	707
					f_z (in)	0.0002	0.0003	0.0007	0.0010	0.0013	0.0016	0.0020	0.0026
					v_f (in/min)	6	6	6	6	6	6	6	6
K	E 12 - 13	1.0	0.75	308	n (rev/min)	18825	9412	4706	3137	2353	1882	1569	1177
					f_z (in)	0.0003	0.0006	0.0011	0.0017	0.0023	0.0028	0.0034	0.0045
					v_f (in/min)	16	16	16	16	16	16	16	16
	E 14 - 15	1.0	0.75	272	n (rev/min)	16625	8312	4156	2771	2078	1662	1385	1039
					f_z (in)	0.0003	0.0006	0.0011	0.0017	0.0023	0.0028	0.0034	0.0045
					v_f (in/min)	14	14	14	14	14	4	14	14
S	E 19	1.0	0.75	88	n (rev/min)	5379	2689	1345	896	672	538	448	336
					f_z (in)	0.0001	0.0002	0.0005	0.0007	0.0009	0.0011	0.0014	0.0018
					v_f (in/min)	2	2	2	2	2	2	2	2
	E 20	1.0	0.75	88	n (rev/min)	5379	2689	1345	896	672	538	448	336
					f_z (in)	0.0001	0.0002	0.0005	0.0007	0.0009	0.0011	0.0014	0.0018
					v_f (in/min)	2	2	2	2	2	2	2	2
	E 21	1.0	0.75	56	n (rev/min)	3423	1711	856	570	428	342	285	214
					f_z (in)	0.0001	0.0002	0.0004	0.0006	0.0008	0.0009	0.0011	0.0015
					v_f (in/min)	1	1	1	1	1	1	1	1
	E 22	1.0	0.75	145	n (rev/min)	8862	4431	2216	1477	1108	886	739	554
f_z (in)					0.0001	0.0003	0.0006	0.0009	0.0011	0.0014	0.0017	0.0023	
				85	-	205	v_f (in/min)	4	4	4	4	4	4

SMG = Seco Material Group
 n [min-1] = RPM
 V_c (sf/min) = Surface feet/min

f_z [in] = Feed/tooth
 a_p/D_c = % of diameter
 v_f [in/min] = Feed rate
 a_e/D_c = % of diameter

A = Air D = Dry E = Emulsion (flood coolant) M = Mist
 All cutting data are start values. All cutting data is in inch values.
 Please reference the Workpiece Material Classification chart located on page 15.

SB335 - START VALUES

SIDE MILLING - ROUGHING													
ISO GROUP	SMG	a _p x Dc (max)	a _e x Dc (max)	v _c (sf / min)		Z _n = 3							
						1/16	1/8	1/4	3/8	1/2	5/8	3/4	1
P	E 1 - 2	1.0	0.20	420	n (rev/min)	25670	12835	6418	4278	3209	2567	2139	1604
					f _z (in)	0.0001	0.0002	0.0005	0.0007	0.0009	0.0011	0.0014	0.0018
					v _f (in/min)	9	9	9	9	9	9	9	9
	E 3 - 4	1.0	0.20	368	n (rev/min)	22492	11246	5623	3749	2812	2249	1874	1406
					f _z (in)	0.0001	0.0002	0.0005	0.0007	0.0009	0.0011	0.0014	0.0018
					v _f (in/min)	8	8	8	8	8	8	8	8
	E 5 - 6	1.0	0.20	264	n (rev/min)	16136	8068	4034	2689	2017	1614	1345	1008
					f _z (in)	0.0001	0.0002	0.0005	0.0007	0.0009	0.0011	0.0014	0.0018
					v _f (in/min)	5	5	5	5	5	5	5	5
M	E 8 - 9	1.0	0.20	225	n (rev/min)	13752	6876	3438	2292	1719	1375	1146	860
					f _z (in)	0.0001	0.0002	0.0004	0.0006	0.0008	0.0011	0.0013	0.0017
					v _f (in/min)	4	4	4	4	4	4	4	4
	E 10 - 11	1.0	0.20	200	n (rev/min)	12224	6112	3056	2037	1528	1222	1019	764
					f _z (in)	0.0001	0.0002	0.0004	0.0006	0.0008	0.0011	0.0013	0.0017
					v _f (in/min)	4	4	4	4	4	4	4	4
K	E 12 - 13	1.0	0.20	272	n (rev/min)	16625	8312	4156	2771	2078	1662	1385	1039
					f _z (in)	0.0001	0.0002	0.0005	0.0007	0.0009	0.0011	0.0014	0.0018
					v _f (in/min)	6	6	6	6	6	6	6	6
	E 14 - 15	1.0	0.20	350	n (rev/min)	21392	10696	5348	3565	2674	2139	1783	1337
					v _f (in/min)	7	7	7	7	7	7	7	7
S	E 19	0.5	0.20	96	n (rev/min)	5868	2934	1467	978	733	587	489	367
					f _z (in)	0.0001	0.0002	0.0005	0.0007	0.0009	0.0011	0.0014	0.0018
					v _f (in/min)	2	2	2	2	2	2	2	2
	E 20	0.5	0.20	96	n (rev/min)	5868	2934	1467	978	733	587	489	367
					f _z (in)	0.0001	0.0002	0.0005	0.0007	0.0009	0.0011	0.0014	0.0018
					v _f (in/min)	2	2	2	2	2	2	2	2
	E 21	0.5	0.20	64	n (rev/min)	3912	1956	978	652	489	391	326	244
					f _z (in)	0.0001	0.0002	0.0004	0.0006	0.0008	0.0009	0.0011	0.0015
	E 22	0.5	0.20	175	n (rev/min)	10696	5348	2674	1783	1337	1070	891	669
					f _z (in)	0.0001	0.0003	0.0006	0.0009	0.0011	0.0014	0.0017	0.0023
v _f (in/min)					5	5	5	5	5	5	5	5	
					115	-	235						

SMG = Seco Material Group
 n [min-1] = RPM
 v_c (sf/min) = Surface feet/min

f_z [in] = Feed/tooth
 a_p/D_c = % of diameter
 v_f [in/min] = Feed rate
 a_e/D_c = % of diameter

A = Air D = Dry E = Emulsion (flood coolant) M = Mist
 All cutting data are start values. All cutting data is in inch values.
 Please reference the Workpiece Material Classification chart located on page 15.

SN335 - START VALUES

		SLOTTING											
ISO GROUP	SMG	a _p x D _c (max)	a _e x D _c (max)	v _c (sf / min)		Z _n = 3							
						1/16	1/8	1/4	3/8	1/2	5/8	3/4	1
P	E 1 - 2	1.0	1.00	316	n (rev/min)	19314	9657	4828	3219	2414	1931	1609	1207
					f _z (in)	0.0002	0.0004	0.0008	0.0011	0.0015	0.0019	0.0023	0.0030
					v _f (in/min)	11	11	11	11	11	11	11	11
	E 3 - 4	1.0	1.00	264	n (rev/min)	16136	8068	4034	2689	2017	1614	1345	1008
					f _z (in)	0.0002	0.0004	0.0008	0.0011	0.0015	0.0019	0.0023	0.0030
					v _f (in/min)	9	9	9	9	9	9	9	9
	E 5 - 6	1.0	1.00	210	n (rev/min)	12835	6418	3209	2139	1604	1284	1070	802
					f _z (in)	0.0002	0.0003	0.0006	0.0009	0.0012	0.0015	0.0018	0.0024
					v _f (in/min)	6	6	6	6	6	6	6	6
M	E 8 - 9	1.0	1.00	210	n (rev/min)	12835	6418	3209	2139	1604	1284	1070	802
					f _z (in)	0.0001	0.0003	0.0005	0.0008	0.0010	0.0013	0.0015	0.0020
					v _f (in/min)	5	5	5	5	5	5	5	5
	E 10 - 11	1.0	1.00	185	n (rev/min)	11307	5654	2827	1885	1413	1131	942	707
					f _z (in)	0.0001	0.0003	0.0005	0.0008	0.0010	0.0013	0.0015	0.0020
					v _f (in/min)	4	4	4	4	4	4	4	4
K	E 12 - 13	1.0	1.00	310	n (rev/min)	18947	9474	4737	3158	2368	1895	1579	1184
					f _z (in)	0.0002	0.0004	0.0009	0.0013	0.0017	0.0021	0.0026	0.0034
					v _f (in/min)	12	12	12	12	12	12	12	12
	E 14 - 15	1.0	1.00	272	n (rev/min)	16625	8312	4156	2771	2078	1662	1385	1039
					f _z (in)	0.0002	0.0004	0.0009	0.0013	0.0017	0.0021	0.0026	0.0034
					v _f (in/min)	11	11	11	11	11	11	11	11
S	E 19	1.0	1.00	88	n (rev/min)	5379	2689	1345	896	672	538	448	336
					f _z (in)	0.0001	0.0002	0.0004	0.0005	0.0007	0.0009	0.0011	0.0014
					v _f (in/min)	1	1	1	1	1	1	1	1
	E 20	1.0	1.00	88	n (rev/min)	5379	2689	1345	896	672	538	448	336
					f _z (in)	0.0001	0.0002	0.0004	0.0005	0.0007	0.0009	0.0011	0.0014
					v _f (in/min)	1	1	1	1	1	1	1	1
	E 21	1.0	1.00	56	n (rev/min)	3423	1711	856	570	428	342	285	214
					f _z (in)	0.0001	0.0001	0.0003	0.0004	0.0006	0.0007	0.0008	0.0011
					v _f (in/min)	1	1	1	1	1	1	1	1
	E 22	1.0	1.00	144	n (rev/min)	8801	4401	2200	1467	1100	880	733	550
f _z (in)					0.0001	0.0002	0.0004	0.0006	0.0009	0.0011	0.0013	0.0017	
v _f (in/min)					3	3	3	3	3	3	3	3	

SMG = Seco Material Group
 n [min-1] = RPM
 v_c (sf/min) = Surface feet/min

f_z [in] = Feed/tooth
 a_p/D_c = % of diameter
 v_f [in/min] = Feed rate
 a_e/D_c = % of diameter

A = Air D = Dry E = Emulsion (flood coolant) M = Mist
 All cutting data are start values. All cutting data is in inch values.
 Please reference the Workpiece Material Classification chart located on page 15.

CUTTING DATA - ELITE S SERIES HIGH PERFORMANCE

SN335 - START VALUES

SIDE MILLING - ROUGHING													
ISO GROUP	SMG	a _p x D _c (max)	a _e x D _c (max)	v _c (sf / min)		Z _n = 3							
						1/16	1/8	1/4	3/8	1/2	5/8	3/4	1
P	E 1 - 2	1.0	0.20	420	n (rev/min)	25670	12835	6418	4278	3209	2567	2139	1604
					f _z (in)	0.0001	0.0002	0.0004	0.0005	0.0007	0.0009	0.0011	0.0014
					v _f (in/min)	7	7	7	7	7	7	7	7
	E 3 - 4	1.0	0.20	368	n (rev/min)	22492	11246	5623	3749	2812	2249	1874	1406
					f _z (in)	0.0001	0.0002	0.0004	0.0005	0.0007	0.0009	0.0011	0.0014
					v _f (in/min)	6	6	6	6	6	6	6	6
	E 5 - 6	1.0	0.20	264	n (rev/min)	16136	8068	4034	2689	2017	1614	1345	1008
					f _z (in)	0.0001	0.0002	0.0004	0.0005	0.0007	0.0009	0.0011	0.0014
					v _f (in/min)	4	4	4	4	4	4	4	4
M	E 8 - 9	1.0	0.20	224	n (rev/min)	13691	6845	3423	2282	1711	1369	1141	856
					f _z (in)	0.0001	0.0002	0.0003	0.0005	0.0007	0.0008	0.0010	0.0013
					v _f (in/min)	3	3	3	3	3	3	3	3
	E 10 - 11	1.0	0.20	200	n (rev/min)	12224	6112	3056	2037	1528	1222	1019	764
					f _z (in)	0.0001	0.0002	0.0003	0.0005	0.0007	0.0008	0.0010	0.0013
					v _f (in/min)	3	3	3	3	3	3	3	3
K	E 12 - 13	1.0	0.20	272	n (rev/min)	16625	8312	4156	2771	2078	1662	1385	1039
					f _z (in)	0.0001	0.0002	0.0004	0.0005	0.0007	0.0009	0.0011	0.0014
					v _f (in/min)	4	4	4	4	4	4	4	4
	E 14 - 15	1.0	0.20	352	n (rev/min)	21514	10757	5379	3586	2689	2151	1793	1345
					f _z (in)	0.0001	0.0002	0.0004	0.0005	0.0007	0.0009	0.0011	0.0014
					v _f (in/min)	6	6	6	6	6	6	6	6
S	E 19	0.5	0.20	96	n (rev/min)	5868	2934	1467	978	733	587	489	367
					f _z (in)	0.0001	0.0002	0.0004	0.0005	0.0007	0.0009	0.0011	0.0014
					v _f (in/min)	2	2	2	2	2	2	2	2
	E 20	0.5	0.20	96	n (rev/min)	5868	2934	1467	978	733	587	489	367
					f _z (in)	0.0001	0.0002	0.0004	0.0005	0.0007	0.0009	0.0011	0.0014
					v _f (in/min)	2	2	2	2	2	2	2	2
	E 21	0.5	0.20	64	n (rev/min)	3912	1956	978	652	489	391	326	244
					f _z (in)	0.0001	0.0001	0.0003	0.0004	0.0006	0.0007	0.0008	0.0011
					v _f (in/min)	1	1	1	1	1	1	1	1
	E 22	0.5	0.20	176	n (rev/min)	10757	5379	2689	1793	1345	1076	896	672
f _z (in)					0.0001	0.0002	0.0004	0.0006	0.0009	0.0011	0.0013	0.0017	
v _f (in/min)					3	3	3	3	3	3	3	3	
					116	-	236						

SMG = Seco Material Group
 n [min-1] = RPM
 v_c (sf/min) = Surface feet/min

f_z [in] = Feed/tooth
 a_p/D_c = % of diameter
 v_f [in/min] = Feed rate
 a_e/D_c = % of diameter

A = Air D = Dry E = Emulsion (flood coolant) M = Mist
 All cutting data are start values. All cutting data is in inch values.
 Please reference the Workpiece Material Classification chart located on page 15.

CUTTING DATA - ELITE S SERIES HIGH PERFORMANCE

S545 / S545R - START VALUES

SIDE MILLING - ROUGHING

ISO GROUP	SMG	a _p x D _c (max)	a _e x D _c (max)	V _c (sf / min)		Z _n = 5							
						1/16	1/8	1/4	3/8	1/2	5/8	3/4	1
P	E 1 - 2	1.0	0.25	500	n (rev/min)	30560	15280	7640	5093	3820	3056	2547	1910
					f _z (in)	0.0003	0.0006	0.0011	0.0017	0.0023	0.0028	0.0034	0.0045
					V _f (in/min)	43	43	43	43	43	43	43	43
	E 3 - 4	1.0	0.25	380	n (rev/min)	23226	11613	5806	3871	2903	2323	1935	1452
					f _z (in)	0.0003	0.0005	0.0010	0.0015	0.0020	0.0025	0.0030	0.0040
					V _f (in/min)	29	29	29	29	29	29	29	29
	E 5 - 6	1.0	0.20	300	n (rev/min)	18336	9168	4584	3056	2292	1834	1528	1146
					f _z (in)	0.0002	0.0004	0.0008	0.0012	0.0016	0.0019	0.0023	0.0031
					V _f (in/min)	18	18	18	18	18	18	18	18
H	M / A / D 7a (48>52HRC)	1.0	0.10	150	n (rev/min)	9168	4584	2292	1528	1146	917	764	573
					f _z (in)	0.0002	0.0004	0.0008	0.0012	0.0016	0.0019	0.0023	0.0031
					V _f (in/min)	9	9	9	9	9	9	9	9
M	E 8 - 9	1.0	0.20	250	n (rev/min)	15280	7640	3820	2547	1910	1528	1273	955
					f _z (in)	0.0002	0.0004	0.0008	0.0012	0.0016	0.0020	0.0024	0.0032
					V _f (in/min)	15	15	15	15	15	15	15	15
	E 10 - 11	1.0	0.20	200	n (rev/min)	12224	6112	3056	2037	1528	1222	1019	764
					f _z (in)	0.0002	0.0003	0.0006	0.0009	0.0012	0.0015	0.0018	0.0024
					V _f (in/min)	9	9	9	9	9	9	9	9
K	E 12 - 13	1.0	0.25	300	n (rev/min)	18336	9168	4584	3056	2292	1834	1528	1146
					f _z (in)	0.0005	0.0009	0.0018	0.0027	0.0036	0.0045	0.0054	0.0072
					V _f (in/min)	41	41	41	41	41	41	41	41
	E 12 - 13	1.0	0.25	180	n (rev/min)	11002	5501	2750	1834	1375	1100	917	688
					f _z (in)	0.0002	0.0004	0.0008	0.0012	0.0016	0.0019	0.0023	0.0031
					V _f (in/min)	11	11	11	11	11	11	11	11
N	E / M / A 16	2.0	0.05	800	n (rev/min)	11002	5501	2750	1834	1375	1100	917	688
					f _z (in)	0.0005	0.0010	0.0020	0.0030	0.0040	0.0050	0.0060	0.0080
					V _f (in/min)	28	28	28	28	28	28	28	28
	E / M / A 17	2.0	0.05	800	n (rev/min)	11002	5501	2750	1834	1375	1100	917	688
					f _z (in)	0.0005	0.0010	0.0020	0.0030	0.0040	0.0050	0.0060	0.0080
					V _f (in/min)	28	28	28	28	28	28	28	28
S	E 19	1.0	0.05	90	n (rev/min)	5501	2750	1375	917	688	550	458	344
					f _z (in)	0.0001	0.0002	0.0004	0.0005	0.0007	0.0009	0.0011	0.0014
					V _f (in/min)	2	2	2	2	2	2	2	2
	E 20	1.0	0.05	90	n (rev/min)	5501	2750	1375	917	688	550	458	344
					f _z (in)	0.0001	0.0002	0.0004	0.0005	0.0007	0.0009	0.0011	0.0014
					V _f (in/min)	2	2	2	2	2	2	2	2
	E 21	1.0	0.05	90	n (rev/min)	5501	2750	1375	917	688	550	458	344
					f _z (in)	0.0001	0.0002	0.0004	0.0005	0.0007	0.0009	0.0011	0.0014
					V _f (in/min)	2	2	2	2	2	2	2	2
	E 22	1.0	0.15	120	n (rev/min)	7334	3667	1834	1222	917	733	611	458
					f _z (in)	0.0002	0.0004	0.0008	0.0011	0.0015	0.0019	0.0023	0.0030
					V _f (in/min)	7	7	7	7	7	7	7	7

SMG = Seco Material Group
 n [min-1] = RPM
 V_c (sf/min) = Surface feet/min

f_z [in] = Feed/tooth
 a_p/D_c = % of diameter
 v_f [in/min] = Feed rate
 a_e/D_c = % of diameter

A = Air D = Dry E = Emulsion (flood coolant) M = Mist
 All cutting data are start values. All cutting data is in inch values.
 Please reference the Workpiece Material Classification chart located on page 15.

CUTTING DATA - ELITE S SERIES HIGH PERFORMANCE



SR420 - START VALUES

		SLOTTING									
ISO GROUP	SMG	a _p x Dc (max)	a _e x Dc (max)	V _c (sf / min)		Z _n = 4					
						1/4	3/8	1/2	5/8	3/4	1
P	E 1 - 2	1.00	1.00	300	n (rev/min)	4584	3056	2292	1834	1528	1146
					f _z (in)	0.0008	0.0012	0.0016	0.0020	0.0023	0.0031
					V _f (in/min)	14	14	14	14	14	14
	E 3 - 4	1.00	1.00	250	n (rev/min)	3820	2547	1910	1528	1273	955
					f _z (in)	0.0005	0.0008	0.0010	0.0013	0.0016	0.0021
					V _f (in/min)	8	8	8	8	8	8
	E 5 - 6	1.00	1.00	380	n (rev/min)	5806	3871	2903	2323	1935	1452
					f _z (in)	0.0004	0.0007	0.0009	0.0011	0.0013	0.0018
					V _f (in/min)	10	10	10	10	10	10
M	E 8 - 9	0.50	1.00	380	n (rev/min)	5806	3871	2903	2323	1935	1452
					f _z (in)	0.0005	0.0008	0.0011	0.0014	0.0016	0.0022
					V _f (in/min)	13	13	13	13	13	13
	E 10 - 11	0.30	1.00	200	n (rev/min)	3056	2037	1528	1222	1019	764
					f _z (in)	0.0004	0.0005	0.0007	0.0009	0.0011	0.0014
					V _f (in/min)	4	4	4	4	4	4
K	E 12 - 13	1.00	1.00	380	n (rev/min)	5806	3871	2903	2323	1935	1452
					f _z (in)	0.0012	0.0017	0.0023	0.0029	0.0035	0.0046
					V _f (in/min)	27	27	27	27	27	27
	E 14 - 15	0.30	1.00	150	n (rev/min)	2292	1528	1146	917	764	573
					f _z (in)	0.0007	0.0010	0.0014	0.0017	0.0020	0.0027
					V _f (in/min)	6	6	6	6	6	6

		SIDE MILLING - ROUGHING									
P	E 1 - 2	1.00	0.40	300	n (rev/min)	4584	3056	2292	1834	1528	1146
					f _z (in)	0.0010	0.0015	0.0020	0.0024	0.0029	0.0039
					V _f (in/min)	18	18	18	18	18	18
	E 3 - 4	1.00	0.40	250	n (rev/min)	3820	2547	1910	1528	1273	955
					f _z (in)	0.0007	0.0010	0.0014	0.0017	0.0020	0.0027
					V _f (in/min)	10	10	10	10	10	10
	E 5 - 6	1.00	0.40	175	n (rev/min)	2674	1783	1337	1070	891	669
					f _z (in)	0.0006	0.0008	0.0011	0.0014	0.0017	0.0022
					V _f (in/min)	6	6	6	6	6	6
M	E 8 - 9	1.00	0.40	380	n (rev/min)	5806	3871	2903	2323	1935	1452
					f _z (in)	0.0007	0.0010	0.0014	0.0017	0.0020	0.0027
					V _f (in/min)	16	16	16	16	16	16
	E 10 - 11	1.00	0.30	200	n (rev/min)	3056	2037	1528	1222	1019	764
					f _z (in)	0.0005	0.0007	0.0009	0.0011	0.0014	0.0018
					V _f (in/min)	6	6	6	6	6	6
K	E 12 - 13	1.00	0.40	380	n (rev/min)	5806	3871	2903	2323	1935	1452
					f _z (in)	0.0015	0.0022	0.0029	0.0036	0.0044	0.0058
					V _f (in/min)	34	34	34	34	34	34
	E 14 - 15	1.00	0.30	150	n (rev/min)	2292	1528	1146	917	764	573
					f _z (in)	0.0009	0.0013	0.0017	0.0021	0.0026	0.0034
					V _f (in/min)	8	8	8	8	8	8

SMG = Seco Material Group
 n [min-1] = RPM
 V_c (sf/min) = Surface feet/min

f_z [in] = Feed/tooth
 a_p/D_c = % of diameter

v_f [in/min] = Feed rate
 a_e/D_c = % of diameter

A = Air D = Dry E = Emulsion (flood coolant) M = Mist
 All cutting data are start values. All cutting data is in inch values.
 Please reference the Workpiece Material Classification chart located on page 15.

SR545 - START VALUES

SIDE MILLING - ROUGHING											
ISO GROUP	SMG	$a_p \times D_c$ (max)	$a_e \times D_c$ (max)	v_c (sf / min)		$Z_n = 5$					
						1/4	3/8	1/2	5/8	3/4	1
P	E 1 - 2	1.00	0.30	300	n (rev/min)	4584	3056	2292	1834	1528	1146
					f_z (in)	0.0010	0.0015	0.0020	0.0024	0.0029	0.0039
					v_f (in/min)	22	22	22	22	22	22
	E 3 - 4	1.00	0.30	250	n (rev/min)	3820	2547	1910	1528	1273	955
					f_z (in)	0.0007	0.0010	0.0014	0.0017	0.0020	0.0027
					v_f (in/min)	13	13	13	13	13	13
	E 5 - 6	1.00	0.30	175	n (rev/min)	2674	1783	1337	1070	891	669
					f_z (in)	0.0006	0.0008	0.0011	0.0014	0.0017	0.0022
					v_f (in/min)	7	7	7	7	7	7
M	E 8 - 9	1.00	0.30	380	n (rev/min)	5806	3871	2903	2323	1935	1452
					f_z (in)	0.0007	0.0010	0.0014	0.0017	0.0020	0.0027
					v_f (in/min)	20	20	20	20	20	20
	E 10 - 11	1.00	0.25	200	n (rev/min)	3056	2037	1528	1222	1019	764
					f_z (in)	0.0005	0.0007	0.0009	0.0011	0.0014	0.0018
					v_f (in/min)	7	7	7	7	7	7
K	E 12 - 13	1.00	0.30	380	n (rev/min)	5806	3871	2903	2323	1935	1452
					f_z (in)	0.0015	0.0022	0.0029	0.0036	0.0044	0.0058
					v_f (in/min)	42	42	42	42	42	42
	E 14 - 15	1.00	0.25	150	n (rev/min)	2292	1528	1146	917	764	573
					f_z (in)	0.0009	0.0013	0.0017	0.0021	0.0026	0.0034
					v_f (in/min)	10	10	10	10	10	10
S	E 22	1.0	0.20	275	n (rev/min)	4202	2801	2101	1681	1401	1051
					f_z (in)	0.0009	0.0013	0.0017	0.0021	0.0026	0.0034
					v_f (in/min)	18	18	18	18	18	18

SMG = Seco Material Group
 n [min-1] = RPM
 v_c (sf/min) = Surface feet/min

f_z [in] = Feed/tooth
 a_p/D_c = % of diameter
 v_f [in/min] = Feed rate
 a_e/D_c = % of diameter

A = Air D = Dry E = Emulsion (flood coolant) M = Mist
 All cutting data are start values. All cutting data is in inch values.
 Please reference the Workpiece Material Classification chart located on page 15.

CUTTING DATA - ELITE S SERIES HIGH PERFORMANCE



S645M - START VALUES

SIDE MILLING - ROUGHING

ISO GROUP	SMG	a _p x Dc (max)	a _e x Dc (max)	v _c (sf / min)		Z _n = 6									
						3	4	5	6	8	10	12	14	16	20
P	E 1 - 2	1.0	0.25	490	n (min-1)	15848	11886	9509	7924	5943	4754	3962	3396	2971	2377
					fz (in)	0.0005	0.0007	0.0009	0.0011	0.0014	0.0018	0.0021	0.0025	0.0028	0.0035
					vf (in/min)	51	51	51	51	51	51	51	51	51	51
	E 3 - 4	1.0	0.25	395	n (min-1)	12775	9582	7665	6388	4791	3833	3194	2738	2395	1916
					fz (in)	0.0005	0.0007	0.0009	0.0011	0.0014	0.0018	0.0021	0.0025	0.0028	0.0035
					vf (in/min)	41	41	41	41	41	41	41	41	41	41
	E 5 - 6	1.0	0.20	295	n (min-1)	9541	7156	5725	4771	3578	2862	2385	2045	1789	1431
					fz (in)	0.0005	0.0007	0.0009	0.0011	0.0014	0.0018	0.0021	0.0025	0.0028	0.0035
					vf (in/min)	30	30	30	30	30	30	30	30	30	30
H	M / A / D 7a (48>52HRC)	1.0	0.10	165	n (min-1)	5337	4002	3202	2668	2001	1601	1334	1144	1001	800
					fz (in)	0.0005	0.0007	0.0009	0.0011	0.0014	0.0018	0.0021	0.0025	0.0028	0.0035
					vf (in/min)	17	17	17	17	17	17	17	17	17	17
M	E 8 - 9	1.0	0.20	260	n (min-1)	8409	6307	5045	4205	3153	2523	2102	1802	1577	1261
					fz (in)	0.0005	0.0007	0.0009	0.0011	0.0014	0.0018	0.0021	0.0025	0.0028	0.0035
					vf (in/min)	27	27	27	27	27	27	27	27	27	27
	E 10 - 11	1.0	0.20	195	n (min-1)	6307	4730	3784	3153	2365	1892	1577	1351	1183	946
					fz (in)	0.0005	0.0007	0.0009	0.0011	0.0014	0.0018	0.0021	0.0025	0.0028	0.0035
					vf (in/min)	20	20	20	20	20	20	20	20	20	20
K	E 12 - 13	1.0	0.25	295	n (min-1)	9541	7156	5725	4771	3578	2862	2385	2045	1789	1431
					fz (in)	0.0005	0.0007	0.0009	0.0011	0.0014	0.0018	0.0021	0.0025	0.0028	0.0035
					vf (in/min)	30	30	30	30	30	30	30	30	30	30
	E 14 - 15	1.0	0.25	165	n (min-1)	5337	4002	3202	2668	2001	1601	1334	1144	1001	800
					fz (in)	0.0005	0.0007	0.0009	0.0011	0.0014	0.0018	0.0021	0.0025	0.0028	0.0035
					vf (in/min)	17	17	17	17	17	17	17	17	17	17
N	E / M / A 16	2.0	0.05	785	n (min-1)	25389	19042	15233	12694	9521	7617	6347	5440	4760	3808
					fz (in)	0.0005	0.0007	0.0009	0.0011	0.0014	0.0018	0.0021	0.0025	0.0028	0.0035
					vf (in/min)	81	81	81	81	81	81	81	81	81	81
	E / M / A 17	2.0	0.05	785	n (min-1)	25389	19042	15233	12694	9521	7617	6347	5440	4760	3808
					fz (in)	0.0005	0.0007	0.0009	0.0011	0.0014	0.0018	0.0021	0.0025	0.0028	0.0035
					vf (in/min)	81	81	81	81	81	81	81	81	81	81
S	E 19	1.0	0.05	100	n (min-1)	3234	2426	1941	1617	1213	970	809	693	606	485
					fz (in)	0.0135	0.0180	0.0225	0.0270	0.0360	0.0450	0.0540	0.0630	0.0720	0.0900
					vf (in/min)	262	262	262	262	262	262	262	262	262	262
	E 20	1.0	0.05	100	n (min-1)	3234	2426	1941	1617	1213	970	809	693	606	485
					fz (in)	0.0005	0.0007	0.0009	0.0011	0.0014	0.0018	0.0021	0.0025	0.0028	0.0035
					vf (in/min)	10	10	10	10	10	10	10	10	10	10
	E 21	1.0	0.05	100	n (min-1)	3234	2426	1941	1617	1213	970	809	693	606	485
					fz (in)	0.0005	0.0007	0.0009	0.0011	0.0014	0.0018	0.0021	0.0025	0.0028	0.0035
					vf (in/min)	10	10	10	10	10	10	10	10	10	10
	E 22	1.0	0.15	130	n (min-1)	4205	3153	2523	2102	1577	1261	1051	901	788	631
					fz (in)	0.0005	0.0007	0.0009	0.0011	0.0014	0.0018	0.0021	0.0025	0.0028	0.0035
					vf (in/min)	13	13	13	13	13	13	13	13	13	13

SMG = Seco Material Group
 n [min-1] = RPM
 v_c (sf/min) = Surface feet/min

fz [in] = Feed/tooth
 a_p/D_c = % of diameter
 vf [in/min] = Feed rate
 a_e/D_c = % of diameter

A = Air D = Dry E = Emulsion (flood coolant) M = Mist
 All cutting data are start values. All cutting data is in inch values.
 Please reference the Workpiece Material Classification chart located on page 15.

CUTTING DATA - ELITE S SERIES HIGH PERFORMANCE

SR420M - START VALUES

		SLOTTING										
ISO GROUP	SMG	$a_p \times D_c$ (max)	$a_e \times D_c$ (max)	v_c (sf / min)		$Z_n = 4$						
						6	8	10	12	14	16	
P	E 1 - 2	1.00	1.00	295 230 - 360	n (min-1)	4771	3578	2862	2385	2045	1789	1431
					fz (in)	0.0007	0.0010	0.0012	0.0015	0.0017	0.0020	0.0024
					vf (in/min)	14	14	14	14	14	14	14
	E 3 - 4	1.00	1.00	260 195 - 295	n (min-1)	4205	3153	2523	2102	1802	1577	1261
					fz (in)	0.0007	0.0010	0.0012	0.0015	0.0017	0.0020	0.0024
					vf (in/min)	12	12	12	12	12	12	12
	E 5 - 6	1.00	1.00	165 130 - 230	n (min-1)	2668	2001	1601	1334	1144	1001	800
					fz (in)	0.0007	0.0010	0.0012	0.0015	0.0017	0.0020	0.0024
					vf (in/min)	8	8	8	8	8	8	8
M	E 8 - 9	0.50	1.00	395 360 - 425	n (min-1)	6388	4791	3833	3194	2738	2395	1916
					fz (in)	0.0007	0.0010	0.0012	0.0015	0.0017	0.0020	0.0024
					vf (in/min)	19	19	19	19	19	19	19
	E 10 - 11	0.30	1.00	195 165 - 230	n (min-1)	3153	2365	1892	1577	1351	1183	946
					fz (in)	0.0007	0.0010	0.0012	0.0015	0.0017	0.0020	0.0024
					vf (in/min)	9	9	9	9	9	9	9
K	E 12 - 13	1.00	1.00	395 330 - 425	n (min-1)	6388	4791	3833	3194	2738	2395	1916
					fz (in)	0.0007	0.0010	0.0012	0.0015	0.0017	0.0020	0.0024
					vf (in/min)	19	19	19	19	19	19	19
	E 14 - 15	0.30	1.00	165 100 - 195	n (min-1)	2668	2001	1601	1334	1144	1001	800
					fz (in)	0.0007	0.0010	0.0012	0.0015	0.0017	0.0020	0.0024
					vf (in/min)	8	8	8	8	8	8	8

SMG = Seco Material Group
 n [min-1] = RPM
 v_c (sf/min) = Surface feet/min

fz [in] = Feed/tooth
 a_p/D_c = % of diameter
 vf [in/min] = Feed rate
 a_e/D_c = % of diameter

A = Air D = Dry E = Emulsion (flood coolant) M = Mist
 All cutting data are start values. All cutting data is in inch values.
 Please reference the Workpiece Material Classification chart located on page 15.

CUTTING DATA - ELITE S SERIES HIGH PERFORMANCE



SR420M - START VALUES

SIDE MILLING - ROUGHING												
ISO GROUP	SMG	a _p x Dc (max)	a _e x Dc (max)	v _c (sf / min)		Z _n = 4						
						6	8	10	12	14	16	20
P	E 1 - 2	1.00	0.40	295	n (min-1)	4771	3578	2862	2385	2045	1789	1431
					fz (in)	0.0007	0.0010	0.0012	0.0015	0.0017	0.0020	0.0024
					vf (in/min)	14	14	14	14	14	14	14
	E 3 - 4	1.00	0.40	260	n (min-1)	4205	3153	2523	2102	1802	1577	1261
					fz (in)	0.0007	0.0010	0.0012	0.0015	0.0017	0.0020	0.0024
					vf (in/min)	12	12	12	12	12	12	12
	E 5 - 6	1.00	0.40	165	n (min-1)	2668	2001	1601	1334	1144	1001	800
					fz (in)	0.0007	0.0010	0.0012	0.0015	0.0017	0.0020	0.0024
					vf (in/min)	8	8	8	8	8	8	8
M	E 8 - 9	1.00	0.40	395	n (min-1)	6388	4791	3833	3194	2738	2395	1916
					fz (in)	0.0006	0.0009	0.0011	0.0013	0.0015	0.0017	0.0021
					vf (in/min)	16	16	16	16	16	16	16
	E 10 - 11	1.00	0.30	195	n (min-1)	3153	2365	1892	1577	1351	1183	946
					fz (in)	0.0007	0.0010	0.0012	0.0015	0.0017	0.0020	0.0024
					vf (in/min)	9	9	9	9	9	9	9
K	E 12 - 13	1.00	0.40	395	n (min-1)	6388	4791	3833	3194	2738	2395	1916
					fz (in)	0.0007	0.0010	0.0012	0.0015	0.0017	0.0020	0.0024
					vf (in/min)	19	19	19	19	19	19	19
	E 14 - 15	1.00	0.30	165	n (min-1)	2668	2001	1601	1334	1144	1001	800
					vf (in/min)	8	8	8	8	8	8	8

SMG = Seco Material Group
 n [min-1] = RPM
 v_c (sf/min) = Surface feet/min

fz [in] = Feed/tooth
 a_p/D_c = % of diameter
 vf [in/min] = Feed rate
 a_e/D_c = % of diameter

A = Air D = Dry E = Emulsion (flood coolant) M = Mist
 All cutting data are start values. All cutting data is in inch values.
 Please reference the Workpiece Material Classification chart located on page 15.

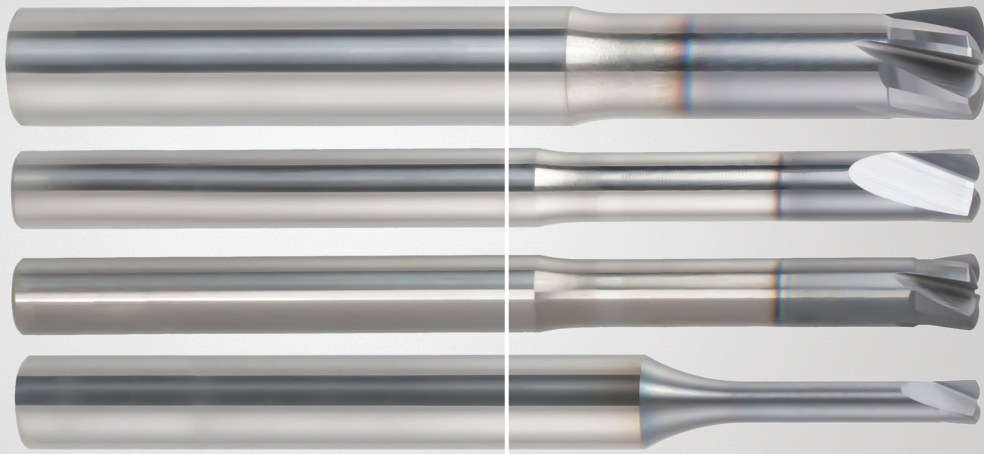

**NIAGARA
CUTTER™**

**HIGH FEED
MILLING**

SOLID CARBIDE HIGH FEED MILL

SN200R, SN400R & SN500R

The SN200R, SN400R and SN500R series offers a complete range of 2-, 4- and 5-flute end mills to cover a broad range of applications and materials. Available in 3, 5 and 7 times diameter reach, these end mills feature a defined radius (r_p) directing radial cutting pressure axially up into the tool holder and spindle. This feature allows for increased metal removal rates in deep pockets and long reach applications.

PRODUCT OVERVIEW

- Solid carbide high feed tools excel in face, slot and plunge milling
- High feed capabilities yield significant productivity gains
- AlTiN coating for high heat and abrasion resistance
- Edge prep to increase cutting edge strength
- Modifications on shank only

YOUR BENEFITS

- Long tool overhang for deep cavity milling
- Axially directed cutting forces
- High heat and abrasion resistant
- Reduced cycle time, higher metal removal rates
- Smoother cutting in long reach applications
- Reduced production costs when processing deep and shallow pockets
- Longer tool life than previous cutters when applied at the same table feed rates
- Low radial forces minimize vibration and machine wear
- Wide application area covered, from steel to exotic materials

RANGE OVERVIEW

- 2-, 4- and 5-flute end mill diameters from 1/16"-1/2" diameter
- 3xD, 5xD and 7xD length versions available

MATERIAL GROUPS
Steel 1-6
Hardened steel 7a
Stainless steel 8-11
Cast Iron 12-15
Superalloys 19-22

Focus on ISO P, S and K materials including stainless steel, Inconel, and titanium.

HOW DOES HIGH FEED MILLING WORK?

High feed mills are set apart by a lead angle (or large radius) that allows you to have higher feed rates based on chip thinning.

When milling with a ball end mill, varying the depth of cut results in a chip-thinning effect. Large depths of cut involve bigger chip thicknesses, while shallow depths of cut mean smaller chip thickness. Machining with smaller depths of cuts, allows you to increase the feed rate to get the proper chip thickness (load).

CHATTER AND SURFACE FINISH

High feed end mills have a low cutting resistance compared to ballnose endmills. This enables higher feed rates & longer overhangs to be achieved with less risk of vibration.

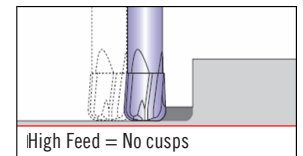
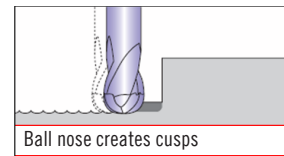
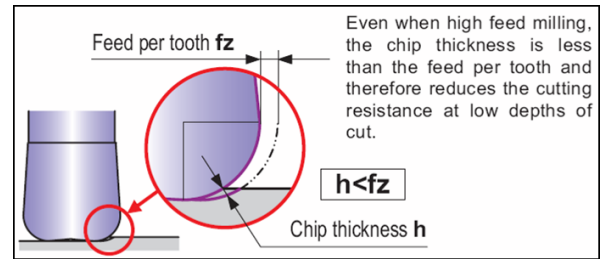

Ball nose directs force sideways, creating chatter.



High feed directs force upwards, minimizing chatter.

CHOOSING THE RIGHT HIGH FEED TOOL

PRODUCT	PRODUCT FAMILY	APMX	RANGE	MATERIAL SUITABILITY	MACHINE SUITABILITY		RAMMING CAPABILITY	PLUNGING SUITABILITY
	MZN410R & MZN510R - 4- and 5-flute versions - 1/8" - 5/8" diameters - 2 mm - 12 mm - AlTiN coating - Open flute cavity	5.5%*DCX	1/8" - 5/8" 2 mm - 12 mm	P K S H	✓	=	✓	✗
	SN200R, 400R & 500R - 2-, 4- and 5-flute versions - 1/16"-1/2" diameter range - 3xD, 5xD and 7xD - Deep pockets and long reach - AlTiN coating	9%*DCX	1/16"-1/2"	P M K S H	✓	=	✓	✓*

* Plunge milling only with SN200 (2 flute) version

SN200R

SOLID CARBIDE

HELIX
0°

RADIUS

NON CENTER CUTTING



- 3, 5, and 7 x Diameter of reach
- Defined radius (rp)
- Wide range of materials including Steels (<52 Rc), Stainless Steels, Titanium, and Cast Iron
- Face, slot, and plunge milling
- Long reach applications
- Deep cavity milling

ITEM NUMBER	DESCRIPTION	FLUTE DIA (DCX)	SHANK DIA	LENGTH OF CUT	OVERALL LENGTH	NECK DIA	REACH	FLUTES	COATING	RADIUS	SHANK TYPE
N13984	SN200R-0.063-G1-H007.0-Z2	1/16	1/4	.004	2	.055	.188	2	ALTIN	0.0074	CYLINDRICAL
N13985	SN200R-0.063-G2-H007.0-Z2	1/16	1/4	.004	2	.055	.313	2	ALTIN	0.0074	CYLINDRICAL
N13986	SN200R-0.063-J3-H007.0-Z2	1/16	1/4	.004	2	.055	.438	2	ALTIN	0.0074	CYLINDRICAL
N13987	SN200R-0.094-G1-H011.0-Z2	3/32	1/4	.006	2	.082	.281	2	ALTIN	0.0111	CYLINDRICAL
N13988	SN200R-0.094-G2-H011.0-Z2	3/32	1/4	.006	2	.082	.469	2	ALTIN	0.0111	CYLINDRICAL
N13989	SN200R-0.094-J3-H011.0-Z2	3/32	1/4	.006	2-1/2	.082	.656	2	ALTIN	0.0111	CYLINDRICAL
N13992	SN200R-0.125-G1-H015.0-Z2	1/8	1/4	.008	2	.109	.375	2	ALTIN	0.0148	CYLINDRICAL
N13993	SN200R-0.125-G2-H015.0-Z2	1/8	1/4	.008	2-1/2	.109	.625	2	ALTIN	0.0148	CYLINDRICAL
N13994	SN200R-0.125-J3-H015.0-Z2	1/8	1/4	.008	2-1/2	.109	.875	2	ALTIN	0.0148	CYLINDRICAL
N13997	SN200R-0.156-G1-H020.0-Z2	5/32	1/4	.010	2	.136	.469	2	ALTIN	0.0200	CYLINDRICAL
N13998	SN200R-0.156-G2-H020.0-Z2	5/32	1/4	.010	2-1/2	.136	.781	2	ALTIN	0.0200	CYLINDRICAL
N13999	SN200R-0.156-J3-H020.0-Z2	5/32	1/4	.010	2-1/2	.136	1.094	2	ALTIN	0.0200	CYLINDRICAL
N14004	SN200R-0.188-G1-H023.0-Z2	3/16	1/4	.012	2	.166	.562	2	ALTIN	0.0230	CYLINDRICAL
N14005	SN200R-0.188-G2-H023.0-Z2	3/16	1/4	.012	2-1/2	.166	.937	2	ALTIN	0.0230	CYLINDRICAL
N14006	SN200R-0.188-J3-H023.0-Z2	3/16	1/4	.012	3	.166	1.313	2	ALTIN	0.0230	CYLINDRICAL
N14009	SN200R-0.250-E1-H032.0-Z2	1/4	1/4	.014	2-1/2	.218	.750	2	ALTIN	0.0322	CYLINDRICAL
N14012	SN200R-0.250-E2-H032.0-Z2	1/4	1/4	.014	3	.218	1.250	2	ALTIN	0.0322	CYLINDRICAL
N14013	SN200R-0.250-J3-H032.0-Z2	1/4	1/4	.014	3-1/2	.218	1.750	2	ALTIN	0.0322	CYLINDRICAL
N14016	SN200R-0.313-G1-H037.0-Z2	5/16	3/8	.016	2-1/2	.273	.938	2	ALTIN	0.0373	CYLINDRICAL
N14017	SN200R-0.313-G2-H037.0-Z2	5/16	3/8	.016	3-1/2	.273	1.563	2	ALTIN	0.0373	CYLINDRICAL
N14018	SN200R-0.313-J3-H037.0-Z2	5/16	3/8	.016	4	.273	2.188	2	ALTIN	0.0373	CYLINDRICAL
N14023	SN200R-0.375-E1-H043.0-Z2	3/8	3/8	.018	3	.329	1.125	2	ALTIN	0.0432	CYLINDRICAL
N14024	SN200R-0.375-E2-H043.0-Z2	3/8	3/8	.018	3-1/2	.329	1.875	2	ALTIN	0.0432	CYLINDRICAL
N14025	SN200R-0.375-J3-H043.0-Z2	3/8	3/8	.018	4-1/2	.329	2.625	2	ALTIN	0.0432	CYLINDRICAL
N14029	SN200R-0.500-E1-H061.0-Z2	1/2	1/2	.020	3-1/2	.444	1.500	2	ALTIN	0.0614	CYLINDRICAL
N14032	SN200R-0.500-E2-H061.0-Z2	1/2	1/2	.020	4-1/2	.444	2.500	2	ALTIN	0.0614	CYLINDRICAL
N14033	SN200R-0.500-J3-H061.0-Z2	1/2	1/2	.020	6	.444	3.500	2	ALTIN	0.0614	CYLINDRICAL

SN400R

SOLID CARBIDE

HELIX

RADIUS

NON CENTER CUTTING



- 3, 5 x Diameter of reach
- Defined radius (rp)
- Wide range of materials including Steels (<52 Rc), Stainless Steels, Titanium, and Cast Iron
- Face, slot, and milling
- Long reach applications
- Deep cavity milling

ITEM NUMBER	DESCRIPTION	FLUTE DIA (DCX)	SHANK DIA	LENGTH OF CUT	OVERALL LENGTH	NECK DIA	REACH	FLUTES	COATING	RADIUS	SHANK TYPE
N13995	SN400R-0.125-G1-H015.0-Z4	1/8	1/4	.008	2	.109	.375	4	ALTIN	0.0148	CYLINDRICAL
N13996	SN400R-0.125-G2-H015.0-Z4	1/8	1/4	.008	2-1/2	.109	.625	4	ALTIN	0.0148	CYLINDRICAL
N14002	SN400R-0.156-G1-H020.0-Z4	5/32	1/4	.010	2	.136	.469	4	ALTIN	0.0200	CYLINDRICAL
N14003	SN400R-0.156-G2-H020.0-Z4	5/32	1/4	.010	2-1/2	.136	.781	4	ALTIN	0.0200	CYLINDRICAL
N14007	SN400R-0.188-G1-H023.0-Z4	3/16	1/4	.012	2	.166	.562	4	ALTIN	0.0230	CYLINDRICAL
N14008	SN400R-0.188-G2-H023.0-Z4	3/16	1/4	.012	2-1/2	.166	.937	4	ALTIN	0.0230	CYLINDRICAL
N14014	SN400R-0.250-E1-H032.0-Z4	1/4	1/4	.014	2-1/2	.218	.750	4	ALTIN	0.0322	CYLINDRICAL
N14015	SN400R-0.250-E2-H032.0-Z4	1/4	1/4	.014	3	.218	1.250	4	ALTIN	0.0322	CYLINDRICAL
N14019	SN400R-0.313-G1-H037.0-Z4	5/16	3/8	.016	2-1/2	.273	.938	4	ALTIN	0.0373	CYLINDRICAL
N14022	SN400R-0.313-G2-H037.0-Z4	5/16	3/8	.016	3-1/2	.273	1.563	4	ALTIN	0.0373	CYLINDRICAL
N14026	SN400R-0.375-E1-H043.0-Z4	3/8	3/8	.018	3	.329	1.125	4	ALTIN	0.0432	CYLINDRICAL
N14028	SN400R-0.375-E2-H043.0-Z4	3/8	3/8	.018	3-1/2	.329	1.875	4	ALTIN	0.0432	CYLINDRICAL
N14034	SN400R-0.500-E1-H061.0-Z4	1/2	1/2	.020	3-1/2	.444	1.500	4	ALTIN	0.0614	CYLINDRICAL
N14036	SN400R-0.500-E2-H061.0-Z4	1/2	1/2	.020	4-1/2	.444	2.500	4	ALTIN	0.0614	CYLINDRICAL

SN500R

SOLID CARBIDE

HELIX

RADIUS

NON CENTER CUTTING



- 3 x Diameter of reach
- Defined radius (rp)
- Wide range of materials including Steels (<52 Rc), Stainless Steels, Titanium, and Cast Iron
- Face, slot, and milling
- Long reach applications
- Deep cavity milling

ITEM NUMBER	DESCRIPTION	FLUTE DIA (DCX)	SHANK DIA	LENGTH OF CUT	OVERALL LENGTH	NECK DIA	REACH	FLUTES	COATING	RADIUS	SHANK TYPE
N14027	SN500R-0.375-E1-H043.0-Z5	3/8	3/8	.018	3	.329	1.125	5	ALTIN	0.0432	CYLINDRICAL
N14035	SN500R-0.500-E1-H061.0-Z5	1/2	1/2	.020	3-1/2	.444	1.500	5	ALTIN	0.0614	CYLINDRICAL

CUTTING DATA -SN200R, SN400R, SN500R SLOT MILLING - START VALUES

SLOT MILLING															
ISO GROUP	SMG	a _e (Max)	v _c (sf / min)		Zn = 2										
					1/16	3/32	1/8	5/32	3/16	1/4	5/16	3/8	1/2		
P	M/A/D 1 - 2	1.00 x DCX	984	n [rev/min]	60157	40105	30079	24062	20052	15039	12031	10026	7520		
				fz [in]	0.0021	0.0031	0.0041	0.0052	0.0062	0.0083	0.0103	0.0124	0.0165		
			820	1148	vf [in/min]	248	248	248	248	248	248	248	248	248	
	M/A/D 3 - 4	1.00 x DCX	738	n [rev/min]	45118	30079	22559	18047	15039	11280	9024	7520	5640		
				fz [in]	0.0019	0.0028	0.0038	0.0047	0.0056	0.0075	0.0094	0.0113	0.0150		
			656	820	vf [in/min]	169	169	169	169	169	169	169	169	169	
			M/A/D 5 - 6	1.00 x DCX	574	n [rev/min]	35092	23395	17546	14036	11697	8773	7018	5849	4386
						fz [in]	0.0017	0.0025	0.0034	0.0042	0.0051	0.0068	0.0084	0.0101	0.0135
					492	656	vf [in/min]	118	118	118	118	118	118	118	118
H	M/A/D 7a	1.00 x DCX	312	n [rev/min]	19050	12700	9525	7620	6350	4762	3810	3175	2381		
				fz [in]	0.0015	0.0023	0.0030	0.0038	0.0045	0.0060	0.0075	0.0090	0.0120		
			262	361	vf [in/min]	57	57	57	57	57	57	57	57	57	
M	E/M/A 8 - 9	1.00 x DCX	410	n [rev/min]	25066	16710	12533	10026	8355	6266	5013	4178	3133		
				fz [in]	0.0015	0.0023	0.0030	0.0038	0.0045	0.0060	0.0075	0.0090	0.0120		
			361	459	vf [in/min]	75	75	75	75	75	75	75	75	75	
	E/M/A 10 - 11	1.00 x DCX	312	n [rev/min]	19050	12700	9525	7620	6350	4762	3810	3175	2381		
				fz [in]	0.0015	0.0023	0.0030	0.0038	0.0045	0.0060	0.0075	0.0090	0.0120		
			262	361	vf [in/min]	57	57	57	57	57	57	57	57	57	
K	E/M/A 12 - 13	1.00 x DCX	574	n [rev/min]	35092	23395	17546	14036	11697	8773	7018	5849	4386		
				fz [in]	0.0019	0.0028	0.0038	0.0047	0.0056	0.0075	0.0094	0.0113	0.0150		
			492	656	vf [in/min]	132	132	132	132	132	132	132	132	132	
	E/M/A 14 - 15	1.00 x DCX	410	n [rev/min]	25066	16710	12533	10026	8355	6266	5013	4178	3133		
				fz [in]	0.0017	0.0025	0.0034	0.0042	0.0051	0.0068	0.0084	0.0101	0.0135		
			328	492	vf [in/min]	85	85	85	85	85	85	85	85	85	
S	E 19	1.00 x DCX	164	n [rev/min]	10026	6684	5013	4010	3342	2507	2005	1671	1253		
				fz [in]	0.0011	0.0017	0.0023	0.0028	0.0034	0.0045	0.0056	0.0068	0.0090		
			131	197	vf [in/min]	23	23	23	23	23	23	23	23	23	
	E 20	1.00 x DCX	164	n [rev/min]	10026	6684	5013	4010	3342	2507	2005	1671	1253		
				fz [in]	0.0011	0.0017	0.0023	0.0028	0.0034	0.0045	0.0056	0.0068	0.0090		
			131	197	vf [in/min]	23	23	23	23	23	23	23	23	23	
	E 21	1.00 x DCX	98	n [rev/min]	6016	4010	3008	2406	2005	1504	1203	1003	752		
				fz [in]	0.0011	0.0017	0.0023	0.0028	0.0034	0.0045	0.0056	0.0068	0.0090		
			66	131	vf [in/min]	14	14	14	14	14	14	14	14	14	
	E 22	1.00 x DCX	377	n [rev/min]	23060	15374	11530	9224	7687	5765	4612	3843	2883		
				fz [in]	0.0011	0.0017	0.0023	0.0028	0.0034	0.0045	0.0056	0.0068	0.0090		
			328	427	vf [in/min]	52	52	52	52	52	52	52	52	52	

**Reduce APMX 20% and Feed per tooth 15% when using 5 x D version

**Reduce APMX 40% and Feed per tooth 30% when using 7 x D version

SMG = Seco Material Group
 n [min-1] = RPM
 v_c (sf/min) = Surface feet/min

fz [in] = Feed/tooth
 a_p/DCX = % of diameter
 vf [in/min] = Feed rate
 a_p/D = % of diameter

A = Air D = Dry E = Emulsion (flood coolant) M = Mist
 All cutting data are start values. All cutting data is in inch values.
 Please reference the Workpiece Material Classification chart located on page 15.

CUTTING DATA -SN200R, SN400R, SN500R SLOT MILLING - START VALUES

ISO GROUP	SMG	a _e (Max)	v _c (sf / min)	SLOT MILLING											
				Zn = 4										Zn = 5	
				1/8	5/32	3/16	1/4	5/16	3/8	1/2	3/8	1/2			
P	M/A/D 1 - 2	1.00 x DCX	984	1148	n [rev/min]	30079	24062	20052	15039	12031	10026	7520	10026	7520	
					fz [in]	0.0041	0.0052	0.0062	0.0083	0.0103	0.0124	0.0165	0.0124	0.0165	
					vf [in/min]	496	496	496	496	496	496	496	620	620	
			820	820	ap max**	0.0080	0.0100	0.0120	0.0140	0.0160	0.0180	0.0200	0.0180	0.0200	
					n [rev/min]	22559	18047	15039	11280	9024	7520	5640	7520	5640	
					fz [in]	0.0038	0.0047	0.0056	0.0075	0.0094	0.0113	0.0150	0.0113	0.0150	
	M/A/D 3 - 4	1.00 x DCX	738	820	vf [in/min]	338	338	338	338	338	338	338	423	423	
					ap max**	0.0080	0.0100	0.0120	0.0140	0.0160	0.0180	0.0200	0.0180	0.0200	
					n [rev/min]	17546	14036	11697	8773	7018	5849	4386	5849	4386	
			656	656	fz [in]	0.0034	0.0042	0.0051	0.0068	0.0084	0.0101	0.0135	0.0101	0.0135	
					vf [in/min]	237	237	237	237	237	237	237	296	296	
					ap max**	0.0080	0.0100	0.0120	0.0140	0.0160	0.0180	0.0200	0.0180	0.0200	
H	M/A/D 7a	1.00 x DCX	312	361	n [rev/min]	9525	7620	6350	4762	3810	3175	2381	3175	2381	
					fz [in]	0.0030	0.0038	0.0045	0.0060	0.0075	0.0090	0.0120	0.0090	0.0120	
					vf [in/min]	114	114	114	114	114	114	114	143	143	
			262	361	ap max**	0.0064	0.0080	0.0096	0.0112	0.0128	0.0144	0.0160	0.0144	0.0160	
					n [rev/min]	12533	10026	8355	6266	5013	4178	3133	4178	3133	
					fz [in]	0.0030	0.0038	0.0045	0.0060	0.0075	0.0090	0.0120	0.0090	0.0120	
M	E/M/A 8 - 9	1.00 x DCX	410	459	vf [in/min]	150	150	150	150	150	150	150	188	188	
					ap max**	0.0064	0.0080	0.0096	0.0112	0.0128	0.0144	0.0160	0.0144	0.0160	
					n [rev/min]	9525	7620	6350	4762	3810	3175	2381	3175	2381	
			361	361	fz [in]	0.0030	0.0038	0.0045	0.0060	0.0075	0.0090	0.0120	0.0090	0.0120	
					vf [in/min]	114	114	114	114	114	114	114	143	143	
					ap max**	0.0064	0.0080	0.0096	0.0112	0.0128	0.0144	0.0160	0.0144	0.0160	
	E/M/A 10 - 11	1.00 x DCX	312	361	n [rev/min]	17546	14036	11697	8773	7018	5849	4386	5849	4386	
					fz [in]	0.0038	0.0047	0.0056	0.0075	0.0094	0.0113	0.0150	0.0113	0.0150	
					vf [in/min]	263	263	263	263	263	263	263	329	329	
			262	361	ap max**	0.0080	0.0100	0.0120	0.0140	0.0160	0.0180	0.0200	0.0180	0.0200	
					n [rev/min]	12533	10026	8355	6266	5013	4178	3133	4178	3133	
					fz [in]	0.0034	0.0042	0.0051	0.0068	0.0084	0.0101	0.0135	0.0101	0.0135	
K	E/M/A 12 - 13	1.00 x DCX	574	656	vf [in/min]	169	169	169	169	169	169	169	211	211	
					ap max**	0.0080	0.0100	0.0120	0.0140	0.0160	0.0180	0.0200	0.0180	0.0200	
					n [rev/min]	22559	18047	15039	11280	9024	7520	5640	7520	5640	
			492	656	fz [in]	0.0038	0.0047	0.0056	0.0075	0.0094	0.0113	0.0150	0.0113	0.0150	
					vf [in/min]	104	104	104	104	104	104	104	130	130	
					ap max**	0.0040	0.0050	0.0060	0.0070	0.0080	0.0090	0.0100	0.0090	0.0100	
	E/M/A 14 - 15	1.00 x DCX	410	492	n [rev/min]	5013	4010	3342	2507	2005	1671	1253	1671	1253	
					fz [in]	0.0023	0.0028	0.0034	0.0045	0.0056	0.0068	0.0090	0.0068	0.0090	
					vf [in/min]	45	45	45	45	45	45	45	56	56	
			328	492	ap max**	0.0040	0.0050	0.0060	0.0070	0.0080	0.0090	0.0100	0.0090	0.0100	
					n [rev/min]	11530	9224	7687	5765	4612	3843	2883	3843	2883	
					fz [in]	0.0023	0.0028	0.0034	0.0045	0.0056	0.0068	0.0090	0.0068	0.0090	
S	E 19	1.00 x DCX	164	197	vf [in/min]	27	27	27	27	27	27	27	34	34	
					ap max**	0.0040	0.0050	0.0060	0.0070	0.0080	0.0090	0.0100	0.0090	0.0100	
					n [rev/min]	3008	2406	2005	1504	1203	1003	752	1003	752	
			131	197	fz [in]	0.0023	0.0028	0.0034	0.0045	0.0056	0.0068	0.0090	0.0068	0.0090	
					vf [in/min]	45	45	45	45	45	45	45	56	56	
					ap max**	0.0040	0.0050	0.0060	0.0070	0.0080	0.0090	0.0100	0.0090	0.0100	
	E 20	1.00 x DCX	164	197	n [rev/min]	5013	4010	3342	2507	2005	1671	1253	1671	1253	
					fz [in]	0.0023	0.0028	0.0034	0.0045	0.0056	0.0068	0.0090	0.0068	0.0090	
					vf [in/min]	45	45	45	45	45	45	45	56	56	
			131	197	ap max**	0.0040	0.0050	0.0060	0.0070	0.0080	0.0090	0.0100	0.0090	0.0100	
					n [rev/min]	11530	9224	7687	5765	4612	3843	2883	3843	2883	
					fz [in]	0.0023	0.0028	0.0034	0.0045	0.0056	0.0068	0.0090	0.0068	0.0090	
	E 21	1.00 x DCX	98	131	vf [in/min]	104	104	104	104	104	104	104	130	130	
					ap max**	0.0040	0.0050	0.0060	0.0070	0.0080	0.0090	0.0100	0.0090	0.0100	
					n [rev/min]	11530	9224	7687	5765	4612	3843	2883	3843	2883	
			66	131	fz [in]	0.0023	0.0028	0.0034	0.0045	0.0056	0.0068	0.0090	0.0068	0.0090	
					vf [in/min]	104	104	104	104	104	104	104	130	130	
					ap max**	0.0040	0.0050	0.0060	0.0070	0.0080	0.0090	0.0100	0.0090	0.0100	
E 22	1.00 x DCX	377	427	n [rev/min]	11530	9224	7687	5765	4612	3843	2883	3843	2883		
				fz [in]	0.0023	0.0028	0.0034	0.0045	0.0056	0.0068	0.0090	0.0068	0.0090		
				vf [in/min]	104	104	104	104	104	104	104	130	130		
		328	427	ap max**	0.0040	0.0050	0.0060	0.0070	0.0080	0.0090	0.0100	0.0090	0.0100		

**Reduce APMX 20% and Feed per tooth 15% when using 5 x D version
 **Reduce APMX 40% and Feed per tooth 30% when using 7 x D version

SMG = Seco Material Group
 n [min-1] = RPM
 v_c (sf/min) = Surface feet/min

fz [in] = Feed/tooth vf [in/min] = Feed rate
 a_p/DCX = % of diameter a_f/DCX = % of diameter

A = Air D = Dry E = Emulsion (flood coolant) M = Mist
 All cutting data are start values. All cutting data is in inch values.
 Please reference the Workpiece Material Classification chart located on page 15.

CUTTING DATA -SN200R, SN400R, SN500R SIDE MILLING - START VALUES

SIDE MILLING													
ISO GROUP	SMG	a _e (Max)	v _c (sf / min)		Zn = 2								
					1/16	3/32	1/8	5/32	3/16	1/4	5/16	3/8	1/2
P	M/A/D 1 - 2	0.30 x DCX	984	n [rev/min]	60157	40105	30079	24062	20052	15039	12031	10026	7520
				fz [in]	0.0034	0.0052	0.0069	0.0086	0.0103	0.0138	0.0172	0.0206	0.0275
			820	1148	vf [in/min]	414	414	414	414	414	414	414	414
		0.30 x DCX	738	n [rev/min]	45118	30079	22559	18047	15039	11280	9024	7520	5640
				fz [in]	0.0031	0.0047	0.0063	0.0078	0.0094	0.0125	0.0156	0.0188	0.0250
			656	820	vf [in/min]	282	282	282	282	282	282	282	282
	M/A/D 3 - 4	0.30 x DCX	574	n [rev/min]	35092	23395	17546	14036	11697	8773	7018	5849	4386
				fz [in]	0.0028	0.0042	0.0056	0.0070	0.0084	0.0113	0.0141	0.0169	0.0225
			492	656	vf [in/min]	197	197	197	197	197	197	197	197
		0.30 x DCX	312	n [rev/min]	19050	12700	9525	7620	6350	4762	3810	3175	2381
				fz [in]	0.0025	0.0038	0.0050	0.0063	0.0075	0.0100	0.0125	0.0150	0.0200
			262	361	vf [in/min]	95	95	95	95	95	95	95	95
M	E/M/A 8 - 9	0.30 x DCX	410	n [rev/min]	25066	16710	12533	10026	8355	6266	5013	4178	3133
				fz [in]	0.0025	0.0038	0.0050	0.0063	0.0075	0.0100	0.0125	0.0150	0.0200
			361	459	vf [in/min]	125	125	125	125	125	125	125	125
		0.30 x DCX	459	n [rev/min]	28073	18716	14037	11229	9358	7018	5615	4679	3509
				fz [in]	0.0025	0.0038	0.0050	0.0063	0.0075	0.0100	0.0125	0.0150	0.0200
			262	361	vf [in/min]	140	140	140	140	140	140	140	140
	E/M/A 10 - 11	0.30 x DCX	574	n [rev/min]	35092	23395	17546	14036	11697	8773	7018	5849	4386
				fz [in]	0.0025	0.0038	0.0050	0.0063	0.0075	0.0100	0.0125	0.0150	0.0200
			492	656	vf [in/min]	175	175	175	175	175	175	175	175
		0.30 x DCX	410	n [rev/min]	25066	16710	12533	10026	8355	6266	5013	4178	3133
				fz [in]	0.0019	0.0028	0.0038	0.0047	0.0056	0.0075	0.0094	0.0113	0.0150
			328	492	vf [in/min]	94	94	94	94	94	94	94	94
K	E/M/A 12 - 13	0.30 x DCX	164	n [rev/min]	10026	6684	5013	4010	3342	2507	2005	1671	1253
				fz [in]	0.0015	0.0023	0.0030	0.0038	0.0045	0.0060	0.0075	0.0090	0.0120
			131	197	vf [in/min]	30	30	30	30	30	30	30	30
		0.30 x DCX	164	n [rev/min]	10026	6684	5013	4010	3342	2507	2005	1671	1253
				fz [in]	0.0015	0.0023	0.0030	0.0038	0.0045	0.0060	0.0075	0.0090	0.0120
			131	197	vf [in/min]	30	30	30	30	30	30	30	30
	E/M/A 14 - 15	0.30 x DCX	98	n [rev/min]	6016	4010	3008	2406	2005	1504	1203	1003	752
				fz [in]	0.0015	0.0023	0.0030	0.0038	0.0045	0.0060	0.0075	0.0090	0.0120
			66	131	vf [in/min]	18	18	18	18	18	18	18	18
		0.30 x DCX	377	n [rev/min]	23060	15374	11530	9224	7687	5765	4612	3843	2883
				fz [in]	0.0022	0.0033	0.0044	0.0055	0.0066	0.0088	0.0109	0.0131	0.0175
			328	427	vf [in/min]	101	101	101	101	101	101	101	101
S	E 19	0.30 x DCX	164	n [rev/min]	10026	6684	5013	4010	3342	2507	2005	1671	1253
				fz [in]	0.0015	0.0023	0.0030	0.0038	0.0045	0.0060	0.0075	0.0090	0.0120
			131	197	vf [in/min]	30	30	30	30	30	30	30	30
		0.30 x DCX	164	n [rev/min]	10026	6684	5013	4010	3342	2507	2005	1671	1253
				fz [in]	0.0015	0.0023	0.0030	0.0038	0.0045	0.0060	0.0075	0.0090	0.0120
			131	197	vf [in/min]	30	30	30	30	30	30	30	30
	E 20	0.30 x DCX	98	n [rev/min]	6016	4010	3008	2406	2005	1504	1203	1003	752
				fz [in]	0.0015	0.0023	0.0030	0.0038	0.0045	0.0060	0.0075	0.0090	0.0120
			66	131	vf [in/min]	18	18	18	18	18	18	18	18
		0.30 x DCX	377	n [rev/min]	23060	15374	11530	9224	7687	5765	4612	3843	2883
				fz [in]	0.0022	0.0033	0.0044	0.0055	0.0066	0.0088	0.0109	0.0131	0.0175
			328	427	vf [in/min]	101	101	101	101	101	101	101	101
E 21	0.30 x DCX	164	n [rev/min]	10026	6684	5013	4010	3342	2507	2005	1671	1253	
			fz [in]	0.0015	0.0023	0.0030	0.0038	0.0045	0.0060	0.0075	0.0090	0.0120	
		131	197	vf [in/min]	30	30	30	30	30	30	30	30	
	0.30 x DCX	98	n [rev/min]	6016	4010	3008	2406	2005	1504	1203	1003	752	
			fz [in]	0.0015	0.0023	0.0030	0.0038	0.0045	0.0060	0.0075	0.0090	0.0120	
		66	131	vf [in/min]	18	18	18	18	18	18	18	18	
E 22	0.30 x DCX	377	n [rev/min]	23060	15374	11530	9224	7687	5765	4612	3843	2883	
			fz [in]	0.0022	0.0033	0.0044	0.0055	0.0066	0.0088	0.0109	0.0131	0.0175	
		328	427	vf [in/min]	101	101	101	101	101	101	101	101	
	0.30 x DCX	164	n [rev/min]	10026	6684	5013	4010	3342	2507	2005	1671	1253	
			fz [in]	0.0015	0.0023	0.0030	0.0038	0.0045	0.0060	0.0075	0.0090	0.0120	
		131	197	vf [in/min]	30	30	30	30	30	30	30	30	

**Reduce APMX 20% and Feed per tooth 15% when using 5 x D version

**Reduce APMX 40% and Feed per tooth 30% when using 7 x D version

SMG = Seco Material Group
 n [min-1] = RPM
 v_c (sf/min) = Surface feet/min

fz [in] = Feed/tooth vf [in/min] = Feed rate
 a_p/DCX = % of diameter a_p/D = % of diameter

A = Air D = Dry E = Emulsion (flood coolant) M = Mist
 All cutting data are start values. All cutting data is in inch values.
 Please reference the Workpiece Material Classification chart located on page 15.

CUTTING DATA -SN200R, SN400R, SN500R SIDE MILLING - START VALUES

SIDE MILLING																
ISO GROUP	SMG	a _e (Max)	v _c (sf / min)		Zn = 4						Zn = 5					
					1/8	5/32	3/16	1/4	5/16	3/8	1/2	3/8	1/2			
P	M/A/D 1 - 2	0.30 x DCX	984	n [rev/min]	30079	24062	20052	15039	12031	10026	7520	10026	7520			
				fz [in]	0.0069	0.0086	0.0103	0.0138	0.0172	0.0206	0.0275	0.0206	0.0275			
			vf [in/min]	827	827	827	827	827	827	827	1034	1034				
		820	1148	ap max**	0.0080	0.0100	0.0120	0.0140	0.0160	0.0180	0.0200	0.0180	0.0200			
			0.30 x DCX	738	n [rev/min]	22559	18047	15039	11280	9024	7520	5640	7520	5640		
					fz [in]	0.0063	0.0078	0.0094	0.0125	0.0156	0.0188	0.0250	0.0188	0.0250		
	M/A/D 3 - 4	0.30 x DCX	656	820	vf [in/min]	564	564	564	564	564	564	564	705	705		
					ap max**	0.0080	0.0100	0.0120	0.0140	0.0160	0.0180	0.0200	0.0180	0.0200		
			492	656	n [rev/min]	17546	14036	11697	8773	7018	5849	4386	5849	4386		
		fz [in]			0.0056	0.0070	0.0084	0.0113	0.0141	0.0169	0.0225	0.0169	0.0225			
		vf [in/min]			395	395	395	395	395	395	395	493	493			
		M/A/D 5 - 6	0.30 x DCX	574	656	ap max**	0.0080	0.0100	0.0120	0.0140	0.0160	0.0180	0.0200	0.0180	0.0200	
n [rev/min]	17546					14036	11697	8773	7018	5849	4386	5849	4386			
492	656			fz [in]	0.0056	0.0070	0.0084	0.0113	0.0141	0.0169	0.0225	0.0169	0.0225			
			vf [in/min]	395	395	395	395	395	395	395	493	493				
			ap max**	0.0080	0.0100	0.0120	0.0140	0.0160	0.0180	0.0200	0.0180	0.0200				
H	M/A/D 7a		0.30 x DCX	312	n [rev/min]	9525	7620	6350	4762	3810	3175	2381	3175	2381		
		fz [in]			0.0050	0.0063	0.0075	0.0100	0.0125	0.0150	0.0200	0.0150	0.0200			
		262		361	vf [in/min]	190	190	190	190	190	190	190	238	238		
					ap max**	0.0064	0.0080	0.0096	0.0125	0.0156	0.0188	0.0250	0.0188	0.0250		
		E/M/A 8 - 9		0.30 x DCX	410	459	n [rev/min]	12533	10026	8355	6266	5013	4178	3133	4178	3133
							fz [in]	0.0050	0.0063	0.0075	0.0100	0.0125	0.0150	0.0200	0.0150	0.0200
361	459		vf [in/min]		251	251	251	251	251	251	251	313	313			
			ap max**		0.0064	0.0080	0.0096	0.0125	0.0156	0.0188	0.0250	0.0188	0.0250			
E/M/A 10 - 11	0.30 x DCX		459		361	n [rev/min]	14037	11229	9358	7018	5615	4679	3509	4679	3509	
						fz [in]	0.0050	0.0063	0.0075	0.0100	0.0125	0.0150	0.0200	0.0150	0.0200	
		262	361	vf [in/min]	281	281	281	281	281	281	281	351	351			
				ap max**	0.0064	0.0080	0.0096	0.0125	0.0156	0.0188	0.0250	0.0188	0.0250			
		E/M/A 12 - 13	0.30 x DCX	574	656	n [rev/min]	17546	14036	11697	8773	7018	5849	4386	5849	4386	
						fz [in]	0.0050	0.0063	0.0075	0.0100	0.0125	0.0150	0.0200	0.0150	0.0200	
492	656			vf [in/min]	351	351	351	351	351	351	351	439	439			
				ap max**	0.0080	0.0100	0.0120	0.0140	0.0160	0.0180	0.0200	0.0180	0.0200			
E/M/A 14 - 15	0.30 x DCX			410	492	n [rev/min]	12533	10026	8355	6266	5013	4178	3133	4178	3133	
						fz [in]	0.0038	0.0047	0.0056	0.0075	0.0094	0.0113	0.0150	0.0113	0.0150	
		328	492	vf [in/min]	188	188	188	188	188	188	188	235	235			
				ap max**	0.0080	0.0100	0.0120	0.0140	0.0160	0.0180	0.0200	0.0180	0.0200			
		E 19	0.30 x DCX	164	197	n [rev/min]	5013	4010	3342	2507	2005	1671	1253	1671	1253	
						fz [in]	0.0030	0.0038	0.0045	0.0060	0.0075	0.0090	0.0120	0.0090	0.0120	
131	197			vf [in/min]	60	60	60	60	60	60	60	75	75			
				ap max**	0.0040	0.0050	0.0060	0.0070	0.0080	0.0090	0.0100	0.0090	0.0100			
E 20	0.30 x DCX			164	197	n [rev/min]	5013	4010	3342	2507	2005	1671	1253	1671	1253	
						fz [in]	0.0030	0.0038	0.0045	0.0060	0.0075	0.0090	0.0120	0.0090	0.0120	
		131	197	vf [in/min]	60	60	60	60	60	60	60	75	75			
				ap max**	0.0040	0.0050	0.0060	0.0070	0.0080	0.0090	0.0100	0.0090	0.0100			
		E 21	0.30 x DCX	98	131	n [rev/min]	3008	2406	2005	1504	1203	1003	752	1003	752	
						fz [in]	0.0030	0.0038	0.0045	0.0060	0.0075	0.0090	0.0120	0.0090	0.0120	
66	131			vf [in/min]	36	36	36	36	36	36	36	45	45			
				ap max**	0.0040	0.0050	0.0060	0.0070	0.0080	0.0090	0.0100	0.0090	0.0100			
E 22	0.30 x DCX			377	427	n [rev/min]	11530	9224	7687	5765	4612	3843	2883	3843	2883	
						fz [in]	0.0044	0.0055	0.0066	0.0088	0.0109	0.0131	0.0175	0.0131	0.0175	
		328	427	vf [in/min]	202	202	202	202	202	202	202	252	252			
				ap max**	0.0040	0.0050	0.0060	0.0070	0.0080	0.0090	0.0100	0.0090	0.0100			

**Reduce APMX 20% and Feed per tooth 15% when using 5 x D version

**Reduce APMX 40% and Feed per tooth 30% when using 7 x D version

SMG = Seco Material Group
 n [min-1] = RPM
 v_c (sf/min) = Surface feet/min

fz [in] = Feed/tooth vf [in/min] = Feed rate
 a_p/DCX = % of diameter a_f/DCX = % of diameter

A = Air D = Dry E = Emulsion (flood coolant) M = Mist
 All cutting data are start values. All cutting data is in inch values.
 Please reference the Workpiece Material Classification chart located on page 15.

CUTTING DATA -SN200R PLUNGE MILLING - START VALUES

		PLUNGE MILLING													
ISO GROUP	SMG	a _e (Max)	v _c (sf / min)		Zn = 2										
					1/16	3/32	1/8	5/32	3/16	1/4	5/16	3/8	1/2		
P	M/A/D 1 - 2	0.30 x DCX	699	n [rev/min]	42712	28475	21356	17084	14237	10678	8542	7119	5339		
			576	822	fz [in]	0.0006	0.0009	0.0013	0.0016	0.0019	0.0025	0.0031	0.0038	0.0050	
				459	577	vf [in/min]	53	53	53	53	53	53	53	53	53
		0.30 x DCX	518		577	ap=pd***	0.1250	0.1875	0.2500	0.3125	0.3750	0.5000	0.6250	0.7500	1.0000
						n [rev/min]	31683	21122	15841	12673	10561	7921	6337	5280	3960
				fz [in]		0.0006	0.0009	0.0013	0.0016	0.0019	0.0025	0.0031	0.0038	0.0050	
	M/A/D 3 - 4	0.30 x DCX	410	n [rev/min]	25066	16710	12533	10026	8355	6266	5013	4178	3133		
			361	459	fz [in]	0.0006	0.0009	0.0013	0.0016	0.0019	0.0025	0.0031	0.0038	0.0050	
				0.30 x DCX	410	459	vf [in/min]	31	31	31	31	31	31	31	31
		ap=pd***	0.1250				0.1875	0.2500	0.3125	0.3750	0.5000	0.6250	0.7500	1.0000	
		n [rev/min]	13034				8689	6517	5213	4345	3259	2607	2172	1629	
		M/A/D 5 - 6	0.30 x DCX	213	fz [in]	0.0004	0.0007	0.0009	0.0011	0.0013	0.0018	0.0022	0.0026	0.0035	
180	246			vf [in/min]	11	11	11	11	11	11	11	11			
	0.30 x DCX			289	331	ap=pd***	0.1250	0.1875	0.2500	0.3125	0.3750	0.5000	0.6250	0.7500	1.0000
n [rev/min]			17646			11764	8823	7058	5882	4412	3529	2941	2206		
fz [in]			0.0004			0.0007	0.0009	0.0011	0.0013	0.0018	0.0022	0.0026	0.0035		
M	E/M/A 8 - 9		0.30 x DCX	246	vf [in/min]	15	15	15	15	15	15	15	15		
		180		246	ap=pd***	0.1250	0.1875	0.2500	0.3125	0.3750	0.5000	0.6250	0.7500	1.0000	
				0.30 x DCX	246	246	n [rev/min]	15039	10026	7520	6016	5013	3760	3008	2507
	fz [in]	0.0004	0.0007				0.0009	0.0011	0.0013	0.0018	0.0022	0.0026	0.0035		
	vf [in/min]	13	13				13	13	13	13	13	13	13		
	K	E/M/A 12 - 13	0.30 x DCX	410	ap=pd***	0.1250	0.1875	0.2500	0.3125	0.3750	0.5000	0.6250	0.7500	1.0000	
361				459	n [rev/min]	25066	16710	12533	10026	8355	6266	5013	4178	3133	
				0.30 x DCX	295	361	fz [in]	0.0004	0.0007	0.0009	0.0011	0.0013	0.0018	0.0022	0.0026
vf [in/min]		22	22				22	22	22	22	22	22	22		
ap=pd***		0.1250	0.1875				0.2500	0.3125	0.3750	0.5000	0.6250	0.7500	1.0000		
S		E/M/A 14 - 15	0.30 x DCX	295	n [rev/min]	18047	12031	9024	7219	6016	4512	3609	3008	2256	
	230			361	fz [in]	0.0004	0.0006	0.0008	0.0009	0.0011	0.0015	0.0019	0.0023	0.0030	
				0.30 x DCX	115	131	vf [in/min]	14	14	14	14	14	14	14	14
	ap=pd***	0.1250	0.1875				0.2500	0.3125	0.3750	0.5000	0.6250	0.7500	1.0000		
	n [rev/min]	7018	4679				3509	2807	2339	1755	1404	1170	877		
	E	E 19	0.30 x DCX	115	fz [in]	0.0004	0.0006	0.0008	0.0009	0.0011	0.0015	0.0019	0.0023	0.0030	
98				131	vf [in/min]	5	5	5	5	5	5	5	5		
				0.30 x DCX	115	131	ap=pd***	0.1250	0.1875	0.2500	0.3125	0.3750	0.5000	0.6250	0.7500
n [rev/min]		7018	4679				3509	2807	2339	1755	1404	1170	877		
fz [in]		0.0004	0.0006				0.0008	0.0009	0.0011	0.0015	0.0019	0.0023	0.0030		
E 20		0.30 x DCX	98	131	vf [in/min]	5	5	5	5	5	5	5	5		
	ap=pd***				0.1250	0.1875	0.2500	0.3125	0.3750	0.5000	0.6250	0.7500	1.0000		
	n [rev/min]				4612	3075	2306	1845	1537	1153	922	769	577		
E 21	0.30 x DCX	49	102	fz [in]	0.0004	0.0006	0.0008	0.0009	0.0011	0.0015	0.0019	0.0023	0.0030		
				vf [in/min]	3	3	3	3	3	3	3	3	3		
				ap=pd***	0.1250	0.1875	0.2500	0.3125	0.3750	0.5000	0.6250	0.7500	1.0000		
E 22	0.30 x DCX	262	295	n [rev/min]	16042	10695	8021	6417	5347	4010	3208	2674	2005		
				fz [in]	0.0004	0.0007	0.0009	0.0011	0.0013	0.0018	0.0022	0.0026	0.0035		
				vf [in/min]	14	14	14	14	14	14	14	14	14		
					ap=pd***	0.1250	0.1875	0.2500	0.3125	0.3750	0.5000	0.6250	0.7500	1.0000	

***pd: plunge depth

SMG = Seco Material Group
 n [min-1] = RPM
 v_c (sf/min) = Surface feet/min

fz [in] = Feed/tooth vf [in/min] = Feed rate
 a_p/DCX = % of diameter a_p/D = % of diameter

A = Air D = Dry E = Emulsion (flood coolant) M = Mist
 All cutting data are start values. All cutting data is in inch values.
 Please reference the Workpiece Material Classification chart located on page 15.

NIAGARA CUTTER™

HARD MILLING

REDUCE CYCLE TIMES WITH HARD MILLING MBZ & MZN

Gain the ability to rough and finish in a single process with Niagara Cutter's MBZ215 and MZN410R for hard milling applications. Instead of traditional methods that require multiple setups, including in some cases Electrical Discharge Machining (EDM), hard milling helps reduce lead times and increase productivity by eliminating multiple setups and difficult polishing processes.

With the increase in Mold and Die manufacturing in the North American market, there is a growing need for a full metric range of MBZ215 and MZN410R/510R products from Niagara Cutter™. Because of this, we have expanded the range to include ball nose end mills from 0.5 mm up to 12 mm in diameter and high feed end mills from 2 mm up to 12 mm in diameter. Both of these product families are effective in hardened steels from 48-65 HRC, cast irons and nickel-based superalloys. With these recent additions, the product family's versatility has now reached new heights in the high speed hard milling sector.

RANGE OVERVIEW

MBZ215M - 2-FLUTE, BALL NOSE

- 0.5 - 12 mm diameters, 1 x dia. flute length, 2 and 4 x dia. straight reach length, 6 x dia. 0.9° tapered reach length, 11 - 37 x dia. long tapered reach, cylindrical shank

MZN410RM - 4-FLUTE, HIGH FEED

- 2 - 12 mm diameters, 0.25 x dia. flute length, 2 and 4 x dia. reach length, cylindrical shank, standard radii available (0.5 mm, 0.75 mm, 1 mm, 1.5 mm, 2 mm and 3 mm)

MZN510RM - 5-FLUTE, HIGH FEED

- 10 - 12 mm diameters, 0.25 x dia. flute length, 2 x dia. reach length, cylindrical shank, standard radii available (2 and 3 mm)

INDUSTRY APPLICATIONS

- **Mold & Die:** With the increase in difficult to machine hardened tool steels, the MZN410RM torical high feed end mill helps reduce semi-finishing and finishing cycle times. With a true radius the MZN410RM can rough closer to near net shape than a true high feed design tool which in turn reduces and sometimes eliminates semi-finishing operations.

MATERIAL GROUPS
Hardened Steels 48-65 HRc
Steel 5-6
Cast Iron 12-15
Superalloys 21

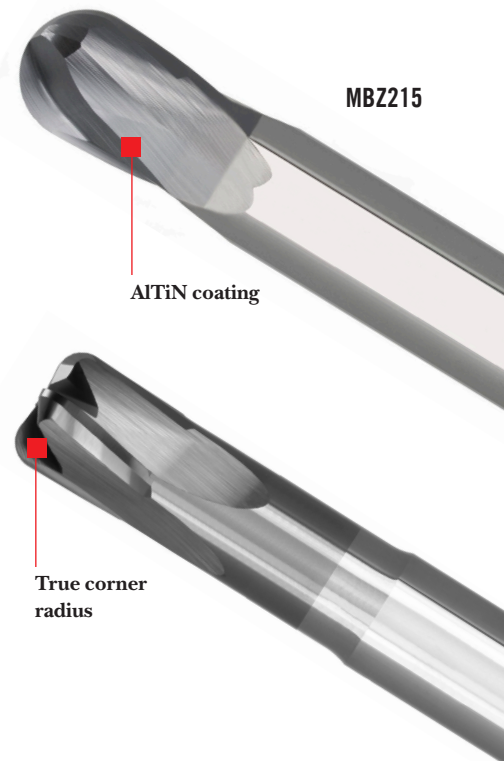

MZN410R/510R

6 TIPS

HARD MILLING

Hard milling can be a highly effective strategy for machining complex 2D and 3D part features such as mold cavities, gates, heat-sinks and even die pockets in tool steel above 48 HRC. However, hard milling requires the utmost attention to detail to achieve maximum performance, tool life and tight tolerances down to .0001".

1. MAINTAINING A CONSTANT CHIP LOAD/FEED RATE

One of the most overlooked concepts when it comes to hard milling is maintaining a constant chip load/feed rate. Complex surfaces and cutter paths used in the mold and die industry cause machine tools to rapidly fluctuate feed rates resulting in a drastic loss of tool life. Feed rates will always fluctuate unless machining in a straight line. When machining complex surfaces, one must take into consideration that machine tools do not reduce rpm in conjunction with feed rate reductions. A good rule of thumb is if the programmed feed rates cannot be maintained for 80% of the time, the average feed rates need to be reduced. Subsequently, feed rates and rpm need to be reduced in the program. For example: programmed rpm is 30,000 and feed rate is 150 ipm. However, the average maintained feed rate is only 75 ipm. Thus, the rpm needs to be reduced to 15,000. This reduction in rpm can increase the tool life upwards of 50% while having a negligible impact on cycle time.

2. DON'T LEAVE TOO MUCH STOCK FOR FINISHING

When machining tool steels above 48 HRC, leaving too much finish stock will not only reduce output but also wreak havoc on surface finishes and tool life. A general guideline for finish stock allowance is 1%-2% of the finish cutter diameter. Most cutting tool manufacturers base their finishing cutting data on 1%-2% of the tooling diameter engagement. Leaving more than this will result in lost productivity. For example: When using a 1/2" diameter tool it is best to not leave more than 0.005"- 0.010" of finish stock.

3. LEAVE CONSISTENT STOCK ON ALL SURFACES FOR MAXIMUM TOOL LIFE

Leaving too much finish stock is bad for tool life and surface finishes. Leaving inconsistent stock for finishing is also bad, if not worse. After a complex surface has been roughed, it is important to run a "rest-rough" and even a "semi-finish" tool path, to ensure a consistent finish stock on all surfaces. Take this example into consideration: A complex 3D surface has just been roughed out with a 12 mm ball nose end mill with an intended finish cutter diameter of 8 mm. A safe practice would be to "rest-rough" with a 10 mm ball nose end mill. Then, "semi-finish" with an 8 mm ball nose ensuring there is only 0.003"- 0.006" of stock on all surfaces. Finally, finish mill with a new 8 mm ball nose end mill to achieve a consistent surface finish as well as extend the life of the finish tool. This strategy may even lend itself to using the finish ball nose end mill as a "semi-finish" tool once the finish tool life has been met.



4. NOT ALL HARDENED TOOL STEELS ARE CREATED EQUAL

Some common hardened tool steels in the Mold and Die industry present unique challenges. Take for example D2 tool steel that can be heat treated to 60-62 HRC. Because of the added Chromium content, this tool steel is not only hard, but also tough. Furthermore, it machines similar to tool steel that is 62-65 HRC. 420 stainless steel is also very common in the mold industry because it is wear resistant and can be polished to a mirror finish. Although this material is typically heat treated to 48-52 HRC, it still retains its sticky stainless steel properties. This material is prone to causing Built Up Edge (BUE) making running the proper surface feet per minute crucial. Utilizing air/oil mist will also help reduce BUE when machining this material.

5. USE RIGID HOLDERS

To achieve maximum tool life, high-precision holders are crucial to hard milling. Run-out needs to be kept to less than 0.0004". This type of precision can be achieved by most shrink fit holders, milling chucks, high precision collet chucks and select manufactures end mill holders. A precise holder also ensures the accuracy of the process, whereas a less secure holder may cause unpredictable tool life and produce surfaces that are out of tolerance.

6. FOLLOW RECOMMENDED CUTTING PARAMETERS

Through meticulous research and years of first-hand experience, we have developed specific recommended cutting parameters. Cutting data is optimized per the tool's design, specifications and for specific material groups. These specifications should always be used as a starting point. Modifications can be made depending on the application.

MZN410R / MZN510R

SOLID CARBIDE

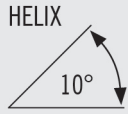

CENTER CUTTING



- Strong end tooth design
- Hardened steels (>48 Rc) and nickel based superalloys such as Inconel 718
- Edge preparation for increased cutting edge strength
- 2° back taper with reduced neck diameter for workpiece clearance
- Shrink fit first choice as toolholder

ITEM NUMBER	DESCRIPTION	FLUTE DIA (DCX)	SHANK DIA	LENGTH OF CUT	OVERALL LENGTH	NECK DIA	REACH	FLUTES	COATING	RADIUS	SHANK TYPE
N00305	MZN410R-0.125-J1-R030.0-Z4	1/8	1/4	0.030	2-1/2	0.112	0.375	4	ALTIN	0.030	CYLINDRICAL
N00001	MZN410R-0.125-J2-R030.0-Z4	1/8	1/4	0.030	2-1/2	0.112	0.625	4	ALTIN	0.030	CYLINDRICAL
N00002	MZN410R-0.188-J1-R050.0-Z4	3/16	1/4	0.050	2-1/2	0.172	0.562	4	ALTIN	0.050	CYLINDRICAL
N00003	MZN410R-0.188-J2-R050.0-Z4	3/16	1/4	0.050	2-1/2	0.172	0.937	4	ALTIN	0.050	CYLINDRICAL
N00004	MZN410R-0.250-E1-R060.0-Z4	1/4	1/4	0.060	2-1/2	0.230	0.750	4	ALTIN	0.060	CYLINDRICAL
N00005	MZN410R-0.250-E2-R060.0-Z4	1/4	1/4	0.060	2-1/2	0.230	1.250	4	ALTIN	0.060	CYLINDRICAL
N00006	MZN410R-0.313-G1-R080.0-Z4	5/16	3/8	0.080	3	0.290	0.750	4	ALTIN	0.080	CYLINDRICAL
N00007	MZN410R-0.313-G2-R080.0-Z4	5/16	3/8	0.080	3	0.290	1.250	4	ALTIN	0.080	CYLINDRICAL
N00008	MZN410R-0.375-E1-R080.0-Z4	3/8	3/8	0.080	3	0.348	1.125	4	ALTIN	0.080	CYLINDRICAL
N00009	MZN510R-0.375-E1-R080.0-Z5	3/8	3/8	0.080	3	0.348	1.125	5	ALTIN	0.080	CYLINDRICAL
N00010	MZN410R-0.375-E3-R080.0-Z4	3/8	3/8	0.080	3	0.348	1.875	4	ALTIN	0.080	CYLINDRICAL
N00011	MZN410R-0.500-E1-R120.0-Z4	1/2	1/2	0.120	4	0.468	1.500	4	ALTIN	0.120	CYLINDRICAL
N00012	MZN510R-0.500-E1-R120.0-Z5	1/2	1/2	0.120	4	0.468	1.500	5	ALTIN	0.120	CYLINDRICAL
N00013	MZN510R-0.625-E1-R120.0-Z5	5/8	5/8	0.120	4	0.584	1.875	5	ALTIN	0.120	CYLINDRICAL
METRIC - MZN410RM / MZN510RM											
03169565	MZN410RM-020-G2-R050.0-Z4	2mm	6mm	0.5mm	50mm	1.8mm	4mm	4	ALTIN	0.50MM	CYLINDRICAL
03169566	MZN410RM-030-G2-R075.0-Z4	3mm	6mm	0.75mm	50mm	2.7mm	6mm	4	ALTIN	0.75MM	CYLINDRICAL
03169567	MZN410RM-040-G2-R100.0-Z4	4mm	6mm	1mm	50mm	3.6mm	8mm	4	ALTIN	1.00MM	CYLINDRICAL
03169568	MZN410RM-060-E2-R150.0-Z4	6mm	6mm	1.5mm	55mm	5.4mm	12mm	4	ALTIN	1.50MM	CYLINDRICAL
03169569	MZN410RM-080-E2-R200.0-Z4	8mm	8mm	2mm	60mm	7.3mm	16mm	4	ALTIN	2.00MM	CYLINDRICAL
03169570	MZN410RM-100-E2-R200.0-Z4	10mm	10mm	2mm	70mm	9.2mm	20mm	4	ALTIN	2.00MM	CYLINDRICAL
03169571	MZN510RM-100-E2-R200.0-Z5	10mm	10mm	2mm	70mm	9.2mm	20mm	5	ALTIN	2.00MM	CYLINDRICAL
03169572	MZN510RM-120-E2-R300.0-Z5	12mm	12mm	3mm	75mm	11mm	24mm	5	ALTIN	3.00MM	CYLINDRICAL
03169573	MZN410RM-020-G4-R050.0-Z4	2mm	6mm	0.5mm	55mm	1.8mm	8mm	4	ALTIN	0.50MM	CYLINDRICAL
03169574	MZN410RM-030-G4-R075.0-Z4	3mm	6mm	0.75mm	55mm	2.7mm	12mm	4	ALTIN	0.75MM	CYLINDRICAL
03169575	MZN410RM-040-G4-R100.0-Z4	4mm	6mm	1mm	65mm	3.6mm	16mm	4	ALTIN	1.00MM	CYLINDRICAL
03169576	MZN410RM-060-E4-R150.0-Z4	6mm	6mm	1.5mm	65mm	5.4mm	24mm	4	ALTIN	1.50MM	CYLINDRICAL
03169577	MZN410RM-080-E4-R200.0-Z4	8mm	8mm	2mm	75mm	7.3mm	32mm	4	ALTIN	2.00MM	CYLINDRICAL
03169578	MZN410RM-100-E4-R200.0-Z4	10mm	10mm	2mm	100mm	9.2mm	40mm	4	ALTIN	2.00MM	CYLINDRICAL
03169579	MZN410RM-120-E4-R300.0-Z4	12mm	12mm	3mm	100mm	11mm	48mm	4	ALTIN	3.00MM	CYLINDRICAL

MZN410R / MZN510R - 2 X D START VALUES - Inch

SLOTING													
ISO GROUP	SMG	a _e x DCX (max)	v _c (sf / min)		Z _n = 4						Z _n = 5		
					1/8	3/16	1/4	5/16	3/8	1/2	5/8	1/2	5/8
P	E / M / A 5 - 6	1.00	740	n (rev/min)	22614	15076	11307	9046	7538	5654	4523	5654	4523
				f _z (in)	0.0031	0.0047	0.0063	0.0078	0.0094	0.0125	0.0156	0.0125	0.0156
			690 - 790	v _f (in/min)	283	283	283	283	283	283	283	353	353
				Max Ap	0.008	0.012	0.014	0.018	0.020	0.022	0.024	0.022	0.024
H	M / A / D 7a (48-56 HRc)	1.00	440	n (rev/min)	13446	8964	6723	5379	4482	3362	2689	3362	2689
				f _z (in)	0.0031	0.0047	0.0063	0.0078	0.0094	0.0125	0.0156	0.0125	0.0156
			390 - 490	v _f (in/min)	168	168	168	168	168	168	168	210	210
				Max Ap	0.008	0.012	0.014	0.018	0.020	0.022	0.024	0.022	0.024
	M / A / D 7b (56-62 HRc)	1.00	230	n (rev/min)	7029	4686	3514	2812	2343	1757	1406	1757	1406
				f _z (in)	0.0025	0.0038	0.005	0.0063	0.0075	0.01	0.0125	0.01	0.0125
			200 - 260	v _f (in/min)	70	70	70	70	70	70	70	88	88
				Max Ap	0.004	0.004	0.007	0.007	0.010	0.011	0.012	0.011	0.012
K	E / M / A 12 - 13	1.00	570	n (rev/min)	17419	11613	8710	6968	5806	4355	3484	4355	3484
				f _z (in)	0.0030	0.0045	0.0060	0.0075	0.0090	0.0120	0.0150	0.0120	0.0150
			490 - 650	v _f (in/min)	209	209	209	209	209	209	209	261	261
				Max Ap	0.008	0.012	0.014	0.016	0.018	0.020	0.022	0.020	0.022
	E / M / A 14 - 15	1.00	410	n (rev/min)	12530	8353	6265	5012	4177	3132	2506	3132	2506
				f _z (in)	0.0023	0.0034	0.0045	0.0056	0.0068	0.0090	0.0113	0.0090	0.0113
			330 - 490	v _f (in/min)	113	113	113	113	113	113	113	141	141
				Max Ap	0.008	0.012	0.014	0.016	0.018	0.020	0.022	0.020	0.022
S	E 21	1.00	100	n (rev/min)	3056	2037	1528	1222	1019	764	611	764	611
				f _z (in)	0.0010	0.0015	0.0021	0.0026	0.0031	0.0041	0.0051	0.0041	0.0051
			90 - 110	v _f (in/min)	13	13	13	13	13	13	13	16	16
				Max Ap	0.004	0.006	0.007	0.008	0.010	0.015	0.015	0.015	0.015

SMG = Seco Material Group
 n [min-1] = RPM
 v_c (sf/min) = Surface feet/min

f_z [in] = Feed/tooth v_f [in/min] = Feed rate
 a_p/DCX = % of diameter a_p/D = % of diameter

A = Air D = Dry E = Emulsion (flood coolant) M = Mist
 All cutting data are start values. All cutting data is in inch values.
 Please reference the Workpiece Material Classification chart located on page 15.

MZN410R / MZN510R - 2 X D START VALUES - Inch

SIDE MILLING													
ISO GROUP	SMG	$a_e \times DCX$ (max)	V_c (sf / min)		$Z_n = 4$						$Z_n = 5$		
					1/8	3/16	1/4	5/16	3/8	1/2	5/8	1/2	5/8
P	E / M / A 5 - 6	0.50	825	n (rev/min)	25212	16808	12606	10085	8404	6303	5042	6303	5042
				f_z (in)	0.0050	0.0075	0.0100	0.0125	0.0150	0.0200	0.0250	0.0200	0.0250
			770 - 880	V_f (in/min)	504	504	504	504	504	504	504	630	630
				Max Ap	0.005	0.006	0.008	0.001	0.013	0.014	0.016	0.017	0.017
H	M / A / D 7a (48-56 HRC)	0.50	480	n (rev/min)	14669	9779	7334	5868	4890	3667	2934	3667	2934
				f_z (in)	0.0050	0.0075	0.0100	0.0125	0.0150	0.0200	0.0250	0.0200	0.0250
			430 - 530	V_f (in/min)	293	293	293	293	293	293	293	367	367
				Max Ap	0.005	0.006	0.008	0.001	0.013	0.014	0.016	0.017	0.017
	M / A / D 7b (56-62 HRC)	0.50	260	n (rev/min)	7946	5297	3973	3178	2649	1986	1589	1986	1589
				f_z (in)	0.0038	0.0056	0.0075	0.0094	0.0113	0.0150	0.0188	0.0150	0.0188
			230 - 290	V_f (in/min)	119	119	119	119	119	119	119	149	149
				Max Ap	0.004	0.006	0.007	0.009	0.011	0.015	0.019	0.015	0.019
K	E / M / A 12 - 13	0.50	570	n (rev/min)	17419	11613	8710	6968	5806	4355	3484	4355	3484
				f_z (in)	0.0050	0.0075	0.0100	0.0125	0.0150	0.0200	0.0250	0.0200	0.0250
			490 - 650	V_f (in/min)	348	348	348	348	348	348	348	435	435
				Max Ap	0.006	0.008	0.010	0.014	0.016	0.018	0.020	0.022	0.022
	E / M / A 14 - 15	0.50	410	n (rev/min)	12530	8353	6265	5012	4177	3132	2506	3132	2506
				f_z (in)	0.0038	0.0056	0.0075	0.0094	0.0113	0.0150	0.0188	0.0150	0.0188
			330 - 490	V_f (in/min)	188	188	188	188	188	188	188	235	235
				Max Ap	0.006	0.008	0.010	0.014	0.016	0.018	0.020	0.022	0.022
S	E 21	0.50	100	n (rev/min)	3056	2037	1528	1222	1019	764	611	764	611
				f_z (in)	0.0026	0.0039	0.0052	0.0065	0.0078	0.0104	0.0130	0.0104	0.0130
			90 - 110	V_f (in/min)	32	32	32	32	32	32	32	40	40
				Max Ap	0.004	0.005	0.007	0.008	0.010	0.015	0.015	0.015	0.015

SMG = Seco Material Group
 n [min-1] = RPM
 V_c (sf/min) = Surface feet/min

f_z [in] = Feed/tooth v_f [in/min] = Feed rate
 a_p/DCX = % of diameter a_e/DCX = % of diameter

A = Air D = Dry E = Emulsion (flood coolant) M = Mist
 All cutting data are start values. All cutting data is in inch values.
 Please reference the Workpiece Material Classification chart located on page 15.

MZN410R / MZN510R - START VALUES

SIDE MILLING - ROUGHING														
ISO GROUP	SMG	a _e x DCX (max)	v _c (sf / min)		Z _n = 4						Z _n = 5			
					1/8	3/16	1/4	5/16	3/8	1/2	5/8	1/2	5/8	
P	E / M / A 5 - 6	0.30	740	n (rev/min)	22614	15076	11967	9046	7538	5654	4523	5654	4523	
				f _z (in)	0.0050	0.0075	0.0094	0.0125	0.0150	0.0200	0.0250	0.0200	0.0250	
			690	790	v _f (in/min)	452	452	452	452	452	452	452	565	565
				max (a _p)	0.0047	0.0063	0.0079	0.0110	0.0126	0.0142	0.0157	0.0173	0.0173	
H	M / A / D 7a	0.30	480	n (rev/min)	14669	9779	7762	5868	4890	3667	2934	3667	2934	
				f _z (in)	0.0050	0.0075	0.0094	0.0125	0.0150	0.0200	0.0250	0.0200	0.0250	
			430	520	v _f (in/min)	293	293	293	293	293	293	293	367	367
				max (a _p)	0.0047	0.0063	0.0079	0.0110	0.0126	0.0142	0.0157	0.0173	0.0173	
	M / A / D 7b	0.30	260	n (rev/min)	7946	5297	4205	3178	2649	1986	1589	1986	1589	
				f _z (in)	0.0038	0.0056	0.0071	0.0094	0.0113	0.0150	0.0188	0.0150	0.0188	
			230	300	v _f (in/min)	119	119	119	119	119	119	119	149	149
				max (a _p)	0.0047	0.0063	0.0079	0.0110	0.0126	0.0142	0.0157	0.0173	0.0173	
K	E / M / A 12 - 13	0.30	570	n (rev/min)	17419	11613	9218	6968	5806	4355	3484	4355	3484	
				f _z (in)	0.0050	0.0075	0.0094	0.0125	0.0150	0.0200	0.0250	0.0200	0.0250	
			490	660	v _f (in/min)	348	348	348	348	348	348	348	435	435
	max (a _p)	0.0059		0.0079	0.0098	0.0138	0.0157	0.0177	0.0197	0.0217	0.0217			
	E / M / A 14 - 15	0.30	410	n (rev/min)	12530	8353	6630	5012	4177	3132	2506	3132	2506	
				f _z (in)	0.0038	0.0056	0.0071	0.0094	0.0113	0.0150	0.0188	0.0150	0.0188	
330			490	v _f (in/min)	188	188	188	188	188	188	188	235	235	
	max (a _p)	0.0059	0.0079	0.0098	0.0138	0.0157	0.0177	0.0197	0.0217	0.0217				
S	E 21	0.30	100	n (rev/min)	3056	2037	1617	1222	1019	764	611	764	611	
				f _z (in)	0.0026	0.0039	0.0049	0.0065	0.0078	0.0105	0.0130	0.0105	0.0130	
			90	110	v _f (in/min)	32	32	32	32	32	32	32	40	40
				max (a _p)	0.0038	0.0050	0.0070	0.0077	0.0100	0.0150	0.0150	0.0150	0.0150	

SMG = Seco Material Group
 n [min-1] = RPM
 v_c (sf/min) = Surface feet/min

f_z [in] = Feed/tooth v_f [in/min] = Feed rate
 a_p/DCX = % of diameter a_p/D = % of diameter

A = Air D = Dry E = Emulsion (flood coolant) M = Mist
 All cutting data are start values. All cutting data is in inch values.
 Please reference the Workpiece Material Classification chart located on page 15.

MZN410RM / MZN510RM - 2 X D START VALUES - Inch

SLOTTING														
ISO GROUP	SMG	$a_p \times DCX$ (max)	v_c (sf / min)		$Z_n = 4$						$Z_n = 5$			
					2	3	4	6	8	10	12	10	12	
P	E / M / A 5 - 6	1.00	740	n (rev/min)	35900	23934	17950	11967	8975	7180	5983	7180	5983	
				f_z (in)	0.0020	0.0030	0.0039	0.0059	0.0079	0.0098	0.0118	0.0098	0.0118	
				v_f (in/min)	283	283	283	283	283	283	283	353	353	
				Max Ap	0.006	0.008	0.010	0.014	0.019	0.020	0.022	0.020	0.022	
H	M / A / D 7a (48-56 HRC)	1.00	440	n (rev/min)	21346	14231	10673	7115	5337	4269	3558	4269	3558	
				f_z (in)	0.0020	0.0030	0.0039	0.0059	0.0079	0.0098	0.0118	0.0098	0.0118	
				v_f (in/min)	168	168	168	168	168	168	168	210	210	
				Max Ap	0.006	0.008	0.010	0.014	0.019	0.020	0.022	0.020	0.022	
	M / A / D 7b (56-62 HRC)	1.00	230	200 - 260	n (rev/min)	11158	7439	5579	3719	2790	2232	1860	2232	1860
					f_z (in)	0.0016	0.0024	0.0031	0.0047	0.0063	0.0079	0.0094	0.0079	0.0094
					v_f (in/min)	70	70	70	70	70	70	70	88	88
					Max Ap	0.003	0.004	0.005	0.007	0.009	0.010	0.011	0.010	0.011
K	E / M / A 12 - 13	1.00	570	n (rev/min)	27653	18435	13826	9218	6913	5531	4609	5531	4609	
				f_z (in)	0.0019	0.0028	0.0038	0.0057	0.0076	0.0094	0.0113	0.0094	0.0113	
				v_f (in/min)	209	209	209	209	209	209	209	261	261	
				Max Ap	0.006	0.008	0.010	0.014	0.016	0.018	0.020	0.018	0.020	
	E / M / A 14 - 15	1.00	410	330 - 490	n (rev/min)	19891	13260	9945	6630	4973	3978	3315	3978	3315
					f_z (in)	0.0014	0.0021	0.0028	0.0043	0.0057	0.0071	0.0085	0.0071	0.0085
					v_f (in/min)	113	113	113	113	113	113	113	141	141
					Max Ap	0.006	0.008	0.010	0.014	0.016	0.018	0.020	0.018	0.020
S	E 21	1.00	100	n (rev/min)	4851	3234	2426	1617	1213	970	809	970	809	
				f_z (in)	0.0006	0.0010	0.0013	0.0019	0.0026	0.0032	0.0039	0.0032	0.0039	
				v_f (in/min)	13	13	13	13	13	13	13	16	16	
				Max Ap	0.003	0.004	0.005	0.008	0.010	0.010	0.015	0.010	0.015	

SMG = Seco Material Group
 n [min-1] = RPM
 v_c (sf/min) = Surface feet/min

f_z [in] = Feed/tooth v_f [in/min] = Feed rate
 a_p/DCX = % of diameter a_p/DCX = % of diameter

A = Air D = Dry E = Emulsion (flood coolant) M = Mist
 All cutting data are start values. All cutting data is in inch values.
 Please reference the Workpiece Material Classification chart located on page 15.

MZN410RM / MZN510RM - 2 X D START VALUES - Inch

SIDE MILLING													
ISO GROUP	SMG	$a_p \times DCX$ (max)	v_c (sf / min)		$Z_n = 4$						$Z_n = 5$		
					2	3	4	6	8	10	12	10	12
P	E / M / A 5 - 6	0.50	825 770 - 880	n (rev/min)	40024	26683	20012	13341	10006	8005	6671	8005	6671
				f_z (in)	0.0031	0.0047	0.0063	0.0094	0.0126	0.0157	0.0189	0.0157	0.0189
				v_f (in/min)	504	504	504	504	504	504	504	630	630
				Max Ap	0.006	0.008	0.010	0.014	0.019	0.020	0.022	0.020	0.022
H	M / A / D 7a (48-56 HRc)	0.50	480 430 - 530	n (rev/min)	23287	15524	11643	7762	5822	4657	3881	4657	3881
				f_z (in)	0.0031	0.0047	0.0063	0.0094	0.0126	0.0157	0.0189	0.0157	0.0189
				v_f (in/min)	293	293	293	293	293	293	293	367	367
				Max Ap	0.006	0.008	0.010	0.014	0.019	0.020	0.022	0.020	0.022
	M / A / D 7b (56-62 HRc)	0.50	260 230 - 290	n (rev/min)	12614	8409	6307	4205	3153	2523	2102	2523	2102
				f_z (in)	0.0024	0.0035	0.0047	0.0071	0.0094	0.0118	0.0142	0.0118	0.0142
				v_f (in/min)	119	119	119	119	119	119	119	149	149
				Max Ap	0.003	0.004	0.005	0.007	0.009	0.010	0.011	0.010	0.011
K	E / M / A 12 - 13	0.50	570 490 - 650	n (rev/min)	27653	18435	13826	9218	6913	5531	4609	5531	4609
				f_z (in)	0.0031	0.0047	0.0063	0.0094	0.0126	0.0157	0.0189	0.0157	0.0189
				v_f (in/min)	348	348	348	348	348	348	348	435	435
				Max Ap	0.006	0.008	0.010	0.014	0.016	0.018	0.020	0.018	0.020
	E / M / A 14 - 15	0.50	410 330 - 490	n (rev/min)	19891	13260	9945	6630	4973	3978	3315	3978	3315
				f_z (in)	0.0024	0.0035	0.0047	0.0071	0.0094	0.0118	0.0142	0.0118	0.0142
				v_f (in/min)	188	188	188	188	188	188	188	235	235
				Max Ap	0.006	0.008	0.010	0.014	0.016	0.018	0.020	0.018	0.020
S	E 21	0.50	100 90 - 110	n (rev/min)	4851	3234	2426	1617	1213	970	809	970	809
				f_z (in)	0.0016	0.0025	0.0033	0.0049	0.0066	0.0082	0.0098	0.0082	0.0098
				v_f (in/min)	32	32	32	32	32	32	32	40	40
				Max Ap	0.003	0.004	0.005	0.008	0.010	0.010	0.015	0.010	0.015

SMG = Seco Material Group
 n [min-1] = RPM
 v_c (sf/min) = Surface feet/min

f_z [in] = Feed/tooth v_f [in/min] = Feed rate
 a_p/DCX = % of diameter a_p/D = % of diameter

A = Air D = Dry E = Emulsion (flood coolant) M = Mist
 All cutting data are start values. All cutting data is in inch values.
 Please reference the Workpiece Material Classification chart located on page 15.

MZN410RM / MZN510RM - 4 X D START VALUES - Inch

SLOTTING														
ISO GROUP	SMG	$a_p \times DCX$ (max)	v_c (sf / min)		$Z_n = 4$						$Z_n = 5$			
					2	3	4	6	8	10	12	10	12	
P	E / M / A 5 - 6	1.00	740	n (rev/min)	35900	23934	17950	11967	8975	7180	5983	7180	5983	
				f_z (in)	0.0017	0.0025	0.0033	0.0050	0.0067	0.0084	0.0100	0.0084	0.0100	
				v_f (in/min)	240	240	240	240	240	240	240	300	300	
				Max Ap	0.005	0.006	0.008	0.011	0.015	0.016	0.018	0.016	0.018	
H	M / A / D 7a (48-56 HRC)	1.00	440	n (rev/min)	21346	14231	10673	7115	5337	4269	3558	4269	3558	
				f_z (in)	0.0017	0.0025	0.0033	0.0050	0.0067	0.0084	0.0100	0.0084	0.0100	
				v_f (in/min)	143	143	143	143	143	143	143	179	179	
				Max Ap	0.005	0.006	0.008	0.011	0.015	0.016	0.018	0.016	0.018	
	M / A / D 7b (56-62 HRC)	1.00	230	200 - 260	n (rev/min)	11158	7439	5579	3719	2790	2232	1860	2232	1860
					f_z (in)	0.0013	0.0020	0.0027	0.0040	0.0054	0.0067	0.0080	0.0067	0.0080
					v_f (in/min)	60	60	60	60	60	60	60	75	75
					Max Ap	0.002	0.003	0.004	0.006	0.007	0.008	0.009	0.008	0.009
K	E / M / A 12 - 13	1.00	570	n (rev/min)	27653	18435	13826	9218	6913	5531	4609	5531	4609	
				f_z (in)	0.0016	0.0024	0.0032	0.0048	0.0064	0.0080	0.0096	0.0080	0.0096	
				v_f (in/min)	178	178	178	178	178	178	178	222	222	
				Max Ap	0.005	0.006	0.008	0.011	0.013	0.014	0.016	0.014	0.016	
	E / M / A 14 - 15	1.00	410	330 - 490	n (rev/min)	19891	13260	9945	6630	4973	3978	3315	3978	3315
					f_z (in)	0.0012	0.0018	0.0024	0.0036	0.0048	0.0060	0.0072	0.0060	0.0072
					v_f (in/min)	96	96	96	96	96	96	96	120	120
					Max Ap	0.005	0.006	0.008	0.011	0.013	0.014	0.016	0.014	0.016
S	E 21	1.00	100	n (rev/min)	4851	3234	2426	1617	1213	970	809	970	809	
				f_z (in)	0.0005	0.0008	0.0011	0.0016	0.0022	0.0027	0.0033	0.0027	0.0033	
				v_f (in/min)	11	11	11	11	11	11	11	13	13	
				Max Ap	0.002	0.003	0.004	0.006	0.008	0.008	0.012	0.008	0.012	

SMG = Seco Material Group
 n [min-1] = RPM
 v_c (sf/min) = Surface feet/min

f_z [in] = Feed/tooth v_f [in/min] = Feed rate
 a_p/DCX = % of diameter a_p/DCX = % of diameter

A = Air D = Dry E = Emulsion (flood coolant) M = Mist
 All cutting data are start values. All cutting data is in inch values.
 Please reference the Workpiece Material Classification chart located on page 15.

MZN410RM / MZN510RM - 4 X D START VALUES - Inch



SIDE MILLING														
ISO GROUP	SMG	$a_e \times DCX$ (max)	v_c (sf / min)		$Z_n = 4$						$Z_n = 5$			
					2	3	4	6	8	10	12	10	12	
P	E / M / A 5 - 6	0.50	825	n (rev/min)	40024	26683	20012	13341	10006	8005	6671	8005	6671	
				f_z (in)	0.0027	0.0040	0.0054	0.0080	0.0107	0.0134	0.0161	0.0134	0.0161	
				v_f (in/min)	429	429	429	429	429	429	429	536	536	
				Max Ap	0.005	0.006	0.008	0.011	0.015	0.016	0.018	0.016	0.018	
H	M / A / D 7a (48-56 HRC)	0.50	480	n (rev/min)	23287	15524	11643	7762	5822	4657	3881	4657	3881	
				f_z (in)	0.0027	0.0040	0.0054	0.0080	0.0107	0.0134	0.0161	0.0134	0.0161	
				v_f (in/min)	249	249	249	249	249	249	249	312	312	
				Max Ap	0.005	0.006	0.008	0.011	0.015	0.016	0.018	0.016	0.018	
	M / A / D 7b (56-62 HRC)	0.50	260	430 - 530	n (rev/min)	12614	8409	6307	4205	3153	2523	2102	2523	2102
					f_z (in)	0.0020	0.0030	0.0040	0.0060	0.0080	0.0100	0.0120	0.0100	0.0120
					v_f (in/min)	101	101	101	101	101	101	101	127	127
					Max Ap	0.002	0.003	0.004	0.006	0.007	0.008	0.009	0.008	0.009
K	E / M / A 12 - 13	0.50	570	n (rev/min)	27653	18435	13826	9218	6913	5531	4609	5531	4609	
				f_z (in)	0.0027	0.0040	0.0054	0.0080	0.0107	0.0134	0.0161	0.0134	0.0161	
				v_f (in/min)	296	296	296	296	296	296	296	370	370	
				Max Ap	0.005	0.006	0.008	0.011	0.013	0.014	0.016	0.014	0.016	
	E / M / A 14 - 15	0.50	410	490 - 650	n (rev/min)	19891	13260	9945	6630	4973	3978	3315	3978	3315
					f_z (in)	0.0020	0.0030	0.0040	0.0060	0.0080	0.0100	0.0120	0.0100	0.0120
					v_f (in/min)	160	160	160	160	160	160	160	200	200
					Max Ap	0.005	0.006	0.008	0.011	0.013	0.014	0.016	0.014	0.016
S	E 21	0.50	100	n (rev/min)	4851	3234	2426	1617	1213	970	809	970	809	
				f_z (in)	0.001	0.002	0.003	0.004	0.006	0.007	0.008	0.007	0.008	
				v_f (in/min)	27	27	27	27	27	27	27	34	34	
				Max Ap	0.002	0.003	0.004	0.006	0.008	0.008	0.012	0.008	0.012	

SMG = Seco Material Group
 n [min-1] = RPM
 v_c (sf/min) = Surface feet/min

f_z [in] = Feed/tooth
 a_p/DCX = % of diameter
 v_f [in/min] = Feed rate
 a_p/D_c = % of diameter

A = Air D = Dry E = Emulsion (flood coolant) M = Mist
 All cutting data are start values. All cutting data is in inch values.
 Please reference the Workpiece Material Classification chart located on page 15.

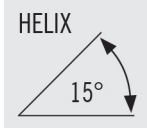
MB215 & MB215M

SOLID CARBIDE	 <p>HELIX 15°</p>	 <p>BALL END</p>	CENTER CUTTING
---------------	--	---	----------------





- Cylindrical Shank
- 7° Draft Angle
- Ideal for milling hardened mold and die steels up to 52HRc
- Rough and finish milling of contours and complex shapes

ITEM NUMBER	DESCRIPTION	FLUTE DIA	SHANK DIA	LENGTH OF CUT	OVERALL LENGTH	NECK DIA	REACH	FLUTES	COATING
INCH - MB215									
N76671	MB215-0.063-G1-B.0-Z2	1/16	1/4	1/16	2-1/2	0.059	1/8	2	ALTIN
N76673	MB215-0.125-G1-B.0-Z2	1/8	1/4	1/8	3	0.121	1/4	2	ALTIN
N76675	MB215-0.250-E1-B.0-Z2	1/4	1/4	1/4	3	0.246	1/2	2	ALTIN
N76677	MB215-0.375-E1-B.0-Z2	3/8	3/8	3/8	3	0.367	3/4	2	ALTIN
N76679	MB215-0.500-E1-B.0-Z2	1/2	1/2	1/2	4	0.492	1	2	ALTIN

METRIC - MB215M									
N76660	MB215M-010-G1-B.0-Z2	1mm	6mm	1mm	64mm	0.9mm	2mm	2	ALTIN
N76661	MB215M-020-G1-B.0-Z2	2mm	6mm	2mm	64mm	1.9mm	4mm	2	ALTIN
N76662	MB215M-030-G1-B.0-Z2	3mm	6mm	3mm	64mm	2.9mm	6mm	2	ALTIN
N76663	MB215M-040-G1-B.0-Z2	4mm	6mm	4mm	64mm	3.9mm	8mm	2	ALTIN
N76665	MB215M-060-E1-B.0-Z2	6mm	6mm	6mm	64mm	5.9mm	12mm	2	ALTIN
N76666	MB215M-080-E1-B.0-Z2	8mm	8mm	8mm	80mm	7.8mm	16mm	2	ALTIN
N76667	MB215M-100-E1-B.0-Z2	10mm	10mm	10mm	82mm	9.8mm	20mm	2	ALTIN
N76668	MB215M-120-E1-B.0-Z2	12mm	12mm	12mm	100mm	11.8mm	24mm	2	ALTIN

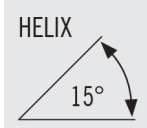
MBZ215

SOLID CARBIDE	 <p>HELIX 15°</p>	 <p>BALL END</p>	CENTER CUTTING
---------------	--	---	----------------



- Cylindrical Shank
- 7° Draft Angle
- Ideal for milling hardened mold and die steels up to 62HRc
- Rough and finish milling of contours and complex shapes

ITEM NUMBER	DESCRIPTION	FLUTE DIA	SHANK DIA	LENGTH OF CUT	OVERALL LENGTH	NECK DIA	REACH	FLUTES	COATING
N76691	MBZ215-0.063-G1-B.0-Z2	1/16	1/4	1/16	2-1/2	0.059	1/8	2	ALTIN
N76693	MBZ215-0.125-G1-B.0-Z2	1/8	1/4	1/8	3	0.121	1/4	2	ALTIN
N76695	MBZ215-0.250-E1-B.0-Z2	1/4	1/4	1/4	3	0.246	1/2	2	ALTIN
N76697	MBZ215-0.375-E1-B.0-Z2	3/8	3/8	3/8	3	0.367	3/4	2	ALTIN
N76699	MBZ215-0.500-E1-B.0-Z2	1/2	1/2	1/2	4	0.492	1	2	ALTIN

MBZ215M

SOLID CARBIDE

HELIX

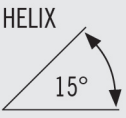

15°

BALL END

CENTER CUTTING



- Cylindrical Shank
- 7° Draft Angle
- Ideal for milling hardened mold and die steels up to 62HRC
- Rough and finish milling of contours and complex shapes

ITEM NUMBER	DESCRIPTION	FLUTE DIA	SHANK DIA	LENGTH OF CUT	OVERALL LENGTH	NECK DIA	REACH	FLUTES	COATING	SHANK TYPE
03180803	MBZ215M-005-G2-B.0-Z2	.5mm	6mm	0.5mm	60mm	0.45mm	1mm	2	ALTIN	CYLINDRICAL
03180804	MBZ215M-005-G4-B.0-Z2	.5mm	6mm	0.5mm	60mm	0.45mm	2mm	2	ALTIN	CYLINDRICAL
03180805	MBZ215M-005-J6-B.0-Z2	.5mm	6mm	0.5mm	60mm	0.45mm	3mm	2	ALTIN	CYLINDRICAL
03180806	MBZ215M-008-G2-B.0-Z2	.8mm	6mm	.8mm	60mm	0.75mm	1.6mm	2	ALTIN	CYLINDRICAL
03180807	MBZ215M-008-G4-B.0-Z2	.8mm	6mm	.8mm	60mm	0.75mm	3.2mm	2	ALTIN	CYLINDRICAL
03180808	MBZ215M-008-J6-B.0-Z2	.8mm	6mm	.8mm	60mm	0.75mm	4.8mm	2	ALTIN	CYLINDRICAL
03180809	MBZ215M-010-G2-B.0-Z2	1mm	6mm	1mm	60mm	0.95mm	2mm	2	ALTIN	CYLINDRICAL
03180810	MBZ215M-010-G4-B.0-Z2	1mm	6mm	1mm	60mm	0.95mm	4mm	2	ALTIN	CYLINDRICAL
03180811	MBZ215M-010-J6-B.0-Z2	1mm	6mm	1mm	60mm	0.95mm	6mm	2	ALTIN	CYLINDRICAL
03180812	MBZ215M-010-J37-B.0-Z2	1mm	6mm	1mm	80mm	0.95mm	37.2mm	2	ALTIN	CYLINDRICAL
03180813	MBZ215M-015-G2-B.0-Z2	1.5mm	6mm	1.5mm	60mm	1.4mm	3mm	2	ALTIN	CYLINDRICAL
03180814	MBZ215M-015-G4-B.0-Z2	1.5mm	6mm	1.5mm	60mm	1.4mm	6mm	2	ALTIN	CYLINDRICAL
03180815	MBZ215M-015-J6-B.0-Z2	1.5mm	6mm	1.5mm	60mm	1.4mm	9mm	2	ALTIN	CYLINDRICAL
03180816	MBZ215M-020-G2-B.0-Z2	2mm	6mm	2mm	60mm	1.9mm	4mm	2	ALTIN	CYLINDRICAL
03180817	MBZ215M-020-G4-B.0-Z2	2mm	6mm	2mm	60mm	1.9mm	8mm	2	ALTIN	CYLINDRICAL
03180818	MBZ215M-020-J6-B.0-Z2	2mm	6mm	2mm	60mm	1.9mm	12mm	2	ALTIN	CYLINDRICAL
03180819	MBZ215M-020-J19-B.0-Z2	2mm	6mm	2mm	80mm	1.9mm	37.2mm	2	ALTIN	CYLINDRICAL
03180820	MBZ215M-025-G2-B.0-Z2	2.5mm	6mm	2.5mm	60mm	2.4mm	5mm	2	ALTIN	CYLINDRICAL
03180821	MBZ215M-025-G4-B.0-Z2	2.5mm	6mm	2.5mm	60mm	2.4mm	10mm	2	ALTIN	CYLINDRICAL
03180822	MBZ215M-025-J6-B.0-Z2	2.5mm	6mm	2.5mm	60mm	2.4mm	15mm	2	ALTIN	CYLINDRICAL
03180823	MBZ215M-030-G2-B.0-Z2	3mm	6mm	3mm	60mm	2.8mm	6mm	2	ALTIN	CYLINDRICAL
03180824	MBZ215M-030-G4-B.0-Z2	3mm	6mm	3mm	60mm	2.8mm	12mm	2	ALTIN	CYLINDRICAL
03180825	MBZ215M-030-J6-B.0-Z2	3mm	6mm	3mm	65mm	2.8mm	18mm	2	ALTIN	CYLINDRICAL
03180826	MBZ215M-030-J13-B.0-Z2	3mm	6mm	3mm	80mm	2.8mm	39.6mm	2	ALTIN	CYLINDRICAL
03180827	MBZ215M-040-G2-B.0-Z2	4mm	6mm	4mm	60mm	3.7mm	8mm	2	ALTIN	CYLINDRICAL
03180828	MBZ215M-040-G4-B.0-Z2	4mm	6mm	4mm	65mm	3.7mm	16mm	2	ALTIN	CYLINDRICAL
03180829	MBZ215M-040-J6-B.0-Z2	4mm	6mm	4mm	65mm	3.7mm	24mm	2	ALTIN	CYLINDRICAL
03180830	MBZ215M-040-J12-B.0-Z2	4mm	6mm	4mm	100mm	3.7mm	47.8mm	2	ALTIN	CYLINDRICAL
03180831	MBZ215M-050-G2-B.0-Z2	5mm	6mm	5mm	60mm	4.6mm	10mm	2	ALTIN	CYLINDRICAL
03180832	MBZ215M-050-G4-B.0-Z2	5mm	6mm	5mm	65mm	4.6mm	20mm	2	ALTIN	CYLINDRICAL
03180833	MBZ215M-050-J6-B.0-Z2	5mm	6mm	5mm	75mm	4.6mm	30mm	2	ALTIN	CYLINDRICAL
03180834	MBZ215M-050-J11-B.0-Z2	5mm	8mm	5mm	100mm	4.6mm	56.8mm	2	ALTIN	CYLINDRICAL
03180835	MBZ215M-060-D1-B.0-Z2	6mm	6mm	6mm	50mm	-	-	2	ALTIN	CYLINDRICAL
03180836	MBZ215M-060-D2-B.0-Z2	6mm	6mm	6mm	75mm	-	-	2	ALTIN	CYLINDRICAL
03180837	MBZ215M-060-J6-B.0-Z2	6mm	8mm	6mm	75mm	5.6mm	36mm	2	ALTIN	CYLINDRICAL
03180838	MBZ215M-060-J9-B.0-Z2	6mm	8mm	6mm	100mm	5.6mm	51.7mm	2	ALTIN	CYLINDRICAL
03180839	MBZ215M-080-D1-B.0-Z2	8mm	8mm	8mm	60mm	-	-	2	ALTIN	CYLINDRICAL
03180840	MBZ215M-080-D2-B.0-Z2	8mm	8mm	8mm	75mm	-	-	2	ALTIN	CYLINDRICAL
03180841	MBZ215M-080-J6-B.0-Z2	8mm	10mm	8mm	100mm	7.4mm	48mm	2	ALTIN	CYLINDRICAL
03180842	MBZ215M-080-J7-B.0-Z2	8mm	10mm	8mm	125mm	7.4mm	57.5mm	2	ALTIN	CYLINDRICAL
03180843	MBZ215M-100-D1-B.0-Z2	10mm	10mm	10mm	70mm	-	-	2	ALTIN	CYLINDRICAL
03180844	MBZ215M-100-D2-B.0-Z2	10mm	10mm	10mm	85mm	-	-	2	ALTIN	CYLINDRICAL
03180845	MBZ215M-100-J6-B.0-Z2	10mm	12mm	10mm	125mm	9.4mm	60mm	2	ALTIN	CYLINDRICAL
03180846	MBZ215M-120-D1-B.0-Z2	12mm	12mm	12mm	75mm	-	-	2	ALTIN	CYLINDRICAL
03180847	MBZ215M-120-D2-B.0-Z2	12mm	12mm	12mm	100mm	-	-	2	ALTIN	CYLINDRICAL

MZ645 / MZ645R

SOLID CARBIDE	HELIX 45°	SQUARE END	RADIUS	CENTER CUTTING
---------------	--------------	------------	--------	----------------



- Cylindrical Shank
- Ideal for peripheral milling of hard steels up to 62HRc

ORDER NO.	DESCRIPTION	FLUTE DIA	SHANK DIA	LENGTH OF CUT	OVERALL LENGTH	FLUTES	COATING	RADIUS
N76617	MZ645-0.125-F3-S.0-Z6	1/8	1/4	3/8	3	6	ALTIN	-
N76619	MZ645-0.188-F3-S.0-Z6	3/16	1/4	1/2	3	6	ALTIN	-
N76621	MZ645-0.250-D3-S.0-Z6	1/4	1/4	5/8	3	6	ALTIN	-
N76623	MZ645-0.313-D2-S.0-Z6	5/16	5/16	3/4	3	6	ALTIN	-
N76625	MZ645-0.375-D3-S.0-Z6	3/8	3/8	1	3	6	ALTIN	-
N76627	MZ645-0.500-D2-S.0-Z6	1/2	1/2	1-1/8	4	6	ALTIN	-
N76616	MZ645R-0.125-F3-R020.0-Z6	1/8	1/4	3/8	3	6	ALTIN	0.020
N76618	MZ645R-0.188-F3-R020.0-Z6	3/16	1/4	1/2	3	6	ALTIN	0.020
N76620	MZ645R-0.250-D3-R020.0-Z6	1/4	1/4	5/8	3	6	ALTIN	0.020
N76622	MZ645R-0.313-D2-R020.0-Z6	5/16	5/16	3/4	3	6	ALTIN	0.020
N76624	MZ645R-0.375-D3-R020.0-Z6	3/8	3/8	1	3	6	ALTIN	0.020
N76626	MZ645R-0.500-D2-R030.0-Z6	1/2	1/2	1-1/8	4	6	ALTIN	0.030

MBZ215 - START VALUES - Inch

COPY MILLING - ROUGHING											
ISO GROUP	SMG	$a_p \times D_c$ (max)	$a_e \times D_c$ (max)	V_c (sf / min)		$Z_n = 2$					
						1/16	1/8	3/16	1/4	3/8	1/2
H	M / A / D 7a (48-56 HRC)	0.10	0.30	560	n (rev/min)	33960	17110	11380	8560	5700	4280
					f_z (in)	0.0012	0.0024	0.0036	0.0048	0.0071	0.0095
					V_f (in/min)	81	81	81	81	81	81
	M / A / D 7b (56-62 HRC)	0.07	0.25	390	n (rev/min)	23650	11920	7920	5960	3970	2980
					f_z (in)	0.0009	0.0019	0.0028	0.0038	0.0056	0.0075
					V_f (in/min)	45	45	45	45	45	45
	M / A / D 7c (62-65 HRC)	0.05	0.20	260	n (rev/min)	15770	7950	5280	3970	2650	1990
					f_z (in)	0.0008	0.0016	0.0024	0.0033	0.0049	0.0065
					V_f (in/min)	26	26	26	26	26	26
	M / A / D 7d (>65 HRC)	0.04	0.15	160	n (rev/min)	9700	4890	3250	2440	1630	1220
					f_z (in)	0.0007	0.0014	0.0021	0.0028	0.0041	0.0055
					V_f (in/min)	13	13	13	13	13	13
K	E 12 - 13	0.15	0.30	820	n (rev/min)	49720	25060	16660	12530	8350	6260
					f_z (in)	0.0008	0.0016	0.0024	0.0033	0.0049	0.0065
					V_f (in/min)	81	81	81	81	81	81
	E 14 - 15	0.14	0.20	660	n (rev/min)	40020	20170	13410	10080	6720	5040
					f_z (in)	0.0008	0.0015	0.0023	0.0030	0.0045	0.0060
					V_f (in/min)	61	61	61	61	61	61

COPY MILLING - FINISHING											
ISO GROUP	SMG	$a_p \times D_c$ (max)	$a_e \times D_c$ (max)	V_c (sf / min)		$Z_n = 2$					
						1/16	1/8	3/16	1/4	3/8	1/2
H	M / A / D 7a (48-56 HRC)	0.02	0.01	920	n (rev/min)	55780	28120	18690	14060	9370	7030
					f_z (in)	0.0008	0.0016	0.0024	0.0033	0.0049	0.0065
					V_f (in/min)	91	91	91	91	91	91
	M / A / D 7b (56-62 HRC)	0.02	0.01	560	n (rev/min)	33960	17110	11380	8560	5700	4280
					f_z (in)	0.0008	0.0015	0.0023	0.0030	0.0045	0.0060
					V_f (in/min)	51	51	51	51	51	51
	M / A / D 7c (62-65 HRC)	0.01	0.01	360	n (rev/min)	21830	11000	7310	5500	3670	2750
					f_z (in)	0.0006	0.0013	0.0019	0.0025	0.0038	0.0050
					V_f (in/min)	28	28	28	28	28	28
	M / A / D 7d (>65 HRC)	0.01	0.01	260	n (rev/min)	15770	7950	5280	3970	2650	1990
					f_z (in)	0.0006	0.0013	0.0019	0.0025	0.0038	0.0050
					V_f (in/min)	20	20	20	20	20	20
K	E 12 - 13	0.03	0.02	1130	n (rev/min)	68520	34530	22960	17270	11510	8630
					f_z (in)	0.0009	0.0019	0.0028	0.0038	0.0056	0.0075
					V_f (in/min)	129	129	129	129	129	129
	E 14 - 15	0.02	0.02	950	n (rev/min)	57600	29030	19300	14520	9680	7260
					f_z (in)	0.0009	0.0018	0.0026	0.0035	0.0053	0.0070
					V_f (in/min)	102	102	102	102	102	102

SMG = Seco Material Group
 n [min-1] = RPM
 V_c (sf/min) = Surface feet/min

f_z [in] = Feed/tooth
 $a_p/D_c = \% \text{ of diameter}$
 $a_e/D_c = \% \text{ of diameter}$
 V_f [in/min] = Feed rate

A = Air D = Dry E = Emulsion (flood coolant) M = Mist
 All cutting data are start values. All cutting data is in inch values.
 Please reference the Workpiece Material Classification chart located on page 15.

MBZ215M - UP TO 4 X D - START VALUES - Inch

COPY MILLING - ROUGHING

ISO GROUP	SMG	a _p x Dc (max)	a _e x Dc (max)	v _c (sf / min)		Z _n = 2													
						0.5	0.8	1	1.5	2	2.5	3	3.5	4	5	6	8	10	12
H	M / A / D 7a (48-56 HRc)	0.10	0.30	560	n (rev/min)	108663	67914	54332	36221	27166	21733	18111	15523	13583	10866	9055	6791	5433	4528
					f _z (in)	0.0004	0.0006	0.0007	0.0011	0.0015	0.0019	0.0022	0.0026	0.0030	0.0037	0.0045	0.0060	0.0075	0.0090
					v _f (in/min)	81	81	81	81	81	81	81	81	81	81	81	81	81	81
	M / A / D 7b (56-62 HRc)	0.07	0.25	390	n (rev/min)	75676	47298	37838	25225	18919	15135	12613	10811	9460	7568	6306	4730	3784	3153
					f _z (in)	0.0003	0.0005	0.0006	0.0009	0.0012	0.0015	0.0018	0.0021	0.0024	0.0030	0.0035	0.0047	0.0059	0.0071
					v _f (in/min)	45	45	45	45	45	45	45	45	45	45	45	45	45	45
	M / A / D 7c (62-65 HRc)	0.05	0.20	260	n (rev/min)	50451	31532	25225	16817	12613	10090	8408	7207	6306	5045	4204	3153	2523	2102
					f _z (in)	0.0003	0.0004	0.0005	0.0008	0.0010	0.0013	0.0015	0.0018	0.0020	0.0026	0.0031	0.0041	0.0051	0.0061
					v _f (in/min)	26	26	26	26	26	26	26	26	26	26	26	26	26	26
	M / A / D 7d (>65 HRc)	0.04	0.15	160	n (rev/min)	31047	19404	15523	10349	7762	6209	5174	4435	3881	3105	2587	1940	1552	1294
					f _z (in)	0.0002	0.0003	0.0004	0.0006	0.0009	0.0011	0.0013	0.0015	0.0017	0.0022	0.0026	0.0035	0.0043	0.0052
					v _f (in/min)	13	13	13	13	13	13	13	13	13	13	13	13	13	13
K	E 12 - 13	0.15	0.30	820	n (rev/min)	159114	99446	79557	53038	39778	31823	26519	22731	19889	15911	13259	9945	7956	6630
					f _z (in)	0.0003	0.0004	0.0005	0.0008	0.0010	0.0013	0.0015	0.0018	0.0020	0.0026	0.0031	0.0041	0.0051	0.0061
					v _f (in/min)	81	81	81	81	81	81	81	81	81	81	81	81	81	81
	E 14 - 15	0.14	0.20	660	n (rev/min)	128067	80042	64034	42689	32017	25613	21345	18295	16008	12807	10672	8004	6403	5336
					f _z (in)	0.0002	0.0004	0.0005	0.0007	0.0009	0.0012	0.0014	0.0017	0.0019	0.0024	0.0028	0.0038	0.0047	0.0057
					v _f (in/min)	61	61	61	61	61	61	61	61	61	61	61	61	61	61

COPY MILLING - FINISHING

ISO GROUP	SMG	a _p x Dc (max)	a _e x Dc (max)	v _c (sf / min)		Z _n = 2													
						0.5	0.8	1	1.5	2	2.5	3	3.5	4	5	6	8	10	12
H	M / A / D 7a (48-56 HRc)	0.02	0.01	920	n (rev/min)	178518	111574	89259	59506	44629	35704	29753	25503	22315	17852	14876	11157	8926	7438
					f _z (in)	0.0003	0.0004	0.0005	0.0008	0.0010	0.0013	0.0015	0.0018	0.0020	0.0026	0.0031	0.0041	0.0051	0.0061
					v _f (in/min)	91	91	91	91	91	91	91	91	91	91	91	91	91	91
	M / A / D 7b (56-62 HRc)	0.02	0.01	560	n (rev/min)	108663	67914	54332	36221	27166	21733	18111	15523	13583	10866	9055	6791	5433	4528
					f _z (in)	0.0002	0.0004	0.0005	0.0007	0.0009	0.0012	0.0014	0.0017	0.0019	0.0024	0.0028	0.0038	0.0047	0.0057
					v _f (in/min)	51	51	51	51	51	51	51	51	51	51	51	51	51	51
	M / A / D 7c (62-65 HRc)	0.01	0.01	360	n (rev/min)	69855	43659	34927	23285	17464	13971	11642	9979	8732	6985	5821	4366	3493	2911
					f _z (in)	0.0002	0.0003	0.0004	0.0006	0.0008	0.0010	0.0012	0.0014	0.0016	0.0020	0.0024	0.0031	0.0039	0.0047
					v _f (in/min)	28	28	28	28	28	28	28	28	28	28	28	28	28	28
	M / A / D 7d (>65 HRc)	0.01	0.01	260	n (rev/min)	50451	31532	25225	16817	12613	10090	8408	7207	6306	5045	4204	3153	2523	2102
					f _z (in)	0.0002	0.0003	0.0004	0.0006	0.0008	0.0010	0.0012	0.0014	0.0016	0.0020	0.0024	0.0031	0.0039	0.0047
					v _f (in/min)	20	20	20	20	20	20	20	20	20	20	20	20	20	20
K	E 12 - 13	0.03	0.02	1130	n (rev/min)	219267	137042	109633	73089	54817	43853	36544	31324	27408	21927	18272	13704	10963	9136
					f _z (in)	0.0003	0.0005	0.0006	0.0009	0.0012	0.0015	0.0018	0.0021	0.0024	0.0030	0.0035	0.0047	0.0059	0.0071
					v _f (in/min)	129	129	129	129	129	129	129	129	129	129	129	129	129	129
	E 14 - 15	0.02	0.02	950	n (rev/min)	184339	115212	92170	61446	46085	36868	30723	26334	23042	18434	15362	11521	9217	7681
					f _z (in)	0.0003	0.0004	0.0006	0.0008	0.0011	0.0014	0.0017	0.0019	0.0022	0.0028	0.0033	0.0044	0.0055	0.0066
					v _f (in/min)	102	102	102	102	102	102	102	102	102	102	102	102	102	102

SMG = Seco Material Group
 n [min-1] = RPM
 v_c (sf/min) = Surface feet/min

f_z [in] = Feed/tooth v_f [in/min] = Feed rate
 a_p/DCX = % of diameter a_e/DCX = % of diameter

A = Air D = Dry E = Emulsion (flood coolant) M = Mist
 All cutting data are start values. All cutting data is in inch values.
 Please reference the Workpiece Material Classification chart located on page 15.

MBZ215M - 6 X D - START VALUES - Inch

COPY MILLING - ROUGHING																	
ISO GROUP	SMG	a _p x Dc (max)	a _e x Dc (max)	V _c (sf / min)		Z _n = 2											
						0.5	0.8	1	1.5	2	2.5	3	4	5	6	8	10
H	M / A / D 7a (48-56 HRC)	0.04	0.23	560	n (rev/min)	108663	67914	54332	36221	27166	21733	18111	13583	10866	9055	6791	5433
					f _z (in)	0.0003	0.0005	0.0007	0.0010	0.0013	0.0017	0.0020	0.0027	0.0034	0.0040	0.0054	0.0067
					v _f (in/min)	73	73	73	73	73	73	73	73	73	73	73	73
	M / A / D 7b (56-62 HRC)	0.03	0.19	390	n (rev/min)	75676	47298	37838	25225	18919	15135	12613	9460	7568	6306	4730	3784
					f _z (in)	0.0003	0.0004	0.0005	0.0008	0.0011	0.0013	0.0016	0.0021	0.0027	0.0032	0.0043	0.0053
					v _f (in/min)	40	40	40	40	40	40	40	40	40	40	40	40
	M / A / D 7c (62-65 HRC)	0.02	0.15	260	n (rev/min)	50451	31532	25225	16817	12613	10090	8408	6306	5045	4204	3153	2523
					f _z (in)	0.0002	0.0004	0.0005	0.0007	0.0009	0.0012	0.0014	0.0018	0.0023	0.0028	0.0037	0.0046
					v _f (in/min)	23	23	23	23	23	23	23	23	23	23	23	23
	M / A / D 7d (>65 HRC)	0.016	0.11	160	n (rev/min)	31047	19404	15523	10349	7762	6209	5174	3881	3105	2587	1940	1552
					f _z (in)	0.0002	0.0003	0.0004	0.0006	0.0008	0.0010	0.0012	0.0016	0.0019	0.0023	0.0031	0.0039
					v _f (in/min)	12	12	12	12	12	12	12	12	12	12	12	12
K	E 12 - 13	0.06	0.23	820	n (rev/min)	159114	99446	79557	53038	39778	31823	26519	19889	15911	13259	9945	7956
					f _z (in)	0.0002	0.0004	0.0005	0.0007	0.0009	0.0012	0.0014	0.0018	0.0023	0.0028	0.0037	0.0046
					v _f (in/min)	73	73	73	73	73	73	73	73	73	73	73	73
	E 14 - 15	0.05	0.15	660	n (rev/min)	128067	80042	64034	42689	32017	25613	21345	16008	12807	10672	8004	6403
					f _z (in)	0.0002	0.0003	0.0004	0.0006	0.0009	0.0011	0.0013	0.0017	0.0021	0.0026	0.0034	0.0043
					v _f (in/min)	54	54	54	54	54	54	54	54	54	54	54	54

COPY MILLING - FINISHING																	
ISO GROUP	SMG	a _p x Dc (max)	a _e x Dc (max)	V _c (sf / min)		Z _n = 2											
						0.5	0.8	1	1.5	2	2.5	3	4	5	6	8	10
H	M / A / D 7a (48-56 HRC)	0.01	0.01	920	n (rev/min)	178518	111574	89259	59506	44629	35704	29753	22315	17852	14876	11157	8926
					f _z (in)	0.0002	0.0004	0.0005	0.0007	0.0009	0.0012	0.0014	0.0018	0.0023	0.0028	0.0037	0.0046
					v _f (in/min)	82	82	82	82	82	82	82	82	82	82	82	82
	M / A / D 7b (56-62 HRC)	0.01	0.01	560	n (rev/min)	108663	67914	54332	36221	27166	21733	18111	13583	10866	9055	6791	5433
					f _z (in)	0.0002	0.0003	0.0004	0.0006	0.0009	0.0011	0.0013	0.0017	0.0021	0.0026	0.0034	0.0043
					v _f (in/min)	46	46	46	46	46	46	46	46	46	46	46	46
	M / A / D 7c (62-65 HRC)	0.01	0.01	360	n (rev/min)	69855	43659	34927	23285	17464	13971	11642	8732	6985	5821	4366	3493
					f _z (in)	0.0002	0.0003	0.0004	0.0005	0.0007	0.0009	0.0011	0.0014	0.0018	0.0021	0.0028	0.0035
					v _f (in/min)	25	25	25	25	25	25	25	25	25	25	25	25
	M / A / D 7d (>65 HRC)	0.01	0.01	260	n (rev/min)	50451	31532	25225	16817	12613	10090	8408	6306	5045	4204	3153	2523
					f _z (in)	0.0002	0.0003	0.0004	0.0005	0.0007	0.0009	0.0011	0.0014	0.0018	0.0021	0.0028	0.0035
					v _f (in/min)	18	18	18	18	18	18	18	18	18	18	18	18
K	E 12 - 13	0.01	0.02	1130	n (rev/min)	219267	137042	109633	73089	54817	43853	36544	27408	21927	18272	13704	10963
					f _z (in)	0.0003	0.0004	0.0005	0.0008	0.0011	0.0013	0.0016	0.0021	0.0027	0.0032	0.0043	0.0053
					v _f (in/min)	117	117	117	117	117	117	117	117	117	117	117	117
	E 14 - 15	0.01	0.02	950	n (rev/min)	184339	115212	92170	61446	46085	36868	30723	23042	18434	15362	11521	9217
					f _z (in)	0.0002	0.0004	0.0005	0.0007	0.0010	0.0012	0.0015	0.0020	0.0025	0.0030	0.0040	0.0050
					v _f (in/min)	91	91	91	91	91	91	91	91	91	91	91	91

SMG = Seco Material Group
 n [min-1] = RPM
 V_c (sf/min) = Surface feet/min

f_z [in] = Feed/tooth
 a_p/Dc = % of diameter
 v_f [in/min] = Feed rate
 a_e/Dc = % of diameter

A = Air D = Dry E = Emulsion (flood coolant) M = Mist
 All cutting data are start values. All cutting data is in inch values.
 Please reference the Workpiece Material Classification chart located on page 15.

MBZ215M - GREATER THAN 6 X D - START VALUES - Inch

COPY MILLING - ROUGHING												
ISO GROUP	SMG	$a_p \times D_c$ (max)	$a_e \times D_c$ (max)	v_c (sf / min)		$Z_n = 2$						
						1	2	3	4	5	6	8
H	M / A / D 7a (48-56 HRc)	0.01	0.17	560	n (rev/min)	54332	27166	18111	13583	10866	9055	6791
					f_z (in)	0.0006	0.0012	0.0018	0.0024	0.0030	0.0036	0.0048
					v_f (in/min)	66	66	66	66	66	66	66
	M / A / D 7b (56-62 HRc)	0.007	0.14	390	n (rev/min)	37838	18919	12613	9460	7568	6306	4730
					f_z (in)	0.0005	0.0010	0.0014	0.0019	0.0024	0.0029	0.0038
					v_f (in/min)	36	36	36	36	36	36	36
	M / A / D 7c (62-65 HRc)	0.005	0.11	260	n (rev/min)	25225	12613	8408	6306	5045	4204	3153
					f_z (in)	0.0004	0.0008	0.0012	0.0017	0.0021	0.0025	0.0033
					v_f (in/min)	21	21	21	21	21	21	21
	M / A / D 7d (>65 HRc)	0.004	0.08	160	n (rev/min)	15523	7762	5174	3881	3105	2587	1940
					f_z (in)	0.0004	0.0007	0.0011	0.0014	0.0018	0.0021	0.0028
					v_f (in/min)	11	11	11	11	11	11	11
K	E 12 - 13	0.015	0.17	820	n (rev/min)	79557	39778	26519	19889	15911	13259	9945
					f_z (in)	0.0004	0.0008	0.0012	0.0017	0.0021	0.0025	0.0033
					v_f (in/min)	66	66	66	66	66	66	66
	E 14 - 15	0.014	0.11	660	n (rev/min)	64034	32017	21345	16008	12807	10672	8004
					f_z (in)	0.0004	0.0008	0.0011	0.0015	0.0019	0.0023	0.0031
					v_f (in/min)	49	49	49	49	49	49	49

COPY MILLING - FINISHING												
ISO GROUP	SMG	$a_p \times D_c$ (max)	$a_e \times D_c$ (max)	v_c (sf / min)		$Z_n = 2$						
						1	2	3	4	5	6	8
H	M / A / D 7a (48-56 HRc)	0.010	0.010	920	n (rev/min)	89259	44629	29753	22315	17852	14876	11157
					f_z (in)	0.0004	0.0008	0.0012	0.0017	0.0021	0.0025	0.0033
					v_f (in/min)	74	74	74	74	74	74	74
	M / A / D 7b (56-62 HRc)	0.010	0.010	560	n (rev/min)	54332	27166	18111	13583	10866	9055	6791
					f_z (in)	0.0004	0.0008	0.0011	0.0015	0.0019	0.0023	0.0031
					v_f (in/min)	42	42	42	42	42	42	42
	M / A / D 7c (62-65 HRc)	0.010	0.010	360	n (rev/min)	34927	17464	11642	8732	6985	5821	4366
					f_z (in)	0.0003	0.0006	0.0010	0.0013	0.0016	0.0019	0.0026
					v_f (in/min)	22	22	22	22	22	22	22
	M / A / D 7d (>65 HRc)	0.010	0.010	260	n (rev/min)	25225	12613	8408	6306	5045	4204	3153
					f_z (in)	0.0003	0.0006	0.0010	0.0013	0.0016	0.0019	0.0026
					v_f (in/min)	16	16	16	16	16	16	16
K	E 12 - 13	0.030	0.020	1130	n (rev/min)	109633	54817	36544	27408	21927	18272	13704
					f_z (in)	0.0005	0.0010	0.0014	0.0019	0.0024	0.0029	0.0038
					v_f (in/min)	105	105	105	105	105	105	105
	E 14 - 15	0.020	0.020	950	n (rev/min)	92170	46085	30723	23042	18434	15362	11521
					f_z (in)	0.0004	0.0009	0.0013	0.0018	0.0022	0.0027	0.0036
					v_f (in/min)	82	82	82	82	82	82	82

SMG = Seco Material Group
 n [min-1] = RPM
 v_c (sf/min) = Surface feet/min

f_z [in] = Feed/tooth v_f [in/min] = Feed rate
 a_p/DCX = % of diameter a_e/DCX = % of diameter

A = Air D = Dry E = Emulsion (flood coolant) M = Mist
 All cutting data are start values. All cutting data is in inch values.
 Please reference the Workpiece Material Classification chart located on page 15.

MB215 - START VALUES - Inch

COPY MILLING - ROUGHING											
ISO GROUP	SMG	a _p x Dc (max)	a _e x Dc (max)	V _c (sf / min)		1/16	1/8	3/16	1/4	3/8	1/2
						P	E 5 - 6	0.11	0.31	710	n (rev/min)
f _z (in)	0.0011	0.0023	0.0034	0.0045	0.0068						0.0090
V _f (in/min)	98	98	98	98	98						98
H	M / A / D 7a (48-52 HRC)	0.10	0.30	560	n (rev/min)	33960	17110	11380	8560	5700	4280
					f _z (in)	0.0012	0.0024	0.0036	0.0048	0.0071	0.0095
					V _f (in/min)	81	81	81	81	81	81

COPY MILLING - FINISHING											
ISO GROUP	SMG	a _p x Dc (max)	a _e x Dc (max)	V _c (sf / min)		1/16	1/8	3/16	1/4	3/8	1/2
						P	E 5 - 6	0.02	0.02	1070	n (rev/min)
f _z (in)	0.0008	0.0016	0.0024	0.0033	0.0049						0.0065
V _f (in/min)	106	106	106	106	106						106
H	M / A / D 7a (48-52 HRC)	0.02	0.01	920	n (rev/min)	55780	28120	18690	14060	9370	7030
					f _z (in)	0.0008	0.0016	0.0024	0.0033	0.0049	0.0065
					V _f (in/min)	91	91	91	91	91	91

MB215M - START VALUES - Inch

COPY MILLING - ROUGHING														
ISO GROUP	SMG	a _p x Dc (max)	a _e x Dc (max)	V _c (m / min)		Z _n = 2								
						1	2	3	4	5	6	8	10	12
P	E 5 - 6	0.10	0.30	710	n (rev/min)	68885	34442	22962	17221	13777	11481	8611	6888	5740
					f _z (in)	0.0007	0.0014	0.0021	0.0028	0.0035	0.0043	0.0057	0.0071	0.0085
					V _f (in/min)	98	98	98	98	98	98	98	98	98
H	M / A / D 7a (48-52HRC)	0.10	0.30	560	n (rev/min)	54332	27166	18111	13583	10866	9055	6791	5433	4528
					f _z (in)	0.0007	0.0015	0.0022	0.0030	0.0037	0.0045	0.0060	0.0075	0.0090
					V _f (in/min)	81	81	81	81	81	81	81	81	81

COPY MILLING - FINISHING														
ISO GROUP	SMG	a _p x Dc (max)	a _e x Dc (max)	V _c (m / min)		Z _n = 2								
						1	2	3	4	5	6	8	10	12
P	E 5 - 6	0.02	0.02	1070	n (rev/min)	103812	51906	34604	25953	20762	17302	12977	10381	8651
					f _z (in)	0.0005	0.0010	0.0015	0.0020	0.0026	0.0031	0.0041	0.0051	0.0061
					V _f (in/min)	106	106	106	106	106	106	106	106	106
H	M / A / D 7a (48-52HRC)	0.02	0.01	920	n (rev/min)	89259	44629	29753	22315	17852	14876	11157	8926	7438
					f _z (in)	0.0005	0.0010	0.0015	0.0020	0.0026	0.0031	0.0041	0.0051	0.0061
					V _f (in/min)	91	91	91	91	91	91	91	91	91

SMG = Seco Material Group
 n [min-1] = RPM
 V_c (sf/min) = Surface feet/min

f_z [in] = Feed/tooth
 a_p/Dc = % of diameter
 v_f [in/min] = Feed rate
 a_e/Dc = % of diameter

A = Air D = Dry E = Emulsion (flood coolant) M = Mist
 All cutting data are start values. All cutting data is in inch values.
 Please reference the Workpiece Material Classification chart located on page 15.

MBZ215 - START VALUES

SIDE MILLING - ROUGHING																	
ISO GROUP	SMG	$a_p \times D_c$ (max)	$a_e \times D_c$ (max)	V_c (sf / min)		$Z_n = 2$											
						1/32	1/16	3/32	1/8	3/16	1/4	5/16	3/8	1/2	5/8	3/4	1
P	E 5 - 6	0.10	0.30	500	n (rev/min)	61120	30560	20373	15280	10187	7640	6112	5093	3820	3056	2547	1910
					f_z (in)	0.00030	0.00059	0.00089	0.00119	0.00178	0.00238	0.00297	0.00356	0.00475	0.00594	0.00713	0.00950
					V_f (in/min)	36.3	36.3	36.3	36.3	36.3	36.3	36.3	36.3	36.3	36.3	36.3	36.3
H	M / A / D 7a (48-52HRc)	0.05	0.20	450	n (rev/min)	55008	27504	18336	13752	9168	6876	5501	4584	3438	2750	2292	1719
					f_z (in)	0.00027	0.00054	0.00081	0.00108	0.00161	0.00215	0.00269	0.00323	0.00430	0.00538	0.00645	0.00860
					V_f (in/min)	29.6	29.6	29.6	29.6	29.6	29.6	29.6	29.6	29.6	29.6	29.6	29.6
	M / A / D 7b (52-62HRc)	0.03	0.10	400	n (rev/min)	48896	24448	16299	12224	8149	6112	4890	4075	3056	2445	2037	1528
					f_z (in)	0.00019	0.00038	0.00056	0.00075	0.00113	0.00150	0.00188	0.00225	0.00300	0.00375	0.00450	0.00600
					V_f (in/min)	18.3	18.3	18.3	18.3	18.3	18.3	18.3	18.3	18.3	18.3	18.3	18.3

SIDE MILLING - FINISHING																	
ISO GROUP	SMG	$a_p \times D_c$ (max)	$a_e \times D_c$ (max)	V_c (sf / min)		$Z_n = 6$											
						1/8	3/16	1/4	5/16	3/8	1/2						
P	E 5 - 6	0.10	0.15	500	n (rev/min)	61120	30560	20373	15280	10187	7640	6112	5093	3820	3056	2547	1910
					f_z (in)	0.00030	0.00059	0.00089	0.00119	0.00178	0.00238	0.00297	0.00356	0.00475	0.00594	0.00713	0.00950
					V_f (in/min)	36.3	36.3	36.3	36.3	36.3	36.3	36.3	36.3	36.3	36.3	36.3	36.3
H	M / A / D 7a (48-52HRc)	0.05	0.10	450	n (rev/min)	55008	27504	18336	13752	9168	6876	5501	4584	3438	2750	2292	1719
					f_z (in)	0.00027	0.00054	0.00081	0.00108	0.00161	0.00215	0.00269	0.00323	0.00430	0.00538	0.00645	0.00860
					V_f (in/min)	29.6	29.6	29.6	29.6	29.6	29.6	29.6	29.6	29.6	29.6	29.6	29.6
	M / A / D 7b (52-62HRc)	0.03	0.05	400	n (rev/min)	48896	24448	16299	12224	8149	6112	4890	4075	3056	2445	2037	1528
					f_z (in)	0.00019	0.00038	0.00056	0.00075	0.00113	0.00150	0.00188	0.00225	0.00300	0.00375	0.00450	0.00600
					V_f (in/min)	18.3	18.3	18.3	18.3	18.3	18.3	18.3	18.3	18.3	18.3	18.3	18.3

MZ645 / MZ645R - START VALUES - Inch

SIDE MILLING - ROUGHING																	
ISO GROUP	SMG	$a_p \times D_c$ (max)	$a_e \times D_c$ (max)	V_c (sf / min)		$Z_n = 6$											
						1/8	3/16	1/4	5/16	3/8	1/2						
P	E 5 - 6	1.50	0.10	450	n (rev/min)	13752	9168	6876	5501	4584	3438						
					f_z (in)	0.00075	0.00113	0.00150	0.00188	0.00225	0.00300						
					V_f (in/min)	62	62	62	62	62	62						
H	M / A / D 7a (48-56HRc)	1.00	0.05	450	n (rev/min)	13752	9168	6876	5501	4584	3438						
					f_z (in)	0.00056	0.00084	0.00113	0.00141	0.00169	0.00225						
					V_f (in/min)	46	46	46	46	46	46						
	M / A / D 7b (56-62HRc)	1.00	0.02	400	n (rev/min)	12224	8149	6112	4890	4075	3056						
					f_z (in)	0.00040	0.00060	0.00080	0.00100	0.00120	0.00160						
					V_f (in/min)	29	29	29	29	29	29						

SMG = Seco Material Group
 n [min-1] = RPM
 V_c (sf/min) = Surface feet/min

f_z [in] = Feed/tooth v_f [in/min] = Feed rate
 a_p/DCX = % of diameter a_e/DCX = % of diameter

A = Air D = Dry E = Emulsion (flood coolant) M = Mist
 All cutting data are start values. All cutting data is in inch values.
 Please reference the Workpiece Material Classification chart located on page 15.



**NIAGARA
CUTTER™**

**CVD DIAMOND
COATING**

GAIN UNSURPASSED TOOL LIFE AND PERFORMANCE

CVD DIAMOND COATING

Niagara Cutter CVD diamond coating raises the bar in performance and tool life when machining the toughest and most graphite and Carbon Fiber Reinforced Plastics (CFRP) components. The unique in-house CVD diamond coating coupled with advanced geometries and the highest quality carbide substrates provide unsurpassed tool life and performance.

Niagara Cutter's graphite machining family of tools includes: DIA230, DIA430, DIA430M, DIACR430, DIAL430, DIAXRR430, DIAB230, DIAB230M, DIAB430, DIALB430, DIAUSB430 and DIAURB430.

Developed for machining CFRP, the CVD Diamond range provides superior tool life while reducing un-cut fibers. Our offering includes the following products with both coarse and fine tooth configurations: Compression cutters DIACC and router burrs DIAEPB, DIABEB, DIAPPB.

PRODUCT OVERVIEW

- Advanced in-house CVD diamond coated end mills for a wide range of applications
- Continuous local and global R&D developments.
- Premium carbide substrates

YOUR BENEFITS

- Wide application area, from graphite electrodes to CFRP
- High performance at a competitive price
- Reduced cycle time and higher material removal rates
- Smoother cutting with advanced geometries
- Long and predictable tool life with CVD diamond coatings

RANGE OVERVIEW

- Inch and metric sizes available
- Wide range of geometries available
- Specials available upon request

PREFERRED MATERIAL GROUPS

Graphite
Plastic
Thermoplast
Thermoset

INDUSTRY TARGETS

- Mold & Die
- Aerospace
- General Engineering
- Automotive

INDUSTRY APPLICATIONS

Aerospace: Well suited for a wide range of materials, a complete CVD diamond coated family sets Niagara Cutter apart from the competition.

DIA230

SOLID CARBIDE	HELIX 30°	SQUARE END	CENTER CUTTING
---------------	--------------	------------	----------------



- Cylindrical Shank
- General purpose geometry designed for carbon fiber, composite applications, graphite and green ceramics

ITEM NUMBER	DESCRIPTION	FLUTE DIA	SHANK DIA	LENGTH OF CUT	OVERALL LENGTH	FLUTES	COATING
INCH - DIA230							
N77898	DIA230-0.016-F3-S.0-Z2	1/64	1/8	3/64	1-1/2	2	CVDDIA
N77901	DIA230-0.031-F3-S.0-Z2	1/32	1/8	3/32	1-1/2	2	CVDDIA
N77904	DIA230-0.063-F3-S.0-Z2	1/16	1/8	3/16	1-1/2	2	CVDDIA
N77910	DIA230-0.125-D4-S.0-Z2	1/8	1/8	1/2	1-1/2	2	CVDDIA
N77913	DIA230-0.188-D3-S.0-Z2	3/16	3/16	5/8	2	2	CVDDIA
N77916	DIA230-0.250-D3-S.0-Z2	1/4	1/4	3/4	2-1/2	2	CVDDIA
N77928	DIA230-0.500-D2-S.0-Z2	1/2	1/2	1	3	2	CVDDIA

DIAB230 & DIAB230M

SOLID CARBIDE

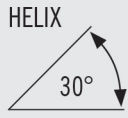

CENTER CUTTING



- Cylindrical Shank
- General purpose geometry designed for carbon fiber, composite applications, graphite and green ceramics

ITEM NUMBER	DESCRIPTION	FLUTE DIA	SHANK DIA	LENGTH OF CUT	OVERALL LENGTH	FLUTES	COATING
INCH - DIAB230							
N77931	DIAB230-0.016-F3-B.0-Z2	1/64	1/8	3/64	1-1/2	2	CVDDIA
N77934	DIAB230-0.031-F3-B.0-Z2	1/32	1/8	3/32	1-1/2	2	CVDDIA
N77174	DIAB230-0.047-F3-B.0-Z2	3/64	1/8	1/8	1-1/2	2	CVDDIA
N77937	DIAB230-0.063-F3-B.0-Z2	1/16	1/8	3/16	1-1/2	2	CVDDIA
N77943	DIAB230-0.125-D4-B.0-Z2	1/8	1/8	1/2	1-1/2	2	CVDDIA
N77946	DIAB230-0.188-D3-B.0-Z2	3/16	3/16	5/8	2	2	CVDDIA
N77949	DIAB230-0.250-D3-B.0-Z2	1/4	1/4	3/4	2-1/2	2	CVDDIA
N77961	DIAB230-0.500-D2-B.0-Z2	1/2	1/2	1	3	2	CVDDIA
METRIC - DIAB230M							
N77267	DIAB230M-010-F4-B.0-Z2	1mm	3mm	4mm	45mm	2	CVDDIA
N77268	DIAB230M-020-F5-B.0-Z2	2mm	3mm	10mm	45mm	2	CVDDIA
N77269	DIAB230M-030-D5-B.0-Z2	3mm	3mm	15mm	45mm	2	CVDDIA
N77270	DIAB230M-040-D4-B.0-Z2	4mm	4mm	15mm	55mm	2	CVDDIA
N77271	DIAB230M-060-D3-B.0-Z2	6mm	6mm	20mm	64mm	2	CVDDIA

DIA430 & DIA430M

SOLID
CARBIDE

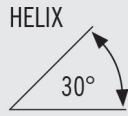

CENTER
CUTTING



- Cylindrical Shank
- General purpose geometry designed for carbon fiber, composite applications, graphite and green ceramics

ITEM NUMBER	DESCRIPTION	FLUTE DIA	SHANK DIA	LENGTH OF CUT	OVERALL LENGTH	FLUTES	COATING
INCH - DIA430							
N77790	DIA430-0.016-F3-S.0-Z4	1/64	1/8	3/64	1-1/2	4	CVDDIA
N77793	DIA430-0.031-F3-S.0-Z4	1/32	1/8	3/32	1-1/2	4	CVDDIA
N77796	DIA430-0.063-F3-S.0-Z4	1/16	1/8	3/16	1-1/2	4	CVDDIA
N77799	DIA430-0.094-F4-S.0-Z4	3/32	1/8	3/8	1-1/2	4	CVDDIA
N77802	DIA430-0.125-D4-S.0-Z4	1/8	1/8	1/2	1-1/2	4	CVDDIA
N77805	DIA430-0.188-D3-S.0-Z4	3/16	3/16	5/8	2	4	CVDDIA
N77808	DIA430-0.250-D3-S.0-Z4	1/4	1/4	3/4	2-1/2	4	CVDDIA
N77814	DIA430-0.375-D2-S.0-Z4	3/8	3/8	7/8	2-1/2	4	CVDDIA
N77820	DIA430-0.500-D2-S.0-Z4	1/2	1/2	1	3	4	CVDDIA
METRIC - DIA430M							
N77276	DIA430M-020-F5-S.0-Z4	2mm	3mm	10mm	45mm	4	CVDDIA
N77277	DIA430M-030-D5-S.0-Z4	3mm	3mm	15mm	45mm	4	CVDDIA
N77278	DIA430M-040-D4-S.0-Z4	4mm	4mm	15mm	55mm	4	CVDDIA
N77279	DIA430M-060-D3-S.0-Z4	6mm	6mm	20mm	64mm	4	CVDDIA
N77280	DIA430M-080-D2-S.0-Z4	8mm	8mm	20mm	64mm	4	CVDDIA

DIACR430

SOLID CARBIDE

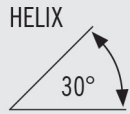

RADIUS



CENTER CUTTING



- Cylindrical Shank
- General purpose geometry designed for carbon fiber, composite applications, graphite and green ceramics

ITEM NUMBER	DESCRIPTION	FLUTE DIA	SHANK DIA	LENGTH OF CUT	OVERALL LENGTH	FLUTES	COATING	RADIUS
N18415	DIACR430-0.063-F3-R010.0-Z4	1/16	1/8	3/16	1-1/2	4	CVDDIA	0.010
N18416	DIACR430-0.063-F3-R015.0-Z4	1/16	1/8	3/16	1-1/2	4	CVDDIA	0.015
N18417	DIACR430-0.125-D4-R015.0-Z4	1/8	1/8	1/2	1-1/2	4	CVDDIA	0.015
N18418	DIACR430-0.125-D4-R020.0-Z4	1/8	1/8	1/2	1-1/2	4	CVDDIA	0.020
N18419	DIACR430-0.188-D3-R020.0-Z4	3/16	3/16	5/8	2	4	CVDDIA	0.020
N18421	DIACR430-0.250-D3-R020.0-Z4	1/4	1/4	3/4	2-1/2	4	CVDDIA	0.020
N18422	DIACR430-0.250-D3-R030.0-Z4	1/4	1/4	3/4	2-1/2	4	CVDDIA	0.030
N77191	DIACR430-0.250-D6-R030.0-Z4	1/4	1/4	1-3/8	4	4	CVDDIA	0.030
N18423	DIACR430-0.375-D2-R020.0-Z4	3/8	3/8	7/8	2-1/2	4	CVDDIA	0.020
N18424	DIACR430-0.375-D2-R030.0-Z4	3/8	3/8	7/8	2-1/2	4	CVDDIA	0.030
N18425	DIACR430-0.500-D2-R030.0-Z4	1/2	1/2	1	3	4	CVDDIA	0.030
N18426	DIACR430-0.500-D2-R060.0-Z4	1/2	1/2	1	3	4	CVDDIA	0.060
N77194	DIACR430-0.500-D3-R030.0-Z4	1/2	1/2	1-3/8	4	4	CVDDIA	0.030

DIAL430

SOLID CARBIDE

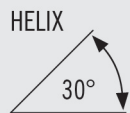

SQUARE END



CENTER CUTTING



- Cylindrical Shank
- General purpose geometry designed for carbon fiber, composite applications, graphite and green ceramics

ITEM NUMBER	DESCRIPTION	FLUTE DIA	SHANK DIA	LENGTH OF CUT	OVERALL LENGTH	FLUTES	COATING
N77856	DIAL430-0.125-D8-S.0-Z4	1/8	1/8	1	3	4	CVDDIA
N77859	DIAL430-0.188-D5-S.0-Z4	3/16	3/16	1	4	4	CVDDIA
N72693	DIAL430-0.188-D6-S.0-Z4	3/16	3/16	1-1/8	3	4	CVDDIA
N77862	DIAL430-0.250-D5-S.0-Z4	1/4	1/4	1-1/4	3	4	CVDDIA
N72699	DIAL430-0.250-D6-S.0-Z4	1/4	1/4	1-3/8	4	4	CVDDIA
N77868	DIAL430-0.375-D4-S.0-Z4	3/8	3/8	1-3/8	3-1/4	4	CVDDIA
N72717	DIAL430-0.375-D5-S.0-Z4	3/8	3/8	1-3/8	4	4	CVDDIA
N18695	DIAL430-0.500-D3-S.0-Z4	1/2	1/2	1-3/8	4	4	CVDDIA
N77874	DIAL430-0.500-D5-S.0-Z4	1/2	1/2	2	4	4	CVDDIA
N72729	DIAL430-0.500-D6-S.0-Z4	1/2	1/2	3	6	4	CVDDIA

DIAB430

SOLID CARBIDE

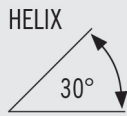

CENTER CUTTING



- Cylindrical Shank
- General purpose geometry designed for carbon fiber, composite applications, graphite and green ceramics

ITEM NUMBER	DESCRIPTION	FLUTE DIA	SHANK DIA	LENGTH OF CUT	OVERALL LENGTH	FLUTES	COATING
N77823	DIAB430-0.016-F3-B.0-Z4	1/64	1/8	3/64	1-1/2	4	CVDDIA
N77826	DIAB430-0.031-F3-B.0-Z4	1/32	1/8	3/32	1-1/2	4	CVDDIA
N77829	DIAB430-0.063-F3-B.0-Z4	1/16	1/8	3/16	1-1/2	4	CVDDIA
N77183	DIAB430-0.078-F3-B.0-Z4	5/64	1/8	1/4	1-1/2	4	CVDDIA
N77832	DIAB430-0.094-F4-B.0-Z4	3/32	1/8	3/8	1-1/2	4	CVDDIA
N77835	DIAB430-0.125-D4-B.0-Z4	1/8	1/8	1/2	1-1/2	4	CVDDIA
N77838	DIAB430-0.188-D3-B.0-Z4	3/16	3/16	5/8	2	4	CVDDIA
N77841	DIAB430-0.250-D3-B.0-Z4	1/4	1/4	3/4	2-1/2	4	CVDDIA
N77847	DIAB430-0.375-D2-B.0-Z4	3/8	3/8	7/8	2-1/2	4	CVDDIA
N77853	DIAB430-0.500-D2-B.0-Z4	1/2	1/2	1	3	4	CVDDIA

DIALB430

SOLID CARBIDE



CENTER CUTTING



- Cylindrical Shank
- General purpose geometry designed for carbon fiber, composite applications, graphite and green Ceramics

ITEM NUMBER	DESCRIPTION	FLUTE DIA	SHANK DIA	LENGTH OF CUT	OVERALL LENGTH	FLUTES	COATING
N77877	DIALB430-0.125-D8-B.0-Z4	1/8	1/8	1	3	4	CVDDIA
N77880	DIALB430-0.188-D5-B.0-Z4	3/16	3/16	1	4	4	CVDDIA
N72696	DIALB430-0.188-D6-B.0-Z4	3/16	3/16	1-1/8	3	4	CVDDIA
N77883	DIALB430-0.250-D5-B.0-Z4	1/4	1/4	1-1/4	3	4	CVDDIA
N72702	DIALB430-0.250-D6-B.0-Z4	1/4	1/4	1-3/8	4	4	CVDDIA
N72708	DIALB430-0.250-D7-B.0-Z4	1/4	1/4	1-3/8	6	4	CVDDIA
N72720	DIALB430-0.375-D5-B.0-Z4	3/8	3/8	1-3/8	4	4	CVDDIA
N72726	DIALB430-0.375-D6-B.0-Z4	3/8	3/8	1-3/8	6	4	CVDDIA
N18697	DIALB430-0.500-D3-B.0-Z4	1/2	1/2	1-3/8	4	4	CVDDIA
N77895	DIALB430-0.500-D5-B.0-Z4	1/2	1/2	2	4	4	CVDDIA
N18698	DIALB430-0.500-D4-B.0-Z4	1/2	1/2	1-3/8	6	4	CVDDIA
N72732	DIALB430-0.500-D6-B.0-Z4	1/2	1/2	3	6	4	CVDDIA

DIAXRB430 & DIAXSB430

SOLID CARBIDE

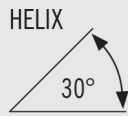

BALL END



CENTER CUTTING



- Cylindrical Shank
- General purpose geometry designed for carbon fiber, composite applications, graphite and green ceramics

ITEM NUMBER	DESCRIPTION	FLUTE DIA	SHANK DIA	LENGTH OF CUT	OVERALL LENGTH	NECK DIA	REACH	FLUTES	COATING
REGULAR LENGTH - DIAXRB430									
N18681	DIAXRB430-0.031-G4-B.0-Z4	1/32	1/8	3/32	3	0.028	3/8	4	CVDDIA
N18686	DIAXRB430-0.031-G5-B.0-Z4	1/32	1/8	3/32	3	0.028	1/2	4	CVDDIA
N18682	DIAXRB430-0.047-G3-B.0-Z4	3/64	1/8	9/64	3	0.043	9/16	4	CVDDIA
N18687	DIAXRB430-0.047-G4-B.0-Z4	3/64	1/8	9/64	3	0.043	3/4	4	CVDDIA
N18683	DIAXRB430-0.063-G4-B.0-Z4	1/16	1/8	3/16	3	0.057	3/4	4	CVDDIA
N18688	DIAXRB430-0.063-G5-B.0-Z4	1/16	1/8	3/16	3	0.057	1	4	CVDDIA
N18684	DIAXRB430-0.094-G3-B.0-Z4	3/32	1/8	9/32	3	0.086	1	4	CVDDIA
N18689	DIAXRB430-0.094-G4-B.0-Z4	3/32	1/8	9/32	3	0.086	1-1/2	4	CVDDIA
N18685	DIAXRB430-0.125-E3-B.0-Z4	1/8	1/8	3/8	3	0.115	1-1/2	4	CVDDIA
N18690	DIAXRB430-0.125-E4-B.0-Z4	1/8	1/8	3/8	3	0.115	2	4	CVDDIA
STUB LENGTH - DIAXSB430									
N77214	DIAXSB430-0.063-G1-B.0-Z4	1/16	1/8	1/16	3	0.057	5/16	4	CVDDIA
N77216	DIAXSB430-0.125-E1-B.0-Z4	1/8	1/8	1/8	3	0.115	5/8	4	CVDDIA
N77218	DIAXSB430-0.250-E1-B.0-Z4	1/4	1/4	1/4	4	0.240	3/4	4	CVDDIA

DIAXRR430

SOLID CARBIDE

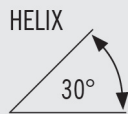

RADIUS



CENTER CUTTING



- Cylindrical Shank
- General purpose geometry designed for carbon fiber, composite applications, graphite and green ceramics

ITEM NUMBER	DESCRIPTION	FLUTE DIA	SHANK DIA	LENGTH OF CUT	OVERALL LENGTH	NECK DIA	REACH	FLUTES	COATING	RADIUS
N18671	DIAXRR430-0.031-G3-R005.0-Z4	1/32	1/8	3/32	3	0.028	3/8	4	CVDDIA	0.005
N18676	DIAXRR430-0.031-G4-R005.0-Z4	1/32	1/8	3/32	3	0.028	1/2	4	CVDDIA	0.005
N18672	DIAXRR430-0.047-G3-R010.0-Z4	3/64	1/8	9/64	3	0.043	9/16	4	CVDDIA	0.010
N18677	DIAXRR430-0.047-G4-R010.0-Z4	3/64	1/8	9/64	3	0.043	3/4	4	CVDDIA	0.010
N18673	DIAXRR430-0.063-G4-R010.0-Z4	1/16	1/8	3/16	3	0.057	3/4	4	CVDDIA	0.010
N18678	DIAXRR430-0.063-G5-R010.0-Z4	1/16	1/8	3/16	3	0.057	1	4	CVDDIA	0.010
N18674	DIAXRR430-0.094-G3-R010.0-Z4	3/32	1/8	9/32	3	0.086	1	4	CVDDIA	0.010
N18679	DIAXRR430-0.094-G4-R010.0-Z4	3/32	1/8	9/32	3	0.086	1-1/2	4	CVDDIA	0.010
N18675	DIAXRR430-0.125-E3-R010.0-Z4	1/8	1/8	3/8	3	0.115	1-1/2	4	CVDDIA	0.010
N77253	DIAXRR430-0.125-E6-R030.0-Z4	1/8	1/8	3/4	3	0.115	1-1/2	4	CVDDIA	0.030

DIACC

SOLID CARBIDE

HELIX

SQUARE END

CENTER CUTTING



- Compression Cutter
- Cylindrical Shank
- Chip breaking notches
- Open flute design
- "X" DIM equals the length to helix transition from end teeth
- Designed to avoid delamination
- Designed for carbon fiber, composite applications, graphite, and green ceramics

COARSE PITCH

ITEM NUMBER	DESCRIPTION	FLUTE DIA	SHANK DIA	LENGTH OF CUT	OVERALL LENGTH	FLUTES	COATING	"X" DIM
N77311	DIACC-0.250-D3-S.0-Z3	1/4	1/4	3/4	2-1/2	3	CVDDIA	0.150
N77312	DIACC-0.375-D3-S.0-Z3	3/8	3/8	1	3	3	CVDDIA	0.213
N77313	DIACC-0.500-D3-S.0-Z5	1/2	1/2	1-1/4	3	5	CVDDIA	0.275

FINE PITCH

ITEM NUMBER	DESCRIPTION	FLUTE DIA	SHANK DIA	LENGTH OF CUT	OVERALL LENGTH	FLUTES	COATING	"X" DIM
N68196	DIACC-0.250-D3-S.0-Z5	1/4	1/4	3/4	2-1/2	5	CVDDIA	0.150
N68197	DIACC-0.375-D3-S.0-Z5	3/8	3/8	1	3	5	CVDDIA	0.213
N68198	DIACC-0.500-D3-S.0-Z7	1/2	1/2	1-1/4	3	7	CVDDIA	0.275

DIAEPB

SOLID
CARBIDE

- End mill point burr
- Cylindrical Shank
- Positive end cutting geometry
- Low cutting forces
- End mill style end teeth geometry
- High shearing capabilities to reduce material delamination
- Designed for carbon fiber, composite applications, graphite and green ceramics

COARSE PITCH



- Can be utilized up to 100% radial engagement

ITEM NUMBER	DESCRIPTION	FLUTE DIA	SHANK DIA	LENGTH OF CUT	OVERALL LENGTH	COATING
N68077	DIAEPB-0.125-D1-S.0-Z	1/8	1/8	1/2	1-1/2	CVDDIA
N68078	DIAEPB-0.250-D2-S.0-Z	1/4	1/4	3/4	2-1/2	CVDDIA
N68079	DIAEPB-0.250-D4-S.0-Z	1/4	1/4	1-3/8	3	CVDDIA
N68081	DIAEPB-0.375-D1-S.0-Z	3/8	3/8	1-3/8	3-1/4	CVDDIA
N68083	DIAEPB-0.500-D1-S.0-Z	1/2	1/2	1	3	CVDDIA
N68084	DIAEPB-0.500-D3-S.0-Z	1/2	1/2	2	4	CVDDIA

FINE PITCH



- Improved surface finish as compared to coarse pitch
- Up to 50% radial engagement

ITEM NUMBER	DESCRIPTION	FLUTE DIA	SHANK DIA	LENGTH OF CUT	OVERALL LENGTH	COATING
N68172	DIAEPB-0.125-D2-S.0-Z	1/8	1/8	1/2	1-1/2	CVDDIA
N68173	DIAEPB-0.250-D1-S.0-Z	1/4	1/4	3/4	2-1/2	CVDDIA
N68176	DIAEPB-0.375-D4-S.0-Z	3/8	3/8	1-3/8	3-1/4	CVDDIA
N68178	DIAEPB-0.500-D2-S.0-Z	1/2	1/2	1	3	CVDDIA
N68179	DIAEPB-0.500-D4-S.0-Z	1/2	1/2	2	4	CVDDIA

DIABEB

SOLID
CARBIDE

- Burr end point
- Positive cutting geometry
- Lower cutting forces
- High shear capabilities to reduce material delamination
- Burr style end teeth geometry
- Designed for carbon fiber, composite applications, graphite and green ceramics

COARSE PITCH

- Can be utilized up to 100% radial engagement



ITEM NUMBER	DESCRIPTION	FLUTE DIA	SHANK DIA	LENGTH OF CUT	OVERALL LENGTH	COATING
N68093	DIABEB-0.125-D1-S.0-Z	1/8	1/8	1/2	1-1/2	CVDDIA
N68094	DIABEB-0.250-D1-S.0-Z	1/4	1/4	3/4	2-1/2	CVDDIA
N68097	DIABEB-0.375-D1-S.0-Z	3/8	3/8	1-3/8	3-1/4	CVDDIA
N68098	DIABEB-0.375-D7-S.0-Z	3/8	3/8	2-1/8	4	CVDDIA
N68099	DIABEB-0.500-D1-S.0-Z	1/2	1/2	1	3	CVDDIA
N68100	DIABEB-0.500-D3-S.0-Z	1/2	1/2	2	4	CVDDIA

FINE PITCH

- Improved surface finish as compared to coarse pitch
- Up to 50% radial engagement



ITEM NUMBER	DESCRIPTION	FLUTE DIA	SHANK DIA	LENGTH OF CUT	OVERALL LENGTH	COATING
N68188	DIABEB-0.125-D2-S.0-Z	1/8	1/8	1/2	1-1/2	CVDDIA
N68189	DIABEB-0.250-D2-S.0-Z	1/4	1/4	3/4	2-1/2	CVDDIA
N68192	DIABEB-0.375-D2-S.0-Z	3/8	3/8	1-3/8	3-1/4	CVDDIA
N68193	DIABEB-0.375-D8-S.0-Z	3/8	3/8	2-1/8	4	CVDDIA
N68194	DIABEB-0.500-D2-S.0-Z	1/2	1/2	1	3	CVDDIA
N68195	DIABEB-0.500-D4-S.0-Z	1/2	1/2	2	4	CVDDIA

DIAPPB

SOLID
CARBIDE

- Plunge point burr
- Cylindrical Shank
- Drill point design
- Positive end cutting geometry
- Low cutting forces
- High shearing capabilities to reduce material delamination
- Designed for carbon fiber, composite applications, graphite and green ceramics

COARSE PITCH



ITEM NUMBER	DESCRIPTION	FLUTE DIA	SHANK DIA	LENGTH OF CUT	OVERALL LENGTH	COATING
N68085	DIAPPB-0.125-D1-C017.0-Z	1/8	1/8	1/2	1-1/2	CVDDIA
N68086	DIAPPB-0.250-D1-C033.0-Z	1/4	1/4	3/4	2-1/2	CVDDIA
N68087	DIAPPB-0.250-D3-C033.0-Z	1/4	1/4	1-3/8	3	CVDDIA
N68088	DIAPPB-0.250-D5-C033.0-Z	1/4	1/4	2	4	CVDDIA

FINE PITCH



- Improved surface finish as compared to coarse pitch

ITEM NUMBER	DESCRIPTION	FLUTE DIA	SHANK DIA	LENGTH OF CUT	OVERALL LENGTH	COATING
N68180	DIAPPB-0.125-D2-C017.0-Z	1/8	1/8	1/2	1-1/2	CVDDIA
N68181	DIAPPB-0.250-D2-C033.0-Z	1/4	1/4	3/4	2-1/2	CVDDIA
N68182	DIAPPB-0.250-D4-C033.0-Z	1/4	1/4	1-3/8	3	CVDDIA
N68183	DIAPPB-0.250-D6-C033.0-Z	1/4	1/4	2	4	CVDDIA

DIA230 / DIAB230 - START VALUES

SLOTTING													
SMG	$a_p \times D_c$ (max)	$a_e \times D_c$ (max)	v_c (sf / min)		$Z_n = 2$								
					1/8	3/16	1/4	5/16	3/8	1/2	5/8	3/4	
GRAPHITE	1.00	1.00	1425	n (rev/min)	43548	29032	21774	17419	14516	10887	8710	7258	
				f_z (in)	0.0005	0.0007	0.0009	0.0011	0.0014	0.0018	0.0023	0.0027	
				v_f (in/min)	40	40	40	40	40	40	40	40	
PLASTIC (SOFT)	1.00	1.00	1425	n (rev/min)	43548	29032	21774	17419	14516	10887	8710	7258	
				f_z (in)	0.0005	0.0007	0.0009	0.0011	0.0014	0.0018	0.0023	0.0027	
				v_f (in/min)	40	40	40	40	40	40	40	40	
PLASTIC (HARD)	1.00	1.00	1425	n (rev/min)	43548	29032	21774	17419	14516	10887	8710	7258	
				f_z (in)	0.0005	0.0007	0.0009	0.0011	0.0014	0.0018	0.0023	0.0027	
				v_f (in/min)	40	40	40	40	40	40	40	40	
THERMOPLAST	CFRP	1.00	1.00	1313	n (rev/min)	40110	26740	20055	16044	13370	10028	8022	6685
					f_z (in)	0.0005	0.0007	0.0010	0.0012	0.0015	0.0020	0.0025	0.0030
					v_f (in/min)	40	40	40	40	40	40	40	40
	GRP	0.80	1.00	1425	n (rev/min)	43548	29032	21774	17419	14516	10887	8710	7258
					f_z (in)	0.0010	0.0015	0.0020	0.0025	0.0030	0.0040	0.0050	0.0059
					v_f (in/min)	87	87	87	87	87	87	87	87
THERMOSET	CFRP	1.00	1.00	1313	n (rev/min)	40110	26740	20055	16044	13370	10028	8022	6685
					f_z (in)	0.0005	0.0007	0.0010	0.0012	0.0015	0.0020	0.0025	0.0030
					v_f (in/min)	40	40	40	40	40	40	40	40
	GRP	0.80	1.00	1425	n (rev/min)	43548	29032	21774	17419	14516	10887	8710	7258
					f_z (in)	0.0010	0.0015	0.0020	0.0025	0.0030	0.0040	0.0050	0.0059
					v_f (in/min)	87	87	87	87	87	87	87	87

SMG = Seco Material Group
 n [min-1] = RPM
 v_c (sf/min) = Surface feet/min

f_z [in] = Feed/tooth
 a_p/D_c = % of diameter
 v_f [in/min] = Feed rate
 a_e/D_c = % of diameter

A = Air D = Dry E = Emulsion (flood coolant) M = Mist
 All cutting data are start values. All cutting data is in inch values.
 Please reference the Workpiece Material Classification chart located on page 15.

DIA230 / DIAB230 - START VALUES

SIDE MILLING - ROUGHING													
SMG	$a_p \times D_c$ (max)	$a_e \times D_c$ (max)	v_c (sf / min)		Zn = 2								
					1/8	3/16	1/4	5/16	3/8	1/2	5/8	3/4	
GRAPHITE	1.00	0.40	1900	n (rev/min)	58064	38709	29032	23226	19355	14516	11613	9677	
				f_z (in)	0.0007	0.0010	0.0014	0.0017	0.0021	0.0028	0.0034	0.0041	
				v_f (in/min)	80	80	80	80	80	80	80	80	
PLASTIC (SOFT)	1.00	0.40	1900	n (rev/min)	58064	38709	29032	23226	19355	14516	11613	9677	
				f_z (in)	0.0007	0.0010	0.0014	0.0017	0.0021	0.0028	0.0034	0.0041	
				v_f (in/min)	80	80	80	80	80	80	80	80	
PLASTIC (HARD)	1.00	0.40	1900	n (rev/min)	58064	38709	29032	23226	19355	14516	11613	9677	
				f_z (in)	0.0007	0.0010	0.0014	0.0017	0.0021	0.0028	0.0034	0.0041	
				v_f (in/min)	80	80	80	80	80	80	80	80	
THERMOPLAST	CFRP	1.00	0.40	1750	n (rev/min)	53480	35653	26740	21392	17827	13370	10696	8913
					f_z (in)	0.0008	0.0011	0.0015	0.0019	0.0023	0.0030	0.0038	0.0045
					v_f (in/min)	80	80	80	80	80	80	80	80
	GRP	1.00	0.40	1900	n (rev/min)	58064	38709	29032	23226	19355	14516	11613	9677
					f_z (in)	0.0015	0.0023	0.0030	0.0038	0.0045	0.0060	0.0075	0.0090
					v_f (in/min)	174	174	174	174	174	174	174	174
THERMOSET	CFRP	1.00	0.40	1750	n (rev/min)	53480	35653	26740	21392	17827	13370	10696	8913
					f_z (in)	0.0008	0.0011	0.0015	0.0019	0.0023	0.0030	0.0038	0.0045
					v_f (in/min)	80	80	80	80	80	80	80	80
	GRP	1.00	0.40	1900	n (rev/min)	58064	38709	29032	23226	19355	14516	11613	9677
					f_z (in)	0.0015	0.0023	0.0030	0.0038	0.0045	0.0060	0.0075	0.0090
					v_f (in/min)	174	174	174	174	174	174	174	174

SMG = Seco Material Group
 n [min-1] = RPM
 v_c (sf/min) = Surface feet/min

f_z [in] = Feed/tooth
 a_p/D_c = % of diameter
 v_f [in/min] = Feed rate
 a_e/D_c = % of diameter

A = Air D = Dry E = Emulsion (flood coolant) M = Mist
 All cutting data are start values. All cutting data is in inch values.
 Please reference the Workpiece Material Classification chart located on page 15.

DIAB230M - START VALUES

SLOTTING													
SMG	$a_p \times D_c$ (max)	$a_e \times D_c$ (max)	v_c (sf / min)		Zn = 2								
					1	2	3	4	6	8	10	12	
GRAPHITE	1.00	1.00	1425	n (min-1)	138265	69132	46088	34566	23044	17283	13826	11522	
				fz (in)	0.0001	0.0003	0.0004	0.0006	0.0009	0.0011	0.0014	0.0017	
				vf (in/min)	39	39	39	39	39	39	39	39	
PLASTIC (SOFT)	1.00	1.00	1425	n (min-1)	138265	69132	46088	34566	23044	17283	13826	11522	
				fz (in)	0.0001	0.0003	0.0004	0.0006	0.0009	0.0011	0.0014	0.0017	
				vf (in/min)	39	39	39	39	39	39	39	39	
PLASTIC (HARD)	1.00	1.00	1425	n (min-1)	138265	69132	46088	34566	23044	17283	13826	11522	
				fz (in)	0.0001	0.0003	0.0004	0.0006	0.0009	0.0011	0.0014	0.0017	
				vf (in/min)	39	39	39	39	39	39	39	39	
THERMOPLAST	CFRP	1.00	1.00	1310	n (min-1)	127107	63553	42369	31777	21184	15888	12711	10592
					fz (in)	0.0002	0.0003	0.0005	0.0006	0.0009	0.0013	0.0016	0.0019
					vf (in/min)	40	40	40	40	40	40	40	40
	GRP	0.80	1.00	1425	n (min-1)	138265	69132	46088	34566	23044	17283	13826	11522
					fz (in)	0.0003	0.0006	0.0009	0.0012	0.0019	0.0025	0.0031	0.0037
					vf (in/min)	86	86	86	86	86	86	86	86
THERMOSET	CFRP	1.00	1.00	1310	n (min-1)	127107	63553	42369	31777	21184	15888	12711	10592
					fz (in)	0.0002	0.0003	0.0005	0.0006	0.0009	0.0013	0.0016	0.0019
					vf (in/min)	40	40	40	40	40	40	40	40
	GRP	0.80	1.00	1425	n (min-1)	138265	69132	46088	34566	23044	17283	13826	11522
					fz (in)	0.0003	0.0006	0.0009	0.0012	0.0019	0.0025	0.0031	0.0037
					vf (in/min)	86	86	86	86	86	86	86	86

SMG = Seco Material Group
 n [min-1] = RPM
 v_c (sf/min) = Surface feet/min

fz [in] = Feed/tooth
 a_p/D_c = % of diameter
 v_f [in/min] = Feed rate
 a_e/D_c = % of diameter

A = Air D = Dry E = Emulsion (flood coolant) M = Mist
 All cutting data are start values. All cutting data is in inch values.
 Please reference the Workpiece Material Classification chart located on page 15.

DIAB230M - START VALUES

SIDE MILLING - ROUGHING													
SMG	$a_p \times D_c$ (max)	$a_e \times D_c$ (max)	v_c (sf / min)		Zn = 2								
					1	2	3	4	6	8	10	12	
GRAPHITE	1.00	0.40	1900	n (min-1)	184353	92177	61451	46088	30726	23044	18435	15363	
				fz (in)	0.0002	0.0004	0.0006	0.0009	0.0013	0.0017	0.0022	0.0026	
				1600 - 2200	vf (in/min)	79	79	79	79	79	79	79	79
PLASTIC (SOFT)	1.00	0.40	1900	n (min-1)	184353	92177	61451	46088	30726	23044	18435	15363	
				fz (in)	0.0001	0.0003	0.0004	0.0006	0.0009	0.0011	0.0014	0.0017	
				1600 - 2200	vf (in/min)	52	52	52	52	52	52	52	52
PLASTIC (HARD)	1.00	0.40	1900	n (min-1)	184353	92177	61451	46088	30726	23044	18435	15363	
				fz (in)	0.0001	0.0003	0.0004	0.0006	0.0009	0.0011	0.0014	0.0017	
				1600 - 2200	vf (in/min)	52	52	52	52	52	52	52	52
THERMOPLAST	CFRP	1.00	0.40	1750	n (min-1)	169799	84900	56600	42450	28300	21225	16980	14150
					fz (in)	0.0002	0.0003	0.0005	0.0006	0.0009	0.0013	0.0016	0.0019
					1600 - 1900	vf (in/min)	54	54	54	54	54	54	54
	GRP	1.00	0.40	1900	n (min-1)	184353	92177	61451	46088	30726	23044	18435	15363
					fz (in)	0.0003	0.0006	0.0009	0.0012	0.0019	0.0025	0.0031	0.0037
					1810 - 1990	vf (in/min)	115	115	115	115	115	115	115
THERMOSET	CFRP	1.00	0.40	1750	n (min-1)	169799	84900	56600	42450	28300	21225	16980	14150
					fz (in)	0.0002	0.0003	0.0005	0.0006	0.0009	0.0013	0.0016	0.0019
					1600 - 1900	vf (in/min)	54	54	54	54	54	54	54
	GRP	1.00	0.40	1900	n (min-1)	184353	92177	61451	46088	30726	23044	18435	15363
					fz (in)	0.0003	0.0006	0.0009	0.0012	0.0019	0.0025	0.0031	0.0037
					1810 - 1990	vf (in/min)	115	115	115	115	115	115	115

SMG = Seco Material Group
 n [min-1] = RPM
 v_c (sf/min) = Surface feet/min

fz [in] = Feed/tooth
 a_p/D_c = % of diameter
 v_f [in/min] = Feed rate
 a_e/D_c = % of diameter

A = Air D = Dry E = Emulsion (flood coolant) M = Mist
 All cutting data are start values. All cutting data is in inch values.
 Please reference the Workpiece Material Classification chart located on page 15.

DIA430 / DIACR430 / DIAB430 - START VALUES

SLOTTING													
SMG	$a_p \times D_c$ (max)	$a_e \times D_c$ (max)	v_c (sf / min)	$Z_n = 4$									
					1/8	3/16	1/4	5/16	3/8	1/2	5/8	3/4	
GRAPHITE	1.00	1.00	1425	n (rev/min)	43548	29032	21774	17419	14516	10887	8710	7258	
				f_z (in)	0.0005	0.0007	0.0009	0.0011	0.0014	0.0018	0.0023	0.0027	
			1125 - 1725	v_f (in/min)	80	80	80	80	80	80	80	80	80
PLASTIC (SOFT)	1.00	1.00	1425	n (rev/min)	43548	29032	21774	17419	14516	10887	8710	7258	
				f_z (in)	0.0005	0.0007	0.0009	0.0011	0.0014	0.0018	0.0023	0.0027	
			1125 - 1725	v_f (in/min)	80	80	80	80	80	80	80	80	80
PLASTIC (HARD)	1.00	1.00	1425	n (rev/min)	43548	29032	21774	17419	14516	10887	8710	7258	
				f_z (in)	0.0005	0.0007	0.0009	0.0011	0.0014	0.0018	0.0023	0.0027	
			1125 - 1725	v_f (in/min)	80	80	80	80	80	80	80	79.0	
THERMOPLAST	CFRP	1.00	1313	f_z (in)	40110	26740	20055	16044	13370	10028	8022	6685	
				v_f (in/min)	0.0005	0.0007	0.0010	0.0012	0.0015	0.0020	0.0025	0.0030	
			1163 - 1463	f_z (in)	79	79	79	79	79	79	79	79	79
	GRP	0.80	1.00	1425	v_f (in/min)	43548	29032	21774	17419	14516	10887	8710	7258
					f_z (in)	0.0010	0.0015	0.0020	0.0025	0.0030	0.0040	0.0050	0.0059
				1335 - 1515	v_f (in/min)	173	173	173	172	173	173	173	173
THERMOSET	CFRP	1.00	1313	f_z (in)	40110	26740	20055	16044	13370	10028	8022	6685	
				v_f (in/min)	0.0005	0.0007	0.0010	0.0012	0.0015	0.0020	0.0025	0.0030	
			1162.5 - 1462.5	f_z (in)	79	79	79	79	79	79	79	79	79
	GRP	0.80	1.00	1425	v_f (in/min)	43548	29032	21774	17419	14516	10887	8710	7258
					f_z (in)	0.0010	0.0015	0.0020	0.0025	0.0030	0.0040	0.0050	0.0059
				1335 - 1515	v_f (in/min)	173	173	173	172	173	173	173	173

SMG = Seco Material Group
 n [min-1] = RPM
 v_c (sf/min) = Surface feet/min

f_z [in] = Feed/tooth
 a_p/D_c = % of diameter
 v_f [in/min] = Feed rate
 a_e/D_c = % of diameter

A = Air D = Dry E = Emulsion (flood coolant) M = Mist
 All cutting data are start values. All cutting data is in inch values.
 Please reference the Workpiece Material Classification chart located on page 15.

DIA430 / DIACR430 / DIAB430 - START VALUES

SIDE MILLING - ROUGHING													
SMG	$a_p \times D_c$ (max)	$a_e \times D_c$ (max)	v_c (sf / min)		$Z_n = 4$								
					1/8	3/16	1/4	5/16	3/8	1/2	5/8	3/4	
GRAPHITE	1.00	0.40	1900	n (rev/min)	58064	38709	29032	23226	19355	14516	11613	9677	
				f_z (in)	0.0007	0.0010	0.0014	0.0017	0.0021	0.0028	0.0034	0.0041	
				v_f (in/min)	160	160	160	160	160	160	160	160	
PLASTIC (SOFT)	1.00	0.40	1900	n (rev/min)	58064	38709	29032	23226	19355	14516	11613	9677	
				f_z (in)	0.0007	0.0010	0.0014	0.0017	0.0021	0.0028	0.0034	0.0041	
				v_f (in/min)	160	160	160	160	160	160	160	160	
PLASTIC (HARD)	1.00	0.40	1900	n (rev/min)	58064	38709	29032	23226	19355	14516	11613	9677	
				f_z (in)	0.0007	0.0010	0.0014	0.0017	0.0021	0.0028	0.0034	0.0041	
				v_f (in/min)	160	160	160	160	160	160	160	160	
THERMOPLAST	CFRP	1.00	0.40	1750	n (rev/min)	53480	35653	26740	21392	17827	13370	10696	8913
					f_z (in)	0.0008	0.0011	0.0015	0.0019	0.0023	0.0030	0.0038	0.0045
					v_f (in/min)	160	160	160	160	160	160	160	160
	GRP	1.00	0.40	1900	n (rev/min)	58064	38709	29032	23226	19355	14516	11613	9677
					f_z (in)	0.0015	0.0023	0.0030	0.0038	0.0045	0.0060	0.0075	0.0090
					v_f (in/min)	348	348	348	348	348	348	348	348
THERMOSET	CFRP	1.00	0.40	1750	n (rev/min)	53480	35653	26740	21392	17827	13370	10696	8913
					f_z (in)	0.0008	0.0011	0.0015	0.0019	0.0023	0.0030	0.0038	0.0045
					v_f (in/min)	160	160	160	160	160	160	160	160
	GRP	1.00	0.40	1900	n (rev/min)	58064	38709	29032	23226	19355	14516	11613	9677
					f_z (in)	0.0015	0.0023	0.0030	0.0038	0.0045	0.0060	0.0075	0.0090
					v_f (in/min)	348	348	348	348	348	348	348	348

SMG = Seco Material Group
 n [min-1] = RPM
 v_c (sf/min) = Surface feet/min

f_z [in] = Feed/tooth
 a_p/D_c = % of diameter
 v_f [in/min] = Feed rate
 a_e/D_c = % of diameter

A = Air D = Dry E = Emulsion (flood coolant) M = Mist
 All cutting data are start values. All cutting data is in inch values.
 Please reference the Workpiece Material Classification chart located on page 15.

DIAXS430 / DIAL430 / DIALB430 / DIAARR430 / DIAARB430 - START VALUES

SLOTTING													
SMG	$a_p \times D_c$ (max)	$a_e \times D_c$ (max)	v_c (sf / min)		$Z_n = 4$								
					1/8	3/16	1/4	5/16	3/8	1/2	5/8	3/4	
GRAPHITE	1.00	1.00	1140	n (rev/min)	34838	23226	17419	13935	11613	8710	6968	5806	
				f_z (in)	0.0003	0.0005	0.0007	0.0009	0.0010	0.0014	0.0017	0.0020	
				v_f (in/min)	47	47	47	47	47	47	47	47	
PLASTIC (SOFT)	1.00	1.00	1140	n (rev/min)	34838	23226	17419	13935	11613	8710	6968	5806	
				f_z (in)	0.0003	0.0005	0.0007	0.0009	0.0010	0.0014	0.0017	0.0020	
				v_f (in/min)	47	47	47	47	47	47	47	47	
PLASTIC (HARD)	1.00	1.00	1140	n (rev/min)	34838	23226	17419	13935	11613	8710	6968	5806	
				f_z (in)	0.0003	0.0005	0.0007	0.0009	0.0010	0.0014	0.0017	0.0020	
				v_f (in/min)	47	47	47	47	47	47	47	47	
THERMOPLAST	CFRP	1.00	1.00	1050	n (rev/min)	32088	21392	16044	12835	10696	8022	6418	5348
					f_z (in)	0.0004	0.0006	0.0007	0.0009	0.0011	0.0015	0.0019	0.0022
					v_f (in/min)	48	48	48	48	48	48	48	48
	GRP	0.80	1.00	1140	n (rev/min)	34838	23226	17419	13935	11613	8710	6968	5806
					f_z (in)	0.0007	0.0011	0.0015	0.0019	0.0022	0.0030	0.0037	0.0045
					v_f (in/min)	104	104	104	104	104	104	104	104
THERMOSET	CFRP	1.00	1.00	1050	n (rev/min)	32088	21392	16044	12835	10696	8022	6418	5348
					f_z (in)	0.0004	0.0006	0.0007	0.0009	0.0011	0.0015	0.0019	0.0022
					v_f (in/min)	48	48	48	48	48	48	48	48
	GRP	0.80	1.00	1140	n (rev/min)	34838	23226	17419	13935	11613	8710	6968	5806
					f_z (in)	0.0007	0.0011	0.0015	0.0019	0.0022	0.0030	0.0037	0.0045
					v_f (in/min)	104	104	104	104	104	104	104	104

SMG = Seco Material Group
 n [min-1] = RPM
 v_c (sf/min) = Surface feet/min

f_z [in] = Feed/tooth
 a_p/D_c = % of diameter
 v_f [in/min] = Feed rate
 a_e/D_c = % of diameter

A = Air D = Dry E = Emulsion (flood coolant) M = Mist
 All cutting data are start values. All cutting data is in inch values.
 Please reference the Workpiece Material Classification chart located on page 15.

DIAXSB430 / DIAL430 / DIALB430 / DIAxRR430 / DIAxRB430 - START VALUES

SIDE MILLING - ROUGHING

SMG	$a_p \times D_c$ (max)	$a_e \times D_c$ (max)	v_c (sf / min)		$Z_n = 4$								
					1/8	3/16	1/4	5/16	3/8	1/2	5/8	3/4	
GRAPHITE	1.00	0.40	1520	n (rev/min)	46451	30967	23226	18580	15484	11613	9290	7742	
				f_z (in)	0.0005	0.0008	0.0010	0.0013	0.0015	0.0021	0.0026	0.0031	
				v_f (in/min)	96	96	96	96	96	96	96	96	
PLASTIC (SOFT)	1.00	0.40	1520	n (rev/min)	46451	30967	23226	18580	15484	11613	9290	7742	
				f_z (in)	0.0005	0.0008	0.0010	0.0013	0.0015	0.0021	0.0026	0.0031	
				v_f (in/min)	96	96	96	96	96	96	96	96	
PLASTIC (HARD)	1.00	0.40	1520	n (rev/min)	46451	30967	23226	18580	15484	11613	9290	7742	
				f_z (in)	0.0005	0.0008	0.0010	0.0013	0.0015	0.0021	0.0026	0.0031	
				v_f (in/min)	96	96	96	96	96	96	96	96	
THERMOPLAST	CFRP	1.00	0.40	1400	n (rev/min)	42784	28523	21392	17114	14261	10696	8557	7131
					f_z (in)	0.0006	0.0008	0.0011	0.0014	0.0017	0.0023	0.0028	0.0034
					v_f (in/min)	96	96	96	96	96	96	96	96
	GRP	1.00	0.40	1520	n (rev/min)	46451	30967	23226	18580	15484	11613	9290	7742
					f_z (in)	0.0011	0.0017	0.0023	0.0028	0.0034	0.0045	0.0056	0.0068
					v_f (in/min)	209	209	209	209	209	209	209	209
THERMOSET	CFRP	1.00	0.40	1400	n (rev/min)	42784	28523	21392	17114	14261	10696	8557	7131
					f_z (in)	0.0006	0.0008	0.0011	0.0014	0.0017	0.0023	0.0028	0.0034
					v_f (in/min)	96	96	96	96	96	96	96	96
	GRP	1.00	0.40	1520	n (rev/min)	46451	30967	23226	18580	15484	11613	9290	7742
					f_z (in)	0.0011	0.0017	0.0023	0.0028	0.0034	0.0045	0.0056	0.0068
					v_f (in/min)	209	209	209	209	209	209	209	209

SMG = Seco Material Group
 n [min-1] = RPM
 v_c (sf/min) = Surface feet/min

f_z [in] = Feed/tooth
 a_p/D_c = % of diameter
 v_f [in/min] = Feed rate
 a_e/D_c = % of diameter

A = Air D = Dry E = Emulsion (flood coolant) M = Mist
 All cutting data are start values. All cutting data is in inch values.
 Please reference the Workpiece Material Classification chart located on page 15.

DIA430M - START VALUES

SLOTTING										
SMG	$a_p \times D_c$ (max)	$a_e \times D_c$ (max)	V_c (sf / min)		$Z_n = 4$					
					2	3	4	6	8	
GRAPHITE	1.00	1.00	1425	n (min-1)	69132	46088	34566	23044	17283	
				fz (in)	0.0003	0.0004	0.0006	0.0009	0.0011	
				vf (in/min)	78	78	78	78	78	
PLASTIC (SOFT)	1.00	1.00	1425	n (min-1)	69132	46088	34566	23044	17283	
				fz (in)	0.0003	0.0004	0.0006	0.0009	0.0011	
				vf (in/min)	78	78	78	78	78	
PLASTIC (HARD)	1.00	1.00	1425	n (min-1)	69132	46088	34566	23044	17283	
				fz (in)	0.0003	0.0004	0.0006	0.0009	0.0011	
				vf (in/min)	78	78	78	78	78	
THERMOPLAST	CFRP	1.00	1.00	1310	n (min-1)	63553	42369	31777	21184	15888
					fz (in)	0.0003	0.0005	0.0006	0.0009	0.0013
					vf (in/min)	80	80	80	80	80
	GRP	0.80	1.00	1425	n (min-1)	69132	46088	34566	23044	17283
					fz (in)	0.0006	0.0009	0.0012	0.0019	0.0025
					vf (in/min)	172	172	172	172	172
THERMOSET	CFRP	1.00	1.00	1310	n (min-1)	63553	42369	31777	21184	15888
					fz (in)	0.0003	0.0005	0.0006	0.0009	0.0013
					vf (in/min)	80	80	80	80	80
	GRP	0.80	1.00	1425	n (min-1)	69132	46088	34566	23044	17283
					fz (in)	0.0006	0.0009	0.0012	0.0019	0.0025
					vf (in/min)	172	172	172	172	172

SMG = Seco Material Group
 n [min-1] = RPM
 V_c (sf/min) = Surface feet/min

fz [in] = Feed/tooth
 a_p/D_c = % of diameter
 vf [in/min] = Feed rate
 a_e/D_c = % of diameter

A = Air D = Dry E = Emulsion (flood coolant) M = Mist
 All cutting data are start values. All cutting data is in inch values.
 Please reference the Workpiece Material Classification chart located on page 15.

DIA430M - START VALUES

SIDE MILLING - ROUGHING														
SMG	$a_p \times D_c$ (max)	$a_e \times D_c$ (max)	V_c (sf / min)			$Z_n = 4$								
						2	3	4	6	8				
GRAPHITE	1.00	0.40	1900		n (min-1)	92177	61451	46088	30726	23044				
						1600	-	2200	fz (in)	0.0004	0.0006	0.0009	0.0013	0.0017
										vf (in/min)	160	160	160	160
PLASTIC (SOFT)	1.00	0.40	1900		n (min-1)	92177	61451	46088	30726	23044				
						1600	-	2200	fz (in)	0.0003	0.0004	0.0006	0.0009	0.0011
										vf (in/min)	105	105	105	105
PLASTIC (HARD)	1.00	0.40	1900		n (min-1)	92177	61451	46088	30726	23044				
						1600	-	2200	fz (in)	0.0003	0.0004	0.0006	0.0009	0.0011
										vf (in/min)	105	105	105	105
THERMOPLAST	CFRP	1.00	0.40	1750	n (min-1)	84900	56600	42450	28300	21225				
						1600	-	1900	fz (in)	0.0003	0.0005	0.0006	0.0009	0.0013
										vf (in/min)	107	107	107	107
	GRP	1.00	0.40	1900	n (min-1)	92177	61451	46088	30726	23044				
						1810	-	1990	fz (in)	0.0006	0.0009	0.0012	0.0019	0.0025
										vf (in/min)	229	229	229	229
THERMOSET	CFRP	1.00	0.40	1750	n (min-1)	84900	56600	42450	28300	21225				
						1600	-	1900	fz (in)	0.0003	0.0005	0.0006	0.0009	0.0013
										vf (in/min)	107	107	107	107
	GRP	1.00	0.40	1900	n (min-1)	92177	61451	46088	30726	23044				
						1810	-	1990	fz (in)	0.0006	0.0009	0.0012	0.0019	0.0025
										vf (in/min)	229	229	229	229

SMG = Seco Material Group
 n [min-1] = RPM
 V_c (sf/min) = Surface feet/min

fz [in] = Feed/tooth
 a_p/D_c = % of diameter

vf [in/min] = Feed rate
 a_e/D_c = % of diameter

A = Air D = Dry E = Emulsion (flood coolant) M = Mist
 All cutting data are start values. All cutting data is in inch values.
 Please reference the Workpiece Material Classification chart located on page 15.

DIACC COARSE-PITCH - START VALUES

SLOTTING										
SMG	$a_p \times D_c$ (max)	$a_e \times D_c$ (max)	V_c (sf / min)		$Z_n = 3$		$Z_n = 5$			
					1/4	3/8	1/2			
GRAPHITE	1.00	1.00	1125	- 1725	1425	n (rev/min)	21774	14516	10887	
						f_z (in)	0.0009	0.0014	0.0018	
						v_f (in/min)	59	59	99	
PLASTIC (SOFT)	1.00	1.00	1125	- 1725	1425	n (rev/min)	21774	14516	10887	
						f_z (in)	0.0009	0.0014	0.0018	
						v_f (in/min)	59	59	99	
PLASTIC (HARD)	1.00	1.00	1125	- 1725	1425	n (rev/min)	21774	14516	10887	
						f_z (in)	0.0009	0.0014	0.0018	
						v_f (in/min)	59	59	99	
THERMOPLAST	CFRP	1.00	1.00	1163	- 1463	1313	n (rev/min)	20055	13370	10028
							f_z (in)	0.0010	0.0015	0.0020
							v_f (in/min)	60	60	99
	GRP	0.80	1.00	1335	- 1515	1425	n (rev/min)	21774	14516	10887
							f_z (in)	0.0010	0.0015	0.0020
							v_f (in/min)	65	65	108
THERMOSET	CFRP	1.00	1.00	1162.5	- 1462.5	1313	n (rev/min)	20055	13370	10028
							f_z (in)	0.0010	0.0015	0.0020
							v_f (in/min)	60	60	99
	GRP	0.80	1.00	1335	- 1515	1425	n (rev/min)	21774	14516	10887
							f_z (in)	0.0010	0.0015	0.0020
							v_f (in/min)	65	65	108

SIDE MILLING - ROUGHING

GRAPHITE	2.00	0.40	1600	- 2200	1900	n (rev/min)	29032	19355	14516	
						f_z (in)	0.0014	0.0021	0.0028	
						v_f (in/min)	120	120	200	
PLASTIC (SOFT)	2.00	0.40	1600	- 2200	1900	n (rev/min)	29032	19355	14516	
						f_z (in)	0.0014	0.0021	0.0028	
						v_f (in/min)	120	120	200	
PLASTIC (HARD)	2.00	0.40	1600	- 2200	1900	n (rev/min)	29032	19355	14516	
						f_z (in)	0.0014	0.0021	0.0028	
						v_f (in/min)	120	120	200	
THERMOPLAST	CFRP	2.00	1600	- 1900	1750	n (rev/min)	26740	17827	13370	
						f_z (in)	0.0015	0.0023	0.0030	
						v_f (in/min)	120	120	201	
	GRP	2.00	0.40	1810	- 1990	1900	n (rev/min)	29032	19355	14516
							f_z (in)	0.0015	0.0023	0.0030
							v_f (in/min)	131	131	218
THERMOSET	CFRP	2.00	1600	- 1900	1750	n (rev/min)	26740	17827	13370	
						f_z (in)	0.0015	0.0023	0.0030	
						v_f (in/min)	120	120	201	
	GRP	2.00	0.40	1810	- 1990	1900	n (rev/min)	29032	19355	14516
							f_z (in)	0.0015	0.0023	0.0030
							v_f (in/min)	131	131	218

DIACC - FINE PITCH - START VALUES

SIDE MILLING - ROUGHING									
SMG	$a_p \times D_c$ (max)	$a_e \times D_c$ (max)	v_c (sf / min)			$Z_n = 5$		$Z_n = 7$	
						1/4	3/8	1/2	
GRAPHITE	2.00	0.40	1900	-	2200	n (rev/min)	29032	19355	14516
						f_z (in)	0.0014	0.0021	0.0028
						v_f (in/min)	200	200	279
PLASTIC (SOFT)	2.00	0.40	1900	-	2200	n (rev/min)	29032	19355	14516
						f_z (in)	0.0014	0.0021	0.0028
						v_f (in/min)	200	200	279
PLASTIC (HARD)	2.00	0.40	1900	-	2200	n (rev/min)	29032	19355	14516
						f_z (in)	0.0014	0.0021	0.0028
						v_f (in/min)	200	200	279
THERMOPLAST	CFRP	0.40	1750	-	1900	n (rev/min)	26740	17827	13370
						f_z (in)	0.0015	0.0023	0.0030
						v_f (in/min)	201	201	281
	GRP	0.40	1900	-	1990	n (rev/min)	29032	19355	14516
						f_z (in)	0.0015	0.0023	0.0030
						v_f (in/min)	218	218	305
THERMOSET	CFRP	0.40	1750	-	1900	n (rev/min)	26740	17827	13370
						f_z (in)	0.0015	0.0023	0.0030
						v_f (in/min)	201	201	281
	GRP	0.40	1900	-	1990	n (rev/min)	29032	19355	14516
						f_z (in)	0.0015	0.0023	0.0030
						v_f (in/min)	218	218	305

SMG = Seco Material Group
 n [min-1] = RPM
 v_c (sf/min) = Surface feet/min

f_z [in] = Feed/tooth
 a_p/D_c = % of diameter
 v_f [in/min] = Feed rate
 a_e/D_c = % of diameter

A = Air D = Dry E = Emulsion (flood coolant) M = Mist
 All cutting data are start values. All cutting data is in inch values.
 Please reference the Workpiece Material Classification chart located on page 15.

DIAEPB / DIAPPB / DIABEB COARSE PITCH - START VALUES

SLOTTING											
SMG	$a_p \times D_c$ (max)	$a_e \times D_c$ (max)	V_c (sf / min)								
					1/8	3/16	1/4	5/16	3/8	1/2	
GRAPHITE	1.00	1.00	1800	n (rev/min)	55008	36672	27504	22003	18336	13752	
				f_z (in)	0.0006	0.0009	0.0012	0.0015	0.0018	0.0024	
				v_f (in/min)	32.9	32.9	32.9	32.9	32.9	32.9	
PLASTIC (SOFT)	1.00	1.00	1800	n (rev/min)	55008	36672	27504	22003	18336	13752	
				f_z (in)	0.0006	0.0009	0.0012	0.0015	0.0018	0.0024	
				v_f (in/min)	32.9	32.9	32.9	32.9	32.9	32.9	
PLASTIC (HARD)	1.00	1.00	1800	n (rev/min)	55008	36672	27504	22003	18336	13752	
				f_z (in)	0.0006	0.0009	0.0012	0.0015	0.0018	0.0024	
				v_f (in/min)	32.9	32.9	32.9	32.9	32.9	32.9	
THERMOPLAST	CFRP	1.00	1.00	1800	n (rev/min)	55008	36672	27504	22003	18336	13752
					f_z (in)	0.0005	0.0007	0.0010	0.0012	0.0015	0.0020
					v_f (in/min)	27.2	27.2	27.2	27.2	27.2	27.2
	GRP	0.80	1.00	1800	n (rev/min)	55008	36672	27504	22003	18336	13752
					f_z (in)	0.0005	0.0007	0.0010	0.0012	0.0015	0.0020
					v_f (in/min)	27.2	27.2	27.2	27.2	27.2	27.2
THERMOSET	CFRP	1.00	1.00	1800	n (rev/min)	55008	36672	27504	22003	18336	13752
					f_z (in)	0.0005	0.0007	0.0010	0.0012	0.0015	0.0020
					v_f (in/min)	27.2	27.2	27.2	27.2	27.2	27.2
	GRP	0.80	1.00	1800	n (rev/min)	55008	36672	27504	22003	18336	13752
					f_z (in)	0.0005	0.0007	0.0010	0.0012	0.0015	0.0020
					v_f (in/min)	27.2	27.2	27.2	27.2	27.2	27.2

SMG = Seco Material Group
 n [min-1] = RPM
 v_c (sf/min) = Surface feet/min

f_z [in] = Feed/tooth
 a_p/D_c = % of diameter
 v_f [in/min] = Feed rate
 a_e/D_c = % of diameter

A = Air D = Dry E = Emulsion (flood coolant) M = Mist
 All cutting data are start values. All cutting data is in inch values.
 Please reference the Workpiece Material Classification chart located on page 15.

DIAEPB / DIAPPB / DIABEB COARSE PITCH - START VALUES

SIDE MILLING - ROUGHING											
SMG	$a_p \times D_c$ (max)	$a_e \times D_c$ (max)	v_c (sf / min)								
					1/8	3/16	1/4	5/16	3/8	1/2	
GRAPHITE	2.00	0.50	2400	n (rev/min)	73344	48896	36672	29338	24448	18336	
				f_z (in)	0.0009	0.0014	0.0018	0.0023	0.0027	0.0036	
				v_f (in/min)	67	67	67	67	67	67	
PLASTIC (SOFT)	2.00	0.50	2400	n (rev/min)	73344	48896	36672	29338	24448	18336	
				f_z (in)	0.0009	0.0014	0.0018	0.0023	0.0027	0.0036	
				v_f (in/min)	67	67	67	67	67	67	
PLASTIC (HARD)	2.00	0.50	2400	n (rev/min)	73344	48896	36672	29338	24448	18336	
				f_z (in)	0.0009	0.0014	0.0018	0.0023	0.0027	0.0036	
				v_f (in/min)	67	67	67	67	67	67	
THERMOPLAST	CFRP	2.00	0.50	2400	n (rev/min)	73344	48896	36672	29338	24448	18336
					f_z (in)	0.0008	0.0011	0.0015	0.0019	0.0023	0.0030
					v_f (in/min)	55	55	55	55	55	55
	GRP	2.00	0.50	2400	n (rev/min)	73344	48896	36672	29338	24448	18336
					f_z (in)	0.0008	0.0011	0.0015	0.0019	0.0023	0.0030
					v_f (in/min)	55	55	55	55	55	55
THERMOSET	CFRP	2.00	0.50	2400	n (rev/min)	73344	48896	36672	29338	24448	18336
					f_z (in)	0.0008	0.0011	0.0015	0.0019	0.0023	0.0030
					v_f (in/min)	55	55	55	55	55	55
	GRP	2.00	0.50	2400	n (rev/min)	73344	48896	36672	29338	24448	18336
					f_z (in)	0.0008	0.0011	0.0015	0.0019	0.0023	0.0030
					v_f (in/min)	55	55	55	55	55	55

SMG = Seco Material Group
 n [min-1] = RPM
 v_c (sf/min) = Surface feet/min

f_z [in] = Feed/tooth
 a_p/D_c = % of diameter
 v_f [in/min] = Feed rate
 a_e/D_c = % of diameter

A = Air D = Dry E = Emulsion (flood coolant) M = Mist
 All cutting data are start values. All cutting data is in inch values.
 Please reference the Workpiece Material Classification chart located on page 15.

DIAEPB / DIAPPB / DIABEB FINE PITCH - START VALUES

SIDE MILLING - ROUGHING								
SMG	$a_p \times D_c$ (max)	$a_e \times D_c$ (max)	v_c (sf / min)					
					1/8	1/4	3/8	1/2
GRAPHITE	2.00	0.25	2400	n (rev/min)	73344	36672	24448	18336
				f_z (in)	0.0009	0.0018	0.0027	0.0036
				v_f (in/min)	67	67	67	67
PLASTIC (SOFT)	2.00	0.25	2400	n (rev/min)	73344	36672	24448	18336
				f_z (in)	0.0009	0.0018	0.0027	0.0036
				v_f (in/min)	67	67	67	67
PLASTIC (HARD)	2.00	0.25	2400	n (rev/min)	73344	36672	24448	18336
				f_z (in)	0.0009	0.0018	0.0027	0.0036
				v_f (in/min)	67	67	67	67
THERMOPLAST	CFRP	0.25	2400	n (rev/min)	73344	36672	24448	18336
				f_z (in)	0.0008	0.0015	0.0023	0.0030
				v_f (in/min)	55	55	55	55
	GRP	0.25	2400	n (rev/min)	73344	36672	24448	18336
				f_z (in)	0.0008	0.0015	0.0023	0.0030
				v_f (in/min)	55	55	55	55
THERMOSET	CFRP	0.25	2400	n (rev/min)	73344	36672	24448	18336
				f_z (in)	0.0008	0.0015	0.0023	0.0030
				v_f (in/min)	55	55	55	55
	GRP	0.25	2400	n (rev/min)	73344	36672	24448	18336
				f_z (in)	0.0008	0.0015	0.0023	0.0030
				v_f (in/min)	55	55	55	55

SMG = Seco Material Group
 n [min-1] = RPM
 v_c (sf/min) = Surface feet/min

f_z [in] = Feed/tooth
 a_p/D_c = % of diameter
 v_f [in/min] = Feed rate
 a_e/D_c = % of diameter

A = Air D = Dry E = Emulsion (flood coolant) M = Mist
 All cutting data are start values. All cutting data is in inch values.
 Please reference the Workpiece Material Classification chart located on page 15.

C230

SOLID CARBIDE

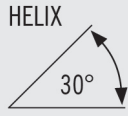

CENTER CUTTING



- General Purpose
- General machining of most material types

ITEM NUMBER	DESCRIPTION	FLUTE DIA	SHANK DIA	LENGTH OF CUT	OVERALL LENGTH	FLUTES	COATING	SHANK TYPE
N85261	C230-0.031-F3-S.0-Z2	1/32	1/8	5/64	1-1/2	2	UNCOATED	CYLINDRICAL
N85337	C230-0.031-F3-S.0-Z2	1/32	1/8	5/64	1-1/2	2	TIALN	CYLINDRICAL
N54012	C230-0.031-F4-S.0-Z2	1/32	1/8	3/32	1-1/2	2	UNCOATED	CYLINDRICAL
N54018	C230-0.031-F4-S.0-Z2	1/32	1/8	3/32	1-1/2	2	TIALN	CYLINDRICAL
N85262	C230-0.047-F2-S.0-Z2	3/64	1/8	7/64	1-1/2	2	UNCOATED	CYLINDRICAL
N85338	C230-0.047-F2-S.0-Z2	3/64	1/8	7/64	1-1/2	2	TIALN	CYLINDRICAL
N54013	C230-0.047-F3-S.0-Z2	3/64	1/8	1/8	1-1/2	2	UNCOATED	CYLINDRICAL
N54019	C230-0.047-F3-S.0-Z2	3/64	1/8	1/8	1-1/2	2	TIALN	CYLINDRICAL
N85408	C230-0.063-F2-S.0-Z2	1/16	1/8	1/8	1-1/2	2	UNCOATED	CYLINDRICAL
N85434	C230-0.063-F2-S.0-Z2	1/16	1/8	1/8	1-1/2	2	TIALN	CYLINDRICAL
N85263	C230-0.063-F3-S.0-Z2	1/16	1/8	3/16	1-1/2	2	UNCOATED	CYLINDRICAL
N85339	C230-0.063-F3-S.0-Z2	1/16	1/8	3/16	1-1/2	2	TIALN	CYLINDRICAL
N55334	C230-0.063-F4-S.0-Z2	1/16	1/8	1/4	1-1/2	2	UNCOATED	CYLINDRICAL
N55430	C230-0.063-F4-S.0-Z2	1/16	1/8	1/4	1-1/2	2	TIALN	CYLINDRICAL
N55335	C230-0.078-F3-S.0-Z2	5/64	1/8	1/4	1-1/2	2	UNCOATED	CYLINDRICAL
N55431	C230-0.078-F3-S.0-Z2	5/64	1/8	1/4	1-1/2	2	TIALN	CYLINDRICAL
N85409	C230-0.094-F2-S.0-Z2	3/32	1/8	3/16	1-1/2	2	UNCOATED	CYLINDRICAL
N85435	C230-0.094-F2-S.0-Z2	3/32	1/8	3/16	1-1/2	2	TIALN	CYLINDRICAL
N85265	C230-0.094-F3-S.0-Z2	3/32	1/8	9/32	1-1/2	2	UNCOATED	CYLINDRICAL
N85341	C230-0.094-F3-S.0-Z2	3/32	1/8	9/32	1-1/2	2	TIALN	CYLINDRICAL
N55336	C230-0.094-F4-S.0-Z2	3/32	1/8	3/8	1-1/2	2	UNCOATED	CYLINDRICAL
N55432	C230-0.094-F4-S.0-Z2	3/32	1/8	3/8	1-1/2	2	TIALN	CYLINDRICAL
N85266	C230-0.109-F3-S.0-Z2	7/64	1/8	3/8	1-1/2	2	UNCOATED	CYLINDRICAL
N85342	C230-0.109-F3-S.0-Z2	7/64	1/8	3/8	1-1/2	2	TIALN	CYLINDRICAL
N85410	C230-0.125-D2-S.0-Z2	1/8	1/8	1/4	1-1/2	2	UNCOATED	CYLINDRICAL
N85436	C230-0.125-D2-S.0-Z2	1/8	1/8	1/4	1-1/2	2	TIALN	CYLINDRICAL
N85267	C230-0.125-D4-S.0-Z2	1/8	1/8	1/2	1-1/2	2	UNCOATED	CYLINDRICAL
N85343	C230-0.125-D4-S.0-Z2	1/8	1/8	1/2	1-1/2	2	TIALN	CYLINDRICAL
N55337	C230-0.125-D5-S.0-Z2	1/8	1/8	5/8	2	2	UNCOATED	CYLINDRICAL
N55433	C230-0.125-D5-S.0-Z2	1/8	1/8	5/8	2	2	TIALN	CYLINDRICAL
N55338	C230-0.125-D6-S.0-Z2	1/8	1/8	3/4	3	2	UNCOATED	CYLINDRICAL
N55434	C230-0.125-D6-S.0-Z2	1/8	1/8	3/4	3	2	TIALN	CYLINDRICAL
N55339	C230-0.125-D8-S.0-Z2	1/8	1/8	1	3	2	UNCOATED	CYLINDRICAL
N55435	C230-0.125-D8-S.0-Z2	1/8	1/8	1	3	2	TIALN	CYLINDRICAL
N85411	C230-0.156-F2-S.0-Z2	5/32	3/16	5/16	2	2	UNCOATED	CYLINDRICAL
N85437	C230-0.156-F2-S.0-Z2	5/32	3/16	5/16	2	2	TIALN	CYLINDRICAL
N85269	C230-0.156-F3-S.0-Z2	5/32	3/16	1/2	2	2	UNCOATED	CYLINDRICAL
N85345	C230-0.156-F3-S.0-Z2	5/32	3/16	1/2	2	2	TIALN	CYLINDRICAL
N85412	C230-0.188-D2-S.0-Z2	3/16	3/16	3/8	2	2	UNCOATED	CYLINDRICAL
N85438	C230-0.188-D2-S.0-Z2	3/16	3/16	3/8	2	2	TIALN	CYLINDRICAL
N85271	C230-0.188-D3-S.0-Z2	3/16	3/16	5/8	2	2	UNCOATED	CYLINDRICAL
N85347	C230-0.188-D3-S.0-Z2	3/16	3/16	5/8	2	2	TIALN	CYLINDRICAL
N85448	C230-0.188-D4-S.0-Z2	3/16	3/16	3/4	2-1/2	2	UNCOATED	CYLINDRICAL
N85484	C230-0.188-D4-S.0-Z2	3/16	3/16	3/4	2-1/2	2	TIALN	CYLINDRICAL
N55341	C230-0.188-D6-S.0-Z2	3/16	3/16	1	4	2	UNCOATED	CYLINDRICAL
N55437	C230-0.188-D6-S.0-Z2	3/16	3/16	1	4	2	TIALN	CYLINDRICAL

C230 (CONT.)

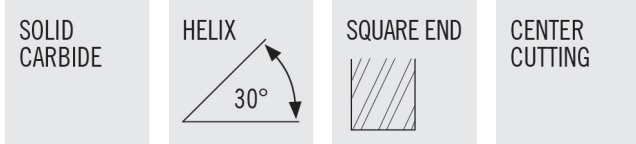

- General Purpose
- General machining of most material types

ITEM NUMBER	DESCRIPTION	FLUTE DIA	SHANK DIA	LENGTH OF CUT	OVERALL LENGTH	FLUTES	COATING	SHANK TYPE
N85272	C230-0.203-F3-S.0-Z2	13/64	1/4	5/8	2-1/2	2	UNCOATED	CYLINDRICAL
N85348	C230-0.203-F3-S.0-Z2	13/64	1/4	5/8	2-1/2	2	TIALN	CYLINDRICAL
N85273	C230-0.219-F3-S.0-Z2	7/32	1/4	5/8	2-1/2	2	UNCOATED	CYLINDRICAL
N85349	C230-0.219-F3-S.0-Z2	7/32	1/4	5/8	2-1/2	2	TIALN	CYLINDRICAL
N85414	C230-0.250-D2-S.0-Z2	1/4	1/4	1/2	2	2	UNCOATED	CYLINDRICAL
N85440	C230-0.250-D2-S.0-Z2	1/4	1/4	1/2	2	2	TIALN	CYLINDRICAL
N85275	C230-0.250-D3-S.0-Z2	1/4	1/4	3/4	2-1/2	2	UNCOATED	CYLINDRICAL
N85351	C230-0.250-D3-S.0-Z2	1/4	1/4	3/4	2-1/2	2	TIALN	CYLINDRICAL
N55342	C230-0.250-D4-S.0-Z2	1/4	1/4	1	3	2	UNCOATED	CYLINDRICAL
N54438	C230-0.250-D4-S.0-Z2	1/4	1/4	1	3	2	TIALN	CYLINDRICAL
N85451	C230-0.250-D7-S.0-Z2	1/4	1/4	1-1/2	4	2	UNCOATED	CYLINDRICAL
N85487	C230-0.250-D7-S.0-Z2	1/4	1/4	1-1/2	4	2	TIALN	CYLINDRICAL
N85277	C230-0.281-F3-S.0-Z2	9/32	5/16	3/4	2-1/2	2	UNCOATED	CYLINDRICAL
N85353	C230-0.281-F3-S.0-Z2	9/32	5/16	3/4	2-1/2	2	TIALN	CYLINDRICAL
N85415	C230-0.313-D2-S.0-Z2	5/16	5/16	1/2	2	2	UNCOATED	CYLINDRICAL
N85441	C230-0.313-D2-S.0-Z2	5/16	5/16	1/2	2	2	TIALN	CYLINDRICAL
N85279	C230-0.313-D3-S.0-Z2	5/16	5/16	13/16	2-1/2	2	UNCOATED	CYLINDRICAL
N85355	C230-0.313-D3-S.0-Z2	5/16	5/16	13/16	2-1/2	2	TIALN	CYLINDRICAL
N55345	C230-0.313-D4-S.0-Z2	5/16	5/16	1	3	2	UNCOATED	CYLINDRICAL
N55441	C230-0.313-D4-S.0-Z2	5/16	5/16	1	3	2	TIALN	CYLINDRICAL
N85281	C230-0.344-F3-S.0-Z2	11/32	3/8	1	2-1/2	2	UNCOATED	CYLINDRICAL
N85357	C230-0.344-F3-S.0-Z2	11/32	3/8	1	2-1/2	2	TIALN	CYLINDRICAL
N85416	C230-0.375-D1-S.0-Z2	3/8	3/8	5/8	2	2	UNCOATED	CYLINDRICAL
N85442	C230-0.375-D1-S.0-Z2	3/8	3/8	5/8	2	2	TIALN	CYLINDRICAL
N85283	C230-0.375-D2-S.0-Z2	3/8	3/8	1	2-1/2	2	UNCOATED	CYLINDRICAL
N85359	C230-0.375-D2-S.0-Z2	3/8	3/8	1	2-1/2	2	TIALN	CYLINDRICAL
N55348	C230-0.375-D3-S.0-Z2	3/8	3/8	1	3	2	UNCOATED	CYLINDRICAL
N55444	C230-0.375-D3-S.0-Z2	3/8	3/8	1	3	2	TIALN	CYLINDRICAL
N55349	C230-0.375-D4-S.0-Z2	3/8	3/8	1	4	2	UNCOATED	CYLINDRICAL
N55445	C230-0.375-D4-S.0-Z2	3/8	3/8	1	4	2	TIALN	CYLINDRICAL
N85454	C230-0.375-D5-S.0-Z2	3/8	3/8	1-1/8	3	2	UNCOATED	CYLINDRICAL
N85490	C230-0.375-D5-S.0-Z2	3/8	3/8	1-1/8	3	2	TIALN	CYLINDRICAL
N55350	C230-0.375-D6-S.0-Z2	3/8	3/8	1-1/2	6	2	UNCOATED	CYLINDRICAL
N55446	C230-0.375-D6-S.0-Z2	3/8	3/8	1-1/2	6	2	TIALN	CYLINDRICAL
N85287	C230-0.438-D2-S.0-Z2	7/16	7/16	1	2-3/4	2	UNCOATED	CYLINDRICAL
N85363	C230-0.438-D2-S.0-Z2	7/16	7/16	1	2-3/4	2	TIALN	CYLINDRICAL
N55355	C230-0.438-D5-S.0-Z2	7/16	7/16	2	4	2	UNCOATED	CYLINDRICAL
N55451	C230-0.438-D5-S.0-Z2	7/16	7/16	2	4	2	TIALN	CYLINDRICAL
N85418	C230-0.500-D1-S.0-Z2	1/2	1/2	5/8	2-1/2	2	UNCOATED	CYLINDRICAL
N85444	C230-0.500-D1-S.0-Z2	1/2	1/2	5/8	2-1/2	2	TIALN	CYLINDRICAL
N85291	C230-0.500-D2-S.0-Z2	1/2	1/2	1	3	2	UNCOATED	CYLINDRICAL
N85367	C230-0.500-D2-S.0-Z2	1/2	1/2	1	3	2	TIALN	CYLINDRICAL
N55356	C230-0.500-D3-S.0-Z2	1/2	1/2	1	4	2	UNCOATED	CYLINDRICAL
N55452	C230-0.500-D3-S.0-Z2	1/2	1/2	1	4	2	TIALN	CYLINDRICAL

C230 (CONT.)

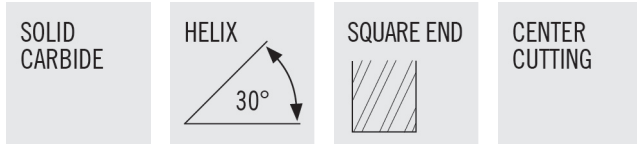

- General Purpose
- General machining of most material types

ITEM NUMBER	DESCRIPTION	FLUTE DIA	SHANK DIA	LENGTH OF CUT	OVERALL LENGTH	FLUTES	COATING	SHANK TYPE
N55357	C230-0.500-D4-S.0-Z2	1/2	1/2	1-1/2	6	2	UNCOATED	CYLINDRICAL
N55453	C230-0.500-D4-S.0-Z2	1/2	1/2	1-1/2	6	2	TIALN	CYLINDRICAL
N55358	C230-0.500-D5-S.0-Z2	1/2	1/2	2	4	2	UNCOATED	CYLINDRICAL
N55454	C230-0.500-D5-S.0-Z2	1/2	1/2	2	4	2	TIALN	CYLINDRICAL
N85459	C230-0.500-D7-S.0-Z2	1/2	1/2	3	6	2	UNCOATED	CYLINDRICAL
N85495	C230-0.500-D7-S.0-Z2	1/2	1/2	3	6	2	TIALN	CYLINDRICAL
N85292	C230-0.563-D2-S.0-Z2	9/16	9/16	1-1/8	3-1/2	2	UNCOATED	CYLINDRICAL
N85368	C230-0.563-D2-S.0-Z2	9/16	9/16	1-1/8	3-1/2	2	TIALN	CYLINDRICAL
N85293	C230-0.625-D2-S.0-Z2	5/8	5/8	1-1/4	3-1/2	2	UNCOATED	CYLINDRICAL
N85369	C230-0.625-D2-S.0-Z2	5/8	5/8	1-1/4	3-1/2	2	TIALN	CYLINDRICAL
N85460	C230-0.625-D4-S.0-Z2	5/8	5/8	2-1/4	5	2	UNCOATED	CYLINDRICAL
N85496	C230-0.625-D4-S.0-Z2	5/8	5/8	2-1/4	5	2	TIALN	CYLINDRICAL
N85461	C230-0.625-D5-S.0-Z2	5/8	5/8	3	6	2	UNCOATED	CYLINDRICAL
N85497	C230-0.625-D5-S.0-Z2	5/8	5/8	3	6	2	TIALN	CYLINDRICAL
N85294	C230-0.688-F2-S.0-Z2	11/16	3/4	1-3/8	4	2	UNCOATED	CYLINDRICAL
N85370	C230-0.688-F2-S.0-Z2	11/16	3/4	1-3/8	4	2	TIALN	CYLINDRICAL
N85420	C230-0.750-D1-S.0-Z2	3/4	3/4	1	3	2	UNCOATED	CYLINDRICAL
N85446	C230-0.750-D1-S.0-Z2	3/4	3/4	1	3	2	TIALN	CYLINDRICAL
N85295	C230-0.750-D2-S.0-Z2	3/4	3/4	1-1/2	4	2	UNCOATED	CYLINDRICAL
N85371	C230-0.750-D2-S.0-Z2	3/4	3/4	1-1/2	4	2	TIALN	CYLINDRICAL
N55362	C230-0.750-D3-S.0-Z2	3/4	3/4	2	6	2	UNCOATED	CYLINDRICAL
N55458	C230-0.750-D3-S.0-Z2	3/4	3/4	2	6	2	TIALN	CYLINDRICAL
N85462	C230-0.750-D4-S.0-Z2	3/4	3/4	2-1/4	5	2	UNCOATED	CYLINDRICAL
N85498	C230-0.750-D4-S.0-Z2	3/4	3/4	2-1/4	5	2	TIALN	CYLINDRICAL
N85463	C230-0.750-D5-S.0-Z2	3/4	3/4	3	6	2	UNCOATED	CYLINDRICAL
N85499	C230-0.750-D5-S.0-Z2	3/4	3/4	3	6	2	TIALN	CYLINDRICAL
N85296	C230-0.875-D2-S.0-Z2	7/8	7/8	1-1/2	4	2	UNCOATED	CYLINDRICAL
N85372	C230-0.875-D2-S.0-Z2	7/8	7/8	1-1/2	4	2	TIALN	CYLINDRICAL
N85297	C230-1.000-D2-S.0-Z2	1	1	1-1/2	4	2	UNCOATED	CYLINDRICAL
N85373	C230-1.000-D2-S.0-Z2	1	1	1-1/2	4	2	TIALN	CYLINDRICAL

C230R

SOLID CARBIDE

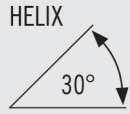

CENTER CUTTING



- General Purpose
- General machining of most material types

ITEM NUMBER	DESCRIPTION	FLUTE DIA	SHANK DIA	LENGTH OF CUT	OVERALL LENGTH	FLUTES	COATING	RADIUS	SHANK TYPE
N91170	C230R-0.250-D3-R015.0-Z2	1/4	1/4	3/4	2-1/2	2	TIALN	0.015	CYLINDRICAL
N91173	C230R-0.250-D3-R030.0-Z2	1/4	1/4	3/4	2-1/2	2	TIALN	0.030	CYLINDRICAL
N91321	C230R-0.375-D3-R015.0-Z2	3/8	3/8	1	2-1/2	2	TIALN	0.015	CYLINDRICAL
N91323	C230R-0.375-D3-R030.0-Z2	3/8	3/8	1	2-1/2	2	TIALN	0.030	CYLINDRICAL
N91335	C230R-0.500-D2-R015.0-Z2	1/2	1/2	1	3	2	TIALN	0.015	CYLINDRICAL
N91337	C230R-0.500-D2-R030.0-Z2	1/2	1/2	1	3	2	TIALN	0.030	CYLINDRICAL
N91339	C230R-0.500-D2-R060.0-Z2	1/2	1/2	1	3	2	TIALN	0.060	CYLINDRICAL
N91341	C230R-0.500-D2-R090.0-Z2	1/2	1/2	1	3	2	TIALN	0.090	CYLINDRICAL
N91342	C230R-0.500-D2-R125.0-Z2	1/2	1/2	1	3	2	TIALN	0.125	CYLINDRICAL
N91343	C230R-0.625-D2-R015.0-Z2	5/8	5/8	1-1/4	3-1/2	2	TIALN	0.015	CYLINDRICAL
N91345	C230R-0.625-D2-R030.0-Z2	5/8	5/8	1-1/4	3-1/2	2	TIALN	0.030	CYLINDRICAL
N91347	C230R-0.625-D2-R060.0-Z2	5/8	5/8	1-1/4	3-1/2	2	TIALN	0.060	CYLINDRICAL
N91348	C230R-0.625-D2-R090.0-Z2	5/8	5/8	1-1/4	3-1/2	2	TIALN	0.090	CYLINDRICAL
N91349	C230R-0.625-D2-R125.0-Z2	5/8	5/8	1-1/4	3-1/2	2	TIALN	0.125	CYLINDRICAL
N91132	C230R-0.750-D2-R015.0-Z2	3/4	3/4	1-1/2	4	2	TIALN	0.015	CYLINDRICAL
N91352	C230R-0.750-D2-R030.0-Z2	3/4	3/4	1-1/2	4	2	TIALN	0.030	CYLINDRICAL
N91159	C230R-0.750-D2-R060.0-Z2	3/4	3/4	1-1/2	4	2	TIALN	0.060	CYLINDRICAL
N91356	C230R-0.750-D2-R090.0-Z2	3/4	3/4	1-1/2	4	2	TIALN	0.090	CYLINDRICAL
N91358	C230R-0.750-D2-R125.0-Z2	3/4	3/4	1-1/2	4	2	TIALN	0.125	CYLINDRICAL
N91362	C230R-0.750-D2-R190.0-Z2	3/4	3/4	1-1/2	4	2	TIALN	0.190	CYLINDRICAL

CB230

SOLID CARBIDE

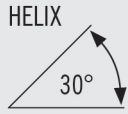

CENTER CUTTING

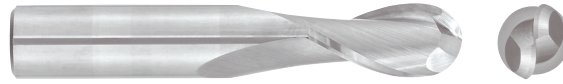

- General Purpose
- General machining of most material types

ITEM NUMBER	DESCRIPTION	FLUTE DIA	SHANK DIA	LENGTH OF CUT	OVERALL LENGTH	FLUTES	COATING	SHANK TYPE
N86149	CB230-0.016-F2-B.0-Z2	1/64	1/8	1/32	1-1/2	2	UNCOATED	CYLINDRICAL
N86225	CB230-0.016-F2-B.0-Z2	1/64	1/8	1/32	1-1/2	2	TIALN	CYLINDRICAL
N86150	CB230-0.031-F3-B.0-Z2	1/32	1/8	5/64	1-1/2	2	UNCOATED	CYLINDRICAL
N86226	CB230-0.031-F3-B.0-Z2	1/32	1/8	5/64	1-1/2	2	TIALN	CYLINDRICAL
N54020	CB230-0.031-F4-B.0-Z2	1/32	1/8	3/32	1-1/2	2	UNCOATED	CYLINDRICAL
N54032	CB230-0.031-F4-B.0-Z2	1/32	1/8	3/32	1-1/2	2	TIALN	CYLINDRICAL
N86151	CB230-0.047-F2-B.0-Z2	3/64	1/8	7/64	1-1/2	2	UNCOATED	CYLINDRICAL
N86227	CB230-0.047-F2-B.0-Z2	3/64	1/8	7/64	1-1/2	2	TIALN	CYLINDRICAL
N54021	CB230-0.047-F3-B.0-Z2	3/64	1/8	1/8	1-1/2	2	UNCOATED	CYLINDRICAL
N54033	CB230-0.047-F3-B.0-Z2	3/64	1/8	1/8	1-1/2	2	TIALN	CYLINDRICAL
N55462	CB230-0.063-F2-B.0-Z2	1/16	1/8	1/8	1-1/2	2	UNCOATED	CYLINDRICAL
N55615	CB230-0.063-F2-B.0-Z2	1/16	1/8	1/8	1-1/2	2	TIALN	CYLINDRICAL
N86152	CB230-0.063-F3-B.0-Z2	1/16	1/8	3/16	1-1/2	2	UNCOATED	CYLINDRICAL
N86228	CB230-0.063-F3-B.0-Z2	1/16	1/8	3/16	1-1/2	2	TIALN	CYLINDRICAL
N54022	CB230-0.063-F4-B.0-Z2	1/16	1/8	1/4	1-1/2	2	UNCOATED	CYLINDRICAL
N54034	CB230-0.063-F4-B.0-Z2	1/16	1/8	1/4	1-1/2	2	TIALN	CYLINDRICAL
N86153	CB230-0.078-F2-B.0-Z2	5/64	1/8	3/16	1-1/2	2	UNCOATED	CYLINDRICAL
N86229	CB230-0.078-F2-B.0-Z2	5/64	1/8	3/16	1-1/2	2	TIALN	CYLINDRICAL
N54023	CB230-0.078-F3-B.0-Z2	5/64	1/8	1/4	1-1/2	2	UNCOATED	CYLINDRICAL
N54035	CB230-0.078-F3-B.0-Z2	5/64	1/8	1/4	1-1/2	2	TIALN	CYLINDRICAL
N55463	CB230-0.094-F2-B.0-Z2	3/32	1/8	3/16	1-1/2	2	UNCOATED	CYLINDRICAL
N55616	CB230-0.094-F2-B.0-Z2	3/32	1/8	3/16	1-1/2	2	TIALN	CYLINDRICAL
N86154	CB230-0.094-F3-B.0-Z2	3/32	1/8	9/32	1-1/2	2	UNCOATED	CYLINDRICAL
N86230	CB230-0.094-F3-B.0-Z2	3/32	1/8	9/32	1-1/2	2	TIALN	CYLINDRICAL
N55464	CB230-0.094-F4-B.0-Z2	3/32	1/8	3/8	1-1/2	2	UNCOATED	CYLINDRICAL
N55617	CB230-0.094-F4-B.0-Z2	3/32	1/8	3/8	1-1/2	2	TIALN	CYLINDRICAL
N55465	CB230-0.125-D2-B.0-Z2	1/8	1/8	1/4	1-1/2	2	UNCOATED	CYLINDRICAL
N55618	CB230-0.125-D2-B.0-Z2	1/8	1/8	1/4	1-1/2	2	TIALN	CYLINDRICAL
N86156	CB230-0.125-D4-B.0-Z2	1/8	1/8	1/2	1-1/2	2	UNCOATED	CYLINDRICAL
N86232	CB230-0.125-D4-B.0-Z2	1/8	1/8	1/2	1-1/2	2	TIALN	CYLINDRICAL
N55466	CB230-0.125-D5-B.0-Z2	1/8	1/8	5/8	2	2	UNCOATED	CYLINDRICAL
N55619	CB230-0.125-D5-B.0-Z2	1/8	1/8	5/8	2	2	TIALN	CYLINDRICAL
N55467	CB230-0.125-D6-B.0-Z2	1/8	1/8	3/4	3	2	UNCOATED	CYLINDRICAL
N55620	CB230-0.125-D6-B.0-Z2	1/8	1/8	3/4	3	2	TIALN	CYLINDRICAL
N86158	CB230-0.156-F3-B.0-Z2	5/32	3/16	1/2	2	2	UNCOATED	CYLINDRICAL
N86234	CB230-0.156-F3-B.0-Z2	5/32	3/16	1/2	2	2	TIALN	CYLINDRICAL
N55470	CB230-0.188-D2-B.0-Z2	3/16	3/16	3/8	2	2	UNCOATED	CYLINDRICAL
N55623	CB230-0.188-D2-B.0-Z2	3/16	3/16	3/8	2	2	TIALN	CYLINDRICAL
N86160	CB230-0.188-D3-B.0-Z2	3/16	3/16	5/8	2	2	UNCOATED	CYLINDRICAL
N86236	CB230-0.188-D3-B.0-Z2	3/16	3/16	5/8	2	2	TIALN	CYLINDRICAL
N55471	CB230-0.188-D4-B.0-Z2	3/16	3/16	1	3	2	UNCOATED	CYLINDRICAL
N55624	CB230-0.188-D4-B.0-Z2	3/16	3/16	1	3	2	TIALN	CYLINDRICAL
N55475	CB230-0.250-D2-B.0-Z2	1/4	1/4	1/2	2	2	UNCOATED	CYLINDRICAL
N55628	CB230-0.250-D2-B.0-Z2	1/4	1/4	1/2	2	2	TIALN	CYLINDRICAL
N86164	CB230-0.250-D3-B.0-Z2	1/4	1/4	3/4	2-1/2	2	UNCOATED	CYLINDRICAL

CB230 (CONT.)

SOLID CARBIDE

HELIX

30°

BALL END

CENTER CUTTING

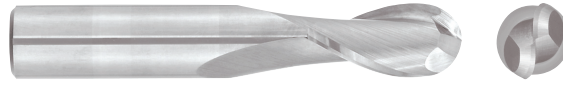

- General Purpose
- General machining of most material types

ITEM NUMBER	DESCRIPTION	FLUTE DIA	SHANK DIA	LENGTH OF CUT	OVERALL LENGTH	FLUTES	COATING	SHANK TYPE
N86240	CB230-0.250-D3-B.0-Z2	1/4	1/4	3/4	2-1/2	2	TIALN	CYLINDRICAL
N55476	CB230-0.250-D4-B.0-Z2	1/4	1/4	1	3	2	UNCOATED	CYLINDRICAL
N55629	CB230-0.250-D4-B.0-Z2	1/4	1/4	1	3	2	TIALN	CYLINDRICAL
N55477	CB230-0.250-D5-B.0-Z2	1/4	1/4	1	4	2	UNCOATED	CYLINDRICAL
N55630	CB230-0.250-D5-B.0-Z2	1/4	1/4	1	4	2	TIALN	CYLINDRICAL
N55478	CB230-0.250-D6-B.0-Z2	1/4	1/4	1-1/2	4	2	UNCOATED	CYLINDRICAL
N55631	CB230-0.250-D6-B.0-Z2	1/4	1/4	1-1/2	4	2	TIALN	CYLINDRICAL
N86166	CB230-0.281-F3-B.0-Z2	9/32	5/16	3/4	2-1/2	2	UNCOATED	CYLINDRICAL
N86242	CB230-0.281-F3-B.0-Z2	9/32	5/16	3/4	2-1/2	2	TIALN	CYLINDRICAL
N86168	CB230-0.313-D3-B.0-Z2	5/16	5/16	13/16	2-1/2	2	UNCOATED	CYLINDRICAL
N86244	CB230-0.313-D3-B.0-Z2	5/16	5/16	13/16	2-1/2	2	TIALN	CYLINDRICAL
N55482	CB230-0.313-D5-B.0-Z2	5/16	5/16	1	4	2	UNCOATED	CYLINDRICAL
N55635	CB230-0.313-D5-B.0-Z2	5/16	5/16	1	4	2	TIALN	CYLINDRICAL
N55484	CB230-0.313-D7-B.0-Z2	5/16	5/16	1-5/8	4	2	UNCOATED	CYLINDRICAL
N55637	CB230-0.313-D7-B.0-Z2	5/16	5/16	1-5/8	4	2	TIALN	CYLINDRICAL
N55485	CB230-0.375-D2-B.0-Z2	3/8	3/8	5/8	2	2	UNCOATED	CYLINDRICAL
N55638	CB230-0.375-D2-B.0-Z2	3/8	3/8	5/8	2	2	TIALN	CYLINDRICAL
N86172	CB230-0.375-D3-B.0-Z2	3/8	3/8	1	2-1/2	2	UNCOATED	CYLINDRICAL
N86248	CB230-0.375-D3-B.0-Z2	3/8	3/8	1	2-1/2	2	TIALN	CYLINDRICAL
N55486	CB230-0.375-D4-B.0-Z2	3/8	3/8	1	3	2	UNCOATED	CYLINDRICAL
N55639	CB230-0.375-D4-B.0-Z2	3/8	3/8	1	3	2	TIALN	CYLINDRICAL
N55488	CB230-0.375-D6-B.0-Z2	3/8	3/8	1-1/2	6	2	UNCOATED	CYLINDRICAL
N55641	CB230-0.375-D6-B.0-Z2	3/8	3/8	1-1/2	6	2	TIALN	CYLINDRICAL
N55489	CB230-0.375-D7-B.0-Z2	3/8	3/8	2	4	2	UNCOATED	CYLINDRICAL
N55642	CB230-0.375-D7-B.0-Z2	3/8	3/8	2	4	2	TIALN	CYLINDRICAL
N55496	CB230-0.500-D1-B.0-Z2	1/2	1/2	5/8	2-1/2	2	UNCOATED	CYLINDRICAL
N55649	CB230-0.500-D1-B.0-Z2	1/2	1/2	5/8	2-1/2	2	TIALN	CYLINDRICAL
N86180	CB230-0.500-D2-B.0-Z2	1/2	1/2	1	3	2	UNCOATED	CYLINDRICAL
N86256	CB230-0.500-D2-B.0-Z2	1/2	1/2	1	3	2	TIALN	CYLINDRICAL
N55497	CB230-0.500-D3-B.0-Z2	1/2	1/2	1	4	2	UNCOATED	CYLINDRICAL
N55650	CB230-0.500-D3-B.0-Z2	1/2	1/2	1	4	2	TIALN	CYLINDRICAL
N55498	CB230-0.500-D4-B.0-Z2	1/2	1/2	1-1/2	6	2	UNCOATED	CYLINDRICAL
N55651	CB230-0.500-D4-B.0-Z2	1/2	1/2	1-1/2	6	2	TIALN	CYLINDRICAL
N55499	CB230-0.500-D5-B.0-Z2	1/2	1/2	2	4	2	UNCOATED	CYLINDRICAL
N55652	CB230-0.500-D5-B.0-Z2	1/2	1/2	2	4	2	TIALN	CYLINDRICAL
N55500	CB230-0.500-D6-B.0-Z2	1/2	1/2	3	6	2	UNCOATED	CYLINDRICAL
N55653	CB230-0.500-D6-B.0-Z2	1/2	1/2	3	6	2	TIALN	CYLINDRICAL
N86182	CB230-0.625-D2-B.0-Z2	5/8	5/8	1-1/4	3-1/2	2	UNCOATED	CYLINDRICAL
N86258	CB230-0.625-D2-B.0-Z2	5/8	5/8	1-1/4	3-1/2	2	TIALN	CYLINDRICAL
N55506	CB230-0.750-D1-B.0-Z2	3/4	3/4	1	3	2	UNCOATED	CYLINDRICAL
N55659	CB230-0.750-D1-B.0-Z2	3/4	3/4	1	3	2	TIALN	CYLINDRICAL
N86184	CB230-0.750-D2-B.0-Z2	3/4	3/4	1-1/2	4	2	UNCOATED	CYLINDRICAL
N86260	CB230-0.750-D2-B.0-Z2	3/4	3/4	1-1/2	4	2	TIALN	CYLINDRICAL
N55507	CB230-0.750-D3-B.0-Z2	3/4	3/4	2	6	2	UNCOATED	CYLINDRICAL
N55660	CB230-0.750-D3-B.0-Z2	3/4	3/4	2	6	2	TIALN	CYLINDRICAL

CB230 (CONT.)

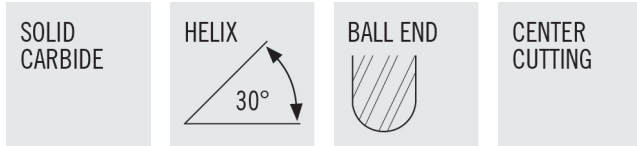

- General Purpose
- General machining of most material types

ITEM NUMBER	DESCRIPTION	FLUTE DIA	SHANK DIA	LENGTH OF CUT	OVERALL LENGTH	FLUTES	COATING	SHANK TYPE
N55508	CB230-0.750-D4-B.0-Z2	3/4	3/4	3	6	2	UNCOATED	CYLINDRICAL
N55661	CB230-0.750-D4-B.0-Z2	3/4	3/4	3	6	2	TIALN	CYLINDRICAL
N86185	CB230-0.875-D2-B.0-Z2	7/8	7/8	1-1/2	4	2	UNCOATED	CYLINDRICAL
N86261	CB230-0.875-D2-B.0-Z2	7/8	7/8	1-1/2	4	2	TIALN	CYLINDRICAL
N86186	CB230-1.000-D1-B.0-Z2	1	1	1-1/2	4	2	UNCOATED	CYLINDRICAL
N86262	CB230-1.000-D1-B.0-Z2	1	1	1-1/2	4	2	TIALN	CYLINDRICAL
N55512	CB230-1.000-D4-B.0-Z2	1	1	4	7	2	UNCOATED	CYLINDRICAL
N55665	CB230-1.000-D4-B.0-Z2	1	1	4	7	2	TIALN	CYLINDRICAL

CD230

SOLID
CARBIDE

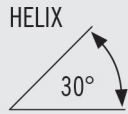

CENTER
CUTTING

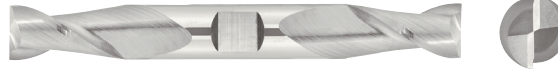

- General Purpose
- General machining of most material types

ITEM NUMBER	DESCRIPTION	FLUTE DIA	SHANK DIA	LENGTH OF CUT	OVERALL LENGTH	FLUTES	COATING	SHANK TYPE
N85375	CD230-0.125-XF3-S.3-Z2	1/8	3/8	3/8	3-1/16	2	UNCOATED	WELDON
N85397	CD230-0.125-XF3-S.3-Z2	1/8	3/8	3/8	3-1/16	2	TIALN	WELDON
N85377	CD230-0.188-XF3-S.3-Z2	3/16	3/8	1/2	3-1/4	2	UNCOATED	WELDON
N85399	CD230-0.188-XF3-S.3-Z2	3/16	3/8	1/2	3-1/4	2	TIALN	WELDON
N85379	CD230-0.250-XF3-S.3-Z2	1/4	3/8	5/8	3-3/8	2	UNCOATED	WELDON
N85401	CD230-0.250-XF3-S.3-Z2	1/4	3/8	5/8	3-3/8	2	TIALN	WELDON
N85381	CD230-0.313-XF2-S.3-Z2	5/16	3/8	3/4	3-1/2	2	UNCOATED	WELDON
N85403	CD230-0.313-XF2-S.3-Z2	5/16	3/8	3/4	3-1/2	2	TIALN	WELDON
N85383	CD230-0.375-XD2-S.3-Z2	3/8	3/8	3/4	3-1/2	2	UNCOATED	WELDON
N85405	CD230-0.375-XD2-S.3-Z2	3/8	3/8	3/4	3-1/2	2	TIALN	WELDON
N85385	CD230-0.500-XD2-S.3-Z2	1/2	1/2	1	4	2	UNCOATED	WELDON
N85407	CD230-0.500-XD2-S.3-Z2	1/2	1/2	1	4	2	TIALN	WELDON

CSD230

SOLID CARBIDE

HELIX

30°

SQUARE END

CENTER CUTTING



- General Purpose
- Stub Length
- General Machining for most material types

ITEM NUMBER	DESCRIPTION	FLUTE DIA	SHANK DIA	LENGTH OF CUT	OVERALL LENGTH	FLUTES	COATING	SHANK TYPE
N89653	CSD230-0.031-XF2-S.0-Z2	1/32	1/8	1/16	1-1/2	2	TIALN	CYLINDRICAL
N89657	CSD230-0.047-XF2-S.0-Z2	3/64	1/8	3/32	1-1/2	2	TIALN	CYLINDRICAL
N89661	CSD230-0.063-XF2-S.0-Z2	1/16	1/8	1/8	1-1/2	2	TIALN	CYLINDRICAL
N89665	CSD230-0.078-XF2-S.0-Z2	5/64	1/8	1/8	1-1/2	2	TIALN	CYLINDRICAL
N89669	CSD230-0.094-XF2-S.0-Z2	3/32	1/8	3/16	1-1/2	2	TIALN	CYLINDRICAL
N89677	CSD230-0.125-XD2-S.0-Z2	1/8	1/8	1/4	1-1/2	2	TIALN	CYLINDRICAL
N89693	CSD230-0.188-XD2-S.0-Z2	3/16	3/16	3/8	2	2	TIALN	CYLINDRICAL
N89709	CSD230-0.250-XD2-S.0-Z2	1/4	1/4	1/2	2-1/2	2	TIALN	CYLINDRICAL
N89717	CSD230-0.313-XD2-S.0-Z2	5/16	5/16	1/2	2-1/2	2	TIALN	CYLINDRICAL
N89725	CSD230-0.375-XD2-S.0-Z2	3/8	3/8	9/16	2-1/2	2	TIALN	CYLINDRICAL
N89733	CSD230-0.500-XD1-S.0-Z2	1/2	1/2	5/8	3	2	TIALN	CYLINDRICAL

CSDB230

SOLID
CARBIDE

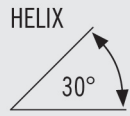

CENTER
CUTTING



- General Purpose Stub Length
- General machining of most material types

ITEM NUMBER	DESCRIPTION	FLUTE DIA	SHANK DIA	LENGTH OF CUT	OVERALL LENGTH	FLUTES	COATING	SHANK TYPE
N89737	CSDB230-0.031-XF2-B.0-Z2	1/32	1/8	1/16	1-1/2	2	TIALN	CYLINDRICAL
N89741	CSDB230-0.047-XF2-B.0-Z2	3/64	1/8	3/32	1-1/2	2	TIALN	CYLINDRICAL
N89745	CSDB230-0.063-XF2-B.0-Z2	1/16	1/8	1/8	1-1/2	2	TIALN	CYLINDRICAL
N89749	CSDB230-0.078-XF2-B.0-Z2	5/64	1/8	1/8	1-1/2	2	TIALN	CYLINDRICAL
N89753	CSDB230-0.094-XF2-B.0-Z2	3/32	1/8	3/16	1-1/2	2	TIALN	CYLINDRICAL
N89761	CSDB230-0.125-XD2-B.0-Z2	1/8	1/8	1/4	1-1/2	2	TIALN	CYLINDRICAL
N89777	CSDB230-0.188-XD2-B.0-Z2	3/16	3/16	3/8	2	2	TIALN	CYLINDRICAL
N89793	CSDB230-0.250-XD2-B.0-Z2	1/4	1/4	1/2	2-1/2	2	TIALN	CYLINDRICAL
N89801	CSDB230-0.313-XD2-B.0-Z2	5/16	5/16	1/2	2-1/2	2	TIALN	CYLINDRICAL
N89809	CSDB230-0.375-XD2-B.0-Z2	3/8	3/8	9/16	2-1/2	2	TIALN	CYLINDRICAL
N89817	CSDB230-0.500-XD1-B.0-Z2	1/2	1/2	5/8	3	2	TIALN	CYLINDRICAL

CNC230

SOLID
CARBIDE



CENTER
CUTTING



- General Purpose
- NC Tolerance
- General machining of most material types

ITEM NUMBER	DESCRIPTION	FLUTE DIA	SHANK DIA	LENGTH OF CUT	OVERALL LENGTH	FLUTES	COATING	SHANK TYPE
N85779	CNC230-0.250-D3-S.0-Z2	1/4	1/4	3/4	2-1/2	2	TIALN	CYLINDRICAL
N85781	CNC230-0.313-D3-S.0-Z2	5/16	5/16	13/16	2-1/2	2	TIALN	CYLINDRICAL
N85782	CNC230-0.375-D2-S.3-Z2	3/8	3/8	7/8	2-1/2	2	TIALN	WELDON
N85784	CNC230-0.500-D2-S.3-Z2	1/2	1/2	1	3	2	TIALN	WELDON
N85786	CNC230-0.625-D2-S.3-Z2	5/8	5/8	1-1/4	3-1/2	2	TIALN	WELDON
N85787	CNC230-0.750-D2-S.3-Z2	3/4	3/4	1-1/2	4	2	TIALN	WELDON

C330

SOLID
CARBIDE

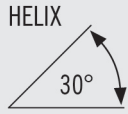

CENTER
CUTTING



- General Purpose
- General machining (slotting/pocketing/profiling) of most material types

ITEM NUMBER	DESCRIPTION	FLUTE DIA	SHANK DIA	LENGTH OF CUT	OVERALL LENGTH	FLUTES	COATING	SHANK TYPE
N85996	C330-0.031-F3-S.0-Z3	1/32	1/8	5/64	1-1/2	3	TIALN	CYLINDRICAL
N85997	C330-0.047-F2-S.0-Z3	3/64	1/8	7/64	1-1/2	3	TIALN	CYLINDRICAL
N85998	C330-0.063-F3-S.0-Z3	1/16	1/8	3/16	1-1/2	3	TIALN	CYLINDRICAL
N85999	C330-0.078-F2-S.0-Z3	5/64	1/8	3/16	1-1/2	3	TIALN	CYLINDRICAL
N86000	C330-0.094-F3-S.0-Z3	3/32	1/8	9/32	1-1/2	3	TIALN	CYLINDRICAL
N86001	C330-0.109-F3-S.0-Z3	7/64	1/8	3/8	1-1/2	3	TIALN	CYLINDRICAL
N86002	C330-0.125-D4-S.0-Z3	1/8	1/8	1/2	1-1/2	3	TIALN	CYLINDRICAL
N86004	C330-0.156-F3-S.0-Z3	5/32	3/16	1/2	2	3	TIALN	CYLINDRICAL
N86006	C330-0.188-D3-S.0-Z3	3/16	3/16	5/8	2	3	TIALN	CYLINDRICAL
N86008	C330-0.219-F3-S.0-Z3	7/32	1/4	5/8	2-1/2	3	TIALN	CYLINDRICAL
N86010	C330-0.250-D3-S.0-Z3	1/4	1/4	3/4	2-1/2	3	TIALN	CYLINDRICAL
N86014	C330-0.313-D3-S.0-Z3	5/16	5/16	13/16	2-1/2	3	TIALN	CYLINDRICAL
N86018	C330-0.375-D3-S.0-Z3	3/8	3/8	1	2-1/2	3	TIALN	CYLINDRICAL
N86022	C330-0.438-D2-S.0-Z3	7/16	7/16	1	2-3/4	3	TIALN	CYLINDRICAL
N86026	C330-0.500-D2-S.0-Z3	1/2	1/2	1	3	3	TIALN	CYLINDRICAL
N86027	C330-0.563-D2-S.0-Z3	9/16	9/16	1-1/8	3-1/2	3	TIALN	CYLINDRICAL
N86028	C330-0.625-D2-S.0-Z3	5/8	5/8	1-1/4	3-1/2	3	TIALN	CYLINDRICAL
N86030	C330-0.750-D2-S.0-Z3	3/4	3/4	1-1/2	4	3	TIALN	CYLINDRICAL
N86032	C330-1.000-D2-S.0-Z3	1	1	1-1/2	4	3	TIALN	CYLINDRICAL

C360

SOLID
CARBIDE



CENTER
CUTTING



- General Purpose
- General machining of most material types

ITEM NUMBER	DESCRIPTION	FLUTE DIA	SHANK DIA	LENGTH OF CUT	OVERALL LENGTH	FLUTES	COATING	SHANK TYPE
N86850	C360-0.250-D3-S.0-Z3	1/4	1/4	3/4	2-1/2	3	TIALN	CYLINDRICAL
N86852	C360-0.375-D2-S.0-Z3	3/8	3/8	7/8	2-1/2	3	TIALN	CYLINDRICAL
N86854	C360-0.500-D2-S.0-Z3	1/2	1/2	1	3	3	TIALN	CYLINDRICAL
N86856	C360-0.625-D2-S.0-Z3	5/8	5/8	1-1/4	3-1/2	3	TIALN	CYLINDRICAL
N86858	C360-0.750-D3-S.0-Z4	3/4	3/4	1-1/2	4	4	TIALN	CYLINDRICAL

C430

SOLID CARBIDE

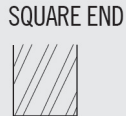
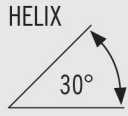

CENTER CUTTING

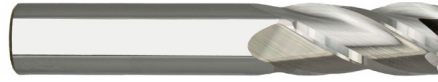

- General Purpose
- General machining of most material types

ITEM NUMBER	DESCRIPTION	FLUTE DIA	SHANK DIA	LENGTH OF CUT	OVERALL LENGTH	FLUTES	COATING	SHANK TYPE
N85503	C430-0.016-F2-S.0-Z4	1/64	1/8	1/32	1-1/2	4	UNCOATED	CYLINDRICAL
N85579	C430-0.016-F2-S.0-Z4	1/64	1/8	1/32	1-1/2	4	TIALN	CYLINDRICAL
N85504	C430-0.031-F3-S.0-Z4	1/32	1/8	5/64	1-1/2	4	UNCOATED	CYLINDRICAL
N85580	C430-0.031-F3-S.0-Z4	1/32	1/8	5/64	1-1/2	4	TIALN	CYLINDRICAL
N55666	C430-0.031-F4-S.0-Z4	1/32	1/8	3/32	1-1/2	4	UNCOATED	CYLINDRICAL
N55792	C430-0.031-F4-S.0-Z4	1/32	1/8	3/32	1-1/2	4	TIALN	CYLINDRICAL
N85505	C430-0.047-F2-S.0-Z4	3/64	1/8	7/64	1-1/2	4	UNCOATED	CYLINDRICAL
N85581	C430-0.047-F2-S.0-Z4	3/64	1/8	7/64	1-1/2	4	TIALN	CYLINDRICAL
N55667	C430-0.047-F3-S.0-Z4	3/64	1/8	1/8	1-1/2	4	UNCOATED	CYLINDRICAL
N55793	C430-0.047-F3-S.0-Z4	3/64	1/8	1/8	1-1/2	4	TIALN	CYLINDRICAL
N85652	C430-0.063-F2-S.0-Z4	1/16	1/8	1/8	1-1/2	4	UNCOATED	CYLINDRICAL
N85678	C430-0.063-F2-S.0-Z4	1/16	1/8	1/8	1-1/2	4	TIALN	CYLINDRICAL
N85506	C430-0.063-F3-S.0-Z4	1/16	1/8	3/16	1-1/2	4	UNCOATED	CYLINDRICAL
N85582	C430-0.063-F3-S.0-Z4	1/16	1/8	3/16	1-1/2	4	TIALN	CYLINDRICAL
N55668	C430-0.063-F4-S.0-Z4	1/16	1/8	1/4	1-1/2	4	UNCOATED	CYLINDRICAL
N55794	C430-0.063-F4-S.0-Z4	1/16	1/8	1/4	1-1/2	4	TIALN	CYLINDRICAL
N55669	C430-0.063-F8-S.0-Z4	1/16	1/8	1	3	4	UNCOATED	CYLINDRICAL
N55795	C430-0.063-F8-S.0-Z4	1/16	1/8	1	3	4	TIALN	CYLINDRICAL
N85507	C430-0.078-F2-S.0-Z4	5/64	1/8	3/16	1-1/2	4	UNCOATED	CYLINDRICAL
N85583	C430-0.078-F2-S.0-Z4	5/64	1/8	3/16	1-1/2	4	TIALN	CYLINDRICAL
N55671	C430-0.078-F3-S.0-Z4	5/64	1/8	1/4	1-1/2	4	UNCOATED	CYLINDRICAL
N55797	C430-0.078-F3-S.0-Z4	5/64	1/8	1/4	1-1/2	4	TIALN	CYLINDRICAL
N85653	C430-0.094-F2-S.0-Z4	3/32	1/8	3/16	1-1/2	4	UNCOATED	CYLINDRICAL
N85679	C430-0.094-F2-S.0-Z4	3/32	1/8	3/16	1-1/2	4	TIALN	CYLINDRICAL
N85508	C430-0.094-F3-S.0-Z4	3/32	1/8	9/32	1-1/2	4	UNCOATED	CYLINDRICAL
N85584	C430-0.094-F3-S.0-Z4	3/32	1/8	9/32	1-1/2	4	TIALN	CYLINDRICAL
N55672	C430-0.094-F4-S.0-Z4	3/32	1/8	3/8	1-1/2	4	UNCOATED	CYLINDRICAL
N55798	C430-0.094-F4-S.0-Z4	3/32	1/8	3/8	1-1/2	4	TIALN	CYLINDRICAL
N55673	C430-0.094-F8-S.0-Z4	3/32	1/8	1	3	4	UNCOATED	CYLINDRICAL
N55799	C430-0.094-F8-S.0-Z4	3/32	1/8	1	3	4	TIALN	CYLINDRICAL
N85509	C430-0.109-F3-S.0-Z4	7/64	1/8	3/8	1-1/2	4	UNCOATED	CYLINDRICAL
N85585	C430-0.109-F3-S.0-Z4	7/64	1/8	3/8	1-1/2	4	TIALN	CYLINDRICAL
N85654	C430-0.125-D2-S.0-Z4	1/8	1/8	1/4	1-1/2	4	UNCOATED	CYLINDRICAL
N85680	C430-0.125-D2-S.0-Z4	1/8	1/8	1/4	1-1/2	4	TIALN	CYLINDRICAL
N85510	C430-0.125-D4-S.0-Z4	1/8	1/8	1/2	1-1/2	4	UNCOATED	CYLINDRICAL
N85586	C430-0.125-D4-S.0-Z4	1/8	1/8	1/2	1-1/2	4	TIALN	CYLINDRICAL
N55675	C430-0.125-D5-S.0-Z4	1/8	1/8	5/8	2	4	UNCOATED	CYLINDRICAL
N55801	C430-0.125-D5-S.0-Z4	1/8	1/8	5/8	2	4	TIALN	CYLINDRICAL
N55676	C430-0.125-D6-S.0-Z4	1/8	1/8	3/4	3	4	UNCOATED	CYLINDRICAL
N55802	C430-0.125-D6-S.0-Z4	1/8	1/8	3/4	3	4	TIALN	CYLINDRICAL
N55677	C430-0.125-D8-S.0-Z4	1/8	1/8	1	3	4	UNCOATED	CYLINDRICAL
N55803	C430-0.125-D8-S.0-Z4	1/8	1/8	1	3	4	TIALN	CYLINDRICAL
N55678	C430-0.125-D9-S.0-Z4	1/8	1/8	1	4	4	UNCOATED	CYLINDRICAL
N55804	C430-0.125-D9-S.0-Z4	1/8	1/8	1	4	4	TIALN	CYLINDRICAL
N85511	C430-0.141-F4-S.0-Z4	9/64	3/16	1/2	2	4	UNCOATED	CYLINDRICAL

C430 (CONT.)

SOLID CARBIDE

HELIX

30°

SQUARE END

CENTER CUTTING

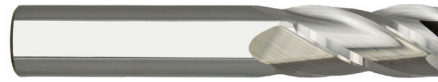

- General Purpose
- General machining of most material types

ITEM NUMBER	DESCRIPTION	FLUTE DIA	SHANK DIA	LENGTH OF CUT	OVERALL LENGTH	FLUTES	COATING	SHANK TYPE
N85587	C430-0.141-F4-S.0-Z4	9/64	3/16	1/2	2	4	TIALN	CYLINDRICAL
N85655	C430-0.156-F2-S.0-Z4	5/32	3/16	5/16	2	4	UNCOATED	CYLINDRICAL
N85681	C430-0.156-F2-S.0-Z4	5/32	3/16	5/16	2	4	TIALN	CYLINDRICAL
N85512	C430-0.156-F3-S.0-Z4	5/32	3/16	1/2	2	4	UNCOATED	CYLINDRICAL
N85588	C430-0.156-F3-S.0-Z4	5/32	3/16	1/2	2	4	TIALN	CYLINDRICAL
N85513	C430-0.172-F4-S.0-Z4	11/64	3/16	5/8	2	4	UNCOATED	CYLINDRICAL
N85589	C430-0.172-F4-S.0-Z4	11/64	3/16	5/8	2	4	TIALN	CYLINDRICAL
N85656	C430-0.188-D2-S.0-Z4	3/16	3/16	3/8	2	4	UNCOATED	CYLINDRICAL
N85682	C430-0.188-D2-S.0-Z4	3/16	3/16	3/8	2	4	TIALN	CYLINDRICAL
N85514	C430-0.188-D3-S.0-Z4	3/16	3/16	5/8	2	4	UNCOATED	CYLINDRICAL
N85590	C430-0.188-D3-S.0-Z4	3/16	3/16	5/8	2	4	TIALN	CYLINDRICAL
N85692	C430-0.188-D4-S.0-Z4	3/16	3/16	3/4	2-1/2	4	UNCOATED	CYLINDRICAL
N85728	C430-0.188-D4-S.0-Z4	3/16	3/16	3/4	2-1/2	4	TIALN	CYLINDRICAL
N55679	C430-0.188-D5-S.0-Z4	3/16	3/16	1	3	4	UNCOATED	CYLINDRICAL
N55805	C430-0.188-D5-S.0-Z4	3/16	3/16	1	3	4	TIALN	CYLINDRICAL
N55680	C430-0.188-D6-S.0-Z4	3/16	3/16	1	4	4	UNCOATED	CYLINDRICAL
N55806	C430-0.188-D6-S.0-Z4	3/16	3/16	1	4	4	TIALN	CYLINDRICAL
N85693	C430-0.188-D7-S.0-Z4	3/16	3/16	1-1/8	3	4	UNCOATED	CYLINDRICAL
N85729	C430-0.188-D7-S.0-Z4	3/16	3/16	1-1/8	3	4	TIALN	CYLINDRICAL
N85515	C430-0.203-F3-S.0-Z4	13/64	1/4	5/8	2-1/2	4	UNCOATED	CYLINDRICAL
N85591	C430-0.203-F3-S.0-Z4	13/64	1/4	5/8	2-1/2	4	TIALN	CYLINDRICAL
N85657	C430-0.219-F2-S.0-Z4	7/32	1/4	7/16	2	4	UNCOATED	CYLINDRICAL
N85683	C430-0.219-F2-S.0-Z4	7/32	1/4	7/16	2	4	TIALN	CYLINDRICAL
N85516	C430-0.219-F3-S.0-Z4	7/32	1/4	5/8	2-1/2	4	UNCOATED	CYLINDRICAL
N85592	C430-0.219-F3-S.0-Z4	7/32	1/4	5/8	2-1/2	4	TIALN	CYLINDRICAL
N85517	C430-0.234-F3-S.0-Z4	15/64	1/4	3/4	2-1/2	4	UNCOATED	CYLINDRICAL
N85593	C430-0.234-F3-S.0-Z4	15/64	1/4	3/4	2-1/2	4	TIALN	CYLINDRICAL
N85658	C430-0.250-D2-S.0-Z4	1/4	1/4	1/2	2	4	UNCOATED	CYLINDRICAL
N85684	C430-0.250-D2-S.0-Z4	1/4	1/4	1/2	2	4	TIALN	CYLINDRICAL
N85518	C430-0.250-D3-S.0-Z4	1/4	1/4	3/4	2-1/2	4	UNCOATED	CYLINDRICAL
N85594	C430-0.250-D3-S.0-Z4	1/4	1/4	3/4	2-1/2	4	TIALN	CYLINDRICAL
N55681	C430-0.250-D4-S.0-Z4	1/4	1/4	1	3	4	UNCOATED	CYLINDRICAL
N55807	C430-0.250-D4-S.0-Z4	1/4	1/4	1	3	4	TIALN	CYLINDRICAL
N55682	C430-0.250-D5-S.0-Z4	1/4	1/4	1	4	4	UNCOATED	CYLINDRICAL
N55808	C430-0.250-D5-S.0-Z4	1/4	1/4	1	4	4	TIALN	CYLINDRICAL
N85694	C430-0.250-D6-S.0-Z4	1/4	1/4	1-1/8	3	4	UNCOATED	CYLINDRICAL
N85730	C430-0.250-D6-S.0-Z4	1/4	1/4	1-1/8	3	4	TIALN	CYLINDRICAL
N85695	C430-0.250-D7-S.0-Z4	1/4	1/4	1-1/2	4	4	UNCOATED	CYLINDRICAL
N85731	C430-0.250-D7-S.0-Z4	1/4	1/4	1-1/2	4	4	TIALN	CYLINDRICAL
N55683	C430-0.250-D8-S.0-Z4	1/4	1/4	1-1/2	6	4	UNCOATED	CYLINDRICAL
N55809	C430-0.250-D8-S.0-Z4	1/4	1/4	1-1/2	6	4	TIALN	CYLINDRICAL
N85519	C430-0.266-F3-S.0-Z4	17/64	5/16	3/4	2-1/2	4	UNCOATED	CYLINDRICAL
N85595	C430-0.266-F3-S.0-Z4	17/64	5/16	3/4	2-1/2	4	TIALN	CYLINDRICAL
N85520	C430-0.281-F3-S.0-Z4	9/32	5/16	3/4	2-1/2	4	UNCOATED	CYLINDRICAL

C430 (CONT.)

SOLID CARBIDE

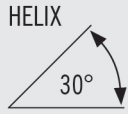

CENTER CUTTING



- General Purpose
- General machining of most material types

ITEM NUMBER	DESCRIPTION	FLUTE DIA	SHANK DIA	LENGTH OF CUT	OVERALL LENGTH	FLUTES	COATING	SHANK TYPE
N85596	C430-0.281-F3-S.0-Z4	9/32	5/16	3/4	2-1/2	4	TIALN	CYLINDRICAL
N85521	C430-0.297-F3-S.0-Z4	19/64	5/16	13/16	2-1/2	4	UNCOATED	CYLINDRICAL
N85597	C430-0.297-F3-S.0-Z4	19/64	5/16	13/16	2-1/2	4	TIALN	CYLINDRICAL
N85659	C430-0.313-D2-S.0-Z4	5/16	5/16	1/2	2	4	UNCOATED	CYLINDRICAL
N85685	C430-0.313-D2-S.0-Z4	5/16	5/16	1/2	2	4	TIALN	CYLINDRICAL
N85522	C430-0.313-D3-S.0-Z4	5/16	5/16	13/16	2-1/2	4	UNCOATED	CYLINDRICAL
N85598	C430-0.313-D3-S.0-Z4	5/16	5/16	13/16	2-1/2	4	TIALN	CYLINDRICAL
N55684	C430-0.313-D4-S.0-Z4	5/16	5/16	1	3	4	UNCOATED	CYLINDRICAL
N55810	C430-0.313-D4-S.0-Z4	5/16	5/16	1	3	4	TIALN	CYLINDRICAL
N55685	C430-0.313-D5-S.0-Z4	5/16	5/16	1	4	4	UNCOATED	CYLINDRICAL
N55811	C430-0.313-D5-S.0-Z4	5/16	5/16	1	4	4	TIALN	CYLINDRICAL
N85696	C430-0.313-D6-S.0-Z4	5/16	5/16	1-1/8	3	4	UNCOATED	CYLINDRICAL
N85732	C430-0.313-D6-S.0-Z4	5/16	5/16	1-1/8	3	4	TIALN	CYLINDRICAL
N55686	C430-0.313-D7-S.0-Z4	5/16	5/16	1-1/2	6	4	UNCOATED	CYLINDRICAL
N55812	C430-0.313-D7-S.0-Z4	5/16	5/16	1-1/2	6	4	TIALN	CYLINDRICAL
N85697	C430-0.313-D8-S.0-Z4	5/16	5/16	1-5/8	4	4	UNCOATED	CYLINDRICAL
N85733	C430-0.313-D8-S.0-Z4	5/16	5/16	1-5/8	4	4	TIALN	CYLINDRICAL
N85523	C430-0.328-F3-S.0-Z4	21/64	3/8	1	2-1/2	4	UNCOATED	CYLINDRICAL
N85599	C430-0.328-F3-S.0-Z4	21/64	3/8	1	2-1/2	4	TIALN	CYLINDRICAL
N85524	C430-0.344-F3-S.0-Z4	11/32	3/8	1	2-1/2	4	UNCOATED	CYLINDRICAL
N85600	C430-0.344-F3-S.0-Z4	11/32	3/8	1	2-1/2	4	TIALN	CYLINDRICAL
N85525	C430-0.359-F3-S.0-Z4	23/64	3/8	1	2-1/2	4	UNCOATED	CYLINDRICAL
N85601	C430-0.359-F3-S.0-Z4	23/64	3/8	1	2-1/2	4	TIALN	CYLINDRICAL
N85660	C430-0.375-D1-S.0-Z4	3/8	3/8	5/8	2	4	UNCOATED	CYLINDRICAL
N85686	C430-0.375-D1-S.0-Z4	3/8	3/8	5/8	2	4	TIALN	CYLINDRICAL
N85526	C430-0.375-D2-S.0-Z4	3/8	3/8	1	2-1/2	4	UNCOATED	CYLINDRICAL
N85602	C430-0.375-D2-S.0-Z4	3/8	3/8	1	2-1/2	4	TIALN	CYLINDRICAL
N55687	C430-0.375-D3-S.0-Z4	3/8	3/8	1	3	4	UNCOATED	CYLINDRICAL
N55813	C430-0.375-D3-S.0-Z4	3/8	3/8	1	3	4	TIALN	CYLINDRICAL
N55688	C430-0.375-D4-S.0-Z4	3/8	3/8	1	4	4	UNCOATED	CYLINDRICAL
N55814	C430-0.375-D4-S.0-Z4	3/8	3/8	1	4	4	TIALN	CYLINDRICAL
N85698	C430-0.375-D5-S.0-Z4	3/8	3/8	1-1/8	3	4	UNCOATED	CYLINDRICAL
N85734	C430-0.375-D5-S.0-Z4	3/8	3/8	1-1/8	3	4	TIALN	CYLINDRICAL
N55689	C430-0.375-D6-S.0-Z4	3/8	3/8	1-1/2	6	4	UNCOATED	CYLINDRICAL
N55815	C430-0.375-D6-S.0-Z4	3/8	3/8	1-1/2	6	4	TIALN	CYLINDRICAL
N85699	C430-0.375-D7-S.0-Z4	3/8	3/8	1-3/4	4	4	UNCOATED	CYLINDRICAL
N85735	C430-0.375-D7-S.0-Z4	3/8	3/8	1-3/4	4	4	TIALN	CYLINDRICAL
N55690	C430-0.375-D8-S.0-Z4	3/8	3/8	2	4	4	UNCOATED	CYLINDRICAL
N55816	C430-0.375-D8-S.0-Z4	3/8	3/8	2	4	4	TIALN	CYLINDRICAL
N55691	C430-0.375-D9-S.0-Z4	3/8	3/8	3	6	4	UNCOATED	CYLINDRICAL
N55817	C430-0.375-D9-S.0-Z4	3/8	3/8	3	6	4	TIALN	CYLINDRICAL
N85527	C430-0.391-F3-S.0-Z4	25/64	7/16	1	2-3/4	4	UNCOATED	CYLINDRICAL
N85603	C430-0.391-F3-S.0-Z4	25/64	7/16	1	2-3/4	4	TIALN	CYLINDRICAL
N85528	C430-0.406-F2-S.0-Z4	13/32	7/16	1	2-3/4	4	UNCOATED	CYLINDRICAL
N85604	C430-0.406-F2-S.0-Z4	13/32	7/16	1	2-3/4	4	TIALN	CYLINDRICAL

C430 (CONT.)

SOLID CARBIDE

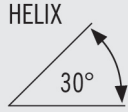

CENTER CUTTING



- General Purpose
- General machining of most material types

ITEM NUMBER	DESCRIPTION	FLUTE DIA	SHANK DIA	LENGTH OF CUT	OVERALL LENGTH	FLUTES	COATING	SHANK TYPE
N85529	C430-0.422-F2-S.0-Z4	27/64	7/16	1	2-3/4	4	UNCOATED	CYLINDRICAL
N85605	C430-0.422-F2-S.0-Z4	27/64	7/16	1	2-3/4	4	TIALN	CYLINDRICAL
N85661	C430-0.438-D1-S.0-Z4	7/16	7/16	5/8	2-1/2	4	UNCOATED	CYLINDRICAL
N85687	C430-0.438-D1-S.0-Z4	7/16	7/16	5/8	2-1/2	4	TIALN	CYLINDRICAL
N85530	C430-0.438-D2-S.0-Z4	7/16	7/16	1	2-3/4	4	UNCOATED	CYLINDRICAL
N85606	C430-0.438-D2-S.0-Z4	7/16	7/16	1	2-3/4	4	TIALN	CYLINDRICAL
N55692	C430-0.438-D3-S.0-Z4	7/16	7/16	1	4	4	UNCOATED	CYLINDRICAL
N55818	C430-0.438-D3-S.0-Z4	7/16	7/16	1	4	4	TIALN	CYLINDRICAL
N55693	C430-0.438-D4-S.0-Z4	7/16	7/16	1-1/2	6	4	UNCOATED	CYLINDRICAL
N55819	C430-0.438-D4-S.0-Z4	7/16	7/16	1-1/2	6	4	TIALN	CYLINDRICAL
N55694	C430-0.438-D5-S.0-Z4	7/16	7/16	2	4	4	UNCOATED	CYLINDRICAL
N55820	C430-0.438-D5-S.0-Z4	7/16	7/16	2	4	4	TIALN	CYLINDRICAL
N85700	C430-0.438-D6-S.0-Z4	7/16	7/16	2	4-1/2	4	UNCOATED	CYLINDRICAL
N85736	C430-0.438-D6-S.0-Z4	7/16	7/16	2	4-1/2	4	TIALN	CYLINDRICAL
N85701	C430-0.438-D7-S.0-Z4	7/16	7/16	3	6	4	UNCOATED	CYLINDRICAL
N85737	C430-0.438-D7-S.0-Z4	7/16	7/16	3	6	4	TIALN	CYLINDRICAL
N85532	C430-0.469-F2-S.0-Z4	15/32	1/2	1	3	4	UNCOATED	CYLINDRICAL
N85608	C430-0.469-F2-S.0-Z4	15/32	1/2	1	3	4	TIALN	CYLINDRICAL
N85662	C430-0.500-D1-S.0-Z4	1/2	1/2	5/8	2-1/2	4	UNCOATED	CYLINDRICAL
N85688	C430-0.500-D1-S.0-Z4	1/2	1/2	5/8	2-1/2	4	TIALN	CYLINDRICAL
N85534	C430-0.500-D2-S.0-Z4	1/2	1/2	1	3	4	UNCOATED	CYLINDRICAL
N85610	C430-0.500-D2-S.0-Z4	1/2	1/2	1	3	4	TIALN	CYLINDRICAL
N55695	C430-0.500-D3-S.0-Z4	1/2	1/2	1	4	4	UNCOATED	CYLINDRICAL
N55821	C430-0.500-D3-S.0-Z4	1/2	1/2	1	4	4	TIALN	CYLINDRICAL
N55696	C430-0.500-D4-S.0-Z4	1/2	1/2	1-1/2	6	4	UNCOATED	CYLINDRICAL
N55822	C430-0.500-D4-S.0-Z4	1/2	1/2	1-1/2	6	4	TIALN	CYLINDRICAL
N55697	C430-0.500-D5-S.0-Z4	1/2	1/2	2	4	4	UNCOATED	CYLINDRICAL
N55823	C430-0.500-D5-S.0-Z4	1/2	1/2	2	4	4	TIALN	CYLINDRICAL
N85702	C430-0.500-D6-S.0-Z4	1/2	1/2	2	4-1/2	4	UNCOATED	CYLINDRICAL
N85738	C430-0.500-D6-S.0-Z4	1/2	1/2	2	4-1/2	4	TIALN	CYLINDRICAL
N85703	C430-0.500-D7-S.0-Z4	1/2	1/2	3	6	4	UNCOATED	CYLINDRICAL
N85739	C430-0.500-D7-S.0-Z4	1/2	1/2	3	6	4	TIALN	CYLINDRICAL
N85535	C430-0.563-D2-S.0-Z4	9/16	9/16	1-1/8	3-1/2	4	UNCOATED	CYLINDRICAL
N85611	C430-0.563-D2-S.0-Z4	9/16	9/16	1-1/8	3-1/2	4	TIALN	CYLINDRICAL
N85663	C430-0.625-D1-S.0-Z4	5/8	5/8	3/4	3	4	UNCOATED	CYLINDRICAL
N85689	C430-0.625-D1-S.0-Z4	5/8	5/8	3/4	3	4	TIALN	CYLINDRICAL
N85536	C430-0.625-D2-S.0-Z4	5/8	5/8	1-1/4	3-1/2	4	UNCOATED	CYLINDRICAL
N85612	C430-0.625-D2-S.0-Z4	5/8	5/8	1-1/4	3-1/2	4	TIALN	CYLINDRICAL
N55700	C430-0.625-D3-S.0-Z4	5/8	5/8	2	6	4	UNCOATED	CYLINDRICAL
N55826	C430-0.625-D3-S.0-Z4	5/8	5/8	2	6	4	TIALN	CYLINDRICAL
N85704	C430-0.625-D4-S.0-Z4	5/8	5/8	2-1/4	5	4	UNCOATED	CYLINDRICAL
N85740	C430-0.625-D4-S.0-Z4	5/8	5/8	2-1/4	5	4	TIALN	CYLINDRICAL
N85705	C430-0.625-D5-S.0-Z4	5/8	5/8	3	6	4	UNCOATED	CYLINDRICAL
N85741	C430-0.625-D5-S.0-Z4	5/8	5/8	3	6	4	TIALN	CYLINDRICAL
N85537	C430-0.688-F2-S.0-Z4	11/16	3/4	1-3/8	4	4	UNCOATED	CYLINDRICAL

C430 (CONT.)

SOLID CARBIDE



CENTER CUTTING

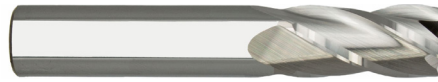

- General Purpose
- General machining of most material types

ITEM NUMBER	DESCRIPTION	FLUTE DIA	SHANK DIA	LENGTH OF CUT	OVERALL LENGTH	FLUTES	COATING	SHANK TYPE
N85662	C430-0.500-D1-S.0-Z4	1/2	1/2	5/8	2-1/2	4	UNCOATED	CYLINDRICAL
N85688	C430-0.500-D1-S.0-Z4	1/2	1/2	5/8	2-1/2	4	TIALN	CYLINDRICAL
N85534	C430-0.500-D2-S.0-Z4	1/2	1/2	1	3	4	UNCOATED	CYLINDRICAL
N85610	C430-0.500-D2-S.0-Z4	1/2	1/2	1	3	4	TIALN	CYLINDRICAL
N55695	C430-0.500-D3-S.0-Z4	1/2	1/2	1	4	4	UNCOATED	CYLINDRICAL
N55821	C430-0.500-D3-S.0-Z4	1/2	1/2	1	4	4	TIALN	CYLINDRICAL
N55696	C430-0.500-D4-S.0-Z4	1/2	1/2	1-1/2	6	4	UNCOATED	CYLINDRICAL
N55822	C430-0.500-D4-S.0-Z4	1/2	1/2	1-1/2	6	4	TIALN	CYLINDRICAL
N55697	C430-0.500-D5-S.0-Z4	1/2	1/2	2	4	4	UNCOATED	CYLINDRICAL
N55823	C430-0.500-D5-S.0-Z4	1/2	1/2	2	4	4	TIALN	CYLINDRICAL
N85702	C430-0.500-D6-S.0-Z4	1/2	1/2	2	4-1/2	4	UNCOATED	CYLINDRICAL
N85738	C430-0.500-D6-S.0-Z4	1/2	1/2	2	4-1/2	4	TIALN	CYLINDRICAL
N85703	C430-0.500-D7-S.0-Z4	1/2	1/2	3	6	4	UNCOATED	CYLINDRICAL
N85739	C430-0.500-D7-S.0-Z4	1/2	1/2	3	6	4	TIALN	CYLINDRICAL
N85535	C430-0.563-D2-S.0-Z4	9/16	9/16	1-1/8	3-1/2	4	UNCOATED	CYLINDRICAL
N85611	C430-0.563-D2-S.0-Z4	9/16	9/16	1-1/8	3-1/2	4	TIALN	CYLINDRICAL
N85663	C430-0.625-D1-S.0-Z4	5/8	5/8	3/4	3	4	UNCOATED	CYLINDRICAL
N85689	C430-0.625-D1-S.0-Z4	5/8	5/8	3/4	3	4	TIALN	CYLINDRICAL
N85536	C430-0.625-D2-S.0-Z4	5/8	5/8	1-1/4	3-1/2	4	UNCOATED	CYLINDRICAL
N85612	C430-0.625-D2-S.0-Z4	5/8	5/8	1-1/4	3-1/2	4	TIALN	CYLINDRICAL
N55700	C430-0.625-D3-S.0-Z4	5/8	5/8	2	6	4	UNCOATED	CYLINDRICAL
N55826	C430-0.625-D3-S.0-Z4	5/8	5/8	2	6	4	TIALN	CYLINDRICAL
N85704	C430-0.625-D4-S.0-Z4	5/8	5/8	2-1/4	5	4	UNCOATED	CYLINDRICAL
N85740	C430-0.625-D4-S.0-Z4	5/8	5/8	2-1/4	5	4	TIALN	CYLINDRICAL
N85705	C430-0.625-D5-S.0-Z4	5/8	5/8	3	6	4	UNCOATED	CYLINDRICAL
N85741	C430-0.625-D5-S.0-Z4	5/8	5/8	3	6	4	TIALN	CYLINDRICAL
N85537	C430-0.688-F2-S.0-Z4	11/16	3/4	1-3/8	4	4	UNCOATED	CYLINDRICAL
N85613	C430-0.688-F2-S.0-Z4	11/16	3/4	1-3/8	4	4	TIALN	CYLINDRICAL
N85664	C430-0.750-D1-S.0-Z4	3/4	3/4	1	3	4	UNCOATED	CYLINDRICAL
N85690	C430-0.750-D1-S.0-Z4	3/4	3/4	1	3	4	TIALN	CYLINDRICAL
N85538	C430-0.750-D2-S.0-Z4	3/4	3/4	1-1/2	4	4	UNCOATED	CYLINDRICAL
N85614	C430-0.750-D2-S.0-Z4	3/4	3/4	1-1/2	4	4	TIALN	CYLINDRICAL
N55701	C430-0.750-D3-S.0-Z4	3/4	3/4	2	6	4	UNCOATED	CYLINDRICAL
N55827	C430-0.750-D3-S.0-Z4	3/4	3/4	2	6	4	TIALN	CYLINDRICAL
N85706	C430-0.750-D4-S.0-Z4	3/4	3/4	2-1/4	5	4	UNCOATED	CYLINDRICAL
N85742	C430-0.750-D4-S.0-Z4	3/4	3/4	2-1/4	5	4	TIALN	CYLINDRICAL
N85707	C430-0.750-D5-S.0-Z4	3/4	3/4	3	6	4	UNCOATED	CYLINDRICAL
N85743	C430-0.750-D5-S.0-Z4	3/4	3/4	3	6	4	TIALN	CYLINDRICAL
INCH - C430 (CONT.)								
N55702	C430-0.750-D6-S.0-Z4	3/4	3/4	4	6	4	UNCOATED	CYLINDRICAL
N55828	C430-0.750-D6-S.0-Z4	3/4	3/4	4	6	4	TIALN	CYLINDRICAL
N85539	C430-0.875-D2-S.0-Z4	7/8	7/8	1-1/2	4	4	UNCOATED	CYLINDRICAL
N85615	C430-0.875-D2-S.0-Z4	7/8	7/8	1-1/2	4	4	TIALN	CYLINDRICAL
N55703	C430-1.000-D1-S.0-Z4	1	1	1	3	4	UNCOATED	CYLINDRICAL
N55829	C430-1.000-D1-S.0-Z4	1	1	1	3	4	TIALN	CYLINDRICAL
N85540	C430-1.000-D2-S.0-Z4	1	1	1-1/2	4	4	UNCOATED	CYLINDRICAL
N85616	C430-1.000-D2-S.0-Z4	1	1	1-1/2	4	4	TIALN	CYLINDRICAL

C430 (CONT.) & C430M

SOLID CARBIDE

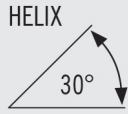

CENTER CUTTING



- General Purpose
- General machining of most material types

ITEM NUMBER	DESCRIPTION	FLUTE DIA	SHANK DIA	LENGTH OF CUT	OVERALL LENGTH	FLUTES	COATING	SHANK TYPE
N55704	C430-1.000-D3-S.0-Z4	1	1	2	6	4	UNCOATED	CYLINDRICAL
N55830	C430-1.000-D3-S.0-Z4	1	1	2	6	4	TIALN	CYLINDRICAL
N85708	C430-1.000-D4-S.0-Z4	1	1	2-1/4	5	4	UNCOATED	CYLINDRICAL
N85744	C430-1.000-D4-S.0-Z4	1	1	2-1/4	5	4	TIALN	CYLINDRICAL
N85709	C430-1.000-D5-S.0-Z4	1	1	3	6	4	UNCOATED	CYLINDRICAL
N85745	C430-1.000-D5-S.0-Z4	1	1	3	6	4	TIALN	CYLINDRICAL
N55705	C430-1.000-D6-S.0-Z4	1	1	4	7	4	UNCOATED	CYLINDRICAL
N55831	C430-1.000-D6-S.0-Z4	1	1	4	7	4	TIALN	CYLINDRICAL
N55706	C430-1.250-D2-S.0-Z4	1-1/4	1-1/4	2	4-1/2	4	UNCOATED	CYLINDRICAL
N55832	C430-1.250-D2-S.0-Z4	1-1/4	1-1/4	2	4-1/2	4	TIALN	CYLINDRICAL
N55707	C430-1.250-D3-S.0-Z4	1-1/4	1-1/4	3	6	4	UNCOATED	CYLINDRICAL
N55833	C430-1.250-D3-S.0-Z4	1-1/4	1-1/4	3	6	4	TIALN	CYLINDRICAL
METRIC - C430M								
N46412	C430M-010-F4-S.0-Z4	1mm	3mm	4mm	39mm	4	ALTIN	CYLINDRICAL
N46414	C430M-015-F3-S.0-Z4	1.5mm	3mm	4.5mm	39mm	4	ALTIN	CYLINDRICAL
N34456	C430M-020-F2-S.0-Z4	2mm	3mm	4mm	39mm	4	ALTIN	CYLINDRICAL
N46416	C430M-020-F3-S.0-Z4	2mm	3mm	6.3mm	39mm	4	ALTIN	CYLINDRICAL
N46420	C430M-030-D4-S.0-Z4	3mm	3mm	12mm	39mm	4	ALTIN	CYLINDRICAL
N46422	C430M-035-F3-S.0-Z4	3.5mm	4mm	12mm	51mm	4	ALTIN	CYLINDRICAL
N46424	C430M-040-D4-S.0-Z4	4mm	4mm	14mm	51mm	4	ALTIN	CYLINDRICAL
N34332	C430M-050-F5-S.0-Z4	5mm	6mm	25mm	75mm	4	ALTIN	CYLINDRICAL
N46428	C430M-050-F3-S.0-Z4	5mm	6mm	16mm	51mm	4	ALTIN	CYLINDRICAL
N46430	C430M-060-D3-S.0-Z4	6mm	6mm	19mm	51mm	4	ALTIN	CYLINDRICAL
N46434	C430M-080-D2-S.0-Z4	8mm	8mm	20mm	64mm	4	ALTIN	CYLINDRICAL
N46436	C430M-090-F2-S.0-Z4	9mm	10mm	22mm	73mm	4	ALTIN	CYLINDRICAL
N46438	C430M-100-D2-S.0-Z4	10mm	10mm	22mm	73mm	4	ALTIN	CYLINDRICAL
N46442	C430M-120-D2-S.0-Z4	12mm	12mm	25mm	74mm	4	ALTIN	CYLINDRICAL
N34346	C430M-120-D4-S.0-Z4	12mm	12mm	50mm	100mm	4	ALTIN	CYLINDRICAL

C430R

SOLID CARBIDE

HELIX
30°

RADIUS

CENTER CUTTING



- General Purpose
- Standard with radius
- General machining of most material types

ITEM NUMBER	DESCRIPTION	FLUTE DIA	SHANK DIA	LENGTH OF CUT	OVERALL LENGTH	FLUTES	COATING	RADIUS	SHANK TYPE
N91372	C430R-0.125-D4-R015.0-Z4	1/8	1/8	1/2	1-1/2	4	TIALN	0.015	CYLINDRICAL
N91373	C430R-0.125-D4-R020.0-Z4	1/8	1/8	1/2	1-1/2	4	TIALN	0.020	CYLINDRICAL
N91374	C430R-0.125-D4-R030.0-Z4	1/8	1/8	1/2	1-1/2	4	TIALN	0.030	CYLINDRICAL
N91375	C430R-0.188-D3-R015.0-Z4	3/16	3/16	5/8	2	4	TIALN	0.015	CYLINDRICAL
N91376	C430R-0.188-D3-R020.0-Z4	3/16	3/16	5/8	2	4	TIALN	0.020	CYLINDRICAL
N91377	C430R-0.188-D3-R030.0-Z4	3/16	3/16	5/8	2	4	TIALN	0.030	CYLINDRICAL
N91378	C430R-0.250-D3-R015.0-Z4	1/4	1/4	3/4	2-1/2	4	TIALN	0.015	CYLINDRICAL
N91379	C430R-0.250-D3-R020.0-Z4	1/4	1/4	3/4	2-1/2	4	TIALN	0.020	CYLINDRICAL
N91380	C430R-0.250-D3-R030.0-Z4	1/4	1/4	3/4	2-1/2	4	TIALN	0.030	CYLINDRICAL
N91381	C430R-0.250-D3-R045.0-Z4	1/4	1/4	3/4	2-1/2	4	TIALN	0.045	CYLINDRICAL
N91382	C430R-0.313-D3-R015.0-Z4	5/16	5/16	13/16	2-1/2	4	TIALN	0.015	CYLINDRICAL
N91383	C430R-0.313-D3-R020.0-Z4	5/16	5/16	13/16	2-1/2	4	TIALN	0.020	CYLINDRICAL
N91384	C430R-0.313-D3-R030.0-Z4	5/16	5/16	13/16	2-1/2	4	TIALN	0.030	CYLINDRICAL
N91385	C430R-0.313-D3-R045.0-Z4	5/16	5/16	13/16	2-1/2	4	TIALN	0.045	CYLINDRICAL
N91386	C430R-0.375-D3-R015.0-Z4	3/8	3/8	1	2-1/2	4	TIALN	0.015	CYLINDRICAL
N91387	C430R-0.375-D3-R020.0-Z4	3/8	3/8	1	2-1/2	4	TIALN	0.020	CYLINDRICAL
N91389	C430R-0.375-D3-R030.0-Z4	3/8	3/8	1	2-1/2	4	TIALN	0.030	CYLINDRICAL
N91390	C430R-0.375-D3-R045.0-Z4	3/8	3/8	1	2-1/2	4	TIALN	0.045	CYLINDRICAL
N91391	C430R-0.438-D2-R015.0-Z4	7/16	7/16	1	2-3/4	4	TIALN	0.015	CYLINDRICAL
N91393	C430R-0.438-D2-R030.0-Z4	7/16	7/16	1	2-3/4	4	TIALN	0.030	CYLINDRICAL
N91395	C430R-0.438-D2-R060.0-Z4	7/16	7/16	1	2-3/4	4	TIALN	0.060	CYLINDRICAL
N91397	C430R-0.438-D2-R125.0-Z4	7/16	7/16	1	2-3/4	4	TIALN	0.125	CYLINDRICAL
N91392	C430R-0.438-D2-R020.0-Z4	7/16	7/16	1	2-3/4	4	TIALN	0.020	CYLINDRICAL
N91394	C430R-0.438-D2-R045.0-Z4	7/16	7/16	1	2-3/4	4	TIALN	0.045	CYLINDRICAL
N91396	C430R-0.438-D2-R090.0-Z4	7/16	7/16	1	2-3/4	4	TIALN	0.090	CYLINDRICAL
N91398	C430R-0.500-D2-R020.0-Z4	1/2	1/2	1	3	4	TIALN	0.020	CYLINDRICAL
N91399	C430R-0.500-D2-R030.0-Z4	1/2	1/2	1	3	4	TIALN	0.030	CYLINDRICAL
N91401	C430R-0.500-D2-R045.0-Z4	1/2	1/2	1	3	4	TIALN	0.045	CYLINDRICAL
N91402	C430R-0.500-D2-R060.0-Z4	1/2	1/2	1	3	4	TIALN	0.060	CYLINDRICAL
N91403	C430R-0.500-D2-R090.0-Z4	1/2	1/2	1	3	4	TIALN	0.090	CYLINDRICAL
N91404	C430R-0.500-D2-R125.0-Z4	1/2	1/2	1	3	4	TIALN	0.125	CYLINDRICAL
N91353	C430R-0.500-D2-R015.0-Z4	1/2	1/2	1	3	4	TIALN	0.015	CYLINDRICAL
N91406	C430R-0.625-D2-R015.0-Z4	5/8	5/8	1-1/4	3-1/2	4	TIALN	0.015	CYLINDRICAL
N91408	C430R-0.625-D2-R020.0-Z4	5/8	5/8	1-1/4	3-1/2	4	TIALN	0.020	CYLINDRICAL
N91409	C430R-0.625-D2-R030.0-Z4	5/8	5/8	1-1/4	3-1/2	4	TIALN	0.030	CYLINDRICAL
N91410	C430R-0.625-D2-R045.0-Z4	5/8	5/8	1-1/4	3-1/2	4	TIALN	0.045	CYLINDRICAL
N91411	C430R-0.625-D2-R060.0-Z4	5/8	5/8	1-1/4	3-1/2	4	TIALN	0.060	CYLINDRICAL
N91412	C430R-0.625-D2-R090.0-Z4	5/8	5/8	1-1/4	3-1/2	4	TIALN	0.090	CYLINDRICAL

C430R (CONT.)

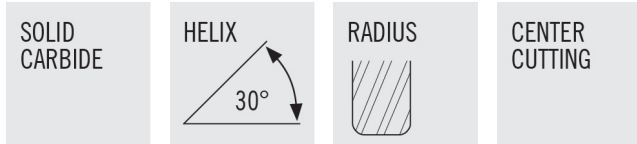

- General Purpose
- Standard with radius
- General machining of most material types

ITEM NUMBER	DESCRIPTION	FLUTE DIA	SHANK DIA	LENGTH OF CUT	OVERALL LENGTH	FLUTES	COATING	RADIUS	SHANK TYPE
N91413	C430R-0.625-D2-R125.0-Z4	5/8	5/8	1-1/4	3-1/2	4	TIALN	0.125	CYLINDRICAL
N91415	C430R-0.750-D2-R020.0-Z4	3/4	3/4	1-1/2	4	4	TIALN	0.020	CYLINDRICAL
N91416	C430R-0.750-D2-R030.0-Z4	3/4	3/4	1-1/2	4	4	TIALN	0.030	CYLINDRICAL
N91417	C430R-0.750-D2-R045.0-Z4	3/4	3/4	1-1/2	4	4	TIALN	0.045	CYLINDRICAL
N91418	C430R-0.750-D2-R060.0-Z4	3/4	3/4	1-1/2	4	4	TIALN	0.060	CYLINDRICAL
N91419	C430R-0.750-D2-R090.0-Z4	3/4	3/4	1-1/2	4	4	TIALN	0.090	CYLINDRICAL
N91420	C430R-0.750-D2-R125.0-Z4	3/4	3/4	1-1/2	4	4	TIALN	0.125	CYLINDRICAL
N91421	C430R-0.750-D2-R190.0-Z4	3/4	3/4	1-1/2	4	4	TIALN	0.190	CYLINDRICAL
N91361	C430R-0.750-D2-R015.0-Z4	3/4	3/4	1-1/2	4	4	TIALN	0.015	CYLINDRICAL
N91422	C430R-1.000-D2-R015.0-Z4	1	1	1-1/2	4	4	TIALN	0.015	CYLINDRICAL
N91425	C430R-1.000-D2-R060.0-Z4	1	1	1-1/2	4	4	TIALN	0.060	CYLINDRICAL
N91426	C430R-1.000-D2-R090.0-Z4	1	1	1-1/2	4	4	TIALN	0.090	CYLINDRICAL
N91427	C430R-1.000-D2-R125.0-Z4	1	1	1-1/2	4	4	TIALN	0.125	CYLINDRICAL
N91428	C430R-1.000-D2-R190.0-Z4	1	1	1-1/2	4	4	TIALN	0.190	CYLINDRICAL
N91405	C430R-1.000-D2-R030.0-Z4	1	1	1-1/2	4	4	TIALN	0.030	CYLINDRICAL

CB430

SOLID CARBIDE

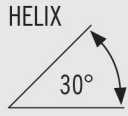

CENTER CUTTING

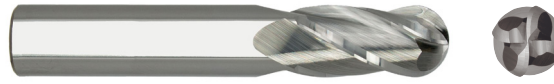

- General Purpose
- General machining for most material types

ITEM NUMBER	DESCRIPTION	FLUTE DIA	SHANK DIA	LENGTH OF CUT	OVERALL LENGTH	FLUTES	COATING	SHANK TYPE
N86340	CB430-0.016-F2-B.0-Z4	1/64	1/8	1/32	1-1/2	4	TIALN	CYLINDRICAL
N86341	CB430-0.031-F3-B.0-Z4	1/32	1/8	5/64	1-1/2	4	TIALN	CYLINDRICAL
N56014	CB430-0.031-F4-B.0-Z4	1/32	1/8	3/32	1-1/2	4	TIALN	CYLINDRICAL
N86342	CB430-0.047-F2-B.0-Z4	3/64	1/8	7/64	1-1/2	4	TIALN	CYLINDRICAL
N56015	CB430-0.047-F3-B.0-Z4	3/64	1/8	1/8	1-1/2	4	TIALN	CYLINDRICAL
N56016	CB430-0.063-F2-B.0-Z4	1/16	1/8	1/8	1-1/2	4	TIALN	CYLINDRICAL
N86343	CB430-0.063-F3-B.0-Z4	1/16	1/8	3/16	1-1/2	4	TIALN	CYLINDRICAL
N56017	CB430-0.063-F4-B.0-Z4	1/16	1/8	1/4	1-1/2	4	TIALN	CYLINDRICAL
N56018	CB430-0.063-F8-B.0-Z4	1/16	1/8	1	3	4	TIALN	CYLINDRICAL
N86344	CB430-0.078-F2-B.0-Z4	5/64	1/8	3/16	1-1/2	4	TIALN	CYLINDRICAL
N56020	CB430-0.078-F3-B.0-Z4	5/64	1/8	1/4	1-1/2	4	TIALN	CYLINDRICAL
N56021	CB430-0.094-F2-B.0-Z4	3/32	1/8	3/16	1-1/2	4	TIALN	CYLINDRICAL
N86345	CB430-0.094-F3-B.0-Z4	3/32	1/8	9/32	1-1/2	4	TIALN	CYLINDRICAL
N56022	CB430-0.094-F4-B.0-Z4	3/32	1/8	3/8	1-1/2	4	TIALN	CYLINDRICAL
N56023	CB430-0.094-F8-B.0-Z4	3/32	1/8	1	3	4	TIALN	CYLINDRICAL
N86346	CB430-0.109-F3-B.0-Z4	7/64	1/8	3/8	1-1/2	4	TIALN	CYLINDRICAL
N56025	CB430-0.125-D2-B.0-Z4	1/8	1/8	1/4	1-1/2	4	TIALN	CYLINDRICAL
N86347	CB430-0.125-D4-B.0-Z4	1/8	1/8	1/2	1-1/2	4	TIALN	CYLINDRICAL
N56026	CB430-0.125-D5-B.0-Z4	1/8	1/8	5/8	2	4	TIALN	CYLINDRICAL
N56027	CB430-0.125-D6-B.0-Z4	1/8	1/8	3/4	3	4	TIALN	CYLINDRICAL
N56028	CB430-0.125-D7-B.0-Z4	1/8	1/8	1	3	4	TIALN	CYLINDRICAL
N56029	CB430-0.125-D8-B.0-Z4	1/8	1/8	1	4	4	TIALN	CYLINDRICAL
N86348	CB430-0.141-F4-B.0-Z4	9/64	3/16	1/2	2	4	TIALN	CYLINDRICAL
N56030	CB430-0.156-F2-B.0-Z4	5/32	3/16	5/16	2	4	TIALN	CYLINDRICAL
N86349	CB430-0.156-F3-B.0-Z4	5/32	3/16	1/2	2	4	TIALN	CYLINDRICAL
N86350	CB430-0.172-F4-B.0-Z4	11/64	3/16	5/8	2	4	TIALN	CYLINDRICAL
N56031	CB430-0.188-D2-B.0-Z4	3/16	3/16	3/8	2	4	TIALN	CYLINDRICAL
N86351	CB430-0.188-D3-B.0-Z4	3/16	3/16	5/8	2	4	TIALN	CYLINDRICAL
N56032	CB430-0.188-D4-B.0-Z4	3/16	3/16	1	3	4	TIALN	CYLINDRICAL
N56033	CB430-0.188-D5-B.0-Z4	3/16	3/16	1	4	4	TIALN	CYLINDRICAL
N53972	CB430-0.188-D6-B.0-Z4	3/16	3/16	1-1/8	3	4	TIALN	CYLINDRICAL
N86352	CB430-0.203-F3-B.0-Z4	13/64	1/4	5/8	2-1/2	4	TIALN	CYLINDRICAL
N86353	CB430-0.219-F3-B.0-Z4	7/32	1/4	5/8	2-1/2	4	TIALN	CYLINDRICAL
N86354	CB430-0.234-F3-B.0-Z4	15/64	1/4	3/4	2-1/2	4	TIALN	CYLINDRICAL
N53974	CB430-0.250-D2-B.0-Z4	1/4	1/4	1/2	2	4	TIALN	CYLINDRICAL
N86355	CB430-0.250-D3-B.0-Z4	1/4	1/4	3/4	2-1/2	4	TIALN	CYLINDRICAL
N53975	CB430-0.250-D4-B.0-Z4	1/4	1/4	1	3	4	TIALN	CYLINDRICAL
N53976	CB430-0.250-D5-B.0-Z4	1/4	1/4	1	4	4	TIALN	CYLINDRICAL
N53977	CB430-0.250-D6-B.0-Z4	1/4	1/4	1-1/2	4	4	TIALN	CYLINDRICAL
N53978	CB430-0.250-D7-B.0-Z4	1/4	1/4	1-1/2	6	4	TIALN	CYLINDRICAL
N86357	CB430-0.281-F3-B.0-Z4	9/32	5/16	3/4	2-1/2	4	TIALN	CYLINDRICAL
N53979	CB430-0.313-D2-B.0-Z4	5/16	5/16	1/2	2	4	TIALN	CYLINDRICAL
N86359	CB430-0.313-D3-B.0-Z4	5/16	5/16	13/16	2-1/2	4	TIALN	CYLINDRICAL
N53980	CB430-0.313-D4-B.0-Z4	5/16	5/16	1	3	4	TIALN	CYLINDRICAL
N53982	CB430-0.313-D6-B.0-Z4	5/16	5/16	1-1/2	6	4	TIALN	CYLINDRICAL
N86360	CB430-0.328-F3-B.0-Z4	21/64	3/8	1	2-1/2	4	TIALN	CYLINDRICAL
N86361	CB430-0.344-F3-B.0-Z4	11/32	3/8	1	2-1/2	4	TIALN	CYLINDRICAL

CB430 (CONT.)

SOLID CARBIDE

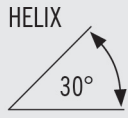

CENTER CUTTING

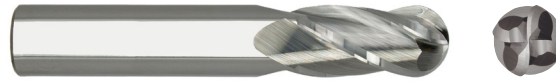

- General Purpose
- General machining for most material types

ITEM NUMBER	DESCRIPTION	FLUTE DIA	SHANK DIA	LENGTH OF CUT	OVERALL LENGTH	FLUTES	COATING	SHANK TYPE
N53984	CB430-0.375-D2-B.0-Z4	3/8	3/8	5/8	2	4	TIALN	CYLINDRICAL
N86363	CB430-0.375-D3-B.0-Z4	3/8	3/8	1	2-1/2	4	TIALN	CYLINDRICAL
N53985	CB430-0.375-D4-B.0-Z4	3/8	3/8	1	3	4	TIALN	CYLINDRICAL
N53986	CB430-0.375-D5-B.0-Z4	3/8	3/8	1	4	4	TIALN	CYLINDRICAL
N53987	CB430-0.375-D6-B.0-Z4	3/8	3/8	1-1/2	6	4	TIALN	CYLINDRICAL
N53988	CB430-0.375-D7-B.0-Z4	3/8	3/8	2	4	4	TIALN	CYLINDRICAL
N53989	CB430-0.375-D8-B.0-Z4	3/8	3/8	3	6	4	TIALN	CYLINDRICAL
N86365	CB430-0.406-F2-B.0-Z4	13/32	7/16	1	2-3/4	4	TIALN	CYLINDRICAL
N86367	CB430-0.438-D2-B.0-Z4	7/16	7/16	1	2-3/4	4	TIALN	CYLINDRICAL
N53991	CB430-0.438-D3-B.0-Z4	7/16	7/16	1	4	4	TIALN	CYLINDRICAL
N86369	CB430-0.469-F2-B.0-Z4	15/32	1/2	1	3	4	TIALN	CYLINDRICAL
N53995	CB430-0.500-D1-B.0-Z4	1/2	1/2	5/8	2-1/2	4	TIALN	CYLINDRICAL
N86371	CB430-0.500-D2-B.0-Z4	1/2	1/2	1	3	4	TIALN	CYLINDRICAL
N53996	CB430-0.500-D3-B.0-Z4	1/2	1/2	1	4	4	TIALN	CYLINDRICAL
N53997	CB430-0.500-D4-B.0-Z4	1/2	1/2	1-1/2	6	4	TIALN	CYLINDRICAL
N53998	CB430-0.500-D5-B.0-Z4	1/2	1/2	2	4	4	TIALN	CYLINDRICAL
N53999	CB430-0.500-D6-B.0-Z4	1/2	1/2	3	6	4	TIALN	CYLINDRICAL
N86372	CB430-0.563-D2-B.0-Z4	9/16	9/16	1-1/8	3-1/2	4	TIALN	CYLINDRICAL
N54002	CB430-0.625-D1-B.0-Z4	5/8	5/8	3/4	3	4	TIALN	CYLINDRICAL
N86373	CB430-0.625-D2-B.0-Z4	5/8	5/8	1-1/4	3-1/2	4	TIALN	CYLINDRICAL
N54003	CB430-0.625-D3-B.0-Z4	5/8	5/8	2	6	4	TIALN	CYLINDRICAL
N54004	CB430-0.625-D5-B.0-Z4	5/8	5/8	3	6	4	TIALN	CYLINDRICAL
N54005	CB430-0.750-D1-B.0-Z4	3/4	3/4	1	3	4	TIALN	CYLINDRICAL
N86375	CB430-0.750-D2-B.0-Z4	3/4	3/4	1-1/2	4	4	TIALN	CYLINDRICAL
N54006	CB430-0.750-D3-B.0-Z4	3/4	3/4	2	6	4	TIALN	CYLINDRICAL
N54007	CB430-0.750-D4-B.0-Z4	3/4	3/4	3	6	4	TIALN	CYLINDRICAL
N54008	CB430-0.750-D5-B.0-Z4	3/4	3/4	4	6	4	TIALN	CYLINDRICAL
N86376	CB430-0.875-D2-B.0-Z4	7/8	7/8	1-1/2	4	4	TIALN	CYLINDRICAL
N86377	CB430-1.000-D2-B.0-Z4	1	1	1-1/2	4	4	TIALN	CYLINDRICAL
N54009	CB430-1.000-D3-B.0-Z4	1	1	2	6	4	TIALN	CYLINDRICAL
N54010	CB430-1.000-D4-B.0-Z4	1	1	3	6	4	TIALN	CYLINDRICAL
N54011	CB430-1.000-D5-B.0-Z4	1	1	4	7	4	TIALN	CYLINDRICAL

CB430M

SOLID
CARBIDE

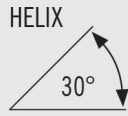

CENTER
CUTTING



- General Purpose
- General machining for most material types

ITEM NUMBER	DESCRIPTION	FLUTE DIA	SHANK DIA	LENGTH OF CUT	OVERALL LENGTH	FLUTES	COATING
N46454	CB430M-010-F4-B.0-Z4	1mm	3mm	4mm	39mm	4	ALTIN
N34478	CB430M-020-F2-B.0-Z4	2mm	3mm	4mm	39mm	4	ALTIN
N47938	CB430M-030-D2-B.0-Z4	3mm	3mm	6mm	39mm	4	ALTIN
N46462	CB430M-030-D4-B.0-Z4	3mm	3mm	12mm	39mm	4	ALTIN
N46466	CB430M-040-D4-B.0-Z4	4mm	4mm	14mm	51mm	4	ALTIN
N34362	CB430M-040-D6-B.0-Z4	4mm	4mm	25mm	75mm	4	ALTIN
N46470	CB430M-050-F3-B.0-Z4	5mm	6mm	16mm	51mm	4	ALTIN
N47942	CB430M-060-D2-B.0-Z4	6mm	6mm	9mm	51mm	4	ALTIN
N46472	CB430M-060-D3-B.0-Z4	6mm	6mm	19mm	51mm	4	ALTIN
N34370	CB430M-080-D3-B.0-Z4	8mm	8mm	25mm	75mm	4	ALTIN
N34372	CB430M-080-D4-B.0-Z4	8mm	8mm	25mm	150mm	4	ALTIN
N46480	CB430M-100-D2-B.0-Z4	10mm	10mm	22mm	73mm	4	ALTIN
N46484	CB430M-120-D2-B.0-Z4	12mm	12mm	25mm	74mm	4	ALTIN

CD430

SOLID CARBIDE



CENTER CUTTING



- General Purpose
- General machining for most material types

ITEM NUMBER	DESCRIPTION	FLUTE DIA	SHANK DIA	LENGTH OF CUT	OVERALL LENGTH	FLUTES	COATING	SHANK TYPE
N85618	CD430-0.125-XF3-S.3-Z4	1/8	3/8	3/8	3-1/16	4	UNCOATED	WELDON
N85640	CD430-0.125-XF3-S.3-Z4	1/8	3/8	3/8	3-1/16	4	TIALN	WELDON
N85619	CD430-0.156-XF3-S.3-Z4	5/32	3/8	7/16	3-1/8	4	UNCOATED	WELDON
N85641	CD430-0.156-XF3-S.3-Z4	5/32	3/8	7/16	3-1/8	4	TIALN	WELDON
N85620	CD430-0.188-XF3-S.3-Z4	3/16	3/8	1/2	3-1/4	4	UNCOATED	WELDON
N85642	CD430-0.188-XF3-S.3-Z4	3/16	3/8	1/2	3-1/4	4	TIALN	WELDON
N85621	CD430-0.219-XF3-S.3-Z4	7/32	3/8	9/16	3-3/8	4	UNCOATED	WELDON
N85643	CD430-0.219-XF3-S.3-Z4	7/32	3/8	9/16	3-3/8	4	TIALN	WELDON
N85622	CD430-0.250-XF3-S.3-Z4	1/4	3/8	5/8	3-3/8	4	UNCOATED	WELDON
N85644	CD430-0.250-XF3-S.3-Z4	1/4	3/8	5/8	3-3/8	4	TIALN	WELDON
N85623	CD430-0.281-XF2-S.3-Z4	9/32	3/8	11/16	3-1/2	4	UNCOATED	WELDON
N85645	CD430-0.281-XF2-S.3-Z4	9/32	3/8	11/16	3-1/2	4	TIALN	WELDON
N85624	CD430-0.313-XF2-S.3-Z4	5/16	3/8	3/4	3-1/2	4	UNCOATED	WELDON
N85646	CD430-0.313-XF2-S.3-Z4	5/16	3/8	3/4	3-1/2	4	TIALN	WELDON
N85625	CD430-0.344-XF2-S.3-Z4	11/32	3/8	3/4	3-1/2	4	UNCOATED	WELDON
N85647	CD430-0.344-XF2-S.3-Z4	11/32	3/8	3/4	3-1/2	4	TIALN	WELDON
N85626	CD430-0.375-XD2-S.3-Z4	3/8	3/8	3/4	3-1/2	4	UNCOATED	WELDON
N85648	CD430-0.375-XD2-S.3-Z4	3/8	3/8	3/4	3-1/2	4	TIALN	WELDON
N85627	CD430-0.438-XF2-S.3-Z4	7/16	1/2	7/8	4	4	UNCOATED	WELDON
N85649	CD430-0.438-XF2-S.3-Z4	7/16	1/2	7/8	4	4	TIALN	WELDON
N85628	CD430-0.500-XD2-S.3-Z4	1/2	1/2	1	4	4	UNCOATED	WELDON
N85650	CD430-0.500-XD2-S.3-Z4	1/2	1/2	1	4	4	TIALN	WELDON

CSD430

SOLID CARBIDE

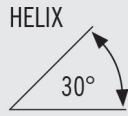

CENTER CUTTING



- General Purpose
- General machining for most material types

ITEM NUMBER	DESCRIPTION	FLUTE DIA	SHANK DIA	LENGTH OF CUT	OVERALL LENGTH	FLUTES	COATING	SHANK TYPE
N89818	CSD430-0.031-XF2-S.0-Z4	1/32	1/8	1/16	1-1/2	4	UNCOATED	CYLINDRICAL
N89821	CSD430-0.031-XF2-S.0-Z4	1/32	1/8	1/16	1-1/2	4	TIALN	CYLINDRICAL
N89822	CSD430-0.047-XF2-S.0-Z4	3/64	1/8	3/32	1-1/2	4	UNCOATED	CYLINDRICAL
N89825	CSD430-0.047-XF2-S.0-Z4	3/64	1/8	3/32	1-1/2	4	TIALN	CYLINDRICAL
N89826	CSD430-0.063-XF2-S.0-Z4	1/16	1/8	1/8	1-1/2	4	UNCOATED	CYLINDRICAL
N89829	CSD430-0.063-XF2-S.0-Z4	1/16	1/8	1/8	1-1/2	4	TIALN	CYLINDRICAL
N89830	CSD430-0.078-XF2-S.0-Z4	5/64	1/8	1/8	1-1/2	4	UNCOATED	CYLINDRICAL
N89833	CSD430-0.078-XF2-S.0-Z4	5/64	1/8	1/8	1-1/2	4	TIALN	CYLINDRICAL
N89834	CSD430-0.094-XF2-S.0-Z4	3/32	1/8	3/16	1-1/2	4	UNCOATED	CYLINDRICAL
N89837	CSD430-0.094-XF2-S.0-Z4	3/32	1/8	3/16	1-1/2	4	TIALN	CYLINDRICAL
N89838	CSD430-0.109-XF2-S.0-Z4	7/64	1/8	3/16	1-1/2	4	UNCOATED	CYLINDRICAL
N89841	CSD430-0.109-XF2-S.0-Z4	7/64	1/8	3/16	1-1/2	4	TIALN	CYLINDRICAL
N89842	CSD430-0.125-XD2-S.0-Z4	1/8	1/8	1/4	1-1/2	4	UNCOATED	CYLINDRICAL
N89845	CSD430-0.125-XD2-S.0-Z4	1/8	1/8	1/4	1-1/2	4	TIALN	CYLINDRICAL
N89846	CSD430-0.141-XF2-S.0-Z4	9/64	3/16	5/16	2	4	UNCOATED	CYLINDRICAL
N89849	CSD430-0.141-XF2-S.0-Z4	9/64	3/16	5/16	2	4	TIALN	CYLINDRICAL
N89850	CSD430-0.156-XF2-S.0-Z4	5/32	3/16	5/16	2	4	UNCOATED	CYLINDRICAL
N89853	CSD430-0.156-XF2-S.0-Z4	5/32	3/16	5/16	2	4	TIALN	CYLINDRICAL
N89854	CSD430-0.172-XF2-S.0-Z4	11/64	3/16	5/16	2	4	UNCOATED	CYLINDRICAL
N89857	CSD430-0.172-XF2-S.0-Z4	11/64	3/16	5/16	2	4	TIALN	CYLINDRICAL
N89858	CSD430-0.188-XD2-S.0-Z4	3/16	3/16	3/8	2	4	UNCOATED	CYLINDRICAL
N89861	CSD430-0.188-XD2-S.0-Z4	3/16	3/16	3/8	2	4	TIALN	CYLINDRICAL
N89862	CSD430-0.203-XF2-S.0-Z4	13/64	1/4	1/2	2-1/2	4	UNCOATED	CYLINDRICAL
N89865	CSD430-0.203-XF2-S.0-Z4	13/64	1/4	1/2	2-1/2	4	TIALN	CYLINDRICAL
N89866	CSD430-0.219-XF2-S.0-Z4	7/32	1/4	1/2	2-1/2	4	UNCOATED	CYLINDRICAL
N89869	CSD430-0.219-XF2-S.0-Z4	7/32	1/4	1/2	2-1/2	4	TIALN	CYLINDRICAL
N89870	CSD430-0.234-XF2-S.0-Z4	15/64	1/4	1/2	2-1/2	4	UNCOATED	CYLINDRICAL
N89873	CSD430-0.234-XF2-S.0-Z4	15/64	1/4	1/2	2-1/2	4	TIALN	CYLINDRICAL
N89874	CSD430-0.250-XD2-S.0-Z4	1/4	1/4	1/2	2-1/2	4	UNCOATED	CYLINDRICAL
N89877	CSD430-0.250-XD2-S.0-Z4	1/4	1/4	1/2	2-1/2	4	TIALN	CYLINDRICAL
N89878	CSD430-0.281-XF2-S.0-Z4	9/32	5/16	1/2	2-1/2	4	UNCOATED	CYLINDRICAL
N89881	CSD430-0.281-XF2-S.0-Z4	9/32	5/16	1/2	2-1/2	4	TIALN	CYLINDRICAL
N89882	CSD430-0.313-XD2-S.0-Z4	5/16	5/16	1/2	2-1/2	4	UNCOATED	CYLINDRICAL
N89885	CSD430-0.313-XD2-S.0-Z4	5/16	5/16	1/2	2-1/2	4	TIALN	CYLINDRICAL
N89886	CSD430-0.344-XF2-S.0-Z4	11/32	3/8	9/16	2-1/2	4	UNCOATED	CYLINDRICAL
N89890	CSD430-0.375-XD2-S.0-Z4	3/8	3/8	9/16	2-1/2	4	UNCOATED	CYLINDRICAL
N89893	CSD430-0.375-XD2-S.0-Z4	3/8	3/8	9/16	2-1/2	4	TIALN	CYLINDRICAL
N89894	CSD430-0.438-XD1-S.0-Z4	7/16	7/16	9/16	2-3/4	4	UNCOATED	CYLINDRICAL
N89897	CSD430-0.438-XD1-S.0-Z4	7/16	7/16	9/16	2-3/4	4	TIALN	CYLINDRICAL
N89898	CSD430-0.500-XD1-S.0-Z4	1/2	1/2	5/8	3	4	UNCOATED	CYLINDRICAL
N89901	CSD430-0.500-XD1-S.0-Z4	1/2	1/2	5/8	3	4	TIALN	CYLINDRICAL

CSDB430

SOLID
CARBIDE



CENTER
CUTTING

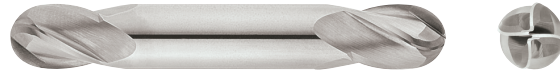

- General Purpose
- General machining for most material types

ITEM NUMBER	DESCRIPTION	FLUTE DIA	SHANK DIA	LENGTH OF CUT	OVERALL LENGTH	FLUTES	COATING	SHANK TYPE
N89905	CSDB430-0.031-XF2-B.0-Z4	1/32	1/8	1/16	1-1/2	4	TIALN	CYLINDRICAL
N89909	CSDB430-0.047-XF2-B.0-Z4	3/64	1/8	3/32	1-1/2	4	TIALN	CYLINDRICAL
N89913	CSDB430-0.063-XF2-B.0-Z4	1/16	1/8	1/8	1-1/2	4	TIALN	CYLINDRICAL
N89917	CSDB430-0.078-XF2-B.0-Z4	5/64	1/8	1/8	1-1/2	4	TIALN	CYLINDRICAL
N89921	CSDB430-0.094-XF2-B.0-Z4	3/32	1/8	3/16	1-1/2	4	TIALN	CYLINDRICAL
N89929	CSDB430-0.125-XD2-B.0-Z4	1/8	1/8	1/4	1-1/2	4	TIALN	CYLINDRICAL
N89937	CSDB430-0.156-XF2-B.0-Z4	5/32	3/16	5/16	2	4	TIALN	CYLINDRICAL
N89941	CSDB430-0.172-XF2-B.0-Z4	11/64	3/16	5/16	2	4	TIALN	CYLINDRICAL
N89945	CSDB430-0.188-XD2-B.0-Z4	3/16	3/16	3/8	2	4	TIALN	CYLINDRICAL
N89961	CSDB430-0.250-XD2-B.0-Z4	1/4	1/4	1/2	2-1/2	4	TIALN	CYLINDRICAL
N89969	CSDB430-0.313-XD2-B.0-Z4	5/16	5/16	1/2	2-1/2	4	TIALN	CYLINDRICAL
N89977	CSDB430-0.375-XD2-B.0-Z4	3/8	3/8	9/16	2-1/2	4	TIALN	CYLINDRICAL
N89985	CSDB430-0.500-XD1-B.0-Z4	1/2	1/2	5/8	3	4	TIALN	CYLINDRICAL

C230 / G230R / CNC230 / CD230 / CSD230 - START VALUES

		SLOTTING											
ISO GROUP	SMG	a _p x Dc (max)	a _e x Dc (max)	V _c (sf / min)		Z _n = 2							
						1/16	1/8	1/4	3/8	1/2	5/8	3/4	1
P	E 1 - 2	0.30	1.00	400	n (rev/min)	24448	12224	6112	4075	3056	2445	2037	1528
					f _z (in)	0.0002	0.0005	0.0009	0.0014	0.0018	0.0023	0.0027	0.0036
					V _f (in/min)	11	11	11	11	11	11	11	11
	E 3 - 4	0.20	1.00	200	n (rev/min)	12224	6112	3056	2037	1528	1222	1019	764
					f _z (in)	0.0001	0.0003	0.0006	0.0008	0.0011	0.0014	0.0017	0.0022
					V _f (in/min)	3	3	3	3	3	3	3	3
	E 5 - 6	0.20	1.00	100	n (rev/min)	6112	3056	1528	1019	764	611	509	382
					f _z (in)	0.0001	0.0002	0.0005	0.0007	0.0010	0.0012	0.0014	0.0019
					V _f (in/min)	2	2	2	2	2	2	2	2
M	E 8 - 9	0.50	1.00	320	n (rev/min)	19558	9779	4890	3260	2445	1956	1630	1222
					f _z (in)	0.0001	0.0002	0.0004	0.0007	0.0009	0.0011	0.0013	0.0018
					V _f (in/min)	4	4	4	4	4	4	4	4
	E 10 - 11	0.30	1.00	250	n (rev/min)	15280	7640	3820	2547	1910	1528	1273	955
					f _z (in)	0.0001	0.0002	0.0004	0.0006	0.0008	0.0010	0.0012	0.0016
					V _f (in/min)	3	3	3	3	3	3	3	3
K	E 12 - 13	0.30	1.00	270	n (rev/min)	16502	8251	4126	2750	2063	1650	1375	1031
					f _z (in)	0.0003	0.0006	0.0012	0.0017	0.0023	0.0029	0.0035	0.0046
					V _f (in/min)	10	10	10	10	10	10	10	10
	E 14 - 15	0.20	1.00	145	n (rev/min)	8862	4431	2216	1477	1108	886	739	554
					f _z (in)	0.0002	0.0003	0.0007	0.0010	0.0014	0.0017	0.0020	0.0027
					V _f (in/min)	3	3	3	3	3	3	3	3
N	E / M / A 16	1.00	1.00	700	n (rev/min)	42784	21392	10696	7131	5348	4278	3565	2674
					f _z (in)	0.0005	0.0009	0.0018	0.0027	0.0036	0.0045	0.0054	0.0072
					V _f (in/min)	39	39	39	39	39	39	39	39
	E / M / A 17	1.00	1.00	700	n (rev/min)	42784	21392	10696	7131	5348	4278	3565	2674
					f _z (in)	0.0005	0.0009	0.0018	0.0027	0.0036	0.0045	0.0054	0.0072
					V _f (in/min)	39	39	39	39	39	39	39	39
S	E 19	0.30	1.00	80	n (rev/min)	4890	2445	1222	815	611	489	407	306
					f _z (in)	0.0002	0.0003	0.0006	0.0009	0.0012	0.0015	0.0018	0.0024
					V _f (in/min)	2	2	2	2	2	2	2	2
	E 20	0.30	1.00	80	n (rev/min)	4890	2445	1222	815	611	489	407	306
					f _z (in)	0.0002	0.0003	0.0006	0.0009	0.0012	0.0015	0.0018	0.0024
					V _f (in/min)	2	2	2	2	2	2	2	2
	E 21	0.30	1.00	80	n (rev/min)	4890	2445	1222	815	611	489	407	306
					f _z (in)	0.0002	0.0003	0.0006	0.0009	0.0012	0.0015	0.0018	0.0024
					V _f (in/min)	2	2	2	2	2	2	2	2
	E 22	0.30	1.00	140	n (rev/min)	8557	4278	2139	1426	1070	856	713	535
f _z (in)					0.0001	0.0003	0.0006	0.0008	0.0011	0.0014	0.0017	0.0022	
V _f (in/min)					2	2	2	2	2	2	2	2	

SMG = Seco Material Group
 n [min-1] = RPM
 V_c (sf/min) = Surface feet/min

f_z [in] = Feed/tooth
 a_p/D_c = % of diameter
 v_f [in/min] = Feed rate
 a_f/D_c = % of diameter

A = Air D = Dry E = Emulsion (flood coolant) M = Mist
 All cutting data are start values. All cutting data is in inch values.
 Please reference the Workpiece Material Classification chart located on page 15.

CUTTING DATA - GENERAL PURPOSE SOLID CARBIDE

C230 / G230R / CNC230 / CD230 / CSD230 - START VALUES

SIDE MILLING - ROUGHING

ISO GROUP	SMG	a _p x D _c (max)	a _e x D _c (max)	v _c (sf / min)	Z _n = 2								
					1/16	1/8	1/4	3/8	1/2	5/8	3/4	1	
P	E 1 - 2	1.00	0.25	400	n (rev/min)	24448	12224	6112	4075	3056	2445	2037	1528
					f _z (in)	0.0003	0.0006	0.0011	0.0017	0.0023	0.0028	0.0034	0.0045
					v _f (in/min)	14	14	14	14	14	14	14	14
	E 3 - 4	1.00	0.25	200	n (rev/min)	12224	6112	3056	2037	1528	1222	1019	764
					f _z (in)	0.0002	0.0004	0.0007	0.0011	0.0014	0.0018	0.0021	0.0028
					v _f (in/min)	4	4	4	4	4	4	4	4
E 5 - 6	1.00	0.20	100	n (rev/min)	6112	3056	1528	1019	764	611	509	382	
				f _z (in)	0.0002	0.0003	0.0006	0.0009	0.0012	0.0015	0.0018	0.0024	
				v _f (in/min)	2	2	2	2	2	2	2	2	
M	E 8 - 9	0.50	0.20	320	n (rev/min)	19558	9779	4890	3260	2445	1956	1630	1222
					f _z (in)	0.0001	0.0003	0.0006	0.0008	0.0011	0.0014	0.0017	0.0022
					v _f (in/min)	5	5	5	5	5	5	5	5
	E 10 - 11	0.30	0.20	250	n (rev/min)	15280	7640	3820	2547	1910	1528	1273	955
					f _z (in)	0.0001	0.0003	0.0005	0.0008	0.0010	0.0013	0.0015	0.0020
					v _f (in/min)	4	4	4	4	4	4	4	4
K	E 12 - 13	1.00	0.25	270	n (rev/min)	16502	8251	4126	2750	2063	1650	1375	1031
					f _z (in)	0.0004	0.0007	0.0015	0.0022	0.0029	0.0036	0.0044	0.0058
					v _f (in/min)	12	12	12	12	12	12	12	12
	E 14 - 15	0.50	0.25	145	n (rev/min)	8862	4431	2216	1477	1108	886	739	554
					f _z (in)	0.0002	0.0004	0.0009	0.0013	0.0017	0.0021	0.0026	0.0034
					v _f (in/min)	4	4	4	4	4	4	4	4
N	E / M / A 16	2.00	0.05	700	n (rev/min)	42784	21392	10696	7131	5348	4278	3565	2674
					f _z (in)	0.0006	0.0011	0.0023	0.0034	0.0045	0.0056	0.0068	0.0090
					v _f (in/min)	48	48	48	48	48	48	48	48
	E / M / A 17	2.00	0.05	700	n (rev/min)	42784	21392	10696	7131	5348	4278	3565	2674
					f _z (in)	0.0006	0.0011	0.0023	0.0034	0.0045	0.0056	0.0068	0.0090
					v _f (in/min)	48	48	48	48	48	48	48	48
S	E 19	0.20	0.05	80	n (rev/min)	4890	2445	1222	815	611	489	407	306
					f _z (in)	0.0002	0.0004	0.0008	0.0011	0.0015	0.0019	0.0023	0.0030
					v _f (in/min)	2	2	2	2	2	2	2	2
	E 20	0.20	0.05	80	n (rev/min)	4890	2445	1222	815	611	489	407	306
					f _z (in)	0.0002	0.0004	0.0008	0.0011	0.0015	0.0019	0.0023	0.0030
					v _f (in/min)	2	2	2	2	2	2	2	2
	E 21	0.20	0.05	80	n (rev/min)	4890	2445	1222	815	611	489	407	306
					f _z (in)	0.0002	0.0004	0.0008	0.0011	0.0015	0.0019	0.0023	0.0030
					v _f (in/min)	2	2	2	2	2	2	2	2
	E 22	0.30	0.15	140	n (rev/min)	8557	4278	2139	1426	1070	856	713	535
					f _z (in)	0.0002	0.0004	0.0007	0.0011	0.0014	0.0018	0.0021	0.0028
					v _f (in/min)	3	3	3	3	3	3	3	3

SMG = Seco Material Group
 n [min-1] = RPM
 v_c (sf/min) = Surface feet/min

f_z [in] = Feed/tooth
 a_p/D_c = % of diameter
 v_f [in/min] = Feed rate
 a_e/D_c = % of diameter

A = Air D = Dry E = Emulsion (flood coolant) M = Mist
 All cutting data are start values. All cutting data is in inch values.
 Please reference the Workpiece Material Classification chart located on page 15.

CB230 / CSDB230 - START VALUES

SLOTTING													
ISO GROUP	SMG	a _p x Dc (max)	a _e x Dc (max)	v _c (sf / min)		Z _n = 2							
						1/16	1/8	1/4	3/8	1/2	5/8	3/4	1
P	E 1 - 2	0.50	1.00	320	n (rev/min)	19558	9779	4890	3260	2445	1956	1630	1222
					f _z (in)	0.0002	0.0005	0.0009	0.0014	0.0018	0.0023	0.0027	0.0036
					v _f (in/min)	9	9	9	9	9	9	9	9
	E 3 - 4	0.40	1.00	160	n (rev/min)	9779	4890	2445	1630	1222	978	815	611
					f _z (in)	0.0001	0.0003	0.0006	0.0008	0.0011	0.0014	0.0017	0.0022
					v _f (in/min)	3	3	3	3	3	3	3	3
	E 5 - 6	0.30	1.00	80	n (rev/min)	4890	2445	1222	815	611	489	407	306
					f _z (in)	0.0001	0.0002	0.0005	0.0007	0.0010	0.0012	0.0014	0.0019
					v _f (in/min)	1	1	1	1	1	1	1	1
M	E 8 - 9	0.50	1.00	256	n (rev/min)	15647	7823	3912	2608	1956	1565	1304	978
					f _z (in)	0.0001	0.0002	0.0004	0.0007	0.0009	0.0011	0.0013	0.0018
					v _f (in/min)	3	3	3	3	3	3	3	3
	E 10 - 11	0.40	1.00	200	n (rev/min)	12224	6112	3056	2037	1528	1222	1019	764
					f _z (in)	0.0001	0.0002	0.0004	0.0006	0.0008	0.0010	0.0012	0.0016
					v _f (in/min)	2	2	2	2	2	2	2	2
K	E 12 - 13	0.50	1.00	216	n (rev/min)	13202	6601	3300	2200	1650	1320	1100	825
					f _z (in)	0.0003	0.0006	0.0012	0.0017	0.0023	0.0029	0.0035	0.0046
					v _f (in/min)	8	8	8	8	8	8	8	8
	E 14 - 15	0.30	1.00	116	n (rev/min)	7090	3545	1772	1182	886	709	591	443
					f _z (in)	0.0002	0.0003	0.0007	0.0010	0.0014	0.0017	0.0020	0.0027
					v _f (in/min)	2	2	2	2	2	2	2	2
N	E / M / A 16	1.00	1.00	560	n (rev/min)	34227	17114	8557	5705	4278	3423	2852	2139
					f _z (in)	0.0005	0.0009	0.0018	0.0027	0.0036	0.0045	0.0054	0.0072
					v _f (in/min)	31	31	31	31	31	31	31	31
	E / M / A 17	1.00	1.00	560	n (rev/min)	34227	17114	8557	5705	4278	3423	2852	2139
					f _z (in)	0.0005	0.0009	0.0018	0.0027	0.0036	0.0045	0.0054	0.0072
					v _f (in/min)	31	31	31	31	31	31	31	31
S	E 19	0.20	1.00	70	n (rev/min)	4278	2139	1070	713	535	428	357	267
					f _z (in)	0.0002	0.0003	0.0006	0.0009	0.0012	0.0015	0.0018	0.0024
					v _f (in/min)	1	1	1	1	1	1	1	1
	E 20	0.20	1.00	70	n (rev/min)	4278	2139	1070	713	535	428	357	267
					f _z (in)	0.0002	0.0003	0.0006	0.0009	0.0012	0.0015	0.0018	0.0024
					v _f (in/min)	1	1	1	1	1	1	1	1
	E 21	0.20	1.00	70	n (rev/min)	4278	2139	1070	713	535	428	357	267
					f _z (in)	0.0002	0.0003	0.0006	0.0009	0.0012	0.0015	0.0018	0.0024
					v _f (in/min)	1	1	1	1	1	1	1	1
	E 22	0.30	1.00	112	n (rev/min)	6845	3423	1711	1141	856	685	570	428
					f _z (in)	0.0001	0.0003	0.0006	0.0008	0.0011	0.0014	0.0017	0.0022
					v _f (in/min)	2	2	2	2	2	2	2	2

SMG = Seco Material Group
 n [min-1] = RPM
 v_c (sf/min) = Surface feet/min

f_z [in] = Feed/tooth
 a_p/D_c = % of diameter
 v_f [in/min] = Feed rate
 a_e/D_c = % of diameter

A = Air D = Dry E = Emulsion (flood coolant) M = Mist
 All cutting data are start values. All cutting data is in inch values.
 Please reference the Workpiece Material Classification chart located on page 15.

CB230 / CSDB230 - START VALUES

SIDE MILLING - ROUGHING													
ISO GROUP	SMG	a _p x D _c (max)	a _e x D _c (max)	V _c (sf / min)	Z _n = 2								
					1/16	1/8	1/4	3/8	1/2	5/8	3/4	1	
P	E 1 - 2	1.00	0.30	320	n (rev/min)	19558	9779	4890	3260	2445	1956	1630	1222
					f _z (in)	0.0003	0.0006	0.0011	0.0017	0.0023	0.0028	0.0034	0.0045
					v _f (in/min)	11	11	11	11	11	11	11	11
	E 3 - 4	1.00	0.30	160	n (rev/min)	9779	4890	2445	1630	1222	978	815	611
					f _z (in)	0.0002	0.0004	0.0007	0.0011	0.0014	0.0018	0.0021	0.0028
					v _f (in/min)	3	3	3	3	3	3	3	3
	E 5 - 6	1.00	0.20	80	n (rev/min)	4890	2445	1222	815	611	489	407	306
					f _z (in)	0.0002	0.0003	0.0006	0.0009	0.0012	0.0015	0.0018	0.0024
					v _f (in/min)	2	2	2	2	2	2	2	2
M	E 8 - 9	0.50	0.30	256	n (rev/min)	15647	7823	3912	2608	1956	1565	1304	978
					f _z (in)	0.0001	0.0003	0.0006	0.0008	0.0011	0.0014	0.0017	0.0022
					v _f (in/min)	4	4	4	4	4	4	4	4
	E 10 - 11	0.30	0.20	200	n (rev/min)	12224	6112	3056	2037	1528	1222	1019	764
					f _z (in)	0.0001	0.0003	0.0005	0.0008	0.0010	0.0013	0.0015	0.0020
					v _f (in/min)	3	3	3	3	3	3	3	3
K	E 12 - 13	1.00	0.50	216	n (rev/min)	13202	6601	3300	2200	1650	1320	1100	825
					f _z (in)	0.0004	0.0007	0.0015	0.0022	0.0029	0.0036	0.0044	0.0058
					v _f (in/min)	10	10	10	10	10	10	10	10
	E 14 - 15	0.50	0.30	116	n (rev/min)	7090	3545	1772	1182	886	709	591	443
					f _z (in)	0.0002	0.0004	0.0009	0.0013	0.0017	0.0021	0.0026	0.0034
					v _f (in/min)	3	3	3	3	3	3	3	3
N	E / M / A 16	2.00	0.50	560	n (rev/min)	34227	17114	8557	5705	4278	3423	2852	2139
					f _z (in)	0.0006	0.0011	0.0023	0.0034	0.0045	0.0056	0.0068	0.0090
					v _f (in/min)	39	39	39	39	39	39	39	39
	E / M / A 17	2.00	0.50	560	n (rev/min)	34227	17114	8557	5705	4278	3423	2852	2139
					f _z (in)	0.0006	0.0011	0.0023	0.0034	0.0045	0.0056	0.0068	0.0090
					v _f (in/min)	39	39	39	39	39	39	39	39
S	E 19	0.20	0.10	70	n (rev/min)	4278	2139	1070	713	535	428	357	267
					f _z (in)	0.0002	0.0004	0.0008	0.0011	0.0015	0.0019	0.0023	0.0030
					v _f (in/min)	2	2	2	2	2	2	2	2
	E 20	0.20	0.10	70	n (rev/min)	4278	2139	1070	713	535	428	357	267
					f _z (in)	0.0002	0.0004	0.0008	0.0011	0.0015	0.0019	0.0023	0.0030
					v _f (in/min)	2	2	2	2	2	2	2	2
	E 21	0.20	0.10	70	n (rev/min)	4278	2139	1070	713	535	428	357	267
					f _z (in)	0.0002	0.0004	0.0008	0.0011	0.0015	0.0019	0.0023	0.0030
					v _f (in/min)	2	2	2	2	2	2	2	2
	E 22	0.30	0.20	112	n (rev/min)	6845	3423	1711	1141	856	685	570	428
					f _z (in)	0.0002	0.0004	0.0007	0.0011	0.0014	0.0018	0.0021	0.0028
					v _f (in/min)	2	2	2	2	2	2	2	2

SMG = Seco Material Group
 n [min-1] = RPM
 V_c (sf/min) = Surface feet/min

f_z [in] = Feed/tooth
 a_p/D_c = % of diameter
 v_f [in/min] = Feed rate
 a_e/D_c = % of diameter

A = Air D = Dry E = Emulsion (flood coolant) M = Mist
 All cutting data are start values. All cutting data is in inch values.
 Please reference the Workpiece Material Classification chart located on page 15.

C330 - START VALUES

SLOTTING													
ISO GROUP	SMG	a _p x D _c (max)	a _e x D _c (max)	v _c (sf / min)		Z _n = 3							
						1/16	1/8	1/4	3/8	1/2	5/8	3/4	1
P	E 1 - 2	0.50	1.00	400	n (rev/min)	24448	12224	6112	4075	3056	2445	2037	1528
					f _z (in)	0.0002	0.0005	0.0009	0.0014	0.0018	0.0023	0.0027	0.0036
					v _f (in/min)	17	17	17	17	17	17	17	17
	E 3 - 4	0.40	1.00	200	n (rev/min)	12224	6112	3056	2037	1528	1222	1019	764
					f _z (in)	0.0001	0.0003	0.0006	0.0008	0.0011	0.0014	0.0017	0.0022
					v _f (in/min)	5	5	5	5	5	5	5	5
	E 5 - 6	0.30	1.00	100	n (rev/min)	6112	3056	1528	1019	764	611	509	382
					f _z (in)	0.0001	0.0002	0.0005	0.0007	0.0010	0.0012	0.0014	0.0019
					v _f (in/min)	2	2	2	2	2	2	2	2
M	E 8 - 9	0.50	1.00	320	n (rev/min)	19558	9779	4890	3260	2445	1956	1630	1222
					f _z (in)	0.0001	0.0002	0.0004	0.0007	0.0009	0.0011	0.0013	0.0018
					v _f (in/min)	7	7	7	7	7	7	7	7
	E 10 - 11	0.40	1.00	290	n (rev/min)	17725	8862	4431	2954	2216	1772	1477	1108
					f _z (in)	0.0001	0.0002	0.0004	0.0006	0.0008	0.0010	0.0012	0.0016
					v _f (in/min)	5	5	5	5	5	5	5	5
K	E 12 - 13	0.50	1.00	270	n (rev/min)	16502	8251	4126	2750	2063	1650	1375	1031
					f _z (in)	0.0003	0.0006	0.0012	0.0017	0.0023	0.0029	0.0035	0.0046
					v _f (in/min)	14	14	14	14	14	14	14	14
	E 14 - 15	0.30	1.00	145	n (rev/min)	8862	4431	2216	1477	1108	886	739	554
					f _z (in)	0.0002	0.0003	0.0007	0.0010	0.0014	0.0017	0.0020	0.0027
					v _f (in/min)	5	5	5	5	5	5	5	5
N	E / M / A 16	1.00	1.00	700	n (rev/min)	42784	21392	10696	7131	5348	4278	3565	2674
					f _z (in)	0.0005	0.0009	0.0018	0.0027	0.0036	0.0045	0.0054	0.0072
					v _f (in/min)	58	58	58	58	58	58	58	58
	E / M / A 17	1.00	1.00	700	n (rev/min)	42784	21392	10696	7131	5348	4278	3565	2674
					f _z (in)	0.0005	0.0009	0.0018	0.0027	0.0036	0.0045	0.0054	0.0072
					v _f (in/min)	58	58	58	58	58	58	58	58
S	E 19	0.20	1.00	80	n (rev/min)	4890	2445	1222	815	611	489	407	306
					f _z (in)	0.0002	0.0003	0.0006	0.0009	0.0012	0.0015	0.0018	0.0024
					v _f (in/min)	2	2	2	2	2	2	2	2
	E 20	0.20	1.00	80	n (rev/min)	4890	2445	1222	815	611	489	407	306
					f _z (in)	0.0002	0.0003	0.0006	0.0009	0.0012	0.0015	0.0018	0.0024
					v _f (in/min)	2	2	2	2	2	2	2	2
	E 21	0.20	1.00	80	n (rev/min)	4890	2445	1222	815	611	489	407	306
					f _z (in)	0.0002	0.0003	0.0006	0.0009	0.0012	0.0015	0.0018	0.0024
					v _f (in/min)	2	2	2	2	2	2	2	2
	E 22	0.30	1.00	130	n (rev/min)	7946	3973	1986	1324	993	795	662	497
					f _z (in)	0.0001	0.0003	0.0006	0.0008	0.0011	0.0014	0.0017	0.0022
					v _f (in/min)	3	3	3	3	3	3	3	3

SMG = Seco Material Group
 n [min-1] = RPM
 v_c (sf/min) = Surface feet/min

f_z [in] = Feed/tooth
 a_p/D_c = % of diameter

v_f [in/min] = Feed rate
 a_e/D_c = % of diameter

A = Air D = Dry E = Emulsion (flood coolant) M = Mist
 All cutting data are start values. All cutting data is in inch values.
 Please reference the Workpiece Material Classification chart located on page 15.

C330 - START VALUES

SIDE MILLING - ROUGHING													
ISO GROUP	SMG	a _p x Dc (max)	a _e x Dc (max)	v _c (sf / min)		Z _n = 3							
						1/16	1/8	1/4	3/8	1/2	5/8	3/4	1
P	E 1 - 2	1.00	0.30	400	n (rev/min)	24448	12224	6112	4075	3056	2445	2037	1528
					f _z (in)	0.0003	0.0006	0.0011	0.0017	0.0023	0.0028	0.0034	0.0045
					v _f (in/min)	21	21	21	21	21	21	21	21
	E 3 - 4	1.00	0.30	200	n (rev/min)	12224	6112	3056	2037	1528	1222	1019	764
					f _z (in)	0.0002	0.0004	0.0007	0.0011	0.0014	0.0018	0.0021	0.0028
					v _f (in/min)	6	6	6	6	6	6	6	6
	E 5 - 6	1.00	0.20	100	n (rev/min)	6112	3056	1528	1019	764	611	509	382
					f _z (in)	0.0002	0.0003	0.0006	0.0009	0.0012	0.0015	0.0018	0.0024
					v _f (in/min)	3	3	3	3	3	3	3	3
M	E 8 - 9	0.50	0.30	320	n (rev/min)	19558	9779	4890	3260	2445	1956	1630	1222
					f _z (in)	0.0001	0.0003	0.0006	0.0008	0.0011	0.0014	0.0017	0.0022
					v _f (in/min)	8	8	8	8	8	8	8	8
	E 10 - 11	0.30	0.20	290	n (rev/min)	17725	8862	4431	2954	2216	1772	1477	1108
					f _z (in)	0.0001	0.0003	0.0005	0.0008	0.0010	0.0013	0.0015	0.0020
					v _f (in/min)	7	7	7	7	7	7	7	7
K	E 12 - 13	1.00	0.50	270	n (rev/min)	16502	8251	4126	2750	2063	1650	1375	1031
					f _z (in)	0.0004	0.0007	0.0015	0.0022	0.0029	0.0036	0.0044	0.0058
					v _f (in/min)	18	18	18	18	18	18	18	18
	E 14 - 15	0.50	0.30	145	n (rev/min)	8862	4431	2216	1477	1108	886	739	554
					f _z (in)	0.0002	0.0004	0.0009	0.0013	0.0017	0.0021	0.0026	0.0034
					v _f (in/min)	6	6	6	6	6	6	6	6
N	E / M / A 16	2.00	0.50	700	n (rev/min)	42784	21392	10696	7131	5348	4278	3565	2674
					f _z (in)	0.0006	0.0011	0.0023	0.0034	0.0045	0.0056	0.0068	0.0090
					v _f (in/min)	72	72	72	72	72	72	72	72
	E / M / A 17	2.00	0.50	700	n (rev/min)	42784	21392	10696	7131	5348	4278	3565	2674
					f _z (in)	0.0006	0.0011	0.0023	0.0034	0.0045	0.0056	0.0068	0.0090
					v _f (in/min)	72	72	72	72	72	72	72	72
S	E 19	0.20	0.10	80	n (rev/min)	4890	2445	1222	815	611	489	407	306
					f _z (in)	0.0002	0.0004	0.0008	0.0011	0.0015	0.0019	0.0023	0.0030
					v _f (in/min)	3	3	3	3	3	3	3	3
	E 20	0.20	0.10	80	n (rev/min)	4890	2445	1222	815	611	489	407	306
					f _z (in)	0.0002	0.0004	0.0008	0.0011	0.0015	0.0019	0.0023	0.0030
					v _f (in/min)	3	3	3	3	3	3	3	3
	E 21	0.20	0.10	80	n (rev/min)	4890	2445	1222	815	611	489	407	306
					f _z (in)	0.0002	0.0004	0.0008	0.0011	0.0015	0.0019	0.0023	0.0030
					v _f (in/min)	3	3	3	3	3	3	3	3
	E 22	0.30	0.20	130	n (rev/min)	7946	3973	1986	1324	993	795	662	497
f _z (in)					0.0002	0.0004	0.0007	0.0011	0.0014	0.0018	0.0021	0.0028	
					v _f (in/min)	4	4	4	4	4	4	4	4

SMG = Seco Material Group
 n [min-1] = RPM
 v_c (sf/min) = Surface feet/min

f_z [in] = Feed/tooth
 a_p/D_c = % of diameter
 v_f [in/min] = Feed rate
 a_e/D_c = % of diameter

A = Air D = Dry E = Emulsion (flood coolant) M = Mist
 All cutting data are start values. All cutting data is in inch values.
 Please reference the Workpiece Material Classification chart located on page 15.

C360 - START VALUES

SIDE MILLING - ROUGHING													
ISO GROUP	SMG	a _p x Dc (max)	a _e x Dc (max)	v _c (sf / min)		Z _n = 3							
						1/16	1/8	1/4	3/8	1/2	5/8	3/4	1
P	E 1 - 2	1.00	0.15	400	n (rev/min)	24448	12224	6112	4075	3056	2445	2037	1528
					f _z (in)	0.0003	0.0006	0.0011	0.0017	0.0023	0.0028	0.0034	0.0045
					v _f (in/min)	21	21	21	21	21	21	21	21
	E 3 - 4	1.00	0.15	200	n (rev/min)	12224	6112	3056	2037	1528	1222	1019	764
					f _z (in)	0.0002	0.0004	0.0007	0.0011	0.0014	0.0018	0.0021	0.0028
					v _f (in/min)	6	6	6	6	6	6	6	6
	E 5 - 6	1.00	0.15	100	n (rev/min)	6112	3056	1528	1019	764	611	509	382
					f _z (in)	0.0002	0.0003	0.0006	0.0009	0.0012	0.0015	0.0018	0.0024
					v _f (in/min)	3	3	3	3	3	3	3	3
M	E 8 - 9	0.50	0.15	320	n (rev/min)	19558	9779	4890	3260	2445	1956	1630	1222
					f _z (in)	0.0001	0.0003	0.0006	0.0008	0.0011	0.0014	0.0017	0.0022
					v _f (in/min)	8	8	8	8	8	8	8	8
	E 10 - 11	0.30	0.15	290	n (rev/min)	17725	8862	4431	2954	2216	1772	1477	1108
					f _z (in)	0.0001	0.0003	0.0005	0.0008	0.0010	0.0013	0.0015	0.0020
					v _f (in/min)	7	7	7	7	7	7	7	7
K	E 12 - 13	1.00	0.15	270	n (rev/min)	16502	8251	4126	2750	2063	1650	1375	1031
					f _z (in)	0.0004	0.0007	0.0015	0.0022	0.0029	0.0036	0.0044	0.0058
					v _f (in/min)	18	18	18	18	18	18	18	18
	E 14 - 15	0.50	0.15	145	n (rev/min)	8862	4431	2216	1477	1108	886	739	554
					f _z (in)	0.0002	0.0004	0.0009	0.0013	0.0017	0.0021	0.0026	0.0034
					v _f (in/min)	6	6	6	6	6	6	6	6
N	E / M / A 16	2.00	0.15	700	n (rev/min)	42784	21392	10696	7131	5348	4278	3565	2674
					f _z (in)	0.0006	0.0011	0.0023	0.0034	0.0045	0.0056	0.0068	0.0090
					v _f (in/min)	72	72	72	72	72	72	72	72
	E / M / A 17	2.00	0.15	700	n (rev/min)	42784	21392	10696	7131	5348	4278	3565	2674
					f _z (in)	0.0006	0.0011	0.0023	0.0034	0.0045	0.0056	0.0068	0.0090
					v _f (in/min)	72	72	72	72	72	72	72	72
S	E 19	0.20	0.15	80	n (rev/min)	4890	2445	1222	815	611	489	407	306
					f _z (in)	0.0002	0.0004	0.0008	0.0011	0.0015	0.0019	0.0023	0.0030
					v _f (in/min)	3	3	3	3	3	3	3	3
	E 20	0.20	0.15	80	n (rev/min)	4890	2445	1222	815	611	489	407	306
					f _z (in)	0.0002	0.0004	0.0008	0.0011	0.0015	0.0019	0.0023	0.0030
					v _f (in/min)	3	3	3	3	3	3	3	3
	E 21	0.20	0.15	80	n (rev/min)	4890	2445	1222	815	611	489	407	306
					f _z (in)	0.0002	0.0004	0.0008	0.0011	0.0015	0.0019	0.0023	0.0030
					v _f (in/min)	3	3	3	3	3	3	3	3
	E 22	0.30	0.15	130	n (rev/min)	7946	3973	1986	1324	993	795	662	497
					f _z (in)	0.0002	0.0004	0.0007	0.0011	0.0014	0.0018	0.0021	0.0028
					v _f (in/min)	4	4	4	4	4	4	4	4

SMG = Seco Material Group
 n [min-1] = RPM
 v_c (sf/min) = Surface feet/min

f_z [in] = Feed/tooth
 a_p/D_c = % of diameter
 v_f [in/min] = Feed rate
 a_e/D_c = % of diameter

A = Air D = Dry E = Emulsion (flood coolant) M = Mist
 All cutting data are start values. All cutting data is in inch values.
 Please reference the Workpiece Material Classification chart located on page 15.

C430 / C430R / CNC430 / CD430 / CSD430 - START VALUES

SLOTTING													
ISO GROUP	SMG	$a_p \times D_c$ (max)	$a_e \times D_c$ (max)	v_c (sf / min)		$Z_n = 4$							
						1/16	1/8	1/4	3/8	1/2	5/8	3/4	1
P	E 1 - 2	0.50	1.00	400	n (rev/min)	24448	12224	6112	4075	3056	2445	2037	1528
					f_z (in)	0.0002	0.0005	0.0009	0.0014	0.0018	0.0023	0.0027	0.0036
					v_f (in/min)	22	22	22	22	22	22	22	22
	E 3 - 4	0.40	1.00	200	n (rev/min)	12224	6112	3056	2037	1528	1222	1019	764
					f_z (in)	0.0001	0.0003	0.0006	0.0008	0.0011	0.0014	0.0017	0.0022
					v_f (in/min)	7	7	7	7	7	7	7	7
	E 5 - 6	0.30	1.00	100	n (rev/min)	6112	3056	1528	1019	764	611	509	382
					f_z (in)	0.0001	0.0002	0.0005	0.0007	0.0010	0.0012	0.0014	0.0019
					v_f (in/min)	3	3	3	3	3	3	3	3
M	E 8 - 9	0.50	1.00	320	n (rev/min)	19558	9779	4890	3260	2445	1956	1630	1222
					f_z (in)	0.0001	0.0002	0.0004	0.0007	0.0009	0.0011	0.0013	0.0018
					v_f (in/min)	9	9	9	9	9	9	9	9
	E 10 - 11	0.40	1.00	250	n (rev/min)	15280	7640	3820	2547	1910	1528	1273	955
					f_z (in)	0.0001	0.0002	0.0004	0.0006	0.0008	0.0010	0.0012	0.0016
					v_f (in/min)	6	6	6	6	6	6	6	6
K	E 12 - 13	0.50	1.00	270	n (rev/min)	16502	8251	4126	2750	2063	1650	1375	1031
					f_z (in)	0.0003	0.0006	0.0012	0.0017	0.0023	0.0029	0.0035	0.0046
					v_f (in/min)	19	19	19	19	19	19	19	19
	E 14 - 15	0.30	1.00	145	n (rev/min)	8862	4431	2216	1477	1108	886	739	554
					f_z (in)	0.0002	0.0003	0.0007	0.0010	0.0014	0.0017	0.0020	0.0027
					v_f (in/min)	6	6	6	6	6	6	6	6
S	E 19	0.20	1.00	70	n (rev/min)	4278	2139	1070	713	535	428	357	267
					f_z (in)	0.0002	0.0004	0.0008	0.0011	0.0015	0.0019	0.0023	0.0030
					v_f (in/min)	3	3	3	3	3	3	3	3
	E 20	0.20	1.00	70	n (rev/min)	4278	2139	1070	713	535	428	357	267
					f_z (in)	0.0002	0.0004	0.0008	0.0011	0.0015	0.0019	0.0023	0.0030
					v_f (in/min)	3	3	3	3	3	3	3	3
	E 21	0.20	1.00	70	n (rev/min)	4278	2139	1070	713	535	428	357	267
					f_z (in)	0.0002	0.0004	0.0008	0.0011	0.0015	0.0019	0.0023	0.0030
					v_f (in/min)	3	3	3	3	3	3	3	3
	E 22	0.20	1.00	112	n (rev/min)	6845	3423	1711	1141	856	685	570	428
					f_z (in)	0.0002	0.0004	0.0007	0.0011	0.0014	0.0018	0.0021	0.0028
					v_f (in/min)	5	5	5	5	5	5	5	5

SMG = Seco Material Group
 n [min-1] = RPM
 v_c (sf/min) = Surface feet/min

f_z [in] = Feed/tooth
 a_p/D_c = % of diameter
 v_f [in/min] = Feed rate
 a_e/D_c = % of diameter

A = Air D = Dry E = Emulsion (flood coolant) M = Mist
 All cutting data are start values. All cutting data is in inch values.
 Please reference the Workpiece Material Classification chart located on page 15.

C430 / C430R / CNC430 / CD430 / CSD430 - START VALUES

SIDE MILLING - ROUGHING

ISO GROUP	SMG	$a_p \times D_c$ (max)	$a_e \times D_c$ (max)	v_c (sf / min)		$Z_n = 4$							
						1/16	1/8	1/4	3/8	1/2	5/8	3/4	1
P	E 1 - 2	1.00	0.30	400	n (rev/min)	24448	12224	6112	4075	3056	2445	2037	1528
					f_z (in)	0.0003	0.0006	0.0011	0.0017	0.0023	0.0028	0.0034	0.0045
					v_f (in/min)	28	28	28	28	28	28	28	28
	E 3 - 4	1.00	0.30	200	n (rev/min)	12224	6112	3056	2037	1528	1222	1019	764
					f_z (in)	0.0002	0.0004	0.0007	0.0011	0.0014	0.0018	0.0021	0.0028
					v_f (in/min)	9	9	9	9	9	9	9	9
	E 5 - 6	1.00	0.20	100	n (rev/min)	6112	3056	1528	1019	764	611	509	382
					f_z (in)	0.0002	0.0003	0.0006	0.0009	0.0012	0.0015	0.0018	0.0024
					v_f (in/min)	4	4	4	4	4	4	4	4
M	E 8 - 9	0.50	0.30	320	n (rev/min)	19558	9779	4890	3260	2445	1956	1630	1222
					f_z (in)	0.0001	0.0003	0.0006	0.0008	0.0011	0.0014	0.0017	0.0022
					v_f (in/min)	11	11	11	11	11	11	11	11
	E 10 - 11	0.30	0.20	250	n (rev/min)	15280	7640	3820	2547	1910	1528	1273	955
					f_z (in)	0.0001	0.0003	0.0005	0.0008	0.0010	0.0013	0.0015	0.0020
					v_f (in/min)	8	8	7.6	8	8	8	8	8
K	E 12 - 13	1.00	0.50	270	n (rev/min)	16502	8251	4126	2750	2063	1650	1375	1031
					f_z (in)	0.0004	0.0007	0.0015	0.0022	0.0029	0.0036	0.0044	0.0058
					v_f (in/min)	24	24	24	24	24	24	24	24
	E 14 - 15	0.50	0.30	145	n (rev/min)	8862	4431	2216	1477	1108	886	739	554
					f_z (in)	0.0002	0.0004	0.0009	0.0013	0.0017	0.0021	0.0026	0.0034
					v_f (in/min)	8	8	8	8	8	8	8	8
S	E 19	0.20	0.10	120	n (rev/min)	7334	3667	1834	1222	917	733	611	458
					f_z (in)	0.0002	0.0003	0.0006	0.0009	0.0012	0.0015	0.0018	0.0024
					v_f (in/min)	4	4	4	4	4	4	4	4
	E 20	0.20	0.10	120	n (rev/min)	7334	3667	1834	1222	917	733	611	458
					f_z (in)	0.0002	0.0003	0.0006	0.0009	0.0012	0.0015	0.0018	0.0024
					v_f (in/min)	4	4	4	4	4	4	4	4
	E 21	0.20	0.10	120	n (rev/min)	7334	3667	1834	1222	917	733	611	458
					f_z (in)	0.0002	0.0003	0.0006	0.0009	0.0012	0.0015	0.0018	0.0024
					v_f (in/min)	4	4	4	4	4	4	4	4
	E 22	0.30	0.20	80	n (rev/min)	4890	2445	1222	815	611	489	407	306
f_z (in)					0.0001	0.0003	0.0006	0.0008	0.0011	0.0014	0.0017	0.0022	
v_f (in/min)					3	3	3	3	3	3	3	3	
					20	-	140						

SMG = Seco Material Group
 n [min-1] = RPM
 v_c (sf/min) = Surface feet/min

f_z [in] = Feed/tooth
 a_p/D_c = % of diameter
 v_f [in/min] = Feed rate
 a_e/D_c = % of diameter

A = Air D = Dry E = Emulsion (flood coolant) M = Mist
 All cutting data are start values. All cutting data is in inch values.
 Please reference the Workpiece Material Classification chart located on page 15.

CB430 / CSDB430 - START VALUES

SLOTTING													
ISO GROUP	SMG	a _p x D _c (max)	a _e x D _c (max)	v _c (sf / min)		Z _n = 4							
						1/16	1/8	1/4	3/8	1/2	5/8	3/4	1
P	E 1 - 2	0.50	1.00	320	n (rev/min)	19558	9779	4890	3260	2445	1956	1630	1222
					f _z (in)	0.0002	0.0005	0.0009	0.0014	0.0018	0.0023	0.0027	0.0036
					v _f (in/min)	18	18	18	18	18	18	18	18
	E 3 - 4	0.40	1.00	160	n (rev/min)	9779	4890	2445	1630	1222	978	815	611
					f _z (in)	0.0001	0.0003	0.0006	0.0008	0.0011	0.0014	0.0017	0.0022
					v _f (in/min)	6	6	6	6	6	6	6	6
	E 5 - 6	0.30	1.00	80	n (rev/min)	4890	2445	1222	815	611	489	407	306
					f _z (in)	0.0001	0.0002	0.0005	0.0007	0.0010	0.0012	0.0014	0.0019
					v _f (in/min)	2	2	2	2	2	2	2	2
M	E 8 - 9	0.50	1.00	256	n (rev/min)	15647	7823	3912	2608	1956	1565	1304	978
					f _z (in)	0.0001	0.0002	0.0004	0.0007	0.0009	0.0011	0.0013	0.0018
					v _f (in/min)	7	7	7	7	7	7	7	7
	E 10 - 11	0.40	1.00	200	n (rev/min)	12224	6112	3056	2037	1528	1222	1019	764
					f _z (in)	0.0001	0.0002	0.0004	0.0006	0.0008	0.0010	0.0012	0.0016
					v _f (in/min)	5	5	5	5	5	5	5	5
K	E 12 - 13	0.50	1.00	216	n (rev/min)	13202	6601	3300	2200	1650	1320	1100	825
					f _z (in)	0.0003	0.0006	0.0012	0.0017	0.0023	0.0029	0.0035	0.0046
					v _f (in/min)	15	15	15	15	15	15	15	15
	E 14 - 15	0.30	1.00	116	n (rev/min)	7090	3545	1772	1182	886	709	591	443
					f _z (in)	0.0002	0.0003	0.0007	0.0010	0.0014	0.0017	0.0020	0.0027
					v _f (in/min)	5	5	5	5	5	5	5	5
S	E 19	0.10	1.00	70	n (rev/min)	4278	2139	1070	713	535	428	357	267
					f _z (in)	0.0002	0.0004	0.0008	0.0011	0.0015	0.0019	0.0023	0.0030
					v _f (in/min)	3	3	3	3	3	3	3	3
	E 20	0.10	1.00	70	n (rev/min)	4278	2139	1070	713	535	428	357	267
					f _z (in)	0.0002	0.0004	0.0008	0.0011	0.0015	0.0019	0.0023	0.0030
					v _f (in/min)	3	3	3	3	3	3	3	3
	E 21	0.10	1.00	70	n (rev/min)	4278	2139	1070	713	535	428	357	267
					f _z (in)	0.0002	0.0004	0.0008	0.0011	0.0015	0.0019	0.0023	0.0030
					v _f (in/min)	3	3	3	3	3	3	3	3
	E 22	0.20	1.00	112	n (rev/min)	6845	3423	1711	1141	856	685	570	428
f _z (in)					0.0002	0.0004	0.0007	0.0011	0.0014	0.0018	0.0021	0.0028	
v _f (in/min)					5	5	5	5	5	5	5	5	

SMG = Seco Material Group
 n [min-1] = RPM
 v_c (sf/min) = Surface feet/min

f_z [in] = Feed/tooth
 a_p/D_c = % of diameter
 v_f [in/min] = Feed rate
 a_e/D_c = % of diameter

A = Air D = Dry E = Emulsion (flood coolant) M = Mist
 All cutting data are start values. All cutting data is in inch values.
 Please reference the Workpiece Material Classification chart located on page 15.

CB430 / CSDB430 - START VALUES

SIDE MILLING - ROUGHING													
ISO GROUP	SMG	$a_p \times D_c$ (max)	$a_e \times D_c$ (max)	v_c (sf / min)		$Z_n = 4$							
						1/16	1/8	1/4	3/8	1/2	5/8	3/4	1
P	E 1 - 2	1.00	0.30	320	n (rev/min)	19558	9779	4890	3260	2445	1956	1630	1222
					f_z (in)	0.0003	0.0006	0.0011	0.0017	0.0023	0.0028	0.0034	0.0045
					v_f (in/min)	22	22	22	22	22	22	22	22
	E 3 - 4	1.00	0.30	160	n (rev/min)	9779	4890	2445	1630	1222	978	815	611
					f_z (in)	0.0002	0.0004	0.0007	0.0011	0.0014	0.0018	0.0021	0.0028
					v_f (in/min)	7	7	7	7	7	7	7	7
	E 5 - 6	1.00	0.20	80	n (rev/min)	4890	2445	1222	815	611	489	407	306
					f_z (in)	0.0002	0.0003	0.0006	0.0009	0.0012	0.0015	0.0018	0.0024
					v_f (in/min)	3	3	3	3	3	3	3	3
M	E 8 - 9	0.50	0.30	256	n (rev/min)	15647	7823	3912	2608	1956	1565	1304	978
					f_z (in)	0.0001	0.0003	0.0006	0.0008	0.0011	0.0014	0.0017	0.0022
					v_f (in/min)	9	9	9	9	9	9	9	9
	E 10 - 11	0.30	0.20	200	n (rev/min)	12224	6112	3056	2037	1528	1222	1019	764
					f_z (in)	0.0001	0.0003	0.0005	0.0008	0.0010	0.0013	0.0015	0.0020
					v_f (in/min)	6	6	6	6	6	6	6	6
K	E 12 - 13	1.00	0.50	216	n (rev/min)	13202	6601	3300	2200	1650	1320	1100	825
					f_z (in)	0.0004	0.0007	0.0015	0.0022	0.0029	0.0036	0.0044	0.0058
					v_f (in/min)	19	19	19	19	19	19	19	19
	E 14 - 15	0.50	0.30	116	n (rev/min)	7090	3545	1772	1182	886	709	591	443
					f_z (in)	0.0002	0.0004	0.0009	0.0013	0.0017	0.0021	0.0026	0.0034
					v_f (in/min)	6	6	6	6	6	6	6	6
S	E 19	0.30	0.10	70	n (rev/min)	4278	2139	1070	713	535	428	357	267
					f_z (in)	0.0002	0.0003	0.0006	0.0009	0.0012	0.0015	0.0018	0.0024
					v_f (in/min)	3	3	3	3	3	3	3	3
	E 20	0.30	0.10	70	n (rev/min)	4278	2139	1070	713	535	428	357	267
					f_z (in)	0.0002	0.0003	0.0006	0.0009	0.0012	0.0015	0.0018	0.0024
					v_f (in/min)	3	3	3	3	3	3	3	3
	E 21	0.30	0.10	70	n (rev/min)	4278	2139	1070	713	535	428	357	267
					f_z (in)	0.0002	0.0003	0.0006	0.0009	0.0012	0.0015	0.0018	0.0024
					v_f (in/min)	3	3	3	3	3	3	3	3
	E 22	0.40	0.20	112	n (rev/min)	6845	3423	1711	1141	856	685	570	428
					f_z (in)	0.0001	0.0003	0.0006	0.0008	0.0011	0.0014	0.0017	0.0022
					v_f (in/min)	4	4	4	4	4	4	4	4

SMG = Seco Material Group
 n [min-1] = RPM
 v_c (sf/min) = Surface feet/min

f_z [in] = Feed/tooth
 a_p/D_c = % of diameter
 v_f [in/min] = Feed rate
 a_e/D_c = % of diameter

A = Air D = Dry E = Emulsion (flood coolant) M = Mist
 All cutting data are start values. All cutting data is in inch values.
 Please reference the Workpiece Material Classification chart located on page 15.

C430M - START VALUES

		SLOTTING																
ISO GROUP	SMG	a _p x D _c (max)	a _e x D _c (max)	v _c (sf / min)		Z _n = 4												
						1	1.5	2	3	3.5	4	5	6	8	9	10	11	12
P	E 1 - 2	0.50	1.00	400	n (min-1)	38811	25874	19406	12937	11089	9703	7762	6469	4851	4312	3881	3528	3234
					fz (in)	.0001	.0002	.0003	.0004	.0005	.0006	.0007	.0009	.0011	.0013	.0014	.0016	.0017
					vf (in/min)	22	22	22	22	22	22	22	22	22	22	22	22	22
	E 3 - 4	0.40	1.00	200	n (min-1)	19406	12937	9703	6469	5544	4851	3881	3234	2426	2156	1941	1764	1617
					fz (in)	.0001	.0001	.0002	.0003	.0003	.0003	.0004	.0005	.0007	.0008	.0009	.0010	.0010
					vf (in/min)	7	7	7	7	7	7	7	7	7	7	7	7	7
	E 5 - 6	0.30	1.00	100	n (min-1)	9703	6469	4851	3234	2772	2426	1941	1617	1213	1078	970	882	809
					fz (in)	.0001	.0001	.0001	.0002	.0003	.0003	.0004	.0004	.0006	.0007	.0007	.0008	.0009
					vf (in/min)	3	3	3	3	3	3	3	3	3	3	3	3	3
M	E 8 - 9	0.50	1.00	320	n (min-1)	31049	20699	15524	10350	8871	7762	6210	5175	3881	3450	3105	2823	2587
					fz (in)	.0001	.0001	.0001	.0002	.0002	.0003	.0004	.0004	.0006	.0006	.0007	.0008	.0009
					vf (in/min)	9	9	9	9	9	9	9	9	9	9	9	9	9
	E 10 - 11	0.40	1.00	250	n (min-1)	24257	16171	12129	8086	6931	6064	4851	4043	3032	2695	2426	2205	2021
					fz (in)	.0001	.0001	.0001	.0002	.0002	.0003	.0003	.0004	.0005	.0006	.0006	.0007	.0008
					vf (in/min)	6	6	6	6	6	6	6	6	6	6	6	6	6
K	E 12 - 13	0.50	1.00	270	n (min-1)	26198	17465	13099	8733	7485	6549	5240	4366	3275	2911	2620	2382	2183
					fz (in)	.0002	.0003	.0004	.0005	.0006	.0007	.0009	.0011	.0014	.0016	.0018	.0020	.0022
					vf (in/min)	19	19	19	19	19	19	19	19	19	19	19	19	19
	E 14 - 15	0.30	1.00	145	n (min-1)	14069	9379	7035	4690	4020	3517	2814	2345	1759	1563	1407	1279	1172
					fz (in)	.0001	.0002	.0002	.0003	.0004	.0004	.0005	.0006	.0009	.0010	.0011	.0012	.0013
					vf (in/min)	6	6	6	6	6	6	6	6	6	6	6	6	6
S	E 19	0.20	1.00	70	n (min-1)	6792	4528	3396	2264	1941	1698	1358	1132	849	755	679	617	566
					fz (in)	.0030	.0045	.0060	.0090	.0105	.0120	.0150	.0180	.0240	.0270	.0300	.0330	.0360
					vf (in/min)	82	82	82	82	82	82	82	82	82	82	82	82	82
	E 20	0.20	1.00	70	n (min-1)	6792	4528	3396	2264	1941	1698	1358	1132	849	755	679	617	566
					fz (in)	.0001	.0002	.0002	.0004	.0004	.0005	.0006	.0007	.0009	.0011	.0012	.0013	.0014
					vf (in/min)	3	3	3	3	3	3	3	3	3	3	3	3	3
	E 21	0.20	1.00	70	n (min-1)	6792	4528	3396	2264	1941	1698	1358	1132	849	755	679	617	566
					fz (in)	.0001	.0002	.0002	.0004	.0004	.0005	.0006	.0007	.0009	.0011	.0012	.0013	.0014
					vf (in/min)	3	3	3	3	3	3	3	3	3	3	3	3	3
	E 22	0.20	1.00	110	n (min-1)	10673	7115	5337	3558	3049	2668	2135	1779	1334	1186	1067	970	889
fz (in)					.0001	.0002	.0002	.0003	.0004	.0004	.0006	.0007	.0009	.0010	.0011	.0012	.0013	
vf (in/min)					5	5	5	5	5	5	5	5	5	5	5	5	5	5

SMG = Seco Material Group
 n [min-1] = RPM
 v_c (sf/min) = Surface feet/min

fz [in] = Feed/tooth
 a_p/D_c = % of diameter
 vf [in/min] = Feed rate
 a_e/D_c = % of diameter

A = Air D = Dry E = Emulsion (flood coolant) M = Mist
 All cutting data are start values. All cutting data is in inch values.
 Please reference the Workpiece Material Classification chart located on page 15.

C430M - START VALUES

		SIDE MILLING - ROUGHING																
ISO GROUP	SMG	$a_p \times D_c$ (max)	$a_e \times D_c$ (max)	V_c (sf / min)		$Z_n = 4$												
						1	1.5	2	3	3.5	4	5	6	8	9	10	11	12
P	E 1 - 2	1.00	0.30	400	n (min-1)	38811	25874	19406	12937	11089	9703	7762	6469	4851	4312	3881	3528	3234
					fz (in)	.0002	.0003	.0004	.0005	.0006	.0007	.0009	.0011	.0014	.0016	.0018	.0019	.0021
					vf (in/min)	27.5	27.5	27.5	27.5	27.5	27.5	27.5	27.5	27.5	27.5	27.5	27.5	27.5
	E 3 - 4	1.00	0.30	200	n (min-1)	19406	12937	9703	6469	5544	4851	3881	3234	2426	2156	1941	1764	1617
					fz (in)	.0001	.0002	.0002	.0003	.0004	.0004	.0006	.0007	.0009	.0010	.0011	.0012	.0013
					vf (in/min)	8.6	8.6	8.6	8.6	8.6	8.6	8.6	8.6	8.6	8.6	8.6	8.6	8.6
	E 5 - 6	1.00	0.20	100	n (min-1)	9703	6469	4851	3234	2772	2426	1941	1617	1213	1078	970	882	809
					fz (in)	.0001	.0001	.0002	.0003	.0003	.0004	.0005	.0006	.0008	.0009	.0009	.0010	.0011
					vf (in/min)	3.7	3.7	3.7	3.7	3.7	3.7	3.7	3.7	3.7	3.7	3.7	3.7	3.7
M	E 8 - 9	0.50	0.30	320	n (min-1)	31049	20699	15524	10350	8871	7762	6210	5175	3881	3450	3105	2823	2587
					fz (in)	.0001	.0001	.0002	.0003	.0003	.0003	.0004	.0005	.0007	.0008	.0009	.0010	.0010
					vf (in/min)	1.8	1.8	1.8	1.8	1.8	1.8	1.8	1.8	1.8	1.8	1.8	1.8	1.8
	E 10 - 11	0.30	0.20	250	n (min-1)	24257	16171	12129	8086	6931	6064	4851	4043	3032	2695	2426	2205	2021
					fz (in)	.0001	.0001	.0002	.0002	.0003	.0003	.0004	.0005	.0006	.0007	.0008	.0009	.0009
					vf (in/min)	7.6	7.6	7.6	7.6	7.6	7.6	7.6	7.6	7.6	7.6	7.6	7.6	7.6
K	E 12 - 13	1.00	0.50	270	n (min-1)	26198	17465	13099	8733	7485	6549	5240	4366	3275	2911	2620	2382	2183
					fz (in)	.0002	.0003	.0005	.0007	.0008	.0009	.0011	.0014	.0018	.0021	.0023	.0025	.0027
					vf (in/min)	23.9	23.9	23.9	23.9	23.9	23.9	23.9	23.9	23.9	23.9	23.9	23.9	23.9
	E 14 - 15	0.50	0.30	145	n (min-1)	14069	9379	7035	4690	4020	3517	2814	2345	1759	1563	1407	1279	1172
					fz (in)	.0001	.0002	.0003	.0004	.0005	.0005	.0007	.0008	.0011	.0012	.0013	.0015	.0016
					vf (in/min)	7.5	7.5	7.5	7.5	7.5	7.5	7.5	7.5	7.5	7.5	7.5	7.5	7.5
S	E 19	0.20	0.10	120	n (min-1)	11643	7762	5822	3881	3327	2911	2329	1941	1455	1294	1164	1058	970
					fz (in)	.0024	.0036	.0048	.0072	.0084	.0096	.0120	.0144	.0192	.0216	.0240	.0264	.0288
					vf (in/min)	111.8	111.8	111.8	111.8	111.8	111.8	111.8	111.8	111.8	111.8	111.8	111.8	111.8
	E 20	0.20	0.10	120	n (min-1)	11643	7762	5822	3881	3327	2911	2329	1941	1455	1294	1164	1058	970
					fz (in)	.0001	.0001	.0002	.0003	.0003	.0004	.0005	.0006	.0008	.0009	.0009	.0010	.0011
					vf (in/min)	4.4	4.4	4.4	4.4	4.4	4.4	4.4	4.4	4.4	4.4	4.4	4.4	4.4
	E 21	0.20	0.10	120	n (min-1)	11643	7762	5822	3881	3327	2911	2329	1941	1455	1294	1164	1058	970
					fz (in)	.0001	.0001	.0002	.0003	.0003	.0004	.0005	.0006	.0008	.0009	.0009	.0010	.0011
					vf (in/min)	4.4	4.4	4.4	4.4	4.4	4.4	4.4	4.4	4.4	4.4	4.4	4.4	4.4
E 22	0.30	0.20	80	n (min-1)	7762	5175	3881	2587	2218	1941	1552	1294	970	862	776	706	647	
				fz (in)	.0001	.0001	.0002	.0003	.0003	.0003	.0004	.0005	.0007	.0008	.0009	.0010	.0010	
				vf (in/min)	2.7	2.7	2.7	2.7	2.7	2.7	2.7	2.7	2.7	2.7	2.7	2.7	2.7	

SMG = Seco Material Group
 n [min-1] = RPM
 V_c (sf/min) = Surface feet/min

fz [in] = Feed/tooth
 a_p/D_c = % of diameter
 vf [in/min] = Feed rate
 a_e/D_c = % of diameter

A = Air D = Dry E = Emulsion (flood coolant) M = Mist
 All cutting data are start values. All cutting data is in inch values.
 Please reference the Workpiece Material Classification chart located on page 15.

CB430M - START VALUES

		SLOTTING													
ISO GROUP	SMG	$a_p \times D_c$ (max)	$a_e \times D_c$ (max)	v_c (sf / min)		$Z_n = 4$									
						1	2	3	4	5	6	8	10	12	
P	E 1 - 2	0.50	1.00	320	n (min-1)	31049	15524	10350	7762	6210	5175	3881	3105	2587	
					fz (in)	0.0001	0.0003	0.0004	0.0006	0.0007	0.0009	0.0011	0.0014	0.0017	
					vf (in/min)	18	18	18	18	18	18	18	18	18	18
	E 3 - 4	0.40	1.00	160	n (min-1)	15524	7762	5175	3881	3105	2587	1941	1552	1294	
					fz (in)	0.0001	0.0002	0.0003	0.0003	0.0004	0.0005	0.0007	0.0009	0.0010	
					vf (in/min)	5	5	5	5	5	5	5	5	5	5
	E 5 - 6	0.30	1.00	80	n (min-1)	7762	3881	2587	1941	1552	1294	970	776	647	
					fz (in)	0.0001	0.0001	0.0002	0.0003	0.0004	0.0004	0.0006	0.0007	0.0009	
					vf (in/min)	2	2	2	2	2	2	2	2	2	2
M	E 8 - 9	0.50	1.00	255	n (min-1)	24742	12371	8247	6186	4948	4124	3093	2474	2062	
					fz (in)	0.0001	0.0001	0.0002	0.0003	0.0004	0.0004	0.0006	0.0007	0.0009	
					vf (in/min)	7	7	7	7	7	7	7	7	7	7
	E 10 - 11	0.40	1.00	200	n (min-1)	19406	9703	6469	4851	3881	3234	2426	1941	1617	
					fz (in)	0.0001	0.0001	0.0002	0.0003	0.0003	0.0004	0.0005	0.0006	0.0008	
					vf (in/min)	5	5	5	5	5	5	5	5	5	5
K	E 12 - 13	0.50	1.00	215	n (min-1)	20861	10431	6954	5215	4172	3477	2608	2086	1738	
					fz (in)	0.0002	0.0004	0.0005	0.0007	0.0009	0.0011	0.0014	0.0018	0.0022	
					vf (in/min)	15	15	15	15	15	15	15	15	15	15
	E 14 - 15	0.30	1.00	115	n (min-1)	11158	5579	3719	2790	2232	1860	1395	1116	930	
					fz (in)	0.0001	0.0002	0.0003	0.0004	0.0005	0.0006	0.0009	0.0011	0.0013	
					vf (in/min)	5	5	5	5	5	5	5	5	5	5
S	E 19	0.10	1.00	70	n (min-1)	6792	3396	2264	1698	1358	1132	849	679	566	
					fz (in)	0.0030	0.0060	0.0090	0.0120	0.0150	0.0180	0.0240	0.0300	0.0360	
					vf (in/min)	82	82	82	82	82	82	82	82	82	82
	E 20	0.10	1.00	70	n (min-1)	6792	3396	2264	1698	1358	1132	849	679	566	
					fz (in)	0.0001	0.0002	0.0004	0.0005	0.0006	0.0007	0.0009	0.0012	0.0014	
					vf (in/min)	3	3	3	3	3	3	3	3	3	3
	E 21	0.10	1.00	70	n (min-1)	6792	3396	2264	1698	1358	1132	849	679	566	
					fz (in)	0.0001	0.0002	0.0004	0.0005	0.0006	0.0007	0.0009	0.0012	0.0014	
					vf (in/min)	3	3	3	3	3	3	3	3	3	3
	E 22	0.20	1.00	110	n (min-1)	10673	5337	3558	2668	2135	1779	1334	1067	889	
fz (in)					0.0001	0.0002	0.0003	0.0004	0.0006	0.0007	0.0009	0.0011	0.0013		
vf (in/min)					5	5	5	5	5	5	5	5	5	5	

SMG = Seco Material Group
 n [min-1] = RPM
 v_c (sf/min) = Surface feet/min

fz [in] = Feed/tooth
 a_p/D_c = % of diameter
 vf [in/min] = Feed rate
 a_e/D_c = % of diameter

A = Air D = Dry E = Emulsion (flood coolant) M = Mist
 All cutting data are start values. All cutting data is in inch values.
 Please reference the Workpiece Material Classification chart located on page 15.

CB430M - START VALUES

SIDE MILLING - ROUGHING														
ISO GROUP	SMG	a _p x D _c (max)	a _e x D _c (max)	v _c (sf / min)		Z _n = 4								
						1	2	3	4	5	6	8	10	12
P	E 1 - 2	1.00	0.30	320	n (min-1)	31049	15524	10350	7762	6210	5175	3881	3105	2587
					fz (in)	0.0002	0.0004	0.0005	0.0007	0.0009	0.0011	0.0014	0.0018	0.0021
					vf (in/min)	22	22	22	22	22	22	22	22	22
	E 3 - 4	1.00	0.30	160	n (min-1)	15524	7762	5175	3881	3105	2587	1941	1552	1294
					fz (in)	0.0001	0.0002	0.0003	0.0004	0.0006	0.0007	0.0009	0.0011	0.0013
					vf (in/min)	7	7	7	7	7	7	7	7	7
	E 5 - 6	1.00	0.20	80	n (min-1)	7762	3881	2587	1941	1552	1294	970	776	647
					fz (in)	0.0001	0.0002	0.0003	0.0004	0.0005	0.0006	0.0008	0.0009	0.0011
					vf (in/min)	3	3	3	3	3	3	3	3	3
M	E 8 - 9	0.50	0.30	255	n (min-1)	24742	12371	8247	6186	4948	4124	3093	2474	2062
					fz (in)	0.0001	0.0002	0.0003	0.0003	0.0004	0.0005	0.0007	0.0009	0.0010
					vf (in/min)	9	9	9	9	9	9	9	9	9
	E 10 - 11	0.30	0.20	200	n (min-1)	19406	9703	6469	4851	3881	3234	2426	1941	1617
					fz (in)	0.0001	0.0002	0.0002	0.0003	0.0004	0.0005	0.0006	0.0008	0.0009
					vf (in/min)	6	6	6	6	6	6	6	6	6
K	E 12 - 13	1.00	0.50	215	n (min-1)	20861	10431	6954	5215	4172	3477	2608	2086	1738
					fz (in)	0.0002	0.0005	0.0007	0.0009	0.0011	0.0014	0.0018	0.0023	0.0027
					vf (in/min)	19	19	19	19	19	19	19	19	19
	E 14 - 15	0.50	0.30	115	n (min-1)	11158	5579	3719	2790	2232	1860	1395	1116	930
					fz (in)	0.0001	0.0003	0.0004	0.0005	0.0007	0.0008	0.0011	0.0013	0.0016
					vf (in/min)	6	6	6	6	6	6	6	6	6
S	E 19	0.30	0.10	70	n (min-1)	6792	3396	2264	1698	1358	1132	849	679	566
					fz (in)	0.0024	0.0048	0.0072	0.0096	0.0120	0.0144	0.0192	0.0240	0.0288
					vf (in/min)	65	65	65	65	65	65	65	65	65
	E 20	0.30	0.10	70	n (min-1)	6792	3396	2264	1698	1358	1132	849	679	566
					fz (in)	0.0001	0.0002	0.0003	0.0004	0.0005	0.0006	0.0008	0.0009	0.0011
					vf (in/min)	3	3	3	3	3	3	3	3	3
	E 21	0.30	0.10	70	n (min-1)	6792	3396	2264	1698	1358	1132	849	679	566
					fz (in)	0.0001	0.0002	0.0003	0.0004	0.0005	0.0006	0.0008	0.0009	0.0011
					vf (in/min)	3	3	3	3	3	3	3	3	3
	E 22	0.40	0.20	110	n (min-1)	10673	5337	3558	2668	2135	1779	1334	1067	889
fz (in)					0.0001	0.0002	0.0003	0.0003	0.0004	0.0005	0.0007	0.0009	0.0010	
vf (in/min)					4	4	4	4	4	4	4	4	4	

SMG = Seco Material Group
 n [min-1] = RPM
 v_c (sf/min) = Surface feet/min

fz [in] = Feed/tooth
 a_p/D_c = % of diameter
 vf [in/min] = Feed rate
 a_e/D_c = % of diameter

A = Air D = Dry E = Emulsion (flood coolant) M = Mist
 All cutting data are start values. All cutting data is in inch values.
 Please reference the Workpiece Material Classification chart located on page 15.

CM260

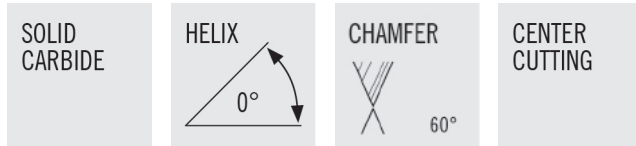

- Cylindrical Shank
- General Purpose

ITEM NUMBER	DESCRIPTION	FLUTE DIA	SHANK DIA	LENGTH OF CUT	OVERALL LENGTH	FLUTES	COATING	CHAMFER
N76590	CM260-0.250-D1-C.0-Z2	1/4	1/4	3/16	2-1/2	2	TIALN	60°
N76591	CM260-0.375-D1-C.0-Z2	3/8	3/8	5/16	2-1/2	2	TIALN	60°
N76592	CM260-0.500-D1-C.0-Z2	1/2	1/2	7/16	3	2	TIALN	60°

CM290

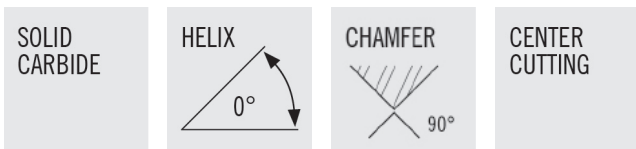

- Cylindrical Shank
- General Purpose

ITEM NUMBER	DESCRIPTION	FLUTE DIA	SHANK DIA	LENGTH OF CUT	OVERALL LENGTH	FLUTES	COATING	CHAMFER
N76593	CM290-0.250-D1-C.0-Z2	1/4	1/4	1/8	2-1/2	2	TIALN	90°
N76594	CM290-0.375-D1-C.0-Z2	3/8	3/8	3/16	2-1/2	2	TIALN	90°
N76595	CM290-0.500-D1-C.0-Z2	1/2	1/2	1/4	3	2	TIALN	90°

CM460

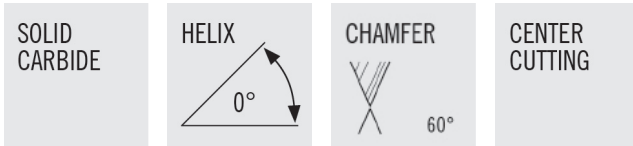

- Cylindrical Shank
- General Purpose

ITEM NUMBER	DESCRIPTION	FLUTE DIA	SHANK DIA	LENGTH OF CUT	OVERALL LENGTH	FLUTES	COATING	CHAMFER
N76596	CM460-0.250-D1-C.0-Z4	1/4	1/4	3/16	2-1/2	4	TIALN	60°
N76597	CM460-0.375-D1-C.0-Z4	3/8	3/8	5/16	2-1/2	4	TIALN	60°
N76598	CM460-0.500-D1-C.0-Z4	1/2	1/2	7/16	3	4	TIALN	60°
N76599	CM460-0.750-D1-C.0-Z4	3/4	3/4	5/8	3	4	TIALN	60°

CM490

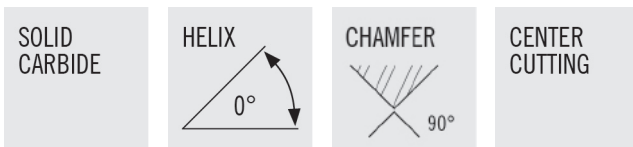

- Cylindrical Shank
- General Purpose

ITEM NUMBER	DESCRIPTION	FLUTE DIA	SHANK DIA	LENGTH OF CUT	OVERALL LENGTH	FLUTES	COATING	CHAMFER
N76600	CM490-0.250-D1-C.0-Z4	1/4	1/4	1/8	2-1/2	4	TIALN	90°
N76601	CM490-0.375-D1-C.0-Z4	3/8	3/8	3/16	2-1/2	4	TIALN	90°
N76602	CM490-0.500-D1-C.0-Z4	1/2	1/2	1/4	3	4	TIALN	90°
N76603	CM490-0.750-D1-C.0-Z4	3/4	3/4	3/8	3	4	TIALN	90°

CM260 / CM290 - START VALUES

		SLOTTING								
ISO GROUP	SMG	$a_p \times D_c$ (max)	$a_e \times D_c$ (max)	v_c (sf / min)		$Z_n = 2$				
						1/4	3/8	1/2	5/8	3/4
P	E 1 - 2	0.30	1.00	400	n (rev/min)	6112	4075	3056	2445	2037
					f_z (in)	0.00050	0.00075	0.00100	0.00125	0.00150
					v_f (in/min)	6.1	6.1	6.1	6.1	6.1
	E 3 - 4	0.20	1.00	200	n (rev/min)	3056	2037	1528	1222	1019
					f_z (in)	0.00028	0.00042	0.00056	0.00070	0.00084
					v_f (in/min)	1.7	1.7	1.7	1.7	1.7
	E 5 - 6	0.20	1.00	100	n (rev/min)	1528	1019	764	611	509
					f_z (in)	0.00240	0.00360	0.00480	0.00600	0.00720
					v_f (in/min)	7.3	7.3	7.3	7.3	7.3
H	M / A / D 7a (48>52HRC)	0.20	1.00	70	n (rev/min)	1070	713	535	428	357
					f_z (in)	0.00016	0.00024	0.00032	0.00040	0.00048
					v_f (in/min)	0.3	0.3	0.3	0.3	0.3
M	E 8 - 9	0.50	1.00	320	n (rev/min)	4890	3260	2445	1956	1630
					f_z (in)	0.00024	0.00036	0.00048	0.00060	0.00072
					v_f (in/min)	2.3	2.3	2.3	2.3	2.3
	E 10 - 11	0.30	1.00	250	n (rev/min)	3820	2547	1910	1528	1273
					f_z (in)	0.00020	0.00030	0.00040	0.00050	0.00060
					v_f (in/min)	1.5	1.5	1.5	1.5	1.5
K	E 12 - 13	0.30	1.00	270	n (rev/min)	4126	2750	2063	1650	1375
					f_z (in)	0.00058	0.00087	0.00116	0.00145	0.00174
					v_f (in/min)	4.8	4.8	4.8	4.8	4.8
	E 14 - 15	0.20	1.00	145	n (rev/min)	2216	1477	1108	886	739
					f_z (in)	0.00034	0.00051	0.00068	0.00085	0.00102
					v_f (in/min)	1.5	1.5	1.5	1.5	1.5

SMG = Seco Material Group
 n [min-1] = RPM
 v_c (sf/min) = Surface feet/min

f_z [in] = Feed/tooth
 a_p/D_c = % of diameter
 v_f [in/min] = Feed rate
 a_e/D_c = % of diameter

A = Air D = Dry E = Emulsion (flood coolant) M = Mist
 All cutting data are start values. All cutting data is in inch values.
 Please reference the Workpiece Material Classification chart located on page 15.

CM260 / CM290 - START VALUES

SIDE MILLING - ROUGHING												
ISO GROUP	SMG	$a_p \times D_c$ (max)	$a_e \times D_c$ (max)	v_c (sf / min)		$Z_n = 2$						
						1/4	3/8	1/2	5/8	3/4		
P	E 1 - 2	1.00	0.50	400	n (rev/min)	6112	4075	3056	2445	2037		
					f_z (in)	0.00063	0.00094	0.00125	0.00156	0.00188		
					v_f (in/min)	7.6	7.6	7.6	7.6	7.6		
	E 3 - 4	1.00	0.50	200	n (rev/min)	3056	2037	1528	1222	1019		
					f_z (in)	0.00035	0.00053	0.00070	0.00088	0.00105		
					v_f (in/min)	2.1	2.1	2.1	2.1	2.1		
	E 5 - 6	1.00	0.50	100	n (rev/min)	1528	1019	764	611	509		
					f_z (in)	0.00030	0.00045	0.00060	0.00075	0.00090		
					v_f (in/min)	0.9	0.9	0.9	0.9	0.9		
H	M / A / D 7a (48>52HRC)	0.30	0.20	70	n (rev/min)	1070	713	535	428	357		
					f_z (in)	0.00020	0.00030	0.00040	0.00050	0.00060		
					v_f (in/min)	0.4	0.4	0.4	0.4	0.4		
M	E 8 - 9	1.00	0.50	320	n (rev/min)	4890	3260	2445	1956	1630		
					f_z (in)	0.00030	0.00045	0.00060	0.00075	0.00090		
					v_f (in/min)	2.9	2.9	2.9	2.9	2.9		
	E 10 - 11	1.00	0.50	250	n (rev/min)	3820	2547	1910	1528	1273		
					f_z (in)	0.00025	0.00038	0.00050	0.00063	0.00075		
					v_f (in/min)	1.9	1.9	1.9	1.9	1.9		
K	E 12 - 13	1.00	0.50	270	n (rev/min)	4126	2750	2063	1650	1375		
					f_z (in)	0.00073	0.00109	0.00145	0.00181	0.00218		
					v_f (in/min)	6.0	6.0	6.0	6.0	6.0		
	E 14 - 15	1.00	0.50	145	n (rev/min)	2216	1477	1108	886	739		
					f_z (in)	0.00043	0.00064	0.00085	0.00106	0.00128		
				85	-	205	v_f (in/min)	1.9	1.9	1.9	1.9	1.9

SMG = Seco Material Group
 n [min-1] = RPM
 v_c (sf/min) = Surface feet/min

f_z [in] = Feed/tooth
 a_p/D_c = % of diameter
 v_f [in/min] = Feed rate
 a_e/D_c = % of diameter

A = Air D = Dry E = Emulsion (flood coolant) M = Mist
 All cutting data are start values. All cutting data is in inch values.
 Please reference the Workpiece Material Classification chart located on page 15.

CM460 / CM490 - START VALUES

		SLOTTING								
ISO GROUP	SMG	$a_p \times D_c$ (max)	$a_e \times D_c$ (max)	v_c (sf / min)		$Z_n = 4$				
						1/4	3/8	1/2	5/8	3/4
P	E 1 - 2	0.30	1.00	400	n (rev/min)	6112	4075	3056	2445	2037
					f_z (in)	0.00050	0.00075	0.00100	0.00125	0.00150
					v_f (in/min)	12.2	12.2	12.2	12.2	12.2
	E 3 - 4	0.20	1.00	200	n (rev/min)	3056	2037	1528	1222	1019
					f_z (in)	0.00028	0.00042	0.00056	0.00070	0.00084
					v_f (in/min)	3.4	3.4	3.4	3.4	3.4
	E 5 - 6	0.20	1.00	100	n (rev/min)	1528	1019	764	611	509
					f_z (in)	0.00240	0.00360	0.00480	0.00600	0.00720
					v_f (in/min)	14.7	14.7	14.7	14.7	14.7
H	M / A / D 7a (48>52HRC)	0.20	1.00	70	n (rev/min)	1070	713	535	428	357
					f_z (in)	0.00016	0.00024	0.00032	0.00040	0.00048
					v_f (in/min)	0.7	0.7	0.7	0.7	0.7
M	E 8 - 9	0.50	1.00	320	n (rev/min)	4890	3260	2445	1956	1630
					f_z (in)	0.00024	0.00036	0.00048	0.00060	0.00072
					v_f (in/min)	4.7	4.7	4.7	4.7	4.7
	E 10 - 11	0.30	1.00	250	n (rev/min)	3820	2547	1910	1528	1273
					f_z (in)	0.00020	0.00030	0.00040	0.00050	0.00060
					v_f (in/min)	3.1	3.1	3.1	3.1	3.1
K	E 12 - 13	0.30	1.00	270	n (rev/min)	4126	2750	2063	1650	1375
					f_z (in)	0.00058	0.00087	0.00116	0.00145	0.00174
					v_f (in/min)	9.6	9.6	9.6	9.6	9.6
	E 14 - 15	0.20	1.00	145	n (rev/min)	2216	1477	1108	886	739
					f_z (in)	0.00034	0.00051	0.00068	0.00085	0.00102
					v_f (in/min)	3.0	3.0	3.0	3.0	3.0

SMG = Seco Material Group
 n [min-1] = RPM
 v_c (sf/min) = Surface feet/min

f_z [in] = Feed/tooth
 a_p/D_c = % of diameter
 v_f [in/min] = Feed rate
 a_e/D_c = % of diameter

A = Air D = Dry E = Emulsion (flood coolant) M = Mist
 All cutting data are start values. All cutting data is in inch values.
 Please reference the Workpiece Material Classification chart located on page 15.

CM460 / CM490 - START VALUES

SIDE MILLING - ROUGHING										
ISO GROUP	SMG	a _p x Dc (max)	a _e x Dc (max)	v _c (sf / min)		Z _n = 4				
						1/4	3/8	1/2	5/8	3/4
P	E 1 - 2	1.00	0.50	400	n (rev/min)	6112	4075	3056	2445	2037
					f _z (in)	0.00063	0.00094	0.00125	0.00156	0.00188
					v _f (in/min)	15.3	15.3	15.3	15.3	15.3
	E 3 - 4	1.00	0.50	200	n (rev/min)	3056	2037	1528	1222	1019
					f _z (in)	0.00035	0.00053	0.00070	0.00088	0.00105
					v _f (in/min)	4.3	4.3	4.3	4.3	4.3
	E 5 - 6	1.00	0.50	100	n (rev/min)	1528	1019	764	611	509
					f _z (in)	0.00030	0.00045	0.00060	0.00075	0.00090
					v _f (in/min)	1.8	1.8	1.8	1.8	1.8
H	M / A / D 7a (48>52HRC)	0.30	0.20	70	n (rev/min)	1070	713	535	428	357
					f _z (in)	0.00020	0.00030	0.00040	0.00050	0.00060
					v _f (in/min)	0.9	0.9	0.9	0.9	0.9
M	E 8 - 9	1.00	0.50	320	n (rev/min)	4890	3260	2445	1956	1630
					f _z (in)	0.00030	0.00045	0.00060	0.00075	0.00090
					v _f (in/min)	5.9	5.9	5.9	5.9	5.9
	E 10 - 11	1.00	0.50	250	n (rev/min)	3820	2547	1910	1528	1273
					f _z (in)	0.00025	0.00038	0.00050	0.00063	0.00075
					v _f (in/min)	3.8	3.8	3.8	3.8	3.8
K	E 12 - 13	1.00	0.50	270	n (rev/min)	4126	2750	2063	1650	1375
					f _z (in)	0.00073	0.00109	0.00145	0.00181	0.00218
					v _f (in/min)	12.0	12.0	12.0	12.0	12.0
	E 14 - 15	1.00	0.50	145	n (rev/min)	2216	1477	1108	886	739
					f _z (in)	0.00043	0.00064	0.00085	0.00106	0.00128
					v _f (in/min)	3.8	3.8	3.8	3.8	3.8

SMG = Seco Material Group
 n [min-1] = RPM
 v_c (sf/min) = Surface feet/min

f_z [in] = Feed/tooth
 a_p/D_c = % of diameter
 v_f [in/min] = Feed rate
 a_e/D_c = % of diameter

A = Air D = Dry E = Emulsion (flood coolant) M = Mist
 All cutting data are start values. All cutting data is in inch values.
 Please reference the Workpiece Material Classification chart located on page 15.

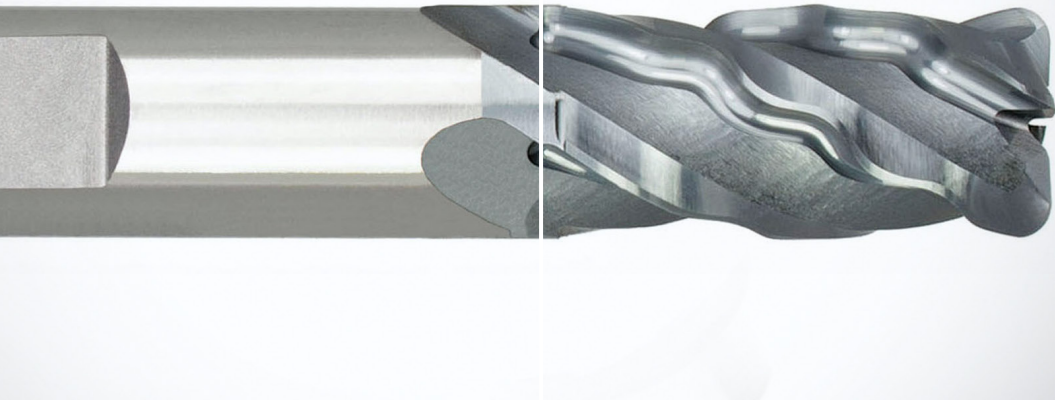

NIAGARA CUTTER™

HIGH PERFORMANCE COBALT END MILLS

SHEAR MORE METAL VFP

The VFP (Variable Face Profile) product family has been specifically engineered for milling titanium. The variable helix and polished rake face provide increased material shearing capability, yielding excellent chip formation and evacuation. The VFP's unique geometry and superior cutting edge result in reduced heat generation and excellent workpiece surface finish. While this product family is specifically designed for application in titanium we also recommend using it for similar applications in ISO-M materials.

The new aero radii additions add commonly produced specials to this product family and also come standard with AlCrN coating.

YOUR BENEFITS

- AlCrN coating for heat and abrasion resistance
- Extended tool life
- Increased metal shearing
- Improved surface finish
- Polished rake face
- Weldon flat standard
- M42 Cobalt
- Reduced horsepower requirements compared to standard end mills

RANGE OVERVIEW

- Chamfer and standard 0.120", 0.156" and 0.250" corner radii
- 4- and 6-flutes
- 1.125" and 2" diameters
- Variable helix

MATERIAL GROUPS
Stainless 8-11
Titanium 22

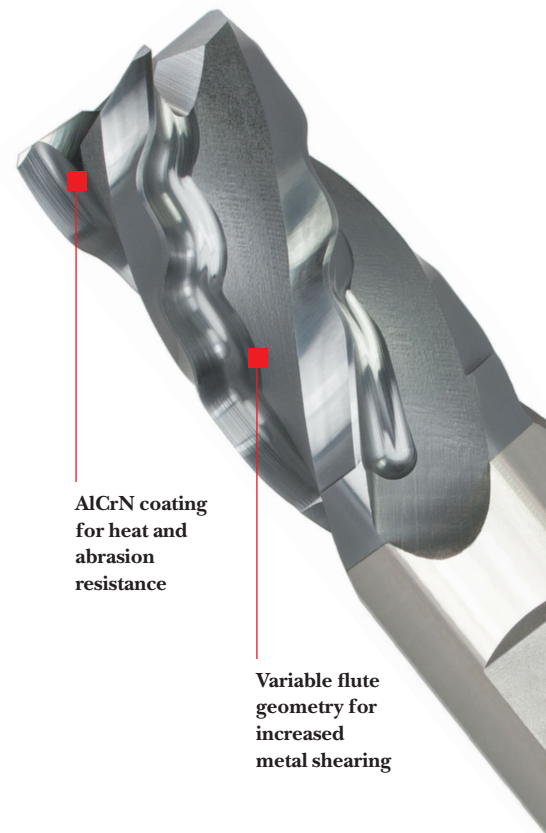

AlCrN coating for heat and abrasion resistance

Variable flute geometry for increased metal shearing

INDUSTRY APPLICATIONS

Aerospace: Many large titanium aerospace components, such as side-a-body and wing spars are produced on large triple-spindle gantry-style milling machines. VFP style cutters, designed for taking large depths of cut, are a perfect fit for these high horsepower machines. The new VFP coated series offer an increase in tool life of over 50% when compared to an uncoated end mill. Reducing tooling cost has never been easier when machining large titanium aerospace components.

VFP435 / VFP635

M42
8% COBALT

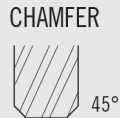
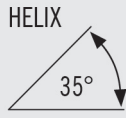

CENTER CUTTING



- Optimal chip formation and evacuation
- Polished rake face
- Weldon flat standard
- Up to .156" Corner Radius through modification
- Designed for stainless steel and titanium

ITEM NUMBER	DESCRIPTION	FLUTE DIA	SHANK DIA	LENGTH OF CUT	OVERALL LENGTH	FLUTES	CHAMFER
N68948	VFP435-0.750-D2-C030.3-Z4	3/4	3/4	1-5/8	3-7/8	4	0.030
N68949	VFP435-0.750-D3-C030.3-Z4	3/4	3/4	2-1/4	4-1/2	4	0.030
N68950	VFP435-0.750-D4-C030.3-Z4	3/4	3/4	3	5-1/4	4	0.030
N68952	VFP435-1.000-D2-C030.3-Z4	1	1	2	4-1/2	4	0.030
N68953	VFP635-1.000-D2-C030.3-Z6	1	1	2	4-1/2	6	0.030
N68954	VFP435-1.000-D3-C030.3-Z4	1	1	3	5-1/2	4	0.030
N68955	VFP635-1.000-D3-C030.3-Z6	1	1	3	5-1/2	6	0.030
N68956	VFP435-1.000-D4-C030.3-Z4	1	1	4	6-1/2	4	0.030
N68957	VFP635-1.000-D4-C030.3-Z6	1	1	4	6-1/2	6	0.030
N68958	VFP435-1.250-D2-C040.3-Z4	1-1/4	1-1/4	2	4-1/2	4	0.040
N68959	VFP635-1.250-D2-C040.3-Z6	1-1/4	1-1/4	2	4-1/2	6	0.040
N68960	VFP435-1.250-D3-C040.3-Z4	1-1/4	1-1/4	3	5-1/2	4	0.040
N68961	VFP635-1.250-D3-C040.3-Z6	1-1/4	1-1/4	3	5-1/2	6	0.040
N68962	VFP435-1.250-D4-C040.3-Z4	1-1/4	1-1/4	4	6-1/2	4	0.040
N68963	VFP635-1.250-D4-C040.3-Z6	1-1/4	1-1/4	4	6-1/2	6	0.040
N68965	VFP635-1.500-P1-C040.3-Z6	1-1/2	1-1/4	2	4-1/2	6	0.040
N68966	VFP635-1.500-P2-C040.3-Z6	1-1/2	1-1/4	3	5-1/2	6	0.040
N68967	VFP635-1.500-P3-C040.3-Z6	1-1/2	1-1/4	4	6-1/2	6	0.040
N68968	VFP635-1.500-P4-C040.3-Z6	1-1/2	1-1/4	6	8-1/2	6	0.040
N68969	VFP635-2.000-D1-C040.3-Z6	2	2	2	5-3/4	6	0.040
N68970	VFP635-2.000-D2-C040.3-Z6	2	2	3	6-3/4	6	0.040
N68971	VFP635-2.000-D3-C040.3-Z6	2	2	4	7-3/4	6	0.040
N68972	VFP635-2.000-D4-C040.3-Z6	2	2	6	9-3/4	6	0.040

SHORT BLOCK-VFP435SB / VFP635SB

M42
8% COBALT

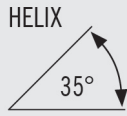

CENTER
CUTTING



- Optimal chip formation and evacuation
- Polished rake face
- Weldon flat standard
- Up to .250" corner radius through modification
- Designed for stainless steel and titanium

ITEM NUMBER	DESCRIPTION	FLUTE DIA	SHANK DIA	LENGTH OF CUT	OVERALL LENGTH	FLUTES	COATING	CHAMFER
N69388	VFP635SB-1.250-D1-C040.3-Z6	1-1/4	1-1/4	2	4-1/2	6	UNCOATED	0.040
N69390	VFP635SB-1.250-D2-C040.3-Z6	1-1/4	1-1/4	3	5-1/2	6	UNCOATED	0.040
N69392	VFP635SB-1.250-D3-C040.3-Z6	1-1/4	1-1/4	4	6-1/2	6	UNCOATED	0.040
N69393	VFP635SB-1.250-D5-C040.3-Z6	1-1/4	1-1/4	6	8-1/2	6	UNCOATED	0.040
N69394	VFP635SB-2.000-D1-C040.3-Z6	2	2	2	5-3/4	6	UNCOATED	0.040
N69395	VFP635SB-2.000-D2-C040.3-Z6	2	2	3	6-3/4	6	UNCOATED	0.040
N69396	VFP635SB-2.000-D3-C040.3-Z6	2	2	4	7-3/4	6	UNCOATED	0.040
N69397	VFP635SB-2.000-D4-C040.3-Z6	2	2	6	9-3/4	6	UNCOATED	0.040
N69398	VFP635SB-2.000-D5-C040.3-Z6	2	2	8	11-3/4	6	UNCOATED	0.040

ALCRN COATED - VFP435SB / VFP435SBR / VFP635SB / VFP635SBR

M42 8% COBALT	HELIX 35°	RADIUS	CHAMFER 45°	CENTER CUTTING
------------------	--------------	--------	----------------	----------------



- Optimal chip formation and evacuation
- Polished rake face
- Weldon flat standard
- AlCrN coated for increased performance and tool life
- Specifically engineered for titanium and stainless steel
- Available with chamfer or corner radius

ITEM NUMBER	DESCRIPTION	FLUTE DIA	SHANK DIA	LENGTH OF CUT	OVERALL LENGTH	FLUTES	COATING	RADIUS	CHAMFER
03136025	VFP435SBR-1.250-D2-R120.3-Z4	1-1/4	1-1/4	2	4-1/2	4	AlCrN	0.120	-
03136026	VFP635SBR-1.250-D2-R120.3-Z6	1-1/4	1-1/4	2	4-1/2	6	AlCrN	0.120	-
03136027	VFP435SB-1.250-D3-C040.3-Z4	1-1/4	1-1/4	3	5-1/2	4	AlCrN	-	0.040
03136028	VFP635SB-1.250-D3-C040.3-Z6	1-1/4	1-1/4	3	5-1/2	6	AlCrN	-	0.040
03136029	VFP635SBR-1.250-D3-R120.3-Z6	1-1/4	1-1/4	3	5-1/2	6	AlCrN	0.120	-
03136030	VFP635SBR-1.250-D3-R156.3-Z6	1-1/4	1-1/4	3	5-1/2	6	AlCrN	0.156	-
03136031	VFP435SBR-1.250-D4-R120.3-Z4	1-1/4	1-1/4	4	6-1/2	4	AlCrN	0.120	-
03136032	VFP635SB-1.250-D4-C040.3-Z6	1-1/4	1-1/4	4	6-1/2	6	AlCrN	-	0.040
03136033	VFP635SBR-1.250-D4-R120.3-Z6	1-1/4	1-1/4	4	6-1/2	6	AlCrN	0.120	-
03136034	VFP635SBR-1.250-D4-R156.3-Z6	1-1/4	1-1/4	4	6-1/2	6	AlCrN	0.156	-
03136035	VFP635SBR-1.250-D6-R120.3-Z6	1-1/4	1-1/4	6	8-1/2	6	AlCrN	0.120	-
03136036	VFP635SB-2.000-D1-C040.3-Z6	2	2	2	5-3/4	6	AlCrN	-	0.040
03136037	VFP635SBR-2.000-D1-R120.3-Z6	2	2	2	5-3/4	6	AlCrN	0.120	-
03136038	VFP635SBR-2.000-D1-R250.3-Z6	2	2	2	5-3/4	6	AlCrN	0.250	-
03136039	VFP635SB-2.000-D2-C040.3-Z6	2	2	3	6-3/4	6	AlCrN	-	0.040
03136040	VFP635SBR-2.000-D2-R120.3-Z6	2	2	3	6-3/4	6	AlCrN	0.120	-
03136041	VFP635SBR-2.000-D2-R250.3-Z6	2	2	3	6-3/4	6	AlCrN	0.250	-
03136042	VFP635SB-2.000-D3-C040.3-Z6	2	2	4	7-3/4	6	AlCrN	-	0.040
03136043	VFP635SBR-2.000-D3-R120.3-Z6	2	2	4	7-3/4	6	AlCrN	0.120	-
03136044	VFP635SBR-2.000-D3-R250.3-Z6	2	2	4	7-3/4	6	AlCrN	0.250	-
03136045	VFP635SB-2.000-D4-C040.3-Z6	2	2	6	9-3/4	6	AlCrN	-	0.040
03136046	VFP635SBR-2.000-D4-R120.3-Z6	2	2	6	9-3/4	6	AlCrN	0.120	-
03136047	VFP635SBR-2.000-D4-R250.3-Z6	2	2	6	9-3/4	6	AlCrN	0.250	-

SP205

M42
8% COBALT

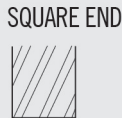
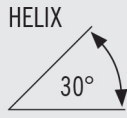

CENTER
CUTTING



- Weldon flat standard
- Designed for pocketing and slotting in all materials including high temperature alloys

ITEM NUMBER	DESCRIPTION	FLUTE DIA	SHANK DIA	LENGTH OF CUT	OVERALL LENGTH	FLUTES	COATING
N50041	SP205-0.125-F3-S.3-Z2	1/8	3/8	3/8	2-5/16	2	UNCOATED
N88565	SP205-0.125-F3-S.3-Z2	1/8	3/8	3/8	2-5/16	2	TICN
N50051	SP205-0.156-F3-S.3-Z2	5/32	3/8	7/16	2-5/16	2	UNCOATED
N88566	SP205-0.156-F3-S.3-Z2	5/32	3/8	7/16	2-5/16	2	TICN
N50061	SP205-0.188-F2-S.3-Z2	3/16	3/8	7/16	2-5/16	2	UNCOATED
N88567	SP205-0.188-F2-S.3-Z2	3/16	3/8	7/16	2-5/16	2	TICN
N50071	SP205-0.219-F2-S.3-Z2	7/32	3/8	1/2	2-5/16	2	UNCOATED
N88568	SP205-0.219-F2-S.3-Z2	7/32	3/8	1/2	2-5/16	2	TICN
N50081	SP205-0.250-F2-S.3-Z2	1/4	3/8	1/2	2-5/16	2	UNCOATED
N88569	SP205-0.250-F2-S.3-Z2	1/4	3/8	1/2	2-5/16	2	TICN
N50091	SP205-0.281-F2-S.3-Z2	9/32	3/8	9/16	2-5/16	2	UNCOATED
N88570	SP205-0.281-F2-S.3-Z2	9/32	3/8	9/16	2-5/16	2	TICN
N50101	SP205-0.313-F2-S.3-Z2	5/16	3/8	9/16	2-5/16	2	UNCOATED
N88571	SP205-0.313-F2-S.3-Z2	5/16	3/8	9/16	2-5/16	2	TICN
N50121	SP205-0.375-D2-S.3-Z2	3/8	3/8	9/16	2-5/16	2	UNCOATED
N88573	SP205-0.375-D2-S.3-Z2	3/8	3/8	9/16	2-5/16	2	TICN
N50141	SP205-0.438-P2-S.3-Z2	7/16	3/8	13/16	2-1/2	2	UNCOATED
N88574	SP205-0.438-P2-S.3-Z2	7/16	3/8	13/16	2-1/2	2	TICN
N50161	SP205-0.500-P2-S.3-Z2	1/2	3/8	13/16	2-1/2	2	UNCOATED
N88575	SP205-0.500-P2-S.3-Z2	1/2	3/8	13/16	2-1/2	2	TICN
N50162	SP205-0.500-D2-S.3-Z2	1/2	1/2	1	3	2	UNCOATED
N88576	SP205-0.500-D2-S.3-Z2	1/2	1/2	1	3	2	TICN
N50182	SP205-0.563-P2-S.3-Z2	9/16	1/2	1-1/8	3-1/8	2	UNCOATED
N88577	SP205-0.563-P2-S.3-Z2	9/16	1/2	1-1/8	3-1/8	2	TICN
N50203	SP205-0.625-D2-S.3-Z2	5/8	5/8	1-5/16	3-7/16	2	UNCOATED
N88578	SP205-0.625-D2-S.3-Z2	5/8	5/8	1-5/16	3-7/16	2	TICN
N50242	SP205-0.750-P2-S.3-Z2	3/4	1/2	1-5/16	3-5/16	2	UNCOATED
N88579	SP205-0.750-P2-S.3-Z2	3/4	1/2	1-5/16	3-5/16	2	TICN
N50244	SP205-0.750-D2-S.3-Z2	3/4	3/4	1-5/16	3-9/16	2	UNCOATED
N88580	SP205-0.750-D2-S.3-Z2	3/4	3/4	1-5/16	3-9/16	2	TICN
N50285	SP205-0.875-D2-S.3-Z2	7/8	7/8	1-1/2	3-3/4	2	UNCOATED
N88581	SP205-0.875-D2-S.3-Z2	7/8	7/8	1-1/2	3-3/4	2	TICN
N50324	SP205-1.000-P2-S.3-Z2	1	3/4	1-1/2	3-3/4	2	UNCOATED
N88582	SP205-1.000-P2-S.3-Z2	1	3/4	1-1/2	3-3/4	2	TICN
N50326	SP205-1.000-D2-S.3-Z2	1	1	1-5/8	4-1/8	2	UNCOATED
N88583	SP205-1.000-D2-S.3-Z2	1	1	1-5/8	4-1/8	2	TICN
N50366	SP205-1.125-P1-S.3-Z2	1-1/8	1	1-5/8	4-1/8	2	UNCOATED
N88584	SP205-1.125-P1-S.3-Z2	1-1/8	1	1-5/8	4-1/8	2	TICN
N50407	SP205-1.250-D1-S.3-Z2	1-1/4	1-1/4	1-5/8	4-1/8	2	UNCOATED
N88586	SP205-1.250-D1-S.3-Z2	1-1/4	1-1/4	1-5/8	4-1/8	2	TICN
N50487	SP205-1.500-P1-S.3-Z2	1-1/2	1-1/4	1-5/8	4-1/8	2	UNCOATED
N88587	SP205-1.500-P1-S.3-Z2	1-1/2	1-1/4	1-5/8	4-1/8	2	TICN
N50647	SP205-2.000-P1-S.3-Z2	2	1-1/4	1-5/8	4-1/8	2	UNCOATED
N88588	SP205-2.000-P1-S.3-Z2	2	1-1/4	1-5/8	4-1/8	2	TICN

SPC408

M42
8% COBALT

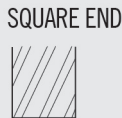
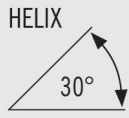

CENTER
CUTTING



- Weldon flat standard
- Designed for profiling in all materials

ITEM NUMBER	DESCRIPTION	FLUTE DIA	SHANK DIA	LENGTH OF CUT	OVERALL LENGTH	FLUTES	COATING
N52041	SPC408-0.125-F3-S.3-Z4	1/8	3/8	3/8	2-5/16	4	UNCOATED
N88604	SPC408-0.125-F3-S.3-Z4	1/8	3/8	3/8	2-5/16	4	TICN
N52051	SPC408-0.156-F3-S.3-Z4	5/32	3/8	1/2	2-3/8	4	UNCOATED
N88605	SPC408-0.156-F3-S.3-Z4	5/32	3/8	1/2	2-3/8	4	TICN
N52049	SPC408-0.188-F1-S.3-Z4	3/16	3/8	3/16	2-1/16	4	UNCOATED
N89446	SPC408-0.188-F1-S.3-Z4	3/16	3/8	3/16	2-1/16	4	TICN
N52061	SPC408-0.188-F3-S.3-Z4	3/16	3/8	1/2	2-3/8	4	UNCOATED
N88606	SPC408-0.188-F3-S.3-Z4	3/16	3/8	1/2	2-3/8	4	TICN
N52071	SPC408-0.219-F3-S.3-Z4	7/32	3/8	5/8	2-7/16	4	UNCOATED
N88607	SPC408-0.219-F3-S.3-Z4	7/32	3/8	5/8	2-7/16	4	TICN
N52069	SPC408-0.250-F1-S.3-Z4	1/4	3/8	1/4	2-1/16	4	UNCOATED
N89447	SPC408-0.250-F1-S.3-Z4	1/4	3/8	1/4	2-1/16	4	TICN
N52081	SPC408-0.250-F3-S.3-Z4	1/4	3/8	5/8	2-7/16	4	UNCOATED
N88608	SPC408-0.250-F3-S.3-Z4	1/4	3/8	5/8	2-7/16	4	TICN
N52082	SPC408-0.250-F5-S.3-Z4	1/4	3/8	1-1/4	3-1/16	4	UNCOATED
N88609	SPC408-0.250-F5-S.3-Z4	1/4	3/8	1-1/4	3-1/16	4	TICN
N52083	SPC408-0.250-F7-S.3-Z4	1/4	3/8	1-3/4	3-9/16	4	UNCOATED
N88610	SPC408-0.250-F7-S.3-Z4	1/4	3/8	1-3/4	3-9/16	4	TICN
N52091	SPC408-0.281-F2-S.3-Z4	9/32	3/8	5/8	2-7/16	4	UNCOATED
N88611	SPC408-0.281-F2-S.3-Z4	9/32	3/8	5/8	2-7/16	4	TICN
N52109	SPC408-0.313-F1-S.3-Z4	5/16	3/8	5/16	2-1/16	4	UNCOATED
N89448	SPC408-0.313-F1-S.3-Z4	5/16	3/8	5/16	2-1/16	4	TICN
N52101	SPC408-0.313-F2-S.3-Z4	5/16	3/8	3/4	2-1/2	4	UNCOATED
N88612	SPC408-0.313-F2-S.3-Z4	5/16	3/8	3/4	2-1/2	4	TICN
N52102	SPC408-0.313-F4-S.3-Z4	5/16	3/8	1-3/8	3-1/8	4	UNCOATED
N88613	SPC408-0.313-F4-S.3-Z4	5/16	3/8	1-3/8	3-1/8	4	TICN
N52103	SPC408-0.313-F6-S.3-Z4	5/16	3/8	2	3-3/4	4	UNCOATED
N88614	SPC408-0.313-F6-S.3-Z4	5/16	3/8	2	3-3/4	4	TICN
N52129	SPC408-0.375-D1-S.3-Z4	3/8	3/8	3/8	2-1/8	4	UNCOATED
N89449	SPC408-0.375-D1-S.3-Z4	3/8	3/8	3/8	2-1/8	4	TICN
N52121	SPC408-0.375-D2-S.3-Z4	3/8	3/8	3/4	2-1/2	4	UNCOATED
N88616	SPC408-0.375-D2-S.3-Z4	3/8	3/8	3/4	2-1/2	4	TICN
N52122	SPC408-0.375-D4-S.3-Z4	3/8	3/8	1-1/2	3-1/4	4	UNCOATED
N88617	SPC408-0.375-D4-S.3-Z4	3/8	3/8	1-1/2	3-1/4	4	TICN
N52123	SPC408-0.375-D7-S.3-Z4	3/8	3/8	2-1/2	4-1/4	4	UNCOATED
N88618	SPC408-0.375-D7-S.3-Z4	3/8	3/8	2-1/2	4-1/4	4	TICN
N52141	SPC408-0.438-P2-S.3-Z4	7/16	3/8	1	2-11/16	4	UNCOATED
N88619	SPC408-0.438-P2-S.3-Z4	7/16	3/8	1	2-11/16	4	TICN
N52142	SPC408-0.438-P5-S.3-Z4	7/16	3/8	2	3-11/16	4	UNCOATED
N88620	SPC408-0.438-P5-S.3-Z4	7/16	3/8	2	3-11/16	4	TICN
N52166	SPC408-0.500-P2-S.3-Z4	1/2	3/8	1	2-11/16	4	UNCOATED
N88625	SPC408-0.500-P2-S.3-Z4	1/2	3/8	1	2-11/16	4	TICN
N52160	SPC408-0.500-D3-S.3-Z4	1/2	1/2	1-1/4	3-1/4	4	UNCOATED
N88621	SPC408-0.500-D3-S.3-Z4	1/2	1/2	1-1/4	3-1/4	4	TICN

SPC408 (CONT.)

M42
8% COBALT

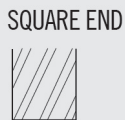
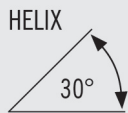

CENTER
CUTTING



- Weldon flat standard
- Designed for profiling in all materials

ITEM NUMBER	DESCRIPTION	FLUTE DIA	SHANK DIA	LENGTH OF CUT	OVERALL LENGTH	FLUTES	COATING
N52162	SPC408-0.500-D3-S.3-Z6	1/2	1/2	1-1/4	3-1/4	6	UNCOATED
N88622	SPC408-0.500-D3-S.3-Z6	1/2	1/2	1-1/4	3-1/4	6	TICN
N52163	SPC408-0.500-D4-S.3-Z4	1/2	1/2	2	4	4	UNCOATED
N88623	SPC408-0.500-D4-S.3-Z4	1/2	1/2	2	4	4	TICN
N52164	SPC408-0.500-D6-S.3-Z4	1/2	1/2	3	5	4	UNCOATED
N88624	SPC408-0.500-D6-S.3-Z4	1/2	1/2	3	5	4	TICN
N52167	SPC408-0.500-D8-S.3-Z4	1/2	1/2	4	6	4	UNCOATED
N88626	SPC408-0.500-D8-S.3-Z4	1/2	1/2	4	6	4	TICN
N52182	SPC408-0.563-P2-S.3-Z4	9/16	1/2	1-3/8	3-3/8	4	UNCOATED
N88627	SPC408-0.563-P2-S.3-Z4	9/16	1/2	1-3/8	3-3/8	4	TICN
N52200	SPC408-0.625-D3-S.3-Z4	5/8	5/8	1-5/8	3-3/4	4	UNCOATED
N88628	SPC408-0.625-D3-S.3-Z4	5/8	5/8	1-5/8	3-3/4	4	TICN
N52203	SPC408-0.625-D3-S.3-Z6	5/8	5/8	1-5/8	3-3/4	6	UNCOATED
N88631	SPC408-0.625-D3-S.3-Z6	5/8	5/8	1-5/8	3-3/4	6	TICN
N52201	SPC408-0.625-D4-S.3-Z4	5/8	5/8	2-1/2	4-5/8	4	UNCOATED
N88629	SPC408-0.625-D4-S.3-Z4	5/8	5/8	2-1/2	4-5/8	4	TICN
N52202	SPC408-0.625-D5-S.3-Z4	5/8	5/8	3	5-1/8	4	UNCOATED
N88630	SPC408-0.625-D5-S.3-Z4	5/8	5/8	3	5-1/8	4	TICN
N52204	SPC408-0.625-D6-S.3-Z4	5/8	5/8	4	6-1/8	4	UNCOATED
N88632	SPC408-0.625-D6-S.3-Z4	5/8	5/8	4	6-1/8	4	TICN
N52206	SPC408-0.750-P2-S.3-Z4	3/4	1/2	1-5/8	3-5/8	4	UNCOATED
N88633	SPC408-0.750-P2-S.3-Z4	3/4	1/2	1-5/8	3-5/8	4	TICN
N52240	SPC408-0.750-D2-S.3-Z4	3/4	3/4	1-5/8	3-7/8	4	UNCOATED
N88634	SPC408-0.750-D2-S.3-Z4	3/4	3/4	1-5/8	3-7/8	4	TICN
N52244	SPC408-0.750-D2-S.3-Z6	3/4	3/4	1-5/8	3-7/8	6	UNCOATED
N88638	SPC408-0.750-D2-S.3-Z6	3/4	3/4	1-5/8	3-7/8	6	TICN
N52241	SPC408-0.750-D3-S.3-Z4	3/4	3/4	2	4-1/4	4	UNCOATED
N88635	SPC408-0.750-D3-S.3-Z4	3/4	3/4	2	4-1/4	4	TICN
N52242	SPC408-0.750-D4-S.3-Z4	3/4	3/4	3	5-1/4	4	UNCOATED
N88636	SPC408-0.750-D4-S.3-Z4	3/4	3/4	3	5-1/4	4	TICN
N52243	SPC408-0.750-D5-S.3-Z4	3/4	3/4	4	6-1/4	4	UNCOATED
N88637	SPC408-0.750-D5-S.3-Z4	3/4	3/4	4	6-1/4	4	TICN
N52247	SPC408-0.750-D5-S.3-Z6	3/4	3/4	4	6-1/4	6	UNCOATED
N88640	SPC408-0.750-D5-S.3-Z6	3/4	3/4	4	6-1/4	6	TICN
N52285	SPC408-0.875-D2-S.3-Z4	7/8	7/8	1-7/8	4-1/8	4	UNCOATED
N88642	SPC408-0.875-D2-S.3-Z4	7/8	7/8	1-7/8	4-1/8	4	TICN
N52286	SPC408-0.875-D4-S.3-Z4	7/8	7/8	3-1/2	5-3/4	4	UNCOATED
N88643	SPC408-0.875-D4-S.3-Z4	7/8	7/8	3-1/2	5-3/4	4	TICN
N52334	SPC408-1.000-P2-S.3-Z4	1	3/4	1-7/8	4-1/8	4	UNCOATED
N88652	SPC408-1.000-P2-S.3-Z4	1	3/4	1-7/8	4-1/8	4	TICN
N52320	SPC408-1.000-D2-S.3-Z4	1	1	2	4-1/2	4	UNCOATED
N88644	SPC408-1.000-D2-S.3-Z4	1	1	2	4-1/2	4	TICN

SPC408 (CONT.)

M42
8% COBALT

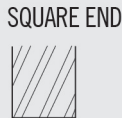
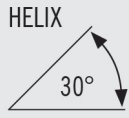

CENTER CUTTING



- Weldon flat standard
- Designed for profiling in all materials

ITEM NUMBER	DESCRIPTION	FLUTE DIA	SHANK DIA	LENGTH OF CUT	OVERALL LENGTH	FLUTES	COATING
N52326	SPC408-1.000-D2-S.3-Z6	1	1	2	4-1/2	6	UNCOATED
N88649	SPC408-1.000-D2-S.3-Z6	1	1	2	4-1/2	6	TICN
N52321	SPC408-1.000-D3-S.3-Z4	1	1	3	5-1/2	4	UNCOATED
N88645	SPC408-1.000-D3-S.3-Z4	1	1	3	5-1/2	4	TICN
N52327	SPC408-1.000-D3-S.3-Z6	1	1	3	5-1/2	6	UNCOATED
N88650	SPC408-1.000-D3-S.3-Z6	1	1	3	5-1/2	6	TICN
N52322	SPC408-1.000-D4-S.3-Z4	1	1	4	6-1/2	4	UNCOATED
N88646	SPC408-1.000-D4-S.3-Z4	1	1	4	6-1/2	4	TICN
N52324	SPC408-1.000-D4-S.3-Z6	1	1	4	6-1/2	6	UNCOATED
N88648	SPC408-1.000-D4-S.3-Z6	1	1	4	6-1/2	6	TICN
N52323	SPC408-1.000-D6-S.3-Z4	1	1	6	8-1/2	4	UNCOATED
N88647	SPC408-1.000-D6-S.3-Z4	1	1	6	8-1/2	4	TICN
N52329	SPC408-1.000-D6-S.3-Z6	1	1	6	8-1/2	6	UNCOATED
N88651	SPC408-1.000-D6-S.3-Z6	1	1	6	8-1/2	6	TICN
N52366	SPC408-1.125-P2-S.3-Z6	1-1/8	1	2	4-1/2	6	UNCOATED
N88653	SPC408-1.125-P2-S.3-Z6	1-1/8	1	2	4-1/2	6	TICN
N52367	SPC408-1.125-P4-S.3-Z6	1-1/8	1	4	6-1/2	6	UNCOATED
N88654	SPC408-1.125-P4-S.3-Z6	1-1/8	1	4	6-1/2	6	TICN
N52414	SPC408-1.250-P2-S.3-Z4	1-1/4	1	2	4-1/2	4	UNCOATED
N88663	SPC408-1.250-P2-S.3-Z4	1-1/4	1	2	4-1/2	4	TICN
N52416	SPC408-1.250-P2-S.3-Z6	1-1/4	1	2	4-1/2	6	UNCOATED
N88664	SPC408-1.250-P2-S.3-Z6	1-1/4	1	2	4-1/2	6	TICN
N52400	SPC408-1.250-D1-S.3-Z4	1-1/4	1-1/4	2	4-1/2	4	UNCOATED
N88655	SPC408-1.250-D1-S.3-Z4	1-1/4	1-1/4	2	4-1/2	4	TICN
N52407	SPC408-1.250-D1-S.3-Z6	1-1/4	1-1/4	2	4-1/2	6	UNCOATED
N88660	SPC408-1.250-D1-S.3-Z6	1-1/4	1-1/4	2	4-1/2	6	TICN
N52401	SPC408-1.250-D2-S.3-Z4	1-1/4	1-1/4	3	5-1/2	4	UNCOATED
N88656	SPC408-1.250-D2-S.3-Z4	1-1/4	1-1/4	3	5-1/2	4	TICN
N52406	SPC408-1.250-D2-S.3-Z6	1-1/4	1-1/4	3	5-1/2	6	UNCOATED
N88659	SPC408-1.250-D2-S.3-Z6	1-1/4	1-1/4	3	5-1/2	6	TICN
N52402	SPC408-1.250-D3-S.3-Z4	1-1/4	1-1/4	4	6-1/2	4	UNCOATED
N88657	SPC408-1.250-D3-S.3-Z4	1-1/4	1-1/4	4	6-1/2	4	TICN
N52409	SPC408-1.250-D3-S.3-Z6	1-1/4	1-1/4	4	6-1/2	6	UNCOATED
N88661	SPC408-1.250-D3-S.3-Z6	1-1/4	1-1/4	4	6-1/2	6	TICN
N52403	SPC408-1.250-D5-S.3-Z4	1-1/4	1-1/4	6	8-1/2	4	UNCOATED
N88658	SPC408-1.250-D5-S.3-Z4	1-1/4	1-1/4	6	8-1/2	4	TICN
N52410	SPC408-1.250-D5-S.3-Z6	1-1/4	1-1/4	6	8-1/2	6	UNCOATED
N88662	SPC408-1.250-D5-S.3-Z6	1-1/4	1-1/4	6	8-1/2	6	TICN
N52480	SPC408-1.500-P1-S.3-Z4	1-1/2	1-1/4	2	4-1/2	4	UNCOATED
N88665	SPC408-1.500-P1-S.3-Z4	1-1/2	1-1/4	2	4-1/2	4	TICN

SPC408 (CONT.)

M42 8% COBALT	HELIX 30°	SQUARE END	CENTER CUTTING		
------------------	--------------	------------	----------------	--	---

- Weldon flat standard
- Designed for profiling in all materials

ITEM NUMBER	DESCRIPTION	FLUTE DIA	SHANK DIA	LENGTH OF CUT	OVERALL LENGTH	FLUTES	COATING
N52487	SPC408-1.500-P1-S.3-Z6	1-1/2	1-1/4	2	4-1/2	6	UNCOATED
N88667	SPC408-1.500-P1-S.3-Z6	1-1/2	1-1/4	2	4-1/2	6	TICN
N52486	SPC408-1.500-P4-S.3-Z6	1-1/2	1-1/4	4	6-1/2	6	UNCOATED
N88666	SPC408-1.500-P4-S.3-Z6	1-1/2	1-1/4	4	6-1/2	6	TICN
N52499	SPC408-1.500-P5-S.3-Z6	1-1/2	1-1/4	8	10-1/2	6	UNCOATED
N88669	SPC408-1.500-P5-S.3-Z6	1-1/2	1-1/4	8	10-1/2	6	TICN
N52644	SPC408-2.000-P1-S.3-Z6	2	1-1/4	2	4-1/2	6	UNCOATED
N88670	SPC408-2.000-P1-S.3-Z6	2	1-1/4	2	4-1/2	6	TICN
N52646	SPC408-2.000-P2-S.3-Z6	2	1-1/4	4	6-1/2	6	UNCOATED
N88671	SPC408-2.000-P2-S.3-Z6	2	1-1/4	4	6-1/2	6	TICN

SPB540

M42 8% COBALT	HELIX 30°	BALL END	CENTER CUTTING		
------------------	--------------	----------	----------------	--	---

- Weldon flat standard
- Designed for profiling and contouring in all materials

ITEM NUMBER	DESCRIPTION	FLUTE DIA	SHANK DIA	LENGTH OF CUT	OVERALL LENGTH	FLUTES	COATING
N88688	SPB540-0.125-F3-B.3-Z4	1/8	3/8	3/8	2-5/16	4	TICN
N88689	SPB540-0.188-F3-B.3-Z4	3/16	3/8	1/2	2-3/8	4	TICN
N88690	SPB540-0.250-F3-B.3-Z4	1/4	3/8	5/8	2-7/16	4	TICN
N88692	SPB540-0.375-D2-B.3-Z4	3/8	3/8	3/4	2-1/2	4	TICN
N67342	SPB540-0.375-D4-B.3-Z4	3/8	3/8	1-1/2	3-1/4	4	TICN
N67345	SPB540-0.500-D2-B.3-Z4	1/2	1/2	1	3	4	TICN
N88693	SPB540-0.500-D3-B.3-Z4	1/2	1/2	1-1/4	3-1/4	4	TICN
N67346	SPB540-0.500-D4-B.3-Z4	1/2	1/2	2	4	4	TICN
N67347	SPB540-0.500-D5-B.3-Z4	1/2	1/2	2-1/2	4-1/2	4	TICN
N88694	SPB540-0.625-D3-B.3-Z4	5/8	5/8	1-5/8	3-3/4	4	TICN
N88695	SPB540-0.750-D2-B.3-Z4	3/4	3/4	1-5/8	3-7/8	4	TICN
N67353	SPB540-0.750-D3-B.3-Z4	3/4	3/4	2-1/4	4-1/2	4	TICN
N88696	SPB540-0.875-D2-B.3-Z4	7/8	7/8	1-7/8	4-1/8	4	TICN
N88697	SPB540-1.000-D2-B.3-Z4	1	1	2	4-1/2	4	TICN
N67357	SPB540-1.000-D3-B.3-Z4	1	1	3	5-1/2	4	TICN
N67358	SPB540-1.000-D4-B.3-Z4	1	1	4	6-1/2	4	TICN
N67360	SPB540-1.000-D6-B.3-Z4	1	1	6	8-1/2	4	TICN
N88698	SPB540-1.250-D1-B.3-Z6	1-1/4	1-1/4	2	4-1/2	6	TICN
N88699	SPB540-1.500-P1-B.3-Z6	1-1/2	1-1/4	2	4-1/2	6	TICN

DISCOUNT CODE D40

RTM713

M42
8% COBALT



CENTER CUTTING

COARSE PITCH



- Weldon flat standard
- Designed for profiling and slotting in all materials

ITEM NUMBER	DESCRIPTION	FLUTE DIA	SHANK DIA	LENGTH OF CUT	OVERALL LENGTH	FLUTES	COATING	CHAMFER
N73081	RTM713-0.250-F3-C020.3-Z3	1/4	3/8	5/8	2-1/2	3	UNCOATED	0.020
N89019	RTM713-0.250-F3-C020.3-Z3	1/4	3/8	5/8	2-1/2	3	TICN	0.020
N73121	RTM713-0.375-D2-C020.3-Z3	3/8	3/8	7/8	2-3/4	3	UNCOATED	0.020
N89022	RTM713-0.375-D2-C020.3-Z3	3/8	3/8	7/8	2-3/4	3	TICN	0.020
N73162	RTM713-0.500-D2-C025.3-Z3	1/2	1/2	1	3-1/16	3	UNCOATED	0.025
N89025	RTM713-0.500-D2-C025.3-Z3	1/2	1/2	1	3-1/16	3	TICN	0.025
N73203	RTM713-0.625-D2-C025.3-Z3	5/8	5/8	1-1/4	3-1/2	3	UNCOATED	0.025
N89027	RTM713-0.625-D2-C025.3-Z3	5/8	5/8	1-1/4	3-1/2	3	TICN	0.025
N73249	RTM713-0.750-D1-C025.3-Z3	3/4	3/4	3/4	3	3	UNCOATED	0.025
N89030	RTM713-0.750-D1-C025.3-Z3	3/4	3/4	3/4	3	3	TICN	0.025
N73244	RTM713-0.750-D2-C025.3-Z3	3/4	3/4	1-1/2	3-3/4	3	UNCOATED	0.025
N89029	RTM713-0.750-D2-C025.3-Z3	3/4	3/4	1-1/2	3-3/4	3	TICN	0.025
N73327	RTM713-1.000-P1-C030.3-Z3	1	3/4	1	3-1/4	3	UNCOATED	0.030
N89035	RTM713-1.000-P1-C030.3-Z3	1	3/4	1	3-1/4	3	TICN	0.030
N73326	RTM713-1.000-D2-C030.3-Z3	1	1	1-3/4	4-5/8	3	UNCOATED	0.030
N89034	RTM713-1.000-D2-C030.3-Z3	1	1	1-3/4	4-5/8	3	TICN	0.030

RHC752

M42
8% COBALT



CENTER
CUTTING



- Weldon flat standard
- Designed for profiling and slotting in aluminum and non-ferrous materials

ITEM NUMBER	DESCRIPTION	FLUTE DIA	SHANK DIA	LENGTH OF CUT	OVERALL LENGTH	FLUTES	COATING	CHAMFER
N75215	RHC752-0.250-F3-C020.3-Z3	1/4	3/8	5/8	2-7/16	3	UNCOATED	0.020
N79460	RHC752-0.250-F3-C020.3-Z3	1/4	3/8	5/8	2-7/16	3	TICN	0.020
N75201	RHC752-0.375-D2-C025.3-Z3	3/8	3/8	3/4	2-1/2	3	UNCOATED	0.025
N69360	RHC752-0.375-D2-C025.3-Z3	3/8	3/8	3/4	2-1/2	3	TICN	0.025
N75203	RHC752-0.375-D4-C025.3-Z3	3/8	3/8	1-1/2	3-1/4	3	UNCOATED	0.025
N79464	RHC752-0.375-D4-C025.3-Z3	3/8	3/8	1-1/2	3-1/4	3	TICN	0.025
N75205	RHC752-0.500-D2-C030.3-Z3	1/2	1/2	1-1/4	3-1/4	3	UNCOATED	0.030
N69361	RHC752-0.500-D2-C030.3-Z3	1/2	1/2	1-1/4	3-1/4	3	TICN	0.030
N75209	RHC752-0.500-D4-C030.3-Z3	1/2	1/2	2	4	3	UNCOATED	0.030
N69362	RHC752-0.500-D4-C030.3-Z3	1/2	1/2	2	4	3	TICN	0.030
N75213	RHC752-0.625-D3-C040.3-Z3	5/8	5/8	1-5/8	3-3/4	3	UNCOATED	0.040
N69363	RHC752-0.625-D3-C040.3-Z3	5/8	5/8	1-5/8	3-3/4	3	TICN	0.040
N75217	RHC752-0.625-D5-C040.3-Z3	5/8	5/8	2-1/2	4-5/8	3	UNCOATED	0.040
N69364	RHC752-0.625-D5-C040.3-Z3	5/8	5/8	2-1/2	4-5/8	3	TICN	0.040
N75233	RHC752-0.750-D1-C040.3-Z3	3/4	3/4	3/4	3	3	UNCOATED	0.040
N69368	RHC752-0.750-D1-C040.3-Z3	3/4	3/4	3/4	3	3	TICN	0.040
N75229	RHC752-0.750-D3-C040.3-Z3	3/4	3/4	1-1/2	3-3/4	3	UNCOATED	0.040
N69367	RHC752-0.750-D3-C040.3-Z3	3/4	3/4	1-1/2	3-3/4	3	TICN	0.040
N75221	RHC752-0.750-D4-C040.3-Z3	3/4	3/4	1-5/8	3-7/8	3	UNCOATED	0.040
N69365	RHC752-0.750-D4-C040.3-Z3	3/4	3/4	1-5/8	3-7/8	3	TICN	0.040
N75225	RHC752-0.750-D5-C040.3-Z3	3/4	3/4	2	4-1/4	3	UNCOATED	0.040
N69366	RHC752-0.750-D5-C040.3-Z3	3/4	3/4	2	4-1/4	3	TICN	0.040
N75223	RHC752-0.750-D6-C040.3-Z3	3/4	3/4	2-1/2	4-3/4	3	UNCOATED	0.040
N79478	RHC752-0.750-D6-C040.3-Z3	3/4	3/4	2-1/2	4-3/4	3	TICN	0.040
N75235	RHC752-0.750-D7-C040.3-Z3	3/4	3/4	3	5-1/4	3	UNCOATED	0.040
N79479	RHC752-0.750-D7-C040.3-Z3	3/4	3/4	3	5-1/4	3	TICN	0.040
N75253	RHC752-1.000-P3-C040.3-Z3	1	3/4	1-1/2	3-3/4	3	UNCOATED	0.040
N69373	RHC752-1.000-P3-C040.3-Z3	1	3/4	1-1/2	3-3/4	3	TICN	0.040
N75245	RHC752-1.000-D3-C040.3-Z3	1	1	2	4-1/2	3	UNCOATED	0.040
N69371	RHC752-1.000-D3-C040.3-Z3	1	1	2	4-1/2	3	TICN	0.040
N75249	RHC752-1.000-D4-C040.3-Z3	1	1	3	5-1/2	3	UNCOATED	0.040
N69372	RHC752-1.000-D4-C040.3-Z3	1	1	3	5-1/2	3	TICN	0.040
N75351	RHC752-1.000-D5-C040.3-Z3	1	1	4	6-1/2	3	UNCOATED	0.040
N79493	RHC752-1.000-D5-C040.3-Z3	1	1	4	6-1/2	3	TICN	0.040

REM710

M42
8% COBALT



NON
CENTER
CUTTING



- Weldon flat standard
- Designed for profiling and slotting in all materials

ITEM NUMBER	DESCRIPTION	FLUTE DIA	SHANK DIA	LENGTH OF CUT	OVERALL LENGTH	FLUTES	COATING	CHAMFER
N71061	REM710-0.188-F3-C020.3-Z4	3/16	3/8	1/2	2-3/8	4	UNCOATED	0.020
N69290	REM710-0.188-F3-C020.3-Z4	3/16	3/8	1/2	2-3/8	4	TICN	0.020
N71081	REM710-0.250-F2-C020.3-Z4	1/4	3/8	5/8	2-7/16	4	UNCOATED	0.020
N71084	REM710-0.250-F2-C020.3-Z4	1/4	3/8	5/8	2-7/16	4	TICN	0.020
N71082	REM710-0.250-F4-C020.3-Z4	1/4	3/8	1-1/4	3-1/16	4	UNCOATED	0.020
N69291	REM710-0.250-F4-C020.3-Z4	1/4	3/8	1-1/4	3-1/16	4	TICN	0.020
N71101	REM710-0.313-F2-C025.3-Z4	5/16	3/8	3/4	2-1/2	4	UNCOATED	0.025
N71104	REM710-0.313-F2-C025.3-Z4	5/16	3/8	3/4	2-1/2	4	TICN	0.025
N71102	REM710-0.313-F4-C025.3-Z4	5/16	3/8	1-3/8	3-1/8	4	UNCOATED	0.025
N69293	REM710-0.313-F4-C025.3-Z4	5/16	3/8	1-3/8	3-1/8	4	TICN	0.025
N71121	REM710-0.375-D2-C025.3-Z4	3/8	3/8	3/4	2-1/2	4	UNCOATED	0.025
N71124	REM710-0.375-D2-C025.3-Z4	3/8	3/8	3/4	2-1/2	4	TICN	0.025
N71126	REM710-0.375-D3-C025.3-Z4	3/8	3/8	1-3/8	3-1/8	4	UNCOATED	0.025
N70940	REM710-0.375-D3-C025.3-Z4	3/8	3/8	1-3/8	3-1/8	4	TICN	0.025
N71122	REM710-0.375-D4-C025.3-Z4	3/8	3/8	1-1/2	3-1/4	4	UNCOATED	0.025
N69294	REM710-0.375-D4-C025.3-Z4	3/8	3/8	1-1/2	3-1/4	4	TICN	0.025
N71141	REM710-0.438-P2-C025.3-Z4	7/16	3/8	1	2-11/16	4	UNCOATED	0.025
N69295	REM710-0.438-P2-C025.3-Z4	7/16	3/8	1	2-11/16	4	TICN	0.025
N71161	REM710-0.500-D1-C025.3-Z4	1/2	1/2	1	3	4	UNCOATED	0.025
N79420	REM710-0.500-D1-C025.3-Z4	1/2	1/2	1	3	4	TICN	0.025
N71162	REM710-0.500-D2-C025.3-Z4	1/2	1/2	1-1/4	3-1/4	4	UNCOATED	0.025
N71165	REM710-0.500-D2-C025.3-Z4	1/2	1/2	1-1/4	3-1/4	4	TICN	0.025
N72162	REM710-0.500-D3-C025.3-Z4	1/2	1/2	1-5/8	3-5/8	4	UNCOATED	0.025
N79421	REM710-0.500-D3-C025.3-Z4	1/2	1/2	1-5/8	3-5/8	4	TICN	0.025
N71163	REM710-0.500-D4-C025.3-Z4	1/2	1/2	2	4	4	UNCOATED	0.025
N69296	REM710-0.500-D4-C025.3-Z4	1/2	1/2	2	4	4	TICN	0.025
N72163	REM710-0.500-D5-C025.3-Z4	1/2	1/2	2-1/2	4-1/2	4	UNCOATED	0.025
N79422	REM710-0.500-D5-C025.3-Z4	1/2	1/2	2-1/2	4-1/2	4	TICN	0.025
N72167	REM710-0.500-D6-C025.3-Z4	1/2	1/2	3	5	4	UNCOATED	0.025
N79423	REM710-0.500-D6-C025.3-Z4	1/2	1/2	3	5	4	TICN	0.025
N71182	REM710-0.563-P2-C025.3-Z4	9/16	1/2	1-3/8	3-3/8	4	UNCOATED	0.025
N69297	REM710-0.563-P2-C025.3-Z4	9/16	1/2	1-3/8	3-3/8	4	TICN	0.025
N71206	REM710-0.625-D1-C030.3-Z4	5/8	5/8	3/4	2-7/8	4	UNCOATED	0.030
N79424	REM710-0.625-D1-C030.3-Z4	5/8	5/8	3/4	2-7/8	4	TICN	0.030
N71202	REM710-0.625-D2-C030.3-Z4	5/8	5/8	1-1/4	3-3/8	4	UNCOATED	0.030
N79425	REM710-0.625-D2-C030.3-Z4	5/8	5/8	1-1/4	3-3/8	4	TICN	0.030
N71203	REM710-0.625-D3-C030.3-Z4	5/8	5/8	1-5/8	3-3/4	4	UNCOATED	0.030
N71208	REM710-0.625-D3-C030.3-Z4	5/8	5/8	1-5/8	3-3/4	4	TICN	0.030
N71204	REM710-0.625-D5-C030.3-Z4	5/8	5/8	2-1/2	4-5/8	4	UNCOATED	0.030
N69298	REM710-0.625-D5-C030.3-Z4	5/8	5/8	2-1/2	4-5/8	4	TICN	0.030
N72204	REM710-0.625-D6-C030.3-Z4	5/8	5/8	3-1/8	5-1/4	4	UNCOATED	0.030
N79427	REM710-0.625-D6-C030.3-Z4	5/8	5/8	3-1/8	5-1/4	4	TICN	0.030
N71243	REM710-0.750-P2-C030.3-Z4	3/4	5/8	1-5/8	3-3/4	4	UNCOATED	0.030
N69301	REM710-0.750-P2-C030.3-Z4	3/4	5/8	1-5/8	3-3/4	4	TICN	0.030
N72243	REM710-0.750-D1-C030.3-Z4	3/4	3/4	3/4	3	4	UNCOATED	0.030
N69300	REM710-0.750-D1-C030.3-Z4	3/4	3/4	3/4	3	4	TICN	0.030
N71241	REM710-0.750-D2-C030.3-Z4	3/4	3/4	1-1/4	3-1/2	4	UNCOATED	0.030

DISCOUNT CODE D41

REM710 - (CONT.)

M42
8% COBALT

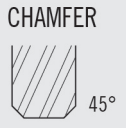

NON
CENTER
CUTTING

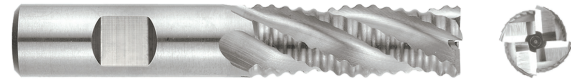

- Weldon flat standard
- Designed for profiling and slotting in all materials

ITEM NUMBER	DESCRIPTION	FLUTE DIA	SHANK DIA	LENGTH OF CUT	OVERALL LENGTH	FLUTES	COATING	CHAMFER
N79429	REM710-0.750-D2-C030.3-Z4	3/4	3/4	1-1/4	3-1/2	4	TICN	0.030
N72241	REM710-0.750-D3-C030.3-Z4	3/4	3/4	1-1/2	3-3/4	4	UNCOATED	0.030
N79430	REM710-0.750-D3-C030.3-Z4	3/4	3/4	1-1/2	3-3/4	4	TICN	0.030
N71244	REM710-0.750-D4-C030.3-Z4	3/4	3/4	1-5/8	3-7/8	4	UNCOATED	0.030
N71245	REM710-0.750-D4-C030.3-Z4	3/4	3/4	1-5/8	3-7/8	4	TICN	0.030
N71247	REM710-0.750-D5-C030.3-Z4	3/4	3/4	2	4-1/4	4	UNCOATED	0.030
N79431	REM710-0.750-D5-C030.3-Z4	3/4	3/4	2	4-1/4	4	TICN	0.030
N72245	REM710-0.750-D6-C030.3-Z4	3/4	3/4	2-1/2	4-3/4	4	UNCOATED	0.030
N79432	REM710-0.750-D6-C030.3-Z4	3/4	3/4	2-1/2	4-3/4	4	TICN	0.030
N72244	REM710-0.750-D7-C030.3-Z4	3/4	3/4	3	5-1/4	4	UNCOATED	0.030
N69299	REM710-0.750-D7-C030.3-Z4	3/4	3/4	3	5-1/4	4	TICN	0.030
N72248	REM710-0.750-D8-C030.3-Z4	3/4	3/4	4-1/8	6-3/8	4	UNCOATED	0.030
N79433	REM710-0.750-D8-C030.3-Z4	3/4	3/4	4-1/8	6-3/8	4	TICN	0.030
N72284	REM710-0.875-P3-C030.3-Z5	7/8	3/4	1-7/8	4-1/8	5	UNCOATED	0.030
N69302	REM710-0.875-P3-C030.3-Z5	7/8	3/4	1-7/8	4-1/8	5	TICN	0.030
N71283	REM710-0.875-P4-C030.3-Z5	7/8	3/4	3-1/2	5-3/4	5	UNCOATED	0.030
N69303	REM710-0.875-P4-C030.3-Z5	7/8	3/4	3-1/2	5-3/4	5	TICN	0.030
N71284	REM710-0.875-D2-C030.3-Z5	7/8	7/8	1-7/8	4-1/8	5	UNCOATED	0.030
N69304	REM710-0.875-D2-C030.3-Z5	7/8	7/8	1-7/8	4-1/8	5	TICN	0.030
N71285	REM710-0.875-D4-C030.3-Z5	7/8	7/8	3-1/2	5-3/4	5	UNCOATED	0.030
N69305	REM710-0.875-D4-C030.3-Z5	7/8	7/8	3-1/2	5-3/4	5	TICN	0.030
N71324	REM710-1.000-P1-C030.3-Z5	1	3/4	3/4	3	5	UNCOATED	0.030
N69310	REM710-1.000-P1-C030.3-Z5	1	3/4	3/4	3	5	TICN	0.030
N72324	REM710-1.000-P3-C030.3-Z5	1	3/4	1-1/2	3-3/4	5	UNCOATED	0.030
N69309	REM710-1.000-P3-C030.3-Z5	1	3/4	1-1/2	3-3/4	5	TICN	0.030
N71330	REM710-1.000-P4-C030.3-Z5	1	3/4	2	4-1/4	5	UNCOATED	0.030
N79439	REM710-1.000-P4-C030.3-Z5	1	3/4	2	4-1/4	5	TICN	0.030
N71326	REM710-1.000-D3-C030.3-Z5	1	1	2	4-1/2	5	UNCOATED	0.030
N71329	REM710-1.000-D3-C030.3-Z5	1	1	2	4-1/2	5	TICN	0.030
N71327	REM710-1.000-D4-C030.3-Z5	1	1	3	5-1/2	5	UNCOATED	0.030
N69306	REM710-1.000-D4-C030.3-Z5	1	1	3	5-1/2	5	TICN	0.030
N72326	REM710-1.000-D5-C030.3-Z5	1	1	4	6-1/2	5	UNCOATED	0.030
N69307	REM710-1.000-D5-C030.3-Z5	1	1	4	6-1/2	5	TICN	0.030
N72327	REM710-1.000-D6-C030.3-Z5	1	1	6	8-1/2	5	UNCOATED	0.030
N69308	REM710-1.000-D6-C030.3-Z5	1	1	6	8-1/2	5	TICN	0.030
N71366	REM710-1.125-P3-C040.3-Z6	1-1/8	1	2	4-1/2	6	UNCOATED	0.040
N69311	REM710-1.125-P3-C040.3-Z6	1-1/8	1	2	4-1/2	6	TICN	0.040
N71367	REM710-1.125-P4-C040.3-Z6	1-1/8	1	3-1/2	6	6	UNCOATED	0.040
N79446	REM710-1.125-P4-C040.3-Z6	1-1/8	1	3-1/2	6	6	TICN	0.040
N71404	REM710-1.250-P1-C040.3-Z6	1-1/4	3/4	3/4	3	6	UNCOATED	0.040
N69317	REM710-1.250-P1-C040.3-Z6	1-1/4	3/4	3/4	3	6	TICN	0.040
N72404	REM710-1.250-P3-C040.3-Z6	1-1/4	3/4	1-1/2	3-3/4	6	UNCOATED	0.040
N69316	REM710-1.250-P3-C040.3-Z6	1-1/4	3/4	1-1/2	3-3/4	6	TICN	0.040
N71406	REM710-1.250-P4-C040.3-Z6	1-1/4	3/4	2	4-1/4	6	UNCOATED	0.040
N79448	REM710-1.250-P4-C040.3-Z6	1-1/4	3/4	2	4-1/4	6	TICN	0.040

REM710 (CONT.)

M42
8% COBALT

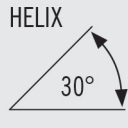

NON
CENTER
CUTTING



- Weldon flat standard
- Designed for profiling and slotting in all materials

ITEM NUMBER	DESCRIPTION	FLUTE DIA	SHANK DIA	LENGTH OF CUT	OVERALL LENGTH	FLUTES	COATING	CHAMFER
N71407	REM710-1.250-D2-C040.3-Z6	1-1/4	1-1/4	2	4-1/2	6	UNCOATED	0.040
N69312	REM710-1.250-D2-C040.3-Z6	1-1/4	1-1/4	2	4-1/2	6	TICN	0.040
N71408	REM710-1.250-D3-C040.3-Z6	1-1/4	1-1/4	3	5-1/2	6	UNCOATED	0.040
N69313	REM710-1.250-D3-C040.3-Z6	1-1/4	1-1/4	3	5-1/2	6	TICN	0.040
N72407	REM710-1.250-D4-C040.3-Z6	1-1/4	1-1/4	4	6-1/2	6	UNCOATED	0.040
N69314	REM710-1.250-D4-C040.3-Z6	1-1/4	1-1/4	4	6-1/2	6	TICN	0.040
N72408	REM710-1.250-D5-C040.3-Z6	1-1/4	1-1/4	6	8-1/2	6	UNCOATED	0.040
N69315	REM710-1.250-D5-C040.3-Z6	1-1/4	1-1/4	6	8-1/2	6	TICN	0.040
N72484	REM710-1.500-P3-C040.3-Z6	1-1/2	3/4	1-1/2	3-3/4	6	UNCOATED	0.040
N69324	REM710-1.500-P3-C040.3-Z6	1-1/2	3/4	1-1/2	3-3/4	6	TICN	0.040
N72485	REM710-1.500-P4-C040.3-Z6	1-1/2	3/4	2	4-1/4	6	UNCOATED	0.040
N79453	REM710-1.500-P4-C040.3-Z6	1-1/2	3/4	2	4-1/4	6	TICN	0.040
N71487	REM710-1.500-P5-C040.3-Z6	1-1/2	1-1/4	2	4-1/2	6	UNCOATED	0.040
N69318	REM710-1.500-P5-C040.3-Z6	1-1/2	1-1/4	2	4-1/2	6	TICN	0.040
N71488	REM710-1.500-P6-C040.3-Z6	1-1/2	1-1/4	3	5-1/2	6	UNCOATED	0.040
N69319	REM710-1.500-P6-C040.3-Z6	1-1/2	1-1/4	3	5-1/2	6	TICN	0.040
N72487	REM710-1.500-P7-C040.3-Z6	1-1/2	1-1/4	4	6-1/2	6	UNCOATED	0.040
N69320	REM710-1.500-P7-C040.3-Z6	1-1/2	1-1/4	4	6-1/2	6	TICN	0.040
N72488	REM710-1.500-P8-C040.3-Z6	1-1/2	1-1/4	5	7-1/2	6	UNCOATED	0.040
N69321	REM710-1.500-P8-C040.3-Z6	1-1/2	1-1/4	5	7-1/2	6	TICN	0.040
N71489	REM710-1.500-P9-C040.3-Z6	1-1/2	1-1/4	6	8-1/2	6	UNCOATED	0.040
N69322	REM710-1.500-P9-C040.3-Z6	1-1/2	1-1/4	6	8-1/2	6	TICN	0.040
N72489	REM710-1.500-P10-C040.3-Z6	1-1/2	1-1/4	8	10-1/2	6	UNCOATED	0.040
N69323	REM710-1.500-P10-C040.3-Z6	1-1/2	1-1/4	8	10-1/2	6	TICN	0.040
N72574	REM710-1.750-P5-C040.3-Z6	1-3/4	1-1/4	4	6-1/2	6	UNCOATED	0.040
N69328	REM710-1.750-P5-C040.3-Z6	1-3/4	1-1/4	4	6-1/2	6	TICN	0.040
N71640	REM710-2.000-P2-C040.3-Z8	2	3/4	1-1/8	3-3/8	8	UNCOATED	0.040
N79456	REM710-2.000-P2-C040.3-Z8	2	3/4	1-1/8	3-3/8	8	TICN	0.040
N71645	REM710-2.000-P4-C040.3-Z8	2	1-1/4	2	4-1/2	8	UNCOATED	0.040
N69331	REM710-2.000-P4-C040.3-Z8	2	1-1/4	2	4-1/2	8	TICN	0.040
N71363	REM710-2.000-D5-C040.7-Z8	2	2	6	9-3/4	8	UNCOATED	0.040
N69337	REM710-2.000-D5-C040.7-Z8	2	2	6	9-3/4	8	TICN	0.040
N71383	REM710-2.000-D7-C040.7-Z8	2	2	8	11-3/4	8	UNCOATED	0.040
N69339	REM710-2.000-D7-C040.7-Z8	2	2	8	11-3/4	8	TICN	0.040

REC700

M42
8% COBALT

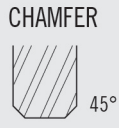
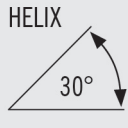

CENTER
CUTTING



COARSE
PITCH



- Weldon flat standard
- Designed for profiling and slotting in all materials

ITEM NUMBER	DESCRIPTION	FLUTE DIA	SHANK DIA	LENGTH OF CUT	OVERALL LENGTH	FLUTES	COATING	CHAMFER
N70013	REC700-0.188-F3-C020.3-Z4	3/16	3/8	1/2	2-3/8	4	UNCOATED	0.020
N88861	REC700-0.188-F3-C020.3-Z4	3/16	3/8	1/2	2-3/8	4	TICN	0.020
N70210	REC700-0.250-F2-C020.3-Z4	1/4	3/8	3/8	2-3/16	4	UNCOATED	0.020
N70212	REC700-0.250-F2-C020.3-Z4	1/4	3/8	3/8	2-3/16	4	TICN	0.020
N70015	REC700-0.250-F3-C020.3-Z4	1/4	3/8	5/8	2-7/16	4	UNCOATED	0.020
N88862	REC700-0.250-F3-C020.3-Z4	1/4	3/8	5/8	2-7/16	4	TICN	0.020
N70017	REC700-0.250-F5-C020.3-Z4	1/4	3/8	1-1/4	3-1/16	4	UNCOATED	0.020
N88863	REC700-0.250-F5-C020.3-Z4	1/4	3/8	1-1/4	3-1/16	4	TICN	0.020
N70019	REC700-0.313-F2-C025.3-Z4	5/16	3/8	3/4	2-1/2	4	UNCOATED	0.025
N88864	REC700-0.313-F2-C025.3-Z4	5/16	3/8	3/4	2-1/2	4	TICN	0.025
N70023	REC700-0.375-D2-C025.3-Z4	3/8	3/8	3/4	2-1/2	4	UNCOATED	0.025
N88866	REC700-0.375-D2-C025.3-Z4	3/8	3/8	3/4	2-1/2	4	TICN	0.025
N70025	REC700-0.375-D4-C025.3-Z4	3/8	3/8	1-1/2	3-1/4	4	UNCOATED	0.025
N88867	REC700-0.375-D4-C025.3-Z4	3/8	3/8	1-1/2	3-1/4	4	TICN	0.025
N70027	REC700-0.438-P2-C025.3-Z4	7/16	3/8	1	2-11/16	4	UNCOATED	0.025
N88868	REC700-0.438-P2-C025.3-Z4	7/16	3/8	1	2-11/16	4	TICN	0.025
N70216	REC700-0.500-D1-C025.3-Z4	1/2	1/2	5/8	2-5/8	4	UNCOATED	0.025
N70218	REC700-0.500-D1-C025.3-Z4	1/2	1/2	5/8	2-5/8	4	TICN	0.025
N70129	REC700-0.500-D2-C025.3-Z4	1/2	1/2	1	3	4	UNCOATED	0.025
N88869	REC700-0.500-D2-C025.3-Z4	1/2	1/2	1	3	4	TICN	0.025
N70031	REC700-0.500-D3-C025.3-Z4	1/2	1/2	1-1/4	3-1/4	4	UNCOATED	0.025
N88870	REC700-0.500-D3-C025.3-Z4	1/2	1/2	1-1/4	3-1/4	4	TICN	0.025
N70033	REC700-0.500-D4-C025.3-Z4	1/2	1/2	1-5/8	3-5/8	4	UNCOATED	0.025
N79526	REC700-0.500-D4-C025.3-Z4	1/2	1/2	1-5/8	3-5/8	4	TICN	0.025
N70035	REC700-0.500-D5-C025.3-Z4	1/2	1/2	2	4	4	UNCOATED	0.025
N88871	REC700-0.500-D5-C025.3-Z4	1/2	1/2	2	4	4	TICN	0.025
N70137	REC700-0.500-D6-C025.3-Z4	1/2	1/2	2-1/2	4-1/2	4	UNCOATED	0.025
N79527	REC700-0.500-D6-C025.3-Z4	1/2	1/2	2-1/2	4-1/2	4	TICN	0.025
N70139	REC700-0.500-D7-C025.3-Z4	1/2	1/2	3	5	4	UNCOATED	0.025
N79528	REC700-0.500-D7-C025.3-Z4	1/2	1/2	3	5	4	TICN	0.025
N70037	REC700-0.563-P2-C025.3-Z4	9/16	1/2	1-3/8	3-3/8	4	UNCOATED	0.025
N88872	REC700-0.563-P2-C025.3-Z4	9/16	1/2	1-3/8	3-3/8	4	TICN	0.025
N70029	REC700-0.625-D3-C030.3-Z4	5/8	5/8	1-1/4	3-3/8	4	UNCOATED	0.030
N79530	REC700-0.625-D3-C030.3-Z4	5/8	5/8	1-1/4	3-3/8	4	TICN	0.030
N70039	REC700-0.625-D4-C030.3-Z4	5/8	5/8	1-5/8	3-3/4	4	UNCOATED	0.030
N88873	REC700-0.625-D4-C030.3-Z4	5/8	5/8	1-5/8	3-3/4	4	TICN	0.030
N70043	REC700-0.625-D6-C030.3-Z4	5/8	5/8	2-1/2	4-5/8	4	UNCOATED	0.030
N88874	REC700-0.625-D6-C030.3-Z4	5/8	5/8	2-1/2	4-5/8	4	TICN	0.030
N70045	REC700-0.625-D7-C030.3-Z4	5/8	5/8	3-1/8	5-1/4	4	UNCOATED	0.030
N79532	REC700-0.625-D7-C030.3-Z4	5/8	5/8	3-1/8	5-1/4	4	TICN	0.030
N70049	REC700-0.750-D1-C030.3-Z4	3/4	3/4	3/4	3	4	UNCOATED	0.030
N88876	REC700-0.750-D1-C030.3-Z4	3/4	3/4	3/4	3	4	TICN	0.030
N70151	REC700-0.750-D2-C030.3-Z4	3/4	3/4	1-1/4	3-1/2	4	UNCOATED	0.030
N79534	REC700-0.750-D2-C030.3-Z4	3/4	3/4	1-1/4	3-1/2	4	TICN	0.030
N70153	REC700-0.750-D3-C030.3-Z4	3/4	3/4	1-1/2	3-3/4	4	UNCOATED	0.030
N79535	REC700-0.750-D3-C030.3-Z4	3/4	3/4	1-1/2	3-3/4	4	TICN	0.030
N70047	REC700-0.750-D4-C030.3-Z4	3/4	3/4	1-5/8	3-7/8	4	UNCOATED	0.030

REC700 (CONT.)

M42 8% COBALT	HELIX  30°	CHAMFER  45°	CENTER CUTTING	COARSE PITCH 	
-------------------------	---	---	-----------------------	--	--

- Weldon flat standard
- Designed for profiling and slotting in all materials

ITEM NUMBER	DESCRIPTION	FLUTE DIA	SHANK DIA	LENGTH OF CUT	OVERALL LENGTH	FLUTES	COATING	CHAMFER
N88875	REC700-0.750-D4-C030.3-Z4	3/4	3/4	1-5/8	3-7/8	4	TICN	0.030
N70149	REC700-0.750-D5-C030.3-Z4	3/4	3/4	2	4-1/4	4	UNCOATED	0.030
N79536	REC700-0.750-D5-C030.3-Z4	3/4	3/4	2	4-1/4	4	TICN	0.030
N70155	REC700-0.750-D6-C030.3-Z4	3/4	3/4	2-1/2	4-3/4	4	UNCOATED	0.030
N79537	REC700-0.750-D6-C030.3-Z4	3/4	3/4	2-1/2	4-3/4	4	TICN	0.030
N70051	REC700-0.750-D7-C030.3-Z4	3/4	3/4	3	5-1/4	4	UNCOATED	0.030
N88877	REC700-0.750-D7-C030.3-Z4	3/4	3/4	3	5-1/4	4	TICN	0.030
N70157	REC700-0.750-D8-C030.3-Z4	3/4	3/4	4-1/8	6-3/8	4	UNCOATED	0.030
N79538	REC700-0.750-D8-C030.3-Z4	3/4	3/4	4-1/8	6-3/8	4	TICN	0.030
N70055	REC700-0.875-P3-C030.3-Z5	7/8	3/4	1-7/8	4-1/8	5	UNCOATED	0.030
N88879	REC700-0.875-P3-C030.3-Z5	7/8	3/4	1-7/8	4-1/8	5	TICN	0.030
N70059	REC700-0.875-P4-C030.3-Z5	7/8	3/4	3-1/2	5-3/4	5	UNCOATED	0.030
N88880	REC700-0.875-P4-C030.3-Z5	7/8	3/4	3-1/2	5-3/4	5	TICN	0.030

EXCEL SERIES-EXR350

PREMIUM PARTICLE METAL
8.5% COBALT



CENTER CUTTING

FINE PITCH



- Weldon flat standard
- Designed for pocketing, profiling and slotting applications

ITEM NUMBER	DESCRIPTION	FLUTE DIA	SHANK DIA	LENGTH OF CUT	OVERALL LENGTH	FLUTES	COATING	CHAMFER
N53911	EXR350-0.375-D2-C025.3-Z4	3/8	3/8	3/4	2-1/2	4	TIALN	0.025
N53912	EXR350-0.375-D4-C025.3-Z4	3/8	3/8	1-1/2	3-1/4	4	TIALN	0.025
N53913	EXR350-0.500-D1-C025.3-Z4	1/2	1/2	1/2	2-1/2	4	TIALN	0.025
N53914	EXR350-0.500-D3-C025.3-Z4	1/2	1/2	1-1/4	3-1/4	4	TIALN	0.025
N53915	EXR350-0.500-D4-C025.3-Z4	1/2	1/2	2	4	4	TIALN	0.025
N53917	EXR350-0.625-D3-C030.3-Z4	5/8	5/8	1-5/8	3-3/4	4	TIALN	0.030
N53920	EXR350-0.750-D2-C030.3-Z4	3/4	3/4	1-5/8	3-1/2	4	TIALN	0.030
N53921	EXR350-0.750-D4-C030.3-Z4	3/4	3/4	3	5-1/4	4	TIALN	0.030
N53922	EXR350-1.000-D1-C030.3-Z5	1	1	1	3-1/2	5	TIALN	0.030
N53923	EXR350-1.000-D2-C030.3-Z5	1	1	2	4-1/2	5	TIALN	0.030
N53924	EXR350-1.000-D3-C030.3-Z5	1	1	3	5-1/2	5	TIALN	0.030
N53925	EXR350-1.000-D4-C030.3-Z5	1	1	4	6-1/2	5	TIALN	0.030

REM445

M42
8% COBALT

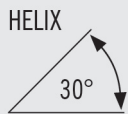

NON CENTER CUTTING

FINE PITCH



- Weldon flat standard
- Designed for profiling and slotting in all materials including high temperature alloys

ITEM NUMBER	DESCRIPTION	FLUTE DIA	SHANK DIA	LENGTH OF CUT	OVERALL LENGTH	FLUTES	COATING	CHAMFER
N44501	REM445-0.188-F3-C020.3-Z4	3/16	3/8	1/2	2-3/8	4	UNCOATED	0.020
N75655	REM445-0.188-F3-C020.3-Z4	3/16	3/8	1/2	2-3/8	4	TIALN	0.020
N44503	REM445-0.250-F3-C020.3-Z4	1/4	3/8	5/8	2-7/16	4	UNCOATED	0.020
N75656	REM445-0.250-F3-C020.3-Z4	1/4	3/8	5/8	2-7/16	4	TIALN	0.020
N44505	REM445-0.250-F5-C020.3-Z4	1/4	3/8	1-1/4	3-1/16	4	UNCOATED	0.020
N75657	REM445-0.250-F5-C020.3-Z4	1/4	3/8	1-1/4	3-1/16	4	TIALN	0.020
N44507	REM445-0.313-F2-C025.3-Z4	5/16	3/8	3/4	2-1/2	4	UNCOATED	0.025
N75658	REM445-0.313-F2-C025.3-Z4	5/16	3/8	3/4	2-1/2	4	TIALN	0.025
N44509	REM445-0.313-F4-C025.3-Z4	5/16	3/8	1-3/8	3-1/8	4	UNCOATED	0.025
N75659	REM445-0.313-F4-C025.3-Z4	5/16	3/8	1-3/8	3-1/8	4	TIALN	0.025
N44511	REM445-0.375-D2-C025.3-Z4	3/8	3/8	3/4	2-1/2	4	UNCOATED	0.025
N75660	REM445-0.375-D2-C025.3-Z4	3/8	3/8	3/4	2-1/2	4	TIALN	0.025
N44513	REM445-0.375-D4-C025.3-Z4	3/8	3/8	1-1/2	3-1/4	4	UNCOATED	0.025
N75661	REM445-0.375-D4-C025.3-Z4	3/8	3/8	1-1/2	3-1/4	4	TIALN	0.025
N44515	REM445-0.438-P2-C025.3-Z4	7/16	3/8	1	2-11/16	4	UNCOATED	0.025

REM445 (CONT.)

M42
8% COBALT

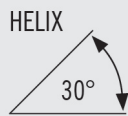

NON
CENTER
CUTTING

FINE PITCH





- Weldon flat standard
- Designed for profiling and slotting in all materials including high temperature alloys

ITEM NUMBER	DESCRIPTION	FLUTE DIA	SHANK DIA	LENGTH OF CUT	OVERALL LENGTH	FLUTES	COATING	CHAMFER
N75662	REM445-0.438-P2-C025.3-Z4	7/16	3/8	1	2-11/16	4	TIALN	0.025
N45415	REM445-0.500-D2-C025.3-Z4	1/2	1/2	1	3	4	UNCOATED	0.025
N75663	REM445-0.500-D2-C025.3-Z4	1/2	1/2	1	3	4	TIALN	0.025
N44517	REM445-0.500-D3-C025.3-Z4	1/2	1/2	1-1/4	3-1/4	4	UNCOATED	0.025
N75664	REM445-0.500-D3-C025.3-Z4	1/2	1/2	1-1/4	3-1/4	4	TIALN	0.025
N45417	REM445-0.500-D5-C025.3-Z4	1/2	1/2	1-5/8	3-5/8	4	UNCOATED	0.025
N75665	REM445-0.500-D5-C025.3-Z4	1/2	1/2	1-5/8	3-5/8	4	TIALN	0.025
N44519	REM445-0.500-D4-C025.3-Z4	1/2	1/2	2	4	4	UNCOATED	0.025
N75666	REM445-0.500-D4-C025.3-Z4	1/2	1/2	2	4	4	TIALN	0.025
N45419	REM445-0.500-D6-C025.3-Z4	1/2	1/2	2-1/2	4-1/2	4	UNCOATED	0.025
N75667	REM445-0.500-D6-C025.3-Z4	1/2	1/2	2-1/2	4-1/2	4	TIALN	0.025
N45421	REM445-0.500-D7-C025.3-Z4	1/2	1/2	3	5	4	UNCOATED	0.025
N75668	REM445-0.500-D7-C025.3-Z4	1/2	1/2	3	5	4	TIALN	0.025
N45423	REM445-0.625-D1-C030.3-Z4	5/8	5/8	3/4	2-7/8	4	UNCOATED	0.030
N75670	REM445-0.625-D1-C030.3-Z4	5/8	5/8	3/4	2-7/8	4	TIALN	0.030
N45425	REM445-0.625-D2-C030.3-Z4	5/8	5/8	1-1/4	3-3/8	4	UNCOATED	0.030
N75671	REM445-0.625-D2-C030.3-Z4	5/8	5/8	1-1/4	3-3/8	4	TIALN	0.030
N44523	REM445-0.625-D3-C030.3-Z4	5/8	5/8	1-5/8	3-3/4	4	UNCOATED	0.030
N75672	REM445-0.625-D3-C030.3-Z4	5/8	5/8	1-5/8	3-3/4	4	TIALN	0.030
N45427	REM445-0.625-D5-C030.3-Z4	5/8	5/8	2-1/8	4-1/4	4	UNCOATED	0.030
N75673	REM445-0.625-D5-C030.3-Z4	5/8	5/8	2-1/8	4-1/4	4	TIALN	0.030
N44525	REM445-0.625-D4-C030.3-Z4	5/8	5/8	2-1/2	4-5/8	4	UNCOATED	0.030
N75674	REM445-0.625-D4-C030.3-Z4	5/8	5/8	2-1/2	4-5/8	4	TIALN	0.030
N45429	REM445-0.625-D6-C030.3-Z4	5/8	5/8	3-1/8	5-1/4	4	UNCOATED	0.030
N75675	REM445-0.625-D6-C030.3-Z4	5/8	5/8	3-1/8	5-1/4	4	TIALN	0.030
N44531	REM445-0.750-D1-C030.3-Z4	3/4	3/4	3/4	3	4	UNCOATED	0.030
N75678	REM445-0.750-D1-C030.3-Z4	3/4	3/4	3/4	3	4	TIALN	0.030
N45433	REM445-0.750-D2-C030.3-Z4	3/4	3/4	1-1/4	3-1/2	4	UNCOATED	0.030
N75679	REM445-0.750-D2-C030.3-Z4	3/4	3/4	1-1/4	3-1/2	4	TIALN	0.030
N45435	REM445-0.750-D3-C030.3-Z4	3/4	3/4	1-1/2	3-3/4	4	UNCOATED	0.030
N75680	REM445-0.750-D3-C030.3-Z4	3/4	3/4	1-1/2	3-3/4	4	TIALN	0.030
N44527	REM445-0.750-D4-C030.3-Z4	3/4	3/4	1-5/8	3-7/8	4	UNCOATED	0.030
N75681	REM445-0.750-D4-C030.3-Z4	3/4	3/4	1-5/8	3-7/8	4	TIALN	0.030
N45437	REM445-0.750-D5-C030.3-Z4	3/4	3/4	2	4-1/4	4	UNCOATED	0.030
N75682	REM445-0.750-D5-C030.3-Z4	3/4	3/4	2	4-1/4	4	TIALN	0.030
N45439	REM445-0.750-D6-C030.3-Z4	3/4	3/4	2-1/2	4-3/4	4	UNCOATED	0.030
N75683	REM445-0.750-D6-C030.3-Z4	3/4	3/4	2-1/2	4-3/4	4	TIALN	0.030
N44529	REM445-0.750-D7-C030.3-Z4	3/4	3/4	3	5-1/4	4	UNCOATED	0.030
N75684	REM445-0.750-D7-C030.3-Z4	3/4	3/4	3	5-1/4	4	TIALN	0.030
N45441	REM445-0.750-D8-C030.3-Z4	3/4	3/4	4-1/8	6-3/8	4	UNCOATED	0.030
N75685	REM445-0.750-D8-C030.3-Z4	3/4	3/4	4-1/8	6-3/8	4	TIALN	0.030
N44551	REM445-1.000-P3-C030.3-Z5	1	3/4	1-1/2	3-3/4	5	UNCOATED	0.030

REM445 (CONT.)

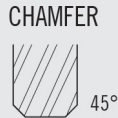
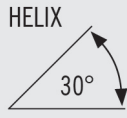
M42
8% COBALT



NON
CENTER
CUTTING

FINE PITCH



- Weldon flat standard
- Designed for profiling and slotting in all materials including high temperature alloys

ITEM NUMBER	DESCRIPTION	FLUTE DIA	SHANK DIA	LENGTH OF CUT	OVERALL LENGTH	FLUTES	COATING	CHAMFER
N75696	REM445-1.000-P3-C030.3-Z5	1	3/4	1-1/2	3-3/4	5	TIALN	0.030
N45453	REM445-1.000-P4-C030.3-Z5	1	3/4	2	4-1/4	5	UNCOATED	0.030
N75697	REM445-1.000-P4-C030.3-Z5	1	3/4	2	4-1/4	5	TIALN	0.030
N45459	REM445-1.000-D1-C030.3-Z5	1	1	1-1/8	3-5/8	5	UNCOATED	0.030
N75700	REM445-1.000-D1-C030.3-Z5	1	1	1-1/8	3-5/8	5	TIALN	0.030
N44543	REM445-1.000-D3-C030.3-Z5	1	1	2	4-1/2	5	UNCOATED	0.030
N75702	REM445-1.000-D3-C030.3-Z5	1	1	2	4-1/2	5	TIALN	0.030
N44545	REM445-1.000-D4-C030.3-Z5	1	1	3	5-1/2	5	UNCOATED	0.030
N75703	REM445-1.000-D4-C030.3-Z5	1	1	3	5-1/2	5	TIALN	0.030
N44547	REM445-1.000-D5-C030.3-Z5	1	1	4	6-1/2	5	UNCOATED	0.030
N75704	REM445-1.000-D5-C030.3-Z5	1	1	4	6-1/2	5	TIALN	0.030
N44549	REM445-1.000-D6-C030.3-Z5	1	1	6	8-1/2	5	UNCOATED	0.030
N75705	REM445-1.000-D6-C030.3-Z5	1	1	6	8-1/2	5	TIALN	0.030
N44557	REM445-1.250-D2-C040.3-Z6	1-1/4	1-1/4	2	4-1/2	6	UNCOATED	0.040
N75715	REM445-1.250-D2-C040.3-Z6	1-1/4	1-1/4	2	4-1/2	6	TIALN	0.040
N44559	REM445-1.250-D3-C040.3-Z6	1-1/4	1-1/4	3	5-1/2	6	UNCOATED	0.040
N75716	REM445-1.250-D3-C040.3-Z6	1-1/4	1-1/4	3	5-1/2	6	TIALN	0.040
N44561	REM445-1.250-D4-C040.3-Z6	1-1/4	1-1/4	4	6-1/2	6	UNCOATED	0.040
N75717	REM445-1.250-D4-C040.3-Z6	1-1/4	1-1/4	4	6-1/2	6	TIALN	0.040
N44563	REM445-1.250-D5-C040.3-Z6	1-1/4	1-1/4	6	8-1/2	6	UNCOATED	0.040
N75718	REM445-1.250-D5-C040.3-Z6	1-1/4	1-1/4	6	8-1/2	6	TIALN	0.040
N44569	REM445-1.500-P5-C040.3-Z6	1-1/2	1-1/4	2	4-1/2	6	UNCOATED	0.040
N75725	REM445-1.500-P5-C040.3-Z6	1-1/2	1-1/4	2	4-1/2	6	TIALN	0.040
N44599	REM445-2.000-D3-C040.7-Z8	2	2	4	7-3/4	8	UNCOATED	0.040
N75745	REM445-2.000-D3-C040.7-Z8	2	2	4	7-3/4	8	TIALN	0.040
N44603	REM445-2.000-D5-C040.7-Z8	2	2	6	9-3/4	8	UNCOATED	0.040
N75747	REM445-2.000-D5-C040.7-Z8	2	2	6	9-3/4	8	TIALN	0.040

REC448

M42
8% COBALT

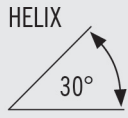

CENTER CUTTING

FINE PITCH



- Weldon flat standard
- Designed for profiling and slotting in all materials including high temperature alloys

ITEM NUMBER	DESCRIPTION	FLUTE DIA	SHANK DIA	LENGTH OF CUT	OVERALL LENGTH	FLUTES	COATING	CHAMFER
N44839	REC448-0.188-F3-C020.3-Z4	3/16	3/8	1/2	2-3/8	4	UNCOATED	0.020
N14554	REC448-0.188-F3-C020.3-Z4	3/16	3/8	1/2	2-3/8	4	TIALN	0.020
N44841	REC448-0.250-F3-C020.3-Z4	1/4	3/8	5/8	2-7/16	4	UNCOATED	0.020
N14555	REC448-0.250-F3-C020.3-Z4	1/4	3/8	5/8	2-7/16	4	TIALN	0.020
N44843	REC448-0.250-F5-C020.3-Z4	1/4	3/8	1-1/4	3-1/16	4	UNCOATED	0.020
N14556	REC448-0.250-F5-C020.3-Z4	1/4	3/8	1-1/4	3-1/16	4	TIALN	0.020
N44845	REC448-0.313-F2-C025.3-Z4	5/16	3/8	3/4	2-1/2	4	UNCOATED	0.025
N14558	REC448-0.313-F2-C025.3-Z4	5/16	3/8	3/4	2-1/2	4	TIALN	0.025
N44873	REC448-0.375-D1-C025.3-Z4	3/8	3/8	1/2	2-1/4	4	UNCOATED	0.025
N14560	REC448-0.375-D1-C025.3-Z4	3/8	3/8	1/2	2-1/4	4	TIALN	0.025
N44849	REC448-0.375-D2-C025.3-Z4	3/8	3/8	3/4	2-1/2	4	UNCOATED	0.025
N14561	REC448-0.375-D2-C025.3-Z4	3/8	3/8	3/4	2-1/2	4	TIALN	0.025
N44876	REC448-0.500-D1-C025.3-Z4	1/2	1/2	5/8	2-5/8	4	UNCOATED	0.025
N14564	REC448-0.500-D1-C025.3-Z4	1/2	1/2	5/8	2-5/8	4	TIALN	0.025
N44801	REC448-0.500-D3-C025.3-Z4	1/2	1/2	1-1/4	3-1/4	4	UNCOATED	0.025
N14565	REC448-0.500-D3-C025.3-Z4	1/2	1/2	1-1/4	3-1/4	4	TIALN	0.025
N44803	REC448-0.500-D4-C025.3-Z4	1/2	1/2	2	4	4	UNCOATED	0.025
N14566	REC448-0.500-D4-C025.3-Z4	1/2	1/2	2	4	4	TIALN	0.025
N44879	REC448-0.625-D1-C030.3-Z4	5/8	5/8	5/8	2-3/4	4	UNCOATED	0.030
N14568	REC448-0.625-D1-C030.3-Z4	5/8	5/8	5/8	2-3/4	4	TIALN	0.030
N44805	REC448-0.625-D3-C030.3-Z4	5/8	5/8	1-5/8	3-3/4	4	UNCOATED	0.030
N14570	REC448-0.625-D3-C030.3-Z4	5/8	5/8	1-5/8	3-3/4	4	TIALN	0.030
N44807	REC448-0.625-D4-C030.3-Z4	5/8	5/8	2-1/2	4-5/8	4	UNCOATED	0.030
N14571	REC448-0.625-D4-C030.3-Z4	5/8	5/8	2-1/2	4-5/8	4	TIALN	0.030
N44859	REC448-0.750-D1-C030.3-Z4	3/4	3/4	3/4	3	4	UNCOATED	0.030
N14573	REC448-0.750-D1-C030.3-Z4	3/4	3/4	3/4	3	4	TIALN	0.030
N44809	REC448-0.750-D2-C030.3-Z4	3/4	3/4	1-5/8	3-7/8	4	UNCOATED	0.030
N14574	REC448-0.750-D2-C030.3-Z4	3/4	3/4	1-5/8	3-7/8	4	TIALN	0.030
N44811	REC448-0.750-D4-C030.3-Z4	3/4	3/4	3	5-1/4	4	UNCOATED	0.030
N14575	REC448-0.750-D4-C030.3-Z4	3/4	3/4	3	5-1/4	4	TIALN	0.030

SP205 - START VALUES

		SLOTTING													
ISO GROUP	SMG	a _p x D _c (max)	a _e x D _c (max)	v _c (sf / min)		Z _n = 2									
						1/4	3/8	1/2	5/8	3/4	1	1 1/4	1 1/2	1 3/4	2
P	E 1 - 2	1.00	1.00	110	n (rev/min)	1681	1121	840	672	560	420	336	280	240	210
					f _z (in)	0.0011	0.0017	0.0023	0.0028	0.0034	0.0045	0.0056	0.0068	0.0079	0.0090
					v _f (in/min)	4	4	4	4	4	4	4	4	4	4
	E 3 - 4	1.00	1.00	50	n (rev/min)	764	509	382	306	255	191	153	127	109	96
					f _z (in)	0.0009	0.0013	0.0018	0.0022	0.0026	0.0035	0.0044	0.0053	0.0061	0.0070
					v _f (in/min)	1	1	1	1	1	1	1	1	1	1
	E 5 - 6	1.00	1.00	35	n (rev/min)	535	357	267	214	178	134	107	89	76	67
					f _z (in)	0.0009	0.0013	0.0018	0.0022	0.0026	0.0035	0.0044	0.0053	0.0061	0.0070
					v _f (in/min)	1	1	1	1	1	1	1	1	1	1
M	E 8 - 9	1.00	1.00	50	n (rev/min)	764	509	382	306	255	191	153	127	109	96
					f _z (in)	0.0009	0.0013	0.0018	0.0022	0.0026	0.0035	0.0044	0.0053	0.0061	0.0070
					v _f (in/min)	1	1	1	1	1	1	1	1	1	1
	E 10 - 11	1.00	1.00	40	n (rev/min)	611	407	306	244	204	153	122	102	87	76
					f _z (in)	0.0008	0.0011	0.0015	0.0019	0.0023	0.0030	0.0038	0.0045	0.0053	0.0060
					v _f (in/min)	1	1	1	1	1	1	1	1	1	1
K	E 12 - 13	1.00	1.00	50	n (rev/min)	764	509	382	306	255	191	153	127	109	96
					f _z (in)	0.0011	0.0017	0.0023	0.0028	0.0034	0.0045	0.0056	0.0068	0.0079	0.0090
					v _f (in/min)	2	2	2	2	2	2	2	2	2	2
	E 14 - 15	1.00	1.00	40	n (rev/min)	611	407	306	244	204	153	122	102	87	76
					f _z (in)	0.0009	0.0013	0.0018	0.0022	0.0026	0.0035	0.0044	0.0053	0.0061	0.0070
					v _f (in/min)	1	1	1	1	1	1	1	1	1	1
N	E 18	1.00	1.00	240	n (rev/min)	3667	2445	1834	1467	1222	917	733	611	524	458
					f _z (in)	0.0013	0.0019	0.0025	0.0031	0.0038	0.0050	0.0063	0.0075	0.0088	0.0100
					v _f (in/min)	9	9	9	9	9	9	9	9	9	9
S	E 20	1.00	1.00	8	n (rev/min)	122	81	61	49	41	31	24	20	17	15
					f _z (in)	0.0004	0.0006	0.0008	0.0009	0.0011	0.0015	0.0019	0.0023	0.0026	0.0030
					v _f (in/min)	1	1	1	1	1	1	1	1	1	1
	E 21	1.00	1.00	8	n (rev/min)	122	81	61	49	41	31	24	20	17	15
					f _z (in)	0.0006	0.0009	0.0013	0.0016	0.0019	0.0025	0.0031	0.0038	0.0044	0.0050
					v _f (in/min)	1	1	1	1	1	1	1	1	1	1
	E 22	1.00	1.00	40	n (rev/min)	611	407	306	244	204	153	122	102	87	76
					f _z (in)	0.0009	0.0013	0.0018	0.0022	0.0026	0.0035	0.0044	0.0053	0.0061	0.0070
					v _f (in/min)	1	1	1	1	1	1	1	1	1	1

SMG = Seco Material Group
 n [min-1] = RPM
 v_c (sf/min) = Surface feet/min

f_z [in] = Feed/tooth
 a_p/D_c = % of diameter
 v_f [in/min] = Feed rate
 a_e/D_c = % of diameter

A = Air D = Dry E = Emulsion (flood coolant) M = Mist
 All cutting data are start values. All cutting data is in inch values.
 Please reference the Workpiece Material Classification chart located on page 15.

SP205 - START VALUES

SIDE MILLING - ROUGHING															
ISO GROUP	SMG	a _p x Dc (max)	a _e x Dc (max)	v _c (sf / min)		Z _n = 2									
						1/4	3/8	1/2	5/8	3/4	1	1 1/4	1 1/2	1 3/4	2
P	E 1 - 2	1.50	0.25	160	n (rev/min)	2445	1630	1222	978	815	611	489	407	349	306
					f _z (in)	0.0014	0.0021	0.0028	0.0035	0.0042	0.0056	0.0070	0.0084	0.0098	0.0113
					v _f (in/min)	7	7	7	7	7	7	7	7	7	7
	E 3 - 4	1.50	0.25	80	n (rev/min)	1222	815	611	489	407	306	244	204	175	153
					f _z (in)	0.0011	0.0016	0.0022	0.0027	0.0033	0.0044	0.0055	0.0066	0.0077	0.0088
					v _f (in/min)	3	3	3	3	3	3	3	3	3	3
	E 5 - 6	1.50	0.25	50	n (rev/min)	764	509	382	306	255	191	153	127	109	96
					f _z (in)	0.0011	0.0016	0.0022	0.0027	0.0033	0.0044	0.0055	0.0066	0.0077	0.0088
					v _f (in/min)	2	2	2	2	2	2	2	2	2	2
M	E 8 - 9	1.50	0.25	80	n (rev/min)	1222	815	611	489	407	306	244	204	175	153
					f _z (in)	0.0011	0.0016	0.0022	0.0027	0.0033	0.0044	0.0055	0.0066	0.0077	0.0088
					v _f (in/min)	3	3	3	3	3	3	3	3	3	3
	E 10 - 11	1.50	0.25	60	n (rev/min)	917	611	458	367	306	229	183	153	131	115
					f _z (in)	0.0009	0.0014	0.0019	0.0023	0.0028	0.0038	0.0047	0.0056	0.0066	0.0075
					v _f (in/min)	2	2	2	2	2	2	2	2	2	2
K	E 12 - 13	1.50	0.25	95	n (rev/min)	1452	968	726	581	484	363	290	242	207	181
					f _z (in)	0.0014	0.0021	0.0028	0.0035	0.0042	0.0056	0.0070	0.0084	0.0098	0.0113
					v _f (in/min)	4	4	4	4	4	4	4	4	4	4
	E 14 - 15	1.50	0.25	65	n (rev/min)	993	662	497	397	331	248	199	166	142	124
					f _z (in)	0.0011	0.0016	0.0022	0.0027	0.0033	0.0044	0.0055	0.0066	0.0077	0.0088
					v _f (in/min)	2	2	2	2	2	2	2	2	2	2
N	E 18	1.50	0.25	350	n (rev/min)	5348	3565	2674	2139	1783	1337	1070	891	764	669
					f _z (in)	0.0016	0.0023	0.0031	0.0039	0.0047	0.0063	0.0078	0.0094	0.0109	0.0125
					v _f (in/min)	17	17	17	17	17	17	17	17	17	17
S	E 20	1.50	0.25	10	n (rev/min)	153	102	76	61	51	38	31	25	22	19
					f _z (in)	0.0006	0.0009	0.0013	0.0016	0.0019	0.0025	0.0031	0.0038	0.0044	0.0050
					v _f (in/min)	1	1	1	1	1	1	1	1	1	1
	E 21	1.50	0.25	12	n (rev/min)	183	122	92	73	61	46	37	31	26	23
					f _z (in)	0.0008	0.0012	0.0016	0.0020	0.0023	0.0031	0.0039	0.0047	0.0055	0.0063
					v _f (in/min)	1	1	1	1	1	1	1	1	1	1
	E 22	1.50	0.25	60	n (rev/min)	917	611	458	367	306	229	183	153	131	115
					f _z (in)	0.0011	0.0016	0.0022	0.0027	0.0033	0.0044	0.0055	0.0066	0.0077	0.0088
					v _f (in/min)	2	2	2	2	2	2	2	2	2	2

SMG = Seco Material Group
 n [min-1] = RPM
 v_c (sf/min) = Surface feet/min

f_z [in] = Feed/tooth
 a_p/D_c = % of diameter
 v_f [in/min] = Feed rate
 a_e/D_c = % of diameter

A = Air D = Dry E = Emulsion (flood coolant) M = Mist
 All cutting data are start values. All cutting data is in inch values.
 Please reference the Workpiece Material Classification chart located on page 15.

CUTTING DATA - GENERAL PURPOSE COBALT END MILLS

SPC408 / SPB540 - START VALUES

SLOTTING															
ISO GROUP	SMG	a _p x Dc (max)	a _e x Dc (max)	V _c (sf / min)		Z _n = 4									
						1/4	3/8	1/2	5/8	3/4	1	1 1/4	1 1/2	1 3/4	2
P	E 1 - 2	1.00	1.00	110	n (rev/min)	1681	1121	840	672	560	420	336	280	240	210
					f _z (in)	0.0011	0.0017	0.0023	0.0028	0.0034	0.0045	0.0056	0.0068	0.0079	0.0090
					V _f (in/min)	8	8	7.6	8	8	8	8	8	8	8
	E 3 - 4	1.00	1.00	50	n (rev/min)	764	509	382	306	255	191	153	127	109	96
					f _z (in)	0.0009	0.0013	0.0018	0.0022	0.0026	0.0035	0.0044	0.0053	0.0061	0.0070
					V _f (in/min)	3	3	3	3	3	3	3	3	3	3
	E 5 - 6	1.00	1.00	35	n (rev/min)	535	357	267	214	178	134	107	89	76	67
					f _z (in)	0.0009	0.0013	0.0018	0.0022	0.0026	0.0035	0.0044	0.0053	0.0061	0.0070
					V _f (in/min)	2	2	2	2	2	2	2	2	2	2
M	E 8 - 9	1.00	1.00	50	n (rev/min)	764	509	382	306	255	191	153	127	109	96
					f _z (in)	0.0009	0.0013	0.0018	0.0022	0.0026	0.0035	0.0044	0.0053	0.0061	0.0070
					V _f (in/min)	3	3	3	3	3	3	3	3	3	3
	E 10 - 11	1.00	1.00	40	n (rev/min)	611	407	306	244	204	153	122	102	87	76
					f _z (in)	0.0008	0.0011	0.0015	0.0019	0.0023	0.0030	0.0038	0.0045	0.0053	0.0060
					V _f (in/min)	2	2	2	2	2	2	2	2	2	2
K	E 12 - 13	1.00	1.00	50	n (rev/min)	764	509	382	306	255	191	153	127	109	96
					f _z (in)	0.0011	0.0017	0.0023	0.0028	0.0034	0.0045	0.0056	0.0068	0.0079	0.0090
					V _f (in/min)	3	3	3	3	3	3	3	3	3	3
	E 14 - 15	1.00	1.00	40	n (rev/min)	611	407	306	244	204	153	122	102	87	76
					f _z (in)	0.0009	0.0013	0.0018	0.0022	0.0026	0.0035	0.0044	0.0053	0.0061	0.0070
					V _f (in/min)	2	2	2	2	2	2	2	2	2	2
N	E 18	1.00	1.00	240	n (rev/min)	3667	2445	1834	1467	1222	917	733	611	524	458
					f _z (in)	0.0013	0.0019	0.0025	0.0031	0.0038	0.0050	0.0063	0.0075	0.0088	0.0100
S	E 20	1.00	1.00	8	n (rev/min)	122	81	61	49	41	31	24	20	17	15
					f _z (in)	0.0004	0.0006	0.0008	0.0009	0.0011	0.0015	0.0019	0.0023	0.0026	0.0030
					V _f (in/min)	1	1	1	1	1	1	1	1	1	1
	E 21	1.00	1.00	8	n (rev/min)	122	81	61	49	41	31	24	20	17	15
					f _z (in)	0.0006	0.0009	0.0013	0.0016	0.0019	0.0025	0.0031	0.0038	0.0044	0.0050
					V _f (in/min)	1	1	1	1	1	1	1	1	1	1
	E 22	1.00	1.00	40	n (rev/min)	611	407	306	244	204	153	122	102	87	76
					f _z (in)	0.0009	0.0013	0.0018	0.0022	0.0026	0.0035	0.0044	0.0053	0.0061	0.0070
					V _f (in/min)	2	2	2	2	2	2	2	2	2	2

SMG = Seco Material Group
 n [min-1] = RPM
 V_c (sf/min) = Surface feet/min

f_z [in] = Feed/tooth
 a_p/D_c = % of diameter
 v_f [in/min] = Feed rate
 a_e/D_c = % of diameter

A = Air D = Dry E = Emulsion (flood coolant) M = Mist
 All cutting data are start values. All cutting data is in inch values.
 Please reference the Workpiece Material Classification chart located on page 15.

SPC408 / SPB540 - START VALUES

SIDE MILLING - ROUGHING															
ISO GROUP	SMG	a _p x D _c (max)	a _e x D _c (max)	v _c (sf / min)		Z _n = 4									
						1/4	3/8	1/2	5/8	3/4	1	1 1/4	1 1/2	1 3/4	2
P	E 1 - 2	1.50	0.25	160	n (rev/min)	2445	1630	1222	978	815	611	489	407	349	306
					f _z (in)	0.0014	0.0021	0.0028	0.0035	0.0042	0.0056	0.0070	0.0084	0.0098	0.0113
					v _f (in/min)	14	14	14	14	14	14	14	14	14	14
	E 3 - 4	1.50	0.25	80	n (rev/min)	1222	815	611	489	407	306	244	204	175	153
					f _z (in)	0.0011	0.0016	0.0022	0.0027	0.0033	0.0044	0.0055	0.0066	0.0077	0.0088
					v _f (in/min)	5	5	5	5	5	5	5	5	5	5
	E 5 - 6	1.50	0.25	50	n (rev/min)	764	509	382	306	255	191	153	127	109	96
					f _z (in)	0.0011	0.0016	0.0022	0.0027	0.0033	0.0044	0.0055	0.0066	0.0077	0.0088
					v _f (in/min)	3	3	3	3	3	3	3	3	3	3
M	E 8 - 9	1.50	0.25	80	n (rev/min)	1222	815	611	489	407	306	244	204	175	153
					f _z (in)	0.0011	0.0016	0.0022	0.0027	0.0033	0.0044	0.0055	0.0066	0.0077	0.0088
					v _f (in/min)	5	5	5	5	5	5	5	5	5	5
	E 10 - 11	1.50	0.25	60	n (rev/min)	917	611	458	367	306	229	183	153	131	115
					f _z (in)	0.0009	0.0014	0.0019	0.0023	0.0028	0.0038	0.0047	0.0056	0.0066	0.0075
					v _f (in/min)	3	3	3	3	3	3	3	3	3	3
K	E 12 - 13	1.50	0.25	95	n (rev/min)	1452	968	726	581	484	363	290	242	207	181
					f _z (in)	0.0014	0.0021	0.0028	0.0035	0.0042	0.0056	0.0070	0.0084	0.0098	0.0113
					v _f (in/min)	8	8	8	8	8	8	8	8	8	8
	E 14 - 15	1.50	0.25	65	n (rev/min)	993	662	497	397	331	248	199	166	142	124
					f _z (in)	0.0011	0.0016	0.0022	0.0027	0.0033	0.0044	0.0055	0.0066	0.0077	0.0088
					v _f (in/min)	4	4	4	4	4	4	4	4	4	4
N	E 18	1.50	0.25	350	n (rev/min)	5348	3565	2674	2139	1783	1337	1070	891	764	669
					f _z (in)	0.0016	0.0023	0.0031	0.0039	0.0047	0.0063	0.0078	0.0094	0.0109	0.0125
					v _f (in/min)	33	33	33	33	33	33	33	33	33	33
S	E 20	1.50	0.25	10	n (rev/min)	153	102	76	61	51	38	31	25	22	19
					f _z (in)	0.0006	0.0009	0.0013	0.0016	0.0019	0.0025	0.0031	0.0038	0.0044	0.0050
					v _f (in/min)	1	1	1	1	1	1	1	1	1	1
	E 21	1.50	0.25	12	n (rev/min)	183	122	92	73	61	46	37	31	26	23
					f _z (in)	0.0008	0.0012	0.0016	0.0020	0.0023	0.0031	0.0039	0.0047	0.0055	0.0063
					v _f (in/min)	1	1	1	1	1	1	1	1	1	1
	E 22	1.50	0.25	60	n (rev/min)	917	611	458	367	306	229	183	153	131	115
					f _z (in)	0.0011	0.0016	0.0022	0.0027	0.0033	0.0044	0.0055	0.0066	0.0077	0.0088
					v _f (in/min)	4	4	4	4	4	4	4	4	4	4

SMG = Seco Material Group
 n [min-1] = RPM
 v_c (sf/min) = Surface feet/min

f_z [in] = Feed/tooth
 a_p/D_c = % of diameter
 v_f [in/min] = Feed rate
 a_e/D_c = % of diameter

A = Air D = Dry E = Emulsion (flood coolant) M = Mist
 All cutting data are start values. All cutting data is in inch values.
 Please reference the Workpiece Material Classification chart located on page 15.

SPC408 / SPB540 - START VALUES

SIDE MILLING - ROUGHING															
ISO GROUP	SMG	a _p x Dc (max)	a _e x Dc (max)	v _c (sf / min)		Z _n = 6									
						1/4	3/8	1/2	5/8	3/4	1	1 1/4	1 1/2	1 3/4	2
P	E 1 - 2	1.50	0.25	160	n (rev/min)	2445	1630	1222	978	815	611	489	407	349	306
					f _z (mm)	0.0014	0.0021	0.0028	0.0035	0.0042	0.0056	0.0070	0.0084	0.0098	0.0113
					v _f (m/min)	21	21	21	21	21	21	21	21	21	21
	E 3 - 4	1.50	0.25	80	n (rev/min)	1222	815	611	489	407	306	244	204	175	153
					f _z (mm)	0.0011	0.0016	0.0022	0.0027	0.0033	0.0044	0.0055	0.0066	0.0077	0.0088
					v _f (m/min)	8	8	8	8	8	8	8	8	8	8
	E 5 - 6	1.50	0.25	50	n (rev/min)	764	509	382	306	255	191	153	127	109	96
					f _z (mm)	0.0011	0.0016	0.0022	0.0027	0.0033	0.0044	0.0055	0.0066	0.0077	0.0088
					v _f (m/min)	5	5	5	5	5	5	5	5	5	5
M	E 8 - 9	1.50	0.25	80	n (rev/min)	1222	815	611	489	407	306	244	204	175	153
					f _z (mm)	0.0011	0.0016	0.0022	0.0027	0.0033	0.0044	0.0055	0.0066	0.0077	0.0088
					v _f (m/min)	8	8	8	8	8	8	8	8	8	8
	E 10 - 11	1.50	0.25	60	n (rev/min)	917	611	458	367	306	229	183	153	131	115
					f _z (mm)	0.0009	0.0014	0.0019	0.0023	0.0028	0.0038	0.0047	0.0056	0.0066	0.0075
					v _f (m/min)	5	5	5	5	5	5	5	5	5	5
K	E 12 - 13	1.50	0.25	95	n (rev/min)	1452	968	726	581	484	363	290	242	207	181
					f _z (mm)	0.0014	0.0021	0.0028	0.0035	0.0042	0.0056	0.0070	0.0084	0.0098	0.0113
					v _f (m/min)	12	12	12	12	12	12	12	12	12	12
	E 14 - 15	1.50	0.25	65	n (rev/min)	993	662	497	397	331	248	199	166	142	124
					f _z (mm)	0.0011	0.0016	0.0022	0.0027	0.0033	0.0044	0.0055	0.0066	0.0077	0.0088
					v _f (m/min)	7	7	7	7	7	7	7	7	7	7
N	E 18	1.50	0.25	350	n (rev/min)	5348	3565	2674	2139	1783	1337	1070	891	764	669
					f _z (mm)	0.0016	0.0023	0.0031	0.0039	0.0047	0.0063	0.0078	0.0094	0.0109	0.0125
					v _f (m/min)	50	50	50	50	50	50	50	50	50	50
S	E 20	1.50	0.25	10	n (rev/min)	153	102	76	61	51	38	31	25	22	19
					f _z (mm)	0.0006	0.0009	0.0013	0.0016	0.0019	0.0025	0.0031	0.0038	0.0044	0.0050
					v _f (m/min)	1	1	1	1	1	1	1	1	1	1
	E 21	1.50	0.25	12	n (rev/min)	183	122	92	73	61	46	37	31	26	23
					f _z (mm)	0.0008	0.0012	0.0016	0.0020	0.0023	0.0031	0.0039	0.0047	0.0055	0.0063
					v _f (m/min)	1	1	1	1	1	1	1	1	1	1
	E 22	1.50	0.25	60	n (rev/min)	917	611	458	367	306	229	183	153	131	115
					f _z (mm)	0.0011	0.0016	0.0022	0.0027	0.0033	0.0044	0.0055	0.0066	0.0077	0.0088
					v _f (m/min)	6	6	6	6	6	6	6	6	6	6

SMG = Seco Material Group
 n [min-1] = RPM
 v_c (sf/min) = Surface feet/min

f_z [in] = Feed/tooth
 a_p/D_c = % of diameter
 v_f [in/min] = Feed rate
 a_e/D_c = % of diameter

A = Air D = Dry E = Emulsion (flood coolant) M = Mist
 All cutting data are start values. All cutting data is in inch values.
 Please reference the Workpiece Material Classification chart located on page 15.

RTM713 - START VALUES

SLOTING												
ISO GROUP	SMG	$a_p \times D_c$ (max)	$a_e \times D_c$ (max)	v_c (sf / min)		$Z_n = 3$						
						1/4	3/8	1/2	5/8	3/4	1	1 1/4
P	E 1 - 2	1.00	1.00	132	n (rev/min)	2017	1345	1008	807	672	504	403
					f_z (in)	0.0014	0.0021	0.0028	0.0035	0.0042	0.0056	0.0070
					v_f (in/min)	9	9	9	9	9	9	9
	E 3 - 4	1.00	1.00	60	n (rev/min)	917	611	458	367	306	229	183
					f_z (in)	0.0011	0.0016	0.0022	0.0027	0.0033	0.0044	0.0055
					v_f (in/min)	3	3	3	3	3	3	3
K	E 12 - 13	1.00	1.00	60	n (rev/min)	917	611	458	367	306	229	183
					f_z (in)	0.0014	0.0021	0.0028	0.0035	0.0042	0.0056	0.0070
					v_f (in/min)	4	4	4	4	4	4	4
	E 18	1.00	1.00	288	n (rev/min)	4401	2934	2200	1760	1467	1100	880
					f_z (in)	0.0016	0.0023	0.0031	0.0039	0.0047	0.0063	0.0078
					v_f (in/min)	21	21	21	21	21	21	21

SIDE MILLING - ROUGHING												
P	E 1 - 2	1.50	0.25	192	n (rev/min)	2934	1956	1467	1174	978	733	587
					f_z (in)	0.0018	0.0026	0.0035	0.0044	0.0053	0.0070	0.0088
					v_f (in/min)	16	16	16	16	16	16	16
	E 3 - 4	1.50	0.25	96	n (rev/min)	1467	978	733	587	489	367	293
					f_z (in)	0.0014	0.0021	0.0027	0.0034	0.0041	0.0055	0.0068
					v_f (in/min)	6	6	6	6	6	6	6
K	E 12 - 13	1.50	0.25	114	n (rev/min)	1742	1161	871	697	581	435	348
					f_z (in)	0.0018	0.0026	0.0035	0.0044	0.0053	0.0070	0.0088
					v_f (in/min)	9	9	9	9	9	9	9
	E 18	1.50	0.25	420	n (rev/min)	6418	4278	3209	2567	2139	1604	1284
					f_z (in)	0.0020	0.0029	0.0039	0.0049	0.0059	0.0078	0.0098
					v_f (in/min)	38	38	38	38	38	38	38

SMG = Seco Material Group
 n [min-1] = RPM
 v_c (sf/min) = Surface feet/min

f_z [in] = Feed/tooth
 a_p/D_c = % of diameter
 v_f [in/min] = Feed rate
 a_e/D_c = % of diameter

A = Air D = Dry E = Emulsion (flood coolant) M = Mist
 All cutting data are start values. All cutting data is in inch values.
 Please reference the Workpiece Material Classification chart located on page 15.

RHC752 - START VALUES

SLOTTING															
ISO GROUP	SMG	$a_p \times D_c$ (max)	$a_e \times D_c$ (max)	v_c (sf / min)		$Z_n = 3$									
						1/4	3/8	1/2	5/8	3/4	1	1 1/4	1 1/2	1 3/4	2
N	E 16	1.00	1.00	600	n (rev/min)	9168	6112	4584	3667	3056	2292	1834	1528	1310	1146
					f_z (in)	0.0031	0.0047	0.0063	0.0078	0.0094	0.0125	0.0156	0.0188	0.0219	0.0250
					v_f (in/min)	86	86	86	86	86	86	86	86	86	86
	E 17	1.00	1.00	600	n (rev/min)	9168	6112	4584	3667	3056	2292	1834	1528	1310	1146
					f_z (in)	0.0031	0.0047	0.0063	0.0078	0.0094	0.0125	0.0156	0.0188	0.0219	0.0250
					v_f (in/min)	86	86	86	86	86	86	86	86	86	86

SIDE MILLING - ROUGHING															
N	E 16	1.50	0.25	900	n (rev/min)	13752	9168	6876	5501	4584	3438	2750	2292	1965	1719
					f_z (in)	0.0039	0.0059	0.0078	0.0098	0.0117	0.0156	0.0195	0.0234	0.0273	0.0313
					v_f (in/min)	161	161	161	161	161	161	161	161	161	161
	E 17	1.50	0.25	900	n (rev/min)	13752	9168	6876	5501	4584	3438	2750	2292	1965	1719
					f_z (in)	0.0039	0.0059	0.0078	0.0098	0.0117	0.0156	0.0195	0.0234	0.0273	0.0313
					v_f (in/min)	161	161	161	161	161	161	161	161	161	161

SMG = Seco Material Group
 n [min-1] = RPM
 v_c (sf/min) = Surface feet/min

f_z [in] = Feed/tooth
 a_p/D_c = % of diameter
 v_f [in/min] = Feed rate
 a_e/D_c = % of diameter

A = Air D = Dry E = Emulsion (flood coolant) M = Mist
 All cutting data are start values. All cutting data is in inch values.
 Please reference the Workpiece Material Classification chart located on page 15.

REM710 / REC700 - START VALUES

SLOTTING														
ISO GROUP	SMG	$a_p \times D_c$ (max)	$a_e \times D_c$ (max)	v_c (sf / min)		$Z_n = 4$					$Z_n = 5$	$Z_n = 6$		
						1/4	3/8	1/2	5/8	3/4	1	1 1/4	1 1/2	1 3/4
P	E 1 - 2	1.00	1.00	132	n (rev/min)	2017	1345	1008	807	672	504	403	336	288
					f_z (in)	0.0014	0.0021	0.0028	0.0035	0.0042	0.0056	0.0070	0.0084	0.0098
					v_f (in/min)	11	11	11	11	11	14	17	17	17
	E 3 - 4	1.00	1.00	60	n (rev/min)	917	611	458	367	306	229	183	153	131
					f_z (in)	0.0011	0.0016	0.0022	0.0027	0.0033	0.0044	0.0055	0.0066	0.0077
					v_f (in/min)	4	4	4	4	4	5	6	6	6
K	E 12 - 13	1.00	1.00	60	n (rev/min)	917	611	458	367	306	229	183	153	131
					f_z (in)	0.0014	0.0021	0.0028	0.0035	0.0042	0.0056	0.0070	0.0084	0.0098
					v_f (in/min)	5	5	5	5	5	6	8	8	8
N	E 18	1.00	1.00	288	n (rev/min)	4401	2934	2200	1760	1467	1100	880	733	629
					f_z (in)	0.0016	0.0023	0.0031	0.0039	0.0047	0.0063	0.0078	0.0094	0.0109
					v_f (in/min)	28	28	28	28	28	34	41	41	41

REM710 / REC700 - START VALUES

SLOTTING									
ISO GROUP	SMG	$a_p \times D_c$ (max)	$a_e \times D_c$ (max)	v_c (sf / min)		$Z_n = 8$		$Z_n = 10$	
						2	2 1/2	3	
P	E 1 - 2	0.50	1.00	132	n (rev/min)	252	202	168	
					f_z (in)	0.0113	0.0141	0.0169	
					v_f (in/min)	23	23	28	
	E 3 - 4	0.50	1.00	60	n (rev/min)	115	92	76	
					f_z (in)	0.0088	0.0109	0.0131	
					v_f (in/min)	8	8	10	
K	E 12 - 13	0.50	1.00	60	n (rev/min)	115	92	76	
					f_z (in)	0.0113	0.0141	0.0169	
					v_f (in/min)	10	10	13	
N	E 18	0.50	1.00	288	n (rev/min)	550	440	367	
					f_z (in)	0.0125	0.0156	0.0188	
					v_f (in/min)	55	55	69	

SMG = Seco Material Group
 n [min-1] = RPM
 v_c (sf/min) = Surface feet/min

f_z [in] = Feed/tooth
 a_p/D_c = % of diameter
 v_f [in/min] = Feed rate
 a_e/D_c = % of diameter

A = Air D = Dry E = Emulsion (flood coolant) M = Mist
 All cutting data are start values. All cutting data is in inch values.
 Please reference the Workpiece Material Classification chart located on page 15.

CUTTING DATA - GENERAL PURPOSE COBALT END MILLS

REM710 / REC700 - START VALUES

SIDE MILLING - ROUGHING																	
ISO GROUP	SMG	a _p x D _c (max)	a _e x D _c (max)	v _c (sf / min)		Z _n = 4					Z _n = 5	Z _n = 6			Z _n = 8		Z _n = 10
						1/4	3/8	1/2	5/8	3/4	1	1 1/4	1 1/2	1 3/4	2	2 1/2	3
P	E 1 - 2	1.50	0.25	192	n (rev/min)	2934	1956	1467	1174	978	733	587	489	419	367	293	244
					f _z (in)	0.0018	0.0026	0.0035	0.0044	0.0053	0.0070	0.0088	0.0105	0.0123	0.0141	0.0176	0.0211
					v _f (in/min)	21	21	21	21	21	26	31	31	31	41	41	52
	E 3 - 4	1.50	0.25	96	n (rev/min)	1467	978	733	587	489	367	293	244	210	183	147	122
					f _z (in)	0.0014	0.0021	0.0027	0.0034	0.0041	0.0055	0.0068	0.0082	0.0096	0.0109	0.0137	0.0164
					v _f (in/min)	8	8	8	8	8	10	12	12	12	16	16	20
K	E 12 - 13	1.50	0.25	114	n (rev/min)	1742	1161	871	697	581	435	348	290	249	218	174	145
					f _z (in)	0.0018	0.0026	0.0035	0.0044	0.0053	0.0070	0.0088	0.0105	0.0123	0.0141	0.0176	0.0211
					v _f (in/min)	12	12	12	12	12	15	18	18	18	25	25	31
N	E 18	1.50	0.25	420	n (rev/min)	6418	4278	3209	2567	2139	1604	1284	1070	917	802	642	535
					f _z (in)	0.0020	0.0029	0.0039	0.0049	0.0059	0.0078	0.0098	0.0117	0.0137	0.0156	0.0195	0.0234
					v _f (in/min)	50	50	50	50	50	63	75	75	75	100	100	125

SMG = Seco Material Group
 n [min-1] = RPM
 v_c (sf/min) = Surface feet/min

f_z [in] = Feed/tooth
 a_p/D_c = % of diameter
 v_f [in/min] = Feed rate
 a_e/D_c = % of diameter

A = Air D = Dry E = Emulsion (flood coolant) M = Mist
 All cutting data are start values. All cutting data is in inch values.
 Please reference the Workpiece Material Classification chart located on page 15.

EXR350 - START VALUES

SLOTTING												
ISO GROUP	SMG	a _p x D _c (max)	a _e x D _c (max)	V _c (sf / min)		Z _n = 4				Z _n = 5	Z _n = 6	
						3/8	1/2	5/8	3/4	1	1 1/4	1 1/2
M	E 8 - 9	1.00	1.00	96	n (rev/min)	978	733	587	489	367	293	244
					f _z (in)	0.0014	0.0019	0.0023	0.0028	0.0038	0.0047	0.0056
					v _f (in/min)	6	6	6	6	7	8	8
	E 10 - 11	1.00	1.00	72	n (rev/min)	733	550	440	367	275	220	183
					f _z (in)	0.0014	0.0019	0.0023	0.0028	0.0038	0.0047	0.0056
					v _f (in/min)	4	4	4	4	5	6	6
S	E 20	1.00	1.00	10	n (rev/min)	98	73	59	49	37	29	24
					f _z (in)	0.0007	0.0009	0.0012	0.0014	0.0019	0.0023	0.0028
					v _f (in/min)	1	1	1	1	1	1	1
	E 21	1.00	1.00	10	n (rev/min)	98	73	59	49	37	29	24
					f _z (in)	0.0012	0.0016	0.0020	0.0023	0.0031	0.0039	0.0047
					v _f (in/min)	1	1	1	1	1	1	1
	E 22	1.00	1.00	48	n (rev/min)	489	367	293	244	183	147	122
					f _z (in)	0.0016	0.0022	0.0027	0.0033	0.0044	0.0055	0.0066
					v _f (in/min)	3	3	3	3	4	5	5

EXR350 - START VALUES

SLOTTING														
ISO GROUP	SMG	a _p x D _c (max)	a _e x D _c (max)	V _c (sf / min)		Z _n = 8								
						2								
M	E 8 - 9	0.50	1.00	96	n (rev/min)							183		
					f _z (in)									0.0075
					v _f (in/min)									11
	E 10 - 11	0.50	1.00	72	n (rev/min)								138	
					f _z (in)									0.0075
					v _f (in/min)									8
S	E 20	0.50	1.00	10	n (rev/min)								18	
					f _z (in)									0.0038
					v _f (in/min)									1
	E 21	0.50	1.00	10	n (rev/min)									18
					f _z (in)									0.0063
					v _f (in/min)									1
	E 22	0.50	1.00	48	n (rev/min)									92
					f _z (in)									0.0088
					v _f (in/min)									6

SMG = Seco Material Group
 n [min-1] = RPM
 V_c (sf/min) = Surface feet/min

f_z [in] = Feed/tooth
 a_p/D_c = % of diameter
 v_f [in/min] = Feed rate
 a_e/D_c = % of diameter

A = Air D = Dry E = Emulsion (flood coolant) M = Mist
 All cutting data are start values. All cutting data is in inch values.
 Please reference the Workpiece Material Classification chart located on page 15.

EXR350 - START VALUES

SIDE MILLING - ROUGHING

ISO GROUP	SMG	a _p x D _c (max)	a _e x D _c (max)	v _c (sf / min)		Z _n = 4				Z _n = 5	Z _n = 6		Z _n = 8
						3/8	1/2	5/8	3/4	1	1 1/4	1 1/2	2
M	E 8 - 9	1.50	0.25	115	n (rev/min)	1174	880	704	587	440	352	293	220
					f _z (in)	0.0018	0.0023	0.0029	0.0035	0.0047	0.0059	0.0070	0.0094
					v _f (in/min)	8	8	8	8	10	12	12	17
	E 10 - 11	1.50	0.25	86	n (rev/min)	880	660	528	440	330	264	220	165
					f _z (in)	0.0018	0.0023	0.0029	0.0035	0.0047	0.0059	0.0070	0.0094
					v _f (in/min)	6	6	6	6	8	9	9	12
S	E 20	1.50	0.25	12	n (rev/min)	122	92	73	61	46	37	31	23
					f _z (in)	0.0009	0.0012	0.0015	0.0018	0.0023	0.0029	0.0035	0.0047
					v _f (in/min)	1	1	1	1	1	1	1	1
	E 21	1.50	0.25	12	n (rev/min)	122	92	73	61	46	37	31	23
					f _z (in)	0.0015	0.0020	0.0024	0.0029	0.0039	0.0049	0.0059	0.0078
					v _f (in/min)	1	1	1	1	1	1	1	1
	E 22	1.50	0.25	57.6	n (rev/min)	587	440	352	293	220	176	147	110
					f _z (in)	0.0021	0.0027	0.0034	0.0041	0.0055	0.0068	0.0082	0.0109
					v _f (in/min)	5	5	5	5	6	7	7	10

SMG = Seco Material Group
 n [min-1] = RPM
 v_c (sf/min) = Surface feet/min

f_z [in] = Feed/tooth
 a_p/D_c = % of diameter
 v_f [in/min] = Feed rate
 a_e/D_c = % of diameter

A = Air D = Dry E = Emulsion (flood coolant) M = Mist
 All cutting data are start values. All cutting data is in inch values.
 Please reference the Workpiece Material Classification chart located on page 15.

REM445 / REC448 - START VALUES

		SLOTTING												
ISO GROUP	SMG	a _p x Dc (max)	a _e x Dc (max)	V _c (sf / min)		Z _n = 4					Z _n = 5	Z _n = 6		
						1/4	3/8	1/2	5/8	3/4	1	1 1/4	1 1/2	1 3/4
P	E 5 - 6	1.00	1.00	42	n (rev/min)	642	428	321	257	214	160	128	107	92
					f _z (in)	0.0011	0.0016	0.0022	0.0027	0.0033	0.0044	0.0055	0.0066	0.0077
					v _f (in/min)	3	3	3	3	3	4	4	4	4
M	E 8 - 9	1.00	1.00	96	n (rev/min)	1467	978	733	587	489	367	293	244	210
					f _z (in)	0.0009	0.0014	0.0019	0.0023	0.0028	0.0038	0.0047	0.0056	0.0066
					v _f (in/min)	6	6	6	6	6	7	8	8	8
	E 10 - 11	1.00	1.00	72	n (rev/min)	1100	733	550	440	367	275	220	183	157
					f _z (in)	0.0009	0.0014	0.0019	0.0023	0.0028	0.0038	0.0047	0.0056	0.0066
					v _f (in/min)	4	4	4	4	4	5	6	6	6
S	E 20	1.00	1.00	9.6	n (rev/min)	147	98	73	59	49	37	29	24	21
					f _z (in)	0.0005	0.0007	0.0009	0.0012	0.0014	0.0019	0.0023	0.0028	0.0033
					v _f (in/min)	1	1	1	1	1	1	1	1	1
	E 21	1.00	1.00	9.6	n (rev/min)	147	98	73	59	49	37	29	24	21
					f _z (in)	0.0008	0.0012	0.0016	0.0020	0.0023	0.0031	0.0039	0.0047	0.0055
					v _f (in/min)	1	1	1	1	1	1	1	1	1
E 22	1.00	1.00	48	n (rev/min)	733	489	367	293	244	183	147	122	105	
				f _z (in)	0.0011	0.0016	0.0022	0.0027	0.0033	0.0044	0.0055	0.0066	0.0077	
				v _f (in/min)	3	3	3	3	3	4	5	5	5	

REM445 / REC448 - START VALUES

		SLOTTING						
ISO GROUP	SMG	a _p x Dc (max)	a _e x Dc (max)	V _c (sf / min)		Z _n = 8		Z _n = 10
						2	2 1/2	3
P	E 5 - 6	0.50	1.00	42	n (rev/min)	80	64	53
					f _z (in)	0.0088	0.0109	0.0131
					v _f (in/min)	6	6	7
M	E 8 - 9	0.50	1.00	96	n (rev/min)	183	147	122
					f _z (in)	0.0075	0.0094	0.0113
					v _f (in/min)	11	11	14
	E 10 - 11	0.50	1.00	72	n (rev/min)	138	110	92
					f _z (in)	0.0075	0.0094	0.0113
					v _f (in/min)	8	8	10
S	E 20	0.50	1.00	9.6	n (rev/min)	18	15	12
					f _z (in)	0.0038	0.0047	0.0056
					v _f (in/min)	1	1	1
	E 21	0.50	1.00	9.6	n (rev/min)	18	15	12
					f _z (in)	0.0063	0.0078	0.0094
					v _f (in/min)	1	1	1
E 22	0.50	1.00	48	n (rev/min)	92	73	61	
				f _z (in)	0.0088	0.0109	0.0131	
				v _f (in/min)	6	6	8	

SMG = Seco Material Group
 n [min-1] = RPM
 v_c (sf/min) = Surface feet/min

f_z [in] = Feed/tooth
 a_p/D_c = % of diameter
 v_f [in/min] = Feed rate
 a_e/D_c = % of diameter

A = Air D = Dry E = Emulsion (flood coolant) M = Mist
 All cutting data are start values. All cutting data is in inch values.
 Please reference the Workpiece Material Classification chart located on page 15.

REM445 / REC448 - START VALUES

SIDE MILLING - ROUGHING																	
ISO GROUP	SMG	a _p x Dc (max)	a _e x Dc (max)	v _c (sf / min)		Z _n = 4					Z _n = 5	Z _n = 6			Z _n = 8		Z _n = 10
						1/4	3/8	1/2	5/8	3/4	1	1 1/4	1 1/2	1 3/4	2	2 1/2	3
P	E 5 - 6	1.50	0.25	63	n (rev/min)	955	637	478	382	318	239	191	159	136	119	96	80
					f _z (in)	0.0014	0.0021	0.0027	0.0034	0.0041	0.0055	0.0068	0.0082	0.0096	0.0109	0.0137	0.0164
					v _f (in/min)	5	5	5	5	5	6	8	8	8	10	10	13
M	E 8 - 9	1.50	0.25	115	n (rev/min)	1760	1174	880	704	587	440	352	293	251	220	176	147
					f _z (in)	0.0012	0.0018	0.0023	0.0029	0.0035	0.0047	0.0059	0.0070	0.0082	0.0094	0.0117	0.0141
					v _f (in/min)	8	8	8	8	8	10	12	12	12	17	17	21
	E 10 - 11	1.50	0.25	86	n (rev/min)	1320	880	660	528	440	330	264	220	189	165	132	110
					f _z (in)	0.0012	0.0018	0.0023	0.0029	0.0035	0.0047	0.0059	0.0070	0.0082	0.0094	0.0117	0.0141
					v _f (in/min)	6	6	6	6	6	8	9	9	9	12	12	16
S	E 20	1.50	0.25	12	n (rev/min)	183	122	92	73	61	46	37	31	26	23	18	15
					f _z (in)	0.0006	0.0009	0.0012	0.0015	0.0018	0.0023	0.0029	0.0035	0.0041	0.0047	0.0059	0.0070
					v _f (in/min)	1	1	1	1	1	1	1	1	1	1	1	1
	E 21	1.50	0.25	14	n (rev/min)	220	147	110	88	73	55	44	37	31	28	22	18
					f _z (in)	0.0010	0.0015	0.0020	0.0024	0.0029	0.0039	0.0049	0.0059	0.0068	0.0078	0.0098	0.0117
					v _f (in/min)	1	1	1	1	1	1	1	1	1	2	2	2
E 22	1.50	0.25	72	n (rev/min)	1100	733	550	440	367	275	220	183	157	138	110	92	
				f _z (in)	0.0014	0.0021	0.0027	0.0034	0.0041	0.0055	0.0068	0.0082	0.0096	0.0109	0.0137	0.0164	
				v _f (in/min)	6	6	6	6	6	8	9	9	9	12	12	15	

SMG = Seco Material Group
 n [min-1] = RPM
 v_c (sf/min) = Surface feet/min

f_z [in] = Feed/tooth
 a_p/D_c = % of diameter
 v_f [in/min] = Feed rate
 a_e/D_c = % of diameter

A = Air D = Dry E = Emulsion (flood coolant) M = Mist
 All cutting data are start values. All cutting data is in inch values.
 Please reference the Workpiece Material Classification chart located on page 15.

VFP435 / VFP635 / VFP435SB / VFP635SB / VFP435SBR / VFP635SBR - START VALUES

SLOTTING											
ISO GROUP	SMG	$a_p \times D_c$ (max)	$a_e \times D_c$ (max)	v_c (sf / min)		$Z_n = 4$			$Z_n = 6$		
						3/4	1	1 1/4	1 1/4	1 1/2	2
M	E 8 - 9	1.00	1.00	65	n (rev/min)	331	248	199	199	166	124
					f_z (in)	0.0024	0.0032	0.0040	0.0040	0.0048	0.0064
					v_f (in/min)	3	3	3	5	5	5
	E 10 - 11	1.00	1.00	40	n (rev/min)	204	153	122	122	102	76
					f_z (in)	0.0024	0.0032	0.0040	0.0040	0.0048	0.0064
					v_f (in/min)	2	2	2	3	3	3
S	E 22	1.00	1.00	60	n (rev/min)	306	229	183	183	153	115
					f_z (in)	0.0021	0.0028	0.0035	0.0035	0.0042	0.0056
					v_f (in/min)	3	3	3	4	4	4

SIDE MILLING - ROUGHING											
M	E 8 - 9	1.50	0.25	78	n (rev/min)	397	298	238	238	199	149
					f_z (in)	0.0030	0.0040	0.0050	0.0050	0.0060	0.0080
					v_f (in/min)	5	5	5	7	7	7
	E 10 - 11	1.50	0.25	48	n (rev/min)	244	183	147	147	122	92
					f_z (in)	0.0030	0.0040	0.0050	0.0050	0.0060	0.0080
					v_f (in/min)	3	3	3	4	4	4
S	E 22	1.50	0.25	72	n (rev/min)	367	275	220	220	183	138
					f_z (in)	0.0026	0.0035	0.0044	0.0044	0.0053	0.0070
					v_f (in/min)	4	4	4	6	6	6

SMG = Seco Material Group
 n [min-1] = RPM
 v_c (sf/min) = Surface feet/min

f_z [in] = Feed/tooth
 a_p/D_c = % of diameter
 v_f [in/min] = Feed rate
 a_e/D_c = % of diameter

A = Air D = Dry E = Emulsion (flood coolant) M = Mist
 All cutting data are start values. All cutting data is in inch values.
 Please reference the Workpiece Material Classification chart located on page 15.

UN THREADMILLS-NTM100UN

SOLID
CARBIDE



- Helical flutes for internal and external threading
- Ideal for flat bottom holes
- Large diameter applications where torque and horsepower requirements for taps are not available
- Suitable for use in most materials

ITEM NUMBER	DESCRIPTION	THREAD SIZE	THREADS PER INCH	CUTTER DIA	SHANK DIA	LENGTH OF CUT	OVERALL LENGTH	CUTTING TEETH	COATING	DRILL SIZE 50%	DRILL SIZE 75%
N68746	NTM100-NR.2X56UN-.125	2	56	0.065	1/8	0.1250	2	3	AICrN	49	50
N68748	NTM100-NR.4X40UN-.125	4	40	0.085	1/8	0.1750	2	3	AICrN	41	43
N68750	NTM100-NR.6X32UN-.125	6	32	0.100	1/8	0.2180	2	3	AICrN	32	36
N68752	NTM100-NR.8X32UN-.125	8	32	0.115	1/8	0.2500	2	3	AICrN	27	29
N68754	NTM100-NR.10X24UN-.187	10	24	0.134	3/16	0.3130	2	3	AICrN	20	25
N68756	NTM100-NR.12X28UN-.187	10	28	0.134	3/16	0.3130	2	3	AICrN	19	23
N68758	NTM100-NR.10X32UN-.187	10	32	0.134	3/16	0.3130	2	3	AICrN	18	21
N68760	NTM100-1/4X20UN-.187	1/4	20	0.180	3/16	0.5000	2-1/2	3	AICrN	7/32	7
N68762	NTM100-1/4X28UN-.187	1/4	28	0.180	3/16	0.5000	2-1/2	3	AICrN	1	3
N68764	NTM100-1/4X32UN-.187	1/4	32	0.180	3/16	0.5000	2-1/2	3	AICrN	1	7/32
N68766	NTM100-5/16X18UN-.250	5/16	18	0.235	1/4	0.6250	2-1/2	3	AICrN	J	F
N68768	NTM100-5/16X24UN-.250	5/16	24	0.235	1/4	0.6250	2-1/2	3	AICrN	9/32	I
N68770	NTM100-5/16X32UN-.250	5/16	32	0.235	1/4	0.6250	2-1/2	3	AICrN	L	9/32
N68772	NTM100-3/8X16UN-.312	3/8	16	0.285	5/16	0.7500	3	3	AICrN	Q	5/16
N68774	NTM100-3/8X24UN-.312	3/8	24	0.285	5/16	0.7500	3	3	AICrN	S	Q
N68776	NTM100-7/16X14UN-.312	7/16	14	0.305	5/16	0.8750	3	3	AICrN	25/64	U
N68778	NTM100-7/16X20UN-.312	7/16	20	0.305	5/16	0.8750	3	3	AICrN	13/32	25/64
N68780	NTM100-1/2X13UN-.375	1/2	13	0.350	3/8	0.8750	3-1/2	3	AICrN	29/64	27/64
N68782	NTM100-1/2X20UN-.375	1/2	20	0.350	3/8	0.8750	3-1/2	3	AICrN	15/32	29/64
N68784	NTM100-1/2X28UN-.375	1/2	28	0.350	3/8	0.8750	3-1/2	3	AICrN	15/32	15/32
N68786	NTM100-9/16X12UN-.375	9/16	12	0.370	3/8	0.8750	3-1/2	4	AICrN	33/64	31/64
N68788	NTM100-9/16X18UN-.375	9/16	18	0.370	3/8	0.8750	3-1/2	4	AICrN	17/32	33/64
N68790	NTM100-5/8X11UN-.500	5/8	11	0.470	1/2	1.2500	4	4	AICrN	9/16	17/32
N68792	NTM100-5/8X12UN-.500	5/8	12	0.470	1/2	1.2500	4	4	AICrN	9/16	35/64
N68794	NTM100-5/8X18UN-.500	5/8	18	0.470	1/2	1.2500	4	4	AICrN	19/32	37/64
N68796	NTM100-3/4X10UN-.500	3/4	10	0.495	1/2	1.2500	4	4	AICrN	11/16	21/32
N68798	NTM100-3/4X12UN-.500	3/4	12	0.495	1/2	1.2500	4	4	AICrN	11/16	43/64
N68800	NTM100-3/4X16UN-.500	3/4	16	0.495	1/2	1.2500	4	4	AICrN	45/64	11/16
N68802	NTM100-3/4X20UN-.500	3/4	20	0.495	1/2	1.2500	4	4	AICrN	23/32	45/64
N68804	NTM100-7/8X9UN-.625	7/8	9	0.620	5/8	1.3750	4	4	AICrN	51/64	49/64
N68806	NTM100-7/8X12UN-.625	7/8	12	0.620	5/8	1.3750	4	4	AICrN	13/16	51/64
N68808	NTM100-7/8X14UN-.625	7/8	14	0.620	5/8	1.3750	4	4	AICrN	53/64	13/16
N68810	NTM100-7/8X16UN-.625	7/8	16	0.620	5/8	1.3750	4	4	AICrN	53/64	13/16
N68812	NTM100-7/8X20UN-.625	7/8	20	0.620	5/8	1.3750	4	4	AICrN	27/32	53/64
N68814	NTM100-1X8UN-.625	1	8	0.620	5/8	1.3750	4	4	AICrN	59/64	7/8
N68816	NTM100-1X12UN-.625	1	12	0.620	5/8	1.3750	4	4	AICrN	61/64	15/16
N68818	NTM100-1X16UN-.625	1	16	0.620	5/8	1.3750	4	4	AICrN	61/64	15/16

UN THREADMILLS-NTM120UN

SOLID
CARBIDE



- Helical flutes for internal and external threading
- Coolant-through feature
- Ideal for flat bottom holes
- Large diameter applications where torque and horsepower requirements for taps are not available
- Suitable for use in most materials

ITEM NUMBER	DESCRIPTION	THREAD SIZE	THREADS PER INCH	CUTTER DIA	SHANK DIA	LENGTH OF CUT	OVERALL LENGTH	CUTTING TEETH	COATING	DRILL SIZE 50%	DRILL SIZE 75%
N34479	NTM120-NR.10X24UN-.187	10	24	0.134	3/16	0.3130	2	3	AICrN	20	25
N34480	NTM120-NR.10X32UN-.187	10	32	0.134	3/16	0.3130	2	3	AICrN	18	21
N34481	NTM120-1/4X20UN-.187	1/4	20	0.180	3/16	0.5000	2-1/2	3	AICrN	7/32	7
N34482	NTM120-1/4X28UN-.187	1/4	28	0.180	3/16	0.5000	2-1/2	3	AICrN	1	3
N34483	NTM120-5/16X18UN-.250	5/16	18	0.235	1/4	0.6250	2-1/2	3	AICrN	J	F
N34484	NTM120-5/16X24UN-.250	5/16	24	0.235	1/4	0.6250	2-1/2	3	AICrN	9/32	I
N34485	NTM120-3/8X16UN-.312	3/8	16	0.285	5/16	0.7500	3	3	AICrN	Q	5/16
N34486	NTM120-3/8X24UN-.312	3/8	24	0.285	5/16	0.7500	3	3	AICrN	S	Q
N34487	NTM120-7/16X14UN-.312	7/16	14	0.305	5/16	0.8750	3	3	AICrN	25/64	U
N34488	NTM120-7/16X20UN-.312	7/16	20	0.305	5/16	0.8750	3	3	AICrN	13/32	25/64
N34489	NTM120-1/2X13UN-.375	1/2	13	0.350	3/8	0.8750	3-1/2	3	AICrN	29/64	27/64
N34490	NTM120-1/2X20UN-.375	1/2	20	0.350	3/8	0.8750	3-1/2	3	AICrN	15/32	29/64
N34491	NTM120-9/16X12UN-.375	9/16	12	0.370	3/8	0.8750	3-1/2	4	AICrN	33/64	31/64
N34492	NTM120-9/16X18UN-.375	9/16	18	0.370	3/8	0.8750	3-1/2	4	AICrN	17/32	33/64
N34493	NTM120-5/8X11UN-.500	5/8	11	0.470	1/2	1.2500	4	4	AICrN	9/16	17/32
N34494	NTM120-3/4X10UN-.500	3/4	10	0.495	1/2	1.2500	4	4	AICrN	11/16	21/32
N34495	NTM120-3/4X12UN-.500	3/4	12	0.495	1/2	1.2500	4	4	AICrN	11/16	43/64
N34496	NTM120-3/4X16UN-.500	3/4	16	0.495	1/2	1.2500	4	4	AICrN	45/64	11/16
N34497	NTM120-7/8X9UN-.625	7/8	9	0.620	5/8	1.3750	4	4	AICrN	51/64	49/64
N34498	NTM120-1X8UN-.625	1	8	0.620	5/8	1.3750	4	4	AICrN	59/64	7/8

UN THREAD MILLS-NTM160UN

SOLID
CARBIDE



- Helical flutes for internal and external threading
- Extended reach
- Ideal for flat bottom holes
- Large diameter applications where torque and horsepower requirements for taps are not available
- Suitable for use in most materials

ITEM NUMBER	DESCRIPTION	THREAD SIZE	THREADS PER INCH	CUTTER DIA	SHANK DIA	LENGTH OF CUT	OVERALL LENGTH	CUTTING TEETH	COATING	REACH	DRILL SIZE 50%	DRILL SIZE 75%
N34572	NTM160-1/4X28UN-.187	1/4	28	0.180	3/16	0.1100	2-1/2	3	AlCrN	0.875	1	3
N34571	NTM160-1/4X20UN-.187	1/4	20	0.180	3/16	0.1500	2-1/2	3	AlCrN	0.670	7/32	7
N34578	NTM160-3/8X24UN-.312	3/8	24	0.285	5/16	0.1250	3	3	AlCrN	1.625	S	Q
N34577	NTM160-3/8X16UN-.312	3/8	16	0.285	5/16	0.1880	3	3	AlCrN	1.350	Q	5/16
N34582	NTM160-1/2X20UN-.375	1/2	20	0.350	3/8	0.1500	4	3	AlCrN	1.250	15/32	29/64
N34581	NTM160-1/2X13UN-.375	1/2	13	0.350	3/8	0.2300	4	3	AlCrN	1.670	29/64	27/64

METRIC THREAD MILLS-NTM400MI

SOLID
CARBIDE



- Helical flutes for internal and external threading

ITEM NUMBER	DESCRIPTION	THREAD SIZE	PITCH (MM)	CUTTER DIA	SHANK DIA	LENGTH OF CUT	OVERALL LENGTH	CUTTING TEETH	COATING	DRILL SIZE 75%
N68850	NTM400-M3X.5ISO-.125	M3	0.5	0.085	1/8	0.1780	2	3	AICrN	39
N68852	NTM400-M3.5X.6ISO-.125	M3.5	0.6	0.095	1/8	0.2350	2	3	AICrN	32
N68854	NTM400-M4X.7ISO-.125	M4	0.7	0.115	1/8	0.2760	2	3	AICrN	30
N68856	NTM400-M4.5X.75ISO-.187	M4.5	0.75	0.134	3/16	0.3130	2	3	AICrN	19
N68858	NTM400-M5-X.8ISO-.187	M5	0.8	0.134	3/16	0.3130	2	3	AICrN	19
N68860	NTM400-M6X1.0ISO-.187	M6	1	0.170	3/16	0.5000	2-1/2	3	AICrN	8
N68862	NTM400-M8X1.0ISO-.250	M8	1	0.235	1/4	0.6250	2-1/2	3	AICrN	J
N68864	NTM400-M8X1.25ISO-.250	M8	1.25	0.235	1/4	0.6250	2-1/2	3	AICrN	H
N68866	NTM400-M10X1.25ISO-.312	M10	1.25	0.300	5/16	0.7500	3	3	AICrN	11/32
N68868	NTM400-M10X1.5ISO-.312	M10	1.5	0.300	5/16	0.7500	3	3	AICrN	R
N68870	NTM400-M12X1.25ISO-.375	M12	1.25	0.360	3/8	0.8750	3-1/2	3	AICrN	27/64
N68872	NTM400-M12X1.75ISO-.375	M12	1.75	0.360	3/8	0.8750	3-1/2	3	AICrN	13/32
N68874	NTM400-M14X1.25ISO-.375	M14	1.25	0.370	3/8	0.8750	3-1/2	4	AICrN	1/2
N68876	NTM400-M14X1.5ISO-.375	M14	1.5	0.370	3/8	0.8750	3-1/2	4	AICrN	1/2
N68878	NTM400-M14X2.0ISO-.375	M14	2	0.370	3/8	0.8750	3-1/2	4	AICrN	15/32
N68880	NTM400-M16X2.0ISO-.500	M16	2	0.470	1/2	1.2500	4	4	AICrN	35/64
N68882	NTM400-M18X2.5ISO-.500	M18	2.5	0.490	1/2	1.2500	4	4	AICrN	39/64
N68884	NTM400-M20X1.5ISO-.500	M20	1.5	0.495	1/2	1.2500	4	4	AICrN	47/64
N68886	NTM400-M20X2.0ISO-.500	M20	2	0.495	1/2	1.2500	4	4	AICrN	11/16
N68888	NTM400-M20X2.5ISO-.500	M20	2.5	0.495	1/2	1.2500	4	4	AICrN	11/16
N68890	NTM400-M24X1.5ISO-.625	M24	1.5	0.620	5/8	1.3730	4	4	AICrN	22.5MM
N68892	NTM400-M24X2.0ISO-.625	M24	2	0.620	5/8	1.3730	4	4	AICrN	7/8
N68894	NTM400-M24X2.5ISO-.625	M24	2.5	0.620	5/8	1.3730	4	4	AICrN	21.5MM
N68896	NTM400-M24X3.0ISO-.625	M24	3	0.620	5/8	1.3750	4	4	AICrN	53/64

THREAD MILLS-NTM200NPT

SOLID CARBIDE



- Straight flutes for internal and external threading
- National Pipe Taper

ITEM NUMBER	DESCRIPTION	THREAD SIZE	THREADS PER INCH	CUTTER DIAMETER	SHANK DIA	LENGTH OF CUT	OVERALL LENGTH	CUTTING TEETH	COATING	DRILL SIZE
N68820	NTM200-1/16X27NPT-.250	1/16	27	0.245	1/4	0.4375	2-1/2	3	AlCrN	B
N68822	NTM200-1/8X27NPT-.250	1/8	27	0.245	1/4	0.4375	2-1/2	3	AlCrN	21/64
N68824	NTM200-1/4X18NPT-.312	1/4	18	0.312	5/16	0.6250	3	3	AlCrN	27/64
N68826	NTM200-3/8X18NPT-.312	3/8	18	0.312	5/16	0.6250	3	3	AlCrN	9/16
N68828	NTM200-1/2X14NPT-.500	1/2	14	0.495	1/2	0.8750	4	4	AlCrN	11/16
N68830	NTM200-3/4X14NPT-.500	3/4	14	0.495	1/2	0.8750	4	4	AlCrN	29/32
N68832	NTM200-1X11.5NPT-.625	1	11.5	0.620	5/8	1.1250	4	4	AlCrN	1-5/32
N68834	NTM200-2-1/2X8NPT-.750	2.5	8	0.745	3/4	1.5000	5	4	AlCrN	2-39/64

THREAD MILLS-NTM300NPTF

SOLID CARBIDE



- Straight flutes for internal and external threading
- National Pipe Taper for Fuels

ITEM NUMBER	DESCRIPTION	THREAD SIZE	THREADS PER INCH	CUTTER DIAMETER	SHANK DIA	LENGTH OF CUT	OVERALL LENGTH	CUTTING TEETH	COATING	DRILL SIZE
N68836	NTM300-1/16X27NPTF-.250	1/16	27	0.245	1/4	0.4375	2-1/2	3	ALCRN	B
N68838	NTM300-1/8X27NPTF-.250	1/8	27	0.245	1/4	0.4375	2-1/2	3	ALCRN	21/64
N68840	NTM300-1/4X18NPTF-.312	1/4	18	0.305	5/16	0.6250	3	3	ALCRN	27/64
N68842	NTM300-3/8X18NPTF-.312	3/8	18	0.305	5/16	0.6250	3	3	ALCRN	9/16
N68844	NTM300-1/2X14NPTF-.500	1/2	14	0.495	1/2	0.8750	4	4	ALCRN	11/16
N68846	NTM300-3/4X14NPTF-.500	3/4	14	0.495	1/2	0.8750	4	4	ALCRN	29/32
N68848	NTM300-1X11.5NPTF-.625	1	11.5	0.620	5/8	1.1250	4	4	ALCRN	1-5/32

THREAD MILLS - INCH - START VALUES

THREAD MILLING												
ISO GROUP	SMG	V _c (sf / min)		Z ₁ = 3						Z ₁ = 4		
				1/8	3/16	1/4	5/16	3/8	1/2	5/8	3/4	1
P	E 1 - 2	500	n (rev/min)	15280	10187	7640	6112	5093	3820	3056	2547	1910
			f _z (in)	0.0005	0.0008	0.0010	0.0013	0.0015	0.0020	0.0025	0.0030	0.0040
		450 - 550	V _f (in/min)	22.9	22.9	22.9	22.9	22.9	22.9	30.6	30.6	30.6
	E 3 - 4	350	n (rev/min)	10696	7131	5348	4278	3565	2674	2139	1783	1337
			f _z (in)	0.0005	0.0007	0.0009	0.0011	0.0014	0.0018	0.0023	0.0027	0.0036
		400 - 400	V _f (in/min)	14.4	14.4	14.4	14.4	14.4	14.4	19.3	19.3	19.3
E 5 - 6	275	n (rev/min)	8404	5603	4202	3362	2801	2101	1681	1401	1051	
		f _z (in)	0.0004	0.0006	0.0008	0.0009	0.0011	0.0015	0.0019	0.0023	0.0030	
	250 - 300	V _f (in/min)	9.5	9.5	9.5	9.5	9.5	9.5	12.6	12.6	12.6	
H	M / A 7 >45HRC	150	n (rev/min)	4584	3056	2292	1834	1528	1146	917	764	573
			f _z (in)	0.0002	0.0003	0.0005	0.0006	0.0007	0.0009	0.0011	0.0014	0.0018
		125 - 175	V _f (in/min)	3.1	3.1	3.1	3.1	3.1	3.1	4.1	4.1	4.1
M	E 8 - 9	350	n (rev/min)	10696	7131	5348	4278	3565	2674	2139	1783	1337
			f _z (in)	0.0004	0.0006	0.0008	0.0009	0.0011	0.0015	0.0019	0.0023	0.0030
		300 - 400	V _f (in/min)	12.0	12.0	12.0	12.0	12.0	12.0	16.0	16.0	16.0
	E 10 - 11	250	n (rev/min)	7640	5093	3820	3056	2547	1910	1528	1273	955
			f _z (in)	0.0004	0.0006	0.0008	0.0009	0.0011	0.0015	0.0019	0.0023	0.0030
		200 - 300	V _f (in/min)	8.6	8.6	8.6	8.6	8.6	8.6	11.5	11.5	11.5
K	E 12 - 13	500	n (rev/min)	15280	10187	7640	6112	5093	3820	3056	2547	1910
			f _z (in)	0.0006	0.0009	0.0013	0.0016	0.0019	0.0025	0.0031	0.0038	0.0050
		450 - 550	V _f (in/min)	28.7	28.7	28.7	28.7	28.7	28.7	38.2	38.2	38.2
	E 14 - 15	425	n (rev/min)	12988	8659	6494	5195	4329	3247	2598	2165	1624
			f _z (in)	0.0005	0.0007	0.0009	0.0011	0.0014	0.0018	0.0023	0.0027	0.0036
		375 - 475	V _f (in/min)	17.5	17.5	17.5	17.5	17.5	17.5	23.4	23.4	23.4
N	E 16	600	n (rev/min)	18336	12224	9168	7334	6112	4584	3667	3056	2292
			f _z (in)	0.0006	0.0009	0.0013	0.0016	0.0019	0.0025	0.0031	0.0038	0.0050
		550 - 650	V _f (in/min)	34.4	34.4	34.4	34.4	34.4	34.4	45.8	45.8	45.8
	E 17	600	n (rev/min)	18336	12224	9168	7334	6112	4584	3667	3056	2292
			f _z (in)	0.0006	0.0009	0.0013	0.0016	0.0019	0.0025	0.0031	0.0038	0.0050
		550 - 650	V _f (in/min)	34.4	34.4	34.4	34.4	34.4	34.4	45.8	45.8	45.8
	E 18	600	n (rev/min)	18336	12224	9168	7334	6112	4584	3667	3056	2292
			f _z (in)	0.0005	0.0008	0.0010	0.0013	0.0015	0.0020	0.0025	0.0030	0.0040
		550 - 650	V _f (in/min)	27.5	27.5	27.5	27.5	27.5	27.5	36.7	36.7	36.7
S	E 20	100	n (rev/min)	3056	2037	1528	1222	1019	764	611	509	382
			f _z (in)	0.0003	0.0005	0.0006	0.0008	0.0009	0.0012	0.0015	0.0018	0.0024
		80 - 120	V _f (in/min)	2.8	2.8	2.8	2.8	2.8	2.8	3.7	3.7	3.7
	E 21	100	n (rev/min)	3056	2037	1528	1222	1019	764	611	509	382
			f _z (in)	0.0003	0.0005	0.0006	0.0008	0.0009	0.0012	0.0015	0.0018	0.0024
		80 - 120	V _f (in/min)	2.8	2.8	2.8	2.8	2.8	2.8	3.7	3.7	3.7
	E 22	350	n (rev/min)	10696	7131	5348	4278	3565	2674	2139	1783	1337
			f _z (in)	0.0004	0.0006	0.0008	0.0009	0.0011	0.0015	0.0019	0.0023	0.0030
		330 - 370	V _f (in/min)	12.0	12.0	12.0	12.0	12.0	12.0	16.0	16.0	16.0
GRAPHITE		300	n (rev/min)	9168	6112	4584	3667	3056	2292	1834	1528	1146
			f _z (in)	0.0004	0.0005	0.0007	0.0009	0.0011	0.0014	0.0018	0.0021	0.0028
		250 - 350	V _f (in/min)	9.6	9.6	9.6	9.6	9.6	9.6	12.8	12.8	12.8

SMG = Seco Material Group
 n [min-1] = RPM
 V_c (sf/min) = Surface feet/min

f_z [in] = Feed/tooth
 a_p/D_c = % of diameter
 v_f [in/min] = Feed rate
 a_p/D_c = % of diameter

A = Air D = Dry E = Emulsion (flood coolant) M = Mist
 All cutting data are start values. All cutting data is in inch values.
 Please reference the Workpiece Material Classification chart located on page 15.

THREAD MILLS - METRIC - START VALUES

THREAD MILLING															
ISO GROUP	SMG	V _c (m / min)		Z _n = 3							Z _n = 4				
				3	4	5	6	8	10	12	14	16	18	20	24
P	E 1 - 2	500	n [min-1]	16171	12129	9703	8086	6064	4851	4043	3465	3032	2695	2426	2021
			fz [in]	.0005	.0006	.0008	.0009	.0013	.0016	.0019	.0022	.0025	.0028	.0031	.0038
		450 - 550	vf [in/min]	22.9	22.9	22.9	22.9	22.9	22.9	22.9	3.6	3.6	3.6	3.6	3.6
	E 3 - 4	350	n [min-1]	11320	8490	6792	5660	4245	3396	2830	2426	2122	1887	1698	1415
			fz [in]	.0004	.0006	.0007	.0009	.0011	.0014	.0017	.0020	.0023	.0026	.0028	.0034
		400 - 400	vf [in/min]	14.4	14.4	14.4	14.4	14.4	14.4	14.4	19.3	19.3	19.3	19.3	19.3
	E 5 - 6	275	n [min-1]	8894	6671	5337	4447	3335	2668	2224	1906	1668	1482	1334	1112
			fz [in]	.0004	.0005	.0006	.0007	.0009	.0012	.0014	.0017	.0019	.0021	.0024	.0028
		250 - 300	vf [in/min]	9.5	9.5	9.5	9.5	9.5	9.5	9.5	12.6	12.6	12.6	12.6	12.6
H	M / A 7 >45Hrc	150	n [min-1]	4851	3639	2911	2426	1819	1455	1213	1040	910	809	728	606
			fz [in]	.0002	.0003	.0004	.0004	.0006	.0007	.0009	.0010	.0011	.0013	.0014	.0017
		125 - 175	vf [in/min]	3.1	3.1	3.1	3.1	3.1	3.1	3.1	4.1	4.1	4.1	4.1	4.1
M	E 8 - 9	350	n [min-1]	11320	8490	6792	5660	4245	3396	2830	2426	2122	1887	1698	1415
			fz [in]	.0004	.0005	.0006	.0007	.0009	.0012	.0014	.0017	.0019	.0021	.0024	.0028
		300 - 1310	vf [in/min]	12.0	12.0	12.0	12.0	12.0	12.0	12.0	16.0	16.0	16.0	16.0	16.0
	E 10 - 11	250	n [min-1]	8086	6064	4851	4043	3032	2426	2021	1733	1516	1348	1213	1011
			fz [in]	.0004	.0005	.0006	.0007	.0009	.0012	.0014	.0017	.0019	.0021	.0024	.0028
		200 - 300	vf [in/min]	8.6	8.6	8.6	8.6	8.6	8.6	8.6	11.5	11.5	11.5	11.5	11.5
K	E 12 - 13	500	n [min-1]	16171	12129	9703	8086	6064	4851	4043	3465	3032	2695	2426	2021
			fz [in]	.0006	.0008	.0010	.0012	.0016	.0020	.0024	.0028	.0031	.0035	.0039	.0047
		450 - 550	vf [in/min]	28.7	28.7	28.7	28.7	28.7	28.7	28.7	38.2	38.2	38.2	38.2	38.2
	E 14 - 15	425	n [min-1]	13746	10309	8247	6873	5155	4124	3436	2945	2577	2291	2062	1718
			fz [in]	.0004	.0006	.0007	.0009	.0011	.0014	.0017	.0020	.0023	.0026	.0028	.0034
		375 - 475	vf [in/min]	17.5	17.5	17.5	17.5	17.5	17.5	17.5	23.4	23.4	23.4	23.4	23.4
N	E 16	600	n [min-1]	19406	14554	11643	9703	7277	5822	4851	4158	3639	3234	2911	2426
			fz [in]	.0006	.0008	.0010	.0012	.0016	.0020	.0024	.0028	.0031	.0035	.0039	.0047
		550 - 650	vf [in/min]	34.4	34.4	34.4	34.4	34.4	34.4	34.4	45.8	45.8	45.8	45.8	45.8
	E 17	600	n [min-1]	19406	14554	11643	9703	7277	5822	4851	4158	3639	3234	2911	2426
			fz [in]	.0006	.0008	.0010	.0012	.0016	.0020	.0024	.0028	.0031	.0035	.0039	.0047
		550 - 650	vf [in/min]	34.4	34.4	34.4	34.4	34.4	34.4	34.4	45.8	45.8	45.8	45.8	45.8
	E 18	600	n [min-1]	19406	14554	11643	9703	7277	5822	4851	4158	3639	3234	2911	2426
			fz [in]	.0005	.0006	.0008	.0009	.0013	.0016	.0019	.0022	.0025	.0028	.0031	.0038
		550 - 650	vf [in/min]	27.5	27.5	27.5	27.5	27.5	27.5	27.5	36.7	36.7	36.7	36.7	36.7
S	E 20	100	n [min-1]	3234	2426	1941	1617	1213	970	809	693	606	539	485	404
			fz [in]	.0003	.0004	.0005	.0006	.0008	.0009	.0011	.0013	.0015	.0017	.0019	.0023
		80 - 120	vf [in/min]	2.8	2.8	2.8	2.8	2.8	2.8	2.8	3.7	3.7	3.7	3.7	3.7
	E 21	100	n [min-1]	3234	2426	1941	1617	1213	970	809	693	606	539	485	404
			fz [in]	.0003	.0004	.0005	.0006	.0008	.0009	.0011	.0013	.0015	.0017	.0019	.0023
		80 - 120	vf [in/min]	2.8	2.8	2.8	2.8	2.8	2.8	2.8	3.7	3.7	3.7	3.7	3.7
E 22	350	n [min-1]	11320	8490	6792	5660	4245	3396	2830	2426	2122	1887	1698	1415	
		fz [in]	.0004	.0005	.0006	.0007	.0009	.0012	.0014	.0017	.0019	.0021	.0024	.0028	
	330 - 370	vf [in/min]	12.0	12.0	12.0	12.0	12.0	12.0	12.0	16.0	16.0	16.0	16.0	16.0	
GRAPHITE		300	n [min-1]	9703	7277	5822	4851	3639	2911	2426	2079	1819	1617	1455	1213
			fz [in]	.0003	.0004	.0006	.0007	.0009	.0011	.0013	.0015	.0018	.0020	.0022	.0026
		250 - 350	vf [in/min]	9.6	9.6	9.6	9.6	9.6	9.6	9.6	12.8	12.8	12.8	12.8	12.8





SMG = Seco Material Group
 n [min-1] = RPM
 V_c (sf/min) = Surface feet/min

fz [in] = Feed/tooth
 a_p/D_c = % of diameter
 vf [in/min] = Feed rate
 a_p/D_c = % of diameter

A = Air D = Dry E = Emulsion (flood coolant) M = Mist
 All cutting data are start values. All cutting data is in inch values.
 Please reference the Workpiece Material Classification chart located on page 15.

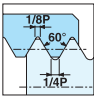
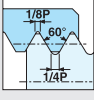
THREAD FORMS AND DESIGN

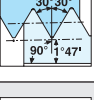
Standard Niagara Cutter Thread Mills - Thread Form Styles

	<p>UNIFIED NATIONAL COARSE UNC / 60 Degree / Common Std.</p>
	<p>UNIFIED NATIONAL FINE UNF / 60 Degree / Common Std.</p>
	<p>UNIFIED NATIONAL EXTRA FINE UNEF / 60 Degree / Common Std.</p>
	<p>NATIONAL PIPE TAPERED NPT – 60 Degree</p>
	<p>NATIONAL PIPE TAPERED NPTF</p>
	<p>METRIC M Series</p>

THREAD MILL DESIGN

Niagara Cutter Thread Mills are designed and comply with following standards:

- UN - ASME B1.1
- NPT / NPTF - ANSI / ASME B1.20.1
- Metric ISO 724



ADVANTAGES OF THREAD MILLING OVER TAPPING

- One thread mill produces various thread diameters of the same pitch
- One tool for left and right-hand threads
- Improves thread quality; milled threads can be cut to full depth with excellent form, finish, and dimensional accuracy
- Easy machining of difficult materials like heat resistant alloys, etc.
- Pitch diameter can be controlled by changing the offsets in the CNC program
- NPT holes do not require taper reaming
- Produces small controllable chips
- Eliminates the safety issues and downtime associated with tap breakage
- Smaller machines can produce larger threads since thread mills require less spindle torque
- Less cutting pressure for thin walled workpieces
- 100% thread depth compared to tapping which usually only permits 65-75%

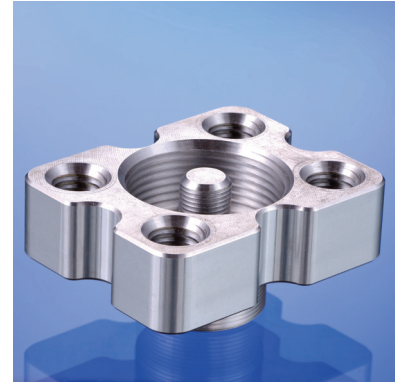

THREADING APPLICATION COMPARISON

Material	4140 Steel	
Thread Size	1/4 - 20	
Depth-of-Thread	1/2"	
Parameters	Thread Milling	Standard Tapping
SFM	150	50
IPM	16.04	38.20
Time-in-Cut (seconds)	.100	.218

Thread milling is generates a very small circumference at a high feed rate.

Example: Circumference = .050" Feed Rate = 16.04 IPM

APPLICATION RECOMMENDATIONS

Thread milling tools form a thread using a motion referred to as helical interpolation. This process involves the movement of all three axes on the machine simultaneously. The X and Y axes move in a circular motion. The Z in an axial direction per 360 degrees at a distance equal to the pitch of the thread being machined.

Shown in Figure 1, the programmed tool path starts from the bottom (Point A) and moves toward the top (Point B). A right-hand thread will be climb cut using this process.

Note: When machining a right-hand thread you will be machining from bottom-to-top for climb cutting. If machining a left-hand thread you will start from top-to-bottom with a right-hand helix tool. Left-hand threads can be climb cut with a left-hand helix tool starting from the bottom to top.

HOW TO EXTEND TOOL LIFE ON THREAD MILLS

- Run-out on Threadmill in holder should not exceed .00015"
- Shrinkfit toolholders recommended
- Arc in at 180 degrees on holes smaller than .375"
- Start with two passes to achieve a correct thread gauge, then try one pass
- Climb milling is the preferred method
- Start from the bottom of the hole to avoid re-cutting any chips
- Offset tool from center of the hole to allow a smooth start into the thread
- For difficult materials it may be necessary to make multiple passes

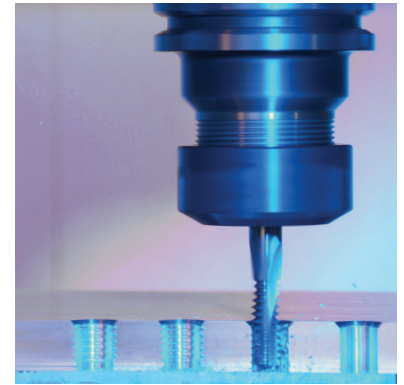
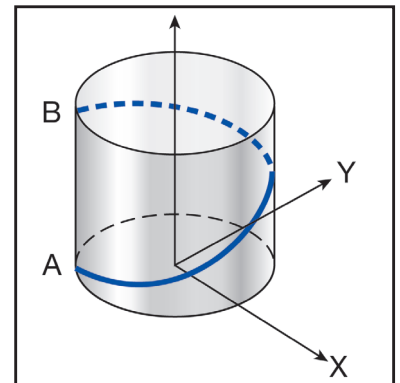
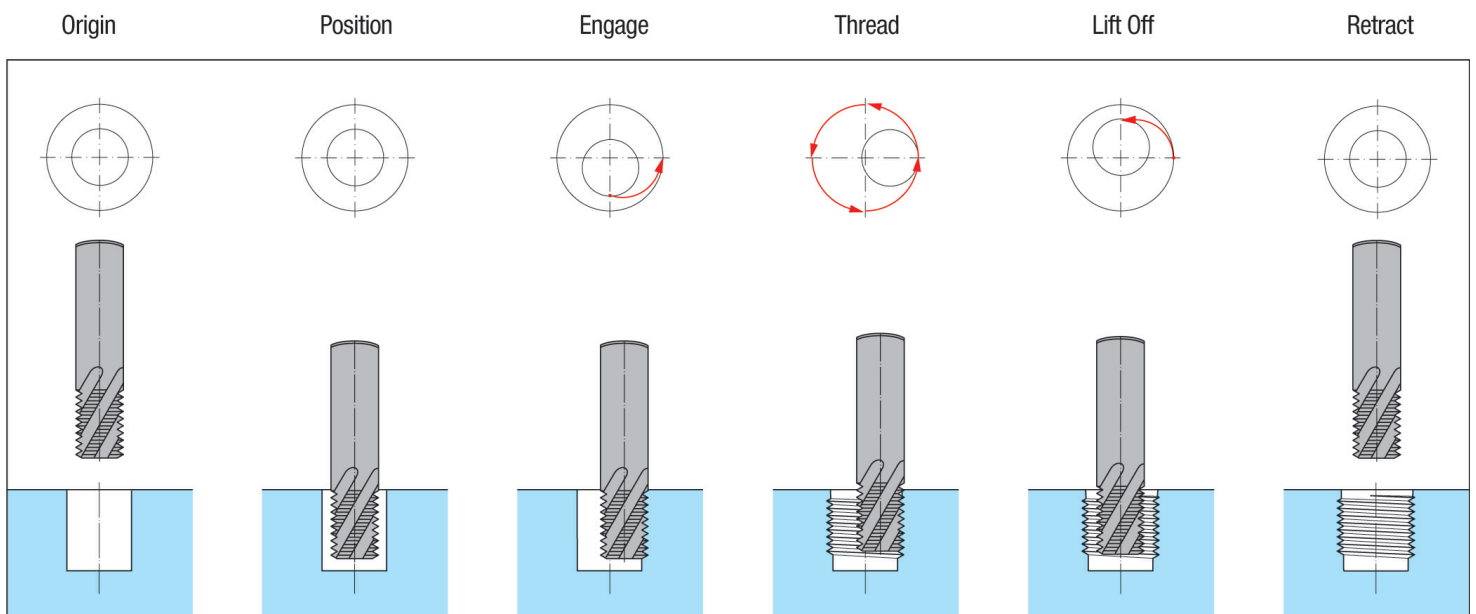
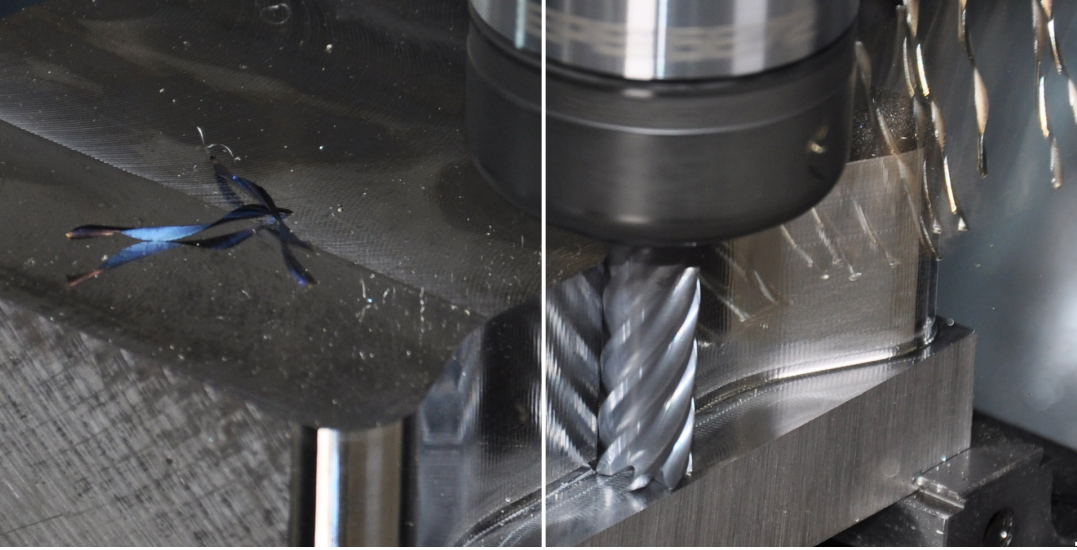

FIGURE 1



TOOL PATH DURING THREADMILLING





**NIAGARA
CUTTER™**

**HTA COATING
PRODUCT FAMILY**

OVERCOME TOUGH MATERIALS

HTA COATING FOR HIGH-TEMP ALLOYS

Gummy, abrasive superalloys and stainless steels are extremely tough on tools and can severely slow down your processes. Secure your applications and ensure consistent tool life with the new HTA coating designed for machining High-Temp Alloys from Niagara Cutter™. Designed specifically for ISO-M and ISO-S materials, the HTA coating significantly improves tool life and reliability by preventing chipping, thermal wear, abrasive wear, and built-up edges.

For critical components like turbine blades and knee implants, process security isn't optional. With the perfect balance of toughness and heat resistance, the HTA coating delivers exceptional tool life for your challenging titanium, Inconel®, and stainless steel applications. Combined with a select range of proven Niagara Cutter geometries like the Stabilizer™ 2.0 and Multi Flute end mills, this coating enables the highest level of reliability and performance.

KEY BENEFITS

- High heat and wear resistance
- Resistance to built-up edge and chipping
- Longer tool life and reduced tool consumption
- Improved process reliability and part quality

RANGE OVERVIEW

Inch range, including:

- S545
- Multi Flute S638/S738/S938
- Stabilizer 2.0
- 5-Flute Stabilizer
- Weldon and cylindrical shank products
- HTA coating can be applied to other products on a custom basis

INDUSTRY TARGETS

- Aerospace
- Medical
- General Machining

SECO MATERIAL GROUPS

Stainless Steel M8-M11

Superalloys S19-S22

Advanced industry proven tool geometries designed for applications from slot milling to optimized roughing and finishing.



Increased process performance and stability with HTA coating.

S545 / S545R

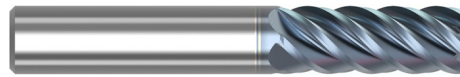

- Eccentric primary relief
- Ideal for light side mill roughing and finishing

ITEM NUMBER	DESCRIPTION	DIMENSIONS IN INCH				FLUTES	COATING	RADIUS	SHANK TYPE
		FLUTE DIA.	SHANK DIA.	LOC	OAL				
S545/S545R (5-FLUTE SQUARE END AND WITH CORNER RADIUS)									
10008044	S545-0.125-D2-S.0-Z5	1/8	1/8	1/4	1-1/2	5	HTA	-	CYLINDRICAL
10115688	S545R-0.125-D2-R015.0-Z5	1/8	1/8	1/4	1-1/2	5	HTA	0.015	CYLINDRICAL
10008045	S545-0.125-D4-S.0-Z5	1/8	1/8	1/2	1-1/2	5	HTA	-	CYLINDRICAL
10115689	S545R-0.125-D4-R015.0-Z5	1/8	1/8	1/2	1-1/2	5	HTA	0.015	CYLINDRICAL
10008046	S545-0.188-D2-S.0-Z5	3/16	3/16	5/16	2	5	HTA	-	CYLINDRICAL
10115690	S545R-0.188-D2-R015.0-Z5	3/16	3/16	5/16	2	5	HTA	0.015	CYLINDRICAL
10115691	S545R-0.188-D2-R030.0-Z5	3/16	3/16	5/16	2	5	HTA	0.030	CYLINDRICAL
10008047	S545-0.188-D3-S.0-Z5	3/16	3/16	9/16	2	5	HTA	-	CYLINDRICAL
10115692	S545R-0.188-D3-R015.0-Z5	3/16	3/16	9/16	2	5	HTA	0.015	CYLINDRICAL
10115693	S545R-0.188-D3-R030.0-Z5	3/16	3/16	9/16	2	5	HTA	0.030	CYLINDRICAL
10008048	S545-0.250-D2-S.0-Z5	1/4	1/4	3/8	2	5	HTA	-	CYLINDRICAL
10115694	S545R-0.250-D2-R015.0-Z5	1/4	1/4	3/8	2	5	HTA	0.015	CYLINDRICAL
10008049	S545R-0.250-D2-R030.0-Z5	1/4	1/4	3/8	2	5	HTA	0.030	CYLINDRICAL
10008050	S545R-0.250-D2-R045.0-Z5	1/4	1/4	3/8	2	5	HTA	0.045	CYLINDRICAL
10115695	S545R-0.250-D2-R060.0-Z5	1/4	1/4	3/8	2	5	HTA	0.060	CYLINDRICAL
10008051	S545-0.250-D3-S.0-Z5	1/4	1/4	3/4	2-1/2	5	HTA	-	CYLINDRICAL
10115696	S545R-0.250-D3-R015.0-Z5	1/4	1/4	3/4	2-1/2	5	HTA	0.015	CYLINDRICAL
10008052	S545R-0.250-D3-R030.0-Z5	1/4	1/4	3/4	2-1/2	5	HTA	0.030	CYLINDRICAL
10115697	S545R-0.250-D3-R045.0-Z5	1/4	1/4	3/4	2-1/2	5	HTA	0.045	CYLINDRICAL
10115698	S545R-0.250-D3-R060.0-Z5	1/4	1/4	3/4	2-1/2	5	HTA	0.060	CYLINDRICAL
10008053	S545-0.375-D1-S.0-Z5	3/8	3/8	1/2	2	5	HTA	-	CYLINDRICAL
10008054	S545R-0.375-D1-R015.0-Z5	3/8	3/8	1/2	2	5	HTA	0.015	CYLINDRICAL
10008055	S545R-0.375-D1-R030.0-Z5	3/8	3/8	1/2	2	5	HTA	0.030	CYLINDRICAL
10115699	S545R-0.375-D1-R045.0-Z5	3/8	3/8	1/2	2	5	HTA	0.045	CYLINDRICAL
10115700	S545R-0.375-D1-R060.0-Z5	3/8	3/8	1/2	2	5	HTA	0.060	CYLINDRICAL
10008056	S545-0.375-D3-S.0-Z5	3/8	3/8	1	2-1/2	5	HTA	-	CYLINDRICAL
10008057	S545R-0.375-D3-R015.0-Z5	3/8	3/8	1	2-1/2	5	HTA	0.015	CYLINDRICAL
10008058	S545R-0.375-D3-R030.0-Z5	3/8	3/8	1	2-1/2	5	HTA	0.030	CYLINDRICAL
10115701	S545R-0.375-D3-R045.0-Z5	3/8	3/8	1	2-1/2	5	HTA	0.045	CYLINDRICAL
10115702	S545R-0.375-D3-R060.0-Z5	3/8	3/8	1	2-1/2	5	HTA	0.060	CYLINDRICAL
10008059	S545-0.500-D1-S.0-Z5	1/2	1/2	5/8	2-1/2	5	HTA	-	CYLINDRICAL
10008060	S545R-0.500-D1-R030.0-Z5	1/2	1/2	5/8	2-1/2	5	HTA	0.030	CYLINDRICAL
10008061	S545R-0.500-D1-R060.0-Z5	1/2	1/2	5/8	2-1/2	5	HTA	0.060	CYLINDRICAL
10008062	S545-0.500-D3-S.0-Z5	1/2	1/2	1-1/4	3	5	HTA	-	CYLINDRICAL
10008063	S545R-0.500-D3-R030.0-Z5	1/2	1/2	1-1/4	3	5	HTA	0.030	CYLINDRICAL
10008064	S545R-0.500-D3-R060.0-Z5	1/2	1/2	1-1/4	3	5	HTA	0.060	CYLINDRICAL
10008065	S545R-0.500-D3-R125.0-Z5	1/2	1/2	1-1/4	3	5	HTA	0.125	CYLINDRICAL
10008066	S545-0.625-D3-S.0-Z5	5/8	5/8	1-5/8	3-1/2	5	HTA	-	CYLINDRICAL
10008067	S545R-0.625-D3-R030.0-Z5	5/8	5/8	1-5/8	3-1/2	5	HTA	0.030	CYLINDRICAL
10008068	S545R-0.625-D3-R060.0-Z5	5/8	5/8	1-5/8	3-1/2	5	HTA	0.060	CYLINDRICAL
10008069	S545-0.750-D2-S.0-Z5	3/4	3/4	1-5/8	4	5	HTA	-	CYLINDRICAL
10008070	S545R-0.750-D2-R015.0-Z5	3/4	3/4	1-5/8	4	5	HTA	0.015	CYLINDRICAL
10008071	S545R-0.750-D2-R030.0-Z5	3/4	3/4	1-5/8	4	5	HTA	0.030	CYLINDRICAL
10008072	S545R-0.750-D2-R060.0-Z5	3/4	3/4	1-5/8	4	5	HTA	0.060	CYLINDRICAL
10008073	S545R-0.750-D2-R125.0-Z5	3/4	3/4	1-5/8	4	5	HTA	0.125	CYLINDRICAL

MULTI FLUTE - S638, S738, S938

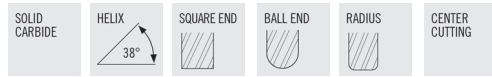

- Eccentric O.D. relief creating a stronger cutting edge
- Excellent in high speed milling and optimized roughing techniques
- High performance with minimal deflection
- Advanced chip splitter options for increased chip control and management

ITEM NUMBER	DESCRIPTION	DIMENSIONS IN INCH				FLUTES	COATING	RADIUS	SHANK TYPE
		FLUTE DIA.	SHANK DIA.	LOC	OAL				
S638/S638R (6-FLUTE SQUARE END AND WITH CORNER RADIUS)									
10115708	S638-0.125-F2-S-0-Z6	1/8	1/4	3/16	2	6	HTA	-	CYLINDRICAL
10115723	S638R-0.125-F2-R010.0-Z6	1/8	1/4	3/16	2	6	HTA	0.010	CYLINDRICAL
10115724	S638R-0.125-F2-R015.0-Z6	1/8	1/4	3/16	2	6	HTA	0.015	CYLINDRICAL
10115725	S638R-0.125-F2-R030.0-Z6	1/8	1/4	3/16	2	6	HTA	0.030	CYLINDRICAL
10115709	S638-0.125-F3-S-0-Z6	1/8	1/4	7/16	2	6	HTA	-	CYLINDRICAL
10008074	S638R-0.125-F4-R010.0-Z6	1/8	1/4	7/16	2	6	HTA	0.010	CYLINDRICAL
10115726	S638R-0.125-F4-R015.0-Z6	1/8	1/4	7/16	2	6	HTA	0.015	CYLINDRICAL
10115727	S638R-0.125-F4-R030.0-Z6	1/8	1/4	7/16	2	6	HTA	0.030	CYLINDRICAL
10115710	S638-0.188-F2-S-0-Z6	3/16	1/4	5/16	2	6	HTA	-	CYLINDRICAL
10115728	S638R-0.188-F2-R010.0-Z6	3/16	1/4	5/16	2	6	HTA	0.010	CYLINDRICAL
10115729	S638R-0.188-F2-R015.0-Z6	3/16	1/4	5/16	2	6	HTA	0.015	CYLINDRICAL
10115730	S638R-0.188-F2-R030.0-Z6	3/16	1/4	5/16	2	6	HTA	0.030	CYLINDRICAL
10115711	S638-0.188-F4-S-0-Z6	3/16	1/4	5/8	2	6	HTA	-	CYLINDRICAL
10008075	S638R-0.188-F4-R010.0-Z6	3/16	1/4	5/8	2	6	HTA	0.010	CYLINDRICAL
10115731	S638R-0.188-F4-R015.0-Z6	3/16	1/4	5/8	2	6	HTA	0.015	CYLINDRICAL
10115732	S638R-0.188-F4-R030.0-Z6	3/16	1/4	5/8	2	6	HTA	0.030	CYLINDRICAL
10115712	S638-0.250-D2-S-0-Z6	1/4	1/4	3/8	2	6	HTA	-	CYLINDRICAL
10115733	S638R-0.250-D2-R015.0-Z6	1/4	1/4	3/8	2	6	HTA	0.015	CYLINDRICAL
10115734	S638R-0.250-D2-R030.0-Z6	1/4	1/4	3/8	2	6	HTA	0.030	CYLINDRICAL
10115735	S638R-0.250-D2-R060.0-Z6	1/4	1/4	3/8	2	6	HTA	0.060	CYLINDRICAL
10115713	S638-0.250-D4-S-0-Z6	1/4	1/4	7/8	2-1/2	6	HTA	-	CYLINDRICAL
10008076	S638R-0.250-D4-R015.0-Z6	1/4	1/4	7/8	2-1/2	6	HTA	0.015	CYLINDRICAL
10008077	S638R-0.250-D4-R030.0-Z6	1/4	1/4	7/8	2-1/2	6	HTA	0.030	CYLINDRICAL
10115736	S638R-0.250-D4-R060.0-Z6	1/4	1/4	7/8	2-1/2	6	HTA	0.060	CYLINDRICAL
10115714	S638-0.313-D1-S-0-Z6	5/16	5/16	7/16	2	6	HTA	-	CYLINDRICAL
10115737	S638R-0.313-D1-R015.0-Z6	5/16	5/16	7/16	2	6	HTA	0.015	CYLINDRICAL
10115738	S638R-0.313-D1-R030.0-Z6	5/16	5/16	7/16	2	6	HTA	0.030	CYLINDRICAL
10115739	S638R-0.313-D1-R060.0-Z6	5/16	5/16	7/16	2	6	HTA	0.060	CYLINDRICAL
10115715	S638-0.313-D3-S-0-Z6	5/16	5/16	1	3	6	HTA	-	CYLINDRICAL
10008078	S638R-0.313-D3-R015.0-Z6	5/16	5/16	1	3	6	HTA	0.015	CYLINDRICAL
10008079	S638R-0.313-D3-R030.0-Z6	5/16	5/16	1	3	6	HTA	0.030	CYLINDRICAL
10115740	S638R-0.313-D3-R060.0-Z6	5/16	5/16	1	3	6	HTA	0.060	CYLINDRICAL
10115716	S638-0.375-D2-S-0-Z6	3/8	3/8	1/2	2	6	HTA	-	CYLINDRICAL
10115741	S638R-0.375-D2-R015.0-Z6	3/8	3/8	1/2	2	6	HTA	0.015	CYLINDRICAL
10115742	S638R-0.375-D2-R030.0-Z6	3/8	3/8	1/2	2	6	HTA	0.030	CYLINDRICAL
10115743	S638R-0.375-D2-R060.0-Z6	3/8	3/8	1/2	2	6	HTA	0.060	CYLINDRICAL
10115717	S638-0.375-D1-S-0-Z6	3/8	3/8	1	3	6	HTA	-	CYLINDRICAL
10115744	S638R-0.375-D1-R015.0-Z6	3/8	3/8	1	3	6	HTA	0.015	CYLINDRICAL
10115745	S638R-0.375-D1-R030.0-Z6	3/8	3/8	1	3	6	HTA	0.030	CYLINDRICAL
10115746	S638R-0.375-D1-R060.0-Z6	3/8	3/8	1	3	6	HTA	0.060	CYLINDRICAL
10008082	S638-0.375-D3-S-0-Z6	3/8	3/8	1-1/4	3	6	HTA	-	CYLINDRICAL
10008080	S638R-0.375-D3-R015.0-Z6	3/8	3/8	1-1/4	3	6	HTA	0.015	CYLINDRICAL
10008081	S638R-0.375-D3-R030.0-Z6	3/8	3/8	1-1/4	3	6	HTA	0.030	CYLINDRICAL
10115747	S638R-0.375-D3-R060.0-Z6	3/8	3/8	1-1/4	3	6	HTA	0.060	CYLINDRICAL
10115718	S638-0.500-D2-S-0-Z6	1/2	1/2	5/8	2-1/2	6	HTA	-	CYLINDRICAL
10115748	S638R-0.500-D2-R015.0-Z6	1/2	1/2	5/8	2-1/2	6	HTA	0.015	CYLINDRICAL
10115749	S638R-0.500-D2-R030.0-Z6	1/2	1/2	5/8	2-1/2	6	HTA	0.030	CYLINDRICAL
10115750	S638R-0.500-D2-R060.0-Z6	1/2	1/2	5/8	2-1/2	6	HTA	0.060	CYLINDRICAL
10115751	S638R-0.500-D2-R120.0-Z6	1/2	1/2	5/8	2-1/2	6	HTA	0.120	CYLINDRICAL

MULTI FLUTE - S638, S738, S938 (CONT.)

ITEM NUMBER	DESCRIPTION	DIMENSIONS IN INCH				FLUTES	COATING	RADIUS	SHANK TYPE
		FLUTE DIA.	SHANK DIA.	LOC	OAL				
10115812	S638-0.500-D4-S.0-Z6	1/2	1/2	1	3	6	HTA	-	CYLINDRICAL
10115813	S638R-0.500-D4-R015.0-Z6	1/2	1/2	1	3	6	HTA	0.015	CYLINDRICAL
10115814	S638R-0.500-D4-R030.0-Z6	1/2	1/2	1	3	6	HTA	0.030	CYLINDRICAL
10115815	S638R-0.500-D4-R060.0-Z6	1/2	1/2	1	3	6	HTA	0.060	CYLINDRICAL
10115816	S638R-0.500-D4-R120.0-Z6	1/2	1/2	1	3	6	HTA	0.120	CYLINDRICAL
10115719	S638-0.500-D1-S.0-Z6	1/2	1/2	1-1/4	3	6	HTA	-	CYLINDRICAL
10115752	S638R-0.500-D1-R015.0-Z6	1/2	1/2	1-1/4	3	6	HTA	0.015	CYLINDRICAL
10115753	S638R-0.500-D1-R030.0-Z6	1/2	1/2	1-1/4	3	6	HTA	0.030	CYLINDRICAL
10115755	S638R-0.500-D1-R060.0-Z6	1/2	1/2	1-1/4	3	6	HTA	0.060	CYLINDRICAL
10115756	S638R-0.500-D1-R120.0-Z6	1/2	1/2	1-1/4	3	6	HTA	0.120	CYLINDRICAL
10008083	S638-0.500-D3-S.0-Z6	1/2	1/2	1-5/8	4	6	HTA	-	CYLINDRICAL
10008084	S638R-0.500-D3-R015.0-Z6	1/2	1/2	1-5/8	4	6	HTA	0.015	CYLINDRICAL
10008085	S638R-0.500-D3-R030.0-Z6	1/2	1/2	1-5/8	4	6	HTA	0.030	CYLINDRICAL
10008086	S638R-0.500-D3-R060.0-Z6	1/2	1/2	1-5/8	4	6	HTA	0.060	CYLINDRICAL
10008087	S638R-0.500-D3-R120.0-Z6	1/2	1/2	1-5/8	4	6	HTA	0.120	CYLINDRICAL
10115720	S638-0.625-D1-S.0-Z6	5/8	5/8	1-5/8	3-1/2	6	HTA	-	CYLINDRICAL
10115757	S638R-0.625-D1-R030.0-Z6	5/8	5/8	1-5/8	3-1/2	6	HTA	0.030	CYLINDRICAL
10115758	S638R-0.625-D1-R060.0-Z6	5/8	5/8	1-5/8	3-1/2	6	HTA	0.060	CYLINDRICAL
10115759	S638R-0.625-D1-R120.0-Z6	5/8	5/8	1-5/8	3-1/2	6	HTA	0.120	CYLINDRICAL
10008088	S638-0.625-D3-S.0-Z6	5/8	5/8	2	4	6	HTA	-	CYLINDRICAL
10008089	S638R-0.625-D3-R015.0-Z6	5/8	5/8	2	4	6	HTA	0.015	CYLINDRICAL
10008090	S638R-0.625-D3-R030.0-Z6	5/8	5/8	2	4	6	HTA	0.030	CYLINDRICAL
10008091	S638R-0.625-D3-R060.0-Z6	5/8	5/8	2	4	6	HTA	0.060	CYLINDRICAL
10008092	S638R-0.625-D3-R120.0-Z6	5/8	5/8	2	4	6	HTA	0.120	CYLINDRICAL
10115721	S638-0.750-D1-S.0-Z6	3/4	3/4	1	3	6	HTA	-	CYLINDRICAL
10115760	S638R-0.750-D1-R030.0-Z6	3/4	3/4	1	3	6	HTA	0.030	CYLINDRICAL
10115761	S638R-0.750-D1-R060.0-Z6	3/4	3/4	1	3	6	HTA	0.060	CYLINDRICAL
10115762	S638R-0.750-D1-R120.0-Z6	3/4	3/4	1	3	6	HTA	0.120	CYLINDRICAL
10115722	S638-0.750-D2-S.0-Z6	3/4	3/4	1-3/4	4	6	HTA	-	CYLINDRICAL
10115763	S638R-0.750-D2-R030.0-Z6	3/4	3/4	1-3/4	4	6	HTA	0.030	CYLINDRICAL
10115764	S638R-0.750-D2-R060.0-Z6	3/4	3/4	1-3/4	4	6	HTA	0.060	CYLINDRICAL
10115765	S638R-0.750-D2-R120.0-Z6	3/4	3/4	1-3/4	4	6	HTA	0.120	CYLINDRICAL
10008093	S638-0.750-D3-S.0-Z6	3/4	3/4	2-1/2	5	6	HTA	-	CYLINDRICAL
10008094	S638R-0.750-D3-R030.0-Z6	3/4	3/4	2-1/2	5	6	HTA	0.030	CYLINDRICAL
10008095	S638R-0.750-D3-R060.0-Z6	3/4	3/4	2-1/2	5	6	HTA	0.060	CYLINDRICAL
10008096	S638R-0.750-D3-R120.0-Z6	3/4	3/4	2-1/2	5	6	HTA	0.120	CYLINDRICAL
10008097	S638R-1.000-D3-R030.0-Z6	1	1	3-1/8	6	6	HTA	0.030	CYLINDRICAL
10008098	S638R-1.000-D3-R060.0-Z6	1	1	3-1/8	6	6	HTA	0.060	CYLINDRICAL
10008100	S638R-1.000-D3-R120.0-Z6	1	1	3-1/8	6	6	HTA	0.120	CYLINDRICAL
10008101	S638R-1.000-D3-R250.0-Z6	1	1	3-1/8	6	6	HTA	0.250	CYLINDRICAL
SCS638/SCS638R (6-FLUTE SQUARE END AND CORNER RADIUS WITH CHIPSPITTER)									
10115855	SCS638-0.250-D2-S.0-Z6	1/4	1/4	3/8	2	6	HTA	-	CYLINDRICAL
10115870	SCS638R-0.250-D2-R015.0-Z6	1/4	1/4	3/8	2	6	HTA	0.015	CYLINDRICAL
10115856	SCS638-0.250-D3-S.0-Z6	1/4	1/4	5/8	2	6	HTA	-	CYLINDRICAL
10115871	SCS638R-0.250-D3-R015.0-Z6	1/4	1/4	5/8	2	6	HTA	0.015	CYLINDRICAL
10115857	SCS638-0.250-D4-S.0-Z6	1/4	1/4	7/8	2-1/2	6	HTA	-	CYLINDRICAL
10115872	SCS638R-0.250-D4-R015.0-Z6	1/4	1/4	7/8	2-1/2	6	HTA	0.015	CYLINDRICAL
10115858	SCS638-0.375-D1-S.0-Z6	3/8	3/8	1/2	2	6	HTA	-	CYLINDRICAL
10115873	SCS638R-0.375-D1-R030.0-Z6	3/8	3/8	1/2	2	6	HTA	0.030	CYLINDRICAL
10115859	SCS638-0.375-D2-S.0-Z6	3/8	3/8	7/8	3	6	HTA	-	CYLINDRICAL
10115874	SCS638R-0.375-D2-R030.0-Z6	3/8	3/8	7/8	3	6	HTA	0.030	CYLINDRICAL
10115860	SCS638-0.375-D3-S.0-Z6	3/8	3/8	1-1/4	3	6	HTA	-	CYLINDRICAL
10115875	SCS638R-0.375-D3-R030.0-Z6	3/8	3/8	1-1/4	3	6	HTA	0.030	CYLINDRICAL
10115861	SCS638-0.500-D1-S.0-Z6	1/2	1/2	5/8	2-1/2	6	HTA	-	CYLINDRICAL
10115876	SCS638R-0.500-D1-R030.0-Z6	1/2	1/2	5/8	2-1/2	6	HTA	0.030	CYLINDRICAL
10115862	SCS638-0.500-D2-S.0-Z6	1/2	1/2	1	3	6	HTA	-	CYLINDRICAL
10115877	SCS638R-0.500-D2-R030.0-Z6	1/2	1/2	1	3	6	HTA	0.030	CYLINDRICAL

MULTI FLUTE - S638, S738, S938 (CONT.)

ITEM NUMBER	DESCRIPTION	DIMENSIONS IN INCH				FLUTES	COATING	RADIUS	SHANK TYPE
		FLUTE DIA.	SHANK DIA.	LOC	OAL				
10115878	SCS638R-0.500-D4-R030.0-Z6	1/2	1/2	1-1/4	3	6	HTA	0.030	CYLINDRICAL
10115864	SCS638-0.500-D4-S.0-Z6	1/2	1/2	1-1/4	3	6	HTA	-	CYLINDRICAL
10115863	SCS638-0.500-D3-S.0-Z6	1/2	1/2	1-5/8	4	6	HTA	-	CYLINDRICAL
10008417	SCS638R-0.500-D3-R030.0-Z6	1/2	1/2	1-5/8	4	6	HTA	0.030	CYLINDRICAL
10115865	SCS638-0.625-D2-S.0-Z6	5/8	5/8	1-1/4	3	6	HTA	-	CYLINDRICAL
10115879	SCS638R-0.625-D2-R030.0-Z6	5/8	5/8	1-1/4	3	6	HTA	0.030	CYLINDRICAL
10115880	SCS638R-0.625-D2-R060.0-Z6	5/8	5/8	1-1/4	3	6	HTA	0.060	CYLINDRICAL
10115866	SCS638-0.625-D3-S.0-Z6	5/8	5/8	2	4	6	HTA	-	CYLINDRICAL
10008418	SCS638R-0.625-D3-R030.0-Z6	5/8	5/8	2	4	6	HTA	0.030	CYLINDRICAL
10008419	SCS638R-0.625-D3-R060.0-Z6	5/8	5/8	2	4	6	HTA	0.060	CYLINDRICAL
10115867	SCS638-0.750-D2-S.0-Z6	3/4	3/4	1-5/8	4	6	HTA	-	CYLINDRICAL
10115881	SCS638R-0.750-D2-R030.0-Z6	3/4	3/4	1-5/8	4	6	HTA	0.030	CYLINDRICAL
10115882	SCS638R-0.750-D2-R060.0-Z6	3/4	3/4	1-5/8	4	6	HTA	0.060	CYLINDRICAL
10115868	SCS638-0.750-D3-S.0-Z6	3/4	3/4	2-1/2	5	6	HTA	-	CYLINDRICAL
10008420	SCS638R-0.750-D3-R030.0-Z6	3/4	3/4	2-1/2	5	6	HTA	0.030	CYLINDRICAL
10008421	SCS638R-0.750-D3-R060.0-Z6	3/4	3/4	2-1/2	5	6	HTA	0.060	CYLINDRICAL
SB638 (6-FLUTE BALL END)									
10115768	SB638-0.250-D2-B.0-Z6	1/4	1/4	3/8	2	6	HTA	-	CYLINDRICAL
10008099	SB638-0.250-D3-B.0-Z6	1/4	1/4	5/8	2	6	HTA	-	CYLINDRICAL
10115769	SB638-0.250-D4-B.0-Z6	1/4	1/4	7/8	2-1/2	6	HTA	-	CYLINDRICAL
10115770	SB638-0.313-D3-B.0-Z6	5/16	5/16	7/16	2	6	HTA	-	CYLINDRICAL
10115771	SB638-0.313-D4-B.0-Z6	5/16	5/16	1	3	6	HTA	-	CYLINDRICAL
10008102	SB638-0.375-D1-B.0-Z6	3/8	3/8	3/8	2	6	HTA	-	CYLINDRICAL
10008103	SB638-0.375-D3-B.0-Z6	3/8	3/8	1	2-1/2	6	HTA	-	CYLINDRICAL
10115772	SB638-0.500-D2-B.0-Z6	1/2	1/2	5/8	2-1/2	6	HTA	-	CYLINDRICAL
10008104	SB638-0.500-D3-B.0-Z6	1/2	1/2	1-1/4	3	6	HTA	-	CYLINDRICAL
10115773	SB638-0.500-D4-B.0-Z6	1/2	1/2	1-5/8	4	6	HTA	-	CYLINDRICAL
10115774	SB638-0.625-D2-B.0-Z6	5/8	5/8	3/4	3	6	HTA	-	CYLINDRICAL
10008105	SB638-0.625-D3-B.0-Z6	5/8	5/8	1-5/8	4	6	HTA	-	CYLINDRICAL
10115817	SB638-0.750-D3-B.0-Z6	3/4	3/4	1	3	6	HTA	-	CYLINDRICAL
10008106	SB638-0.750-D2-B.0-Z6	3/4	3/4	1-3/4	4	6	HTA	-	CYLINDRICAL
10115775	SB638-0.750-D4-B.0-Z6	3/4	3/4	2-1/2	5	6	HTA	-	CYLINDRICAL
S738/S738R (7-FLUTE SQUARE END AND WITH CORNER RADIUS)									
10115821	S738-0.250-D2-S.0-Z7	1/4	1/4	3/8	2	7	HTA	-	CYLINDRICAL
10115829	S738R-0.250-D2-R015.0-Z7	1/4	1/4	3/8	2	7	HTA	0.015	CYLINDRICAL
10115830	S738R-0.250-D2-R030.0-Z7	1/4	1/4	3/8	2	7	HTA	0.030	CYLINDRICAL
10115822	S738-0.250-D4-S.0-Z7	1/4	1/4	7/8	2-1/2	7	HTA	-	CYLINDRICAL
10115831	S738R-0.250-D4-R015.0-Z7	1/4	1/4	7/8	2-1/2	7	HTA	0.015	CYLINDRICAL
10115832	S738R-0.250-D4-R030.0-Z7	1/4	1/4	7/8	2-1/2	7	HTA	0.030	CYLINDRICAL
10115823	S738-0.375-D1-S.0-Z7	3/8	3/8	1/2	2-1/2	7	HTA	-	CYLINDRICAL
10115833	S738R-0.375-D1-R030.0-Z7	3/8	3/8	1/2	2-1/2	7	HTA	0.030	CYLINDRICAL
10115834	S738R-0.375-D1-R060.0-Z7	3/8	3/8	1/2	2-1/2	7	HTA	0.060	CYLINDRICAL
10115824	S738-0.375-D3-S.0-Z7	3/8	3/8	1	3	7	HTA	-	CYLINDRICAL
10115835	S738R-0.375-D3-R030.0-Z7	3/8	3/8	1	3	7	HTA	0.030	CYLINDRICAL
10115836	S738R-0.375-D3-R060.0-Z7	3/8	3/8	1	3	7	HTA	0.060	CYLINDRICAL
10008107	S738-0.500-D2-S.0-Z7	1/2	1/2	3/4	3	7	HTA	-	CYLINDRICAL
10008108	S738R-0.500-D2-R030.0-Z7	1/2	1/2	3/4	3	7	HTA	0.030	CYLINDRICAL
10115837	S738R-0.500-D2-R060.0-Z7	1/2	1/2	3/4	3	7	HTA	0.060	CYLINDRICAL
10008109	S738-0.500-D3-S.0-Z7	1/2	1/2	1-1/4	3	7	HTA	-	CYLINDRICAL
10008110	S738R-0.500-D3-R030.0-Z7	1/2	1/2	1-1/4	3	7	HTA	0.030	CYLINDRICAL
10115838	S738R-0.500-D3-R060.0-Z7	1/2	1/2	1-1/4	3	7	HTA	0.060	CYLINDRICAL
10008111	S738-0.500-D5-S.0-Z7	1/2	1/2	1-5/8	4	7	HTA	-	CYLINDRICAL
10008112	S738R-0.500-D5-R030.0-Z7	1/2	1/2	1-5/8	4	7	HTA	0.030	CYLINDRICAL
10115839	S738R-0.500-D5-R060.0-Z7	1/2	1/2	1-5/8	4	7	HTA	0.060	CYLINDRICAL
10115825	S738-0.625-D1-S.0-Z7	5/8	5/8	3/4	3	7	HTA	-	CYLINDRICAL
10115840	S738R-0.625-D1-R030.0-Z7	5/8	5/8	3/4	3	7	HTA	0.030	CYLINDRICAL

MULTI FLUTE - S638, S738, S938 (CONT.)

ITEM NUMBER	DESCRIPTION	DIMENSIONS IN INCH				FLUTES	COATING	RADIUS	SHANK TYPE
		FLUTE DIA.	SHANK DIA.	LOC	OAL				
10115841	S738R-0.625-D1-R060.0-Z7	5/8	5/8	3/4	3	7	HTA	0.060	CYLINDRICAL
10115826	S738-0.625-D2-S.0-Z7	5/8	5/8	1-1/4	4	7	HTA	-	CYLINDRICAL
10115842	S738R-0.625-D2-R030.0-Z7	5/8	5/8	1-1/4	4	7	HTA	0.030	CYLINDRICAL
10115843	S738R-0.625-D2-R060.0-Z7	5/8	5/8	1-1/4	4	7	HTA	0.060	CYLINDRICAL
10115827	S738-0.750-D1-S.0-Z7	3/4	3/4	1	3	7	HTA	-	CYLINDRICAL
10115844	S738R-0.750-D1-R030.0-Z7	3/4	3/4	1	3	7	HTA	0.030	CYLINDRICAL
10115845	S738R-0.750-D1-R060.0-Z7	3/4	3/4	1	3	7	HTA	0.060	CYLINDRICAL
10115846	S738R-0.750-D1-R120.0-Z7	3/4	3/4	1	3	7	HTA	0.120	CYLINDRICAL
10115828	S738-0.750-D2-S.0-Z7	3/4	3/4	1-5/8	4	7	HTA	-	CYLINDRICAL
10115847	S738R-0.750-D2-R030.0-Z7	3/4	3/4	1-5/8	4	7	HTA	0.030	CYLINDRICAL
10115848	S738R-0.750-D2-R060.0-Z7	3/4	3/4	1-5/8	4	7	HTA	0.060	CYLINDRICAL
10115849	S738R-0.750-D2-R120.0-Z7	3/4	3/4	1-5/8	4	7	HTA	0.120	CYLINDRICAL
SCS738R (7-FLUTE CORNER RADIUS WITH CHIPSPITTER)									
10008503	SCS738R-0.500-D3-R030.0-Z7	1/2	1/2	1-1/4	3	7	HTA	0.030	CYLINDRICAL
10008504	SCS738R-0.500-D5-R030.0-Z7	1/2	1/2	1-5/8	4	7	HTA	0.030	CYLINDRICAL
S938/S938R (9-FLUTE SQUARE END AND WITH CORNER RADIUS)									
10008115	S938-0.625-D1-S.0-Z9	5/8	5/8	3/4	3	9	HTA	-	CYLINDRICAL
10008116	S938R-0.625-D1-R030.0-Z9	5/8	5/8	3/4	3	9	HTA	0.030	CYLINDRICAL
10008117	S938-0.625-D4-S.0-Z9	5/8	5/8	2	4	9	HTA	-	CYLINDRICAL
10008118	S938R-0.625-D4-R030.0-Z9	5/8	5/8	2	4	9	HTA	0.030	CYLINDRICAL
10008119	S938-0.750-D2-S.0-Z9	3/4	3/4	1-5/8	4	9	HTA	-	CYLINDRICAL
10008120	S938R-0.750-D2-R030.0-Z9	3/4	3/4	1-5/8	4	9	HTA	0.030	CYLINDRICAL
10008121	S938R-0.750-D2-R060.0-Z9	3/4	3/4	1-5/8	4	9	HTA	0.060	CYLINDRICAL
10008122	S938R-0.750-D2-R120.0-Z9	3/4	3/4	1-5/8	4	9	HTA	0.120	CYLINDRICAL
10008123	S938-0.750-D4-S.0-Z9	3/4	3/4	2-1/2	5	9	HTA	-	CYLINDRICAL
10008124	S938R-0.750-D4-R030.0-Z9	3/4	3/4	2-1/2	5	9	HTA	0.030	CYLINDRICAL
10008125	S938R-0.750-D4-R060.0-Z9	3/4	3/4	2-1/2	5	9	HTA	0.060	CYLINDRICAL
10008126	S938R-0.750-D4-R120.0-Z9	3/4	3/4	2-1/2	5	9	HTA	0.120	CYLINDRICAL
SCS938R (9-FLUTE CORNER RADIUS WITH CHIPSPITTER)									
10008513	SCS938R-0.625-D5-R030.0-Z9	5/8	5/8	2	4	9	HTA	0.030	CYLINDRICAL
10008514	SCS938R-0.750-D5-R030.0-Z9	3/4	3/4	2-1/2	5	9	HTA	0.030	CYLINDRICAL
10008515	SCS938R-1.000-D5-R030.0-Z9	1	1	3-1/8	6	9	HTA	0.030	CYLINDRICAL

STABILIZER™ 2.0 - STS430.2, STR430.2, & STR440.2

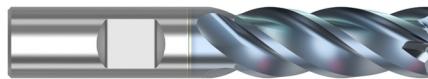

- Eccentric primary relief
- Continuous varying asymmetrical flute geometry
- Ideal for profiling and slotting

ITEM NUMBER	DESCRIPTION	DIMENSIONS IN INCH				FLUTES	COATING	RADIUS	SHANK TYPE
		FLUTE DIA.	SHANK DIA.	LOC	OAL				
STS430.2 (4-FLUTE SQUARE END)									
10008525	STS430.2-0.125-D3-S.0-Z4	1/8	1/8	3/8	1-1/2	4	HTA	-	CYLINDRICAL
10008526	STS430.2-0.156-F3-S.0-Z4	5/32	3/16	15/32	2	4	HTA	-	CYLINDRICAL
10008527	STS430.2-0.188-D3-S.0-Z4	3/16	3/16	9/16	2	4	HTA	-	CYLINDRICAL
10008528	STS430.2-0.250-D1-S.0-Z4	1/4	1/4	1/4	2	4	HTA	-	CYLINDRICAL
10008529	STS430.2-0.250-D2-S.0-Z4	1/4	1/4	1/2	2-1/2	4	HTA	-	CYLINDRICAL
10008530	STS430.2-0.250-D3-S.0-Z4	1/4	1/4	3/4	2-1/2	4	HTA	-	CYLINDRICAL
10008531	STS430.2-0.375-D1-S.3-Z4	3/8	3/8	3/8	2	4	HTA	-	WELDON
10008532	STS430.2-0.375-D2-S.3-Z4	3/8	3/8	3/4	2-1/2	4	HTA	-	WELDON
10008533	STS430.2-0.375-D3-S.3-Z4	3/8	3/8	1-1/8	3	4	HTA	-	WELDON
10008534	STS430.2-0.500-D2-S.3-Z4	1/2	1/2	1	3	4	HTA	-	WELDON
10008535	STS430.2-0.500-D3-S.3-Z4	1/2	1/2	1-1/4	3	4	HTA	-	WELDON

STABILIZER™ 2.0 - STS430.2, STR430.2, & STR440.2 (CONT.)

ITEM NUMBER	DESCRIPTION	DIMENSIONS IN INCH				FLUTES	COATING	RADIUS	SHANK TYPE
		FLUTE DIA.	SHANK DIA.	LOC	OAL				
10008536	STS430.2-0.625-D2-S.3-Z4	5/8	5/8	1-1/4	3-1/2	4	HTA	-	WELDON
10008537	STS430.2-0.750-D1-S.3-Z4	3/4	3/4	3/4	3	4	HTA	-	WELDON
10008538	STS430.2-0.750-D2-S.3-Z4	3/4	3/4	1-1/2	4	4	HTA	-	WELDON
10008539	STS430.2-0.750-D3-S.3-Z4	3/4	3/4	2-1/4	5	4	HTA	-	WELDON
STR430.2 (4-FLUTE WITH CORNER RADIUS)									
10008540	STR430.2-0.250-D2-R020.0-Z4	1/4	1/4	1/2	2-1/2	4	HTA	0.020	CYLINDRICAL
10008541	STR430.2-0.250-D3-R020.0-Z4	1/4	1/4	3/4	2-1/2	4	HTA	0.020	CYLINDRICAL
10008542	STR430.2-0.375-D1-R020.3-Z4	3/8	3/8	3/8	2	4	HTA	0.020	WELDON
10008543	STR430.2-0.375-D2-R020.3-Z4	3/8	3/8	3/4	2-1/2	4	HTA	0.020	WELDON
10008544	STR430.2-0.375-D3-R020.3-Z4	3/8	3/8	1-1/8	3	4	HTA	0.020	WELDON
10008545	STR430.2-0.500-D2-R030.3-Z4	1/2	1/2	1	3	4	HTA	0.030	WELDON
10008546	STR430.2-0.500-D3-R030.3-Z4	1/2	1/2	1-1/4	3	4	HTA	0.030	WELDON
10008547	STR430.2-0.625-D2-R030.3-Z4	5/8	5/8	1-1/4	3-1/2	4	HTA	0.030	WELDON
10008548	STR430.2-0.750-D1-R030.3-Z4	3/4	3/4	3/4	3	4	HTA	0.030	WELDON
10008549	STR430.2-0.750-D2-R030.3-Z4	3/4	3/4	1-1/2	4	4	HTA	0.030	WELDON
10008550	STR430.2-0.750-D3-R030.3-Z4	3/4	3/4	2-1/4	5	4	HTA	0.030	WELDON
STR440.2 (4-FLUTE WITH CORNER RADIUS)									
10008555	STR440.2-0.125-D1-R010.0-Z4	1/8	1/8	1/8	1-1/2	4	HTA	0.010	CYLINDRICAL
10008556	STR440.2-0.125-D2-R010.0-Z4	1/8	1/8	1/4	1-1/2	4	HTA	0.010	CYLINDRICAL
10008557	STR440.2-0.125-D3-R010.0-Z4	1/8	1/8	3/8	1-1/2	4	HTA	0.010	CYLINDRICAL
10008558	STR440.2-0.156-F1-R010.0-Z4	5/32	3/16	5/32	2	4	HTA	0.010	CYLINDRICAL
10008559	STR440.2-0.156-F2-R010.0-Z4	5/32	3/16	5/16	2	4	HTA	0.010	CYLINDRICAL
10008560	STR440.2-0.156-F3-R010.0-Z4	5/32	3/16	15/32	2	4	HTA	0.010	CYLINDRICAL
10008561	STR440.2-0.188-D1-R010.0-Z4	3/16	3/16	3/16	2	4	HTA	0.010	CYLINDRICAL
10008562	STR440.2-0.188-D2-R010.0-Z4	3/16	3/16	3/8	2	4	HTA	0.010	CYLINDRICAL
10115918	STR440.2-0.188-D2-R030.0-Z4	3/16	3/16	3/8	2	4	HTA	0.030	CYLINDRICAL
10115919	STR440.2-0.188-D2-R060.0-Z4	3/16	3/16	3/8	2	4	HTA	0.060	CYLINDRICAL
10008563	STR440.2-0.188-D3-R010.0-Z4	3/16	3/16	9/16	2	4	HTA	0.010	CYLINDRICAL
10115920	STR440.2-0.188-D3-R030.0-Z4	3/16	3/16	9/16	2	4	HTA	0.030	CYLINDRICAL
10115921	STR440.2-0.188-D3-R060.0-Z4	3/16	3/16	9/16	2	4	HTA	0.060	CYLINDRICAL
10008564	STR440.2-0.250-D1-R020.0-Z4	1/4	1/4	1/4	2	4	HTA	0.020	CYLINDRICAL
10115922	STR440.2-0.250-D2-R015.0-Z4	1/4	1/4	1/2	2-1/2	4	HTA	0.015	CYLINDRICAL
10008565	STR440.2-0.250-D2-R020.0-Z4	1/4	1/4	1/2	2-1/2	4	HTA	0.020	CYLINDRICAL
10115923	STR440.2-0.250-D2-R030.0-Z4	1/4	1/4	1/2	2-1/2	4	HTA	0.030	CYLINDRICAL
10115924	STR440.2-0.250-D2-R060.0-Z4	1/4	1/4	1/2	2-1/2	4	HTA	0.060	CYLINDRICAL
10115925	STR440.2-0.250-D3-R015.0-Z4	1/4	1/4	3/4	2-1/2	4	HTA	0.015	CYLINDRICAL
10008566	STR440.2-0.250-D3-R020.0-Z4	1/4	1/4	3/4	2-1/2	4	HTA	0.020	CYLINDRICAL
10115926	STR440.2-0.250-D3-R030.0-Z4	1/4	1/4	3/4	2-1/2	4	HTA	0.030	CYLINDRICAL
10115927	STR440.2-0.250-D3-R060.0-Z4	1/4	1/4	3/4	2-1/2	4	HTA	0.060	CYLINDRICAL
10008567	STR440.2-0.375-D1-R020.0-Z4	3/8	3/8	3/8	2	4	HTA	0.020	CYLINDRICAL
10008568	STR440.2-0.375-D1-R020.3-Z4	3/8	3/8	3/8	2	4	HTA	0.020	WELDON
10115928	STR440.2-0.375-D2-R015.0-Z4	3/8	3/8	3/4	2-1/2	4	HTA	0.015	CYLINDRICAL
10008569	STR440.2-0.375-D2-R020.0-Z4	3/8	3/8	3/4	2-1/2	4	HTA	0.020	CYLINDRICAL
10115929	STR440.2-0.375-D2-R030.0-Z4	3/8	3/8	3/4	2-1/2	4	HTA	0.030	CYLINDRICAL
10115930	STR440.2-0.375-D2-R060.0-Z4	3/8	3/8	3/4	2-1/2	4	HTA	0.060	CYLINDRICAL
10008570	STR440.2-0.375-D2-R020.3-Z4	3/8	3/8	3/4	2-1/2	4	HTA	0.020	WELDON
10008571	STR440.2-0.375-D3-R020.0-Z4	3/8	3/8	1-1/8	3	4	HTA	0.020	CYLINDRICAL
10008572	STR440.2-0.375-D3-R020.3-Z4	3/8	3/8	1-1/8	3	4	HTA	0.020	WELDON
10008573	STR440.2-0.500-D1-R030.0-Z4	1/2	1/2	1/2	2-1/2	4	HTA	0.030	CYLINDRICAL
10008574	STR440.2-0.500-D1-R030.3-Z4	1/2	1/2	1/2	2-1/2	4	HTA	0.030	WELDON
10008575	STR440.2-0.500-D2-R030.0-Z4	1/2	1/2	1	3	4	HTA	0.030	CYLINDRICAL
10008576	STR440.2-0.500-D2-R030.3-Z4	1/2	1/2	1	3	4	HTA	0.030	WELDON

STABILIZER™ 2.0 - STS430.2, STR430.2, & STR440.2 (CONT.)

ITEM NUMBER	DESCRIPTION	DIMENSIONS IN INCH				FLUTES	COATING	RADIUS	SHANK TYPE
		FLUTE DIA.	SHANK DIA.	LOC	OAL				
10008577	STR440.2-0.500-D2-R060.0-Z4	1/2	1/2	1	3	4	HTA	0.060	CYLINDRICAL
10008578	STR440.2-0.500-D2-R060.3-Z4	1/2	1/2	1	3	4	HTA	0.060	WELDON
10008579	STR440.2-0.500-D2-R120.0-Z4	1/2	1/2	1	3	4	HTA	0.120	CYLINDRICAL
10008580	STR440.2-0.500-D2-R120.3-Z4	1/2	1/2	1	3	4	HTA	0.120	WELDON
10008581	STR440.2-0.500-D3-R030.0-Z4	1/2	1/2	1-1/4	3	4	HTA	0.030	CYLINDRICAL
10008582	STR440.2-0.500-D3-R030.3-Z4	1/2	1/2	1-1/4	3	4	HTA	0.030	WELDON
10008583	STR440.2-0.750-D2-R030.0-Z4	3/4	3/4	1-1/2	4	4	HTA	0.030	CYLINDRICAL
10008584	STR440.2-0.750-D2-R030.3-Z4	3/4	3/4	1-1/2	4	4	HTA	0.030	WELDON
10008585	STR440.2-0.750-D2-R060.0-Z4	3/4	3/4	1-1/2	4	4	HTA	0.060	CYLINDRICAL
10008586	STR440.2-0.750-D2-R060.3-Z4	3/4	3/4	1-1/2	4	4	HTA	0.060	WELDON
10008587	STR440.2-0.750-D2-R120.0-Z4	3/4	3/4	1-1/2	4	4	HTA	0.120	CYLINDRICAL
10008588	STR440.2-0.750-D2-R120.3-Z4	3/4	3/4	1-1/2	4	4	HTA	0.120	WELDON

STABILIZER™ 2.0 - STB440.2



- US Patent # 6,991,409
- Eccentric Primary Relief
- Continuous Varying Asymmetrical Flute Geometry
- Ideal for profiling and slotting

ITEM NUMBER	DESCRIPTION	DIMENSIONS IN INCH				FLUTES	COATING	RADIUS	SHANK TYPE
		FLUTE DIA.	SHANK DIA.	LOC	OAL				
STB440.2 (4-FLUTE BALL END)									
10115886	STB440.2-0.125-D2-B.0-Z4	1/8	1/8	1/4	1-1/2	4	HTA	-	CYLINDRICAL
10115887	STB440.2-0.125-D3-B.0-Z4	1/8	1/8	3/8	2	4	HTA	-	CYLINDRICAL
10115889	STB440.2-0.188-D2-B.0-Z4	3/16	3/16	3/8	2	4	HTA	-	CYLINDRICAL
10115891	STB440.2-0.250-D1-B.0-Z4	1/4	1/4	3/8	2	4	HTA	-	CYLINDRICAL
10115892	STB440.2-0.250-D2-B.0-Z4	1/4	1/4	1/2	2-1/2	4	HTA	-	CYLINDRICAL
10115893	STB440.2-0.250-D3-B.0-Z4	1/4	1/4	3/4	2-1/2	4	HTA	-	CYLINDRICAL
10115895	STB440.2-0.313-D2-B.0-Z4	5/16	5/16	5/8	2-1/2	4	HTA	-	CYLINDRICAL
10115896	STB440.2-0.313-D3-B.0-Z4	5/16	5/16	3/4	2-1/2	4	HTA	-	CYLINDRICAL
10115898	STB440.2-0.375-D1-B.0-Z4	3/8	3/8	1/2	2	4	HTA	-	CYLINDRICAL
10115899	STB440.2-0.375-D1-B.3-Z4	3/8	3/8	1/2	2	4	HTA	-	WELDON
10115900	STB440.2-0.375-D2-B.0-Z4	3/8	3/8	3/4	2-1/2	4	HTA	-	CYLINDRICAL
10115901	STB440.2-0.375-D2-B.3-Z4	3/8	3/8	3/4	2-1/2	4	HTA	-	WELDON
10115902	STB440.2-0.375-D3-B.0-Z4	3/8	3/8	1	3	4	HTA	-	CYLINDRICAL
10115903	STB440.2-0.375-D3-B.3-Z4	3/8	3/8	1	3	4	HTA	-	WELDON
10115906	STB440.2-0.500-D1-B.0-Z4	1/2	1/2	5/8	2-1/2	4	HTA	-	CYLINDRICAL
10115907	STB440.2-0.500-D1-B.3-Z4	1/2	1/2	5/8	2-1/2	4	HTA	-	WELDON
10115908	STB440.2-0.500-D2-B.0-Z4	1/2	1/2	1	3	4	HTA	-	CYLINDRICAL
10115909	STB440.2-0.500-D2-B.3-Z4	1/2	1/2	1	3	4	HTA	-	WELDON
10115910	STB440.2-0.500-D3-B.0-Z4	1/2	1/2	1-1/4	3	4	HTA	-	CYLINDRICAL
10115911	STB440.2-0.500-D3-B.3-Z4	1/2	1/2	1-1/4	3	4	HTA	-	WELDON
10115914	STB440.2-0.750-D1-B.0-Z4	3/4	3/4	7/8	3	4	HTA	-	CYLINDRICAL
10115915	STB440.2-0.750-D1-B.3-Z4	3/4	3/4	7/8	3	4	HTA	-	WELDON
10115916	STB440.2-0.750-D2-B.0-Z4	3/4	3/4	1-1/2	4	4	HTA	-	CYLINDRICAL
10115917	STB440.2-0.750-D2-B.3-Z4	3/4	3/4	1-1/2	4	4	HTA	-	WELDON

STABILIZER 5-FLUTE - STS540 & STR540



- Asymmetrical flute geometry
- Full eccentric relief
- Ideal for profiling, high speed milling, and optimized roughing techniques

ITEM NUMBER	DESCRIPTION	DIMENSIONS IN INCH				FLUTES	COATING	RADIUS	SHANK TYPE
		FLUTE DIA.	SHANK DIA.	LOC	OAL				
STS540/STR540 (5-FLUTE SQUARE END AND WITH CORNER RADIUS)									
10115960	STS540-0.125-D2-S.0-Z5	1/8	1/8	1/4	1-1/2	5	HTA	-	CYLINDRICAL
10115932	STR540-0.125-D2-R015.0-Z5	1/8	1/8	1/4	1-1/2	5	HTA	0.015	CYLINDRICAL
10115933	STR540-0.125-D2-R030.0-Z5	1/8	1/8	1/4	1-1/2	5	HTA	0.030	CYLINDRICAL
10115961	STS540-0.125-D4-S.0-Z5	1/8	1/8	1/2	1-1/2	5	HTA	-	CYLINDRICAL
10115934	STR540-0.125-D4-R015.0-Z5	1/8	1/8	1/2	1-1/2	5	HTA	0.015	CYLINDRICAL
10115935	STR540-0.125-D4-R030.0-Z5	1/8	1/8	1/2	1-1/2	5	HTA	0.030	CYLINDRICAL
10115962	STS540-0.188-D2-S.0-Z5	3/16	3/16	5/16	2	5	HTA	-	CYLINDRICAL
10115936	STR540-0.188-D2-R015.0-Z5	3/16	3/16	5/16	2	5	HTA	0.015	CYLINDRICAL
10115937	STR540-0.188-D2-R030.0-Z5	3/16	3/16	5/16	2	5	HTA	0.030	CYLINDRICAL
10115938	STR540-0.188-D2-R045.0-Z5	3/16	3/16	5/16	2	5	HTA	0.045	CYLINDRICAL
10115963	STS540-0.188-D3-S.0-Z5	3/16	3/16	9/16	2	5	HTA	-	CYLINDRICAL
10115939	STR540-0.188-D3-R015.0-Z5	3/16	3/16	9/16	2	5	HTA	0.015	CYLINDRICAL
10115940	STR540-0.188-D3-R030.0-Z5	3/16	3/16	9/16	2	5	HTA	0.030	CYLINDRICAL
10115941	STR540-0.188-D3-R045.0-Z5	3/16	3/16	9/16	2	5	HTA	0.045	CYLINDRICAL
10115964	STS540-0.250-D1-S.0-Z5	1/4	1/4	3/8	2	5	HTA	-	CYLINDRICAL
10115942	STR540-0.250-D1-R015.0-Z5	1/4	1/4	3/8	2	5	HTA	0.015	CYLINDRICAL
10115943	STR540-0.250-D1-R030.0-Z5	1/4	1/4	3/8	2	5	HTA	0.030	CYLINDRICAL
10115944	STR540-0.250-D1-R045.0-Z5	1/4	1/4	3/8	2	5	HTA	0.045	CYLINDRICAL
10115945	STR540-0.250-D1-R060.0-Z5	1/4	1/4	3/8	2	5	HTA	0.060	CYLINDRICAL
10008608	STS540-0.250-D3-S.0-Z5	1/4	1/4	3/4	2-1/2	5	HTA	-	CYLINDRICAL
10008595	STR540-0.250-D3-R015.0-Z5	1/4	1/4	3/4	2-1/2	5	HTA	0.015	CYLINDRICAL
10008596	STR540-0.250-D3-R030.0-Z5	1/4	1/4	3/4	2-1/2	5	HTA	0.030	CYLINDRICAL
10115946	STR540-0.250-D3-R045.0-Z5	1/4	1/4	3/4	2-1/2	5	HTA	0.045	CYLINDRICAL
10115947	STR540-0.250-D3-R060.0-Z5	1/4	1/4	3/4	2-1/2	5	HTA	0.060	CYLINDRICAL
10115948	STR540-0.313-D2-R015.0-Z5	5/16	5/16	3/4	2-1/2	5	HTA	0.015	CYLINDRICAL
10115949	STR540-0.313-D2-R030.0-Z5	5/16	5/16	3/4	2-1/2	5	HTA	0.030	CYLINDRICAL
10115950	STR540-0.313-D2-R045.0-Z5	5/16	5/16	3/4	2-1/2	5	HTA	0.045	CYLINDRICAL
10115951	STR540-0.313-D2-R060.0-Z5	5/16	5/16	3/4	2-1/2	5	HTA	0.060	CYLINDRICAL
10115965	STS540-0.375-D1-S.0-Z5	3/8	3/8	1/2	2-1/2	5	HTA	-	CYLINDRICAL
10115952	STR540-0.375-D1-R015.0-Z5	3/8	3/8	1/2	2-1/2	5	HTA	0.015	CYLINDRICAL
10115953	STR540-0.375-D1-R030.0-Z5	3/8	3/8	1/2	2-1/2	5	HTA	0.030	CYLINDRICAL
10115954	STR540-0.375-D1-R045.0-Z5	3/8	3/8	1/2	2-1/2	5	HTA	0.045	CYLINDRICAL
10115955	STR540-0.375-D1-R060.0-Z5	3/8	3/8	1/2	2-1/2	5	HTA	0.060	CYLINDRICAL
10008609	STS540-0.375-D2-S.0-Z5	3/8	3/8	7/8	2-1/2	5	HTA	-	CYLINDRICAL
10008597	STR540-0.375-D2-R015.0-Z5	3/8	3/8	7/8	2-1/2	5	HTA	0.015	CYLINDRICAL
10008598	STR540-0.375-D2-R030.0-Z5	3/8	3/8	7/8	2-1/2	5	HTA	0.030	CYLINDRICAL
10008599	STR540-0.375-D2-R045.0-Z5	3/8	3/8	7/8	2-1/2	5	HTA	0.045	CYLINDRICAL
10115956	STR540-0.375-D2-R060.0-Z5	3/8	3/8	7/8	2-1/2	5	HTA	0.060	CYLINDRICAL
10115966	STS540-0.500-D2-S.0-Z5	1/2	1/2	1	3	5	HTA	-	CYLINDRICAL
10115957	STR540-0.500-D2-R030.0-Z5	1/2	1/2	1	3	5	HTA	0.030	CYLINDRICAL
10115958	STR540-0.500-D2-R060.0-Z5	1/2	1/2	1	3	5	HTA	0.060	CYLINDRICAL
10115959	STR540-0.500-D2-R125.0-Z5	1/2	1/2	1	3	5	HTA	0.125	CYLINDRICAL
10008610	STS540-0.500-D3-S.0-Z5	1/2	1/2	1-1/4	3	5	HTA	-	CYLINDRICAL
10008600	STR540-0.500-D3-R030.0-Z5	1/2	1/2	1-1/4	3	5	HTA	0.030	CYLINDRICAL
10008601	STR540-0.500-D3-R060.0-Z5	1/2	1/2	1-1/4	3	5	HTA	0.060	CYLINDRICAL
10008602	STR540-0.500-D3-R125.0-Z5	1/2	1/2	1-1/4	3	5	HTA	0.125	CYLINDRICAL
10008611	STS540-0.625-D2-S.0-Z5	5/8	5/8	1-1/4	3-1/2	5	HTA	-	CYLINDRICAL
10008603	STR540-0.625-D2-R030.0-Z5	5/8	5/8	1-1/4	3-1/2	5	HTA	0.030	CYLINDRICAL
10008604	STR540-0.625-D2-R060.0-Z5	5/8	5/8	1-1/4	3-1/2	5	HTA	0.060	CYLINDRICAL
10008612	STS540-0.750-D2-S.0-Z5	3/4	3/4	1-1/2	4	5	HTA	-	CYLINDRICAL
10008606	STR540-0.750-D2-R030.0-Z5	3/4	3/4	1-1/2	4	5	HTA	0.030	CYLINDRICAL
10008607	STR540-0.750-D2-R060.0-Z5	3/4	3/4	1-1/2	4	5	HTA	0.060	CYLINDRICAL
10008605	STR540-0.750-D2-R125.0-Z5	3/4	3/4	1-1/2	4	5	HTA	0.125	CYLINDRICAL

SECO MATERIAL GROUP (SMG)

STEEL, FERRITIC AND MARTENSITIC STAINLESS STEEL

ISO	SMG	REPRESENTATIVE MATERIAL	DESCRIPTION	BHN	KC1.1 X 1000 LBF/IN2	MC
P	1	1010	Very soft carbon steels Purely ferritic steels	< 135	196	0.21
	2	1140	Free-cutting steels	120 < 210	218	0.22
	3	1045	Structural steels. Ordinary carbon steels with low to medium carbon content (<0.5%C)	135 < 165	218	0.25
	4	4140	Carbon steels with high carbon content (>0.5%C) Medium hard steels for toughening. Ordinary low-alloy steels Ferritic and martensitic stainless steels	165 < 210	247	0.24
	5	4340	Normal tool steels Harder steels for toughening Martensitic stainless steels	210 < 270	276	0.24
	6	D2	Difficult tool steels High-alloy steels with high hardness Martensitic stainless steels	270 < 360	290	0.24
H	7	A128 Grade A	Difficult high-strength steels with 42 to 56 HRC hardness Hardened steels from material group 3-6 Martensitic stainless steels	> 360	421	0.22

FREE-CUTTING, AUSTENITIC AND DUPLEX STAINLESS STEEL

M	8	304	Easy-cutting stainless steels Free-cutting stainless steels Calcium-treated stainless steels		254	0.22
	9	316	Moderately difficult stainless steels Austenitic and duplex stainless steels		276	0.2
	10	310	Difficult stainless steels Austenitic and duplex stainless steels		297	0.2
	11	330	Very difficult stainless steels Austenitic and duplex stainless steels		312	0.2

CAST IRON

K	12	60-40-18	Medium hard cast iron Grey cast iron		167	0.22
	13	A536 80-55-06	Low-alloy cast iron Malleable cast iron Nodular cast iron		178	0.25
	14	A536 100-70-03	Moderately difficult alloy cast iron Moderately difficult malleable cast iron Nodular cast iron		196	0.28
	15	A536 120-90-02	Difficult high-alloy cast iron Difficult malleable cast iron Nodular cast iron		213	0.3

OTHER MATERIALS

N	16	A380	Aluminum alloys: Low Si		101	0.25
	17	B390.0	Aluminum alloys: High Si		101	0.27
	18	CA937	Copper alloys			
S	19	Disalloy	Fe-based superalloys			
	20	Stellite 21	Co-based superalloys		377	0.24
	21	Inconel 718 (bar, forge, ring)	Ni-based superalloys		479	0.24
	22	Ti 6Al-4V (annealed)	Titanium alloys		210	0.23

k_{c1} -values with 0 degree effective cutting rake angle. For other rake angles, reduce the k_{c1} -value by 1% for every degree increase in the cutting rake angle and vice versa. Keep in mind that the BHN-value is only an aid in the selection of the material group when the material has been worked by rolling, drawing, heat treatment or other methods that increase the strength of the material.

S545 / S545R HTA

SIDE MILLING - ROUGHING

ISO GROUP	SMG	a _p x D _c (max)	a _e x D _c (max)	v _c (sf / min)		Z _n = 5							
						1/8	3/16	1/4	3/8	1/2	5/8	3/4	
M	E 8-9	2.00	0.10	380	285 - 475	n [min-1]	11613	7742	5806	3871	2903	2323	1935
						fz [in]	0.0008	0.0012	0.0016	0.0024	0.0033	0.0041	0.0049
						vf [in/min]	47	47	47	47	47	47	47
	A/E 10-11	2.00	0.08	360	250 - 450	n [min-1]	11002	7334	5501	3667	2750	2200	1834
						fz [in]	0.0008	0.0011	0.0015	0.0023	0.0030	0.0038	0.0045
						vf [in/min]	41	41	41	41	41	41	41
S	E 19	2.00	0.05	100	75 - 125	n [min-1]	3056	2037	1528	1019	764	611	509
						fz [in]	0.0006	0.0008	0.0011	0.0017	0.0023	0.0028	0.0034
						vf [in/min]	9	9	9	9	9	9	9
	E 20	2.00	0.05	75	56 - 94	n [min-1]	2292	1528	1146	764	573	458	382
						fz [in]	0.0005	0.0008	0.0010	0.0015	0.0020	0.0025	0.0030
						vf [in/min]	6	6	6	6	6	6	6
	E 21	2.00	0.05	65	49 - 81	n [min-1]	1986	1324	993	662	497	397	331
						fz [in]	0.0005	0.0008	0.0010	0.0015	0.0020	0.0025	0.0030
						vf [in/min]	5	5	5	5	5	5	5
	E 22	2.00	0.08	170	128 - 213	n [min-1]	5195	3463	2598	1732	1299	1039	866
						fz [in]	0.0008	0.0011	0.0015	0.0023	0.0030	0.0038	0.0045
						vf [in/min]	19	19	19	19	19	19	19

SMG = Seco Material Group

n (min-1) = RPM

fz (in) = Feed/tooth

vf (in/min) = Feed rate

v_c (sf/min) = Surface feet/min

a_p x D_c = % of diameter

a_e x D_c = % of diameter

All cutting data are start values

All cutting data is in inch values

S545 / S545R HTA

SIDE MILLING - FINISHING												
ISO GROUP	SMG	$a_p \times D_c$ (max)	$a_e \times D_c$ (max)	v_c (sf / min)		$Z_1 = 5$						
						1/8	3/16	1/4	3/8	1/2	5/8	3/4
M	E 8-9	2.00	0.02	470	n [min-1]	14363	9575	7182	4788	3591	2873	2394
					fz [in]	0.0006	0.0009	0.0013	0.0019	0.0025	0.0031	0.0038
					vf [in/min]	45	45	45	45	45	45	45
	A/E 10-11	2.00	0.02	450	n [min-1]	13752	9168	6876	4584	3438	2750	2292
					fz [in]	0.0006	0.0009	0.0013	0.0019	0.0025	0.0031	0.0038
					vf [in/min]	43	43	43	43	43	43	43
S	E 19	2.00	0.02	120	n [min-1]	3667	2445	1834	1222	917	733	611
					fz [in]	0.0005	0.0008	0.0010	0.0015	0.0020	0.0025	0.0030
					vf [in/min]	9	9	9	9	9	9	9
	E 20	2.00	0.02	90	n [min-1]	2750	1834	1375	917	688	550	458
					fz [in]	0.0005	0.0008	0.0010	0.0015	0.0020	0.0025	0.0030
					vf [in/min]	7	7	7	7	7	7	7
	E 21	2.00	0.02	75	n [min-1]	2292	1528	1146	764	573	458	382
					fz [in]	0.0005	0.0008	0.0010	0.0015	0.0020	0.0025	0.0030
					vf [in/min]	6	6	6	6	6	6	6
	E 22	2.00	0.02	200	n [min-1]	6112	4075	3056	2037	1528	1222	1019
					fz [in]	0.0006	0.0009	0.0013	0.0019	0.0025	0.0031	0.0038
					vf [in/min]	19	19	19	19	19	19	19

SMG = Seco Material Group

n (min-1) = RPM

fz (in) = Feed/tooth

vf (in/min) = Feed rate

v_c (sf/min) = Surface feet/min

$a_p \times D_c$ = % of diameter

$a_e \times D_c$ = % of diameter

All cutting data are start values

All cutting data is in inch values

S638 / S638R / SB638 HTA

SIDE MILLING - ROUGHING																
ISO GROUP	SMG	$a_p \times D_c$ (max)	$a_e \times D_c$ (max)	v_c (sf / min)				$Z_n = 6$								
								1/8	3/16	1/4	5/16	3/8	1/2	5/8	3/4	1
M	E 8-9	2.00	0.12	450	-	750	n [min-1]	18336	12224	9168	7334	6112	4584	3667	3056	2292
							fz [in]	0.0011	0.0017	0.0023	0.0028	0.0034	0.0045	0.0056	0.0068	0.0090
							vf [in/min]	124	124	124	124	124	124	124	124	124
	A/E 10-11	2.00	0.10	424	-	706	n [min-1]	17266	11511	8633	6907	5755	4317	3453	2878	2158
							fz [in]	0.0010	0.0015	0.0020	0.0025	0.0030	0.0040	0.0050	0.0060	0.0080
							vf [in/min]	104	104	104	104	104	104	104	104	104
S	E 19	2.00	0.07	113	-	188	n [min-1]	4584	3056	2292	1834	1528	1146	917	764	573
							fz [in]	0.0008	0.0011	0.0015	0.0019	0.0023	0.0030	0.0038	0.0045	0.0060
							vf [in/min]	21	21	21	21	21	21	21	21	21
	E 20	2.00	0.06	90	-	150	n [min-1]	3667	2445	1834	1467	1222	917	733	611	458
							fz [in]	0.0007	0.0010	0.0014	0.0017	0.0021	0.0028	0.0034	0.0041	0.0055
							vf [in/min]	15	15	15	15	15	15	15	15	15
	E 21	2.00	0.06	75	-	125	n [min-1]	3056	2037	1528	1222	1019	764	611	509	382
							fz [in]	0.0007	0.0010	0.0014	0.0017	0.0021	0.0028	0.0034	0.0041	0.0055
							vf [in/min]	13	13	13	13	13	13	13	13	13
	E 22	2.00	0.10	203	-	338	n [min-1]	8251	5501	4126	3300	2750	2063	1650	1375	1031
							fz [in]	0.0010	0.0015	0.0020	0.0025	0.0030	0.0040	0.0050	0.0060	0.0080
							vf [in/min]	50	50	50	50	50	50	50	50	50

SMG = Seco Material Group

n (min-1) = RPM

fz (in) = Feed/tooth

vf (in/min) = Feed rate

v_c (sf/min) = Surface feet/min

$a_p \times D_c$ = % of diameter

$a_e \times D_c$ = % of diameter

All cutting data are start values

All cutting data is in inch values

S638 / S638R / SB638 HTA

SIDE MILLING - FINISHING															
ISO GROUP	SMG	ap x Dc (max)	ae x Dc (max)	vc (sf / min)		Z _n = 6									
						1/8	3/16	1/4	5/16	3/8	1/2	5/8	3/4	1	
M	E 8-9	2.00	0.02	750	563 - 938	n [min-1]	22920	15280	11460	9168	7640	5730	4584	3820	2865
						fz [in]	0.0006	0.0009	0.0013	0.0016	0.0019	0.0025	0.0031	0.0038	0.0050
						vf [in/min]	86	86	86	86	86	86	86	86	86
	A/E 10-11	2.00	0.02	700	525 - 875	n [min-1]	21392	14261	10696	8557	7131	5348	4278	3565	2674
						fz [in]	0.0006	0.0009	0.0013	0.0016	0.0019	0.0025	0.0031	0.0038	0.0050
						vf [in/min]	80	80	80	80	80	80	80	80	80
S	E 19	2.00	0.02	190	143 - 238	n [min-1]	5806	3871	2903	2323	1935	1452	1161	968	726
						fz [in]	0.0005	0.0008	0.0010	0.0013	0.0015	0.0020	0.0025	0.0030	0.0040
						vf [in/min]	17	17	17	17	17	17	17	17	17
	E 20	2.00	0.02	150	113 - 188	n [min-1]	4584	3056	2292	1834	1528	1146	917	764	573
						fz [in]	0.0005	0.0008	0.0010	0.0013	0.0015	0.0020	0.0025	0.0030	0.0040
						vf [in/min]	14	14	14	14	14	14	14	14	14
	E 21	2.00	0.02	125	94 - 156	n [min-1]	3820	2547	1910	1528	1273	955	764	637	478
						fz [in]	0.0005	0.0008	0.0010	0.0013	0.0015	0.0020	0.0025	0.0030	0.0040
						vf [in/min]	11	11	11	11	11	11	11	11	11
	E 22	2.00	0.02	340	255 - 425	n [min-1]	10390	6927	5195	4156	3463	2598	2078	1732	1299
						fz [in]	0.0006	0.0009	0.0013	0.0016	0.0019	0.0025	0.0031	0.0038	0.0050
						vf [in/min]	39	39	39	39	39	39	39	39	39

SMG = Seco Material Group
n (min-1) = RPM
fz (in) = Feed/tooth
vf (in/min) = Feed rate
vc (sf/min) = Surface feet/min
ap x Dc = % of diameter
ae x Dc = % of diameter
All cutting data are start values
All cutting data is in inch values

NOTE: Optimized Roughing is an excellent strategy for achieving quality parts and extending tool life, but requires use of the right equipment and cutting parameters. If you are having problems implementing the approach or want to learn more about how to use the strategy to process a part, contact the Technical Support Team at 1-800-TEC-TEAM.

S738 HTA

SIDE MILLING - ROUGHING													
ISO GROUP	SMG	ap x Dc (max)	ae x Dc (max)	vc (sf / min)		Z _n = 7							
						1/4	3/8	1/2	5/8	3/4			
M	E 8-9	2.00	0.07	680	510	-	850	n [min-1]	10390	6927	5195	4156	3463
								fz [in]	0.0023	0.0034	0.0045	0.0056	0.0068
								vf [in/min]	164	164	164	164	164
	A/E 10-11	2.00	0.06	630	473	-	788	n [min-1]	9626	6418	4813	3851	3209
								fz [in]	0.0020	0.0030	0.0040	0.0050	0.0060
								vf [in/min]	135	135	135	135	135
S	E 19	2.00	0.04	170	128	-	213	n [min-1]	2598	1732	1299	1039	866
								fz [in]	0.0015	0.0023	0.0030	0.0038	0.0045
								vf [in/min]	27	27	27	27	27
	E 20	2.00	0.04	135	101	-	169	n [min-1]	2063	1375	1031	825	688
								fz [in]	0.0014	0.0021	0.0028	0.0034	0.0041
								vf [in/min]	20	20	20	20	20
	E 21	2.00	0.04	115	86	-	144	n [min-1]	1757	1171	879	703	586
								fz [in]	0.0014	0.0021	0.0028	0.0034	0.0041
	E 22	2.00	0.06	310	233	-	388	n [min-1]	4737	3158	2368	1895	1579
								fz [in]	0.0016	0.0024	0.0033	0.0041	0.0049
vf [in/min]								54	54	54	54	54	

S738 HTA

SIDE MILLING - FINISHING													
ISO GROUP	SMG	ap x Dc (max)	ae x Dc (max)	vc (sf / min)		Z _n = 7							
						1/4	3/8	1/2	5/8	3/4			
M	E 8-9	2.00	0.02	850	638	-	1063	n [min-1]	12988	8659	6494	5195	4329
								fz [in]	0.0013	0.0019	0.0025	0.0031	0.0038
								vf [in/min]	114	114	114	114	114
	A/E 10-11	2.00	0.02	790	593	-	988	n [min-1]	12071	8047	6036	4828	4024
								fz [in]	0.0013	0.0019	0.0025	0.0031	0.0038
								vf [in/min]	106	106	106	106	106
S	E 19	2.00	0.02	210	158	-	263	n [min-1]	3209	2139	1604	1284	1070
								fz [in]	0.0010	0.0015	0.0020	0.0025	0.0030
								vf [in/min]	22	22	22	22	22
	E 20	2.00	0.02	170	128	-	213	n [min-1]	2598	1732	1299	1039	866
								fz [in]	0.0010	0.0015	0.0020	0.0025	0.0030
								vf [in/min]	18	18	18	18	18
	E 21	2.00	0.02	145	109	-	181	n [min-1]	2216	1477	1108	886	739
								fz [in]	0.0010	0.0015	0.0020	0.0025	0.0030
	E 22	2.00	0.02	390	293	-	488	n [min-1]	5959	3973	2980	2384	1986
								fz [in]	0.0013	0.0019	0.0025	0.0031	0.0038
vf [in/min]								52	52	52	52	52	

S938 HTA

SIDE MILLING - ROUGHING									
ISO GROUP	SMG	ap x Dc (max)	ae x Dc (max)	vc (sf / min)			Zn = 9		
							5/8	3/4	
M	E 8-9	2.00	0.07	680	510	- 850	n [min-1]	4156	3463
							fz [in]	0.0056	0.0068
							vf [in/min]	210	210
	A/E 10-11	2.00	0.06	630	473	- 788	n [min-1]	3851	3209
							fz [in]	0.0050	0.0060
							vf [in/min]	173	173
S	E 19	2.00	0.04	170	128	- 213	n [min-1]	1039	866
							fz [in]	0.0038	0.0045
							vf [in/min]	35	35
	E 20	2.00	0.04	135	101	- 169	n [min-1]	825	688
							fz [in]	0.0034	0.0041
							vf [in/min]	26	26
	E 21	2.00	0.04	115	86	- 144	n [min-1]	703	586
							fz [in]	0.0034	0.0041
	E 22	2.00	0.06	310	233	- 388	n [min-1]	1895	1579
							fz [in]	0.0041	0.0049
							vf [in/min]	69	69

S938 HTA

SIDE MILLING - FINISHING									
ISO GROUP	SMG	ap x Dc (max)	ae x Dc (max)	vc (sf / min)			Zn = 9		
							5/8	3/4	
M	E 8-9	2.00	0.02	850	638	- 1063	n [min-1]	5195	4329
							fz [in]	0.0031	0.0038
							vf [in/min]	146	146
	A/E 10-11	2.00	0.02	790	593	- 988	n [min-1]	4828	4024
							fz [in]	0.0031	0.0038
							vf [in/min]	136	136
S	E 19	2.00	0.02	210	158	- 263	n [min-1]	1284	1070
							fz [in]	0.0025	0.0030
							vf [in/min]	29	29
	E 20	2.00	0.02	170	128	- 213	n [min-1]	1039	866
							fz [in]	0.0025	0.0030
							vf [in/min]	23	23
	E 21	2.00	0.02	145	109	- 181	n [min-1]	886	739
							fz [in]	0.0025	0.0030
	E 22	2.00	0.02	390	293	- 488	n [min-1]	2384	1986
							fz [in]	0.0031	0.0038
							vf [in/min]	67	67

SB638 HTA

COPY MILLING - ROUGHING											
ISO GROUP	SMG	ap x Dc (max)	ae x Dc (max)	vc (sf / min)		Z _n = 6					
						1/4	5/16	3/8	1/2	5/8	3/4
M	E 8-9	0.05	0.05	360	n [min-1]	5501	4401	3667	2750	2200	1834
					fz [in]	0.0030	0.0038	0.0045	0.0060	0.0075	0.0090
					vf [in/min]	99	99	99	99	99	99
	A/E 10-11	0.04	0.04	230	n [min-1]	3514	2812	2343	1757	1406	1171
					fz [in]	0.0030	0.0038	0.0045	0.0060	0.0075	0.0090
					vf [in/min]	63	63	63	63	63	63
S	E 19	0.045	0.045	295	n [min-1]	4508	3606	3005	2254	1803	1503
					fz [in]	0.0025	0.0031	0.0038	0.0050	0.0063	0.0075
					vf [in/min]	68	68	68	68	68	68
	E 20	0.04	0.04	295	n [min-1]	4508	3606	3005	2254	1803	1503
					fz [in]	0.0025	0.0031	0.0038	0.0050	0.0063	0.0075
					vf [in/min]	68	68	68	68	68	68
	E 21	0.035	0.035	145	n [min-1]	2216	1772	1477	1108	886	739
					fz [in]	0.0020	0.0025	0.0030	0.0040	0.0050	0.0060
					vf [in/min]	27	27	27	27	27	27
	E 22	0.05	0.05	295	n [min-1]	4508	3606	3005	2254	1803	1503
					fz [in]	0.0025	0.0031	0.0038	0.0050	0.0063	0.0075
					vf [in/min]	68	68	68	68	68	68

SB638 HTA

COPY MILLING - FINISHING											
ISO GROUP	SMG	ap x Dc (max)	ae x Dc (max)	vc (sf / min)		Z _n = 6					
						1/4	5/16	3/8	1/2	5/8	3/4
M	E 8-9	0.02	0.02	395	n [min-1]	6036	4828	4024	3018	2414	2012
					fz [in]	0.0024	0.0030	0.0036	0.0048	0.0060	0.0072
					vf [in/min]	87	87	87	87	87	87
	A/E 10-11	0.02	0.02	250	n [min-1]	3820	3056	2547	1910	1528	1273
					fz [in]	0.0024	0.0030	0.0036	0.0048	0.0060	0.0072
					vf [in/min]	55	55	55	55	55	55
S	E 19	0.02	0.02	325	n [min-1]	4966	3973	3311	2483	1986	1655
					fz [in]	0.0020	0.0025	0.0030	0.0040	0.0050	0.0060
					vf [in/min]	60	60	60	60	60	60
	E 20	0.02	0.02	325	n [min-1]	4966	3973	3311	2483	1986	1655
					fz [in]	0.0020	0.0025	0.0030	0.0040	0.0050	0.0060
					vf [in/min]	60	60	60	60	60	60
	E 21	0.02	0.02	160	n [min-1]	2445	1956	1630	1222	978	815
					fz [in]	0.0016	0.0020	0.0024	0.0032	0.0040	0.0048
					vf [in/min]	23	23	23	23	23	23
	E 22	0.02	0.02	325	n [min-1]	4966	3973	3311	2483	1986	1655
					fz [in]	0.0020	0.0025	0.0030	0.0040	0.0050	0.0060
					vf [in/min]	60	60	60	60	60	60

SCS638R HTA

SIDE MILLING - SEMI ROUGHING										
ISO GROUP	SMG	ap x Dc (max)	ae x Dc (max)	vc (sf / min)		Z _n = 6				
						1/4	3/8	1/2	5/8	3/4
M	E 8-9	3.00	0.08	600	n [min-1]	9168	6112	4584	3667	3056
					fz [in]	0.0019	0.0028	0.0038	0.0047	0.0056
					vf [in/min]	103	103	103	103	103
	A/E 10-11	3.00	0.07	565	n [min-1]	8633	5755	4317	3453	2878
					fz [in]	0.0016	0.0024	0.0033	0.0041	0.0049
					vf [in/min]	84	84	84	84	84
S	E 19	3.00	0.05	150	n [min-1]	2292	1528	1146	917	764
					fz [in]	0.0013	0.0019	0.0025	0.0031	0.0038
					vf [in/min]	17	17	17	17	17
	E 20	3.00	0.04	120	n [min-1]	1834	1222	917	733	611
					fz [in]	0.0012	0.0017	0.0023	0.0029	0.0035
					vf [in/min]	13	13	13	13	13
	E 21	3.00	0.04	100	n [min-1]	1528	1019	764	611	509
					fz [in]	0.0012	0.0017	0.0023	0.0029	0.0035
					vf [in/min]	11	11	11	11	11
	E 22	3.00	0.07	270	n [min-1]	4126	2750	2063	1650	1375
					fz [in]	0.0016	0.0024	0.0033	0.0041	0.0049
					vf [in/min]	40	40	40	40	40

SCS738R HTA

SIDE MILLING - SEMI ROUGHING										
ISO GROUP	SMG	ap x Dc (max)	ae x Dc (max)	vc (sf / min)		Z _n = 7				
						1/2				
M	E 8-9	3.00	0.05	680	n [min-1]		5195			
					fz [in]		0.0040			
					vf [in/min]	510	850	145		
	A/E 10-11	3.00	0.04	630	n [min-1]		4813			
					fz [in]		0.0035			
					vf [in/min]	473	788	118		
S	E 19	3.00	0.03	170	n [min-1]		1299			
					fz [in]		0.0030			
					vf [in/min]	128	213	27		
	E 20	3.00	0.03	135	n [min-1]		1031			
					fz [in]		0.0028			
					vf [in/min]	101	169	20		
	E 21	3.00	0.03	115	n [min-1]		879			
					fz [in]		0.0028			
					vf [in/min]	86	144	17		
	E 22	3.00	0.04	310	n [min-1]		2368			
					fz [in]		0.0030			
					vf [in/min]	233	388	50		

SCS938R HTA

SIDE MILLING - SEMI ROUGHING										
ISO GROUP	SMG	ap x Dc (max)	ae x Dc (max)	vc (sf / min)			Z _n = 9			
							5/8	3/4	1	
M	E 8-9	3.00	0.05	680	510	- 850	n [min-1]	4156	3463	2598
							fz [in]	0.0056	0.0068	0.0090
							vf [in/min]	210	210	210
	A/E 10-11	3.00	0.04	630	473	- 788	n [min-1]	3851	3209	2407
							fz [in]	0.0050	0.0060	0.0080
							vf [in/min]	173	173	173
S	E 19	3.00	0.03	170	128	- 213	n [min-1]	1039	866	649
							fz [in]	0.0038	0.0045	0.0060
							vf [in/min]	35	35	35
	E 20	3.00	0.03	135	101	- 169	n [min-1]	825	688	516
							fz [in]	0.0034	0.0041	0.0055
							vf [in/min]	26	26	26
	E 21	3.00	0.03	115	86	- 144	n [min-1]	703	586	439
							fz [in]	0.0034	0.0041	0.0055
							vf [in/min]	22	22	22
	E 22	3.00	0.04	310	233	- 388	n [min-1]	1895	1579	1184
fz [in]							0.0041	0.0049	0.0065	
vf [in/min]							69	69	69	

SMG = Seco Material Group
n (min-1) = RPM
fz (in) = Feed/tooth
vf (in/min) = Feed rate
vc (sf/min) = Surface feet/min
a_p x D_c = % of diameter
a_e x D_c = % of diameter
All cutting data are start values
All cutting data is in inch values

NOTE: Optimized Roughing is an excellent strategy for achieving quality parts and extending tool life, but requires use of the right equipment and cutting parameters. If you are having problems implementing the approach or want to learn more about how to use the strategy to process a part, contact the Technical Support Team at 1-800-TEC-TEAM.

STS540 / STR540 HTA

SLOTTING															
ISO GROUP	SMG	ap x Dc (max)	ae x Dc (max)	vc (sf / min)			Z _n = 5								
							1/8	3/16	1/4	5/16	3/8	1/2	5/8	3/4	
M	E 8-9	0.50	1.00	325	n [min-1]	406	9932	6621	4966	3973	3311	2483	1986	1655	
							fz [in]	0.0003	0.0005	0.0006	0.0008	0.0009	0.0013	0.0016	0.0019
							vf [in/min]	16	16	16	16	16	16	16	16
	A/E 10-11	0.50	1.00	275	n [min-1]	344	8404	5603	4202	3362	2801	2101	1681	1401	
							fz [in]	0.00025	0.000375	0.0005	0.0006	0.0008	0.0010	0.0013	0.0015
							vf [in/min]	11	11	11	11	11	11	11	11
S	E 19	0.50	1.00	90	n [min-1]	113	2750	1834	1375	1100	917	688	550	458	
							fz [in]	0.0003	0.0004	0.0006	0.0007	0.0008	0.0011	0.0014	0.0017
							vf [in/min]	4	4	4	4	4	4	4	4
	E 20	0.25	1.00	75	n [min-1]	94	2292	1528	1146	917	764	573	458	382	
							fz [in]	0.0003	0.0004	0.0005	0.0006	0.0008	0.0010	0.0013	0.0015
							vf [in/min]	3	3	3	3	3	3	3	3
	E 21	0.25	1.00	65	n [min-1]	81	1986	1324	993	795	662	497	397	331	
							fz [in]	0.0003	0.0004	0.0005	0.0006	0.0008	0.0010	0.0013	0.0015
							vf [in/min]	2	2	2	2	2	2	2	2
	E 22	0.50	1.00	170	n [min-1]	213	5195	3463	2598	2078	1732	1299	1039	866	
							fz [in]	0.0004	0.0006	0.0008	0.0009	0.0011	0.0015	0.0019	0.0023
							vf [in/min]	10	10	10	10	10	10	10	10

STS540 / STR540 HTA

SIDE MILLING - LIGHT ROUGHING															
ISO GROUP	SMG	ap x Dc (max)	ae x Dc (max)	vc (sf / min)			Z _n = 5								
							1/8	3/16	1/4	5/16	3/8	1/2	5/8	3/4	
M	E 8-9	2.00	0.15	510	n [min-1]	638	15586	10390	7793	6234	5195	3896	3117	2598	
							fz [in]	0.0009	0.0014	0.0019	0.0023	0.0028	0.0038	0.0047	0.0056
							vf [in/min]	73	73	73	73	73	73	73	73
	A/E 10-11	2.00	0.12	480	n [min-1]	600	14669	9779	7334	5868	4890	3667	2934	2445	
							fz [in]	0.0008	0.0012	0.0016	0.0020	0.0024	0.0033	0.0041	0.0049
							vf [in/min]	60	60	60	60	60	60	60	60
S	E 19	2.00	0.12	130	n [min-1]	163	3973	2649	1986	1589	1324	993	795	662	
							fz [in]	0.0006	0.0009	0.0013	0.0016	0.0019	0.0025	0.0031	0.0038
							vf [in/min]	12	12	12	12	12	12	12	12
	E 20	2.00	0.10	100	n [min-1]	125	3056	2037	1528	1222	1019	764	611	509	
							fz [in]	0.0006	0.0008	0.0011	0.0014	0.0017	0.0023	0.0028	0.0034
							vf [in/min]	9	9	9	9	9	9	9	9
	E 21	2.00	0.10	85	n [min-1]	106	2598	1732	1299	1039	866	649	520	433	
							fz [in]	0.0006	0.0008	0.0011	0.0014	0.0017	0.0023	0.0028	0.0034
							vf [in/min]	7	7	7	7	7	7	7	7
	E 22	2.00	0.15	230	n [min-1]	288	7029	4686	3514	2812	2343	1757	1406	1171	
							fz [in]	0.0008	0.0012	0.0016	0.0020	0.0024	0.0033	0.0041	0.0049
							vf [in/min]	29	29	29	29	29	29	29	29

STS540 / STR540 HTA

SIDE MILLING - HEAVY ROUGHING																							
ISO GROUP	SMG	ap x Dc (max)	ae x Dc (max)	vc (sf / min)			Z _n = 5																
							1/8	3/16	1/4	5/16	3/8	1/2	5/8	3/4									
M	E 8-9	2.00	0.30	430	n [min-1]	13141	8761	6570	5256	4380	3285	2628	2190										
														fz [in]	0.0006	0.0008	0.0011	0.0014	0.0017	0.0023	0.0028	0.0034	
														vf [in/min]	37	37	37	37	37	37	37	37	
	A/E 10-11	2.00	0.25	400	n [min-1]	12224	8149	6112	4890	4075	3056	2445	2037										
															fz [in]	0.0005	0.0008	0.0010	0.0013	0.0015	0.0020	0.0025	0.0030
															vf [in/min]	31	31	31	31	31	31	31	31
S	E 19	2.00	0.20	110	n [min-1]	3362	2241	1681	1345	1121	840	672	560										
														fz [in]	0.0006	0.0008	0.0011	0.0014	0.0017	0.0022	0.0028	0.0033	
														vf [in/min]	9	9	9	9	9	9	9	9	
	E 20	2.00	0.20	90	n [min-1]	2750	1834	1375	1100	917	688	550	458										
															fz [in]	0.0004	0.0007	0.0009	0.0011	0.0013	0.0018	0.0022	0.0026
															vf [in/min]	6	6	6	6	6	6	6	6
	E 21	2.00	0.20	80	n [min-1]	2445	1630	1222	978	815	611	489	407										
															fz [in]	0.0004	0.0007	0.0009	0.0011	0.0013	0.0018	0.0022	0.0026
															vf [in/min]	5	5	5	5	5	5	5	5
	E 22	2.00	0.40	190	n [min-1]	5806	3871	2903	2323	1935	1452	1161	968										
															fz [in]	0.0008	0.0012	0.0016	0.0020	0.0024	0.0033	0.0041	0.0049
															vf [in/min]	24	24	24	24	24	24	24	24

STS540 / STR540 HTA

SIDE MILLING - FINISHING																							
ISO GROUP	SMG	ap x Dc (max)	ae x Dc (max)	vc (sf / min)			Z _n = 5																
							1/8	3/16	1/4	5/16	3/8	1/2	5/8	3/4									
M	E 8-9	2.00	0.02	630	n [min-1]	19253	12835	9626	7701	6418	4813	3851	3209										
														fz [in]	0.0006	0.0009	0.0013	0.0016	0.0019	0.0025	0.0031	0.0038	
														vf [in/min]	60	60	60	60	60	60	60	60	
	A/E 10-11	2.00	0.02	600	n [min-1]	18336	12224	9168	7334	6112	4584	3667	3056										
															fz [in]	0.0006	0.0009	0.0013	0.0016	0.0019	0.0025	0.0031	0.0038
															vf [in/min]	57	57	57	57	57	57	57	57
S	E 19	2.00	0.02	160	n [min-1]	4890	3260	2445	1956	1630	1222	978	815										
														fz [in]	0.0005	0.0008	0.0010	0.0013	0.0015	0.0020	0.0025	0.0030	
														vf [in/min]	12	12	12	12	12	12	12	12	
	E 20	2.00	0.02	125	n [min-1]	3820	2547	1910	1528	1273	955	764	637										
															fz [in]	0.0005	0.0008	0.0010	0.0013	0.0015	0.0020	0.0025	0.0030
															vf [in/min]	10	10	10	10	10	10	10	10
	E 21	2.00	0.02	100	n [min-1]	3056	2037	1528	1222	1019	764	611	509										
															fz [in]	0.0005	0.0008	0.0010	0.0013	0.0015	0.0020	0.0025	0.0030
															vf [in/min]	8	8	8	8	8	8	8	8
	E 22	2.00	0.02	270	n [min-1]	8251	5501	4126	3300	2750	2063	1650	1375										
															fz [in]	0.0006	0.0009	0.0013	0.0016	0.0019	0.0025	0.0031	0.0038
															vf [in/min]	26	26	26	26	26	26	26	26

STS430.2 / STR430.2 HTA

SLOTTING														
ISO GROUP	SMG	ap x Dc (max)	ae x Dc (max)	vc (sf / min)		Z _n = 4								
						1/8	5/32	3/16	1/4	3/8	1/2	5/8	3/4	
M	E 10-11	1.00	1.00	300	250 - 350	n [min-1]	9168	7334	6112	4584	3056	2292	1834	1528
						fz [in]	0.0008	0.0009	0.0011	0.0015	0.0023	0.0030	0.0038	0.0045
						vf [in/min]	28	28	28	28	28	28	28	28

STS430.2 / STR430.2 HTA

SIDE MILLING - ROUGHING														
ISO GROUP	SMG	ap x Dc (max)	ae x Dc (max)	vc (sf / min)		Z _n = 4								
						1/8	5/32	3/16	1/4	3/8	1/2	5/8	3/4	
M	E 10-11	2.00	0.25	400	350 - 450	n [min-1]	12224	9779	8149	6112	4075	3056	2445	2037
						fz [in]	0.0010	0.0013	0.0015	0.0020	0.0030	0.0040	0.0050	0.0060
						vf [in/min]	49	49	49	49	49	49	49	49

SMG = Seco Material Group

n (min-1) = RPM

fz (in) = Feed/tooth

vf (in/min) = Feed rate

vc (sf/min) = Surface feet/min

a_p x D_c = % of diameter

a_e x D_c = % of diameter

All cutting data are start values

All cutting data is in inch values

STB440.2 / STR440.2 HTA

SLOTING														
ISO GROUP	SMG	ap x Dc (max)	ae x Dc (max)	vc (sf / min)		Z _n = 4								
						1/8	5/32	3/16	1/4	3/8	1/2	5/8	3/4	
M	E 8-9	1.00	1.00	370	n [min-1]	11307	9046	7538	5654	3769	2827	2261	1885	
						fz [in]	0.0008	0.0009	0.0011	0.0015	0.0023	0.0030	0.0038	0.0045
						vf [in/min]	34	34	34	34	34	34	34	34
	A/E 10-11	1.00	1.00	300	n [min-1]	9168	7334	6112	4584	3056	2292	1834	1528	
						fz [in]	0.0008	0.0009	0.0011	0.0015	0.0023	0.0030	0.0038	0.0045
						vf [in/min]	28	28	28	28	28	28	28	28
S	E 19	1.00	1.00	90	n [min-1]	2750	2200	1834	1375	917	688	550	458	
						fz [in]	0.0004	0.0005	0.0006	0.0008	0.0012	0.0016	0.0020	0.0024
						vf [in/min]	4	4	4	4	4	4	4	4
	E 20	1.00	1.00	85	n [min-1]	2598	2078	1732	1299	866	649	520	433	
						fz [in]	0.0004	0.0005	0.0006	0.0008	0.0012	0.0016	0.0020	0.0024
						vf [in/min]	4	4	4	4	4	4	4	4
	E 21	1.00	1.00	75	n [min-1]	2292	1834	1528	1146	764	573	458	382	
						fz [in]	0.0004	0.0005	0.0006	0.0008	0.0012	0.0016	0.0020	0.0024
						vf [in/min]	4	4	4	4	4	4	4	4
	E 22	1.00	1.00	185	n [min-1]	5654	4523	3769	2827	1885	1413	1131	942	
						fz [in]	0.0006	0.0008	0.0009	0.0013	0.0019	0.0025	0.0031	0.0038
						vf [in/min]	14	14	14	14	14	14	14	14
				165	-	205								

STB440.2 / STR440.2 HTA

SIDE MILLING - ROUGHING														
ISO GROUP	SMG	ap x Dc (max)	ae x Dc (max)	vc (sf / min)		Z _n = 4								
						1/8	5/32	3/16	1/4	3/8	1/2	5/8	3/4	
M	E 8-9	2.00	0.30	430	n [min-1]	13141	10513	8761	6570	4380	3285	2628	2190	
						fz [in]	0.0010	0.0013	0.0015	0.0020	0.0030	0.0040	0.0050	0.0060
						vf [in/min]	53	53	53	53	53	53	53	53
	A/E 10-11	2.00	0.25	400	n [min-1]	12224	9779	8149	6112	4075	3056	2445	2037	
						fz [in]	0.0010	0.0013	0.0015	0.0020	0.0030	0.0040	0.0050	0.0060
						vf [in/min]	49	49	49	49	49	49	49	49
S	E 19	2.00	0.20	110	n [min-1]	3362	2689	2241	1681	1121	840	672	560	
						fz [in]	0.0006	0.0008	0.0009	0.0013	0.0019	0.0025	0.0031	0.0038
						vf [in/min]	8	8	8	8	8	8	8	8
	E 20	2.00	0.20	90	n [min-1]	2750	2200	1834	1375	917	688	550	458	
						fz [in]	0.0006	0.0008	0.0009	0.0013	0.0019	0.0025	0.0031	0.0038
						vf [in/min]	7	7	7	7	7	7	7	7
	E 21	2.00	0.20	90	n [min-1]	2750	2200	1834	1375	917	688	550	458	
						fz [in]	0.0006	0.0008	0.0009	0.0013	0.0019	0.0025	0.0031	0.0038
						vf [in/min]	7	7	7	7	7	7	7	7
	E 22	2.00	0.40	190	n [min-1]	5806	4645	3871	2903	1935	1452	1161	968	
						fz [in]	0.0010	0.0013	0.0015	0.0020	0.0030	0.0040	0.0050	0.0060
						vf [in/min]	23	23	23	23	23	23	23	23
				170	-	210								

STB440.2 HTA

COPY MILLING - ROUGHING													
ISO GROUP	SMG	ap x Dc (max)	ae x Dc (max)	vc (sf / min)		Z _n = 4							
						1/8	3/16	1/4	5/16	3/8	1/2	3/4	
M	E 8-9	0.05	0.05	360	270 - 450	n [min-1]	11002	7334	5501	4401	3667	2750	1834
						fz [in]	0.0015	0.0023	0.0030	0.0038	0.0045	0.0060	0.0090
						vf [in/min]	66	66	66	66	66	66	66
	E 10-11	0.04	0.04	230	173 - 288	n [min-1]	7029	4686	3514	2812	2343	1757	1171
						fz [in]	0.0015	0.0023	0.0030	0.0038	0.0045	0.0060	0.0090
						vf [in/min]	42	42	42	42	42	42	42
S	E 19	0.045	0.045	295	221 - 369	n [min-1]	9015	6010	4508	3606	3005	2254	1503
						fz [in]	0.0013	0.0019	0.0025	0.0031	0.0038	0.0050	0.0075
						vf [in/min]	45	45	45	45	45	45	45
	E 20	0.04	0.04	295	221 - 369	n [min-1]	9015	6010	4508	3606	3005	2254	1503
						fz [in]	0.0013	0.0019	0.0025	0.0031	0.0038	0.0050	0.0075
						vf [in/min]	45	45	45	45	45	45	45
	E 21	0.035	0.035	145	109 - 181	n [min-1]	4431	2954	2216	1772	1477	1108	739
						fz [in]	0.0010	0.0015	0.0020	0.0025	0.0030	0.0040	0.0060
						vf [in/min]	18	18	18	18	18	18	18
	E 22	0.05	0.05	295	221 - 369	n [min-1]	9015	6010	4508	3606	3005	2254	1503
						fz [in]	0.0013	0.0019	0.0025	0.0031	0.0038	0.0050	0.0075
						vf [in/min]	45	45	45	45	45	45	45

STB440.2 HTA

COPY MILLING - FINISHING													
ISO GROUP	SMG	ap x Dc (max)	ae x Dc (max)	vc (sf / min)		Z _n = 4							
						1/8	3/16	1/4	5/16	3/8	1/2	3/4	
M	E 8-9	0.02	0.02	395	296 - 494	n [min-1]	12071	8047	6036	4828	4024	3018	2012
						fz [in]	0.0012	0.0018	0.0024	0.0030	0.0036	0.0048	0.0072
						vf [in/min]	58	58	58	58	58	58	58
	E 10-11	0.02	0.02	250	188 - 313	n [min-1]	7640	5093	3820	3056	2547	1910	1273
						fz [in]	0.0012	0.0018	0.0024	0.0030	0.0036	0.0048	0.0072
						vf [in/min]	37	37	37	37	37	37	37
S	E 19	0.02	0.02	325	244 - 406	n [min-1]	9932	6621	4966	3973	3311	2483	1655
						fz [in]	0.0010	0.0015	0.0020	0.0025	0.0030	0.0040	0.0060
						vf [in/min]	40	40	40	40	40	40	40
	E 20	0.02	0.02	325	244 - 406	n [min-1]	9932	6621	4966	3973	3311	2483	1655
						fz [in]	0.0010	0.0015	0.0020	0.0025	0.0030	0.0040	0.0060
						vf [in/min]	40	40	40	40	40	40	40
	E 21	0.02	0.02	160	120 - 200	n [min-1]	4890	3260	2445	1956	1630	1222	815
						fz [in]	0.0008	0.0012	0.0016	0.0020	0.0024	0.0032	0.0048
						vf [in/min]	16	16	16	16	16	16	16
	E 22	0.02	0.02	325	- 406	n [min-1]	9932	6621	4966	3973	3311	2483	1655
						fz [in]	0.0010	0.0015	0.0020	0.0025	0.0030	0.0040	0.0060
						vf [in/min]	40	40	40	40	40	40	40

We can help you to increase your productivity, enhance your performance and reduce your costs with the range of products we offer that cover the full spectrum of application and performance requirements. Although every situation is different, we can make some general suggestions on tool selection, per material and machining application. You will need to assess every opportunity and decide which tool is the best fit for your requirements.

PROVIDING SOLUTIONS FOR ANY APPLICATION

Stabilizer™ series tools provide high performance in the general machining category. These tools should be applied where performance is critical. The Stabilizer family offers high performance and versatility in a variety of materials and operations. The 4 flute Stabilizer 2.0 is available in square, ball and radius ends and an AlTiN coating. The 5 flute Stabilizer is available in square and radius ends with AlCrN coated inch tools and AlTiN coated metric tools.

Elite series tools are a high performance solution for material specific machining applications where performance is important. These tools come with and AlTiN coatings as standard and are available in multiple geometries and number of flutes to provide process optimization in various materials.

Niagara C series should be applied in basic general machining environments. These tools are offered in uncoated or TiAlN coated as standard. Square shoulder and ball end geometries with 2, 3 or 4 flute versions are available.

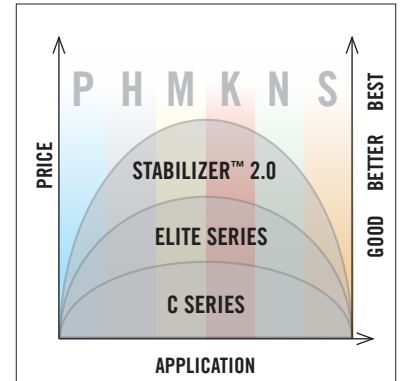

RECOMMENDED TOOLING

ISO GROUP	SELECTION	SLOTTING		PROFILING		COPY MILLING	
		PRODUCT FAMILY	RANGE	PRODUCT FAMILY	RANGE	PRODUCT FAMILY	RANGE
P	1ST CHOICE	STR430.2	1/8 - 1"	ST540	1/8 - 1"	STB430.2	1/8 - 1"
	2ND CHOICE	ST540	1/8 - 1"	S638	1/8 - 1"	CB230	1/64 - 1"
M	1ST CHOICE	STR440.2	1/8 - 1"	S638	1/8 - 1"	STB440.2	1/8 - 1"
	2ND CHOICE	STR430.2	1/8 - 1"	S738/S938	1/4 - 1"	SB335	1/8 - 1"
K	1ST CHOICE	STR430.2	1/8 - 1"	S638	1/8 - 1"	STB430.2	1/8 - 1"
	2ND CHOICE	ST540	1/8 - 1"	S545	1/8 - 1 1/4"	CB230	1/64 - 1"
N	1ST CHOICE	AN340	3/16 - 1"	A345	1/8 - 1"	AB245	1/4 - 1"
	2ND CHOICE	A245	1/8 - 1"	A345R	1/8 - 1"	CB230	1/64 - 1"
S	1ST CHOICE	STR440.2	1/8 - 1"	S638	1/8 - 1"	STB440.2	1/8 - 1"
	2ND CHOICE	STR430.2	1/8 - 1"	S738/S938	1/4 - 1"	MB215	1/16 - 1/2"
H	1ST CHOICE	MZN410R	1/8 - 5/8"	MZ645/MZ645R	1/8 - 1/2"	MB2215	1/16 - 1/2"
	2ND CHOICE	STR440.2	1/8 - 1"	S738/S938	1/4 - 1"	MB215	1/16 - 1/2"

HIGH PERFORMANCE VS. GENERAL PURPOSE

Both High Performance and General Purpose tools use the highest quality carbide substrate and coatings. The difference between the two categories lies in their geometries.

High performance tools are designed to run exceptionally well in specific applications. General purpose tools are designed with versatility in mind, and run well over a wide application area.

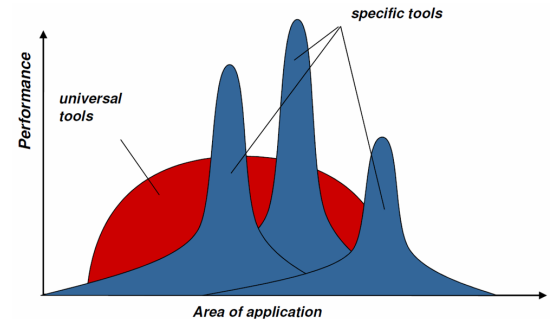

TOOL MATERIAL TYPES

COBALT (HSCO)

- Low Cost
- Tough
- Shock Absorbing
- Versatile
- Greater heat and wear resistance than HSS

SOLID CARBIDE

- Hardest material
- Most wear resistant
- Most brittle
- Most cost (above 1/2")
- Longest life
- High productivity
- Higher SFPM

POWDER METAL (ASP2030)

- Finer grain size as compared to HSCO yielding increased toughness, superior wear resistance, and more shock resistance
- Great for High Temp Alloys (Inconel, Waspalloy)
- Higher cost than HSS or HSCO

FACTORS IN CHOOSING THE CORRECT TOOL MATERIAL

- Age, type, strength, condition, hp of machine
- Rigidity of the machine and fixturing
- Spindle speed available
- Manual or power feed
- Workpiece material and condition
- Number of pcs to be produced
- Material removal rate required

WHAT DO COATINGS DO?

In short, coatings increase tool life. They provide a thermal barrier between the cutting edge & the workpiece. Coatings increase the hardness on the surface of the tool. Coatings also increase lubricity for better chip flow and evacuation, causing less heat. They minimize built-up edge, improving surface finish, and reduce abrasive wear.

PVD COATINGS

TiCN - TITANIUM CARBONITRIDE

Incorporation of Carbon into the TiN matrix to increase hardness and abrasion resistance. TiCN is an alternative to TiN for HSS and HSCO applications where additional wear resistance is required. Primary Solid Carbide applications are milling aluminum alloys & cast iron.

TiAlN - TITANIUM ALUMINUM NITRIDE

TiAlN offers a higher level of thermal stability above TiN and TiCN with abrasion resistance. Ideal for high heat applications found in milling steels, stainless steels and high temp alloys with a hardness 52 Rc and below.

AlTiN - ALUMINUM TITANIUM NITRIDE

Increased thermal stability when milling high temp alloys and Die/Mold steels with a hardness 52 Rc and above. Excellent for HSM applications, Titanium, and Stainless Steels. HSS/HSCO end mills can't be coated with AlTiN.

AlCrN - ALUMINUM CHROMIUM NITRIDE

Excellent wear resistance under conventional and extreme conditions when milling Die/Mold steels with a hardness 52 Rc and below. Excellent choice for tool steel, alloy steel, and stainless steel applications.

CVD COATINGS

DIAMONDPLUS

DiamondPlus coatings are made of multiple layers of uniquely structured nano-crystalline diamonds. The 100% ultra fine-grain diamond throughout the coating results in a tool that resists abrasive & adhesive wear and stands up to mechanical shock. The hard, smooth surface provides the best part finish with no built up edges. Primary applications are composite materials, high silicon aluminum, and graphite. When milling graphite, tool life 12-20 times longer than uncoated tungsten carbide is typical.

Do not use DiamondPlus on steels. The high heat generated from milling steels causes the carbon from the diamond to diffuse into the iron, causing chemical wear. Regrinding a DiamondPlus endmill is not recommended. Standard C430's or similar cannot be coated with DiamondPlus.

FLUTE NUMBERS

2 & 3 FLUTE

- For slotting
- Maximum chip evacuation
- Preferred for softer materials

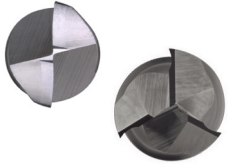

4 FLUTE

- For slotting and profiling
- Transitional tool between 3 flute and Multi Flute



5 FLUTE

- For profiling
- More teeth in cut for greater stability

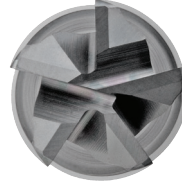

6 FLUTE

- Profiling in hard milling
- Reduced chip loads
- Larger core diameter for greatest rigidity

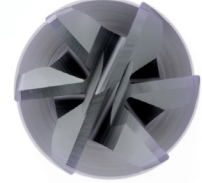

END MILL CORNER DESIGN

SQUARE

Designed for general machining at a true square angle.



CORNER RADIUS / CORNER CHAMFER

For general machining. Creates corner protection for increased tool life. Good in roughing operations.

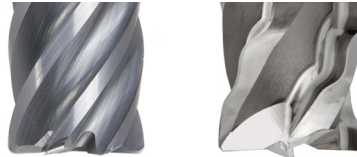

BALL NOSE

Designed for molds and dies, especially finishing 3d parts. There is zero cutting speed at center.



RADIAL RELIEF

STANDARD

The most common type of radial relief. Regrind primary relief to sharpen cutting edge (caution: radial rake can be affected).

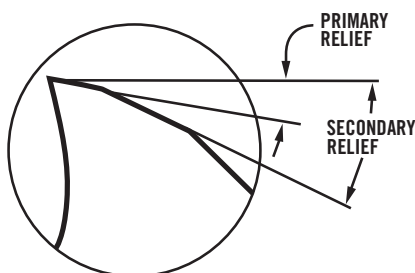

ECCENTRIC

Stronger cutting edge than standard relief. Easier to regrind (face regrind). Constant relief angle.

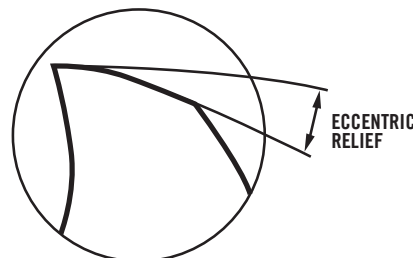

CYLINDRICAL LAND

Balances the cutting edge in the cut. Best in aluminum applications. Reduced chatter and vibration. Eccentric relief strengthens the tooth.

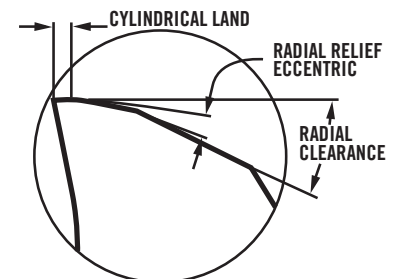

HELIX ANGLES

The helix angle is the angle of the cutting edge in relationship to the centerline. It affects the following:

- Cutting forces or shearing of the material
- Chip evacuation
- Surface finish

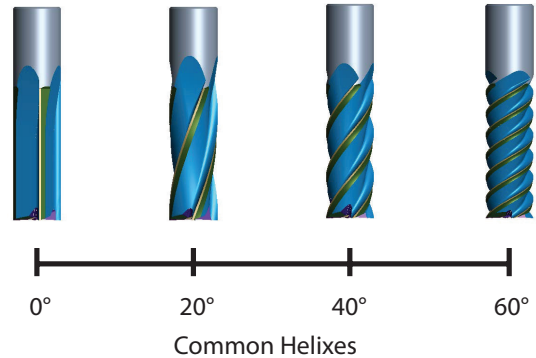

KNUCKLE PITCH

FINE PITCH



- Moderate chip loads
- Wide range of materials

APPLICATION AREAS

Ductile Cast Irons, Alloy Steels, Stainless Steels, Cobalt Alloys, Magnesium Alloys, Nickel Alloys, Titanium Alloys, Super Alloys

COARSE PITCH



- Higher chip loads
- General purpose

APPLICATION AREAS

Plastics, Wood, Aluminum Alloys, Copper Alloys, Lead, Tin, Zinc, Carbon Steel, Gray Cast Iron

RAKE ANGLE

POSITIVE RAKE ANGLE

Allows for freer machining and reduced cutting pressure. It is effective in softer and ferrous materials such as steels and stainless steels.

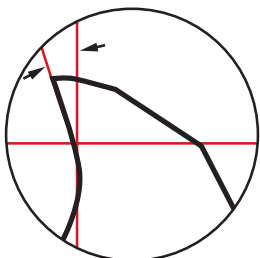

NEGATIVE RAKE ANGLE

Creates stronger cutting edges optimal for harder to machine materials such as tool steels and hardened steels.

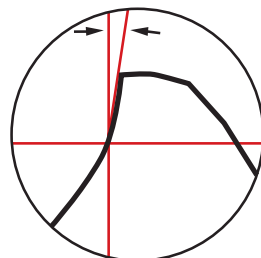

SIDE VIEW

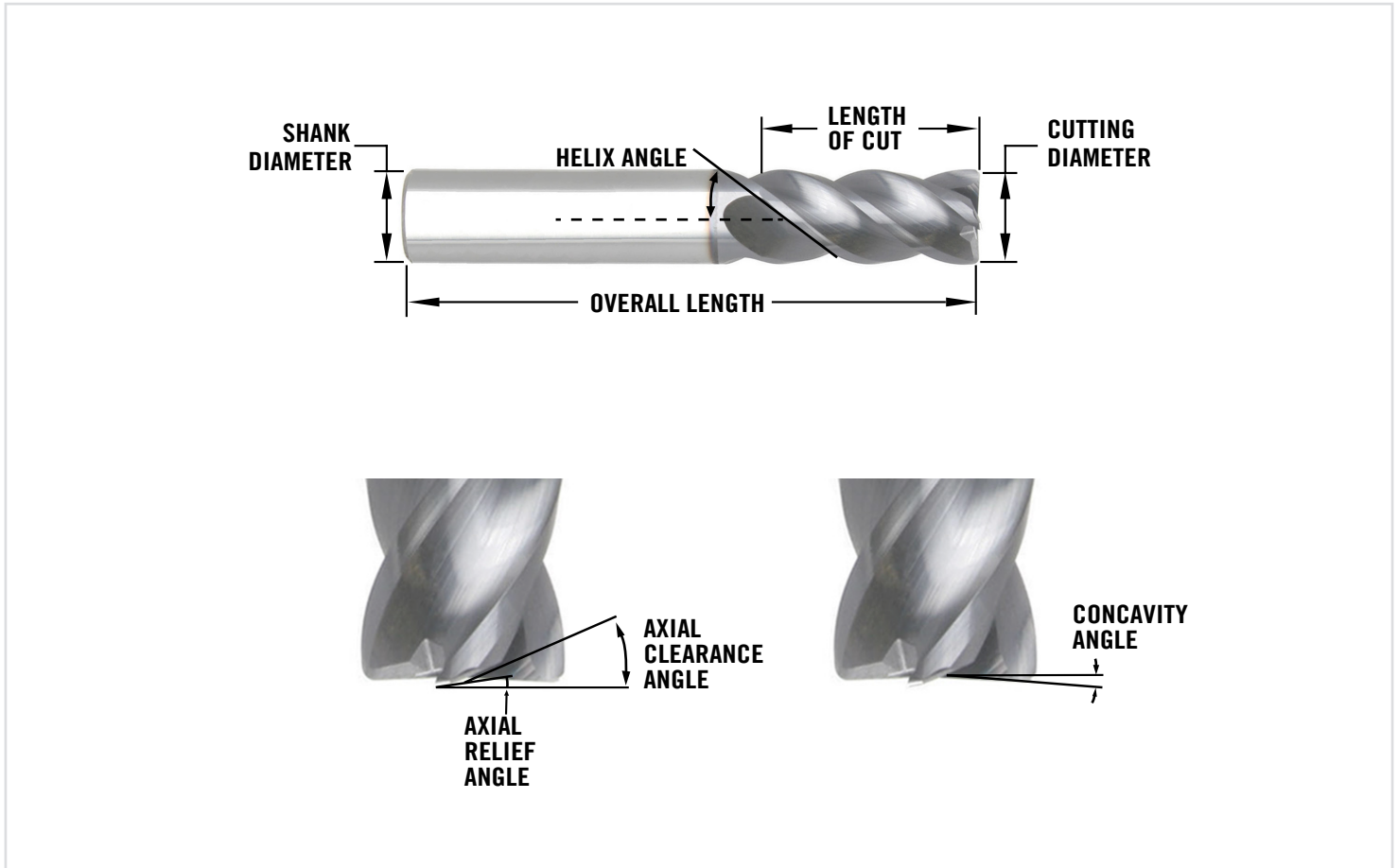

END VIEW

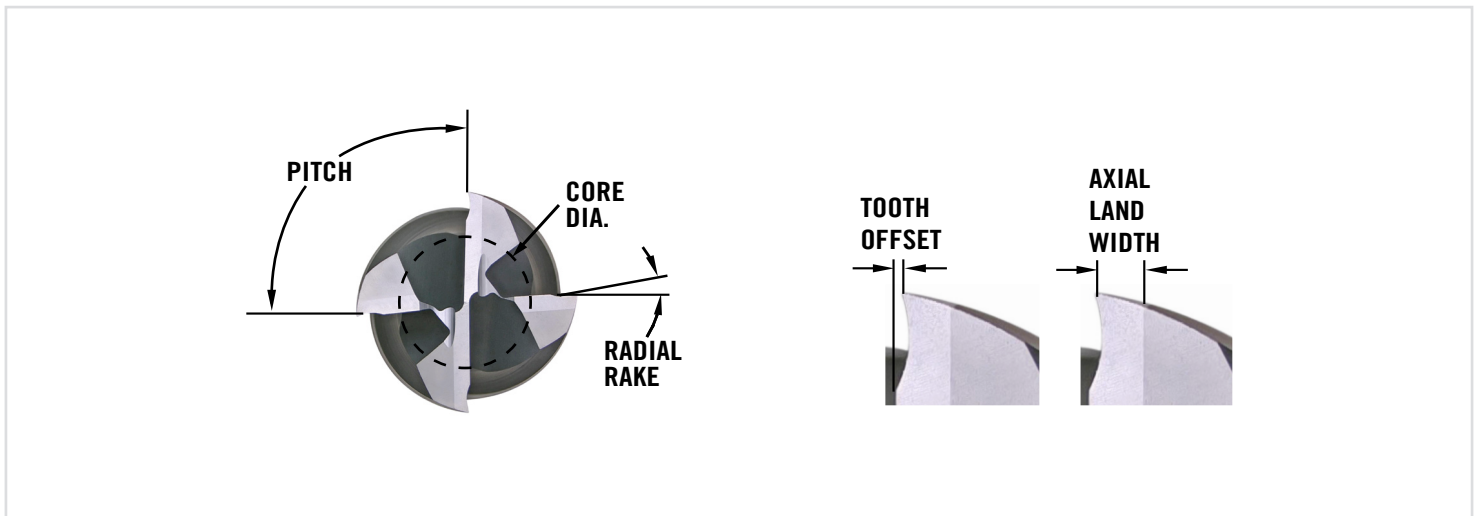

CLIMB MILLING VS. CONVENTIONAL MILLING

CLIMB MILLING (1ST CHOICE)

The tooth meets the work at the top of the cut, producing the thickest part of the chip first.

- Efficient cutting
- Long and reliable tool life
- Better surface finish, especially with stainless steels, aluminum or titanium alloys
- Risk tool breakage due to sudden machining backlash if the machine lacks rigidity

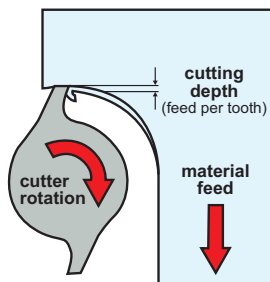

CONVENTIONAL MILLING

The width of the chip starts at zero and increases to a maximum at the end of the cut.

- Use only when the machine tool lacks rigidity or works loosely (old milling machine, low quality machine, worn machine)
- Tendency to push the workpiece away
- Tool edge slides instead of cutting, causing high friction between tool flank face and material

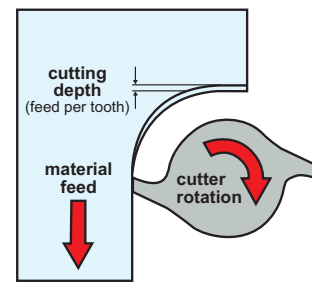

MILLING CONSIDERATIONS IN STEEL, ALUMINUM, AND STAINLESS STEEL

STEEL

- Material grade
- Material hardness
- Rigidity is a must (machine, fixturing)
- Chip formation
- Chip evacuation
- Tool overhang must be kept to a minimum

ALUMINUM

- Chatter
- Minimizing aluminum sticking to the cutting edge
- Chip formation
- Chip evacuation (controlling large amount of chips)
- Tool Rigidity / core strength

STAINLESS STEEL

- Rigidity is a must (machine, fixturing)
- Tool overhang must be kept to a minimum
- Use flood coolant
- Use sufficient cutting depth so not to work harden the part (avoid rubbing and dwelling)
- Use a tool with a corner radius whenever possible (corner strength)
- Higher chip loads per tooth can be used with end mills that have a corner radius
- Surface finish is improved with a corner radius (larger radius the better the finish)



Good aluminum chips.



Caution!

Work Hardening: The remaining milled surface becomes harder, changing the cutting conditions. This occurs when the radial depth of cut is not sufficient and there is a rubbing action at the cutting interface. Work hardening results in increased cutting forces and increased heat.

TOOL OVERHANG AND RUN-OUT

Tool Overhang is the distance that the tool extends from the end of toolholder (diameter to length ratio). Cutting forces, which push the tool away from the cut, cause tool deflection when tool overhang is excessive. The rule of thumb is to keep the maximum overhang 8:1 for length of cut and 12:1 for overall length.

Keeping tool overhang to a minimum can lead to the following benefits: increased tool life, reduced chatter and vibration, improved part finish, increased speed and feed, and increased productivity.

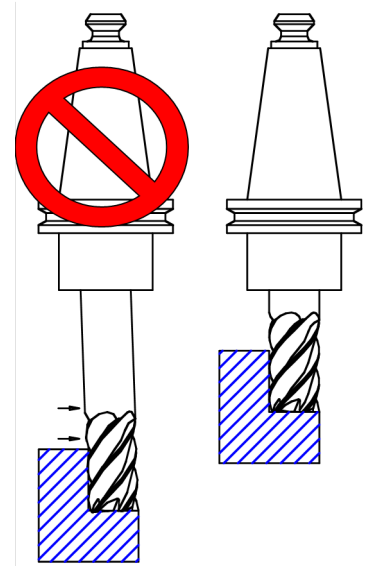

DEFLECTION AND RELATIVE RIGIDITY (CANTILEVER BEAM)

The table below shows the relative rigidity of an endmill based on the diameter and tool overhang*. In this case the basis is 1/4" x 1". From the table below, a 1/2" x 1" end mill is 16 times more rigid than a 1/4" x 1" end mill.

Quick Tips:

A 20% reduction of length reduces deflection by 50%.

A 20% increase in tool diameter reduces deflection by 50%.

Optimal tool life can only be achieved if run-out is less than 0.0004".

DIAMETER	OVERHANG	RELATIVE RIGIDITY
1/4"	1"	1X
1/2"	1"	16X
1/2"	2"	2X
1/2"	4"	.26X
3/4"	1"	81X
3/4"	2"	10X
3/4"	4"	1.3X
1"	1"	260X
1"	2"	34X
1"	4"	4X

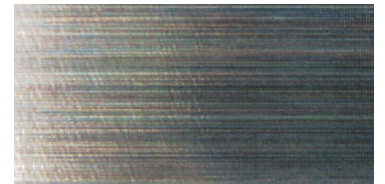

Smooth surface - rigid setup.

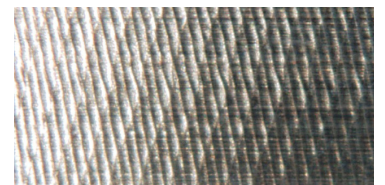

Chatter - unstable setup.

WELDON TOOLHOLDERS - RECOMMENDED SET SCREW TIGHTENING TORQUE

HOLDER HOLE SIZE	SET SCREW SIZE	MAX FOOT POUNDS
3/16"	1/4" - 20	6.5
3/8"	3/8" - 16	16.7
1/2"	7/16" - 14	25
5/8"	9/16" - 12	37.5
3/4"	5/8" - 11	76.7
7/8"	5/8" - 11	76.7
1"	3/4" - 10	125
1 1/4"	3/4" - 10	125
2"	1" - 14	300
2 1/2"	1" - 14	300





TROUBLESHOOTING GUIDE

PROBLEM / CAUSE	SOLUTION
TOOL BREAKAGE	
Feed rate excessive	Reduce feed rate
Depth of cut excessive	Decrease width and depth of cut
Overhang of tool is too much	Hold shank deeper, use shorter end mill
Wear is too much	Regrind at earlier stage
EXCESSIVE WEAR	
Speed is too fast	Decrease spindle speed, use better coolant
Hard work material	Use the right coating
Improper speed and feed (usually too slow)	Increase feed and speed
Improper helix angle	Change tool to correct helix angle
Primary relief angle is too large	Change to smaller relief angle
Recutting chips	Change feed and speed / Use more coolant or high pressure coolant/air
REDUCED TOOL LIFE	
Cutting friction is excessive	Regrind at earlier stage
Hard work material	Use an appropriate coolant
Improper helix and relief angle	Change to correct helix angle and primary relief
CHIPPED CUTTING EDGES	
Feed rate excessive	Reduce feed rate
Feed too heavy on first cut	Reduce feed rate on first cut
Lack of rigidity (machine & holder)	Use better machine or tool holder or change parameters
Lack of rigidity (tool)	Use shorter tool, hold shank deeper, try climb milling
Tool cutting corner too sharp	Decrease primary relief and cutting angle, reduce radial width-of-cut
Single chipped cutting edge	Reduce run-out to less than .0004"
CHIP PACKING	
Cut too heavy	Decrease width and depth of cut
Not enough chip clearance	Use end mill with fewer flutes
Not enough coolant	Use higher coolant pressure and reposition nozzle to point of cut or use air pressure

PROBLEM / CAUSE	SOLUTION
WORK PIECE BURRS	
Wear on primary relief is too much	Regrind at earlier stage
Incorrect feed and speed rates	Correct cutting parameters
Improper helix angle	Change to correct cutting angle
ROUGH SURFACE FINISH	
Feed rate too high	Reduce feed rate
Cutting speed too slow	Increase RPM
Wear is excessive	Regrind at earlier stage
Recutting chips	Change feed and speed. Use more coolant or high pressure coolant/air
SQUEAL AND CHATTERING	
Feed and speed too fast	Correct cutting parameters
Lack of rigidity (machine & holder)	Use better machine or tool holder or change parameters
Poor set up	Improve clamping rigidity
Cut is too heavy	Decrease width and depth of cut
Overhang of tool excessive	Hold shank deeper, use shorter end mill
Lack of relief	Decrease relief angle
SIDE WALL TAPER IN WORKPIECE	
Feed rate too heavy	Reduce feed rate
Overhang of tool excessive	Hold shank deeper, use shorter end mill
Too few flutes	Use multiflute end mill, use end mill with higher rigidity
NO DIMENSIONAL ACCURACY	
Cut is too heavy	Decrease width and depth of cut
Lack of accuracy (machine & holder)	Repair machine or holder
Rigidity is insufficient (machine & holder)	Change machine or tool holder or change parameters
Too few flutes	Use multiflute end mill, use end mill with higher rigidity

WHEN IS IT TIME TO CHANGE A TOOL?

- When the part's surface finish is no longer acceptable
- When accuracy is no longer achievable and constant offset adjustment is required
- When Burrs start to appear on the work piece that were not there before
- When chips change to a blue, purple, black color
- When unusual noises start (increased vibration)
- When the spindle load reaches an unacceptable level (power consumption)
- When a pre-determined number of parts has been reached
- When the wear land reaches a certain level for the diameter and type of end mill (reference only, see right)

CUTTING DIAMETER	FINISHING END MILL	ROUGHING END MILL
1/8" - 3/8"	UP TO 0.004"	0.004" - 0.006"
3/8" - 3/4"	UP TO 0.006"	0.006" - 0.010"
3/4" - 1"	UP TO 0.008"	0.010" - 0.012"
1" - 1 1/4"	UP TO 0.010"	0.012" - 0.016"

Surface speed, surface footage, surface area are directly related. Cutting speed is the peripheral speed (velocity) at the outside edge of an endmill (surface speed). The faster the spindle speed the higher the SFM. SFM is the distance in feet that the cutting edge travels in one minute. IPM and IPT (The rate at which the cutting tool is advanced into the workpiece). Feed per tooth is the thickness of chip that each cutting edge removes in one pass.

RPM

$$n = \frac{v_c \cdot 12}{\pi \cdot D_c} \text{ or } \frac{v_c \cdot 3.82}{D_c} \quad (\text{rev/min})$$

CUTTING SPEED

$$v_c = \frac{n \cdot \pi \cdot D_c}{12} \text{ or } \frac{n \cdot D_c}{3.82} \quad (\text{sf/min})$$

FEED SPEED

$$v_f = n \cdot Z_n \cdot f_z \quad (\text{inch/min})$$

$$v_f = n \cdot Z_c \cdot f_z$$

FEED PER REVOLUTION

$$f = Z_n \cdot f_z \quad (\text{inch/rev})$$

$$f = Z_c \cdot f_z$$

METAL REMOVAL RATE

$$Q = a_e \cdot a_p \cdot v_f \quad (\text{inch}^3/\text{min})$$

CUTTING SPEED AND RPM FOR COPYING

$$v_c = \frac{n \cdot \pi \cdot D_w}{12} \text{ or } \frac{n \cdot D_w}{3.82} \quad (\text{sf/min})$$

$$n = \frac{v_c \cdot 12}{\pi \cdot D_w} \text{ or } \frac{v_c \cdot 3.82}{D_w} \quad (\text{RPM})$$

$$D_w = 2 \cdot \sqrt{a_p (D_c - a_p)} \quad (\text{inch})$$

CALCULATION OF a_p VS. OVERHANG LENGTH:

If the overhang length (XS) is longer than $4 \times D_c$ and Cylindrical shanks are used it is important to adopt another depth of cut (a_p) value than that indicated in the table. Use the following formula to calculate the new a_p value

$$a_p = a_p \cdot (4 \cdot D_c / XS) 2$$

PROFILE HEIGHT

$$H = \frac{D_c}{2} - \sqrt{\frac{D_c^2 - a_e^2}{2}}$$

$$D_w = 2 \cdot \sqrt{a_p (D_c - a_p)}$$

Profile height H (μm)

D_c	Pitch a_e (μm)						
	0.06	0.08	0.11	0.15	0.20	0.30	0.45
1	0.90	1.60	3.00	5.70	10.00	23.00	53.00
2	0.45	0.80	1.50	2.80	5.00	11.00	26.00
4	0.23	0.40	0.76	1.40	2.50	5.60	13.00
6	0.15	0.27	0.50	0.94	1.70	3.80	8.40
8	0.11	0.20	0.38	0.70	1.30	2.80	6.30
10	0.09	0.16	0.30	0.56	1.00	2.30	5.10
12	0.08	0.13	0.25	0.47	0.83	1.90	4.20

- a_p = Depth of cut mm/axial depth of cut (in)
- a_e = Width of cut mm/radial depth of cut (in)
- D_c = Cutter diameter
- f = Feed per revolution (in/rev)
- f_z = Feed per tooth (in/tooth)
- z_n = No. of teeth
- n = RPM (rev/min)
- Q = Material removal rate (in³/min)
- v_c = Cutting speed (sf/min)
- v_f = Feed speed (in/min)
- D_w = Working diameter

HELICAL INTERPOLATION

The table below shows the minimum hole diameter that should be made per the diameter of the end mill being used.

RECOMMENDED DIAMETER OF HOLE FOR HELICAL INTERPOLATION RAMPING

DIAMETER OF END MILL D_c	DIAMETER OF HOLE
1/32 - 3/32	$1.4 \times D_c$
1/8 - 1/4	$1.3 \times D_c$
3/8 - 1/2	$1.2 \times D_c$
5/8 - 1 1/4	$1.15 \times D_c$

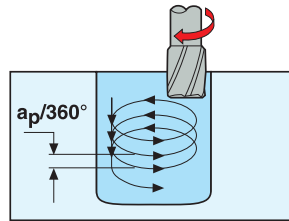

TROCHOIDAL METHOD

The figure below shows a method often called the trochoidal method for milling slots.

RECOMMENDED WIDTH OF SLOT

DIAMETER OF END MILL D_c	SLOT WIDTH
1/32 - 3/32	$1.8 \times D_c$
1/8 - 1/4	$1.6 \times D_c$
3/8 - 1/2	$1.4 \times D_c$
5/8 - 1 1/4	$1.2 \times D_c$

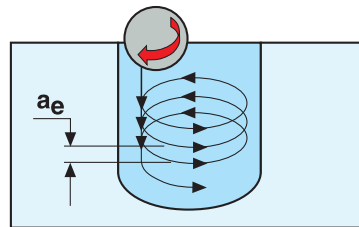

CORNER CONTACT

Generate component corners to optimize tool life.

- Use maximum diameter of cutting tool, but have maximum difference between the radius of the tool and the radius in the corner of the component.
- In a corner the contact arc of the tool increases rapidly according to the difference in radius between the tool and the component. This results in more forces on the tool, resulting in deflection and increased temperature in the corner, which means a reduction in tool life.

RECOMMENDATIONS

END MILL DIAMETER	MINIMUM CORNER RADIUS
1/64 - 3/32	$D_c / 2 \times 1.4$
1/8 - 1/4	$D_c / 2 \times 1.3$
3/8 - 1/2	$D_c / 2 \times 1.2$
5/8 - 1 1/4	$D_c / 2 \times 1.15$

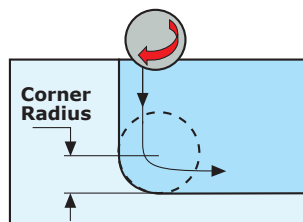

Ex: 1/4 tool, minimum corner radius to be generated is .1625.

SOLID CARBIDE END MILLS

END MILL STYLE	NUMBER OF FLUTES	NIAGARA CUT DIAMETER TOLERANCE	CORRESPONDING LIST NUMBERS
SINGLE-END DOUBLE-END FINISHERS	ALL	+ .000 / - .002	STS430.2, STR430.2, STB430.2, STRN430.2, STBN430.2, STS430M.2, STR430M.2, STB430M.2, STR440.2, STB440.2, STRN440.2, STBN440.2, STR440M.2, STB440M.2, STS540, STR540, STS540M, STSN540, STRN540, STRCS540, STR540M, A245, A245R, AB245, AN230, AN230R, AN335, AN335R, AN245, ANB245, AN340, A345, A345R, AN345, AN345R, A345M, S335, SB335, SN335, S545, S545R, S638, S638R, SB638, SBN638, SN638, SN638R, SCS638, SCS638R, S738, S738R, SCS738R, S938, S938R, SCS938R, S545M, S645M, SN200R, SN400R, SN500R C230, C230R, C330, C360, C430, C430R, CB230, CB330, CB430, C430M, CB430M, CD230, CD430, CSD230, CSD430, CSDB230, CSDB430
SINGLE-END & DOUBLE-END FINISHERS (FLUTE DIA <=7/64")	ALL	+ / - .0005	C230, CB230, CSD230, CSDB230, C330, CB330, C430, CB430, CSD430, CSDB430, C430M, CB430M
HIGH FEED (FLUTE DIA <1/8")	2	+ / - .0005	SN200R
SINGLE-END FINISHERS NC TOLERANCE	2 & 4	+ .001 / - .000	CNC230, CNC430
SINGLE-END ROUGHERS	3, 4 & 5	+ .000 / - .003	AR330, SR420, SR545, SR420M
THREAD MILLS	ALL	+ .000 / - .002	NTM100UN, NTM120UN, NTM160UN, NTM200NPT, NTM300NPTF, NTM400MI
COMPOSITE CUTTING TOOLS	ALL	+ .000 / - .002	DIARTREM, DIARTRBE, DIACC, DIAEPB, DIAPPB, DIABEB
DIAMOND COATED END MILLS	2 & 4	+ / - .001	DIA230, DIA430, DIAB230, DIAB430, DIACR430, DIAL230, DIAL430, DIALB430, DIAXRB430, DIAXRR430, DIAXS430, DIA230M, DIAB230M, DIA430M
MOLD AND DIE	6	+ .000 / - .002	MZ645, MZ645R, MZN410R, MZN510R, MZN410RM, MZN510RM
MOLD AND DIE (FLUTE DIA < SHANK DIA)	2	+ / - .0005	MB215, MB215M, MBZ215, MBZ215M
MOLD AND DIE (FLUTE DIA = SHANK DIA)	2	+ .000 / - .001	MB215, MB215M, MBZ215, MBZ215M
BALL-END	ALL	BALL RADIUS TOLERANCE: FLUTE DIA TOLERANCE / 2	ALL
CORNER RADIUS	ALL	+ / - .001	ALL SERIES

SHANK DIAMETER TOLERANCES	END MILL STYLE	NIAGARA TOLERANCE
	ALL INCH SHANK	- .0001 / - .0004
	ALL METRIC SHANK	H6
LENGTH OF CUT TOLERANCES	END MILL STYLE	NIAGARA TOLERANCE
	ALL	+ .030 / - 0
OVERALL LENGTH TOLERANCES	END MILL STYLE	NIAGARA TOLERANCE
	ALL	+ / - .060

TIR CONDITION	END MILL STYLE	CUTTING DIAMETER	NIAGARA TOLERANCE
	ALL EXCEPT ROUGHERS	.005 - .030	.0001 MAX
		.031 - .060	.0002 MAX
		.061 - .111	.0003 MAX
		.112 AND ABOVE	.0005 MAX
ROUGHERS	ALL	.0010 MAX	

BACK TAPER	END MILL STYLE	NIAGARA TOLERANCE
	ALL	.0005 MAX BACK TAPER PER INCH PERMISSIBLE. NOT TO EXCEED THE CUTTING DIAMETER TOLERANCE.

NOTE: ALL DIMENSIONS IN INCH UNLESS OTHERWISE NOTED

COBALT END MILLS

END MILL STYLE	NUMBER OF FLUTES	TYPE OR RANGE	ANSI* TOLERANCE	NIAGARA CUT DIAMETER TOLERANCE	CORRESPONDING LIST NUMBERS
SINGLE-END FINISHERS	2, 4, & 6	ALL SIZES	+ .003 / - .000	+ .001 / - .000	SP205 , SPC408, SPB540
MULTI FLUTE COARSE & FINE PITCH ROUGHERS	4, 5, 6, & 8	1" FLUTE & UNDER 1-1/8" FLUTE & OVER	+ .025 / - .005	+ .003 / - .000 + .006 / - .000	EXR350 , RMB700 , RMB449 , REM710 , REC700 , RXC753, REM445 , REC448
ALL 3 FLUTE COARSE & FINE PITCH ROUGHERS	3	ALL SIZES	+ .025 / - .005	+ .005 / - .000	RTM713, RHC752, RHLC754, RTM447
TRUNCATED ROUGHER/FINISHERS AND CHIP-BREAKERS	4, 5, 6, & 8	ALL SIZES	NO SPECIFICATIONS	+ .001 / - .000	RFM440 , RFM441 , RFCB444
METRIC FINISHERS WITH INCH SHANK	4	ALL SIZES	NO SPECIFICATIONS	+ .001 / - .000	SMM845
VFP	4 & 6	ALL SIZES	NO SPECIFICATIONS	+ .002 / - .000	VFP435, VFP635, VFP ² 435, VFP ² 635, VFP435SB, VFP635SB, VFP435SB, VFP435SBR, VFP635SB, VFP635SBR
BALL-END	ALL	ALL SIZES	NO SPECIFICATIONS	BALL RADIUS TOLERANCES: FLUTE DIA TOLERANCES / 2	

SHANK DIAMETER TOLERANCES	END MILL STYLE	OTHER SPECIFICATION	ANSI* TOLERANCE	NIAGARA TOLERANCE
	ALL INCH SHANK		- .0001 / - .0005	- .0001 / - .0005
	ALL METRIC SHANK	SPECIFICATION PER DIN 1835 FORM B	NO SPECIFICATION	DIN (H6)MM

LENGTH OF CUT TOLERANCES	END MILL STYLE	OTHER SPECIFICATION	ANSI* TOLERANCE	NIAGARA TOLERANCE
	ALL EXCLUDING HEAVY DUTY		+ .031 / - .031	+ .031 / - .000
	HEAVY DUTY		+ .062 / - .062	+ .062 / - .000
	ALL METRIC SHANK	SPECIFICATION PER DIN ANS	NO SPECIFICATION	+ 0.7MM / - 0

OVERALL LENGTH TOLERANCES	END MILL STYLE	OTHER SPECIFICATION	ANSI* TOLERANCE	NIAGARA TOLERANCE
	ALL EXCEPT HEAVY DUTY 3" DIA FLUTE		+ .062 / - .062	+ .062 / - .000
	3" DIA HEAVY DUTY		+ .125 / - .125	+ .125 / - .000
	ALL METRIC SHANK	SPECIFICATION PER DIN ANS	NO SPECIFICATION	+ 0.7MM / - 0

TIR CONDITION	END MILL STYLE	CUTTING DIAMETER	NIAGARA TOLERANCE
	ALL EXCEPT ROUGHERS	ALL SIZES	.0010 MAX
	ROUGHERS	LESS THAN .750	.0010 MAX
		.750 - 1.249	.0020 MAX
		1.250 AND ABOVE	.0030 MAX

BACK TAPER	END MILL STYLE	NIAGARA TOLERANCE
	ALL	.0005 MAX BACK TAPER PER INCH PERMISSIBLE. NOT TO EXCEED THE CUTTING DIAMETER TOLERANCE.

*TAKEN FROM TABLE 77 OF THE USA STANDARDS FOR MILLING CUTTERS AND END MILLS, ANSI B94.19-1985 PUBLISHED BY THE AMERICAN SOCIETY OF MECHANICAL ENGINEERS.

NOTE: ALL DIMENSIONS IN INCH UNLESS OTHERWISE NOTED.

**MECHANICAL/PHYSICAL HAZARD**

Cutting tools and holders may fragment in use. Metal chips can be very hot with sharp edges and should not be moved by hand. Chips can cause burns to the skin and damage to the eyes.

Make sure the insert and component are correctly secured in their holder before use, to prevent them coming loose during the process operation. Too much overhang can result in vibration and lead to tool damage/breakage.

Always wear appropriate safety equipment at all times and ensure all machine guards and safety interlocks are in place prior and during the operation. **DO NOT USE** any tool or product that shows signs of damage. Return the product to the appropriate location for repair, replacement or recycling.

Use all appropriate safety guards or machine encapsulations to securely collect particles such as chips or cutting elements that may spin off. Always use appropriate personal protective equipment.

**DUST AND MIST HAZARD**

Hardmetal products and tools should not be reground or sharpened without taking appropriate safety measures to contain dust and to prevent exposure to dust (e.g. ventilation and personal protection equipment). Operations such as grinding, cutting, burning and welding of hardmetal products may produce dust or fumes, which can be inhaled, swallowed or come in contact with the skin and eyes. Dust/mist may cause inflammation of the airways and irritate nose, throat, skin and eyes. Repeatedly inhaling high levels of hardmetal dust has been reported in publications to cause hardmetal disease (interstitial lung fibrosis). In a two-year study on rats and mice, inhalation of cobalt was shown to cause cancer.

SENSITIZING HAZARD

Uncoated hardmetal products may cause an allergic skin reaction as a result of prolonged skin contact with the product. Handle in a way that avoids direct skin contact or use gloves to minimize the risk of an allergic skin reaction when handling hardmetal products and tools. Cobalt and hardmetal are known sensitizers having potential to cause allergy through repeated exposure. A sensitized person could react with asthmatic symptoms or eczema.

Always review and understand the Safety Data Sheet or Safety Information Sheet for the product you are using, before using the product.

PREVENTIVE MEASURES

- Avoid formation and inhalation of dust. Use adequate local exhaust ventilation to keep personal exposure below the nationally allowed limits.
- If ventilation is not available or adequate, use nationally approved respirators for the purpose.
- Avoid skin contact. Wear suitable gloves. Wash skin thoroughly after handling.
- Use suitable protective clothing. Launder clothing as needed.
- Do not eat, drink, or smoke in the working area. Wash skin thoroughly before eating, drinking or smoking.
- Use safety goggles or glasses with side shields when necessary.
- Always wear appropriate safety equipment.
- Only operate machinery when all necessary guards, interlocks and other safety devices are in place and functional.
- **DO NOT** use or operate damaged tools or products.

Revised May 25, 2017. For more information and documents, visit niagaracutter.com/safety and P65Warnings.ca.gov.

CEMENTED CARBIDE END MILLS

Cemented carbide end mills from Niagara Cutter are not included in the product range intended for the following requirements. Nevertheless Niagara Cutter can make the following declaration.

These products meet all requirements in RoHS (Restriction of the use of certain Hazardous Substances in electrical and electronic equipment), WEEE (Waste Electrical & Electronic Equipment) and ELV (End of Life Vehicles) requirements. Products do not contain mercury, lead, hexavalent chromium, cadmium, CFC, HCFC, flame retardants or solvents in concentrations that exceed specifications in the regulations.

REGRINDING

Wet or dry grinding can produce potentially hazardous dusts or mists that can irritate skin, eyes, nose, throat and result in lung damage or disease. To avoid injury use proper safety precautions and protective equipment.

DISPOSAL

Niagara Cutter will buy back solid carbide tools for recycling. Solid carbide tools should be separated from other metal waste (steel, aluminium, copper etc). All packing material is fully recyclable.

This work is published with the understanding that Seco Tools and its editors are supplying information aimed to present a general orientation and direction of metal cutting and related sciences. If professional services are required for specific applications, the assistance of an appropriate professional should be acquired.

The information is provided "as is";

Seco Tools and its editors disclaim all representations and warranties, express or implied, of any kind, including, without limitations, any warranties of merchantability, fitness for a particular purpose, title, or non-infringement. In no event will Seco Tools or its editors be liable to any party for any direct, indirect, special or other consequential damages for any use of the information, even if Seco Tools or its editors are advised of the possibility of such damage.

The information provided herein is for reference purposes only. Actual prices, specifications, and product descriptions are finalized at the time of sale and may vary by location. The information provided herein is subject to change without prior notice.

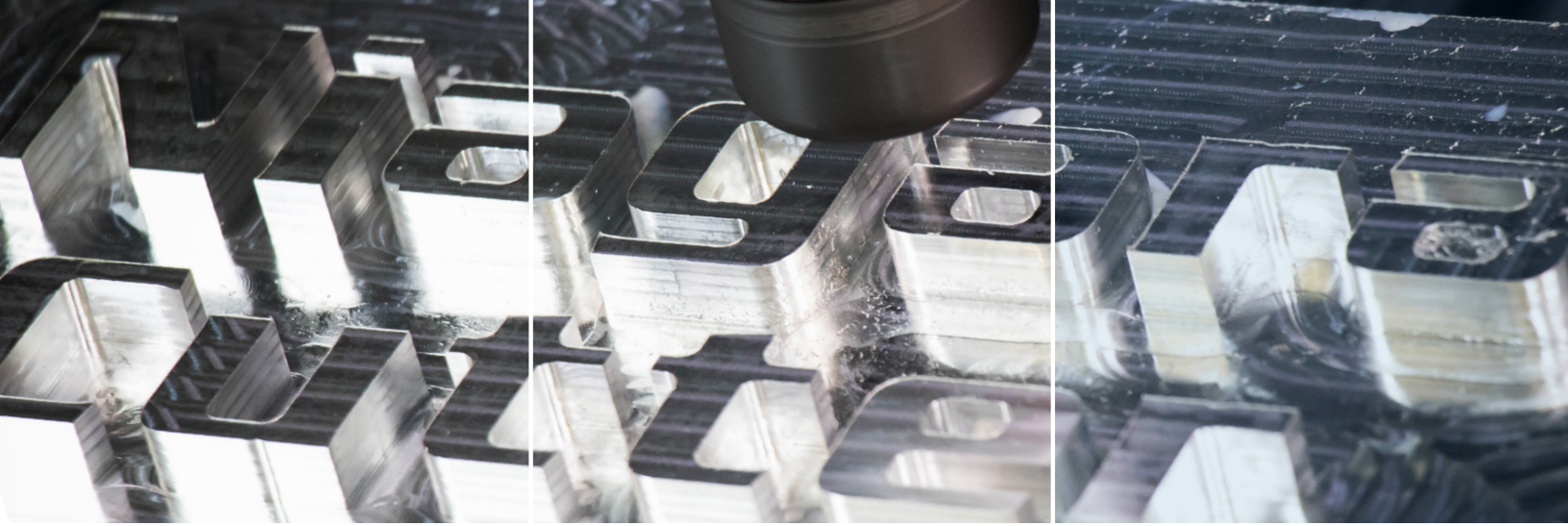

CUSTOMIZED TOOLING

A significant portion of Niagara Cutter's offering is in the form of customized tools. Our engineers work in close cooperation with you to provide the best possible solution to specific machining challenges where the demands stretch beyond standard tools. We also offer a quick delivery solution for standard tools requiring simple modifications to meet specific dimensional requirements. Fast turnaround from quotation to product delivery is a hallmark of our modified tool program.

RECONDITIONING CUTS COST & TOOL INVENTORY

Niagara Cutter's modern carbide tools offer remarkable performance by utilizing the best combinations of carbide substrates with high wear resistant coatings, optimized cutting geometry and controlled edge preparation.

However good a tool is, as part of its function, it will eventually show signs of wear on the cutting edge. Controlling this wear and the timely replacement of the tool will allow the used tool to be reconditioned, thus reducing tool investment costs.

We recondition your solid carbide tools using the same advanced technology and care that we use to manufacture our new products. These tools are remanufactured to our normal high standards with the original Niagara Cutter geometry, edge preparation and coating processes.

RECYCLING

Tungsten carbide is a valuable and limited resource. Estimations of the existing reserves of tungsten suggest that with present consumption resources will be depleted within 40 - 100 years. For the last few years demand has been higher than production and a general trend toward higher consumption can clearly be seen.

Recycling of used material compared to the mining of virgin material reduces the environmental impact. By recycling we can prolong the time before the resources are at an end and reduce energy consumption by approximately 35%. At the same time, recycling tungsten carbide reduces CO2 emissions by approximately 40%.

For further information on custom, modified, reconditioned tools or to set-up your recycling program please contact your local Authorized Distributor.

MORE
THAN
JUST A
BRAND

AHB

TOOLING & MACHINERY

COMPLETE METALWORKING SOLUTIONS

(800) 991-4225

www.ahbinc.com

ISO Certified

customerservice@ahbinc.com

Seco Tools, LLC

North American Headquarters

2805 Bellingham Drive

Troy, MI 48083

GT23-200
Copyright © 2023 Seco Tools, LLC
Printed in USA. All rights reserved.

Niagara Cutter, LLC

North American Production Unit

150 South Fifth Street

Reynoldsville, PA 15851-0279

NIAGARACUTTER.COM

Niagara Cutter is a Seco Tools Company.



Niagara Cutter
A SECO TOOLS COMPANY