



Cutting Tools

Indexable and Round Tools





Cutting Tools

Quick Lookup

Indexable Tooling

■ MILLING	5
■ TURNING – INSERTS	91
TOOLS	161
■ PARTING AND GROOVING	199
■ THREADING	219
■ DRILLING	237

Round Tooling

■ DRILLS	247
■ ANNULAR CUTTERS	295
■ REAMERS	299
■ COUNTERBORES AND COUNTERSINKS	321
■ CARBIDE BURRS	329
■ END MILLS	333
■ MILLING CUTTERS AND SAWS	363
■ TAPS	387
■ DIES	405
■ BROACHES AND TOOLBITS	414
■ INDEX BY GROUP	419
■ INDEXABLE APPENDIX	428

Table of Contents



Indexable Tools

MILLING

Nomenclature	6
Overview	10
90 DEGREE SYSTEMS, MILLS AND INSERTS	14
XD90	14
AP90	16
AN90	26
AD90	30
TP90	34
60 DEGREE SYSTEMS, MILLS AND INSERTS	40
PN60	40
45 DEGREE SYSTEMS, MILLS AND INSERTS	42
SEH-45	42
SEK-45	45
SN-45	49
43 DEGREE SYSTEMS, MILLS AND INSERTS	52
OFC	52
SPECIALTY SYSTEMS, MILLS AND INSERTS	54
RD-TORO	54
SP-HI-Feed	59
WN-HI-Feed	63
R8 SHANK TOOLS, MILLS AND INSERTS	65
AP90	66
TP90	67
R8 Technical Date	69
UTILITY INSERTS	72
SNGN/SNUN	72
SPGN/SPUN	75
SDNT	81
SPMT	81
TPKN	82
TPGN/TPUN/TPMR	82
Milling Formulas	89

TURNING

TURNING INSERTS	
Turning Inserts Technical Data	92
NEGATIVE INSERTS	
CNMG/CNMA	97
DNMG/DNMA	102
RNMG	106
SNMG/SNMA	107
SNGN/SNUN	112
TNMG/TNMA	115
VNMG/VNMA	121
WNMG/WNMA	122
POSITIVE INSERTS	
CCMT/CCGT	126
DCMT/DCGT	131
RPGN	134
SCMT	135
SPGN/SPUN	136
SPMR	141
SPMT/SPGH	143
TCMT/TCGT	145
TPGN/TPUN	148
TPMR	152
TPEE/TPGC/TPGH	154
VBMT	157
VCMT/VCGT	158
TURNING NEGATIVE TOOL HOLDERS	
Negative Tool Holders Overview	162
HOLDERS FOR CNMG/CNMA	
MCLNR/L	167
MCMNN	167
MCRNR/L	168
MCKNR	168

continued on next page

The information contained herein is subject to change without notice. We do our best to maintain in stock full and complete inventories of all regular lines. Close-out items may be depleted and will be replaced with comparable merchandise subject to prior sales. Photos and drawings shown are a general representation; occasionally we may change the exterior packaging of some products. Toolmex Industrial Solutions shall not be liable for technical or editorial errors or omissions contained herein.



Table of Contents

Cutting Tools

TABLE OF CONTENTS

TURNING *continued*

TURNING NEGATIVE TOOL HOLDERS

HOLDERS FOR DNMG/DNMA

MDJNR/L	169
MDPNN	169

HOLDERS FOR RNMG/RNMA

MRGNR/L	170
---------	-----

HOLDERS FOR SNMG/SNMA

MSSNR/L	171
MSDNN	171
MSRNR/L	172
MSKNR/L	172

HOLDERS FOR TNMG/TNMA

MTJNR/L	173
MTENN	174
MTGNR/L	174
MTFNR/L	174

HOLDERS FOR VNMG/VNMA

MVJNR/L	175
MVVN	175

HOLDERS FOR WNMG/WNMA

MWLNRL	176
--------	-----

TURNING POSITIVE TOOL HOLDERS

Positive Tool Holders Overview	177
--------------------------------	-----

HOLDERS FOR CCMT/CCGT

SCLRR/L	180
SCMCN	180

HOLDERS FOR DCMT/DCGT

SDJCR/L	181
SDPCN	181

HOLDERS FOR SCMT/SCGT

SSDCN	182
-------	-----

HOLDERS FOR TCMT/TCGT

STECN	183
STJCR/L	183
STGCR/L	184
STFCR/L	184

HOLDERS FOR VCMT/VCGT

SVJCR/L	185
---------	-----

TURNING NEGATIVE BORING BARS

Negative Boring Bars Overview	186
-------------------------------	-----

BORING BARS FOR CNMG/CNMA

SI-MCLNR/L	188
AI-MCLNR/L	188

BORING BARS FOR DNMG/DNMA

SI-MDUNR/L	189
------------	-----

BORING BARS FOR TNMG/TNMA

SI-MTUNR/L	190
------------	-----

BORING BARS FOR VNMG/VNMA

SI-MVUNR/L	191
------------	-----

BORING BARS FOR WNMG/WNMA

SI-MWLNRL	192
AI-MWLNRL	192

TURNING POSITIVE BORING BARS

Positive Boring Bars Overview	193
-------------------------------	-----

BORING BARS FOR CCMT/CCGT

SI-SCLCR/L	195
------------	-----

BORING BARS FOR DCMT/DCGT

SI-SDUCR/L	195
------------	-----

BORING BARS FOR TCMT/TCGT

SI-STUCR/L	196
------------	-----

BORING BARS FOR TPGN/TPUN/TPMR

SI-CTUPR	196
----------	-----

BORING BARS FOR VCMT/VCGT

SI-SVUCR/L	197
------------	-----

BORING BARS FOR WCMT/WCGT

SI-SWUCR/L	197
------------	-----

PARTING AND GROOVING

Overview	200
----------	-----

GTN SYSTEM

Inserts	202
Blades	203
One Piece Flexible Clamp Tool Blocks	203
Two Piece Clamp Tool Blocks	204
Blade and Insert Sets	204
Tool Block, Blade, and Insert Sets	204

NOTCH SYSTEM

R / L Handed Hand Notch-Grooving Inserts	206
R Handed Notch-Full Radius Grooving Inserts	207
R / L Handed Notch-Threading Inserts	207
External Notch Holders – R / L Hand	208
Gang Style External Notch Holders – R / L Hand	209
Internal Notch Holders – R Hand	210

TNMA SYSTEM

Insert Nomenclature	212
Right and Left Hand TNMA On Edge Inserts	214
External TNMA On Edge Holders – R / L Hand	215
External 90° TNMA On Edge Holders – R / L Hand	216
Internal TNMA On Edge Boring Bars – R / L Hand	217

Table of Contents



Cutting Tools

THREADING

Overview	220
Threading Insert Nomenclature	222
THREADING INSERTS	
Partial Profile 60°	224
Partial Profile 55°	225
ISO Metric External	226
ISO Metric Internal	227
UN (UNC, UNF, UNEF) External	228
UN (UNC, UNF, UNEF) Internal	229
UNJ	230
NPT	231
NPTF	232
API Round	233
Stub ACME	234
THREADING TOOL HOLDERS	
External Threading Tool Holders	235
Internal Threading Tool Holders (Boring Bars) ..	236

DRILLING

Overview	240
Drill Tool Nomenclature	241
SCI Indexable Drills 3XD	241
SCI Indexable Drills 4XD	242
SCS Metric Indexable Drills 3XD	243
SCS Metric Indexable Drills 4XD	244

Round Tools

DRILLS

Drill Size & Decimal Equivalents	248
Tap Drill Chart	249
Solid Carbide Technical Reference	250
Solid Carbide Jobber Drills	251
Solid Carbide Coolant Feeding Drills	257
HSS Jobber Drills	260
HSS TiN Coated & Cobalt Jobber Drills Overview ..	265
General Purpose HSS TiN Coated Jobber Drills ..	266
Heavy Duty TiN Coated Jobber Drills	271
Heavy Duty Cobalt Jobber Drills	276
Drill Sets	281
Aircraft Extension Drills	282
Taper Shank Drills	285
Silver and Deming Drills	288
Spotting and Centering Drills	292
Core Drills	293

ANNULAR CUTTERS

Technical Reference	296
Annular Cutters	297
Annular Cutter Holders	298

REAMERS

Technical Reference	300
Straight Shank Chucking Reamers	301
Taper Shank Chucking Reamers	310
Expansion Chucking Reamers	312
Hand Reamers	313
Expansion Hand Reamers	315
Bridge Reamers	316
Adjustable Blade Reamers	316
Taper Pin Reamers	317
Car Reamers	318
Taper Pipe Reamers	319
Shell Reamers	320

continued on next page



Table of Contents

Cutting Tools

TABLE OF CONTENTS

COUNTERBORES & COUNTERSINKS

Technical Reference	322
Fillister Head Counterbores	323
Capscrew Counterbores	323
Combined Drill and Countersinks	325
Countersinks	326

CARBIDE BURRS

Technical Reference	330
Carbide Burrs	331

END MILLS

SOLID CARBIDE

Technical Reference	334
Single End, Square	335
Single End, Ball Nose	341
Double End, Square	345
Double End, Weldon	346
Variable Helix, Corner	348
Variable Helix, Sharp and Ball Nose	349
6 Flute, 45°, Corner Radius	350
2 and 3 Flute for Aluminum	351
Roughing	352
Drill Mills	353

HSS AND COBALT

2 Flute	354
Multiple Flute	358
Roughing	362

MILLING CUTTERS & SAWS

Technical Reference	364
Milling Cutters with Shanks	365
Corner Rounding Cutters	367
Woodruff Keyseat Cutters	368
Milling Cutters	369
Single Angle Milling Cutters	370
Double Angle Milling Cutters	370
Shell End Mills	371
Involute Gear Cutters	372
Jewelers Saws	374
Saw Arbors	377
Screw Slotting Saws	377
Plain Metal Slitting Saws	379
Side Milling Cutters	382
Power Hacksaw Blades	386

TAPS

Technical Reference	388
Hand Taps	390
Tap and Reamer Wrenches	395
Spiral Point Taps	398
Spiral Flute Taps	400
Combined Tap and Drills	401
Tap and Drill Sets	402
Pipe Taps	403

DIES

Straight Pipe NPS	407
Taper Pipe NPT	407
Heavy Duty Die Stocks	407
Round Adjustable Split Dies	408
Round Adjustable Split Dies, Special Threads	409
Round Adjustable Split Dies, Special Threads, L Hand ..	410
Metric Round Adjustable Split Dies	411

BROACHES AND TOOL BITS

BROACHES

Individual Keyway Broaches	414
Keyway Broach Sets	415

TOOL BITS

Carbide Tipped Tool Bits	416
Ground Tool Bits	418

INDEX

Index By Group	419
Indexable Appendix	428

TABLE OF CONTENTS

MILLING

Nomenclature.....	6
Overview.....	10
90 DEGREE SYSTEMS, MILLS AND INSERTS ...	14
XD90.....	14
AP90.....	16
AN90.....	26
AD90.....	30
TP90.....	34
60 DEGREE SYSTEMS, MILLS AND INSERTS ...	40
PN60.....	40
45 DEGREE SYSTEMS, MILLS AND INSERTS ...	42
SEH-45.....	42
SEK-45.....	45
SN-45.....	49
43 DEGREE SYSTEMS, MILLS AND INSERTS ...	52
OFC.....	52
SPECIALTY SYSTEMS, MILLS AND INSERTS ...	54
RD-TORO.....	54
SP-HI-Feed.....	59
WN-HI-Feed.....	63
R8 SHANK TOOLS, MILLS AND INSERTS.....	65
AP90.....	66
TP90.....	67
R8 Technical Date.....	69
UTILITY INSERTS.....	72
SNGN/SNUN.....	72
SPGN/SPUN.....	75
SDNT.....	81
SPMT.....	81
TPKN.....	82
TPGN/TPUN/TPMR.....	82
Milling Formulas.....	89

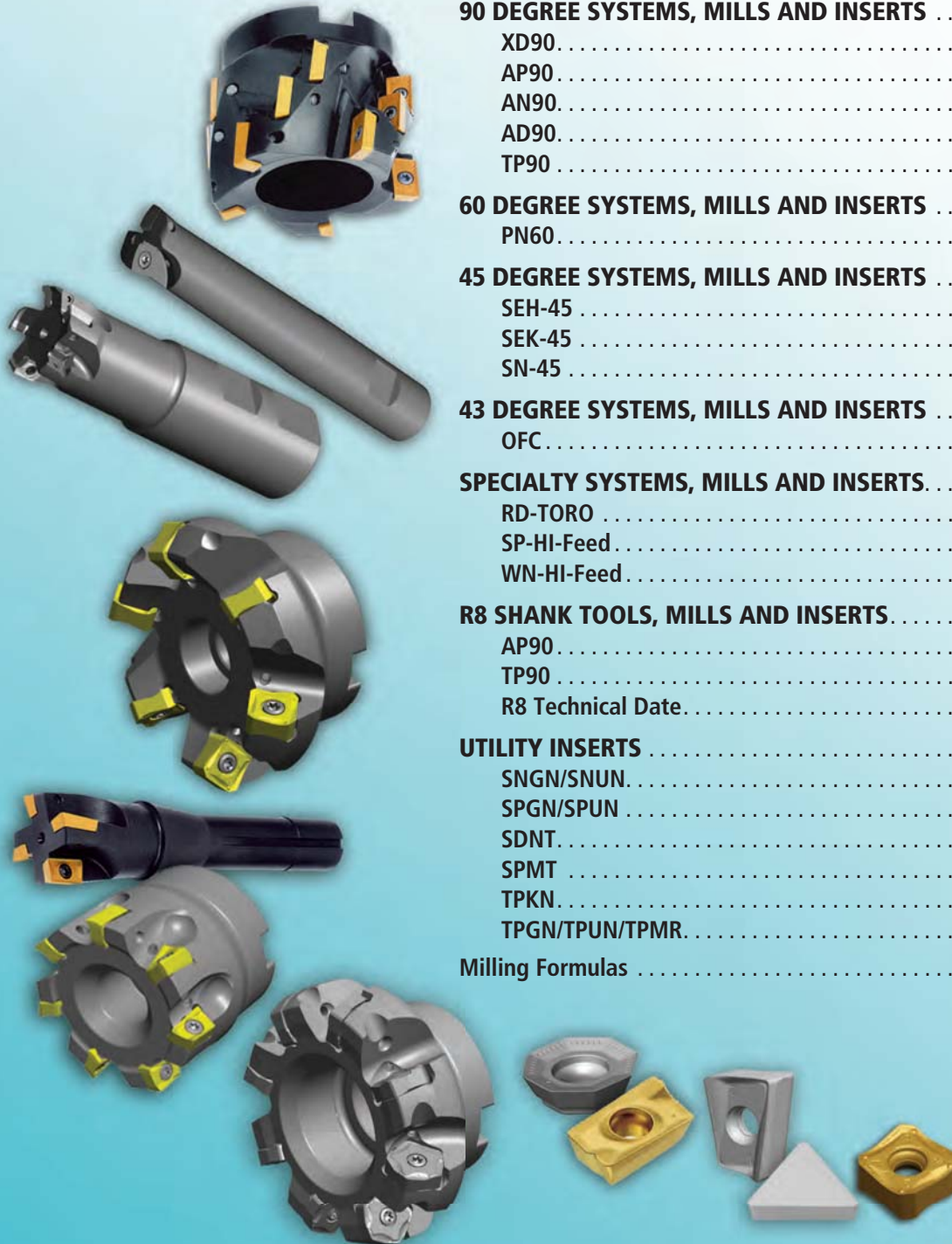



Milling Cutter Body Nomenclature

Cutting Tools

MILLING

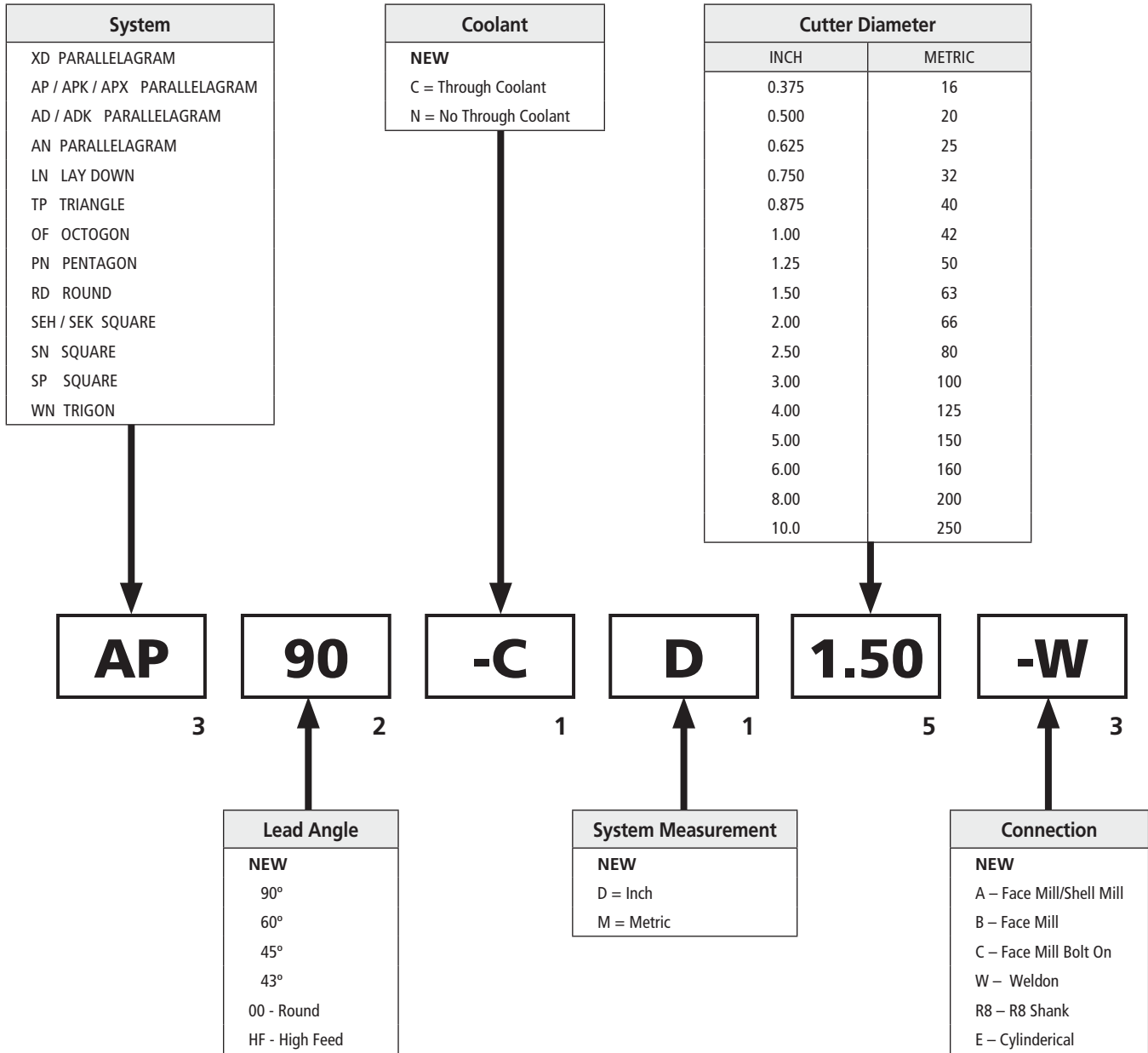

Milling Cutter Body Nomenclature



TMX Cutting Tools

MILLING

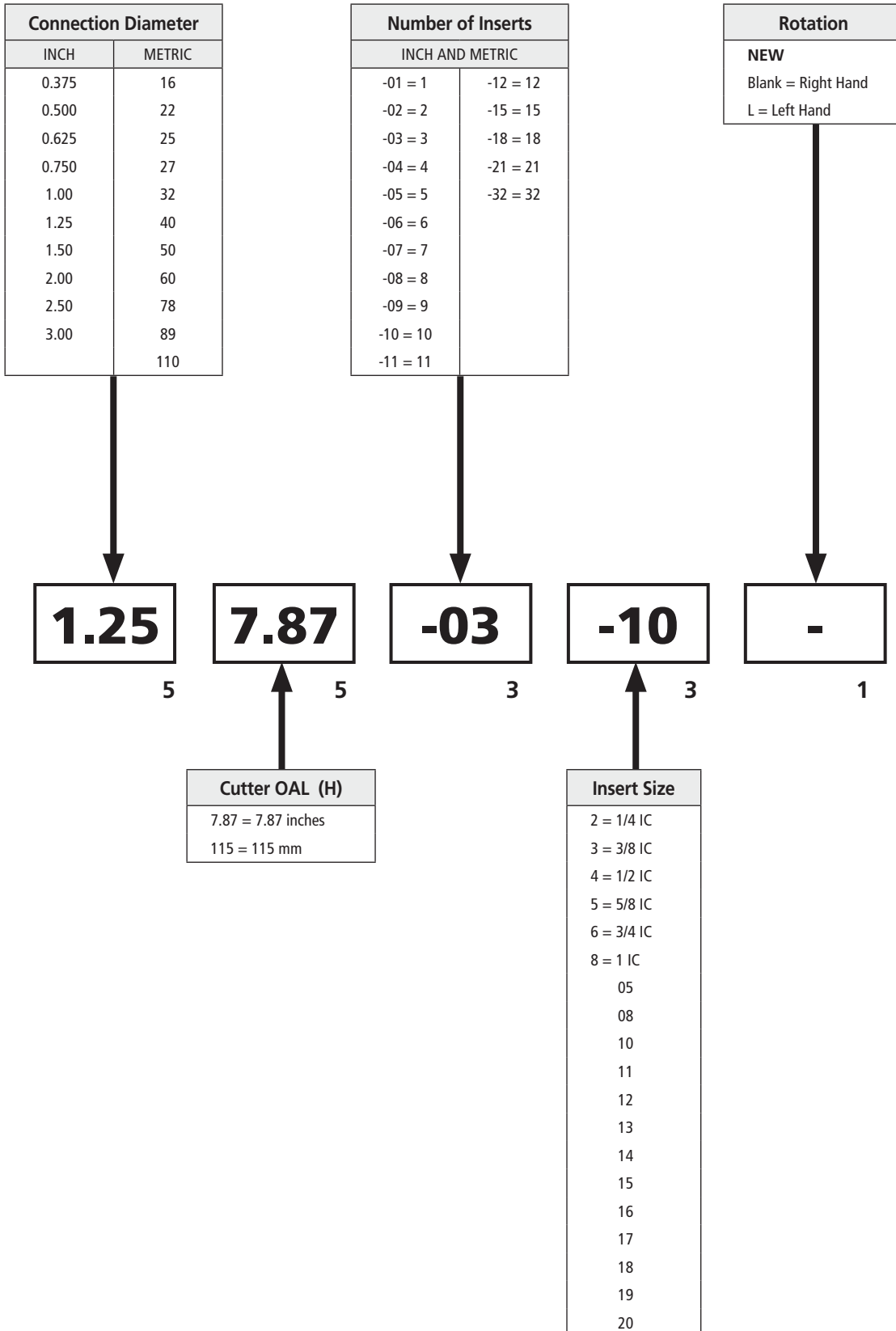



Milling Inserts Nomenclature

Cutting Tools

MILLING

Tolerance											
		INCH			METRIC						
Tolerance Class	IC	m	d	s	m	d	s				
Fixed Tolerances	A	ALL	± 0.0002	± 0.001	± 0.001	± 0.005	± 0.025	± 0.025			
	F	ALL	± 0.0002	± 0.0005		± 0.005	0.013				
	C	ALL	± 0.0005	± 0.001		± 0.013	± 0.025				
	H	ALL	± 0.0005	± 0.0005		± 0.013	± 0.013				
	E	ALL	± 0.001	± 0.001		± 0.025	± 0.025				
	G	ALL	± 0.001	± 0.001		± 0.005	± 0.025		0.025	± 0.13	
Size Dependent Tolerances	J	5/32 - 3/8	± 0.0002	± 0.002	± 0.001	± 0.005	± 0.051	± 0.025			
		0.394 - 0.550		± 0.003			± 0.076				
		0.590 - 0.80		± 0.004			± 0.102				
		0.86 - 1.25		± 0.005			± 0.127				
	K	5/32 - 3/8	± 0.0005	± 0.002		± 0.013	± 0.051				
		0.394 - 0.550		± 0.003			± 0.076				
		0.590 - 0.80		± 0.004			± 0.102				
		0.86 - 1.25		± 0.005			± 0.127				
	L	5/32 - 3/8	± 0.001	± 0.002		± 0.025	± 0.051				
		0.394 - 0.550		± 0.003			± 0.076				
		0.590 - 0.80		± 0.004			± 0.102				
		0.86 - 1.25		± 0.005			± 0.127				
	M	5/32 - 3/8	± 0.003	± 0.002		± 0.005	± 0.076		± 0.051	± 0.13	
		0.394 - 0.550		± 0.005			± 0.003		± 0.127		± 0.076
		0.590 - 0.80		± 0.006			± 0.004		± 0.152		± 0.102
		0.86 - 1.25		± 0.007			± 0.005		± 0.178		± 0.127
	N	5/32 - 3/8	± 0.003	± 0.002		± 0.001	± 0.076		± 0.051	± 0.025	
		0.394 - 0.550		± 0.005			± 0.003		± 0.127		± 0.076
		0.590 - 0.80		± 0.006			± 0.004		± 0.152		± 0.102
		0.86 - 1.25		± 0.007			± 0.005		± 0.178		± 0.127
	U	5/32 - 3/8	± 0.005	± 0.003		± 0.005	± 0.127		± 0.076	± 0.13	
		0.394 - 0.550		± 0.008			± 0.005		± 0.203		± 0.127
		0.590 - 0.80		± 0.011			± 0.007		± 0.279		± 0.178
		0.86 - 1.25		± 0.015			± 0.010		± 0.381		± 0.254

S
S

E
E

H
H

N
N

12
4

03
2

Clearance	
N = 0°	
B = 5°	
C = 7°	
P = 11°	
D = 15°	
E = 20°	
F = 25°	

Insert Shape			
H 120°		A 85°	
O 135°		L 90°	
P 108°		X Special	
S 90°		R	
T 60°		K 55°	
C 80°		V 35°	
D 55°		W 80°	

Insert Thickness			
Symbol	Type of Hole	Chipbreaker Configuration	Shape
W	Through Hole 40° - 60° countersink	Without Chipbreaker	
T		Single-Sided Chipbreaker	
C	Through Hole 70° - 90° countersink	Without Chipbreaker	
H		Single-Sided Chipbreaker	
A		Without Chipbreaker	
M	Through Hole No Countersink	Single-Sided Chipbreaker	
G		Double-Sided Chipbreaker	
N		Without Chipbreaker	
R	No Through Hole Top-Clamp Secured	Single-Sided Chipbreaker	
F		Double-Sided Chipbreaker	
X	Non-Industry Standard	Non-Industry Standard	Non-Industry Standard

Insert Thickness			
ANSI	INCH	mm	ISO
1.2	0.078	1.98	T1
1.5	0.094	2.38	O2
2	0.125	3.18	O3
2.5	0.156	3.97	T3
3	0.187 (4.76)	4.76	O4
3.5	0.219 (5.56)	5.56	O5
4	0.250 (6.35)	6.35	O6
5	0.312 (7.94)	7.94	O7
6	0.375 (9.52)	9.52	O9
8	0.500 (12.70)	12.70	12

Milling Inserts Nomenclature



Cutting Tools

MILLING

Insert Size			Turning										Milling		
ANSI SYMBOL	INCH	mm	80°	55°	35°	90°	60°	80°			85°	90°	135°	120°	108°
			C	D	V	S	T	W	R	A	L	O	H	P	
1.2	5/32	3.97		04	06	03	06	02							
1.5	3/16	4.76	04	05	08	04	08	L3							
1.8	7/32	5.56	05	06	09	05	09	03							
	0.236	6.00							06	06	06				
2	1/4	6.35	06	07	11	06	11	04		6.35	6.35	02	03		
2.5	5/16	7.95	08	09	13	07	13	05	07	08	08				
	0.315	8.00							08						
3	3/8	9.53	09	11	16	09	16	06	09	9.53	9.53	04	05		
	0.394	10.00							10	10	10				
	0.472	12.00							12	12	2				
4	1/2	12.70	12	15	22	12	22	08		12.70	12.70	05	07		
		13.50													
		14.00							14	14					
		15.00									15				
5	5/8	15.88	16	19	27	15	27	10	15	15.88	15.88	06	09		
		13.50							16	16	16				
		14.00													11
		15.00													
6	3/4	19.05	19	23	33	19	33	13	19	19.05	19.05	07	11		
	0.787	20.00							20	20	20				
		24.50													13
	0.984	25.00							25	25	25				
8	1.00	25.40	25	31	44	25	44	17		25.4	25.4	10	14		
10	1-1/4	31.75	32	38	54	31	54	21	31						
	1.26	32.00							32						

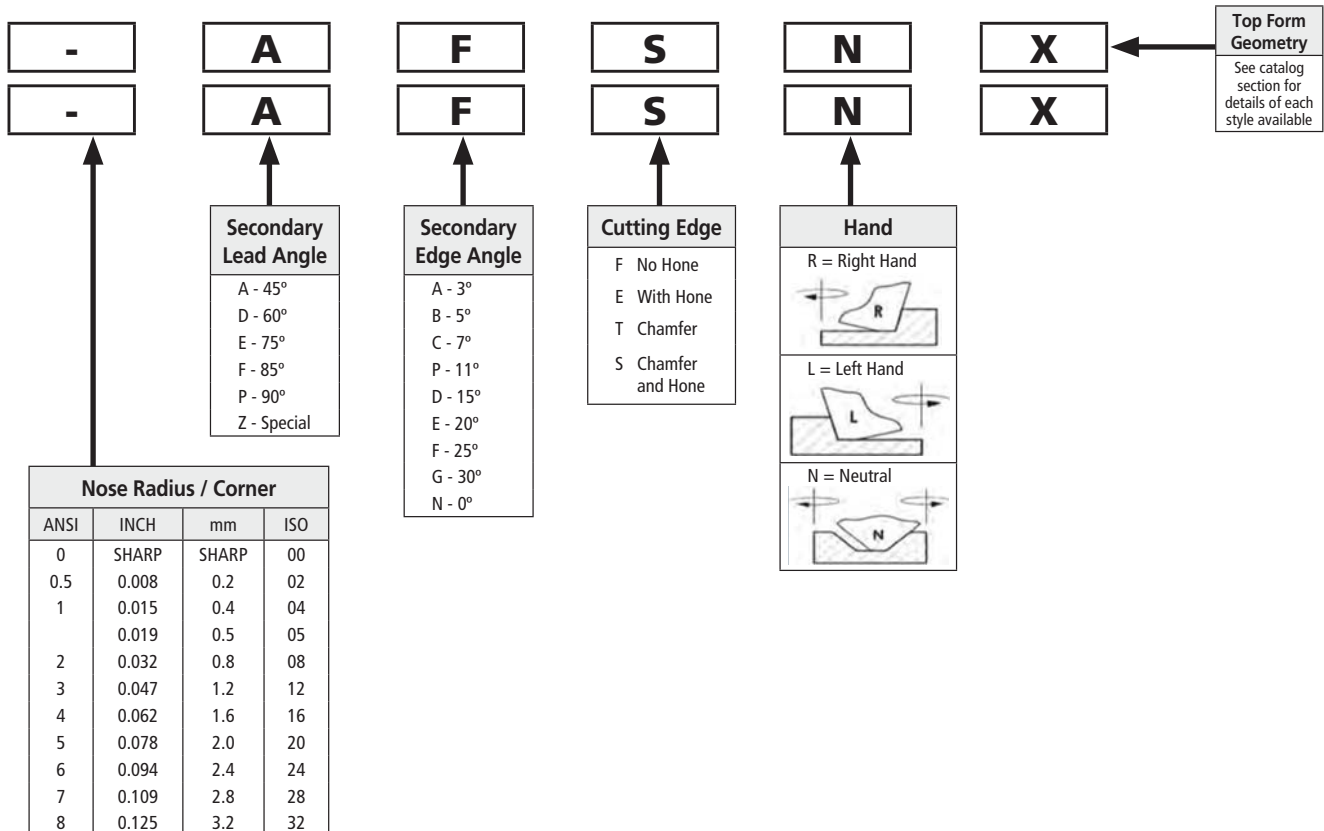



Milling Overview

Cutting Tools

MILLING

60°, 45°, 43°, and Specialty Cutters

System	Main Feature	Insert Sizes	Mill Type	Diameters	Number of Inserts
90° Lead Cutter Systems					
AN-90 	Heavy Duty Two Insert Sizes High Ramping angle for Cutters Multiple Pitch Four Cutting edges on each insert	ANHX 10 04	END MILL	0.75 - 2.00	2 - 7
			FACE MILL	1.50 - 4.00	4 - 12
		ANHX 16 0	END MILL	1.25 - 2.00	2 - 4
			FACE MILL	2.00 - 6.00	3 - 11
AD-90 	Accurate 90° Shoulder Ramping up to 11.5"	ADKT 15 05	END MILL	1.00 - 1.25	2 - 3
TP-90 	90° Triangle Insert, Square Shoulder Mills TPG and TPU (TPUN) Style inserts Three size inserts 1/4, 3/8, and 1/2	TPG 22 TPUN 22	END MILL	0.50 - 1.00	1 - 2
			END MILL - INTEGRAL	1.00	2
		TPG 32 TPUN 32	END MILL	2.00 - 6.00	6 - 32
			END MILL - INTEGRAL	1.25 - 3.00	2 - 5
			FACE MILL	1.50 - 2.50	3
		TPG 43 TPUN 43	FACE MILL	3.00 - 8.00	4 - 8

Replace worn or damaged screws, inserts and cutter bodies. The proper use of thread anti-seize (290-ASEIZE-03) will aid in increasing the life of the screws.

90° Lead Cutter Systems *continued*

System	Main Feature	Insert Sizes	Mill Type	Diameters	Number of Inserts
90° Lead Cutter Systems (continued)					
 <p>XD-90</p>	Light Duty Versatile High Ramping Weldon Shanks Arbor Mount	XDKT 10 03 08	END MILL	0.625 - 1.50	2 - 6
			FACE MILL	2.00 - 3.00	5 - 7
    <p>AP-90 / APX-90</p>	Medium Duty High Ramping Side Milling Weldon Shanks Arbor Mount R8 Shanks CAT40 Shank CAT50 Shank Extended Flute	APKT 10 03	END MILL	0.375 - 1.50	1 - 5
			END MILL - EXTENDED	0.75 - 1.50	4 - 24
		APKT 16 04	END MILL	0.875 - 2.00	2 - 5
			END MILL - INTEGRAL SHANK R-8	1.00 - 2.50	2 - 6
			END MILL - EXTENDED FLUTE	0.75 - 2.50	4 - 24
			END MILL - EXTENDED FLUTE INTEGRAL SHANK CAT 40	2.0	12
			END MILL - EXTENDED FLUTE INTEGRAL SHANK CAT 50	2.00 - 3.00	15 - 35
			FACE MILL	1.50 - 8.00	4 - 12
		FACE MILL - EXTENDED FLUTE	2.00 - 6.00	6 - 32	
APKT 17 05	END MILL	0.75 - 1.25	1 - 5		









Milling Overview





Cutting Tools

MILLING

60°, 45°, 43°, and Specialty Cutters

System	Main Feature	Insert Sizes	Mill Type	Diameters	Number of Inserts
60° Lead Cutter Systems					
 60° Lead PN-60	10 Cutting edges per insert Through Coolant Design Arbor Mount	PNHX-11	FACE MILL	2.00 - 10.00	5 - 18
45° Lead Cutter Systems					
 SEH-45	General Purpose Screw Down Insert Clamping	SEHT 43	FACE MILL	2.00 - 6.00	4 - 8
 SEK-45	General Purpose Standard ANSI Inserts Full Range of Diameters available with Shim Seat	SEKN 42	FACE MILL	1.50 - 4.00	3 - 6
			FACE MILL - HO	2.50 - 10.00	5 - 10
 SN-45		SNHX 12 06	FACE MILL	2.00 - 10.00	4 - 16
43° Lead Cutter Systems					
 OFC	Economical 8-cutting edges per insert Ramping Capability up to Arbor Mount	OFMT 05	FACE MILL	2.00 - 4.00	4 - 7
Specialty Milling Systems					
 RD-TORO	Inserts Available in 10mm, 12mm and 16mm sizes Anti-Rotation Top Clamp on all Face Mills for 12mm insert	RD...10 03	END MILL	1.00	2
		RD...12 T3	END MILL	1.00 - 1.25	2 - 3
			FACE MILL	2.00 - 3.00	5 - 7
		RD...16 04	FACE MILL	2.00 - 6.00	4 - 9

60°, 45°, 43°, and Specialty Cutters

System	Main Feature	Insert Sizes	Mill Type	Diameters	Number of Inserts
Specialty Milling Systems (continued)					
SP-HI Feed 	Four Cutting Edges per insert Medium Duty	SPKT 08 T3 SPKW 08 T	END MILL	0.75 - 1.50	2 - 5
		SPKT 13 03 SPKW 13 03	FACE MILL	2.00 - 4.00	4 - 6
WN-HI Feed 	Three Cutting Edges per Insert Feed Rates up to 0.118 ipt (3.0 mm/t)	WNMW 12 07	FACE MILL	2.00 - 4.00	3 - 5
R8 Shank Tools					
AP-90 / APX-90 	Medium Duty High Ramping Side Milling	APKT 16 04	END MILL – INTEGRAL SHANK R-8	1.00 - 2.50	2 - 6
TP-90 	90° Triangle Insert Square Shoulder Mills Utilize Common TPG and TPU	TPG 22, TPUN 22	END MILL – INTEGRAL SHANK R-8	1.00	2
		TPG 32 TPUN 32	END MILL – INTEGRAL SHANK R-8	1.25 - 3.00	2 - 5



XD-90 Milling System

Cutting Tools

MILLING

System	Main Feature	Insert Sizes	Mill Type	Diameters	Number of Inserts
 XD-90	Light Duty Versatile High Ramping Weldon Shanks Arbor Mount	XDKT 10 03 08	END MILL	0.625 - 1.50	2 - 6
			FACE MILL	2.00 - 3.00	5 - 7

palbit XD-90 Milling System

- Economical 10mm insert size
- Through Coolant
- Perfect tool for light duty
- Pocket Milling
- Helical interpolating
- Plunging
- Channel Milling
- Diameter range: 0.625 to 3.00



palbit Square Shoulder End Mills XD-90



Part Number	Description	Number of Inserts	Effective Teeth	ØD	Ød	L	L1	Ramp Angle	Shank Style	ap Max	Insert Style
181-0572-00	XD90 D.625-W.625/3.94-02-10	2	2	0.625	0.625	3.94	1.18	4.0	Weldon	0.35	XDKT 10
181-0573-00	XD90 D.625-W.625/5.91-02-10	2	2	0.625	0.652	5.91					
181-0574-00	XD90 D.750-W.750/3.94-03-10	3	3	0.75	0.75	3.94					
181-0575-00	XD90 D.750-W.750/5.91-03-10	3	3	0.75	0.75	5.91					
181-0576-00	XD90 D1.00-W1.00/3.94-04-10	4	4	1.00	1.00	3.94	1.58	2.0			
181-0577-00	XD90 D1.00-W1.00/5.91-04-10	4	4	1.00	1.00	5.91					
181-0578-00	XD90 D1.25-W1.25/5.91-05-10	5	5	1.25	1.25	5.91	1.97	1.3			
181-0579-00	XD90 D1.50-W1.50/5.91-06-10	6	6	1.50	1.50	5.91		1.0			

For related inserts see page 150

palbit Square Shoulder Face Mills XD-90

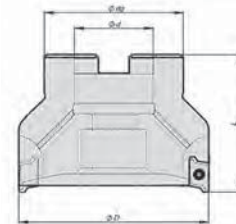

Part Number	Description	Number of Inserts	Effective Teeth	ØDc	Ød	Ødg	L	Ramp Angle	Shank Style	ap Max	Insert Style
181-0580-00	XD90 D2.00-A.750/1.75-05-10	5	5	2.00	0.75	1.77	1.75	2.5	Arbor	0.35	XDKT 10
181-0581-00	XD90 D2.50-A1.00/1.75-06-10	6	6	2.50	1.00	2.21		2.0			
181-0582-00	XD90 D3.00-A1.00/2.00-07-10	7	7	3.00	1.00	2.21	2.00	1.6			

Spare Parts Part Number	Description	Torque
290-0489-00	Insert screw M2.5 x 0.45 - 3.5 mm long	1.2 Nm
290-0117-00	Key (T-8)	

Replace worn or damaged screws, inserts and cutter bodies. The proper use of thread anti-seize (290-ASEIZE-03) will aid in increasing the life of the screws.



palbit XDKT Inserts

	Primary Applications							
Steel	●	●	●	●	●	●	●	●
Stainless Steel	●	●	●	●	●	●	●	●
Cast Irons	●	●	●	●	●	●	●	●
Non-Ferrous	●	●	●	●	●	●	●	●
Heat Resistant Alloys	●	●	●	●	●	●	●	●

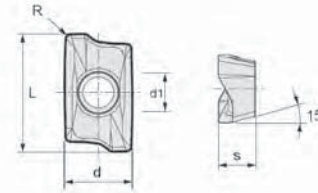

Description	Geometry Code	PVD Coated					TiN PVD		Geometry	d	S	L	R	d1
		PH6910	PH6920	PH6125	PH6135	PH6740	PH8910	PH8125						
XDKT 100308 PDSR	111-1224-	54	68	78	86	15	58	53	T-Land and Hone	.394	.143	.394	.031	.110

To order please use the geometry code plus the grade code

MILLING

XD-90 Speeds and Feeds

Material	Speed SFM (m/min)				Feed ipt (mm/tooth)
	PVD COATED (Increasing Toughness →)				Geometry
	PH6910 PH8910	PH6920	PH6125 PH8125	PH6135	PDSR
P Low Carbon Steels	590-750 (180-230)	550-680 (170-210)	520-620 (160-190)	490-590 (150-180)	0.008-0.016 (0.20-0.40)
	Alloy Steels	550-680 (170-210)	520-720 (160-200)	460-590 (140-180)	
	Tool Steels	520-720 (160-200)	460-620 (140-190)	420-520 (130-160)	
M Ferritic and Martensitic		490-620 (150-190)			0.006-0.014 (0.15-0.35)
	Austenitic	330-520 (100-160)			
	PH and Duplex	330-490 (100-150)			
K Gray Iron Class 25-35	590-850 (180-260)	550-810 (170-250)			0.008-0.016 (0.20-0.40)
	Cast Iron Class 45	490-680 (150-210)	490-680 (140-200)		
	Ductile Iron	290-620 (90-190)	260-590 (80-180)		
N Aluminum < 8% Si					
	Copper and Brass				
	Aluminum > 8% Si				
S Iron Based	100-200 (30-60)	100-200 (30-60)	100-160 (30-50)		0.004-0.012 (0.10-0.30)
	Nickel and Cobalt Based	70-230 (20-70)	70-230 (20-70)	70-200 (20-60)	
	Titanium Alloys	130-290 (40-90)	130-290 (40-90)	130-230 (40-70)	
H Alloy Steels Rc > 50	200-330 (60-100)				0.002-0.008 (0.05-0.20)
	Stainless Steels Rc > 45				
	Tool Steels RC > 50				

P = Steel	M = Stainless Steel	K = Cast Iron	N = Aluminum	S = High-Temp Alloy	H = Hard Steel
-----------	---------------------	---------------	--------------	---------------------	----------------



AP-90 Milling System

Cutting Tools

MILLING

System	Main Feature	Insert Sizes	Mill Type	Diameters	Number of Inserts
AP-90 / APX-90 	Medium Duty High Ramping Side Milling Weldon Shanks Arbor Mount R8 Shanks CAT40 Shank CAT50 Shank Extended Flute	APKT 10 03	END MILL	0.375 - 1.50	1 - 5
			END MILL – EXTENDED FLUTE	0.75 - 1.50	4 - 24
		APKT 16 04	END MILL	0.875 - 2.00	2 - 5
			END MILL – INTEGRAL SHANK R-8	1.00 - 2.50	2 - 6
			END MILL – EXTENDED FLUTE	0.75 - 2.50	4 - 24
			END MILL – EXTENDED FLUTE INTEGRAL SHANK CAT 40	2.00	12.00
			END MILL – EXTENDED FLUTE INTEGRAL SHANK CAT 50	2.00 - 3.00	15 - 35
			FACE MILL	1.50 - 8.00	4 - 12
		APKT 17 05	FACE MILL – EXTENDED FLUTE	2.00 - 6.00	6 - 32
		APKT 17 05	END MILL	0.75 - 1.25	1 - 5

palbit AP-90 / APX-90 Milling System

- 90° Square Shoulder Mill
- Three Insert sizes to fit the Application
- Extended Flute for Side Milling
- High Performance designs with Ramping Capability up to 7.5°
- DOC up to 0.570 (14.5 mm)
- Select Offering with Through Coolant
- Excellent All around Milling Tool
- Pocket Milling
- Side Milling
- Helical interpolating
- Plunging
- Channel Milling
- Select Offering in CAT40, CAT50, and Integral R8 shank
- Diameter range: 0.375 to 8.00
- Extended Reach available in select End Mill Diameters



palbit 90° Lead Square Shoulder End Mills – High Performance

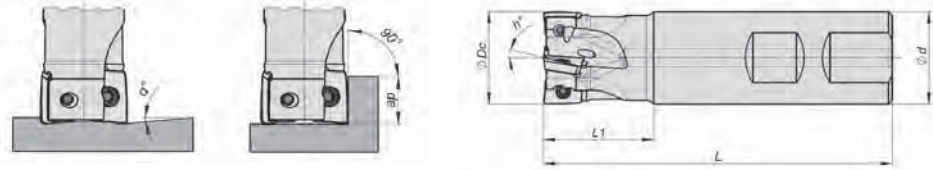

Part Number	Description	Number of Inserts	Effective Teeth	ØD	Ød	L	L1	Ramp Angle	Shank Style	ap Max	Insert Style
181-0644-00	AP90 D.375-W.375/3.15-01-10	1	1	0.375	0.375	3.15	0.79	5.0	Weldon	0.354	APKT 10
181-0604-00	AP90 D.500-W.500/3.94-01-10	1	1	0.50	0.50	3.94	0.98	32.0			
181-0605-00	AP90 D.625-W.625/3.94-02-10	2	2	0.63	0.625	3.94	1.02	15.0			
181-0607-00	AP90 D.750-W.750/3.94-02-10	2	2	0.75	0.75	3.94	1.18	7.5			
181-0645-00	AP90 D.750-W.750/3.94-03-10	3	3	0.75	0.75	3.94	1.18	7.5			
181-0608-00	AP90 D.750-W.750/7.87-02-10	2	2	0.75	0.75	7.87	1.58	7.5			
181-0688-00	AP90 D1.00-W1.00/4.53-03-10	3	3	1.00	1.00	4.53	1.38	5.0			
181-0689-00	AP90 D1.00-W1.00/4.53-04-10	4	4	1.00	1.00	4.53	1.38	5.0			
181-0609-00	AP90 D1.00-W1.00/5.91-03-10	3	3	1.00	1.00	5.91	3.15	5.0			
181-0610-00	AP90 D1.00-W1.00/9.84-03-10	3	3	1.00	1.00	9.84	1.58	5.0			
181-0690-00	AP90 D1.25-W1.25/4.92-04-10	4	4	1.25	1.25	4.92	1.58	2.0			
181-0611-00	AP90 D1.25-W1.25/6.30-03-10	3	3	1.25	1.25	6.30	3.94	3.0			
181-0612-00	AP90 D1.25-W1.25/9.84-04-10	4	4	1.25	1.25	9.84	1.58	2.0			
181-0613-00	AP90 D1.50-W1.25/7.87-03-10	3	3	1.50	1.25	7.87	1.18	2.7			
181-0614-00	AP90 D1.50-W1.25/9.84-05-10	5	5	1.50	1.25	9.84	1.18	2.7			
181-0615-00	AP90 D.875-W.750/3.94-02-16	2	2	0.875	0.75	3.94	1.38	6	Weldon	0.571	APKT 16
181-0616-00	AP90 D1.00-W1.00/3.94-02-16	2	2	1.00	1.00	3.94	1.58	5			
181-0620-00	AP90 D1.00-W1.00/5.91-02-16	2	2	1.00	1.00	5.91	3.15	5			
181-0619-00	AP90 D1.00-W1.00/7.87-02-16	2	2	1.00	1.00	7.87	1.97	5			
181-0618-00	AP90 D1.25-W1.00/4.92-03-16	3	3	1.25	1.00	4.92	1.58	4			
181-0617-00	AP90 D1.25-W1.25/4.92-03-16	3	3	1.25	1.25	4.92	1.97	4			
181-0622-00	AP90 D1.25-W1.25/6.30-03-16	3	3	1.25	1.25	6.30	3.94	4			
181-0623-00	AP90 D1.50-W1.25/7.87-03-16	3	3	1.50	1.25	7.87	1.58	3			
181-0624-00	AP90 D1.50-W1.25/9.84-03-16	3	3	1.50	1.25	9.84	1.58	3			

See page 22-23 for inserts

Mills	Spare Parts Part Number	Description	Torque
APKT 10	290-0331-00	APKT 10 - Insert Screw	1.2 Nm
	290-0117-00	APKT 10 Key (T8 Torx)	
APKT 16	290-0482-00	APKT 16 Insert Screw	3Nm
	290-0124-00	APKT 16 Driver (T15 Torx)	
	290-ASEIZE-03	Thread Anti-Seize 3-gm pack	



AP-90 Milling System

Cutting Tools

MILLING

90° Lead Square Shoulder End Mills

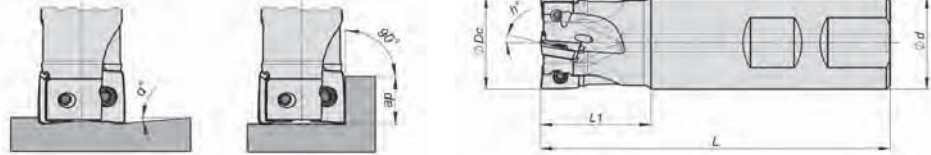

Part Number	Description	Number of Inserts	Effective Teeth	ØDc	Ød	L	I	Insert Screw P/N	Shank Style	ap Max	Insert Style
6-110-0501	APX-D.500-W.500-3.9-1-10	1	1	0.50	0.50	3.94	0.98	6-998-4110	Weldon	0.35	APKT 10
6-110-0561	APX-D.500-W.625-4.0-1-10	1	1	0.50	0.625	4.00	0.98				
6-110-0602	APX-D.625-W.625-3.9-2-10	2	2	0.625	0.625	3.94	0.98				
6-110-0702	APX-D.750-W.750-3.9-2-10	2	2	0.75	0.75	3.94	1.18				
6-110-0702XL	APX-D.750-W.750-4.75-2-10	2	2	0.75	0.75	4.75	2.00				
6-110-0702B	APX-D.750-C.750-4.75-2-10	2	2	0.75	0.75	4.75	1.57				
6-110-1003B	APX-D1.00-C1.00-10.0-3-10	3	3	1.00	1.00	10.00	1.57				
6-110-1003XL	APX-D1.00-W1.00-5.5-3-10	3	3	1.00	1.00	5.50	3.15				
6-110-1073	APX-D1.00-W.750-5.5-3-10	3	3	.750	.750	5.50	1.63				
6-110-1213	APX-D1.25-W1.00-4.0-3-10	3	3	1.25	1.00	4.00	1.20				
6-110-1214	APX-D1.25-W1.00-4.0-4-10	4	4	1.25	1.00	4.00	1.20				
6-110-1215	APX-D1.25-W1.00-4.0-5-10	5	5	1.25	1.00	4.00	1.20				
6-110-1513	APX-D1.50-W1.00-4.0-3-10	3	3	1.50	1.00	4.00	1.20				
6-110-1523	APX-D1.50-W1.25-4.30-3-10	3	3	1.50	1.25	4.30	1.20				
6-110-1525	APX-D1.50-W1.25-4.30-5-10	5	5	1.50	1.25	4.30	1.20				
6-110-1526	APX-D1.50-W1.25-4.30-6-10	6	6	1.50	1.25	4.30	1.20				
6-110-1203XL	APX-D1.25-W1.25-6.3-3-10	3	3	1.25	1.25	6.30	4.00				
6-110-1204B	APX-D1.25-C1.25-10.0-4-10	4	4	1.25	1.25	10.00	1.57				
6-110-1503XL	APX-D1.50-W1.50-7.75-3-10	3	3	1.50	1.50	7.75	5.00				
6-110-1505B	APX-D1.50-C1.50-9.84-5-10	5	5	1.50	1.50	9.84	1.57				
6-116-0702	APX-D.875-W.750-3.9-2-16	2	2	0.875	0.75	3.94	1.38	6-998-4116	Weldon	0.57	APKT 16
6-116-1072	APX-D1.00-W.75-5.6-2-16	2	2	1.00	0.75	3.69	1.66				
6-116-1002	APX-D1.00-W1.00-3.9-2-16	2	2	1.00	1.00	3.94	1.57				
6-116-1002C	APX-D1.00-W1.00-5.6-2-16C	2	2	1.00	1.00	3.94	1.57				
6-116-1002B	APX-D1.00-C1.00-7.9-2-16	2	2	1.00	1.00	7.87	1.97				
6-116-1002XL	APX-D1.00-W1.00-5.6-2-16	2	2	1.00	1.00	5.60	3.15				
6-116-1203	APX-D1.250-W1.250-4.9-3-16	3	3	1.25	1.25	4.92	1.57				
6-116-1213	APX-D1.250-W1.00-4.9-3-16	3	3	1.25	1.00	4.92	1.57				
6-116-1203B	APX-D1.250-C1.25-9.9-3-16	3	3	1.25	1.25	9.84	1.97				
6-116-1203XL	APX-D1.250-W1.25-6.3-3-16	3	3	1.25	1.25	6.25	3.25				
6-116-2015	APX-D2.00-W1.00-5.3-2-16	5	5	2.00	1.00	5.35	1.77				
6-116-1503B	APX-D1.50-C1.50-9.8-3-16	3	3	1.50	1.50	9.84	1.97				
6-116-1503XL	APX-D1.50-W1.50-7.8-3-16	3	3	1.50	1.50	7.75	5.00				
R8 Shank											
6-941-105	APK-D1.00-R8-5.8-2-16	2	2	1.00	R8	5.80	1.70	6-998-4008M	R8	0.57	APKT16
6-941-110	APK-D1.25-R8-5.8-3-16	3	3	1.25		5.80	1.70				
6-941-115	APK-D1.50-R8-6.1-4-16	4	4	1.50		6.00	2.00				
6-941-120	APK-D2.00-R8-6.1-5-16	5	5	2.00		6.00	2.00				
6-941-125	APK-D2.50-R8-6.1-6-16	6	6	2.50		6.00	2.00	6-998-4011			

See page 22-23 for inserts

Mills	Spare Parts Part Number	Description	Torque
APKT 10	6-998-4110	APKT 10 - Insert Screw	1.2 Nm
	6-998-208	APKT 10 Key (T8 Torx)	
APKT 16	6-998-4008M	Insert Screw M4 X 0.7 L -8.4 mm	3.0Nm
	6-998-4011	Insert Screw M4 X 0.7 L -11.4mm	3.0Nm
	6-998-4116	Insert Screw M3.5 x 12	
	6-998-015	APKT 16 Key (T15 Torx)	
	290-ASEIZE-03	Thread Anti-Seize 3-gm pack	



90° Lead Extended Flute Square Shoulder End Mills

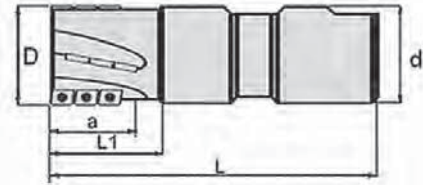

APX Ext Flute Part Number	Description	Number of Inserts	Effective Teeth	D	d	L	L1	Insert Screw P/N	Shank Style	ap Max	Insert Style
6-958-010	APX D.750-W.750-1.16-3.50-4-10	4	1	0.75	0.75	3.50	1.47	6-998-2506	Weldon	1.16	APKT 10
6-958-015	APX D1.00-W1.00-1.47-4.25-8-10	8	2	1.00	1.00	4.25	1.97			1.47	
6-958-025	APX D1.25-W1.25-1.83-4.50-15-10	15	3	1.25	1.25	4.50	2.22			1.83	
6-958-035	APX D1.50-W1.25-2.20-5.00-24-10	24	4	1.50	1.25	5.00	2.72			2.20	
6-958-040	APX D1.25-W1.25-1.00-4.00-4-16	4	2	1.25	1.25	4.00	1.72	6-998-4008M	Weldon	1.00	APKT 16
6-958-045	APX D1.50-W1.25-1.50-4.50-6-16	6	2	1.50	1.25	4.50	2.22			1.50	
6-958-050	APX D1.75-W1.50-2.00-5.16-8-16	8	2	1.75	1.50	5.16	2.47			2.00	
6-958-055	APX D2.00-W1.50-2.28-5.41-12-16	12	3	2.00	1.50	5.41	2.72			2.28	
6-958-060	APX D2.00-W1.50-2.81-5.94-15-16	15	3	2.00	1.50	5.94	3.25			2.81	
6-958-065	APX D2.00-W2.00-2.81-6.50-15-16	15	3	2.00	2.00	6.50	3.25			2.81	
6-958-070	APX D2.50-W1.50-3.34-6.47-24-16	24	4	2.50	1.50	6.47	3.78			3.34	
Integral CAT Shank											
6-958-220	APX D2.00-C40-2.28-7.44-12-16	12	3	2.00	CAT-40	7.44	4.75	6-998-4011	CAT-40	2.28	APKT 16
6-958-320	APX D2.00-C50-2.81-9.50-15-16	15	3	2.00	CAT-50	9.50	5.50		CAT-50	2.81	
6-958-325	APX D2.50-C50-3.34-10.50-24-16	24	4	2.50		10.50	6.50		3.34		

See page 22-23 for inserts

Mills	Spare Parts Part Number	Description	Torque
APKT 10	6-998-2506	Insert Screw M2.5 - 0.45 L 3.5 mm	1.2 Nm
	6-998-208	APKT 10 Key (T8 Torx)	
APKT 16	6-998-4008M	Insert Screw M4 X 0.7 L -8.4 mm	3.0Nm
	6-998-4011	Insert Screw M4 X 0.7 L -11.4mm	3.0Nm
	6-998-015	APKT 16 Key (T15 Torx)	
	290-ASEIZE-03	Thread Anti-Seize 3-gm pack	



AP-90 Milling System

Cutting Tools

MILLING

TMX 90° Lead Square Shoulder End Mill for APKT 17 mm

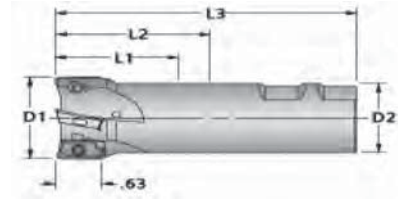

APK 17 Part Number	Description	Number of Inserts	Effective Teeth	D1	D2	L3 Overall Length	L1 Projection Length	L2 Extension Length	Ramp Angle	Shank Style	ap Max	Insert Style
6-117-0701	APK-D.75-W.75-3.75-1-17	1	1	0.75	0.75	3.750	1.250	1.750	40	Weldon	0.63	APKT 1705
6-117-1002	APK-D1.00-W1.00-4.00-2-17	2	2	1.00	1.00	4.000	1.500	1.750	8			
6-117-1203	APK-D1.25-W1.25-4.50-3-17	3	3	1.25	1.25	4.500	1.600	2.250	3.5			
6-117-1504	APK-D1.50-W1.25-4.50-4-17	4	4	1.50	1.25	4.500	1.600	2.250	2.5			
6-117-2005	APK-D2.00-W1.25-4.50-5-17	5	5	2.00	1.25	4.500	1.700	2.250	1.5			

Mills	Spare Parts Part Number	Description	Torque
APKT 17	6-998-4008M	Insert Screw M4 X 0.7 L -8.4 mm	3.0Nm
	6-998-015	Key (T15 Torx)	
	290-ASEIZE-03	Thread Anti-Seize 3-gm pack	

TMX 90° Lead Square Shoulder Face Mills

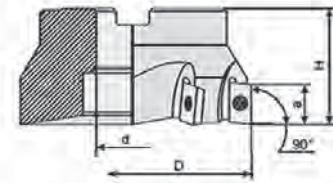

APX90 Part Number	Description	Number of Inserts	Effective Teeth	D	d	H	α°	Insert Screw P/N	ap Max	Insert Style
6-954-015	APX-D1.50-.500-4-16	4	4	1.50	0.50	1.58	3.0	6-998-4008M	0.625	APKT 16
6-954-020	APX-D2.00-.750-5-16	5	5	2.00	0.75		1.9			
6-954-025	APX-D2.50-1.00-6-16	6	6	2.50	1.00		1.4			
6-954-030	APX-D3.00-1.00-6-16	6	6	3.00	1.00	1.97	1.0	6-998-4011	0.625	APKT 16
6-954-040	APX-D4.00-1.25-8-16	8	8	4.00	1.25		0.7			
6-954-050	APX-D5.00-1.50-9-16	9	9	5.00	1.50	2.48	0.5	6-998-4011	0.625	APKT 16
6-954-060	APX-D6.00-2.00-10-16	10	10	6.00	2.00	2.48	0.5			
6-954-080	APX-D8.00-2.50-12-16	12	12	8.00	2.50		0.3			

See page 22-23 for inserts

APT90 Part Number	Description	Number of Inserts	Effective Teeth	D	d	H	Note	Insert Screw P/N	ap Max	Insert Style
6-955-020	APT-D2.00-.750-5-16	5	5	2.00	0.75	1.75	Staggered Pitch - To Reduce Resonance	6-998-4008M	0.625	APKT 16
6-955-030	APT-D3.00-1.00-6-16	6	6	3.00	1.00	2.00				
6-955-040	APT-D4.00-1.25-8-16	8	8	4.00	1.25					
6-955-045	APT-D4.00-1.50-8-16	8	8	4.00	1.50					

Mills	Spare Parts Part Number	Description	Torque
APKT 16	6-998-4011	Insert Screw M4 - 0.7 L 11.4 mm	3Nm
	6-998-4008M	Insert Screw M4 - 0.8	3Nm
	6-998-015	Key (T15 Torx)	
	290-ASEIZE-03	Thread Anti-Seize 3-gm pack	



TMX 90° Lead Extended Flute Square Shoulder Face Mills

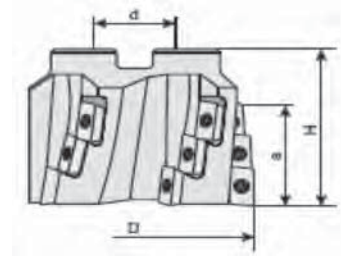

MILLING

APX90 Part Number	Description	Number of Inserts	Effective Teeth	D	d	H	a	Insert Screw P/N	Insert Style
6-956-020	APX-D2.00-1.00-1.00-6-16	6	3	2.0	1.00	2.38	1.00	6-998-4008M	APKT 1604
6-956-025	APX-D2.50-1.50-1.00-12-16	12	4	2.5	1.00	2.38	1.50		
6-956-030	APX-D3.00-1.50-1.25-15-16	15	5	3.0	1.25				
6-956-050	APX-D5.00-1.50-1.50-21-16	21	7	5.0	1.50	3.14	2.00	6-998-4011	
6-956-060	APX-D6.00-2.00-2.00-32-16	32	8	6.0	2.00				

See page 22-23 for inserts

Mills	Spare Parts Part Number	Description	Torque
APKT 17	6-998-4011	Insert Screw M4 - 0.7 L 11.4 mm	3Nm
	6-998-015	Key (T15 Torx)	
	290-ASEIZE-03	Thread Anti-Seize 3-gm pack	



AP-90 Milling System

Cutting Tools

MILLING



palbit APKT 10 Inserts

	Primary Applications							
Steel	•	•	•	•	•	•	•	•
Stainless Steel	•	•	•	•	•	•	•	•
Cast Irons	•	•	•	•	•	•	•	•
Non-Ferrous	•	•	•	•	•	•	•	•
Heat Resistant Alloys	•	•	•	•	•	•	•	•

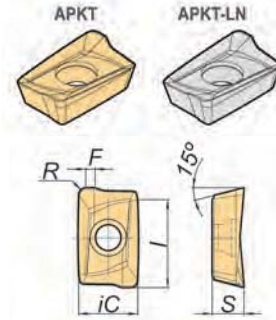

Description	Geometry Code	PVD Coated						TIN+TITAN	UC	Cutting Edge	iC	s	L	R	F
		PH6910	PH6325	PH6920	PH6125	PH6930	PH6135	PHC315	PH0910						
APKT 100305 PDFR-AL	211-0054-								10	Sharp					
APKT 100305 PDR	111-0022-							86		Hone					
APKT 100305 PDER	111-1070-			68	78			86		Hone				0.019	0.047
APKT 100305 PDTR	111-0946-				78	66		86		T-Land					
APKT 100305 PDSR	111-2167-			68						T-Land & Hone	0.263	0.137	0.393		
APKT 100305 PDSR	111-1041-				78					T-Land & Hone					
APKT 100308 PDER	111-1071-	54		68				86		Hone				.031	.035
APKT 100308 PDTR	111-1042-				78			86		T-Land					
APKT 100308 PDSR	111-1044-			68	78			86		T-Land & Hone					

To order please use the geometry code plus the grade code



palbit APKT 16 Inserts

	Primary Applications							
Steel	•	•	•	•	•	•	•	•
Stainless Steel	•	•	•	•	•	•	•	•
Cast Irons	•	•	•	•	•	•	•	•
Non-Ferrous	•	•	•	•	•	•	•	•
Heat Resistant Alloys	•	•	•	•	•	•	•	•

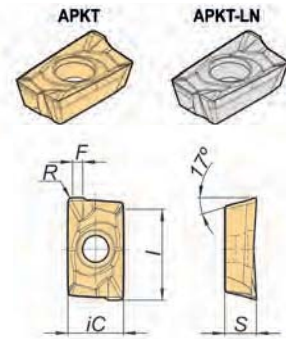

Description	Geometry Code	PVD Coated						TIN+TITAN	UC	Cutting Edge	iC	s	L	R	F
		PH6910	PH6325	PH6920	PH6125	PH6930	PH6135	PHC315	PH0910						
APKT 160408 PDFR-AL	111-1923-								10	Sharp					
APKT 160408 PDER	111-2159-		67	68						Sharp	0.372	0.210	0.629	0.031	0.069
APKT 160408 PDER	111-1073-	54			78			86		Hone					
APKT 160408 PDSR	111-2158-			68	78	66		86		T-Land					
APKT 160416 PDFR	111-1049-			68						Hone					
APKT 160416 PDER	111-1074-			68						Hone					
APKT 160416 PDTR	111-0988-				78					T-Land	0.372	0.210	0.629	0.063	0.047
APKT 160416 PDSR	111-1050-			68	78	66				T-Land & Hone					
APKT 160432 PDER	111-1075-			68						Hone					
APKT 160432 PDTR	111-1051-							86		T-Land	0.372	0.210	0.629	0.126	-
APKT 160432 PDSR	111-1052-			68	78			86		T-Land & Hone					

To order please use the geometry code plus the grade code



TMX APKT Style Speciality Inserts

	Primary Applications		
	Steel	•	•
Stainless Steel	•	•	•
Cast Irons	•	•	•
Non-Ferrous	•	•	•
Heat Resistant Alloys	•	•	•

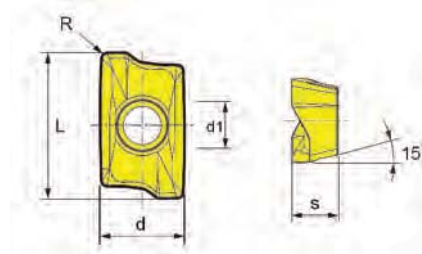

Description	Geometry Code	TiAlN		Uncoated	Cutting Edge	d	S	L	R	d1
		TMX 05	TMX 30	HO1						
APKT 100305 PDFR-MA	6-APM-302				Sharp	0.263	0.137	0.393	0.019	0.110
APGT 100305 PDER-ALU	6-APK-302	X			Hone					
APLX 100305 PDTR	6-APK-302		Z		T-Land					
APLX 100308 TR	6-APX-303		Z		T-Land	0.263	0.137	0.393	0.031	0.110
APKT 160402 PDFR-MA2	6-APM-503				Sharp	0.372	0.187	0.629	0.008	0.173
APKT 160404 PDFR-MA	6-APM-504				Sharp				0.016	
APGT 160408 PDER-ALU	6-APX-503	X			Hone				0.031	
APKT 160408 PDFR-MA2	6-APM-502				Sharp	0.372	0.210	0.629	0.031	0.173
APKT 160416 PDFR-MA	6-APM-505				Sharp				0.063	
APKT 160432 PDFR-MA	6-APM-508				Sharp				0.126	
APKT 170508 PETR	6-APK-605		Z		T-Land	0.372	0.210	0.669	0.031	0.173

To order please use the **geometry code** plus the **grade code**



AP-90 Milling System

Cutting Tools

MILLING

AP-90 Milling Speeds

Material		Speed SFM (m/min)								
		PVD COATED (Increasing Toughness →)							Uncoated	
		TMX05	PH6910 PH8910	PH6325 PHC315	PH6920	TMX30	PH6125 PH8125	PH6930	PH6135	PH0910
P	Low Carbon Steels		590-750 (180-230)		550-680 (170-210)	590-980 (180-300)	520-620 (160-190)	490-590 (150-180)	490-590 (150-180)	
	Alloy Steels		550-680 (170-210)		520-720 (160-200)	330-620 (100-190)	460-590 (140-180)	460-550 (140-170)	460-550 (140-170)	
	Tool Steels		520-720 (160-200)		460-620 (140-190)	130-360 (40-110)	420-520 (130-160)	390-490 (120-150)	390-490 (120-150)	
M	Ferritic and Martensitic				490-620 (150-190)	490-590 (150-180)		460-550 (140-170)		
	Austenitic				330-520 (100-160)	230-520 (70-160)		290-460 (90-140)		
	PH and Duplex				330-490 (100-150)	290-420 (90-130)		260-420 (80-130)		
K	Gray Iron Class 25-35		590-850 (180-260)	490-720 (150-220)	550-810 (170-250)	590-780 (180-240)		590-780 (180-240)		280-420 (85-130)
	Cast Iron Class 45		490-680 (150-210)	500-760 (155-235)	490-680 (140-200)	520-750 (160-230)		520-750 (160-230)		210-390 (65-120)
	Ductile Iron		290-620 (90-190)	370-550 (115-170)	260-590 (80-180)	330-520 (100-160)		330-520 (100-160)		160-260 (50-80)
N	Aluminum < 8% Si	850-4000 (260-1230)								2630-3070 (810-945)
	Copper and Brass	590-1200 (180-370)								1320-1530 (405-470)
	Aluminum > 8% Si	390-810 (120-250)								800-930 (245-285)
S	Iron Based		100-200 (30-60)		100-200 (30-60)	100-160 (30-50)	100-160 (30-50)			
	Nickel and Cobalt Based		70-230 (20-70)		70-230 (20-70)	70-200 (20-60)	70-200 (20-60)			
	Titanium Alloys		130-290 (40-90)		130-290 (40-90)	130-230 (40-70)	130-230 (40-70)			
H	Steels Rc > 50		200-330 (60-100)							
	Stainless Steels Rc > 45									
	Tool Steels RC > 50									

P = Steel

M = Stainless Steel

K = Cast Iron

N = Aluminum

S = High-Temp Alloy

H = Hard Steel

AP-90 Milling Feeds

Material		Feed ipt (mm/tooth)					
		Geometry / Edge Preparation (Increasing Toughness →)					
		ALU	AL	PDFR(X)	PDER(X)	PDTR(X)	PDSR(X)
P	Low Carbon Steels						
	Alloy Steels				0.003-0.012 (0.07-0.25)	0.004-0.012 (0.10-0.25)	0.004-0.012 (0.10-0.25)
	Tool Steels						
M	Ferritic and Martensitic						
	Austenitic			0.002-0.004 (0.05-0.10)	0.003-0.004 (0.07-0.10)	0.003-0.006 (0.08-0.15)	0.004-0.008 (0.10-0.20)
	PH and Duplex						
K	Gray Iron Class 25-35						
	Cast Iron Class 45				0.003-0.012 (0.07-0.25)	0.004-0.012 (0.10-0.25)	0.004-0.012 (0.10-0.25)
	Ductile Iron						
N	Aluminum < 8% Si						
	Copper and Brass	0.004-0.013 (0.10-0.33)	0.004-0.013 (0.10-0.33)				
	Aluminum > 8% Si						
S	Iron Based						
	Nickel and Cobalt Based				0.003-0.004 (0.07-0.10)	0.003-0.006 (0.08-0.15)	0.004-0.008 (0.1-0.20)
	Titanium Alloys						
H	Steels Rc > 50						
	Stainless Steels Rc > 45						0.004-0.006 (0.10-0.15)
	Tool Steels RC > 50						

P = Steel
M = Stainless Steel
K = Cast Iron
N = Aluminum
S = High-Temp Alloy
H = Hard Steel



AN-90 Milling System

Cutting Tools

MILLING

System	Main Feature	Insert Sizes	Mill Type	Diameters	Number of Inserts
AN-90 	Heavy Duty Two Insert Sizes High Ramping angle for Cutters utilizing 10 size insert Multiple Pitch offered for key diameters Four Cutting edges on each insert	ANHX 10	END MILL	0.75 - 2.00	2 - 7
			FACE MILL	1.50 - 4.00	4 - 12
		ANHX 16	END MILL	1.25 - 2.00	2 - 4
			FACE MILL	2.00 - 6.00	3 - 11

palbit AN-90 Heavy Duty Milling System

- 90° Square Shoulder Mill
- Two insert sizes 10 mm and 16 mm
- Four cutting Edges on Each Insert
- Ramping Capability up to 6.8° (With Size 10 Insert)
- Multiple Pitch offered for key Diameters
- DOC up to 0.590 (15 mm)
- Through Coolant
- Perfect tool for heavy duty square shoulder milling
- Pocket Milling
- Helical Interpolating
- Plunging
- Channel Milling
- Ramping
- Diameter range: 0.750 to 6.00



palbit 90° Lead ANHX End Mills

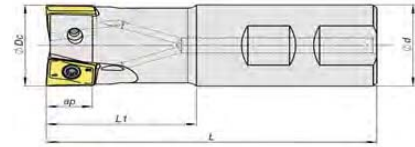

Part Number	Description	Number of Inserts	Effective Teeth	ØDc	Ød	L	L1	α°	Shank Style	ap Max	Insert Style
181-0712-00	AN90 D.750-W.750/3.94-02-10	2	2	0.750	0.750	3.94	1.18	3.0	Weldon	0.354	ANHX 10
181-0713-00	AN90 D.750-W.750/3.94-03-10	3	3	0.750	0.750	3.94	1.18	3.0			
181-0770-00	AN90 D1.00-W1.00/4.53-02-10	2	2	1.00	1.000	4.53	1.38	2.0			
181-0643-00	AN90 D1.00-W1.00/4.53-03-10	3	3	1.00	1.000	4.53	1.38	2.0			
181-0771-00	AN90 D1.25-W1.25/4.92-03-10	3	3	1.25	1.250	4.92	1.58	1.4			
181-0772-00	AN90 D1.25-W1.25/4.92-04-10	4	4	1.25	1.250	4.92	1.58	1.4			
181-0773-00	AN90 D1.50-W1.50/5.12-04-10	4	4	1.50	1.500	5.12	1.65	1.2			
181-0774-00	AN90 D1.50-W1.50/5.12-05-10	5	5	1.50	1.500	5.12	1.65	1.2			
181-0775-00	AN90 D2.00-W1.50/5.32-05-10	5	5	2.00	1.500	5.32	1.77	1.0			
181-0776-00	AN90 D2.00-W1.50/5.32-07-10	7	7	2.00	1.500	5.32	1.77	1.0			
181-0601-00	AN90 D1.25-W1.25/4.92-02-16	2	2	1.25	1.250	4.92	1.58	1.2	Weldon	0.591	ANHX 16
181-0602-00	AN90 D1.50-W1.25/5.12-03-16	3	3	1.50	1.250	5.12	1.65	1.0			
181-0603-00	AN90 D2.00-W1.25/5.32-04-16	4	4	2.00	1.250	5.32	1.77	0.5			

See next page for inserts

palbit 90° Lead ANHX Face Mills

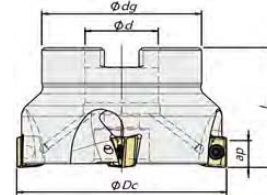

Part Number	Description	Number of Inserts	Effective Teeth	ØDc	Pilot Ød	Ødg	L	α°	Connection Style	ap Max	Insert Style
181-0777-00	AN90 D1.50-A.500/1.50-04-10	4	4	1.50	0.50	1.42	1.500	3.0	Arbor Mount	0.354	ANHX 10
181-0778-00	AN90 D1.50-A.500/1.50-05-10	5	5	1.50				3.0			
181-0779-00	AN90 D2.00-A.750/1.75-05-10	5	5	2.00	0.75	1.77	1.750	2.0			
181-0780-00	AN90 D2.00-A.750/1.75-07-10	7	7	2.00				2.0			
181-0781-00	AN90 D2.50-A1.00/1.75-07-10	7	7	2.50	1.00	2.21	1.750	1.4			
181-0782-00	AN90 D2.50-A1.00/1.75-09-10	9	9	2.50				1.4			
181-0783-00	AN90 D3.00-A1.00/2.00-08-10	8	8	3.00	1.00	2.21	2.000	1.2			
181-0784-00	AN90 D3.00-A1.00/2.00-10-10	10	10	3.00				1.2			
181-0785-00	AN90 D4.00-A1.25/2.00-09-10	9	9	4.00	1.25	2.87	2.000	1.0			
181-0786-00	AN90 D4.00-A1.25/2.00-12-10	12	12	4.00				1.0			
181-0589-00	AN90 D2.00-A.750/1.75-03-16	3	3	2.00	0.75	1.77	1.75	0.5	Arbor Mount	0.591	ANHX 16
181-0590-00	AN90 D2.00-A.750/1.75-04-16	4	4	2.00				0.5			
181-0591-00	AN90 D2.50-A1.00/1.75-04-16	4	4	2.50	1.00	2.21	2.000	-			
181-0592-00	AN90 D2.50-A1.00/1.75-06-16	6	6	2.50				-			
181-0593-00	AN90 D3.00-A1.00/2.00-05-16	5	5	3.00	1.00	2.21	2.000	-			
181-0594-00	AN90 D3.00-A1.00/2.00-06-16	6	6	3.00				-			
181-0595-00	AN90 D4.00-A1.25/2.00-05-16	5	5	4.00	1.25	2.87	2.000	-			
181-0596-00	AN90 D4.00-A1.25/2.00-08-16	8	8	4.00				-			
181-0597-00	AN90 D5.00-A1.50/2.50-07-16	7	7	5.00	1.50	3.39	2.500	-			
181-0598-00	AN90 D5.00-A1.50/2.50-10-16	10	10	5.00				-			
181-0599-00	AN90 D6.00-A2.00/2.50U-08-16	8	8	6.00	2.00	4.88	2.500	-			
181-0600-00	AN90 D6.00-A2.00/2.50U-11-16	11	11	6.00				-			

See page 22-23 for inserts

Mills	Spare Parts Part Number	Description	Torque
ANHX 10	290-0091-00	Insert Screw M3 X 0.5 L -7.4 mm	3.0Nm
	290-0257-00	Key (Torx T9)	
ANHX 16	290-0475-00	Insert Screw M4 X 0.7 L -11.0 mm	3.0Nm
	290-0124-00	Driver (Torx T15)	
	290-0148-00	Key (Torx T15)	
	290-ASEIZE-03	Thread Anti-Seize 3-gm pack	



AN-90 Milling System

Cutting Tools

MILLING



palbit ANHX 10 MM & 16 MM Inserts

	Primary Applications				
	Steel	•	•	•	•
Stainless Steel	•	•	•	•	•
Cast Irons	•	•	•	•	•
Non-Ferrous	•	•	•	•	•
Heat Resistant Alloys	•	•	•	•	•
	PVD Coated				UC
	PH6705	PH6910	PH6920	PH6930	PH0910

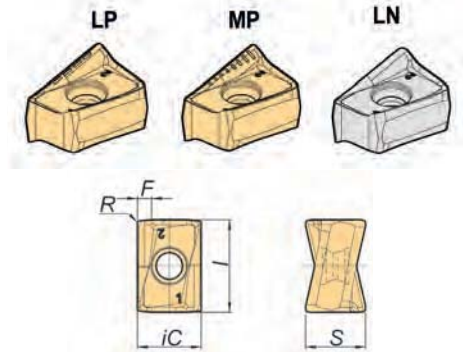

Description	Geometry Code	PH6705	PH6910	PH6920	PH6930	PH0910	Geometry	iC	S	I	R	F
ANHX 100405 PNR-LP	111-1652-	D2	54	68	66		LP	0.260	0.244	0.394	0.020	0.039
ANHX 100412 PNR-LP	111-1908-	D2	54	68	66						0.047	
ANHX 160708 PNR-LP	111-1519-	D2	54	68	66		LP	0.440	0.315	0.630	0.031	0.179
ANHX 160712 PNR-LP	111-1596-		54	68							0.062	
ANHX 160708 PNR-MP	111-1595-	D2	54	68	66		MP	0.440	0.315	0.630	0.031	0.179
ANHX 160712 PNR-MP	111-1598-			68							0.062	
ANHX 160712 PNR-LN	111-1597-					10	LN	0.440	0.315	0.630	0.062	0.179

To order please use the geometry code plus the grade code

AN-90 Speeds and Feeds

MILLING

Material	Speed SFM (m/min)					Feed IPT (mm/tooth)			
	PVD COATED (Increasing Toughness →)				Uncoated	Geometry / Edge Preparation (Increasing Toughness →)			
	PH6705	PH6910	PH6920	PH6930	PH0910	FR-LN	R-LP	ER-LP	MP
P	Low Carbon Steels		590-750 (180-230)	550-680 (170-210)	490-590 (150-180)				
	Alloy Steels		550-680 (170-210)	520-720 (160-200)	460-550 (140-170)		0.004-0.008 (0.10-0.20)	0.004-0.009 (0.10-0.22)	0.004-0.009 (0.10-0.22)
	Tool Steels		520-720 (160-200)	460-620 (140-190)	390-490 (120-150)				
M	Ferritic and Martensitic			490-620 (150-190)	460-550 (140-170)				
	Austenitic			330-520 (100-160)	290-460 (90-140)				
	PH and Duplex			330-490 (100-150)	260-420 (80-130)				
K	Gray Iron Class 25-35	590-880 (180-270)	590-850 (180-260)	550-810 (170-250)	590-780 (180-240)	280-420 (85-130)			
	Cast Iron Class 45	550-830 (170-255)	490-680 (150-210)	490-680 (140-200)	520-750 (160-230)	210-390 (65-120)	0.004-0.009 (0.10-0.22)	0.004-0.010 (0.10-0.25)	0.004-0.010 (0.10-0.25)
	Ductile Iron	420-630 (130-195)	290-620 (90-190)	260-590 (80-180)	330-520 (100-160)	160-260 (50-80)			
N	Aluminum < 8% Si				2630-3070 (810-945)				
	Copper and Brass				1320-1530 (405-470)	0.004-0.014 (0.10-0.35)			
	Aluminum > 8% Si				800-930 (245-285)				
S	Iron Based		100-200 (30-60)	100-200 (30-60)					
	Nickel and Cobalt Based		70-230 (20-70)	70-230 (20-70)			0.004-0.005 (0.10-0.12)	0.004-0.005 (0.10-0.12)	
	Titanium Alloys		130-290 (40-90)	130-290 (40-90)					
H	Steels Rc > 50		200-330 (60-100)						
	Stainless Steels Rc > 45								
	Tool Steels RC > 50								

P = Steel
M = Stainless Steel
K = Cast Iron
N = Aluminum
S = High-Temp Alloy
H = Hard Steel



AD-90 Milling System

Cutting Tools

MILLING

System	Main Feature	Insert Sizes	Mill Type	Diameters	Number of Inserts
AD-90 	Accurate 90° Shoulder Ramping up to 11.5°	ADKT 15 05	END MILL	1.00 - 1.25	2 - 3

palbit AD-90 End Mills

- 90° Square Shoulder Mill
- Accurate 90° Shoulder
- Ramping Capability up to 11.5°
- DOC up to 0.530 (13.5 mm)
- Select Offering with Through Coolant
- Good All around Milling Tool
- Pocket Milling
- Side Milling
- Helical interpolating
- Plunging
- Channel Milling
- Diameter range: 1.0 and 1.25

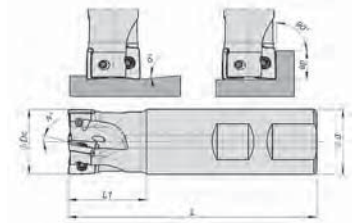

palbit 90° Lead High Performance ADKT 15 Style

Part Number	Description	Number of Inserts	Effective Teeth	ØDc	Ød	L	I	Ramp Angle	Shank Style	ap Max	Insert Style
181-0625-00	AD90 D1.00-W1.00/3.94-02-15	2	2	1.00	1.00	3.94	1.38	11.5	Weldon	0.532	ADKT1505
181-0626-00	AD90 D1.25-W1.25/4.92-03-15	3	3	1.25	1.25	4.92	1.58	5.3			

See next page for inserts

Spare Parts Part Number	Description	Torque
290-0482-00	Insert Screw	3.0Nm
290-0124-00	Driver (T15 Torx)	
290-ASEIZE-03	Thread Anti-Seize 3-gm pack	

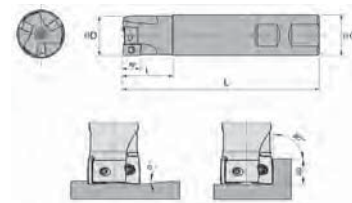

TMS 90° Lead General Purpose ADKT 15 Style

Part Number	Description	Number of Inserts	Effective Teeth	ØDc	Ød	L	I	Ramp Angle	Shank Style	ap Max	Insert Style
6-215-1002	ADK-D1.00-W1.00-3.9-2-15	2	2	1.00	1.00	3.94	1.38	0.5	Weldon	0.540	ADKT1505
6-215-1203	ADK-D1.25-W1.25-4.9-3-15	3	3	1.25	1.25	4.92	1.58	0.5			

See next page for inserts

Spare Parts Part Number	Description	Torque
6-998-4116	Insert Screw	3.0Nm
290-0124-00	Driver (T15 Torx)	
290-ASEIZE-03	Thread Anti-Seize 3-gm pack	



AD-90 Inserts

	Primary Applications				
Steel	•	•	•	•	•
Stainless Steel	•	•	•	•	•
Cast Irons	•	•	•	•	•
Non-Ferrous	•	•	•	•	•
Heat Resistant Alloys	•	•	•	•	•

Description	Geometry Code	Palbit				TMX	Geometry	d	S	L	R	d1
		PH6910	PH6920	PH6125	PH6135	TMX 30						
ADKT 1505 PDFR	111-0611-		68				Sharp	0.374	0.220	0.624	0.031	0.173
ADKT 1505 PDER	111-0006-	54	68				Hone					
ADKT 1505 PDTR	111-1209-			78	86		T-Land					
ADKT 1505 PDSR	111-1218-		68				T-Land & Hone					

To order please use the **geometry code** plus the **grade code**



AD-90 Milling System

Cutting Tools

MILLING

AD-90 Milling Speeds

Material	Speed SFM (m/min)							
	PVD COATED (Increasing Toughness →)							
	PH6910	PH6315 PHC315	PH6920	TMX30	PH6125	PH6930	PH6135	
P	Low Carbon Steels	590-750 (180-230)		550-680 (170-210)	590-980 (180-300)	520-620 (160-190)	490-590 (150-180)	490-590 (150-180)
	Alloy Steels	550-680 (170-210)		520-720 (160-200)	330-620 (100-190)	460-590 (140-180)	460-550 (140-170)	460-550 (140-170)
	Tool Steels	520-720 (160-200)		460-620 (140-190)	130-360 (40-110)	420-520 (130-160)	390-490 (120-150)	390-490 (120-150)
M	Ferritic and Martensitic			490-620 (150-190)	490-590 (150-180)		460-550 (140-170)	
	Austenitic			330-520 (100-160)	230-520 (70-160)		290-460 (90-140)	
	PH and Duplex			330-490 (100-150)	290-420 (90-130)		260-420 (80-130)	
K	Gray Iron Class 25-35	590-850 (180-260)	490-720 (150-220)	550-810 (170-250)	590-780 (180-240)		590-780 (180-240)	
	Cast Iron Class 45	490-680 (150-210)	500-760 (155-235)	490-680 (140-200)	520-750 (160-230)		520-750 (160-230)	
	Ductile Iron	290-620 (90-190)	370-550 (115-170)	260-590 (80-180)	330-520 (100-160)		330-520 (100-160)	
N	Aluminum < 8% Si							
	Copper and Brass							
	Aluminum > 8% Si							
S	Iron Based	100-200 (30-60)		100-200 (30-60)	100-160 (30-50)	100-160 (30-50)		
	Nickel and Cobalt Based	70-230 (20-70)		70-230 (20-70)	70-200 (20-60)	70-200 (20-60)		
	Titanium Alloys	130-290 (40-90)		130-290 (40-90)	130-230 (40-70)	130-230 (40-70)		
H	Steels Rc > 50	200-330 (60-100)						
	Stainless Steels Rc > 45							
	Tool Steels RC > 50							

P = Steel

M = Stainless Steel

K = Cast Iron

N = Aluminum

S = High-Temp Alloy

H = Hard Steel



AD-90 Feeds

Material		Feed ipt (mm/tooth)			
		Geometry / Edge Preparation (Increasing Toughness →)			
		PDFR	PDER	PDTR	PDSR
P	Low Carbon Steels				
	Alloy Steels		0.003-0.012 (0.07-0.25)	0.004-0.012 (0.10-0.25)	0.004-0.012 (0.10-0.25)
	Tool Steels				
M	Ferritic and Martensitic				
	Austenitic	0.002-0.004 (0.05-0.10)	0.003-0.004 (0.07-0.10)	0.003-0.006 (0.08-0.15)	0.004-0.008 (0.10-0.20)
	PH and Duplex				
K	Gray Iron Class 25-35				
	Cast Iron Class 45		0.003-0.012 (0.07-0.25)	0.004-0.012 (0.10-0.25)	0.004-0.012 (0.10-0.25)
	Ductile Iron				
N	Aluminum < 8% Si				
	Copper and Brass				
	Aluminum > 8% Si				
S	Iron Based				
	Nickel and Cobalt Based		0.003-0.004 (0.07-0.10)	0.003-0.006 (0.08-0.15)	0.004-0.008 (0.1-0.20)
	Titanium Alloys				
H	Steels Rc > 50				
	Stainless Steels Rc > 45				0.004-0.006 (0.10-0.15)
	Tool Steels RC > 50				



P = Steel	M = Stainless Steel	K = Cast Iron	N = Aluminum	S = High-Temp Alloy	H = Hard Steel
------------------	----------------------------	----------------------	---------------------	----------------------------	-----------------------



TP-90 Milling System

Cutting Tools

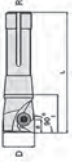
MILLING

System	Main Feature	Insert Sizes	Mill Type	Diameters	Number of Inserts
TP-90   	90° Triangle Insert, Square Shoulder Mills Utilize Common TPG and TPU (TPUN) Style inserts Three size inserts 1/4, 3/8, and 1/2 IC Weldon, R-8 Shanks, and Arbor mounts	TPG 22, TPUN 22	END MILL	0.50 - 1.00	2 - 7
			END MILL – INTEGRAL SHANK R-8	1.00	4 - 12
		TPG 32, TPUN 32	END MILL	1.50 - 2.00	3
			END MILL – INTEGRAL SHANK R-8	1.25 - 3.00	2 - 5
			FACE MILL	1.50 - 2.50	3
		TPG 43, TPUN 43	FACE MILL	3.00 - 8.00	4 - 8

palbit TP-90 Mills

- 90° Triangle Insert, Square Shoulder Mills
- Utilize common TPG and TPU (TPUN) Style Inserts
- Various sizes 1/4, 3/8, and 1/2 Inserts
- R8 Shanks
- Weldon Shanks
- Arbor Mount Sheel Mills
- Large Insert Assortment
- Diameter range: 0.5 to 8.0

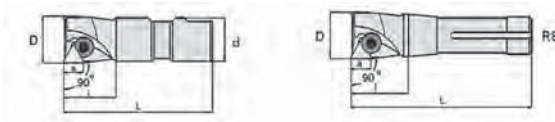

TP-90 Square Shoulder End Mills

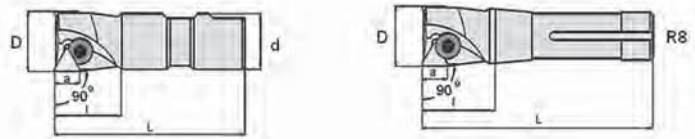

Part Number	Description	Number of Inserts	Effective Teeth	D	d	L	I	Clamping Screw Part Number	Wrench Part Number	Shank Style	ap Max	Insert Style
Weldon Shank												
6-901-002	TPG-D.500-W.500-2.8-1-2	1	1	0.50	0.50	2.78	1.00	6-999-260	6-999-583	Weldon	0.437	TPG/TPU-21
6-901-005	TPG-D.750-W.750-3.2-2-2	2	2	0.75	0.75	3.25	1.22	6-999-262				TPG/TPU-22
6-901-010	TPG-D1.00-W.750-3.2-2-2	2	2	1.00	0.75	3.25	1.22	6-999-268	6-999-584	Weldon	0.656	TPG/TPU-32
6-901-015	TPG-D1.25-W.750-3.2-2-3	2	3	1.25	0.75	3.25	1.52					
6-901-020	TPG-D1.50-W.750-3.2-3-3	3	3	1.50	0.75	3.25	1.22	6-999-270	6-999-584	Weldon	0.656	TPG/TPU-32
6-901-070	TPG-D1.50-W1.00-3.7-3-3	3	3	1.50	1.00	3.69	1.41					
6-901-030	TPG-D2.00-W.750-3.2-3-3	3	3	2.00	0.75	3.69	1.22	6-999-270	6-999-584	Weldon	0.656	TPG/TPU-32
6-901-080	TPG-D2.00-W1.00-3.7-3-3	3	3	2.00	1.00	3.69	1.41					
R8 Shank												
6-901-510	TPG-D1.00-R8-5.4-2-2	2	2	1.00	0.949	5.38	1.33	6-999-262	6-999-583	R8	0.437	TPG/TPU-22
6-901-515	TPG-D1.25-R8-5.6-2-3	2	2	1.25		5.58	1.52	6-999-270	6-999-584			
6-901-520	TPG-D1.50-R8-5.6-3-3	3	3	1.50	0.949	5.58	1.52	6-999-268		6-999-584	R8	0.656
6-901-525	TPG-D1.75-R8-5.6-3-3	3	3	1.75				6-999-270				
6-901-530	TPG-D2.00-R8-5.6-3-3	3	3	2.00	0.949	5.58	1.52	6-999-270	6-999-584	R8	0.656	TPG/TPU-32
6-901-535	TPG-D2.50-R8-5.6-4-3	4	4	2.50								
6-901-540	TPG-D3.00-R8-5.6-5-3	5	5	3.00	0.949	5.58	1.52	6-999-270	6-999-584	R8	0.656	TPG/TPU-32

See next 2 pages for inserts

Spare Parts Part Number	Description	Torque
6-999-260	Insert Clamping Screw M4 x 0.7 L-6.0mm	3Nm
6-999-262	Insert Clamping Screw M5 x 0.8 L-8.0 mm	6Nm
6-999-583	3 mm Hex Wrench	
6-999-268	Insert Clamping Screw M6 x 0.75 L-8.0mm	8Nm
6-999-270	Insert Clamping Screw M6 x 0.75 L-12.0mm	8Nm
6-999-584	4 mm Hex Wrench	
290-ASEIZE-03	Thread Anti-Seize 3-gm pack	

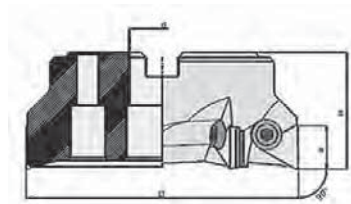

TP-90 Square Shoulder Face Mills

Part Number	Description	Number of Inserts	Effective Teeth	D	d	H	Shim P/N	Shim Screw Part Number	Clamping Screw Part Number	Wrench Part Number	ap Max	Insert Style	
Weldon Shank													
6-902-156	TPG-D1.50-.500-3-3	3	3	1.50	0.50	1.58	-	-	6-999-270	6-999-584	0.656	TPG/TPU-32	
6-902-157	TPG-D2.00-.750-3-3	3	3	2.00	0.75	1.66							
6-902-158	TPG-D2.50-1.00-3-3	3	3	2.50	1.00	1.84	6-999-394	6-999-400	6-999-274	6-999-585	0.860	TPG/TPU-43	
6-902-159	TPG-D3.00-1.00-4-4	4	4	3.00	1.00	1.97							
6-902-160	TPG-D4.00-1.50-5-4	5	5	4.00	1.50	1.78	2.48	6-999-394	6-999-400	6-999-274	6-999-585	0.860	TPG/TPU-43
6-902-161	TPG-D5.00-1.50-6-4	6	6	5.00	1.50								
6-902-162	TPG-D6.00-2.00-7-4	7	7	6.00	2.00								
6-902-163	TPG-D8.00-2.50-8-4	8	8	8.00	2.50								

See next 2 pages for inserts

Spare Parts Part Number	Description	Torque
6-999-394	Shim	
6-999-400	Shim Screw	
6-999-270	Insert Clamping Screw M6 x 0.75 L-12.0mm	8Nm
6-999-584	4mm Hex Wrench	

Spare Parts Part Number	Description
6-999-274	Insert Clamping Screw M8 x 1.0 L-18.0mm
6-999-585	5mm Hex Wrench
290-ASEIZE-03	Thread Anti-Seize 3-gm pack



TP-90 Milling System

Cutting Tools

MILLING



palbit 90° Lead High Performance Carbide Inserts

	Primary Applications						
Steel	•	•	•	•	•	•	•
Stainless Steel	•	•	•	•	•	•	•
Cast Irons	•	•	•	•	•	•	•
Non-Ferrous	•	•	•	•	•	•	•
Heat Resistant Alloys	•	•	•	•	•	•	•

PVD Coated				Uncoated		
PH6215	PH6920	PH6125	PH6135	PH0910	PH0120	PH0320

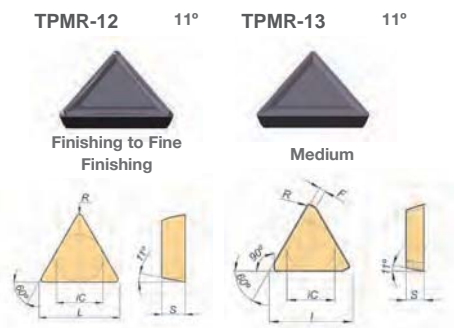

Description	Geometry Code	PH6215	PH6920	PH6125	PH6135	PH0910	PH0120	PH0320	Features	Cutting Edge/Geometry	iC	S	I	R	F
TPMR 222-12	112-0743-	56							Utility w Top Form	-12	0.250	0.125	0.4	0.031	-
TPMR 222-13	112-0744-	56						Utility w Top Form	-13						
TPMR 321-12	112-0745-		68						Utility w Top Form	-13	0.375	0.125	0.6	0.015	-
TPGN 322	111-0426-		68			10	02	09	Precision Flat Top	-	0.375	0.125	0.6	0.031	-
TPMR 322-12	112-0748-						02	Utility w Top Form	-12						
TPMR 322-13	112-0749-		68					Utility w Top Form	-13						
TPGN 323	111-0427-			78					Precision Flat Top	-	0.375	0.125	0.6	0.047	-
TPKN 32 PDTR TPKN 1603 PDTR	111-0455-		68		86				Flatted Corner, R.H.	T-Land	0.375	0.125	0.6	0.028	0.047
TPKR 32 PDSR TPKR 1603 PDSR	111-0476-				86			Flatted Corner, R.H w Top Form	T-Land & Hone						
TPGN 432	111-0431-	56							Precision Flat Top	-	0.500	0.187	0.8	0.031	-
TPKR 43 PDSR TPKR 2204 PDSR	111-0477-				86				Flat Corner with Top Form	T-Land & Hone					

Note: Additional TPGN, TPUN and TPMS inserts can be located in the Turning Insert section of the catalog, pages XXX
To order please use the **geometry code** plus the **grade code**



TMX 90° Lead Standard Carbide Inserts

Primary Applications			
Steel	•	•	•
Stainless Steel	•	•	•
Cast Irons	•	•	•
Non-Ferrous	•	•	•
Heat Resistant Alloys	•	•	•

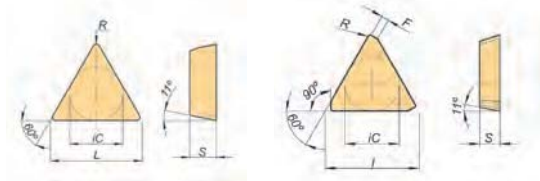

Description	Geometry Code	Coated		Uncoated		Feature	Cutting Edge/Geometry	iC	s	l	R	F
		⊖	TMX 30	⊖	⊖							
TPGN 222	6-TPG-222	LA		2	5	Precision Flat Top		0.250	0.125	0.433	0.031	-
TPUN 222	6-TPU-222	LA		2	5	Utility						
TPGN 322	6-TPG-322	LA		2	5	Precision Flat Top		0.375	0.125	0.649	0.031	-
TPMR 322	6-TPM-322	LA		2	5	Top Form						
TPUN 322	6-TPU-322	LA		2	5	Utility						
TPUN 323	6-TPU-323	LA		2	5	Utility		0.375	0.125	0.649	0.047	-
TPGN 324	6-TPG-34	LA		2	5	Precision Flat Top		0.375	0.125	0.649	0.062	-
TPUN 324	6-TPU-324	LA		2	5	Utility						
TPGN 432	6-TPG-432	LA		2	5	Precision Flat Top		0.500	0.187	0.866	0.031	-
TPUN 432	6-TPU-432	LA		2	5	Utility						
TPGN 433	6-TPG-433	LA		2	5	Precision Flat Top		0.500	0.187	0.866	0.047	-
TPUN 433	6-TPU-433	LA		2	5	Utility						
TPGN 434	6-TPG-434	LA			5	Precision Flat Top		0.500	0.187	0.866	0.063	-
TPUN 434	6-TPU-434	LA		2	5	Utility						
TPGN 436	6-TPG-436	LA		2	5	Precision Flat Top		0.500	0.187	0.866	0.094	-
TPGN 438	6-TPG-438	LA		2	5	Precision Flat Top		0.500	0.187	0.866	0.125	-
TPKR 43 PDTR	6-TPR-43		Z			Flatted Corner w/Top Form	T-LAND	0.500	0.187	0.866	-	0.047

To order please use the geometry code plus the grade code



TP-90 Milling System

Cutting Tools

MILLING

TP-90 Milling Speeds

Material	Speed SFM (m/min)						
	PVD COATED (Increasing Toughness →)				CVD COATED (Increasing Toughness →)		
	PH6215 (56)	PH6920 (68)	PH6125 (78)	TMX 30 (Z)	PH6135 (86)	PH5125 (L8)	C5 (LA)
P Low Carbon Steels		550-680 (170-210)	520-620 (160-190)	590-980 (180-300)	490-590 (150-180)		300-500 (90-150)
	Alloy Steels	520-720 (160-200)	460-590 (140-180)	330-620 (100-190)	460-550 (140-170)		250-400 (75-120)
	Tool Steels	460-620 (140-190)	420-520 (130-160)	130-360 (40-110)	390-490 (120-150)		200-300 (60-90)
M Ferritic and Martensitic	300-450 (90-140)	490-620 (150-190)					
	Austenitic	150-350 (50-110)	330-520 (100-160)				
	PH and Duplex	100-300 (30-90)	330-490 (100-150)				
K Gray Iron Class 25-35		490-750 (130-230)		590-780 (180-240)		590-780 (180-240)	
	Cast Iron Class 45	420-680 (130-200)		520-750 (160-230)		520-750 (160-230)	
	Ductile Iron	230-520 (70-160)		330-520 (100-160)		330-520 (100-160)	
N Aluminum < 8% Si							
	Copper and Brass						
	Aluminum > 8% Si						
S Iron Based		100-200 (30-60)	100-160 (30-50)	100-160 (30-50)			
	Nickel and Cobalt Based	70-230 (20-70)	70-200 (20-60)	70-200 (20-60)			
	Titanium Alloys	130-290 (40-90)	130-230 (40-70)	130-230 (40-70)			
H Steels Rc > 50							
	Stainless Steels Rc > 45						
	Tool Steels RC > 50						

P = Steel

M = Stainless Steel

K = Cast Iron

N = Aluminum

S = High-Temp Alloy

H = Hard Steel



TP-90 Milling Speeds

Material	Speed SFM (m/min)							Feed ipt (mm/tooth)			
	UNCOATED (Increasing Toughness →)							Geometry / Edge Preparation (Increasing Toughness →)			
	PH0910 (10)	PH0120 (02)	PH0320 (09)	PH0125 (15)	PH0135 (14)	C2 (2)	C5 (5)	Uncoated Grades	PVD Coated Grades	CVD Coated Grades	
P	Low Carbon Steels		290-390 (90-120)		200-300 (60-90)	150-280 (50-85)		250-400 (75-120)	0.002-0.005 (0.05-0.13)	0.003-0.006 (0.08-0.15)	0.003-0.004 (0.08-0.10)
	Alloy Steels		200-300 (60-90)		150-250 (50-80)	100-220 (30-70)		200-300 (60-90)			
	Tool Steels							150-250 (45-75)			
M	Ferritic and Martensitic	280-420 (85-130)		150-350 (50-110)			75-150 (25-50)		0.002-0.004 (0.05-0.10)	0.003-0.005 (0.08-0.13)	0.003-0.005 (0.08-0.13)
	Austenitic	210-390 (65-120)		120-300 (40-90)			50-125 (15-40)				
	PH and Duplex	160-260 (50-80)					40-75 (10-25)				
K	Gray Iron Class 25-35	2630-3070 (810-945)		800-3000 (250-920)			160-260 (50-80)		0.002-0.005 (0.05-0.13)	0.003-0.008 (0.08-0.20)	0.003-0.008 (0.08-0.20)
	Cast Iron Class 45	1320-1530 (405-470)		800-1000 (250-310)			100-200 (30-60)				
	Ductile Iron	800-930 (245-285)		300-700 (90-220)							
N	Aluminum < 8% Si						800-3000 (250-920)		0.002-0.010 (0.05-0.25)		
	Copper and Brass						800-1000 (250-310)				
	Aluminum > 8% Si						300-700 (90-220)				
S	Iron Based						50-100 (15-30)	40-80 (10-25)	0.002-0.004 (0.05-0.10)	0.002-0.006 (0.05-0.15)	
	Nickel and Cobalt Based						40-80 (10-25)	40-75 (10-20)			
	Titanium Alloys						45-90 (10-28)				
H	Steels Rc > 50										
	Stainless Steels Rc > 45										
	Tool Steels RC > 50										

P = Steel	M = Stainless Steel	K = Cast Iron	N = Aluminum	S = High-Temp Alloy	H = Hard Steel
-----------	---------------------	---------------	--------------	---------------------	----------------



PN-60 Milling System

Cutting Tools

MILLING

System	Main Feature	Insert Sizes	Mill Type	Diameters	Number of Inserts
PN 60 	10 Cutting edges per insert Through Coolant Design Arbor Mount	PNHX 11	FACE MILL	2.00 - 10.00	5 - 18



PN-60 Face Mills

- 10 Cutting Edges per Insert
- Through Coolant Capability
- Multiple Pitches Offered for Select Diameters
- Diameter Range: 2.0 to 10.0

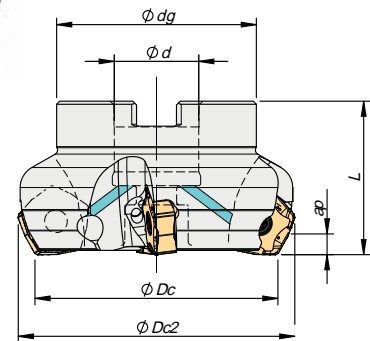
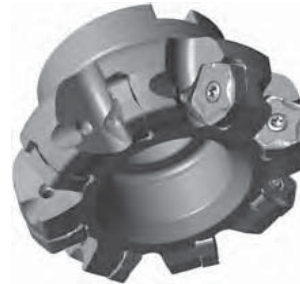

Part Number	Description	Number of Inserts	Effective Teeth	ϕDc	$\phi Dc2$	ϕd	ϕdg	L	ap Max	Insert Style
181-0557-00	PN60D2.00-A.750/1.75-05-11	5	5	2.00	2.36	0.75	1.77	1.75	0.197	PNHX 11
181-0638-00	PN60D2.50-A1.00/1.75-05-11	5	5	2.50	2.86	1.00	2.21	1.75		
181-0558-00	PN60D2.50-A1.00/1.75-06-11	6	6	2.50						
181-0639-00	PN60D3.00-A1.00/2.00-06-11	6	6	3.00	3.36	1.00	2.21	2.00		
181-0559-00	PN60D3.00-A1.00/2.00-08-11	8	8	3.00						
181-0640-00	PN60D4.00-A1.25/2.00-07-11	7	7	4.00						
181-0560-00	PN60D4.00-A1.25/2.00-10-11	10	10	4.00	4.36	1.25	2.87	2.00		
181-0641-00	PN60D5.00-A1.50/2.50-08-11	8	8	5.00						
181-0561-00	PN60D5.00-A1.50/2.50-12-11	12	12	5.00	5.36	1.50	3.39	2.50		
181-0642-00	PN60D6.00-A2.00/2.50U-10-11	10	10	6.00						
181-0562-00	PN60D6.00-A2.00/2.50U-14-11	14	14	6.00	6.36	2.00	4.88	2.50		
181-0563-00	PN60D8.00-A2.50/2.50U-16-11	16	16	8.00						
181-0564-00	PN60D10.0-A2.50/2.50U-18-11	18	18	10.00	10.36	2.50	7.09	2.50		

See next page for inserts

Spare Parts Part Number	Description	Torque
290-0475-00	Insert Screw M4 X 0.7 L -11.0 mm	3.0Nm
290-0124-00	Driver (Torx T15)	
290-0148-00	Key (Torx T15)	
290-ASEIZE-03	Thread Anti-Seize 3-gm pack	



palbit PNHX Inserts

	Primary Applications							
Steel	•	•	•	•	•	•	•	•
Stainless Steel	•	•	•	•	•	•	•	•
Cast Irons	•	•	•	•	•	•	•	•
Non-Ferrous	•	•	•	•	•	•	•	•
Heat Resistant Alloys	•	•	•	•	•	•	•	•
	PVD Coated							
	PH6705	PH7910	PH6910	PH6920	PH6125	PH6930	PH6135	PH6740

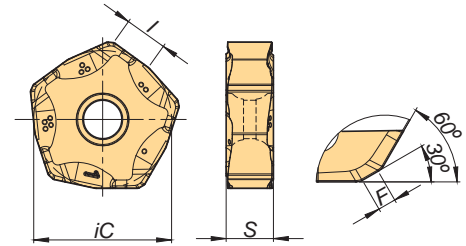

Description	Geometry Code	PH6705	PH7910	PH6910	PH6920	PH6125	PH6930	PH6135	PH6740	Geometry	iC	S	I	F
PNHX 1105 ZNER	111-1374-	D2	G1	54	68	78	66	86	15	Hone	0.650	0.223	0.197	0.051

To order please use the **geometry code** plus the **grade code**

MILLING

PN-60 Milling Speeds and Feeds

Material	Speed SFM (m/min)								Feed ipt (mm/tooth)
	PVD COATED (Increasing Toughness →)								Geometry / Edge Preparation (Increasing Toughness →)
	PH6705	PH7910	PH6910	PH6920	PH6125	PH6930	PH6135	PH6740	ZNER
P Low Carbon Steels		620-780 (190-240)	590-750 (180-230)	550-680 (170-210)	520-620 (160-190)	490-590 (150-180)	490-590 (150-180)	420-520 (130-160)	.006-0.011 (0.15-0.28)
	Alloy Steels	590-720 (180-220)	550-680 (170-210)	520-720 (160-200)	460-590 (140-180)	460-550 (140-170)	460-550 (140-170)	390-490 (120-150)	
	Tool Steels	550-680 (170-210)	520-720 (160-200)	460-620 (140-190)	420-520 (130-160)	390-490 (120-150)	390-490 (120-150)	330-420 (100-130)	
M Ferritic and Martensitic				490-620 (150-190)		460-550 (140-170)		390-490 (120-150)	0.004-0.008 (0.10-0.20)
	Austenitic			330-520 (100-160)		290-460 (90-140)		330-390 (100-120)	
	PH and Duplex			330-490 (100-150)		260-420 (80-130)		260-360 (80-110)	
K Gray Iron Class 25-35		590-880 (180-270)	590-860 (180-265)	590-850 (180-260)	550-810 (170-250)		590-780 (180-240)		0.005-0.014 (0.12-0.35)
	Cast Iron Class 45	550-830 (170-255)	550-700 (170-215)	490-680 (150-210)	490-680 (140-200)		520-750 (160-230)		
	Ductile Iron	420-630 (130-195)	290-630 (90-195)	290-620 (90-190)	260-590 (80-180)		330-520 (100-160)		
N Aluminum < 8% Si									
	Copper and Brass								
	Aluminum > 8% Si								
S Iron Based			100-200 (30-60)	100-200 (30-60)	100-160 (30-50)				0.004-0.006 (0.10-0.15)
	Nickel and Cobalt Based		70-230 (20-70)	70-230 (20-70)	70-200 (20-60)				
	Titanium Alloys		130-290 (40-90)	130-290 (40-90)	130-230 (40-70)				
H Steels Rc > 50									
	Stainless Steels Rc > 45								
	Tool Steels RC > 50								

P = Steel

M = Stainless Steel

K = Cast Iron

N = Aluminum

S = High-Temp Alloy

H = Hard Steel



SEH-45 Milling System

Cutting Tools

MILLING

System	Main Feature	Insert Sizes	Mill Type	Diameters	"Effective Teeth (# of Inserts)"	Number of Inserts
 SEH-45	General Purpose Screw Down Insert Clamping	SEHT 43	FACE MILL	2.00-6.00	4 - 8	4 - 8



SEH-45 Face Mills

- Screw down inserts
- Maximum DOC 0.230 (5.8 mm)
- Utilizes Industry Standard Insert Styles
- Simple and Economical Set-up and Operation
- Diameter Range: 2 to 6

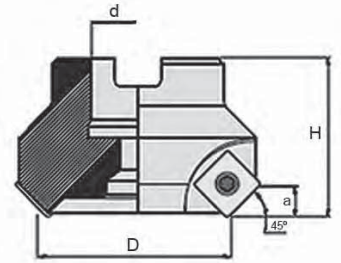

Part Number	Description	Number of Inserts	Effective Teeth	D	d	H	ap Max	Insert Style
6-963-020	SEH-D2.00-.750-4-4	4	4	2.00	0.75	1.58	0.230	SEHT 43
6-963-025	SEH-D2.50-.750-5-4	5	5	2.50				
6-963-030	SEH-D3.00-1.00-5-4	5	5	3.00	1.00	1.97		
6-963-040	SEH-D4.00-1.25-6-4	6	6	4.00	1.25	2.48		
6-963-050	SEH-D5.00-1.50-7-4	7	7	5.00	1.50			
6-963-060	SEH-D6.00-2.00-8-4	8	8	6.00	2.00			

See next page for inserts

Spare Parts Part Number	Description	Torque
6-998-5012	Insert Screw M5 x 0.8 L-12 mm	6Nm
290-ASEIZE-03	Thread Anti-Seize 3-gm pack	



SEH-45 Inserts

	Primary Applications						
	Steel	•	•	•	•		
	Stainless Steel	•		•			
	Cast Irons	•		•			
Non-Ferrous	•			•			
Heat Resistant Alloys	•		•				
	TMX	Palbit			TMX		
		Coated			Uncoated		
		TMX 05	PH6920	PH6125	PH6930	PH6135	H01

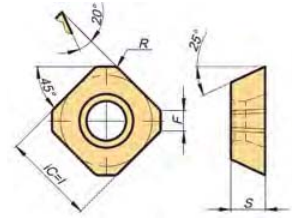
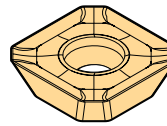

Description	Geometry Code	TMX 05	PH6920	PH6125	PH6930	PH6135	H01	Cutting Edge	Geometry	iC	S	R	F
SEGT 43 ALU	6-SEG-43	X						Sharp	ALU	0.500	0.187	0.01	0.08
SEHT 43 AFFN-X83	6-SEG-43T						2	Sharp	-X83				
SEHT 43 AFTN	111-0218-			78		86		T-Land		0.500	0.187	0.010	0.110
SEHT 43 AFSN	111-0217-			78				T-Land & Hone					
SEKT 43 AFSN	111-0243-			78		86		T-Land & Hone					
SEHT 13T3 AGSN	111-0559-		68		66			T-Land & Hone		0.526	0.156	-	0.079

To order please use the **geometry code** plus the **grade code**



SEH-45 Milling System

Cutting Tools

MILLING

SEH-45 Speeds and Feeds

Material	Speed SFM (m/min)					Feed ipt (mm/tooth)			
	PVD COATED (Increasing Toughness →)			CVD COATED	Uncoated	Geometry / Edge Preparation (Increasing Toughness →) (← Decreasing Tool Pressure)			
	TMX05	PH6125	PH6135	PH3125	H01	ALU	AFFN - X83	AFTN	AFSN
P Low Carbon Steels		520-620 (160-190)	490-590 (150-180)	390-490 (120-150)					
	Alloy Steels	460-590 (140-180)	460-550 (140-170)	290-390 (90-120)				0.005-0.008 (0.12-0.20)	0.005-0.008 (0.12-0.20)
	Tool Steels	420-520 (130-160)	390-490 (120-150)						
M Ferritic and Martensitic		460-570 (140-180)	460-530 (140-160)	315-400 (100-120)					
	Austenitic	290-480 (90-150)	290-440 (90-140)	170-350 (50-110)				0.005-0.008 (0.12-0.20)	0.005-0.008 (0.12-0.20)
	PH and Duplex	260-440 (80-140)	260-400 (80-120)	150-300 (50-90)					
K Gray Iron Class 25-35									
	Cast Iron Class 45							0.005-0.008 (0.12-0.20)	0.005-0.008 (0.12-0.20)
	Ductile Iron								
N Aluminum < 8% Si	850-4000 (260-1230)				850-2000 (260-615)	0.004-0.012 (0.10-0.30)	0.004-0.012 (0.10-0.30)		
	Copper and Brass	590-1200 (180-370)			590-1000 (180-305)				
	Aluminum > 8% Si	390-810 (120-250)			390-800 (120-245)				
S Iron Based		100-160 (30-50)							
	Nickel and Cobalt Based	70-200 (20-60)						0.005-0.008 (0.12-0.20)	0.005-0.008 (0.12-0.20)
	Titanium Alloys	130-230 (40-70)							
H Steels Rc > 50									
	Stainless Steels Rc > 45								
	Tool Steels RC > 50								

P = Steel

M = Stainless Steel

K = Cast Iron

N = Aluminum

S = High-Temp Alloy

H = Hard Steel

SEK-45 Milling System



MILLING

System	Main Feature	Insert Sizes	Mill Type	Diameters	Number of Inserts
 SEK-45	General Purpose and Heavy Duty with replacable shim seat Standard ANSI Inserts Full Range of Diameters available	SEKN 42 SEHN 42 SEEN 42	FACE MILL	1.50 - 4.00	3 - 6
			FACE MILL – HD	2.50 - 10.00	5 - 10

TMX SEK-45 Face Mills



- Top Clamp Secured Inserts
- Maximum DOC 0.230 (5.8 mm)
- Heavy Duty Offered with Shim Seats
- Solid Insert for Increased Strength
- Diameter Range: 1.5 to 10

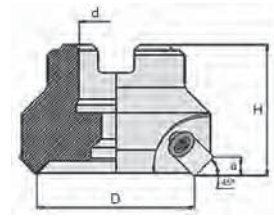

Part Number	Description	Number of Inserts	Effective Teeth	D	d	H	Insert Clamp Screw P/N	ap Max	Insert Style
6-923-001	SEK-D1.50-.750-3-4	3	3	1.50	0.75	2.09	6-999-250	0.240	SEA/SEK 42
6-923-002	SEK-D2.00-.750-4-4	4	4	2.00	0.75	1.89	6-999-251		
6-923-003	SEK-D2.50-.750-5-4	5	5	2.50	0.75	1.58			
6-923-004	SEK-D3.00-1.00-6-4	6	6	3.00	1.00	1.97			
6-923-005	SEK-D4.00-1.25-6-4	6	6	4.00	1.25	1.97			

See next page for inserts

Spare Parts Part Number	Description	Torque
6-999-250	Insert Screw M6 X 0.75 L -12.0 mm	10 Nm
6-999-251	Insert Screw M8 X 1.25 L -19.5mm	20 Nm
6-999-171	4 mm Hex Key	
290-ASEIZE-03	Thread Anti-Seize 3-gm pack	

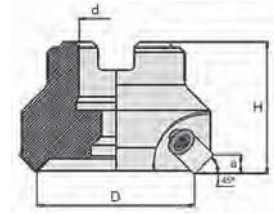

TMX SEK-45 HD Face Mills

Part Number	Description	Number of Inserts	Effective Teeth	D	d	H	Insert Clamp Screw P/N	Shim Seat Part Number	Shim Screw Part Number	ap Max	Insert Style
6-924-001	SEK-D2.50-.750-5-4HD	5	5	2.50	0.75	1.58	6-999-251	116-0153-23	6-999-400	0.230	SEA/SEK 42
6-924-002	SEK-D3.00-1.00-6-4HD	6	6	3.00	1.00	1.97					
6-924-003	SEK-D4.00-1.25-6-4HD	6	6	4.00	1.25						
6-924-004	SEK-D5.00-1.50-7-4HD	7	7	5.00	1.50	2.48					
6-924-005	SEK-D6.00-2.00-7-4HD	7	7	6.00	2.00						
6-924-006	SEK-D8.00-2.50-8-4HD	8	8	8.00	2.50	2.48					
6-924-010	SEK-D10.00-2.50-10-4HD	10	10	10.00							

See next page for inserts

Spare Parts Part Number	Description	Torque
116-0153-23	Shim Seat	
6-999-400	Shim Screw M4 x 0.9	n/a
6-999-251	Insert Screw M8 X 1.25 L -19.5mm	20 Nm
6-999-171	4 mm Hex Key	
290-ASEIZE-03	Thread Anti-Seize 3-gm pack	



SEK-45 Milling System

Cutting Tools

MILLING

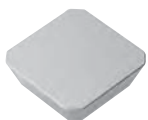

TMX 45° Lead SEKN / SEKR High Performance Inserts

	Primary Applications				
Steel	●	●	●	●	●
Stainless Steel	●	●	●	●	●
Cast Irons	●	●	●	●	●
Non-Ferrous	●	●	●	●	●
Heat Resistant Alloys	●	●	●	●	●

SEKN 12...

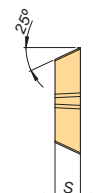
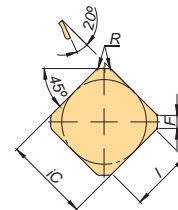
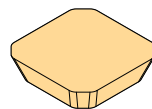

Description	Geometry Code	PVD Coated					Uncoated		Features	Geometry	iC	S	I	F	
		PHC315	PH6125	PH6135	PH6740	PH6920	PH0125	PH0325							
SEKN 42 AFTN	111-0230-		78					15	17	Flat Top	T-Land	0.500	0.125	0.362	0.094
SEKR 42 AFSN	111-0240-			86					Top Form	T-Land & Hone					
SEKN 42 AFSN	111-0228-					68			Flat Top	T-Land & Hone					
SEKN 43 AFSN	111-0232-		78	86						Flat Top	T-Land & Hone	0.500	0.187	0.362	0.094
SEKN 53 AFSN	111-0237-		78	86						Flat Top	T-Land & Hone	0.625	0.187	0.484	0.094
SEKN 53 AFTN	111-0238-		78	86	15				Top Form	T-Land & Hone					
SEKR 53 AFSN	111-0759-					68			Flat Top	T-Land & Hone					

To order please use the geometry code plus the grade code

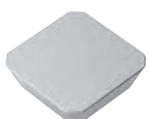

TMX 45° Lead SEAN / SEKN / SEKR Inserts

	Primary Applications				
Steel	●	●	●	●	●
Stainless Steel	●	●	●	●	●
Cast Irons	●	●	●	●	●
Non-Ferrous	●	●	●	●	●
Heat Resistant Alloys	●	●	●	●	●

SEKN 12...

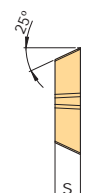
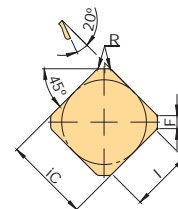
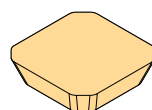

Description	Geometry Code	PVD Coated					Uncoated		Features	Geometry	iC	S	I	F
		TMX 30	C	C5	C	C5								
SEAN 42 AFN	6-SEA-42F				LA	2	5	Flat Top	Hone	0.500	0.125	0.500	0.097	
SEAN 42 AFTN	6-SEA-42T				LA	2	5		T-Land					
SEKN 42 AFN	6-SEK-42F				LA	2	5		Hone					
SEKN 42 AFTN	6-SEK-42	Z						Top Form	T-Land	0.500	0.125	0.500	0.097	
		6-SEK-42T			LA	2	5		T-Land					
SEKR 42 AFTN	6-SER-42	Z						Top Form	T-Land					0.500
		6-SER-42T		H	LA	2	5		T-Land					
SEKN 42 AFSN	6-SEK-42S				LA	2	5	Flat Top	T-Land & Hone					
SEAN 43 AFN	6-SEA-43F				LA	2	5	Flat Top	Hone	0.500	0.187	-	0.097	
SEAN 43 AFTN	6-SEA-43T				LA	2	5	Flat Top	T-Land					
SEKN 43 AFN	6-SEK-43F				LA	2	5	Flat Top	Hone					
SEAN 43 AFTN	6-SEK-43T					2	5	Flat Top	T-Land	0.625	0.187	-	0.097	
SEKR 43 AFTN	6-SER-43T		H	LA	2			Top Form	T-Land & Hone					
SEAN 53 AFN	6-SEA-53F				LA	2	5	Flat Top	Hone					
SEAN 53 AFTN	6-SEA-53T				LA	2	5	Flat Top	T-Land	0.625	0.187	-	0.097	
SEKR 53 AFTN	6-SER-53T		H			2	5	Top Form	T-Land & Hone					

To order please use the geometry code plus the grade code

SEK-45 Speeds

Material	Speed SFM (m/min)								
	PVD COATED (Increasing Toughness →)						CVD COATED (Increasing Toughness →)		
	PHC315	C2 (H)	PH6125	C5 (LA)	TMX30	PH6135	PH3125	PH3225	PH3235
P Low Carbon Steels			520-620 (160-190)	300-500 (90-150)	590-980 (180-300)	490-590 (150-180)	390-490 (120-150)	390-490 (120-150)	290-390 (90-120)
			460-590 (140-180)	250-400 (75-120)	330-620 (100-190)	460-550 (140-170)	290-390 (90-120)	290-390 (90-120)	200-300 (60-90)
			420-520 (130-160)	200-300 (60-90)	130-360 (40-110)	390-490 (120-150)			
M Ferritic and Martensitic			460-570 (140-180)		490-590 (150-180)	460-530 (140-160)	315-400 (100-120)	170-350 (50-110)	150-300 (50-90)
			290-480 (90-150)		230-520 (70-160)	290-440 (90-140)	170-350 (50-110)	150-300 (50-90)	100-200 (30-60)
			260-440 (80-140)		290-420 (90-130)	260-400 (80-120)	150-300 (50-90)	100-200 (30-60)	75-150 (25-50)
K Gray Iron Class 25-35	490-720 (150-220)	120-300 (40-90)			590-780 (180-240)				
	500-760 (155-235)	110-290 (30-60)			520-750 (160-230)				
	370-550 (115-170)				330-520 (100-160)				
N Aluminum < 8% Si									
S Iron Based			100-160 (30-50)		100-160 (30-50)				
			70-200 (20-60)		70-200 (20-60)				
			130-230 (40-70)		130-230 (40-70)				
H Steels Rc > 50									

P = Steel	M = Stainless Steel	K = Cast Iron	N = Aluminum	S = High-Temp Alloy	H = Hard Steel
-----------	---------------------	---------------	--------------	---------------------	----------------



SEK-45 Milling System

Cutting Tools

MILLING

SEK-45 Speeds and Feeds

Material	Speed SFM (m/min)				Feed ipt (mm/tooth)				
	UNCOATED (Increasing Toughness →)				Geometry / Edge Preparation (Increasing Toughness →) (← Decreasing Tool Pressure)				
	PH0125	PH0325	C2 (2)	C5 (5)	AFN	AFEN	AFTN	AFSN	
P	Low Carbon Steels	200-300 (60-90)			250-400 (75-120)	0.004-0.012 (0.10-0.30)	0.004-0.012 (0.10-0.30)	0.004-0.012 (0.10-0.30)	0.004-0.012 (0.10-0.30)
	Alloy Steels	150-250 (50-80)			200-300 (60-90)				
	Tool Steels				150-250 (45-75)				
M	Ferritic and Martensitic			75-150 (25-50)		0.004-0.012 (0.10-0.30)	0.004-0.012 (0.10-0.30)	0.004-0.012 (0.10-0.30)	0.004-0.012 (0.10-0.30)
	Austenitic			50-125 (15-40)					
	PH and Duplex			40-75 (10-25)					
K	Gray Iron Class 25-35		120-300 (40-90)	160-260 (50-80)		0.004-0.012 (0.10-0.30)	0.004-0.012 (0.10-0.30)	0.004-0.012 (0.10-0.30)	0.004-0.012 (0.10-0.30)
	Cast Iron Class 45		110-290 (30-60)	100-200 (30-60)					
	Ductile Iron								
N	Aluminum < 8% Si			800-3000 (250-920)		.004-.014 (0.10-0.35)			
	Copper and Brass			800-1000 (250-310)					
	Aluminum > 8% Si			300-700 (90-220)					
S	Iron Based			50-100 (15-30)	40-80 (10-25)	0.004-0.012 (0.10-0.30)	0.004-0.012 (0.10-0.30)	0.004-0.012 (0.10-0.30)	0.004-0.012 (0.10-0.30)
	Nickel and Cobalt Based			40-80 (10-25)	40-75 (10-20)				
	Titanium Alloys			45-90 (10-28)					
H	Steels Rc > 50								
	Stainless Steels Rc > 45								
	Tool Steels RC > 50								

P = Steel M = Stainless Steel K = Cast Iron N = Aluminum S = High-Temp Alloy H = Hard Steel

System	Main Feature	Insert Sizes	Mill Type	Diameters	Number of Inserts
 SN-45		SNHX 12 06	FACE MILL	2.00 - 10.00	4 - 16

palbit SN-45 Face Mills

- 8-Cutting Edges per Insert
- Through Coolant Capable
- Strong, Secure Pocket
- 2 Pitches Offered for Every Diameter
- Diameter Range: 2.0 to 10.0

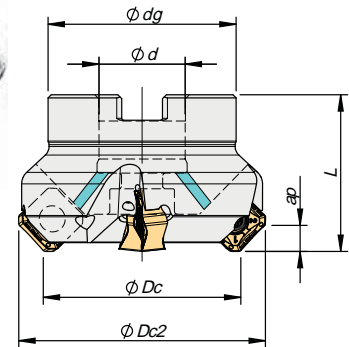

palbit 45° Lead SN-45 Face Mills

Part Number	Description	Number of Inserts	Effective Teeth	ϕDc	$\phi Dc2$	ϕd	ϕdg	H	ap Max	Insert Style
181-0728-00	SN45 D1.50-A.500/1.50-03-12	3	3	1.50	2.01	0.500	1.42	1.50	0.236	SNHX 12
181-0488-00	SN45 D2.00-A.750/1.75-04-12	4	4	2.00	2.51	0.750	1.77	1.750		
181-0627-00	SN45 D2.00-A.750/1.75-06-12	6	6							
181-0489-00	SN45 D2.50-A1.00/1.75-06-12	6	6	2.50	3.01	1.000	2.21			
181-0628-00	SN45 D2.50-A1.00/1.75-08-12	8	8							
181-0490-00	SN45 D3.00-A1.00/2.00-07-12	7	7	3.00	3.51	1.000	2.21	2.000		
181-0629-00	SN45 D3.00-A1.00/2.00-10-12	10	10							
181-0491-00	SN45 D4.00-A1.25/2.00-08-12	8	8	4.00	4.51	1.250	2.87			
181-0630-00	SN45 D4.00-A1.25/2.00-12-12	12	12							
181-0722-00	SN45 D5.00-A1.50/2.50-05-12	5	5	5.00	5.51	1.500	3.39			
181-0492-00	SN45 D5.00-A1.50/2.50-10-12	10	10							
181-0723-00	SN45 D6.00-A2.00/2.50U-07-12	7	7	6.00	6.51	2.000	4.88	2.500		
181-0724-00	SN45 D8.00-A2.50/2.50U-09-12	9	9							
181-0544-00	SN45 D8.00-A2.50/2.50U-14-12	14	14	8.00	8.51	2.500	5.51			
181-0725-00	SN45 D10.0-A2.50/2.50U-11-12	11	11							
181-0545-00	SN45 D10.0-A2.50/2.50U-16-12	16	16	10.00	10.51	2.500	7.09			

See next page for inserts

Spare Parts Part Number	Description	Torque
290-0475-00	Insert Screw M4 X 0.7 L -11.0 mm	3.0Nm
290-0124-00	Driver (Torx T15)	
290-0148-00	Key (Torx T15)	
290-ASEIZE-03	Thread Anti-Seize 3-gm pack	



SN-45 Milling System

Cutting Tools

MILLING



palbit SN-45 Inserts

	Primary Applications					
Steel	•	•	•	•	•	•
Stainless Steel	•	•	•	•	•	•
Cast Irons	•	•	•	•	•	•
Non-Ferrous	•	•	•	•	•	•
Heat Resistant Alloys	•	•	•	•	•	•

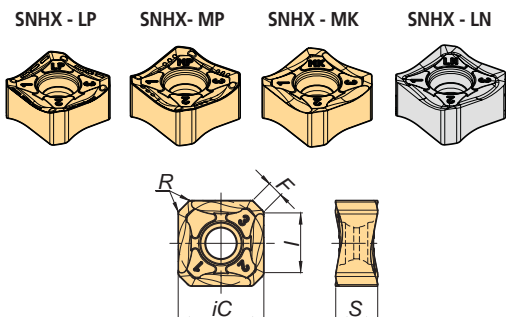

Description	Geometry Code	PVD Coated						TIN PVD	Edge Prep	Geometry	iC	S	I	R	F
		PH6910	PH6920	PH6125	PH6930	PH6135	PH6740	PH0910							
SNHX 1206 ANFN-LN	111-1504-								Sharp	LN					
SNHX 1206 ANEN-LP	111-1452-	54	68	78	66	86			Hone	LP	0.500	0.250	0.366	0.031	0.079
SNHX 1206 ANEN-MK	111-1503-	54	68		66				Hone	MK					
SNHX 1206 ANSN-MP	111-1502-	54	68		66	86			T-Land & Hone	MP					

To order please use the **geometry code** plus the **grade code**

SN-45 Speeds and Feeds

Material	Speed SFM (m/min)						Feed ipt (mm/tooth)			
	PVD COATED (Increasing Toughness →)					UNCOATED	Geometry / Edge Preparation (Increasing Toughness →) (← Decreasing Tool Pressure)			
	PH6910	PH6920	PH6125	PH6930	PH6135	PH0910	ANFN - LN	ANEN - LP	ANEN - MK	ANSN - MP
P Low Carbon Steels	590-750 (180-230)	550-680 (170-210)	520-620 (160-190)	490-590 (150-180)	490-590 (150-180)					
	Alloy Steels	550-680 (170-210)	520-720 (160-200)	460-590 (140-180)	460-550 (140-170)	460-550 (140-170)		0.004-0.014 (0.10-0.35)		0.004-0.014 (0.10-0.35)
	Tool Steels	520-720 (160-200)	460-620 (140-190)	420-520 (130-160)	390-490 (120-150)	390-490 (120-150)				
M	Ferritic and Martensitic		490-620 (150-190)	460-570 (140-180)	460-550 (140-170)	460-530 (140-160)				
	Austenitic		330-520 (100-160)	290-480 (90-150)	290-460 (90-140)	290-440 (90-140)		0.004-0.014 (0.10-0.35)		0.004-0.014 (0.10-0.35)
	PH and Duplex		330-490 (100-150)	260-440 (80-140)	260-420 (80-130)	260-400 (80-120)				
K	Gray Iron Class 25-35	590-850 (180-260)	550-810 (170-250)		590-780 (180-240)		280-420 (85-130)			
	Cast Iron Class 45	490-680 (150-210)	490-680 (140-200)		520-750 (160-230)		210-390 (65-120)		0.004-0.016 (0.10-0.040)	
	Ductile Iron	290-620 (90-190)	260-590 (80-180)		330-520 (100-160)		160-260 (50-80)			
N	Aluminum < 8% Si					2630-3070 (810-945)				
	Copper and Brass					1320-1530 (405-470)	0.004-0.016 (0.10-0.40)			
	Aluminum > 8% Si					800-930 (245-285)				
S	Iron Based	100-200 (30-60)	100-200 (30-60)	100-160 (30-50)						
	Nickel and Cobalt Based	70-230 (20-70)	70-230 (20-70)	70-200 (20-60)				0.004-0.016 (0.10-0.40)		
	Titanium Alloys	130-290 (40-90)	130-290 (40-90)	130-230 (40-70)						
H	Steels Rc > 50	200-330 (60-100)								
	Stainless Steels Rc > 45									0.003-0.005 (0.08-0.013)
	Tool Steels RC > 50									

P = Steel
M = Stainless Steel
K = Cast Iron
N = Aluminum
S = High-Temp Alloy
H = Hard Steel



OFC-43 Milling System

Cutting Tools

MILLING

System	Main Feature	Insert Sizes	Mill Type	Diameters	Number of Inserts
 <p>OFC</p>	<p>Economical 8-cutting edges per insert</p> <p>Ramping Capability up to 4°</p> <p>Arbor Mount</p>	OFMT 05	FACE MILL	2.00 - 4.00	4 - 7

palbit OFC-43 Face Mills

- 43° Lead
- Economical 8-cutting Edges per Insert
- Ramping Capability up to 4°
- DOC up to 0.140 (3.5 mm)
- Simple and Economical to Use.
- Diameter range: 2.0 to 4.0

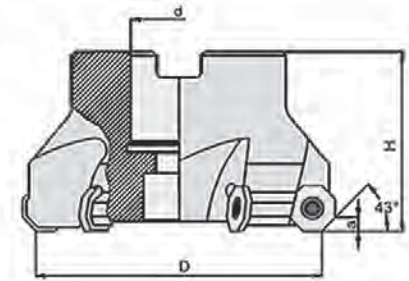

palbit 43° Lead OFC Face Mills

Part Number	Description	Number of Inserts	D	d	H	a	Insert Style
6-970-020	OFC-D2.00-.750-4-05	4	2.00	2.51	0.750	1.77	OFMT 05
6-970-030	OFC-D3.00-1.00-5-05	5					
6-970-040	OFC-D4.00-1.25-7-05	7	2.50	3.01	1.000	2.21	

Spare Parts Part Number	Description	Torque
6-998-4008M	Screw M4 x 0.7 L - 8.4	3.4Nm
6-998-015	T-15 Wrench	
290-ASEIZE-03	Thread Anti-Seize 3-gm pack	



TMX OFMT, OFKR inserts



	Primary Applications			
	Steel	•	•	•
Stainless Steel		•	•	
Cast Irons	•	•	•	
Non-Ferrous				
Heat Resistant Alloys	•	•	•	
	PVD Coated		TIN PVD	
	PH6920	PH6125	TMX 30	H01

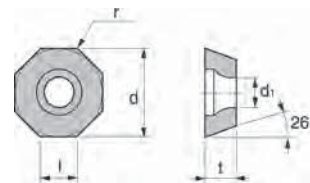

Description	Geometry Code	PH6920	PH6125	TMX 30	H01	Geometry	d	t	l	r	d1
OFMT 05T305 TN	6-OFT-05T			Z		LN	0.500	0.157	0.205	0.031	0.173
OFMT 070405 TN	6-OFT-070			Z		LP	0.709	0.189	0.291	0.031	0.228
OFKR 070405 TN-A1	111-1568-	68	78			SN	0.709	0.188	0.294	0.020	-

To order please use the geometry code plus the grade code

OFC-43 Speeds and Feeds

	Material	Speed SFM (m/min)	Feed ipt (mm/tooth)
		PVD COATED	Geometry / Edge Preparation
		TMX30	TN
P	Low Carbon Steels	590-980 (180-300)	0.006-0.011 (0.15-0.28)
	Alloy Steels	330-620 (100-190)	
	Tool Steels	130-360 (40-110)	
M	Ferritic and Martensitic	490-590 (150-180)	0.006-0.010 (0.15-0.25)
	Austenitic	230-520 (70-160)	
	PH and Duplex	290-420 (90-130)	
K	Gray Iron Class 25-35	590-780 (180-240)	0.006-0.020 (0.15-0.50)
	Cast Iron Class 45	520-750 (160-230)	
	Ductile Iron	330-520 (100-160)	
N	Aluminum < 8% Si		
	Copper and Brass		
	Aluminum > 8% Si		
S	Iron Based	100-160 (30-50)	0.006-0.010 (0.15-0.25)
	Nickel and Cobalt Based	70-200 (20-60)	
	Titanium Alloys	130-230 (40-70)	
H	Steels Rc > 50		
	Stainless Steels Rc > 45		
	Tool Steels RC > 50		

P = Steel
M = Stainless Steel
K = Cast Iron
N = Aluminum
S = High-Temp Alloy
H = Hard Steel



Die & Mold RD-TORO Milling System

Cutting Tools

MILLING

System	Main Feature	Insert Sizes	Mill Type	Diameters	Number of Inserts	Catalog Pages
	Inserts Available In 10mm, 12mm and 16mm Sizes Anti-Rotation Top Clamp On all Face Mills for 12 mm Insert	RD...10 03	END MILL	1.00	2	
		RD...12 T3	END MILL	1.00-1.25	2 - 3	
			FACE MILL	2.00 - 3.00	5 - 7	
		RD...16 04	FACE MILL	2.00 - 6.00	4 - 9	

palbit RD TORO Mills

- End Mill and Face Mills
- Through Coolant Capability
- Anti-Rotation Top Clamp On all Face Mills for 12 mm Insert
- Inserts Available In 10 mm, 12 mm and 16 mm Sizes
- Diameter Range: 1.0 to 6.0

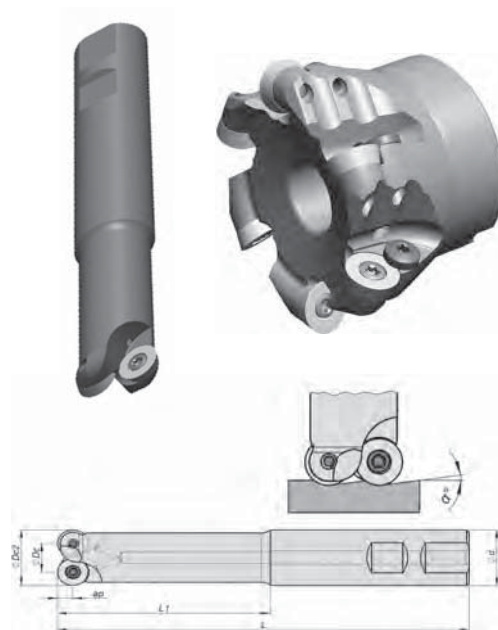

palbit RD-TORO End Mills

Part Number	Description	Number of Inserts	Effective Teeth	ØDc2	ØDc	Ød	L	L1	Ramp Angle	Shank Style	ap Max	Insert Style
181-0532-00	RD90 D1.00-W1.00/6.00-02-10	2	2	1.00	0.606	1.000	6.00	1.97	16	Weldon	0.196	RD__10
181-0533-00	RD90 D1.00-W1.00/9.00-02-12	2	2	1.00	0.528	1.000	9.00	4.72	16	Weldon	0.236	RD__12
181-0534-00	RD90 D1.25-W1.25/9.00-03-12	3	3	1.25	0.780	1.250	9.00	4.72	10			

See page 56 for inserts

Spare Parts Part Number	Description	Torque
290-0199-00	Insert Screw M3.5 X 0.6 L -7.7 mm	3.0Nm
290-0124-00	Driver (Torx T15)	
290-0148-00	Key (Torx T15)	
290-ASEIZE-03	Thread Anti-Seize 3-gm pack	

palbit RD-TORO Face Mills with Anti-Rotation Clamp

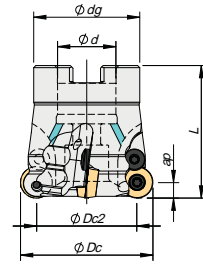

Part Number	Description	Number of Inserts	Effective Teeth	ØD	ØDc	Ød	Ødg	L	Ramp Angle	Insert Screw Part Number	Anti-Rotation Clamp Screw Part Number	ap Max	Insert Style
241-0535-00	RD90 D2.00-A.750/1.75-05-12	5	5	2.00	1.53	0.75	1.77	1.75	6.0				
241-0536-00	RD90 D2.50-A.750/1.75-06-12	6	6	2.50	2.03	0.75	1.77	1.75	3.7	290-0199-00	290-0142-00	0.236	RD__12
241-0537-00	RD90 D3.00-A1.00/2.00-07-12	7	7	3.00	2.53	1.00	2.21	2.00	3.0				

See next page for inserts

Spare Parts Part Number	Description	Torque
290-0199-00	Insert Screw M3.5 X 0.6 L -7.7 mm	3.0Nm
290-0124-00	Driver (Torx T15)	
290-0148-00	Key (Torx T15)	
290-ASEIZE-03	Thread Anti-Seize 3-gm pack	

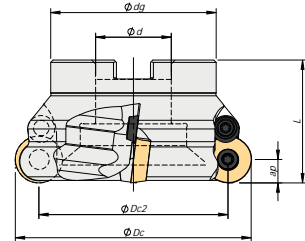

palbit RD-TORO Face Mills

Part Number	Description	Number of Inserts	Effective Teeth	ØD	ØDc	Ød	Ødg	L	Ramp Angle	Insert Screw Part Number	ap Max	Insert Style
181-0538-00	RD90 D2.00-A.750/2.00-04-16	4	4	2.00	1.37	0.75	1.77	2.00	6.0	290-0269-00	0.314	RD__16
181-0539-00	RD90 D2.50-A.750/2.00-05-16	5	5	2.50	1.87				5.0			
181-0540-00	RD90 D3.00-A1.00/2.00-06-16	6	6	3.00	2.37	1.00	2.21		4.0			
181-0541-00	RD90 D4.00-A1.25/2.00-07-16	7	7	4.00	3.37	1.25	2.87		2.8			
181-0542-00	RD90 D5.00-A1.50/2.50-08-16	8	8	5.00	4.37	1.50	3.39	2.50	2.2			
181-0543-00	RD90 D6.00-A1.50/2.50U-09-16	9	9	6.00	5.37	1.50	3.94		1.8			

See next page for inserts

Spare Parts Part Number	Description	Torque
290-0269-00	Insert Screw M3.5 X 0.6 L -7.7 mm	5.0Nm
290-0132-00	Key(Torx T20)	
290-0149-00	Driver (Torx T20)	
290-ASEIZE-03	Thread Anti-Seize 3-gm pack	



Die & Mold RD-TORO Milling System

Cutting Tools

MILLING



palbit RD-TORO Inserts

	Primary Applications				
Steel	•	•	•	•	•
Stainless Steel			•		
Cast Irons	•	•	•	•	•
Non-Ferrous					
Heat Resistant Alloys	•	•	•	•	•
	PVD Coated				
	PH6903	PH6910	PH6920	PH6125	PH6135

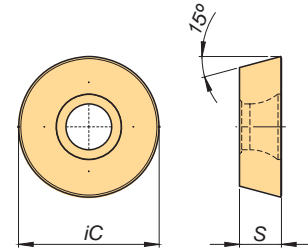

Description	Geometry Code	PH6903	PH6910	PH6920	PH6125	PH6135	Feature	iC	S
RDHW 1003 MOT	111-0087-		54	68			Flat Top	0.394	0.125
RDMW 1003 MOT	111-0549-				78	86	General Purpose		
RDHT 12T3 MOT	111-0083-					86	Top Form	0.472	0.156
RDHW 12T3 MOT	111-0090-	64	54	68			Flat Top		
RDMW 12T3 MOT	111-0096-			68	78	86	General Purpose		
RDHW 1604 MOT	111-0092-		54	68			Flat Top	0.630	0.187
RDMW 1604 MOT	111-0097-			68		86	General Purpose		

To order please use the **geometry code** plus the **grade code**

RD-TORO Speeds and Feeds

Material	Speed SFM (m/min)					Feed ipt (mm/tooth)	
	PVD COATED (Increasing Toughness →)					Geometry / Edge Preparation	
	PH6903	PH6910	PH6920	PH6125	PH6135	Insert Size	T
P Low Carbon Steels	980-1140 (300-350)	590-750 (180-230)	550-680 (170-210)	520-620 (160-190)	490-590 (150-180)	10 12 16	0.004-0.018 (0.10-0.45)
	810-1040 (250-320)	550-680 (170-210)	520-720 (160-200)	460-590 (140-180)	460-550 (140-170)		0.004-0.019 (0.10-0.49)
	810-980 (250-300)	520-720 (160-200)	460-620 (140-190)	420-520 (130-160)	390-490 (120-150)		0.004-0.020 (0.10-0.50)
M Ferritic and Martensitic			490-620 (150-190)			10 12 16	0.004-0.012 (0.10-0.30)
	Austenitic		330-520 (100-160)				0.004-0.014 (0.10-0.35)
	PH and Duplex		330-490 (100-150)				
K Gray Iron Class 25-35	980-1140 (300-350)	590-850 (180-260)	550-810 (170-250)			10 12 16	0.004-0.018 (0.10-0.45)
	810-1040 (250-320)	490-680 (150-210)	490-680 (140-200)				0.004-0.019 (0.10-0.49)
	810-980 (250-300)	290-620 (90-190)	260-590 (80-180)				0.004-0.020 (0.10-0.50)
N Aluminum < 8% Si							
	Copper and Brass						
	Aluminum > 8% Si						
S Iron Based		100-200 (30-60)	100-200 (30-60)	100-160 (30-50)		10 12 16	0.003-0.008 (0.08-0.20)
	Nickel and Cobalt Based		70-230 (20-70)	70-230 (20-70)	70-200 (20-60)		0.004-0.010 (0.10-0.25)
	Titanium Alloys		130-290 (40-90)	130-290 (40-90)	130-230 (40-70)		0.004-0.012 (0.10-0.30)
H Steels Rc > 50	200-330 (60-100)	200-330 (60-100)				10 12 16	0.003-0.008 (0.08-0.20)
	Stainless Steels Rc > 45						
	Tool Steels RC > 50						

P = Steel
M = Stainless Steel
K = Cast Iron
N = Aluminum
S = High-Temp Alloy
H = Hard Steel



Die & Mold RD-TORO Milling System

Cutting Tools

MILLING

Correction Factors for Copy Mills

Due to the large radius of Button style inserts, the feed rate should be adjusted when the depth-of-cut (DOC) is less than 1/2 the insert diameter.

If the width-of-cut (WOC) is less than half the cutter diameter, the feed rate should be adjusted. In some applications, both factors should be applied.

CF DOC = Correction Factor for the Depth of Cut
 Ins Dia = Insert Diameter
 DOC = Depth of Cut

DOC (inch)	Insert Size		
	10	12	16
	0.394	0.472	0.630
0.010	3.18	3.47	4.00
0.025	2.05	2.23	2.56
0.050	1.50	1.62	1.85
0.100	1.15	1.22	1.37
0.150	1.03	1.07	1.17
0.200		1.01	1.07
0.250			1.02
0.300			1.00

$$CF_{DOC} = \frac{\frac{1}{2} * (Ins\ Dia / DOC)}{\sqrt{\left(\frac{Ins\ Dia}{DOC}\right)^2 - 1}}$$

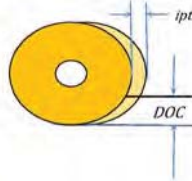

Example: Cutter Diameter = 2" 241-0535-00 (5 flutes)
 WOC = 0.125
 DOC = 0.050
 Insert Size 12 (0.472")
 Desired Feed rate = 0.006 ipt

From the table Feed Rate Correction Factor for DOC
 CF DOC = 1.62

From the table Feed Rate Correction Factor (CF) for WOC
 CF WOC = 2.066

The corrected Feed Rate is = 0.006 x 1.62 x 2.066
 = 0.020 ipt



Feed Rate Correction Factor (CF) for WOC													
WOC (inch)	0.375	0.500	0.625	0.750	1.00	1.25	1.50	2.00	2.50	3.00	4.00	5.00	6.00
0.025	2.004	2.294	2.552	2.785	3.203	3.571	3.906	4.500	5.025	5.500	6.344	7.089	7.762
0.050	1.471	1.667	1.843	2.004	2.294	2.552	2.785	3.203	3.571	3.906	4.500	5.025	5.500
0.075	1.250	1.400	1.539	1.667	1.898	2.105	2.294	2.632	2.931	3.203	3.686	4.113	4.500
0.100	1.131	1.250	1.364	1.471	1.667	1.843	2.004	2.294	2.552	2.785	3.203	3.571	3.906
0.125	1.061	1.155	1.250	1.342	1.512	1.667	1.809	2.066	2.294	2.502	2.874	3.203	3.501
0.150	1.021	1.091	1.171	1.250	1.400	1.539	1.667	1.898	2.105	2.294	2.632	2.931	3.203
0.175	1.002	1.048	1.114	1.182	1.316	1.441	1.558	1.769	1.960	2.133	2.445	2.721	2.971
0.250		1.000	1.021	1.061	1.155	1.250	1.342	1.512	1.667	1.809	2.066	2.294	2.502
0.500					1.000	1.021	1.061	1.155	1.250	1.342	1.512	1.667	1.809
0.750							1.000	1.033	1.091	1.155	1.281	1.400	1.512
1.000								1.000	1.021	1.061	1.155	1.250	1.342
1.250									1.000	1.014	1.079	1.155	1.231
1.500										1.000	1.033	1.091	1.155
2.000											1.000	1.021	1.061
2.500												1.000	1.014
3.000													1.000

$$CF_{WOC} = \frac{[D/WOC]}{2 * \sqrt{\frac{D}{WOC} - 1}}$$

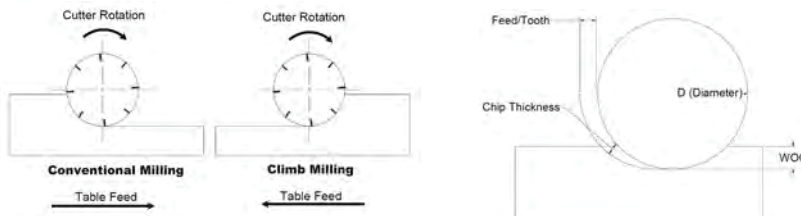

Die & Mold SP-HI Feed Milling System



MILLING

System	Main Feature	Insert Sizes	Mill Type	Diameters	Number of Inserts
 <p>SP-HI FEED</p>	<p>Four Cutting Edges per Insert</p> <p>Medium Duty</p>	<p>SPKT 08 T3</p> <p>SPKW 08 T3</p>	<p>END MILL</p>	<p>0.75 - 1.50</p>	<p>2 - 5</p>
		<p>SPKT 13 03</p> <p>SPKW 13 03</p>	<p>FACE MILL</p>	<p>2.00 - 4.00</p>	<p>4 - 6</p>

palbit SP-HI Feed Mills

- Four Cutting Edges per Insert
- Available in both End Mill and Face Mill Styles
- Feed Rates up to 0.118 ipt (3.0 mm/t)
- Through Coolant Capable
- Ramping
- Diameter Range: 1.0 to 4.0

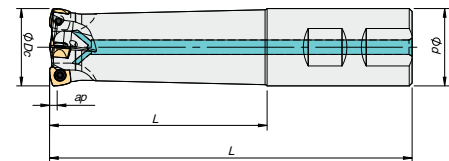
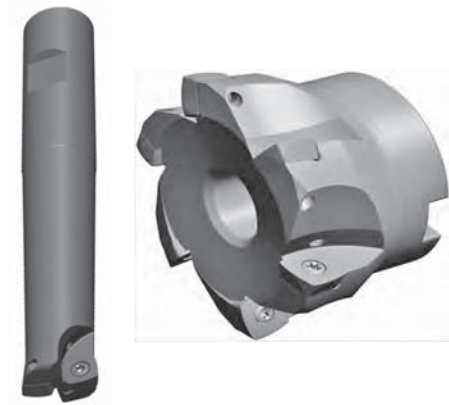

palbit SP-HI Feed End Mills

Part Number	Description	Number of Inserts	Effective Teeth	ØDc	Ød	L	L1	Rp	Ramp Angle	Shank Style	ap Max	Insert Style
181-0549-00	SP90D.750-W.750/5.00-02-08	2	2	0.75	0.750	5.00	2.76	0.071	3.0	Weldon	0.047	SPKT/ SPKW-08
181-0550-00	SP90D.750-W.750/8.00-02-08	2	2	0.75	0.750	8.00	4.33		3.0			
181-0551-00	SP90D1.00-W1.00/5.00-03-08	3	3	1.00	1.000	5.00	2.84		2.0			
181-0552-00	SP90D1.00-W1.00/8.00-03-08	3	3	1.00	1.000	8.00	4.84		2.0			
181-0553-00	SP90D1.25-W1.25/6.00-04-08	4	4	1.25	1.250	6.00	3.54		1.5			
181-0554-00	SP90D1.25-W1.25/8.00-04-08	4	4	1.25	1.250	8.00	4.84		1.5			
181-0555-00	SP90D1.50-W1.25/6.00-05-08	5	5	1.50	1.250	6.00	3.54		1.0			
181-0556-00	SP90D1.50-W1.25/8.00-05-08	5	5	1.50	1.250	8.00	3.54		1.0			

See next page for inserts

Spare Parts Part Number	Description	Torque
290-0091-00	Insert Screw M3 X 0.5 L -7.4 mm	1.4Nm
290-0257-00	Driver (Torx T9)	
290-ASEIZE-03	Thread Anti-Seize 3-gm pack	



Die & Mold SP-HI Feed Milling System

Cutting Tools

MILLING

palbit SP and SO Hi-Feed Face Mills

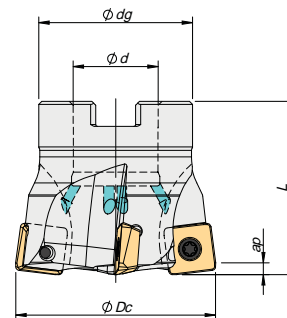

Part Number	Description	Number of Inserts	Effective Teeth	ϕDc	ϕd	ϕdg	L	Rp	Ramp Angle	Mount	ap Max	Insert Style
181-0495-00	SP90D2.00-A.750/1.75-04-13	4	4	2.00	0.75	1.77	1.75	0.098	1.5	Arbor	0.079	SPKT/SPKW-13
181-0697-00	SP90D2.50-A1.00/1.75-05-13	5	5	2.50	1.00							
181-0382-00	SP90D2.50-A1.00/2.00-05-13	5	5	2.50	1.00	2.21	2.00	1.0				
181-0381-00	SP90D3.00-A1.00/2.00-06-13	6	6	3.00	1.00	2.21		0.5				
181-0696-00	SP90D4.00-A1.25/2.00-06-13	6	6	4.00	1.25	2.87		0.5				
181-0739-00	SO90 D2.50-A1.00/1.75-05-16	5	5	2.50	1.00	2.21	1.57	3.0	Arbor	.138	SOE-16	
181-0740-00	SO90 D3.00-A1.00/2.00-06-16	6	6	3.00				2.0				
181-0741-00	SO90 D4.00-A1.25/2.00-08-16	8	8	4.00	1.25	2.85	2.00	.177				1.5
181-0742-00	SO90 D5.00-A1.50/2.50-10-16	10	10	5.00	1.50	3.39	2.50	1.0				
181-0743-00	SO90 D6.00-A2.00/2.50-12-16	12	12	6.00	2.00	4.88		0.5				

Spare Parts Part Number	Description	Torque
290-0475-00	Insert Screw M4 X 0.7 L -11.0mm	3.0Nm
290-0124-00	Driver (Torx T15)	
290-ASEIZE-03	Thread Anti-Seize 3-gm pack	



palbit SP and SO Hi-Feed Inserts

- Steel
- Stainless Steel
- Cast Irons
- Non-Ferrous
- Heat Resistant Alloys

Primary Applications			
Steel	•	•	•
Stainless Steel		•	
Cast Irons	•	•	•
Non-Ferrous			
Heat Resistant Alloys	•	•	•

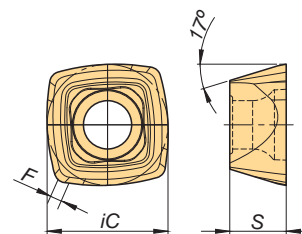

Description	Geometry Code	PVD Coated				Feature	iC	S	F
		PH6910	PH6920	PH6125	PH6135				
SPKT 08T308-E	111-1314-	54	68	78	86	E	0.335	0.156	-
SPKT 130510-E	111-1195-	54	68	78	86	E	0.512	0.219	0.079
SPKW 08T308-E	111-1364-	54	68			E	0.335	0.156	-
SPKW 130510-E	111-1355-		68			E	0.512	0.219	0.079
SPKW 08T308-S	112-1227-	54	68			S	0.335	0.156	-
SPKW 130510-S	111-0888-	54	68		86	S	0.512	0.219	0.079
SOEW 160512 S	111-1907-		68			S	0.646	0.207	0.059

To order please use the geometry code plus the grade code

Die & Mold SP-HI Feed Milling System



SP-HI Feed Speeds and Feeds

Material	Speed SFM (m/min)				Feed ipt (mm/tooth)		
	PVD COATED (Increasing Toughness →)				Geometry / Edge Preparation (Increasing Toughness →)		
	PH6910	PH6920	PH6125	PH6135	Insert Size	E	S
P Low Carbon Steels	590-750 (180-230)	550-680 (170-210)	520-620 (160-190)	490-590 (150-180)	08	0.012-0.059 (0.30-1.50)	0.012-0.059 (0.30-1.50)
	Alloy Steels	550-680 (170-210)	520-720 (160-200)	460-590 (140-180)			
	Tool Steels	520-720 (160-200)	460-620 (140-190)	420-520 (130-160)	390-490 (120-150)		
M Ferritic and Martensitic		490-620 (150-190)			08	0.012-0.059 (0.30-1.50)	0.012-0.059 (0.30-1.50)
	Austenitic	330-520 (100-160)					
	PH and Duplex	330-490 (100-150)					
K Gray Iron Class 25-35	590-850 (180-260)	550-810 (170-250)			08	0.012-0.059 (0.30-1.50)	0.012-0.059 (0.30-1.50)
	Cast Iron Class 45	490-680 (150-210)	490-680 (140-200)				
	Ductile Iron	290-620 (90-190)	260-590 (80-180)				
N Aluminum < 8% Si							
	Copper and Brass						
	Aluminum > 8% Si						
S Iron Based	100-200 (30-60)	100-200 (30-60)	100-160 (30-50)		08	0.012-0.039 (0.30-1.00)	0.012-0.039 (0.30-1.00)
	Nickel and Cobalt Based	70-230 (20-70)	70-230 (20-70)	70-200 (20-60)			
	Titanium Alloys	130-290 (40-90)	130-290 (40-90)	130-230 (40-70)			
H Steels Rc > 50	200-330 (60-100)						0.003-0.008 (0.08-0.20)
	Stainless Steels Rc > 45						
	Tool Steels RC > 50						

MILLING

P = Steel M = Stainless Steel K = Cast Iron N = Aluminum S = High-Temp Alloy H = Hard Steel



Die & Mold SP-HI Feed Milling System

Cutting Tools

MILLING

Technical Data

Dimensions

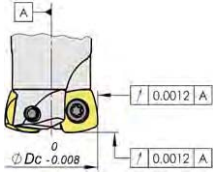

Tolerance when setting with master insert

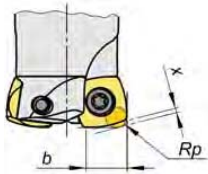

CNC Program - Corner Radius Definition

Insert	Rp	x	b
SP... 08 T3 08	0.071	0.028	0.256
SP... 13 05 10	0.098	0.046	0.416
WN... 12 07 - SP	0.138	--	--

Ramping

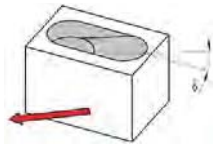

a° = max ramp angle utilizing full contact + internal corner radius

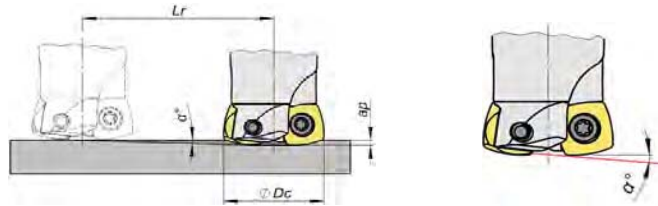

ØDc	°	ØDHmin = 2Dc - 2b	ØDHmax = 2Dc - .079
0.750	0°	--	--
1.00	0°	--	--
1.25	1.5°	1.988	2.421
1.50	1°	2.488	2.921

Helical Interpolation

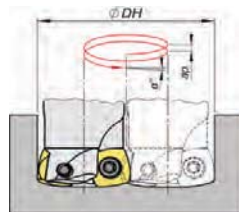
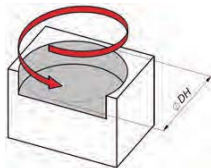

Side Plunging

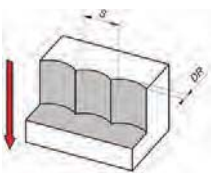

ØDc	S	DR	Feed (fz)
0.750	0.38	0.080 - 0.216	0.003 - 0.008
1.00	0.50	0.080 - 0.216	0.003 - 0.008
1.25	0.63	0.080 - 0.216	0.003 - 0.008
1.50	0.75	0.080 - 0.216	0.003 - 0.008
2.00	1.00	0.080 - 0.216	0.003 - 0.008
2.50	1.25	0.080 - 0.216	0.003 - 0.008
3.00	1.50	0.080 - 0.216	0.003 - 0.008
4.00	2.00	0.080 - 0.216	0.003 - 0.008

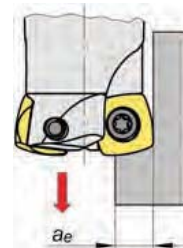

Die & Mold WN-HI Feed Milling System



System	Main Feature	Insert Sizes	Mill Type	Diameters	Number of Inserts
 WN-HI FEED	Three Cutting Edges per Insert Feed Rates up to 0.118 ipt (3.0 mm/t)	WNMW 12 07	FACE MILL	2.00 - 4.00	3 - 5

palbit WN-HI Feed Mills

- Three Cutting Edges per Insert
- Insert Designed with Integral Shim
- Feed Rates up to 0.118 ipt (3.0 mm/t)
- Through Coolant Capable
- Ramping Capable
- Diameter Range: 2.0 to 4.0

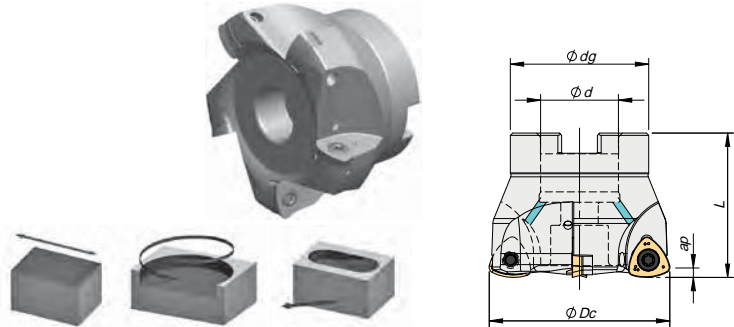

palbit WN-HI FEED Face Mills

Part Number	Description	Number of Inserts	Effective Teeth	ϕDc	ϕd	ϕdg	L	Ramp Angle	Rp	ap Max	Insert Style
181-0546-00	WN60 D2.00-A.750/1.75-03-12	3	3	2.00	0.75	1.77	1.75	1.5	0.138	0.071	WNMW 12
181-0547-00	WN60 D2.50-A.750/1.75-04-12	4	4	2.50	0.75	1.77		0.9			
181-0807-00	WN60 D2.50-A1.00/1.75-04-12	4	4	2.50	1.00	1.77		0.8			
181-0548-00	WN60 D3.00-A1.00/2.00-05-12	5	5	3.00	1.00	2.28	2.00	0.5			
181-0729-00	WN60 D4.00-A1.25/2.00-05-12	5	5	4.00	1.00	2.87		0.5			
181-0825-00	WN60 D4.00-A1.50/2.00-05-12	5	5	4.00	1.50	2.87					
Part Number	Clamping System										
181-0837-00	WN60-D2.00-A.750/2.00-03-12	3	3	2.00	0.75	1.77	1.97	1.5	0.138	0.071	WNMW 12
181-0838-00	WN60-D2.50-A1.00/2.00-04-12	4	4	2.50	1.00	2.21	2.00	0.9			
181-0839-00	WN60-D3.00-A1.00/2.50-05-12	5	5	3.00	1.00	2.28	2.50	0.8			
181-0840-00	WN60-D4.00-A1.50/2.50-05-12	5	5	4.00	1.50	2.87		0.5			

Spare Parts Part Number	Description	Torque
290-0067-00	Insert Screw M4.5 X 0.75 L -14.0 mm	5.0Nm
290-0132-00	Driver (Torx T20)	
290-ASEIZE-03	Thread Anti-Seize 3-gm pack	



palbit WN-HI Feed Inserts

	Primary Applications			
Steel	•	•	•	•
Stainless Steel	•			
Cast Irons	•	•		
Non-Ferrous				
Heat Resistant Alloys	•	•	•	
PVD Coated				
	PH6910	PH6920	PH6125	PH6135

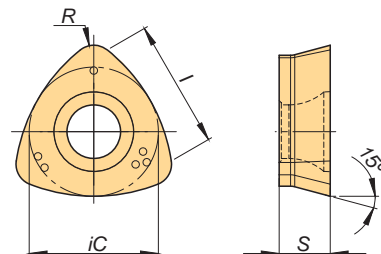

Description	Geometry Code	PH6910	PH6920	PH6125	PH6135	Geometry	iC	S	I	R
WNMW 1207-SP	112-1148-	54	68	78	86	SP	0.472	0.187	0.469	0.079

To order please use the **geometry code** plus the **grade code**



Die & Mold WN-HI Feed Milling System

Cutting Tools

MILLING

WN-HI Feed Speeds and Feeds

Material	Speed SFM (m/min)				Feed ipt (mm/tooth)
	PVD COATED (Increasing Toughness →)				Geometry / Edge Preparation (Increasing Toughness →)
	PH6910	PH6920	PH6125	PH6135	SP
P Low Carbon Steels	590-750 (180-230)	550-680 (170-210)	520-620 (160-190)	490-590 (150-180)	0.012-0.118 (0.30-3.00)
	Alloy Steels	550-680 (170-210)	520-720 (160-200)	460-590 (140-180)	
	Tool Steels	520-720 (160-200)	460-620 (140-190)	420-520 (130-160)	
M	Ferritic and Martensitic		490-620 (150-190)		0.012-0.039 (0.30-1.00)
	Austenitic		330-520 (100-160)		
	PH and Duplex		330-490 (100-150)		
K	Gray Iron Class 25-35	590-850 (180-260)	550-810 (170-250)		0.012-0.118 (0.30-3.00)
	Cast Iron Class 45	490-680 (150-210)	490-680 (140-200)		
	Ductile Iron	290-620 (90-190)	260-590 (80-180)		
N	Aluminum < 8% Si				
	Copper and Brass				
	Aluminum > 8% Si				
S	Iron Based	100-200 (30-60)	100-200 (30-60)	100-160 (30-50)	0.010-0.031 (0.25-0.80)
	Nickel and Cobalt Based	70-230 (20-70)	70-230 (20-70)	70-200 (20-60)	
	Titanium Alloys	130-290 (40-90)	130-290 (40-90)	130-230 (40-70)	
H	Steels Rc > 50	200-330 (60-100)			0.003-0.008 (0.08-0.20)
	Stainless Steels Rc > 45				
	Tool Steels RC > 50				

P = Steel

M = Stainless Steel

K = Cast Iron

N = Aluminum

S = High-Temp Alloy



H = Hard Steel

R8 Shank Tools



Cutting Tools

MILLING

System	Main Feature	Insert Sizes	Mill Type	Diameters	Number of Inserts
AP-90 / APX-90 	Medium Duty High Ramping Side Milling	RD...10 03	END MILL - INTEGRAL SHANK R-8	1.00 - 2.50	2 - 6
TP-90 	90° Triangle Insert, Square Shoulder Mills Utilize Common TPG and TPU (TPUN) Style insets	RD...12 T3	END MILL - INTEGRAL SHANK R-8	1.00	2
			END MILL - INTEGRAL SHANK R-8	1.25 - 3.00	2 - 5



R8 Shank Tools

Cutting Tools

MILLING

TMX AP-90 R8 Shank End Mills

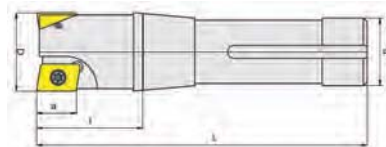

Part Number	Description	Number of Inserts	Effective Teeth	ØD	Ød	L	I	Insert Screw Part Number	Wrench Part Number	Shank Style	ap Max	Insert Style
6-941-105	APK-D1.00-R8-5.8-2-16	2	2	1.00	R8	5.80	1.70	6-998-4008M	6-998-015	R8	0.570	APKT16
6-941-110	APK-D1.25-R8-5.8-3-16	3	3	1.25		5.80	1.70					
6-941-115	APK-D1.50-R8-6.1-4-16	4	4	1.50		6.00	2.00					
6-941-120	APK-D2.00-R8-6.1-5-16	5	5	2.00		6.00	2.00	6-998-4011				
6-941-125	APK-D2.50-R8-6.1-6-16	6	6	2.50		6.00	2.00					

See next page for inserts

Spare Parts Part Number	Description	Torque
6-998-4008M	Insert Screw M4 X 0.7 L -8.4 mm	3.0Nm
6-998-4011	Insert Screw M4 X 0.7 L -11.4mm	3.0Nm
6-998-015	Key (Torx T15)	
290-ASEIZE-03	Thread Anti-Seize 3-gm pack	



palbit APKT 16 Inserts

Steel
Stainless Steel
Cast Irons
Non-Ferrous
Heat Resistant Alloys

Primary Applications					
Steel	•	•	•	•	•
Stainless Steel	•	•	•	•	•
Cast Irons	•	•	•	•	•
Non-Ferrous	•	•	•	•	•
Heat Resistant Alloys	•	•	•	•	•

PVD Coated

PH6910	PH6325	PH6920	PH6125	PH6930	PH6135
--------	--------	--------	--------	--------	--------

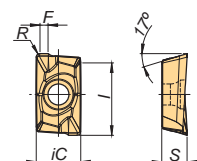
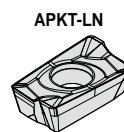
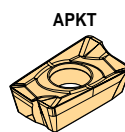

Description	Geometry Code	PH6910	PH6325	PH6920	PH6125	PH6930	PH6135	Cutting Edge / Geometry	iC	S	L	R	F
APKT 160408 PDER	111-1073-	54			78		86	Hone	0.372	0.210	0.629	0.631	0.069
APKT 160408 PDTR	111-0937-						86	T-Land					
APKT 160416 PDFR	111-1049-			68				Hone	0.372	0.210	0.629	0.629	0.047
APKT 160416 PDER	111-1074-			68				Hone					
APKT 160416 PDTR	111-0988-				78			T-Land					
APKT 160416 PDSR	111-1050-			68	78	66		T-Land & Hone	0.372	0.210	0.629	0.126	-
APKT 160432 PDER	111-1075-			68				Hone					
APKT 160432 PDTR	111-1051-						86	T-Land					
APKT 160432 PDSR	111-1052-			68	78		86	T-Land & Hone					

To order please use the geometry code plus the grade code

Note: Additional Inserts available in AP90 Milling Section (pages XXX)



TP-90 R8 Shank End Mills

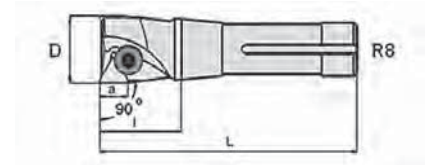

MILLING

Part Number	Description	Number of Inserts	Effective Teeth	D	d	L	l	Insert Screw Part Number	Wrench Part Number	Shank Style	ap Max	Insert Style
6-901-510	TPG-D1.00-R8-5.4-2-2	2	2	1.00	0.949	5.38	1.33	6-999-262	6-999-583	R8	0.437	TPG/TPU-22
6-901-515	TPG-D1.25-R8-5.6-2-3	2	2	1.25	0.949	5.58	1.52	6-999-270	6-999-584	R8	0.656	TPG/TPU-32
6-901-520	TPG-D1.50-R8-5.6-3-3	3	3	1.50	0.949	5.58	1.52	6-999-268				
6-901-525	TPG-D1.75-R8-5.6-3-3	3	3	1.75	0.949	5.58	1.52	6-999-270				
6-901-530	TPG-D2.00-R8-5.6-3-3	3	3	2.00								
6-901-535	TPG-D2.50-R8-5.6-4-3	4	4	2.50								
6-901-540	TPG-D3.00-R8-5.6-5-3	5	5	3.00								

See next page for inserts

Spare Parts Part Number	Description	Torque
6-999-262	Insert Clamping Screw M5 x 0.8 L-8.0 mm	6Nm
6-999-583	3 mm Hex Wrench	
6-999-268	Insert Clamping Screw M6 x 0.75 L-8.0mm	8Nm
6-999-270	Insert Clamping Screw M6 x 0.75 L-12.0mm	8Nm
6-999-584	4 mm Hex Wrench	
290-ASEIZE-03	Thread Anti-Seize 3-gm pack	

Spare Parts Part Number	Sets Available
6-901-5501	R8 End Mill Set, 1 1/4in, 1 1/2in, 2in
6-901-5505	R8 End Mill Set, 2in, 2 1/2in, 3in



R8 Shank Tools

Cutting Tools

MILLING



palbit 90° Lead High Performance Carbide Inserts

	Primary Applications							
Steel	•	•	•	•	•	•	•	•
Stainless Steel	•	•	•	•	•	•	•	•
Cast Irons	•	•	•	•	•	•	•	•
Non-Ferrous	•	•	•	•	•	•	•	•
Heat Resistant Alloys	•	•	•	•	•	•	•	•

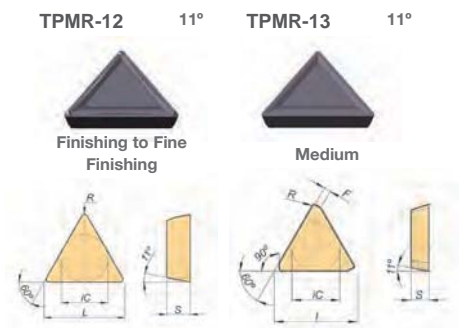

Description	Geometry Code	PVD Coated				MTCVD Coated	Uncoated			Features	Cutting Edge/Geometry	iC	S	I	R	F
		PH6215	PH6920	PH6125	PH6135	PH5125	PH0910	PH0120	PH0320							
TPMR 222-12	112-0743-	56								Utility w Top Form	-12	0.250	0.125	0.4	0.031	-
TPMR 222-13	112-0744-	56							Utility w Top Form	-13						
TPMR 321-12	112-0745-		68							Utility w Top Form	-13	0.375	0.125	0.6	0.015	-
TPGN 322	111-0426-		68				10	02	09	Precision Flat Top	-	0.375	0.125	0.6	0.031	-
TPMR 322-12	112-0748-							02	Utility w Top Form	-12						
TPMR 322-13	112-0749-		68						Utility w Top Form	-13						
TPGN 323	111-0427-			78						Precision Flat Top	-	0.375	0.125	0.6	0.047	-
TPKN 32 PDTR TPKN 1603 PDTR	111-0455-		68		86					Flatted Corner, R.H.	T-Land	0.375	0.125	0.6	0.028	0.047
TPKR 32 PDSR TPKR 1603 PDSR	111-0476-				86				Flatted Corner, R.H w Top Form	T-Land & Hone						
TPGN 432	111-0431-	56								Precision Flat Top	-	0.500	0.187	0.8	0.031	-
TPKR 43 PDSR TPKR 2204 PDSR	111-0477-				86					Flat Corner with Top Form	T-Land & Hone					

Note: Additional TPGN, TPUN and TPMS inserts can be located in the Turning Insert section of the catalog, pages XXX
To order please use the **geometry code** plus the **grade code**



SFM calculated by RPM and Cutter Diameter								
CUTTER DIAMETER								
RPM	1.00	1.25	1.50	1.75	2.00	2.50	3.00	
50							39	High Temp Alloys
75						49	59	
100						52	66	
150		49	59	69		79	98	118
200	52	66	79	92	105	131	157	Stainless Steels
250	66	82	98	115	131	164	197	
300	79	98	118	138	157	197	236	Steels and Irons
350	92	115	138	160	183	229	275	
400	105	131	157	183	210	262	314	
500	131	164	197	229	262	328	393	
600	157	197	236	275	314	393	472	
700	183	229	275	321	367	459	550	
800	210	262	314	367	419	524	629	
900	236	295	354	413	472	590	707	
1000	262	328	393	459	524	655	786	
1100	288	360	432	504	576	721	865	
1200	314	393	472	550	629	786	943	
1300	341	426	511	596	681	852	1022	
1400	367	459	550	642	734	917	1100	
1500	393	491	590	688	786	983	1179	
1600	419	524	629	734	838	1048	1258	
1700	445	557	668	779	891	1114	1336	
1800	472	590	707	825	943	1179	1415	
1900	498	622	747	871	996	1245	1493	
2000	524	655	786	917	1048	1310	1572	
2100	550	688	825	963	1100	1376	1651	
2200	576	721	865	1009	1153	1441	1729	
2300	603	753	904	1055	1205	1507	1808	
2400	629	786	943	1100	1258	1572	1886	
2500	655	819	983	1146	1310	1638	1965	
2600	681	852	1022	1192	1362	1703	2044	
2700	707	884	1061	1238	1415	1769	2122	
2800	734	917	1100	1284	1467	1834	2201	
2900	760	950	1140	1330	1520	1900	2279	
3000	786	983	1179	1376	1572	1965	2358	
3100	812	1015	1218	1421	1624	2031	2437	
3200	838	1048	1258	1467	1677	2096	2515	
3300	865	1081	1297	1513	1729	2162	2594	

Example:
 1.50 (6-941-115) diameter cutter , 4-flute, with Grade PH6920 (111-1073-68) to machine Ductile Iron at 230 SFM, 0.004 ipt, 0.150 DOC

1. Select Speed for material to be cut directly under cutter diameter.
2. determine RPM.

Important Safety Notes:

Always follow machine tool manufacturer’s recommendations. Estimating the power required for machining should always be done prior to any machining to avoid damaging the machine and/or personal injury. Always ensure that inserts are properly seated and secured prior to spinning cutter to avoid inserts from becoming a danger to equipment and personnel. Always utilize protective guarding - Hardened tools may fracture during machining and become dangerous projectiles.

HP of the motor is not the same as HP at the spindle. Some loss of power due to machine efficiency and general wear should be considered. A 2 HP machine will have less than 2HP at the spindle.

- HP est. =WOC x DOC x IPM x PF
- WOC = Width of Cut (in)
- DOC - Depth of Cut (in)
- IPM= Inch Per Minute (Table speed in/min)
- PF = Material Power Factor (see Chart HP(min/in3))

Material Power Factor HP(min/in3)	
Aluminum	0.25
Brass	0.33
Brass - Hard	0.50
Bronze	0.71
Bronze - Hard	1.54
Cast Iron (<200BHN)	0.67
Cast Iron (>200BHN)	1.00
Ductile Iron	0.80
Steel (100 BHN)	1.25
Steel (150 BHN)	1.43
Steel (200 BHN)	1.54
Steel (250 BHN)	1.67
Steel (300 BHN)	1.82
Steel (400 BHN)	2.00
Stainless Steels	1.28
HTA	1.58



R8 Shank Tools

Cutting Tools

MILLING

Speeds by Grade

Material	Speed SFM (m/min)										
	PVD COATED (Increasing Toughness →)						CVD Coated (Increasing Toughness →)			Uncoated (Increasing Toughness →)	
	PH6910	PH6215	PH6315	PH6920	PH6125	PH6135	PH3125	PH3225	PH3235	PH0910	PH0135
P Low Carbon Steels	590-750 (180-230)			550-680 (170-210)	520-620 (160-190)	490-590 (150-180)	390-490 (120-150)	390-490 (120-150)	290-390 (90-120)		200-300 (60-90)
	550-680 (170-210)			520-720 (160-200)	460-590 (140-180)	460-550 (140-170)	290-390 (90-120)	290-390 (90-120)	200-300 (60-90)		150-250 (50-80)
	520-720 (160-200)			460-620 (140-190)	420-520 (130-160)	390-490 (120-150)					
M Ferritic and Martensitic		300-450 (90-140)		490-620 (150-190)			315-400 (100-120)	170-350 (50-110)	150-300 (50-90)		
		150-350 (50-110)		330-520 (100-160)			170-350 (50-110)	150-300 (50-90)	100-200 (30-60)		
		100-300 (30-90)		330-490 (100-150)			150-300 (50-90)	100-200 (30-60)	75-150 (25-50)		
K Gray Iron Class 25-35	590-850 (180-260)		490-850 (150-260)	490-750 (130-230)						280-420 (85-130)	
	490-680 (150-210)		490-720 (150-220)	420-680 (130-200)						210-390 (65-120)	
	290-620 (90-190)		260-590 (80-180)	230-520 (70-160)						160-260 (50-80)	
N Aluminum < 8% Si										2630-3070 (810-945)	
										1320-1530 (405-470)	
										800-930 (245-285)	
S Iron Based	100-200 (30-60)			100-200 (30-60)	100-160 (30-50)						
	70-230 (20-70)			70-230 (20-70)	70-200 (20-60)						
	130-290 (40-90)			130-290 (40-90)	130-230 (40-70)						
H Steels Rc > 50											

P = Steel

M = Stainless Steel

K = Cast Iron

N = Aluminum

S = High-Temp Alloy

H = Hard Steel

Feeds by Insert Style and Edge Preparation

Material		Feed ipt (mm/tooth)							
		Geometry / Edge Preparation (Increasing Toughness →)							
		TPG/TPU Uncoated Grades	TPG/TPU PVD Coated Grades	TPG/TPU CVD Coated Grades	APKT 1604 PDFR-AL	APKT 1604 PDFR(X)	APKT 1604 PDER(X)	APKT 1604 PDTR(X)	APKT 1604 PDSR(X)
P	Low Carbon Steels								
	Alloy Steels	0.002-0.005 (0.05-0.13)	0.003-0.006 (0.08-0.15)	0.003-0.004 (0.08-0.10)			0.003-0.012 (0.07-0.25)	0.004-0.012 (0.10-0.25)	0.004-0.012 (0.10-0.25)
	Tool Steels								
M	Ferritic and Martensitic								
	Austenitic	0.002-0.004 (0.05-0.10)	0.003-0.005 (0.08-0.13)	0.003-0.005 (0.08-0.13)		0.002-0.004 (0.05-0.10)	0.003-0.004 (0.07-0.10)	0.003-0.006 (0.08-0.15)	0.004-0.008 (0.10-0.20)
	PH and Duplex								
K	Gray Iron Class 25-35								
	Cast Iron Class 45	0.002-0.005 (0.05-0.13)	0.003-0.008 (0.08-0.20)	0.003-0.008 (0.08-0.20)			0.003-0.012 (0.07-0.25)	0.004-0.012 (0.10-0.25)	0.004-0.012 (0.10-0.25)
	Ductile Iron								
N	Aluminum < 8% Si								
	Copper and Brass	0.002-0.010 (0.05-0.25)			0.004-0.013 (0.10-0.33)				
	Aluminum > 8% Si								
S	Iron Based								
	Nickel and Cobalt Based	0.002-0.004 (0.05-0.10)	0.002-0.006 (0.05-0.15)				0.003-0.004 (0.07-0.10)	0.003-0.006 (0.08-0.15)	0.004-0.008 (0.1-0.20)
	Titanium Alloys								
H	Steels Rc > 50								
	Stainless Steels Rc > 45								
	Tool Steels RC > 50								

P = Steel	M = Stainless Steel	K = Cast Iron	N = Aluminum	S = High-Temp Alloy	H = Hard Steel
-----------	---------------------	---------------	--------------	---------------------	----------------



Utility Milling Inserts

Cutting Tools

MILLING



Negative Square Utility Inserts, SNGN/SNUN

	Primary Applications			
Steel	•	•	•	•
Stainless Steel	•	•		
Cast Irons	•	•	•	•
Non-Ferrous			•	•
Heat Resistant Alloys				

TMX			
CVD Increasing Toughness →		Uncoated Increasing Toughness →	
C2 TiN	C5 TiN	C2	C5



Description	Geometry Code	C2 TiN	C5 TiN	C2	C5	Application	Feed Rate – in (mm)	DOC – in (mm)
SNGN 421 SNGN 120304	6-SNG-421		LA	2	5	Flat-Top	0.002-0.010 (0.05-0.25)	0.008-0.177 (0.20-4.5)

To order please use the **geometry code** plus the **grade code**

TMX			
CVD Increasing Toughness →		Uncoated Increasing Toughness →	
C2 TiN	C5 TiN	C2	C5

Description	Geometry Code	C2 TiN	C5 TiN	C2	C5	Application	Feed Rate – in (mm)	DOC – in (mm)
SNGN 422 SNGN 120308	6-SNG-422		LA	2	5	Flat-Top	0.003-0.015 (0.08-0.38)	0.008-0.177 (0.20-4.5)

To order please use the **geometry code** plus the **grade code**



Negative Square Utility Inserts, SNGN/SNUN (continued)

		Primary Applications						
Steel		•	•	•	•			•
Stainless Steel		•	•	•	•			•
Cast Irons		•	•			•	•	
Non-Ferrous							•	•
Heat Resistant Alloys				•		•		
		TMX		Palbit			TMX	
		CVD Increasing Toughness →		PVD Coated Increasing Toughness →		Uncoated Increasing Toughness →		
		C2 TiN	C5 TiN	PH6125	PH6135	PH0905	C2	C5



Description	Geometry Code	C2 TiN	C5 TiN	PH6125	PH6135	PH0905	C2	C5	Application	Feed Rate – in (mm)	DOC – in (mm)
SNGN 433 SNGN 120412	6-SNG-433		LA				2	5	Flat-Top	0.003-0.018 (0.08-0.46)	0.008-0.197 (0.20-5.0)
	112-0544-			78	86						

To order please use the **geometry code** plus the **grade code**

		TMX		Palbit			TMX				
		CVD Increasing Toughness →		PVD Coated Increasing Toughness →		Uncoated Increasing Toughness →					
		C2 TiN	C5 TiN	PH6125	PH6135	PH0905	C2	C5			
SNUN 434 SNUN 120416	6-SNG-434		LA				2	5	Flat-Top	0.006-0.024 (0.15-0.60)	0.008-0.197 (0.20-5.0)
	112-0547-				86						

To order please use the **geometry code** plus the **grade code**

MILLING



Utility Milling Inserts

Cutting Tools

MILLING



Negative Square Utility Inserts, SNGN/SNUN (continued)

Primary Applications					
Steel	•	•	•	•	
Stainless Steel	•	•			
Cast Irons	•	•		•	
Non-Ferrous				•	
Heat Resistant Alloys			•		
	TMX		Palbit	TMX	
	CVD Increasing Toughness →		PVD Coated Increasing Toughness →	Uncoated Increasing Toughness →	
	C2 TIN	C5 TIN	PH6125	C2	C5



Description	Geometry Code	C2 TIN	C5 TIN	PH6125	C2	C5	Application	Feed Rate – in (mm)	DOC – in (mm)
SNUN 632 SNUN 190408	6-SNG-632		LA		2	5	Flat-Top	0.006-0.020 (0.15-0.50)	0.118-0.394 (3.00-10.0)
	112-0553-			78					

To order please use the **geometry code** plus the **grade code**

TMX	Palbit	TMX
CVD Increasing Toughness →	PVD Coated Increasing Toughness →	Uncoated Increasing Toughness →
C2 TIN	C5 TIN	PH6125

Description	Geometry Code	C2 TIN	C5 TIN	PH6125	C2	C5	Application	Feed Rate – in (mm)	DOC – in (mm)
SNGN 633 SNGN 1904012	6-SNG-633		LA		2	5	Flat-Top	0.009-0.031 (0.25-0.80)	0.118-0.394 (3.00-10.0)

To order please use the **geometry code** plus the **grade code**

TMX	Palbit	TMX
CVD Increasing Toughness →	PVD Coated Increasing Toughness →	Uncoated Increasing Toughness →
C2 TIN	C5 TIN	PH6125

Description	Geometry Code	C2 TIN	C5 TIN	PH6125	C2	C5	Application	Feed Rate – in (mm)	DOC – in (mm)
SNGN 634 SNGN 1904016	6-SNG-634		LA		2	5	Flat-Top	0.012-0.031 (0.30-1.07)	0.118-0.394 (3.00-10.0)

To order please use the **geometry code** plus the **grade code**



Positive Square Utility Inserts, SPGN/SPUN

Primary Applications				
Steel	•	•	•	•
Stainless Steel	•	•	•	•
Cast Irons	•	•	•	•
Non-Ferrous	•	•	•	•
Heat Resistant Alloys	•	•	•	•
	TMX		Palbit	TMX
	CVD Increasing Toughness →		PVD Increasing Toughness →	Uncoated Increasing Toughness →
	C2 TiN	C5 TiN	PH6125	C2 C5

Description	Geometry Code	C2 TiN		C5 TiN	PH6125	C2 C5		Application		Feed Rate – in (mm) (0.08-0.23)	DOC – in (mm) (0.25-2.00)
SPUN 321 SPUN 090304	6-SPG-321			LA		2	5	Flat Top	GROUND		

To order please use the **geometry code** plus the **grade code**

TMX		Palbit	TMX	
CVD Increasing Toughness →		PVD Increasing Toughness →	Uncoated Increasing Toughness →	
C2 TiN	C5 TiN	PH6125	C2	C5

Description	Geometry Code	C2 TiN		C5 TiN	PH6125	C2 C5		Application		Feed Rate – in (mm) (0.08-0.25)	DOC – in (mm) (0.25-3.00)
SPGN 322 SPGN 090308	6-SPG-322			LA		2	5	Flat Top	GROUND		

To order please use the **geometry code** plus the **grade code**

TMX		Palbit	TMX	
CVD Increasing Toughness →		PVD Increasing Toughness →	Uncoated Increasing Toughness →	
C2 TiN	C5 TiN	PH6125	C2	C5

Description	Geometry Code	C2 TiN		C5 TiN	PH6125	C2 C5		Application		Feed Rate – in (mm) (0.08-0.25)	DOC – in (mm) (0.25-4.00)
SPGN 421 SPGN 120304	6-SPG-421			LA		2	5	Flat Top	GROUND		

To order please use the **geometry code** plus the **grade code**



Utility Milling Inserts

Cutting Tools

MILLING



Positive Square Utility Inserts, SPGN/SPUN (continued)

Primary Applications										
Steel	•	•	•	•	•	•	•	•	•	•
Stainless Steel	•	•	•	•	•	•	•	•	•	•
Cast Irons	•	•	•	•	•	•	•	•	•	•
Non-Ferrous	•	•	•	•	•	•	•	•	•	•
Heat Resistant Alloys	•	•	•	•	•	•	•	•	•	•
	TMX		Palbit				TMX		Palbit	
	CVD Increasing Toughness →		PVD Increasing Toughness →				Uncoated Increasing Toughness →			
	C2 TiN	C5 TiN	PH6920	PH6225	PH6125	PH6135	PH0905	C2	C5	PH0320

Description	Geometry Code										Application		Feed Rate – in (mm)	DOC – in (mm)	
		C2 TiN	C5 TiN	PH6920	PH6225	PH6125	PH6135	PH0905	C2	C5	PH0320				
SPGN 422 SPGN 120308	6-SPG-422		LA						2	5		Flat Top	GROUND	0.003-0.015 (0.08-0.38)	0.020-0.157 (0.50-4.00)
	111-0300-			68											
SPUN 422 SPUN 120308	6-SPU-422		LA						2	5		Long Chip	GENERAL PURPOSE TOP FORM	0.003-0.015 (0.08-0.38)	0.020-0.157 (0.50-4.00)
	112-0581-				78		07			09					

To order please use the **geometry code** plus the **grade code**



Positive Square Utility Inserts, SPGN/SPUN (continued)

		Primary Applications										
Steel		•	•	•	•			•				
Stainless Steel		•	•	•	•			•				
Cast Irons		•	•	•	•			•				
Non-Ferrous		•	•	•	•			•				
Heat Resistant Alloys		•	•	•	•			•				
		TMX		PVD			TMX					
		CVD Increasing Toughness →		PVD Increasing Toughness →			Uncoated Increasing Toughness →					
Description	Geometry Code	C2 TiN	C5 TiN	PH6125	PH6135	PH0905	C2	C5	Application		Feed Rate – in (mm)	DOC – in (mm)
SPGN 423 SPGN 120312	6-SPG-423		LA				2	5	Flat Top	GROUND	0.006-0.018 (0.16-0.46)	0.020-0.157 (0.50-4.00)
SPUN 423 SPUN 120312	6-SPU-423		LA				2		Long Chip	GENERAL PURPOSE TOP FORM		
	112-0583-			78	86							

To order please use the **geometry code** plus the **grade code**

		TMX		PVD			TMX					
		CVD Increasing Toughness →		PVD Increasing Toughness →			Uncoated Increasing Toughness →					
Description	Geometry Code	C2 TiN	C5 TiN	PH6125	PH6135	PH0905	C2	C5	Application		Feed Rate – in (mm)	DOC – in (mm)
SPGN 424 SPGN 120316	6-SPG-424		LA				2	5	Flat Top	GROUND	0.008-0.020 (0.20-0.50)	0.020-0.118 (0.50-3.00)
SPUN 424 SPUN 120316	112-0926-			78					Long Chip	GENERAL PURPOSE TOP FORM		

To order please use the **geometry code** plus the **grade code**

		TMX		PVD			TMX					
		CVD Increasing Toughness →		PVD Increasing Toughness →			Uncoated Increasing Toughness →					
Description	Geometry Code	C2 TiN	C5 TiN	PH6125	PH6135	PH0905	C2	C5	Application		Feed Rate – in (mm)	DOC – in (mm)
SPGN 432 SPGN 120408	6-SPG-432		LA				2	5	Flat Top	GROUND	0.003-0.018 (0.08-0.46)	0.020-0.197 (0.50-5.00)
SPUN 432 SPUN 120408	6-SPU-432		LA				2	5	Long Chip	GENERAL PURPOSE TOP FORM		

To order please use the **geometry code** plus the **grade code**



Utility Milling Inserts

Cutting Tools

MILLING



Positive Square Utility Inserts, SPGN/SPUN (continued)

Primary Applications										
Steel	•	•	•	•	•	•	•	•	•	
Stainless Steel	•	•	•	•	•	•	•	•	•	
Cast Irons	•	•	•	•	•	•	•	•	•	
Non-Ferrous	•	•	•	•	•	•	•	•	•	
Heat Resistant Alloys	•	•	•	•	•	•	•	•	•	
	TMX		Palbit			TMX		Palbit		
	CVD Increasing Toughness →		PVD Increasing Toughness →		Uncoated Increasing Toughness →					
	C2 TIN	C5 TIN	PH6135	PH0905	C2	C5	PH0320	PH0125	PH0230	PH0135

Description	Geometry Code	C2 TIN		C5 TIN	PH6135	PH0905	C2	C5	PH0320	PH0125	PH0230	PH0135	Application		Feed Rate – in (mm)	DOC – in (mm)
													Flat Top	GROUND		
SPGN 433 SPGN 120412	6-SPG-433			LA			2	5							0.006-0.018 (0.16-0.46)	0.020-0.197 (0.50-5.00)

To order please use the **geometry code** plus the **grade code**

TMX		Palbit			TMX		Palbit			
CVD Increasing Toughness →		PVD Increasing Toughness →			Uncoated Increasing Toughness →					
C2 TIN	C5 TIN	PH6135	PH0905	C2	C5	PH0320	PH0125	PH0230	PH0135	

Description	Geometry Code	C2 TIN		C5 TIN	PH6135	PH0905	C2	C5	PH0320	PH0125	PH0230	PH0135	Application		Feed Rate – in (mm)	DOC – in (mm)
													Flat Top	GROUND		
SPGN 434 SPGN 120416	6-SPG-434			LA			2	5							0.008-0.020 (0.20-0.50)	0.020-0.197 (0.50-5.00)

To order please use the **geometry code** plus the **grade code**

TMX		Palbit			TMX		Palbit			
CVD Increasing Toughness →		PVD Increasing Toughness →			Uncoated Increasing Toughness →					
C2 TIN	C5 TIN	PH6135	PH0905	C2	C5	PH0320	PH0125	PH0230	PH0135	

Description	Geometry Code	C2 TIN		C5 TIN	PH6135	PH0905	C2	C5	PH0320	PH0125	PH0230	PH0135	Application		Feed Rate – in (mm)	DOC – in (mm)
													Flat Top	GROUND		
SPGN 533 SPGN 150412	6-SPG-533			LA			2	5							0.006-0.018 (0.16-0.46)	0.020-0.197 (0.50-5.00)
SPUN 533 SPUN 150412	6-SPU-533			LA			2	5					Long Chip	GENERAL PURPOSE TOP FORM		
	112-0595-				86											

To order please use the **geometry code** plus the **grade code**



Positive Square Utility Inserts, SPGN/SPUN (continued)

Primary Applications										
Steel	•	•	•	•	•	•	•	•	•	•
Stainless Steel	•	•	•							
Cast Irons	•	•	•	•	•	•	•	•	•	•
Non-Ferrous				•	•					•
Heat Resistant Alloys				•						
	TMX		Palbit			TMX		Palbit		
	CVD Increasing Toughness →		PVD Increasing Toughness →		Uncoated Increasing Toughness →					
	C2 TiN	C5 TiN	PH6135	PH0905	C2	C5	PH0320	PH0125	PH0230	PH0135

Description	Geometry Code										Application	Feed Rate – in (mm)	DOC – in (mm)	
		C2 TiN	C5 TiN	PH6135	PH0905	C2	C5	PH0320	PH0125	PH0230				PH0135
SPGN 632 SPGN 190408	6-SPG-632		LA			2	5					Flat Top	0.003-0.018 (0.08-0.46)	0.020-0.197 (0.50-5.00)
SPUN 632 SPUN 150408	6-SPU-632		LA			2	5					Long Chip		
	112-0597-			86										

To order please use the **geometry code** plus the **grade code**

		TMX		Palbit			TMX		Palbit		
		CVD Increasing Toughness →		PVD Increasing Toughness →		Uncoated Increasing Toughness →					
		C2 TiN	C5 TiN	PH6135	PH0905	C2	C5	PH0320	PH0125	PH0230	PH0135

Description	Geometry Code										Application	Feed Rate – in (mm)	DOC – in (mm)	
		C2 TiN	C5 TiN	PH6135	PH0905	C2	C5	PH0320	PH0125	PH0230				PH0135
SPGN 633 SPGN 190412	6-SPG-633		LA			2						Flat Top	0.006-0.018 (0.16-0.46)	0.020-0.197 (0.50-5.00)
SPUN 633 SPUN 150412	6-SPU-633		LA			2	5					Long Chip		
	112-0598-			86							14			

To order please use the **geometry code** plus the **grade code**



Utility Milling Inserts

Cutting Tools

MILLING



Positive Square Utility Inserts, SPGN/SPUN (continued)

	Primary Applications			
Steel	•	•	•	•
Stainless Steel	•	•		
Cast Irons	•	•	•	•
Non-Ferrous			•	•
Heat Resistant Alloys				
	TMX			
	CVD Increasing Toughness →		Uncoated Increasing Toughness →	
	C2 TiN	C5 TiN	C2	C5

Description	Geometry Code	CVD		Uncoated		Application		Feed Rate – in (mm)	DOC – in (mm)
		C2 TiN	C5 TiN	C2	C5				
SPGN 634 SPGN 190416	6-SPG-634		LA	2	5	Flat Top	GROUND	0.008-0.020 (0.20-0.50)	0.020-0.197 (0.50-5.00)
SPUN 634 SPUN 150416	6-SPU-634		LA			Long Chip	GENERAL PURPOSE TOP FORM		

To order please use the geometry code plus the grade code



Positive Square Utility Inserts, SDNT

		Primary Applications			
Steel		•	•	•	•
Stainless Steel		•	•	•	•
Cast Irons		•	•	•	•
Non-Ferrous		•	•	•	•
Heat Resistant Alloys		•	•	•	•
		Palbit			
		PVD Increasing Toughness →			
		PH6920	PH6125	PH6135	PH6740

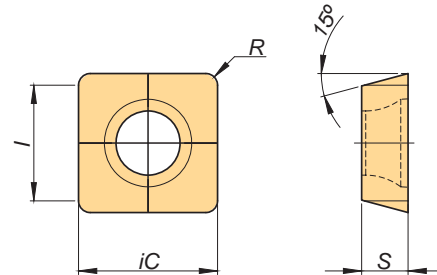

Description	Geometry Code	PH6920	PH6125	PH6135	PH6740	Geometry	iC	S	I	R	F
SDNT 322 SDNT 090308	111-0204-		78			Top Form	0.375	0.125	0.650	0.031	-

To order please use the **geometry code** plus the **grade code**



90° Lead Standard Carbide

		Primary Applications			
		Coated		Uncoated	
Steel		•	•	•	•
Stainless Steel		•	•	•	•
Cast Irons		•	•	•	•
Non-Ferrous		•	•	•	•
		TMX			
		C2 TiN	C5 TiN	C2	C5

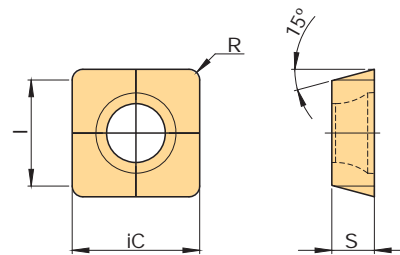

Description	Geometry Code	C2 TiN	C5 TiN	C2	C5	iC	S	I	R
SPMT 32.51	6-SPMT-3251					0.250	0.156	0.375	0.016
SPMT 32.52	6-SPMT-3252	H	LA	2	5				0.031
SPMT 431	6-SPMT-431	H	LA	2	5	0.375	0.187	0.500	0.016
SPMT 432	6-SPMT-432	H	LA	2	5				0.031

To order please use the **geometry code** plus the **grade code**



Utility Milling Inserts

Cutting Tools

MILLING



Positive Triangular Utility Inserts, TPKN

	Primary Applications			
Steel	•	•	•	•
Stainless Steel	•	•	•	•
Cast Irons	•	•	•	•
Non-Ferrous	•	•	•	•
Heat Resistant Alloys	•	•	•	•

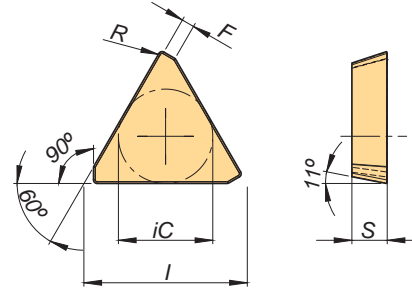

Description	Geometry Code	Palbit				Geometry	iC	S	I	R	F
		PH6920	PH6125	PH6135	PH6740						
TPKN 32 PDTR TPKN 1603 PDTR	111-0455-	68				T-Land	0.375	0.125	0.650	0.028	0.047

To order please use the geometry code plus the grade code

Description	Geometry Code	Palbit				Geometry	iC	S	I	R	F
		PH6920	PH6125	PH6135	PH6740						
TPKN 43 PDSR TPKN 2204 PDSR	111-0467-				15	T-Land & Hone	0.500	0.187	0.866	0.020	0.067

To order please use the geometry code plus the grade code



Positive Triangular Utility Inserts, TPGN/TPUN/TPMR

	Primary Applications			
Steel	•	•	•	•
Stainless Steel	•	•	•	•
Cast Irons	•	•	•	•
Non-Ferrous	•	•	•	•
Heat Resistant Alloys	•	•	•	•

TMX			
CVD Increasing Toughness		Uncoated Increasing Toughness	
C2	C5	C	C5

Description	Geometry Code	TMX				Application		Feed Rate – in (mm)	DOC – in (mm)
		C2	C5	C	C5				
TPGN 221 TPGN 110304	6-TPG-221		LA	2	5	Flat Top	GROUND	0.003-0.009 (0.08-0.23)	0.009-0.079 (0.25-2.00)
TPUN 221 TPUN 110304	6-TPU-221		LA	2	5	Flat Top	UTILITY	0.003-0.009 (0.08-0.23)	0.009-0.079 (0.25-2.00)
TPMR 221 TPMR 110304	6-TPM-221		LA	2	5	Short Chip	FINISHING	0.003-0.009 (0.08-0.23)	0.009-0.079 (0.25-2.00)

To order please use the geometry code plus the grade code



Positive Triangular Utility Inserts, TPGN/TPUN/TPMR (continued)

		Primary Applications								
		Steel								
		Stainless Steel								
		Cast Irons								
		Non-Ferrous								
		Heat Resistant Alloys								
			TMX		Palbit		TMX			
			CVD Increasing Toughness →		PVD Increasing Toughness →		Uncoated Increasing Toughness →			
Description	Geometry Code	C2 TiN	C5 TiN	PH6215	C2	C5	Application		Feed Rate – in (mm)	DOC – in (mm)
TPGN 222 TPGN 110308	6-TPG-222				2	5	Flat Top	GROUND	0.003-0.009 (0.08-0.23)	0.009-0.079 (0.25-2.00)
TPUN 222 TPUN 110308	6-TPU-222		LA		2	5	Flat Top	UTILITY		
TPMR 222 TPMR 110308	112-0743-			56			Short Chip	FINISHING		
TPMR 222-13 TPMR 110308-13	112-0744-			56			Short Chip	GENERAL PURPOSE		

To order please use the **geometry code** plus the **grade code**

		Primary Applications								
		Steel								
		Stainless Steel								
		Cast Irons								
		Non-Ferrous								
		Heat Resistant Alloys								
			TMX		Palbit		TMX			
			CVD Increasing Toughness →		PVD Increasing Toughness →		Uncoated Increasing Toughness →			
Description	Geometry Code	C2 TiN	C5 TiN	PH6215	C2	C5	Application		Feed Rate – in (mm)	DOC – in (mm)
TPGN 320 TPGN 160300	6-TPG-320		LA		2	5	Flat Top	GROUND	0.003-0.009 (0.08-0.23)	0.009-0.079 (0.25-2.00)

To order please use the **geometry code** plus the **grade code**



Utility Milling Inserts

Cutting Tools

MILLING



Positive Triangular Utility Inserts, TPGN/TPUN/TPMR (continued)

Primary Applications											
Steel	•	•	•	•	•	•	•	•	•	•	•
Stainless Steel	•	•	•	•	•	•	•	•	•	•	•
Cast Irons	•	•	•	•	•	•	•	•	•	•	•
Non-Ferrous	•	•	•	•	•	•	•	•	•	•	•
Heat Resistant Alloys	•	•	•	•	•	•	•	•	•	•	•
	TMX		Palbit				TMX		Palbit		
	CVD Increasing Toughness →		PVD Increasing Toughness →			Uncoated Increasing Toughness →					
	C2 TiN	C5 TiN	PH6920	PH6225	PH6125	PH0309	PH0910	C2	C5	PH0120	PH0135

Description	Geometry Code											Application	Feed Rate - in (mm)	DOC - in (mm)		
		C2 TiN	C5 TiN	PH6920	PH6225	PH6125	PH0309	PH0910	C2	C5	PH0120				PH0135	
TPGN 321 TPGN 160304	6-TPG-321		LA						2	5			Flat Top	GROUND	0.003-0.009 (0.08-0.23)	0.009-0.079 (0.25-2.00)
	111-0425-						08	10			02					
TPUN 321 TPUN 160304	6-TPU-321		LA						2	5			Flat Top	UTILITY		
	112-0765-			68		78						14				
TPMR 321 TPMR 160304	6-TPM-321		LA						2	5			Short Chip	FINISHING		
	112-0745-			68												

To order please use the **geometry code** plus the **grade code**



Positive Triangular Utility Inserts, TPGN/TPUN/TPMR (continued)

Steel	•	•					•	•	•	•	•	•
Stainless Steel	•	•										
Cast Irons	•	•				•	•	•	•	•	•	•
Non-Ferrous					•	•	•					•
Heat Resistant Alloys												
	TMX		Palbit				TMX		Palbit			
	CVD Increasing Toughness →		PVD Increasing Toughness →		Uncoated Increasing Toughness →							
	C2 TiN	C5 TiN	PH6920	PH0910	C2	C5	PH0120	PH0320	PH0125	PH0230	PH0135	

Description	Geometry Code			PH6920	PH0910	C2	C5	PH0120	PH0320	PH0125	PH0230	PH0135	Application		Feed Rate – in (mm) (0.08-0.23)	DOC – in (mm) (0.25-2.00)
		C2 TiN	C5 TiN													
TPGN 322 TPGN 160308	6-TPG-322		LA			2	5						Flat Top	GROUND	0.003-0.009 (0.08-0.23)	0.009-0.079 (0.25-2.00)
	111-0426-				10				09							
TPUN 322 TPUN 160308	6-TPU-322		LA			2	5						Flat Top	UTILITY		
	TPMR 322 TPMR 160308	6-TPM-322	LA			2	5						Short Chip	FINISHING		
TPMR 322-13 TPMR 160308-13	112-0749-			68					02					GENERAL PURPOSE		

To order please use the **geometry code** plus the **grade code**



Utility Milling Inserts

Cutting Tools

MILLING



Positive Triangular Utility Inserts, TPGN/TPUN/TPMR (continued)

Primary Applications				
Steel	•	•	•	•
Stainless Steel	•	•	•	•
Cast Irons	•	•	•	•
Non-Ferrous	•	•	•	•
Heat Resistant Alloys	•	•	•	•
TMX				
	CVD Increasing Toughness →		Uncoated Increasing Toughness →	
	C2 TiN	C5 TiN	♁	♁

Description	Geometry Code	TMX		♁	♁	Application	Feed Rate – in (mm)	DOC – in (mm)
		C2 TiN	C5 TiN					
TPUN 323 TPUN 160312	6-TPU-323		LA	2	5	Flat Top UTILITY	0.003-0.009 (0.08-0.23)	0.009-0.079 (0.25-2.00)

To order please use the **geometry code** plus the **grade code**

TMX				
	CVD Increasing Toughness →		Uncoated Increasing Toughness →	
	C2 TiN	C5 TiN	♁	♁

Description	Geometry Code	TMX		♁	♁	Application	Feed Rate – in (mm)	DOC – in (mm)
		C2 TiN	C5 TiN					
TPGN 324 TPGN 160316	6-TPG-34		LA	2	5	Flat Top GROUND	0.003-0.009 (0.08-0.23)	0.009-0.079 (0.25-2.00)
TPUN 324 TPUN 160316	6-TPU-324		LA	2	5	Flat Top UTILITY	0.003-0.009 (0.08-0.23)	0.009-0.079 (0.25-2.00)

To order please use the **geometry code** plus the **grade code**



Positive Triangular Utility Inserts, TPGN/TPUN/TPMR (continued)

		Primary Applications								
		Steel	Stainless Steel	Cast Irons	Non-Ferrous	Heat Resistant Alloys				
		TMX	Palbit	TMX						
		CVD Increasing Toughness →	PVD Increasing Toughness →	Uncoated Increasing Toughness →						
Description	Geometry Code	C2 TIN	C5 TIN	PH0910	2	5	Application		Feed Rate – in (mm)	DOC – in (mm)
TPGN 430 TPGN 220400	6-TPG-430		LA		2	5	Flat Top	GROUND	0.003-0.009 (0.08-0.23)	0.009-0.079 (0.25-2.00)

To order please use the **geometry code** plus the **grade code**

		TMX	Palbit	TMX						
		CVD Increasing Toughness →	PVD Increasing Toughness →	Uncoated Increasing Toughness →						
Description	Geometry Code	C2 TIN	C5 TIN	PH6920	2	5	Application		Feed Rate – in (mm)	DOC – in (mm)
TPGN 431 TPGN 220404	6-TPG-431		LA		2	5	Flat Top	GROUND	0.003-0.009 (0.08-0.23)	0.009-0.079 (0.25-2.00)

To order please use the **geometry code** plus the **grade code**



Utility Milling Inserts

Cutting Tools

MILLING



Positive Triangular Utility Inserts, TPGN/TPUN/TPMR (continued)

Primary Applications								
Steel	•	•	•	•	•	•	•	•
Stainless Steel	•	•	•	•	•	•	•	•
Cast Irons	•	•	•	•	•	•	•	•
Non-Ferrous	•	•	•	•	•	•	•	•
Heat Resistant Alloys	•	•	•	•	•	•	•	•
	TMX		Palbit			TMX		Palbit
	CVD Increasing Toughness →		PVD Increasing Toughness →			Uncoated Increasing Toughness →		
	C2 TiN	C5 TiN	PH6215	PH6125	PH6135	C2	C5	PH0320

Description	Geometry Code	C2 TiN		C5 TiN			C2		C5	PH0320	Application	Feed Rate – in (mm)	DOC – in (mm)	
			LA	PH6215	PH6125	PH6135								
TPGN 432 TPGN 220408	6-TPG-432		LA				2	5			Flat Top	GROUND	0.003-0.009 (0.08-0.23)	0.009-0.079 (0.25-2.00)
	111-0431-			56										
TPUN 432 TPUN 220408	6-TPU-432		LA				2	5						
	112-0779-				78					09				

To order please use the **geometry code** plus the **grade code**

TMX		Palbit			TMX		Palbit
CVD Increasing Toughness →		PVD Increasing Toughness →			Uncoated Increasing Toughness →		
C2 TiN	C5 TiN	PH6215	PH6125	PH6135	C2	C5	PH0320

Description	Geometry Code	C2 TiN		C5 TiN			C2		C5	PH0320	Application	Feed Rate – in (mm)	DOC – in (mm)	
			LA	PH6215	PH6125	PH6135								
TPGN 433 TPGN 220412	6-TPG-433		LA				2	5			Flat Top	GROUND	0.003-0.009 (0.08-0.23)	0.009-0.079 (0.25-2.00)
TPUN 433 TPUN 220412	6-TPU-433		LA				2	5						
	112-0783-					86								

To order please use the **geometry code** plus the **grade code**



Milling Formulas

U.S. Units

SPEED

$$SFM = 0.262 \times RPM \times DIA$$

$$RPM = 3.820 \times SFM / DIA$$

METRIC

$$SMM = \pi / 1000 \times RPM \times DIA$$

$$RPM = 1000 / \pi \times SMM / DIA$$

FEED

(ipt) $f_T = f_m / Z \times RPM$

(ipm) $f_m = f_T \times Z \times RPM$

(in/REV) $f_{REV} = f_m / RPM$

(mm/tooth) $f_T = f_m / Z \times RPM$

(mm/minute) $f_m = f_T \times Z \times RPM$

(mm/REV) $f_{REV} = f_m / RPM$

Feed Rate correction if $WOC \leq DIA/2$

$$f_{mc} = DIA \times f_T \times Z \times RPM / 2 \times \sqrt{(DIA - WOC) \times WOC}$$

$$f_{mc} = DIA \times f_m / 2 \times \sqrt{(DIA - WOC) \times WOC}$$

SFM = Surface Feet per Minute

SMM = Surface Meters per Minute

DIA = Diameter of the cutter

RPM = Rotations per Minute

Z = Number of Teeth

ipt = inch per tooth

f_T = feed per tooth (in or mm)

ipm = inch per minute

f_m = feed per minute (in or mm)

f_{mc} = Corrected feed per minute (in or mm)

WOC = Width of Cut

f_{REV} = feed per revolution (in or mm)

Used for determining wiper coverage



Milling Formulas

Cutting Tools

MILLING

Correction Factors for Large Radii

Due to the large radius of Button style inserts, the feed rate should be adjusted when the depth-of-cut (DOC) is less than 1/2 the insert diameter.

If the width-of-cut (WOC) is less than half the cutter diameter, the feed rate should be adjusted. In some applications, both factors should be applied.

CF DOC = Correction Factor for the Depth of Cut
 Ins Dia = Insert Diameter
 DOC = Depth of Cut

$$CF\ DOC = \frac{\frac{1}{2} * (Ins\ Dia / DOC)}{\sqrt{\left(\frac{Ins\ Dia}{DOC}\right)^2 - 1}}$$

Feed Rate Correction Factor (CF) for DOC (inch)					
DOC (inch)	Radius				
	0.064	0.125	0.197	0.236	0.315
0.010	1.86	2.55	3.18	3.47	4.00
0.025	1.26	1.67	2.05	2.23	2.56
0.050	1.02	1.25	1.50	1.62	1.85
0.100	1.21	1.02	1.15	1.22	1.37
0.150		1.02	1.03	1.07	1.17
0.200				1.01	1.07
0.250					1.02
0.300					1.00

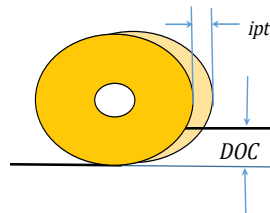

Example: Cutter Diameter = 2" 241-0535-00 (5 flutes)
 WOC = 0.125
 DOC = 0.050
 Insert Size 12 (0.472")
 Desired Feed rate = 0.006 ipt

From the table Feed Rate Correction Factor for DOC
 CF DOC = 1.62

From the table Feed Rate Correction Factor (CF) for WOC
 CF WOC = 2.066

The corrected Feed Rate is = 0.006 x 1.62 x 2.066
 = 0.020 ipt

Correction Factors for Width of Cut (WOC) Less than 1/2 Diameter

In Face milling when the width of cut is less than 1/2 the diameter of the cutter, the feed rate may need to be increased to maintain proper chip load. To determine the correction factor locate the cutter diameter along the top then locate the width-of-cut (WOC) along the left side of the table. The intersection of these two is the correction factor. Multiple this time your feed to determine the corrected feed to program into the machine. This can be calculated by using the formula given below the table.

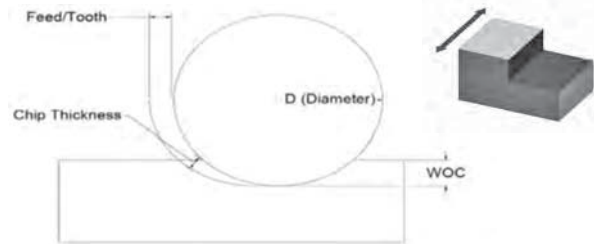

Feed Rate Correction Factor (CF) for WOC													
Cutter Diameter (D) (inch)													
WOC (inch)	0.375	0.500	0.625	0.750	1.00	1.25	1.50	2.00	2.50	3.00	4.00	5.00	6.00
0.025	2.004	2.294	2.552	2.785	3.203	3.571	3.906	4.500	5.025	5.500	6.344	7.089	7.762
0.050	1.471	1.667	1.843	2.004	2.294	2.552	2.785	3.203	3.571	3.906	4.500	5.025	5.500
0.075	1.250	1.400	1.539	1.667	1.898	2.105	2.294	2.632	2.931	3.203	3.686	4.113	4.500
0.100	1.131	1.250	1.364	1.471	1.667	1.843	2.004	2.294	2.552	2.785	3.203	3.571	3.906
0.125	1.061	1.155	1.250	1.342	1.512	1.667	1.809	2.066	2.294	2.502	2.874	3.203	3.501
0.150	1.021	1.091	1.171	1.250	1.400	1.539	1.667	1.898	2.105	2.294	2.632	2.931	3.203
0.175	1.002	1.048	1.114	1.182	1.316	1.441	1.558	1.769	1.960	2.133	2.445	2.721	2.971
0.250		1.000	1.021	1.061	1.155	1.250	1.342	1.512	1.667	1.809	2.066	2.294	2.502
0.500					1.000	1.021	1.061	1.155	1.250	1.342	1.512	1.667	1.809
0.750							1.000	1.033	1.091	1.155	1.281	1.400	1.512
1.000								1.000	1.021	1.061	1.155	1.250	1.342
1.250									1.000	1.014	1.079	1.155	1.231
1.500										1.000	1.033	1.091	1.155
2.000											1.000	1.021	1.061
2.500												1.000	1.014
3.000													1.000

$$CFWOC = \frac{[D/WOC]}{2 + \sqrt{\frac{D}{WOC} - 1}}$$

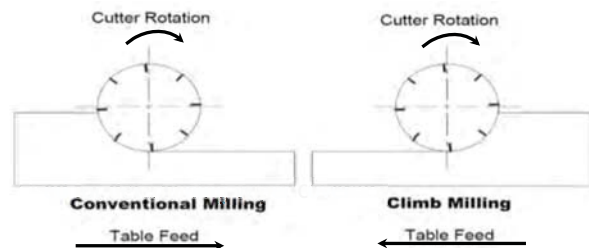

TABLE OF CONTENTS

TURNING INSERTS

Turning Inserts Technical Data 92

NEGATIVE INSERTS

CNMG/CNMA	97
DNMG/DNMA	102
RNMG	106
SNMG/SNMA	107
SNGN/SNUN	112
TNMG/TNMA	115
VNMG/VNMA	121
WNMG/WNMA	122

POSITIVE INSERTS

CCMT/CCGT	126
DCMT/DCGT	131
RPGN	134
SCMT	135
SPGN/SPUN	136
SPMR	141
SPMT/SPGH	143
TCMT/TCGT	145
TPGN/TPUN	148
TPMR	152
TPEE/TPGC/TPGH	154
VBMT	157
VCMT/VCGT	158

Turning Tools (see page 161)

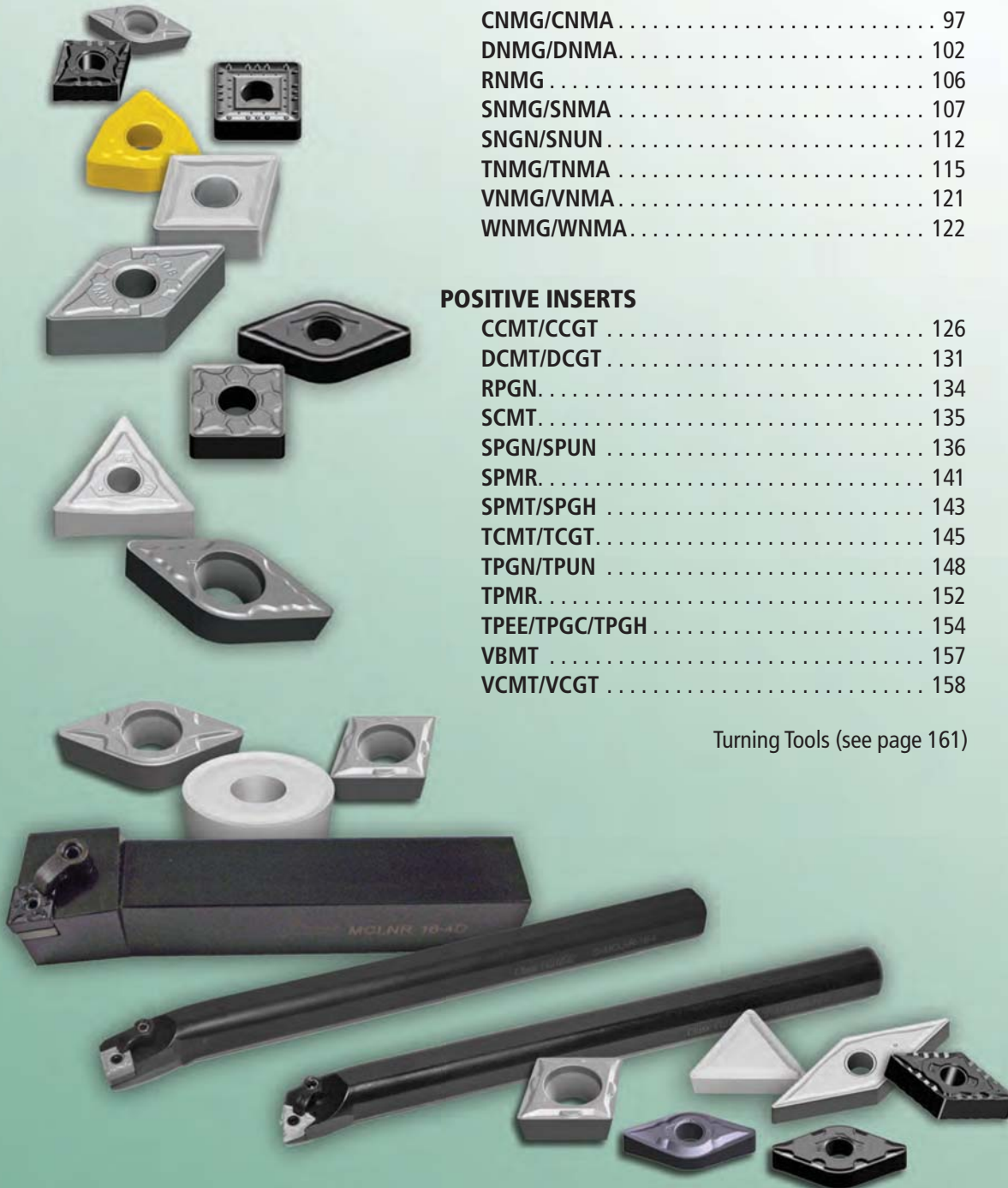



Turning Inserts – Technical Reference

Cutting Tools

Chip Breaker Summary – Negative Turning Inserts

TURNING

Application	Designation	Primary Materials	Feed Range	Doc Range	CNMG	DNMG	RNMG	SNMG	TNMG	VNMG	WNMG
FINISHING	HA	P	0.002-0.024 (0.05-0.06)	0.004-0.157 (0.10-4.00)							
		M									
		K									
		N									
	MF	P	0.002-0.024 (0.05-0.06)	0.004-0.157 (0.10-4.00)							
		M									
		K									
		N									
MEDIUM TO FINISHING	MS	P	0.004-0.031 (0.10-0.80)	0.008-0.394 (0.20-10.00)							
		M									
		K									
		N									
MEDIUM	ST	P	0.005-0.063 (0.10-1.60)	0.006-0.413 (0.15-10.50)							
		M									
		K									
		N									
MEDIUM WIPER	MW	P	0.006-0.043 (0.15-1.10)	0.008-0.276 (0.20-7.00)							
		M									
		K									
		N									
MEDIUM TO ROUGHING	MR	P	0.004-0.028 (0.10-0.70)	0.016-0.394 (0.40-10.00)							
		M									
		K									
		N									
	SS	P	0.004-0.039 (0.10-1.00)	0.012-0.370 (0.30-9.50)							
		M									
		K									
		N									
ROUGHING	HR	P	0.008-0.039 (0.20-1.00)	0.059-0.472 (1.50-12.00)							
		M									
		K									
		N									
	FLAT TOP	P	0.003-0.047 (0.08-1.19)	0.004-0.472 (0.10-12.00)							
		M									
		K									
		N									



Chip Breaker Summary – Positive Turning Inserts

Application	Top Form	Primary Materials	Feed Range	Doc Range	CCMT CCGT	DCMT DCGT	SCMT SCGT	SPMT SPMR SPGN SPUN	TCMT TCGT	TPMR TPGN TPGC TPGH TPEE	VBMT	VCMT	
FINE FINISHING	AK	P	0.001-0.020 (0.03-0.50)	0.004-0.200 (0.10-5.00)									
		M											
		K											
		N											
	LN	P	0.001-0.039 (0.03-1.00)	0.002-0.276 (0.05-7.00)									
		M											
		K											
		N											
	FP	P	0.002-0.024 (0.05-0.60)	0.004-0.157 (0.10-4.00)									
		M											
		K											
		N											
	FM	P	0.001-0.012 (0.03-0.005)	0.002-0.094 (0.05-2.40)									
		M											
		K											
		N											
	FK	P	0.001-0.012 (0.03-0.30)	0.002-0.094 (0.06-2.40)									
		M											
		K											
		N											
	FS	P	0.004-0.010 (0.10-0.25)	0.004-0.118 (0.10-3.00)									
		M											
		K											
		N											
FINISHING WIPER	P	0.006-0.043 (0.15-1.10)	0.008-0.276 (0.20-7.00)										
	M												
	K												
	N												
ROUGHING	P	0.002-0.017 (0.06-0.43)	0.007-0.142 (0.19-3.60)										
	M												
	K												
	N												
MM	P	0.002-0.017 (0.06-0.43)	0.007-0.142 (0.19-3.60)										
	M												
	K												
	N												
FINISHING	MK	P	0.002-0.017 (0.06-0.43)	0.007-0.142 (0.19-3.60)									
		M											
		K											
		N											
	MW	P	0.002-0.017 (0.06-0.43)	0.007-0.142 (0.19-3.60)									
		M											
		K											
		N											
	GENERAL PURPOSE	P	0.002-0.017 (0.06-0.43)	0.007-0.142 (0.19-3.60)									
		M											
		K											
		N											
FLAT TOP	P	0.002-0.017 (0.06-0.43)	0.007-0.142 (0.19-3.60)										
	M												
	K												
	N												

P = Steel M = Stainless Steel K = Cast Iron N = Aluminum S = High-Temp Alloy H = Hard Steel



Turning Inserts – Technical Reference

Cutting Tools

Grade Speeds

TURNING

Material	MTCVD (Increasing Toughness →)					CVD (Increasing Toughness →)	
	PH5705	PH5115	PH5320	PH5125	PH5740	C2 (TiN)	C5 (TiN)
P Low Carbon Steels		560-1150 (170-350)		490-965 (150-295)	430-890 (130-270)	460-720 (140-220)	460-720 (140-220)
	Alloy Steels	460-820 (140-250)		390-750 (120-230)	330-690 (100-210)	460-690 (140-210)	460-690 (140-210)
	Tool Steels	390-790 (120-240)		330-720 (100-220)	295-660 (90-200)	390-660 (120-200)	390-660 (120-200)
M Ferritic and Mar- tensitic		262-850 (80-260)		165-750 (50-230)	165-490 (50-150)	295-400 (90-155)	260-600 (80-260)
	Austenitic	262-950 (80-290)		180-790 (55-240)	165-660 (50-200)	295-400 (90-155)	260-400 (80-155)
	PH and Duplex	390-720 (120-220)		295-620 (90-190)	230-345 (70-105)		295-400 (90-155)
K Gray Iron Class 25-35	490-1150 (150-350)	390-820 (120-250)	490-980 (150-300)		360-660 (110-200)	390-690 (120-210)	390-690 (120-210)
	Cast Iron Class 45	390-1080 (120-330)	260-790 (80-240)	360-980 (110-300)		260-660 (80-200)	295-460 (90-140)
	Ductile Iron	390-820 (120-250)	260-660 (80-200)	360-720 (110-220)		260-620 (80-190)	330-660 (100-200)
N Aluminum < 8% Si							
	Copper and Brass						
	Aluminum > 8% Si						
S Iron Based							
	Nickel and Cobalt Based						
	Titanium Alloys						
H Alloy Steels Rc> 50							
	Stainless Steels Rc > 45						
	Tool Steels RC > 50						

Important Note: Speed range is given based on Ideal conditions. Please adjust the speed according to your conditions and set-up. Always follow Machine Tool Manufacturer's recommendations and safe machining practices.

P = Steel	M = Stainless Steel	K = Cast Iron	N = Aluminum	S = High-Temp Alloy	H = Hard Steel
-----------	---------------------	---------------	--------------	---------------------	----------------

Grade Speeds

TURNING

Material	PVD (Increasing Toughness →)							UNCOATED					
	PH6910	PH6705	PH6215	PH6325	PH6920	PH6225	PH6740	PH0705	PH0910	C2 PH0905 PH0309	PH0120 PH0320 PH0125	C5 PH0230 PH0135	HO1
P Low Carbon Steels	490-850 (150-260)		490-790 (150-240)		490-750 (150-230)	460-720 (140-220)	430-690 (130-210)			100-200 (30-60)	100-200 (30-60)	100-200 (30-60)	
	490-820 (150-250)		490-750 (150-230)		490-720 (150-220)	460-690 (140-210)	360-660 (110-200)			75-150 (20-45)	75-150 (20-45)	75-150 (20-45)	
	430-790 (130-240)		490-720 (130-220)		430-690 (130-210)	390-660 (120-200)	295-620 (90-190)						
M Ferritic and Martensitic	520-1080 (160-330)		390-1020 (120-310)		360-980 (110-300)	330-920 (100-280)	260-850 (80-260)						
	475-1350 (145-410)		390-850 (120-260)		360-735 (110-225)	330-720 (100-220)	260-660 (80-200)						
	590-1020 (180-315)		430-850 (130-260)		390-820 (120-250)	360-690 (110-210)	295-620 (90-190)						
K Gray Iron Class 25-35		660-1150 (200-350)		460-690 (140-210)	430-690 (130-210)		390-690 (120-210)	390-690 (120-210)		100-200 (30-60)	100-200 (30-60)	100-200 (30-60)	
		390-1080 (120-330)		520-720 (160-220)	360-690 (110-210)		295-460 (90-140)	295 - 140 (90-140)		75-150 (20-45)	75-150 (20-45)	75-150 (20-45)	
		390-820 (120-250)		520-720 (160-220)	360-690 (110-210)		330-660 (100-200)	330-460 (100-140)					
N Aluminum < 8% Si									130-3000 (40-1000)				130-1000 (40-300)
									115-2000 (35-630)	115-2000 (35-630)	115-2000 (35-630)	115-2000 (35-630)	115-660 (35-200)
S Iron Based		197-490 (60-150)			165-390 (50-120)								
		75-295 (24-90)			60-230 (19-70)								
					145-590 (45-180)				145-260 (45-80)	145-260 (45-80)	145-260 (45-80)	145-260 (45-80)	
H Alloy Steels Rc > 50													

Important Note: Speed range is given based on Ideal conditions. Please adjust the speed according to your conditions and set-up. Always follow Machine Tool Manufacturer's recommendations and safe machining practices.

P = Steel	M = Stainless Steel	K = Cast Iron	N = Aluminum	S = High-Temp Alloy	H = Hard Steel
-----------	---------------------	---------------	--------------	---------------------	----------------



Turning Inserts – Technical Reference

Cutting Tools

Grade Summary

TURNING

Grade	STEEL	STAINLESS STEEL	CAST IRONS	NON-FERROUS	HEAT RESISTANT ALLOYS (HRSA)	Coating / Substrate	Primary Application	
MTCVD	PH5705		K00 - K010			Medium Temperature CVD Coating with Al ₂ O ₃ and Ti(C,N)	Hard substrate for deformation resistance	Irons
	PH5115	P10 - P25	M10 - M20	K15 - K30	S10 - S20		Cobalt Gradient for enhanced Toughness	Steels and Irons
	PH5320			K10 - K30			Enhanced coating for Abrasive Materials	Irons
	PH5125	P15 - P30		K25 - K35			Superior toughness and deformation resistance	Steels
	PH5740	P25 - P45		K25 - K50			Medium WC gains size and Cobalt for heavy interruptions	Steels and Irons
PVD	PH6705		K05 - K15		S05 - S20	TiAlN SN	Ideal for high cutting speeds in Irons and HRSA	Irons and HRSA
	PH6910	P05 - P10	M05 - M10				Micro-grain Carbide -For light Turning	Steel and Stainless Steel
	PH6215	P10 - P25	M10 - M25				Good General Purpose Steel and Stainless Steel	Steel and Stainless Steel
	PH6315		M15 - M25	K10 - K30			Enhanced coating for Abrasive Materials	Irons and Stainless Steel
	PH6920	P10 - P35	M15 - M25	K10 - K30	S10 - S30		Excellent all-around grade	Steels, Stainless Steels, Irons, HRSA
	PH6325	P10-P30	M10-M30	K10 - K30	S05-S25	TiAlN	Fine Grain finishing to medium operation	Steel, Stainless Steels and Cast Iron
	PH6225	P15 - P30	M15 - M30			TiAlN SN	Good Shock Resistance at Moderate Speeds	
	PH6740	P25 - P50	M25 - M40	K25 - K45	S20 - S35		Extremely Tough grade for most materials	Steels, Stainless Steels, Irons, HRSA
Uncoated	PH0705		K10-K30		S10 - S30	Uncoated	Fine grain for machining nodular cast irons and light alloys	Cast Iron
	PH0910			N00 - N20	S05 - S10		Micro-grain Carbide - Good wear resistance and Tough	Aluminum, HSRA, Titanium
	HO1			N05 - N20			General Purpose Polish Carbide	Aluminum, HSRA, Titanium

Negative Turning Inserts



CNMG/CNMA Inserts

		Primary Applications																																	
		Steel	Steel	Steel	Steel	Steel	Steel	Steel	Steel	Steel	Steel	Stainless Steel	Stainless Steel	Stainless Steel	Stainless Steel	Stainless Steel	Stainless Steel	Cast Irons	Cast Irons	Cast Irons	Cast Irons	Cast Irons	Cast Irons	Non-Ferrous	Non-Ferrous	Non-Ferrous	Non-Ferrous	Non-Ferrous	Non-Ferrous	Heat Resistant Alloys	Heat Resistant Alloys	Heat Resistant Alloys	Heat Resistant Alloys	Heat Resistant Alloys	Heat Resistant Alloys
		Palbit										TMX																							
		MTCVD Increasing Toughness					PVD Coated Increasing Toughness					Uncoated																							
		PH5705	PH5115	PH5320	PH5125	PH5740	PH6705	PH6215	PH6325	PH6920	PH6225	PH6740	PH0705	PH0910	H01																				
CNMG 431 CNMG 120404	Description	Geometry Code														Application	Feed Rate – in (mm)	DOC – in (mm)																	
	CNMG 431-MF CNMG 120404-MF		L7		L8				67							Medium Finishing	0.002-0.008 (0.05-0.2)	0.004-0.060 (0.10-1.5)																	
	CNMG 431-MS CNMG 120404-MS								68							General Purpose Long Chip	0.004-0.007 (0.10-0.18)	0.008-0.140 (0.20-3.6)																	
	CNMG 431-ST CNMG 120404-ST			L6									25			General Purpose Short Chip	0.006-0.020 (0.15-0.5)	0.008-0.235 (0.20-6.0)																	
	CNMG 431-MR CNMG 120404-MR		L7		L8	L9			56							Medium Roughing	0.004-0.012 (0.10-0.3)	0.016-0.215 (0.40-5.5)																	
	CNMG 431-SS CNMG 120404-SS								56	68						Medium Roughing Long Chip	0.005-0.018 (0.12-0.45)	0.020-0.225 (0.50-5.7)																	

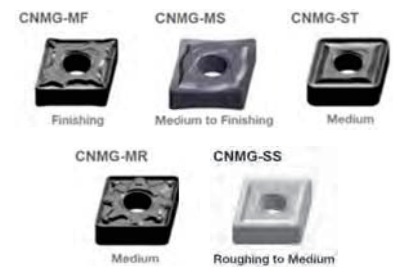

To order please use the geometry code plus the grade code

		Palbit										TMX						
		MTCVD Increasing Toughness					PVD Coated Increasing Toughness					Uncoated						
		PH5705	PH5115	PH5320	PH5125	PH5740	PH6705	PH6215	PH6325	PH6920	PH6225	PH6740	PH0705	PH0910	H01			
CNMG 432 CNMG 120408	Description	Geometry Code														Application	Feed Rate – in (mm)	DOC – in (mm)
	CNMG 432-MF CNMG 120408-MF		L7		L8				67	77						Medium Finishing	0.004-0.016 (0.10-0.40)	0.004-0.059 (0.10-1.50)
	CNMG 432-MS CNMG 120408-MS								68							General Purpose Long Chip	0.005-0.009 (0.13-0.24)	0.016-0.142 (0.40-3.60)
	CNMG 432-ST CNMG 120408-ST	L5		L6									25			General Purpose Short Chip	0.006-0.020 (0.15-0.50)	0.008-0.236 (0.20-6.00)
	CNMG 432-MR CNMG 120408-MR		L7	L6	L8	L9				77	I5					Medium Roughing	0.006-0.020 (0.15-0.50)	0.020-0.217 (0.50-5.50)
	CNMG 432-SS CNMG 120408-SS				L8	L9			56					10		Medium Roughing Long Chip	0.005-0.018 (0.12-0.45)	0.020-0.224 (0.50-5.70)
	CNMG 432-HR CNMG 120408-HR	L5	L7	L6	L8	L9										Roughing	0.008-0.024 (0.20-0.60)	0.079-0.299 (2.00-7.60)
	CNMA 432 CNMA 120408	L5		L6												FLAT TOP	0.006-0.024 (0.15-0.60)	0.004-0.299 (0.10-7.60)

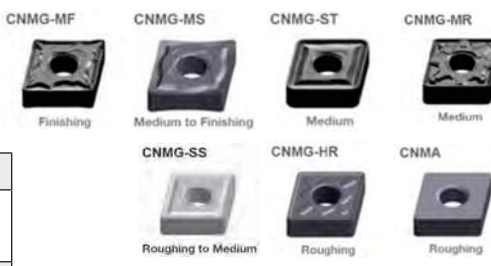

To order please use the geometry code plus the grade code

TURNING



Negative Turning Inserts

Cutting Tools

CNMG/CNMA Inserts (continued)

TURNING

	Primary Applications									
Steel	•	•	•	•	•	•	•	•	•	•
Stainless Steel	•	•	•	•	•	•	•	•	•	•
Cast Irons	•	•	•	•	•	•	•	•	•	•
Non-Ferrous	•	•	•	•	•	•	•	•	•	•
Heat Resistant Alloys	•	•	•	•	•	•	•	•	•	•

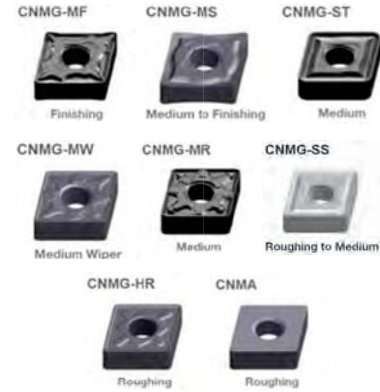

**CNMG 433
CNMG 120412**

Description	Geometry Code	Palbit										TMX				
		MTCVD Increasing Toughness					PVD Coated Increasing Toughness						Uncoated			
		PH5705	PH5115	PH5320	PH5125	PH5740	PH6705	PH6215	PH6325	PH6920	PH6225		PH6740	PH0705	PH0910	H01
CNMG 433-MF CNMG 120412-MF	112-1482-		L7	L8				56	67	77						
CNMG 433-MS CNMG 120412-MS	112-1483-							56	68							
CNMG 433-ST CNMG 120412-ST	112-1166-	L5	L7	L6									25			
CNMG 433-MW CNMG 120412-MW	112-1191-		L7													
CNMG 433-MR CNMG 120412-MR	112-1198-		L7		L8	L9		56		77	I5					
CNMG 433-SS CNMG 120412-SS	112-1202-				L8			56	68	77	I5		10			
CNMG 433-HR CNMG 120412-HR	112-1192-	L5	L7	L6	L8	L9		56		77	I5					
CNMA 433 CNMA 120412	112-0221-	L5		L6												

Application	Feed Rate – in (mm)	DOC – in (mm)
General Purpose Long Chip	0.006-0.012 (0.16-0.29)	0.016-0.142 (0.40-3.60)
General Purpose Short Chip	0.007-0.024 (0.18-0.60)	0.012-0.236 (0.30-6.00)
Wiper	0.008-0.035 (0.20-0.90)	0.031-0.236 (0.80-6.00)
Medium Roughing	0.006-0.020 (0.15-0.50)	0.031-0.217 (0.80-5.50)
Medium Roughing Long Chip	0.006-0.024 (0.15-0.60)	0.020-0.224 (0.50-5.70)
Roughing	0.008-0.024 (0.20-0.60)	0.079-0.299 (2.00-7.60)
FLAT TOP	0.008-0.031 (0.20-0.80)	0.004-0.299 (0.10-7.60)

To order please use the geometry code plus the grade code



**CNMG 434
CNMG 120416**

Description	Geometry Code	Palbit										TMX				
		MTCVD Increasing Toughness					PVD Coated Increasing Toughness						Uncoated			
		PH5705	PH5115	PH5320	PH5125	PH5740	PH6705	PH6215	PH6325	PH6920	PH6225		PH6740	PH0705	PH0910	H01
CNMG 434-MS CNMG 120416-MS	112-1486-								68							
CNMG 434-ST CNMG 120416-ST	112-1488-	L5		L6												
CNMG 434-MR CNMG 1200416-MR	112-1485-			L7			L9									
CNMG 434-HR CNMG 120416-HR	112-1484-	L5	L7													
CNMA 434 CNMA 120416	112-0223-	L5		L6												

Application	Feed Rate – in (mm)	DOC – in (mm)
General Purpose Short Chip	0.008-0.028 (0.20-0.70)	0.012-0.236 (0.30-6.00)
Medium Roughing	0.009-0.026 (0.23-0.65)	0.031-0.217 (0.80-5.50)
Roughing	0.010-0.028 (0.25-0.70)	0.079-0.299 (2.00-7.60)
FLAT TOP	0.008-0.039 (0.20-1.00)	0.004-0.299 (0.10-7.60)

To order please use the geometry code plus the grade code

CNMG/CNMA Inserts (continued)

		Primary Applications																
Steel		•	•	•	•	•	•	•	•	•	•							
Stainless Steel		•	•	•	•	•	•	•	•	•	•							
Cast Irons		•	•	•	•	•	•	•	•	•	•							
Non-Ferrous		•	•	•	•	•	•	•	•	•	•							
Heat Resistant Alloys		•	•	•	•	•	•	•	•	•	•							
		Palbit										TMX						
		MTCVD Increasing Toughness →					PVD Coated Increasing Toughness →					Uncoated						
		PH5705	PH5115	PH5320	PH5125	PH5740	PH6705	PH6215	PH6325	PH6920	PH6225	PH6740	PH0705	PH0910	H01			
Description	Geometry Code														Application	Feed Rate – in (mm)	DOC – in (mm)	
CNMG 542-MR CNMG 160608-MR	112-1239-		L7		L8											Medium Roughing	0.006-0.020 (0.15-0.50)	0.031-0.283 (0.50-7.20)
CNMG 542-SS CNMG 160608-SS	112-1332-				L8				68						Medium Roughing Long Chip	0.005-0.018 (0.12-0.45)	0.031-0.283 (0.50-7.20)	
CNMG 542-HR CNMG 160608-HR	112-1331-		L7		L8	L9									Roughing	0.013-0.024 (0.35-0.60)	0.079-0.335 (2.00-8.50)	

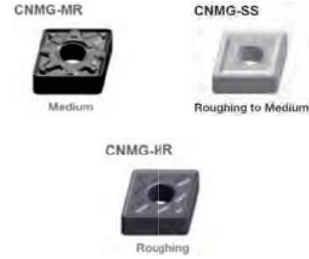

To order please use the geometry code plus the grade code

		Palbit										TMX						
		MTCVD Increasing Toughness →					PVD Coated Increasing Toughness →					Uncoated						
		PH5705	PH5115	PH5320	PH5125	PH5740	PH6705	PH6215	PH6325	PH6920	PH6225	PH6740	PH0705	PH0910	H01			
Description	Geometry Code														Application	Feed Rate – in (mm)	DOC – in (mm)	
CNMG 543-MR CNMG 160612-MR	112-1355-		L7		L8	L9										Medium Roughing	0.007-0.024 (0.18-0.60)	0.031-0.283 (0.80-7.20)
CNMG 543-ST CNMG 160612-ST	112-1303-			L6									25			General Purpose Short Chip	0.007-0.024 (0.18-0.60)	0.031-0.236 (0.80-6.00)
CNMG 543-SS CNMG 160612-SS	112-1333-												15			Medium Roughing Long Chip	0.007-0.024 (0.18-0.60)	0.020-0.283 (0.50-7.20)
CNMG 543-HR CNMG 160612-HR	112-1358-	L5	L7		L8	L9										Roughing	0.008-0.024 (0.20-0.60)	0.079-0.394 (2.00-10.00)
CNMA 543 CNMA 160612	122-0225-			L6												FLAT TOP	0.008-0.031 (0.20-0.80)	0.012-0.394 (0.30-10.00)



To order please use the geometry code plus the grade code



Negative Turning Inserts

Cutting Tools

TURNING

CNMG/CNMA Inserts (continued)

		Primary Applications										Palbit		TMX							
Steel		•	•	•	•	•	•	•	•	•	•	•	•	•							
Stainless Steel		•	•	•	•	•	•	•	•	•	•	•	•	•							
Cast Irons		•	•	•	•	•	•	•	•	•	•	•	•	•							
Non-Ferrous		•	•	•	•	•	•	•	•	•	•	•	•	•							
Heat Resistant Alloys		•	•	•	•	•	•	•	•	•	•	•	•	•							
		MTCVD Increasing Toughness →										PVD Coated Increasing Toughness →					Uncoated				
		PH5705	PH5115	PH5320	PH5125	PH5740	PH6705	PH6215	PH6325	PH6920	PH6225	PH6740	PH0910	H01							
Description	Geometry Code													Application	Feed Rate – in (mm)	DOC – in (mm)					
CNMG 544-MR CNMG 160616-MR	112-1490-		L7		L8	L9									↑ REDUCED CUTTING FORCES ↓ INCREASING TOUGHNESS	Medium Roughing	0.007-0.024 (0.18-0.60)	0.031-0.283 (0.80-7.20)			
CNMG 544-HR CNMG 160616-HR	112-1489-	L5			L8	L9						I5		Roughing		0.008-0.024 (0.20-0.60)	0.079-0.394 (2.00-10.00)				

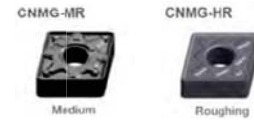

To order please use the geometry code plus the grade code

		Palbit										TMX						
		MTCVD Increasing Toughness →					PVD Coated Increasing Toughness →					Uncoated						
		PH5705	PH5115	PH5320	PH5125	PH5740	PH6705	PH6215	PH6325	PH6920	PH6225	PH6740	PH0910	H01				
Description	Geometry Code													Application	Feed Rate – in (mm)	DOC – in (mm)		
CNMG 643-MR CNMG 190612-MR	112-1302-		L7		L8	L9							I5		↑ REDUCED CUTTING FORCES ↓ INCREASING TOUGHNESS	Medium Roughing	0.007-0.024 (0.18-0.60)	0.031-0.283 (0.80-7.20)
CNMG 643-HR CNMG 190612-HR	112-1359-	L5	L7	L6	L8	L9						I5		Roughing		0.008-0.024 (0.20-0.60)	0.079-0.450 (2.00-11.40)	

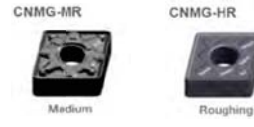

To order please use the geometry code plus the grade code

Negative Turning Inserts



CNMG/CNMA Inserts (continued)

		Primary Applications																	
	Steel	•	•	•	•	•	•	•	•	•	•	•	•	•	•	•	•		
	Stainless Steel	•	•	•	•	•	•	•	•	•	•	•	•	•	•	•	•		
	Cast Irons	•	•	•	•	•	•	•	•	•	•	•	•	•	•	•	•		
	Non-Ferrous	•	•	•	•	•	•	•	•	•	•	•	•	•	•	•	•		
	Heat Resistant Alloys	•	•	•	•	•	•	•	•	•	•	•	•	•	•	•	•		
		Palbit											TMX						
		MTCVD Increasing Toughness →					PVD Coated Increasing Toughness →					Uncoated →							
		PH5705	PH5115	PH5320	PH5125	PH5740	PH6705	PH6215	PH6325	PH6920	PH6225	PH6740	PH0910	H01					
Description	Geometry Code												Application	Feed Rate – in (mm)	DOC – in (mm)				
CNMG 644-MR CNMG 190616-MR	112-1301-		L7		L8	L9										↑ REDUCED CUTTING FORCES ↓ INCREASING TOUGHNESS	Medium Roughing	0.007-0.024 (0.18-0.60)	0.031-0.283 (0.80-7.20)
CNMG 644-HR CNMG 190616-HR	112-1360-	L5	L7	L6	L8	L9											Roughing	0.008-0.024 (0.20-0.60)	0.079-0.450 (2.00-11.40)



TURNING

To order please use the **geometry code** plus the **grade code**



Negative Turning Inserts

Cutting Tools

DNMG/ DNMA Inserts

TURNING

		Primary Applications																																	
		Steel	Steel	Steel	Steel	Steel	Steel	Steel	Steel	Steel	Steel	Stainless Steel	Stainless Steel	Stainless Steel	Stainless Steel	Stainless Steel	Stainless Steel	Cast Irons	Cast Irons	Cast Irons	Cast Irons	Cast Irons	Cast Irons	Non-Ferrous	Non-Ferrous	Non-Ferrous	Non-Ferrous	Non-Ferrous	Non-Ferrous	Heat Resistant Alloys	Heat Resistant Alloys	Heat Resistant Alloys	Heat Resistant Alloys	Heat Resistant Alloys	Heat Resistant Alloys
		Palbit										TMX																							
		MTCVD Increasing Toughness →					PVD Coated Increasing Toughness →					Uncoated																							
		PH5705	PH5115	PH5320	PH5125	PH5740	PH6705	PH6215	PH6325	PH6920	PH6225	PH6740	PH0910	H01																					
Description	Geometry Code																																		
DNMG 331-MF DNMG 110404-MF	112-1497-		L7		L8				56			77																							
DNMG 331-ST DNMG 110404-ST	112-1346-		L5																																
DNMG 331-MR DNMG 110404-MR	112-1498-		L7		L8							77																							

Application	Feed Rate – in (mm)	DOC – in (mm)
Medium Finishing	0.002-0.008 (0.05-0.2)	0.004-0.060 (0.10-1.5)
General Purpose Short Chip	0.002-0.008 (0.05-0.2)	0.008-0.138 (0.20-3.50)
Medium Roughing	0.004-0.012 (0.10-0.3)	0.016-0.197 (0.40-5.0)

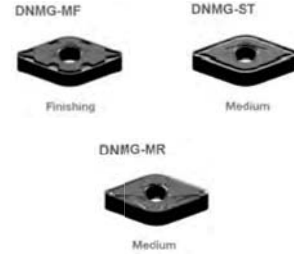

To order please use the geometry code plus the grade code

		Palbit										TMX		
		MTCVD Increasing Toughness →					PVD Coated Increasing Toughness →					Uncoated		
		PH5705	PH5115	PH5320	PH5125	PH5740	PH6705	PH6215	PH6325	PH6920	PH6225	PH6740	PH0910	H01
Description	Geometry Code													
DNMG 332-MF DNMG 110408-MF	112-1499-		L7		L8				56			77		
DNMG 332-ST DNMG 110408-ST	112-1347-		L5		L6									
DNMG 332-MR DNMG 110408-MR	112-1500-		L7		L8							77		
DNMG 332-SS DNMG 110408-SS	112-1501-							56	68					

Application	Feed Rate – in (mm)	DOC – in (mm)
Medium Finishing	0.004-0.016 (0.10-0.40)	0.004-0.060 (0.10-1.5)
General Purpose Short Chip	0.006-0.020 (0.15-0.50)	0.008-0.138 (0.20-3.50)
Medium Roughing	0.006-0.020 (0.15-0.50)	0.016-0.197 (0.40-5.0)
Medium Roughing Long Chip	0.005-0.018 (0.12-0.45)	0.020-0.173 (0.50-4.4)



To order please use the geometry code plus the grade code

DNMG/DNMA Inserts (continued)

		Primary Applications															
		Palbit										TMX					
		MTCVD Increasing Toughness →					PVD Coated Increasing Toughness →					Uncoated					
		PH5705	PH5115	PH5320	PH5125	PH5740	PH6705	PH6215	PH6325	PH6920	PH6225	PH6740	PH0910	H01			
Description	Geometry Code													Application	Feed Rate – in (mm)	DOC – in (mm)	
Steel		●	●	●	●	●	●	●	●	●	●	●					
Stainless Steel		●	●	●	●	●	●	●	●	●	●	●					
Cast Irons		●	●	●	●	●	●	●	●	●	●	●					
Non-Ferrous		●	●	●	●	●	●	●	●	●	●	●	●	●			
Heat Resistant Alloys		●	●	●	●	●	●	●	●	●	●	●					
		DNMG 431 DNMG 150404															
DNMG 431-HA DNMG 150404-HA	6-DNP-431													2	Aluminum	0.002-0.008 (0.05-0.2)	0.004-0.060 (0.10-1.5)
DNMG 431-MF DNMG 150404-MF	112-1502-		L7		L8										Medium Finishing		
DNMG 431-MS DNMG 150404-MS	112-1503-							56		68					General Purpose Long Chip	0.004-0.007 (0.10-0.18)	0.008-0.140 (0.20-3.6)
DNMG 431-ST DNMG 150404-ST	112-1255-		L5												General Purpose Short Chip	0.006-0.020 (0.15-0.5)	0.008-0.197 (0.20-5.0)
DNMG 431-MR DNMG 150404-MR	112-1218-		L7		L8	L9		56				77			Medium Roughing	0.004-0.012 (0.10-0.3)	0.016-0.215 (0.40-5.5)
DNMG 431-SS DNMG 150404-SS	112-1291-							56		68					Medium Roughing Long Chip	0.005-0.018 (0.12-0.45)	0.016-0.203 (0.40-5.16)



TURNING

To order please use the **geometry code** plus the **grade code**



Negative Turning Inserts

Cutting Tools

DNMG/DNMA Inserts (continued)

TURNING

	Primary Applications									
Steel	•	•	•	•	•	•	•	•	•	•
Stainless Steel	•	•	•	•	•	•	•	•	•	•
Cast Irons	•	•	•	•	•	•	•	•	•	•
Non-Ferrous	•	•	•	•	•	•	•	•	•	•
Heat Resistant Alloys	•	•	•	•	•	•	•	•	•	•



DNMG 432
DNMG 150408

Description	Geometry Code	Palbit										TMX	Application	Feed Rate – in (mm)	DOC – in (mm)			
		MTCVD Increasing Toughness →					PVD Coated Increasing Toughness →					Uncoated						
		PH5705	PH5115	PH5320	PH5125	PH5740	PH6705	PH6215	PH6325	PH6920	PH6225	PH6740				PH0910	H01	
DNMG 432-HA DNMG 150408-HA	6-DNP-432														2	Aluminum	0.004-0.016 (0.10-0.40)	0.004-0.059 (0.10-1.50)
DNMG 432-MF DNMG 150408-MF	112-1504-		L7		L8			56								Medium Finishing	0.004-0.016 (0.10-0.40)	0.004-0.059 (0.10-1.50)
DNMG 432-MS DNMG 150408-MS	112-1505-							56		68						General Purpose Long Chip	0.005-0.009 (0.13-0.24)	0.016-0.142 (0.40-3.60)
DNMG 432-ST DNMG 150408-ST	112-1256-		L5		L6											General Purpose Short Chip	0.006-0.020 (0.15-0.50)	0.008-0.276 (0.20-7.00)
DNMG 432-MR DNMG 150408-MR	112-1219-			L7		L8 L9		56								Medium Roughing	0.006-0.020 (0.15-0.50)	0.020-0.217 (0.50-6.00)
DNMG 432-SS DNMG 150408-SS	112-1292-							56		68	15					Medium Roughing Long Chip	0.005-0.018 (0.12-0.45)	0.020-0.224 (0.50-5.70)
DNMG 432-HR DNMG 150408-HR	112-1253-		L5	L7	L6	L8 L9		56								Roughing	0.008-0.024 (0.20-0.60)	0.079-0.295 (2.00-7.50)
DNMA 432 DNMA 150408	112-0313-		L5		L6											FLAT TOP	0.006-0.024 (0.15-0.60)	0.004-0.236 (0.10-6.00)

REDUCED CUTTING FORCES
↑
INCREASING TOUGHNESS
↓

To order please use the geometry code plus the grade code

DNMG/DNMA Inserts (continued)

		Primary Applications																
		Palbit										TMX						
		MTCVD Increasing Toughness →					PVD Coated Increasing Toughness →					Uncoated						
		PH5705	PH5115	PH5320	PH5125	PH5740	PH6705	PH6215	PH6325	PH6920	PH6225	PH6740	PH0910	H01				
Description	Geometry Code											Application			Feed Rate – in (mm)	DOC – in (mm)		
DNMG 433-MF DNMG 150412-MF	112-1507-		L7	L8				56							↑ REDUCED CUTTING FORCES ↓ INCREASING TOUGHNESS	Medium Finishing	0.008-0.024 (0.20-0.60)	0.004-0.059 (0.10-1.50)
DNMG 433-MS DNMG 150412-MS	112-1509-							56	68					General Purpose Long Chip		0.006-0.012 (0.16-0.29)	0.016-0.142 (0.40-3.60)	
DNMG 433-ST DNMG 150412-ST	112-1512-	L5		L6										General Purpose Short Chip		0.007-0.024 (0.18-0.60)	0.008-0.276 (0.20-7.00)	
DNMG 433-MR DNMG 150412-MR	112-1508-		L7		L8 L9			56		77	I5			Medium Roughing		0.006-0.020 (0.15-0.50)	0.020-0.217 (0.50-5.50)	
DNMG 433-SS DNMG 150412-SS	112-1511-							56	68					Medium Roughing Long Chip		0.006-0.024 (0.15-0.60)	0.020-0.224 (0.50-5.70)	
DNMG 433-HR DNMG 150412-HR	112-1506-				L8 L9			56		77	I5			Roughing		0.008-0.024 (0.20-0.60)	0.079-0.295 (2.00-7.50)	



TURNING

To order please use the **geometry code** plus the **grade code**



Negative Turning Inserts

Cutting Tools

RNMG Inserts

TURNING

Primary Applications													
Steel	•	•	•	•	•	•	•	•	•	•	•	•	
Stainless Steel	•	•	•	•	•	•	•	•	•	•	•	•	
Cast Irons	•	•	•	•	•	•	•	•	•	•	•	•	
Non-Ferrous	•	•	•	•	•	•	•	•	•	•	•	•	
Heat Resistant Alloys	•	•	•	•	•	•	•	•	•	•	•	•	
Palbit											TMX		
MTCVD Increasing Toughness →					PVD Coated Increasing Toughness →					Uncoated			
	PH5705	PH5115	PH5320	PH5125	PH5740	PH6910	PH6215	PH6325	PH6920	PH6225	PH6740	PH0910	H01

RNMG-ST



RNMG

Description	Geometry Code	PH5705	PH5115	PH5320	PH5125	PH5740	PH6910	PH6215	PH6325	PH6920	PH6225	PH6740	PH0910	H01	Application	Feed Rate – in (mm)	DOC – in (mm)
RNMG 32-ST RNMG 090300-ST	112-0439-					L9									General Purpose Short Chip	0.008-0.029 (0.20-0.70)	0.012-0.315 (0.30-8.0)
RNMG 43-ST RNMG 120400-ST	112-0440-				L8										General Purpose Short Chip	0.008-0.029 (0.20-0.70)	0.012-0.315 (0.30-8.0)
RNMG 53-ST RNMG 150600-ST	112-0441-				L8										General Purpose Short Chip	0.008-0.029 (0.20-0.70)	0.012-0.315 (0.30-8.0)
RNMG 64-ST RNMG 190600-ST	112-0442-				L8	L9	54								General Purpose Short Chip	0.008-0.029 (0.20-0.70)	0.012-0.315 (0.30-8.0)

SNMG/SNMA Inserts

		Primary Applications																																		
		Steel	Steel	Steel	Steel	Steel	Steel	Steel	Steel	Steel	Steel	Stainless Steel	Stainless Steel	Stainless Steel	Stainless Steel	Stainless Steel	Stainless Steel	Cast Irons	Cast Irons	Cast Irons	Cast Irons	Cast Irons	Cast Irons	Non-Ferrous	Non-Ferrous	Non-Ferrous	Non-Ferrous	Non-Ferrous	Non-Ferrous	Non-Ferrous	Heat Resistant Alloys	Heat Resistant Alloys	Heat Resistant Alloys	Heat Resistant Alloys	Heat Resistant Alloys	Heat Resistant Alloys
		Palbit										UC																								
		MTCVD Increasing Toughness →					PVD Coated Increasing Toughness →																													
		PH5705	PH5115	PH5320	PH5125	PH5740	PH6705	PH6215	PH6325	PH6920	PH6225	PH6740	PH0910																							
Description	Geometry Code											Application	Feed Rate – in (mm)	DOC – in (mm)																						
SNMA 322 SNMA 090308	112-0474-	L5		L6									Flat Top	.008-.024 (.20 - .60)	.016-.177 (.4 - 4.5)																					



To order please use the geometry code plus the grade code

		Palbit													
		MTCVD Increasing Toughness →					PVD Coated Increasing Toughness →					UC			
		PH5705	PH5115	PH5320	PH5125	PH5740	PH6705	PH6215	PH6325	PH6920	PH6225	PH6740	PH0910		
Description	Geometry Code											Application	Feed Rate – in (mm)	DOC – in (mm)	
SNMG 431-MF SNMG 120404-MF	112-1528-		L7		L8	L9		56			77		Medium Finishing	0.002-0.008 (0.05-0.2)	0.004-0.060 (0.10-1.5)
SNMG 431-MR SNMG 120404-MR	112-1529-		L7		L8	L9		56			77		Medium Roughing	0.004-0.012 (0.10-0.3)	0.016-0.215 (0.40-5.5)
SNMG 431-SS SNMG 120404-SS	112-1365-								68				Medium Roughing Long Chip	0.005-0.018 (0.12-0.45)	0.020-0.225 (0.50-5.7)



To order please use the geometry code plus the grade code



Negative Turning Inserts

Cutting Tools

SNMG/SNMA Inserts (continued)

TURNING

	Primary Applications									
Steel	•	•	•	•	•	•	•	•	•	•
Stainless Steel	•	•	•	•	•	•	•	•	•	•
Cast Irons	•	•	•	•	•	•	•	•	•	•
Non-Ferrous	•	•	•	•	•	•	•	•	•	•
Heat Resistant Alloys	•	•	•	•	•	•	•	•	•	•



SNMG 432 SNMG 120408

Description	Geometry Code	Palbit										Application	Feed Rate – in (mm)	DOC – in (mm)						
		MTCVD Increasing Toughness →					PVD Coated Increasing Toughness →								UC					
		PH5705	PH5115	PH5320	PH5125	PH5740	PH6705	PH6215	PH6325	PH6920	PH6225	PH6740	PH0910							
SNMG 432-MF SNMG 120408-MF	112-1530-		L7		L8							56			77		Medium Finishing	0.004-0.016 (0.10-0.40)	0.004-0.059 (0.10-1.50)	
SNMG 432-ST SNMG 120408-ST	112-1181-	L5			L6												General Purpose Short Chip	0.006-0.020 (0.15-0.50)	0.008-0.236 (0.20-6.00)	
SNMG 432-MR SNMG 120408-MR	112-1179-				L7	L8	L9					56				15	Medium Roughing	0.006-0.020 (0.15-0.50)	0.020-0.217 (0.50-5.50)	
SNMG 432-SS SNMG 120408-SS	112-1315-														68	15	Medium Roughing Long Chip	0.005-0.018 (0.12-0.45)	0.020-0.224 (0.50-5.70)	
SNMG 432-HR SNMG 120408-HR	112-1194-				L7	L6	L8	L9				56				77	15	Roughing	0.008-0.024 (0.20-0.60)	0.079-0.299 (2.00-7.60)
SNMA 432 SNMA 120408	112-0476-	L5			L6												FLAT TOP	0.006-0.024 (0.15-0.60)	0.004-0.299 (0.10-7.60)	

To order please use the geometry code plus the grade code



SNMG 433 SNMG 120412

Description	Geometry Code	Palbit										Application	Feed Rate – in (mm)	DOC – in (mm)						
		MTCVD Increasing Toughness →					PVD Coated Increasing Toughness →								UC					
		PH5705	PH5115	PH5320	PH5125	PH5740	PH6705	PH6215	PH6325	PH6920	PH6225	PH6740	PH0910							
SNMG 433-MF SNMG 120412-MF	112-1531-		L7		L8												Medium Finishing	0.008-0.024 (0.20-0.60)	0.004-0.079 (0.10-2.00)	
SNMG 433-ST SNMG 120412-ST	112-1310-	L5			L6												General Purpose Short Chip	0.007-0.024 (0.18-0.60)	0.012-0.236 (0.30-6.00)	
SNMG 433-MR SNMG 120412-MR	112-1311-				L7	L8	L9								77	15	Medium Roughing	0.006-0.020 (0.15-0.50)	0.031-0.217 (0.80-5.50)	
SNMG 433-SS SNMG 120412-SS	112-1366-														68	15	Medium Roughing Long Chip	0.006-0.024 (0.15-0.60)	0.020-0.224 (0.50-5.70)	
SNMG 433-HR SNMG 120412-HR	112-1195-				L7	L6	L8	L9				56				77	15	Roughing	0.008-0.024 (0.20-0.60)	0.079-0.299 (2.00-7.60)
SNMA 433 SNMA 120412	112-0478-	L5			L6												FLAT TOP	0.008-0.031 (0.20-0.80)	0.004-0.299 (0.10-7.60)	

To order please use the geometry code plus the grade code

SNMG/SNMA Inserts (continued)

		Primary Applications																																
		Steel	Steel	Steel	Steel	Steel	Steel	Steel	Steel	Steel	Steel	Stainless Steel	Stainless Steel	Stainless Steel	Stainless Steel	Stainless Steel	Cast Irons	Cast Irons	Cast Irons	Cast Irons	Cast Irons	Cast Irons	Non-Ferrous	Non-Ferrous	Non-Ferrous	Non-Ferrous	Non-Ferrous	Non-Ferrous	Heat Resistant Alloys	Heat Resistant Alloys	Heat Resistant Alloys	Heat Resistant Alloys	Heat Resistant Alloys	Heat Resistant Alloys
		Palbit																																
		MTCVD Increasing Toughness →					PVD Coated Increasing Toughness →					UC																						
		PH5705	PH5115	PH5320	PH5125	PH5740	PH6705	PH6215	PH6325	PH6920	PH6225	PH6740	PH0910																					
		SNMG 434 SNMG 120416																																
Description	Geometry Code																																	
SNMG 434-ST SNMG 120416-ST	112-1242-	L5	L6											General Purpose Short Chip	0.008-0.028 (0.20-0.70)	0.012-0.236 (0.30-6.00)																		
SNMG 434-MR SNMG 120416-MR	112-1357-				L8	L9								Medium Roughing	0.009-0.026 (0.23-0.65)	0.031-0.217 (0.80-5.50)																		
SNMG 434-HR SNMG 120416-HR	112-1361-	L5	L7	L6	L8	L9								Roughing	0.010-0.028 (0.25-0.70)	0.079-0.299 (2.00-7.60)																		
SNMA 434 SNMA 120416	112-0479-	L5	L6											FLAT TOP	0.008-0.039 (0.20-1.00)	0.004-0.299 (0.10-7.60)																		

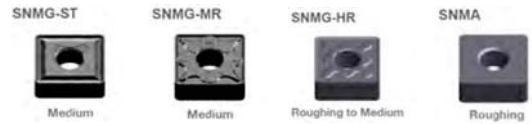

TURNING

To order please use the **geometry code** plus the **grade code**

		Palbit															
		MTCVD Increasing Toughness →					PVD Coated Increasing Toughness →					UC					
		PH5705	PH5115	PH5320	PH5125	PH5740	PH6705	PH6215	PH6325	PH6920	PH6225	PH6740	PH0910				
		SNMG 542 SNMG 150608															
Description	Geometry Code																
SNMG 542-MR SNMG 150608-MR	112-1533-		L7	L8	L9									Medium Roughing	0.006-0.020 (0.15-0.50)	0.031-0.283 (0.50-7.20)	

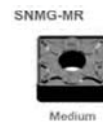

To order please use the **geometry code** plus the **grade code**



Negative Turning Inserts

Cutting Tools

SNMG/SNMA Inserts (continued)

TURNING

	Primary Applications									
Steel	•	•	•	•	•	•	•	•	•	•
Stainless Steel	•	•	•	•	•	•	•	•	•	•
Cast Irons	•	•	•	•	•	•	•	•	•	•
Non-Ferrous	•	•	•	•	•	•	•	•	•	•
Heat Resistant Alloys	•	•	•	•	•	•	•	•	•	•

Palbit											
MTCVD Increasing Toughness →					PVD Coated Increasing Toughness →					UC	
PH5705	PH5115	PH5320	PH5125	PH5740	PH6705	PH6215	PH6325	PH6920	PH6225	PH6740	PH0910

SNMG-MR



Medium

SNMG-HR



Roughing to Medium

SNMG 543
SNMG 150612

Description	Geometry Code											Application	Feed Rate – in (mm)	DOC – in (mm)			
		PH5705	PH5115	PH5320	PH5125	PH5740	PH6705	PH6215	PH6325	PH6920	PH6225				PH6740	PH0910	
SNMG 543-MR SNMG 150612-MR	112-1536-		L7		L8	L9								REDUCED CUTTING FORCES ↑ ↓ INCREASING TOUGHNESS	Medium Roughing	0.007-0.024 (0.18-0.60)	0.031-0.283 (0.80-7.20)
SNMG 543-HR SNMG 150612-HR	112-1535-				L8	L9									Roughing	0.008-0.024 (0.20-0.60)	0.079-0.394 (2.00-10.00)

To order please use the geometry code plus the grade code

SNMG 643
SNMG 190612

Palbit											
MTCVD Increasing Toughness →					PVD Coated Increasing Toughness →					UC	
PH5705	PH5115	PH5320	PH5125	PH5740	PH6705	PH6215	PH6325	PH6920	PH6225	PH6740	PH0910

SNMG-HR



Roughing to Medium

Description	Geometry Code											Application	Feed Rate – in (mm)	DOC – in (mm)		
		PH5705	PH5115	PH5320	PH5125	PH5740	PH6705	PH6215	PH6325	PH6920	PH6225				PH6740	PH0910
SNMG 643-HR SNMG 190612-HR	112-1542-											15		Roughing	0.008-0.024 (0.20-0.60)	0.079-0.450 (2.00-11.40)

To order please use the geometry code plus the grade code

SNMG/SNMA Inserts (continued)

		Primary Applications																				
		Steel	•	•	•	•	•	•	•	•	•	•	•	•	•	•	•	•	•	•	•	•
		Stainless Steel	•	•	•	•	•	•	•	•	•	•	•	•	•	•	•	•	•	•	•	•
		Cast Irons	•	•	•	•	•	•	•	•	•	•	•	•	•	•	•	•	•	•	•	•
		Non-Ferrous	•	•	•	•	•	•	•	•	•	•	•	•	•	•	•	•	•	•	•	•
		Heat Resistant Alloys	•	•	•	•	•	•	•	•	•	•	•	•	•	•	•	•	•	•	•	•
		Palbit																				
		MTCVD Increasing Toughness →					PVD Coated Increasing Toughness →					UC										
		PH5705	PH5115	PH5320	PH5125	PH5740	PH6705	PH6215	PH6325	PH6920	PH6225	PH6740	PH0910									
Description	Geometry Code												Application	Feed Rate – in (mm)	DOC – in (mm)							
		SNMG 644-SS SNMG 190616-SS	112-1547-															15	↑ REDUCED CUTTING FORCES ↓ INCREASING TOUGHNESS	Medium Roughing Long Chip	0.007-0.024 (0.18-0.60)	0.031-0.283 (0.80-7.20)
SNMG 644-HR SNMG 190616-HR	112-1545-												15	Roughing	0.008-0.024 (0.20-0.60)	0.079-0.450 (2.00-11.40)						

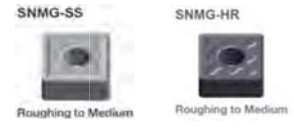

TURNING

To order please use the **geometry code** plus the **grade code**

		Palbit														
		MTCVD Increasing Toughness →					PVD Coated Increasing Toughness →					UC				
		PH5705	PH5115	PH5320	PH5125	PH5740	PH6705	PH6215	PH6325	PH6920	PH6225	PH6740	PH0910			
Description	Geometry Code												Application	Feed Rate – in (mm)	DOC – in (mm)	
		SNMG 866-HR SNMG 250924-HR	112-1638-													



To order please use the **geometry code** plus the **grade code**



Negative Turning Inserts

Cutting Tools

SNGN/SNUN Inserts

TURNING

	Primary Applications														
Steel	•	•	•	•	•	•	•	•	•	•	•	•	•	•	•
Stainless Steel	•	•	•	•	•	•	•	•	•	•	•	•	•	•	•
Cast Irons	•	•	•	•	•	•	•	•	•	•	•	•	•	•	•
Non-Ferrous	•	•	•	•	•	•	•	•	•	•	•	•	•	•	•
Heat Resistant Alloys	•	•	•	•	•	•	•	•	•	•	•	•	•	•	•

SNGN 421
SNGN 120304

Description	Geometry Code	Palbit					TMX		Palbit					TMX		Palbit		Application	Feed Rate – in (mm)	DOC – in (mm)	
		PH5705	PH5115	PH5320	PH5125	PH5740	C2 TiN	C5 TiN	PH6910	PH6920	PH6225	PH6125	PH6135	PH0905	C2	C5	PH0120				PH0135
SNGN 421 SNGN 120304	6-SNG-421							LA							2	5			Flat-Top	0.002-0.010 (0.05-0.25)	0.008-0.177 (0.20-4.5)



To order please use the **geometry code** plus the **grade code**

SNGN 422
SNGN 120308
SNUN 422
SNUN 120308

Description	Geometry Code	Palbit					TMX		Palbit					TMX		Palbit		Application	Feed Rate – in (mm)	DOC – in (mm)	
		PH5705	PH5115	PH5320	PH5125	PH5740	C2 TiN	C5 TiN	PH6910	PH6920	PH6225	PH6125	PH6135	PH0905	C2	C5	PH0120				PH0135
SNGN 422 SNGN 120308	6-SNG-422							LA							2	5			Flat-Top	0.003-0.015 (0.08-0.38)	0.008-0.177 (0.20-4.5)
SNUN 422 SNUN 120308	6-SNU-422							LA							2						



To order please use the **geometry code** plus the **grade code**

Negative Turning Inserts



SNGN/SNUN Inserts (continued)

		Primary Applications																											
		Steel					Stainless Steel					Cast Irons					Non-Ferrous					Heat Resistant Alloys							
		Palbit					TMX					Palbit					TMX					Palbit							
		MTCVD Increasing Toughness					CVD Increasing Toughness					PVD Coated Increasing Toughness					Uncoated Increasing Toughness												
		→					→					→					→												
		PH5705	PH5115	PH5320	PH5125	PH5740	C2 TiN	C5 TiN	PH6910	PH6920	PH6225	PH6125	PH6135	PH0905	C2	C5	PH0120	PH0135											
Description	Geometry Code																Application	Feed Rate – in (mm)	DOC – in (mm)										
SNUN 432 SNUN 120408	6-SNU-432																					Flat-Top	0.003-0.018 (0.08-0.46)	0.008-0.197 (0.20-5.0)					



TURNING

To order please use the **geometry code** plus the **grade code**

		Palbit					TMX					Palbit					TMX					Palbit							
		MTCVD Increasing Toughness					CVD Increasing Toughness					PVD Coated Increasing Toughness					Uncoated Increasing Toughness												
		→					→					→					→												
		PH5705	PH5115	PH5320	PH5125	PH5740	C2 TiN	C5 TiN	PH6910	PH6920	PH6225	PH6125	PH6135	PH0905	C2	C5	PH0120	PH0135											
Description	Geometry Code																Application	Feed Rate – in (mm)	DOC – in (mm)										
SNGN 433 SNGN 120412	6-SNG-433						LA															Flat-Top	0.003-0.018 (0.08-0.46)	0.008-0.197 (0.20-5.0)					
	112-0544-									78	86																		



To order please use the **geometry code** plus the **grade code**

		Palbit					TMX					Palbit					TMX					Palbit							
		MTCVD Increasing Toughness					CVD Increasing Toughness					PVD Coated Increasing Toughness					Uncoated Increasing Toughness												
		→					→					→					→												
		PH5705	PH5115	PH5320	PH5125	PH5740	C2 TiN	C5 TiN	PH6910	PH6920	PH6225	PH6125	PH6135	PH0905	C2	C5	PH0120	PH0135											
Description	Geometry Code																Application	Feed Rate – in (mm)	DOC – in (mm)										
SNGN 434 SNGN 120416	6-SNG-434						LA															Flat-Top	0.006-0.024 (0.15-0.60)	0.008-0.197 (0.20-5.0)					
	112-0547-											86																	



To order please use the **geometry code** plus the **grade code**



Negative Turning Inserts

Cutting Tools

SNGN/SNUN Inserts (continued)

TURNING

	Primary Applications									
Steel	•	•	•	•	•	•	•	•	•	•
Stainless Steel	•	•	•	•	•	•	•	•	•	•
Cast Irons	•	•	•	•	•	•	•	•	•	•
Non-Ferrous	•	•	•	•	•	•	•	•	•	•
Heat Resistant Alloys	•	•	•	•	•	•	•	•	•	•

SNGN 632
SNGN 190408
SNUN 632
SNUN 190408



Description	Geometry Code	Palbit		TMX	Palbit					TMX	Palbit	Application	Feed Rate – in (mm)	DOC – in (mm)				
		MTCVD Increasing Toughness		CVD Increasing Toughness	PVD Coated Increasing Toughness					Uncoated Increasing Toughness								
		PH5705	PH5115	PH5320	PH5125	PH5740	C2 TiN	C5 TiN	PH6910	PH6920	PH6225	PH6125	PH6135	PH0905	C2	C5	PH0120	PH0135
SNGN 632 SNGN 190408	6-SNG-632							LA							2	5		
SNUN 632 SNUN 190408	6-SNU-632							LA							2			
	112-0553-										78							

To order please use the geometry code plus the grade code

SNGN 633
SNGN 190412
SNUN 633
SNUN 190412



Description	Geometry Code	Palbit		TMX	Palbit					TMX	Palbit	Application	Feed Rate – in (mm)	DOC – in (mm)				
		MTCVD Increasing Toughness		CVD Increasing Toughness	PVD Coated Increasing Toughness					Uncoated Increasing Toughness								
		PH5705	PH5115	PH5320	PH5125	PH5740	C2 TiN	C5 TiN	PH6910	PH6920	PH6225	PH6125	PH6135	PH0905	C2	C5	PH0120	PH0135
SNGN 633 SNGN 190412	6-SNG-633							LA							2	5		
SNUN 633 SNUN 190412	6-SNU-633														2			

To order please use the geometry code plus the grade code

SNGN 634
SNGN 190416
SNUN 634
SNUN 190416



Description	Geometry Code	Palbit		TMX	Palbit					TMX	Palbit	Application	Feed Rate – in (mm)	DOC – in (mm)				
		MTCVD Increasing Toughness		CVD Increasing Toughness	PVD Coated Increasing Toughness					Uncoated Increasing Toughness								
		PH5705	PH5115	PH5320	PH5125	PH5740	C2 TiN	C5 TiN	PH6910	PH6920	PH6225	PH6125	PH6135	PH0905	C2	C5	PH0120	PH0135
SNGN 634 SNGN 190416	6-SNG-634							LA							2	5		
SNUN 634 SNUN 190416	6-SNU-634							LA							2	5		

To order please use the geometry code plus the grade code

TNMG/TNMA Inserts

		Primary Applications										Palbit		TMX						
												MTCVD Increasing Toughness →		PVD Coated Increasing Toughness →		Uncoated				
		PH5705	PH5115	PH5320	PH5125	PH5740	PH6705	PH6215	PH6325	PH6920	PH6225	PH6740	PH0910	H01						
TNMG 321 TNMG 160304	Description	Geometry Code												Application		Feed Rate – in (mm)	DOC – in (mm)			
	TNMG 321-ST TNMG 160304-ST	112-1211-												General Purpose Short Chip		0.006-0.020 (0.15-0.5)	0.008-0.138 (0.20-3.50)			



To order please use the **geometry code** plus the **grade code**

		Primary Applications										Palbit		TMX						
												MTCVD Increasing Toughness →		PVD Coated Increasing Toughness →		Uncoated				
		PH5705	PH5115	PH5320	PH5125	PH5740	PH6705	PH6215	PH6325	PH6920	PH6225	PH6740	PH0910	H01						
TNMG 322 TNMG 160308	Description	Geometry Code												Application		Feed Rate – in (mm)	DOC – in (mm)			
	TNMG 322-ST TNMG 160308-ST	112-1212-												General Purpose Short Chip		0.006-0.020 (0.15-0.5)	0.008-0.138 (0.20-3.50)			



To order please use the **geometry code** plus the **grade code**

		Primary Applications										Palbit		TMX						
												MTCVD Increasing Toughness →		PVD Coated Increasing Toughness →		Uncoated				
		PH5705	PH5115	PH5320	PH5125	PH5740	PH6705	PH6215	PH6325	PH6920	PH6225	PH6740	PH0910	H01						
TNMG 331 TNMG 160404	Description	Geometry Code												Application		Feed Rate – in (mm)	DOC – in (mm)			
	TNMG 331-HA TNMG 160404-HA	6-TNJ-331												Aluminum		0.002-0.008 (0.05-0.2)	0.004-0.060 (0.10-1.5)			
	TNMG 331-MF TNMG 160404-MF	112-1556-												Medium Finishing		0.002-0.008 (0.05-0.20)	0.004-0.060 (0.10-1.5)			
	TNMG 331-MS TNMG 160404-MS	112-1557-												General Purpose Long Chip		0.004-0.008 (0.11-0.20)	0.008-0.118 (0.20-3.0)			
	TNMG 331-MR TNMG 160404-MR	112-1281-												Medium Roughing		0.004-0.012 (0.10-0.30)	0.016-0.157 (0.40-4.0)			
	TNMG 331-SS TNMG 160404-SS	112-1289-												Medium Roughing Long Chip		0.004-0.012 (0.10-0.30)	0.016-0.157 (0.40-4.0)			



↑ REDUCED CUTTING FORCES
↓ INCREASING TOUGHNESS

To order please use the **geometry code** plus the **grade code**



Negative Turning Inserts

Cutting Tools

TNMG/TNMA Inserts (continued)

TURNING

	Primary Applications										
Steel	•	•	•	•	•	•	•	•	•	•	•
Stainless Steel	•	•	•	•	•	•	•	•	•	•	•
Cast Irons	•	•	•	•	•	•	•	•	•	•	•
Non-Ferrous	•	•	•	•	•	•	•	•	•	•	•
Heat Resistant Alloys	•	•	•	•	•	•	•	•	•	•	•



TNMG 332
TNMG 160408

Description	Geometry Code	MTCVD Increasing Toughness →					PVD Coated Increasing Toughness →					Uncoated		Application	Feed Rate – in (mm)	DOC – in (mm)				
		PH5705	PH5115	PH5320	PH5125	PH5740	PH6705	PH6215	PH6325	PH6920	PH6225	PH6740	PH0705				PH0910	H01		
TNMG 332-MF TNMG 160408-MF	112-1558-		L7		L8					56			77				↑ REDUCED CUTTING FORCES ↓ INCREASING TOUGHNESS	Medium Finishing	0.004-0.016 (0.10-0.40)	0.004-0.059 (0.10-1.50)
TNMG 332-MS TNMG 160408-MS	112-1559-												68	77		General Purpose Long Chip		0.005-0.009 (0.13-0.24)	0.016-0.142 (0.40-3.60)	
TNMG 332-ST TNMG 160408-ST	112-1268-			L5		L6									25	General Purpose Short Chip		0.006-0.020 (0.15-0.50)	0.008-0.217 (0.20-5.50)	
TNMG 332-MR TNMG 160408-MR	112-1269-				L7											Medium Roughing		0.006-0.020 (0.15-0.50)	0.020-0.217 (0.50-6.00)	
TNMG 332-SS TNMG 160408-SS	112-1271-									56			68	77	15	Medium Roughing Long Chip		0.005-0.018 (0.12-0.45)	0.020-0.217 (0.50-5.50)	
TNMG 332-HR TNMG 160408-HR	112-1270-			L5	L7	L6	L8	L9		56						Roughing		0.013-0.022 (0.35-0.55)	0.079-0.217 (2.00-5.50)	
TNMA 332 TNMA 160408	112-0630-															FLAT TOP		0.006-0.024 (0.15-0.60)	0.004-0.236 (0.10-6.00)	

To order please use the geometry code plus the grade code

TNMG/TNMA Inserts (continued)

		Primary Applications										TMX								
		Steel					Stainless Steel					Cast Irons		Non-Ferrous		Heat Resistant Alloys				
		Palbit										TMX								
		MTCVD Increasing Toughness →					PVD Coated Increasing Toughness →					Uncoated								
		PH5705	PH5115	PH5320	PH5125	PH5740	PH6705	PH6215	PH6325	PH6920	PH6225	PH6740	PH0910	H01						
Description	Geometry Code													Application	Feed Rate – in (mm)	DOC – in (mm)				
TNMG 333-MF TNMG 160412-MF	112-1560-		L7		L8										↑ REDUCED CUTTING FORCES ↓ INCREASING TOUGHNESS	Medium Finishing	0.008-0.024 (0.20-0.60)	0.004-0.059 (0.10-1.50)		
TNMG 333-ST TNMG 160412-ST	112-1348-		L5		L6									General Purpose Short Chip		0.007-0.024 (0.18-0.60)	0.008-0.217 (0.20-5.50)			
TNMG 333-MR TNMG 160412-MR	112-1282-			L7		L8 L9						I5		Medium Roughing		0.006-0.020 (0.15-0.50)	0.020-0.217 (0.50-5.50)			
TNMG 333-SS TNMG 160412-SS	112-1290-											I5		Medium Roughing Long Chip		0.006-0.024 (0.15-0.60)	0.020-0.217 (0.50-5.50)			
TNMG 333-HR TNMG 160412-HR	112-1283-	L5	L7	L6	L8	L9						I5		Roughing		0.008-0.024 (0.20-0.60)	0.079-0.217 (2.00-5.50)			



To order please use the **geometry code** plus the **grade code**

		Palbit										TMX						
		MTCVD Increasing Toughness →					PVD Coated Increasing Toughness →					Uncoated						
		PH5705	PH5115	PH5320	PH5125	PH5740	PH6705	PH6215	PH6325	PH6920	PH6225	PH6740	PH0910	H01				
Description	Geometry Code													Application	Feed Rate – in (mm)	DOC – in (mm)		
TNMG 431-ST TNMG 220404-ST	112-1349-		L7													General Purpose Short Chip	0.006-0.020 (0.15-0.5)	0.008-0.315 (0.20-8.00)

To order please use the **geometry code** plus the **grade code**



Negative Turning Inserts

Cutting Tools

TURNING

TNMG/TNMA Inserts (continued)

		Primary Applications												
		Palbit										TMX		
		MTCVD Increasing Toughness →					PVD Coated Increasing Toughness →					Uncoated		
		PH5705	PH5115	PH5320	PH5125	PH5740	PH6705	PH6215	PH6325	PH6920	PH6225	PH6740	PH0910	H01
Description	Geometry Code													
TNMG 432-MF TNMG 220408-MF	112-1369-		L7											
TNMG 432-ST TNMG 220408-ST	112-1350-	L5		L6										
TNMG 432-MR TNMG 220408-MR	112-1305-		L7		L8	L9				77	I5			
TNMG 432-SS TNMG 220408-SS	112-1330-								67			I5		
TNMG 432-HR TNMG 220408-HR	112-1306-	L5	L7	L6	L8	L9						I5		
TNMA 432 TNMA 220408	112-0635-	L5												

		Application	Feed Rate – in (mm)	DOC – in (mm)
↑ REDUCED CUTTING FORCES ↓ INCREASING TOUGHNESS	Medium Finishing	0.004-0.016 (0.10-0.40)	0.004-0.118 (0.10-3.50)	
	General Purpose Short Chip	0.006-0.020 (0.15-0.50)	0.008-0.315 (0.20-8.00)	
	Medium Roughing	0.006-0.020 (0.15-0.50)	0.020-0.217 (0.50-5.50)	
	Medium Roughing Long Chip	0.005-0.018 (0.12-0.45)	0.020-0.217 (0.50-5.50)	
	Roughing	0.013-0.022 (0.35-0.55)	0.079-0.315 (2.00-8.00)	
	FLAT TOP	0.006-0.024 (0.15-0.60)	0.004-0.394 (0.10-10.00)	



To order please use the geometry code plus the grade code

		Palbit												
		MTCVD Increasing Toughness →					PVD Coated Increasing Toughness →					Uncoated		
		PH5705	PH5115	PH5320	PH5125	PH5740	PH6705	PH6215	PH6325	PH6920	PH6225	PH6740	PH0910	H01
Description	Geometry Code													
TNMG 433-ST TNMG 220412-ST	112-1354-	L5		L6										
TNMG 433-MR TNMG 220412-MR	112-1307-		L7		L8	L9						I5		
TNMG 433-SS TNMG 220412-SS	112-1368-											I5		
TNMG 433-HR TNMG 220412-HR	112-1308-	L5	L7	L6	L8	L9						I5		
TNMA 433 TNMA 220412	112-0636-	L5												

		Application	Feed Rate – in (mm)	DOC – in (mm)
↑ REDUCED CUTTING FORCES ↓ INCREASING TOUGHNESS	General Purpose Short Chip	0.007-0.024 (0.18-0.60)	0.008-0.315 (0.20-8.00)	
	Medium Roughing	0.006-0.020 (0.15-0.50)	0.020-0.217 (0.50-5.50)	
	Medium Roughing Long Chip	0.006-0.024 (0.15-0.60)	0.020-0.217 (0.50-5.50)	
	Roughing	0.008-0.024 (0.20-0.60)	0.079-0.315 (2.00-8.00)	
	FLAT TOP	0.008-0.031 (0.20-0.80)	0.004-0.394 (0.10-10.00)	



To order please use the geometry code plus the grade code

TNMG/TNMA Inserts (continued)

		Primary Applications																
		Steel					Stainless Steel											
		Cast Irons					Non-Ferrous											
		Heat Resistant Alloys																
		Palbit										TMX						
		MTCVD Increasing Toughness →					PVD Coated Increasing Toughness →					Uncoated						
		PH5705	PH5115	PH5320	PH5125	PH5740	PH6705	PH6215	PH6325	PH6920	PH6225	PH6740	PH0910	H01				
Description	Geometry Code											Application	Feed Rate – in (mm)	DOC – in (mm)				
TNMG 434-ST TNMG 220416-ST	112-1351-	L5		L6												General Purpose Short Chip	0.008-0.028 (0.20-0.70)	0.012-0.236 (0.30-6.00)
TNMG 434-MR TNMG 220416-MR	112-1564-				L8	L9										Medium Roughing	0.009-0.026 (0.23-0.65)	0.031-0.217 (0.80-5.50)
TNMG 434-HR TNMG 220416-HR	112-1309-	L5	L7	L6	L8	L9										Roughing	0.010-0.028 (0.25-0.70)	0.079-0.299 (2.00-7.60)
TNMA 434 TNMA 220416	112-0637-	L5	L6				D2									FLAT TOP	0.008-0.039 (0.20-1.00)	0.004-0.299 (0.10-7.60)



To order please use the **geometry code** plus the **grade code**

		Palbit										TMX						
		MTCVD Increasing Toughness →					PVD Coated Increasing Toughness →					Uncoated						
		PH5705	PH5115	PH5320	PH5125	PH5740	PH6705	PH6215	PH6325	PH6920	PH6225	PH6740	PH0910	H01				
Description	Geometry Code											Application	Feed Rate – in (mm)	DOC – in (mm)				
TNMG 543-ST TNMG 270612-ST	112-1569-															General Purpose Short Chip	0.007-0.024 (0.18-0.60)	0.008-0.346 (0.20-8.80)
TNMG 543-HR TNMG 270612-HR	112-1567-												I5			Roughing	0.008-0.024 (0.20-0.60)	0.079-0.433 (2.00-11.00)

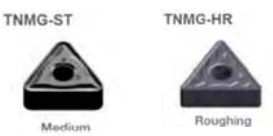

To order please use the **geometry code** plus the **grade code**

Negative Turning Inserts



VNMG/VNMA Inserts

		Primary Applications														
	Steel	●	●	●	●	●	●	●	●	●	●					
	Stainless Steel	●	●	●	●	●	●	●	●	●	●					
	Cast Irons	●	●	●	●	●	●	●	●	●	●					
	Non-Ferrous	●	●	●	●	●	●	●	●	●	●	●	●			
	Heat Resistant Alloys	●	●	●	●	●	●	●	●	●	●					
		Palbit										TMX				
		MTCVD Increasing Toughness					PVD Coated Increasing Toughness					Uncoated				
		PH5705	PH5115	PH5320	PH5125	PH5740	PH6705	PH6215	PH6325	PH6920	PH6225	PH6740	PH0910	H01		
VNMG 331 VNMG 160404	Description	Geometry Code											Application	Feed Rate – in (mm)	DOC – in (mm)	
	VNMG 331-MS VNMG 160404-MS	112-1579-											 Medium to Finishing	General Purpose Long Chip	0.004-0.007 (0.10-0.18)	0.008-0.140 (0.20-3.6)
	VNMG 331-MR VNMG 160404-MR	112-1278-												Medium Roughing	0.004-0.012 (0.10-0.3)	0.039-0.157 (1.0-4.0)

To order please use the **geometry code** plus the **grade code**

		Palbit										TMX				
	Steel	●	●	●	●	●	●	●	●	●	●					
	Stainless Steel	●	●	●	●	●	●	●	●	●	●					
	Cast Irons	●	●	●	●	●	●	●	●	●	●					
	Non-Ferrous	●	●	●	●	●	●	●	●	●	●	●	●			
	Heat Resistant Alloys	●	●	●	●	●	●	●	●	●	●					
		Palbit										TMX				
		MTCVD Increasing Toughness					PVD Coated Increasing Toughness					Uncoated				
		PH5705	PH5115	PH5320	PH5125	PH5740	PH6705	PH6215	PH6325	PH6920	PH6225	PH6740	PH0910	H01		
VNMG 332 VNMG 160408	Description	Geometry Code											Application	Feed Rate – in (mm)	DOC – in (mm)	
	VNMG 332-MS VNMG 160408-MS	112-1580-											 Medium to Finishing	General Purpose Long Chip	0.004-0.009 (0.15-0.25)	0.008-0.140 (0.20-3.6)
	VNMG 332-ST VNMG 160408-ST	112-1277-												General Purpose Short Chip	0.006-0.020 (0.15-0.5)	0.008-0.138 (0.20-3.50)
	VNMG 332-MR VNMG 160408-MR	112-1279-												Medium Roughing	0.006-0.020 (0.15-0.5)	0.039-0.157 (1.0-4.0)
	VNMA 332 VNMA 160408	112-1077-												Flat Top	.004-.019 (0.10-0.5)	.004-.130 (0.10-3.3)

To order please use the **geometry code** plus the **grade code**

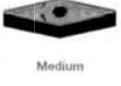
		Palbit										TMX				
	Steel	●	●	●	●	●	●	●	●	●	●					
	Stainless Steel	●	●	●	●	●	●	●	●	●	●					
	Cast Irons	●	●	●	●	●	●	●	●	●	●					
	Non-Ferrous	●	●	●	●	●	●	●	●	●	●	●	●			
	Heat Resistant Alloys	●	●	●	●	●	●	●	●	●	●					
		Palbit										TMX				
		MTCVD Increasing Toughness					PVD Coated Increasing Toughness					Uncoated				
		PH5705	PH5115	PH5320	PH5125	PH5740	PH6705	PH6215	PH6325	PH6920	PH6225	PH6740	PH0910	H01		
VNMG 432 VNMG 220408	Description	Geometry Code											Application	Feed Rate – in (mm)	DOC – in (mm)	
	VNMG 432-MR VNMG 220408-MR	112-1581-											 Medium	Medium Roughing	0.006-0.020 (0.15-0.5)	0.059-0.197 (1.50-5.00)

To order please use the **geometry code** plus the **grade code**

TURNING



Negative Turning Inserts

Cutting Tools

WNMG/WNMA Inserts

TURNING

		Primary Applications																																																																									
		<table border="1"> <tr><td>Steel</td><td>•</td><td>•</td><td>•</td><td>•</td><td>•</td><td>•</td><td>•</td><td>•</td><td>•</td><td>•</td><td>•</td></tr> <tr><td>Stainless Steel</td><td>•</td><td>•</td><td>•</td><td>•</td><td>•</td><td>•</td><td>•</td><td>•</td><td>•</td><td>•</td><td>•</td></tr> <tr><td>Cast Irons</td><td>•</td><td>•</td><td>•</td><td>•</td><td>•</td><td>•</td><td>•</td><td>•</td><td>•</td><td>•</td><td>•</td></tr> <tr><td>Non-Ferrous</td><td>•</td><td>•</td><td>•</td><td>•</td><td>•</td><td>•</td><td>•</td><td>•</td><td>•</td><td>•</td><td>•</td></tr> <tr><td>Heat Resistant Alloys</td><td>•</td><td>•</td><td>•</td><td>•</td><td>•</td><td>•</td><td>•</td><td>•</td><td>•</td><td>•</td><td>•</td></tr> </table>										Steel	•	•	•	•	•	•	•	•	•	•	•	Stainless Steel	•	•	•	•	•	•	•	•	•	•	•	Cast Irons	•	•	•	•	•	•	•	•	•	•	•	Non-Ferrous	•	•	•	•	•	•	•	•	•	•	•	Heat Resistant Alloys	•	•	•	•	•	•	•	•	•	•	•	TMX			
Steel	•	•	•	•	•	•	•	•	•	•	•																																																																
Stainless Steel	•	•	•	•	•	•	•	•	•	•	•																																																																
Cast Irons	•	•	•	•	•	•	•	•	•	•	•																																																																
Non-Ferrous	•	•	•	•	•	•	•	•	•	•	•																																																																
Heat Resistant Alloys	•	•	•	•	•	•	•	•	•	•	•																																																																
		MTCVD Increasing Toughness →					PVD Coated Increasing Toughness →					Uncoated																																																															
		PH5705	PH5115	PH5320	PH5125	PH5740	PH6705	PH6215	PH6325	PH6920	PH6225	PH6740	PH0910	H01																																																													
Description	Geometry Code											(1.50-5.00)"																																																															
WNMG 331-MF WNMG 060404-MF	112-1207-		L7												Medium Finishing	0.002-0.008 (0.05-0.2)	0.004-0.060 (0.10-1.5)																																																										
WNMG 331-MR WNMG 060404-MR	112-1240-						56								Medium Roughing	0.004-0.012 (0.10-0.3)	0.020-0.118 (0.50-3.0)																																																										



To order please use the **geometry code** plus the **grade code**

		Palbit										TMX					
		MTCVD Increasing Toughness →					PVD Coated Increasing Toughness →					Uncoated					
		PH5705	PH5115	PH5320	PH5125	PH5740	PH6705	PH6215	PH6325	PH6920	PH6225	PH6740	PH0910	H01			
Description	Geometry Code											Application					
WNMG 332-MF WNMG 060408-MF	112-1208-		L7		L8			56							Medium Finishing	0.004-0.016 (0.10-0.40)	0.004-0.060 (0.10-1.5)
WNMG 332-MR WNMG 060408-MR	112-1168-		L7		L8							I5			Medium Roughing	0.006-0.024 (0.15-0.60)	0.020-0.118 (0.50-3.0)
WNMG 332-SS WNMG 060408-SS	112-1325-											I5			Medium Roughing Long Chip	0.006-0.020 (0.15-0.50)	0.020-0.118 (0.50-3.0)



To order please use the **geometry code** plus the **grade code**

WNMG/WNMA Inserts (continued)

		Primary Applications										Palbit		TMX																																																																			
		<table border="1"> <tr><td>Steel</td><td>•</td><td>•</td><td>•</td><td>•</td><td>•</td><td>•</td><td>•</td><td>•</td><td>•</td><td>•</td><td>•</td></tr> <tr><td>Stainless Steel</td><td>•</td><td>•</td><td>•</td><td>•</td><td>•</td><td>•</td><td>•</td><td>•</td><td>•</td><td>•</td><td>•</td></tr> <tr><td>Cast Irons</td><td>•</td><td>•</td><td>•</td><td>•</td><td>•</td><td>•</td><td>•</td><td>•</td><td>•</td><td>•</td><td>•</td></tr> <tr><td>Non-Ferrous</td><td>•</td><td>•</td><td>•</td><td>•</td><td>•</td><td>•</td><td>•</td><td>•</td><td>•</td><td>•</td><td>•</td></tr> <tr><td>Heat Resistant Alloys</td><td>•</td><td>•</td><td>•</td><td>•</td><td>•</td><td>•</td><td>•</td><td>•</td><td>•</td><td>•</td><td>•</td></tr> </table>										Steel	•	•	•	•	•	•	•	•	•	•	•	Stainless Steel	•	•	•	•	•	•	•	•	•	•	•	Cast Irons	•	•	•	•	•	•	•	•	•	•	•	Non-Ferrous	•	•	•	•	•	•	•	•	•	•	•	Heat Resistant Alloys	•	•	•	•	•	•	•	•	•	•	•	MTCVD Increasing Toughness →		PVD Coated Increasing Toughness →			Uncoated				
Steel	•	•	•	•	•	•	•	•	•	•	•																																																																						
Stainless Steel	•	•	•	•	•	•	•	•	•	•	•																																																																						
Cast Irons	•	•	•	•	•	•	•	•	•	•	•																																																																						
Non-Ferrous	•	•	•	•	•	•	•	•	•	•	•																																																																						
Heat Resistant Alloys	•	•	•	•	•	•	•	•	•	•	•																																																																						
		PH5705	PH5115	PH5320	PH5125	PH5740	PH6705	PH6215	PH6325	PH6920	PH6225	PH6740	PH0910	H01																																																																			
Description	Geometry Code																																																																																
WNMG 431-MF WNMG 080404-MF	112-1213-		L7					56			77				Finishing Medium Roughing to Medium	Application	Feed Rate – in (mm)	DOC – in (mm)																																																															
WNMG 431-MR WNMG 080404-MR	112-1356-		L7	L8										Medium Finishing		0.002-0.008 (0.05-0.2)	0.004-0.060 (0.10-1.5)																																																																
WNMG 431-SS WNMG 080404-SS	112-1323-					L9								Medium Roughing		0.004-0.012 (0.10-0.3)	0.016-0.215 (0.40-5.5)																																																																
															↑ REDUCED CUTTING FORCES ↓ INCREASING TOUGHNESS	Medium Roughing Long Chip	0.006-0.020 (0.15-0.50)	0.020-0.118 (0.50-3.0)																																																															

To order please use the geometry code plus the grade code

TURNING



Negative Turning Inserts

Cutting Tools

WNMG/WNMA Inserts (continued)

TURNING

		Primary Applications												
Steel		•	•	•	•	•	•	•	•	•	•			
Stainless Steel		•	•	•	•	•	•	•	•	•	•			
Cast Irons		•	•	•	•	•	•	•	•	•	•			
Non-Ferrous		•	•	•	•	•	•	•	•	•	•			
Heat Resistant Alloys		•	•	•	•	•	•	•	•	•	•			
		Palbit										TMX		
		MTCVD Increasing Toughness →					PVD Coated Increasing Toughness →					Uncoated		
		PH5705	PH5115	PH5320	PH5125	PH5740	PH6705	PH6215	PH6325	PH6920	PH6225	PH6740	PH0910	H01

WNMG 432
WNMG 080408



Description	Geometry Code											Application	Feed Rate – in (mm)	DOC – in (mm)			
		PH5705	PH5115	PH5320	PH5125	PH5740	PH6705	PH6215	PH6325	PH6920	PH6225				PH6740	PH0910	H01
WNMG 432-HA WNMG 080408-HA	6-WNJ-432													2	Aluminum	0.004-0.016 (0.10-0.40)	0.004-0.059 (0.10-1.50)
WNMG 432-MF WNMG 080408-MF	112-1214-		L7		L8			56							Medium Finishing	0.004-0.016 (0.10-0.40)	0.004-0.059 (0.10-1.50)
WNMG 432-MS WNMG 080408-MS	112-1588-								68	77					General Purpose Long Chip	0.005-0.009 (0.13-0.24)	0.016-0.142 (0.40-3.60)
WNMG 432-ST WNMG 080408-ST	112-1163-	L5													General Purpose Short Chip	0.006-0.020 (0.15-0.50)	0.008-0.236 (0.20-6.00)
WNMG 432-MR WNMG 080408-MR	112-1327-	L5	L7	L6	L8	L9		56		77	15				Medium Roughing	0.006-0.020 (0.15-0.50)	0.020-0.217 (0.50-5.50)
WNMG 432-SS WNMG 080408-SS	112-1326-							56	68	77	15				Medium Roughing Long Chip	0.005-0.018 (0.12-0.45)	0.020-0.224 (0.50-5.70)
WNMG 432-HR WNMG 080408-HR	112-1127-		L7		L8	L9		56				15			Roughing	0.008-0.024 (0.20-0.60)	0.079-0.217 (2.00-5.50)
WNMA 432 WNMA 080408	112-0835-	L5		L6											FLAT TOP	0.006-0.024 (0.15-0.60)	0.004-0.217 (0.10-5.50)

REDUCED CUTTING FORCES →
← INCREASING TOUGHNESS

To order please use the geometry code plus the grade code

Negative Turning Inserts



WNMG/WNMA Inserts (continued)

		Primary Applications										Palbit		TMX			
		MTCVD Increasing Toughness →					PVD Coated Increasing Toughness →					Uncoated					
		PH5705	PH5115	PH5320	PH5125	PH5740	PH6705	PH6215	PH6325	PH6920	PH6225	PH6740	PH0910	H01			
Steel		•	•	•	•	•	•	•	•	•	•	•					
Stainless Steel		•	•	•	•	•	•	•	•	•	•	•					
Cast Irons		•	•	•	•	•	•	•	•	•	•	•					
Non-Ferrous		•	•	•	•	•	•	•	•	•	•	•	•	•			
Heat Resistant Alloys		•	•	•	•	•	•	•	•	•	•	•	•	•			

WNMG 433 WNMG 080412		Application			Feed Rate – in (mm)	DOC – in (mm)		
WNMG 433-MF WNMG 080412-MF	112-1589-	L7	L8	56	77	Medium Finishing 0.008-0.024 (0.20-0.60) 0.004-0.059 (0.10-1.50)		
WNMG 433-MS WNMG 080412-MS	112-1590-				68 77	General Purpose Long Chip 0.006-0.012 (0.16-0.29) 0.004-0.059 (0.10-1.50)		
WNMG 433-ST WNMG 080412-ST	112-1164-	L5				General Purpose Short Chip 0.007-0.024 (0.18-0.60) 0.008-0.236 (0.20-6.00)		
WNMG 433-MW WNMG 080412-MW	112-1371-	L7	L6	L8		Wiper 0.008-0.035 (0.20-0.90) 0.020-0.197 (0.50-5.00)		
WNMG 433-MR WNMG 080412-MR	112-1261-	L7	L8	L9	56	77	Medium Roughing 0.006-0.020 (0.15-0.50) 0.031-0.217 (0.80-5.50)	
WNMG 433-SS WNMG 080412-SS	112-1591-				56	68 77 15	Medium Roughing Long Chip 0.006-0.024 (0.15-0.60) 0.020-0.224 (0.50-5.70)	
WNMG 433-HR WNMG 080412-HR	112-1128-	L5	L7	L8	L9	56	77	Roughing 0.008-0.024 (0.20-0.60) 0.079-0.217 (2.00-5.50)
WNMA 433 WNMA 080412	112-1076-	L5						FLAT TOP 0.008-0.031 (0.20-0.80) 0.004-0.217 (0.10-5.50)

To order please use the geometry code plus the grade code

WNMG 434 WNMG 080416		Palbit										TMX					
		MTCVD Increasing Toughness →					PVD Coated Increasing Toughness →					Uncoated					
		PH5705	PH5115	PH5320	PH5125	PH5740	PH6705	PH6215	PH6325	PH6920	PH6225	PH6740	PH0910	H01			
WNMG 434-ST WNMG 080416-ST	112-1593-	L5															
WNMA 434 WNMA 080416	112-1582-	L5	L6														

WNMG 434 WNMG 080416		Application			Feed Rate – in (mm)	DOC – in (mm)
WNMG 434-ST WNMG 080416-ST	112-1593-	L5				General Purpose Short Chip 0.008-0.028 (0.20-0.70) 0.012-0.236 (0.30-6.00)
WNMA 434 WNMA 080416	112-1582-	L5	L6			FLAT TOP 0.008-0.039 (0.20-1.00) 0.004-0.217 (0.10-5.50)

To order please use the geometry code plus the grade code



Positive Turning Inserts

Cutting Tools

CCMT / CCGT Inserts

TURNING

	Primary Applications											
Steel	•	•	•	•	•	•	•	•	•	•	•	•
Stainless Steel	•	•	•	•	•	•	•	•	•	•	•	•
Cast Irons	•	•	•	•	•	•	•	•	•	•	•	•
Non-Ferrous	•	•	•	•	•	•	•	•	•	•	•	•
Heat Resistant Alloys	•	•	•	•	•	•	•	•	•	•	•	•

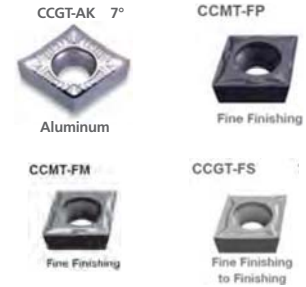

CCMT 21.50.5
CCGT 21.50.5
CCMT 060202
CCGT 060202

Description	Geometry Code	Palbit										TMX	Application	Feed Rate – in (mm)	DOC – in (mm)					
		MTCVD Increasing Toughness →					PVD Coated Increasing Toughness →									Uncoated				
		PH5705	PH5115	PH5320	PH5125	PH5740	PH6705	PH6910	PH6215	PH6325	PH6920						PH6225	PH6740	PH0910	H01
CCGT 21.50.5-AK CCGT 060202-AK	6-CCG-210															2	ALUMINUM	0.001-0.005 (0.03-0.12)	0.002-0.118 (0.05-3.0)	
CCMT 21.50.5-FP CCMT 060202-FP	112-1655-						54										Short Chip	FINE FINISHING	0.001-0.004 (0.03-0.11)	0.024-0.066 (0.60-1.70)
CCMT 21.50.5-FM CCMT 060202-FM	112-1654-								67	68							Tough Mat.	FINE FINISHING TO FINISHING	0.001-0.003 (0.03-0.08)	0.002 - 0.067 (0.06 - 1.7)
CCGT 21.50.5 -FS CCGT 060202-FS	112-1726-									68							Tough Mat.	FINE FINISHING TO FINISHING	0.005-0.018 (0.03-0.06)	0.004-0.039 (0.10-1.0)

To order please use the geometry code plus the grade code



CCMT 21.51
CCGT 21.51
CCMT 060204
CCGT 060204

Description	Geometry Code	Palbit										TMX	Application	Feed Rate – in (mm)	DOC – in (mm)					
		MTCVD Increasing Toughness →					PVD Coated Increasing Toughness →									Uncoated				
		PH5705	PH5115	PH5320	PH5125	PH5740	PH6705	PH6910	PH6215	PH6325	PH6920						PH6225	PH6740	PH0910	H01
CCGT 21.51-AK CCGT 060204-AK	6-CCG-211															2	ALUMINUM	0.001-0.006 (0.03-0.15)	0.004-0.118 (0.10-3.0)	
CCMT 21.51-FP CCMT 060204-FP	112-1658-		L7		L8		54			68							Short Chip	FINE FINISHING	0.002-0.004 (0.03-0.11)	0.024-0.066 (0.60-1.70)
CCMT 21.51-FM CCMT 060204-FM	112-1657-								67	68							Long Chip	FINE FINISHING		
CCGT 21.51-FS CCGT 060204-FS	112-1727-						54			68							Tough Mat.	FINE FINISHING TO FINISHING	0.005-0.018 (0.03-0.06)	0.004-0.039 (0.10-1.0)
CCMT 21.51-MP CCMT 060204-MP	112-1697-									68							Short Chip	FINISHING	0.003-0.009 (0.08-0.23)	0.016-0.094 (0.40-2.40)
CCMT 21.51-MM CCMT 060204-MM	112-1696-								67	68							Long Chip	FINISHING	0.002-0.007 (0.06-0.17)	0.008-0.094 (0.20-2.40)

To order please use the geometry code plus the grade code

CCMT/CCGT Inserts (continued)

		Primary Applications																																		
		Steel	Steel	Steel	Steel	Steel	Steel	Steel	Steel	Steel	Steel	Stainless Steel	Stainless Steel	Stainless Steel	Stainless Steel	Stainless Steel	Stainless Steel	Cast Irons	Cast Irons	Cast Irons	Cast Irons	Cast Irons	Cast Irons	Non-Ferrous	Non-Ferrous	Non-Ferrous	Non-Ferrous	Non-Ferrous	Non-Ferrous	Non-Ferrous	Heat Resistant Alloys	Heat Resistant Alloys	Heat Resistant Alloys	Heat Resistant Alloys	Heat Resistant Alloys	Heat Resistant Alloys
CCMT 21.52 CCGT 21.52 CCMT 060208 CCGT 060208	Palbit										TMX																									
	MTCVD Increasing Toughness →					PVD Coated Increasing Toughness →					Uncoated																									
	PH5705	PH5115	PH5320	PH5125	PH5740	PH6705	PH6910	PH6215	PH6325	PH6920	PH6225	PH6740	PH0910	H01																						
	Description	Geometry Code													Application	Feed Rate – in (mm)	DOC – in (mm)																			
CCGT 21.52-AK CCGT 060208-AK	6-CCG-212												2	ALUMINUM	0.001-0.020 (0.03-0.50)	0.004-0.118 (0.10-3.0)																				
CCMT 21.52-MM CCMT 060208-MM	112-1660-							67	68					Long Chip	FINISHING	0.003-0.009 (0.08-0.23)	0.008-0.094 (0.20-2.40)																			

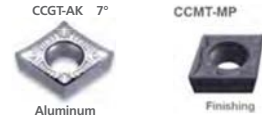

TURNING

To order please use the **geometry code** plus the **grade code**

		Palbit																																
		Steel	Steel	Steel	Steel	Steel	Steel	Steel	Steel	Steel	Steel	Stainless Steel	Stainless Steel	Stainless Steel	Stainless Steel	Stainless Steel	Cast Irons	Cast Irons	Cast Irons	Cast Irons	Cast Irons	Cast Irons	Non-Ferrous	Non-Ferrous	Non-Ferrous	Non-Ferrous	Non-Ferrous	Non-Ferrous	Heat Resistant Alloys	Heat Resistant Alloys	Heat Resistant Alloys	Heat Resistant Alloys	Heat Resistant Alloys	Heat Resistant Alloys
CCMT 32.50.5 CCGT 32.50.5 CCMT 09T302 CCGT 09T302	Palbit										TMX																							
	MTCVD Increasing Toughness →					PVD Coated Increasing Toughness →					Uncoated																							
	PH5705	PH5115	PH5320	PH5125	PH5740	PH6705	PH6910	PH6215	PH6325	PH6920	PH6225	PH6740	PH0910	H01																				
	Description	Geometry Code													Application	Feed Rate – in (mm)	DOC – in (mm)																	
CCGT 32.50.5-AK CCGT 09T302-AK	6-CCG-320												2	ALUMINUM	0.001-0.006 (0.03-0.15)	0.004-0.118 (0.10-3.0)																		
CCMT 32.50.5-FP CCMT 09T302-FP	112-1690-						54							Short Chip	FINE FINISHING	0.002-0.004 (0.03-0.11)	0.024-0.066 (0.60-1.70)																	
CCMT 32.50.5-FM CCMT 09T302-FM	112-1689-							67	68					Long Chip	FINE FINISHING																			
CCGT 32.50.5-FS CCGT 09T302-FS	112-1456-					D2			68					Tough Mat.	FINE FINISHING TO FINISHING	0.005-0.018 (0.03-0.06)	0.004-0.039 (0.10-1.0)																	
CCGT 32.50.5-FN CCGT 09T302-FN	112-1886-						10							ALUMINUM	0.001-0.006 (0.03-0.15)	0.004-0.118 (0.10-3.0)																		



To order please use the **geometry code** plus the **grade code**



Positive Turning Inserts

Cutting Tools

CCMT / CCGT Inserts (continued)

TURNING

	Primary Applications											
Steel	•	•	•	•	•	•	•	•	•	•	•	•
Stainless Steel	•	•	•	•	•	•	•	•	•	•	•	•
Cast Irons	•	•	•	•	•	•	•	•	•	•	•	•
Non-Ferrous	•	•	•	•	•	•	•	•	•	•	•	•
Heat Resistant Alloys	•	•	•	•	•	•	•	•	•	•	•	•



CCMT 32.51
CCGT 32.51
CCMT 09T304
CCGT 09T304

Description	Geometry Code	Palbit												TMX	Application	Feed Rate – in (mm)	DOC – in (mm)			
		MTCVD Increasing Toughness →					PVD Coated Increasing Toughness →					Uncoated								
		PH5705	PH5115	PH5320	PH5125	PH5740	PH6705	PH6910	PH6215	PH6325	PH6920	PH6225	PH6740					PH0910	H01	
CCGT 32.51-AK CCGT 09T304-AK	6-CCG-321															2	ALUMINUM	0.001-0.012 (0.03-0.30)	0.004-0.197 (0.10-5.0)	
CCMT 32.51-FP CCMT 09T304-FP	112-1666-																Short Chip	FINE FINISHING	0.002-0.009 (0.06-0.23)	0.004-0.079 (0.11-2.00)
CCMT 32.51-FM CCMT 09T304-FM	112-1692-																Long Chip	FINE FINISHING	0.002-0.004 (0.03-0.11)	0.024-0.076 (0.60-2.00)
CCGT 32.51-FS CCGT 09T304-FS	112-1457-																Tough Mat.	FINE FINISHING TO FINISHING	0.003-0.010 (0.08-0.25)	0.020-0.118 (0.50-3.0)
CCMT 32.51-FW CCMT 09T304-FW	112-1399-																Wiper	FINISHING	0.003-0.012 (0.07-0.30)	0.012-0.118 (0.30-3.0)
CCMT 32.51-MP CCMT 09T304-MP	112-1700-																Short Chip	FINISHING	0.003-0.009 (0.08-0.23)	0.010-0.118 (0.25-3.0)
CCMT 32.51-MM CCMT 09T304-MM	112-1699-																Long Chip	FINISHING		

To order please use the geometry code plus the grade code

CCMT/CCGT Inserts continued

		Primary Applications										Palbit		TMX						
		Steel	Stainless Steel	Cast Irons	Non-Ferrous	Heat Resistant Alloys	MTCVD Increasing Toughness →					PVD Coated Increasing Toughness →					Uncoated			
Description	Geometry Code	PH5705	PH5115	PH5320	PH5125	PH5740	PH6705	PH6910	PH6215	PH6325	PH6920	PH6225	PH6740	PH0910	H01	Application	Feed Rate – in (mm)	DOC – in (mm)		
		CCGT 32.52-AK CCGT 09T308-AK	6-CCG-322																	2
CCMT 32.51-FP CCMT 09T308-FP	112-1652-		L7					54		68	77					Short Chip	FINE FINISHING	0.002-0.009 (0.06-0.23)	0.004-0.079 (0.11-2.00)	
CCMT 32.52-FM CCMT 09T308-FM	112-1651-				L8			54	67	68						Long Chip	FINE FINISHING	0.002-0.004 (0.03-0.11)	0.024-0.076 (0.60-2.00)	
CCMT 32.52-FW CCMT 09T308-FW	112-1744-								67							Wiper	FINISHING	.005 - .020 (0.12-0.50)	.012 - .118 (0.3-3.0)	
CCMT32.52-MP CCMT 09T308-MP	112-1687-									68						Short Chip	FINISHING	0.003-0.009 (0.08-0.23)	0.010-0.118 (0.25-3.0)	
CCMT 32.52-MM CCMT 09T308-MM	112-1686-		L7				D2		67	68					Long Chip	FINISHING				
CCMT 32.52-MK CCMT 09T308-MK	112-1685-						D2									FINISHING	0.004-0.012 (0.10-0.30)	0.020-0.118 (0.50-3.0)		



TURNING

To order please use the **geometry code** plus the **grade code**

		Palbit										TMX						
		MTCVD Increasing Toughness →					PVD Coated Increasing Toughness →					Uncoated						
Description	Geometry Code	PH5705	PH5115	PH5320	PH5125	PH5740	PH6705	PH6910	PH6215	PH6325	PH6920	PH6225	PH6740	PH0910	H01	Application	Feed Rate – in (mm)	DOC – in (mm)
		CCGT 430-AK CCGT 120400-AK	6-CCG-430															



To order please use the **geometry code** plus the **grade code**



Positive Turning Inserts

Cutting Tools

CCMT / CCGT Inserts (continued)

	Primary Applications											
Steel	•	•	•	•	•	•	•	•	•	•	•	•
Stainless Steel	•	•	•	•	•	•	•	•	•	•	•	•
Cast Irons	•	•	•	•	•	•	•	•	•	•	•	•
Non-Ferrous	•	•	•	•	•	•	•	•	•	•	•	•
Heat Resistant Alloys	•	•	•	•	•	•	•	•	•	•	•	•



CCMT 431
CCGT 431
CCMT 120404
CCGT 120404

Description	Geometry Code	Palbit												TMX	Application	Feed Rate - in (mm)	DOC - in (mm)	
		MTCVD Increasing Toughness →					PVD Coated Increasing Toughness →					Uncoated						
		PH5705	PH5115	PH5320	PH5125	PH5740	PH6705	PH6910	PH6215	PH6325	PH6920	PH6225	PH6740	PH0910	H01			
CCGT 431-AK CCGT 120404-AK	6-CCG-431														2	ALUMINUM	0.001-0.020 (0.03-0.50)	0.004-0.197 (0.10-5.0)
CCGT 431-AL CCGT 120404-AL	211-0062-													10				
CCMT 431-FP CCMT 120404-FP	112-1665-		L7					54		68						Short Chip		
CCMT 431-FM CCMT 120404-FM	112-1664-				L8					68						Long Chip		
CCMT 431-MP CCMT 120404-MP	112-1719-							54		68						Short Chip		
CCMT 431MM CCMT 120404-MM	112-1718-									68						Long Chip		

To order please use the geometry code plus the grade code

CCMT 432
CCGT 432
CCMT 120408
CCGT 120408

	Palbit												TMX	
	MTCVD Increasing Toughness →					PVD Coated Increasing Toughness →					Uncoated			
	PH5705	PH5115	PH5320	PH5125	PH5740	PH6705	PH6910	PH6215	PH6325	PH6920	PH6225	PH6740	PH0910	H01

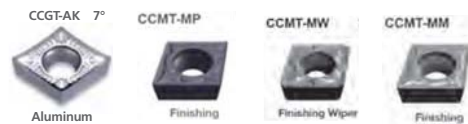

Description	Geometry Code	Palbit												TMX	Application	Feed Rate - in (mm)	DOC - in (mm)	
		MTCVD Increasing Toughness →					PVD Coated Increasing Toughness →					Uncoated						
		PH5705	PH5115	PH5320	PH5125	PH5740	PH6705	PH6910	PH6215	PH6325	PH6920	PH6225	PH6740	PH0910	H01			
CCGT 432-AK CCGT 120408-AK	6-CCG-432														2	ALUMINUM	0.001-0.031 (0.04-0.80)	0.004-0.217 (0.10-5.5)
CCMT 432-MP CCMT 120408-MP	112-1722-				L8			54		68						Short Chip	0.005-0.014 (0.13-0.36)	0.010-0.142 (0.60-3.60)
CCMT 432-MW CCMT 120408-FM	112-1413-							54								Wiper	0.005-0.020 (0.15-0.50)	0.028-0.157 (0.70-4.00)
CCMT 432-MM CCMT 120408-MM	112-1721-							54		67	68					Long Chip	0.005-0.014 (0.13-0.36)	0.010-0.142 (0.30-3.60)

To order please use the geometry code plus the grade code

CCMT 433
CCMT 120412

	Palbit												TMX	
	MTCVD Increasing Toughness →					PVD Coated Increasing Toughness →					Uncoated			
	PH5705	PH5115	PH5320	PH5125	PH5740	PH6705	PH6910	PH6215	PH6325	PH6920	PH6225	PH6740	PH0910	H01



Description	Geometry Code	Palbit												TMX	Application	Feed Rate - in (mm)	DOC - in (mm)	
		MTCVD Increasing Toughness →					PVD Coated Increasing Toughness →					Uncoated						
		PH5705	PH5115	PH5320	PH5125	PH5740	PH6705	PH6910	PH6215	PH6325	PH6920	PH6225	PH6740	PH0910	H01			
CCMT 433-MP CCMT 120412-MP	112-1724-		L7		L8											Short Chip		
CCMT 433-MM CCMT 120412-MM	112-1723-		L7													Long Chip		

To order please use the geometry code plus the grade code

TURNING

Positive Turning Inserts



DCMT / DCGT Inserts

	Primary Applications						
Steel	•	•	•	•	•	•	•
Stainless Steel	•	•	•	•	•	•	•
Cast Irons	•	•	•	•	•	•	•
Non-Ferrous	•	•	•	•	•	•	•
Heat Resistant Alloys	•	•	•	•	•	•	•

DCMT 21.50.5
DCGT 21.50.5
DCMT 070202
DCGT 070202

Palbit							TMX	
PVD Coated Increasing Toughness →							Uncoated	
PH6705	PH6910	PH6215	PH6325	PH6920	PH6225	PH6740	PH0910	H01



Description	Geometry Code								Application	Feed Rate – in (mm)	DOC – in (mm)	
		PH6705	PH6910	PH6215	PH6325	PH6920	PH6225	PH6740				PH0910
DCGT 21.50.5-AK DCGT 070202-AK	6-DCG-210									ALUMINUM	0.001-0.008 (0.03-0.20)	0.002-0.118 (0.05-3.0)
DCMT 21.50.5-FP DCMT 070202-FP	112-1675-							77	Short Chip	FINE FINISHING	0.001-0.004 (0.03-0.11)	0.003-0.059 (0.06-1.50)
DCMT 21.50.5-FM DCMT 070202-FM	112-1674-					68			Long Chip	FINE FINISHING TO FINISHING		
DCGT 21.50.5-FS DCGT 070202-FS	112-1748-					68			Tough Mat.	FINE FINISHING TO FINISHING	0.005-0.005 (0.03-0.12)	0.004-0.059 (0.10-1.50)

To order please use the **geometry code** plus the **grade code**

DCMT 21.51
DCMT 070204

Palbit							TMX	
PVD Coated Increasing Toughness →							Uncoated	
PH6705	PH6910	PH6215	PH6325	PH6920	PH6225	PH6740	PH0910	H01



Description	Geometry Code								Application	Feed Rate – in (mm)	DOC – in (mm)	
		PH6705	PH6910	PH6215	PH6325	PH6920	PH6225	PH6740				PH0910
DCMT 21.51-MM DCMT 070204-MM	112-1680-				67	68			Short Chip	FINISHING	0.003-0.009 (0.08-0.23)	0.004-0.089 (0.19-2.25)

To order please use the **geometry code** plus the **grade code**

DCMT 21.52
DCMT 070208

Palbit							TMX	
PVD Coated Increasing Toughness →							Uncoated	
PH6705	PH6910	PH6215	PH6325	PH6920	PH6225	PH6740	PH0910	H01



Description	Geometry Code								Application	Feed Rate – in (mm)	DOC – in (mm)	
		PH6705	PH6910	PH6215	PH6325	PH6920	PH6225	PH6740				PH0910
DCMT 21.52-MP DCMT 070208-MP	112-1684-					68			Short Chip	FINISHING	0.003-0.009 (0.08-0.23)	0.004-0.089 (0.19-2.25)
DCMT 21.52-MM DCMT 070208-MM	112-1683-	D2				68			Long Chip	FINISHING	0.003-0.009 (0.08-0.23)	0.004-0.089 (0.19-2.25)

To order please use the **geometry code** plus the **grade code**

TURNING



Positive Turning Inserts

Cutting Tools

DCMT/DCGT Inserts (continued)

TURNING

	Primary Applications						
Steel	•	•	•	•	•	•	•
Stainless Steel	•	•	•	•	•	•	•
Cast Irons	•	•	•	•	•	•	•
Non-Ferrous	•	•	•	•	•	•	•
Heat Resistant Alloys	•	•	•	•	•	•	•

DCMT 32.50.5
DCGT 32.50.5
DCMT 11T302
DCGT 11T302

Palbit							TMX	
PVD Coated Increasing Toughness →							Uncoated	
PH6705	PH6910	PH6215	PH6325	PH6920	PH6225	PH6740	PH0910	H01



Description	Geometry Code									Application	Feed Rate – in (mm)	DOC – in (mm)			
		PH6705	PH6910	PH6215	PH6325	PH6920	PH6225	PH6740	PH0910				H01		
DCGT 32.50.5-AK DCGT 11T302-AK	6-DCG-320										2	ALUMINUM	0.001-0.012 (0.03-0.30)	0.002-0.157 (0.05-4.0)	
DCMT 32.50.5-FP DCMT 11T302-FP	112-1668-							77				Short Chip	FINE FINISHING	0.001-0.006 (0.03-0.15)	0.003-0.079 (0.06-2.00)
DCMT 32.50.5-FM DCMT 11T302-FM	112-1667-					68						Long Chip	FINE FINISHING TO FINISHING	0.001-0.006 (0.03-0.15)	0.003-0.079 (0.06-2.00)

To order please use the geometry code plus the grade code



DCMT 32.51
DCGT 32.51
DCMT 11T304
DCGT 11T304

Palbit							TMX	
PVD Coated Increasing Toughness →							Uncoated	
PH6705	PH6910	PH6215	PH6325	PH6920	PH6225	PH6740	PH0910	H01

Description	Geometry Code									Application	Feed Rate – in (mm)	DOC – in (mm)			
		PH6705	PH6910	PH6215	PH6325	PH6920	PH6225	PH6740	PH0910				H01		
DCGT 32.51-AK DCGT 11T304-AK	6-DCG-321										2	ALUMINUM	0.001-0.020 (0.03-0.50)	0.004-0.157 (0.10-4.0)	
DCMT 32.51-FP DCMT 11T304-FP	112-1711-		54			68						Short Chip	FINE FINISHING	0.003-0.009 (0.06-0.23)	0.005-0.079 (0.11-2.00)
DCMT 32.51-FM DCMT 11T304-FM	112-1710-					68						Long Chip	FINE FINISHING TO FINISHING		
DCMT 32.51-MP DCMT 11T304-MP	112-1648-		54			68						Short Chip	FINISHING	0.003-0.009 (0.08-0.23)	0.010-0.118 (0.25-3.00)

To order please use the geometry code plus the grade code

DCMT/DCGT Inserts (continued)

		Primary Applications													
Steel		•	•	•	•	•	•			DCGT-AK 7°		DCMT-FP 7°	DCMT-FM 7°		
Stainless Steel		•	•	•	•	•	•								
Cast Irons		•	•	•	•	•	•			Aluminum		Fine Finishing	Fine Finishing		
Non-Ferrous		•	•	•	•	•	•			DCMT-MP 7°		DCMT-MM 7°	DCMT-MW 7°		
Heat Resistant Alloys		•	•	•	•	•	•								
		Palbit							TMX						
		PVD Coated Increasing Toughness →						Uncoated							
Description	Geometry Code	PH6705	PH6910	PH6215	PH6325	PH6920	PH6225	PH6740	PH0910	H01	Application		Feed Rate – in (mm)	DOC – in (mm)	
DCGT 32.52-AK DCGT 11T308-AK	6-DCG-322										2	ALUMINUM	0.001-0.020 (0.03-0.50)	0.004-0.197 (0.10-5.0)	
DCGT 32.52-TA DCGT 11T308-TA	6-DCA-322										2	ALUMINUM	0.001-0.020 (0.03-0.50)	0.004-0.197 (0.10-5.0)	
DCMT 32.52-FP DCMT 11T308-FP	112-1713-					68						Short Chip	FINE FINISHING	0.003-0.012 (0.08-0.30)	0.005-0.079 (0.11-2.00)
DCMT 32.52-FM DCMT 11T308-FM	112-1712-					68						Long Chip	FINE FINISHING TO FINISHING		
DCMT 32.52-MP DCMT 11T308-MP	112-1706-		54									Short Chip	FINISHING	0.005-0.014 (0.12-0.36)	0.020-0.118 (0.50-3.00)
DCMT 32.52-MM DCMT 11T308-MM	112-1705-					68						Long Chip	FINISHING	0.004-0.012 (0.10-0.30)	0.020-0.118 (0.50-3.00)
DCMT 32.52-MW DCMT 11T308-MW	112-1756-	D2										Wiper	FINISHING	0.006-0.020 (0.15-0.50)	0.020-0.157 (0.50-4.00)

To order please use the geometry code plus the grade code

		Primary Applications													
Steel		•	•	•	•	•	•			DCMT-MM 7°					
Stainless Steel		•	•	•	•	•	•								
Cast Irons		•	•	•	•	•	•			Finishing					
Non-Ferrous		•	•	•	•	•	•								
Heat Resistant Alloys		•	•	•	•	•	•								
		Palbit							TMX						
		PVD Coated Increasing Toughness →						Uncoated							
Description	Geometry Code	PH6705	PH6910	PH6215	PH6315	PH6920	PH6225	PH6740	PH0910	H01	Application		Feed Rate – in (mm)	DOC – in (mm)	
DCMT 32.53-MM DCMT 11T312-MM	112-1707-					68						Long Chip	FINISHING	0.005-0.014 (0.12-0.36)	0.024-0.118 (0.60-3.00)

To order please use the geometry code plus the grade code

TURNING



Positive Turning Inserts

Cutting Tools

RPGN Inserts

TURNING

	Primary Applications									
Steel	•	•	•	•	•	•	•	•	•	•
Stainless Steel	•	•	•	•	•	•	•	•	•	•
Cast Irons	•	•	•	•	•	•	•	•	•	•
Non-Ferrous	•	•	•	•	•	•	•	•	•	•
Heat Resistant Alloys	•	•	•	•	•	•	•	•	•	•



RPGN	Description	Geometry Code	CVD		PVD Coated						Uncoated		Application	Feed Rate – in (mm)	DOC – in (mm)			
			Increasing Toughness →		Increasing Toughness →													
			C2 TiN	C5 TiN	PH3235	PH6910	PH6920	PH6225	PH6125	PH6135	PH0910	C2				C5		
	RPGN 32	6-RPG-32		LA									2	5	Flat Top	GROUND	0.006-0.020 (0.14-0.50)	0.025-0.118 (0.65-3.00)
	RPGN 42	6-RPG-42		LA									2	5	Flat Top	UTILITY	0.010-0.030 (0.26-0.75)	0.025-0.138 (0.65-3.50)
	RPGN 43	6-RPG-43		LA									2	5	Flat Top	UTILITY	0.015-0.035 (0.38-0.90)	0.035-0.157 (0.90-4.00)

To order please use the **geometry code** plus the **grade code**

SCMT Inserts

	Primary Applications						
Steel	•	•	•	•	•	•	•
Stainless Steel	•	•	•	•	•	•	•
Cast Irons	•	•	•	•	•	•	•
Non-Ferrous	•	•	•	•	•	•	•
Heat Resistant Alloys	•	•	•	•	•	•	•

SCMT 32.51
SCMT 09T304

Description	Geometry Code	Palbit						TMX	Application		Feed Rate – in (mm)	DOC – in (mm)		
		PH6705	PH6910	PH6215	PH6325	PH6920	PH6225	PH6740					PH0910	H01
SCMT 32.51-MM SCMT 09T304-MM	112-1761-					68					Long Chip	FINISHING	0.003-0.009 (0.08-0.23)	0.009-0.118 (0.25-3.00)



To order please use the **geometry code** plus the **grade code**

SCMT 32.52
SCMT 09T308

Description	Geometry Code	Palbit						TMX	Application		Feed Rate – in (mm)	DOC – in (mm)		
		PH6705	PH6910	PH6215	PH6325	PH6920	PH6225	PH6740					PH0910	H01
SCMT 32.52-MM SCMT 09T308-MM	112-1767-					68					Long Chip	FINISHING	0.004-0.012 (0.10-0.30)	0.020-0.118 (0.50-3.00)



To order please use the **geometry code** plus the **grade code**

SCMT 431
SCMT 120404

Description	Geometry Code	Palbit						TMX	Application		Feed Rate – in (mm)	DOC – in (mm)		
		PH6705	PH6910	PH6215	PH6325	PH6920	PH6225	PH6740					PH0910	H01
SCMT 431-MM SCMT 120404-MM	112-1769-					68					Long Chip	FINISHING	0.004-0.012 (0.10-0.30)	0.020-0.118 (0.50-3.00)



To order please use the **geometry code** plus the **grade code**

SCMT 432
SCMT 120408

Description	Geometry Code	Palbit						TMX	Application		Feed Rate – in (mm)	DOC – in (mm)		
		PH6705	PH6910	PH6215	PH6325	PH6920	PH6225	PH6740					PH0910	H01
SCMT 432-MP SCMT 120408-MP	112-1783-					68					Short Chip	FINISHING	0.005-0.014 (0.12-0.36)	0.012-0.142 (0.30-3.60)
SCMT 432-MM SCMT 120408-MM	112-1782-					68					Long Chip	FINISHING		



To order please use the **geometry code** plus the **grade code**



Positive Turning Inserts

Cutting Tools

TURNING

SPGN/SPUN Inserts

		Primary Applications																																
		Steel						Stainless Steel						Cast Irons						Non-Ferrous						Heat Resistant Alloys								
		TMX		Palbit						TMX		Palbit																						
		CVD Increasing Toughness →		PVD Coated Increasing Toughness →						Uncoated Increasing Toughness →																								
		C2 TiN	C5 TiN	PH6910	PH6215	PH6920	PH6225	PH6125	PH6135	PH0905	C2	C5	PH0320	PH0125	PH0230	PH0135																		
Description	Geometry Code															Application	Feed Rate - in (mm)	DOC - in (mm)																
SPGN 321 SPGN 090304	6-SPG-321		LA								2	5					Flat Top	GROUND	0.003-0.009 (0.08-0.23)	0.009-0.079 (0.25-2.00)														



To order please use the **geometry code** plus the **grade code**

		TMX		Palbit						TMX		Palbit								
		CVD Increasing Toughness →		PVD Coated Increasing Toughness →						Uncoated Increasing Toughness →										
		C2 TiN	C5 TiN	PH6910	PH6215	PH6920	PH6225	PH6125	PH6135	PH0905	C2	C5	PH0320	PH0125	PH0230	PH0135				
Description	Geometry Code															Application	Feed Rate - in (mm)	DOC - in (mm)		
SPGN 322 SPGN 090308	6-SPG-322		LA								2	5					Flat Top	GROUND	0.003-0.010 (0.08-0.25)	0.009-0.118 (0.25-3.00)



To order please use the **geometry code** plus the **grade code**

		TMX		Palbit						TMX		Palbit								
		CVD Increasing Toughness →		PVD Coated Increasing Toughness →						Uncoated Increasing Toughness →										
		C2 TiN	C5 TiN	PH6910	PH6215	PH6920	PH6225	PH6125	PH6135	PH0905	C2	C5	PH0320	PH0125	PH0230	PH0135				
Description	Geometry Code															Application	Feed Rate - in (mm)	DOC - in (mm)		
SPGN 421 SPGN 120304	6-SPG-421		LA								2	5					Flat Top	GROUND	0.003-0.010 (0.08-0.25)	0.009-0.157 (0.25-4.00)
SPUN 421 SPUN 120304	112-0580-							78												



To order please use the **geometry code** plus the **grade code**

SPGN/SPUN Inserts (continued)

		Primary Applications																		
		Steel		Stainless Steel		Cast Irons		Non-Ferrous		Heat Resistant Alloys		TMX		Palbit						
		CVD Increasing Toughness →		PVD Coated Increasing Toughness →						Uncoated Increasing Toughness →										
		C2 TiN	C5 TiN	PH6910	PH6215	PH6920	PH6225	PH6125	PH6135	PH0905	C2	C5	PH0320	PH0125	PH0230	PH0135				
Description	Geometry Code															Application	Feed Rate – in (mm)	DOC – in (mm)		
SPGN 422 SPGN 120308	6-SPG-422		LA								2	5					Flat Top	GROUND	0.003-0.015 (0.08-0.38)	0.020-0.157 (0.50-4.00)
SPUN 422 SPUN 120308	6-SPU-422		LA								2	5					Long Chip	GENERAL PURPOSE TOP FORM	0.003-0.015 (0.08-0.38)	0.020-0.157 (0.50-4.00)
	112-0581-							78		07					09					



TURNING

To order please use the **geometry code** plus the **grade code**

		Primary Applications																		
		Steel		Stainless Steel		Cast Irons		Non-Ferrous		Heat Resistant Alloys		TMX		Palbit						
		CVD Increasing Toughness →		PVD Coated Increasing Toughness →						Uncoated Increasing Toughness →										
		C2 TiN	C5 TiN	PH6910	PH6215	PH6920	PH6225	PH6125	PH6135	PH0905	C2	C5	PH0320	PH0125	PH0230	PH0135				
Description	Geometry Code															Application	Feed Rate – in (mm)	DOC – in (mm)		
SPGN 423 SPGN 120312	6-SPG-423		LA								2	5					Flat Top	GROUND	0.006-0.018 (0.16-0.46)	0.020-0.157 (0.50-4.00)
SPUN 423 SPUN 120312	6-SPU-423		LA								2						Long Chip	GENERAL PURPOSE TOP FORM	0.006-0.018 (0.16-0.46)	0.020-0.157 (0.50-4.00)
	112-0583-							78	86											



To order please use the **geometry code** plus the **grade code**



Positive Turning Inserts

Cutting Tools

SPGN/SPUN Inserts (continued)

TURNING

	Primary Applications											
Steel	•	•	•	•	•	•	•	•	•	•	•	•
Stainless Steel	•	•	•	•	•	•	•	•	•	•	•	•
Cast Irons	•	•	•	•	•	•	•	•	•	•	•	•
Non-Ferrous	•	•	•	•	•	•	•	•	•	•	•	•
Heat Resistant Alloys	•	•	•	•	•	•	•	•	•	•	•	•

SPGN 424
SPGN 120316
SPUN 424
SPUN 120316



Description	Geometry Code	CVD		PVD Coated						Uncoated				Application	Feed Rate – in (mm)	DOC – in (mm)				
		Increasing Toughness →	Increasing Toughness →	Increasing Toughness →		Increasing Toughness →		Increasing Toughness →		Increasing Toughness →										
		C2 TIN	C5 TIN	PH6910	PH6215	PH6920	PH6225	PH6125	PH6135	PH0905	C2	C5	PH0320	PH0125	PH0230	PH0135				
SPGN 424 SPGN 120316	6-SPG-424		LA								2	5					Flat Top	GROUND	0.008-0.020 (0.20-0.50)	0.020-0.118 (0.50-3.00)
SPUN 424 SPUN 120316	112-0926-							78									Long Chip	GENERAL PURPOSE TOP FORM		

To order please use the geometry code plus the grade code

SPGN 432
SPGN 120408
SPUN 432
SPUN 120408



Description	Geometry Code	CVD		PVD Coated						Uncoated				Application	Feed Rate – in (mm)	DOC – in (mm)				
		Increasing Toughness →	Increasing Toughness →	Increasing Toughness →		Increasing Toughness →		Increasing Toughness →		Increasing Toughness →										
		C2 TIN	C5 TIN	PH6910	PH6215	PH6920	PH6225	PH6125	PH6135	PH0905	C2	C5	PH0320	PH0125	PH0230	PH0135				
SPGN 432 SPGN 120408	6-SPG-432		LA								2	5					Flat Top	GROUND	0.003-0.018 (0.08-0.46)	0.020-0.197 (0.50-5.00)
SPUN 432 SPUN 120408	6-SPU-432		LA								2	5					Long Chip	GENERAL PURPOSE TOP FORM		

To order please use the geometry code plus the grade code

SPGN 433
SPGN 120412



Description	Geometry Code	CVD		PVD Coated						Uncoated				Application	Feed Rate – in (mm)	DOC – in (mm)				
		Increasing Toughness →	Increasing Toughness →	Increasing Toughness →		Increasing Toughness →		Increasing Toughness →		Increasing Toughness →										
		C2 TIN	C5 TIN	PH6910	PH6215	PH6920	PH6225	PH6125	PH6135	PH0905	C2	C5	PH0320	PH0125	PH0230	PH0135				
SPGN 433 SPGN 120412	6-SPG-433		LA								2	5					Flat Top	GROUND	0.006-0.018 (0.16-0.46)	0.020-0.197 (0.50-5.00)

To order please use the geometry code plus the grade code

SPGN/SPUN Inserts (continued)

		Primary Applications																					
		Steel		Stainless Steel		Cast Irons		Non-Ferrous		Heat Resistant Alloys			TMX		Palbit		TMX		Palbit				
		CVD Increasing Toughness →		PVD Coated Increasing Toughness →				Uncoated Increasing Toughness →															
		C2 TIN	C5 TIN	PH6910	PH6215	PH6920	PH6225	PH6125	PH6135	PH0905	C2	C5	PH0320	PH0125	PH0230	PH0135							
Description	Geometry Code																Application		Feed Rate - in (mm)	DOC - in (mm)			
SPGN 434 SPGN 120416	6-SPG-434		LA								2	5					Flat Top	GROUND	0.008-0.020 (0.20-0.50)	0.020-0.197 (0.50-5.00)			



To order please use the **geometry code** plus the **grade code**

		TMX		Palbit						TMX		Palbit											
		CVD Increasing Toughness →		PVD Coated Increasing Toughness →				Uncoated Increasing Toughness →															
		C2 TIN	C5 TIN	PH6910	PH6215	PH6920	PH6225	PH6125	PH6135	PH0905	C2	C5	PH0320	PH0125	PH0230	PH0135							
Description	Geometry Code																Application		Feed Rate - in (mm)	DOC - in (mm)			
SPGN 533 SPGN 150412	6-SPG-533		LA								2	5					Flat Top	GROUND	0.006-0.018 (0.16-0.46)	0.020-0.197 (0.50-5.00)			
SPUN 533 SPUN 150412	6-SPU-533		LA								2	5					Long Chip	GENERAL PURPOSE TOP FORM	0.006-0.018 (0.16-0.46)	0.020-0.197 (0.50-5.00)			
	112-0595-								86					15									



To order please use the **geometry code** plus the **grade code**

		TMX		Palbit						TMX		Palbit											
		CVD Increasing Toughness →		PVD Coated Increasing Toughness →				Uncoated Increasing Toughness →															
		C2 TIN	C5 TIN	PH6910	PH6215	PH6920	PH6225	PH6125	PH6135	PH0905	C2	C5	PH0320	PH0125	PH0230	PH0135							
Description	Geometry Code																Application		Feed Rate - in (mm)	DOC - in (mm)			
SPGN 632 SPGN 190408	6-SPG-632		LA								2	5					Flat Top	GROUND	0.003-0.018 (0.08-0.46)	0.020-0.197 (0.50-5.00)			
SPUN 632 SPUN 190408	6-SPU-632		LA								2	5					Long Chip	GENERAL PURPOSE TOP FORM	0.003-0.018 (0.08-0.46)	0.020-0.197 (0.50-5.00)			
	112-0597-								86														



To order please use the **geometry code** plus the **grade code**



Positive Turning Inserts

Cutting Tools

SPGN/SPUN Inserts (continued)

TURNING

Primary Applications											
Steel	•	•	•	•	•	•	•	•	•	•	•
Stainless Steel	•	•	•	•	•	•	•	•	•	•	•
Cast Irons	•	•	•	•	•	•	•	•	•	•	•
Non-Ferrous	•	•	•	•	•	•	•	•	•	•	•
Heat Resistant Alloys	•	•	•	•	•	•	•	•	•	•	•

SPGN 633
SPGN 190412
SPUN 633
SPUN 190412



Description	Geometry Code	CVD		PVD Coated						Uncoated					Application	Feed Rate - in (mm)	DOC - in (mm)			
		C2 TIN	C5 TIN	PH6910	PH6215	PH6920	PH6225	PH6125	PH6135	PH0905	C2	C5	PH0320	PH0125				PH0230	PH0135	
SPGN 633 SPGN 190412	6-SPG-633		LA								2						Flat Top	GROUND	0.006-0.018 (0.16-0.46)	0.020-0.197 (0.50-5.00)
SPUN 633 SPUN 190412	6-SPU-633 112-0598-		LA								2	5					Long Chip	GENERAL PURPOSE TOP FORM		

To order please use the geometry code plus the grade code

SPGN 634
SPGN 190416
SPUN 634
SPUN 190416

CVD		PVD Coated						Uncoated						
C2 TIN	C5 TIN	PH6910	PH6215	PH6920	PH6225	PH6125	PH6135	PH0905	C2	C5	PH0320	PH0125	PH0230	PH0135



Description	Geometry Code	CVD		PVD Coated						Uncoated					Application	Feed Rate - in (mm)	DOC - in (mm)			
		C2 TIN	C5 TIN	PH6910	PH6215	PH6920	PH6225	PH6125	PH6135	PH0905	C2	C5	PH0320	PH0125				PH0230	PH0135	
SPGN 634 SPGN 190416	6-SPG-634		LA								2	5					Flat Top	GROUND	0.008-0.020 (0.20-0.50)	0.020-0.197 (0.50-5.00)
SPUN 634 SPUN 190416	6-SPU-634		LA								2						Long Chip	GENERAL PURPOSE TOP FORM		

To order please use the geometry code plus the grade code

SPMR Inserts

		Primary Applications																				
		Steel		Stainless Steel		Cast Irons		Non-Ferrous		Heat Resistant Alloys		TMX		Palbit		TMX		Palbit				
		CVD Increasing Toughness →		PVD Coated Increasing Toughness →						Uncoated Increasing Toughness →												
		C2 TiN	C5 TiN	PH6910	PH6215	PH6920	PH6225	PH6125	PH6135	PH0905	C2	C5	PH0320	PH0125	PH0230	PH0135	Application			Feed Rate - in (mm)	DOC - in (mm)	
SPMR 321 SPMR 090304	6-SPMR-321		LA								2	5					Long Chip	GENERAL PURPOSE TOP FORM	0.003-0.009 (0.08-0.23)	0.009-0.079 (0.25-2.00)		



To order please use the geometry code plus the grade code

		TMX		Palbit						TMX		Palbit									
		CVD Increasing Toughness →		PVD Coated Increasing Toughness →						Uncoated Increasing Toughness →											
		C2 TiN	C5 TiN	PH6910	PH6215	PH6920	PH6225	PH6125	PH6135	PH0905	C2	C5	PH0320	PH0125	PH0230	PH0135	Application			Feed Rate - in (mm)	DOC - in (mm)
SPMR 322 SPMR 090308	6-SPMR-322		LA								2	5					Long Chip	GENERAL PURPOSE TOP FORM	0.003-0.010 (0.08-0.25)	0.009-0.079 (0.25-2.00)	
SPMR 322-13 SPMR 090308-13	112-0562-					68											Long Chip	GENERAL PURPOSE TOP FORM			



To order please use the geometry code plus the grade code



Positive Turning Inserts

Cutting Tools

SPMR Inserts (continued)

TURNING

Primary Applications															
Steel	•	•	•	•	•	•	•	•	•	•	•				
Stainless Steel	•	•	•	•	•	•	•	•	•	•	•				
Cast Irons	•	•	•	•	•	•	•	•	•	•	•				
Non-Ferrous	•	•	•	•	•	•	•	•	•	•	•				
Heat Resistant Alloys	•	•	•	•	•	•	•	•	•	•	•				
	TMX		Palbit					TMX		Palbit					
	CVD Increasing Toughness →		PVD Coated Increasing Toughness →					Uncoated Increasing Toughness →							
	C2 TiN	C5 TiN	PH6910	PH6215	PH6920	PH6225	PH6125	PH6135	PH0905	C2	C5	PH0320	PH0125	PH0230	PH0135



SPMR 421
SPMR 120304

Description	Geometry Code	C2 TiN	C5 TiN	PH6910	PH6215	PH6920	PH6225	PH6125	PH6135	PH0905	C2	C5	PH0320	PH0125	PH0230	PH0135	Application	Feed Rate - in (mm)	DOC - in (mm)	
SPMR 421 SPMR 120304	6-SPMR-421		LA								2	5					Long Chip	GENERAL PURPOSE TOP FORM	0.003-0.010 (0.08-0.25)	0.009-0.118 (0.25-3.00)
	112-0580-						78									14				

To order please use the **geometry code** plus the **grade code**

TMX		Palbit					TMX		Palbit					
CVD Increasing Toughness →		PVD Coated Increasing Toughness →					Uncoated Increasing Toughness →							
C2 TiN	C5 TiN	PH6910	PH6215	PH6920	PH6225	PH6125	PH6135	PH0905	C2	C5	PH0320	PH0125	PH0230	PH0135



SPMR 422
SPMR 120308

Description	Geometry Code	C2 TiN	C5 TiN	PH6910	PH6215	PH6920	PH6225	PH6125	PH6135	PH0905	C2	C5	PH0320	PH0125	PH0230	PH0135	Application	Feed Rate - in (mm)	DOC - in (mm)	
SPMR 422 SPMR 120308	6-SPMR-422		LA								2	5					Long Chip	GENERAL PURPOSE TOP FORM	0.004-0.015 (0.10-0.38)	0.009-0.118 (0.25-3.00)

To order please use the **geometry code** plus the **grade code**

Positive Turning Inserts



TMX Cutting Tools

TURNING

SPMT/SPGH Inserts

	Primary Applications													
Steel	•	•	•	•	•	•	•	•	•	•	•	•	•	•
Stainless Steel	•	•	•	•	•	•	•	•	•	•	•	•	•	•
Cast Irons	•	•	•	•	•	•	•	•	•	•	•	•	•	•
Non-Ferrous	•	•	•	•	•	•	•	•	•	•	•	•	•	•
Heat Resistant Alloys	•	•	•	•	•	•	•	•	•	•	•	•	•	•

SPGH 322
SPGH 090308

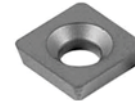

Description	Geometry Code	CVD Increasing Toughness →		PVD Coated Increasing Toughness →						Uncoated Increasing Toughness →						Application		Feed Rate – in (mm)	DOC – in (mm)		
		C2 TiN	C5 TiN	PH6910	PH6215	PH6920	PH6225	PH6125	PH6135	PH0905	C2	C5	PH0320	PH0125	PH0230					PH0135	
SPGH 322 SPGH 090308	6-SPH-322		LA									2	5					Flat Top	GROUND	0.003-0.010 (0.08-0.25)	0.009-0.079 (0.25-2.00)

To order please use the geometry code plus the grade code

SPMT 32.51
SPMT 09T304



Description	Geometry Code	CVD Increasing Toughness →		PVD Coated Increasing Toughness →						Uncoated Increasing Toughness →						Application		Feed Rate – in (mm)	DOC – in (mm)		
		C2 TiN	C5 TiN	PH6910	PH6215	PH6920	PH6225	PH6125	PH6135	PH0905	C2	C5	PH0320	PH0125	PH0230					PH0135	
SPMT 32.51 SPMT 09T304	6-SPMT-3251	H	LA									2	5					Long Chip	GENERAL PURPOSE TOP FORM	0.003-0.010 (0.08-0.25)	0.009-0.118 (0.25-3.00)

To order please use the geometry code plus the grade code

SPMT 32.52
SPMT 09T308



Description	Geometry Code	CVD Increasing Toughness →		PVD Coated Increasing Toughness →						Uncoated Increasing Toughness →						Application		Feed Rate – in (mm)	DOC – in (mm)		
		C2 TiN	C5 TiN	PH6910	PH6215	PH6920	PH6225	PH6125	PH6135	PH0905	C2	C5	PH0320	PH0125	PH0230					PH0135	
SPMT 32.52 SPMT 09T308	6-SPMT-3252	H	LA									2	5					Long Chip	GENERAL PURPOSE TOP FORM	0.003-0.012 (0.08-0.32)	0.009-0.118 (0.25-3.00)

To order please use the geometry code plus the grade code



Positive Turning Inserts

Cutting Tools

SPMT/SPGH Inserts (continued)

TURNING

		Primary Applications																		
		Steel	Stainless Steel	Cast Irons	Non-Ferrous	Heat Resistant Alloys	TMX	Palbit					TMX	Palbit						
		CVD Increasing Toughness →		PVD Coated Increasing Toughness →					Uncoated Increasing Toughness →											
		C2 TiN	C5 TiN	PH6910	PH6215	PH6920	PH6225	PH6125	PH6135	PH0905	C2	C5	PH0320	PH0125	PH0230	PH0135	Application		Feed Rate - in (mm)	DOC - in (mm)
SPMT 431 SPMT 120404	6-SPMT-431	H	LA								2	5					Flat Top	GROUND	0.003-0.010 (0.08-0.26)	0.020-0.157 (0.50-4.00)



To order please use the **geometry code** plus the **grade code**

		Primary Applications																		
		Steel	Stainless Steel	Cast Irons	Non-Ferrous	Heat Resistant Alloys	TMX	Palbit					TMX	Palbit						
		CVD Increasing Toughness →		PVD Coated Increasing Toughness →					Uncoated Increasing Toughness →											
		C2 TiN	C5 TiN	PH6910	PH6215	PH6920	PH6225	PH6125	PH6135	PH0905	C2	C5	PH0320	PH0125	PH0230	PH0135	Application		Feed Rate - in (mm)	DOC - in (mm)
SPMT 432 SPMT 120408	6-SPMT-432	H	LA								2	5					Flat Top	GROUND	0.004-0.018 (0.10-0.46)	0.020-0.197 (0.50-5.00)



To order please use the **geometry code** plus the **grade code**

		Primary Applications																		
		Steel	Stainless Steel	Cast Irons	Non-Ferrous	Heat Resistant Alloys	TMX	Palbit					TMX	Palbit						
		CVD Increasing Toughness →		PVD Coated Increasing Toughness →					Uncoated Increasing Toughness →											
		C2 TiN	C5 TiN	PH6910	PH6215	PH6920	PH6225	PH6125	PH6135	PH0905	C2	C5	PH0320	PH0125	PH0230	PH0135	Application		Feed Rate - in (mm)	DOC - in (mm)
SPGH 433 SPGH 120412	6-SPH-433		LA								2	5					Flat Top	GROUND	0.006-0.018 (0.16-0.46)	0.020-0.197 (0.50-5.00)

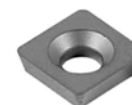

To order please use the **geometry code** plus the **grade code**

TCMT/TCGT Inserts

		Primary Applications												
		Steel	Stainless Steel	Cast Irons	Non-Ferrous	Heat Resistant Alloys	Palbit		TMX					
		PVD Coated Increasing Toughness →						Uncoated						
		PH6705	PH6910	PH6215	PH6325	PH6920	PH6225	PH6740	PH0910	H01				
Description	Geometry Code									Application		Feed Rate – in (mm)	DOC – in (mm)	
TCMT 21.51-FM TCMT 110204-FM	112-1958-				67						Long Chip	FINE FINISHING TO FINISHING	0.001-0.007 (0.05-0.17)	0.003-0.067 (0.08-1.70)
TCMT 21.51-MP TCMT 110204-MP	112-1970-					68					Short Chip	FINISHING	0.002-0.008 (0.05-0.19)	0.009-0.098 (0.25-2.50)
TCMT 21.51-MM TCMT 110204-MM	112-1968-					68					Long Chip	FINISHING	0.003-0.008 (0.06-0.19)	0.009-0.098 (0.25-2.50)
TCMT 21.51-MK TCMT 110204-MK	112-1966-	D2			67							FINISHING	0.003-0.008 (0.06-0.19)	0.009-0.098 (0.25-2.50)



To order please use the **geometry code** plus the **grade code**

		Palbit								TMX				
		PVD Coated Increasing Toughness →						Uncoated						
		PH6705	PH6910	PH6215	PH6325	PH6920	PH6225	PH6740	PH0910	H01				
Description	Geometry Code									Application		Feed Rate – in (mm)	DOC – in (mm)	
TCMT 21.52-FM TCMT 110208-FM	112-1959-					68					Long Chip	FINE FINISHING TO FINISHING	0.001-0.007 (0.05-0.17)	0.003-0.067 (0.08-1.70)
TCMT 21.52-MP TCMT 110208-MP	112-1971-					68					Short Chip	FINISHING	0.002-0.008 (0.05-0.19)	0.009-0.098 (0.25-2.50)
TCMT 21.52-MM TCMT 110208-MM	112-1969-		54			68					Long Chip	FINISHING	0.003-0.008 (0.06-0.19)	0.009-0.098 (0.25-2.50)
TCMT 21.52-MK TCMT 110208-MK	112-1967-				67							FINISHING	0.003-0.008 (0.06-0.19)	0.009-0.098 (0.25-2.50)



To order please use the **geometry code** plus the **grade code**



Positive Turning Inserts

Cutting Tools

TCMT/TCGT Inserts (continued)

TURNING

	Primary Applications											
Steel	•	•	•	•	•	•	•	•	•	•	•	•
Stainless Steel	•	•	•	•	•	•	•	•	•	•	•	•
Cast Irons	•	•	•	•	•	•	•	•	•	•	•	•
Non-Ferrous	•	•	•	•	•	•	•	•	•	•	•	•
Heat Resistant Alloys	•	•	•	•	•	•	•	•	•	•	•	•



TCMT 32.51
TCGT 32.51
TCMT 16T304
TCGT 16T304

Description	Geometry Code	Palbit												TMX	Application	Feed Rate – in (mm)	DOC – in (mm)	
		MTCVD Increasing Toughness →					PVD Coated Increasing Toughness →					Uncoated						
		PH5705	PH5115	PH5320	PH5125	PH5740	PH6705	PH6910	PH6215	PH6325	PH6920	PH6225	PH6740	PH0910	H01			
TCGT 32.51-AK TCGT 16T304-AK	6-TCG-321														2	ALUMINUM	0.001-0.016 (0.03-0.40)	0.004-0.217 (0.10-5.5)
TCMT 32.51-FP TCMT 16T304-FP	112-1832-										68					Short Chip	0.002-0.009 (0.06-0.23)	0.004-0.067 (0.10-2.00)
TCMT 32.51-FM TCMT 16T304-FM	112-1831-								67	68					Long Chip			
TCMT 32.51-MP TCMT 16T304-MP	112-1836-				L8			54								Short Chip	0.004-0.009 (0.08-0.23)	0.009-0.118 (0.25-3.00)
TCMT 32.51-MM TCMT 16T304-MM	112-1835-								67	68					Long Chip			
TCMT 32.51-MK TCMT 16T304-MK	112-1834-						D2								FINISHING			

To order please use the geometry code plus the grade code



TCMT 32.52
TCGT 32.52
TCMT 16T308
TCGT 16T308

Description	Geometry Code	Palbit												TMX	Application	Feed Rate – in (mm)	DOC – in (mm)	
		MTCVD Increasing Toughness →					PVD Coated Increasing Toughness →					Uncoated						
		PH5705	PH5115	PH5320	PH5125	PH5740	PH6705	PH6910	PH6215	PH6325	PH6920	PH6225	PH6740	PH0910	H01			
TCMT 32.52-AK TCMT 16T308-AK	6-TCG-322														2	ALUMINUM	0.001-0.020 (0.03-0.50)	0.004-0.217 (0.10-5.5)
TCMT 32.52-MP TCMT 16T308-MP	112-1840-							54								Short Chip	0.004-0.009 (0.08-0.23)	0.009-0.118 (0.25-3.00)
TCMT 32.52-MW TCMT 16T308-MW	112-1841-						D2									Wiper	0.006-0.020 (0.15-0.50)	0.009-0.118 (0.25-3.00)
TCMT 32.52-MM TCMT 16T308-MM	112-1839-								67							Long Chip	0.003-0.009 (0.08-0.23)	0.010-0.118 (0.25-3.0)

To order please use the geometry code plus the grade code

TCMT/TCGT Inserts (continued)

		Primary Applications																	
		Steel	Stainless Steel	Cast Irons	Non-Ferrous	Heat Resistant Alloys				TMX									
		Palbit								Uncoated									
		PVD Coated Increasing Toughness →																	
		PH6705	PH6910	PH6215	PH6325	PH6920	PH6225	PH6740	PH0910	H01									
TCMT 32.53 TCMT 16T312	Description	Geometry Code									Application		Feed Rate – in (mm)	DOC – in (mm)					
			TCMT 32.53-MP TCMT 16T312-MP	112-1844-					68							Short Chip	FINISHING	0.005-0.014 (0.12-0.36)	0.009-0.118 (0.25-3.00)
			TCMT 32.53-MM TCMT 16T312-MM	112-1843-					68							Long Chip	FINISHING	0.005-0.014 (0.12-0.36)	0.009-0.118 (0.25-3.00)

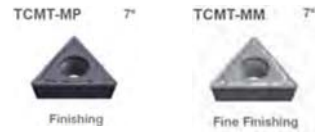

TURNING

To order please use the geometry code plus the grade code

		Palbit								TMX				
		PVD Coated Increasing Toughness →						Uncoated						
		PH6705	PH6910	PH6215	PH6325	PH6920	PH6225	PH6740	PH0910	H01				
TCMT 432 TCMT 220408	Description	Geometry Code									Application		Feed Rate – in (mm)	DOC – in (mm)
			TCMT 21.52-FM TCMT 110208-FM	112-1849-					68					



To order please use the geometry code plus the grade code



Positive Turning Inserts

Cutting Tools

TPGN/TPUN Inserts

TURNING

	Primary Applications													
Steel	•	•	•	•	•	•	•	•	•	•	•	•	•	•
Stainless Steel	•	•	•	•	•	•	•	•	•	•	•	•	•	•
Cast Irons	•	•	•	•	•	•	•	•	•	•	•	•	•	•
Non-Ferrous	•	•	•	•	•	•	•	•	•	•	•	•	•	•
Heat Resistant Alloys	•	•	•	•	•	•	•	•	•	•	•	•	•	•

TPGN 221
TPUN 221
TPGN 110304
TPUN 110304



Description	Geometry Code	CVD		PVD Coated						Uncoated						Application		Feed Rate – in (mm)	DOC – in (mm)				
		CZ TiN	C5 TiN	PH6910	PH6215	PH6920	PH6225	PH6125	PH6135	PH0905	PH0309	PH0910	CZ	C5	PH0120					PH0320	PH0125	PH0230	PH0135
TPGN 221 TPUN 110304	6-TPG-221		LA																	Flat Top	GROUND	0.003-0.009 (0.08-0.23)	0.009-0.079 (0.25-2.00)
TPUN 221 TPUN 110304	6-TPU-221		LA																	Flat Top	UTILITY		

To order please use the geometry code plus the grade code

TPGN 222
TPUN 222
TPGN 110308
TPUN 110308

	CVD		PVD Coated						Uncoated						Application		Feed Rate – in (mm)	DOC – in (mm)					
	CZ TiN	C5 TiN	PH6910	PH6215	PH6920	PH6225	PH6125	PH6135	PH0905	PH0309	PH0910	CZ	C5	PH0120					PH0320	PH0125	PH0230	PH0135	
TPGN 222 TPUN 110308	6-TPG-222		LA																	Flat Top	GROUND	0.003-0.010 (0.08-0.26)	0.009-0.079 (0.25-2.00)
TPUN 222 TPUN 110308	6-TPU-222		LA																	Flat Top	UTILITY		



To order please use the geometry code plus the grade code

TPGN 320
TPGN 160300

	CVD		PVD Coated						Uncoated						Application		Feed Rate – in (mm)	DOC – in (mm)					
	CZ TiN	C5 TiN	PH6910	PH6215	PH6920	PH6225	PH6125	PH6135	PH0905	PH0309	PH0910	CZ	C5	PH0120					PH0320	PH0125	PH0230	PH0135	
TPGN 320 TPGN 160300	6-TPG-320		LA																	Flat Top	GROUND	0.001-0.008 (0.06-0.20)	0.009-0.118 (0.25-3.00)



To order please use the geometry code plus the grade code

TPGN/TPUN Inserts (continued)

		Primary Applications																					
		Steel		Stainless Steel		Cast Irons		Non-Ferrous		Heat Resistant Alloys		TMX		Palbit		TMX		Palbit					
		CVD Increasing Toughness →		PVD Coated Increasing Toughness →				Uncoated Increasing Toughness →															
		CZ TiN	C5 TiN	PH6910	PH6215	PH6920	PH6225	PH6125	PH6135	PH0905	PH0309	PH0910	CZ	C5	PH0120	PH0320	PH0125	PH0230	PH0135				
TPGN 321 TPUN 321 TPGN 160304 TPUN 160304	6-TPG-321		LA										2	5						Flat Top	GROUND	0.003-0.009 (0.08-0.23)	0.009-0.118 (0.25-3.00)
	111-0425-											08	10		02								
TPUN 321 TPUN 160304	6-TPU-321		LA										2	5						Flat Top	UTILITY	0.003-0.009 (0.08-0.23)	0.009-0.118 (0.25-3.00)
	112-0765-					68	78												14				



TURNING

To order please use the **geometry code** plus the **grade code**

		TMX		Palbit						TMX		Palbit											
		CVD Increasing Toughness →		PVD Coated Increasing Toughness →				Uncoated Increasing Toughness →															
		CZ TiN	C5 TiN	PH6910	PH6215	PH6920	PH6225	PH6125	PH6135	PH0905	PH0309	PH0910	CZ	C5	PH0120	PH0320	PH0125	PH0230	PH0135				
TPGN 322 TPUN 322 TPGN 160308 TPUN 160308	6-TPG-322		LA										2	5						Flat Top	GROUND	0.003-0.010 (0.08-0.26)	0.009-0.118 (0.25-3.00)
	111-0426-					68						10			02	09							
TPUN 322 TPUN 160308	6-TPU-322		LA										2	5						Flat Top	UTILITY	0.003-0.010 (0.08-0.26)	0.009-0.118 (0.25-3.00)
	112-0766-							78	86								15		14				



To order please use the **geometry code** plus the **grade code**



Positive Turning Inserts

Cutting Tools

TURNING

TPGN / TPUN Inserts (continued)

		Primary Applications																				
		Steel		Stainless Steel		Cast Irons		Non-Ferrous		Heat Resistant Alloys		TMX		Palbit		TMX		Palbit				
		CVD Increasing Toughness →		PVD Coated Increasing Toughness →				Uncoated Increasing Toughness →														
		C2 TIN	C5 TIN	PH6910	PH6215	PH6920	PH6225	PH6125	PH6135	PH0905	PH0309	PH0910	C2	C5	PH0120	PH0320	PH0125	PH0230	PH0135			
Description	Geometry Code															Application	Feed Rate – in (mm)	DOC – in (mm)				
TPGN 323 TPGN 160312	111-0427-															Flat Top	GROUND	0.004-0.012 (0.10-0.30)	0.009-0.118 (0.25-3.00)			
TPUN 323 TPUN 160312	6-TPU-323	LA																Flat Top	UTILITY	0.004-0.012 (0.10-0.30)	0.009-0.118 (0.25-3.00)	
	112-0770-																					



To order please use the **geometry code** plus the **grade code**

		Primary Applications																				
		Steel		Stainless Steel		Cast Irons		Non-Ferrous		Heat Resistant Alloys		TMX		Palbit		TMX		Palbit				
		CVD Increasing Toughness →		PVD Coated Increasing Toughness →				Uncoated Increasing Toughness →														
		C2 TIN	C5 TIN	PH6910	PH6215	PH6920	PH6225	PH6125	PH6135	PH0905	PH0309	PH0910	C2	C5	PH0120	PH0320	PH0125	PH0230	PH0135			
Description	Geometry Code															Application	Feed Rate – in (mm)	DOC – in (mm)				
TPGN 324 TPGN 160316	6-TPG-34	LA																Flat Top	GROUND	0.006-0.014 (0.16-0.363)	0.012-0.118 (0.30-3.00)	
TPUN 324 TPUN 160316	6-TPU-324	LA																Flat Top	UTILITY	0.006-0.014 (0.16-0.363)	0.012-0.118 (0.30-3.00)	



To order please use the **geometry code** plus the **grade code**

		Primary Applications																				
		Steel		Stainless Steel		Cast Irons		Non-Ferrous		Heat Resistant Alloys		TMX		Palbit		TMX		Palbit				
		CVD Increasing Toughness →		PVD Coated Increasing Toughness →				Uncoated Increasing Toughness →														
		C2 TIN	C5 TIN	PH6910	PH6215	PH6920	PH6225	PH6125	PH6135	PH0905	PH0309	PH0910	C2	C5	PH0120	PH0320	PH0125	PH0230	PH0135			
Description	Geometry Code															Application	Feed Rate – in (mm)	DOC – in (mm)				
TPGN 430 TPGN 220400	6-TPG-430	LA																Flat Top	GROUND	0.001-0.008 (0.06-0.20)	0.009-0.118 (0.25-3.00)	



To order please use the **geometry code** plus the **grade code**



TPGN / TPUN Inserts (continued)

		Primary Applications																																																																																																
		<table border="1"> <tr><td>Steel</td><td>•</td><td>•</td><td>•</td><td>•</td><td>•</td><td>•</td><td>•</td><td>•</td><td>•</td><td>•</td><td>•</td><td>•</td><td>•</td><td>•</td><td>•</td></tr> <tr><td>Stainless Steel</td><td>•</td><td>•</td><td>•</td><td>•</td><td>•</td><td>•</td><td>•</td><td>•</td><td>•</td><td>•</td><td>•</td><td>•</td><td>•</td><td>•</td><td>•</td></tr> <tr><td>Cast Irons</td><td>•</td><td>•</td><td>•</td><td>•</td><td>•</td><td>•</td><td>•</td><td>•</td><td>•</td><td>•</td><td>•</td><td>•</td><td>•</td><td>•</td><td>•</td></tr> <tr><td>Non-Ferrous</td><td>•</td><td>•</td><td>•</td><td>•</td><td>•</td><td>•</td><td>•</td><td>•</td><td>•</td><td>•</td><td>•</td><td>•</td><td>•</td><td>•</td><td>•</td></tr> <tr><td>Heat Resistant Alloys</td><td>•</td><td>•</td><td>•</td><td>•</td><td>•</td><td>•</td><td>•</td><td>•</td><td>•</td><td>•</td><td>•</td><td>•</td><td>•</td><td>•</td><td>•</td></tr> </table>														Steel	•	•	•	•	•	•	•	•	•	•	•	•	•	•	•	Stainless Steel	•	•	•	•	•	•	•	•	•	•	•	•	•	•	•	Cast Irons	•	•	•	•	•	•	•	•	•	•	•	•	•	•	•	Non-Ferrous	•	•	•	•	•	•	•	•	•	•	•	•	•	•	•	Heat Resistant Alloys	•	•	•	•	•	•	•	•	•	•	•	•	•	•	•			
Steel	•	•	•	•	•	•	•	•	•	•	•	•	•	•	•																																																																																			
Stainless Steel	•	•	•	•	•	•	•	•	•	•	•	•	•	•	•																																																																																			
Cast Irons	•	•	•	•	•	•	•	•	•	•	•	•	•	•	•																																																																																			
Non-Ferrous	•	•	•	•	•	•	•	•	•	•	•	•	•	•	•																																																																																			
Heat Resistant Alloys	•	•	•	•	•	•	•	•	•	•	•	•	•	•	•																																																																																			
		TMX		Palbit						TMX		Palbit																																																																																						
		CVD Increasing Toughness →		PVD Coated Increasing Toughness →						Uncoated Increasing Toughness →																																																																																								
		C2 TIN	C5 TIN	PH6910	PH6215	PH6920	PH6225	PH6125	PH6135	PH0905	PH0309	PH0910	C2	C5	PH0120	PH0320	PH0125	PH0230	PH0135																																																																															
Description	Geometry Code																			Application		Feed Rate – in (mm)	DOC – in (mm)																																																																											
TPGN 431 TPGN 220404	6-TPG-431		LA										2	5						Flat Top	GROUND	0.003-0.009 (0.08-0.23)	0.009-0.157 (0.25-4.00)																																																																											



To order please use the geometry code plus the grade code

		TMX		Palbit						TMX		Palbit											
		CVD Increasing Toughness →		PVD Coated Increasing Toughness →						Uncoated Increasing Toughness →													
		C2 TIN	C5 TIN	PH6910	PH6215	PH6920	PH6225	PH6125	PH6135	PH0905	PH0309	PH0910	C2	C5	PH0120	PH0320	PH0125	PH0230	PH0135				
Description	Geometry Code																			Application		Feed Rate – in (mm)	DOC – in (mm)
TPGN 432 TPGN 220408	6-TPG-432		LA										2	5						Flat Top	GROUND	0.003-0.010 (0.08-0.26)	0.009-0.157 (0.25-4.00)
	111-0431-				56																		
TPUN 432 TPUN 220408	6-TPU-432		LA										2	5						Flat Top	GROUND	0.003-0.010 (0.08-0.26)	0.009-0.157 (0.25-4.00)
	112-0779-						78									09							



To order please use the geometry code plus the grade code

		TMX		Palbit						TMX		Palbit											
		CVD Increasing Toughness →		PVD Coated Increasing Toughness →						Uncoated Increasing Toughness →													
		C2 TIN	C5 TIN	PH6910	PH6215	PH6920	PH6225	PH6125	PH6135	PH0905	PH0309	PH0910	C2	C5	PH0120	PH0320	PH0125	PH0230	PH0135				
Description	Geometry Code																			Application		Feed Rate – in (mm)	DOC – in (mm)
TPGN 433 TPGN 220412	6-TPG-433		LA										2	5						Flat Top	GROUND	0.004-0.012 (0.10-0.30)	0.009-0.157 (0.25-4.00)
TPUN 433 TPUN 220412	6-TPU-433		LA										2	5						Flat Top	GROUND	0.004-0.012 (0.10-0.30)	0.009-0.157 (0.25-4.00)



To order please use the geometry code plus the grade code



Positive Turning Inserts

Cutting Tools

TURNING

TPMR Inserts

Primary Applications												
Steel	•	•	•	•	•	•	•	•	•	•	•	
Stainless Steel	•	•	•	•	•	•	•	•	•	•	•	
Cast Irons	•	•	•	•	•	•	•	•	•	•	•	
Non-Ferrous	•	•	•	•	•	•	•	•	•	•	•	
Heat Resistant Alloys	•	•	•	•	•	•	•	•	•	•	•	
	TMX		Palbit						TMX		Palbit	



TPMR 221
TPMR 110304

Description	Geometry Code	CVD Increasing Toughness →		PVD Coated Increasing Toughness →						Uncoated Increasing Toughness →			Application		Feed Rate – in (mm)	DOC – in (mm)		
		C2 TiN	C5 TiN	PH6910	PH6215	PH6920	PH6225	PH6125	PH6135	PH0910	C2	C5					PH0120	
TPMR 221 TPMR 110304	6-TPM-221		LA												Short Chip	FINISHING	0.003-0.009 (0.08-0.23)	0.009-0.079 (0.25-2.00)

To order please use the geometry code plus the grade code

TPMR 222
TPMR 110308

TMX		Palbit						TMX		Palbit	
CVD Increasing Toughness →		PVD Coated Increasing Toughness →						Uncoated Increasing Toughness →			
C2 TiN	C5 TiN	PH6910	PH6215	PH6920	PH6225	PH6125	PH6135	PH0910	C2	C5	PH0120



Description	Geometry Code	CVD Increasing Toughness →		PVD Coated Increasing Toughness →						Uncoated Increasing Toughness →			Application		Feed Rate – in (mm)	DOC – in (mm)	
		C2 TiN	C5 TiN	PH6910	PH6215	PH6920	PH6225	PH6125	PH6135	PH0910	C2	C5					PH0120
TPMR 222-12 TPMR 110308-12	112-0743-				56									Short Chip	FINISHING	0.003-0.010 (0.08-0.26)	0.009-0.60 (0.25-1.50)
TPMR 222-13 TPMR 110308-13	112-0744-				56										GENERAL PURPOSE	0.005-0.015 (0.13-0.40)	0.04-0.118 (1.0-3.0)

To order please use the geometry code plus the grade code

TPMR 321
TPMR 160304

TMX		Palbit						TMX		Palbit	
CVD Increasing Toughness →		PVD Coated Increasing Toughness →						Uncoated Increasing Toughness →			
C2 TiN	C5 TiN	PH6910	PH6215	PH6920	PH6225	PH6125	PH6135	PH0910	C2	C5	PH0120



Description	Geometry Code	CVD Increasing Toughness →		PVD Coated Increasing Toughness →						Uncoated Increasing Toughness →			Application		Feed Rate – in (mm)	DOC – in (mm)	
		C2 TiN	C5 TiN	PH6910	PH6215	PH6920	PH6225	PH6125	PH6135	PH0910	C2	C5					PH0120
TPMR 321 TPMR 160304	6-TPM-321		LA											Short Chip	FINISHING	0.003-0.009 (0.08-0.23)	0.009-0.118 (0.25-3.00)
TPMR 321-12 TPMR 160304-12	112-0745-				68										GENERAL PURPOSE		

To order please use the geometry code plus the grade code

TPMR Inserts (continued)

		Primary Applications															
		Steel		Stainless Steel		Cast Irons		Non-Ferrous		Heat Resistant Alloys		TMX	Palbit	TMX	Palbit		
		CVD Increasing Toughness →		PVD Coated Increasing Toughness →						Uncoated Increasing Toughness →							
		C2 TiN	C5 TiN	PH6910	PH6215	PH6920	PH6225	PH6125	PH6135	PH0910	C2	C5	PH0120	Application		Feed Rate – in (mm)	DOC – in (mm)
TPMR 322 TPMR 160308	6-TPM-322		LA								2	5		Short Chip	FINISHING	0.003-0.010 (0.08-0.26)	0.009-0.118 (0.25-3.00)
	112-0748-												02	Short Chip	GENERAL PURPOSE		
TPMR 322-13 TPMR 160308-13	112-0749-					68								Short Chip	GENERAL PURPOSE		



TURNING

To order please use the geometry code plus the grade code



Positive Turning Inserts

Cutting Tools

TURNING

TPEE/TPGC
TPGH
Inserts

	Primary Applications									
Steel	•	•	•	•	•	•	•	•	•	•
Stainless Steel	•	•	•	•	•	•	•	•	•	•
Cast Irons	•	•	•	•	•	•	•	•	•	•
Non-Ferrous	•	•	•	•	•	•	•	•	•	•
Heat Resistant Alloys	•	•	•	•	•	•	•	•	•	•

TPEE 730

Description	Geometry Code	CVD		PVD Coated					Uncoated		Application	Feed Rate – in (mm)	DOC – in (mm)		
		C2 TiN	C5 TiN	PH6910	PH6920	PH6225	PH6125	PH6135	PH0910	C2				C5	
TPEE 730	6-TPE-730		LA								2	5	Flat-Top	0.001-0.004 (0.04-0.10)	0.009-0.039 (0.25-1.00)



To order please use the geometry code plus the grade code

TPEE 731

Description	Geometry Code	CVD		PVD Coated					Uncoated		Application	Feed Rate – in (mm)	DOC – in (mm)		
		C2 TiN	C5 TiN	PH6910	PH6920	PH6225	PH6125	PH6135	PH0910	C2				C5	
TPEE 731	6-TPE-731		LA								2	5	Flat-Top	0.003-0.006 (0.08-0.16)	0.009-0.039 (0.25-1.00)



To order please use the geometry code plus the grade code

TPGH 21.50
TPGH 110202

Description	Geometry Code	CVD		PVD Coated					Uncoated		Application	Feed Rate – in (mm)	DOC – in (mm)		
		C2 TiN	C5 TiN	PH6910	PH6920	PH6225	PH6125	PH6135	PH0910	C2				C5	
TPGH 21.50 TPGH 110202	6-TPGH-150	H	LA								2	5	Flat-Top	0.001-0.006 (0.04-0.16)	0.009-0.079 (0.25-2.00)

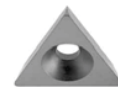

To order please use the geometry code plus the grade code

TPGH 21.51
TPGH 110204

Description	Geometry Code	CVD		PVD Coated					Uncoated		Application	Feed Rate – in (mm)	DOC – in (mm)		
		C2 TiN	C5 TiN	PH6910	PH6920	PH6225	PH6125	PH6135	PH0910	C2				C5	
TPGH 21.51 TPGH 110204	6-TPGH-151	H	LA								2	5	Flat-Top	0.003-0.009 (0.08-0.23)	0.009-0.079 (0.25-2.00)



To order please use the geometry code plus the grade code

TPEE/TPGC/TPGH Inserts (continued)

		Primary Applications																
		Steel	Stainless Steel	Cast Irons	Non-Ferrous	Heat Resistant Alloys	TMX	Palbit					TMX					
		•	•	•	•	•		PH6910	PH6920	PH6225	PH6125	PH6135	PH0910	C2	C5			
		→	→	→	→	→		→	→	→	→	→	→	→	→			
		C2 TiN	C5 TiN	PH6910	PH6920	PH6225	PH6125	PH6135	PH0910	C2	C5	Application		Feed Rate – in (mm)	DOC – in (mm)			
TPGC 221 TPGC 110304	6-TPGC-221		LA							2	5	Short Chip	FINISHING	0.003-0.009 (0.08-0.23)	0.009-0.079 (0.25-2.00)			



To order please use the **geometry code** plus the **grade code**

		Primary Applications																
		Steel	Stainless Steel	Cast Irons	Non-Ferrous	Heat Resistant Alloys	TMX	Palbit					TMX					
		•	•	•	•	•		PH6910	PH6920	PH6225	PH6125	PH6135	PH0910	C2	C5			
		→	→	→	→	→		→	→	→	→	→	→	→	→			
		C2 TiN	C5 TiN	PH6910	PH6920	PH6225	PH6125	PH6135	PH0910	C2	C5	Application		Feed Rate – in (mm)	DOC – in (mm)			
TPGC 222 TPGC 110308	6-TPGC-222		LA							2	5	Short Chip	FINISHING	0.003-0.012 (0.08-0.30)	0.009-0.079 (0.25-2.00)			



To order please use the **geometry code** plus the **grade code**

		Primary Applications																
		Steel	Stainless Steel	Cast Irons	Non-Ferrous	Heat Resistant Alloys	TMX	Palbit					TMX					
		•	•	•	•	•		PH6910	PH6920	PH6225	PH6125	PH6135	PH0910	C2	C5			
		→	→	→	→	→		→	→	→	→	→	→	→	→			
		C2 TiN	C5 TiN	PH6910	PH6920	PH6225	PH6125	PH6135	PH0910	C2	C5	Application		Feed Rate – in (mm)	DOC – in (mm)			
TPGH 320.5 TPGH 160302	6-TPGH-3205	H	LA							2	5	Flat-Top		0.003-0.009 (0.08-0.23)	0.009-0.118 (0.25-3.00)			



To order please use the **geometry code** plus the **grade code**



Positive Turning Inserts

Cutting Tools

TURNING

TPEE/TPGC/TPGH Inserts (continued)

		Primary Applications																																	
		Steel	Steel	Steel	Steel	Steel	Steel	Steel	Steel	Steel	Steel	Stainless Steel	Stainless Steel	Stainless Steel	Stainless Steel	Stainless Steel	Stainless Steel	Cast Irons	Cast Irons	Cast Irons	Cast Irons	Cast Irons	Cast Irons	Non-Ferrous	Non-Ferrous	Non-Ferrous	Non-Ferrous	Non-Ferrous	Non-Ferrous	Heat Resistant Alloys	Heat Resistant Alloys	Heat Resistant Alloys	Heat Resistant Alloys	Heat Resistant Alloys	Heat Resistant Alloys
		TMX	Palbit								TMX																								
		CVD Increasing Toughness →		PVD Coated Increasing Toughness →						Uncoated Increasing Toughness →																									
		C2 TiN	C5 TiN	PH6910	PH6920	PH6225	PH6125	PH6135	PH0910	C2	C5																								
Description	Geometry Code											Application		Feed Rate – in (mm)	DOC – in (mm)																				
TPGH 321 TPGC 321 TPGH 160304 TPGC 160304	6-TPGC-321		LA								2	5	Short Chip	FINISHING	0.003-0.009 (0.08-0.23)	0.009-0.118 (0.25-3.00)																			
TPGH 321 TPGH 160304	6-TPGH-321	H	LA								2	5		Flat-Top	0.003-0.009 (0.08-0.23)	0.009-0.118 (0.25-3.00)																			



To order please use the **geometry code** plus the **grade code**

		Primary Applications																																
		Steel	Steel	Steel	Steel	Steel	Steel	Steel	Steel	Steel	Steel	Stainless Steel	Stainless Steel	Stainless Steel	Stainless Steel	Stainless Steel	Cast Irons	Cast Irons	Cast Irons	Cast Irons	Cast Irons	Cast Irons	Non-Ferrous	Non-Ferrous	Non-Ferrous	Non-Ferrous	Non-Ferrous	Non-Ferrous	Heat Resistant Alloys	Heat Resistant Alloys	Heat Resistant Alloys	Heat Resistant Alloys	Heat Resistant Alloys	Heat Resistant Alloys
		TMX	Palbit								TMX																							
		CVD Increasing Toughness →		PVD Coated Increasing Toughness →						Uncoated Increasing Toughness →																								
		C2 TiN	C5 TiN	PH6910	PH6920	PH6225	PH6125	PH6135	PH0910	C2	C5																							
Description	Geometry Code											Application		Feed Rate – in (mm)	DOC – in (mm)																			
TPGH 322 TPGC 322 TPGH 160308 TPGC 160308	6-TPGC-322		LA								2	5	Short Chip	FINISHING	0.003-0.012 (0.08-0.30)	0.009-0.118 (0.25-3.00)																		
TPGH 322 TPGH 160308	6-TPGH-322	H	LA								2	5		Flat-Top	0.003-0.012 (0.08-0.30)	0.009-0.118 (0.25-3.00)																		



To order please use the **geometry code** plus the **grade code**

VBMT Inserts

		Primary Applications											
		Steel	Stainless Steel	Cast Irons	Non-Ferrous	Heat Resistant Alloys							
		Palbit							TMX				
		PVD Coated Increasing Toughness →							Uncoated				
		PH6705	PH6910	PH6215	PH6325	PH6920	PH6225	PH6740	PH0910				
Description	Geometry Code								Application		Feed Rate – in (mm)	DOC – in (mm)	
VBMT 331 VBMT 160404													
VBMT 331-FP VBMT 160404-FP	112-1865-					68				Short Chip	FINE FINISHING	0.002-0.008 (0.05-0.20)	0.004-0.071 (0.10-1.80)
VBMT 331-MM VBMT 160404-MM	112-1867-					68				Short Chip	FINISHING	0.003-0.009 (0.08-0.23)	0.004-0.106 (0.10-2.70)

To order please use the **geometry code** plus the **grade code**



TURNING

		Palbit							TMX				
		PVD Coated Increasing Toughness →							Uncoated				
		PH6705	PH6910	PH6215	PH6325	PH6920	PH6225	PH6740	PH0910				
Description	Geometry Code								Application		Feed Rate – in (mm)	DOC – in (mm)	
VBMT 332 VBMT 160408													
VBMT 332-FP VBMT 160408-FP	112-1670-					68				Short Chip	FINE FINISHING	0.003-0.011 (0.08-0.27)	0.004-0.071 (0.10-1.80)
VBMT 332-MM VBMT 160408-MM	112-1790-					68				Short Chip	FINISHING	0.003-0.011 (0.08-0.27)	0.006-0.106 (0.16-2.70)
VBMT 332-MP VBMT 160408-MP	112-1791-						77			Long Chip	FINISHING	0.003-0.011 (0.08-0.27)	0.006-0.106 (0.16-2.70)

To order please use the **geometry code** plus the **grade code**





Positive Turning Inserts

Cutting Tools

VCMT/VCMT Inserts

TURNING

Primary Applications													
Steel					•	•	•	•	•				
Stainless Steel	•	•	•	•	•	•	•	•	•				
Cast Irons					•		•	•	•				
Non-Ferrous										•			
Heat Resistant Alloys					•		•	•	•				
Palbit										TMX			
CVD Increasing Toughness →				PVD Coated Increasing Toughness →						Uncoated			
	PH3215	PH3225	PH3235	PH3240	PH6705	PH6910	PH6215	PH6325	PH6920	PH6225	PH6740	PH0910	H01

VCMT 220.5
VCMT 110302



Description	Geometry Code	PH3215	PH3225	PH3235	PH3240	PH6705	PH6910	PH6215	PH6325	PH6920	PH6225	PH6740	PH0910	H01	Application	Feed Rate – in (mm)	DOC – in (mm)
VCMT 220.5-AK VCMT 110302-AK	6-VCG-225													2	ALUMINUM	0.002-0.008 (0.05-0.20)	0.004-0.071 (0.10-1.80)

To order please use the geometry code plus the grade code

VCMT 221
VCMT 221
VCMT 110304
VCMT 110304

Palbit											TMX		
CVD Increasing Toughness →				PVD Coated Increasing Toughness →						Uncoated			
	PH3215	PH3225	PH3235	PH3240	PH6705	PH6910	PH6215	PH6325	PH6920	PH6225	PH6740	PH0910	H01
									68				

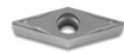

Description	Geometry Code	PH3215	PH3225	PH3235	PH3240	PH6705	PH6910	PH6215	PH6325	PH6920	PH6225	PH6740	PH0910	H01	Application	Feed Rate – in (mm)	DOC – in (mm)
VCMT 221-HFP VCMT 110304-HFP	6-VCG-221													2	ALUMINUM	0.002-0.010 (0.05-0.25)	0.004-0.071 (0.10-1.80)
VCMT 221-MM VCMT 110304-MM	112-1780-									68					Short Chip FINISHING	0.003-0.009 (0.08-0.23)	0.004-0.071 (0.10-1.80)

To order please use the geometry code plus the grade code

VCMT 222
VCMT 110308

Palbit											TMX		
CVD Increasing Toughness →				PVD Coated Increasing Toughness →						Uncoated			
	PH3215	PH3225	PH3235	PH3240	PH6705	PH6910	PH6215	PH6325	PH6920	PH6225	PH6740	PH0910	H01
									68				



Description	Geometry Code	PH3215	PH3225	PH3235	PH3240	PH6705	PH6910	PH6215	PH6325	PH6920	PH6225	PH6740	PH0910	H01	Application	Feed Rate – in (mm)	DOC – in (mm)
VCMT 222-MM VCMT 110308-MM	112-1751-									68					FINISHING	0.002-0.012 (0.05-0.30)	0.004-0.071 (0.10-1.80)

To order please use the geometry code plus the grade code

VCMT/VCGT Inserts (continued)

		Primary Applications													
		Steel	Stainless Steel	Cast Irons	Non-Ferrous	Heat Resistant Alloys	Palbit		TMX						
		PH6705	PH6910	PH6215	PH6325	PH6920	PH6225	PH6740	PH0910	H01					
VCGT 330.5 VCGT 160402	6-VCG-335	PVD Coated Increasing Toughness →							Uncoated						
											ALUMINUM	0.002-0.008 (0.05-0.20)	0.004-0.157 (0.10-4.00)		
Description	Geometry Code	PH6705	PH6910	PH6215	PH6325	PH6920	PH6225	PH6740	PH0910	H01	Application	Feed Rate – in (mm)	DOC – in (mm)		
VCGT 330.5-AK VCGT 160402-AK	6-VCG-335									2	ALUMINUM	0.002-0.008 (0.05-0.20)	0.004-0.157 (0.10-4.00)		



To order please use the geometry code plus the grade code

		Palbit								TMX					
		PVD Coated Increasing Toughness →							Uncoated						
		PH6705	PH6910	PH6215	PH6325	PH6920	PH6225	PH6740	PH0910	H01					
VCGT 331 VCGT 160404	6-VCG-331	PVD Coated Increasing Toughness →							Uncoated						
											ALUMINUM	0.003-0.016 (0.08-0.40)	0.004-0.197 (0.10-5.00)		
Description	Geometry Code	PH6705	PH6910	PH6215	PH6325	PH6920	PH6225	PH6740	PH0910	H01	Application	Feed Rate – in (mm)	DOC – in (mm)		
VCGT 331-AK VCGT 160404-AK	6-VCG-331									2	ALUMINUM	0.003-0.016 (0.08-0.40)	0.004-0.197 (0.10-5.00)		
VCGT 331-LN VCGT 160404-LN	111-1533-								10		ALUMINUM	0.003-0.016 (0.08-0.40)	0.004-0.197 (0.10-5.00)		

VCGT-LN 7°



Finishing to Fine Finishing

To order please use the geometry code plus the grade code

		Palbit								TMX					
		PVD Coated Increasing Toughness →							Uncoated						
		PH6705	PH6910	PH6215	PH6325	PH6920	PH6225	PH6740	PH0910	H01					
VCGT 332 VCGT 160408	6-VCG-332	PVD Coated Increasing Toughness →							Uncoated						
											ALUMINUM	0.004-0.018 (0.1-0.46)	0.004-0.071 (0.10-1.80)		
Description	Geometry Code	PH6705	PH6910	PH6215	PH6325	PH6920	PH6225	PH6740	PH0910	H01	Application	Feed Rate – in (mm)	DOC – in (mm)		
VCGT 332-AK VCGT 160408-AK	6-VCG-332									2	ALUMINUM	0.004-0.018 (0.1-0.46)	0.004-0.071 (0.10-1.80)		



To order please use the geometry code plus the grade code



Positive Turning Inserts

Cutting Tools

TURNING

WCMT Inserts

	Primary Applications								
Steel				•	•	•	•	•	
Stainless Steel	•	•		•	•	•	•	•	
Cast Irons			•	•	•	•	•	•	
Non-Ferrous									•
Heat Resistant Alloys			•	•	•	•	•	•	



WCMT 21.51
WCMT 040204

Description	Geometry Code	CVD		PVD Coated							PH0910	Application	Feed Rate - in (mm)	DOC - in (mm)
		C2 TiN	C5 TiN	PH6705	PH6910	PH6215	PH6325	PH6920	PH6225	PH6740				
WCMT 21.51 WCMT 040204	6-WCM-2151	H										General Purpose	0.002-0.008 (0.05-0.20)	0.004-0.071 (0.10-1.80)

To order please use the geometry code plus the grade code

WCMT 32.52
WCMT 06T308



Description	Geometry Code	CVD		PVD Coated							PH0910	Application	Feed Rate - in (mm)	DOC - in (mm)
		C2 TiN	C5 TiN	PH6705	PH6910	PH6215	PH6325	PH6920	PH6225	PH6740				
WCMT 32.52 WCMT 06T308	6-WCM-3252	H										General Purpose	.002-0.008 (0.05-0.20)	0.004-0.071 (0.10-1.80)

To order please use the geometry code plus the grade code

TABLE OF CONTENTS

TURNING NEGATIVE TOOL HOLDERS

Negative Tool Holders Overview 162

HOLDERS FOR CNMG/CNMA

MCLNR/L 167
MCMNN 167
MCRNR/L 168
MCKNR 168

HOLDERS FOR DNMG/DNMA

MDJNR/L 169
MDPNN 169

HOLDERS FOR RNMG/RNMA

MGRNR/L 170

HOLDERS FOR SNMG/SNMA

MSSNR/L 171
MSDNN 171
MSRNR/L 172
MSKNR/L 172

HOLDERS FOR TNMG/TNMA

MTJNR/L 173
MTENN 174
MTGNR/L 174
MTFNR/L 174

HOLDERS FOR VNMG/VNMA

MVJNR/L 175
MVVN 175

HOLDERS FOR WNMG/WNMA

MWLNR/L 176

TURNING POSITIVE TOOL HOLDERS

Positive Tool Holders Overview 177

HOLDERS FOR CCMT/CCGT

SCLRR/L 180
SCMCN 180

HOLDERS FOR DCMT/DCGT

SDJCR/L 181
SDPCN 181

HOLDERS FOR SCMT/SCGT

SSDCN 182

HOLDERS FOR TCMT/TCGT

STECN 183
STJCR/L 183
STGCR/L 184
STFCR/L 184

HOLDERS FOR VCMT/VCGT

SVJCR/L 185

TURNING NEGATIVE BORING BARS

Negative Boring Bars Overview 186

BORING BARS FOR CNMG/CNMA

SI-MCLNR/L 188
AI-MCLNR/L 188

BORING BARS FOR DNMG/DNMA

SI-MDUNR/L 189

BORING BARS FOR TNMG/TNMA

SI-MTUNR/L 190

BORING BARS FOR VNMG/VNMA

SI-MVUNR/L 191

BORING BARS FOR WNMG/WNMA

SI-MWLNR/L 192
AI-MWLNR/L 192

TURNING POSITIVE BORING BARS

Positive Boring Bars Overview 193

BORING BARS FOR CCMT/CCGT

SI-SCLCR/L 195

BORING BARS FOR DCMT/DCGT

SI-SDUCR/L 195

BORING BARS FOR TCMT/TCGT

SI-STUCR/L 196

BORING BARS FOR TPGN/TPUN/TPMR

SI-CTUPR 196

BORING BARS FOR VCMT/VCGT

SI-SVUCR/L 197

BORING BARS FOR WCMT/WCGT

SI-SWUCR/L 197

Turning Inserts (see page 91)



Negative Turning Tool Holders Overview

Cutting Tools

Negative Tool Holders

TURNING

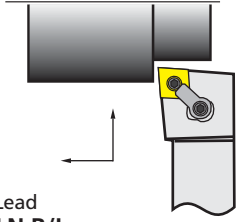
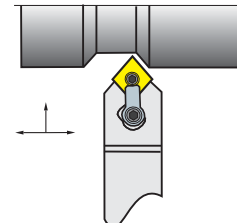
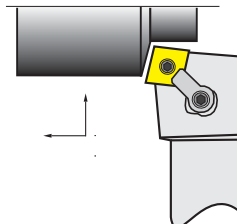
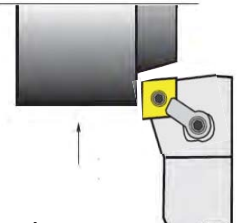
System	Insert Sizes ANSI (ISO)	Styles Available	Shank Sizes	Operations	Lead
CNMG – CNMA – CNMM – CNMP – CNGG – CNGP					
MCLN (R/L) (right shown)  -5° Lead MCLN R/L 6-710-	43_ (1204 __) 54_ (1606 __) 64_ (1906 __)	RIGHT / LEFT	0.75 - 1.50	FACING TURNING	-5°
MCMNN  40° Lead MCMNN 6-711-	43_ (1204 __) 54_ (1606 __) 64_ (1906 __)	NEUTRAL	1.00 - 1.25	TURNING PROFILING	40°
MCRN (R/L) (right shown)  15° Lead MCRN R/L 6-712-	43_ (1204 __) 54_ (1606 __) 64_ (1906 __)	RIGHT / LEFT	1.00 - 1.25	TURNING	15°
MCKN (R/L) (right shown)  15° Lead MCKN R/L 6-737-	43_ (1204 __) 54_ (1606 __)	RIGHT / LEFT	1.00 - 1.25	FACING	15°

Negative Turning Tool Holders Overview

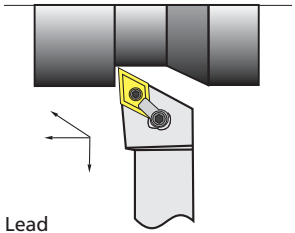
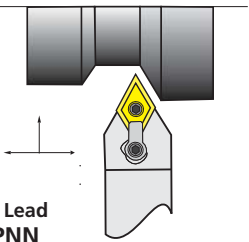
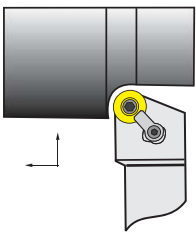
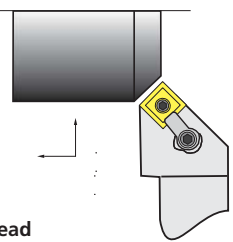

Negative Tool Holders

System	Insert Sizes ANSI (ISO)	Styles Available	Shank Sizes	Operations	Lead
DNMG – DNMA – DNMM					
MDJN (R/L) (right shown)  -3° Lead MDJN R/L 6-715-	43_ (1504 __) 54_ (1906 __)	RIGHT / LEFT	0.75 - 1.50	TURNING PROFILING BACKFACING	-3°
MDPNN  27.5° Lead MDPNN 6-714-	43_ (1504 __) 54_ (1906 __)	NEUTRAL	1.00 - 1.50	TURNING PROFILING	27.5°
RNMG – RNMA					
MRGN (R/L) (right shown)  0° Lead MRGN R/L 6-700-	32 43 (INCH SIZES ONLY)	RIGHT / LEFT	0.75 - 1.25	FACING TURNING	0°
SNMG – SNMA – SNMM					
MSSN (R/L) (right shown)  45° Lead MSSN R/L 6-735-	43_ (1204 __) 54_ (1606 __) 64_ (1906 __)	RIGHT / LEFT	0.75 - 1.50	FACING TURNING	45°

TURNING



Negative Turning Tool Holders Overview

Cutting Tools

Negative Tool Holders

TURNING

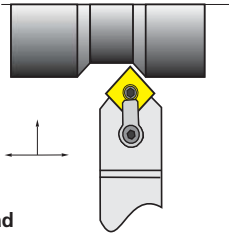
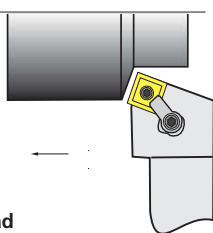
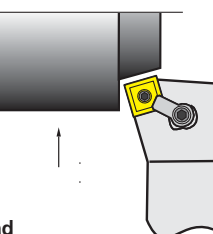
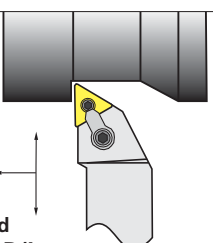
System	Insert Sizes ANSI (ISO)	Styles Available	Shank Sizes	Operations	Lead
SNMG – SNMA – SNMM (cont.)					
MSDNN  45° Lead MSDNN 6-734-	43_ (1204 _) 54_ (1606 _) 64_ (1906 _)	NEUTRAL	0.75 - 1.50	TURNING PROFILING	45°
MSRN (R/L) (right shown)  15° Lead MSRN R/L 6-736-	43_ (1204 _) 54_ (1606 _) 64_ (1906 _)	RIGHT / LEFT	0.75 - 1.50	TURNING	15°
MSKN (R/L) (right shown)  15° Lead MSKN R/L 6-737-	43_ (1204 _) 54_ (1606 _) 64_ (1906 _)	RIGHT / LEFT	0.75 - 1.50	FACING	15°
TNMG – TNMA – TNMM					
MTJN (R/L) (right shown)  -3° Lead MTJN R/L 6-740-	33_ (1604 _) 43_ (2204 _) 54_ (2706 _)	RIGHT / LEFT	0.625-1.50	FACING TURNING PROFILING BACKFACING	-3°

Negative Turning Tool Holders Overview

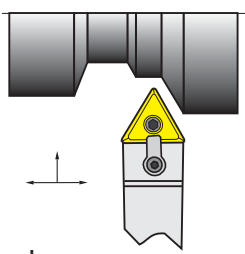
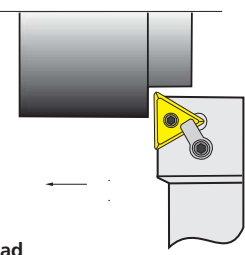
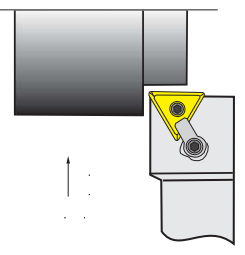

Negative Tool Holders

System	Insert Sizes ANSI (ISO)	Styles Available	Shank Sizes	Operations	Lead
TNMG – TNMA – TNMM (cont.)					
<p>MTENN</p>  <p>30° Lead MTENN 6-741-</p>	<p>33 _ (1604 _) 43 _ (2204 _) 54 _ (2706 _)</p>	NEUTRAL	0.625-1.50	TURNING PROFILING	30°
<p>MTGN (R/L) (right shown)</p>  <p>0° Lead MTGN R/L 6-742-</p>	<p>33 _ (1604 _) 43 _ (2204 _) 54 _ (2706 _)</p>	RIGHT / LEFT	0.75 - 1.25	TURNING	0°
<p>MTFN (R/L) (right shown)</p>  <p>0° Lead MTFN R/L 6-746-</p>	<p>33 _ (1604 _) 43 _ (2204 _) 54 _ (2706 _)</p>	RIGHT / LEFT	0.75 - 1.25	FACING	0°

TURNING



Negative Turning Tool Holders Overview

Cutting Tools

Negative Tool Holders

TURNING

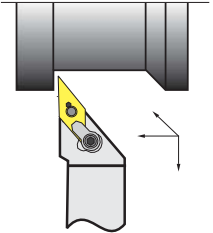
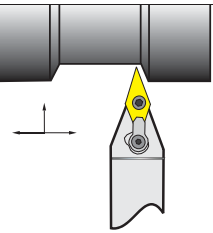
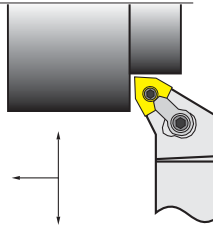
System	Insert Sizes ANSI (ISO)	Styles Available	Shank Sizes	Operations	Lead
VNMG – VNMA					
MVJN (R/L) (right shown)  -3° Lead MVJN R/L 6-755-	33_ (1604 _) 43_ (2204 _)	RIGHT / LEFT	0.75 - 1.50	TURNING PROFILING BACKFACING	-3°
MVVNN  17.5° Lead MVVNN 6-754-	33_ (1604 _) 43_ (2204 _)	NEUTRAL	0.75 - 1.00	TURNING PROFILING	17.5°
WNMG – WNMA					
MWLN (R/L) (right shown)  -5° Lead MWLN (R/L) 6-750-	33_ (0604 _) 43_ (0804 _) 54_ (1006 _)	RIGHT / LEFT	0.75 - 1.50	FACING TURNING BACKFACING	-5°

Negative Turning Tool Holders – CN



TURNING

Tool Holders for 80° Diamond Negative Inserts

CNMG – CNMA – CNMM

FACING, TURNING

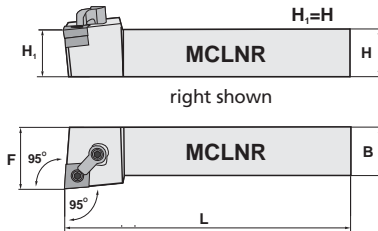

MCLNR

MCLNL

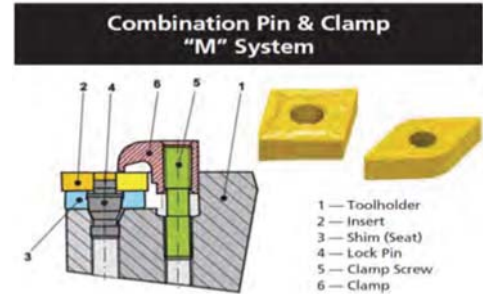
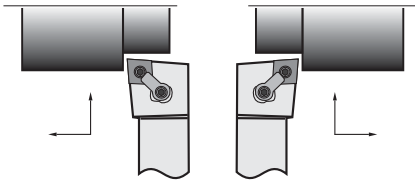

Style	Dimensions				Insert Size	Part Number		Spare Part List					
	Shank		OAL	Head		Right Hand	Left Hand	Shim ³	Shim Screw*	Lock Pin ⁴	Clamp ⁶	Clamp Screw ⁵	Hex Key
	H	B	L	F									
MCLNR/L 12-4B	0.75	0.75	4.5	1.00	43 ₋	6-710-012R	6-710-012L	6-998-6009	6-998-6543	6-998-6265	6-998-6415	6-998-6526	6-998-150 6-998-153
MCLNR/L 16-4D	1.00	1.00	6.0	1.25		6-710-016R	6-710-016L						
MCLNR/L 20-4D	1.25	1.25		1.50		6-710-020R	6-710-020L						
MCLNR/L 24-4D	1.50	1.50		2.00		6-710-024R	6-710-024L						
MCLNR/L 16-5D	1.00	1.00	6.0	1.25	54 ₋	6-710-116R	6-710-116L	6-998-6015	6-998-6545	6-998-6270	6-998-6411	6-998-6531	6-998-153 6-998-159
MCLNR/L 20-5D	1.25	1.25		1.50		6-710-120R	6-710-120L						
MCLNR/L 24-5D	1.50	1.50		2.00		6-710-124R	6-710-124L						
MCLNR/L 16-6D	1.00	1.00	6.0	1.25		64 ₋	6-710-216R						
MCLNR/L 20-6D	1.25	1.25		1.50	6-710-220R		6-710-220L						
MCLNR/L 24-6E	1.50	1.50		7.0	2.00		6-710-224R	6-710-224L					

Tool Holder Plus Inserts Sets				Set Number	
MCLNR 12-4B	10	CNMG 432	6-710-512R		
MCLNR 16-4B	10	CNMG 432	6-710-516R		

TURNING, PROFILING

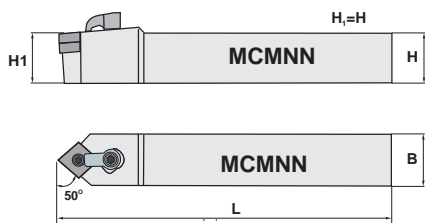

MCMNN

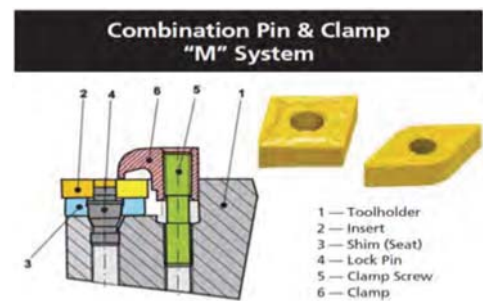
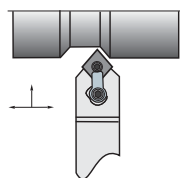

Style	Dimensions				Insert Size	Part Number	Spare Part List					
	Shank		OAL	Head			Shim ³	Shim Screw*	Lock Pin ⁴	Clamp ⁶	Clamp Screw ⁵	Hex Key
	H	B	L	F								
MCMNN 16-4D	1.00	1.00	6.0	-	43 ₋	6-711-016	6-998-6009	6-998-6543	6-998-6265	6-998-6415	6-998-6526	6-998-150 6-998-153
MCMNN 20-5D	1.25	1.25	6.0	-	54 ₋	6-711-120	6-998-6015	6-998-6545	6-998-6270	6-998-6411	6-998-6531	6-998-153 6-998-159
MCMNN 20-6D	1.25	1.25	6.0	-	64 ₋	6-711-220	6-998-6020	6-998-6547	6-998-6275	6-998-6411	6-998-6531	6-998-156 6-998-159

* Shim Screw to replace Lock Pin (4) when using Inserts without hole





Negative Turning Tool Holders – CN

Cutting Tools

CNMG – CNMA – CNMM (continued)

TURNING

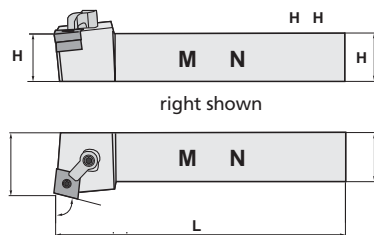

MCRNR

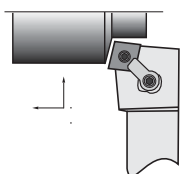

MCRNL

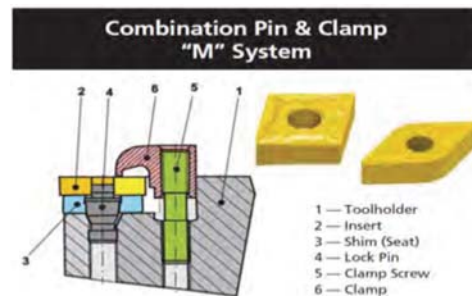
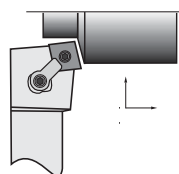

TURNING

Style	Dimensions				Insert Size	Part Number		Spare Part List					
	Shank		OAL	Head		Right Hand	Left Hand	Shim ³	Shim Screw*	Lock Pin ⁴	Clamp ⁶	Clamp Screw ⁵	Hex Key
	H	B	L	F									
MCRNR/L 16-4D	1.00	1.00	6.0	1.25	43_	6-712-016R	6-712-016L	6-998-6009	6-998-6543	6-998-6265	6-998-6415	6-998-6526	6-998-150 6-998-153
MCRNR/L 20-5D	1.25	1.25	6.0	1.50	54_	6-712-120R	6-712-120L	6-998-6015	6-998-6545	6-998-6270	6-998-6411	6-998-6531	6-998-153 6-998-159
MCRNR/L 20-6D	1.25	1.25	6.0	1.50	64_	6-712-220R	6-712-220L	6-998-6020	6-998-6547	6-998-6275	6-998-6411	6-998-6531	6-998-156 6-998-159

FACING

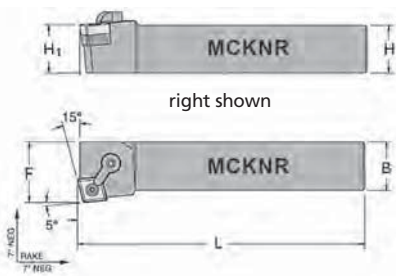

MCKNR

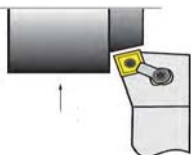

MCKNL

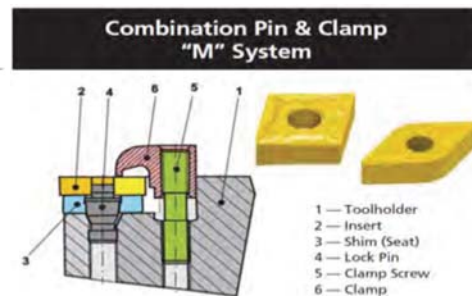
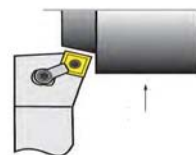

Style	Dimensions				Insert Size	Part Number		Spare Part List					
	Shank		OAL	Head		Right Hand	Left Hand	Shim ³	Shim Screw*	Lock Pin ⁴	Clamp ⁶	Clamp Screw ⁵	Hex Key
	H	B	L	F									
MCKNR/L 12-4B	0.75	0.75	4.5	1.00		6-705-012R	—						
MCKNR/L 16-4D	1.00	1.00	6.0	1.25	43_	6-705-016R	6-705-016L	6-998-6009	6-998-6543	6-998-6265	6-998-6415	6-998-6526	6-998-150 6-998-153
MCKNR/L 20-4D	1.25	1.25	6.0	1.50		6-705-020R	6-705-020L						
MCKNR/L 16-5D	1.00	1.00	6.0	1.25	54_	6-705-116R	—	6-998-6015	6-998-6545	6-998-6270	6-998-6411	6-998-6531	6-998-153 6-998-159
MCKNR/L 20-5D	1.25	1.25		1.50		6-705-120R	—						

* Shim Screw to replace Lock Pin (4) when using Inserts without hole



Tool Holders for 55° Diamond Negative Inserts

DNMG – DNMA

TURNING, PROFILING, BACKFACING

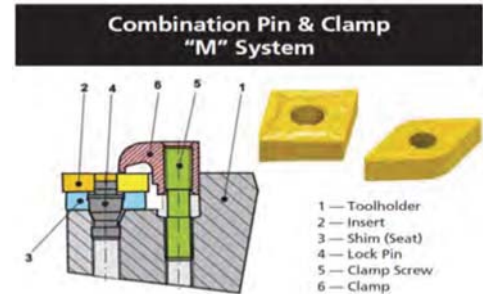
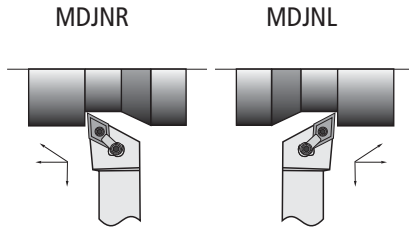
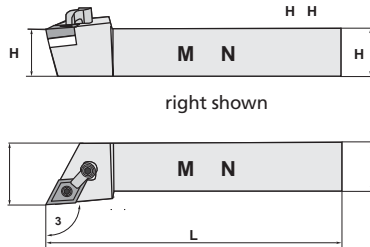

Style	Dimensions				Insert Size	Part Number		Spare Part List					
	Shank		OAL	Head		Right Hand	Left Hand	Shim ³	Shim Screw*	Lock Pin ⁴	Clamp ⁶	Clamp Screw ⁵	Hex Key
	H	B	L	F									
MDJNR/L 12-4B	0.75	0.75	4.5	1.00	43 ₋	6-715-124R	6-715-124L	6-998-6081	6-998-6543	6-998-6265	6-998-6411	6-998-6531	6-998-150 6-998-159
MDJNR/L 16-4D	1.00	1.00	6.0	1.25		6-715-165R	6-715-165L						
MDJNR/L 20-4D	1.25	1.25		1.50		6-715-204R	6-715-204L						
MDJNR/L 24-4D	1.50	1.50		2.00		6-715-244R	6-715-244L						
MDJNR/L 85-4D	1.25	1.00		1.25		6-715-285R	6-715-285L						
MDJNR/L 16-5D	1.00	1.00	6.0	1.25	54 ₋	6-715-416R	6-715-416L	6-998-6086	6-998-6545	6-998-6270	6-998-6411	6-998-6531	6-998-153 6-998-159
MDJNR/L 20-5D	1.25	1.25		1.50		6-715-420R	6-715-420L						
MDJNR/L 24-5D	1.50	1.50		2.00		6-715-424R	6-715-424L						
MDJNR/L 86-5E		1.00		7.0		1.25	6-715-486R						

TURNING, PROFILING

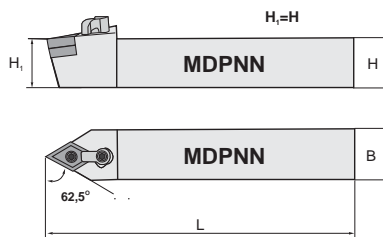

MDPNN

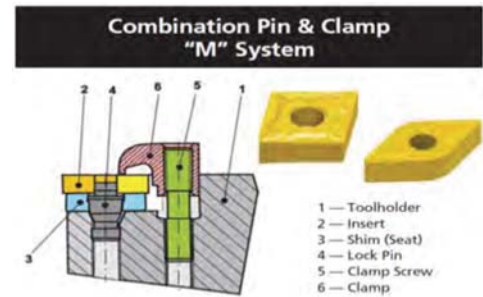
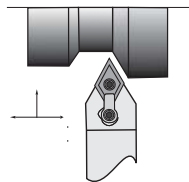

Style	Dimensions				Insert Size	Part Number	Spare Part List					
	Shank		OAL	Head			Shim ³	Shim Screw*	Lock Pin ⁴	Clamp ⁶	Clamp Screw ⁵	Hex Key
	H	B	L	F								
MDPNN 16-4D	1.00	1.00	6.0	—	43 ₋	6-714-165	6-998-6081	6-998-6543	6-998-6265	6-998-6411	6-998-6531	6-998-150 6-998-153
MDPNN 20-4D	1.25	1.25		—		6-714-204						
MDPNN 20-5D	1.25	1.25	6.0	—	54 ₋	6-714-320	6-998-6086	6-998-6545	6-998-6270	6-998-6411	6-998-6531	6-998-153 6-998-159
MDPNN 24-5D	1.50	1.50		—		6-714-324						

* Shim Screw to replace Lock Pin (4) when using Inserts without hole





Negative Turning Tool Holders – RN

Cutting Tools

Tool Holders for Round Negative Inserts

RNMG – RNMA

FACING, TURNING

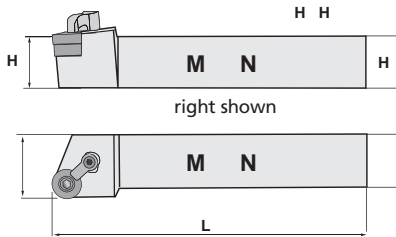

MRGNR

MRGNL

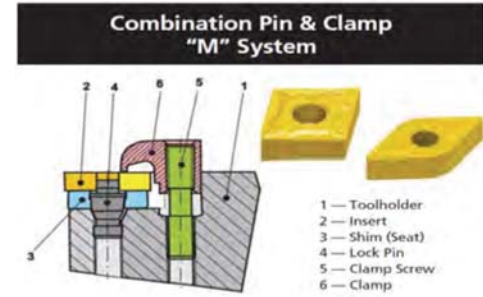
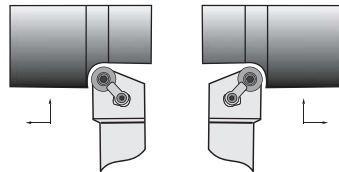

TURNING

Style	Dimensions				Insert Size	Part Number		Spare Part List					
	Shank		OAL	Head		Right Hand	Left Hand	Shim ³	Shim Screw*	Lock Pin ⁴	Clamp ⁶	Clamp Screw ⁵	Hex Key
	H	B	L	F									
MRGNR/L 12-3B	0.75	0.75	4.5	1.00	32	6-700-012R	6-700-012L	6-998-6122	6-998-6541	6-998-6254	6-998-6405	6-998-6515	6-998-147 6-998-150
MRGNR/L 16-3D	1.00	1.00	6.0	1.25		6-700-016R	6-700-016L						
MRGNR/L 12-4B	0.75	0.75	4.5	1.00	43	6-700-112R	6-700-112L	6-998-6123	6-998-6543	6-998-6265	6-998-6415	6-998-6526	6-998-150 6-998-153
MRGNR/L 16-4D	1.00	1.00	6.0	1.25		6-700-116R	6-700-116L						
MRGNR/L 20-4D	1.25	1.25		1.50		6-700-204R	6-700-204L						

* Shim Screw to replace Lock Pin (4) when using Inserts without hole



Tool Holders for 90° Square Negative Inserts SNMG – SNMA

FACING, TURNING

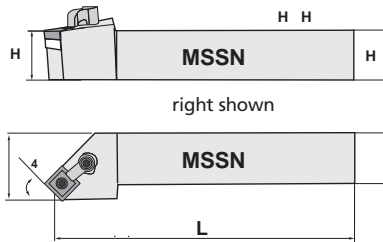

MSSNR

MSSNL

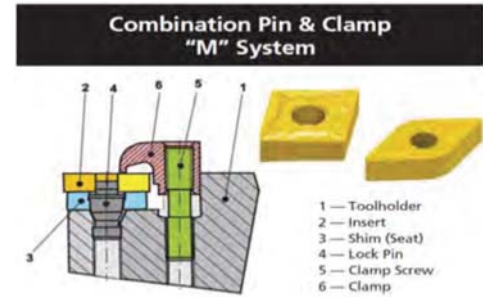
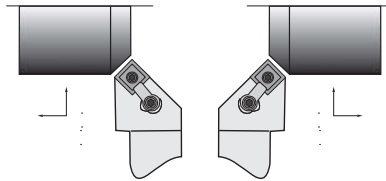

Style	Dimensions				Insert Size	Part Number		Spare Part List					
	Shank		OAL	Head		Right Hand	Left Hand	Shim ³	Shim Screw*	Lock Pin ⁴	Clamp ⁶	Clamp Screw ⁵	Hex Key
	H	B	L	F				Part Number					
MSSNR/L 12-4B	0.75	0.75	4.5	0.675	43 ₋	6-735-124R	6-735-124L	6-998-6100	6-998-6543	6-998-6265	6-998-6415	6-998-6526	6-998-150 6-998-153
MSSNR/L 16-4D	1.00	1.00	6.0	0.925		6-735-165R	6-735-165L						
MSSNR/L 16-5D	1.00	1.00	6.0	0.847	54 ₋	6-735-216R	6-735-216L	6-998-6108	6-998-6545	6-998-6270	6-998-6411	6-998-6531	6-998-153 6-998-159
MSSNR/L 20-5D	1.25	1.25		1.09		6-735-220R	—						
MSSNR/L 20-6D	1.25	1.25	6.0	1.01	64 ₋	6-735-320R	6-735-320L	6-998-6113	6-998-6547	6-998-6275	6-998-6411	6-998-6531	6-998-150 6-998-159
MSSNR/L 24-6E	1.50	1.50	7.0	1.49		6-735-324R	6-735-324L						

TURNING, PROFILING

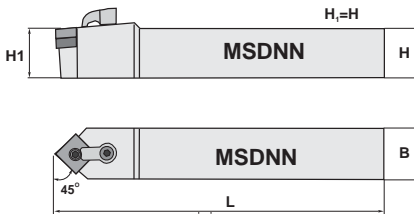

MSDNN

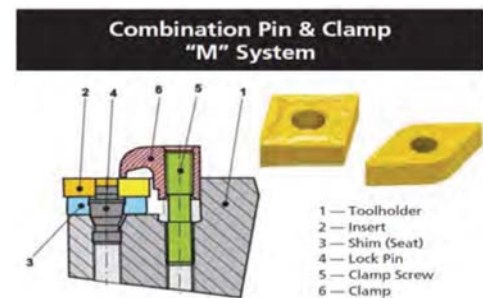
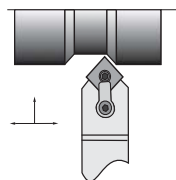

Style	Dimensions				Insert Size	Part Number	Spare Part List					
	Shank		OAL	Head			Shim ³	Shim Screw*	Lock Pin ⁴	Clamp ⁶	Clamp Screw ⁵	Hex Key
	H	B	L	F			Part Number					
MSDNN 12-4B	0.75	0.75	4.5	—	43 ₋	6-734-412	6-998-6100	6-998-6543	6-998-6265	6-998-6415	6-998-6526	6-998-150 6-998-153
MSDNN 16-4D	1.00	1.00	6.0	—		6-734-416						
MSDNN 85-4D	1.25			—		6-734-485						
MSDNN 16-5D	1.00	1.00	6.0	—	54 ₋	6-734-516	6-998-6108	6-998-6545	6-998-6270	6-998-6411	6-998-6531	6-998-153 6-998-159
MSDNN 20-5D	1.25	1.25		—		6-734-520						
MSDNN 85-5D	1.25	1.00		—		6-734-585						
MSDNN 86-5E	1.50			7.0		—						
MSDNN 16-6D	1.00	1.00	6.0	—	64 ₋	6-734-616	6-998-6113	6-998-6547	6-998-6275	6-998-6411	6-998-6531	6-998-156 6-998-159
MSDNN 20-6D	1.25	1.25		—		6-734-620						
MSDNN 24-6E	1.50	1.50		7.0		—						
MSDNN 85-6D	1.25	1.00	6.0	—	64 ₋	6-734-685	6-998-6113	6-998-6547	6-998-6275	6-998-6411	6-998-6531	6-998-156 6-998-159
MSDNN 86-6E	1.50		7.0	—		6-734-686						

* Shim Screw to replace Lock Pin (4) when using Inserts without hole





Negative Turning Tool Holders – SN

Cutting Tools

SNMG – SNMA (continued)

TURNING

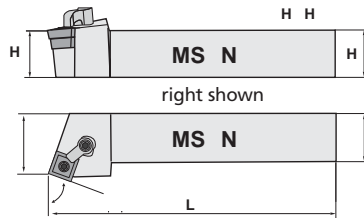

MSRNR

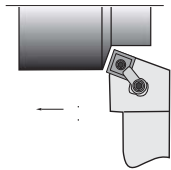

MSRNL

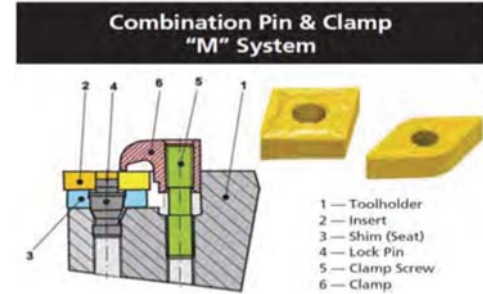
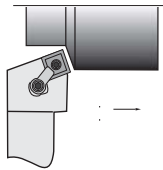

Style	Dimensions				Insert Size	Part Number		Spare Part List					
	Shank		OAL	Head		Right Hand	Left Hand	Shim ³	Shim Screw*	Lock Pin ⁴	Clamp ⁶	Clamp Screw ⁵	Hex Key
	H	B	L	F									
MSRNR/L 12-4B	0.75	0.75	4.5	0.88	43 ₋	6-736-124R	6-736-124L	6-998-6100	6-998-6543	6-998-6265	6-998-6415	6-998-6526	6-998-150 6-998-153
MSRNR/L 16-4D	1.00	1.00	6.0	1.13		6-736-165R	6-736-165L						
MSRNR/L 20-4D	1.25			1.35		6-736-204R	6-736-204L						
MSRNR/L 16-5D	1.00	1.00	6.0	1.10	54 ₋	6-736-316R	6-736-316L	6-998-6108	6-998-6545	6-998-6270	6-998-6411	6-998-6531	6-998-153 6-998-159
MSRNR/L 20-5D	1.25	1.25		1.35		6-736-320R	6-736-320L						
MSRNR/L 16-6D	1.00	1.00	6.0	1.07	64 ₋	6-736-416R	6-736-416L	6-998-6113	6-998-6547	6-998-6275	6-998-6411	6-998-6531	6-998-156 6-998-159
MSRNR/L 20-6D	1.25	1.25		1.32		6-736-420R	6-736-420L						
MSRNR/L 24-6E	1.50	1.50		7.0		1.82	6-736-424R						

FACING

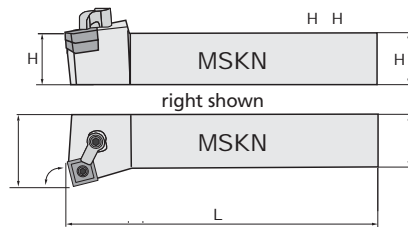

MSKNR

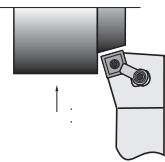

MSKNL

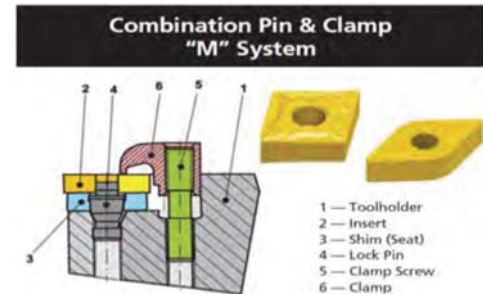
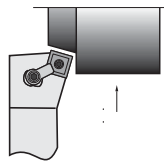

Style	Dimensions				Insert Size	Part Number		Spare Part List					
	Shank		OAL	Head		Right Hand	Left Hand	Shim ³	Shim Screw*	Lock Pin ⁴	Clamp ⁶	Clamp Screw ⁵	Hex Key
	H	B	L	F									
MSKNR/L 12-4B	0.75	0.75	4.5	1.00	43 ₋	6-737-012R	6-737-012L	6-998-6100	6-998-6543	6-998-6265	6-998-6415	6-998-6526	6-998-150 6-998-153
MSKNR/L 16-4D	1.00	1.00	6.0	1.25		6-737-016R	6-737-016L						
MSKNR/L 16-5D	1.00	1.00	6.0	1.25	54 ₋	6-737-116R	6-737-116L	6-998-6108	6-998-6545	6-998-6270	6-998-6411	6-998-6531	6-998-153 6-998-159
MSKNR/L 20-5D	1.25	1.25		1.50		6-737-120R	6-737-120L						
MSKNR/L 20-6D	1.25	1.25	6.0	1.50	64 ₋	6-737-220R	6-737-220L	6-998-6113	6-998-6547	6-998-6275	6-998-6411	6-998-6531	6-998-156 6-998-159
MSKNR/L 24-6E	1.50	1.50	7.0	2.00		6-737-224R	6-737-224L						

* Shim Screw to replace Lock Pin (4) when using Inserts without hole



Tool Holders for 60° Triangle Negative Inserts

TNMG – TNMA

FACING, TURNING, PROFILING,
BACKFACING

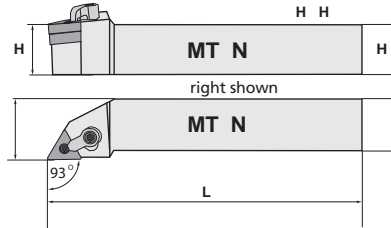

MTJNR

MTJNL

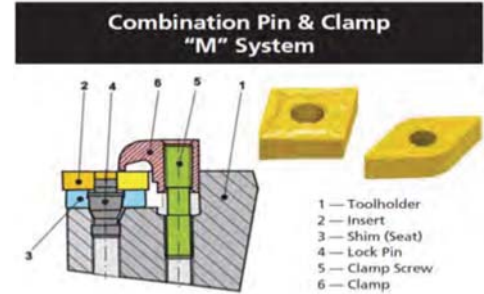
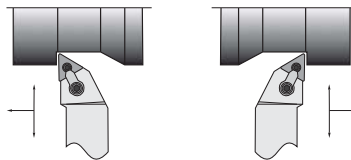

Style	Dimensions				Insert Size	Part Number		Spare Part List					
	Shank		OAL	Head		Right Hand	Left Hand	Shim ³	Shim Screw*	Lock Pin ⁴	Clamp ⁶	Clamp Screw ⁵	Hex Key
	H	B	L	F									
MTJNR/L 10-3B	0.75	0.75	4.5	0.63	33 ₋	6-740-010R	6-740-010L	6-998-6053	6-998-6541	6-998-6255	6-998-6405	6-998-6515	6-998-147 6-998-150
MTJNR/L 12-3B	1.00	1.00	6.0	1.00		6-740-012R	6-740-012L						
MTJNR/L 16-3D	1.25	1.25		1.25		6-740-016R	6-740-016L						
MTJNR/L 16-4D	1.00	1.00	6.0	1.25	43 ₋	6-740-116R	6-740-116L	6-998-6060	6-998-6543	6-998-6265	6-998-6415	6-998-6520	6-998-150 6-998-153
MTJNR/L 20-4D	1.25	1.25		1.25		6-740-120R	6-740-120L						
MTJNR/L 16-5D	1.00	1.00	6.0	1.25	54 ₋	6-740-216R	6-740-216L	6-998-6070	6-998-6547	6-998-6270	6-998-6415	6-998-6520	6-998-153
MTJNR/L 20-5D	1.25	1.25		1.50		6-740-220R	6-740-220L						
MTJNR/L 24-5D	1.50	1.50	7.0	2.00	54 ₋	6-740-224R	6-740-224L	6-998-6070	6-998-6547	6-998-6270	6-998-6415	6-998-6520	6-998-153
MTJNR/L 24-5E				2.00		6-740-226R	6-740-226L						
MTJNR/L 86-5E	1.00	1.00	7.0	1.25	54 ₋	6-740-235R	6-740-235L	6-998-6070	6-998-6547	6-998-6270	6-998-6415	6-998-6520	6-998-153

TURNING, PROFILING

MTENN

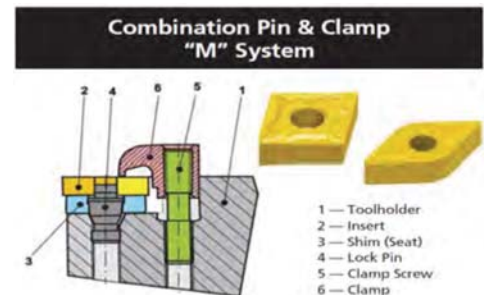
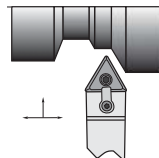
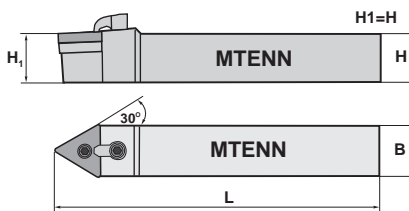

Style	Dimensions				Insert Size	Part Number	Spare Part List					
	Shank		OAL	Head			Shim ³	Shim Screw*	Lock Pin ⁴	Clamp ⁶	Clamp Screw ⁵	Hex Key
	H	B	L	F								
MTENN 10-3B	0.75	0.75	4.5	0.63	33 ₋	6-741-310	6-998-6053	6-998-6541	6-998-6255	6-998-6405	6-998-6515	6-998-147 6-998-150
MTENN 12-3B	1.00	1.00		0.75		6-741-312						
MTENN 64-3D	1.00	0.75	6.0	1.00		6-741-364						
MTENN 12-4B	0.75	0.75	6.0	0.75	43 ₋	6-741-412	6-998-6060	6-998-6543	6-998-6265	6-998-6415	6-998-6526	6-998-150 6-998-153
MTENN 16-4D	1.00	1.00		1.00		6-741-416						
MTENN 85-4D	1.25		1.25	6-741-485								
MTENN 86-4E	1.50	1.50	7.0	1.25	43 ₋	6-741-486	6-998-6060	6-998-6543	6-998-6265	6-998-6415	6-998-6526	6-998-150 6-998-153
MTENN 16-5D	1.00	1.00	6.0	1.00	54 ₋	6-741-516	6-998-6070	6-998-6547	6-998-6270	6-998-6415	6-998-6526	6-998-153
MTENN 20-5D	1.25	1.25		1.25		6-741-520						
MTENN 24-5E	1.50	1.50	7.0	1.50		54 ₋						
MTENN 86-5E				1.00	1.50	6-741-585						

* Shim Screw to replace Lock Pin (4) when using Inserts without hole





Negative Turning Tool Holders – TN

Cutting Tools

TNMG – TNMA (continued)

TURNING

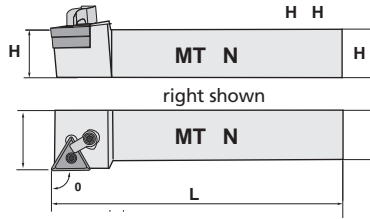

MTGNR

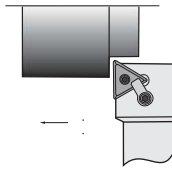

MTGNL

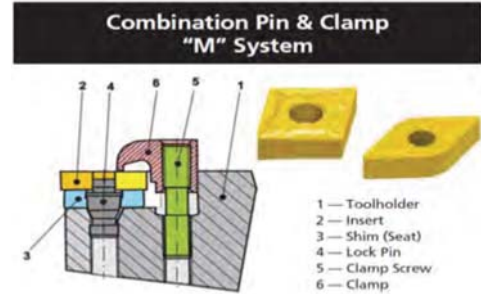
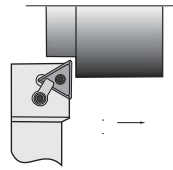

Style	Dimensions				Insert Size	Part Number		Spare Part List					
	Shank		OAL	Head		Right Hand	Left Hand	Shim ³	Shim Screw*	Lock Pin ⁴	Clamp ⁶	Clamp Screw ⁵	Hex Key
	H	B	L	F									
MTGNR/L 12-3B	0.75	0.75	4.5	1.00	33 ₋	6-742-012R	6-742-012L	6-998-6053	6-998-6541	6-998-6255	6-998-6405	6-998-6515	6-998-147 6-998-150
MTGNR/L 16-3D	1.00	1.00	6.0	1.25		6-742-016R	6-742-016L						
MTGNR/L 16-4D	1.00	1.00	6.0	1.25	43 ₋	6-742-216R	6-742-216L	6-998-6060	6-998-6543	6-998-6265	6-998-6415	6-998-6526	6-998-150 6-998-153
MTGNR/L 20-4D	1.25	1.25		1.50		6-742-220R	6-742-220L						
MTGNR/L 20-5D	1.25	1.25	6.0	1.50	54 ₋	6-742-320R	6-742-320L	6-998-6070	6-998-6545	6-998-6270	6-998-6415	6-998-6526	6-998-153

FACING

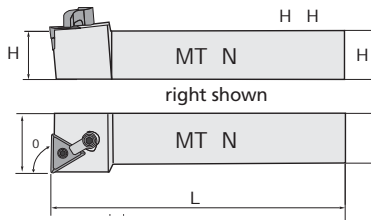

MTFNR

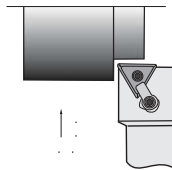

MTFNL

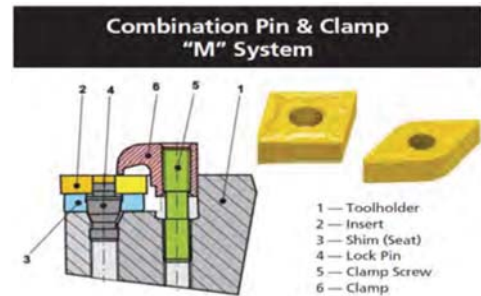
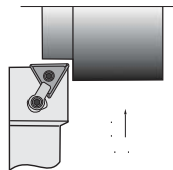

Style	Dimensions				Insert Size	Part Number		Spare Part List					
	Shank		OAL	Head		Right Hand	Left Hand	Shim ³	Shim Screw*	Lock Pin ⁴	Clamp ⁶	Clamp Screw ⁵	Hex Key
	H	B	L	F									
MTFNR/L 12-3B	0.75	0.75	4.5	1.00	33 ₋	6-746-012R	6-746-012L	6-998-6053	6-998-6541	6-998-6255	6-998-6405	6-998-6515	6-998-147 6-998-150
MTFNR/L 16-3D	1.00	1.00	6.0	1.25		6-746-016R	6-746-016L						
MTFNR/L 16-4D	1.00	1.00	6.0	1.25	43 ₋	6-746-216R	6-746-216L	6-998-6060	6-998-6543	6-998-6265	6-998-6415	6-998-6526	6-998-150 6-998-153
MTFNR/L 20-4D	1.25	1.25		1.50		6-746-220R	6-746-220L						
MTFNR/L 20-5D	1.25	1.25	6.0	1.50	54 ₋	6-746-320R	6-746-320L	6-998-6070	6-998-6545	6-998-6270	6-998-6415	6-998-6526	6-998-153

* Shim Screw to replace Lock Pin (4) when using Inserts without hole



Tool Holders for 35° Diamond Negative Inserts VNMG – VNMA

TURNING, PROFILING, BACKFACING

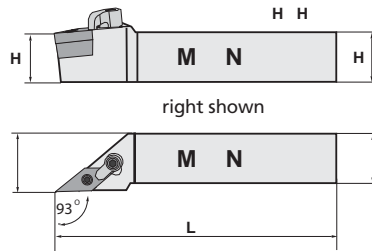

MVJNR

MVJNL

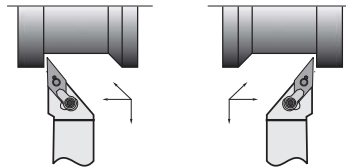

Combination Pin & Clamp "M" System

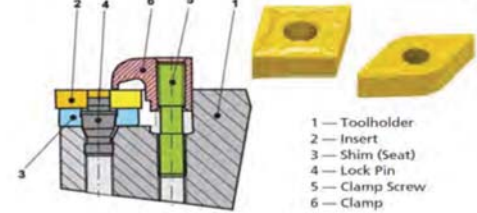

Style	Dimensions				Insert Size	Part Number		Spare Part List					
	Shank		OAL	Head		Right Hand	Left Hand	Shim ³	Shim Screw*	Lock Pin ⁴	Clamp ⁶	Clamp Screw ⁵	Hex Key
	H	B	L	F									
MVJNR/L 12-3B	0.75	0.75	4.5	1.00	33 ₋	6-755-012R	6-755-012L	6-998-6074P	6-998-6541	6-998-6255	6-998-6423	6-998-6531	6-998-147 6-998-159
MVJNR/L 16-3D	1.00	1.00	6.0	1.25		6-755-016R	6-755-016L						
MVJNR/L 20-3D	1.25	1.25		1.50		6-755-020R	6-755-020L						
MVJNR/L 16-4D	1.00	1.00	6.0	1.25	44 ₋	6-755-116R	6-755-116L	6-998-6077	6-998-6543	6-998-6265	6-998-6423	6-998-6531	6-998-150 6-998-159
MVJNR/L 20-4D	1.25	1.25		1.50		6-755-220R	6-755-220L						
MVJNR/L 24-4E	1.50	1.50		2.00		6-755-224R	6-755-224L						

TURNING, PROFILING

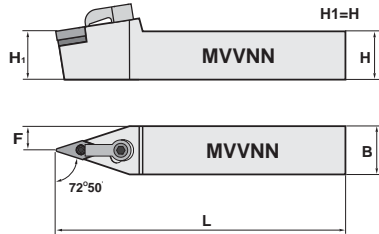

MVVNN

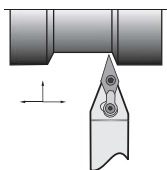

Combination Pin & Clamp "M" System

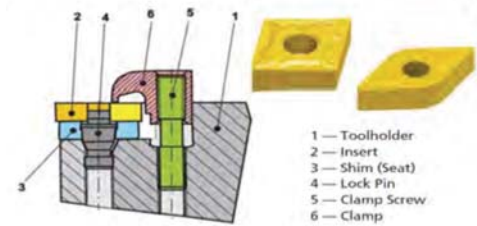

Style	Dimensions				Insert Size	Part Number	Spare Part List					
	Shank		OAL	Head			Shim ³	Shim Screw*	Lock Pin ⁴	Clamp ⁶	Clamp Screw ⁵	Hex Key
	H	B	L	F								
MVVNN 12-3B	0.75	0.75	4.5	1.00	33 ₋	6-754-012	6-998-6074P	6-998-6541	6-998-6255	6-998-6423	6-998-6531	6-998-147 6-998-159
MVVNN 16-3D	1.00	1.00	6.0	1.25		6-754-016						
MVVNN 16-4D	1.00	1.00	6.0	1.25	44 ₋	6-754-116	6-998-6077	6-998-6543	6-998-6265	6-998-6423	6-998-6531	6-998-150 6-998-159

* Shim Screw to replace Lock Pin (4) when using Inserts without hole





Negative Turning Tool Holders – WN

Cutting Tools

Tool Holders for 80° Trigon Negative Inserts

WNMG – WNMA

FACING, TURNING, BACKFACING

MWLN

MWLN

Combination Pin & Clamp "M" System

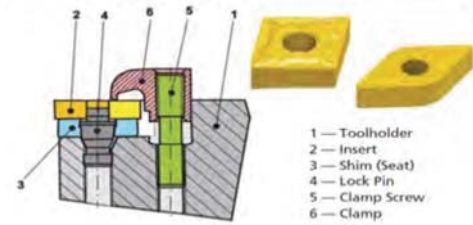
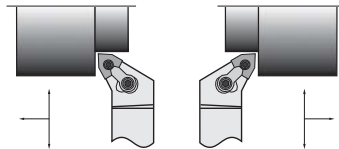
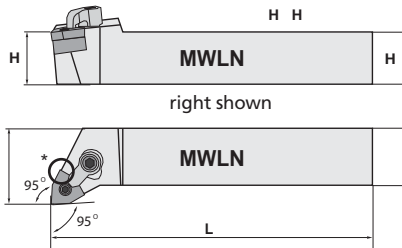

TURNING

Style	Dimensions				Insert Size	Part Number		Spare Part List					
	Shank		OAL	Head		Right Hand	Left Hand	Shim ³	Shim Screw*	Lock Pin ⁴	Clamp ⁶	Clamp Screw ⁵	Hex Key
	H	B	L	F				Part Number					
MWLN/L 12-3B	0.75	0.75	4.5	1.00	33_	6-750-012R	6-750-012L	6-998-6033	6-998-6541	6-998-6255	6-998-6405	6-998-6515	6-998-147 6-998-150
MWLN/L 16-3D	1.00	1.00	6.0	1.25		6-750-016R	6-750-016L						
MWLN/L 12-4B	0.75	0.75	4.5	1.00	43_	6-750-112R	6-750-112L	6-998-6035	6-998-6543	6-998-6265	6-998-6415	6-998-6526	6-998-153 6-998-150
MWLN/L 16-4D	1.00	1.00	6.0	1.25		6-750-116R	6-750-116L						
MWLN/L 20-4D	1.25	1.25		1.50		6-750-120R	6-750-120L						
MWLN/L 24-4E	1.50	1.50	7.0	2.00		6-750-124R	6-750-124L						
MWLN/L 16-5D	1.00	1.00	6.0	1.25	54_	6-750-216R	6-750-216L	6-998-6041	6-998-6547	6-998-6270	6-998-6415	6-998-6526	6-998-153
MWLN/L 20-5D	1.25	1.25		1.50		6-750-220R	6-750-220L						
MWLN/L 24-5E	1.50	1.50		7.0		2.00	6-750-224R						

* Shim Screw to replace Lock Pin (4) when using Inserts without hole



Positive Turning Tool Holders Overview



TURNING

Positive Tool Holders

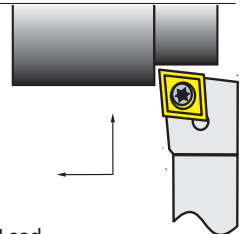
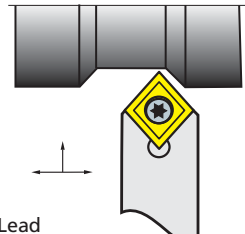
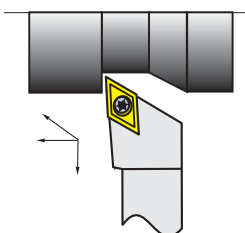
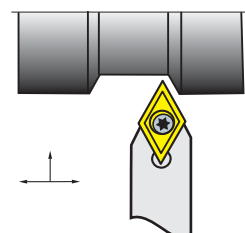
System	Insert Sizes ANSI (ISO)	Styles Available	Shank Sizes	Operations	Lead
CCGT – CCMT – CCMW					
SCLC (R/L) (right shown)  - 5° Lead SCLC R/L 6-800-	21.5_ (0602 __) 32.5_ (09T3 __) 43_ (1204 __)	RIGHT / LEFT	0.315 - 1.00	FACING TURNING	-5°
SCMCN  40° Lead SCMCN 6-801-	21.5_ (0602 __) 32.5_ (09T3 __) 43_ (1204 __)	NEUTRAL	0.375 - 0.75	TURNING PROFILING	40°
DCMT – DCGT – DCMW					
SDJC (R/L) (right shown)  -3° Lead SDJC R/L 6-805-	21.5_ (0702 __) 32.5_ (11T3 __) 43_ (1504 __)	RIGHT / LEFT	0.375 - 1.00	TURNING PROFILING BACKFACING	-3°
SDPCN  27.5° Side Cutting Edge Angle SDPCN 6-804-	21.5_ (0702 __) 32.5_ (11T3 __)	NEUTRAL	0.375 - 1.00	TURNING PROFILING	27.5°



Positive Turning Tool Holders Overview

Cutting Tools

Positive Tool Holders

TURNING

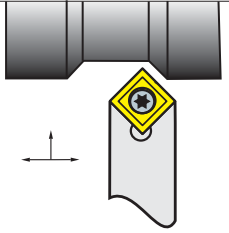
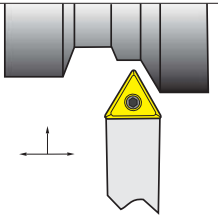
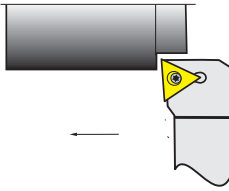
System	Insert Sizes ANSI (ISO)	Styles Available	Shank Sizes	Operations	Lead
SCMT – SCGT – SCMW					
SSDCN  45° Lead SSDCN 6-810-	21.5_ (0602 __) 32.5_ (09T3 __) 43_ (1204 __)	NEUTRAL	0.315-1.25	TURNING PROFILING	45°
TCMT – TCGT – TCMW					
STECN  30° Lead STECN 6-813-	21.5_ (1102 __) 32.5_ (16T3 __)	NEUTRAL	0.375 - 1.00	TURNING PROFILING	30°
STJC (R/L) (right shown)  -3° Lead STJC R/L 6-816-	21.5_ (1102 __) 32.5_ (16T3 __)	RIGHT / LEFT	0.50 - 0.75	TURNING	-3°

Positive Tool Holders

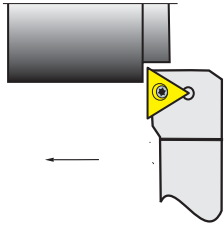
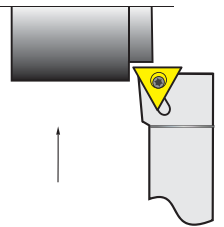
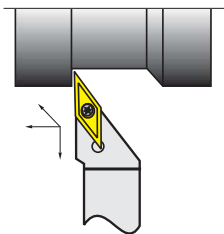
System	Insert Sizes ANSI (ISO)	Styles Available	Shank Sizes	Operations	Lead
TCMT – TCGT – TCMW (cont.)					
STGC (R/L) (right shown)  0° Lead STGC R/L 6-815-	21.5_ (1102 __) 32.5_ (16T3 __)	RIGHT / LEFT	0.375 - 1.00	TURNING	1°
STFC (R/L) (right shown)  0° Lead STFC R/L 6-814-	21.5_ (1102 __) 32.5_ (16T3 __)	RIGHT / LEFT	0.375 - 1.00	FACING	0°
VCGT – VCMT – VCMW					
SVJC (R/L) (right shown)  -3° Lead SVJC R/L 6-806-	22_ (1103 __) 33_ (1604 __)	RIGHT / LEFT	0.375 - 1.00	TURNING PROFILING BACKFACING	-3°

TURNING



Positive Turning Tool Holders – CC

Cutting Tools

Tool Holders for 80° Diamond Positive Inserts

CCMT – CCGT

FACING, TURNING

SCLCR

SCLCL

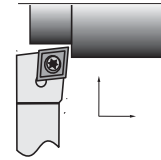
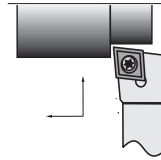
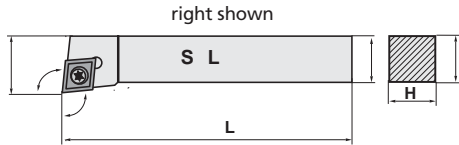

TURNING

Style	Dimensions				Insert Size	Part Number		Spare Part List		
	Shank		OAL	Head		Right Hand	Left Hand	Insert Screw	Hex Key	Anti-Seize
	H	B	L	F						
SCLCR/L 04-2	0.315	0.315	2.36	0.39	21.5_	6-800-042R	–	6-998-2506	6-998-007	290-ASEIZE-03
SCLCR/L 06-2J	0.375	0.375	3.5	0.50		6-800-062R	6-800-062L			
SCLCR/L 08-3A	0.50	0.50	4.0	0.625	32.5_	6-800-103R	6-800-103L	6-998-4008T	6-998-015	290-ASEIZE-03
SCLCR/L 10-3B	0.625	0.625	4.5	0.75		6-800-113R	6-800-113L			
SCLCR/L 12-3B	0.75	0.75		1.00		6-800-123R	6-800-123L			
SCLCR/L 16-3D	1.00	1.00	6.0	1.25		6-800-163R	6-800-163L			
SCLCR/L 12-4B	0.75	0.75	4.5	1.00	43_	6-800-224R	6-800-224L	6-998-5012	6-998-015	290-ASEIZE-03
SCLCR/L 16-4D	1.00	1.00	6.0	1.25		6-800-264R	6-800-264L			

TURNING, PROFILING

SCMCN

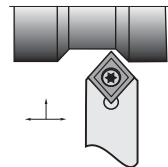
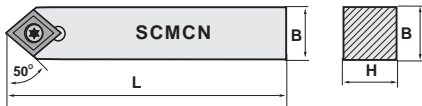

Style	Dimensions				Insert Size	Part Number	Spare Part List		
	Shank		OAL	Head			Insert Screw	Hex Key	Anti-Seize
	H	B	L	F					
SCMCN 06-2	0.375	0.375	2.36	–	21.5_	6-801-062	6-998-2506	6-998-007	290-ASEIZE-03
SCMCN 08-3A	0.50	0.50	3.5	–	32.5_	6-801-103	6-998-4008T	6-998-015	290-ASEIZE-03
SCMCN 10-3B	0.625	0.625	4.0	–		6-801-113			
SCMCN 12-3B	1.00	0.50	4.5	–		6-801-123			
SCMCN 12-4B	0.75	0.75	4.5	–	43_	6-801-224	6-998-5012	6-998-015	290-ASEIZE-03

Tool Holders for 55° Diamond Positive Inserts

DCMT – DCGT

TURNING, PROFILING, BACKFACING

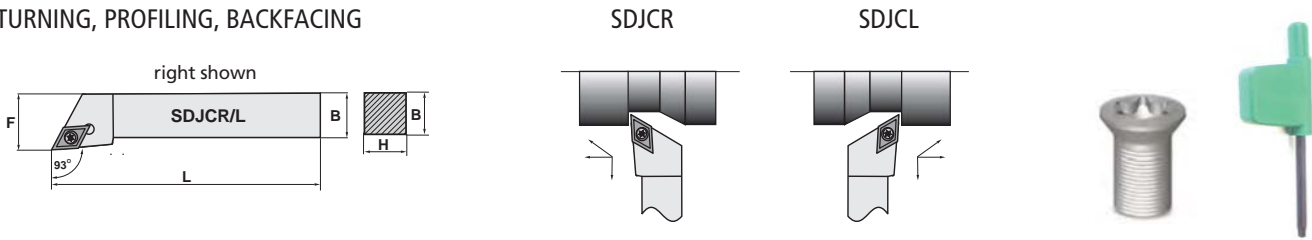

Style	Dimensions				Insert Size	Part Number		Spare Part List		
	Shank		OAL	Head		Right Hand	Left Hand	Insert Screw	Hex Key	Anti-Seize
	H	B	L	F						
SDJCR/L 06-2J	0.375	0.375	3.5	0.50	21.5 ₋	6-805-062R	6-805-062L	6-998-2506	6-998-007	290-ASEIZE-03
SDJCR/L 08-2A	0.50	0.50	4.0	0.625		6-805-082R	6-805-082L			
SDJCR/L 08-3A	0.50	0.50	4.0	0.625	32.5 ₋	6-805-103R	6-805-103L	6-998-4008T	6-998-015	290-ASEIZE-03
SDJCR/L 10-3B	0.625	0.625	4.5	0.75		6-805-113R	6-805-113L			
SDJCR/L 12-3B	0.750	0.750		0.88		6-805-123R	6-805-123L			
SDJCR/L 16-3D	1.00	1.00	6.0	1.250		6-805-163R	6-805-163L			
SDJCR/L 12-4B	0.75	0.75	4.5	1.00	43 ₋	6-805-224R	6-805-224L	6-998-5012	6-998-015	290-ASEIZE-03
SDJCR/L 16-4D	1.00	1.00	6.0	1.25		6-805-264R	6-805-264L			

TURNING, PROFILING

SDPCN

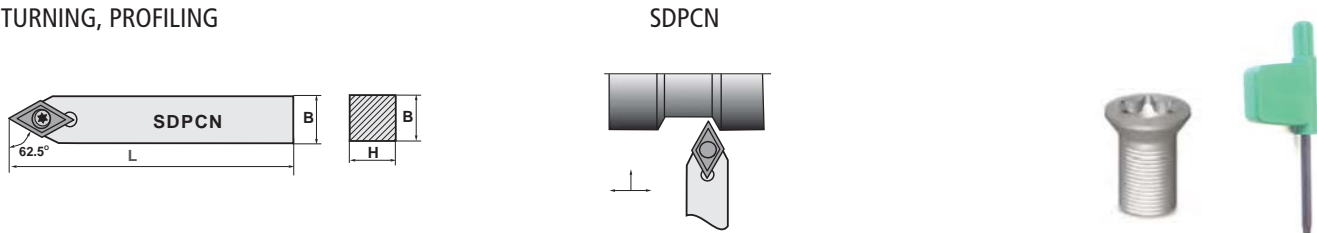

Style	Dimensions				Insert Size	Part Number	Spare Part List		
	Shank		OAL	Head			Insert Screw	Hex Key	Anti-Seize
	H	B	L	F					
SDPCN 06-2	0.375	0.375	2.36	–	21.5 ₋	6-804-062	6-998-2506	6-998-007	290-ASEIZE-03
SDPCN 08-2A	0.500	0.500	4.0	–		6-804-082			
SDPCN 10-3B	0.625	0.625	4.0	–	32.5 ₋	6-804-113	6-998-4008T	6-998-015	290-ASEIZE-03
SDPCN 12-3B	0.750	0.750	4.5	–		6-804-123			
SDPCN 16-3D	1.00	1.00	6.0	–		6-804-163			



Positive Turning Tool Holders – SC

Cutting Tools

Tool Holders for 90° Square Positive Inserts

SCMT – SCGT

TURNING, PROFILING

SSDCN

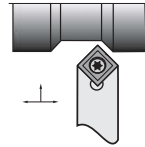
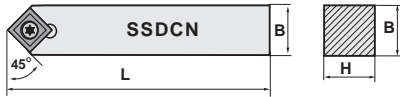

TURNING

Style	Dimensions				Insert Size	Part Number	Spare Part List		
	Shank		OAL	Head			Insert Screw	Hex Key	Anti-Seize
	H	B	L	F					
SSDCN 04-2	0.315	0.315	2.36	–	21.5_	6-810-042	6-998-2506	6-998-007	290-ASEIZE-03
SSDCN 08-3A	0.50	0.50	4.0	–	32.5_	6-810-108	6-998-4008T	6-998-015	290-ASEIZE-03
SSDCN 10-3B	0.625	0.625	4.5	–		6-810-110			
SSDCN 12-3B	0.75	0.75		–		6-810-112			
SSDCN 16-4D	1.00	1.00	6.0	–	43_	6-810-216	6-998-5012	6-998-015	290-ASEIZE-03
SSDCN 20-4D	1.25	1.25		–		6-810-220			

Tool Holders for 60° Triangle Positive Inserts

TCMT – TCGT

TURNING, PROFILING

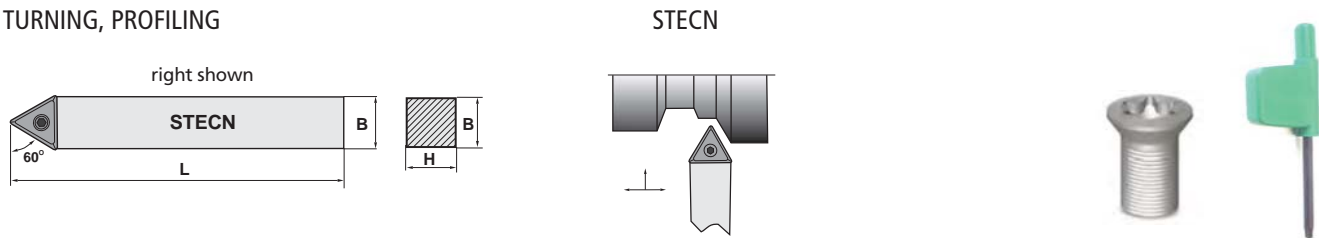

Style	Dimensions				Insert Size	Part Number	Spare Part List		
	Shank		OAL	Head			Insert Screw	Hex Key	Anti-Seize
	H	B	L	F					
STECN 06-2	0.375	0.375	2.5	0.50	21.5_	6-813-006	6-998-2506	6-998-007	290-ASEIZE-03
STECN 08-2J	0.50	0.50	3.5	0.625		6-813-008			
STECN 10-3B	0.75	0.75	4.5	0.625	32.5_	6-813-112	6-998-4008T	6-998-015	290-ASEIZE-03
STECN 64-3B	0.75	1.00	6.0	0.75		6-813-164			

TURNING

STJCR

STJCL

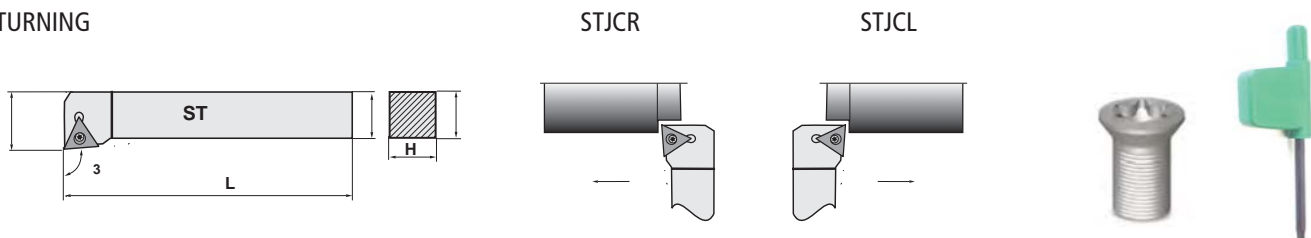

Style	Dimensions				Insert Size	Part Number		Spare Part List		
	Shank		OAL	Head		Right Hand	Left Hand	Insert Screw	Hex Key	Anti-Seize
	H	B	L	F						
STJCR/L 08-2J	0.50	0.50	3.5	0.625	21.5_	6-816-082R	6-816-082L	6-998-2506	6-998-007	290-ASEIZE-03
STJCR/L 13-3B	0.75	0.75	4.5	0.875	32.5_	6-816-123R	6-816-123L			



Positive Turning Tool Holders – TC

Cutting Tools

Tool Holders for 55° Diamond Positive Inserts (continued)

TCMT – TCGT

TURNING

STGCR

STGCL

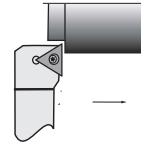
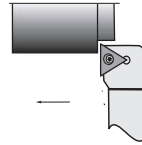
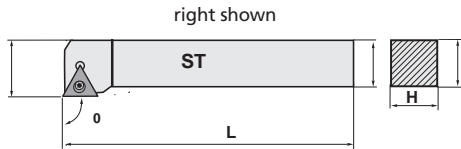

TURNING

Style	Dimensions				Insert Size	Part Number		Spare Part List		
	Shank		OAL	Head		Right Hand	Left Hand	Insert Screw	Hex Key	Anti-Seize
	H	B	L	F						
STGCR/L 06-2	0.375	0.375	2.5	0.50	21.5_	6-815-062R	6-815-062L	6-998-2506	6-998-007	290-ASEIZE-03
STGCR/L 08-2J	0.50	0.50	3.5	0.625		6-815-082R	6-815-082L			
STGCR/L 10-2A	0.625	0.625	4.0	0.75		6-815-110R	6-815-110L			
STGCR/L 10-3B	0.625	0.625	4.5	0.75	32.5_	6-815-113R	6-815-113L	6-998-4008T	6-998-015	290-ASEIZE-03
STGCR/L 12-3B	0.75	0.75	4.5	0.875		6-815-123R	6-815-123L			
STGCR/L 16-3D	1.00	1.00	6.0	1.125		6-815-163R	6-815-163L			

FACE

STFCR

STFCL

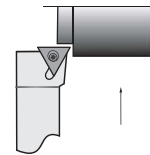
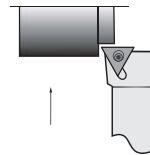

Style	Dimensions				Insert Size	Part Number		Spare Part List		
	Shank		OAL	Head		Right Hand	Left Hand	Insert Screw	Hex Key	Anti-Seize
	H	B	L	F						
STFCR/L 06-2	0.375	0.375	2.5	0.50	21.5_	6-814-006R	6-814-006L	6-998-2506	6-998-007	290-ASEIZE-03
STFCR/L 08-2J	0.50	0.50	3.5	0.625		6-814-008R	6-814-008L			
STFCR/L 10-2A	0.625	0.625	4.0	0.75		6-814-010R	6-814-010L			
STFCR/L 10-3B	0.625	0.625	4.5	0.75	32.5_	6-814-110R	6-814-110L	6-998-4008T	6-998-015	290-ASEIZE-03
STFCR/L 12-3B	0.75	0.75		0.875		6-814-112R	–			
STFCR/L 16-3D	1.00	1.00	6.0	1.125		6-814-116R	6-814-116L			

Tool Holders for 35° Diamond Positive Inserts

VCMT – VCGT

TURNING, PROFILING, BACKFACING

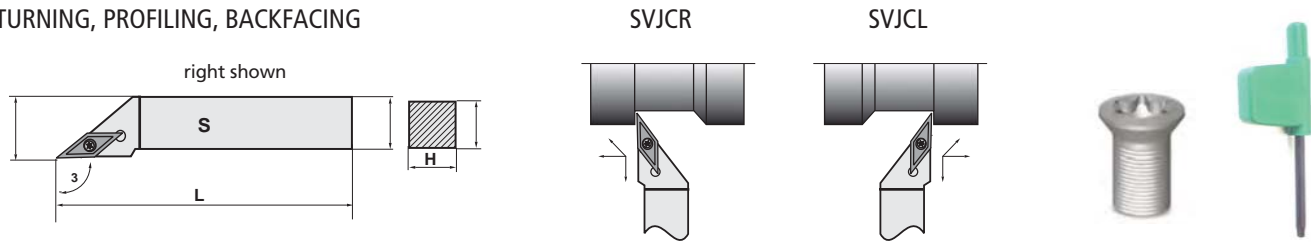

Style	Dimensions				Insert Size	Part Number		Spare Part List		
	Shank		OAL	Head		Right Hand	Left Hand	Insert Screw	Hex Key	Anti-Seize
	H	B	L	F						
SVJCR/L 06-2J	0.375	0.375	3.5	0.50	22_	6-806-062R	6-806-062L	6-998-2506	6-998-007	290-ASEIZE-03
SVJCR/L 08-2A	0.50	0.50	4.0	0.625		6-806-082R	6-806-082L			
SVJCR/L 10-2B	0.625	0.625	4.5	0.75		6-806-102R	6-806-102L			
SVJCR/L 12-3B	0.75	0.75	4.5	1.00	33_	6-806-123R	6-806-123L	6-998-3509	6-998-015	290-ASEIZE-03
SVJCR/L 16-3C	1.00	1.00	5.0	1.25		6-806-163R	6-806-163L			
SVJCR/L 16-3D			6.0	1.25		6-806-167R	6-806-167L			

TURNING



Negative Boring Bars Overview

Cutting Tools

Negative Boring Bars

TURNING

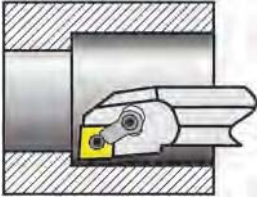
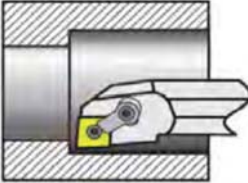
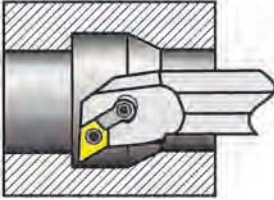
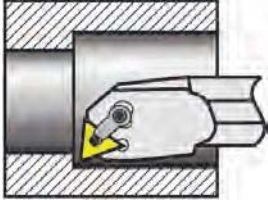
System	Insert Sizes ANSI (ISO)	Styles Available	Diameters	Minimum Bore Range	Lead
CNMG – CNMA – CNMM – CNMP – CNGG – CNGP					
SI-MCLNR (R/L) (right shown) NO THROUGH COOLANT  -5° Lead SI-MCLN R/L 6-760-	43_ (1204 __) 54_ (1606 __) 64_ (1906 __)	RIGHT / LEFT	1.0 - 2.0	1.280 - 2.562	-5°
AI-MCLN (R/L) (right shown) THROUGH COOLANT  -5° Lead AI-MCLN R/L 6-760-	43_ (1204 __)	RIGHT / LEFT	1.00 - 1.50	1.280 - 1.780	-5°
DNMG – DNMA – DNMM					
SI-MDUN (R/L) (right shown) NO THROUGH COOLANT  -3° Lead SI-MDUN R/L 6-770-	43_ (1504 __) 54_ (1906 __)	RIGHT / LEFT	1.125 - 2.0	1.705 - 3.000	-3°
TNMG – TNMA					
SI-MTUN (R/L) (right shown) NO THROUGH COOLANT  -3° Lead SI-MTUN R/L 6-783-	33_ (1604 __) 43_ (2204 __)	RIGHT / LEFT	0.75 - 2.00	1.000 - 2.562	-3°

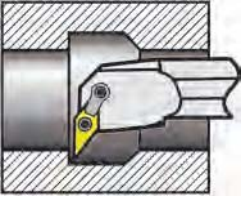
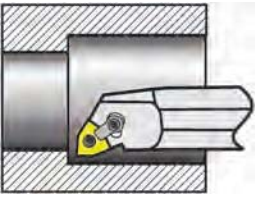
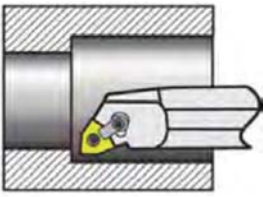

Negative Boring Bars

System	Insert Sizes ANSI (ISO)	Styles Available	Diameters	Minimum Bore Range	Lead
VNMG – VNMA					
<p>SI-MVUN (R/L) (right shown) NO THROUGH COOLANT</p>  <p>-3° Lead SI-MVUN R/L 6-785-</p>	<p>33 (1604 ___) 43 (2204 ___)</p>	<p>RIGHT / LEFT</p>	<p>1.00 - 2.00</p>	<p>2.000 - 3.250</p>	<p>-3°</p>
WNMG – WNMA					
<p>SI-MWLN (R/L) (right shown) NO THROUGH COOLANT</p>  <p>-5° Lead SI-MWLN (R/L) 6-765-</p>	<p>33 (0604 ___) 43 (0804 ___)</p>	<p>RIGHT / LEFT</p>	<p>0.75 - 1.50</p>	<p>0.930 - 1.780</p>	<p>-5°</p>
<p>AI-MWLN (R/L) (right shown) THROUGH COOLANT</p>  <p>-5° Lead AI-MWLN R/L 6-765-</p>	<p>33 (0604 ___) 43 (0804 ___)</p>	<p>RIGHT / LEFT</p>	<p>1.00 - 1.50</p>	<p>1.280 - 1.780</p>	<p>-5°</p>



Negative Boring Bars – CN

Cutting Tools

Boring Bars for 80° Diamond Negative Inserts

CNMG – CNMA – CNMM

NO THROUGH COOLANT

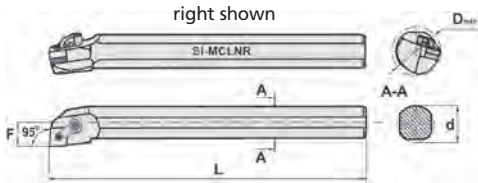

SI-MCLNL

SI-MCLNR

Combination Pin & Clamp "M" System

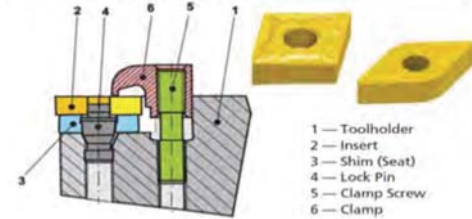

TURNING

Style	Dimensions				Insert Size	Part Number		Spare Part List					
	Shank		OAL	Head		Right Hand	Left Hand	Shim ³	Shim Screw*	Lock Pin ⁴	Clamp ⁶	Clamp Screw ⁵	Hex Key
	H	B	L	F									
SI-MCLNR/L 16-4	1.00	1.280	12.0	0.640	43 ₋	6-760-164R	6-760-164L	6-998-6009	6-998-6543	6-998-6265	6-998-6415	6-998-6526	6-998-150 6-998-153
SI-MCLNR/L 20-4	1.25	1.530	14.0	0.765		6-760-204R	6-760-204L						
SI-MCLNR/L 24-4	1.50	1.780		0.890		6-760-244R	6-760-244L						
SI-MCLNR/L 28-4	1.75	2.030		1.015		6-760-284R	6-760-284L						
SI-MCLNR/L 32-4	2.00	2.562		1.281		6-760-294R	6-760-294L						
SI-MCLNR/L 24-5	1.50	2.374	14.0	1.187	54 ₋	6-760-315R	6-760-315L	6-998-6015	6-998-6545	6-998-6270	6-998-6411	6-998-6531	6-998-153 6-998-159
SI-MCLNR/L 32-6	2.00	2.562	18.0	1.281	64 ₋	6-760-326R	6-760-326L	6-998-6020	6-998-6547	6-998-6275	6-998-6411	6-998-6531	6-998-156 6-998-159

THROUGH COOLANT

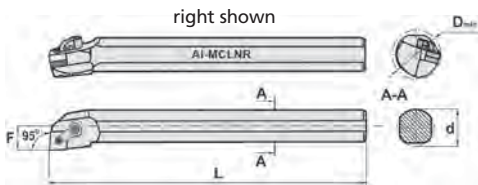

AI-MCLNL

AI-MCLNR

Combination Pin & Clamp "M" System

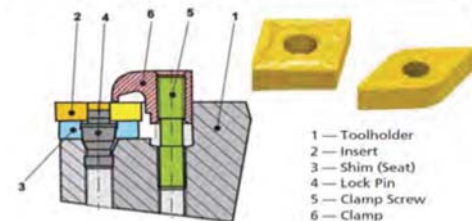

Style	Dimensions				Insert Size	Part Number		Spare Part List					
	Shank		OAL	Head		Right Hand	Left Hand	Shim ³	Shim Screw*	Lock Pin ⁴	Clamp ⁶	Clamp Screw ⁵	Hex Key
	H	B	L	F									
AI-MCLNR/L 16-4	1.00	1.280	12.0	0.640	43 ₋	6-760-564R	6-760-564L	6-998-6009	6-998-6543	6-998-6265	6-998-6415	6-998-6526	6-998-150 6-998-153
AI-MCLNR/L 20-4	1.25	1.530	14.0	0.765		6-760-604R	6-760-604L						
AI-MCLNR/L 24-4	1.50	1.780		0.890		6-760-644R	6-760-644L						

* Shim Screw to replace Lock Pin (4) when using Inserts without hole



Boring Bars for 55° Diamond Negative Inserts

DNMG – DNMA

NO THROUGH COOLANT

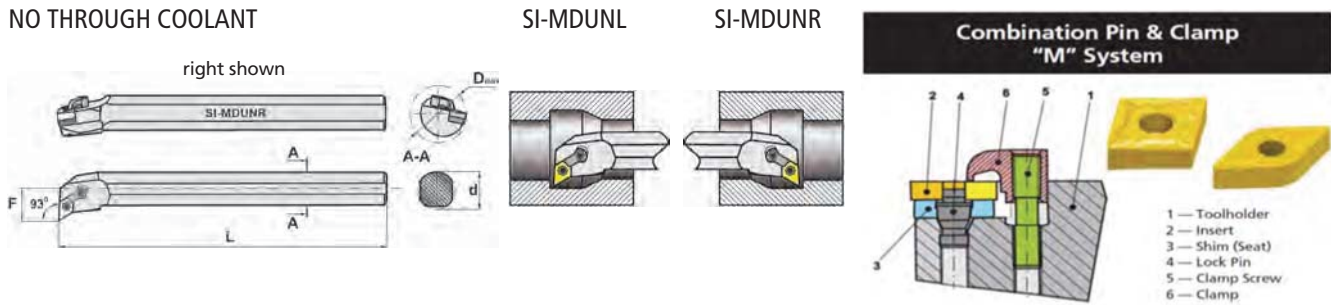

Style	Dimensions				Insert Size	Part Number		Spare Part List					
	Shank		OAL	Head		Right Hand	Left Hand	Shim ³	Shim Screw*	Lock Pin ⁴	Clamp ⁶	Clamp Screw ⁵	Hex Key
	H	B	L	F									
SI-MDUNR/L 20-4	1.25	1.705	14.0	1.000	43_	6-770-120R	6-770-120L	6-998-6081	6-998-6543	6-998-6265	6-998-6411	6-998-6531	6-998-150 6-998-159
SI-MDUNR/L 24-4	1.50	2.000		1.125		6-770-124R	6-770-124L						
SI-MDUNR/L 28-4	1.75	2.250		1.250		6-770-128R	6-770-128L						
SI-MDUNR/L 32-4	2.00	2.500		1.375		6-770-132R	6-770-132L						
SI-MDUNR/L 32-5	2.00	3.000	16.0	1.375	54_	6-770-232R	6-770-232L	6-998-6086	6-998-6545	6-998-6270	6-998-6423	6-998-6531	6-998-153 6-998-159

* Shim Screw to replace Lock Pin (4) when using Inserts without hole





Negative Boring Bars – TN

Cutting Tools

Boring Bars for 90° Square Negative Inserts

TNMG – TNMA

NO THROUGH COOLANT

SI-MTUNL

SI-MTUNR

Combination Pin & Clamp "M" System

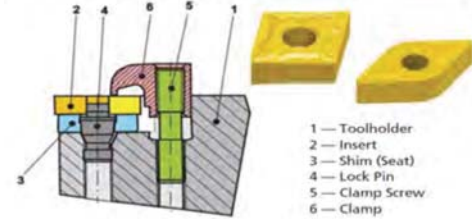
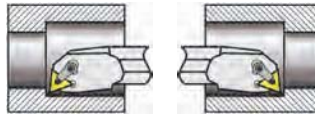
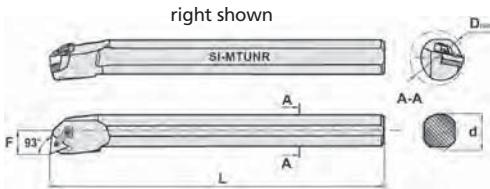

TURNING

Style	Dimensions				Insert Size	Part Number		Spare Part List					
	Shank		OAL	Head		Right Hand	Left Hand	Shim ³	Shim Screw*	Lock Pin ⁴	Clamp ⁶	Clamp Screw ⁵	Hex Key
	H	B	L	F				Part Number					
SI-MTUNR/L 12-3	0.75	1.000	10.0	0.500	33_	6-783-012R	6-783-012L	–	–	6-998-6251	6-998-6405	6-998-6513	6-998-147 6-998-150
SI-MTUNR/L 16-3	1.00	1.280	12.0	0.640		6-783-016R	6-783-016L	6-998-6053	6-998-6541	6-998-6255	6-998-6405	6-998-6515	6-998-147 6-998-150
SI-MTUNR/L 20-3	1.25	1.530	14.0	0.765		6-783-020R	6-783-020L						
SI-MTUNR/L 24-3	1.50	2.060		0.890	6-783-024R	6-783-024L							
SI-MTUNR/L 20-4	1.25	1.530	14.0	0.765	43_	6-783-120R	6-783-120L	6-998-6060	6-998-6543	6-998-6265	6-998-6415	6-998-6526	6-998-150 6-998-153
SI-MTUNR/L 24-4	1.50	2.060		0.890		6-783-124R	6-783-124L						
SI-MTUNR/L 32-4	2.00	2.562		1.281		6-783-132R	6-783-132L						

* Shim Screw to replace Lock Pin (4) when using Inserts without hole



Boring Bars for 35° Diamond Negative Inserts

VNMG – VNMA

NO THROUGH COOLANT

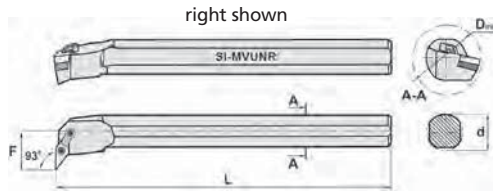

SI-MTUNL

SI-MTUNR

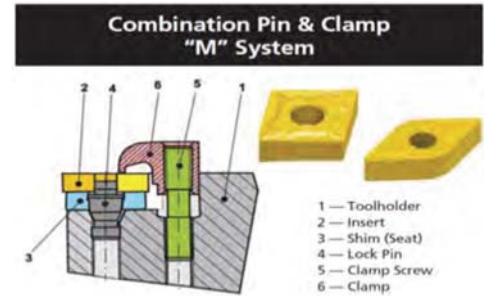
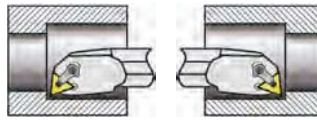

Style	Dimensions				Insert Size	Part Number		Spare Part List					
	Shank		OAL	Head		Right Hand	Left Hand	Shim ³	Shim Screw*	Lock Pin ⁴	Clamp ⁶	Clamp Screw ⁵	Hex Key
	H	B	L	F									
SI-MVUNR/L 16-3	1.00	2.000	12.0	0.500	33_	6-785-016R	6-785-016L	6-998-6047P	6-998-6541	6-998-6255	6-998-6423	6-998-6531	6-998-147 6-998-159
SI-MVUNR/L 20-3	1.25	2.250	14.0	0.640		6-785-020R	6-785-020L						
SI-MVUNR/L 24-3	1.50	2.500	14.0	0.765		6-785-024R	6-785-024L						
SI-MVUNR/L 28-4	1.75	3.000	14.0	0.765	43_	6-785-128R	6-785-128L	6-998-6077	6-998-6543	6-998-6265	6-998-6423	6-998-6531	6-998-150 6-998-159
SI-MVUNR/L 32-4	2.00	3.250	16.0	0.890		6-785-132R	6-785-132L						

* Shim Screw to replace Lock Pin (4) when using Inserts without hole



TURNING



Negative Boring Bars – WN

Cutting Tools

Boring Bars for 80° Trigon Negative Inserts

WNMG – WNMA

NO THROUGH COOLANT

SI-MWNL

SI-MWLNLR

Combination Pin & Clamp "M" System

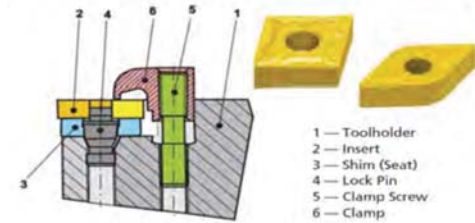
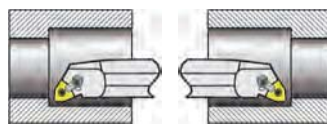
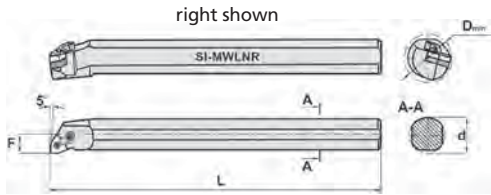

TURNING

Style	Dimensions				Insert Size	Part Number		Spare Part List					
	Shank		OAL	Head		Right Hand	Left Hand	Shim ³	Shim Screw*	Lock Pin ⁴	Clamp ⁶	Clamp Screw ⁵	Hex Key
	H	B	L	F									
SI-MWLNLR/L 12-3	0.75	0.930	10.0	0.500	33_	6-765-123R	6-765-123L	-	-	6-998-6251**	6-998-6405	6-998-6513	6-998-147
SI-MWLNLR/L 16-3	1.00	1.800	12.0	0.640		6-765-163R	-	-	-	-	-	-	6-998-159
SI-MWLNLR/L 12-4	0.75	0.930	10.0	0.500	43_	6-765-124R	6-765-124L	-	-	6-998-6220	6-998-6415	6-998-6520	6-998-150
SI-MWLNLR/L 16-4	1.00	1.280	12.0	0.640		6-765-164R	6-765-164L	-	-	6-998-6220	6-998-6415	6-998-6520	6-998-153
SI-MWLNLR/L 20-4	1.25	1.530	14.0	0.765		6-765-204R	6-765-204L	6-998-6035	6-998-6543	6-998-6265	6-998-6415	6-998-6526	6-998-150
SI-MWLNLR/L 24-4	1.50	1.780	14.0	0.890		6-765-244R	6-765-244L	6-998-6035	6-998-6543	6-998-6265	6-998-6415	6-998-6526	6-998-153

** 6-998-6251 (NL33) IS SHORTER THAN INDUSTRY STANDARD TO ALLOW BORING SMALLER DIAMETERS

THROUGH COOLANT

AI-MWLNLR

MWLNLR

Combination Pin & Clamp "M" System

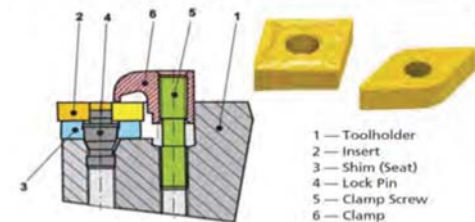
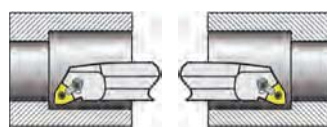
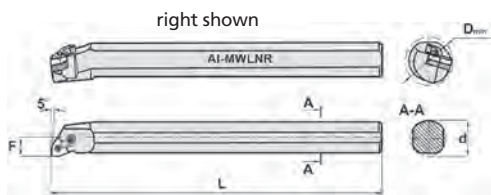

Style	Dimensions				Insert Size	Part Number		Spare Part List					
	Shank		OAL	Head		Right Hand	Left Hand	Shim ³	Shim Screw*	Lock Pin ⁴	Clamp ⁶	Clamp Screw ⁵	Hex Key
	H	B	L	F									
AI-MWLNLR/L 16-4T	1.00	1.280	12.0	0.640	43_	6-765-564R	6-765-564L	-	-	6-998-6260	6-998-6415	6-998-6520	6-998-150
AI-MWLNLR/L 20-4T	1.25	1.530	14.0	0.765		6-765-604R	6-765-604L	6-998-6035	6-998-6543	6-998-6265	6-998-6415	6-998-6526	6-998-150
AI-MWLNLR/L 24-4T	1.50	1.780	14.0	0.890		6-765-644R	6-765-644L	6-998-6035	6-998-6543	6-998-6265	6-998-6415	6-998-6526	6-998-153

Coolant Through bars have 3/8 NPT thread

* Shim Screw to replace Lock Pin (4) when using Inserts without hole



Positive Boring Bars

TURNING

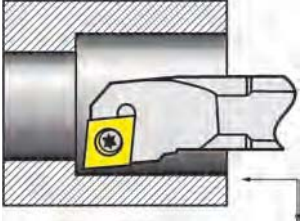
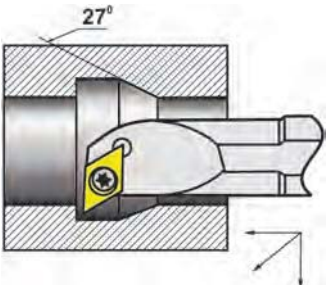
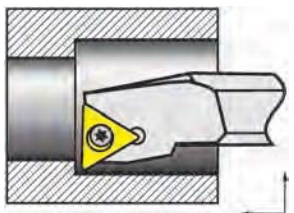
System	Insert Sizes ANSI (ISO)	Styles Available	Diameters	Minimum Bore Range	Lead
CCGT – CCMT – CCMW					
SI-SCLC (R/L) (right shown) NO THROUGH COOLANT  -5° Lead SI-SCLC R/L 6-870-	21.5_ (0602 _) 32.5_ (09T3 _) 	RIGHT / LEFT	0.315 - 1.00	0.354 - 1.120	-5°
DCMT – DCGT – DCMW					
SI-SDUC (R/L) (right shown) NO THROUGH COOLANT  -3° Lead SI-SDUC R/L 6-875-	21.5_ (1504 _) 54_ (11T3 _) 	RIGHT / LEFT	0.375 - 1.25	0.625 - 1.750	-3°
TCMT – TCGT – TCMW					
SI-STUC (R/L) (right shown) NO THROUGH COOLANT  -3° Lead SI-STUC R/L 6-884-	21.5_ (1102 _) 32.5_ (16T3 _) 	RIGHT / LEFT	0.375 - 1.50	0.500 - 1.680	-3°



Positive Boring Bars Overview

Cutting Tools

Positive Boring Bars

TURNING

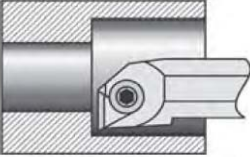
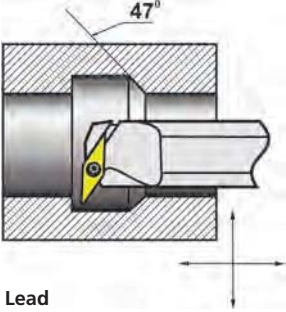
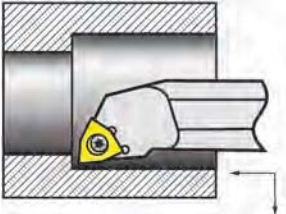
System	Insert Sizes ANSI (ISO)	Styles Available	Diameters	Minimum Bore Range	Lead
TPUN – TPGN – TPMR					
SI-CTUPR  0° Lead SI-CTUPR (RIGHT HAND) 6-939-	21_ (1102_ 32_ (1603_ 43 (2204_)	RIGHT	0.625 - 2.0	0.827 - 2.559	0°
VCGT – VCMT – VCMW					
SI-SVUC (R/L) (right shown) NO THROUGH COOLANT  -3° Lead SI-SVUC R/L 6-887-	22_ (1103_ 33_ (1604_)	RIGHT / LEFT	0.75 - 1.25	1.125 - 2.250	-3°
WCMT – WCGT					
SI-SWUC (R/L) (right shown) NO THROUGH COOLANT  -3° Lead SI-SWUC R/L 6-889-	32.5_ (06T3 _)	RIGHT / LEFT	0.50 - 0.75	0.625 - 1.000	-3°

Boring Bars for 80° Diamond Positive Inserts

CCMT – CCGT

NO THROUGH COOLANT

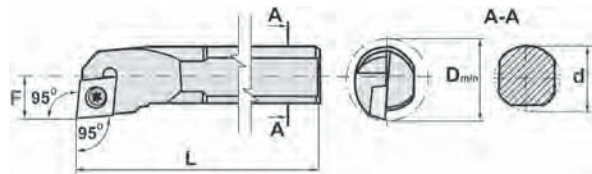

SI-SCLCL

SI-SCLCR

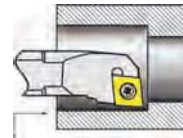
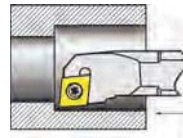

Style	Dimensions				Insert Size	Part Number		Spare Part List		
	Shank	Min. Bore	OAL	Center Line		Right Hand	Left Hand	Insert Screw	Hex Key	Anti-Seize
	d	Dmin	L	F						
SI-SCLCR/L 04-2	0.315	0.354	4.0	0.188	21.5_	6-870-042R	6-870-042L	6-998-2506	6-998-007	290-ASEIZE-03
SI-SCLCR/L 06-2	0.375	0.468	6.0	0.250		6-870-062R	6-870-062L			
SI-SCLCR/L 08-2	0.50	0.560	7.0	0.290		6-870-082R	6-870-082L			
SI-SCLCR/L 10-2	0.625	0.810	8.0	0.405		6-870-085R	6-870-085L			
SI-SCLCR/L 08-3	0.50	0.625	7.0	0.312	32.5_	6-870-093R	6-870-093L	6-998-4008T	6-998-015	290-ASEIZE-03
SI-SCLCR/L 10-3	0.625	0.812	8.0	0.406		6-870-103R	6-870-103L			
SI-SCLCR/L 12-3	0.75	1.000	10.0	0.500		6-870-123R	6-870-123L			
SI-SCLCR/L 16-3	1.00	1.120	12.0	0.609		6-870-163R	6-870-163L			

Boring Bars for 55° Diamond Positive Inserts

DCMT – DCGT

NO THROUGH COOLANT

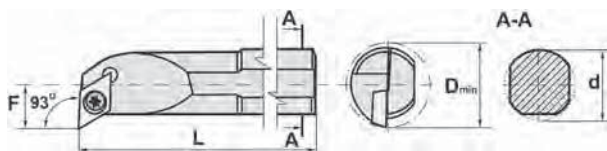

SI-SDUCL

SI-SDUCR

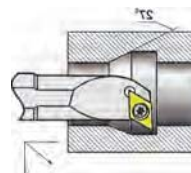
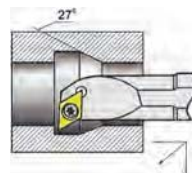

Style	Dimensions				Insert Size	Part Number		Spare Part List		
	Shank	Min. Bore	OAL	Center Line		Right Hand	Left Hand	Insert Screw	Hex Key	Anti-Seize
	d	Dmin	L	F						
SI-SDUCR/L 06-2	0.375	0.625	6.0	0.375	21.5_	6-875-006R	6-875-006L	6-998-2506	6-998-007	290-ASEIZE-03
SI-SDUCR/L 08-2	0.50	0.780	6.0	0.437		6-875-008R	6-875-008L			
SI-SDUCR/L 10-2	0.625	0.840	8.0	0.500		6-875-010R	6-875-010L			
SI-SDUCR/L 12-3	0.75	1.125	10.0	0.562	32.5_	6-875-012R	6-875-012L	6-998-4008T	6-998-015	290-ASEIZE-03
SI-SDUCR/L 16-3	1.00	1.500	12.0	0.750		6-875-016R	6-875-016L			
SI-SDUCR/L 20-3	1.25	1.750	14.0	0.875		6-875-020R	6-875-020L			



Positive Boring Bars – TC, TP

Cutting Tools

Boring Bars for 60° Triangle Positive Inserts

TCMT – TCGT

NO THROUGH COOLANT

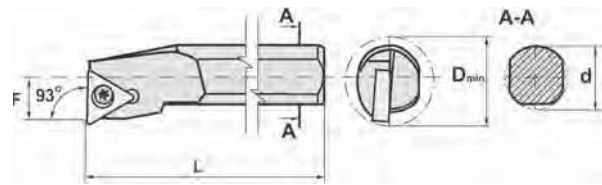

SI-STUCL

SI-STUCR

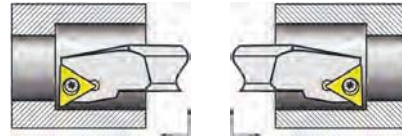

Style	Dimensions				Insert Size	Part Number		Spare Part List		
	Shank	Min. Bore	OAL	Center Line		Right Hand	Left Hand	Insert Screw	Hex Key	Anti-Seize
	d	Dmin	L	F				Part Number		
SI-STUCR/L 06-2	0.375	0.500	5.0	0.208	21.5_	6-884-006R	6-884-006L	6-998-2506	6-998-007	290-ASEIZE-03
SI-STUCR/L 08-2	0.50	0.590	6.0	0.287		6-884-008R	6-884-008L			
SI-STUCR/L 10-2	0.625	0.750	8.0	0.350		6-884-010R	6-884-010L			
SI-STUCR/L 12-3	0.75	0.845	10.0	0.422	32.5_	6-884-012R	6-884-012L	6-998-4008T	6-998-015	290-ASEIZE-03
SI-STUCR/L 16-3	1.00	1.115	12.0	0.555		6-884-016R	6-884-016L			
SI-STUCR/L 20-3	1.25	1.370	12.0	0.682		6-884-020R	6-884-020L			
SI-STUCR/L 24-3	1.50	1.680	12.0	0.840		6-884-024R	6-884-024L			

TPGN – TPUN – TPMR

NO THROUGH COOLANT

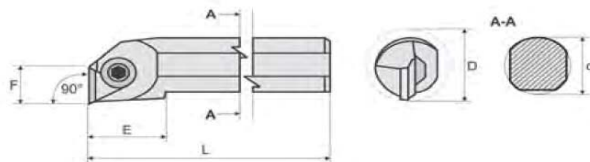

SI-CTUPR

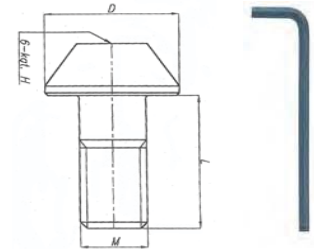
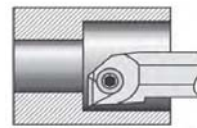

Style	Dimensions					Insert Size	Part Number		Spare Part List			
	Shank	Min. Bore	OAL	Center Line			Right Hand	Shim	Shim Screw	Lock Screw	Hex Key	
	d	Dmin	L	F	E			Part Number				
SI-CTUPR 10-2	0.625	0.827	8.3	0.709	1.181	21_	6-939-172	–	–	6-999-265	6-999-583	
SI-CTUPR 12-3	0.75	1.063	9.9	0.925	1.378	32_	6-939-173	–	–	6-999-271	6-999-584	
SI-CTUPR 16-3	1.000	1.339	11.8	1.201	1.575		6-939-174					
SI-CTUPR 20-3	1.25	1.693	14.0	1.516	1.772	32_	6-939-175	6-999-391	6-999-400	6-999-271	6-999-582 6-999-584	
SI-CTUPR 24-3	1.50	2.086	15.0	1.889	1.968		6-939-176					
SI-CTUPR 32-4	2.00	2.559	16.0	2.362	1.968	43_	6-939-178	6-999-394	6-999-400	6-999-275	6-999-582 6-999-585	

Style	Spare Part List – Mechanical Chip Breakers		
	Fine < 0.004 ipr (< 0.1 mm/rev)	Medium 0.003-0.006 ipr (0.08 - 0.14 mm/rev)	Coarse > 0.006 ipr (>0.14 mm/rev)
SI-CTUPR 10-2	–	–	6-999-265
SI-CTUPR 12-3	6-999-863	6-999-864	6-999-865
SI-CTUPR 16-3			
SI-CTUPR 20-3	6-999-863	6-999-864	6-999-865
SI-CTUPR 24-3			
SI-CTUPR 32-4	6-999-867	6-999-868	6-999-869

Boring Bars for 35° Diamond Positive Inserts

VCMT – VCGT

NO THROUGH COOLANT

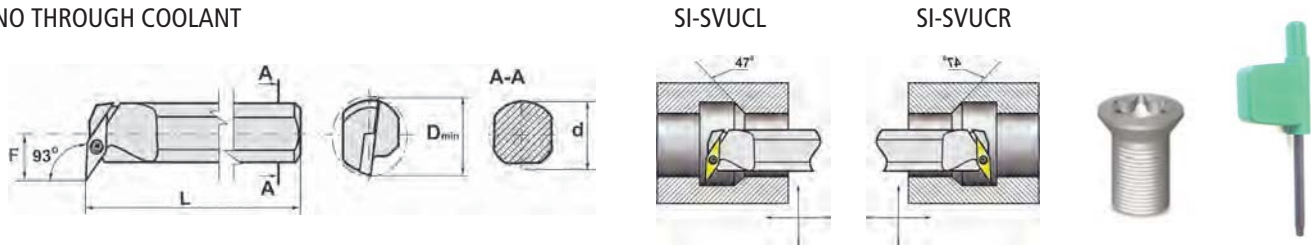

Style	Dimensions				Insert Size	Part Number		Spare Part List		
	Shank	Min. Bore	OAL	Center Line		Right Hand	Left Hand	Insert Screw	Hex Key	Anti-Seize
	d	D _{min}	L	F						
SI-SVUCR/L 12-2	0.750	1.125	10.0	0.625	22_	6-887-122R	6-887-122L	6-998-2506	6-998-007	290-ASEIZE-03
SI-SVUCR/L 16-2	1.000	1.500	12.0	0.750		6-887-162R	6-887-162L			
SI-SVUCR/L 16-3	1.00	2.000	12.0	0.750	33_	6-887-163R	6-887-163L	6-998-3509	6-998-015	290-ASEIZE-03
SI-SVUCR/L 20-3	1.25	2.250	14.0	1.000		6-887-203R	6-887-203L			

Boring Bars for 80° Trigon Positive Inserts

WCMT – WCGT

NO THROUGH COOLANT

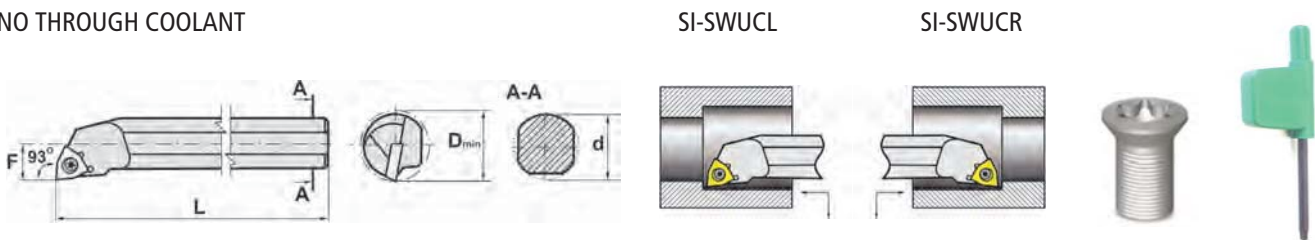

Style	Dimensions				Insert Size	Part Number		Spare Part List		
	Shank	Min. Bore	OAL	Center Line		Right Hand	Left Hand	Insert Screw	Hex Key	Anti-Seize
	d	D _{min}	L	F						
SI-SWUCR/L 08-3	0.500	0.625	6.0	0.311	32.5_	6-889-083R	–	6-998-4008T	6-998-015	290-ASEIZE-03
SI-SWUCR/L 10-3	0.63	0.812	8.0	0.405		6-889-103R	6-889-103L			
SI-SWUCR/L 12-3	0.75	1.000	10.0	0.500		6-889-123R	6-889-123L			



Boring Bar Sets

Cutting Tools

Boring Bar Sets



TURNING

Part Number	Set Description	Qty	Description	
6-870-505	5 Piece Boring Bar Set with CCMT Inserts	1	SI-SCLCR 06-3	Boring Bar
		1	SI-SCLCR 08-3	Boring Bar
		1	SI-SCLCR 10-3	Boring Bar
		4	CCMT 21.51	Inserts
		6	CCMT 32.52	Inserts
6-870-510	3 Piece Larger Diameter Boring Bars with CCMT Inserts	1	SI-SCLCR 06-3	Boring Bar
		1	SI-SCLCR 08-3	Boring Bar
		1	SI-SCLCR 10-3	Boring Bar
		6	CCMT 32.52	Inserts
6-870-515	3 Piece Boring Bars with CCMT Inserts	1	SI-SCLCR 06-2	Boring Bar
		1	SI-SCLCR 08-3	Boring Bar
		1	SI-SCLCR 10-3	Boring Bar
		2	CCMT 21.51	Inserts
		4	CCMT 32.52	Inserts
6-884-500	3 Piece Boring Bars with TCMT Inserts	1	SI-STUCR 06-2	Boring Bar
		1	SI-STUCR 08-2	Boring Bar
		1	SI-STUCR 10-2	Boring Bar
		6	TCMT 21.51	Inserts
6-890-510	5 Piece Mini Toolholder and Boring Bar Set	1	SCLCR 04-2	Toolholder
		1	SDJCR 04-2	Toolholder
		1	SDJCL 04-2	Toolholder
		1	SSDCN 04-2	Toolholder
		1	SI-SCLCR 04-2	Boring Bar
		4	CCMT 21.51	Inserts
		4	DCMT 21.51	Inserts
	SCMT 21.51	Inserts		

TABLE OF CONTENTS

PARTING AND GROOVING

Overview 200

GTN SYSTEM

Inserts 202

Blades 203

One Piece Flexible Clamp Tool Blocks 203

Two Piece Clamp Tool Blocks 204

Blade and Insert Sets 204

Tool Block, Blade, and Insert Sets 204

NOTCH SYSTEM

Right and Left Handed Hand Notch-Grooving Inserts 206

Right Handed Notch-Full Radius Grooving Inserts 207

Right and Left Handed Notch-Threading Inserts 207

External Notch Holders – Right and Left Hand 208

Gang Style External Notch Holders – Right and Left Hand 209

Internal Notch Holders – Right Hand 210

TNMA SYSTEM

Insert Nomenclature 212

Right and Left Hand TNMA On Edge Inserts 214

External TNMA On Edge Holders – Right and Left Hand 215

External 90° TNMA On Edge Holders – Right and Left Hand 216

Internal TNMA On Edge Boring Bars – Right and Left Hand 217





Parting and Grooving Overview

Cutting Tools

Overview

PARTING AND GROOVING

System	Insert Sizes	Width	Hand	Application	Lead or Clearance Angle
GTN System					
GTN Inserts 	GTN-2	0.087 (2 mm)	N, R, L	CUT-OFF / GROOVE	0°, 8°
	GTN-3	0.122 (3 mm)	N, R, L		0°, 4°, 8°, 15°
	GTN-4	0.161 (4 mm)	N, R, L		0°, 4°, 8°
	GTN-4.8	0.188 (4.8 mm)	N, R, L		0°, 8°
	GTN-5	0.201 (5 mm)	N, R, L		0°, 8°
	GTN-6	0.252 (6 mm)	N, R, L		0°
Holders 	BLADES	HEIGHT 1.02, 1.26	NEUTRAL	CUT-OFF / GROOVE	-
	BLOCKS	INTEGRAL CLAMPING 1 and 2-PIECE DESIGN		CUT-OFF / GROOVE	
Notch System					
Notch Inserts 	NG 2, 3, 4	0.031 - 0.250	RIGHT / LEFT	GROOVE	3°
	NR 3, 4	0.031 - 0.125	FULL RADIUS	GROOVE AND PROFILE	-
	NT 2, 3, 4	0.075 - 0.128	THREADING	60° V	-
External 	NS(R/L)	SHANK SIZES 0.625 - 1.50	RIGHT / LEFT	GROOVING AND THREADING	
	NE(R/L) (gang style)	0.625 - 1.25			
Internal 	NE (R/L)	DIAMETERS 0.625 - 2.0	MIN BORE 1.0 - 2.75	GROOVING AND THREADING	
TNMA On-Edge System					
TNMA Inserts 	GROOVING 32, 43, 54	0.031 - 0.250	RIGHT / LEFT	GROOVING	2°
	THREADING 32, 43, 54	0.125 - 0.250	NEUTRAL	THREADING 60° V	
External 	32, 43, 54	SHANK SIZES 0.625 - 1.25			
	32, 43, 54	0.625 - 1.25			
Internal 	32, 43, 54	DIAMETERS 1.0 - 3.0	MIN BORE 0.687 - 1.891		

Grade Speeds

Material		Steel	Stainless Steel	Cast Iron	Non-Ferrous	Heat Resistant Alloys (HRSA)	COATING / SUBSTRATE	PRIMARY APPLICATION	
MTCVD Palbit	PH5705			K00 - K010			Medium Temperature CVD Coating with Al ₂ O ₃ and Ti(C,N)	Hard substrate for deformation resistance	Irons
	PH5115	P10 - P25	M10 - M20	K15 - K30		S10 - S20		Cobalt Gradient for enhanced Toughness	Steels and Irons
	PH5320			K10 - K30				Enhanced coating for Abrasive Materials	Irons
	PH5125	P15 - P30		K25 - K35				Superior toughness and deformation resistance	Steels including Stainless Steels
	PH 5135	P20 - P40	M15 - M35	K15 - K30				High toughness for a wide range of materials including interrupted cuts	Steels, Stainless Steels and Cast Irons
	PH5740	P25 - P45		K25 - K50				Medium WC gains size and Cobalt for heavy interruptions	Steels and Irons
CVD Palbit	PH3225		M20 - M30				First Choice for Austenitic and Duplex SS at Low Speeds	Stainless Steels	
	PH3235		M30 - M40				Good shock resistance at Low to Moderate Speeds	Stainless Steels	
PVD Palbit	PH6705			K05 - K15		S05 - S20	Ideal for high cutting speeds in Irons and HRSA	Irons and HRSA	
	PH6910	P05 - P10	M05 - M10				Micro-grain Carbide For light Turning	Steel and Stainless Steel	
	PH6215	P10 - P25	M10 - M25				Good General Purpose Steel and Stainless Steel	Steel and Stainless Steel	
	PH6315		M15 - M25	K10 - K30			Enhanced coating for Abrasive Materials	Irons and Stainless Steel	
	PH6920	P10 - P35	M15 - M25	K10 - K30		S10 - S30	Excellent all-around grade	Steels, Stainless Steels, Irons, HRSA	
	PH6225	P15 - P30	M15 - M30				Good Shock Resistance at Moderate Speeds		
	PH6740	P25 - P50	M25 - M40	K25 - K45		S20 - S35	Extremely Tough grade for most materials	Steels, Stainless Steels, Irons, HRSA	
Uncoated	PH0910				N00 - N20	S05 - S10	Micro-grain Carbide Good wear resistance and Tough	Aluminum, HSRA, Titanium	

GTN System – Tech Tips

Application
<ul style="list-style-type: none"> • GTN inserts should be selected primarily for cut off use. Grooving applications may experience variations in groove depth, insert to insert. • When cutting off, position the insert at least .002" above center. • We recommend the one piece block and the narrowest insert practical to reduce cut off waste, this would suggest the # 2 and # 3 size blades. • Palbit GTN inserts are interchangeable with the leading brand GTN inserts.
Lead Angles
<ul style="list-style-type: none"> • The lowest lead angle gives the best tool life, hence N (neutral) results in the best tool life. • If burrs occur in the cutoff operations we recommended using a higher lead angle insert. • For a right hand insert in a normal lathe operations the burr will be reduced in the part that falls off and not the part remaining in the chuck. • The more ductile the material the higher the lead angle to reduce the burrs, thus the 15 degree angle is recommend for aluminum, other soft materials and very small diameter parts with less rigidity.



palbit GTN Inserts

	Primary Applications					
Steel	•	•	•	•	•	•
Stainless Steel	•	•	•	•	•	•
Cast Irons	•	•	•	•	•	•
Heat Resistant Alloys	•	•	•	•	•	•
	CVD Coated			PVD Coated		

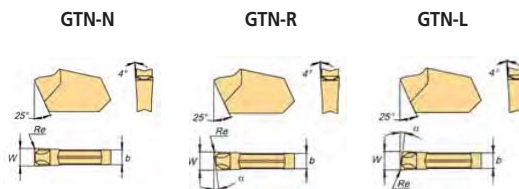

Description	Geometry Code	PH5115	PH3225	PH3235	PH5135	PH6215	PH6135	Dimensions					Feed Rates
								Hand	W	B	Re	α	
GTN-2N	113-0165-			37	N2		86	Neutral	0.087	0.071	0.006	–	0.002-0.006 (0.05-0.16)
GTN-2R 8	113-0167-				N2			Right	0.087	0.071	0.006	8°	0.002-0.004 (0.06-.09)
GTN-2L 8	113-0220-			37				Left	0.087	0.071	0.006	8°	
GTN-3N	113-0169-	L7	36	37	N2	56	86	Neutral	0.122	0.102	0.008	–	0.004-0.010 (0.1-0.25)
GTN-3R 4	113-0170-					56	86	Right	0.122	0.102	0.008	4°	0.002-0.005 (0.05-0.15)
GTN-3L 4	113-0221-						86	Left					
GTN-3R 8	113-0171-						86	Right	0.122	0.102	0.008	8°	
GTN-3L 8	113-0168-			37		56	86	Left					
GTN-3R 15	113-0253-						86	Right	0.122	0.102	0.008	15°	
GTN-3L 15	113-0254-						86	Left					
GTN-4N	113-0174-	L7		37	N2		86	Neutral	0.161	0.138	0.010	–	0.004-0.012 (0.1-0.3)
GTN-4R 4	113-0261-						86	Right	0.161	0.138	0.010	4°	0.003-0.008 (0.08-0.20)
GTN-4R 8	113-0222-						86	Right	0.161	0.138	0.010	8°	0.003-0.005 (0.08-0.12)
GTN-4.8N	113-0229-			37				Neutral	0.189	0.165	0.011	–	0.008-0.014 (0.12-0.35)
GTN-4.8L 8	113-0231-			37				Left	0.189	0.165	0.011	8°	0.004-0.007 (0.1-0.18)
GTN-5N	113-0175-			37	N2		86	Neutral	0.201	0.177	0.011	–	0.005-0.014 (0.12-0.35)
GTN-5R 8	113-0224-						86	Right	0.201	0.177	0.011	8°	0.004-0.007 (0.1-0.18)
GTN-5L 8	113-0225-						86	Left					
GTN-6N	113-0176-			37				Neutral	0.252	0.217	0.014	–	

To order please use the **geometry code** plus the **grade code**

TMX Blades

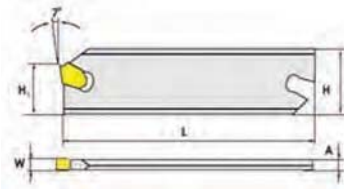

Blade Size	Insert Size	Marked Blade Number	Dimensions						Blade Part Number
			H	H1	L	W	A	D	
1.02" (26 mm)	GTN-2	150.19-26-2	1.02	0.83	4.33	0.087	0.065	1.97	6-895-262
	GTN-3	150.19-26-3				0.122	0.091	2.95	6-895-263
	GTN-4	150.19-26-4				0.161	0.126	3.15	6-895-264
	GTN-5	150.19-26-5				0.201	0.169	3.15	6-895-265
1.26" (32 mm)	GTN-3	150.19-32-3	1.26	0.97	5.91	0.122	0.091	3.94	6-895-323
	GTN-4	150.19-32-4				0.166	0.126	3.94	6-895-324
	GTN-5	150.19-32-5				0.201	0.169	4.70	6-895-325
	GTN-6	150.19-32-6				0.240	0.217	4.70	6-895-326

Blade Size	Associated Tool Blocks for Blade	Insert Extractor
26 mm	6-895-6195 6-896-001 6-896-003	6-998-913
32 mm	6-895-6196 6-895-6256 6-896-002 6-896-004	

Extractor included with blades

Application Notes: When cutting off solid bar, adjust center height 0.004 to 0.006 above center

PARTING AND GROOVING

TMX One-Piece Flexible Clamp Tool Blocks

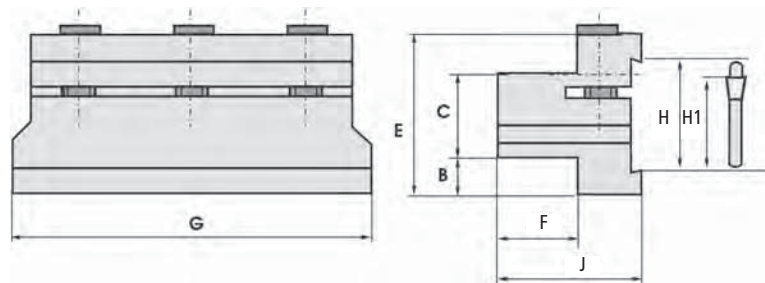

Block Number	Blade Size	Machine Mounting Dimensions		Dimensions						Tool Block Part Number
		C	F	H	H1	E	B	J	G	
19-5	1.02" (26 mm)	0.79	0.79	1.02	0.83	1.5	0.315	1.42	3.5	6-895-6195
19-6	1.26" (32 mm)	0.79	0.79	1.26	0.97	1.89	0.512	1.42	4.0	6-895-6196
25-6		1.00					0.315		4.3	6-895-6256



TMX Two-Piece Clamp Tool Blocks

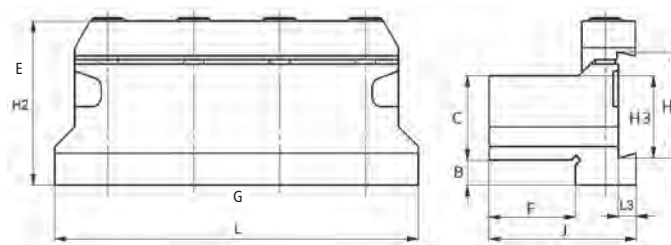

Block Number	Blade Size	Machine Mounting Dimensions		Dimensions							Tool Block Part Number
		C	F	H	H3	L3	E	B	J	G	
19-5X	1.02" (26 mm)	0.75	0.79	1.02	0.843	0.16	1.70	0.39	1.45	3.4	6-896-001
25-4-5X		1.00	1.03				1.75	0.20	1.70	4.33	6-896-003
19-6X	1.26" (32 mm)	0.75	0.79	1.26	0.976	0.21	1.94	0.55	1.50	3.95	6-896-002
25.4-6X		1.00	1.03				1.95	0.30	1.75	4.33	6-896-004

PARTING AND GROOVING

TMX Blades and Insert Sets

Blade Size	Marked Blade Number	Insert Size	Insert QTY	Set Part Number
1.02" (26 mm)	150.19-26-2	GTN-2	10	6-895-722
	150.19-26-3	GTN-3	10	6-895-723
1.26" (32 mm)	150.19-32-4	GTN-4	10	6-895-734
	150.19-32-5	GTN-5	10	6-895-735
	150.19-32-6	GTN-6	10	6-895-736



Each set includes one Blade and 10 Inserts

TMX Tool Block, Blade and Insert Sets

Blade Size	Marked Blade Number	Insert Size	Insert QTY	Block Number	SetPart Number
1.02" (26 mm)	150.19-26-3	GTN-3	10	19-5	6-895-903
	150.19-26-4	GTN-4	10		6-895-904
	150.19-26-5	GTN-5	10		6-895-905
1.26" (32 mm)	150.19-32-3	GTN-3	10	19-6	6-895-913
	150.19-32-4	GTN-4	10		6-895-914
1.26" (32 mm)	150.19-32-3	GTN-3	10	25-6	6-895-923
	150.19-32-4	GTN-4	10		6-895-924
	150.19-32-5	GTN-5	10		6-895-925

Each set includes one Flexible-Clamp Tool Block, one Blade and 10 Inserts

Grade Speeds

Material	Speed SFM (m/min)								
	CVD (Increasing Toughness →)				PVD (Increasing Toughness →)				
	PH5115	PH3225	PH3235	PH51325	PH6215	PH6315	PH6920	PH6135	
P Low Carbon Steels	280-540 (85-165)	280-540 (85-165)	230-490 (70-150)	230-475 (70-145)	280-560 (85-170)		280-540 (85-165)	230-490 (70-150)	
	Alloy Steels	200-460 (60-140)	200-460 (60-140)	180-410 (55-125)	180-390 (55-120)	200-480 (60-145)		200-460 (60-140)	180-410 (55-125)
	Tool Steels	165-430 (50-130)	165-430 (50-130)	150-375 (45-115)	150-360 (45-110)	165-450 (50-135)		165-430 (50-130)	150-375 (45-115)
M Ferritic and Martensitic	165-475 (50-145)	165-475 (50-145)	145-590 (45-180)	145-490 (45-150)	180-490 (55-150)		180-475 (55-145)		
	Austenitic	165-430 (50-130)	165-430 (50-130)	145-560 (45-170)	165-430 (50-130)	180-445 (55-135)		180-430 (55-130)	
	PH and Duplex	165-390 (50-120)	165-390 (50-120)	150-520 (45-160)	165-390 (50-120)	180-410 (55-125)		180-390 (55-120)	
K Gray Iron Class 25-35					245-490 (75-150)	330-660 (100-200)	245-460 (75-140)		
	Cast Iron Class 45				230-460 (70-140)	310-660 (95-200)	230-460 (70-140)		
	Ductile Iron				130-390 (45-120)	210-590 (65-180)	130-390 (45-120)		

PARTING AND GROOVING

P = Steel M = Stainless Steel K = Cast Iron



Notch System

Cutting Tools

TMX Right and Left Handed Notch-Grooving Inserts

- General Purpose
- Industry Standard Widths

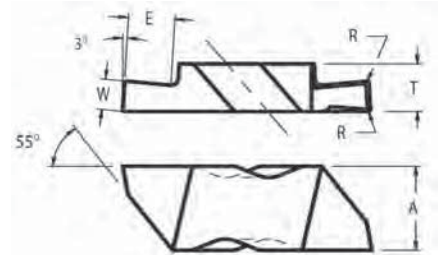

Right-hand diagram shown dimension purposes

	Primary Applications	
Steel		•
Stainless Steel		•
Cast Irons		•
Non-Ferrous		•
	CVD Coated	

Right-Hand		Left-Hand		CVD Coated		Dimensions					Feed Rates
Description	Geometry Code	Description	Geometry Code	C2	C5	W	T	E	A	A	in/rev (mm/rev)
NG-2031R	6-NG-2031R__	—	6-NG-2031L__	H	LA	0.031	0.150	0.050	0.219	0.002/0.005	0.002-0.004 (0.06-.09)
NG-2041R	6-NG-2041R__	NG-2041L	6-NG-2041L__	H	LA	0.041					
NG-2047R	6-NG-2047R__	NG-2047L	6-NG-2047L__	H	LA	0.047					
NG-2056R	6-NG-2056R__	NG-2056L	6-NG-2056L__	H	LA	0.056					
NG-2062R	6-NG-2062R__	NG-2062L	6-NG-2062L__	H	LA	0.062					
NG-2094R	6-NG-2094R__	NG-2094L	6-NG-2094L__	H	LA	0.094					
NG-2125R	6-NG-2125R__	NG-2125L	6-NG-2125L__	H	LA	0.125					
NG-3031R	6-NG-3031R__	NG-3031L	6-NG-3031L__	H	LA	0.031	0.195	0.075	0.344	0.002-0.004 (0.05-.09)	
NG-3047R	6-NG-3047R__	NG-3047L	6-NG-3047L__	H	LA	0.047					
NG-3062R	6-NG-3062R__	NG-3062L	6-NG-3062L__	H	LA	0.062					
NG-3072R	6-NG-3072R__	NG-3072L	6-NG-3072L__	H	LA	0.072					
NG-3088R	6-NG-3088R__	NG-3088L	6-NG-3088L__	H	LA	0.088					
NG-3094R	6-NG-3094R__	NG-3094L	6-NG-3094L__	H	LA	0.094					
NG-3097R	6-NG-3097R__	NG-3097L	6-NG-3097L__	H	LA	0.097					
NG-3105R	6-NG-3105R__	NG-3105L	6-NG-3105L__	H	LA	0.105					
NG-3125R	6-NG-3125R__	NG-3125L	6-NG-3125L__	H	LA	0.125					
NG-3142R	6-NG-3142R__	NG-3142L	6-NG-3142L__	H	LA	0.142					
NG-3156R	6-NG-3156R__	NG-3156L	6-NG-3156L__	H	LA	0.156					
NG-3178R	6-NG-3178R__	NG-3178L	6-NG-3178L__	H	LA	0.178					
NG-3189R	6-NG-3189R__	NG-3189L	6-NG-3189L__	H	LA	0.189					
NG-4125R	6-NG-4125RL__	NG-4125L	6-NG-4125LL__	H	LA	0.125				0.255	0.250
NG-4189R	6-NG-4189R__	NG-4189L	6-NG-4189L__	H	LA	0.189					
NG-4250R	6-NG-4250R__	NG-4250L	6-NG-4250L__	H	LA	0.250					
											0.003-0.010 (0.08-0.25)

To order, please use the geometry code plus the grade code

TMX Right Handed Notch-Full Radius Grooving Inserts

- General Purpose Grooving
- Light duty profiling

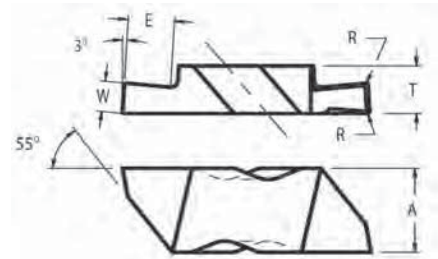

	Primary Applications	
Steel		•
Stainless Steel		•
Cast Irons		•
Non-Ferrous		•
	CVD Coated	

Description	Part Number	C2	C5	Dimensions					Feed Rates in/rev (mm/rev)
				W	T	E	A	R	
NR-3031R	6-NR-3031R__	H	LA	0.062	0.195	0.094	0.344	0.031	0.002-0.004 (0.05-.09)
NR-3047R	6-NR-3047R__	H	LA	0.094				0.047	0.002-0.004 (0.06-.09)
NR-3062R	6-NR-3062R__	H	LA	0.124				0.062	0.002-0.006 (0.05-0.16)
NR-3078R	6-NR-3078R__	H	LA	0.156				0.078	0.003-0.010 (0.08-0.25)
NR-3094R	6-NR-3094R__	H	LA	0.188				0.094	
NR-4062R	6-NR-4062R__	H	LA	0.124	0.255	0.250	0.453	0.062	0.003-0.010 (0.08-0.25)
NR-4094R	6-NR-4094R__	H	LA	0.188				0.094	
NR-4125R	6-NR-4125R__	H	LA	0.250				0.125	

To order, please use the geometry code plus the grade code

PARTING AND GROOVING

TMX Right and Left Handed Notch-Threading Inserts

- General Purpose
- 60°

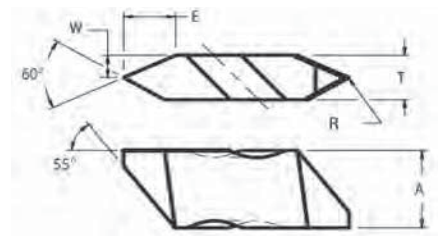

Above diagram shown for dimension purposes

	Primary Applications	
Steel		•
Stainless Steel		•
Cast Irons		•
Non-Ferrous		•
	CVD Coated	

Right Hand		Left Hand		C2	C5	Dimensions				
Description	Geometry Code	Description	Geometry Code			W	T	E	A	R
NT-2R	6-NT-2R__	NT-2L	6-NT-2L__	H	LA	0.075	0.150	0.114	0.219	0.003/0.005
NT-3R	6-NT-3R__	NT-3L	6-NT-3L__	H	LA	0.098	0.195	0.146	0.344	0.005/0.008
NT-4R	6-NT-4R__	NT-4L	6-NT-4L__	H	LA	0.128	0.225	0.194	0.453	0.005/0.008



Notch System

Cutting Tools

External Notch Holders – Right and Left Hand

- Right Hand Tools use Right Hand Inserts
- Left Hand Tools use Left Hand Inserts

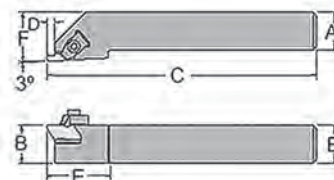

Insert Size	Right Hand		Left Hand			Dimensions					
	Description	Part Number	Insert Size	Description	Part Number	A	B	C	D	E	F
N_-2R	NS-102BR	6-NS-102BR	N_-2L	NS-102BL	6-NS-102BL	0.625	0.625	4.5	0.138	0.75	0.88
	NS-102DR	6-NS-102DR		NS-102DL	6-NS-102DL			6.0			
	NS-122BR	6-NS-122BR		NS-122BL	6-NS-122BL	0.75	0.75	4.5			
	NS-162CR	6-NS-162CR		NS-162CL	6-NS-162CL	1.00	1.00	5.0			
N_-3R	NS-123AR	6-NS-123AR	N_-3L	NS-123AL	6-NS-123AL	0.75	0.75	4.0	0.210	1.25	1.00
	NS-123BR	6-NS-123BR		NS-123BL	6-NS-123BL			4.5			
	NS-163CR	6-NS-163CR		NS-163CL	6-NS-163CL	1.00	1.00	5.0			1.25
	NS-163DR	6-NS-163DR		NS-163DL	6-NS-163DL			6.0			
	NS-203DR	6-NS-203DR		NS-203DL	6-NS-203DL			1.25			1.25
N_-4R	NS-164CR	6-NS-164CR	N_-4L	NS-164CL	6-NS-164CL	1.00	1.00	5.0	0.294	1.38	1.25
	NS-164DR	6-NS-164DR		NS-164DL	6-NS-164DL			6.0			
	NS-204CR	6-NS-204CR		NS-204CL	6-NS-204CL	1.25	1.25	5.0			1.50
	NS-204DR	6-NS-204DR		NS-204DL	6-NS-204DL	1.25	1.25	6.0			
	NS-244DR	6-NS-244DR		NS-244DL	6-NS-244DL	1.50	1.50	6.0			1.75

PARTING AND GROOVING

Spare Parts				
Insert Size	Seat 1 Part Number	Seat Screw 2 Part Number	Clamp 3 Part Number	Clamp Screw 4 Part Number
N_-2R & N_-2L	-	-	6-998-6674	6-998-6550
N_-3R & N_-3L	-	-	6-998-6672	6-998-6562
N_-4R & N_-4L	6-998-6720	6-998-6554	6-998-6672	6-998-6562

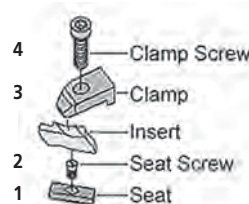

TMX Gang Style External Notch Holders – Right and Left Hand

- Right Hand Tools use Left Hand Inserts
- Left Hand Tools use Right Hand Inserts

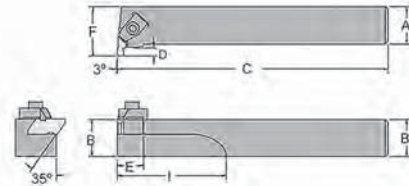

Right Hand Tool shown

Insert Size	Right Hand		Left Hand			Dimensions						
	Description	Part Number	Insert Size	Description	Part Number	A	B	C	D	E	F	I
N_-2L	NE-102BR	6-NE-102BR	N_-2R	NE-102BL	6-NE-102BL	0.625	0.625	4.5	0.138	-	0.750	1.0
	NE-122BR	6-NE-122BR		NE-122BL	6-NE-122BL	0.75	0.75				0.50	
N_-3L	NE-123BR	6-NE-123BR	N_-3R	NE-123BL	6-NE-123BL	0.75	0.75	4.5	0.210	0.75	1.125	2.0
	NE-163DR	6-NE-163DR		NE-163DL	6-NE-163DL	1.00	1.00				6.0	
	NE-203DR	6-NE-203DR		NE-203DL	6-NE-203DL	1.25	1.25				1.50	
N_-4L	NE-164DR	6-NE-164DR	N_-4R	NE-164DL	6-NE-164DL	1.00	1.00	6.0	0.294	0.75	1.375	2.0
	NE-204DR	6-NE-204DR		NE-204DL	6-NE-204DL	1.25	1.25				5.0	

Spare Parts				
Insert Size	Seat 1 Part Number	Seat Screw 2 Part Number	Clamp 3 Part Number	Clamp Screw 4 Part Number
N_-2L & N_-2R	-	-	6-998-6675	6-998-6550
N_-3L & N_-3R	-	-	6-998-6673	6-998-6562
N_-4L & N_-4R	-	-	6-998-6673	6-998-6562

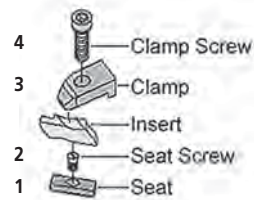



Notch System

Cutting Tools

TMX Internal Notch Holders – Right Hand

- Right Hand Tools use Left Hand Inserts
- Left Hand Tools use Right Hand Inserts

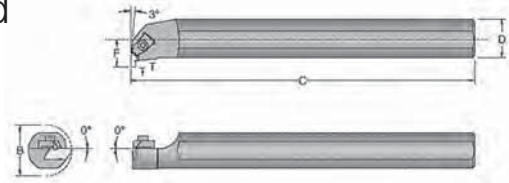

Right Hand Tool shown

Insert Size	Right Hand		Left Hand			Dimensions				
	Description	Part Number	Insert Size	Description	Part Number	A	B	C	D	F
N_-2L	NE-S102R	6-NE-S102R	N_-2R	NE-S102L	6-NE-S102L	0.625	1.000	10.0	0.500	0.138
	NE-S122R	6-NE-S122R		NE-S122L	6-NE-S122L	0.75	1.125		0.562	
N_-3L	NE-S163R	6-NE-S163R	N_-3R	NE-S163L	6-NE-S163L	1.00	1.375	14.0	0.688	0.210
	NE-S203R	6-NE-S203R		NE-S203L	6-NE-S203L	1.25	1.750		0.875	
	NE-S243R	6-NE-S243R		NE-S243L	6-NE-S243L	1.50	2.000		1.000	
	NE-S283R	6-NE-S283R		NE-S283L	6-NE-S283L	1.75	2.250		1.125	
LN_-4L	NE-S284R	6-NE-S284R	LN_-4R	NE-S284L	6-NE-S284L	1.75	2.500	14.0	1.250	0.294
	NE-S324R	6-NE-S324R		NE-S324L	6-NE-S324L	2.00	2.750	16.0	1.375	

PARTING AND GROOVING

Spare Parts				
Insert Size	Seat 1 Part Number	Seat Screw 2 Part Number	Clamp 3 Part Number	Clamp Screw 4 Part Number
N_-2L & N_-2R	-	-	6-998-6675	6-998-6550
N_-3L & LN_-3R	-	-	6-998-6673	6-998-6562
N_-4L & LN_-4R	-	-	6-998-6673	6-998-6562

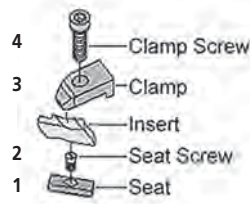

Notch Speeds

Material	Speed SFM (m/min)	
	C2	C5
P Low Carbon Steels		280-540 (85-165)
		200-460 (60-140)
		165-430 (50-130)
M Ferritic and Martensitic		165-475 (50-145)
		165-430 (50-130)
		150-350 (50-105)
K Gray Iron Class 25-35	200-600 (60-185)	
	150-450 (45-135)	
	150-500 (45-150)	
N Aluminum < 8% Si	115-2000 (35-630)	
	115-800 (35-245)	

P = Steel M = Stainless Steel K = Cast Iron N = Aluminum



TNMA System Insert Nomenclature

Cutting Tools

PARTING AND GROOVING

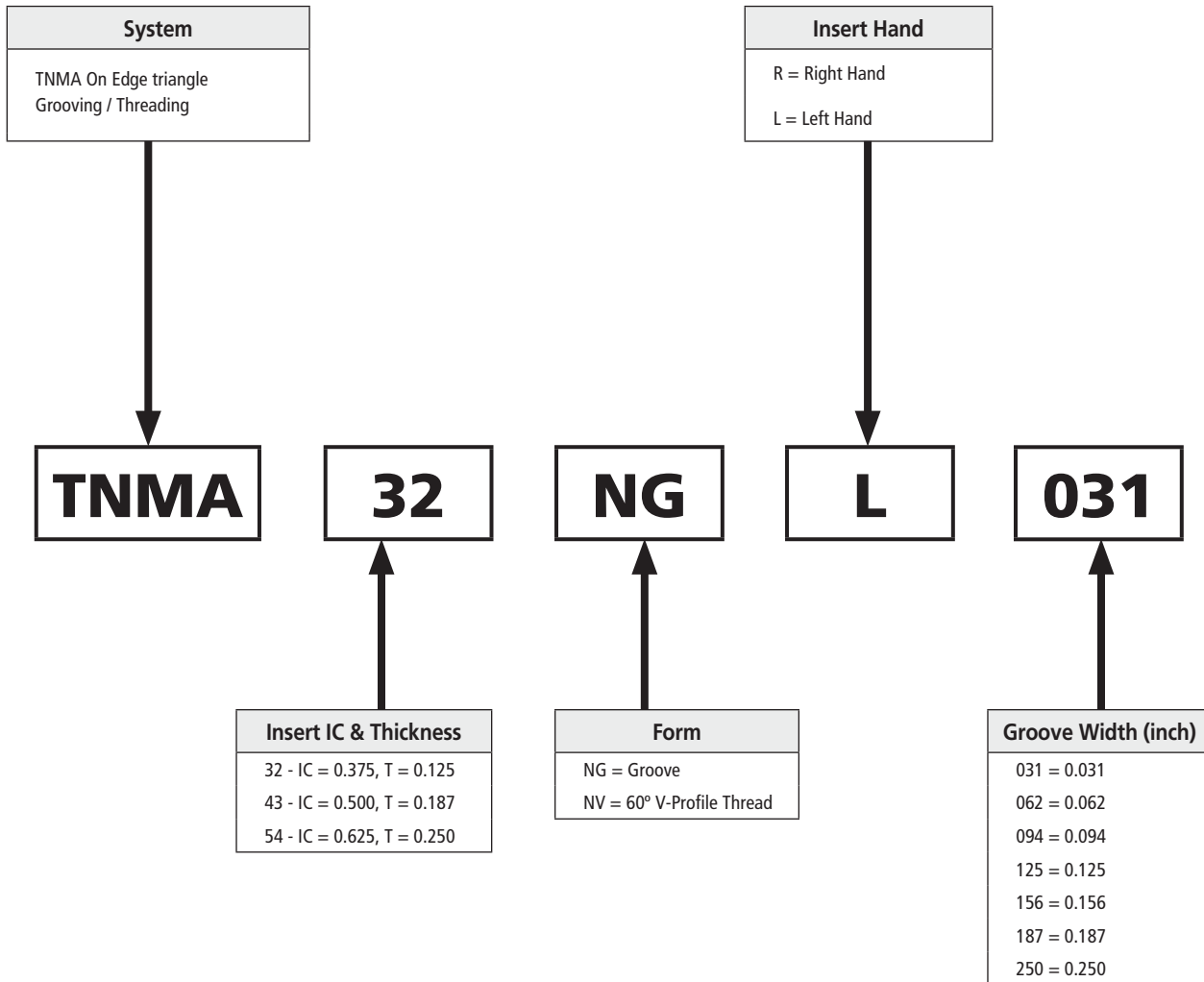

TNMA System Insert Nomenclature



TMX Cutting Tools

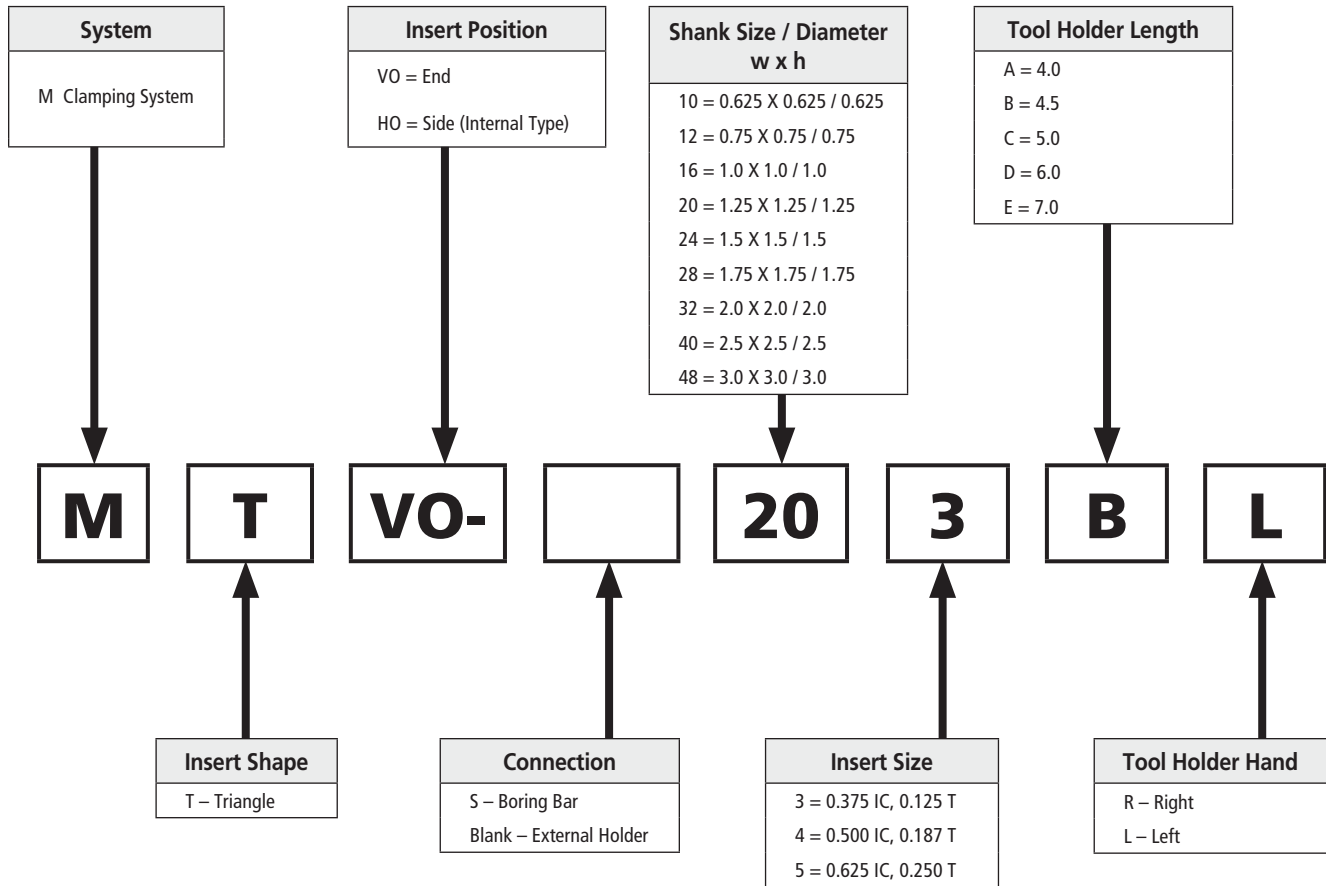

PARTING AND GROOVING



TMX Right and Left Hand TNMA On Edge Inserts

- General Purpose
- Industry Standard Widths

	Primary Applications	
Steel	•	•
Stainless Steel	•	•
Cast Irons	•	•
Non-Ferrous	•	•
	TMX	
	CVD Coated	

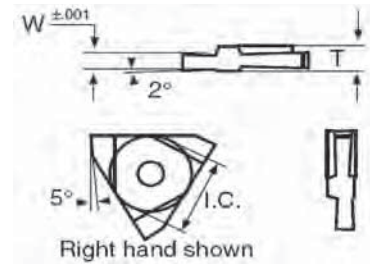

PARTING AND GROOVING

Right Hand		Left Hand		Primary Applications		Dimensions				Feed Rates in/rev (mm/rev)
Description	Geometry Code	Description	Geometry Code	C2	C5	W	IC	T	Max DOC	
TNMA-32R031	6-TNMA-32R031__	TNMA-32L031	6-TNMA-32L031__	H	LA	0.031	0.375	0.125	0.075	0.002-0.004 (0.06-.09)
TNMA-32R062	6-TNMA-32R062__	TNMA-32L062	6-TNMA-32L062__	H	LA	0.062			0.150	0.002-0.006 (0.05-0.16)
TNMA-32R094	6-TNMA-32R094__	TNMA-32L094	6-TNMA-32L094__	H	LA	0.094			0.002-0.010 (0.05-0.25)	
TNMA-32R125	6-TNMA-32R125__	-	-	H	LA	0.125				
TNMA-43R062	6-TNMA-43R062__	TNMA-43L062	6-TNMA-43L062__	H	LA	0.062	0.500	0.187	0.125	0.002-0.006 (0.05-0.16)
TNMA-43R094	6-TNMA-43R094__	TNMA-43L094	6-TNMA-43L094__	H	LA	0.094			0.150	0.003-0.010 (0.08-0.25)
TNMA-43R125	6-TNMA-43R125__	TNMA-43L125	6-TNMA-43L125__	H	LA	0.125			0.210	
TNMA-43R156	6-TNMA-43R156__	TNMA-43L156	6-TNMA-43L156__	H	LA	0.156				
TNMA-43R187	6-TNMA-43R187__	TNMA-43L187	6-TNMA-43L187__	H	LA	0.187				
TNMA-54R250	6-TNMA-54R250__	-	-	H	LA	0.250	0.625	0.250	0.270	0.003-0.010 (0.08-0.25)

To order, please use the geometry code plus the grade code

TMX External TNMA On Edge Holders – Right and Left Hand

- OD Threading
- Shallow Grooving

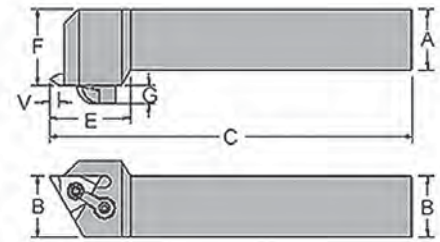

Right Hand Tool shown

Insert Size	Right Hand				Dimensions				
	Geometry Code	Part Number	Geometry Code	Part Number	C	E	F	G	V
TNMA-32	MTVO-103BR	6-MTVO-103BR	MTVO-103BL	6-MTVO-103BL	4.5	1.02	0.750	0.25	0.150
	MTVO-123BR	6-MTVO-123BR	MTVO-123BL	6-MTVO-123BL			0.875		
	MTVO-163DR	6-MTVO-163DR	MTVO-163DL	6-MTVO-163DL	6.0	1.16	1.25		
TNMA-43	MTVO-124BR	6-MTVO-124BR	MTVO-124BL	6-MTVO-124BL	4.5	1.25	0.875	0.25	0.230
	MTVO-164DR	6-MTVO-164DR	MTVO-164DL	6-MTVO-164DL	6.0		1.25		
	MTVO-204DR	6-MTVO-204DR	MTVO-204DL	6-MTVO-204DL	6.0		1.50		
	MTVO-244ER	6-MTVO-244ER	MTVO-244EL	6-MTVO-244EL	7.0		1.75		
TNMA-54	MTVO-165DR	6-MTVO-165DR	MTVO-165DL	6-MTVO-165DL	6.0	1.50	1.25	0.25	0.292
	MTVO-205DR	6-MTVO-205DR	MTVO-205DL	6-MTVO-205DL			1.50		

Spare Parts			
Insert Size	Lock Pin 1 Part Number	Clamp 2 Part Number	Clamp Screw 3 Part Number
TNMA-32	6-998-6521	6-998-6675	6-998-6513
TNMA-43	6-998-6260	6-998-6675	6-998-6513
TNMA-54	6-998-6266	6-998-6675	6-998-6513

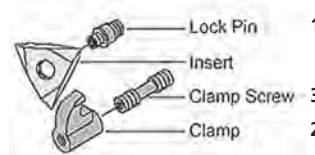



External 90° TNMA On Edge Holders – Right and Left Hand

- Gang Toolholder
- ID Threading
- Shallow Grooving

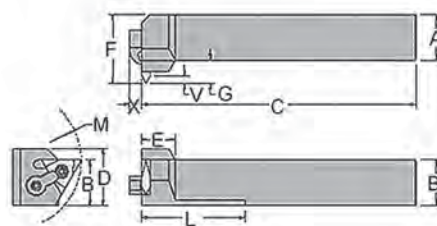

Right Hand Tool shown

Insert Size	Right Hand				Dimensions								Max M	Max Groove	Depth V
	Geometry Code	Part Number	Geometry Code	Part Number	A	B	C	E	F	G	X	L			
TNMA-32	MTHO-103BR	6-MTHO-103BR	MTHO-103BL	6-MTHO-103BL	0.625	0.625	4.5	0.875	1.000	0.375	0.250	–	2.00	0.100	0.125
	MTHO-123BR	6-MTHO-123BR	MTHO-123BL	6-MTHO-123BL	0.75	0.75			1.125			1.50			
TNMA-43	MTHO-124BR	6-MTHO-124BR	MTHO-124BL	6-MTHO-124BL	0.75	0.75	6.0	0.875	1.250	0.500	0.250	–	3.00	0.125	0.194
	MTHO-164DR	6-MTHO-164DR	MTHO-164DL	6-MTHO-164DL	1.00	1.00			1.500			2.00			
	MTHO-204DR	6-MTHO-204DR	MTHO-204DL	6-MTHO-204DL	1.25	1.25			1.750						
TNMA-54	MTHO-165DR	6-MTHO-165DR	MTHO-165DL	6-MTHO-165DL	1.00	1.00	6.0	1.00	1.500	0.625	0.250	2.50	3.00	0.170	0.242
	MTHO-205DR	6-MTHO-205DR	MTHO-205DL	6-MTHO-205DL	1.25	1.25			1.750						

PARTING AND GROOVING

Spare Parts			
Insert Size	Lock Pin 1 Part Number	Clamp 2 Part Number	Clamp Screw 3 Part Number
TNMA-32	6-998-6521	6-998-6675	6-998-6513
TNMA-43	6-998-6260	6-998-6675	6-998-6513
TNMA-54	6-998-6266	6-998-6675	6-998-6513

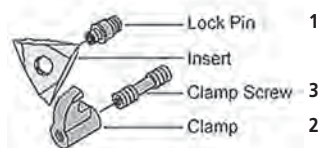

TMX Internal TNMA On Edge Boring Bars – Right and Left Hand

- Gang Toolholder
- ID Threading
- Shallow Grooving

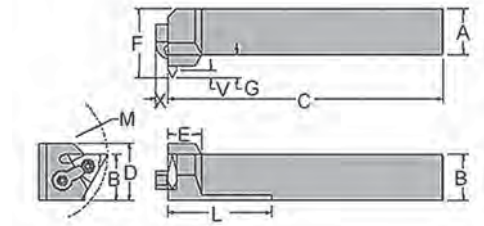

Right Hand shown
Left Hand Opposite

Insert Size	Right Hand				Dimensions					
	Geometry Code	Part Number	Geometry Code	Part Number	D	Min Bore B	C	F	X	Max Groove Depth V
TNMA-32	MTHO-S163R	6-MTHO-S163R	MTHO-S163L	6-MTHO-S163L	1.00	1.388	12	0.687	0.250	0.120
	MTHO-S203R	6-MTHO-S203R	MTHO-S203L	6-MTHO-S203L	1.25	1.656	14	0.828		
TNMA-43	MTHO-S204R	6-MTHO-S204R	MTHO-S204L	6-MTHO-S204L	1.25	1.812	14	0.875	0.250	0.190
	MTHO-S244R	6-MTHO-S244R	MTHO-S244L	6-MTHO-S244L	1.50	2.25		1.000		
	MTHO-S324R	6-MTHO-S324R	MTHO-S324L	6-MTHO-S324L	2.00	3.00	16	1.328		
TNMA-54	MTHO-S235R	6-MTHO-S235R	MTHO-S235L	–	2.00	3.50	16	1.375	0.250	0.250
	MTHO-S405R	6-MTHO-S405R	MTHO-S405L	6-MTHO-S405L	2.50	3.75		1.687		
	MTHO-S485R	6-MTHO-S485R	MTHO-S485L	6-MTHO-S485L	3.00	4.00	18	1.891		

PARTING AND GROOVING

Spare Parts			
Insert Size	Lock Pin 1 Part Number	Clamp 2 Part Number	Clamp Screw 3 Part Number
TNMA-32	6-998-6521	6-998-6675	6-998-6513
TNMA-43	6-998-6260	6-998-6675	6-998-6513
TNMA-54	6-998-6266	6-998-6675	6-998-6513

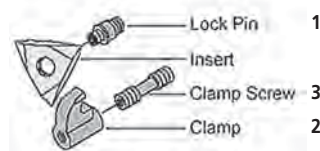



TNMA Speeds

Material	Speed SFM (m/min)	
	C2	C5
P Low Carbon Steels		280-540 (85-165)
		200-460 (60-140)
		165-430 (50-130)
M Ferritic and Martensitic		165-475 (50-145)
		165-430 (50-130)
		150-350 (50-105)
K Gray Iron Class 25-35	200-600 (60-185)	
	150-450 (45-135)	
	150-500 (45-150)	
N Aluminum < 8% Si	115-2000 (35-630)	
	115-800 (35-245)	

PARTING AND GROOVING

P = Steel	M = Stainless Steel	K = Cast Iron	N = Aluminum
-----------	---------------------	---------------	--------------

TABLE OF CONTENTS

THREADING

Overview220
Threading Insert Nomenclature222

THREADING INSERTS

Partial Profile 60°224
Partial Profile 55°225
ISO Metric External226
ISO Metric Internal227
UN (UNC, UNF, UNEF) External228
UN (UNC, UNF, UNEF) Internal229
UNJ230
NPT231
NPTF232
API Round233
Stub ACME234

THREADING TOOL HOLDERS

External Threading Tool Holders235
Internal Threading Tool Holders (Boring Bars) ..	.236





Threading Overview

Cutting Tools

Overview

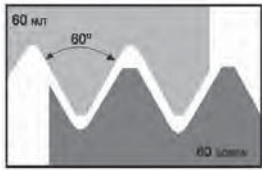
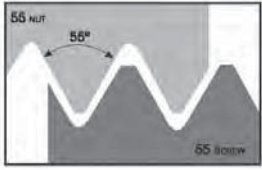
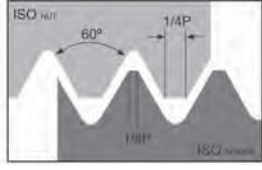
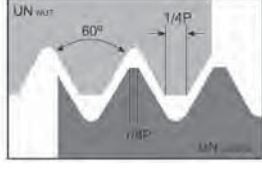
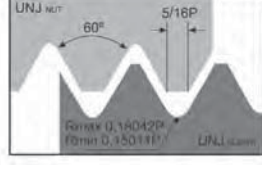
Threading				
System	Insert Sizes	TPI Pitch	Hand	Internal/External
Partial Profile 60° 	11 (0.250 ic) 16 (0.500 ic) 22 (0.625 ic)	48 to 5	Right / Left	Internal / External
Partial Profile 55° 	11 (0.250 ic) 16 (0.500 ic) 22 (0.625 ic)	48 to 5	Right / Left	Internal / External
ISO Metric 	11 (0.250 ic) 16 (0.500 ic) 22 (0.625 ic)	0.5 to 5.0	Right / Left	Internal / External
UN 	11 (0.250 ic) 16 (0.500 ic) 22 (0.625 ic)	32 to 5	Right / Left	Internal / External
UNJ 	16 (0.500 ic)	32 to 8	Right	External

THREADING

Overview

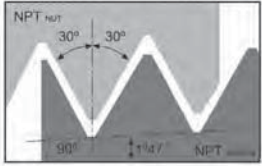
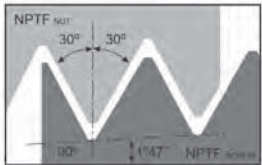
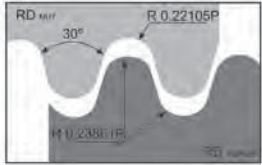
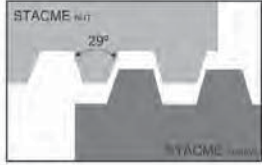
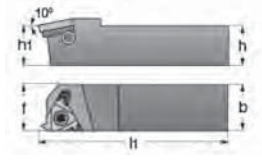
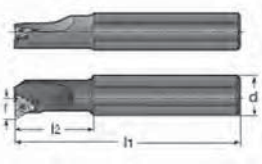
Threading				
System	Insert Sizes	TPI Pitch	Hand	Internal/External
NPT 	11 (0.250 ic) 16 (0.500 ic)	27 to 8	Right	Internal / External
NPTF 	11 (0.250 ic) 16 (0.500 ic)	18 to 11.5	Right	Internal / External
API Round 	16 (0.500 ic) 22 (0.625 ic)	10 to 4	Right	Internal / External
Stub ACME 	16 (0.500 ic) 22 (0.625 ic)	16 to 4	Right	Internal / External
Threading Holders 	11 (0.250 ic) 16 (0.500 ic) 22 (0.625 ic)	Shank Sizes 0.375 to 1.25	Right / Left	External
Threading Boring Bars 	11 (0.250 ic) 16 (0.500 ic) 22 (0.625 ic)	Diameters 0.375 to 1.50 Min. Bore Dia. 0.470 to 1.75	Right / Left	Internal

THREADING



Threading Insert Nomenclature

Cutting Tools

THREADING

Insert Size	
06	= 0.157 (4.00 mm)
08	= 0.197 (5.00 mm)
11	= 0.250 (6.35 mm)
16	= 0.375 (9.525 mm)
22	= 0.500 (12.70 mm)
27	= 0.625 (15.875 mm)

16

ER

Insert Type
ER = EXTERNAL RIGHT HAND
EL = EXTERNAL LEFT HAND
IR = INTERNAL RIGHT HAND
IL = INTERNAL LEFT HAND

Pitch	
Partial Profile	
	tpi (mm)
AG	48-8 (0.5-3.0)
A	48-16 (0.5-1.5)
G	14-8 (1.75-3.0)
N	7-5 (3.5-5.0)
Q	4.5-4 (5.5-6.0)
Full Profile	
	(mm)
-	72-4 (0.35-6.0)

UN

PROFILE	
Partial Profile	
60	60°
55	55°
Full Profile	
ISO	ISO METRIC (ISO 965-1:1998, DIN 13)
BSPT	BRITISH STANDARD PIPE THREAD (BS21: 1985)
ABUT	AMERICAN BUTTRESS (ANSI B 1.9 - 1973)
BUT	API BUTTRESS CASING
APIRD	API ROUND
NPT	NATIONAL PIPE THREAD (ANSI/ASME B 1.2.1 - 1983)
NPTF	NATIONAL PIPE THREAD DRY SEAL (ANSI B1.20.3 -1976)
RRD	ROUND (DIN 405 - 1997)
TR	TRAPEZ (DIN 103 -1977)
UN	UNIFIED SCREW THREADS (UNC COARSE-THREAD, UNF FINE-THREAD, UNEF EXTRA- FINE-THREAD)
UNJ	UNIFIED SCREW THREADS "J" (MIL-S-8879A)
MJ	METRIC "J" ISO 5855-1:1989
ACME	ACME ANSI/ASME 1.5 - 1988
STACME	STUB ACME ANSI/ASME 1.8 - 1988
W	WHITWORTH (BRITISH STANDARD B.S.84: 1956, ISO 228 - 1982)

Pitch		
Inch		Metric
4	12	0.5
4.5	13	0.75
5	14	1
6	16	1.25
7	18	1.5
8	19	1.75
9	20	2
10	24	2.5
11	28	3
11.5	32	3.5
		4
		4.5
		5
		5.5
		6

28

Threading Holder Nomenclature



Cutting Tools

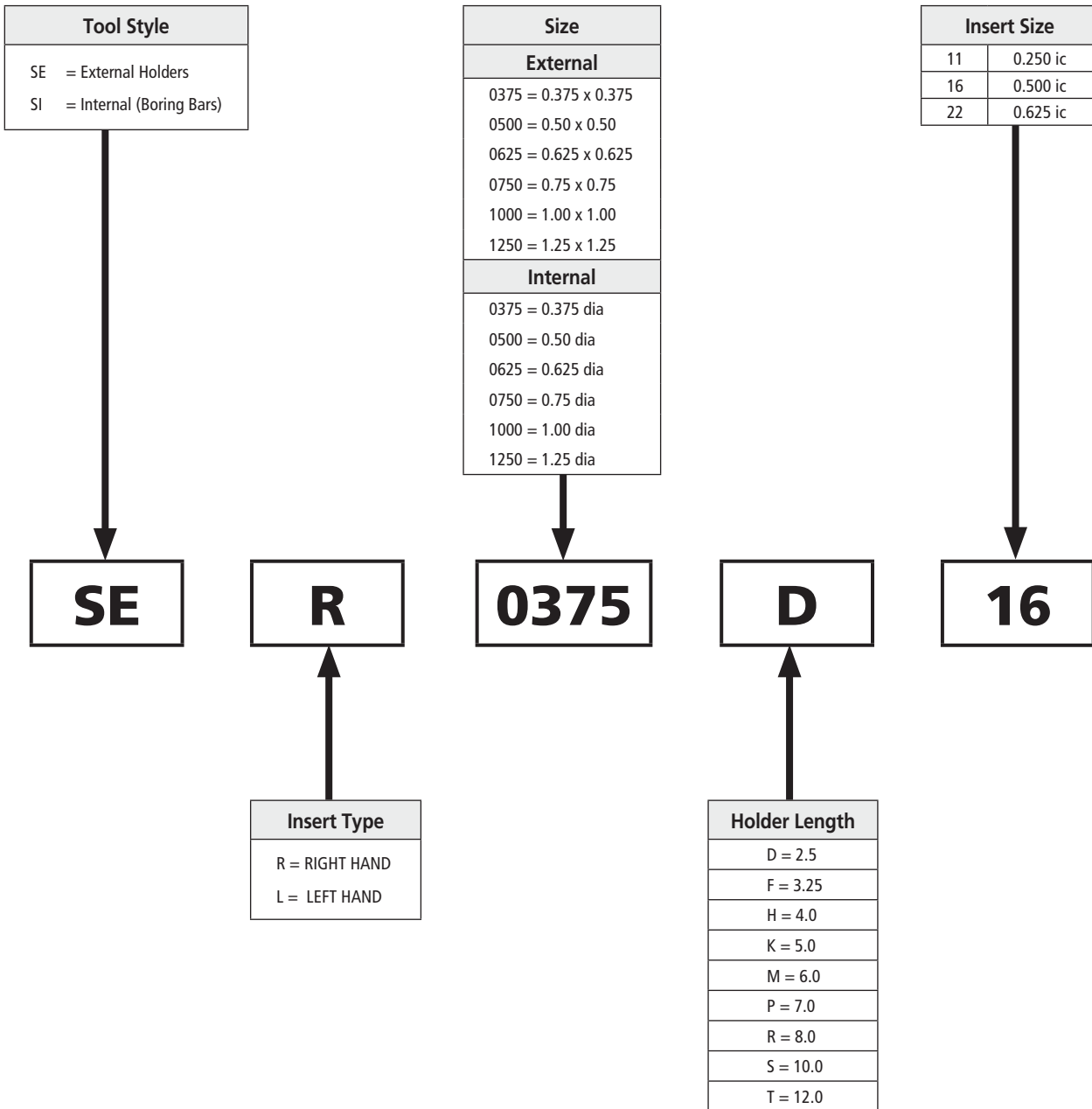

THREADING



Threading Inserts

Cutting Tools

palbit Partial Profile 60°

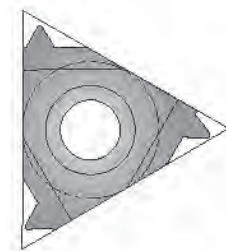
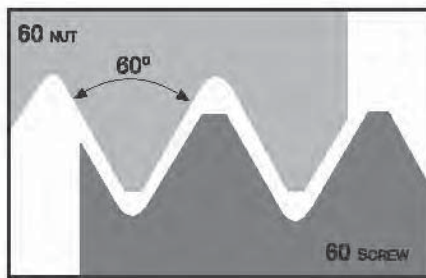

Insert Size	TPI/Pitch (mm)	External Inserts					
		Right Hand			Left Hand		
		Part Number	Stock	Description	Part Number	Stock	Description
16 __ A60	48-16 (0.5-1.5)	188-0429-68	●	16 ER A60 PH6920	188-0771-68		16 ER A60 PH6920
16 __ AG60	48-8 (0.5-3.0)	188-0388-68	●	16 ER AG60 PH6920	188-0524-68	●	16 ER AG60 PH6920
16 __ G60	14-8 (1.75-3.0)	188-0431-68	●	16 ER G60 PH6920	188-0773-68	●	16 ER G60 PH6920
22 __ N60	7-5 (3.5-5.0)	188-0046-68	●	22 ER N60 PH6920	188-0853-68	●	22 ER N60 PH6920

Insert Size	TPI/Pitch (mm)	Internal Inserts					
		Right Hand			Left Hand		
		Part Number	Stock	Description	Part Number	Stock	Description
11 __ A60	48-16 (0.5-1.5)	188-0595-68	●	11 IR A60 PH6920	188-0855-68	●	11 IL A60 PH6920
16 __ A60	48-16 (0.5-1.5)	188-0045-68	●	16 IR A60 PH6920	188-0772-68	●	16 IL A60 PH6920
16 __ AG60	48-8 (0.5-3.0)	188-0437-68	●	16 IR AG60 PH6920	188-0775-68	●	16 IL AG60 PH6920
16 __ G60	14-8 (1.75-3.0)	188-0435-68	●	16 IR G60 PH6920	188-0774-68	●	16 IL G60 PH6920
22 __ N60	7-5 (3.5-5.0)	188-0769-68	●	22 IR N60 PH6920	188-0854-68	●	22 IL N60 PH6920

- stock standard
- stock available with 2-3 week lead time

THREADING

palbit Partial Profile 55°

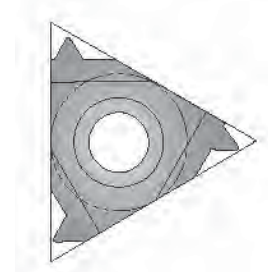
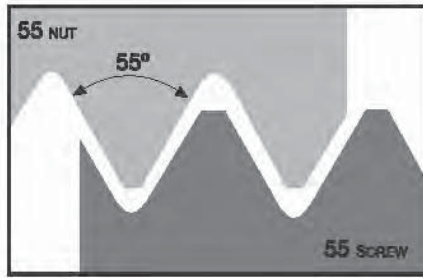

Insert Size	TPI/Pitch (mm)	External Inserts					
		Right Hand			Left Hand		
		Part Number	Stock	Description	Part Number	Stock	Description
16 __ A55	48-16 (0.5-1.5)	188-0430-68	●	16 ER A55 PH6920	188-0776-68	○	16 EL A55 PH6920
16 __ AG55	48-8 (0.5-3.0)	188-0433-68	●	16 ER AG55 PH6920	188-0780-68	○	16 EL AG55 PH6920
16 __ G55	14-8 (1.75-3.0)	188-0432-68	●	16 ER G55 PH6920	188-0778-68	●	16 EL G55 PH6920
22 __ N55	7-5 (3.5-5.0)	188-0770-68	○	22 ER N55 PH6920	188-0858-68	○	22 EL N55 PH6920

Insert Size	TPI/Pitch (mm)	Internal Inserts					
		Right Hand			Left Hand		
		Part Number	Stock	Description	Part Number	Stock	Description
11 __ A55	48-16 (0.5-1.5)	188-0006-68	○	11 IR A55 PH6920	188-0856-68	○	11 IL A55 PH6920
16 __ A55	48-16 (0.5-1.5)	188-0434-68	●	16 IR A55 PH6920	188-0777-68	○	16 IL A55 PH6920
16 __ AG55	48-8 (0.5-3.0)	188-0438-68	●	16 IR AG55 PH6920	188-0781-68	●	16 IL AG55 PH6920
16 __ G55	14-8 (1.75-3.0)	188-0436-68	●	16 IR G55 PH6920	188-0779-68	○	16 IL G55 PH6920
22 __ N55	7-5 (3.5-5.0)	188-0047-68	○	22 IR N55 PH6920	188-0857-68	○	22 IL N55 PH6920

- stock standard
- stock available with 2-3 week lead time

THREADING



Threading Inserts

Cutting Tools

palbit ISO Metric External Inserts

ISO 965-1: 1999-11
DIN 13: 2005-08

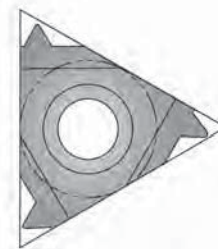
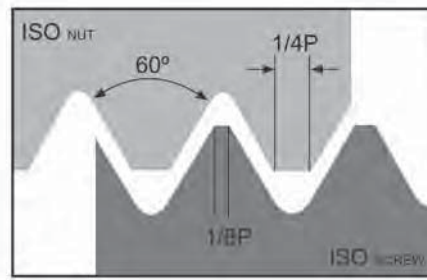

Insert Size	Pitch	External Inserts					
		Right Hand			Left Hand		
		Part Number	Stock	Description	Part Number	Stock	Description
16 __ ISO 0.50	0.50	188-0819-68	●	16 ER ISO .50 PH6920	–	–	–
16 __ ISO 0.75	0.75	188-0447-68	●	16 ER ISO .75 PH6920	–	–	–
16 __ ISO 0.80	0.80	188-0804-68	●	16 ER ISO .80 PH6920	–	–	–
16 __ ISO 1.00	1.00	188-0479-68	●	16 ER ISO 1.00 PH6920	188-0782-68	○	16 EL ISO 1.00 PH6920
16 __ ISO 1.25	1.25	188-0007-68	●	16 ER ISO 1.25 PH6920	188-0651-68	○	16 EL ISO 1.25 PH6920
16 __ ISO 1.50	1.50	188-0262-68	●	16 ER ISO 1.50 PH6920	188-0652-68	○	16 EL ISO 1.50 PH6920
16 __ ISO 1.75	1.75	188-0732-68	●	16 ER ISO 1.75 PH6920	188-0653-68	○	16 EL ISO 1.75 PH6920
16 __ ISO 2.00	2.00	188-0018-68	●	16 ER ISO 2.00 PH6920	188-0654-68	●	16 EL ISO 2.00 PH6920
16 __ ISO 2.50	2.50	188-0020-68	○	16 ER ISO 2.50 PH6920	188-0788-68	○	16 EL ISO 2.50 PH6920
16 __ ISO 3.00	3.00	188-0022-68	○	16 ER ISO 3.00 PH6920	188-0488-68	●	16 EL ISO 3.00 PH6920
22 __ ISO 3.50	3.50	188-0823-68	○	22 ER ISO 3.5 PH6920	188-0844-68	○	22 EL ISO 3.5 PH6920
22 __ ISO 4.00	4.00	188-0811-68	○	22 ER ISO 4 PH6920	188-0845-68	○	22 EL ISO 4 PH6920
22 __ ISO 4.50	4.50	188-0824-68	○	22 ER ISO 4.5 PH6920	188-0846-68	○	22 EL ISO 4.5 PH6920
22 __ ISO 5.00	5.00	188-0649-68	○	22 ER ISO 5 PH6920	188-0847-68	○	22 EL ISO 5 PH6920

● stock standard

○ stock available with 2-3 week lead time

THREADING

palbit ISO Metric Internal Inserts

ISO 965-1: 1999-11
DIN 13: 2005-08

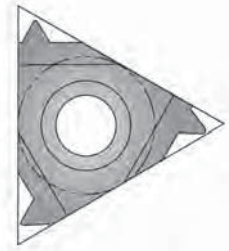
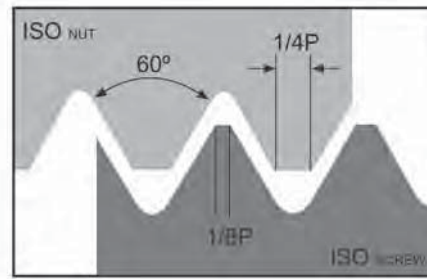

Insert Size	Pitch	Internal Inserts					
		Right Hand			Left Hand		
		Part Number	Stock	Description	Part Number	Stock	Description
11 __ ISO 0.50	0.50	188-0825-68	○	11 IR ISO .50 PH6920	188-0837-68	○	11 IL ISO .50 PH6920
11 __ ISO 0.75	0.75	188-0762-68	○	11 IR ISO .75 PH6920	188-0838-68	○	11 IL ISO .75 PH6920
11 __ ISO 1.00	1.00	188-0604-68	○	11 IR ISO 1.00 PH6920	188-0839-68	○	11 IL ISO 1.00 PH6920
11 __ ISO 1.25	1.25	188-0827-68	○	11 IR ISO 1.25 PH6920	188-0840-68	○	11 IL ISO 1.25 PH6920
11 __ ISO 1.50	1.50	188-0605-68	○	11 IR ISO 1.50 PH6920	188-0841-68	○	11 IL ISO 1.50 PH6920
11 __ ISO 1.75	1.75	188-0828-68	○	11 IR ISO 1.75 PH6920	188-0842-68	○	11 IL ISO 1.75 PH6920
11 __ ISO 2.00	2.00	188-0829-68	○	11 IR ISO 2.00 PH6920	188-0843-68	○	11 IL ISO 2.00 PH6920
16 __ ISO 0.50	0.50	188-0830-68	●	16 IR ISO .50 PH6920	-	-	-
16 __ ISO 0.75	0.75	188-0831-68	●	16 IR ISO .75 PH6920	-	-	-
16 __ ISO 0.80	0.80	188-0832-68	●	16 IR ISO .80 PH6920	-	-	-
16 __ ISO 1.00	1.00	188-0025-68	●	16 IR ISO 1.00 PH6920	188-0783-68	○	16 IL ISO 1.00 PH6920
16 __ ISO 1.25	1.25	188-0026-68	●	16 IR ISO 1.25 PH6920	188-0784-68	○	16 IL ISO 1.25 PH6920
16 __ ISO 1.50	1.50	188-0619-68	●	16 IR ISO 1.50 PH6920	188-0785-68	●	16 IL ISO 1.50 PH6920
16 __ ISO 1.75	1.75	188-0733-68	●	16 IR ISO 1.75 PH6920	188-0786-68	●	16 IL ISO 1.75 PH6920
16 __ ISO 2.00	2.00	188-0039-68	○	16 IR ISO 2.00 PH6920	188-0787-68	○	16 IL ISO 2.00 PH6920
16 __ ISO 2.50	2.50	188-0041-68	○	16 IR ISO 2.50 PH6920	188-0789-68	○	16 IL ISO 2.50 PH6920
16 __ ISO 3.00	3.00	188-0042-68	●	16 IR ISO 3.00 PH6920	188-0790-68	○	16 IL ISO 3.00 PH6920
22 __ ISO 3.50	3.50	188-0834-68	○	22 IR ISO 3.50 PH6920	188-0848-68	○	22 IL ISO 3.50 PH6920
22 __ ISO 4.00	4.00	188-0818-68	○	22 IR ISO 4.00 PH6920	188-0849-68	○	22 IL ISO 4.00 PH6920
22 __ ISO 4.50	4.50	188-0835-68	○	22 IR ISO 4.50 PH6920	188-0850-68	○	22 IL ISO 4.50 PH6920
22 __ ISO 5.00	5.00	188-0650-68	○	22 IR ISO 5.00 PH6920	188-0851-68	○	22 IL ISO 5.00 PH6920

- stock standard
- stock available with 2-3 week lead time

THREADING



Threading Inserts

Cutting Tools

palbit UN (UNC, UNF, UNEF) External Inserts

ANSI B1.1-1982

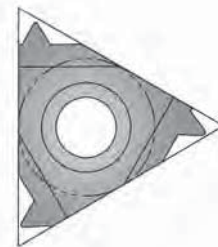
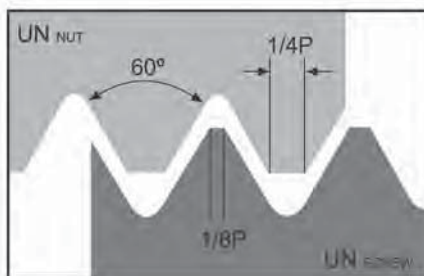

THREADING

Insert Size	TPI	External Inserts					
		Right Hand			Left Hand		
		Part Number	Stock	Description	Part Number	Stock	Description
16 __ UN 32	32	188-0870-68	○	16 ER UN 32 PH6920	188-0886-68	○	16 EL UN 32 PH6920
16 __ UN 28	28	188-0869-68	○	16 ER UN 28 PH6920	188-0885-68	○	16 EL UN 28 PH6920
16 __ UN 24	24	188-0868-68	○	16 ER UN 24 PH6920	188-0884-68	○	16 EL UN 24 PH6920
16 __ UN 20	20	188-0021-68	○	16 ER UN 20 PH6920	188-0883-68	○	16 EL UN 20 PH6920
16 __ UN 18	18	188-0867-68	●	16 ER UN 18 PH6920	188-0882-68	●	16 EL UN 18 PH6920
16 __ UN 16	16	188-0616-68	○	16 ER UN 16 PH6920	188-0881-68	○	16 EL UN 16 PH6920
16 __ UN 14	14	188-0014-68	○	16 ER UN 14 PH6920	188-0880-68	○	16 EL UN 14 PH6920
16 __ UN 13	13	188-0866-68	○	16 ER UN 13 PH6920	188-0879-68	○	16 EL UN 13 PH6920
16 __ UN 12	12	188-0865-68	○	16 ER UN 12 PH6920	188-0878-68	○	16 EL UN 12 PH6920
16 __ UN 11	11	188-0864-68	●	16 ER UN 11 PH6920	188-0877-68	●	16 EL UN 11 PH6920
16 __ UN 10	10	188-0863-68	○	16 ER UN 10 PH6920	188-0876-68	○	16 EL UN 10 PH6920
16 __ UN 9	9	188-0862-68	●	16 ER UN 9 PH6920	188-0875-68	●	16 EL UN 9 PH6920
16 __ UN 8	8	188-0024-68	○	16 ER UN 8 PH6920	188-0874-68	○	16 EL UN 8 PH6920
22 __ UN 7	7	188-0861-68	○	22 ER UN 7 PH6920	188-0873-68	○	22 EL UN 7 PH6920
22 __ UN 6	6	188-0860-68	○	22 ER UN 6 PH6920	188-0872-68	○	22 EL UN 6 PH6920
22 __ UN 5	5	188-0859-68	○	22 ER UN 5 PH6920	188-0871-68	○	22 EL UN 5 PH6920

● stock standard

○ stock available with 2-3 week lead time

palbit UN (UNC, UNF, UNEF) Internal Inserts

ANSI B1.1-1982

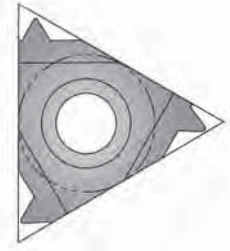
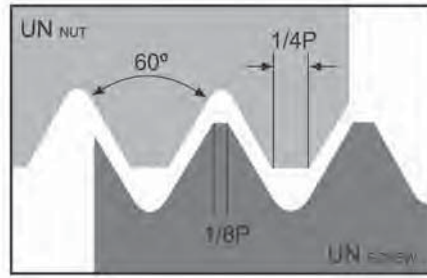

Insert Size	TPI	Internal Inserts					
		Right Hand			Left Hand		
		Part Number	Stock	Description	Part Number	Stock	Description
11 __ UN 32	32	188-0910-68	○	11 IR UN 32 PH6920	188-0935-68	○	11 IL UN 32 PH6920
11 __ UN 28	28	188-0909-68	○	11 IR UN 28 PH6920	188-0934-68	○	11 IL UN 28 PH6920
11 __ UN 24	24	188-0908-68	○	11 IR UN 24 PH6920	188-0933-68	○	11 IL UN 24 PH6920
11 __ UN 20	20	188-0907-68	○	11 IR UN 20 PH6920	188-0932-68	○	11 IL UN 20 PH6920
11 __ UN 18	18	188-0906-68	○	11 IR UN 18 PH6920	188-0931-68	○	11 IL UN 18 PH6920
11 __ UN 16	16	188-0905-68	○	11 IR UN 16 PH6920	188-0930-68	○	11 IL UN 16 PH6920
11 __ UN 14	14	188-0904-68	○	11 IR UN 14 PH6920	188-0929-68	○	11 IL UN 14 PH6920
11 __ UN 13	13	188-0903-68	○	11 IR UN 13 PH6920	188-0928-68	○	11 IL UN 13 PH6920
11 __ UN 12	12	188-0902-68	○	11 IR UN 12 PH6920	188-0927-68	○	11 IL UN 12 PH6920
11 __ UN 11	11	188-0901-68	○	11 IR UN 11 PH6920	188-0926-68	○	11 IL UN 11 PH6920
16 __ UN 32	32	188-0900-68	○	16 IR UN 32 PH6920	188-0925-68	○	16 IL UN 32 PH6920
16 __ UN 28	28	188-0899-68	○	16 IR UN 28 PH6920	188-0924-68	○	16 IL UN 28 PH6920
16 __ UN 24	24	188-0898-68	○	16 IR UN 24 PH6920	188-0923-68	○	16 IL UN 24 PH6920
16 __ UN 20	20	188-0618-68	○	16 IR UN 20 PH6920	188-0922-68	○	16 IL UN 20 PH6920
16 __ UN 18	18	188-0897-68	●	16 IR UN 18 PH6920	188-0921-68	●	16 IL UN 18 PH6920
16 __ UN 16	16	188-0037-68	○	16 IR UN 16 PH6920	188-0920-68	○	16 IL UN 16 PH6920
16 __ UN 14	14	188-0034-68	○	16 IR UN 14 PH6920	188-0919-68	○	16 IL UN 14 PH6920
16 __ UN 13	13	-	-	-	-	-	-
16 __ UN 12	12	188-0894-68	○	16 IR UN 12 PH6920	188-0918-68	○	16 IL UN 12 PH6920
16 __ UN 11	11	188-0893-68	○	16 IR UN 11 PH6920	188-0917-68	○	16 IL UN 11 PH6920
16 __ UN 10	10	188-0892-68	○	16 IR UN 10 PH6920	188-0916-68	○	16 IL UN 10 PH6920
16 __ UN 9	9	188-0891-68	○	16 IR UN 9 PH6920	188-0915-68	○	16 IL UN 9 PH6920
16 __ UN 8	8	188-0044-68	○	16 IR UN 8 PH6920	188-0914-68	○	16 IL UN 8 PH6920
22 __ UN 7	7	188-0889-68	○	22 IR UN 7 PH6920	188-0913-68	○	22 IL UN 7 PH6920
22 __ UN 6	6	188-0888-68	○	22 IR UN 6 PH6920	188-0912-68	○	22 IL UN 6 PH6920
22 __ UN 5	5	188-0887-68	○	22 IR UN 5 PH6920	188-0911-68	○	22 IL UN 5 PH6920

- stock standard
- stock available with 2-3 week lead time

THREADING



Threading Inserts

Cutting Tools

palbit UNJ

MIL - S - 8879A

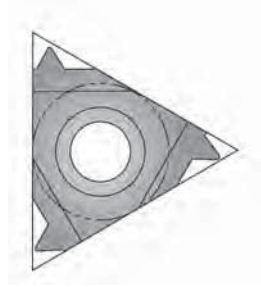
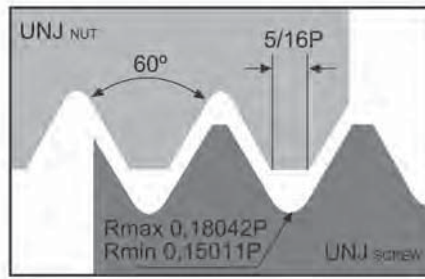

THREADING

Insert Size	TPI	External Inserts		
		Right Hand		
		Part Number	Stock	Description
16 __ UNJ 32	32	188-1165-68	○	16 ER UNJ 32 PH6920
16 __ UNJ 28	28	188-1164-68	○	16 ER UNJ 28 PH6920
16 __ UNJ 24	24	188-1163-68	○	16 ER UNJ 24 PH6920
16 __ UNJ 20	20	188-1162-68	○	16 ER UNJ 20 PH6920
16 __ UNJ 18	18	188-1161-68	○	16 ER UNJ 18 PH6920
16 __ UNJ 16	16	188-1160-68	●	16 ER UNJ 16 PH6920
16 __ UNJ 14	14	188-1159-68	○	16 ER UNJ 14 PH6920
16 __ UNJ 13	13	188-1158-68	○	16 ER UNJ 13 PH6920
16 __ UNJ 12	12	188-1157-68	○	16 ER UNJ 12 PH6920
16 __ UNJ 11	11	188-1156-68	○	16 ER UNJ 11 PH6920
16 __ UNJ 10	10	188-1155-68	○	16 ER UNJ 10 PH6920
16 __ UNJ 9	9	188-1154-68	○	16 ER UNJ 9 PH6920
16 __ UNJ 8	8	188-1153-68	○	16 ER UNJ 8 PH6920

● stock standard

○ stock available with 2-3 week lead time

palbit NPT

ANSI/ASME B 1.20.1 - 1983

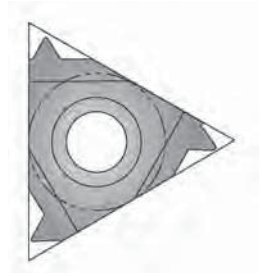
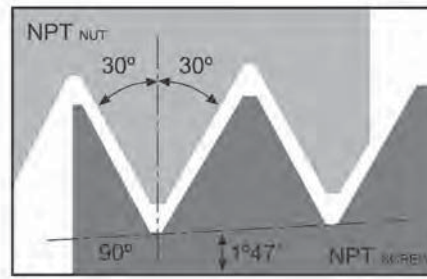

Insert Size	TPI	External Inserts		
		Right Hand		
		Part Number	Stock	Description
16__ NPT 27	27	188-1017-68	●	16 ER NPT 27 PH6920
16__ NPT 18	18	188-1016-68	●	16 ER NPT 18 PH6920
16__ NPT 14	14	188-0013-68	●	16 ER NPT 14 PH6920
16__ NPT 11.5	11.5	188-0009-68	●	16 ER NPT 11.5 PH6920
16__ NPT 8	8	188-0023-68	○	16 ER NPT 8 PH6920

Insert Size	TPI	Internal Inserts		
		Right Hand		
		Part Number	Stock	Description
11__ NPT 18	18	188-1020-68	○	11 IR NPT 18 PH6920
11__ NPT 14	14	188-0003-68	○	11 IR NPT 14 PH6920
16__ NPT 27	27	188-1019-68	●	16 IR NPT 27 PH6920
16__ NPT 18	18	188-1018-68	●	16 IR NPT 18 PH6920
16__ NPT 14	14	188-0033-68	●	16 IR NPT 14 PH6920
16__ NPT 11.5	11.5	188-0029-68	●	16 IR NPT 11.5 PH6920
16__ NPT 8	8	188-0043-68	○	16 IR NPT 8 PH6920

- stock standard
- stock available with 2-3 week lead time

THREADING



Threading Inserts

Cutting Tools

palbit NPTF

ANSI/ASME B 1.20.3 - 1976

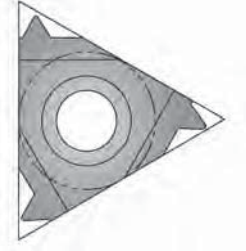
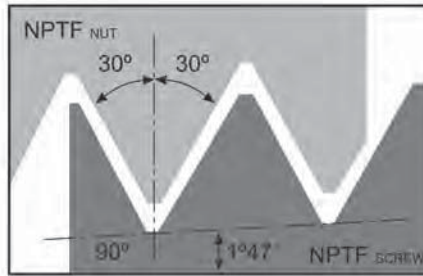

Insert Size	TPI	External Inserts		
		Right Hand		
		Part Number	Stock	Description
16 __ NPTF 27	27	188-1030-68	○	16 ER NPTF 27 PH6920
16 __ NPTF 18	18	188-1029-68	○	16 ER NPTF 18 PH6920
16 __ NPTF 14	14	188-1028-68	○	16 ER NPTF 14 PH6920
16 __ NPTF 11.5	11.5	188-1027-68	○	16 ER NPTF 11.5 PH6920

Insert Size	TPI	Internal Inserts		
		Right Hand		
		Part Number	Stock	Description
11 __ NPT 18	18	188-1026-68	○	11 IR NPTF 18 PH6920
11 __ NPT 14	14	188-1025-68	○	11 IR NPTF 14 PH6920
16 __ NPT 27	27	188-1024-68	○	16 IR NPTF 27 PH6920
16 __ NPT 18	18	188-1023-68	○	16 IR NPTF 18 PH6920
16 __ NPT 14	14	188-1022-68	○	16 IR NPTF 14 PH6920
16 __ NPT 11.5	11.5	188-1021-68	●	16 IR NPTF 11.5 PH6920

- stock standard
- stock available with 2-3 week lead time

THREADING

palbit API Round

DIN 405: 1997

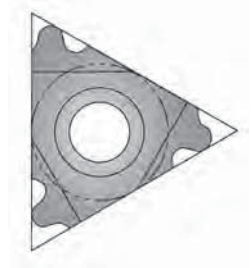
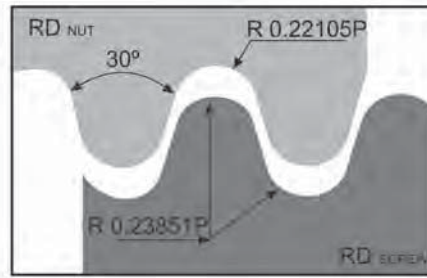

Insert Size	TPI	External Inserts		
		Right Hand		
		Part Number	Stock	Description
16 __ RD 10	10	188-1031-68	○	16 ER RD 10 PH6920
16 __ RD 8	8	188-1032-68	○	16 ER RD 8 PH6920
16 __ RD 6	6	188-1033-68	○	16 ER RD 6 PH6920
22 __ RD 6	6	188-1034-68	○	22 ER RD 6 PH6920
22 __ RD 4	4	188-1035-68	○	22 ER RD 4 PH6920

Insert Size	TPI	Internal Inserts		
		Right Hand		
		Part Number	Stock	Description
11 __ NPT 18	18	188-1039-68	●	16 IR RD 10 PH6920
11 __ NPT 14	14	188-1040-68	●	16 IR RD 8 PH6920
16 __ NPT 27	27	188-1041-68	○	16 IR RD 6 PH6920
16 __ NPT 18	18	188-1042-68	○	22 IR RD 6 PH6920
16 __ NPT 14	14	188-1043-68	○	22 IR RD 4 PH6920

- stock standard
- stock available with 2-3 week lead time



Threading Inserts

Cutting Tools

palbit Stub ACME

ANSI/ASME B 1.8-1988

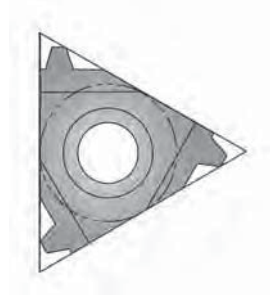
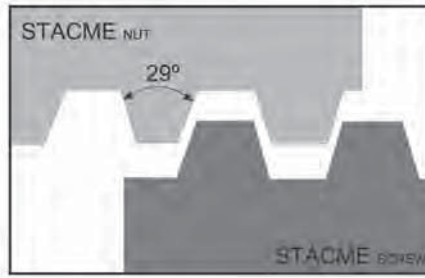

THREADING

Insert Size	TPI	External Inserts		
		Right Hand		
		Part Number	Stock	Description
16 __ STACME 16	16	188-1116-68	○	16 ER STACME 16 PH6920
16 __ STACME 14	14	188-1117-68	○	16 ER STACME 14 PH6920
16 __ STACME 12	12	188-1118-68	○	16 ER STACME 12 PH6920
16 __ STACME 10	10	188-1119-68	○	16 ER STACME 10 PH6920
16 __ STACME 8	8	188-1120-68	○	16 ER STACME 8 PH6920
16 __ STACME 6	6	188-1121-68	●	16 ER STACME 6 PH6920
22 __ STACME 5	5	188-1122-68	○	22 ER STACME 5 PH6920
22 __ STACME 4	4	188-1123-68	●	22 ER STACME 4 PH6920

Insert Size	TPI	Internal Inserts		
		Right Hand		
		Part Number	Stock	Description
16 __ STACME 16	16	188-1108-68	○	16 IR STACME 16 PH6920
16 __ STACME 14	14	188-1109-68	○	16 IR STACME 14 PH6920
16 __ STACME 12	12	--	--	--
16 __ STACME 10	10	188-1111-68	○	16 IR STACME 10 PH6920
16 __ STACME 8	8	188-1112-68	○	16 IR STACME 8 PH6920
16 __ STACME 6	6	188-1113-68	○	16 IR STACME 6 PH6920
22 __ STACME 5	5	188-1114-68	○	22 IR STACME 5 PH6920
22 __ STACME 4	4	188-1115-68	○	22 IR STACME 4 PH6920

- stock standard
- stock available with 2-3 week lead time

TMX External Threading Tool Holders

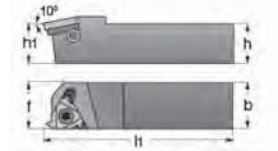

Insert Size	Description	Dimensions					Right Hand Part Number	Left Hand Part Number
		h	b	h1	l1	f		
11	SE(R/L) 375 H11	0.375	0.375	0.375	4.00	0.430	6-SER-375-H11	–
16	SE(R/L) 375 D16	0.375	0.375	0.375	2.50	0.630	6-SER-375-D16	–
	SE(R/L) 500 F16	0.500	0.500	0.500	3.25	0.630	6-SER-500-F16	6-SEL-500-F16
	SE(R/L) 625 H16	0.625	0.625	0.625	4.00	0.630	6-SER-625-H16	6-SEL-625-H16
	SE(R/L) 750-K16	0.750	0.750	0.750	5.00	0.750	6-SER-750-K16	6-SEL-750-K16
	SE(R/L) 1000 M16	1.000	1.000	1.000	6.00	1.000	6-SER-1000-M16	6-SEL-1000-M16
	SE(R/L) 1250 P16	1.250	1.250	1.250	7.00	0.125	6-SER-1250-P16	6-SEL-1250-P16
22	SE(R/L) 1000 M22	1.000	1.000	1.000	6.00	1.000	6-SER-1000-M22	6-SEL-1000-M22
	SE(R/L) 1250 P22	1.250	1.250	1.250	7.00	1.250	6-SER-1250-P22	6-SEL-1250-P22
	SE(R/L) 1500 R22	1.500	1.500	1.500	8.00	1.500	–	6-SEL-1500-R22



Insert Size	Spare Parts			
	Shim	Shim Screw	Insert Screw	Torx Key
11	–	–	6-998-725N	6-998-7008
16	–	–	6-998-73509	6-998-7015
	6-998-716N	6-998-73006	6-998-73512	6-998-7015
22	6-998-722N	6-998-74010	6-998-74016	6-998-7020



Threading Tool Holders

Cutting Tools

TMX Internal Threading Tool Holders (Boring Bars)

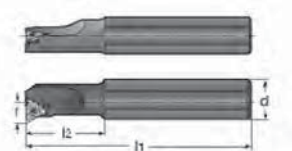

Insert Size	Description	Dimensions					Right Hand Part Number	Left Hand Part Number
		d	D min	l1	l2	f		
11	SI(R/L) 0375 H11	0.375	0.47	4.00	–	0.290	6-SIR-375-H11	6-SIL-375-H11
	SI(R/L) 0375 K11	0.625	0.47	5.00	1.00	0.260	6-SIR-375-K11	6-SIL-375-K11
	SI(R/L) 0500 L11	0.625	0.63	5.50	1.25	0.320	6-SIR-500-L11	6-SIL-500-L11
16	SI(R/L) 0500 M16	0.625	0.64	6.00	1.25	0.390	6-SIR-500-M16	6-SIL-500-M16
	SI(R/L) 0625 P16	0.750	0.75	7.00	1.50	0.450	6-SIR-625-P16	6-SIL-625-P16
	SI(R/L) 0750 P16	0.750	1.00	7.00	–	0.510	6-SIR-750-P16	6-SIL-750-P16
	SI(R/L) 1000 R16	1.000	1.20	8.00	–	0.650	6-SIR-1000-R16	6-SIL-1000-R16
	SI(R/L) 1250 S16	1.250	1.42	10.00	–	0.770	6-SIR-1250-S16	6-SIL-1250-S16
	SI(R/L) 1500 T16	1.500	1.65	12.00	–	0.900	6-SIR-1500-T16	6-SIL-1500-T16
22	SI(R/L) 0750 P22	0.750	0.95	7.00	–	0.510	6-SIR-750-P22	6-SIL-750-P22
	SI(R/L) 1000 R22	1.000	1.20	8.00	–	0.710	6-SIR-1000-R22	6-SIL-1000-R22
	SI(R/L) 1250 S22	1.250	1.50	10.00	–	0.850	6-SIR-1250-S22	–
	SI(R/L) 1500 T22	1.500	1.75	12.00	–	0.980	6-SIR-1500-T22	–

THREADING



Insert Size	Spare Parts			
	Shim	Shim Screw	Insert Screw	Torx Key
11	–	–	6-998-725N	6-998-7008
16	6-998-716N	6-998-73006	6-998-73516	6-998-7015
	6-998-716N	6-998-73006	6-998-73512	6-998-7015
22	–	–	6-998-74016	6-998-7020
	6-998-722N	6-998-74010	6-998-74016	6-998-7020

TABLE OF CONTENTS

DRILLING

Overview.....	240
Drill Tool Nomenclature.....	241
SCI Indexable Drills 3XD.....	241
SCI Indexable Drills 4XD.....	242
SCS Metric Indexable Drills 3XD.....	243
SCS Metric Indexable Drills 4XD.....	244









Drilling Overview

Cutting Tools

Drilling

System	Diameters	Drilling Lengths (L1)	OAL (L)	Features
SCI-3X Inch Drills 	0.531 to 1.938	1.59 to 5.81	4.34 to 9.94	Through Coolant Side or Rear Ports Expanded Flute Size
SCI-4X Inch Drills 	0.531 to 1.938	2.12 to 7.75	4.87 to 11.88	Through Coolant Side or Rear Ports Expanded Flute Size
SCS-3X Metric 	13 to 50	39 to 150	112 to 260	Through Coolant Side or Rear Ports Expanded Flute Size
SCS-4X Metric Drills 	13 to 50	75 to 240	125 to 310	Through Coolant Side or Rear Ports Expanded Flute Size

DRILLING

SCI Special Features

New Larger Capacity Flutes Offer Excellent Chip Evacuation

- Innovative new design features an expanded flute size, resulting in excellent chip evacuation
- Extreme chip evacuation at high speeds
- Rigid shank for smooth quiet operation, extending tool life
- Excellent hole diameter repeatability

Indexable Drills are stocked in the following sizes

SCI Drills

- .531" - 1.938"

Nickel Plated Drill Body

- Excellent surface finish



Performance Drilling Inserts in two General Purpose Grades

PH6920

- Excellent balance between wear resistance and Toughness
- TiAlN PVD Coating for Improved High Speed capability
- Micro-Grain Carbide Substrate

PH6930

- Superior Toughness for interrupted cutting
- TiAlN PVD Coating for Improved High Speed capability
- Micro-Grain Carbide Substrate





Drilling Tool Nomenclature

Cutting Tools

System
SCI = Inch Drills
SCS = Metric Drills

Diameter	
Inch Examples	Metric Examples
0531 = 0.531 in	0130 = 13.0 mm
0625 = 0.625 in	0155 = 15.5 mm
0844 = 0.844 in	0215 = 21.5 mm
1000 = 1.000 in	0255 = 25.5 mm
1125 = 1.125 in	0285 = 28.5 mm
1406 = 1.406 in	0360 = 36.0 mm

SCI-

100-

0844-

4D

Shank Diameter	
Inch	Metric
075 = 0.75 in	20 = 20 mm
100 = 1.00 in	25 = 25 mm
125 = 1.25 in	32 = 32 mm
150 = 1.50 in	40 = 40 mm

Depth Capability
3D = 3 x Diameter
4D = 4 x Diameter

DRILLING

palbit SCI Indexable Drills 3XD

- 3 x Diameter Drilling Depth
- Through Coolant
- Insert with four cutting edges for improved economy

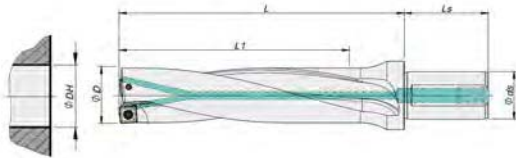

Description	Dimensions						Insert	Part Number
	φ D	Drilled Hole Tolerance	L1	L	φ ds	Ls		
SCI-075-0531-3D	0.531	-0.004 +0.006	1.59	2.34	0.75	2.00	SPKX050204	184-1979-00
SCI-075-0563-3D	0.563		1.69	2.44	0.75	2.00		184-1980-00
SCI-075-0594-3D	0.594		1.78	2.53	0.75	2.00		184-1981-00
SCI-100-0625-3D	0.625	-0.004 +0.006	1.88	2.88	1.00	2.25	SPKX060204	184-1982-00
SCI-100-0656-3D	0.656		1.97	2.97	1.00	2.25		184-1983-00
SCI-100-0688-3D	0.688		2.06	3.06	1.00	2.25		184-1984-00
SCI-100-0703-3D	0.703		2.11	3.11	1.00	2.25		184-1985-00
SCI-100-0734-3D	0.734		2.20	3.20	1.00	2.25		184-1986-00
SCI-100-0750-3D	0.750		2.25	3.25	1.00	2.25		184-1987-00
SCI-100-0781-3D	0.781		2.34	3.34	1.00	2.25		184-1988-00
SCI-100-0813-3D	0.813		2.44	3.44	1.00	2.25		184-1989-00
SCI-100-0844-3D	0.844		2.53	3.53	1.00	2.25		184-1990-00
SCI-125-0875-3D	0.875		-0.005 +0.008	2.63	3.75	1.25		2.38
SCI-125-0906-3D	0.906	2.72		3.84	1.25	2.38	184-1992-00	
SCI-125-0938-3D	0.938	2.81		3.93	1.25	2.38	184-1993-00	
SCI-125-0969-3D	0.969	2.91		4.03	1.25	2.38	184-1994-00	
SCI-125-0984-3D	0.984	2.95		4.07	1.25	2.38	184-1995-00	
SCI-125-1000-3D	1.000	3.00		4.12	1.25	2.38	184-1996-00	
SCI-125-1031-3D	1.031	3.09		4.21	1.25	2.38	184-1997-00	
SCI-125-1063-3D	1.063	3.19		4.31	1.25	2.38	184-1998-00	
SCI-125-1094-3D	1.094	3.28		4.40	1.25	2.38	184-1999-00	
SCI-125-1125-3D	1.125	-0.005 +0.008		3.38	4.50	1.25	2.38	SPKX090408
SCI-125-1156-3D	1.156		3.47	4.59	1.25	2.38	184-2001-00	
SCI-125-1188-3D	1.188		3.56	4.68	1.25	2.38	184-2002-00	
SCI-125-1219-3D	1.219		3.66	4.78	1.25	2.38	184-2003-00	
SCI-125-1250-3D	1.250		3.75	4.87	1.25	2.38	184-2004-00	
SCI-125-1281-3D	1.281		3.84	4.96	1.25	2.38	184-2005-00	
SCI-150-1375-3D	1.375	-0.005 +0.008	4.13	5.50	1.50	2.75	SPKX110408	184-2007-00
SCI-150-1406-3D	1.406		4.22	5.59	1.50	2.75		184-2008-00
SCI-150-1438-3D	1.438		4.31	5.69	1.50	2.75		184-2009-00
SCI-150-1469-3D	1.469		4.41	5.78	1.50	2.75		184-2010-00
SCI-150-1500-3D	1.500		4.50	5.88	1.50	2.75		184-2011-00
SCI-150-1531-3D	1.531		4.59	5.97	1.50	2.75		184-2012-00
SCI-150-1563-3D	1.563		4.69	6.06	1.50	2.75		184-2013-00
SCI-150-1625-3D	1.625		4.88	6.25	1.50	2.75		184-2014-00
SCI-150-1688-3D	1.688	-0.005 +0.008	5.06	6.44	1.50	2.75	SPKX140512	184-2015-00
SCI-150-1750-3D	1.750		5.25	6.63	1.50	2.75		184-2016-00
SCI-150-1813-3D	1.813		5.44	6.81	1.50	2.75		184-2017-00
SCI-150-1875-3D	1.875		5.63	7.00	1.50	2.75		184-2018-00
SCI-150-1938-3D	1.938		5.81	7.19	1.50	2.75		184-2019-00

Spare Parts	
Insert Screw Part Number	Torx Key Part Number
290-0314-00	6-998-006
290-0306-00	6-998-006
290-0313-00	6-998-008
290-0309-00	6-998-015
290-0475-00	6-998-015
290-0317-00	6-998-020

DRILLING



palbit SCI Indexable Drills 4XD

- 4 x Diameter Drilling Depth
- Through Coolant
- Insert with four cutting edges for improved economy

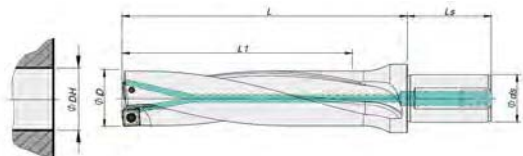

Description	Dimensions						Insert	Part Number
	ϕD	Drilled Hole Tolerance	L1	L	ϕds	Ls		
SCI-075-0531-4D	0.531	-0.006 +0.008	2.12	4.87	0.75	2.00	SPKX050204	184-2020-00
SCI-075-0563-4D	0.563		2.25	5.00	0.75	2.00		184-2021-00
SCI-075-0594-4D	0.594		2.38	5.13	0.75	2.00		184-2022-00
SCI-100-0625-4D	0.625	-0.006 +0.008	2.50	5.25	1.00	2.25	SPKX060204	184-2023-00
SCI-100-0656-4D	0.656		2.62	5.37	1.00	2.25		184-2024-00
SCI-100-0688-4D	0.688		2.75	5.50	1.00	2.25		184-2025-00
SCI-100-0703-4D	0.703		2.81	5.56	1.00	2.25		184-2026-00
SCI-100-0734-4D	0.734		2.94	5.69	1.00	2.25		184-2027-00
SCI-100-0750-4D	0.750		3.00	6.25	1.00	2.25		184-2028-00
SCI-100-0781-4D	0.781		3.12	6.37	1.00	2.25		184-2029-00
SCI-100-0813-4D	0.813		3.25	6.50	1.00	2.25		184-2030-00
SCI-100-0844-4D	0.844		3.38	6.63	1.00	2.25		184-2031-00
SCI-125-0875-4D	0.875		-0.006 +0.010	3.50	6.75	1.25		2.38
SCI-125-0906-4D	0.906	3.62		6.87	1.25	2.38	184-2033-00	
SCI-125-0938-4D	0.938	3.75		7.00	1.25	2.38	184-2034-00	
SCI-125-0969-4D	0.969	3.88		7.13	1.25	2.38	184-2035-00	
SCI-125-0984-4D	0.984	3.94		7.19	1.25	2.38	184-2036-00	
SCI-125-1000-4D	1.000	4.00		7.50	1.25	2.38	184-2037-00	
SCI-125-1031-4D	1.031	4.12		7.62	1.25	2.38	184-2038-00	
SCI-125-1063-4D	1.063	4.25		7.75	1.25	2.38	184-2039-00	
SCI-125-1094-4D	1.094	4.38		7.88	1.25	2.38	184-2040-00	
SCI-125-1125-4D	1.125	-0.006 +0.010		4.50	8.00	1.25	2.38	SPKX090408
SCI-125-1156-4D	1.156		4.62	8.12	1.25	2.38	184-2042-00	
SCI-125-1188-4D	1.188		4.75	8.25	1.25	2.38	184-2043-00	
SCI-125-1219-4D	1.219		4.88	8.38	1.25	2.38	184-2044-00	
SCI-125-1250-4D	1.250		5.00	8.50	1.25	2.38	184-2045-00	
SCI-125-1281-4D	1.281		5.12	8.62	1.25	2.38	184-2046-00	
SCI-125-1313-4D	1.313		5.25	8.75	1.25	2.38	184-2047-00	
SCI-150-1375-4D	1.375		-0.006 +0.010	5.50	9.00	1.50	2.75	
SCI-150-1406-4D	1.406	5.62		9.12	1.50	2.75	184-2049-00	
SCI-150-1438-4D	1.438	5.75		9.25	1.50	2.75	184-2050-00	
SCI-150-1469-4D	1.469	5.88		9.38	1.50	2.75	184-2051-00	
SCI-150-1500-4D	1.500	6.00		10.13	1.50	2.75	184-2052-00	
SCI-150-1531-4D	1.531	6.12		10.25	1.50	2.75	184-2053-00	
SCI-150-1563-4D	1.563	6.25		10.38	1.50	2.75	184-2054-00	
SCI-150-1625-4D	1.625	6.50		10.63	1.50	2.75	184-2055-00	
SCI-150-1688-4D	1.688	-0.006 +0.010	6.75	10.88	1.50	2.75	SPKX140512	184-2056-00
SCI-150-1750-4D	1.750		7.00	11.13	1.50	2.75		184-2057-00
SCI-150-1813-4D	1.813		7.25	11.38	1.50	2.75		184-2058-00
SCI-150-1875-4D	1.875		7.50	11.63	1.50	2.75		184-2059-00
SCI-150-1938-4D	1.938		7.75	11.88	1.50	2.75		184-2060-00

Spare Parts	
Insert Screw Part Number	Torx Key Part Number
290-0314-00	6-998-006
290-0306-00	6-998-006
290-0313-00	6-998-008
290-0309-00	6-998-015
290-0475-00	6-998-015
290-0317-00	6-998-020

palbit SCS Metric Indexable Drills 3XD

- 3 x Diameter Drilling Depth
- Through Coolant

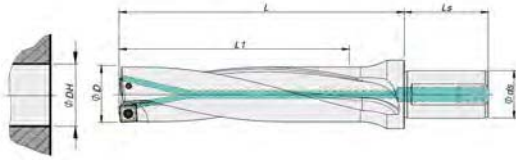

Description	Dimensions						Insert	Part Number		
	φ D	Drilled Hole Tolerance	L1	L	φ ds	Ls				
SCS-20-0130-3D	13.0	-0.10 +0.15	39	62	20	50	SPKX050204	184-0414-00		
SCS-20-0135-3D	13.5		41	64	20	50		184-0415-00		
SCS-20-0140-3D	14.0		42	65	20	50		184-0416-00		
SCS-20-0145-3D	14.5		44	67	20	50		184-0417-00		
SCS-20-0150-3D	15.0		45	68	20	50		184-0418-00		
SCS-25-0155-3D	15.5	-0.10 +0.15	47	75	25	56	SPKX060204	184-0419-00		
SCS-25-0160-3D	16.0		48	76	25	56		184-0420-00		
SCS-25-0165-3D	16.5		50	78	25	56		184-0421-00		
SCS-25-0170-3D	17.0		51	79	25	56		184-0422-00		
SCS-25-0175-3D	17.5		53	81	25	56		184-0423-00		
SCS-25-0180-3D	18.0		54	82	25	56		184-0424-00		
SCS-25-0185-3D	18.5		56	84	25	56		184-0425-00		
SCS-25-0190-3D	19.0		57	85	25	56		184-0426-00		
SCS-25-0195-3D	19.5		59	87	25	56		184-0427-00		
SCS-25-0200-3D	20.0		60	88	25	56		184-0428-00		
SCS-25-0205-3D	20.5		62	90	25	56		184-0429-00		
SCS-25-0210-3D	21.0		63	91	25	56		184-0430-00		
SCS-25-0215-3D	21.5		65	93	25	56		184-0431-00		
SCS-32-0220-3D	22.0	-0.12 +0.20	66	99	32	60	SPKX07T308	184-0432-00		
SCS-32-0225-3D	22.5		68	101	32	60		184-0433-00		
SCS-32-0230-3D	23.0		69	102	32	60		184-0434-00		
SCS-32-0235-3D	23.5		71	104	32	60		184-0435-00		
SCS-32-0240-3D	24.0		72	105	32	60		184-0436-00		
SCS-32-0245-3D	24.5		74	107	32	60		184-0437-00		
SCS-32-0250-3D	25.0		75	108	32	60		184-0438-00		
SCS-32-0255-3D	25.5		77	110	32	60		184-0439-00		
SCS-32-0260-3D	26.0		78	111	32	60		184-0440-00		
SCS-32-0265-3D	26.5		80	113	32	60		184-0441-00		
SCS-32-0270-3D	27.0		81	114	32	60		184-0442-00		
SCS-32-0275-3D	27.5		83	116	32	60		184-0444-00		
SCS-32-0280-3D	28.0		-0.12 +0.20	84	117	32		60	SPKX090408	184-0445-00
SCS-32-0285-3D	28.5			86	119	32		60		184-0446-00
SCS-32-0290-3D	29.0			87	120	32		60		184-0447-00
SCS-32-0295-3D	29.5	89		123	32	60	184-0448-00			
SCS-32-0300-3D	30.0	90		125	32	60	184-0449-00			
SCS-32-0310-3D	31.0	93		128	32	60	184-0450-00			
SCS-32-0320-3D	32.0	96		131	32	60	184-0451-00			
SCS-32-0330-3D	33.0	99		134	32	60	184-0452-00			
SCS-40-0340-3D	34.0	-0.12 +0.20	102	142	40	70	SPKX110408	184-0453-00		
SCS-40-0350-3D	35.0		105	145	40	70		184-0454-00		
SCS-40-0360-3D	36.0		108	148	40	70		184-0455-00		
SCS-40-0370-3D	37.0		111	151	40	70		184-0456-00		
SCS-40-0380-3D	38.0		114	154	40	70		184-0457-00		
SCS-40-0390-3D	39.0		117	157	40	70		184-0458-00		
SCS-40-0400-3D	40.0		120	160	40	70		184-0459-00		
SCS-40-0410-3D	41.0		123	163	40	70		184-0460-00		
SCS-40-0420-3D	42.0	-0.12 +0.20	126	166	40	70	SPKX140512	184-0461-00		
SCS-40-0430-3D	43.0		129	169	40	70		184-0462-00		
SCS-40-0440-3D	44.0		132	172	40	70		184-0463-00		
SCS-40-0450-3D	45.0		135	175	40	70		184-0464-00		
SCS-40-0460-3D	46.0		138	178	40	70		184-0465-00		
SCS-40-0470-3D	47.0		141	181	40	70		184-0466-00		
SCS-40-0480-3D	48.0		144	184	40	70		184-0467-00		
SCS-40-0490-3D	49.0		147	187	40	70		184-0468-00		
SCS-40-0500-3D	50.0		150	190	40	70		184-0469-00		

Spare Parts	
Insert Screw Part Number	Torx Key Part Number
290-0314-00	6-998-006
290-0306-00	6-998-006
290-0313-00	6-998-008
290-0309-00	6-998-015
290-0475-00	6-998-015
290-0317-00	6-998-020

DRILLING



Drilling

Cutting Tools

palbit SCS Metric Indexable Drills 4XD

- 4 x Diameter Drilling Depth
- Through Coolant

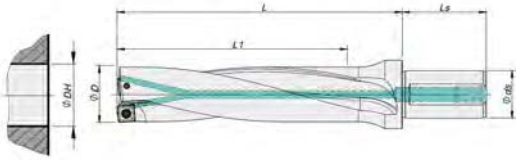

Description	Dimensions						Insert	Part Number
	ϕD	Drilled Hole Tolerance	L1	L	ϕds	Ls		
SCS-20-0130-4D	13.0	-0.10 +0.15	52	75	20	50	SPKX050204	184-0471-00
SCS-20-0135-4D	13.5		54	77	20	50		184-0472-00
SCS-20-0140-4D	14.0		56	79	20	50		184-0473-00
SCS-20-0145-4D	14.5		58	81	20	50		184-0474-00
SCS-20-0150-4D	15.0		60	83	20	50		184-0475-00
SCS-25-0155-4D	15.5	-0.10 +0.15	62	90	25	56	SPKX060204	184-0476-00
SCS-25-0160-4D	16.0		64	92	25	56		184-0477-00
SCS-25-0165-4D	16.5		66	94	25	56		184-0478-00
SCS-25-0170-4D	17.0		68	96	25	56		184-0479-00
SCS-25-0175-4D	17.5		70	98	25	56		184-0480-00
SCS-25-0180-4D	18.0		72	100	25	56		184-0481-00
SCS-25-0185-4D	18.5		74	102	25	56		184-0482-00
SCS-25-0190-4D	19.0		76	104	25	56		184-0483-00
SCS-25-0195-4D	19.5		78	106	25	56		184-0484-00
SCS-25-0200-4D	20.0		80	108	25	56		184-0485-00
SCS-25-0205-4D	20.5		82	110	25	56		184-0486-00
SCS-25-0210-4D	21.0		84	112	25	56		184-0487-00
SCS-25-0215-4D	21.5		86	114	25	56		184-0488-00
SCS-32-0220-4D	22.0	-0.12 +0.20	88	121	32	60	SPKX07T308	184-0489-00
SCS-32-0225-4D	22.5		90	123	32	60		184-0490-00
SCS-32-0230-4D	23.0		92	125	32	60		184-0491-00
SCS-32-0235-4D	23.5		94	127	32	60		184-0492-00
SCS-32-0240-4D	24.0		96	129	32	60		184-0493-00
SCS-32-0245-4D	24.5		98	131	32	60		184-0494-00
SCS-32-0250-4D	25.0		100	133	32	60		184-0495-00
SCS-32-0255-4D	25.5		102	135	32	60		184-0496-00
SCS-32-0260-4D	26.0		104	137	32	60		184-0497-00
SCS-32-0265-4D	26.5		106	139	32	60		184-0498-00
SCS-32-0270-4D	27.0		108	141	32	60		184-0499-00
SCS-32-0275-4D	27.5		110	143	32	60		184-0500-00
SCS-32-0280-4D	28.0		-0.12 +0.20	112	145	32		60
SCS-32-0285-4D	28.5	114		147	32	60	184-0502-00	
SCS-32-0290-4D	29.0	116		150	32	60	184-0503-00	
SCS-32-0295-4D	29.5	118		153	32	60	184-0504-00	
SCS-32-0300-4D	30.0	120		155	32	60	184-0505-00	
SCS-32-0310-4D	31.0	124		159	32	60	184-0506-00	
SCS-32-0320-4D	32.0	128		163	32	60	184-0507-00	
SCS-32-0330-4D	33.0	132		167	32	60	184-0508-00	
SCS-40-0340-4D	34.0	-0.12 +0.20	136	176	40	70	SPKX110408	184-0509-00
SCS-40-0350-4D	35.0		140	180	40	70		184-0510-00
SCS-40-0360-4D	36.0		144	184	40	70		184-0511-00
SCS-40-0370-4D	37.0		148	188	40	70		184-0512-00
SCS-40-0380-4D	38.0		152	192	40	70		184-0513-00
SCS-40-0390-4D	39.0		156	196	40	70		184-0514-00
SCS-40-0400-4D	40.0		160	200	40	70		184-0515-00
SCS-40-0410-4D	41.0		164	204	40	70		184-0516-00
SCS-40-0420-4D	42.0	-0.12 +0.20	168	208	40	70	SPKX140512	184-0517-00
SCS-40-0430-4D	43.0		172	212	40	70		184-0518-00
SCS-40-0440-4D	44.0		176	216	40	70		184-0519-00
SCS-40-0450-4D	45.0		180	220	40	70		184-0520-00
SCS-40-0460-4D	46.0		184	224	40	70		184-0521-00
SCS-40-0470-4D	47.0		188	228	40	70		184-0522-00
SCS-40-0480-4D	48.0		192	232	40	70		184-0523-00
SCS-40-0490-4D	49.0		196	236	40	70		184-0524-00
SCS-40-0500-4D	50.0		200	240	40	70		184-0525-00

Spare Parts	
Insert Screw Part Number	Torx Key Part Number
290-0314-00	6-998-006
290-0306-00	6-998-006
290-0313-00	6-998-008
290-0309-00	6-998-015
290-0475-00	6-998-015
290-0317-00	6-998-020

DRILLING



Cutting Tools

Round Tooling





Cutting Tools

Quick Lookup

Round Tooling

■ DRILLS	247
■ ANNULAR CUTTERS	295
■ REAMERS	299
■ COUNTERBORES AND COUNTERSINKS	321
■ CARBIDE BURRS	329
■ END MILLS	333
■ MILLING CUTTERS AND SAWS	363
■ TAPS	387
■ DIES	405
■ BROACHES AND TOOLBITS	414
■ INDEX	419

The information contained herein is subject to change without notice. We do our best to maintain in stock full and complete inventories of all regular lines. Close-out items may be depleted and will be replaced with comparable merchandise subject to prior sales. Photos and drawings shown are a general representation; occasionally we may change the exterior packaging of some products. Toolmex Industrial Solutions shall not be liable for technical or editorial errors or omissions contained herein.

TABLE OF CONTENTS

DRILLS

Drill Size & Decimal Equivalents	248
Tap Drill Chart	249
Solid Carbide Technical Reference	250
Solid Carbide Jobber Drills	251
Solid Carbide Coolant Feeding Drills	257
HSS Jobber Drills	260
HSS TiN Coated & Cobalt Jobber Drills Overview	265
General Purpose HSS TiN Coated Jobber Drills	266
Heavy Duty TiN Coated Jobber Drills	271
Heavy Duty Cobalt Jobber Drills	276
Drill Sets	281
Aircraft Extension Drills	282
Taper Shank Drills	285
Silver and Deming Drills	288
Spotting and Centering Drills	292
Core Drills	293





Drill – Size Equivalents

Cutting Tools

DRILLS

Drill Size Decimal Equivalent

Drill Size	mm	Decimal Equivalent
–	0.10	.0039
–	0.20	.0079
–	0.25	.0098
–	0.30	.0118
80	0.34	.0135
79	0.37	.0145
1/64	0.40	.0156
78	0.41	.0160
77	0.46	.0180
–	0.50	.0197
76	0.51	.0200
75	0.53	.0210
74	0.57	.0225
–	0.60	.0236
73	0.61	.0240
72	0.64	.0250
71	0.66	.0260
–	0.70	.0276
70	0.71	.0280
69	0.74	.0292
–	0.75	.0295
68	0.79	.0310
1/32	0.79	.0313
–	0.80	.0315
67	0.81	.0320
66	0.84	.0330
65	0.89	.0350
–	0.90	.0354
64	0.91	.0360
63	0.94	.0370
62	0.97	.0380
61	0.99	.0390
–	1.00	.0394
60	1.02	.0400
59	1.04	.0410
58	1.07	.0420
57	1.09	.0430
56	1.18	.0465
3/64	1.19	.0469
55	1.32	.0520
54	1.40	.0550
53	1.51	.0595
1/16	1.59	.0625
52	1.61	.0635
51	1.70	.0670
50	1.78	.0700
49	1.85	.0730
48	1.93	.0760
5/64	1.98	.0781
47	1.99	.0785
–	2.00	.0787
46	2.06	.0810

Drill Size	mm	Decimal Equivalent
45	2.08	.0820
44	2.18	.0860
43	2.26	.0890
42	2.37	.0935
3/32	2.38	.0938
41	2.44	.0960
40	2.50	.980
39	2.53	.0995
38	2.58	.1015
37	2.64	.1040
36	2.71	.1065
7/64	2.78	.1094
35	2.79	.1100
34	2.82	.1110
33	2.87	.1130
32	2.95	.1160
–	3.00	.1181
31	3.05	.1200
1/8	3.18	.1250
30	3.26	.1285
29	3.45	.1360
28	3.57	.1405
9/64	3.57	.1406
27	3.66	.1440
26	3.73	.1470
25	3.80	.1495
24	3.86	.1520
23	3.91	.1540
5/32	3.97	.1562
22	3.99	.1570
–	4.00	.1575
21	4.04	.1590
20	4.09	.1610
19	4.22	.1660
18	4.31	.1695
11/64	4.37	.1719
17	4.39	.1730
16	4.50	.1770
15	4.57	.1800
14	4.62	.1820
13	4.70	.1850
3/16	4.76	.1875
12	4.80	.1890
11	4.85	.1910
10	4.91	.1935
9	4.98	.1960
–	5.00	.1968
8	5.05	.1990
7	5.11	.2010
13/64	5.16	.2031
6	5.18	.2040
5	5.22	.2055

Drill Size	mm	Decimal Equivalent
4	5.31	.2090
3	5.41	.2130
7/32	5.56	.2188
2	5.61	.2210
1	5.79	.2280
A	5.94	.2340
15/64	5.95	.2344
–	6.00	.2362
B	6.05	.2380
C	6.15	.2420
D	6.25	.2460
1/4	6.35	.2500
E	6.35	.2500
F	6.53	.2570
G	6.63	.2610
17/64	6.75	.2656
H	6.76	.2660
I	6.91	.2720
–	7.00	.2756
J	7.04	.2770
K	7.14	.2810
9/32	7.14	.2812
L	7.37	.2900
M	7.49	.2950
19/64	7.54	.2969
N	7.67	.3020
5/16	7.94	.3125
–	8.00	.3150
O	8.03	.3160
P	8.20	.3230
21/64	8.33	.3281
Q	8.43	.3320
R	8.61	.3390
11/32	8.73	.3438
S	8.84	.3480
–	9.00	.3543
T	9.09	.3580
23/64	9.13	.3594
U	9.35	.3680
3/8	9.53	.3750
V	9.56	.3770
W	9.80	.3860
25/64	9.92	.3906
–	10.00	.3937
X	10.08	.3970
Y	10.26	.4040
13/32	10.32	.4062
Z	10.49	.4130
27/64	10.72	.4219
–	11.00	.4331
7/16	11.11	.4375
29/64	11.51	.4531

Drill Size	mm	Decimal Equivalent
15/32	11.91	.4688
–	12.00	.4724
31/64	12.30	.4844
1/2	12.70	.5000
–	13.00	.5118
33/64	13.10	.5156
17/32	13.49	.5312
35/64	13.89	.5469
–	14.00	.5512
9/16	14.29	.5625
37/64	14.68	.5781
–	15.00	.5906
19/32	15.08	.5938
39/64	15.48	.6094
5/8	15.88	.6250
–	16.00	.6299
41/64	16.27	.6406
21/32	16.67	.6562
–	17.00	.6693
43/64	17.07	.6719
11/16	17.46	.6875
45/64	17.86	.7031
–	18.00	.7087
23/32	18.26	.7188
47/64	18.65	.7344
–	19.00	.7480
3/4	19.05	.7500
49/64	19.45	.7656
24/32	19.84	.7812
–	20.00	.7874
51/64	20.24	.7969
13/16	20.64	.8125
–	21.00	.8269
53/64	21.03	.8282
27/32	21.43	.8438
55/64	21.84	.8594
–	22.00	.8661
7/8	22.23	.8750
57/64	22.62	.8906
–	23.00	.9055
29/32	23.02	.9062
59/64	23.42	.9219
15/16	23.81	.9375
–	24.00	.9449
61/64	24.21	.9531
31/32	24.61	.9688
–	25.00	.9842
63/64	25.00	.9844
1	25.40	1.0000

Tap Drill Chart

Tap Size	Drill Size	Probable % thread
0 - 80	3/64	71 - 81
M1.6 x .35	1.25 mm	67 - 77
1 - 64	53	59 - 67
M2 x .4	1/16	72 - 79
1 - 72	53	67 - 75
2 - 56	51	62 - 69
2 - 64	50	70 - 79
M2.5 x .45	2.05 mm	69 - 77
3 - 48	5/64	70 - 77
3 - 56	46	69 - 78
4 - 40	44	65 - 71
4 - 48	42	61 - 68
M3 x .5	40	70 - 79
5 - 40	39	65 - 72
5 - 44	38	63 - 71
M3.5 x .6	33	72 - 81
6 - 32	36	71 - 78
6 - 40	33	69 - 77
M4 x .7	3.25 mm	74 - 82
8 - 32	29	62 - 69
8 - 36	29	70 - 78
10 - 24	25	69 - 75
10 - 32	21	68 - 76
M5 x .8	4.2 mm	69 - 77
12 - 24	17	66 - 72
12 - 28	15	70 - 78
M6 x 1	10	76 - 84
1/4 - 20	7	70 - 75
1/4 - 28	3	72 - 80
5/16 - 18	F	72 - 77
5/16 - 24	I	67 - 75
M8 1.25	6.7 mm	74 - 80
3/8 - 16	5/16	72 - 77

Tap Size	Drill Size	Probable % thread
3/8 - 24	Q	71 - 79
M10 x 1.5	8.4 mm	76 - 82
7/16 - 14	U	70 - 75
7/16 - 20	25/64	65 - 72
M12 x 1.75	13/32	69 - 74
1/2 - 13	27/64	73 - 78
1/2 - 20	29/64	65 - 72
M14 x 2	15/32	76 - 81
9/16 - 12	31/64	68 - 72
9/16 - 18	33/64	58 - 65
5/8 - 11	17/32	75 - 79
5/8	37/64	58 - 65
M16 x 2	35/64	76 - 81
3/4 - 10	21/32	68 - 72
3/4 - 16	11/16	71 - 77
M20 x 2.5	11/16	74 - 78
7/8 - 9	49/64	72 - 76
7/8 - 14	13/16	62 - 67
M24 x 3	53/64	72 - 76
1 - 8	7/8	73 - 77
1 - 12	59/64	67 - 72
1 - 14	15/16	61 - 67
1-1/8 - 7	63/64	72 - 76
1/18 - 12	1-3/64	66 - 72
M30 x 3.5	1-3/64	75
-1/4 - 7	1-7/64	76
1-1/4 - 12	1-11/64	72
1-3/8 - 6	1-7/32	72
1-3/8 - 12	1-19/64	72
M36 x 4	1-1/4	82
1-1/2 - 6	1-11/32	72
1-1/2 - 12	1-27/64	72



Solid Carbide Drills Technical Reference

Cutting Tools

DRILLS

Speeds and Feeds for Carbide Drills

Material Group	Material Type	Cutting Speed SFM		
		Carbide 5XD and 8XD Coolant Drills	Carbide 5XD and 8XD Coolant Drills	Carbide Jobber Drills
Steel	Structural Steel	263 - 328	197 - 230	197 - 230
	Free Cutting Steel	328 - 393	197 - 230	197 - 230
	Unalloyed Heat Treatable Steel	263 - 295	197 - 230	197 - 230
	Unalloyed Case Hard Steel	295 - 328	197 - 230	197 - 230
	Alloyed Case Hardened Steel	164 - 246	164 - 197	164 - 197
	Nitriding Steel	230 - 262	131 - 164	131 - 164
Acid Resistant / Stainless Steel	Stainless Steel, Sulphured Austenitic Steel, Martensitic	98 - 131	66 - 82	66 - 82
High Tensile Steel	Alloyed Heat Treatable Steel	197 - 262	131 - 164	131 - 164
	Tool Steel	131 - 164	131 - 164	131 - 164
	High Speed Steel	98 - 131		
	Spring Steel	98 - 131	66 - 82	66 - 82
Cast Materials	Cast Iron	328 - 426	230 - 263	230 - 263
	Spheroidal Graphite and Malleable Ci	263 - 238	197 - 230	197 - 230
	Chilled Ci	66 - 98	32 - 49	32 - 49
Aluminium and Aluminium Alloys	Aluminium Alloys	574 - 656	492 - 590	492 - 590
	Al Wrought Alloys	574 - 656	492 - 590	492 - 590
	Al Cast Alloys < 10%si	525 - 590	328 - 427	328 - 427
	Al Cast Alloys > 10%si	525 - 590	328 - 427	328 - 427
Special Alloys	Special Alloys	66 - 82	15	15
	Ti and Ti Alloys	66 - 98	15-20	15-20
Non Ferrous Metals	Copper Low Alloys	246 - 295	60-70	60-70
	Brass	524 - 590	130-150	130-150
	Bronze	246 - 295	100-110	100-110
Magnesium Alloys	Magnesium Alloys	574 - 656	120-150	120-150

Minimum recommended coolant pressure:

- for 1/4" diameter = 400 PSI
- for 1/2" diameter = 200 PSI
- for 3/4" diameter = 150 PSI

Feed Rate IPR

Material	Feed (inch/rev) Dia									
	0.079	0.118	0.197	0.236	0.315	0.394	0.472	0.63	0.787	1
Steel	0.002	0.004	0.005	0.006	0.007	0.009	0.009	0.011	0.012	0.014
High Tensile Steels / Acid Resistant	0.002	0.002	0.003	0.004	0.005	0.006	0.006	0.008	0.010	0.012
Cast Material	0.003	0.004	0.006	0.007	0.008	0.009	0.009	0.011	0.012	0.014
Aluminium Alloys	0.004	0.005	0.007	0.009	0.010	0.012	0.012	0.014	0.016	0.017
Titanium Alloys	0.001	0.002	0.002	0.003	0.004	0.004	0.004	0.006	0.007	0.008
Non Ferrous	0.002	0.003	0.004	0.005	0.007	0.008	0.008	0.010	0.012	0.014
Magnesium Alloys	0.003	0.004	0.005	0.007	0.008	0.010	0.010	0.011	0.012	0.014

Recommended starting points



2 Flute Jobber Length Drills

Features and Applications:

- Designed for high feed rates with good chip removal
- Excellent results in highly abrasive materials
- For most general purpose applications
- Excellent heat and wear resistance for drilling abrasive materials generating high temperature

Aluminium Alloy	Carbon Steel	Alloy Steel	Hard Steel	Nickel / Inconel Alloy	Stainless Steel	Cast Iron	Titanium
●	●	◐		◐	◐	●	

● Excellent ◐ Good

See Speeds and Feeds on page 8

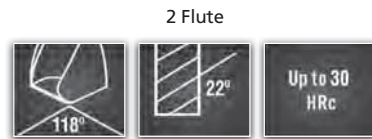

Tolerance: Shank Dia h6, Cut Dia h7



Fractional and Metric	Wire Gage	Letter	Metric	Decimal Equiv	Flute	Overall	Series 1-200 Fractional and Metric Sizes	Series 1-202 Wire Gage Sizes
							Uncoated	
							Part Number	
–	80	–	.34	.1350	3/16"	3/4"	–	1-202-080
–	79	–	.37	.0145	3/16"	3/4"	–	1-202-079
1/64"	–	–	.40	.0156	3/16"	3/4"	1-200-0016	–
–	78	–	.41	.0160	3/16"	3/4"	–	1-202-078
–	77	–	.46	.0180	3/16"	3/4"	–	1-202-077
–	76	–	.51	.0200	1/4"	7/8"	–	1-202-076
–	75	–	.53	.0210	1/4"	7/8"	–	1-202-075
–	74	–	.57	.0225	1/4"	7/8"	–	1-202-074
–	73	–	.61	.0240	1/4"	7/8"	–	1-202-073
–	72	–	.64	.0250	5/16"	1"	–	1-202-072
–	71	–	.66	.0260	5/16"	1"	–	1-202-071
–	70	–	.71	.0280	1/2"	1-1/4"	–	1-202-070
–	69	–	.74	.0292	1/2"	1-1/4"	–	1-202-069
–	68	–	.79	.0310	1/2"	1-1/4"	–	1-202-068
1/32"	–	–	–	.0312	1/2"	1-1/4"	1-200-0031	–
.80mm	–	–	.80	.3150	10mm	30mm	1-200-0032	–
–	67	–	.81	.0320	1/2"	1-1/4"	–	1-202-067
–	66	–	.84	.0330	1/2"	1-1/4"	–	1-202-066
–	65	–	.89	.0350	5/8"	1-3/8"	–	1-202-065
–	64	–	.91	.0360	5/8"	1-3/8"	–	1-202-064
–	63	–	.94	.0370	5/8"	1-3/8"	–	1-202-063
–	62	–	.97	.0380	5/8"	1-3/8"	–	1-202-062
–	61	–	.99	.0390	5/8"	1-3/8"	–	1-202-061
1.00mm	–	–	1.00	.0393	12mm	34mm	1-200-0039	–
–	60	–	1.02	.0400	3/4"	1-1/2"	–	1-202-060
–	59	–	1.04	.0410	3/4"	1-1/2"	–	1-202-059
–	58	–	1.07	.0420	3/4"	1-1/2"	–	1-202-058
–	57	–	1.09	.0430	3/4"	1-1/2"	–	1-202-057
1.10mm	–	–	1.10	.0433	14mm	36mm	1-200-0043	–
–	56	–	1.18	.0465	3/4"	1-1/2"	–	1-202-056
3/64"	–	–	1.19	.0469	3/4"	1-1/2"	1-200-0047	–
1.20mm	–	–	1.20	.0472	16mm	38mm	1-200-0048	–
1.30mm	–	–	1.30	.0512	16mm	38mm	1-200-0051	–
–	55	–	1.32	.0520	3/4"	1-1/2"	–	1-202-055
–	54	–	–	.0550	3/4"	1-1/2"	–	1-202-054
1.40mm	–	–	1.40	.0551	18mm	40mm	1-200-0055	–



Solid Carbide Drills

Cutting Tools

DRILLS

2 Flute Jobber Length Drills (continued)

Fractional and Metric	Wire Gage	Letter	Metric	Decimal Equiv	Flute	Overall	Series 1-200 Fractional and Metric Sizes	Series 1-202 Wire Gage Sizes
							Uncoated	
							Part Number	
1.50mm	–	–	1.50	.0591	18mm	40mm	1-200-0059	–
–	53	–	1.51	.0595	3/4"	1-1/2"	–	1-202-053
1/16"	–	–	1.59	.0625	3/4"	1-1/2"	1-200-0063	–
1.60mm	–	–	1.60	.0630	20mm	43mm	1-200-0064	–
–	52	–	1.61	.0635	3/4"	1-1/2"	–	1-202-052
1.70mm	–	–	1.70	.0669	20mm	43mm	1-200-0067	–
–	51	–	–	.0670	3/4"	1-1/2"	–	1-202-051
–	50	–	1.78	.0700	7/8"	1-3/4"	–	1-202-050
1.80mm	–	–	1.80	.0709	22mm	46mm	1-200-0071	–
–	49	–	1.85	.0730	7/8"	1-3/4"	–	1-202-049
1.90mm	–	–	1.90	.0748	22mm	46mm	1-200-0075	–
–	48	–	1.93	.0760	7/8"	1-3/4"	–	1-202-048
5/64"	–	–	1.98	.0781	7/8"	1-3/4"	1-200-0078	–
–	47	–	1.99	.0785	7/8"	1-3/4"	–	1-202-047
2.0mm	–	–	2.00	.0787	24mm	49mm	1-200-0079	–
–	46	–	2.06	.0810	7/8"	1-3/4"	–	1-202-046
–	45	–	2.08	.0820	7/8"	1-3/4"	–	1-202-045
2.10mm	–	–	2.10	.0827	24mm	49mm	1-200-0083	–
–	44	–	2.18	.0860	1"	2"	–	1-202-044
2.20mm	–	–	2.20	.0866	27mm	53mm	1-200-0087	–
–	43	–	2.26	.0890	1"	2"	–	1-202-043
2.30mm	–	–	2.30	.0906	27mm	53mm	1-200-0091	–
–	42	–	2.37	.0935	1"	2"	–	1-202-042
3/32"	–	–	2.38	.0938	1"	2"	1-200-0094	–
2.40mm	–	–	2.40	.0945	30mm	57mm	1-200-0095	–
–	41	–	2.44	.0960	1"	2"	–	1-202-041
–	40	–	2.49	.0980	1"	2"	–	1-202-040
2.50mm	–	–	2.50	.0984	30mm	57mm	1-200-0099	–
–	39	–	2.53	.0995	1-1/4"	2-1/4"	–	1-202-039
–	38	–	2.58	.1015	1-1/4"	2-1/4"	–	1-202-038
2.60mm	–	–	2.60	.1024	30mm	57mm	1-200-0100	–
–	37	–	2.64	.1040	1-1/4"	2-1/4"	–	1-202-037
2.70mm	–	–	2.70	.1063	33mm	61mm	1-200-0101	–
–	36	–	2.71	.1065	1-1/4"	2-1/4"	–	1-202-036
7/64"	–	–	2.78	.1094	1-1/4"	2-1/4"	1-200-0109	–
–	35	–	2.79	.1100	1-1/4"	2-1/4"	–	1-202-035
2.80mm	–	–	2.80	.1102	33mm	61mm	1-200-0110	–
–	34	–	2.82	.1110	1-1/4"	2-1/4"	–	1-202-034
–	33	–	2.87	.1130	1-1/4"	2-1/4"	–	1-202-033
2.90mm	–	–	2.90	.1142	33mm	61mm	1-200-0114	–
–	32	–	2.95	.1160	1-1/4"	2-1/4"	–	1-202-032
3.00mm	–	–	3.00	.1181	33mm	61mm	1-200-0118	–
–	31	–	3.05	.1200	1-1/4"	2-1/4"	–	1-202-031
3.10mm	–	–	3.10	.1220	36mm	65mm	1-200-0122	–
1/8"	–	–	3.18	.1250	1-1/4"	2-1/4"	1-200-0125	–
3.20mm	–	–	3.20	.1260	36mm	65mm	1-200-0126	–
–	30	–	3.26	.1285	1-1/4"	2-1/4"	–	1-202-030
3.30mm	–	–	3.30	.1299	36mm	65mm	1-200-0130	–
3.40mm	–	–	3.40	.1339	39mm	70mm	1-200-0134	–
–	29	–	3.45	.1360	1-3/8"	2-1/2"	–	1-202-029
3.50mm	–	–	3.50	.1378	39mm	70mm	1-200-0138	–

2 Flute Jobber Length Drills (continued)

Fractional and Metric	Wire Gage	Letter	Metric	Decimal Equiv.	Flute	Overall	Series 1-200 Fractional and Metric Sizes	Series 1-202 Wire Gage Sizes
							Uncoated	
							Part Number	
–	28	–	3.57	.1405	1-3/8"	2-1/2"	–	1-202-028
9/64"	–	–	3.57	.1406	1-3/8"	2-1/2"	1-200-0141	–
3.60mm	–	–	3.60	.1417	39mm	70mm	1-200-0142	–
–	27	–	3.66	.1440	1-3/8"	2-1/2"	–	1-202-027
3.70mm	–	–	3.70	.1457	39mm	70mm	1-200-0146	–
–	26	–	3.73	.1470	1-3/8"	2-1/2"	–	1-202-026
–	25	–	3.80	.1495	1-3/8"	2-1/2"	–	1-202-025
3.80mm	–	–	3.80	.1496	43mm	75mm	1-200-0150	–
–	24	–	3.86	.1520	1-3/8"	2-1/2"	–	1-202-024
3.90mm	–	–	3.90	.1535	43mm	75mm	1-200-0154	–
–	23	–	3.91	.1540	1-3/8"	2-1/2"	–	1-202-023
5/32"	–	–	3.97	.1562	1-3/8"	2-1/2"	1-200-0156	–
–	22	–	3.99	.1570	1-3/8"	2-1/2"	–	1-202-022
4.00mm	–	–	4.00	.1575	43mm	75mm	1-200-0158	–
–	21	–	4.04	.1590	1-3/8"	2-1/2"	–	1-202-021
–	20	–	4.09	.1610	1-3/8"	2-1/2"	–	1-202-020
4.10mm	–	–	4.10	.1614	43mm	75mm	1-200-0161	–
4.20mm	–	–	4.20	.1654	43mm	75mm	1-200-0165	–
–	19	–	4.22	.1660	1-5/8"	2-3/4"	–	1-202-019
4.30mm	–	–	4.30	.1693	47mm	80mm	1-200-0169	–
–	18	–	4.31	.1695	1-5/8"	2-3/4"	–	1-202-018
11/64"	–	–	4.37	.1719	1-5/8"	2-3/4"	1-200-0172	–
–	17	–	4.39	.1730	1-5/8"	2-3/4"	–	1-202-017
4.40mm	–	–	4.40	.1732	47mm	80mm	1-200-0173	–
–	16	–	–	.1770	1-5/8"	2-3/4"	–	1-202-016
4.50mm	–	–	4.50	.1772	47mm	80mm	1-200-0177	–
–	15	–	4.57	.1800	1-5/8"	2-3/4"	–	1-202-015
4.60mm	–	–	4.60	.1811	47mm	80mm	1-200-0181	–
–	14	–	4.62	.1820	1-5/8"	2-3/4"	–	1-202-014
4.70mm	–	–	4.70	.1850	47mm	80mm	1-200-0185	–
–	13	–	–	.1850	1-5/8"	2-3/4"	–	1-202-013
3/16"	–	–	4.76	.1875	1-5/8"	2-3/4"	1-200-0187	–
4.80mm	–	–	4.80	.1890	52mm	86mm	1-200-0189	–
–	12	–	–	.1890	1-5/8"	2-3/4"	–	1-202-012
–	11	–	4.85	.1910	1-5/8"	2-3/4"	–	1-202-011
4.90mm	–	–	4.90	.1929	52mm	86mm	1-200-0193	–
–	10	–	4.91	.1935	1-5/8"	2-3/4"	–	1-202-010
–	9	–	4.98	.1960	1-3/4"	3"	–	1-202-009
5.00mm	–	–	5.00	.1968	52mm	86mm	1-200-0197	–
–	8	–	5.05	.1990	1-3/4"	3"	–	1-202-008
5.10mm	–	–	5.10	.2008	52mm	86mm	1-200-0201	–
–	7	–	5.11	.2010	1-3/4"	3"	–	1-202-007
13/64"	–	–	5.16	.2031	1-3/4"	3"	1-200-0203	–
–	6	–	5.18	.2040	1-3/4"	3"	–	1-202-006
5.20mm	–	–	5.20	.2047	52mm	86mm	1-200-0205	–
–	5	–	5.22	.2055	1-3/4"	3"	–	1-202-005
5.30mm	–	–	5.30	.2087	52mm	86mm	1-200-0209	–
–	4	–	5.31	.2090	1-3/4"	3"	–	1-202-004
5.40mm	–	–	5.40	.2126	57mm	93mm	1-200-0213	–
–	3	–	5.41	.2130	1-3/4"	3"	–	1-202-003
5.50mm	–	–	5.50	.2165	57mm	93mm	1-200-0217	–



Solid Carbide Drills

Cutting Tools

DRILLS

2 Flute Jobber Length Drills (continued)

Fractional and Metric	Wire Gage	Letter	Metric	Decimal Equiv.	Flute	Overall	Series 1-200 Fractional and Metric Sizes	Series 1-202 Wire Gage Sizes	Series 1-201 Letter Sizes
							Uncoated		
Length						Part Number			
7/32"	–	–	5.55	.2187	1-3/4"	3"	1-200-0219	–	–
5.60mm	–	–	5.60	.2205	57mm	93mm	1-200-0221	–	–
–	2	–	5.61	.2210	1-3/4"	3"	–	1-202-002	–
5.70mm	–	–	5.70	.2244	57mm	93mm	1-200-0225	–	–
–	1	–	5.79	.2280	1-3/4"	3"	–	1-202-001	–
5.80mm	–	–	5.80	.2283	57mm	93mm	1-200-0228	–	–
5.90mm	–	–	5.90	.2323	57mm	93mm	1-200-0232	–	–
–	–	A	5.94	.2340	2"	3-1/4"	–	–	1-201-001
15/64"	–	–	5.95	.2344	2"	3-1/4"	1-200-0234	–	–
6.00mm	–	–	6.00	.2362	57mm	93mm	1-200-0236	–	–
–	–	B	6.04	.2380	2"	3-1/4"	–	–	1-201-002
6.10mm	–	–	6.10	.2402	63mm	101mm	1-200-0240	–	–
–	–	C	6.15	.2420	2"	3-1/4"	–	–	1-201-003
6.20mm	–	–	6.20	.2441	63mm	101mm	1-200-0244	–	–
–	–	D	6.25	.2460	2"	3-1/4"	–	–	1-201-004
6.30mm	–	–	6.30	.2480	63mm	101mm	1-200-0249	–	–
1/4"	–	E	6.35	.2500	2"	3-1/4"	1-200-005	–	1-201-005
6.40mm	–	–	6.40	.2520	63mm	101mm	1-200-0252	–	–
6.50mm	–	–	6.50	.2559	63mm	101mm	1-200-0256	–	–
–	–	F	6.53	.2570	2"	3-1/4"	–	–	1-201-006
6.60mm	–	–	6.60	.2598	63mm	101mm	1-200-0260	–	–
–	–	G	6.63	.2610	2-1/8"	3-1/2"	–	–	1-201-007
6.70mm	–	–	6.70	.2638	63mm	101mm	1-200-0264	–	–
17/64"	–	–	6.75	.2656	2-1/8"	3-1/2"	1-200-0266	–	–
–	–	H	6.76	.2660	2-1/8"	3-1/2"	–	–	1-201-008
6.80mm	–	–	6.80	.2677	69mm	109mm	1-200-0267	–	–
6.90mm	–	–	6.90	.2717	69mm	109mm	1-200-0272	–	–
–	–	I	6.91	.2720	2-1/8"	3-1/2"	–	–	1-201-009
7.00mm	–	–	7.00	.2756	69mm	109mm	1-200-0276	–	–
–	–	J	7.04	.2770	2-1/8"	3-1/2"	–	–	1-201-010
7.10mm	–	–	7.10	.2795	69mm	109mm	1-200-0280	–	–
–	–	K	7.14	.2810	2-1/8"	3-1/2"	–	–	1-201-011
9/32"	–	–	7.14	.2812	2-1/8"	3-1/2"	1-200-0281	–	–
7.20mm	–	–	7.20	.2835	69mm	109mm	1-200-0284	–	–
7.30mm	–	–	7.30	.2874	69mm	109mm	1-200-0287	–	–
–	–	L	7.37	.2900	2-1/8"	3-1/2"	–	–	1-201-012
7.40mm	–	–	7.40	.2913	69mm	109mm	1-200-0291	–	–
–	–	M	7.49	.2950	2-3/8"	3-3/4"	–	–	1-201-013
7.50mm	–	–	7.50	.2953	69mm	109mm	1-200-0295	–	–
19/64"	–	–	7.54	.2969	2-3/8"	3-3/4"	1-200-0297	–	–
7.60mm	–	–	7.60	.2992	75mm	117mm	1-200-0300	–	–
–	–	N	7.67	.3020	2-3/8"	3-3/4"	–	–	1-201-014
7.70mm	–	–	7.70	.3031	75mm	117mm	1-200-0303	–	–
7.80mm	–	–	7.80	.3071	75mm	117mm	1-200-0307	–	–
7.90mm	–	–	7.90	.3110	75mm	117mm	1-200-0311	–	–
5/16"	–	–	7.94	.3125	2-3/8"	3-3/4"	1-200-0313	–	–
8.00mm	–	–	8.00	.3150	75mm	117mm	1-200-0315	–	–
–	–	O	8.03	.3160	2-3/8"	3-3/4"	–	–	1-201-015
8.10mm	–	–	8.10	.3189	75mm	117mm	1-200-0319	–	–
8.20mm	–	–	8.20	.3228	75mm	117mm	1-200-0323	–	–
–	–	P	8.21	.3230	2-3/8"	3-3/4"	–	–	1-201-016



2 Flute Jobber Length Drills (continued)

Fractional and Metric	Wire Gage	Letter	Metric	Decimal Equiv.	Flute	Overall	Series 1-200 Fractional and Metric Sizes	Series 1-201 Letter Sizes
							Uncoated	
							Part Number	
8.30mm	—	—	8.30	.3268	75mm	117mm	1-200-0327	—
21/64"	—	—	8.33	.3281	2-1/2"	4"	1-200-0328	—
8.40mm	—	—	8.40	.3307	75mm	117mm	1-200-0331	—
—	—	Q	8.43	.3320	2-1/2"	4"	—	1-201-017
8.50mm	—	—	8.50	.3346	75mm	117mm	1-200-0335	—
8.60mm	—	—	8.60	.3386	81mm	125mm	1-200-0339	—
—	—	R	8.61	.3390	2-1/2"	4"	—	1-201-018
8.70mm	—	—	8.70	.3425	81mm	125mm	1-200-0343	—
11/32"	—	—	8.73	.3438	2-1/2"	4"	1-200-0344	—
8.80mm	—	—	8.80	.3465	81mm	125mm	1-200-0346	—
—	—	S	8.84	.3480	2-1/2"	4"	—	1-201-019
8.90mm	—	—	8.90	.3504	81mm	125mm	1-200-0350	—
9.00mm	—	—	9.00	.3543	81mm	125mm	1-200-0354	—
—	—	T	9.09	.3580	2-1/2"	4"	—	1-201-020
9.10mm	—	—	9.10	.3583	81mm	125mm	1-200-0358	—
23/64"	—	—	9.13	.3594	2-3/4"	4-1/4"	1-200-0359	—
9.20mm	—	—	9.20	.3622	81mm	125mm	1-200-0362	—
9.30mm	—	—	9.30	.3661	81mm	125mm	1-200-0366	—
—	—	U	9.35	.3680	2-3/4"	4-1/4"	—	1-201-021
9.40mm	—	—	9.40	.3701	81mm	125mm	1-200-0370	—
9.50mm	—	—	9.50	.3740	81mm	125mm	1-200-0374	—
3/8"	—	—	9.53	.3750	2-3/4"	4-1/4"	1-200-0375	—
—	—	V	9.58	.3770	2-3/4"	4-1/4"	—	1-201-022
9.60mm	—	—	9.60	.3780	87mm	133mm	1-200-0378	—
9.70mm	—	—	9.70	.3819	87mm	133mm	1-200-0382	—
9.80mm	—	—	9.80	.3858	87mm	133mm	1-200-0386	—
—	—	W	9.81	.3860	2-7/8"	4-1/2"	—	1-201-023
9.90mm	—	—	9.90	.3898	87mm	133mm	1-200-0390	—
25/64"	—	—	9.92	.3906	2-7/8"	4-1/2"	1-200-0391	—
10.00mm	—	—	10.00	.3937	87mm	133mm	1-200-0394	—
—	—	X	10.08	.3970	2-7/8"	4-1/2"	—	1-201-024
10.20mm	—	—	10.20	.4016	87mm	133mm	1-200-0402	—
—	—	Y	10.26	.4040	2-7/8"	4-1/2"	—	1-201-025
10.30mm	—	—	10.30	.4055	87mm	133mm	1-200-0405	—
13/32"	—	—	10.32	.4062	2-7/8"	4-1/2"	1-200-0406	—
—	—	Z	10.49	.4130	2-7/8"	4-1/2"	—	1-201-026
10.50mm	—	—	10.50	.4134	87mm	133mm	1-200-0413	—
27/64"	—	—	10.72	.4219	2-7/8"	4-1/2"	1-200-0422	—
11.00mm	—	—	11.00	.4331	94mm	142mm	1-200-0433	—
7/16"	—	—	11.11	.4375	2-7/8"	4-1/2"	1-200-0437	—
11.50mm	—	—	11.50	.4528	94mm	142mm	1-200-0452	—
29/64"	—	—	11.51	.4531	3"	4-3/4"	1-200-0453	—
15/32"	—	—	11.91	.4688	3"	4-3/4"	1-200-0469	—
12.00mm	—	—	12.00	.4724	101mm	151mm	1-200-0472	—
31/64"	—	—	12.30	.4844	3"	4-3/4"	1-200-0484	—
12.50mm	—	—	12.50	.4920	101mm	151mm	1-200-0492	—
1/2"	—	—	12.70	.5000	3"	4-3/4"	1-200-0500	—
12.90mm	—	—	12.90	.5079	101mm	151mm	1-200-0508	—
13.00mm	—	—	13.00	.5118	101mm	151mm	1-200-0512	—
17/32"	—	—	13.49	.5313	4"	6"	1-200-0531	—
13.50mm	—	—	13.50	.5315	108mm	160mm	1-200-0532	—



Solid Carbide Drills

Cutting Tools

DRILLS

2 Flute Jobber Length Drills (continued)

Fractional and Metric	Wire Gage	Letter	Metric	Decimal Equiv.	Flute	Overall	Series 1-200 Fractional and Metric Sizes
							Uncoated
							Part Number
14.00mm	—	—	14.00	.5512	108mm	160mm	1-200-0551
9/16"	—	—	14.29	.5625	4"	6"	1-200-0563
14.50mm	—	—	14.50	.5709	114mm	169mm	1-200-0571
15.00mm	—	—	15.00	.5906	114mm	153mm	1-200-0591
19/32"	—	—	15.08	.5937	4"	6"	1-200-0594
15.50mm	—	—	15.50	.6102	120mm	178mm	1-200-0610
5/8"	—	—	15.88	.6250	4"	6"	1-200-0625
16.00mm	—	—	16.00	.6299	120mm	178mm	1-200-0630
16.50mm	—	—	16.50	.6496	125mm	184mm	1-200-0650
21/32"	—	—	16.67	.6562	4"	6"	1-200-0656
17.00mm	—	—	17.00	.6693	125mm	184mm	1-200-0669
11/16"	—	—	17.46	.6875	4"	6"	1-200-0687
17.50mm	—	—	17.50	.6890	130mm	191mm	1-200-0689
18.00mm	—	—	18.00	.7087	130mm	191mm	1-200-0709
23/32"	—	—	18.25	.7187	4"	6"	1-200-0719
18.50mm	—	—	18.50	.7283	130mm	191mm	1-200-0728
19.00mm	—	—	19.00	.7480	130mm	191mm	1-200-0748
3/4"	—	—	19.05	.7500	4"	6"	1-200-0750
25/32"	—	—	19.87	.7812	4"	6"	1-200-0782
20.00mm	—	—	20.00	.7874	130mm	191mm	1-200-0787
7/8"	—	—	22.22	.8750	4"	6"	1-200-0875
1"	—	—	24.40	1.0000	4"	6"	1-200-1000

2 Flute High Performance Coolant Feeding Drills 5xD

Features and Applications:

- 140° angle provides excellent chip flow over entire cutting edge
- Coolant holes result in higher penetration rates
- TiAlN coated provides wear resistance in abrasive and high temperature materials

Aluminium Alloy	Carbon Steel	Alloy Steel	Hard Steel	Nickel / Inconel Alloy	Stainless Steel	Cast Iron	Titanium
●	●	●	●	●	●	●	●

● Excellent ● Good

See Speeds and Feeds on page 8

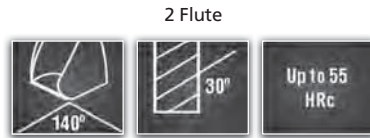

Tolerance: Shank Dia h6, Cut Dia h7



Drill Dia	Shank Dia	Flute Length	Overall Length	Series 1-215 Fractional Dia TiAlN coated
				Part Number
1/4	1/4	2-5/64	3-9/16	1-215-250
17/64	5/16	2-5/64	3-9/16	1-215-266
9/32	5/16	2-5/64	3-9/16	1-215-281
19/64	5/16	2-5/64	3-9/16	1-215-297
5/16	5/16	2-5/64	3-9/16	1-215-313
21/64	3/8	2-3/8	4-3/64	1-215-328
11/32	3/8	2-3/8	4-3/64	1-215-344
23/64	3/8	2-3/8	4-3/64	1-215-359
3/8	3/8	2-3/8	4-3/64	1-215-375
25/64	7/16	2-25/32	4-3/64	1-215-390
13/32	7/16	2-25/32	4-5/8	1-215-406
27/64	7/16	2-25/32	4-5/8	1-215-422
7/16	7/16	2-25/32	4-5/8	1-215-438
29/64	1/2	3-1/32	4-7/8	1-215-453
15/32	1/2	3-1/32	4-7/8	1-215-469
31/64	1/2	3-1/32	4-7/8	1-215-484
1/2	1/2	3-1/32	4-7/8	1-215-500
33/64	9/16	3-1/32	4-7/8	1-215-516
17/32	9/16	3-1/32	4-7/8	1-215-531
35/64	9/16	3-1/32	4-7/8	1-215-547
9/16	9/16	3-1/32	4-7/8	1-215-563
37/64	5/8	3-17/64	5-1/4	1-215-579
19/32	5/8	3-17/64	5-1/4	1-215-594
39/64	5/8	3-17/64	5-1/4	1-215-609
5/8	5/8	3-17/64	5-1/4	1-215-625
41/64	11/16	3-5/8	5-5/8	1-215-640
21/32	11/16	3-5/8	5-5/8	1-215-656
43/64	11/16	3-5/8	5-5/8	1-215-672
11/16	11/16	3-5/8	5-5/8	1-215-687
45/64	3/4	3-31/32	6	1-215-703
23/32	3/4	3-31/32	6	1-215-719
47/64	3/4	3-31/32	6	1-215-734
3/4	3/4	3-31/32	6	1-215-750



Solid Carbide Coolant Drills

Cutting Tools

DRILLS

2 Flute High Performance Coolant Feeding Drills 5xD (continued)

Drill Dia	Shank Dia	Flute Length	Overall Length	Series 1-225 Metric Dia TiAlN coated
Metric				Part Number
3	4	28	66	1-225-0304
3.1	4	28	66	1-225-0314
3.3	4	28	66	1-225-0334
3.5	4	28	66	1-225-0354
3.7	4	28	66	1-225-0374
3.8	4	36	74	1-225-0384
4	4	36	74	1-225-0404
4.2	6	36	74	1-225-042
4.5	6	36	74	1-225-045
4.8	6	44	82	1-225-048
5	6	44	82	1-225-050
5.1	6	44	82	1-225-051
5.2	6	44	82	1-225-052
5.5	6	44	82	1-225-055
5.8	6	44	82	1-225-058
6	6	44	82	1-225-060
6.3	8	53	91	1-225-063
6.5	8	53	91	1-225-065
6.8	8	53	91	1-225-068
7	8	53	91	1-225-070
7.5	8	53	91	1-225-075
7.8	8	53	91	1-225-078
8	8	53	91	1-225-080
8.5	10	61	103	1-225-085
8.8	10	61	103	1-225-088
9	10	61	103	1-225-090
9.2	10	61	103	1-225-092
9.5	10	61	103	1-225-095
9.8	10	61	103	1-225-098
10	10	61	103	1-225-100
10.2	12	71	118	1-225-102
10.5	12	71	118	1-225-105
10.8	12	71	118	1-225-108
11	12	71	118	1-225-110
11.5	12	71	118	1-225-115
11.8	12	71	118	1-225-118
12	12	71	118	1-225-120
12.3	14	77	124	1-225-123
12.5	14	77	124	1-225-125
12.8	14	77	124	1-225-128
13	14	77	124	1-225-130
13.5	14	77	124	1-225-135
14	14	77	124	1-225-140
14.5	16	83	133	1-225-145
15	16	83	133	1-225-150
15.5	16	83	133	1-225-155
16	16	83	133	1-225-160
16.5	18	93	143	1-225-165
17	18	93	143	1-225-170
17.5	18	93	143	1-225-175
18	18	93	143	1-225-180
20	20	101	153	1-225-200

2 Flute High Performance Coolant Feeding Drills 8xD

Features and Applications:

- 140° angle provides excellent chip flow over entire cutting edge
- Coolant holes result in higher penetration rates
- TiAlN coated will provide wear resistance in abrasive and high temperature materials

Aluminium Alloy	Carbon Steel	Alloy Steel	Hard Steel	Nickel / Inconel Alloy	Stainless Steel	Cast Iron	Titanium

● Excellent ◐ Good

See Speeds and Feeds on page 8

2 Flute



Tolerance: +.000/-0.0005 Metric=h7



Drill Dia	Shank Dia	Flute Length	Overall Length	Series 1-228 Metric Dia TiAlN coated
				Part Number
3.5	4	34	72	1-228-0354
3.7	4	34	72	1-228-0374
3.8	4	43	81	1-228-0384
4	4	43	81	1-228-0404
4.2	6	43	81	1-228-042
4.5	6	43	81	1-228-045
4.8	6	57	95	1-228-048
5	6	57	95	1-228-050
5.1	6	57	95	1-228-051
5.2	6	57	95	1-228-052
5.5	6	57	95	1-228-055
5.8	6	57	95	1-228-058
6	6	57	95	1-228-060
6.3	8	76	114	1-228-063
6.5	8	76	114	1-228-065
6.8	8	76	114	1-228-068
7	8	76	114	1-228-070
7.5	8	76	114	1-228-075
7.8	8	76	114	1-228-078
8	8	76	114	1-228-080
8.5	10	95	142	1-228-085
8.8	10	95	142	1-228-088
9	10	95	142	1-228-090
9.2	10	95	142	1-228-092
9.5	10	95	142	1-228-095
9.8	10	95	142	1-228-098
10	10	95	142	1-228-100
10.2	12	114	162	1-228-102
10.5	12	114	162	1-228-105
10.8	12	114	162	1-228-108
11	12	114	162	1-228-110
11.5	12	114	162	1-228-115
11.8	12	114	162	1-228-118
12	12	114	162	1-228-120
12.3	14	133	178	1-228-123
12.5	14	133	178	1-228-125
12.8	14	133	178	1-228-128
13	14	133	178	1-228-130
13.5	14	133	178	1-228-135
14	14	133	178	1-228-140
14.5	16	152	203	1-228-145
15	16	152	203	1-228-150
15.5	16	152	203	1-228-155
16	16	152	203	1-228-160



HSS Jobber Drills

Cutting Tools

DRILLS

Twist Drills and Drill Sets



Fractional Diameters – Straight Shank

- Jobber Length
- General Purpose (GP) 118 point
High Speed Steel Black Oxide
- ANSI Standard

Sold in the following package quantities:
 1/64" thru 17/64" = 10/envelope
 6/32" thru 1/2" = 5/envelope
 over 1/2" = 1/tube

Dia Inches		Flute Length	Overall Length	HSS GP Part Number
Fractional	Decimal			
1/64	.0156	3/16	3/4	5-160-005
1/32	.0312	1/2	1-3/8	5-160-010
3/64	.0469	3/4	1-3/4	5-160-015
1/16	.0625	7/8	1-7/8	5-160-020
5/64	.0781	1	2	5-160-025
3/32	.0938	1-1/4	2-1/4	5-160-030
7/64	.1094	1-1/2	2-5/8	5-160-035
1/8	.1250	1-5/8	2-3/4	5-160-040
9/64	.1406	1-3/4	2-7/8	5-160-045
5/32	.1562	2	3-1/8	5-160-050
11/64	.1719	2-1/8	3-1/4	5-160-055
3/16	.1875	2-5/16	3-1/2	5-160-060
13/64	.2031	2-7/16	3-5/8	5-160-065
7/32	.2188	2-1/2	3-3/4	5-160-070
15/64	.2344	2-5/8	3-7/8	5-160-075
1/4	.2500	2-3/4	4	5-160-080
17/64	.2565	2-7/8	4-1/8	5-160-085
9/32	.2812	2-15/16	4-1/4	5-160-090
19/64	.2969	3-1/16	4-3/8	5-160-095
5/16	.3125	3-3/16	4-1/2	5-160-100
21/64	.3281	3-5/16	4-5/8	5-160-105
11/32	.3438	3-7/16	4-3/4	5-160-110
23/64	.3594	3-1/2	4-7/8	5-160-115
3/8	.3750	3-5/8	5	5-160-120
25/64	.3906	3-3/4	5-1/8	5-160-125
13/32	.4062	3-7/8	5-1/4	5-160-130
27/64	.4219	3-15/16	5-1/2	5-160-135
7/16	.4375	4-1/16	5-5/8	5-160-140
29/64	.4531	4-3/16	5-5/8	5-160-145
15/32	.4688	4-5/16	5-3/4	5-160-150
31/64	.4844	4-3/8	5-7/8	5-160-155
1/2	.5000	4-1/2	6	5-160-160
33/64	.5156	4-13/16	6-5/8	5-160-165
17/32	.5313	4-13/16	6-5/8	5-160-170
35/64	.5469	4-13/16	6-5/8	5-160-175
9/16	.5625	4-13/16	6-5/8	5-160-180
37/64	.5781	4-13/16	6-5/8	5-160-185
19/32	.5938	5-3/16	7-1/4	5-160-190
39/64	.6094	5-3/16	7-1/4	5-160-195
5/8	.6250	5-3/16	7-1/4	5-160-200
41/64	.6406	5-3/16	7-1/4	5-160-205
21/32	.6563	5-3/16	7-1/4	5-160-210
43/64	.6719	5-5/8	7-5/8	5-160-215
11/16	.6875	5-5/8	7-5/8	5-160-220
45/64	.7031	5-5/8	7-5/8	5-160-221
23/32	.7188	5-5/8	7-5/8	5-160-222
47/64	.7344	5-5/8	7-5/8	5-160-223
3/4	.7500	5-5/8	7-5/8	5-160-225
49/64	.7656	6-1/8	8-1/8	5-160-226
25/32	.7812	6-1/8	8-1/8	5-160-230



Twist Drill Sets

Set Size	Sizes Included in Kit	Case	HSS GP Part Number
13 Piece	1/16" to 1/4" by 64ths	Metal Case	5-160-600
15 Piece	1/16" to 1/2" by 32nds	Plastic Case	5-160-905
29 Piece	1/16" to 1/2" by 64ths	Plastic Case	5-160-705

See page 225 for all our drill sets

Twist Drills and Drill Sets

Wire Gage Diameters – Straight Shank

- Jobber Length
- General Purpose (GP) 118 point
- High Speed Steel Black Oxide
- Designed for high production drilling in a wide range of materials
- Performs well in various operating conditions

Size	Decimal	Flute Length	OAL	HSS GP Part Number
80	.0135	1/8	3/4	5-170-400
79	.0145	1/8	3/4	5-170-395
78	.0160	3/16	7/8	5-170-390
77	.0180	3/16	7/8	5-170-385
76	.0200	3/16	7/8	5-170-380
75	.0210	1/4	1	5-170-375
74	.0225	1/4	1	5-170-370
73	.0240	5/16	1-1/8	5-170-365
72	.0250	5/16	1-1/8	5-170-360
71	.0260	3/8	1-1/4	5-170-355
70	.0280	3/8	1-1/4	5-170-350
69	.0292	1/2	1-3/8	5-170-345
68	.0310	1/2	1-3/8	5-170-340
67	.0320	1/2	1-3/8	5-170-335
66	.0330	1/2	1-3/8	5-170-330
65	.0350	5/8	1-1/2	5-170-325
64	.0360	5/8	1-1/2	5-170-320
63	.0370	5/8	1-1/2	5-170-315
62	.0380	5/8	1-1/2	5-170-310
61	.0390	11/16	1-5/8	5-170-305
60	.0400	11/16	1-5/8	5-170-300
59	.0410	11/16	1-5/8	5-170-295
58	.0420	11/16	1-5/8	5-170-290
57	.0430	3/4	1-3/4	5-170-285
56	.0465	3/4	1-3/4	5-170-280
55	.0520	7/8	1-7/8	5-170-275
54	.0550	7/8	1-7/8	5-170-270
53	.0595	7/8	1-7/8	5-170-265
52	.0635	7/8	1-7/8	5-170-260
51	.0670	1	2	5-170-255
50	.0700	1	2	5-170-250
49	.0730	1	2	5-170-245
48	.0760	1	2	5-170-240
47	.0785	1	2	5-170-235
46	.0810	1-1/8	2-1/8	5-170-230
45	.0820	1-1/8	2-1/8	5-170-225
44	.0860	1-1/8	2-1/8	5-170-220
43	.0890	1-1/4	2-1/4	5-170-215
42	.0935	1-1/4	2-1/4	5-170-210
41	.0960	1-3/8	2-3/8	5-170-205
40	.0980	1-3/8	2-3/8	5-170-200
39	.0995	1-3/8	2-3/8	5-170-195
38	.1015	1-7/16	2-1/2	5-170-190
37	.1040	1-7/16	2-1/2	5-170-185
36	.1065	1-7/16	2-1/2	5-170-180

Sold in the following packages quantities:
All wire gage diameters are 10 / pack

Size	Decimal	Flute Length	OAL	HSS GP Part Number
35	.1100	1-1/2	2-5/8	5-170-175
34	.1110	1-1/2	2-5/8	5-170-170
33	.1130	1-1/2	2-5/8	5-170-165
32	.1160	1-5/8	2-3/4	5-170-160
31	.1200	1-5/8	2-3/4	5-170-155
30	.1285	1-5/8	2-3/4	5-170-150
29	.1360	1-3/4	2-7/8	5-170-145
28	.1405	1-3/4	2-7/8	5-170-140
27	.1140	1-7/8	3	5-170-135
26	.1470	1-7/8	3	5-170-130
25	.1495	1-7/8	3	5-170-125
24	.1520	2	3-1/8	5-170-120
23	.1540	2	3-1/8	5-170-115
22	.1570	2	3-1/8	5-170-110
21	.1590	2-1/8	3-1/4	5-170-105
20	.1610	2-1/8	3-1/4	5-170-100
19	.1660	2-1/8	3-1/4	5-170-095
18	.1695	2-1/8	3-1/4	5-170-090
17	.1730	2-3/16	3-3/8	5-170-085
16	.1770	2-3/16	3-3/8	5-170-080
15	.1880	2-3/16	3-3/8	5-170-075
14	.1820	2-3/16	3-3/8	5-170-070
13	.1850	2-5/16	3-1/2	5-170-065
12	.1890	2-5/16	3-1/2	5-170-060
11	.1910	2-5/16	3-1/2	5-170-055
10	.1935	2-7/16	3-5/8	5-170-050
9	.1960	2-7/16	3-5/8	5-170-045
8	.1990	2-7/16	3-5/8	5-170-040
7	.2010	2-7/16	3-5/8	5-170-035
6	.2040	2-1/2	3-3/4	5-170-030
5	.2055	2-1/2	3-3/4	5-170-025
4	.2090	2-1/2	3-3/4	5-170-020
3	.2130	2-1/2	3-3/4	5-170-015
2	.2210	2-5/8	3-7/8	5-170-010
1	.2280	2-5/8	3-7/8	5-170-005

Sold in the following packages quantities:
All wire gage diameters are 10 / pack

Twist Drill Sets

Set Size	Sizes Included in Kit	Case	HSS GP Part Number
60 Piece	1 to 60 Complete	Metal	5-170-505

See page 225 for all our drill sets



HSS Jobber Drills

Cutting Tools

DRILLS

Twist Drills and Drill Sets

Letter Diameters – Straight Shank

- Jobber Length
- General Purpose (GP) 118 point High Speed Steel Black Oxide
- ANSI Standard



Size	Decimal Equiv.	Flute Length	Overall Length	HSS GP Part Number
A	.2340	2-5/8	3-7/8	5-180-005
B	.2380	2-3/4	4	5-180-010
C	.2420	2-3/4	4	5-180-015
D	.2460	2-3/4	4	5-180-020
E	.2500	2-3/4	4	5-180-025
F	.2570	2-7/8	4-1/8	5-180-030
G	.2610	2-7/8	4-1/8	5-180-035
H	.2660	2-7/8	4-1/8	5-180-040
I	.2720	2-7/8	4-1/8	5-180-045
J	.2770	2-7/8	4-1/8	5-180-050
K	.2810	2-15/16	4-1/4	5-180-055
L	.2900	2-15/16	4-1/4	5-180-060
M	.2950	3-1/16	4-3/8	5-180-065
N	.3020	3-1/16	4-3/8	5-180-070
O	.3160	3-3/16	4-1/2	5-180-075
P	.3230	3-5/16	4-5/8	5-180-080
Q	.3320	3-7/16	4-3/4	5-180-085
R	.3390	3-7/16	4-3/4	5-180-090
S	.3480	3-1/2	4-7/8	5-180-095
T	.3580	3-1/2	4-7/8	5-180-100
U	.3680	3-5/8	5	5-180-105
V	.3770	3-5/8	5	5-180-110
W	.3860	3-3/4	5-1/8	5-180-115
X	.3970	3-3/4	5-1/8	5-180-120
Y	.4040	3-7/8	5-1/4	5-180-125
Z	.4130	3-7/8	5-1/4	5-180-130

Sold in the following package quantities:

A thru I = 10/envelope

J thru Z = 5/envelope

26 Piece Drill Sets

Sizes Included in Kit	Case	HSS GP Part Number
A to Z Complete	included	5-180-505

115 Piece 3-in-1 Master Drill Sets

Sizes Included in Kit	Case	HSS GP Part Number
Fractional: 1/16" to 1/4" by 64ths Wire Gage: #1 to #60 Complete Letter: A to Z Complete	included	5-199-005

See page 39 for additional drill sets

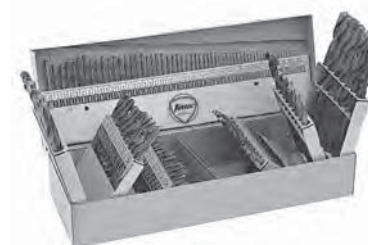



Twist Drills

Metric Diameters – Straight Shank

- General Purpose (GP) 118 point
- High Speed Steel, ISO Standards
- Black Oxide
- Jobber Length



Dia mm	Dia inch	Flute Length mm	Overall Length mm	Part Number
0.30	.0118	3	19	5-161-018
0.35	.0138	4	19	5-161-021
0.40	.0157	5	20	5-161-024
0.45	.0177	5	20	5-161-026
0.50	.0197	6	22	5-161-028
0.55	.0217	7	24	5-161-031
0.60	.0236	7	24	5-161-034
0.65	.0256	8	26	5-161-037
0.70	.0276	9	28	5-161-040
0.75	.0295	9	28	5-161-043
0.80	.0315	10	30	5-161-045
0.85	.0335	10	30	5-161-047
0.90	.0354	11	32	5-161-049
0.95	.0374	11	32	5-161-051
1.00	.0394	12	34	5-161-053
1.05	.0413	12	34	5-161-054
1.10	.0433	14	36	5-161-055
1.15	.0452	14	36	5-161-056
1.20	.0472	16	38	5-161-057
1.25	.0492	16	38	5-161-058
1.30	.0512	16	38	5-161-059
1.35	.0531	18	40	5-161-060
1.40	.0551	18	40	5-161-061
1.45	.0570	18	40	5-161-062
1.50	.0591	18	40	5-161-063
1.55	.0610	20	43	5-161-064
1.60	.0630	20	43	5-161-065
1.65	.0650	20	43	5-161-066
1.70	.0669	20	43	5-161-067
1.75	.0689	22	46	5-161-068
1.80	.0709	22	46	5-161-069
1.85	.0728	22	46	5-161-070
1.90	.0748	22	46	5-161-071
1.95	.0767	24	46	5-161-072
2.00	.0787	24	49	5-161-073
2.05	.0807	24	49	5-161-074
2.10	.0827	24	49	5-161-075
2.15	.0846	27	53	5-161-076
2.20	.0866	27	53	5-161-077
2.25	.0886	27	53	5-161-078
2.30	.0906	27	53	5-161-079
2.35	.0925	27	53	5-161-0795
2.40	.0945	30	57	5-161-080
2.45	.0964	30	57	5-161-081
2.50	.0984	30	57	5-161-082
2.55	.1003	30	57	5-161-083
2.60	.1024	30	57	5-161-084
2.65	.1043	30	57	5-161-085
2.70	.1063	33	61	5-161-086

Dia mm	Dia inch	Flute Length mm	Overall Length mm	Part Number
2.75	.1083	33	61	5-161-087
2.80	.1102	33	61	5-161-088
2.85	.1122	33	61	5-161-089
2.90	.1142	33	61	5-161-090
2.95	.1161	33	61	5-161-091
3.00	.1181	33	61	5-161-092
3.10	.1220	36	65	5-161-093
3.15	.1240	36	65	5-161-094
3.20	.1260	36	65	5-161-095
3.25	.1280	36	65	5-161-0955
3.30	.1299	36	65	5-161-096
3.40	.1339	39	70	5-161-097
3.50	.1378	39	70	5-161-098
3.55	.1397	39	70	5-161-099
3.60	.1417	39	70	5-161-100
3.70	.1457	39	70	5-161-101
3.75	.1476	39	75	5-161-102
3.80	.1496	43	75	5-161-103
3.90	.1535	43	75	5-161-104
4.00	.1575	43	75	5-161-105
4.10	.1614	43	75	5-161-106
4.20	.1654	43	75	5-161-107
4.25	.1673	43	75	5-161-1075
4.30	.1693	47	80	5-161-108
4.40	.1732	47	80	5-161-109
4.50	.1772	47	80	5-161-110
4.60	.1811	47	80	5-161-111
4.70	.1850	47	80	5-161-112
4.75	.1870	47	80	5-161-1125
4.80	.1890	52	86	5-161-113
4.90	.1929	52	86	5-161-114
5.00	.1969	52	86	5-161-115
5.10	.2008	52	86	5-161-116
5.20	.2047	52	86	5-161-117
5.25	.2067	52	86	5-161-118
5.30	.2087	52	86	5-161-119
5.40	.2126	57	93	5-161-120
5.50	.2165	57	93	5-161-121
5.60	.2205	57	93	5-161-122
5.70	.2244	57	93	5-161-123
5.75	.2264	57	93	5-161-1230
5.80	.2283	57	93	5-161-124
5.90	.2323	57	93	5-161-125
6.0	.2362	57	93	5-161-126
6.1	.2402	63	101	5-161-127
6.2	.2441	63	101	5-161-128
6.25	.2461	63	101	5-161-129
6.3	.2480	63	101	5-161-130
6.4	.2520	63	101	5-161-131
6.5	.2560	63	101	5-161-132
6.6	.2598	63	101	5-161-133
6.7	.2638	63	101	5-161-134
6.8	.2677	69	109	5-161-135

Sold in the following package quantities:
 thru 6.7 mm = 10/envelope
 6.8 mm thru 13.00 mm = 5/envelope
 over 13.00 mm = 1/tube



HSS Jobber Drills

Cutting Tools

DRILLS

Twist Drills (continued)

Metric Diameters – Straight Shank

- Genral Purpose (GP) 118 point High Speed Steel, ISO Standards
- Black Oxide



Dia mm	Dia inch	Flute Length	Overall Length mm	Part Number
6.9	.2717	69	109	5-161-136
7.0	.2756	69	109	5-161-137
7.1	.2795	69	109	5-161-138
7.2	.2835	69	109	5-161-139
7.25	.2854	69	109	5-161-140
7.3	.2874	69	109	5-161-141
7.4	.2913	69	109	5-161-142
7.5	.2953	69	109	5-161-143
7.6	.2992	75	117	5-161-144
7.7	.3031	75	117	5-161-145
7.8	.3071	75	117	5-161-146
7.9	.3110	75	117	5-161-147
8.0	.3150	75	117	5-161-148
8.1	.3189	75	117	5-161-149
8.2	.3228	75	117	5-161-150
8.25	.3248	75	117	5-161-151
8.3	.3268	75	117	5-161-152
8.4	.3307	75	117	5-161-153
8.5	.3346	75	117	5-161-154
8.6	.3386	81	125	5-161-155
8.7	.3425	81	125	5-161-156
8.8	.3465	81	125	5-161-157
8.9	.3504	81	125	5-161-158
9.0	.3543	81	125	5-161-159
9.1	.3583	81	125	5-161-160
9.2	.3622	81	125	5-161-161
9.25	.3642	81	125	5-161-162
9.3	.3661	81	125	5-161-163
9.4	.3701	81	125	5-161-164
9.5	.3740	81	125	5-161-165
9.6	.3780	87	133	5-161-166
9.7	.3819	87	133	5-161-167
9.8	.3858	87	133	5-161-168
9.9	.3898	87	133	5-161-169
10.0	.3937	87	133	5-161-170
10.1	.3976	87	133	5-161-171
10.2	.4016	87	133	5-161-172
10.25	.4035	87	133	5-161-173
10.3	.4055	87	133	5-161-174
10.4	.4094	87	133	5-161-175
10.5	.4134	87	133	5-161-176
10.6	.4173	87	133	5-161-177
10.7	.4213	94	142	5-161-178
10.8	.4252	94	142	5-161-179
10.9	.4291	94	142	5-161-180
11.0	.4331	94	142	5-161-181
11.1	.4370	94	142	5-161-182
11.2	.4409	94	142	5-161-183
11.3	.4449	94	142	5-161-184

Dia mm	Dia inch	Flute Length	Overall Length mm	Part Number
11.4	.4488	94	142	5-161-185
11.5	.4528	94	142	5-161-186
11.6	.4567	94	142	5-161-187
11.7	.4606	94	142	5-161-188
11.8	.4646	94	142	5-161-189
11.9	.4685	101	151	5-161-190
12.0	.4724	101	151	5-161-191
12.1	.4764	101	151	5-161-192
12.2	.4803	101	151	5-161-1935
12.25	.4823	101	151	5-161-193
12.3	.4843	101	151	5-161-194
12.4	.4882	101	151	5-161-195
12.5	.4921	101	151	5-161-196
12.6	.4961	101	151	5-161-197
12.8	.5039	101	151	5-161-199
12.9	.5079	101	151	5-161-200
13.0	.5118	101	151	5-161-201
13.1	.5187	101	151	5-161-202
13.2	.5197	101	151	5-161-203
13.3	.5236	5-161-165	160	5-161-204
13.4	.5276	101	160	5-161-205
13.5	.5315	108	160	5-161-206
13.6	.5354	108	160	5-161-207
13.7	.5394	108	160	5-161-208
13.75	.5413	108	160	5-161-209
13.8	.5433	108	160	5-161-210
13.9	.5472	108	160	5-161-211
14.0	.5512	108	160	5-161-212
14.25	.5610	114	169	5-161-213
14.5	.5709	114	169	5-161-214
14.75	.5807	114	169	5-161-215
15.0	.5906	114	169	5-161-216
15.25	.6004	120	178	5-161-217
15.5	.6102	120	178	5-161-218
15.75	.6201	120	178	5-161-219
16.0	.6299	120	178	5-161-220
16.25	.6398	125	184	5-161-221
16.5	.6495	125	184	5-161-222
16.75	.6594	125	184	5-161-223
17.0	.6693	125	184	5-161-224
17.25	.6791	130	191	5-161-225
17.5	.6890	130	191	5-161-226
17.75	.6988	130	191	5-161-227
18.0	.7087	130	191	5-161-228
18.25	.7185	135	198	5-161-229
18.5	.7283	135	198	5-161-230
18.75	.7382	135	198	5-161-231
19.0	.7480	135	198	5-161-232
19.25	.7579	140	205	5-161-233
19.5	.7677	140	205	5-161-234
19.75	.7776	140	205	5-161-235
20.0	.7874	140	205	5-161-236

Sold in package the following package quantities:
 thru 6.7 mm = 10/envelope
 6.8 mm thru 13.00 mm = 5/envelope
 over 13.00 mm = 1/tube

General Purpose HSS TiN Coated Jobber Drills with 118° Point

The basic all purpose drill of the industry just got better, TiN coatings offers the ability to increase speeds and feeds with extended tool life



- Series 5-131 Fractional – page 24
- Series 5-132 Wire Gage – page 25
- Series 5-133 Letter – page 26
- Series 5-134 Metric – page 27

Heavy Duty HSS TiN Coated Jobber Drills with 135° Split Point

For rugged applications that do not require the heat retention properties of Cobalt, this heavy duty drill is a great economical alternative to Cobalt, the TiN coating offers wear and heat resistance as well as increased surface hardness resulting in the ability to run at higher speeds and feeds. In addition to the TiN coating the split point feature reduces walking with its self centering ability



- Series 5-141 Fractional – page 29
- Series 5-142 Wire Gage – page 30
- Series 5-143 Letter – page 31
- Series 5-144 Metric – page 32

Heavy Duty Cobalt Jobber Drills with 135° Split Point

Cobalt offers increase heat resistance. Recommended for drilling high temperature Alloys such as Titanium and high Nickel Alloys



- # 53 (.0595") and smaller have 135 point only – no notch
- Cobalt drills are amber/straw in color
- Series 5-158 Fractional – page 34
- Series 5-175 Wire Gage – page 35
- Series 5-185 Letter – page 36
- Series 5-174 Metric – page 37

All jobber drills sold in the following package quantities:

Fractional: thru 17/64" = 10/envelope
9/32" thru 1/2" = 5/envelope
over 1/2" = 1/tube

Letter: A thru I = 10/envelope
J thru Z = 5/envelope

Wire: all = 10/envelope

Metric: thru 6.7 mm = 10/envelope
6.8 mm thru 13.00 mm = 5/envelope
over 13.00 mm = 1/tube





HSS TiN Coated Jobber Drills

Cutting Tools

General Purpose HSS TiN Coated Jobber Drills with 118° Point

Fractional Diameters



Sold in the following package quantities:

1/64" thru 17/64" = 10/envelope

6/32" thru 1/2" = 5/envelope

over 1/2" = 1/tube

DRILLS

Fractional Dia	Decimal Equivalent	Flute Length	OAL	Part Number
1/64	.0156	3/16	3/4	5-131-0016
1/32	.0313	1/2	1-3/8	5-131-0031
3/64	.0469	3/4	1-3/4	5-131-0047
1/16	.0625	7/8	1-7/8	5-131-0063
5/64	.0781	1	2	5-131-0078
3/32	.0938	1-1/4	2-1/4	5-131-0094
7/64	.1094	1-1/2	2-5/8	5-131-0109
1/8	.1250	1-5/8	2-3/4	5-131-0125
9/64	.1406	1-3/4	2-7/8	5-131-0141
5/32	.1563	2	3-1/8	5-131-0156
11/64	.1719	2-1/8	3-1/4	5-131-0172
3/16	.1875	2-5/16	3-1/2	5-131-0187
13/64	.2031	2-7/16	3-5/8	5-131-0203
7/32	.2188	2-1/2	3-3/4	5-131-0219
15/64	.2344	2-5/8	3-7/8	5-131-0234
1/4	.2500	2-3/4	4	5-131-0250
17/64	.2656	2-7/8	4-1/8	5-131-0266
9/32	.2813	2-15/16	4-1/4	5-131-0281
19/64	.2969	3-1/16	4-3/8	5-131-0297
5/16	.3125	3-3/16	4-1/2	5-131-0313
21/64	.3281	3-5/16	4-5/8	5-131-0328
11/32	.3438	3-7/16	4-3/4	5-131-0344
23/64	.3594	3-1/2	4-7/8	5-131-0359
3/8	.3750	3-5/8	5	5-131-0375
25/64	.3906	3-3/4	5-1/8	5-131-0391
13/32	.4063	3-7/8	5-1/4	5-131-0406
27/64	.4219	3-15/16	5-3/8	5-131-0422
7/16	.4375	4-1/16	5-1/2	5-131-0437
29/64	.4531	4-3/16	5-5/8	5-131-0453
15/32	.4688	4-5/16	5-3/4	5-131-0469
31/64	.4844	4-3/8	5-7/8	5-131-0484
1/2	.5000	4-1/2	6	5-131-0500
33/64	.5156	4-13/16	6-5/8	5-131-0515
17/32	.5313	4-13/16	6-5/8	5-131-0531
35/64	.5156	4-13/16	6-5/8	5-131-0547
9/16	.5625	4-13/16	6-5/8	5-131-0563
37/64	.5781	4-13/16	6-5/8	5-131-0578
19/32	.5938	5-3/16	7-1/8	5-131-0594
39/64	.6094	5-3/16	7-1/8	5-131-0609
5/8	.6250	5-3/16	7-1/8	5-131-0625
41/64	.6406	5-3/16	7-1/8	5-131-0641
21/32	.6563	5-3/16	7-1/8	5-131-0656
43/64	.6719	5-5/8	7-5/8	5-131-0672
11/16	.6875	5-5/8	7-5/8	5-131-0687

HSS TiN Coated Jobber Drills



General Purpose HSS TiN Coated Jobber Drills with 118° Point

Wire Gage Diameters



Wire Gage Dia	Decimal Equivalent	Flute Length	OAL	Part Number
80	.0135	1/8	3/4	5-132-0013
79	.0145	1/8	3/4	5-132-0014
78	.0160	3/16	7/8	5-132-0016
77	.0180	3/16	7/8	5-132-0018
76	.0200	3/16	7/8	5-132-0020
75	.0210	1/4	1	5-132-0021
74	.0225	1/4	1	5-132-0022
73	.0240	5/16	1-1/8	5-132-0024
72	.0250	5/16	1-1/8	5-132-0025
71	.0260	3/8	1-1/4	5-132-0026
70	.0280	3/8	1-1/4	5-132-0028
69	.0292	1/2	1-3/8	5-132-0029
68	.0310	1/2	1-3/8	5-132-0031
67	.0320	1/2	1-3/8	5-132-0032
66	.0330	1/2	1-3/8	5-132-0033
65	.0350	5/8	1-1/2	5-132-0035
64	.0360	5/8	1-1/2	5-132-0036
63	.0370	5/8	1-1/2	5-132-0037
62	.0380	5/8	1-1/2	5-132-0038
61	.0390	11/16	1-5/8	5-132-0039
60	.0400	11/16	1-5/8	5-132-0040
59	.0410	11/16	1-5/8	5-132-0041
58	.0420	11/16	1-5/8	5-132-0042
57	.0430	3/4	1-3/4	5-132-0043
56	.0465	3/4	1-3/4	5-132-0046
55	.0520	7/8	1-7/8	5-132-0052
54	.0550	7/8	1-7/8	5-132-0055
53	.0595	7/8	1-7/8	5-132-0059
52	.0635	7/8	1-7/8	5-132-0063
51	.0670	1	2	5-132-0067
50	.0700	1	2	5-132-0070
49	.0730	1	2	5-132-0073
48	.0760	1	2	5-132-0076
47	.0785	1	2	5-132-0078
46	.0810	1-1/8	2-1/8	5-132-0081
45	.0820	1-1/8	2-1/8	5-132-0082
44	.0860	1-1/8	2-1/8	5-132-0086
43	.0890	1-1/4	2-1/4	5-132-0089
42	.0935	1-1/4	2-1/4	5-132-0093
41	.0960	1-3/8	2-3/8	5-132-0096

Wire Gage Dia	Decimal Equivalent	Flute Length	OAL	Part Number
40	.0980	1-3/8	2-3/8	5-132-0098
39	.0995	1-3/8	2-3/8	5-132-0099
38	.1015	1-7/16	2-1/2	5-132-0101
37	.1040	1-7/16	2-1/2	5-132-0104
36	.1065	1-7/16	2-1/2	5-132-0106
35	.1100	1-1/2	2-5/8	5-132-0110
34	.1110	1-1/2	2-5/8	5-132-0111
33	.1130	1-1/2	2-5/8	5-132-0113
32	.1160	1-5/8	2-3/4	5-132-0116
31	.1200	1-5/8	2-3/4	5-132-0120
30	.1285	1-5/8	2-3/4	5-132-0128
29	.1360	1-3/4	2-7/8	5-132-0136
28	.1405	1-3/4	2-7/8	5-132-0140
27	.1440	1-7/8	3	5-132-0114
26	.1470	1-7/8	3	5-132-0147
25	.1495	1-7/8	3	5-132-0149
24	.1520	2	3-1/8	5-132-0152
23	.1540	2	3-1/8	5-132-0154
22	.1570	2	3-1/8	5-132-0157
21	.1590	2-1/8	3-1/4	5-132-0159
20	.1610	2-1/8	3-1/4	5-132-0161
19	.1660	2-1/8	3-1/4	5-132-0166
18	.1695	2-1/8	3-1/4	5-132-0169
17	.1730	2-3/16	3-3/8	5-132-0173
16	.1770	2-3/16	3-3/8	5-132-0177
15	.1800	2-3/16	3-3/8	5-132-0188
14	.1820	2-3/16	3-3/8	5-132-0182
13	.1850	2-5/16	3-1/2	5-132-0185
12	.1890	2-5/16	3-1/2	5-132-0189
11	.1910	2-5/16	3-1/2	5-132-0191
10	.1935	2-7/16	3-5/8	5-132-0193
9	.1960	2-7/16	3-5/8	5-132-0196
8	.1990	2-7/16	3-5/8	5-132-0199
7	.2010	2-7/16	3-5/8	5-132-0201
6	.2040	2-1/2	3-3/4	5-132-0204
5	.2055	2-1/2	3-3/4	5-132-0205
4	.2090	2-1/2	3-3/4	5-132-0209
3	.2130	2-1/2	3-3/4	5-132-0213
2	.2210	2-5/8	3-7/8	5-132-0221
1	.2280	2-5/8	3-7/8	5-132-0228

Sold in the following packages quantities:
All wire gage diameters are 10 / pack

DRILLS



HSS TiN Coated Jobber Drills

Cutting Tools

DRILLS

General Purpose HSS TiN Coated Jobber Drills with 118° Point

Letter Diameters



Sold in the following package quantities:

A thru I = 10/envelope

J thru Z = 5/envelope

Letter Dia	Decimal Equivalent	Flute Length	OAL	Part Number
A	.2340	2-5/8	3-7/8	5-133-0234
B	.2380	2-3/4	4	5-133-0238
C	.2420	2-3/4	4	5-133-0242
D	.2460	2-3/4	4	5-133-0246
F	.2570	2-7/8	4-1/8	5-133-0257
G	.2610	2-7/8	4-1/8	5-133-0261
H	.2660	2-7/8	4-1/8	5-133-0266
I	.2720	2-7/8	4-1/8	5-133-0272
J	.2770	2-7/8	4-1/8	5-133-0277
K	.2810	2-15/16	4-1/4	5-133-0281
L	.2900	2-15/16	4-1/4	5-133-0290
M	.2950	3-1/16	4-3/8	5-133-0295
N	.3020	3-1/16	4-3/8	5-133-0302
O	.3160	3-3/16	4-1/2	5-133-0316
P	.3230	3-5/16	4-5/8	5-133-0323
Q	.3320	3-7/16	4-3/4	5-133-0332
R	.3390	3-7/16	4-3/4	5-133-0339
S	.3480	3-1/2	4-7/8	5-133-0348
T	.3580	3-1/2	4-7/8	5-133-0358
U	.3680	3-5/8	5	5-133-0368
V	.3770	3-5/8	5	5-133-0377
W	.3860	3-3/4	5-1/8	5-133-0386
X	.3970	3-3/4	5-1/8	5-133-0397
Y	.4040	3-7/8	5-1/4	5-133-0404
Z	.4130	3-7/8	5-1/4	5-133-0413

HSS TiN Coated Jobber Drills



General Purpose HSS TiN Coated Jobber Drills with 118° Point

Metric Diameters

Sold in the following package quantities: thru 6.7 mm = 10/envelope
 6.8 mm thru 13.00 mm = 5/envelope
 over 13.00 mm = 1/tube



Metric Dia	Decimal Equivalent	Flute Length	OAL	Part Number
.30	.0118	3	19	5-134-0012
.35	.0138	4	19	5-134-0014
.40	.0157	5	20	5-134-0016
.45	.0177	5	20	5-134-0018
.50	.0197	6	22	5-134-0020
.55	.0217	7	24	5-134-0022
.60	.0236	7	24	5-134-0024
.65	.0256	8	26	5-134-0026
.70	.0276	9	28	5-134-0028
.75	.0295	9	28	5-134-0029
.80	.0315	10	30	5-134-0031
.85	.0335	10	30	5-134-0033
.90	.0354	11	32	5-134-0035
.95	.0374	11	32	5-134-0037
1.00	.0394	12	34	5-134-0039
1.05	.0413	12	34	5-134-0041
1.10	.0433	14	36	5-134-0043
1.15	.0453	14	36	5-134-0045
1.20	.0472	16	38	5-134-0047
1.25	.0492	16	38	5-134-0049
1.30	.0512	16	38	5-134-0051
1.35	.0531	18	40	5-134-0053
1.40	.0551	18	40	5-134-0055
1.45	.0571	18	40	5-134-0057
1.50	.0591	18	40	5-134-0059
1.55	.0610	20	43	5-134-0061
1.60	.0630	20	43	5-134-0063
1.65	.0650	20	43	5-134-0065
1.70	.0669	20	43	5-134-0067
1.75	.0689	22	46	5-134-0069
1.80	.0709	22	46	5-134-0071
1.85	.0728	22	46	5-134-0073
1.90	.0748	22	46	5-134-0075
1.95	.0768	24	49	5-134-0077
2.00	.0787	24	49	5-134-0079
2.05	.0807	24	49	5-134-0081
2.10	.0827	24	49	5-134-0083
2.15	.0846	27	53	5-134-0085
2.20	.0866	27	53	5-134-0087
2.25	.0886	27	53	5-134-0089
2.30	.0906	27	53	5-134-0091
2.35	.0925	27	53	5-134-0092
2.40	.0945	30	57	5-134-0094
2.45	.0965	30	57	5-134-0096
2.50	.0984	30	57	5-134-0098
2.55	.1004	30	57	5-134-0100
2.60	.1024	30	57	5-134-0102
2.65	.1043	30	57	5-134-0104
2.70	.1063	33	61	5-134-0106
2.75	.1083	33	61	5-134-0108
2.80	.1102	33	61	5-134-0110
2.85	.1122	33	61	5-134-0112
2.90	.1142	33	61	5-134-0114
2.95	.1161	33	61	5-134-0116

Metric Dia	Decimal Equivalent	Flute Length	OAL	Part Number
3.00	.1181	33	61	5-134-0118
3.10	.1220	36	65	5-134-0122
3.15	.1240	36	65	5-134-0124
3.20	.1260	36	65	5-134-0126
3.25	.1280	36	65	5-134-0128
3.30	.1299	36	65	5-134-0130
3.40	.1339	39	70	5-134-0133
3.50	.1378	39	70	5-134-0138
3.60	.1417	39	70	5-134-0142
3.70	.1457	39	70	5-134-0146
3.75	.1476	39	75	5-134-0148
3.80	.1496	43	75	5-134-0150
3.90	.1535	43	75	5-134-0153
4.00	.1575	43	75	5-134-0157
4.10	.1614	43	75	5-134-0161
4.20	.1654	43	75	5-134-0165
4.25	.1673	43	75	5-134-0167
4.30	.1693	47	80	5-134-0169
4.40	.1732	47	80	5-134-0173
4.50	.1772	47	80	5-134-0172
4.60	.1811	47	80	5-134-0181
4.70	.1850	47	80	5-134-0185
4.75	.1870	47	80	5-134-0187
4.80	.1890	52	86	5-134-0189
4.90	.1929	52	86	5-134-0193
5.00	.1969	52	86	5-134-0197
5.10	.2008	52	86	5-134-0201
5.20	.2047	52	86	5-134-0205
5.25	.2067	52	86	5-134-0207
5.30	.2087	52	86	5-134-0209
5.40	.2126	57	93	5-134-0213
5.50	.2165	57	93	5-134-0216
5.60	.2205	57	93	5-134-0220
5.70	.2244	57	93	5-134-0224
5.75	.2264	57	93	5-134-0226
5.80	.2283	57	93	5-134-0228
5.90	.2323	57	93	5-134-0232
6.00	.2362	57	93	5-134-0236
6.10	.2402	63	101	5-134-0240
6.20	.2441	63	101	5-134-0244
6.25	.2461	63	101	5-134-0246
6.30	.2480	63	101	5-134-0248
6.40	.2520	63	101	5-134-0252
6.50	.2559	63	101	5-134-0256
6.60	.2598	63	101	5-134-0260
6.70	.2638	63	101	5-134-0264
6.75	.2657	69	109	5-134-0266
6.80	.2677	69	109	5-134-0268
6.90	.2717	69	109	5-134-0272
7.00	.2756	69	109	5-134-0276
7.10	.2795	69	109	5-134-0279
7.20	.2835	69	109	5-134-0283
7.25	.2854	69	109	5-134-0285
7.30	.2874	69	109	5-134-0287

DRILLS



HSS TiN Coated Jobber Drills

Cutting Tools

DRILLS

General Purpose HSS TiN Coated Jobber Drills with 118° Point (continued)

Metric Diameters

Sold in the following package quantities: thru 6.7 mm = 10/envelope
 6.8 mm thru 13.00 mm = 5/envelope
 over 13.00 mm = 1/tube



Metric Dia	Decimal Equivalent	Flute Length	OAL	Part Number
7.40	.2913	69	109	5-134-0291
7.50	.2953	69	109	5-134-0295
7.60	.2992	75	117	5-134-0299
7.70	.3031	75	117	5-134-0303
7.80	.3071	75	117	5-134-0307
7.90	.3110	75	117	5-134-0311
8.00	.3150	75	117	5-134-0315
8.10	.3189	75	117	5-134-0319
8.20	.3228	75	117	5-134-0323
8.25	.3248	75	117	5-134-0325
8.30	.3268	75	117	5-134-0327
8.40	.3307	75	117	5-134-0331
8.50	.3346	75	117	5-134-0335
8.60	.3386	81	125	5-134-0337
8.70	.3425	81	125	5-134-0342
8.80	.3465	81	125	5-134-0346
8.90	.3504	81	125	5-134-0350
9.00	.3543	81	125	5-134-0354
9.10	.3583	81	125	5-134-0358
9.20	.3622	81	125	5-134-0362
9.25	.3642	81	125	5-134-0364
9.30	.3661	81	125	5-134-0366
9.40	.3701	81	125	5-134-0370
9.50	.3740	81	125	5-134-0374
9.60	.3780	87	133	5-134-0376
9.70	.3819	87	133	5-134-0382
9.80	.3858	87	133	5-134-0386
9.90	.3898	87	133	5-134-0389
10.00	.3937	87	133	5-134-0394
10.10	.3976	87	133	5-134-0398
10.20	.4016	87	133	5-134-0402
10.25	.4035	87	133	5-134-0403
10.30	.4055	87	133	5-134-0405
10.40	.4094	87	133	5-134-0409
10.50	.4134	87	133	5-134-0413
10.60	.4173	87	133	5-134-0417
10.70	.4213	94	142	5-134-0421
10.80	.4252	94	142	5-134-0425
10.90	.4291	94	142	5-134-0429
11.00	.4331	94	142	5-134-0433
11.10	.4370	94	142	5-134-0437
11.20	.4409	94	142	5-134-0441
11.30	.4449	94	142	5-134-0445
11.40	.4488	94	142	5-134-0449
11.50	.4528	94	142	5-134-0453
11.60	.4567	94	142	5-134-0457
11.70	.4606	94	142	5-134-0461
11.80	.4646	94	142	5-134-0465

Metric Dia	Decimal Equivalent	Flute Length	OAL	Part Number
11.90	.4685	101	151	5-134-0468
12.00	.4724	101	151	5-134-0472
12.10	.4764	101	151	5-134-0476
12.20	.4803	101	151	5-134-0480
12.25	.4823	101	151	5-134-0482
12.30	.4843	101	151	5-134-0484
12.40	.4882	101	151	5-134-0488
12.50	.4921	101	151	5-134-0492
12.60	.4961	101	151	5-134-0496
12.80	.5039	101	151	5-134-0504
12.90	.5079	101	151	5-134-0508
13.00	.5118	101	151	5-134-0512
13.10	.5157	101	151	5-134-0516
13.20	.5197	101	151	5-134-0520
13.30	.5236	101	151	5-134-0524
13.40	.5276	101	151	5-134-0528
13.50	.5315	108	160	5-134-0531
13.60	.5354	108	160	5-134-0535
13.70	.5394	108	160	5-134-0539
13.75	.5413	108	160	5-134-0541
13.80	.5433	108	160	5-134-0543
13.90	.5472	108	160	5-134-0547
14.00	.5512	108	160	5-134-0551
14.25	.5610	114	169	5-134-0561
14.50	.5709	114	169	5-134-0571
14.75	.5807	114	169	5-134-0581
15.00	.5906	114	169	5-134-0591
15.25	.6004	120	178	5-134-0600
15.50	.6102	120	178	5-134-0610
15.75	.6201	120	178	5-134-0620
16.00	.6299	120	178	5-134-0630
16.25	.6398	125	184	5-134-0640
16.50	.6496	125	184	5-134-0649
16.75	.6594	125	184	5-134-0659
17.00	.6693	125	184	5-134-0669
17.26	.6794	130	191	5-134-0679
17.50	.6890	130	191	5-134-0689
17.75	.6988	130	191	5-134-0699
18.00	.7087	130	191	5-134-0709
18.25	.7185	135	198	5-134-0718
18.50	.7283	135	198	5-134-0728
18.75	.7382	135	198	5-134-0738
19.00	.7480	135	198	5-134-0748
19.25	.7579	140	205	5-134-0758
19.50	.7677	140	205	5-134-0768
19.75	.7776	140	205	5-134-0778
20.00	.7874	140	205	5-134-0787



Heavy Duty HSS TiN Coated Jobber Drills with 135° Split Point

Fractional Diameters



Sold in the following package quantities: 1/64" thru 17/64" = 10/envelope
 6/32" thru 1/2" = 5/envelope
 over 1/2" = 1/tube

Fractional Dia	Decimal Equivalent	Flute Length	OAL	Part Number
1/16	.0625	7/8	1-7/8	5-141-0063
5/64	.0781	1	2	5-141-0078
3/32	.0938	1-1/4	2-1/4	5-141-0094
7/64	.1094	1-1/2	2-5/8	5-141-0109
1/8	.1250	1-5/8	2-3/4	5-141-0125
9/64	.1406	1-3/4	2-7/8	5-141-0141
5/32	.1563	2	3-1/8	5-141-0156
11/64	.1719	2-1/8	3-1/4	5-141-0172
3/16	.1875	2-5/16	3-1/2	5-141-0187
13/64	.2031	2-7/16	3-5/8	5-141-0203
7/32	.2188	2-1/2	3-3/4	5-141-0219
15/64	.2344	2-5/8	3-7/8	5-141-0234
1/4	.2500	2-3/4	4	5-141-0250
17/64	.2656	2-7/8	4-1/8	5-141-0266
9/32	.2813	2-15/16	4-1/4	5-141-0281
19/64	.2969	3-1/16	4-3/8	5-141-0297
5/16	.3125	3-3/16	4-1/2	5-141-0313
21/64	.3281	3-5/16	4-5/8	5-141-0328
11/32	.3438	3-7/16	4-3/4	5-141-0344
23/64	.3594	3-1/2	4-7/8	5-141-0359
3/8	.3750	3-5/8	5	5-141-0375
25/64	.3906	3-3/4	5-1/8	5-141-0391
13/32	.4063	3-7/8	5-1/4	5-141-0406
27/64	.4219	3-15/16	5-3/8	5-141-0422
7/16	.4375	4-1/16	5-1/2	5-141-0437
29/64	.4531	4-3/16	5-5/8	5-141-0453
15/32	.4688	4-5/16	5-3/4	5-141-0469
31/64	.4844	4-3/8	5-7/8	5-141-0484
1/2	.5000	4-1/2	6	5-141-0500
33/64	.5156	4-13/16	6-5/8	5-141-0515
17/32	.5313	4-13/16	6-5/8	5-141-0531
35/64	.5156	4-13/16	6-5/8	5-141-0547
9/16	.5625	4-13/16	6-5/8	5-141-0563
37/64	.5781	4-13/16	6-5/8	5-141-0578
19/32	.5938	5-3/16	7-1/8	5-141-0594
39/64	.6094	5-3/16	7-1/8	5-141-0609
5/8	.6250	5-3/16	7-1/8	5-141-0625
41/64	.6406	5-3/16	7-1/8	5-141-0641
21/32	.6563	5-3/16	7-1/8	5-141-0656
43/64	.6719	5-5/8	7-5/8	5-141-0672
11/16	.6875	5-5/8	7-5/8	5-141-0687



HSS Heavy Duty TiN Coated Jobber Drills

Cutting Tools

DRILLS

Heavy Duty HSS TiN Coated Jobber Drills with 135° Split Point

Wire Gage Diameters



Sold in the following packages quantities:
All wire gage diameters are 10 / pack

Wire Gage Dia	Decimal Equivalent	Flute Length	OAL	Part Number
52	.0635	7/8	1-7/8	5-142-0063
51	.0670	1	2	5-142-0067
50	.0700	1	2	5-142-0070
49	.0730	1	2	5-142-0073
48	.0760	1	2	5-142-0076
47	.0785	1	2	5-142-0078
46	.0810	1-1/8	2-1/8	5-142-0081
45	.0820	1-1/8	2-1/8	5-142-0082
44	.0860	1-1/8	2-1/8	5-142-0086
43	.0890	1-1/4	2-1/4	5-142-0089
42	.0935	1-1/4	2-1/4	5-142-0093
41	.0960	1-3/8	2-3/8	5-142-0096
40	.0980	1-3/8	2-3/8	5-142-0098
39	.0995	1-3/8	2-3/8	5-142-0099
38	.1015	1-7/16	2-1/2	5-142-0101
37	.1040	1-7/16	2-1/2	5-142-0104
36	.1065	1-7/16	2-1/2	5-142-0106
35	.1100	1-1/2	2-5/8	5-142-0110
34	.1110	1-1/2	2-5/8	5-142-0111
33	.1130	1-1/2	2-5/8	5-142-0113
32	.1160	1-5/8	2-3/4	5-142-0116
31	.1200	1-5/8	2-3/4	5-142-0120
30	.1285	1-5/8	2-3/4	5-142-0128
29	.1360	1-3/4	2-7/8	5-142-0136
28	.1405	1-3/4	2-7/8	5-142-0140
27	.1440	1-7/8	3	5-142-0114
26	.1470	1-7/8	3	5-142-0147
25	.1495	1-7/8	3	5-142-0149
24	.1520	2	3-1/8	5-142-0152
23	.1540	2	3-1/8	5-142-0154
22	.1570	2	3-1/8	5-142-0157
21	.1590	2-1/8	3-1/4	5-142-0159
20	.1610	2-1/8	3-1/4	5-142-0161
19	.1660	2-1/8	3-1/4	5-142-0166
18	.1695	2-1/8	3-1/4	5-142-0169
17	.1730	2-3/16	3-3/8	5-142-0173
16	.1770	2-3/16	3-3/8	5-142-0177
15	.1800	2-3/16	3-3/8	5-142-0188
14	.1820	2-3/16	3-3/8	5-142-0182
13	.1850	2-5/16	3-1/2	5-142-0185
12	.1890	2-5/16	3-1/2	5-142-0189
11	.1910	2-5/16	3-1/2	5-142-0191
10	.1935	2-7/16	3-5/8	5-142-0193
9	.1960	2-7/16	3-5/8	5-142-0196
8	.1990	2-7/16	3-5/8	5-142-0199
7	.2010	2-7/16	3-5/8	5-142-0201
6	.2040	2-1/2	3-3/4	5-142-0204
5	.2055	2-1/2	3-3/4	5-142-0205
4	.2090	2-1/2	3-3/4	5-142-0209
3	.2130	2-1/2	3-3/4	5-142-0213
2	.2210	2-5/8	3-7/8	5-142-0221
1	.2280	2-5/8	3-7/8	5-142-0228

HSS Heavy Duty TiN Coated Jobber Drills



Cutting Tools

Heavy Duty HSS TiN Coated Jobber Drills with 135° Split Point

Letter Diameters



Sold in the following package quantities:

A thru I = 10/envelope

J thru Z = 5/envelope

Letter Dia	Decimal Equivalent	Flute Length	OAL	Part Number
A	.2340	2-5/8	3-7/8	5-143-0234
B	.2380	2-3/4	4	5-143-0238
C	.2420	2-3/4	4	5-143-0242
D	.2460	2-3/4	4	5-143-0246
F	.2570	2-7/8	4-1/8	5-143-0257
G	.2610	2-7/8	4-1/8	5-143-0261
H	.2660	2-7/8	4-1/8	5-143-0266
I	.2720	2-7/8	4-1/8	5-143-0272
J	.2770	2-7/8	4-1/8	5-143-0277
K	.2810	2-15/16	4-1/4	5-143-0281
L	.2900	2-15/16	4-1/4	5-143-0290
M	.2950	3-1/16	4-3/8	5-143-0295
N	.3020	3-1/16	4-3/8	5-143-0302
O	.3160	3-3/16	4-1/2	5-143-0316
P	.3230	3-5/16	4-5/8	5-143-0323
Q	.3320	3-7/16	4-3/4	5-143-0332
R	.3390	3-7/16	4-3/4	5-143-0339
S	.3480	3-1/2	4-7/8	5-143-0348
T	.3580	3-1/2	4-7/8	5-143-0358
U	.3680	3-5/8	5	5-143-0368
V	.3770	3-5/8	5	5-143-0377
W	.3860	3-3/4	5-1/8	5-143-0386
X	.3970	3-3/4	5-1/8	5-143-0397
Y	.4040	3-7/8	5-1/4	5-143-0404
Z	.4130	3-7/8	5-1/4	5-143-0413

DRILLS



HSS Heavy Duty TiN Coated Jobber Drills

Cutting Tools

Heavy Duty HSS TiN Coated Jobber Drills with 135° Split Point (continued)

Metric Diameters

Sold In the following package quantities: thru 6.7 mm = 10/envelope
6.8 mm thru 13.00 mm = 5/envelope
over 13.00 mm = 1/tube



DRILLS

Metric Dia	Decimal Equivalent	Flute Length	OAL	Part Number
1.55	.0610	20	43	5-144-0061
1.60	.0630	20	43	5-144-0063
1.65	.0650	20	43	5-144-0065
1.70	.0669	20	43	5-144-0067
1.75	.0689	22	46	5-144-0069
1.80	.0709	22	46	5-144-0071
1.85	.0728	22	46	5-144-0073
1.90	.0748	22	46	5-144-0075
1.95	.0768	24	49	5-144-0077
2.00	.0787	24	49	5-144-0079
2.05	.0807	24	49	5-144-0081
2.10	.0827	24	49	5-144-0083
2.15	.0846	27	53	5-144-0085
2.20	.0866	27	53	5-144-0087
2.25	.0886	27	53	5-144-0089
2.30	.0906	27	53	5-144-0091
2.35	.0925	27	53	5-144-0092
2.40	.0945	30	57	5-144-0094
2.45	.0965	30	57	5-144-0096
2.50	.0984	30	57	5-144-0098
2.55	.1004	30	57	5-144-0100
2.60	.1024	30	57	5-144-0102
2.65	.1043	30	57	5-144-0104
2.70	.1063	33	61	5-144-0106
2.75	.1083	33	61	5-144-0108
2.80	.1102	33	61	5-144-0110
2.85	.1122	33	61	5-144-0112
2.90	.1142	33	61	5-144-0114
2.95	.1161	33	61	5-144-0116
3.00	.1181	33	61	5-144-0118
3.10	.1220	36	65	5-144-0122
3.15	.1240	36	65	5-144-0124
3.20	.1260	36	65	5-144-0126
3.25	.1280	36	65	5-144-0128
3.30	.1299	36	65	5-144-0130
3.40	.1339	39	70	5-144-0133
3.50	.1378	39	70	5-144-0138
3.60	.1417	39	70	5-144-0142
3.70	.1457	39	70	5-144-0146
3.75	.1476	39	75	5-144-0148
3.80	.1496	43	75	5-144-0150
3.90	.1535	43	75	5-144-0153
4.00	.1575	43	75	5-144-0157
4.10	.1614	43	75	5-144-0161
4.20	.1654	43	75	5-144-0165
4.25	.1673	43	75	5-144-0167
4.30	.1693	47	80	5-144-0169
4.40	.1732	47	80	5-144-0173
4.50	.1772	47	80	5-144-0172
4.60	.1811	47	80	5-144-0181
4.70	.1850	47	80	5-144-0185
4.75	.1870	47	80	5-144-0187
4.80	.1890	52	86	5-144-0189
4.90	.1929	52	86	5-144-0193

Metric Dia	Decimal Equivalent	Flute Length	OAL	Part Number
5.00	.1969	52	86	5-144-0197
5.10	.2008	52	86	5-144-0201
5.20	.2047	52	86	5-144-0205
5.25	.2067	52	86	5-144-0207
5.30	.2087	52	86	5-144-0209
5.40	.2126	57	93	5-144-0213
5.50	.2165	57	93	5-144-0216
5.60	.2205	57	93	5-144-0220
5.70	.2244	57	93	5-144-0224
5.75	.2264	57	93	5-144-0226
5.80	.2283	57	93	5-144-0228
5.90	.2323	57	93	5-144-0232
6.00	.2362	57	93	5-144-0236
6.10	.2402	63	101	5-144-0240
6.20	.2441	63	101	5-144-0244
6.25	.2461	63	101	5-144-0246
6.30	.2480	63	101	5-144-0248
6.40	.2520	63	101	5-144-0252
6.50	.2559	63	101	5-144-0256
6.60	.2598	63	101	5-144-0260
6.70	.2638	63	101	5-144-0264
6.75	.2657	69	109	5-144-0266
6.80	.2677	69	109	5-144-0268
6.90	.2717	69	109	5-144-0272
7.00	.2756	69	109	5-144-0276
7.10	.2795	69	109	5-144-0279
7.20	.2835	69	109	5-144-0283
7.25	.2854	69	109	5-144-0285
7.30	.2874	69	109	5-144-0287
7.40	.2913	69	109	5-144-0291
7.50	.2953	69	109	5-144-0295
7.60	.2992	75	117	5-144-0299
7.70	.3031	75	117	5-144-0303
7.80	.3071	75	117	5-144-0307
7.90	.3110	75	117	5-144-0311
8.00	.3150	75	117	5-144-0315
8.10	.3189	75	117	5-144-0319
8.20	.3228	75	117	5-144-0323
8.25	.3248	75	117	5-144-0325
8.30	.3268	75	117	5-144-0327
8.40	.3307	75	117	5-144-0331
8.50	.3346	75	117	5-144-0335
8.60	.3386	81	125	5-144-0337
8.70	.3425	81	125	5-144-0342
8.80	.3465	81	125	5-144-0346
8.90	.3504	81	125	5-144-0350
9.00	.3543	81	125	5-144-0354
9.10	.3583	81	125	5-144-0358
9.20	.3622	81	125	5-144-0362
9.25	.3642	81	125	5-144-0364
9.30	.3661	81	125	5-144-0366
9.40	.3701	81	125	5-144-0370
9.50	.3740	81	125	5-144-0374
9.60	.3780	87	133	5-144-0376

HSS Heavy Duty TiN Coated Jobber Drills



Cutting Tools

Heavy Duty HSS TiN Coated Jobber Drills with 135° Split Point (continued)

Metric Diameters



Sold in the following package quantities: thru 6.7 mm = 10/envelope
6.8 mm thru 13.00 mm = 5/envelope
over 13.00 mm = 1/tube

Metric Dia	Decimal Equivalent	Flute Length	OAL	Part Number
9.70	.3819	87	133	5-144-0382
9.80	.3858	87	133	5-144-0386
9.90	.3898	87	133	5-144-0389
10.00	.3937	87	133	5-144-0394
10.10	.3976	87	133	5-144-0398
10.20	.4016	87	133	5-144-0402
10.25	.4035	87	133	5-144-0403
10.30	.4055	87	133	5-144-0405
10.40	.4094	87	133	5-144-0409
10.50	.4134	87	133	5-144-0413
10.60	.4173	87	133	5-144-0417
10.70	.4213	94	142	5-144-0421
10.80	.4252	94	142	5-144-0425
10.90	.4291	94	142	5-144-0429
11.00	.4331	94	142	5-144-0433
11.10	.4370	94	142	5-144-0437
11.20	.4409	94	142	5-144-0441
11.30	.4449	94	142	5-144-0445
11.40	.4488	94	142	5-144-0449
11.50	.4528	94	142	5-144-0453
11.60	.4567	94	142	5-144-0457
11.70	.4606	94	142	5-144-0461
11.80	.4646	94	142	5-144-0465
11.90	.4685	101	151	5-144-0468
12.00	.4724	101	151	5-144-0472
12.10	.4764	101	151	5-144-0476
12.20	.4803	101	151	5-144-0480
12.25	.4823	101	151	5-144-0482
12.30	.4843	101	151	5-144-0484
12.40	.4882	101	151	5-144-0488
12.50	.4921	101	151	5-144-0492
12.60	.4961	101	151	5-144-0496
12.80	.5039	101	151	5-144-0504
12.90	.5079	101	151	5-144-0508
13.00	.5118	101	151	5-144-0512

Metric Dia	Decimal Equivalent	Flute Length	OAL	Part Number
13.10	.5157	101	151	5-144-0516
13.20	.5197	101	151	5-144-0520
13.30	.5236	101	151	5-144-0524
13.40	.5276	101	151	5-144-0528
13.50	.5315	108	160	5-144-0531
13.60	.5354	108	160	5-144-0535
13.70	.5394	108	160	5-144-0539
13.75	.5413	108	160	5-144-0541
13.80	.5433	108	160	5-144-0543
13.90	.5472	108	160	5-144-0547
14.00	.5512	108	160	5-144-0551
14.25	.5610	114	169	5-144-0561
14.50	.5709	114	169	5-144-0571
14.75	.5807	114	169	5-144-0581
15.00	.5906	114	169	5-144-0591
15.25	.6004	120	178	5-144-0600
15.50	.6102	120	178	5-144-0610
15.75	.6201	120	178	5-144-0620
16.00	.6299	120	178	5-144-0630
16.25	.6398	125	184	5-144-0640
16.50	.6496	125	184	5-144-0649
16.75	.6594	125	184	5-144-0659
17.00	.6693	125	184	5-144-0669
17.26	.6794	130	191	5-144-0679
17.50	.6890	130	191	5-144-0689
17.75	.6988	130	191	5-144-0699
18.00	.7087	130	191	5-144-0709
18.25	.7185	135	198	5-144-0718
18.50	.7283	135	198	5-144-0728
18.75	.7382	135	198	5-144-0738
19.00	.7480	135	198	5-144-0748
19.25	.7579	140	205	5-144-0758
19.50	.7677	140	205	5-144-0768
19.75	.7776	140	205	5-144-0778
20.00	.7874	140	205	5-144-0787

DRILLS



Cobalt Jobber Drills

Cutting Tools

DRILLS

Heavy Duty Cobalt Jobber Drills with 135° Split Point

Fractional Diameters



Sold in the following package quantities: 1/64" thru 17/64" = 10/envelope
6/32" thru 1/2" = 5/envelope
over 1/2" = 1/tube

Fractional Dia	Decimal Equivalent	Flute Length	OAL	Part Number
1/64	.0156	3/16	3/4	5-158-005
1/32	.0313	1/2	1-3/8	5-158-010
3/64	.0469	3/4	1-3/4	5-158-015
1/16	.0625	7/8	1-7/8	5-158-020
5/64	.0781	1	2	5-158-025
3/32	.0938	1-1/4	2-1/4	5-158-030
7/64	.1094	1-1/2	2-5/8	5-158-035
1/8	.1250	1-5/8	2-3/4	5-158-040
9/64	.1406	1-3/4	2-7/8	5-158-045
5/32	.1563	2	3-1/8	5-158-050
11/64	.1719	2-1/8	3-1/4	5-158-055
3/16	.1875	2-5/16	3-1/2	5-158-060
13/64	.2031	2-7/16	3-5/8	5-158-065
7/32	.2188	2-1/2	3-3/4	5-158-070
15/64	.2344	2-5/8	3-7/8	5-158-075
1/4	.2500	2-3/4	4	5-158-080
17/64	.2656	2-7/8	4-1/8	5-158-085
9/32	.2813	2-15/16	4-1/4	5-158-090
19/64	.2969	3-1/16	4-3/8	5-158-095
5/16	.3125	3-3/16	4-1/2	5-158-100
21/64	.3281	3-5/16	4-5/8	5-158-105
11/32	.3438	3-7/16	4-3/4	5-158-110
23/64	.3594	3-1/2	4-7/8	5-158-115
3/8	.3750	3-5/8	5	5-158-120
25/64	.3906	3-3/4	5-1/8	5-158-125
13/32	.4063	3-7/8	5-1/4	5-158-130
27/64	.4219	3-15/16	5-3/8	5-158-135
7/16	.4375	4-1/16	5-1/2	5-158-140
29/64	.4531	4-3/16	5-5/8	5-158-145
15/32	.4688	4-5/16	5-3/4	5-158-150
31/64	.4844	4-3/8	5-7/8	5-158-155
1/2	.5000	4-1/2	6	5-158-160
33/64	.5156	4-13/16	6-5/8	5-158-165
17/32	.5313	4-13/16	6-5/8	5-158-170
35/64	.5469	4-13/16	6-5/8	5-158-175
9/16	.5625	4-13/16	6-5/8	5-158-180
37/64	.5781	4-13/16	6-5/8	5-158-185
19/32	.5938	5-3/16	7-1/8	5-158-190
39/64	.6094	5-3/16	7-1/8	5-158-195
5/8	.6250	5-3/16	7-1/8	5-158-200
41/64	.6406	5-3/16	7-1/8	5-158-205
21/32	.6563	5-3/16	7-1/8	5-158-210
43/64	.6719	5-5/8	7-5/8	5-158-215
11/16	.6875	5-5/8	7-5/8	5-158-220

Heavy Duty Cobalt Jobber Drills with 135° Split Point

Wire Gage Diameters



Wire Gage Dia	Decimal Equivalent	Flute Length	OAL	Part Number
60	.0400	11/16	1-5/8	5-175-300
59	.0410	11/16	1-5/8	5-175-295
58	.0420	11/16	1-5/8	5-175-290
57	.0430	3/4	1-3/4	5-175-285
56	.0465	3/4	1-3/4	5-175-280
55	.0520	7/8	1-7/8	5-175-275
54	.0550	7/8	1-7/8	5-175-270
53	.0595	7/8	1-7/8	5-175-265
52	.0635	7/8	1-7/8	5-175-260
51	.0670	1	2	5-175-255
50	.0700	1	2	5-175-250
49	.0730	1	2	5-175-245
48	.0760	1	2	5-175-240
47	.0785	1	2	5-175-235
46	.0810	1-1/8	2-1/8	5-175-230
45	.0820	1-1/8	2-1/8	5-175-225
44	.0860	1-1/8	2-1/8	5-175-220
43	.0890	1-1/4	2-1/4	5-175-215
42	.0935	1-1/4	2-1/4	5-175-210
41	.0960	1-3/8	2-3/8	5-175-205
40	.0980	1-3/8	2-3/8	5-175-200
39	.0995	1-3/8	2-3/8	5-175-195
38	.1015	1-7/16	2-1/2	5-175-190
37	.1040	1-7/16	2-1/2	5-175-185
36	.1065	1-7/16	2-1/2	5-175-180
35	.1100	1-1/2	2-5/8	5-175-175
34	.1110	1-1/2	2-5/8	5-175-170
33	.1130	1-1/2	2-5/8	5-175-165
32	.1160	1-5/8	2-3/4	5-175-160
31	.1200	1-5/8	2-3/4	5-175-155

Wire Gage Dia	Decimal Equivalent	Flute Length	OAL	Part Number
30	.1285	1-5/8	2-3/4	5-175-150
29	.1360	1-3/4	2-7/8	5-175-145
28	.1405	1-3/4	2-7/8	5-175-140
27	.1440	1-7/8	3	5-175-135
26	.1470	1-7/8	3	5-175-130
25	.1495	1-7/8	3	5-175-125
24	.1520	2	3-1/8	5-175-120
23	.1540	2	3-1/8	5-175-115
22	.1570	2	3-1/8	5-175-110
21	.1590	2-1/8	3-1/4	5-175-105
20	.1610	2-1/8	3-1/4	5-175-100
19	.1660	2-1/8	3-1/4	5-175-095
18	.1695	2-1/8	3-1/4	5-175-090
17	.1730	2-3/16	3-3/8	5-175-085
16	.1770	2-3/16	3-3/8	5-175-080
15	.1800	2-3/16	3-3/8	5-175-075
14	.1820	2-3/16	3-3/8	5-175-070
13	.1850	2-5/16	3-1/2	5-175-065
12	.1890	2-5/16	3-1/2	5-175-060
11	.1910	2-5/16	3-1/2	5-175-055
10	.1935	2-7/16	3-5/8	5-175-050
9	.1960	2-7/16	3-5/8	5-175-045
8	.1990	2-7/16	3-5/8	5-175-040
7	.2010	2-7/16	3-5/8	5-175-035
6	.2040	2-1/2	3-3/4	5-175-030
5	.2055	2-1/2	3-3/4	5-175-025
4	.2090	2-1/2	3-3/4	5-175-020
3	.2130	2-1/2	3-3/4	5-175-015
2	.2210	2-5/8	3-7/8	5-175-010
1	.2280	2-5/8	3-7/8	5-175-005

Sold in the following packages quantities:
All wire gage diameters are 10 / pack



Cobalt Jobber Drills

Cutting Tools

DRILLS

Heavy Duty Cobalt Jobber Drills with 135° Split Point

Letter Diameters



Sold in the following package quantities:

A thru I = 10/envelope

J thru Z = 5/envelope

Letter Dia	Decimal Equivalent	Flute Length	OAL	Part Number
A	.2340	2-5/8	3-7/8	5-185-005
B	.2380	2-3/4	4	5-185-010
C	.2420	2-3/4	4	5-185-015
D	.2460	2-3/4	4	5-185-020
F	.2570	2-7/8	4-1/8	5-185-030
G	.2610	2-7/8	4-1/8	5-185-035
H	.2660	2-7/8	4-1/8	5-185-040
I	.2720	2-7/8	4-1/8	5-185-045
J	.2770	2-7/8	4-1/8	5-185-050
K	.2810	2-15/16	4-1/4	5-185-055
L	.2900	2-15/16	4-1/4	5-185-060
M	.2950	3-1/16	4-3/8	5-185-065
N	.3020	3-1/16	4-3/8	5-185-070
O	.3160	3-3/16	4-1/2	5-185-075
P	.3230	3-5/16	4-5/8	5-185-080
Q	.3320	3-7/16	4-3/4	5-185-085
R	.3390	3-7/16	4-3/4	5-185-090
S	.3480	3-1/2	4-7/8	5-185-095
T	.3580	3-1/2	4-7/8	5-185-100
U	.3680	3-5/8	5	5-185-105
V	.3770	3-5/8	5	5-185-110
W	.3860	3-3/4	5-1/8	5-185-115
X	.3970	3-3/4	5-1/8	5-185-120
Y	.4040	3-7/8	5-1/4	5-185-125
Z	.4130	3-7/8	5-1/4	5-185-130

Heavy Duty Cobalt Jobber Drills with 135° Split Point

Metric Diameters

Sold In the following package quantities: thru 6.7 mm = 10/envelope
6.8 mm thru 13.00 mm = 5/envelope
over 13.00 mm = 1/tube



Metric Dia	Decimal Equivalent	Flute Length	OAL	Part Number
.30	.0118"	3	19	5-174-0012
.35	.0138"	4	19	5-174-0014
.40	.0157"	5	20	5-174-0016
.45	.0177"	5	20	5-174-0018
.50	.0197"	6	22	5-174-0020
.55	.0217"	7	24	5-174-0022
.60	.0236"	7	24	5-174-0024
.65	.0256"	8	26	5-174-0026
.70	.0276"	9	28	5-174-0028
.75	.0295"	9	28	5-174-0029
.80	.0315"	10	30	5-174-0031
.85	.0335"	10	30	5-174-0033
.90	.0354"	11	32	5-174-0035
.95	.0374"	11	32	5-174-0037
1.00	.0394"	12	34	5-174-0039
1.05	.0413"	12	34	5-174-0041
1.10	.0433"	14	36	5-174-0043
1.15	.0453"	14	36	5-174-0045
1.20	.0472"	16	38	5-174-0047
1.25	.0492"	16	38	5-174-0049
1.30	.0512"	16	38	5-174-0051
1.35	.0531"	18	40	5-174-0053
1.40	.0551"	18	40	5-174-0055
1.45	.0571"	18	40	5-174-0057
1.50	.0591"	18	40	5-174-0059
1.55	.0610"	20	43	5-174-0061
1.60	.0630"	20	43	5-174-0063
1.65	.0650"	20	43	5-174-0065
1.70	.0669"	20	43	5-174-0067
1.75	.0689"	22	46	5-174-0069
1.80	.0709"	22	46	5-174-0071
1.85	.0728"	22	46	5-174-0073
1.90	.0748"	22	46	5-174-0075
1.95	.0768"	24	49	5-174-0077
2.00	.0787"	24	49	5-174-0079
2.05	.0807"	24	49	5-174-0081
2.10	.0827"	24	49	5-174-0083
2.15	.0846"	27	53	5-174-0085
2.20	.0866"	27	53	5-174-0087
2.25	.0886"	27	53	5-174-0089
2.30	.0906"	27	53	5-174-0091
2.35	.0925"	27	53	5-174-0092
2.40	.0945"	30	57	5-174-0094
2.45	.0965"	30	57	5-174-0096
2.50	.0984"	30	57	5-174-0098
2.55	.1004"	30	57	5-174-0100
2.60	.1024"	30	57	5-174-0102
2.65	.1043"	30	57	5-174-0104
2.70	.1063"	33	61	5-174-0106
2.75	.1083"	33	61	5-174-0108
2.80	.1102"	33	61	5-174-0110
2.85	.1122"	33	61	5-174-0112
2.90	.1142"	33	61	5-174-0114
2.95	.1161"	33	61	5-174-0116

Metric Dia	Decimal Equivalent	Flute Length	OAL	Part Number
3.00	.1181"	33	61	5-174-0118
3.10	.1220"	36	65	5-174-0122
3.15	.1240"	36	65	5-174-0124
3.20	.1260"	36	65	5-174-0126
3.25	.1280"	36	65	5-174-0128
3.30	.1299"	36	65	5-174-0130
3.40	.1220"	39	70	5-174-0133
3.50	.1378"	39	70	5-174-0138
3.60	.1417"	39	70	5-174-0142
3.70	.1457"	39	70	5-174-0146
3.75	.1476"	43	75	5-174-0148
3.80	.1496"	43	75	5-174-0150
3.90	.1535"	43	75	5-174-0153
4.00	.1575"	43	75	5-174-0157
4.10	.1614"	43	75	5-174-0161
4.20	.1654"	43	75	5-174-0165
4.25	.1673"	43	75	5-174-0167
4.30	.1693"	47	80	5-174-0169
4.50	.1772"	47	80	5-174-0172
4.40	.1732"	47	80	5-174-0173
4.60	.1811"	47	80	5-174-0181
4.70	.1850"	47	80	5-174-0185
4.75	.1870"	47	80	5-174-0187
4.80	.1890"	52	86	5-174-0189
4.90	.1929"	52	86	5-174-0193
5.00	.1969"	52	86	5-174-0197
5.10	.2008"	52	86	5-174-0201
5.20	.2047"	52	86	5-174-0205
5.25	.2067"	52	86	5-174-0207
5.30	.2087"	52	86	5-174-0209
5.40	.2126"	57	93	5-174-0213
5.50	.2165"	57	93	5-174-0216
5.60	.2205"	57	93	5-174-0220
5.70	.2244"	57	93	5-174-0224
5.75	.2264"	57	93	5-174-0226
5.80	.2283"	57	93	5-174-0228
5.90	.2323"	57	93	5-174-0232
6.00	.2362"	57	93	5-174-0236
6.10	.2402"	63	101	5-174-0240
6.20	.2441"	63	101	5-174-0244
6.25	.2461"	63	101	5-174-0246
6.30	.2480"	63	101	5-174-0248
6.40	.2520"	63	101	5-174-0252
6.50	.2559"	63	101	5-174-0256
6.60	.2598"	63	101	5-174-0260
6.70	.2638"	63	101	5-174-0264
6.75	.2657"	69	109	5-174-0266
6.80	.2677"	69	109	5-174-0268
6.90	.2717"	69	109	5-174-0272
7.00	.2756"	69	109	5-174-0276
7.10	.2795"	69	109	5-174-0279
7.20	.2835"	69	109	5-174-0283
7.25	.2854"	69	109	5-174-0285
7.30	.2874"	69	109	5-174-0287



Cobalt Jobber Drills

Cutting Tools

DRILLS

Heavy Duty Cobalt Jobber Drills with 135° Split Point (continued)

Metric Diameters



Sold In the following package quantities: thru 6.7 mm = 10/envelope
 6.8 mm thru 13.00 mm = 5/envelope
 over 13.00 mm = 1/tube

Metric Dia	Decimal Equivalent	Flute Length	OAL	Part Number
7.40	.2913	69	109	5-174-0291
7.50	.2953	69	109	5-174-0295
7.60	.2992	75	117	5-174-0299
7.70	.3031	75	117	5-174-0303
7.80	.3071	75	117	5-174-0307
7.90	.3110	75	117	5-174-0311
8.00	.3150	75	117	5-174-0315
8.10	.3189	75	117	5-174-0319
8.20	.3228	75	117	5-174-0323
8.25	.3248	75	117	5-174-0325
8.30	.3268	75	117	5-174-0327
8.40	.3307	75	117	5-174-0331
8.50	.3346	75	117	5-174-0335
8.60	.3386	81	125	5-174-0337
8.70	.3425	81	125	5-174-0342
8.80	.3465	81	125	5-174-0346
8.90	.3504	81	125	5-174-0350
9.00	.3543	81	125	5-174-0354
9.10	.3583	81	125	5-174-0358
9.20	.3622	81	125	5-174-0362
9.25	.3642	81	125	5-174-0364
9.30	.3661	81	125	5-174-0366
9.40	.3701	81	125	5-174-0370
9.50	.3740	81	125	5-174-0374
9.60	.3780	87	133	5-174-0376
9.70	.3819	87	133	5-174-0382
9.80	.3858	87	133	5-174-0386
9.90	.3898	87	133	5-174-0389
10.00	.3937	87	133	5-174-0394
10.10	.3976	87	133	5-174-0398
10.20	.4016	87	133	5-174-0402
10.25	.4035	87	133	5-174-0403
10.30	.4055	87	133	5-174-0405
10.40	.4094	87	133	5-174-0409
10.50	.4134	87	133	5-174-0413
10.60	.4173	87	133	5-174-0417
10.70	.4213	94	142	5-174-0421
10.80	.4252	94	142	5-174-0425
10.90	.4291	94	142	5-174-0429
11.00	.4331	94	142	5-174-0433
11.10	.4370	94	142	5-174-0437
11.20	.4409	94	142	5-174-0441
11.30	.4449	94	142	5-174-0445
11.40	.4488	94	142	5-174-0449
11.50	.4528	94	142	5-174-0453
11.60	.4567	94	142	5-174-0457
11.70	.4606	94	142	5-174-0461
11.80	.4646	94	142	5-174-0465

Metric Dia	Decimal Equivalent	Flute Length	OAL	Part Number
11.90	.4685	101	151	5-174-0468
12.00	.4724	101	151	5-174-0472
12.10	.4764	101	151	5-174-0476
12.20	.4803	101	151	5-174-0480
12.25	.4823	101	151	5-174-0482
12.30	.4843	101	151	5-174-0484
12.40	.4882	101	151	5-174-0488
12.50	.4921	101	151	5-174-0492
12.60	.4961	101	151	5-174-0496
12.80	.5039	101	151	5-174-0504
12.90	.5079	101	151	5-174-0508
13.00	.5118	101	151	5-174-0512
13.10	.5157	101	151	5-174-0516
13.20	.5197	101	151	5-174-0520
13.30	.5236	101	151	5-174-0524
13.40	.5276	101	151	5-174-0528
13.50	.5315	108	160	5-174-0531
13.60	.5354	108	160	5-174-0535
13.70	.5394	108	160	5-174-0539
13.75	.5413	108	160	5-174-0541
13.80	.5433	108	160	5-174-0543
13.90	.5472	108	160	5-174-0547
14.00	.5512	108	160	5-174-0551
14.25	.5610	114	169	5-174-0561
14.50	.5709	114	169	5-174-0571
14.75	.5807	114	169	5-174-0581
15.00	.5906	114	169	5-174-0591
15.25	.6004	120	178	5-174-0600
15.50	.6102	120	178	5-174-0610
15.75	.6201	120	178	5-174-0620
16.00	.6299	120	178	5-174-0630
16.25	.6398	125	184	5-174-0640
16.50	.6496	125	184	5-174-0649
16.75	.6594	125	184	5-174-0659
17.00	.6693	125	184	5-174-0669
17.26	.6794	130	191	5-174-0679
17.50	.6890	130	191	5-174-0689
17.75	.6988	130	191	5-174-0699
18.00	.7087	130	191	5-174-0709
18.25	.7185	135	198	5-174-0718
18.50	.7283	135	198	5-174-0728
18.75	.7382	135	198	5-174-0738
19.00	.7480	135	198	5-174-0748
19.25	.7579	140	205	5-174-0758
19.50	.7677	140	205	5-174-0768
19.75	.7776	140	205	5-174-0778
20.00	.7874	140	205	5-174-0787

General Purpose HSS Black Oxide Jobber Drills with 118° Point



Number of pieces in the Set	Sizes included in Set	Part Number
15	1/16 to 1/2 by 32 rds	5-160-905
29	1/16 to 1/2 by 64 ths	5-160-705
60	# 1 thru # 60	5-170-505
26	A to Z	5-180-505
115	1/16 to 1/2 by 64 ths + #1 to # 60 + A to Z	5-199-005
19	1.0 mm to 10.0 mm by .5	5-161-605
25	1.0 mm to 13.0 mm by .5	5-161-705

General Purpose HSS TiN Coated Jobber Drills with 118° Point



Number of pieces in the Set	Sizes included in Set	Part Number
15	1/16 to 1/2 by 32 rds	5-131-905
29	1/16 to 1/2 by 64 ths	5-131-705
60	# 1 thru # 60	5-132-505
26	A to Z	5-133-505
19	1.0 mm to 10.0 mm by .5	5-134-605
25	1.0 mm to 13.0 mm by .5	5-134-705

Heavy Duty HSS TiN Coated Jobber Drills with 135° Point



Number of pieces in the Set	Sizes included in Set	Part Number
15	1/16 to 1/2 by 32 rds	5-141-905
29	1/16 to 1/2 by 64 ths	5-141-705

Heavy Duty Cobalt Jobber Drills with 135° Point



Number of pieces in the Set	Sizes included in Set	Part Number
15	1/16 to 1/2 by 32 rds	5-158-905
29	1/16 to 1/2 by 64 ths	5-158-705
60	# 1 thru # 60	5-175-505
26	A to Z	5-185-505
19	1.0 mm to 10.0 mm by .5	5-174-605
25	1.0 mm to 13.0 mm by .5	5-174-705



Aircraft Extension Drills

Cutting Tools

6" OAL Heavy Duty HSS Black Oxide with 135° Split Point for Self Centering



Fractional Diameters

Fractional Dia	Decimal Equivalent	Flute Length	Part Number
1/16	.0625	7/8	5-183-0063
5/64	.0781	1	5-183-0078
3/32	.0938	1-1/4	5-183-0094
7/64	.1094	1-1/2	5-183-0109
1/8	.1250	1-5/8	5-183-0125
9/64	.1406	1-3/4	5-183-0141
5/32	.1563	2	5-183-0156
11/64	.1719	2-1/8	5-183-0172
3/16	.1875	2-5/16	5-183-0187
13/64	.2031	2-7/16	5-183-0203
7/32	.2188	2-1/2	5-183-0219
15/64	.2344	2-5/8	5-183-0234
1/4	.2500	2-3/4	5-183-0250
17/64	.2656	2-7/8	5-183-0266
9/32	.2813	2-15/16	5-183-0281
19/64	.2969	3-1/16	5-183-0297
5/16	.3125	3-3/16	5-183-0313
21/64	.3281	3-5/16	5-183-0328
11/32	.3438	3-7/16	5-183-0344
23/64	.3594	3-1/2	5-183-0359
3/8	.3750	3-5/8	5-183-0375
25/64	.3906	3-3/4	5-183-0391
13/32	.4063	3-7/8	5-183-0406
27/64	.4219	3-15/16	5-183-0422
7/16	.4375	4-1/16	5-183-0437
29/64	.4531	4-3/16	5-183-0453
15/32	.4688	4-5/16	5-183-0469
31/64	.4844	4-3/8	5-183-0484
1/2	.5000	4-1/2	5-183-0500

Aircraft Extension Drills are sold in the following package quantities:

Fractional: thru 17/64" = 10/envelope or tube
 15/64" thru 11/32" = 5/envelope or tube
 23/64" and larger = 1/tube

DRILLS

6" OAL Heavy Duty HSS Black Oxide with 135° Split Point for Self Centering

Wire Gage Diameters



Wire Gage Dia	Decimal Equivalent	Flute Length	Part Number
52	.0635	7/8	5-184-0063
51	.0670	1	5-184-0067
50	.0700	1	5-184-0070
49	.0730	1	5-184-0073
48	.0760	1	5-184-0076
47	.0785	1	5-184-0078
46	.0810	1-1/8	5-184-0081
45	.0820	1-1/8	5-184-0082
44	.0860	1-1/8	5-184-0086
43	.0890	1-1/4	5-184-0089
42	.0935	1-1/4	5-184-0093
41	.0960	1-3/8	5-184-0096
40	.0980	1-3/8	5-184-0098
39	.0995	1-3/8	5-184-0099
38	.1015	1-7/16	5-184-0101
37	.1040	1-7/16	5-184-0104
36	.1065	1-7/16	5-184-0106
35	.1100	1-1/2	5-184-0110
34	.1110	1-1/2	5-184-0111
33	.1130	1-1/2	5-184-0113
32	.1160	1-5/8	5-184-0116
31	.1200	1-5/8	5-184-0120
30	.1285	1-5/8	5-184-0128
29	.1360	1-3/4	5-184-0136
28	.1405	1-3/4	5-184-0140
27	.1140	1-7/8	5-184-0114

Wire Gage Dia	Decimal Equivalent	Flute Length	Part Number
26	.1470	1-7/8	5-184-0147
25	.1495	1-7/8	5-184-0149
24	.1520	2	5-184-0152
23	.1540	2	5-184-0154
22	.1570	2	5-184-0157
21	.1590	2-1/8	5-184-0159
20	.1610	2-1/8	5-184-0161
19	.1660	2-1/8	5-184-0166
18	.1695	2-1/8	5-184-0169
17	.1730	2-3/16	5-184-0173
16	.1770	2-3/16	5-184-0177
15	.1880	2-3/16	5-184-0188
14	.1820	2-3/16	5-184-0184
13	.1850	2-5/16	5-184-0185
12	.1890	2-5/16	5-184-0189
11	.1910	2-5/16	5-184-0191
10	.1935	2-7/16	5-184-0193
9	.1960	2-7/16	5-184-0196
8	.1990	2-7/16	5-184-0199
7	.2010	2-7/16	5-184-0201
6	.2040	2-1/2	5-184-0204
5	.2055	2-1/2	5-184-0205
4	.2090	2-1/2	5-184-0209
3	.2130	2-1/2	5-184-0213
2	.2210	2-5/8	5-184-0221
1	.2280	2-5/8	5-184-0228

Aircraft Extension Drills are sold in the following package quantities: **Wire Gage:** all = 10/envelope or tube

12" OAL Heavy Duty HSS Black Oxide with 135° Split Point for Self Centering

Fractional Diameters

Fractional Dia	Decimal Equivalent	Flute Length	Part Number
1/16	.0625	7/8	5-186-0063
5/64	.0781	1	5-186-0078
3/32	.0938	1-1/4	5-186-0094
7/64	.1094	1-1/2	5-186-0109
1/8	.1250	1-5/8	5-186-0125
9/64	.1406	1-3/4	5-186-0141
5/32	.1563	2	5-186-0156
11/64	.1719	2-1/8	5-186-0172
3/16	.1875	2-5/16	5-186-0187
13/64	.2031	2-7/16	5-186-0203
7/32	.2188	2-1/2	5-186-0219
15/64	.2344	2-5/8	5-186-0234
1/4	.2500	2-3/4	5-186-0250
17/64	.2656	2-7/8	5-186-0266
9/32	.2813	2-15/16	5-186-0281

Fractional Dia	Decimal Equivalent	Flute Length	Part Number
19/64	.2969	3-1/16	5-186-0297
5/16	.3125	3-3/16	5-186-0313
21/64	.3281	3-5/16	5-186-0328
11/32	.3438	3-7/16	5-186-0344
23/64	.3594	3-1/2	5-186-0359
3/8	.3750	3-5/8	5-186-0375
25/64	.3906	3-3/4	5-186-0391
13/32	.4063	3-7/8	5-186-0406
27/64	.4219	3-15/16	5-186-0422
7/16	.4375	4-1/16	5-186-0437
29/64	.4531	4-3/16	5-186-0453
15/32	.4688	4-5/16	5-186-0469
31/64	.4844	4-3/8	5-186-0484
1/2	.5000	4-1/2	5-186-0500

Aircraft Extension Drills are sold in the following package quantities: **Fractional:** thru 17/64" = 10/envelope or tube
 15/64" thru 11/32" = 5/envelope or tube
 23/64" and larger = 1/tube



Aircraft Extension Drills

Cutting Tools

12" OAL Heavy Duty HSS Black Oxide with 135° Split Point for Self Centering



Wire Gage Diameters

Wire Gage Dia	Decimal Equivalent	Flute Length	Part Number
52	.0635	7/8	5-187-0063
51	.0670	1	5-187-0067
50	.0700	1	5-187-0070
49	.0730	1	5-187-0073
48	.0760	1	5-187-0076
47	.0785	1	5-187-0078
46	.0810	1-1/8	5-187-0081
45	.0820	1-1/8	5-187-0082
44	.0860	1-1/8	5-187-0086
43	.0890	1-1/4	5-187-0089
42	.0935	1-1/4	5-187-0093
41	.0960	1-3/8	5-187-0096
40	.0980	1-3/8	5-187-0098
39	.0995	1-3/8	5-187-0099
38	.1015	1-7/16	5-187-0101
37	.1040	1-7/16	5-187-0104
36	.1065	1-7/16	5-187-0106
35	.1100	1-1/2	5-187-0110
34	.1110	1-1/2	5-187-0111
33	.1130	1-1/2	5-187-0113
32	.1160	1-5/8	5-187-0116
31	.1200	1-5/8	5-187-0120
30	.1285	1-5/8	5-187-0128
29	.1360	1-3/4	5-187-0136
28	.1405	1-3/4	5-187-0140
27	.1140	1-7/8	5-187-0114
26	.1470	1-7/8	5-187-0147
25	.1495	1-7/8	5-187-0149
24	.1520	2	5-187-0152
23	.1540	2	5-187-0154
22	.1570	2	5-187-0157
21	.1590	2-1/8	5-187-0159
20	.1610	2-1/8	5-187-0161
19	.1660	2-1/8	5-187-0166
18	.1695	2-1/8	5-187-0169
17	.1730	2-3/16	5-187-0173
16	.1770	2-3/16	5-187-0177
15	.1880	2-3/16	5-187-0188
14	.1820	2-3/16	5-187-0187
13	.1850	2-5/16	5-187-0185
12	.1890	2-5/16	5-187-0189
11	.1910	2-5/16	5-187-0191
10	.1935	2-7/16	5-187-0193
9	.1960	2-7/16	5-187-0196
8	.1990	2-7/16	5-187-0199
7	.2010	2-7/16	5-187-0201
6	.2040	2-1/2	5-187-0204
5	.2055	2-1/2	5-187-0205
4	.2090	2-1/2	5-187-0209
3	.2130	2-1/2	5-187-0213
2	.2210	2-5/8	5-187-0221
1	.2280	2-5/8	5-187-0228

Aircraft Extension Drills are sold in the following package quantities:

Wire Gage: all = 10/envelope or tube

DRILLS

Twist Drills with Standard Taper Shanks

Taper Shank – Fractional Diameter Twist Drills

- High Speed Steel
- 118° Point General Purpose
- Black Oxide



Dia Inches	Dia Decimal	Flute Length	Overall Length	Morse Taper Shank Size	Part Number
1/8	.1250	1-7/8	5-1/8	1	5-190-040
9/64	.1406	2-1/8	5-3/8	1	5-190-045
5/32	.1563	2-1/8	5-3/8	1	5-190-050
11/64	.1719	2-1/2	5-3/4	1	5-190-055
3/16	.1875	2-1/2	5-3/4	1	5-190-060
13/64	.2031	2-3/4	6	1	5-190-065
7/32	.2188	2-3/4	6	1	5-190-070
15/64	.2344	2-7/8	6-1/8	1	5-190-075
1/4	.2500	2-7/8	6-1/8	1	5-190-080
17/64	.2656	3	6-1/4	1	5-190-085
9/32	.2813	3	6-1/4	1	5-190-090
19/64	.2969	3-1/8	6-3/8	1	5-190-095
5/16	.3125	3-1/8	6-3/8	1	5-190-100
21/64	.3281	3-1/4	6-1/2	1	5-190-105
11/32	.3438	3-1/4	6-1/2	1	5-190-110
23/64	.3594	3-1/2	6-3/4	1	5-190-115
3/8	.3750	3-1/2	6-3/4	1	5-190-120
25/64	.3906	3-5/8	7	1	5-190-125
13/32	.4063	3-5/8	7	1	5-190-130
27/64	.4219	3-7/8	7-1/4	1	5-190-135
7/16	.4375	3-7/8	7-1/4	1	5-190-140
29/64	.4531	4-1/8	7-1/2	1	5-190-145
15/32	.4688	4-1/8	7-1/2	1	5-190-150
31/64	.4844	4-3/8	8-1/4	2	5-190-1551
1/2	.5000	4-3/8	8-1/4	2	5-190-1601
33/64	.5156	4-5/8	8-1/2	2	5-190-1651
17/32	.5313	4-5/8	8-1/2	2	5-190-172
35/64	.5469	4-7/8	8-3/4	2	5-190-177
9/16	.5625	4-7/8	8-3/4	2	5-190-1801
37/64	.5781	4-7/8	8-3/4	2	5-190-185
19/32	.5938	4-7/8	8-3/4	2	5-190-190
39/64	.6094	4-7/8	8-3/4	2	5-190-195
5/8	.6250	4-7/8	8-3/4	2	5-190-200
41/64	.6406	5-1/8	9	2	5-190-205
21/32	.6563	5-1/8	9	2	5-190-210
43/64	.6719	5-3/8	9-1/4	2	5-190-215
11/16	.6875	5-3/8	9-1/4	2	5-190-220
45/64	.6923	5-3/8	9-1/2	2	5-190-221
23/32	.7188	5-5/8	9-1/2	2	5-190-222
47/64	.7344	5-7/8	9-3/4	2	5-190-223
3/4	.7500	5-7/8	9-3/4	2	5-190-225
49/64	.7656	6	9-7/8	2	5-190-227
25/32	.7813	6	9-7/8	2	5-190-230
51/64	.7969	6-1/8	10-3/4	3	5-190-237
13/16	.8125	6-1/8	10-3/4	3	5-190-2401
53/64	.8281	6-1/8	10-3/4	3	5-190-2451
27/32	.8438	6-1/8	10-3/4	3	5-190-252
55/64	.8594	6-1/8	10-3/4	3	5-190-257
7/8	.8750	6-1/8	10-3/4	3	5-190-262
57/64	.8906	6-1/8	10-3/4	3	5-190-267
29/32	.9063	6-1/8	10-3/4	3	5-190-272
59/64	.9219	6-1/8	10-3/4	3	5-190-275
15/16	.9375	6-1/8	10-3/4	3	5-190-280

Dia Inches	Dia Decimal	Flute Length	Overall Length	Morse Taper Shank Size	Part Number
61/64	.9531	6-3/8	11	3	5-190-285
31/32	.9688	6-3/8	11	3	5-190-290
63/64	.9844	6-3/8	11	3	5-190-295
1	1.0000	6-3/8	11	3	5-190-300
1-1/64	1.0156	6-1/2	11-1/8	3	5-190-301
1-1/32	1.0313	6-1/2	11-1/8	3	5-190-302
1-3/64	1.0469	6-5/8	11-1/4	3	5-190-303
1-1/16	1.0625	6-5/8	11-1/4	3	5-190-304
1-7/64	1.1094	7-1/8	12-3/4	4	5-190-3071
1-1/8	1.1250	7-1/8	12-3/4	4	5-190-3081
1-9/64	1.1406	7-1/4	12-7/8	4	5-190-3091
1-5/32	1.1563	7-1/4	12-7/8	4	5-190-3100
1-11/64	1.1719	7-3/8	13	4	5-190-3111
1-3/16	1.1875	7-3/8	13	4	5-190-3121
1-7/32	1.2188	7-1/2	13-1/8	4	5-190-3145
1-1/4	1.2500	7-7/8	13-1/2	4	5-190-3161
1-17/64	1.2656	8-1/2	14-1/8	4	5-190-317
1-9/32	1.2813	8-1/2	14-1/8	4	5-190-318
1-19/64	1.2969	8-5/8	14-1/4	4	5-190-319
1-5/16	1.3125	8-5/8	14-1/4	4	5-190-320
1-21/64	1.3281	8-3/4	14-3/8	4	5-190-321
1-11/32	1.3438	8-3/4	14-3/8	4	5-190-322
1-23/64	1.3594	8-7/8	14-1/2	4	5-190-323
1-3/8	1.3750	8-7/8	14-1/2	4	5-190-324
1-25/64	1.3906	9	14-5/8	4	5-190-325
1-13/32	1.4063	9	14-5/8	4	5-190-326
1-27/64	1.4219	9-1/8	14-3/4	4	5-190-327
1-7/16	1.4375	9-1/8	14-3/4	4	5-190-328
1-29/64	1.4531	9-1/4	14-7/8	4	5-190-329
1-15/32	1.4688	9-1/4	14-7/8	4	5-190-330
1-31/64	1.4844	9-3/8	15	4	5-190-331
1-1/2	1.5000	9-3/8	15	4	5-190-332
1-5/8	1.6250	10	17	5	5-190-3405
1-3/4	1.7500	10-1/8	17-1/8	5	5-190-3481
1-13/16	1.8125	10-1/8	17-1/8	5	5-190-3525
1-7/8	1.8750	10-3/8	17-3/8	5	5-190-3561
1-15/16	1.9375	10-3/8	17-3/8	5	5-190-3601
2	2.0000	10-3/8	17-3/8	5	5-190-401
2-1/32	2.0313	10-5/8	17-3/8	5	5-190-402
2-1/16	2.0625	10-1/4	17-3/8	5	5-190-404
2-1/8	2.1250	10-1/4	17-3/8	5	5-190-408
2-3/16	2.1875	10-1/4	17-3/8	5	5-190-412
2-1/4	2.2500	10-1/8	17-3/8	5	5-190-416
2-5/16	2.3125	10-1/8	17-3/8	5	5-190-420
2-3/8	2.3750	10-1/8	17-3/8	5	5-190-424
2-7/16	2.4375	11-1/4	18-3/4	5	5-190-428
2-1/2	2.5000	11-1/4	18-3/4	5	5-190-432
2-9/16	2.5625	11-7/8	19-1/2	5	5-190-436
2-5/8	2.6250	11-7/8	19-1/2	5	5-190-440
2-3/4	2.7500	12-3/4	20-3/8	5	5-190-448
2-7/8	2.8750	13-3/8	21-1/8	5	5-190-456
3	3.0000	14	21-3/4	5	5-190-500



HSS Taper Shank Drills

Cutting Tools

DRILLS

Twist Drills with Smaller or Larger Taper Shanks

Taper Shank – Fractional Diameter Twist Drills

- High Speed Steel
- 118° Point General Purpose
- Black Oxide



Dia Inches	Dia Decimal	Flute Length	Overall Length	Morse Taper Shank Size	Part Number
1/2	.5000	4-3/8	7-3/4	1	5-190-160
33/64	.5156	4-5/8	8	1	5-190-165
17/32	.5313	4-5/8	8	1	5-190-170
35/64	.5469	4-7/8	8-1/4	1	5-190-175
9/16	.5625	4-7/8	8-1/4	1	5-190-180
51/64	.7969	6-1/8	10	2	5-190-235
13/16	.4063	6-1/8	10	2	5-190-240
53/64	.8281	6-1/8	10	2	5-190-245
27/32	.8438	6-1/8	10	2	5-190-250
55/64	.8594	6-1/8	10	2	5-190-255
7/8	.8750	6-1/8	10	2	5-190-260
57/64	.8906	6-1/8	10	2	5-190-265
29/32	.9063	6-1/8	10	2	5-190-270
1	1.000	6-3/8	12	4	5-190-3001
1-3/32	1.0938	6-7/8	11-1/2	3	5-190-306
1-7/64	1.1094	7-1/8	11-3/4	3	5-190-307
1-1/8	1.1250	7-1/8	11-3/4	3	5-190-308
1-9/64	1.1406	7-1/4	11-7/8	3	5-190-309
1-5/32	1.1563	7-1/4	11-7/8	3	5-190-310

Dia Inches	Dia Decimal	Flute Length	Overall Length	Morse Taper Shank Size	Part Number
1-3/16	1.1875	7-3/8	12	3	5-190-312
1-7/32	1.2188	7-1/2	12-1/8	3	5-190-314
1-1/4	1.2500	7-7/8	12-1/2	3	5-190-316
1-33/64	1.5156	9-3/8	15	4	5-190-333
1-17/32	1.5313	9-3/8	15	4	5-190-334
1-9/16	1.5625	9-5/8	15-1/4	4	5-190-336
1-5/8	1.6250	10	15-5/8	4	5-190-340
1-11/16	1.6875	10-1/8	15-3/4	4	5-190-344
1-23/32	1.7188	10-1/8	15-3/4	4	5-190-346
1-3/4	1.7500	10-3/8	16-1/4	4	5-190-348
1-25/32	1.7813	10-3/8	16-1/4	4	5-190-350
1-13/16	1.8125	10-3/8	16-1/4	4	5-190-352
1-53/64	1.8281	10-3/8	16-1/4	4	5-190-353
1-27/32	1.8438	10-3/8	16-1/4	4	5-190-354
1-7/8	1.8750	10-1/2	16-1/2	4	5-190-356
1-29/32	1.9063	10-1/2	16-1/2	4	5-190-358
1-15/16	2.0000	10-5/8	16-5/8	4	5-190-360
1-31/32	1.9688	10-5/8	16-5/8	4	5-190-362
2	2.0000	10-5/8	16-5/8	4	5-190-400

Stub Length Taper Shank Drills

- High Speed Steel
- 5" Flute length



Size	Morse Taper	OAL	Part Number
2	4	11-3/8	5-194-049
2	5	12	5-194-050
2-1/16	4	11-3/8	5-194-052
2-1/16	5	12	5-194-055
2-1/8	4	11-3/8	5-194-057
2-1/8	5	12	5-194-060
2-13/16	4	11-3/8	5-194-062
2-13/16	5	12	5-194-065
2-1/4	4	11-3/8	5-194-067
2-1/4	5	12	5-194-070
2-15/16	4	11-3/8	5-194-072
2-3/8	4	11-3/8	5-194-077
2-3/8	5	12	5-194-080
2-7/16	4	11-3/8	5-194-082

Size	Morse Taper	OAL	Part Number
2-7/16	5	12	5-194-085
2-1/2	4	11-3/8	5-194-087
2-1/2	5	12	5-194-090
2-9/16	5	12	5-194-093
2-5/8	4	11-3/8	5-194-094
2-5/8	5	12	5-194-095
2-3/4	5	12	5-194-100
2-7/8	5	12	5-194-105
3	5	12	5-194-110
3-1/8	5	12	5-194-115
3-1/4	5	12	5-194-120
3-1/2	5	12	5-194-130

Twist Drills with Standard Taper Shanks – DIN 345

Taper Shank – Metric Diameters

- High Speed Steel
- 118° Point Genral Purpose
- Black Oxide



Dia	Dia Decimal	Flute Length	Overall Length	Morse Taper Shank Size	Part Number
8.0	.3150	75	156	1	5-191-148
8.5	.3346	75	156	1	5-191-154
9.0	.3543	81	162	1	5-191-159
9.5	.3740	81	162	1	5-191-165
10.0	.3937	87	168	1	5-191-170
10.5	.4134	87	168	1	5-191-176
11.0	.4331	94	175	1	5-191-181
11.5	.4528	94	175	1	5-191-186
12.0	.4724	101	182	1	5-191-191
12.5	.4921	101	182	1	5-191-196
13.0	.5118	101	182	1	5-191-201
13.5	.5315	101	182	1	5-191-206
14.0	.5512	108	189	1	5-191-212
14.5	.5709	114	212	2	5-191-214
15.0	.5906	114	212	2	5-191-216
15.5	.6102	120	218	2	5-191-218
16.0	.6299	120	218	2	5-191-220
16.5	.6496	125	223	2	5-191-222
17.0	.6693	125	223	2	5-191-224
17.5	.6890	130	228	2	5-191-226
18.0	.7087	130	228	2	5-191-228
18.5	.7283	135	233	2	5-191-230
19.0	.7480	135	233	2	5-191-232
19.5	.7677	140	238	2	5-191-234
20.0	.7874	140	238	2	5-191-236
20.5	.8071	145	243	2	5-191-238
21.0	.8268	145	243	2	5-191-240
22.0	.8661	150	248	2	5-191-2441
22.5	.8858	155	253	2	5-191-2461
23.0	.9055	155	253	2	5-191-247
23.5	.9252	155	276	3	5-191-250
24.0	.9449	160	281	3	5-191-252

Dia	Dia Decimal	Flute Length	Overall Length	Morse Taper Shank Size	Part Number
24.5	.9646	160	281	3	5-191-254
25.0	.9843	160	281	3	5-191-256
25.5	1.0039	165	286	3	5-191-258
26.0	1.0236	165	286	3	5-191-260
26.5	1.0433	165	286	3	5-191-262
27.0	1.0630	170	291	3	5-191-264
27.5	1.0827	170	291	3	5-191-266
28.0	1.1024	170	291	3	5-191-268
28.5	1.1220	175	296	3	5-191-270
29.0	1.1417	175	296	3	5-191-272
29.5	1.1614	175	296	3	5-191-274
30.0	1.1811	175	296	3	5-191-276
30.5	1.2008	180	301	3	5-191-278
31.0	1.2205	180	301	3	5-191-280
31.5	1.2402	180	301	3	5-191-282
32.0	1.2598	185	334	4	5-191-284
32.5	1.2795	185	334	4	5-191-285
33.0	1.2992	185	334	4	5-191-286
33.5	1.3189	185	334	4	5-191-287
34.0	1.3386	190	339	4	5-191-288
34.5	1.3583	190	339	4	5-191-289
35.0	1.3780	190	339	4	5-191-290
35.5	1.3976	190	339	4	5-191-291
36.0	1.4173	195	344	4	5-191-292
36.5	1.4370	195	344	4	5-191-293
37.0	1.4567	195	344	4	5-191-294
37.5	1.4764	195	344	4	5-191-295
38.0	1.4961	200	349	4	5-191-296
38.5	1.5157	200	349	4	5-191-297
39.0	1.5354	200	349	4	5-191-298
39.5	1.5551	200	349	4	5-191-299
40.0	1.5748	200	349	4	5-191-300

Twist Drills with Larger Taper Shanks – DIN 346

Taper Shank – Metric Diameters

- High Speed Steel
- 118° Point Genral Purpose
- Black Oxide



Dia	Dia Decimal	Flute Length	Overall Length	Morse Taper Shank Size	Part Number
21.5	.8465	150	271	3	5-191-242
22.0	.8661	150	271	3	5-191-244
22.5	.8858	155	278	3	5-191-246
23.0	.9055	155	278	3	5-191-248



Silver and Deming Drills Sets

Cutting Tools

DRILLS

Silver and Deming Drills

1/2" Diameter Shanks – Fractional Sizes

- 6" overall length
- 3" Flute length
- High Speed Steel or Cobalt



Drill Size Inches		HSS Part Number	Cobalt Part Number
Fraction	Decimal		
1/2	.5000	5-166-008	–
33/64	.5156	5-166-010	–
17/32	.5312	5-166-012	5-169-012
35/64	.5469	5-166-014	5-169-014
9/16	.5625	5-166-016	5-169-016
37/64	.5781	5-166-018	5-169-018
19/32	.5938	5-166-020	5-169-020
39/64	.6094	5-166-022	5-169-022
5/8	.6250	5-166-024	5-169-024
41/64	.6406	5-166-026	5-169-026
21/32	.6562	5-166-028	5-169-028
43/64	.6719	5-166-030	5-169-030
11/16	.6875	5-166-032	5-169-032
45/64	.7031	5-166-034	5-169-034
23/32	.7188	5-166-036	5-169-036
47/64	.7344	5-166-038	5-169-038
3/4	.7500	5-166-040	5-169-040
49/64	.7656	5-166-042	5-169-042
25/32	.7812	5-166-044	5-169-044
51/64	.7969	5-166-046	5-169-046
13/16	.8125	5-166-048	5-169-048
53/64	.8281	5-166-050	5-169-050
27/32	.8438	5-166-052	5-169-052
55/64	.8594	5-166-054	5-169-054
7/8	.8750	5-166-056	5-169-056
57/64	.8906	5-166-058	5-169-058
29/32	.9062	5-166-060	5-169-060
59/64	.9219	5-166-062	5-169-062
15/16	.9375	5-166-064	5-169-064
61/64	.9531	5-166-066	5-169-066
31/32	.9688	5-166-068	5-169-068
63/64	.9844	5-166-070	5-169-070
1	1.0000	5-166-072	5-169-072
1-1/64	1.0156	5-166-074	–
1-1/32	1.0312	5-166-076	–
1-3/64	1.0469	5-166-078	–
1-1/16	1.0625	5-166-080	5-169-080
1-5/64	1.0781	5-166-082	–
1-3/32	1.0938	5-166-084	–
1-7/64	1.1094	5-166-086	–
1-1/8	1.1250	5-166-088	5-169-088
1-9/64	1.1406	5-166-090	–
1-5/32	1.1562	5-166-092	–
1-11/64	1.1719	5-166-094	–
1-3/16	1.1875	5-166-096	5-169-096
1-13/64	1.2031	5-166-098	–
1-7/32	1.2188	5-166-100	–
1-15/64	1.2344	5-166-102	–

Silver and Deming Drills

1/2" Diameter Shanks – Fractional Sizes (continued)

- 6" overall length
- 3" Flute length
- High Speed Steel or Cobalt



Drill Size Inches		HSS Part Number	Cobalt Part Number
Fraction	Decimal		
1-1/4	1.2500	5-166-104	5-169-104
1-17/64	1.2656	5-166-106	–
1-9/32	1.2812	5-166-108	–
1-19/64	1.2969	5-166-110	–
1-5/16	1.3125	5-166-112	5-169-112
1-21/64	1.3281	5-166-114	–
1-11/32	1.3438	5-166-116	–
1-23/64	1.3594	5-166-118	–
1-3/8	1.3750	5-166-120	5-169-120
1-25/64	1.3906	5-166-122	–
1-13/32	1.4062	5-166-124	–
1-27/64	1.4219	5-166-126	–
1-7/16	1.4375	5-166-128	5-169-128
1-29/64	1.4531	5-166-130	–
1-15/32	1.4688	5-166-132	–
1-31/64	1.4844	5-166-134	–
1-1/2	1.5000	5-166-136	5-169-136

Silver and Deming Drills

3/4" Diameter Shanks – Fractional Sizes

- High Speed Steel
- 6" overall length and 3" Flute length

Drill Size Inches		Part Number
Fraction	Decimal	
25/32	.7812	5-168-044
13/16	.8125	5-168-048
27/32	.8438	5-168-052
7/8	.8750	5-168-056
29/32	.9062	5-168-060
15/16	.9375	5-168-064
31/32	.9688	5-168-068
1	1.0000	5-168-072
1-1/32	1.0312	5-168-076
1-1/16	1.0625	5-168-080
1-3/32	1.0938	5-168-084
1-1/8	1.1250	5-168-088
1-5/32	1.1562	5-168-092
1-3/16	1.1875	5-168-096
1-7/32	1.2188	5-168-100
1-1/4	1.2500	5-168-104
1-9/32	1.2812	5-168-108
1-5/16	1.3125	5-168-112
1-11/32	1.3438	5-168-116
1-3/8	1.3750	5-168-120
1-13/32	1.4062	5-168-124

Drill Size Inches		Part Number
Fraction	Decimal	
1-7/16	1.4375	5-168-128
1-15/32	1.4688	5-168-132
1-1/2	1.5000	5-168-136
1-17/32	1.5313	5-168-140
1-9/16	1.5625	5-168-144
1-19/32	1.5938	5-168-148
1-5/8	1.6250	5-168-152
1-21/32	1.6562	5-168-156
1-11/16	1.6875	5-168-160
1-23/32	1.7188	5-168-164
1-3/4	1.7500	5-168-168
1-25/32	1.7812	5-168-172
1-13/16	1.8125	5-168-176
1-27/32	1.8438	5-168-180
1-7/8	1.8750	5-168-184
1-29/32	1.9062	5-168-188
1-15/16	1.9375	5-168-192
1-31/32	1.9688	5-168-196
2	2.0000	5-168-200
2 Piece Set: 1" thru 1-1/2"		5-168-510



Silver and Deming Drills Sets

Cutting Tools

DRILLS

Silver and Deming Drills

1/2" Diameter Shanks – Metric Sizes

- 6" overall length
- 3" Flute length
- Eliminates tool presetting
- High Speed Steel



Drill Size mm		Part Number
Size	Decimal	
12.5 MM	.4921	5-167-125
13.0 MM	.5118	5-167-130
13.5 MM	.5315	5-167-135
14.0 MM	.5512	5-167-140
14.5 MM	.5709	5-167-145
15.0 MM	.5906	5-167-150
15.5 MM	.6102	5-167-155
16.0 MM	.6299	5-167-160
16.5 MM	.6496	5-167-165
17.0 MM	.6693	5-167-170
17.5 MM	.6890	5-167-175
18.0 MM	.7087	5-167-180
18.5 MM	.7283	5-167-185
19.0 MM	.7480	5-167-190
19.5 MM	.7677	5-167-195
20.0 MM	.7874	5-167-200
20.5 MM	.8071	5-167-205
21.0 MM	.8268	5-167-210
21.5 MM	.8465	5-167-215
22.0 MM	.8661	5-167-220
22.5 MM	.8858	5-167-225
23.0 MM	.9055	5-167-230
23.5 MM	.9252	5-167-235
24.0 MM	.9449	5-167-240
24.5 MM	.9646	5-167-245
25.0 MM	.9843	5-167-250

Drill Size mm		Part Number
Size	Decimal	
25.5 MM	1.0039	5-167-255
26.0 MM	1.0236	5-167-260
26.5 MM	1.0433	5-167-265
27.0 MM	1.0630	5-167-270
27.5 MM	1.0837	5-167-275
28.0 MM	1.1024	5-167-280
28.5 MM	1.1220	5-167-285
29.0 MM	1.1417	5-167-290
29.5 MM	1.1614	5-167-295
30.0 MM	1.1811	5-167-300
30.5 MM	1.2008	5-167-305
31.0 MM	1.2205	5-167-310
31.5 MM	1.2402	5-167-315
32.0 MM	1.2598	5-167-320
32.5 MM	1.2795	5-167-325
33.0 MM	1.2992	5-167-330
33.5 MM	1.3189	5-167-335
34.0 MM	1.3386	5-167-340
34.5 MM	1.3583	5-167-345
35.0 MM	1.3780	5-167-350
35.5 MM	1.3976	5-167-355
36.0 MM	1.4173	5-167-360
36.5 MM	1.4370	5-167-365
37.0 MM	1.4567	5-167-370
37.5 MM	1.4764	5-167-375
38.0 MM	1.4961	5-167-380

Silver and Deming Drill Sets

- High Speed Steel or Cobalt
- 1/2" diameter shanks, 6" overall length and 3" Flute length
- Design allows for minimal adjustments during tool changes
- Eliminates tool presetting



5 Piece Drill Sets

Sizes: 1", 1-1/8", 1-1/4", 1-3/8" & 1-1/2"
Sets Include Hardwood Block

Description	Part Number
HSS Drill Set with 1/2" dia shanks	5-166-510
Cobalt Drill Set with 1/2" dia shanks	5-169-510
HSS Drill Set with 3/4" dia shanks	5-168-510



8 Piece Drill Sets

Sizes: 9/16", 5/8", 11/16", 3/4",
13/16", 7/8", 15/16" & 1"
Sets include case

Description	Part Number
HSS Drill Set with 1/2" dia shanks	5-166-502
Cobalt Drill Set with 1/2" dia shanks	5-169-502



13 Piece Drill Sets

Sizes: 17/32", 9/16", 19/32", 5/8", 21/32", 11/16", 23/32", 3/4",
13/16", 7/8", 15/16" & 1"
Sets Include Hardwood Block

Description	Part Number
HSS Drill Set with 1/2" dia shanks	5-166-505
Cobalt Drill Set with 1/2" dia shanks	5-169-505



8 Piece Drill Sets

Sizes: 9/16", 5/8", 11/16", 3/4",
13/16", 7/8", 15/16" & 1"
Sets Include Hardwood Block

Description	Part Number
HSS Drill Set with 1/2" dia shanks	5-166-504
Cobalt Drill Set with 1/2" dia shanks	5-169-504



HS Spotting and Centering Drills

Cutting Tools

DRILLS

Spotting and Centering Drills

- High Speed Steel
- 90° and 118° Point Angles

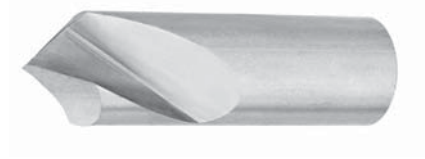

Body Dia Inches	Overall Length Inches	Flute Length Inches	90 Degree	118 Degree
			Right Hand Part Number	Right Hand Part Number
1/8	1-1/4	3/8	5-164-301	5-164-001
3/16	1-3/8	1/2	5-164-302	5-164-002
1/4	1-1/2	5/8	5-164-303	5-164-003
5/16	1-1/2	5/8	5-164-304	5-164-004
3/8	2	1	5-164-305	5-164-005
7/16	2	1	5-164-310	5-164-010
1/2	2	1	5-164-320	5-164-020
5/8	2-1/4	1-1/8	5-164-340	5-164-040
3/4	2-1/4	1-1/8	5-164-350	5-164-050
7/8	2-1/2	1-1/4	5-164-360	5-164-060
1	2-1/2	1-1/4	5-164-370	5-164-070
1-1/4	4	2	–	5-164-080
1-1/2	5	2-1/2	5-164-390	5-164-090

NC Spotting Drills

- High Speed Steel
- Right Hand Cut
- 90° and 120° Point Angles



Body Dia Inches	Overall Length Inches	Flute Length Inches	90 Degree Part Number	120 Degree Part Number
1/4	2-1/2	3/4	5-165-0912	5-165-1212
1/4	4	3/4	5-165-0914	5-165-1214
1/4	6	3/4	5-165-0916	5-165-1216
3/8	3-1/8	1-1/8	5-165-0933	5-165-1233
3/8	5	1-1/8	5-165-0935	5-165-1235
3/8	7	1-1/8	5-165-0937	5-165-1237
1/2	3-3/4	1-3/8	5-165-0943	5-165-1243
1/2	6	1-3/8	5-165-0946	5-165-1246
1/2	8	1-3/8	5-165-0948	5-165-1248
5/8	4-3/8	1-5/8	5-165-0954	5-165-1254
5/8	7	1-5/8	5-165-0957	5-165-1257
5/8	9	1-5/8	5-165-0959	–
3/4	5	1-7/8	5-165-0965	5-165-1265
3/4	8	1-7/8	5-165-0968	5-165-1268
3/4	10	1-7/8	5-165-0969	5-165-1269
1	6	2-1/4	5-165-0996	5-165-1296
1	8	2-1/4	5-165-0998	–
1	10	2-1/4	5-165-0999	5-165-1299

Core Drills – Taper Shank

- Taper Shank
- 4 Flute
- High Speed Steel



Dia Inches	Shank Taper Number	Flute Length	Overall Length	Part Number
13/32	1	3-5/8	7	5-215-005
7/16	1	2-7/8	7-1/4	5-215-010
1/2	2	4-3/8	8-1/4	5-215-025
17/32	2	4-5/8	8-1/2	5-215-035
9/16	2	4-7/8	8-3/4	5-215-040
19/32	2	4-7/8	8-3/4	5-215-045
5/8	2	4-7/8	8-3/4	5-215-050
21/32	2	5-1/8	9	5-215-060
11/16	2	5-3/8	9-1/4	5-215-065
23/32	2	5-5/8	9-1/2	5-215-075
3/4	2	5-7/8	9-3/4	5-215-080
49/64	2	6	9-7/8	5-215-085
25/32	2	6	9-7/8	5-215-090
13/16	3	6-1/8	10-3/4	5-215-100
7/8	3	6-1/8	10-3/4	5-215-115
15/16	3	6-1/8	10-3/4	5-215-130
31/32	3	6-3/8	11	5-215-140
63/64	3	6-3/8	11	5-215-145
1	3	6-3/8	11	5-215-150
1-3/32	4	6-7/8	12-1/2	5-215-175
1-1/8	4	7-1/8	12-3/4	5-215-180
1-5/32	4	7-1/4	12-7/8	5-215-185
1-3/16	4	7-3/8	13	5-215-195
1-7/32	4	7-1/2	13-1/8	5-215-205
1-1/4	4	7-7/8	13--1/2	5-215-215
1-9/32	4	8-1/2	14-1/8	5-215-225
1-5/16	4	8-5/8	14-1/4	5-215-235
1-3/8	4	8-7/8	14-1/2	5-215-250

Dia Inches	Shank Taper Number	Flute Length	Overall Length	Part Number
1-7/16	4	9-1/8	14-3/4	5-215-270
1-1/2	4	9-3/8	15	5-215-280
1-17/32	5	9-3/8	16-3/8	5-215-290
1-9/16	5	9-5/8	16-5/8	5-215-300
1-19/32	5	9-7/8	16-7/8	5-215-310
1-5/8	5	10	17	5-215-320
1-21/32	5	10-1/8	17-1/8	5-215-325
1-23/32	5	10-1/8	17-1/8	5-215-335
1-3/4	5	10-1/8	17-1/8	5-215-345
1-25/32	5	10-1/8	17-1/8	5-215-350
1-27/32	5	10-1/8	17-1/8	5-215-360
1-7/8	5	10-3/8	17-3/8	5-215-365
1-29/32	5	10-3/8	17-3/8	5-215-370
1-15/16	5	10-3/8	17-3/8	5-215-375
1-31/32	5	10-3/8	17-3/8	5-215-380
2	5	10-3/8	17-3/8	5-215-385
2-1/32	5	10-3/8	17-3/8	5-215-390
2-1/16	5	10-1/4	17-3/8	5-215-395
2-1/8	5	10-1/4	17-3/8	5-215-400
2-1/4	5	10-1/8	17-3/8	5-215-410
2-7/16	5	11-1/4	18-3/4	5-215-425
2-1/2	5	11-1/4	18-3/4	5-215-430
2-5/8	5	11-7/8	19-1/2	5-215-440
2-11/16	5	12-3/4	20-3/8	5-215-445
2-3/4	5	12-3/4	20-3/8	5-215-450
2-13/16	5	13-3/8	21-1/8	5-215-455
2-7/8	5	13-3/8	21-1/8	5-215-460



HSS Core Drills

Cutting Tools

DRILLS

Core Drills – Straight Shank

- Straight Shank
- 4 Flute
- High Speed Steel

Dia Inches	Flute Length	Overall Length	Part Number
1/4	3-1/2	6-1/8	5-205-00
17/64	3-3/4	6-1/8	5-205-000
9/32	3-7/8	6-1/4	5-205-0000
5/16	4	6-3/8	5-205-0005
21/64	4-1/8	6-1/2	5-205-001
11/32	4-1/8	6-1/2	5-205-0015
3/8	4-1/4	6-3/4	5-205-002
11/32	4-3/8	7	5-205-0025
27/64	4-5/8	7-1/4	5-205-003
7/16	4-5/8	7-1/4	5-205-004
15/32	4-3/4	7-1/2	5-205-0045
1/2	4-3/4	7-3/4	5-205-005
33/64	4-3/4	8	5-205-006
17/32	4-3/4	8	5-205-010
9/16	4-7/8	8-1/4	5-205-015
19/32	4-7/8	8-3/4	5-205-020
5/8	4-7/8	8-3/4	5-205-025
41/64	5	9	5-205-026
21/32	5-1/8	9	5-205-030
11/16	5-3/8	9-1/4	5-205-035
23/32	5-5/8	9-1/2	5-205-040
3/4	5-7/8	9-3/4	5-205-045
49/64	6	9-7/8	5-205-046
25/32	9-7/8	6	5-205-050

Dia Inches	Flute Length	Overall Length	Part Number
13/16	10	6-1/8	5-205-055
27/32	10	6-1/8	5-205-056
7/8	10	6-1/8	5-205-060
29/32	10	6-1/8	5-205-061
31/32	11	6-3/8	5-205-066
1	11	6-3/8	5-205-070
1-1/32	11-1/8	6-1/2	5-205-071
1-1/16	11-1/4	6-5/8	5-205-075
1-3/32	11-1/2	6-7/8	5-205-076
1-1/8	11-3/4	7-1/8	5-205-080
1-3/16	12	7-3/8	5-205-082
1-1/4	12-1/2	7-7/8	5-205-085
1-9/32	14-1/8	8-1/2	5-205-086
1-5/16	14-1/4	8-5/8	5-205-087
1-11/32	14-3/8	8-3/4	5-205-088
1-13/32	14-5/8	9	5-205-091
1-15/32	14-7/8	9-1/4	5-205-093
1-5/8	15-5/8	9-7/8	5-205-105
1-11/16	15-3/4	10	5-205-110
1-3/4	16-1/4	10-1/2	5-205-115
1-7/8	16-1/2	10-3/4	5-205-125
1-15/16	16-5/8	10-3/4	5-205-130
2	16-5/8	10-3/4	5-205-135

TABLE OF CONTENTS

ANNULAR CUTTERS

Technical Reference	296
Annular Cutters	297
Annular Cutter Holders	298





Speeds and Feeds Annular Cutters

ANNULAR CUTTERS

Material being Cut	Hardness (Brinell)	SFM
Steels:		
Carbon Steel	125-175	85-95
Soft Alloyed Steels	175-225	60-75
Medium Alloyed Steels	225-250	50-75
Hard Alloyed Steels	250-300	30-45
Tool Steels (D2, H13)	200-250	35-55
Stainless - Ferritic (400 series)	125-175	80-110
Stainless - Austenitic (300 series)	125-175	50-75
Stainless - Austenitic (300 series)	200-275	40-60
Cast Iron:		
Soft	110-150	75-100
Medium	150-225	50-80
Aluminum		
Wrought	50-150	500-750
Cast	45-125	450-750
Cast Copper	–	115-130

SFM = Surface Feet per Minute

RPM (Revolutions per Minute) = (SFM *3.82) / Cutter Diameter (inches)

Feed:

- Typical Feed Rate per Tooth is .003" / .004" inches per tool

Inches per Minute = # of teeth(flutes) X Feed Rate per Tooth X RPM

Annular Cutters

- Eliminate multi-step drilling
- Lower cost per hole
- Better finishing
- More accurate, cleaner hole
- Longer tool life (can be resharpened)
- 3/4" shank diameter with two flats for both inch and metric cutters
- Cutters are interchangeable with other standard hole cutting systems
- High Speed Steel



Inch Sizes	Number of Flutes	Part Number 1 inch Depth	Part Number 2 inch Depth	Part Number 3 inch Depth
7/16	4	5-530-110	5-530-210	—
1/2	4	5-530-111	5-530-211	—
9/16	4	5-530-113	5-530-213	—
5/8	5	5-530-116	5-530-216	—
11/16	5	5-530-119	5-530-219	—
3/4	6	5-530-121	5-530-221	—
13/16	6	5-530-124	5-530-224	5-530-324
7/8	6	5-530-127	5-530-227	5-530-327
15/16	6	5-530-130	5-530-230	5-530-330
1	6	5-530-133	5-530-233	5-530-333
1-1/16	8	5-530-136	5-530-236	5-530-336
1-1/8	8	5-530-139	5-530-239	5-530-339
1-3/16	8	5-530-142	5-530-242	5-530-342
1-1/4	8	5-530-145	5-530-245	5-530-345
1-5/16	8	5-530-148	5-530-248	5-530-348
1-3/8	10	5-530-151	5-530-251	5-530-351
1-7/16	10	5-530-154	5-530-254	5-530-354
1-1/2	10	5-530-157	5-530-257	5-530-357
1-9/16	10	5-530-160	5-530-260	5-530-360
1-5/8	10	5-530-163	5-530-263	5-530-363
1-11/16	10	5-530-166	5-530-266	5-530-366
1-3/4	10	5-530-169	5-530-269	5-530-369
1-13/16	10	5-530-172	5-530-272	5-530-372
1-7/8	10	5-530-175	5-530-275	5-530-375
1-15/16	10	5-530-178	5-530-278	5-530-378
2	12	5-530-181	5-530-281	5-530-381
2-1/16	12	5-530-183	5-530-283	5-530-383
2-1/8	12	5-530-186	—	—
2-3/16	12	5-530-187	—	—
2-1/4	12	5-530-189	—	—
2-5/16	12	5-530-190	—	—
2-3/8	12	5-530-192	—	—
2-7/16	12	5-530-193	—	—
2-1/2	12	5-530-195	—	—
Set of 5 Pieces Includes: 9/16, 11/16, 13/16, 15/16 and 1-1/16	—	5-530-501	—	—

Ejector Pilots



Description	Part Number
Ejector – Pilot, Short for 7/16" diameter cutter x 1" cutter depths	5-530-903
Ejector – Pilot, Short for all 1" cutter depths except 7/16" dia.	5-530-905
Ejector – Pilot, Long for 7/16" diameter cutter x 2" cutter depths	5-530-913
Ejector – Pilot, Long for all 2" cutter depths except 7/16" dia.	5-530-915
Ejector – Pilot, Extra-Long for all 3" cutter depths	5-530-925





Annular Cutter Holders

- Straight, R8 or MT Shank
- Holder shank allows different machines to drive cutter
- Easily reaches out of the way places
- Select adapter lengths reduce the number of machine set ups
- For 1" depth of cut Annular Cutters



ANNULAR CUTTERS

Straight Shank – 3 Flats				
Type	Shank Size Inches	Cutter Shank Size Inches	Gage Length Inches	Part Number
HEN-1	1/2	3/4	2-1/8	7-980-100
HEN-2	3/4	3/4	2	7-980-200
HEN-2-6	3/4	3/4	6	7-980-206
HEN-2-12	3/4	3/4	12	7-980-212
Straight Shank – 2 Flats				
Type	Shank Size Inches	Cutter Shank Size Inches	Gage Length Inches	Part Number
HEN-9-6	3/4	3/4	6	7-983-906
Morse Taper Shank				
HEN-3	MT2	3/4	2	7-981-300
HEN-3-6	MT2	3/4	6	7-981-306
HEN-4	MT3	3/4	2	7-981-400
HEN-4-6	MT3	3/4	6	7-981-406
HEN-4-12	MT3	3/4	12	7-981-412
HEN-8	MT3	1-1/4	2-3/4	7-981-800
R8 Shank				
HEN-5	R8	3/4	1-3/4	7-982-500

TABLE OF CONTENTS

REAMERS

Technical Reference	300
Straight Shank Chucking Reamers	301
Taper Shank Chucking Reamers	310
Expansion Chucking Reamers	312
Hand Reamers	313
Expansion Hand Reamers	315
Bridge Reamers	316
Adjustable Blade Reamers	316
Taper Pin Reamers	317
Car Reamers	318
Taper Pipe Reamers	319
Shell Reamers	320





Recommended Feeds and Speeds for HSS Finish Reaming

Material being Cut	Hardness (Brinell)	SFM	Feed Rate (In.) per Flute
Aluminum	–	130-150	.002 - .003
Brass & Bronze	–	100-130	.002 - .003
Bronze – High Tensil	–	40-60	.002 - .003
Cast Iron – Soft	120-175	65-90	.002 - .003
Cast Iron – Medium Hard	200-275	50-70	.002 - .003
Cast Iron – Chilled	300-375	20-30	.002 - .003
Malleable Cast iron	110-160	45-70	.002 - .003
Plain Carbon Steel	150-225	55-65	.002 - .003
	230-325	40-50	.002 - .003
	330-400	25-35	.001 - .002
Alloyed Steel	150-225	55-65	.002 - .003
	230-325	30-40	.002 - .003
	330-400	20-30	.002 - .003
Tool Steel	150-250	40-50	.002 - .003
	255-375	20-30	.002 - .003
Stainless – Free machining	135-185	40-50	.001 - .002
Stainless – 300 series	135-300	35-45	.001 - .002
Stainless – PH	300-375	20-30	.001 - .002

Calculations:

RPM's = (3.82 X SFM) / reamer diameter in inches

Inches per Min (IPM) = Feed per flute X # of flutes X RPM

Recommended stock removal in inches for Reaming

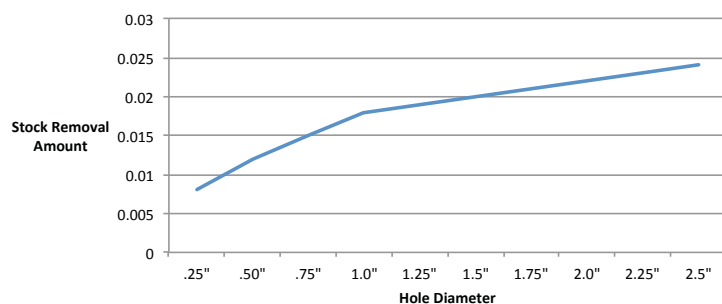

Tech Tips:

- Chatter may result when speed is too high
- Too low a feed may produce chatter and excessive reamer wear
- Too high a feed may reduce hole size accuracy
- When not enough material is being reamed, increase feed rate or decrease pre-reaming hole size
- Reamer will follow the existing hole. Only end cutting reamers (like an end mill) can cut their own path
- Standard reamer chamfer angle is 45 degrees. If difficulty when starting the reamer, reduce angle to 30 degrees

Straight Shank Chucking Reamers



Chucking Reamers

Straight Shank, Straight Flute – Fractional Sizes

- High Speed Steel and Cobalt
- Right-Hand Cut



Dia Fractional Size	Dia Decimal Size	Shank Dia	Flute Length	Overall Length	Number of Flutes	HSS Part Number	Cobalt Part Number
1/16	.0625	.0625	1/2	2 1/2	4	5-015-001	–
5/64	.0781	.0781	3/4	3	4	5-015-002	–
3/32	.0938	.0938	7/8	3 1/2	4	5-015-003	–
7/64	.1094	.1094	7/8	3 1/2	4	5-015-004	–
1/8	.1250	.1190	7/8	3 1/2	6	5-015-005	5-022-005
9/64	.1406	.1350	1	4	6	5-015-010	5-022-010
5/32	.1563	.1510	1	4	6	5-015-015	5-022-015
11/64	.1719	.1645	1-1/8	4 1/2	6	5-015-020	5-022-020
3/16	.1875	.1805	1-1/8	4 1/2	6	5-015-025	5-022-025
13/64	.2031	.1945	1-1/4	5	6	5-015-030	5-022-030
7/32	.2188	.2075	1-1/4	5	6	5-015-035	5-022-035
15/64	.2344	.2265	1-1/2	6	6	5-015-040	5-022-040
1/4	.2500	.2405	1-1/2	6	6	5-015-045	5-022-045
17/64	.2656	.2485	1-1/2	6	6	5-015-050	5-022-050
9/32	.2813	.2485	1-1/2	6	6	5-015-055	5-022-055
19/64	.2969	.2807	1-1/2	6	6	5-015-060	5-022-060
5/16	.3125	.2807	1-1/2	6	6	5-015-065	5-022-065
21/64	.3281	.2807	1-1/2	6	6	5-015-070	5-022-070
11/32	.3438	.2807	1-1/2	6	6	5-015-075	5-022-075
23/64	.3594	.3120	1-3/4	7	6	5-015-080	5-022-080
3/8	.3750	.3120	1-3/4	7	6	5-015-085	5-022-085
25/64	.3906	.3120	1-3/4	7	6	5-015-090	5-022-090
13/32	.4063	.3120	1-3/4	7	6	5-015-095	5-022-095
27/64	.4219	.3745	1-3/4	7	8	5-015-100	5-022-100
7/16	.4375	.3745	1-3/4	7	8	5-015-105	5-022-105
29/64	.4531	.3745	1-3/4	7	8	5-015-110	5-022-110
15/32	.4688	.3745	1-3/4	7	8	5-015-115	5-022-115
31/64	.4844	.4370	2	8	8	5-015-120	5-022-120
1/2	.5000	.4370	2	8	8	5-015-125	5-022-125
33/64	.5156	.4370	2	8	8	5-015-130	–
17/32	.5313	.4370	2	8	8	5-015-135	5-022-135
35/64	.5469	.4370	2	8	8	5-015-140	–
9/16	.5625	.4370	2	8	8	5-015-145	5-022-145
37/64	.5781	.4370	2	8	8	5-015-150	–
19/32	.5938	.4370	2	8	8	5-015-155	5-022-155
39/64	.6094	.5620	2-1/4	9	8	5-015-160	5-022-160
5/8	.6250	.5620	2-1/4	9	8	5-015-165	5-022-165
41/64	.6406	.5620	2-1/4	9	8	5-015-170	–
21/32	.6563	.5620	2-1/4	9	8	5-015-175	5-022-175
43/64	.6719	.5620	2-1/4	9	8	5-015-180	–

Chucking Reamer Diameter Tolerances
 Up to and including 1/4": +.0001" to +.0004"
 Over 1/4" to include 1": +.0001" to +.0005"
 Over 1": +.0002" to .0006"

REAMERS



Straight Shank Chucking Reamers

Cutting Tools

Chucking Reamers

Straight Shank, Straight Flute – Fractional Sizes (continued)

- High Speed Steel and Cobalt
- Right-Hand Cut



REAMERS

Dia Fractional Size	Dia Decimal Size	Shank Dia	Flute Length	Overall Length	Number of Flutes	HSS Part Number	Cobalt Part Number
11/16	.6875	.5620	2-1/4	9	8	5-015-185	5-022-185
45/64	.7031	.5620	2-1/4	9	8	5-015-190	–
23/32	.7188	.5620	2-1/4	9	8	5-015-195	5-022-195
47/64	.7344	.6245	2-1/2	9-1/2	8	5-015-200	–
3/4	.7500	.6245	2-1/2	9-1/2	8	5-015-205	5-022-205
49/64	.7656	.6245	2-1/2	9-1/2	10	5-015-210	–
25/32	.7813	.6245	2-1/2	9-1/2	10	5-015-215	5-022-215
51/64	.7969	.6245	2-1/2	9-1/2	10	5-015-220	–
13/16	.8125	.6245	2-1/2	9-1/2	10	5-015-225	5-022-225
53/64	.8281	.6245	2-1/2	9-1/2	10	5-015-230	–
27/32	.8438	.6245	2-1/2	9-1/2	10	5-015-235	5-022-235
55/64	.8594	.7495	2-5/8	10	10	5-015-240	–
7/8	.8750	.7495	2-5/8	10	10	5-015-245	5-022-245
57/64	.8906	.7495	2-5/8	10	10	5-015-250	–
29/32	.9063	.7495	2-5/8	10	10	5-015-255	5-022-255
59/64	.9219	.7495	2-5/8	10	10	5-015-260	–
15/16	.9375	.7495	2-5/8	10	10	5-015-265	5-022-265
61/64	.9531	.7495	2-5/8	10	10	5-015-270	–
31/32	.9688	.7495	2-5/8	10	10	5-015-275	5-022-275
63/64	.9844	.8745	2-3/4	10-1/2	10	5-015-280	–
1	1.0000	.8745	2-3/4	10-1/2	10	5-015-285	5-022-285
1-1/32	1.0313	.8745	2-3/4	10-1/2	10	5-015-290	–
1-1/16	1.0625	.8745	2-3/4	10-1/2	10	5-015-295	–
1-3/32	1.0938	.8745	2-7/8	11	10	5-015-300	–
1-1/8	1.1250	.8745	2-7/8	11	10	5-015-305	–
1-5/32	1.1563	.8745	2-7/8	11	12	5-015-310	–
1-3/16	1.1875	.9995	2-7/8	11	12	5-015-315	–
1-7/32	1.2188	.9995	3	11-1/2	12	5-015-318	–
1-1/4	1.2500	.9995	3	11-1/2	12	5-015-320	–
1-5/16	1.3125	.9995	3	11-1/2	12	5-015-325	–
1-3/8	1.3750	.9995	3-1/4	12	12	5-015-330	–
1-7/16	1.4375	1.2495	3-1/4	12	12	5-015-335	–
1-1/2	1.5000	1.2495	3-1/2	12-1/2	12	5-015-340	–
1-9/16	1.5625	1.2495	3-1/2	12-1/2	12	5-015-345	–
1-5/8	1.6250	1.2495	3-1/2	13	12	5-015-350	–
1-11/16	1.0625	1.2495	3-1/2	13	12	5-015-355	–
1-3/4	1.7500	1.2495	4	13-1/2	12	5-015-360	–
1-7/8	1.8750	1.5000	4	14	12	5-015-365	–
2	2.0000	1.5000	4	14	14	5-015-370	–
29 piece SET - 1/16" thru 1/2" by 64ths in index						5-015-529	–

Chucking Reamer Diameter Tolerances
 Up to and including 1/4": +.0001" to +.0004"
 Over 1/4" to include 1": +.0001" to +.0005"
 Over 1": +.0002" to .0006"

Straight Shank Chucking Reamers



Chucking Reamers

Straight Shank, Straight Flute – Letter Sizes

- High Speed Steel
- Right-Hand Cut



Letter Sizes: A thru Z						Part Number
Letter Sizes	Decimal Dia	Shank Dia	Flute Length	Overall Length	Number of Flutes	
A	.2340	.2265	1-1/2	6	6	5-017-005
B	.2380	.2329	1-1/2	6	6	5-017-010
C	.2420	.2329	1-1/2	6	6	5-017-015
D	.2460	.2329	1-1/2	6	6	5-017-020
E	.2500	.2405	1-1/2	6	6	5-017-025
F	.2570	.2485	1-1/2	6	6	5-017-030
G	.2610	.2485	1-1/2	6	6	5-017-035
H	.2660	.2485	1-1/2	6	6	5-017-040
I	.2720	.2485	1-1/2	6	6	5-017-045
J	.2770	.2485	1-1/2	6	6	5-017-050
K	.2810	.2485	1-1/2	6	6	5-017-055
L	.2900	.2807	1-1/2	6	6	5-017-060
M	.2950	.2807	1-1/2	6	6	5-017-065
N	.3020	.2807	1-1/2	6	6	5-017-070
O	.3160	.2807	1-1/2	6	6	5-017-075
P	.3230	.2807	1-1/2	6	6	5-017-080
Q	.3320	.2807	1-1/2	6	6	5-017-085
R	.3390	.2807	1-1/2	6	6	5-017-090
S	.3480	.3120	1-3/4	7	6	5-017-095
T	.3580	.3120	1-3/4	7	6	5-017-100
U	.3680	.3120	1-3/4	7	6	5-017-105
V	.3770	.3120	1-3/4	7	6	5-017-110
W	.3860	.3120	1-3/4	7	6	5-017-115
X	.3970	.3120	1-3/4	7	6	5-017-120
Y	.4040	.3120	1-3/4	7	6	5-017-125
Z	.4130	.3745	1-3/4	7	6	5-017-130
26 piece SET – Letter A-Z in index						5-017-260

Chucking Reamer Diameter Tolerances
 Up to and including 1/4": +.0001" to +.0004"
 Over 1/4" to include 1": +.0001" to +.0005"
 Over 1": +.0002" to .0006"

REAMERS



Straight Shank Chucking Reamers

Cutting Tools

Chucking Reamers

Straight Shank, Straight Flute – Wire Gage Sizes

- High Speed Steel
- Right-Hand Cut



REAMERS

Wire Gage Sizes: 1 thru 32						Part Number
Number	Decimal Dia	Shank Dia	Flute Length	Overall Length	Number of Flutes	
1	.2280	.2173	1-1/2	6	6	5-016-005
2	.2210	.2173	1-1/2	6	6	5-016-010
3	.2130	.2075	1-1/4	5	6	5-016-015
4	.2090	.2016	1-1/4	5	6	5-016-020
5	.2055	.2016	1-1/4	5	6	5-016-025
6	.2040	.1945	1-1/4	5	6	5-016-030
7	.2010	.1945	1-1/4	5	6	5-016-035
8	.1990	.1895	1-1/4	5	6	5-016-040
9	.1960	.1895	1-1/4	5	6	5-016-045
10	.1935	.1860	1-1/4	5	6	5-016-050
11	.1910	.1860	1-1/4	5	6	5-016-055
12	.1890	.1805	1-1/8	4-1/2	6	5-016-060
13	.1850	.1805	1-1/8	4-1/2	6	5-016-065
14	.1820	.1755	1-1/8	4-1/2	6	5-016-070
15	.1800	.1755	1-1/8	4-1/2	6	5-016-075
16	.1770	.1704	1-1/8	4-1/2	6	5-016-080
17	.1730	.1645	1-1/8	4-1/2	6	5-016-085
18	.1695	.1595	1-1/8	4-1/2	6	5-016-090
19	.1660	.1595	1-1/8	4-1/2	6	5-016-095
20	.1610	.1530	1-1/8	4-1/2	6	5-016-100
21	.1590	.1530	1-1/8	4-1/2	6	5-016-105
22	.1570	.1510	1	4	6	5-016-110
23	.1540	.1460	1	4	6	5-016-115
24	.1520	.1460	1	4	6	5-016-120
25	.1495	.1430	1	4	6	5-016-125
26	.1470	.1430	1	4	6	5-016-130
27	.1440	.1350	1	4	6	5-016-135
28	.1405	.1350	1	4	6	5-016-140
29	.1360	.1275	1	4	6	5-016-145
30	.1285	.1190	7/8	3-1/2	6	5-016-150
31	.1200	.1120	7/8	3-1/2	6	5-016-155
32	.1160	.1120	7/8	3-1/2	6	5-016-160

Chucking Reamer Diameter Tolerances

Up to and including 1/4": +.0001" to +.0004"

Over 1/4" to include 1": +.0001" to +.0005"

Over 1": +.0002" to .0006"

Straight Shank Chucking Reamers



Cutting Tools

Chucking Reamers

Straight Shank, Straight Flute – Metric Sizes

- High Speed Steel
- Right Hand Cut



Dia mm	Flute Length	Overall Length	Shank Dia	DIN 212/A Part Number
2.5	14	57	2.5	5-019-030
3	15	61	3	5-019-040
3.2	16	65	3.2	5-019-045
3.5	18	70	4	5-019-050
4	19	75	4.5	5-019-055
4.5	21	80	5	5-019-060
5	23	86	5.6	5-019-065
5.5	26	93	5.6	5-019-067
6	26	93	6.3	5-019-070
6.5	28	101	7.1	5-019-072
7	31	109	7.1	5-019-075
7.5	31	109	8	5-019-077
8	33	117	8	5-019-080
8.5	33	117	9	5-019-082
9	36	125	9	5-019-085
9.5	36	125	10	5-019-087
10	38	133	10	5-019-090
10.5	38	133	10	5-019-092
11	41	142	10	5-019-095
11.5	41	142	10	5-019-097
12	44	151	10	5-019-100
12.5	44	151	10	5-019-102
13	44	151	10	5-019-105
13.5	47	160	12.5	5-019-107

Dia mm	Flute Length	Overall Length	Shank Dia	DIN 212/A Part Number
14	47	160	12.5	5-019-110
14.5	50	162	12.5	5-019-112
15	50	162	12.5	5-019-115
15.5	52	170	12.5	5-019-117
16	52	170	12.5	5-019-120
16.5	54	175	14	5-019-122
17	54	175	14	5-019-125
17.5	56	182	14	5-019-127
18	56	182	14	5-019-130
18.5	58	189	16	5-019-132
19	58	189	16	5-019-135
19.5	60	195	16	5-019-137
20	60	195	16	5-019-140
20.5	60	215	18	5-019-142
21	60	215	18	5-019-145
21.5	60	225	18	5-019-147
22	60	225	18	5-019-150
22.5	60	230	18	5-019-152
23	60	230	18	5-019-155
23.5	60	240	20	5-019-157
24	60	240	20	5-019-160
24.5	60	245	20	5-019-162
25	60	245	20	5-019-165

REAMERS



Straight Shank Chucking Reamers

Cutting Tools

Chucking Reamers

Straight Shank, Straight Flute – Decimal Sizes

- High Speed Steel
- Right-Hand Cut



REAMERS

Size	# Flutes	Flute Length	Overall Length	Part Number
.1230	6	7/8"	3-1/2"	5-018-123
.1240	6	7/8"	3-1/2"	5-018-124
.1245	6	7/8"	3-1/2"	5-018-1245
.1247	6	7/8"	3-1/2"	5-018-1247
.1255	6	7/8"	3-1/2"	5-018-1255
.1260	6	7/8"	3-1/2"	5-018-126
.1265	6	7/8"	3-1/2"	5-018-1265
.1270	6	7/8"	3-1/2"	5-018-127
.1280	6	7/8"	3-1/2"	5-018-128
.1290	6	7/8"	3-1/2"	5-018-129
.1295	6	7/8"	3-1/2"	5-018-1295
.1300	6	1"	4"	5-018-130
.1370	6	1"	4"	5-018-137
.1380	6	1"	4"	5-018-138
.1400	6	1"	4"	5-018-140
.1410	6	1"	4"	5-018-141
.1415	6	1"	4"	5-018-1415
.1420	6	1"	4"	5-018-142
.1470	6	1"	4"	5-018-147
.1520	6	1"	4"	5-018-152
.1560	6	1"	4"	5-018-156
.1580	6	1"	4"	5-018-158
.1640	6	1-1/8"	4-1/2"	5-018-164
.1670	6	1-1/8"	4-1/2"	5-018-167
.1720	6	1-1/8"	4-1/2"	5-018-172
.1740	6	1-1/8"	4-1/2"	5-018-174
.1750	6	1-1/8"	4-1/2"	5-018-175
.1760	6	1-1/8"	4-1/2"	5-018-176
.1770	6	1-1/8"	4-1/2"	5-018-177
.1810	6	1-1/8"	4-1/2"	5-018-181
.1820	6	1-1/8"	4-1/2"	5-018-182
.1840	6	1-1/8"	4-1/2"	5-018-184
.1845	6	1-1/8"	4-1/2"	5-018-1845
.1850	6	1-1/8"	4-1/2"	5-018-185
.1855	6	1-1/8"	4-1/2"	5-018-1855
.1860	6	1-1/8"	4-1/2"	5-018-186
.1865	6	1-1/8"	4-1/2"	5-018-1865
.1870	6	1-1/8"	4-1/2"	5-018-187

Size	# Flutes	Flute Length	Overall Length	Part Number
.1875	6	1-1/8"	4-1/2"	5-018-1875
.1880	6	1-1/8"	4-1/2"	5-018-188
.1885	6	1-1/8"	4-1/2"	5-018-1885
.1895	6	1-1/8"	4-1/2"	5-018-1895
.1900	6	1-1/8"	4-1/2"	5-018-190
.1905	6	1-1/8"	4-1/2"	5-018-1905
.1910	6	1-1/4"	5"	5-018-191
.1915	6	1-1/4"	5"	5-018-1915
.1920	6	1-1/4"	5"	5-018-192
.1930	6	1-1/4"	5"	5-018-193
.1940	6	1-1/4"	5"	5-018-194
.1950	6	1-1/4"	5"	5-018-195
.1960	6	1-1/4"	5"	5-018-196
.1970	6	1-1/4"	5"	5-018-197
.1980	6	1-1/4"	5"	5-018-198
.1990	6	1-1/4"	5"	5-018-199
.2000	6	1-1/4"	5"	5-018-200
.2020	6	1-1/4"	5"	5-018-202
.2024	6	1-1/4"	5"	5-018-2024
.2030	6	1-1/4"	5"	5-018-203
.2050	6	1-1/4"	5"	5-018-205
.2060	6	1-1/4"	5"	5-018-206
.2070	6	1-1/4"	5"	5-018-207
.2080	6	1-1/4"	5"	5-018-208
.2090	6	1-1/4"	5"	5-018-209
.2100	6	1-1/4"	5"	5-018-210
.2110	6	1-1/4"	5"	5-018-211
.2140	6	1-1/4"	5"	5-018-214
.2150	6	1-1/4"	5"	5-018-215
.2155	6	1-1/4"	5"	5-018-2155
.2160	6	1-1/4"	5"	5-018-216
.2170	6	1-1/4"	5"	5-018-217
.2180	6	1-1/4"	5"	5-018-218
.2190	6	1-1/4"	5"	5-018-219
.2200	6	1-1/4"	5"	5-018-220
.2211	6	1-1/2"	6"	5-018-2211
.2270	6	1-1/2"	6"	5-018-227
.2300	6	1-1/2"	6"	5-018-230

Chucking Reamer Diameter Tolerances
 Up to and including 1/4": +.0001" to +.0004"
 Over 1/4" to include 1": +.0001" to +.0005"
 Over 1": +.0002" to .0006"

Straight Shank Chucking Reamers



Chucking Reamers (continued)

Straight Shank, Straight Flute – Decimal Sizes

- High Speed Steel
- Right-Hand Cut



Size	# Flutes	Flute Length	Overall Length	Part Number
.2310	6	1-1/2"	6"	5-018-231
.2320	6	1-1/2"	6"	5-018-232
.2340	6	1-1/2"	6"	5-018-234
.2350	6	1-1/2"	6"	5-018-235
.2360	6	1-1/2"	6"	5-018-236
.2370	6	1-1/2"	6"	5-018-237
.2380	6	1-1/2"	6"	5-018-238
.2390	6	1-1/2"	6"	5-018-239
.2400	6	1-1/2"	6"	5-018-240
.2410	6	1-1/2"	6"	5-018-241
.2420	6	1-1/2"	6"	5-018-242
.2430	6	1-1/2"	6"	5-018-243
.2440	6	1-1/2"	6"	5-018-244
.2450	6	1-1/2"	6"	5-018-245
.2460	6	1-1/2"	6"	5-018-246
.2470	6	1-1/2"	6"	5-018-247
.2475	6	1-1/2"	6"	5-018-2475
.2480	6	1-1/2"	6"	5-018-248
.2485	6	1-1/2"	6"	5-018-2485
.2490	6	1-1/2"	6"	5-018-249
.2495	6	1-1/2"	6"	5-018-2495
.2505	6	1-1/2"	6"	5-018-2505
.2510	6	1-1/2"	6"	5-018-251
.2515	6	1-1/2"	6"	5-018-2515
.2520	6	1-1/2"	6"	5-018-252
.2530	6	1-1/2"	6"	5-018-253
.2540	6	1-1/2"	6"	5-018-254
.2550	6	1-1/2"	6"	5-018-255
.2560	6	1-1/2"	6"	5-018-256
.2570	6	1-1/2"	6"	5-018-257
.2580	6	1-1/2"	6"	5-018-258
.2590	6	1-1/2"	6"	5-018-259
.2600	6	1-1/2"	6"	5-018-260
.2620	6	1-1/2"	6"	5-018-262
.2650	6	1-1/2"	6"	5-018-265
.2690	6	1-1/2"	6"	5-018-269
.2710	6	1-1/2"	6"	5-018-271
.2760	6	1-1/2"	6"	5-018-276

Size	# Flutes	Flute Length	Overall Length	Part Number
.2770	6	1-1/2"	6"	5-018-277
.2800	6	1-1/2"	6"	5-018-280
.2820	6	1-1/2"	6"	5-018-282
.2830	6	1-1/2"	6"	5-018-283
.2840	6	1-1/2"	6"	5-018-284
.2860	6	1-1/2"	6"	5-018-286
.2870	6	1-1/2"	6"	5-018-287
.2890	6	1-1/2"	6"	5-018-289
.2900	6	1-1/2"	6"	5-018-290
.2920	6	1-1/2"	6"	5-018-292
.2930	6	1-1/2"	6"	5-018-293
.2940	6	1-1/2"	6"	5-018-294
.2960	6	1-1/2"	6"	5-018-296
.2990	6	1-1/2"	6"	5-018-299
.3030	6	1-1/2"	6"	5-018-303
.3050	6	1-1/2"	6"	5-018-305
.3060	6	1-1/2"	6"	5-018-306
.3070	6	1-1/2"	6"	5-018-307
.3090	6	1-1/2"	6"	5-018-309
.3100	6	1-1/2"	6"	5-018-310
.3105	6	1-1/2"	6"	5-018-3105
.3110	6	1-1/2"	6"	5-018-311
.3115	6	1-1/2"	6"	5-018-3115
.3120	6	1-1/2"	6"	5-018-312
.3130	6	1-1/2"	6"	5-018-313
.3135	6	1-1/2"	6"	5-018-3135
.3140	6	1-1/2"	6"	5-018-314
.3145	6	1-1/2"	6"	5-018-3145
.3150	6	1-1/2"	6"	5-018-315
.3160	6	1-1/2"	6"	5-018-316
.3165	6	1-1/2"	6"	5-018-3165
.3170	6	1-1/2"	6"	5-018-317
.3180	6	1-1/2"	6"	5-018-318
.3190	6	1-1/2"	6"	5-018-319
.3200	6	1-1/2"	6"	5-018-320
.3220	6	1-1/2"	6"	5-018-322
.3240	6	1-1/2"	6"	5-018-324
.3250	6	1-1/2"	6"	5-018-325

Chucking Reamer Diameter Tolerances

Up to and including 1/4": +.0001" to +.0004"

Over 1/4" to include 1": +.0001" to +.0005"

Over 1": +.0002" to .0006"

REAMERS



Straight Shank Chucking Reamers

Cutting Tools

Chucking Reamers (continued)

Straight Shank, Straight Flute – Decimal Sizes

- High Speed Steel
- Right-Hand Cut



REAMERS

Size	# Flutes	Flute Length	Overall Length	Part Number
.3270	6	1-1/2"	6"	5-018-327
.3280	6	1-1/2"	6"	5-018-328
.3290	6	1-1/2"	6"	5-018-329
.3300	6	1-1/2"	6"	5-018-330
.3360	6	1-1/2"	6"	5-018-336
.3370	6	1-1/2"	6"	5-018-337
.3440	6	1-1/2"	6"	5-018-344
.3490	6	1-3/4"	7"	5-018-349
.3550	6	1-3/4"	7"	5-018-355
.3590	6	1-3/4"	7"	5-018-359
.3690	6	1-3/4"	7"	5-018-369
.3730	6	1-3/4"	7"	5-018-373
.3740	6	1-3/4"	7"	5-018-374
.3745	6	1-3/4"	7"	5-018-3745
.3755	6	1-3/4"	7"	5-018-3755
.3760	6	1-3/4"	7"	5-018-376
.3765	6	1-3/4"	7"	5-018-3765
.3770	6	1-3/4"	7"	5-018-377
.3790	6	1-3/4"	7"	5-018-379
.3800	6	1-3/4"	7"	5-018-380
.3860	6	1-3/4"	7"	5-018-386
.3880	6	1-3/4"	7"	5-018-388
.4000	6	1-3/4"	7"	5-018-400
.4070	6	1-3/4"	7"	5-018-407
.4300	4	1-3/4"	7"	5-018-430
.4320	4	1-3/4"	7"	5-018-432
.4355	4	1-3/4"	7"	5-018-4355
.4365	4	1-3/4"	7"	5-018-4365
.4370	4	1-3/4"	7"	5-018-437
.4385	4	1-3/4"	7"	5-018-4385
.4390	4	1-3/4"	7"	5-018-439
.4410	4	1-3/4"	7"	5-018-441
.4420	4	1-3/4"	7"	5-018-442
.4430	4	1-3/4"	7"	5-018-443
.4440	4	1-3/4"	7"	5-018-444
.4480	4	1-3/4"	7"	5-018-448
.4490	4	1-3/4"	7"	5-018-449
.4550	4	1-3/4"	7"	5-018-455

Size	# Flutes	Flute Length	Overall Length	Part Number
.4560	4	1-3/4"	7"	5-018-456
.4820	4	2"	8"	5-018-482
.4900	4	2"	8"	5-018-490
.4970	4	2"	8"	5-018-497
.4980	4	2"	8"	5-018-498
.4990	4	2"	8"	5-018-499
.4995	4	2"	8"	5-018-4995
.5010	4	2"	8"	5-018-501
.5015	4	2"	8"	5-018-5015
.5020	4	2"	8"	5-018-502
.5030	4	2"	8"	5-018-503
.5040	4	2"	8"	5-018-504
.5050	4	2"	8"	5-018-505
.5240	4	2"	8"	5-018-524
.5250	4	2"	8"	5-018-525
.5260	4	2"	8"	5-018-526
.5300	4	2"	8"	5-018-530
.5500	4	2"	8"	5-018-550
.5580	4	2"	8"	5-018-558
.5590	4	2"	8"	5-018-559
.5615	4	2"	8"	5-018-5615
.5690	4	2"	8"	5-018-569
.5740	4	2"	8"	5-018-574
.5840	4	2"	8"	5-018-584
.5850	4	2"	8"	5-018-585
.5860	4	2"	8"	5-018-586
.5880	4	2"	8"	5-018-588
.6050	4	2"	8"	5-018-605
.6220	4	2-1/4"	9"	5-018-622
.6240	4	2-1/4"	9"	5-018-624
.6250	4	2-1/4"	9"	5-018-625
.6255	4	2-1/4"	9"	5-018-6255
.6260	4	2-1/4"	9"	5-018-626
.6300	4	2-1/4"	9"	5-018-630
.7480	4	2-1/2"	9-1/2"	5-018-748
.7490	4	2-1/2"	9-1/2"	5-018-749
.7510	4	2-1/2"	9-1/2"	5-018-751
.7580	4	2-1/2"	9-1/2"	5-018-758

Chucking Reamer Diameter Tolerances
 Up to and including 1/4": +.0001" to +.0004"
 Over 1/4" to include 1": +.0001" to +.0005"
 Over 1": +.0002" to .0006"

Straight Shank Chucking Reamers



Chucking Reamers

Straight Shank, Spiral Flute – Fractional Sizes

- High Speed Steel
- Right Hand Cut



Fractional Sizes	Decimal Sizes	Shank Dia	Flute Length	Overall Length	Number of Flutes	Part Number
1/8	0.1250	.1190	7/8	3-1/2	6	5-020-005
9/64	0.1406	.1350	1	4	6	5-020-010
5/32	0.1563	.1510	1	4	6	5-020-015
11/64	0.1719	.1645	1-1/8	4-1/2	6	5-020-020
3/16	0.1875	.1805	1-1/8	4-1/2	6	5-020-025
13/64	0.2031	.1945	1-1/4	5	6	5-020-030
7/32	0.2188	.2075	1-1/4	5	6	5-020-035
15/64	0.2344	.2265	1-1/2	6	6	5-020-040
1/4	0.2500	.2405	1-1/2	6	6	5-020-045
17/64	0.2656	.2485	1-1/2	6	6	5-020-050
9/32	0.2813	.2485	1-1/2	6	6	5-020-055
19/64	0.2969	.2807	1-1/2	6	6	5-020-060
5/16	0.3125	.2807	1-1/2	6	6	5-020-065
21/64	0.3281	.2807	1-1/2	6	6	5-020-070
11/32	0.3438	.2807	1-1/2	6	6	5-020-075
23/64	0.3594	.3120	1-3/4	7	6	5-020-080
3/8	0.3750	.2120	1-3/4	7	6	5-020-085
25/64	0.3906	.3120	1-3/4	7	6	5-020-090
13/32	0.4063	.3745	1-3/4	7	6	5-020-095
27/64	0.4219	.3745	1-3/4	7	8	5-020-100
7/16	0.4375	.3745	1-3/4	7	8	5-020-105
29/64	0.4531	.3745	1-3/4	7	8	5-020-110
15/32	0.4688	.4370	1-3/4	7	8	5-020-115
31/64	0.4844	.4370	2	8	8	5-020-120
1/2	0.5000	.4370	2	8	8	5-020-125
33/64	0.5156	.4370	2	8	8	5-020-130
17/32	0.5313	.4370	2	8	8	5-020-135
35/64	0.5469	.4370	2	8	8	5-020-140
9/16	0.5625	.4370	2	8	8	5-020-145
37/64	0.5781	.4370	2	8	8	5-020-150
19/32	0.5938	.5620	2	8	8	5-020-155
39/64	0.6094	.5620	2-1/4	9	8	5-020-160
5/8	0.6250	.5620	2-1/4	9	8	5-020-165
41/64	0.6406	.5620	2-1/4	9	8	5-020-170
21/32	0.6563	.5620	2-1/4	9	8	5-020-175
43/64	0.6719	.5620	2-1/4	9	8	5-020-180
11/16	0.6875	.5620	2-1/4	9	8	5-020-185
23/32	0.7188	.5620	2-1/4	9	8	5-020-190
3/4	0.7500	.6245	2-1/2	9-1/2	8	5-020-195
25/32	0.7813	.6245	2-1/2	9-1/2	10	5-020-200
13/16	0.8125	.6245	2-1/2	9-1/2	10	5-020-205
27/32	0.8438	.6245	2-1/2	9-1/2	10	5-020-210
7/8	0.8750	.7495	2-5/8	10	10	5-020-215
29/32	0.9063	.7495	2-5/8	10	10	5-020-220
15/16	0.9375	.7495	2-5/8	10	10	5-020-225
1	1.0000	.8745	2-3/4	10-1/2	10	5-020-235
1-1/32	1.0313	.8745	2-3/4	10-1/2	10	5-020-238
1-1/16	1.0625	.8745	2-3/4	10-1/2	10	5-020-240
1-1/8	1.1250	.8745	2-7/8	11	10	5-020-245
1-3/16	1.1875	.9995	2-7/8	11	12	5-020-250
1-1/4	1.2500	.9995	3	11-1/2	12	5-020-255
1-5/16	1.3125	.9995	3	11-1/2	12	5-020-260
1-3/8	1.3750	.9995	3-1/4	12	12	5-020-265
1-7/16	1.4375	1.2495	3-1/4	12	12	5-020-270
1-1/2	1.5000	1.2495	3-1/2	12-1/2	12	5-020-275

Chucking Reamer Diameter Tolerances
 Up to and including 1/4": +.0001" to +.0004"
 Over 1/4" to include 1": +.0001" to +.0005"
 Over 1": +.0002" to .0006"

REAMERS



Taper Shank Chucking Reamers

Cutting Tools

Chucking Reamers

Taper Shank, Straight and Helical Flute – Fractional Sizes

- High Speed Steel
- Right Hand Cut



REAMERS

Fractional Sizes	Decimal Sizes	Flute Length	Overall Length	Number of Flutes	Taper Shank Number	Straight Flute Part Number	Helical Flute Part Number
1/4	0.2500	1-1/2	6	6	1	5-025-005	5-030-005
9/32	0.2813	1-1/2	6	6	1	5-025-010	–
5/16	0.3125	1-1/2	6	6	1	5-025-015	5-030-015
11/32	0.3438	1-1/2	6	6	1	5-025-020	–
3/8	0.3750	1-3/4	7	6	1	5-025-025	5-030-025
13/32	0.4063	1-3/4	7	6	1	5-025-030	5-030-030
7/16	0.4375	1-3/4	7	8	1	5-025-035	5-030-035
15/32	0.4688	1-3/4	7	8	1	5-025-040	5-030-040
1/2	0.5000	2	8	8	1	5-025-045	5-030-045
17/32	0.5313	2	8	8	1	5-025-050	5-030-050
9/16	0.5625	2	8	8	1	5-025-055	5-030-055
19/32	0.5938	2	8	8	1	5-025-060	5-030-060
5/8	0.6250	2-1/4	9	8	2	5-025-065	5-030-065
21/32	0.6563	2-1/4	9	8	2	5-025-070	5-030-070
11/16	0.6875	2-1/4	9	8	2	5-025-075	5-030-075
23/32	0.7188	2-1/4	9	8	2	5-025-080	5-030-080
3/4	0.7500	2-1/2	9-1/2	8	2	5-025-085	5-030-085
25/32	0.7813	2-1/2	9-1/2	10	2	5-025-090	5-030-090
13/16	0.8125	2-1/2	9-1/2	10	2	5-025-095	5-030-095
27/32	0.8438	2-1/2	9-1/2	10	2	5-025-100	5-030-100
7/8	0.8750	2-5/8	10	10	2	5-025-105	5-030-105
29/32	0.9063	2-5/8	10	10	2	5-025-110	5-030-110
15/16	0.9375	2-5/8	10	10	3	5-025-115	5-030-115
31/32	0.9688	2-5/8	10	10	3	5-025-120	5-030-120
1	1.0000	2-3/4	10-1/2	10	3	5-025-125	5-030-125
1-1/32	1.0313	2-3/4	10-1/2	10	3	5-025-130	5-030-130
1-1/16	1.0625	2-3/4	10-1/2	10	3	5-025-135	5-030-135
1-3/32	1.0938	2-3/4	10-1/2	10	3	5-025-138	–
1-1/8	1.1250	2-7/8	11	10	3	5-025-140	5-030-140
1-5/32	1.1563	2-7/8	11	10	3	5-025-143	5-030-143
1-3/16	1.1875	2-7/8	11	10	3	5-025-145	5-030-145
1-1/4	1.2500	3	11-1/2	12	4	5-025-150	5-030-150
1-9/32	1.2813	3	11-1/2	12	4	5-025-153	–
1-5/16	1.3125	3	11-1/2	12	4	5-025-155	5-030-155
1-3/8	1.3750	3-1/4	12	12	4	5-025-160	5-030-160
1-7/16	1.4375	3-1/4	12	12	4	5-025-165	5-030-165
1-1/2	1.5000	3-1/2	12-1/2	12	4	5-025-170	5-030-170
1-9/16	1.5625	3-1/2	12-1/2	12	4	5-025-300	5-030-300
1-5/8	1.6250	3-1/2	13	12	4	5-025-330	5-030-330
1-11/16	1.0625	4	13-1/2	12	4	5-025-350	5-030-350
1-3/4	1.7500	4	13-1/2	12	4	5-025-370	5-030-370
1-7/8	1.8750	4	14	12	4	5-025-380	5-030-380
2	2.0000	4	14-1/2	14	4	5-025-400	5-030-400

Chucking Reamer Diameter Tolerances
 Up to and including 1/4": +.0001" to +.0004"
 Over 1/4" to include 1": +.0001" to +.0005"
 Over 1": +.0002" to .0006"

Chucking Reamers

Taper Shank, Straight Flute – Metric Sizes

- High Speed Steel
- Right Hand Cut



Dia mm	Flute Length	Overall Length	Number of Flutes	Morse Taper Shank	DIN 208/A Part Number
5	23	133	6	1	5-026-005
6	26	138	6	1	5-026-010
7	31	150	6	1	5-026-015
8	33	156	6	1	5-026-020
9	36	162	6	1	5-026-025
10	38	168	6	1	5-026-030
12	44	182	8	1	5-026-040
13	44	182	8	1	5-026-045
14	47	189	8	1	5-026-050
15	50	204	8	2	5-026-055
16	52	210	8	2	5-026-060
17	54	214	8	2	5-026-065
18	56	219	8	2	5-026-070
19	58	223	10	2	5-026-075
20	60	228	10	2	5-026-080
21	62	232	10	2	5-026-085
22	64	237	10	2	5-026-090
23	66	241	10	2	5-026-095
24	68	268	10	3	5-026-100
25	68	268	10	3	5-026-105
26	70	273	10	3	5-026-110
27	71	277	10	3	5-026-115
28	71	277	10	3	5-026-120
29	73	281	10	3	5-026-125
30	73	281	10	3	5-026-130
31	75	285	12	3	5-026-135
32	77	317	12	4	5-026-140
33	77	317	12	4	5-026-145
34	78	321	12	4	5-026-150
35	78	321	12	4	5-026-155
36	79	325	12	4	5-026-160
37	79	325	12	4	5-026-165
38	81	329	12	4	5-026-170
40	81	329	12	4	5-026-175



Expansion Chucking Reamers

Cutting Tools

Expansion Chucking Reamers

- High Speed Steel
- Taper and Straight Shank
- Straight Flute
- Right-Hand Cut



REAMERS

Sizes		Flute Length	Overall Length	Number of Flutes	Taper Shank		Straight Shank	
Fractional	Decimal				Taper	Part Number	Shank Dia	Part Number
3/8	.3750	3/4	7	6	1	5-034-025	5/16	5-033-025
7/16	.4375	7/8	7	6	1	–	3/8	5-033-035
15/32	.4688	7/8	7	6	1	–	3/8	5-033-040
1/2	.5000	1	8	6	1	5-034-045	7/16	5-033-045
17/32	.5312	1	8	6	1	–	7/16	5-033-050
9/16	.5625	1-1/8	8	6	1	–	7/16	5-033-055
5/8	.6250	1-1/4	9	6	2	5-034-065	9/16	5-033-065
21/32	.6562	1-1/4	9	6	2	–	9/16	5-033-070
11/16	.6875	1-1/4	9	6	2	–	9/16	5-033-075
3/4	.7500	1-3/8	9-1/2	6	2	5-034-085	5/8	5-033-085
25/32	.7812	1-3/8	9-1/2	6	2	–	5/8	5-033-090
13/16	.8125	1-3/8	9-1/2	6	2	5-034-095	5/8	5-033-095
7/8	.8750	1-1/2	10	6	2	5-034-105	3/4	5-033-105
15/16	.9375	1-1/2	10	6	3	–	3/4	5-033-115
31/32	.9688	1-1/2	10	6	3	–	3/4	5-033-120
1	1.0000	1-5/8	10-1/2	8	3	5-034-125	7/8	5-033-125
1-1/32	1.0312	1-5/8	10-1/2	8	3	–	7/8	5-033-130
1-1/16	1.0625	1-5/8	10-1/2	8	3	5-034-135	7/8	5-033-135
1-3/32	1.0938	1-3/4	10-1/2	8	3	–	7/8	5-033-140
1-1/8	1.1250	1-3/4	11	8	3	5-034-145	7/8	5-033-145
1-5/32	1.1563	1-3/4	11	8	3	–	7/8	5-033-150
1-3/16	1.1875	1-3/4	11	8	3	5-034-155	1	5-033-155
1-7/32	1.2188	1-3/4	11	8	3	5-034-160	1	–
1-1/4	1.2500	1-7/8	11-1/2	8	4	5-034-165	1	5-033-165
1-5/16	1.3125	1-7/8	11-1/2	8	4	5-034-170	1	–
1-3/8	1.3750	2	12	8	4	5-034-175	1-1/4	5-033-175
1-7/16	1.4375	2	12	8	4	–	1-1/4	5-033-180
1-1/2	1.5000	2-1/8	12-1/2	10	4	5-034-185	1-1/4	5-033-185
1-9/16	1.5625	2-1/8	12-1/2	10	4	–	1-1/4	5-033-190
1-5/8	1.6220	2-1/4	13	10	4	5-034-195	1-1/4	5-033-195
1-3/4	1.7500	2-3/8	13-1/2	10	5	5-034-205	1-1/2	5-033-205
1-13/16	1.8125	2-3/8	13-1/2	10	5	–	1-1/2	5-033-210
1-7/8	1.8750	2-1/2	14	10	5	5-034-215	1-1/2	–
1-15/16	1.9375	2-1/2	14	10	5	5-034-220	1-1/2	–
2	2.0000	2-1/2	14	12	5	5-034-225	1-1/2	5-033-225
2-3/16	2.1875	2-3/4	14-1/2	12	5	5-034-240	–	–
2-1/4	2.2500	2-3/4	14-1/2	12	5	5-034-245	–	–
2-1/2	2.5000	3	15	14	5	5-034-265	–	–
2-3/4	2.7500	3-1/4	15-1/2	14	5	5-034-270	–	–

NOTE: Recommended Expansion Limit = 0.005 x Outside Diameter

Straight Shank Hand Reamers



Cutting Tools

Hand Reamers

Straight Shank, Straight and Left Hand Helical Flutes – Fractional Sizes

- High Speed Steel
- Cutting end is ground with a starting taper to provide easy entry
- Use Helical reamers for interrupted cuts



Dia Inches	Flute Length	Overall Length	Number of Flutes	Straight Flute Part Number	LH Helical Flute Part Number
1/8	1-1/2	3	6	5-005-005	5-010-005
9/64	1-5/8	3-1/4	6	5-005-008	–
5/32	1-5/8	3-1/4	6	5-005-010	5-010-010
11/64	1-3/4	3-1/2	6	5-005-012	–
3/16	1-3/4	3-1/2	6	5-005-015	5-010-015
7/32	1-7/8	3-3/4	6	5-005-020	5-010-020
1/4	2	4	6	5-005-025	5-010-025
9/32	2-1/8	4-1/4	6	5-005-030	5-010-030
5/16	2-1/4	4-1/2	6	5-005-035	5-010-035
11/32	2-3/8	4-3/4	6	5-005-040	5-010-040
25/64	2-1/2	4-3/4	6	5-005-042	–
3/8	2-1/2	5	6	5-005-045	5-010-045
13/32	2-5/8	5-1/4	6	5-005-050	5-010-050
7/16	2-3/4	5-1/2	8	5-005-055	5-010-055
15/32	2-7/8	5-3/4	8	5-005-060	–
31/64	3	6	8	5-005-062	–
1/2	3	6	8	5-005-065	5-010-065
17/32	3-1/8	6-1/4	8	5-005-070	5-010-070
9/16	3-1/4	6-1/2	8	5-005-075	5-010-075
19/32	3-3/8	6-3/4	8	5-005-080	5-010-080
5/8	3-1/2	7	8	5-005-085	5-010-085
21/32	3-11/16	7-3/8	8	5-005-090	5-010-090
11/16	3-7/8	7-3/4	8	5-005-095	5-010-095
23/32	4-1/16	8-1/8	8	5-005-100	5-010-100
3/4	4-3/16	8-3/8	8	5-005-105	5-010-105
25/32	4-3/8	8-3/4	10	5-005-110	5-010-110
13/16	4-9/16	9-1/8	10	5-005-115	5-010-115
27/32	4-11/16	9-3/8	10	5-005-120	5-010-120
7/8	4-7/8	9-3/4	10	5-005-125	5-010-125
29/32	5	10	10	5-005-130	5-010-130
15/16	5-1/8	10-1/4	10	5-005-135	5-010-135
31/32	5-5/16	10-5/8	10	5-005-140	–
1	5-7/16	10-7/8	10	5-005-145	5-010-145
1-1/16	5-5/8	11-1/4	10	5-005-150	5-010-150
1-1/8	5-13/16	11-5/8	10	5-005-155	5-010-155
1-3/16	6	12	10	5-005-160	5-010-160
1-1/4	6-1/8	12-1/4	12	5-005-165	5-010-165
1-5/16	6-1/4	12-1/2	12	5-005-170	5-010-170
1-3/8	6-5/16	12-5/8	12	5-005-175	5-010-175
1-7/16	6-7/16	12-7/8	12	5-005-180	–
1-1/2	6-1/2	13	12	5-005-185	5-010-185

REAMERS



Straight Shank Hand Reamers

Cutting Tools

Hand Reamers

Straight Shank, Straight and Left Hand Helical Flutes – Metric Sizes

- High Speed Steel
- Cutting end is ground with a starting taper to provide easy entry
- Use Helical reamer for interrupted cuts



REAMERS

Dia mm	Flute Length	Overall Length	Number of Flutes	Straight Flute DiN 206/A Part Number	LH Helical Flute DiN 206/B Part Number
3.0	31	62	6	5-006-005	5-011-005
3.2	33	66	6	5-006-010	5-011-010
3.5	35	71	6	5-006-015	5-011-015
4.0	38	76	6	5-006-020	5-011-020
4.5	41	81	6	5-006-025	5-011-025
5.0	44	87	6	5-006-030	5-011-030
5.5	47	93	6	5-006-035	5-011-035
6.0	47	93	6	5-006-040	5-011-040
6.5	50	100	6	5-006-042	–
7.0	54	107	6	5-006-045	5-011-045
8.0	58	115	6	5-006-050	5-011-050
8.5	58	115	6	5-006-052	–
9.0	62	124	6	5-006-055	5-011-055
9.5	62	124	6	5-006-057	–
10.0	66	133	6	5-006-060	5-011-060
10.5	66	133	6	5-006-062	–
11.0	71	142	8	5-006-065	5-011-065
11.5	71	142	8	5-006-067	–
12.0	76	152	8	5-006-070	5-011-070
12.5	76	152	8	5-006-072	–
13.0	76	152	8	5-006-075	5-011-075
13.5	81	163	8	5-006-077	–
14.0	81	163	8	5-006-080	5-011-080
15.0	81	163	8	5-006-085	5-011-085
16.0	87	175	8	5-006-090	5-011-090
16.5	87	175	8	5-006-092	–
17.0	87	175	8	5-006-095	5-011-095
18.0	93	188	8	5-006-100	5-011-100
19.0	93	188	10	–	5-011-105
20.0	100	201	10	5-006-110	5-011-110

Straight Shank Hand Reamers



Cutting Tools

Expansion Hand Reamers

- High Speed Steel
- Available in Straight and Left Hand Helical Flutes



Dia inches	Flute Length	Overall Length	Number of Flutes	Straight Flute Part Number	Helical Flute Part Number
5/16	1-3/4	4	6	5-013-020	5-014-020
3/8	2	5	6	5-013-025	5-014-025
7/16	2	5	6	5-013-035	–
1/2	2	5-1/2	6	5-013-045	5-014-045
9/16	2-1/2	6	6	5-013-055	5-014-055
19/32	2-1/2	6	6	–	5-014-060
5/8	3	7	6	5-013-065	5-014-065
21/32	3	7	6	5-013-070	–
23/32	3	7	6	5-013-080	–
3/4	3-1/2	8	8	5-013-085	5-014-085
7/8	4	9	8	5-013-105	5-014-105
1	4-1/2	10	8	5-013-125	5-014-125
1-1/8	4-3/4	10-1/2	8	5-013-135	–
1-1/4	5	11	8	5-013-145	5-014-145
1-1/2	5-1/2	12	10	5-013-165	–

Recommended Expansion Limit = 0.01 x Outside Diameter
 Maximum Expansion Limit: Diameters 5/16" thru 15/32" = .006"
 Diameters 1/2" thru 7/8" = .010"
 Diameters 1" thru 1-1/2" = .012"
 Diameters over 1-1/2" = .015"

REAMERS



Bridge and Adjustable Reamers

Cutting Tools

Bridge Reamers

- High Speed Steel
- Taper Shank
- Available in Straight and Left Hand Helical Flutes
- Right Hand Cut



Dia Inches	Approx Dia at point	Flute Length	Overall Length	Number of Flutes	Shank Taper Number	Straight Flute Part Number	Helical Flute Part Number
5/16	11/64	4-3/8	8-1/4	5	2	–	5-050-003
13/32	7/32	4-3/8	8-1/4	5	2	–	5-050-004
7/16	17/64	4-3/8	8-1/4	5	2	5-055-005	5-050-005
15/32	9/32	5-1/8	9	5	2	–	5-050-007
1/2	5/16	5-1/8	9	5	2	5-055-010	5-050-010
17/32	11/32	5-1/8	9	5	2	5-055-011	5-050-012
9/16	3/8	5-1/8	9	5	2	5-055-015	5-050-015
5/8	25/64	6-1/8	10	5	2	5-055-020	5-050-020
11/16	13/32	7-1/8	11-3/4	5	3	5-055-025	5-050-025
3/4	15/32	7-3/8	12	5	3	5-055-030	5-050-030
13/16	35/64	7-3/8	12	5	3	5-055-035	5-050-035
7/8	39/64	7-3/8	12	5	3	5-055-040	5-050-040
15/16	43/64	7-3/8	12	5	3	5-055-045	5-050-045
1	47/64	7-3/8	12	5	3	5-055-050	5-050-050
1-1/16	13/16	7-3/8	12	5	3	5-055-055	5-050-055
1-1/8	55/64	7-3/8	12	5	3	5-055-060	5-050-060
1-3/16	59/64	7-3/8	12	5	3	5-055-065	5-050-065
1-1/4	63/64	7-3/8	13	5	4	5-055-070	5-050-070
1-5/16	1-1/16	7-3/8	13	5	4	5-055-075	5-050-075
1-3/8	1-1/8	7-3/8	13	5	4	5-055-080	5-050-080
1-7/16	1-3/16	7-3/8	13	5	4	–	5-050-085
1-1/2	1-1/4	7-3/8	13	5	4	5-055-085	5-050-090
1-9/16	1-1/4	7-3/8	13	5	4	5-055-088	5-050-095
1-5/8	1-3/8	7-3/8	13	5	4	5-055-090	5-050-100
1-11/16	1-3/8	7-3/8	13	5	4	–	5-050-105
1-3/4	1-7/16	7-3/8	13	5	4	–	5-050-110
1-13/16	1-7/16	7-3/8	13	5	4	–	5-050-115
1-7/8	1-1/2	7-3/8	13	5	4	–	5-050-120
1-15/16	1-1/2	7-3/8	13	5	4	–	5-050-125
2	1-3/4	7-3/8	13	5	4	–	5-050-130

REAMERS

Adjustable Blade Reamers

- High Speed Steel



Size	Size Range	OAL	Number of Blades	Part Number
8/A	1/4 to 9/32	3-1/2	4	5-012-001
7/A	9/32 to 5/16	3-3/4	4	5-012-002
6/A	5/16 to 11/32	4	4	5-012-003
5/A	11/32 to 3/8	4-1/4	4	5-012-004
4/A	3/8 to 3/32	4-1/2	4	5-012-005
3/A	13/32 to 7/16	4-3/4	6	5-012-006
2/A	7/16 to 15/32	5	6	5-012-007
A	15/32 to 17/32	5-1/4	6	5-012-008
B	17/32 to 19/32	5-3/4	6	5-012-009
C	19/32 to 21/32	6-1/4	6	5-012-010
D	21/32 to 23/32	6-3/4	6	5-012-011

Size	Size Range	OAL	Number of Blades	Part Number
E	23/32 to 25/32	7-1/4	6	5-012-012
F	25/32 to 27/32	7-3/4	6	5-012-013
G	27/32 to 15/16	8-1/4	6	5-012-014
H	15/16 to 1-1/16	8-3/4	6	5-012-015
I	1-1/16 to 1-3/16	10	6	5-012-016
J	1-3/16 to 1-11/32	11	6	5-012-017
K	1-11/32 to 1-1/2	12	6	5-012-018
L	1-1/2 to 1-13/16	13	6	5-012-019
M	1-13/16 to 2-7/32	15	6	5-012-020
N	2-7/32 to 2-3/4	17	6	5-012-021
O	2-3/4 to 3-11/32	19	6	5-012-022

Taper Pin Reamers

- High Speed Steel
- Taper 1/4" per foot
- Right-Hand Cut
- Available in Straight and Left Hand Helical Flutes



Size	Dia of Small End	Dia of Large End	Flute Length	Overall Length	Straight Flute A Part Number	Slow Helical Flute B Part Number	High Helical Flute C Part Number
5/0	.0719	.0966	1-3/16	2-3/16	5-100-003	5-105-003	–
4/0	.0869	.1142	1-5/16	2-5/16	5-100-004	5-105-004	–
3/0	.1029	.1302	1-5/16	2-5/16	5-100-005	5-105-005	–
2/0	.1137	.1462	1-9/16	2-9/16	5-100-010	5-105-010	–
0	.1287	.1638	1-11/16	2-15/16	5-100-015	5-105-015	5-110-015
1	.1447	.1798	1-11/16	2-15/16	5-100-020	5-105-020	5-110-020
2	.1605	.2008	1-15/16	3-3/16	5-100-025	5-105-025	5-110-025
3	.1813	.2294	2-5/16	3-11/16	5-100-030	5-105-030	5-110-030
4	.2071	.2604	2-9/16	4-1/16	5-100-035	5-105-035	5-110-035
5	.2409	.2994	2-13/16	4-5/16	5-100-040	5-105-040	5-110-040
6	.2773	.3540	3-11/16	5-7/16	5-100-045	5-105-045	5-110-045
7	.3297	.4220	4-7/16	6-5/16	5-100-050	5-105-050	5-110-050
8	.3971	.5050	5-3/16	7-3/16	5-100-055	5-105-055	5-110-055
9	.4805	.6066	6-1/16	8-5/16	5-100-060	5-105-060	5-110-060
10	.5799	.7216	6-13/16	9-5/16	5-100-065	5-105-065	5-110-065

Taper Pin Reamers, Metric

- High Speed Steel
- Right Hand Cut
- DIN 9A and 9B
- Taper is 1:50

Size	Dia of Small End	Dia of Large End	Flute Length	Overall Length	Number of Flutes	Straight Flute DiN 9/A Part Number	Slow Helical Flute DiN 9/B Part Number
3	2.9	4.06	58	80	5	5-101-005	–
4	3.9	5.26	68	93	5	5-101-010	5-106-010
5	4.9	6.36	73	100	5	5-101-015	5-106-015
6	5.9	8	105	135	6	5-101-020	5-106-020
7	6.9	9	105	135	6	5-101-025	5-106-025
8	7.9	10.8	145	180	7	5-101-030	5-106-030
10	9.9	13.4	175	215	7	5-101-035	5-106-035
12	11.86	16	210	255	7	5-101-040	5-106-040
13	12.86	17	220	265	7	5-101-042	5-106-042
16	15.8	20.4	230	280	9	5-101-045	5-106-045
20	19.8	24.8	250	310	9	5-101-050	5-106-050
25	24.7	30.7	300	370	9	5-101-055	5-106-055
30	29.7	36.1	320	400	9	5-101-060	5-106-060
40	39.7	46.5	340	430	11	5-101-065	5-106-065



Car Reamers

Cutting Tools

Car Reamers

- High Speed Steel
- 5 Flute
- Left Hand Helix
- Right-Hand Cut

Hex Shank

Reamer Dia	Hex Shank Length	Flute Length	Overall Length	Part Number
11/16	1-1/16	4-1/2	6-1/2	5-058-025
13/16	1-1/4	5	7	5-058-035
15/16	1-7/16	5	7	5-058-045
1-1/16	1-5/8	5	7	5-058-055



3 Equal Flat Straight Shank

Reamer Dia	Shank Dia	Shank Length	Flute Length	Overall Length	Part Number
5/16	5/16	1-1/2	2-3/4	4-5/8	5-057-003
3/8	3/8	1-1/2	2-3/4	4-5/8	5-057-004
7/16	7/16	1-1/2	3-1/2	5-3/8	5-057-005
1/2	1/2	1-1/2	4	5-7/8	5-057-010
9/16	1/2	1-1/2	4	5-7/8	5-057-015
5/8	1/2	1-1/2	4-1/2	6-3/8	5-057-020
11/16	1/2	1-1/2	4-1/2	6-3/8	5-057-025
3/4	1/2	1-1/2	5	6-7/8	5-057-030
13/16	1/2	1-1/2	5	6-7/8	5-057-035
7/8	1/2	1-1/2	5	6-7/8	5-057-040
15/16	1/2	1-1/2	5	6-7/8	5-057-045
1	1/2	1-1/2	5	6-7/8	5-057-050
1-1/16	1/2	1-1/2	5	6-7/8	5-057-055



Taper Shank

Reamer Dia	Morse Shank Length	Flute Length	Overall Length	Part Number
5/16	No. 1	2-3/4	5-11/16	5-056-003
3/8	No. 1	2-3/4	5-11/16	5-056-004
7/16	No. 2	3-1/2	6-15/16	5-056-005
1/2	No. 2	4	7-9/16	5-056-010
9/16	No. 2	4	7-9/16	5-056-015
11/16	No. 3	4-1/2	8-13/16	5-056-025
3/4	No. 3	5	9-1/2	5-056-030
13/16	No. 3	5	9-1/2	5-056-035
15/16	No. 3	5	9-1/2	5-056-045
1	No. 3	5	9-1/2	5-056-050
1-1/16	No. 3	5	9-1/2	5-056-055



REAMERS

Taper Pipe Reamers

- High Speed Steel
- Taper 3/4" per foot
- Right-Hand Cut
- Available in Straight and Left Hand Helical Flutes

Size	Large End Dia	Small End Dia	Flute Length	Number of Flutes	Overall Length	Straight Flute Part Number
1/16	.291	.245	3/4	6	2	5-060-005
1/8	.362	.316	3/4	6	2-1/8	5-060-010
1/4	.472	.406	1-1/16	6	2-7/16	5-060-015
3/8	.606	.540	1-1/16	6	2-9/16	5-060-020
1/2	.751	.665	1-3/8	6	3-1/8	5-060-025
3/4	.962	.876	1-3/8	8	3-1/4	5-060-030
1	1.212	1.103	1-3/4	10	3-3/4	5-060-035
1-1/4	1.553	1.444	1-3/4	10	4	5-060-040
1-1/2	1.793	1.684	1-3/4	10	4-1/4	5-060-045
2	2.268	2.159	1-3/4	12	4-1/2	5-060-050
2-1/2	2.772	2.561	2-5/8	12	5-1/2	5-060-055
3	3.380	3.202	2-3/4	12	6	5-060-060
5 Piece Set 1/8" thru 3/4"						5-060-105



Size	Large End Dia	Small End Dia	Flute Length	Number of Flutes	Overall Length	Helical Flute Part Number
1/16	.291	.245	3/4	6	2	5-065-005
1/8	.362	.316	3/4	6	2-1/8	5-065-010
1/4	.472	.406	1-1/16	6	2-7/16	5-065-015
3/8	.606	.540	1-1/16	6	2-9/16	5-065-020
1/2	.751	.665	1-3/8	6	3-1/8	5-065-025
3/4	.962	.876	1-3/8	8	3-1/4	5-065-030
1	1.212	1.103	1-3/4	10	3-3/4	5-065-035
1-1/4	1.553	1.444	1-3/4	10	4	5-065-040
1-1/2	1.793	1.684	1-3/4	10	4-1/4	5-065-045
2	2.268	2.159	1-3/4	12	4-1/2	5-065-050
2-1/2	2.772	2.561	2-5/8	12	5-1/2	5-065-055
3	3.380	3.202	2-3/4	12	6	5-065-060





Shell Reamers

Cutting Tools

Shell Reamers

- High Speed Steel
- Available in Straight and Left Hand Helical Flutes



Straight Flute

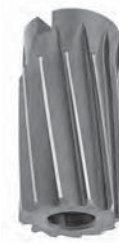

Helical Flute LH 10°

REAMERS

Dia	Overall Length	Hole Dia	Number of Flutes	Fitting Arbor Number	Straight Flute Part Number	Helical Flute Part Number
13/16	2-1/2	1/2	10	5	5-150-010	—
7/8	2-1/2	1/2	10	5	5-150-015	5-155-015
15/16	2-1/2	1/2	10	5	5-150-020	5-155-020
1	2-1/2	1/2	10	5	5-150-025	5-155-025
1-1/16	2-3/4	5/8	10	6	5-150-030	5-155-030
1-1/8	2-3/4	5/8	10	6	5-150-035	5-155-035
1-3/16	2-3/4	5/8	10	6	5-150-040	5-155-040
1-1/4	2-3/4	5/8	12	6	5-150-045	5-155-045
1-5/16	3	3/4	12	7	5-150-050	5-155-050
1-3/8	3	3/4	12	7	5-150-055	5-155-055
1-7/16	3	3/4	12	7	5-150-060	5-155-060
1-1/2	3	3/4	12	7	5-150-065	5-155-065
1-9/16	3	3/4	12	7	5-150-070	5-155-070
1-5/8	3	3/4	12	7	5-150-075	5-155-075
1-11/16	3-1/2	1	12	8	5-150-080	5-155-080
1-3/4	3-1/2	1	12	8	5-150-085	5-155-085
1-13/16	3-1/2	1	12	8	5-150-090	5-155-090
1-7/8	3-1/2	1	12	8	5-150-095	5-155-095
1-15/16	3-1/2	1	12	8	5-150-100	5-155-100
2	3-1/2	1	14	8	5-150-105	5-155-105
2-1/16	3-3/4	1-1/4	14	9	5-150-110	5-155-110
2-1/8	3-3/4	1-1/4	14	9	5-150-115	5-155-115
2-3/16	3-3/4	1-1/4	14	9	5-150-120	5-155-120
2-1/4	3-3/4	1-1/4	14	9	5-150-125	5-155-125
2-5/16	3-3/4	1-1/4	14	9	5-150-130	5-155-130
2-3/8	3-3/4	1-1/4	14	9	5-150-135	5-155-135
2-7/16	3-3/4	1-1/4	14	9	5-150-140	5-155-140
2-1/2	3-3/4	1-1/4	14	9	5-150-145	5-155-145
2-9/16	4	1-1/2	16	10	5-150-150	5-155-150
2-5/8	4	1-1/2	16	10	5-150-155	5-155-155
2-11/16	4	1-1/2	16	10	5-150-160	5-155-160
2-3/4	4	1-1/2	16	10	5-150-165	5-155-165
2-13/16	4	1-1/2	16	10	5-150-170	5-155-170
2-7/8	4	1-1/2	16	10	5-150-175	5-155-175
2-15/16	4	1-1/2	16	10	5-150-180	5-155-180
3	4	1-1/2	16	10	5-150-185	5-155-185
3-1/16	4-1/2	1-3/4	18	11	5-150-190	5-155-190
3-1/8	4-1/2	1-3/4	18	11	5-150-195	5-155-195
3-3/16	4-1/2	1-3/4	18	11	5-150-200	5-155-200
3-1/4	4-1/2	1-3/4	18	11	5-150-205	5-155-205
3-5/16	4-1/2	1-3/4	18	11	5-150-210	5-155-210
3-3/8	4-1/2	1-3/4	18	11	5-150-215	5-155-215
3-7/16	4-1/2	1-3/4	18	11	5-150-220	5-155-220
3-1/2	4-1/2	1-3/4	18	11	5-150-225	5-155-225
3-9/16	5	2	20	12	5-150-230	5-155-230
3-5/8	5	2	20	12	5-150-235	5-155-235
3-11/16	5	2	20	12	5-150-240	—
3-3/4	5	2	20	12	5-150-245	5-155-245
3-13/16	5	2	20	12	5-150-250	5-155-250
3-7/8	5	2	20	12	—	5-155-255
3-15/16	5	2	20	12	5-150-260	5-155-260
4	5	2	20	12	5-150-265	5-155-265

TABLE OF CONTENTS

COUNTERBORES AND COUNTERSINKS

Technical Reference	322
Fillister Head Counterbores	323
Capscrew Counterbores	323
Combined Drill and Countersinks	325
Countersinks	326





Counterboring and Countersinking Recommended starting points for Speeds and Feeds



Speed

Material	Speed (SFM)
Mild Steel	75-85
Alloy Steel	40-80
Cast Iron - Soft	120-140
Brass	150-300

Feed

Cutting Major Diameter	Inch per Rev.
1/4 to 3/8	.003 - .005
7/16 to 5/8	.004 - .006
11/16 to 7/8	.005 - .007
15/16 to 1-3/16	.006 - .008
1-1/4 to 1-1/2	.007 - .009



Fillister Head Counterbores

- Straight Shank
- 2 Flute
- High Speed Steel

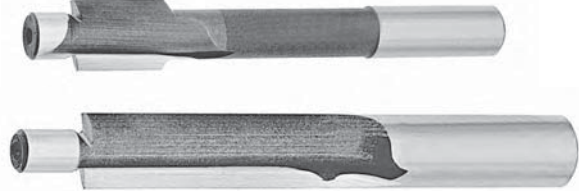

Screw Size	Pilot Size	Shank Dia	Overall Length	Part Number
4	0.111	0.198	2-1/2	5-625-060
5	0.124	0.220	2-1/2	5-625-080
6	0.137	0.241	2-1/2	5-625-100
8	0.163	0.285	2-3/4	5-625-120
10	0.189	0.328	2-3/4	5-625-140
12	0.215	0.372	3	5-625-160

Pilot and Cutting Size	Shank Dia	Overall Length	Part Number
1/4 x 13/32	5/16	3-5/8	5-650-020
5/16 x 15/32	3/8	4	5-650-040
3/8 x 19/32	7/16	4-3/8	5-650-060
7/16 x 21/32	1/2	4-3/4	5-650-080
1/2 x 25/32	9/16	5-1/4	5-650-100
5 Piece Set 1/4" thru 1/2" in Box			5-650-505

Capscrew Counterbores

- Straight Shank
- 3 Flute
- High Speed Steel



Cap Screw Size	Pilot Dia	Cutter Dia	Shank Dia	Overall Length	Part Number
#5	0.141	0.221	3/16	3	5-610-005
#6	0.150	0.242	7/32	3	5-610-006
#8	11/64	19/64	1/4	3	5-610-008
#10	13/64	21/64	5/16	3-1/2	5-610-010
1/4	9/32	13/32	3/8	5	5-610-015
5/16	11/32	1/2	7/16	5	5-610-020
3/8	13/32	19/32	1/2	6	5-610-025
7/16	15/32	11/16	1/2	7	5-610-030
1/2	17/32	25/32	1/2	7-1/2	5-610-033
1/2	17/32	25/32	3/4	7-1/2	5-610-035
1/2	9/16	13/16	3/4	7-1/2	5-610-037
5/8	21/32	31/32	3/4	7-1/2	5-610-040
5/8	11/16	1	3/4	7-1/2	5-610-043
3/4	13/16	1-3/16	1	8	5-610-045
7/8	15/16	1-3/8	1	8	5-610-050
1	1-1/16	1-9/16	1	10	5-610-055
7 Piece Set: 6-1/2 Metal Case					5-610-107
7 Piece Set: 6-1/2 No Block					5-610-117

COUNTERBORES / COUNTERSINKS



Capscrew Counterbores

Cutting Tools

Capscrew Counterbores, Metric Sizes

- Straight Shank and Tapered Shank
- 3 Flute
- High Speed Steel



Cap Screw Size	Pilot Dia mm	Cutter Dia mm	Shank Dia inches	Overall Length inches	Part Number
M3	3.4	6	7/32	3	5-614-003
M4	4.5	8	5/16	3-1/2	5-614-004
M5	5.5	10	3/8	4-1/2	5-614-005
M6	6.6	11	7/16	5	5-614-006
M8	9	15	1/2	6	5-614-008
M10	11	18	1/2	7	5-614-010
M12	14	20	1/2	7-1/2	5-614-012
M14*	15	24	MT2	8-1/4	5-614-014
M16*	17	26	MT2	9	5-614-016
M20*	21	33	MT2	10	5-614-020
7 Piece Set: 3 thru 12 mm, Includes Metal Case					5-614-107

* Taper Shank

COUNTERBORES / COUNTERSINKS

Capscrew Counterbores, Fractional Sizes

- Taper Shank
- 3 Flute
- High Speed Steel

Cap Screw Size	Pilot Dia	Cutter Dia	Shank Taper	Overall Length inches	Part Number
1/4	9/32	13/32	2MT	5-3/4	5-612-015
5/16	11/32	1/2	2MT	6	5-612-020
3/8	13/32	19/32	2MT	6-1/2	5-612-025
7/16	15/32	11/16	2MT	7	5-612-030
1/2	17/32	25/32	2MT	7-1/4	5-612-035
5/8	21/32	31/32	2MT	7-1/2	5-612-040
3/4	13/16	1-3/16	3MT	9	5-612-045
7/8	15/16	1-3/8	3MT	9	5-612-050
1	1-1/16	1-9/16	3MT	10	5-612-055

3 Flute Solid Capscrew Counterbore Sets

- Fractional and Metric Sizes
- High Speed Steel

Set Description	Part Number
1/4, 5/16, 3/8, 1/2, #6, #8 & #10	5-610-107
3, 4, 5, 6, 8, 10 & 12 mm	5-614-107



Combined Drill and Countersinks

- High Speed Steel and Cobalt
- Plain Type
- Right Hand
- 60° - 82° - 90° degree



Size Number	Body Dia	Drill Dia	Drill Length	Overall Length	Part Number			
					60°	82°	90°	Cobalt 60°
00	1/8	.025	.025	1-1/4	5-600-002	–	–	–
0	1/8	1/32	1/32	1-1/4	5-600-005	–	–	–
1	1/8	3/64	3/64	1-1/4	5-600-010	5-600-210	–	5-601-010
2	3/16	5/64	5/64	1-7/8	5-600-015	5-600-215	5-600-315	5-601-015
3	1/4	7/64	7/64	2	5-600-020	5-600-220	5-600-320	5-601-020
4	5/16	1/8	1/8	2-1/8	5-600-025	5-600-225	5-600-325	5-601-025
5	7/16	3/16	3/16	2-3/4	5-600-030	5-600-230	5-600-330	5-601-030
6	1/2	7/32	7/32	3	5-600-035	5-600-235	5-600-335	5-601-035
7	5/8	1/4	1/4	3-1/4	5-600-040	5-600-240	5-600-340	5-601-040
8	3/4	5/16	5/16	3-1/2	5-600-045	5-600-245	5-600-345	5-601-045
9	7/8	11/32	11/32	3-5/8	5-600-050	–	–	–
10	1	3/8	3/8	3-3/4	5-600-055	–	–	–
5 Piece Set: #1 thru #5					5-600-100	5-600-300	5-600-400	5-601-100

- Bell Type
- Right Hand

Size Number	Body Dia	Drill Dia	Drill Length	Overall Length	Part Number 60°
11	1/8	3/64	3/64	1-1/4	5-605-005
12	3/16	1/16	1/16	1-7/8	5-605-010
13	1/4	3/32	3/32	2	5-605-015
14	5/16	7/64	7/64	2-1/8	5-605-020
15	7/16	5/32	5/32	2-3/4	5-605-025
16	1/2	3/16	3/16	3	5-605-030
17	5/8	7/32	7/32	3-1/4	5-605-035
18	3/4	1/4	1/4	3-1/2	5-605-040

- Metric Sizes
- DIN 333A
- Right Hand

Size	Shank Dia mm	OAL mm	Part Number
0.8	3.15	21	5-603-008
1	3.15	33.5	5-603-010
1.6	4	37.5	5-603-016
2	5	42	5-603-020
2.5	6.3	47	5-603-025
3.15	8	52	5-603-031
4	10	59	5-603-040
5	12.5	66	5-603-050
6.3	16	74	5-603-063
8	20	83	5-603-080
10	25	103	5-603-100

- Long Type
- Right Hand



Size Number	Body Dia	Drill Dia	Drill Length	Overall Length	Part Number
1	1/8	3/64	3/64	3	5-602-103
1	1/8	3/64	3/64	4	5-602-104
1	1/8	3/64	3/64	5	5-602-105
1	1/8	3/64	3/64	6	5-602-106
2	3/16	5/64	5/64	4	5-602-204
2	3/16	5/64	5/64	5	5-602-205
2	3/16	5/64	5/64	6	5-602-206
3	1/4	7/64	7/64	4	5-602-304
3	1/4	7/64	7/64	5	5-602-305
3	1/4	7/64	7/64	6	5-602-306
4	5/16	1/8	1/8	4	5-602-404
4	5/16	1/8	1/8	5	5-602-405
4	5/16	1/8	1/8	6	5-602-406
4-1/2	3/8	9/64	9/64	4	5-602-454
4-1/2	3/8	9/64	9/64	5	5-602-455
4-1/2	3/8	9/64	9/64	6	5-602-456
5	7/16	3/16	3/16	4	5-602-504
5	7/16	3/16	3/16	5	5-602-505
5	7/16	3/16	3/16	6	5-602-506
6	1/2	7/32	7/32	5	5-602-605
6	1/2	7/32	7/32	6	5-602-606
7	5/8	1/4	1/4	5	5-602-705
7	5/8	1/4	1/4	6	5-602-706
8	3/4	5/16	5/16	6	5-602-806

COUNTERBORES / COUNTERSINKS



Countersinks

Cutting Tools

6 Flute Machine Countersinks

- High Speed Steel



Dia of Mill	Dia of Shank	60° Part Number	82° Part Number	90° Part Number
3/16	3/16	5-660-6005	5-660-8205	5-660-9005
1/4	1/4	5-660-6010	5-660-8210	5-660-9010
5/16	1/4	5-660-6015	5-660-8215	5-660-9015
3/8	1/4	5-660-6020	5-660-8220	5-660-9020
1/2	1/4	5-660-6025	5-660-8225	5-660-9025
5/8	1/2	5-660-6030	5-660-8230	5-660-9030
3/4	1/2	5-660-6035	5-660-8235	5-660-9035
7/8	1/2	5-660-6040	5-660-8240	5-660-9040
1	1/2	5-660-6045	5-660-8245	5-660-9045
1-1/4	3/4	5-660-6050	5-660-8250	5-660-9050
1-1/2	3/4	5-660-6055	5-660-8255	5-660-9055
1-3/4	1	5-660-6060	5-660-8260	5-660-9060
2	1	5-660-6065	5-660-8265	5-660-9065
5 Piece Set: 1/4 to 1"		5-660-6085	5-660-8285	5-660-9085
8 Piece Set: 1/4 to 1"		5-660-6088	5-660-8288	5-660-9088
10 Piece Set: 1/4 to 1-1/2"		5-660-6090	5-660-8290	5-660-9090
11 Piece Set: 3/16 to 1-1/2"		5-660-6091	5-660-8291	5-660-9091

COUNTERBORES / COUNTERSINKS

Zero Flute Countersinks and Deburring Tools

- High Speed Steel

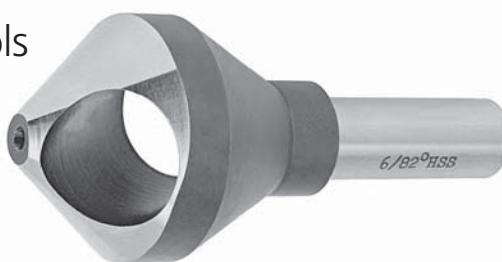

Size Number	Range of Hole		Shank Dia	60° Part Number	82° Part Number	90° Part Number
	Small Dia	Large Dia				
0	1/16	15/64	1/4	5-652-6000	5-652-8200	5-652-9000
1	5/32	13/32	1/4	5-652-6001	5-652-8201	5-652-9001
2	3/16	17/32	1/4	5-652-6002	5-652-8202	5-652-9002
3	5/16	25/32	1/2	5-652-6003	5-652-8203	5-652-9003
4	9/16	1-1/16	1/2	5-652-6004	5-652-8204	5-652-9004
5	5/8	1-15/32	1/2	—	5-652-8205	—
6	3/4	1-3/4	5/8	—	5-652-8206	—
7	1	2	5/8	—	5-652-8207	—
8	1-1/4	2-1/2	3/4	—	5-652-8208	—
0-4	Set of 5 Pieces			5-652-6010	5-652-8210	5-652-9010
1-5	Set of 5 Pieces			—	5-652-8215	—



Single Flute Countersinks

- High Speed Steel



Size	Shank Dia	Shank Length	Overall Length	60° Part Number	82° Part Number	90° Part Number	100° Part Number
3/16	3/16	3/4	1-1/2	5-654-6005	5-654-8205	5-654-9005	5-654-9505
1/4	1/4	3/4	2	5-654-6010	5-654-8210	5-654-9010	5-654-9510
5/16	1/4	1	2	5-654-6015	5-654-8215	5-654-9015	5-654-9515
3/8	1/4	1	2	5-654-6020	5-654-8220	5-654-9020	5-654-9520
1/2	1/4	1	2	5-654-6025	5-654-8225	5-654-9025	5-654-9525
5/8	3/8	1-1/8	2-3/4	5-654-6030	5-654-8230	5-654-9030	5-654-9530
5/8	1/2	1-1/8	2-3/4	5-654-6032	5-654-8232	5-654-9032	–
3/4	3/8	1-5/16	2-3/4	5-654-6035	5-654-8235	5-654-9035	5-654-9535
3/4	1/2	1-5/16	2-3/4	5-654-6037	5-654-8237	5-654-9037	5-654-9537
7/8	1/2	1-5/16	2-3/4	5-654-6040	5-654-8240	5-654-9040	–
1	1/2	1-5/16	2-3/4	5-654-6045	5-654-8245	5-654-9045	5-654-9545
1-1/4	3/4	1-5/8	3-3/8	5-654-6050	5-654-8250	5-654-9050	–
1-1/2	3/4	1-5/8	3-1/2	5-654-6055	5-654-8255	5-654-9055	5-654-9555
2	3/4	1-5/8	3-3/4	5-654-6060	5-654-8260	5-654-9060	5-654-9560
5 Piece Set: 1/4 to 1"				5-654-6085	5-654-8285	5-654-9085	5-654-9585
9 Piece Set: 3/16 to 1"				5-654-6089	5-654-8289	5-654-9089	5-654-9589
12 Piece Set: 3/16 to 2"				5-654-6092	5-654-8292	5-654-9092	5-654-9592

3 Flute Reamer Countersinks

- High Speed Steel



Size	Shank Dia	Shank Length	Overall Length	60° Part Number	82° Part Number	90° Part Number	100° Part Number
1/4	3/16	3/4	1-1/2	5-656-6005	5-656-8205	5-656-9005	5-656-9505
3/8	1/4	7/8	1-3/4	5-656-6010	5-656-8210	5-656-9010	5-656-9510
1/2	3/8	1	2	5-656-6015	5-656-8215	5-656-9015	5-656-9515
5/8	3/8	1	2-1/4	5-656-6020	5-656-8220	5-656-9020	5-656-9520
3/4	1/2	1-1/4	2-5/8	5-656-6025	5-656-8225	5-656-9025	5-656-9525
1	1/2	1-1/4	2-3/4	5-656-6030	5-656-8230	5-656-9030	5-656-9530
1-1/4	3/4	1-1/4	3	5-656-6035	5-656-8235	5-656-9035	5-656-9535
1-1/2	3/4	1-1/4	3	5-656-6040	5-656-8240	5-656-9040	5-656-9540
2	3/4	1-1/4	3-1/4	5-656-6045	5-656-8245	5-656-9045	5-656-9545
5 Piece Set: 1/4 to 1"				5-656-6085	5-656-8285	5-656-9085	5-656-9585
6 Piece Set: 1/4 to 1"				5-656-6086	5-656-8286	5-656-9086	5-656-9586

4 Flute Machine Countersinks

- High Speed Steel



Size	Shank Dia	Shank Length	Overall Length	60° Part Number	82° Part Number	90° Part Number
1/2	1/2	2-1/4	3-7/8	5-658-6005	5-658-8205	5-658-9005
5/8	1/2	2-1/4	4	5-658-6010	5-658-8210	5-658-9010
3/4	1/2	2-1/4	4-1/8	5-658-6015	5-658-8215	5-658-9015
7/8	1/2	2-1/4	4-1/4	5-658-6020	5-658-8220	5-658-9020
1	1/2	2-1/4	4-3/8	5-658-6025	5-658-8225	5-658-9025
1-1/4	1/2	2-1/4	5	5-658-6030	5-658-8230	5-658-9030
1-1/2	1/2	2-1/4	5-3/8	5-658-6035	5-658-8235	5-658-9035

COUNTERBORES / COUNTERSINKS



Countersink Sets

- High Speed Steel

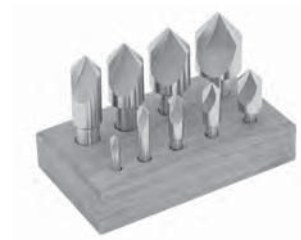

Single Flute Countersink Sets

Set Size	Part Number			
	60°	82°	90°	100°
5 Piece: 1/4 to 1"	5-654-6085	5-654-8285	5-654-9085	5-654-9585
9 Piece: 3/16 to 1"	5-654-6089	5-654-8289	5-654-9089	5-654-9589
12 Piece: 3/16 to 2"	5-654-6092	5-654-8292	5-654-9092	5-654-9592

5 Piece Set Includes: 1/4, 3/8, 1/2, 3/4, and 1"

9 Piece Set Includes: 3/16, 1/4, 5/16, 3/8, 1/2, 5/8, 3/4, 7/8, and 1"

12 Piece Set Includes: 3/16, 1/4, 5/16, 3/8, 1/2, 5/8, 3/4, 7/8, 1, 1-1/4, 1-1/2, and 2"

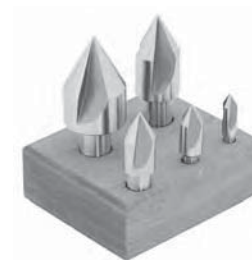

3 Flute Center Countersink Sets

Set Size	Part Number			
	60°	82°	90°	100°
5 Piece: 1/4 to 1"	5-656-6085	5-656-8285	5-656-9085	5-656-9585
6 Piece: 1/4 to 1"	5-656-6086	5-656-8286	5-656-9086	5-656-9586

5 Piece Set Includes: 1/4, 3/8, 1/2, 3/4, and 1"

6 Piece Set Includes: 1/4, 3/8, 1/2, 5/8, 3/4 and 1"

6 Flute Machine Countersink Sets

Set Size	Part Number		
	60°	82°	90°
5 Piece: 1/4 to 1"	5-660-6085	5-660-8285	5-660-9085
8 Piece: 1/4 to 1"	5-660-6088	5-660-8288	5-660-9088
10 Piece: 1/4 to 1-1/2"	5-660-6090	5-660-8290	5-660-9090
11 Piece: 3/16 to 1-1/2"	5-660-6091	5-660-8291	5-660-9091

5 Piece Set Includes: 1/4, 3/8, 1/2, 3/4, and 1"

8 Piece Set Includes: 1/4, 5/16, 3/8, 1/2, 5/8, 3/4, 7/8, and 1"

10 Piece Set Includes: 1/4, 5/16, 3/8, 1/2, 5/8, 3/4, 7/8, 1, 1-1/4, and 1-1/2"

11 Piece Set Includes: 3/16, 1/4, 5/16, 3/8, 1/2, 5/8, 3/4, 7/8, 1, 1-1/4, and 1-1/2"

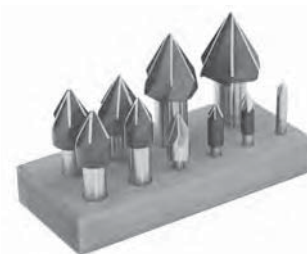

TABLE OF CONTENTS

CARBIDE BURRS

Technical Reference	330
Carbide Burrs	331





Recommended Speeds for Carbide Headed Burrs

Double cut burrs are not recommended for machining aluminum, zinc or plastic

Burr Diameter	RPM
3/16"	30,000
1/4" - 3/8"	25,000
7/16- 1/2"	20,000
5/8" - 3/4"	15,000
1"	12,000

Cylinder Shape End Cut (SB)

- Double cut
- Superb geometry
- Consistency from tool to tool

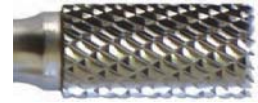
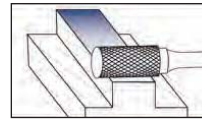
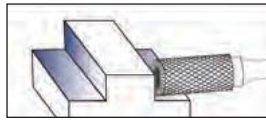

Shape and Size	Cutting Dia	Shank Dia	Length of Cut	Overall Length	Part Number Double Cut
SB-43	1/8	1/8	9/16	1-1/2	1-302-1013
SB-14	3/16	1/4	5/8	2-1/2	1-302-2019
SB-51	1/4	1/8	3/16	1-5/8	1-302-1025
SB-1	1/4	1/4	5/8	2-1/2	1-302-2025
SB-2	5/16	1/4	3/4	2-1/2	1-302-2031
SB-3	3/8	1/4	3/4	2-1/2	1-302-2038
SB-5	1/2	1/4	1	2-3/4	1-302-2050
SB-6	5/8	1/4	1	2-3/4	1-302-2063
SB-7	3/4	1/4	1	2-3/4	1-302-2075
SB-9	1	1/4	1	2-3/4	1-302-2100

Cylinder Shape Radius End (SC)

- Double cut
- Superb geometry
- Consistency from tool to tool

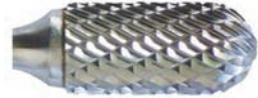

Shape and Size	Cutting Dia	Shank Dia	Length of Cut	Overall Length	Part Number Double Cut
SC-41	3/32	1/8	7/16	1-1/2	1-303-1009
SC-42	1/8	1/8	1/2	1-1/2	1-303-1013
SC-14	3/16	1/4	5/8	2-1/2	1-303-2019
SC-51	1/4	1/8	1/2	2	1-303-1025
SC-1	1/4	1/4	5/8	2	1-303-2025
SC-2	5/16	1/4	3/4	2-1/2	1-303-2031
SC-3	3/8	1/4	3/4	2-1/2	1-303-2038
SC-5	1/2	1/4	1	2-3/4	1-303-2050
SC-6	5/8	1/4	1	2-3/4	1-303-2063
SC-7	3/4	1/4	1	2-3/4	1-303-2075

Ball Shape (SD)

- Double cut
- Superb geometry
- Consistency from tool to tool



Shape and Size	Cutting Dia	Shank Dia	Length of Cut	Overall Length	Part Number Double Cut
SD-41	3/32	1/8	3/32	1-1/2	1-304-1009
SD-42	1/8	1/8	1/8	1-1/2	1-304-1013
SD-14	3/16	1/4	5/8	2	1-304-2019
SD-51	1/4	1/8	1/4	1-3/4	1-304-1025
SD-1	1/4	1/4	1/4	2	1-304-2025
SD-2	5/16	1/4	5/16	2-1/16	1-304-2031
SD-3	3/8	1/4	3/8	2-1/8	1-304-2038
SD-5	1/2	1/4	1/2	2-1/4	1-304-2050
SD-6	5/8	1/4	5/8	2-3/8	1-304-2063
SD-7	3/4	1/4	3/4	2-1/2	1-304-2075

CARBIDE BURRS



Carbide Burrs

Cutting Tools

Oval (SE)

- Double cut
- Superb geometry
- Consistency from tool to tool



Shape and Size	Cutting Dia	Shank Dia	Length of Cut	Overall Length	Part Number Double Cut
SE-41	1/8	1/8	7/32	1-1/2	1-305-1013
SE-51	1/4	1/8	3/8	1-1/2	1-305-1025
SE-1	1/4	1/4	3/8	2-1/4	1-305-2025
SE-3	3/8	1/4	5/8	2-1/2	1-305-2038
SE-5	1/2	1/4	7/8	2-1/2	1-305-2050

Tree Shape Radius End (SF)

- Double cut
- Superb geometry
- Consistency from tool to tool



Shape and Size	Cutting Dia	Shank Dia	Length of Cut	Overall Length	Part Number Double Cut
SF-42	1/8	1/8	1/2	1-1/2	1-306-1013
SF-51	1/4	1/8	1/2	2	1-306-1025
SF-1	1/4	1/4	3/4	2-1/2	1-306-2025
SF-3	3/8	1/4	3/4	2-1/2	1-306-2038
SF-5	1/2	1/4	1	2-3/4	1-306-2050
SF-6	5/8	1/4	1	2-3/4	1-306-2063
SF-7	3/4	1/4	1	2-3/4	1-306-2075

Tree Shape Pointed End (SG)

- Double cut
- Superb geometry
- Consistency from tool to tool

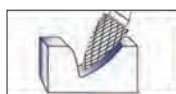

Shape and Size	Cutting Dia	Shank Dia	Length of Cut	Overall Length	Part Number Double Cut
SG-44	1/8	1/8	1/2	1-1/2	1-307-1013
SG-1	1/4	1/4	3/4	2-1/2	1-307-2025
SG-2	5/16	1/4	3/4	2-1/2	1-307-2031
SG-3	3/8	1/4	3/4	2-1/2	1-307-2038
SG-5	1/2	1/4	1	2-3/4	1-307-2050
SG-6	5/8	1/4	1	2-3/4	1-307-2063
SG-7	3/4	1/4	1	2-3/4	1-307-2075

Flame (SH)

- Double cut
- Superb geometry
- Consistency from tool to tool



Shape and Size	Cutting Dia	Shank Dia	Length of Cut	Overall Length	Part Number Double Cut
SH-41	1/8	1/8	1/4	1-1/2	1-308-1013
SH-1	1/4	1/4	1/2	2-3/8	1-308-2025
SH-2	5/16	1/4	3/4	2-5/8	1-308-2031
SH-5	1/2	1/4	1-1/4	3	1-308-2050
SH-6	5/8	1/4	1-7/16	3-3/16	1-308-2063
SH-7	3/4	1/4	1-5/8	3-3/8	1-308-2075

CARBIDE BURRS

Taper Shape Radius End (SL)

- Double cut
- Superb geometry
- Consistency from tool to tool



Shape and Size	Cutting Dia	Shank Dia	Length of Cut	Included Angle	Overall Length	Part Number Double Cut
SL-42	1/8	1/8	1/2	8°	1-1/2	1-312-1013
SL-1	1/4	1/4	5/8	14°	2-1/2	1-312-2025
SL-2	5/16	1/4	7/8	14°	2-5/8	1-312-2031
SL-3	3/8	1/4	1	14°	2-13/16	1-312-2038
SL-4	1/2	1/4	1-1/8	14°	2-7/8	1-312-2050
SL-5	5/8	1/4	1-5/16	14°	2-15/16	1-312-2063

Cone Shape (SM)

- Double cut
- Superb geometry
- Consistency from tool to tool

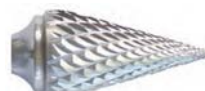
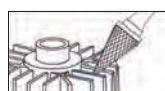

Shape and Size	Cutting Dia	Shank Dia	Length of Cut	Included Angle	Overall Length	Part Number Double Cut
SM-2	1/4	1/4	3/4	14°	2-1/2	1-313-2025
SM-4	3/8	1/4	7/8	14°	2-1/2	1-313-2038
SM-5	1/2	1/4	1	14°	2-3/4	1-313-2050

TABLE OF CONTENTS

END MILLS

SOLID CARBIDE

Technical Reference	334
Single End, Square	335
Single End, Ball Nose	341
Double End, Square	345
Double End, Weldon	346
Variable Helix, Corner	348
Variable Helix, Sharp and Ball Nose	349
6 Flute, 45°, Corner Radius	350
2 and 3 Flute for Aluminum	351
Roughing	352
Drill Mills	353

HSS AND COBALT

2 Flute	354
Multiple Flute	358
Roughing	362





Solid Carbide End Mills Technical Reference

Cutting Tools

END MILLS

Speeds and Feeds for Solid Carbide End Mills – Variable Helix End Mills

Material	SFM	Chip Load Per Tooth			
		1/8"	1/4"	1/2"	1"
Aluminum Alloys	1120	0.0010	0.0020	0.0040	0.0080
Carbon Steel	300-600	0.0010	0.0015	0.0030	0.0060
Cast Iron	350-550	0.0010	0.0015	0.0030	0.0060
Copper Alloys	500-900	0.0010	0.0020	0.0030	0.0060
Steel – Annealed	350-500	0.0010	0.0020	0.0030	0.0050
Steel – Rc 18-24	150-500	0.0004	0.0008	0.0015	0.0045
Steel – Rc 25-37	125-200	0.0003	0.0005	0.0010	0.0030
Stainless Steel – Free Machining	250-400	0.0005	0.0010	0.0020	0.0030
Stainless Steel – Other	150-300	0.0005	0.0010	0.0020	0.0030
Inconel/Monel	60-100	0.0005	0.0010	0.0015	0.0030
Titanium	175-300	0.0005	0.0008	0.0015	0.0030

Carbide Roughing End Mills

Material	SFM		Example	Chip Load Per Tooth		
	Under 32 HRC	Over 32 HRC		1/4"	3/8"	1/2"
Carbon Steel	200-450	100-250	10, 11, 13xx	.0014-.0019	.0020-.0030	.0030-.0040
Alloy Steel	150-400	80-280	40, 41, 42xx	.0012-.0017	.0018-.0025	.0025-.0035
Grey Cast Iron	250-500	140-300	–	.0012-.0017	.0018-.0025	.0025-.0035
Ductile Cast Iron	120-400	90-150	–	.0012-.0017	.0018-.0025	.0025-.0035
SS 300 Series	150-550	100-240	304, 316, 304L	.0015-.0020	.0020-.0030	.0030-.0040
SS 400 Series	150-400	100-280	420, 420F	.0015-.0020	.0020-.0030	.0030-.0040
Precipitation Steel	100-400	90-240	15-5PH, 16-6PH	.0015-.0020	.0018-.0030	.0025-.0040
High Temp. Alloys	60-150	50-160	Inconel	.0010-.0015	.0015-.0025	.0020-.0030

Material	SFM		Example	Chip Load Per Tooth		
	Under 32 HRC	Over 32 HRC		5/8"	3/4"	1"
Carbon Steel	200-450	100-250	10, 11, 13xx	.0038-.0044	.0038-.0053	.0060-.0080
Alloy Steel	150-400	80-280	40, 41, 42xx	.0031-.0044	.0038-.0053	.0050-.0070
Grey Cast Iron	250-500	140-300	–	.0031-.0044	.0038-.0053	.0050-.0070
Ductile Cast Iron	120-400	90-150	–	.0031-.0044	.0038-.0053	.0050-.0070
SS 300 Series	150-550	100-240	304, 316, 304L	.0035-.0050	.0040-.0060	.0055-.0080
SS 400 Series	150-400	100-280	420, 420F	.0035-.0050	.0040-.0060	.0055-.0080
Precipitation Steel	100-400	90-240	15-5PH, 16-6PH	.0030-.0045	.0035-.0055	.0050-.0070
High Temp. Alloys	60-150	50-160	Inconel	.0025-.0040	.0030-.0045	.0040-.0060

End Mills for Aluminum

Material	SFM	Chip Load Per Tooth							
		1/8"	1/4"	5/16"	3/8"	1/2"	5/8"	3/4"	1"
Aluminum Alloys	1120	1600-2000	0.0015	0.0040	0.0050	0.0060	0.0070	0.0080	0.0100
Brass/Bronze	300-600	800-1500	0.0015	0.0040	0.0050	0.0060	0.0070	0.0080	0.0100
Copper Alloys	350-550	800-1200	0.0015	0.0040	0.0050	0.0060	0.0070	0.0080	0.0100
Plastics	500-900	1200-1600	0.0030	0.0080	0.0100	0.0120	0.0140	0.0160	0.0180

Note: All speeds and feeds are suggested starting points. They may be increased or decreased depending on machine condition, depth of cut, finished required, coolant, etc.

2 Flute Single End – Square End

Features and Applications:

- Center cutting geometry
- Designed for increased chip removal rate
- Capable of slotting, profiling, and plunging operations
- Used for roughing and finishing operations
- Premium sub micro grain Carbide

Aluminium Alloy	Carbon Steel	Alloy Steel	Hard Steel	Nickel / Inconel Alloy	Stainless Steel	Cast Iron	Titanium
●	●	●	◐	◐	◐	●	◐

● Excellent ◐ Good



Tolerance: Shank dia: h6 and Cutting dia: h10



2 Flute

2 Flute Standard Length – Fractional Diameters – Square End

Cut Dia	Shank Dia	Length of Cut	Overall Length	Series 1-100 2 Flute uncoated Part Number	Series 1-102 2 Flute TiAlN coated Part Number
1/32"	1/8"	1/8"	1-1/2"	1-100-2003	1-102-2003
3/64"	1/8"	1/8"	1-1/2"	1-100-2004	1-102-2004
1/16"	1/8"	3/16"	1-1/2"	1-100-2006	1-102-2006
5/64"	1/8"	1/4"	1-1/2"	1-100-2007	1-102-2007
3/32"	1/8"	3/8"	1-1/2"	1-100-2009	1-102-2009
7/64"	1/8"	3/8"	1-1/2"	1-100-2010	1-102-2010
1/8"	1/8"	1/2"	1-1/2"	1-100-2012	1-102-2012
9/64"	3/16"	9/16"	2"	1-100-2014	1-102-2014
5/32"	3/16"	9/16"	2"	1-100-2015	1-102-2015
11/64"	3/16"	5/8"	2"	1-100-2017	1-102-2017
3/16"	3/16"	5/8"	2"	1-100-2018	1-102-2018
13/64"	1/4"	5/8"	2-1/2"	1-100-2020	1-102-2020
7/32"	1/4"	5/8"	2-1/2"	1-100-2021	1-102-2021
15/64"	1/4"	3/4"	2-1/2"	1-100-2023	1-102-2023
1/4"	1/4"	3/4"	2-1/2"	1-100-2025	1-102-2025
17/64"	5/16"	3/4"	2-1/2"	1-100-2027	1-102-2027
9/32"	5/16"	3/4"	2-1/2"	1-100-2028	1-102-2028
19/64"	5/16"	13/16"	2-1/2"	1-100-2030	1-102-2030
5/16"	5/16"	13/16"	2-1/2"	1-100-2031	1-102-2031
11/32"	3/8"	1"	2-1/2"	1-100-2034	1-102-2034
3/8"	3/8"	1"	2-1/2"	1-100-2038	1-102-2038
13/32"	7/16"	1"	2-3/4"	1-100-2041	1-102-2041
7/16"	7/16"	1"	2-3/4"	1-100-2044	1-102-2044
1/2"	1/2"	1"	3"	1-100-2050	1-102-2050
9/16"	9/16"	1-1/8"	3-1/2"	1-100-2056	1-102-2056
5/8"	5/8"	1-1/4"	3-1/2"	1-100-2062	1-102-2062
11/16"	3/4"	1-3/8"	4"	1-100-2069	1-102-2069
3/4"	3/4"	1-1/2"	4"	1-100-2075	1-102-2075
7/8"	7/8"	1-1/2"	4"	1-100-2087	1-102-2087
1"	1"	1-1/2"	4"	1-100-2100	1-102-2100



Solid Carbide End Mills

Cutting Tools

END MILLS

2 Flute Long and Extra Long Length – Fractional Diameters – Square End

Cut Dia	Shank Dia	Length of Cut	Overall Length	Series 1-110 2 Flute uncoated Part Number	Series 1-112 2 Flute TiAlN coated Part Number
1/8"	1/8"	3/4"	2-1/4"	1-110-20122	1-112-20122
1/8"	1/8"	1"	3"	1-110-20123	1-112-20123
1/8"	1/8"	1-1/8"	4"	1-110-20124	1-112-20124
3/16"	3/16"	3/4"	2-1/2"	1-110-20182	1-112-20182
3/16"	3/16"	1-1/8"	3"	1-110-20183	1-112-20183
3/16"	3/16"	1-1/2"	4"	1-110-20184	1-112-20184
3/16"	3/16"	1-1/2"	6"	1-110-20186	1-112-20186
1/4"	1/4"	1-1/8"	3"	1-110-20253	1-112-20253
1/4"	1/4"	1-1/2"	4"	1-110-20254	1-112-20254
1/4"	1/4"	1-1/2"	6"	1-110-20256	1-112-20256
1/4"	1/4"	2-1/2"	6"	1-110-20257	1-112-20257
5/16"	5/16"	1-1/8"	3"	1-110-20313	1-112-20313
5/16"	5/16"	1-5/8"	4"	1-110-20314	1-112-20314
5/16"	5/16"	2-1/2"	6"	1-110-20316	1-112-20316
3/8"	3/8"	1-1/8"	3"	1-110-20373	1-112-20373
3/8"	3/8"	1-3/4"	4"	1-110-20374	1-112-20374
3/8"	3/8"	1-1/2"	6"	1-110-20376	1-112-20376
7/16"	7/16"	2"	4"	1-110-20434	1-112-20434
7/16"	7/16"	3"	6"	1-110-20436	1-112-20436
1/2"	1/2"	2"	4"	1-110-20504	1-112-20504
1/2"	1/2"	3"	6"	1-110-20506	1-112-20506
1/2"	1/2"	1-1/2"	6"	1-110-205061	1-112-205061
1/2"	1/2"	4"	7"	1-110-20507	1-112-20507
5/8"	5/8"	2-1/4"	5"	1-110-20625	1-112-20625
5/8"	5/8"	3"	6"	1-110-20626	1-112-20626
3/4"	3/4"	2-1/4"	5"	1-110-20755	1-112-20755
3/4"	3/4"	3"	6"	1-110-20758	1-112-20758
1"	1"	2-1/4"	5"	1-110-21005	1-112-21005
1"	1"	3"	6"	1-110-21006	1-112-21006



2 Flute Standard Length – Metric Diameters – Square End

Cut Dia	Shank Dia	Length of Cut	Overall Length	Series 1-180 2 Flute uncoated Part Number	Series 1-182 2 Flute TiAlN coated Part Number
1.0	3	4	38	1-180-2001	1-182-2001
1.5	3	4.5	38	1-180-20015	1-182-20015
2.0	3	6.3	38	1-180-2002	1-182-2002
2.5	3	9.5	38	1-180-20025	1-182-20025
3.0	3	12	38	1-180-2003	1-182-2003
3.5	4	12	50	1-180-20035	1-182-20035
4.0	4	14	50	1-180-2004	1-182-2004
4.5	6	16	50	1-180-20045	1-182-20045
5.0	6	16	50	1-180-2005	1-182-2005
6.0	6	19	50	1-180-2006	1-182-2006
7.0	8	20	63	1-180-2007	1-182-2007
8.0	8	20	63	1-180-2008	1-182-2008
9.0	10	22	75	1-180-2009	1-182-2009
10.0	10	22	75	1-180-20010	1-182-2010
11.0	12	25	75	1-180-20011	1-182-2011
12.0	12	25	75	1-180-20012	1-182-2012
13.0	14	32	89	1-180-20013	–
14.0	14	32	89	1-180-20014	1-182-2014
16.0	16	32	89	1-180-20016	1-182-2016



Solid Carbide End Mills

Cutting Tools

END MILLS

4 Flute Single End – Square End

Features and Applications:

- Center cutting geometry
- Designed for increased chip removal rate
- Capable of slotting, profiling, and plunging operations
- Used for roughing and finishing operations
- Premium sub micro grain Carbide

Aluminium Alloy	Carbon Steel	Alloy Steel	Hard Steel	Nickel / Inconel Alloy	Stainless Steel	Cast Iron	Titanium
●	●	●	◐	◐	◐	●	

● Excellent ◐ Good



Shank tolerance h6 and Cutting dia – +0.000 to -0.050 mm



4 Flute

4 Flute Standard Length – Fractional Diameters – Square End

Cut Dia	Shank Dia	Length of Cut	Overall Length	Series 1-100 4 Flute uncoated Part Number	Series 1-102 4 Flute TiAlN coated Part Number
1/32"	1/8"	1/8"	1-1/2"	1-100-4003	1-102-4003
3/64"	1/8"	1/8"	1-1/2"	1-100-4004	1-102-4004
1/16"	1/8"	3/16"	1-1/2"	1-100-4006	1-102-4006
5/64"	1/8"	1/4"	1-1/2"	1-100-4007	–
3/32"	1/8"	3/8"	1-1/2"	1-100-4009	1-102-4009
7/64"	1/8"	3/8"	1-1/2"	1-100-4010	1-102-4010
1/8"	1/8"	1/2"	1-1/2"	1-100-4012	1-102-4012
9/64"	3/16"	9/16"	2"	1-100-4014	1-102-4014
5/32"	3/16"	9/16"	2"	1-100-4015	1-102-4015
11/64"	3/16"	5/8"	2"	1-100-4017	1-102-4017
3/16"	3/16"	5/8"	2"	1-100-4018	1-102-4018
13/64"	1/4"	5/8"	2-1/2"	1-100-4020	1-102-4020
7/32"	1/4"	5/8"	2-1/2"	1-100-4021	1-102-4021
15/64"	1/4"	3/4"	2-1/2"	1-100-4023	1-102-4023
1/4"	1/4"	3/4"	2-1/2"	1-100-4025	1-102-4025
17/64"	5/16"	3/4"	2-1/2"	1-100-4027	1-102-4027
9/32"	5/16"	3/4"	2-1/2"	1-100-4028	1-102-4028
19/64"	5/16"	13/16"	2-1/2"	1-100-4030	1-102-4030
5/16"	5/16"	13/16"	2-1/2"	1-100-4031	1-102-4031
11/32"	3/8"	1"	2-1/2"	1-100-4034	1-102-4034
3/8"	3/8"	1"	2-1/2"	1-100-4038	1-102-4038
13/32"	7/16"	1"	2-3/4"	1-100-4041	1-102-4041
7/16"	7/16"	1"	2-3/4"	1-100-4044	1-102-4044
1/2"	1/2"	1"	3"	1-100-4050	1-102-4050
9/16"	9/16"	1-1/8"	3-1/2"	1-100-4056	1-102-4056
5/8"	5/8"	1-1/4"	3-1/2"	1-100-4062	1-102-4062
11/16"	3/4"	1-3/8"	4"	1-100-4069	1-102-4069
3/4"	3/4"	1-1/2"	4"	1-100-4075	1-102-4075
7/8"	7/8"	1-1/2"	4"	1-100-4087	1-102-4087
1"	1"	1-1/2"	4"	1-100-4100	1-102-4100



4 Flute Long and Extra Long Lengths – Fractional Diameters – Square End

Cut Dia	Shank Dia	Length of Cut	Overall Length	Series 1-110 4 Flute uncoated Part Number	Series 1-112 4 Flute TiAlN coated Part Number
1/8"	1/8"	3/4"	2-1/4"	1-110-40122	1-112-40122
1/8"	1/8"	1"	3"	1-110-40123	1-112-40123
1/8"	1/8"	1-1/8"	4"	1-110-40124	1-112-40124
3/16"	3/16"	3/4"	2-1/2"	1-110-40182	1-112-40182
3/16"	3/16"	1-1/8"	3"	1-110-40183	1-112-40183
3/16"	3/16"	1-1/2"	4"	1-110-40184	1-112-40184
3/16"	3/16"	1-1/2"	6"	1-110-40186	1-112-40186
1/4"	1/4"	1-1/8"	3"	1-110-40253	1-112-40253
1/4"	1/4"	1-1/2"	4"	1-110-40254	1-112-40254
1/4"	1/4"	1-1/2"	6"	1-110-40256	1-112-40256
1/4"	1/4"	2-1/2"	6"	1-110-40257	1-112-40257
5/16"	5/16"	1-1/8"	3"	1-110-40313	1-112-40313
5/16"	5/16"	1-5/8"	4"	1-110-40314	1-112-40314
5/16"	5/16"	2-1/2"	6"	1-110-40316	1-112-40316
3/8"	3/8"	1-1/8"	3"	1-110-40373	1-112-40373
3/8"	3/8"	1-3/4"	4"	1-110-40374	1-112-40374
3/8"	3/8"	1-1/2"	6"	1-110-40376	1-112-40376
3/8"	3/8"	2-1/2"	6"	1-110-40377	1-112-40377
7/16"	7/16"	2"	4"	1-110-40434	1-112-40434
7/16"	7/16"	3"	6"	1-110-40436	1-112-40436
1/2"	1/2"	2"	4"	1-110-40502	1-112-40502
1/2"	1/2"	3"	6"	1-110-40506	1-112-40506
1/2"	1/2"	1-1/2"	6"	1-110-405061	1-112-405061
1/2"	1/2"	4"	7"	1-110-40507	1-112-40507
1/2"	1/2"	4"	8"	1-110-40508	1-112-40508
5/8"	5/8"	2-1/4"	5"	1-110-40625	1-112-40625
5/8"	5/8"	3"	6"	1-110-40626	1-112-40626
5/8"	5/8"	4"	7"	1-110-40627	1-112-40627
3/4"	3/4"	2-1/4"	5"	1-110-40755	1-112-40755
3/4"	3/4"	3"	6"	1-110-40756	1-112-40756
1"	1"	2-1/4"	5"	1-110-41005	1-112-41005
1"	1"	3"	6"	1-110-41006	1-112-41006
1"	1"	4"	7"	1-110-41007	1-112-41007



Solid Carbide End Mills

Cutting Tools

END MILLS

4 Flute Standard Length – Metric Diameters – Square End

Cut Dia	Shank Dia	Length of Cut	Overall Length	Series 1-180 4 Flute uncoated Part Number	Series 1-182 4 Flute TiAlN coated Part Number
1.0	3	4	38	1-180-4001	1-182-4001
1.5	3	4.5	38	1-180-40015	1-182-40015
2.0	3	6.3	38	1-180-4002	1-182-4002
2.5	3	9.5	38	1-180-40025	1-182-40025
3.0	3	12	38	1-180-4003	1-182-4003
3.5	4	12	50	1-180-40035	1-182-40035
4.0	4	14	50	1-180-4004	1-182-4004
4.5	6	16	50	1-180-40045	1-182-40045
5.0	6	16	50	1-180-4005	1-182-4005
6.0	6	19	50	1-180-4006	1-182-4006
7.0	8	20	63	1-180-4007	1-182-4007
8.0	8	20	63	1-180-4008	1-182-4008
9.0	10	22	75	1-180-4009	1-182-4009
10.0	10	22	75	1-180-4010	1-182-4010
11.0	12	25	75	1-180-4011	1-182-4011
12.0	12	25	75	1-180-4012	1-182-4012
13.0	14	32	89	1-180-4013	–
14.0	14	32	89	1-180-4014	1-182-4014
16.0	16	32	89	1-180-4016	1-182-4016

2 Flute Single End – Ball Nose

Features and Applications:

- Center cutting geometry
- Designed for increased chip removal rate
- Capable of slotting, profiling, and plunging operations
- Used for roughing and finishing operations
- Premium sub micro grain Carbide

Aluminium Alloy	Carbon Steel	Alloy Steel	Hard Steel	Nickel / Inconel Alloy	Stainless Steel	Cast Iron	Titanium
●	●	●	◐	◐	◐	●	◐

● Excellent ◐ Good



Shank tolerance h6 and Cutting dia – +0.000 to -0.050 mm



2 Flute

2 Flute Standard Length – Fractional Diameters – Ball Nose

Cut Dia	Shank Dia	Length of Cut	Overall Length	Series 1-103 2 Flute uncoated Part Number	Series 1-104 2 Flute TiAlN coated Part Number
1/32"	1/8"	1/8"	1-1/2"	1-103-2003	1-104-2003
3/64"	1/8"	1/8"	1-1/2"	1-103-2004	1-104-2004
1/16"	1/8"	3/16"	1-1/2"	1-103-2006	1-104-2006
5/64"	1/8"	1/4"	1-1/2"	1-103-2007	1-104-2007
3/32"	1/8"	3/8"	1-1/2"	1-103-2009	1-104-2009
7/64"	1/8"	3/8"	1-1/2"	1-103-2010	1-104-2010
1/8"	1/8"	1/2"	1-1/2"	1-103-2012	1-104-2012
9/64"	3/16"	9/16"	2"	1-103-2014	1-104-2014
5/32"	3/16"	9/16"	2"	1-103-2015	1-104-2015
11/64"	3/16"	5/8"	2"	1-103-2017	1-104-2017
3/16"	3/16"	5/8"	2"	1-103-2018	1-104-2018
13/64"	1/4"	5/8"	2-1/2"	1-103-2020	1-104-2020
7/32"	1/4"	5/8"	2-1/2"	1-103-2021	1-104-2021
1/4"	1/4"	3/4"	2-1/2"	1-103-2025	1-104-2025
9/32"	5/16"	3/4"	2-1/2"	1-103-2028	1-104-2028
5/16"	5/16"	13/16"	2-1/2"	1-103-2031	1-104-2031
11/32"	3/8"	1"	2-1/2"	1-103-2034	1-104-2034
3/8"	3/8"	1"	2-1/2"	1-103-2038	1-104-2038
13/32"	7/16"	1"	2-3/4"	1-103-2041	1-104-2041
7/16"	7/16"	1"	2-3/4"	1-103-2044	1-104-2044
1/2"	1/2"	1"	3"	1-103-2050	1-104-2050
9/16"	9/16"	1-1/8"	3-1/2"	1-103-2056	1-104-2056
5/8"	5/8"	1-1/4"	3-1/2"	1-103-2062	1-104-2062
11/16"	3/4"	1-3/8"	4"	1-103-2069	1-104-2069
3/4"	3/4"	1-1/2"	4"	1-103-2075	1-104-2075
7/8"	7/8"	1-1/2"	4"	1-103-2087	1-104-2087
1"	1"	1-1/2"	4"	1-103-2100	1-104-2100



Solid Carbide End Mills

Cutting Tools

END MILLS

2 Flute Long and Extra Long Lengths – Ball Nose

Cut Dia	Shank Dia	Length of Cut	Overall Length	Series 1-111 2 Flute uncoated Part Number	Series 1-113 2 Flute TiAlN coated Part Number
1/8"	1/8"	3/4"	2-1/4"	1-111-20122	1-113-20122
1/8"	1/8"	1"	4"	1-111-20124	1-113-20124
3/16"	3/16"	3/4"	2-1/2"	1-111-20182	1-113-20182
3/16"	3/16"	1-1/8"	3"	1-111-20183	1-113-20183
1/4"	1/4"	1-1/8"	3"	1-111-20253	1-113-20253
1/4"	1/4"	1-1/2"	4"	1-111-20254	1-113-20254
5/16"	5/16"	1-1/8"	3"	1-111-20313	1-113-20313
5/16"	5/16"	1-5/8"	4"	1-111-20314	1-113-20314
5/16"	5/16"	1-1/2"	6"	1-111-20316	1-113-20316
3/8"	3/8"	1-1/8"	3"	1-111-20373	1-113-20373
3/8"	3/8"	1-3/4"	4"	1-111-20374	1-113-20374
7/16"	7/16"	2"	4"	1-111-20434	1-113-20434
1/2"	1/2"	2"	4"	1-111-20502	1-113-20502
1/2"	1/2"	3"	6"	1-111-20506	1-113-20506
5/8"	5/8"	2-1/4"	5"	1-111-20625	1-113-20625
5/8"	5/8"	3"	6"	1-111-20626	1-113-20626
3/4"	3/4"	2-1/4"	5"	1-111-20755	1-113-20755
3/4"	3/4"	4"	7"	1-111-20757	1-113-20757
1"	1"	2-1/4"	5"	1-111-21005	1-113-21005
1"	1"	3"	6"	1-111-21006	1-113-21006

2 Flute Standard Length – Metric Diameters – Ball Nose

Cut Dia	Shank Dia	Length of Cut	Overall Length	Series 1-181 2 Flute uncoated Part Number	Series 1-183 2 Flute TiAlN coated Part Number
1.0	3	4	38	1-181-2001	1-183-2001
1.5	3	4.5	38	1-181-20015	1-183-20015
2.0	3	6.3	38	1-181-2002	1-183-2002
2.5	3	9.5	38	1-181-20025	1-183-20025
3.0	3	12	38	1-181-2003	1-183-2003
3.5	4	12	50	1-181-20035	1-183-20035
4.0	4	14	50	1-181-2004	1-183-2004
4.5	6	16	50	1-181-20045	1-183-20045
5.0	6	16	50	1-181-2005	1-183-2005
6.0	6	19	50	1-181-2006	1-183-2006
7.0	8	19	63	1-181-2007	1-183-2007
8.0	8	20	63	1-181-2008	1-183-2008
9.0	10	22	75	1-181-2009	1-183-2009
10.0	10	22	75	1-181-2010	1-183-2010
11.0	12	25	75	1-181-2011	1-183-2011
12.0	12	25	75	1-181-2012	1-183-2012
14.0	14	32	89	1-181-2014	1-183-2014
16.0	16	32	89	1-181-2016	1-183-2016
18.0	18	38	100	1-181-2018	1-183-2018



4 Flute Single End – Ball Nose

Features and Applications:

- Center cutting geometry
- Designed for increased chip removal rate
- Capable of slotting, profiling, and plunging operations
- Used for roughing and finishing operations
- Premium sub micro grain Carbide

Aluminium Alloy	Carbon Steel	Alloy Steel	Hard Steel	Nickel / Inconel Alloy	Stainless Steel	Cast Iron	Titanium
●	●	●	◐	◐	◐	●	

● Excellent ◐ Good



Shank tolerance h6 and Cutting dia – +0.000 to -0.050 mm



4 Flute

4 Flute Standard Length – Fractional Diameters – Ball Nose

Cut Dia	Shank Dia	Length of Cut	Overall Length	Series 1-103 4 Flute uncoated Part Number	Series 1-104 4 Flute TiAlN coated Part Number
1/32"	1/8"	1/8"	1-1/2"	1-103-4003	1-104-4003
3/64"	1/8"	1/8"	1-1/2"	1-103-4004	1-104-4004
1/16"	1/8"	3/16"	1-1/2"	1-103-4006	1-104-4006
5/64"	1/8"	1/4"	1-1/2"	1-103-4007	1-104-4007
3/32"	1/8"	3/8"	1-1/2"	1-103-4009	1-104-4009
7/64"	1/8"	3/8"	1-1/2"	1-103-4010	1-104-4010
1/8"	1/8"	1/2"	1-1/2"	1-103-4012	1-104-4012
9/64"	3/16"	9/16"	2"	1-103-4014	1-104-4014
5/32"	3/16"	9/16"	2"	1-103-4015	1-104-4015
11/64"	3/16"	5/8"	2"	1-103-4017	1-104-4017
3/16"	3/16"	5/8"	2"	1-103-4018	1-104-4018
13/64"	1/4"	5/8"	2-1/2"	1-103-4020	1-104-4020
7/32"	1/4"	5/8"	2-1/2"	1-103-4021	1-104-4021
15/64"	1/4"	3/4"	2-1/2"	1-103-4023	1-104-4023
1/4"	1/4"	3/4"	2-1/2"	1-103-4025	1-104-4025
17/64"	5/16"	3/4"	2-1/2"	1-103-4027	1-104-4027
9/32"	5/16"	3/4"	2-1/2"	1-103-4028	1-104-4028
19/64"	5/16"	13/16"	2-1/2"	1-103-4030	1-104-4030
5/16"	5/16"	13/16"	2-1/2"	1-103-4031	1-104-4031
11/32"	3/8"	1"	2-1/2"	1-103-4034	1-104-4034
3/8"	3/8"	1"	2-1/2"	1-103-4038	1-104-4038
13/32"	7/16"	1"	2-3/4"	1-103-4041	1-104-4041
7/16"	7/16"	1"	2-3/4"	1-103-4044	1-104-4044
1/2"	1/2"	1"	3"	1-103-4050	1-104-4050
9/16"	9/16"	1-1/8"	3-1/2"	1-103-4056	1-104-4056
5/8"	5/8"	1-1/4"	3-1/2"	1-103-4062	1-104-4062
11/16"	3/4"	1-3/8"	4"	1-103-4069	1-104-4069
3/4"	3/4"	1-1/2"	4"	1-103-4075	1-104-4075
7/8"	7/8"	1-1/2"	4"	1-103-4087	1-104-4087
1"	1"	1-1/2"	4"	1-103-4100	1-104-4100



Solid Carbide End Mills

Cutting Tools

END MILLS

4 Flute Long and Extra Long Lengths – Ball Nose

Cut Dia	Shank Dia	Length of Cut	Overall Length	Series 1-111 4 Flute uncoated Part Number	Series 1-113 4 Flute TiAlN coated Part Number
1/8"	1/8"	3/4"	2-1/4"	1-111-40122	1-113-40122
1/8"	1/8"	1"	3"	1-111-40123	1-113-40123
3/16"	3/16"	3/4"	2-1/2"	1-111-40182	1-113-40182
3/16"	3/16"	1-1/8"	3"	1-111-40183	1-113-40183
1/4"	1/4"	1-1/8"	3"	1-111-40253	1-113-40253
1/4"	1/4"	1-1/2"	4"	1-111-40254	1-113-40254
1/4"	1/4"	1-1/2"	6"	1-111-40256	1-113-40256
5/16"	5/16"	1-1/8"	3"	1-111-40313	1-113-40313
5/16"	5/16"	1-5/8"	4"	1-111-40314	1-113-40314
3/8"	3/8"	1-1/8"	3"	1-111-40373	1-113-40373
3/8"	3/8"	1-3/4"	4"	1-111-40374	1-113-40374
3/8"	3/8"	1-1/2"	6"	1-111-40376	1-113-40376
7/16"	7/16"	2"	4"	1-111-40434	1-113-40434
1/2"	1/2"	2"	4"	1-111-40502	1-113-40502
1/2"	1/2"	3"	6"	1-111-40506	1-113-40506
1/2"	1/2"	1-1/2"	6"	1-111-405061	1-113-405061
1/2"	1/2"	4"	7"	1-111-40507	1-113-40507
5/8"	5/8"	2-1/4"	5"	1-111-40625	1-113-40625
5/8"	5/8"	3"	6"	1-111-40626	1-113-40626
5/8"	5/8"	4"	7"	1-111-40627	1-113-40627
3/4"	3/4"	2-1/4"	5"	1-111-40755	1-113-40755
3/4"	3/4"	3"	6"	1-111-40756	1-113-40756
3/4"	3/4"	5"	8"	1-111-40758	1-113-40758
1"	1"	2-1/4"	5"	1-111-41005	1-113-41005
1"	1"	3"	6"	1-111-41006	1-113-41006
1"	1"	4"	7"	1-111-41007	1-113-41007

4 Flute Standard Length – Metric Diameters – Ball Nose

Cut Dia	Shank Dia	Length of Cut	Overall Length	Series 1-181 4 Flute uncoated Part Number	Series 1-183 4 Flute TiAlN coated Part Number
1.0	3	4	38	1-181-4001	1-183-4001
1.5	3	4.5	38	1-181-40015	1-183-40015
2.0	3	6.3	38	1-181-4002	1-183-4002
2.5	3	9.5	38	1-181-40025	1-183-40025
3.0	3	12	38	1-181-4003	1-183-4003
3.5	4	12	50	1-181-40035	1-183-40035
4.0	4	14	50	1-181-4004	1-183-4004
4.5	6	16	50	1-181-40045	1-183-40045
5.0	6	16	50	1-181-4005	1-183-4005
6.0	6	19	50	1-181-4006	1-183-4006
7.0	8	19	63	1-181-4007	1-183-4007
8.0	8	20	63	1-181-4008	1-183-4008
9.0	10	22	75	1-181-4009	1-183-4009
10.0	10	22	75	1-181-4010	1-183-4010
11.0	12	25	75	1-181-4011	1-183-4011
12.0	12	25	75	1-181-4012	1-183-40112
14.0	14	32	89	1-181-4014	1-183-4014
16.0	16	32	89	1-181-4016	1-183-4016
18.0	18	38	100	1-181-4018	1-183-4018

2 Flute Double End – Square End

Features and Applications:

- Center cutting geometry
- Designed for increased chip removal rate
- Capable of slotting, profiling, and plunging operations
- Used for roughing and finishing operations
- Premium sub micro grain Carbide



Tolerance: Shank dia: h6 and Cutting dia: h10



2 Flute

Aluminium Alloy	Carbon Steel	Alloy Steel	Hard Steel	Nickel / Inconel Alloy	Stainless Steel	Cast Iron	Titanium
●	●	●	◐	◐	◐	●	

● Excellent ◐ Good

Stub Length

Cut Dia	Shank Dia	Length of Cut	Overall Length	Series 1-124 2 Flute uncoated Part Number
1/32"	1/8"	5/64"	1-1/2"	1-124-2003
1/16"	1/8"	1/8"	1-1/2"	1-124-2006
3/32"	1/8"	3/16"	1-1/2"	1-124-2009
1/8"	1/8"	1/4"	1-1/2"	1-124-2012
5/32"	3/16"	5/16"	2"	1-124-2015
3/16"	3/16"	3/8"	2"	1-124-2018
1/4"	1/4"	1/2"	2-1/2"	1-124-2025
5/16"	5/16"	1/2"	2-1/2"	1-124-2031
3/8"	3/8"	1/2"	2-1/2"	1-124-2038
1/2"	1/2"	5/8"	3"	1-124-2050

4 Flute Double End – Square End

Features and Applications:

- Center cutting geometry
- Designed for increased chip removal rate
- Capable of slotting, profiling, and plunging operations
- Used for roughing and finishing operations
- Premium sub micro grain Carbide



Shank tolerance h6 and Cutting dia – +0.000 to -0.050 mm



4 Flute

Aluminium Alloy	Carbon Steel	Alloy Steel	Hard Steel	Nickel / Inconel Alloy	Stainless Steel	Cast Iron	Titanium
●	●	●	◐	◐	◐	●	

● Excellent ◐ Good

Stub Length

Cut Dia	Shank Dia	Length of Cut	Overall Length	Series 1-124 4 Flute uncoated Part Number
1/32"	1/8"	5/64"	1-1/2"	1-124-4003
1/16"	1/8"	1/8"	1-1/2"	1-124-4006
3/32"	1/8"	3/16"	1-1/2"	1-124-4009
1/8"	1/8"	1/4"	1-1/2"	1-124-4012
5/32"	3/16"	5/16"	2"	1-124-4015
3/16"	3/16"	3/8"	2"	1-124-4018
1/4"	1/4"	1/2"	2-1/2"	1-124-4025
5/16"	5/16"	1/2"	2-1/2"	1-124-4031
3/8"	3/8"	1/2"	2-1/2"	1-124-4038
1/2"	1/2"	5/8"	3"	1-124-4050



Solid Carbide End Mills

Cutting Tools

END MILLS

2 and 4 Flute Double End – Weldon Shank – Square End

Features and Applications:

- Center cutting geometry
- Designed for increased chip removal rate
- Capable of slotting, profiling, and plunging operations
- Used for roughing and finishing operations
- Premium sub micro grain Carbide

Aluminium Alloy	Carbon Steel	Alloy Steel	Hard Steel	Nickel / Inconel Alloy	Stainless Steel	Cast Iron	Titanium
●	●	●	◐	◐	◐	●	

● Excellent ◐ Good



2 Flute



4 Flute



Tolerance: Shank dia: h6 and Cutting dia: h10



Shank tolerance h6 and Cutting dia – +0.000 to -0.050 mm

Standard Length

Cut Dia	Shank Dia	Length of Cut	Overall Length	Series 1-134 2 Flute uncoated Part Number	Series 1-134 4 Flute uncoated Part Number
1/8"	3/8"	3/8"	3-1/16"	1-134-2012	1-134-4012
5/32"	3/8"	7/16"	3-1/8"	1-134-2015	1-134-4015
3/16"	3/8"	1/2"	3-1/4"	1-134-2018	1-134-4018
7/32"	3/8"	9/16"	3-3/8"	1-134-2021	1-134-4021
1/4"	3/8"	5/8"	3-3/8"	1-134-2025	1-134-4025
9/32"	3/8"	11/16"	3-3/8"	1-134-2028	1-134-4028
5/16"	3/8"	3/4"	3-1/2"	1-134-2031	1-134-4031
11/32"	3/8"	3/4"	3-1/2"	1-134-2034	1-134-4034
3/8"	3/8"	3/4"	3-1/2"	1-134-2038	1-134-4038
7/16"	1/2"	7/8"	4"	1-134-2044	1-134-4044
1/2"	1/2"	1"	4"	1-134-2050	1-134-4050

2 and 4 Flute Double End – Weldon Shank – Ball Nose

Features and Applications:

- Center cutting geometry
- Designed for increased chip removal rate
- Capable of slotting, profiling, and plunging operations
- Used for roughing and finishing operations
- Premium sub micro grain Carbide

Aluminium Alloy	Carbon Steel	Alloy Steel	Hard Steel	Nickel / Inconel Alloy	Stainless Steel	Cast Iron	Titanium
●	●	●	◐	◐	◐	●	

● Excellent ◐ Good



2 Flute



4 Flute



Shank tolerance h6 and Cutting dia – +0.000 to -0.050 mm



Shank tolerance h6 and Cutting dia – +0.000 to -0.050 mm

Standard Length

Cut Dia	Shank Dia	Length of Cut	Overall Length	Series 1-135 2 Flute uncoated Part Number	Series 1-135 4 Flute uncoated Part Number
1/8"	3/8"	3/8"	3-1/16"	1-135-2012	1-135-4012
5/32"	3/8"	7/16"	3-1/8"	1-135-2015	1-135-4015
3/16"	3/8"	1/2"	3-1/4"	1-135-2018	1-135-4018
7/32"	3/8"	9/16"	3-3/8"	1-135-2021	1-135-4021
1/4"	3/8"	5/8"	3-3/8"	1-135-2025	1-135-4025
9/32"	3/8"	11/16"	3-3/8"	1-135-2028	1-135-4028
5/16"	3/8"	3/4"	3-1/2"	1-135-2031	1-135-4031
11/32"	3/8"	3/4"	3-1/2"	1-135-2034	1-135-4034
3/8"	3/8"	3/4"	3-1/2"	1-135-2038	1-135-4038
7/16"	1/2"	7/8"	4"	1-135-2044	1-135-4044
1/2"	1/2"	1"	4"	1-135-2050	1-135-4050



Solid Carbide End Mills

Cutting Tools

END MILLS

4 and 5 Flute Variable Helix – Corner Radius

Features and Applications:

- Helix angle varies along Flutes
- Substantial increase in metal removal rates
- Increased stability during cutting action
- Unequal Flutes reduces chatter
- Use for roughing and finishing operations
- Effective for slotting and profiling operations

Aluminium Alloy	Carbon Steel	Alloy Steel	Hard Steel	Nickel / Inconel Alloy	Stainless Steel	Cast Iron	Titanium
	●	●	●	●	●		

● Excellent ○ Good

See Speeds and Feeds on page 92



4 Flute



5 Flute



Cut Dia	Shank Dia	Length of Cut	Overall Length	Corner Radius	Series 1-150 4 Flute Corner Radius TiAlN coated Part Number	Series 1-150 5 Flute Corner Radius TiAlN coated Part Number
1/8"	1/8"	1/2"	1-1/2"	.010-.015	1-150-401215	–
3/16"	3/16"	5/8"	2"	.015-.020	1-150-40182	–
1/4"	1/4"	1/2"	2"	.015-.020	1-150-40252	–
1/4"	1/4"	3/4"	2-1/2"	.015-.020	1-150-402525	1-150-5025
1/4"	1/4"	1-1/8"	3"	.015-.020	1-150-40253	–
5/16"	5/16"	1/2"	2"	.015-.020	1-150-40312	–
5/16"	5/16"	13/16"	2-1/2"	.015-.020	1-150-403125	–
5/16"	5/16"	1-1/8"	3"	.015-.020	1-150-40313	–
3/8"	3/8"	5/8"	2"	.015-.020	1-150-40382	–
3/8"	3/8"	1"	2-1/2"	.015-.020	1-150-403825	1-150-5038
3/8"	3/8"	1-1/8"	3"	.015-.020	1-150-40383	–
7/16"	7/16"	1"	2-3/4"	.015-.020	1-150-404427	–
1/2"	1/2"	5/8"	2-1/2"	.025-.030	1-150-405025	–
1/2"	1/2"	1-1/4"	3"	.025-.030	1-150-40503	1-150-5050
1/2"	1/2"	2"	4"	.025-.030	1-150-40504	–
5/8"	5/8"	3/4"	3"	.030-.035	1-150-40623	–
5/8"	5/8"	1-1/4"	3-1/2"	.030-.035	1-150-406235	1-150-5062
5/8"	5/8"	2-1/4"	5"	.030-.035	1-150-40625	–
3/4"	3/4"	1"	3"	.030-.035	1-150-40753	–
3/4"	3/4"	1-1/2"	4"	.030-.035	1-150-40754	1-150-5075
3/4"	3/4"	2-1/4"	5"	.030-.035	1-150-40755	–
1"	1"	1-1/2"	4"	.030-.035	1-150-41004	1-150-5100

4 Flute Variable Helix – Sharp and Ball Nose

Features and Applications:

- Helix angle varies along Flutes
- Substantial increases in metal removal rates
- Increase stability during cutting action
- Unequal Flutes reduces chatter
- Use as a rougher or finisher
- Slotting and profiling operations

Aluminium Alloy	Carbon Steel	Alloy Steel	Hard Steel	Nickel / Inconel Alloy	Stainless Steel	Cast Iron	Titanium
	●	●	●	●	●		

● Excellent ● Good

See Speeds and Feeds on page 92



4 Flute SHARP



4 Flute Ball Nose



Shank Tolerance h6

Standard Length

Cut Dia	Shank Dia	Length of Cut	Overall Length	Series 1-150 4 Flute SHARP TiAlN coated Part Number	Series 1-151 4 Flute Ball Nose TiAlN coated Part Number
1/8"	1/8"	1/2"	1-1/2"	–	1-151-4012
3/16"	3/16"	5/8"	2"	–	1-151-4018
1/4"	1/4"	3/4"	2-1/2"	1-150-402525S	1-151-4025
5/16"	5/16"	7/8"	2-1/2"	–	1-151-4031
3/8"	3/8"	1"	2-1/2"	1-150-403825S	1-151-4037
7/16"	7/16"	1-1/8"	2-3/4"	–	1-151-4043
1/2"	1/2"	1-1/4"	3"	1-150-40503S	1-151-4050
5/8"	5/8"	1-1/2"	3-1/2"	1-150-406235S	1-151-4062
3/4"	3/4"	1-3/4"	4"	1-150-40754S	1-151-4075
1"	1"	1-3/4"	4"	1-150-41004S	1-151-4100



Solid Carbide End Mills

Cutting Tools

END MILLS

6 Flute Single End – 45° Helix with Corner Radius

Features and Applications:

- Premium ultra fine Carbide grade
- Increased core diameter for added strength
- Use for light finishing cuts
- AlTiN coated for increased tool life

Aluminium Alloy	Carbon Steel	Alloy Steel	Hard Steel	Nickel / Inconel Alloy	Stainless Steel	Cast Iron	Titanium
	●	●	●	◐	●	◐	◐

● Excellent ◐ Good



6 Flute



Standard Length

Cut Dia	Shank Dia	Length of Cut	Overall Length	Corner Radius	Series 1-170 6 Flute Corner Radius TiAlN coated Part Number
1/4"	1/4"	3/4"	2-1/2"	.015	1-170-60252
5/16"	5/16"	13/16"	2-1/2"	.020	1-170-60312
3/8"	3/8"	1"	2-1/2"	.020	1-170-60372
1/2"	1/2"	1"	3"	.025	1-170-60503
5/8"	5/8"	1-1/4"	3-1/2"	.030	1-170-60623
3/4"	3/4"	1-1/2"	4"	.035	1-170-60754
1"	1"	1-1/2"	4"	.035	1-170-61004



2 and 3 Flute for Aluminium

Features and Applications:

- Advance Flute geometry results in maximum metal removal and better chip evacuation
- Superb surface finish
- Choices for finishing and light roughing applications
- Excellent for slotting and profiling at high speeds
- 3 Flute comes with small corner radius (.005") for added strength

Aluminium Alloy	Copper	Plastic
●	●	●

● Excellent ● Good

See Speeds and Feeds on page 92



2 Flute



Tolerance +.000/- .002



3 Flute



Tolerance +.000/- .002

Standard Length

Cut Dia	Shank Dia	Length of Cut	Overall Length	2 Flute Corner Radius	Series 1-173 2 Flute uncoated Part Number	Series 1-173 3 Flute uncoated (.005 radius) Part Number
1/4"	1/4"	3/4"	2-1/2"	.010"	1-173-2025	1-173-3025
5/16"	5/16"	13/16"	2-1/2"	.010"	1-173-2031	1-173-3031
3/8"	3/8"	1"	2-1/2"	.015"	1-173-2037	1-173-3037
7/16"	7/16"	1"	2-3/4"	–	–	1-173-3044
1/2"	1/2"	1"	3"	.020"	1-173-2050	–
1/2"	1/2"	1-1/4"	3"	–	–	1-173-3050
5/8"	5/8"	1-1/4"	3-1/2"	.020"	1-173-2062	–
5/8"	5/8"	1-5/8"	3-1/2"	–	–	1-173-3062
3/4"	3/4"	1-1/4"	4"	.030"	1-173-2075	–
3/4"	3/4"	1-5/8"	4"	–	–	1-173-3075
1"	1"	1-1/2"	4"	–	–	1-173-3100

Long Length

Cut Dia	Shank Dia	Length of Cut	Overall Length	2 Flute Corner Radius	Series 1-174 2 Flute uncoated Part Number	Series 1-174 3 Flute uncoated (.005 radius) Part Number
1/4"	1/4"	1-1/8"	3"	.010"	1-174-2025	1-174-3025
5/16"	5/16"	1-1/8"	3"	.010"	1-174-2031	1-174-3031
3/8"	3/8"	1-1/8"	3"	.015"	1-174-2037	1-174-3037
1/2"	1/2"	1-1/2"	4"	–	–	1-174-3050
1/2"	1/2"	2"	4"	.020"	1-174-2052	1-174-3052
5/8"	5/8"	2-1/4"	5"	.020"	1-174-2062	1-174-3062
3/4"	3/4"	2-1/4"	5"	.030"	1-174-2075	1-174-3075
1"	1"	2-1/4"	5"	–	–	1-174-3100



Solid Carbide End Mills

Cutting Tools

END MILLS

4 Flute Roughing End Mills – Fine Pitch

Features and Applications:

- Center cutting geometry
- Designed for increased chip removal rate
- Capable of slotting, profiling, and plunging operations
- Premium sub micro grain Carbide
- Form relieved
- Small corner radius for strength

Aluminium Alloy	Carbon Steel	Alloy Steel	Hard Steel	Nickel / Inconel Alloy	Stainless Steel	Cast Iron	Titanium
	●	●	◐	●	●		

● Excellent ◐ Good

See Speeds and Feeds on page 92

4 Flute



Shank Tolerance h6 and Cutting dia: +0.000 to -0.050 mm

Standard Length

Cut Dia	Shank Dia	Length of Cut	Overall Length	Series 1-160 4 Flute uncoated Part Number	Series 1-161 4 Flute TiAlN coated Part Number
1/4"	1/4"	3/4"	2-1/2"	1-160-40252	1-161-40252
5/16"	5/16"	11/32"	2-1/2"	1-160-40312	1-161-40312
3/8"	3/8"	7/8"	2-1/2"	1-160-40372	1-161-40382
7/16"	7/16"	1"	2-3/4"	1-160-40442	1-161-40442
1/2"	1/2"	1-1/4"	3"	1-160-40503	1-161-40503
9/16"	9/16"	1-1/4"	3-1/2"	1-160-40563	1-161-40563
5/8"	5/8"	1-1/4"	3-1/2"	1-160-40623	1-161-40623
3/4"	3/4"	1-1/2"	4"	1-160-40754	1-161-40754
1"	1"	1-1/2"	4"	1-160-41004	1-161-41004

Long Length

Cut Dia	Shank Dia	Length of Cut	Overall Length	Series 1-163 4 Flute uncoated Part Number	Series 1-164 4 Flute TiAlN coated Part Number
1/4"	1/4"	1-1/8"	3"	1-163-40253	1-164-40253
3/8"	3/8"	1-1/8"	3"	1-163-40373	1-164-40383
1/2"	1/2"	2"	4"	1-163-40504	1-164-40504
5/8"	5/8"	2-1/4"	5"	1-163-40625	1-164-40625
3/4"	3/4"	2-1/4"	5"	1-163-40755	1-164-40755
1"	1"	2-1/4"	5"	1-163-41005	1-164-41005

2 and 4 Flute – Drill Mill – 90° point

Features and Applications:

- Premium sub micro grain Carbide
- Use for drilling, slotting, chamfering and profile milling
- Available In 90° point angle

Aluminium Alloy	Carbon Steel	Alloy Steel	Hard Steel	Nickel / Inconel Alloy	Stainless Steel	Cast Iron	Titanium
●	●	●	◐	◐	◐	●	□

● Excellent ◐ Good



2 Flute



4 Flute



Shank Tolerance h6 and Cutting dia: +0.000 to -0.050 mm

Standard Length

Cut Dia	Shank Dia	Length of Cut	Overall Length	Series 1-190	Series 1-191	Series 1-190	Series 1-191
				2 Flute uncoated	2 Flute TiAlN coated	4 Flute uncoated	4 Flute TiAlN coated
Part Number							
1/8"	1/8"	1/2"	1-1/2"	1-190-2012	1-191-2012	1-190-4012	1-191-4012
3/16"	3/16"	5/8"	2"	1-190-2018	1-191-2018	1-190-4018	1-191-4018
1/4"	1/4"	3/4"	2-1/2"	1-190-2025	1-191-2025	1-190-4025	1-191-4025
5/16"	5/16"	13/16"	2-1/2"	1-190-2031	1-191-2031	1-190-4031	1-191-4031
3/8"	3/8"	1"	2-1/2"	1-190-2037	1-191-2037	1-190-4037	1-191-4037
7/16"	7/16"	1"	2-1/2"	1-190-2043	1-191-2043	1-190-4043	1-191-4043
1/2"	1/2"	1"	3"	1-190-2050	1-191-2050	1-190-4050	1-191-4050
5/8"	5/8"	1-1/4"	3-1/2"	1-190-2062	1-191-2062	1-190-4062	1-191-4062
3/4"	3/4"	1-1/2"	4"	1-190-2075	1-191-2075	1-190-4075	1-191-4075



HSS and Cobalt End Mills

Cutting Tools

END MILLS

2 Flute Regular Length End Mills

- Single End
- Center Cutting
- Right Hand Cut
- High Speed Steel and 8% Cobalt M-42



Dia of Mill	Dia of Shank	Length of Cut	OAL	HSS Part Number	Cobalt M-42 Part Number
1/8	3/8	3/8	2-5/16	5-300-005	5-301-005
5/32	3/8	7/16	2-5/16	5-300-010	5-301-010
3/16	3/8	7/16	2-5/16	5-300-015	5-301-015
7/32	3/8	1/2	2-5/16	5-300-020	5-301-020
1/4	3/8	1/2	2-5/16	5-300-025	5-301-025
9/32	3/8	9/16	2-5/16	5-300-030	5-301-030
5/16	3/8	9/16	2-5/16	5-300-035	–
11/32	3/8	9/16	2-5/16	5-300-040	5-301-040
3/8	3/8	9/16	2-5/16	5-300-045	5-301-045
13/32	3/8	13/16	2-1/2	5-300-050	5-301-050
7/16	3/8	13/16	2-1/2	5-300-055	5-301-055
15/32	3/8	13/16	2-1/2	5-300-060	–
1/2	3/8	13/16	2-1/2	5-300-065	5-301-065
1/2	1/2	1	3	5-300-070	5-301-070
9/16	1/2	1-1/8	3-1/8	5-300-075	5-301-075
5/8	1/2	1-1/8	3-1/8	5-300-080	5-301-080
11/16	1/2	1-5/16	3-1/16	5-300-085	5-301-085
3/4	1/2	1-5/16	3-1/16	5-300-090	5-301-090
13/16	1/2	1-1/2	3-5/8	5-300-095	–
7/8	1/2	1-1/2	3-5/8	5-300-100	5-301-100
15/16	1/2	1-1/2	3-5/8	5-300-105	–
1	1/2	1-1/2	3-5/8	5-300-110	5-301-110
5/8	5/8	1-5/16	3-7/16	5-300-115	5-301-115
11/16	5/8	1-5/16	3-7/16	5-300-120	5-301-120
3/4	5/8	1-5/16	3-7/16	5-300-125	5-301-125
13/16	5/8	1-1/2	3-5/8	5-300-130	5-301-130
7/8	5/8	1-1/2	3-5/8	5-300-135	–
15/16	5/8	1-1/2	3-5/8	5-300-140	5-301-140
1	5/8	1-1/2	3-5/8	5-300-145	5-301-145
1-1/16	5/8	1-5/8	3-7/8	5-300-150	–
3/4	3/4	1-5/16	3-7/16	5-300-155	5-301-155
13/16	3/4	1-1/2	3-3/4	5-300-160	5-301-160
7/8	3/4	1-1/2	3-3/4	5-300-165	5-301-165
15/16	3/4	1-1/2	3-3/4	5-300-170	–
1	3/4	1-1/2	3-3/4	5-300-175	5-301-175
1-1/16	3/4	1-5/8	3-7/8	5-300-180	–
1-1/8	3/4	1-5/8	3-7/8	5-300-185	5-301-185
1-1/4	3/4	1-5/8	3-7/8	5-300-190	5-301-190
1-3/16	3/4	1-5/8	3-7/8	5-300-195	–

Dia of Mill	Dia of Shank	Length of Cut	OAL	HSS Part Number
1-1/2	3/4	1-5/8	3-7/8	5-300-205
1-5/8	3/4	1-5/8	3-7/8	5-300-207
1-3/4	3/4	1-5/8	3-7/8	5-300-208
1-7/8	3/4	1-5/8	3-7/8	5-300-206
2	3/4	1-5/8	3-7/8	5-300-209
7/8	7/8	1-1/2	3-3/4	5-300-210
15/16	7/8	1-1/2	3-3/4	5-300-215
1	7/8	1-1/2	3-3/4	5-300-220
1-1/8	7/8	1-5/8	3-7/8	5-300-225
1	1	1-5/8	4-1/8	5-300-235
1-1/8	1	1-5/8	4-1/8	5-300-240
1-1/4	1	1-5/8	4-1/8	5-300-245
1-1/2	1	1-5/8	4-1/8	5-300-255
1-1/4	1-1/4	1-5/8	4-1/8	5-300-260
1-1/2	1-1/4	1-5/8	4-1/8	5-300-265
1-5/8	1-1/4	1-5/8	4-1/8	5-300-270
1-3/4	1-1/4	1-5/8	4-1/8	5-300-275
2	1-1/4	1-5/8	4-1/8	5-300-285
2	1-1/4	2-1/2	5	5-300-290
2-1/2	2	4	7-5/8	5-300-300



END MILLS

2 Flute Regular Length Metric End Mills

- Single End
- High Speed Steel



Dia of Cut	Dia of Shank	Length of Cut	OAL	HSS Part Number
3 MM	3/8	3/8	2-5/16	5-302-003
4 MM	3/8	7/16	2-5/16	5-302-004
5 MM	3/8	1/2	2-5/16	5-302-005
6 MM	3/8	1/2	2-5/16	5-302-006
7 MM	3/8	9/16	2-5/16	5-302-007
8 MM	3/8	9/16	2-5/16	5-302-008
9 MM	3/8	9/16	2-5/16	5-302-009
10 MM	3/8	13/16	2-1/2	5-302-010
11 MM	3/8	13/16	2-1/2	5-302-011
12 MM	3/8	13/16	2-1/2	5-302-012
12 MM	1/2	1-1/8	3-1/8	5-302-112
13 MM	1/2	1-1/8	3-1/8	5-302-113
14 MM	1/2	1-1/8	3-1/8	5-302-114
15 MM	1/2	1-1/8	3-1/8	5-302-115
16 MM	1/2	1-1/8	3-1/8	5-302-116
18 MM	1/2	1-5/16	3-7/16	5-302-118
24 MM	1/2	2	4-1/2	5-302-124
16 MM	5/8	1-5/16	3-7/16	5-302-216
18 MM	5/8	1-5/16	3-7/16	5-302-218
20 MM	5/8	1-1/2	3-3/4	5-302-220
19 MM	3/4	1-5/16	3-7/16	5-302-319
20 MM	3/4	1-1/2	3-3/4	5-302-320
22 MM	3/4	1-1/2	3-3/4	5-302-322
24 MM	3/4	2	4-1/2	5-302-324
25 MM	3/4	2	4-1/2	5-302-325
26 MM	3/4	2	4-1/2	5-302-326
25 MM	1	2	4-1/2	5-302-525
30 MM	1	2	4-1/2	5-302-530
32 MM	1	2	4-1/2	5-302-532
36 MM	1	2	4-1/2	5-302-536

2 Flute Long Length End Mills

- Single End
- High Speed Steel



Dia of Mill	Dia of Shank	Length of Cut	OAL	HSS Part Number
1/4	3/8	1	3-1/4	5-400-002
3/8	3/8	1-1/2	3-1/4	5-400-005
1/2	1/2	2	4	5-400-010
5/8	5/8	2	4-1/8	5-400-015
3/4	3/4	2-1/4	4-1/2	5-400-020
7/8	7/8	2-1/2	4-3/4	5-400-025
1	1	3	5-1/2	5-400-030
1-1/8	1	3	5-1/2	5-400-035
1-1/4	1	3	5-1/2	5-400-040
1-3/8	1	3	5-1/2	5-400-045
2	1-1/4	3	5-1/2	5-400-075



HSS and Cobalt End Mills

Cutting Tools

END MILLS

2 Flute Extended Length End Mills

- Single End
- Right Hand Cut
- Weldon Shank
- High Speed Steel



Dia of Mill	Dia of Shank	Length Below Shank	Length of Cut	OAL	HSS Part Number
1/4	3/8	1-1/2	5/8	3-1/16	5-310-005
5/16	3/8	1-3/4	3/4	3-5/16	5-310-010
3/8	3/8	1-3/4	3/4	3-5/16	5-310-015
1/2	1/2	2-1/4	1	4	5-310-020
5/8	5/8	2-3/4	1-3/8	4-5/8	5-310-025
3/4	3/4	3-3/8	1-5/8	5-3/8	5-310-030
7/8	7/8	4	2	6	5-310-035
1	1	5	2-1/2	7-1/4	5-310-040
1-1/4	1-1/4	5	3	7-1/4	5-310-045

2 Flute Double End, End Mills

- High Speed Steel and 8% Cobalt M-42



Dia of Mill	Dia of Shank	Length of Cut	OAL	HSS Part Number	Cobalt M-42 Part Number
1/8	3/8	3/8	3-1/16	5-250-005	5-251-005
5/32	3/8	7/16	3-1/8	5-250-010	5-251-010
3/16	3/8	7/16	3-1/8	5-250-015	5-251-015
7/32	3/8	1/2	3-1/8	5-250-020	5-251-020
1/4	3/8	1/2	3-1/8	5-250-025	5-251-025
9/32	3/8	9/16	3-1/8	5-250-030	-
5/16	3/8	9/16	3-1/8	5-250-035	5-251-035
11/32	3/8	9/16	3-1/8	5-250-040	5-251-040
3/8	3/8	9/16	3-1/8	5-250-045	5-251-045
13/32	1/2	13/16	3-3/4	5-250-050	5-251-050
7/16	1/2	13/16	3-3/4	5-250-055	5-251-055
15/32	1/2	13/16	3-3/4	5-250-060	5-251-060
1/2	1/2	13/16	3-3/4	5-250-065	5-251-065
9/16	5/8	1-1/8	4-1/2	5-250-070	5-251-070
5/8	5/8	1-1/8	4-1/2	5-250-075	5-251-075
11/16	3/4	1-5/16	5	5-250-080	-
3/4	3/4	1-5/16	5	5-250-085	5-251-085
13/16	7/8	1-9/16	5-1/2	5-250-090	5-251-090
7/8	7/8	1-9/16	5-1/2	5-250-095	5-251-095
1	1	1-5/8	5-7/8	5-250-105	5-251-105

2 Flute Regular Length Ball Nose End Mills

- Single End
- Right Hand Cut
- Center Cutting
- High Speed Steel and 8% Cobalt M-42



Dia of Mill	Dia of Shank	Length of Cut	OAL	HSS Part Number	Cobalt M-42 Part Number
1/8	3/8	3/8	2-5/16	5-220-005	–
3/16	3/8	1/2	2-3/8	5-220-010	5-221-010
1/4	3/8	5/8	2-7/16	5-220-015	5-221-015
5/16	3/8	3/4	2-1/2	5-220-020	5-221-020
3/8	3/8	3/4	2-1/2	5-220-025	5-221-025
7/16	1/2	1	3	5-220-030	5-221-030
1/2	1/2	1	3	5-220-035	5-221-035
9/16	1/2	1-1/8	3-1/8	5-220-040	–
5/8	1/2	1-1/8	3-1/8	5-220-045	–
5/8	5/8	1-3/8	3-1/2	5-220-050	5-221-050
3/4	1/2	1-5/16	3-5/16	5-220-052	5-221-052
3/4	3/4	1-5/8	3-7/8	5-220-055	5-221-055
13/16	3/4	2	4-1/4	5-220-057	5-221-057
7/8	3/4	2	4-1/4	5-220-058	5-221-058
7/8	7/8	2	4-1/4	5-220-060	5-221-060
15/16	3/4	2-1/4	4-1/2	5-220-065	–
1	3/4	2-1/4	4-1/2	5-220-070	5-221-070
1	1	2-1/4	4-3/4	5-220-080	5-221-080
1-1/8	1	2-1/4	4-3/4	5-220-090	5-221-090
1-1/4	1-1/4	2-1/2	5	5-220-100	–
1-3/8	1-1/4	2-1/2	5	5-220-105	–
1-1/2	1-1/4	2-1/2	5	5-220-110	–
2	1-1/4	2-1/2	5	5-220-120	–

2 Flute Double End Ball Nose End Mills

- High Speed Steel



Dia of Mill	Dia of Shank	Length of Flute	OAL	HSS Part Number
1/8	3/8	3/8	3-1/16	5-230-005
3/16	3/8	7/16	3-1/8	5-230-010
1/4	3/8	1/2	3-1/8	5-230-015
5/16	3/8	9/16	3-1/8	5-230-020
3/8	3/8	9/16	3-1/8	5-230-025
7/16	1/2	13/16	3-3/4	5-230-030
1/2	1/2	13/16	3-3/4	5-230-035
5/8	5/8	1-1/8	4-1/2	5-230-040
3/4	3/4	1-5/16	5	5-230-045
7/8	7/8	1-9/16	5-1/2	5-230-050
1	1	1-5/8	5-7/8	5-230-055



HSS and Cobalt End Mills

Cutting Tools

END MILLS

Multiple Flute Regular Length End Mills

- Single End
- Center Cutting
- Right Hand Cut
- High Speed Steel and 8% Cobalt M-42



Dia of Mill	Dia of Shank	Length of Cut	OAL	Number of Flutes	HSS Center Cutting Part Number	Cobalt M-42 Center Cutting Part Number
1/8	3/8	3/8	2-5/16	4	5-304-005	5-306-005
5/32	3/8	3/8	2-5/16	4	5-304-010	5-306-010
3/16	3/8	1/2	2-3/8	4	5-304-015	5-306-015
7/32	3/8	5/8	2-7/16	4	5-304-020	5-306-020
1/4	3/8	5/8	2-7/16	4	5-304-025	5-306-025
9/32	3/8	3/4	2-1/2	4	5-304-030	5-306-030
5/16	3/8	3/4	2-1/2	4	5-304-035	5-306-035
11/32	3/8	3/4	2-1/2	4	5-304-040	5-306-040
3/8	3/8	3/4	2-1/2	4	5-304-045	5-306-045
13/32	3/8	1	2-11/16	4	5-304-050	5-306-050
7/16	3/8	1	2-11/16	4	5-304-055	5-306-055
15/32	3/8	1	2-11/16	4	—	5-306-060
1/2	3/8	1	2-11/16	4	5-304-065	5-306-065
1/2	1/2	1-1/4	3-1/4	4	5-304-070	5-306-070
9/16	1/2	1-3/8	3-3/8	4	5-304-080	5-306-080
5/8	1/2	1-3/8	3-3/8	4	5-304-085	5-306-085
11/16	1/2	1-5/8	3-5/8	4	—	5-306-090
3/4	1/2	1-5/8	3-5/8	4	5-304-095	5-306-095
13/16	1/2	1-7/8	4	4	5-304-100	5-306-100
7/8	1/2	1-7/8	4	4	5-304-104	5-306-104
7/8	1/2	1-7/8	4	6	—	5-306-105
1	1/2	1-7/8	4	4	5-304-115	—
1	1/2	1-7/8	3-7/8	4	—	5-306-115
1	1/2	1-7/8	4	6	5-304-120	—
5/8	5/8	1-5/8	3-3/4	4	5-304-125	5-306-125
11/16	5/8	1-5/8	3-3/4	4	5-304-130	5-306-130
3/4	5/8	1-5/8	3-3/4	4	5-304-135	5-306-135
13/16	5/8	1-7/8	4	4	5-304-140	5-306-140
7/8	5/8	1-7/8	4	6	5-304-150	5-306-150
1	5/8	1-7/8	4	4	5-304-160	5-306-160
1	5/8	1-7/8	4	6	5-304-165	5-306-165
3/4	3/4	1-5/8	3-3/4	4	5-304-170	5-306-170
3/4	3/4	1-5/8	3-3/4	6	5-304-175	5-306-175
13/16	3/4	1-7/8	4-1/8	4	5-304-180	5-306-180
7/8	3/4	1-7/8	4-1/8	4	5-304-185	5-306-185
7/8	3/4	1-7/8	4-1/8	6	5-304-190	5-306-190
15/16	3/4	1-7/8	4-1/8	4	5-304-195	—
1	3/4	1-7/8	4-1/8	4	5-304-200	5-306-200
1	3/4	1-7/8	4-1/8	6	5-304-205	5-306-205
1-1/16	3/4	2	4-1/4	4	—	5-306-208
1-1/16	3/4	2	4-1/4	6	5-304-210	5-306-210
1-1/8	3/4	2	4-1/4	6	5-304-215	5-306-215
1-3/16	3/4	2	4-1/4	6	5-304-220	5-306-220
1-1/4	3/4	2	4-1/4	6	5-304-225	5-306-225
1-5/16	3/4	2	4-1/2	6	5-304-227	5-306-227
1-3/8	3/4	2	4-1/2	6	5-304-230	5-306-230



Multiple Flute Regular Length End Mills (continued)

- Single End
- Center Cutting
- Right Hand Cut
- High Speed Steel and 8% Cobalt M-42



Dia of Mill	Dia of Shank	Length of Cut	OAL	Number of Flutes	HSS Center Cutting Part Number	Cobalt M-42 Center Cutting Part Number
1-7/16	3/4	2	4-1/2	6	5-304-233	—
1-7/16	3/4	2	4-1/4	6	—	5-306-233
1-1/2	3/4	2	4-1/2	6	5-304-235	5-306-235
1-5/8	3/4	2	4-1/2	6	5-304-237	5-306-237
1-3/4	3/4	2	4-1/2	6	5-304-238	—
1-7/8	3/4	2	4-1/2	6	5-304-234	5-306-234
2	3/4	2	4-1/2	8	5-304-239	5-306-239
7/8	7/8	1-7/8	4-1/8	4	5-304-236	5-306-236
1	7/8	1-7/8	4-1/8	4	5-304-245	5-306-245
1	1	2	4-1/2	4	5-304-265	5-306-265
1	1	2	4-1/2	6	5-304-267	5-306-267
1-1/8	1	2	4-1/2	6	5-304-270	—
1-1/4	1	2	4-1/2	6	5-304-275	5-306-275
1-3/8	1	2	4-1/2	6	5-304-280	5-306-280
1-1/2	1	2	4-1/2	4	5-304-285	5-306-285
1-1/2	1	2	4-1/2	6	5-304-290	5-306-290
1-1/4	1-1/4	2	4-1/2	6	5-304-295	5-306-295
1-1/4	1-1/4	2	4-1/2	4	5-304-300	5-306-300
1-3/8	1-1/4	2	4-1/2	6	5-304-305	—
1-1/2	1-1/4	2	4-1/2	4	—	5-306-310
1-1/2	1-1/4	2	4-1/2	6	5-304-315	5-306-315
1-5/8	1-1/4	2	4-1/2	6	5-304-325	5-306-325
1-3/4	1-1/4	2	4-1/2	4	—	5-306-330
1-3/4	1-1/4	2	4-1/2	6	5-304-335	—
1-7/8	1-1/4	2	4-1/2	6	—	5-306-340
2	1-1/4	2	4-1/2	6	5-304-355	5-306-355
14 Piece 1/8" to 1" Set Includes: 1/8 to 7/16 x 3/8 Shank, 1/2 to 9/16 x 1/2 Shank, 5/8 to 3/4 x 5/8 Shank, 13/16 to 1 x 3/4 Shank					5-304-514	5-306-514

Multiple Flute Heavy Duty End Mills

- Twin Drive Shank
- Single End
- High Speed Steel



6 Flute				
Dia of Mill	Dia of Shank	Length of Cut	OAL	HSS Part Number
2	2	6	9-3/4	5-360-040
2	2	8	11-3/4	5-360-060



HSS and Cobalt End Mills

Cutting Tools

END MILLS

Multiple Flute Regular Length Metric End Mills

- Single End
- Center Cutting
- High Speed Steel



Dia of Cut	Dia of Shank	Length of Cut	OAL	Number of Flutes	HSS Center Cutting Part Number
3 MM	3/8	3/8	2-5/16	4	5-307-003
4 MM	3/8	1/2	2-3/8	4	5-307-004
5 MM	3/8	9/16	2-1/2	4	5-307-005
6 MM	3/8	5/8	2-1/2	4	5-307-006
7 MM	3/8	3/4	2-1/2	4	5-307-007
8 MM	3/8	3/4	2-1/2	4	5-307-008
9 MM	3/8	3/4	2-1/2	4	5-307-009
10 MM	3/8	1	2-11/16	4	5-307-010
11 MM	3/8	1	2-11/16	4	5-307-011
12 MM	3/8	1	2-11/16	4	5-307-012
13 MM	1/2	1-1/4	3-1/4	4	5-307-113
14 MM	1/2	1-1/4	3-1/4	4	5-307-114
15 MM	1/2	1-3/8	3-3/8	4	5-307-115

Dia of Cut	Dia of Shank	Length of Cut	OAL	Number of Flutes	HSS Center Cutting Part Number
16 MM	5/8	1-5/8	3-3/4	4	5-307-216
18 MM	5/8	1-5/8	3-3/4	4	5-307-218
20 MM	5/8	1-7/8	4-1/8	4	5-307-220
18 MM	3/4	1-5/8	3-3/4	4	5-307-318
19 MM	3/4	1-5/8	3-3/4	4	5-307-319
20 MM	3/4	1-7/8	4-1/8	4	5-307-320
22 MM	3/4	1-7/8	4-1/8	4	5-307-322
24 MM	3/4	2	4-1/2	4	5-307-324
22 MM	7/8	1-7/8	4-1/8	4	5-307-422
24 MM	7/8	2	4-1/2	4	5-307-424
32 MM	1	2	4-1/2	6	5-307-532
36 MM	1	2	4-1/2	6	5-307-536

Multiple Flute Long Length End Mills

- Non-Center and Center Cutting
- Single End
- Right Hand Cut
- High Speed Steel and 8% Cobalt M-42



Dia of Mill	Dia of Shank	Length of Cut	OAL	Number of Flutes	HSS Center Cutting Part Number	Cobalt M-42 Center Cutting Part Number
1/4	3/8	1-1/4	3-1/16	4	5-314-005	5-316-005
5/16	3/8	1-3/8	3-1/8	4	5-314-010	5-316-010
3/8	3/8	1-1/2	3-1/4	4	5-314-015	5-316-015
7/16	1/2	1-3/4	3-3/4	4	5-314-020	5-316-020
1/2	1/2	2	4	4	5-314-025	5-316-025
3/4	1/2	3	5-1/4	4	5-314-030	—
5/8	5/8	2-1/2	4-5/8	4	5-314-035	5-316-035
3/4	3/4	3	5-1/4	4	5-314-040	5-316-040
1	3/4	4	6-1/2	4	5-314-045	—
7/8	7/8	3-1/2	5-3/4	4	5-314-060	5-316-060
1	1	4	6-1/2	4	5-314-065	5-316-065
1-1/4	1	4	6-1/2	6	5-314-075	—
1-3/8	1	4	6-1/2	6	5-314-080	—
1-1/2	1	4	6-1/2	6	5-314-085	—
1-1/4	1-1/4	4	6-1/2	4	5-314-090	—
1-1/4	1-1/4	4	6-1/2	6	5-314-095	—
1-1/2	1-1/4	4	6-1/2	6	5-314-100	—

Multiple Flute Extra Long End Mills

- Center Cutting
- Single Ended
- High Speed Steel



Dia of Mill	Dia of Shank	Length of Cut	OAL	Number of Flutes	HSS Center Cutting Part Number
1/4	3/8	1-3/4	3-9/16	4	5-424-005
5/16	3/8	2	3-3/4	4	5-424-010
3/8	3/8	2-1/2	4-1/4	4	5-424-015
1/2	1/2	3	5	4	5-424-020
5/8	1/2	4	6-1/8	4	5-424-025
3/4	1/2	4	6-1/4	4	5-424-030
5/8	5/8	4	6-1/8	4	5-424-035
3/4	3/4	4	6-1/4	4	5-424-040
7/8	7/8	5	7-1/4	4	5-424-045
1	1	6	8-1/2	4	5-424-050
1-1/4	1-1/4	6	8-1/2	4	5-424-055
1-1/4	1-1/4	6	8-1/2	6	5-424-060
1-1/2	1-1/4	8	10-9/16	6	5-424-065

4 Flute Double End, End Mills

- Non-Center and Center Cutting
- High Speed Steel and 8% Cobalt M-42



Dia of Mill	Dia of Shank	Length of Cut	OAL	HSS Center Cutting Part Number	Cobalt M-42 Center Cut Part Number
1/8	3/8	3/8	3-1/16	5-254-005	5-256-005
5/32	3/8	7/16	3-1/8	5-254-010	5-256-010
3/16	3/8	1/2	3-1/4	5-254-015	5-256-015
13/64	3/8	9/16	3-1/4	5-254-020	5-256-020
7/32	3/8	9/16	3-1/4	5-254-025	5-256-025
15/64	3/8	9/16	3-1/4	5-254-030	5-256-030
1/4	3/8	5/8	3-3/8	5-254-035	5-256-035
9/32	3/8	11/16	3-3/8	5-254-040	5-256-040
5/16	3/8	3/4	3-1/2	5-254-045	5-256-045
11/32	3/8	3/4	3-1/2	5-254-050	5-256-050
3/8	3/8	3/4	3-1/2	5-254-055	5-256-055
13/32	1/2	1	4-1/8	5-254-060	5-256-060
7/16	1/2	1	4-1/8	5-254-065	5-256-065
15/32	1/2	1	4-1/8	5-254-070	5-256-070
1/2	1/2	1	4-1/8	5-254-075	5-256-075
9/16	5/8	1-3/8	5	5-254-080	5-256-080
5/8	5/8	1-3/8	5	5-254-085	5-256-085
11/16	3/4	1-5/8	5-5/8	5-254-090	5-256-090
3/4	3/4	1-5/8	5-5/8	5-254-095	5-256-095
13/16	7/8	1-7/8	6-1/8	–	5-256-100
7/8	7/8	1-7/8	6-1/8	5-254-105	5-256-105
15/16	1	1-7/8	6-3/8	–	5-256-110
1	1	1-7/8	6-3/8	5-254-115	–



HSS and Cobalt End Mills

Cutting Tools

END MILLS

Multiple Flute Regular Length Ball Nose End Mills

- Single End
- Right Hand Cut
- High Speed Steel and 8% Cobalt M-42

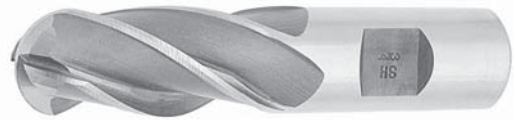

Dia of Mill	Dia of Shank	Length of Flute	OAL	Number of Flutes	HSS Part Number	Cobalt M-42 Part Number
1/8	3/8	3/8	2-5/16	4	5-225-003	5-226-003
3/16	3/8	1/2	2-3/8	4	5-225-005	5-226-005
1/4	3/8	5/8	2-7/16	4	5-225-010	5-226-010
5/16	3/8	3/4	2-1/2	4	5-225-012	5-226-012
3/8	3/8	3/4	2-1/2	4	5-225-015	5-226-015
7/16	3/8	1	2-11/16	4	5-225-0181	–
1/2	1/2	1-1/4	3-1/4	4	5-225-020	5-226-020
5/8	5/8	1-5/8	3-3/4	4	5-225-025	5-226-025
3/4	3/4	1-5/8	3-7/8	4	5-225-030	5-226-030
7/8	7/8	1-7/8	4-1/8	4	5-225-035	–
1	1	2	4-1/2	4	5-225-040	5-226-040
1-1/4	1-1/4	2	4-1/2	6	5-225-045	–
1-1/2	1-1/4	2	4-1/2	6	5-225-050	5-226-050

Roughing End Mills

- Single End
- Coarse Tooth
- 8% Cobalt M-42



Dia of Mill	Dia of Shank	Length of Cut	Number of Flutes	Overall Length	Cobalt M-42 Part Number
1/4	3/8	5/8	3	2-7/16	5-431-005
5/16	3/8	3/4	3	2-1/2	5-431-010
3/8	3/8	3/4	4	2-1/2	5-431-015
7/16	3/8	1	4	2-11/16	5-431-017
1/2	1/2	1-1/4	4	3-1/4	5-431-020
1/2	1/2	2	4	4	5-431-025
9/16	1/2	1-3/8	4	3-3/8	5-431-027
5/8	5/8	1-5/8	4	3-3/4	5-431-030
5/8	5/8	2-1/2	4	4-5/8	5-431-031
11/16	5/8	1-5/8	4	3-3/4	5-431-033
3/4	5/8	1-5/8	4	3-3/4	5-431-035
3/4	3/4	1-5/8	4	3-3/4	5-431-040
3/4	5/8	3	4	5-1/8	5-431-045
3/4	3/4	3	4	5-1/4	5-431-050
7/8	3/4	1-7/8	5	4-1/8	5-431-055
7/8	3/4	3-1/2	5	5-3/4	5-431-060
1	1	2	5	4-1/2	5-431-065
1	3/4	2	5	4-1/4	5-431-070
1	1	4	5	6-1/2	5-431-075
1-1/8	1	2	6	4-1/2	5-431-080
1-1/4	3/4	2	6	4-1/4	5-431-083
1-1/4	1-1/4	2	6	4-1/2	5-431-085
1-1/4	1-1/4	3	6	5-1/2	5-431-086
1-1/4	1-1/4	4	6	6-1/2	5-431-087
1-1/2	3/4	2	6	4-1/4	5-431-0880
1-1/2	1-1/4	2	6	4-1/2	5-431-090
1-1/2	1-1/4	4	6	6-1/2	5-431-095
*Set of 4 Pieces: 1/2, 5/8, 3/4 & 1"					5-431-150

TABLE OF CONTENTS

MILLING CUTTERS AND SAWS

Technical Reference	364
Milling Cutters with Shanks	365
Corner Rounding Cutters	367
Woodruff Keyseat Cutters	368
Milling Cutters	369
Single Angle Milling Cutters	370
Double Angle Milling Cutters	370
Shell End Mills	371
Involute Gear Cutters	372
Jewelers Saws	374
Saw Arbors	377
Screw Slotting Saws	377
Plain Metal Slitting Saws	379
Side Milling Cutters	382
Power Hacksaw Blades	386





Recommended Speeds and Feeds for Side Milling Cutters

- Depth of cut = .050" to .250"
- Use higher recommended speed and feed for smaller depth of cut

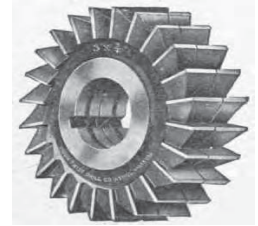

Material to be Machined	Hardness (BHN)	SFM range	Chip loads per tooth Range
Free Machining Carbon Steels 1212, 1108, 1213, 1116, 1118, 1211, 1140, 1151	100-150	120-180	.002-.006"
Free Machining Carbon Steels - leaded 12L14	100-150	120-190	.002-.006"
Carbon Steel - wrought low carbon = 1009, 1011, 1012, 1016, 1018, 1022, 1025, 1518 medium carbon = 1030, 1035, 1040, 1045, 1049, 1053, 1524 high carbon = 1070, 1075, 1090, 1551	85-125	100-130	.002-.006"
Alloyed steel 4110 4120 4140, 4320, 5120, 8115 8620	175-225	50-65	.002-.004"
Ductile Cast Iron class 25, 30, 35, 40, 45 & 50	190-225	80-100	.002-.006"
Stainless Steel	175-225	50-65	.002-.004"
Aluminum Alloys 2024, 5050, 5056, 6061	N/A	200-400	.002-.010"

MILLING CUTTERS / SAWS

Revolution per Minute (RPM) = $(3.82 \times \text{SFM}) / \text{Cutter Diameter}$
 Inches per Revolution (IPR) feed rate = Chip load per tooth x # of teeth
 Inches per Minute (IPM) feed rate = IPR x RPM

Standard Keyways for Milling Cutters & Saws

Cutter Hole Diameter	Nominal size square KEY
1/2"	3/32"
5/8"	1/8"
3/4"	1/8"
7/8"	1/8"
1"	1/4"
1-1/4"	5/16"
1-1/2"	3/8"
1-3/4"	7/16"
2"	1/2"
2-1/2"	5/8"
3"	3/4"
3-1/2"	7/8"
4"	1"
4-1/2"	1-1/8"
5"	1-1/4"

Single Angle Chamfering Cutters

- Right-Hand Cut
- Weldon Shank
- High Speed Steel

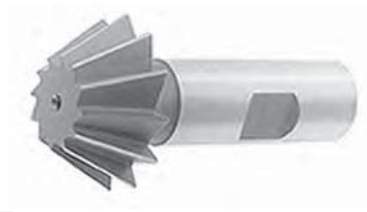

Cutter Dia	Width	Shank Dia	OAL	Angle	Part Number
1/2	1/8	3/8	2-1/8	45°	5-680-001
3/4	3/16	3/8	2-1/8	45°	5-680-002
1	5/16	1/2	2-1/2	45°	5-680-003
1-1/2	1/2	3/4	2-3/4	45°	5-680-004
1/2	7/32	3/8	2-1/8	60°	5-680-005
3/4	5/16	3/8	2-1/8	60°	5-680-006
1	7/16	1/2	2-1/2	60°	5-680-007
1-1/2	5/8	3/4	2-3/4	60°	5-680-008

Concave – Shank Type Cutters

- High Speed Steel



Radius	Shank Dia	Overall Length	Cutter Dia	Number of Flutes	Part Number
1/32	1/2	3	3/4	6	5-693-005
1/16	1/2	3	3/4	6	5-693-010
3/32	1/2	3	3/4	6	5-693-015
1/8	3/4	3-1/2	1	6	5-693-020
5/32	3/4	3-1/2	1	6	5-693-025
3/16	3/4	3-1/2	1	6	5-693-030
1/4	3/4	4	1-1/4	4	5-693-035
5/16	3/4	4	1-1/4	4	5-693-040
3/8	3/4	4-3/16	1-1/2	4	5-693-045

Note: Full form is radius x 2

Convex – Shank Type Cutters

- High Speed Steel



Radius	Shank Dia	Overall Length	Cutter Dia	Number of Flutes	Part Number
1/32	1/2	3	3/4	6	5-690-005
1/16	1/2	3	3/4	6	5-690-010
3/32	1/2	3	7/8	6	5-690-015
1/8	3/4	3-1/2	1-1/4	6	5-690-020
5/32	3/4	3-1/2	1-5/16	6	5-690-025
3/16	3/4	3-1/2	1-3/8	6	5-690-030
1/4	3/4	4	1-1/2	6	5-690-035
5/16	3/4	4	1-5/8	6	5-690-040
3/8	3/4	4	1-3/4	6	5-690-045



Milling Cutters with Shanks

Cutting Tools

Double Angle – Shank Type Cutters

- Right Hand Cut
- High Speed Steel

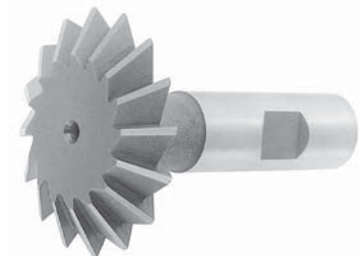

Included Angle	Cutter Dia	Shank Dia	Overall Length	Cutter Thickness	Part Number
60°	3/4	3/8	2-3/8	3/16	5-682-010
60°	1	1/2	2-27/32	5/16	5-682-020
60°	1-3/8	5/8	3-7/32	7/16	5-682-040
60°	1-1/2	5/8	3-3/8	1/2	5-682-060
60°	1-7/8	3/4	3-25/32	5/8	5-682-080
90°	3/4	3/8	2-7/16	1/4	5-682-110
90°	1	1/2	2-29/32	3/8	5-682-120
90°	1-3/8	5/8	3-9/32	1/2	5-682-140
90°	1-1/2	5/8	3-7/16	9/16	5-682-160
90°	1-7/8	3/4	3-25/32	5/8	5-682-180

MILLING CUTTERS / SAWS

Dovetail Cutters

- Regular Length
- Right-Hand Cut
- Weldon Shank
- High Speed Steel and Cobalt



Dia of Cutter	Width of Cutter	Dia of Shank	OAL	Number of Flutes	Angle	High Speed Steel Part Number	Cobalt Part Number
3/8	1/8	3/8	2-1/8	6	45°	5-721-003	5-722-003
1/2	5/32	3/8	2-1/8	6	45°	5-721-005	5-722-005
3/4	1/4	3/8	2-1/8	8	45°	5-721-010	5-722-010
1-3/8	7/16	5/8	2-7/8	10	45°	5-721-015	5-722-015
1-7/8	9/16	7/8	3-1/4	12	45°	5-721-020	5-722-020
2-1/4	5/8	1	3-3/4	12	45°	5-721-025	5-722-025
3/8	3/16	3/8	2-1/8	6	60°	5-721-028	5-722-028
1/2	1/4	3/8	2-1/8	6	60°	5-721-030	5-722-030
3/4	5/16	3/8	2-1/8	8	60°	5-721-035	5-722-035
1-3/8	9/16	5/8	2-7/8	10	60°	5-721-040	5-722-040
1-7/8	13/16	7/8	3-1/4	12	60°	5-721-045	5-722-045
2-1/4	1-1/16	1	3-3/4	12	60°	5-721-050	5-722-050
5 Piece Set: 3/8"						5-721-200	5-722-200
5 Piece Set: 3/8 thru 2-1/4", 60°						5-721-201	-

Corner Rounding Cutters

- Regular Length
- Right-Hand Cut
- Weldon Shank
- High Speed Steel and Cobalt



Radius	Shank Dia	Cutter Dia	OAL	High Speed Steel Part Number	Cobalt Part Number
1/16	3/8	7/16	2-1/2	5-550-005	5-551-005
3/32	3/8	1/2	2-1/2	5-550-010	5-551-010
1/8	3/8	5/8	2-1/2	5-550-014	–
1/8	1/2	5/8	3	5-550-015	5-551-015
5/32	1/2	3/4	3	5-550-020	5-551-020
3/16	1/2	7/8	3	5-550-025	5-551-025
3/16	3/4	7/8	3-1/8	5-550-030	5-551-030
1/4	1/2	1	3	5-550-035	5-551-035
1/4	3/4	1	3-1/4	5-550-040	5-551-040
9/32	1/2	1	3	5-550-041	–
9/32	5/8	1	3	5-550-042	5-551-042
5/16	1/2	1-1/8	3-1/4	5-550-045	5-551-045
5/16	5/8	1-1/8	3-1/2	5-550-046	–
5/16	3/4	1-1/8	3-1/4	5-550-047	5-551-047
5/16	7/8	1-1/8	3-1/2	5-550-050	–
3/8	1/2	1-1/4	3-1/2	5-550-055	5-551-055
3/8	3/4	1-1/4	3-1/2	5-550-057	5-551-057
3/8	7/8	1-1/4	3-3/4	5-550-060	5-551-060
7/16	3/4	1-3/8	3-3/4	5-550-062	5-551-062
7/16	1	1-3/8	4	5-550-065	–
15/32	3/4	1-7/16	3-3/4	5-550-066	–
1/2	3/4	1-1/2	3-7/8	5-550-067	5-551-067
1/2	1	1-1/2	4-1/8	5-550-070	5-551-070
9/16	3/4	1-5/8	4	5-550-071	–
5/8	3/4	1-5/8	4	5-550-073	5-551-073
5/8	1	1-5/8	4	5-550-075	–
21/32	3/4	1-3/16	4	5-550-077	–
3/4	3/4	1-7/8	4	5-550-083	5-551-083
3/4	1	1-7/8	4	5-550-085	5-551-085
13/16	1	2-1/8	4	5-550-092	–
1	3/4	2-9/16	4	5-550-097	–
1	1	2-9/16	4	5-550-098	–
8 Piece Set: 1/16" to 1/4" and 5/16" to 3/8"				5-550-100	5-551-100



Woodruff Keyseat Cutters

Cutting Tools

Woodruff Keyseat Cutters

- Shank Type
- Staggered and Straight Teeth
- 1/2" Diameter Straight Shank
- High Speed Steel

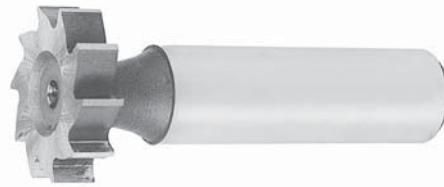

MILLING CUTTERS / SAWS

American Standard	Nominal Dia	Width of Face	Overall Length	Straight Teeth Part Number	Staggered Teeth Part Number
202	1/4	1/16	2-1/16	5-727-0005	5-728-0005
202-1/2	5/16	1/16	2-1/16	5-727-0006	5-728-0006
302-1/2	5/16	3/32	2-3/32	5-727-001	5-728-001
203	3/8	1/16	2-1/16	5-727-002	5-728-002
303	3/8	3/32	2-3/32	5-727-003	5-728-003
403	3/8	1/8	2-1/8	5-727-004	5-728-004
204	1/2	1/16	2-1/16	5-727-005	5-728-005
304	1/2	3/32	2-3/32	5-727-010	5-728-010
305	5/8	3/32	2-3/32	5-727-015	5-728-015
404	1/2	1/8	2-1/8	5-727-020	5-728-020
405	5/8	1/8	2-1/8	5-727-025	5-728-025
406	3/4	1/8	2-1/8	5-727-030	5-728-030
505	5/8	5/32	2-5/32	5-727-035	5-728-035
605	5/8	3/16	2-3/16	5-727-040	5-728-040
506	3/4	5/32	2-5/32	5-727-045	5-728-045
806	3/4	1/4	2-1/4	5-727-050	5-728-050
507	7/8	5/32	2-5/32	5-727-055	5-728-055
606	3/4	3/16	2-3/16	5-727-060	5-728-060
607	7/8	3/16	2-3/16	5-727-065	5-728-065
707	7/8	7/32	2-7/32	5-727-070	5-728-070
608	1	3/16	2-3/16	5-727-075	5-728-075
708	1	7/32	2-7/32	5-727-080	5-728-080
1208	1	3/8	2-3/8	5-727-085	5-728-085
609	1-1/8	3/16	2-3/16	5-727-090	5-728-090
807	7/8	1/4	2-1/4	5-727-095	5-728-095
808	1	1/4	2-1/4	5-727-100	5-728-100
709	1-1/8	7/32	2-7/32	5-727-105	5-728-105
809	1-1/8	1/4	2-1/4	5-727-110	5-728-110
610	1-1/4	3/16	2-3/16	5-727-115	5-728-115
710	1-1/4	7/32	2-7/32	5-727-120	5-728-120
810	1-1/4	1/4	2-1/4	5-727-125	5-728-125
811	1-3/8	1/4	2-1/4	5-727-130	5-728-130
812	1-1/2	1/4	2-1/4	5-727-135	5-728-135
1008	1	5/16	2-5/16	5-727-140	5-728-140
1009	1-1/8	5/16	2-5/16	5-727-145	5-728-145
1010	1-1/4	5/16	2-5/16	5-727-150	5-728-150
1011	1-3/8	5/16	2-5/16	5-727-155	5-728-155
1012	1-1/2	5/16	2-5/16	5-727-160	5-728-160
1210	1-1/4	3/8	2-3/8	5-727-165	5-728-165
1211	1-3/8	3/8	2-3/8	5-727-170	5-728-170
1212	1-1/2	3/8	2-3/8	5-727-175	5-728-175
8 Piece Set: American Standard # 204, 304, 305, 406, 605, 606, 608, 806				5-727-508	5-728-508
9 Piece Set: American Standard # 204, 404, 406, 806, 606, 608, 808, 610, 1210				5-727-509	5-728-509
41 Piece Set Includes all Sizes				5-727-541	-

Milling Cutters

- High Speed Steel



Concave Cutters



Convex Cutters

Concave Cutters				
Dia of Circle	Dia of Cutter	Hole	Number of Teeth	Part Number
1/8	2-1/4	1	14	5-703-015
5/32	2-1/4	1	14	5-703-020
3/16	2-1/4	1	14	5-703-025
7/32	2-1/4	1	14	5-703-030
1/4	2-1/2	1	14	5-703-035
9/32	2-1/2	1	12	5-703-037
5/16	2-3/4	1	12	5-703-040
11/32	2-3/4	1	12	5-703-045
3/8	2-3/4	1	12	5-703-050
7/16	3	1	12	5-703-060
1/2	2-1/4	7/8	12	5-703-063
1/2	3	1	12	5-703-065
9/16	3	1	12	5-703-070
5/8	2-3/4	1	12	5-703-073
1/2	3	1	12	5-703-074
5/8	3-1/2	1-1/4	12	5-703-075
3/4	3	1	12	5-703-082
3/4	3-3/4	1-1/4	12	5-703-085
7/8	3-1/4	1	12	5-703-092
1	3-1/4	1	10	5-703-105
1	4-1/4	1-1/4	10	5-703-110
1-1/16	4	1-1/4	14	5-703-115
1-1/4	4	1-1/4	10	5-703-125
1-1/2	4-1/4	1-1/4	10	5-703-135
1-3/4	5-1/2	1-1/4	10	5-703-145

Convex Cutters				
Dia of Circle	Dia of Cutter	Hole	Number of Teeth	Part Number
1/16	2-1/4	1	14	5-700-005
3/32	2-1/4	1	14	5-700-010
1/8	2	7/8	14	5-700-015
1/8	2-1/4	1	14	5-700-020
5/32	2-1/4	1	14	5-700-025
3/16	2-1/4	1	14	5-700-030
7/32	2-1/4	1	14	5-700-035
1/4	1	7/8	14	5-700-037
1/4	2-1/4	1	14	5-700-039
1/4	2-1/2	1	14	5-700-040
9/32	2-1/2	1	14	5-700-045
5/16	2-3/4	1	12	5-700-050
11/32	2-3/4	1	12	5-700-055
3/8	2-1/4	7/8	12	5-700-057
3/8	2-3/4	1	12	5-700-060
13/32	2-3/4	1	12	5-700-065
7/16	3	1	12	5-700-070
1/2	3	1	12	5-700-075
9/16	2-3/4	1	12	5-700-077
9/16	3	1	12	5-700-080
5/8	2-3/4	1	12	5-700-082
5/8	3	1	12	5-700-083
5/8	3-1/2	1	12	5-700-084
5/8	3-1/2	1-1/4	12	5-700-085
11/16	3	1	12	5-700-090
3/4	3	1	12	5-700-092
3/4	3-3/4	1-1/4	12	5-700-095
7/8	3-1/4	1	12	5-700-102
7/8	4	1-1/4	12	5-700-105
1	3-1/4	1	12	5-700-115
1	4-1/4	1-1/4	12	5-700-120
1-1/8	4	1-1/4	12	5-700-125
1-1/4	4	1-1/4	12	5-700-130
1-3/8	4-1/4	1-1/4	12	5-700-135
1-1/2	4-1/4	1-1/4	12	5-700-140
1-5/8	5-1/2	1-1/4	12	5-700-145

MILLING CUTTERS / SAWS



Milling Cutters

Cutting Tools

Single Angle Milling Cutters

- Right Hand and Left Hand in 45° and 60° Angles
- High Speed Steel



Dia	Width of Face	Hole Size	Number of Teeth	Right Hand 45°	Left Hand 45°	Right Hand 60°	Left Hand 60°
2-1/2	1/2	7/8	18	5-712-005	5-715-005	5-712-010	5-715-010
2-3/4	1/2	1	18	5-712-015	5-715-015	5-712-020	5-715-020
3	1/2	1	22	5-712-023	5-715-023	5-712-024	5-715-024
3	1/2	1-1/4	22	5-712-025	–	5-712-030	–
3	5/8	1	22	5-712-035	5-715-035	5-712-040	–
3	5/8	1-1/4	22	5-712-045	–	5-712-050	–
3	3/4	1	22	5-712-055	5-715-055	5-712-060	5-715-060
3	3/4	1-1/4	22	–	–	5-712-070	5-715-070
4	1/2	1	26	5-712-075	5-715-075	5-712-080	–
4	1/2	1-1/4	26	–	5-715-085	5-712-090	–
4	3/4	1	26	5-712-095	5-715-095	5-712-100	5-715-100
4	3/4	1-1/4	26	5-712-105	5-715-105	5-712-110	5-715-110
4	1	1-1/4	26	5-712-115	5-715-115	5-712-120	5-715-120
5	3/4	1-1/4	28	–	5-715-125	5-712-130	5-715-130
5	1	1-1/4	28	5-712-135	5-715-135	5-712-140	5-715-140
6	3/4	1-1/4	30	5-712-145	–	–	–

MILLING CUTTERS / SAWS

Double Angle Milling Cutters

- 45°, 60°, and 90° Angles
- High Speed Steel



Dia	Width of Face	Hole Size	Number of Teeth	45° Part Number	60° Part Number	90° Part Number
2-3/4	1/2	1	18	5-718-005	5-718-010	5-718-015
3	5/8	1	22	5-718-020	5-718-025	5-718-030
3	3/4	1	22	–	5-718-035	5-718-040
4	1/2	1-1/4	26	5-718-045	5-718-050	5-718-055
4	3/4	1	26	5-718-060	5-718-065	5-718-070
4	3/4	1-1/4	26	5-718-075	5-718-080	5-718-085
4	1	1-1/4	26	–	5-718-090	5-718-095
5	3/4	1-1/4	28	–	5-718-105	5-718-110
5	1	1-1/4	28	5-718-115	5-718-120	5-718-125
6	3/4	1-1/4	30	–	5-718-135	5-718-140
6	1	1-1/4	30	5-718-145	5-718-150	5-718-155
6	1-1/2	1-1/4	30	5-718-160	5-718-165	5-718-170



Shell End Mills

- 20° Right Hand Helix
- High Speed Steel

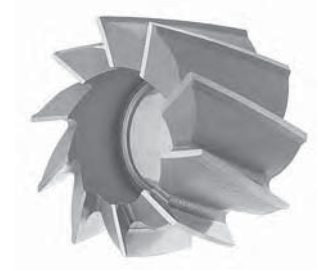

Dia of Mill	Size of Hole	Length of Cut	Number of Flutes	Drive Slot Width	HSS Right Hand Part Number
1-1/4	1/2	1	8	1/4	5-450-005
1-1/2	1/2	1-1/8	8	1/4	5-450-010
1-3/4	3/4	1-1/4	8	5/16	5-450-015
2	3/4	1-3/8	10	5/16	5-450-020
2-1/4	1	1-1/2	10	3/8	5-450-025
2-1/2	1	1-5/8	10	3/8	5-450-030
2-3/4	1	1-5/8	10	3/8	5-450-035
3	1-1/4	1-3/4	10	1/2	5-450-040
3-1/2	1-1/4	1-7/8	12	1/2	5-450-045
4	1-1/2	2-1/4	14	5/8	5-450-050
5	1-1/2	2-1/4	16	3/4	5-450-060
5-1/2	2	2-1/4	16	3/4	5-450-065
6	2	2-1/4	16	3/4	5-450-070

MILLING CUTTERS / SAWS



Involute Gear Cutters

Cutting Tools

Involute Gear Cutters, 14-1/2°

- Used to mill spur gears with a 14-1/2 degree pressure angle
- For each diametral pitch listed, 8 cutters are required to produce a full set of gears from 12 teeth to a rack
- When ordering, state diametral pitch and the number of cutters from the chart in accordance with the number of teeth to be cut. Specify the arbor hole when possible
- These cutters may be sharpened repeatedly without changing the original form
- High Speed Steel



Tooth height (H) is in inches
DP is diametral pitch

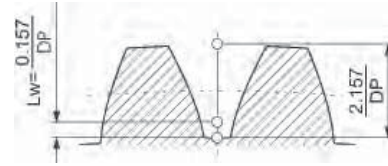

Part number series 5-860-

When ordering, please use complete part number, 5-860- plus a 3 digit suffix from the table

Diametral Pitch	Dia of Cutter	Hole Size	Tooth height (H) is in inches								
			1	2	3	4	5	6	7	8	
3	5-1/4	1-1/2	-	018	-	-	-	-	-	-	-
3	5-1/4	1-1/4	-	-	-	444	-	-	446	-	-
3	4-3/4	1-1/4	-	026	027	028	029	-	031	-	-
4	4-1/2	1-1/2	033	-	035	036	-	038	039	-	-
4	4-1/4	1-1/4	-	042	043	044	045	046	-	048	-
4	3-5/8	1	-	050	-	052	053	-	055	056	-
5	3-3/4	1-1/4	057	058	059	060	061	062	063	-	-
5	3-5/8	1	417	418	-	420	421	-	423	-	-
5	3-3/8	1	065	-	-	-	069	070	-	-	-
6	3-1/2	1-1/4	-	074	075	076	077	078	079	080	-
6	3-1/8	1	081	082	083	084	085	086	087	088	-
7	3-3/8	1-1/4	-	090	091	092	-	-	095	-	-
7	2-7/8	1	097	098	099	100	101	102	103	-	-
8	3-1/4	1-1/4	105	-	-	108	-	-	-	-	-
8	2-7/8	1	113	114	115	116	117	118	119	120	-
9	3-1/8	1-1/4	-	-	-	-	-	126	-	-	-
9	2-3/4	1	-	130	131	132	133	134	-	136	-
10	2-3/4	1	137	138	139	140	141	142	143	144	-
10	2-3/8	7/8	145	146	147	148	149	150	-	152	-
12	2-5/8	1	169	170	171	172	173	174	175	176	-
12	2-1/4	7/8	177	178	179	180	181	182	183	184	-
14	2-1/2	1	185	186	187	188	189	190	191	192	-
14	2-1/8	7/8	-	194	195	196	-	-	199	200	-
16	2-1/2	1	201	202	203	204	205	206	207	208	-
16	2-1/8	1	425	426	-	428	-	-	-	432	-
16	2-1/8	7/8	-	210	211	212	213	214	215	216	-
18	2-3/8	1	217	218	219	220	221	222	223	224	-
18	2	7/8	-	-	-	-	-	230	-	-	-
20	2-3/8	1	233	234	235	236	237	238	239	240	-
20	2	7/8	241	242	243	244	-	246	247	248	-
24	2-1/4	1	265	266	267	268	269	270	271	272	-
24	1-3/4	7/8	273	274	275	276	277	278	-	280	-
26	2-1/4	1	-	-	-	284	-	-	287	-	-
26	1-3/4	7/8	-	290	291	-	-	-	-	-	-
28	2-1/4	1	-	-	-	300	-	-	303	-	-
28	1-3/4	7/8	305	-	307	-	-	-	311	-	-
30	2-1/4	1	313	-	-	-	317	318	319	-	-
30	1-3/4	7/8	-	-	-	-	-	-	327	328	-
32	2-1/4	1	329	330	331	332	333	334	335	336	-
32	2-1/4	7/8	-	434	-	-	-	-	-	-	-
32	1-3/4	7/8	337	338	339	340	-	342	343	344	-
36	2-1/4	1	345	-	-	-	349	-	-	-	-
36	1-3/4	7/8	353	354	-	356	-	-	359	-	-
40	2-1/4	1	-	362	-	-	-	-	-	368	-
40	1-3/4	7/8	369	-	-	-	-	-	-	-	-
48	2-1/4	1	-	378	-	-	-	-	383	-	-
48	1-3/4	7/8	385	386	387	388	389	390	391	392	-

Cutter Number	Range of Teeth
1	135-Rack
2	55-134
3	35-54
4	26-34
5	21-25
6	17-20
7	14-16
8	12-13

MILLING CUTTERS / SAWS

Involute Gear Cutters, 20°

- Pressure Angle 20 degrees
- For each module listed from 0.5 mm to 7 mm, 8 cutters are required to produce a full set of gears from 12 teeth to a rack
- These cutters may be sharpened repeatedly without changing their original form
- High Speed Steel



Part number series 5-862-

When ordering, please use complete part number, 5-862- plus a 4 digit suffix from the table.

Module	Dia of Cutter	Hole mm	Individual Cutters								8 Piece Sets Part Number
			1	2	3	4	5	6	7	8	
0.5	40	16	0051	0052	0053	0054	0055	0056	0057	0058	5-862-0050
0.7	40	16	0071	0072	0073	0074	0075	0076	0077	0078	5-862-0070
0.8	40	16	0081	0082	0083	0084	0085	0086	0087	0088	5-862-0080
1.0	50	16	0101	0102	0103	0104	0105	0106	0107	0108	5-862-0100
1.25	50	16	0121	0122	0123	0124	0125	0126	0127	0128	5-862-0120
1.5	56	22	0151	0152	0153	0154	0155	0156	0157	0158	5-862-0150
1.75	56	22	0171	0172	0173	0174	0175	0176	0177	0178	5-862-0170
2.0	63	22	0201	0202	0203	0204	0205	0206	0207	0208	5-862-0200
2.25	63	22	0221	0222	0223	0224	0225	0226	0227	0228	5-862-0220
2.5	63	22	0251	0252	0253	0254	0255	0256	0257	0258	5-862-0250
2.75	71	27	0271	0272	0273	0274	0275	0276	0277	0278	5-862-0270
3.00	71	27	0301	0302	0303	0304	0305	0306	0307	0308	5-862-0300
3.25	71	27	0321	0322	0323	0324	0325	0326	0327	0328	5-862-0320
3.50	80	27	0351	0352	0353	0354	0355	0356	0357	0358	5-862-0350
3.75	80	27	0371	0372	0373	0374	0375	0376	0377	0378	5-862-0370
4.0	80	27	0401	0402	0403	0404	0405	0406	0407	0408	5-862-0400
4.5	90	32	0451	0452	0453	0454	0455	0456	0457	0458	5-862-0450
5.0	90	32	0501	0502	0503	0504	0505	0506	0507	0508	5-862-0500
5.5	90	32	0551	0552	0553	0554	0555	0556	0557	0558	5-862-0550
6.0	100	32	0601	0602	0603	0604	0605	0606	0607	0608	5-862-0600
6.5	100	32	0651	0652	0653	0654	0655	0656	0657	0658	5-862-650
7.0	100	32	0701	0702	0703	0704	0705	0706	0707	0708	5-862-0700

MILLING CUTTERS / SAWS

m = module

$$m = \frac{H}{2.2}$$

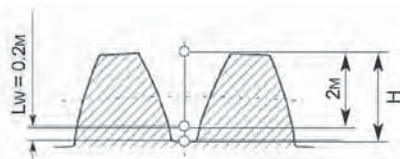

Tooth height (H) is in mm

Modules 1 thru 7	
Cutter Number	Range of Teeth Cut
1	12 & 13
2	14 to 16
3	17 to 20
4	21 to 25
5	26 to 34
6	35 to 54
7	55 to 134
8	135 to rack



Jewelers Slotting Saws

- Tolerances: Outside diameter: +.015"
Hole diameter: +.001"
Width: +.001"
- Saws with 5/16" diameter hole sizes are manufactured without a keyway
- ANSI/ASME B94.19
- Used in slotting, sheeting and tubing
- For cutting thin tubing, wire and similar items as well as for slotting very thin materials
- High Speed Steel

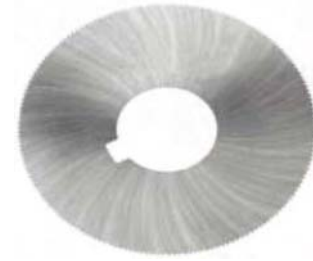

MILLING CUTTERS / SAWS

Dia	Thickness (inches)	Teeth Per Saw	Hole Size 1/4" Part Number	Hole Size 5/16" Part Number	Hole Size 3/8" Part Number	Hole Size 1/2" Part Number
1	.008	99	5-746-001	5-746-002	5-746-003	5-746-004
1	.010	99	5-746-006	5-746-007	5-746-005	5-746-008
1	.012	99	5-746-011	–	5-746-010	5-746-013
1	.014	75	5-746-016	–	5-746-015	5-746-018
1	.016	75	5-746-021	–	5-746-020	5-746-023
1	.018	75	5-746-026	–	5-746-025	5-746-028
1	.020	75	5-746-031	5-746-032	5-746-030	5-746-033
1	.023	75	5-746-036	–	5-746-035	5-746-038
1	.025	75	5-746-039	–	5-746-040	5-746-042
1	.028	75	5-746-043	–	5-746-045	5-746-046
1	.032	75	5-746-047	–	5-746-050	5-746-049
1-1/4	.008	120	–	–	5-746-052	5-746-053
1-1/4	.010	120	–	5-746-054	5-746-055	5-746-056
1-1/4	.012	120	–	–	5-746-060	5-746-061
1-1/4	.014	99	–	–	5-746-065	5-746-066
1-1/4	.016	99	–	–	5-746-070	5-746-071
1-1/4	.018	99	–	5-746-074	5-746-075	5-746-076
1-1/4	.020	99	–	5-746-079	5-746-080	5-746-081
1-1/4	.023	99	–	5-746-084	5-746-085	–
1-1/4	.025	99	–	5-746-089	5-746-090	–
1-1/4	.028	99	–	–	5-746-095	5-746-096
1-1/4	.032	99	–	5-746-099	5-746-100	5-746-101
1-1/2	.008	140	–	–	5-746-102	5-746-103
1-1/2	.010	140	–	–	5-746-104	5-746-105
1-1/2	.012	140	–	–	5-746-109	5-746-110
1-1/2	.013	140	–	–	–	5-746-111
1-1/2	.014	110	–	–	5-746-114	5-746-115
1-1/2	.016	110	–	–	5-746-119	5-746-120
1-1/2	.018	110	–	–	5-746-124	5-746-125
1-1/2	.020	110	–	–	5-746-129	5-746-130
1-1/2	.023	110	–	–	–	5-746-135
1-1/2	.025	110	–	–	5-746-139	5-746-140
1-1/2	.028	110	–	–	5-746-144	5-746-145
1-1/2	.032	110	–	–	5-746-149	5-746-150



Jewelers Slotting Saws (continued)

- Tolerances: Outside diameter: $+.015''$
Hole diameter: $+.001''$
Width: $+.001''$
- ANSI/ASME B94.19
- Used in slotting, sheeting and tubing
- For cutting thin tubing, wire and similar items as well as for slotting very thin materials
- High Speed Steel



Dia	Thickness (inches)	Teeth Per Saw	Hole Size 3/8" Part Number	Hole Size 1/2" Part Number
1-3/4	.008	160	–	5-746-153
1-3/4	.010	160	5-746-154	5-746-155
1-3/4	.012	160	5-746-159	5-746-160
1-3/4	.014	132	5-746-164	5-746-165
1-3/4	.016	132	–	5-746-170
1-3/4	.018	132	5-746-174	5-746-175
1-3/4	.020	132	5-746-179	5-746-180
1-3/4	.023	132	–	5-746-185
1-3/4	.025	132	5-746-189	5-746-190
1-3/4	.028	132	–	5-746-195
1-3/4	.032	132	5-746-199	5-746-200
2	.008	190	5-746-202	5-746-203
2	.010	190	5-746-204	5-746-205
2	.012	190	5-746-209	5-746-210
2	.014	152	5-746-214	5-746-215
2	.016	152	5-746-219	5-746-220
2	.018	152	5-746-224	5-746-225
2	.020	152	5-746-229	5-746-230
2	.023	152	5-746-234	5-746-235
2	.025	152	5-746-239	5-746-240
2	.028	152	5-746-244	5-746-245
2	.032	110	5-746-249	5-746-250
2	.035	110	5-746-254	5-746-255
2	.036	110	–	5-746-258
2	.040	110	5-746-259	5-746-260
2	.045	110	5-746-264	5-746-265
2	.051	110	5-746-269	5-746-270
2	.057	110	5-746-274	5-746-275
2-1/4	.010	210	–	5-746-277
2-1/4	.014	210	–	5-746-279

Dia	Thickness (inches)	Teeth Per Saw	Hole Size 1/2" Part Number
2-1/2	.010	240	5-746-280
2-1/2	.012	240	5-746-285
2-1/2	.013	240	5-746-288
2-1/2	.014	190	5-746-290
2-1/2	.016	190	5-746-295
2-1/2	.018	190	5-746-300
2-1/2	.020	190	5-746-305
2-1/2	.023	190	5-746-310
2-1/2	.025	190	5-746-315
2-1/2	.028	190	5-746-320
2-1/2	.032	140	5-746-325
2-1/2	.035	140	5-746-330
2-1/2	.040	140	5-746-335
2-1/2	.045	140	5-746-340
2-1/2	.051	140	5-746-345
2-1/2	.057	140	5-746-350

MILLING CUTTERS / SAWS



Jewelers Slotting Saws (continued)

- Tolerances: Outside diameter: $+ .015''$, Hole diameter: $+ .001''$, Width: $+ .001''$
- ANSI/ASME B94.19
- Used in slotting, sheeting and tubing
- For cutting thin tubing, wire and similar items as well as for slotting very thin materials
- High Speed Steel



Dia	Thickness (inches)	Teeth Per Saw	Hole Size 1/2" Part Number	Hole Size 3/4" Part Number	Hole Size 1" Part Number
3	.010	280	5-746-355	5-746-430	5-746-505
3	.012	280	5-746-360	—	5-746-510
3	.014	230	5-746-365	—	5-746-515
3	.016	230	5-746-370	—	5-746-520
3	.018	230	5-746-375	—	5-746-525
3	.020	230	5-746-380	—	5-746-530
3	.023	230	5-746-385	—	5-746-535
3	.025	230	5-746-390	—	5-746-540
3	.028	230	5-746-395	5-746-470	5-746-545
3	.032	168	5-746-400	5-746-475	5-746-550
3	.035	168	5-746-405	5-746-480	5-746-555
3	.040	168	5-746-410	5-746-485	5-746-560
3	.045	168	5-746-415	—	5-746-565
3	.051	168	5-746-420	5-746-495	5-746-570
3	.057	168	5-746-425	—	5-746-575
4	.016	310	5-746-580	—	5-746-710
4	.018	310	5-746-585	—	5-746-715
4	.020	310	5-746-590	—	5-746-720
4	.023	310	5-746-595	—	5-746-725
4	.025	310	5-746-600	—	5-746-730
4	.028	310	5-746-605	—	5-746-735
4	.032	220	5-746-610	5-746-675	5-746-740
4	.035	220	5-746-615	—	5-746-745
4	.040	220	5-746-620	5-746-685	5-746-750
4	.045	220	—	5-746-690	5-746-755
4	.051	220	5-746-630	5-746-695	5-746-760
4	.057	220	5-746-635	5-746-700	5-746-765
4	.064	220	5-746-640	5-746-705	5-746-770
5	.025	280	5-746-785	—	5-746-840
5	.028	280	5-746-790	—	5-746-845
5	.032	280	5-746-795	—	5-746-850
5	.035	280	5-746-800	—	5-746-855
5	.036	280	—	—	5-746-858
5	.040	280	5-746-805	—	5-746-860
5	.045	280	5-746-810	—	5-746-865
5	.051	280	5-746-815	—	5-746-870
5	.057	280	5-746-820	—	5-746-875
5	.064	280	5-746-825	—	5-746-880
6	.035	340	—	—	5-746-925
6	.040	340	5-746-895	—	5-746-930
6	.045	340	5-746-900	—	5-746-935
6	.051	232	5-746-905	5-746-906	5-746-940
6	.057	232	—	—	5-746-945
6	.064	232	5-746-915	—	5-746-950
6	.072	232	—	—	5-746-953
6	.081	232	—	—	5-746-956
6	.091	232	—	—	5-746-959
6	.102	232	—	—	5-746-962
6	.114	232	—	—	5-746-965
6	.128	232	—	—	5-746-968

Slitting or Slotting Saw Arbors

Straight Shank			
Dia of Arbor	Length	Hole Size	Part Number
1/2	3-3/4	3/8	3-121-010

R8 Shank		
Length	Hole Size	Part Number
5-3/32	1/2", 5/8", 3/4", 7/8", 1"	3-120-010
Arbor Screw	5/16x24	3-120-900

Weldon Shank			
Dia of Arbor	Length	Hole Size	Part Number
1/2	2-9/16	1/2, 5/8, 3/4, 7/8, 1	3-120-005



Screw Slotting Saws

- Tolerances: Outside diameter: $+0.015"$
Hole diameter: $+0.001"$
Width: $+0.001"$
- High Speed Steel



56 Teeth				
Dia	Width of Face	Hole Size	Number of Teeth	Part Number
2-3/4	.012	1	56	5-745-455
2-3/4	.014	1	56	5-745-460
2-3/4	.016	1	56	5-745-465
2-3/4	.018	1	56	5-745-470
2-3/4	.020	1	56	5-745-475
2-3/4	.023	1	56	5-745-480
2-3/4	.025	1	56	5-745-485
2-3/4	.028	1	56	5-745-490
2-3/4	.032	1	56	5-745-495
2-3/4	.036	1	56	5-745-500
2-3/4	.040	1	56	5-745-505
2-3/4	.045	1	56	5-745-510
2-3/4	.051	1	56	5-745-515
2-3/4	.057	1	56	5-745-520
2-3/4	.064	1	56	5-745-525
2-3/4	.072	1	56	5-745-530
2-3/4	.081	1	56	5-745-535
2-3/4	.091	1	56	5-745-540
2-3/4	.102	1	56	5-745-545
2-3/4	.114	1	56	5-745-550
2-3/4	.128	1	56	5-745-555
2-3/4	.144	1	56	5-745-560
2-3/4	.162	1	56	5-745-565

60 Teeth				
Dia	Width of Face	Hole Size	Number of Teeth	Part Number
2-1/4	.008	5/8	60	5-745-084
2-1/4	.010	5/8	60	5-745-085
2-1/4	.012	5/8	60	5-745-090
2-1/4	.014	5/8	60	5-745-095
2-1/4	.016	5/8	60	5-745-100
2-1/4	.018	5/8	60	5-745-105
2-1/4	.020	5/8	60	5-745-110
2-1/4	.023	5/8	60	5-745-115
2-1/4	.025	5/8	60	5-745-120
2-1/4	.028	5/8	60	5-745-125
2-1/4	.032	5/8	60	5-745-130
2-1/4	.035	5/8	60	5-745-134
2-1/4	.036	5/8	60	5-745-135
2-1/4	.040	5/8	60	5-745-140
2-1/4	.045	5/8	60	5-745-145
2-1/4	.051	5/8	60	5-745-150
2-1/4	.057	5/8	60	5-745-155
2-1/4	.064	5/8	60	5-745-160
2-1/4	.072	5/8	60	5-745-165
2-1/4	.081	5/8	60	5-745-170
2-1/4	.091	5/8	60	5-745-175
2-1/4	.102	5/8	60	5-745-180



Screw Slotting Saws

Cutting Tools

Screw Slotting Saws (continued)

- Tolerances: Outside diameter: $+.015''$
Hole diameter: $+.001''$
Width: $+.001''$
- High Speed Steel



MILLING CUTTERS / SAWS

72 Teeth				
Dia	Width of Face	Hole Size	Number of Teeth	Part Number
2-3/4	.010	3/4	72	5-745-185
2-3/4	.016	3/4	72	5-745-200
2-3/4	.020	3/4	72	5-745-210
2-3/4	.023	3/4	72	5-745-215
2-3/4	.025	3/4	72	5-745-220
2-3/4	.028	3/4	72	5-745-225
2-3/4	.032	3/4	72	5-745-230
2-3/4	.036	3/4	72	5-745-235
2-3/4	.040	3/4	72	5-745-240
2-3/4	.045	3/4	72	5-745-245
2-3/4	.051	3/4	72	5-745-250
2-3/4	.057	3/4	72	5-745-255
2-3/4	.064	3/4	72	5-745-260
2-3/4	.072	3/4	72	5-745-265
2-3/4	.081	3/4	72	5-745-270
2-3/4	.091	3/4	72	5-745-275
2-3/4	.102	3/4	72	5-745-280
2-3/4	.114	3/4	72	5-745-285
2-3/4	.128	3/4	72	5-745-290
2-3/4	.162	3/4	72	5-745-291
2-3/4	.182	3/4	72	5-745-292
2-3/4	.010	1	72	5-745-295
2-3/4	.012	1	72	5-745-300
2-3/4	.013	1	72	5-745-301

72 Teeth				
Dia	Width of Face	Hole Size	Number of Teeth	Part Number
2-3/4	.014	1	72	5-745-305
2-3/4	.016	1	72	5-745-310
2-3/4	.018	1	72	5-745-315
2-3/4	.020	1	72	5-745-320
2-3/4	.023	1	72	5-745-325
2-3/4	.025	1	72	5-745-330
2-3/4	.028	1	72	5-745-335
2-3/4	.032	1	72	5-745-340
2-3/4	.035	1	72	5-745-343
2-3/4	.036	1	72	5-745-345
2-3/4	.040	1	72	5-745-350
2-3/4	.045	1	72	5-745-355
2-3/4	.051	1	72	5-745-360
2-3/4	.057	1	72	5-745-365
2-3/4	.064	1	72	5-745-370
2-3/4	.072	1	72	5-745-375
2-3/4	.074	1	72	5-745-377
2-3/4	.081	1	72	5-745-380
2-3/4	.091	1	72	5-745-385
2-3/4	.102	1	72	5-745-390
2-3/4	.114	1	72	5-745-395
2-3/4	.128	1	72	5-745-400
2-3/4	.144	1	72	5-745-405
2-3/4	.162	1	72	5-745-410
2-3/4	.182	1	72	5-745-415

90 Teeth				
Dia	Width of Face	Hole Size	Number of Teeth	Part Number
1-3/4	.010	1/2	90	5-745-006
1-3/4	.013	1/2	90	5-745-014
1-3/4	.020	1/2	90	5-745-031
1-3/4	.008	5/8	90	5-745-004
1-3/4	.010	5/8	90	5-745-005
1-3/4	.012	5/8	90	5-745-010
1-3/4	.014	5/8	90	5-745-015
1-3/4	.016	5/8	90	5-745-020
1-3/4	.018	5/8	90	5-745-025
1-3/4	.020	5/8	90	5-745-030
1-3/4	.023	5/8	90	5-745-035

90 Teeth				
Dia	Width of Face	Hole Size	Number of Teeth	Part Number
1-3/4	.025	5/8	90	5-745-040
1-3/4	.028	5/8	90	5-745-045
1-3/4	.032	5/8	90	5-745-050
1-3/4	.036	5/8	90	5-745-055
1-3/4	.040	5/8	90	5-745-060
1-3/4	.045	5/8	90	5-745-065
1-3/4	.051	5/8	90	5-745-070
1-3/4	.057	5/8	90	5-745-075
1-3/4	.064	5/8	90	5-745-080
1-3/4	.072	5/8	90	5-745-082



Plain Metal Slitting Saws

- Tolerances: Outside diameter: $+0.015''$
Hole diameter: $+0.001''$
Width: $+0.001''$
- High Speed Steel



Dia	Width of Face	Hole Size	Number of Teeth	Part Number
1-3/4	1/32	1/2	28	5-747-002
2	1/16	1/2	28	5-747-005
2	3/32	1/2	28	5-747-007
2	1/8	1/2	28	5-747-010
2-1/2	3/64	3/8	28	5-747-012
2-1/2	1/32	3/8	28	5-747-013
2-1/2	1/32	7/8	28	5-747-015
2-1/2	3/64	7/8	28	5-747-020
2-1/2	1-1/16	7/8	28	5-747-025
2-1/2	3/32	7/8	28	5-747-030
2-1/2	1/8	7/8	28	5-747-035
2-1/2	1/16	1	28	5-747-038
3	1/64	1	30	5-747-040
3	1/32	1	30	5-747-045
3	3/64	1	30	5-747-050
3	1/16	1	30	5-747-055
3	5/64	1	30	5-747-060
3	3/32	1	30	5-747-065
3	7/64	1	30	5-747-070
3	1/8	1	30	5-747-075
3	9/64	1	30	5-747-080
3	5/32	1	30	5-747-085
3	3/16	1	30	5-747-087
3-1/2	1/32	1	30	5-747-090
3-1/2	3/64	1	30	5-747-095
3-1/2	1/16	1	30	5-747-100
3-1/2	3/32	1	30	5-747-105
3-1/2	1/8	1	30	5-747-109
3-1/2	1/8	1	30	5-747-110
3-1/2	9/64	1	30	5-747-111
3-1/2	5/32	1	30	5-747-112
3-1/2	3/16	1	30	5-747-113
3-1/2	3/16	1	36	5-747-114
4	1/64	1	36	5-747-115
4	1/32	1	36	5-747-120
4	3/64	1	36	5-747-125
4	1/16	1	36	5-747-130
4	5/64	1	36	5-747-135
4	3/32	1	36	5-747-140
4	7/64	1	36	5-747-145
4	1/8	1	36	5-747-150
4	9/64	1	36	5-747-155
4	5/32	1	36	5-747-160
4	3/16	1	36	5-747-165

Dia	Width of Face	Hole Size	Number of Teeth	Part Number
4-1/2	1/32	1	36	5-747-170
4-1/2	3/64	1	36	5-747-175
4-1/2	1/16	1	36	5-747-180
4-1/2	3/32	1	36	5-747-185
4-1/2	1/8	1	36	5-747-190
5	3/64	1	40	5-747-195
5	1/16	1	40	5-747-200
5	5/64	1	40	5-747-205
5	3/32	1	40	5-747-210
5	7/64	1	40	5-747-215
5	1/8	1	40	5-747-220
5	9/64	1	40	5-747-225
5	5/32	1	40	5-747-230
5	3/16	1	40	5-747-235
5	1/16	1-1/4	40	5-747-201
5	3/32	1-1/4	40	5-747-211
5	1/8	1-1/4	40	5-747-240
5	5/32	1-1/4	40	5-747-231
5	3/16	1-1/4	40	5-747-236
6	3/64	1	42	5-747-245
6	1/16	1	42	5-747-250
6	5/64	1	42	5-747-255
6	3/32	1	42	5-747-260
6	7/64	1	42	5-747-265
6	1/8	1	42	5-747-270
6	9/64	1	42	5-747-275
6	5/32	1	42	5-747-276
6	3/16	1	42	5-747-280
6	1/16	1-1/4	42	5-747-283
6	3/32	1-1/4	42	5-747-284
6	1/8	1-1/4	42	5-747-285
6	5/32	1-1/4	42	5-747-287
6	3/16	1-1/4	42	5-747-290
8	3/32	1	48	5-747-292
8	1/8	1	48	5-747-295
8	3/16	1	48	5-747-297
8	3/32	1-1/4	48	5-747-293
8	1/8	1-1/4	48	5-747-300
8	3/16	1-1/4	48	5-747-305
8	1/4	1-1/4	48	5-747-307
10	3/32	1-1/4	56	5-747-318
10	1/8	1-1/4	56	5-747-320
10	3/16	1-1/4	56	5-747-335
10	1/4	1-1/4	62	5-747-340

MILLING CUTTERS / SAWS



Metal Slitting Saws

Cutting Tools

Metal Slitting Saws

Plain Teeth with Side Chip Clearance

- High Speed Steel

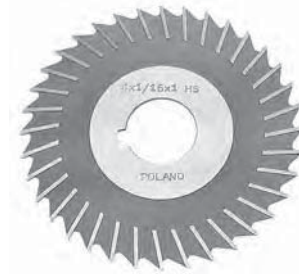

MILLING CUTTERS / SAWS

Dia	Thickness	Hole Size	Depth of Cut	Number of Teeth	Part Number
2	1/16	5/8	.448	22	5-748-202
2	5/64	5/8	.448	22	5-748-204
2	3/32	5/8	.448	22	5-748-206
2	1/8	5/8	.448	22	5-748-210
2	5/32	5/8	.448	22	5-748-214
2-1/2	1/16	7/8	.561	28	5-748-220
2-1/2	1/16	1	.521	28	5-748-222
2-1/2	3/32	7/8	.561	28	5-748-226
2-1/2	3/32	1	.521	28	5-748-228
2-1/2	7/64	7/8	.561	28	5-748-230
2-1/2	1/8	7/8	.561	28	5-748-232
2-1/2	1/8	1	.521	28	5-748-234
3	1/16	1	.751	32	5-748-252
3	5/64	1	.751	32	5-748-254
3	3/32	1	.751	32	5-748-258
3	7/64	1	.751	32	5-748-260
3	1/8	1	.751	32	5-748-264
3	9/64	1	.751	32	5-748-266
3	9/64	1-1/4	.633	32	5-748-268
3	5/32	1	.751	32	5-748-270
3	11/64	1	.751	32	5-748-272
3	3/16	1	.751	32	5-748-276
3	3/16	1-1/4	.633	32	5-748-278
3	7/32	1	.751	32	5-748-280
3	1/4	1	.751	32	5-748-284
3	1/4	1-1/4	.633	32	5-748-286
4	1/16	1	.976	36	5-748-290
4	1/16	1-1/4	.976	36	5-748-292
4	5/64	1	.976	36	5-748-294
4	3/32	1	.976	36	5-748-298
4	3/32	1-1/4	.976	36	5-748-300
4	7/64	1	.976	36	5-748-302
4	1/8	1	.976	36	5-748-306
4	1/8	1-1/4	.976	36	5-748-308
4	9/64	1	.976	36	5-748-310
4	9/64	1-1/4	.976	36	5-748-312
4	5/32	1	.976	36	5-748-314
4	5/32	1-1/4	.976	36	5-748-316
4	11/64	1	1.212	36	5-748-318

Dia	Thickness	Hole Size	Depth of Cut	Number of Teeth	Part Number
4	3/16	1	1.212	36	5-748-322
4	3/16	1-1/4	1.015	36	5-748-324
4	7/32	1	1.212	36	5-748-326
4	7/32	1-1/4	1.015	36	5-748-328
4	1/4	1	1.212	36	5-748-330
4	1/4	1-1/4	1.015	36	5-748-332
5	1/16	1	1.318	40	5-748-340
5	1/16	1-1/4	1.318	40	5-748-342
5	3/32	1	1.318	40	5-748-344
5	3/32	1-1/4	1.318	40	5-748-346
5	7/64	1	1.318	40	5-748-348
5	1/8	1	1.318	40	5-748-352
5	1/8	1-1/4	1.318	40	5-748-354
5	9/64	1	1.318	40	5-748-356
5	9/64	1-1/4	1.318	40	5-748-358
5	5/32	1	1.318	40	5-748-360
5	5/32	1-1/4	1.318	40	5-748-362
5	11/64	1	1.318	40	5-748-364
5	3/16	1	1.673	40	5-748-368
5	3/16	1-1/4	1.318	40	5-748-380
5	7/32	1	1.673	40	5-748-382
5	7/32	1-1/4	1.318	40	5-748-384
5	1/4	1	1.673	40	5-748-386
5	1/4	1-1/4	1.318	40	5-748-388
6	1/16	1	1.818	42	5-748-400
6	1/16	1-1/4	-	42	5-748-402
6	3/32	1	1.818	42	5-748-404
6	3/32	1-1/4	1.720	42	5-748-406
6	7/64	1	1.818	42	5-748-408
6	1/8	1	1.818	42	5-748-412
6	1/8	1-1/4	1.720	42	5-748-414
6	9/64	1	1.818	42	5-748-416
6	5/32	1	1.818	42	5-748-420
6	5/32	1-1/4	1.720	42	5-748-422
6	3/16	1	2.173	42	5-748-428
6	3/16	1-1/4	1.976	42	5-748-430
6	1/4	1	2.173	42	5-748-432
8	1/8	1-1/4	2.622	42	5-748-450
8	3/16	1-1/4	2.976	42	5-748-452

Metal Slitting Saws

Staggered Teeth with Side Chip Clearance

- High Speed Steel



Dia	Thickness	Hole Size	Depth of Cut	Number of Teeth	Part Number
3	1/16	1	.751	32	5-749-252
3	1/16	1-1/4	.633	32	5-749-253
3	5/64	1	.751	32	5-749-254
3	5/64	1-1/4	.633	32	5-749-256
3	3/32	1	.751	32	5-749-258
3	3/32	1-1/4	.633	32	5-749-259
3	7/64	1	.751	32	5-749-260
3	1/8	1	.751	32	5-749-264
3	9/64	1	.751	32	5-749-266
3	9/64	1-1/4	.633	32	5-749-268
3	5/32	1	.751	32	5-749-270
3	5/32	1-1/4	.633	32	5-749-271
3	11/64	1	.751	32	5-749-272
3	3/16	1	.751	32	5-749-276
3	3/16	1-1/4	.633	32	5-749-278
3	7/32	1	.751	32	5-749-280
3	1/4	1	.751	32	5-749-284
4	1/16	1	.976	34	5-749-290
4	1/16	1-1/4	.976	34	5-749-292
4	5/64	1	.976	34	5-749-294
4	5/64	1-1/4	.976	34	5-749-296
4	3/32	1	.976	34	5-749-298
4	3/32	1-1/4	.976	34	5-749-300
4	7/64	1	.976	34	5-749-302
4	1/8	1	.976	34	5-749-306
4	1/8	1-1/4	.976	34	5-749-308
4	9/64	1	.976	34	5-749-310
4	9/64	1-1/4	.976	34	5-749-312
4	5/32	1	.976	34	5-749-314
4	5/32	1-1/4	.976	34	5-749-316

Dia	Thickness	Hole Size	Depth of Cut	Number of Teeth	Part Number
4	11/64	1	.976	34	5-749-318
4	3/16	1	1.212	34	5-749-322
4	3/16	1-1/4	1.015	34	5-749-324
4	7/32	1	1.212	34	5-749-326
4	1/4	1	1.212	34	5-749-330
4	1/4	1-1/4	1.015	34	5-749-332
5	3/32	1	1.318	38	5-749-344
5	1/8	1	1.318	38	5-749-352
5	1/8	1-1/4	1.318	38	5-749-354
5	5/32	1	1.318	38	5-749-360
5	3/16	1	1.712	38	5-749-368
5	3/16	1-1/4	1.476	38	5-749-370
5	1/4	1	1.712	38	5-749-386
5	1/4	1-1/4	1.476	38	5-749-388
6	1/8	1	1.818	42	5-749-412
6	1/8	1-1/4	1.720	42	5-749-414
6	5/32	1	1.818	42	5-749-420
6	5/32	1-1/4	1.818	42	5-749-422
6	11/64	1	2.173	42	5-749-424
6	3/16	1	2.173	42	5-749-428
6	3/16	1-1/4	1.976	42	5-749-430
6	1/4	1	2.173	42	5-749-432
6	1/4	1-1/4	1.976	42	5-749-434
7	1/8	1	2.318	46	5-749-436
7	3/16	1-1/4	2.476	46	5-749-439
8	3/16	1	3.173	50	5-749-451
8	3/16	1-1/4	2.976	50	5-749-452
8	1/4	1-1/4	2.976	50	5-749-454
10	3/16	1-1/4	3.976	50	5-749-468
10	1/4	1-1/4	3.976	50	5-749-472



Side Milling Cutters

Cutting Tools

Side Milling Cutters

Plain Teeth

- High Speed Steel



MILLING CUTTERS / SAWS

Dia	Hole Size	Number of Teeth	Width of Face	Depth of Cut	Part Number
2	1/2	14	3/16	.527	5-706-005
2	1/2	14	1/4	.527	5-706-010
2	1/2	14	3/8	.527	5-706-015
2	5/8	14	3/16	.488	5-706-020
2	5/8	14	1/4	.488	5-706-025
2	5/8	14	5/16	.488	5-706-028
2	5/8	14	3/8	.488	5-706-030
2	7/8	14	1/4	.370	5-706-031
2	7/8	14	5/16	.370	5-706-032
2	7/8	14	3/8	.370	5-706-033
2	7/8	14	7/16	.370	5-706-034
2-1/2	7/8	16	3/16	.581	5-706-035
2-1/2	7/8	16	1/4	.581	5-706-040
2-1/2	7/8	16	5/16	.581	5-706-045
2-1/2	7/8	16	3/8	.581	5-706-050
2-1/2	7/8	16	7/16	.581	5-706-055
2-1/2	7/8	16	1/2	.581	5-706-060
2-1/2	1	16	3/16	.502	5-706-064
2-1/2	1	16	1/4	.502	5-706-065
2-1/2	1	16	5/16	.502	5-706-070
2-1/2	1	16	3/8	.502	5-706-075
2-1/2	1	16	7/16	.502	5-706-077
2-1/2	1	16	1/2	.502	5-706-080
2-1/2	1	16	5/8	.502	5-706-085
3	1	18	3/16	.712	5-706-090
3	1	18	7/32	.712	5-706-095
3	1	18	1/4	.712	5-706-100
3	1	18	9/32	.712	5-706-105
3	1	18	5/16	.712	5-706-110
3	1	18	11/32	.712	5-706-115
3	1	18	3/8	.712	5-706-120
3	1	18	13/32	.712	5-706-121
3	1	18	7/16	.712	5-706-125
3	1	18	1/2	.712	5-706-130
3	1	18	9/16	.712	5-706-135
3	1	18	5/8	.712	5-706-140
3	1	18	11/16	.712	5-706-145
3	1	18	3/4	.712	5-706-150
3	1	18	13/16	.712	5-706-155
3	1	18	7/8	.712	5-706-160
3	1	18	1	.712	5-706-170
3	1-1/4	18	3/16	.633	5-706-173
3	1-1/4	18	1/4	.633	5-706-175
3	1-1/4	18	5/16	.633	5-706-180
3	1-1/4	18	3/8	.633	5-706-185

Dia	Hole Size	Number of Teeth	Width of Face	Depth of Cut	Part Number
3	1-1/4	18	1/2	.633	5-706-195
3	1-1/4	18	3/4	.633	5-706-205
3-1/2	1	20	3/16	.962	5-706-211
3-1/2	1	20	1/4	.962	5-706-212
3-1/2	1	20	5/16	.962	5-706-215
3-1/2	1	20	3/8	.962	5-706-220
3-1/2	1	20	1/2	.962	5-706-226
3-1/2	1	20	5/8	.962	5-706-228
3-1/2	1-1/4	20	1/2	.805	5-706-227
4	1	22	3/16	1.212	5-706-229
4	1	22	7/32	1.212	5-706-230
4	1	22	1/4	1.212	5-706-235
4	1	22	9/32	1.212	5-706-240
4	1	22	5/16	1.212	5-706-245
4	1	22	11/32	1.212	5-706-250
4	1	22	3/8	1.212	5-706-255
4	1	22	7/16	1.212	5-706-260
4	1	22	13/32	1.212	5-706-265
4	1	22	1/2	1.212	5-706-270
4	1	22	9/16	1.212	5-706-275
4	1	22	5/8	1.212	5-706-280
4	1	22	11/16	1.212	5-706-285
4	1	22	3/4	1.212	5-706-290
4	1	22	13/16	1.212	5-706-295
4	1	22	7/8	1.212	5-706-300
4	1	22	1	1.212	5-706-310
4	1	22	1-1/8	1.212	5-706-311
4	1-1/4	22	3/16	1.074	5-706-314
4	1-1/4	22	7/32	1.074	5-706-315
4	1-1/4	22	1/4	1.074	5-706-320
4	1-1/4	22	5/16	1.074	5-706-330
4	1-1/4	22	11/32	1.074	5-706-335
4	1-1/4	22	3/8	1.074	5-706-340
4	1-1/4	22	7/16	1.074	5-706-345
4	1-1/4	22	1/2	1.074	5-706-355
4	1-1/4	22	9/16	1.074	5-706-360
4	1-1/4	22	5/8	1.074	5-706-365
4	1-1/4	22	11/16	1.074	5-706-370
4	1-1/4	22	3/4	1.074	5-706-375
4	1-1/4	22	7/8	1.074	5-706-385
4	1-1/4	22	1	1.074	5-706-395
4	1-1/4	22	1-1/8	1.074	5-706-400
4-1/2	1-1/4	24	3/8	1.305	5-706-408
4-1/2	1-1/4	24	1/2	1.305	5-706-410
5	1	24	1/4	1.712	5-706-415



Side Milling Cutters

Plain Teeth (continued)

- High Speed Steel



Dia	Hole Size	Number of Teeth	Width of Face	Depth of Cut	Part Number
5	1	24	9/32	1.712	5-706-420
5	1	24	5/16	1.712	5-706-425
5	1	24	3/8	1.712	5-706-435
5	1	24	13/32	1.712	5-706-440
5	1	24	7/16	1.712	5-706-445
5	1	24	1/2	1.712	5-706-450
5	1	24	5/8	1.712	5-706-460
5	1	24	11/16	1.712	5-706-465
5	1	24	3/4	1.712	5-706-470
5	1-1/4	24	1/4	1.555	5-706-495
5	1-1/4	24	9/32	1.555	5-706-497
5	1-1/4	24	5/16	1.555	5-706-500
5	1-1/4	24	3/8	1.555	5-706-510
5	1-1/4	24	7/16	1.555	5-706-520
5	1-1/4	24	1/2	1.555	5-706-525
5	1-1/4	24	9/16	1.555	5-706-530
5	1-1/4	24	5/8	1.555	5-706-535
5	1-1/4	24	3/4	1.555	5-706-545
5	1-1/4	24	1	1.555	5-706-565
6	1	26	1/4	2.192	5-706-570
6	1	26	5/16	2.192	5-706-575
6	1	26	3/8	2.192	5-706-580
6	1	26	7/16	2.192	5-706-585
6	1	26	1/2	2.192	5-706-590
6	1	26	9/16	2.192	5-706-595
6	1	26	11/16	2.192	5-706-605
6	1	26	3/4	2.192	5-706-610
6	1	26	15/16	2.192	5-706-625
6	1-1/4	26	1/4	2.055	5-706-635

Dia	Hole Size	Number of Teeth	Width of Face	Depth of Cut	Part Number
6	1-1/4	26	9/32	2.055	5-706-640
6	1-1/4	26	5/16	2.055	5-706-645
6	1-1/4	26	11/32	2.055	5-706-650
6	1-1/4	26	3/8	2.055	5-706-655
6	1-1/4	26	7/16	2.055	5-706-665
6	1-1/4	26	1/2	2.055	5-706-670
6	1-1/4	26	9/16	2.055	5-706-675
6	1-1/4	26	5/8	2.055	5-706-680
6	1-1/4	26	3/4	2.055	5-706-690
6	1-1/4	26	1	2.055	5-706-710
7	1-1/4	28	1/4	2.555	5-706-721
7	1-1/4	28	5/16	2.555	5-706-722
7	1-1/4	28	3/8	2.555	5-706-723
7	1-1/4	28	1/2	2.555	5-706-725
7	1-1/4	28	5/8	2.555	5-706-730
7	1-1/4	28	3/4	2.555	5-706-735
7	1-1/4	28	1	2.555	5-706-740
8	1	32	1/4	3.212	5-706-745
8	1	32	5/16	3.212	5-706-750
8	1	32	3/8	3.212	5-706-755
8	1	32	1/2	3.212	5-706-765
8	1-1/4	32	1/4	3.055	5-706-770
8	1-1/4	32	3/8	3.055	5-706-780
8	1-1/4	32	1/2	3.055	5-706-790
8	1-1/4	32	5/8	3.055	5-706-800
8	1-1/4	32	3/4	3.055	5-706-810
8	1-1/4	32	1	3.055	5-706-830
9	1-1/4	34	1/4	3.555	5-706-836
9	1-1/4	34	3/4	3.555	5-706-840

MILLING CUTTERS / SAWS



Side Milling Cutters

Cutting Tools

Side Milling Cutters

Staggered Teeth

- High Speed Steel



MILLING CUTTERS / SAWS

Dia	Hole Size	Number of Teeth	Width of Face	Depth of Cut	Part Number
2-1/2	7/8	16	3/16	.620	5-709-005
2-1/2	7/8	16	1/4	.620	5-709-010
2-1/2	7/8	16	5/16	.620	5-709-015
2-1/2	7/8	16	3/8	.620	5-709-020
2-1/2	7/8	16	1/2	.620	5-709-030
2-1/2	1	16	1/4	.502	5-709-032
2-1/2	1	16	7/16	.502	5-709-035
2-1/2	1	16	1/2	.502	5-709-036
3	1	16	5/32	.751	5-709-039
3	1	16	3/16	.751	5-709-040
3	1	16	7/32	.751	5-709-045
3	1	16	1/4	.751	5-709-050
3	1	16	9/32	.751	5-709-055
3	1	16	5/16	.751	5-709-060
3	1	16	3/8	.751	5-709-065
3	1	16	7/16	.751	5-709-070
3	1	16	1/2	.751	5-709-075
3	1	16	9/16	.751	5-709-080
3	1	16	5/8	.751	5-709-085
3	1	16	3/4	.751	5-709-095
3	1	16	1	.751	5-709-115
3	1-1/4	16	3/16	.633	5-709-120
3	1-1/4	16	1/4	.633	5-709-125
3	1-1/4	16	3/8	.633	5-709-135
3	1-1/4	16	1/2	.633	5-709-145
3	1-1/4	16	5/8	.633	5-709-155
3	1-1/4	16	3/4	.633	5-709-165
3	1-1/4	16	13/16	.633	5-709-170
3	1-1/4	16	1	.633	5-709-185
3-1/2	1	18	1/4	.962	5-709-190
3-1/2	1	18	5/16	.962	5-709-192
3-1/2	1	18	3/8	.962	5-709-195
3-1/2	1	18	1/2	.962	5-709-200
3-1/2	1	18	5/8	.962	5-709-201
4	1	18	3/16	1.212	5-709-205
4	1	18	7/32	1.212	5-709-210
4	1	18	1/4	1.212	5-709-215
4	1	18	9/32	1.212	5-709-220
4	1	18	5/16	1.212	5-709-225
4	1	18	11/32	1.212	5-709-230

Dia	Hole Size	Number of Teeth	Width of Face	Depth of Cut	Part Number
4	1	18	3/8	1.212	5-709-235
4	1	18	7/16	1.212	5-709-240
4	1	18	1/2	1.212	5-709-245
4	1	18	9/16	1.212	5-709-250
4	1	18	5/8	1.212	5-709-255
4	1	18	3/4	1.212	5-709-265
4	1	18	13/16	1.212	5-709-270
4	1	18	1	1.212	5-709-285
4	1-1/4	18	3/16	1.074	5-709-290
4	1-1/4	18	7/32	1.074	5-709-295
4	1-1/4	18	1/4	1.074	5-709-300
4	1-1/4	18	9/32	1.074	5-709-305
4	1-1/4	18	5/16	1.074	5-709-310
4	1-1/4	18	3/8	1.074	5-709-320
4	1-1/4	18	13/32	1.074	5-709-321
4	1-1/4	18	7/16	1.074	5-709-325
4	1-1/4	18	1/2	1.074	5-709-330
4	1-1/4	18	9/16	1.074	5-709-335
4	1-1/4	18	5/8	1.074	5-709-340
4	1-1/4	18	3/4	1.074	5-709-350
4	1-1/4	18	1	1.074	5-709-370
4-1/2	1	20	1/2	1.462	5-709-390
4-1/2	1-1/4	20	1/2	1.305	5-709-395
5	1	22	3/16	1.712	5-709-398
5	1	22	1/4	1.712	5-709-400
5	1	22	5/16	1.712	5-709-405
5	1	22	3/8	1.712	5-709-410
5	1	22	7/16	1.712	5-709-415
5	1	22	1/2	1.712	5-709-420
5	1	22	5/8	1.712	5-709-430
5	1	22	3/4	1.712	5-709-440
5	1	22	7/8	1.712	5-709-450
5	1-1/4	22	1/4	1.555	5-709-460
5	1-1/4	22	5/16	1.555	5-709-465
5	1-1/4	22	3/8	1.555	5-709-470
5	1-1/4	22	7/16	1.555	5-709-475
5	1-1/4	22	1/2	1.555	5-709-480
5	1-1/4	22	5/8	1.555	5-709-490
5	1-1/4	22	3/4	1.555	5-709-500

Side Milling Cutters

Staggered Teeth (continued)

- High Speed Steel



Dia	Hole Size	Number of Teeth	Width of Face	Depth of Cut	Part Number
5	1-1/4	22	1	1.555	5-709-520
6	1	24	1/4	2.192	5-709-525
6	1	24	5/16	2.192	5-709-530
6	1	24	3/8	2.192	5-709-535
6	1	24	7/16	2.192	5-709-540
6	1	24	1/2	2.192	5-709-545
6	1	24	3/4	2.192	5-709-565
6	1	24	7/8	2.192	5-709-575
6	1-1/4	24	1/4	2.055	5-709-585
6	1-1/4	24	9/32	2.055	5-709-586
6	1-1/4	24	5/16	2.055	5-709-590
6	1-1/4	24	3/8	2.055	5-709-595
6	1-1/4	24	7/16	2.055	5-709-600
6	1-1/4	24	1/2	2.055	5-709-605
6	1-1/4	24	9/16	2.055	5-709-610
6	1-1/4	24	5/8	2.055	5-709-615
6	1-1/4	24	3/4	2.055	5-709-625
6	1-1/4	24	7/8	2.055	5-709-635
6	1-1/4	24	1	2.055	5-709-645
6	1-1/4	24	1-1/4	2.055	5-709-660
7	1-1/4	26	1/4	2.255	5-709-675
7	1-1/4	26	5/16	2.255	5-709-680
8	1	28	1/4	3.212	5-709-772
8	1-1/4	28	1/4	3.055	5-709-775
8	1-1/4	28	5/16	3.055	5-709-780
8	1-1/4	28	3/8	3.055	5-709-785
8	1-1/4	28	1/2	3.055	5-709-795
8	1-1/2	28	3/8	2.858	5-709-850



Power Hacksaw Blades

Cutting Tools

Power Hacksaw Blades

- High Speed Steel
- Designed for production applications
- Fully heat treated to resist wear and provide efficient cutting



Tolerances		
	Blade Dimension	Tolerance inches
Width	single-edge blades 1 inch zzzz	+3/32, -0
	single-edge blades over 1 inch	+1/8, -0
Thickness	.050	±0.005
	.062	±0.006
	.079	±0.007
	.088 and .100	±0.008
Overall Length	–	±5/64
Pinholes	Center to center	±5/64
	Diameter .281	+0.014/-0
	.391	+0.017/-0

MILLING CUTTERS / SAWS

Nominal Length	Teeth/Inch	Width	Thickness	OAL	C to C of Pinholes	Pinhole Dia	Part Number
inches		inches					
12	10	1	.050	12-3/4	17-7/8	.281	5-676-123
	14	1	.050	12-3/4			5-676-124
14	10	1	.050	14-3/8	13-1/2	.281	5-676-141
	14	1	.050	14-3/8			5-676-142
	6	1-1/4	.062	14-1/2			5-676-143
14	10	1-1/4	.062	14-1/2	13-1/2	.281	5-676-144
	6	1-1/2	.079	14-1/2			5-676-146
17	10	1	.050	17-3/8	16-1/2	.281	5-676-171
	14	1	.050	17-3/8			5-676-172
	6	1-1/4	.062	17-1/2			5-676-174
	10	1-1/4	.062	17-1/2			5-676-175
18	6	1-1/4	.062	18-1/2	17-1/2	.281	5-676-181
	10	1-1/4	.062	18-1/2			5-676-182
	6	1-1/2	.079	18-1/2			5-676-184
	4	1-3/4	.088	18-3/4			5-676-185
	6	1-3/4	.088	18-3/4			5-676-186
21	6	1-3/4	.088	22-1/4	21	.281	5-676-212
24	6	1-3/4	.088	25-1/4	24	.391	5-676-242
	4	2	.100	25-1/4			5-676-244

TABLE OF CONTENTS

TAPS

Technical Reference	388
Hand Taps	390
Tap and Reamer Wrenches	395
Spiral Point Taps	398
Spiral Flute Taps	400
Combined Tap and Drills	401
Tap and Drill Sets	402
Pipe Taps	403





Regular Hand Tap Dimensions

Fractional Sizes – Regular Length – ANSI Table 302

- American Standard
- Ground Thread
- High Speed Steel

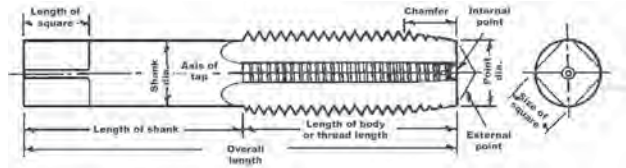

TAPS

Dia of Tap	Threads per Inch				Overall Length, A	Length of Full Thread, B	Length of Square, C	Dia of Shank, D	Size of Square
	NC	NF	N8	N10					
1/4	20	28	–	–	2-1/2	1	5/16	.255	.191
5/16	18	24	–	–	2-23/32	1-1/8	3/8	.318	.238
3/8	16	24	–	–	2-15/16	1-1/4	7/16	.381	.286
7/16	14	20	–	–	3-5/32	1-7/16	13/32	.323	.242
1/2	13	20	–	–	3-3/8	1-21/32	7/16	.367	.275
9/16	12	18	–	–	3-19/32	1-21/32	1/2	.429	.322
5/8	11	18	–	–	3-13/16	1-13/16	9/16	.480	.360
3/4	10	16	–	–	4-1/4	2	11/16	.590	.442
7/8	9	14	–	–	4-11/16	2-7/32	3/4	.697	.523
1	8	12	–	10	5-1/8	2-1/2	13/16	.800	.600
1-1/16	–	12	8	10	5-1/8	2-1/2	7/8	.896	.672
1-1/8	7	12	8	10	5-7/16	2-9/16	7/8	.896	.672
1-3/16	–	12	8	10	5-7/16	2-9/16	1	1.021	.766
1-1/4	7	12	8	10	5-3/4	2-9/16	1	1.021	.766
1-5/16	–	12	8	10	5-3/4	2-9/16	1-1/16	1.108	.831
1-3/8	6	12	8	10	6-1/16	3	1-1/16	1.108	.831
1-7/16	–	12	8	10	6-1/16	3	1-1/8	1.233	.925
1-1/2	6	12	8	10	6-3/8	3	1-1/8	1.233	.925
1-5/8	–	–	8	10	6-11/16	3-3/16	1-1/8	1.305	.979
1-3/4	5	5-1/2	8	10	7	3-3/16	1-1/4	1.430	1.072
1-7/8	–	–	8	10	7-5/16	3-9/16	1-1/4	1.519	1.139
2	4	4-1/2	8	10	7-5/8	3-9/16	1-3/8	1.644	1.233
2-1/8	–	–	8	–	8	3-9/16	1-3/8	1.769	1.327
2-1/4	4	4-1/2	8	–	8-1/4	3-9/16	1-7/16	1.894	1.420
2-3/8	–	–	8	–	8-1/2	4	1-7/16	2.019	1.514
2-1/2	4	–	8	–	8-3/4	4	1-1/2	2.100	1.575
2-3/4	4	–	8	–	9-1/4	4	1-9/16	2.350	1.762
3	4	–	8	–	9-3/4	4-9/16	1-5/8	2.543	1.907
3-1/4	4	–	8	–	10	4-9/16	1-3/4	2.793	2.095
3-1/2	4	–	8	–	10-1/4	4-15/16	2	3.008	2.256
3-3/4	4	–	8	–	10-1/2	5-5/16	2-1/8	3.217	2.413
4	4	–	8	–	10-3/4	5-5/16	2-1/4	3.467	2.600

Regular Hand Tap Dimensions

Fractional Sizes – Short Length

- American Standard
- Ground Thread
- High Speed Steel

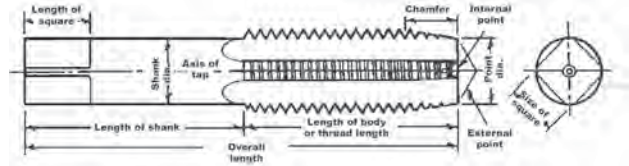

Dia of Tap	Threads per Inch N12	Overall Length, A	Length of Full Thread, B	Length of Square, C	Dia of Shank, D	Size of Square
1-5/8	12	5	2	1-1/8	1.305	.979
1-3/4	12	5	2	1-1/4	1.430	1.072
1-7/8	12	5	2	1-1/4	1.519	1.139
2	12	5	2	1-3/8	1.644	1.233
2-1/8	12	5-1/4	2	1-3/8	1.769	1.327
2-1/4	12	5-1/4	2	1-7/16	1.894	1.420
2-3/8	12	5-1/4	2	1-7/16	2.019	1.514
2-1/2	12	5-1/4	2	1-1/2	2.100	1.575
2-5/8	12	5-1/2	2	1-1/2	2.100	1.575
2-3/4	12	5-1/2	2	1-1/2	2.100	1.575
2-7/8	12	5-1/2	2	1-1/2	2.100	1.575
3	12	5-1/2	2	1-1/2	2.100	1.575
3-1/8	12	5-1/2	2	1-1/2	2.100	1.575
3-1/4	12	5-1/2	2	1-1/2	2.100	1.575
3-3/8	12	5-1/2	2	1-1/2	2.100	1.575
3-1/2	12	5-3/4	2	1-1/2	2.100	1.575
3-5/8	12	6	2	1-3/4	2.100	1.575
3-3/4	12	6	2	1-3/4	2.100	1.575
3-7/8	12	6	2	1-3/4	2.100	1.575
4	12	6	2	1-3/4	2.100	1.575

TAPS

Regular Hand Tap Dimensions

Machine Screw Sizes – ANSI Table 304

- Ground Thread
- Right Hand
- High Speed Steel M2

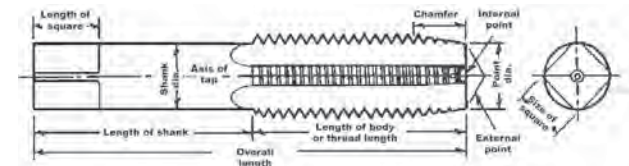

Tap Sizes	Basic Major Dia	Threads per inch		Number of Flutes	Overall Length A	Length of Thread B	Length of Square C	Diameter of Shank D	Size of Square
		NC UNC	NF UNF						
0	0.060		80	2	1-5/8	5/16	3/16	0.141	0.110
1	0.073	64	72	2	1-11/16	3/8	3/16	0.141	0.110
2	0.086	56	64	3	1-3/4	7/16	3/16	0.141	0.110
3	0.099	48	56	3	1-13/16	1/2	3/16	0.141	0.110
4	0.112	40	48	3	1-7/8	9/16	3/16	0.141	0.110
5	0.125	40	44	3	1-15/16	5/8	3/16	0.141	0.110
6	0.138	32	40	3	2	11/16	3/16	0.141	0.110
8	0.164	32	36	4	2-1/8	3/4	1/4	0.168	0.131
10	0.190	24	32	4	2-3/8	7/8	1/4	0.194	0.152
12	0.216	24	28	4	2-3/8	15/16	9/32	0.220	0.165



Hand Taps

Cutting Tools

Regular Thread Hand Taps

- Right Hand
- Fractional Sizes
- High Speed Steel – M2
- 1/4" thru 1-1/2" have 4 Flutes
- 1-5/8" and larger have 6 Flutes

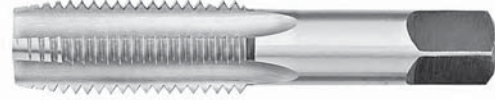

TAPS

Tap Sizes	Threads per Inch	H Limit	OAL	Taper Part Number	Plug Part Number	Bottoming Part Number	TPB-Set Part Number
1/4	20	H2	2-1/2	5-750-0023	–	–	–
1/4	20	H3	2-1/2	5-750-0026	5-750-0027	5-750-0028	5-750-0029
1/4	28	H2	2-1/2	5-750-0038	5-750-0039	–	–
1/4	28	H3	2-1/2	5-750-0042	5-750-0043	5-750-0044	5-750-0045
5/16	18	H2	2-23/32	–	–	–	5-750-0060
5/16	18	H3	2-23/32	5-750-0064	5-750-0065	5-750-0066	5-750-0067
5/16	24	H3	2-23/32	5-750-0080	5-750-0081	5-750-0082	5-750-0083
3/8	16	H3	2-15/16	5-750-0099	5-750-0100	5-750-0101	5-750-0102
3/8	16	H5	2-15/16	–	5-750-0107	–	–
3/8	24	H3	2-15/16	5-750-0121	5-750-0122	5-750-0123	5-750-0124
7/16	14	H3	3-5/32	5-750-0140	5-750-0141	5-750-0142	5-750-0143
7/16	20	H3	3-5/32	5-750-0156	5-750-0157	5-750-0158	5-750-0159
1/2	13	H1	3-3/8	–	–	5-750-0177	–
1/2	13	H3	3-3/8	5-750-0181	5-750-0182	5-750-0183	5-750-0184
1/2	20	H3	3-3/8	5-750-0203	5-750-0204	5-750-0205	5-750-0206
9/16	12	H3	3-19/32	5-750-0222	5-750-0223	5-750-0224	5-750-0225
9/16	18	H3	3-19/32	5-750-0238	5-750-0239	5-750-0240	5-750-0241
5/8	11	H3	3-13/16	5-750-0263	5-750-0264	5-750-0265	5-750-0266
5/8	18	H3	3-13/16	5-750-0292	5-750-0293	5-750-0294	5-750-0295
11/16	11	H3	4-1/32	–	5-750-0340	–	5-750-0342
11/16	16	H3	4-1/32	5-750-0358	5-750-0359	5-750-0360	5-750-0361
3/4	10	H3	4-1/4	5-750-0383	5-750-0384	5-750-0385	5-750-0386
3/4	16	H3	4-1/4	5-750-0405	5-750-0406	5-750-0407	5-750-0408
7/8	9	H2	4-11/16	–	5-750-0425	5-750-0426	–
7/8	9	H4	4-11/16	5-750-0431	5-750-0432	5-750-0433	5-750-0434
7/8	12	H4	4-11/16	–	5-750-0449	5-750-0450	5-750-0451
7/8	14	H4	4-11/16	5-750-0471	5-750-0472	5-750-0473	5-750-0474
1	8	H4	5-1/8	5-750-0499	5-750-0500	5-750-0501	5-750-0502
1	12	H4	5-1/8	5-750-0539	5-750-0540	5-750-0541	5-750-0542
1	14	H4	5-1/8	5-750-0561	5-750-0562	5-750-0563	5-750-0564
1-1/16	12	H4	5-1/8	5-750-0618	5-750-0619	5-750-0620	–
1-1/8	7	H4	5-7/16	5-750-0642	5-750-0643	5-750-0644	5-750-0645
1-1/8	8	H4	5-7/16	5-750-0660	5-750-0661	5-750-0662	–
1-1/8	10	H5	5-7/16	–	5-750-0685	–	–
1-1/8	12	H3	5-7/16	–	–	5-750-0698	–
1-1/8	12	H4	5-7/16	5-750-0699	5-750-0700	5-750-0701	5-750-0702
1-3/16	8	H4	5-7/16	–	5-750-0724	–	–
1-3/16	12	H4	5-7/16	–	5-750-0754	5-750-0755	–
1-1/4	7	H4	5-3/4	5-750-0811	5-750-0812	5-750-0813	5-750-0814
1-1/4	7	H3	5-3/4	–	5-750-0808	–	–
1-1/4	8	H4	5-3/4	5-750-0832	5-750-0833	5-750-0834	–
1-1/4	10	H4	5-3/4	–	–	5-750-0861	–
1-1/4	12	H3	5-3/4	5-750-0874	–	5-750-0876	–
1-1/4	12	H4	5-3/4	5-750-0877	5-750-0878	5-750-0879	5-750-0880



Regular Thread Hand Taps (continued)

- Regular Thread
- Right Hand
- Fractional Sizes
- High Speed Steel – M2
- 1/4" thru 1-1/2" have 4 Flutes
- 1-5/8" and larger have 6 Flutes

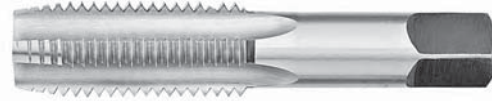

Tap Sizes	Threads per Inch	H Limit	OAL	Taper Part Number	Plug Part Number	Bottoming Part Number	TPB-Set Part Number
1-5/16	8	H4	5-3/4	–	5-750-0902	–	–
1-5/16	12	H4	5-3/4	5-750-0919	5-750-0920	5-750-0921	–
1-3/8	6	H4	6-1/16	5-750-0943	5-750-0944	5-750-0945	5-750-0946
1-3/8	8	H4	6-1/16	5-750-0961	5-750-0962	5-750-0963	–
1-3/8	12	H4	6-1/16	5-750-1000	5-750-1001	5-750-1002	–
1-1/2	6	H4	6-3/8	5-750-1024	5-750-1025	5-750-1026	5-750-1027
1-1/2	8	H4	6-3/8	5-750-1045	5-750-1046	5-750-1047	–
1-1/2	12	H4	6-3/8	5-750-1084	5-750-1085	5-750-1086	–
1-5/8	5-1/2	H4	6-11/16	–	5-750-1109	–	–
1-5/8	8	H4	6-11/16	5-750-1129	5-750-1130	5-750-1131	–
1-5/8	12	H4	5	5-750-1168	5-750-1169	5-750-1170	–
1-3/4	5	H6	7	5-750-1204	5-750-1205	5-750-1206	–
1-3/4	8	H6	7	5-750-1222	5-750-1223	5-750-1224	–
1-3/4	10	H5	7	–	5-750-1238	–	–
1-3/4	12	H6	5	5-750-1261	5-750-1262	5-750-1263	–
1-7/8	8	H6	7-5/16	5-750-1291	5-750-1292	5-750-1293	–
1-7/8	12	H6	5	5-750-1330	5-750-1331	5-750-1332	–
2	4-1/2	H6	7-5/8	5-750-1360	5-750-1361	5-750-1362	–
2	8	H6	7-5/8	5-750-1390	5-750-1391	5-750-1392	–
2	10	H5	7-5/8	–	5-750-1406	–	–
2	12	H6	5	5-750-1429	5-750-1430	5-750-1431	–
2-1/8	8	H6	8	–	5-750-1457	5-750-1458	–
2-1/8	12	H5	5-1/4	–	–	5-750-1479	–
2-1/8	12	H6	5-1/4	–	–	5-750-1481	–
2-1/4	4-1/2	H6	8-1/4	5-750-1504	5-750-1505	5-750-1506	–
2-1/4	8	H5	8-1/4	–	5-750-1520	5-750-1521	–
2-1/4	8	H6	8-1/4	5-750-1522	5-750-1523	5-750-1524	–
2-1/4	12	H6	5-1/4	5-750-1546	5-750-1547	5-750-1548	–
2-1/2	4	H6	8-3/4	5-750-1570	5-750-1571	5-750-1572	–
2-1/2	8	H6	8-3/4	5-750-1588	5-750-1589	5-750-1590	–
2-1/2	12	H6	5-1/4	5-750-1612	5-750-1613	5-750-1614	–
2-3/4	8	H6	9-1/4	5-750-1660	5-750-1661	–	–
2-3/4	8	H8	5-1/2	–	–	5-750-1668	–
2-3/4	12	H6	5-1/2	–	5-750-1688	5-750-1689	–
3	8	H8	9-3/4	5-750-1756	5-750-1757	5-750-1758	–
3	12	H6	5-1/2	–	5-750-1779	–	–
3-1/2	8	H8	10-1/2	–	5-750-1842	5-750-1843	–
3-1/2	12	H8	5-1/2	–	5-750-1869	5-750-1870	–
4	8	H10	10-3/4	5-750-1922	5-750-1923	5-750-1924	–
4	12	H8	10-3/4	–	5-750-1944	–	–



Hand Taps

Cutting Tools

Special Thread Hand Taps

- Ground Thread
- Right Hand
- High Speed Steel – M2

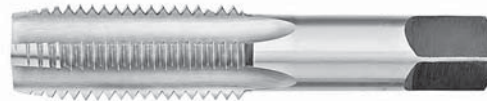

TAPS

Tap Sizes	Threads per Inch	H Limit	Taper Part Number	Plug Part Number	Bottoming Part Number
5/32	32	H3	5-750-5109	5-750-5110	5-750-5111
5/32	40	H3	–	5-750-5128	–
7/32	32	H3	5-750-5163	5-750-5164	5-750-5165
7/32	40	H3	–	5-750-5173	–
1/4	24	H3	5-750-5208	5-750-5209	5-750-5210
1/4	26	H3	–	5-750-5220	–
1/4	32	H3	5-750-5244	5-750-5245	5-750-5246
1/4	36	H3	–	5-750-5254	5-750-5255
1/4	40	H3	–	5-750-5263	5-750-5264
9/32	32	H3	5-750-5352	5-750-5353	5-750-5354
9/32	40	H3	5-750-5361	5-750-5362	–
5/16	20	H3	–	5-750-5389	5-750-5390
5/16	22	H3	–	5-750-5398	–
5/16	26	H3	–	5-750-5420	–
5/16	28	H3	–	5-750-5432	–
5/16	32	H3	5-750-5442	5-750-5443	5-750-5444
5/16	36	H3	–	5-750-5452	–
5/16	40	H3	5-750-5460	5-750-5461	5-750-5462
11/32	32	H3	–	5-750-5515	5-750-5516
3/8	14	H3	–	5-750-5524	–
3/8	18	H3	5-750-5532	5-750-5533	5-750-5534
3/8	20	H3	–	5-750-5542	5-750-5543
3/8	26	H3	–	5-750-5570	–
3/8	32	H3	5-750-5586	5-750-5587	5-750-5588
3/8	40	H3	–	5-750-5613	5-750-5614
7/16	24	H3	5-750-5694	5-750-5695	5-750-5696
7/16	26	H3	–	5-750-5707	–
7/16	27	H3	–	5-750-5713	–
7/16	28	H3	–	–	5-750-5718
15/32	32	H3	5-750-5766	5-750-5767	5-750-5768
1/2	12	H3	5-750-5793	5-750-5794	5-750-5795
1/2	14	H3	–	5-750-5803	–
1/2	16	H3	5-750-5811	5-750-5812	5-750-5813
1/2	18	H3	–	5-750-5821	–
1/2	24	H3	–	5-750-5830	5-750-5831
1/2	28	H3	5-750-5856	5-750-5857	5-750-5858
1/2	32	H3	5-750-5874	5-750-5875	5-750-5876
1/2	40	H3	–	5-750-5902	5-750-5903
9/16	16	H3	–	5-750-5938	5-750-5939
9/16	20	H3	5-750-5946	5-750-5947	5-750-5948
9/16	24	H3	5-750-5955	5-750-5956	5-750-5957
9/16	27	H3	5-750-5973	5-750-5974	–
9/16	28	H3	–	5-750-5983	–
9/16	32	H3	–	5-750-6001	5-750-6002
9/16	40	H2	–	5-750-6019	–
5/8	12	H3	5-750-6063	–	–
5/8	16	H3	5-750-6081	5-750-6082	5-750-6083

Tap Sizes	Threads per Inch	H Limit	Taper Part Number	Plug Part Number	Bottoming Part Number
5/8	20	H3	5-750-6090	5-750-6091	5-750-6092
5/8	24	H3	5-750-6099	5-750-6100	5-750-6101
5/8	26	H3	–	5-750-6109	–
5/8	27	H3	5-750-6117	5-750-6118	5-750-6119
5/8	28	H3	–	5-750-6127	5-750-6128
5/8	32	H3	5-750-6144	5-750-6145	5-750-6146
5/8	40	H2	–	5-750-6163	5-750-6164
11/16	12	H4	–	5-750-6199	5-750-6200
11/16	18	H3	5-750-6207	5-750-6208	5-750-6209
11/16	20	H3	5-750-6216	5-750-6217	5-750-6218
11/16	24	H3	5-750-6225	5-750-6226	5-750-6227
11/16	27	H3	–	5-750-6235	–
11/16	32	H3	–	5-750-6244	–
3/4	12	H3	–	5-750-6280	5-750-6281
3/4	14	H4	–	5-750-6289	5-750-6290
3/4	18	H3	–	5-750-6298	–
3/4	20	H3	5-750-6306	5-750-6307	5-750-6308
3/4	24	H3	–	5-750-6316	5-750-6317
3/4	26	H3	5-750-6324	5-750-6325	–
3/4	27	H3	–	5-750-6334	–
3/4	28	H3	–	5-750-6343	–
3/4	32	H3	5-750-6351	5-750-6352	–
13/16	10	H3	5-750-6414	5-750-6415	5-750-6416
13/16	12	H4	–	5-750-6424	–
13/16	14	H4	5-750-6432	5-750-6433	5-750-6434
13/16	16	H3	–	5-750-6442	5-750-6443
13/16	18	H3	–	5-750-6451	–
13/16	20	H3	5-750-6459	5-750-6460	5-750-6461
13/16	24	H3	–	5-750-6469	–
13/16	32	H3	–	5-750-6514	5-750-6515
7/8	16	H4	–	5-750-6541	–
7/8	18	H4	5-750-6549	5-750-6550	5-750-6551
7/8	20	H4	5-750-6558	5-750-6559	5-750-6560
7/8	24	H3	5-750-6567	5-750-6568	5-750-6569
7/8	32	H3	–	5-750-6604	–
15/16	12	H4	–	5-750-6640	–
15/16	16	H4	5-750-6648	5-750-6649	5-750-6650
15/16	20	H4	5-750-6666	5-750-6667	5-750-6668
15/16	24	H3	–	5-750-6676	–
15/16	27	H3	–	5-750-6685	–
15/16	32	H4	5-750-6702	5-750-6703	–
1	10	H4	5-750-6711	5-750-6712	5-750-6713
1	16	H4	5-750-6720	5-750-6721	5-750-6722
1	18	H4	5-750-6729	5-750-6730	5-750-6731
1	20	H4	5-750-6738	5-750-6739	5-750-6740
1	24	H4	5-750-6747	5-750-6748	–
1	32	H4	5-750-6792	5-750-6793	5-750-6794

The H limit for special thread taps, fractional sizes 5/32" thru 2-3/8", are the same as the most popular in Standard Thread Taps 2B Class Fit

ANSI dimensions to Table 302 - page 146



Special Thread Hand Taps (continued)

- Ground Thread
- Right Hand
- High Speed Steel – M2

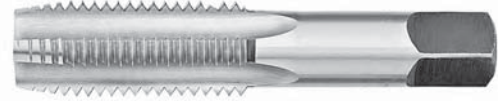

Tap Sizes	Threads per Inch	H Limit	Taper Part Number	Plug Part Number	Bottoming Part Number
1-1/16	16	H4	–	5-750-6856	5-750-6857
1-1/16	18	H4	–	5-750-6865	5-750-6866
1-1/16	20	H4	–	5-750-6874	–
1-1/8	16	H4	–	5-750-6937	5-750-6938
1-1/8	18	H4	–	5-750-6946	5-750-6947
1-1/8	20	H4	5-750-6954	5-750-6955	5-750-6956
1-3/16	16	H4	5-750-7026	5-750-7027	5-750-7028
1-3/16	18	H4	–	5-750-7036	5-750-7037
1-1/4	14	H5	–	5-750-7090	–
1-1/4	16	H4	5-750-7098	5-750-7099	5-750-7100
1-1/4	18	H4	–	5-750-7108	5-750-7109
1-1/4	20	H4	5-750-7116	5-750-7117	5-750-7118
1-5/16	16	H4	5-750-7206	5-750-7207	5-750-7208
1-5/16	18	H4	–	5-750-7216	5-750-7217
1-3/8	16	H4	5-750-7260	5-750-7261	5-750-7262
1-3/8	18	H4	–	5-750-7270	5-750-7271
1-7/16	12	H4	–	5-750-7324	5-750-7325
1-1/2	16	H4	–	5-750-7405	5-750-7406
1-1/2	18	H4	–	5-750-7414	5-750-7415
1-9/16	16	H4	–	5-750-7459	–
1-9/16	18	H4	5-750-7467	5-750-7468	5-750-7469
1-5/8	16	H4	–	5-750-7540	5-750-7541
1-11/16	12	H4	–	5-750-7585	–
1-3/4	6	H4	–	5-750-7648	5-750-7649
1-3/4	16	H4	–	5-750-7693	–
1-3/4	20	H4	–	5-750-7711	5-750-7712
1-7/8	16	H4	5-750-7809	5-750-7810	5-750-7811
2	16	H4	–	5-750-7927	–
2	20	H4	–	5-750-7945	5-750-7946
2-3/8	8	H6	–	5-750-8125	–
2-3/8	12	H6	–	5-750-8134	–
2-1/2	16	H5	–	5-750-8197	–
3-1/4	8	H8	5-750-8358	5-750-8359	5-750-8360

The H Limits for special thread taps, fractional sizes 5/32" thru 2-3/8", are the same as the most popular in the Standard Thread Taps 2B Class Fit. Coarse pitches are made in a longer length, and finer pitches are made in a shorter length.

ANSI dimensions to Table 302 - page 146

TAPS



Hand Taps

Cutting Tools

Hand Taps, Machine Screw Sizes

- Right Hand
- High Speed Steel – M2

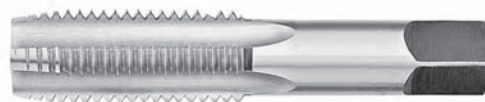

Regular Thread

Tap Sizes	Threads per Inch	H Limit	Overall Length	Taper Part Number	Plug Part Number	Bottoming Part Number	TPB-Set Part Number
1	64	H2	1-11/16	–	5-752-0061	–	5-752-0063
1	72	H2	1-11/16	5-752-0080	5-752-0081	5-752-0082	5-752-0083
2	56	H2	1-3/4	5-752-0100	5-752-0101	5-752-0102	5-752-0103
2	64	H2	1-3/4	5-752-0118	5-752-0119	–	–
3	48	H2	1-13/16	5-752-0143	5-752-0144	5-752-0145	5-752-0146
3	56	H2	1-13/16	5-752-0161	5-752-0162	5-752-0163	–
4	40	H2	1-7/8	5-752-0203	5-752-0204	5-752-0205	5-752-0206
4	48	H2	1-7/8	5-752-0221	5-752-0222	5-752-0223	5-752-0224
5	40	H2	1-15/16	5-752-0245	5-752-0246	5-752-0247	5-752-0248
5	44	H2	1-15/16	5-752-0263	5-752-0264	5-752-0265	5-752-0266
6	32	H2	2	5-752-0287	–	5-752-0289	–
6	32	H3	2	5-752-0305	5-752-0306	5-752-0307	5-752-0308
6	40	H2	2	5-752-0323	5-752-0324	5-752-0325	5-752-0326
6	40	H3	2	–	5-752-0336	–	–
8	32	H3	2-1/8	5-752-0347	5-752-0348	5-752-0349	5-752-0350
8	36	H2	2-1/8	5-752-0365	–	5-752-0367	–
8	36	H3	2-1/8	–	5-752-0384	5-752-0385	5-752-0386
10	24	H3	2-3/8	5-752-0407	5-752-0408	5-752-0409	5-752-0410
10	32	H3	2-3/8	5-752-0425	5-752-0426	5-752-0427	5-752-0428
12	24	H3	2-3/8	5-752-0449	5-752-0450	5-752-0451	5-752-0452
12	28	H3	2-3/8	5-752-0467	5-752-0468	–	5-752-0470

TAPS

Special Thread

Tap Sizes	Threads per Inch	Taper Part Number	Plug Part Number	Bottoming Part Number
6	36	–	5-752-5218	5-752-5219
6	48	5-752-5226	5-752-5227	5-752-5228
7	40	5-752-5280	–	–
8	24	–	5-752-5299	–
8	40	5-752-5316	5-752-5317	5-752-5318
8	48	–	5-752-5326	–
10	28	5-752-5379	5-752-5380	–
10	36	5-752-5397	5-752-5398	–
10	40	–	5-752-5407	5-752-5408
10	48	–	5-752-5416	5-752-5417
12	32	5-752-5487	5-752-5488	5-752-5489
12	36	–	5-752-5497	–
12	40	–	5-752-5506	5-752-5507
12	48	5-752-5514	5-752-5515	–

Left Hand Taps

- High Speed Steel – M2

Tap Sizes	Threads per Inch	H Limit	Overall Length	Taper Part Number	Plug Part Number	Bottoming Part Number	TPB-Set Part Number
1/4	20	H3	2-1/2	5-756-0026	5-756-0027	5-756-0028	5-756-0029
1/4	28	H3	2-1/2	5-756-0042	5-756-0043	5-756-0044	5-756-0045
5/16	18	H3	2-23/32	5-756-0064	5-756-0065	–	5-756-0067
5/16	24	H3	2-23/32	5-756-0080	5-756-0081	5-756-0082	5-756-0083
3/8	16	H3	2-15/16	5-756-0099	5-756-0100	5-756-0101	5-756-0102
3/8	24	H3	2-15/16	5-756-0121	5-756-0122	5-756-0123	5-756-0124
7/16	14	H3	3-5/32	5-756-0140	5-756-0141	–	–
7/16	20	H3	3-5/32	5-756-0156	5-756-0157	5-756-0158	5-756-0159
1/2	13	H3	3-3/8	5-756-0188	5-756-0189	5-756-0190	5-756-0191
1/2	20	H3	3-3/8	5-756-0203	5-756-0204	5-756-0205	5-756-0206
9/16	12	H3	3-19/32	–	5-756-0223	–	–
9/16	18	H3	3-19/32	5-756-0238	5-756-0239	–	–
5/8	11	H3	3-13/16	5-756-0263	5-756-0264	5-756-0265	5-756-0266
5/8	18	H3	3-13/16	5-756-0292	5-756-0293	5-756-0294	5-756-0295
3/4	10	H3	4-1/4	5-756-0383	5-756-0384	5-756-0385	5-756-0386
3/4	16	H3	4-1/4	5-756-0405	5-756-0406	5-756-0407	5-756-0408
7/8	9	H3	4-11/16	5-756-0427	5-756-0428	5-756-0429	–
7/8	14	H3	4-11/16	5-756-0467	5-756-0468	5-756-0469	–
1	8	H3	5-1/8	5-756-0495	5-756-0496	–	–
1	8	H4	5-1/8	–	5-756-0500	5-756-0501	–
1	14	H4	5-1/8	5-756-0561	5-756-0562	5-756-0563	–
1-1/8	7	H3	5-7/16	5-756-0642	5-756-0643	5-756-0644	–
1-1/8	12	H4	5-7/16	–	5-756-0700	5-756-0701	–
1-1/4	7	H4	5-3/4	–	5-756-0812	5-756-0813	–
1-1/4	12	H4	5-3/4	5-756-0877	5-756-0878	5-756-0879	–
1-3/8	12	H4	6	–	5-756-1001	–	–
1-1/2	6	H4	6-1/4	–	5-756-1025	–	–
1-1/2	8	H4	6-1/4	–	5-756-1046	–	–
1-1/2	12	H4	6-1/4	5-756-1084	5-756-1085	5-756-1086	–

Oversized Right Hand Taps

Fractional Sizes

- Ground Thread G13: G13 = GH3 + .005"
- High Speed Steel – M2



Adjustable Tap and Reamer Wrenches

Tap Sizes	Threads per Inch	H Limit	Plug Part Number
1/4	20	H13	5-750-9000
5-16	18	H13	5-750-9040
3/8	16	H13	5-750-9080
1/2	13	H13	5-750-9120
1/2	20	H13	5-750-9140
5/8	11	H13	5-750-9150
3/4	10	H13	5-750-9180

Size	Tap Capacity	Pipe Tap Range	Overall Length	Part Number
0	0 to 1/14"	–	5"	4-410-000
4	1/8 to 3/8"	–	7"	4-410-004
5	3/16 to 1/2"	1/8 to 1/4"	11-1/2"	4-410-005
6	1/4 to 3/4"	1/8 to 3/8"	15-3/8"	4-410-006

Machine Screw Sizes

Tap Sizes	Threads per Inch	H Limit	Plug Part Number
6	32	H13	5-752-6000
8	32	H13	5-752-6040
10	32	H13	5-752-6060



Hand Taps

Cutting Tools

ISO Metric Hand Taps

- Right-Hand
- High Speed Steel – M2

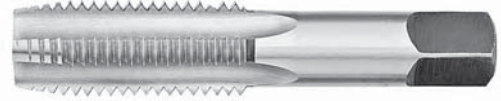

TAPS

Tap Size mm	Pitch mm	D Limit	Taper Part Number	Plug Part Number	Bottoming Part Number	TPB Set Part Number
M1.6	.35	D3	5-775-001	5-775-002	5-775-003	5-775-004
M1.8	.35	D3	5-775-006	5-775-007	5-775-008	5-775-009
M2.0	.40	D3	5-775-011	5-775-012	5-775-013	5-775-014
M2.0	.45	D3	5-775-016	5-775-017	5-775-018	5-775-019
M2.2	.45	D3	–	5-775-022	5-775-023	5-775-024
M2.3	.40	D3	–	5-775-027	5-775-028	5-775-029
M2.5	.45	D3	5-775-031	5-775-032	5-775-033	5-775-034
M2.6	.45	D3	–	5-775-037	5-775-038	5-775-039
M3.0	.50	D3	5-775-041	5-775-042	5-775-043	5-775-044
M3.0	.60	D3	5-775-046	5-775-047	5-775-048	5-775-049
M3.5	.60	D4	5-775-051	5-775-052	5-775-053	5-775-054
M4.0	.70	D4	5-775-056	5-775-057	5-775-058	5-775-059
M4.0	.50	D4	5-775-061	5-775-062	5-775-063	5-775-064
M4.5	.75	D4	5-775-066	5-775-067	5-775-068	5-775-069
M5.0	.80	D4	5-775-071	5-775-072	5-775-073	5-775-074
M5.0	.90	D4	5-775-076	5-775-077	5-775-078	5-775-079
M5.0	.50	D4	–	5-775-082	–	5-775-084
M5.5	.90	D4	–	5-775-087	5-775-088	5-775-089
M6.0	.50	D4	5-775-1000	5-775-1001	5-775-1002	5-775-1003
M6.0	1.00	D5	5-775-091	5-775-092	5-775-093	5-775-094
M6.0	0.75	D4	5-775-096	5-775-097	5-775-098	5-775-099
M6.3	1.00	D5	5-775-101	5-775-102	–	5-775-104
M7.0	1.00	D5	5-775-106	5-775-107	5-775-108	5-775-109
M8.0	0.75	D5	5-775-1200	5-775-1201	5-775-1202	5-775-1203
M8.0	1.25	D5	5-775-111	5-775-112	5-775-113	5-775-114
M8.0	1.00	D5	5-775-116	5-775-117	5-775-118	5-775-119
M9.0	1.25	D5	5-775-121	5-775-122	5-775-123	5-775-124
M10	1.50	D6	5-775-126	5-775-127	5-775-128	5-775-129
M10	1.25	D5	5-775-131	5-775-132	5-775-133	5-775-134
M10	1.00	D5	5-775-136	5-775-137	5-775-138	5-775-139
M11	1.50	D6	5-775-141	5-775-142	5-775-143	5-775-144
M12	1.75	D6	5-775-146	5-775-147	5-775-148	5-775-149
M12	1.50	D4	5-775-151	5-775-152	5-775-153	5-775-154
M12	1.25	D5	5-775-156	5-775-157	5-775-158	5-775-159
M12	1.00	D5	5-775-1600	5-775-1601	5-775-1602	5-775-1603
M14	2.00	D7	5-775-161	5-775-162	5-775-163	5-775-164
M14	1.50	D6	5-775-166	5-775-167	5-775-168	5-775-169

Note: These taps have ANSI shanks

ISO Metric Hand Taps (continued)

- Right-Hand
- High Speed Steel – M2

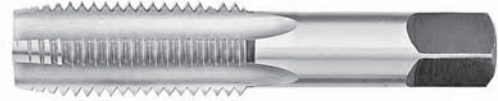

Tap Size mm	Pitch mm	D Limit	Taper Part Number	Plug Part Number	Bottoming Part Number	TPB Set Part Number
M14	1.25	D6	5-775-171	5-775-172	5-775-173	5-775-174
M14	1.00	D6	5-775-1750	5-775-1751	5-775-1752	5-775-1753
M16	2.00	D7	5-775-176	5-775-177	5-775-178	5-775-179
M16	1.50	D5	5-775-181	5-775-182	5-775-183	5-775-184
M16	1.00	D6	–	5-775-1851	5-775-1852	5-775-1853
M18	2.50	D7	5-775-186	5-775-187	5-775-188	5-775-189
M18	2.00	D7	–	5-775-192	–	5-775-194
M18	1.00	D6	–	5-775-197	5-775-198	5-775-199
M18	1.50	D6	5-775-201	5-775-202	5-775-203	5-775-204
M20	2.50	D7	5-775-206	5-775-207	5-775-208	5-775-209
M20	1.50	D6	5-775-211	5-775-212	5-775-213	5-775-214
M20	1.00	D7	–	5-775-217	–	5-775-219
M20	2.00	D6	5-775-221	5-775-222	5-775-223	5-775-224
M22	2.50	D7	5-775-226	5-775-227	5-775-228	5-775-229
M22	1.50	D6	5-775-231	5-775-232	5-775-233	5-775-234
M22	1.00	D5	5-775-2350	5-775-2351	–	–
M24	3.00	D8	5-775-236	5-775-237	5-775-238	5-775-239
M24	2.00	D7	5-775-241	5-775-242	5-775-243	5-775-244
M24	1.50	D6	5-775-246	5-775-247	5-775-248	5-775-249
M26	1.50	D6	5-775-2506	5-775-2507	5-775-2508	–
M27	3.00	D8	–	5-775-252	5-775-253	5-775-254
M27	2.00	D7	5-775-256	5-775-257	5-775-258	5-775-259
M28	1.50	D6	5-775-2606	5-775-2607	5-775-2608	–
M30	3.50	D9	5-775-261	5-775-262	5-775-263	5-775-264
M30	2.00	D7	5-775-266	5-775-267	5-775-268	5-775-269
M30	1.50	D6	5-775-271	5-775-272	5-775-273	5-775-274
M32	2.00	D7	5-775-276	5-775-277	5-775-278	5-775-279
M33	3.50	D9	–	5-775-282	–	5-775-284
M33	2.00	D9	–	5-775-287	5-775-288	5-775-289
M36	4.00	D9	5-775-291	5-775-292	5-775-293	5-775-294
M36	3.00	D8	5-775-296	5-775-297	5-775-298	5-775-299
M39	4.00	D9	5-775-301	5-775-302	5-775-303	5-775-304
M39	3.00	D8	5-775-306	–	5-775-308	–
M42	4.50	D10	5-775-311	5-775-312	5-775-313	–
M42	1.50	D6	–	5-775-317	–	–
M45	4.50	D10	–	5-775-322	–	–
M45	1.50	D5	–	5-775-327	5-775-328	–
M48	5.00	D10	–	5-775-332	–	–
M48	1.50	D6	–	5-775-337	–	–
M52	5.00	D10	–	5-775-342	–	–
M52	1.50	D6	–	5-775-347	–	–

Note: These taps have ANSI shanks



Spiral Point Taps

Cutting Tools

Spiral Point – Gun Style Hand Taps

- Right-Hand Cut
- Ground Thread
- Fractional Size
- High Speed Steel - M2
- 1/4" and 5/16" have 2 Flutes
- 3/8" thru 1" have 3 Flutes



Plug Only, Fractional Sizes

Tap Sizes	Threads per Inch	H Limit	Overall Length	Part Number
1/4	20	H3	2-1/2	5-770-058
1/4	28	H3	2-1/2	5-770-078
5/16	18	H3	2-23/32	5-770-100
5/16	24	H3	2-23/32	5-770-120
3/8	16	H3	2-5/16	5-770-138
3/8	24	H3	2-5/16	5-770-153
7/16	14	H3	3-5/32	5-770-167
7/16	20	H3	3-5/32	5-770-179
1/2	13	H3	3-3/8	5-770-191
1/2	20	H3	3-3/8	5-770-205
9/16	12	H3	3-19/32	5-770-220
9/16	18	H5	3-19/32	5-770-225
5/8	11	H3	3-13/16	5-770-245
5/8	18	H3	3-13/16	5-770-257
3/4	10	H3	4-1/4	5-770-271
3/4	16	H3	4-1/4	5-770-283
7/8	9	H4	4-11/16	5-770-299
7/8	14	H6	4-11/16	5-770-311
1	8	H4	5-1/8	5-770-325
1	12	H4	5-1/8	5-770-337
1	14	H4	5-1/8	5-770-345

TAPS

Oversized Spiral Pointed Hand Taps

- Right-Hand Cut
- Ground Thread, GH13 (GH3 + .005)
- High Speed Steel – M42

Fractional Sizes

Tap Sizes	Threads per Inch	Plug Part Number
1/4	20	5-770-550
1/4	28	5-770-570
5/16	18	5-770-590
5/16	24	5-770-610
3/8	16	5-770-630
3/8	24	5-770-650
1/2	13	5-770-670
1/2	20	5-770-690

Machine Screw Sizes

Tap Sizes	Threads per Inch	Plug Part Number
6	32	5-772-550
8	32	5-772-570
10	24	5-772-590
10	32	5-772-610

Machine Screw Size Spiral Point – Gun Style Hand Taps

- Right-Hand
- Ground Thread
- High Speed Steel – M2



Plug Only, Fractional Sizes				
Tap Sizes	Threads per Inch	H Limit	Overall Length	Part Number
0	80	H2	1-5/8	5-772-022
1	64	H2	1-11/16	5-772-032
1	72	H2	1-11/16	5-772-043
2	56	H2	1-3/4	5-772-052
2	64	H2	1-3/4	5-772-063
3	48	H2	1-3/16	5-772-077
3	56	H2	1-3/16	5-772-088
4	40	H2	1-7/8	5-772-113
4	48	H2	7-7/8	5-772-124
5	40	H2	1-15/16	5-772-138
5	44	H2	1-15/16	5-772-149
6	32	H3	2	5-772-165

Plug Only, Fractional Sizes				
Tap Sizes	Threads per Inch	H Limit	Overall Length	Part Number
6	32	H13	2	5-772-550
6	40	H2	2	5-772-174
8	32	H3	2-1/8	5-772-190
8	32	H13	2-1/8	5-772-570
8	36	H2	2-1/8	5-772-199
10	24	H3	2-3/8	5-772-215
10	24	H13	2-3/8	5-772-590
10	32	H3	2-3/8	5-772-226
10	32	H13	2-3/8	5-772-610
12	24	H3	2-3/8	5-772-240
12	28	H3	2-3/8	5-772-251

ISO Metric Spiral Point – Gun Style Hand Taps

- 2 Flute
- High Speed Steel – M2



Plug Only, Metric Sizes			
Tap Size mm	Pitch mm	D Limit	Part Number
1.6	0.35	D3	5-776-001
1.8	0.35	D3	5-776-002
2.0	0.40	D3	5-776-003
2.2	0.45	D3	5-776-004
2.5	0.45	D3	5-776-005
3.0	0.50	D3	5-776-006
3.5	0.60	D4	5-776-007
4.0	0.70	D4	5-776-008
4.0	0.50	D4	5-776-0085
4.5	0.75	D4	5-776-009
5.0	0.80	D4	5-776-010
5.0	0.50	D4	5-776-0105
6.0	1.00	D5	5-776-011
6.0	0.75	D5	5-776-0115
7.0	1.00	D5	5-776-013

Plug Only, Metric Sizes			
Tap Size mm	Pitch mm	D Limit	Part Number
8.0	1.25	D5	5-776-014
8.0	1.00	D5	5-776-015
10.0	1.50	D6	5-776-016
10.0	1.25	D5	5-776-017
10.0	1.00	D5	5-776-0175
12.0	1.75	D6	5-776-018
12.0	1.50	D4	5-776-0185
12.0	1.25	D5	5-776-019
12.0	1.00	D5	5-776-0190
14.0	2.00	D7	5-776-020
14.0	1.50	D6	5-776-021
14.0	1.25	D6	5-776-0215
16.0	2.00	D7	5-776-022
16.0	1.50	D5	5-776-023
18.0	2.50	D7	5-776-024
20.0	2.50	D7	5-776-025

Note: These metric taps have ANSI shanks



Spiral Flute Taps

Cutting Tools

Fast Spiral Fluted Taps

- Right-Hand
- High Speed Steel – M2



TAPS

Fractional Sizes				
Tap Sizes	Threads per Inch	H Limit	Plug Part Number	Bottoming Part Number
1/4	20	H3	5-760-050	5-760-051
1/4	28	H3	5-760-060	5-760-061
5/16	18	H3	5-760-080	5-760-081
5/16	24	H3	5-760-090	5-760-091
3/8	16	H3	5-760-110	5-760-111
3/8	24	H3	5-760-120	5-760-121
7/16	14	H3	5-760-140	5-760-141
7/16	20	H3	5-760-150	5-760-151
1/2	13	H3	5-760-170	5-760-171
1/2	20	H3	5-760-180	5-760-181
9/16	12	H3	5-760-190	5-760-191
9/16	18	H3	5-760-200	5-760-201
5/8	11	H3	5-760-210	5-760-211
5/8	18	H3	5-760-220	5-760-221
11/16	16	H3	–	5-760-241
3/4	10	H3	5-760-250	5-760-251
3/4	16	H3	5-760-260	5-760-261
7/8	9	H4	5-760-270	5-760-271
7/8	14	H4	5-760-290	5-760-291
1	8	H4	5-760-300	5-760-301
1	14	H4	5-760-320	5-760-321

Machine Screw Sizes				
Tap Sizes	Threads per Inch	H Limit	Plug Part Number	Bottoming Part Number
3	48	H2	5-762-030	5-762-031
3	56	H2	5-762-040	–
4	40	H2	5-762-050	5-762-051
5	40	H2	5-762-070	5-762-071
5	44	H2	5-762-080	5-762-081
6	32	H3	5-762-100	5-762-101
6	40	H2	5-762-110	–
8	32	H3	5-762-130	5-762-131
8	36	H3	5-762-140	5-762-141
10	24	H3	5-762-160	5-762-161
10	32	H3	5-762-170	5-762-171
12	24	H3	5-762-190	5-762-191
12	28	H3	5-762-200	–

ANSI Dimensions to Table 302 on page 146

Combined Tap and Drills

- Ground Thread
- High Speed Steel



Machine and Fractional Sizes

Thread Size	Thread Length	H Limit	Drill		Overall Length	Part Number
			Size	Flute Length		
4-40 NC	9/16	H2	.0890	1/4	1-7/8	5-780-005
4-48 NF	9/16	H2	.0930	1/4	1-7/8	5-780-010
5-40 NC	5/8	H2	.1015	9/32	1-5/16	5-780-015
5-44 NF	5/8	H2	.1040	9/32	1-5/16	5-780-020
6-32 NC	11/16	H3	.1095	5/16	2	5-780-025
8-32 NC	3/4	H3	.1360	3/8	2-1/8	5-780-035
8-36 NF	3/4	H3	.1385	3/8	2-1/8	5-780-040
10-24 NC	7/8	H3	.1520	13/32	2-3/8	5-780-045
10-32 NF	7/8	H3	.1610	13/32	2-3/8	5-780-050
12-24 NC	7/8	H3	.1770	15/32	2-3/8	5-780-055
1/4-20 NC	15/16	H3	.2010	17/32	2-1/2	5-780-065
1/4-28 NF	15/16	H3	.2175	17/32	2-1/2	5-780-070
5/16-18 NC	1-1/8	H3	.2570	11/16	3	5-780-075
5/16-24 NF	1-1/8	H3	.2720	11/16	3	5-780-080
3/8-16 NC	1-1/4	H3	.3125	13/16	3-1/2	5-780-085
3/8-24 NF	1-1/4	H3	.3345	13/16	3-1/2	5-780-090
7/16-14 NC	1-7/16	H3	.3680	1	3-7/8	5-780-095
7/16-20 NF	1-7/16	H3	.3890	1	3-7/8	5-780-100
1/2-13 NC	1-21/32	H3	.4250	1-1/8	4-1/4	5-780-105
1/2-20 NF	1-21/32	H3	.4510	1-1/8	4-1/4	5-780-110

TAPS

Metric Sizes

Thread Size (mm)	Pitch Dia Limits	Overall Length (Inches)	Drill Length (Inches)	Drill Dia (Inches)	Thread Length (Inches)	Square Length (Inches)	Shank Dia (Inches)	Square Size (Inches)	Part Number
M 3 X 5	D3	1-15/16	9/32	.1015	13/32	3/16	.141	.110	5-782-005
M 4 X .7	D4	2-1/8	3/8	.1340	1/2	1/4	.168	.131	5-782-015
M 5 X .8	D4	2-3/8	13/32	.1700	5/8	1/4	.194	.152	5-782-025
M 6 X 1	D5	2-1/2	17/32	.2030	25/32	5/16	.255	.191	5-782-030
M 8 X 1.25	D5	2-27/32	11/16	.2735	15/16	3/8	.318	.238	5-782-040
M 10 X 1.5	D6	3-3/8	13/16	.3440	1-1/16	7/16	.381	.286	5-782-045
M 12 X 1.75	D6	4-1/16	1-1/8	.4140	1-3/8	7/16	.367	.275	5-782-050



Tap and Drill Sets

Cutting Tools

18 Piece Tap and Drill Sets

- Metal Case Included
- High Speed Steel – M2

National Coarse

Hand & Spiral Point Tap and Drill Set			
Tap Size	Drill Size	Set Part Number	Spiral Point Set Part Number
6-32	P	#36	5-790-100 5-790-300
8-32	P	#29	
10-24	P	#25	
10-24	P	#21	
1/4"-20	P	#7	
5/16"-18	P	F	
3/8"-16	P	5/16"	
7/16"-14	P	U	
1/2"-13	P	27/64	

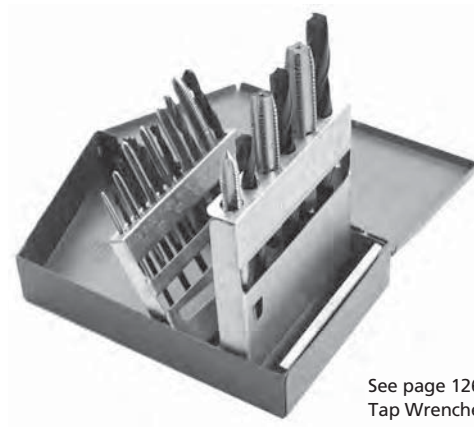

See page 126 for Tap Wrenches

TAPS

National Fine

Spiral Point Tap and Drill Set		
Tap Size	Drill Size	Set Part Number
6-32	P	#36
8-32	P	#29
10-24	P	#25
10-32	P	#21
1/4"-20	P	#7
5/16"-18	P	F
3/8"-16	P	5/16"
7/16"-14	P	U
1/2"-13	P	27/64"

Metric Sizes

Hand Tap and Drill Set		
Tap Size mm	Drill Size mm	Set Part Number
M 2.5 X 0.45	P	2.05
M 3.0 X 0.50	P	2.50
M 3.5 X 0.60	P	2.90
M 4.0 X 0.70	P	3.30
M 5.0 X 0.80	P	4.20
M 6.0 X 1.0	P	5.00
M 8.0 X 1.25	P	6.70
M 10.0 X 1.50	P	8.50
M 12.0 X 1.75	P	10.20

Spiral Point Tap and Drill Set		
Tap Size mm	Drill Size mm	Set Part Number
M 2.5 X 0.45	P	2.05
M 3.0 X 0.50	P	2.50
M 3.5 X 0.60	P	2.90
M 4.0 X 0.70	P	3.30
M 5.0 X 0.80	P	4.20
M 6.0 X 1.0	P	5.00
M 8.0 X 1.25	P	6.70
M 10.0 X 1.50	P	8.50
M 12.0 X 1.75	P	10.20



Taper Pipe Taps, NPT and NPTF Straight Pipe Taps, NPS and NPSF

- Ground Thread
- High Speed Steel – M2

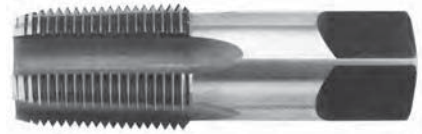

Tap Size (Pipe)	Threads per Inch	Number of Flutes	Overall Length	Length of Thread	Taper		Straight	
					NPT Part Number	NPTF Dry Seal Part Number	NPS Part Number	NPSF Dry Seal Part Number
1/16	27	4	2-1/8	11/16	5-764-001	5-766-001	5-763-001	–
1/8 (Sm Sk)*	27	4	2-1/8	3/4	5-764-0020	5-766-0020	5-763-0020	–
1/8 (Lg Sk)*	27	4	2-1/8	3/4	5-764-002	5-766-002	5-763-002	5-765-002
1/4	18	4	2-7/16	1-1/16	5-764-003	5-766-003	5-763-003	5-765-003
3/8	18	4	2-9/16	1-1/16	5-764-004	5-766-004	5-763-004	5-765-004
1/2	14	4	3-1/8	1-3/8	5-764-005	5-766-005	5-763-005	5-765-005
3/4	14	5	3-1/4	1-3/8	5-764-006	5-766-006	5-763-006	5-765-006
1	11-1/2	5	3-3/4	1-3/4	5-764-007	5-766-007	5-763-007	–
1-1/4	11-1/2	5	4	1-3/4	5-764-008	5-766-008	5-763-008	–
1-1/2	11-1/2	7	4-1/4	1-3/4	5-764-009	5-766-009	5-763-009	5-765-009
2	11-1/2	7	4-1/2	1-3/4	5-764-010	5-766-010	5-763-010	–
2-1/2	8	8	5-1/2	2-9/16	5-764-011	5-766-011	5-763-011	–
3	8	8	6	2-5/8	5-764-012	5-766-012	–	–
4	8	8	6-3/4	2-3/4	5-764-014	–	–	–

* small shank = .3125 and large shank = .4375



Pipe Taps

Cutting Tools

Interrupted Thread Pipe Taps, NPT and NPTF

- Ground Thread
- High Speed Steel – M2

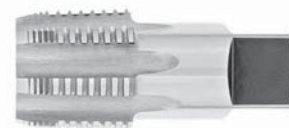

Tap Size (Pipe)	Threads per Inch	Number of Flutes	Overall Length	Length of Thread	NPT Part Number	NPTF Part Number
1/16	27	5	2-1/8	11/16	5-767-001	5-769-001
1/8	27	5	2-1/8	3/4	5-767-002	5-769-002
1/4	18	5	2-7/16	1-1/16	5-767-003	–
3/8	18	5	2-9/16	1-1/16	5-767-004	–
1/2	14	5	3-1/8	1-3/8	5-767-005	5-769-005
3/4	14	5	3-1/4	1-3/8	5-767-006	5-769-006
1	11-1/2	5	3-3/4	1-3/4	5-767-007	–
1-1/4	11-1/2	5	4	1-3/4	5-767-008	5-769-008
1-1/2	11-1/2	7	4-1/2	1-3/4	5-767-009	–
2	11-1/2	7	4-1/2	1-3/4	5-767-010	–

TAPS

Long Taper Pipe Taps, NPT

- Ground Thread
- High Speed Steel – M2



Tap Size (Pipe)	Threads per Inch	Shank Dia	4" OAL	6" OAL	8" OAL	12" OAL
1/8	27	.4375	5-768-0024	5-768-0026	5-768-0028	–
1/4	18	.5625	5-768-0034	5-768-0036	–	5-768-0039
3/8	18	.7000	–	5-768-0046	–	5-768-0049
1/2	14	.6875	–	5-768-0056	–	5-768-0059
3/4	14	.9063	–	–	5-768-0068	5-768-0069
1	11-1/2	1.250	–	5-768-0076	–	–

TABLE OF CONTENTS

DIES

Straight Pipe NPS	407
Taper Pipe NPT	407
Heavy Duty Die Stocks	407
Round Adjustable Split Dies	408
Round Adjustable Split Dies, Special Threads	409
Round Adjustable Split Dies, Special Threads, Left Hand ...	410
Metric Round Adjustable Split Dies	411

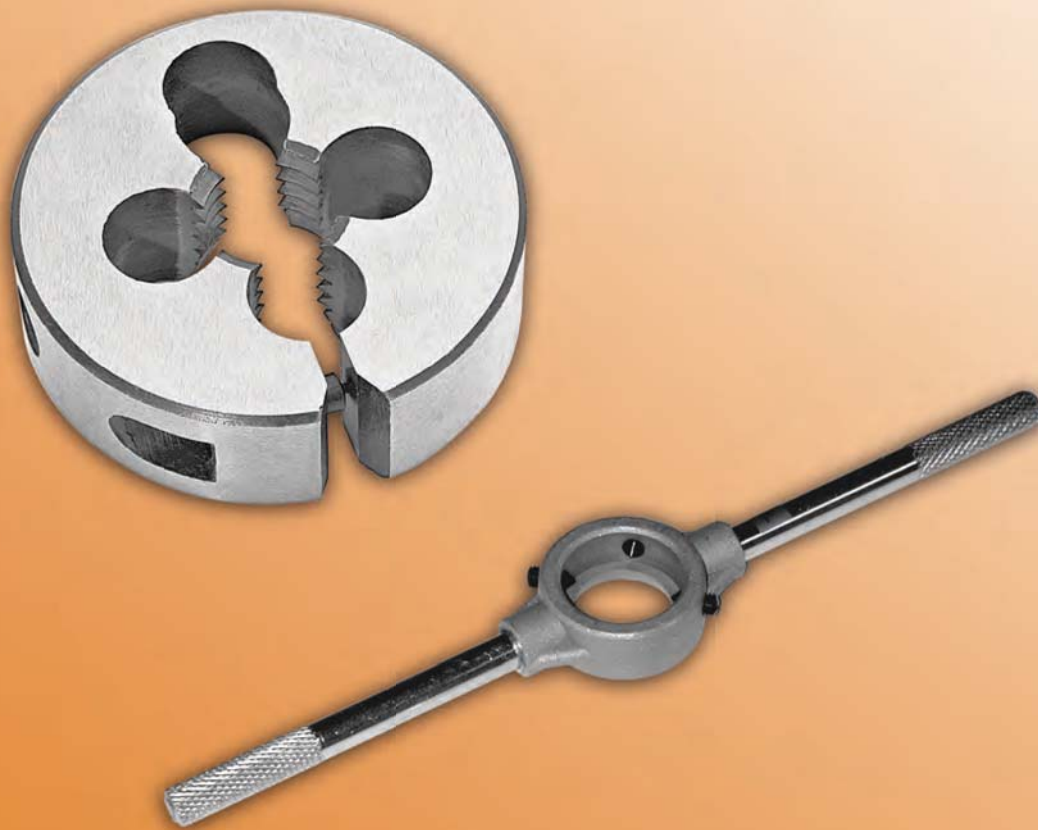

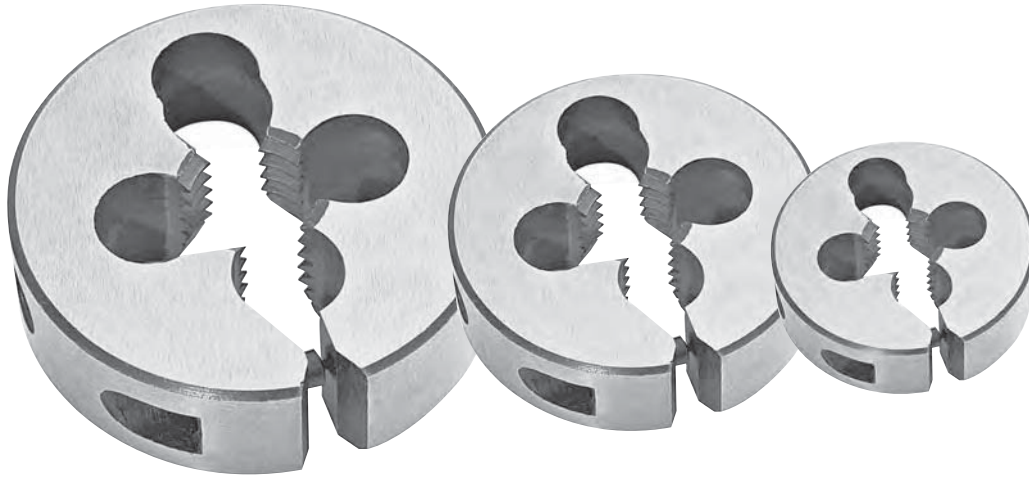

- Advancing the adjusting screw opens up the die resulting in slightly larger cutting size
- Retracting the screw closes when holding screw is tightened, resulting in a slightly smaller cutting size

Round Adjustable Split Dies

- High Speed Steel - M2

Straight Pipe NPS

Size	Threads per Inch	OD	Part Number
1/16	27	1	5-815-005
1/8	27	1	5-815-010
1/8	27	1-1/2	5-815-015
1/4	18	1-1/2	5-815-020
3/8	18	1-1/2	5-815-025
3/8	18	2	5-815-035
1/2	14	2	5-815-040
3/4	14	2	5-815-045
1	11-1/2	2-1/2	5-815-050
1-1/4	11-1/2	3	5-815-055

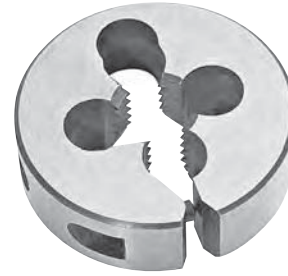

Taper Pipe NPT

Size	Threads per Inch	OD	Part Number
1/16	27	1	5-816-005
1/8	27	1	5-816-010
1/8	27	1-1/2	5-816-015
1/4	18	1-1/2	5-816-020
3/8	18	1-1/2	5-816-025
1/4	18	2	5-816-030
3/8	18	2	5-816-035
1/2	14	2	5-816-040
3/4	14	2	5-816-045
1	11-1/2	2-1/2	5-816-050
1-1/4	11-1/2	3	5-816-055
1-1/2	11-1/2	3	5-816-060
2	11-1/2	4	5-816-070
2-1/2	8	5	5-816-075
3	8	5	5-816-080

Heavy Duty Die Stocks

Die Dia	Overall Length	Part Number
13/16	6-1/4	4-400-005
1	9	4-400-010
1-1/2	12	4-400-015
2	19-1/2	4-400-020
2-1/2	20	4-400-025
3	22	4-400-030





Round Adjustable Split Dies

- Right Hand
- High Speed Steel - M2



National Coarse Thread			
Nominal Size	Threads per Inch	OD	Part Number
#4	40	13/16	5-800-003
#5	40	13/16	5-800-004
#6	32	13/16	5-800-005
#8	32	13/16	5-800-010
#10	24	13/16	5-800-015
#12	24	13/16	5-800-020
1/4	20	13/16	5-800-025
5/16	18	13/16	5-800-030
#4	40	1	5-800-032
#5	40	1	5-800-034
#6	32	1	5-800-035
#8	32	1	5-800-040
#10	24	1	5-800-045
#12	24	1	5-800-050
1/4	20	1	5-800-055
5/16	18	1	5-800-060
3/8	16	1	5-800-065
7/16	14	1	5-800-070
1/2	13	1	5-800-075
1/4	20	1-1/2	5-800-080
5/16	18	1-1/2	5-800-085
3/8	16	1-1/2	5-800-090
7/16	14	1-1/2	5-800-095
1/2	13	1-1/2	5-800-100
9/16	12	1-1/2	5-800-105
5/8	11	1-1/2	5-800-110
3/4	10	1-1/2	5-800-115
1/4	20	2	5-800-116
5/16	18	2	5-800-117
3/8	16	2	5-800-118
7/16	14	2	5-800-1185
1/2	13	2	5-800-1191
9/16	12	2	5-800-1192
5/8	11	2	5-800-120
3/4	10	2	5-800-125
7/8	9	2	5-800-130
1	8	2	5-800-135
1-1/8	7	2-1/2	5-800-200
1-1/4	7	2-1/2	5-800-205
1-3/8	6	2-1/2	5-800-210
1-1/2	6	2-1/2	5-800-215
1	8	3	5-800-300
1-1/4	7	3	5-800-310
1-3/8	6	3	5-800-315
1-1/2	6	3	5-800-320
1-5/8	5-1/2	3	5-800-325
1-3/4	5	3	5-800-330
1-7/8	5	3	5-800-335
2	4-1/2	3	5-800-340

National Fine Thread			
Nominal Size	Threads per Inch	OD	Part Number
#4	48	13/16	5-805-003
#5	44	13/16	5-805-004
#6	40	13/16	5-805-005
#*	36	13/16	5-805-010
#10	32	13/16	5-805-015
#12	28	13/16	5-805-020
1/4	28	13/16	5-805-025
5/16	24	13/16	5-805-030
#4	48	1	5-805-034
#6	40	1	5-805-035
#8	36	1	5-805-040
#10	32	1	5-805-045
#12	28	1	5-805-050
1/4	28	1	5-805-055
5/16	24	1	5-805-060
3/8	24	1	5-805-065
7/16	20	1	5-805-070
1/2	20	1	5-805-075
1/4	28	1-1/2	5-805-080
5/16	24	1-1/2	5-805-085
3/8	24	1-1/2	5-805-090
7/16	20	1-1/2	5-805-095
1/2	20	1-1/2	5-805-100
9/16	18	1-1/2	5-805-105
5/8	18	1-1/2	5-805-110
3/4	16	1-1/2	5-805-115
1/4	28	2	5-805-116
5/16	24	2	5-805-117
3/8	24	2	5-805-118
7/16	20	2	5-805-1181
1/2	20	2	5-805-1191
9/16	18	2	5-805-1192
5/8	18	2	5-805-120
3/4	16	2	5-805-125
7/8	14	2	5-805-130
1	12	2	5-805-134
1	14	2	5-805-135
1-1/8	12	2-1/2	5-805-200
1-1/4	12	2-1/2	5-805-205
1-3/8	12	2-1/2	5-805-210
1-1/2	12	2-1/2	5-805-215
1	14	3	5-805-305
1-1/4	12	3	5-805-315
1-3/8	12	3	5-805-320
1-1/2	12	3	5-805-325
1-5/8	12	3	5-805-330
1-3/4	12	3	5-805-335
1-7/8	12	3	5-805-340
2	12	3	5-805-345

Round Adjustable Split Dies with Special Threads per Inch



- Right Hand
- High Speed Steel - M2

Size	Threads per Inch	OD	Part Number
7/32	32	13/16	5-807-014
9/32	32	13/16	5-807-021
#4	36	13/16	5-807-036
#6	36	13/16	5-807-057
#6	48	13/16	5-807-059
#8	40	13/16	5-807-075
#10	36	13/16	5-807-078
#10	40	13/16	5-807-079
#10	48	13/16	5-807-080
#12	32	13/16	5-807-083
5/32	40	1	5-807-085
#10	40	1	5-807-087
#12	32	1	5-807-0876
#12	40	1	5-807-088
7/32	32	1	5-807-090
1/4	24	1	5-807-105
1/4	26	1	5-807-110
1/4	27	1	5-807-111
1/4	32	1	5-807-115
1/4	36	1	5-807-116
1/4	40	1	5-807-117
1/4	48	1	5-807-119
1/4	56	1	5-807-1195
5/16	20	1	5-807-120
5/16	22	1	5-807-122
5/16	26	1	5-807-126
5/16	27	1	5-807-127
5/16	28	1	5-807-128
5/16	32	1	5-807-135
5/16	36	1	5-807-136
5/16	40	1	5-807-137
5/16	48	1	5-807-138
3/8	14	1	5-807-142
3/8	20	1	5-807-145
3/8	26	1	5-807-146
3/8	27	1	5-807-1465
3/8	28	1	5-807-147
3/8	32	1	5-807-149
3/8	36	1	5-807-1495
3/8	40	1	5-807-1496
3/8	48	1	5-807-1497
7/16	18	1	5-807-1499
7/16	24	1	5-807-150
7/16	28	1	5-807-151
7/16	32	1	5-807-1510
7/16	40	1	5-807-1512
1/2	12	1	5-807-152
1/2	24	1	5-807-154
1/2	27	1	5-807-156
1/2	28	1	5-807-1565
1/2	32	1	5-807-157
1/2	40	1	5-807-158
1/4	24	1-1/2	5-807-186
5/16	32	1-1/2	5-807-188
3/8	32	1-1/2	5-807-195
7/16	27	1-1/2	5-807-197
7/16	28	1-1/2	5-807-198
15/32	32	1-1/2	5-807-200
1/2	12	1-1/2	5-807-202
1/2	16	1-1/2	5-807-204
1/2	18	1-1/2	5-807-2042

Size	Threads per Inch	OD	Part Number
1/2	24	1-1/2	5-807-205
1/2	27	1-1/2	5-807-206
1/2	28	1-1/2	5-807-207
1/2	32	1-1/2	5-807-208
1/2	40	1-1/2	5-807-210
9/16	14	1-1/2	5-807-212
9/16	16	1-1/2	5-807-214
9/16	20	1-1/2	5-807-218
9/16	24	1-1/2	5-807-219
9/16	27	1-1/2	5-807-2195
9/16	28	1-1/2	5-807-220
9/16	32	1-1/2	5-807-222
9/16	36	1-1/2	5-807-223
5/8	14	1-1/2	5-807-225
5/8	16	1-1/2	5-807-226
5/8	20	1-1/2	5-807-228
5/8	24	1-1/2	5-807-230
5/8	27	1-1/2	5-807-231
5/8	28	1-1/2	5-807-2311
5/8	32	1-1/2	5-807-232
5/8	40	1-1/2	5-807-235
11/16	11	1-1/2	5-807-237
11/16	12	1-1/2	5-807-238
11/16	16	1-1/2	5-807-2385
11/16	18	1-1/2	5-807-239
11/16	20	1-1/2	5-807-240
11/16	24	1-1/2	5-807-241
11/16	27	1-1/2	5-807-242
11/16	32	1-1/2	5-807-243
3/4	12	1-1/2	5-807-245
3/4	14	1-1/2	5-807-247
3/4	18	1-1/2	5-807-250
3/4	20	1-1/2	5-807-252
3/4	24	1-1/2	5-807-254
3/4	27	1-1/2	5-807-256
3/4	28	1-1/2	5-807-257
3/4	32	1-1/2	5-807-258
3/4	40	1-1/2	5-807-275
3/4	18	2	5-807-281
3/4	20	2	5-807-282
3/4	32	2	5-807-288
13/16	16	2	5-807-299
13/16	18	2	5-807-300
13/16	20	2	5-807-301
13/16	24	2	5-807-303
13/16	32	2	5-807-310
7/8	16	2	5-807-320
7/8	18	2	5-807-322
7/8	20	2	5-807-332
7/8	24	2	5-807-335
7/8	27	2	5-807-336
7/8	28	2	5-807-337
7/8	32	2	5-807-340
15/16	12	2	5-807-362
15/16	16	2	5-807-364
15/16	20	2	5-807-366
15/16	32	2	5-807-376
1	16	2	5-807-394
1	18	2	5-807-395
1	20	2	5-807-396
1	24	2	5-807-398



Round Adjustable Split Dies with Special Threads per Inch



Right Hand (continued)

- High Speed Steel – M2

Size	Threads per Inch	OD	Part Number
1	32	2	5-807-3984
1-1/16	12	2	5-807-3985
1-1/16	14	2	5-807-3986
1-1/16	16	2	5-807-3987
1-1/16	18	2	5-807-3988
3/4	10	2-1/2	5-807-399
1	8	2-1/2	5-807-401
1-1/16	12	2-1/2	5-807-403
1-1/16	14	2-1/2	5-807-404
1-1/16	16	2-1/2	5-807-405
1-1/16	18	2-1/2	5-807-406
1-1/16	20	2-1/2	5-807-407
1-1/8	8	2-1/2	5-807-420
1-1/8	10	2-1/2	5-807-422
1-1/8	16	2-1/2	5-807-425
1-1/8	18	2-1/2	5-807-426
1-1/8	20	2-1/2	5-807-427
1-1/8	24	2-1/2	5-807-428
1-1/8	32	2-1/2	5-807-430
1-3/16	12	2-1/2	5-807-432
1-3/16	18	2-1/2	5-807-435
1-1/4	8	2-1/2	5-807-441
1-1/4	14	2-1/2	5-807-443
1-1/4	16	2-1/2	5-807-444
1-1/4	18	2-1/2	5-807-445
1-1/4	20	2-1/2	5-807-446
1-5/16	12	2-1/2	5-807-452
1-5/16	18	2-1/2	5-807-454
1-3/8	8	2-1/2	5-807-462
1-3/8	16	2-1/2	5-807-465

Size	Threads per Inch	OD	Part Number
1-3/8	18	2-1/2	5-807-466
1-3/8	20	2-1/2	5-807-467
1-3/8	24	2-1/2	5-807-468
1-1/2	8	2-1/2	5-807-482
1-1/2	16	2-1/2	5-807-486
1-1/2	18	2-1/2	5-807-488
1-1/2	32	2-1/2	5-807-495
1-9/16	18	3	5-807-523
1-5/8	8	3	5-807-526
1-5/8	16	3	5-807-530
1-3/4	8	3	5-807-545
1-3/4	10	3	5-807-547
1-3/4	16	3	5-807-549
1-3/4	20	3	5-807-550
1-3/16	16	3	5-807-560
1-7/8	8	3	5-807-570
1-7/8	16	3	5-807-572
2	8	3	5-807-582
2	10	3	5-807-583
2	16	3	5-807-588
2-1/4	4-1/2	4	5-807-621
2-1/4	12	4	5-807-623
2-1/4	16	4	5-807-624
2-3/8	16	4	5-807-627
2-1/2	4	4	5-807-628
2-1/2	12	4	5-807-630
2-5/8	16	5	5-807-716
3	12	5	5-807-736
3-1/4	12	5	5-807-748
3-1/2	12	5	5-807-760

Left Hand

- High Speed Steel – M2

Size	Threads per Inch	OD	Part Number
#4	40	13/16	5-808-048
#5	40	13/16	5-808-051
#6	32	13/16	5-808-053
#8	32	13/16	5-808-059
#10	24	13/16	5-808-063
#10	32	13/16	5-808-067
#8	32	1	5-808-086
#10	24	1	5-808-088
#10	32	1	5-808-090
#12	24	1	5-808-092
1/4	20	1	5-808-098
1/4	28	1	5-808-100
1/4	32	1	5-808-102
5/16	18	1	5-808-112
5/16	24	1	5-808-115
3/8	16	1	5-808-129
3/8	24	1	5-808-136
7/16	14	1	5-808-142
7/16	20	1	5-808-146
1/2	13	1	5-808-148
1/2	20	1	5-808-150
1/4	20	1-1/2	5-808-189
1/4	28	1-1/2	5-808-192
5/16	18	1-1/2	5-808-195
5/16	24	1-1/2	5-808-198
3/8	16	1-1/2	5-808-211

Size	Threads per Inch	OD	Part Number
3/8	24	1-1/2	5-808-214
7/16	14	1-1/2	5-808-283
7/16	20	1-1/2	5-808-285
1/2	13	1-1/2	5-808-301
1/2	20	1-1/2	5-808-311
9/16	12	1-1/2	5-808-334
9/16	18	1-1/2	5-808-338
9/16	24	1-1/2	5-808-344
5/8	11	1-1/2	5-808-352
5/8	18	1-1/2	5-808-361
11/16	16	1-1/2	5-808-398
3/4	10	1-1/2	5-808-452
3/4	16	1-1/2	5-808-456
3/4	10	2	5-808-495
3/4	16	2	5-808-500
7/8	9	2	5-808-505
7/8	14	2	5-808-508
1	8	2	5-808-522
1	12	2	5-808-525
1	14	2	5-808-529
1-1/8	7	2-1/2	5-808-600
1-1/8	12	2-1/2	5-808-605
1-1/4	7	2-1/2	5-808-630
1-1/4	12	2-1/2	5-808-634
1-1/2	6	2-1/2	5-808-675
1-1/2	12	2-1/2	5-808-680

Round Adjustable Split Dies – Metric

Left Hand

- High Speed Steel – M2
- Metric ISO Threads

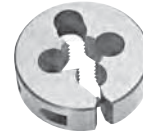

Size	Millimeter Pitch	OD	Part Number
4	.7	1	5-809-100
5	.8	1	5-809-110
6	1	1	5-809-120
7	1	1	5-809-130
8	1.25	1	5-809-140
8	1.5	1	5-809-145
9	1	1	5-809-150
9	1.25	1	5-809-155
10	1	1	5-809-160
10	1.25	1	5-809-165
10	1.5	1	5-809-170
11	1	1	5-809-180
12	1	1	5-809-190
12	1.25	1	5-809-195
12	1.5	1	5-809-200

Size	Millimeter Pitch	OD	Part Number
12	1.75	1	5-809-205
14	1	1.5	5-809-300
14	1.25	1.5	5-809-305
14	1.5	1.5	5-809-310
14	2	1.5	5-809-315
16	1	1.5	5-809-325
16	1.5	1.5	5-809-330
16	2	1.5	5-809-335
18	1.5	1.5	5-809-345
18	2	1.5	5-809-350
18	2.5	1.5	5-809-355
20	1.5	1.5	5-809-365
20	2	1.5	5-809-370
20	2.5	1.5	5-809-375



Metric Round Adjustable Split Dies

- Right Hand
- Metric ISO Threads
- High Speed Steel - M2



Coarse Pitch			
Size mm	Pitch mm	OD	Part Number
M 3	.60	13/16	5-801-055
M 4	.70	13/16	5-801-065
M 4	.75	13/16	5-801-070
M 5	.80	13/16	5-801-075
M 3	.5	1	5-801-190
M 3.5	.5	1	5-801-195
M 3.5	.6	1	5-801-200
M 4	.7	1	5-801-205
M 4.5	.75	1	5-801-210
M 5	1	1	5-801-214
M 5	.8	1	5-801-215
M 5.5	.9	1	5-801-217
M 6	1	1	5-801-225
M 6	1.25	1	5-801-220
M 6.3	1	1	5-801-227
M 7	1	1	5-801-230
M 8	1.25	1	5-801-235
M 9	1.25	1	5-801-238
M 10	1.5	1	5-801-240
M 11	1.5	1	5-801-245
M 9	1.25	1-1/2	5-801-310
M 10	1.5	1-1/2	5-801-320
M 11	1.5	1-1/2	5-801-335
M 12	1.75	1-1/2	5-801-345
M 14	2	1-1/2	5-801-360
M 16	2	1-1/2	5-801-385
M 18	2.5	1-1/2	5-801-405
M 20	2.5	1-1/2	5-801-415
M 18	2.5	2	5-801-480
M 20	2.5	2	5-801-490
M 22	2.5	2	5-801-505
M 24	3	2	5-801-520
M 27	3	2	5-801-523
M 30	3.5	2	5-801-550
M 36	4	2-1/2	5-801-570
M 42	4.5	3	5-801-615
M 48	5	3	5-801-630

Fine Pitch			
Size mm	Pitch mm	OD	Part Number
M 3	.5	13/16	5-806-055
M 4	.5	13/16	5-806-105
M 4	.5	1	5-806-205
M 4.5	.5	1	5-806-210
M 5	.5	1	5-806-215
M 6	.75	1	5-806-225
M 6	.5	1	5-806-226
M 7	.75	1	5-806-230
M 8	1	1	5-806-235
M 8	.75	1	5-806-237
M 10	1.25	1	5-806-240
M 10	1	1	5-806-241
M 10	.75	1	5-806-243
M 12	1	1	5-806-260
M 9	1	1-1/2	5-806-310
M 10	1.25	1-1/2	5-806-320
M 10	1	1-1/2	5-806-325
M 10	.75	1-1/2	5-806-330
M 11	1	1-1/2	5-806-335
M 12	1.5	1-1/2	5-806-345
M 12	1.25	1-1/2	5-806-350
M 12	1	1-1/2	5-806-355
M 13	1	1-1/2	5-806-358
M 14	1.5	1-1/2	5-806-360
M 14	1.25	1-1/2	5-806-365
M 14	1	1-1/2	5-806-370
M 15	1.5	1-1/2	5-806-375
M 15	1	1-1/2	5-806-380
M 16	1.5	1-1/2	5-806-385
M 16	1	1-1/2	5-806-390
M 17	1.5	1-1/2	5-806-395
M 17	1	1-1/2	5-806-400
M 18	2	1-1/2	5-806-405
M 18	1.5	1-1/2	5-806-410
M 18	1	1-1/2	5-806-415
M 20	1.5	1-1/2	5-806-425
M 20	1	1-1/2	5-806-427
M 19	1.5	2	5-806-485
M 20	2	2	5-806-490
M 20	1.5	2	5-806-495
M 20	1	2	5-806-497
M 22	2	2	5-806-505
M 22	1.5	2	5-806-510
M 22	1	2	5-806-514
M 24	2	2	5-806-520
M 24	1.5	2	5-806-525
M 26	1.5	2	5-806-540
M 27	2	2	5-806-545
M 28	1.5	2	5-806-550
M 30	2	2	5-806-560
M 30	1.5	2	5-806-565
M 33	2	2-1/2	5-806-580

TABLE OF CONTENTS

BROACHES AND TOOL BITS

BROACHES

Individual Keyway Broaches 414

Keyway Broach Sets 415

TOOL BITS

Carbide Tipped Tool Bits 416

Ground Tool Bits 418

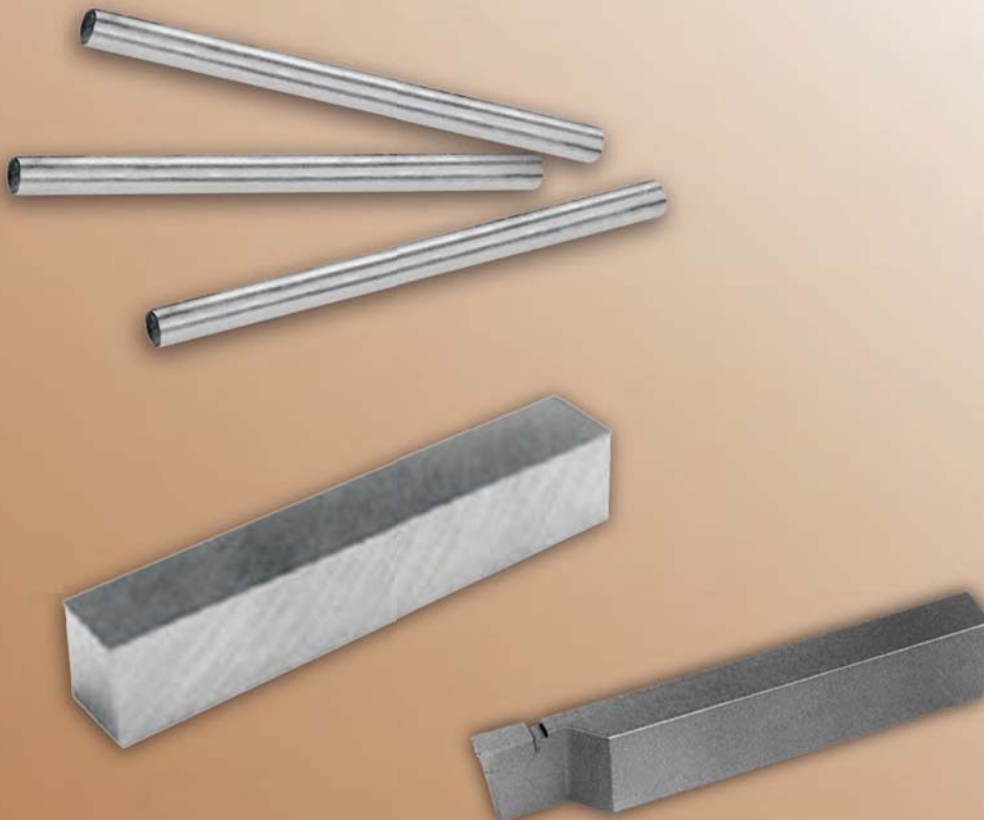



Individual Keyway Broaches

- High Speed Steel
- Shims are included



Fractional Sizes							Part Number
Keyway Nominal Width	Keyway Decimal Range	Broach		Shims Required	Length of Cut		
		W	L		Minimum	Maximum	
1/16-AA	.0625 to .0635	1/8	5	0	13/64	1-1/8	5-868-001
3/32-AA	.0938 to .0948	1/8	5	0	13/64	1-1/8	5-868-002
1/8-AA	.1252 to .1262	1/8	5	1	13/64	1-1/8	5-868-003
3/32-BB	.0938 to .0948	3/16	6-3/4	0	19/64	1-11/16	5-868-004
1/8-BB	.1252 to .1262	3/16	6-3/4	1	19/64	1-11/16	5-868-005
5/32-BB	.1564 to .1574	3/16	6-3/4	1	19/64	1-11/16	5-868-006
3/16-BB	.1877 to .1887	3/16	6-3/4	1	19/64	1-11/16	5-868-007
3/16-CC	.1877 to .1887	3/8	11-3/4	1	25/64	2-1/2	5-868-008
1/4-CC	.2502 to .2512	3/8	11-3/4	1	25/64	2-1/2	5-868-009
5/16-CC	.3127 to .3137	3/8	11-3/4	2	25/64	2-1/2	5-868-010
3/8-CC	.3755 to .3765	3/8	11-3/4	2	25/64	2-1/2	5-868-011
5/16-DD	.3127 to .3137	9/16	13-7/8	2	1	6	5-868-012
3/8-DD	.3755 to .3765	9/16	13-7/8	2	1	6	5-868-013
7/16-DD	.4380 to .4390	9/16	13-7/8	3	1	6	5-868-014
1/2-DD	.5006 to .5016	9/16	13-7/8	3	1	6	5-868-015
5/8-EE	.6260 to .6270	3/4	15-1/2	4	1	6	5-868-016
3/4-EE	.7515 to .7525	3/4	15-1/2	5	1	6	5-868-017
7/8-FF	.8767 to .8775	1	20-1/4	6	1	6	5-868-018
1-FF	1.0015 to 1.0025	1	20-1/4	7	1	6	5-868-019

BROACHES / TOOL BITS

Metric Standard, ISO							Part Number	
Keyway Nominal Width	Keyway Decimal Range	Broach Dimensions (Inches)		Shims Required	Standard Millimeter Keys	Length of Cut		
		W	L			Minimum		Maximum
2 mm-AA	.0782 to .0792	1/8	5	0	2 X 2	13/64	1-1/8	5-869-001
3 mm-AA	.1172 to .1186	1/8	5	1	3 X 3	13/64	1-1/8	5-869-002
4 mm-BB	.1568 to .1581	1/4	6-3/4	1	4 X 4	19/64	1-7/16	5-869-003
5 mm-BB	.1963 to .1974	1/4	6-3/4	1	5 X 5	16/64	1-7/16	5-869-004
5 mm-CC	.1963 to .1974	3/8	11-3/4	1	5 X 5	25/64	2-1/2	5-869-005
6 mm-CC	.2356 to .2368	3/8	11-3/4	1	6 X 6	25/64	2-1/2	5-869-006
8 mm-CC	.3143 to .3157	3/8	11-3/4	2	8 X 7	25/64	2-1/2	5-869-007
10 mm-DD	.3930 to .3944	9/16	13-7/8	2	10 X 8	1	6	5-869-008
12 mm-DD	.4716 to .4733	9/16	13-7/8	2	12 X 8	1	6	5-869-009
14 mm-DD	.5503 to .5520	9/16	13-7/8	2	14 X 9	1	6	5-869-010
16 mm-EE	.6290 to .6307	3/4	15-1/2	3	16 X 10	1	6	5-869-011
18 mm-EE	.7078 to .7095	3/4	15-1/2	3	18 X 11	1	6	5-869-012
20 mm-FF	.7864 to .7884	1	20-1/4	3	20 X 12	1	6	5-869-013
22 mm-FF	.8651 to .8671	1	20-1/4	4	22 X 14	1	6	5-869-014
24 mm-FF	.9439 to .9459	1	20-1/4	5	24 X 14	1	6	5-869-015
25 mm-FF	.9832 to .9852	1	20-1/4	4	25 X 14	1	6	5-869-016

Keyway Broach Sets

- Each set comes in a handsome Dura Case. They include keyway broaches, slotted bushings and the necessary shims.

Broaches Included		Keyway combinations	Collared Bushings Included	Part Number
American Standard Set				
1/16, 3/32, 1/8	A	15	1/4, 5/16, 3/8, 7/16, 1/2	5-868-500
1/8, 3/16	B	18	1/2, 5/8, 3/4, 7/8	5-868-510
1/4, 3/8	C		1, 1-1/8, 1-1/4, 1-3/8, 1-1/2	
1/8, 3/16	B	36	1/2, 9/16, 5/8, 11/16, 3/4, 13/16, 7/8	5-868-511
1/4, 3/8	C		15/16, 1, 1-1/16, 1-1/8, 1-3/16, 1-1/4, 1-5/16, 1-3/8, 1-7/16, 1-1/2, 1-9/16	
Metric Standard Sets				
2mm, 3mm	A	10	6, 7, 8, 9, 10	5-869-510
4mm, 5mm	B	18	12, 14, 16, 18	5-869-518
6mm, 8mm	C		20, 22, 24, 26, 28	
10mm, 12mm, 14mm	D	24	34, 36, 38, 40, 42, 44, 46, 48	5-869-524
2mm, 3mm	A	36	8, 10	5-869-540
4mm, 5mm	B		12, 14, 16, 18	
6mm, 8mm	C		18, 19, 20, 22, 24, 25, 26, 28, 30, 32, 34, 36	

Shims for Keyway Broaches	
Inch & Metric	
Broach Size	Shim Part Number
A 1/8" & AA 3MM	5-873-201
B 1/8"	5-873-202
B 5/32"	5-873-203
BB 4MM	5-873-204
B 3/16"	5-873-205
BB 5MM	5-873-206
C 3/16"	5-873-207
CC 5MM	5-873-208
C 1/4" & 3/8" CC 6MM	5-873-209
C 5/16" & CC 8MM	5-873-210
D 5/16"	5-873-211
D 3/8" & 1/2", DD 14MM	5-873-212
DD 10 & 12MM	5-873-213
D 7/16"	5-873-214
E 5/8" 3/4", EE 16 & 18MM	5-873-215
F 7/8 & 1", FF 20-25MM	5-873-216



Carbide Tipped Tool Bits

Cutting Tools

Carbide Tipped Tool Bits

- C5 Grade for Steel
- C2 Grade for Cast Iron

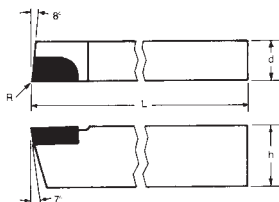

Turning Style A
0° Lead Angle

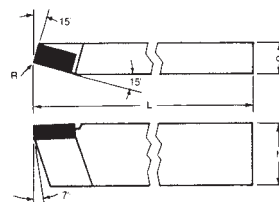

Turning Style B
15° Lead Angle

Tool Style		Square Shank	OAL	Nose	Blank	Part Number			
Right Hand	Left Hand	d	L	R	Number	Grade C2		Grade C5	
Right Hand	Left Hand					Right Hand	Left Hand	Right Hand	Left Hand
Turning Style A									
AR4	AL4	1/4	2	1/64	2040	6-082-004	6-082-104	6-085-004	6-085-104
AR5	AL5	5/16	2-1/4	1/64	2070	6-082-005	6-082-105	6-085-005	6-085-105
AR6	AL6	3/8	2-1/2	1/64	2070	6-082-006	6-082-106	6-085-006	6-085-106
AR7	AL7	7/16	3	1/32	2070	6-082-007	6-082-107	6-085-007	6-085-107
AR8	AL8	1/2	3-1/2	1/32	2170	6-082-008	6-082-108	6-085-008	6-085-108
AR10	AL10	5/8	4	1/32	2230	6-082-010	6-082-110	6-085-010	6-085-110
AR12	AL12	3/4	4-1/2	1/32	2310	6-082-012	6-082-112	6-085-012	6-085-112
AR16	AL16	1	7	—	—	6-082-016	6-082-116	6-085-016	—
Turning Style B									
BR4	BL4	1/4	2	1/64	2020	6-082-204	6-082-304	6-085-204	6-085-304
BR5	BL5	5/16	2-1/4	1/64	2040	6-082-205	6-082-305	6-085-205	6-085-305
BR6	BL6	3/8	2-1/2	1/64	2070	6-082-206	6-082-306	6-085-206	6-085-306
BR7	BL7	7/16	3	1/32	2070	6-082-207	6-082-307	6-085-207	—
BR8	BL8	1/2	3-1/2	1/32	2170	6-082-208	6-082-308	6-085-208	6-085-308
BR10	BL10	5/8	4	1/32	2230	6-082-210	6-082-310	6-085-210	6-085-310
BR12	BL12	3/4	4-1/2	1/32	2310	6-082-212	6-082-312	6-085-212	6-085-312
BR16	BL16	1	7	—	—	6-082-216	6-082-316	6-085-216	6-085-316

Package Quantities

- #4 - #6: 10 per package
- #7 - #10: 5 per package
- #12: 2 per package
- #16: 1 per package

BROACHES / TOOL BITS



Carbide Tipped Tool Bits

- C5 Grade for Steel
- C2 Grade for Cast Iron

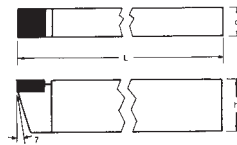

Turning/Facing Style C
Square End

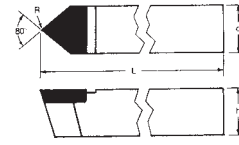

Chamfering Style D
80° Included Angle

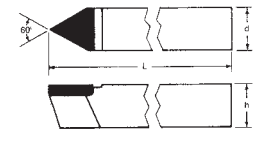

Threading Style E
60° Included Angle

Tool Style	Square Shank	OAL	Nose Radius	Blank	Grade C2 Part Number	Grade C5 Part Number
Turning/Facing Style C						
C4	1/4	2	–	1030	6-082-404	6-085-404
C5	5/16	2-1/4	–	1080	6-082-405	6-085-405
C6	3/8	2-1/2	–	1090	6-082-406	6-085-406
C7	7/16	3	–	1105	6-082-407	6-085-407
C8	1/2	3-1/2	–	1200	6-082-408	6-085-408
C10	5/8	4	–	1240	6-082-410	6-085-410
C12	3/4	4-1/2	–	1340	6-082-412	6-085-412
C13	1	7	–	1410	6-082-416	6-085-416
Chamfering Style D						
D4	1/4	2	1/64	5030	6-082-504	6-085-504
D5	5/16	2-1/4	1/64	5080	6-082-505	6-085-505
D6	3/8	2-1/2	1/64	5100	6-082-506	6-085-506
D7	7/16	3	1/32	5105	6-082-507	6-085-507
D8	1/2	3-1/2	1/32	5200	6-082-508	6-085-508
D10	5/8	4	1/32	5240	6-082-510	6-085-510
D12	3/4	4-1/2	1/32	5340	6-082-512	6-085-512
D16	1	7	–	–	6-082-516	6-085-516
Threading Style E						
E4	1/4	2	–	6030	6-082-604	6-085-604
E5	5/16	2-1/4	–	6080	6-082-605	6-085-605
E6	3/8	2-1/2	–	6100	6-082-606	6-085-606
E7	7/16	3	–	–	6-082-607	6-085-607
E8	1/2	3-1/2	–	6200	6-082-608	6-085-608
E10	5/8	4	–	6240	6-082-610	6-085-610
E12	3/4	4-1/2	–	6340	6-082-612	6-085-612
E16	1	7	–	–	6-082-616	6-085-616

Package Quantities
 #4 - #6: 10 per package
 #7 - #10: 5 per package
 #12: 2 per package
 #16: 1 per package

BROCHES / TOOL BITS

Carbide Tipped Tool Bits

- C5 Grade for Steel
- C2 Grade for Cast Iron



Cut-Off: Styles CTR and CTL

Tool Style		Tip Width	Shank			Part Number for Styles CTR and CTL			
						Grade C2		Grade C5	
Right Hand	Left Hand		d	h	L	Right Hand	Left Hand	Right Hand	Left Hand
CTR-11	CTL-11	1/8	1/2	1	5	6-102-011	6-102-111	6-105-011	6-105-111
CTR-22	CTL-22	3/16	1/2	1	5	6-102-022	6-102-122	6-105-022	6-105-122
CTR-33	CTL-33	1/4	1/2	1	5	6-102-033	6-102-133	6-105-033	6-105-133
CTR-44	CTL-44	5/16	1/2	1	5	6-102-044	6-102-144	6-105-044	6-105-144
CTR-55	CTL-55	3/8	5/8	1-1/4	5	6-102-055	6-102-155	6-105-055	6-105-155



Ground Tool Bits

Cutting Tools

Ground Tool Bits

- High Speed Steel – M2 (W 7%, Mo 5%) and Cobalt Steel (CO 5%)



Rectangular	
Dimensions	HSS Part Number
1/4 x 3/8 x 3	5-093-008
1/4 x 1/2 x 4	5-093-012
1/4 x 3/4 x 5	5-093-016
1/4 x 1 x 6	5-093-020
3/8 x 1/2 x 4	5-093-032
3/8 x 5/8 x 4-1/2	5-093-036
3/8 x 3/4 x 5	5-093-040
1/2 x 3/4 x 5	5-093-048
1/2 x 1 x 7	5-093-052
1/2 x 1-1/4 x 7	5-093-056
5/8 x 1 x 7	5-093-072
3/4 x 1 x 6	5-093-082
3/4 x 1 x 7	5-093-084

Round	
Dimensions	HSS Part Number
1/8 x 2-3/4	5-091-002
3/16 x 3-1/2	5-091-008
1/4 x 4	5-091-013
5/16 x 4-1/2	5-091-018
3/8 x 5	5-091-023
7/16 x 5-1/2	5-091-028
1/2 x 6	5-091-033
9/16 x 6	5-091-038
5/8 x 6	5-091-043
3/4 x 6	5-091-053
1/8 x 4	5-091-116
1/4 x 8	5-091-126
5/16 x 8	5-091-136



Square		
Dimensions	HSS Part Number	Cobalt Steel Part Number
1/8 x 2-1/2	5-092-002	5-095-002
3/16 x 2-1/2	5-092-007	5-095-007
1/4 x 2-1/2	5-092-012	5-095-012
5/16 x 2-1/2	5-092-017	5-095-017
5/16 x 3	5-092-018	5-095-018
5/16 x 4	5-092-020	-
3/8 x 3	5-092-022	5-095-022
3/8 x 4	5-092-024	-
7/16 x 3-1/2	5-092-028	5-095-028
1/2 x 4	5-092-032	5-095-032
5/8 x 4-1/2	5-092-042	5-095-042
3/4 x 5	5-092-052	5-095-052

Square Long		
Dimensions	HSS Part Number	Cobalt Steel Part Number
1/4 x 4	5-092-108	5-095-108
1/4 x 6	5-092-110	5-095-110
1/4 x 8	5-092-112	5-095-112
5/16 x 6	5-092-115	5-095-115
5/16 x 8	5-092-117	5-095-117
3/8 x 6	5-092-120	5-095-120
3/8 x 8	5-092-122	5-095-122
1/2 x 6	5-092-130	5-095-130
1/2 x 8	5-092-132	5-095-132
5/8 x 8	5-092-142	5-095-142
7/8 x 6	5-092-063	5-095-063
1 x 7	5-092-073	5-095-073
1-1/4 x 7	5-092-077	5-095-077

BROACHES / TOOL BITS

Index By Group



Cutting Tools

INDEX BY GROUP

Group	Description	Page #
1-100-2	2F SC Single End End Mills Std Len Uncoated	335
1-100-4	4F SC Single End End Mills Std Len Uncoated	338
1-102-2	2F SC Single End End Mills Std Len Altin	335
1-102-4	4F SC Single End End Mills Std Len Altin	338
1-103-2	2F SC Single End End Mills Std Len Ball Uncoated	341
1-103-4	4F SC Single End End Mills Std Len Ball Uncoated	343
1-104-2	2F SC Single End End Mills Std Len Ball Altin	341
1-104-4	4F SC Single End End Mills Std Len Ball Altin	343
1-110-2	2F SC Single End End Mills Long Len Uncoated	336
1-110-4	4F SC Single End End Mills Long Len Uncoated	339
1-111-2	2F SC Single End End Mills Long Len Ball Uncoated	342
1-111-4	4F SC Single End End Mills Long Len Ball Uncoated	344
1-112-2	2F SC Single End End Mills Long Len Ball Altin	336
1-112-4	4F SC Single End End Mills Long Len Ball Altin	339
1-113-2	2F SC Single End End Mills Long Len Ball Altin	342
1-113-4	4F SC Single End End Mills Long Len Ball Altin	344
1-124-2	2F SC Double End End Mills Square End, Uncoated	345
1-124-4	4F SC Double End End Mills Square End, Uncoated	345
1-134-2	2F SC Double End End Mills Weldon Shank Square End	346
1-134-4	4F SC Double End End Mills Weldon Shank Square End	346
1-135-2	2F SC Double End End Mills Weldon Shank Ball End	347
1-135-4	4F SC Double End End Mills Weldon Shank Ball End	347
1-150-4	4F SC Variable Helix Corner Radius End Mills Altin	348-349
1-150-5	5F SC Variable Helix Corner Radius End Mills Altin	348
1-151-4	4F SC Variable Helix Ball End Mills Altin	349
1-160-4	4F SC Roughing End Mills Uncoated	352
1-161-4	4F SC Roughing End Mills Altin	352
1-163-4	4F SC Roughing End Mills, Long, Uncoated	352
1-164-4	4F SC Roughing End Mills, Long, Coated	352
1-170-6	6F SC 45° Helix End Mills Altin	350
1-173-2	2f SC 45° End Mills for Aluminum	351
1-173-3	3F SC 45° End Mills for Aluminum	351
1-174-2	2F SC Long Len End Mills for Aluminum	351
1-174-3	3F SC Long Len End Mills for Aluminum	351
1-180-2	2F SC Metric End Mills Square End, Uncoated	337
1-180-4	4F SC Metric End Mills Square End, Uncoated	340
1-181-2	2F SC Metric End Mills Ball End, Uncoated	342

continued on next page



Index By Group

Cutting Tools

INDEX BY GROUP

Group	Description	Page #
1-181-4	4F SC Metric End Mills Ball End, Uncoated	344
1-182-2	2F SC Metric End Mills Square End, Coated	337, 340
1-183-2	2F SC Metric End Mills Ball End, Coated.	342
1-183-4	4F SC Metric End Mills Ball End, Coated.	344
1-190-2	2F 90° Point Angle Drill Mills Uncoated	353
1-190-4	4F 90° Point Angle Drill Mills Uncoated	353
1-191-2	2F 90° Point Angle Drill Mills Altin	353
1-191-4	4F 90° Point Angle Drill Mills Altin	353
1-200	SC Jobber Drills, Fractional Sizes	252-255
1-201	SC Jobber Drills, Letter Sizes.	254-255
1-202	SC Jobber Drills, Number Sizes	251-254
1-215	High Performance 5XD Coolant Fed Drills	257
1-225	High Performance 5XD Coolant Fed Drills, Metric	258
1-228	High Performance 8XD Coolant Fed Drills, Metric	259
1-302	Carbide Burrs, SB	331
1-303	Carbide Burrs, SC	331
1-304	Carbide Burrs, SD	331
1-305	Carbide Burrs, SE	332
1-306	Carbide Burrs, SF	332
1-307	Carbide Burrs, SG	332
1-308	Carbide Burrs, SH	332
1-312	Carbide Burrs, SL	332
1-313	Carbide Burrs, SM.	332
3-120	TMX Slitting & Slotting Saw Arbors	377
3-121	TMX Slotting Saw Arbor, Weldon Shank	377
4-400	Heavy Duty Die Stocks 3-Screw Type	407
5-005	Straight Shank Straight Flute Hand Reamers	313
5-006	Straight Shank Straight Flute Hand Reamers Metric - DIN 206/A.	314
5-010	Straight Shank Helical Flute Hand Reamers	313
5-011	Straight Shank Helical Flute Hand Reamers Metric - DIN 206/B.	314
5-012	Adjustable Blade Reamers	316
5-013	HSS Expansion Hand Reamer Straight Flute	315
5-014	HSS Expansion Hand Reamers, Spiral Flute	315
5-015	Straight Shank Straight Flute Chucking Reamers	301-302
5-016	Straight Shank Straight Flute Chucking Reamers Number Sizes.	304

Index By Group



Cutting Tools

INDEX BY GROUP

Group	Description	Page #
5-017	Straight Shank Straight Flute Chucking Reamers Letter Sizes	303
5-018	Straight Shank Straight Flute Chucking Reamers Decimal Sizes.	306-308
5-019	Straight Shank Straight Flute Chucking Reamers Metric - DIN 212	305
5-020	Straight Shank Helical Flute Chucking Reamers.	309
5-022	Straight Shank Straight Flute Chucking Reamers Cobalt Steel(M42)	301-302
5-025	Taper Shank Straight Flute Chucking Reamers.	310
5-026	Taper Shank Straight Flute Chucking Reamers Metric - DIN 208	311
5-030	Taper Shank Helical Flute Chucking Reamers.	310
5-033	Expansion Chucking Reamers Straight Shank Straight Flute RH	312
5-034	Expansion Chucking Reamers Morse Taper Shank Straight Flute RH	312
5-050	Taper Shank Helical Flute Bridge Reamers 5F.	316
5-055	Taper Shank Straight Flute Bridge Reamers 5F.	316
5-056	HSS Car Reamers Taper Shank Spiral Flute LH	318
5-057	HSS Car Reamers Straight Shank 3 Equal Flats, LH.	318
5-058	HSS Car Reamers HEX Shank Spiral Flute, LH.	318
5-060	Taper Pipe Reamers Straight Flute, HSS	319
5-065	Taper Pipe Reamers Spiral Flute, HSS	319
5-091	HSS Tool Bits Ground, Round	418
5-092	HSS Tool Bits Ground, Square	418
5-093	HSS Tool Bits Ground Rectangular	418
5-095	Cobalt M35 Tool Bits Ground, Square	418
5-100	Taper Pin Reamers Straight Flute	317
5-101	Taper Pin Reamers Metric DIN 9/A Straight Flute.	317
5-105	Taper Pin Reamers Spiral Flute	317
5-106	Taper Pin Reamers MetricDIN 9/B Spiral Flute	317
5-110	Taper Pin Reamers Helical Flute	317
5-131	Jobber Drills Fractional Sizes	266, 281
5-132	Jobber Drills Number Sizes.	267, 281
5-133	Jobber Drills Letter Sizes	268, 281
5-134	Jobber Drills Metric Sizes	269-270, 281
5-141	Jobber Drills Split Point Fractional Sizes	271, 281
5-142	Jobber Drills Split Point Number Sizes	272
5-143	Jobber Drills Split Point Letter Sizes	273
5-144	Jobber Drills Split Point Metric Sizes	274-275
5-150	Shell Reamers Straight Flute	320
5-155	Shell Reamers Helical Flute	320
5-158	Cobalt 135°Split HD Jobber Length Drill	276, 281
5-160	HSS Jobber Drills 118° Point.	260, 281

continued on next page



Index By Group

Cutting Tools

INDEX BY GROUP

Group	Description	Page #
5-161	Straight Shank Twist Drills Metric Sizes 118°Point	263-264, 281
5-164	Spotting & Centering Drills HSS	292
5-165	NC Spotting Drills HSS	292
5-166	Silver & Deming Drills 1/2in Shank HSS	288-289, 291
5-167	Metric Silver & Deming Drill 1/2inSh HSS.	290
5-168	Silver & Deming Drills 3/4in Shank HSS	289, 291
5-169	Silver & Deming Drill 1/2in Shank M42Cobalt	288-289, 291
5-170	HSS Jobber Drills Number Sizes	261, 281
5-174	Cobalt 135°Split, HD Jobber Metric Sizes.	279-281
5-175	Cobalt 135°Split, HD Jobber Number Sizes	277, 281
5-180	HSS Jobber Drills Letter Sizes	251, 262, 281
5-183	135° Point Ext Len Split Drill, Black Fractional Sizes.	282
5-184	135° Point Ext Len Split Drill, Black Number Sizes	283
5-185	Cobalt 135°Split HD Jobber Letter Sizes.	278, 281
5-186	135° Point 12in Len Split Drill, Black Fractional Sizes.	283
5-187	135° Point 12in Len Split Drill, Black Fractional Sizes.	284
5-190	HSS Taper Shank Drills 118° Point	285-286
5-191	HSS Taper Shank Drill Metric Sizes 118°Point.	287
5-194	Stub Length Taper Shank Drills.	286
5-199	Miscellaneous Drills and Sets.	262, 281
5-205	Straight Shank4F Core Drills.	294
5-215	Taper Shank 4F Core Drills	293
5-220	HSS 2 Flute Ball End Mills	357
5-221	Cobalt M42 2 Flute Ball End Mills	357
5-225	HSS MultiFlute Ball End Mills Center Cutting.	362
5-226	Cobalt M42 MultiFlute Ball End Mill Center Cutting	362
5-230	HSS 2 Flute Ball Double End Mills	357
5-250	HSS, 2 Flute Double End Mills	356
5-251	Cobalt M42 2 Flute Double End Mills.	356
5-254	HSS Centercut 4 Flute Double End Mills.	361
5-256	Cobalt M42 4 Fl Centercut Dbl End Mills.	361
5-300	HSS 2 Flute Single End End Mills	354
5-301	Cobalt M42 2 Flute Single End End Mills.	354
5-302	HSS Metric 2 Flute Single End End Mills.	355
5-304	HSS Centercut MultiFlute Single End End Mills	358-359
5-306	Cobalt M42 MultiFLute Centercut Single End End Mills.	358-359
5-307	HSS Metric 4 Flute Single End End Mills Centercut	360
5-310	2F Long Single End End Mills Extension Type.	356

Index By Group



TMX Cutting Tools

INDEX BY GROUP

Group	Description	Page #
5-314	HSS Centercut MultiFlute Long Single End End Mills	360
5-316	Cobalt M42 MultiFl Centercut Long Len E/M	360
5-360	6F HD End Mill with Twin Drive Shank	359
5-400	2F End Mills Long Len Non-Extension	355
5-424	HSS Centercut MultiFlute End Mills Extra Long	361
5-431	Rough End Mills Coarse Tooth M42 Cobalt Ground	362
5-450	Shell End Mills RH HSS	371
5-530	TMX Annular Cutters HSS	297
5-550	HSS Corner Rounding End Mills	367
5-600	Combined Drill & Countersink Plain Type RH HSS	325
5-601	Combined Drill & Countersink Plain 60°RH M42 Cobalt	325
5-602	Long Combined Drill & Countersink RH HSS	325
5-603	Combined Drill & Countersink Metric DIN 333A RH HSS	325
5-605	Combined Drill & Countersink Bell Type RH HSS	325
5-610	Capscrew Counterbores Straight Shank 3F HSS	323-324
5-612	Capscrew Counterbores Taper Shank 3F HSS	324
5-614	Capscrew Counterbores Metric Straight Shank 3F HSS	324
5-625	Fillister Head Counterbores	323
5-650	Fillister Head Counterbores	323
5-652	0 Flute Counterbores & Deburring Tools HSS	326
5-654	Single Flute Countersinks HSS	327-328
5-656	3 Flute Center Reamers HSS	327-328
5-658	4 Flute Machine Countersinks HSS	327
5-660	6 Flute Chatterless Countersinks HSS	326, 328
5-676	Power Hacksaw Blades	386
5-680	HSS Single Angle Chamfering Shank Cutters	365
5-682	HSS Double Angle Shank Cutters	366
5-690	HSS Convex Radius Shank Cutters	365
5-693	HSS Concave Radius Shank Cutters	365
5-700	Convex Cutters	369
5-703	Concave Cutters	369
5-706	Plain Tooth Side Milling Cutters	382-383
5-709	Staggered Tooth Side Milling Cutters	384-384
5-712	Single Angle Cutters RH	370
5-715	Single Angle Cutters LH	370
5-718	Double Angle Cutters	370
5-721	HSS Dovetail Cutters	366
5-722	Cobalt M42 Dovetail Cutters	366

continued on next page



Index By Group

Cutting Tools

INDEX BY GROUP

Group	Description	Page #
5-727	Straight Tooth 1/2in Shank Woodruff Keyseat Cutters	368
5-728	Staggered Tooth 1/2in Shank Woodruff Keyseat Cutters.	368
5-745	Screw Slotting Saws.	377-378
5-746	Jewelers Saws	374-376
5-747	Plain Slitting Saws	379
5-748	Plain Tooth Metal Slitting Saws with Side Chip Clearance	380
5-749	Staggered Tooth Metal Slitting Saws with Side Chip Cleanance.	381
5-750	HSS Hand Taps Ground RH Fractional Sizes	390-393, 395
5-752	HSS Hand Taps Ground RH Mach Screw Size	394-395
5-756	HSS Hand Taps Ground LH	395
5-760	HSS Fast Spiral Fluted Taps, Ground RH Fractional	400
5-762	HSS Fast Spiral Fluted Taps, Ground RH Machine Screw.	400
5-763	HSS Straight Pipe Taps, NPS Ground RH.	403
5-764	HSS Taper Pipe Taps, NPT Ground RH	403
5-765	HSS Straight Pipe Taps, NPSF Ground RH Dry Seal	403
5-766	HSS Taper Pipe Taps, NPTF Ground RH	403
5-767	HSS Taper Pipe Taps, NPT Interrupted Thread Ground.	404
5-768	HSS Long Taper Pipe Taps, NPT Ground RH.	404
5-769	Taper Pipe Tap NPTF Interrupted Thread Ground	404
5-770	HSS Spiral Point Taps RH Ground Fractional	398
5-772	HSS Spiral Point Taps RH Ground Machine Screw.	398-399
5-775	ISO Metric HSS Hand Taps Ground RH	396-397
5-776	ISO Metric HSS Hand Tap Spiral Point Ground	399
5-780	Combination Tap and Drills HSS	401
5-782	Combination Tap and Drills HSS Metric	401
5-790	Tap & Drill Sets HSS	402
5-800	HSS Adjustable Round Split Dies NC	408
5-801	HSS Coarse ISO Metric Round Adjustable Dies Inch OD	412
5-805	HSS Adjustable Round Split Dies NF.	408
5-806	HSS Fine ISO Metric Round Adjustable Dies Inch OD	412
5-807	HSS Adjustable Round Dies Special Threads	409-410
5-808	HSS Adjustable Round Dies Special Threads LH	411
5-809	HSS Adjustable Round Dies Metric LH	411
5-815	Straight Pipe Adjustable Round Dies NPS HSS	407
5-816	Taper Pipe Adjustable Round Dies NPT HSS	407
5-860	Involute Gear Cutters 14 1/2 ° Pressure Angle	372
5-862	Involute Gear Cutters 20° Pressure Angle Metric.	373
5-868	Keyway Broaches HSS	414-415

Index By Group



TMX Cutting Tools

INDEX BY GROUP

Group	Description	Page #
5-869	Keyway Broaches Metric HSS	414-415
5-873	Shims for Keyway Broaches, Inch & Metric.	415
6-082	Brazed Tools Carbide Tip C2/K20 Grade	416-471
6-085	Brazed Tools Carbide Tip C5/P30 Grade	416-417
6-102	Carbide Tipped Cut-Off Tool C2/K20 Grade	417
6-105	Carbide Tipped Cut-Off Tool C5/P30 Grade.	417
6-117	End Mills, APKT 17	20
6-215	End Mills, ADKT 1505	30
6-700	Toolholders, MRGNR/L for RN__ Inserts.	170
6-705	Toolholders, MSKNR/L for CN__ Inserts	168
6-710	Toolholders, MCLNR/L for CN__ Inserts	167
6-711	Toolholders, MCMNN for CN__ Inserts	167
6-712	Toolholders, MCRNR/L for CN__ Inserts	168
6-714	Toolholders, MDPNN for DN__ Inserts	169
6-715	Toolholders, MDJNR/L for DN__ Inserts	169
6-734	Toolholders, MSDNN for SN__ Inserts	171
6-735	Toolholders, MSSNR/L for SN__ Inserts	171
6-736	Toolholders, MSRNR/L for SN__ Inserts	172
6-737	Toolholders, MSKNR/L for SN__ Inserts	172
6-740	Toolholders, MTJNR/L for TN__ Inserts.	173
6-741	Toolholders, MTENN for TN__ Inserts.	173
6-742	Toolholders, MTGNR/L for TN__ Inserts	174
6-746	Toolholders, MTFNR/L for TN__ Inserts	174
6-750	Toolholders, MWLNR/L for WN__ Inserts	176
6-754	Toolholders, MVVNN for VN__ Inserts	175
6-755	Toolholders, MVJNR/L for VN__ Inserts	175
6-760	Boring Bars, SI-MCLNR/L for CN__ Inserts	188
6-765	Boring Bars, SI-MWLNR/Lfor WN__ Inserts	192
6-770	Boring Bars, SI-MDUNR/L for DN__ Inserts	189
6-783	Boring Bars, SI-MTUNR/L for TN__ Inserts	190
6-785	Boring Bars, SI-MVUNR/L for VN__ Inserts.	191
6-800	Toolholders, SCLCR/L for CC__ Inserts	180
6-801	Toolholders, SCMCN for CC__ Inserts	180
6-804	Toolholders, SDPCN for DC__ Inserts	181
6-805	Toolholders, SDJCR/L for DC__ Inserts	181
6-806	Toolholders, SVJCR/L for VC__ Inserts	185
6-810	Toolholders, SSDCN for SC__ Inserts	182

continued on next page



Index By Group

Cutting Tools

INDEX BY GROUP

Group	Description	Page #
6-813	Toolholders, STECN for TC__ Inserts	183
6-814	Toolholders, STFCR/L for TC__ Inserts	184
6-815	Toolholders, STGCR/L for TC__ Inserts	184
6-816	Toolholders, STJCR/L for TC__ Inserts	183
6-870	Boring Bars, SI-SCLCR/L for CC__ Inserts	195, 198
6-875	Boring Bars, SI-SDUCR/L for DC__ Inserts	195
6-884	Boring Bars, SI-STUCR/L for TC__ Inserts	196, 198
6-887	Boring Bars, SI-SVUCR/L for VC__ Inserts	197
6-889	Boring Bars, SI-SWUCR/L for WC__ Inserts	197
6-890	5-PC Mini Toolholder & Boring Bar Set	198
6-895	P&G GTN System Blades	203
6-895-6	P&G GTN System Flexible Clamp Tool Blocks	203
6-895-7	P&G GTN System Blade & Inserts Sets	204
6-895-9	P&G GTN System Blade Block Inserts Sets	204
6-896	P&G GTN System 2 Piece Tool Blocks	203-204
6-901	End Mills, TP__	35
6-901-5	End Mills, TP__, R8 Shank	35, 67
6-902	Face Mills, TP__	35
6-923	Face Mills, SE__ 42	45
6-924	Face Mills, SE__ 42, Heavy Duty	45
6-939	Boring Bars, SI-CTUPR for TP__ Inserts	196
6-941	End Mills, APKT 16, R8 Shank	18, 66
6-954	Face Mills, APKT 16	20
6-955	Face Mills, APKT 16	20
6-956	Face Mills, APKT 16, Lead Ext	21
6-958	End Mills, APKT 10 & APKT 16, Lead Ext	19
6-963	Face Mills, SEHT 43	42
6-970	Face Mills, OFMT 05	52
6-AN10EM	End Mills, ANHX 10	27
6-AN10FM	Face Mills, ANHX 10	27
6-AN16EM	End Mills, ANHX 16	27
6-AN16FM	Face Mills, ANHX 16	27
6-AP10EM	End Mills, APKT 10	17-18
6-AP16EM	End Mills, APKT 16	17-18
6-MTHO	P&G TNMA System External Holders	216
6-MTHO-S	P&G TNMA System Internal Holders	217
6-MTVO	P&G TNMA System External Holders	215
6-NE	P&G Notch System Ext Gang Style Holders	209

Index By Group



Cutting Tools

INDEX BY GROUP

Group	Description	Page #
6-NE-S	P&G Notch System Internal Holders210
6-NS	P&G Notch System External Holders208
6-PNFM	Face Mills, PNHX 1140
6-RDEM	End Mills, RD-TORO54
6-RDFM	Face Mills, RD-TORO335
6-RDFMAC	Face Mills, RD-TORO Anti Rotation Clamp55
6-SCI-3X	Indexable Drills, 3X241
6-SCI-4X	Indexable Drills, 4X242
6-SCS-3X	Indexable Drills Metric, 3X243
6-SCS-4X	Indexable Drills Metric, 4X244
6-SERL	Threading Toolholders, SER/SEL External235
6-SIRL	Threading Toolholders, SIR/SIL Internal236
6-SNFM	Face Mills, SNHX 1249
6-SP13FM	HI-Feed Face Mills, SPKT13, SPKW1360
6-SP16FM	HI-Feed Face Mills, SOE_1660
6-SPEM	HI-Feed End Mills, SPKT0859
6-WNFM	High Feed Face Mills, WNMW1263
6-WNFMCS	High Feed Face Mills, Clamping WNMW1263
6-XDEM	End Mills, XDKT 1014
6-XDFM	Face Mills, XDKT 1014
7-980	Annular Cutter Holder Strght 3-Flat Sh.298
7-981	Annular Cutter Holders Morse Taper Shank298
7-982	Annular Cutter Holders R8 Shank298
7-983	Annular Cutter Holder Strght 2-Flat Sh.298



Indexable Appendix

Cutting Tools

INDEXABLE APPENDIX

Tools

Milling Tools

Page #

END MILLS

End Mills, ADKT 1505	30
End Mills, ANHX 10	27
End Mills, ANHX 16	27
End Mills, APKT 10	17-18
End Mills, APKT 10 & APKT 16, Lead Ext	19
End Mills, APKT 16	17-18
End Mills, APKT 16, R8 Shank	18, 66
End Mills, APKT 17	20
End Mills, HI-Feed, SPKT08	59
End Mills, RD-TORO	54
End Mills, TP__	35
End Mills, TP__, R8 Shank	35, 67
End Mills, XDKT 10	14

FACE MILLS

Face Mills, ANHX 10	27
Face Mills, ANHX 16	27
Face Mills, APKT 16	20
Face Mills, APKT 16	20
Face Mills, APKT 16, Lead Ext	21
Face Mills, HI-Feed, SOE_16	60
Face Mills, HI-Feed, SPKT13, SPKW13	60
Face Mills, High Feed, Clamping WNMW12	63
Face Mills, High Feed, WNMW12	63
Face Mills, OFMT 05	52
Face Mills, PNHX 11	40
Face Mills, RD-TORO	54
Face Mills, RD-TORO Anti Rotation Clamp	55
Face Mills, SE__ 42	45
Face Mills, SE__ 42, Heavy Duty	45
Face Mills, SEHT 43	42
Face Mills, SNHX 12	49
Face Mills, TP__	35
Face Mills, XDKT 10	14

Tools

Turning Tools

Page #

BORING BARS

5-PC Mini Toolholder & Boring Bar Set	198
SI-CTUPR for TP__ Inserts	196
SI-MCLNR/L for CN__ Inserts	188
SI-MDUNR/L for DN__ Inserts	189
SI-MTUNR/L for TN__ Inserts	190
SI-MVUNR/L for VN__ Inserts	191
SI-MWLNR/L for WN__ Inserts	192
SI-SCLCR/L for CC__ Inserts	195, 198
SI-SDUCR/L for DC__ Inserts	195
SI-STUCR/L for TC__ Inserts	196, 198
SI-SVUCR/L for VC__ Inserts	197
SI-SWUCR/L for WC__ Inserts	197

TOOL HOLDERS

MCLNR/L for CN__ Inserts	167
MCMNN for CN__ Inserts	167
MCRNR/L for CN__ Inserts	168
MDJNR/L for DN__ Inserts	169
MDPNN for DN__ Inserts	169
MRGNR/L for RN__ Inserts	170
MSDNN for SN__ Inserts	171
MSKNR/L for CN__ Inserts	168
MSKNR/L for SN__ Inserts	172
MSRNR/L for SN__ Inserts	172
MSSNR/L for SN__ Inserts	171
MTENN for TN__ Inserts	173
MTFNR/L for TN__ Inserts	174
MTGNR/L for TN__ Inserts	174
MTJNR/L for TN__ Inserts	173
MVJNR/L for VN__ Inserts	175
MVVNN for VN__ Inserts	175
MWLNR/L for WN__ Inserts	176
SCLCR/L for CC__ Inserts	180
SCMCN for CC__ Inserts	180
SDJCR/L for DC__ Inserts	181
SDPCN for DC__ Inserts	181
SSDCN for SC__ Inserts	182
STECN for TC__ Inserts	183

continued on next page



Indexable Appendix

Cutting Tools

INDEXABLE APPENDIX

Tools

Turning Tools

Page #

TOOL HOLDERS

STFCR/L for TC__ Inserts	184
STGCR/L for TC__ Inserts	184
STJCR/L for TC__ Inserts	183
SVJCR/L for VC__ Inserts	185

Parting and Grooving Tools

GTN SYSTEM

2 Piece Tool Blocks	203-204
Blade & Inserts Sets	204
Blade Block Inserts Sets	204
Blades	203
Flexible Clamp Tool Blocks	203

TOOL HOLDERS

Notch System External	208
Notch System External Gang Style	209
Notch System Internal	210
TNMA System External	215
TNMA System External 90°	216
TNMA System Internal	217

Threading Tools

TOOL HOLDERS

SER/SEL External	235
SIR/SIL Internal	236

Drilling Tools

DRILLS

Indexable Drills, 3X	241
Indexable Drills, 3X Metric	243
Indexable Drills, 4X	242
Indexable Drills, 4X Metric	244



Inserts

Insert Letters	Page #	Reference
ADKT.....	30-31	Milling
ANHX.....	28	Milling
APKT.....	22-23, 66	Milling
APXT.....	23	Milling
CCGT.....	126-130	Turning
CCMT.....	126-130	Turning
CNMA.....	97-99	Turning
CNMG.....	97	Turning
DCGT.....	131-133	Turning
DCMT.....	131-133	Turning
DNMA.....	104	Turning
DNMG.....	102-105	Turning
GTN.....	202	Parting & Grooving
NG.....	206	Parting & Grooving
NR.....	207	Parting & Grooving
NT.....	207	Parting & Grooving
OFKR.....	52	Milling
OFMT.....	52	Milling
PNHX.....	41	Milling
RDHT.....	56	Milling
RDHW.....	56	Milling
RDMW.....	56	Milling
RNMG.....	106	Turning
RPGN.....	134	Turning
SCMT.....	135	Turning
SDNT.....	81	Utility
SEAN.....	46	Milling
SEGT.....	43	Milling
SEHT.....	43	Milling
SEKN.....	46	Milling
SEKR.....	46	Milling
SEKT.....	43	Milling
SNGN.....	72-74, 112-114	Utility
SNHX.....	50	Milling
SNMA.....	107-109	Turning
SNMG.....	107-111	Turning
SNUN.....	73-74, 112-114	Utility
SOEW.....	60	Milling
SPGH.....	143-144	Turning

continued on next page



Indexable Appendix

Inserts

Insert Letters	Page #	Reference
SPGN.....	75-80, 136-140	Utility
SPKT.....	60	Milling
SPKW.....	60	Milling
SPMR.....	141-142	Turning
SPMT.....	81, 143-144	Utility
SPUN.....	76-80, 136-140	Utility
TCGT.....	146	Turning
TCMT.....	145-147	Turning
THR-AD Stub Acme.....	234	Threading
THR-AR API Round.....	233	Threading
THR-IS ISO Metric.....	226-227	Threading
THR-N NPT.....	231	Threading
THR-NF NPTF.....	232	Threading
THR-P5 Partial Profile 55°.....	225	Threading
THR-P6 Partial Profile 60°.....	224	Threading
THR-U UN (UNC, UNF, UNEF).....	228-229	Threading
THR-UJ UNJ.....	230	Threading
TNMA.....	116-119	Turning
TNMA On Edge.....	214	Parting & Grooving
TNMG.....	115-120	Turning
TPEE.....	154	Turning
TPGC.....	155-156	Turning
TPGH.....	154-156	Turning
TPGN.....	36-37, 68, 82-88, 148-151	Utility
TPKN.....	36, 68, 82	Utility
TPKR.....	36-37, 68	Utility
TPMR.....	36-37, 68, 82-85, 152-153	Utility
TPUN.....	37, 82-88, 148-151	Utility
VBMT.....	157	Turning
VCGT.....	158-159	Turning
VCMT.....	158	Turning
VNMA.....	121	Turning
VNMG.....	121, 125	Turning
WCM.....	160	Turning
WNMA.....	124-125	Turning
WNMG.....	122-125	Turning
WNMW.....	63	Milling
XDKT.....	15	Milling



Cutting Tools

Natick, MA
Corporate Headquarters
1075 Worcester Street
Natick, MA 01760

TOOLMEX 
Industrial Solutions



4-999-2015C
©2014 Toolmex Corporation, Inc.

+1-508-653-8897 • 844-TMX-TOOL • Fax +1-508-653-5110 • www.tmxtools.com