



**THREADING
TECHNOLOGY**

**Main catalogue
Catálogo general**

EN-ES-ID-2011

Availability of the articles

ID *Identification number, available from stock*

*** ID** *Identification number, available from stock, while stock lasts*

Disponibilidad de los artículos

ID Numero de identificación, artículos disponibles de stock

*** ID** Numero de identificación, artículos disponibles hasta agotamiento de stock

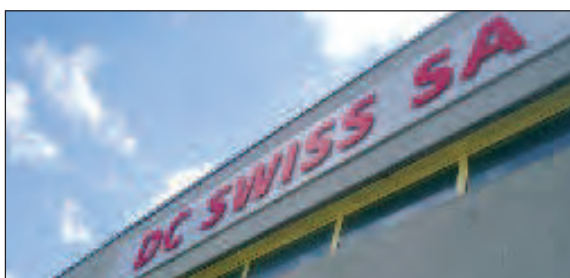

Main catalogue
Catálogo general

SGS • SGS • SGS • SGS • SGS • SGS • SGS • SGS • SGS • SGS

SGS

Certificate CH07/0649

The management system of

DC Swiss SA

Grand rue 19, CP 363
2735 Malleray, Switzerland



has been assessed and certified as meeting the requirements of

ISO 9001:2008

For the following activities

**Cutting tool designer and manufacturer,
expert in Threading Technology.**

Further clarifications regarding the scope of this certificate and the applicability of
ISO 9001:2008 requirements may be obtained by consulting the organization

This certificate is valid from 7 September 2010 until 6 September 2013
Issue 3, Certified since September 2007

Authorised by



Accreditation No. 017

SGS Société Générale de Surveillance SA, Systems & Services Certification
Technoparkstrasse 1, 9000 Zürich, Switzerland
t+41 (0)44 445-10-00 f+41 (0)44 445-10-00 www.sgs.com

Page 1 of 1



Warning

Thread tools can break or shatter either through technical failure or negligence, and can endanger the health of the operator. Always obey the safety and health regulations, also the wearing of safety glasses is compulsory.

The grinding of threading tools causes hazardous particles, and must be performed only under most rigorous safety standards.

Atención

Un problema técnico o una negligencia pueden ser el origen que un herramienta se rompa parcial o totalmente, pudiendo afectar a la integridad física del operario. Es de obligado cumplimiento seguir escrupulosamente las normativas de seguridad y de salud de las empresas activas en el tratamiento de los metales. El uso de gafas de protección es indispensable.

El reafilado de útiles de roscado provoca partículas peligrosas para la salud y debe ser ejecutado según las instrucciones de seguridad necesarias.

We have made every effort to ensure that the information (drawings, prints, technical data) given is correct. However, we do not assume any responsibility for any errors, omissions or subsequent changes.

The reproduction of drawings and other documents and their transmission to a third party is prohibited.

Eventuales cambios de los datos técnicos, modificaciones de toda índole, errores de impresión, no dan en modo alguno derecho a indemnizaciones.

Las reproducciones de textos, imágenes o extractos están prohibidas.

NEW

Z.70
Z.73



RT5462V5-5
G (BSP)



FPS FAS



SRT

CODIFICATION - CODIFICACIÓN

DC Taps Machos DC

Example - Ejemplo



Normal materials	Materiales normales	N							
Soft materials	Materiales blandos	W							
Tough materials	Materiales tenaces	Z							
High tensile materials	Materiales de alta resistencia	H							
Special alloys	Aleaciones especiales	S							
Special alloys (Aero)	Aleaciones especiales (Aero)	SA							
Titanium alloys (Aero)	Aleaciones al titanio (Aero)	TL							
Cast iron and aluminium casting	Fundición gris y fundición Al	GG							
Rigid Tapping	Roscado rígido	RTS							
Swarf breaker	Rompe virutas	K							
Special execution	Fabricación especial		3						
DIN short - reduced shank	DIN corto - mango pasante					2			
DIN long - reinforced shank	DIN largo - mango reforzado					3			
DIN long - reduced shank	DIN largo - mango pasante					4			
DIN extra-long - reinforced shank	DIN extra-largo - mango reforzado					5			
DIN extra-long - reduced shank	DIN extra-largo - mango pasante					6			
ISO short - reinforced shank	ISO corto - mango reforzado					11			
ISO short - reduced shank	ISO corto - mango pasante					12			
ISO long - reinforced shank	ISO largo - mango reforzado					13			
ISO long - reduced shank	ISO largo - mango pasante					14			
Straight flutes	Ranuras rectas						1		
Straight flutes with spiral point	Ranuras rectas con entrada en hélice						2		
Spiral point	Entrada en hélice						3		
< 27° left hand slow spiral flutes	< 27° helicoidales izquierda						4		
< 27° right hand slow spiral flutes	< 27° helicoidales derecha						5		
> 27° right hand fast spiral flutes	> 27° helicoidales derecha						6		
> 40° right hand fast spiral flutes	> 40° helicoidales derecha						7		
10° right hand fast spiral flutes, spiral point	10° helicoidales derecha, entrada en hélice						9		
Standard	Estándar							0	
Interrupted thread	Dientes alternos							1	
Truncated thread	Dientes truncados							2	
Internal coolant	Lubricación interna							3	
Interrupted thread, internal coolant	Dientes alternos, lubricación interna							4	
Truncated thread, internal coolant	Dientes truncados, lubricación interna							5	
"V" surface treatment	Tratamiento superficial "Vaporizado"								V
Wear-protective coating	Protección contra el desgaste								VS
Titanium-nitride coating (TiN)	Recubierto de nitruro de titanio (TiN)								TN
Titanium carbonitride coating (TiCN)	Recubierto de carbonitruro de titanio (TiCN)								TC
Nitrided	Nitruración								NI
Taper tap	Desbaste								-1
Second tap	Intermedio								-2
Bottoming tap / 2 - 3 chamfered threads	Acabado / 2 - 3 hilos de entrada								-3
3.5 - 5 chamfered threads, spiral point	3.5 - 5 hilos de entrada, entrada en hélice								-4
1.5 - 2 chamfered threads	1.5 - 2 hilos de entrada								-5
6 - 8 chamfered threads	6 - 8 hilos de entrada								-8
Thread taps set	Juego de machos								-S

CODIFICATION - CODIFICACIÓN

DC Thread formers Machos de laminación DC

Example - Ejemplo



Standard polygon form $\lt; \varnothing 3 \text{ mm}$	Poligono estándar $\lt; \varnothing 3 \text{ mm}$	FS							
Passive polygon form $\geq \varnothing 3 \text{ mm}$	Poligono pasivo $\geq \varnothing 3 \text{ mm}$	FPS							
Active polygon form $\geq \varnothing 3 \text{ mm}$	Poligono activo $\geq \varnothing 3 \text{ mm}$	FAS							
Special execution	Fabricación especial		3						
Reinforced DIN shank	DIN - mango reforzado			3					
Reduced DIN shank	DIN - mango pasante			4					
Thread former	Macho de laminación				8				
Without lubrication grooves	Sin ranuras de lubricación						0		
With lubrication grooves	Con ranuras de lubricación						1		
Internal coolant with radial outflow	Lubricación interna, salidas radiales						4		
Wear-protective coating	Protección contra el desgaste							VS	
Chromenitride coating (CrN)	Recubierto al nitruro de cromo(CrN)							CN	
2 - 3 chamfered threads	2 - 3 hilos de entrada								-3
1.5 - 2 chamfered threads	1.5 - 2 hilos de entrada								-5

DC Solid carbide thread whirl cutters Fresas torbellino en metal duro DC

Example - Ejemplo

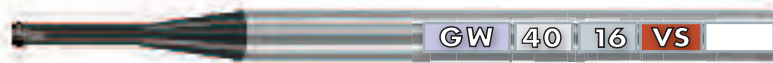

Thread whirl cutter	Fresa torbellino	GW						
Single tooth	Un diente		10					
Single profile, multi toothed	Multi-diente a un perfil		20					
Double pitch with multi flutes	Multi-diente a doble perfil		30					
Multi fluted with full profile	Multi-diente con perfil completo		40					
Thread length $2.5 \times D_1$	Longitud roscada $2.5 \times D_1$			16				
Thread length $4 \times D_1$	Longitud roscada $4 \times D_1$			19				
Wear-protective coating	Protección contra el desgaste						VS	
Special execution	Fabricación especial							SP

















































DC Solid carbide thread milling cutters Fresas de roscar en metal duro DC

Example - Ejemplo



Standard execution	Ejecución estándar	GF						
For hardened steels (55 - 63 HRC)	Para aceros templado (55 - 63 HRC)	GFH						
With 45° chamfer for countersinking	Con corte de chaflán a 45°	GFS						
For multi sizes thread milling cutters	Fresas de roscar polivalentes	GFM						
Thrillers	Fresas de taladrar/roscar	BGF						
Spiral flutes 27° (GF), 10° (GFH)	Helicoidale 27° (GF), 10° (GFH)		61					
Spiral flutes 27° (GFS)	Helicoidale 27° (GFS)		66					
Spiral flutes 15° (GFM)	Helicoidale 15° (GFM)		62					
Thrillers 2 flutes	Fresa de taladrar/roscar 2 ranuras		67					
Thrillers 3 flutes	Fresa de taladrar/roscar 3 ranuras		68					
External lubrication	Lubricación exterior				1			
Internal lubrication	Lubricación interior				6			
Thread length $1.5 \times D$	Longitud roscada $1.5 \times D$						0	
Thread length $2 \times D$	Longitud roscada $2 \times D$						5	
Thread length $2.5 \times D$	Longitud roscada $2.5 \times D$						6	
Wear-protective coating	Protección contra el desgaste							VS
Special execution	Fabricación especial							SP

PICTOGRAPHS - PICTOGRAMAS

		Reinforced shank as per DIN 371 Mango reforzado DIN 371		For material groups as per  application chart
		Reduced shank as per DIN 376 Mango pasante DIN 376		Para grupos de materiales según tabla de utilización 
		HSSE HSSE		Through hole, long chipping materials Agujero pasante, virutas largas
		HSSE-PM HSSE-PM		Through hole < 1.5 x D, short chipping materials Agujero pasante < 1.5 x D, virutas cortas
		Number of flutes (Z) Número de ranuras (Z)		Blind hole < 1.5 x D, long chipping materials Agujero ciego < 1.5 x D, virutas largas
		Core hole diameter Diámetro del agujero		Blind hole < 2.5 x D, short chipping materials Agujero ciego < 2.5 x D, virutas cortas
		Straight flutes Ranuras rectas		Through / blind hole > 2.5 x D Agujero pasante / ciego > 2.5 x D
		Straight flutes with spiral point Ranuras rectas con entrada en hélice		2 - 3 chamfered threads, form C 2 - 3 hilos de entrada, forma C
		Spiral point only Solamente entrada en hélice		Taper tap Macho de desbaste
		40° right hand spiral flutes Ranuras helicoidales con hélice a 40° derecha		Second tap Macho intermedio
		Thread former Macho de roscar por laminación		Bottoming tap Macho de acabado
		Thread former with lubrication grooves Macho de roscar por laminación con ranuras de lubrif.		Hand taps, set of 3 pieces Juego de machos a mano
		Crown tap Macho de corona		Tolerance class ISO 2 6H Clase de tolerancia ISO 2 6H
		Combination drill/tap Brocas-macho		 "V" surface treatment Tratamiento superficial  "Vaporizado"
		Interrupted thread Dientes alternos		 wear-protective coating Protección contra el desgaste 
		Truncated thread Dientes truncados		Titanium-nitride coating Recubierto de nitruro de titanio
		Internal coolant with frontal outflow Lubricación interna con salida frontal		Titanium-carbonitride coating Recubierto de carbonitruro de titanio
		Internal coolant with radial outflow Lubricación interna con salidas radiales		Nitrided (surface hardness about 1'100 HV) Nitruración (dureza superficial cerca 1'100 HV)
		Tapered thread 1:16 (NPT - NPTF - Rc) Rosca cónica 1:16 (NPT - NPTF - Rc)		Chromenitride coating Recubierto al nitruro de cromo
		Thread EG Rosca EG		For Classic Tapping Para roscado clásico
		Left hand thread Rosca izquierda		For Rigid Tapping Para roscado rígido

APPLICATION GROUPS

CLASIFICACIÓN DE LOS MATERIALES

Examples for application groups

Ejemplos prácticos de clasificación de los materiales

11 Free-cutting steels 1.0711 9 S 20 1.0715 9 SMn 28 1.0718 9 SMnPb 28 1.0726 35 S 20 1.0737 9 SMnPb 36	12 Structural, cementation steels 1.0037 Si 37-2 (S235JR) 1.0050 Si 50-2 (E295) 1.0060 Si 60-2 (E335) 1.5919 15 CrNi6 1.7131 16 MnCr5	13 Carbon steels 1.0503 C 45 1.0535 C 55 1.0601 C 60 1.1545 C 105 W1 1.2067 100 Cr 6	14 Alloy steels < 850 N/mm ² 1.2363 X100CrMoV5-1 1.3551 80MoCrV42-16 1.4922 X20CrMoV12-1 1.7218 25CrMo4 1.7220 34CrMo4	11 Aceros de decolaje 1.0711 1212 1.0715 1213 1.0718 12 L 13 1.0726 1140 1.0737 12 L 14	12 Aceros de construcción o de cementación 1.0037 1015 1.0050 1.0600 1.5919 4320 1.7131 5115	13 Aceros al carbón 1.0503 1043 1.0535 1055 1.0601 1060 1.1545 W 110 1.2067 L 3	14 Aceros aleados < 850 N/mm ² 1.2363 A 2 1.3551 M 50 1.4922 1.7218 4130 1.7220 4135
15 Alloy steels hard./imp. > 850 - < 1150 N/mm ² 1.3553 X82WCrV6-5-4 1.6580 30CrNiMo8 1.7220 34CrMo4 1.7225 42CrMo4 1.8507 34CrAlMo5	16 High tensile alloy steels EN-GJS-1200-2 1.6582 34CrNiMo6v 1.7225 42CrMo4v 1.7228 50CrMo4v 1.8515 31CrMo12v	21 Free machining stainless steels 1.4005 X12CrS13 1.4006 X12Cr13 1.4016 X6Cr17 1.4104 X12CrMoS17 1.4305 X10CrNiS18 9	22 Austenitic stainless steels 1.4301 X5CrNi18 10 1.4406 X2CrNiMoN17 12 2 1.4435 X2CrNiMo18 14 3 1.4541 X6CrNiTi18 10 1.4571 X6CrNiMoTi17 12 2	15 Aceros aleados/trat. > 850 - < 1150 N/mm ² 1.3553 1.6580 1.7220 4135 1.7225 4140 1.8507 K 23510 (UNS)	16 Aceros de alta resistencia EN-GJS-1200-2 1.6582 4340 1.7225 4140 1.7228 4147 1.8515	21 Aceros inoxidables al azufre 1.4005 416 1.4006 410 1.4016 430 1.4104 430 F 1.4305 303	22 Austeníticos 1.4301 304 1.4406 316 LN 1.4435 316 L 1.4541 321 1.4571 316 Ti
23 Ferritic and martensitic < 850 N/mm ² 1.4112 X90CrMoV18 1.4582 X4CrNiMoNb25 7 1.4762 X10CrAl24 1.4821 X20 CrNiS25 4	24 Ferritic and martensitic > 850 - < 1150 N/mm ² 1.4057 X20CrNi17 2 1.4125 X15CrMo17 1.4704 45 SiCr16 11 1.4748 X85CrMoV18 2	31 Cast iron 0.6015 GG 15 0.6020 GG 20 0.6025 GG 25 0.6030 GG 30	32 Spheroidal graphite + malleable cast iron 0.7040 GG 40 0.7043 GG 40.3 0.7050 GG 50 0.7060 GG 60 0.7080 GG 80	23 Ferritas y martensíticas < 850 N/mm ² 1.4112 440 B 1.4582 1.4762 446 1.4821	24 Ferritas y martensíticas > 850 - < 1150 N/mm ² 1.4057 431 1.4125 440 C 1.4704 HNV 2 (SAE) 1.4748	31 Fundición gris 0.6015 A 48-25 B 0.6020 A 48-30 B 0.6025 A 48-40 B 0.6030 A 48-45 B	32 Fundición de grafito + esterooidal y maleable 0.7040 60-40-18 0.7043 0.7050 65-45-12 0.7060 80-55-06 0.7080 120-90-02
41 Pure titanium 3.7024 Grad 1 3.7034 Grad 2 3.7055 Grad 3 3.7065 Grad 4	42 Titanium alloys 3.7124 Ti Cu 2.5 3.7164 Ti Al 6 V 4 (Grad 5) 3.7174 Ti Al 6 V 6 Sn 2	51 Nickel alloys 1 < 850 N/mm ² 1.3912 Ni36 (Invar) 2.4360 NiCu30 Fe (Monel 400) 2.4816 NiCr 15 Fe (Inconel 600) 2.4876 X10NiCrAlTi32 20 Hastelloy	52 Nickel alloys 2 > 850 - < 1150 N/mm ² 2.4631 NiCr 20 TiAl (Nimonic 80) 2.4668 NiCr 19 NiMo (Inconel 718)	41 Titanio puro 3.7024 Gr. 1 3.7034 Gr. 2 3.7055 Gr. 3 3.7065 Gr. 4	42 Aleación al titanio 3.7124 3.7164 Gr. 5 3.7174	51 Aleación de Níquel 1 < 850 N/mm ² 1.3912 Invar 2.4360 Monel alloy 400 2.4816 Inconel alloy 600 2.4876 Incoloy alloy 800 Hastelloy	52 Aleación de Níquel 2 > 850 - < 1150 N/mm ² 2.4631 Nimonic alloy 80A 2.4668 Inconel alloy 718
53 Nickel alloys 3 > 1150 - < 1600 N/mm ² 2.4631 NiCr 20 TiAl (Nimonic 80) 2.4668 NiCr 19 NiMo (Inconel 718)	61 Pure copper (electrolytic copper) 2.0060 E-Cu57 (E-Cu)	62 Short chip brass + phosphor brass + gun metal 2.0401 CuZn39Pb 3 (Mc58) 2.0402 CuZn40Pb 2 (Mc58) 2.1030 CuSn 8 (Bz) 2.1096 G-CuSn 5 ZnPb	63 Long chip brass 2.0240 CuZn15 (Mc85) 2.0265 CuZn30 (Mc70) 2.0321 CuZn37 (Mc63)	53 Aleación de Níquel 3 > 1150 - < 1600 N/mm ² 2.4631 Nimonic alloy 80A 2.4668 Inconel alloy 718	61 Cobre puro (electrolítico) 2.0060	62 Latón, bronce (virutas cortas) 2.0401 C 38500 2.0402 C 37800 2.1030 C 52100 2.1096	63 Latón (virutas largas) 2.0240 C 2300 2.0265 C 26000 2.0321 C 27200
71 Al unalloyed 3.0205 Al 99 3.0255 Al 99.5	72 Al alloyed Si < 1.5% 3.1255 AlCuSiMn 3.1355 AlCuMg 2 3.2315 AlMgSi 1 3.3206 AlMgSi 0.5 3.4345 AlZnMgCu 0.5	73 Al alloyed Si > 1.5% - < 10% 3.2161 G-AlSi8Cu3 3.2162 GD-AlSi8Cu3 3.2341 G-AlSi5Mg 3.2371 G-AlSi7 Mg	74 Al alloyed Si > 10% Mg-alloys 3.2381 G-AlSi10Mg 3.2382 GD-AlSi10Mg 3.2581 G-AlSi 12 3.2583 G-AlSi 12 (Cu)	71 Al no aleado 3.0205 1200 3.0255 1050 A	72 Al aleado Si < 1.5% 3.1255 2014 3.1355 2024 3.2315 6082 3.3206 6060 3.4345 7020	73 Al aleado Si > 1.5% - < 10% 3.2161 A 380.1 3.2162 3.2341 3.2371 A 356.2	74 Al aleado Si > 10% Aleaciones Magnesio 3.2381 A 360 3.2382 3.2581 A 413 3.2583 A 413.1
81 Thermoplastics Delrin (POM) Teflon Nylon	82 Duroplastics Bakelit Novopan	83 Glass fibre reinforced plastics Glass fibre reinforced, Thermo and Duroplastics	81 Materiales termoplásticos Delrin (POM) Teflon Nylon	82 Materiales duroplásticos Bakelit Novopan	83 Materiales plásticos reforzados por fibras Termo y duroplásticos, reforzados por fibras de vidrio	Referencia: DIN	

Reference: AISI/ASTM

Referencia: DIN

APPLICATION CHART - TABLA DE UTILIZACIÓN

THREAD CUTTING - ROSCADO CLÁSICO

Thread cutting Roscado clásico

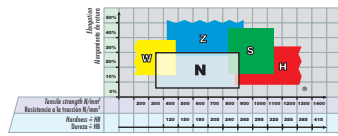

Thread cutting Roscado clásico

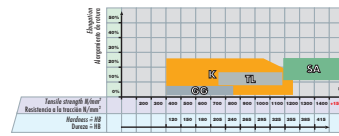

Rigid Tapping Roscado rígido

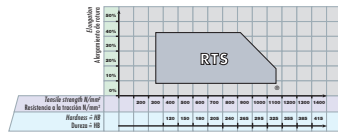

Thread forming Roscado por laminación

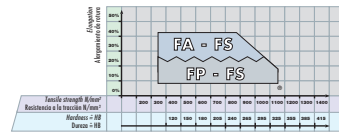

Material classification Clasificación de los materiales

Material groups Grupos de materiales	Material designation	Clasificación de los materiales	Hardness Dureza (HB)	Tensile strength Resistencia Rm (N/mm²)	Elongation Alargamiento A (%)
10 Steels Aceros	11 Free-cutting steels	Aceros de decoletaje	< 200	< 700	< 10
	12 Structural / cementation steels	Aceros de construcción / cementación	< 200	< 700	< 30
	13 Carbon steels	Aceros al carbón	< 300	< 1000	< 20
	14 Alloy steels < 850 N/mm²	Aceros aleados < 850 N/mm²	< 250	< 850	< 30
	15 Alloy steels hard / temp. > 850 - < 1150 N/mm²	Aceros aleados / tratados > 850 - < 1150 N/mm²	> 250	> 850	< 30
	16 High tensile alloy steels	Aceros de alta resistencia	> 250	> 850	< 12
20 Stainless Steels Aceros inoxidables	21 Free machining stainless steels	Aceros inoxidables al azufre	< 250	< 850	< 25
	22 Austenitic stainless steels	Austeníticos	< 250	< 850	> 20
	23 Ferritic and martensitic < 850 N/mm²	Feríticos y martensíticos < 850 N/mm²	< 250	< 850	> 20
	24 Ferritic and martens. > 850 - < 1150 N/mm²	Feríticos y martens. > 850 - < 1150 N/mm²	> 250	> 850	> 15
30 Cast iron Fundición	31 Cast iron	Fundición gris	< 250	< 850	< 10
	32 Spheroidal graphite + malleable cast iron	Fundición de grafito esférico y maleable	< 250	< 850	> 10
40 Titanium Titanio	41 Pure titanium	Titanio puro	< 250	< 850	> 20
	42 Titanium alloys	Aleación al titanio	> 250	> 850	< 20
50 Nickel Níquel	51 Nickel alloys 1 < 850 N/mm²	Aleación al Níquel 1 < 850 N/mm²	< 250	< 850	> 25
	52 Nickel alloys 2 > 850 - < 1150 N/mm²	Aleación al Níquel 2 > 850 - < 1150 N/mm²	> 250	> 850	< 25
	53 Nickel alloys 3 > 1150 - < 1600 N/mm²	Aleación al Níquel 3 > 1150 - < 1600 N/mm²	> 340	> 1150	< 20
60 Copper Cobre	61 Pure copper (electrolytic copper)	Cobre puro (electrolítico)	< 120	< 400	> 12
	62 Short chip brass, phosphor bronze, gun metal	Laitón, bronce (virutas cortas)	< 200	< 700	< 12
	63 Long chip brass	Laitón (virutas largas)	< 200	< 700	> 12
70 Aluminium Magnesio Aluminio Magnesio	71 Al unalloyed	Al no aleado	< 100	< 350	> 15
	72 Al alloyed Si < 1.5 %	Al aleado Si < 1.5 %	< 150	< 500	> 15
	73 Al alloyed Si > 1.5 % - < 10 %	Al aleado Si > 1.5 % - < 10 %	< 120	< 400	< 15
	74 Al alloyed Si > 10 %, Mg-Alloys	Al aleado Si > 10 %, Aleaciones Magnesio	< 120	< 400	< 10
80 Plastic comp. Materiales plásticos	81 Thermoplastics	Materiales termoplásticos	-	-	-
	82 Duroplastics	Materiales duroplásticos	-	-	-
	83 Glass fibre reinforced plastics	Materiales plásticos reforzados por fibras	-	-	-

From page :
Desde página :

M	22	24	24	30	32	34	34	34	34	46	47	48
MF	83	82	83	83	89	90	90	90	90			92
UNC (UNJC)	110	110	110			112	112					114
UNF (UNJF)	130	130	130			132	132					134
UNEF/UN/UNS	146	146				147	147					
G/Rp/Rc	152	153	153			154	154	154			155	156
W	162	162										
NPT/NPTF	166											
PG/TR	168	168										
EG M/EG UNC/EG UNF	172	172				173	173					



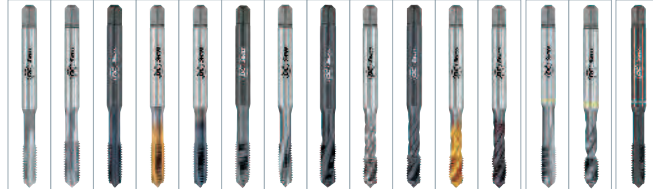







Normal materials Materiales normales													Soft materials Materiales blandos		Z			
N	22	24	24	30	32	34	34	34	34	34	46	47	48	48	92	114	134	156
M	22	24	24	30	32	34	34	34	34	34	46	47	48					
MF	83	82	83	83	89	90	90	90	90	90								
UNC (UNJC)	110	110	110			112	112											
UNF (UNJF)	130	130	130			132	132											
UNEF/UN/UNS	146	146				147	147											
G/Rp/Rc	152	153	153			154	154	154				155	156					
W	162	162																
NPT/NPTF	166																	
PG/TR	168	168																
EG M/EG UNC/EG UNF	172	172				173	173											





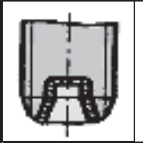



Vc (m/min)	Standard +V / +Ni	Coated TiN / TiC / VS
< 20 mm Guide Flute		
10 - 15	20 - 30	
10 - 15	20 - 30	
8 - 12	16 - 24	
8 - 12	16 - 24	
3 - 5	6 - 12	
3 - 5	3 - 5	
10 - 15	20 - 30	
10 - 15	20 - 30	
4 - 8	8 - 16	
4 - 8	8 - 16	
3 - 5	6 - 12	
10 - 15	20 - 30	
10 - 15	20 - 30	
4 - 8	4 - 8	
3 - 5	3 - 5	
3 - 5	6 - 12	
3 - 5	4 - 8	
2 - 3		
8 - 12	12 - 16	
20 - 30		
16 - 24		
10 - 15		
20 - 30		
10 - 15	20 - 30	
10 - 15	20 - 30	
20 - 30		
8 - 16	16 - 24	
4 - 8	8 - 16	

S Optimal with cutting oil / Óptima con aceite de corte
S Suitable with cutting oil / Aceptable con aceite de corte
E Optimal with emulsion / Óptima con emulsión
E Suitable with emulsion / Aceptable con emulsión



	<p>Thread Cutting Roscado clásico</p> <p style="text-align: right;"></p>		<p>Rigid Tapping Roscado rígido</p> <p style="text-align: right;"></p>
<p>M</p> <p>N 22-45/74-76 W 46-47 Z 48-51 H 52-55</p> <p>S 56-57 SA 57-59 TL 58-59 GG 60-61</p> <p>K 66-67</p> <p>MF</p> <p>N 82-91/103-105 Z 92-93 H 94-95 S 96</p> <p>SA 97-99 TL 98-99</p> <p>UNC, UNC(J)</p> <p>N 110-113/124-125 Z 114-116 H 117 S 118-119</p> <p>SA 119-121 TL 120-121</p> <p>UNF, UNF(J), UNEF, UN, UNS</p> <p>N 130-133/144-147 Z 134-135 H 136-137 S 138</p> <p>SA 139-141 TL 140-141</p> <p>G (BSP), Rp, Rc, W</p> <p>N 152-154/159-163 W 155 Z 156-157 H 155</p> <p>GG 155</p> <p>NPT, NPTF, PG, TR</p> <p>N 166-169</p> <p>EG M, EG UNC, EG UNF</p> <p>N 172-173/176/179 Z 177/180 S 181 SA 174-175/178/181-182</p> <p>TL 174/178/182</p>		<p>M</p> <p>RTS 62-65 Z.70/Z.73 50-51 K 66-67</p> <p>MF</p> <p>RTS 100 Z.70 92-93</p> <p>UNC</p> <p>RTS 122 Z.70 116</p> <p>UNF</p> <p>RTS 142 Z.70 135</p> <p>G (BSP)</p> <p>RTS 157 Z.70 157</p> <p>EG UNC, EG UNF</p> <p>Z.70 177/180</p>	
			<p>Thread Forming Roscado por laminación</p> <p style="text-align: right;"></p>
		<p>M</p> <p>FS 68 FPS 69-71 FAS 72-73</p> <p>MF</p> <p>FPS 101 FAS 102</p> <p>UNC</p> <p>FS 123 FPS 123 FAS 123</p> <p>UNF</p> <p>FS 143 FPS 143 FAS 143</p> <p>G (BSP)</p> <p>FPS 158 FAS 158</p>	
	<p>Crown taps Machos de corona</p> <p style="text-align: right;"></p>		<p>Combination drill/taps Brocas-machos</p> <p style="text-align: right;"></p>
<p>M, MF</p> <p>N 184-185</p> <p>UN, G (BSP)</p> <p>N 186</p>		<p>M, MF</p> <p>N 190</p> <p>UNC, G (BSP), PG</p> <p>N 191</p>	

 <p>Thread Whirling Torbellino</p> 	 <p>Thread gauges Calibres de control</p> 
<p>S, M, MF, UNC, UNF GW 204-209</p>	<p>M D 264-265</p>
 <p>Thread Milling Roscado por interpolación</p> 	<p>MF D 266-269</p>
<p>M GF 210-212 GFH 210 GFS 221-223 GFM 232 BGF 236-238</p> <p>MF GF 213-214 GFS 224-225 GFM 232 BGF 239</p> <p>UNC, UNF, UNEF, UN, UNS GF 215-218 GFS 226-229 GFM 233</p> <p>G (BSP), PG GF 219 GFS 230 GFM 234</p> <p>NPT, NPTF GF 220 GFS 231 GFM 235</p>	<p>UNC, UNF, UNEF D 270-271</p> <p>G (BSP), PG D 272</p> <p>NPT, NPTF D 273</p> <p>EG M, EG UNC, EG UNF D 274</p>
 <p>Dies Cojinetes de roscar</p> 	 <p>Tapping chucks SRT Aparatos de roscar SRT</p>  <p>HSK 276 BT40 276 SK40/50 277 DIN1835 B 278-279</p>
<p>M N 242/256/258/261 Z 243/256</p> <p>MF N 244-246/257/259 Z 244-245</p> <p>UNC, UNF, UNEF, UN, UNS N 247-249</p> <p>G (BSP), R N 250/252/260 Z 251 MS 251</p> <p>NPT, NPTF, PG, TR, W N 253-255/260</p>	    <p>D 280/281 F 282 D 283 D 284-285</p>
	
	<p><i>Cutting speeds, conversion tables, core hole diameters, turned diameters</i> <i>Technical questionnaire</i> <i>Delivery and payment conditions</i></p> <p>Tablas de velocidad de corte, de conversión, diámetro del agujero, diámetro del torneado Cuestionarios técnicos Condiciones de entrega</p>

M

MF

UNC, UNF(J)
UNF, UNF(J),
UNEF, UN, UNS















G, Rp, Rc, W









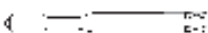
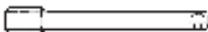

































NPT, NPTF,
PG, TR















EG M, EG UN

Crown taps
Machos de corona

Combination drill/taps
Brocas-machos

		N						
Characteristics Características				 V	 TiN	 TiCN		
Hole type Tipo de agujero								
		N310-3	N320-3 N320-4	N320V-3 N320V-4	N320TN-3 N320TN-4	N320TC-4	N321-3 N321-4	N330-3 N330-4
DIN long DIN largo	DIN 371	22	22/24	24	24	24	30	30
Extra-long Extra-largo	DIN 371							
ISO short ISO corto	ISO 529							
DIN long DIN largo	~DIN 2174							
Tolerance Tolerancia	ISO 2 6H	22	22/24	24	24	24	30	30
Oversize Sobremedida	ISO 3 6G		28	28				
Oversize Sobremedida	7G		28					
Oversize Sobremedida	+ 0.10 mm		28					
Oversize Sobremedida	+ 0.20 mm							
Fine tolerance Tolerancia fina	ISO 1 4H		26					
LH Left hand thread LH Rosca izquierda	ISO 2 6H	22	26	26				
		N410-3	N420-4	N420V-4	N420TN-4	N420TC-4	N421-4	N430-4
DIN long DIN largo	DIN 376	23	25	25	25	25	31	31
Extra-long Extra-largo	DIN 376							
ISO short ISO corto	ISO 529							
DIN long DIN largo	~DIN 2174							
Tolerance Tolerancia	ISO 2 6H	23	25	25	25	25	31	31
Oversize Sobremedida	ISO 3 6G		29	29				
Oversize Sobremedida	7G		29					
Oversize Sobremedida	+ 0.10 mm		29					
Oversize Sobremedida	+ 0.20 mm		31					
Fine tolerance Tolerancia fina	ISO 1 4H		27					
LH Left hand thread LH Rosca izquierda	ISO 2 6H	23	27	27				



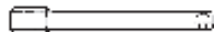

























































































































































































N								
 V	 H13	 H13	 K40	 K40	 K40	 K40	 K40	 K40
 V		 V		 V	 TiN	 TiCN	 E 1.5 x P	 E 1.5 x P
								
 N330V-3 N330V-4	 N350-3	 N350V-3	 N360-3	 N360V-3	 N360TN-3	 N360TC-3	 N360-5	 N360V-5
30	32	32	34	34	34	34	40	40
30	32	32	34	34	34	34	40	40
			36	36				
			38	38				
			38					
			38					
			36	36				
 N430V-4	 N450-3	 N450V-3	 N460-3	 N460V-3	 N460TN-3	 N460TC-3	 N460-5	 N460V-5
31	33	33	35	35	35	35	41	41
31	33	33	35	35	35	35	41	41
			37	37				
			39	39				
			39					
			39					
			37	37				



















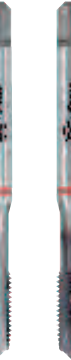

		N						
Characteristics Características								
Hole type Tipo de agujero								
		N361-3	N362V-3	N520-4	N520V-4	N520TN-4	N560-3	N560V-3
<i>DIN long</i> DIN largo	DIN 371	40	40					
<i>Extra-long</i> Extra-largo	DIN 371			42	42	42	44	44
<i>ISO short</i> ISO corto	ISO 529							
<i>DIN long</i> DIN largo	~DIN 2174							
<i>Tolerance</i> Tolerancia	ISO 2 6H	40	40	42	42	42	44	44
<i>Oversize</i> Sobremedida	ISO 3 6G							
<i>Oversize</i> Sobremedida	7G							
<i>Oversize</i> Sobremedida	+ 0.10 mm							
<i>Oversize</i> Sobremedida	+ 0.20 mm							
<i>Fine tolerance</i> Tolerancia fina	ISO 1 4H							
<i>LH Left hand thread</i> LH Rosca izquierda	ISO 2 6H							
		N461-3	N462V-3	N620-4	N620V-4	N620TN-4	N660-3	N660V-3
<i>DIN long</i> DIN largo	DIN 376	41	41					
<i>Extra-long</i> Extra-largo	DIN 376			43	43	43	45	45
<i>ISO short</i> ISO corto	ISO 529							
<i>DIN long</i> DIN largo	~DIN 2174							
<i>Tolerance</i> Tolerancia	ISO 2 6H	41	41	43	43	43	45	45
<i>Oversize</i> Sobremedida	ISO 3 6G							
<i>Oversize</i> Sobremedida	7G							
<i>Oversize</i> Sobremedida	+ 0.10 mm							
<i>Oversize</i> Sobremedida	+ 0.20 mm							
<i>Fine tolerance</i> Tolerancia fina	ISO 1 4H							
<i>LH Left hand thread</i> LH Rosca izquierda	ISO 2 6H							



Directory - Machine and hand taps DIN 13

Directorio - Machos para roscar a máquina y a mano DIN 13

N		W		Z				
 TiN								
								
								
								
								
								
								
								
								
								
								
								
								
								
								
								
								
								
								
								
								
N560TN-3	N1120-4 N1121-4	N1110 -1-2-3-S	W320-3 W320-4	W360-3	Z320V-3 Z320V-4	Z320VS-4	Z360V-3 Z362V-3	Z360VS-3 Z362VS-3
44	74	76	46	47	48	48	49	50
44	74	76	46	47	48	48	49	50
N660TN-3	N1220-4 N1221-4	N1210 -1-2-3-S	W420-4	W460-3	Z420V-4	Z420VS-4	Z462V-3	Z462VS-3
45	74	77	46	47	48	48	49	51
45	74	77	46	47	48	48	49	51

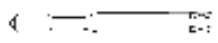
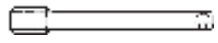





















		Z		H		S		SA
Characteristics Características		 RMS	 RMS	 TICN	 RMS	 TICN	 RMS	 TICN
		VS	VS	TICN	TICN	VS	VS	
								
Hole type Tipo de agujero								
		Z370VS-3	Z373VS-3	H320-4 H320TC-4	H350-3 H350TC-3	S320VS-4	S360VS-3	SA320-4
<i>DIN long</i> DIN largo	DIN 371	50	50	52	54	56	57	58
<i>Extra-long</i> Extra-largo	DIN 371							
<i>ISO short</i> ISO short	ISO 529							
<i>DIN long</i> DIN largo	~DIN 2174							
<i>Tolerance</i> Tolerancia	ISO 2 6H	50	50	52	54	56	57	58
<i>Oversize</i> Sobremedida	ISO 3 6G				54			
<i>Oversize</i> Sobremedida	7G							
<i>Oversize</i> Sobremedida	+ 0.10 mm							
<i>Oversize</i> Sobremedida	+ 0.20 mm							
<i>Fine tolerance</i> Tolerancia fina	ISO 1 4H	50				56		58
<i>LH Left hand thread</i> LH Rosca izquierda	ISO 2 6H							
		Z470VS-3	Z473VS-3	H420-4 H420TC-4	H450-3 H450TC-3	S420VS-4	S460VS-3	SA420-4
<i>DIN long</i> DIN largo	DIN 376	51	51	53	55	56	57	59
<i>Extra-long</i> Extra-largo	DIN 376							
<i>ISO short</i> ISO corto	ISO 529							
<i>DIN long</i> DIN largo	~DIN 2174							
<i>Tolerance</i> Tolerancia	ISO 2 6H	51	51	53	55	56	57	59
<i>Oversize</i> Sobremedida	ISO 3 6G				55			
<i>Oversize</i> Sobremedida	7G							
<i>Oversize</i> Sobremedida	+ 0.10 mm							
<i>Oversize</i> Sobremedida	+ 0.20 mm							
<i>Fine tolerance</i> Tolerancia fina	ISO 1 4H							59
<i>LH Left hand thread</i> LH Rosca izquierda	ISO 2 6H							









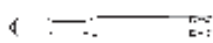
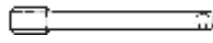



















Directory - Machine taps DIN 13

Directorio - Machos para roscar a máquina DIN 13

SA		TL		GG			K		
								NEW	
SA350-3	SA390-3	TL320VS-4	TL351VS-3	GG350NI-3	GG350TC-3	GG353TC-3	GG550NI-3	K313TC-3	
58	57	58	58	60	60	60		66	
							60		
58	57	58	58	60	60	60	60	66	
58	57	58	58						
SA450-3		TL420VS-4	TL451VS-3	GG450NI-3	GG450TC-3	GG453TC-3	GG650NI-3	K413TC-3	K613TC-3
59		59	59	61	61	61		66	
							61	67	
59		59	59	61	61	61	61	66/67	
59		59	59						











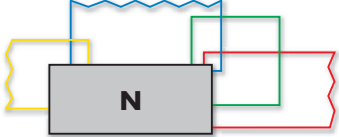





		RTS						
Characteristics Características								 VS
		VS	VS	VS	VS	 VS	 VS	
								
Hole type Tipo de agujero								
		RTS320VS-4	RTS323VS-4	RTS360VS-3 RTS362VS-3	RTS365VS-3	RTS362VS-5	RTS365VS-5	RTS523VS-4
<i>DIN long</i> <i>DIN largo</i>	DIN 371	62	62	63	63	64	64	
<i>Extra-long</i> <i>Extra-largo</i>	DIN 371							65
<i>ISO short</i> <i>ISO corto</i>	ISO 529							
<i>DIN long</i> <i>DIN largo</i>	~DIN 2174							
<i>Tolerance</i> <i>Tolerancia</i>	ISO 2 6H	62	62	63	63	64	64	65
<i>Oversize</i> <i>Sobremedida</i>	ISO 3 6G			64				
<i>Oversize</i> <i>Sobremedida</i>	7G							
<i>Oversize</i> <i>Sobremedida</i>	+ 0.10 mm							
<i>Oversize</i> <i>Sobremedida</i>	+ 0.20 mm							
<i>Fine tolerance</i> <i>Tolerancia fina</i>	ISO 1 4H							
<i>LH Left hand thread</i> <i>LH Rosca izquierda</i>	ISO 2 6H							
		RTS420VS-4	RTS423VS-4	RTS462VS-3	RTS465VS-3			RTS623VS-4
<i>DIN long</i> <i>DIN largo</i>	DIN 376	62	62	63	63			
<i>Extra-long</i> <i>Extra-largo</i>	DIN 376							65
<i>ISO short</i> <i>ISO corto</i>	ISO 529							
<i>DIN long</i> <i>DIN largo</i>	~DIN 2174							
<i>Tolerance</i> <i>Tolerancia</i>	ISO 2 6H	62	62	63	63			65
<i>Oversize</i> <i>Sobremedida</i>	ISO 3 6G							
<i>Oversize</i> <i>Sobremedida</i>	7G							
<i>Oversize</i> <i>Sobremedida</i>	+ 0.10 mm							
<i>Oversize</i> <i>Sobremedida</i>	+ 0.20 mm							
<i>Fine tolerance</i> <i>Tolerancia fina</i>	ISO 1 4H							
<i>LH Left hand thread</i> <i>LH Rosca izquierda</i>	ISO 2 6H							



RTS		FS	FPS					FAS	
	VS								
									
									
RTS565VS-3	FS380VS-5 FS380VS-3	FPS380CN-3	FPS381CN-3	FPS380VS-3	FPS381VS-3	FPS384VS-3	FAS380VS-3 FAS381VS-3	FAS384VS-3	
65									
	68	69	69	69	70	71	72	73	
65	68	69	69	69	70	71	72	73	
	68			69	70		72		
RTS665VS-3					FPS481VS-3	FPS484VS-3	FAS481VS-3	FAS484VS-3	
65									
					70	71	72	73	
65					70	71	72	73	
							72		



									N310-3	N310-3 LH	N320-3	
N310-3												
N310-3 LH	LH											
N320-3												
Ø d ₁ M	P mm	l ₁ mm	l ₂ mm	l ₃ mm	d ₂ mm	a mm			ID	ID	ID	
1	0.25	40	5.5		2.5	2.1	2	0.75			111467	
1.1	0.25	40	5.5		2.5	2.1	2	0.85			111468	
1.2	0.25	40	5.5		2.5	2.1	2	0.95			111469	
1.4	0.30	40	7.0		2.5	2.1	2	1.10			111470	
1.5	0.30	40	7.0		2.5	2.1	2	1.20			111471	
1.6	0.35	40	8.0		2.5	2.1	2	1.25			101454	
1.7	0.35	40	8.0		2.5	2.1	2	1.35			101455	
1.8	0.35	40	8.0		2.5	2.1	2	1.45			101456	
2	0.40	45	8.0		2.8	2.1	*3	1.60	101439	111460	101458	
2.2	0.45	45	9.0		2.8	2.1	2	1.75			101459	
2.3	0.40	45	9.0		2.8	2.1	2	1.90			101460	
2.5	0.45	50	10.0		2.8	2.1	*3	2.05	101440	111461	101461	
2.6	0.45	50	10.0		2.8	2.1	3	2.15	101441			
3	0.50	56	12.0	18	3.5	2.7	*3	2.50	101442	111462	101462	
3.5	0.60	56	13.0	20	4.0	3.0	*3	2.90	101443		101463	
4	0.70	63	14.0	21	4.5	3.4	*3	3.30	101444	111464	101464	
5	0.80	70	15.0	25	6.0	4.9	*3	4.20	101445	111465	101465	
6	1.00	80	17.0	30	6.0	4.9	*3	5.00	101446	111466	101466	
8	1.25	90	20.0	35	8.0	6.2	3	6.80	101447			
10	1.50	100	22.0	39	10.0	8.0	3	8.50	101438			
<p>* N320-3 = 2</p>									<p>≤ M1.5 </p>			











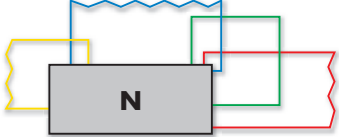

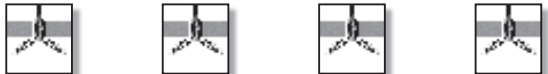
								N410-3	N410-3 LH						
															
N410-3  															
N410-3 LH  LH 															
								 							
								 							
								 							
								 							
$\varnothing d_1$	P	l_1	l_2	d_2	α			ID	ID						
M	mm	mm	mm	mm	mm										
3	0.50	56	12.0	2.2	1.8	3	2.50	101897							
4	0.70	63	14.0	2.8	2.1	3	3.30	101924							
5	0.80	70	15.0	3.5	2.7	3	4.20	101942							
6	1.00	80	17.0	4.5	3.4	3	5.00	101953							
7	1.00	80	17.0	5.5	4.3	3	6.00	142645	111491						
8	1.25	90	20.0	6.0	4.9	3	6.80	101958	111492						
10	1.50	100	22.0	7.0	5.5	3	8.50	101866	111478						
12	1.75	110	24.0	9.0	7.0	3	10.20	101870	111479						
14	2.00	110	28.0	11.0	9.0	3	12.00	101874	111480						
16	2.00	110	30.0	12.0	9.0	3	14.00	101880	111481						
18	2.50	125	33.0	14.0	11.0	3	15.50	101883	111482						
20	2.50	140	36.0	16.0	12.0	3	17.50	101885	125530						
22	2.50	140	36.0	18.0	14.5	3	19.50	101888							
24	3.00	160	39.0	18.0	14.5	4	21.00	101891	111485						
27	3.00	160	42.0	20.0	16.0	4	24.00	101895	111486						
30	3.50	180	45.0	22.0	18.0	4	26.50	101901	111487						
33	3.50	180	48.0	25.0	20.0	4	29.50	101907							
36	4.00	200	51.0	28.0	22.0	4	32.00	101915	111488						
39	4.00	200	55.0	32.0	24.0	4	35.00	101922							
42	4.50	200	55.0	32.0	24.0	4	37.50	101932							
48	5.00	250	63.0	36.0	29.0	4	43.00	111489							
56	5.50	280	71.0	45.0	35.0	5	50.50	111447							



									N320-4	N320V-4	N320TN-4	N320TC-4	
N320-4													
N320V-4		V											
N320TN-4		TiN											
N320TC-4		TiCN											
Ø d ₁ M	P mm	l ₁ mm	l ₂ mm	l ₃ mm	d ₂ mm	a mm			ID	ID	ID	ID	
* 2	0.40	45	8.0		2.8	2.1	2			101536	101528		
2.5	0.45	50	10.0		2.8	2.1	3		101483	101545	101530	101522	
2.6	0.45	50	10.0		2.8	2.1	3		101484				
3	0.50	56	12.0	18	3.5	2.7	3		101485	101546	101531	101523	
3.5	0.60	56	13.0	20	4.0	3.0	3		101491	101547			
4	0.70	63	14.0	21	4.5	3.4	3		101495	101548	101532	101524	
5	0.80	70	15.0	25	6.0	4.9	3		101499	101549	101533	101525	
6	1.00	80	17.0	30	6.0	4.9	3		101503	101550	101534	101526	
8	1.25	90	20.0	35	8.0	6.2	3		101506	101551	101535	101527	
10	1.50	100	22.0	39	10.0	8.0	3		101481	101544	101529	101521	

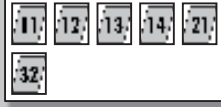









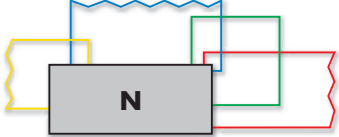

* N320V-3 / N320TN-3

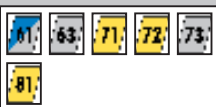
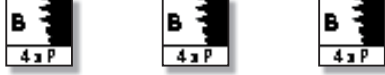

								N420-4	N420V-4	N420TN-4	N420TC-4																				
																															
																															
																															
																															
$\varnothing d_1$ M	P mm	l_1 mm	l_2 mm	d_2 mm	α mm			ID	ID	ID	ID																				
3	0.50	56	12.0	2.2	1.8	3	2.50	102119	143418																						
4	0.70	63	14.0	2.8	2.1	3	3.30	102146	102279																						
5	0.80	70	15.0	3.5	2.7	3	4.20	102171	102280																						
6	1.00	80	17.0	4.5	3.4	3	5.00	102182	102282																						
7	1.00	80	17.0	5.5	4.3	3	6.00	102189	144713																						
8	1.25	90	20.0	6.0	4.9	3	6.80	102195	102285	102251	102233																				
9	1.25	90	20.0	7.0	5.5	3	7.80	102202																							
10	1.50	100	22.0	7.0	5.5	3	8.50	102061	102263	102240	102228																				
11	1.50	100	19.0	8.0	6.2	3	9.50	162770																							
12	1.75	110	24.0	9.0	7.0	3	10.20	102072	102265	102243	102229																				
14	2.00	110	28.0	11.0	9.0	3	12.00	102081	102267	102245																					
16	2.00	110	30.0	12.0	9.0	3	14.00	102090	102269	102247	102231																				
18	2.50	125	33.0	14.0	11.0	3	15.50	102097	102271																						
20	2.50	140	36.0	16.0	12.0	3	17.50	102101	102273	102248	102232																				
22	2.50	140	36.0	18.0	14.5	3	19.50	102106	102275																						
24	3.00	160	39.0	18.0	14.5	4	21.00	102110	102278	144220																					
27	3.00	160	42.0	20.0	16.0	4	24.00	102117	143856																						
30	3.50	180	45.0	22.0	18.0	4	26.50	102124	105124																						
33	3.50	180	48.0	25.0	20.0	4	29.50	102130	146968																						
36	4.00	200	51.0	28.0	22.0	4	32.00	102137	143430																						
39	4.00	200	55.0	32.0	24.0	4	35.00	102144	158724																						
42	4.50	200	55.0	32.0	24.0	4	37.50	102158	143107																						
45	4.50	220	59.0	36.0	29.0	4	40.50	110225																							
48	5.00	250	63.0	36.0	29.0	4	43.00	110226	157517																						
56	5.50	280	71.0	45.0	35.0	5	50.50	110229	158178																						

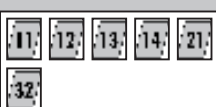

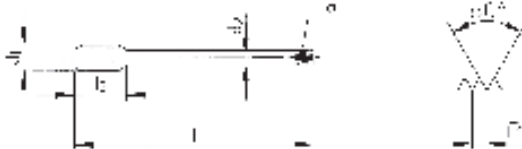
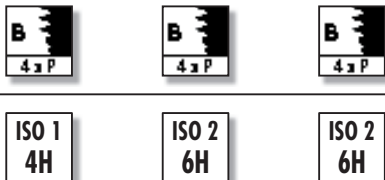
									N320-4	N320-4 LH	N320V-4 LH		
N320-4													
N320-4 LH		LH											
N320V-4 LH		V	LH										
Ø d ₁ M	P mm	l ₁ mm	l ₂ mm	l ₃ mm	d ₂ mm	a mm			ID	ID	ID		
* 2	0.40	45	8.0		2.8	2.1	2	1.60	162503	111472	162771		
2.5	0.45	50	10.0		2.8	2.1	3	2.05	159345				
3	0.50	56	12.0	18	3.5	2.7	3	2.50	101487	111473	162772		
4	0.70	63	14.0	21	4.5	3.4	3	3.30	101493	111474	162773		
5	0.80	70	15.0	25	6.0	4.9	3	4.20	101497	111475	162774		
6	1.00	80	17.0	30	6.0	4.9	3	5.00	101501	111476	162775		
8	1.25	90	20.0	35	8.0	6.2	3	△ 6.80	146482				
10	1.50	100	22.0	39	10.0	8.0	3	8.50	146484				
<p>* N320-3 </p> <p>△ ISO 1 4H = 6.70 </p>													

									N420-4	N420-4 LH	N420V-4 LH	
												
N420-4												
N420-4 LH	 LH											
N420V-4 LH	 V LH											
												
$\varnothing d_1$	P	l_1	l_2	d_2	α			ID	ID	ID		
M	mm	mm	mm	mm	mm							
8	1.25	90	20.0	6.0	4.9	3	Δ 6.80	102193	102198	142621		
10	1.50	100	22.0	7.0	5.5	3	8.50	102059	102064	143287		
12	1.75	110	24.0	9.0	7.0	3	10.20	102070	102040	146583		
14	2.00	110	28.0	11.0	9.0	3	12.00		102084	146563		
16	2.00	110	30.0	12.0	9.0	3	14.00		102093	143108		
20	2.50	140	36.0	16.0	12.0	3	17.50		102103	145579		
24	3.00	160	39.0	18.0	14.5	4	21.00		111493			
30	3.50	180	45.0	22.0	18.0	4	26.50		111494			

Δ ISO 1 4H =  = 6.70











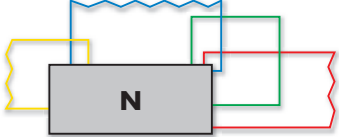

									N320-4	N320V-4	N320-4	N320-4			
N320-4															
N320V-4		V													
									B 4 x P	B 4 x P	B 4 x P	B 4 x P			
									ISO 3 6G	ISO 3 6G	7G	6H +0.1mm			
Ø d ₁ M	P mm	l ₁ mm	l ₂ mm	l ₃ mm	d ₂ mm	a mm		6H mm	ID	6H + mm	ID	6H + mm	ID	6H + mm	ID
* 2	0.40	45	8.0		2.8	2.1	2	1.60	101457	0.019	143584	0.019			
2.5	0.45	50	10.0		2.8	2.1	3	2.05	101482	0.020	150522	0.020			
3	0.50	56	12.0	18	3.5	2.7	3	2.50	101486	0.020	143116	0.020	101489	0.036	101488
3.5	0.60	56	13.0	20	4.0	3.0	3	2.95	101490	0.021					
4	0.70	63	14.0	21	4.5	3.4	3	3.35	101494	0.022	143087	0.022	101496	0.041	111522
5	0.80	70	15.0	25	6.0	4.9	3	4.25	101498	0.024	143088	0.024	101500	0.044	111523
6	1.00	80	17.0	30	6.0	4.9	3	5.00	101502	0.026	143089	0.026	101504	0.050	111524
8	1.25	90	20.0	35	8.0	6.2	3	6.80	101505	0.028	143604	0.028			

* N320-3 / N320V-3

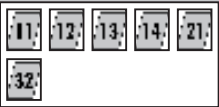

M ISO DIN 13

HSSE  DIN 376

									N420-4	N420V-4	N420-4	N420-4		
									<p>N420-4  </p> <p>N420V-4   </p>					
														
														
$\varnothing d_1$	P	l_1	l_2	d_2	α			ID	6H + mm	ID	6H + mm	ID	6H + mm	ID
M	mm	mm	mm	mm	mm									
8	1.25	90	20.0	6.0	4.9	3	6.80	102194	0.028			102199	0.052	102196
10	1.50	100	22.0	7.0	5.5	3	8.50	102060	0.032	143726	0.032	102065	0.060	102062
12	1.75	110	24.0	9.0	7.0	3	10.30	102071	0.034	145655	0.034	102076	0.066	102073
16	2.00	110	30.0	12.0	9.0	3	14.00	135531	0.038	162795	0.038	102094	0.072	102091













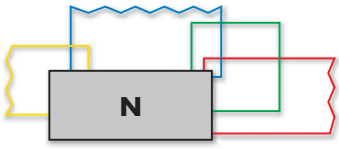

									N321-4	N330-4	N330V-4	
N321-4												
N330-4												
N330V-4												
$\varnothing d_1$ M	P mm	l_1 mm	l_2 mm	l_3 mm	d_2 mm	a mm		6H	ID	ID	ID	
* 1	0.25	40	5.5		2.5	2.1	2	0.75		101558		
* 1.1	0.25	40	5.5		2.5	2.1	2	0.85		* 101559		
* 1.2	0.25	40	5.5		2.5	2.1	2	0.95		101560		
* 1.4	0.30	40	7.0		2.5	2.1	2	1.10		101561		
* 1.6	0.35	40	8.0		2.5	2.1	2	1.25		101562	151246	
* 1.7	0.35	40	8.0		2.5	2.1	2	1.35		101563		
* 2	0.40	45	8.0		2.8	2.1	2	1.60	101552	105125	101572	
* 2.2	0.45	45	9.0		2.8	2.1	2	1.75		105126		
* 2.3	0.40	45	9.0		2.8	2.1	2	1.90		105127		
2.5	0.45	50	10.0		2.8	2.1	* 3	2.05	101553	101565	101573	
2.6	0.45	50	10.0		2.8	2.1	2	2.15		101566		
3	0.50	56	12.0	18	3.5	2.7	* 3	2.50	101555	101567	101574	
3.5	0.60	56	13.0	20	4.0	3.0	2	2.90		101568	* 110953	
4	0.70	63	14.0	21	4.5	3.4	3	3.30	101557	101569	101576	
5	0.80	70	15.0	25	6.0	4.9	3	4.20		101570	101577	
6	1.00	80	17.0	30	6.0	4.9	3	5.00		101571	101578	

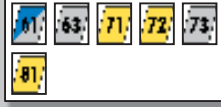
* N321-3 / N330-3 / N330V-3 * N330-4 = 2

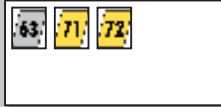

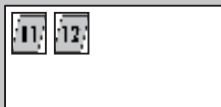

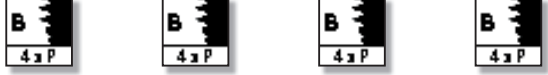
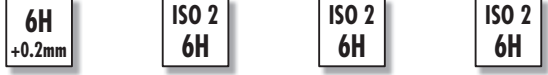







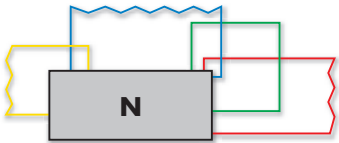





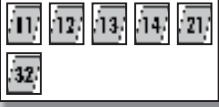

* N330V-4 = 2

≤ M1.5

								N420-4	N421-4	N430-4	N430V-4
											
N420-4											
N421-4											
N430-4											
N430V-4											
											
											
$\varnothing d_1$	P	l_1	l_2	d_2	α			ID	ID	ID	ID
M	mm	mm	mm	mm	mm						
4	0.70	63	14.0	2.8	2.1	3	3.30		102293		
5	0.80	70	15.0	3.5	2.7	3	4.20		102294		
6	1.00	80	17.0	4.5	3.4	3	5.00		102295		
8	1.25	90	20.0	6.0	4.9	3	6.80	102197	102296	102301	102306
10	1.50	100	22.0	7.0	5.5	3	8.50	102063	102286	102297	102302
12	1.75	110	24.0	9.0	7.0	3	10.20	102074	102287	102298	102303
14	2.00	110	28.0	11.0	9.0	3	12.00		* 102288		
16	2.00	110	30.0	12.0	9.0	3	14.00	102092	102289		
20	2.50	140	36.0	16.0	12.0	3	17.50	* 102102	* 102291		
24	3.00	160	39.0	18.0	14.5	4	21.00		* 102292		









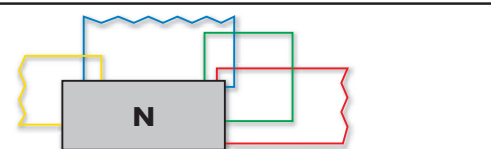

									N350-3	N350V-3		
N350-3												
N350V-3												
Ø d ₁ M	P mm	l ₁ mm	l ₂ mm	l ₃ mm	d ₂ mm	a mm			ID	ID		
2	0.40	45	8.0		2.8	2.1	2	1.60	101580	101593		
2.3	0.40	45	9.0		2.8	2.1	2	1.90	101581			
2.5	0.45	50	10.0		2.8	2.1	2	2.05	101582	101594		
2.6	0.45	50	10.0		2.8	2.1	2	2.15	101583			
3	0.50	56	12.0	18	3.5	2.7	2	2.50	101584	101595		
3.5	0.60	56	13.0	20	4.0	3.0	2	2.90	101585			
4	0.70	63	14.0	21	4.5	3.4	2	3.30	101587	101596		
5	0.80	70	15.0	25	6.0	4.9	3	4.20	101589	101597		
6	1.00	80	17.0	30	6.0	4.9	3	5.00	101591	101598		
8	1.25	90	20.0	35	8.0	6.2	3	6.80	101592	146810		
10	1.50	100	22.0	39	10.0	8.0	3	8.50	101579	147217		

									N450-3	N450V-3						
																
N450-3																
N450V-3	 															
																
																
																
																
$\varnothing d_1$	P	l_1	l_2	d_2	a			ID	ID							
M	mm	mm	mm	mm	mm											
8	1.25	90	20.0	6.0	4.9	3	6.80	102327	102334							
10	1.50	100	22.0	7.0	5.5	3	8.50	102314	102329							
12	1.75	110	24.0	9.0	7.0	3	10.20	102317	102330							
14	2.00	110	28.0	11.0	9.0	3	12.00	102319	145487							
16	2.00	110	30.0	12.0	9.0	3	14.00	102321	102331							
20	2.50	140	36.0	16.0	12.0	4	17.50	102324	102332							
24	3.00	160	39.0	18.0	14.5	4	21.00	102325	102333							









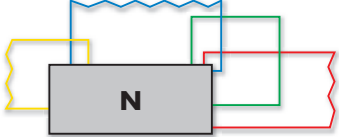

									N360-3	N360V-3	N360TN-3	N360TC-3
N360-3												
N360V-3	V											
N360TN-3	TiN											
N360TC-3	TiCN											
Ø d ₁ M	P mm	l ₁ mm	l ₂ mm	l ₃ mm	d ₂ mm	a mm			ID	ID	ID	ID
2	0.40	45	7.0		2.8	2.1	2	1.60	101618	101708	101697	
2.2	0.45	45	8.0		2.8	2.1	2	1.75	101619			
2.3	0.40	45	8.0		2.8	2.1	2	1.90	101620			
2.5	0.45	50	9.0		2.8	2.1	2	2.05	101622	101709	101698	101689
2.6	0.45	50	9.0		2.8	2.1	2	2.15	101623	101710		
3	0.50	56	5.5	18	3.5	2.7	3	2.50	101626	101711	101699	101690
3.5	0.60	56	6.5	20	4.0	3.0	3	2.90	101630	142625		
4	0.70	63	7.5	21	4.5	3.4	3	3.30	101635	101713	101700	101691
4.5	0.75	70	9.0	25	6.0	4.9	3	3.75	101639			
5	0.80	70	9.0	25	6.0	4.9	3	4.20	101644	101715	101701	101692
6	1.00	80	11.0	30	6.0	4.9	3	5.00	101652	101717	101703	101693
7	1.00	80	11.0	30	7.0	5.5	3	6.00	101656	101718		
8	1.25	90	12.5	35	8.0	6.2	3	6.80	101663	101721	101705	101694
9	1.25	90	12.5	35	9.0	7.0	3	7.80	101668			
10	1.50	100	14.0	39	10.0	8.0	3	8.50	101612	101707	101696	101688

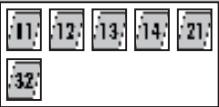
									N460-3	N460V-3	N460TN-3	N460TC-3
												
												
												
$\varnothing d_1$ M	P mm	l_1 mm	l_2 mm	d_2 mm	α mm			ID	ID	ID	ID	
5	0.80	70	9.0	3.5	2.7	3	4.20	102410	102489	160682		
6	1.00	80	11.0	4.5	3.4	3	5.00	102411	102491	152850		
8	1.25	90	12.5	6.0	4.9	3	6.80	102412	102492	152849		
10	1.50	100	14.0	7.0	5.5	3	8.50	102351	102461	150242		
12	1.75	110	14.0	9.0	7.0	3	10.20	102359	102465	102449	102438	
14	2.00	110	14.0	11.0	9.0	3	12.00	102369	102468	102451	111615	
16	2.00	110	18.0	12.0	9.0	3	14.00	102376	102471	102453	102440	
18	2.50	125	21.0	14.0	11.0	3	15.50	102383	102473			
20	2.50	140	24.0	16.0	12.0	4	17.50	102389	102475	102454	143280	
22	2.50	140	24.0	18.0	14.5	4	19.50	102394	102477			
24	3.00	160	27.0	18.0	14.5	4	21.00	102398	102480	143119		
27	3.00	160	27.0	20.0	16.0	4	24.00		102481			
30	3.50	180	30.0	22.0	18.0	4	26.50		102482			
33	3.50	180	33.0	25.0	20.0	4	29.50		102483			
36	4.00	200	36.0	28.0	22.0	5	32.00		102484			
39	4.00	200	40.0	32.0	24.0	5	35.00		102485			
42	4.50	200	40.0	32.0	24.0	5	37.50		102486			
45	4.50	220	44.0	36.0	29.0	5	40.50		102487			
48	5.00	250	48.0	36.0	29.0	5	43.00		102488			
52	5.00	250	52.0	40.0	32.0	5	47.00		110228			
56	5.50	280	56.0	45.0	35.0	6	50.50		102490			
64	6.00	315	64.0	50.0	39.0	6	58.00		143805			

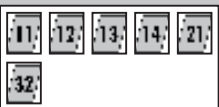

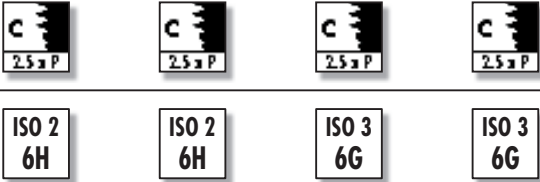
									N360-3 LH	N360V-3 LH	N360-3	N360V-3
N360-3 LH		LH										
N360V-3 LH		V LH										
N360-3												
N360V-3		V										
Ø d ₁ M	P mm	l ₁ mm	l ₂ mm	l ₃ mm	d ₂ mm	a mm		6H 	ID	ID	ID 6H + mm	ID 6H + mm
2	0.40	45	7.0		2.8	2.1	2	1.60			101617 0.019	
2.5	0.45	50	9.0		2.8	2.1	2	2.05			101621 0.020	143294 0.020
3	0.50	56	5.5	18	3.5	2.7	3	2.50	101627	146811	101625 0.020	104816 0.020
3.5	0.60	56	6.5	20	4.0	3.0	3	2.95			101629 0.021	125829 0.021
4	0.70	63	7.5	21	4.5	3.4	3	3.30	101637	162540	101634 0.022	104817 0.022
5	0.80	70	9.0	25	6.0	4.9	3	4.20	101646	144003	101643 0.024	104818 0.024
6	1.00	80	11.0	30	6.0	4.9	3	5.00	101654	144004	101669 0.026	104819 0.026
8	1.25	90	12.5	35	8.0	6.2	3	6.80	101666	143925	101662 0.028	104820 0.028
10	1.50	100	14.0	39	10.0	8.0	3	8.50	101615	143587	101611 0.032	104821 0.032

									N460-3 LH	N460V-3 LH	N460-3	N460V-3	
													
													
													
													
$\varnothing d_1$ M	P mm	l_1 mm	l_2 mm	d_2 mm	α mm			ID	ID	ID	6H + mm	ID	6H + mm
12	1.75	110	14.0	9.0	7.0	3	10.20	102362	146354	102358	0.034	143602	0.034
14	2.00	110	14.0	11.0	9.0	3	12.00			102368	0.038	144712	0.038
16	2.00	110	18.0	12.0	9.0	3	14.00	102378	143439	102375	0.038	150197	0.038
20	2.50	140	24.0	16.0	12.0	4	17.50	102390	146564	102388	0.042	145420	0.042



									N360-3	N360-3	N360V-3	N360-3		
N360-3 														
N360V-3 														
Ø d ₁ M	P mm	l ₁ mm	l ₂ mm	l ₃ mm	d ₂ mm	a mm		6H 	ID	ID	ID 6H + mm	ID 6H + mm	ID	
3	0.50	56	5.5	18	3.5	2.7	3	2.50	101624	101628	0.036	144311	0.036	
4	0.70	63	7.5	21	4.5	3.4	3	3.30	101633	101638	0.041	144192	0.041	101636
5	0.80	70	9.0	25	6.0	4.9	3	4.20	101642	101647	0.044	143208	0.044	101645
6	1.00	80	11.0	30	6.0	4.9	3	5.00	101651	101655	0.050	146709	0.050	101653
8	1.25	90	12.5	35	8.0	6.2	3	6.80	101661	101667	0.052	146267	0.052	101664
10	1.50	100	14.0	39	10.0	8.0	3	8.50	101610	101616	0.060	142547	0.060	101613

△ ISO 1 4H = 6.70

M ISO DIN 13

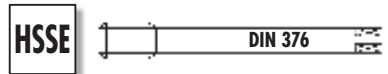









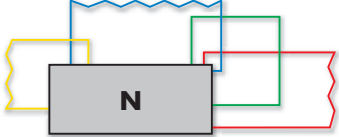

								N460-3	N460-3	N460V-3	N460-3		
N460-3													
N460V-3													
$\varnothing d_1$	P	l_1	l_2	d_2	α			ID	ID	6H + mm	ID	6H + mm	ID
M	mm	mm	mm	mm	mm								
12	1.75	110	14.0	9.0	7.0	3	10.20	124987	102363	0.066	142532	0.066	102360
16	2.00	110	18.0	12.0	9.0	3	14.00		102379	0.072	144956	0.072	102377

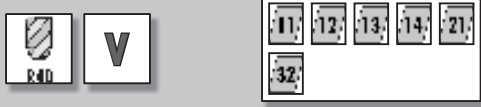

									N360-5	N360V-5	N361-3	N362V-3
N360-5												
N360V-5	V											
N361-3												
N362V-3	V											
Ø d ₁ M	P mm	l ₁ mm	l ₂ mm	l ₃ mm	d ₂ mm	a mm			ID	ID	ID	ID
2	0.40	45	7.0		2.8	2.1	2	1.60	158079	150058		
3	0.50	56	5.5	18	3.5	2.7	3	2.50	104809	142646	101735	
4	0.70	63	7.5	21	4.5	3.4	3	3.30	104810	142647	101736	101741
5	0.80	70	9.0	25	6.0	4.9	3	4.20	104811	142648	101737	101742
6	1.00	80	11.0	30	6.0	4.9	3	5.00	104812	142649	101738	101743
8	1.25	90	12.5	35	8.0	6.2	3	6.80	104813	142650	101739	101744
10	1.50	100	14.0	39	10.0	8.0	3	8.50	104814	124899	101734	101740

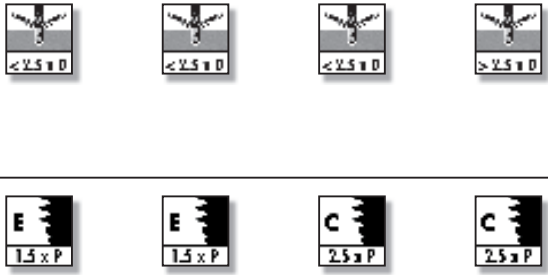









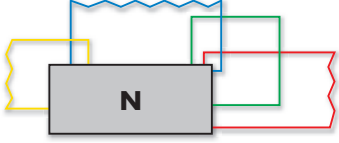

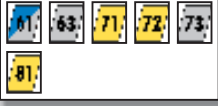

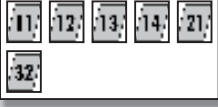



M ISO DIN 13

HSSE 

								N460-5	N460V-5	N461-3	N462V-3				
															
															
															
															
															
$\varnothing d_1$ M	P mm	l_1 mm	l_2 mm	d_2 mm	α mm			ID	ID	ID	ID				
12	1.75	110	14.0	9.0	7.0	3	10.20	104815	142651	102506	102512				
14	2.00	110	14.0	11.0	9.0	3	12.00			102507	102513				
16	2.00	110	18.0	12.0	9.0	3	14.00			102508	102514				
18	2.50	125	21.0	14.0	11.0	3	15.50			* 111614	102515				
20	2.50	140	24.0	16.0	12.0	4	17.50			* 102510	102516				
22	2.50	140	24.0	18.0	14.5	4	19.50				* 158295				
24	3.00	160	27.0	18.0	14.5	4	21.00				102517				
27	3.00	160	27.0	20.0	16.0	4	24.00				159244				
30	3.50	180	30.0	22.0	18.0	4	26.50				143090				











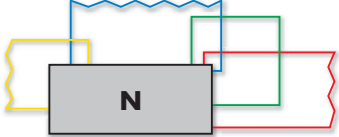

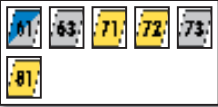

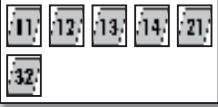





									N520-4	N520V-4	N520TN-4						
N520-4																	
N520V-4	V																
N520TN-4	TiN																
Ø d ₁ M	P mm	l ₁ mm	l ₂ mm	l ₃ mm	d ₂ mm	a mm			ID	ID	ID						
2.5	0.45	100	10.0		2.8	2.1	3	2.05	102594								
3	0.50	112	12.0	18	3.5	2.7	3	2.50	102595	143399	162790						
4	0.70	112	14.0	21	4.5	3.4	3	3.30	102596	143400	146837						
5	0.80	125	15.0	25	6.0	4.9	3	4.20	102597	142654	150113						
6	1.00	125	17.0	30	6.0	4.9	3	5.00	102598	143137	148821						

									N620-4	N620V-4	N620TN-4									
																				
N620-4																				
N620V-4	 V																			
N620TN-4	 TiN																			
																				
																				
$\varnothing d_1$ M	P mm	l_1 mm	l_2 mm	d_2 mm	α mm			ID	ID	ID										
4	0.70	112	14.0	2.8	2.1	3	3.30	102619	142582											
5	0.80	125	15.0	3.5	2.7	3	4.20	102620	142657											
6	1.00	125	17.0	4.5	3.4	3	5.00	102621	142658											
8	1.25	140	20.0	6.0	4.9	3	6.80	102622	143401	146262										
10	1.50	160	22.0	7.0	5.5	3	8.50	102614	142660	146849										
12	1.75	180	24.0	9.0	7.0	3	10.20	102615	143127	146295										
14	2.00	180	28.0	11.0	9.0	3	12.00	102616	151905											
16	2.00	200	30.0	12.0	9.0	3	14.00	102617	143106	143574										
20	2.50	224	36.0	16.0	12.0	3	17.50	102618	143596											



									N560-3	N560V-3	N560TN-3	
N560-3												
N560V-3	V											
N560TN-3	TiN											
Ø d ₁ M	P mm	l ₁ mm	l ₂ mm	l ₃ mm	d ₂ mm	a mm			ID	ID	ID	
2.5	0.45	100	9.0		2.8	2.1	2	2.05	102600	102607		
3	0.50	112	5.5	18	3.5	2.7	3	2.50	102601	102608	142663	
4	0.70	112	7.5	21	4.5	3.4	3	3.30	102602	102609	142664	
5	0.80	125	9.0	25	6.0	4.9	3	4.20	102603	102610	142665	
6	1.00	125	11.0	30	6.0	4.9	3	5.00	102604	102611	142666	
8	1.25	140	12.5	35	8.0	6.2	3	6.80	102605	102612	142667	
10	1.50	160	14.0	39	10.0	8.0	3	8.50	102599	102606	142668	

									N660-3	N660V-3	N660TN-3									
																				
N660-3																				
N660V-3	 V																			
N660TN-3	 TiN																			
																				
																				
$\varnothing d_1$ M	P mm	l_1 mm	l_2 mm	d_2 mm	α mm			ID	ID	ID										
6	1.00	125	11.0	4.5	3.4	3	5.00	162792	115657											
8	1.25	140	12.5	6.0	4.9	3	6.80	162793	115544											
10	1.50	160	14.0	7.0	5.5	3	8.50	162794	135539											
12	1.75	180	14.0	9.0	7.0	3	10.20	102623	102626	142669										
14	2.00	180	14.0	11.0	9.0	3	12.00	162253	147500											
16	2.00	200	18.0	12.0	9.0	3	14.00	102624	102627	142670										
20	2.50	224	24.0	16.0	12.0	4	17.50	102625	102628											

									W320-4	W420-4		
<p>W320-4</p>												
<p>W420-4</p>												
$\varnothing d_1$	P	l_1	l_2	l_3	d_2	a			ID	ID		
M	mm	mm	mm	mm	mm	mm						
* 2	0.40	45	8.0		2.8	2.1	2	1.60	104612			
2.5	0.45	50	10.0		2.8	2.1	2	2.05	104613			
2.6	0.45	50	10.0		2.8	2.1	2	2.15	104614			
3	0.50	56	12.0	18	3.5	2.7	2	2.50	104615			
3.5	0.60	56	13.0	20	4.0	3.0	2	2.90	104616			
4	0.70	63	14.0	21	4.5	3.4	2	3.30	104617			
5	0.80	70	15.0	25	6.0	4.9	2	4.20	104618			
6	1.00	80	17.0	30	6.0	4.9	2	5.00	104619			
8	1.25	90	20.0		6.0	4.9	2	6.80		104636		
10	1.50	100	22.0		7.0	5.5	2	8.50		104632		
12	1.75	110	24.0		9.0	7.0	3	10.20		104633		
16	2.00	110	30.0		12.0	9.0	3	14.00		104634		
<p>* W320-3</p>												

									W360-3	W460-3		
									W360-3 W460-3 			
									 $< \sqrt{5} \times D$	 $< \sqrt{5} \times D$		
									 $2.5 \times P$	 $2.5 \times P$		
									ISO 2 6H	ISO 2 6H		
$\varnothing d_1$ M	P mm	l_1 mm	l_2 mm	l_3 mm	d_2 mm	α mm			ID	ID		
2	0.40	45	7.0		2.8	2.1	2	1.60	104625			
2.5	0.45	50	9.0		2.8	2.1	2	2.05	104626			
3	0.50	56	5.5	18	3.5	2.7	2	2.50	104627			
4	0.70	63	7.5	21	4.5	3.4	2	3.30	104628			
5	0.80	70	9.0	25	6.0	4.9	2	4.20	104629			
6	1.00	80	11.0	30	6.0	4.9	2	5.00	104630			
8	1.25	90	12.5	35	8.0	6.2	2	6.80	104631			
10	1.50	100	14.0	39	10.0	8.0	2	8.50	104624			
12	1.75	110	14.0		9.0	7.0	3	10.20		104640		
16	2.00	110	18.0		12.0	9.0	3	14.00		104641		

									Z320V-4	Z420V-4	Z320VS-4	Z420VS-4
Z320V-4		V										
Z420V-4		V										
Z320VS-4		VS										
Z420VS-4		VS										
									ISO 2 6H	ISO 2 6H	ISO 2 6H	ISO 2 6H
Ø d ₁ M	P mm	l ₁ mm	l ₂ mm	l ₃ mm	d ₂ mm	a mm			ID	ID	ID	ID
* 1.6	0.35	40	8.0		2.5	2.1	2	1.25	142671			
* 2	0.40	45	8.0		2.8	2.1	2	1.60	111613			
2.5	0.45	50	10.0		2.8	2.1	3	2.05	111455		143683	
2.6	0.45	50	10.0		2.8	2.1	3	2.15	142672			
3	0.50	56	12.0	18	3.5	2.7	3	2.50	104669		104830	
4	0.70	63	14.0	21	4.5	3.4	3	3.30	104670		104831	
5	0.80	70	15.0	25	6.0	4.9	3	4.20	104671		104832	
6	1.00	80	17.0	30	6.0	4.9	3	5.00	104672		104833	
8	1.25	90	20.0	35	8.0	6.2	3	6.80	104673		104834	
10	1.50	100	22.0	39	10.0	8.0	3	8.50	104668		104835	
12	1.75	110	24.0		9.0	7.0	3	10.20		104723		104836
14	2.00	110	28.0		11.0	9.0	3	12.00		142673		143684
16	2.00	110	30.0		12.0	9.0	3	14.00		105068		111569
18	2.50	125	33.0		14.0	11.0	4	15.50		142674		
20	2.50	140	36.0		16.0	12.0	4	17.50		105069		111570
24	3.00	160	39.0		18.0	14.5	4	21.00		142675		
30	3.50	180	45.0		22.0	18.0	4	26.50		142676		

* Z320V-3











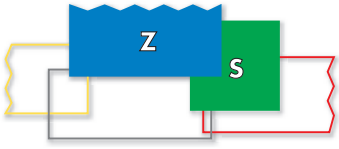















									Z362V-3	Z462V-3		
<p>Z362V-3</p>												
Ø d ₁ M	P mm	l ₁ mm	l ₂ mm	l ₃ mm	d ₂ mm	a mm			ID	ID		
* 2	0.40	45	7.0		2.8	2.1	2	1.60	104684			
* 2.5	0.45	50	9.0		2.8	2.1	2	2.05	104685			
* 2.6	0.45	50	9.0		2.8	2.1	2	2.15	104686			
* 3	0.50	56	5.5	18	3.5	2.7	3	2.50	104687			
3.5	0.60	56	6.5	20	4.0	3.0	3	2.90	104688			
4	0.70	63	7.5	21	4.5	3.4	3	3.30	104689			
5	0.80	70	9.0	25	6.0	4.9	3	4.20	104690			
6	1.00	80	11.0	30	6.0	4.9	3	5.00	104691			
8	1.25	90	12.5	35	8.0	6.2	3	6.80	104692			
10	1.50	100	14.0	39	10.0	8.0	3	8.50	104683			
12	1.75	110	14.0		9.0	7.0	3	10.20			104742	
14	2.00	110	14.0		11.0	9.0	3	12.00			104743	
16	2.00	110	18.0		12.0	9.0	3	14.00			104744	
18	2.50	125	21.0		14.0	11.0	3	15.50			104745	
20	2.50	140	24.0		16.0	12.0	3	17.50			104746	
22	2.50	140	24.0		18.0	14.5	3	19.50			104752	
24	3.00	160	27.0		18.0	14.5	4	21.00			104747	
27	3.00	160	27.0		20.0	16.0	4	24.00			104748	
30	3.50	180	30.0		22.0	18.0	4	26.50			104749	
36	4.00	200	36.0		28.0	22.0	4	32.00			104750	
42	4.50	200	40.0		32.0	24.0	4	37.50			104751	

* Z360V-3



										Z362VS-3	Z370VS-3	Z370VS-3	Z373VS-3																																																																																																
<p>Z362VS-3</p>										<p>NEW NEW</p>																																																																																																			
<p>Z370VS-3</p>										<p>PM PM PM</p>																																																																																																			
<p>Z373VS-3</p>										<p>PM PM PM</p>																																																																																																			
										<p>6HX 6HX 4HX 6HX</p>																																																																																																			
<table border="1"> <thead> <tr> <th>$\varnothing d_1$</th> <th>P</th> <th>l_1</th> <th>l_2</th> <th>l_3</th> <th>d_2</th> <th>a</th> <th></th> <th></th> <th>ID</th> </tr> <tr> <th>M</th> <th>mm</th> <th>mm</th> <th>mm</th> <th>mm</th> <th>mm</th> <th>mm</th> <th></th> <th></th> <th></th> </tr> </thead> <tbody> <tr><td>* 3</td><td>0.50</td><td>56</td><td>5.5</td><td>18</td><td>3.5</td><td>2.7</td><td>3</td><td>2.50</td><td>111504</td></tr> <tr><td>4</td><td>0.70</td><td>63</td><td>7.5</td><td>21</td><td>4.5</td><td>3.4</td><td>3</td><td>3.30</td><td>111505</td></tr> <tr><td>5</td><td>0.80</td><td>70</td><td>9.0</td><td>25</td><td>6.0</td><td>4.9</td><td>3</td><td>4.20</td><td>111506</td></tr> <tr><td>6</td><td>1.00</td><td>80</td><td>11.0</td><td>30</td><td>6.0</td><td>4.9</td><td>3</td><td>5.00</td><td>111507</td></tr> <tr><td>8</td><td>1.25</td><td>90</td><td>12.5</td><td>35</td><td>8.0</td><td>6.2</td><td>3</td><td>6.80</td><td>111508</td></tr> <tr><td>10</td><td>1.50</td><td>100</td><td>14.0</td><td>39</td><td>10.0</td><td>8.0</td><td>3</td><td>8.50</td><td>111509</td></tr> </tbody> </table>										$\varnothing d_1$	P	l_1	l_2	l_3	d_2	a			ID	M	mm	mm	mm	mm	mm	mm				* 3	0.50	56	5.5	18	3.5	2.7	3	2.50	111504	4	0.70	63	7.5	21	4.5	3.4	3	3.30	111505	5	0.80	70	9.0	25	6.0	4.9	3	4.20	111506	6	1.00	80	11.0	30	6.0	4.9	3	5.00	111507	8	1.25	90	12.5	35	8.0	6.2	3	6.80	111508	10	1.50	100	14.0	39	10.0	8.0	3	8.50	111509																				
$\varnothing d_1$	P	l_1	l_2	l_3	d_2	a			ID																																																																																																				
M	mm	mm	mm	mm	mm	mm																																																																																																							
* 3	0.50	56	5.5	18	3.5	2.7	3	2.50	111504																																																																																																				
4	0.70	63	7.5	21	4.5	3.4	3	3.30	111505																																																																																																				
5	0.80	70	9.0	25	6.0	4.9	3	4.20	111506																																																																																																				
6	1.00	80	11.0	30	6.0	4.9	3	5.00	111507																																																																																																				
8	1.25	90	12.5	35	8.0	6.2	3	6.80	111508																																																																																																				
10	1.50	100	14.0	39	10.0	8.0	3	8.50	111509																																																																																																				
<p>* Z360VS-3</p>																																																																																																													
<table border="1"> <thead> <tr> <th>$\varnothing d_1$</th> <th>P</th> <th>l_1</th> <th>l_2</th> <th>l_3</th> <th>d_2 h6</th> <th>a</th> <th></th> <th></th> <th>ID</th> <th>ID</th> <th>ID</th> </tr> <tr> <th>M</th> <th>mm</th> <th>mm</th> <th>mm</th> <th>mm</th> <th>mm</th> <th>mm</th> <th></th> <th></th> <th></th> <th></th> <th></th> </tr> </thead> <tbody> <tr><td>3</td><td>0.50</td><td>56</td><td>5.5</td><td>18</td><td>3.5(h9)</td><td>2.7</td><td>3</td><td>2.50</td><td>162776</td><td>165324</td><td>165236</td></tr> <tr><td>4</td><td>0.70</td><td>63</td><td>7.5</td><td>21</td><td>4.5(h9)</td><td>3.4</td><td>3</td><td>3.30</td><td>162777</td><td>165325</td><td>165237</td></tr> <tr><td>5</td><td>0.80</td><td>70</td><td>9.0</td><td>25</td><td>6.0</td><td>4.9</td><td>3</td><td>4.20</td><td>162778</td><td>165326</td><td>165238</td></tr> <tr><td>6</td><td>1.00</td><td>80</td><td>11.0</td><td>30</td><td>6.0</td><td>4.9</td><td>3</td><td>5.00</td><td>162779</td><td>165327</td><td>165239</td></tr> <tr><td>8</td><td>1.25</td><td>90</td><td>12.5</td><td>35</td><td>8.0</td><td>6.2</td><td>3</td><td>Δ 6.80</td><td>162780</td><td>165328</td><td>165240</td></tr> <tr><td>10</td><td>1.50</td><td>100</td><td>14.0</td><td>39</td><td>10.0</td><td>8.0</td><td>3</td><td>8.50</td><td>162781</td><td>165438</td><td>165241</td></tr> </tbody> </table>										$\varnothing d_1$	P	l_1	l_2	l_3	d_2 h6	a			ID	ID	ID	M	mm	mm	mm	mm	mm	mm						3	0.50	56	5.5	18	3.5(h9)	2.7	3	2.50	162776	165324	165236	4	0.70	63	7.5	21	4.5(h9)	3.4	3	3.30	162777	165325	165237	5	0.80	70	9.0	25	6.0	4.9	3	4.20	162778	165326	165238	6	1.00	80	11.0	30	6.0	4.9	3	5.00	162779	165327	165239	8	1.25	90	12.5	35	8.0	6.2	3	Δ 6.80	162780	165328	165240	10	1.50	100	14.0	39	10.0	8.0	3	8.50	162781	165438	165241				
$\varnothing d_1$	P	l_1	l_2	l_3	d_2 h6	a			ID	ID	ID																																																																																																		
M	mm	mm	mm	mm	mm	mm																																																																																																							
3	0.50	56	5.5	18	3.5(h9)	2.7	3	2.50	162776	165324	165236																																																																																																		
4	0.70	63	7.5	21	4.5(h9)	3.4	3	3.30	162777	165325	165237																																																																																																		
5	0.80	70	9.0	25	6.0	4.9	3	4.20	162778	165326	165238																																																																																																		
6	1.00	80	11.0	30	6.0	4.9	3	5.00	162779	165327	165239																																																																																																		
8	1.25	90	12.5	35	8.0	6.2	3	Δ 6.80	162780	165328	165240																																																																																																		
10	1.50	100	14.0	39	10.0	8.0	3	8.50	162781	165438	165241																																																																																																		
<p>Δ 4HX = = 6.70</p>																																																																																																													

									Z462VS-3	Z470VS-3	Z473VS-3	
<p>Z462VS-3   VS </p> <p>Z470VS-3  VS   </p> <p>Z473VS-3  VS   </p>												
												
									PM	PM		
												
									6HX	6HX	6HX	
∅ d ₁ M	P mm	l ₁ mm	l ₂ mm	d ₂ mm	a mm			ID				
12	1.75	110	14.0	9.0	7.0	4	10.20	111510				
14	2.00	110	14.0	11.0	9.0	4	12.00	148169				
16	2.00	110	18.0	12.0	9.0	4	14.00	111511				
20	2.50	140	24.0	16.0	12.0	4	17.50	111512				
24	3.00	160	27.0	18.0	14.5	4	21.00	111620				
∅ d ₁ M	P mm	l ₁ mm	l ₂ mm	d ₂ h6 mm	a mm			ID	ID			
12	1.75	110	14.0	*10.0	*8.0	4	10.20	162782	165242			
14	2.00	110	14.0	*12.0	*9.0	4	12.00	162783	165243			
16	2.00	110	18.0	12.0	9.0	4	14.00	162784	165244			
18	2.50	125	21.0	14.0	11.0	4	15.50	170643				
20	2.50	140	24.0	16.0	12.0	4	17.50	162785	165234			
24	3.00	160	27.0	16.0	12.0	4	21.00	162786	165235			
* Norme DC / * DC Norm / * Norma DC												



									H320-4	H320TC-4		
H320-4												
H320TC-4	TiCN											
$\varnothing d_1$ M	P mm	l_1 mm	l_2 mm	l_3 mm	d_2 mm	a mm			ID	ID		
2	0.40	45	8.0		2.8	2.1	2	1.60	101206			
2.2	0.45	45	9.0		2.8	2.1	2	1.75	111801			
2.5	0.45	50	10.0		2.8	2.1	3	2.05	101207			
3	0.50	56	12.0	18	3.5	2.7	3	2.50	101209	111836		
3.5	0.60	56	13.0	20	4.0	3.0	3	2.90	101210			
4	0.70	63	14.0	21	4.5	3.4	3	3.30	101211	111502		
4.5	0.75	70	15.0	25	6.0	4.9	3	3.75	101212			
5	0.80	70	15.0	25	6.0	4.9	3	4.20	101213	111458		
6	1.00	80	17.0	30	6.0	4.9	3	5.00	101215	111456		
8	1.25	90	20.0	35	8.0	6.2	3	6.80	101218	111453		
10	1.50	100	22.0	39	10.0	8.0	3	8.50	101205	110911		

M ISO DIN 13

≤ Ø 25.4 > Ø 25.4

PM

HSSE

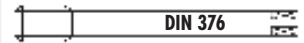

									H420-4	H420TC-4		
<p>H420-4</p>												
Ø d ₁ M	P mm	l ₁ mm	l ₂ mm	d ₂ mm	α mm				ID	ID		
12	1.75	110	24.0	9.0	7.0	4	10.20		101275	110912		
14	2.00	110	28.0	11.0	9.0	4	12.00		101277			
16	2.00	110	30.0	12.0	9.0	4	14.00		101279	111612		
18	2.50	125	33.0	14.0	11.0	4	15.50		101281			
20	2.50	140	36.0	16.0	12.0	4	17.50		101284			
24	3.00	160	39.0	18.0	14.5	4	21.00		101286			
27	3.00	160	42.0	20.0	16.0	4	24.00		101287			
30	3.50	180	45.0	22.0	18.0	4	26.50		101288			
36	4.00	200	51.0	28.0	22.0	4	32.00		101289			



									H350-3	H350-3	H350TC-3	
H350-3 												
H350TC-3 												
$\varnothing d_1$	P	l_1	l_2	l_3	d_2	α		$6H$	ID	ID	$6H$	ID
M	mm	mm	mm	mm	mm	mm					+ mm	
2	0.40	45	7.0		2.8	2.1	2	1.60	101238			
2.5	0.45	50	9.0		2.8	2.1	3	2.05	101239			144957
3	0.50	56	5.5	18	3.5	2.7	3	2.50	101242	101241	0.020	111835
3.5	0.60	56	6.5	20	4.0	3.0	3	2.90	101243			
4	0.70	63	7.5	21	4.5	3.4	3	3.30	101245	101244	0.022	111607
4.5	0.75	70	9.0	25	6.0	4.9	3	3.75	101246			
5	0.80	70	9.0	25	6.0	4.9	3	4.20	101248	101247	0.024	111610
6	1.00	80	11.0	30	6.0	4.9	3	5.00	101251	101250	0.026	111500
8	1.25	90	12.5	35	8.0	6.2	3	6.80	101255	101254	0.028	110963
10	1.50	100	14.0	39	10.0	8.0	3	8.50	101237	101236	0.032	111454

M ISO DIN 13

≤ Ø 25.4 > Ø 25.4











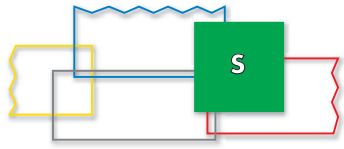









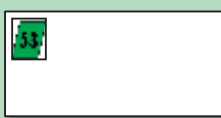





PM HSSE





















































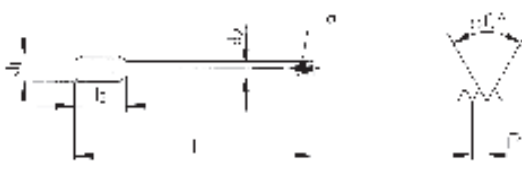

									H450-3	H450-3	H450TC-3	
H450-3 												
H450TC-3 												
Ø d ₁ M	P mm	l ₁ mm	l ₂ mm	d ₂ mm	α mm				ID	ID 6H + mm	ID	
12	1.75	110	14.0	9.0	7.0	4	10.20		101305	101304	0.034	111501
14	2.00	110	14.0	11.0	9.0	4	12.00		101307			
16	2.00	110	18.0	12.0	9.0	4	14.00		101309			111605
18	2.50	125	21.0	14.0	11.0	4	15.50		101311			
20	2.50	140	24.0	16.0	12.0	4	17.50		101313			
22	2.50	140	24.0	18.0	14.5	4	19.50		101315			
24	3.00	160	27.0	18.0	14.5	4	21.00		101318			
27	3.00	160	27.0	20.0	16.0	4	24.00		101320			
30	3.50	180	30.0	22.0	18.0	4	26.50		101323			
36	4.00	200	36.0	28.0	22.0	4	32.00		101324			
42	4.50	200	40.0	32.0	24.0	4	37.50		101325			

		S320VS-4		S320VS-4		S420VS-4					
S320VS-4											
S420VS-4											
$\varnothing d_1$	P	l_1	l_2	l_3	d_2	α			ID	ID	ID
M	mm	mm	mm	mm	mm	mm					
3	0.50	56	12.0	18	3.5	2.7	3	2.50	111596	165318	
4	0.70	63	14.0	21	4.5	3.4	3	3.30	111597	165319	
5	0.80	70	15.0	25	6.0	4.9	3	4.20	111598	165320	
6	1.00	80	17.0	30	6.0	4.9	3	5.00	111599	165321	
8	1.25	90	20.0	35	8.0	6.2	3	Δ 6.80	111600	165322	
10	1.50	100	22.0	39	10.0	8.0	3	8.50	111601	165323	
12	1.75	110	24.0		9.0	7.0	4	10.20			111602
14	2.00	110	30.0		11.0	9.0	4	12.50			162537
16	2.00	110	30.0		12.0	9.0	4	14.00			111603
20	2.50	140	36.0		16.0	12.0	4	17.50			111604

Δ **4HX** = = 6.70

		AERO				S360VS-3		S460VS-3		SA390-3		SA390-3		
														
S360VS-3  														
S460VS-3  														
SA390-3  														
														
														
$\varnothing d_1$	P	l_1	l_2	l_3	d_2	α			ID		ID			
M	mm	mm	mm	mm	mm	mm			ID		ID			
3	0.50	56	5.5	18	3.5	2.7	3	2.50	111513					
4	0.70	63	7.5	21	4.5	3.4	3	3.30	111514					
5	0.80	70	9.0	25	6.0	4.9	3	4.20	111515					
6	1.00	80	11.0	30	6.0	4.9	3	5.00	111516					
8	1.25	90	12.5	35	8.0	6.2	3	6.80	111517					
10	1.50	100	14.0	39	10.0	8.0	3	8.50	111518					
12	1.75	110	14.0		9.0	7.0	4	10.20			111519			
14	2.00	110	14.0		11.0	9.0	4	12.00			148171			
16	2.00	110	18.0		12.0	9.0	4	14.00			111520			
20	2.50	140	24.0		16.0	12.0	4	17.50			111521			
24	3.00	160	27.0		18.0	14.5	4	21.00			111606			
$\varnothing d_1$	P	l_1	l_2		d_2	α			ID		ID			
M	mm	mm	mm		mm	mm			ID		ID			
4	0.70	63	14.0		4.5	3.4	3	3.30	149673		149674			
5	0.80	70	15.0		6.0	4.9	3	4.20	149693		149694			
6	1.00	80	20.0		6.0	4.9	3	5.00	149707		149708			
8	1.25	90	25.0		8.0	6.2	3	Δ 6.80	149736		149737			
10	1.50	100	30.0		10.0	8.0	3	8.50	149754		149755			
12	1.75	110	35.0		12.0	9.0	4	10.20			149775			
14	2.00	110	40.0		16.0	12.0	4	12.00			* 149792			
16	2.00	110	40.0		16.0	12.0	4	14.00			149816			
Δ  =  = 6.70														

<h1>AERO</h1>									SA320-4	SA350-3	TL320VS-4	TL351VS-3					
<div style="display: flex; justify-content: space-between;"> <div style="width: 45%;"> <p>SA320-4  </p> <p>SA350-3  </p> <p>TL320VS-4  VS </p> <p>TL351VS-3   VS </p> </div> <div style="width: 45%; text-align: center;">     </div> </div>									   								
 																	
									4HX		4HX		4HX		4HX		
$\varnothing d_1$ M	P mm	l_1 mm	l_2 mm	l_3 mm	d_2 mm	α mm			ID	ID	ID	ID					
3	0.50	56	12.0		3.5	2.7	3	2.50	147975	147987	152006	152012					
4	0.70	63	14.0		4.5	3.4	3	3.30	147976	147988	152007	152013					
5	0.80	70	15.0		6.0	4.9	3	4.20	147977	147989	152008	152014					
6	1.00	80	15.0	23	6.0	4.9	3	5.00	147978	147990	152009	152015					
8	1.25	90	18.0	29	8.0	6.2	3	6.70	147979	147991	152010	152016					
10	1.50	100	20.0	33	10.0	8.0	3	8.50	147980	147992	152011	152017					
									6HX		6HX		6HX		6HX		
$\varnothing d_1$ M	P mm	l_1 mm	l_2 mm	l_3 mm	d_2 mm	α mm			ID	ID	ID	ID					
3	0.50	56	12.0		3.5	2.7	3	2.50	147981	147993	148001	148000					
4	0.70	63	14.0		4.5	3.4	3	3.30	147982	147994	148003	148002					
5	0.80	70	15.0		6.0	4.9	3	4.20	147983	147995	148007	148006					
6	1.00	80	15.0	23	6.0	4.9	3	5.00	147984	147996	148011	148010					
8	1.25	90	18.0	29	8.0	6.2	3	6.80	147985	147997	148020	148018					
10	1.50	100	20.0	33	10.0	8.0	3	8.50	147986	147998	148027	148025					

<h1>AERO</h1>								SA420-4	SA450-3	TL420VS-4	TL451VS-3
<div style="display: flex; justify-content: space-between;"> <div style="width: 20%;"> <p>SA420-4 </p> <p>SA450-3 </p> </div> <div style="width: 20%;"> <p></p> <p></p> </div> </div>											
<div style="display: flex; justify-content: space-between;"> <div style="width: 20%;"> <p>TL420VS-4  VS</p> <p>TL451VS-3   VS</p> </div> <div style="width: 20%;"> <p></p> <p></p> </div> </div>											
											
								4HX	4HX	4HX	4HX
$\varnothing d_1$	P	l_1	l_2	d_2	α			ID	ID	ID	ID
M	mm	mm	mm	mm	mm						
12	1.75	110	24.0	9.0	7.0	4	10.20	148096	152189	152192	152195
14	2.00	110	28.0	11.0	9.0	4	12.00	* 152187	* 152190	* 152193	* 152196
16	2.00	110	30.0	12.0	9.0	4	14.00	* 152188	* 152191	* 152194	152197
								6HX	6HX	6HX	6HX
$\varnothing d_1$	P	l_1	l_2	d_2	α			ID	ID	ID	ID
M	mm	mm	mm	mm	mm						
12	1.75	110	24.0	9.0	7.0	4	10.20	152198	152201	152204	148028
14	2.00	110	28.0	11.0	9.0	4	12.00	* 152199	* 152202	* 152205	152207
16	2.00	110	30.0	12.0	9.0	4	14.00	152200	152203	152206	148029

										GG350NI-3	GG350TC-3	GG353TC-3	GG550NI-3				
GG350NI-3																	
GG350TC-3																	
GG353TC-3																	
GG550NI-3																	
$\varnothing d_1$	P	l_1	l_2	l_3	d_2	α				ID	ID						
M	mm	mm	mm	mm	mm	mm											
3	0.50	56	12.0	18	3.5	2.7	3	2.50	101172	101178							
4	0.70	63	14.0	21	4.5	3.4	3	3.30	101173	101179							
5	0.80	70	15.0	25	6.0	4.9	3	4.20	101174	101180							
6	1.00	80	17.0	30	6.0	4.9	3	5.00	101175	101181							
8	1.25	90	20.0	35	8.0	6.2	4	6.80	101076	101182							
10	1.50	100	22.0	39	10.0	8.0	4	8.50	101171	101177							
$\varnothing d_1$	P	l_1	l_2	l_3	d_2 h6	α				ID							
M	mm	mm	mm	mm	mm	mm											
5	0.80	70	15.0	25	6.0	4.9	3	4.20		144947							
6	1.00	80	17.0	30	6.0	4.9	3	5.00		147710							
8	1.25	90	20.0	35	8.0	6.2	4	6.80		147711							
10	1.50	100	22.0	39	10.0	8.0	4	8.50		146708							
$\varnothing d_1$	P	l_1	l_2	l_3	d_2	α				ID							
M	mm	mm	mm	mm	mm	mm											
4	0.70	112	14.0	21	4.5	3.4	3	3.30		101196							
5	0.80	125	15.0	25	6.0	4.9	3	4.20		101197							
6	1.00	125	17.0	30	6.0	4.9	3	5.00		101198							

									GG450NI-3	GG450TC-3	GG453TC-3	GG650NI-3
$\varnothing d_1$ M	P mm	l_1 mm	l_2 mm	d_2 mm	α mm			ID	ID			
8	1.25	90	20.0	6.0	4.9	4	6.80	101189	101194			
10	1.50	100	22.0	7.0	5.5	4	8.50	101183	101195			
12	1.75	110	24.0	9.0	7.0	4	10.20	101184	101190			
14	2.00	110	28.0	11.0	9.0	4	12.00	101185	101191			
16	2.00	110	30.0	12.0	9.0	4	14.00	101186	101192			
20	2.50	140	36.0	16.0	12.0	4	17.50	101187	101193			
24	3.00	160	39.0	18.0	14.5	4	21.00	101188				
$\varnothing d_1$ M	P mm	l_1 mm	l_2 mm	d_2 h6 mm	α mm			ID				
12	1.75	110	24.0	* 10.0	* 8.0	4	10.20	146707				
16	2.00	110	30.0	12.0	9.0	4	14.00	162796				
* Norme DC / * DC Norm / * Norma DC												
$\varnothing d_1$ M	P mm	l_1 mm	l_2 mm	d_2 mm	α mm			ID				
8	1.25	140	20.0	6.0	4.9	4	6.80	101203				
10	1.50	160	22.0	7.0	5.5	4	8.50	101199				
12	1.75	180	24.0	9.0	7.0	4	10.20	101200				
16	2.00	200	30.0	12.0	9.0	4	14.00	101201				
20	2.50	224	36.0	16.0	12.0	4	17.50	101202				



Uniquement pour taraudage synchrone
Nur für Synchrobearbeitung
Only for rigid tapping
Solo per maschiatura sincrona
Solo para roscado sincronizado



RTS

Rigid Tapping Synchro

RTS320VS-4



RTS420VS-4



RTS323VS-4



RTS423VS-4



RTS320VS-4

RTS420VS-4

RTS323VS-4

RTS423VS-4



$\varnothing d_1$ M	P mm	l_1 mm	l_2 mm	l_3 mm	d_2 h6 mm	a mm		
* 2	0.40	45	8.0		2.8(h9)	2.1	2	1.60
2.5	0.45	50	10.0		2.8(h9)	2.1	3	2.05
3	0.50	56	5.5	18	3.5(h9)	2.7	3	2.50
4	0.70	63	7.5	21	4.5(h9)	3.4	3	3.30
5	0.80	70	9.0	25	6.0	4.9	3	4.20
6	1.00	80	11.0	30	6.0	4.9	3	5.00
8	1.25	90	12.5	35	8.0	6.2	3	6.80
10	1.50	100	14.0	39	10.0	8.0	3	8.50
12	1.75	110	14.0		* 10.0	* 8.0	3	10.20
14	2.00	110	14.0		* 12.0	* 9.0	3	12.00
16	2.00	110	18.0		12.0	9.0	3	14.00
20	2.50	140	24.0		16.0	12.0	4	17.50
24	3.00	160	27.0		16.0	12.0	4	21.00

ID

ID

ID

ID

143532			
143534			
150601			
150603			
150605		150606	
150610		150611	
150620		150621	
150635		150636	
	151863		151864
	162535		
	150670		150671
	150679		
	162787		

* Norme DC / * DC Norm / * Norma DC

* RTS320VS-3



sur demande
auf Anfrage
on request
su richiesta
sobre pedido



Uniquement pour taraudage synchrone
Nur für Synchrobearbeitung
Only for rigid tapping
Solo per maschiatura sincrona
Solo para roscado sincronizado

PM

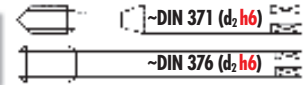

RTS Rigid Tapping Synchro

RTS362VS-3			VS	
RTS462VS-3			VS	
RTS365VS-3			VS	
RTS465VS-3			VS	

RTS362VS-3	RTS462VS-3	RTS365VS-3	RTS465VS-3
------------	------------	------------	------------

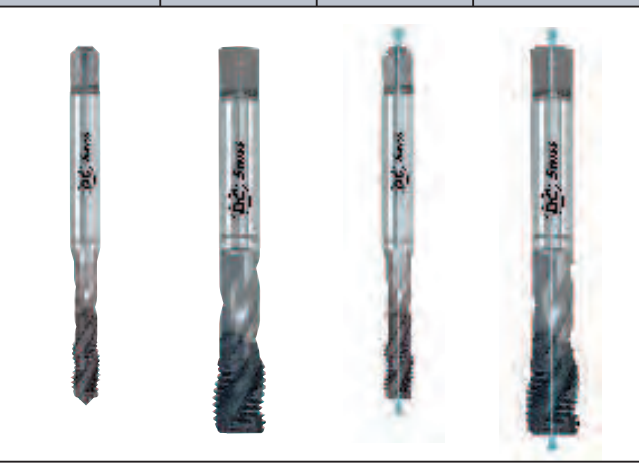

--	--	--	--



6HX	6HX	6HX	6HX

$\varnothing d_1$ M	P mm	l_1 mm	l_2 mm	l_3 mm	d_2 h6 mm	a mm		
* 2	0.40	45	7.0		2.8 (h9)	2.1	3	1.60
* 2.5	0.45	50	9.0		2.8 (h9)	2.1	3	2.05
3	0.50	56	5.5	18	3.5 (h9)	2.7	3	2.50
4	0.70	63	7.5	21	4.5 (h9)	3.4	3	3.30
5	0.80	70	9.0	25	6.0	4.9	3	4.20
6	1.00	80	11.0	30	6.0	4.9	3	5.00
8	1.25	90	12.5	35	8.0	6.2	3	6.80
10	1.50	100	14.0	39	10.0	8.0	3	8.50
12	1.75	110	14.0		* 10.0	* 8.0	3	10.20
14	2.00	110	14.0		* 12.0	* 9.0	3	12.00
16	2.00	110	18.0		12.0	9.0	3	14.00
20	2.50	140	24.0		16.0	12.0	4	17.50
24	3.00	160	27.0		16.0	12.0	4	21.00

ID	ID	ID	ID
143536			
143538			
150602		160477	
150604		160478	
150607		150608	
150612		150613	
150622		150623	
150637		150638	
	151865		151866
	151870		150663
	150672		150673
	150681		150682
	151873		150690

* Norme DC / * DC Norm / * Norma DC

* RTS360VS-3



sur demande
auf Anfrage
on request
su richiesta
sobre pedido

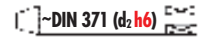

RTS Rigid Tapping Synchro

RTS362VS-5

11	12	13	14
15	21	22	31
32	41	63	72
73	74		

RTS365VS-5

11	12	13	14
15	21	22	31
32	41	63	72
73	74		

RTS362VS-3

RTS362VS-5 RTS365VS-5 RTS362VS-3



$\varnothing d_1$ M	P mm	l_1 mm	l_2 mm	l_3 mm	d_2 h6 mm	a mm		
3	0.50	56	5.5	18	3.5(h9)	2.7	3	2.50
4	0.70	63	7.5	21	4.5(h9)	3.4	3	3.30
5	0.80	70	9.0	25	6.0	4.9	3	4.20
6	1.00	80	11.0	30	6.0	4.9	3	5.00
8	1.25	90	12.5	35	8.0	6.2	3	6.80
10	1.50	100	14.0	39	10.0	8.0	3	8.50

ID	ID
157648	
157650	
157652	162791
158074	151803
158076	157821
153286	157823

$\varnothing d_1$ M	P mm	l_1 mm	l_2 mm	l_3 mm	d_2 h6 mm	a mm			6H + mm
3	0.50	56	5.5	18	3.5(h9)	2.7	3	2.50	162797 0.020
4	0.70	63	7.5	21	4.5(h9)	3.4	3	3.35	162798 0.022
5	0.80	70	9.0	25	6.0	4.9	3	4.25	162799 0.024
6	1.00	80	11.0	30	6.0	4.9	3	5.00	162800 0.026
8	1.25	90	12.5	35	8.0	6.2	3	6.80	162801 0.028
10	1.50	100	14.0	39	10.0	8.0	3	8.50	162802 0.032

ID	6H + mm
162797	0.020
162798	0.022
162799	0.024
162800	0.026
162801	0.028
162802	0.032

sur demande
auf Anfrage
on request
su richiesta
sobre pedido
 $\ge \varnothing 6$ mm



Uniquement pour taraudage synchrone
Nur für Synchrobearbeitung
Only for rigid tapping
Solo per maschiatura sincrona
Solo para rosado sincronizado



DC -DIN 371 (d₂ h₆)
DC -DIN 376 (d₂ h₆)

<h2 style="text-align: center;">RTS</h2> <p style="text-align: center;">Rigid Tapping Synchro</p>										RTS523VS-4	RTS623VS-4	RTS565VS-3	RTS665VS-3																																																																													
										<div style="border: 1px solid black; padding: 2px; text-align: center;">6HX</div>		<div style="border: 1px solid black; padding: 2px; text-align: center;">6HX</div>																																																																														
<table border="1" style="width: 100%; border-collapse: collapse;"> <thead> <tr> <th>∅ d₁ M</th> <th>P mm</th> <th>l₁ mm</th> <th>l₂ mm</th> <th>l₃ mm</th> <th>d₂ h₆ mm</th> <th>a mm</th> <th></th> <th></th> <th>ID</th> <th>ID</th> </tr> </thead> <tbody> <tr><td>5</td><td>0.80</td><td>125</td><td>9.0</td><td>25</td><td>6.0</td><td>4.9</td><td>3</td><td>4.20</td><td>161038</td><td></td></tr> <tr><td>6</td><td>1.00</td><td>125</td><td>11.0</td><td>30</td><td>6.0</td><td>4.9</td><td>3</td><td>5.00</td><td>161041</td><td></td></tr> <tr><td>8</td><td>1.25</td><td>140</td><td>12.5</td><td>35</td><td>8.0</td><td>6.2</td><td>3</td><td>6.80</td><td>161044</td><td></td></tr> <tr><td>10</td><td>1.50</td><td>160</td><td>14.0</td><td>39</td><td>10.0</td><td>8.0</td><td>3</td><td>8.50</td><td>161047</td><td></td></tr> <tr><td>12</td><td>1.75</td><td>180</td><td>14.0</td><td></td><td>* 10.0</td><td>* 8.0</td><td>3</td><td>10.20</td><td></td><td>161050</td></tr> <tr><td>16</td><td>2.00</td><td>200</td><td>18.0</td><td></td><td>12.0</td><td>9.0</td><td>3</td><td>14.00</td><td></td><td>161053</td></tr> </tbody> </table> <p style="text-align: center;">* Norme DC / * DC Norm / * Norma DC</p>										∅ d ₁ M	P mm	l ₁ mm	l ₂ mm	l ₃ mm	d ₂ h ₆ mm	a mm			ID	ID	5	0.80	125	9.0	25	6.0	4.9	3	4.20	161038		6	1.00	125	11.0	30	6.0	4.9	3	5.00	161041		8	1.25	140	12.5	35	8.0	6.2	3	6.80	161044		10	1.50	160	14.0	39	10.0	8.0	3	8.50	161047		12	1.75	180	14.0		* 10.0	* 8.0	3	10.20		161050	16	2.00	200	18.0		12.0	9.0	3	14.00		161053				
∅ d ₁ M	P mm	l ₁ mm	l ₂ mm	l ₃ mm	d ₂ h ₆ mm	a mm			ID	ID																																																																																
5	0.80	125	9.0	25	6.0	4.9	3	4.20	161038																																																																																	
6	1.00	125	11.0	30	6.0	4.9	3	5.00	161041																																																																																	
8	1.25	140	12.5	35	8.0	6.2	3	6.80	161044																																																																																	
10	1.50	160	14.0	39	10.0	8.0	3	8.50	161047																																																																																	
12	1.75	180	14.0		* 10.0	* 8.0	3	10.20		161050																																																																																
16	2.00	200	18.0		12.0	9.0	3	14.00		161053																																																																																
<table border="1" style="width: 100%; border-collapse: collapse;"> <thead> <tr> <th>∅ d₁ M</th> <th>P mm</th> <th>l₁ mm</th> <th>l₂ mm</th> <th>l₃ mm</th> <th>d₂ h₆ mm</th> <th>a mm</th> <th></th> <th></th> <th>ID</th> <th>ID</th> </tr> </thead> <tbody> <tr><td>6</td><td>1.00</td><td>125</td><td>11.0</td><td>30</td><td>6.0</td><td>4.9</td><td>3</td><td>5.00</td><td>150614</td><td></td></tr> <tr><td>8</td><td>1.25</td><td>140</td><td>12.5</td><td>35</td><td>8.0</td><td>6.2</td><td>3</td><td>6.80</td><td>150624</td><td></td></tr> <tr><td>10</td><td>1.50</td><td>160</td><td>14.0</td><td>39</td><td>10.0</td><td>8.0</td><td>3</td><td>8.50</td><td>150639</td><td></td></tr> <tr><td>12</td><td>1.75</td><td>180</td><td>14.0</td><td></td><td>* 10.0</td><td>* 8.0</td><td>3</td><td>10.20</td><td></td><td>151867</td></tr> <tr><td>16</td><td>2.00</td><td>200</td><td>18.0</td><td></td><td>12.0</td><td>9.0</td><td>3</td><td>14.00</td><td></td><td>150674</td></tr> </tbody> </table> <p style="text-align: center;">* Norme DC / * DC Norm / * Norma DC</p>										∅ d ₁ M	P mm	l ₁ mm	l ₂ mm	l ₃ mm	d ₂ h ₆ mm	a mm			ID	ID	6	1.00	125	11.0	30	6.0	4.9	3	5.00	150614		8	1.25	140	12.5	35	8.0	6.2	3	6.80	150624		10	1.50	160	14.0	39	10.0	8.0	3	8.50	150639		12	1.75	180	14.0		* 10.0	* 8.0	3	10.20		151867	16	2.00	200	18.0		12.0	9.0	3	14.00		150674															
∅ d ₁ M	P mm	l ₁ mm	l ₂ mm	l ₃ mm	d ₂ h ₆ mm	a mm			ID	ID																																																																																
6	1.00	125	11.0	30	6.0	4.9	3	5.00	150614																																																																																	
8	1.25	140	12.5	35	8.0	6.2	3	6.80	150624																																																																																	
10	1.50	160	14.0	39	10.0	8.0	3	8.50	150639																																																																																	
12	1.75	180	14.0		* 10.0	* 8.0	3	10.20		151867																																																																																
16	2.00	200	18.0		12.0	9.0	3	14.00		150674																																																																																
												<p>sur demande auf Anfrage on request su richiesta sobre pedido</p> <p>≥ ∅ 6 mm</p>																																																																														

K

K313TC-3
K413TC-3









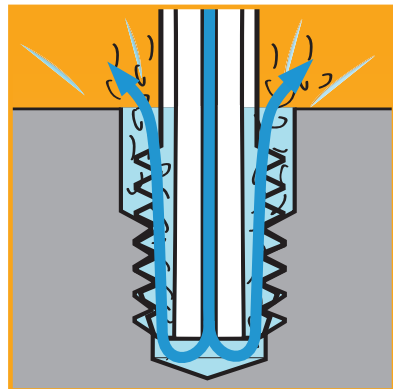



11	12	13	14
15	31	32	62
63	74		



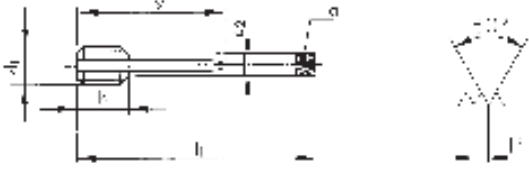

NEW

NEW

$\varnothing d_1$ M	P mm	l_1 mm	l_2 mm	l_3 mm	d_2 mm	a mm			ID	ID
6	1.00	80	17.0	28.0	6.0	4.9	3	5.00	170766	
8	1.25	90	20.0	33.0	8.0	6.2	3	6.80	170769	
10	1.50	100	22.0	37.0	10.0	8.0	3	8.50	170772	
12	1.75	110	24.0	42.0	9.0	7.0	3	10.20		165838
14	2.00	110	28.0	49.0	11.0	9.0	3	12.00		170778
16	2.00	110	30.0	56.0	12.0	9.0	4	14.00		170783
20	2.50	140	36.0	70.0	16.0	12.0	5	17.50		170786
24	3.00	160	39.0	84.0	18.0	14.5	5	21.00		170775

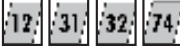

K										K613TC-3			
<div style="display: flex; justify-content: space-between; align-items: center;"> <div style="text-align: left;"> <p>K613TC-3</p>    <p>>20 bar</p>  </div> <div style="text-align: center;">  </div> </div>										 <p>NEW</p>			
													
 <p>6HX</p>										 <p>< 4 x D</p>			
$\varnothing d_1$ M	P mm	l_1 mm	l_2 mm	l_3 mm	d_2 mm	a mm			ID				
6	1.00	110	17.0	30	4.5	3.4	3	5.00	170646				
8	1.25	110	20.0	40	6.0	4.9	3	6.80	170649				
10	1.50	125	22.0	50	7.0	5.5	3	8.50	170652				
12	1.75	140	24.0	60	9.0	7.0	3	10.20	167982				
14	2.00	140	28.0	70	11.0	9.0	3	12.00	167983				
16	2.00	160	30.0	80	12.0	9.0	4	14.00	167984				
20	2.50	180	36.0	100	16.0	12.0	5	17.50	167985				
24	3.00	200	39.0	120	18.0	14.5	5	21.00	167986				
27	3.00	225	42.0	135	20.0	16.0	5	24.00	167987				
30	3.50	250	45.0	150	22.0	18.0	5	26.50	165542				
33	3.50	280	48.0	165	25.0	20.0	5	29.50	167988				
36	4.00	300	51.0	180	28.0	22.0	6	32.00	167989				
39	4.00	300	55.0	195	32.0	24.0	6	35.00	167990				
42	4.50	355	55.0	210	32.0	24.0	6	37.50	167999				

Vc (m/min)				
	M6 - M10	M12 - M16	M20 - M30	M33 - M42
	32	28	22	18
	30	25	20	15
	24	20	16	12
	15	12	8	6
	35	30	25	20

FS FORMING

FS380VS-5  







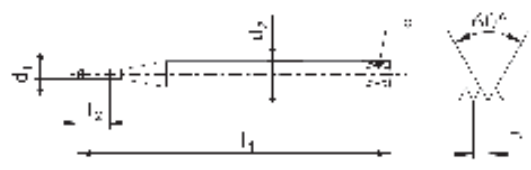







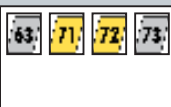









FS380VS-3  

11	12	13	14
15	21	22	23
24	41	51	61
63	71	72	73

FS380VS-5	FS380VS-5	FS380VS-3	FS380VS-3
-----------	-----------	-----------	-----------



$\varnothing d_1$ M	P mm	l_1 mm	l_2 mm	d_2 mm	a mm	4HX Tol. → $\le 6HX$	ID	ID	ID	ID 6H + mm
1	0.25	40	3.0	2.5		0.88 +/- 0.01	157171			
1.2	0.25	40	3.6	2.5		1.08 +/- 0.01	157172			
1.4	0.30	40	4.2	2.5		1.25 +/- 0.01	157173			
1.6	0.35	40	4.8	2.5		1.45 +/- 0.02		157174	169779	
1.7	0.35	40	5.1	2.5		1.55 +/- 0.02			169782	
1.8	0.35	40	5.4	2.5		1.65 +/- 0.02		157175	169785	
2	0.40	45	8.0	2.8	2.1	1.80 +/- 0.02			157176	157180 0.019
2.5	0.45	50	10.0	2.8	2.1	2.30 +/- 0.03			157178	157181 0.020
2.6	0.45	50	10.0	2.8	2.1	2.40 +/- 0.03			157179	

<h2 style="text-align: center;">FPS FORMING</h2>								FPS380CN-3	FPS381CN-3	FPS380VS-3	FPS380VS-3																																																									
								<p>FPS380CN-3   </p> <p>FPS381CN-3   </p> <p>FPS380VS-3   </p>																																																												
																																																																				
																																																																				
																																																																				
	ID	ID	ID	ID ^{6H} + mm																																																																
<table border="1"> <thead> <tr> <th>∅ d₁ M</th> <th>P mm</th> <th>l₁ mm</th> <th>l₂ mm</th> <th>l₃ mm</th> <th>d₂ mm</th> <th>α mm</th> <th>6HX Tol. → ←</th> </tr> </thead> <tbody> <tr><td>3</td><td>0.50</td><td>56</td><td>12.0</td><td>18</td><td>3.5</td><td>2.7</td><td>2.80 +/- 0.03</td></tr> <tr><td>3.5</td><td>0.60</td><td>56</td><td>13.0</td><td>20</td><td>4.0</td><td>3.0</td><td>3.25 +/- 0.03</td></tr> <tr><td>4</td><td>0.70</td><td>63</td><td>14.0</td><td>21</td><td>4.5</td><td>3.4</td><td>3.70 +/- 0.03</td></tr> <tr><td>5</td><td>0.80</td><td>70</td><td>15.0</td><td>25</td><td>6.0</td><td>4.9</td><td>4.65 +/- 0.03</td></tr> <tr><td>6</td><td>1.00</td><td>80</td><td>17.0</td><td>30</td><td>6.0</td><td>4.9</td><td>5.55 +/- 0.05</td></tr> <tr><td>8</td><td>1.25</td><td>90</td><td>20.0</td><td>35</td><td>8.0</td><td>6.2</td><td>7.40 +/- 0.05</td></tr> <tr><td>10</td><td>1.50</td><td>100</td><td>22.0</td><td>39</td><td>10.0</td><td>8.0</td><td>9.30 +/- 0.05</td></tr> </tbody> </table>	∅ d ₁ M	P mm	l ₁ mm	l ₂ mm	l ₃ mm	d ₂ mm	α mm	6HX Tol. → ←	3	0.50	56	12.0	18	3.5	2.7	2.80 +/- 0.03	3.5	0.60	56	13.0	20	4.0	3.0	3.25 +/- 0.03	4	0.70	63	14.0	21	4.5	3.4	3.70 +/- 0.03	5	0.80	70	15.0	25	6.0	4.9	4.65 +/- 0.03	6	1.00	80	17.0	30	6.0	4.9	5.55 +/- 0.05	8	1.25	90	20.0	35	8.0	6.2	7.40 +/- 0.05	10	1.50	100	22.0	39	10.0	8.0	9.30 +/- 0.05	166613	166615	166614	166697 0.020
∅ d ₁ M	P mm	l ₁ mm	l ₂ mm	l ₃ mm	d ₂ mm	α mm	6HX Tol. → ←																																																													
3	0.50	56	12.0	18	3.5	2.7	2.80 +/- 0.03																																																													
3.5	0.60	56	13.0	20	4.0	3.0	3.25 +/- 0.03																																																													
4	0.70	63	14.0	21	4.5	3.4	3.70 +/- 0.03																																																													
5	0.80	70	15.0	25	6.0	4.9	4.65 +/- 0.03																																																													
6	1.00	80	17.0	30	6.0	4.9	5.55 +/- 0.05																																																													
8	1.25	90	20.0	35	8.0	6.2	7.40 +/- 0.05																																																													
10	1.50	100	22.0	39	10.0	8.0	9.30 +/- 0.05																																																													
	166619	166621	166620	166687 0.021																																																																
	166626	166628	166627	166688 0.022																																																																
	166634	166636	166635	166689 0.024																																																																
	166643	166645	166644	166686 0.026																																																																
	166653	166655	166654	166740 0.028																																																																
	166663	166665	166664	166739 0.032																																																																

FPS FORMING

FPS381VS-3



VS



FPS481VS-3



VS

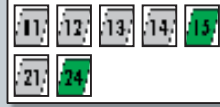

FPS381VS-3

FPS481VS-3

FPS381VS-3



NEW



NEW



NEW













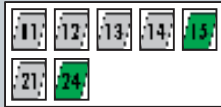

6HX

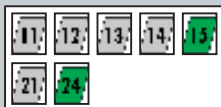
6HX

6GX

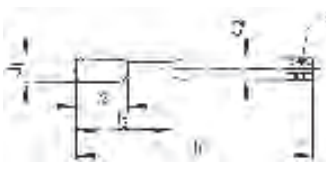
$\varnothing d_1$ M	P mm	l_1 mm	l_2 mm	l_3 mm	d_2 mm	a mm	\downarrow 6HX Tol. $\rightarrow \leftarrow$
3	0.50	56	12.0	18	3.5	2.7	2.80 +/- 0.03
3.5	0.60	56	13.0	20	4.0	3.0	3.25 +/- 0.03
4	0.70	63	14.0	21	4.5	3.4	3.70 +/- 0.03
5	0.80	70	15.0	25	6.0	4.9	4.65 +/- 0.03
6	1.00	80	17.0	30	6.0	4.9	5.55 +/- 0.05
8	1.25	90	20.0	35	8.0	6.2	7.40 +/- 0.05
10	1.50	100	22.0	39	10.0	8.0	9.30 +/- 0.05
12	1.75	110	24.0		9.0	7.0	11.20 +/- 0.05
14	2.00	110	28.0		11.0	9.0	13.10 +/- 0.05
16	2.00	110	30.0		12.0	9.0	15.10 +/- 0.05
20	2.50	140	36.0		16.0	12.0	18.85 +/- 0.05

ID	ID	ID	6H + mm
166616		166617	0.020
166622		166623	0.021
166629		166630	0.022
166637		166638	0.024
166646		166647	0.026
166656		166657	0.028
166666		166667	0.032
	166673		
	166678		
	166683		
	168713		

<h1>FPS FORMING</h1>										FPS384VS-3	FPS484VS-3		
<p>FPS384VS-3   VS </p> <p>FPS484VS-3   VS </p>										 			
										NEW	NEW		
													
 													
										6HX	6HX		
$\varnothing d_1$ M	P mm	l_1 mm	l_2 mm	l_3 mm	d_2 mm	α mm		Tol.	ID	ID			
3	0.50	56	12.0	18	3.5	2.7	2.80	+/- 0.03	166737				
4	0.70	63	14.0	21	4.5	3.4	3.70	+/- 0.03	166738				
5	0.80	70	15.0	25	6.0	4.9	4.65	+/- 0.03	166640				
6	1.00	80	17.0	30	6.0	4.9	5.55	+/- 0.05	166650				
8	1.25	90	20.0	35	8.0	6.2	7.40	+/- 0.05	166660				
10	1.50	100	22.0	39	10.0	8.0	9.30	+/- 0.05	166670				
12	1.75	110	24.0		9.0	7.0	11.20	+/- 0.05		166675			
14	2.00	110	28.0		11.0	9.0	13.10	+/- 0.05		166680			
16	2.00	110	30.0		12.0	9.0	15.10	+/- 0.05		166685			

FAS FORMING

FAS380VS-3



FAS381VS-3



FAS481VS-3



FAS380VS-3

FAS381VS-3

FAS481VS-3



NEW



NEW



NEW



6HX

6HX

6HX

$\varnothing d_1$ M	P mm	l_1 mm	l_2 mm	l_3 mm	d_2 mm	α mm	\downarrow 6HX \rightarrow \leftarrow Tol.
3	0.50	56	12.0	18	3.5	2.7	2.80 +/- 0.03
3.5	0.60	56	13.0	20	4.0	3.0	3.25 +/- 0.03
4	0.70	63	14.0	21	4.5	3.4	3.70 +/- 0.03
5	0.80	70	15.0	25	6.0	4.9	4.65 +/- 0.03
6	1.00	80	17.0	30	6.0	4.9	5.55 +/- 0.05
8	1.25	90	20.0	35	8.0	6.2	7.40 +/- 0.05
10	1.50	100	22.0	39	10.0	8.0	9.30 +/- 0.05
12	1.75	110	24.0		9.0	7.0	11.20 +/- 0.05
14	2.00	110	28.0		11.0	9.0	13.10 +/- 0.05
16	2.00	110	30.0		12.0	9.0	15.10 +/- 0.05
20	2.50	140	36.0		16.0	12.0	18.85 +/- 0.05

ID

ID

ID

$\varnothing d_1$ M	P mm	l_1 mm	l_2 mm	l_3 mm	d_2 mm	α mm	\downarrow 6HX \rightarrow \leftarrow Tol.
3	0.50	56	12.0	18	3.5	2.7	2.80 +/- 0.03
3.5	0.60	56	13.0	20	4.0	3.0	3.25 +/- 0.03
4	0.70	63	14.0	21	4.5	3.4	3.70 +/- 0.03
5	0.80	70	15.0	25	6.0	4.9	4.65 +/- 0.03
6	1.00	80	17.0	30	6.0	4.9	5.55 +/- 0.05
8	1.25	90	20.0	35	8.0	6.2	7.40 +/- 0.05
10	1.50	100	22.0	39	10.0	8.0	9.30 +/- 0.05
12	1.75	110	24.0		9.0	7.0	11.20 +/- 0.05
14	2.00	110	28.0		11.0	9.0	13.10 +/- 0.05
16	2.00	110	30.0		12.0	9.0	15.10 +/- 0.05

6GX

6GX

















ID

6H
+ mm

ID











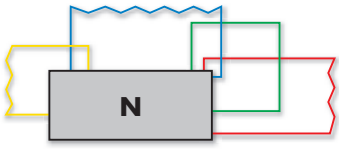



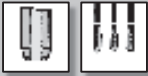

6H
+ mm

3	166703	0.020
3.5	166704	0.021
4	166705	0.022
5	166706	0.024
6	166707	0.026
8	166708	0.028
10	166709	0.032
12		166710 0.034
14		166711 0.038
16		166712 0.038

<h1>FAS FORMING</h1>										FAS384VS-3	FAS484VS-3		
<p>FAS384VS-3   VS </p> <p>FAS484VS-3   VS</p>										 			
													
													
													
													
$\varnothing d_1$ M	P mm	l_1 mm	l_2 mm	l_3 mm	d_2 mm	α mm		Tol.	ID	ID			
3	0.50	56	12.0	18	3.5	2.7	2.80	+/- 0.03	166741				
4	0.70	63	14.0	21	4.5	3.4	3.70	+/- 0.03	166742				
5	0.80	70	15.0	25	6.0	4.9	4.65	+/- 0.03	166690				
6	1.00	80	17.0	30	6.0	4.9	5.55	+/- 0.05	166691				
8	1.25	90	20.0	35	8.0	6.2	7.40	+/- 0.05	166692				
10	1.50	100	22.0	39	10.0	8.0	9.30	+/- 0.05	166693				
12	1.75	110	24.0		9.0	7.0	11.20	+/- 0.05		166694			
14	2.00	110	28.0		11.0	9.0	13.10	+/- 0.05		166695			
16	2.00	110	30.0		12.0	9.0	15.10	+/- 0.05		166696			



									N1110-1	N1110-2	N1110-3	N1110-S	
N1110-1													
N1110-2													
N1110-3													
N1110-S													
$\varnothing d_1$ M	P mm	l_1 mm	l_2 mm	l_3 mm	d_2 mm	a mm			ID	ID	ID	ID	
1	0.25	40	5.5		2.50	2.10	3	0.75	102744	102844	102917	111015	
1.2	0.25	40	5.5		2.50	2.10	3	0.95	102746	102846	102919	111017	
1.4	0.30	40	7.0		2.50	2.10	3	1.10	102747	102847	102920	111018	
1.6	0.35	40	8.0		2.50	2.10	3	1.25	102749	102849	102922	111020	
1.7	0.35	40	8.0		2.50	2.10	3	1.35	102750	102850	102923	111021	
1.8	0.35	40	8.0		2.50	2.10	3	1.45	102751	102851	102924	111022	
2	0.40	45	8.0		2.80	2.10	3	1.60	102759	102854	102934	111028	
2.2	0.45	45	9.5		2.80	2.10	3	1.75	102761	102856	102937	111030	
2.5	0.45	45	9.5		2.80	2.10	3	2.05	102763	102858	102941	111032	
2.6	0.45	45	9.5		2.80	2.10	3	2.15	102765	102860	102944	111034	
3	0.50	48	11.0	18	3.15	2.50	3	2.50	102766	102861	102947	111036	
3.5	0.60	50	13.0	20	3.55	2.80	3	2.90	102769	102864	102950	111038	
4	0.70	53	13.0	21	4.00	3.15	3	3.30	102771	102866	102956	111042	
4.5	0.75	53	13.0	21	4.50	3.55	3	3.75	102775	102869	102959	111044	
5	0.80	58	16.0	25	5.00	4.00	3	4.20	102776	102870	102965	111047	
6	1.00	66	19.0	30	6.30	5.00	3	5.00	102781	102874	102973	111053	
7	1.00	66	19.0	30	7.10	5.60	3	6.00	102786	102876	102978	111055	
8	1.25	72	22.0	35	8.00	6.30	3	6.80	102788	102878	102986	111059	
9	1.25	72	22.0	36	9.00	7.10	3	7.80	102792	102880	102991	111061	
10	1.50	80	24.0	39	10.00	8.00	3	8.50	102752	102852	102931	111026	





















									N1210-1	N1210-2	N1210-3	N1210-S				
																
N1210-1																
N1210-2																
N1210-3																
N1210-S																
																
											ISO 2 6H		ISO 2 6H			
$\varnothing d_1$ M	P mm	l_1 mm	l_2 mm	d_2 mm	α mm			ID	ID	ID	ID					
11	1.50	85	22.0	8.0	6.3	3	9.50	103302	103427	103489	111168					
12	1.75	89	24.0	9.0	7.1	3	10.20	103303	103428	103499	111173					
14	2.00	95	24.0	11.2	9.0	3	12.00	103310	103430	103510	111179					
16	2.00	102	32.0	12.5	10.0	3	14.00	103319	103432	103522	111185					
18	2.50	112	30.0	14.0	11.2	3	15.50	103324	103434	103534	111191					
20	2.50	112	37.0	14.0	11.2	3	17.50	103330	103436	103543	111196					
22	2.50	115	32.0	16.0	12.5	3	19.50	103337	103438	103550	125567					
24	3.00	130	45.0	18.0	14.0	4	21.00	103341	103440	103557	111204					
27	3.00	135	45.0	20.0	16.0	4	24.00	103347	103442	103568	111211					
30	3.50	138	48.0	20.0	16.0	4	26.50	103353	103444	103579	111216					
33	3.50	151	51.0	22.4	18.0	4	29.50	103357	103446	103581	111218					
36	4.00	162	57.0	25.0	20.0	4	32.00	103359	103448	103583	111220					
39	4.00	170	60.0	28.0	22.4	4	35.00	* 103361	* 103450	* 103585	* 111222					



									N1120-4	N1121-4	N1220-4	N1221-4
N1120-4												
N1121-4												
N1220-4												
N1221-4												
Ø d ₁ M	P mm	l ₁ mm	l ₂ mm	l ₃ mm	d ₂ mm	a mm			ID	ID	ID	ID
2.5	0.45	45	9.5		2.80	2.10	3	2.05		* 103135		
3	0.50	48	11.0	18	3.15	2.50	3	2.50	103068	* 103137		
4	0.70	53	13.0	21	4.00	3.15	3	3.30	103075			
4.5	0.75	53	13.0	21	4.50	3.55	3	3.75	* 103078			
5	0.80	58	16.0	25	5.00	4.00	3	4.20	103082			
6	1.00	66	19.0	30	6.30	5.00	3	5.00	103090			
8	1.25	72	22.0	35	8.00	6.30	3	6.80	103102			
10	1.50	80	24.0	39	10.00	8.00	3	8.50	103060			
11	1.50	85	22.0		8.00	6.30	3	9.50			* 103661	
12	1.75	89	24.0		9.00	7.10	3	10.20			103670	* 103773
14	2.00	95	24.0		11.20	9.00	3	12.00			103680	
16	2.00	102	32.0		12.50	10.00	3	14.00			103690	



NEW
 **283**

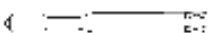
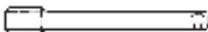

















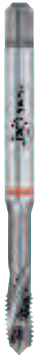



		N						
Characteristics Características					 V	 TiN	 H13	 R40
								
Hole type Tipo de agujero								
			N320-3	N320-4			N350-3	N360-3
<i>DIN long</i> DIN largo	DIN 371		82	82			89	90
<i>ISO short</i> ISO corto	ISO 529							
<i>DIN long</i> DIN largo	~DIN 2174							
<i>Tolerance</i> Tolerancia	ISO 2 6H			82			89	90
<i>Fine tolerance</i> Tolerancia fina	ISO 1 4H		82					
<i>Oversize</i> Sobremedida	ISO 3 6G							90
		N410-3	N420-3	N420-4	N420V-4	N420TN-4	N450-3	N460-3
<i>DIN long</i> DIN largo	DIN 374	83/88	86/87	83/88	83/86	83/84	89	91
<i>ISO short</i> ISO corto	ISO 529							
<i>DIN long</i> DIN largo	~DIN 2174							
<i>Tolerance</i> Tolerancia	ISO 2 6H	83/87		83/87	83/86	83/84	89	91
<i>Fine tolerance</i> Tolerancia fina	ISO 1 4H							
<i>Oversize</i> Sobremedida	ISO 3 6G							91
<i>Tolerance</i> Tolerancia	7H (EN 60423)		86/87					
<i>LH Left hand thread</i> LH Rosca izquierda	ISO 2 6H	88		88				









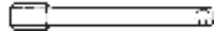









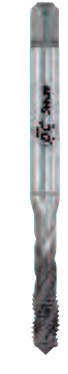

N					Z			
N360V-3	N360TN-3	N1110-1	N1110-3	N1110-S	Z320V-3 Z320V-4	Z360V-3	Z360VS-3	Z370VS-3
90	90				92	92	92	92
		103	103	103				
90	90		103	103	92	92	92	92
					92			
N460V-3	N460TN-3	N1210-1	N1210-3	N1210-S	Z420V-4	Z460V-3	Z460VS-3	Z470VS-3
91	91				93	93	93	93
		104/105	104/105	104/105				
91	91		104/105	104/105	93	93	93	93



MF Directory - Machine taps DIN 13



Directorio - Machos para roscar a máquina DIN 13

		H		S		SA		
Characteristics Características								
				VS	VS			
								
Hole type Tipo de agujero								
		H320-4	H350-3	S320VS-4	S360VS-3	SA320-4	SA350-3	SA390-3
<i>DIN long</i> DIN largo	DIN 371	94	95	96	96	98	98	97
<i>ISO short</i> ISO corto	ISO 529							
<i>DIN long</i> DIN largo	~DIN 2174							
<i>Tolerance</i> Tolerancia	ISO 2 6H	94	95	96	96	98	98	97
<i>Fine tolerance</i> Tolerancia fina	ISO 1 4H					98	98	
<i>Oversize</i> Sobremedida	ISO 3 6G							
		H420-4	H450-3	S420VS-4	S460VS-3	SA420-4	SA450-3	
<i>DIN long</i> DIN largo	DIN 374	94	95	96	96	99	99	
<i>ISO short</i> ISO corto	ISO 529							
<i>DIN long</i> DIN largo	~DIN 2174							
<i>Tolerance</i> Tolerancia	ISO 2 6H	94	95	96	96	99	99	
<i>Fine tolerance</i> Tolerancia fina	ISO 1 4H					99	99	

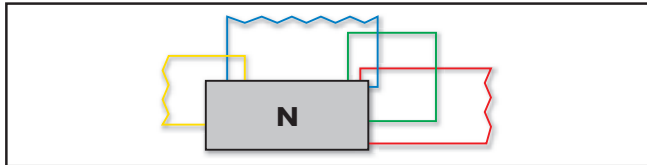
TL		RTS		FPS		FAS		
								
VS	VS	VS	VS	CrN	VS	VS		
								
				NEW	NEW	NEW		
								
TL320VS-4	TL351VS-3	RTS320VS-4	RTS362VS-3	FPS381CN-3	FPS381VS-3	FAS381VS-3		
98	98	100	100					
				101	101	102		
98	98	100	100	101	101	102		
98	98							
TL420VS-4	TL451VS-3	RTS420VS-4	RTS462VS-3	FPS481CN-3	FPS481VS-3	FAS481VS-3		
99	99	100	100					
					101	102		
99	99	100	100		101	102		
99	99							



N320-4





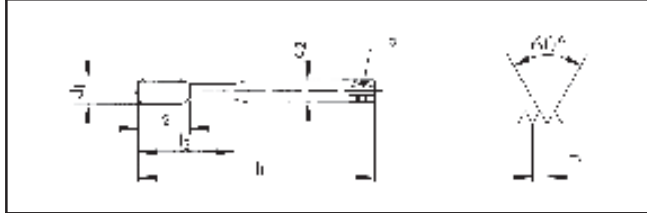
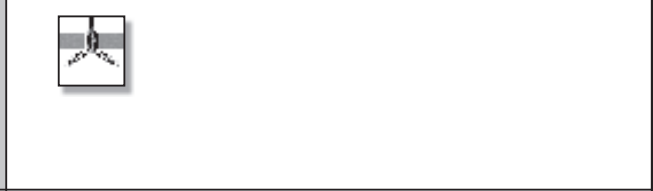
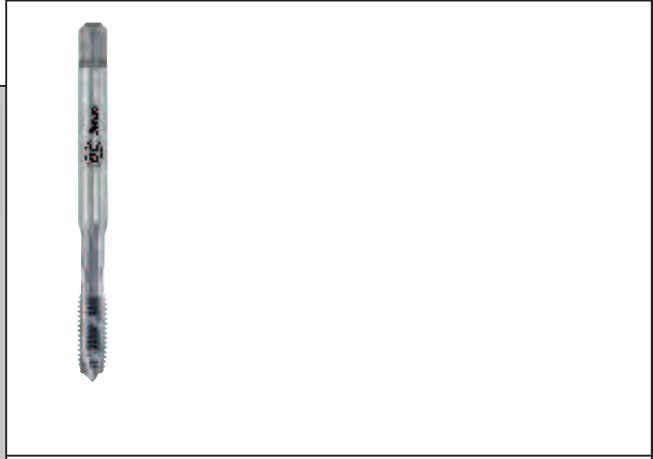

N320-4













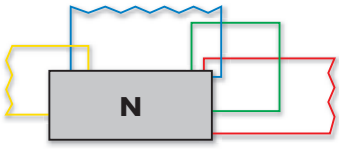



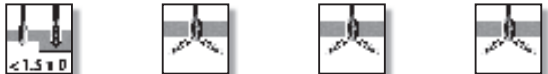

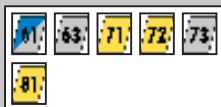

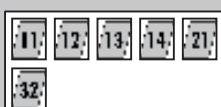
B
4 x P

ISO 2
6H

Ø d ₁ MF	P mm	l ₁ mm	l ₂ mm	l ₃ mm	d ₂ mm	a mm			ID
* 2	0.25	45	8.0		2.8	2.1	2	1.75	142689
2.5	0.35	50	10.0		2.8	2.1	3	2.15	142691
2.6	0.35	50	10.0		2.8	2.1	3	2.25	142692
3	0.35	56	12.0	18	3.5	2.7	3	2.65	142693
3.5	0.35	56	13.0	20	4.0	3.0	3	3.15	142694

* N320-3 



P 0.25 

								N410-3	N420-4	N420V-4	N420TN-4
											
N410-3											
N420-4											
N420V-4	 V										
N420TN-4	 TiN										
											
											
$\varnothing d_1$ MF	P mm	l_1 mm	l_2 mm	d_2 mm	α mm			ID	ID	ID	ID
4	0.35	63	14.0	2.8	2.1	3	3.65		142695		
4	0.50	63	14.0	2.8	2.1	3	3.50	101923	102145	142715	
4.5	0.50	70	15.0	3.5	2.7	3	4.00		102150		
5	0.50	70	15.0	3.5	2.7	3	4.50	101941	102167	142716	
5	0.75	70	15.0	3.5	2.7	3	4.25		102168		
5.5	0.50	80	17.0	4.0	3.0	3	5.00		142696		
6	0.50	80	17.0	4.5	3.4	3	5.50	101951	102178	142717	
6	0.75	80	17.0	4.5	3.4	3	5.25	101952	102179	102281	102249
7	0.50	80	17.0	5.5	4.3	3	6.50		102187		
7	0.75	80	17.0	5.5	4.3	3	6.25	101954	102188		
8	0.50	90	20.0	6.0	4.9	3	7.50	101955	102190	142718	
8	0.75	90	20.0	6.0	4.9	3	7.25	101956	102191	102283	
8	1.00	90	20.0	6.0	4.9	3	7.00	101957	102192	102284	102250
9	0.50	90	20.0	7.0	5.5	3	8.50		142697		
9	0.75	90	20.0	7.0	5.5	3	8.25		102200		
9	1.00	90	20.0	7.0	5.5	3	8.00		102201	143935	
10	0.50	100	22.0	7.0	5.5	3	9.50		142698		
10	0.75	100	22.0	7.0	5.5	3	9.25	101863	102056		
10	1.00	100	22.0	7.0	5.5	3	9.00	101864	102057	102262	102239
10	1.25	100	22.0	7.0	5.5	3	8.80	101865	102058	142719	

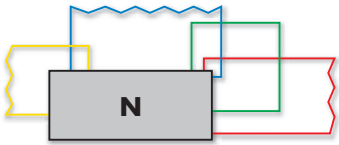

								N410-3	N420-4	N420V-4	N420TN-4
N410-3											
N420-4											
N420V-4	V										
N420TN-4	TiN										
$\varnothing d_1$ MF	P mm	l_1 mm	l_2 mm	d_2 mm	a mm			ID	ID	ID	ID
11	0.50	100	19.0	8.0	6.2	3	10.50		142699		
11	0.75	100	19.0	8.0	6.2	3	10.25		142700		
11	1.00	100	19.0	8.0	6.2	3	10.00		142701		
11	1.25	100	19.0	8.0	6.2	3	9.80		142702		
12	0.50	100	14.0	9.0	7.0	3	11.50		102066		
12	0.75	100	24.0	9.0	7.0	3	11.25		142703		
12	1.00	100	24.0	9.0	7.0	3	11.00	101867	102067	142345	102241
12	1.25	100	24.0	9.0	7.0	3	10.80	101868	102068	142721	
12	1.50	100	24.0	9.0	7.0	3	10.50	101869	102069	102264	102242
13	1.00	100	21.0	11.0	9.0	3	12.00	158401	142704		
14	0.50	100	14.0	11.0	9.0	3	13.50		142705		
14	0.75	100	24.0	11.0	9.0	3	13.25		142706		
14	1.00	100	24.0	11.0	9.0	3	13.00	101871	102077		
14	1.25	100	24.0	11.0	9.0	3	12.80	101872	102078		
14	1.50	100	24.0	11.0	9.0	3	12.50	101873	102079	102266	102244
15	1.00	100	26.0	12.0	9.0	3	14.00	101875	102085		
15	1.50	100	26.0	12.0	9.0	3	13.50	101876	102086		
16	0.75	100	26.0	12.0	9.0	3	15.25		142708		
16	1.00	100	26.0	12.0	9.0	*3	15.00	101877	102087		
16	1.25	100	26.0	12.0	9.0	*3	14.80	101878	102088		
16	1.50	100	26.0	12.0	9.0	*3	14.50	101879	102089	102268	102246
17	1.00	100	26.0	12.0	9.0	3	16.00		142709		
17	1.50	100	26.0	12.0	9.0	3	15.50		142710		
18	0.75	110	26.0	14.0	11.0	4	17.25		142711		
18	1.00	110	26.0	14.0	11.0	4	17.00	101881	102095		
18	1.50	110	26.0	14.0	11.0	4	16.50	101882	102096	102270	
18	2.00	125	33.0	14.0	11.0	3	16.00		142712		
19	1.00	110	26.0	14.0	11.0	4	18.00		142713		

* N410-3 = 4



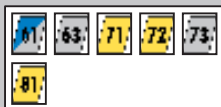

N410-3  

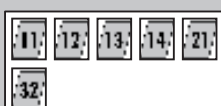
N420-4  



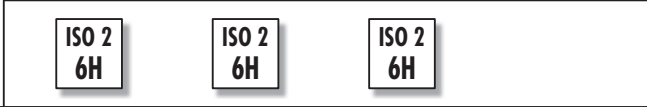
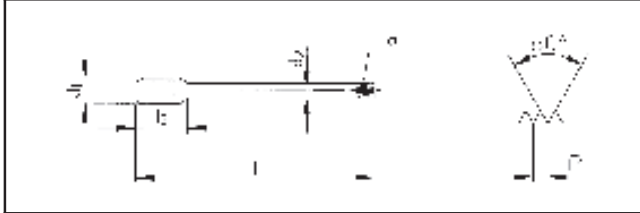
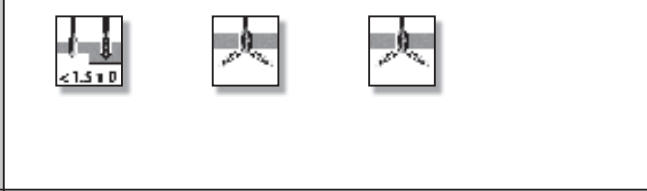







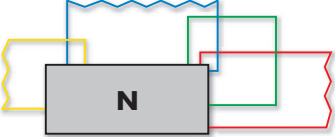



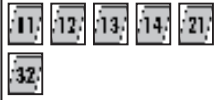

N420V-4   

N410-3	N420-4	N420V-4	
--------	--------	---------	--





MF	$\varnothing d_1$	P	l_1	l_2	d_2	α			ID	ID	ID
20	1.00	125	28.0	16.0	12.0	4	19.00			102098	
20	1.50	125	28.0	16.0	12.0	4	18.50		101884	102099	102272
20	2.00	140	36.0	16.0	12.0	3	18.00		105130	102100	
22	1.00	125	28.0	18.0	14.5	4	21.00			102104	
22	1.50	125	28.0	18.0	14.5	4	20.50		101886	102105	102274
22	2.00	140	36.0	18.0	14.5	3	20.00		101887	142714	
24	1.00	140	30.0	18.0	14.5	4	23.00			102107	
24	1.50	140	30.0	18.0	14.5	4	22.50		101889	102108	102276
24	2.00	140	34.0	18.0	14.5	4	22.00		101890	102109	102277
25	1.00	140	30.0	18.0	14.5	4	24.00			142722	
25	1.50	140	30.0	18.0	14.5	4	23.50		101892	102112	
25	2.00	140	34.0	18.0	14.5	4	23.00			142723	
26	1.00	140	30.0	18.0	14.5	4	25.00			102113	
26	1.50	140	30.0	18.0	14.5	4	24.50		101893	102114	145896
27	1.50	140	34.0	20.0	16.0	4	25.50			102115	
27	2.00	140	34.0	20.0	16.0	4	25.00		101894	102116	
28	1.00	140	30.0	20.0	16.0	4	27.00			142725	
28	1.50	140	30.0	20.0	16.0	4	26.50		101896	102118	
28	2.00	140	30.0	20.0	16.0	4	26.00		122023		

MF

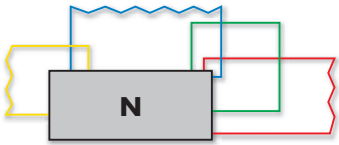
								N410-3	N420-4	N420V-4	N420-3
											
N410-3											
N420-4											
N420V-4	 V										
N420-3											
								C 2.5 x P	B 4 x P	B 4 x P	B 2.5 x P
								ISO 2 6H	ISO 2 6H	ISO 2 6H	ISO 3 7H
$\varnothing d_1$ MF	P mm	l_1 mm	l_2 mm	d_2 mm	a mm		$6H$ 	ID	ID	ID	ID
30	1.00	150	32.0	22.0	18.0	4	29.00	101898	102121		
30	1.50	150	32.0	22.0	18.0	4	28.50	101899	102122	143978	
30	2.00	150	32.0	22.0	18.0	4	28.00	101900	102123	143766	
32	1.00	150	32.0	22.0	18.0	4	31.00	101902			
32	1.50	150	32.0	22.0	18.0	4	30.50	101903	102126		143812
32	2.00	150	32.0	22.0	18.0	4	30.00	101904	102127		
33	1.50	160	32.0	25.0	20.0	4	31.50	101905	102128		
33	2.00	160	32.0	25.0	20.0	4	31.00	101906	102129		
34	1.00	170	32.0	28.0	22.0	4	33.00	* 101908			
34	1.50	170	32.0	28.0	22.0	4	32.50	101909	* 102131		
35	1.50	170	32.0	28.0	22.0	4	33.50	101910	102132		
35	2.00	170	32.0	28.0	22.0	4	33.00	101911			
36	1.00	170	34.0	28.0	22.0	4	35.00		* 102133		
36	1.50	170	34.0	28.0	22.0	4	34.50	101912	102134		
36	2.00	170	34.0	28.0	22.0	4	34.00	101913	102135		
36	3.00	200	45.0	28.0	22.0	4	33.00	101914	102136		
38	1.00	170	34.0	28.0	22.0	4	37.00	* 101916	* 102138		
38	1.50	170	34.0	28.0	22.0	4	36.50	101917	102139		
38	2.00	170	34.0	28.0	22.0	4	36.00	101918			
39	1.50	170	34.0	32.0	24.0	4	37.50	* 101919			
39	2.00	170	34.0	32.0	24.0	4	37.00	101920			
39	3.00	200	45.0	32.0	24.0	4	36.00	101921			



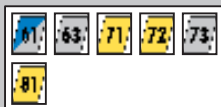

N410-3  

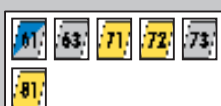

N420-4  

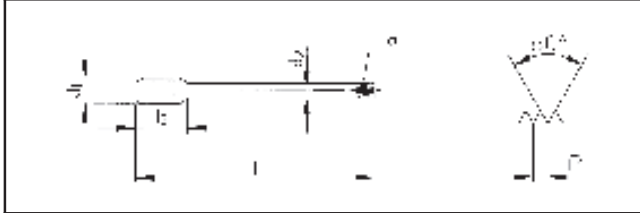
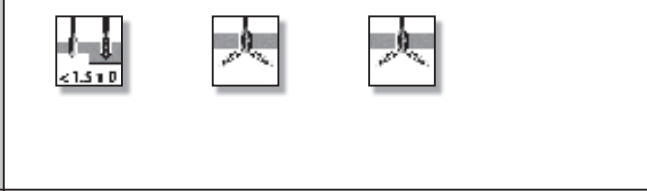
N420-3  

N410-3	N420-4	N420-3	
--------	--------	--------	--











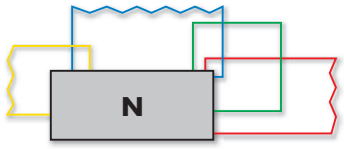

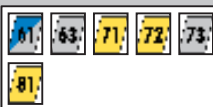

		
---	--	---

		
--	---	--











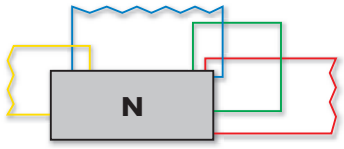





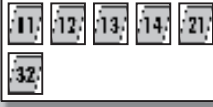

MF	∅ d ₁ mm	P mm	l ₁ mm	l ₂ mm	d ₂ mm	α mm		6H	ID	ID	ID
40	1.00	170	34.0	32.0	24.0	5	39.00	101925			
40	1.50	170	34.0	32.0	24.0	5	38.50	101926	102152	143813	
40	2.00	170	34.0	32.0	24.0	5	38.00	101927	102153		
40	3.00	200	45.0	32.0	24.0	4	37.00	* 101928	102154		
42	1.50	170	34.0	32.0	24.0	5	40.50	101929	102155		
42	2.00	170	34.0	32.0	24.0	5	40.00	101930	102156		
42	3.00	200	45.0	32.0	24.0	4	39.00	101931	102157		
45	1.50	180	34.0	36.0	29.0	5	43.50	101933	102159		
45	2.00	180	34.0	36.0	29.0	5	43.00	101934	* 102160		
45	3.00	200	45.0	36.0	29.0	4	42.00	101935	102161		
48	1.50	190	36.0	36.0	29.0	5	46.50	101937	102163		
48	2.00	190	36.0	36.0	29.0	5	46.00	101938	102164		
48	3.00	220	48.0	36.0	29.0	5	45.00	101939	102165		
50	1.50	190	36.0	36.0	29.0	5	48.50	101943	102176	143814	
50	2.00	190	36.0	36.0	29.0	5	48.00	101944	* 102177		
52	1.50	190	36.0	40.0	32.0	5	50.50	* 101946			
52	2.00	190	36.0	40.0	32.0	5	50.00	101947			
52	3.00	220	48.0	40.0	32.0	5	49.00	101948			
55	2.00	190	40.0	40.0	32.0	5	53.00	105131			
60	2.00	220	42.0	45.0	35.0	5	58.00	105132			
63	1.50	220	38.0	45.0	35.0	5	61.50			143815	











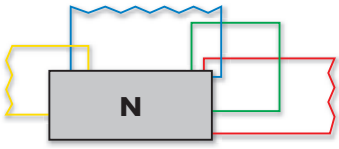

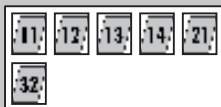

MF

									N410-3 LH		N420-4 LH			
														
N410-3 LH  LH 														
N420-4 LH  LH 														
														
														
$\varnothing d_1$ MF	P mm	l_1 mm	l_2 mm	d_2 mm	a mm			ID	ID					
4	0.50	63	14.0	2.8	2.1	3	3.50	104844						
5	0.50	70	15.0	3.5	2.7	3	4.50	104845						
6	0.50	80	17.0	4.5	3.4	3	5.50	104846	104870					
6	0.75	80	17.0	4.5	3.4	3	5.25	104847	105133					
7	0.75	80	17.0	5.5	4.3	3	6.25	104848						
8	0.50	90	20.0	6.0	4.9	3	7.50	104849						
8	0.75	90	20.0	6.0	4.9	3	7.25	104850	104871					
8	1.00	90	20.0	6.0	4.9	3	7.00	104851	104872					
10	0.75	100	22.0	7.0	5.5	3	9.25	104852						
10	1.00	100	22.0	7.0	5.5	3	9.00	104853	104873					
10	1.25	100	22.0	7.0	5.5	3	8.80		104874					
12	1.00	100	24.0	9.0	7.0	3	11.00	104854	104875					
12	1.25	100	24.0	9.0	7.0	3	10.80	104855	104876					
12	1.50	100	24.0	9.0	7.0	3	10.50	104856	104877					
14	1.00	100	24.0	11.0	9.0	3	13.00	104857	104878					
14	1.25	100	24.0	11.0	9.0	3	12.80	104858						
14	1.50	100	24.0	11.0	9.0	3	12.50	104859	104879					
16	1.00	100	26.0	12.0	9.0	*3	15.00	104860	104880					
16	1.50	100	26.0	12.0	9.0	*3	14.50	104861	104881					
18	1.00	110	26.0	14.0	11.0	4	17.00	104862						
18	1.50	110	26.0	14.0	11.0	4	16.50	104863	104882					
20	1.00	125	28.0	16.0	12.0	4	19.00	104864						
20	1.50	125	28.0	16.0	12.0	4	18.50	104865	104883					
22	1.50	125	28.0	18.0	14.5	4	20.50	104866	104884					
24	1.50	140	30.0	18.0	14.5	4	22.50	104867	104885					
24	2.00	140	34.0	18.0	14.5	4	22.00	104868	104886					
28	1.50	140	30.0	20.0	16.0	4	26.50	105166	* 105080					
30	1.50	150	32.0	22.0	18.0	4	28.50	105167	105165					
30	2.00	150	32.0	22.0	18.0	4	28.00	105168						

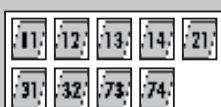
* N410-3 LH =  4

									N350-3	N450-3		
N350-3												
N450-3												
$\varnothing d_1$ MF	P mm	l_1 mm	l_2 mm	l_3 mm	d_2 mm	α mm			ID	ID		
4	0.50	63	14.0	21	4.5	3.4	2	3.50	101586			
5	0.50	70	15.0	25	6.0	4.9	3	4.50	101588			
6	0.75	80	17.0	30	6.0	4.9	3	5.25	101590			
8	1.00	90	20.0		6.0	4.9	3	7.00		102326		
9	0.75	90	20.0		7.0	5.5	3	8.25		102328		
10	1.00	100	22.0		7.0	5.5	3	9.00		102313		
12	1.00	100	24.0		9.0	7.0	3	11.00		102315		
12	1.50	100	24.0		9.0	7.0	3	10.50		102316		
14	1.50	100	24.0		11.0	9.0	3	12.50		102318		
16	1.50	100	26.0		12.0	9.0	3	14.50		102320		
18	1.50	110	26.0		14.0	11.0	4	16.50		102322		
20	1.50	125	28.0		16.0	12.0	4	18.50		102323		

										N360-3	N360V-3	N360TN-3	N360-3
													
N360-3													
N360V-3	 												
N360TN-3	 												
													
													
													
$\varnothing d_1$	P	l_1	l_2	l_3	d_2	a			ID	ID	ID	ID ^{6H} + mm	
MF	mm	mm	mm	mm	mm	mm							
4	0.50	63	7.5	21	4.5	3.4	3	3.50	101632	101712	111618	101631 0.020	
5	0.50	70	9.0	25	6.0	4.9	3	4.50	101641	101714	111617	101640 0.020	
6	0.50	80	11.0	30	6.0	4.9	3	5.50	101648	143990			
6	0.75	80	11.0	30	6.0	4.9	3	5.25	101650	101716	101702	101649 0.022	
8	0.75	90	12.5	35	8.0	6.2	3	7.25	101658	101719		101657 0.022	
8	1.00	90	12.5	35	8.0	6.2	3	7.00	101660	101720	101704	101659 0.026	
10	0.75	100	14.0	39	10.0	8.0	3	9.25	101606	144401			
10	1.00	100	14.0	39	10.0	8.0	3	9.00	101608	101706	101695	101607 0.026	
10	1.25	100	14.0	39	10.0	8.0	3	8.80	101609	105134	110965		

								N460-3	N460V-3	N460TN-3	N460-3
											
N460-3											
N460V-3	 V										
N460TN-3	 TiN										
											
											
$\varnothing d_1$ MF	P mm	l_1 mm	l_2 mm	d_2 mm	α mm		6H 	ID	ID	ID	ID 6H + mm
12	1.00	100	14.0	9.0	7.0	3	11.00	102353	102462	102447	102352 0.026
12	1.25	100	14.0	9.0	7.0	3	10.80	102354	102463	144202	
12	1.50	100	14.0	9.0	7.0	3	10.50	102356	102464	102448	102355 0.032
13	1.00	100	14.0	11.0	9.0	3	12.00	102364			
14	1.00	100	14.0	11.0	9.0	3	13.00	102365	102466		
14	1.50	100	14.0	11.0	9.0	3	12.50	102367	102467	102450	102366 0.032
15	1.00	100	14.0	12.0	9.0	3	14.00	102370			
15	1.50	100	18.0	12.0	9.0	3	13.50	102371			
16	1.00	100	14.0	12.0	9.0	4	15.00	102372	102469		
16	1.50	100	14.0	12.0	9.0	4	14.50	102374	102470	102452	102373 0.032
18	1.00	110	18.0	14.0	11.0	4	17.00	102380	143926		
18	1.50	110	18.0	14.0	11.0	4	16.50	102382	102472		102381 0.032
20	1.00	125	20.0	16.0	12.0	4	19.00	102384			
20	1.50	125	20.0	16.0	12.0	4	18.50	102386	102474		
20	2.00	140	24.0	16.0	12.0	4	18.00	102387			
22	1.00	125	20.0	18.0	14.5	4	21.00	102392			
22	1.50	125	20.0	18.0	14.5	4	20.50	102393	102476		
24	1.50	140	22.0	18.0	14.5	4	22.50	102396	102478		
24	2.00	140	22.0	18.0	14.5	4	22.00	102397	102479		
25	1.50	140	22.0	18.0	14.5	4	23.50	102399	143810		
26	1.50	140	22.0	18.0	14.5	4	24.50	102400	143952		
27	1.50	140	22.0	20.0	16.0	4	25.50	102401			
27	2.00	140	22.0	20.0	16.0	4	25.00	102402	144201		
28	1.50	140	22.0	20.0	16.0	4	26.50	102403			
30	1.50	150	24.0	22.0	18.0	4	28.50	102404	142524		
30	2.00	150	24.0	22.0	18.0	4	28.00	102405	142581		
32	1.50	150	24.0	22.0	18.0	4	30.50	102406			
33	2.00	160	26.0	25.0	20.0	4	31.00	102407			
35	1.50	170	24.0	28.0	22.0	5	33.50	102408			
36	1.50	170	24.0	28.0	22.0	5	34.50	102409			

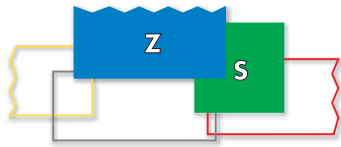



									Z320V-4	Z360V-3	Z360VS-3	Z370VS-3
<p>Z320V-4 </p> <p>Z360V-3 </p> <p>Z360VS-3 </p> <p>Z370VS-3 </p>												

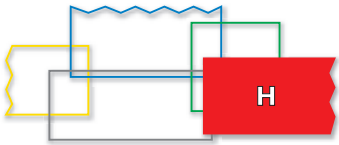

									Z420V-4	Z460V-3	Z460VS-3	Z470VS-3	
<p>Z420V-4</p>													
<p>Z460V-3</p>													
<p>Z460VS-3</p>												NEW	
<p>Z470VS-3</p>												PM	
									ISO 2 6H	ISO 2 6H	6HX	6HX	
$\varnothing d_1$	P	l_1	l_2	d_2	a				ID				
MF	mm	mm	mm	mm	mm								
12	1.00	100	24.0	9.0	7.0	3	11.00		142729				
12	1.50	100	24.0	9.0	7.0	3	10.50		142730				
14	1.50	100	24.0	11.0	9.0	3	12.50		142731				
16	1.50	100	26.0	12.0	9.0	3	14.50		142732				
$\varnothing d_1$	P	l_1	l_2	d_2	a				ID	ID			
MF	mm	mm	mm	mm	mm								
12	1.00	100	14.0	9.0	7.0	3	11.00		104729				
12	1.50	100	14.0	9.0	7.0	*3	10.50		104730	* 111555			
14	1.50	100	14.0	11.0	9.0	*3	12.50		104731	* 111556			
16	1.50	100	14.0	12.0	9.0	4	14.50		104732	* 111557			
18	1.50	110	18.0	14.0	11.0	4	16.50		104733				
20	1.50	125	20.0	16.0	12.0	4	18.50		104734				
22	1.50	125	20.0	18.0	14.5	4	20.50		104735				
24	1.50	140	22.0	18.0	14.5	4	22.50		104736				
24	2.00	140	22.0	18.0	14.5	4	22.00		104737				
$\varnothing d_1$	P	l_1	l_2	d_2 h ₆	a								ID
MF	mm	mm	mm	mm	mm								
12	1.50	110	14.0	*10.0	*8.0	4	10.50						166120
14	1.50	110	14.0	*12.0	*9.0	4	12.50						166121
16	1.50	110	18.0	12.0	9.0	4	14.50						166122
<p>* Norme DC / * DC Norm / * Norma DC</p>													
<p>* Z460VS-3 = 4</p>													

MF

									H320-4	H420-4		
H320-4												
H420-4												
$\varnothing d_1$ MF	P mm	l_1 mm	l_2 mm	l_3 mm	d_2 mm	a mm			ID	ID		
6	0.75	80	17.0	30	6.0	4.9	3	5.25	101214			
8	0.75	90	20.0	35	8.0	6.2	3	7.25	101216			
8	1.00	90	20.0	35	8.0	6.2	3	7.00	101217			
10	1.00	100	22.0	39	10.0	8.0	3	9.00	101204			
12	1.25	100	24.0		9.0	7.0	4	10.80		101273		
12	1.50	100	24.0		9.0	7.0	4	10.50		101274		
14	1.50	100	24.0		11.0	9.0	4	12.50		101276		
16	1.50	100	26.0		12.0	9.0	4	14.50		101278		
20	1.50	125	28.0		16.0	12.0	4	18.50		101282		
24	2.00	140	34.0		18.0	14.5	4	22.00		101285		





H350-3  

H450-3  

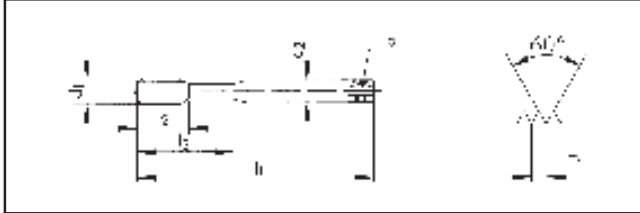



































H350-3 **H450-3**



ISO 2 6H **ISO 2 6H**

Ø d ₁ MF	P mm	l ₁ mm	l ₂ mm	l ₃ mm	d ₂ mm	a mm			ID	ID
6	0.75	80	11.0	30	6.0	4.9	3	5.25	101249	
8	0.75	90	12.5	35	8.0	6.2	3	7.25	101252	
8	1.00	90	12.5	35	8.0	6.2	3	7.00	101253	
10	1.00	100	14.0	39	10.0	8.0	3	9.00	101235	
12	1.00	100	14.0		9.0	7.0	4	11.00		101302
12	1.50	100	14.0		9.0	7.0	4	10.50		101303
14	1.50	100	14.0		11.0	9.0	4	12.50		101306
16	1.50	100	14.0		12.0	9.0	4	14.50		101308
18	1.50	110	18.0		14.0	11.0	4	16.50		101310
20	1.50	125	20.0		16.0	12.0	4	18.50		101312
22	1.50	125	20.0		18.0	14.5	4	20.50		101314
24	1.50	140	22.0		18.0	14.5	4	22.50		101316
24	2.00	140	22.0		18.0	14.5	4	22.00		101317
27	2.00	140	22.0		20.0	16.0	4	25.00		101319
30	1.50	150	24.0		22.0	18.0	4	28.50		101321
30	2.00	150	24.0		22.0	18.0	4	28.00		101322

MF

		S		AERO		S320VS-4	S420VS-4	S360VS-3	S460VS-3	
			VS							
			VS							
			VS							
			VS							
										
$\varnothing d_1$ MF	P mm	l_1 mm	l_2 mm	l_3 mm	d_2 mm	α mm			ID	ID
6	0.75	80	17.0	30	6.0	4.9	3	5.25	* 123690	
8	1.00	90	20.0	35	8.0	6.2	3	7.00	124288	
10	1.00	100	22.0	39	10.0	8.0	3	9.00	120059	
12	1.50	100	24.0		9.0	7.0	4	10.50		120420
14	1.50	100	24.0		11.0	9.0	4	12.50		120687
16	1.50	100	26.0		12.0	9.0	4	14.50		120877
$\varnothing d_1$ MF	P mm	l_1 mm	l_2 mm	l_3 mm	d_2 mm	α mm			ID	ID
6	0.75	80	11.0	30	6.0	4.9	3	5.25	* 111527	
8	1.00	90	12.5	35	8.0	6.2	3	7.00	111528	
10	1.00	100	14.0	39	10.0	8.0	3	9.00	111529	
12	1.50	100	14.0		9.0	7.0	4	10.50		111540
14	1.50	100	14.0		11.0	9.0	4	12.50		111541
16	1.50	100	14.0		12.0	9.0	4	14.50		111542

AERO

SA390-3





SA390-3







































































6HX























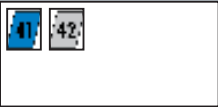





$\varnothing d_1$ MF	P mm	l_1 mm	l_2 mm	d_2 mm	a mm			ID
8	1.00	90	25.0	8.0	6.2	3	7.00	149735
10	1.00	100	30.0	10.0	8.0	3	9.00	149751
10	1.25	100	30.0	10.0	8.0	3	8.80	149753
12	1.00	110	35.0	12.0	9.0	4	11.00	149769
12	1.50	110	35.0	12.0	9.0	4	10.50	149773
14	1.50	110	40.0	16.0	12.0	4	12.50	149790

MF

AERO

									SA320-4	SA350-3	TL320VS-4	TL351VS-3
<div style="display: flex; justify-content: space-between;"> <div style="width: 20%;"> <p>SA320-4 </p> <p>SA350-3 </p> </div> <div style="width: 20%;"> <p>TL320VS-4  VS</p> <p>TL351VS-3  VS</p> </div> <div style="width: 20%;"> <p></p> <p></p> <p></p> <p></p> </div> </div>									   			
   									   			
   									   			
   									   			
   									   			
   									   			
   									   			
   									   			

<h1>AERO</h1>								SA420-4	SA450-3	TL420VS-4	TL451VS-3
<p>SA420-4  </p> <p>SA450-3  </p>											
<p>TL420VS-4  VS </p> <p>TL451VS-3   VS </p>											
											
								4HX	4HX	4HX	4HX
$\varnothing d_1$	P	l_1	l_2	d_2	α			ID	ID	ID	ID
MF	mm	mm	mm	mm	mm						
12	1.00	100	19.0	9.0	7.0	4	11.00	152209	* 148964	* 152218	* 152223
12	1.50	100	24.0	9.0	7.0	4	10.50	152208	152213	* 152217	* 152222
14	1.50	100	24.0	11.0	9.0	4	12.50	* 152210	* 152214	* 152219	* 152224
16	1.50	100	26.0	12.0	9.0	4	14.50	* 152212	* 152216	* 152221	* 152226
								6HX	6HX	6HX	6HX
$\varnothing d_1$	P	l_1	l_2	d_2	α			ID	ID	ID	ID
MF	mm	mm	mm	mm	mm						
12	1.00	100	19.0	9.0	7.0	4	11.00	* 152228	148967	* 152237	152242
12	1.50	100	24.0	9.0	7.0	4	10.50	152227	152232	* 152236	152241
14	1.50	100	24.0	11.0	9.0	4	12.50	152229	152233	* 152238	152243
16	1.00	100	23.0	12.0	9.0	4	15.00			* 152239	* 152244
16	1.50	100	26.0	12.0	9.0	4	14.50	* 152231	* 152235	* 152240	152245



Uniquement pour taraudage synchrone
Nur für Synchrobearbeitung
Only for rigid tapping
Solo per maschiatura sincrona
Solo para roscado sincronizado

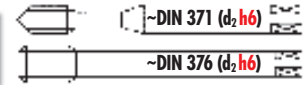

RTS Rigid Tapping Synchro

RTS320VS-4



RTS420VS-4



RTS362VS-3



RTS462VS-3



RTS320VS-4

RTS420VS-4

RTS362VS-3

RTS462VS-3

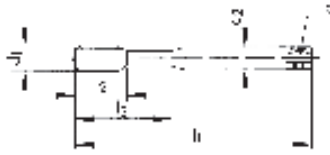

$\varnothing d_1$ MF	P mm	l_1 mm	l_2 mm	l_3 mm	d_2 h6 mm	a mm	α	α_2
8	1.00	90	12.5	35	8.0	6.2	3	7.00
10	1.00	100	14.0	39	10.0	8.0	3	9.00
12	1.50	110	14.0	* 10.0	* 8.0	3	3	10.50
14	1.50	110	14.0	* 12.0	* 9.0	3	3	12.50
16	1.50	110	18.0	12.0	9.0	3	3	14.50

* Norme DC / * DC Norm / * Norma DC

ID	ID	ID	ID
150615			
150630			
	150640		
	150655		
	150665		

$\varnothing d_1$ MF	P mm	l_1 mm	l_2 mm	l_3 mm	d_2 h6 mm	a mm	α	α_2
8	1.00	90	12.5	35	8.0	6.2	3	7.00
10	1.00	100	14.0	39	10.0	8.0	3	9.00
12	1.50	110	14.0	* 10.0	* 8.0	3	3	10.50
14	1.50	110	14.0	* 12.0	* 9.0	3	3	12.50
16	1.50	110	18.0	12.0	9.0	3	3	14.50



* Norme DC / * DC Norm / * Norma DC

ID	ID
150617	
150632	
	151862
	151869
	151871



sur demande
auf Anfrage
on request
su richiesta
sobre pedido

FPS FORMING

FPS381CN-3   

FPS381VS-3   

FP481VS-3   

FPS381CN-3	FPS381VS-3	FPS481VS-3	
------------	------------	------------	--

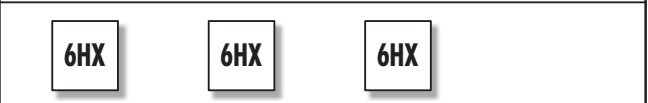
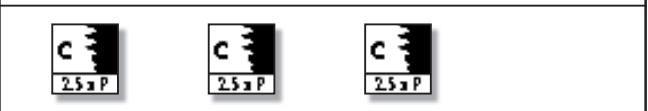

∅ d ₁ MF	P mm	l ₁ mm	l ₂ mm	l ₃ mm	d ₂ mm	α mm	Tol.
4	0.50	63	14.0	21	4.5	3.4	3.80 +/- 0.03
5	0.50	70	15.0	25	6.0	4.9	4.80 +/- 0.03
6	0.50	80	17.0	30	6.0	4.9	5.80 +/- 0.03
6	0.75	80	17.0	30	6.0	4.9	5.65 +/- 0.03
8	0.75	90	20.0	35	8.0	6.2	7.65 +/- 0.05
8	1.00	90	20.0	35	8.0	6.2	7.55 +/- 0.05
10	1.00	100	22.0	39	10.0	8.0	9.55 +/- 0.05
12	1.00	100	19.0		9.0	7.0	11.55 +/- 0.05
14	1.50	100	24.0		11.0	9.0	13.30 +/- 0.05
16	1.50	100	26.0		12.0	9.0	15.30 +/- 0.05

ID	ID	ID
	166631	
	166639	
	166699	
166648	166649	
166701	166702	
166658	166659	
166668	166669	
		166674
		166679
		166684

MF

FAS FORMING

FAS381VS-3



VS

FAS481VS-3



VS



FAS381VS-3

FAS481VS-3



NEW



NEW



$\varnothing d_1$ MF	P mm	l_1 mm	l_2 mm	l_3 mm	d_2 mm	a mm	α °	Tol. mm
4	0.50	63	14.0	21	4.5	3.4	3.80	+/- 0.03
5	0.50	70	15.0	25	6.0	4.9	4.80	+/- 0.03
6	0.50	80	17.0	30	6.0	4.9	5.80	+/- 0.03
6	0.75	80	17.0	30	6.0	4.9	5.65	+/- 0.03
8	0.75	90	20.0	35	8.0	6.2	7.65	+/- 0.05
8	1.00	90	20.0	35	8.0	6.2	7.55	+/- 0.05
10	1.00	100	22.0	39	10.0	8.0	9.55	+/- 0.05
12	1.00	100	19.0		9.0	7.0	11.55	+/- 0.05
14	1.50	100	24.0		11.0	9.0	13.30	+/- 0.05
16	1.50	100	26.0		12.0	9.0	15.30	+/- 0.05

ID

ID

166625

166633

166698

166642

166700

166652

166662







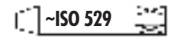



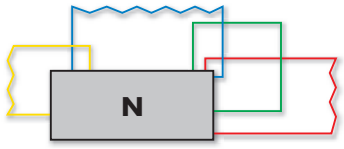





166672











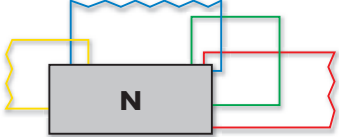





166677

166682

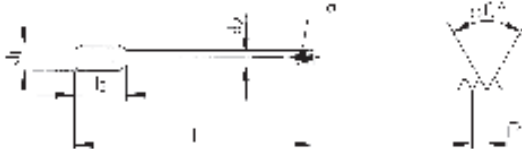

									N1110-1	N1110-3	N1110-S	
<p>N1110-1</p>												
<p>N1110-3</p>												
<p>N1110-S</p>												

								N1210-1	N1210-3	N1210-S			
													
N1210-1													
N1210-3													
N1210-S													
													
													
													
$\varnothing d_1$	P	l_1	l_2	d_2	a			ID	ID	ID			
MF	mm	mm	mm	mm	mm								
11	0.50	85	22.0	8.0	6.3	3	10.50		103485				
11	0.75	85	22.0	8.0	6.3	3	10.25		103486				
11	1.00	85	22.0	8.0	6.3	3	10.00		103487				
11	1.25	85	22.0	8.0	6.3	3	9.80		103488				
12	0.50	89	24.0	9.0	7.1	3	11.50		103490				
12	0.75	89	24.0	9.0	7.1	3	11.25		103491				
12	1.00	89	24.0	9.0	7.1	3	11.00	103305	103493	111169			
12	1.25	89	24.0	9.0	7.1	3	10.80	103307	103495	111171			
12	1.50	89	24.0	9.0	7.1	3	10.50	103308	103497	111172			
14	0.50	95	24.0	11.2	9.0	3	13.50		103502				
14	0.75	95	24.0	11.2	9.0	3	13.25		103503				
14	1.00	95	24.0	11.2	9.0	3	13.00	103312	103504	111175			
14	1.25	95	24.0	11.2	9.0	3	12.80	103314	103506	111177			
14	1.50	95	24.0	11.2	9.0	3	12.50	103315	103508	111178			
15	0.75	90	23.0	11.2	9.0	3	14.25		103512				
15	1.00	90	23.0	11.2	9.0	3	14.00	* 103317	103513				
16	0.50	102	32.0	12.5	10.0	4	15.50		103515				
16	0.75	102	32.0	12.5	10.0	4	15.25		103516				
16	1.00	102	32.0	12.5	10.0	4	15.00	103321	103517	111183			
16	1.50	102	32.0	12.5	10.0	4	14.50	103322	103520	111184			
17	1.00	95	23.0	12.5	10.0	4	16.00		103525				
18	0.75	112	30.0	14.0	11.2	4	17.25		103527				
18	1.00	112	30.0	14.0	11.2	4	17.00	103326	103528	111187			
18	1.50	112	30.0	14.0	11.2	4	16.50	103327	103531	111188			
18	2.00	112	30.0	14.0	11.2	3	16.00		103533				
19	1.00	112	33.0	14.0	11.2	4	18.00		103536				

















									N1210-1	N1210-3	N1210-S
									<p>N1210-1</p> 		
<p>N1210-3</p>  											
<p>N1210-S</p> 											
											
<p>$\varnothing d_1$</p> <p>MF</p>	<p>P</p> <p>mm</p>	<p>l_1</p> <p>mm</p>	<p>l_2</p> <p>mm</p>	<p>d_2</p> <p>mm</p>	<p>α</p> <p>mm</p>			<p>ID</p>	<p>ID</p>	<p>ID</p>	
20	1.00	112	37.0	14.0	11.2	4	19.00	103332	103537	111198	
20	1.25	112	37.0	14.0	11.2	4	18.80		103539		
20	1.50	112	37.0	14.0	11.2	4	18.50	103334	103540	111195	
22	1.00	115	32.0	16.0	12.5	4	21.00		103545		
22	1.50	115	32.0	16.0	12.5	4	20.50	103340	103546	121669	
22	2.00	115	32.0	16.0	12.5	3	20.00		103548		
24	1.00	120	30.0	18.0	14.0	4	23.00		103552		
24	1.50	120	30.0	18.0	14.0	4	22.50	103343	103553	111202	
24	2.00	130	45.0	18.0	14.0	4	22.00	103344	103555	111203	
25	1.00	120	30.0	18.0	14.0	4	24.00		103559		
25	1.50	120	30.0	18.0	14.0	4	23.50		103560		
25	2.00	120	30.0	18.0	14.0	4	23.00		103561		
26	1.00	120	30.0	18.0	14.0	4	25.00		103562		
26	1.50	120	30.0	18.0	14.0	4	24.50	103346	103563	111207	
26	2.00	120	30.0	18.0	14.0	4	24.00		103564		
27	1.00	127	30.0	20.0	16.0	4	26.00		103565		
27	1.50	127	30.0	20.0	16.0	4	25.50		103566		
27	2.00	135	45.0	20.0	16.0	4	25.00	103351	103567	111210	
28	1.00	127	30.0	20.0	16.0	4	27.00		103570		
28	1.50	127	30.0	20.0	16.0	4	26.50		103571		
30	1.50	127	32.0	20.0	16.0	4	28.50	103355	103575	111214	
30	2.00	127	32.0	20.0	16.0	4	28.00	103356	103577	111215	

MF

		N					Z		
Характеристики Cechy charakterystyczne									
Типы отверстий Typ otworu									
			N310-3	N320-3 N320-4	N320V-4	N360-3 N360V-3	N1110 -1-2-3-S	Z320V-3 Z320V-4	Z320VS-4
Длинный по DIN DIN długi	DIN 371	110	110	110	112		114	114	
Короткий по ISO ISO krótki	ISO 529					124			
Класс точности Tolerancja	UNC 2B	110	110	110	112	124	114	114	
Класс точности Tolerancja	UNC 3B								
Класс точности Tolerancja	UNC(J) 3B		110		112				
			N410-3	N420-4	N420V-4	N460-3 N460V-3	N1210 -1-2-3-S	Z420V-4	Z420VS-4
Длинный по DIN DIN długi	DIN 376	111	111	111	113		114	114	
Короткий по ISO ISO krótki	ISO 529					125			
Класс точности Tolerancja	UNC 2B	111	111	111	113	125	114	114	
Класс точности Tolerancja	UNC 3B								
Класс точности Tolerancja	UNC(J) 3B								



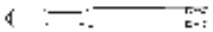







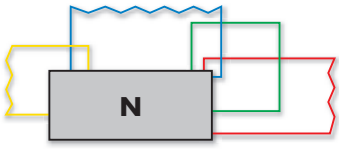





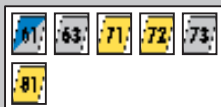

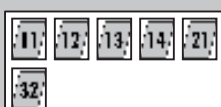
Z			H		S		SA	
V	VS	VS			VS	VS		
Z360V-3 Z362V-3	Z362VS-3	Z370VS-3	H320-4	H350-3	S320VS-4	S360VS-3	SA320-4	SA350-3
115	115	116	117	117	118	119	120	120
115	115	116	117	117	118	119	120	120
		116			118		120	120
Z462V-3	Z462VS-3	Z470VS-3	H420-4	H450-3	S420VS-4	S460VS-3	SA420-4	SA450-3
115	115	116	117	117	118	119	121	121
115	115	116	117	117	118	119	121	121
							121	121



	SA	TL		RTS			
Характеристики Cechy charakterystyczne		 VS	 VS	 VS	 VS		
							
Типы отверстий Typ otworu							
	SA390-3	TL320VS-4	TL351VS-3	RTS320VS-4	RTS362VS-3		
Длинный по DIN DIN długi	DIN 371	119	120	120	122	122	
Длинный по DIN DIN długi	~ DIN 2184-1						
Класс точности Tolerancja	UNC 2B		120	120	122	122	
Класс точности Tolerancja	UNC 3B						
Класс точности Tolerancja	UNC(J) 3B	119	120	120			
		TL420VS-4	TL451VS-3	RTS420VS-4	RTS462VS-3		
Длинный по DIN DIN długi	DIN 376		121	121	122	122	
Длинный по DIN DIN długi	~ DIN 2184-1						
Класс точности Tolerancja	UNC 2B		121	121	122	122	
Класс точности Tolerancja	UNC 3B						
Класс точности Tolerancja	UNC(J) 3B		121	121			



										N310-3	N320-3	N320-4	N320V-4	
N310-3														
N320-3														
N320-4														
N320V-4	V													
Ø" d ₁ UNC	P TPI	d ₁ mm	l ₁ mm	l ₂ mm	l ₃ mm	d ₂ mm	α mm			ID	ID	ID	ID	
2	56	2.18	45	9.0		2.8	2.1	2	1.75		101469			
3	48	2.51	50	10.0		2.8	2.1	2	2.00		101470			
4	40	2.84	56	12.0	18	3.5	2.7	3	2.25	101450		101511	142738	
5	40	3.17	56	12.0	18	3.5	2.7	3	2.55		* 101472	101512		
6	32	3.50	56	13.0	20	4.0	3.0	3	2.75	101451		101514	144402	
8	32	4.16	63	14.0	21	4.5	3.4	3	3.40	101452		101515	142739	
10	24	4.82	70	15.0	25	6.0	4.9	3	3.80	101449	* 101468	101508	142740	
12	24	5.48	80	17.0	30	6.0	4.9	3	4.40			101509		
1/4	20	6.35	80	17.0	30	7.0	5.5	3	5.10	101448		101507	142741	
Ø" d ₁ UNC	P TPI	d ₁ mm	l ₁ mm	l ₂ mm	l ₃ mm	d ₂ mm	α mm			ID				
4	40	2.84	56	12.0	18	3.5	2.7	3	2.30		145656			
6	32	3.50	56	13.0	20	4.0	3.0	3	2.80		155317			
8	32	4.16	63	14.0	21	4.5	3.4	3	3.45		155319			

										N410-3	N420-4	N420V-4	
										  			
N410-3													
N420-4													
N420V-4	 V												
										  			
										  			
Ø" d ₁	P	d ₁	l ₁	l ₂	d ₂	a				ID	ID	ID	
UNC	TPI	mm	mm	mm	mm	mm							
5/16	18	7.93	90	20.0	6.0	4.9	3	6.50		101997	102213	142742	
3/8	16	9.52	100	22.0	7.0	5.5	3	8.00		101996	102212	142743	
7/16	14	11.11	100	19.0	8.0	6.2	3	9.30			102215	142744	
1/2	13	12.70	110	24.0	9.0	7.0	3	10.80		101993	102208	142745	
9/16	12	14.28	110	28.0	11.0	9.0	3	12.20			102217		
5/8	11	15.87	110	30.0	12.0	9.0	3	13.60		101998	102214	142746	
3/4	10	19.05	125	33.0	14.0	11.0	3	16.60		101995	102211	142747	
7/8	9	22.22	140	36.0	18.0	14.5	3	19.50			102216	142748	
1	8	25.40	160	39.0	18.0	14.5	4	22.30		101994	102209	142749	
1 1/8	7	28.57	180	45.0	22.0	18.0	4	25.00			102205		
1 1/4	7	31.75	180	45.0	22.0	18.0	4	28.20		101991	102204		
1 3/8	6	34.92	200	51.0	28.0	22.0	4	30.80			* 102207		
1 1/2	6	38.10	200	55.0	32.0	24.0	4	34.00		* 101990	102203		
1 3/4	5	44.45	220	59.0	36.0	29.0	4	39.50		* 101992	102206		
2	4.5	50.80	250	67.0	40.0	32.0	4	45.30			102210		

UNC

UNC ANSI B1.1



										N460-3	N460V-3		
N460-3 													
N460V-3 													
Ø" d ₁ UNC	P TPI	d ₁ mm	l ₁ mm	l ₂ mm	d ₂ mm	α mm				ID	ID		
7/16	14	11.11	100	14.0	8.0	6.2	3	9.30		102424	105135		
1/2	13	12.70	110	14.0	9.0	7.0	3	10.80		102420	102497		
9/16	12	14.28	110	14.0	11.0	9.0	3	12.20		102426	102502		
5/8	11	15.87	110	18.0	12.0	9.0	3	13.60		102423	102500		
3/4	10	19.05	125	21.0	14.0	11.0	3	16.60		102422	102499		
7/8	9	22.22	140	24.0	18.0	14.5	4	19.50		102425	102501		
1	8	25.40	160	27.0	18.0	14.5	4	22.30		102421	102498		
1 1/8	7	28.57	180	30.0	22.0	18.0	4	25.00		102418	102495		
1 1/4	7	31.75	180	30.0	22.0	18.0	4	28.20		102417	102494		
1 1/2	6	38.10	200	40.0	32.0	24.0	5	34.00		102416	102493		
1 3/4	5	44.45	220	44.0	36.0	29.0	5	39.50			128062		
2	4.5	50.80	250	52.0	40.0	32.0	5	45.30			128084		

UNC

										Z320V-4	Z320VS-4	Z420V-4	Z420VS-4
Z320V-4		V											
Z320VS-4		VS											
Z420V-4		V											
Z420VS-4		VS											
Ø" d ₁ UNC	P TPI	d ₁ mm	l ₁ mm	l ₂ mm	l ₃ mm	d ₂ mm	a mm			ID	ID	ID	ID
*2	56	2.18	45	9.0		2.8	2.1	2	1.75	142750			
4	40	2.84	56	12.0	18	3.5	2.7	3	2.25	142751			
6	32	3.50	56	13.0	20	4.0	3.0	3	2.75	142752	111560		
8	32	4.16	63	14.0	21	4.5	3.4	3	3.40	142753	111561		
10	24	4.82	70	15.0	25	6.0	4.9	3	3.80	142754	111562		
1/4	20	6.35	80	17.0	30	7.0	5.5	3	5.10	142755	111563		
5/16	18	7.93	90	20.0	35	8.0	6.2	3	6.50	142756	111564		
3/8	16	9.52	100	22.0	39	10.0	8.0	3	8.00	142757	111565		
1/2	13	12.70	110	24.0		9.0	7.0	3	10.80			142758	111566
5/8	11	15.87	110	30.0		12.0	9.0	3	13.60			142759	111567
3/4	10	19.05	125	33.0		14.0	11.0	4	16.60			142760	111568
7/8	9	22.22	140	36.0		18.0	14.5	4	19.50			142761	
1	8	25.40	160	39.0		18.0	14.5	4	22.30			142762	
<p>* Z320V-3 </p>													

UNC ANSI B1.1

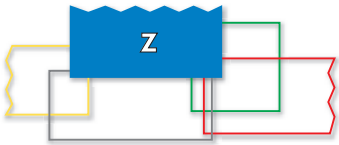
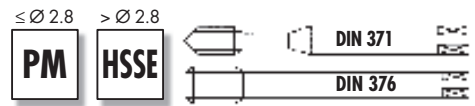

Z362V-3			V	
Z362VS-3			VS	
Z462V-3			V	
Z462VS-3			VS	

Z362V-3	Z362VS-3	Z462V-3	Z462VS-3
---------	----------	---------	----------

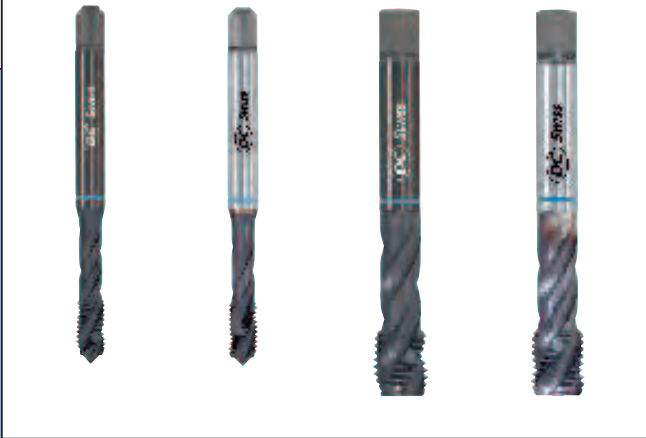

--	--	--	--



--	--	--	--

2B	2BX	2B	2BX
-----------	------------	-----------	------------

Ø" d ₁ UNC	P TPI	d ₁ mm	l ₁ mm	l ₂ mm	l ₃ mm	d ₂ mm	α mm		
*2	56	2.18	45	8.0		2.8	2.1	2	1.75
*4	40	2.84	56	5.5	18	3.5	2.7	3	2.25
6	32	3.50	56	6.5	20	4.0	3.0	3	2.75
8	32	4.16	63	7.5	21	4.5	3.4	3	3.40
10	24	4.82	70	9.0	25	6.0	4.9	3	3.80
1/4	20	6.35	80	11.0	30	7.0	5.5	3	5.10
5/16	18	7.93	90	12.5	35	8.0	6.2	3	6.50
3/8	16	9.52	100	14.0	39	10.0	8.0	3	8.00
7/16	14	11.11	100	14.0		8.0	6.2	3	9.30
1/2	13	12.70	110	14.0		9.0	7.0	* 3	10.80
5/8	11	15.87	110	18.0		12.0	9.0	* 3	13.60
3/4	10	19.05	125	21.0		14.0	11.0	* 3	16.60
7/8	9	22.22	140	24.0		18.0	14.5	3	19.50
1	8	25.40	160	27.0		18.0	14.5	4	22.30

ID	ID	ID	ID
104695			
104697			
104699	* 111543		
104700	* 111544		
104694	* 111545		
104693	* 111546		
104698	* 111547		
104696	* 111548		
		104757	* 111549
		104753	* 111550
		104756	* 111551
		104755	* 111559
		104758	
		104754	

* Z360V-3









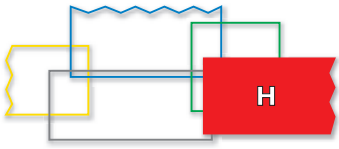
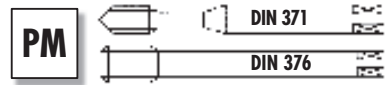



















* Z462VS-3 = 4

UNC











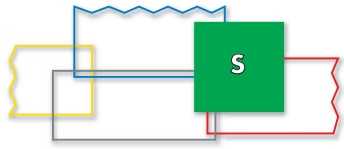













										Z370VS-3	Z470VS-3				
Z370VS-3		VS													
Z470VS-3		VS													
Ø" d ₁ UNC	P TPI	d ₁ mm	l ₁ mm	l ₂ mm	l ₃ mm	d ₂ h6 mm	a mm			ID	ID				
6	32	3.50	56	6.5	20	4.0 (h9)	3.0	3	2.75	166123					
8	32	4.16	63	7.5	21	4.5 (h9)	3.4	3	3.40	166124					
10	24	4.82	70	9.0	25	6.0	4.9	3	3.80	166125					
1/4	20	6.35	80	11.0	30	*6.0	*4.9	3	5.10	166126					
5/16	18	7.93	90	12.5	35	8.0	6.2	3	6.50	166127					
3/8	16	9.52	100	14.0	39	10.0	8.0	3	8.00	166128					
7/16	14	11.11	100	14.0		8.0	6.2	3	9.30		166129				
1/2	13	12.70	110	14.0		*10.0	*8.0	4	10.80		166130				
5/8	11	15.87	110	18.0		12.0	9.0	4	13.60		166131				
3/4	10	19.05	125	21.0		14.0	11.0	4	16.60		166132				
* Norme DC / * DC Norm / * Norma DC															
Ø" d ₁ UNC	P TPI	d ₁ mm	l ₁ mm	l ₂ mm	l ₃ mm	d ₂ h6 mm	a mm			ID					
4	40	2.84	56	5.5	18	3.5 (h9)	2.7	3	2.30	165114					
6	32	3.50	56	6.5	20	4.0 (h9)	3.0	3	2.80	165115					
8	32	4.16	63	7.5	21	4.5 (h9)	3.4	3	3.45	165116					
1/4	20	6.35	80	11.0	30	*6.0	*4.9	3	5.20	165117					
5/16	18	7.93	90	12.5	35	8.0	6.2	3	6.70	165118					
* Norme DC / * DC Norm / * Norma DC															

UNC ANSI B1.1















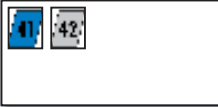

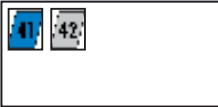













										H320-4	H420-4	H350-3	H450-3												
<p>H320-4  </p> <p>H420-4  </p> <p>H350-3  </p> <p>H450-3  </p>																									
																									
																									
																									
\varnothing " d ₁	P	d ₁	l ₁	l ₂	l ₃	d ₂	a			ID	ID					ID	ID								
UNC	TPI	mm	mm	mm	mm	mm	mm																		
2	56	2.18	45	8.0		2.8	2.1	2	1.75	101221															
4	40	2.84	56	10.0	18	3.5	2.7	3	2.25	101223															
6	32	3.50	56	13.0	20	4.0	3.0	3	2.75	101225															
8	32	4.16	63	14.0	21	4.5	3.4	3	3.40	101226															
10	24	4.82	70	15.0	25	6.0	4.9	3	3.80	101220															
1/4	20	6.35	80	17.0	30	7.0	5.5	3	5.10	101219															
5/16	18	7.93	90	20.0	35	8.0	6.2	3	6.50	101224															
3/8	16	9.52	100	22.0	39	10.0	8.0	3	8.00	101222															
1/2	13	12.70	110	24.0		9.0	7.0	4	10.80							101290									
\varnothing " d ₁	P	d ₁	l ₁	l ₂	l ₃	d ₂	a			ID	ID					ID	ID								
UNC	TPI	mm	mm	mm	mm	mm	mm																		
2	56	2.18	45	8.0		2.8	2.1	2	1.75							101258									
4	40	2.84	56	5.5	18	3.5	2.7	3	2.25							101260									
6	32	3.50	56	6.5	20	4.0	3.0	3	2.75							101262									
8	32	4.16	63	7.5	21	4.5	3.4	3	3.40							101263									
10	24	4.82	70	9.0	25	6.0	4.9	3	3.80							101257									
1/4	20	6.35	80	11.0	30	7.0	5.5	3	5.10							101256									
5/16	18	7.93	90	12.5	35	8.0	6.2	3	6.50							101261									
3/8	16	9.52	100	14.0	39	10.0	8.0	3	8.00							101259									
7/16	14	11.11	100	14.0		8.0	6.2	3	9.30								101330								
1/2	13	12.70	110	14.0		9.0	7.0	4	10.80								101326								
5/8	11	15.87	110	18.0		12.0	9.0	4	13.60								101329								
3/4	10	19.05	125	21.0		14.0	11.0	4	16.60								101328								
1	8	25.40	160	27.0		18.0	14.5	4	22.30								101327								





















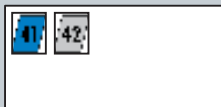





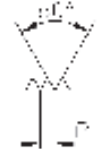









UNC



 											S360VS-3	S460VS-3	SA390-3
											     		
 													
 													
Ø" d ₁ UNC	P TPI	d ₁ mm	l ₁ mm	l ₂ mm	l ₃ mm	d ₂ mm	a mm			ID	ID		
6	32	3.50	56	6.5	20	4.0	3.0	3	2.75	* 111530			
8	32	4.16	63	7.5	21	4.5	3.4	3	3.40	* 111531			
10	24	4.82	70	9.0	25	6.0	4.9	3	3.80	* 111532			
1/4	20	6.35	80	11.0	30	7.0	5.5	3	5.10	* 111533			
5/16	18	7.93	90	12.5	35	8.0	6.2	3	6.50	* 111534			
3/8	16	9.52	100	14.0	39	10.0	8.0	3	8.00	* 111535			
7/16	14	11.11	100	14.0		8.0	6.2	3	9.30		* 111536		
1/2	13	12.70	110	14.0		9.0	7.0	4	10.80		* 111537		
5/8	11	15.87	110	18.0		12.0	9.0	4	13.60		* 111538		
3/4	10	19.05	125	21.0		14.0	11.0	4	16.60		* 111539		
 													
Ø" d ₁ UNC	P TPI	d ₁ mm	l ₁ mm	l ₂ mm		d ₂ mm	a mm			ID			
4	40	2.84	56	12.0		3.5	2.7	3	2.30		149652		
6	32	3.50	56	13.0		4.0	3.0	3	2.80		149666		
8	32	4.16	63	14.0		4.5	3.4	3	3.45		149677		
10	24	4.82	70	15.0		6.0	4.9	3	3.90		149685		
1/4	20	6.35	80	20.0		7.0	5.5	3	5.20		149713		
5/16	18	7.93	90	25.0		8.0	6.2	3	6.70		149726		
3/8	16	9.52	100	30.0		10.0	8.0	3	8.10		149747		

UNC

<h1>AERO</h1>										SA320-4	SA350-3	TL320VS-4	TL351VS-3
<div style="display: flex; justify-content: space-between;"> <div style="width: 45%;"> <p>SA320-4  </p> <p>SA350-3  </p> <p>TL320VS-4  VS </p> <p>TL351VS-3   VS </p> </div> <div style="width: 45%; text-align: center;">     </div> </div>													
													
													
\varnothing " d ₁ UNC	P TPI	d ₁ mm	l ₁ mm	l ₂ mm	l ₃ mm	d ₂ mm	a mm			ID	ID	ID	ID
4	40	2.84	56	12.0		3.5	2.7	3	2.25	147271	149003	* 152000	152018
5	40	3.17	56	12.0		3.5	2.7	3	2.55	* 149031	* 149033	* 152023	* 152024
6	32	3.50	56	13.0		4.0	3.0	3	2.75	149055	149057	* 152027	152028
8	32	4.16	63	14.0		4.5	3.4	3	3.40	149093	149095	* 152036	152037
10	24	4.82	70	15.0		6.0	4.9	3	3.80	149125	149127	* 152042	* 152043
1/4	20	6.35	80	15.0	23	7.0	5.5	3	5.10	149222	149224	* 152062	127972
5/16	18	7.93	90	18.0	29	8.0	6.2	3	6.50	149269	149271	* 152067	152068
3/8	16	9.52	100	20.0	33	10.0	8.0	3	8.00	149346	149348	* 152084	152085
													
\varnothing " d ₁ UNC	P TPI	d ₁ mm	l ₁ mm	l ₂ mm	l ₃ mm	d ₂ mm	a mm			ID	ID	ID	ID
4	40	2.84	56	12.0		3.5	2.7	3	2.30	149005	149007	* 148804	150194
5	40	3.17	56	12.0		3.5	2.7	3	2.60	* 149035	* 149037	* 152025	* 152026
6	32	3.50	56	13.0		4.0	3.0	3	2.80	149059	149061	* 152029	150210
8	32	4.16	63	14.0		4.5	3.4	3	3.45	149097	149099	* 152038	152039
10	24	4.82	70	15.0		6.0	4.9	3	3.90	149129	149131	* 152044	152045
1/4	20	6.35	80	15.0	23	7.0	5.5	3	5.20	149226	149228	* 152063	152064
5/16	18	7.93	90	18.0	29	8.0	6.2	3	6.70	149273	149275	* 152069	152070
3/8	16	9.52	100	20.0	33	10.0	8.0	3	8.10	149350	149352	* 152086	152087

AERO

										SA420-4	SA450-3	TL420VS-4	TL451VS-3
   										   			
   										   			
 										   			
   										   			
Ø" d ₁	P	d ₁	l ₁	l ₂	d ₂	a				ID	ID	ID	ID
UNC	TPI	mm	mm	mm	mm	mm							
7/16	14	11.11	100	22.0	8.0	6.2	* 4	9.30	* 152246	* 152251	* 152256	* 152261	
1/2	13	12.70	110	24.0	9.0	7.0	4	10.80	152247	152252	* 152257	* 152262	
5/8	11	15.87	110	30.0	12.0	9.0	4	13.60	152249	152254			
3/4	10	19.05	125	33.0	14.0	11.0	4	16.60	* 152250	* 152255			
										   			
Ø" d ₁	P	d ₁	l ₁	l ₂	d ₂	a			UNC	ID	ID	ID	ID
UNC	TPI	mm	mm	mm	mm	mm							
7/16	14	11.11	100	22.0	8.0	6.2	* 4	9.40		* 152266	* 152271	* 152276	* 152281
1/2	13	12.70	110	24.0	9.0	7.0	4	10.90		* 152267	* 152272	* 152277	* 152282

* SA420-4 =  3
 * TL420VS-4 =  3

UNC



Uniquement pour taraudage synchrone
Nur für Synchrobearbeitung
Only for rigid tapping
Solo per maschiatura sincrona
Solo para roscado sincronizado



~DIN 371 (d₂ h6)
~DIN 376 (d₂ h6)

RTS Rigid Tapping Synchro

RTS320VS-4



RTS420VS-4



RTS362VS-3



RTS462VS-3



RTS320VS-4

RTS420VS-4

RTS362VS-3

RTS462VS-3



Ø" d ₁ UNC	P TPI	d ₁ mm	l ₁ mm	l ₂ mm	l ₃ mm	d ₂ h6 mm	a mm		
6	32	3.50	56	6.5	20	4.0 (h9)	3.0	3	2.75
8	32	4.16	63	7.5	21	4.5 (h9)	3.4	3	3.40
10	24	4.82	70	9.0	25	6.0	4.9	3	3.80
1/4	20	6.35	80	11.0	30	*6.0	*4.9	3	5.10
5/16	18	7.93	90	12.5	35	8.0	6.2	3	6.50
3/8	16	9.52	100	14.0	39	10.0	8.0	3	8.00
1/2	13	12.70	110	14.0		*10.0	*8.0	3	10.80



ID	ID	ID	ID
157395		157402	
157396		157403	
157397		157404	
157398		157405	
157399		157406	
157400		157407	
	157401		157408

* Norme DC / * DC Norm / * Norma DC



sur demande
auf Anfrage
on request
su richiesta
sobre pedido

FS FPS FAS FORMING

FS380VS-3  **VS** 

FPS381VS-3  **VS** 

FAS381VS-3  **VS** 

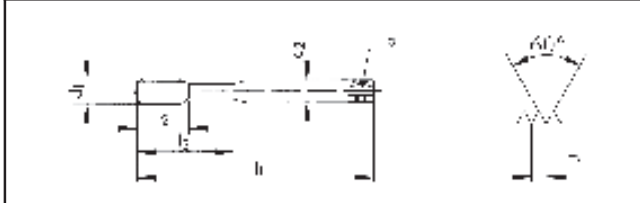

Ø" d ₁ UNC	P TPI	d ₁ mm	l ₁ mm	l ₂ mm	l ₃ mm	d ₂ mm	a mm	Tol.
2	56	2.18	45	9.0		2.8	2.1	1.95 +/- 0.02
4	40	2.84	56	12.0	18	3.5	2.7	2.55 +/- 0.03
6	32	3.50	56	13.0	20	4.0	3.0	3.15 +/- 0.03
8	32	4.16	63	14.0	21	4.5	3.4	3.80 +/- 0.03
10	24	4.82	70	15.0	25	6.0	4.9	4.35 +/- 0.03
1/4	20	6.35	80	17.0	30	7.0	5.5	5.75 +/- 0.03
5/16	18	7.93	90	20.0	35	8.0	6.2	7.30 +/- 0.03

FS380VS-3	FPS381VS-3	FAS381VS-3
-----------	------------	------------

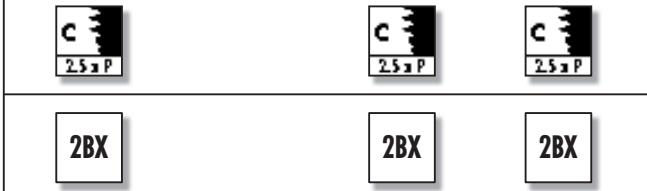

2BX	2BX	2BX
ID	ID	ID
157285		
* 157287	170063	170065
	166713	166725
	166714	166726
	166715	166727
	166716	166728
	166717	166729

UNC

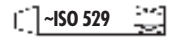























										N1110-1	N1110-2	N1110-3	N1110-S						
N1110-1																			
N1110-2																			
N1110-3																			
N1110-S																			
Ø" d ₁	P	d ₁	l ₁	l ₂	l ₃	d ₂	a			ID	ID	ID	ID						
UNC	TPI	mm	mm	mm	mm	mm	mm												
2	56	2.18	45	9.5		2.80	2.10	3	1.75	102799	102885	102998	111067						
3	48	2.51	45	9.5		2.80	2.10	3	2.00	*102800	*102886	*102999	*111068						
4	40	2.84	48	11.0	18	3.15	2.50	3	2.25	102802	102888	103001	111070						
5	40	3.17	48	11.0	18	3.15	2.50	3	2.55	*102803	*102889	103002	*111071						
6	32	3.50	50	13.0	20	3.55	2.80	3	2.75	102805	102891	103004	111073						
8	32	4.16	53	13.0	21	4.50	3.55	3	3.40	102806	102892	103005	111074						
10	24	4.82	58	16.0	25	5.00	4.00	3	3.80	102797	102883	102996	111065						
1/4	20	6.35	66	19.0	30	6.30	5.00	3	5.10	102796	102882	102995	111064						
5/16	18	7.93	72	22.0	35	8.00	6.30	3	6.50	102804	102890	103003	111072						
3/8	16	9.52	80	24.0	39	10.00	8.00	3	8.00	102801	102887	103000	111069						























										N1210-1	N1210-2	N1210-3	N1210-S	
N1210-1														
N1210-2														
N1210-3														
N1210-S														
												2B	2B	
Ø" d ₁ UNC	P TPI	d ₁ mm	l ₁ mm	l ₂ mm	d ₂ mm	α mm				ID	ID	ID	ID	
7/16	14	11.11	85	22.0	8.0	6.3	3	9.30		103392	103466	103606	111236	
1/2	13	12.70	89	24.0	9.0	7.1	3	10.80		103387	103461	103601	111229	
5/8	11	15.87	102	32.0	12.5	10.0	3	13.60		103391	103465	103605	111235	
3/4	10	19.05	112	33.0	14.0	11.2	3	16.60		103390	103464	103604	111234	
1	8	25.40	130	45.0	18.0	14.0	4	22.30		103388	103462	103602	111230	

UNC

























UNF, UNEF, UNS, UN

Directory - Machine and hand taps ANSI B1.1
 Directorio - Machos para roscar a máquina y a mano ANSI B1.1

		N						
Characteristics Características								
								
Hole type Tipo de agujero								
		N310-3	N320-3 N320-4	N320V-4	N360-3	N360V-3	N1110 -1-3-S	N1120-4
DIN long DIN largo	DIN 371	130	130	130	132	132		
ISO short ISO corto	ISO 529						144	146
Tolerance Tolerancia	UNF 2B	130	130	130	132	132	144	
Tolerance Tolerancia	UNF 3B							
Tolerance Tolerancia	UNF(J) 3B		130		132			
Tolerance Tolerancia	UNEF 2B						146	146
Tolerance Tolerancia	UNS 2B							
Tolerance Tolerancia	UN 2B							
		N410-3	N420-4	N420V-4	N460-3	N460V-3	N1210 -1-3-S	N1220-4
DIN long DIN largo	DIN 374	131	131	131	133	133		
ISO short ISO corto	ISO 529						145	146
Tolerance Tolerancia	UNF 2B	131	131	131	133	133	145	
Tolerance Tolerancia	UNF 3B							
Tolerance Tolerancia	UNF(J) 3B		131		133			
Tolerance Tolerancia	UNEF 2B						146	146
Tolerance Tolerancia	UNS 2B	147			147	147		
Tolerance Tolerancia	UN 2B				147	147		

Z				H		S		SA
								
V	V	VS	VS			VS	VS	
								
								
Z320V-4	Z360V-3	Z360VS-3	Z370VS-3	H320-4	H350-3	S320VS-4	S360VS-3	SA320-4
134	134	135	135	136	137	138	138	140
134	134	135	135	136	137		138	140
			135			138	138	140
Z420V-4	Z460V-3	Z460VS-3	Z470VS-3	H420-4	H450-3	S420VS-4	S460VS-3	SA420-4
134	134	135	135	136	137	138	138	141
134	134	135	135	136	137		138	141
						138	138	141

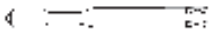
UNF,
UNEF, UNS, UN

		SA		TL		RTS	
Characteristics Características		 HLS	 R10	 VS	 HLS	 VS	 R10
				 VS	 VS	 VS	 VS
							
Hole type Tipo de agujero							
		SA350-3	SA390-3	TL320VS-4	TL351VS-3	RTS320VS-4	RTS362VS-3
DIN long DIN largo	DIN 371	140	139	140	140	142	142
DIN long DIN largo	~ DIN 2184-1						
Tolerance Tolerancia	UNF 2B	140		140	140	142	142
Tolerance Tolerancia	UNF(J) 3B	140	139	140	140		
Tolerance Tolerancia	UNEF 2B						
Tolerance Tolerancia	UNS 2B						
Tolerance Tolerancia	UN 2B						
		SA450-3		TL420VS-4	TL451VS-3	RTS420VS-4	RTS462VS-3
DIN long DIN largo	DIN 374	141		141	141	142	142
DIN long DIN largo	~ DIN 2184-1						
Tolerance Tolerancia	UNF 2B	141		141	141	142	142
Tolerance Tolerancia	UNF(J) 3B	141		141	141		
Tolerance Tolerancia	UNEF 2B						
Tolerance Tolerancia	UNS 2B						
Tolerance Tolerancia	UN 2B						

UNF ANSI B1.1

≤ Ø 2.8 > Ø 2.8

PM

HSSE





DIN 371



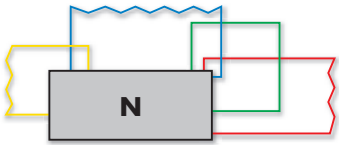

										N310-3	N320-3	N320-4	N320V-4
N310-3													
N320-3													
N320-4													
N320V-4	V												
										C 2.5 x P	C 2.5 x P	B 4 x P	B 4 x P
										2B	2B	2B	2B
Ø" d ₁	P	d ₁	l ₁	l ₂	l ₃	d ₂	a			ID	ID	ID	ID
UNF	TPI	mm	mm	mm	mm	mm	mm						
0	80	1.52	40	7.0		2.5	2.1	2	1.20		101475		
1	72	1.85	40	8.0		2.5	2.1	2	1.50		101476		
2	64	2.18	45	9.0		2.8	2.1	2	1.80		101477		
4	48	2.84	56	12.0	18	3.5	2.7	3	2.35			128847	
5	44	3.17	56	12.0	18	3.5	2.7	3	2.60			142764	
6	40	3.50	56	13.0	20	4.0	3.0	3	2.90			101519	142765
8	36	4.16	63	14.0	21	4.5	3.4	3	3.50			101520	
10	32	4.82	70	15.0	25	6.0	4.9	3	4.05			101517	142766
12	28	5.48	80	17.0	30	6.0	4.9	3	4.60			101518	
1/4	28	6.35	80	17.0	30	7.0	5.5	3	5.50	101453		101516	142767
										3B UNF(J)			
Ø" d ₁	P	d ₁	l ₁	l ₂	l ₃	d ₂	a				ID		
UNF	TPI	mm	mm	mm	mm	mm	mm						
10	32	4.82	70	15.0	25	6.0	4.9	3	4.10			135506	
1/4	28	6.35	80	17.0	30	7.0	5.5	3	5.55			155323	

UNF ANSI B1.1



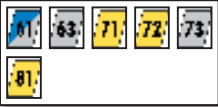

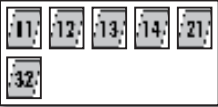

N410-3  

N420-4  

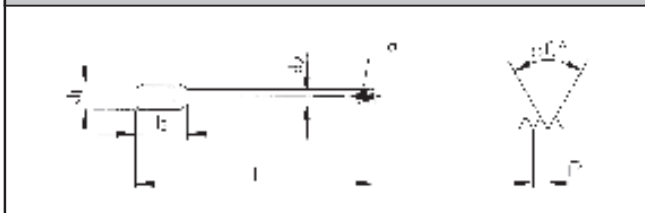

N420V-4   

N410-3	N420-4	N420V-4	
--------	--------	---------	--



		
---	---	---

2B	2B	2B
-----------	-----------	-----------

\varnothing " d ₁ UNF	P TPI	d ₁ mm	l ₁ mm	l ₂ mm	d ₂ mm	α mm		
5/16	24	7.93	90	20.0	6.0	4.9	3	6.90
3/8	24	9.52	100	22.0	7.0	5.5	3	8.50
7/16	20	11.11	100	19.0	8.0	6.2	3	9.80
1/2	20	12.70	100	24.0	9.0	7.0	3	11.40
9/16	18	14.28	100	24.0	11.0	9.0	3	12.90
5/8	18	15.87	100	26.0	12.0	9.0	3	14.50
3/4	16	19.05	125	33.0	14.0	11.0	4	17.50
7/8	14	22.22	140	36.0	18.0	14.5	4	20.40
1	12	25.40	160	39.0	18.0	14.5	4	23.30
1 1/8	12	28.57	180	39.0	22.0	18.0	4	26.50
1 1/4	12	31.75	180	39.0	22.0	18.0	4	29.70
1 3/8	12	34.92	200	36.0	28.0	22.0	4	32.80
1 1/2	12	38.10	200	41.0	32.0	24.0	4	36.00

ID	ID	ID
102004	102223	142774
102003	102222	142775
102006	102225	142776
102000	102219	142777
	102227	
102005	102224	142778
102002	102221	142779
102007	102226	
* 102001	102220	142780
	142773	
	102218	
	105137	
* 110986	105138	

\varnothing " d ₁ UNF	P TPI	d ₁ mm	l ₁ mm	l ₂ mm	d ₂ mm	α mm		
---------------------------------------	----------	----------------------	----------------------	----------------------	----------------------	----------------	---	---

3B UNF(J)

5/16	24	7.93	90	20.0	6.0	4.9	3	7.00
3/8	24	9.52	100	22.0	7.0	5.5	3	8.60
7/16	20	11.11	100	19.0	8.0	6.2	3	10.00
1/2	20	12.70	100	24.0	9.0	7.0	3	11.55

ID
155328
155326
155330
155321

UNF



										N360-3	N360V-3		
<p>N360-3</p>													
\varnothing " d ₁	P	d ₁	l ₁	l ₂	l ₃	d ₂	α			ID	ID		
UNF	TPI	mm	mm	mm	mm	mm	mm						
6	40	3.50	56	6.5	20	4.0	3.0	3	2.90	101686			
8	36	4.16	63	7.5	21	4.5	3.4	3	3.50	101687	101733		
10	32	4.82	70	9.0	25	6.0	4.9	3	4.05	101682	101730		
12	28	5.48	80	11.0	30	6.0	4.9	3	4.60	101683			
1/4	28	6.35	80	11.0	30	7.0	5.5	3	5.50	101681	101729		
5/16	24	7.93	90	12.5	35	8.0	6.2	3	6.90	101685	101732		
3/8	24	9.52	100	14.0	39	10.0	8.0	3	8.50	101684	101731		
\varnothing " d ₁	P	d ₁	l ₁	l ₂	l ₃	d ₂	α			ID			
UNF	TPI	mm	mm	mm	mm	mm	mm						
10	32	4.82	70	9.0	25	6.0	4.9	3	4.10	155325			
1/4	28	6.35	80	11.0	30	7.0	5.5	3	5.55	155324			
5/16	24	7.93	90	12.5	35	8.0	6.2	3	7.00	155329			
3/8	24	9.52	100	14.0	39	10.0	8.0	3	8.60	155327			

UNF ANSI B1.1

Z .20
PM

Z .60
HSSE

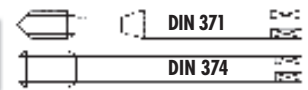

										Z320V-4	Z420V-4	Z360V-3	Z460V-3
Z320V-4													
Z420V-4													
Z360V-3													
Z460V-3													
\varnothing " d ₁	P	d ₁	l ₁	l ₂	l ₃	d ₂	a			ID	ID		
UNF	TPI	mm	mm	mm	mm	mm	mm						
10	32	4.82	70	15.0	25	6.0	4.9	3	4.05	142783			
1/4	28	6.35	80	17.0	30	7.0	5.5	3	5.50	142784			
5/16	24	7.93	90	20.0	35	8.0	6.2	3	6.90	142785			
3/8	24	9.52	100	22.0	39	10.0	8.0	3	8.50	142786			
7/16	20	11.11	100	19.0		8.0	6.2	3	9.80		142787		
1/2	20	12.70	100	24.0		9.0	7.0	3	11.40		142788		
\varnothing " d ₁	P	d ₁	l ₁	l ₂	l ₃	d ₂	a			ID	ID		
UNF	TPI	mm	mm	mm	mm	mm	mm						
10	32	4.82	70	9.0	25	6.0	4.9	3	4.05		104680		
1/4	28	6.35	80	11.0	30	7.0	5.5	3	5.50		104679		
5/16	24	7.93	90	12.5	35	8.0	6.2	3	6.90		104682		
3/8	24	9.52	100	14.0	39	10.0	8.0	3	8.50		104681		
7/16	20	11.11	100	14.0		8.0	6.2	3	9.80			104741	
1/2	20	12.70	100	14.0		9.0	7.0	3	11.40			104738	
5/8	18	15.87	100	14.0		12.0	9.0	3	14.50			104740	
3/4	16	19.05	125	18.0		14.0	11.0	4	17.50			104739	

UNF ANSI B1.1



										Z360VS-3	Z460VS-3	Z370VS-3	Z470VS-3	
Z360VS-3		VS												
Z460VS-3		VS												
Z370VS-3		VS												
Z470VS-3		VS												
\varnothing " d ₁	P	d ₁	l ₁	l ₂	l ₃	d ₂	a			ID	ID			
UNF	TPI	mm	mm	mm	mm	mm	mm							
10	32	4.82	70	9.0	25	6.0	4.9	3	4.05	* 111576				
1/4	28	6.35	80	11.0	30	7.0	5.5	3	5.50	* 111575				
5/16	24	7.93	90	12.5	35	8.0	6.2	3	6.90	* 111574				
3/8	24	9.52	100	14.0	39	10.0	8.0	3	8.50	* 111573				
7/16	20	11.11	100	14.0		8.0	6.2	3	9.80		* 111572			
1/2	20	12.70	100	14.0		9.0	7.0	4	11.40		* 111571			
\varnothing " d ₁	P	d ₁	l ₁	l ₂	l ₃	d ₂ h6	a			ID	ID			
UNF	TPI	mm	mm	mm	mm	mm	mm							
10	32	4.82	70	9.0	25	6.0	4.9	3	4.05		166136			
1/4	28	6.35	80	11.0	30	*6.0	*4.9	3	5.50		166135			
5/16	24	7.93	90	12.5	35	8.0	6.2	3	6.90		166134			
3/8	24	9.52	100	14.0	39	10.0	8.0	3	8.50		166133			
7/16	20	11.11	100	14.0		8.0	6.2	3	9.80			166138		
1/2	20	12.70	110	14.0		*10.0	*8.0	4	11.40			166137		
										* Norme DC / * DC Norm / * Norma DC				
\varnothing " d ₁	P	d ₁	l ₁	l ₂	l ₃	d ₂ h6	a			ID				
UNF	TPI	mm	mm	mm	mm	mm	mm							
10	32	4.82	70	9.0	25	6.0	4.9	3	4.10	165121				
1/4	28	6.35	80	11.0	30	*6.0	*4.9	3	5.55	165122				
5/16	24	7.93	90	12.5	35	8.0	6.2	3	7.00	165123				
3/8	24	9.52	100	14.0	39	10.0	8.0	3	8.60	165124				
										* Norme DC / * DC Norm / * Norma DC				

UNF

UNF ANSI B1.1

PM



										H320-4	H420-4		
H320-4													
H420-4													
Ø" d ₁	P	d ₁	l ₁	l ₂	l ₃	d ₂	a			ID	ID		
UNF	TPI	mm	mm	mm	mm	mm	mm						
10	32	4.82	70	15.0	25	6.0	4.9	3	4.05	101228			
1/4	28	6.35	80	17.0	30	7.0	5.5	3	5.50	101227			
5/16	24	7.93	90	20.0	35	8.0	6.2	3	6.90	105139			
3/8	24	9.52	100	22.0	39	10.0	8.0	3	8.50	101229			
1/2	20	12.70	100	24.0		9.0	7.0	4	11.40		101291		
3/4	16	19.05	125	33.0		14.0	11.0	4	17.50		* 101292		

UNF ANSI B1.1

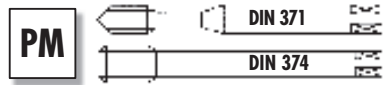

										H350-3	H450-3		
H350-3													
H450-3													
Ø" d ₁ UNF	P TPI	d ₁ mm	l ₁ mm	l ₂ mm	l ₃ mm	d ₂ mm	α mm			ID	ID		
10	32	4.82	70	9.0	25	6.0	4.9	3	4.05	101265			
1/4	28	6.35	80	11.0	30	7.0	5.5	3	5.50	101264			
5/16	24	7.93	90	12.5	35	8.0	6.2	3	6.90	101267			
3/8	24	9.52	100	14.0	39	10.0	8.0	3	8.50	101266			
7/16	20	11.11	100	14.0		8.0	6.2	3	9.80		101334		
1/2	20	12.70	100	14.0		9.0	7.0	4	11.40		101331		
5/8	18	15.87	100	14.0		12.0	9.0	4	14.50		101333		
3/4	16	19.05	125	18.0		14.0	11.0	4	17.50		101332		

UNF

		S		AERO		S320VS-4	S420VS-4	S360VS-3	S460VS-3		
S320VS-4											
S420VS-4											
S360VS-3											
S460VS-3											
\varnothing d ₁ UNF	P TPI	d ₁ mm	l ₁ mm	l ₂ mm	l ₃ mm	d ₂ mm	a mm			ID	ID
10	32	4.82	70	15.0	25	6.0	4.9	3	4.10	111814	
1/4	28	6.35	80	17.0	30	7.0	5.5	3	5.55	111813	
5/16	24	7.93	90	20.0	35	8.0	6.2	3	7.00	111816	
3/8	24	9.52	100	22.0	39	10.0	8.0	3	8.60	111818	
7/16	20	11.11	100	22.0		8.0	6.2	3	10.00		111837
\varnothing d ₁ UNF	P TPI	d ₁ mm	l ₁ mm	l ₂ mm	l ₃ mm	d ₂ mm	a mm			ID	ID
10	32	4.82	70	9.0	25	6.0	4.9	3	4.05		* 111581
1/4	28	6.35	80	11.0	30	7.0	5.5	3	5.50		* 111582
5/16	24	7.93	90	12.5	35	8.0	6.2	3	6.90		* 111583
3/8	24	9.52	100	14.0	39	10.0	8.0	3	8.50		* 111584
7/16	20	11.11	100	14.0		8.0	6.2	3	9.80		* 111585
1/2	20	12.70	100	14.0		9.0	7.0	4	11.40		* 111586
\varnothing d ₁ UNF	P TPI	d ₁ mm	l ₁ mm	l ₂ mm	l ₃ mm	d ₂ mm	a mm			ID	ID
10	32	4.82	70	9.0	25	6.0	4.9	3	4.10	111815	
1/4	28	6.35	80	11.0	30	7.0	5.5	3	5.55	111820	
5/16	24	7.93	90	12.5	35	8.0	6.2	3	7.00	111817	
3/8	24	9.52	100	14.0	39	10.0	8.0	3	8.60	111819	
7/16	20	11.11	100	14.0		8.0	6.2	3	10.00		111833



AERO

SA390-3































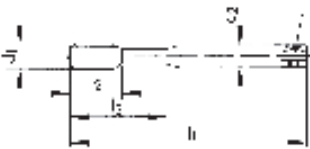







SA390-3





















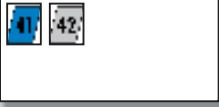
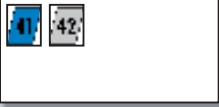























\varnothing " d_1 UNF	P TPI	d_1 mm	l_1 mm	l_2 mm	d_2 mm	a mm			ID
10	32	4.82	70	15.0	6.0	4.9	3	4.10	149687
1/4	28	6.35	80	20.0	7.0	5.5	3	5.55	149715
5/16	24	7.93	90	25.0	8.0	6.2	3	7.00	149728
3/8	24	9.52	100	30.0	10.0	8.0	3	8.60	149745

UNF

<h1>AERO</h1>										SA320-4	SA350-3	TL320VS-4	TL351VS-3						
<div style="display: flex; justify-content: space-between;"> <div style="width: 45%;"> <p>SA320-4  </p> <p>SA350-3  </p> <p>TL320VS-4  VS </p> <p>TL351VS-3   VS </p> </div> <div style="width: 45%; text-align: center;">     </div> </div>										       									
 										   									
   										   									
\varnothing " d ₁	P	d ₁	l ₁	l ₂	l ₃	d ₂	a			ID	ID	ID	ID						
UNF	TPI	mm	mm	mm	mm	mm	mm		UNF										
10	32	4.82	70	15.0		6.0	4.9	3	4.05	149133	149135	* 152046	152047						
1/4	28	6.35	80	15.0	23	7.0	5.5	3	5.50	149230	149232	* 152065	152066						
5/16	24	7.93	90	18.0	29	8.0	6.2	3	6.90	149277	149279	* 152071	152072						
3/8	24	9.52	100	20.0	33	10.0	8.0	3	8.50	149339	149341	* 152082	152083						
4	48	2.84	56	12.0		3.5	2.7	3	2.35		149015								
10	32	4.82	70	15.0		6.0	4.9	3	4.10	146098	149138	* 148005	148004						
1/4	28	6.35	80	15.0	23	7.0	5.5	3	5.55	146404	149235	* 148013	148012						
5/16	24	7.93	90	18.0	29	8.0	6.2	3	7.00	146393	149282	* 148017	148016						
3/8	24	9.52	100	20.0	33	10.0	8.0	3	8.60	147165	149344	* 148024	148023						

AERO

										SA420-4	SA450-3	TL420VS-4	TL451VS-3																																																																														
   										   																																																																																	
   										   																																																																																	
 										   																																																																																	
<table border="1"> <thead> <tr> <th>Ø" d₁</th> <th>P</th> <th>d₁</th> <th>l₁</th> <th>l₂</th> <th>d₂</th> <th>a</th> <th></th> <th></th> <th>ID</th> <th>ID</th> <th>ID</th> <th>ID</th> </tr> <tr> <th>UNF</th> <th>TPI</th> <th>mm</th> <th>mm</th> <th>mm</th> <th>mm</th> <th>mm</th> <th></th> <th></th> <th></th> <th></th> <th></th> <th></th> </tr> </thead> <tbody> <tr> <td>7/16</td> <td>20</td> <td>11.11</td> <td>100</td> <td>22.0</td> <td>8.0</td> <td>6.2</td> <td>*4</td> <td>9.80</td> <td>152286</td> <td>152290</td> <td>* 152294</td> <td>152298</td> </tr> <tr> <td>1/2</td> <td>20</td> <td>12.70</td> <td>100</td> <td>24.0</td> <td>9.0</td> <td>7.0</td> <td>4</td> <td>11.40</td> <td>152287</td> <td>152291</td> <td>* 152295</td> <td>152299</td> </tr> <tr> <td>9/16</td> <td>18</td> <td>14.28</td> <td>100</td> <td>24.0</td> <td>11.0</td> <td>9.0</td> <td>4</td> <td>12.90</td> <td>* 152288</td> <td></td> <td></td> <td></td> </tr> <tr> <td>5/8</td> <td>18</td> <td>15.87</td> <td>100</td> <td>26.0</td> <td>12.0</td> <td>9.0</td> <td>4</td> <td>14.50</td> <td>* 152289</td> <td></td> <td></td> <td></td> </tr> </tbody> </table>										Ø" d ₁	P	d ₁	l ₁	l ₂	d ₂	a			ID	ID	ID	ID	UNF	TPI	mm	mm	mm	mm	mm							7/16	20	11.11	100	22.0	8.0	6.2	*4	9.80	152286	152290	* 152294	152298	1/2	20	12.70	100	24.0	9.0	7.0	4	11.40	152287	152291	* 152295	152299	9/16	18	14.28	100	24.0	11.0	9.0	4	12.90	* 152288				5/8	18	15.87	100	26.0	12.0	9.0	4	14.50	* 152289				   			
Ø" d ₁	P	d ₁	l ₁	l ₂	d ₂	a			ID	ID	ID	ID																																																																															
UNF	TPI	mm	mm	mm	mm	mm																																																																																					
7/16	20	11.11	100	22.0	8.0	6.2	*4	9.80	152286	152290	* 152294	152298																																																																															
1/2	20	12.70	100	24.0	9.0	7.0	4	11.40	152287	152291	* 152295	152299																																																																															
9/16	18	14.28	100	24.0	11.0	9.0	4	12.90	* 152288																																																																																		
5/8	18	15.87	100	26.0	12.0	9.0	4	14.50	* 152289																																																																																		
<table border="1"> <thead> <tr> <th>Ø" d₁</th> <th>P</th> <th>d₁</th> <th>l₁</th> <th>l₂</th> <th>d₂</th> <th>a</th> <th></th> <th></th> <th>ID</th> <th>ID</th> <th>ID</th> <th>ID</th> </tr> <tr> <th>UNF</th> <th>TPI</th> <th>mm</th> <th>mm</th> <th>mm</th> <th>mm</th> <th>mm</th> <th></th> <th></th> <th></th> <th></th> <th></th> <th></th> </tr> </thead> <tbody> <tr> <td>7/16</td> <td>20</td> <td>11.11</td> <td>100</td> <td>22.0</td> <td>8.0</td> <td>6.2</td> <td>*4</td> <td>10.00</td> <td>147187</td> <td>152302</td> <td>* 152306</td> <td>148031</td> </tr> <tr> <td>1/2</td> <td>20</td> <td>12.70</td> <td>100</td> <td>24.0</td> <td>9.0</td> <td>7.0</td> <td>4</td> <td>11.55</td> <td>147189</td> <td>152303</td> <td>* 152307</td> <td>152310</td> </tr> <tr> <td>9/16</td> <td>18</td> <td>14.28</td> <td>100</td> <td>24.0</td> <td>11.0</td> <td>9.0</td> <td>4</td> <td>13.05</td> <td>146395</td> <td></td> <td></td> <td></td> </tr> <tr> <td>5/8</td> <td>18</td> <td>15.87</td> <td>100</td> <td>26.0</td> <td>12.0</td> <td>9.0</td> <td>4</td> <td>14.60</td> <td>147169</td> <td></td> <td></td> <td></td> </tr> </tbody> </table>										Ø" d ₁	P	d ₁	l ₁	l ₂	d ₂	a			ID	ID	ID	ID	UNF	TPI	mm	mm	mm	mm	mm							7/16	20	11.11	100	22.0	8.0	6.2	*4	10.00	147187	152302	* 152306	148031	1/2	20	12.70	100	24.0	9.0	7.0	4	11.55	147189	152303	* 152307	152310	9/16	18	14.28	100	24.0	11.0	9.0	4	13.05	146395				5/8	18	15.87	100	26.0	12.0	9.0	4	14.60	147169				   			
Ø" d ₁	P	d ₁	l ₁	l ₂	d ₂	a			ID	ID	ID	ID																																																																															
UNF	TPI	mm	mm	mm	mm	mm																																																																																					
7/16	20	11.11	100	22.0	8.0	6.2	*4	10.00	147187	152302	* 152306	148031																																																																															
1/2	20	12.70	100	24.0	9.0	7.0	4	11.55	147189	152303	* 152307	152310																																																																															
9/16	18	14.28	100	24.0	11.0	9.0	4	13.05	146395																																																																																		
5/8	18	15.87	100	26.0	12.0	9.0	4	14.60	147169																																																																																		
<p>* SA420-4 =  3</p> <p>* TL420VS-4 =  3</p>																																																																																											

UNF



RTS

Rigid Tapping Synchro

RTS320VS-4



RTS420VS-4

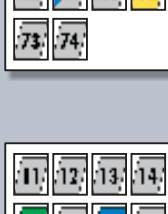

RTS362VS-3



RTS462VS-3

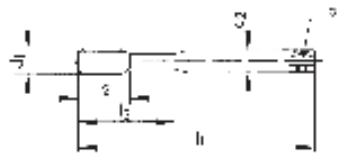
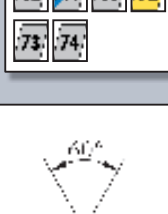

RTS320VS-4

RTS420VS-4

RTS362VS-3

RTS462VS-3



Ø" d ₁	P	d ₁	l ₁	l ₂	l ₃	d ₂ h ₆	a		
UNF	TPI	mm	mm	mm	mm	mm	mm		
10	32	4.82	70	9.0	25	6.0	4.9	3	4.05
1/4	28	6.35	80	11.0	30	*6.0	*4.9	3	5.50
5/16	24	7.93	90	12.5	35	8.0	6.2	3	6.90
3/8	24	9.52	100	14.0	39	10.0	8.0	3	8.50
1/2	20	12.70	110	14.0		*10.0	*8.0	3	11.40

ID	ID	ID	ID
157409		157413	
157410		157414	
157411		157415	
157412		157416	
	157417		157418

* Norme DC / * DC Norm / * Norma DC



sur demande
auf Anfrage
on request
su richiesta
sobre pedido

FS FPS FAS FORMING

FS380VS-5  **VS**

11	12	13	14
15	21	22	23
24	41	51	61
63	71	72	73

FPS381VS-3  **VS**

11	12	13	14	15
21	24			

FAS381VS-3  **VS**

12	13	14	15	21	22
23	24	41	51	61	63

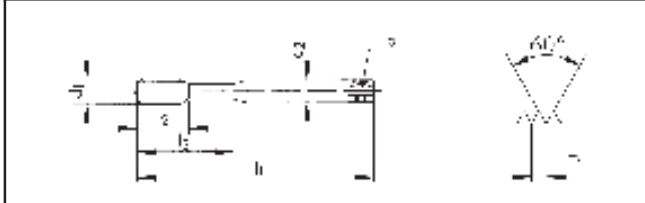

Ø" d ₁ UNF	P TPI	d ₁ mm	l ₁ mm	l ₂ mm	l ₃ mm	d ₂ mm	a mm	Tol.
0	80	1.52	40	4.6		2.5	1.37	+/- 0.01
10	32	4.82	70	15.0	25	6.0	4.9	4.45 +/- 0.03
1/4	28	6.35	80	17.0	30	7.0	5.5	5.95 +/- 0.03
5/16	24	7.93	90	20.0	35	8.0	6.2	7.45 +/- 0.03

FS380VS-5	FPS381VS-3	FAS381VS-3
-----------	------------	------------



ID	ID	ID
161498	166718	166730
	166719	166731
	166720	166732

UNF

UNF ANSI B1.1

HSSE

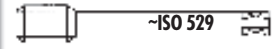

										N1210-1	N1210-3	N1210-S	
N1210-1													
N1210-3													
N1210-S													
\varnothing d ₁ UNF	P TPI	d ₁ mm	l ₁ mm	l ₂ mm	d ₂ mm	a mm			ID	ID	ID		
7/16	20	11.11	85	22.0	8.0	6.3	3	9.80	103411	103626	111255		
1/2	20	12.70	89	24.0	9.0	7.1	3	11.40	103407	103622	111251		
5/8	18	15.87	102	32.0	12.5	10.0	3	14.50	103410	103625	111254		
3/4	16	19.05	112	33.0	14.0	11.2	4	17.50	103409	103624	111253		
7/8	14	22.22	115	32.0	16.0	12.5	4	20.40	103412	103627	111256		
1	12	25.40	130	45.0	18.0	14.0	4	23.30	103408	103623	111252		

UNF









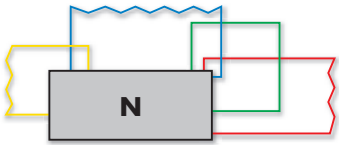



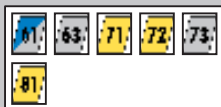

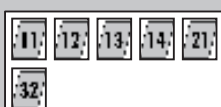



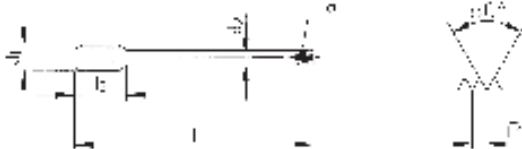

										N1110-3	N1120-4	N1210-3	N1220-4
N1110-3													
N1120-4													
N1210-3													
N1220-4													
Ø" d ₁	P	d ₁	l ₁	l ₂	l ₃	d ₂	a			ID	ID	ID	ID
UNEF	TPI	mm	mm	mm	mm	mm	mm						
12	32	5.48	62	17.0	26	5.6	4.5	3	4.70	103007	103118		
1/4	32	6.35	66	19.0	30	6.3	5.0	3	5.60	103006	103117		
5/16	32	7.93	72	22.0	35	8.0	6.3	3	7.20	103009	103120		
3/8	32	9.52	80	24.0	39	10.0	8.0	3	8.75	103008	103119		
7/16	28	11.11	85	22.0		8.0	6.3	3	10.25			103615	103754
1/2	28	12.70	89	24.0		9.0	7.1	3	11.85			103609	103749
9/16	24	14.28	95	24.0		11.2	9.0	3	13.20			103617	103756
5/8	24	15.87	102	32.0		12.5	10.0	3	14.80			103614	103753
11/16	24	17.46	104	26.0		14.0	11.2	*3	16.40			103611	* 103751
3/4	20	19.05	112	33.0		14.0	11.2	4	17.80			103613	103752
7/8	20	22.22	115	32.0		16.0	12.5	4	21.00			103616	* 103755
1	20	25.40	120	30.0		18.0	14.0	4	24.10			103610	* 103750

* N1210-3 = 4

UNS, UN ANSI B1.1

























										N410-3	N460-3	N460V-3	
<p>N410-3  </p> <p>N460-3  </p> <p>N460V-3   </p>										  			
													
													
										2B	2B	2B	
\varnothing " d_1	P	d_1	l_1	l_2	d_2	a				ID	ID	ID	
UN	TPI	mm	mm	mm	mm	mm							
1/4	36	6.35	80	17.0	4.5	3.4	3	5.65		104899			
1/2	24	12.70	100	24.0	9.0	7.0	3	11.60		104900			
1	14	25.40	140	34.0	18.0	14.5	4	23.60		104898			
1	14	25.40	140	22.0	18.0	14.5	4	23.60			102437	142789	
\varnothing " d_1	P	d_1	l_1	l_2	d_2	a				ID	ID		
UN	TPI	mm	mm	mm	mm	mm							
1 1/8	8	28.57	180	30.0	22.0	18.0	4	25.50			102415	142790	
1 1/4	8	31.75	180	30.0	22.0	18.0	4	28.70			102414	142520	
1 3/8	8	34.92	200	36.0	28.0	22.0	5	31.80			104896	142792	
1 1/2	8	38.10	200	40.0	32.0	24.0	5	35.00			102413	142793	
1 3/4	8	44.45	220	44.0	36.0	29.0	5	41.40				115198	
2	8	50.80	250	38.0	40.0	32.0	5	47.70				111622	







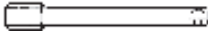















UNEF, UNS, UN

G Directory - Machine taps G (BSP) DIN ISO 228

Directorio - Machos para roscar a máquina G (gas) DIN ISO 228

		N						
Characteristics Características				 V	 TiN	 R10	 R10 V	 R10 V
								
Hole type Tipo de agujero								
								
		N410-3	N420-4	N420V-4	N420TN-4	N460-3	N460V-3	N462V-3
<i>DIN long</i> DIN largo	DIN 5156	152	153	153	153	154	154	154
<i>DIN short</i> DIN corto	DIN 5157							
<i>LH Left hand thread</i> LH Rosca izquierda	DIN 5156	152						

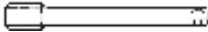

	Z	H	GG	RTS	RTS	FPS	FAS
Characteristics Características	 R45 VS	 R25	 R15 NI	 R40 VS	 R40 VS	 VS	 VS
	 NEW				 NEW	 NEW	 NEW
Hole type Tipo de agujero							
							
	Z470VS-3	H450-3	GG450NI-3	RTS462VS-3	RTS462VS-5	FPS481VS-3	FAS481VS-3
<i>DIN long</i> DIN largo	DIN 5156	155	155				
<i>DIN long</i> DIN largo	~DIN 376	157		157	157		
<i>DIN long</i> DIN largo	~DIN 2189					158	158

									N410-3	N410-3 LH						
N410-3																
N410-3 LH		LH														
\varnothing " d ₁	P	d ₁	l ₁	l ₂	d ₂	a			ID	ID						
G	TPI	mm	mm	mm	mm	mm										
1/8	28	9.72	90	22.0	7.0	5.5	3	8.75	101855	* 101856						
1/4	19	13.15	100	20.0	11.0	9.0	3	11.60	101853	101854						
3/8	19	16.66	100	20.0	12.0	9.0	4	15.20	101861	101862						
1/2	14	20.95	125	22.0	16.0	12.0	4	18.90	101851	101852						
3/4	14	26.44	140	28.0	20.0	16.0	4	24.40	101859	101860						
1	11	33.24	160	32.0	25.0	20.0	4	30.70	101857	101858						
1 1/4	11	41.91	170	32.0	32.0	24.0	5	39.30	101850							
1 1/2	11	47.80	190	32.0	36.0	29.0	5	45.20	101849							

G DIN ISO 228 (BSP)



										N420-4	N420V-4	N420TN-4		
N420-4														
N420V-4														
N420TN-4														
$\varnothing^r d_1$ G	P TPI	d_1 mm	l_1 mm	l_2 mm	d_2 mm	α mm					ID	ID	ID	
1/16	28	7.72	90	18.0	6.0	4.9	3	6.75			102045			
1/8	28	9.72	90	22.0	7.0	5.5	3	8.75			102048	102258	102236	
1/4	19	13.15	100	20.0	11.0	9.0	3	11.60			102047	102257	102235	
3/8	19	16.66	100	20.0	12.0	9.0	3	15.20			102053	102261	102238	
1/2	14	20.95	125	22.0	16.0	12.0	4	18.90			102046	102256	102234	
5/8	14	22.91	125	25.0	18.0	14.5	4	20.90			102054	144722		
3/4	14	26.44	140	28.0	20.0	16.0	4	24.40			102052	102260	102237	
1	11	33.24	160	32.0	25.0	20.0	4	30.70			102049	102259		
1 1/4	11	41.91	170	32.0	32.0	24.0	5	39.30			102043			
1 1/2	11	47.80	190	32.0	36.0	29.0	5	45.20			102042			
2	11	59.61	220	36.0	45.0	35.0	5	57.00			102051			
2 1/2	11	75.18	280	36.0	50.0	39.0	6	72.60			102050			

G

										N460-3	N460V-3	N460TN-3	N462V-3
N460-3													
N460V-3													
N460TN-3													
N462V-3													
$\varnothing^r d_1$ G	P TPI	d_1 mm	l_1 mm	l_2 mm	d_2 mm	α mm				ID	ID	ID	ID
1/16	28	7.72	90	12.5	6.0	4.9	3	6.75		102341			
1/8	28	9.72	90	14.0	7.0	5.5	3	8.75		102344	102457	102444	143687
1/4	19	13.15	100	14.0	11.0	9.0	3	11.60		102343	102456	102443	143600
3/8	19	16.66	100	14.0	12.0	9.0	4	15.20		102348	102460	102446	143431
1/2	14	20.95	125	20.0	16.0	12.0	4	18.90		102342	102455	102442	143921
5/8	14	22.91	125	20.0	18.0	14.5	4	20.90		102349	143711		
3/4	14	26.44	140	22.0	20.0	16.0	4	24.40		102347	102459	102445	143688
7/8	14	30.20	150	24.0	22.0	18.0	4	28.20		*102350			
1	11	33.24	160	26.0	25.0	20.0	4	30.70		102345	102458		
1 1/4	11	41.91	170	30.0	32.0	24.0	5	39.30		102340	111608		
1 1/2	11	47.80	190	35.0	36.0	29.0	5	45.20		102339	111609		
2	11	59.61	220	41.0	45.0	35.0	6	57.00		102346	111503		

G DIN ISO 228 (BSP)

H
PM HSSE
≤ Ø 25.4 > Ø 25.4

GG W
PM HSSE

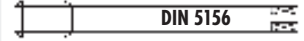

									W460-5		H450-3	GG450NI-3
W460-5 												
H450-3 												
GG450NI-3 												
Ø" d ₁ G	P TPI	d ₁ mm	l ₁ mm	l ₂ mm	d ₂ mm	a mm			ID	ID		
1/8	28	9.72	90	14.0	7.0	5.5	3	8.75	119350	101298		
1/4	19	13.15	100	14.0	11.0	9.0	*4	11.60	119300	101297		
3/8	19	16.66	100	14.0	12.0	9.0	4	15.20	119682	101301		
1/2	14	20.95	125	20.0	16.0	12.0	4	18.90	119199	101296		
3/4	14	26.44	140	22.0	20.0	16.0	4	24.40		101300		
1	11	33.24	160	26.0	25.0	20.0	4	30.70		101299		
* W460-5 = 3												
Ø" d ₁ G	P TPI	d ₁ mm	l ₁ mm	l ₂ mm	d ₂ mm	a mm			ID			
1/8	28	9.72	90	22.0	7.0	5.5	4	8.75	102309			
1/4	19	13.15	100	20.0	11.0	9.0	4	11.60	102308			
3/8	19	16.66	100	20.0	12.0	9.0	4	15.20	102312			
1/2	14	20.95	125	22.0	16.0	12.0	4	18.90	102307			
3/4	14	26.44	140	28.0	20.0	16.0	4	24.40	102311			
1	11	33.24	160	32.0	25.0	20.0	4	30.70	102310			

G DIN ISO 228 (BSP)

< Ø 25.4 > Ø 25.4
PM **HSSE** **HSSE**
 Z420 Z420 Z460



										Z420V-4	Z420VS-4	Z460V-3	Z460VS-3
Z420V-4													
Z420VS-4													
Z460V-3													
Z460VS-3													
Ø" d ₁ G	P TPI	d ₁ mm	l ₁ mm	l ₂ mm	d ₂ mm	α mm			ID	ID			
1/8	28	9.72	90	22.0	7.0	5.5	3	8.75	142794	142800			
1/4	19	13.15	100	20.0	11.0	9.0	3	11.60	142795	119303			
3/8	19	16.66	100	20.0	12.0	9.0	3	15.20	142796	142802			
1/2	14	20.95	125	22.0	16.0	12.0	4	18.90	142797	142803			
3/4	14	26.44	140	28.0	20.0	16.0	4	24.40	142798				
1	11	33.24	160	32.0	25.0	20.0	4	30.70	142799				
Ø" d ₁ G	P TPI	d ₁ mm	l ₁ mm	l ₂ mm	d ₂ mm	α mm			ID	ID			
1/8	28	9.72	90	14.0	7.0	5.5	3	8.75	104726	* 111577			
1/4	19	13.15	100	14.0	11.0	9.0	*3	11.60	104725	* 111578			
3/8	19	16.66	100	14.0	12.0	9.0	4	15.20	104728	* 111579			
1/2	14	20.95	125	20.0	16.0	12.0	4	18.90	104724	* 111580			
3/4	14	26.44	140	22.0	20.0	16.0	4	24.40	104727				
1	11	33.24	160	26.0	25.0	20.0	4	30.70	105142				

* Z460VS-3 = 4

G DIN ISO 228 (BSP)



Uniquement pour taraudage synchrone
Nur für Synchrobearbeitung
Only for rigid tapping
Solo per maschiatura sincrona
Solo para roscado sincronizado

PM

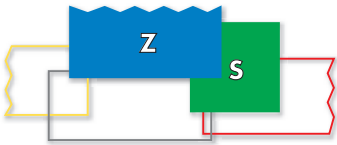

Z470VS-3



VS



RTS

Rigid Tapping Synchro

RTS462VS-3



VS



RTS462VS-5



VS

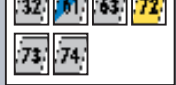

Z470VS-3

RTS462VS-3

RTS462VS-5



NEW



NEW



\varnothing " d ₁ G	P TPI	d ₁ mm	l ₁ mm	l ₂ mm	d ₂ h6 mm	a mm		
1/8	28	9.72	100	14.0	*8.0	*6.2	3	8.75
1/4	19	13.15	110	14.0	*12.0	*9.0	4	11.60
3/8	19	16.66	110	18.0	12.0	9.0	4	15.20
1/2	14	20.95	125	20.0	16.0	12.0	4	18.90

* Norme DC / * DC Norm / * Norma DC

ID

165198
165199
165200
165201

\varnothing " d ₁ G	P TPI	d ₁ mm	l ₁ mm	l ₂ mm	d ₂ h6 mm	a mm		
1/8	28	9.72	100	14.0	*8.0	*6.2	3	8.75
1/4	19	13.15	110	14.0	*12.0	*9.0	3	11.60
3/8	19	16.66	110	18.0	12.0	9.0	4	15.20
1/2	14	20.95	125	20.0	16.0	12.0	4	18.90











* Norme DC / * DC Norm / * Norma DC

ID

ID



sur demande
auf Anfrage
on request
su richiesta
sobre pedido

<div style="display: flex; justify-content: space-between; align-items: center;"> <div style="font-size: 2em; font-weight: bold;">FPS FAS</div> <div style="text-align: center;">  </div> </div>										FPS481VS-3	FAS481VS-3												
<div style="display: flex; justify-content: space-between; align-items: center;"> <div style="text-align: center;"> FPS481VS-3  VS </div> <div style="border: 1px solid black; padding: 2px;"> <table border="1" style="font-size: 0.8em;"> <tr><td>11</td><td>12</td><td>13</td><td>14</td><td>15</td></tr> <tr><td>21</td><td>24</td><td></td><td></td><td></td></tr> </table> </div> </div>										11	12	13	14	15	21	24							
11	12	13	14	15																			
21	24																						
<div style="display: flex; justify-content: space-between; align-items: center;"> <div style="text-align: center;"> FAS481VS-3  VS </div> <div style="border: 1px solid black; padding: 2px;"> <table border="1" style="font-size: 0.8em;"> <tr><td>12</td><td>13</td><td>14</td><td>15</td><td>21</td><td>22</td></tr> <tr><td>23</td><td>24</td><td>41</td><td>51</td><td>61</td><td>63</td></tr> </table> </div> </div>										12	13	14	15	21	22	23	24	41	51	61	63	NEW	NEW
12	13	14	15	21	22																		
23	24	41	51	61	63																		
																							
																							
\varnothing d ₁ G	P TPI	d ₁ mm	l ₁ mm	l ₂ mm	d ₂ mm	α mm		Tol.	ID	ID													
1/8	28	9.72	90	22.0	7.0	5.5	9.25	+/- 0.05	166721	166733													
1/4	19	13.15	100	20.0	11.0	9.0	12.50	+/- 0.05	166722	166734													
3/8	19	16.66	100	20.0	12.0	9.0	16.00	+/- 0.05	166723	166735													
1/2	14	20.95	125	22.0	16.0	12.0	20.00	+/- 0.05	166724	166736													

G DIN ISO 228 (BSP)

HSSE



									N210-1	N210-3	N210-S		
N210-1													
N210-3													
N210-S													
$\varnothing^* d_1$ G	P TPI	d_1 mm	l_1 mm	l_2 mm	d_2 mm	a mm			ID	ID	ID		
1/16	28	7.72	63	18.0	6.0	4.9	3	6.75	* 101401	101418	* 119173		
1/8	28	9.72	63	22.0	7.0	5.5	3	8.75	101404	101421	119386		
1/4	19	13.15	70	20.0	11.0	9.0	3	11.60	101403	101420	119336		
3/8	19	16.66	70	20.0	12.0	9.0	4	15.20	101409	101427	119338		
1/2	14	20.95	80	22.0	16.0	12.0	4	18.90	101402	101419	119264		
5/8	14	22.91	80	25.0	18.0	14.5	4	20.90	101411	105140	110940		
3/4	14	26.44	90	28.0	20.0	16.0	4	24.40	101408	101426	110937		
7/8	14	30.20	90	28.0	22.0	18.0	4	28.20	* 101412	* 101429	* 110941		
1	11	33.24	100	32.0	25.0	20.0	4	30.70	101405	101422	110933		
1 1/8	11	37.89	125	32.0	28.0	22.0	4	35.30		101415			
1 1/4	11	41.91	125	32.0	32.0	24.0	5	39.30	101400	101414	111425		
1 3/8	11	44.32	125	32.0	36.0	29.0	5	41.80		101417			
1 1/2	11	47.80	140	32.0	36.0	29.0	5	45.20	101399	101413	110934		
1 3/4	11	53.74	140	36.0	40.0	32.0	5	51.20		101416			
2	11	59.61	160	36.0	45.0	35.0	5	57.00	101407	101425	110935		
2 1/4	11	65.71	160	36.0	50.0	39.0	6	63.10		* 101424			
2 1/2	11	75.18	160	36.0	50.0	39.0	6	72.60		101423			
3	11	87.88	160	40.0	50.0	39.0	6	85.30		101428			

G

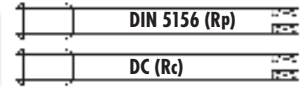

Rp, Rc DIN EN 10226

HSSE

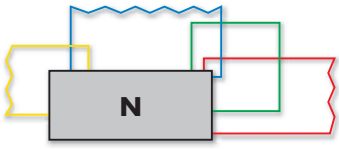

		N420-3		N410-3																																																																							
<table border="1"> <thead> <tr> <th>Ø" d₁ Rp</th> <th>P TPI</th> <th>d₁ mm</th> <th>l₁ mm</th> <th>l₂ mm</th> <th>d₂ mm</th> <th>a mm</th> <th colspan="2"> </th> <th>ID</th> </tr> </thead> <tbody> <tr><td>1/8</td><td>28</td><td>9.72</td><td>90</td><td>22.0</td><td>7.0</td><td>5.5</td><td>3</td><td>8.60</td><td>104911</td></tr> <tr><td>1/4</td><td>19</td><td>13.15</td><td>100</td><td>20.0</td><td>11.0</td><td>9.0</td><td>3</td><td>11.50</td><td>104912</td></tr> <tr><td>3/8</td><td>19</td><td>16.66</td><td>100</td><td>20.0</td><td>12.0</td><td>9.0</td><td>3</td><td>15.00</td><td>104913</td></tr> <tr><td>1/2</td><td>14</td><td>20.95</td><td>125</td><td>22.0</td><td>16.0</td><td>12.0</td><td>4</td><td>18.50</td><td>104914</td></tr> <tr><td>3/4</td><td>14</td><td>26.44</td><td>140</td><td>28.0</td><td>20.0</td><td>16.0</td><td>4</td><td>24.00</td><td>104915</td></tr> <tr><td>1</td><td>11</td><td>33.24</td><td>160</td><td>32.0</td><td>25.0</td><td>20.0</td><td>4</td><td>30.25</td><td>104916</td></tr> </tbody> </table>		Ø" d ₁ Rp	P TPI	d ₁ mm	l ₁ mm	l ₂ mm	d ₂ mm	a mm			ID	1/8	28	9.72	90	22.0	7.0	5.5	3	8.60	104911	1/4	19	13.15	100	20.0	11.0	9.0	3	11.50	104912	3/8	19	16.66	100	20.0	12.0	9.0	3	15.00	104913	1/2	14	20.95	125	22.0	16.0	12.0	4	18.50	104914	3/4	14	26.44	140	28.0	20.0	16.0	4	24.00	104915	1	11	33.24	160	32.0	25.0	20.0	4	30.25	104916				
Ø" d ₁ Rp	P TPI	d ₁ mm	l ₁ mm	l ₂ mm	d ₂ mm	a mm			ID																																																																		
1/8	28	9.72	90	22.0	7.0	5.5	3	8.60	104911																																																																		
1/4	19	13.15	100	20.0	11.0	9.0	3	11.50	104912																																																																		
3/8	19	16.66	100	20.0	12.0	9.0	3	15.00	104913																																																																		
1/2	14	20.95	125	22.0	16.0	12.0	4	18.50	104914																																																																		
3/4	14	26.44	140	28.0	20.0	16.0	4	24.00	104915																																																																		
1	11	33.24	160	32.0	25.0	20.0	4	30.25	104916																																																																		
<table border="1"> <thead> <tr> <th>Ø" d₁ Rc</th> <th>P TPI</th> <th>d₁ mm</th> <th>l₁ mm</th> <th>l₂ mm</th> <th>d₂ mm</th> <th>a mm</th> <th colspan="2"> </th> <th>ID</th> </tr> </thead> <tbody> <tr><td>1/8</td><td>28</td><td>9.72</td><td>71</td><td>13.0</td><td>8.0</td><td>6.2</td><td>5</td><td></td><td>104917</td></tr> <tr><td>1/4</td><td>19</td><td>13.15</td><td>80</td><td>20.0</td><td>11.0</td><td>9.0</td><td>5</td><td></td><td>104918</td></tr> <tr><td>3/8</td><td>19</td><td>16.66</td><td>90</td><td>20.0</td><td>12.0</td><td>9.0</td><td>5</td><td></td><td>104919</td></tr> <tr><td>1/2</td><td>14</td><td>20.95</td><td>100</td><td>26.0</td><td>16.0</td><td>12.0</td><td>5</td><td></td><td>104920</td></tr> <tr><td>3/4</td><td>14</td><td>26.44</td><td>110</td><td>26.0</td><td>20.0</td><td>16.0</td><td>5</td><td></td><td>104921</td></tr> <tr><td>1</td><td>11</td><td>33.24</td><td>125</td><td>32.0</td><td>25.0</td><td>20.0</td><td>5</td><td></td><td>104922</td></tr> </tbody> </table>		Ø" d ₁ Rc	P TPI	d ₁ mm	l ₁ mm	l ₂ mm	d ₂ mm	a mm			ID	1/8	28	9.72	71	13.0	8.0	6.2	5		104917	1/4	19	13.15	80	20.0	11.0	9.0	5		104918	3/8	19	16.66	90	20.0	12.0	9.0	5		104919	1/2	14	20.95	100	26.0	16.0	12.0	5		104920	3/4	14	26.44	110	26.0	20.0	16.0	5		104921	1	11	33.24	125	32.0	25.0	20.0	5		104922				
Ø" d ₁ Rc	P TPI	d ₁ mm	l ₁ mm	l ₂ mm	d ₂ mm	a mm			ID																																																																		
1/8	28	9.72	71	13.0	8.0	6.2	5		104917																																																																		
1/4	19	13.15	80	20.0	11.0	9.0	5		104918																																																																		
3/8	19	16.66	90	20.0	12.0	9.0	5		104919																																																																		
1/2	14	20.95	100	26.0	16.0	12.0	5		104920																																																																		
3/4	14	26.44	110	26.0	20.0	16.0	5		104921																																																																		
1	11	33.24	125	32.0	25.0	20.0	5		104922																																																																		

Rp, Rc	Vc (m/min) Ø d1			
	1/16" - 1/4"	3/8" - 1/2"	3/4" - 1"	1.1/4" - 2"
	6	5	4	3
	5	4	3	2
	10	8	7	5
	18	15	13	10

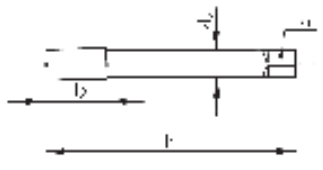
					D5800			
D5800 								
								
\varnothing'' Rc	l_1 mm	l_2 mm	d_2 mm	a mm	ID			
1/16	70	17.0	6.0	4.9	118701			
1/8	70	17.0	8.0	6.2	110531			
1/4	80	27.0	10.0	8.0	110530			
3/8	85	27.0	12.0	9.0	110535			
1/2	95	35.0	16.0	12.0	110529			
3/4	105	35.0	20.0	16.0	110534			
1	130	43.0	25.0	20.0	110532			

Core hole diameters for tapered pipe thread to DIN EN 10226 Taladros previos para roscas gas cónicas, según DIN EN 10226

Parallel hole
Increased tap wear, not recommended

Taladros previos cilíndricos
Desgaste más rápido del macho. A evitar.

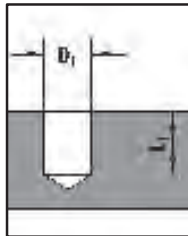

Tapered hole 1:16
Pre-drill at $\varnothing D_2$ and taper-ream to $\varnothing D_3$

Taladros previos cónicos 1:16
Taladrar cilíndrico según $\varnothing D_2$ y escariar cónico según $\varnothing D_3$

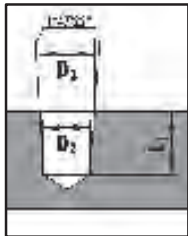

Tapped hole
Engage tap to hole depth $L_2 = \text{nominal } \varnothing$

Roscar
Roscar hasta la profundidad $L_2 = \varnothing \text{ nominal}$

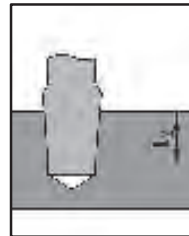

\varnothing'' Rc	L_1 min. mm	D_1 mm	D_2 mm	D_3 mm	L_2 mm
1/16	11.90	6.20	6.10	6.56	10.574
1/8	11.90	8.20	8.10	8.57	10.574
1/4	17.70	11.00	10.75	11.45	15.679
3/8	18.10	14.50	14.25	14.95	16.079
1/2	24.00	18.00	17.75	18.63	21.349
3/4	25.30	23.50	23.00	24.12	21.465
1	30.60	29.50	29.00	30.29	26.227



										N1110-1	N1110-2	N1110-3	N1120-4
N1110-1													
N1110-2													
N1110-3													
N1120-4													
Ø" d ₁	P	d ₁	l ₁	l ₂	l ₃	d ₂	a			ID	ID	ID	ID
W	TPI	mm	mm	mm	mm	mm	mm						
1/8	40	3.17	48	11.0	18	3.15	2.50	3	2.50	* 102825	* 102894	103025	103126
5/32	32	3.96	53	13.0	21	4.00	3.15	3	3.10	* 102830	* 102898	103031	103130
3/16	24	4.76	58	16.0	25	5.00	4.00	3	3.60	* 102826	* 102895	103026	103127
1/4	20	6.35	66	19.0	30	6.30	5.00	3	4.90	* 102824	* 102893	103024	103125
5/16	18	7.93	72	22.0	35	8.00	6.30	3	6.40			103030	103129
3/8	16	9.52	80	24.0	39	10.00	8.00	3	7.70	* 102827	* 102896	103028	103128

W BS 84 (BSW)

HSSE











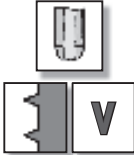

										N1210-1	N1210-2	N1210-3	N1220-4
N1210-1													
N1210-2													
N1210-3													
N1220-4													
\varnothing d ₁ W	P TPI	d ₁ mm	l ₁ mm	l ₂ mm	d ₂ mm	α mm			ID	ID	ID	ID	
7/16	14	11.11	85	22.0	8.0	6.3	3	9.10	* 103425	* 103476	103642	103771	
1/2	12	12.70	89	24.0	9.0	7.1	3	10.30	* 103417	* 103471	103634	103767	
9/16	12	14.28	95	24.0	11.2	9.0	3	11.90			* 103644		
5/8	11	15.87	102	32.0	12.5	10.0	3	13.30	* 103424	* 103475	103641	103770	
3/4	10	19.05	112	33.0	14.0	11.2	3	16.20	* 103423	* 103474	103640	103769	
1	8	25.40	130	45.0	18.0	14.0	4	21.90	* 103418	* 103472	103635	* 103768	

W





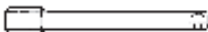



















NPT, NPTF

Directory - Machine taps, NPT ANSI B1.20.1 and NPTF B1.20.3
Machos para roscar a máquina NPT ANSI B1.20.1 y NPTF B1.20.3

		N						
Characteristics Características			 V	 V				
								
Hole type Tipo de agujero								
								
		N410-3	N410V-3	N411V-3	D5800			
NPT DIN long NPT DIN largo	DC	166	166	166	167			
NPTF DIN long NPTF DIN largo	DC	166			167			

PG, TR

Directory - Machine and hand taps, PG DIN 40430, TR ISO 2901-2904, DIN 103
 Machos para roscar a máquina y a mano PG DIN 40430, TR ISO 2901-2904, DIN 103

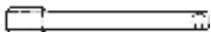
		N						
Characteristics Características								
								
								
Hole type Tipo de agujero								
								
	N420-3	N410-1	N410-2	N410-3	N410-S	N410-8		
PG DIN long PG DIN largo	DIN 40433	168						
TR DIN long TR DIN largo	DC	169	169	169	169	168		
Tolerance Tolerancia	TR 7H			169	169	168		

NPT, NPTF
PG, TR

NPT, NPTF

ANSI B1.20.1, ANSI B1.20.3



							N410-3	N410V-3	N411V-3	N410-3
N410-3										
N410V-3	V									
N411V-3	V									
N410-3										
\varnothing d ₁ NPT, NPTF	P TPI	l ₁ mm	l ₂ mm	d ₂ mm	a mm		ID	ID	ID	ID
1/16	27	71	13.0	7.0	5.5	3	101961	102021	102031	101971
1/8	27	71	13.0	8.0	6.2	5	101964	102024	102034	101974
1/4	18	80	20.0	11.0	9.0	5	101963	102023	102033	101973
3/8	18	90	20.0	12.0	9.0	5	101968	102028	102038	101978
1/2	14	100	26.0	16.0	12.0	5	101962	102022	102032	101972
3/4	14	110	26.0	20.0	16.0	5	101967	102027	102037	101977
1	11.5	125	32.0	25.0	20.0	5	101965	102025	102035	101975
1 1/4	11.5	125	32.0	32.0	24.0	5	101960	102020		
1 1/2	11.5	140	32.0	36.0	29.0	5	101959	102019		* 101969
2	11.5	160	32.0	36.0	29.0	7	101966	102026		* 101976

NPT, NPTF	Vc (m/min) Ø d1			
	1/16" - 1/4"	3/8" - 1/2"	3/4" - 1"	1.1/4" - 2"
	6	5	4	3
	5	4	3	2
	10	8	7	5
	18	15	13	10

NPT, NPTF

ANSI B1.20.1, ANSI B1.20.3

HSSE



					D5800
D5800					
\varnothing "	L_1	L_2	d_2	α	ID 118701 110531 110530 110535 110529 110534 110532
NPT, NPTF	mm	mm	mm	mm	
1/16	70	17.0	6.0	4.9	
1/8	70	17.0	8.0	6.2	
1/4	80	27.0	10.0	8.0	
3/8	85	27.0	12.0	9.0	
1/2	95	35.0	16.0	12.0	
3/4	105	35.0	20.0	16.0	
1	130	43.0	25.0	20.0	

Core hole diameters for NPT and NPTF threads Taladros previos para roscas NPT y NPTF

Parallel hole
Increased tap wear, not recommended

Taladros previos cilíndricos
Desgaste más rápido del macho. A evitar.

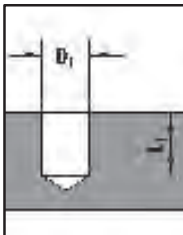

Tapered hole 1:16
Pre-drill at $\varnothing D_1$ and taper-ream to $\varnothing D_2$

Taladros previos cónicos 1:16
Taladrar cilíndrico según $\varnothing D_1$ y escariar cónico según $\varnothing D_2$

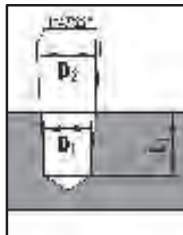

Tapped hole
Engage tap to hole depth $L_2 = \text{nominal } \varnothing$

Roscar
Roscar hasta la profundidad $L_2 = \varnothing \text{ nominal}$

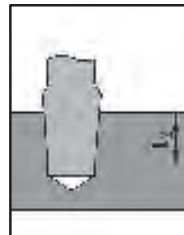

*Taper-ream at upper limit D_2 is recommended

*Es recomendado de escariar D_2 al máximo

\varnothing "	L_1 min.	D_1	* D_2 mini	* D_2 maxi	L_2
NPT, NPTF	mm	mm	mm	mm	mm
1/16	11.40	6.00	6.413	6.505	10.179
1/8	11.65	8.30	8.760	8.852	10.217
1/4	16.85	10.80	11.397	11.483	14.958
3/8	17.20	14.20	14.836	14.922	15.268
1/2	22.25	17.50	18.333	18.419	19.920
3/4	22.70	22.80	23.678	23.764	20.403
1	27.20	28.65	29.726	29.812	24.518



NPT, NPTF

PG DIN 40430 TR ISO 2901-2904, DIN 103

HSSE

DIN 40433	
DC	

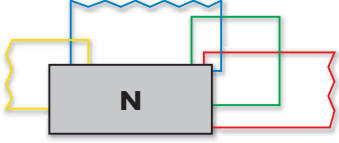
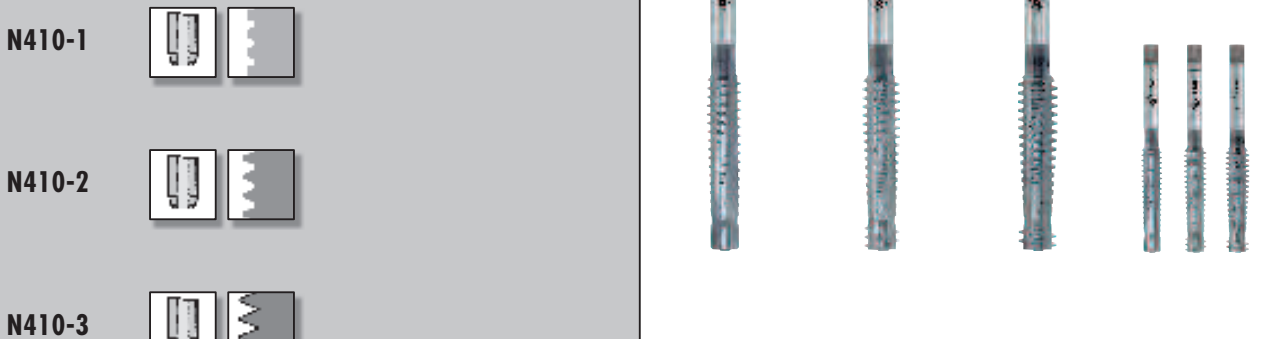
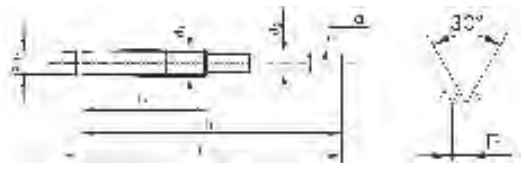



















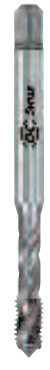



		N420-3			N410-8																																																																																																				
N420-3	 	 		 																																																																																																					
N410-8	 	 		 																																																																																																					
<table border="1"> <thead> <tr> <th>Ø d₁</th> <th>P</th> <th>d₁</th> <th>l₁</th> <th>l₂</th> <th>d₂</th> <th>a</th> <th></th> <th></th> <th>ID</th> </tr> <tr> <th>PG</th> <th>TPI</th> <th>mm</th> <th>mm</th> <th>mm</th> <th>mm</th> <th>mm</th> <th></th> <th></th> <th></th> </tr> </thead> <tbody> <tr><td>7</td><td>20</td><td>12.50</td><td>100</td><td>24.0</td><td>9.0</td><td>7.0</td><td>3</td><td>11.30</td><td>104901</td></tr> <tr><td>9</td><td>18</td><td>15.20</td><td>100</td><td>26.0</td><td>12.0</td><td>9.0</td><td>3</td><td>13.90</td><td>104902</td></tr> <tr><td>11</td><td>18</td><td>18.60</td><td>110</td><td>26.0</td><td>14.0</td><td>11.0</td><td>4</td><td>17.30</td><td>104903</td></tr> <tr><td>13.5</td><td>18</td><td>20.40</td><td>125</td><td>28.0</td><td>16.0</td><td>12.0</td><td>4</td><td>19.10</td><td>104904</td></tr> <tr><td>16</td><td>18</td><td>22.50</td><td>125</td><td>28.0</td><td>18.0</td><td>14.5</td><td>4</td><td>21.20</td><td>104905</td></tr> <tr><td>21</td><td>16</td><td>28.30</td><td>150</td><td>36.0</td><td>22.0</td><td>18.0</td><td>4</td><td>26.80</td><td>104906</td></tr> <tr><td>29</td><td>16</td><td>37.00</td><td>170</td><td>38.0</td><td>28.0</td><td>22.0</td><td>4</td><td>35.50</td><td>104907</td></tr> <tr><td>36</td><td>16</td><td>47.00</td><td>190</td><td>38.0</td><td>36.0</td><td>29.0</td><td>5</td><td>45.50</td><td>104908</td></tr> </tbody> </table>		Ø d ₁	P	d ₁	l ₁	l ₂	d ₂	a			ID	PG	TPI	mm	mm	mm	mm	mm				7	20	12.50	100	24.0	9.0	7.0	3	11.30	104901	9	18	15.20	100	26.0	12.0	9.0	3	13.90	104902	11	18	18.60	110	26.0	14.0	11.0	4	17.30	104903	13.5	18	20.40	125	28.0	16.0	12.0	4	19.10	104904	16	18	22.50	125	28.0	18.0	14.5	4	21.20	104905	21	16	28.30	150	36.0	22.0	18.0	4	26.80	104906	29	16	37.00	170	38.0	28.0	22.0	4	35.50	104907	36	16	47.00	190	38.0	36.0	29.0	5	45.50	104908	 		 	
Ø d ₁	P	d ₁	l ₁	l ₂	d ₂	a			ID																																																																																																
PG	TPI	mm	mm	mm	mm	mm																																																																																																			
7	20	12.50	100	24.0	9.0	7.0	3	11.30	104901																																																																																																
9	18	15.20	100	26.0	12.0	9.0	3	13.90	104902																																																																																																
11	18	18.60	110	26.0	14.0	11.0	4	17.30	104903																																																																																																
13.5	18	20.40	125	28.0	16.0	12.0	4	19.10	104904																																																																																																
16	18	22.50	125	28.0	18.0	14.5	4	21.20	104905																																																																																																
21	16	28.30	150	36.0	22.0	18.0	4	26.80	104906																																																																																																
29	16	37.00	170	38.0	28.0	22.0	4	35.50	104907																																																																																																
36	16	47.00	190	38.0	36.0	29.0	5	45.50	104908																																																																																																
<table border="1"> <thead> <tr> <th>Ø d₁</th> <th>P</th> <th>l₁₁</th> <th>l₂</th> <th>d₁₀</th> <th>d₂</th> <th>a</th> <th></th> <th></th> <th>ID</th> </tr> <tr> <th>TR</th> <th>mm</th> <th>mm</th> <th>mm</th> <th>mm</th> <th>mm</th> <th>mm</th> <th></th> <th></th> <th></th> </tr> </thead> <tbody> <tr><td>10</td><td>2.00</td><td>100</td><td>45.0</td><td>8.20</td><td>7.0</td><td>5.5</td><td>3</td><td>8.20</td><td>102008</td></tr> <tr><td>12</td><td>3.00</td><td>140</td><td>75.0</td><td>9.25</td><td>8.0</td><td>6.2</td><td>3</td><td>9.25</td><td>102009</td></tr> <tr><td>14</td><td>3.00</td><td>150</td><td>75.0</td><td>11.25</td><td>10.0</td><td>8.0</td><td>3</td><td>11.25</td><td>102010</td></tr> <tr><td>16</td><td>4.00</td><td>180</td><td>100.0</td><td>12.25</td><td>11.0</td><td>9.0</td><td>3</td><td>12.25</td><td>102011</td></tr> <tr><td>18</td><td>4.00</td><td>180</td><td>100.0</td><td>14.25</td><td>12.0</td><td>9.0</td><td>3</td><td>14.25</td><td>102012</td></tr> <tr><td>20</td><td>4.00</td><td>190</td><td>100.0</td><td>16.25</td><td>14.0</td><td>11.0</td><td>3</td><td>16.25</td><td>102013</td></tr> <tr><td>22</td><td>5.00</td><td>220</td><td>110.0</td><td>17.25</td><td>16.0</td><td>12.0</td><td>4</td><td>17.25</td><td>111616</td></tr> <tr><td>24</td><td>5.00</td><td>220</td><td>110.0</td><td>19.25</td><td>18.0</td><td>14.5</td><td>4</td><td>19.25</td><td>102015</td></tr> </tbody> </table>		Ø d ₁	P	l ₁₁	l ₂	d ₁₀	d ₂	a			ID	TR	mm	mm	mm	mm	mm	mm				10	2.00	100	45.0	8.20	7.0	5.5	3	8.20	102008	12	3.00	140	75.0	9.25	8.0	6.2	3	9.25	102009	14	3.00	150	75.0	11.25	10.0	8.0	3	11.25	102010	16	4.00	180	100.0	12.25	11.0	9.0	3	12.25	102011	18	4.00	180	100.0	14.25	12.0	9.0	3	14.25	102012	20	4.00	190	100.0	16.25	14.0	11.0	3	16.25	102013	22	5.00	220	110.0	17.25	16.0	12.0	4	17.25	111616	24	5.00	220	110.0	19.25	18.0	14.5	4	19.25	102015	 		 	
Ø d ₁	P	l ₁₁	l ₂	d ₁₀	d ₂	a			ID																																																																																																
TR	mm	mm	mm	mm	mm	mm																																																																																																			
10	2.00	100	45.0	8.20	7.0	5.5	3	8.20	102008																																																																																																
12	3.00	140	75.0	9.25	8.0	6.2	3	9.25	102009																																																																																																
14	3.00	150	75.0	11.25	10.0	8.0	3	11.25	102010																																																																																																
16	4.00	180	100.0	12.25	11.0	9.0	3	12.25	102011																																																																																																
18	4.00	180	100.0	14.25	12.0	9.0	3	14.25	102012																																																																																																
20	4.00	190	100.0	16.25	14.0	11.0	3	16.25	102013																																																																																																
22	5.00	220	110.0	17.25	16.0	12.0	4	17.25	111616																																																																																																
24	5.00	220	110.0	19.25	18.0	14.5	4	19.25	102015																																																																																																

										N410-1	N410-2	N410-3	N410-S
													
										7H		7H	
$\varnothing d_1$ TR	P mm	l_{11} mm	l_2 mm	d_{10} mm	d_2 mm	a mm			ID	ID	ID	ID	
10	2.00	85	30.0	8.20	7.0	5.5	3	8.20	101827	101838	101979	110972	
12	3.00	115	45.0	9.25	8.0	6.2	3	9.25	101828	101839	101980	110973	
16	4.00	165	65.0	12.25	11.0	9.0	3	12.25	101830	101841	101982	110975	
20	4.00	175	65.0	16.25	14.0	11.0	3	16.25	101832	101843	101984	110977	

PG, TR



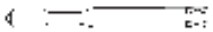

















EG Directory - Machine taps for wire screw thread inserts EG M, EG UNC, EG UNF

Directorio - Machos para rosca a máquina para insertos metálicos, EG M, EG UNC, EG UNF

	N				Z	S	
Characteristics Características 		 V	 R40	 V	 R45 VS	 VS	 R45 VS
					 NEW		
Hole type Tipo de agujero							
	N320-4	N320V-4	N360-3	N360V-3	Z370VS-3	S320VS-4	S360VS-3
DIN long DIN largo	~DIN 40435	172	172	173	173		
DIN long DIN largo	~DIN 2184-1	176/179		176/179		177/180	181
Thread Rosca	EG M	172	172	173	173		
Thread Rosca	EG UNC	176		176		177	
Thread Rosca	EG UNF	179		179		180	181
	N420-4	N420V-4	N460-3	N460V-3			
DIN long DIN largo	~DIN 40435	172	172	173	173		
DIN long DIN largo	~DIN 2184-1	176/179		176/179			
Thread Rosca	EG M	172	172	173	173		
Thread Rosca	EG UNC	176		176			
Thread Rosca	EG UNF	179		179			

EG

Directory - Machine taps for wire screw thread inserts, EG M, EG UNC, EG UNF
 Directorio - Machos para roscar a máquina para insertos metálicos, EG M, EG UNC, EG UNF

SA			TL	
				
				
				
				
SA320-4	SA350-3	SA390-3	TL320VS-4	TL351VS-3
174	174	175	174	174
178/182	178/182	181	178/182	178/182
174	174	175	174	174
178	178		178	178
182	182	181	182	182

**THREADING
TECHNOLOGY**

DC[®]

www.dcswiss.com

EG M, EG UN

EG M ISO DIN 8140



≤ Ø 2.8 > Ø 2.8

PM **HSSE**



~DIN 40435

~DIN 40435

										N320-4	N320V-4	N420-4	N420V-4
N320-4													
N320V-4	V												
N420-4													
N420V-4	V												
Ø d ₁	P	d ₁	l ₁	l ₂	l ₃	d ₂	a			ID	ID	ID	ID
EG M	mm	mm	mm	mm	mm	mm	mm						
2	0.40	2.520	50	10.0		2.8	2.1	3	2.10	101537	118788		
2.5	0.45	3.084	56	12.0	18	3.5	2.7	3	2.65	101538			
3	0.50	3.650	56	13.0	20	4.0	3.0	3	3.15	101539	142804		
4	0.70	4.910	70	15.0	25	6.0	4.9	3	4.20	101540	142805		
5	0.80	6.040	80	17.0	30	6.0	4.9	3	5.25	101541	142806		
6	1.00	7.300	80	17.0	30	7.0	5.5	3	6.30	101542	142807		
8	1.25	9.624	100	22.0	39	10.0	8.0	3	8.40	101543	142808		
10	1.50	11.948	100	24.0		9.0	7.0	3	10.40			102252	142809
12	1.75	14.274	110	28.0		11.0	9.0	3	12.50			102253	142810
14	2.00	16.598	110	30.0		12.0	9.0	3	14.60			* 110987	* 142811
16	2.00	18.598	125	33.0		14.0	11.0	3	16.60			102255	142812

EG M ISO DIN 8140



≤ Ø 2.8 > Ø 2.8

PM



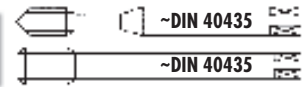

























HSSE



										N360-3	N360V-3	N460-3	N460V-3
N360-3													
N360V-3	V												
N460-3													
N460V-3	V												
Ø d ₁ EG M	P mm	d ₁ mm	l ₁ mm	l ₂ mm	l ₃ mm	d ₂ mm	a mm			ID	ID	ID	ID
2	0.40	2.520	50	9.0		2.8	2.1	2	2.10	101599			
2.5	0.45	3.084	56	5.5	18	3.5	2.7	3	2.65	101600			
3	0.50	3.650	56	6.5	20	4.0	3.0	3	3.15	101601	142813		
4	0.70	4.910	70	9.0	25	6.0	4.9	3	4.20	101602	142814		
5	0.80	6.040	80	11.0	30	6.0	4.9	3	5.25	101603	142815		
6	1.00	7.300	80	11.0	30	7.0	5.5	3	6.30	101604	142816		
8	1.25	9.624	100	14.0	39	10.0	8.0	3	8.40	101605	142817		
10	1.50	11.948	100	14.0		9.0	7.0	3	10.40			102335	142818
12	1.75	14.274	110	14.0		11.0	9.0	3	12.50			102336	142819
14	2.00	16.598	110	18.0		12.0	9.0	3	14.60			102337	142820
16	2.00	18.598	125	21.0		14.0	11.0	3	16.60			102338	142821

EG M



<h1>AERO</h1>										SA320-4	SA350-3	TL320VS-4	TL351VS-3
<div style="display: flex; justify-content: space-between;"> <div style="width: 20%;"> <p>SA320-4</p>  </div> <div style="width: 20%;">  </div> </div>													
<div style="display: flex; justify-content: space-between;"> <div style="width: 20%;"> <p>SA350-3</p>  </div> <div style="width: 20%;">  </div> </div>													
<div style="display: flex; justify-content: space-between;"> <div style="width: 20%;"> <p>TL320VS-4</p>  </div> <div style="width: 20%;"> <p>VS</p> </div> <div style="width: 20%;">  </div> </div>													
<div style="display: flex; justify-content: space-between;"> <div style="width: 20%;"> <p>TL351VS-3</p>  </div> <div style="width: 20%;">  </div> <div style="width: 20%;"> <p>VS</p> </div> <div style="width: 20%;">  </div> </div>													
													
													
$\varnothing d_1$	P	d_1	l_1	l_2	l_3	d_2	a			ID	ID	ID	ID
EG M	mm	mm	mm	mm	mm	mm	mm						
3	0.50	3.650	56	13.0		4.0	3.0	3	3.15	147676	147682	* 152001	150478
4	0.70	4.910	70	15.0		6.0	4.9	3	4.20	147678	147684	* 152002	152003
5	0.80	6.040	80	15.0	23	6.0	4.9	3	5.25	147680	147686	* 147808	150184
6	1.00	7.300	80	15.0	23	7.0	5.5	3	6.30	147688	147692	* 152004	152005
8	1.25	9.624	100	20.0	33	10.0	8.0	3	8.40	149354	149356	* 152088	152089



AERO

SA390-3



SA390-3



Ø d ₁ EG M	P mm	d ₁ mm	l ₁ mm	l ₂ mm	d ₂ mm	α mm			ID
3	0.50	3.650	56	13.0	4.0	3.0	3	3.15	149669
4	0.70	4.910	70	15.0	6.0	4.9	3	4.20	149688
5	0.80	6.040	80	20.0	6.0	4.9	3	5.25	149710
6	1.00	7.300	80	20.0	7.0	5.5	3	6.30	149723
8	1.25	9.624	100	30.0	10.0	8.0	3	8.40	149748
10	1.50	11.948	110	35.0	12.0	9.0	3	10.40	149767

EG UNC NASM33537



HSSE



~DIN 2184-1

~DIN 2184-1

										N320-4	N420-4	N360-3	N460-3
N320-4													
N420-4													
N360-3													
N460-3													
\varnothing d ₁ EG UNC	P TPI	d ₁ mm	l ₁ mm	l ₂ mm	l ₃ mm	d ₂ mm	a mm			ID	ID		
4	40	3.67	56	13.0	20	4.0	3.0	3	3.05	110946			
6	32	4.53	70	15.0	25	6.0	4.9	3	3.75	110948			
8	32	5.19	70	15.0	25	6.0	4.9	3	4.45	110949			
10	24	6.20	80	17.0	30	7.0	5.5	3	5.10	110945			
1/4	20	8.00	90	20.0	35	8.0	6.2	3	6.70	110944			
5/16	18	9.77	100	22.0	39	10.0	8.0	3	8.40	110947			
3/8	16	11.59	110	24.0		9.0	7.0	3	10.00		110033		
1/2	13	15.23	110	30.0		12.0	9.0	3	13.30		104935		
\varnothing d ₁ EG UNC	P TPI	d ₁ mm	l ₁ mm	l ₂ mm	l ₃ mm	d ₂ mm	a mm			ID	ID		
4	40	3.67	56	6.5	20	4.0	3.0	3	3.05		110018		
6	32	4.53	70	9.0	25	6.0	4.9	3	3.75		110019		
8	32	5.19	70	9.0	25	6.0	4.9	3	4.45		110956		
10	24	6.20	80	11.0	30	7.0	5.5	3	5.10		110954		
1/4	20	8.00	90	12.5	35	8.0	6.2	3	6.70		110024		
5/16	18	9.77	100	14.0	39	10.0	8.0	3	8.40		111759		
3/8	16	11.58	110	14.0		9.0	7.0	3	10.00			111715	
1/2	13	15.23	110	18.0		12.0	9.0	3	13.30			111558	

EG UNC NASM33537



PM



DIN 2184-1 (d₂h6)

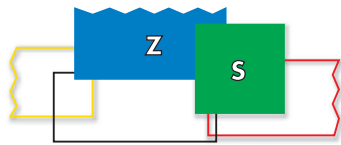

Z370VS-3

Z370VS-3



VS



NEW



3B

Ø" d ₁ EG UNC	P TPI	d ₁ mm	l ₁ mm	l ₂ mm	l ₃ mm	d ₂ h6 mm	α mm			ID
4	40	3.67	56	6.5	20	4.0(h9)	3.0	3	3.05	165126
6	32	4.53	70	9.0	25	6.0	4.9	3	3.75	165127
8	32	5.19	70	9.0	25	6.0	4.9	3	4.45	165128

























EG UNC



DIN 2184-1



AERO









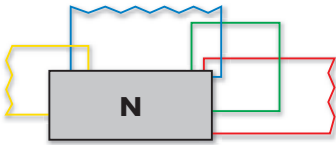
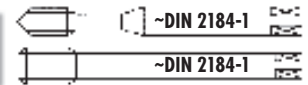



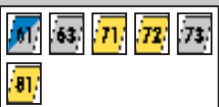

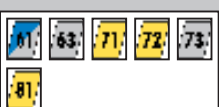

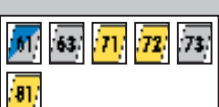











										SA320-4	SA350-3	TL320VS-4	TL351VS-3																																																																																																		
<div style="display: flex; justify-content: space-between;"> <div style="width: 20%;"> <p>SA320-4</p>  </div> <div style="width: 20%; border: 1px solid black; padding: 5px;"> <p>32 33</p> </div> </div>																																																																																																															
<div style="display: flex; justify-content: space-between;"> <div style="width: 20%;"> <p>SA350-3</p>  </div> <div style="width: 20%; border: 1px solid black; padding: 5px;"> <p>32 33</p> </div> </div>																																																																																																															
<div style="display: flex; justify-content: space-between;"> <div style="width: 20%;"> <p>TL320VS-4</p>  </div> <div style="width: 20%; border: 1px solid black; padding: 5px;"> <p>VS</p> </div> <div style="width: 20%; border: 1px solid black; padding: 5px;"> <p>41 42</p> </div> </div>																																																																																																															
<div style="display: flex; justify-content: space-between;"> <div style="width: 20%;"> <p>TL351VS-3</p>  </div> <div style="width: 20%; border: 1px solid black; padding: 5px;"> <p>VS</p> </div> <div style="width: 20%; border: 1px solid black; padding: 5px;"> <p>41 42</p> </div> </div>																																																																																																															
																																																																																																															
																																																																																																															
																																																																																																															
																																																																																																															
																																																																																																															
																																																																																																															
																																																																																																															
																																																																																																															
																																																																																																															
																																																																																																															
																																																																																																															
																																																																																																															
<table border="1"> <thead> <tr> <th>Ø" d₁</th> <th>P</th> <th>d₁</th> <th>l₁</th> <th>l₂</th> <th>l₃</th> <th>d₂</th> <th>a</th> <th colspan="2"></th> <th>ID</th> <th>ID</th> <th>ID</th> <th>ID</th> </tr> <tr> <th>EG UNC</th> <th>TPI</th> <th>mm</th> <th>mm</th> <th>mm</th> <th>mm</th> <th>mm</th> <th>mm</th> <th colspan="2"></th> <th></th> <th></th> <th></th> <th></th> </tr> </thead> <tbody> <tr> <td>4</td> <td>40</td> <td>3.67</td> <td>56</td> <td>13.0</td> <td></td> <td>4.0</td> <td>3.0</td> <td>3</td> <td>3.05</td> <td>149073</td> <td>149075</td> <td>* 152030</td> <td>152031</td> </tr> <tr> <td>6</td> <td>32</td> <td>4.53</td> <td>70</td> <td>15.0</td> <td></td> <td>6.0</td> <td>4.9</td> <td>3</td> <td>3.75</td> <td>149121</td> <td>149123</td> <td>* 152040</td> <td>152041</td> </tr> <tr> <td>8</td> <td>32</td> <td>5.19</td> <td>70</td> <td>15.0</td> <td></td> <td>6.0</td> <td>4.9</td> <td>3</td> <td>4.45</td> <td>149170</td> <td>149172</td> <td>* 152052</td> <td>152053</td> </tr> <tr> <td>1/4</td> <td>20</td> <td>8.00</td> <td>90</td> <td>18.0</td> <td>29</td> <td>8.0</td> <td>6.2</td> <td>3</td> <td>6.70</td> <td>149284</td> <td>149286</td> <td>* 152073</td> <td>152074</td> </tr> <tr> <td>5/16</td> <td>18</td> <td>9.77</td> <td>100</td> <td>20.0</td> <td>33</td> <td>10.0</td> <td>8.0</td> <td>3</td> <td>8.40</td> <td>* 149358</td> <td>* 149360</td> <td>* 152090</td> <td>* 152091</td> </tr> </tbody> </table>										Ø" d ₁	P	d ₁	l ₁	l ₂	l ₃	d ₂	a			ID	ID	ID	ID	EG UNC	TPI	mm	mm	mm	mm	mm	mm							4	40	3.67	56	13.0		4.0	3.0	3	3.05	149073	149075	* 152030	152031	6	32	4.53	70	15.0		6.0	4.9	3	3.75	149121	149123	* 152040	152041	8	32	5.19	70	15.0		6.0	4.9	3	4.45	149170	149172	* 152052	152053	1/4	20	8.00	90	18.0	29	8.0	6.2	3	6.70	149284	149286	* 152073	152074	5/16	18	9.77	100	20.0	33	10.0	8.0	3	8.40	* 149358	* 149360	* 152090	* 152091				
Ø" d ₁	P	d ₁	l ₁	l ₂	l ₃	d ₂	a			ID	ID	ID	ID																																																																																																		
EG UNC	TPI	mm	mm	mm	mm	mm	mm																																																																																																								
4	40	3.67	56	13.0		4.0	3.0	3	3.05	149073	149075	* 152030	152031																																																																																																		
6	32	4.53	70	15.0		6.0	4.9	3	3.75	149121	149123	* 152040	152041																																																																																																		
8	32	5.19	70	15.0		6.0	4.9	3	4.45	149170	149172	* 152052	152053																																																																																																		
1/4	20	8.00	90	18.0	29	8.0	6.2	3	6.70	149284	149286	* 152073	152074																																																																																																		
5/16	18	9.77	100	20.0	33	10.0	8.0	3	8.40	* 149358	* 149360	* 152090	* 152091																																																																																																		

EG UNF NASM33537



HSSE



											N320-4	N420-4	N360-3	N460-3																																																																																																
<p>N320-4  </p> <p>N420-4  </p> <p>N360-3  </p> <p>N460-3  </p>																																																																																																														
																																																																																																														
											3B	3B	3B	3B																																																																																																
<table border="1"> <thead> <tr> <th>Ø" d₁ EG UNF</th> <th>P TPI</th> <th>d₁ mm</th> <th>l₁ mm</th> <th>l₂ mm</th> <th>l₃ mm</th> <th>d₂ mm</th> <th>a mm</th> <th></th> <th></th> <th>ID</th> <th>ID</th> </tr> </thead> <tbody> <tr><td>6</td><td>40</td><td>4.33</td><td>63</td><td>14.0</td><td>21</td><td>4.5</td><td>3.4</td><td>3</td><td>3.70</td><td>118879</td><td></td></tr> <tr><td>8</td><td>36</td><td>5.08</td><td>70</td><td>15.0</td><td>25</td><td>6.0</td><td>4.9</td><td>3</td><td>4.40</td><td>118882</td><td></td></tr> <tr><td>10</td><td>32</td><td>5.85</td><td>80</td><td>17.0</td><td>30</td><td>6.0</td><td>4.9</td><td>3</td><td>5.10</td><td>104941</td><td></td></tr> <tr><td>1/4</td><td>28</td><td>7.52</td><td>90</td><td>20.0</td><td>35</td><td>8.0</td><td>6.2</td><td>3</td><td>6.65</td><td>110234</td><td></td></tr> <tr><td>5/16</td><td>24</td><td>9.31</td><td>90</td><td>20.0</td><td>35</td><td>9.0</td><td>7.0</td><td>3</td><td>8.20</td><td>118876</td><td></td></tr> <tr><td>3/8</td><td>24</td><td>10.89</td><td>100</td><td>19.0</td><td></td><td>8.0</td><td>6.2</td><td>3</td><td>9.80</td><td></td><td>118873</td></tr> <tr><td>1/2</td><td>20</td><td>14.35</td><td>100</td><td>24.0</td><td></td><td>11.0</td><td>9.0</td><td>3</td><td>13.10</td><td></td><td>118865</td></tr> </tbody> </table>											Ø" d ₁ EG UNF	P TPI	d ₁ mm	l ₁ mm	l ₂ mm	l ₃ mm	d ₂ mm	a mm			ID	ID	6	40	4.33	63	14.0	21	4.5	3.4	3	3.70	118879		8	36	5.08	70	15.0	25	6.0	4.9	3	4.40	118882		10	32	5.85	80	17.0	30	6.0	4.9	3	5.10	104941		1/4	28	7.52	90	20.0	35	8.0	6.2	3	6.65	110234		5/16	24	9.31	90	20.0	35	9.0	7.0	3	8.20	118876		3/8	24	10.89	100	19.0		8.0	6.2	3	9.80		118873	1/2	20	14.35	100	24.0		11.0	9.0	3	13.10		118865				
Ø" d ₁ EG UNF	P TPI	d ₁ mm	l ₁ mm	l ₂ mm	l ₃ mm	d ₂ mm	a mm			ID	ID																																																																																																			
6	40	4.33	63	14.0	21	4.5	3.4	3	3.70	118879																																																																																																				
8	36	5.08	70	15.0	25	6.0	4.9	3	4.40	118882																																																																																																				
10	32	5.85	80	17.0	30	6.0	4.9	3	5.10	104941																																																																																																				
1/4	28	7.52	90	20.0	35	8.0	6.2	3	6.65	110234																																																																																																				
5/16	24	9.31	90	20.0	35	9.0	7.0	3	8.20	118876																																																																																																				
3/8	24	10.89	100	19.0		8.0	6.2	3	9.80		118873																																																																																																			
1/2	20	14.35	100	24.0		11.0	9.0	3	13.10		118865																																																																																																			
<table border="1"> <thead> <tr> <th>Ø" d₁ EG UNF</th> <th>P TPI</th> <th>d₁ mm</th> <th>l₁ mm</th> <th>l₂ mm</th> <th>l₃ mm</th> <th>d₂ mm</th> <th>a mm</th> <th></th> <th></th> <th>ID</th> <th>ID</th> </tr> </thead> <tbody> <tr><td>6</td><td>40</td><td>4.33</td><td>63</td><td>7.5</td><td>21</td><td>4.5</td><td>3.4</td><td>3</td><td>3.70</td><td>110959</td><td></td></tr> <tr><td>8</td><td>36</td><td>5.08</td><td>70</td><td>9.0</td><td>25</td><td>6.0</td><td>4.9</td><td>3</td><td>4.40</td><td>110960</td><td></td></tr> <tr><td>10</td><td>32</td><td>5.85</td><td>80</td><td>11.0</td><td>30</td><td>6.0</td><td>4.9</td><td>3</td><td>5.10</td><td>104946</td><td></td></tr> <tr><td>1/4</td><td>28</td><td>7.52</td><td>90</td><td>12.5</td><td>35</td><td>8.0</td><td>6.2</td><td>3</td><td>6.65</td><td>110020</td><td></td></tr> <tr><td>5/16</td><td>24</td><td>9.31</td><td>90</td><td>12.5</td><td>35</td><td>9.0</td><td>7.0</td><td>3</td><td>8.20</td><td>111619</td><td></td></tr> <tr><td>3/8</td><td>24</td><td>10.89</td><td>100</td><td>19.0</td><td></td><td>8.0</td><td>6.2</td><td>3</td><td>9.80</td><td></td><td>110027</td></tr> <tr><td>1/2</td><td>20</td><td>14.35</td><td>100</td><td>14.0</td><td></td><td>11.0</td><td>9.0</td><td>3</td><td>13.10</td><td></td><td>104951</td></tr> </tbody> </table>											Ø" d ₁ EG UNF	P TPI	d ₁ mm	l ₁ mm	l ₂ mm	l ₃ mm	d ₂ mm	a mm			ID	ID	6	40	4.33	63	7.5	21	4.5	3.4	3	3.70	110959		8	36	5.08	70	9.0	25	6.0	4.9	3	4.40	110960		10	32	5.85	80	11.0	30	6.0	4.9	3	5.10	104946		1/4	28	7.52	90	12.5	35	8.0	6.2	3	6.65	110020		5/16	24	9.31	90	12.5	35	9.0	7.0	3	8.20	111619		3/8	24	10.89	100	19.0		8.0	6.2	3	9.80		110027	1/2	20	14.35	100	14.0		11.0	9.0	3	13.10		104951				
Ø" d ₁ EG UNF	P TPI	d ₁ mm	l ₁ mm	l ₂ mm	l ₃ mm	d ₂ mm	a mm			ID	ID																																																																																																			
6	40	4.33	63	7.5	21	4.5	3.4	3	3.70	110959																																																																																																				
8	36	5.08	70	9.0	25	6.0	4.9	3	4.40	110960																																																																																																				
10	32	5.85	80	11.0	30	6.0	4.9	3	5.10	104946																																																																																																				
1/4	28	7.52	90	12.5	35	8.0	6.2	3	6.65	110020																																																																																																				
5/16	24	9.31	90	12.5	35	9.0	7.0	3	8.20	111619																																																																																																				
3/8	24	10.89	100	19.0		8.0	6.2	3	9.80		110027																																																																																																			
1/2	20	14.35	100	14.0		11.0	9.0	3	13.10		104951																																																																																																			

EG UNC
EG UNF

EG UNF NASM33537



PM



DIN 2184-1 (d₂ h6)

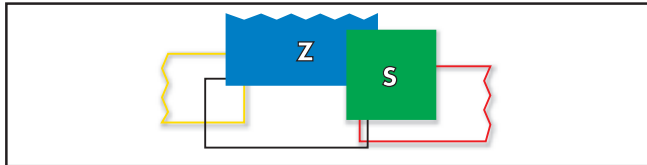

Z370VS-3

Z370VS-3



VS



NEW



3B

Ø" d ₁ EG UNF	P TPI	d ₁ mm	l ₁ mm	l ₂ mm	l ₃ mm	d ₂ h6 mm	a mm			ID
10	32	5.85	80	11.0	30	6.0	4.9	3	5.10	165129
1/4	28	7.52	90	12.5	35	8.0	6.2	3	6.65	165130
5/16	24	9.31	90	12.5	35	*8.0	*6.2	3	8.20	165131

* Norme DC / * DC Norm / * Norma DC

EG UNF NASM33537



PM

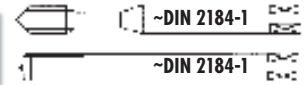

											S320VS-4	S360VS-3		SA390-3																																																							
S320VS-4																																																																					
S360VS-3																																																																					
SA390-3																																																																					
<table border="1"> <thead> <tr> <th>Ø" d₁</th> <th>P</th> <th>d₁</th> <th>l₁</th> <th>l₂</th> <th>l₃</th> <th>d₂</th> <th>α</th> <th></th> <th></th> <th>ID</th> </tr> <tr> <th>EG UNF</th> <th>TPI</th> <th>mm</th> <th>mm</th> <th>mm</th> <th>mm</th> <th>mm</th> <th>mm</th> <th></th> <th></th> <th></th> </tr> </thead> <tbody> <tr> <td>10</td> <td>32</td> <td>5.85</td> <td>80</td> <td>17.0</td> <td>30</td> <td>6.0</td> <td>4.9</td> <td>3</td> <td>5.10</td> <td>111821</td> </tr> <tr> <td>1/4</td> <td>28</td> <td>7.52</td> <td>90</td> <td>20.0</td> <td>35</td> <td>8.0</td> <td>6.2</td> <td>3</td> <td>6.65</td> <td>111822</td> </tr> <tr> <td>5/16</td> <td>24</td> <td>9.31</td> <td>90</td> <td>20.0</td> <td>35</td> <td>9.0</td> <td>7.0</td> <td>3</td> <td>8.20</td> <td>111823</td> </tr> </tbody> </table>											Ø" d ₁	P	d ₁	l ₁	l ₂	l ₃	d ₂	α			ID	EG UNF	TPI	mm	mm	mm	mm	mm	mm				10	32	5.85	80	17.0	30	6.0	4.9	3	5.10	111821	1/4	28	7.52	90	20.0	35	8.0	6.2	3	6.65	111822	5/16	24	9.31	90	20.0	35	9.0	7.0	3	8.20	111823				
Ø" d ₁	P	d ₁	l ₁	l ₂	l ₃	d ₂	α			ID																																																											
EG UNF	TPI	mm	mm	mm	mm	mm	mm																																																														
10	32	5.85	80	17.0	30	6.0	4.9	3	5.10	111821																																																											
1/4	28	7.52	90	20.0	35	8.0	6.2	3	6.65	111822																																																											
5/16	24	9.31	90	20.0	35	9.0	7.0	3	8.20	111823																																																											
<table border="1"> <thead> <tr> <th>Ø" d₁</th> <th>P</th> <th>d₁</th> <th>l₁</th> <th>l₂</th> <th>l₃</th> <th>d₂</th> <th>α</th> <th></th> <th></th> <th>ID</th> </tr> <tr> <th>EG UNF</th> <th>TPI</th> <th>mm</th> <th>mm</th> <th>mm</th> <th>mm</th> <th>mm</th> <th>mm</th> <th></th> <th></th> <th></th> </tr> </thead> <tbody> <tr> <td>10</td> <td>32</td> <td>5.85</td> <td>80</td> <td>11.0</td> <td>30</td> <td>6.0</td> <td>4.9</td> <td>3</td> <td>5.10</td> <td>111811</td> </tr> <tr> <td>1/4</td> <td>28</td> <td>7.52</td> <td>90</td> <td>12.5</td> <td>35</td> <td>8.0</td> <td>6.2</td> <td>3</td> <td>6.65</td> <td>111812</td> </tr> <tr> <td>5/16</td> <td>24</td> <td>9.31</td> <td>90</td> <td>12.5</td> <td>35</td> <td>9.0</td> <td>7.0</td> <td>3</td> <td>8.20</td> <td>111824</td> </tr> </tbody> </table>											Ø" d ₁	P	d ₁	l ₁	l ₂	l ₃	d ₂	α			ID	EG UNF	TPI	mm	mm	mm	mm	mm	mm				10	32	5.85	80	11.0	30	6.0	4.9	3	5.10	111811	1/4	28	7.52	90	12.5	35	8.0	6.2	3	6.65	111812	5/16	24	9.31	90	12.5	35	9.0	7.0	3	8.20	111824				
Ø" d ₁	P	d ₁	l ₁	l ₂	l ₃	d ₂	α			ID																																																											
EG UNF	TPI	mm	mm	mm	mm	mm	mm																																																														
10	32	5.85	80	11.0	30	6.0	4.9	3	5.10	111811																																																											
1/4	28	7.52	90	12.5	35	8.0	6.2	3	6.65	111812																																																											
5/16	24	9.31	90	12.5	35	9.0	7.0	3	8.20	111824																																																											
<table border="1"> <thead> <tr> <th>Ø" d₁</th> <th>P</th> <th>d₁</th> <th>l₁</th> <th>l₂</th> <th>d₂</th> <th>α</th> <th></th> <th></th> <th>ID</th> </tr> <tr> <th>EG UNF</th> <th>TPI</th> <th>mm</th> <th>mm</th> <th>mm</th> <th>mm</th> <th>mm</th> <th></th> <th></th> <th></th> </tr> </thead> <tbody> <tr> <td>10</td> <td>32</td> <td>5.85</td> <td>80</td> <td>20.0</td> <td>6.0</td> <td>4.9</td> <td>3</td> <td>5.10</td> <td>149702</td> </tr> <tr> <td>1/4</td> <td>28</td> <td>7.52</td> <td>90</td> <td>25.0</td> <td>8.0</td> <td>6.2</td> <td>3</td> <td>6.65</td> <td>149724</td> </tr> </tbody> </table>											Ø" d ₁	P	d ₁	l ₁	l ₂	d ₂	α			ID	EG UNF	TPI	mm	mm	mm	mm	mm				10	32	5.85	80	20.0	6.0	4.9	3	5.10	149702	1/4	28	7.52	90	25.0	8.0	6.2	3	6.65	149724																			
Ø" d ₁	P	d ₁	l ₁	l ₂	d ₂	α			ID																																																												
EG UNF	TPI	mm	mm	mm	mm	mm																																																															
10	32	5.85	80	20.0	6.0	4.9	3	5.10	149702																																																												
1/4	28	7.52	90	25.0	8.0	6.2	3	6.65	149724																																																												

EG UNF



-DIN 2184-1



AERO

SA320-4



SA350-3



TL320VS-4



VS



TL351VS-3



VS



SA320-4

SA350-3

TL320VS-4

TL351VS-3



3B

3B

3B

3B

Ø" d ₁	P	d ₁	l ₁	l ₂	l ₃	d ₂	a		
EG UNF	TPI	mm	mm	mm	mm	mm	mm		
10	32	5.85	80	15.0	23	6.0	4.9	3	5.10
1/4	28	7.52	90	18.0	29	8.0	6.2	3	6.65
5/16	24	9.31	90	20.0	31	9.0	7.0	3	8.20

ID

ID

ID

ID

149190

149192

* 148009

148008

146099

149268

* 148015

148014

149336

149338

* 148022

148021

CROWN TAPS

MACHO DE CORONA

General information

The DC crown tap with "V" surface treatment to prevent cold welding is a tool of high performance, which offers a very high quality surface finish of the tapped threads.

Application rang

Thanks to the front recess providing space for the chip collection, the DC crown tap is suitable for both, through and blind hole tapping. The crown tap can be used for materials with a tensile strength up to 850 N/mm² and an elongation of maximum 30 %.

Utilization

The crown tap can be used for through holes of any depth. However, for an optimal blind hole threading, the core hole depth must be adapted accordingly and the following application instructions must be followed:

- Tap until tapping head clutch slips
- Retract tap and clear chips
- Tap to the full depth.

General hints

The efficient operation of DC crown taps, as well as the quality of the cut threads, depend on observation of the following rules:

- Do not exceed the maximum permissible centering error of 0.1 mm
- The tap must run concentrically, use a suitable tapping head
- Tap at the correct cutting speed
- Select a coolant to suit the material being tapped
- Use a tapping head with axial compensation and safety clutch
- Set the safety clutch so that it will slip at just above the tapping torque.

When tapping the first hole, slacken the clutch until it slips, then gradually tighten it until the tap is driven.

Chip accumulation

The chip accumulation capacity of the recess is the following :

Thread diameter	Ø 20 - 29 mm	≥ Ø 30 mm
M	-	1.4 x D
MF	1.2 x D	1.4 x D
UN-8	-	1.4 x D
G	1.2 x D	1.4 x D

Generalidad

El macho de corona DC con tratamiento superficial "V" es un útil de alto rendimiento que realiza tolerancias de rosca precisas y una calidad superficial del roscado particularmente buena.

Campos de aplicación

El ahuecamiento delantero permite alojar las virutas. Por esta razón, el macho de corona puede ser utilizado tanto en agujeros pasantes como en agujeros ciegos. Su campo de aplicación se sitúa para materiales con resistencia hasta 850 N/mm² y alargamiento máximo a la rotura de 30 %.

Utilización

El macho de corona DC puede ser utilizado para todas las profundidades de roscados en agujeros pasantes. En caso de agujeros ciegos, para un roscado correcto, hay que adaptar la profundidad del taladro previo y seguir las siguientes instrucciones :

- roscar hasta que la fricción del aparato de roscar patine
- retroceder el macho y quitar las virutas
- terminar de roscar hasta el fondo de agujero.

Exigencias particulares

El funcionamiento correcto del macho de corona DC, así como la calidad de la rosca, dependen de los puntos siguientes :

- el error de alineación no debe exceder 0.1 mm
- el macho debe girar perfectamente centrado, utilizar un porta-machos de roscar adecuado
- trabajar con una velocidad de corte correcta
- lubricante adaptado al material
- fijar el útil en un aparato de roscar con compensación axial y embrague de seguridad
- reglar el embrague de seguridad sobre una posición superior al par de potencia de trabajo.

En el momento del primer roscado, aflojar el embrague, y apretar progresivamente hasta que el macho entre en movimiento.

Virutas

La capacidad de acumulación de las virutas en el ahuecamiento es la siguiente :

Roscas	Ø 20 - 29 mm	≥ Ø 30 mm
M	-	1.4 x D
MF	1.2 x D	1.4 x D
UN-8	-	1.4 x D
G	1.2 x D	1.4 x D







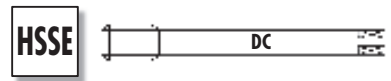

Cutting and spindle speeds (guide values) - Velocidad de corte y revoluciones por minuto (directivas)

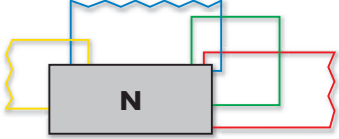
M	P	V _c (m/min)	n (U/min)	MF	P	V _c (m/min)	n (U/min)	MF	P	V _c (m/min)	n (U/min)	UN-8	P	V _c (m/min)	n (U/min)
30	3.5	7.9	84	22	1.5	8.0	116	45	1.5	6.9	49	1 1/4"	8.0	7.8	77
33	3.5	7.7	74	24	1.5	8.0	106	45	2.0	6.9	49	1 3/8"	8.0	7.6	69
36	4.0	7.5	66	26	1.5	7.9	97	48	1.5	6.6	44	1 1/2"	8.0	7.3	62
39	4.0	7.3	60	28	1.5	7.9	90	48	2.0	6.6	44	1 5/8"	8.0	7.1	55
42	4.5	7.1	54	30	1.5	7.9	84	48	3.0	6.6	44	1 3/4"	8.0	6.9	49
45	4.5	6.9	49	30	2.0	7.9	84	48	4.0	6.6	44	1 7/8"	8.0	6.7	45
48	5.0	6.6	44	32	1.5	7.8	77	50	1.5	6.5	41	2"	8.0	6.4	40
52	5.0	6.4	39	32	2.0	7.8	77	52	1.5	6.4	39				
56	5.5	6.1	35	33	1.5	7.7	74	52	3.0	6.4	39				
60	5.5	5.8	31	33	2.0	7.7	74	55	1.5	6.2	36				
64	6.0	5.5	28	34	1.5	7.6	71	56	4.0	6.1	35				
68	6.0	5.2	25	35	1.5	7.6	69	60	2.0	5.8	31				
				36	1.5	7.5	66	64	4.0	5.5	28				
				36	2.0	7.5	66	68	4.0	5.2	25				
				36	3.0	7.5	66	72	6.0	5.0	22				
				38	1.5	7.3	62	76	6.0	4.7	20				
				40	1.5	7.2	57	80	2.0	4.4	18				
				40	2.0	7.2	57	80	4.0	4.4	18				
				42	1.5	7.1	54	80	6.0	4.4	18				
				42	2.0	7.1	54	90	6.0	3.7	13				
				42	3.0	7.1	54	100	6.0	3.0	10				
				42	4.0	7.1	54	110	6.0	2.5	7				
												G	P	V _c	n
													TPI	(m/min)	(U/min)
												1"	11.0	7.7	74
												1 1/4"	11.0	7.1	54
												1 1/2"	11.0	6.6	44
												2"	11.0	5.8	31
												2 1/4"	11.0	5.4	26
												2 1/2"	11.0	4.8	20
												2 3/4"	11.0	4.3	17
												3"	11.0	3.8	14

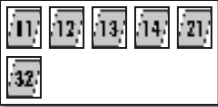
M, MF ISO DIN 13

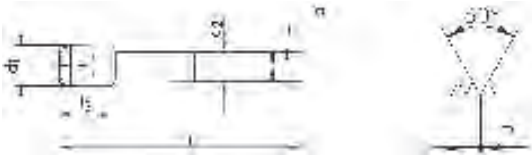

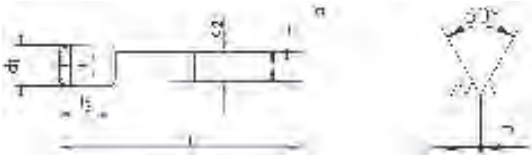
									N470V-4			N470V-3
N470V-4 												
N470V-3 												
									ISO 2 6H		ISO 2 6H	
$\varnothing d_1$	P	l_1	l_2	d_2	a			ID				
M	mm	mm	mm	mm	mm							
30	3.50	180	39.0	22.0	18.0	5	26.50	102575				
33	3.50	180	39.0	22.0	18.0	5	29.50	102576				
36	4.00	200	43.0	25.0	20.0	5	32.00	102577				
39	4.00	200	43.0	25.0	20.0	5	35.00	102578				
42	4.50	220	47.0	28.0	22.0	5	37.50	102579				
45	4.50	220	47.0	28.0	22.0	5	40.50	102580				
48	5.00	240	52.0	32.0	24.0	5	43.00	102581				
52	5.00	240	52.0	32.0	24.0	5	47.00	102582				
56	5.50	260	58.0	36.0	29.0	6	50.50	102583				
60	5.50	260	58.0	36.0	29.0	6	54.50	102584				
64	6.00	290	64.0	40.0	32.0	6	58.00	102585				
68	6.00	290	64.0	40.0	32.0	6	62.00	*102586				
$\varnothing d_1$	P	l_1	l_2	d_2	a			ID				
MF	mm	mm	mm	mm	mm							
^Δ 22	1.50	125	28.0	18.0	14.5	4	20.50	*102526				
^Δ 26	1.50	140	30.0	18.0	14.5	4	24.50	*102529				
^Δ 28	1.50	140	30.0	20.0	16.0	4	26.50	*102530				
30	1.50	160	32.0	22.0	18.0	5	28.50	*102531				
30	2.00	160	32.0	22.0	18.0	5	28.00	*102532				
32	1.50	160	32.0	22.0	18.0	5	30.50	*102533				
34	1.50	160	26.0	22.0	18.0	5	32.50	*102537				
35	1.50	175	28.0	25.0	20.0	5	33.50	*102538				
36	2.00	175	35.0	25.0	20.0	5	34.00	102540				
36	3.00	200	43.0	25.0	20.0	5	33.00	102541				
38	1.50	175	28.0	25.0	20.0	5	36.50	*102542				
40	1.50	190	31.0	28.0	22.0	5	38.50	*102543				
40	2.00	190	38.0	28.0	22.0	5	38.00	*102544				
42	2.00	190	38.0	28.0	22.0	5	40.00	102546				

								N470V-3	
N470V-3   									
									
								ISO 2 6H	
$\varnothing d_1$ MF	P mm	l_1 mm	l_2 mm	d_2 mm	a mm			ID	
42	3.00	220	47.0	28.0	22.0	5	39.00	102547	
48	1.50	205	34.0	32.0	24.0	5	46.50	* 102551	
48	3.00	205	41.0	32.0	24.0	5	45.00	102553	
52	1.50	205	34.0	32.0	24.0	5	50.50	* 102556	
52	3.00	205	41.0	32.0	24.0	5	49.00	102557	
56	4.00	260	58.0	36.0	29.0	6	52.00	102559	
60	2.00	220	37.0	36.0	29.0	6	58.00	* 102560	
64	4.00	290	64.0	40.0	32.0	6	60.00	102561	
68	4.00	290	64.0	40.0	32.0	6	64.00	* 102562	
80	4.00	270	56.0	45.0	35.0	7	76.00	* 102564	



										N470V-3			
N470V-3													
\varnothing " d ₁	P	d ₁	l ₁	l ₂	d ₂	α			ID				
UN	TPI	mm	mm	mm	mm	mm							
1 1/4	8	31.75	180	39.0	22.0	18.0	5	28.70	102566				
1 3/8	8	34.92	180	39.0	22.0	18.0	5	31.80	102568				
1 1/2	8	38.10	200	43.0	25.0	20.0	5	35.00	102565				
1 5/8	8	41.27	220	47.0	28.0	22.0	5	38.20	102569				
1 3/4	8	44.45	220	47.0	28.0	22.0	5	41.40	102567				
1 7/8	8	47.62	240	52.0	32.0	24.0	5	44.50	102570				
2	8	50.80	205	41.0	32.0	24.0	5	47.70	102572				
2 1/4	8	57.15	220	45.0	36.0	29.0	6	54.10	102571				
2 1/2	8	63.50	220	45.0	36.0	29.0	6	60.40	111879				
\varnothing " d ₁	P	d ₁	l ₁	l ₂	d ₂	α			ID				
G	TPI	mm	mm	mm	mm	mm							
△ 1/2	14	20.95	140	32.0	16.0	12.0	4	18.90	102521				
△ 3/4	14	26.44	150	34.0	20.0	16.0	4	24.40	102525				
1	11	33.24	160	32.0	22.0	18.0	5	30.70	102522				
1 1/4	11	41.91	190	38.0	28.0	22.0	5	39.30	102519				
1 1/2	11	47.80	205	41.0	32.0	24.0	5	45.20	102518				
1 3/4	11	53.74	205	41.0	32.0	24.0	5	51.20	* 102520				
2	11	59.61	220	45.0	36.0	29.0	6	57.00	102524				

△



MEGA

Ø 42 - 160 mm



**ON
REQUEST**

COMBINATION DRILL/TAPS

General information

DC combination drill/taps - two tools in one, which allows the drilling and the threading of a workpiece without changing the tool.

It is the optimal solution for CNC-machines, drilling heads, turret lathes and tapping machines.

Application rang

DC combination drill/taps are recommended for use in materials with a tensile strenght up to 750 N/mm², such as certain steels, cast iron, aluminium, brass.

General hints

- The core hole must be completely drilled through before the tap starts cutting.
- In short chipping materials, the depth of thread should not exceed 1.8 x D (type N5952 up to 2 x D).
- In long chipping materials, the depth of thread should not exceed 1.2 x D.
- Lubricate as for tapping.

Cutting speeds

On drilling heads and CNC-machines, the ideal speeds for drilling and tapping are selected (see our application chart on page 7).

If the same speed is selected for both drilling and tapping, we recommend the values indicated below.

Cutting and spindle speeds (guide values)

Material groups	Vc (m/min)	Speeds for different diameters										
		M3	M4	M5	M6	M8	M10	M12	M14	M16	M18	M20
Steels up to 500 N/mm ²	20	2120	1600	1270	1060	800	640	530	460	400	360	320
Steels over 500 N/mm ²	15	1600	1200	950	800	600	480	400	340	300	270	240
Cast iron, soft	20	2120	1600	1270	1060	800	640	530	460	400	360	320
Cast iron, hard	15	1600	1200	950	800	600	480	400	340	300	270	240
Brass	25	2650	2000	1600	1330	950	800	660	570	500	450	400
Aluminium	25	2650	2000	1600	1330	950	800	660	570	500	450	400

Programming instructions

Countersinking:

Center and countersink simultaneously.

Programming steps for spindle feed and rotation 100 % synchronised (ideal case):

- 1) Combi-drill-tap in rapid to start position
- 2) Drilling:
 - set speed
 - set feed
 - avoid long chips
 - clear shavings
- 3) Tapping section in start position
- 4) Tapping:
 - set speed
 - feed = 100 % pitch
 - set thread depth
 - tap must be free of swarf before starting to cut
- 5) Combi-drill-tap returns to start position.

Programming steps for spindle feed rotation not fully synchronised:

Important: Mount combination drill-tap in chuck with locked pressure spring, but with axial compensation on pull.

- 1) Combi-drill-tap in rapid to start position
- 2) Drilling:
 - set speed
 - set feed
 - avoid long chips
 - clear shavings
- 3) Tapping section in start position
- 4) Tapping:
 - set speed
 - feed = 90 - 95 % pitch
 - set thread depth
- 5) Combi-drill-tap returns to start position.

BROCAS-MACHOS

Generalidad

Broca-macho DC es un útil que permite taladrar y roscar en una sola operación (sin cambiar de herramienta).

Su utilización es ideal para máquinas CNC, máquinas de transmisión, tornos, roscadoras

Campos de aplicación

Los materiales adecuados para trabajar con la broca-macho DC son los situados con una resistencia hasta 750 N/mm² como los aceros, la fundición gris, la fundición gris dúctil, el latón y el aluminio.

Exigencias particulares

- El taladro previo debe estar terminado antes que el macho de roscar empiece a trabajar.
- Para los materiales de virutas cortas, la profundidad de la rosca a realizar no debe superar 1.8 x D (2 x D para N5952).
- Para los materiales de virutas cortas, la profundidad de la rosca a realizar no debe superar 1.2 x D.
- La lubricación es la misma.

Velocidad de corte

Si las máquinas lo permiten, es preferible trabajar con las velocidades de taladro y roscado apropiadas (ver tabla de utilización en página 7).

Sobre las máquinas donde las velocidades de taladro y de roscado no pueden ser variadas, es recomendable aplicar los valores indicados en la siguiente tabla.

Velocidad de corte y revoluciones por minuto (directivas)

Grupos de materiales	Vc (m/min)	Ø y números de revoluciones/min										
		M3	M4	M5	M6	M8	M10	M12	M14	M16	M18	M20
Aceros hasta 500 N/mm ²	20	2120	1600	1270	1060	800	640	530	460	400	360	320
Aceros desde 500 N/mm ²	15	1600	1200	950	800	600	480	400	340	300	270	240
Fundición gris dúctil	20	2120	1600	1270	1060	800	640	530	460	400	360	320
Fundición gris	15	1600	1200	950	800	600	480	400	340	300	270	240
Latón	25	2650	2000	1600	1330	950	800	660	570	500	450	400
Aluminio	25	2650	2000	1600	1330	950	800	660	570	500	450	400

Utilización

Chaflán :

Centrar y achaflanar simultáneamente.

Programación con avance y rotación, 100 % sincronizados (caso ideal) :

- 1) Acercar la broca-macho en aceleración a su lugar de trabajo
- 2) Taladrar :
 - regular las vueltas
 - regular el avance
 - evitar las virutas largas
 - eliminar las virutas
- 3) Posicionar la broca-macho para iniciar el roscado
- 4) Roscar :
 - regular la velocidad del roscado
 - el avance debe corresponder a 100 % del paso
 - regular la profundidad
 - el roscado debe estar libre de virutas en el momento de empezar el trabajo
- 5) Volver con la broca-macho a la posición inicial.

Programación sin sincronización total del avance y de la rotación :

Importante : utilizar mandril con muelle de compresión bloqueado y extensión axial libre.

- 1) Acercar la broca-macho en aceleración a su lugar de trabajo
- 2) Taladrar :
 - regular las vueltas
 - regular el avance
 - evitar las virutas largas
 - eliminar las virutas
- 3) Posicionar la broca-macho para iniciar el roscado
- 4) Roscar :
 - regular la velocidad del roscado
 - el avance debe corresponder a 90-95 % del paso
 - regular la profundidad
- 5) Volver con la broca-macho a la posición inicial.

M, MF ISO DIN 13

HSSE



N5951									N5951	N5952	N5951	
N5952												
N5951												
									ISO 2 6H	ISO 2 6H	7H EN 60423	
$\varnothing d_1$	P	l_{11}	l_2	d_2	α	d_{10}	l_{10}		ID			
M	mm	mm	mm	mm	mm	mm	mm					
3	0.50	62.0	12.5	3.5	2.7	2.55	9.0		104578			
3.5	0.60	66.0	16.0	4.0	3.0	2.95	10.0		* 102613			
4	0.70	66.0	16.0	4.5	3.4	3.36	10.0		104580			
5	0.80	75.5	18.0	6.0	4.9	4.26	12.5		104583			
6	1.00	81.0	20.0	6.0	4.9	5.05	14.0		104585			
8	1.25	93.0	12.0	6.0	4.9	6.80	20.0		104588			
10	1.50	99.0	14.0	7.0	5.5	8.55	22.0		104571			
12	1.75	106.0	16.0	9.0	7.0	10.30	25.0		104573			
16	2.00	123.0	20.0	12.0	9.0	14.10	32.0		104576			
20	2.50	132.0	22.0	16.0	12.0	17.60	36.0		104577			
$\varnothing d_1$	P	l_{11}	l_2	d_2	α	d_{10}	l_{10}		ID			
M	mm	mm	mm	mm	mm	mm	mm					
3	0.50	71.0	12.5	3.5	2.7	2.55	18.0		* 104607			
4	0.70	77.0	16.0	4.5	3.4	3.36	21.0		104608			
5	0.80	87.0	18.0	6.0	4.9	4.26	24.0		104609			
6	1.00	94.0	20.0	6.0	4.9	5.05	27.0		104610			
8	1.25	109.0	12.0	6.0	4.9	6.80	36.0		104611			
10	1.50	118.0	14.0	7.0	5.5	8.55	41.0		104603			
12	1.75	127.0	16.0	9.0	7.0	10.30	46.0		* 104604			
$\varnothing d_1$	P	l_{11}	l_2	d_2	α	d_{10}	l_{10}		ID			
MF	mm	mm	mm	mm	mm	mm	mm					
4	0.50	66.0	16.0	4.5	3.4	3.55	10.0		* 104579			
5	0.75	75.5	18.0	6.0	4.9	4.31	12.5		* 123379			
8	1.00	93.0	12.0	6.0	4.9	7.05	20.0		104587			
10	1.00	99.0	14.0	7.0	5.5	9.05	22.0		104570			
$\varnothing d_1$	P	l_{11}	l_2	d_2	α	d_{10}	l_{10}		ID			
MF	mm	mm	mm	mm	mm	mm	mm					
12	1.50	106.0	16.0	9.0	7.0	10.55	25.0		142825			
16	1.50	123.0	16.0	12.0	9.0	14.55	32.0		142826			
20	1.50	132.0	18.0	16.0	12.0	18.55	36.0		111844			
25	1.50	155.0	22.0	18.0	14.5	23.55	45.0		111845			
32	1.50	170.0	24.0	22.0	18.0	30.55	50.0		111846			

UNC ANSI B1.1 G DIN ISO 228 PG DIN 40430

HSSE

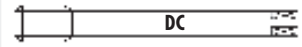

N5951										N5951			
										<div style="border: 1px solid black; padding: 5px; display: inline-block;">2B</div>			
\varnothing " d ₁	P	d ₁	l ₁₁	l ₂	d ₂	a	d ₁₀	l ₁₀		ID			
UNC	TPI	mm	mm	mm	mm	mm	mm	mm					
6	32	3.50	66.0	16.0	4.0	3.0	2.80	10.0		* 104601			
10	24	4.82	75.5	18.0	4.5	3.4	3.86	12.5		* 104598			
1/4	20	6.35	81.0	20.0	7.0	5.5	5.15	14.0		* 104597			
1/2	13	12.70	106.0	16.0	9.0	7.0	10.85	25.0		* 104596			
\varnothing " d ₁	P	d ₁	l ₁₁	l ₂	d ₂	a	d ₁₀	l ₁₀		ID			
G	TPI	mm	mm	mm	mm	mm	mm	mm					
1/8	28	9.72	93.0	12.0	7.0	5.5	8.75	20.0		104567			
1/4	19	13.15	106.0	14.0	11.0	9.0	11.75	25.0		104566			
3/8	19	16.66	123.0	16.0	12.0	9.0	15.25	32.0		104569			
1/2	14	20.95	132.0	18.0	16.0	12.0	19.00	36.0		104565			
3/4	14	26.44	155.0	22.0	18.0	14.5	24.45	45.0		* 104568			
\varnothing d ₁	P	d ₁	l ₁₁	l ₂	d ₂	a	d ₁₀	l ₁₀		ID			
PG	TPI	mm	mm	mm	mm	mm	mm	mm					
7	20	12.50	106.0	14.0	9.0	7.0	11.40	25.0		104594			
9	18	15.20	114.0	15.0	12.0	9.0	13.95	28.0		104595			
11	18	18.60	132.0	18.0	14.0	11.0	17.35	36.0		* 104589			
13.5	18	20.40	132.0	18.0	16.0	12.0	19.15	36.0		* 104590			
16	18	22.50	142.0	20.0	18.0	14.5	21.25	40.0		* 104591			
21	16	28.30	155.0	22.0	20.0	16.0	26.95	45.0		* 104592			
29	16	37.00	203.0	28.0	28.0	22.0	35.65	63.0		* 104593			



SOLID CARBIDE THREAD WHIRL CUTTERS, THREAD MILLING CUTTERS AND THRILLERS FRESA TORBELLINO, FRESA DE ROSCAR Y DE TALADRAR/ROSCAR EN METAL DURO INTEGRAL

Pictographs - Pictogramas



Solid carbide
Metal duro



10° right hand spiral flutes
Ranuras helicoidales con hélice a 10° a derecha



15° right hand spiral flutes
Ranuras helicoidales con hélice a 15° a derecha



27° right hand spiral flutes
Ranuras helicoidales con hélice a 27° a derecha



27° right hand spiral flutes
Ranuras helicoidales con hélice a 27° a derecha



With 45° chamfer for countersinking
Con corte de chaflán a 45°



Number of flutes (Z)
Número de ranuras (Z)



Internal cooling channel
Canal de lubricación interna



Internal cooling channel (BGF, 2 flutes)
Canal de lubricación interna (BGF, 2 ranuras)



Internal cooling channel (BGF, 3 flutes)
Canal de lubricación interna (BGF, 3 ranuras)



DC wear-protective coating
Protección contra el desgaste DC



Thread EG (for wire screw thread inserts)
Rosca EG



Thread length 2.5 x D₁
Longitud roscada 2.5 x D₁



Thread length 4 x D₁
Longitud roscada 4 x D₁



Core hole diameter
Diámetro del agujero



Thread length 1.5 x D₁
Longitud roscada 1.5 x D₁



Thread length 2 x D₁
Longitud roscada 2 x D₁



Thread length 2.5 x D₁
Longitud roscada 2.5 x D₁



Internal thread
Rosca interior



External thread
Rosca exterior



For Blind holes (BGF)
Para agujero ciego (BGF)



For Through holes (BGF)
Para agujero pasante (BGF)



BGF, 2 flutes
BGF, 2 ranuras



BGF, 3 flutes
BGF, 3 ranuras



For materials ≤ 63 HRC (GFH)
Para materiales ≤ 63 HRC (GFH)



Tapered thread 1:16 (NPT - NPTF)
Rosca cónica 1:16 (NPT - NPTF)



Shape accuracy
Coaxialidad



Tolerance class h5
Clase de tolerancia h5



Helix angle
Ángulo de hélice



Norm of Swiss Watch Industry
Norma de la industria relojera suiza

Notice GFM



In order to avoid profile defects it is important that the tool diameter does not exceed $\frac{2}{3}$ of the diameter of the work-piece thread for coarse threads ($\frac{3}{4}$ for fine threads).



Para evitar de recortar el perfil, el diámetro de la fresa no deberá superar $\frac{2}{3}$ del diámetro a realizar para los pasos standard y $\frac{3}{4}$ para los pasos finos.

ADVANTAGES - VENTAJAS

GW-GF-GFH-
GFS-GFM-BGF

GW-GF-GFH-GFS-GFM

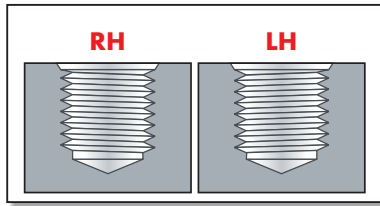

The same cutter can be used for right and left hand threads
Una única fresa para rosca derecha o izquierda

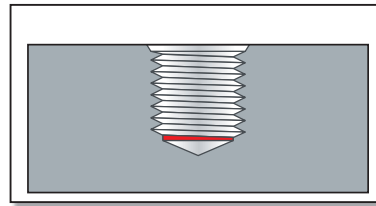

For threads to be cut near to the bottom of blind holes
Fresado a fondo de hilo

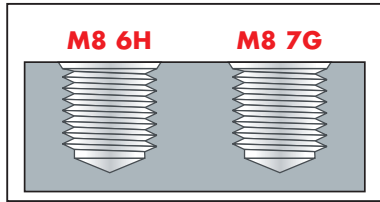

Required tolerance adjustable as per users choice
Tolerancia requerida ajustable

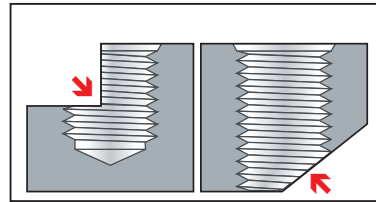

For threads with interrupted cut or with oblique entrance or exit
Posibilidad de roscar partes oblicuas o interrumpidas

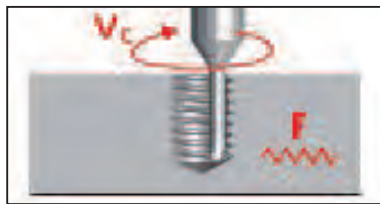

The cutting speed and feed rate can be matched individually to each work-piece material.
Velocidad de corte y avance gestionada individualmente en función del material a roscar.

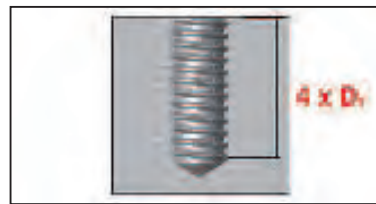

Ideal for deep blind holes.
Óptimo par agujeros ciegos profundos.

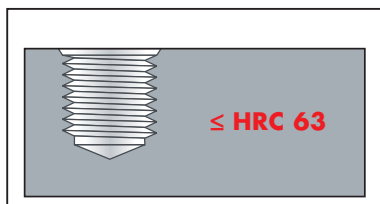

To realise threads in hardened materials
Para roscar aceros templados

GW
GFH

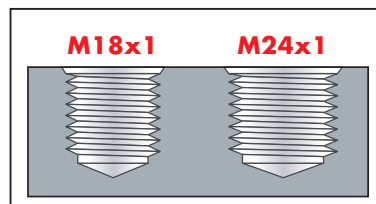

One only tool for threads of a wide range of diameters with the same pitch
Posibilidad de trabajar una multitud de diámetros a paso idéntico

GFM

BGF

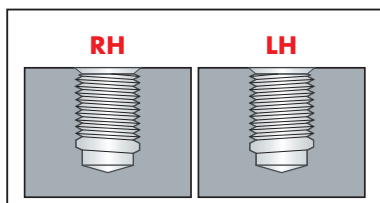

The same cutter can be used for right and left hand threads
Una única fresa para rosca derecha o izquierda

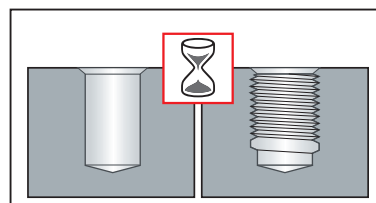

Time-saving when tool changing and space-saving in the tool carousel
Ganancia de tiempo y de sitio en el almacén de la máquina

PROGRAMMING CYCLE - CICLO DE PROGRAMACIÓN

Right hand thread climb milling – Roscado a derecha en concordancia

GW1016
GW1016VS
GW2016
GW2016VS

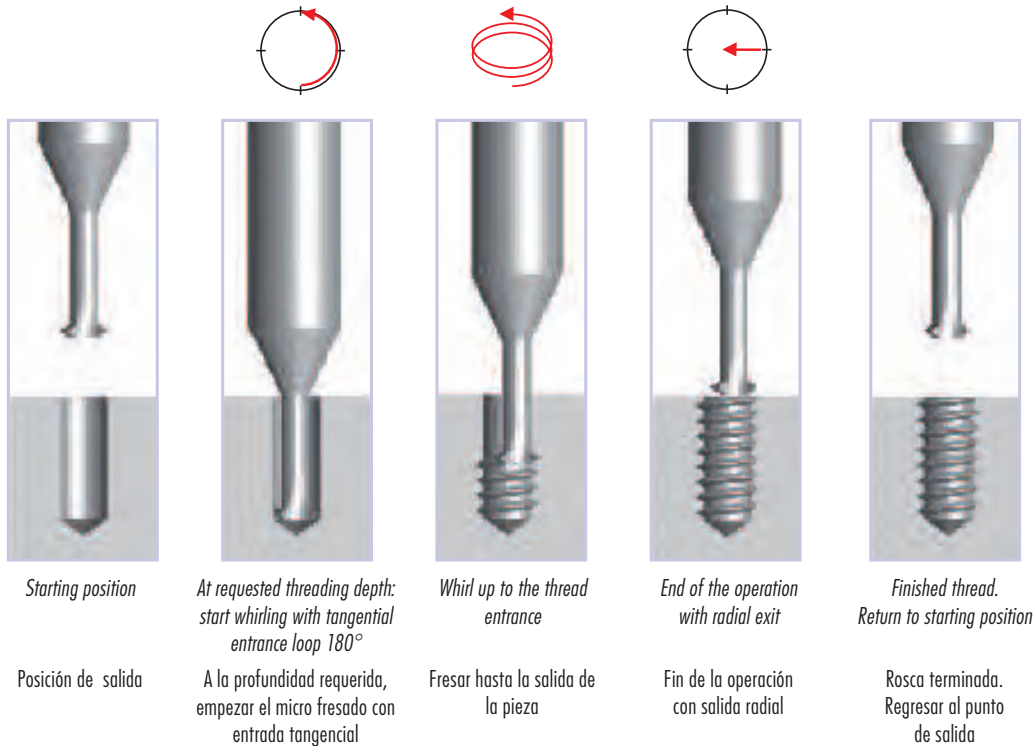

Conventional right hand thread milling – Roscado a derecha en oposición

GW3016
GW3016VS
GW3019
GW3019VS
GW4016
GW4016VS
GW4019
GW4019VS

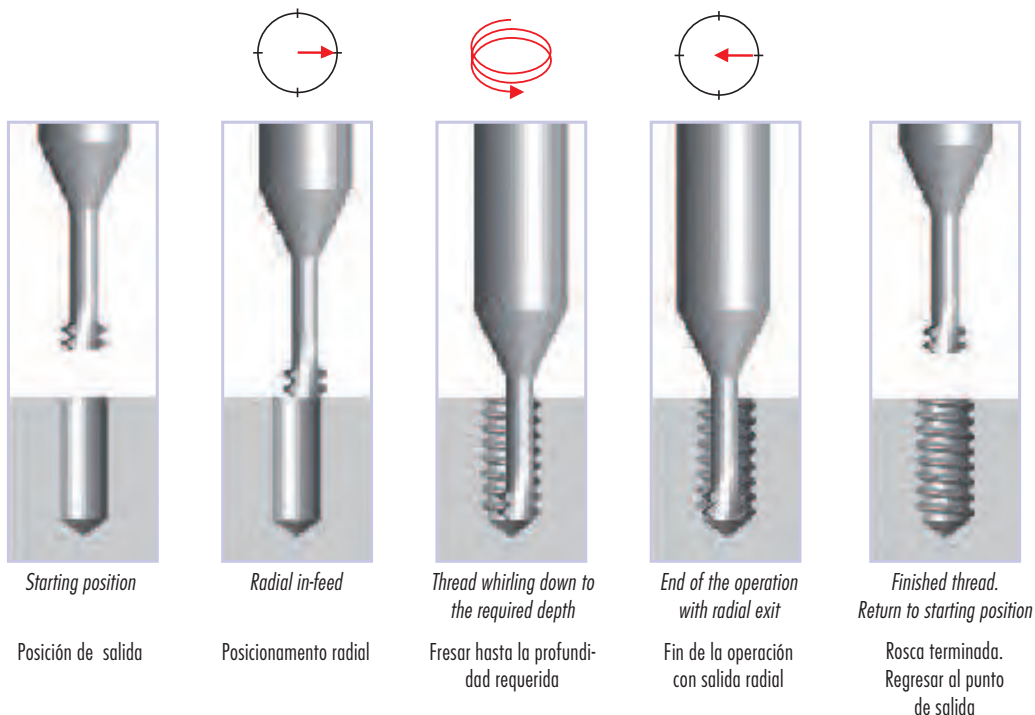

Operating cycle type GF - Ciclo de operaciones tipo GF

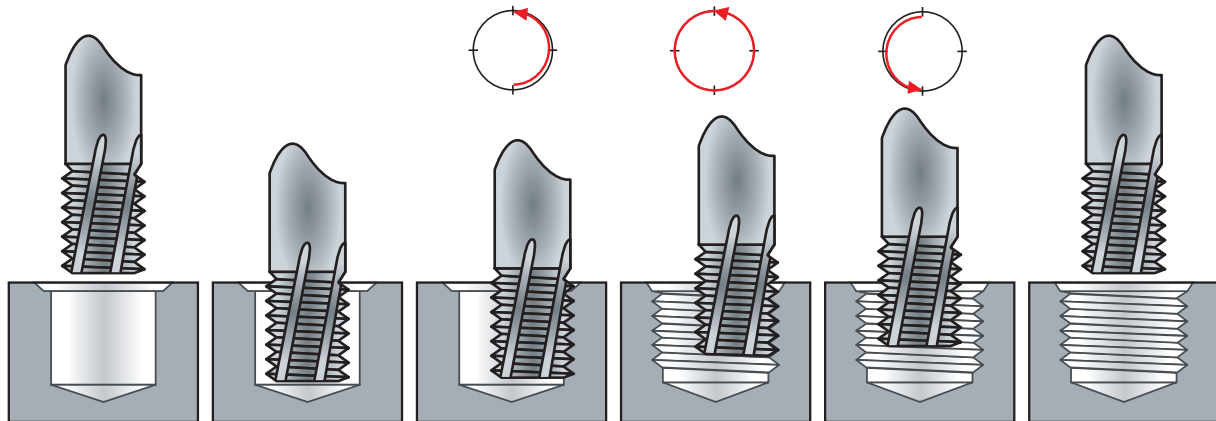

Operating cycle type BGF - Ciclo de operaciones tipo BGF

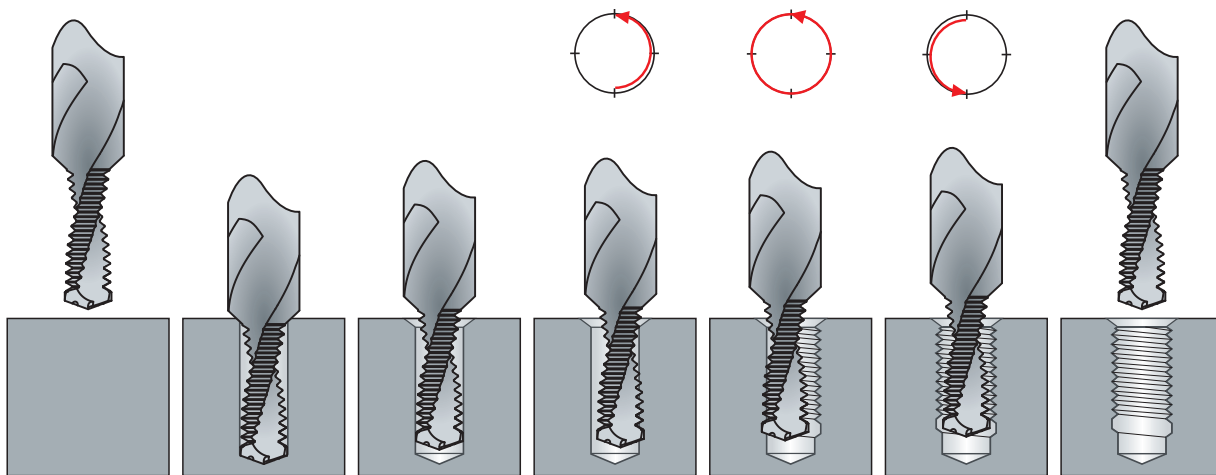

Special executions - Fabricación especial

Spot facing cutter
Corte frontal

Spot facing cutter and 90° chamfer
Corte frontal y achaflanante a 90°

With 45° circular chamfer for countersinking
Con corte de chafán a 45°

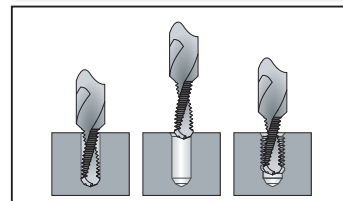
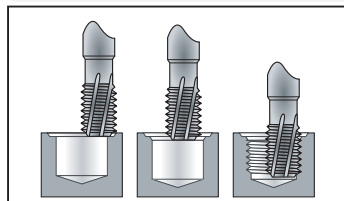
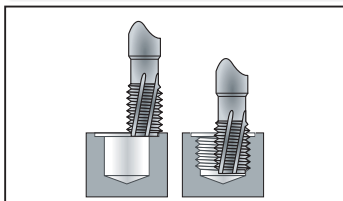

GFMS

GFMS

BGFS

Specific requirements – Exigencias particulares

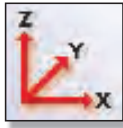

CNC machine with 3-D continuous path control

CNC con 3 ejes sincronizados



High speed cutting

Mecanizado HSC

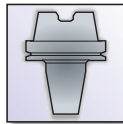

Perfect concentricity of fixture

Concentricidad perfecta del dispositivo de amarre

DC Application chart for thread whirling
Tabla de utilización DC para fresas torbellino

Material groups Grupos de materiales	Material designation Examples for application groups, pag. 5-6.	Clasificación de los materiales Ejemplos de materiales, páginas 5-6.	Hardness Dureza (HB)	Tensile strength Resistencia Rm (N/mm ²)	Elongation Alargamiento A (%)
10 Steels Aceros	11 Free-cutting steels	Aceros de decoletaje	< 200	< 700	< 10
	12 Structural / cementation steels	Aceros de construcción / cementación	< 200	< 700	< 30
	13 Carbon steels	Aceros al carbón	< 300	<1000	< 20
	14 Alloy steels <850 N/mm ²	Aceros aleados <850 N/mm ²	< 250	< 850	< 30
	15 Alloy steels hard. / temp. >850 - <1150 N/mm ²	Aceros aleados / tratados >850 - <1150 N/mm ²	> 250	> 850	< 30
	16 High tensile alloy steels	Aceros de alta resistencia	> 250	> 850	< 12
20 Stainless Steels Aceros inoxidables	21 Free machining stainless steels	Aceros inoxidables al azufre	< 250	< 850	< 25
	22 Austenitic stainless steels	Austeníticos	< 250	< 850	> 20
	23 Ferritic and martensitic <850 N/mm ²	Ferríticos y martensíticos <850 N/mm ²	< 250	< 850	> 20
	24 Ferritic and martens. >850 - <1150 N/mm ²	Ferríticos y martens. >850 - <1150 N/mm ²	> 250	> 850	> 15
30 Cast iron Fundición	31 Cast iron	Fundición gris	< 250	< 850	< 10
	32 Spheroidal graphite + malleable cast iron	Fundición de grafito esferoidal y maleable	< 250	< 850	> 10
40 Titanium Titanio	41 Pure titanium	Titanio puro	< 250	< 850	> 20
	42 Titanium alloys	Aleación al titanio	> 250	> 850	< 20
50 Nickel Níquel	51 Nickel alloys 1 <850 N/mm ²	Aleación al Níquel 1 <850 N/mm ²	< 250	< 850	> 25
	52 Nickel alloys 2 >850 - <1150 N/mm ²	Aleación al Níquel 2 >850 - <1150 N/mm ²	> 250	> 850	< 25
	53 Nickel alloys 3 >1150 - ≤1600 N/mm ²	Aleación al Níquel 3 >1150 - ≤1600 N/mm ²	> 340	> 1150	< 20
60 Copper Cobre	61 Pure copper (electrolitic copper)	Cobre puro (electrolítico)	< 120	< 400	> 12
	62 Short chip brass, phosphor bronze, gun metal	Latón, bronce (virutas cortas)	< 200	< 700	< 12
	63 Long chip brass	Latón (virutas largas)	< 200	< 700	> 12
70 Aluminium Magnesium Aluminio Magnesio	71 Al unalloyed	Al no aleado	< 100	< 350	> 15
	72 Al alloyed Si < 1.5 %	Al aleado Si < 1.5 %	< 150	< 500	> 15
	73 Al alloyed Si > 1.5 % - < 10 %	Al aleado Si > 1.5 % - < 10 %	< 120	< 400	< 15
	74 Al alloyed Si > 10 %, Mg-Alloys	Al aleado Si > 10 %, Aleaciones Magnesio	< 120	< 400	< 10
80 Plastic comp. Materiales plásticos	81 Thermoplastics	Materiales termoplásticos	-	-	-
	82 Duroplastics	Materiales duroplásticos	-	-	-
	83 Glass fibre reinforced plastics	Materiales plásticos reforzados por fibras	-	-	-
90 M. Prec. - M. Prec.	91 Silver / Gold	Plata / Oro	-	-	-

Use – Usar

☑ Optimal with cutting oil
 ☑ Suitable with cutting oil

☑ Óptima con aceite de corte
 ☑ Aceptable con aceite de corte

☑ Optimal with emulsion
 ☑ Suitable with emulsion

☑ Óptima con emulsión
 ☑ Aceptable con emulsión

GW



GW1016/VS

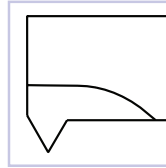

GW2016/VS

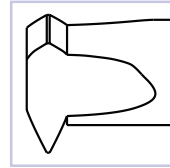

**GW3016/VS
GW3019/VS**

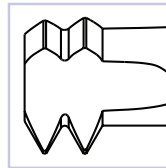

**GW4016/VS
GW4019/VS**

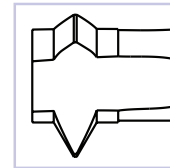

		Vc (m/min)		Milling fz (mm/tooth)			Avanze fz (mm/diente)	
		Standard	Coated Recub.	0.3 - 1.0	1.01 - 3.0	3.01 - 6.0		
		60 - 80	80 - 100	0.004 - 0.01	0.01 - 0.05	0.04 - 0.1	11	
		60 - 80	80 - 100	0.004 - 0.01	0.01 - 0.05	0.04 - 0.1	12	
		50 - 70	70 - 90	0.004 - 0.01	0.01 - 0.05	0.04 - 0.1	13	
		50 - 70	70 - 90	0.004 - 0.01	0.01 - 0.05	0.04 - 0.1	14	
		15 - 35	30 - 50	0.004 - 0.01	0.01 - 0.05	0.03 - 0.08	15	
		10 - 30	20 - 40	0.004 - 0.01	0.005 - 0.015	0.01 - 0.05	16	
			40 - 60	0.004 - 0.01	0.01 - 0.03	0.03 - 0.08	21	
			30 - 50	0.004 - 0.01	0.01 - 0.03	0.03 - 0.08	22	
			30 - 50	0.004 - 0.01	0.01 - 0.03	0.03 - 0.08	23	
			30 - 50	0.004 - 0.01	0.01 - 0.03	0.03 - 0.08	24	
		60 - 90	90 - 120	0.004 - 0.01	0.01 - 0.05	0.04 - 0.15	31	
		50 - 70	70 - 90	0.004 - 0.01	0.01 - 0.04	0.03 - 0.08	32	
		15 - 35	20 - 40	0.004 - 0.01	0.01 - 0.03	0.03 - 0.08	41	
		10 - 30	15 - 35	0.004 - 0.01	0.01 - 0.03	0.03 - 0.08	42	
			20 - 40	0.004 - 0.01	0.01 - 0.03	0.03 - 0.08	51	
			20 - 40	0.004 - 0.01	0.01 - 0.03	0.03 - 0.08	52	
			20 - 30	0.004 - 0.01	0.005 - 0.015	0.01 - 0.05	53	
		150 - 200	200 - 250	0.004 - 0.01	0.01 - 0.05	0.04 - 0.15	61	
		100 - 150	150 - 200	0.004 - 0.01	0.01 - 0.05	0.04 - 0.15	62	
		100 - 150	150 - 200	0.004 - 0.01	0.01 - 0.05	0.04 - 0.15	63	
		150 - 250	200 - 300	0.004 - 0.01	0.01 - 0.05	0.04 - 0.15	71	
		150 - 250	200 - 300	0.004 - 0.01	0.01 - 0.05	0.04 - 0.15	72	
		150 - 250	200 - 300	0.004 - 0.01	0.01 - 0.05	0.04 - 0.15	73	
		150 - 250	200 - 300	0.004 - 0.01	0.01 - 0.05	0.04 - 0.15	74	
		150 - 250	200 - 300	0.004 - 0.01	0.01 - 0.05	0.04 - 0.15	81	
		80 - 150	100 - 200	0.004 - 0.01	0.01 - 0.05	0.04 - 0.15	82	
			80 - 100	0.004 - 0.01	0.01 - 0.05	0.04 - 0.15	83	
		100 - 150	150 - 250	0.004 - 0.01	0.01 - 0.05	0.04 - 0.15	91	

The values are a guideline. Los valores son una pauta.

CUTTING SPEEDS AND FEED RATES VELOCIDADES DE CORTE Y AVANCES

DC Application chart for thread milling cutters and thrillers

Tabla de utilización DC para fresas de roscar y fresas de taladrar/roscar

Material groups Grupos de materiales	Material designation Examples for application groups, pag. 5-6.	Clasificación de los materiales Ejemplos de materiales, páginas 5-6.	Hardness Dureza (HB)	Tensile strength Resistencia Rm (N/mm ²)
10 Steels Aceros	11 Free-cutting steels	Aceros de decoletaje	< 200	< 700
	12 Structural / cementation steels	Aceros de construcción / cementación	< 200	< 700
	13 Carbon steels	Aceros al carbón	< 300	< 1000
	14 Alloy steels <850 N/mm ²	Aceros aleados <850 N/mm ²	< 250	< 850
	15 Alloy steels hard./temp. >850 - <1150 N/mm ²	Aceros aleados/tratados >850 - <1150 N/mm ²	> 250	> 850
	16 High tensile alloy steels	Aceros de alta resistencia	> 250	> 850
	* High tensile alloy steels 55 - 63 HRC	Aceros de alta resistencia 55 - 63 HRC	> 560	> 2000
20 Stainless Steels Aceros inoxidables	21 Free machining stainless steels	Aceros inoxidables al azufre	< 250	< 850
	22 Austenitic stainless steels	Austeníticos	< 250	< 850
	23 Ferritic and martensitic <850 N/mm ²	Ferríticos y martensíticos <850 N/mm ²	< 250	< 850
	24 Ferritic and martens. >850 - <1150 N/mm ²	Ferríticos y martens. >850 - <1150 N/mm ²	> 250	> 850
30 Cast iron Fundición	31 Cast iron	Fundición gris	< 250	< 850
	32 Spheroidal graphite + malleable cast iron	Fundición de grafito esferoidal y maleable	< 250	< 850
40 Titanium Titanio	41 Pure titanium	Titanio puro	< 250	< 850
	42 Titanium alloys	Aleación al titanio	> 250	> 850
50 Nickel Niquel	51 Nickel alloys 1 <850 N/mm ²	Aleación al Niquel 1 <850 N/mm ²	< 250	< 850
	52 Nickel alloys 2 >850 - <1150 N/mm ²	Aleación al Niquel 2 >850 - <1150 N/mm ²	> 250	> 850
	53 Nickel alloys 3 >1150 - ≤1600 N/mm ²	Aleación al Niquel 3 >1150 - ≤1600 N/mm ²	> 340	> 1150
60 Copper Cobre	61 Pure copper (electrolytic copper)	Cobre puro (electrolítico)	< 120	< 400
	62 Short chip brass, phosphor bronze, gun metal	Latón, bronce (virutas cortas)	< 200	< 700
	63 Long chip brass	Latón (virutas largas)	< 200	< 700
70 Aluminium Magnesium Aluminio Magnesio	71 Al / Mg unalloyed	Al no aleado	< 100	< 350
	72 Al alloyed Si < 1.5 %	Al aleado Si < 1.5 %	< 150	< 500
	73 Al alloyed Si > 1.5 % - < 10 %	Al aleado Si > 1.5 % - < 10 %	< 120	< 400
	74 Al alloyed Si > 10 %, Mg-Alloys	Al aleado Si > 10 %, Aleaciones Magnesio	< 120	< 400
80 Plastic comp. Materiales plásticos	81 Thermoplastics	Materiales termoplásticos	-	-
	82 Duroplastics	Materiales duroplásticos	-	-
	83 Glass fibre reinforced plastics	Materiales plásticos reforzados por fibras	-	-

* Thread milling cutter type GFH Fresa de roscar tipo GFH

Thread milling feed rates

$$\begin{aligned} \text{Feed rate} \quad V_{FK} &= f_z \times Z \times n \\ \text{Feed rate of the tool middle} \quad V_{FM} &= \frac{V_{FK} \times (\text{nominal thread } \varnothing - \varnothing \text{ of the thread milling cutter})}{\text{nominal thread } \varnothing} \end{aligned}$$

























On CNC machines, which do not calculate for themselves the feed rate at the tool-centre, the value "centre of the tool V_{FM} " must be considered.

Fórmula de cálculo para el avance de la fresa















$$\begin{aligned} \text{Avance de contorno} \quad V_{FK} &= f_z \times Z \times n \\ \text{Avance centro del útil} \quad V_{FM} &= \frac{V_{FK} \times (\varnothing \text{ nominal del roscado} - \varnothing \text{ de la fresa de roscar})}{\varnothing \text{ nominal del roscado}} \end{aligned}$$

Para las máquinas CN que no calculan automáticamente el avance del centro del útil, el valor "avance centro del útil V_{FM} " debe tomarse en consideración.









Directory - Solid carbide thread whirl cutters type GW
Directorio - Fresas torbellino en metal duro integral tipo GW

		GW					
Type Tipo		GW1016 GW1016VS	GW2016 GW2016VS	GW3016 GW3016VS	GW3019 GW3019VS	GW4016 GW4016VS	GW4019 GW4019VS
Coating Recubrimiento		VS	VS	VS	VS	VS	VS
		 NEW	 NEW	 NEW	 NEW	 NEW	 NEW
Thread length Longitud roscada		 2.5 x D.	 2.5 x D.	 2.5 x D.	 4 x D.	 2.5 x D.	 4 x D.
Characteristics Características		  R10	  R10	  R10	  R10	  R10	  R10
M	ISO DIN 13	204	205	206	206	208	208
MF	ISO DIN 13						
UNC	ANSI B1.1			207	207	209	209
UNF	ANSI B1.1			207	207	209	209

Directory - Solid carbide thread milling cutters type GF
Directorio - Fresas de roscar en metal duro integral tipo GF

		GF											
Type Tipo		GF6110	GF6110VS	GF6160	GF6160VS	GF6115	GF6115VS	GF6165	GF6165VS	GF6116	GF6116VS	GF6166	GF6166VS
Coating Recubrimiento		VS		VS		VS		VS		VS		VS	
													
Thread length Longitud roscada													
Characteristics Características													
M	ISO DIN 13	210				211		211		212		212	
MF	ISO DIN 13	213						214				214	
UNC	ANSI B1.1	215						216				216	
UNF	ANSI B1.1	217						218				218	
UN	ANSI B1.1												
G (BSP)	DIN ISO 228							219				219	
PG	DIN 40430												
NPT	ANSI B1.20.1			220									
NPTF	ANSI B1.20.3			220									
EG M	DIN 8140												

Directory - Solid carbide thread milling cutters type GFH and GFS
Directorio - Fresas de roscar en metal duro integral tipo GF y GFS

		GFH		GFS					
Type Tipo		GFH6110VS	GFS6610 GFS6610VS	GFS6660 GFS6660VS	GFS6615 GFS6615VS	GFS6665 GFS6665VS	GFS6616 GFS6616VS		
Coating Recubrimiento		VS	VS	VS	VS	VS	VS	VS	
Thread length Longitud roscada									
Characteristics Características									
M	ISO DIN 13	210	221	221	222	222	223		
MF	ISO DIN 13		224	224	225	225			
UNC	ANSI B1.1		226	226	227	227			
UNF	ANSI B1.1		228	228	229	229			
UN/EF/S	ANSI B1.1								
G (BSP)	DIN ISO 228			230		230			
PG	DIN 40430								
NPT	ANSI B1.20.1			231					
NPTF	ANSI B1.20.3			231					
EG M	DIN 8140								

Directory - Solid carbide thread milling cutters and thrillers type GFM and BGF
Directorio - Fresas de roscar y de taladrar/roscar en metal duro integral tipo GFM y BGF

GW-GF-GFH-
GFS-GFM-BGF

		GFM		BGF									
GFS6666	GFS6666VS	GFM6260	GFM6260VS	BGF6760	BGF6760VS	BGF6765	BGF6765VS	BGF6766	BGF6766VS	BGF6865	BGF6865VS	BGF6866	BGF6866VS
VS		VS		VS		VS		VS		VS		VS	
223	232	236	237	237	238	238							
	232	239	239										
	233												
	233												
	233												
	234												
	234												
	235												
	235												

GW

GW1016



GW1016VS



GW1016

GW1016VS



NEW



NEW

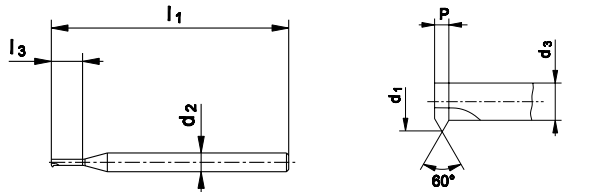

$\varnothing D_1$	P	d_1	l_1	l_3	d_2 h5	d_3		
S	mm	mm	mm	mm	mm	mm		
0.3	0.08	0.21	39	0.9	3	0.10	1	0.23 *
0.4	0.10	0.29	39	1.2	3	0.15	1	0.32 *
0.5	0.125	0.36	39	1.5	3	0.18	1	0.40 *
0.6	0.15	0.43	39	1.7	3	0.22	1	0.48 *
0.7	0.175	0.50	39	2.0	3	0.25	1	0.56 *
0.8	0.20	0.57	39	2.3	3	0.29	1	0.64 *
0.9	0.225	0.64	39	2.6	3	0.33	1	0.72 *
1.0	0.25	0.71	39	2.9	3	0.36	1	0.80 *
1.2	0.25	0.91	39	3.4	3	0.56	1	1.00 *
1.4	0.30	1.06	39	3.9	3	0.64	1	1.15 *

ID

ID

166930	166940
166931	166941
166932	166942
166933	166943
166934	166944
166935	166945
166936	166946
166937	166947
166938	166948
166939	166949

*Tol. $\begin{matrix} +0.02 \text{ mm} \\ 0 \end{matrix}$

GW

GW2016



GW2016VS



GW2016

GW2016VS



NEW



NEW

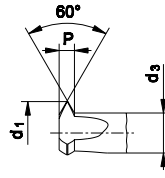
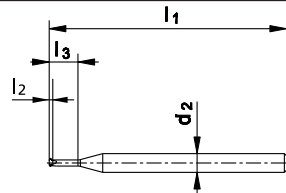

∅ D ₁ S	P mm	d ₁ mm	l ₁ mm	l ₂ mm	l ₃ mm	d ₂ h5 mm	d ₃ mm		
0.8	0.20	0.57	39	0.20	2.3	3	0.29	3	0.64 *
0.9	0.225	0.64	39	0.225	2.6	3	0.33	3	0.72 *
1.0	0.25	0.71	39	0.25	2.9	3	0.36	3	0.80 *
1.2	0.25	0.91	39	0.25	3.4	3	0.56	3	1.00 *
1.4	0.30	1.06	39	0.30	3.9	3	0.64	3	1.15 *

ID

ID

∅ D ₁ M	P mm	d ₁ mm	l ₁ mm	l ₂ mm	l ₃ mm	d ₂ h5 mm	d ₃ mm		
0.8	0.20	0.57	39	0.20	2.3	3	0.29	3	0.62
0.9	0.225	0.64	39	0.225	2.6	3	0.33	3	0.70
1.0	0.25	0.71	39	0.25	2.9	3	0.36	3	0.75
1.2	0.25	0.91	39	0.25	3.4	3	0.56	3	0.95
1.4	0.30	1.06	39	0.30	3.9	3	0.64	3	1.10
1.6	0.35	1.20	39	0.35	4.5	3	0.71	3	1.25
1.8	0.35	1.40	39	0.35	5.0	3	0.91	3	1.45
2.0	0.40	1.54	39	0.40	5.6	3	0.98	3	1.60
2.5	0.45	1.98	39	0.45	6.9	3	1.35	3	2.05
3.0	0.50	2.43	51	0.50	8.4	5	1.73	4	2.50
3.5	0.60	2.81	51	0.60	9.9	5	1.97	4	2.90
4.0	0.70	3.20	51	0.70	11.3	5	2.22	4	3.30
5.0	0.80	4.08	51	0.80	14.0	5	2.96	4	4.20
6.0	1.00	4.90	51	1.00	16.8	5	3.50	4	5.00

ID

ID

*Tol. +0.02 mm
0

GW

GW

GW3016



R10

GW3016VS



R10

VS

GW3019



R10

GW3019VS



R10

VS

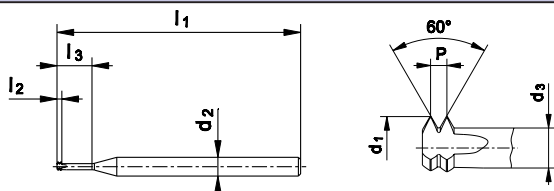

GW3016

GW3016VS

GW3019

GW3019VS



NEW



NEW





NEW





NEW



∅ D ₁ M	P mm	d ₁ mm	l ₁ mm	l ₂ mm	l ₃ mm	d ₂ h5 mm	d ₃ mm		
0.8	0.20	0.57	39	0.40	2.3	3	0.29	3	0.62
0.9	0.225	0.64	39	0.45	2.6	3	0.33	3	0.70
1.0	0.25	0.71	39	0.50	2.9	3	0.36	3	0.75
1.2	0.25	0.91	39	0.50	3.4	3	0.56	3	0.95
1.4	0.30	1.06	39	0.60	3.9	3	0.64	3	1.10
1.6	0.35	1.20	39	0.70	4.5	3	0.71	3	1.25
1.8	0.35	1.40	39	0.70	5.0	3	0.91	3	1.45
2.0	0.40	1.54	39	0.80	5.6	3	0.98	3	1.60
2.5	0.45	1.98	39	0.90	6.9	3	1.35	3	2.05
3.0	0.50	2.43	51	1.00	8.4	5	1.73	4	2.50
3.5	0.60	2.81	51	1.20	9.9	5	1.97	4	2.90
4.0	0.70	3.20	51	1.40	11.3	5	2.22	4	3.30
5.0	0.80	4.08	51	1.60	14.0	5	2.96	4	4.20
6.0	1.00	4.85	51	2.00	16.8	5	3.45	4	5.00

ID

ID

∅ D ₁ M	P mm	d ₁ mm	l ₁ mm	l ₂ mm	l ₃ mm	d ₂ h5 mm	d ₃ mm		
0.8	0.20	0.57	39	0.40	3.5	3	0.29	3	0.62
0.9	0.225	0.64	39	0.45	3.9	3	0.33	3	0.70
1.0	0.25	0.71	39	0.50	4.4	3	0.36	3	0.75
1.2	0.25	0.91	39	0.50	5.2	3	0.56	3	0.95
1.4	0.30	1.06	39	0.60	6.0	3	0.64	3	1.10
1.6	0.35	1.20	39	0.70	6.9	3	0.71	3	1.25
1.8	0.35	1.40	39	0.70	7.7	3	0.91	3	1.45
2.0	0.40	1.54	39	0.80	8.6	3	0.98	3	1.60
2.5	0.45	1.98	39	0.90	10.6	3	1.35	3	2.05
3.0	0.50	2.43	51	1.00	12.9	5	1.73	4	2.50
3.5	0.60	2.81	51	1.20	15.1	5	1.97	4	2.90
4.0	0.70	3.20	51	1.40	17.3	5	2.22	4	3.30
5.0	0.80	4.08	51	1.60	21.5	5	2.96	4	4.20
6.0	1.00	4.85	51	2.00	25.8	5	3.45	4	5.00

ID

ID

167063

167077

167064

167078

167065

167079

167066

167080

167067

167081

167068

167082

167069

167083

167070

167084

167071

167085

167072

167086

167073

167087

167074

167088

167075

167089

167076

167090

UNC-UNF ANSI B1.1

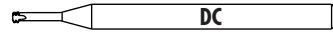

h5

GW

GW

GW3016			
GW3016VS			VS
GW3019			
GW3019VS			VS

GW3016	GW3016VS	GW3019	GW3019VS
--------	----------	--------	----------

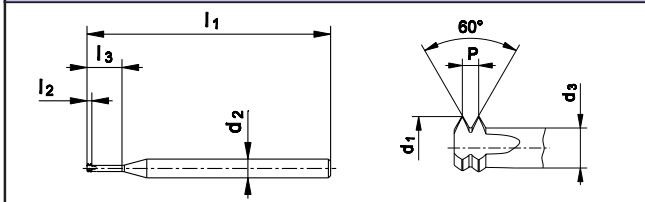
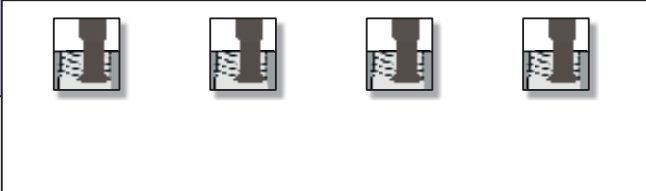

Ø" D ₁	P	d ₁	l ₁	l ₂	l ₃	d ₂ h5	d ₃		
UNC	TPI	mm	mm	mm	mm	mm	mm		
2	56	1.66	39	0.91	6.1	3	1.02	3	1.75
4	40	2.11	39	1.27	8.0	3	1.22	3	2.25
6	32	2.59	51	1.59	10.2	5	1.48	4	2.75
1/4	20	4.89	51	2.54	18.2	5	3.11	4	5.10

ID	ID
167472	167500
167473	167501
167474	167502
167476	167504

Ø" D ₁	P	d ₁	l ₁	l ₂	l ₃	d ₂ h5	d ₃		
UNF	TPI	mm	mm	mm	mm	mm	mm		
10	32	3.91	51	1.58	13.5	5	2.80	4	4.05
1/4	28	4.95	51	1.81	17.6	5	3.68	4	5.50

ID	ID
167477	167505
167478	167506

Ø" D ₁	P	d ₁	l ₁	l ₂	l ₃	d ₂ h5	d ₃		
UNC	TPI	mm	mm	mm	mm	mm	mm		
2	56	1.66	39	0.91	9.4	3	1.02	3	1.75
4	40	2.11	39	1.27	12.2	3	1.22	3	2.25
6	32	2.59	51	1.59	15.5	5	1.48	4	2.75
1/4	20	4.89	51	2.54	27.7	5	3.11	4	5.10

ID	ID
167479	167507
167480	167508
167481	167509
167483	167511

Ø" D ₁	P	d ₁	l ₁	l ₂	l ₃	d ₂ h5	d ₃		
UNF	TPI	mm	mm	mm	mm	mm	mm		
10	32	3.91	51	1.59	20.8	5	2.80	4	4.05
1/4	28	4.95	51	1.81	27.1	5	3.68	4	5.50

ID	ID
167484	167512
167485	167513

UNC-UNF ANSI B1.1

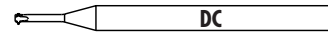

h5

GW

GW

											GW4016	GW4016VS	GW4019	GW4019VS
\varnothing " D ₁	P	d ₁	l ₁	l ₂	l ₃	d ₂ h5	d ₃				ID	ID		
UNC	TPI	mm	mm	mm	mm	mm	mm							
2	56	1.52	39	0.91	6.2	3	0.89	3	1.65*		167486	167514		
4	40	1.92	39	1.27	8.1	3	1.03	3	2.10*		167487	167515		
6	32	2.35	51	1.59	10.4	5	1.24	4	2.60*		167488	167516		
1/4	20	4.51	51	2.54	18.5	5	2.73	4	5.00*		167490	167518		
\varnothing " D ₁	P	d ₁	l ₁	l ₂	l ₃	d ₂ h5	d ₃				ID	ID		
UNF	TPI	mm	mm	mm	mm	mm	mm							
10	32	3.67	51	1.59	13.7	5	2.56	4	3.95*		167491	167519		
1/4	28	4.95	51	1.81	17.7	5	3.68	4	5.35*		167492	167520		
\varnothing " D ₁	P	d ₁	l ₁	l ₂	l ₃	d ₂ h5	d ₃				ID	ID		
UNC	TPI	mm	mm	mm	mm	mm	mm							
2	56	1.52	39	0.90	9.5	3	0.89	3	1.65*				167493	167521
4	40	1.92	39	1.27	12.4	3	1.03	3	2.10*				167494	167522
6	32	2.35	51	1.59	15.6	5	1.24	4	2.60*				167495	167523
1/4	20	4.51	51	2.54	28.0	5	2.73	4	5.00*				167497	167525
\varnothing " D ₁	P	d ₁	l ₁	l ₂	l ₃	d ₂ h5	d ₃				ID	ID		
UNF	TPI	mm	mm	mm	mm	mm	mm							
10	32	3.67	51	1.59	20.9	5	2.56	4	3.95*				167498	167526
1/4	28	4.95	51	1.81	27.3	5	3.68	4	5.35*				167499	167527

*Tol. $\begin{matrix} +0.03 \text{ mm} \\ 0 \end{matrix}$

GF - GFH

GF6110



GF6110VS



GFH6110VS

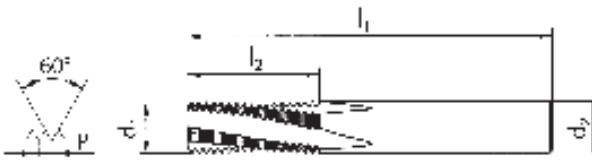

GF6110



GF6110VS



GFH6110VS



HRC
≤ 63



∅ D ₁ M	P mm	d ₁ mm	l ₁ mm	l ₂ mm	d ₂ mm	GF	GFH	ε
2	0.40	1.50	48	3.4	6	2		1.60
2.5	0.45	1.90	48	4.3	6	3		2.05
3	0.50	2.30	48	5.3	6	3	3	2.50
3.5	0.60	2.70	48	6.3	6	3		2.90
4	0.70	3.00	48	7.4	6	3	3	3.30
5	0.80	3.80	48	9.2	6	3	4	4.20
6	1.00	4.50	54	10.5	6		4	5.00
8	1.25	5.95	54	13.1	6		5	6.80
10	1.50	7.95	64	17.3	8		5	8.50
12	1.75	9.95	74	20.1	10		5	10.20

ID

125233

ID

115993

ID

150072

150565

152124

125660

116395

116350

135217

125944

116396

126158

116397

150073

150074

150075

150076













150077

151326

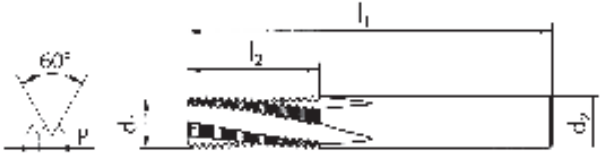
GF

									GF6115	GF6115VS	GF6165	GF6165VS
<p>GF6115 </p> <p>GF6115VS VS</p> <p>GF6165 </p> <p>GF6165VS VS</p>												
$\varnothing D_1$	P	d_1	l_1	l_2	d_2				ID	ID	ID	ID
M	mm	mm	mm	mm	mm							
4	0.70	3.00	48	8.8	6	3		3.30	146298	146969		
5	0.80	3.80	48	10.8	6	3		4.20	146299	146970		
6	1.00	4.50	54	13.5	6	3		5.00	146300	146971	126350	116398
8	1.25	5.95	54	18.1	6	3		6.80	146321	146972	126586	116399
10	1.50	7.95	64	21.8	8	4		8.50	146322	146973	124836	116400
12	1.75	9.95	72	25.4	10	4		10.20			116342	116401
14	2.00	9.95	74	31.0	10	4		12.00			125066	116402
16	2.00	11.95	80	35.0	12	4		14.00			125114	115990
18	2.50	13.95	90	41.3	14	4		15.50			125229	116403
20								17.50				









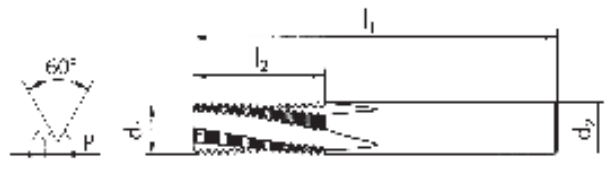

GF-GFH-GFS

<h1>GF</h1>								GF6116	GF6116VS	GF6166	GF6166VS
<p>GF6116 </p> <p>GF6116VS  VS</p> <p>GF6166  </p> <p>GF6166VS   VS</p>											
											
											
$\varnothing D_1$ M	P mm	d_1 mm	l_1 mm	l_2 mm	d_2 mm			ID	ID	ID	ID
4	0.70	3.00	48	10.9	6	3	3.30	155365	155370		
5	0.80	3.80	48	13.2	6	3	4.20	155366	155371		
6	1.00	4.50	54	16.5	6	3	5.00	155367	155372	155375	155382
8	1.25	5.95	54	21.9	6	3	6.80	155368	155373	155376	155383
10	1.50	7.95	64	26.3	8	4	8.50	155369	155374	155377	155384
12	1.75	9.95	74	32.4	10	4	10.20			155378	155385
14	2.00	9.95	74	37.0	10	4	12.00			155379	155386
16	2.00	11.95	90	43.0	12	4	14.00			155380	155387
18	2.50	13.95	105	53.8	14	4	15.50			155381	155388
20							17.50				

<div style="text-align: center; font-size: 2em; color: #4F81BD; font-weight: bold;">GF</div>								GF6110	GF6110VS		
								<p>GF6110 </p> <p>GF6110VS VS</p>			
$\varnothing D_1$ MF	P mm	d_1 mm	l_1 mm	l_2 mm	d_2 mm			ID	ID		
4	0.50	3.00	48	7.3	6	3		135218	135219		
5	0.50	3.80	48	8.8	6	3		135069	135220		

GF-GFH-GFS

GF									GF6165	GF6165VS	GF6166	GF6166VS				
<div style="display: flex; justify-content: space-between;"> <div style="width: 45%;"> <p>GF6165</p> <p>GF6165VS</p> <p>GF6166</p> <p>GF6166VS</p> </div> <div style="width: 50%;"> </div> </div>																
$\varnothing D_1$ MF	P	d_1	l_1	l_2	d_2				ID	ID	ID	ID				
6	0.50	4.50	54	12.8	6	3			135221	135222						
6	0.75	4.50	54	13.1	6	3			123664	123665						
8	0.50	5.95	54	17.8	6	3			135002	135223						
8	0.75	5.95	54	16.9	6	3			143110	135224						
8	1.00	5.95	54	17.5	6	3			124239	116404						
10	1.00	7.95	64	21.5	8	4			119986	116405						
10	1.25	7.95	64	21.9	8	4			120102	116406						
12	1.00	9.95	72	25.5	10	4			120303	116407						
12	1.50	9.95	72	26.3	10	4			120392	120393						
$\varnothing D_1$ MF	P	d_1	l_1	l_2	d_2				ID	ID	ID	ID				
6	0.50	4.50	54	15.8	6	3					155389	155398				
6	0.75	4.50	54	16.1	6	3					155390	155399				
8	0.50	5.95	54	20.8	6	3					155391	155400				
8	0.75	5.95	54	20.6	6	3					155392	155401				
8	1.00	5.95	54	21.5	6	3					155393	155402				
10	1.00	7.95	64	26.5	8	4					155394	155403				
10	1.25	7.95	64	26.9	8	4					155395	155404				
12	1.00	9.95	74	31.5	10	4					155396	155405				
12	1.50	9.95	74	32.3	10	4					155397	155406				

<h1>GF</h1>								GF6110	GF6110VS				
<p>GF6110 </p> <p>GF6110VS  VS</p>													
								 					
 								 					
\varnothing " D_1	P	d_1	l_1	l_2	d_2			ID	ID				
UNC	TPI	mm	mm	mm	mm								
10	24	3.60	48	10.1	6.0	3	3.80	135225	135226				
12	24	4.10	48	10.1	6.0	3	4.40	135227	135228				
1/4	20	4.80	54	12.1	6.0	3	5.10	135229	135230				

GF-GFH-GFS

GF									GF6165	GF6165VS	GF6166	GF6166VS
GF6165												
GF6165VS			VS									
GF6166												
GF6166VS			VS									
\varnothing D ₁ UNC	P TPI	d₁ mm	l₁ mm	l₂ mm	d₂ mm				ID	ID		
1/4	20	4.80	54	14.6	6.0	3			155407	155408		
5/16	18	5.95	54	17.6	6.0	3			116047	135231		
3/8	16	7.10	64	21.5	8.0	4			135232	135233		
7/16	14	7.95	64	24.5	8.0	4			116049	135234		
1/2	13	9.95	72	28.4	10.0	4			135235	135236		
\varnothing D ₁ UNC	P TPI	d₁ mm	l₁ mm	l₂ mm	d₂ mm					ID	ID	
1/4	20	4.80	54	17.1	6.0	3				155409	155414	
5/16	18	5.95	54	21.9	6.0	3				155410	155415	
3/8	16	7.10	64	26.2	8.0	4				155411	155416	
7/16	14	7.95	64	29.9	8.0	4				155412	155417	
1/2	13	9.95	74	34.2	10.0	4				155413	155418	

GF

GF6110



GF6110VS

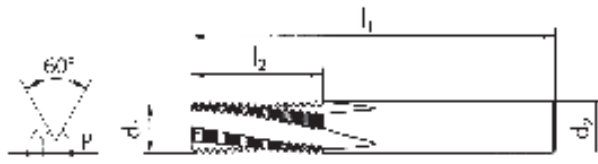

\emptyset " D_1	P	d_1	l_1	l_2	d_2		
UNF	TPI	mm	mm	mm	mm		
10	32	3.60	48	8.3	6.0	3	4.05
12	28	4.10	48	9.5	6.0	3	4.60
1/4	28	4.80	54	11.3	6.0	3	5.50

GF6110

GF6110VS



ID

ID

128659

135237

135238

135239

135240

135176

GF-GFH-GFS

GF									GF6165	GF6165VS	GF6166	GF6166VS
<p>GF6165</p>												
<p>GF6165VS</p>												
<p>GF6166</p>												
<p>GF6166VS</p>												
\varnothing D ₁	P	d ₁	l ₁	l ₂	d ₂				ID	ID		
UNF	TPI	mm	mm	mm	mm							
1/4	28	4.80	54	14.1	6.0	3			155419	155420		
5/16	24	5.95	54	17.5	6.0	3			135242	135243		
3/8	24	7.10	64	20.6	8.0	4			135182	135245		
7/16	20	7.95	64	24.8	8.0	4			135246	135247		
1/2	20	9.95	72	27.3	10.0	4			135183	135249		
\varnothing D ₁	P	d ₁	l ₁	l ₂	d ₂				ID	ID		
UNF	TPI	mm	mm	mm	mm							
1/4	28	4.80	54	16.8	6.0	3			155421	155426		
5/16	24	5.95	54	20.6	6.0	3			155422	155427		
3/8	24	7.10	64	24.9	8.0	4			155423	155428		
7/16	20	7.95	64	28.6	8.0	4			155424	155429		
1/2	20	9.95	74	33.7	10.0	4			155425	155430		

G DIN ISO 228 (BSP)

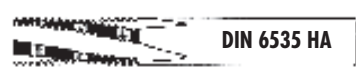

sur demande
auf Anfrage
on request
su richiesta
sobre pedido

GF

								GF6165	GF6165VS	GF6166	GF6166VS
<p>GF6165</p>											
<p>GF6165VS</p>											
<p>GF6166</p>											
<p>GF6166VS</p>											
\varnothing " D₁	P	d₁	l₁	l₂	d₂			ID	ID		
G	TPI	mm	mm	mm	mm						
1/8	28	7.95	64	21.3	8.0	4	8.75	119347	116409		
1/4	19	9.95	72	28.7	10.0	4	11.60	119292	116410		
3/8	19	13.60	80	35.4	14.0	4	15.20	119678	116411		
\varnothing " D₁	P	d₁	l₁	l₂	d₂				ID	ID	
G	TPI	mm	mm	mm	mm						
1/8	28	7.95	64	24.9	8.0	4	8.75		155431	155434	
1/4	19	9.95	74	34.1	10.0	4	11.60		155432	155435	
3/8	19	13.60	90	43.4	14.0	4	15.20		155433	155436	

GF-GFH-GFS

NPT, NPTF

ANSI B1.20.1
ANSI B1.20.3

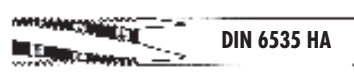

sur demande
auf Anfrage
on request
su richiesta
sobre pedido

GF

GF6160



GF6160VS



GF6160

GF6160VS

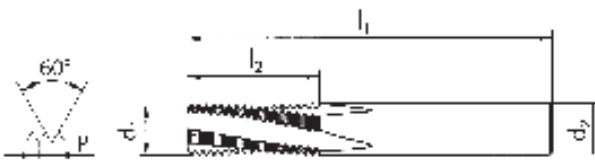

Ø" D ₁ NPT	P TPI	d ₁ mm	l ₁ mm	l ₂ mm	d ₂ mm	
1/8	27	7.30	64	9.9	8.0	4
1/4	18	9.95	72	14.8	12.0	4
3/8	18	12.50	80	14.8	14.0	4
1/2	14	14.70	90	19.1	16.0	4

ID

ID

116371	116435
135250	135251
135252	135253
155437	155438

Ø" D ₁ NPTF	P TPI	d ₁ mm	l ₁ mm	l ₂ mm	d ₂ mm	
1/8	27	7.30	64	9.9	8.0	4
1/4	18	9.95	72	14.8	12.0	4
3/8	18	12.50	80	14.8	14.0	4
1/2	14	14.70	90	19.1	16.0	4

ID

ID

* 135254	
135256	135257
135258	135259
155439	155440

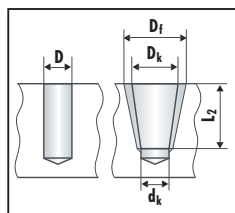

Ø D ₁	Core hole Agujero			Milling Fresado	
	D	d _k	D _k	D _f	L ₂
1/8	8.5	8.3	8.85	9.81	6.92
1/4	11.1	10.8	11.48	12.99	10.02
3/8	14.5	14.2	14.92	16.41	10.33
1/2	17.9	17.5	18.42	20.37	13.57

GFS

GFS6610



GFS6610VS



GFS6660



GFS6660VS



GFS6610

GFS6610VS

GFS6660

GFS6660VS



$\varnothing D_1$ M	P mm	d_1 mm	l_1 mm	l_2 mm	l_3 mm	d_3 mm	d_2 mm	α	β
2	0.40	1.50	48	3.4	3.7	2.1	6	2	1.60
2.5	0.45	1.90	48	4.3	4.7	2.6	6	3	2.05
3	0.50	2.30	48	5.3	5.6	3.1	6	3	2.50
3.5	0.60	2.70	48	5.7	6.2	3.6	6	3	2.90
4	0.70	3.00	48	7.3	7.9	4.1	6	3	3.30
5	0.80	3.80	54	9.2	9.9	5.1	6	3	4.20
6	1.00	4.50	62	10.5	11.3	6.2	8	3	5.00
8	1.25	5.95	74	13.1	14.3	8.2	10	3	6.80
10	1.50	7.95	80	17.3	18.4	10.3	12	4	8.50
12	1.75	9.95	90	20.1	21.3	12.3	14	4	10.20
14	2.00	10.80	102	25.0	26.8	14.4	16	4	12.00
16	2.00	12.80	102	27.0	28.8	16.4	18	4	14.00
18	2.50	13.95	125	33.8	36.0	18.5	25	4	15.50
20				37.0	20.5				17.50

ID

ID

ID

ID

135331

135332

155441

155443

135333

135334

155442

155444

135335

135336

135337

135338

135339

116175

135340

116172

135341

116173

135342

116174

135343

135344

135345

135346

135347

135348

GFS

GFS6615



GFS6615VS



GFS6665



GFS6665VS

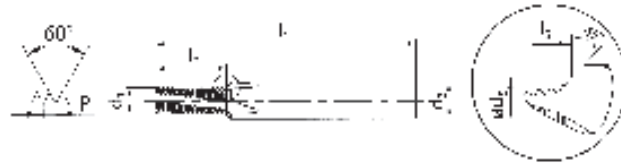

∅ D ₁ M	P mm	d ₁ mm	l ₁ mm	l ₂ mm	l ₃ mm	d ₅ mm	d ₂ mm		
2	0.40	1.50	48	4.6	4.9	2.1	6	2	1.60
2.5	0.45	1.90	48	5.6	6.0	2.6	6	3	2.05
3	0.50	2.30	48	6.8	7.1	3.1	6	3	2.50
3.5	0.60	2.70	48	7.5	8.0	3.6	6	3	2.90
4	0.70	3.00	48	8.8	9.3	4.1	6	3	3.30
5	0.80	3.80	54	10.8	11.5	5.1	6	3	4.20
6	1.00	4.50	62	13.5	14.3	6.2	8	3	5.00
8	1.25	5.95	74	18.1	19.3	8.2	10	3	6.80
10	1.50	7.95	80	21.8	22.9	10.3	12	4	8.50
12	1.75	9.95	90	25.4	26.6	12.3	14	4	10.20
14	2.00	10.80	102	31.0	32.8	14.4	16	4	12.00
16	2.00	12.80	102	35.0	36.8	16.4	18	4	14.00
18	2.50	13.95	125	41.3	43.5	18.5	25	4	15.50
20					44.5	20.5			17.50

GFS6615

GFS6615VS

GFS6665

GFS6665VS



ID

ID

ID

ID

135349

135350

155445

155447

125661

135351

155446

147108

125946

135352

126160

116178

126352

135353

155524

155525

126587

116343

124837

135354

124973

135355

125067

135356

125116

135357

125231

135358

GFS

GFS6616



GFS6616VS



GFS6666



GFS6666VS



$\varnothing D_1$ M	P mm	d_1 mm	l_1 mm	l_2 mm	l_3 mm	d_s mm	d_2 mm	ϵ	ϵ
3	0.50	2.30	48	8.3	8.7	3.1	6	3	2.50
4	0.70	3.00	48	10.9	11.5	4.1	6	3	3.30
5	0.80	3.80	54	13.2	13.9	5.1	6	3	4.20
6	1.00	4.50	62	16.5	17.4	6.2	8	3	5.00
8	1.25	5.95	74	21.9	23.0	8.2	10	3	6.80
10	1.50	7.95	80	26.3	27.5	10.3	12	4	8.50
12	1.75	9.95	90	32.4	33.6	12.3	14	4	10.20
14	2.00	10.80	102	37.0	38.8	14.4	16	4	12.00
16	2.00	12.80	102	43.0	44.8	16.4	18	4	14.00
18	2.50	13.95	125	53.8	56.1	18.5	25	4	15.50
20					57.1	20.5			17.50

GFS6616

GFS6616VS

GFS6666

GFS6666VS



ID

ID

ID

ID

155448

155452

155449

155453

155450

155454

155451

155455

155456

155463

155457

155464

155458

155465

155459

155466

155460

155467

155461

155468

155462

155469

GFS

GFS6610



GFS6610VS



GFS6660



GFS6660VS



GFS6610

GFS6610VS

GFS6660

GFS6660VS



∅ D ₁ MF	P mm	d ₁ mm	l ₁ mm	l ₂ mm	l ₃ mm	d _s mm	d ₂ mm		
4	0.50	3.00	48	7.3	7.8	4.1	6	3	3.50
5	0.50	3.80	54	8.8	9.4	5.1	6	3	4.50
6	0.50	4.50	62	9.8	10.6	6.2	8	3	5.50
6	0.75	4.50	62	10.1	11.0	6.2	8	3	5.25
8	0.50	5.95	74	12.8	13.9	8.2	10	3	7.50
8	0.75	5.95	74	13.1	14.3	8.2	10	3	7.25
8	1.00	5.95	74	13.5	14.6	8.2	10	3	7.00
10	1.00	7.95	80	16.5	17.7	10.3	12	4	9.00
10	1.25	7.95	80	16.9	18.1	10.3	12	4	8.80
12	1.00	9.95	90	19.5	20.7	12.3	14	4	11.00
12	1.50	9.95	90	20.3	21.4	12.3	14	4	10.50
14	1.50	10.80	102	23.3	25.0	14.4	16	4	12.50
16	1.50	12.80	102	26.3	28.1	16.4	18	4	14.50

ID

ID

ID

ID

135359

135360

135361

135362

135363

135364

135365

135366

135367

135368

135369

135370

135371

135372

135373

135374

135375

135376

135377

135378

135379

135380

135381

135382

135383

135384

GFS

GFS6615



GFS6615VS



GFS6665



GFS6665VS



GFS6615

GFS6615VS

GFS6665

GFS6665VS



















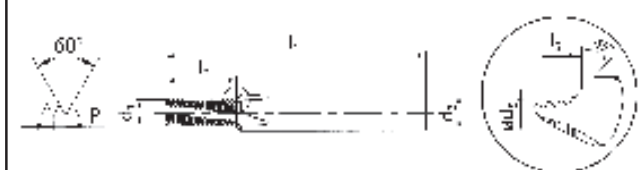

∅ D ₁ MF	P mm	d ₁ mm	l ₁ mm	l ₂ mm	l ₃ mm	d _s mm	d ₂ mm		
4	0.50	3.00	48	8.8	9.3	4.1	6	3	3.50
5	0.50	3.80	54	10.8	11.4	5.1	6	3	4.50
6	0.50	4.50	62	12.8	13.6	6.2	8	3	5.50
6	0.75	4.50	62	13.1	14.0	6.2	8	3	5.25
8	0.50	5.95	74	17.8	18.9	8.2	10	3	7.50
8	0.75	5.95	74	16.9	18.0	8.2	10	3	7.25
8	1.00	5.95	74	17.5	18.6	8.2	10	3	7.00
10	1.00	7.95	80	21.5	22.7	10.3	12	4	9.00
10	1.25	7.95	80	21.9	23.0	10.3	12	4	8.80
12	1.00	9.95	90	25.5	26.7	12.3	14	4	11.00
12	1.50	9.95	90	26.3	27.4	12.3	14	4	10.50
14	1.50	10.80	102	30.8	32.5	14.4	16	4	12.50
16	1.50	12.80	102	33.8	35.6	16.4	18	4	14.50

ID ID ID ID

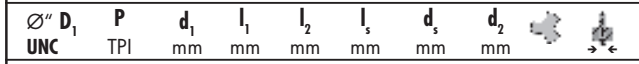
135385	135386		
135387	135388		
135389	135390		
135391	135392		
		135393	135394
		135395	135396
		135397	135398
		135399	135400
		135401	135402
		135403	135404
		135405	135406
		135407	135408
		135409	135410

GFS

<h1>GFS</h1>											GFS6610	GFS6610VS	GFS6660	GFS6660VS
<p>GFS6610  </p> <p>GFS6610VS   </p> <p>GFS6660   </p> <p>GFS6660VS    </p>														
														
														
Ø" D ₁ UNC	P TPI	d ₁ mm	l ₁ mm	l ₂ mm	l ₃ mm	d ₅ mm	d ₂ mm				ID	ID	ID	ID
10	24	3.60	54	10.1	10.7	4.9	6	3	3.80		135420	135421		
12	24	4.10	54	10.1	10.8	5.6	6	3	4.40		135422	135423		
1/4	20	4.80	62	12.1	12.9	6.5	8	3	5.10		135424	135425	155470	155473
5/16	18	5.95	74	14.8	15.9	8.1	10	3	6.50		135426	135427	155471	155474
3/8	16	7.10	80	16.7	18.0	9.8	12	4	8.00		135428	135429	155472	155475
7/16	14	7.95	80	19.0	20.8	11.4	12	4	9.30				135430	135431
1/2	13	9.95	90	22.5	24.0	13.0	14	4	10.80				135432	135433
9/16	12	10.80	102	24.4	26.3	14.6	16	4	12.20				135434	135435
5/8	11	11.90	102	26.5	28.8	16.3	18	4	13.60				135436	135437

GFS



GFS6615  

GFS6615VS   

GFS6665   

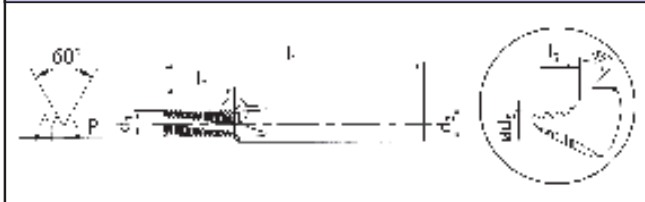
GFS6665VS    



Ø" D ₁	P	d ₁	l ₁	l ₂	l ₃	d ₅	d ₂		
UNC	TPI	mm	mm	mm	mm	mm	mm		
10	24	3.60	54	12.2	12.8	4.9	6	3	3.80
12	24	4.10	54	13.2	14.0	5.6	6	3	4.40
1/4	20	4.80	62	14.6	15.5	6.5	8	3	5.10
5/16	18	5.95	74	17.6	18.7	8.1	10	3	6.50
3/8	16	7.10	80	21.5	22.8	9.8	12	4	8.00
7/16	14	7.95	80	24.5	26.2	11.4	12	4	9.30
1/2	13	9.95	90	28.4	29.9	13.0	14	4	10.80
9/16	12	10.80	102	32.8	34.7	14.6	16	4	12.20
5/8	11	11.90	102	35.8	38.0	16.3	18	4	13.60

GFS6615	GFS6615VS	GFS6665	GFS6665VS
---------	-----------	---------	-----------

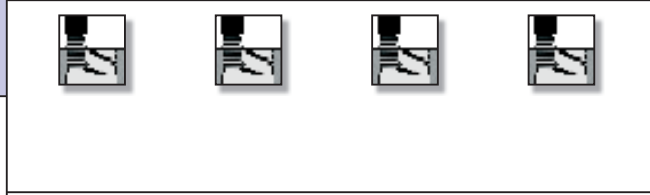

ID	ID	ID	ID
135438	135439		
135440	135441		
135442	135443	155476	155479
135444	135445	155477	155480
135446	135447	155478	155481
		135448	135449
		135450	135451
		135452	135453
		135454	135455

GFS

GFS

GFS6610



GFS6610VS



GFS6660



GFS6660VS

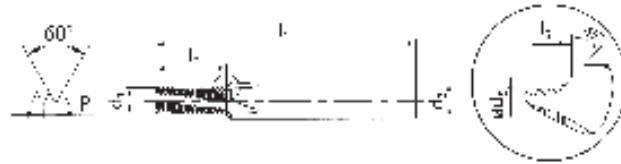
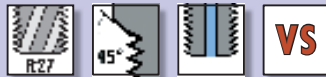

GFS6610

GFS6610VS

GFS6660

GFS6660VS



Ø" D ₁ UNF	P TPI	d ₁ mm	l ₁ mm	l ₂ mm	l _s mm	d _s mm	d ₂ mm			
10	32	3.60	54	8.3	9.0	4.9	6	3	4.05	
12	28	4.10	54	9.5	10.3	5.6	6	3	4.60	
1/4	28	4.80	62	11.3	12.2	6.5	8	3	5.50	
5/16	24	5.95	74	13.2	14.3	8.1	10	3	6.90	
3/8	24	7.95	80	16.4	17.3	9.8	12	4	8.50	
7/16	20	7.95	80	18.4	20.1	11.4	12	4	9.80	
1/2	20	9.95	90	21.0	22.5	13.0	14	4	11.40	
9/16	18	11.60	102	23.3	24.8	14.6	16	4	12.90	
5/8	18	11.90	102	26.1	28.3	16.3	18	4	14.50	

ID

ID

ID

ID

135456

135457

135458

135459

135460

135461

155482

155485

135462

135463

155483

155486

135464

135465

155484

155487

135466

135467

135468

135469

135470

135471

135472

135473

GFS



GFS6615  

GFS6615VS   

GFS6665   

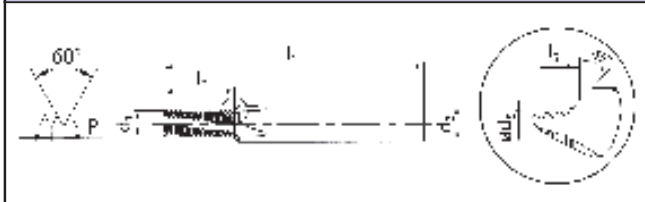
GFS6665VS    



Ø" D ₁ UNF	P TPI	d ₁ mm	l ₁ mm	l ₂ mm	l _s mm	d _s mm	d ₂ mm		
10	32	3.60	54	11.5	12.2	4.9	6	3	4.05
12	28	4.10	54	12.3	13.0	5.6	6	3	4.60
1/4	28	4.80	62	14.1	14.9	6.5	8	3	5.50
5/16	24	5.95	74	17.5	18.6	8.1	10	3	6.90
3/8	24	7.95	80	20.6	21.5	9.8	12	4	8.50
7/16	20	7.95	80	24.8	26.5	11.4	12	4	9.80
1/2	20	9.95	90	27.3	28.8	13.0	14	4	11.40
9/16	18	11.60	102	30.4	31.9	14.6	16	4	12.90
5/8	18	11.90	102	34.6	36.8	16.3	18	4	14.50

GFS6615	GFS6615VS	GFS6665	GFS6665VS
---------	-----------	---------	-----------



ID	ID	ID	ID
128660	135474		
135475	135476		
128578	135477	155488	155491
135478	135479	155489	155492
135480	135481	155490	155493
		135482	135483
		135484	135485
		135486	135487
		135488	135489

GFS

GFS

GFS6660



GFS6660VS



GFS6665



GFS6665VS

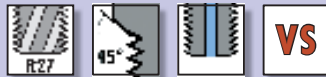

Ø" D ₁	P	d ₁	l ₁	l ₂	l ₃	d ₅	d ₂		
G	TPI	mm	mm	mm	mm	mm	mm		
1/8	28	7.95	80	15.9	16.9	10.0	12	4	8.75
1/4	19	9.95	90	22.1	23.8	13.5	14	4	11.60
3/8	19	12.80	102	27.4	29.5	17.1	18	4	15.20

GFS6660

GFS6660VS

GFS6665

GFS6665VS

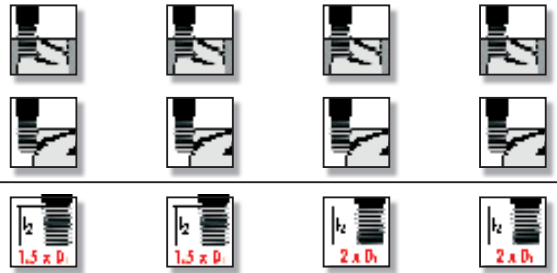

Ø" D ₁	P	d ₁	l ₁	l ₂	l ₃	d ₅	d ₂		
G	TPI	mm	mm	mm	mm	mm	mm		
1/8	28	7.95	80	21.3	22.3	10.0	12	4	8.75
1/4	19	9.95	90	28.7	30.5	13.5	14	4	11.60
3/8	19	12.80	102	35.4	37.6	17.1	18	4	15.20

ID	ID
135411	135412
135413	135414
135415	135416

ID	ID
119349	135417
119298	135418
119680	135419

NPT, NPTF

ANSI B1.20.1
ANSI B1.20.3

VHM
CAR

DIN 6535 HA

HB
HE

sur demande
auf Anfrage
on request
su richiesta
sobre pedido

GFS

GFS6660



GFS6660VS



GFS6660

GFS6660VS



GFS



Ø" D ₁ NPT	P TPI	d ₁ mm	l ₁ mm	l ₂ mm	l _s mm	d _s mm	d ₂ mm	✂
1/8	27	7.30	70	9.9	11.2	10.6	12	4
1/4	18	9.95	80	14.8	16.4	14.0	16	4
3/8	18	12.50	80	14.8	16.9	17.6	18	4

ID ID

126910	135490
126899	135491
126928	135492

Ø" D ₁ NPTF	P TPI	d ₁ mm	l ₁ mm	l ₂ mm	l _s mm	d _s mm	d ₂ mm	✂
1/8	27	7.30	70	9.9	11.2	10.6	12	4
1/4	18	9.95	80	14.8	16.4	14.0	16	4
3/8	18	12.50	80	14.8	16.9	17.6	18	4

ID ID

135493	135494
135495	135496
135497	135498

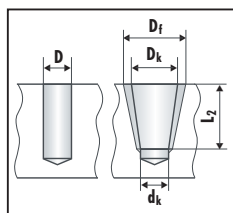

Ø D ₁	Core hole Agujero			Milling Fresado	
	D	dk	Dk	Df	L ₂
1/8	8.5	8.3	8.85	9.81	6.92
1/4	11.1	10.8	11.48	12.99	10.02
3/8	14.5	14.2	14.92	16.41	10.33

GFM

GFM6260

GFM6260VS

GFM6260
GFM6260VS

d_1 mm	P mm	$\varnothing D_1$ ≥ M, MF	l_1 mm	l_2 mm	l_3 mm	d_2 mm		ID	ID
8	0.50	10	64	16.0	16	8.0	4	116450	135260
8	0.75	10	64	15.8	16	8.0	4	116340	135261
10	0.75	14	70	15.8	26	10.0	4	116128	135262
10	1.00	14	70	16.0	26	10.0	4	118657	135263
10	1.25	14	70	16.3	26	10.0	4	118659	135264
10	1.50	14	70	16.5	26	10.0	4	118661	135265
12	0.50	18	80	20.0	32	12.0	4	116129	135214
12	0.75	18	80	20.3	32	12.0	4	155526	155527
12	1.00	18	80	20.0	32	12.0	4	118664	135007
12	1.25	18	80	20.0	32	12.0	4	* 118666	
12	1.50	18	80	21.0	32	12.0	4	118669	135181
12	2.00	18	80	20.0	32	12.0	4	118673	135269
16	1.00	24	90	25.0	42	16.0	4	118680	135270
16	1.50	24	90	25.5	42	16.0	4	118682	116017
16	2.00	24	90	26.0	42	16.0	4	118684	135271
16	2.50	24	90	25.0	42	16.0	4	118689	135272
16	3.00	24	90	27.0	42	16.0	4	158760	150564
20	1.00	30	105	33.0	52	20.0	5	135273	135274
20	1.50	30	105	33.0	52	20.0	5	118694	135275
20	2.00	30	105	34.0	52	20.0	5	116338	135276
20	2.50	30	105	32.5	52	20.0	5	* 135277	
20	3.00	30	105	33.0	52	20.0	5	118699	135279
20	3.50	30	105	38.5	55	20.0	5	144195	144065



GFM

GFM6260



GFM6260VS



GFM6260

GFM6260VS



d ₁ mm	P TPI	Ø" D ₁ ≥ UN	l ₁ mm	l ₂ mm	l ₃ mm	d ₂ mm		ID	ID
10	24	1/2	70	15.9	26	10	4	135288	135289
12	24	3/4	80	20.1	32	12	4	135290	135291
12	20	3/4	80	20.3	32	12	4	135292	135293
12	18	3/4	80	19.8	32	12	4	135294	135295
12	16	3/4	80	20.6	32	12	4	135296	135297
12	10	3/4	80	20.3	32	12	4	150963	155494
16	24	1	90	25.4	42	16	4	135298	135299
16	20	1	90	25.4	42	16	4	135300	135301
16	18	1	90	25.4	42	16	4	135302	135303
16	16	1	90	25.4	42	16	4	135304	135305
16	14	1	90	25.4	42	16	4	135306	135307
16	12	1	90	25.4	42	16	4	135308	135309
16	9	1	90	25.4	42	16	4	150964	155495
16	8	1	90	25.4	42	16	4	150965	155496
20	24	1 1/4	105	32.8	52	20	5	135310	135311
20	20	1 1/4	105	33.0	52	20	5	135312	135313
20	18	1 1/4	105	32.5	52	20	5	135314	135315
20	16	1 1/4	105	33.4	52	20	5	118697	135316
20	14	1 1/4	105	32.7	52	20	5	135317	135318
20	12	1 1/4	105	31.8	52	20	5	135319	135320
20	8	1 1/4	105	31.8	52	20	5	135321	135322
20	7	1 1/4	105	32.7	52	20	5	150962	155497

GFM

G DIN ISO 228 (BSP) PG DIN 40430



DIN 6535 HA



sur demande
auf Anfrage
on request
su richiesta
sobre pedido

GFM

GFM6260



GFM6260VS



GFM6260

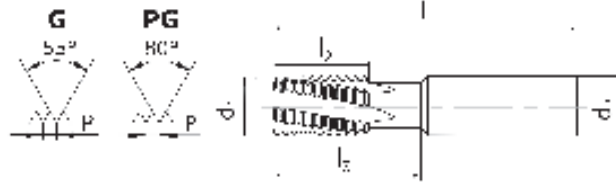

d ₁ mm	P TPI	∅ D ₁ G	l ₁ mm	l ₂ mm	l ₃ mm	d ₂ mm	
10	19	1/4 - 3/8	70	16.0	26	10	4
16	14	1/2 - 7/8	90	25.4	42	16	4
20	11	≥ 1	105	32.3	52	20	5

d ₁ mm	P TPI	∅ D ₁ PG	l ₁ mm	l ₂ mm	l ₃ mm	d ₂ mm	
10	20	7	70	16.0	26	10	4
12	18	9 - 16	80	20.0	32	12	4
16	16	21 - 48	90	25.0	42	16	4

GFM6260

GFM6260VS

GFM6260



ID

ID

118655	135280
118678	135281
118691	135282

ID

* 116177
* 135284
* 135286

NPT, NPTF ANSI B1.20.1 ANSI B1.20.3



DIN 6535 HA



sur demande
auf Anfrage
on request
su richiesta
sobre pedido

GFM

GFM6260



GFM6260VS



GFM6260

GFM6260VS



GFM

d_1 mm	P TPI	$\varnothing'' D_1$ \geq NPT	l_1 mm	l_2 mm	d_2 mm		ID	ID
14.5	14	1/2	90	19.1	16	4	135323	135324
18.5	11.5	1	90	23.2	20	5	135325	135326

d_1 mm	P TPI	$\varnothing'' D_1$ \geq NPTF	l_1 mm	l_2 mm	d_2 mm		ID	ID
14.5	14	1/2	90	19.1	16	4	135327	135328
18.5	11.5	1	90	23.2	20	5	135329	135330

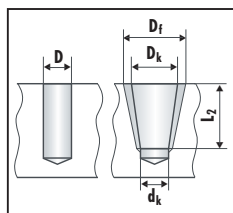

$\varnothing D_1$	Core hole Agujero			Milling Fresado	
	D	d_k	D_k	D_f	L_2
1/2	17.9	17.5	18.42	20.37	13.57
3/4	23.2	22.8	23.76	25.69	14.05
1	29.1	28.7	29.81	32.18	16.79
1 1/4	37.7	37.4	38.57	40.90	17.30
1 1/2	44.0	43.5	44.64	49.67	17.30
2	56.0	55.5	56.67	58.99	17.70

BGF

BGF6760



BGF6760VS



BGF6760

BGF6760VS

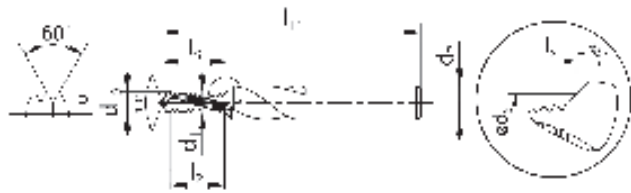

$\varnothing D_1$ M	P mm	d_1 mm	d_{10} mm	l_{11} mm	l_2 mm	l_s mm	d_s mm	d_2 mm	
4	0.70	3.10	3.30	48	5.6	7.4	4.1	6	2
5	0.80	4.00	4.20	54	7.2	9.4	5.1	6	2
6	1.00	4.75	5.00	62	9.0	11.7	6.2	8	2
8	1.25	6.50	6.75	74	11.2	14.6	8.2	10	2
10	1.50	8.25	8.50	80	14.9	19.1	10.3	12	2
12	1.75	9.95	10.25	90	17.4	22.1	12.3	14	2
14	2.00	11.60	12.00	102	19.9	25.1	14.4	16	2
16	2.00	13.60	14.00	102	23.9	29.5	16.4	18	2

ID

ID

153400

153415

153401

153416

153402

153417

151911

153418

153403

151442

153404

153419

153405

153420

153406

153421

BGF

BGF6765



BGF6765VS



BGF6766



BGF6766VS

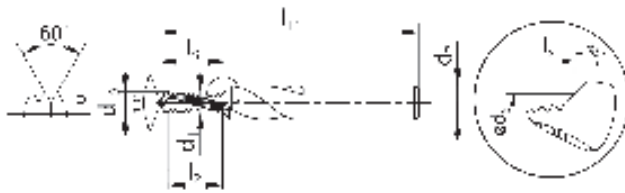

BGF6765	BGF6765VS	BGF6766	BGF6766VS
---------	-----------	---------	-----------

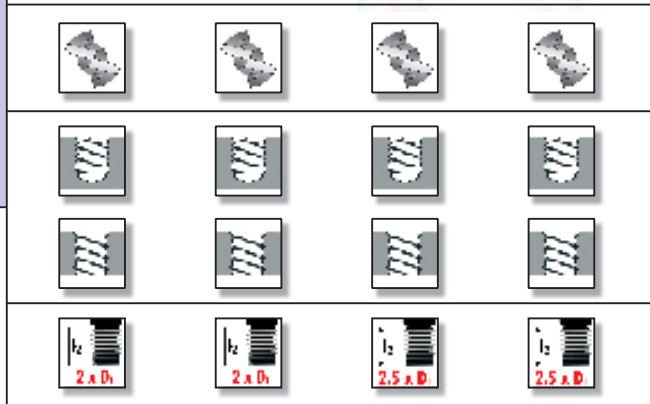

$\varnothing D_1$ M	P mm	d_1 mm	d_{10} mm	l_{11} mm	l_2 mm	l_s mm	d_s mm	d_2 mm	
4	0.70	3.10	3.30	48	7.7	9.5	4.1	6	2
5	0.80	4.00	4.20	54	9.6	11.8	5.1	6	2
6	1.00	4.75	5.00	62	12.0	14.7	6.2	8	2
8	1.25	6.50	6.75	74	15.0	18.4	8.2	10	2
10	1.50	8.25	8.50	80	19.4	23.6	10.3	12	2
12	1.75	9.95	10.25	90	22.7	27.3	12.3	14	2
14	2.00	11.60	12.00	102	27.9	33.1	14.4	16	2
16	2.00	13.60	14.00	102	31.9	37.5	16.4	18	2

ID	ID
153430	153442
151305	151306
150933	151776
153431	150588
153432	150589
153433	150927
153434	153443
153435	151324

$\varnothing D_1$ M	P mm	d_1 mm	d_{10} mm	l_{11} mm	l_2 mm	l_s mm	d_s mm	d_2 mm	
6	1.00	4.75	5.00	62	15.0	17.7	6.2	8	2
8	1.25	6.50	6.75	74	20.0	23.4	8.2	10	2
10	1.50	8.25	8.50	80	23.9	28.1	10.3	12	2
12	1.75	9.95	10.25	90	29.7	34.3	12.3	14	2
14	2.00	11.60	12.00	102	35.9	41.1	14.4	16	2
16	2.00	13.60	14.00	102	39.9	45.5	16.4	18	2

ID	ID
153451	153467
153452	153468
153453	153469
153454	153470
153455	153471
153456	153472

BGF

BGF

BGF6865

BGF6865VS

BGF6866

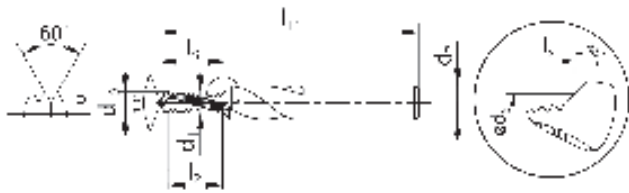
BGF6866VS

$\varnothing D_1$	P	d_1	d_{10}	l_{11}	l_2	l_s	d_s	d_2	
M	mm	mm	mm	mm	mm	mm	mm	mm	

6	1.00	4.75	5.00	62	12.0	14.7	6.2	8	3
8	1.25	6.50	6.75	74	14.9	18.4	8.2	10	3
10	1.50	8.25	8.50	80	19.4	23.6	10.3	12	3
12	1.75	9.95	10.25	90	22.7	27.3	12.3	14	3
14	2.00	11.60	12.00	102	27.9	33.1	14.4	16	3
16	2.00	13.60	14.00	102	31.9	37.5	16.4	18	3

$\varnothing D_1$	P	d_1	d_{10}	l_{11}	l_2	l_s	d_s	d_2	
M	mm	mm	mm	mm	mm	mm	mm	mm	

6	1.00	4.75	5.00	62	15.0	17.7	6.2	8	3
8	1.25	6.50	6.75	74	20.0	23.4	8.2	10	3
10	1.50	8.25	8.50	80	23.9	28.1	10.3	12	3
12	1.75	9.95	10.25	90	29.7	34.3	12.3	14	3
14	2.00	11.60	12.00	102	35.9	41.1	14.4	16	3
16	2.00	13.60	14.00	102	39.9	45.5	16.4	18	3

BGF6865
BGF6865VS
BGF6866
BGF6866VS

ID
ID

153577	153589
153578	153590
153579	153591
* 153580	* 153592
* 153581	* 153593
* 153582	* 153594

ID
ID

153601	153613
153602	153614
153603	153615
* 153604	* 153616
* 153605	* 153617
* 153606	* 153618

BGF

BGF6760



BGF6760VS



BGF6765



BGF6765VS

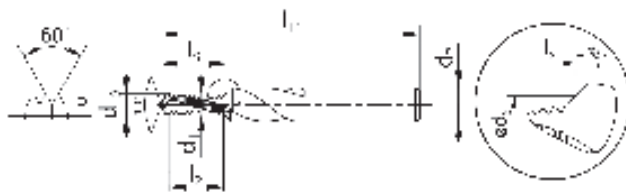

BGF6760

BGF6760VS

BGF6765

BGF6765VS



$\varnothing D_1$	P	d_1	d_{10}	l_{11}	l_2	l_s	d_s	d_2	
MF	mm	mm	mm	mm	mm	mm	mm	mm	

6	0.75	5.00	5.25	62	9.0	11.4	6.2	8	2
8	1.00	6.75	7.00	74	12.0	15.0	8.2	10	2
10	1.00	8.75	9.00	80	15.0	18.5	10.3	12	2
12	1.00	10.70	11.00	90	18.0	21.9	12.3	14	2
12	1.50	10.20	10.50	90	17.9	22.5	12.3	14	2
14	1.50	12.10	12.50	102	20.9	26.0	14.4	16	2
16	1.50	14.10	14.50	102	23.9	29.4	16.4	18	2

ID

ID

153759	153780
153761	153782
153762	153783
153764	153785
153765	153786
153766	153787
153767	153788

$\varnothing D_1$	P	d_1	d_{10}	l_{11}	l_2	l_s	d_s	d_2	
MF	mm	mm	mm	mm	mm	mm	mm	mm	

6	0.75	5.00	5.25	62	9.0	11.4	6.2	8	2
8	1.00	6.75	7.00	74	12.0	15.0	8.2	10	2
10	1.00	8.75	9.00	80	15.0	18.5	10.3	12	2
12	1.00	10.70	11.00	90	18.0	21.9	12.3	14	2
12	1.50	10.20	10.50	90	17.9	22.5	12.3	14	2
14	1.50	12.10	12.50	102	20.9	26.0	14.4	16	2
16	1.50	14.10	14.50	102	23.9	29.4	16.4	18	2





























ID

ID

153802	153824
153804	153826
153805	153827
153807	153829
153808	153830
153809	153831
153810	153832

BGF

Directory - Round dies, button dies for Swiss automatics, hexagon die nuts and bell form dies
Directorio - Cojinetes redondos, para tornos automáticos, hexagonales y de campana

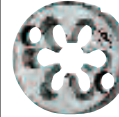
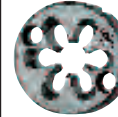
		N		MS	Z		N	Z
Characteristics Características								
			 	 	 	 	 	 
								
								
		N5110	N5120	MS5120	Z5120	Z5120LL	N5220	Z5220
M 6g	DIN 13	242	242		243	243	256	256
M 6e	DIN 13		242				256	
M 6g LH	DIN 13	242	242					
MF 6g	DIN 13	244	244-246		244-245		257	
MF 6e	DIN 13		244-245					
MF 6g LH	DIN 13		244-246					
UNC	ANSI B1.1	247	247					
UNF	ANSI B1.1	248	248					
UNEF	ANSI B1.1		249					
UN	ANSI B1.1		249					
UNS	ANSI B1.1		249					
G (BSP)	DIN ISO 228		250	251	251			
G (BSP) LH	DIN ISO 228		250					
G (BSP) -0.1 mm	DIN ISO 228			251				
R (BSPT)	DIN EN 10226		252					
NPT	ANSI B1.20.1		253					
NPTF	ANSI B1.20.3		253					
PG	DIN 40430		254					
TR	DIN 103		254					
W (BSW)	BS 84	255	255					
W (BSW) LH	BS 84		255					

N	
N5310	N5420
258	261
259	
260	
260	

Pictographs - Pictogramas

	HSS HSS
	HSSE HSSE
	1.25 chamfered threads 1.25 hilos de entrada
	1.75 chamfered threads 1.75 hilos de entrada
	2 chamfered threads 2 hilos de entrada
	Peeling cut from $\varnothing 3$ mm Entrada en hélice desde $\varnothing 3$ mm
	Peeling cut on both sides from $\varnothing 3$ mm Entrada en hélice de los 2 lados desde $\varnothing 3$ mm
	Number of flutes Números de ranuras
	Turned diameters Diámetro del torneado
	Nitrided ($d_1 \geq 3$ mm, $P \geq 0.5$ mm) Nitruración ($d_1 \geq 3$ mm, $P \geq 0.5$ mm)
	Die with 2 securing holes Cojinete con 2 agujeros de fijación
	Tolerance 6g Tolerancia 6g
	Tolerance 6e Tolerancia 6e
	Tolerance "Medium Class" Tolerancia "Medium Class"
	Tolerance A Tolerancia A
	Tapered thread 1:16 (NPT - NPTF - R) Rosca cónica 1:16 (NPT - NPTF - R)
	Left hand thread Rosca izquierda

									N5110	N5120	N5120 LH	N5120
									1.75 x P	1.75 x P	1.75 x P	1.75 x P
									6g	6g	6g	6e
$\varnothing d_1$ M	P mm	d_2 mm	l_1 mm						ID	ID	ID	ID 6g - mm
1	0.25	16.0	5.0	3		0.97			103851			
1.1	0.25	16.0	5.0	3		1.07			124659			
1.2	0.25	16.0	5.0	3		1.17			103852			
1.4	0.30	16.0	5.0	3		1.36			103853			
1.6	0.35	16.0	5.0	3		1.54			103855			
1.7	0.35	16.0	5.0	3		1.64			103856			
1.8	0.35	16.0	5.0	3		1.74			103857			
* 2	0.40	16.0	5.0	3		1.93	1.90		103864			
2.2	0.45	16.0	5.0	3		2.13			103867			
* 2.3	0.40	16.0	5.0	3		2.23			103869			
* 2.5	0.45	16.0	5.0	3		2.43	2.40		103872			
* 2.6	0.45	16.0	5.0	3	4	2.53			103876		* 103877	
3	0.50	20.0	5.0	3	4	2.92	2.90		103879	104067	104068	104066 0.030
3.5	0.60	20.0	5.0	3	4	3.41	3.38		103880	104071	104072	* 104070 0.030
4	0.70	20.0	5.0	3	4	3.91	3.87		103881	104114	104115	104113 0.035
4.5	0.75	20.0	7.0	4		4.40			103882	104117		
5	0.80	20.0	7.0	4	4	4.90	4.87		103883	104146	104147	104145 0.035
5.5	0.90	20.0	7.0	4		5.40			103884			
6	1.00	20.0	7.0	4	4	5.88	5.85		103885	104165	104166	104164 0.035
7	1.00	25.0	9.0	4	4	6.88			103886	104174	104175	
8	1.25	25.0	9.0	4	4	7.87	7.83		103887	104186	104187	104185 0.035
9	1.25	25.0	9.0	4		8.87			103888	104191		
10	1.50	30.0	11.0	4	4	9.85	9.82		103858	103953	103954	103952 0.035
12	1.75	38.0	14.0	4	4	11.83	11.80		103859	103973	103974	103972 0.035
14	2.00	38.0	14.0	4	4	13.82			103860	103989	103990	
16	2.00	45.0	18.0	4	4	15.82	15.79		103861	104003	104004	104002 0.035
18	2.50	45.0	18.0	5		17.79			103862	104015		
20	2.50	45.0	18.0	5	5	19.79			103878	104028	104029	
22	2.50	55.0	22.0	5		21.79				104035		
24	3.00	55.0	22.0	5	5	23.76				104043	104044	
27	3.00	65.0	25.0	5		26.76				104058		
30	3.50	65.0	25.0	5	5	29.73				104079	104080	
33	3.50	65.0	25.0	6		32.73				104089		
36	4.00	65.0	25.0	7		35.70				104100		
52	5.00	90.0	36.0	7		51.66				* 104155		
* N5110 / N5110 LH									≤ M1.4			

Z5120		NI		13, 14, 21			Z5120	Z5120 LL		
Z5120 LL		NI		13, 14, 15, 21						
							2 x P	2.25 x P		
							6g	6g		
$\varnothing d_1$	P	d_2	l_1				ID	ID		
M	mm	mm	mm	Z5120	Z5120LL	→6g←				
2	0.40	16.0	3.5	4	4	1.93	125269	105115		
2.5	0.45	16.0	5.0	4	4	2.43	104779	105116		
2.6	0.45	16.0	5.0	4		2.53	104780			
3	0.50	20.0	5.0	4	5	2.92	104788	105117		
3.5	0.60	20.0	5.0	4		3.41	104789			
4	0.70	20.0	5.0	4	5	3.91	104790	105118		
5	0.80	20.0	7.0	4	5	4.90	104792	105119		
6	1.00	20.0	7.0	4	5	5.88	104795	105120		
7	1.00	25.0	9.0	4		6.88	111424			
8	1.25	25.0	9.0	5	6	7.87	104798	105121		
10	1.50	30.0	11.0	5	6	9.85	104767	105122		
12	1.75	38.0	14.0	5	6	11.83	104770	105123		
14	2.00	38.0	14.0	5		13.82	104773			
16	2.00	45.0	18.0	5		15.82	104776			
18	2.50	45.0	18.0	5		17.79	104778			
20	2.50	45.0	18.0	5		19.79	104783			
22	2.50	55.0	22.0	6		21.79	* 104785			
24	3.00	55.0	22.0	6		23.76	104787			



								N5120	N5120 LH	N5120	Z5120	
$\varnothing d_1$ MF	P mm	d_2 mm	l_1 mm	N	Z	$\rightarrow 6g \leftarrow$	$\rightarrow 6e \leftarrow$	ID	ID	ID	$6g$ - mm	ID
* 2	0.25	16.0	5.0	4		1.93		103863				
* 2.5	0.35	16.0	5.0	4		2.44		103871				
3	0.35	20.0	5.0	4		2.94		104064				
3.5	0.35	20.0	5.0	4		3.44		104069				
4	0.35	20.0	5.0	4		3.94		104108				
4	0.50	20.0	5.0	4		3.93		104110				
4.5	0.50	20.0	5.0	4		4.43		104116				
5	0.50	20.0	5.0	4	4	4.93	4.90	104141	104142	104140	0.030	104791
5	0.75	20.0	7.0	4		4.90		104143				
5.5	0.50	20.0	5.0	4		5.43		104148				
6	0.50	20.0	5.0	4		5.93		104159	104160			104793
6	0.75	20.0	7.0	4	4	5.90		104162	104163			104794
7	0.50	25.0	9.0	4	4	6.93		104169				
7	0.75	25.0	9.0	4		6.90	6.87	104171		* 104170	0.035	
8	0.50	25.0	9.0	5		7.93		104177				
8	0.75	25.0	9.0	4	4	7.90		104180				104796
8	1.00	25.0	9.0	4	4	7.88	7.85	104183	104184	104182	0.035	104797
9	0.50	25.0	9.0	5		8.93		104188				
9	0.75	25.0	9.0	5		8.90		104189				
9	1.00	25.0	9.0	5		8.88		104190				
10	0.50	30.0	11.0	5		9.93		103942				
10	0.75	30.0	11.0	5	5	9.90	9.87	103945		* 103944	0.035	104765
10	1.00	30.0	11.0	5	5	9.88	9.85	103948	103949	103947	0.035	104766
10	1.25	30.0	11.0	4		9.86		103950	103951			
11	0.75	30.0	11.0	5		10.90		103956				
11	1.00	30.0	11.0	5		10.88		103957				
11	1.25	30.0	11.0	5		10.87		103958				
12	0.50	38.0	10.0	5		11.93		103960				
12	0.75	38.0	10.0	5		11.90	11.87	103962		* 103961	0.035	
12	1.00	38.0	10.0	5	5	11.88	11.85	103965	103966	103964	0.035	104768
12	1.25	38.0	10.0	4		11.86		103967	103968			
12	1.50	38.0	10.0	4	5	11.85		103970	103971			104769
13	1.00	38.0	10.0	5		12.88		103976				

* N5110







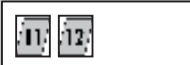
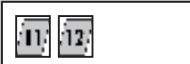

P 0.25

6h

								N5120	N5120 LH	N5120	Z5120	
$\varnothing d_1$ MF	P mm	d_2 mm	l_1 mm	N	Z	$\rightarrow 6g \leftarrow$	$\rightarrow 6e \leftarrow$	ID	ID	ID	$6g$ - mm	ID
14	0.50	38.0	10.0	5		13.93		103977				
14	0.75	38.0	10.0	5		13.90		103979				
14	1.00	38.0	10.0	5	5	13.88		103981	103982			104771
14	1.25	38.0	10.0	5		13.86		103983	* 103984			
14	1.50	38.0	10.0	5	5	13.85		103986	103987			104772
15	1.00	38.0	10.0	5		14.88		103991				
15	1.50	38.0	10.0	5		14.85		103992				
16	1.00	45.0	14.0	5	5	15.88	15.85	103996	103997	* 103995	0.035	104774
16	1.25	45.0	14.0	5		15.87		103998				
16	1.50	45.0	14.0	5	5	15.85		104000	104001			104775
17	1.00	45.0	14.0	5		16.88		104005				
18	1.00	45.0	14.0	5		17.88		104008				
18	1.50	45.0	14.0	5	5	17.85		104011	104012			
18	2.00	45.0	14.0	5		17.82		104013				
19	1.00	45.0	14.0	6		18.88		104017				
20	1.00	45.0	14.0	6	6	19.88		104021	104022			104781
20	1.50	45.0	14.0	6	6	19.85		104024	104025			104782
20	2.00	45.0	14.0	6		19.82		104026	* 104027			
21	1.00	45.0	14.0	7		20.88		111386				
22	1.00	55.0	16.0	6		21.88		104030				
22	1.50	55.0	16.0	5	6	21.85		104032				
22	2.00	55.0	16.0	5		21.82		104034				
23	1.00	55.0	16.0	6		22.88		121704				
24	1.00	55.0	16.0	6		23.88		104037				
24	1.50	55.0	16.0	6	6	23.85		104039				
24	2.00	55.0	16.0	6		23.82		104041	104042			
25	1.00	55.0	16.0	6		24.88		104045				
25	1.50	55.0	16.0	6		24.85		104046				
26	1.00	55.0	16.0	7		25.88		104049				
26	1.50	55.0	16.0	6		25.85		104050	* 104051			
26	2.00	55.0	16.0	6		25.82		104052				
27	1.00	65.0	18.0	6		26.88		104053				
27	1.50	65.0	18.0	6		26.85		104054	* 104055			
27	2.00	65.0	18.0	6		26.82		104056				



<div style="display: flex; justify-content: space-between;"> <div style="width: 45%;"> <p>N5120 </p> <p>N5120 LH LH</p> </div> <div style="width: 45%;"> <p></p> <p></p> </div> </div>						N5120	N5120 LH		
$\varnothing d_1$ MF	P mm	d_2 mm	l_1 mm		 →6g←	ID	ID		
28	1.00	65.0	18.0	6	27.88	104060			
28	1.50	65.0	18.0	6	27.85	104061			
30	1.00	65.0	18.0	7	29.88	104073			
30	1.50	65.0	18.0	6	29.85	104074			
30	2.00	65.0	18.0	6	29.82	104076			
32	1.00	65.0	18.0	7	31.88	* 104081			
32	1.50	65.0	18.0	7	31.85	104082	* 104083		
32	2.00	65.0	18.0	7	31.82	* 104084			
33	1.50	65.0	18.0	7	32.85	104085			
33	2.00	65.0	18.0	7	32.82	104086			
33	3.00	65.0	25.0	7	32.76	* 104088			
34	1.50	65.0	18.0	7	33.85	104091			
35	1.50	65.0	18.0	8	34.85	104092	* 104093		
36	1.50	65.0	18.0	8	35.85	104095	* 104096		
36	2.00	65.0	18.0	8	35.82	104097	* 104098		
36	3.00	65.0	25.0	7	35.76	104099			
38	1.50	75.0	20.0	7	37.85	104101			
38	2.00	75.0	20.0	7	37.82	* 104103			
39	1.50	75.0	20.0	7	38.85	104104			
39	2.00	75.0	20.0	7	38.82	* 104105			
40	1.50	75.0	20.0	8	39.85	104118	* 104119		
40	2.00	75.0	20.0	7	39.82	104120			
42	1.50	75.0	20.0	8	41.85	104122			
42	3.00	75.0	20.0	8	41.76	104125			
45	1.50	90.0	22.0	7	44.85	104127			
45	2.00	90.0	22.0	7	44.82	104129			
48	1.50	90.0	22.0	8	47.85	104133	* 104134		
48	2.00	90.0	22.0	8	47.82	104135			
48	3.00	90.0	22.0	7	47.76	104137			
50	1.50	90.0	22.0	8	49.85	104150			
52	1.50	90.0	22.0	9	51.85	* 104151			
52	2.00	90.0	22.0	9	51.82	* 104152			
60	1.50	105.0	22.0	9	59.85	* 104167			
60	2.00	105.0	22.0	9	59.82	104168			

<div style="display: flex; justify-content: space-between;"> <div style="width: 45%;"> <p>N5110</p> <p>N5120</p>    </div> <div style="width: 50%; text-align: center;"> <p>N5110 N5120</p>  </div> </div>							
							 
							
		 					
\varnothing d ₁ UNF	P TPI	d ₂ mm	l ₁ mm		 →2A←	ID	ID
0	80	16.0	5.0	3	1.47	103897	
1	72	16.0	5.0	3	1.79	103898	
2	64	16.0	5.0	4	2.12	103899	
3	56	16.0	5.0	4	2.44	103900	
4	48	16.0	5.0	4	2.77	103901	
5	44	20.0	5.0	4	3.10		104299
6	40	20.0	5.0	4	3.42		104302
8	36	20.0	7.0	4	4.08		104305
10	32	20.0	7.0	4	4.73		104295
12	28	20.0	7.0	4	5.38		104296
1/4	28	20.0	7.0	4	6.24		104293
5/16	24	25.0	9.0	4	7.82		104300
3/8	24	30.0	11.0	4	9.41		104298
7/16	20	30.0	11.0	5	10.98		104303
1/2	20	38.0	10.0	5	12.56		104292
9/16	18	38.0	10.0	5	14.14		104306
5/8	18	45.0	14.0	5	15.73		104301
3/4	16	45.0	14.0	6	18.89		104297
7/8	14	55.0	16.0	5	22.05		104304
1	12	55.0	16.0	6	25.21		104294
1 1/4	12	65.0	18.0	7	31.56		104289
1 1/2	12	75.0	20.0	7	37.91		111390

UNEF, UNS, UN ANSI B1.1

HSS



N5120						N5120			
Ø" d ₁ UNEF	P TPI	d ₂ mm	l ₁ mm		 →2A←	ID			
12	32	20.0	7.0	4	5.39	104278			
1/4	32	20.0	7.0	4	6.25	104275			
5/16	32	25.0	9.0	4	7.84	104283			
3/8	32	30.0	11.0	4	9.42	104282			
7/16	28	30.0	11.0	5	11.00	104285			
1/2	28	38.0	10.0	5	12.59	104274			
9/16	24	38.0	10.0	5	14.17	104287			
5/8	24	45.0	14.0	5	15.75	104284			
11/16	24	45.0	14.0	5	17.34	104277			
3/4	20	45.0	14.0	5	18.91	104281			
13/16	20	45.0	14.0	6	20.50	* 104279			
7/8	20	55.0	16.0	5	22.09	104286			
1	20	55.0	16.0	6	25.26	104276			
1 3/8	18	65.0	18.0	8	34.78	* 104273			
Ø" d ₁ UNS	P TPI	d ₂ mm	l ₁ mm		 →2A←	ID			
1/4	40	20.0	5.0	4	6.26	104309			
1/4	36	20.0	5.0	4	6.26	104308			
7/16	24	30.0	11.0	5	10.99	104311			
1/2	24	38.0	10.0	5	12.58	104307			
1	14	55.0	16.0	6	25.23	104310			
Ø" d ₁ UN	P TPI	d ₂ mm	l ₁ mm		 →2A←	ID			
1 1/8	8	65.0	25.0	5	28.33	104246			
1 1/4	8	65.0	25.0	6	31.51	104245			
1 1/2	8	75.0	20.0	7	37.85	104244			
1 3/4	8	90.0	22.0	7	44.20	104247			



N5120		N5120 LH					
\varnothing " d ₁	P	d ₂	l ₁			ID	ID
G	TPI	mm	mm		→ A ←		
1/8	28	30.0	11.0	5	9.62	103926	
1/4	19	38.0	10.0	5	13.03	103924	103925
3/8	19	45.0	14.0	5	16.54	103935	103936
1/2	14	45.0	14.0	6	20.81	103922	103923
5/8	14	55.0	16.0	5	22.77	103938	
3/4	14	55.0	16.0	6	26.30	103933	103934
7/8	14	65.0	18.0	6	30.06	103940	
1	11	65.0	18.0	7	33.07	103928	* 103929
1 1/8	11	75.0	20.0	7	37.72	* 103919	
1 1/4	11	75.0	20.0	8	41.73	103918	
1 3/8	11	90.0	22.0	7	44.14	* 103921	
1 1/2	11	90.0	22.0	8	47.62	103917	
2	11	105.0	22.0	9	59.43	103932	
2 1/2	11	120.0	22.0	10	74.97	103930	

G DIN ISO 228 (BSP)

Z
HSSE

MS
HSS



Z5120		NI		Z5120	MS5120	MS5120	
MS5120							
MS5120							
\varnothing " d ₁ G	P TPI	d ₂ mm	l ₁ mm				ID
1/8	28	30.0	11.0	5	5	9.62	104761 101339 * 142831
1/4	19	38.0	10.0	5	5	13.03	104760 101338 * 142832
3/8	19	45.0	14.0	5	5	16.54	104764 101342 119716
1/2	14	45.0	14.0	6	6	20.81	104759 101337 119243
3/4	14	55.0	16.0	6	6	26.30	104763 101341 119648
1	11	65.0	18.0	8	7	33.07	104762 101340 135186
1 1/2	11	90.0	22.0		8	47.62	* 142830



NPT ANSI B1.20.1 NPTF ANSI B1.20.3

HSS









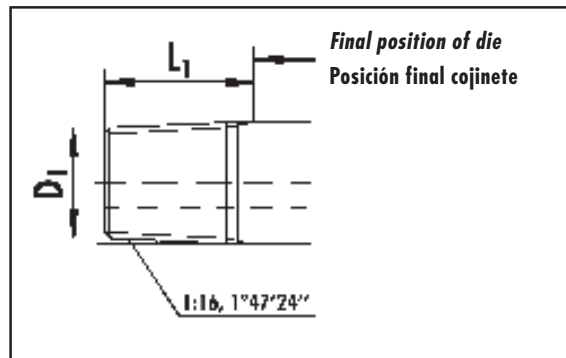



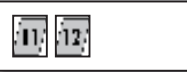

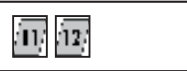

N5120			N5120	N5120		
N5120			NPT	NPTF		
			1.75 x P	1.75 x P		
			1:16	1:16		
\varnothing " d_1 NPT, NPTF	P TPI	d_2 mm	l_1 mm		ID	ID
1/16	27	25.0	9.0	4	104194	* 104204
1/8	27	30.0	11.0	5	104197	* 104207
1/4	18	38.0	14.0	5	104196	* 104206
3/8	18	45.0	14.0	5	104201	* 104211
1/2	14	45.0	18.0	6	104195	* 104205
3/4	14	55.0	22.0	6	104200	
1	11.5	65.0	25.0	7	104198	* 104208
1 1/4	11.5	75.0	26.0	8	104193	









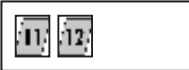
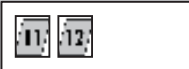
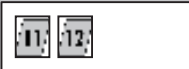

Turning dimensions for NPT and NPTF threads (in mm)

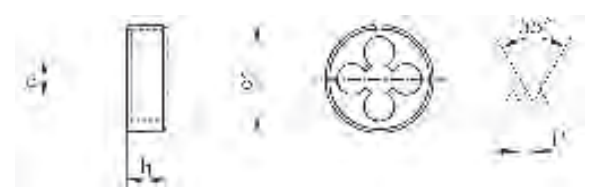
Dimensiones de torneado para roscas NPT y NPTF (en mm)



\varnothing " NPT	D_1 mini mm	D_1 maxi mm	D_1 (guide line) mm	L_1 (guide line) mm	\varnothing " NPTF	D_1 mini mm	D_1 maxi mm	D_1 (guide line) mm	L_1 (guide line) mm
1/16	7.521	7.643	7.58	8.4	1/16	7.525	7.617	7.57	8.4
1/8	9.866	9.988	9.93	8.5	1/8	9.870	9.962	9.92	8.5
1/4	13.099	13.255	13.18	12.7	1/4	13.129	13.215	13.17	12.7
3/8	16.518	16.674	16.60	12.9	3/8	16.548	16.634	16.59	12.9
1/2	20.551	20.713	20.63	16.8	1/2	20.617	20.703	20.66	16.8
3/4	25.866	26.028	25.95	17.1	3/4	25.932	26.018	25.98	17.1
1	32.419	32.591	32.51	21.3	1	32.475	32.561	32.52	21.3
1 1/4	41.144	41.316	41.23	21.9					

<p>N5120  </p> <p>N5120  </p>						N5120	N5120			
						PG	TR			
										
										
$\varnothing d_1$	P	d_2	l_1			ID				
PG	TPI	mm	mm							
7	20	38.0	10.0	5	12.40	104220				
9	18	38.0	10.0	5	15.10	104221				
11	18	45.0	14.0	5	18.50	104212				
13.5	18	45.0	14.0	6	20.30	104213				
16	18	55.0	16.0	5	22.40	104214				
21	16	65.0	18.0	6	28.15	104215				
29	16	65.0	18.0	8	36.85	104216				
36	16	90.0	22.0	8	46.85	104217				
42	16	90.0	22.0	10	53.85	* 104218				
48	16	105.0	22.0	9	59.15	104219				
										
$\varnothing d_1$	P	d_2	l_1			ID				
TR	mm	mm	mm							
*10	2	38.0	14.0	4	9.91	104231				
12	3	38.0	14.0	4	11.88	104232				
16	4	45.0	18.0	4	15.85	104234				
18	4	45.0	18.0	5	17.85	* 104235				
20	4	55.0	22.0	5	19.85	* 104236				
24	5	65.0	25.0	5	23.83	* 104238				
26	5	65.0	25.0	5	25.83	* 104239				
28	5	65.0	25.0	5	27.83	* 104240				
32	6	65.0	25.0	6	31.81	* 104242				
36	6	65.0	25.0	6	35.81	* 104243				
<p>* </p>										

N5110  N5120  N5120 LH  LH						N5110	N5120	N5120 LH		
										
										
										
\varnothing " d ₁	P	d ₂	l ₁			ID	ID	ID		
W	TPI	mm	mm		→ ←					
3/32	48	16.0	5.0	4	2.30	* 103903				
1/8	40	20.0	5.0	4	3.09		104320			
5/32	32	20.0	7.0	4	3.88		104333			
3/16	24	20.0	7.0	4	4.66		104325			
1/4	20	20.0	7.0	4	6.24		104318			
5/16	18	25.0	9.0	4	7.82		104331			
3/8	16	30.0	11.0	4	9.40		104329			
7/16	14	30.0	11.0	4	10.98		104336			
1/2	12	38.0	14.0	4	12.56		104316			
5/8	11	45.0	18.0	4	15.72		104334	* 104335		
3/4	10	45.0	18.0	5	18.89		104327	* 104328		
7/8	9	55.0	22.0	5	22.10		104338			
1	8	55.0	22.0	5	25.27		104322			
1 1/8	7	65.0	25.0	5	28.44		* 104314			
1 3/8	6	65.0	25.0	6	34.77		* 104315			
2	4.5	90.0	36.0	7	50.62		* 104324			



















N5220							N5220		Z5220	
N5220										
Z5220										
$\varnothing d_1$ M	P mm	d_2 mm	l_1 mm				ID	ID	$6g$ - mm	ID
1.4	0.30	16.0	2.6	4	1.36		104346			
1.6	0.35	16.0	2.6	4	1.54		104347			
1.7	0.35	16.0	2.6	4	1.64		104348			
2	0.40	16.0	3.5	4	1.93	1.90	104367			
2.3	0.40	16.0	3.5	4	2.23		104369			
2.5	0.45	16.0	3.5	4	2.43	2.40	104371	104370	0.030	104803
2.6	0.45	16.0	3.5	4	2.53		104372			
3	0.50	16.0	3.5	4	2.92	2.90	104375	104374	0.030	104804
3.5	0.60	16.0	4.0	4	3.41		104376			
4	0.70	16.0	5.0	4	3.91	3.87	104380	104379	0.035	104805
5	0.80	20.0	7.0	4	4.90	4.87	104384	104383	0.035	104806
6	1.00	20.0	7.0	4	5.88	5.85	104388	104387	0.035	104807
7	1.00	25.0	7.0	4	6.88		104392			
8	1.25	25.0	9.0	4	7.87	7.83	104397	104396	0.035	104808
10	1.50	30.0	11.0	6	9.85	9.82	104354	104353	0.035	
12	1.75	30.0	11.0	6	11.83		104358			

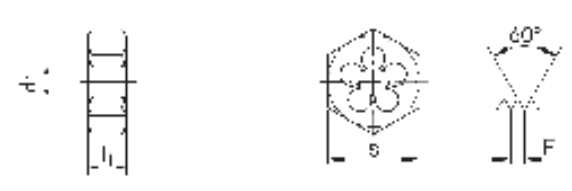
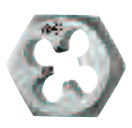



$\leq M1.4$



N5220  						N5220	
							
							
$\varnothing d_1$ MF	P mm	d_2 mm	l_1 mm			ID	
3	0.35	16.0	3.0	4	2.94	104373	
4	0.35	16.0	3.5	4	3.94	* 104377	
4	0.50	16.0	4.0	4	3.93	104378	
5	0.50	20.0	5.0	4	4.93	104382	
6	0.50	20.0	5.0	4	5.93	104385	
6	0.75	20.0	7.0	4	5.90	104386	
7	0.50	25.0	7.0	4	6.93	* 104389	
7	0.75	25.0	7.0	4	6.90	104390	
8	0.75	25.0	7.0	4	7.90	104394	
8	1.00	25.0	7.0	4	7.88	104395	
10	0.75	30.0	7.0	6	9.90	* 104350	
10	1.00	30.0	7.0	6	9.88	104351	
10	1.25	25.0	9.0	6	9.86	104352	
12	1.00	30.0	7.0	6	11.88	104355	
12	1.50	30.0	11.0	6	11.85	104356	
14	1.00	35.0	10.0	6	13.88	104359	
14	1.50	35.0	10.0	6	13.85	* 104360	

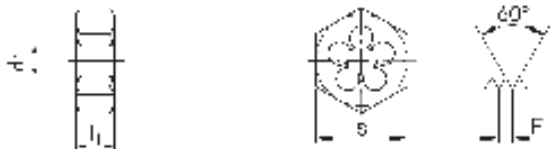
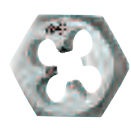







N5310						N5310																																																																																																																																																																																		
																																																																																																																																																																																								
																																																																																																																																																																																								
<table border="1"> <thead> <tr> <th>$\varnothing d_1$ M</th> <th>P mm</th> <th>s mm</th> <th>l_1 mm</th> <th></th> <th></th> <th>ID</th> </tr> </thead> <tbody> <tr><td>3</td><td>0.50</td><td>18.0</td><td>5.0</td><td>3</td><td>2.92</td><td>104464</td></tr> <tr><td>3.5</td><td>0.60</td><td>18.0</td><td>5.0</td><td>3</td><td>3.41</td><td>* 104465</td></tr> <tr><td>4</td><td>0.70</td><td>18.0</td><td>5.0</td><td>3</td><td>3.91</td><td>104478</td></tr> <tr><td>4.5</td><td>0.75</td><td>18.0</td><td>7.0</td><td>3</td><td>4.41</td><td>* 104479</td></tr> <tr><td>5</td><td>0.80</td><td>18.0</td><td>7.0</td><td>4</td><td>4.90</td><td>104487</td></tr> <tr><td>6</td><td>1.00</td><td>18.0</td><td>7.0</td><td>4</td><td>5.88</td><td>104493</td></tr> <tr><td>7</td><td>1.00</td><td>21.0</td><td>9.0</td><td>4</td><td>6.88</td><td>* 104497</td></tr> <tr><td>8</td><td>1.25</td><td>21.0</td><td>9.0</td><td>4</td><td>7.87</td><td>104502</td></tr> <tr><td>9</td><td>1.25</td><td>21.0</td><td>9.0</td><td>5</td><td>8.87</td><td>* 104503</td></tr> <tr><td>10</td><td>1.50</td><td>27.0</td><td>11.0</td><td>4</td><td>9.85</td><td>104438</td></tr> <tr><td>11</td><td>1.50</td><td>27.0</td><td>11.0</td><td>5</td><td>10.85</td><td>* 104439</td></tr> <tr><td>12</td><td>1.75</td><td>36.0</td><td>14.0</td><td>4</td><td>11.83</td><td>104443</td></tr> <tr><td>14</td><td>2.00</td><td>36.0</td><td>14.0</td><td>4</td><td>13.82</td><td>104445</td></tr> <tr><td>16</td><td>2.00</td><td>41.0</td><td>18.0</td><td>4</td><td>15.82</td><td>104447</td></tr> <tr><td>18</td><td>2.50</td><td>41.0</td><td>18.0</td><td>5</td><td>17.79</td><td>104450</td></tr> <tr><td>20</td><td>2.50</td><td>41.0</td><td>18.0</td><td>5</td><td>19.79</td><td>104453</td></tr> <tr><td>22</td><td>2.50</td><td>50.0</td><td>22.0</td><td>5</td><td>21.79</td><td>104456</td></tr> <tr><td>24</td><td>3.00</td><td>50.0</td><td>22.0</td><td>5</td><td>23.76</td><td>104459</td></tr> <tr><td>27</td><td>3.00</td><td>60.0</td><td>25.0</td><td>5</td><td>26.76</td><td>104463</td></tr> <tr><td>30</td><td>3.50</td><td>60.0</td><td>25.0</td><td>5</td><td>29.73</td><td>104468</td></tr> <tr><td>33</td><td>3.50</td><td>60.0</td><td>25.0</td><td>6</td><td>32.73</td><td>* 104471</td></tr> <tr><td>36</td><td>4.00</td><td>60.0</td><td>25.0</td><td>6</td><td>35.70</td><td>104474</td></tr> <tr><td>48</td><td>5.00</td><td>85.0</td><td>36.0</td><td>7</td><td>47.66</td><td>* 104486</td></tr> <tr><td>52</td><td>5.00</td><td>85.0</td><td>36.0</td><td>8</td><td>51.66</td><td>* 104489</td></tr> </tbody> </table>						$\varnothing d_1$ M	P mm	s mm	l_1 mm			ID	3	0.50	18.0	5.0	3	2.92	104464	3.5	0.60	18.0	5.0	3	3.41	* 104465	4	0.70	18.0	5.0	3	3.91	104478	4.5	0.75	18.0	7.0	3	4.41	* 104479	5	0.80	18.0	7.0	4	4.90	104487	6	1.00	18.0	7.0	4	5.88	104493	7	1.00	21.0	9.0	4	6.88	* 104497	8	1.25	21.0	9.0	4	7.87	104502	9	1.25	21.0	9.0	5	8.87	* 104503	10	1.50	27.0	11.0	4	9.85	104438	11	1.50	27.0	11.0	5	10.85	* 104439	12	1.75	36.0	14.0	4	11.83	104443	14	2.00	36.0	14.0	4	13.82	104445	16	2.00	41.0	18.0	4	15.82	104447	18	2.50	41.0	18.0	5	17.79	104450	20	2.50	41.0	18.0	5	19.79	104453	22	2.50	50.0	22.0	5	21.79	104456	24	3.00	50.0	22.0	5	23.76	104459	27	3.00	60.0	25.0	5	26.76	104463	30	3.50	60.0	25.0	5	29.73	104468	33	3.50	60.0	25.0	6	32.73	* 104471	36	4.00	60.0	25.0	6	35.70	104474	48	5.00	85.0	36.0	7	47.66	* 104486	52	5.00	85.0	36.0	8	51.66	* 104489				
$\varnothing d_1$ M	P mm	s mm	l_1 mm			ID																																																																																																																																																																																		
3	0.50	18.0	5.0	3	2.92	104464																																																																																																																																																																																		
3.5	0.60	18.0	5.0	3	3.41	* 104465																																																																																																																																																																																		
4	0.70	18.0	5.0	3	3.91	104478																																																																																																																																																																																		
4.5	0.75	18.0	7.0	3	4.41	* 104479																																																																																																																																																																																		
5	0.80	18.0	7.0	4	4.90	104487																																																																																																																																																																																		
6	1.00	18.0	7.0	4	5.88	104493																																																																																																																																																																																		
7	1.00	21.0	9.0	4	6.88	* 104497																																																																																																																																																																																		
8	1.25	21.0	9.0	4	7.87	104502																																																																																																																																																																																		
9	1.25	21.0	9.0	5	8.87	* 104503																																																																																																																																																																																		
10	1.50	27.0	11.0	4	9.85	104438																																																																																																																																																																																		
11	1.50	27.0	11.0	5	10.85	* 104439																																																																																																																																																																																		
12	1.75	36.0	14.0	4	11.83	104443																																																																																																																																																																																		
14	2.00	36.0	14.0	4	13.82	104445																																																																																																																																																																																		
16	2.00	41.0	18.0	4	15.82	104447																																																																																																																																																																																		
18	2.50	41.0	18.0	5	17.79	104450																																																																																																																																																																																		
20	2.50	41.0	18.0	5	19.79	104453																																																																																																																																																																																		
22	2.50	50.0	22.0	5	21.79	104456																																																																																																																																																																																		
24	3.00	50.0	22.0	5	23.76	104459																																																																																																																																																																																		
27	3.00	60.0	25.0	5	26.76	104463																																																																																																																																																																																		
30	3.50	60.0	25.0	5	29.73	104468																																																																																																																																																																																		
33	3.50	60.0	25.0	6	32.73	* 104471																																																																																																																																																																																		
36	4.00	60.0	25.0	6	35.70	104474																																																																																																																																																																																		
48	5.00	85.0	36.0	7	47.66	* 104486																																																																																																																																																																																		
52	5.00	85.0	36.0	8	51.66	* 104489																																																																																																																																																																																		

N5310						N5310
						
						
$\varnothing d_1$ MF	P mm	s mm	l_1 mm			ID
6	0.75	18.0	7.0	4	5.90	* 104492
8	0.75	21.0	9.0	4	7.90	* 104500
8	1.00	21.0	9.0	4	7.88	* 104501
10	1.00	27.0	11.0	5	9.88	* 104436
12	1.00	36.0	10.0	4	11.88	* 104440
12	1.25	36.0	10.0	4	11.86	* 104441
14	1.50	36.0	10.0	5	13.85	* 104444
16	1.50	41.0	14.0	5	15.85	* 104446
18	1.50	41.0	14.0	5	17.85	* 104448
18	2.00	41.0	14.0	5	17.82	* 104449
20	1.50	41.0	14.0	6	19.85	* 104451
22	1.50	50.0	16.0	5	21.85	* 104454
24	1.50	50.0	16.0	6	23.85	* 104457
27	1.50	60.0	18.0	6	26.85	* 104461
27	2.00	60.0	18.0	6	26.82	* 104462
30	1.50	60.0	18.0	6	29.85	* 104466
30	2.00	60.0	18.0	6	29.82	* 104467
33	1.50	60.0	18.0	7	32.85	* 104469
33	2.00	60.0	18.0	7	32.82	* 104470
38	1.50	70.0	20.0	8	37.85	* 104475
39	1.50	70.0	20.0	8	38.85	* 104476
40	1.50	70.0	20.0	8	39.85	* 104480
45	1.50	85.0	22.0	7	44.85	* 104483
64	2.00	115.0	22.0	8	63.82	* 104495

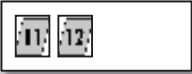
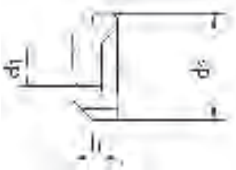

N5310						N5310			N5310



N5420  						N5420	
  							
							
$\varnothing d_1$ M	P mm	d_2 mm	l_1 mm			ID	
2.5	0.45	16.0	8.0	4	2.43	* 104527	
3.5	0.60	16.0	9.5	4	3.41	* 104530	
4	0.70	16.0	9.5	4	3.90	* 104531	
5	0.80	16.0	9.5	4	4.90	* 104532	
6	1.00	16.0	9.5	5	5.88	* 104533	
8	1.25	25.0	14.0	5	7.86	* 104535	











Directory - Screw thread plug and ring gauges
Directorio - Tampones de roscas y calibres anillos de roscas











Characteristics Características								
								
		D5701-1	D5701-2	D5703	D5703TC	D5720	D5722	D5725
M 6H /6g	ISO DIN 13	264	264	264	264			
M 6G /6e	ISO DIN 13			264				
M 6H /6g LH	ISO DIN 13			264				
MF 6H /6g	ISO DIN 13	266-267	267	266-267				
MF 6G /6e	ISO DIN 13			266				
MF 6H /6g LH	ISO DIN 13			266				
UNC	ANSI B1.1	270		270				
UNF	ANSI B1.1	271		271				
UNEF	ANSI B1.1			271				
NPT	ANSI B1.20.1					273		
NPTF	ANSI B1.20.3					273		
G (BSP)	DIN ISO 228	272	272	272				
PG	DIN 40430							272
EG M	ISO DIN 8140			274				
EG UNC	NASM 33537			274				
EG UNF	NASM 33537			274				

D5704	D5714	D5721	D5723
265	265		
265	265		
265			
268-269	268-269		
268			
270	270		
271	271		
271	271		
		273	
		273	
272	272		
272			









Pictographs - Pictogramas

-  "Go"
"Pasa"
-  "No-go"
"No pasa"
-  "Go" / "No-go"
"Pasa" / "No pasa"
-  Tolerance 6H, "Go"
Tolerancia 6H, "Pasa"
-  Tolerance 6G, "Go" / "No-go"
Tolerancia 6G, "Pasa" / "No pasa"
-  Tolerance 6g, "No-go"
Tolerancia 6g, "No pasa"
-  "Go" gauge with TiCN coating and certificate
Lado "Pasa" con revestimiento TiCN y certificado
-  Left hand thread
Rosca izquierda

















		D5701-1	D5701-2	D5703	D5703TC	D5703 LH	D5703
D5701-1 M1 - M1.4 =							
D5703 M1 - M1.4 =							
D5703TC							
							
							
Ø D M	P mm	ID	ID	ID	ID	ID	ID
1	0.25	* 100021		100242			
1.1	0.25	* 100022		100243			
1.2	0.25	* 100023		100244			
1.4	0.30			100245			
1.6	0.35			100246		* 110168	
1.7	0.35			100247			
1.8	0.35	* 100027		100248		* 110169	
2	0.40			100278		105159	104982
2.2	0.45			100280			
2.3	0.40			100281			
2.5	0.45	* 100062		100283		105160	104979
2.6	0.45	* 100064		100285			
3	0.50	* 100089		100310	* 104954	104964	104976
3.5	0.60			100312			104977
4	0.70			100333	* 104955	104966	104978
4.5	0.75	* 100114		* 100335			
5	0.80			100348	* 104956	104967	104980
6	1.00	* 100142		100363	* 104957	104968	104981
7	1.00	* 100148		100369		* 110186	
8	1.25			100373	* 104958	104969	104983
9	1.25			100375			
10	1.50	* 100032		100253	* 104959	104970	104984
11	1.50			* 100256			
12	1.75	* 100040		100261		104971	104985
14	2.00	* 100045		100266			104986
16	2.00			100271		104973	104987
18	2.50	* 100055		100276			* 104988
20	2.50	* 100068		100289		104975	104989
22	2.50	* 100072		100293		* 110178	
24	3.00	* 100076		100297		110179	
27	3.00	* 100084		100305		* 110180	
30	3.50	* 100095		100316			
33	3.50	* 100101		100322			
36	4.00	* 100107		100328			
39	4.00	* 100109		100330			
42	4.50	100119	142843				
45	4.50	100122	142844				
48	5.00	100125	142845				
52	5.00	100132	142846				
56	5.50	100137	142847				

M ISO DIN 13





		D5704	D5704 LH	D5704	D5714	D5714		
D5704 M1 - M1.4 = 								
D5714 M1 - M1.4 = 								
			 LH					
∅ D M	P mm	ID	ID	ID	ID	ID		
1	0.25	100480			110419			
1.2	0.25	100481			110420			
1.4	0.30	100482			110421			
1.6	0.35	100483			110422			
1.7	0.35	100484			111439			
1.8	0.35	100485			110423			
2	0.40	100515	105006	104997	100734	142833		
2.2	0.45	100517			100735			
2.3	0.40	100518			100736			
2.5	0.45	100520		104991	100737	142834		
2.6	0.45	100522			100738			
3	0.50	100547	105001	104990	100763	142835		
3.5	0.60	100549	110302	110301	100765	142836		
4	0.70	100570	105003	104992	100774	142837		
5	0.80	100585	105004	104993	100778	143406		
6	1.00	100600	105005	104994	100781	135556		
7	1.00	100605	126560	104995	100783	142840		
8	1.25	100611	105007	104996	100786	142841		
9	1.25	100610			100788			
10	1.50	100490	105008	104998	100711	142842		
11	1.50	* 100493			* 100713			
12	1.75	100498	105009	* 104999	100718			
14	2.00	100503	105010		100723			
16	2.00	100508	105011	* 105000	100728			
18	2.50	100513	105012		100733			
20	2.50	100526	105013		100742			
22	2.50	100530	110298		100746			
24	3.00	100534	110299		100750			
27	3.00	100542	* 110300		100758			
30	3.50	100553	* 110303		100769			
33	3.50	* 100559	* 110304		* 100770			
36	4.00	* 100565	* 110305		* 100771			
39	4.00	* 100567			* 110440			
42	4.50	* 100577			* 110445			
45	4.50	* 100580			* 110448			
48	5.00	* 100583			* 110451			
52	5.00	* 100590			* 110456			
56	5.50	* 100595			* 110461			





		D5701-1	D5703	D5703 LH	D5703		
							
							
∅ D MF	P mm	ID	ID	ID	ID		
2.5	0.35		100282				
3	0.35		100309				
4	0.35	* 100110	100331				
4	0.50		100332			* 105044	
4.5	0.50		100334				
5	0.50	* 100126	100347	105016		105045	
6	0.50	* 100140	100361	110184			
6	0.75		100362			105046	
7	0.50		100367				
7	0.75	* 100147	100368				
8	0.50	* 100149	100370				
8	0.75	* 100150	100371	105018		105047	
8	1.00	* 100151	100372	105019		105048	
9	1.00	* 100153	100374				
10	0.50	* 100028	100249				
10	0.75		100250				
10	1.00		100251	105020		105049	
10	1.25	* 100031	100252				
11	0.75	* 100033	100254				
11	1.00	* 100034	100255				
12	0.75	* 100036	100257				
12	1.00		100258	105021		105050	
12	1.25		100259				
12	1.50	* 100039	100260	105022			
13	1.00		* 100262				
14	1.00		100263	110171			
14	1.25		100264				
14	1.50	* 100044	100265	105023		105052	
15	1.00	* 100046	100267				
15	1.50		100268				
16	1.00		100269	110172			
16	1.50	* 100049	100270	105024		105053	
17	1.00		100272				
18	1.00		100273				
18	1.50	* 100053	100274	105025		105054	
18	2.00	* 100054	100275				
20	1.00	* 100065	100286				
20	1.50	* 100066	100287	105026			
20	2.00	* 100067	100288			* 110176	
22	1.00	* 100069	100290				
22	1.50	* 100070	100291	110177			
22	2.00		100292				
24	1.00		100294				
24	1.50		100295				
24	2.00		100296				

		D5701-1	D5701-2	D5703			
							
							
∅ D MF	P mm	ID	ID	ID			
25	1.00	* 100077		100298			
25	1.50			100299			
25	2.00			100300			
26	1.00	* 100080		100301			
26	1.50	* 100081		100302			
27	1.50	* 100082		100303			
27	2.00	* 100083		100304			
28	1.00			100306			
28	1.50	* 100086		100307			
28	2.00	* 100087		100308			
30	1.00	* 100092		100313			
30	1.50			100314			
30	2.00			100315			
32	1.00			100317			
32	1.50	* 100097		100318			
32	2.00			100319			
33	1.50			100320			
33	2.00	* 100100		100321			
35	1.50	* 100102		100323			
36	1.50	* 100104		100325			
36	2.00	* 100105		100326			
36	3.00			100327			
38	1.50	* 100108		100329			
40	1.50			100336			
40	2.00			100337			
42	1.50	100117	142848				
42	2.00	100118	142849				
45	1.50	100120	110127				
45	2.00	100121	142851				
48	1.50	100123	123180				
48	2.00	100124	142853				
50	1.50	100128	142854				
50	2.00	100129	142855				
52	1.50	100130	123428				
52	2.00	100131	142857				
55	1.50	100133	123468				
55	2.00	100134	142859				
56	1.50	100135	142860				
56	2.00	100136	142861				
58	1.50	100138	142862				
58	2.00	100139	142863				
60	1.50	100143	142864				
60	2.00	100144	142865				



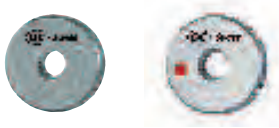







		D5704	D5704 LH	D5714			
							
				LH			
∅ D MF	P mm	ID	ID	ID			
2.5	0.35	100519		110427			
3	0.35	100546		100762			
3.5	0.35	100548		100764			
4	0.35	100568		100772			
4	0.50	100569		100773			
4.5	0.50	100571		100775			
5	0.50	100584	105057	100777			
6	0.50	100598	110307	100779			
6	0.75	100599	105058	100780			
7	0.50	100603		110467			
7	0.75	100604		100782			
8	0.50	100606		110468			
8	0.75	100607	105059	100784			
8	1.00	100608	105060	100785			
9	1.00	100609		100787			
10	0.50	100486		100707			
10	0.75	100487		100708			
10	1.00	100488	105061	100709			
10	1.25	100489		100710			
11	0.75	100491		110424			
11	1.00	100492		100712			
12	0.75	100494		100714			
12	1.00	100495	105062	100715			
12	1.25	100496		100716			
12	1.50	100497	105063	100717			
13	1.00	100499		100719			
14	1.00	100500	110290	100720			
14	1.25	100501		100721			
14	1.50	100502	105064	100722			
15	1.00	100504		100724			
15	1.50	100505		100725			
16	1.00	100506	110292	100726			
16	1.50	100507	105065	100727			
17	1.00	100509		100729			
18	1.00	100510		100730			
18	1.50	100511	105066	100731			
18	2.00			* 100732			
20	1.00	100523	110295	100739			
20	1.50	100524	105067	100740			
20	2.00	100525		100741			
22	1.00	100527		100743			
22	1.50	100528	* 110297	100744			
22	2.00	100529		100745			
24	1.00	100531		100747			
24	1.50	100532		100748			
24	2.00	100533		* 100749			









		D5704	D5714				
							
							
∅ D MF	P mm	ID	ID				
25	1.00	100535	* 100751				
25	1.50	100536	* 100752				
26	1.00	100538	* 100754				
26	1.50	100539	* 100755				
27	1.50	100540	* 100756				
27	2.00	100541	* 100757				
28	1.00	100543	* 100759				
28	1.50	100544	* 100760				
30	1.00	100550	* 100766				
30	1.50	100551	* 100767				
30	2.00	100552	* 100768				
32	1.00	100554	* 110429				
32	1.50	100555	* 110430				
32	2.00	100556	* 110431				
33	1.50	100557	* 110432				
33	2.00	100558	* 110433				
35	1.50	100560	* 110434				
36	1.50	100562	* 110436				
36	2.00	100563	* 110437				
36	3.00	100564	* 110438				
38	1.50	100566	* 110439				
40	1.50	100573	* 110441				
42	1.50	100575	* 110443				
42	2.00	100576	* 110444				
45	1.50	100578	* 110446				
45	2.00	100579	* 110447				
48	1.50	100581	* 110449				
48	2.00	100582	* 110450				
50	1.50	100586	* 110452				
50	2.00	100587	* 110453				
52	1.50		* 110454				
52	2.00	100589	* 110455				
55	1.50	100591	* 110457				
55	2.00	100592	* 110458				
56	1.50	100593	* 110459				
56	2.00	100594	* 110460				
58	1.50	100596	* 110462				
58	2.00	100597	* 110463				
60	1.50	100601	* 110464				
60	2.00	105014	* 110465				



UNC ANSI B1.1













		D5701-1	D5703	D5704	D5714		
							
							
Ø" D UNC	P TPI	ID	ID	ID	ID		
1	64		100408	110347	110473		
2	56	* 110076	100414	110353	110479		
3	48	* 110077	100416	* 110354	* 110480		
4	40	* 110080	110224	110357	110483		
5	40		100420	110358	110484		
6	32	* 110084	100423	110361	110487		
8	32	* 110087	100426	110364	110490		
10	24	* 110074	100412	110351	110477		
12	24		100413	* 110352	* 110478		
1/4	20	* 110072	100410	110349	110475		
5/16	18	* 110082	100421	110359	110485		
3/8	16	* 110079	100418	110356	110482		
7/16	14	* 110085	100424	110362	110488		
1/2	13	* 110071	100409	110348	110474		
9/16	12		100427	110365	* 110491		
5/8	11	* 110083	100422	110360	* 110486		
3/4	10	* 110078	100417	110355	* 110481		
7/8	9		100425	110363	* 110489		
1	8	* 110073	100411	110350	* 110476		
1 1/8	7	* 110068	100405	110345	* 110471		
1 1/4	7	* 110067	100404	110344	* 110470		
1 3/8	6	* 110069	100407	110346	* 110472		
1 1/2	6	* 110066	100403	110343	* 110469		

UNF, UNEF ANSI B1.1

		D5701-1	D5703	D5704	D5714		
							
							
Ø" D UNF	P TPI	ID	ID	ID	ID		
0	80		110246	* 110378	* 110503		
1	72	* 110105	110251	110383	110508		
2	64		110256	110389	110514		
3	56	* 110112	110257	110390	110515		
4	48		110260	110393	110518		
5	44	* 110116	110261				
6	40		110264	110397	110522		
8	36	* 110122	110267	* 110400			
10	32	* 110109	110254	110387	110512		
12	28		110255	110388	110513		
1/4	28	* 110107	110006	110385	110510		
5/16	24	* 110117	110262	110395	110520		
3/8	24	* 110114	110259	110392	110517		
7/16	20	* 110120	110265	110398	111440		
1/2	20	* 110106	110252	110384	110509		
9/16	18		110268	110401	* 110525		
5/8	18	* 110118	110263	110396	* 110521		
3/4	16	* 110113	110258	110391	* 110516		
7/8	14	* 110121	110266	110399	* 110523		
1	12	* 110108	128646	110386	* 110511		
1 1/8	12	* 110103	110249	110381	* 110506		
1 1/4	12	* 110102	110248	110380	* 110505		
1 3/8	12	* 110104	110250	110382	* 110507		
1 1/2	12		110247	110379	* 110504		
Ø" D UNEF	P TPI	ID	ID	ID			
12	32		110238	110370	110495		
1/4	32		110236	110368	110493		
5/16	32		110241	110373	110498		
3/8	32		110240	110372	110497		
7/16	28		110243	110375	110500		
1/2	28		110235	110367	110492		
9/16	24		110245	110377	110502		
5/8	24		110242	110374	110499		
3/4	20		110239	110371	110496		
7/8	20		110244		* 110501		
1	20		110253	110369	110494		





G DIN ISO 228 (BSP) PG DIN 40430

		D5701-1	D5701-2	D5703	D5704	D5714	D5725
							
							
Ø" D G	P TPI	ID	ID	ID	ID	ID	
1/8	28	* 110044		110009	110277	110408	
1/4	19			110003	110276	110407	
3/8	19	* 110052		110162	110284	110415	
1/2	14	* 110000		110001	110275	110406	
5/8	14			110164	110286	110417	
3/4	14			110161	110283	110414	
7/8	14	* 110054		110165	* 110287	* 110418	
1	11	* 110045		110156	110278	110409	
1 1/8	11			110154		* 110404	
1 1/4	11	110041	119459		110272	* 110403	
1 1/2	11	110040	119429		110271	* 110402	
1 3/4	11	110043	142868		110274	* 110405	
2	11	110050	110126		110282	* 110413	
2 1/4	11					* 110411	
2 1/2	11	* 110046	* 110125				
2 3/4	11					* 110412	
3	11				* 110285	* 110416	
Ø D PG	P TPI			ID			ID
7	20			* 110335			110216
9	18			* 110336			110217
11	18			* 110328			110205
13.5	18			* 110329			110209
16	18			* 110330			110210
21	16			* 110331			110211
29	16			* 110332			110212

NPT, NPTF



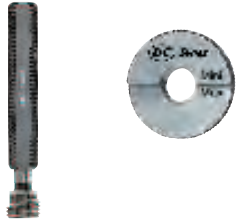







ANSI B1.20.1

ANSI B1.20.3

		D5720	D5721				
							
							
Ø" D NPT	P TPI	ID	ID				
1/16	27	110190	110313				
1/8	27	110193	110316				
1/4	18	110192	110315				
3/8	18	110197	110320				
1/2	14	110191	110314				
3/4	14	110196	110319				
1	11.5	110194	110317				
1 1/4	11.5	110189	110312				
1 1/2	11.5	110188	110311				
2	11.5	110195	110318				
Ø" D NPTF	P TPI	ID	ID				
1/8	27	110201	110324				
1/4	18	110200	110323				
3/8	18	110204	110327				
1/2	14	110199	110322				
3/4	14	110203	110326				
1	11.5	110202	110325				



EG M ISO DIN 8140 EG UNC, EG UNF NASM 33537

		D5703	D5703	D5703	D5703	D5703	
							
							
Ø D EG M	P mm	ID					
2.5	0.45	110132					
3	0.50	110133					
4	0.70	110134					
5	0.80	110135					
6	1.00	110136					
8	1.25	110137					
10	1.50	110128					
12	1.75	110129					
16	2.00	110131					
Ø" D EG UNC	P TPI	ID	ID				
4	40	* 110141	170252				
6	32	* 110143	170253				
8	32	* 110144	170254				
10	24	* 110139	170255				
1/4	20	* 110138	170256				
5/16	18	* 110142	170257				
3/8	16	* 110140	170258				
Ø" D EG UNF	P TPI	ID	ID				
6	40	* 110150	170259				
8	36	* 110151	170260				
10	32	* 110147	161020				
1/4	28	* 110145	151790				
5/16	24	* 110149	170261				
3/8	24	* 110148	160134				

SRT



HSK A 63  **276**

SK 40 / 50  **277**

BT 40  **276**

DIN 1835 B  **278**
279

S1/2/3/4  **280**

SC1/2/3/4  **281**



SRT *Tapping chucks with axial shock absorber* Mandril de roscar con amortiguador axial



Uniquement pour taraudage synchrone
Nur für Synchronbearbeitung
Only for rigid tapping
Solo per maschiatura sincrona
Solo para roscado sincronizado

DIN 69 893 A					SRT-HSK63-312	SRT-HSK63-520	SRT-HSK63-1433																																																
<h1>HSK</h1>																																																							
<table border="1"> <thead> <tr> <th></th> <th>D_1 mm</th> <th>L_1 mm</th> <th></th> <th></th> <th>280-281</th> <th>ID</th> <th>ID</th> <th>ID</th> </tr> </thead> <tbody> <tr> <td>M3 - M12</td> <td>36</td> <td>72.0</td> <td>HSK A 63</td> <td>S1-/SC1-</td> <td></td> <td>170111</td> <td></td> <td></td> </tr> <tr> <td>M5 - M20</td> <td>53</td> <td>89.0</td> <td>HSK A 63</td> <td>S2-/SC2-</td> <td></td> <td></td> <td>170112</td> <td></td> </tr> <tr> <td>M14 - M33</td> <td>78</td> <td>121.0</td> <td>HSK A 63</td> <td>S3-/SC3-</td> <td></td> <td></td> <td></td> <td>170114</td> </tr> </tbody> </table>						D_1 mm	L_1 mm			280-281	ID	ID	ID	M3 - M12	36	72.0	HSK A 63	S1-/SC1-		170111			M5 - M20	53	89.0	HSK A 63	S2-/SC2-			170112		M14 - M33	78	121.0	HSK A 63	S3-/SC3-				170114	<table border="1"> <thead> <tr> <th>ID</th> <th>ID</th> <th>ID</th> </tr> </thead> <tbody> <tr> <td>170111</td> <td></td> <td></td> </tr> <tr> <td></td> <td>170112</td> <td></td> </tr> <tr> <td></td> <td></td> <td>170114</td> </tr> </tbody> </table>			ID	ID	ID	170111				170112				170114
	D_1 mm	L_1 mm			280-281	ID	ID	ID																																															
M3 - M12	36	72.0	HSK A 63	S1-/SC1-		170111																																																	
M5 - M20	53	89.0	HSK A 63	S2-/SC2-			170112																																																
M14 - M33	78	121.0	HSK A 63	S3-/SC3-				170114																																															
ID	ID	ID																																																					
170111																																																							
	170112																																																						
		170114																																																					
MAS/BT Form AD + B					SRT-BT40-312	SRT-BT40-520	SRT-BT40-1433																																																
<h1>BT</h1>																																																							
<table border="1"> <thead> <tr> <th></th> <th>D_1 mm</th> <th>L_1 mm</th> <th></th> <th></th> <th>280-281</th> <th>ID</th> <th>ID</th> <th>ID</th> </tr> </thead> <tbody> <tr> <td>M3 - M12</td> <td>36</td> <td>71.0</td> <td>BT 40</td> <td>S1-/SC1-</td> <td></td> <td>170133</td> <td></td> <td></td> </tr> <tr> <td>M5 - M20</td> <td>53</td> <td>85.0</td> <td>BT 40</td> <td>S2-/SC2-</td> <td></td> <td></td> <td>170134</td> <td></td> </tr> <tr> <td>M14 - M33</td> <td>78</td> <td>121.0</td> <td>BT 40</td> <td>S3-/SC3-</td> <td></td> <td></td> <td></td> <td>170135</td> </tr> </tbody> </table>						D_1 mm	L_1 mm			280-281	ID	ID	ID	M3 - M12	36	71.0	BT 40	S1-/SC1-		170133			M5 - M20	53	85.0	BT 40	S2-/SC2-			170134		M14 - M33	78	121.0	BT 40	S3-/SC3-				170135	<table border="1"> <thead> <tr> <th>ID</th> <th>ID</th> <th>ID</th> </tr> </thead> <tbody> <tr> <td>170133</td> <td></td> <td></td> </tr> <tr> <td></td> <td>170134</td> <td></td> </tr> <tr> <td></td> <td></td> <td>170135</td> </tr> </tbody> </table>			ID	ID	ID	170133				170134				170135
	D_1 mm	L_1 mm			280-281	ID	ID	ID																																															
M3 - M12	36	71.0	BT 40	S1-/SC1-		170133																																																	
M5 - M20	53	85.0	BT 40	S2-/SC2-			170134																																																
M14 - M33	78	121.0	BT 40	S3-/SC3-				170135																																															
ID	ID	ID																																																					
170133																																																							
	170134																																																						
		170135																																																					

SRT *Tapping chucks with axial shock absorber* Mandril de roscar con amortiguador axial



Uniquement pour taraudage synchrone
Nur für Synchronbearbeitung
Only for rigid tapping
Solo per maschiatura sincrona
Solo para rosado sincronizado

DIN 69 871 Form AD + B					SRT-SK40-312	SRT-SK40-520	SRT-SK40-1433																				
<h1>SK</h1>																											
280-281					NEW	NEW	NEW																				
					<50 bar	<50 bar	<50 bar																				
					ID	ID	ID																				
<table border="1"> <thead> <tr> <th></th> <th>D₁ mm</th> <th>L₁ mm</th> <th></th> <th></th> </tr> </thead> <tbody> <tr> <td>M3 - M12</td> <td>36</td> <td>65.0</td> <td>SK 40</td> <td>S1-/SC1-</td> </tr> <tr> <td>M5 - M20</td> <td>53</td> <td>79.0</td> <td>SK 40</td> <td>S2-/SC2-</td> </tr> <tr> <td>M14 - M33</td> <td>78</td> <td>115.0</td> <td>SK 40</td> <td>S3-/SC3-</td> </tr> </tbody> </table>						D ₁ mm	L ₁ mm			M3 - M12	36	65.0	SK 40	S1-/SC1-	M5 - M20	53	79.0	SK 40	S2-/SC2-	M14 - M33	78	115.0	SK 40	S3-/SC3-	170124	170125	170126
	D ₁ mm	L ₁ mm																									
M3 - M12	36	65.0	SK 40	S1-/SC1-																							
M5 - M20	53	79.0	SK 40	S2-/SC2-																							
M14 - M33	78	115.0	SK 40	S3-/SC3-																							
DIN 69 871 Form AD + B					SRT-SK50-520	SRT-SK50-1433	SRT-SK50-2248																				
<h1>SK</h1>																											
280-281					NEW	NEW	NEW																				
					<50 bar	<50 bar	<50 bar																				
					ID	ID	ID																				
<table border="1"> <thead> <tr> <th></th> <th>D₁ mm</th> <th>L₁ mm</th> <th></th> <th></th> </tr> </thead> <tbody> <tr> <td>M5 - M20</td> <td>53</td> <td>79.0</td> <td>SK 50</td> <td>S2-/SC2-</td> </tr> <tr> <td>M14 - M33</td> <td>78</td> <td>115.0</td> <td>SK 50</td> <td>S3-/SC3-</td> </tr> <tr> <td>M22 - M48</td> <td>96</td> <td>132.0</td> <td>SK 50</td> <td>S4-/SC4-</td> </tr> </tbody> </table>						D ₁ mm	L ₁ mm			M5 - M20	53	79.0	SK 50	S2-/SC2-	M14 - M33	78	115.0	SK 50	S3-/SC3-	M22 - M48	96	132.0	SK 50	S4-/SC4-	170128	170129	170130
	D ₁ mm	L ₁ mm																									
M5 - M20	53	79.0	SK 50	S2-/SC2-																							
M14 - M33	78	115.0	SK 50	S3-/SC3-																							
M22 - M48	96	132.0	SK 50	S4-/SC4-																							



SRT *Tapping chucks with axial shock absorber* Mandril de roscar con amortiguador axial



Uniquement pour taraudage synchrone
Nur für Synchronbearbeitung
Only for rigid tapping
Solo per maschiatura sincrona
Solo para roscado sincronizado

DIN 1835 B		SRT032-D6	SRT054-D12	ER8																														
<p>SRT032 / SRT054 D9865-</p>																																		
	<table border="1"> <thead> <tr> <th>D</th> <th>D₁</th> <th>D₂</th> <th>L</th> <th>L₁</th> <th>L₂</th> </tr> <tr> <th>mm</th> <th>mm</th> <th>mm</th> <th>mm</th> <th>mm</th> <th>mm</th> </tr> </thead> <tbody> <tr> <td>M0.3 - M2</td> <td>12</td> <td>11</td> <td>6</td> <td>25</td> <td>40</td> </tr> <tr> <td>M0.5 - M4</td> <td>12</td> <td>20</td> <td>12</td> <td>33</td> <td>59</td> </tr> </tbody> </table>	D	D ₁	D ₂	L	L ₁	L ₂	mm	mm	mm	mm	mm	mm	M0.3 - M2	12	11	6	25	40	M0.5 - M4	12	20	12	33	59	ID	ID							
D	D ₁	D ₂	L	L ₁	L ₂																													
mm	mm	mm	mm	mm	mm																													
M0.3 - M2	12	11	6	25	40																													
M0.5 - M4	12	20	12	33	59																													
		157610	127413																															
No	<table border="1"> <thead> <tr> <th>D₂</th> <th>L₃</th> <th>d₂</th> </tr> <tr> <th>mm</th> <th>mm</th> <th>mm</th> </tr> </thead> <tbody> <tr> <td>ER8-0200</td> <td>8.5</td> <td>13.5</td> <td>2.0</td> </tr> <tr> <td>ER8-0250</td> <td>8.5</td> <td>13.5</td> <td>2.5</td> </tr> <tr> <td>ER8-0300</td> <td>8.5</td> <td>13.5</td> <td>3.0</td> </tr> <tr> <td>ER8-0350</td> <td>8.5</td> <td>13.5</td> <td>3.5</td> </tr> <tr> <td>ER8-0400</td> <td>8.5</td> <td>13.5</td> <td>4.0</td> </tr> <tr> <td>ER8-0450</td> <td>8.5</td> <td>13.5</td> <td>4.5</td> </tr> </tbody> </table>	D ₂	L ₃	d ₂	mm	mm	mm	ER8-0200	8.5	13.5	2.0	ER8-0250	8.5	13.5	2.5	ER8-0300	8.5	13.5	3.0	ER8-0350	8.5	13.5	3.5	ER8-0400	8.5	13.5	4.0	ER8-0450	8.5	13.5	4.5		ID	
D ₂	L ₃	d ₂																																
mm	mm	mm																																
ER8-0200	8.5	13.5	2.0																															
ER8-0250	8.5	13.5	2.5																															
ER8-0300	8.5	13.5	3.0																															
ER8-0350	8.5	13.5	3.5																															
ER8-0400	8.5	13.5	4.0																															
ER8-0450	8.5	13.5	4.5																															
				118895	118896	118897	118898	118899	118900																									
DIN 1835 B		SRT312-D20	SRT312-D25	SRT520-D25																														
	<table border="1"> <thead> <tr> <th>D₁</th> <th>D₂</th> <th>L</th> <th>L₁</th> <th></th> <th></th> </tr> <tr> <th>mm</th> <th>mm</th> <th>mm</th> <th>mm</th> <th></th> <th>280-281</th> </tr> </thead> <tbody> <tr> <td>M3 - M12</td> <td>39</td> <td>20</td> <td>47</td> <td>86.0</td> <td>S1-/SC1-</td> </tr> <tr> <td>M3 - M12</td> <td>39</td> <td>25</td> <td>53</td> <td>90.0</td> <td>S1-/SC1-</td> </tr> <tr> <td>M5 - M20</td> <td>56</td> <td>25</td> <td>53</td> <td>110.0</td> <td>S2-/SC2-</td> </tr> </tbody> </table>	D ₁	D ₂	L	L ₁			mm	mm	mm	mm		280-281	M3 - M12	39	20	47	86.0	S1-/SC1-	M3 - M12	39	25	53	90.0	S1-/SC1-	M5 - M20	56	25	53	110.0	S2-/SC2-	ID	ID	ID
D ₁	D ₂	L	L ₁																															
mm	mm	mm	mm		280-281																													
M3 - M12	39	20	47	86.0	S1-/SC1-																													
M3 - M12	39	25	53	90.0	S1-/SC1-																													
M5 - M20	56	25	53	110.0	S2-/SC2-																													
		162832	162831	162833																														

SRT Tapping chucks with axial shock absorber

Mandril de roscar con amortiguador axial



Uniquement pour taraudage synchrone
Nur für Synchrobearbeitung
Only for rigid tapping
Solo per maschiatura sincrona
Solo para roscado sincronizado

DIN 1835 B	SRT-1D20-312	SRT-1D25-312	SRT-2D25-520																																				
SRT																																							
<table border="1"> <thead> <tr> <th></th> <th>D₁ mm</th> <th>D₂ mm</th> <th>L mm</th> <th>L₁ mm</th> <th> 280-281</th> <th>ID</th> <th>ID</th> <th>ID</th> </tr> </thead> <tbody> <tr> <td>M3 - M12</td> <td>36</td> <td>20</td> <td>51.0</td> <td>97</td> <td>S1-/SC1-</td> <td>170140</td> <td></td> <td></td> </tr> <tr> <td>M3 - M12</td> <td>36</td> <td>25</td> <td>57.0</td> <td>103</td> <td>S1-/SC1-</td> <td></td> <td>170020</td> <td></td> </tr> <tr> <td>M5 - M20</td> <td>53</td> <td>25</td> <td>57.0</td> <td>131</td> <td>S2-/SC2-</td> <td></td> <td></td> <td>170141</td> </tr> </tbody> </table>		D ₁ mm	D ₂ mm	L mm	L ₁ mm	280-281	ID	ID	ID	M3 - M12	36	20	51.0	97	S1-/SC1-	170140			M3 - M12	36	25	57.0	103	S1-/SC1-		170020		M5 - M20	53	25	57.0	131	S2-/SC2-			170141			
	D ₁ mm	D ₂ mm	L mm	L ₁ mm	280-281	ID	ID	ID																															
M3 - M12	36	20	51.0	97	S1-/SC1-	170140																																	
M3 - M12	36	25	57.0	103	S1-/SC1-		170020																																
M5 - M20	53	25	57.0	131	S2-/SC2-			170141																															
<table border="1"> <thead> <tr> <th></th> <th>D₁ mm</th> <th>D₂ mm</th> <th>L mm</th> <th>L₁ mm</th> <th> 280-281</th> <th>ID</th> <th>ID</th> <th>ID</th> </tr> </thead> <tbody> <tr> <td>M5 - M20</td> <td>53</td> <td>32</td> <td>61.5</td> <td>135.5</td> <td>S2-/SC2-</td> <td>170142</td> <td></td> <td></td> </tr> <tr> <td>M14 - M33</td> <td>78</td> <td>25</td> <td>57.0</td> <td>164.5</td> <td>S3-/SC3-</td> <td></td> <td>170143</td> <td></td> </tr> <tr> <td>M14 - M33</td> <td>78</td> <td>32</td> <td>61.5</td> <td>169.0</td> <td>S3-/SC3-</td> <td></td> <td></td> <td>170144</td> </tr> </tbody> </table>		D ₁ mm	D ₂ mm	L mm	L ₁ mm	280-281	ID	ID	ID	M5 - M20	53	32	61.5	135.5	S2-/SC2-	170142			M14 - M33	78	25	57.0	164.5	S3-/SC3-		170143		M14 - M33	78	32	61.5	169.0	S3-/SC3-			170144			
	D ₁ mm	D ₂ mm	L mm	L ₁ mm	280-281	ID	ID	ID																															
M5 - M20	53	32	61.5	135.5	S2-/SC2-	170142																																	
M14 - M33	78	25	57.0	164.5	S3-/SC3-		170143																																
M14 - M33	78	32	61.5	169.0	S3-/SC3-			170144																															
DIN 1835 B	SRT-2D32-520	SRT-3D25-1433	SRT-3D32-1433																																				
SRT																																							
<table border="1"> <thead> <tr> <th></th> <th>D₁ mm</th> <th>D₂ mm</th> <th>L mm</th> <th>L₁ mm</th> <th> 280-281</th> <th>ID</th> <th>ID</th> <th>ID</th> </tr> </thead> <tbody> <tr> <td>M5 - M20</td> <td>53</td> <td>32</td> <td>61.5</td> <td>135.5</td> <td>S2-/SC2-</td> <td>170142</td> <td></td> <td></td> </tr> <tr> <td>M14 - M33</td> <td>78</td> <td>25</td> <td>57.0</td> <td>164.5</td> <td>S3-/SC3-</td> <td></td> <td>170143</td> <td></td> </tr> <tr> <td>M14 - M33</td> <td>78</td> <td>32</td> <td>61.5</td> <td>169.0</td> <td>S3-/SC3-</td> <td></td> <td></td> <td>170144</td> </tr> </tbody> </table>		D ₁ mm	D ₂ mm	L mm	L ₁ mm	280-281	ID	ID	ID	M5 - M20	53	32	61.5	135.5	S2-/SC2-	170142			M14 - M33	78	25	57.0	164.5	S3-/SC3-		170143		M14 - M33	78	32	61.5	169.0	S3-/SC3-			170144			
	D ₁ mm	D ₂ mm	L mm	L ₁ mm	280-281	ID	ID	ID																															
M5 - M20	53	32	61.5	135.5	S2-/SC2-	170142																																	
M14 - M33	78	25	57.0	164.5	S3-/SC3-		170143																																
M14 - M33	78	32	61.5	169.0	S3-/SC3-			170144																															



SRT *Inserts without slipping clutch* Pinza sin embrague de seguridad



Uniquement pour taraudage synchrone
Nur für Synchronbearbeitung
Only for rigid tapping
Solo per maschiatura sincrona
Solo para roscado sincronizado

SRT

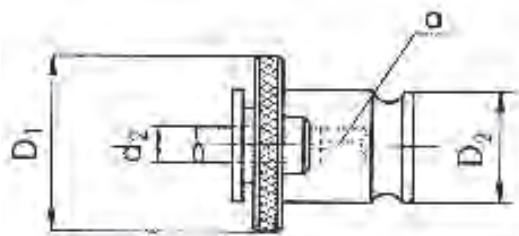

S1-

S2-

S3-

S4-



NEW

NEW

No	D ₁ mm	D ₂ mm	d ₂ mm	α mm	ID	ID	ID	ID
S1-0028	30	19.0	2.8	2.1	129915			
S1-0035	30	19.0	3.5	2.7	129916			
S1-0045	30	19.0	4.5	3.4	129918			
S1-0060	30	19.0	6.0	4.9	129920			
S1-0070	30	19.0	7.0	5.5	129921			
S1-0080	30	19.0	8.0	6.2	129922			
S1-0090	30	19.0	9.0	7.0	129923			
S1-0100	30	19.0	10.0	8.0	129924			
S1-0110	30	19.0	11.0	9.0	129925			
S2-0060	48	31.0	6.0	4.9		129927		
S2-0070	48	31.0	7.0	5.5		129928		
S2-0080	48	31.0	8.0	6.2		129929		
S2-0090	48	31.0	9.0	7.0		129930		
S2-0100	48	31.0	10.0	8.0		129931		
S2-0110	48	31.0	11.0	9.0		148303		
S2-0120	48	31.0	12.0	9.0		129932		
S2-0140	48	31.0	14.0	11.0		129933		
S2-0160	48	31.0	16.0	12.0		129934		
S2-0180	48	31.0	18.0	14.5		151355		
S3-0110	70	48.0	11.0	9.0			170145	
S3-0120	70	48.0	12.0	9.0			170146	
S3-0140	70	48.0	14.0	11.0			170147	
S3-0160	70	48.0	16.0	12.0			170148	
S3-0180	70	48.0	18.0	14.5			170149	
S3-0200	70	48.0	20.0	16.0			170150	
S3-0220	70	48.0	22.0	18.0			170151	
S3-0250	70	48.0	25.0	20.0			170152	
S4-0180	96	60.0	18.0	14.5				170153
S4-0200	96	60.0	20.0	16.0				170154
S4-0220	96	60.0	22.0	18.0				170155
S4-0250	96	60.0	25.0	20.0				170156
S4-0280	96	60.0	28.0	22.0				170157
S4-0320	96	60.0	32.0	24.0				170158
S4-0360	96	60.0	36.0	29.0				170159

SRT

Inserts with slipping clutch
Pinza con embrague de seguridad



Uniquement pour taraudage synchrone
 Nur für Synchronbearbeitung
 Only for rigid tapping
 Solo per maschiatura sincrona
 Solo para roscado sincronizado

SRT

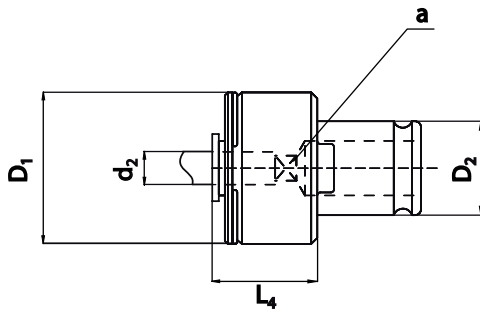

SC1-

SC2-

SC3-

SC4-

NEW

NEW

NEW

NEW

ID

ID

ID

ID

No	D ₁ mm	D ₂ mm	d ₂ mm	a mm	L ₄ mm	ID	ID	ID	ID
SC1-0028	32	19.0	2.8	2.1	25	170160			
SC1-0035	32	19.0	3.5	2.7	25	170161			
SC1-0045	32	19.0	4.5	3.4	25	170162			
SC1-0060	32	19.0	6.0	4.9	25	170163			
SC1-0070	32	19.0	7.0	5.5	25	170164			
SC1-0080	32	19.0	8.0	6.2	25	170165			
SC1-0090	32	19.0	9.0	7.0	25	170166			
SC1-0100	32	19.0	10.0	8.0	25	170167			
SC2-0060	50	31.0	6.0	4.9	34		170168		
SC2-0070	50	31.0	7.0	5.5	34		170169		
SC2-0080	50	31.0	8.0	6.2	34		170170		
SC2-0090	50	31.0	9.0	7.0	34		170171		
SC2-0100	50	31.0	10.0	8.0	34		170172		
SC2-0110	50	31.0	11.0	9.0	34		170173		
SC2-0120	50	31.0	12.0	9.0	34		170174		
SC2-0140	50	31.0	14.0	11.0	34		170175		
SC2-0160	50	31.0	16.0	12.0	34		170176		
SC2-0180	50	31.0	18.0	14.5	34		170177		
SC3-0110	72	48.0	11.0	9.0	45			170178	
SC3-0120	72	48.0	12.0	9.0	45			170179	
SC3-0140	72	48.0	14.0	11.0	45			170180	
SC3-0160	72	48.0	16.0	12.0	45			170181	
SC3-0180	72	48.0	18.0	14.5	45			170182	
SC3-0200	72	48.0	20.0	16.0	45			170183	
SC3-0220	72	48.0	22.0	18.0	45			170184	
SC3-0250	72	48.0	25.0	20.0	45			170185	
SC4-0180	96	60.0	18.0	14.5	68				170186
SC4-0200	96	60.0	20.0	16.0	68				170187
SC4-0220	96	60.0	22.0	18.0	68				170188
SC4-0250	96	60.0	25.0	20.0	68				170189
SC4-0280	96	60.0	28.0	22.0	68				170190
SC4-0320	96	60.0	32.0	24.0	68				170191
SC4-0360	96	60.0	36.0	29.0	68				170192



Solid carbide twist drills













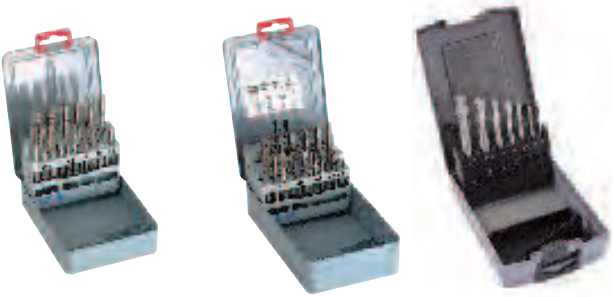



Brocas helicoidales en metal duro integral



sur demande
auf Anfrage
on request
su richiesta
sobre pedido

							F313VS	F285VS	F286VS		
F313VS			VS								
F285VS			VS								
F286VS			VS								
$\varnothing d_1$ (h ₇)	d_2 (h ₈) mm	l_1 mm	l_2 mm				ID				
0.88	3.0	38.0	8.0	2	M 1		158515				
1.08	3.0	38.0	10.0	2	M 1.2		158516				
1.25	3.0	38.0	12.0	2	M 1.4		158517				
1.45	3.0	38.0	12.0	2	M 1.6		158518				
1.65	3.0	38.0	12.0	2	M 1.8		158519				
1.80	3.0	38.0	12.0	2	M 2		158520				
1.95	3.0	38.0	12.0	2	UNC 2-56		158521				
2.30	3.0	38.0	16.0	2	M 2.5		158522				
2.55	3.0	38.0	16.0	2	UNC 4-40		158523				
2.80	3.0	38.0	16.0	2	M 3		158524				
$\varnothing d_1$ (m ₇)	d_2 (h ₈) mm	l_1 mm	l_2 mm	l_3 mm			ID				
3.25	6.0	62.0	20.0	14.0	2	M 3.5	158527				
3.70	6.0	62.0	20.0	14.0	2	M 4	158528				
4.65	6.0	66.0	24.0	17.0	2	M 5	158532				
5.55	6.0	66.0	28.0	20.0	2	M 6	158534				
7.40	8.0	79.0	41.0	29.0	2	M 8	158540				
9.30	10.0	89.0	47.0	35.0	2	M 10	158544				
11.20	12.0	102.0	55.0	40.0	2	M 12	158546				
$\varnothing d_1$ (m ₇)	d_2 (h ₈) mm	l_1 mm	l_2 mm	l_3 mm			ID				
3.30	6.0	66.0	28.0	23.0	2	M 4	160989				
4.20	6.0	74.0	36.0	29.0	2	M 5	160990				
5.00	6.0	82.0	44.0	35.0	2	M 6	160991				
6.80	8.0	91.0	53.0	43.0	2	M 8	160992				
8.50	10.0	103.0	61.0	49.0	2	M 10	160993				
10.20	12.0	118.0	71.0	56.0	2	M 12	160994				

Tap assortments
Juegos de herramientas de roscar

Boxset		D5855	D5860	D5891
D5855	  N1110-S M3, M4, M5, M6, M8, M10 N1210-S M12			
D5860	  N1110-S M3, M4, M5, M6, M8, M10 N1210-S M12   FO DIN 338 D2.5, 3.3, 4.2, 5.0, 6.8, FO DIN 338 8.5, 10.2			
D5891	  N310-3 M3, M4, M5, M6, M8, M10 N410-3 M12			
No D5855 / D5860 / D5891		ID	ID	ID
M3 - M12		118728	118733	170922
Boxset		D5892		
D5892	   N320V-4 M3, M4, M5, M6, M8, M10			
No D5892			ID	
M3 - M10			170921	
Boxset		D5896		
D5896	   N360V-3 M3, M4, M5, M6, M8, M10			
No D5896			ID	
M3 - M10			167599	



Die stocks and tap wrenches

Porta-cojinetes y giramachos

D5810- Die stocks for round dies to DIN EN 22568, DIN EN 24230, DIN EN 24231, DIN EN 40434. Porta-cojinete para cojinetes redondos según DIN EN 22568, DIN EN 24230, DIN EN 24231, DIN EN 40434.									D5810-	D5820-
D5820- Tap wrenches, adjustable DIN 1814 Giramacho regulable DIN 1814										
DIN EN	M	MF	UNC	UNF	UNEF	W	G (BSP)	NPT	ID	
No D5810- Ø	Ø	Ø	Ø	Ø	UNF UN UN Ø	Ø	Ø	NPTF R (BSPT) Ø		
1 16 x 5	1 - 2.6	2 - 2.6	No 1 - 4	No 1 - 4		1/16" - 3/32"			170712	
2 20 x 5	3 - 4	3 - 6	No 5	No 5 - 6		1/8"			170713	
3 20 x 7	4.5 - 6		No 6 - 1/4"	No 8 - 1/4"	No 12 - 1/4"	5/32" - 1/4"			170714	
4 25 x 9	7 - 9	7 - 9	5/16"	5/16"	5/16"	5/16"		1/16"	170715	
5 30 x 11	10 - 11	10 - 11	3/8" - 7/16"	3/8" - 7/16"	3/8" - 7/16"	3/8" - 7/16"	1/8"	1/8"	170716	
6 38 x 10		12 - 15		1/2" - 9/16"	1/2" - 9/16"		1/4"		170717	
7 38 x 14	12 - 14		1/2" - 9/16"			1/2" - 9/16"		1/4"	170718	
8 45 x 14		16 - 20		5/8" - 3/4"	5/8" - 13/16"		3/8" - 1/2"	3/8"	170719	
9 45 x 18	16 - 20		5/8" - 3/4"			5/8" - 3/4"		1/2"	170720	
10 55 x 16		22 - 26		7/8" - 1"	7/8" - 1"		5/8" - 3/4"		170721	
11 55 x 22	22 - 24		7/8" - 1"			7/8" - 1"		3/4"	170722	
12 65 x 18		*27 - 36		1 1/8" - 1 3/8"	1 1/16" - 1 3/8"		7/8" - 1"		170723	
13 65 x 25	27 - 36		1 1/8" - 1 3/8"			1 1/8" - 1 3/8"		1"	170724	
14 75 x 20		38 - 42		1 1/2"	1 7/16" - 1 1/2"		1 1/8" - 1 1/4"		170725	
15 75 x 30	39 - 42		1 1/2"			1 1/2" - 1 5/8"			170726	
16 90 x 22		45 - 52			1 3/4" - 2"		1 3/8" - 1 3/4"		170727	
17 90 x 36	45 - 52		1 3/4" - 2"			1 3/4" - 2"			170728	
18 105 x 22		55 - 65					2" - 2 1/4"		170729	
* For 3 mm pitches use No. 13. Excepto el paso de 3 mm (utilizar el N° 13).										
No D5820-	a mm									ID
0	1.9 - 3.0									170730
1	2.5 - 5.5									170731
2	4.3 - 8.0									170732
3	5.5 - 12.0									170733
4	9.5 - 15.5									170734
5	12.5 - 22.4									170735

Tap extension sleeves

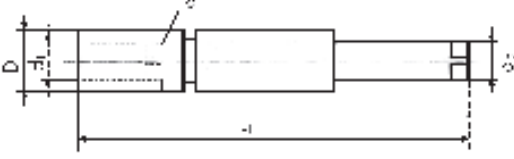
Alargaderas para machos de roscar

D5830- Tap extension sleeves ~DIN 377. Alargadera para machos de roscar, ~DIN 377.		D5830-	D5840-			
D5840- Tap extension sleeves. Alargadera para machos de roscar.						
 		ID				
No	a	L ₁				
D5830-	mm	mm				
1	2.10	60	110571			
2	2.24	70	110572			
3	2.40	70	110573			
4	2.50	80	110574			
5	2.80	90	110575			
6	3.00	90	110579			
7	3.15	95	110580			
8	3.40	95	110581			
9	3.55	110	118706			
10	3.80	100	118707			
11	4.00	110	118708			
12	4.30	105	118709			
13	4.50	110	118710			
14	4.90	110	118711			
15	5.00	110	118712			
16	5.50	115	118713			
17	5.60	110	118714			
18	6.20	120	118715			
19	6.30	120	118716			
20	7.00	125	118717			
21	7.10	125	118718			
22	7.50	125	118719			
23	8.00	125	118720			
24	9.00	130	118721			
25	10.00	140	110562			
26	11.00	150	110563			
27	11.20	150	110564			
28	12.00	155	110565			
29	12.50	160	110566			
30	14.00	170	110567			
31	14.50	175	110568			
32	16.00	180	110569			
33	18.00	200	110570			
34	20.00	220	110576			
35	22.00	220	110577			
36	22.40	240	110578			
No	a	L ₁	d ₂	d ₁	D ₁	ID
D5840-	mm	mm	mm	mm	mm	
10	2.70	130	6	3.5	7.5	169928
11	3.40	130	6	4.5	8.5	169929
1	4.90	130	6	6.0	12.0	142137
2	5.50	130	7	7.0	13.0	142138
3	6.20	130	8	8.0	13.0	142139
4	7.00	130	9	9.0	17.0	142140
5	8.00	130	10	10.0	17.0	142141
6	9.00	130	11	11.0	17.0	142142
7	9.00	130	12	12.0	20.0	142143
8	11.00	130	14	14.0	20.0	142144
9	12.00	130	16	16.0	25.0	142145



HARDNESS CHART - TABLA DE DUREZA

HRC <i>Hardness Rockwell</i> Dureza Rockwell	HB <i>Hardness Brinell</i> Dureza Brinell	HV <i>Hardness Vickers</i> Dureza Vickers	N/mm ² Mpa <i>Tensile strength</i> Resistencia a la tracción
25	253	266	854
26	254	273	873
27	265	279	897
28	272	286	914
29	274	294	944
30	287	302	970
31	295	310	995
32	302	318	1024
33	311	327	1052
34	320	336	1082
35	329	345	1111
36	337	355	1139
37	346	364	1168
38	354	373	1198
39	363	382	1227
40	373	392	1262
41	382	402	1296
42	392	412	1327
43	402	423	1362
44	413	434	1401
45	424	446	1442
46	436	459	1481
47	448	471	1524
48	460	484	1572
49	474	499	1625
50	488	513	1668
51	502	528	1733
52	518	545	1793
53	532	560	1845
54	548	578	1912
55	566	596	1979
56	585	615	2050
57	603	634	2121
58		654	
59		675	
60		698	

Conversion chart for hardness values, according to DIN 50150
 Tabla de equivalencia de dureza, según DIN 50150

INCHES-MM - PULGADAS-MM

Ø" d ₁	Ø mm	IPT UN											W(BSW)	BSF	G (BSF) Rp	Ø mm			
		UNC	UNF	UNEF	4	6	8	12	16	20	28	32							
0 1/16"	1.52 1.59		80												48		28	7.72	
1 2 3/32"	1.85 2.18 2.38	64 56	72 64																
3 4 5 1/8"	2.51 2.84 3.17 3.17 3.50	48 40 40 32	56 48 44 40												40		28	9.72	
5/32" 8 9 10 12	3.96 4.14 4.75 4.82 5.48	32 32 24 24	36 36 32 28												32 24	32			
7/32" 1/4" 7/32" 5/16" 3/8"	5.55 6.35 7.14 7.93 9.52	20 20 18 16	28 28 24 24	32 32 32											24 20 16	28 26 26 20	19 19	13.15 16.66	
7/16" 1/2" 9/16" 5/8" 11/16"	11.11 12.70 14.28 15.87 17.46	14 13 12 11	20 20 18 18 24	28 28 24 24				16 16 16 12							32 32 28 32 20	14 12 16 14 14	18 16 16 14	20.95 22.91	
3/4" 13/16" 7/8" 9/16" 1"	19.05 20.64 22.22 23.81 25.40	10 9 9 8	16 14 14 12	20 20 20 20				12 12 12 16							28 28 28 28 32	10 9 9 8	12 12 11 10	14 14 11	26.44 30.20 33.24
1 1/16" 1 1/8" 1 1/4" 1 1/2" 1 3/4"	26.99 28.57 30.16 31.75 33.34	7 7	12 12	18 18 18 18			8 8 8 8	12 12 16 16	20 20 20 20	28 28 28				7 7	9 9	11 11	37.89 41.91		
1 3/8" 1 7/16" 1 1/2" 1 9/16" 1 5/8"	34.92 36.51 38.10 39.69 41.28	6 6	12	18 18 18 18		6 6	8 8 8 8	12 12 16 16	20 20 20 20	28 28 28				6 6 5	8 8 8	11 11	44.32 47.80		
1 11/16" 1 3/4" 1 13/16" 1 7/8" 1 15/16"	42.86 44.45 46.04 47.63 49.21	5		18 18 18 18		6 6 6 6	8 8 8 8	12 12 16 16	20 20 20 20					5 4 1/2	7	11	53.74		
2" 2 1/8" 2 1/4" 2 3/8" 2 1/2"	50.80 53.97 57.15 60.32 63.50	4 1/2 4 1/2 4				6 6 6 6	8 8 8 8	12 12 16 16	20 20 20 20					4 1/2 4 4	7 6 6	11 11 11	59.61 65.71 75.18		
2 5/8" 2 3/4" 2 7/8" 3" 3 1/8"	66.67 69.85 73.02 76.20 79.37	4 4 4			4 4 4	6 6 6	8 8 8	12 12 16 16	20 20 20					3 1/2 3 1/2	6 5	11 11	81.53 87.88		
3 1/4" 3 3/8" 3 1/2" 3 5/8" 3 3/4"	82.55 85.72 88.90 92.07 95.25	4 4 4			4 4	6 6 6	8 8 8	12 12 16 16						3 1/2 3 1/4 3	5 4 1/2 4 1/2	11 11 11	95.98 100.33 106.68		
3 7/8" 4"	98.42 101.60	4			4	6 6	8 8	12 16						3	4 1/2	11	113.03		



CONVERSION TABLE - TABLA DE CONVERSIÓN

		Vc m/min															
		1	2	3	4	5	6	8	10	12	15	20	25	30	40	50	60
		min ⁻¹															
Ø d _r	1	318	637	955	1273	1592	1910	2546	3183	3820	4775	6366	7958	9549	12732	15915	19099
	2	159	318	477	637	796	955	1273	1592	1910	2387	3183	3979	4775	6366	7958	9549
3	3	106	212	318	424	531	637	849	1061	1273	1592	2122	2653	3183	4244	5305	6366
	4	80	159	239	318	398	477	637	796	955	1194	1592	1989	2387	3183	3979	4775
5	5	64	127	191	255	318	382	509	637	764	955	1273	1592	1910	2546	3183	3820
	6	53	106	159	212	265	318	424	531	637	796	1061	1326	1592	2122	2653	3183
8	8	40	80	119	159	199	239	318	398	477	597	796	995	1194	1592	1989	2387
	10	32	64	95	127	159	191	255	318	382	477	637	796	955	1273	1592	1910
12	12	27	53	80	106	133	159	212	265	318	398	531	663	796	1061	1326	1592
	14	23	45	68	91	114	136	182	227	273	341	455	568	682	909	1137	1384
16	16	20	40	60	80	99	119	159	199	239	298	398	497	597	796	995	1194
	18	18	35	53	71	88	106	141	177	212	265	354	442	531	707	884	1061
20	20	16	32	48	64	80	95	127	159	191	239	318	398	477	637	796	955
	25	13	25	38	51	64	76	102	127	153	191	255	318	382	509	637	764
30	30	11	21	32	42	53	64	85	106	127	159	212	265	318	424	531	637
	35	9	18	27	36	45	55	73	91	109	136	182	227	273	364	455	546
40	40	8	16	24	32	40	48	64	80	95	119	159	199	239	318	398	477
	45	7	14	21	28	35	42	57	71	85	106	141	177	212	283	354	424
50	50	6	13	19	25	32	38	51	64	76	95	127	159	191	255	318	382

CORE HOLES - DIÁMETRO DEL AGUJERO

M DIN 13, ISO 261, *5H / 6H

Ø	P	Core Ø nut - Ø Núcleo		
		Ø mini	Ø maxi	
d ₁	mm			Ø guide line
*1	0.25	0.729	0.785	0.75
*1.1	0.25	0.829	0.885	0.85
*1.2	0.25	0.929	0.985	0.95
*1.4	0.30	1.075	1.142	1.10
1.6	0.35	1.221	1.321	1.25
1.7	0.35	1.321	1.421	1.35
1.8	0.35	1.421	1.521	1.45
2	0.40	1.567	1.679	1.60
2.2	0.45	1.713	1.838	1.75
2.3	0.40	1.867	1.979	1.90
2.5	0.45	2.013	2.138	2.05
2.6	0.45	2.113	2.238	2.15
3	0.50	2.459	2.599	2.50
3.5	0.60	2.850	3.010	2.90
4	0.70	3.242	3.422	3.30
4.5	0.75	3.688	3.878	3.75
5	0.80	4.134	4.334	4.20
6	1.00	4.917	5.153	5.00
7	1.00	5.917	6.153	6.00
8	1.25	6.647	6.912	6.80
9	1.25	7.647	7.912	7.80
10	1.50	8.376	8.676	8.50
11	1.50	9.376	9.676	9.50
12	1.75	10.106	10.441	10.20
14	2.00	11.835	12.210	12.00
16	2.00	13.835	14.210	14.00
18	2.50	15.294	15.744	15.50
20	2.50	17.294	17.744	17.50
22	2.50	19.294	19.744	19.50
24	3.00	20.752	21.252	21.00
27	3.00	23.752	24.252	24.00
30	3.50	26.211	26.771	26.50
33	3.50	29.211	29.771	29.50
36	4.00	31.670	32.270	32.00
39	4.00	34.670	35.270	35.00
42	4.50	37.129	37.799	37.50
45	4.50	40.129	40.799	40.50
48	5.00	42.587	43.297	43.00
52	5.00	46.587	47.297	47.00
56	5.50	50.046	50.796	50.50

MF DIN 13, ISO 261, 6H

Ø	P	Core Ø nut - Ø Núcleo		
		Ø mini	Ø maxi	
d ₁	mm			Ø guide line
8	1.00	6.917	7.153	7.00
9	0.75	8.188	8.378	8.25
9	1.00	7.917	8.153	8.00
10	0.75	9.188	9.378	9.25
10	1.00	8.917	9.153	9.00
10	1.25	8.647	8.912	8.80
11	0.75	10.188	10.378	10.25
11	1.00	9.917	10.153	10.00
12	1.00	10.917	11.153	11.00
12	1.25	10.647	10.912	10.80
12	1.50	10.376	10.676	10.50
14	1.00	12.917	13.153	13.00
14	1.25	12.647	12.912	12.80
14	1.50	12.376	12.676	12.50
15	1.00	13.917	14.153	14.00
15	1.50	13.376	13.676	13.50
16	1.00	14.917	15.153	15.00
16	1.50	14.376	14.676	14.50
17	1.00	15.917	16.153	16.00
17	1.50	15.376	15.676	15.50
18	1.00	16.917	17.153	17.00
18	1.50	16.376	16.676	16.50
18	2.00	15.835	16.210	16.00
20	1.00	18.917	19.153	19.00
20	1.50	18.376	18.676	18.50
20	2.00	17.835	18.210	18.00
22	1.00	20.917	21.153	21.00
22	1.50	20.376	20.676	20.50
22	2.00	19.835	20.210	20.00
24	1.00	22.917	23.153	23.00
24	1.50	22.376	22.676	22.50
24	2.00	21.835	22.210	22.00
25	1.00	23.917	24.153	24.00
25	1.50	23.376	23.676	23.50
25	2.00	22.835	23.210	23.00
27	1.50	25.376	25.676	25.50
27	2.00	24.835	25.210	25.00
28	1.00	26.917	27.153	27.00
28	1.50	26.376	26.676	26.50
28	2.00	25.835	26.210	26.00
30	1.00	28.917	29.153	29.00
30	1.50	28.376	28.676	28.50
30	2.00	27.835	28.210	28.00
32	1.50	30.376	30.676	30.50
32	2.00	29.835	30.210	30.00
33	1.50	31.376	31.676	31.50
33	2.00	30.835	31.210	31.00
35	1.50	33.376	33.676	33.50
36	1.50	34.376	34.676	34.50
36	2.00	33.835	34.210	34.00
36	3.00	32.752	33.252	33.00
39	1.50	37.376	37.676	37.50
39	2.00	36.835	37.210	37.00
39	3.00	35.752	36.252	36.00
40	1.50	38.376	38.676	38.50

MF DIN 13, ISO 261, 6H

Ø	P	Core Ø nut - Ø Núcleo		
		Ø mini	Ø maxi	
d ₁	mm			Ø guide line
2.5	0.35	2.121	2.221	2.15
3	0.35	2.621	2.721	2.65
3.5	0.35	3.121	3.221	3.15
4	0.50	3.459	3.599	3.50
4.5	0.50	3.959	4.099	4.00
5	0.50	4.459	4.599	4.50
5.5	0.50	4.959	5.099	5.00
6	0.75	5.188	5.378	5.25
7	0.75	6.188	6.378	6.25
8	0.75	7.188	7.378	7.25



CORE HOLES - DIÁMETRO DEL AGUJERO

MF DIN 13, ISO 261, 6H

Ø	P	Core Ø nut - Ø Núcleo		Ø guide line
		Ø mini	Ø maxi	
d ₁	mm			
40	2.00	37.835	38.210	38.00
40	3.00	36.752	37.252	37.00
42	1.50	40.376	40.676	40.50
42	2.00	39.835	40.210	40.00
42	3.00	38.752	39.252	39.00
45	1.50	43.376	43.676	43.50
45	2.00	42.835	43.210	43.00
45	3.00	41.752	42.252	42.00
48	1.50	46.376	46.676	46.50
48	2.00	45.835	46.210	46.00
48	3.00	44.752	45.252	45.00
50	1.50	48.376	48.676	48.50
50	2.00	47.835	48.210	48.00
50	3.00	46.752	47.252	47.00
52	1.50	50.376	50.676	50.50
52	2.00	49.835	50.210	50.00
52	3.00	48.752	49.252	49.00
55	2.00	52.835	53.210	53.00
60	2.00	57.835	58.210	58.00

MF EN 60423:1994, 7H

Ø	P	Core Ø nut - Ø Núcleo		Ø guide line
		Ø mini	Ø maxi	
d ₁	mm			
8	1.00	6.917	7.217	7.00
10	1.00	8.917	9.217	9.00
12	1.50	10.376	10.751	10.50
16	1.50	14.376	14.751	14.50
20	1.50	18.376	18.751	18.50
25	1.50	23.376	23.751	23.50
32	1.50	30.376	30.751	30.50
40	1.50	38.376	38.751	38.50
63	1.50	61.376	61.751	61.50

UNC ANSI B1.1, 2B

Ø"	P	P	Core Ø nut - Ø Núcleo		Ø guide line
			Ø mini	Ø maxi	
d ₁	TPI	mm			
1	64	0.397	1.425	1.582	1.45
2	56	0.454	1.695	1.871	1.75
3	48	0.529	1.941	2.146	2.00
4	40	0.635	2.157	2.385	2.25
5	40	0.635	2.487	2.697	2.55
6	32	0.794	2.642	2.895	2.75
8	32	0.794	3.302	3.530	3.40
10	24	1.058	3.683	3.962	3.80
12	24	1.058	4.344	4.597	4.40
1/4"	20	1.270	4.979	5.257	5.10
5/16"	18	1.411	6.401	6.731	6.50

UNC ANSI B1.1, 2B

Ø"	P	P	Core Ø nut - Ø Núcleo		Ø guide line
			Ø mini	Ø maxi	
d ₁	TPI	mm			
3/8"	16	1.588	7.798	8.153	8.00
7/16"	14	1.814	9.144	9.550	9.30
1/2"	13	1.954	10.592	11.023	10.80
9/16"	12	2.117	11.989	12.446	12.20
5/8"	11	2.309	13.386	13.868	13.60
3/4"	10	2.540	16.307	16.840	16.60
7/8"	9	2.822	19.177	19.761	19.50
1"	8	3.175	21.971	22.606	22.30
1 1/8"	7	3.629	24.638	25.349	25.00
1 1/4"	7	3.629	27.813	28.524	28.20
1 3/8"	6	4.233	30.353	31.115	30.80
1 1/2"	6	4.233	33.528	34.290	34.00
1 3/4"	5	5.080	38.964	39.827	39.50
2"	4.5	5.644	44.679	45.593	45.30

UNJC ISO 3161:1999, 3B

Ø"	P	P	Core Ø nut - Ø Núcleo		Ø guide line
			Ø mini	Ø maxi	
d ₁	TPI	mm			
4	40	0.635	2.228	2.393	2.30
5	40	0.635	2.558	2.723	2.60
6	32	0.794	2.733	2.939	2.80
8	32	0.794	3.393	3.599	3.45
10	24	1.058	3.795	4.064	3.90
12	24	1.058	4.455	4.704	4.55
1/4"	20	1.270	5.113	5.387	5.20
5/16"	18	1.411	6.563	6.833	6.70
3/8"	16	1.588	7.978	8.255	8.10
7/16"	14	1.814	9.347	9.639	9.40
1/2"	13	1.954	10.798	11.095	10.90
9/16"	12	2.117	12.228	12.482	12.40
5/8"	11	2.309	13.627	13.904	13.80
3/4"	10	2.540	16.576	16.881	16.70

CORE HOLES - DIÁMETRO DEL AGUJERO

UNF ANSI B1.1, 2B

Ø"	P	P	Core Ø nut - Ø Núcleo		
d _i	TPI	mm	Ø mini	Ø maxi	Ø guide line
0	80	0.318	1.182	1.305	1.20
1	72	0.353	1.474	1.612	1.50
2	64	0.397	1.756	1.912	1.80
3	56	0.454	2.025	2.197	2.10
4	48	0.529	2.271	2.458	2.35
5	44	0.577	2.551	2.740	2.60
6	40	0.635	2.820	3.022	2.90
8	36	0.706	3.404	3.606	3.50
10	32	0.794	3.963	4.165	4.05
12	28	0.907	4.496	4.724	4.60
1/4"	28	0.907	5.360	5.588	5.50
5/16"	24	1.058	6.782	7.035	6.90
3/8"	24	1.058	8.382	8.636	8.50
7/16"	20	1.270	9.729	10.033	9.80
1/2"	20	1.270	11.329	11.607	11.40
9/16"	18	1.411	12.751	13.081	12.90
5/8"	18	1.411	14.351	14.681	14.50
3/4"	16	1.588	17.323	17.678	17.50
7/8"	14	1.814	20.270	20.675	20.40
1"	12	2.117	23.114	23.571	23.30
1 1/8"	12	2.117	26.289	26.746	26.50
1 1/4"	12	2.117	29.464	29.921	29.70
1 3/8"	12	2.117	32.639	33.096	32.80
1 1/2"	12	2.117	35.814	36.271	36.00

UNEF ANSI B1.1, 2B

Ø"	P	P	Core Ø nut - Ø Núcleo		
d _i	TPI	mm	Ø mini	Ø maxi	Ø guide line
1/4"	32	0.794	4.623	4.826	4.70
5/16"	32	0.794	5.487	5.689	5.60
3/8"	32	0.794	7.087	7.264	7.20
7/16"	28	0.907	8.662	8.864	8.75
1/2"	28	0.907	10.135	10.337	10.25
9/16"	24	1.058	11.710	11.938	11.85
5/8"	24	1.058	13.132	13.385	13.20
11/16"	24	1.058	14.732	14.986	14.80
3/4"	20	1.270	16.307	16.560	16.40
13/16"	20	1.270	17.679	17.957	17.80
7/8"	20	1.270	19.254	19.558	19.40
1"	20	1.270	20.854	21.132	21.00
			24.029	24.307	24.10

UN ANSI B1.1, 2B

Ø"	P	P	Core Ø nut - Ø Núcleo		
d _i	TPI	mm	Ø mini	Ø maxi	Ø guide line
5/16"	20	1.270	6.554	6.858	6.70
3/8"	20	1.270	8.154	8.432	8.30
9/16"	20	1.270	12.904	13.208	13.00
5/8"	20	1.270	14.504	14.782	14.60
1 1/8"	8	3.175	25.146	25.781	25.50
1 1/4"	8	3.175	28.321	28.956	28.70
1 3/8"	8	3.175	31.496	32.131	31.80
1 1/2"	8	3.175	34.671	35.306	35.00
1 5/8"	8	3.175	37.846	38.481	38.20
1 3/4"	8	3.175	41.021	41.656	41.40
1 7/8"	8	3.175	44.196	44.831	44.50
2"	8	3.175	47.371	48.006	47.70
2 1/4"	8	3.175	53.721	54.356	54.10
2 1/2"	8	3.175	60.071	60.706	60.40

UNJF ISO 3161:1999, 3B

Ø"	P	P	Core Ø nut - Ø Núcleo		
d _i	TPI	mm	Ø mini	Ø maxi	Ø guide line
0	80	0.318	1.217	1.298	1.25
1	72	0.353	1.511	1.603	1.55
2	64	0.397	1.798	1.902	1.85
3	56	0.454	2.073	2.189	2.15
4	48	0.529	2.329	2.466	2.35
5	44	0.577	2.614	2.764	2.70
6	40	0.635	2.888	3.053	2.95
8	36	0.706	3.480	3.663	3.60
10	32	0.794	4.054	4.255	4.10
12	28	0.907	4.602	4.816	4.70
1/4"	28	0.907	5.466	5.662	5.55
5/16"	24	1.058	6.906	7.109	7.00
3/8"	24	1.058	8.494	8.679	8.60
7/16"	20	1.270	9.876	10.084	10.00
1/2"	20	1.270	11.463	11.661	11.55
9/16"	18	1.411	12.913	13.122	13.05
5/8"	18	1.411	14.501	14.702	14.60
3/4"	16	1.588	17.506	17.722	17.60
7/8"	14	1.814	20.460	20.706	20.50
1"	12	2.117	23.340	23.594	23.40



CORE HOLES - DIÁMETRO DEL AGUJERO

UNS ANSI B1.1, 2B

Ø"	P	P	Core Ø nut - Ø Núcleo		
d ₁	TPI	mm	Ø mini	Ø maxi	Ø guide line
10	36	0.706	4.064	4.216	4.10
10	40	0.635	4.141	4.292	4.20
10	56	0.454	4.344	4.445	4.40
1/4"	36	0.706	5.588	5.740	5.65
1/4"	40	0.635	5.665	5.816	5.70
1/4"	48	0.529	5.766	5.892	5.80
1/4"	56	0.454	5.868	5.969	5.90
5/16"	36	0.706	7.163	7.340	7.25
3/8"	36	0.706	8.763	8.940	8.80
7/16"	24	1.058	9.957	10.210	10.00
1/2"	24	1.058	11.557	11.811	11.60
1"	14	1.814	23.445	23.825	23.60

W (BSW) BS 84, (DIN11 - 1970)

Ø"	P	P	Core Ø nut - Ø Núcleo		
d ₁	TPI	mm	Ø mini	Ø maxi	Ø guide line
(3/32")	48				1.80
1/8"	40	0.635	2.362	2.591	2.50
(5/32")	32				3.10
3/16"	24	1.058	3.406	3.744	3.60
(7/32")	24				4.40
1/4"	20	1.270	4.724	5.156	4.90
5/16"	18	1.411	6.129	6.588	6.40
3/8"	16	1.588	7.493	7.988	7.70
7/16"	14	1.814	8.791	9.332	9.10
1/2"	12	2.117	9.987	10.589	10.30
5/8"	11	2.309	12.918	13.558	13.30
3/4"	10	2.540	15.799	16.484	16.20
7/8"	9	2.822	18.613	19.355	19.25
1"	8	3.175	21.336	22.149	21.90

G (BSP) DIN ISO 228

Ø"	P	P	Core Ø nut - Ø Núcleo		
d ₁	TPI	mm	Ø mini	Ø maxi	Ø guide line
1/16"	28	0.907	6.561	6.843	6.75
1/8"	28	0.907	8.566	8.848	8.75
1/4"	19	1.337	11.445	11.890	11.60
3/8"	19	1.337	14.950	15.395	15.20
1/2"	14	1.814	18.631	19.172	18.90
5/8"	14	1.814	20.587	21.128	20.90
3/4"	14	1.814	24.117	24.658	24.40
7/8"	14	1.814	27.877	28.418	28.20
1"	11	2.309	30.291	30.931	30.70
1 1/8"	11	2.309	34.939	35.579	35.30
1 1/4"	11	2.309	38.952	39.592	39.30
1 3/8"	11	2.309	41.365	42.005	41.80
1 1/2"	11	2.309	44.845	45.485	45.20
1 3/4"	11	2.309	50.788	51.428	51.20
2"	11	2.309	56.656	57.296	57.00
2 1/4"	11	2.309	62.752	63.392	63.10
2 1/2"	11	2.309	72.226	72.866	72.60
3"	11	2.309	84.926	85.566	85.30

PG DIN 40430

Ø	P	P	Core Ø nut - Ø Núcleo		
d ₁	TPI	mm	Ø mini	Ø maxi	Ø guide line
7	20	1.270	11.28	11.43	11.35
9	18	1.411	13.86	14.01	13.90
11	18	1.411	17.26	17.41	17.30
13.5	18	1.411	19.06	19.21	19.10
16	18	1.411	21.16	21.31	21.20
21	16	1.588	26.78	27.03	26.80
29	16	1.588	35.48	35.73	35.50
36	16	1.588	45.48	45.73	45.50
42	16	1.588	52.48	52.73	52.50
48	16	1.588	57.78	58.03	57.80

TR ISO 2901-2904, DIN 103, 7H

Ø	P	Core Ø nut - Ø Núcleo		
d ₁	mm	Ø mini	Ø maxi	Ø guide line
10	2	8	8.236	8.20
12	3	9	9.315	9.25
14	3	11	11.315	11.25
16	4	12	12.375	12.25
18	4	14	14.375	14.25
20	4	16	16.375	16.25
22	5	17	17.450	17.25
24	5	19	19.450	19.25
26	5	21	21.450	21.25
28	5	23	23.450	23.25
30	6	24	24.500	24.25
32	6	26	26.500	26.25

TURNED DIAMETERS - DIÁMETRO DE TORNEADO

M DIN 13, ISO 261, *6h / 6g

Ø	P	Thread outside Ø - Ø Exterior			
		Ø mini	Ø maxi	Ø guide line	
d ₁	mm				
*1	0.25	0.933	1.000	0.97	
*1.1	0.25	1.033	1.100	1.07	
*1.2	0.25	1.133	1.200	1.17	
*1.4	0.30	1.325	1.400	1.36	
1.6	0.35	1.496	1.581	1.54	
1.7	0.35	1.596	1.681	1.64	
1.8	0.35	1.696	1.781	1.74	
2	0.40	1.886	1.981	1.93	
2.2	0.45	2.080	2.180	2.13	
2.3	0.40	2.186	2.300	2.23	
2.5	0.45	2.380	2.480	2.43	
2.6	0.45	2.480	2.600	2.53	
3	0.50	2.874	2.980	2.92	
3.5	0.60	3.354	3.479	3.41	
4	0.70	3.838	3.978	3.91	
4.5	0.75	4.338	4.478	4.40	
5	0.80	4.826	4.976	4.90	
6	1.00	5.794	5.974	5.88	
7	1.00	6.794	6.974	6.88	
8	1.25	7.760	7.972	7.87	
9	1.25	8.760	8.972	8.87	
10	1.50	9.732	9.968	9.85	
11	1.50	10.732	10.968	10.85	
12	1.75	11.701	11.966	11.83	
14	2.00	13.682	13.962	13.82	
16	2.00	15.682	15.962	15.82	
18	2.50	17.623	17.958	17.79	
20	2.50	19.623	19.958	19.79	
22	2.50	21.623	21.958	21.79	
24	3.00	23.577	23.952	23.76	
27	3.00	26.577	26.952	26.76	
30	3.50	29.522	29.947	29.73	
33	3.50	32.522	32.947	32.73	
36	4.00	35.465	35.940	35.70	
39	4.00	38.465	38.940	38.70	
42	4.50	41.437	41.937	41.69	
45	4.50	44.437	44.937	44.69	
48	5.00	47.399	47.929	47.66	
52	5.00	51.399	51.929	51.66	
56	5.50	55.365	55.925	55.65	

MF DIN 13, ISO 261, 6g

Ø	P	Thread outside Ø - Ø Exterior			
		Ø mini	Ø maxi	Ø guide line	
d ₁	mm				
8	1.00	7.794	7.974	7.88	
9	0.75	8.838	8.978	8.90	
9	1.00	8.794	8.974	8.88	
10	0.75	9.838	9.978	9.90	
10	1.00	9.794	9.974	9.88	
10	1.25	9.760	9.972	9.86	
11	0.75	10.838	10.978	10.90	
11	1.00	10.794	10.974	10.88	
12	1.00	11.794	11.974	11.88	
12	1.25	11.760	11.972	11.86	
12	1.50	11.732	11.968	11.85	
14	1.00	13.794	13.974	13.88	
14	1.25	13.760	13.972	13.86	
14	1.50	13.732	13.968	13.85	
15	1.00	14.794	14.974	14.88	
15	1.50	14.732	14.968	14.85	
16	1.00	15.794	15.974	15.88	
16	1.50	15.732	15.968	15.85	
17	1.00	16.794	16.974	16.88	
17	1.50	16.732	16.968	16.85	
18	1.00	17.794	17.974	17.88	
18	1.50	17.732	17.968	17.85	
18	2.00	17.682	17.962	17.82	
20	1.00	19.794	19.974	19.88	
20	1.50	19.732	19.968	19.85	
20	2.00	19.682	19.962	19.82	
22	1.00	21.794	21.974	21.88	
22	1.50	21.732	21.968	21.85	
22	2.00	21.682	21.962	21.82	
24	1.00	23.794	23.974	23.88	
24	1.50	23.732	23.968	23.85	
24	2.00	23.682	23.962	23.82	
25	1.00	24.794	24.974	24.88	
25	1.50	24.732	24.968	24.85	
25	2.00	24.682	24.962	24.82	
27	1.00	26.794	26.974	26.88	
27	1.50	26.732	26.968	26.85	
27	2.00	26.682	26.962	26.82	
28	1.00	27.794	27.974	27.88	
28	1.50	27.732	27.968	27.85	
28	2.00	27.682	27.962	27.82	
30	1.00	29.794	29.974	29.88	
30	1.50	29.732	29.968	29.85	
30	2.00	29.682	29.962	29.82	
30	3.00	29.577	29.952	29.76	
32	1.50	31.732	31.968	31.85	
32	2.00	31.682	31.962	31.82	
33	1.50	32.732	32.968	32.85	
33	2.00	32.682	32.962	32.82	
33	3.00	32.577	32.952	32.76	
35	1.50	34.732	34.968	34.85	
36	1.50	35.732	35.968	35.85	
36	2.00	35.682	35.962	35.82	
36	3.00	35.577	35.952	35.76	
39	1.50	38.732	38.968	38.85	
39	2.00	38.682	38.962	38.82	
39	3.00	38.577	38.952	38.76	

MF DIN 13, ISO 261, 6g

Ø	P	Thread outside Ø - Ø Exterior			
		Ø mini	Ø maxi	Ø guide line	
d ₁	mm				
2.5	0.35	2.396	2.481	2.44	
3	0.35	2.896	2.981	2.94	
3.5	0.35	3.396	3.481	3.44	
4	0.50	3.874	3.980	3.93	
4.5	0.50	4.374	4.480	4.43	
5	0.50	4.874	4.980	4.93	
5.5	0.50	5.374	5.480	5.43	
6	0.75	5.838	5.978	5.90	
7	0.75	6.838	6.978	6.90	
8	0.75	7.838	7.978	7.90	



TURNED DIAMETERS - DIÁMETRO DE TORNEADO

MF DIN 13, ISO 261, 6g

Ø	P	Thread outside Ø - Ø Exterior			
		Ø mini	Ø maxi	Ø guide line	
d ₁	mm				
40	1.50	39.732	39.968	39.85	
40	2.00	39.682	39.962	39.82	
40	3.00	39.577	39.952	39.76	
42	1.50	41.732	41.968	41.85	
42	2.00	41.682	41.962	41.82	
42	3.00	41.577	41.952	41.76	
45	1.50	44.732	44.968	44.85	
45	2.00	44.682	44.962	44.82	
45	3.00	44.577	44.952	44.76	
48	1.50	47.732	47.968	47.85	
48	2.00	47.682	47.962	47.82	
48	3.00	47.577	47.952	47.76	
50	1.50	49.732	49.968	49.85	
50	2.00	49.682	49.962	49.82	
50	3.00	49.577	49.952	49.76	
52	1.50	51.732	51.968	51.85	
52	2.00	51.682	51.962	51.82	
52	3.00	51.577	51.952	51.76	
52	4.00	51.465	51.940	51.70	

UNC ANSI B1.1, 2A

Ø"	P	P	Thread outside Ø - Ø Exterior			
			Ø mini	Ø maxi	Ø guide line	
d ₁	TPI	mm				
1	64	0.397	1.743	1.838	1.79	
2	56	0.454	2.066	2.169	2.12	
3	48	0.529	2.383	2.496	2.44	
4	40	0.635	2.695	2.824	2.76	
5	40	0.635	3.026	3.154	3.09	
6	32	0.794	3.333	3.484	3.41	
8	32	0.794	3.991	4.142	4.07	
10	24	1.058	4.618	4.800	4.71	
12	24	1.058	5.279	5.461	5.37	
1/4"	20	1.270	6.117	6.322	6.22	
5/16"	18	1.411	7.687	7.907	7.80	
3/8"	16	1.588	9.254	9.491	9.37	
7/16"	14	1.814	10.816	11.076	10.95	
1/2"	13	1.954	12.386	12.661	12.52	
9/16"	12	2.117	13.958	14.246	14.10	
5/8"	11	2.309	15.528	15.834	15.68	
3/4"	10	2.540	18.677	19.004	18.84	
7/8"	9	2.822	21.824	22.176	22.00	
1"	8	3.175	24.969	25.349	25.16	
1 1/8"	7	3.629	28.103	28.519	28.31	
1 1/4"	7	3.629	31.278	31.694	31.49	
1 3/8"	6	4.233	34.402	34.864	34.63	
1 1/2"	6	4.233	37.577	38.039	37.81	
1 3/4"	5	5.080	43.860	44.381	44.12	
2"	4.5	5.644	50.168	50.726	50.45	
2 1/4"	4.5	5.644	56.518	57.076	56.80	
2 1/2"	4	6.350	62.817	63.421	63.12	
2 3/4"	4	6.350	69.165	69.768	69.47	
3"	4	6.350	75.515	76.118	75.82	
3 1/4"	4	6.350	81.862	82.466	82.16	
3 1/2"	4	6.350	88.212	88.816	88.51	

UNC ANSI B1.1, 2A

Ø"	P	P	Thread outside Ø - Ø Exterior			
			Ø mini	Ø maxi	Ø guide line	
d ₁	TPI	mm				
3 3/4"	4	6.350	94.560	95.163	94.86	
4"	4	6.350	100.910	101.513	101.21	

UNF ANSI B1.1, 2A

Ø"	P	P	Thread outside Ø - Ø Exterior			
			Ø mini	Ø maxi	Ø guide line	
d ₁	TPI	mm				
0	80	0.318	1.431	1.511	1.47	
1	72	0.353	1.751	1.838	1.79	
2	64	0.397	2.073	2.169	2.12	
3	56	0.454	2.393	2.496	2.44	
4	48	0.529	2.713	2.827	2.77	
5	44	0.577	3.036	3.157	3.10	
6	40	0.635	3.356	3.484	3.42	
8	36	0.706	4.006	4.145	4.08	
10	32	0.794	4.651	4.803	4.73	
12	28	0.907	5.296	5.461	5.38	
1/4"	28	0.907	6.160	6.324	6.24	
5/16"	24	1.058	7.727	7.909	7.82	
3/8"	24	1.058	9.315	9.497	9.41	
7/16"	20	1.270	10.874	11.079	10.98	
1/2"	20	1.270	12.462	12.666	12.56	
9/16"	18	1.411	14.031	14.251	14.14	
5/8"	18	1.411	15.619	15.839	15.73	
3/4"	16	1.588	18.774	19.011	18.89	
7/8"	14	1.814	21.923	22.184	22.05	
1"	12	2.117	25.065	25.354	25.21	
1 1/8"	12	2.117	28.240	28.529	28.38	
1 1/4"	12	2.117	31.415	31.704	31.56	
1 3/8"	12	2.117	34.588	34.876	34.73	
1 1/2"	12	2.117	37.763	38.051	37.91	

UNEF ANSI B1.1, 2A

Ø"	P	P	Thread outside Ø - Ø Exterior			
			Ø mini	Ø maxi	Ø guide line	
d ₁	TPI	mm				
12	32	0.794	5.312	5.463	5.39	
1/4"	32	0.794	6.173	6.324	6.25	
5/16"	32	0.794	7.760	7.912	7.84	
3/8"	32	0.794	9.348	9.499	9.42	
7/16"	28	0.907	10.920	11.084	11.00	
1/2"	28	0.907	12.507	12.672	12.59	
9/16"	24	1.058	14.075	14.257	14.17	
5/8"	24	1.058	15.662	15.844	15.75	
11/16"	24	1.058	17.250	17.432	17.34	
3/4"	20	1.270	18.812	19.016	18.91	
13/16"	20	1.270	20.339	20.604	20.50	
7/8"	20	1.270	21.987	22.191	22.09	
15/16"	20	1.270	23.572	23.776	23.67	
1"	20	1.270	25.159	25.364	25.26	
1 1/8"	18	1.411	28.319	28.539	28.43	
1 1/4"	18	1.411	31.491	31.711	31.60	
1 1/2"	18	1.411	37.841	38.061	37.95	

TURNED DIAMETERS - DIÁMETRO DE TORNEADO

UN ANSI B1.1, 2A

Ø"	P	P	Thread outside Ø - Ø Exterior			
d ₁	TPI	mm	Ø mini	Ø maxi	Ø guide line	
5/16"	20	1.270	7.702	7.907	7.80	
3/8"	20	1.270	9.289	9.494	9.39	
9/16"	20	1.270	14.049	14.254	14.15	
5/8"	20	1.270	15.637	15.841	15.74	
1 1/8"	8	3.175	28.141	28.521	28.33	
1 1/4"	8	3.175	31.316	31.696	31.51	
1 3/8"	8	3.175	34.489	34.869	34.68	
1 1/2"	8	3.175	37.664	38.044	37.85	
1 5/8"	8	3.175	40.839	41.219	41.03	
1 3/4"	8	3.175	44.011	44.391	44.20	
1 7/8"	8	3.175	47.186	47.566	47.38	
2"	8	3.175	50.361	50.741	50.55	
2 1/4"	8	3.175	56.709	57.089	56.90	
2 1/2"	8	3.175	63.059	63.439	63.25	
2 3/4"	8	3.175	69.406	69.786	69.60	
3"	8	3.175	75.753	76.133	75.94	

W (BSW) BS 84

Ø"	P	P	Thread outside Ø - Ø Exterior			
d ₁	TPI	mm	Ø mini	Ø maxi	Ø guide line	
1/4"	20	1.270	6.165	6.319	6.24	
5/16"	18	1.411	7.737	7.904	7.82	
3/8"	16	1.588	9.312	9.489	9.40	
7/16"	14	1.814	10.884	11.074	10.98	
1/2"	12	2.117	12.456	12.662	12.56	
5/8"	11	2.309	15.613	15.832	15.72	
3/4"	10	2.540	18.771	19.004	18.89	
7/8"	9	2.822	21.979	22.225	22.10	
1"	8	3.175	25.138	25.400	25.27	
1 1/8"	7	3.629	28.296	28.575	28.44	
1 1/4"	7	3.629	31.465	31.750	31.61	
1 1/2"	6	4.233	37.793	38.100	37.95	
1 3/4"	5	5.080	44.117	44.450	44.28	
2"	4.5	5.644	50.449	50.800	50.62	
2 1/4"	4	6.350	56.779	57.150	56.96	
2 1/2"	4	6.350	63.119	63.500	63.31	

UNS ANSI B1.1, 2A

Ø"	P	P	Thread outside Ø - Ø Exterior			
d ₁	TPI	mm	Ø mini	Ø maxi	Ø guide line	
10	36	0.706	4.664	4.803	4.73	
10	40	0.635	4.674	4.803	4.74	
10	56	0.454	4.705	4.808	4.76	
1/4"	36	0.706	6.188	6.327	6.26	
1/4"	40	0.635	6.198	6.327	6.26	
1/4"	48	0.529	6.216	6.329	6.27	
1/4"	56	0.454	6.226	6.329	6.28	
5/16"	36	0.706	7.775	7.914	7.84	
3/8"	36	0.706	9.360	9.499	9.43	
7/16"	24	1.058	10.902	11.084	10.99	
1/2"	24	1.058	12.487	12.669	12.58	
1"	14	1.814	25.096	25.356	25.23	

PG DIN 40430

Ø	P	P	Thread outside Ø - Ø Exterior			
d ₁	TPI	mm	Ø mini	Ø maxi	Ø guide line	
7	20	1.270	12.3	12.5	12.40	
9	18	1.411	15.0	15.2	15.10	
11	18	1.411	18.4	18.6	18.50	
13.5	18	1.411	20.2	20.4	20.30	
16	18	1.411	22.3	22.5	22.40	
21	16	1.588	28.0	28.3	28.15	
29	16	1.588	36.7	37.0	36.85	
36	16	1.588	46.7	47.0	46.85	
42	16	1.588	53.7	54.0	53.85	
48	16	1.588	59.0	59.3	59.15	

G (BSP) DIN ISO 228

Ø"	P	P	Thread outside Ø - Ø Exterior			
d ₁	TPI	mm	Ø mini	Ø maxi	Ø guide line	
1/16"	28	0.907	7.509	7.723	7.62	
1/8"	28	0.907	9.514	9.728	9.62	
1/4"	19	1.337	12.907	13.157	13.03	
3/8"	19	1.337	16.412	16.662	16.54	
1/2"	14	1.814	20.671	20.955	20.81	
5/8"	14	1.814	22.627	22.911	22.77	
3/4"	14	1.814	26.157	26.441	26.30	
7/8"	14	1.814	29.917	30.201	30.06	
1"	11	2.309	32.889	33.249	33.07	
1 1/8"	11	2.309	37.537	37.897	37.72	
1 1/4"	11	2.309	41.550	40.910	41.73	
1 3/8"	11	2.309	43.963	44.323	44.14	
1 1/2"	11	2.309	47.443	47.803	47.62	
1 3/4"	11	2.309	53.386	53.746	53.57	
2"	11	2.309	59.254	59.614	59.43	
2 1/4"	11	2.309	65.276	65.710	65.49	
2 1/2"	11	2.309	74.750	75.184	74.97	
2 3/4"	11	2.309	81.100	81.534	81.32	
3"	11	2.309	87.450	87.884	87.67	
3 1/2"	11	2.309	99.896	100.330	100.11	

TR ISO 2901-2904, DIN 103, 7e

Ø	P	Thread outside Ø - Ø Exterior			
d ₁	mm	Ø mini	Ø maxi	Ø guide line	
10	2	9.820	10.000	9.91	
12	3	11.764	12.000	11.88	
14	3	13.764	14.000	13.88	
16	4	15.700	16.000	15.85	
18	4	17.700	18.000	17.85	
20	4	19.700	20.000	19.85	
22	5	21.665	22.000	21.83	
24	5	23.665	24.000	23.83	
26	5	25.665	26.000	25.83	
28	5	27.665	28.000	27.83	
30	6	29.625	30.000	29.81	
32	6	31.625	32.000	31.81	

