

1970-2020

2020
PERSPECTIVE
MASTER CATALOG



AHB

TOOLING & MACHINERY

COMPLETE METALWORKING SOLUTIONS

(800) 991-4225

www.ahbinc.com

ISO Certified

customerservice@ahbinc.com



END MILLS | THREAD MILLS | COUNTERSINKS
CHAMFER MILLS | DRILLS | DRILL MILLS | BURS
MICRO END MILLS | TAPS & DIES | REAMERS

TITANCUTTINGTOOLS.COM | 888.482.6872



TITAN USA
140 B



MADE IN THE U.S.A.

titancuttingtools.com

Our commitment to serve our customers with premium quality, American-Made cutting tools endures as our number one priority. We strive to provide exceptional service with unmatched ship rates for a customer experience that's second to none.

For the last 50 years we've worked continuously to achieve these goals. We are proud to uphold this commitment to our valued customers throughout North America. The "Titan Team" continues to grow, we invite you to join us today.

ENTERPRISES INC.
ALDWIN STREET



ALL TITAN USA TOOLS



100% MADE IN THE USA

- 
- 26,000 sq/ft of advanced distribution space
 - Over 300 Lista® brand cabinets accommodate all existing and future inventory
 - Multiple work-stations to handle all customer requirements, reducing valuable wait times
 - Enhanced logistics for superior order processing and shipping
 - New and improved shipping, receiving and pick up areas to better service our customers
 - Over 13,000 premium quality products available for same day shipping until 6 pm EST with no minimum order requirement
 - Orders can be placed online, by email, via EDI, or just call us. Your order will be acknowledged within 15 minutes
 - Full catalog available as stand-alone mobile app in both Apple and Android app stores

DISTRIBUTION

Every tool in this catalog is manufactured right here in the USA. You can order with confidence knowing that you are buying the absolute highest quality round cutting tools available. Contact us today to experience the TITAN USA difference.

While phone, email, and EDI orders are always accepted, many of our customers prefer to place their orders online through our easy-to-use Titan USA website at: titancuttingtools.com

Order today, we'll ship today!



Our inventory is your inventory

From basic orders to technical challenges, our dedicated customer service professionals and technical advisors are here to help you find the best tools for even the most challenging applications.

Our industry leading distribution center is setup to respond as though it were your own. Buy with confidence knowing that all orders are confirmed via email within 15 minutes. Our strategic layout enables us to quickly access our expansive in-stock inventory for same day processing and shipment.

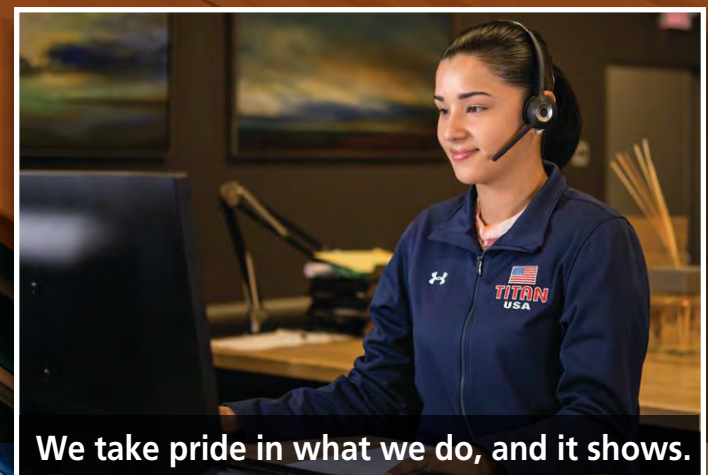

We take pride in what we do, and it shows.

It has been more than a decade since TITAN USA's commitment to uncompromising quality opened our enduring partnership with PLATIT® to bring PVD tool coating services in-house.

In the years since that first load of tools came out of our first high production PL1001 PVD coating machine, we have expanded the facility to over 16,000 square feet and added another five matching PLATIT PL1001 vessels.

Our massive **SIX-vessel** in-house coating center provides TITAN USA and our customers with uninterrupted production of the industry's highest quality PVD coatings. This allows us to maintain a robust level of inventory available to all our customers throughout North America.

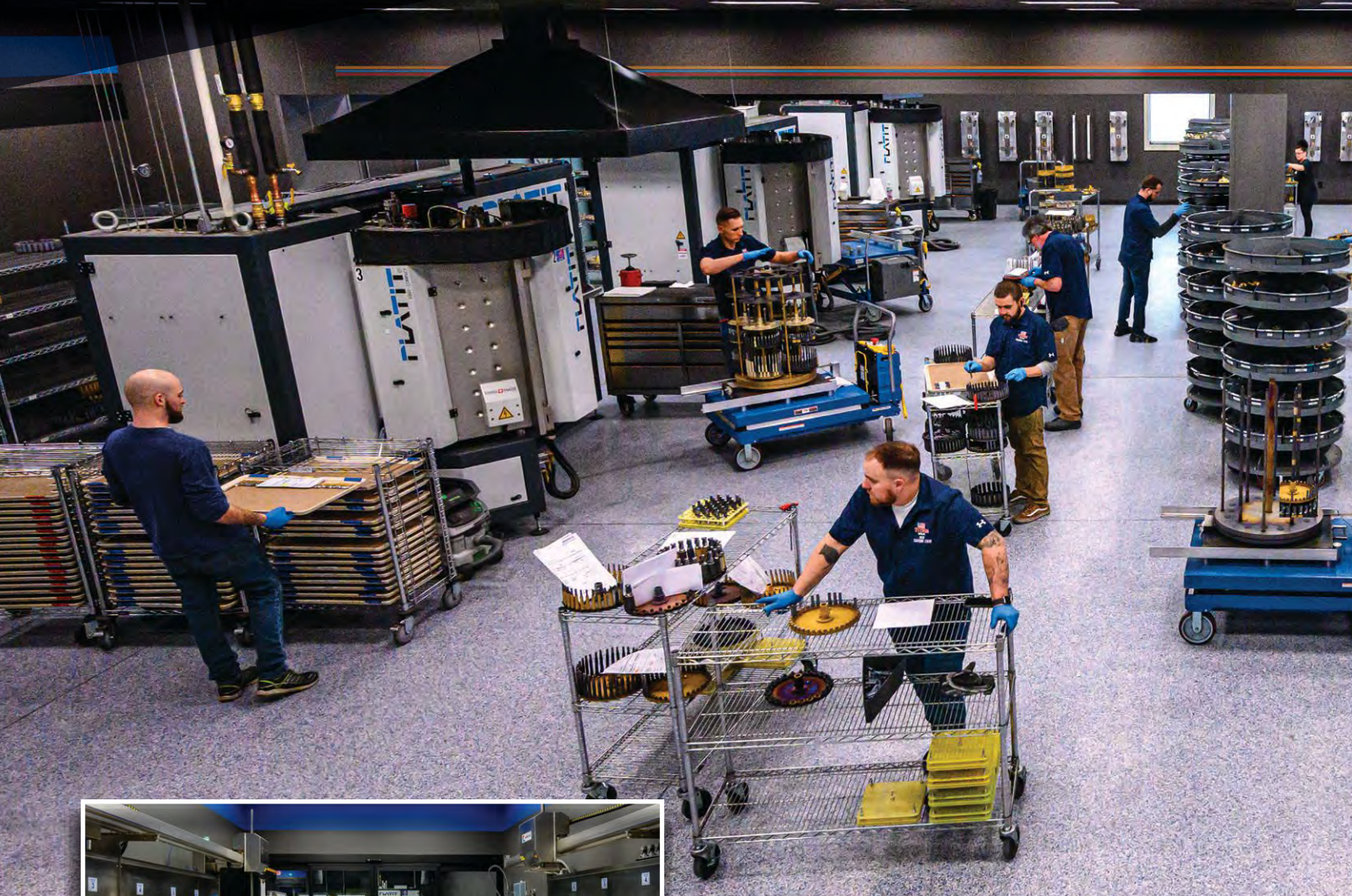

TWO advanced robotic EUROCOLD Pluritank® cleaning systems, removes oils and contaminants from tools prior to coating.

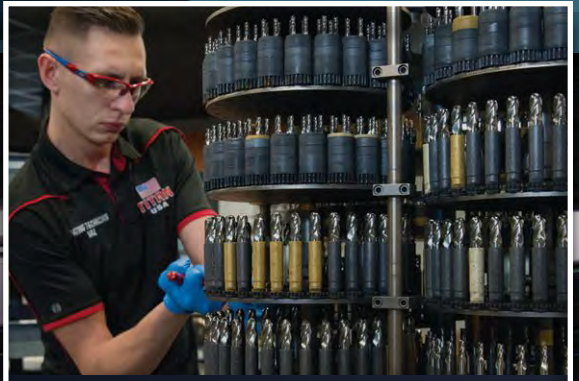

With PLATIT's easy loading carousel tool holders, different tool types of similar diameters can be mixed and coated in one load maximizing cycle times.

COATING CENTER

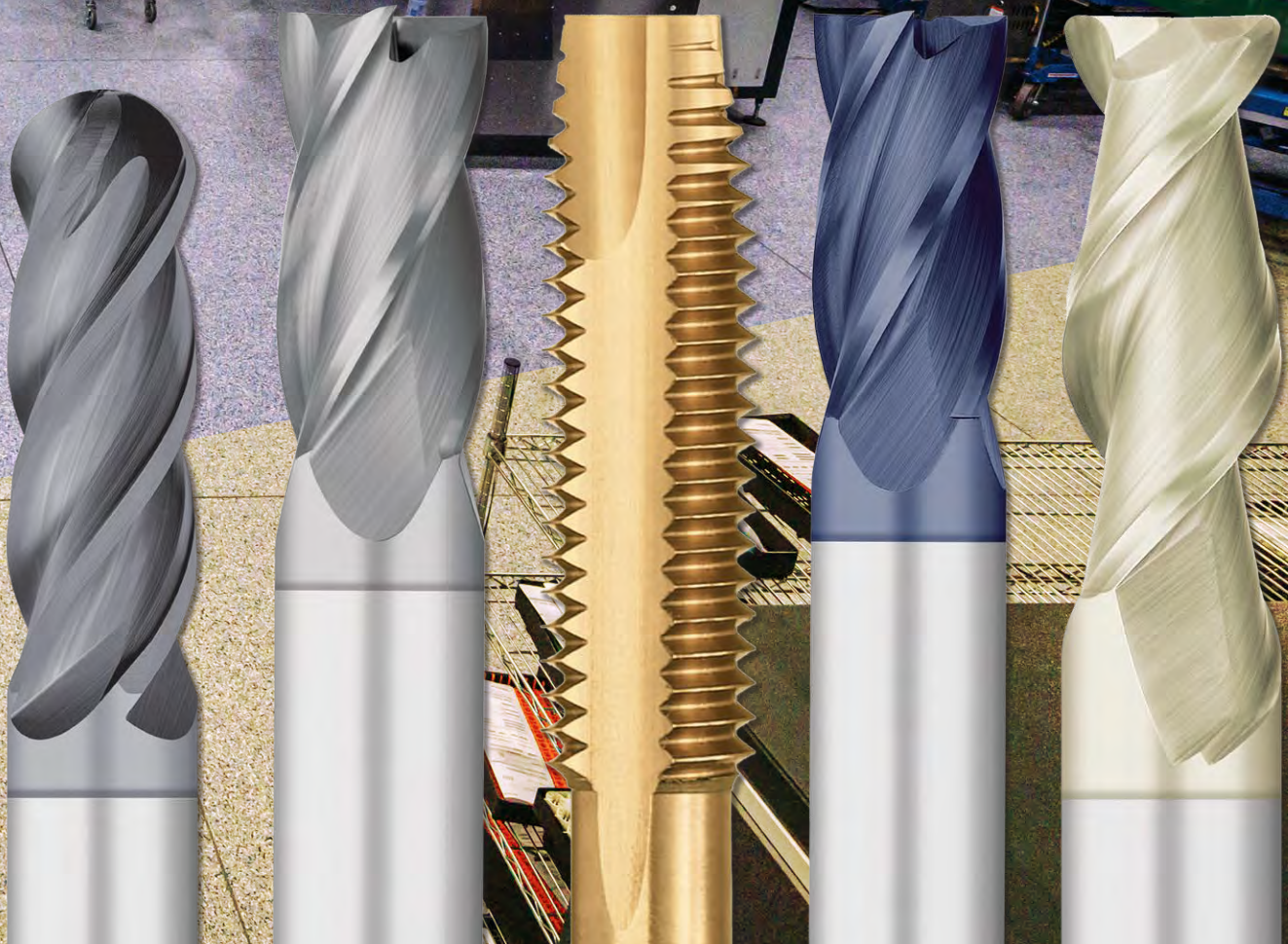



ZOLLER GENIUS 3M

Quality and precision take priority at Titan USA. We have the latest inspection technology to ensure our tools meet or exceed industry standards. Our Zoller Genius 3m provides the most accurate testing from individual dimensions to complete fully automatic inspection of all tool geometries.



Tool performance comes down to the finest of details. Our Alicona EdgeMasterX allows for accurate 3D measurements of the cutting edge as well as surface finish and coating smoothness. Our customers will get only the highest quality tools and coatings. With the EdgeMasterX we can be certain of this.



INSPECTION CENTER

ZOLLER POM BASIC

Quick inspection is necessary in this fast paced industry. Our Zoller PomBasic allows for quick, simple and extremely precise measurement results. Getting product from production to inventory is key to keep our inventory levels high. The PomBasic allows just that while ensuring the tools are inspected correctly.

PVD Coatings

Multi Layer ~ Physical Vapor Deposition

Increases cutting tool performance in terms of wear resistance, abrasion prevention, corrosion and oxidation at high temperatures.



AlCrO-MAX

AlCrO-MAX is a high performance Coating based on AlCrN with a titanium addition that has been engineered to give an optimum balance between the toughness of the core layer and abrasion resistance of the top nano-layer. Titanium's addition reduces the adhesive wear while increasing the micro-hardness up to 3500Hv. This coating has excellent thermal and chemical stability at temperatures up to 950°C and is recommended for a wide range of materials in high performance applications. AlCrO-MAX receives a post-polish treatment to smooth out the coating and maximize chip evacuation at high speeds and feeds. AlCrO-MAX is a true high performance coating that outperforms all generic coatings available.



nACo

nACo is a nanocomposite coating with extremely high nanohardness and heat resistance up to 1200°C – nACo coating is an enhanced AlTiN with the addition of Si3N4 Silicon Nitride. This coating receives a post-polish treatment and excels in drilling and milling of ferrous hardened steels (54-60HRC) as well as drilling and milling standard ferrous steels at +25% feedrate over AlTiN.



AlTiN

AlTiN is a high performance coating for milling, drilling, and tapping. This coating works well in a wide range of materials and exotics including high temp alloys, stainless steels, alloy steels, cast iron, high temp nickel base alloys, titanium alloys, and inconel. AlTiN is extremely heat resistant and can be used with or without coolant. It is exceptional in difficult to machine materials where adhesive wear is particularly high.

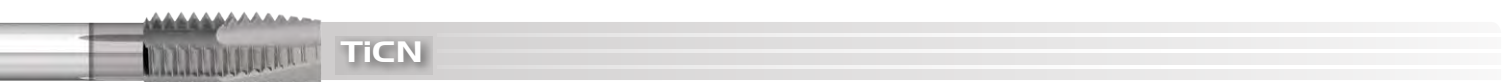

TiCN

TiCN is a general purpose coating used for milling, drilling and tapping in all stainless steels, and a wide variety of other materials. This would be an option when AlTiN cannot be used, as in applications that can't generate the speeds and feeds required for higher cutting temperatures.

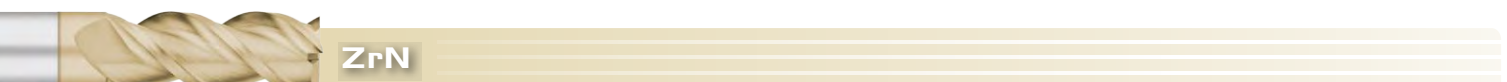

ZrN

ZrN is a high performance coating for milling non-ferrous materials such as aluminum, brass, and bronze applications. It prevents edge build up that is typical in soft and sticky materials. This coating allows for higher speed and feed rates as well as prolonged tool life. ZrN does not have an affinity for aluminum.

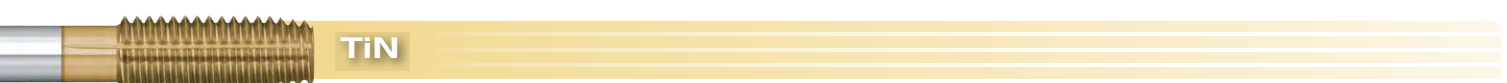

TiN

TiN is a general purpose coating for drilling and tapping in a wide variety of materials, and generally used in applications with lower cutting speeds.

Titan Technology



OTEC EDGE PREPARATION

We have acquired FOUR Otec drag finish machines for doing edge preparation. This process accurately removes micro burs and rounds over the cut edge to a specific micron for a more stable cutting edge.

OTEC POST POLISHING

This process microscopically smooths the finish of our advanced coatings allowing for cooler temps at higher speeds with better chip evacuation. The result is a longer lasting better cutting tool.

R&D CENTER

Our in house VF2 SS HAAS machining center allows us to always be looking into the future. We can test and prove new cutting tool geometries along with new PVD coatings in all materials. Additionally, we can use this technology to train our staff on Milling, Drilling, Tapping, Reaming along with general machining techniques. We also are using this important resource to manufacture parts for our coating center and post polish departments.



CUSTOM TOOLING

Looking for something less common? Try our specials department. From minor alterations to completely unique tooling solutions – we'd love to hear about your project and help you to achieve it.

- Modify Standard Tooling
- Adding a Radius
- Grinding Diameters
- Chamfers
- Neck Downs
- Flats

We also quote on a variety of full special round tooling and coating. Contact us today by emailing: quotes@titancuttingtools.com

HIGH PERFORMANCE VI-PRO® VARIABLE INDEX CARBIDE END MILLS

VI-PRO® - INTRODUCTION	16 - 17
4 Flute - Stub & Regular Length - Square End - AlCrO-MAX	18
4 Flute - Long & Extra Long Length - Square End - AlCrO-MAX	19
4 Flute - Stub Length ☞ Corner Radius - AlCrO-MAX	20
4 Flute - Regular Length ☞ Corner Radius - AlCrO-MAX	21
4 Flute - Long Length ☞ Corner Radius - AlCrO-MAX	22
4 Flute - Extra Long Length ☞ Corner Radius - AlCrO-MAX	23
4 Flute - Stub & Regular Length - Ball Nose - AlCrO-MAX	24
4 Flute - Long & Extra Long Length - Ball Nose - AlCrO-MAX	25
5 Flute - Stub & Regular Length - Square End - AlCrO-MAX	26
5 Flute - Long & Extra Long Length - Square End - AlCrO-MAX	27
5 Flute - Stub Length ☞ Corner Radius - AlCrO-MAX	28
5 Flute - Regular Length ☞ Corner Radius - AlCrO-MAX	29
5 Flute - Long Length ☞ Corner Radius - AlCrO-MAX	30
5 Flute - Extra Long Length ☞ Corner Radius - AlCrO-MAX	31
HSM & HEM INFORMATION	32
6 Flute - Stub Length - Square End & ☞ Corner Radius - AlCrO-MAX	33
6 Flute - Regular Length - Square End & ☞ Corner Radius - AlCrO-MAX	34
6 Flute - Long Length - Square End & ☞ Corner Radius - AlCrO-MAX	35









GENERAL PURPOSE CARBIDE END MILLS - ALUMINUM

2 Flute - 45° - Stub Length - Square End & ☞ Corner Radius - ZrN	36
2 Flute - 45° - Regular Length - Square End & ☞ Corner Radius - ZrN	37
2 Flute - 45° - Long Length - Square End & ☞ Corner Radius - ZrN	38
3 Flute - 45° - Stub Length - Square End & ☞ Corner Radius - ZrN	39
3 Flute - 45° - Regular Length - Square End & ☞ Corner Radius - ZrN	40
3 Flute - 45° - Long Length - Square End & ☞ Corner Radius - ZrN	41

GENERAL PURPOSE CARBIDE END MILLS - ROUGHING

4 Flute - 30° - Fine Pitch - Stub Length - AlTiN	42
4 Flute - 30° - Fine Pitch - Regular & Long Length - AlTiN	43
4 Flute - 30° - Fine Pitch - Regular Length - Ball Nose - AlTiN	44
4 Flute - 40° - Rougher-Finisher - Regular Length - ☞ Corner Radius - AlTiN	45

GENERAL PURPOSE CARBIDE END MILLS - SINGLE END

2 Flute - 30° - Stub Length - Square End & Ball Nose - Uncoated & AlTiN	46 - 47
2 Flute - 30° - Regular, Long & Extra Long Length - Square End - Uncoated, AlTiN & TiCN	48 - 49
2 Flute - 30° - Regular, Long & Extra Long Length - Ball Nose - Uncoated, AlTiN & TiCN	50 - 51
4 Flute - 30° - Stub Length - Square End & Ball Nose - Uncoated & AlTiN	52 - 53
4 Flute - 30° - Regular, Long & Extra Long Length - Square End - Uncoated, AlTiN & TiCN	54 - 55
4 Flute - 30° - Regular, Long & Extra Long Length - Ball Nose - Uncoated, AlTiN & TiCN	56 - 57
4 Flute - 30° - Stub Length -  Corner Radius - AlTiN	58
4 Flute - 30° - Regular Length -  Corner Radius - AlTiN	59
4 Flute - 30° - Long Length -  Corner Radius - AlTiN	60
4 Flute - 30° - Extra Long Length -  Corner Radius - AlTiN	61
4 Flute - 30° - Regular Length - Metric - Square End - Uncoated & AlTiN	62
4 Flute - 30° - Regular Length - Metric - Ball Nose - Uncoated & AlTiN	63
3 Flute - 45° - Regular Length - Square End &  Corner Radius - AlTiN	64
3 Flute - 60° - Regular Length - Square End &  Corner Radius - AlTiN	65
5 Flute - 45° - Stub Length - Square End &  Corner Radius - AlTiN	66
5 Flute - 45° - Regular Length - Square End &  Corner Radius - AlTiN	67

GENERAL PURPOSE CARBIDE END MILLS - DOUBLE END

4 Flute - 30° - Stub Length - Square End & Ball Nose - AlTiN	68
4 Flute - 30° - Regular Length - Square End & Ball Nose - AlTiN	69

GENERAL PURPOSE M42 COBALT END MILLS

4, 5, 6, & 8 Flute Roughing - 30° - Coarse & Fine Pitch - AlTiN	70
2, 4, & 6 Flute - 30° - Single End - Regular Length - AlTiN	71 - 72
2 & 4 Flute - 30° - Double End - AlTiN	73

GENERAL PURPOSE CARBIDE DRILL MILLS

2 Flute - 60° & 90° Points - Uncoated & AlTiN	74
4 Flute - 60° & 90° Points - Uncoated & AlTiN	75

GENERAL PURPOSE CARBIDE CHAMFER MILLS



2 Flute - 60°, 82°, 90°, 100°, 120° - Single & Double End - Uncoated & AlTiN	76
4 Flute - 60°, 82°, 90°, 100°, 120° - Single & Double End - Uncoated & AlTiN	77

TECHNICAL INFORMATION: MILLING 78-93

MICRO MILLING

PAGES 94 - 126

GENERAL PURPOSE CARBIDE MICRO END MILLS

MICRO END MILL INTRODUCTION	94 - 95
2 Flute - Stub Flute - Square End - Uncoated & AlTiN	96
2 Flute - Stub Flute - Ball Nose - Uncoated & AlTiN	97
2 Flute - Regular Flute - Square End - Uncoated & AlTiN	98 - 99
2 Flute - Regular Flute - Ball Nose - Uncoated & AlTiN	100 - 101
4 Flute - Stub Flute - Square End - Uncoated & AlTiN	102
4 Flute - Stub Flute - Ball Nose - Uncoated & AlTiN	103
4 Flute - Stub Flute  Corner Radius - Uncoated & AlTiN	104
4 Flute - Regular Flute  Corner Radius - Uncoated & AlTiN	105
4 Flute - Regular Flute - Square End - Uncoated & AlTiN	106 - 107
4 Flute - Regular Flute - Ball Nose - Uncoated & AlTiN	108 - 109
3 Flute - Long Reach - Stub Flute - Square End - Uncoated & AlTiN	110 - 111
3 Flute - Long Reach - Stub Flute - Ball Nose - Uncoated & AlTiN	112 - 113
3 Flute - Long Reach - Regular Flute - Square End - Uncoated & AlTiN	114 - 115
3 Flute - Long Reach - Regular Flute - Ball Nose - Uncoated & AlTiN	116 - 117
3 Flute - Long Reach - Long Flute - Square End - Uncoated & AlTiN	118 - 119
3 Flute - Long Reach - Long Flute - Ball Nose - Uncoated & AlTiN	120 - 121
3 Flute - Long Length - Long Flute - Square End - Uncoated & AlTiN	122 - 123
3 Flute - Long Length - Long Flute - Ball Nose - Uncoated & AlTiN	124 - 125
TECHNICAL INFORMATION: MICRO MILLING	126

THREAD MILLING

PAGES 127 - 133

GENERAL PURPOSE CARBIDE THREAD MILLS

THREAD MILLING INTRODUCTION	127
UN Threads - AlTiN	128
UN Threads - Coolant End Fed - AlTiN	129
NPT Pipe Threads - AlTiN	130
NPTF Pipe Threads - AlTiN	131
Metric Threads - AlTiN	132
TECHNICAL INFORMATION: THREAD MILLING	133

HIGH PERFORMANCE PREDATOR TAPS

Spiral Point - Uncoated, Steam Oxide, AlTiN & TiCN	134
Spiral Point - Metric - Uncoated, Steam Oxide, AlTiN & TiCN	135
Spiral Flute - Semi Bottoming - Uncoated, Steam Oxide, AlTiN & TiCN	136
Spiral Flute - Semi Bottoming - Metric - Uncoated, Steam Oxide, AlTiN & TiCN	137

GENERAL PURPOSE GROUND THREAD TAPS

Hand Tap Sets - Standard & Metric - HSS	138 - 139
Hand - Taper, Plug, Bottom - HSS	140 - 143
Hand - Taper, Plug & Bottom - HSS - Steam Oxide	144
Hand - Plug & Bottom - HSS - Nitride & Steam Oxide	145
Hand - Metric - Taper, Plug, Bottom - HSS - Uncoated	146
Hand - Metric - Taper, Plug, Bottom - HSS - TiN	147
Hand - Taper, Plug, Bottom - HSS - TiN	148
Spiral Point Plug - HSS	149
Spiral Point Plug - HSS - Steam Oxide, Nitride & Steam Oxide	150
Spiral Point Plug - HSS - TiN & AlTiN	151
Spiral Point Plug - Metric - HSS - Uncoated & TiN	152
Spiral Point Bottoming - HSS - Uncoated & TiN	152
STI - Screw Thread Insert • +.005 Oversize - HSS	153
Combination Drill & Tap - ANSI & Metric - HSS	154
Pulley - Plug • Small Shank Extension - Spiral Point Plug - HSS	155
Spiral Flute - 52° Helix - ANSI & Metric - Semi Bottoming - HSS	156
Straight Pipe NPS • NPT Extension Taper Pipe - HSS - Uncoated & TiN	157
Taper Pipe NPT • Taper Pipe NPT Interrupted - HSS - Uncoated, Steam Oxide & TiN	158
Taper Pipe NPTF Dryseal • Taper Pipe NPTF Dryseal Interrupted - HSS - Uncoated & TiN	159
Thread Forming - ANSI & Metric - Single, Bottom, & Plug Thread Chamfers - HSS	160
Thread Forming - ANSI & Metric - Single, Bottom, & Plug Thread Chamfers - HSS - TiN	161

GENERAL PURPOSE DIES

Carbon Steel - Adjustable Round Split, Hexagon Rethreading, NPT Hexagon Rethreading	162 - 163
HSS - Adjustable Round Split	164
Die Stocks • T-Handle Tap Wrenches	165

TECHNICAL INFORMATION: TAPPING	166 - 171
---------------------------------------	------------------

DRILLING

PAGES 172 - 211

GENERAL PURPOSE CARBIDE SPOT DRILLS

Spot - 90°, 120° & 142° Points - Uncoated & AlTiN	172 - 173
---	-----------

GENERAL PURPOSE CARBIDE DRILLS

Stub Length - 135° Split Point - Uncoated & AlTiN	174 - 175
---	-----------

Jobber Length - 118° Split Point - Uncoated & AlTiN	176 - 177
---	-----------

Straight Flute - 140° Split Point - Uncoated & AlTiN	178 - 179
--	-----------

GENERAL PURPOSE HSS & M42 COBALT DRILLS

Stub Length - Heavy Duty - 135° Split Point - M42 Cobalt - Uncoated & AlTiN	180 - 181
---	-----------

Jobber Length - Heavy Duty - 135° Split Point - M42 Cobalt - Uncoated & AlTiN	182 - 183
---	-----------

Stub Length - Heavy Duty - 135° Split Point - HSS Oxidized	184 - 185
--	-----------

Jobber Length - Heavy Duty - 135° Split Point - HSS Oxidized & Black/Gold	186 - 187
---	-----------

Jobber Length - 118° Point - HSS - Oxidized	188 - 189
---	-----------

Jobber Length - 118° Point - HSS - Bright Finish & TiN	190 - 191
--	-----------

A/C Extension - 6" Overall Length - HSS Oxidized & M42 Cobalt	192
---	-----

A/C Extension - 12" Overall Length - HSS Oxidized & M42 Cobalt	193
--	-----

Silver & Deming - HSS, HSS w/Flats, HSS Black/Gold w/Flats & M42 Cobalt	194 - 195
---	-----------

Taper Length - 118° Point - HSS Oxidized	196 - 197
--	-----------

Taper Shank - 118° Point - HSS Oxidized	198
---	-----

Extra Length - 12" Overall Length - HSS - Bright	199
--	-----

Screw Extractors	199
------------------	-----

Mechanics Length - Heavy Duty - 135° Split Point - Black/Gold - Flatted Shank - HSS	200
---	-----

Drill Sets - HSS, Black Gold, & M42 Cobalt	201 - 203
--	-----------

GENERAL PURPOSE COUNTERSINKS

Carbide - Single Flute, Three Flute & Six Flute - 60°, 82°, 90° & 100°	204
--	-----

HSS - Single Flute - 60°, 82°, 90° • Four Flute - 60°, 82°	205
--	-----

Combined Drill & Countersinks - Double End - Carbide - Regular Length 60° - Uncoated & AlTiN	206
--	-----

Combined Drill & Countersinks - Double End - M42 Cobalt - Regular Length 60°	206
--	-----

Combined Drill & Countersinks - Double End - HSS - Regular Length 60° - Uncoated & AlTiN	207
--	-----

Combined Drill & Countersinks - Double End - HSS - Long Length 60°	207
--	-----

TECHNICAL INFORMATION: DRILLING

208 - 211

GENERAL PURPOSE CARBIDE BURS

SA Cylindrical - Single Cut, Double Cut, & Aluminum Cut	212
SB Cylindrical End Cut - Single Cut, Double Cut, & Aluminum Cut	213
SC Cylindrical Ball Nose - Single Cut, Double Cut, & Aluminum Cut	214
SD Ball Shape - Single Cut, Double Cut, & Aluminum Cut	215
SE Egg Shape - Single Cut, Double Cut, & Aluminum Cut	216
SF Round Nose Tree - Single Cut, Double Cut, & Aluminum Cut	217
SG Pointed Tree - Single Cut & Double Cut	218
SH Flame Shape - Single Cut & Double Cut	218
SJ Included Angle - Single Cut & Double Cut	219
SK Included Angle - Single Cut & Double Cut	219
SL Included Angle With Radius - Single Cut, Double Cut, & Aluminum Cut	220
SM Pointed Cone - Single Cut & Double Cut	221
SN Inverted Taper - Single Cut & Double Cut	221
Bur Sets	222

TECHNICAL INFORMATION: DEBURRING 223

REAMING

GENERAL PURPOSE CARBIDE REAMERS

Straight Flute - Stocked Intermediate & Standard Sizes	224 - 230
Special Sizes - Quantity Pricing	231

GENERAL PURPOSE HSS & M42 COBALT REAMERS

Chucking - Straight Flute - Stocked Intermediate & Standard Sizes - HSS	232 - 245
Chucking - Straight Flute - M42 Cobalt	246 - 247
Chucking - Straight Flute - Special Sizes - HSS & M42 Cobalt	248 - 249
Chucking - Right Hand Spiral - Right Hand Cut - HSS & M42 Cobalt	250 - 253
Dowel Pin - HSS & M42 Cobalt	254
Expansion - Straight & Taper Shank - Straight Flute - HSS	255
Hand - Straight Flute - HSS	256
Taper Pipe • Taper Pin - HSS	257
Capscrew Counterbores - HSS	258
Construction • Safety • Bridge - HSS	259
Reamer Sets - HSS & M42 Cobalt	260 - 261

TECHNICAL INFORMATION: REAMING 262 - 263



HIGH PERFORMANCE SOLID CARBIDE END MILLS

VI-PRO®

VARIABLE INDEX GEOMETRY

YOUR #1 SOURCE FOR AMERICAN-MADE PREMIUM QUALITY CUTTING TOOLS



TITAN's VI-PRO® is a High Performance, carbide end mill, that incorporates the ultimate in variable index geometry. Our flute configuration produces a harmonics shift, resulting in minimal chatter and an exceptional finish.

- Post polished AlCrO-MAX coating covers a wide range of materials
- Made in the USA from premium micrograin carbide
- Used in all slotting, roughing, profiling and finishing applications
- High Performance, chatter free machining provides versatility in use for all ferrous materials
- Designed for use in Alloy Steels, Inconel, Cast Iron, Titanium, Stainless Steel, High Temp and all other exotic materials up to 50HRc
- Enables higher SFM and heavier chip loads
- Eccentric Relief on the cutting edge provides enhanced edge strength
- Available in 4, 5 & 6 Flute - Stub, Regular, Long & Extra Long Lengths
- Available in Square End, Ball Nose and various  Corner Radius sizes
- Recommended for slotting up to 1 x Diameter

Outperform Under Budget with Corner Radius VI-PRO®

The sharp corner of an end mill is the weakest point on the tool. The corner radius design eliminates this vulnerability which reduces chipping and provides longer tool life. VI-PRO™ tools are available with corner radiuses starting at .010 all the way up to .250. Longer tool life means increased productivity which has real impact on your bottom line.



HIGH PERFORMANCE

VI-PRO - 4 FLUTE
38° HELIXVI-PRO - 5 FLUTE
38° HELIXVI-PRO - 6 FLUTE
38° HELIX

TECHNICAL

4 on-site Otec Post Polish and Edge Prep machines



Benefits of Post Polishing

AlCrO-MAX by nature of the coating process leaves tiny “droplets” of the coating on the surface of the tool. Proven results have shown that the removal of these droplets provide a smoother tool surface which results in a better cut. Perhaps the most important benefit, is that the tool is able to run at faster feed rates due to the smoothness of the flute area. This results in better chip evacuation and cooler temperatures resulting in longer tool life.

TITAN's High-Performance VI-PRO® carbide end mills utilize an Eccentric Relief on the cutting edge to provide enhanced edge strength and a smoother cutting action.

GENERAL PURPOSE STANDARD RELIEF

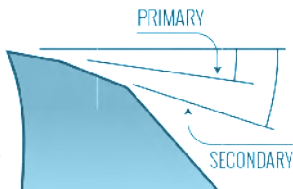

Most common relief for non-ferrous alloys. Includes a primary and secondary relief angle.

VI-PRO® ECCENTRIC RELIEF

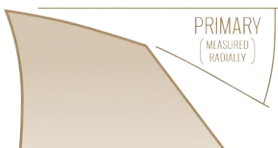

A powerful edge design for ferrous and tough material cutting. This design includes a primary relief measured radially along its edge.

VI-PRO® Weldon Flat Specifications

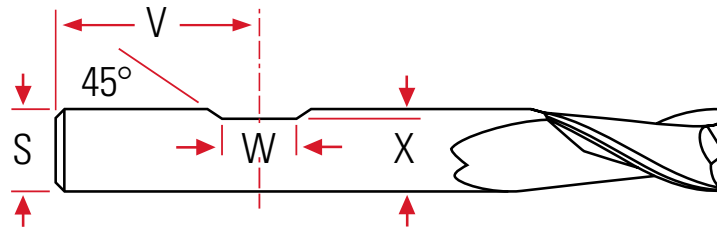

STUB LENGTH				
S SHANK DIAMETER	V	W MIN	W MAX	X
1/2"	.750"	.330"	.332"	.440"
5/8"	.750"	.400"	.402"	.560"
3/4"	.750"	.455"	.457"	.675"

REGULAR LENGTH				
S SHANK DIAMETER	V	W MIN	W MAX	X
1/2" (1-1/4" LOC)	.750"	.330"	.332"	.440"
1/2"	.875"	.330"	.332"	.440"
5/8"	.875"	.400"	.402"	.560"
3/4"	.875"	.455"	.457"	.675"
1"	.875"	.515"	.517"	.925"

LONG LENGTH				
S SHANK DIAMETER	V	W MIN	W MAX	X
1/2" (2" LOC)	.875"	.330"	.332"	.440"
1/2"	1.250"	.330"	.332"	.440"
5/8"	1.250"	.400"	.402"	.560"
3/4"	1.250"	.455"	.457"	.675"
1"	1.250"	.515"	.517"	.925"

EXTRA LONG LENGTH				
S SHANK DIAMETER	V	W MIN	W MAX	X
1/2"	1.5"	.330"	.332"	.440"
5/8"	1.5"	.400"	.402"	.560"
3/4"	1.5"	.455"	.457"	.675"
1"	1.5"	.515"	.517"	.925"
-	-	-	-	-

HIGH PERFORMANCE

VI-PRO - 4 FLUTE
38° HELIX

VI-PRO - 5 FLUTE
38° HELIX

VI-PRO - 6 FLUTE
38° HELIX

TECHNICAL



HIGH PERFORMANCE SOLID CARBIDE END MILLS

VI-PRO[®]

VARIABLE INDEX GEOMETRY

YOUR #1 SOURCE FOR AMERICAN-MADE PREMIUM QUALITY CUTTING TOOLS

4 FLUTE - STUB LENGTH - SQUARE END - 38° HELIX



SERIES V42S
ALCRO-MAX COATED

VI-PRO DIAMETER	★★★ TOOL ATTRIBUTES ★★★				ROUND SHANK		WELDON FLAT	
	SHANK	LOC	OAL	# OF FLUTES	ITEM #	LIST PRICE	ITEM #	LIST PRICE
1/8	1/8	1/4	1-1/2	4	TC21133	30.34	-	-
3/16	3/16	3/8	2	4	TC21136	39.04	-	-
1/4	1/4	3/8	2	4	TC21139	44.18	-	-
5/16	5/16	7/16	2	4	TC21142	64.26	-	-
3/8	3/8	1/2	2	4	TC21145	71.24	-	-
7/16	7/16	5/8	2-1/2	4	TC21147	92.80	-	-
1/2	1/2	5/8	2-1/2	4	TC21148	106.52	TC21173	112.58
5/8	5/8	3/4	3	4	TC21151	209.71	TC21176	215.77
3/4	3/4	1	3	4	TC21154	276.58	TC21179	282.64

4 FLUTE - REGULAR LENGTH - SQUARE END - 38° HELIX



SERIES V42R
ALCRO-MAX COATED

VI-PRO DIAMETER	★★★ TOOL ATTRIBUTES ★★★				ROUND SHANK		WELDON FLAT	
	SHANK	LOC	OAL	# OF FLUTES	ITEM #	LIST PRICE	ITEM #	LIST PRICE
1/8	1/8	1/2	2	4	TC21821	36.25	-	-
3/16	3/16	9/16	2	4	TC21824	41.44	-	-
1/4	1/4	3/4	2-1/2	4	TC21827	52.60	-	-
5/16	5/16	13/16	2-1/2	4	TC21830	69.66	-	-
3/8	3/8	1	2-1/2	4	TC21833	81.60	-	-
7/16	7/16	1	2-3/4	4	TC21835	101.20	-	-
1/2	1/2	1	3	4	TC21836	122.41	TC21863	128.47
1/2	1/2	1-1/4	3	4	TC21839	122.41	TC21866	128.47
5/8	5/8	1-5/8	3-1/2	4	TC21842	221.59	TC21869	227.65
3/4	3/4	1-5/8	4	4	TC21845	306.17	TC21872	312.23
1	1	2	4	4	TC21848	571.53	TC21875	577.59

The VI-PRO performs very well in a wide range of materials including:

HIGH TEMP ALLOYS • STAINLESS STEELS • ALLOY STEELS • INCONEL
CAST IRON • HIGH TEMP NICKEL BASE ALLOYS • TITANIUM ALLOYS • EXOTICS

For coating information see page 8. For VI-PRO technical information, please see pages 78-79, 91-93.

TOLERANCES	DIAMETER	SHANK
1/8" - 1/2"	+ .000, -.002	-.0001, -.0004 ISO H6
5/8" - 1"	+ .000, -.003	-.0001, -.0004 ISO H6

YOUR #1 SOURCE FOR AMERICAN-MADE PREMIUM QUALITY CUTTING TOOLS

4 FLUTE - LONG LENGTH - SQUARE END - 38° HELIX



SERIES V42L
ALCRO-MAX COATED

VI-PRO DIAMETER	★★★ TOOL ATTRIBUTES ★★★				ROUND SHANK		WELDON FLAT	
	SHANK	LOC	OAL	# OF FLUTES	ITEM #	LIST PRICE	ITEM #	LIST PRICE
1/4	1/4	1-1/8	3	4	TC23201	59.90	-	-
5/16	5/16	1-1/8	3	4	TC23204	82.88	-	-
3/8	3/8	1-1/4	3	4	TC23207	111.31	-	-
7/16	7/16	2	4	4	TC23209	141.19	-	-
1/2	1/2	1-1/2	4	4	TC23210	153.69	TC23331	159.75
1/2	1/2	2	4	4	TC23213	170.42	TC23334	176.48
5/8	5/8	2-1/4	5	4	TC23216	316.96	TC23337	323.02
3/4	3/4	2-1/4	5	4	TC23219	383.53	TC23340	389.59
1	1	2-1/4	5	4	TC23222	632.10	TC23343	638.16

4 FLUTE - EXTRA LONG LENGTH - SQUARE END - 38° HELIX



SERIES V42XL
ALCRO-MAX COATED

VI-PRO DIAMETER	★★★ TOOL ATTRIBUTES ★★★				ROUND SHANK		WELDON FLAT	
	SHANK	LOC	OAL	# OF FLUTES	ITEM #	LIST PRICE	ITEM #	LIST PRICE
1/4	1/4	1-1/2	4	4	TC24408	71.56	-	-
3/8	3/8	2	4	4	TC24411	125.44	-	-
7/16	7/16	3	6	4	TC24413	205.68	-	-
1/2	1/2	3	6	4	TC24414	240.33	TC24543	246.39
5/8	5/8	3	6	4	TC24417	341.81	TC24546	347.88
3/4	3/4	3	6	4	TC24420	451.19	TC24549	457.25
3/4	3/4	4	7	4	TC24423	740.92	TC24552	746.98
1	1	3	6	4	TC24426	735.59	TC24555	741.65
1	1	4-1/4	7	4	TC24429	1085.87	TC24558	1092.38

The VI-PRO performs very well in a wide range of materials including:
 HIGH TEMP ALLOYS • STAINLESS STEELS • ALLOY STEELS • INCONEL
 CAST IRON • HIGH TEMP NICKEL BASE ALLOYS • TITANIUM ALLOYS • EXOTICS

For coating information see page 8. For VI-PRO technical information, please see pages 78-79, 91-93.

TOLERANCES	DIAMETER	SHANK
1/4" - 1/2"	+ .000, -.002	-.0001, -.0004 ISO H6
5/8" - 1"	+ .000, -.003	-.0001, -.0004 ISO H6

HIGH PERFORMANCE

VI-PRO - 4 FLUTE
38° HELIX

VI-PRO - 5 FLUTE
38° HELIX

VI-PRO - 6 FLUTE
38° HELIX

TECHNICAL



HIGH PERFORMANCE SOLID CARBIDE END MILLS

VI-PRO®

VARIABLE INDEX GEOMETRY

YOUR #1 SOURCE FOR AMERICAN-MADE PREMIUM QUALITY CUTTING TOOLS

4 FLUTE - STUB LENGTH  CORNER RADIUS - 38° HELIX



SERIES V42SR ALCRO-MAX COATED

VI-PRO DIAMETER	★★★ TOOL ATTRIBUTES ★★★					ROUND SHANK		WELDON FLAT	
	SHANK	LOC	OAL	# OF FLUTES	RAD	ITEM#	LIST PRICE	ITEM#	LIST PRICE
1/8	1/8	1/4	1-1/2	4	0.010	TC21503	34.97	-	-
3/16	3/16	3/8	2	4	0.010	TC21506	43.67	-	-
1/4	1/4	3/8	2	4	0.015	TC21509	51.48	-	-
5/16	5/16	7/16	2	4	0.015	TC21512	69.30	-	-
3/8	3/8	1/2	2	4	0.015	TC21515	76.27	-	-
7/16	7/16	5/8	2-1/2	4	0.030	TC21517	97.73	-	-
1/2	1/2	5/8	2-1/2	4	0.030	TC21518	116.59	TC21541	122.65
5/8	5/8	3/4	3	4	0.030	TC21521	219.77	TC21544	225.84
3/4	3/4	1	3	4	0.030	TC21524	286.64	TC21547	292.71



All TITAN USA tools are 100% Made in the USA

The VI-PRO performs very well in a wide range of materials including:

HIGH TEMP ALLOYS • STAINLESS STEELS • ALLOY STEELS • INCONEL
CAST IRON • HIGH TEMP NICKEL BASE ALLOYS • TITANIUM ALLOYS • EXOTICS

For coating information see page 8. For VI-PRO technical information, please see pages 78-79, 91-93.

TOLERANCES	DIAMETER	SHANK	RADIUS
1/8" - 1/2"	+0.00, -.002	-.0001, -.0004 ISO H6	+0.01, -.001
5/8" - 3/4"	+0.00, -.003	-.0001, -.0004 ISO H6	+0.01, -.001

YOUR #1 SOURCE FOR AMERICAN-MADE PREMIUM QUALITY CUTTING TOOLS

4 FLUTE - REGULAR LENGTH CORNER RADIUS - 38° HELIX



SERIES V42RR
ALCRO-MAX COATED

VI-PRO DIAMETER	★★★ TOOL ATTRIBUTES ★★★					ROUND SHANK		WELDON FLAT	
	SHANK	LOC	OAL	# OF FLUTES	RAD	ITEM#	LIST PRICE	ITEM#	LIST PRICE
1/8	1/8	1/2	2	4	0.010	TC22617	40.88	-	-
1/8	1/8	1/2	2	4	0.020	TC22620	40.88	-	-
1/8	1/8	1/2	2	4	0.030	TC22623	40.88	-	-
3/16	3/16	9/16	2	4	0.010	TC22626	46.07	-	-
3/16	3/16	9/16	2	4	0.020	TC22629	46.07	-	-
3/16	3/16	9/16	2	4	0.030	TC22632	46.07	-	-
1/4	1/4	3/4	2-1/2	4	0.015	TC22635	57.23	-	-
1/4	1/4	3/4	2-1/2	4	0.030	TC22638	57.23	-	-
1/4	1/4	3/4	2-1/2	4	0.060	TC22641	57.23	-	-
5/16	5/16	13/16	2-1/2	4	0.015	TC22644	73.72	-	-
5/16	5/16	13/16	2-1/2	4	0.030	TC22647	73.72	-	-
5/16	5/16	13/16	2-1/2	4	0.060	TC22650	73.72	-	-
3/8	3/8	1	2-1/2	4	0.015	TC22653	86.09	-	-
3/8	3/8	1	2-1/2	4	0.030	TC22656	86.09	-	-
3/8	3/8	1	2-1/2	4	0.060	TC22659	86.09	-	-
7/16	7/16	1	2-3/4	4	0.015	TC22660	112.35	-	-
7/16	7/16	1	2-3/4	4	0.030	TC22661	112.35	-	-
7/16	7/16	1	2-3/4	4	0.060	TC22663	112.35	-	-
1/2	1/2	1	3	4	0.015	TC22662	137.54	TC22801	144.41
1/2	1/2	1	3	4	0.030	TC22665	137.54	TC22804	144.41
1/2	1/2	1	3	4	0.060	TC22668	137.54	TC22807	144.41
1/2	1/2	1	3	4	0.090	TC22671	137.54	TC22810	144.41
1/2	1/2	1	3	4	0.120	TC22674	137.54	TC22813	144.41
1/2	1/2	1-1/4	3	4	0.015	TC22677	137.54	TC22816	144.41
1/2	1/2	1-1/4	3	4	0.030	TC22680	137.54	TC22819	144.41
1/2	1/2	1-1/4	3	4	0.060	TC22683	137.54	TC22822	144.41
1/2	1/2	1-1/4	3	4	0.090	TC22686	137.54	TC22825	144.41
1/2	1/2	1-1/4	3	4	0.120	TC22689	137.54	TC22828	144.41
5/8	5/8	1-5/8	3-1/2	4	0.030	TC22692	231.72	TC22831	237.78
5/8	5/8	1-5/8	3-1/2	4	0.060	TC22695	231.72	TC22834	237.78
5/8	5/8	1-5/8	3-1/2	4	0.090	TC22698	231.72	TC22837	237.78
5/8	5/8	1-5/8	3-1/2	4	0.120	TC22701	231.72	TC22840	237.78
3/4	3/4	1-5/8	4	4	0.030	TC22704	321.32	TC22843	327.39
3/4	3/4	1-5/8	4	4	0.060	TC22707	321.32	TC22846	327.39
3/4	3/4	1-5/8	4	4	0.090	TC22710	321.32	TC22849	327.39
3/4	3/4	1-5/8	4	4	0.120	TC22713	321.32	TC22852	327.39
3/4	3/4	1-5/8	4	4	0.190	TC22714	321.32	TC22853	327.38
3/4	3/4	1-5/8	4	4	0.250	TC22715	321.32	TC22854	327.38
1	1	2	4	4	0.030	TC22716	586.69	TC22855	592.75
1	1	2	4	4	0.060	TC22719	586.69	TC22858	592.75
1	1	2	4	4	0.090	TC22722	586.69	TC22861	592.75
1	1	2	4	4	0.120	TC22725	586.69	TC22864	592.75
1	1	2	4	4	0.190	TC22728	586.69	TC22867	592.75
1	1	2	4	4	0.250	TC22731	586.69	TC22870	592.75

For coating information see page 8. For VI-PRO technical information, please see pages 78-79, 91-93.

TOLERANCES	DIAMETER	SHANK	RADIUS
1/8" - 1/2"	+0.00, -.002	-.0001, -.0004 ISO H6	+0.01, -.001
5/8" - 3/4"	+0.00, -.003	-.0001, -.0004 ISO H6	+0.01, -.001



HIGH PERFORMANCE SOLID CARBIDE END MILLS

VI-PRO[®]

VARIABLE INDEX GEOMETRY

YOUR #1 SOURCE FOR AMERICAN-MADE PREMIUM QUALITY CUTTING TOOLS

4 FLUTE - LONG LENGTH  CORNER RADIUS - 38° HELIX



SERIES V42LR ALCRO-MAX COATED

VI-PRO DIAMETER	★★★ TOOL ATTRIBUTES ★★★					ROUND SHANK		WELDON FLAT	
	SHANK	LOC	OAL	# OF FLUTES	RAD	ITEM #	LIST PRICE	ITEM #	LIST PRICE
1/4	1/4	1-1/8	3	4	0.015	TC23820	64.53	-	-
1/4	1/4	1-1/8	3	4	0.030	TC23823	64.53	-	-
5/16	5/16	1-1/8	3	4	0.015	TC23826	87.91	-	-
5/16	5/16	1-1/8	3	4	0.030	TC23829	87.91	-	-
3/8	3/8	1-1/4	3	4	0.030	TC23832	116.34	-	-
3/8	3/8	1-1/4	3	4	0.060	TC23835	116.34	-	-
7/16	7/16	2	4	4	0.030	TC23836	149.43	-	-
7/16	7/16	2	4	4	0.060	TC23837	149.43	-	-
1/2	1/2	1-1/2	4	4	0.030	TC23838	163.75	TC23905	169.82
1/2	1/2	1-1/2	4	4	0.060	TC23841	163.75	TC23908	169.82
1/2	1/2	2	4	4	0.030	TC23844	180.49	TC23911	186.55
1/2	1/2	2	4	4	0.060	TC23847	180.49	TC23914	186.55
5/8	5/8	2-1/4	5	4	0.030	TC23850	327.02	TC23917	333.08
5/8	5/8	2-1/4	5	4	0.060	TC23853	327.02	TC23920	333.08
3/4	3/4	2-1/4	5	4	0.030	TC23856	411.81	TC23923	419.69
3/4	3/4	2-1/4	5	4	0.060	TC23859	411.81	TC23926	419.69
1	1	2-1/4	5	4	0.030	TC23862	642.16	TC23929	648.22
1	1	2-1/4	5	4	0.060	TC23865	642.16	TC23932	648.22



PVD coatings increase cutting tool performance and tool life

The VI-PRO performs very well in a wide range of materials including:

HIGH TEMP ALLOYS • STAINLESS STEELS • ALLOY STEELS • INCONEL
CAST IRON • HIGH TEMP NICKEL BASE ALLOYS • TITANIUM ALLOYS • EXOTICS

For coating information see page 8. For VI-PRO technical information, please see pages 78-79, 91-93.

TOLERANCES	DIAMETER	SHANK	RADIUS
1/4" - 1/2"	+0.00, -0.02	-0.001, -0.004 ISO H6	+0.01, -0.01
5/8" - 1"	+0.00, -0.03	-0.001, -0.004 ISO H6	+0.01, -0.01

4 FLUTE - EXTRA LONG LENGTH CORNER RADIUS - 38° HELIX

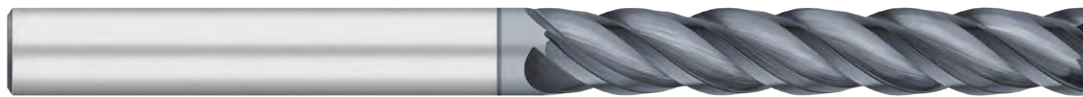

SERIES V42XLR
ALCRO-MAX COATED

VI-PRO DIAMETER	★★★ TOOL ATTRIBUTES ★★★					ROUND SHANK		WELDON FLAT	
	SHANK	LOC	OAL	# OF FLUTES	RAD	ITEM#	LIST PRICE	ITEM#	LIST PRICE
1/4	1/4	1-1/2	4	4	0.015	TC25217	78.53	-	-
1/4	1/4	1-1/2	4	4	0.030	TC25220	78.53	-	-
3/8	3/8	2	4	4	0.030	TC25223	133.02	-	-
3/8	3/8	2	4	4	0.060	TC25226	133.02	-	-
7/16	7/16	3	6	4	0.030	TC25227	210.67	-	-
7/16	7/16	3	6	4	0.060	TC25228	210.67	-	-
1/2	1/2	3	6	4	0.030	TC25229	247.90	TC25302	253.97
1/2	1/2	3	6	4	0.060	TC25232	247.90	TC25305	253.97
5/8	5/8	3	6	4	0.030	TC25235	349.33	TC25308	355.39
5/8	5/8	3	6	4	0.060	TC25238	349.33	TC25311	355.39
3/4	3/4	3	6	4	0.030	TC25241	461.25	TC25314	467.31
3/4	3/4	3	6	4	0.060	TC25244	461.25	TC25317	467.31
3/4	3/4	4	7	4	0.030	TC25247	750.99	TC25320	757.05
3/4	3/4	4	7	4	0.060	TC25250	750.99	TC25323	757.05
1	1	3	6	4	0.030	TC25253	754.99	TC25326	761.05
1	1	3	6	4	0.060	TC25256	754.99	TC25329	761.05
1	1	4-1/4	7	4	0.030	TC25259	1096.28	TC25332	1102.78
1	1	4-1/4	7	4	0.060	TC25262	1096.28	TC25335	1102.78



TITAN USA - America's tooling provider for over 50 years

The VI-PRO performs very well in a wide range of materials including:
 HIGH TEMP ALLOYS • STAINLESS STEELS • ALLOY STEELS • INCONEL
 CAST IRON • HIGH TEMP NICKEL BASE ALLOYS • TITANIUM ALLOYS • EXOTICS

For coating information see page 8. For VI-PRO technical information, please see pages 78-79, 91-93.

TOLERANCES	DIAMETER	SHANK	RADIUS
1/4" - 1/2"	+0.00, -.002	-.0001, -.0004 ISO H6	+0.01, -.001
5/8" - 1"	+0.00, -.003	-.0001, -.0004 ISO H6	+0.01, -.001



HIGH PERFORMANCE SOLID CARBIDE END MILLS

VI-PRO[®]

VARIABLE INDEX GEOMETRY

YOUR #1 SOURCE FOR AMERICAN-MADE PREMIUM QUALITY CUTTING TOOLS

4 FLUTE - STUB LENGTH - BALL NOSE - 38° HELIX



SERIES V42SB
ALCRO-MAX COATED

VI-PRO DIAMETER	★★★ TOOL ATTRIBUTES ★★★				ROUND SHANK		WELDON FLAT	
	SHANK	LOC	OAL	# OF FLUTES	ITEM #	LIST PRICE	ITEM #	LIST PRICE
1/8	1/8	1/4	1-1/2	4	TC25499	35.01	-	-
3/16	3/16	3/8	2	4	TC25501	50.02	-	-
1/4	1/4	3/8	2	4	TC25502	56.85	-	-
5/16	5/16	7/16	2	4	TC25504	74.16	-	-
3/8	3/8	1/2	2	4	TC25506	82.20	-	-
7/16	7/16	5/8	2-1/2	4	TC25507	110.66	-	-
1/2	1/2	5/8	2-1/2	4	TC25508	122.91	TC25514	129.90
5/8	5/8	3/4	3	4	TC25510	241.97	TC25516	248.97
3/4	3/4	1	3	4	TC25512	319.13	TC25518	326.12

4 FLUTE - REGULAR LENGTH - BALL NOSE - 38° HELIX



SERIES V42RB
ALCRO-MAX COATED

VI-PRO DIAMETER	★★★ TOOL ATTRIBUTES ★★★				ROUND SHANK		WELDON FLAT	
	SHANK	LOC	OAL	# OF FLUTES	ITEM #	LIST PRICE	ITEM #	LIST PRICE
1/8	1/8	1/2	2	4	TC25547	49.80	-	-
3/16	3/16	9/16	2	4	TC25549	55.04	-	-
1/4	1/4	3/4	2-1/2	4	TC25550	66.42	-	-
5/16	5/16	13/16	2-1/2	4	TC25552	80.38	-	-
3/8	3/8	1	2-1/2	4	TC25554	94.16	-	-
7/16	7/16	1	2-3/4	4	TC25555	128.79	-	-
1/2	1/2	1	3	4	TC25556	141.24	TC25566	148.24
1/2	1/2	1-1/4	3	4	TC25558	141.24	TC25568	148.24
5/8	5/8	1-5/8	3-1/2	4	TC25560	255.69	TC25570	262.68
3/4	3/4	1-5/8	4	4	TC25562	353.27	TC25572	360.26
1	1	2	4	4	TC25564	659.46	TC25574	666.45

The VI-PRO performs very well in a wide range of materials including:

HIGH TEMP ALLOYS • STAINLESS STEELS • ALLOY STEELS • INCONEL
CAST IRON • HIGH TEMP NICKEL BASE ALLOYS • TITANIUM ALLOYS • EXOTICS

For coating information see page 8. For VI-PRO technical information, please see pages 78-79, 91-93.

TOLERANCES	DIAMETER	SHANK
1/8" - 1/2"	+0.00, -0.002	-0.001, -.0004 ISO H6
5/8" - 1"	+0.00, -0.003	-0.001, -.0004 ISO H6

YOUR #1 SOURCE FOR AMERICAN-MADE PREMIUM QUALITY CUTTING TOOLS

4 FLUTE - LONG LENGTH - BALL NOSE - 38° HELIX



SERIES V42LB
ALCRO-MAX COATED

VI-PRO DIAMETER	★★★ TOOL ATTRIBUTES ★★★				ROUND SHANK		WELDON FLAT	
	SHANK	LOC	OAL	# OF FLUTES	ITEM#	LIST PRICE	ITEM#	LIST PRICE
1/4	1/4	1-1/8	3	4	TC25602	69.11	-	-
5/16	5/16	1-1/8	3	4	TC25604	95.63	-	-
3/8	3/8	1-1/4	3	4	TC25606	128.43	-	-
7/16	7/16	2	4	4	TC25607	160.06	-	-
1/2	1/2	1-1/2	4	4	TC25608	177.33	TC25618	184.32
1/2	1/2	2	4	4	TC25610	196.64	TC25620	203.63
5/8	5/8	2-1/4	5	4	TC25612	365.72	TC25622	372.71
3/4	3/4	2-1/4	5	4	TC25614	442.53	TC25624	449.52
1	1	2-1/4	5	4	TC25616	729.34	TC25626	736.33

4 FLUTE - EXTRA LONG LENGTH - BALL NOSE - 38° HELIX



SERIES V42XLB
ALCRO-MAX COATED

VI-PRO DIAMETER	★★★ TOOL ATTRIBUTES ★★★				ROUND SHANK		WELDON FLAT	
	SHANK	LOC	OAL	# OF FLUTES	ITEM#	LIST PRICE	ITEM#	LIST PRICE
1/4	1/4	1-1/2	4	4	TC25656	99.86	-	-
3/8	3/8	2	4	4	TC25658	144.74	-	-
7/16	7/16	3	6	4	TC25659	237.34	-	-
1/2	1/2	3	6	4	TC25660	277.30	TC25672	284.29
5/8	5/8	3	6	4	TC25662	394.40	TC25674	401.40
3/4	3/4	3	6	4	TC25664	520.60	TC25676	527.60
3/4	3/4	4	7	4	TC25666	854.90	TC25678	861.91
1	1	3	6	4	TC25668	848.75	TC25680	855.74
1	1	4-1/4	7	4	TC25670	1252.93	TC25682	1260.43

The VI-PRO performs very well in a wide range of materials including:
 HIGH TEMP ALLOYS • STAINLESS STEELS • ALLOY STEELS • INCONEL
 CAST IRON • HIGH TEMP NICKEL BASE ALLOYS • TITANIUM ALLOYS • EXOTICS

For coating information see page 8. For VI-PRO technical information, please see pages 78-79, 91-93.

TOLERANCES	DIAMETER	SHANK
1/4" - 1/2"	+ .000, -.002	-.0001, -.0004 ISO H6
5/8" - 1"	+ .000, -.003	-.0001, -.0004 ISO H6

HIGH PERFORMANCE

VI-PRO - 4 FLUTE
38° HELIX

VI-PRO - 5 FLUTE
38° HELIX

VI-PRO - 6 FLUTE
38° HELIX

TECHNICAL



HIGH PERFORMANCE SOLID CARBIDE END MILLS

VI-PRO®

VARIABLE INDEX GEOMETRY

YOUR #1 SOURCE FOR AMERICAN-MADE PREMIUM QUALITY CUTTING TOOLS

5 FLUTE - STUB LENGTH - SQUARE END - 38° HELIX



SERIES V52S
ALCRO-MAX COATED

VI-PRO DIAMETER	★★★ TOOL ATTRIBUTES ★★★				ROUND SHANK		WELDON FLAT	
	SHANK	LOC	OAL	# OF FLUTES	ITEM #	LIST PRICE	ITEM #	LIST PRICE
1/8	1/8	1/4	1-1/2	5	TC25807	33.37	-	-
3/16	3/16	3/8	2	5	TC25809	42.94	-	-
1/4	1/4	3/8	2	5	TC25796	48.59	-	-
5/16	5/16	7/16	2	5	TC25797	70.69	-	-
3/8	3/8	1/2	2	5	TC25798	78.36	-	-
1/2	1/2	5/8	2-1/2	5	TC25799	117.17	TC25802	123.84
5/8	5/8	3/4	3	5	TC25800	230.68	TC25803	237.35
3/4	3/4	1	3	5	TC25801	304.24	TC25804	310.90

5 FLUTE - REGULAR LENGTH - SQUARE END - 38° HELIX



SERIES V52R
ALCRO-MAX COATED

VI-PRO DIAMETER	★★★ TOOL ATTRIBUTES ★★★				ROUND SHANK		WELDON FLAT	
	SHANK	LOC	OAL	# OF FLUTES	ITEM #	LIST PRICE	ITEM #	LIST PRICE
1/8	1/8	1/2	2	5	TC25829	39.88	-	-
3/16	3/16	9/16	2	5	TC25835	45.59	-	-
1/4	1/4	3/4	2-1/2	5	TC25836	57.87	-	-
5/16	5/16	13/16	2-1/2	5	TC25838	76.64	-	-
3/8	3/8	1	2-1/2	5	TC25840	89.77	-	-
1/2	1/2	1	3	5	TC25842	134.65	TC25852	141.32
1/2	1/2	1-1/4	3	5	TC25844	134.65	TC25854	141.32
5/8	5/8	1-5/8	3-1/2	5	TC25846	243.76	TC25856	250.43
3/4	3/4	1-5/8	4	5	TC25848	336.78	TC25858	343.45
1	1	2	4	5	TC25850	628.69	TC25860	635.36

The VI-PRO performs very well in a wide range of materials including:

HIGH TEMP ALLOYS • STAINLESS STEELS • ALLOY STEELS • INCONEL
CAST IRON • HIGH TEMP NICKEL BASE ALLOYS • TITANIUM ALLOYS • EXOTICS

For coating information see page 8. For VI-PRO technical information, please see pages 80-81, 91-93.

TOLERANCES	DIAMETER	SHANK
1/8" - 1/2"	+0.000, -0.002	-0.0001, -.0004 ISO H6
5/8" - 1"	+0.000, -0.003	-0.0001, -.0004 ISO H6

5 FLUTE - LONG LENGTH - SQUARE END - 38° HELIX



SERIES V52L
ALCRO-MAX COATED

VI-PRO DIAMETER	★★★ TOOL ATTRIBUTES ★★★				ROUND SHANK		WELDON FLAT	
	SHANK	LOC	OAL	# OF FLUTES	ITEM #	LIST PRICE	ITEM #	LIST PRICE
1/4	1/4	1-1/8	3	5	TC25888	65.89	-	-
5/16	5/16	1-1/8	3	5	TC25890	91.16	-	-
3/8	3/8	1-1/4	3	5	TC25892	122.44	-	-
1/2	1/2	1-1/2	4	5	TC25894	169.06	TC25904	175.72
1/2	1/2	2	4	5	TC25896	187.47	TC25906	194.13
5/8	5/8	2-1/4	5	5	TC25898	348.65	TC25908	355.32
3/4	3/4	2-1/4	5	5	TC25900	421.88	TC25910	428.55
1	1	2-1/4	5	5	TC25902	695.31	TC25912	701.97

5 FLUTE - EXTRA LONG LENGTH - SQUARE END - 38° HELIX



SERIES V52XL
ALCRO-MAX COATED

VI-PRO DIAMETER	★★★ TOOL ATTRIBUTES ★★★				ROUND SHANK		WELDON FLAT	
	SHANK	LOC	OAL	# OF FLUTES	ITEM #	LIST PRICE	ITEM #	LIST PRICE
1/4	1/4	1-1/2	4	5	TC25942	78.72	-	-
3/8	3/8	2	4	5	TC25944	137.99	-	-
1/2	1/2	3	6	5	TC25946	264.35	TC25958	271.03
5/8	5/8	3	6	5	TC25948	375.99	TC25960	382.67
3/4	3/4	3	6	5	TC25950	496.32	TC25962	502.97
3/4	3/4	4	7	5	TC25952	815.00	TC25964	821.69
1	1	3	6	5	TC25954	809.14	TC25966	815.81
1	1	4-1/4	7	5	TC25956	1194.46	TC25968	1201.61

The VI-PRO performs very well in a wide range of materials including:
 HIGH TEMP ALLOYS • STAINLESS STEELS • ALLOY STEELS • INCONEL
 CAST IRON • HIGH TEMP NICKEL BASE ALLOYS • TITANIUM ALLOYS • EXOTICS

For coating information see page 8. For VI-PRO technical information, please see pages 80-81, 91-93.

TOLERANCES	DIAMETER	SHANK
1/4" - 1/2"	+0.000, -0.002	-0.0001, -.0004 ISO H6
5/8" - 1"	+0.000, -0.003	-0.0001, -.0004 ISO H6

HIGH PERFORMANCE

VI-PRO - 4 FLUTE
38° HELIX

VI-PRO - 5 FLUTE
38° HELIX

VI-PRO - 6 FLUTE
38° HELIX

TECHNICAL



HIGH PERFORMANCE SOLID CARBIDE END MILLS

VI-PRO®

VARIABLE INDEX GEOMETRY

YOUR #1 SOURCE FOR AMERICAN-MADE PREMIUM QUALITY CUTTING TOOLS

5 FLUTE - STUB LENGTH  CORNER RADIUS - 38° HELIX



SERIES V52SR ALCRO-MAX COATED

VI-PRO DIAMETER	★★★ TOOL ATTRIBUTES ★★★					ROUND SHANK		WELDON FLAT	
	SHANK	LOC	OAL	# OF FLUTES	RAD	ITEM #	LIST PRICE	ITEM #	LIST PRICE
1/8	1/8	1/4	1-1/2	5	0.010	TC25995	38.47	-	-
3/16	3/16	3/8	2	5	0.010	TC25996	48.04	-	-
1/4	1/4	3/8	2	5	0.015	TC25986	56.63	-	-
5/16	5/16	7/16	2	5	0.015	TC25987	76.23	-	-
3/8	3/8	1/2	2	5	0.015	TC25988	83.90	-	-
1/2	1/2	5/8	2-1/2	5	0.030	TC25989	128.24	TC25992	134.91
5/8	5/8	3/4	3	5	0.030	TC25990	241.75	TC25993	248.42
3/4	3/4	1	3	5	0.030	TC25991	315.31	TC25994	321.98



The VI-PRO 5 Flute Stub Length is stocked in 3 radius sizes; 0.010, 0.015, 0.030

The VI-PRO performs very well in a wide range of materials including:

HIGH TEMP ALLOYS • STAINLESS STEELS • ALLOY STEELS • INCONEL
CAST IRON • HIGH TEMP NICKEL BASE ALLOYS • TITANIUM ALLOYS • EXOTICS

For coating information see page 8. For VI-PRO technical information, please see pages 80-81, 91-93.

TOLERANCES	DIAMETER	SHANK	RADIUS
1/8" - 1/2"	+ .000, -.002	-.0001, -.0004 ISO H6	+ .001, -.001
5/8" - 3/4"	+ .000, -.003	-.0001, -.0004 ISO H6	+ .001, -.001

YOUR #1 SOURCE FOR AMERICAN-MADE PREMIUM QUALITY CUTTING TOOLS

5 FLUTE - REGULAR LENGTH CORNER RADIUS - 38° HELIX



SERIES V52RR
ALCRO-MAX COATED

VI-PRO DIAMETER	★★★ TOOL ATTRIBUTES ★★★					ROUND SHANK		WELDON FLAT	
	SHANK	LOC	OAL	# OF FLUTES	RAD	ITEM #	LIST PRICE	ITEM #	LIST PRICE
1/8	1/8	1/2	2	5	0.010	TC26404	45.97	-	-
1/8	1/8	1/2	2	5	0.020	TC26406	45.97	-	-
1/8	1/8	1/2	2	5	0.030	TC26408	45.97	-	-
3/16	3/16	9/16	2	5	0.010	TC26410	54.47	-	-
3/16	3/16	9/16	2	5	0.020	TC26412	54.47	-	-
3/16	3/16	9/16	2	5	0.030	TC26414	54.47	-	-
1/4	1/4	3/4	2-1/2	5	0.015	TC26416	62.95	-	-
1/4	1/4	3/4	2-1/2	5	0.030	TC26419	62.95	-	-
1/4	1/4	3/4	2-1/2	5	0.060	TC26422	62.95	-	-
5/16	5/16	13/16	2-1/2	5	0.015	TC26425	81.09	-	-
5/16	5/16	13/16	2-1/2	5	0.030	TC26428	81.09	-	-
5/16	5/16	13/16	2-1/2	5	0.060	TC26431	81.09	-	-
3/8	3/8	1	2-1/2	5	0.015	TC26434	94.70	-	-
3/8	3/8	1	2-1/2	5	0.030	TC26437	94.70	-	-
3/8	3/8	1	2-1/2	5	0.060	TC26440	94.70	-	-
1/2	1/2	1	3	5	0.015	TC26443	151.29	TC26625	158.86
1/2	1/2	1	3	5	0.030	TC26446	151.29	TC26628	158.86
1/2	1/2	1	3	5	0.060	TC26449	151.29	TC26631	158.86
1/2	1/2	1	3	5	0.090	TC26452	151.29	TC26634	158.86
1/2	1/2	1	3	5	0.120	TC26455	151.29	TC26637	158.86
1/2	1/2	1-1/4	3	5	0.015	TC26458	151.29	TC26640	158.86
1/2	1/2	1-1/4	3	5	0.030	TC26461	151.29	TC26643	158.86
1/2	1/2	1-1/4	3	5	0.060	TC26464	151.29	TC26646	158.86
1/2	1/2	1-1/4	3	5	0.090	TC26467	151.29	TC26649	158.86
1/2	1/2	1-1/4	3	5	0.120	TC26470	151.29	TC26652	158.86
5/8	5/8	1-5/8	3-1/2	5	0.030	TC26473	254.89	TC26655	261.56
5/8	5/8	1-5/8	3-1/2	5	0.060	TC26476	254.89	TC26658	261.56
5/8	5/8	1-5/8	3-1/2	5	0.090	TC26479	254.89	TC26661	261.56
5/8	5/8	1-5/8	3-1/2	5	0.120	TC26482	254.89	TC26664	261.56
3/4	3/4	1-5/8	4	5	0.030	TC26485	353.45	TC26667	360.12
3/4	3/4	1-5/8	4	5	0.060	TC26488	353.45	TC26670	360.12
3/4	3/4	1-5/8	4	5	0.090	TC26491	353.45	TC26673	360.12
3/4	3/4	1-5/8	4	5	0.120	TC26494	353.45	TC26676	360.12
3/4	3/4	1-5/8	4	5	0.190	TC26495	353.45	TC26677	360.12
3/4	3/4	1-5/8	4	5	0.250	TC26496	353.45	TC26678	360.12
1	1	2	4	5	0.030	TC26497	645.36	TC26679	652.02
1	1	2	4	5	0.060	TC26500	645.36	TC26682	652.02
1	1	2	4	5	0.090	TC26503	645.36	TC26685	652.02
1	1	2	4	5	0.120	TC26506	645.36	TC26688	652.02
1	1	2	4	5	0.190	TC26507	645.36	TC26689	652.02
1	1	2	4	5	0.250	TC26508	645.36	TC26690	652.02

The VI-PRO performs very well in a wide range of materials including:
 HIGH TEMP ALLOYS • STAINLESS STEELS • ALLOY STEELS • INCONEL
 CAST IRON • HIGH TEMP NICKEL BASE ALLOYS • TITANIUM ALLOYS • EXOTICS

For coating information see page 8. For VI-PRO technical information, please see pages 80-81, 91-93.

TOLERANCES	DIAMETER	SHANK	RADIUS
1/4" - 1/2"	+0.00, -.002	-.0001, -.0004 ISO H6	+0.01, -.001
5/8" - 1"	+0.00, -.003	-.0001, -.0004 ISO H6	+0.01, -.001

HIGH PERFORMANCE

VI-PRO - 4 FLUTE
38° HELIX

VI-PRO - 5 FLUTE
38° HELIX

VI-PRO - 6 FLUTE
38° HELIX

TECHNICAL



HIGH PERFORMANCE SOLID CARBIDE END MILLS

VI-PRO[®]

VARIABLE INDEX GEOMETRY

YOUR #1 SOURCE FOR AMERICAN-MADE PREMIUM QUALITY CUTTING TOOLS

5 FLUTE - LONG LENGTH  CORNER RADIUS - 38° HELIX



SERIES V52LR ALCRO-MAX COATED

VI-PRO DIAMETER	★★★ TOOL ATTRIBUTES ★★★					ROUND SHANK		WELDON FLAT	
	SHANK	LOC	OAL	# OF FLUTES	RAD	ITEM #	LIST PRICE	ITEM #	LIST PRICE
1/4	1/4	1-1/8	3	5	0.015	TC27109	70.99	-	-
1/4	1/4	1-1/8	3	5	0.030	TC27112	70.99	-	-
5/16	5/16	1-1/8	3	5	0.015	TC27115	96.70	-	-
5/16	5/16	1-1/8	3	5	0.030	TC27118	96.70	-	-
3/8	3/8	1-1/4	3	5	0.030	TC27121	127.98	-	-
3/8	3/8	1-1/4	3	5	0.060	TC27124	127.98	-	-
1/2	1/2	2	4	5	0.030	TC27127	198.53	TC27262	205.20
1/2	1/2	2	4	5	0.060	TC27130	198.53	TC27265	205.20
5/8	5/8	2-1/4	5	5	0.030	TC27133	359.72	TC27268	366.39
5/8	5/8	2-1/4	5	5	0.060	TC27136	359.72	TC27271	366.39
3/4	3/4	2-1/4	5	5	0.030	TC27139	452.99	TC27274	461.66
3/4	3/4	2-1/4	5	5	0.060	TC27142	452.99	TC27277	461.66
1	1	2-1/4	5	5	0.030	TC27145	706.38	TC27280	713.04
1	1	2-1/4	5	5	0.060	TC27148	706.38	TC27283	713.04



Preparing tools in our advanced PVD Coating Center

For coating information see page 8. For VI-PRO technical information, please see pages 80-81, 91-93.

TOLERANCES	DIAMETER	SHANK	RADIUS
1/4" - 1/2"	+0.000, -.002	-.0001, -.0004 ISO H6	+0.001, -.001
5/8" - 1"	+0.000, -.003	-.0001, -.0004 ISO H6	+0.001, -.001

YOUR #1 SOURCE FOR AMERICAN-MADE PREMIUM QUALITY CUTTING TOOLS

5 FLUTE - EXTRA LONG LENGTH CORNER RADIUS - 38° HELIX



SERIES V52XLR
ALCRO-MAX COATED

VI-PRO DIAMETER	★★★ TOOL ATTRIBUTES ★★★					ROUND SHANK		WELDON FLAT	
	SHANK	LOC	OAL	# OF FLUTES	RAD	ITEM#	LIST PRICE	ITEM#	LIST PRICE
1/4	1/4	1-1/2	4	5	0.015	TC27928	86.39	-	-
1/4	1/4	1-1/2	4	5	0.030	TC27931	86.39	-	-
3/8	3/8	2	4	5	0.030	TC27934	146.32	-	-
3/8	3/8	2	4	5	0.060	TC27937	146.32	-	-
1/2	1/2	3	6	5	0.030	TC27940	272.69	TC28002	279.36
1/2	1/2	3	6	5	0.060	TC27943	272.69	TC28005	279.36
5/8	5/8	3	6	5	0.030	TC27946	384.27	TC28008	390.93
5/8	5/8	3	6	5	0.060	TC27949	384.27	TC28011	390.93
3/4	3/4	3	6	5	0.030	TC27952	507.37	TC28014	514.04
3/4	3/4	3	6	5	0.060	TC27955	507.37	TC28017	514.04
3/4	3/4	4	7	5	0.030	TC27958	826.08	TC28020	832.75
3/4	3/4	4	7	5	0.060	TC27961	826.08	TC28023	832.75
1	1	3	6	5	0.030	TC27964	830.49	TC28026	837.15
1	1	3	6	5	0.060	TC27967	830.49	TC28029	837.15
1	1	4-1/4	7	5	0.030	TC27970	1205.90	TC28032	1213.06
1	1	4-1/4	7	5	0.060	TC27973	1205.90	TC28035	1213.06



Every coating load is rigorously inspected for thickness and adhesion

For coating information see page 8. For VI-PRO technical information, please see pages 80-81, 91-93.

TOLERANCES	DIAMETER	SHANK	RADIUS
1/4" - 1/2"	+0.00, -.002	-.0001, -.0004 ISO H6	+0.01, -.001
5/8" - 1"	+0.00, -.003	-.0001, -.0004 ISO H6	+0.01, -.001

HIGH PERFORMANCE

VI-PRO - 4 FLUTE
38° HELIX

VI-PRO - 5 FLUTE
38° HELIX

VI-PRO - 6 FLUTE
38° HELIX

TECHNICAL



HIGH PERFORMANCE SOLID CARBIDE END MILLS

VI-PRO
VARIABLE INDEX GEOMETRY

YOUR #1 SOURCE FOR AMERICAN-MADE PREMIUM QUALITY CUTTING TOOLS

High Efficiency Milling and High Speed Machining are machining techniques aimed at maximizing metal removal rates (MRR) with the use of technology advancements in machines, software and end mill geometries. Both methods have the simple principle of increasing the metal removal rates (MRR).

HIGH SPEED MACHINING • HSM

High Speed Machining is based on a very light axial depth of cut, while allowing for maximum radial engagement of the end mill. This combination, along with very high spindle speed, allows for an extremely high feed rate and greatly increased metal removal rates (MRR). HSM can be used in a wide range of applications and has many benefits.

- Used in applications ranging from simple slotting to complex 5 axis contouring
- Final result is achieved with quick light cuts, which allows for an extremely smooth finish in a roughing application
- Flexibility to use higher flute counts to achieve the best finish with the least production time

High Speed Machining is a high demand application where the VI Pro End Mill and Alcro-Max coating excel to give the absolute best results in High Performance applications.



HIGH EFFICIENCY MILLING • HEM

High Efficiency Milling is based on radial chip thinning with the basic idea of keeping the end mill cutting at an ideal chip load. The stepover is substantially reduced from the typical 50% of tool diameter, while the feed rate is greatly increased to maintain the correct chip load. There are multiple benefits to the process in the correct applications.

- Reduced spindle load due to low percentage of tool diameter being engaged in the work material.
- Allows for increased axial depth of cuts using the entire LOC on extra length end mills allowing for even tool wear and increased tool life.
- HEM tool paths allow for high flute count tools with heavier core, such as our 6 flute VI Pro, to be used which also means increased tool life as well as better finish on parts.

Today's advancements in CAM software technology have paved the way for HEM to be incorporated in many applications. In combination with a High Performance VI Pro 6 flute End Mill High Efficiency Machining can increase metal removal rates by 50% or more versus conventional roughing applications, all while extending tool life and machine life together.



6 FLUTE - STUB LENGTH - SQUARE END - 38° HELIX



SERIES V62S
ALCRO-MAX COATED

VI-PRO DIAMETER	★★★ TOOL ATTRIBUTES ★★★					ROUND SHANK		WELDON FLAT	
	SHANK	LOC	OAL	# OF FLUTES		ITEM #	LIST PRICE	ITEM #	LIST PRICE
1/4	1/4	3/8	2	6		TC64404	51.82	-	-
5/16	5/16	7/16	2	6		TC64406	77.10	-	-
3/8	3/8	1/2	2	6		TC64408	85.47	-	-
1/2	1/2	5/8	2-1/2	6		TC64410	126.74	TC64416	135.08
5/8	5/8	3/4	3	6		TC64412	243.14	TC64418	251.95
3/4	3/4	1	3	6		TC64414	316.88	TC64420	324.07

6 FLUTE - STUB LENGTH CORNER RADIUS - 38° HELIX



SERIES V62SR
ALCRO-MAX COATED

VI-PRO DIAMETER	★★★ TOOL ATTRIBUTES ★★★						ROUND SHANK		WELDON FLAT	
	SHANK	LOC	OAL	# OF FLUTES	RAD		ITEM #	LIST PRICE	ITEM #	LIST PRICE
1/4	1/4	3/8	2	6	0.015		TC64426	62.32	-	-
5/16	5/16	7/16	2	6	0.015		TC64428	83.16	-	-
3/8	3/8	1/2	2	6	0.015		TC64430	91.54	-	-
1/2	1/2	5/8	2-1/2	6	0.030		TC64432	139.89	TC64438	147.16
5/8	5/8	3/4	3	6	0.030		TC64434	257.30	TC64440	263.50
3/4	3/4	1	3	6	0.030		TC64436	333.39	TC64442	339.45

The VI-PRO performs very well in a wide range of materials including:
 HIGH TEMP ALLOYS • STAINLESS STEELS • ALLOY STEELS • INCONEL
 CAST IRON • HIGH TEMP NICKEL BASE ALLOYS • TITANIUM ALLOYS • EXOTICS

For coating information see page 8. For VI-PRO technical information, please see see pages 82-83, 91-93.

TOLERANCES	DIAMETER	SHANK	RADIUS
1/4" - 1/2"	+0.00, -.002	-.0001, -.0004 ISO H6	+0.01, -.001
5/8" - 1"	+0.00, -.003	-.0001, -.0004 ISO H6	+0.01, -.001



HIGH PERFORMANCE SOLID CARBIDE END MILLS

VI-PRO®

VARIABLE INDEX GEOMETRY

YOUR #1 SOURCE FOR AMERICAN-MADE PREMIUM QUALITY CUTTING TOOLS

6 FLUTE - REGULAR LENGTH - SQUARE END - 38° HELIX



SERIES V62R ALCRO-MAX COATED

VI-PRO DIAMETER	★★★ TOOL ATTRIBUTES ★★★				ROUND SHANK		WELDON FLAT	
	SHANK	LOC	OAL	# OF FLUTES	ITEM #	LIST PRICE	ITEM #	LIST PRICE
1/4	1/4	3/4	2-1/2	6	TC64516	102.84	-	-
5/16	5/16	13/16	2-1/2	6	TC64520	122.14	-	-
3/8	3/8	1	2-1/2	6	TC64524	131.62	-	-
1/2	1/2	1-1/4	3	6	TC64532	175.99	TC64579	184.78
5/8	5/8	1-5/8	3-1/2	6	TC64540	293.28	TC64581	302.06
3/4	3/4	1-5/8	4	6	TC64548	368.14	TC64583	379.16
1	1	2	4	6	TC64564	563.84	TC64585	575.10

6 FLUTE - REGULAR LENGTH CORNER RADIUS - 38° HELIX



SERIES V62RR ALCRO-MAX COATED

VI-PRO DIAMETER	★★★ TOOL ATTRIBUTES ★★★						ROUND SHANK		WELDON FLAT	
	SHANK	LOC	OAL	# OF FLUTES	RAD	ITEM #	LIST PRICE	ITEM #	LIST PRICE	
1/4	1/4	3/4	2-1/2	6	0.015	TC67116	114.79	-	-	
5/16	5/16	13/16	2-1/2	6	0.015	TC67120	136.39	-	-	
3/8	3/8	1	2-1/2	6	0.015	TC67124	147.00	-	-	
1/2	1/2	1-1/4	3	6	0.030	TC67132	196.50	TC67184	206.31	
5/8	5/8	1-5/8	3-1/2	6	0.030	TC67140	313.21	TC67186	322.59	
3/4	3/4	1-5/8	4	6	0.060	TC67148	393.16	TC67188	404.94	
1	1	2	4	6	0.060	TC67164	602.14	TC67190	620.21	

The VI-PRO performs very well in a wide range of materials including:

HIGH TEMP ALLOYS • STAINLESS STEELS • ALLOY STEELS • INCONEL
CAST IRON • HIGH TEMP NICKEL BASE ALLOYS • TITANIUM ALLOYS • EXOTICS

For coating information see page 8. For VI-PRO technical information, please see see pages 82-83, 91-93.

TOLERANCES	DIAMETER	SHANK	RADIUS
1/4" - 1/2"	+0.000, -.002	-.0001, -.0004 ISO H6	+0.001, -.001
5/8" - 1"	+0.000, -.003	-.0001, -.0004 ISO H6	+0.001, -.001

6 FLUTE - LONG LENGTH - SQUARE END - 38° HELIX



**SERIES V62L
ALCRO-MAX COATED**

VI-PRO DIAMETER	★★★ TOOL ATTRIBUTES ★★★				ROUND SHANK		WELDON FLAT	
	SHANK	LOC	OAL	# OF FLUTES	ITEM #	LIST PRICE	ITEM #	LIST PRICE
1/4	1/4	1-1/8	3	6	TC61316	113.37	-	-
5/16	5/16	1-1/8	3	6	TC61320	132.29	-	-
3/8	3/8	1-1/4	3	6	TC61324	150.34	-	-
1/2	1/2	2	4	6	TC61332	233.84	TC61384	245.52
5/8	5/8	2-1/4	5	6	TC61340	363.25	TC61386	374.16
3/4	3/4	2-1/4	5	6	TC61348	453.64	TC61388	467.25
1	1	3	6	6	TC61364	919.44	TC61390	937.82

6 FLUTE - LONG LENGTH  CORNER RADIUS - 38° HELIX



**SERIES V62LR
ALCRO-MAX COATED**

VI-PRO DIAMETER	★★★ TOOL ATTRIBUTES ★★★						ROUND SHANK		WELDON FLAT	
	SHANK	LOC	OAL	# OF FLUTES	RAD	ITEM #	LIST PRICE	ITEM #	LIST PRICE	
1/4	1/4	1-1/8	3	6	0.015	TC61216	126.61	-	-	
5/16	5/16	1-1/8	3	6	0.015	TC61220	147.71	-	-	
3/8	3/8	1-1/4	3	6	0.015	TC61224	167.88	-	-	
1/2	1/2	2	4	6	0.030	TC61232	261.07	TC61287	274.11	
5/8	5/8	2-1/4	5	6	0.030	TC61240	387.94	TC61289	399.59	
3/4	3/4	2-1/4	5	6	0.060	TC61248	484.47	TC61291	499.02	
1	1	3	6	6	0.060	TC61264	981.89	TC61293	1001.55	

The VI-PRO performs very well in a wide range of materials including:
 HIGH TEMP ALLOYS • STAINLESS STEELS • ALLOY STEELS • INCONEL
 CAST IRON • HIGH TEMP NICKEL BASE ALLOYS • TITANIUM ALLOYS • EXOTICS

For coating information see page 8. For VI-PRO technical information, please see see pages 82-83, 91-93.

TOLERANCES	DIAMETER	SHANK	RADIUS
1/4" - 1/2"	+0.00, -.002	-.0001, -.0004 ISO H6	+0.01, -.001
5/8" - 1"	+0.00, -.003	-.0001, -.0004 ISO H6	+0.01, -.001

HIGH PERFORMANCE

VI-PRO - 4 FLUTE
38° HELIX

VI-PRO - 5 FLUTE
38° HELIX

VI-PRO - 6 FLUTE
38° HELIX

TECHNICAL



GENERAL PURPOSE SOLID CARBIDE ALUMINUM END MILLS

YOUR #1 SOURCE FOR AMERICAN-MADE PREMIUM QUALITY CUTTING TOOLS

2 FLUTE - STUB LENGTH - SQUARE END - 45° HELIX



SERIES 621 ZRN COATED

DIA	SHANK	LOC	OAL	ITEM#	LIST PRICE
1/8	1/8	1/4	1-1/2	TC62100	21.53
3/16	3/16	3/8	2	TC62102	31.86
1/4	1/4	1/2	2	TC62104	45.71
5/16	5/16	1/2	2	TC62106	55.22
3/8	3/8	5/8	2	TC62108	60.58
1/2	1/2	5/8	2-1/2	TC62110	102.13
5/8	5/8	3/4	3	TC62112	205.69
3/4	3/4	1	3	TC62114	310.22
1	1	1-1/4	3-1/2	TC62116	520.23

2 FLUTE - STUB LENGTH CORNER RADIUS - 45° HELIX



SERIES 624 ZRN COATED

DIA	SHANK	LOC	OAL	RAD	ITEM#	LIST PRICE
1/8	1/8	1/4	1-1/2	0.010	TC62400	26.48
3/16	3/16	3/8	2	0.010	TC62402	38.31
1/4	1/4	1/2	2	0.020	TC62404	53.82
5/16	5/16	1/2	2	0.020	TC62406	62.71
3/8	3/8	5/8	2	0.020	TC62408	67.20
1/2	1/2	5/8	2-1/2	0.040	TC62410	108.89
5/8	5/8	3/4	3	0.040	TC62412	216.56
3/4	3/4	1	3	0.040	TC62414	320.42
1	1	1-1/4	3-1/2	0.040	TC62416	535.68

These 2 flute end mills are designed specifically for high speed machining in Aluminum. This tool will plunge, slot and profile in all non-ferrous materials. Our ZrN coating allows for higher speed rates and prolonged tool life and does not have an affinity for Aluminum.

WORKS WELL IN ALL NON-FERROUS MATERIALS APPLICATIONS

For coating information see page 8. For technical information, please see pages 86-87, 91-93.

TOLERANCES	DIAMETER	SHANK	RADIUS
1/8" - 1/2"	+0.00, -.002	-.0001, -.0004 ISO H6	+0.01, -.001
5/8" - 1"	+0.00, -.003	-.0001, -.0004 ISO H6	+0.01, -.001

GENERAL PURPOSE SOLID CARBIDE ALUMINUM END MILLS



YOUR #1 SOURCE FOR AMERICAN-MADE PREMIUM QUALITY CUTTING TOOLS

2 FLUTE - REGULAR LENGTH - SQUARE END - 45° HELIX



SERIES 627 ZRN COATED

DIA	SHANK	LOC	OAL	ITEM#	LIST PRICE
1/8	1/8	1/2	1-1/2	TC62708	29.88
3/16	3/16	5/8	2	TC62712	41.66
1/4	1/4	3/4	2-1/2	TC62716	58.13
5/16	5/16	13/16	2-1/2	TC62720	68.65
3/8	3/8	1	2-1/2	TC62724	72.65
1/2	1/2	1-1/4	3	TC62732	115.38
5/8	5/8	1-5/8	3-1/2	TC62740	230.62
3/4	3/4	1-3/4	4	TC62748	331.21
1	1	1-3/4	4	TC62764	545.21

2 FLUTE - REGULAR LENGTH CORNER RADIUS - 45° HELIX



SERIES 647 ZRN COATED

DIA	SHANK	LOC	OAL	RAD	ITEM#	LIST PRICE
1/8	1/8	1/2	1-1/2	0.010	TC64708	35.72
3/16	3/16	5/8	2	0.010	TC64712	48.98
1/4	1/4	3/4	2-1/2	0.020	TC64716	64.88
5/16	5/16	13/16	2-1/2	0.020	TC64720	76.66
3/8	3/8	1	2-1/2	0.020	TC64724	81.12
1/2	1/2	1-1/4	3	0.040	TC64732	128.80
5/8	5/8	1-5/8	3-1/2	0.040	TC64740	246.28
3/4	3/4	1-3/4	4	0.040	TC64748	353.74
1	1	1-3/4	4	0.040	TC64764	582.26

These 2 flute end mills are designed specifically for high speed machining in Aluminum. This tool will plunge, slot and profile in all non-ferrous materials. Our ZrN coating allows for higher speed rates and prolonged tool life and does not have an affinity for Aluminum.

WORKS WELL IN ALL NON-FERROUS MATERIALS APPLICATIONS

For coating information see page 8. For technical information, please see pages 86-87, 91-93.

TOLERANCES	DIAMETER	SHANK	RADIUS
1/8" - 1/2"	+0.000, -.002	-.0001, -.0004 ISO H6	+0.001, -.001
5/8" - 1"	+0.000, -.003	-.0001, -.0004 ISO H6	+0.001, -.001



GENERAL PURPOSE SOLID CARBIDE ALUMINUM END MILLS

YOUR #1 SOURCE FOR AMERICAN-MADE PREMIUM QUALITY CUTTING TOOLS

2 FLUTE - LONG LENGTH - SQUARE END - 45° HELIX



SERIES 633 ZRN COATED

DIA	SHANK	LOC	OAL	ITEM#	LIST PRICE
1/8	1/8	3/4	2-1/4	TC63308	50.74
3/16	3/16	3/4	2-1/2	TC63312	58.51
1/4	1/4	1-1/4	3	TC63316	79.74
5/16	5/16	1-3/8	3	TC63320	108.48
3/8	3/8	1-1/2	4	TC63324	129.41
1/2	1/2	2	4	TC63332	181.79
5/8	5/8	2-3/8	5	TC63340	395.63
3/4	3/4	2-1/2	5	TC63348	427.57
1	1	2-1/4	5	TC63364	673.28

2 FLUTE - LONG LENGTH CORNER RADIUS - 45° HELIX



SERIES 653 ZRN COATED

DIA	SHANK	LOC	OAL	RAD	ITEM#	LIST PRICE
1/8	1/8	3/4	2-1/4	0.010	TC65308	60.88
3/16	3/16	3/4	2-1/2	0.010	TC65312	70.21
1/4	1/4	1-1/4	3	0.020	TC65316	89.04
5/16	5/16	1-3/8	3	0.020	TC65320	121.10
3/8	3/8	1-1/2	4	0.020	TC65324	144.51
1/2	1/2	2	4	0.040	TC65332	202.98
5/8	5/8	2-3/8	5	0.040	TC65340	422.50
3/4	3/4	2-1/2	5	0.040	TC65348	456.62
1	1	2-1/4	5	0.040	TC65364	719.06

These 2 flute end mills are designed specifically for high speed machining in Aluminum. This tool will plunge, slot and profile in all non-ferrous materials. Our ZrN coating allows for higher speed rates and prolonged tool life and does not have an affinity for Aluminum.

WORKS WELL IN ALL NON-FERROUS MATERIALS APPLICATIONS

For coating information see page 8. For technical information, please see pages 86-87, 91-93.

TOLERANCES	DIAMETER	SHANK	RADIUS
1/8" - 1/2"	+0.00, -.002	-.0001, -.0004 ISO H6	+0.01, -.001
5/8" - 1"	+0.00, -.003	-.0001, -.0004 ISO H6	+0.01, -.001

GENERAL PURPOSE SOLID CARBIDE ALUMINUM END MILLS



YOUR #1 SOURCE FOR AMERICAN-MADE PREMIUM QUALITY CUTTING TOOLS

3 FLUTE - STUB LENGTH - SQUARE END - 45° HELIX



SERIES 630 ZRN COATED

DIA	SHANK	LOC	OAL	ITEM#	LIST PRICE
1/8	1/8	1/4	1-1/2	TC63000	21.53
3/16	3/16	3/8	2	TC63002	31.86
1/4	1/4	1/2	2	TC63004	45.71
5/16	5/16	1/2	2	TC63006	55.22
3/8	3/8	5/8	2	TC63008	60.58
1/2	1/2	5/8	2-1/2	TC63010	102.13
5/8	5/8	3/4	3	TC63012	205.69
3/4	3/4	1	3	TC63014	310.22
1	1	1-1/4	3-1/2	TC63016	520.23

3 FLUTE - STUB LENGTH CORNER RADIUS - 45° HELIX



SERIES 636 ZRN COATED

DIA	SHANK	LOC	OAL	RAD	ITEM#	LIST PRICE
1/8	1/8	1/4	1-1/2	0.010	TC63600	26.48
3/16	3/16	3/8	2	0.010	TC63602	38.31
1/4	1/4	1/2	2	0.020	TC63604	53.82
5/16	5/16	1/2	2	0.020	TC63606	62.71
3/8	3/8	5/8	2	0.020	TC63608	67.20
1/2	1/2	5/8	2-1/2	0.040	TC63610	108.89
5/8	5/8	3/4	3	0.040	TC63612	216.56
3/4	3/4	1	3	0.040	TC63614	320.42
1	1	1-1/4	3-1/2	0.040	TC63616	535.68

These 3 flute end mills are designed specifically for high speed machining in Aluminum. This tool will plunge, slot and profile in all non-ferrous materials. Our ZrN coating allows for higher speed rates and prolonged tool life and does not have an affinity for Aluminum.

WORKS WELL IN ALL NON-FERROUS MATERIALS APPLICATIONS

For coating information see page 8. For technical information, please see pages 86-87, 91-93.

TOLERANCES	DIAMETER	SHANK	RADIUS
1/8" - 1/2"	+0.00, -.002	-.0001, -.0004 ISO H6	+0.01, -.001
5/8" - 1"	+0.00, -.003	-.0001, -.0004 ISO H6	+0.01, -.001



GENERAL PURPOSE SOLID CARBIDE ALUMINUM END MILLS

YOUR #1 SOURCE FOR AMERICAN-MADE PREMIUM QUALITY CUTTING TOOLS

3 FLUTE - REGULAR LENGTH - SQUARE END - 45° HELIX



SERIES 629 ZRN COATED

DIA	SHANK	LOC	OAL	ITEM#	LIST PRICE
1/8	1/8	1/2	1-1/2	TC62908	29.88
3/16	3/16	5/8	2	TC62912	41.66
1/4	1/4	3/4	2-1/2	TC62916	58.13
5/16	5/16	13/16	2-1/2	TC62920	68.65
3/8	3/8	1	2-1/2	TC62924	72.65
1/2	1/2	1-1/4	3	TC62932	115.38
5/8	5/8	1-5/8	3-1/2	TC62940	230.62
3/4	3/4	1-3/4	4	TC62948	331.21
1	1	1-3/4	4	TC62964	545.21

3 FLUTE - REGULAR LENGTH CORNER RADIUS - 45° HELIX



SERIES 659 ZRN COATED

DIA	SHANK	LOC	OAL	RAD	ITEM#	LIST PRICE
1/8	1/8	1/2	1-1/2	0.010	TC65908	35.72
3/16	3/16	5/8	2	0.010	TC65912	48.98
1/4	1/4	3/4	2-1/2	0.020	TC65916	64.88
5/16	5/16	13/16	2-1/2	0.020	TC65920	76.66
3/8	3/8	1	2-1/2	0.020	TC65924	81.12
1/2	1/2	1-1/4	3	0.040	TC65932	128.80
5/8	5/8	1-5/8	3-1/2	0.040	TC65940	246.28
3/4	3/4	1-3/4	4	0.040	TC65948	353.74
1	1	1-3/4	4	0.040	TC65964	582.26

These 3 flute end mills are designed specifically for high speed machining in Aluminum. This tool will plunge, slot and profile in all non-ferrous materials. Our ZrN coating allows for higher speed rates and prolonged tool life and does not have an affinity for Aluminum.

WORKS WELL IN ALL NON-FERROUS MATERIALS APPLICATIONS

For coating information see page 8. For technical information, please see pages 86-87, 91-93.

TOLERANCES	DIAMETER	SHANK	RADIUS
1/8" - 1/2"	+0.00, -.002	-.0001, -.0004 ISO H6	+0.01, -.001
5/8" - 1"	+0.00, -.003	-.0001, -.0004 ISO H6	+0.01, -.001

GENERAL PURPOSE SOLID CARBIDE ALUMINUM END MILLS



YOUR #1 SOURCE FOR AMERICAN-MADE PREMIUM QUALITY CUTTING TOOLS

3 FLUTE - LONG LENGTH - SQUARE END - 45° HELIX



SERIES 635 ZRN COATED

DIA	SHANK	LOC	OAL	ITEM#	LIST PRICE
1/8	1/8	3/4	2-1/4	TC63508	50.62
3/16	3/16	3/4	2-1/2	TC63512	58.51
1/4	1/4	1-1/4	3	TC63516	79.74
5/16	5/16	1-3/8	3	TC63520	108.48
3/8	3/8	1-1/2	4	TC63524	129.41
1/2	1/2	2	4	TC63532	181.79
5/8	5/8	2-3/8	5	TC63540	395.63
3/4	3/4	2-1/2	5	TC63548	427.57
1	1	2-1/4	5	TC63564	673.28

3 FLUTE - LONG LENGTH CORNER RADIUS - 45° HELIX



SERIES 665 ZRN COATED

DIA	SHANK	LOC	OAL	RAD	ITEM#	LIST PRICE
1/8	1/8	3/4	2-1/4	0.010	TC66508	60.88
3/16	3/16	3/4	2-1/2	0.010	TC66512	70.21
1/4	1/4	1-1/4	3	0.020	TC66516	89.04
5/16	5/16	1-3/8	3	0.020	TC66520	121.10
3/8	3/8	1-1/2	4	0.020	TC66524	144.51
1/2	1/2	2	4	0.040	TC66532	202.98
5/8	5/8	2-3/8	5	0.040	TC66540	422.50
3/4	3/4	2-1/2	5	0.040	TC66548	456.62
1	1	2-1/4	5	0.040	TC66564	719.06

These 3 flute end mills are designed specifically for high speed machining in Aluminum. This tool will plunge, slot and profile in all non-ferrous materials. Our ZrN coating allows for higher speed rates and prolonged tool life and does not have an affinity for Aluminum.

WORKS WELL IN ALL NON-FERROUS MATERIALS APPLICATIONS

For coating information see page 8. For technical information, please see pages 86-87, 91-93.

TOLERANCES	DIAMETER	SHANK	RADIUS
1/8" - 1/2"	+0.00, -.002	-.0001, -.0004 ISO H6	+0.01, -.001
5/8" - 1"	+0.00, -.003	-.0001, -.0004 ISO H6	+0.01, -.001



GENERAL PURPOSE SOLID CARBIDE ROUGHING END MILLS

YOUR #1 SOURCE FOR AMERICAN-MADE PREMIUM QUALITY CUTTING TOOLS

4 FLUTE - STUB LENGTH - FINE PITCH - 30° HELIX



SERIES 293
ALTiN COATED

DIA	SHANK	LOC	OAL	ITEM#	LIST PRICE
1/4	1/4	3/8	2	TC29316	62.76
5/16	5/16	1/2	2	TC29320	88.13
3/8	3/8	9/16	2	TC29324	102.79
1/2	1/2	5/8	2-1/2	TC29332	128.47
5/8	5/8	3/4	3	TC29340	277.56
3/4	3/4	1	3	TC29348	333.12



ALTiN coating extends tool life and improves the overall tool performance

Our fine pitch rougher is designed to remove maximum material with minimum vibration or chatter, while milling faster than conventional finishing end mills. Excellent for:

HARDENED STEELS • TITANIUM • INCONEL • SPACE AGE MATERIALS

For coating information see page 8. For technical information, please see pages 84, 91-93.

TOLERANCES	DIAMETER	SHANK
1/4" - 1/2"	+0.00, -0.002	-0.0001, -.0004 ISO H6
5/8" - 3/4"	+0.00, -0.003	-0.0001, -.0004 ISO H6

GENERAL PURPOSE SOLID CARBIDE ROUGHING END MILLS



YOUR #1 SOURCE FOR AMERICAN-MADE PREMIUM QUALITY CUTTING TOOLS

4 FLUTE - REGULAR LENGTH - FINE PITCH - 30° HELIX



SERIES 295
ALTiN COATED

DIA	SHANK	LOC	OAL	ITEM#	LIST PRICE
1/4	1/4	3/4	2-1/2	TC29516	70.39
5/16	5/16	13/16	2-1/2	TC29520	97.92
3/8	3/8	7/8	2-1/2	TC29524	114.21
1/2	1/2	1-1/4	3	TC29532	144.12
5/8	5/8	1-5/8	3-1/2	TC29540	308.39
3/4	3/4	1-5/8	4	TC29548	373.65
1	1	2	4	TC29564	687.25

4 FLUTE - LONG LENGTH - FINE PITCH - 30° HELIX



SERIES 296
ALTiN COATED

DIA	SHANK	LOC	OAL	ITEM#	LIST PRICE
1/4	1/4	1-1/2	4	TC29616	100.80
5/16	5/16	1-1/2	4	TC29620	129.25
3/8	3/8	1-3/4	4	TC29624	161.59
1/2	1/2	2	4	TC29632	186.75
5/8	5/8	2-1/2	5	TC29640	439.35
3/4	3/4	2-1/2	5	TC29648	527.71
1	1	2-1/2	5	TC29664	900.46

Our fine pitch rougher is designed to remove maximum material with minimum vibration or chatter, while milling faster than conventional finishing end mills. Excellent for:

HARDENED STEELS • TITANIUM • INCONEL • SPACE AGE MATERIALS

For coating information see page 8. For technical information, please see pages 84, 91-93.

TOLERANCES	DIAMETER	SHANK
1/4" - 1/2"	+0.00, -0.002	-0.0001, -.0004 ISO H6
5/8" - 3/4"	+0.00, -0.003	-0.0001, -.0004 ISO H6



GENERAL PURPOSE SOLID CARBIDE ROUGHING END MILLS

YOUR #1 SOURCE FOR AMERICAN-MADE PREMIUM QUALITY CUTTING TOOLS

4 FLUTE - REGULAR LENGTH - FINE PITCH - BALL NOSE - 30° HELIX



SERIES 299
ALTIN COATED

DIA	SHANK	LOC	OAL	ITEM#	LIST PRICE
1/4	1/4	3/4	2-1/2	TC29916	88.20
5/16	5/16	7/8	2-1/2	TC29920	113.39
3/8	3/8	1	2-1/2	TC29924	144.89
1/2	1/2	1-1/4	3	TC29932	199.07
5/8	5/8	1-5/8	3-1/2	TC29940	347.74
3/4	3/4	1-5/8	4	TC29948	485.07
1	1	2	4	TC29964	787.46



"Order today, we'll ship today" Same day shipping until 6pm EST

Our fine pitch rougher is designed to remove maximum material with minimum vibration or chatter, while milling faster than conventional finishing end mills. Excellent for:

HARDENED STEELS • TITANIUM • INCONEL • SPACE AGE MATERIALS

For coating information see page 8. For technical information, please see pages 84, 91-93.

TOLERANCES	DIAMETER	SHANK	RADIUS
1/4" - 1/2"	+ .000, -.002	-.0001, -.0004 ISO H6	+ .001, -.001
5/8" - 3/4"	+ .000, -.003	-.0001, -.0004 ISO H6	+ .001, -.001

GENERAL PURPOSE SOLID CARBIDE ROUGHER - FINISHER END MILLS



YOUR #1 SOURCE FOR AMERICAN-MADE PREMIUM QUALITY CUTTING TOOLS

MILLING

4 FLUTE - REGULAR LENGTH  CORNER RADIUS - 40° HELIX



SERIES 298
ALTiN COATED

DIA	SHANK	LOC	OAL	RAD	ITEM#	LIST PRICE
1/4	1/4	3/4	2-1/2	0.020	TC29816	121.94
5/16	5/16	13/16	2-1/2	0.020	TC29820	132.05
3/8	3/8	7/8	2-1/2	0.020	TC29824	143.50
1/2	1/2	1-1/4	3	0.040	TC29832	165.89
* 5/8	5/8	1-5/8	3-1/2	0.040	TC29840	330.28
* 3/4	3/4	1-5/8	4	0.040	TC29848	441.28
* 1	1	1-5/8	4	0.040	TC29864	720.13

* Weldon Flats

ROUGHING END MILLS

4 FLUTE
30° HELIX

4 FLUTE
40° HELIX

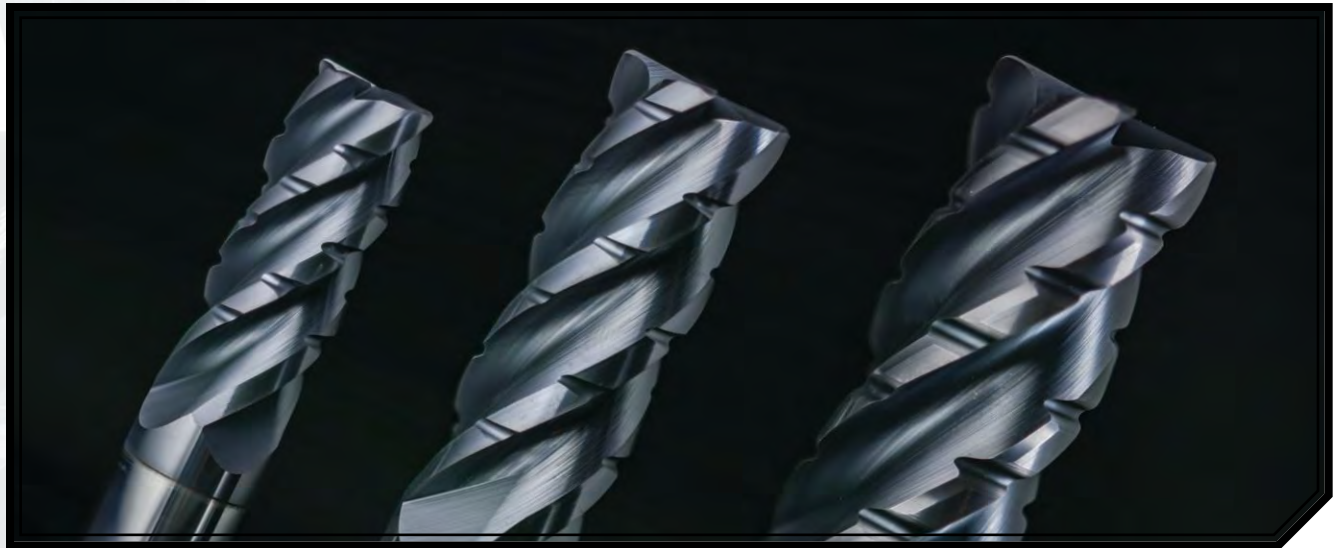

High material removal rate (MRR) with excellent surface finish

The radius chipbreakers in this high performance tool allow for higher feed rates than a finishing end mill yet does not appreciably degrade the finish that the tool produces.

WORKS WELL IN HARD TO MACHINE MATERIALS SUCH AS STAINLESS STEEL AND TITANIUM.

For coating information see page 8. For technical information, please see pages 84, 91-93.

TOLERANCES	DIAMETER	SHANK	RADIUS
ALL SIZES	+0.00, -0.002	-0.0001, -0.0004 ISO H6	+0.001, -0.001

TECHNICAL



GENERAL PURPOSE SOLID CARBIDE END MILLS

YOUR #1 SOURCE FOR AMERICAN-MADE PREMIUM QUALITY CUTTING TOOLS

2 FLUTE - STUB LENGTH - SQUARE END - 30° HELIX



SERIES 102 UNCOATED

DIA	SHANK	LOC	OAL	ITEM#	LIST PRICE
1/64	1/8	0.023	1-1/2	TC10201	27.85
1/32	1/8	1/16	1-1/2	TC10202	17.15
3/64	1/8	3/32	1-1/2	TC10203	17.15
1/16	1/8	1/8	1-1/2	TC10204	12.83
5/64	1/8	1/8	1-1/2	TC10205	21.70
3/32	1/8	3/16	1-1/2	TC10206	12.83
1/8	1/8	1/4	1-1/2	TC10208	12.25
5/32	3/16	5/16	2	TC10210	20.41
3/16	3/16	3/8	2	TC10212	19.16

DIA	SHANK	LOC	OAL	ITEM#	LIST PRICE
7/32	1/4	7/16	2	TC10214	25.75
1/4	1/4	1/2	2	TC10216	22.59
5/16	5/16	1/2	2	TC10220	30.52
3/8	3/8	5/8	2	TC10224	39.39
7/16	7/16	5/8	2-1/2	TC10228	49.14
1/2	1/2	5/8	2-1/2	TC10232	62.07
5/8	5/8	3/4	3	TC10240	131.39
3/4	3/4	1	3	TC10248	183.92

2 FLUTE - STUB LENGTH - SQUARE END - 30° HELIX



SERIES 112 ALTiN COATED

DIA	SHANK	LOC	OAL	ITEM#	LIST PRICE
1/64	1/8	0.023	1-1/2	TC11201	34.80
1/32	1/8	1/16	1-1/2	TC11202	22.23
3/64	1/8	3/32	1-1/2	TC11203	22.23
1/16	1/8	1/8	1-1/2	TC11204	16.75
5/64	1/8	1/8	1-1/2	TC11205	27.13
3/32	1/8	3/16	1-1/2	TC11206	16.75
1/8	1/8	1/4	1-1/2	TC11208	16.00
5/32	3/16	5/16	2	TC11210	25.22
3/16	3/16	3/8	2	TC11212	23.75

DIA	SHANK	LOC	OAL	ITEM#	LIST PRICE
7/32	1/4	7/16	2	TC11214	31.95
1/4	1/4	1/2	2	TC11216	28.07
5/16	5/16	1/2	2	TC11220	39.70
3/8	3/8	5/8	2	TC11224	48.79
7/16	7/16	5/8	2-1/2	TC11228	61.00
1/2	1/2	5/8	2-1/2	TC11232	77.08
5/8	5/8	3/4	3	TC11240	155.23
3/4	3/4	1	3	TC11248	227.59

For coating information see page 8. For technical information, please see pages 88-89, 91-93.

TOLERANCES	DIAMETER	SHANK
1/64" - 1/2"	+0.000, -0.002	-0.0001, -0.0004 ISO H6
5/8" - 1"	+0.000, -0.003	-0.0001, -0.0004 ISO H6

GENERAL PURPOSE SOLID CARBIDE END MILLS



YOUR #1 SOURCE FOR AMERICAN-MADE PREMIUM QUALITY CUTTING TOOLS

MILLING

2 FLUTE - STUB LENGTH - BALL NOSE - 30° HELIX



SERIES 103 UNCOATED

DIA	SHANK	LOC	OAL	ITEM#	LIST PRICE
1/64	1/8	0.023	1-1/2	TC10301	34.75
1/32	1/8	1/16	1-1/2	TC10302	22.32
3/64	1/8	3/32	1-1/2	TC10303	22.32
1/16	1/8	1/8	1-1/2	TC10304	16.80
5/64	1/8	1/8	1-1/2	TC10305	27.18
3/32	1/8	3/16	1-1/2	TC10306	16.80
1/8	1/8	1/4	1-1/2	TC10308	15.91
5/32	3/16	5/16	2	TC10310	26.51
3/16	3/16	3/8	2	TC10312	24.86

DIA	SHANK	LOC	OAL	ITEM#	LIST PRICE
7/32	1/4	7/16	2	TC10314	33.42
1/4	1/4	1/2	2	TC10316	29.27
5/16	5/16	1/2	2	TC10320	39.61
3/8	3/8	5/8	2	TC10324	51.15
7/16	7/16	5/8	2-1/2	TC10328	63.98
1/2	1/2	5/8	2-1/2	TC10332	80.60
5/8	5/8	3/4	3	TC10340	153.94
3/4	3/4	1	3	TC10348	234.05

2 FLUTE - STUB LENGTH - BALL NOSE - 30° HELIX



SERIES 113 ALTIN COATED

DIA	SHANK	LOC	OAL	ITEM#	LIST PRICE
1/64	1/8	0.023	1-1/2	TC11301	43.44
1/32	1/8	1/16	1-1/2	TC11302	28.56
3/64	1/8	3/32	1-1/2	TC11303	28.56
1/16	1/8	1/8	1-1/2	TC11304	21.48
5/64	1/8	1/8	1-1/2	TC11305	33.95
3/32	1/8	3/16	1-1/2	TC11306	21.48
1/8	1/8	1/4	1-1/2	TC11308	20.41
5/32	3/16	5/16	2	TC11310	33.95
3/16	3/16	3/8	2	TC11312	31.81

DIA	SHANK	LOC	OAL	ITEM#	LIST PRICE
7/32	1/4	7/16	2	TC11314	42.77
1/4	1/4	1/2	2	TC11316	37.47
5/16	5/16	1/2	2	TC11320	50.70
3/8	3/8	5/8	2	TC11324	62.38
7/16	7/16	5/8	2-1/2	TC11328	78.02
1/2	1/2	5/8	2-1/2	TC11332	103.15
5/8	5/8	3/4	3	TC11340	188.47
3/4	3/4	1	3	TC11348	299.59

For coating information see page 8. For technical information, please see pages 88-89, 91-93.

TOLERANCES	DIAMETER	SHANK
1/64" - 1/2"	+0.000, -0.002	-0.0001, -0.0004 ISO H6
5/8" - 1"	+0.000, -0.003	-0.0001, -0.0004 ISO H6

SINGLE-END END MILLS

2 FLUTE
30° HELIX

4 FLUTE
30° HELIX

3 FLUTE
45° HELIX

3 FLUTE
60° HELIX

5 FLUTE
45° HELIX

TECHNICAL



GENERAL PURPOSE SOLID CARBIDE END MILLS

YOUR #1 SOURCE FOR AMERICAN-MADE PREMIUM QUALITY CUTTING TOOLS

2 FLUTE - REGULAR LENGTH - SQUARE END - 30° HELIX

SERIES 100
UNCOATED



SERIES 101
ALTIM COATED



SERIES 900
TICN COATED



DIA	SHANK	LOC	OAL	UNCOATED	LIST PRICE	ALTIM	LIST PRICE	TICN	LIST PRICE
1/64	1/8	1/32	1-1/2	TC10001	29.32	TC10101	39.29	TC90001	39.29
1/32	1/8	1/8	1-1/2	TC10002	19.65	TC10102	26.55	TC90002	26.55
3/64	1/8	1/8	1-1/2	TC10003	16.79	TC10103	22.62	TC90003	22.62
1/16	1/8	1/4	1-1/2	TC10004	16.75	TC10104	19.23	TC90004	19.23
5/64	1/8	1/4	1-1/2	TC10005	17.29	TC10105	23.33	TC90005	23.33
3/32	1/8	3/8	1-1/2	TC10006	15.22	TC10106	19.23	TC90006	19.23
7/64	1/8	3/8	1-1/2	TC10007	15.88	TC10107	21.42	TC90007	21.42
1/8	1/8	1/2	1-1/2	TC10008	14.60	TC10108	17.87	TC90008	17.87
9/64	3/16	9/16	2	TC10009	21.38	TC10109	28.87	TC90009	28.87
5/32	3/16	9/16	2	TC10010	21.51	TC10110	24.94	TC90010	24.94
11/64	3/16	5/8	2	TC10011	20.43	TC10111	27.63	TC90011	27.63
3/16	3/16	5/8	2	TC10012	19.89	TC10112	24.94	TC90012	24.94
13/64	1/4	5/8	2-1/2	TC10013	29.03	TC10113	38.05	TC90013	38.05
7/32	1/4	5/8	2-1/2	TC10014	29.65	TC10114	34.45	TC90014	34.45
15/64	1/4	3/4	2-1/2	TC10015	33.50	TC10115	43.18	TC90015	43.18
1/4	1/4	3/4	2-1/2	TC10016	24.57	TC10116	34.45	TC90016	34.45
17/64	5/16	3/4	2-1/2	TC10017	44.30	TC10117	56.91	TC90017	56.91
9/32	5/16	3/4	2-1/2	TC10018	44.30	TC10118	56.91	TC90018	56.91
19/64	5/16	13/16	2-1/2	TC10019	44.30	TC10119	56.91	TC90019	56.91
5/16	5/16	13/16	2-1/2	TC10020	31.97	TC10120	41.24	TC90020	41.24
21/64	3/8	1	2-1/2	TC10021	49.67	TC10121	63.86	TC90021	63.86
11/32	3/8	1	2-1/2	TC10022	49.67	TC10122	63.86	TC90022	63.86
23/64	3/8	1	2-1/2	TC10023	49.67	TC10123	63.86	TC90023	63.86
3/8	3/8	1	2-1/2	TC10024	38.13	TC10124	47.15	TC90024	47.15
25/64	7/16	1	2-3/4	TC10025	65.02	TC10125	83.92	TC90025	83.92
13/32	7/16	1	2-3/4	TC10026	65.02	TC10126	83.92	TC90026	83.92
27/64	7/16	1	2-3/4	TC10027	67.13	TC10127	86.69	TC90027	86.69
7/16	7/16	1	2-3/4	TC10028	58.52	TC10128	72.05	TC90028	72.05
29/64	1/2	1	3	TC10029	96.62	TC10129	123.66	TC90029	123.66
15/32	1/2	1	3	TC10030	96.62	TC10130	123.66	TC90030	123.66
31/64	1/2	1	3	TC10031	96.62	TC10131	123.66	TC90031	123.66
1/2	1/2	1	3	TC10032	70.27	TC10132	87.68	TC90032	87.68
9/16	9/16	1-1/4	3-1/2	TC10036	132.80	TC10136	175.36	TC90036	175.36
5/8	5/8	1-1/4	3-1/2	TC10040	134.33	TC10140	171.27	TC90040	171.27
3/4	3/4	1-1/2	4	TC10048	188.68	TC10148	243.03	TC90048	243.03
7/8	7/8	1-1/2	4	TC10056	345.10	TC10156	436.79	TC90056	436.79
1	1	1-1/2	4	TC10064	308.66	TC10164	394.82	TC90064	394.82

For coating information see page 8. For technical information, please see pages 88-89, 91-93.

TOLERANCES	DIAMETER	SHANK
1/64" - 7/64"	+0.000, -0.001	-0.0001, -.0004 ISO H6
1/8" - 1/2"	+0.000, -0.002	-0.0001, -.0004 ISO H6
9/16" - 1"	+0.000, -0.003	-0.0001, -.0004 ISO H6

GENERAL PURPOSE SOLID CARBIDE END MILLS



YOUR #1 SOURCE FOR AMERICAN-MADE PREMIUM QUALITY CUTTING TOOLS

MILLING

2 FLUTE - LONG LENGTH - SQUARE END - 30° HELIX

SERIES 150
UNCOATED



SERIES 151
ALTiN COATED



SERIES 950
TiCN COATED



DIA	SHANK	LOC	OAL	UNCOATED	LIST PRICE	ALTiN	LIST PRICE	TiCN	LIST PRICE
1/8	1/8	3/4	2-1/4	TC15008	23.57	TC15108	30.32	TC95008	30.32
3/16	3/16	3/4	2-1/2	TC15012	27.67	TC15112	35.57	TC95012	35.57
1/4	1/4	1-1/8	3	TC15016	39.62	TC15116	51.08	TC95016	51.08
1/4	1/4	1	4	TC15017	41.73	TC15117	53.81	TC95017	53.81
5/16	5/16	1-1/8	3	TC15020	44.71	TC15120	60.34	TC95020	60.34
3/8	3/8	1-1/8	3	TC15024	51.29	TC15124	69.24	TC95024	69.24
3/8	3/8	1	4	TC15025	59.89	TC15125	77.05	TC95025	77.05
7/16	7/16	2	4	TC15028	80.82	TC15128	105.09	TC95028	105.09
1/2	1/2	1	4	TC15032	87.52	TC15132	112.70	TC95032	112.70
1/2	1/2	2	4	TC15033	92.69	TC15133	118.95	TC95033	118.95
5/8	5/8	2-1/4	5	TC15040	207.17	TC15140	256.39	TC95040	256.39
3/4	3/4	2-1/4	5	TC15048	286.12	TC15148	369.17	TC95048	369.17
7/8	7/8	2-1/4	5	TC15056	542.30	TC15156	640.90	TC95056	640.90
1	1	2-1/4	5	TC15064	391.71	TC15164	505.58	TC95064	505.58

2 FLUTE - EXTRA LONG LENGTH - SQUARE END - 30° HELIX

SERIES 170
UNCOATED



SERIES 171
ALTiN COATED



SERIES 970
TiCN COATED



DIA	SHANK	LOC	OAL	UNCOATED	LIST PRICE	ALTiN	LIST PRICE	TiCN	LIST PRICE
1/8	1/8	1	3	TC17008	26.35	TC17108	35.57	TC97008	35.57
3/16	3/16	1-1/8	3	TC17012	28.66	TC17112	36.81	TC97012	36.81
1/4	1/4	1-1/2	4	TC17016	42.92	TC17116	55.28	TC97016	55.28
1/4	1/4	1-1/2	6	TC17017	54.76	TC17117	70.43	TC97017	70.43
5/16	5/16	1-5/8	4	TC17020	55.26	TC17120	71.30	TC97020	71.30
3/8	3/8	1-3/4	4	TC17024	62.74	TC17124	80.36	TC97024	80.36
3/8	3/8	1-1/2	6	TC17025	95.00	TC17125	122.46	TC97025	122.46
7/16	7/16	3	6	TC17028	127.97	TC17128	164.07	TC97028	164.07
1/2	1/2	1-1/2	6	TC17032	144.59	TC17132	179.46	TC97032	179.46
1/2	1/2	3	6	TC17033	151.79	TC17133	186.65	TC97033	186.65
5/8	5/8	3	6	TC17040	223.55	TC17140	274.83	TC97040	274.83
3/4	3/4	3	6	TC17048	332.24	TC17148	408.13	TC97048	408.13
7/8	7/8	3	6	TC17056	591.60	TC17156	739.54	TC97056	739.54
1	1	3	6	TC17064	564.02	TC17164	693.10	TC97064	693.10

For coating information see page 8. For technical information, please see pages 88-89, 91-93.

TOLERANCES	DIAMETER	SHANK
1/8" - 1/2"	+0.00, -0.002	-0.0001, -.0004 ISO H6
5/8" - 1"	+0.00, -0.003	-0.0001, -.0004 ISO H6

SINGLE-END END MILLS

2 FLUTE
30° HELIX

4 FLUTE
30° HELIX

3 FLUTE
45° HELIX

3 FLUTE
60° HELIX

5 FLUTE
45° HELIX

TECHNICAL



GENERAL PURPOSE SOLID CARBIDE END MILLS

YOUR #1 SOURCE FOR AMERICAN-MADE PREMIUM QUALITY CUTTING TOOLS

2 FLUTE - REGULAR LENGTH - BALL NOSE - 30° HELIX

SERIES 110
UNCOATED



SERIES 111
ALTIN COATED



SERIES 910
TICN COATED



DIA	SHANK	LOC	OAL	UNCOATED	LIST PRICE	ALTIN	LIST PRICE	TICN	LIST PRICE
1/64	1/8	1/32	1-1/2	TC11001	32.84	TC11101	44.01	TC91001	44.01
1/32	1/8	1/8	1-1/2	TC11002	21.01	TC11102	27.30	TC91002	27.30
3/64	1/8	1/8	1-1/2	TC11003	21.01	TC11103	27.30	TC91003	27.30
1/16	1/8	1/4	1-1/2	TC11004	19.48	TC11104	26.30	TC91004	26.30
5/64	1/8	1/4	1-1/2	TC11005	19.48	TC11105	26.30	TC91005	26.30
3/32	1/8	3/8	1-1/2	TC11006	20.43	TC11106	27.63	TC91006	27.63
7/64	1/8	3/8	1-1/2	TC11007	20.43	TC11107	27.63	TC91007	27.63
1/8	1/8	1/2	1-1/2	TC11008	18.74	TC11108	25.31	TC91008	25.31
9/64	3/16	9/16	2	TC11009	27.46	TC11109	37.10	TC91009	37.10
5/32	3/16	9/16	2	TC11010	27.46	TC11110	37.10	TC91010	37.10
11/64	3/16	5/8	2	TC11011	27.46	TC11111	37.10	TC91011	37.10
3/16	3/16	5/8	2	TC11012	24.69	TC11112	33.34	TC91012	33.34
13/64	1/4	5/8	2-1/2	TC11013	35.94	TC11113	45.37	TC91013	45.37
7/32	1/4	5/8	2-1/2	TC11014	35.94	TC11114	45.37	TC91014	45.37
15/64	1/4	3/4	2-1/2	TC11015	35.94	TC11115	45.37	TC91015	45.37
1/4	1/4	3/4	2-1/2	TC11016	34.73	TC11116	43.22	TC91016	43.22
17/64	5/16	3/4	2-1/2	TC11017	45.37	TC11117	58.36	TC91017	58.36
9/32	5/16	3/4	2-1/2	TC11018	45.45	TC11118	58.44	TC91018	58.44
19/64	5/16	13/16	2-1/2	TC11019	49.38	TC11119	64.81	TC91019	64.81
5/16	5/16	13/16	2-1/2	TC11020	41.81	TC11120	53.77	TC91020	53.77
21/64	3/8	1	2-1/2	TC11021	57.45	TC11121	77.55	TC91021	77.55
11/32	3/8	1	2-1/2	TC11022	60.30	TC11122	77.55	TC91022	77.55
23/64	3/8	1	2-1/2	TC11023	57.45	TC11123	77.55	TC91023	77.55
3/8	3/8	1	2-1/2	TC11024	44.75	TC11124	63.24	TC91024	63.24
25/64	7/16	1	2-3/4	TC11025	77.80	TC11125	100.25	TC91025	100.25
13/32	7/16	1	2-3/4	TC11026	77.80	TC11126	100.25	TC91026	100.25
27/64	7/16	1	2-3/4	TC11027	77.80	TC11127	100.25	TC91027	100.25
7/16	7/16	1	2-3/4	TC11028	66.22	TC11128	85.37	TC91028	85.37
29/64	1/2	1	3	TC11029	102.57	TC11129	132.27	TC91029	132.27
15/32	1/2	1	3	TC11030	102.57	TC11130	132.27	TC91030	132.27
31/64	1/2	1	3	TC11031	102.57	TC11131	132.27	TC91031	132.27
1/2	1/2	1	3	TC11032	90.82	TC11132	117.05	TC91032	117.05
9/16	9/16	1-1/4	3-1/2	TC11036	138.43	TC11136	170.36	TC91036	170.36
5/8	5/8	1-1/4	3-1/2	TC11040	146.87	TC11140	189.30	TC91040	189.30
3/4	3/4	1-1/2	4	TC11048	216.39	TC11148	281.99	TC91048	281.99
7/8	7/8	1-1/2	4	TC11056	419.05	TC11156	532.46	TC91056	532.46
1	1	1-1/2	4	TC11064	386.50	TC11164	498.05	TC91064	498.05

For coating information see page 8. For technical information, please see pages 88-89, 91-93.

TOLERANCES	DIAMETER	SHANK	RADIUS
1/64" - 7/64"	+0.000, -0.001	-0.0001, -0.0004 ISO H6	
1/8" - 1/2"	+0.000, -0.002	-0.0001, -0.0004 ISO H6	
9/16" - 1"	+0.000, -0.003	-0.0001, -0.0004 ISO H6	

GENERAL PURPOSE SOLID CARBIDE END MILLS



YOUR #1 SOURCE FOR AMERICAN-MADE PREMIUM QUALITY CUTTING TOOLS

MILLING

2 FLUTE - LONG LENGTH - BALL NOSE - 30° HELIX

SERIES 160
UNCOATED



SERIES 161
ALTiN COATED



SERIES 960
TiCN COATED



DIA	SHANK	LOC	OAL	UNCOATED	LIST PRICE	ALTiN	LIST PRICE	TiCN	LIST PRICE
1/8	1/8	3/4	2-1/4	TC16008	28.04	TC16108	36.07	TC96008	36.07
3/16	3/16	3/4	2-1/2	TC16012	32.26	TC16112	41.44	TC96012	41.44
1/4	1/4	1-1/8	3	TC16016	45.37	TC16116	58.40	TC96016	58.40
1/4	1/4	1	4	TC16017	50.09	TC16117	64.56	TC96017	64.56
5/16	5/16	1-1/8	3	TC16020	53.35	TC16120	72.01	TC96020	72.01
3/8	3/8	1-1/8	3	TC16024	61.58	TC16124	83.17	TC96024	83.17
3/8	3/8	1	4	TC16025	75.44	TC16125	98.02	TC96025	98.02
7/16	7/16	2	4	TC16028	103.15	TC16128	134.13	TC96028	134.13
1/2	1/2	1	4	TC16032	105.63	TC16132	134.33	TC96032	134.33
1/2	1/2	2	4	TC16033	106.67	TC16133	135.37	TC96033	135.37
5/8	5/8	2-1/4	5	TC16040	243.03	TC16140	308.66	TC96040	308.66
3/4	3/4	2-1/4	5	TC16048	338.40	TC16148	428.65	TC96048	428.65
7/8	7/8	2-1/4	5	TC16056	581.76	TC16156	714.89	TC96056	714.89
1	1	2-1/4	5	TC16064	669.61	TC16164	823.46	TC96064	823.46

2 FLUTE - EXTRA LONG LENGTH - BALL NOSE - 30° HELIX

SERIES 180
UNCOATED



SERIES 181
ALTiN COATED



SERIES 980
TiCN COATED



DIA	SHANK	LOC	OAL	UNCOATED	LIST PRICE	ALTiN	LIST PRICE	TiCN	LIST PRICE
1/8	1/8	1	3	TC18008	31.39	TC18108	42.35	TC98008	42.35
3/16	3/16	1-1/8	3	TC18012	37.62	TC18112	44.21	TC98012	44.21
1/4	1/4	1-1/2	4	TC18016	55.16	TC18116	61.38	TC98016	61.38
1/4	1/4	1-1/2	6	TC18017	63.39	TC18117	72.09	TC98017	72.09
5/16	5/16	1-5/8	4	TC18020	66.67	TC18120	86.07	TC98020	86.07
3/8	3/8	1-3/4	4	TC18024	71.76	TC18124	91.73	TC98024	91.73
3/8	3/8	1-1/2	6	TC18025	101.12	TC18125	124.12	TC98025	124.12
7/16	7/16	3	6	TC18028	151.79	TC18128	194.84	TC98028	194.84
1/2	1/2	1-1/2	6	TC18032	161.01	TC18132	206.13	TC98032	206.13
1/2	1/2	3	6	TC18033	162.00	TC18133	207.17	TC98033	207.17
5/8	5/8	3	6	TC18040	255.35	TC18140	313.79	TC98040	313.79
3/4	3/4	3	6	TC18048	362.10	TC18148	488.82	TC98048	488.82
7/8	7/8	3	6	TC18056	640.90	TC18156	798.69	TC98056	798.69
1	1	3	6	TC18064	646.03	TC18164	831.73	TC98064	831.73

For coating information see page 8. For technical information, please see pages 88-89, 91-93.

TOLERANCES	DIAMETER	SHANK
1/8" - 1/2"	+0.00, -0.002	-0.001, -.0004 ISO H6
5/8" - 1"	+0.00, -0.003	-0.001, -.0004 ISO H6

SINGLE-END END MILLS

2 FLUTE
30° HELIX

4 FLUTE
30° HELIX

3 FLUTE
45° HELIX

3 FLUTE
60° HELIX

5 FLUTE
45° HELIX

TECHNICAL



GENERAL PURPOSE SOLID CARBIDE END MILLS

YOUR #1 SOURCE FOR AMERICAN-MADE PREMIUM QUALITY CUTTING TOOLS

4 FLUTE - STUB LENGTH - SQUARE END - 30° HELIX



SERIES 106 UNCOATED

DIA	SHANK	LOC	OAL	ITEM#	LIST PRICE	DIA	SHANK	LOC	OAL	ITEM#	LIST PRICE
1/64	1/8	0.023	1-1/2	TC10601	27.85	7/32	1/4	7/16	2	TC10614	25.75
1/32	1/8	1/16	1-1/2	TC10602	17.15	1/4	1/4	1/2	2	TC10616	22.59
3/64	1/8	3/32	1-1/2	TC10603	17.15	5/16	5/16	1/2	2	TC10620	30.52
1/16	1/8	1/8	1-1/2	TC10604	12.83	3/8	3/8	5/8	2	TC10624	39.39
5/64	1/8	1/8	1-1/2	TC10605	21.70	7/16	7/16	5/8	2-1/2	TC10628	49.14
3/32	1/8	3/16	1-1/2	TC10606	12.83	1/2	1/2	5/8	2-1/2	TC10632	62.07
1/8	1/8	1/4	1-1/2	TC10608	12.25	5/8	5/8	3/4	3	TC10640	131.39
5/32	3/16	5/16	2	TC10610	20.41	3/4	3/4	1	3	TC10648	183.92
3/16	3/16	3/8	2	TC10612	19.16	1	1	1-1/4	3-1/2	TC10664	303.10

4 FLUTE - STUB LENGTH - SQUARE END - 30° HELIX



SERIES 109 ALUMIN COATED

DIA	SHANK	LOC	OAL	ITEM#	LIST PRICE	DIA	SHANK	LOC	OAL	ITEM#	LIST PRICE
1/64	1/8	0.023	1-1/2	TC10901	34.80	7/32	1/4	7/16	2	TC10914	31.95
1/32	1/8	1/16	1-1/2	TC10902	22.23	1/4	1/4	1/2	2	TC10916	28.07
3/64	1/8	3/32	1-1/2	TC10903	22.23	5/16	5/16	1/2	2	TC10920	39.70
1/16	1/8	1/8	1-1/2	TC10904	16.75	3/8	3/8	5/8	2	TC10924	48.79
5/64	1/8	1/8	1-1/2	TC10905	27.13	7/16	7/16	5/8	2-1/2	TC10928	61.00
3/32	1/8	3/16	1-1/2	TC10906	16.75	1/2	1/2	5/8	2-1/2	TC10932	77.30
1/8	1/8	1/4	1-1/2	TC10908	16.00	5/8	5/8	3/4	3	TC10940	155.28
5/32	3/16	5/16	2	TC10910	25.22	3/4	3/4	1	3	TC10948	227.59
3/16	3/16	3/8	2	TC10912	23.75	1	1	1-1/4	3-1/2	TC10964	377.98

For coating information see page 8. For technical information, please see pages 88-89, 91-93.

TOLERANCES	DIAMETER	SHANK
1/64" - 1/2"	+0.000, -0.002	-0.0001, -.0004 ISO H6
5/8" - 1"	+0.000, -0.003	-0.0001, -.0004 ISO H6

GENERAL PURPOSE SOLID CARBIDE END MILLS



MILLING

YOUR #1 SOURCE FOR AMERICAN-MADE PREMIUM QUALITY CUTTING TOOLS

4 FLUTE - STUB LENGTH - BALL NOSE - 30° HELIX



SERIES 107 UNCOATED

DIA	SHANK	LOC	OAL	ITEM#	LIST PRICE	DIA	SHANK	LOC	OAL	ITEM#	LIST PRICE
1/64	1/8	0.023	1-1/2	TC10701	34.75	7/32	1/4	7/16	2	TC10714	33.42
1/32	1/8	1/16	1-1/2	TC10702	22.32	1/4	1/4	1/2	2	TC10716	31.77
3/64	1/8	3/32	1-1/2	TC10703	22.32	5/16	5/16	1/2	2	TC10720	39.61
1/16	1/8	1/8	1-1/2	TC10704	16.80	3/8	3/8	5/8	2	TC10724	51.15
5/64	1/8	1/8	1-1/2	TC10705	27.18	7/16	7/16	5/8	2-1/2	TC10728	63.98
3/32	1/8	3/16	1-1/2	TC10706	16.80	1/2	1/2	5/8	2-1/2	TC10732	80.60
1/8	1/8	1/4	1-1/2	TC10708	15.91	5/8	5/8	3/4	3	TC10740	153.94
5/32	3/16	5/16	2	TC10710	26.51	3/4	3/4	1	3	TC10748	234.05
3/16	3/16	3/8	2	TC10712	24.86	1	1	1-1/4	3-1/2	TC10764	362.53

4 FLUTE - STUB LENGTH - BALL NOSE - 30° HELIX



SERIES 117 ALTIN COATED

DIA	SHANK	LOC	OAL	ITEM#	LIST PRICE	DIA	SHANK	LOC	OAL	ITEM#	LIST PRICE
1/64	1/8	0.023	1-1/2	TC11701	43.44	7/32	1/4	7/16	2	TC11714	42.77
1/32	1/8	1/16	1-1/2	TC11702	28.56	1/4	1/4	1/2	2	TC11716	41.22
3/64	1/8	3/32	1-1/2	TC11703	28.56	5/16	5/16	1/2	2	TC11720	50.70
1/16	1/8	1/8	1-1/2	TC11704	21.48	3/8	3/8	5/8	2	TC11724	62.38
5/64	1/8	1/8	1-1/2	TC11705	33.95	7/16	7/16	5/8	2-1/2	TC11728	78.02
3/32	1/8	3/16	1-1/2	TC11706	21.48	1/2	1/2	5/8	2-1/2	TC11732	103.15
1/8	1/8	1/4	1-1/2	TC11708	20.41	5/8	5/8	3/4	3	TC11740	188.47
5/32	3/16	5/16	2	TC11710	33.95	3/4	3/4	1	3	TC11748	299.59
3/16	3/16	3/8	2	TC11712	31.81	1	1	1-1/4	3-1/2	TC11764	445.73

For coating information see page 8. For technical information, please see pages 88-89, 91-93.

TOLERANCES	DIAMETER	SHANK
1/64" - 1/2"	+ .000, -.002	-.0001, -.0004 ISO H6
5/8" - 1"	+ .000, -.003	-.0001, -.0004 ISO H6

SINGLE-END END MILLS

2 FLUTE
30° HELIX

4 FLUTE
30° HELIX

3 FLUTE
45° HELIX

3 FLUTE
60° HELIX

5 FLUTE
45° HELIX

TECHNICAL



GENERAL PURPOSE SOLID CARBIDE END MILLS

YOUR #1 SOURCE FOR AMERICAN-MADE PREMIUM QUALITY CUTTING TOOLS

4 FLUTE - REGULAR LENGTH - SQUARE END - 30° HELIX

SERIES 105
UNCOATED



SERIES 995
ALTIN COATED



SERIES 905
TICN COATED



DIA	SHANK	LOC	OAL	UNCOATED	LIST PRICE	ALTIN	LIST PRICE	TICN	LIST PRICE
1/64	1/8	1/32	1-1/2	TC10501	29.32	TC99501	39.29	TC90501	39.29
1/32	1/8	1/8	1-1/2	TC10502	19.65	TC99502	26.55	TC90502	26.55
3/64	1/8	1/8	1-1/2	TC10503	16.79	TC99503	22.62	TC90503	22.62
1/16	1/8	1/4	1-1/2	TC10504	16.75	TC99504	19.23	TC90504	19.23
5/64	1/8	1/4	1-1/2	TC10505	17.29	TC99505	23.33	TC90505	23.33
3/32	1/8	3/8	1-1/2	TC10506	15.22	TC99506	19.23	TC90506	19.23
7/64	1/8	3/8	1-1/2	TC10507	15.88	TC99507	21.42	TC90507	21.42
1/8	1/8	1/2	1-1/2	TC10508	14.60	TC99508	17.87	TC90508	17.87
9/64	3/16	9/16	2	TC10509	21.38	TC99509	28.87	TC90509	28.87
5/32	3/16	9/16	2	TC10510	21.51	TC99510	24.94	TC90510	24.94
11/64	3/16	5/8	2	TC10511	20.43	TC99511	27.63	TC90511	27.63
3/16	3/16	5/8	2	TC10512	19.89	TC99512	24.94	TC90512	24.94
13/64	1/4	5/8	2-1/2	TC10513	29.03	TC99513	38.05	TC90513	38.05
7/32	1/4	5/8	2-1/2	TC10514	29.65	TC99514	34.45	TC90514	34.45
15/64	1/4	3/4	2-1/2	TC10515	33.50	TC99515	43.18	TC90515	43.18
1/4	1/4	3/4	2-1/2	TC10516	24.57	TC99516	34.45	TC90516	34.45
17/64	5/16	3/4	2-1/2	TC10517	44.30	TC99517	56.91	TC90517	56.91
9/32	5/16	3/4	2-1/2	TC10518	44.30	TC99518	56.91	TC90518	56.91
19/64	5/16	13/16	2-1/2	TC10519	44.30	TC99519	56.91	TC90519	56.91
5/16	5/16	13/16	2-1/2	TC10520	31.97	TC99520	41.24	TC90520	41.24
21/64	3/8	1	2-1/2	TC10521	49.67	TC99521	63.86	TC90521	63.86
11/32	3/8	1	2-1/2	TC10522	49.67	TC99522	63.86	TC90522	63.86
23/64	3/8	1	2-1/2	TC10523	49.67	TC99523	63.86	TC90523	63.86
3/8	3/8	1	2-1/2	TC10524	38.13	TC99524	47.15	TC90524	47.15
25/64	7/16	1	2-3/4	TC10525	65.02	TC99525	83.92	TC90525	83.92
13/32	7/16	1	2-3/4	TC10526	65.02	TC99526	83.92	TC90526	83.92
27/64	7/16	1	2-3/4	TC10527	67.13	TC99527	86.69	TC90527	86.69
7/16	7/16	1	2-3/4	TC10528	58.52	TC99528	72.05	TC90528	72.05
29/64	1/2	1	3	TC10529	96.62	TC99529	123.66	TC90529	123.66
15/32	1/2	1	3	TC10530	96.62	TC99530	123.66	TC90530	123.66
31/64	1/2	1	3	TC10531	96.62	TC99531	123.66	TC90531	123.66
1/2	1/2	1	3	TC10532	70.27	TC99532	87.68	TC90532	87.68
1/2	1/2	1-1/4	3	TC10533	70.27	TC99533	87.68	TC90533	87.68
9/16	9/16	1-1/4	3-1/2	TC10536	132.80	TC99536	175.36	TC90536	175.36
5/8	5/8	1-1/4	3-1/2	TC10540	134.33	TC99540	171.27	TC90540	171.27
3/4	3/4	1-1/2	4	TC10548	188.68	TC99548	243.03	TC90548	243.03
7/8	7/8	1-1/2	4	TC10556	345.10	TC99556	436.79	TC90556	436.79
1	1	1-1/2	4	TC10564	317.65	TC99564	406.31	TC90564	406.31
1-1/4	1-1/4	2	4-1/2	TC10580	1084.65	TC99580	1232.55	TC90580	1232.55

For coating information see page 8. For technical information, please see pages 88-89, 91-93.

TOLERANCES	DIAMETER	SHANK
1/64" - 7/64"	+ .000, - .001	-.0001, -.0004 ISO H6
1/8" - 1/2"	+ .000, - .002	-.0001, -.0004 ISO H6
9/16" - 1-1/4"	+ .000, - .003	-.0001, -.0004 ISO H6

GENERAL PURPOSE SOLID CARBIDE END MILLS



YOUR #1 SOURCE FOR AMERICAN-MADE PREMIUM QUALITY CUTTING TOOLS

MILLING

4 FLUTE - LONG LENGTH - SQUARE END - 30° HELIX

SERIES 155
UNCOATED



SERIES 156
ALTiN COATED



SERIES 955
TiCN COATED



DIA	SHANK	LOC	OAL	UNCOATED	LIST PRICE	ALTiN	LIST PRICE	TiCN	LIST PRICE
1/8	1/8	3/4	2-1/4	TC15508	23.57	TC15608	30.32	TC95508	30.32
3/16	3/16	3/4	2-1/2	TC15512	29.58	TC15612	35.57	TC95512	35.57
1/4	1/4	1-1/8	3	TC15516	39.62	TC15616	51.08	TC95516	51.08
1/4	1/4	1	4	TC15517	41.73	TC15617	53.81	TC95517	53.81
5/16	5/16	1-1/8	3	TC15520	44.71	TC15620	60.34	TC95520	60.34
3/8	3/8	1-1/8	3	TC15524	51.29	TC15624	69.24	TC95524	69.24
3/8	3/8	1	4	TC15525	59.89	TC15625	77.05	TC95525	77.05
7/16	7/16	2	4	TC15528	80.82	TC15628	105.09	TC95528	105.09
1/2	1/2	1	4	TC15532	90.07	TC15632	115.99	TC95532	115.99
1/2	1/2	2	4	TC15533	95.39	TC15633	122.41	TC95533	122.41
5/8	5/8	2-1/4	5	TC15540	207.17	TC15640	256.39	TC95540	256.39
3/4	3/4	2-1/4	5	TC15548	286.12	TC15648	346.36	TC95548	346.36
7/8	7/8	2-1/4	5	TC15556	542.30	TC15656	640.90	TC95556	640.90
1	1	2-1/4	5	TC15564	391.71	TC15664	505.58	TC95564	505.58

4 FLUTE - EXTRA LONG LENGTH - SQUARE END - 30° HELIX

SERIES 175
UNCOATED



SERIES 176
ALTiN COATED



SERIES 975
TiCN COATED



DIA	SHANK	LOC	OAL	UNCOATED	LIST PRICE	ALTiN	LIST PRICE	TiCN	LIST PRICE
1/8	1/8	1	3	TC17508	26.35	TC17608	35.57	TC97508	35.57
3/16	3/16	1-1/8	3	TC17512	28.66	TC17612	36.81	TC97512	36.81
1/4	1/4	1-1/2	4	TC17516	40.49	TC17616	52.15	TC97516	52.15
1/4	1/4	1-1/2	6	TC17517	54.76	TC17617	70.43	TC97517	70.43
5/16	5/16	1-5/8	4	TC17520	55.26	TC17620	71.30	TC97520	71.30
3/8	3/8	1-3/4	4	TC17524	62.74	TC17624	80.36	TC97524	80.36
3/8	3/8	1-1/2	6	TC17525	95.00	TC17625	122.46	TC97525	122.46
7/16	7/16	3	6	TC17528	127.97	TC17628	164.07	TC97528	164.07
1/2	1/2	1-1/2	6	TC17532	144.59	TC17632	179.46	TC97532	179.46
1/2	1/2	3	6	TC17533	151.79	TC17633	186.65	TC97533	186.65
5/8	5/8	3	6	TC17540	223.55	TC17640	274.83	TC97540	274.83
3/4	3/4	3	6	TC17548	332.24	TC17648	390.14	TC97548	390.14
3/4	3/4	4	7	TC17549	570.18	TC17649	646.37	TC97549	646.37
7/8	7/8	3	6	TC17556	591.60	TC17656	739.54	TC97556	739.54
1	1	3	6	TC17564	564.02	TC17664	629.64	TC97564	629.64
1	1	4	7	TC17565	739.38	TC17665	907.55	TC97565	907.55

For coating information see page 8. For technical information, please see pages 88-89, 91-93.

TOLERANCES	DIAMETER	SHANK
1/8" - 1/2"	+0.00, -0.02	-0.001, -.0004 ISO H6
5/8" - 1"	+0.00, -0.03	-0.001, -.0004 ISO H6

SINGLE-END END MILLS

2 FLUTE
30° HELIX

4 FLUTE
30° HELIX

3 FLUTE
45° HELIX

3 FLUTE
60° HELIX

5 FLUTE
45° HELIX

TECHNICAL



GENERAL PURPOSE SOLID CARBIDE END MILLS

YOUR #1 SOURCE FOR AMERICAN-MADE PREMIUM QUALITY CUTTING TOOLS

4 FLUTE - REGULAR LENGTH - BALL NOSE - 30° HELIX

SERIES 115
UNCOATED



SERIES 116
ALTiN COATED



SERIES 915
TiCN COATED



DIA	SHANK	LOC	OAL	UNCOATED	LIST PRICE	ALTiN	LIST PRICE	TiCN	LIST PRICE
1/64	1/8	1/32	1-1/2	TC11501	32.84	TC11601	44.01	TC91501	44.01
1/32	1/8	1/8	1-1/2	TC11502	21.01	TC11602	27.30	TC91502	27.30
3/64	1/8	1/8	1-1/2	TC11503	21.01	TC11603	27.30	TC91503	27.30
1/16	1/8	1/4	1-1/2	TC11504	19.48	TC11604	26.30	TC91504	26.30
5/64	1/8	1/4	1-1/2	TC11505	19.48	TC11605	26.30	TC91505	26.30
3/32	1/8	3/8	1-1/2	TC11506	20.43	TC11606	27.63	TC91506	27.63
7/64	1/8	3/8	1-1/2	TC11507	20.43	TC11607	27.63	TC91507	27.63
1/8	1/8	1/2	1-1/2	TC11508	18.74	TC11608	25.31	TC91508	25.31
9/64	3/16	9/16	2	TC11509	27.46	TC11609	37.10	TC91509	37.10
5/32	3/16	9/16	2	TC11510	27.46	TC11610	37.10	TC91510	37.10
11/64	3/16	5/8	2	TC11511	27.46	TC11611	37.10	TC91511	37.10
3/16	3/16	5/8	2	TC11512	24.69	TC11612	33.34	TC91512	33.34
13/64	1/4	5/8	2-1/2	TC11513	35.62	TC11613	45.37	TC91513	45.37
7/32	1/4	5/8	2-1/2	TC11514	35.62	TC11614	45.37	TC91514	45.37
15/64	1/4	3/4	2-1/2	TC11515	35.62	TC11615	45.37	TC91515	45.37
1/4	1/4	3/4	2-1/2	TC11516	33.54	TC11616	43.22	TC91516	43.22
17/64	5/16	3/4	2-1/2	TC11517	45.37	TC11617	58.36	TC91517	58.36
9/32	5/16	3/4	2-1/2	TC11518	45.45	TC11618	58.44	TC91518	58.44
19/64	5/16	13/16	2-1/2	TC11519	49.38	TC11619	64.81	TC91519	64.81
5/16	5/16	13/16	2-1/2	TC11520	41.81	TC11620	53.77	TC91520	53.77
21/64	3/8	1	2-1/2	TC11521	57.45	TC11621	77.55	TC91521	77.55
11/32	3/8	1	2-1/2	TC11522	60.30	TC11622	77.55	TC91522	77.55
23/64	3/8	1	2-1/2	TC11523	57.45	TC11623	77.55	TC91523	77.55
3/8	3/8	1	2-1/2	TC11524	44.75	TC11624	63.24	TC91524	63.24
25/64	7/16	1	2-3/4	TC11525	77.80	TC11625	100.25	TC91525	100.25
13/32	7/16	1	2-3/4	TC11526	77.80	TC11626	100.25	TC91526	100.25
27/64	7/16	1	2-3/4	TC11527	77.80	TC11627	100.25	TC91527	100.25
7/16	7/16	1	2-3/4	TC11528	66.22	TC11628	85.37	TC91528	85.37
29/64	1/2	1	3	TC11529	102.57	TC11629	132.27	TC91529	132.27
15/32	1/2	1	3	TC11530	102.57	TC11630	132.27	TC91530	132.27
31/64	1/2	1	3	TC11531	102.57	TC11631	132.27	TC91531	132.27
1/2	1/2	1	3	TC11532	90.82	TC11632	117.05	TC91532	117.05
9/16	9/16	1-1/4	3-1/2	TC11536	138.43	TC11636	170.36	TC91536	170.36
5/8	5/8	1-1/4	3-1/2	TC11540	146.87	TC11640	189.30	TC91540	189.30
3/4	3/4	1-1/2	4	TC11548	216.39	TC11648	281.99	TC91548	281.99
7/8	7/8	1-1/2	4	TC11556	419.05	TC11656	532.46	TC91556	532.46
1	1	1-1/2	4	TC11564	386.50	TC11664	498.05	TC91564	498.05

For coating information see page 8. For technical information, please see pages 88-89, 91-93.

TOLERANCES	DIAMETER	SHANK
1/64" - 7/64"	+0.00, -0.01	-0.001, -.0004 ISO H6
1/8" - 1/2"	+0.00, -0.02	-0.001, -.0004 ISO H6
9/16" - 1"	+0.00, -0.03	-0.001, -.0004 ISO H6

GENERAL PURPOSE SOLID CARBIDE END MILLS



YOUR #1 SOURCE FOR AMERICAN-MADE PREMIUM QUALITY CUTTING TOOLS

MILLING

4 FLUTE - LONG LENGTH - BALL NOSE - 30° HELIX

SERIES 165
UNCOATED



SERIES 166
ALTiN COATED



SERIES 965
TiCN COATED



DIA	SHANK	LOC	OAL	UNCOATED	LIST PRICE	ALTiN	LIST PRICE	TiCN	LIST PRICE
1/8	1/8	3/4	2-1/4	TC16508	28.04	TC16608	36.07	TC96508	36.07
3/16	3/16	3/4	2-1/2	TC16512	32.26	TC16612	41.44	TC96512	41.44
1/4	1/4	1-1/8	3	TC16516	45.37	TC16616	58.40	TC96516	58.40
1/4	1/4	1	4	TC16517	50.09	TC16617	64.56	TC96517	64.56
5/16	5/16	1-1/8	3	TC16520	53.35	TC16620	72.01	TC96520	72.01
3/8	3/8	1-1/8	3	TC16524	61.58	TC16624	83.17	TC96524	83.17
3/8	3/8	1	4	TC16525	75.44	TC16625	98.02	TC96525	98.02
7/16	7/16	2	4	TC16528	103.15	TC16628	134.13	TC96528	134.13
1/2	1/2	1	4	TC16532	105.63	TC16632	134.33	TC96532	134.33
1/2	1/2	2	4	TC16533	106.67	TC16633	135.37	TC96533	135.37
5/8	5/8	2-1/4	5	TC16540	243.03	TC16640	308.66	TC96540	308.66
3/4	3/4	2-1/4	5	TC16548	338.40	TC16648	428.65	TC96548	428.65
7/8	7/8	2-1/4	5	TC16556	581.76	TC16656	714.89	TC96556	714.89
1	1	2-1/4	5	TC16564	669.61	TC16664	823.46	TC96564	823.46

4 FLUTE - EXTRA LONG LENGTH - BALL NOSE - 30° HELIX

SERIES 185
UNCOATED



SERIES 186
ALTiN COATED



SERIES 985
TiCN COATED



DIA	SHANK	LOC	OAL	UNCOATED	LIST PRICE	ALTiN	LIST PRICE	TiCN	LIST PRICE
1/8	1/8	1	3	TC18508	31.39	TC18608	42.35	TC98508	42.35
3/16	3/16	1-1/8	3	TC18512	37.81	TC18612	44.21	TC98512	44.21
1/4	1/4	1-1/2	4	TC18516	55.14	TC18616	61.38	TC98516	61.38
1/4	1/4	1-1/2	6	TC18517	64.84	TC18617	76.32	TC98517	76.32
5/16	5/16	1-5/8	4	TC18520	66.67	TC18620	86.07	TC98520	86.07
3/8	3/8	1-3/4	4	TC18524	71.76	TC18624	91.73	TC98524	91.73
3/8	3/8	1-1/2	6	TC18525	101.12	TC18625	126.15	TC98525	126.15
7/16	7/16	3	6	TC18528	151.79	TC18628	194.84	TC98528	194.84
1/2	1/2	1-1/2	6	TC18532	161.01	TC18632	206.13	TC98532	206.13
1/2	1/2	3	6	TC18533	162.00	TC18633	209.20	TC98533	209.20
5/8	5/8	3	6	TC18540	255.35	TC18640	313.79	TC98540	313.79
3/4	3/4	3	6	TC18548	362.10	TC18648	488.82	TC98548	488.82
3/4	3/4	4	7	TC18549	596.23	TC18649	754.06	TC98549	754.06
7/8	7/8	3	6	TC18556	640.90	TC18656	798.69	TC98556	798.69
1	1	3	6	TC18564	646.03	TC18664	831.73	TC98564	831.73
1	1	4	7	TC18565	781.40	TC18665	930.62	TC98565	930.62

For coating information see page 8. For technical information, please see pages 88-89, 91-93.

TOLERANCES	DIAMETER	SHANK
1/8" - 1/2"	+0.00, -0.02	-.0001, -.0004 ISO H6
5/8" - 1"	+0.00, -0.03	-.0001, -.0004 ISO H6

SINGLE-END END MILLS

2 FLUTE
30° HELIX

4 FLUTE
30° HELIX

3 FLUTE
45° HELIX

3 FLUTE
60° HELIX

5 FLUTE
45° HELIX

TECHNICAL



GENERAL PURPOSE SOLID CARBIDE END MILLS

YOUR #1 SOURCE FOR AMERICAN-MADE PREMIUM QUALITY CUTTING TOOLS

4 FLUTE - STUB LENGTH  CORNER RADIUS - 30° HELIX



SERIES 739
ALTIM COATED

DIA	SHANK	LOC	OAL	RAD	ITEM #	LIST PRICE
1/8	1/8	1/4	1-1/2	0.015	TC73904	29.22
1/8	1/8	1/4	1-1/2	0.020	TC73906	29.22
1/8	1/8	1/4	1-1/2	0.030	TC73908	29.22
3/16	3/16	3/8	2	0.015	TC73910	35.51
3/16	3/16	3/8	2	0.020	TC73912	35.51
3/16	3/16	3/8	2	0.030	TC73914	35.51
1/4	1/4	1/2	2	0.015	TC73916	41.48
1/4	1/4	1/2	2	0.020	TC73918	41.48
1/4	1/4	1/2	2	0.030	TC73920	41.48
1/4	1/4	1/2	2	0.045	TC73922	41.48
1/4	1/4	1/2	2	0.060	TC73924	41.48
5/16	5/16	1/2	2	0.015	TC73926	57.68
5/16	5/16	1/2	2	0.020	TC73928	57.68
5/16	5/16	1/2	2	0.030	TC73930	57.68
5/16	5/16	1/2	2	0.045	TC73932	57.68
5/16	5/16	1/2	2	0.060	TC73934	57.68
3/8	3/8	5/8	2	0.015	TC73936	71.76
3/8	3/8	5/8	2	0.020	TC73938	71.76
3/8	3/8	5/8	2	0.030	TC73940	71.76
3/8	3/8	5/8	2	0.045	TC73942	71.76
3/8	3/8	5/8	2	0.060	TC73944	71.76
1/2	1/2	5/8	2-1/2	0.015	TC73946	111.00
1/2	1/2	5/8	2-1/2	0.020	TC73948	111.00
1/2	1/2	5/8	2-1/2	0.030	TC73950	111.00

DIA	SHANK	LOC	OAL	RAD	ITEM #	LIST PRICE
1/2	1/2	5/8	2-1/2	0.045	TC73952	111.00
1/2	1/2	5/8	2-1/2	0.060	TC73954	111.00
1/2	1/2	5/8	2-1/2	0.090	TC73956	111.00
1/2	1/2	5/8	2-1/2	0.125	TC73958	111.00
5/8	5/8	3/4	3	0.015	TC73960	181.53
5/8	5/8	3/4	3	0.020	TC73962	181.53
5/8	5/8	3/4	3	0.030	TC73964	181.53
5/8	5/8	3/4	3	0.045	TC73966	181.53
5/8	5/8	3/4	3	0.060	TC73968	181.53
5/8	5/8	3/4	3	0.090	TC73970	181.53
3/4	3/4	1	3	0.015	TC73972	253.68
3/4	3/4	1	3	0.020	TC73974	253.68
3/4	3/4	1	3	0.030	TC73976	253.68
3/4	3/4	1	3	0.045	TC73978	253.68
3/4	3/4	1	3	0.060	TC73980	253.68
3/4	3/4	1	3	0.090	TC73982	253.68
3/4	3/4	1	3	0.125	TC73984	253.68
1	1	1-1/4	3-1/2	0.015	TC73986	488.39
1	1	1-1/4	3-1/2	0.020	TC73988	488.39
1	1	1-1/4	3-1/2	0.030	TC73990	488.39
1	1	1-1/4	3-1/2	0.045	TC73992	488.39
1	1	1-1/4	3-1/2	0.060	TC73994	488.39
1	1	1-1/4	3-1/2	0.090	TC73996	488.39
1	1	1-1/4	3-1/2	0.125	TC73998	488.39



Radius tools stocked in Stub, Regular, Long, and Extra Long lengths

For coating information see page 8. For technical information, please see pages 88-89, 91-93.

TOLERANCES	DIAMETER	SHANK	RADIUS
1/8" - 1/2"	+0.00, -0.002	-0.0001, -0.0004 ISO H6	+0.001, -.001
5/8" - 1"	+0.00, -0.003	-0.0001, -0.0004 ISO H6	+0.001, -.001

GENERAL PURPOSE SOLID CARBIDE END MILLS



MILLING

YOUR #1 SOURCE FOR AMERICAN-MADE PREMIUM QUALITY CUTTING TOOLS

4 FLUTE - REGULAR LENGTH  CORNER RADIUS - 30° HELIX



SERIES 741
ALTIN COATED

DIA	SHANK	LOC	OAL	RAD	ITEM#	LIST PRICE
1/8	1/8	1/2	1-1/2	0.015	TC74104	33.80
1/8	1/8	1/2	1-1/2	0.020	TC74106	33.80
1/8	1/8	1/2	1-1/2	0.030	TC74108	33.80
3/16	3/16	5/8	2	0.015	TC74110	39.73
3/16	3/16	5/8	2	0.020	TC74112	39.73
3/16	3/16	5/8	2	0.030	TC74114	39.73
1/4	1/4	3/4	2-1/2	0.015	TC74116	46.44
1/4	1/4	3/4	2-1/2	0.020	TC74118	46.44
1/4	1/4	3/4	2-1/2	0.030	TC74120	46.44
1/4	1/4	3/4	2-1/2	0.045	TC74122	46.44
1/4	1/4	3/4	2-1/2	0.060	TC74124	46.44
5/16	5/16	13/16	2-1/2	0.015	TC74126	62.28
5/16	5/16	13/16	2-1/2	0.020	TC74128	62.28
5/16	5/16	13/16	2-1/2	0.030	TC74130	62.28
5/16	5/16	13/16	2-1/2	0.045	TC74132	62.28
5/16	5/16	13/16	2-1/2	0.060	TC74134	62.28
3/8	3/8	1	2-1/2	0.015	TC74136	78.18
3/8	3/8	1	2-1/2	0.020	TC74138	78.18
3/8	3/8	1	2-1/2	0.030	TC74140	78.18
3/8	3/8	1	2-1/2	0.045	TC74142	78.18
3/8	3/8	1	2-1/2	0.060	TC74144	78.18
1/2	1/2	1	3	0.015	TC74146	117.93
1/2	1/2	1	3	0.020	TC74148	117.93
1/2	1/2	1	3	0.030	TC74150	117.93

DIA	SHANK	LOC	OAL	RAD	ITEM#	LIST PRICE
1/2	1/2	1	3	0.045	TC74152	117.93
1/2	1/2	1	3	0.060	TC74154	117.93
1/2	1/2	1	3	0.090	TC74156	117.93
1/2	1/2	1	3	0.125	TC74158	117.93
5/8	5/8	1-1/4	3-1/2	0.015	TC74160	192.14
5/8	5/8	1-1/4	3-1/2	0.020	TC74162	192.14
5/8	5/8	1-1/4	3-1/2	0.030	TC74164	192.14
5/8	5/8	1-1/4	3-1/2	0.045	TC74166	192.14
5/8	5/8	1-1/4	3-1/2	0.060	TC74168	192.14
5/8	5/8	1-1/4	3-1/2	0.090	TC74170	192.14
3/4	3/4	1-1/2	4	0.015	TC74172	263.70
3/4	3/4	1-1/2	4	0.020	TC74174	263.70
3/4	3/4	1-1/2	4	0.030	TC74176	263.70
3/4	3/4	1-1/2	4	0.045	TC74178	263.70
3/4	3/4	1-1/2	4	0.060	TC74180	263.70
3/4	3/4	1-1/2	4	0.090	TC74182	263.70
3/4	3/4	1-1/2	4	0.125	TC74184	263.70
1	1	1-1/2	4	0.015	TC74186	511.06
1	1	1-1/2	4	0.020	TC74188	511.06
1	1	1-1/2	4	0.030	TC74190	511.06
1	1	1-1/2	4	0.045	TC74192	511.06
1	1	1-1/2	4	0.060	TC74194	511.06
1	1	1-1/2	4	0.090	TC74196	511.06
1	1	1-1/2	4	0.125	TC74198	511.06

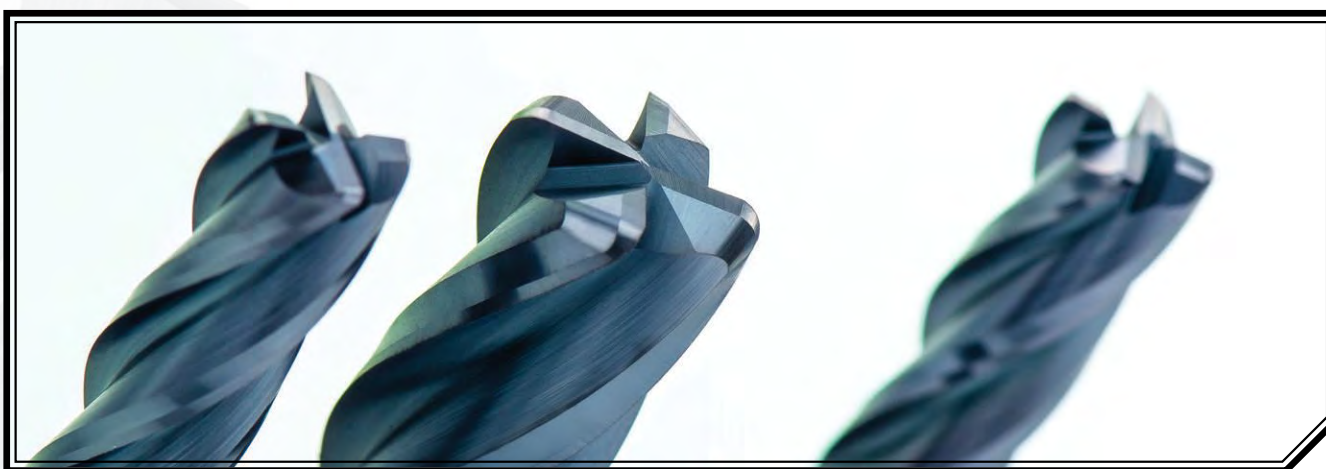

Radius options stocked from 0.015" through 0.125"

For coating information see page 8. For technical information, please see pages 88-89, 91-93.

TOLERANCES	DIAMETER	SHANK	RADIUS
1/8" - 1/2"	+ .000, -.002	-.0001, -.0004 ISO H6	+ .001, -.001
5/8" - 1"	+ .000, -.003	-.0001, -.0004 ISO H6	+ .001, -.001

SINGLE-END END MILLS

2 FLUTE
30° HELIX

4 FLUTE
30° HELIX

3 FLUTE
45° HELIX

3 FLUTE
60° HELIX

5 FLUTE
45° HELIX

TECHNICAL



GENERAL PURPOSE SOLID CARBIDE END MILLS

YOUR #1 SOURCE FOR AMERICAN-MADE PREMIUM QUALITY CUTTING TOOLS

4 FLUTE - LONG LENGTH CORNER RADIUS - 30° HELIX



SERIES 744
ALTiN COATED

SINGLE-END END MILLS

2 FLUTE
30° HELIX

4 FLUTE
30° HELIX

3 FLUTE
45° HELIX

3 FLUTE
60° HELIX

5 FLUTE
45° HELIX

DIA	SHANK	LOC	OAL	RAD	ITEM#	LIST PRICE
1/8	1/8	3/4	2-1/4	0.015	TC74401	37.14
1/8	1/8	3/4	2-1/4	0.020	TC74402	37.14
1/8	1/8	3/4	2-1/4	0.030	TC74403	37.14
3/16	3/16	3/4	2-1/2	0.015	TC74404	43.17
3/16	3/16	3/4	2-1/2	0.020	TC74405	43.17
3/16	3/16	3/4	2-1/2	0.030	TC74406	43.17
1/4	1/4	1-1/8	3	0.015	TC74407	60.23
1/4	1/4	1-1/8	3	0.020	TC74408	60.23
1/4	1/4	1-1/8	3	0.030	TC74409	60.23
1/4	1/4	1-1/8	3	0.045	TC74410	60.23
1/4	1/4	1-1/8	3	0.060	TC74411	60.23
1/4	1/4	1	4	0.015	TC74412	63.24
1/4	1/4	1	4	0.020	TC74413	63.24
1/4	1/4	1	4	0.030	TC74414	63.24
1/4	1/4	1	4	0.045	TC74415	63.24
1/4	1/4	1	4	0.060	TC74416	63.24
5/16	5/16	1-1/8	3	0.015	TC74417	68.26
5/16	5/16	1-1/8	3	0.020	TC74418	68.26
5/16	5/16	1-1/8	3	0.030	TC74419	68.26
5/16	5/16	1-1/8	3	0.045	TC74420	68.26
5/16	5/16	1-1/8	3	0.060	TC74421	68.26
3/8	3/8	1-1/8	3	0.015	TC74422	86.13
3/8	3/8	1-1/8	3	0.020	TC74423	86.13
3/8	3/8	1-1/8	3	0.030	TC74424	86.13
3/8	3/8	1-1/8	3	0.045	TC74425	86.13
3/8	3/8	1-1/8	3	0.060	TC74426	86.13
3/8	3/8	1	4	0.015	TC74427	107.33
3/8	3/8	1	4	0.020	TC74428	107.33
3/8	3/8	1	4	0.030	TC74429	107.33
3/8	3/8	1	4	0.045	TC74430	107.33
3/8	3/8	1	4	0.060	TC74431	107.33
1/2	1/2	1	4	0.015	TC74432	148.41
1/2	1/2	1	4	0.020	TC74433	148.41

DIA	SHANK	LOC	OAL	RAD	ITEM#	LIST PRICE
1/2	1/2	1	4	0.030	TC74434	148.41
1/2	1/2	1	4	0.045	TC74435	148.41
1/2	1/2	1	4	0.060	TC74436	148.41
1/2	1/2	1	4	0.090	TC74437	148.41
1/2	1/2	1	4	0.125	TC74438	148.41
1/2	1/2	2	4	0.015	TC74439	157.69
1/2	1/2	2	4	0.020	TC74440	157.69
1/2	1/2	2	4	0.030	TC74441	157.69
1/2	1/2	2	4	0.045	TC74442	157.69
1/2	1/2	2	4	0.060	TC74443	157.69
1/2	1/2	2	4	0.090	TC74444	157.69
1/2	1/2	2	4	0.125	TC74445	157.69
5/8	5/8	2-1/4	5	0.015	TC74446	285.10
5/8	5/8	2-1/4	5	0.020	TC74447	285.10
5/8	5/8	2-1/4	5	0.030	TC74448	285.10
5/8	5/8	2-1/4	5	0.045	TC74449	285.10
5/8	5/8	2-1/4	5	0.060	TC74450	285.10
5/8	5/8	2-1/4	5	0.090	TC74451	285.10
3/4	3/4	2-1/4	5	0.015	TC74452	371.03
3/4	3/4	2-1/4	5	0.020	TC74453	371.03
3/4	3/4	2-1/4	5	0.030	TC74454	371.03
3/4	3/4	2-1/4	5	0.045	TC74455	371.03
3/4	3/4	2-1/4	5	0.060	TC74456	371.03
3/4	3/4	2-1/4	5	0.090	TC74457	371.03
3/4	3/4	2-1/4	5	0.125	TC74458	371.03
1	1	2-1/4	5	0.015	TC74459	583.04
1	1	2-1/4	5	0.020	TC74460	583.04
1	1	2-1/4	5	0.030	TC74461	583.04
1	1	2-1/4	5	0.045	TC74462	583.04
1	1	2-1/4	5	0.060	TC74463	583.04
1	1	2-1/4	5	0.090	TC74464	583.04
1	1	2-1/4	5	0.125	TC74465	583.04

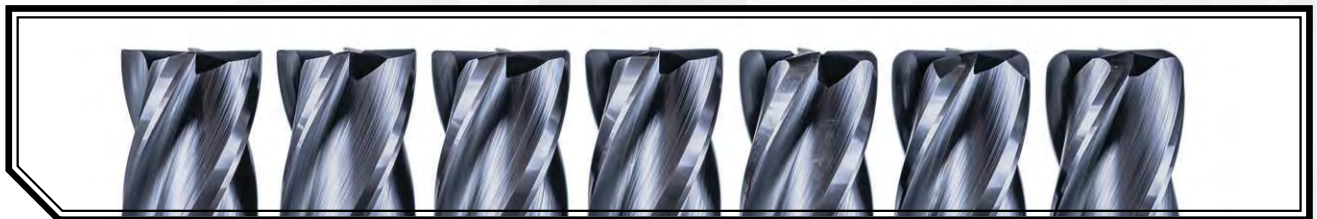

For coating information see page 8. For technical information, please see pages 88-89, 91-93.

TOLERANCES	DIAMETER	SHANK	RADIUS
1/8" - 1/2"	+0.00, -.002	-.0001, -.0004 ISO H6	+0.001, -.001
5/8" - 1"	+0.00, -.003	-.0001, -.0004 ISO H6	+0.001, -.001

GENERAL PURPOSE SOLID CARBIDE END MILLS



YOUR #1 SOURCE FOR AMERICAN-MADE PREMIUM QUALITY CUTTING TOOLS

MILLING

4 FLUTE - EXTRA LONG LENGTH  CORNER RADIUS - 30° HELIX



SERIES 746
ALTiN COATED

DIA	SHANK	LOC	OAL	RAD	ITEM #	LIST PRICE
1/8	1/8	1	3	0.015	TC74601	42.16
1/8	1/8	1	3	0.020	TC74602	42.16
1/8	1/8	1	3	0.030	TC74603	42.16
3/16	3/16	1-1/8	3	0.015	TC74604	46.18
3/16	3/16	1-1/8	3	0.020	TC74605	46.18
3/16	3/16	1-1/8	3	0.030	TC74606	46.18
1/4	1/4	1-1/2	4	0.015	TC74607	64.25
1/4	1/4	1-1/2	4	0.020	TC74608	64.25
1/4	1/4	1-1/2	4	0.030	TC74609	64.25
1/4	1/4	1-1/2	4	0.045	TC74610	64.25
1/4	1/4	1-1/2	4	0.060	TC74611	64.25
1/4	1/4	1-1/2	6	0.015	TC74612	86.33
1/4	1/4	1-1/2	6	0.020	TC74613	86.33
1/4	1/4	1-1/2	6	0.030	TC74614	86.33
1/4	1/4	1-1/2	6	0.045	TC74615	86.33
1/4	1/4	1-1/2	6	0.060	TC74616	86.33
5/16	5/16	1-5/8	4	0.015	TC74617	88.34
5/16	5/16	1-5/8	4	0.020	TC74618	88.34
5/16	5/16	1-5/8	4	0.030	TC74619	88.34
5/16	5/16	1-5/8	4	0.045	TC74620	88.34
5/16	5/16	1-5/8	4	0.060	TC74621	88.34
3/8	3/8	1-3/4	4	0.015	TC74622	96.37
3/8	3/8	1-3/4	4	0.020	TC74623	96.37
3/8	3/8	1-3/4	4	0.030	TC74624	96.37
3/8	3/8	1-3/4	4	0.045	TC74625	96.37
3/8	3/8	1-3/4	4	0.060	TC74626	96.37
3/8	3/8	1-1/2	6	0.015	TC74627	136.53
3/8	3/8	1-1/2	6	0.020	TC74628	136.53
3/8	3/8	1-1/2	6	0.030	TC74629	136.53
3/8	3/8	1-1/2	6	0.045	TC74630	136.53
3/8	3/8	1-1/2	6	0.060	TC74631	136.53
1/2	1/2	1-1/2	6	0.015	TC74632	206.80
1/2	1/2	1-1/2	6	0.020	TC74633	206.80
1/2	1/2	1-1/2	6	0.030	TC74634	206.80
1/2	1/2	1-1/2	6	0.045	TC74635	206.80
1/2	1/2	1-1/2	6	0.060	TC74636	206.80
1/2	1/2	1-1/2	6	0.090	TC74637	206.80
1/2	1/2	1-1/2	6	0.125	TC74638	206.80
1/2	1/2	3	6	0.015	TC74639	216.83
1/2	1/2	3	6	0.020	TC74640	216.83

DIA	SHANK	LOC	OAL	RAD	ITEM #	LIST PRICE
1/2	1/2	3	6	0.030	TC74641	216.83
1/2	1/2	3	6	0.045	TC74642	216.83
1/2	1/2	3	6	0.060	TC74643	216.83
1/2	1/2	3	6	0.090	TC74644	216.83
1/2	1/2	3	6	0.125	TC74645	216.83
5/8	5/8	3	6	0.015	TC74646	305.18
5/8	5/8	3	6	0.020	TC74647	305.18
5/8	5/8	3	6	0.030	TC74648	305.18
5/8	5/8	3	6	0.045	TC74649	305.18
5/8	5/8	3	6	0.060	TC74650	305.18
5/8	5/8	3	6	0.090	TC74651	305.18
3/4	3/4	3	6	0.015	TC74652	418.73
3/4	3/4	3	6	0.020	TC74653	418.73
3/4	3/4	3	6	0.030	TC74654	418.73
3/4	3/4	3	6	0.045	TC74655	418.73
3/4	3/4	3	6	0.060	TC74656	418.73
3/4	3/4	3	6	0.090	TC74657	418.73
3/4	3/4	3	6	0.125	TC74658	418.73
3/4	3/4	4	7	0.015	TC74659	687.73
3/4	3/4	4	7	0.020	TC74660	687.73
3/4	3/4	4	7	0.030	TC74661	687.73
3/4	3/4	4	7	0.045	TC74662	687.73
3/4	3/4	4	7	0.060	TC74663	687.73
3/4	3/4	4	7	0.090	TC74664	687.73
3/4	3/4	4	7	0.125	TC74665	687.73
1	1	3	6	0.015	TC74666	682.43
1	1	3	6	0.020	TC74667	682.43
1	1	3	6	0.030	TC74668	682.43
1	1	3	6	0.045	TC74669	682.43
1	1	3	6	0.060	TC74670	682.43
1	1	3	6	0.090	TC74671	682.43
1	1	3	6	0.125	TC74672	682.43
1	1	4	7	0.015	TC74673	983.79
1	1	4	7	0.020	TC74674	983.79
1	1	4	7	0.030	TC74675	983.79
1	1	4	7	0.045	TC74676	983.79
1	1	4	7	0.060	TC74677	983.79
1	1	4	7	0.090	TC74678	983.79
1	1	4	7	0.125	TC74679	983.79

SINGLE-END END MILLS

2 FLUTE
30° HELIX

4 FLUTE
30° HELIX

3 FLUTE
45° HELIX

3 FLUTE
60° HELIX

5 FLUTE
45° HELIX

TECHNICAL

For coating information see page 8. For technical information, please see pages 88-89, 91-93.

TOLERANCES	DIAMETER	SHANK	RADIUS
1/8" - 1/2"	+0.000, -0.002	-0.0001, -0.0004 ISO H6	+0.001, -0.001
5/8" - 1"	+0.000, -0.003	-0.0001, -0.0004 ISO H6	+0.001, -0.001



GENERAL PURPOSE SOLID CARBIDE END MILLS

YOUR #1 SOURCE FOR AMERICAN-MADE PREMIUM QUALITY CUTTING TOOLS

4 FLUTE - REGULAR LENGTH - SQUARE END - 30° HELIX - METRIC



SERIES 118
UNCOATED

DIA	SHANK	LOC	OAL	ITEM#	LIST PRICE
1.0	3	3	38	TC11859	24.67
1.5	3	4.5	38	TC11860	24.67
2.0	3	6.3	38	TC11861	24.67
2.5	3	9.5	38	TC11862	24.67
3.0	3	12	38	TC11863	24.67
3.5	4	12	50	TC11864	30.39
4.0	4	14	50	TC11865	30.39
4.5	6	16	50	TC11866	37.16
5.0	6	16	50	TC11867	37.16
5.5	6	16	50	TC11881	37.16
6.0	6	19	50	TC11868	38.84
6.5	8	19	63	TC11882	42.25

DIA	SHANK	LOC	OAL	ITEM#	LIST PRICE
7.0	8	19	63	TC11869	42.25
7.5	8	19	63	TC11883	43.93
8.0	8	20	63	TC11870	43.93
9.0	10	22	75	TC11871	64.19
10.0	10	22	75	TC11872	81.09
11.0	12	25	75	TC11873	89.54
12.0	12	25	75	TC11874	92.90
14.0	14	32	89	TC11875	157.13
16.0	16	32	89	TC11876	179.08
18.0	18	38	100	TC11877	244.99
20.0	20	38	100	TC11878	388.59
25.0	25	38	100	TC11879	506.84

4 FLUTE - REGULAR LENGTH - SQUARE END - 30° HELIX - METRIC



SERIES 119
ALTIN COATED

DIA	SHANK	LOC	OAL	ITEM#	LIST PRICE
1.0	3	3	38	TC11959	30.80
1.5	3	4.5	38	TC11960	30.80
2.0	3	6.3	38	TC11961	30.80
2.5	3	9.5	38	TC11962	30.80
3.0	3	12	38	TC11963	30.80
3.5	4	12	50	TC11964	38.02
4.0	4	14	50	TC11965	38.02
4.5	6	16	50	TC11966	46.47
5.0	6	16	50	TC11967	46.47
5.5	6	16	50	TC11981	46.47
6.0	6	19	50	TC11968	48.56
6.5	8	19	63	TC11982	52.79

DIA	SHANK	LOC	OAL	ITEM#	LIST PRICE
7.0	8	19	63	TC11969	52.79
7.5	8	19	63	TC11983	54.92
8.0	8	20	63	TC11970	54.92
9.0	10	22	75	TC11971	80.23
10.0	10	22	75	TC11972	101.35
11.0	12	25	75	TC11973	111.93
12.0	12	25	75	TC11974	116.16
14.0	14	32	89	TC11975	196.43
16.0	16	32	89	TC11976	223.87
18.0	18	38	100	TC11977	306.23
20.0	20	38	100	TC11978	485.71
25.0	25	38	100	TC11979	633.58

For coating information see page 8. For technical information, please see pages 88-89, 91-93.

TOLERANCES	DIAMETER	SHANK
ALL SIZES	+0.00, -.05	-.0025, -.01

GENERAL PURPOSE SOLID CARBIDE END MILLS



YOUR #1 SOURCE FOR AMERICAN-MADE PREMIUM QUALITY CUTTING TOOLS

4 FLUTE - REGULAR LENGTH - BALL NOSE - 30° HELIX - METRIC



SERIES 127
UNCOATED

DIA	SHANK	LOC	OAL	ITEM #	LIST PRICE
1.0	3	3	38	TC12701	28.01
1.5	3	4.5	38	TC12703	28.01
2.0	3	6.3	38	TC12705	28.01
2.5	3	9.5	38	TC12707	28.01
3.0	3	12	38	TC12709	28.01
3.5	4	12	50	TC12711	34.52
4.0	4	14	50	TC12713	34.52
4.5	6	16	50	TC12715	42.20
5.0	6	16	50	TC12717	42.20
5.5	6	16	50	TC12719	42.20
6.0	6	19	50	TC12721	44.11
6.5	8	19	63	TC12723	50.14

DIA	SHANK	LOC	OAL	ITEM #	LIST PRICE
7.0	8	19	63	TC12725	50.14
7.5	8	19	63	TC12727	52.05
8.0	8	20	63	TC12729	52.05
9.0	10	22	75	TC12731	72.90
10.0	10	22	75	TC12733	95.33
11.0	12	25	75	TC12735	101.69
12.0	12	25	75	TC12737	105.51
14.0	14	32	89	TC12739	178.46
16.0	16	32	89	TC12741	203.38
18.0	18	38	100	TC12743	278.24
20.0	20	38	100	TC12745	441.32
25.0	25	38	100	TC12747	575.62

4 FLUTE - REGULAR LENGTH - BALL NOSE - 30° HELIX - METRIC



SERIES 128
ALTIN COATED

DIA	SHANK	LOC	OAL	ITEM #	LIST PRICE
1.0	3	3	38	TC12802	35.66
1.5	3	4.5	38	TC12804	35.66
2.0	3	6.3	38	TC12806	35.66
2.5	3	9.5	38	TC12808	35.66
3.0	3	12	38	TC12810	35.66
3.5	4	12	50	TC12812	44.02
4.0	4	14	50	TC12814	44.02
4.5	6	16	50	TC12816	53.80
5.0	6	16	50	TC12818	53.80
5.5	6	16	50	TC12820	53.80
6.0	6	19	50	TC12822	56.22
6.5	8	19	63	TC12824	61.11

DIA	SHANK	LOC	OAL	ITEM #	LIST PRICE
7.0	8	19	63	TC12826	61.11
7.5	8	19	63	TC12828	63.58
8.0	8	20	63	TC12830	63.59
9.0	10	22	75	TC12832	92.88
10.0	10	22	75	TC12834	117.34
11.0	12	25	75	TC12836	129.59
12.0	12	25	75	TC12838	134.48
14.0	14	32	89	TC12840	227.41
16.0	16	32	89	TC12842	259.18
18.0	18	38	100	TC12844	354.53
20.0	20	38	100	TC12846	562.33
25.0	25	38	100	TC12848	733.52

For coating information see page 8. For technical information, please see pages 88-89, 91-93.

TOLERANCES	DIAMETER	SHANK
ALL SIZES	+0.00, -.05	-.0025, -.01



GENERAL PURPOSE SOLID CARBIDE END MILLS

YOUR #1 SOURCE FOR AMERICAN-MADE PREMIUM QUALITY CUTTING TOOLS

3 FLUTE - REGULAR LENGTH - SQUARE END - 45° HELIX



SERIES 495 ALTIN COATED

DIA	SHANK	LOC	OAL	ITEM#	LIST PRICE
1/8	1/8	1/2	1-1/2	TC49508	33.33
3/16	3/16	5/8	2	TC49512	39.92
1/4	1/4	3/4	2-1/2	TC49516	42.80
5/16	5/16	13/16	2-1/2	TC49520	51.78
3/8	3/8	1	2-1/2	TC49524	69.32
1/2	1/2	1-1/4	3	TC49532	118.27
5/8	5/8	1-5/8	3-1/2	TC49540	235.36
3/4	3/4	1-5/8	4	TC49548	330.29

3 FLUTE - REGULAR LENGTH CORNER RADIUS - 45° HELIX



SERIES 497 ALTIN COATED

DIA	SHANK	LOC	OAL	RAD	ITEM#	LIST PRICE
1/8	1/8	1/2	1-1/2	0.010	TC49708	37.21
3/16	3/16	5/8	2	0.010	TC49712	44.56
1/4	1/4	3/4	2-1/2	0.020	TC49716	47.77
5/16	5/16	13/16	2-1/2	0.020	TC49720	57.80
3/8	3/8	1	2-1/2	0.020	TC49724	77.42
1/2	1/2	1-1/4	3	0.040	TC49732	132.01
5/8	5/8	1-5/8	3-1/2	0.040	TC49740	251.36
3/4	3/4	1-5/8	4	0.040	TC49748	352.75

These 3 flute 45° tools are designed to slot and profile at higher speeds and feeds while providing a shearing action that produces excellent finishes.

WORKS WELL IN STAINLESS STEELS AND OTHER SIMILAR ALLOYS

For coating information see page 8. For technical information, please see pages 86-87, 91-93.

TOLERANCES	DIAMETER	SHANK	RADIUS
1/8" - 1/2"	+0.000, -.002	-.0001, -.0004 ISO H6	+0.001, -.001
5/8" - 3/4"	+0.000, -.003	-.0001, -.0004 ISO H6	+0.001, -.001

GENERAL PURPOSE SOLID CARBIDE END MILLS



MILLING

YOUR #1 SOURCE FOR AMERICAN-MADE PREMIUM QUALITY CUTTING TOOLS

3 FLUTE - REGULAR LENGTH - SQUARE END - 60° HELIX



SERIES 395 ALTIN COATED

DIA	SHANK	LOC	OAL	ITEM#	LIST PRICE
1/8	1/8	1/2	1-1/2	TC39508	33.33
3/16	3/16	5/8	2	TC39512	39.92
1/4	1/4	3/4	2-1/2	TC39516	42.80
5/16	5/16	13/16	2-1/2	TC39520	51.78
3/8	3/8	1	2-1/2	TC39524	69.32
1/2	1/2	1-1/4	3	TC39532	118.27
5/8	5/8	1-5/8	3-1/2	TC39540	235.36
3/4	3/4	1-5/8	4	TC39548	330.29

3 FLUTE - REGULAR LENGTH CORNER RADIUS - 60° HELIX



SERIES 396 ALTIN COATED

DIA	SHANK	LOC	OAL	RAD	ITEM#	LIST PRICE
1/8	1/8	1/2	1-1/2	0.010	TC39608	37.21
3/16	3/16	5/8	2	0.010	TC39612	44.56
1/4	1/4	3/4	2-1/2	0.020	TC39616	47.77
5/16	5/16	13/16	2-1/2	0.020	TC39620	57.80
3/8	3/8	1	2-1/2	0.020	TC39624	77.42
1/2	1/2	1-1/4	3	0.040	TC39632	132.01
5/8	5/8	1-5/8	3-1/2	0.040	TC39640	251.36
3/4	3/4	1-5/8	4	0.040	TC39648	352.75

These 3 flute 60° tools are designed to machine all high temperature alloys. This high shear design geometry will slot and profile while giving excellent surface finishes.

WORKS WELL IN HIGH TEMPERATURE ALLOYS SUCH AS INCONELS, HASTALLOY, WASPALLOY AND TITANIUM.

For coating information see page 8. For technical information, please see pages 86-87, 91-93.

TOLERANCES	DIAMETER	SHANK	RADIUS
1/8" - 1/2"	+0.000, -0.002	-0.0001, -0.0004 ISO H6	+0.001, -0.001
5/8" - 3/4"	+0.000, -0.003	-0.0001, -0.0004 ISO H6	+0.001, -0.001

SINGLE-END END MILLS

2 FLUTE
30° HELIX

4 FLUTE
30° HELIX

3 FLUTE
45° HELIX

3 FLUTE
60° HELIX

5 FLUTE
45° HELIX

TECHNICAL



GENERAL PURPOSE SOLID CARBIDE END MILLS

YOUR #1 SOURCE FOR AMERICAN-MADE PREMIUM QUALITY CUTTING TOOLS

5 FLUTE - STUB LENGTH - SQUARE END - 45° HELIX



SERIES 615 ALTiN COATED

DIA	SHANK	LOC	OAL	ITEM#	LIST PRICE
1/8	1/8	1/4	1-1/2	TC61508	18.24
3/16	3/16	3/8	2	TC61512	27.40
1/4	1/4	1/2	2	TC61516	32.78
5/16	5/16	1/2	2	TC61520	41.43
3/8	3/8	5/8	2	TC61524	64.90
7/16	7/16	5/8	2-1/2	TC61528	74.21
1/2	1/2	5/8	2-1/2	TC61532	85.78
5/8	5/8	3/4	3	TC61540	154.81
3/4	3/4	1	3	TC61548	212.69

5 FLUTE - STUB LENGTH CORNER RADIUS - 45° HELIX



SERIES 617 ALTiN COATED

DIA	SHANK	LOC	OAL	RAD	ITEM#	LIST PRICE
1/8	1/8	1/4	1-1/2	0.010	TC61708	20.24
3/16	3/16	3/8	2	0.010	TC61712	30.61
1/4	1/4	1/2	2	0.020	TC61716	36.62
5/16	5/16	1/2	2	0.020	TC61720	46.23
3/8	3/8	5/8	2	0.020	TC61724	72.45
7/16	7/16	5/8	2-1/2	0.020	TC61728	82.90
1/2	1/2	5/8	2-1/2	0.040	TC61732	95.76
5/8	5/8	3/4	3	0.040	TC61740	165.29
3/4	3/4	1	3	0.040	TC61748	227.14

Designed for profiling and finishing, the 5 flute 45° geometry to this tool allows it to be run 20 - 40% faster than general purpose end mills while providing an excellent finish.

WORKS WELL IN EXOTIC MATERIALS, STAINLESS STEEL, CARBON STEELS AND OTHER SIMILAR MATERIALS.

For coating information see page 8. For technical information, please see pages 86-87, 91-93.

TOLERANCES	DIAMETER	SHANK	RADIUS
1/8" - 1/2"	+0.000, -0.002	-0.0001, -0.0004 ISO H6	+0.001, -0.001
5/8" - 3/4"	+0.000, -0.003	-0.0001, -0.0004 ISO H6	+0.001, -0.001

GENERAL PURPOSE SOLID CARBIDE END MILLS



YOUR #1 SOURCE FOR AMERICAN-MADE PREMIUM QUALITY CUTTING TOOLS

5 FLUTE - REGULAR LENGTH - SQUARE END - 45° HELIX



SERIES 619
ALTiN COATED

DIA	SHANK	LOC	OAL	ITEM#	LIST PRICE
1/8	1/8	1/2	1-1/2	TC61908	34.79
3/16	3/16	3/4	2	TC61912	41.72
1/4	1/4	3/4	2-1/2	TC61916	44.89
5/16	5/16	7/8	2-1/2	TC61920	54.04
3/8	3/8	1	2-1/2	TC61924	72.50
1/2	1/2	1-1/4	3	TC61932	141.32
5/8	5/8	1-5/8	3-1/2	TC61940	273.24
3/4	3/4	1-5/8	4	TC61948	371.50

5 FLUTE - REGULAR LENGTH CORNER RADIUS - 45° HELIX



SERIES 639
ALTiN COATED

DIA	SHANK	LOC	OAL	RAD	ITEM#	LIST PRICE
1/8	1/8	1/2	1-1/2	0.010	TC63908	38.84
3/16	3/16	3/4	2	0.010	TC63912	46.56
1/4	1/4	3/4	2-1/2	0.020	TC63916	50.07
5/16	5/16	7/8	2-1/2	0.020	TC63920	60.34
3/8	3/8	1	2-1/2	0.020	TC63924	80.93
1/2	1/2	1-1/4	3	0.040	TC63932	157.77
5/8	5/8	1-5/8	3-1/2	0.040	TC63940	291.82
3/4	3/4	1-5/8	4	0.040	TC63948	396.73

Designed for profiling and finishing, the 5 flute 45° geometry to this tool allows it to be run 20 - 40% faster than general purpose end mills while providing an excellent finish.

WORKS WELL IN EXOTIC MATERIALS, STAINLESS STEEL, CARBON STEELS AND OTHER SIMILAR MATERIALS.

For coating information see page 8. For technical information, please see pages 86-87, 91-93.

TOLERANCES	DIAMETER	SHANK	RADIUS
1/8" - 1/2"	+0.000, -0.002	-0.0001, -0.0004 ISO H6	+0.001, -0.001
5/8" - 3/4"	+0.000, -0.003	-0.0001, -0.0004 ISO H6	+0.001, -0.001



GENERAL PURPOSE SOLID CARBIDE END MILLS

YOUR #1 SOURCE FOR AMERICAN-MADE PREMIUM QUALITY CUTTING TOOLS

4 FLUTE - STUB LENGTH - DOUBLE END - SQUARE END - 30° HELIX



SERIES 149
ALTIM COATED

DIA	SHANK	LOC	OAL	ITEM#	LIST PRICE
1/16	1/8	1/8	1-1/2	TC14904	35.37
3/32	1/8	3/16	1-1/2	TC14906	36.45
1/8	1/8	1/4	1-1/2	TC14908	29.38
5/32	3/16	5/16	2	TC14910	39.54
3/16	3/16	3/8	2	TC14912	39.54
7/32	1/4	1/2	2-1/2	TC14914	54.25
1/4	1/4	1/2	2-1/2	TC14916	54.25
5/16	5/16	1/2	2-1/2	TC14920	66.66
3/8	3/8	9/16	2-1/2	TC14924	73.53
7/16	7/16	9/16	2-3/4	TC14928	103.95
1/2	1/2	5/8	3	TC14932	139.90

4 FLUTE - STUB LENGTH - DOUBLE END - BALL NOSE - 30° HELIX



SERIES 147
ALTIM COATED

DIA	SHANK	LOC	OAL	ITEM#	LIST PRICE
1/16	1/8	1/8	1-1/2	TC14704	44.25
3/32	1/8	3/16	1-1/2	TC14706	45.52
1/8	1/8	1/4	1-1/2	TC14708	36.74
5/32	3/16	5/16	2	TC14710	49.40
3/16	3/16	3/8	2	TC14712	49.40
7/32	1/4	1/2	2-1/2	TC14714	67.79
1/4	1/4	1/2	2-1/2	TC14716	67.79
5/16	5/16	1/2	2-1/2	TC14720	83.29
3/8	3/8	9/16	2-1/2	TC14724	91.93
7/16	7/16	9/16	2-3/4	TC14728	129.94
1/2	1/2	5/8	3	TC14732	174.93

For coating information see page 8. For technical information, please see pages 88-89, 91-93.

TOLERANCES	DIAMETER	SHANK
ALL SIZES	+0.000, -0.002	-0.0001, -0.0004 ISO H6

GENERAL PURPOSE SOLID CARBIDE END MILLS



YOUR #1 SOURCE FOR AMERICAN-MADE PREMIUM QUALITY CUTTING TOOLS

4 FLUTE - REGULAR LENGTH - DOUBLE END - SQUARE END - 30° HELIX



SERIES 126 ALTiN COATED

DIA	SHANK	LOC	OAL	ITEM#	LIST PRICE
1/8	3/8	3/8	3-1/8	TC12608	121.89
5/32	3/8	7/16	3-1/4	TC12610	121.90
3/16	3/8	1/2	3-1/4	TC12612	121.90
7/32	3/8	9/16	3-1/2	TC12614	124.69
1/4	3/8	5/8	3-1/2	TC12616	124.69
9/32	3/8	11/16	3-1/2	TC12618	133.82
5/16	3/8	3/4	3-1/2	TC12620	133.82
11/32	3/8	3/4	3-1/2	TC12622	133.82
3/8	3/8	3/4	3-1/2	TC12624	133.82
7/16	1/2	7/8	4	TC12628	199.10
1/2	1/2	1	4	TC12632	223.67

NOTE: ALL TOOLS HAVE WELDON FLATS

4 FLUTE - REGULAR LENGTH - DOUBLE END - BALL NOSE - 30° HELIX



SERIES 136 ALTiN COATED

DIA	SHANK	LOC	OAL	ITEM#	LIST PRICE
1/8	3/8	3/8	3-1/8	TC13608	144.97
5/32	3/8	7/16	3-1/4	TC13610	144.97
3/16	3/8	1/2	3-1/4	TC13612	144.97
7/32	3/8	9/16	3-1/2	TC13614	149.77
1/4	3/8	5/8	3-1/2	TC13616	149.77
9/32	3/8	11/16	3-1/2	TC13618	166.48
5/16	3/8	3/4	3-1/2	TC13620	166.48
11/32	3/8	3/4	3-1/2	TC13622	166.48
3/8	3/8	3/4	3-1/2	TC13624	166.48
7/16	1/2	7/8	4	TC13628	226.58
1/2	1/2	1	4	TC13632	246.28

NOTE: ALL TOOLS HAVE WELDON FLATS

For coating information see page 8. For technical information, please see pages 88-89, 91-93.

TOLERANCES	DIAMETER	SHANK
ALL SIZES	+0.000, -.002	-.0001, -.0004 ISO H6



GENERAL PURPOSE M42 COBALT END MILLS

YOUR #1 SOURCE FOR AMERICAN-MADE PREMIUM QUALITY CUTTING TOOLS

COARSE PITCH - CENTER CUTTING - 30° HELIX



SERIES 826 ALTIN COATED

DIA	SHANK	LOC	OAL	# OF FLUTES	ITEM #	LIST PRICE
1/4	3/8	5/8	2-7/16	4	TE63504	110.04
5/16	3/8	3/4	2-1/2	4	TE63509	120.18
3/8	3/8	3/4	2-1/2	4	TE63514	125.54
7/16	3/8	1	2-11/16	4	TE63519	126.28
1/2	1/2	1	3	4	TE63528	128.57
1/2	1/2	1-1/4	3-1/4	4	TE63529	132.97
5/8	5/8	1-5/8	3-3/4	4	TE63536	169.21
* 3/4	3/4	1-5/8	3-7/8	4	TE63545	186.23
* 7/8	3/4	1-7/8	4-1/8	5	TE63554	258.06
* 1	1	2	4-1/2	5	TE63566	249.44
* 1-1/8	1	2	4-1/2	6	TE63571	387.36
* 1-1/4	1-1/4	2	4-1/2	6	TE63575	420.39
* 1-1/2	1-1/4	2	4-1/2	6	TE63583	493.04
* 2	1-1/4	2	4-1/2	8	TE63592	685.10

* Non Center Cutting

FINE PITCH - CENTER CUTTING - 30° HELIX



SERIES 831 ALTIN COATED

DIA	SHANK	LOC	OAL	# OF FLUTES	ITEM #	LIST PRICE
1/4	3/8	5/8	2-7/16	4	TE66204	110.04
5/16	3/8	3/4	2-1/2	4	TE66209	120.18
3/8	3/8	3/4	2-1/2	4	TE66214	126.28
7/16	3/8	1	2-11/16	4	TE66219	126.92
1/2	1/2	1-1/4	3-1/4	4	TE66229	128.57
5/8	5/8	1-5/8	3-3/4	4	TE66236	169.21
* 3/4	3/4	1-5/8	3-7/8	4	TE66245	186.23
* 7/8	3/4	1-7/8	4-1/8	5	TE66254	243.61
* 1	1	2	4-1/2	5	TE66266	249.62
* 1-1/8	1	2	4-1/2	6	TE66271	413.83
* 1-1/4	1-1/4	2	4-1/2	6	TE66275	420.39
* 1-1/2	1-1/4	2	4-1/2	6	TE66283	519.47
* 2	1-1/4	2	4-1/2	8	TE66292	732.25

* Non Center Cutting

For coating information see page 8. For technical information please see pages 85, 91-93.

TOLERANCES	DIAMETER	SHANK
ALL SIZES	+0.005, -0.005	+0.000, -0.005

GENERAL PURPOSE M42 COBALT END MILLS



YOUR #1 SOURCE FOR AMERICAN-MADE PREMIUM QUALITY CUTTING TOOLS

2 FLUTE - CENTER CUTTING - 30° HELIX



SERIES 808
ALTiN COATED

DIA	SHANK	LOC	OAL	# OF FLUTES	ITEM#	LIST PRICE
1/8	3/8	3/8	2-5/16	2	TE82802	52.59
3/16	3/8	7/16	2-5/16	2	TE82806	52.59
1/4	3/8	1/2	2-5/16	2	TE82810	52.59
5/16	3/8	9/16	2-5/16	2	TE82814	52.59
3/8	3/8	9/16	2-5/16	2	TE82816	52.59
7/16	3/8	13/16	2-1/2	2	TE82818	72.66
1/2	3/8	13/16	2-1/2	2	TE82820	72.66
1/2	1/2	1	3	2	TE82822	76.87
9/16	1/2	1-1/8	3-1/8	2	TE82824	86.50
5/8	1/2	1-1/8	3-1/8	2	TE82826	96.85
5/8	5/8	1-5/16	3-7/16	2	TE82828	98.38
3/4	1/2	1-5/16	3-5/16	2	TE82830	112.58
3/4	5/8	1-5/16	3-7/16	2	TE82832	112.58
3/4	3/4	1-5/16	3-9/16	2	TE82834	112.58
13/16	5/8	1-1/2	3-5/8	2	TE82836	138.24
13/16	3/4	1-1/2	3-3/4	2	TE82838	138.73
7/8	3/4	1-1/2	3-3/4	2	TE82842	154.07
7/8	7/8	1-1/2	3-3/4	2	TE82844	154.07
15/16	5/8	1-1/2	3-5/8	2	TE82846	167.44
15/16	3/4	1-1/2	3-3/4	2	TE82848	177.41
1	3/4	1-1/2	3-3/4	2	TE82854	156.78
1	1	1-5/8	4-1/8	2	TE82858	178.52
1-1/8	1	1-5/8	4-1/8	2	TE82862	261.09
1-1/4	1	1-5/8	4-1/8	2	TE82866	291.05
1-1/2	1-1/4	1-5/8	4-1/8	2	TE82874	348.12



All Titan USA cobalt End Mills are PVD coated with ALTiN

For coating information, please see page 8. For technical information please see pages 91-93.

TOLERANCES	DIAMETER	SHANK
ALL SIZES	+ .003, -.0000	+ .0000, -.0004



GENERAL PURPOSE M42 COBALT END MILLS

YOUR #1 SOURCE FOR AMERICAN-MADE PREMIUM QUALITY CUTTING TOOLS

4 & 6 FLUTE - CENTER CUTTING - 30° HELIX



SERIES 813 ALTiN COATED

DIA	SHANK	LOC	OAL	# OF FLUTES	ITEM#	LIST PRICE
1/8	3/8	3/8	2-5/16	4	TE81302	53.67
5/32	3/8	7/16	2-5/16	4	TE81304	73.52
3/16	3/8	1/2	2-3/8	4	TE81306	53.67
7/32	3/8	1/2	2-3/8	4	TE81308	73.52
1/4	3/8	5/8	2-7/16	4	TE81310	53.67
9/32	3/8	11/16	2-1/2	4	TE81312	73.52
5/16	3/8	3/4	2-1/2	4	TE81314	53.67
11/32	3/8	3/4	2-1/2	4	TE81316	75.09
3/8	3/8	3/4	2-1/2	4	TE81318	53.67
13/32	3/8	11/16	2-1/2	4	TE81320	109.73
7/16	3/8	1	2-11/16	4	TE81322	72.53
15/32	3/8	1	2-11/16	4	TE81324	115.80
1/2	3/8	1	2-11/16	4	TE81326	72.53
1/2	1/2	1-1/4	3-1/4	4	TE81328	72.53
17/32	1/2	1-3/8	3-3/8	4	TE81330	135.91
9/16	1/2	1-3/8	3-3/8	4	TE81332	86.99
5/8	1/2	1-3/8	3-3/8	4	TE81334	94.72
5/8	5/8	1-5/8	3-3/4	4	TE81336	105.23
11/16	1/2	1-5/8	3-5/8	4	TE81338	109.80
11/16	5/8	1-5/8	3-3/4	4	TE81340	111.89
3/4	1/2	1-5/8	3-5/8	4	TE81342	133.21
3/4	5/8	1-5/8	3-3/4	4	TE81344	133.21
3/4	3/4	1-5/8	3-7/8	4	TE81346	133.21
13/16	3/4	1-7/8	4-1/8	4	TE81348	150.38
7/8	3/4	1-7/8	4-1/8	4	TE81350	149.85
7/8	7/8	1-7/8	4-1/8	4	TE81352	149.85
15/16	3/4	1-7/8	4-1/8	4	TE81354	192.41
1	3/4	1-7/8	4-1/8	4	TE81358	170.52
1	1	2	4-1/2	4	TE81362	180.57
1-1/8	3/4	1-5/8	3-7/8	6	TE81366	256.90
1-1/4	1	2	4-1/2	6	TE81370	276.17
1-1/4	1-1/4	2	4-1/2	6	TE81374	281.50
1-3/8	3/4	2	4-1/4	6	TE81376	382.96
1-1/2	1	2	4-1/2	6	TE81378	430.22
1-1/2	1-1/4	2	4-1/2	4	TE81380	352.66
1-5/8	1-1/4	2	4-1/2	6	TE81384	561.10
2	1-1/4	2	4-1/2	6	TE81392	636.28

For coating information, please see page 8. For technical information please see pages 91-93.

TOLERANCES	DIAMETER	SHANK
ALL SIZES	+0.003, -.0000	+0.0000, -.0004

GENERAL PURPOSE M42 COBALT END MILLS



YOUR #1 SOURCE FOR AMERICAN-MADE PREMIUM QUALITY CUTTING TOOLS

2 FLUTE - DOUBLE END - CENTER CUTTING - 30° HELIX



SERIES 818 ALTiN COATED

DIA	SHANK	LOC	OAL	# OF FLUTES	ITEM #	LIST PRICE
1/8	3/8	3/8	3-1/16	2	TE81802	80.46
5/32	3/8	7/16	3-1/8	2	TE81804	85.41
3/16	3/8	7/16	3-1/8	2	TE81806	80.50
7/32	3/8	1/2	3-1/8	2	TE81808	85.45
1/4	3/8	1/2	3-1/8	2	TE81810	80.50
9/32	3/8	9/16	3-1/8	2	TE81812	85.45
5/16	3/8	9/16	3-1/8	2	TE81814	80.50
11/32	3/8	9/16	3-1/8	2	TE81816	85.45
3/8	3/8	9/16	3-1/8	2	TE81818	80.50
13/32	1/2	13/16	3-3/4	2	TE81820	55.90
7/16	1/2	13/16	3-3/4	2	TE81822	122.44
1/2	1/2	13/16	3-3/4	2	TE81826	122.44
9/16	5/8	1-1/8	4-1/2	2	TE81828	153.66
5/8	5/8	1-1/8	4-1/2	2	TE81830	153.66
3/4	3/4	1-5/16	5	2	TE81834	193.55
7/8	7/8	1-9/16	5-1/2	2	TE81838	243.47
1	1	1-5/8	5-7/8	2	TE81842	299.47

4 FLUTE - DOUBLE END - CENTER CUTTING - 30° HELIX



SERIES 824 ALTiN COATED

DIA	SHANK	LOC	OAL	# OF FLUTES	ITEM #	LIST PRICE
1/8	3/8	3/8	3-1/16	4	TE82402	81.28
5/32	3/8	7/16	3-1/8	4	TE82404	85.83
3/16	3/8	1/2	3-1/8	4	TE82406	81.28
7/32	3/8	9/16	3-1/4	4	TE82408	85.83
1/4	3/8	5/8	3-3/8	4	TE82410	81.28
9/32	3/8	11/16	3-3/8	4	TE82412	85.83
5/16	3/8	3/4	3-1/2	4	TE82414	81.28
11/32	3/8	3/4	3-1/2	4	TE82416	85.83
3/8	3/8	3/4	3-1/2	4	TE82418	81.28
13/32	1/2	1	4-1/8	4	TE82420	126.16
7/16	1/2	1	4-1/8	4	TE82422	122.73
1/2	1/2	1	4-1/8	4	TE82426	122.73
9/16	5/8	1-3/8	5	4	TE82428	151.07
5/8	5/8	1-3/8	5	4	TE82430	151.07
3/4	3/4	1-5/8	5-5/8	4	TE82434	190.28
7/8	7/8	1-7/8	6-1/8	4	TE82438	254.05
1	1	1-7/8	6-3/8	4	TE82442	294.79

For coating information, please see page 8. For technical information please see pages 91-93.

TOLERANCES	DIAMETER		SHANK
	IF SIZE & SHANK DIA. ARE NOT THE SAME	IF SIZE & SHANK DIA. ARE THE SAME	
ALL SIZES	+0.000, -.0015	+0.000, -.0025	+0.001, -.0005



GENERAL PURPOSE SOLID CARBIDE DRILL MILLS

YOUR #1 SOURCE FOR AMERICAN-MADE PREMIUM QUALITY CUTTING TOOLS

2 FLUTE - 60° POINT - 30° HELIX



SERIES 316
UNCOATED

DIA	SHANK	LOC	OAL	ITEM #	LIST PRICE
1/32	1/8	1/8	1-1/2	TC31602	27.21
1/16	1/8	3/16	1-1/2	TC31604	27.21
3/32	1/8	3/8	1-1/2	TC31606	27.21
1/8	1/8	1/2	1-1/2	TC31608	26.10
3/16	3/16	5/8	2	TC31612	36.75
1/4	1/4	3/4	2-1/2	TC31616	45.99
5/16	5/16	13/16	2-1/2	TC31620	57.10
3/8	3/8	1	2-1/2	TC31624	71.75
7/16	7/16	1	2-3/4	TC31628	96.99
1/2	1/2	1	3	TC31632	118.92
5/8	5/8	1-1/4	3-1/2	TC31640	227.07
3/4	3/4	1-1/2	4	TC31648	334.46



SERIES 318
ALTiN COATED

DIA	SHANK	LOC	OAL	ITEM #	LIST PRICE
1/32	1/8	1/8	1-1/2	TC31802	34.02
1/16	1/8	3/16	1-1/2	TC31804	34.02
3/32	1/8	3/8	1-1/2	TC31806	34.02
1/8	1/8	1/2	1-1/2	TC31808	32.66
3/16	3/16	5/8	2	TC31812	45.94
1/4	1/4	3/4	2-1/2	TC31816	57.48
5/16	5/16	13/16	2-1/2	TC31820	71.36
3/8	3/8	1	2-1/2	TC31824	89.71
7/16	7/16	1	2-3/4	TC31828	121.27
1/2	1/2	1	3	TC31832	148.69
5/8	5/8	1-1/4	3-1/2	TC31840	283.87
3/4	3/4	1-1/2	4	TC31848	418.08

2 FLUTE - 90° POINT - 30° HELIX



SERIES 320
UNCOATED

DIA	SHANK	LOC	OAL	ITEM #	LIST PRICE
1/32	1/8	1/8	1-1/2	TC32002	27.21
1/16	1/8	3/16	1-1/2	TC32004	27.21
3/32	1/8	3/8	1-1/2	TC32006	27.21
1/8	1/8	1/2	1-1/2	TC32008	26.10
3/16	3/16	5/8	2	TC32012	36.75
1/4	1/4	3/4	2-1/2	TC32016	45.99
5/16	5/16	13/16	2-1/2	TC32020	57.10
3/8	3/8	1	2-1/2	TC32024	71.75
7/16	7/16	1	2-3/4	TC32028	96.99
1/2	1/2	1	3	TC32032	118.92
5/8	5/8	1-1/4	3-1/2	TC32040	227.07
3/4	3/4	1-1/2	4	TC32048	334.46

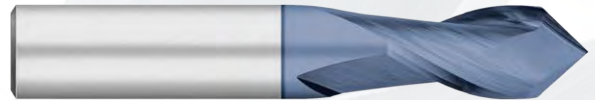

SERIES 322
ALTiN COATED

DIA	SHANK	LOC	OAL	ITEM #	LIST PRICE
1/32	1/8	1/8	1-1/2	TC32202	34.02
1/16	1/8	3/16	1-1/2	TC32204	34.02
3/32	1/8	3/8	1-1/2	TC32206	34.02
1/8	1/8	1/2	1-1/2	TC32208	32.66
3/16	3/16	5/8	2	TC32212	45.94
1/4	1/4	3/4	2-1/2	TC32216	57.48
5/16	5/16	13/16	2-1/2	TC32220	71.36
3/8	3/8	1	2-1/2	TC32224	89.71
7/16	7/16	1	2-3/4	TC32228	121.27
1/2	1/2	1	3	TC32232	148.69
5/8	5/8	1-1/4	3-1/2	TC32240	283.87
3/4	3/4	1-1/2	4	TC32248	418.08

Drill mills are very popular in job shop environments because of their versatility in performing a wide range of machining operations:

**THE FOLLOWING APPLICATIONS CAN BE PERFORMED WITH DRILL MILLS:
DRILLING • CHAMFERING • COUNTERSINKING • SPOTTING • PROFILE MILLING**

For coating information see page 8. For technical information, please see pages 88-89, 91-93.

TOLERANCES	DIAMETER	SHANK
1/32" - 3/32"	+0.000, -0.001	-0.0001, -.0004 ISO H6
1/8" - 1/2"	+0.000, -0.002	-0.0001, -.0004 ISO H6
5/8" - 3/4"	+0.000, -0.003	-0.0001, -.0004 ISO H6

GENERAL PURPOSE SOLID CARBIDE DRILL MILLS



YOUR #1 SOURCE FOR AMERICAN-MADE PREMIUM QUALITY CUTTING TOOLS

4 FLUTE - 60° POINT - 30° HELIX



SERIES 347
UNCOATED



SERIES 349
ALTiN COATED

DIA	SHANK	LOC	OAL	ITEM#	LIST PRICE
1/32	1/8	1/8	1-1/2	TC34702	27.21
1/16	1/8	3/16	1-1/2	TC34704	27.21
3/32	1/8	3/8	1-1/2	TC34706	27.21
1/8	1/8	1/2	1-1/2	TC34708	26.10
3/16	3/16	5/8	2	TC34712	36.75
1/4	1/4	3/4	2-1/2	TC34716	45.99
5/16	5/16	13/16	2-1/2	TC34720	57.10
3/8	3/8	1	2-1/2	TC34724	71.75
7/16	7/16	1	2-3/4	TC34728	96.99
1/2	1/2	1	3	TC34732	118.92
5/8	5/8	1-1/4	3-1/2	TC34740	227.07
3/4	3/4	1-1/2	4	TC34748	334.46

DIA	SHANK	LOC	OAL	ITEM#	LIST PRICE
1/32	1/8	1/8	1-1/2	TC34902	34.02
1/16	1/8	3/16	1-1/2	TC34904	34.02
3/32	1/8	3/8	1-1/2	TC34906	34.02
1/8	1/8	1/2	1-1/2	TC34908	32.66
3/16	3/16	5/8	2	TC34912	45.94
1/4	1/4	3/4	2-1/2	TC34916	57.48
5/16	5/16	13/16	2-1/2	TC34920	71.36
3/8	3/8	1	2-1/2	TC34924	89.71
7/16	7/16	1	2-3/4	TC34928	121.27
1/2	1/2	1	3	TC34932	148.69
5/8	5/8	1-1/4	3-1/2	TC34940	283.87
3/4	3/4	1-1/2	4	TC34948	418.08

4 FLUTE - 90° POINT - 30° HELIX



SERIES 341
UNCOATED



SERIES 343
ALTiN COATED

DIA	SHANK	LOC	OAL	ITEM#	LIST PRICE
1/32	1/8	1/8	1-1/2	TC34102	27.21
1/16	1/8	3/16	1-1/2	TC34104	27.21
3/32	1/8	3/8	1-1/2	TC34106	27.21
1/8	1/8	1/2	1-1/2	TC34108	26.10
3/16	3/16	5/8	2	TC34112	36.75
1/4	1/4	3/4	2-1/2	TC34116	45.99
5/16	5/16	13/16	2-1/2	TC34120	57.10
3/8	3/8	1	2-1/2	TC34124	71.75
7/16	7/16	1	2-3/4	TC34128	96.99
1/2	1/2	1	3	TC34132	118.92
5/8	5/8	1-1/4	3-1/2	TC34140	227.07
3/4	3/4	1-1/2	4	TC34148	334.46

DIA	SHANK	LOC	OAL	ITEM#	LIST PRICE
1/32	1/8	1/8	1-1/2	TC34302	34.02
1/16	1/8	3/16	1-1/2	TC34304	34.02
3/32	1/8	3/8	1-1/2	TC34306	34.02
1/8	1/8	1/2	1-1/2	TC34308	32.66
3/16	3/16	5/8	2	TC34312	45.94
1/4	1/4	3/4	2-1/2	TC34316	57.48
5/16	5/16	13/16	2-1/2	TC34320	71.36
3/8	3/8	1	2-1/2	TC34324	89.71
7/16	7/16	1	2-3/4	TC34328	121.27
1/2	1/2	1	3	TC34332	148.69
5/8	5/8	1-1/4	3-1/2	TC34340	283.87
3/4	3/4	1-1/2	4	TC34348	418.08

Drill mills are very popular in job shop environments because of their versatility in performing a wide range of machining operations:

**THE FOLLOWING APPLICATIONS CAN BE PERFORMED WITH DRILL MILLS:
DRILLING • CHAMFERING • COUNTERSINKING • SPOTTING • PROFILE MILLING**

For coating information see page 8. For technical information, please see pages 88-89, 91-93.

TOLERANCES	DIAMETER	SHANK
1/32" - 3/32"	+0.000, -0.001	-0.0001, -.0004 ISO H6
1/8" - 1/2"	+0.000, -0.002	-0.0001, -.0004 ISO H6
5/8" - 3/4"	+0.000, -0.003	-0.0001, -.0004 ISO H6



GENERAL PURPOSE SOLID CARBIDE CHAMFER MILLS

YOUR #1 SOURCE FOR AMERICAN-MADE PREMIUM QUALITY CUTTING TOOLS



2 FLUTE - SINGLE END

60° • 82° • 90° • 100° • 120°

SERIES 850

UNCOATED

DIA	SHANK	OAL	PKG. QTY.	60°- ITEM#	82°- ITEM#	90°- ITEM#	100°- ITEM#	120°- ITEM#	LIST PRICE
1/8	1/8	1-1/2	1	TC87600	TC87612	TC87624	TC87636	TC87648	23.30
1/4	1/4	2-1/2	1	TC87603	TC87615	TC87627	TC87639	TC87651	41.03
3/8	3/8	2-1/2	1	TC87606	TC87618	TC87630	TC87642	TC87654	64.00
1/2	1/2	3	1	TC87609	TC87621	TC87633	TC87645	TC87657	105.95



2 FLUTE - SINGLE END

60° • 82° • 90° • 100° • 120°

SERIES 852

ALTIN COATED

DIA	SHANK	OAL	PKG. QTY.	60°- ITEM#	82°- ITEM#	90°- ITEM#	100°- ITEM#	120°- ITEM#	LIST PRICE
1/8	1/8	1-1/2	1	TC87660	TC87672	TC87684	TC87696	TC87708	29.14
1/4	1/4	2-1/2	1	TC87663	TC87675	TC87687	TC87699	TC87711	51.20
3/8	3/8	2-1/2	1	TC87666	TC87678	TC87690	TC87702	TC87714	80.02
1/2	1/2	3	1	TC87669	TC87681	TC87693	TC87705	TC87717	132.53



2 FLUTE - DOUBLE END

60° • 82° • 90° • 100° • 120°

SERIES 858

UNCOATED

DIA	SHANK	OAL	PKG. QTY.	60°- ITEM#	82°- ITEM#	90°- ITEM#	100°- ITEM#	120°- ITEM#	LIST PRICE
1/8	1/8	2	1	TC87840	TC87858	TC87876	TC87894	TC87912	41.94
3/16	3/16	2-1/2	1	TC87843	TC87861	TC87879	TC87897	TC87915	57.76
1/4	1/4	2-1/2	1	TC87846	TC87864	TC87882	TC87900	TC87918	73.85
5/16	5/16	2-1/2	1	TC87849	TC87867	TC87885	TC87903	TC87921	94.52
3/8	3/8	2-1/2	1	TC87852	TC87870	TC87888	TC87906	TC87924	115.20
1/2	1/2	3	1	TC87855	TC87873	TC87891	TC87909	TC87927	190.70



2 FLUTE - DOUBLE END

60° • 82° • 90° • 100° • 120°

SERIES 860

ALTIN COATED

DIA	SHANK	OAL	PKG. QTY.	60°- ITEM#	82°- ITEM#	90°- ITEM#	100°- ITEM#	120°- ITEM#	LIST PRICE
1/8	1/8	2	1	TC87930	TC87948	TC87966	TC87984	TC88002	52.46
3/16	3/16	2-1/2	1	TC87933	TC87951	TC87969	TC87987	TC88005	72.21
1/4	1/4	2-1/2	1	TC87936	TC87954	TC87972	TC87990	TC88008	92.16
5/16	5/16	2-1/2	1	TC87939	TC87957	TC87975	TC87993	TC88011	118.09
3/8	3/8	2-1/2	1	TC87942	TC87960	TC87978	TC87996	TC88014	144.15
1/2	1/2	3	1	TC87945	TC87963	TC87981	TC87999	TC88017	238.61

TOLERANCES	SHANK
ALL SIZES	-.0001, -.0004 ISO H6

For coating information see page 8. For technical information, please see pages 90 - 91.

GENERAL PURPOSE SOLID CARBIDE CHAMFER MILLS



YOUR #1 SOURCE FOR AMERICAN-MADE PREMIUM QUALITY CUTTING TOOLS



4 FLUTE - SINGLE END
60° • 82° • 90° • 100° • 120°
SERIES 854
UNCOATED

DIA	SHANK	OAL	PKG. QTY.	60°- ITEM#	82°- ITEM#	90°- ITEM#	100°- ITEM#	120°- ITEM#	LIST PRICE
1/8	1/8	1-1/2	1	TC87720	TC87732	TC87744	TC87756	TC87768	23.30
1/4	1/4	2-1/2	1	TC87723	TC87735	TC87747	TC87759	TC87771	41.03
3/8	3/8	2-1/2	1	TC87726	TC87738	TC87750	TC87762	TC87774	64.00
1/2	1/2	3	1	TC87729	TC87741	TC87753	TC87765	TC87777	105.95



4 FLUTE - SINGLE END
60° • 82° • 90° • 100° • 120°
SERIES 856
ALTIN COATED

DIA	SHANK	OAL	PKG. QTY.	60°- ITEM#	82°- ITEM#	90°- ITEM#	100°- ITEM#	120°- ITEM#	LIST PRICE
1/8	1/8	1-1/2	1	TC87780	TC87792	TC87804	TC87816	TC87828	29.14
1/4	1/4	2-1/2	1	TC87783	TC87795	TC87807	TC87819	TC87831	51.20
3/8	3/8	2-1/2	1	TC87786	TC87798	TC87810	TC87822	TC87834	80.02
1/2	1/2	3	1	TC87789	TC87801	TC87813	TC87825	TC87837	132.53



4 FLUTE - DOUBLE END
60° • 82° • 90° • 100° • 120°
SERIES 862
UNCOATED

DIA	SHANK	OAL	PKG. QTY.	60°- ITEM#	82°- ITEM#	90°- ITEM#	100°- ITEM#	120°- ITEM#	LIST PRICE
1/8	1/8	2	1	TC88020	TC88038	TC88056	TC88074	TC88092	41.94
3/16	3/16	2-1/2	1	TC88023	TC88041	TC88059	TC88077	TC88095	57.76
1/4	1/4	2-1/2	1	TC88026	TC88044	TC88062	TC88080	TC88098	73.85
5/16	5/16	2-1/2	1	TC88029	TC88047	TC88065	TC88083	TC88101	94.52
3/8	3/8	2-1/2	1	TC88032	TC88050	TC88068	TC88086	TC88104	115.20
1/2	1/2	3	1	TC88035	TC88053	TC88071	TC88089	TC88107	190.70



4 FLUTE - DOUBLE END
60° • 82° • 90° • 100° • 120°
SERIES 864
ALTIN COATED

DIA	SHANK	OAL	PKG. QTY.	60°- ITEM#	82°- ITEM#	90°- ITEM#	100°- ITEM#	120°- ITEM#	LIST PRICE
1/8	1/8	2	1	TC88110	TC88128	TC88146	TC88164	TC88182	52.46
3/16	3/16	2-1/2	1	TC88113	TC88131	TC88149	TC88167	TC88185	72.21
1/4	1/4	2-1/2	1	TC88116	TC88134	TC88152	TC88170	TC88188	92.16
5/16	5/16	2-1/2	1	TC88119	TC88137	TC88155	TC88173	TC88191	118.09
3/8	3/8	2-1/2	1	TC88122	TC88140	TC88158	TC88176	TC88194	144.15
1/2	1/2	3	1	TC88125	TC88143	TC88161	TC88179	TC88197	238.61

TOLERANCES	SHANK
ALL SIZES	-.0001, -.0004 ISO H6

For coating information see page 8. For technical information, please see pages 90 - 91.



4 FLUTE

SFM					
MATERIAL / TYPE	Rc HARDNESS	4 FLUTE STUB LENGTH	4 FLUTE REG LENGTH	4 FLUTE LONG LENGTH	4 FLUTE EXTRA LONG
COBALT BASE ALLOYS					
STELLITE, HS-21,	UNDER 32	275 - 350	275 - 350	200 - 275	200 - 275
HAYNES 25/188, X-40, L-605	OVER 32	175 - 250	175 - 250	125 - 175	125 - 175
NICKEL BASE ALLOYS					
INCONEL-625/718, WASPALLOY,	UNDER 32	200 - 300	200 - 300	150 - 200	150 - 200
RENE, HASTELLOY	OVER 32	125 - 200	125 - 200	90 - 125	90 - 125
IRON BASE ALLOYS					
INCOLOY 800-802, MULTIMET N-155,	UNDER 32	250 - 350	250 - 350	200 - 300	200 - 300
TIMKIN 16-25-6, CARPENTER 22-b3	OVER 32	200 - 250	200 - 250	150 - 200	150 - 200
MONEL					
MONEL-65% NICKEL	-	275 - 350	275 - 350	200 - 300	200 - 300
TITANIUM ALLOYS					
COMMERCIALLY PURE, 6Al-4V,	-	-	-	-	-
ASTM 1/2/3, 6Al-25N-4Zr-2Mo-Si	-	250 - 400	250 - 400	150 - 300	150 - 300
STAINLESS STEEL (PRECIPITATION)					
12/8, 15/5, 17/4, AM-350/355	UNDER 32	250 - 300	250 - 300	175 - 210	175 - 210
	OVER 32	200 - 250	200 - 250	140 - 175	140 - 175
STAINLESS STEEL (AUSTENITIC)					
200 SERIES, 302, 303, 304, 316	-	290 - 375	290 - 375	200 - 260	200 - 260
STAINLESS STEEL (AUSTENITIC)					
304L, 316L	UNDER 32	250 - 300	250 - 300	175 - 210	175 - 210
	OVER 32	200 - 250	200 - 250	140 - 175	140 - 175
STAINLESS STEEL (MARTENSITIC)					
403, 410, 416, 440	-	250 - 300	250 - 300	175 - 210	175 - 210
HIGH STRENGTH TOOL STEELS					
4140, 4340, 6150, 5210, A2,	UNDER 32	250 - 350	250 - 350	175 - 210	175 - 210
D2, P20, H11, H13, S2, 01	OVER 32	150 - 200	150 - 200	100 - 140	100 - 140
CARBON STEELS					
1000's, 1100's, 1300'S	-	560 - 595	560 - 595	300 - 500	300 - 500
DUCTILE					
DUCTILE CAST IRONS	-	560 - 595	560 - 595	400 - 500	400 - 500
CAST IRONS					
GRAY CAST IRONS	-	560 - 595	560 - 595	400 - 500	400 - 500

Speed and feed chart parameters are for 4 flute full diameter slotting

Recommended slotting up to 1 x Diameter
 Tool holding important for maximizing tool life. Minimize TIR
 Max ramp angle recommended 3° or less

4 FLUTE

I.P.T. (INCH PER TOOTH)										
MATERIAL / TYPE	1/8"	3/16"	1/4"	5/16"	3/8"	7/16"	1/2"	5/8"	3/4"	1"
COBALT BASE ALLOYS										
STELLITE, HS-21, HAYNES 25/188, X-40, L-605	.0004 - .0008	.0005 - .0011	.0009 - .0016	.0010 - .0018	.0012 - .0019	.0014 - .0021	.0016 - .0028	.0019 - .0031	.0024 - .0037	.0029 - .0041
NICKEL BASE ALLOYS										
INCONEL-625/718, WASPALLOY, RENE, HASTELLOY	.0004 - .0008	.0005 - .0011	.0009 - .0016	.0010 - .0018	.0012 - .0019	.0014 - .0021	.0016 - .0028	.0019 - .0031	.0024 - .0037	.0029 - .0041
IRON BASE ALLOYS										
INCOLOY 800-802, MULTIMET N-155, TIMKIN 16-25-6, CARPENTER 22-b3	.0004 - .0008	.0005 - .0011	.0009 - .0016	.0010 - .0018	.0012 - .0019	.0014 - .0021	.0016 - .0028	.0019 - .0031	.0024 - .0037	.0029 - .0041
MONEL										
MONEL-65% NICKEL	.0004 - .0008	.0009 - .0011	.0014 - .0016	.0015 - .0017	.0017 - .0019	.0019 - .0021	.0026 - .0028	.0029 - .0031	.0035 - .0037	.0039 - .0041
TITANIUM ALLOYS										
COMMERCIALLY PURE, 6Al-4V, ASTM 1/2/3, 6Al-25N-4Zr-2Mo-Si	.0004 - .0008	.0009 - .0011	.0014 - .0016	.0015 - .0017	.0017 - .0019	.0019 - .0021	.0026 - .0028	.0029 - .0031	.0035 - .0037	.0039 - .0041
STAINLESS STEEL (PRECIPITATION)										
12/8, 15/5, 17/4, AM-350/355	.0004 - .0008	.0009 - .0011	.0014 - .0016	.0016 - .0020	.0017 - .0025	.0019 - .0031	.0026 - .0032	.0029 - .0037	.0035 - .0039	.0039 - .0041
STAINLESS STEEL (AUSTENITIC)										
200 SERIES, 302, 303, 304, 316	.0004 - .0008	.0009 - .0011	.0014 - .0016	.0016 - .0020	.0017 - .0025	.0019 - .0031	.0026 - .0032	.0029 - .0037	.0035 - .0039	.0039 - .0041
STAINLESS STEEL (AUSTENITIC)										
304L, 316L	.0004 - .0008	.0009 - .0011	.0014 - .0016	.0016 - .0020	.0017 - .0025	.0019 - .0031	.0026 - .0032	.0029 - .0037	.0035 - .0039	.0039 - .0041
STAINLESS STEEL (MARTENSITIC)										
403, 410, 416, 440	.0004 - .0008	.0009 - .0011	.0014 - .0016	.0016 - .0020	.0017 - .0025	.0019 - .0031	.0026 - .0032	.0029 - .0037	.0035 - .0039	.0039 - .0041
HIGH STRENGTH TOOL STEELS										
4140, 4340, 6150, 5210, A2, D2, P20, H11, H13, S2, O1	.0004 - .0008	.0009 - .0011	.0014 - .0016	.0016 - .0020	.0017 - .0025	.0019 - .0031	.0026 - .0032	.0029 - .0037	.0035 - .0039	.0039 - .0041
CARBON STEELS										
1000's, 1100's, 1300'S	.0004 - .0008	.0011 - .0013	.0018 - .0020	.0024 - .0026	.0030 - .0032	.0033 - .0035	.0035 - .0037	.0039 - .0041	.0041 - .0043	.0054 - .0056
DUCTILE										
DUCTILE CAST IRONS	.0004 - .0008	.0011 - .0013	.0018 - .0020	.0024 - .0026	.0030 - .0032	.0033 - .0035	.0035 - .0037	.0039 - .0041	.0041 - .0043	.0054 - .0056
CAST IRONS										
GRAY CAST IRONS	.0004 - .0008	.0011 - .0013	.0018 - .0020	.0024 - .0026	.0030 - .0032	.0033 - .0035	.0035 - .0037	.0039 - .0041	.0041 - .0043	.0054 - .0056

Chip Thinning recommended for 4 Flute to optimize tool life:

5% of Diameter Radial engaged: Multiply Feed 3X
 10% of Diameter Radial engaged: Multiply Feed 2X
 20% of Diameter Radial engaged: Multiply Feed 1.5X



5 FLUTE

SFM SEMI-ROUGHING & FINISH PASSES, UP TO 25% OF DIAMETER					
MATERIAL / TYPE	Rc HARDNESS	5 FLUTE STUB LENGTH	5 FLUTE REG LENGTH	5 FLUTE LONG LENGTH	5 FLUTE EXTRA LONG
COBALT BASE ALLOYS					
STELLITE, HS-21,	UNDER 32	550 - 570	550 - 570	385 - 400	385 - 400
HAYNES 25/188, X-40, L-605	OVER 32	200 - 225	200 - 225	140 - 160	140 - 160
NICKEL BASE ALLOYS					
INCONEL-625/718, WASPALLOY,	UNDER 32	550 - 570	550 - 570	385 - 400	385 - 400
RENE, HASTELLOY	OVER 32	200 - 225	200 - 225	140 - 160	140 - 160
IRON BASE ALLOYS					
INCOLOY 800-802, MULTIMET N-155,	UNDER 32	550 - 570	550 - 570	385 - 400	385 - 400
TIMKIN 16-25-6, CARPENTER 22-b3	OVER 32	200 - 225	200 - 225	140 - 160	140 - 160
MONEL					
MONEL-65% NICKEL	-	550 - 570	550 - 570	385 - 400	385 - 400
TITANIUM ALLOYS					
COMMERCIALLY PURE, 6Al-4V,	-	-	-	-	-
ASTM 1/2/3, 6Al-25N-4Zr-2Mo-Si	-	550 - 570	550 - 570	385 - 400	385 - 400
STAINLESS STEEL (PRECIPITATION)					
12/8, 15/5, 17/4, AM-350/355	UNDER 32	600 - 625	600 - 625	420 - 440	420 - 440
	OVER 32	550 - 570	550 - 570	385 - 400	385 - 400
STAINLESS STEEL (AUSTENITIC)					
200 SERIES, 302, 303, 304, 316	-	600 - 625	600 - 625	420 - 440	420 - 440
STAINLESS STEEL (AUSTENITIC)					
304L, 316L	UNDER 32	600 - 625	600 - 625	420 - 440	420 - 440
	OVER 32	550 - 570	550 - 570	385 - 400	385 - 400
STAINLESS STEEL (MARTENSITIC)					
403, 410, 416, 440	-	600 - 625	600 - 625	420 - 440	420 - 440
HIGH STRENGTH TOOL STEELS					
4140, 4340, 6150, 5210, A2,	UNDER 32	600 - 625	600 - 625	420 - 440	420 - 440
D2, P20, H11, H13, S2, 01	OVER 32	550 - 570	550 - 570	385 - 400	385 - 400
CARBON STEELS					
1000's, 1100's, 1300's	-	800 - 850	800 - 850	560 - 595	560 - 595
DUCTILE					
DUCTILE CAST IRONS	-	800 - 850	800 - 850	560 - 595	560 - 595
CAST IRONS					
GRAY CAST IRONS	-	800 - 850	800 - 850	560 - 595	560 - 595

5 FLUTE

I.P.T. (INCH PER TOOTH)										
MATERIAL / TYPE	1/8"	3/16"	1/4"	5/16"	3/8"	7/16"	1/2"	5/8"	3/4"	1"
COBALT BASE ALLOYS										
STELLITE, HS-21, HAYNES 25/188, X-40, L-605	.0004 - .0008	.0005 - .0011	.0009 - .0016	.0010 - .0018	.0012 - .0019	.0014 - .0021	.0016 - .0028	.0019 - .0031	.0024 - .0037	.0029 - .0041
NICKEL BASE ALLOYS										
INCONEL-625/718, WASPALLOY, RENE, HASTELLOY	.0004 - .0008	.0005 - .0011	.0009 - .0016	.0010 - .0018	.0012 - .0019	.0014 - .0021	.0016 - .0028	.0019 - .0031	.0024 - .0037	.0029 - .0041
IRON BASE ALLOYS										
INCOLOY 800-802, MULTIMET N-155, TIMKIN 16-25-6, CARPENTER 22-b3	.0004 - .0008	.0005 - .0011	.0009 - .0016	.0010 - .0018	.0012 - .0019	.0014 - .0021	.0016 - .0028	.0019 - .0031	.0024 - .0037	.0029 - .0041
MONEL										
MONEL-65% NICKEL	.0004 - .0008	.0009 - .0011	.0014 - .0016	.0015 - .0017	.0017 - .0019	.0019 - .0021	.0026 - .0028	.0029 - .0031	.0035 - .0037	.0039 - .0041
TITANIUM ALLOYS										
COMMERCIALLY PURE, 6Al-4V, ASTM 1/2/3, 6Al-25N-4Zr-2Mo-Si	.0004 - .0008	.0009 - .0011	.0014 - .0016	.0015 - .0017	.0017 - .0019	.0019 - .0021	.0026 - .0028	.0029 - .0031	.0035 - .0037	.0039 - .0041
STAINLESS STEEL (PRECIPITATION)										
12/8, 15/5, 17/4, AM-350/355	.0004 - .0008	.0009 - .0011	.0014 - .0016	.0016 - .0020	.0017 - .0025	.0019 - .0031	.0026 - .0032	.0029 - .0037	.0035 - .0039	.0039 - .0041
STAINLESS STEEL (AUSTENITIC)										
200 SERIES, 302, 303, 304, 316	.0004 - .0008	.0009 - .0011	.0014 - .0016	.0016 - .0020	.0017 - .0025	.0019 - .0031	.0026 - .0032	.0029 - .0037	.0035 - .0039	.0039 - .0041
STAINLESS STEEL (AUSTENITIC)										
304L, 316L	.0004 - .0008	.0009 - .0011	.0014 - .0016	.0016 - .0020	.0017 - .0025	.0019 - .0031	.0026 - .0032	.0029 - .0037	.0035 - .0039	.0039 - .0041
STAINLESS STEEL (MARTENSITIC)										
403, 410, 416, 440	.0004 - .0008	.0009 - .0011	.0014 - .0016	.0016 - .0020	.0017 - .0025	.0019 - .0031	.0026 - .0032	.0029 - .0037	.0035 - .0039	.0039 - .0041
HIGH STRENGTH TOOL STEELS										
4140, 4340, 6150, 5210, A2, D2, P20, H11, H13, S2, 01	.0004 - .0008	.0009 - .0011	.0014 - .0016	.0016 - .0020	.0017 - .0025	.0019 - .0031	.0026 - .0032	.0029 - .0037	.0035 - .0039	.0039 - .0041
CARBON STEELS										
1000's, 1100's, 1300'S	.0004 - .0008	.0011 - .0013	.0018 - .0020	.0024 - .0026	.0030 - .0032	.0033 - .0035	.0035 - .0037	.0039 - .0041	.0041 - .0043	.0054 - .0056
DUCTILE										
DUCTILE CAST IRONS	.0004 - .0008	.0011 - .0013	.0018 - .0020	.0024 - .0026	.0030 - .0032	.0033 - .0035	.0035 - .0037	.0039 - .0041	.0041 - .0043	.0054 - .0056
CAST IRONS										
GRAY CAST IRONS	.0004 - .0008	.0011 - .0013	.0018 - .0020	.0024 - .0026	.0030 - .0032	.0033 - .0035	.0035 - .0037	.0039 - .0041	.0041 - .0043	.0054 - .0056

Chip Thinning recommended for optimized tool life:

5% of Diameter Radial engaged: Multiply Feed 3X
10% of Diameter Radial engaged: Multiply Feed 2X



6 FLUTE

SFM FINISHING PASSES ONLY, UP TO 10% OF DIAMETER			
MATERIAL / TYPE	Rc HARDNESS	6 FLUTE REG LENGTH	6 FLUTE LONG LENGTH
COBALT BASE ALLOYS			
STELLITE, HS-21,	UNDER 32	550 - 570	385 - 400
HAYNES 25/188, X-40, L-605	OVER 32	200 - 225	140 - 160
NICKEL BASE ALLOYS			
INCONEL-625/718, WASPALLOY,	UNDER 32	550 - 570	385 - 400
RENE, HASTELLOY	OVER 32	200 - 225	140 - 160
IRON BASE ALLOYS			
INCOLOY 800-802, MULTIMET N-155,	UNDER 32	550 - 570	385 - 400
TIMKIN 16-25-6, CARPENTER 22-b3	OVER 32	200 - 225	140 - 160
MONEL			
MONEL-65% NICKEL	-	550 - 570	385 - 400
TITANIUM ALLOYS			
COMMERCIALLY PURE, 6Al-4V,	-	-	-
ASTM 1/2/3, 6Al-25N-4Zr-2Mo-Si	-	550 - 570	385 - 400
STAINLESS STEEL (PRECIPITATION)			
12/8, 15/5, 17/4, AM-350/355	UNDER 32	600 - 625	420 - 440
	OVER 32	550 - 570	385 - 400
STAINLESS STEEL (AUSTENITIC)			
200 SERIES, 302, 303, 304, 316	-	600 - 625	420 - 440
STAINLESS STEEL (AUSTENITIC)			
304L, 316L	UNDER 32	600 - 625	420 - 440
	OVER 32	550 - 570	385 - 400
STAINLESS STEEL (MARTENSITIC)			
403, 410, 416, 440	-	600 - 625	420 - 440
HIGH STRENGTH TOOL STEELS			
4140, 4340, 6150, 5210, A2,	UNDER 32	600 - 625	420 - 440
D2, P20, H11, H13, S2, 01	OVER 32	550 - 570	385 - 400
CARBON STEELS			
1000's, 1100's, 1300's	-	800 - 850	560 - 595
DUCTILE			
DUCTILE CAST IRONS	-	800 - 850	560 - 595
CAST IRONS			
GRAY CAST IRONS	-	800 - 850	560 - 595

6 FLUTE

I.P.T. (INCH PER TOOTH)							
MATERIAL / TYPE	1/4"	5/16"	3/8"	1/2"	5/8"	3/4"	1"
COBALT BASE ALLOYS							
STELLITE, HS-21, HAYNES 25/188, X-40, L-605	.0009 - .0016	.0010 - .0018	.0012 - .0019	.0016 - .0028	.0019 - .0031	.0024 - .0037	.0029 - .0041
NICKEL BASE ALLOYS							
INCONEL-625/718, WASPALLOY, RENE, HASTELLOY	.0009 - .0016	.0010 - .0018	.0012 - .0019	.0016 - .0028	.0019 - .0031	.0024 - .0037	.0029 - .0041
IRON BASE ALLOYS							
INCOLOY 800-802, MULTIMET N-155, TIMKIN 16-25-6, CARPENTER 22-b3	.0009 - .0016	.0010 - .0018	.0012 - .0019	.0016 - .0028	.0019 - .0031	.0024 - .0037	.0029 - .0041
MONEL							
MONEL-65% NICKEL	.0014 - .0016	.0015 - .0017	.0017 - .0019	.0026 - .0028	.0029 - .0031	.0035 - .0037	.0039 - .0041
TITANIUM ALLOYS							
COMMERCIALLY PURE, 6Al-4V, ASTM 1/2/3, 6Al-25N-4Zr-2Mo-Si	.0014 - .0016	.0015 - .0017	.0017 - .0019	.0026 - .0028	.0029 - .0031	.0035 - .0037	.0039 - .0041
STAINLESS STEEL (PRECIPITATION)							
12/8, 15/5, 17/4, AM-350/355	.0014 - .0016	.0016 - .0020	.0017 - .0025	.0026 - .0032	.0029 - .0037	.0035 - .0039	.0039 - .0041
STAINLESS STEEL (AUSTENITIC)							
200 SERIES, 302, 303, 304, 316	.0014 - .0016	.0016 - .0020	.0017 - .0025	.0026 - .0032	.0029 - .0037	.0035 - .0039	.0039 - .0041
STAINLESS STEEL (AUSTENITIC)							
304L, 316L	.0014 - .0016	.0016 - .0020	.0017 - .0025	.0026 - .0032	.0029 - .0037	.0035 - .0039	.0039 - .0041
STAINLESS STEEL (MARTENSITIC)							
403, 410, 416, 440	.0014 - .0016	.0016 - .0020	.0017 - .0025	.0026 - .0032	.0029 - .0037	.0035 - .0039	.0039 - .0041
HIGH STRENGTH TOOL STEELS							
4140, 4340, 6150, 5210, A2, D2, P20, H11, H13, S2, 01	.0014 - .0016	.0016 - .0020	.0017 - .0025	.0026 - .0032	.0029 - .0037	.0035 - .0039	.0039 - .0041
CARBON STEELS							
1000's, 1100's, 1300'S	.0018 - .0020	.0024 - .0026	.0030 - .0032	.0035 - .0037	.0039 - .0041	.0041 - .0043	.0054 - .0056
DUCTILE							
DUCTILE CAST IRONS	.0018 - .0020	.0024 - .0026	.0030 - .0032	.0035 - .0037	.0039 - .0041	.0041 - .0043	.0054 - .0056
CAST IRONS							
GRAY CAST IRONS	.0018 - .0020	.0024 - .0026	.0030 - .0032	.0035 - .0037	.0039 - .0041	.0041 - .0043	.0054 - .0056

Chip Thinning recommended for optimized tool life:

5% of Diameter Radial engaged: Multiply Feed 3X
10% of Diameter Radial engaged: Multiply Feed 2X



ROUGHING END MILLS - CARBIDE

TECHNICAL INFORMATION

YOUR #1 SOURCE FOR AMERICAN-MADE PREMIUM QUALITY CUTTING TOOLS

MATERIAL	GRADES	STUB & REGULAR		LONG LENGTH		1/4	3/8	1/2	5/8	3/4	1
		SFM	SFM	SFM	SFM	(.2500)	(.3750)	(.5000)	(.0625)	(.7500)	(1.000)
		UNCOATED	ALTIM	UNCOATED	ALTIM	IPT	IPT	IPT	IPT	IPT	IPT
ALLOYS											
COBALT BASE	STELLITE, HS-21, HAYNES 25/188	25-45	45-75	20-35	35-60	.0009-.0012	.0012-.0015	.0015-.0018	.0018-.0021	.0021-.0025	.0025-.0027
COBALT BASE >32HRC	X40, L605	25-45	45-75	20-35	35-60	.0009-.0012	.0012-.0015	.0015-.0018	.0018-.0021	.0021-.0025	.0025-.0027
IRON BASE	INCOLOY 800-802, MULTMET N-155	25-45	45-75	20-35	35-60	.0009-.0012	.0012-.0015	.0015-.0018	.0018-.0021	.0021-.0025	.0025-.0027
IRON BASE >32HRC	TIMKIN 16-25-6, CARPENTER 22-B3	25-45	45-75	20-35	35-60	.0009-.0012	.0012-.0015	.0015-.0018	.0018-.0021	.0021-.0025	.0025-.0027
NICKEL BASE	INCONEL 625/718, INCO 700, 713C, 718	40-85	65-145	30-65	50-115	.0009-.0012	.0012-.0015	.0015-.0018	.0018-.0021	.0021-.0025	.0025-.0027
NICKEL BASE >32HRC	MONEL 400-401, 404, K401, RENE, RENE 41 & 95 HASTELLOY, WASPOLOY, UDIMET 500 & 700	30-65	55-110	25-50	45-90	.0009-.0012	.0012-.0015	.0015-.0018	.0018-.0021	.0021-.0025	.0025-.0027
TITANIUM	COMMERCIAL PURE, 6AL-4VASTM 1/2/3, 6AL-25N-4ZR-2MO-SITI-8AL-1MO, TI-8AL-4MO	75-130	125-215	60-100	100-170	.0009-.0012	.0012-.0015	.0015-.0018	.0018-.0021	.0021-.0025	.0025-.0027
ALUMINUM											
ALUMINUM ALLOYS		N/A	N/A	N/A	N/A	N/A	N/A	N/A	N/A	N/A	N/A
HIGH SILICON		N/A	N/A	N/A	N/A	N/A	N/A	N/A	N/A	N/A	N/A
BRASS/BRONZE											
	ALUMINUM BRONZE, LOW SILICON BRONZE	N/A	N/A	N/A	N/A	N/A	N/A	N/A	N/A	N/A	N/A
CAST IRON											
DUCTILE	A536, J434, 60-40-18	200-250	300-350	140-175	210-250	.0005-.0015	.0015-.002	.002-.0025	.0025-.003	.003-.0035	.0035-.004
GRAY	A48, A436, A319, CLASS 20, G4000	250-300	450-500	175-210	315-350	.0005-.0015	.0015-.002	.002-.0025	.0025-.003	.003-.0035	.0035-.004
MALLEABLE	A220, A602, J158	N/A	N/A	N/A	N/A	N/A	N/A	N/A	N/A	N/A	N/A
COMPOSITES											
	G-10, FIBERGLASS, GRAPHITE, GRAPHITE EPOXY, PLASTICS	N/A	N/A	N/A	N/A	N/A	N/A	N/A	N/A	N/A	N/A
COPPER											
		N/A	N/A	N/A	N/A	N/A	N/A	N/A	N/A	N/A	N/A
MAGNESIUM											
		N/A	N/A	N/A	N/A	N/A	N/A	N/A	N/A	N/A	N/A
STAINLESS STEEL											
AUSTENITIC	301-304L, 310, 316L, 321, 347	150-300	250-500	120-240	200-400	.0010-.0015	.0015-.0020	.0020-.0025	.0025-.0030	.0030-.0035	.0035-.0040
MARTENSITIC	403, 410, 416, 420, 430,	135-255	225-430	110-200	180-340	.0015-.0020	.0020-.0030	.0030-.0035	.0035-.0040	.0038-.0042	.0040-.0045
PRECIPITATION HARDENING	12/8, 15/5, 17/4, AM-350/355/363, PH13-8MO, PH14-8/MO	135-255	225-430	110-200	180-340	.0015-.0020	.0020-.0030	.0030-.0035	.0035-.0040	.0038-.0042	.0040-.0045
STEELALLOY											
HIGH STRENGTH TOOL STEEL	A2, D2, P20, H11, H13,	200-230	250-320	140-160	180-210	.0003-.001	.001-.0015	.0015-.002	.002-.003	.003-.0035	.0035-.004
HIGH STRENGTH TOOL STEEL >32 HRC		180-220	240-280	130-150	170-190	.0003-.001	.001-.0015	.0015-.002	.002-.003	.003-.0035	.0035-.004
LOW CARBON	A36, 12L14, 12L15, 1005, 1018, 1020, 1108-1119, 1213-1215, 1513-1518, 4012, 5015, 9310	210-345	350-575	165-275	280-460	.0015-.0020	.0020-.0030	.0030-.0035	.0035-.0040	.0038-.0042	.0040-.0045
LOW CARBON >32HRC		125-190	210-320	100-150	165-255	.0011-.0015	.0015-.0020	.0020-.0025	.0023-.0025	.0025-.0030	.0028-.0032
MEDIUM CARBON	1040-1095, 1140-1151, 1330-1345, 1520-1572, 4023-4063, 4120-4161, 4330-4340, 4620-4640, 8620-8660, 8740-8750, 6150, 51000, 52100	210-345	350-575	165-275	280-460	.0015-.0020	.0020-.0030	.0030-.0035	.0035-.0040	.0038-.0042	.0040-.0045
MEDIUM CARBON >32 HRC		180-220	240-280	130-150	170-190	.0003-.001	.001-.0015	.0015-.002	.002-.003	.003-.0035	.0035-.004

ROUGHING END MILLS - M42 COBALT TECHNICAL INFORMATION



YOUR #1 SOURCE FOR AMERICAN-MADE PREMIUM QUALITY CUTTING TOOLS

MILLING

SFM & I.P.T. (INCH PER TOOTH)									
MATERIAL / TYPE	CONDITIONS	STARTING SFM ALTN	DIAMETER RANGE - SUGGESTED CHIP LOAD PER TOOTH						
			1/4"	1/2"	3/4"	1"	1-1/4"	1-1/2"	2"
STAINLESS STEELS									
PRECIPITATION 13-8, 15-5, 17-4PH	Slotting Axial 1 x D	100-150	.0015"	.0020"	.0026"	.0036"	.0046"	.0054"	.0070"
	Heavy Profiling		.0015"	.0020"	.0029"	.0040"	.0050"	.0060"	.0075"
AUSTENITIC 302, 303, 304L, 316L	Slotting 1 x D	100-150	.0015"	.0020"	.0030"	.0045"	.0056"	.0067"	.0090"
	Heavy Profiling		.0019"	.0025"	.0034"	.0049"	.0061"	.0074"	.0098"
MARTENSITIC 403, 410, 416	Slotting Axial 1 x D	100-170	.0015"	.0020"	.0030"	.0045"	.0056"	.0067"	.0090"
	Heavy Profiling		.0019"	.0025"	.0034"	.0049"	.0061"	.0074"	.0098"
HIGH TEMP ALLOYS									
COBALT BASE Stellite, Haynes 25, 188, X-40, L-605	Slotting 1 x D	10-40	.0011"	.0014"	.0018"	.0026"	.0033"	.0040"	.0053"
	Heavy Profiling		.0011"	.0014"	.0020"	.0029"	.0037"	.0045"	.0059"
NICKEL BASE Inconel 600, 625, 718, Nickel 200, 270, Invar, Monel 400, 405, K-Monel PermaNickel 300, Incoly 600	Slotting Axial 1 x D	20-40	.0011"	.0014"	.0018"	.0026"	.0033"	.0040"	.0053"
	Heavy Profiling		.0011"	.0014"	.0020"	.0029"	.0037"	.0045"	.0059"
IRON BASE Incoly 800-802, Multimet N-155, Timken 16-26-6	Slotting 1 x D	30-80	.0011"	.0014"	.0018"	.0026"	.0033"	.0040"	.0053"
	Heavy Profiling		.0011"	.0014"	.0020"	.0029"	.0037"	.0045"	.0059"
STEELS									
HIGH STRENGTH STEELS 4140, 4340, 52100	Slotting Axial 1 x D	100-150	.0015"	.0020"	.0025"	.0035"	.0045"	.0053"	.0071"
	Heavy Profiling		.0015"	.0020"	.0028"	.0039"	.0050"	.0059"	.0079"
HIGH ALLOY STEELS MOLD & DIE A-2, P20, 01, 02, D2, H-13	Slotting 1 x D	80-115	.0015"	.0020"	.0025"	.0035"	.0045"	.0053"	.0071"
	Heavy Profiling		.0015"	.0020"	.0028"	.0039"	.0050"	.0059"	.0079"
MEDIUM ALLOY STEELS 200, 250, 300	Slotting Axial 1 x D	100-180	.0016"	.0023"	.0033"	.0050"	.0032"	.0075"	.0093"
	Heavy Profiling		.0020"	.0027"	.0040"	.0054"	.0070"	.0082"	.0110"
LOW ALLOY STEELS MARAGING 10XX, 11XX, 13XX	Slotting 1 x D	130-200	.0018"	.0025"	.0037"	.0053"	.0068"	.0080"	.0100"
	Heavy Profiling		.0022"	.0029"	.0042"	.0059"	.0074"	.0090"	.0115"
CAST IRONS									
DUCTILE IRON Ductile Cast Iron	Slotting Axial 1 x D	70-130	.0015"	.0019"	.0030"	.0042"	.0056"	.0065"	.0087"
	Heavy Profiling		.0018"	.0024"	.0034"	.0048"	.0061"	.0073"	.0093"
CAST IRON Gray Cast Iron	Slotting 1 x D	120-200	.0014"	.0018"	.0024"	.0034"	.0044"	.0053"	.0070"
	Heavy Profiling		.0014"	.0018"	.0027"	.0038"	.0050"	.0058"	.0078"
TITANIUMS									
TITANIUM ALLOYS 6AL-4V, ASTM 1, 2, 3, 6AL-2S For 5553, decrease SFM & IPM 25%	Slotting Axial 1 x D	75-150	.0015"	.0020"	.0028"	.0040"	.0052"	.0062"	.0080"
	Heavy Profiling		.0017"	.0022"	.0030"	.0045"	.0057"	.0067"	.0090"
ALUMINUM									
ALUMINUM ALLOYS 6061-T6, 7075	Slotting Axial 1 x D	650-950	.0024"	.0058"	.0067"	.0103"	.0112"	.0180"	.0210"
	Heavy Profiling		.0027"	.0058"	.0076"	.0110"	.0120"	.0205"	.0260"

SPEED & FEED CALCULATION FORMULAS

RPM = (3.82 x SFM) ÷ Dia.	IPR = IPM ÷ RPM	SFM = (RPM x Dia.) ÷ 3.82
IPM = IPT(chip load) x No. of Teeth x RPM		IPT(chip load) = IPM ÷ (No. of teeth x RPM)

TECHNICAL



45° & 60° HELIX END MILLS - CARBIDE TECHNICAL INFORMATION

YOUR #1 SOURCE FOR AMERICAN-MADE PREMIUM QUALITY CUTTING TOOLS

THESE VALUES ARE FOR UNCOATED TOOLS
FOR COATED TOOLS INCREASE SFM: ZRN = +30% ALTIN = +40%

SFM FOR GENERAL PURPOSE CARBIDE END MILLS

MATERIAL / TYPE	Rc HARDNESS	2 Fl, 3 Fl 45° Helix Aluminum	3 Flute 45° & 60° Helix	5 Flute 45° Helix
COBALT BASE ALLOYS				
STELLITE, HS-21, HAYNES 25/188, X-40, L-605	UNDER 32 OVER 32	- -	200 - 275 125 - 175	250 - 300 150 - 200
NICKEL BASE ALLOYS				
INCONEL-625/718, WASPALLOY, RENE, HASTELLOY	UNDER 32 OVER 32	- -	150 - 200 90 - 125	250 - 300 150 - 200
IRON BASE ALLOYS				
INCOLOY 800-802, MULTIMET N-155, TIMKIN 16-25-6, CARPENTER 22-b3	UNDER 32 OVER 32	- -	250 - 300 150 - 200	250 - 300 150 - 200
MONEL				
MONEL-65% NICKEL	-	-	200 - 300	225 - 350
TITANIUM ALLOYS				
COMMERCIALLY PURE, 6Al-4V, ASTM 1/2/3, 6Al-25N-4Zr-2Mo-Si	- -	500 min. -	250 - 400 -	250 - 400 -
STAINLESS STEEL (PRECIPITATION)				
12/8, 15/5, 17/4, AM-350/355	UNDER 32 OVER 32	- -	200 - 350 150 - 250	200 - 350 150 - 250
STAINLESS STEEL (AUSTENITIC)				
200 SERIES, 302, 303, 304, 316	UNDER 32 OVER 32	- -	250 - 350 175 - 275	250 - 350 175 - 275
STAINLESS STEEL (AUSTENITIC)				
304L, 316L	UNDER 32 OVER 32	- -	125 - 200 90 - 125	125 - 200 90 - 125
STAINLESS STEEL (MARTENSITIC)				
403, 410, 416, 440	UNDER 32 OVER 32	- -	200 - 350 150 - 250	200 - 350 150 - 250
HIGH STRENGTH TOOL STEELS				
4140, 4340, 6150, 5210, A2, D2, P20, H11, H13, S2, 01	UNDER 32 OVER 32	- -	225 - 300 125 - 200	225 - 300 125 - 200
MEDIUM ALLOY STEELS				
200, 250, 300	UNDER 32 OVER 32	- -	250 - 350 150 - 200	250 - 350 150 - 200
CARBON STEELS				
1000's, 1100's, 1300's	UNDER 32 OVER 32	- -	250 - 350 150 - 200	250 - 350 150 - 200
DUCTILE				
DUCTILE CAST IRONS	-	-	350 - 450	300 - 400
CAST IRONS				
GRAY CAST IRONS	-	-	300 - 400	250 - 350
ALUMINUM				
2014, 2024, 6061-(T1-T6) 7075, DIE CAST, EXTRUDED	- -	500 min. -	500 min. -	500 min. -
MAGNESIUM				
	-	500 min.	500 min.	500 min.
COPPER, COPPER ALLOYS				
	-	400 - 500	400 - 500	250 - 350
BRASS BRONZE				
BRASS, ALUM/BRONZE, LOW SILICON BRONZE	- -	300 - 400 -	300 - 400 -	- -
COMPOSITES				
G-10 FIBERGLASS, GRAPHITE, GRAPHITE/EPOXY, PLASTICS	- -	250 - 1000 -	- -	- -

45° & 60° HELIX END MILLS - CARBIDE TECHNICAL INFORMATION



YOUR #1 SOURCE FOR AMERICAN-MADE PREMIUM QUALITY CUTTING TOOLS

I.P.T. (INCH PER TOOTH)					
MATERIAL / TYPE	Rc HARDNESS	1/8"	1/8" - 1/4"	1/4" - 1/2"	1/2" - 1"
COBALT BASE ALLOYS					
STELLITE, HS-21, HAYNES 25/188, X-40, L-605	UNDER 32 OVER 32	.0005"-.0010" .0003"-.0005"	.0005"-.0010" .0003"-.0005"	.0008"-.0020" .0005"-.0015"	.0020"-.0040" .0010"-.0030"
NICKEL BASE ALLOYS					
INCONEL-625/718, WASPALLOY, RENE, HASTELLOY	UNDER 32 OVER 32	.0005"-.0010" .0003"-.0005"	.0005"-.0010" .0003"-.0005"	.0008"-.0020" .0005"-.0015"	.0020"-.0040" .0010"-.0030"
IRON BASE ALLOYS					
INCOLOY 800-802, MULTIMET N-155, TIMKIN 16-25-6, CARPENTER 22-b3	UNDER 32 OVER 32	.0005"-.0010" .0003"-.0005"	.0005"-.0010" .0003"-.0005"	.0008"-.0020" .0005"-.0015"	.0020"-.0040" .0010"-.0030"
MONEL					
MONEL-65% NICKEL	-	.0007"-.0015"	.0007"-.0015"	.0010"-.0025"	.0030"-.0050"
TITANIUM ALLOYS					
COMMERCIALLY PURE, 6Al-4V, ASTM 1/2/3, 6Al-25N-4Zr-2Mo-Si	- -	.0007"-.0015" -	.0007"-.0015" -	.0010"-.0025" -	.0030"-.0050" -
STAINLESS STEEL (PRECIPITATION)					
12/8, 15/5, 17/4, AM-350/355	UNDER 32 OVER 32	.0005"-.0010" .0003"-.0005"	.0005"-.0010" .0003"-.0005"	.0008"-.0020" .0005"-.0015"	.0020"-.0040" .0010"-.0030"
STAINLESS STEEL (AUSTENITIC)					
200 SERIES, 302, 303, 304, 316	UNDER 32 OVER 32	.0005"-.0010" .0003"-.0005"	.0005"-.0010" .0003"-.0005"	.0008"-.0020" .0005"-.0015"	.0020"-.0040" .0010"-.0030"
STAINLESS STEEL (AUSTENITIC)					
304L, 316L	UNDER 32 OVER 32	.0005"-.0008" .0003"-.0005"	.0005"-.0008" .0003"-.0005"	.0008"-.0015" .0005"-.0010"	.0015"-.0030" .0010"-.0020"
STAINLESS STEEL (MARTENSITIC)					
403, 410, 416, 440	UNDER 32 OVER 32	.0005"-.0010" .0003"-.0005"	.0005"-.0010" .0003"-.0005"	.0008"-.0020" .0005"-.0015"	.0020"-.0040" .0010"-.0030"
HIGH STRENGTH TOOL STEELS					
4140, 4340, 6150, 5210, A2, D2, P20, H11, H13, S2, 01	UNDER 32 OVER 32	.0005"-.0010" .0003"-.0005"	.0005"-.0010" .0003"-.0005"	.0008"-.0020" .0005"-.0015"	.0020"-.0040" .0010"-.0030"
MEDIUM ALLOY STEELS					
200, 250, 300	UNDER 32 OVER 32	.0007"-.0015" .0005"-.0010"	.0007"-.0015" .0005"-.0010"	.0010"-.0025" .0008"-.0020"	.0030"-.0050" .0020"-.0040"
CARBON STEELS					
1000's, 1100's, 1300's	UNDER 32 OVER 32	.0007"-.0015" .0005"-.0010"	.0007"-.0015" .0005"-.0010"	.0010"-.0025" .0008"-.0020"	.0030"-.0050" .0020"-.0040"
DUCTILE					
DUCTILE CAST IRONS	-	.0010"-.0020"	.0010"-.0020"	.0015"-.0040"	.0030"-.0100"
CAST IRONS					
GRAY CAST IRONS	-	.0010"-.0020"	.0010"-.0020"	.0015"-.0040"	.0030"-.0100"
ALUMINUM					
2014, 2024, 6061-(T1-T6) 7075, DIE CAST, EXTRUDED	- -	.0010"-.0020" -	.0010"-.0020" -	.0015"-.0040" -	.0030"-.0150" -
MAGNESIUM					
	-	.0010"-.0020"	.0010"-.0020"	.0015"-.0040"	.0030"-.0100"
COPPER, COPPER ALLOYS					
	-	.0007"-.0015"	.0007"-.0015"	.0010"-.0025"	.0020"-.0080"
BRASS BRONZE					
BRASS, ALUM/BRONZE, LOW SILICON BRONZE	- -	.0007"-.0015" -	.0007"-.0015" -	.0010"-.0025" -	.0020"-.0080" -
COMPOSITES					
G-10 FIBERGLASS, GRAPHITE, GRAPHITE/EPOXY, PLASTICS	- -	.0010"-.0020" -	.0010"-.0020" -	.0015"-.0040" -	.0030"-.0100" -



30° HELIX END MILLS - CARBIDE TECHNICAL INFORMATION

YOUR #1 SOURCE FOR AMERICAN-MADE PREMIUM QUALITY CUTTING TOOLS

THESE SFM VALUES ARE FOR UNCOATED TOOLS.
FOR COATED TOOLS INCREASE SFM: TICN = +25% ALTIN = +40%

SFM FOR GENERAL PURPOSE CARBIDE END MILLS

MATERIAL / TYPE	Rc HARDNESS	2 Flute 30° Helix Stub, Reg	2 Flute 30° Helix Long, X-Long	4 Flute 30° Helix Stub, Reg	4 Flute 30° Helix Long, X-Long
COBALT BASE ALLOYS					
STELLITE, HS-21, HAYNES 25/188, X-40, L-605	UNDER 32 OVER 32	- -	- -	175 - 225 125 - 175	150 - 200 100 - 150
NICKEL BASE ALLOYS					
INCONEL-625/718, WASPALLOY, RENE, HASTELLOY	UNDER 32 OVER 32	- -	- -	125 - 175 70 - 115	100 - 150 70 - 100
IRON BASE ALLOYS					
INCOLOY 800-802, MULTIMET N-155, TIMKIN 16-25-6, CARPENTER 22-b3	UNDER 32 OVER 32	- -	- -	175 - 225 125 - 175	150 - 200 100 - 150
MONEL					
MONEL-65% NICKEL	-	175 - 300	125 - 175	175 - 300	125 - 175
TITANIUM ALLOYS					
COMMERCIALLY PURE, 6Al-4V, ASTM 1/2/3, 6Al-25N-4Zr-2Mo-Si	- -	200 - 300 -	125 - 250 -	200 - 300 -	125 - 250 -
STAINLESS STEEL (PRECIPITATION)					
12/8, 15/5, 17/4, AM-350/355	UNDER 32 OVER 32	- -	- -	150 - 250 125 - 175	100 - 150 80 - 150
STAINLESS STEEL (AUSTENITIC)					
200 SERIES, 302, 303, 304, 316	UNDER 32 OVER 32	- -	- -	200 - 250 150 - 200	125 - 175 100 - 150
STAINLESS STEEL (AUSTENITIC)					
304L, 316L	UNDER 32 OVER 32	- -	- -	90 - 125 75 - 110	80 - 120 60 - 90
STAINLESS STEEL (MARTENSITIC)					
403, 410, 416, 440	UNDER 32 OVER 32	- -	- -	150 - 250 125 - 175	100 - 150 80 - 150
HIGH STRENGTH TOOL STEELS					
4140, 4340, 6150, 5210, A2, D2, P20, H11, H13, S2, 01	UNDER 32 OVER 32	- -	- -	150 - 225 60 - 125	125 - 175 80 - 120
MEDIUM ALLOY STEELS					
200, 250, 300	UNDER 32 OVER 32	- -	- -	200 - 250 125 - 175	150 - 200 100 - 150
CARBON STEELS					
1000's, 1100's, 1300's	UNDER 32 OVER 32	- -	- -	200 - 250 125 - 175	150 - 200 100 - 150
DUCTILE					
DUCTILE CAST IRONS	-	250 - 350	200 - 300	300 - 400	200 - 300
CAST IRONS					
GRAY CAST IRONS	-	225 - 325	175 - 250	250 - 350	175 - 250
ALUMINUM					
2014, 2024, 6061-(T1-T6) 7075, DIE CAST, EXTRUDED	- -	500 min. -	500 min. -	500 min. -	500 min. -
MAGNESIUM					
	-	500 min.	500 min.	500 min.	500 min.
COPPER, COPPER ALLOYS					
	-	400 - 500	400 - 500	300 - 400	250 - 350
BRASS BRONZE					
BRASS, ALUM/BRONZE, LOW SILICON BRONZE	- -	300 - 400 -	300 - 400 -	250 - 350 -	200 - 300 -
COMPOSITES					
G-10 FIBERGLASS, GRAPHITE, GRAPHITE/EPOXY, PLASTICS	- -	250 - 1000 -	250 - 1000 -	250 - 1000 -	250 - 1000 -

30° HELIX END MILLS - CARBIDE TECHNICAL INFORMATION



YOUR #1 SOURCE FOR AMERICAN-MADE PREMIUM QUALITY CUTTING TOOLS

I.P.T. (INCH PER TOOTH) FOR GENERAL PURPOSE CARBIDE END MILLS						
MATERIAL / TYPE	Rc HARDNESS	UP TO 1/8"	1/8" - 1/4"	1/4" - 1/2"	1/2" - 1"	1" - 1-1/4"
COBALT BASE ALLOYS						
STELLITE, HS-21, HAYNES 25/188, X-40, L-605	UNDER 32	.0005"-.0010"	.0005"-.0010"	.0008"-.0020"	.0020"-.0040"	.0030"-.0050"
	OVER 32	.0003"-.0005"	.0003"-.0005"	.0005"-.0015"	.0010"-.0030"	.0020"-.0040"
NICKEL BASE ALLOYS						
INCONEL-625/718, WASPALLOY, RENE, HASTELLOY	UNDER 32	.0005"-.0010"	.0005"-.0010"	.0008"-.0020"	.0020"-.0040"	.0030"-.0050"
	OVER 32	.0003"-.0005"	.0003"-.0005"	.0005"-.0015"	.0010"-.0030"	.0020"-.0040"
IRON BASE ALLOYS						
INCOLOY 800-802, MULTIMET N-155, TIMKIN 16-25-6, CARPENTER 22-b3	UNDER 32	.0005"-.0010"	.0005"-.0010"	.0008"-.0020"	.0020"-.0040"	.0030"-.0050"
	OVER 32	.0003"-.0005"	.0003"-.0005"	.0005"-.0015"	.0010"-.0030"	.0020"-.0040"
MONEL						
MONEL-65% NICKEL	-	.0007"-.0015"	.0007"-.0015"	.0010"-.0025"	.0030"-.0050"	.0040"-.0060"
TITANIUM ALLOYS						
COMMERCIALLY PURE, 6Al-4V, ASTM 1/2/3, 6Al-25N-4Zr-2Mo-Si	-	.0007"-.0015"	.0007"-.0015"	.0010"-.0025"	.0030"-.0050"	.0040"-.0060"
	-	-	-	-	-	-
STAINLESS STEEL (PRECIPITATION)						
12/8, 15/5, 17/4, AM-350/355	UNDER 32	.0005"-.0010"	.0005"-.0010"	.0008"-.0020"	.0020"-.0040"	.0030"-.0050"
	OVER 32	.0003"-.0005"	.0003"-.0005"	.0005"-.0015"	.0010"-.0030"	.0020"-.0040"
STAINLESS STEEL (AUSTENITIC)						
200 SERIES, 302, 303, 304, 316	UNDER 32	.0005"-.0010"	.0005"-.0010"	.0008"-.0020"	.0020"-.0040"	.0030"-.0050"
	OVER 32	.0003"-.0005"	.0003"-.0005"	.0005"-.0015"	.0010"-.0030"	.0020"-.0040"
STAINLESS STEEL (AUSTENITIC)						
304L, 316L	UNDER 32	.0005"-.0008"	.0005"-.0008"	.0008"-.0015"	.0015"-.0030"	.0020"-.0040"
	OVER 32	.0003"-.0005"	.0003"-.0005"	.0005"-.0010"	.0010"-.0020"	.0015"-.0030"
STAINLESS STEEL (MARTENSITIC)						
403, 410, 416, 440	UNDER 32	.0005"-.0010"	.0005"-.0010"	.0008"-.0020"	.0020"-.0040"	.0030"-.0050"
	OVER 32	.0003"-.0005"	.0003"-.0005"	.0005"-.0015"	.0010"-.0030"	.0020"-.0040"
HIGH STRENGTH TOOL STEELS						
4140, 4340, 6150, 5210, A2, D2, P20, H11, H13, S2, O1	UNDER 32	.0005"-.0010"	.0005"-.0010"	.0008"-.0020"	.0020"-.0040"	.0030"-.0050"
	OVER 32	.0003"-.0005"	.0003"-.0005"	.0005"-.0015"	.0010"-.0030"	.0020"-.0040"
MEDIUM ALLOY STEELS						
200, 250, 300	UNDER 32	.0007"-.0015"	.0007"-.0015"	.0010"-.0025"	.0030"-.0050"	.0040"-.0060"
	OVER 32	.0005"-.0010"	.0005"-.0010"	.0008"-.0020"	.0020"-.0040"	.0030"-.0050"
CARBON STEELS						
1000's, 1100's, 1300's	UNDER 32	.0007"-.0015"	.0007"-.0015"	.0010"-.0025"	.0030"-.0050"	.0040"-.0060"
	OVER 32	.0005"-.0010"	.0005"-.0010"	.0008"-.0020"	.0020"-.0040"	.0030"-.0050"
DUCTILE						
DUCTILE CAST IRONS	-	.0010"-.0020"	.0010"-.0020"	.0015"-.0040"	.0030"-.0100"	.0050"-.0100"
CAST IRONS						
GRAY CAST IRONS	-	.0010"-.0020"	.0010"-.0020"	.0015"-.0040"	.0030"-.0100"	.0050"-.0100"
ALUMINUM						
2014, 2024, 6061-(T1-T6) 7075, DIE CAST, EXTRUDED	-	.0010"-.0020"	.0010"-.0020"	.0015"-.0040"	.0030"-.0150"	.0050"-.0150"
	-	-	-	-	-	-
MAGNESIUM						
	-	.0010"-.0020"	.0010"-.0020"	.0015"-.0040"	.0030"-.0100"	.0050"-.0100"
COPPER, COPPER ALLOYS						
	-	.0007"-.0015"	.0007"-.0015"	.0010"-.0025"	.0020"-.0080"	.0040"-.0100"
BRASS BRONZE						
BRASS, ALUM/BRONZE, LOW SILICON BRONZE	-	.0007"-.0015"	.0007"-.0015"	.0010"-.0025"	.0020"-.0080"	.0040"-.0100"
	-	-	-	-	-	-
COMPOSITES						
G-10 FIBERGLASS, GRAPHITE, GRAPHITE/EPOXY, PLASTICS	-	.0010"-.0020"	.0010"-.0020"	.0015"-.0040"	.0030"-.0100"	.0050"-.0100"
	-	-	-	-	-	-



GENERAL PURPOSE CHAMFER MILLS - CARBIDE TECHNICAL INFORMATION

YOUR #1 SOURCE FOR AMERICAN-MADE PREMIUM QUALITY CUTTING TOOLS

THESE VALUES ARE A STARTING POINT BASED ON A UNCOATED TOOL.
FOR AITiN COATED TOOLS INCREASE VALUES BY UP TO +40%

SFM & I.P.T. (INCH PER TOOTH)							
MATERIAL TYPE (<32 HRC)	SFM	SUGGESTED CHIP LOAD PER TOOTH					
		1/8"	3/16"	1/4"	5/16"	3/8"	1/2"
NON FERROUS							
ALUMINUM ALLOYS — 2024-T4/T6, 2014, 6061-T6/T651, 7075-T68	500 - 1000	.001	.002	.002	.002	.003	.004
COPPER — YELLOW BRASS, HIGH LEAD BRASS, RED BRASS	400 - 750	.001	.001	.002	.002	.0025	.003
COPPER ALLOYS — ALUM/BRONZE, LOW SILICON BRONZE	400 - 500	.001	.001	.002	.002	.0025	.003
MAGNESIUM — DE-CAT, EXTRUDED	450 - 650	.001	.002	.002	.002	.003	.004
PLASTICS, ACRYLICS, PHENOLICS — POLYSULFONE	100 - 300	.001	.002	.003	.003	.004	.006
CARBON, GRAPHITES	100 - 200	.040	.040	.060	.060	.080	.10
STAINLESS STEEL							
PRECIPITATION — 13/8, 15/5, AM-350/355	40 - 125	.0005	.0005	.001	.001	.001	.002
AUSTENIC — 200 SERIES, 302, 303, 304L, 316L	50 - 175	.0001	.0002	.0005	.0005	.001	.0015
MARTENSITIC — 403, 410, 416	50 - 125	.0001	.0002	.0005	.0005	.0005	.001
HIGH TEMP ALLOYS							
COBALT BASE — STELLITE, HS-21, HAYNES25/188, X-40, L-605	30 - 50	.0004	.0005	.001	.001	.001	.001
IRON BASE — INCOLY 600-802, MULTIMET N-155, TIMKIN 16-25-6	40 - 65	.0005	.0005	.001	.001	.0015	.002
TITANIUM ALLOYS — 6AL-4V, ASTM 1/2/3, 6 AL-25N-4ZR-2MO-SI	25 - 125	.0005	.0005	.0005	.0005	.001	.001
STEEL							
HIGH STRENGTH STEELS — 4340, 6150, 52100, H-11, H-13	25 - 125	.0005	.0005	.001	.001	.001	.001
HIGH ALLOY STEELS — A-2/6/10, P-3/10, 01, 02, 06	50 - 150	.0005	.0005	.001	.001	.001	.001
MEDIUM ALLOY STEELS — 200, 250, 300	75 - 175	.0005	.0005	.001	.001	.002	.0025
LOW ALLOY STEELS MARAGING — 10XX, 11XX, 13XX	50 - 200	.0005	.001	.0015	.0015	.002	.003
CAST IRON							
DUCTILE IRON — DUCTILE CAST IRON	50 - 200	.0005	.001	.0015	.0015	.002	.002
CAST IRON — GRAY CAST IRON	50 - 200	.0005	.001	.002	.002	.003	.004

CHAMFER MILL FLAT DIMMENSIONS							
SIZE	FLUTES	FLAT WIDTH	DISTANCE TO THEORETICAL POINT				
			60°	82°	90°	100°	120°
1/8	2	0.018	0.0156	0.0104	0.0090	0.0076	0.0052
1/8	4	0.020	0.0173	0.0115	0.0100	0.0084	0.0058
3/16	2	0.028	0.0242	0.0161	0.0140	0.0117	0.0081
3/16	4	0.030	0.0260	0.0173	0.0150	0.0126	0.0087
1/4	2 & 4	0.044	0.0381	0.0253	0.0220	0.0185	0.0127
5/16	2 & 4	0.060	0.0450	0.0300	0.0260	0.0220	0.0150
3/8	2 & 4	0.060	0.0520	0.0350	0.0300	0.0250	0.0170
1/2	2 & 4	0.080	0.0690	0.0460	0.0400	0.0340	0.0230

Milling Trouble Shooting Guide

PROBLEM	CAUSE	SOLUTION
Premature Wear	<ul style="list-style-type: none"> • Cutting speed is too fast • Hard/Abrasive work-piece material • Speed and/or feed is too light • Helix angle is incorrect for application • Re-cutting chips 	<ul style="list-style-type: none"> • Decrease spindle speed • Use coatings (TiCN, AlTiN) • Increase speed and/or feed • Select tool with appropriate helix angle • Adjust speed & feed, axial and/or radial D.O.C., Increase coolant pressure and/or air to clear chips.
Edge Chipping	<ul style="list-style-type: none"> • Feed rate too aggressive • Feed rate too aggressive on initial cut • D.O.C. too aggressive • Tool rigidity • Work-piece rigidity • Machine tool rigidity 	<ul style="list-style-type: none"> • Reduce feed rate • Reduce feed rate on initial pass • Decrease axial and/or radial D.O.C. • Change tool holder, hold shank deeper and/or use shorter tool • Re-fixture work-piece and/or improve setup • Check spindle for run-out
Breakage	<ul style="list-style-type: none"> • Feed rate too aggressive • D.O.C. too aggressive • Excessive tool overhang • Chip packing • Excessive wear 	<ul style="list-style-type: none"> • Reduce feed rate • Reduce axial and/or radial D.O.C. • Hold shank deeper, use shorter endmill • Adjust speed and/or feed, select endmill with fewer flutes, increase coolant pressure and/or air • Re-grind tool sooner
Chip Packing	<ul style="list-style-type: none"> • Speed and/or feed too aggressive • Flute gullet too small for chips • Insufficient coolant volume and/or pressure 	<ul style="list-style-type: none"> • Reduce speed and/or feed • Use endmill with less flutes • Increase coolant and/or air pressure, reposition nozzle to point of cut
Chattering	<ul style="list-style-type: none"> • Speed and/or feed too aggressive • Tool rigidity • Work-piece rigidity • Machine tool rigidity • D.O.C. too aggressive • Wrong tool geometry 	<ul style="list-style-type: none"> • Reduce speed and/or feed • Change tool holder, hold shank deeper and/or use shorter tool • Re-fixture work-piece and/or improve setup • Check spindle for run-out • Reduce axial and/or radial D.O.C.
Burs	<ul style="list-style-type: none"> • Incorrect speed & feed • Helix angle is incorrect for application • Primary cutting edge(s) are dull 	<ul style="list-style-type: none"> • Adjust speed & feed • Change to correct helix angle, use climb milling • Re-grind tool sooner
Poor Finish	<ul style="list-style-type: none"> • Feed rate too aggressive • Speed is too slow • D.O.C. too aggressive • Excessive wear 	<ul style="list-style-type: none"> • Reduce feed rate • Increase spindle speed (RPM) • Reduce axial and/or radial D.O.C. • Re-grind tool sooner
Poor Dimensional Accuracy	<ul style="list-style-type: none"> • D.O.C. too aggressive • Tool Rigidity • Machine tool rigidity 	<ul style="list-style-type: none"> • Reduce axial and/or radial D.O.C. • Use tool with more flutes • Check, inspect & repair machine tool, tool holder and fixtures



END MILL GEOMETRY

YOUR #1 SOURCE FOR AMERICAN-MADE PREMIUM QUALITY CUTTING TOOLS

Core Diameter: The diameter measured tangent from bottom of all flutes. This diameter dictates the strength of your end mill.

Cutting Diameter: Measured from margin-to-margin on cutting end of tool. An even number of flutes can be measured 180° apart.

Dish Angle: Angle perpendicular to centerline of tool and allows proper end cut characteristics and reduces full diameter contact.

Flute Wash: Amount of non-cutting flute area past the length of cut.

Gash Angle: The secondary cuts on a tool to provide chip space at corners and ends. The space forming the end cutting edge, which is used when feeding axially.

Helix Angle: This is the angle formed by a line tangent to the angle of the flute grind and parallel to the centerline of the tool.

Land: The narrow surface of a profile sharpened cutter tooth immediately behind the cutting edge.

Length of Cut (LOC): This is the actual cutting depth of the tool in the axial direction.

Overall Length (OAL): A measurement taken from end-to-end of the tool.

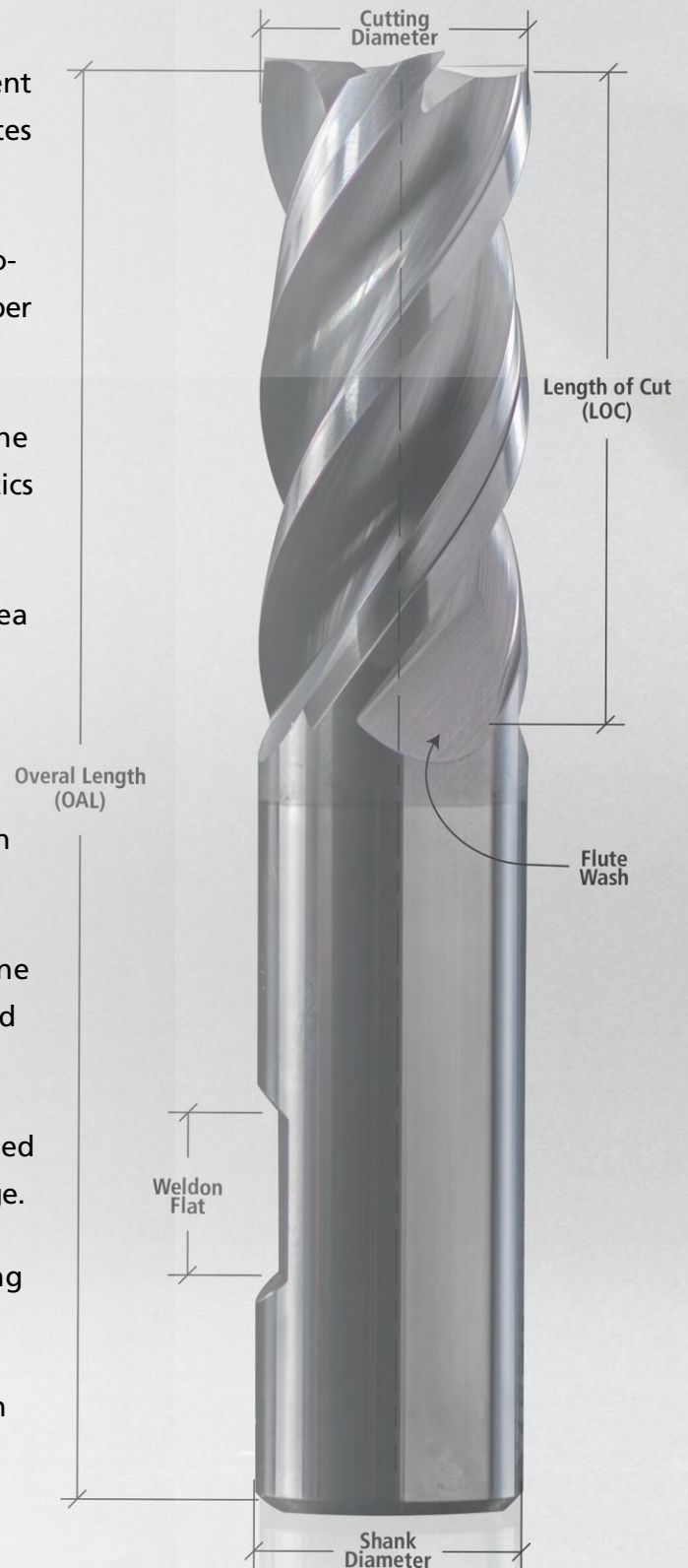

END MILL GEOMETRY



YOUR #1 SOURCE FOR AMERICAN-MADE PREMIUM QUALITY CUTTING TOOLS

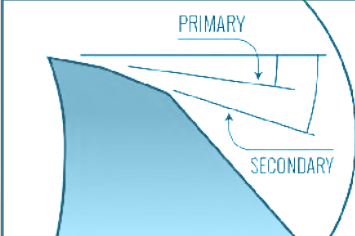

Most common relief for non-ferrous alloys. Includes a primary and secondary relief angle.

GENERAL PURPOSE - STANDARD RELIEF

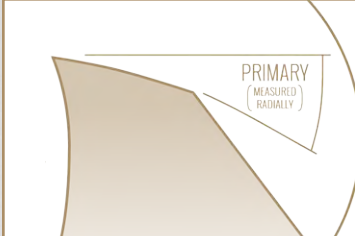

A powerful edge design for ferrous and tough material cutting. This design includes a primary relief measured radially along its edge.

HIGH PERFORMANCE - ECCENTRIC RELIEF

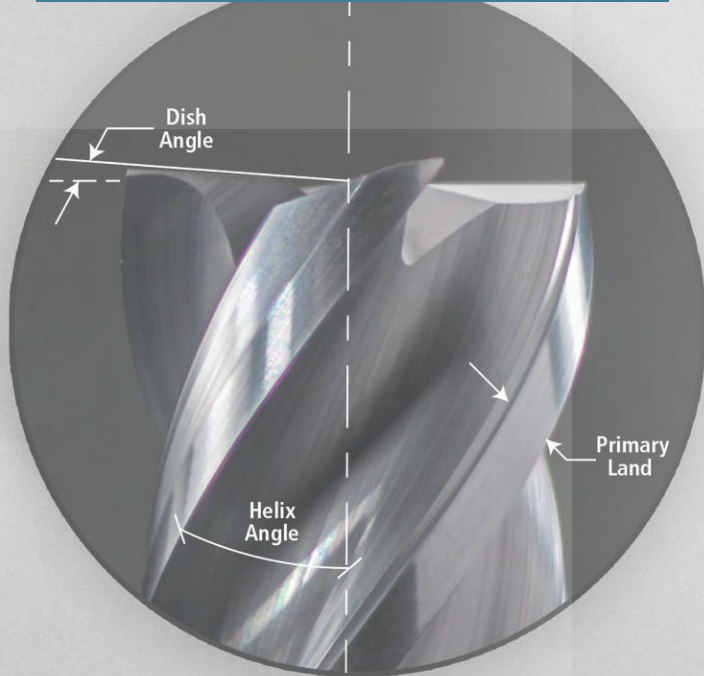

Radial Relief: Area where cutting face is relieved behind the cutting edge in order to avoid rubbing while maintaining maximum edge strength. We offer 2 types of Radial Relief:

1. **Standard Relief**- General purpose relief shape consisting of a primary and secondary grind behind the cutting edge.
2. **Eccentric Relief** - A strong high performance edge design for ferrous and tough material cutting consisting of a primary relief measured radially along its edge.

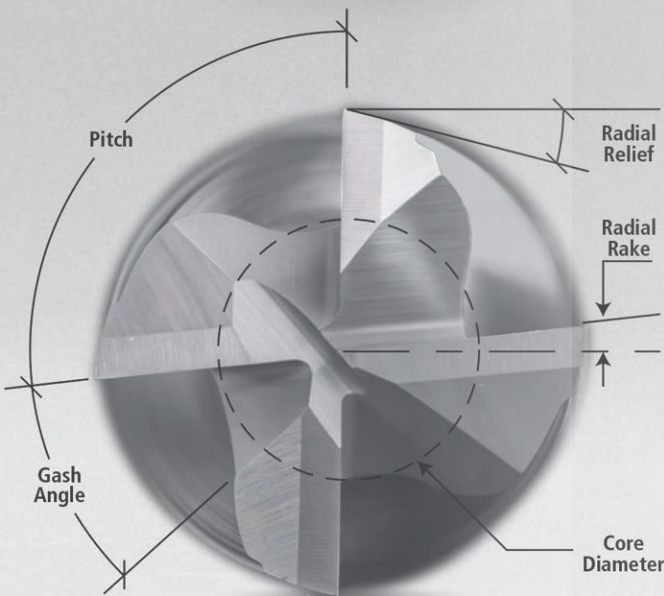

Pitch: This is an equal angular measurement from flute-to-flute. If the tool is a variable index style then this spacing is unequal.

Radial Rake: The angle of the rake face measured from center of the tool.

Shank Diameter: The end of the tool that is held in the holder and requires a high degree of accuracy and concentricity.

Weldon Flat: The flat on the shank provides positive driving surface for the end mill.



GENERAL PURPOSE SOLID CARBIDE MICRO END MILLS

YOUR #1 SOURCE FOR AMERICAN-MADE PREMIUM QUALITY CUTTING TOOLS

Our selection of Micro End Mills covers a wide range of profiles. Choose from 2, 3 and 4 Flute, Square, Ball, Corner Radius, and Stub, Regular, Long Flute lengths and Long Reaches. All micro tools stocked uncoated, and Altin coated for optimum tool performance. All tools are stocked and ready to ship. Order today, and we'll ship today!

Micro End Mills are stocked in sizes from 0.005" to 0.120" in the following:

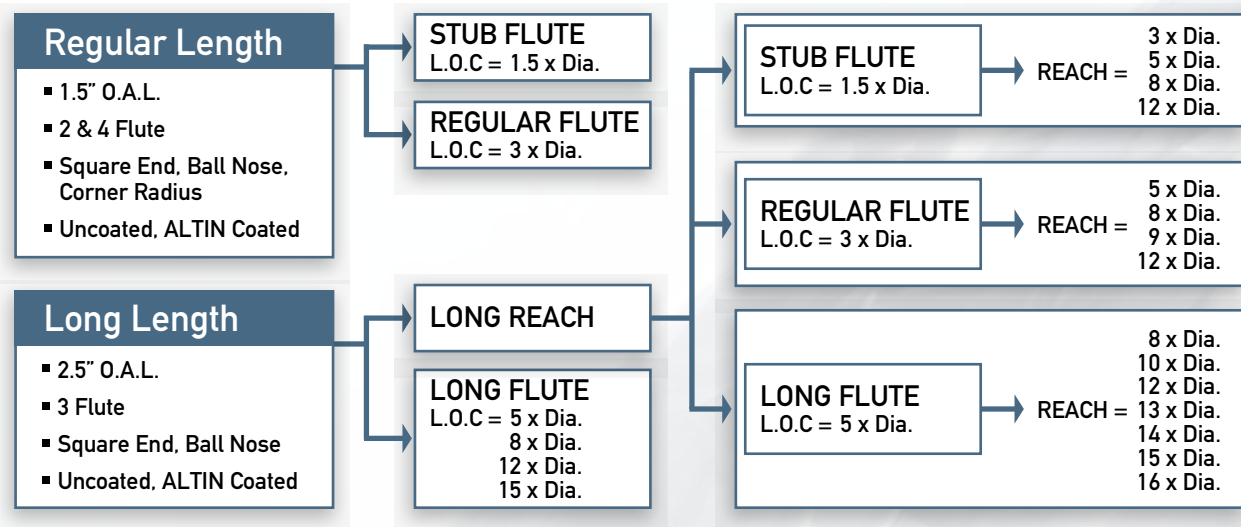

GENERAL PURPOSE SOLID CARBIDE MICRO END MILLS



YOUR #1 SOURCE FOR AMERICAN-MADE PREMIUM QUALITY CUTTING TOOLS

MICRO MILLING

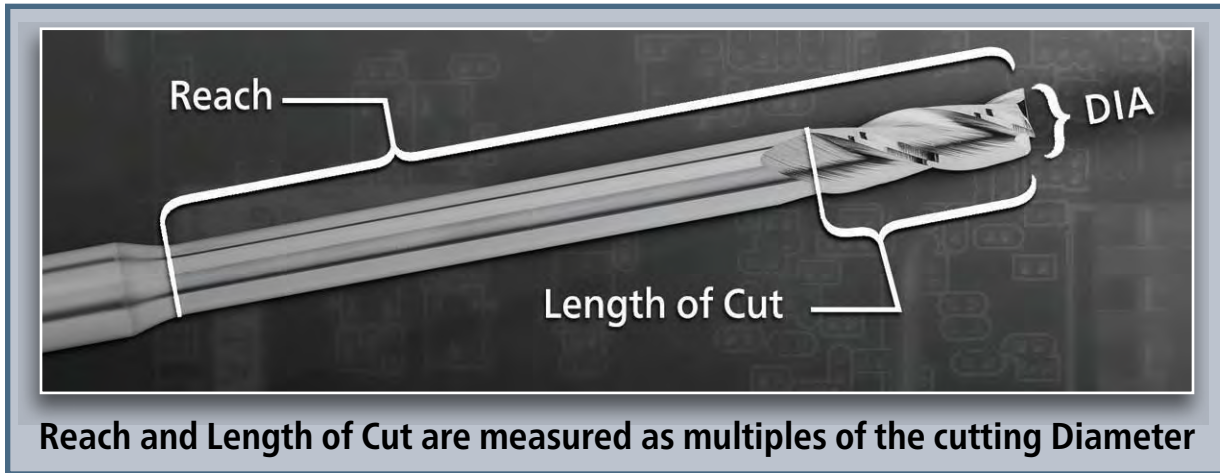

Long Reaches of 3x, 5x, 8x, 9x, 10x, 12x, 13x, 14x, 15x and 16x Dia.
Lengths of Cut of 1.5x, 3x, 5x, 8x, 12x and 15x Dia.

- REGULAR LENGTH - STUB FLUTE
2FL & 4FL • Square End, Ball Nose & Corner Radius



- REGULAR LENGTH - REGULAR FLUTE
2FL & 4FL • Square End, Ball Nose & Corner Radius



- LONG REACH - STUB FLUTE
3FL • Square End & Ball Nose



- LONG REACH - REGULAR FLUTE
3FL • Square End & Ball Nose



- LONG REACH - LONG FLUTE
3FL • Square End & Ball Nose



- LONG LENGTH - LONG FLUTE
3FL • Square End & Ball Nose



With over 2400 carbide Micro End Mills in stock and ready to ship, TITAN USA is committed to providing you with the highest quality, American-made Micro End Mills for all your micro machining needs.
Also stocked with ALTIN coating



MICRO END MILLS

TECHNICAL



GENERAL PURPOSE SOLID CARBIDE MICRO END MILLS

YOUR #1 SOURCE FOR AMERICAN-MADE PREMIUM QUALITY CUTTING TOOLS

2 FLUTE - STUB FLUTE - SQUARE END - 30° HELIX
LOC = 1.5 X DIA



SERIES 520
UNCOATED

DIA	LOC	ITEM#	LIST PRICE
0.005	0.008	TC52005	67.37
0.010	0.015	TC52010	60.38
0.015	0.023	TC52015	37.78
0.020	0.030	TC52020	34.35
0.025	0.038	TC52025	34.35
0.030	0.045	TC52030	32.24
0.031	0.047	TC52031	30.21
0.035	0.053	TC52035	30.21
0.040	0.060	TC52040	30.21
0.045	0.068	TC52045	29.47
0.047	0.071	TC52047	29.47
0.050	0.075	TC52050	29.47
0.055	0.083	TC52055	29.47

DIA	LOC	ITEM#	LIST PRICE
0.060	0.090	TC52060	29.47
0.062	0.093	TC52062	29.47
0.065	0.098	TC52065	29.47
0.070	0.105	TC52070	29.47
0.075	0.113	TC52075	29.47
0.078	0.117	TC52078	29.47
0.080	0.120	TC52080	29.47
0.085	0.128	TC52085	29.47
0.090	0.135	TC52090	29.47
0.093	0.140	TC52093	29.47
0.095	0.143	TC52095	29.47
0.100	0.150	TC52100	29.47



SERIES 522
ALTIN COATED

DIA	LOC	ITEM#	LIST PRICE
0.005	0.008	TC52205	80.84
0.010	0.015	TC52210	72.44
0.015	0.023	TC52215	45.36
0.020	0.030	TC52220	41.22
0.025	0.038	TC52225	41.22
0.030	0.045	TC52230	38.68
0.031	0.047	TC52231	36.22
0.035	0.053	TC52235	36.22
0.040	0.060	TC52240	36.22
0.045	0.068	TC52245	35.36
0.047	0.071	TC52247	35.36
0.050	0.075	TC52250	35.36
0.055	0.083	TC52255	35.36

DIA	LOC	ITEM#	LIST PRICE
0.060	0.090	TC52260	35.36
0.062	0.093	TC52262	35.36
0.065	0.098	TC52265	35.36
0.070	0.105	TC52270	35.36
0.075	0.113	TC52275	35.36
0.078	0.117	TC52278	35.36
0.080	0.120	TC52280	35.36
0.085	0.128	TC52285	35.36
0.090	0.135	TC52290	35.36
0.093	0.140	TC52293	35.36
0.095	0.143	TC52295	35.36
0.100	0.150	TC52300	35.36

All regular length Micro End Mills are 1/8" shank, 1-1/2" OAL.
For coating information see page 8. For technical information, please see page 126.

TOLERANCES	DIAMETER	SHANK
ALL SIZES	+0.005, -0.005	-0.001, -.0003 ISO H6

GENERAL PURPOSE SOLID CARBIDE MICRO END MILLS



YOUR #1 SOURCE FOR AMERICAN-MADE PREMIUM QUALITY CUTTING TOOLS

MICRO MILLING

2 FLUTE - STUB FLUTE - BALL NOSE - 30° HELIX
LOC = 1.5 X DIA



SERIES 530 UNCOATED

DIA	LOC	ITEM#	LIST PRICE
0.005	0.008	TC53005	84.19
0.010	0.015	TC53010	75.49
0.015	0.023	TC53015	47.23
0.020	0.030	TC53020	42.94
0.025	0.038	TC53025	42.94
0.030	0.045	TC53030	40.28
0.031	0.047	TC53031	37.78
0.035	0.053	TC53035	37.78
0.040	0.060	TC53040	37.78
0.045	0.068	TC53045	36.85
0.047	0.071	TC53047	36.85
0.050	0.075	TC53050	36.85
0.055	0.083	TC53055	36.85

DIA	LOC	ITEM#	LIST PRICE
0.060	0.090	TC53060	36.85
0.062	0.093	TC53062	36.85
0.065	0.098	TC53065	36.85
0.070	0.105	TC53070	36.85
0.075	0.113	TC53075	36.85
0.078	0.117	TC53078	36.85
0.080	0.120	TC53080	36.85
0.085	0.128	TC53085	36.85
0.090	0.135	TC53090	36.85
0.093	0.140	TC53093	36.85
0.095	0.143	TC53095	36.85
0.100	0.150	TC53100	36.85



SERIES 532 ALTIN COATED

DIA	LOC	ITEM#	LIST PRICE
0.005	0.008	TC53205	101.05
0.010	0.015	TC53210	90.55
0.015	0.023	TC53215	56.67
0.020	0.030	TC53220	51.52
0.025	0.038	TC53225	51.52
0.030	0.045	TC53230	48.32
0.031	0.047	TC53231	45.36
0.035	0.053	TC53235	45.36
0.040	0.060	TC53240	45.36
0.045	0.068	TC53245	44.26
0.047	0.071	TC53247	44.26
0.050	0.075	TC53250	44.26
0.055	0.083	TC53255	44.26

DIA	LOC	ITEM#	LIST PRICE
0.060	0.090	TC53260	44.26
0.062	0.093	TC53262	44.26
0.065	0.098	TC53265	44.26
0.070	0.105	TC53270	44.26
0.075	0.113	TC53275	44.26
0.078	0.117	TC53278	44.26
0.080	0.120	TC53280	44.26
0.085	0.128	TC53285	44.26
0.090	0.135	TC53290	44.26
0.093	0.140	TC53293	44.26
0.095	0.143	TC53295	44.26
0.100	0.150	TC53300	44.26

All regular length Micro End Mills are 1/8" shank, 1-1/2" OAL.
For coating information see page 8. For technical information, please see page 126.

TOLERANCES	DIAMETER	SHANK
ALL SIZES	+.0005, -.0005	-.0001, -.0003 ISO H6

MICRO END MILLS

REGULAR LENGTH

LONG REACH STUB FLUTE

LONG REACH REG FLUTE

LONG REACH LONG FLUTE

LONG LENGTH LONG FLUTE

TECHNICAL



GENERAL PURPOSE SOLID CARBIDE MICRO END MILLS

YOUR #1 SOURCE FOR AMERICAN-MADE PREMIUM QUALITY CUTTING TOOLS

2 FLUTE - REGULAR FLUTE - SQUARE END - 30° HELIX
LOC = 3 X DIA



SERIES 560
UNCOATED

MICRO END MILLS

REGULAR LENGTH

LONG REACH STUB FLUTE

LONG REACH REG FLUTE

LONG REACH LONG FLUTE

LONG LENGTH LONG FLUTE

TECHNICAL

DIA	LOC	ITEM#	LIST PRICE
0.005	0.015	TC56005	58.59
0.006	0.018	TC56006	58.59
0.007	0.021	TC56007	58.59
0.008	0.024	TC56008	58.59
0.009	0.027	TC56009	52.50
0.010	0.030	TC56010	52.50
0.011	0.033	TC56011	46.99
0.012	0.036	TC56012	46.99
0.013	0.039	TC56013	38.88
0.014	0.042	TC56014	38.88
0.015	0.045	TC56015	32.87
0.016	0.048	TC56016	32.87
0.017	0.051	TC56017	32.87
0.018	0.054	TC56018	32.87
0.019	0.057	TC56019	32.87
0.020	0.060	TC56020	29.86
0.021	0.063	TC56021	29.86
0.022	0.066	TC56022	29.86
0.023	0.069	TC56023	29.86
0.024	0.072	TC56024	29.86
0.025	0.075	TC56025	29.86
0.026	0.078	TC56026	28.02
0.027	0.081	TC56027	28.02
0.028	0.084	TC56028	28.02
0.029	0.087	TC56029	28.02
0.030	0.090	TC56030	28.02
0.031	0.093	TC56031	26.27
0.032	0.096	TC56032	26.27
0.033	0.099	TC56033	26.27
0.034	0.102	TC56034	26.27
0.035	0.105	TC56035	26.27
0.036	0.108	TC56036	26.27
0.037	0.111	TC56037	26.27
0.038	0.114	TC56038	26.27
0.039	0.117	TC56039	26.27
0.040	0.120	TC56040	26.27

DIA	LOC	ITEM#	LIST PRICE
0.041	0.123	TC56041	26.27
0.042	0.126	TC56042	26.27
0.043	0.129	TC56043	26.27
0.044	0.132	TC56044	25.61
0.045	0.135	TC56045	25.61
0.046	0.138	TC56046	25.61
0.047	0.141	TC56047	25.61
0.048	0.144	TC56048	25.61
0.049	0.147	TC56049	25.61
0.050	0.150	TC56050	25.61
0.051	0.153	TC56051	25.61
0.052	0.156	TC56052	25.61
0.053	0.159	TC56053	25.61
0.054	0.162	TC56054	25.61
0.055	0.165	TC56055	25.61
0.056	0.168	TC56056	25.61
0.057	0.171	TC56057	25.61
0.058	0.174	TC56058	25.61
0.059	0.177	TC56059	25.61
0.060	0.180	TC56060	25.61
0.061	0.183	TC56061	25.61
0.062	0.186	TC56062	25.61
0.063	0.189	TC56063	25.61
0.064	0.192	TC56064	25.61
0.065	0.195	TC56065	25.61
0.066	0.198	TC56066	25.61
0.067	0.201	TC56067	25.61
0.068	0.204	TC56068	25.61
0.069	0.207	TC56069	25.61
0.070	0.210	TC56070	25.61
0.071	0.213	TC56071	25.61
0.072	0.216	TC56072	25.61
0.073	0.219	TC56073	25.61
0.074	0.222	TC56074	25.61
0.075	0.225	TC56075	25.61
0.076	0.228	TC56076	25.61

DIA	LOC	ITEM#	LIST PRICE
0.077	0.231	TC56077	25.61
0.078	0.234	TC56078	25.61
0.079	0.237	TC56079	25.61
0.080	0.240	TC56080	25.61
0.081	0.243	TC56081	25.61
0.082	0.246	TC56082	25.61
0.083	0.249	TC56083	25.61
0.084	0.252	TC56084	25.61
0.085	0.255	TC56085	25.61
0.086	0.258	TC56086	25.61
0.087	0.261	TC56087	25.61
0.088	0.264	TC56088	25.61
0.089	0.267	TC56089	25.61
0.090	0.270	TC56090	25.61
0.091	0.273	TC56091	25.61
0.092	0.276	TC56092	25.61
0.093	0.279	TC56093	25.61
0.094	0.282	TC56094	25.61
0.095	0.285	TC56095	25.61
0.096	0.288	TC56096	25.61
0.097	0.291	TC56097	25.61
0.098	0.294	TC56098	25.61
0.099	0.297	TC56099	25.61
0.100	0.300	TC56100	25.61
0.101	0.303	TC56101	25.61
0.102	0.306	TC56102	25.61
0.103	0.309	TC56103	25.61
0.104	0.312	TC56104	25.61
0.105	0.315	TC56105	25.61
0.106	0.318	TC56106	25.61
0.107	0.321	TC56107	25.61
0.108	0.324	TC56108	25.61
0.109	0.327	TC56109	25.61
0.110	0.330	TC56110	25.61
0.115	0.345	TC56115	25.61
0.120	0.360	TC56120	25.61

All regular length Micro End Mills are 1/8" shank, 1-1/2" OAL.
For technical information, please see page 126.

TOLERANCES	DIAMETER	SHANK
ALL SIZES	+.0005, -.0005	-.0001, -.0003 ISO H6

GENERAL PURPOSE SOLID CARBIDE MICRO END MILLS



YOUR #1 SOURCE FOR AMERICAN-MADE PREMIUM QUALITY CUTTING TOOLS

2 FLUTE - REGULAR FLUTE - SQUARE END - 30° HELIX
LOC = 3 X DIA



SERIES 562
ALTIN COATED

DIA	LOC	ITEM#	LIST PRICE
0.005	0.015	TC56205	70.30
0.006	0.018	TC56206	70.30
0.007	0.021	TC56207	70.30
0.008	0.024	TC56208	70.30
0.009	0.027	TC56209	63.00
0.010	0.030	TC56210	63.00
0.011	0.033	TC56211	56.40
0.012	0.036	TC56212	56.40
0.013	0.039	TC56213	46.64
0.014	0.042	TC56214	46.64
0.015	0.045	TC56215	39.42
0.016	0.048	TC56216	39.42
0.017	0.051	TC56217	39.42
0.018	0.054	TC56218	39.42
0.019	0.057	TC56219	39.42
0.020	0.060	TC56220	35.83
0.021	0.063	TC56221	35.83
0.022	0.066	TC56222	35.83
0.023	0.069	TC56223	35.83
0.024	0.072	TC56224	35.83
0.025	0.075	TC56225	35.83
0.026	0.078	TC56226	33.65
0.027	0.081	TC56227	33.65
0.028	0.084	TC56228	33.65
0.029	0.087	TC56229	33.65
0.030	0.090	TC56230	33.65
0.031	0.093	TC56231	31.50
0.032	0.096	TC56232	31.50
0.033	0.099	TC56233	31.50
0.034	0.102	TC56234	31.50
0.035	0.105	TC56235	31.50
0.036	0.108	TC56236	31.50
0.037	0.111	TC56237	31.50
0.038	0.114	TC56238	31.50
0.039	0.117	TC56239	31.50
0.040	0.120	TC56240	31.50

DIA	LOC	ITEM#	LIST PRICE
0.041	0.123	TC56241	31.50
0.042	0.126	TC56242	31.50
0.043	0.129	TC56243	31.50
0.044	0.132	TC56244	30.76
0.045	0.135	TC56245	30.76
0.046	0.138	TC56246	30.76
0.047	0.141	TC56247	30.76
0.048	0.144	TC56248	30.76
0.049	0.147	TC56249	30.76
0.050	0.150	TC56250	30.76
0.051	0.153	TC56251	30.76
0.052	0.156	TC56252	30.76
0.053	0.159	TC56253	30.76
0.054	0.162	TC56254	30.76
0.055	0.165	TC56255	30.76
0.056	0.168	TC56256	30.76
0.057	0.171	TC56257	30.76
0.058	0.174	TC56258	30.76
0.059	0.177	TC56259	30.76
0.060	0.180	TC56260	30.76
0.061	0.183	TC56261	30.76
0.062	0.186	TC56262	30.76
0.063	0.189	TC56263	30.76
0.064	0.192	TC56264	30.76
0.065	0.195	TC56265	30.76
0.066	0.198	TC56266	30.76
0.067	0.201	TC56267	30.76
0.068	0.204	TC56268	30.76
0.069	0.207	TC56269	30.76
0.070	0.210	TC56270	30.76
0.071	0.213	TC56271	30.76
0.072	0.216	TC56272	30.76
0.073	0.219	TC56273	30.76
0.074	0.222	TC56274	30.76
0.075	0.225	TC56275	30.76
0.076	0.228	TC56276	30.76

DIA	LOC	ITEM#	LIST PRICE
0.077	0.231	TC56277	30.76
0.078	0.234	TC56278	30.76
0.079	0.237	TC56279	30.76
0.080	0.240	TC56280	30.76
0.081	0.243	TC56281	30.76
0.082	0.246	TC56282	30.76
0.083	0.249	TC56283	30.76
0.084	0.252	TC56284	30.76
0.085	0.255	TC56285	30.76
0.086	0.258	TC56286	30.76
0.087	0.261	TC56287	30.76
0.088	0.264	TC56288	30.76
0.089	0.267	TC56289	30.76
0.090	0.270	TC56290	30.76
0.091	0.273	TC56291	30.76
0.092	0.276	TC56292	30.76
0.093	0.279	TC56293	30.76
0.094	0.282	TC56294	30.76
0.095	0.285	TC56295	30.76
0.096	0.288	TC56296	30.76
0.097	0.291	TC56297	30.76
0.098	0.294	TC56298	30.76
0.099	0.297	TC56299	30.76
0.100	0.300	TC56300	30.76
0.101	0.303	TC56301	30.76
0.102	0.306	TC56302	30.76
0.103	0.309	TC56303	30.76
0.104	0.312	TC56304	30.76
0.105	0.315	TC56305	30.76
0.106	0.318	TC56306	30.76
0.107	0.321	TC56307	30.76
0.108	0.324	TC56308	30.76
0.109	0.327	TC56309	30.76
0.110	0.330	TC56310	30.76
0.115	0.345	TC56315	30.76
0.120	0.360	TC56320	30.76

All regular length Micro End Mills are 1/8" shank, 1-1/2" OAL.
For coating information see page 8. For technical information, please see page 126.

TOLERANCES	DIAMETER	SHANK
ALL SIZES	+.0005, -.0005	-.0001, -.0003 ISO H6



GENERAL PURPOSE SOLID CARBIDE MICRO END MILLS

YOUR #1 SOURCE FOR AMERICAN-MADE PREMIUM QUALITY CUTTING TOOLS

2 FLUTE - REGULAR FLUTE - BALL NOSE - 30° HELIX
LOC = 3 X DIA



SERIES 570
UNCOATED

DIA	LOC	ITEM#	LIST PRICE
0.005	0.015	TC57005	73.22
0.006	0.018	TC57006	73.22
0.007	0.021	TC57007	73.22
0.008	0.024	TC57008	73.22
0.009	0.027	TC57009	65.65
0.010	0.030	TC57010	65.65
0.011	0.033	TC57011	58.74
0.012	0.036	TC57012	58.74
0.013	0.039	TC57013	48.67
0.014	0.042	TC57014	48.67
0.015	0.045	TC57015	41.06
0.016	0.048	TC57016	41.06
0.017	0.051	TC57017	41.06
0.018	0.054	TC57018	41.06
0.019	0.057	TC57019	41.06
0.020	0.060	TC57020	37.35
0.021	0.063	TC57021	37.35
0.022	0.066	TC57022	37.35
0.023	0.069	TC57023	37.35
0.024	0.072	TC57024	37.35
0.025	0.075	TC57025	37.35
0.026	0.078	TC57026	35.05
0.027	0.081	TC57027	35.05
0.028	0.084	TC57028	35.05
0.029	0.087	TC57029	35.05
0.030	0.090	TC57030	35.05
0.031	0.093	TC57031	32.87
0.032	0.096	TC57032	32.87
0.033	0.099	TC57033	32.87
0.034	0.102	TC57034	32.87
0.035	0.105	TC57035	32.87
0.036	0.108	TC57036	32.87
0.037	0.111	TC57037	32.87
0.038	0.114	TC57038	32.87
0.039	0.117	TC57039	32.87
0.040	0.120	TC57040	32.87

DIA	LOC	ITEM#	LIST PRICE
0.041	0.123	TC57041	32.87
0.042	0.126	TC57042	32.87
0.043	0.129	TC57043	32.87
0.044	0.132	TC57044	32.05
0.045	0.135	TC57045	32.05
0.046	0.138	TC57046	32.05
0.047	0.141	TC57047	32.05
0.048	0.144	TC57048	32.05
0.049	0.147	TC57049	32.05
0.050	0.150	TC57050	32.05
0.051	0.153	TC57051	32.05
0.052	0.156	TC57052	32.05
0.053	0.159	TC57053	32.05
0.054	0.162	TC57054	32.05
0.055	0.165	TC57055	32.05
0.056	0.168	TC57056	32.05
0.057	0.171	TC57057	32.05
0.058	0.174	TC57058	32.05
0.059	0.177	TC57059	32.05
0.060	0.180	TC57060	32.05
0.061	0.183	TC57061	32.05
0.062	0.186	TC57062	32.05
0.063	0.189	TC57063	32.05
0.064	0.192	TC57064	32.05
0.065	0.195	TC57065	32.05
0.066	0.198	TC57066	32.05
0.067	0.201	TC57067	32.05
0.068	0.204	TC57068	32.05
0.069	0.207	TC57069	32.05
0.070	0.210	TC57070	32.05
0.071	0.213	TC57071	32.05
0.072	0.216	TC57072	32.05
0.073	0.219	TC57073	32.05
0.074	0.222	TC57074	32.05
0.075	0.225	TC57075	32.05
0.076	0.228	TC57076	32.05

DIA	LOC	ITEM#	LIST PRICE
0.077	0.231	TC57077	32.05
0.078	0.234	TC57078	32.05
0.079	0.237	TC57079	32.05
0.080	0.240	TC57080	32.05
0.081	0.243	TC57081	32.05
0.082	0.246	TC57082	32.05
0.083	0.249	TC57083	32.05
0.084	0.252	TC57084	32.05
0.085	0.255	TC57085	32.05
0.086	0.258	TC57086	32.05
0.087	0.261	TC57087	32.05
0.088	0.264	TC57088	32.05
0.089	0.267	TC57089	32.05
0.090	0.270	TC57090	32.05
0.091	0.273	TC57091	32.05
0.092	0.276	TC57092	32.05
0.093	0.279	TC57093	32.05
0.094	0.282	TC57094	32.05
0.095	0.285	TC57095	32.05
0.096	0.288	TC57096	32.05
0.097	0.291	TC57097	32.05
0.098	0.294	TC57098	32.05
0.099	0.297	TC57099	32.05
0.100	0.300	TC57100	32.05
0.101	0.303	TC57101	32.05
0.102	0.306	TC57102	32.05
0.103	0.309	TC57103	32.05
0.104	0.312	TC57104	32.05
0.105	0.315	TC57105	32.05
0.106	0.318	TC57106	32.05
0.107	0.321	TC57107	32.05
0.108	0.324	TC57108	32.05
0.109	0.327	TC57109	32.05
0.110	0.330	TC57110	32.05
0.115	0.345	TC57115	32.05
0.120	0.360	TC57120	32.05

All regular length Micro End Mills are 1/8" shank, 1-1/2" OAL.
For technical information, please see page 126.

TOLERANCES	DIAMETER	SHANK
ALL SIZES	+.0005, -.0005	-.0001, -.0003 ISO H6

GENERAL PURPOSE SOLID CARBIDE MICRO END MILLS



YOUR #1 SOURCE FOR AMERICAN-MADE PREMIUM QUALITY CUTTING TOOLS

2 FLUTE - REGULAR FLUTE - BALL NOSE - 30° HELIX
LOC = 3 X DIA



SERIES 572 ALTiN COATED

DIA	LOC	ITEM#	LIST PRICE
0.005	0.015	TC57205	87.86
0.006	0.018	TC57206	87.86
0.007	0.021	TC57207	87.86
0.008	0.024	TC57208	87.86
0.009	0.027	TC57209	78.77
0.010	0.030	TC57210	78.77
0.011	0.033	TC57211	70.53
0.012	0.036	TC57212	70.53
0.013	0.039	TC57213	58.39
0.014	0.042	TC57214	58.39
0.015	0.045	TC57215	49.26
0.016	0.048	TC57216	49.26
0.017	0.051	TC57217	49.26
0.018	0.054	TC57218	49.26
0.019	0.057	TC57219	49.26
0.020	0.060	TC57220	44.81
0.021	0.063	TC57221	44.81
0.022	0.066	TC57222	44.81
0.023	0.069	TC57223	44.81
0.024	0.072	TC57224	44.81
0.025	0.075	TC57225	44.81
0.026	0.078	TC57226	42.04
0.027	0.081	TC57227	42.04
0.028	0.084	TC57228	42.04
0.029	0.087	TC57229	42.04
0.030	0.090	TC57230	42.04
0.031	0.093	TC57231	39.42
0.032	0.096	TC57232	39.42
0.033	0.099	TC57233	39.42
0.034	0.102	TC57234	39.42
0.035	0.105	TC57235	39.42
0.036	0.108	TC57236	39.42
0.037	0.111	TC57237	39.42
0.038	0.114	TC57238	39.42
0.039	0.117	TC57239	39.42
0.040	0.120	TC57240	39.42

DIA	LOC	ITEM#	LIST PRICE
0.041	0.123	TC57241	39.42
0.042	0.126	TC57242	39.42
0.043	0.129	TC57243	39.42
0.044	0.132	TC57244	38.49
0.045	0.135	TC57245	38.49
0.046	0.138	TC57246	38.49
0.047	0.141	TC57247	38.49
0.048	0.144	TC57248	38.49
0.049	0.147	TC57249	38.49
0.050	0.150	TC57250	38.49
0.051	0.153	TC57251	38.49
0.052	0.156	TC57252	38.49
0.053	0.159	TC57253	38.49
0.054	0.162	TC57254	38.49
0.055	0.165	TC57255	38.49
0.056	0.168	TC57256	38.49
0.057	0.171	TC57257	38.49
0.058	0.174	TC57258	38.49
0.059	0.177	TC57259	38.49
0.060	0.180	TC57260	38.49
0.061	0.183	TC57261	38.49
0.062	0.186	TC57262	38.49
0.063	0.189	TC57263	38.49
0.064	0.192	TC57264	38.49
0.065	0.195	TC57265	38.49
0.066	0.198	TC57266	38.49
0.067	0.201	TC57267	38.49
0.068	0.204	TC57268	38.49
0.069	0.207	TC57269	38.49
0.070	0.210	TC57270	38.49
0.071	0.213	TC57271	38.49
0.072	0.216	TC57272	38.49
0.073	0.219	TC57273	38.49
0.074	0.222	TC57274	38.49
0.075	0.225	TC57275	38.49
0.076	0.228	TC57276	38.49

DIA	LOC	ITEM#	LIST PRICE
0.077	0.231	TC57277	38.49
0.078	0.234	TC57278	38.49
0.079	0.237	TC57279	38.49
0.080	0.240	TC57280	38.49
0.081	0.243	TC57281	38.49
0.082	0.246	TC57282	38.49
0.083	0.249	TC57283	38.49
0.084	0.252	TC57284	38.49
0.085	0.255	TC57285	38.49
0.086	0.258	TC57286	38.49
0.087	0.261	TC57287	38.49
0.088	0.264	TC57288	38.49
0.089	0.267	TC57289	38.49
0.090	0.270	TC57290	38.49
0.091	0.273	TC57291	38.49
0.092	0.276	TC57292	38.49
0.093	0.279	TC57293	38.49
0.094	0.282	TC57294	38.49
0.095	0.285	TC57295	38.49
0.096	0.288	TC57296	38.49
0.097	0.291	TC57297	38.49
0.098	0.294	TC57298	38.49
0.099	0.297	TC57299	38.49
0.100	0.300	TC57300	38.49
0.101	0.303	TC57301	38.49
0.102	0.306	TC57302	38.49
0.103	0.309	TC57303	38.49
0.104	0.312	TC57304	38.49
0.105	0.315	TC57305	38.49
0.106	0.318	TC57306	38.49
0.107	0.321	TC57307	38.49
0.108	0.324	TC57308	38.49
0.109	0.327	TC57309	38.49
0.110	0.330	TC57310	38.49
0.115	0.345	TC57315	38.49
0.120	0.360	TC57320	38.49

All regular length Micro End Mills are 1/8" shank, 1-1/2" OAL.
For coating information see page 8. For technical information, please see page 126.

TOLERANCES	DIAMETER	SHANK
ALL SIZES	+.0005, -.0005	-.0001, -.0003 ISO H6



GENERAL PURPOSE SOLID CARBIDE MICRO END MILLS

YOUR #1 SOURCE FOR AMERICAN-MADE PREMIUM QUALITY CUTTING TOOLS

4 FLUTE - STUB FLUTE - SQUARE END - 30° HELIX
LOC = 1.5 X DIA



SERIES 540
UNCOATED

DIA	LOC	ITEM#	LIST PRICE
0.010	0.015	TC54010	60.38
0.015	0.023	TC54015	37.78
0.020	0.030	TC54020	34.35
0.025	0.038	TC54025	34.35
0.030	0.045	TC54030	32.24
0.031	0.047	TC54031	30.21
0.035	0.053	TC54035	30.21
0.040	0.060	TC54040	30.21
0.045	0.068	TC54045	29.47
0.047	0.071	TC54047	29.47
0.050	0.075	TC54050	29.47
0.055	0.083	TC54055	29.47

DIA	LOC	ITEM#	LIST PRICE
0.060	0.090	TC54060	29.47
0.062	0.093	TC54062	29.47
0.065	0.098	TC54065	29.47
0.070	0.105	TC54070	29.47
0.075	0.113	TC54075	29.47
0.078	0.117	TC54078	29.47
0.080	0.120	TC54080	29.47
0.085	0.128	TC54085	29.47
0.090	0.135	TC54090	29.47
0.093	0.140	TC54093	29.47
0.095	0.143	TC54095	29.47
0.100	0.150	TC54100	29.47



SERIES 542
ALTIN COATED

DIA	LOC	ITEM#	LIST PRICE
0.010	0.015	TC54210	72.44
0.015	0.023	TC54215	45.36
0.020	0.030	TC54220	41.22
0.025	0.038	TC54225	41.22
0.030	0.045	TC54230	38.68
0.031	0.047	TC54231	36.22
0.035	0.053	TC54235	36.22
0.040	0.060	TC54240	36.22
0.045	0.068	TC54245	35.36
0.047	0.071	TC54247	35.36
0.050	0.075	TC54250	35.36
0.055	0.083	TC54255	35.36

DIA	LOC	ITEM#	LIST PRICE
0.060	0.090	TC54260	35.36
0.062	0.093	TC54262	35.36
0.065	0.098	TC54265	35.36
0.070	0.105	TC54270	35.36
0.075	0.113	TC54275	35.36
0.078	0.117	TC54278	35.36
0.080	0.120	TC54280	35.36
0.085	0.128	TC54285	35.36
0.090	0.135	TC54290	35.36
0.093	0.140	TC54293	35.36
0.095	0.143	TC54295	35.36
0.100	0.150	TC54300	35.36

All regular length Micro End Mills are 1/8" shank, 1-1/2" OAL.
For coating information see page 8. For technical information, please see page 126.

TOLERANCES	DIAMETER	SHANK
ALL SIZES	+ .0005, - .0005	- .0001, -.0003 ISO H6

GENERAL PURPOSE SOLID CARBIDE MICRO END MILLS



YOUR #1 SOURCE FOR AMERICAN-MADE PREMIUM QUALITY CUTTING TOOLS

4 FLUTE - STUB FLUTE - BALL NOSE - 30° HELIX
LOC = 1.5 X DIA



SERIES 551 UNCOATED

DIA	LOC	ITEM#	LIST PRICE
0.010	0.015	TC55010	65.65
0.015	0.023	TC55015	41.06
0.020	0.030	TC55020	37.35
0.025	0.038	TC55025	37.35
0.030	0.045	TC55030	35.05
0.031	0.047	TC55031	32.87
0.035	0.053	TC55035	32.87
0.040	0.060	TC55040	32.87
0.045	0.068	TC55045	32.05
0.047	0.071	TC55047	32.05
0.050	0.075	TC55050	32.05
0.055	0.083	TC55055	32.05

DIA	LOC	ITEM#	LIST PRICE
0.060	0.090	TC55060	32.05
0.062	0.093	TC55062	32.05
0.065	0.098	TC55065	32.05
0.070	0.105	TC55070	32.05
0.075	0.113	TC55075	32.05
0.078	0.117	TC55078	32.05
0.080	0.120	TC55080	32.05
0.085	0.128	TC55085	32.05
0.090	0.135	TC55090	32.05
0.093	0.140	TC55093	32.05
0.095	0.143	TC55095	32.05
0.100	0.150	TC55100	32.05



SERIES 552 ALUMINIZED COATED

DIA	LOC	ITEM#	LIST PRICE
0.010	0.015	TC55210	90.55
0.015	0.023	TC55215	56.67
0.020	0.030	TC55220	51.52
0.025	0.038	TC55225	51.52
0.030	0.045	TC55230	48.32
0.031	0.047	TC55231	45.36
0.035	0.053	TC55235	45.36
0.040	0.060	TC55240	45.36
0.045	0.068	TC55245	44.26
0.047	0.071	TC55247	44.26
0.050	0.075	TC55250	44.26
0.055	0.083	TC55255	44.26

DIA	LOC	ITEM#	LIST PRICE
0.060	0.090	TC55260	44.26
0.062	0.093	TC55262	44.26
0.065	0.098	TC55265	44.26
0.070	0.105	TC55270	44.26
0.075	0.113	TC55275	44.26
0.078	0.117	TC55278	44.26
0.080	0.120	TC55280	44.26
0.085	0.128	TC55285	44.26
0.090	0.135	TC55290	44.26
0.093	0.140	TC55293	44.26
0.095	0.143	TC55295	44.26
0.100	0.150	TC55300	44.26

All regular length Micro End Mills are 1/8" shank, 1-1/2" OAL.
For coating information see page 8. For technical information, please see page 126.

TOLERANCES	DIAMETER	SHANK
ALL SIZES	+.0005, -.0005	-.0001, -.0003 ISO H6



GENERAL PURPOSE SOLID CARBIDE MICRO END MILLS

YOUR #1 SOURCE FOR AMERICAN-MADE PREMIUM QUALITY CUTTING TOOLS

4 FLUTE - STUB FLUTE CORNER RADIUS - 30° HELIX
LOC = 1.5 X DIA



SERIES 502 UNCOATED

DIA	LOC	RAD	ITEM#	LIST PRICE
0.015	0.023	0.003	TC50203	79.90
0.020	0.030	0.005	TC50205	74.59
0.025	0.038	0.005	TC50207	74.59
0.030	0.045	0.005	TC50209	53.28
0.030	0.045	0.010	TC50211	53.28
0.031	0.047	0.005	TC50213	53.28
0.031	0.047	0.010	TC50215	53.28
0.035	0.053	0.005	TC50217	53.28
0.035	0.053	0.010	TC50219	53.28
0.040	0.060	0.005	TC50221	53.28
0.040	0.060	0.010	TC50223	53.28
0.045	0.068	0.005	TC50225	53.28
0.045	0.068	0.010	TC50227	53.28
0.045	0.068	0.015	TC50229	53.28

DIA	LOC	RAD	ITEM#	LIST PRICE
0.047	0.071	0.005	TC50231	53.28
0.047	0.071	0.010	TC50233	53.28
0.047	0.071	0.015	TC50235	53.28
0.050	0.075	0.005	TC50237	53.28
0.050	0.075	0.010	TC50239	53.28
0.050	0.075	0.015	TC50241	53.28
0.060	0.090	0.005	TC50249	53.28
0.060	0.090	0.010	TC50251	53.28
0.060	0.090	0.015	TC50253	53.28
0.062	0.093	0.005	TC50255	53.28
0.062	0.093	0.010	TC50257	53.28
0.062	0.093	0.015	TC50259	53.28
0.075	0.113	0.005	TC50273	53.28
0.075	0.113	0.010	TC50275	53.28

DIA	LOC	RAD	ITEM#	LIST PRICE
0.075	0.113	0.015	TC50277	53.28
0.078	0.117	0.005	TC50279	53.28
0.078	0.117	0.010	TC50281	53.28
0.078	0.117	0.015	TC50283	53.28
0.090	0.135	0.005	TC50297	53.28
0.090	0.135	0.010	TC50299	53.28
0.090	0.135	0.015	TC50301	53.28
0.093	0.140	0.005	TC50303	53.28
0.093	0.140	0.010	TC50305	53.28
0.093	0.140	0.015	TC50307	53.28
0.100	0.150	0.005	TC50315	53.28
0.100	0.150	0.010	TC50317	53.28
0.100	0.150	0.015	TC50319	53.28



SERIES 504 ALTIN COATED

DIA	LOC	RAD	ITEM#	LIST PRICE
0.015	0.023	0.003	TC50404	99.06
0.020	0.030	0.005	TC50406	92.47
0.025	0.038	0.005	TC50408	92.47
0.030	0.045	0.005	TC50410	66.04
0.030	0.045	0.010	TC50412	66.04
0.031	0.047	0.005	TC50414	66.04
0.031	0.047	0.010	TC50416	66.04
0.035	0.053	0.005	TC50418	66.04
0.035	0.053	0.010	TC50420	66.04
0.040	0.060	0.005	TC50422	66.04
0.040	0.060	0.010	TC50424	66.04
0.045	0.068	0.005	TC50426	66.04
0.045	0.068	0.010	TC50428	66.04
0.045	0.068	0.015	TC50430	66.04

DIA	LOC	RAD	ITEM#	LIST PRICE
0.047	0.071	0.005	TC50432	66.04
0.047	0.071	0.010	TC50434	66.04
0.047	0.071	0.015	TC50436	66.04
0.050	0.075	0.005	TC50438	66.04
0.050	0.075	0.010	TC50440	66.04
0.050	0.075	0.015	TC50442	66.04
0.060	0.090	0.005	TC50450	66.04
0.060	0.090	0.010	TC50452	66.04
0.060	0.090	0.015	TC50454	66.04
0.062	0.093	0.005	TC50456	66.04
0.062	0.093	0.010	TC50458	66.04
0.062	0.093	0.015	TC50460	66.04
0.075	0.113	0.005	TC50474	66.04
0.075	0.113	0.010	TC50476	66.04

DIA	LOC	RAD	ITEM#	LIST PRICE
0.075	0.113	0.015	TC50478	66.04
0.078	0.117	0.005	TC50480	66.04
0.078	0.117	0.010	TC50482	66.04
0.078	0.117	0.015	TC50484	66.04
0.090	0.135	0.005	TC50498	66.04
0.090	0.135	0.010	TC50500	66.04
0.090	0.135	0.015	TC50502	66.04
0.093	0.140	0.005	TC50504	66.04
0.093	0.140	0.010	TC50506	66.04
0.093	0.140	0.015	TC50508	66.04
0.100	0.150	0.005	TC50516	66.04
0.100	0.150	0.010	TC50518	66.04
0.100	0.150	0.015	TC50520	66.04

All regular length Micro End Mills are 1/8" shank, 1-1/2" OAL.
For coating information see page 8. For technical information, please see page 126.

TOLERANCES	DIAMETER	SHANK	RADIUS
ALL SIZES	+.0005, -.0005	-.0001, -.0003 ISO H6	+.0002, -.0002

GENERAL PURPOSE SOLID CARBIDE MICRO END MILLS



YOUR #1 SOURCE FOR AMERICAN-MADE PREMIUM QUALITY CUTTING TOOLS

4 FLUTE - REGULAR FLUTE  CORNER RADIUS - 30° HELIX
LOC = 3 X DIA



SERIES 506 UNCOATED

DIA	LOC	RAD	ITEM#	LIST PRICE
0.015	0.045	0.003	TC50603	79.90
0.020	0.060	0.005	TC50605	74.59
0.025	0.075	0.005	TC50607	74.59
0.030	0.090	0.005	TC50609	53.28
0.030	0.090	0.010	TC50611	53.28
0.031	0.093	0.005	TC50613	53.28
0.031	0.093	0.010	TC50615	53.28
0.035	0.105	0.005	TC50617	53.28
0.035	0.105	0.010	TC50619	53.28
0.040	0.120	0.005	TC50621	53.28
0.040	0.120	0.010	TC50623	53.28
0.045	0.135	0.005	TC50625	53.28
0.045	0.135	0.010	TC50627	53.28
0.045	0.135	0.015	TC50629	53.28

DIA	LOC	RAD	ITEM#	LIST PRICE
0.047	0.141	0.005	TC50631	53.28
0.047	0.141	0.010	TC50633	53.28
0.047	0.141	0.015	TC50635	53.28
0.050	0.150	0.005	TC50637	53.28
0.050	0.150	0.010	TC50639	53.28
0.050	0.150	0.015	TC50641	53.28
0.060	0.180	0.005	TC50649	53.28
0.060	0.180	0.010	TC50651	53.28
0.060	0.180	0.015	TC50653	53.28
0.062	0.186	0.005	TC50655	53.28
0.062	0.186	0.010	TC50657	53.28
0.062	0.186	0.015	TC50659	53.28
0.075	0.225	0.005	TC50673	53.28
0.075	0.225	0.010	TC50675	53.28

DIA	LOC	RAD	ITEM#	LIST PRICE
0.075	0.225	0.015	TC50677	53.28
0.078	0.234	0.005	TC50679	53.28
0.078	0.234	0.010	TC50681	53.28
0.078	0.234	0.015	TC50683	53.28
0.090	0.270	0.005	TC50697	53.28
0.090	0.270	0.010	TC50699	53.28
0.090	0.270	0.015	TC50701	53.28
0.093	0.279	0.005	TC50703	53.28
0.093	0.279	0.010	TC50705	53.28
0.093	0.279	0.015	TC50707	53.28
0.100	0.300	0.005	TC50715	53.28
0.100	0.300	0.010	TC50717	53.28
0.100	0.300	0.015	TC50719	53.28



SERIES 508 ALTIN COATED

DIA	LOC	RAD	ITEM#	LIST PRICE
0.015	0.045	0.003	TC50804	99.06
0.020	0.060	0.005	TC50806	92.47
0.025	0.075	0.005	TC50808	92.47
0.030	0.090	0.005	TC50810	66.04
0.030	0.090	0.010	TC50812	66.04
0.031	0.093	0.005	TC50814	66.04
0.031	0.093	0.010	TC50816	66.04
0.035	0.105	0.005	TC50818	66.04
0.035	0.105	0.010	TC50820	66.04
0.040	0.120	0.005	TC50822	66.04
0.040	0.120	0.010	TC50824	66.04
0.045	0.135	0.005	TC50826	66.04
0.045	0.135	0.010	TC50828	66.04
0.045	0.135	0.015	TC50830	66.04

DIA	LOC	RAD	ITEM#	LIST PRICE
0.047	0.141	0.005	TC50832	66.04
0.047	0.141	0.010	TC50834	66.04
0.047	0.141	0.015	TC50836	66.04
0.050	0.150	0.005	TC50838	66.04
0.050	0.150	0.010	TC50840	66.04
0.050	0.150	0.015	TC50842	66.04
0.060	0.180	0.005	TC50850	66.04
0.060	0.180	0.010	TC50852	66.04
0.060	0.180	0.015	TC50854	66.04
0.062	0.186	0.005	TC50856	66.04
0.062	0.186	0.010	TC50858	66.04
0.062	0.186	0.015	TC50860	66.04
0.075	0.225	0.005	TC50874	66.04
0.075	0.225	0.010	TC50876	66.04

DIA	LOC	RAD	ITEM#	LIST PRICE
0.075	0.225	0.015	TC50878	66.04
0.078	0.234	0.005	TC50880	66.04
0.078	0.234	0.010	TC50882	66.04
0.078	0.234	0.015	TC50884	66.04
0.090	0.270	0.005	TC50898	66.04
0.090	0.270	0.010	TC50900	66.04
0.090	0.270	0.015	TC50902	66.04
0.093	0.279	0.005	TC50904	66.04
0.093	0.279	0.010	TC50906	66.04
0.093	0.279	0.015	TC50908	66.04
0.100	0.300	0.005	TC50916	66.04
0.100	0.300	0.010	TC50918	66.04
0.100	0.300	0.015	TC50920	66.04

All regular length Micro End Mills are 1/8" shank, 1-1/2" OAL.
For coating information see page 8. For technical information, please see page 126.

TOLERANCES	DIAMETER	SHANK	RADIUS
ALL SIZES	+.0005, -.0005	-.0001, -.0003 ISO H6	+.0002, -.0002



GENERAL PURPOSE SOLID CARBIDE MICRO END MILLS

YOUR #1 SOURCE FOR AMERICAN-MADE PREMIUM QUALITY CUTTING TOOLS

4 FLUTE - REGULAR FLUTE - SQUARE END - 30° HELIX
LOC = 3 X DIA



**SERIES 580
UNCOATED**

DIA	LOC	ITEM#	LIST PRICE
0.010	0.030	TC58010	52.50
0.011	0.033	TC58011	46.99
0.012	0.036	TC58012	46.99
0.013	0.039	TC58013	38.88
0.014	0.042	TC58014	38.88
0.015	0.045	TC58015	32.87
0.016	0.048	TC58016	32.87
0.017	0.051	TC58017	32.87
0.018	0.054	TC58018	32.87
0.019	0.057	TC58019	32.87
0.020	0.060	TC58020	29.86
0.021	0.063	TC58021	29.86
0.022	0.066	TC58022	29.86
0.023	0.069	TC58023	29.86
0.024	0.072	TC58024	29.86
0.025	0.075	TC58025	29.86
0.026	0.078	TC58026	28.02
0.027	0.081	TC58027	28.02
0.028	0.084	TC58028	28.02
0.029	0.087	TC58029	28.02
0.030	0.090	TC58030	28.02
0.031	0.093	TC58031	26.27
0.032	0.096	TC58032	26.27
0.033	0.099	TC58033	26.27
0.034	0.102	TC58034	26.27
0.035	0.105	TC58035	26.27
0.036	0.108	TC58036	26.27
0.037	0.111	TC58037	26.27
0.038	0.114	TC58038	26.27
0.039	0.117	TC58039	26.27
0.040	0.120	TC58040	26.27
0.041	0.123	TC58041	26.27
0.042	0.126	TC58042	26.27
0.043	0.129	TC58043	26.27
0.044	0.132	TC58044	25.61

DIA	LOC	ITEM#	LIST PRICE
0.045	0.135	TC58045	25.61
0.046	0.138	TC58046	25.61
0.047	0.141	TC58047	25.61
0.048	0.144	TC58048	25.61
0.049	0.147	TC58049	25.61
0.050	0.150	TC58050	25.61
0.051	0.153	TC58051	25.61
0.052	0.156	TC58052	25.61
0.053	0.159	TC58053	25.61
0.054	0.162	TC58054	25.61
0.055	0.165	TC58055	25.61
0.056	0.168	TC58056	25.61
0.057	0.171	TC58057	25.61
0.058	0.174	TC58058	25.61
0.059	0.177	TC58059	25.61
0.060	0.180	TC58060	25.61
0.061	0.183	TC58061	25.61
0.062	0.186	TC58062	25.61
0.063	0.189	TC58063	25.61
0.064	0.192	TC58064	25.61
0.065	0.195	TC58065	25.61
0.066	0.198	TC58066	25.61
0.067	0.201	TC58067	25.61
0.068	0.204	TC58068	25.61
0.069	0.207	TC58069	25.61
0.070	0.210	TC58070	25.61
0.071	0.213	TC58071	25.61
0.072	0.216	TC58072	25.61
0.073	0.219	TC58073	25.61
0.074	0.222	TC58074	25.61
0.075	0.225	TC58075	25.61
0.076	0.228	TC58076	25.61
0.077	0.231	TC58077	25.61
0.078	0.234	TC58078	25.61
0.079	0.237	TC58079	25.61

DIA	LOC	ITEM#	LIST PRICE
0.080	0.240	TC58080	25.61
0.081	0.243	TC58081	25.61
0.082	0.246	TC58082	25.61
0.083	0.249	TC58083	25.61
0.084	0.252	TC58084	25.61
0.085	0.255	TC58085	25.61
0.086	0.258	TC58086	25.61
0.087	0.261	TC58087	25.61
0.088	0.264	TC58088	25.61
0.089	0.267	TC58089	25.61
0.090	0.270	TC58090	25.61
0.091	0.273	TC58091	25.61
0.092	0.276	TC58092	25.61
0.093	0.279	TC58093	25.61
0.094	0.282	TC58094	25.61
0.095	0.285	TC58095	25.61
0.096	0.288	TC58096	25.61
0.097	0.291	TC58097	25.61
0.098	0.294	TC58098	25.61
0.099	0.297	TC58099	25.61
0.100	0.300	TC58100	25.61
0.101	0.303	TC58101	25.61
0.102	0.306	TC58102	25.61
0.103	0.309	TC58103	25.61
0.104	0.312	TC58104	25.61
0.105	0.315	TC58105	25.61
0.106	0.318	TC58106	25.61
0.107	0.321	TC58107	25.61
0.108	0.324	TC58108	25.61
0.109	0.327	TC58109	25.61
0.110	0.330	TC58110	25.61
0.115	0.345	TC58115	25.61
0.120	0.360	TC58120	25.61

All regular length Micro End Mills are 1/8" shank, 1-1/2" OAL.
For technical information, please see page 126.

TOLERANCES	DIAMETER	SHANK
ALL SIZES	+ .0005, -.0005	-.0001, -.0003 ISO H6

MICRO END MILLS

REGULAR LENGTH

LONG REACH STUB FLUTE

LONG REACH REG FLUTE

LONG REACH LONG FLUTE

LONG LENGTH LONG FLUTE

TECHNICAL

GENERAL PURPOSE SOLID CARBIDE MICRO END MILLS



YOUR #1 SOURCE FOR AMERICAN-MADE PREMIUM QUALITY CUTTING TOOLS

4 FLUTE - REGULAR FLUTE - SQUARE END - 30° HELIX
LOC = 3 X DIA



SERIES 582 ALTiN COATED

DIA	LOC	ITEM#	LIST PRICE
0.010	0.030	TC58210	63.00
0.011	0.033	TC58211	56.40
0.012	0.036	TC58212	56.40
0.013	0.039	TC58213	46.64
0.014	0.042	TC58214	46.64
0.015	0.045	TC58215	39.42
0.016	0.048	TC58216	39.42
0.017	0.051	TC58217	39.42
0.018	0.054	TC58218	39.42
0.019	0.057	TC58219	39.42
0.020	0.060	TC58220	35.83
0.021	0.063	TC58221	35.83
0.022	0.066	TC58222	35.83
0.023	0.069	TC58223	35.83
0.024	0.072	TC58224	35.83
0.025	0.075	TC58225	35.83
0.026	0.078	TC58226	33.65
0.027	0.081	TC58227	33.65
0.028	0.084	TC58228	33.65
0.029	0.087	TC58229	33.65
0.030	0.090	TC58230	33.65
0.031	0.093	TC58231	31.50
0.032	0.096	TC58232	31.50
0.033	0.099	TC58233	31.50
0.034	0.102	TC58234	31.50
0.035	0.105	TC58235	31.50
0.036	0.108	TC58236	31.50
0.037	0.111	TC58237	31.50
0.038	0.114	TC58238	31.50
0.039	0.117	TC58239	31.50
0.040	0.120	TC58240	31.50
0.041	0.123	TC58241	31.50
0.042	0.126	TC58242	31.50
0.043	0.129	TC58243	31.50
0.044	0.132	TC58244	30.76

DIA	LOC	ITEM#	LIST PRICE
0.045	0.135	TC58245	30.76
0.046	0.138	TC58246	30.76
0.047	0.141	TC58247	30.76
0.048	0.144	TC58248	30.76
0.049	0.147	TC58249	30.76
0.050	0.150	TC58250	30.76
0.051	0.153	TC58251	30.76
0.052	0.156	TC58252	30.76
0.053	0.159	TC58253	30.76
0.054	0.162	TC58254	30.76
0.055	0.165	TC58255	30.76
0.056	0.168	TC58256	30.76
0.057	0.171	TC58257	30.76
0.058	0.174	TC58258	30.76
0.059	0.177	TC58259	30.76
0.060	0.180	TC58260	30.76
0.061	0.183	TC58261	30.76
0.062	0.186	TC58262	30.76
0.063	0.189	TC58263	30.76
0.064	0.192	TC58264	30.76
0.065	0.195	TC58265	30.76
0.066	0.198	TC58266	30.76
0.067	0.201	TC58267	30.76
0.068	0.204	TC58268	30.76
0.069	0.207	TC58269	30.76
0.070	0.210	TC58270	30.76
0.071	0.213	TC58271	30.76
0.072	0.216	TC58272	30.76
0.073	0.219	TC58273	30.76
0.074	0.222	TC58274	30.76
0.075	0.225	TC58275	30.76
0.076	0.228	TC58276	30.76
0.077	0.231	TC58277	30.76
0.078	0.234	TC58278	30.76
0.079	0.237	TC58279	30.76

DIA	LOC	ITEM#	LIST PRICE
0.080	0.240	TC58280	30.76
0.081	0.243	TC58281	30.76
0.082	0.246	TC58282	30.76
0.083	0.249	TC58283	30.76
0.084	0.252	TC58284	30.76
0.085	0.255	TC58285	30.76
0.086	0.258	TC58286	30.76
0.087	0.261	TC58287	30.76
0.088	0.264	TC58288	30.76
0.089	0.267	TC58289	30.76
0.090	0.270	TC58290	30.76
0.091	0.273	TC58291	30.76
0.092	0.276	TC58292	30.76
0.093	0.279	TC58293	30.76
0.094	0.282	TC58294	30.76
0.095	0.285	TC58295	30.76
0.096	0.288	TC58296	30.76
0.097	0.291	TC58297	30.76
0.098	0.294	TC58298	30.76
0.099	0.297	TC58299	30.76
0.100	0.300	TC58300	30.76
0.101	0.303	TC58301	30.76
0.102	0.306	TC58302	30.76
0.103	0.309	TC58303	30.76
0.104	0.312	TC58304	30.76
0.105	0.315	TC58305	30.76
0.106	0.318	TC58306	30.76
0.107	0.321	TC58307	30.76
0.108	0.324	TC58308	30.76
0.109	0.327	TC58309	30.76
0.110	0.330	TC58310	30.76
0.115	0.345	TC58315	30.76
0.120	0.360	TC58320	30.76

All regular length Micro End Mills are 1/8" shank, 1-1/2" OAL.
For coating information see page 8. For technical information, please see page 126.

TOLERANCES	DIAMETER	SHANK
ALL SIZES	+ .0005, -.0005	-.0001, -.0003 ISO H6



GENERAL PURPOSE SOLID CARBIDE MICRO END MILLS

YOUR #1 SOURCE FOR AMERICAN-MADE PREMIUM QUALITY CUTTING TOOLS

4 FLUTE - REGULAR FLUTE - BALL NOSE - 30° HELIX
LOC = 3 X DIA



SERIES 590
UNCOATED

DIA	LOC	ITEM#	LIST PRICE
0.010	0.030	TC59010	65.65
0.011	0.033	TC59011	58.74
0.012	0.036	TC59012	58.74
0.013	0.039	TC59013	48.67
0.014	0.042	TC59014	48.67
0.015	0.045	TC59015	41.06
0.016	0.048	TC59016	41.06
0.017	0.051	TC59017	41.06
0.018	0.054	TC59018	41.06
0.019	0.057	TC59019	41.06
0.020	0.060	TC59020	37.35
0.021	0.063	TC59021	37.35
0.022	0.066	TC59022	37.35
0.023	0.069	TC59023	37.35
0.024	0.072	TC59024	37.35
0.025	0.075	TC59025	37.35
0.026	0.078	TC59026	35.05
0.027	0.081	TC59027	35.05
0.028	0.084	TC59028	35.05
0.029	0.087	TC59029	35.05
0.030	0.090	TC59030	35.05
0.031	0.093	TC59031	32.87
0.032	0.096	TC59032	32.87
0.033	0.099	TC59033	32.87
0.034	0.102	TC59034	32.87
0.035	0.105	TC59035	32.87
0.036	0.108	TC59036	32.87
0.037	0.111	TC59037	32.87
0.038	0.114	TC59038	32.87
0.039	0.117	TC59039	32.87
0.040	0.120	TC59040	32.87
0.041	0.123	TC59041	32.87
0.042	0.126	TC59042	32.87
0.043	0.129	TC59043	32.87
0.044	0.132	TC59044	32.05

DIA	LOC	ITEM#	LIST PRICE
0.045	0.135	TC59045	32.05
0.046	0.138	TC59046	32.05
0.047	0.141	TC59047	32.05
0.048	0.144	TC59048	32.05
0.049	0.147	TC59049	32.05
0.050	0.150	TC59050	32.05
0.051	0.153	TC59051	32.05
0.052	0.156	TC59052	32.05
0.053	0.159	TC59053	32.05
0.054	0.162	TC59054	32.05
0.055	0.165	TC59055	32.05
0.056	0.168	TC59056	32.05
0.057	0.171	TC59057	32.05
0.058	0.174	TC59058	32.05
0.059	0.177	TC59059	32.05
0.060	0.180	TC59060	32.05
0.061	0.183	TC59061	32.05
0.062	0.186	TC59062	32.05
0.063	0.189	TC59063	32.05
0.064	0.192	TC59064	32.05
0.065	0.195	TC59065	32.05
0.066	0.198	TC59066	32.05
0.067	0.201	TC59067	32.05
0.068	0.204	TC59068	32.05
0.069	0.207	TC59069	32.05
0.070	0.210	TC59070	32.05
0.071	0.213	TC59071	32.05
0.072	0.216	TC59072	32.05
0.073	0.219	TC59073	32.05
0.074	0.222	TC59074	32.05
0.075	0.225	TC59075	32.05
0.076	0.228	TC59076	32.05
0.077	0.231	TC59077	32.05
0.078	0.234	TC59078	32.05
0.079	0.237	TC59079	32.05

DIA	LOC	ITEM#	LIST PRICE
0.080	0.240	TC59080	32.05
0.081	0.243	TC59081	32.05
0.082	0.246	TC59082	32.05
0.083	0.249	TC59083	32.05
0.084	0.252	TC59084	32.05
0.085	0.255	TC59085	32.05
0.086	0.258	TC59086	32.05
0.087	0.261	TC59087	32.05
0.088	0.264	TC59088	32.05
0.089	0.267	TC59089	32.05
0.090	0.270	TC59090	32.05
0.091	0.273	TC59091	32.05
0.092	0.276	TC59092	32.05
0.093	0.279	TC59093	32.05
0.094	0.282	TC59094	32.05
0.095	0.285	TC59095	32.05
0.096	0.288	TC59096	32.05
0.097	0.291	TC59097	32.05
0.098	0.294	TC59098	32.05
0.099	0.297	TC59099	32.05
0.100	0.300	TC59100	32.05
0.101	0.303	TC59101	32.05
0.102	0.306	TC59102	32.05
0.103	0.309	TC59103	32.05
0.104	0.312	TC59104	32.05
0.105	0.315	TC59105	32.05
0.106	0.318	TC59106	32.05
0.107	0.321	TC59107	32.05
0.108	0.324	TC59108	32.05
0.109	0.327	TC59109	32.05
0.110	0.330	TC59110	32.05
0.115	0.345	TC59115	32.05
0.120	0.360	TC59120	32.05

All regular length Micro End Mills are 1/8" shank, 1-1/2" OAL.
For technical information, please see page 126.

TOLERANCES	DIAMETER	SHANK
ALL SIZES	+.0005, -.0005	-.0001, -.0003 ISO H6

MICRO END MILLS

REGULAR LENGTH

LONG REACH STUB FLUTE

LONG REACH REG FLUTE

LONG REACH LONG FLUTE

LONG LENGTH LONG FLUTE

TECHNICAL

GENERAL PURPOSE SOLID CARBIDE MICRO END MILLS



YOUR #1 SOURCE FOR AMERICAN-MADE PREMIUM QUALITY CUTTING TOOLS

4 FLUTE - REGULAR FLUTE - BALL NOSE - 30° HELIX
LOC = 3 X DIA



SERIES 592
ALTIN COATED

DIA	LOC	ITEM#	LIST PRICE
0.010	0.030	TC59210	78.77
0.011	0.033	TC59211	70.53
0.012	0.036	TC59212	70.53
0.013	0.039	TC59213	58.39
0.014	0.042	TC59214	58.39
0.015	0.045	TC59215	49.26
0.016	0.048	TC59216	49.26
0.017	0.051	TC59217	49.26
0.018	0.054	TC59218	49.26
0.019	0.057	TC59219	49.26
0.020	0.060	TC59220	44.81
0.021	0.063	TC59221	44.81
0.022	0.066	TC59222	44.81
0.023	0.069	TC59223	44.81
0.024	0.072	TC59224	44.81
0.025	0.075	TC59225	44.81
0.026	0.078	TC59226	42.04
0.027	0.081	TC59227	42.04
0.028	0.084	TC59228	42.04
0.029	0.087	TC59229	42.04
0.030	0.090	TC59230	42.04
0.031	0.093	TC59231	39.42
0.032	0.096	TC59232	39.42
0.033	0.099	TC59233	39.42
0.034	0.102	TC59234	39.42
0.035	0.105	TC59235	39.42
0.036	0.108	TC59236	39.42
0.037	0.111	TC59237	39.42
0.038	0.114	TC59238	39.42
0.039	0.117	TC59239	39.42
0.040	0.120	TC59240	39.42
0.041	0.123	TC59241	39.42
0.042	0.126	TC59242	39.42
0.043	0.129	TC59243	39.42
0.044	0.132	TC59244	38.49

DIA	LOC	ITEM#	LIST PRICE
0.045	0.135	TC59245	38.49
0.046	0.138	TC59246	38.49
0.047	0.141	TC59247	38.49
0.048	0.144	TC59248	38.49
0.049	0.147	TC59249	38.49
0.050	0.150	TC59250	38.49
0.051	0.153	TC59251	38.49
0.052	0.156	TC59252	38.49
0.053	0.159	TC59253	38.49
0.054	0.162	TC59254	38.49
0.055	0.165	TC59255	38.49
0.056	0.168	TC59256	38.49
0.057	0.171	TC59257	38.49
0.058	0.174	TC59258	38.49
0.059	0.177	TC59259	38.49
0.060	0.180	TC59260	38.49
0.061	0.183	TC59261	38.49
0.062	0.186	TC59262	38.49
0.063	0.189	TC59263	38.49
0.064	0.192	TC59264	38.49
0.065	0.195	TC59265	38.49
0.066	0.198	TC59266	38.49
0.067	0.201	TC59267	38.49
0.068	0.204	TC59268	38.49
0.069	0.207	TC59269	38.49
0.070	0.210	TC59270	38.49
0.071	0.213	TC59271	38.49
0.072	0.216	TC59272	38.49
0.073	0.219	TC59273	38.49
0.074	0.222	TC59274	38.49
0.075	0.225	TC59275	38.49
0.076	0.228	TC59276	38.49
0.077	0.231	TC59277	38.49
0.078	0.234	TC59278	38.49
0.079	0.237	TC59279	38.49

DIA	LOC	ITEM#	LIST PRICE
0.080	0.240	TC59280	38.49
0.081	0.243	TC59281	38.49
0.082	0.246	TC59282	38.49
0.083	0.249	TC59283	38.49
0.084	0.252	TC59284	38.49
0.085	0.255	TC59285	38.49
0.086	0.258	TC59286	38.49
0.087	0.261	TC59287	38.49
0.088	0.264	TC59288	38.49
0.089	0.267	TC59289	38.49
0.090	0.270	TC59290	38.49
0.091	0.273	TC59291	38.49
0.092	0.276	TC59292	38.49
0.093	0.279	TC59293	38.49
0.094	0.282	TC59294	38.49
0.095	0.285	TC59295	38.49
0.096	0.288	TC59296	38.49
0.097	0.291	TC59297	38.49
0.098	0.294	TC59298	38.49
0.099	0.297	TC59299	38.49
0.100	0.300	TC59300	38.49
0.101	0.303	TC59301	38.49
0.102	0.306	TC59302	38.49
0.103	0.309	TC59303	38.49
0.104	0.312	TC59304	38.49
0.105	0.315	TC59305	38.49
0.106	0.318	TC59306	38.49
0.107	0.321	TC59307	38.49
0.108	0.324	TC59308	38.49
0.109	0.327	TC59309	38.49
0.110	0.330	TC59310	38.49
0.115	0.345	TC59315	38.49
0.120	0.360	TC59320	38.49

All regular length Micro End Mills are 1/8" shank, 1-1/2" OAL.
For coating information see page 8. For technical information, please see page 126.

TOLERANCES	DIAMETER	SHANK
ALL SIZES	+.0005, -.0005	-.0001, -.0003 ISO H6



GENERAL PURPOSE SOLID CARBIDE MICRO END MILLS

YOUR #1 SOURCE FOR AMERICAN-MADE PREMIUM QUALITY CUTTING TOOLS

3 FLUTE - LONG REACH - STUB FLUTE - SQUARE END - 30° HELIX
LOC = 1.5 X DIA



SERIES 583
UNCOATED

MICRO END MILLS

REGULAR LENGTH

LONG REACH STUB FLUTE

LONG REACH REG FLUTE

LONG REACH LONG FLUTE

LONG LENGTH LONG FLUTE

TECHNICAL

DIA	LOC	xDIA	REACH	ITEM#	LIST PRICE
0.010	0.015	3	0.030	TC54310	83.31
0.010	0.015	5	0.050	TC54313	83.31
0.010	0.015	8	0.080	TC54316	83.31
0.010	0.015	12	0.125	TC54319	87.90
0.015	0.022	3	0.045	TC54322	69.10
0.015	0.022	5	0.078	TC54325	69.10
0.015	0.022	8	0.125	TC54328	69.10
0.015	0.022	12	0.187	TC54331	71.50
0.020	0.030	3	0.060	TC54334	66.26
0.020	0.030	5	0.100	TC54337	66.26
0.020	0.030	8	0.160	TC54340	66.26
0.020	0.030	12	0.250	TC54343	68.88
0.025	0.037	3	0.075	TC54346	63.63
0.025	0.037	5	0.125	TC54349	63.63
0.025	0.037	8	0.203	TC54352	63.63
0.025	0.037	12	0.312	TC54355	65.82
0.030	0.045	3	0.090	TC54358	63.63
0.030	0.045	5	0.156	TC54361	63.63
0.030	0.045	8	0.250	TC54364	63.63
0.030	0.045	12	0.375	TC54367	65.82
0.031	0.046	3	0.093	TC54370	63.63
0.031	0.046	5	0.156	TC54373	63.63
0.031	0.046	8	0.250	TC54376	63.63
0.031	0.046	12	0.375	TC54379	65.82
0.035	0.052	3	0.105	TC54382	63.63
0.035	0.052	5	0.187	TC54385	63.63
0.035	0.052	8	0.281	TC54388	63.63
0.035	0.052	12	0.425	TC54391	65.82
0.040	0.060	3	0.120	TC54394	63.63
0.040	0.060	5	0.203	TC54397	63.63
0.040	0.060	8	0.325	TC54400	63.63
0.040	0.060	12	0.480	TC54403	65.82

DIA	LOC	xDIA	REACH	ITEM#	LIST PRICE
0.045	0.067	3	0.135	TC54406	62.32
0.045	0.067	5	0.225	TC54409	62.32
0.045	0.067	8	0.375	TC54412	62.32
0.045	0.067	12	0.550	TC54415	64.29
0.047	0.070	3	0.141	TC54418	62.32
0.047	0.070	5	0.250	TC54421	62.32
0.047	0.070	8	0.375	TC54424	62.32
0.047	0.070	12	0.570	TC54427	64.29
0.050	0.075	3	0.150	TC54430	62.32
0.050	0.075	5	0.250	TC54433	62.32
0.050	0.075	8	0.400	TC54436	62.32
0.050	0.075	12	0.600	TC54439	64.29
0.055	0.082	3	0.165	TC54442	62.32
0.055	0.082	5	0.275	TC54445	62.32
0.055	0.082	8	0.450	TC54448	62.32
0.055	0.082	12	0.660	TC54451	64.29
0.060	0.090	3	0.180	TC54454	62.32
0.060	0.090	5	0.312	TC54457	62.32
0.060	0.090	8	0.500	TC54460	62.32
0.060	0.090	12	0.720	TC54463	64.29
0.062	0.093	3	0.186	TC54466	62.32
0.062	0.093	5	0.312	TC54469	62.32
0.062	0.093	8	0.500	TC54472	62.32
0.062	0.093	12	0.750	TC54475	64.29
0.065	0.097	3	0.195	TC54478	62.32
0.065	0.097	5	0.325	TC54481	62.32
0.065	0.097	8	0.530	TC54484	62.32
0.065	0.097	12	0.800	TC54487	64.29
0.070	0.105	3	0.210	TC54490	62.32
0.070	0.105	5	0.375	TC54493	62.32
0.070	0.105	8	0.570	TC54496	62.32
0.070	0.105	12	0.850	TC54499	64.29

DIA	LOC	xDIA	REACH	ITEM#	LIST PRICE
0.075	0.112	3	0.225	TC54502	62.32
0.075	0.112	5	0.375	TC54505	62.32
0.075	0.112	8	0.625	TC54508	62.32
0.075	0.112	12	0.900	TC54511	64.29
0.078	0.117	3	0.234	TC54514	62.32
0.078	0.117	5	0.406	TC54517	62.32
0.078	0.117	8	0.625	TC54520	62.32
0.078	0.117	12	0.940	TC54523	64.29
0.080	0.120	3	0.240	TC54526	62.32
0.080	0.120	5	0.406	TC54529	62.32
0.080	0.120	8	0.650	TC54532	62.32
0.080	0.120	12	0.960	TC54535	64.29
0.085	0.127	3	0.255	TC54538	62.32
0.085	0.127	5	0.425	TC54541	62.32
0.085	0.127	8	0.700	TC54544	62.32
0.085	0.127	12	1.020	TC54547	64.29
0.090	0.135	3	0.270	TC54550	62.32
0.090	0.135	5	0.450	TC54553	62.32
0.090	0.135	8	0.750	TC54556	62.32
0.090	0.135	12	1.080	TC54559	64.29
0.093	0.139	3	0.279	TC54562	62.32
0.093	0.139	5	0.500	TC54565	62.32
0.093	0.139	8	0.750	TC54568	62.32
0.093	0.139	12	1.125	TC54571	64.29
0.095	0.142	3	0.285	TC54574	62.32
0.095	0.142	5	0.500	TC54577	62.32
0.095	0.142	8	0.750	TC54580	62.32
0.095	0.142	12	1.150	TC54583	64.29
0.100	0.150	3	0.300	TC54586	62.32
0.100	0.150	5	0.500	TC54589	62.32
0.100	0.150	8	0.800	TC54592	62.32
0.100	0.150	12	1.200	TC54595	64.29

All long reach Micro End Mills are 1/8" shank, 2-1/2" OAL.
For technical information, please see page 126.

TOLERANCES	DIAMETER	SHANK	REACH
ALL SIZES	+0.005, -0.005	-0.001, -0.003 ISO H6	+0.010, -0.000

GENERAL PURPOSE SOLID CARBIDE MICRO END MILLS



YOUR #1 SOURCE FOR AMERICAN-MADE PREMIUM QUALITY CUTTING TOOLS

3 FLUTE - LONG REACH - STUB FLUTE - SQUARE END - 30° HELIX
LOC = 1.5 X DIA



SERIES 585 ALTIN COATED

DIA	LOC	xDIA	REACH	ITEM#	LIST PRICE
0.010	0.015	3	0.030	TC59501	99.97
0.010	0.015	5	0.050	TC59504	99.97
0.010	0.015	8	0.080	TC59507	99.97
0.010	0.015	12	0.125	TC59510	105.48
0.015	0.022	3	0.045	TC59513	82.92
0.015	0.022	5	0.078	TC59516	82.92
0.015	0.022	8	0.125	TC59519	82.92
0.015	0.022	12	0.187	TC59522	85.80
0.020	0.030	3	0.060	TC59525	79.51
0.020	0.030	5	0.100	TC59528	79.51
0.020	0.030	8	0.160	TC59531	79.51
0.020	0.030	12	0.250	TC59534	82.66
0.025	0.037	3	0.075	TC59537	76.36
0.025	0.037	5	0.125	TC59540	76.36
0.025	0.037	8	0.203	TC59543	76.36
0.025	0.037	12	0.312	TC59546	78.98
0.030	0.045	3	0.090	TC59549	76.36
0.030	0.045	5	0.156	TC59552	76.36
0.030	0.045	8	0.250	TC59555	76.36
0.030	0.045	12	0.375	TC59558	78.98
0.031	0.046	3	0.093	TC59561	76.36
0.031	0.046	5	0.156	TC59564	76.36
0.031	0.046	8	0.250	TC59567	76.36
0.031	0.046	12	0.375	TC59570	78.98
0.035	0.052	3	0.105	TC59573	76.36
0.035	0.052	5	0.187	TC59576	76.36
0.035	0.052	8	0.281	TC59579	76.36
0.035	0.052	12	0.425	TC59582	78.98
0.040	0.060	3	0.120	TC59585	76.36
0.040	0.060	5	0.203	TC59588	76.36
0.040	0.060	8	0.325	TC59591	76.36
0.040	0.060	12	0.480	TC59594	78.98

DIA	LOC	xDIA	REACH	ITEM#	LIST PRICE
0.045	0.067	3	0.135	TC59597	74.78
0.045	0.067	5	0.225	TC59600	74.78
0.045	0.067	8	0.375	TC59603	74.78
0.045	0.067	12	0.550	TC59606	77.15
0.047	0.070	3	0.141	TC59609	74.78
0.047	0.070	5	0.250	TC59612	74.78
0.047	0.070	8	0.375	TC59615	74.78
0.047	0.070	12	0.570	TC59618	77.15
0.050	0.075	3	0.150	TC59621	74.78
0.050	0.075	5	0.250	TC59624	74.78
0.050	0.075	8	0.400	TC59627	74.78
0.050	0.075	12	0.600	TC59630	77.15
0.055	0.082	3	0.165	TC59633	74.78
0.055	0.082	5	0.275	TC59636	74.78
0.055	0.082	8	0.450	TC59639	74.78
0.055	0.082	12	0.660	TC59642	77.15
0.060	0.090	3	0.180	TC59645	74.78
0.060	0.090	5	0.312	TC59648	74.78
0.060	0.090	8	0.500	TC59651	74.78
0.060	0.090	12	0.720	TC59654	77.15
0.062	0.093	3	0.186	TC59657	74.78
0.062	0.093	5	0.312	TC59660	74.78
0.062	0.093	8	0.500	TC59663	74.78
0.062	0.093	12	0.750	TC59666	77.15
0.065	0.097	3	0.195	TC59669	74.78
0.065	0.097	5	0.325	TC59672	74.78
0.065	0.097	8	0.530	TC59675	74.78
0.065	0.097	12	0.800	TC59678	77.15
0.070	0.105	3	0.210	TC59681	74.78
0.070	0.105	5	0.375	TC59684	74.78
0.070	0.105	8	0.570	TC59687	74.78
0.070	0.105	12	0.850	TC59690	77.15

DIA	LOC	xDIA	REACH	ITEM#	LIST PRICE
0.075	0.112	3	0.225	TC59693	74.78
0.075	0.112	5	0.375	TC59696	74.78
0.075	0.112	8	0.625	TC59699	74.78
0.075	0.112	12	0.900	TC59702	77.15
0.078	0.117	3	0.234	TC59705	74.78
0.078	0.117	5	0.406	TC59708	74.78
0.078	0.117	8	0.625	TC59711	74.78
0.078	0.117	12	0.940	TC59714	77.15
0.080	0.120	3	0.240	TC59717	74.78
0.080	0.120	5	0.406	TC59720	74.78
0.080	0.120	8	0.650	TC59723	74.78
0.080	0.120	12	0.960	TC59726	77.15
0.085	0.127	3	0.255	TC59729	74.78
0.085	0.127	5	0.425	TC59732	74.78
0.085	0.127	8	0.700	TC59735	74.78
0.085	0.127	12	1.020	TC59738	77.15
0.090	0.135	3	0.270	TC59741	74.78
0.090	0.135	5	0.450	TC59744	74.78
0.090	0.135	8	0.750	TC59747	74.78
0.090	0.135	12	1.080	TC59750	77.15
0.093	0.139	3	0.279	TC59753	74.78
0.093	0.139	5	0.500	TC59756	74.78
0.093	0.139	8	0.750	TC59759	74.78
0.093	0.139	12	1.125	TC59762	77.15
0.095	0.142	3	0.285	TC59765	74.78
0.095	0.142	5	0.500	TC59768	74.78
0.095	0.142	8	0.750	TC59771	74.78
0.095	0.142	12	1.150	TC59774	77.15
0.100	0.150	3	0.300	TC59777	74.78
0.100	0.150	5	0.500	TC59780	74.78
0.100	0.150	8	0.800	TC59783	74.78
0.100	0.150	12	1.200	TC59786	77.15

All long reach Micro End Mills are 1/8" shank, 2-1/2" OAL.
For coating information see page 8. For technical information, please see page 126.

TOLERANCES	DIAMETER	SHANK	REACH
ALL SIZES	+0.005, -.0005	-.0001, -.0003 ISO H6	+0.010, -.000



GENERAL PURPOSE SOLID CARBIDE MICRO END MILLS

YOUR #1 SOURCE FOR AMERICAN-MADE PREMIUM QUALITY CUTTING TOOLS

3 FLUTE - LONG REACH - STUB FLUTE - BALL NOSE - 30° HELIX
LOC = 1.5 X DIA



SERIES 587
UNCOATED

MICRO END MILLS

REGULAR LENGTH

LONG REACH STUB FLUTE

LONG REACH REG FLUTE

LONG REACH LONG FLUTE

LONG LENGTH LONG FLUTE

TECHNICAL

DIA	LOC	xDIA	REACH	ITEM#	LIST PRICE
0.010	0.015	3	0.030	TC55400	104.52
0.010	0.015	5	0.050	TC55403	104.52
0.010	0.015	8	0.080	TC55406	109.11
0.010	0.015	12	0.125	TC55409	122.67
0.015	0.022	3	0.045	TC55412	89.43
0.015	0.022	5	0.078	TC55415	89.43
0.015	0.022	8	0.125	TC55418	89.43
0.015	0.022	12	0.187	TC55421	91.62
0.020	0.030	3	0.060	TC55424	86.59
0.020	0.030	5	0.100	TC55427	86.59
0.020	0.030	8	0.160	TC55430	86.59
0.020	0.030	12	0.250	TC55433	89.00
0.025	0.037	3	0.075	TC55436	74.78
0.025	0.037	5	0.125	TC55439	74.78
0.025	0.037	8	0.203	TC55442	74.78
0.025	0.037	12	0.312	TC55445	76.97
0.030	0.045	3	0.090	TC55448	74.78
0.030	0.045	5	0.156	TC55451	74.78
0.030	0.045	8	0.250	TC55454	74.78
0.030	0.045	12	0.375	TC55457	76.97
0.031	0.046	3	0.093	TC55460	74.78
0.031	0.046	5	0.156	TC55463	74.78
0.031	0.046	8	0.250	TC55466	74.78
0.031	0.046	12	0.375	TC55469	76.97
0.035	0.052	3	0.105	TC55472	74.78
0.035	0.052	5	0.187	TC55475	74.78
0.035	0.052	8	0.281	TC55478	74.78
0.035	0.052	12	0.425	TC55481	76.97
0.040	0.060	3	0.120	TC55484	74.78
0.040	0.060	5	0.203	TC55487	74.78
0.040	0.060	8	0.325	TC55490	74.78
0.040	0.060	12	0.480	TC55493	76.97

DIA	LOC	xDIA	REACH	ITEM#	LIST PRICE
0.045	0.067	3	0.135	TC55496	73.03
0.045	0.067	5	0.225	TC55499	73.03
0.045	0.067	8	0.375	TC55502	73.03
0.045	0.067	12	0.550	TC55505	75.00
0.047	0.070	3	0.141	TC55508	73.03
0.047	0.070	5	0.250	TC55511	73.03
0.047	0.070	8	0.375	TC55514	73.03
0.047	0.070	12	0.570	TC55517	75.00
0.050	0.075	3	0.150	TC55520	73.03
0.050	0.075	5	0.250	TC55523	73.03
0.050	0.075	8	0.400	TC55526	73.03
0.050	0.075	12	0.600	TC55529	75.00
0.055	0.082	3	0.165	TC55532	73.03
0.055	0.082	5	0.275	TC55535	73.03
0.055	0.082	8	0.450	TC55538	73.03
0.055	0.082	12	0.660	TC55541	75.00
0.060	0.090	3	0.180	TC55544	73.03
0.060	0.090	5	0.312	TC55547	73.03
0.060	0.090	8	0.500	TC55550	73.03
0.060	0.090	12	0.720	TC55553	75.00
0.062	0.093	3	0.186	TC55556	73.03
0.062	0.093	5	0.312	TC55559	73.03
0.062	0.093	8	0.500	TC55562	73.03
0.062	0.093	12	0.750	TC55565	75.00
0.065	0.097	3	0.195	TC55568	73.03
0.065	0.097	5	0.325	TC55571	73.03
0.065	0.097	8	0.530	TC55574	73.03
0.065	0.097	12	0.780	TC55577	75.00
0.070	0.105	3	0.210	TC55580	73.03
0.070	0.105	5	0.375	TC55583	73.03
0.070	0.105	8	0.570	TC55586	73.03
0.070	0.105	12	0.840	TC55589	75.00

DIA	LOC	xDIA	REACH	ITEM#	LIST PRICE
0.075	0.112	3	0.225	TC55592	73.03
0.075	0.112	5	0.375	TC55595	73.03
0.075	0.112	8	0.625	TC55598	73.03
0.075	0.112	12	0.900	TC55601	75.00
0.078	0.117	3	0.234	TC55604	73.03
0.078	0.117	5	0.406	TC55607	73.03
0.078	0.117	8	0.625	TC55610	73.03
0.078	0.117	12	0.940	TC55613	75.00
0.080	0.120	3	0.240	TC55616	73.03
0.080	0.120	5	0.406	TC55619	73.03
0.080	0.120	8	0.650	TC55622	73.03
0.080	0.120	12	0.960	TC55625	75.00
0.085	0.127	3	0.255	TC55628	73.03
0.085	0.127	5	0.425	TC55631	73.03
0.085	0.127	8	0.700	TC55634	73.03
0.085	0.127	12	1.020	TC55637	75.00
0.090	0.135	3	0.270	TC55640	73.03
0.090	0.135	5	0.450	TC55643	73.03
0.090	0.135	8	0.750	TC55646	73.03
0.090	0.135	12	1.080	TC55649	75.00
0.093	0.139	3	0.279	TC55652	73.03
0.093	0.139	5	0.500	TC55655	73.03
0.093	0.139	8	0.750	TC55658	73.03
0.093	0.139	12	1.125	TC55661	75.00
0.095	0.142	3	0.285	TC55664	73.03
0.095	0.142	5	0.500	TC55667	73.03
0.095	0.142	8	0.750	TC55670	73.03
0.095	0.142	12	1.150	TC55673	75.00
0.100	0.150	3	0.300	TC55676	73.03
0.100	0.150	5	0.500	TC55679	73.03
0.100	0.150	8	0.800	TC55682	73.03
0.100	0.150	12	1.200	TC55685	75.00

All long reach Micro End Mills are 1/8" shank, 2-1/2" OAL.
For technical information, please see page 126.

TOLERANCES	DIAMETER	SHANK	REACH
ALL SIZES	+0.005, -0.005	-0.001, -0.003 ISO H6	+0.010, -0.000

GENERAL PURPOSE SOLID CARBIDE MICRO END MILLS



YOUR #1 SOURCE FOR AMERICAN-MADE PREMIUM QUALITY CUTTING TOOLS

3 FLUTE - LONG REACH - STUB FLUTE - BALL NOSE - 30° HELIX
LOC = 1.5 X DIA



SERIES 589
ALTIN COATED

DIA	LOC	xDIA	REACH	ITEM#	LIST PRICE
0.010	0.015	3	0.030	TC55701	125.43
0.010	0.015	5	0.050	TC55704	125.43
0.010	0.015	8	0.080	TC55707	130.94
0.010	0.015	12	0.125	TC55710	147.21
0.015	0.022	3	0.045	TC55713	107.32
0.015	0.022	5	0.078	TC55716	107.32
0.015	0.022	8	0.125	TC55719	107.32
0.015	0.022	12	0.187	TC55722	109.95
0.020	0.030	3	0.060	TC55725	103.91
0.020	0.030	5	0.100	TC55728	103.91
0.020	0.030	8	0.160	TC55731	103.91
0.020	0.030	12	0.250	TC55734	106.80
0.025	0.037	3	0.075	TC55737	89.74
0.025	0.037	5	0.125	TC55740	89.74
0.025	0.037	8	0.203	TC55743	89.74
0.025	0.037	12	0.312	TC55746	92.36
0.030	0.045	3	0.090	TC55749	89.74
0.030	0.045	5	0.156	TC55752	89.74
0.030	0.045	8	0.250	TC55755	89.74
0.030	0.045	12	0.375	TC55758	92.36
0.031	0.046	3	0.093	TC55761	89.74
0.031	0.046	5	0.156	TC55764	89.74
0.031	0.046	8	0.250	TC55767	89.74
0.031	0.046	12	0.375	TC55770	92.36
0.035	0.052	3	0.105	TC55773	89.74
0.035	0.052	5	0.187	TC55776	89.74
0.035	0.052	8	0.281	TC55779	89.74
0.035	0.052	12	0.425	TC55782	92.36
0.040	0.060	3	0.120	TC55785	89.74
0.040	0.060	5	0.203	TC55788	89.74
0.040	0.060	8	0.325	TC55791	89.74
0.040	0.060	12	0.480	TC55794	92.36

DIA	LOC	xDIA	REACH	ITEM#	LIST PRICE
0.045	0.067	3	0.135	TC55797	87.64
0.045	0.067	5	0.225	TC55800	87.64
0.045	0.067	8	0.375	TC55803	87.64
0.045	0.067	12	0.550	TC55806	90.00
0.047	0.070	3	0.141	TC55809	87.64
0.047	0.070	5	0.250	TC55812	87.64
0.047	0.070	8	0.375	TC55815	87.64
0.047	0.070	12	0.570	TC55818	90.00
0.050	0.075	3	0.150	TC55821	87.64
0.050	0.075	5	0.250	TC55824	87.64
0.050	0.075	8	0.400	TC55827	87.64
0.050	0.075	12	0.600	TC55830	90.00
0.055	0.082	3	0.165	TC55833	87.64
0.055	0.082	5	0.275	TC55836	87.64
0.055	0.082	8	0.450	TC55839	87.64
0.055	0.082	12	0.660	TC55842	90.00
0.060	0.090	3	0.180	TC55845	87.64
0.060	0.090	5	0.312	TC55848	87.64
0.060	0.090	8	0.500	TC55851	87.64
0.060	0.090	12	0.720	TC55854	90.00
0.062	0.093	3	0.186	TC55857	87.64
0.062	0.093	5	0.312	TC55860	87.64
0.062	0.093	8	0.500	TC55863	87.64
0.062	0.093	12	0.750	TC55866	90.00
0.065	0.097	3	0.195	TC55869	87.64
0.065	0.097	5	0.325	TC55872	87.64
0.065	0.097	8	0.530	TC55875	87.64
0.065	0.097	12	0.780	TC55878	90.00
0.070	0.105	3	0.210	TC55881	87.64
0.070	0.105	5	0.375	TC55884	87.64
0.070	0.105	8	0.570	TC55887	87.64
0.070	0.105	12	0.840	TC55890	90.00

DIA	LOC	xDIA	REACH	ITEM#	LIST PRICE
0.075	0.112	3	0.225	TC55893	87.64
0.075	0.112	5	0.375	TC55896	87.64
0.075	0.112	8	0.625	TC55899	87.64
0.075	0.112	12	0.900	TC55902	90.00
0.078	0.117	3	0.234	TC55905	87.64
0.078	0.117	5	0.406	TC55908	87.64
0.078	0.117	8	0.625	TC55911	87.64
0.078	0.117	12	0.940	TC55914	90.00
0.080	0.120	3	0.240	TC55917	87.64
0.080	0.120	5	0.406	TC55920	87.64
0.080	0.120	8	0.650	TC55923	87.64
0.080	0.120	12	0.960	TC55926	90.00
0.085	0.127	3	0.255	TC55929	87.64
0.085	0.127	5	0.425	TC55932	87.64
0.085	0.127	8	0.700	TC55935	87.64
0.085	0.127	12	1.020	TC55938	90.00
0.090	0.135	3	0.270	TC55941	87.64
0.090	0.135	5	0.450	TC55944	87.64
0.090	0.135	8	0.750	TC55947	87.64
0.090	0.135	12	1.080	TC55950	90.00
0.093	0.139	3	0.279	TC55953	87.64
0.093	0.139	5	0.500	TC55956	87.64
0.093	0.139	8	0.750	TC55959	87.64
0.093	0.139	12	1.125	TC55962	90.00
0.095	0.142	3	0.285	TC55965	87.64
0.095	0.142	5	0.500	TC55968	87.64
0.095	0.142	8	0.750	TC55971	87.64
0.095	0.142	12	1.150	TC55974	90.00
0.100	0.150	3	0.300	TC55977	87.64
0.100	0.150	5	0.500	TC55980	87.64
0.100	0.150	8	0.800	TC55983	87.64
0.100	0.150	12	1.200	TC55986	90.00

All long reach Micro End Mills are 1/8" shank, 2-1/2" OAL.
For coating information see page 8. For technical information, please see page 126.

TOLERANCES	DIAMETER	SHANK	REACH
ALL SIZES	+0.005, -0.005	-0.001, -0.003 ISO H6	+0.010, -0.000



GENERAL PURPOSE SOLID CARBIDE MICRO END MILLS

YOUR #1 SOURCE FOR AMERICAN-MADE PREMIUM QUALITY CUTTING TOOLS

3 FLUTE - LONG REACH - REGULAR FLUTE - SQUARE END - 30° HELIX
LOC = 3 X DIA



SERIES 574
UNCOATED

DIA	LOC	xDIA	REACH	ITEM#	LIST PRICE
0.010	0.030	5	0.050	TC57400	83.31
0.010	0.030	8	0.080	TC57403	83.31
0.010	0.030	12	0.125	TC57406	87.90
0.015	0.045	5	0.078	TC57409	69.10
0.015	0.045	8	0.128	TC57412	69.10
0.015	0.045	12	0.187	TC57415	71.50
0.020	0.060	5	0.100	TC57418	66.26
0.020	0.060	8	0.170	TC57421	66.26
0.020	0.060	12	0.250	TC57424	68.88
0.025	0.075	5	0.125	TC57427	63.63
0.025	0.075	8	0.213	TC57430	63.63
0.025	0.075	12	0.312	TC57433	66.04
0.030	0.090	5	0.156	TC57436	63.63
0.030	0.090	9	0.270	TC57439	63.63
0.030	0.090	12	0.375	TC57442	65.82
0.031	0.093	5	0.156	TC57445	63.63
0.031	0.093	9	0.279	TC57448	63.63
0.031	0.093	12	0.375	TC57451	65.82
0.035	0.105	5	0.175	TC57454	63.63
0.035	0.105	9	0.315	TC57457	63.63
0.035	0.105	12	0.420	TC57460	65.82
0.040	0.120	5	0.203	TC57463	63.63
0.040	0.120	9	0.360	TC57466	63.63
0.040	0.120	12	0.480	TC57469	65.82
0.045	0.135	5	0.225	TC57472	62.32
0.045	0.135	9	0.405	TC57475	62.32
0.045	0.135	12	0.540	TC57478	65.82
0.047	0.141	5	0.250	TC57481	62.32
0.047	0.141	9	0.423	TC57484	62.32
0.047	0.141	12	0.570	TC57487	64.29
0.050	0.150	5	0.250	TC57490	62.32
0.050	0.150	8	0.400	TC57493	62.32
0.050	0.150	12	0.600	TC57496	64.29
0.055	0.165	5	0.275	TC57499	62.32
0.055	0.165	8	0.440	TC57502	62.32
0.055	0.165	12	0.660	TC57505	64.29

DIA	LOC	xDIA	REACH	ITEM#	LIST PRICE
0.060	0.180	5	0.312	TC57508	62.32
0.060	0.180	8	0.500	TC57511	62.32
0.060	0.180	12	0.720	TC57514	64.29
0.062	0.186	5	0.312	TC57517	62.32
0.062	0.186	8	0.500	TC57520	62.32
0.062	0.186	12	0.750	TC57523	64.29
0.065	0.195	5	0.325	TC57526	62.32
0.065	0.195	8	0.500	TC57529	62.32
0.065	0.195	12	0.780	TC57532	64.29
0.070	0.210	5	0.350	TC57535	62.32
0.070	0.210	8	0.560	TC57538	62.32
0.070	0.210	12	0.850	TC57541	64.29
0.075	0.225	5	0.375	TC57544	62.32
0.075	0.225	8	0.600	TC57547	62.32
0.075	0.225	12	0.900	TC57550	64.29
0.078	0.234	5	0.390	TC57553	62.32
0.078	0.234	8	0.624	TC57556	62.32
0.078	0.234	12	0.940	TC57559	64.29
0.080	0.240	5	0.400	TC57562	62.32
0.080	0.240	8	0.640	TC57565	62.32
0.080	0.240	12	0.960	TC57568	64.29
0.085	0.255	5	0.425	TC57571	62.32
0.085	0.255	8	0.680	TC57574	62.32
0.085	0.255	12	1.020	TC57577	64.29
0.090	0.270	5	0.450	TC57580	62.32
0.090	0.270	8	0.720	TC57583	62.32
0.090	0.270	12	1.080	TC57586	64.29
0.093	0.279	5	0.500	TC57589	62.32
0.093	0.279	8	0.744	TC57592	62.32
0.093	0.279	12	1.125	TC57595	64.29
0.095	0.285	5	0.475	TC57598	62.32
0.095	0.285	8	0.760	TC57601	62.32
0.095	0.285	12	1.140	TC57604	64.29
0.100	0.300	5	0.500	TC57607	62.32
0.100	0.300	8	0.800	TC57610	62.32
0.100	0.300	12	1.200	TC57613	64.29

All long reach Micro End Mills are 1/8" shank, 2-1/2" OAL.
For technical information, please see page 126.

TOLERANCES	DIAMETER	SHANK	REACH
ALL SIZES	+ .0005, -.0005	-.0001, -.0003 ISO H6	+ .010, -.000

GENERAL PURPOSE SOLID CARBIDE MICRO END MILLS



YOUR #1 SOURCE FOR AMERICAN-MADE PREMIUM QUALITY CUTTING TOOLS

3 FLUTE - LONG REACH - REGULAR FLUTE - SQUARE END - 30° HELIX
LOC = 3 X DIA



SERIES 576
ALTIN COATED

DIA	LOC	xDIA	REACH	ITEM#	LIST PRICE
0.010	0.030	5	0.050	TC57701	99.97
0.010	0.030	8	0.080	TC57704	99.97
0.010	0.030	12	0.125	TC57707	105.48
0.015	0.045	5	0.078	TC57710	82.92
0.015	0.045	8	0.128	TC57713	82.92
0.015	0.045	12	0.187	TC57716	85.80
0.020	0.060	5	0.100	TC57719	79.51
0.020	0.060	8	0.170	TC57722	79.51
0.020	0.060	12	0.250	TC57725	82.66
0.025	0.075	5	0.125	TC57728	76.36
0.025	0.075	8	0.213	TC57731	76.36
0.025	0.075	12	0.312	TC57734	79.24
0.030	0.090	5	0.156	TC57737	76.36
0.030	0.090	9	0.270	TC57740	76.36
0.030	0.090	12	0.375	TC57743	78.98
0.031	0.093	5	0.156	TC57746	76.36
0.031	0.093	9	0.279	TC57749	76.36
0.031	0.093	12	0.375	TC57752	78.98
0.035	0.105	5	0.175	TC57755	76.36
0.035	0.105	9	0.315	TC57758	76.36
0.035	0.105	12	0.420	TC57761	78.98
0.040	0.120	5	0.203	TC57764	76.36
0.040	0.120	9	0.360	TC57767	76.36
0.040	0.120	12	0.480	TC57770	78.98
0.045	0.135	5	0.225	TC57773	74.78
0.045	0.135	9	0.405	TC57776	74.78
0.045	0.135	12	0.540	TC57779	78.98
0.047	0.141	5	0.250	TC57782	74.78
0.047	0.141	9	0.423	TC57785	74.78
0.047	0.141	12	0.570	TC57788	77.15
0.050	0.150	5	0.250	TC57791	74.78
0.050	0.150	8	0.400	TC57794	74.78
0.050	0.150	12	0.600	TC57797	77.15
0.055	0.165	5	0.275	TC57800	74.78
0.055	0.165	8	0.440	TC57803	74.78
0.055	0.165	12	0.660	TC57806	77.15

DIA	LOC	xDIA	REACH	ITEM#	LIST PRICE
0.060	0.180	5	0.312	TC57809	74.78
0.060	0.180	8	0.500	TC57812	74.78
0.060	0.180	12	0.720	TC57815	77.15
0.062	0.186	5	0.312	TC57818	74.78
0.062	0.186	8	0.500	TC57821	74.78
0.062	0.186	12	0.750	TC57824	77.15
0.065	0.195	5	0.325	TC57827	74.78
0.065	0.195	8	0.500	TC57830	74.78
0.065	0.195	12	0.780	TC57833	77.15
0.070	0.210	5	0.350	TC57836	74.78
0.070	0.210	8	0.560	TC57839	74.78
0.070	0.210	12	0.850	TC57842	77.15
0.075	0.225	5	0.375	TC57845	74.78
0.075	0.225	8	0.600	TC57848	74.78
0.075	0.225	12	0.900	TC57851	77.15
0.078	0.234	5	0.390	TC57854	74.78
0.078	0.234	8	0.624	TC57857	74.78
0.078	0.234	12	0.940	TC57860	77.15
0.080	0.240	5	0.400	TC57863	74.78
0.080	0.240	8	0.640	TC57866	74.78
0.080	0.240	12	0.960	TC57869	77.15
0.085	0.255	5	0.425	TC57872	74.78
0.085	0.255	8	0.680	TC57875	74.78
0.085	0.255	12	1.020	TC57878	77.15
0.090	0.270	5	0.450	TC57881	74.78
0.090	0.270	8	0.720	TC57884	74.78
0.090	0.270	12	1.080	TC57887	77.15
0.093	0.279	5	0.500	TC57890	74.78
0.093	0.279	8	0.744	TC57893	74.78
0.093	0.279	12	1.125	TC57896	77.15
0.095	0.285	5	0.475	TC57899	74.78
0.095	0.285	8	0.760	TC57902	74.78
0.095	0.285	12	1.140	TC57905	77.15
0.100	0.300	5	0.500	TC57908	74.78
0.100	0.300	8	0.800	TC57911	74.78
0.100	0.300	12	1.200	TC57914	77.15

All long reach Micro End Mills are 1/8" shank, 2-1/2" OAL.
For coating information see page 8. For technical information, please see page 126.

TOLERANCES	DIAMETER	SHANK	REACH
ALL SIZES	+ .0005, -.0005	-.0001, -.0003 ISO H6	+ .010, -.000



GENERAL PURPOSE SOLID CARBIDE MICRO END MILLS

YOUR #1 SOURCE FOR AMERICAN-MADE PREMIUM QUALITY CUTTING TOOLS

3 FLUTE - LONG REACH - REGULAR FLUTE - BALL NOSE - 30° HELIX
LOC = 3 X DIA



SERIES 578
UNCOATED

DIA	LOC	xDIA	REACH	ITEM#	LIST PRICE
0.010	0.030	5	0.050	TC58400	112.83
0.010	0.030	8	0.080	TC58403	112.83
0.010	0.030	12	0.125	TC58406	114.80
0.015	0.045	5	0.078	TC58409	90.53
0.015	0.045	8	0.128	TC58412	90.53
0.015	0.045	12	0.187	TC58415	92.50
0.020	0.060	5	0.100	TC58418	87.03
0.020	0.060	8	0.170	TC58421	87.03
0.020	0.060	12	0.250	TC58424	89.00
0.025	0.075	5	0.125	TC58427	79.59
0.025	0.075	8	0.213	TC58430	79.59
0.025	0.075	12	0.312	TC58433	81.56
0.030	0.090	5	0.156	TC58436	79.59
0.030	0.090	9	0.270	TC58439	79.59
0.030	0.090	12	0.375	TC58442	81.56
0.031	0.093	5	0.156	TC58445	79.59
0.031	0.093	9	0.279	TC58448	79.59
0.031	0.093	12	0.375	TC58451	81.56
0.035	0.105	5	0.175	TC58454	79.59
0.035	0.105	8	0.280	TC58457	79.59
0.035	0.105	12	0.420	TC58460	81.56
0.040	0.120	5	0.200	TC58463	79.59
0.040	0.120	8	0.320	TC58466	79.59
0.040	0.120	12	0.480	TC58469	81.56
0.045	0.135	5	0.225	TC58472	76.97
0.045	0.135	8	0.360	TC58475	76.97
0.045	0.135	12	0.540	TC58478	78.94
0.047	0.141	5	0.250	TC58481	76.97
0.047	0.141	8	0.376	TC58484	76.97
0.047	0.141	12	0.570	TC58487	78.94
0.050	0.150	5	0.250	TC58490	76.97
0.050	0.150	8	0.400	TC58493	76.97
0.050	0.150	12	0.600	TC58496	78.94
0.055	0.165	5	0.275	TC58499	76.97
0.055	0.165	8	0.440	TC58502	76.97
0.055	0.165	12	0.660	TC58505	78.94

DIA	LOC	xDIA	REACH	ITEM#	LIST PRICE
0.060	0.180	5	0.300	TC58508	76.97
0.060	0.180	8	0.500	TC58511	76.97
0.060	0.180	12	0.720	TC58514	78.94
0.062	0.186	5	0.312	TC58517	76.97
0.062	0.186	8	0.500	TC58520	76.97
0.062	0.186	12	0.750	TC58523	78.94
0.065	0.195	5	0.325	TC58526	76.97
0.065	0.195	8	0.500	TC58529	76.97
0.065	0.195	12	0.780	TC58532	78.94
0.070	0.210	5	0.350	TC58535	76.97
0.070	0.210	8	0.560	TC58538	76.97
0.070	0.210	12	0.840	TC58541	78.94
0.075	0.225	5	0.375	TC58544	76.97
0.075	0.225	8	0.600	TC58547	76.97
0.075	0.225	12	0.900	TC58550	78.94
0.078	0.234	5	0.390	TC58553	76.97
0.078	0.234	8	0.624	TC58556	76.97
0.078	0.234	12	0.940	TC58559	78.94
0.080	0.240	5	0.400	TC58562	76.97
0.080	0.240	8	0.640	TC58565	76.97
0.080	0.240	12	0.960	TC58568	78.94
0.085	0.255	5	0.425	TC58571	76.97
0.085	0.255	8	0.680	TC58574	76.97
0.085	0.255	12	1.020	TC58577	78.94
0.090	0.270	5	0.450	TC58580	76.97
0.090	0.270	8	0.720	TC58583	76.97
0.090	0.270	12	1.080	TC58586	78.94
0.093	0.279	5	0.500	TC58589	76.97
0.093	0.279	8	0.744	TC58592	76.97
0.093	0.279	12	1.125	TC58595	78.94
0.095	0.285	5	0.475	TC58598	76.97
0.095	0.285	8	0.760	TC58601	76.97
0.095	0.285	12	1.140	TC58604	78.94
0.100	0.300	5	0.500	TC58607	76.97
0.100	0.300	8	0.800	TC58610	76.97
0.100	0.300	12	1.200	TC58613	78.94

All long reach Micro End Mills are 1/8" shank, 2-1/2" OAL.
For technical information, please see page 126.

TOLERANCES	DIAMETER	SHANK	REACH
ALL SIZES	+0.005, -0.005	-.0001, -.0003 ISO H6	+0.010, -.000

MICRO END MILLS

REGULAR LENGTH

LONG REACH STUB FLUTE

LONG REACH REG FLUTE

LONG REACH LONG FLUTE

LONG LENGTH LONG FLUTE

TECHNICAL

GENERAL PURPOSE SOLID CARBIDE MICRO END MILLS



YOUR #1 SOURCE FOR AMERICAN-MADE PREMIUM QUALITY CUTTING TOOLS

3 FLUTE - LONG REACH - REGULAR FLUTE - BALL NOSE - 30° HELIX
LOC = 3 X DIA



SERIES 579
ALTIN COATED

DIA	LOC	xDIA	REACH	ITEM#	LIST PRICE
0.010	0.030	5	0.050	TC58701	135.40
0.010	0.030	8	0.080	TC58704	135.40
0.010	0.030	12	0.125	TC58707	137.76
0.015	0.045	5	0.078	TC58710	108.63
0.015	0.045	8	0.128	TC58713	108.63
0.015	0.045	12	0.187	TC58716	110.99
0.020	0.060	5	0.100	TC58719	104.43
0.020	0.060	8	0.170	TC58722	104.43
0.020	0.060	12	0.250	TC58725	106.80
0.025	0.075	5	0.125	TC58728	95.51
0.025	0.075	8	0.213	TC58731	95.51
0.025	0.075	12	0.312	TC58734	97.87
0.030	0.090	5	0.156	TC58737	95.51
0.030	0.090	9	0.270	TC58740	95.51
0.030	0.090	12	0.375	TC58743	97.87
0.031	0.093	5	0.156	TC58746	95.51
0.031	0.093	9	0.279	TC58749	95.51
0.031	0.093	12	0.375	TC58752	97.87
0.035	0.105	5	0.175	TC58755	95.51
0.035	0.105	8	0.280	TC58758	95.51
0.035	0.105	12	0.420	TC58761	97.87
0.040	0.120	5	0.200	TC58764	95.51
0.040	0.120	8	0.320	TC58767	95.51
0.040	0.120	12	0.480	TC58770	97.87
0.045	0.135	5	0.225	TC58773	92.36
0.045	0.135	8	0.360	TC58776	92.36
0.045	0.135	12	0.540	TC58779	94.73
0.047	0.141	5	0.250	TC58782	92.36
0.047	0.141	8	0.376	TC58785	92.36
0.047	0.141	12	0.570	TC58788	94.73
0.050	0.150	5	0.250	TC58791	92.36
0.050	0.150	8	0.400	TC58794	92.36
0.050	0.150	12	0.600	TC58797	94.73
0.055	0.165	5	0.275	TC58800	92.36
0.055	0.165	8	0.440	TC58803	92.36
0.055	0.165	12	0.660	TC58806	94.73

DIA	LOC	xDIA	REACH	ITEM#	LIST PRICE
0.060	0.180	5	0.300	TC58809	92.36
0.060	0.180	8	0.500	TC58812	92.36
0.060	0.180	12	0.720	TC58815	94.73
0.062	0.186	5	0.312	TC58818	92.36
0.062	0.186	8	0.500	TC58821	92.36
0.062	0.186	12	0.750	TC58824	94.73
0.065	0.195	5	0.325	TC58827	92.36
0.065	0.195	8	0.500	TC58830	92.36
0.065	0.195	12	0.780	TC58833	94.73
0.070	0.210	5	0.350	TC58836	92.36
0.070	0.210	8	0.560	TC58839	92.36
0.070	0.210	12	0.840	TC58842	94.73
0.075	0.225	5	0.375	TC58845	92.36
0.075	0.225	8	0.600	TC58848	92.36
0.075	0.225	12	0.900	TC58851	94.73
0.078	0.234	5	0.390	TC58854	92.36
0.078	0.234	8	0.624	TC58857	92.36
0.078	0.234	12	0.940	TC58860	94.73
0.080	0.240	5	0.400	TC58863	92.36
0.080	0.240	8	0.640	TC58866	92.36
0.080	0.240	12	0.960	TC58869	94.73
0.085	0.255	5	0.425	TC58872	92.36
0.085	0.255	8	0.680	TC58875	92.36
0.085	0.255	12	1.020	TC58878	94.73
0.090	0.270	5	0.450	TC58881	92.36
0.090	0.270	8	0.720	TC58884	92.36
0.090	0.270	12	1.080	TC58887	94.73
0.093	0.279	5	0.500	TC58890	92.36
0.093	0.279	8	0.744	TC58893	92.36
0.093	0.279	12	1.125	TC58896	94.73
0.095	0.285	5	0.475	TC58899	92.36
0.095	0.285	8	0.760	TC58902	92.36
0.095	0.285	12	1.140	TC58905	94.73
0.100	0.300	5	0.500	TC58908	92.36
0.100	0.300	8	0.800	TC58911	92.36
0.100	0.300	12	1.200	TC58914	94.73

All long reach Micro End Mills are 1/8" shank, 2-1/2" OAL.
For coating information see page 8. For technical information, please see page 126.

TOLERANCES	DIAMETER	SHANK	REACH
ALL SIZES	+ .0005, -.0005	-.0001, -.0003 ISO H6	+ .010, -.000



GENERAL PURPOSE SOLID CARBIDE MICRO END MILLS

YOUR #1 SOURCE FOR AMERICAN-MADE PREMIUM QUALITY CUTTING TOOLS

3 FLUTE - LONG REACH - LONG FLUTE - SQUARE END - 30° HELIX
LOC = 5 X DIA



SERIES 554
UNCOATED

DIA	LOC	xDIA	REACH	ITEM#	LIST PRICE
0.010	0.050	10	0.100	TC54650	84.62
0.010	0.050	15	0.150	TC54653	104.52
0.015	0.075	10	0.150	TC54656	70.63
0.015	0.075	15	0.225	TC54659	89.87
0.020	0.100	10	0.200	TC54662	68.01
0.020	0.100	15	0.300	TC54665	86.59
0.025	0.125	10	0.250	TC54668	65.16
0.025	0.125	15	0.375	TC54671	83.97
0.030	0.150	10	0.300	TC54674	65.16
0.030	0.150	15	0.450	TC54677	83.97
0.031	0.155	10	0.310	TC54680	65.16
0.031	0.155	15	0.470	TC54683	83.97
0.035	0.175	10	0.350	TC54686	65.16
0.035	0.175	15	0.525	TC54689	83.97
0.040	0.200	10	0.400	TC54692	65.16
0.040	0.200	15	0.600	TC54695	83.97
0.045	0.225	10	0.450	TC54698	63.85
0.045	0.225	15	0.675	TC54701	79.81
0.047	0.250	10	0.500	TC54704	63.85
0.047	0.250	15	0.710	TC54707	79.81
0.050	0.300	10	0.500	TC54710	63.85
0.050	0.300	15	0.750	TC54713	79.81
0.055	0.385	10	0.550	TC54716	63.85
0.055	0.385	15	0.825	TC54719	79.81

DIA	LOC	xDIA	REACH	ITEM#	LIST PRICE
0.060	0.312	10	0.625	TC54722	63.85
0.060	0.500	16	1.000	TC54725	63.85
0.062	0.312	10	0.625	TC54728	63.85
0.062	0.500	16	1.000	TC54731	63.85
0.065	0.325	10	0.650	TC54734	63.85
0.065	0.500	15	1.000	TC54737	63.85
0.070	0.350	10	0.700	TC54740	63.85
0.070	0.500	14	1.000	TC54743	63.85
0.075	0.375	10	0.750	TC54746	63.85
0.075	0.500	13	1.000	TC54749	63.85
0.078	0.406	10	0.800	TC54752	63.85
0.078	0.406	15	1.187	TC54755	63.85
0.080	0.400	10	0.800	TC54758	63.85
0.080	0.750	15	1.250	TC54761	63.85
0.085	0.425	10	0.850	TC54764	63.85
0.085	0.750	14	1.250	TC54767	63.85
0.090	0.450	10	0.900	TC54770	63.85
0.090	0.750	13	1.250	TC54773	63.85
0.093	0.500	10	0.950	TC54776	63.85
0.093	0.500	15	1.400	TC54779	63.85
0.095	0.500	10	0.950	TC54782	63.85
0.095	0.750	13	1.250	TC54785	63.85
0.100	0.500	10	1.000	TC54788	63.85
0.100	0.750	12	1.250	TC54791	63.85



All long reach Micro End Mills are 1/8" shank, 2-1/2" OAL.
For technical information, please see page 126.

TOLERANCES	DIAMETER	SHANK	REACH
ALL SIZES	+0.005, -0.005	-0.001, -0.003 ISO H6	+0.010, -0.000

MICRO END MILLS

REGULAR LENGTH

LONG REACH STUB FLUTE

LONG REACH REG FLUTE

LONG REACH LONG FLUTE

LONG LENGTH LONG FLUTE

TECHNICAL

GENERAL PURPOSE SOLID CARBIDE MICRO END MILLS



YOUR #1 SOURCE FOR AMERICAN-MADE PREMIUM QUALITY CUTTING TOOLS

3 FLUTE - LONG REACH - LONG FLUTE - SQUARE END - 30° HELIX
LOC = 5 X DIA



SERIES 555
ALTIN COATED

DIA	LOC	xDIA	REACH	ITEM#	LIST PRICE
0.010	0.050	10	0.100	TC54801	101.55
0.010	0.050	15	0.150	TC54804	125.43
0.015	0.075	10	0.150	TC54807	84.76
0.015	0.075	15	0.225	TC54810	107.85
0.020	0.100	10	0.200	TC54813	81.61
0.020	0.100	15	0.300	TC54816	103.91
0.025	0.125	10	0.250	TC54819	78.19
0.025	0.125	15	0.375	TC54822	100.76
0.030	0.150	10	0.300	TC54825	78.19
0.030	0.150	15	0.450	TC54828	100.76
0.031	0.155	10	0.310	TC54831	78.19
0.031	0.155	15	0.470	TC54834	100.76
0.035	0.175	10	0.350	TC54837	78.19
0.035	0.175	15	0.525	TC54840	100.76
0.040	0.200	10	0.400	TC54843	78.19
0.040	0.200	15	0.600	TC54846	100.76
0.045	0.225	10	0.450	TC54849	76.62
0.045	0.225	15	0.675	TC54852	95.78
0.047	0.250	10	0.500	TC54855	76.62
0.047	0.250	15	0.710	TC54858	95.78
0.050	0.300	10	0.500	TC54861	76.62
0.050	0.300	15	0.750	TC54864	95.78
0.055	0.385	10	0.550	TC54867	76.62
0.055	0.385	15	0.825	TC54870	95.78

DIA	LOC	xDIA	REACH	ITEM#	LIST PRICE
0.060	0.312	10	0.625	TC54873	76.62
0.060	0.500	16	1.000	TC54876	76.62
0.062	0.312	10	0.625	TC54879	76.62
0.062	0.500	16	1.000	TC54882	76.62
0.065	0.325	10	0.650	TC54885	76.62
0.065	0.500	15	1.000	TC54888	76.62
0.070	0.350	10	0.700	TC54891	76.62
0.070	0.500	14	1.000	TC54894	76.62
0.075	0.375	10	0.750	TC54897	76.62
0.075	0.500	13	1.000	TC54900	76.62
0.078	0.406	10	0.800	TC54903	76.62
0.078	0.406	15	1.187	TC54906	76.62
0.080	0.400	10	0.800	TC54909	76.62
0.080	0.750	15	1.250	TC54912	76.62
0.085	0.425	10	0.850	TC54915	76.62
0.085	0.750	14	1.250	TC54918	76.62
0.090	0.450	10	0.900	TC54921	76.62
0.090	0.750	13	1.250	TC54924	76.62
0.093	0.500	10	0.950	TC54927	76.62
0.093	0.500	15	1.400	TC54930	76.62
0.095	0.500	10	0.950	TC54933	76.62
0.095	0.750	13	1.250	TC54936	76.62
0.100	0.500	10	1.000	TC54939	76.62
0.100	0.750	12	1.250	TC54942	76.62

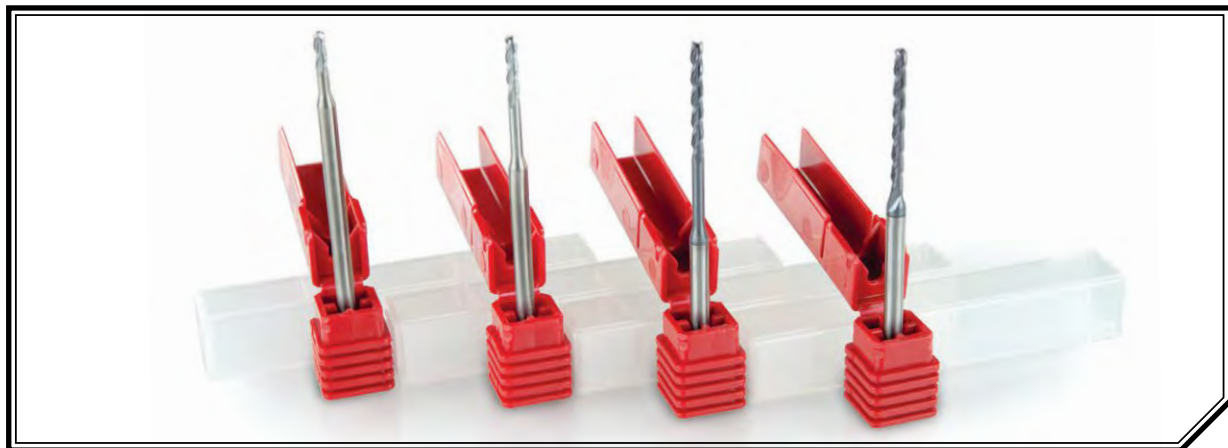

All long reach Micro End Mills are 1/8" shank, 2-1/2" OAL.
For coating information see page 8. For technical information, please see page 126.

TOLERANCES	DIAMETER	SHANK	REACH
ALL SIZES	+0.005, -0.005	-0.001, -0.003 ISO H6	+0.010, -0.000



GENERAL PURPOSE SOLID CARBIDE MICRO END MILLS

YOUR #1 SOURCE FOR AMERICAN-MADE PREMIUM QUALITY CUTTING TOOLS

3 FLUTE - LONG REACH - LONG FLUTE - BALL NOSE - 30° HELIX
LOC = 5 X DIA



SERIES 558
UNCOATED

DIA	LOC	xDIA	REACH	ITEM#	LIST PRICE
0.010	0.050	10	0.100	TC52750	105.83
0.010	0.050	15	0.150	TC52753	105.83
0.015	0.075	10	0.150	TC52756	90.75
0.015	0.075	15	0.225	TC52759	90.75
0.020	0.100	10	0.200	TC52762	87.90
0.020	0.100	15	0.300	TC52765	87.90
0.025	0.125	10	0.250	TC52768	76.10
0.025	0.125	15	0.375	TC52771	76.10
0.030	0.150	10	0.300	TC52774	76.10
0.030	0.150	15	0.450	TC52777	76.10
0.031	0.155	10	0.310	TC52780	76.10
0.031	0.155	15	0.470	TC52783	76.10
0.035	0.175	10	0.350	TC52786	76.10
0.035	0.175	15	0.525	TC52789	76.10
0.040	0.200	10	0.400	TC52792	76.10
0.040	0.200	15	0.600	TC52795	76.10
0.045	0.225	10	0.450	TC52798	74.13
0.045	0.225	15	0.675	TC52801	74.13
0.047	0.250	10	0.500	TC52804	74.13
0.047	0.250	15	0.710	TC52807	74.13
0.050	0.300	10	0.500	TC52810	74.13
0.050	0.300	15	0.750	TC52813	74.13
0.055	0.385	10	0.550	TC52816	74.13
0.055	0.385	15	0.825	TC52819	74.13

DIA	LOC	xDIA	REACH	ITEM#	LIST PRICE
0.060	0.312	10	0.625	TC52822	74.13
0.060	0.500	16	1.000	TC52825	74.13
0.062	0.312	10	0.625	TC52828	74.13
0.062	0.500	16	1.000	TC52831	74.13
0.065	0.325	10	0.650	TC52834	74.13
0.065	0.500	15	1.000	TC52837	74.13
0.070	0.350	10	0.700	TC52840	74.13
0.070	0.500	14	1.000	TC52843	74.13
0.075	0.375	10	0.750	TC52846	74.13
0.075	0.500	13	1.000	TC52849	74.13
0.078	0.406	10	0.800	TC52852	74.13
0.078	0.406	15	1.187	TC52855	74.13
0.080	0.400	10	0.800	TC52858	74.13
0.080	0.750	15	1.250	TC52861	74.13
0.085	0.425	10	0.850	TC52864	74.13
0.085	0.750	14	1.250	TC52867	74.13
0.090	0.450	10	0.900	TC52870	74.13
0.090	0.750	13	1.250	TC52873	74.13
0.093	0.500	10	0.950	TC52876	74.13
0.093	0.500	15	1.400	TC52879	74.13
0.095	0.500	10	0.950	TC52882	74.13
0.095	0.750	13	1.250	TC52885	74.13
0.100	0.500	10	1.000	TC52888	74.13
0.100	0.750	12	1.250	TC52891	74.13



All long reach Micro End Mills are 1/8" shank, 2-1/2" OAL.
For technical information, please see page 126.

TOLERANCES	DIAMETER	SHANK	REACH
ALL SIZES	+0.0005, -0.0005	-0.0001, -0.0003 ISO H6	+0.010, -0.000

MICRO END MILLS

REGULAR LENGTH

LONG REACH STUB FLUTE

LONG REACH REG FLUTE

LONG REACH LONG FLUTE

LONG LENGTH LONG FLUTE

TECHNICAL

GENERAL PURPOSE SOLID CARBIDE MICRO END MILLS



YOUR #1 SOURCE FOR AMERICAN-MADE PREMIUM QUALITY CUTTING TOOLS

3 FLUTE - LONG REACH - LONG FLUTE - BALL NOSE - 30° HELIX
LOC = 5 X DIA



SERIES 559
ALTiN COATED

DIA	LOC	xDIA	REACH	ITEM#	LIST PRICE
0.010	0.050	10	0.100	TC52900	127.00
0.010	0.050	15	0.150	TC52902	127.00
0.015	0.075	10	0.150	TC52904	108.90
0.015	0.075	15	0.225	TC52906	108.90
0.020	0.100	10	0.200	TC52908	105.48
0.020	0.100	15	0.300	TC52910	105.48
0.025	0.125	10	0.250	TC52912	91.31
0.025	0.125	15	0.375	TC52914	91.31
0.030	0.150	10	0.300	TC52916	91.31
0.030	0.150	15	0.450	TC52918	91.31
0.031	0.155	10	0.310	TC52920	91.31
0.031	0.155	15	0.470	TC52922	91.31
0.035	0.175	10	0.350	TC52924	91.31
0.035	0.175	15	0.525	TC52926	91.31
0.040	0.200	10	0.400	TC52928	91.31
0.040	0.200	15	0.600	TC52930	91.31
0.045	0.225	10	0.450	TC52932	88.95
0.045	0.225	15	0.675	TC52934	88.95
0.047	0.250	10	0.500	TC52936	88.95
0.047	0.250	15	0.710	TC52938	88.95
0.050	0.300	10	0.500	TC52940	88.95
0.050	0.300	15	0.750	TC52942	88.95
0.055	0.385	10	0.550	TC52944	88.95
0.055	0.385	15	0.825	TC52946	88.95

DIA	LOC	xDIA	REACH	ITEM#	LIST PRICE
0.060	0.312	10	0.625	TC52948	88.95
0.060	0.500	16	1.000	TC52950	88.95
0.062	0.312	10	0.625	TC52952	88.95
0.062	0.500	16	1.000	TC52954	88.95
0.065	0.325	10	0.650	TC52956	88.95
0.065	0.500	15	1.000	TC52958	88.95
0.070	0.350	10	0.700	TC52960	88.95
0.070	0.500	14	1.000	TC52962	88.95
0.075	0.375	10	0.750	TC52964	88.95
0.075	0.500	13	1.000	TC52966	88.95
0.078	0.406	10	0.800	TC52968	88.95
0.078	0.406	15	1.187	TC52970	88.95
0.080	0.400	10	0.800	TC52972	88.95
0.080	0.750	15	1.250	TC52974	88.95
0.085	0.425	10	0.850	TC52976	88.95
0.085	0.750	14	1.250	TC52978	88.95
0.090	0.450	10	0.900	TC52980	88.95
0.090	0.750	13	1.250	TC52982	88.95
0.093	0.500	10	0.950	TC52984	88.95
0.093	0.500	15	1.400	TC52986	88.95
0.095	0.500	10	0.950	TC52988	88.95
0.095	0.750	13	1.250	TC52990	88.95
0.100	0.500	10	1.000	TC52992	88.95
0.100	0.750	12	1.250	TC52994	88.95



All long reach Micro End Mills are 1/8" shank, 2-1/2" OAL.
For coating information see page 8. For technical information, please see page 126.

TOLERANCES	DIAMETER	SHANK	REACH
ALL SIZES	+0.0005, -0.0005	-.0001, -.0003 ISO H6	+0.010, -.000



GENERAL PURPOSE SOLID CARBIDE MICRO END MILLS

YOUR #1 SOURCE FOR AMERICAN-MADE PREMIUM QUALITY CUTTING TOOLS

3 FLUTE - LONG LENGTH - LONG FLUTE - SQUARE END - 30° HELIX



SERIES 563
UNCOATED

DIA	xDIA	LOC	ITEM#	LIST PRICE
0.010	5	0.050	TC53420	68.01
0.010	8	0.080	TC53421	114.14
0.010	12	0.120	TC53422	135.57
0.015	5	0.078	TC53423	63.19
0.015	8	0.125	TC53424	109.11
0.015	12	0.187	TC53425	134.26
0.020	5	0.100	TC53426	54.23
0.020	8	0.160	TC53427	98.02
0.020	12	0.250	TC53428	128.79
0.025	5	0.125	TC53429	51.82
0.025	8	0.203	TC53430	98.02
0.025	12	0.312	TC53431	113.93
0.030	5	0.150	TC53432	49.86
0.030	8	0.250	TC53433	84.00
0.030	12	0.375	TC53434	108.24
0.031	5	0.156	TC53435	49.86
0.031	8	0.250	TC53436	80.18
0.031	12	0.375	TC53437	108.24
0.035	5	0.175	TC53438	49.86
0.035	8	0.280	TC53439	80.18
0.035	12	0.425	TC53440	108.24
0.040	5	0.200	TC53441	49.86
0.040	8	0.325	TC53442	80.18
0.040	12	0.480	TC53443	108.24
0.045	5	0.225	TC53444	49.86
0.045	8	0.375	TC53445	80.18
0.045	12	0.550	TC53446	107.58
0.047	5	0.250	TC53447	49.86
0.047	8	0.375	TC53448	80.18
0.047	12	0.570	TC53449	107.58
0.050	5	0.250	TC53450	49.86
0.050	8	0.400	TC53451	80.18
0.050	12	0.600	TC53452	108.24
0.055	5	0.275	TC53453	49.86
0.055	8	0.440	TC53454	80.18
0.055	12	0.660	TC53455	108.24
0.060	5	0.312	TC53456	44.39
0.060	8	0.500	TC53457	49.86
0.060	12	0.720	TC53458	108.24
0.062	5	0.312	TC53459	44.39
0.062	8	0.500	TC53460	49.64
0.062	12	0.750	TC53461	84.84

DIA	xDIA	LOC	ITEM#	LIST PRICE
0.062	15	0.950	TC53462	116.11
0.065	5	0.325	TC53463	44.39
0.065	8	0.500	TC53464	49.64
0.065	12	0.780	TC53465	84.84
0.070	5	0.375	TC53466	44.39
0.070	8	0.560	TC53467	49.64
0.070	12	0.850	TC53468	84.84
0.075	5	0.375	TC53469	44.39
0.075	8	0.625	TC53470	49.64
0.075	12	0.900	TC53471	84.84
0.078	5	0.406	TC53472	44.39
0.078	8	0.625	TC53473	49.64
0.078	12	0.940	TC53474	84.84
0.078	15	1.187	TC53475	116.11
0.080	5	0.406	TC53476	44.39
0.080	8	0.750	TC53477	49.64
0.080	12	0.960	TC53478	84.84
0.085	5	0.425	TC53479	44.39
0.085	8	0.750	TC53480	49.64
0.085	12	1.020	TC53481	84.84
0.090	5	0.450	TC53482	44.39
0.090	8	0.750	TC53483	49.64
0.090	12	1.080	TC53484	84.84
0.093	5	0.500	TC53485	44.39
0.093	8	0.750	TC53486	49.64
0.093	12	1.125	TC53487	84.84
0.093	15	1.400	TC53488	120.70
0.095	5	0.500	TC53489	44.39
0.095	8	0.750	TC53490	49.64
0.095	12	1.140	TC53491	84.84
0.100	5	0.500	TC53492	44.39
0.100	8	0.800	TC53493	49.64
0.100	12	1.200	TC53494	84.84
0.109	5	0.570	TC53495	44.39
0.109	8	0.900	TC53496	49.64
0.109	12	1.320	TC53497	84.84
0.118	5	0.625	TC53498	44.39
0.118	8	0.950	TC53499	49.64
0.118	12	1.375	TC53500	84.84
0.120	5	0.600	TC53501	44.39
0.120	8	1.000	TC53502	49.64
0.120	12	1.500	TC53503	84.84

All long length Micro End Mills are 1/8" shank, 2-1/2" OAL.
For technical information, please see page 126.

TOLERANCES	DIAMETER	SHANK
ALL SIZES	+.0005, -.0005	-.0001, -.0003 ISO H6

MICRO END MILLS

REGULAR LENGTH

LONG REACH STUB FLUTE

LONG REACH REG FLUTE

LONG REACH LONG FLUTE

LONG LENGTH LONG FLUTE

TECHNICAL

GENERAL PURPOSE SOLID CARBIDE MICRO END MILLS



YOUR #1 SOURCE FOR AMERICAN-MADE PREMIUM QUALITY CUTTING TOOLS

3 FLUTE - LONG LENGTH - LONG FLUTE - SQUARE END - 30° HELIX



SERIES 565
ALTIN COATED

DIA	xDIA	LOC	ITEM#	LIST PRICE
0.010	5	0.050	TC53602	81.61
0.010	8	0.080	TC53603	136.97
0.010	12	0.120	TC53604	162.69
0.015	5	0.078	TC53605	75.83
0.015	8	0.125	TC53606	130.94
0.015	12	0.187	TC53607	161.11
0.020	5	0.100	TC53608	65.08
0.020	8	0.160	TC53609	117.62
0.020	12	0.250	TC53610	154.55
0.025	5	0.125	TC53611	62.19
0.025	8	0.203	TC53612	117.62
0.025	12	0.312	TC53613	136.71
0.030	5	0.150	TC53614	59.83
0.030	8	0.250	TC53615	100.79
0.030	12	0.375	TC53616	129.89
0.031	5	0.156	TC53617	59.83
0.031	8	0.250	TC53618	96.21
0.031	12	0.375	TC53619	129.89
0.035	5	0.175	TC53620	59.83
0.035	8	0.280	TC53621	96.21
0.035	12	0.425	TC53622	129.89
0.040	5	0.200	TC53623	59.83
0.040	8	0.325	TC53624	96.21
0.040	12	0.480	TC53625	129.89
0.045	5	0.225	TC53626	59.83
0.045	8	0.375	TC53627	96.21
0.045	12	0.550	TC53628	129.10
0.047	5	0.250	TC53629	59.83
0.047	8	0.375	TC53630	96.21
0.047	12	0.570	TC53631	129.10
0.050	5	0.250	TC53632	59.83
0.050	8	0.400	TC53633	96.21
0.050	12	0.600	TC53634	129.89
0.055	5	0.275	TC53635	59.83
0.055	8	0.440	TC53636	96.21
0.055	12	0.660	TC53637	129.89
0.060	5	0.312	TC53638	53.27
0.060	8	0.500	TC53639	59.83
0.060	12	0.720	TC53640	129.89
0.062	5	0.312	TC53641	53.27
0.062	8	0.500	TC53642	59.56
0.062	12	0.750	TC53643	101.81

DIA	xDIA	LOC	ITEM#	LIST PRICE
0.062	15	0.950	TC53644	139.33
0.065	5	0.325	TC53645	53.27
0.065	8	0.500	TC53646	59.56
0.065	12	0.780	TC53647	101.81
0.070	5	0.375	TC53648	53.27
0.070	8	0.560	TC53649	59.56
0.070	12	0.850	TC53650	101.81
0.075	5	0.375	TC53651	53.27
0.075	8	0.625	TC53652	59.56
0.075	12	0.900	TC53653	101.81
0.078	5	0.406	TC53654	53.27
0.078	8	0.625	TC53655	59.56
0.078	12	0.940	TC53656	101.81
0.078	15	1.187	TC53657	139.33
0.080	5	0.406	TC53658	53.27
0.080	8	0.750	TC53659	59.56
0.080	12	0.960	TC53660	101.81
0.085	5	0.425	TC53661	53.27
0.085	8	0.750	TC53662	59.56
0.085	12	1.020	TC53663	101.81
0.090	5	0.450	TC53664	53.27
0.090	8	0.750	TC53665	59.56
0.090	12	1.080	TC53666	101.81
0.093	5	0.500	TC53667	53.27
0.093	8	0.750	TC53668	59.56
0.093	12	1.125	TC53669	101.81
0.093	15	1.400	TC53670	144.84
0.095	5	0.500	TC53671	53.27
0.095	8	0.750	TC53672	59.56
0.095	12	1.140	TC53673	101.81
0.100	5	0.500	TC53674	53.27
0.100	8	0.800	TC53675	59.56
0.100	12	1.200	TC53676	101.81
0.109	5	0.570	TC53677	53.27
0.109	8	0.900	TC53678	59.56
0.109	12	1.320	TC53679	101.81
0.118	5	0.625	TC53680	53.27
0.118	8	0.950	TC53681	59.56
0.118	12	1.375	TC53682	101.81
0.120	5	0.600	TC53683	53.27
0.120	8	1.000	TC53684	59.56
0.120	12	1.500	TC53685	101.81

All long length Micro End Mills are 1/8" shank, 2-1/2" OAL.

For coating information see page 8. For technical information, please see page 126.

TOLERANCES	DIAMETER	SHANK
ALL SIZES	+.0005, -.0005	-.0001, -.0003 ISO H6



GENERAL PURPOSE SOLID CARBIDE MICRO END MILLS

YOUR #1 SOURCE FOR AMERICAN-MADE PREMIUM QUALITY CUTTING TOOLS

3 FLUTE - LONG LENGTH - LONG FLUTE - BALL NOSE - 30° HELIX



SERIES 567
UNCOATED

DIA	xDIA	LOC	ITEM#	LIST PRICE
0.010	5	0.050	TC53730	77.85
0.010	8	0.080	TC53731	130.76
0.010	12	0.120	TC53732	153.07
0.015	5	0.078	TC53733	72.38
0.015	8	0.125	TC53734	125.30
0.015	12	0.187	TC53735	154.82
0.020	5	0.100	TC53736	62.32
0.020	8	0.160	TC53737	116.33
0.020	12	0.250	TC53738	145.41
0.025	5	0.125	TC53739	59.26
0.025	8	0.203	TC53740	113.27
0.025	12	0.312	TC53741	139.95
0.030	5	0.150	TC53742	57.29
0.030	8	0.250	TC53743	93.71
0.030	12	0.375	TC53744	137.76
0.031	5	0.156	TC53745	57.29
0.031	8	0.250	TC53746	90.24
0.031	12	0.375	TC53747	124.20
0.035	5	0.175	TC53748	57.29
0.035	8	0.281	TC53749	93.71
0.035	12	0.425	TC53750	124.20
0.040	5	0.200	TC53751	57.29
0.040	8	0.325	TC53752	93.71
0.040	12	0.480	TC53753	124.20
0.045	5	0.225	TC53754	57.29
0.045	8	0.375	TC53755	93.71
0.045	12	0.550	TC53756	124.20
0.047	5	0.250	TC53757	57.29
0.047	8	0.375	TC53758	93.71
0.047	12	0.570	TC53759	124.20
0.050	5	0.250	TC53760	57.29
0.050	8	0.400	TC53761	93.71
0.050	12	0.600	TC53762	124.20
0.055	5	0.275	TC53763	50.73
0.055	8	0.440	TC53764	61.23
0.055	12	0.660	TC53765	115.89
0.060	5	0.312	TC53766	50.73
0.060	8	0.500	TC53767	57.29
0.060	12	0.720	TC53768	105.40
0.062	5	0.312	TC53769	50.73
0.062	8	0.500	TC53770	56.63
0.062	12	0.750	TC53771	97.31

DIA	xDIA	LOC	ITEM#	LIST PRICE
0.062	15	0.950	TC53772	133.17
0.065	5	0.325	TC53773	50.73
0.065	8	0.500	TC53774	56.63
0.065	12	0.780	TC53775	97.31
0.070	5	0.375	TC53776	50.73
0.070	8	0.560	TC53777	56.63
0.070	12	0.900	TC53778	97.31
0.075	5	0.375	TC53779	50.73
0.075	8	0.625	TC53780	56.63
0.075	12	0.900	TC53781	97.31
0.078	5	0.406	TC53782	50.73
0.078	8	0.625	TC53783	56.63
0.078	12	0.940	TC53784	97.31
0.078	15	1.187	TC53785	133.17
0.080	5	0.406	TC53786	50.73
0.080	8	0.750	TC53787	56.63
0.080	12	0.960	TC53788	97.31
0.085	5	0.425	TC53789	50.73
0.085	8	0.750	TC53790	56.63
0.085	12	1.020	TC53791	97.31
0.090	5	0.450	TC53792	50.73
0.090	8	0.750	TC53793	56.63
0.090	12	1.080	TC53794	97.31
0.093	5	0.500	TC53795	50.73
0.093	8	0.750	TC53796	56.63
0.093	12	1.125	TC53797	97.31
0.093	15	1.400	TC53798	136.01
0.095	5	0.500	TC53799	50.73
0.095	8	0.750	TC53800	56.63
0.095	12	1.140	TC53801	97.31
0.100	5	0.500	TC53802	50.73
0.100	8	0.800	TC53803	56.63
0.100	12	1.200	TC53804	97.31
0.109	5	0.570	TC53805	50.73
0.109	8	0.900	TC53806	56.63
0.109	12	1.320	TC53807	97.31
0.118	5	0.625	TC53808	50.73
0.118	8	0.950	TC53809	56.63
0.118	12	1.375	TC53810	97.31
0.120	5	0.600	TC53811	50.73
0.120	8	1.000	TC53812	56.63
0.120	12	1.500	TC53813	97.31

All long reach Micro End Mills are 1/8" shank, 2-1/2" OAL.
For technical information, please see page 126.

TOLERANCES	DIAMETER	SHANK	REACH
ALL SIZES	+0.0005, -0.0005	-0.0001, -0.0003 ISO H6	+0.010, -0.000

MICRO END MILLS

REGULAR LENGTH

LONG REACH STUB FLUTE

LONG REACH REG FLUTE

LONG REACH LONG FLUTE

LONG LENGTH LONG FLUTE

TECHNICAL

GENERAL PURPOSE SOLID CARBIDE MICRO END MILLS



YOUR #1 SOURCE FOR AMERICAN-MADE PREMIUM QUALITY CUTTING TOOLS

3 FLUTE - LONG LENGTH - LONG FLUTE - BALL NOSE - 30° HELIX



SERIES 568
ALTIN COATED

DIA	xDIA	LOC	ITEM#	LIST PRICE
0.010	5	0.050	TC53861	93.41
0.010	8	0.080	TC53862	156.91
0.010	12	0.120	TC53863	183.68
0.015	5	0.078	TC53864	86.85
0.015	8	0.125	TC53865	150.35
0.015	12	0.187	TC53866	185.78
0.020	5	0.100	TC53867	74.78
0.020	8	0.160	TC53868	139.60
0.020	12	0.250	TC53869	174.50
0.025	5	0.125	TC53870	71.11
0.025	8	0.203	TC53871	135.92
0.025	12	0.312	TC53872	167.94
0.030	5	0.150	TC53873	68.75
0.030	8	0.250	TC53874	112.46
0.030	12	0.375	TC53875	165.31
0.031	5	0.156	TC53876	68.75
0.031	8	0.250	TC53877	108.29
0.031	12	0.375	TC53878	149.04
0.035	5	0.175	TC53879	68.75
0.035	8	0.281	TC53880	112.46
0.035	12	0.425	TC53881	149.04
0.040	5	0.200	TC53882	68.75
0.040	8	0.325	TC53883	112.46
0.040	12	0.480	TC53884	149.04
0.045	5	0.225	TC53885	68.75
0.045	8	0.375	TC53886	112.46
0.045	12	0.550	TC53887	149.04
0.047	5	0.250	TC53888	68.75
0.047	8	0.375	TC53889	112.46
0.047	12	0.570	TC53890	149.04
0.050	5	0.250	TC53891	68.75
0.050	8	0.400	TC53892	112.46
0.050	12	0.600	TC53893	149.04
0.055	5	0.275	TC53894	60.88
0.055	8	0.440	TC53895	73.47
0.055	12	0.660	TC53896	139.07
0.060	5	0.312	TC53897	60.88
0.060	8	0.500	TC53898	68.75
0.060	12	0.720	TC53899	126.48
0.062	5	0.312	TC53900	60.88
0.062	8	0.500	TC53901	67.96
0.062	12	0.750	TC53902	116.77

DIA	xDIA	LOC	ITEM#	LIST PRICE
0.062	15	0.950	TC53903	159.80
0.065	5	0.325	TC53904	60.88
0.065	8	0.500	TC53905	67.96
0.065	12	0.780	TC53906	116.77
0.070	5	0.375	TC53907	60.88
0.070	8	0.560	TC53908	67.96
0.070	12	0.900	TC53909	116.77
0.075	5	0.375	TC53910	60.88
0.075	8	0.625	TC53911	67.96
0.075	12	0.900	TC53912	116.77
0.078	5	0.406	TC53913	60.88
0.078	8	0.625	TC53914	67.96
0.078	12	0.940	TC53915	116.77
0.078	15	1.187	TC53916	159.80
0.080	5	0.406	TC53917	60.88
0.080	8	0.750	TC53918	67.96
0.080	12	0.960	TC53919	116.77
0.085	5	0.425	TC53920	60.88
0.085	8	0.750	TC53921	67.96
0.085	12	1.020	TC53922	116.77
0.090	5	0.450	TC53923	60.88
0.090	8	0.750	TC53924	67.96
0.090	12	1.080	TC53925	116.77
0.093	5	0.500	TC53926	60.88
0.093	8	0.750	TC53927	67.96
0.093	12	1.125	TC53928	116.77
0.093	15	1.400	TC53929	163.21
0.095	5	0.500	TC53930	60.88
0.095	8	0.750	TC53931	67.96
0.095	12	1.140	TC53932	116.77
0.100	5	0.500	TC53933	60.88
0.100	8	0.800	TC53934	67.96
0.100	12	1.200	TC53935	116.77
0.109	5	0.570	TC53936	60.88
0.109	8	0.900	TC53937	67.96
0.109	12	1.320	TC53938	116.77
0.118	5	0.625	TC53939	60.88
0.118	8	0.950	TC53940	67.96
0.118	12	1.375	TC53941	116.77
0.120	5	0.600	TC53942	60.88
0.120	8	1.000	TC53943	67.96
0.120	12	1.500	TC53944	116.77

All long reach Micro End Mills are 1/8" shank, 2-1/2" OAL.

For coating information see page 8. For technical information, please see page 126.

TOLERANCES	DIAMETER	SHANK	REACH
ALL SIZES	+ .0005, -.0005	-.0001, -.0003 ISO H6	+ .010, -.000



MICRO END MILLS - CARBIDE TECHNICAL INFORMATION

YOUR #1 SOURCE FOR AMERICAN-MADE PREMIUM QUALITY CUTTING TOOLS

THESE VALUES ARE FOR UNCOATED TOOLS. FOR ALTiN COATED TOOLS INCREASE SFM +40%

		SFM & I.P.T. (INCH PER TOOTH)									
MATERIAL / TYPE	CONDITIONS	STARTING SFM	DIAMETER RANGE - SUGGESTED CHIP LOAD PER TOOTH								
			.005-.015	.015-.030	.030-.045	.045-.060	.06-.075	.075-.090	.090-.105	.105-.125	
STAINLESS STEELS											
PRECIPITATION 13-8, 15-5, 17-4PH	Slotting @ ≤10% of D	90	.0002"	.0002"	.0003"	.0003"	.0004"	.0004"	.0005"	.0005"	
	Profiling @ 6% of D Axial ≤ 20% of D Radial	250	.0002"	.0002"	.0003"	.0003"	.0004"	.0004"	.0005"	.0005"	
AUSTENITIC 302, 303, 304L, 316L	Slotting @ ≤15% of D	100	.0002"	.0002"	.0003"	.0003"	.0004"	.0004"	.0005"	.0005"	
	Profiling @ 6% of D Axial ≤ 30% of D Radial	250	.0002"	.0002"	.0003"	.0003"	.0004"	.0004"	.0005"	.0005"	
MARTENSITIC 302, 303, 304L, 316L	Slotting @ ≤15% of D	100	.0002"	.0002"	.0003"	.0003"	.0004"	.0004"	.0005"	.0005"	
	Profiling @ 6% of D Axial ≤ 30% of D Radial	250	.0002"	.0002"	.0003"	.0003"	.0004"	.0004"	.0005"	.0005"	
HIGH TEMP ALLOYS											
COBALT BASE Stellite, Haynes 25, 188, X-40, L-605	Slotting @ 7% of D	50	.0001"	.0001"	.0002"	.0002"	.0003"	.0003"	.0004"	.0004"	
	Profiling @ 5% of D Axial ≤ 20% of D Radial	80	.0001"	.0001"	.0002"	.0002"	.0003"	.0003"	.0004"	.0004"	
NICKEL BASE Inconel 600, 625, 718, Nickel 200, 270, Invar, Monel 400, 405, K-Monel PermaNickel 300, Incoly 600	Slotting @ 7% of D	40	.0001"	.0001"	.0002"	.0002"	.0003"	.0003"	.0004"	.0004"	
	Profiling @ 5% of D Axial ≤ 20% of D Radial	60	.0001"	.0001"	.0002"	.0002"	.0003"	.0003"	.0004"	.0004"	
IRON BASE Incoly 800-802, Multimet N-155, Timken 16-26-6	Slotting @ 7% of D	80	.0001"	.0001"	.0002"	.0002"	.0003"	.0003"	.0004"	.0004"	
	Profiling @ 5% of D Axial ≤ 20% of D Radial	100	.0001"	.0001"	.0002"	.0002"	.0003"	.0003"	.0004"	.0004"	
STEELS											
HIGH STRENGTH STEELS 4140, 4340, 52100	Slotting @ ≤15% of D	100	.0002"	.0002"	.0003"	.0003"	.0004"	.0004"	.0005"	.0005"	
	Profiling @ 6% of D Axial ≤ 30% of D Radial	180	.0002"	.0002"	.0003"	.0003"	.0004"	.0004"	.0005"	.0005"	
HIGH ALLOY STEELS MOLD & DIE A-2, P20, O1, O2, D2, H-13	Slotting @ ≤10% of D	125	.0002"	.0002"	.0003"	.0003"	.0004"	.0004"	.0005"	.0005"	
	Profiling @ 6% of D Axial ≤ 20% of D Radial	250	.0002"	.0002"	.0003"	.0003"	.0004"	.0004"	.0005"	.0005"	
MEDIUM ALLOY STEELS 200, 250, 300	Slotting @ ≤15% of D	125	.0003"	.0003"	.0004"	.0004"	.0005"	.0005"	.0006"	.0006"	
	Profiling @ 6% of D Axial ≤ 30% of D Radial	250	.0003"	.0003"	.0004"	.0004"	.0005"	.0005"	.0006"	.0006"	
LOW ALLOY STEELS MARAGING 10XX, 11XX, 13XX	Slotting @ ≤15% of D	150	.0004"	.0004"	.0005"	.0005"	.0006"	.0006"	.0007"	.0007"	
	Profiling @ 6% of D Axial ≤ 35% of D Radial	300	.0004"	.0004"	.0005"	.0005"	.0006"	.0006"	.0007"	.0007"	
CAST IRONS											
DUCTILE IRON Ductile Cast Iron	Slotting @ ≤15% of D	100	.0004"	.0004"	.0005"	.0005"	.0006"	.0006"	.0007"	.0007"	
	Profiling @ 10% of D Axial ≤ 25% of D Radial	250	.0004"	.0004"	.0005"	.0005"	.0006"	.0006"	.0007"	.0007"	
CAST IRON Gray Cast Iron	Slotting @ ≤25% of D	125	.0004"	.0004"	.0005"	.0005"	.0008"	.0008"	.0010"	.0010"	
	Profiling @ 10% of D Axial ≤ 35% of D Radial	400	.0004"	.0004"	.0005"	.0005"	.0008"	.0008"	.0010"	.0010"	
TITANIUMS											
TITANIUM ALLOYS 6AL-4V, ASTM 1, 2, 3, 6AL-2S For 5553, decrease SFM & IPM 25%	Slotting @ ≤15% of D	125	.0002"	.0002"	.0003"	.0003"	.0004"	.0004"	.0005"	.0005"	
	Profiling @ 6% of D Axial ≤ 20% of D Radial	250	.0002"	.0002"	.0003"	.0003"	.0004"	.0004"	.0005"	.0005"	
ALUMINUM											
ALUMINUM ALLOYS 6061-T6, 7075	Slotting @ ≤15% of D	650	.0004"	.0004"	.0005"	.0006"	.0008"	.0008"	.0010"	.0010"	
	Profiling @ 10% of D Axial ≤ 35% of D Radial	775	.0004"	.0004"	.0005"	.0006"	.0008"	.0008"	.0010"	.0010"	

SPEED & FEED CALCULATION FORMULAS

RPM = (3.82 x SFM) ÷ Dia.	IPR = IPM ÷ RPM	SFM = (RPM x Dia.) ÷ 3.82
IPM = IPT(chip load) x No. of Teeth x RPM		IPT(chip load) = IPM ÷ (No. of teeth x RPM)

GENERAL PURPOSE SOLID CARBIDE THREAD MILLS



YOUR #1 SOURCE FOR AMERICAN-MADE PREMIUM QUALITY CUTTING TOOLS

THREAD MILLING

When producing a range of threads across materials on the same machine, thread mills have a distinct advantage over traditional taps. A single thread mill can produce internal or external threads in a left or right-hand direction, and with single or multiple leads. The same thread mill will work in a full range of materials from soft non-ferrous materials all the way through tough alloys where taps are more prone to breaking. Thread mills also have an advantage when threading pipes since there is no stop line or leftover chips as there would be with traditional tapping.

How it Works

Unlike taps that feed into the part at the rate of the lead thread and use the first chamfer to cut the threads to finished size - thread mills cut all threads at the same time in a single motion. To do this, the thread mill is lowered into a hole to the desired depth and moved to the side wall, then using helical interpolation it moves around the outer wall of the hole and up one thread height until it returns to the first position. From there it returns to center and is removed from the hole.

AlTiN Coated for Better Performance

Our solid carbide thread mills are coated in AlTiN for lasting reliable performance in a wide variety of materials. For a complete speed and feed information, please refer to the technical information at the end of this section.



CARBIDE THREAD MILLS

TECHNICAL



GENERAL PURPOSE SOLID CARBIDE THREAD MILLS

YOUR #1 SOURCE FOR AMERICAN-MADE PREMIUM QUALITY CUTTING TOOLS

INTERNAL • EXTERNAL - UN THREADS



SERIES 840
ALTiN COATED

DIAMETER	SHANK	CUTTING DIA	THREAD LENGTH	OAL	# OF FLUTES	ITEM#	LIST PRICE
2-56	1/8	0.065	0.125	2	3	TC83995	183.26
4-40	1/8	0.085	0.180	2	3	TC83998	183.26
6 - 32	1/8	0.100	0.218	2	3	TC84001	196.40
8 - 32	1/8	0.115	0.250	2	3	TC84003	196.40
8 - 36	1/8	0.115	0.250	2	3	TC84005	196.40
10 - 24	3/16	0.120	0.312	2	3	TC84007	196.40
10 - 32	3/16	0.120	0.312	2	3	TC84009	196.40
1/4 - 20	3/16	0.180	0.500	2-1/2	3	TC84011	222.14
1/4 - 28	3/16	0.180	0.500	2-1/2	3	TC84013	222.14
5/16 - 18	1/4	0.240	0.625	2-1/2	3	TC84015	261.41
5/16 - 24	1/4	0.240	0.625	2-1/2	3	TC84017	261.41
3/8 - 16	5/16	0.290	0.750	3	4	TC84019	311.48
3/8 - 24	5/16	0.290	0.750	3	4	TC84021	311.48
7/16 - 14	3/8	0.340	0.875	3	4	TC84023	335.89
7/16 - 20	3/8	0.340	0.875	3	4	TC84025	335.89
1/2 - 13	3/8	0.350	0.875	3-1/2	4	TC84027	335.89
1/2 - 20	3/8	0.350	0.875	3-1/2	4	TC84029	335.89
9/16 - 12	1/2	0.370	0.875	3-1/2	4	TC84031	335.89
9/16 - 18	1/2	0.370	0.875	3-1/2	4	TC84033	335.89
5/8 - 11	1/2	0.470	1.250	3-1/2	5	TC84035	419.86
5/8 - 18	1/2	0.470	1.250	3-1/2	5	TC84037	419.86
3/4 - 10	1/2	0.495	1.250	3-1/2	5	TC84039	419.86
3/4 - 16	1/2	0.495	1.250	3-1/2	5	TC84041	419.86
7/8 - 9	5/8	0.620	1.250	3-1/2	5	TC84043	525.50
7/8 - 14	5/8	0.620	1.250	3-1/2	5	TC84045	525.50
1 - 8	3/4	0.620	1.375	4	5	TC84047	525.50
1 - 12	3/4	0.620	1.375	4	5	TC84049	525.50



Wide assortment of thread mill styles stocked and ready to ship

For coating information see page 8. For technical information please see page 133.

THREAD MILL CUTTING DIAMETER TOLERANCE

+ .000, -.002

GENERAL PURPOSE SOLID CARBIDE THREAD MILLS



YOUR #1 SOURCE FOR AMERICAN-MADE PREMIUM QUALITY CUTTING TOOLS

INTERNAL • EXTERNAL - UN THREADS
COOLANT END FED



END VIEW

SERIES 848
ALTiN COATED

DIAMETER	SHANK	CUTTING DIA	THREAD LENGTH	OAL	# OF FLUTES	ITEM #	LIST PRICE
10 - 32	3/16	0.120	0.312	2	3	TC84810	227.93
1/4 - 20	3/16	0.180	0.500	2-1/2	3	TC84812	240.53
1/4 - 28	3/16	0.180	0.500	2-1/2	3	TC84814	240.53
5/16 - 18	1/4	0.240	0.625	2-1/2	3	TC84816	297.80
5/16 - 24	1/4	0.240	0.625	2-1/2	3	TC84818	297.80
3/8 - 16	5/16	0.290	0.750	3	4	TC84820	368.82
3/8 - 24	5/16	0.290	0.750	3	4	TC84822	368.82
7/16 - 14	3/8	0.340	0.875	3	4	TC84824	429.52
7/16 - 20	3/8	0.340	0.875	3	4	TC84826	429.52
1/2 - 13	3/8	0.350	0.875	3-1/2	4	TC84828	445.56
1/2 - 20	3/8	0.350	0.875	3-1/2	4	TC84830	445.56
3/4 - 10	1/2	0.495	1.250	3-1/2	4	TC84840	571.55
3/4 - 16	1/2	0.495	1.250	3-1/2	4	TC84842	571.55



Advanced packaging holds tools tight to prevent damage

For coating information see page 8. For technical information please see page 133.

THREAD MILL CUTTING DIAMETER TOLERANCE

+ .000, -.002



GENERAL PURPOSE SOLID CARBIDE THREAD MILLS

YOUR #1 SOURCE FOR AMERICAN-MADE PREMIUM QUALITY CUTTING TOOLS

INTERNAL • EXTERNAL - NPT PIPE THREADS



SERIES 842
ALTiN COATED

DIAMETER	SHANK	CUTTING DIA	THREAD LENGTH	OAL	# OF FLUTES	ITEM#	LIST PRICE
1/16 - 27	1/4	0.245	0.437	2-1/2	3	TC84200	261.41
1/8 - 27	5/16	0.310	0.437	2-1/2	4	TC84202	261.41
1/4 - 18	3/8	0.370	0.625	3	4	TC84204	297.95
3/8 - 18	3/8	0.370	0.625	3	4	TC84206	297.95
1/2 - 14	1/2	0.495	0.875	3-1/2	4	TC84208	419.86
3/4 - 14	1/2	0.495	0.875	3-1/2	4	TC84210	419.86
1 - 11-1/2	3/4	0.620	1.125	4	5	TC84212	525.50



50 years of providing American-Made tooling

For coating information see page 8. For technical information please see page 133.

THREAD MILL CUTTING DIAMETER TOLERANCE

+.000, -.002

GENERAL PURPOSE SOLID CARBIDE THREAD MILLS



YOUR #1 SOURCE FOR AMERICAN-MADE PREMIUM QUALITY CUTTING TOOLS

THREAD MILLING

INTERNAL • EXTERNAL - NPTF PIPE THREADS



SERIES 844
ALTIM COATED

DIAMETER	SHANK	CUTTING DIA	THREAD LENGTH	OAL	# OF FLUTES	ITEM#	LIST PRICE
1/16 - 27	1/4	0.245	0.437	2-1/2	3	TC84401	261.41
1/8 - 27	5/16	0.310	0.437	2-1/2	4	TC84403	261.41
1/4 - 18	3/8	0.370	0.625	3	4	TC84405	297.95
3/8 - 18	3/8	0.370	0.625	3	4	TC84407	297.95
1/2 - 14	1/2	0.495	0.875	3-1/2	4	TC84409	419.86
3/4 - 14	1/2	0.495	0.875	3-1/2	4	TC84411	419.86
1 - 11-1/2	3/4	0.620	1.125	4	5	TC84413	525.50

CARBIDE THREAD MILLS

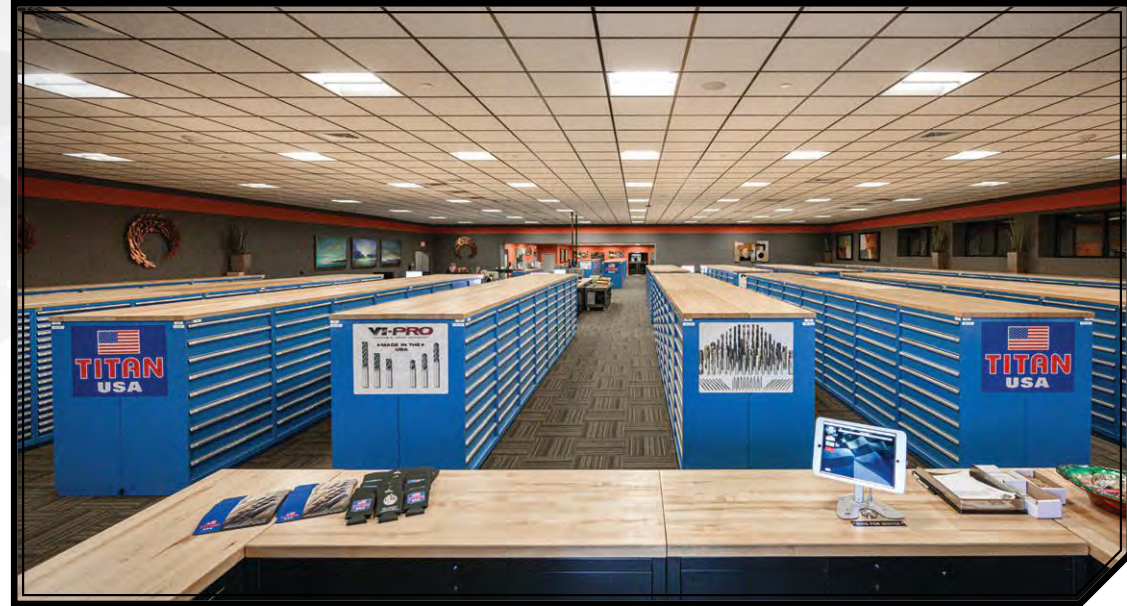

Massive inventory ensures orders are shipped or picked up on the same day they are placed

For coating information see page 8. For technical information please see page 133.

THREAD MILL CUTTING DIAMETER TOLERANCE	+ .000, -.002
--	---------------

TECHNICAL



GENERAL PURPOSE SOLID CARBIDE THREAD MILLS

YOUR #1 SOURCE FOR AMERICAN-MADE PREMIUM QUALITY CUTTING TOOLS

INTERNAL • EXTERNAL - METRIC THREADS



SERIES 846
ALTiN COATED

DIAMETER	SHANK	CUTTING DIA	THREAD LENGTH	OAL	# OF FLUTES	ITEM #	LIST PRICE
M4 x 0.70	1/8	0.115	0.250	2	3	TC84620	200.45
M4.5 x 0.75	1/8	0.120	0.250	2	3	TC84622	200.45
M5 x 0.80	3/16	0.120	0.312	2	3	TC84624	200.45
M6 x 1.00	3/16	0.170	0.500	2-1/2	3	TC84626	220.77
M8 x 0.75	1/4	0.235	0.625	2-1/2	3	TC84628	261.41
M8 x 1.00	1/4	0.235	0.625	2-1/2	3	TC84630	261.41
M8 x 1.25	1/4	0.235	0.625	2-1/2	3	TC84632	261.41
M10 x 1.25	5/16	0.300	0.750	3	4	TC84634	311.48
M10 x 1.50	5/16	0.300	0.750	3	4	TC84636	311.48
M12 x 1.00	3/8	0.360	0.875	3-1/2	4	TC84638	337.22
M12 x 1.25	3/8	0.360	0.875	3-1/2	4	TC84640	337.22
M12 x 1.75	3/8	0.360	0.875	3-1/2	4	TC84642	337.22
M14 x 1.50	3/8	0.360	0.875	3-1/2	4	TC84644	337.22
M16 x 2.00	1/2	0.470	1.250	3-1/2	5	TC84646	419.86
M18 x 2.50	1/2	0.470	1.250	3-1/2	5	TC84648	419.86
M20 x 3.00	5/8	0.470	1.250	3-1/2	5	TC84650	419.86

CARBIDE THREAD MILLS



*On site research and development center
HAAS VF2SS*

For coating information see page 8. For technical information please see page 133.

THREAD MILL CUTTING DIAMETER TOLERANCE

+ .000, -.002

TECHNICAL

THREAD MILLS - CARBIDE TECHNICAL INFORMATION



YOUR #1 SOURCE FOR AMERICAN-MADE PREMIUM QUALITY CUTTING TOOLS

THREAD MILLING

CARBIDE THREAD MILLS

TECHNICAL

MATERIAL	GRADES		1/16	1/8	3/16	1/4	5/16	3/8	1/2	5/8	3/4
			(.0625)	(.1250)	(.1875)	(.2500)	(.3125)	(.3750)	(.5000)	(.6250)	(.7500)
			SFM	IPT	IPT	IPT	IPT	IPT	IPT	IPT	IPT
ALLOYS											
COBALT BASE	STELLITE, HS-21, HAYNES 25/188,	50-90	.00015-.00025	.0002-.0005	.0003-.0005	.0004-.0006	.0006-.0009	.0008-.0015	.0010-.0020	.0014-.0028	.0018-.0030
IRON BASE	INCOLOY 800-802, MULTMET N-15, TIMKIN 16-25-6, CARPENTER 22-B3, TIMKIN 16-25-6, CARPENTER 22-B3	50-90	.00015-.00025	.0002-.0005	.0003-.0005	.0004-.0006	.0006-.0009	.0008-.0015	.0010-.0020	.0014-.0028	.0018-.0030
NICKEL BASE	INCONEL 625/718, INCO 700, 713C, 718, MONEL 400-401, 404, K401, RENE, RENE 41 & 95 HASTELLOY, WASPOLOY, UDIMET 500 & 700	60-100	.0002-.0003	.0003-.0006	.0005-.001	.0008-.0015	.001-.002	.0015-.0025	.0015-.0025	.002-.003	.0025-.0040
TITANIUM	COMMERCIALLY PURE, 6AL-4V, ASTM 1/2/3, 6AL-25N-4ZR-2MO-SI, TI-8AL-1MO, TI-8AL-4MO	80-150	.0002-.0005	.0003-.0006	.0005-.001	.0008-.0015	.001-.002	.0015-.0025	.0015-.0025	.0025-.0035	.0030-.0045
ALUMINUM											
ALUMINUM ALLOYS	2014, 2024, 6061, 7075	800-1400	.0002-.0004	.0005-.001	.001-.0015	.0015-.0025	.002-.003	.003-.0045	.0035-.0055	.005-.007	.006-.010
HIGH SILICON	A380, A390	475-750	.00015-.00022	.00035-.00040	.00075-.0008	.0010-.0020	.0015-.0025	.0018-.0028	.0023-0.0030	.0028-.0031	.0035-.0050
BRASS/BRONZE											
	ALUMINUM BRONZE, LOW SILICON BRONZE	550-800	.0002-.0005	.0005-.001	.001-.0015	.0015-.0025	.002-.003	.003-.0045	.0035-.0055	.005-.007	.006-.010
CAST IRON											
DUCTILE	A536, J434, 60-40-18	200-300	.00025-.00035	.0003-.0006	.0005-.0010	.0008-.0015	.001-.002	.0015-.0025	.002-.003	.003-.004	.0030-.0050
GRAY	A48, A436, A319, CLASS 20, G4000	250-350	.00025-.00035	.0004-.0008	.0007-.0013	.0007-.0013	.0015-.002	.002-.003	.002-.004	.003-.005	.0040-.0060
MALLEABLE	A220, A602, J158	200-300	.00025-.00035	.0003-.0006	.0005-.0010	.0008-.0015	.001-.002	.0015-.0025	.002-.003	.003-.004	.0030-.0050
COMPOSITES											
	G-10, FIBERGLASS, GRAPHITE, GRAPHITE EPOXY, PLASTICS	800-1400	.0003-.0005	.0005-.001	.001-.0015	.0015-.0025	.002-.003	.003-.0045	.0035-.0055	.005-.007	.0060-.0100
COPPER											
		450-1000	.00025-.00035	.0003-.0006	.0005-.001	.0008-.0015	.001-.002	.0015-.0025	.002-.003	.003-.004	.0035-.0050
MAGNESIUM											
		800-1400	.0003-.0005	.0005-.001	.001-.0015	.0015-.0025	.002-.003	.003-.0045	.0035-.0055	.005-.007	.0060-.0100
STAINLESS STEEL											
AUSTENITIC	301-304L, 310, 316L, 321, 347	100-250	.00015-.00025	.00025-.00055	.0005-.001	.0008-.0015	.001-.002	.0015-.0025	.002-.003	.003-.004	.0035-.0050
MARTENSITIC	403, 410, 416, 420, 430, 431, 440	150-250	.0002-.0003	.0004-.0008	.0006-.001	.001-.0015	.0015-.002	.0015-.003	.002-.0035	.003-.004	.0030-.0040
PRECIPITATION HARDENING	12/8, 15/5, 17/4, AM-350/355/363, PH13-8MO, PH14-8/MO	100-250	.00015-.00025	.00025-.00055	.0005-.001	.0008-.0015	.001-.002	.0015-.0025	.002-.003	.003-.004	.0035-.0050
STEELALLOY											
HIGH STRENGTH TOOL STEEL	A2, D2, P20, H11, H13,	250-400	.00015-.0003	.0003-.0006	.0005-.001	.0008-.0015	.001-.002	.0015-.0025	.002-.003	.003-.004	.0035-.0050
LOW CARBON	A36, 12L14, 12L15, 1005, 1018, 1020, 1108-1119, 1213-1215, 1513-1518, 4012, 5015, 9310	350-500	.0002-.0004	.0005-.001	.001-.0015	.0015-.0025	.002-.003	.003-.0045	.0035-.0055	.005-.007	.0060-.0080
MEDIUM CARBON	1040-1095, 1140-1151, 1330-1345	300-450	.0002-.0004	.0005-.001	.001-.0015	.0015-.0025	.002-.003	.003-.0045	.0035-.0055	.005-.007	.0060-.0080



HIGH PERFORMANCE SPIRAL POINT TAPS

Predator

YOUR #1 SOURCE FOR AMERICAN-MADE PREMIUM QUALITY CUTTING TOOLS

PREMIUM POWDERED METAL ANSI THREADS



SERIES 772 - UNCOATED



SERIES 773 - ALTiN COATED



SERIES 771 - STEAM OXIDE



SERIES 778 - TiCN COATED

SIZE	H LIMIT	# OF FLUTES	UNCOATED	LIST PRICE	STM OXIDE	LIST PRICE	ALTiN	LIST PRICE	TiCN	LIST PRICE
2-56	H2	2	TT97003	40.95	TT96903	43.32	TT97103	48.65	TT97903	48.65
4-40	H2	3	TT97015	31.62	TT96915	36.38	TT97115	48.65	TT97915	48.65
6-32	H3	3	TT97024	31.62	TT96924	36.38	TT97124	48.65	TT97924	48.65
8-32	H3	3	TT97030	31.62	TT96930	36.38	TT97130	48.65	TT97930	48.65
10-24	H3	3	TT97036	31.62	TT96936	36.38	TT97136	48.65	TT97936	48.65
10-32	H3	3	TT97040	31.62	TT96940	36.38	TT97140	48.65	TT97940	48.65
1/4-20	H3	3	TT97044	34.55	TT96944	39.74	TT97144	53.15	TT97944	53.16
1/4-20	H5	3	TT97048	34.55	TT96948	39.74	TT97148	53.15	TT97948	53.16
1/4-28	H3	3	TT97051	34.55	TT96951	39.74	TT97151	53.15	TT97951	53.16
1/4-28	H4	3	TT97054	34.55	TT96954	39.74	TT97154	53.15	TT97954	53.16
5/16-18	H3	3	TT97057	37.78	TT96957	43.46	TT97157	58.13	TT97957	58.14
5/16-18	H5	3	TT97060	37.78	TT96960	43.46	TT97160	58.13	TT97960	58.14
5/16-24	H3	3	TT97063	37.78	TT96963	43.46	TT97163	58.13	TT97963	58.14
5/16-24	H4	3	TT97066	37.78	TT96966	43.46	TT97166	58.13	TT97966	58.14
3/8-16	H3	3	TT97069	44.94	TT96969	51.67	TT97169	69.14	TT97969	69.14
3/8-16	H5	3	TT97071	44.94	TT96971	51.67	TT97171	69.14	TT97971	69.14
3/8-24	H3	3	TT97073	44.94	TT96973	51.67	TT97173	69.14	TT97973	69.14
3/8-24	H4	3	TT97075	44.94	TT96975	51.67	TT97175	69.14	TT97975	69.14
7/16-14	H3	3	TT97076	57.56	TT96976	66.17	TT97176	88.53	TT97976	88.53
7/16-14	H5	3	TT97078	57.56	TT96978	66.17	TT97178	88.53	TT97978	88.53
7/16-20	H3	3	TT97079	57.56	TT96979	66.17	TT97179	88.53	TT97979	88.53
7/16-20	H5	3	TT97081	57.56	TT96981	66.17	TT97181	88.53	TT97981	88.53
1/2-13	H3	4	TT97083	68.70	TT96983	79.01	TT97183	105.69	TT97983	105.69
1/2-13	H5	4	TT97085	68.70	TT96985	79.01	TT97185	105.69	TT97985	105.69
1/2-20	H3	4	TT97087	68.70	TT96987	79.01	TT97187	105.69	TT97987	105.69
1/2-20	H5	4	TT97089	68.70	TT96989	79.01	TT97189	105.69	TT97989	105.69
5/8-11	H3	4	TT97091	130.89	TT96991	150.54	TT97191	201.38	TT97991	201.39
5/8-11	H6	4	TT97093	130.89	TT96993	150.54	TT97193	201.38	TT97993	201.39
5/8-18	H3	4	TT97094	130.89	TT96994	150.54	TT97194	201.38	TT97994	201.39
5/8-18	H5	4	TT97095	130.89	TT96995	150.54	TT97195	201.38	TT97995	201.39
3/4-10	H3	4	TT97099	169.24	TT96999	194.61	TT97199	260.34	TT97999	260.34
3/4-10	H6	4	TT97096	169.24	TT96996	194.61	TT97196	260.34	TT97996	260.34
3/4-16	H3	4	TT97097	169.24	TT96997	194.61	TT97197	260.34	TT97997	260.34
3/4-16	H5	4	TT97098	169.24	TT96998	194.61	TT97198	260.34	TT97998	260.34

All taps sold individually

Predator Tap sizes 3/8" and smaller have male center.

For coating information see page 8. For technical information, please see page 166.

YOUR #1 SOURCE FOR AMERICAN-MADE PREMIUM QUALITY CUTTING TOOLS

PREMIUM POWDERED METAL METRIC THREADS



SERIES 711 - UNCOATED



SERIES 713 - ALTiN COATED



SERIES 712 - STEAM OXIDE



SERIES 714 - TiCN COATED

SIZE	D LIMIT	# OF FLUTES	UNCOATED	LIST PRICE	STM OXIDE	LIST PRICE	ALTiN	LIST PRICE	TiCN	LIST PRICE
M2.5 x 0.45	D3	2	TT98208	35.89	TT98301	41.29	TT98418	53.81	TT98955	53.81
M3 x 0.5	D3	3	TT98210	35.88	TT98303	41.29	TT98420	53.80	TT98961	53.81
M3.5 x 0.6	D3	3	TT98221	35.89	TT98317	41.29	TT98431	53.81	TT98979	53.81
M3.5 x 0.6	D4	3	TT98222	35.89	TT98318	41.29	TT98432	53.81	TT98962	53.81
M4 x 0.7	D3	3	TT98224	35.88	TT98321	41.29	TT98433	53.80	TT98981	53.81
M4 x 0.7	D4	3	TT98211	35.88	TT98304	41.29	TT98421	53.80	TT98963	53.81
M5 x 0.8	D3	3	TT98226	35.88	TT98323	41.29	TT98435	53.80	TT98983	53.81
M5 x 0.8	D4	3	TT98212	35.88	TT98305	41.29	TT98422	53.80	TT98965	53.81
M6 x 1.0	D3	3	TT98228	39.43	TT98325	45.34	TT98437	59.13	TT98985	59.13
M6 x 1.0	D5	3	TT98213	39.43	TT98306	45.34	TT98423	59.13	TT98967	59.13
M8 x 1.25	D3	3	TT98230	42.90	TT98327	49.34	TT98439	64.41	TT98987	64.41
M8 x 1.25	D5	3	TT98214	42.90	TT98308	49.34	TT98424	64.41	TT98969	64.41
M10 x 1.5	D3	3	TT98232	50.95	TT98329	58.55	TT98441	75.81	TT98989	75.81
M10 x 1.5	D6	3	TT98215	50.95	TT98310	58.55	TT98425	75.81	TT98971	75.81
M12 x 1.75	D3	4	TT98234	78.08	TT98331	89.77	TT98443	116.73	TT98991	116.73
M12 x 1.75	D6	4	TT98216	78.08	TT98312	89.77	TT98426	116.73	TT98973	116.73
M14 x 2.0	D3	4	TT98236	119.04	TT98333	136.88	TT98445	160.58	TT98993	160.58
M14 x 2.0	D7	4	TT98218	119.04	TT98314	136.88	TT98428	160.58	TT98975	160.58
M16 x 2.0	D3	4	TT98238	139.81	TT98335	160.79	TT98447	188.66	TT98995	188.66
M16 x 2.0	D7	4	TT98220	139.81	TT98316	160.79	TT98430	188.66	TT98977	188.66

- CNC STYLE
- SHANK & OAL MANUFACTURED TO ANSI SPECIFICATIONS
- BEST USED FOR THROUGH HOLE TAPPING
- MATERIALS: STEEL, STEEL ALLOYS, STAINLESS STEELS, AND A VARIETY OF OTHER STEELS WITH A MAXIMUM OF RC 32

All taps sold individually

Predator Tap sizes 3/8" and smaller have male center.

For coating information see page 8. For technical information, please see page 166.



HIGH PERFORMANCE SPIRAL FLUTE TAPS

Predator

YOUR #1 SOURCE FOR AMERICAN-MADE PREMIUM QUALITY CUTTING TOOLS

HIGH VANADIUM POWDERED METAL ANSI THREADS



SERIES 774 - UNCOATED



SERIES 779 - ALTIN COATED



SERIES 799 - STEAM OXIDE



SERIES 781 - TiCN COATED

SIZE	H LIMIT	# OF FLUTES	UNCOATED	LIST PRICE	STM OXIDE	LIST PRICE	ALTIN	LIST PRICE	TiCN	LIST PRICE
2-56	H2	2	TT97203	48.91	TT97503	56.25	TT97303	75.21	TT97603	75.21
4-40	H2	2	TT97207	48.91	TT97507	56.25	TT97307	75.21	TT97607	75.21
6-32	H3	3	TT97215	48.91	TT97515	56.25	TT97315	75.21	TT97615	75.21
8-32	H3	3	TT97223	48.91	TT97523	56.25	TT97323	75.21	TT97623	75.21
10-24	H3	3	TT97227	48.91	TT97527	56.25	TT97327	75.21	TT97627	75.21
10-32	H3	3	TT97231	48.91	TT97531	56.25	TT97331	75.21	TT97631	75.21
1/4-20	H3	3	TT97237	50.40	TT97537	57.95	TT97337	77.52	TT97637	77.53
1/4-20	H5	3	TT97239	50.40	TT97539	57.95	TT97339	77.52	TT97639	77.53
1/4-28	H3	3	TT97241	50.40	TT97541	57.95	TT97341	77.52	TT97641	77.53
1/4-28	H4	3	TT97243	50.40	TT97543	57.95	TT97343	77.52	TT97643	77.53
5/16-18	H3	3	TT97245	55.20	TT97545	63.46	TT97345	84.90	TT97645	84.90
5/16-18	H5	3	TT97247	55.20	TT97547	63.46	TT97347	84.90	TT97647	84.90
5/16-24	H3	3	TT97249	55.20	TT97549	63.46	TT97349	84.90	TT97649	84.90
5/16-24	H4	3	TT97251	55.20	TT97551	63.46	TT97351	84.90	TT97651	84.90
3/8-16	H3	3	TT97253	65.38	TT97553	75.21	TT97353	100.62	TT97653	100.62
3/8-16	H5	3	TT97255	65.38	TT97555	75.21	TT97355	100.62	TT97655	100.62
3/8-24	H3	3	TT97257	65.38	TT97557	75.21	TT97357	100.62	TT97657	100.62
3/8-24	H4	3	TT97259	65.38	TT97559	75.21	TT97359	100.62	TT97659	100.62
7/16-14	H3	3	TT97261	82.72	TT97561	95.16	TT97361	127.26	TT97661	127.26
7/16-14	H5	3	TT97263	82.72	TT97563	95.16	TT97363	127.26	TT97663	127.26
7/16-20	H3	3	TT97265	82.72	TT97565	95.16	TT97365	127.26	TT97665	127.26
7/16-20	H5	3	TT97267	82.72	TT97567	95.16	TT97367	127.26	TT97667	127.26
1/2-13	H3	3	TT97269	98.09	TT97569	112.85	TT97369	150.94	TT97669	150.94
1/2-13	H5	3	TT97271	98.09	TT97571	112.85	TT97371	150.94	TT97671	150.94
1/2-20	H3	3	TT97273	98.09	TT97573	112.85	TT97373	150.94	TT97673	150.94
1/2-20	H5	3	TT97275	98.09	TT97575	112.85	TT97375	150.94	TT97675	150.94
5/8-11	H3	4	TT97277	187.40	TT97577	215.53	TT97377	288.33	TT97677	288.33
5/8-11	H6	4	TT97279	187.40	TT97579	215.53	TT97379	288.33	TT97679	288.33
5/8-18	H3	4	TT97281	187.40	TT97581	215.53	TT97381	288.33	TT97681	288.33
5/8-18	H5	4	TT97283	187.40	TT97583	215.53	TT97383	288.33	TT97683	288.33
3/4-10	H3	4	TT97285	219.02	TT97585	251.91	TT97385	337.03	TT97685	337.04
3/4-10	H6	4	TT97287	219.02	TT97587	251.91	TT97387	337.03	TT97687	337.04
3/4-16	H3	4	TT97289	219.02	TT97589	251.91	TT97389	337.03	TT97689	337.04
3/4-16	H5	4	TT97291	219.02	TT97591	251.91	TT97391	337.03	TT97691	337.04

All taps sold individually

Predator Tap sizes 3/8" and smaller have male center.

For coating information see page 8. For technical information, please see page 166.

YOUR #1 SOURCE FOR AMERICAN-MADE PREMIUM QUALITY CUTTING TOOLS

HIGH VANADIUM POWDERED METAL METRIC THREADS



SERIES 716 - UNCOATED



SERIES 718 - ALTiN COATED



SERIES 717 - STEAM OXIDE



SERIES 719 - TiCN COATED

SIZE	D LIMIT	# OF FLUTES	UNCOATED	LIST PRICE	STM OXIDE	LIST PRICE	ALTiN	LIST PRICE	TiCN	LIST PRICE
M2.5 x 0.45	D3	2	TT98508	55.49	TT98601	63.80	TT98715	81.88	TT98845	81.88
M3 x 0.5	D3	3	TT98510	55.50	TT98603	63.80	TT98720	81.88	TT98851	81.88
M3.5 x 0.6	D3	3	TT98521	55.49	TT98617	63.80	TT98731	81.88	TT98869	81.88
M3.5 x 0.6	D4	3	TT98522	55.49	TT98618	63.80	TT98732	81.88	TT98852	81.88
M4 x 0.7	D3	3	TT98523	55.50	TT98619	63.80	TT98733	81.88	TT98871	81.88
M4 x 0.7	D4	3	TT98511	55.50	TT98604	63.80	TT98721	81.88	TT98853	81.88
M5 x 0.8	D3	3	TT98525	55.50	TT98621	63.80	TT98735	81.88	TT98873	81.88
M5 x 0.8	D4	3	TT98512	55.50	TT98605	63.80	TT98722	81.88	TT98855	81.88
M6 x 1.0	D3	3	TT98527	57.15	TT98623	65.74	TT98737	84.90	TT98875	84.90
M6 x 1.0	D5	3	TT98513	57.15	TT98606	65.74	TT98723	84.90	TT98857	84.90
M8 x 1.25	D3	3	TT98529	62.76	TT98625	72.18	TT98739	93.98	TT98877	93.97
M8 x 1.25	D5	3	TT98514	62.76	TT98608	72.18	TT98724	93.98	TT98859	93.97
M10 x 1.5	D3	3	TT98531	74.20	TT98627	85.35	TT98741	110.66	TT98879	110.66
M10 x 1.5	D6	3	TT98515	74.20	TT98610	85.35	TT98725	110.66	TT98861	110.66
M12 x 1.75	D3	3	TT98533	111.36	TT98629	128.04	TT98743	166.78	TT98881	166.77
M12 x 1.75	D6	3	TT98516	111.36	TT98612	128.04	TT98726	166.78	TT98863	166.77
M14 x 2.0	D3	4	TT98535	157.82	TT98631	181.52	TT98745	213.06	TT98883	213.06
M14 x 2.0	D7	4	TT98518	157.82	TT98614	181.52	TT98728	213.06	TT98865	213.06
M16 x 2.0	D3	4	TT98537	184.66	TT98633	212.36	TT98747	249.28	TT98885	249.28
M16 x 2.0	D7	4	TT98520	184.66	TT98616	212.36	TT98730	249.28	TT98867	249.28

- CNC STYLE
- 2 - 2½ THREAD CHAMFER
- 45° HELIX - SEMI BOTTOMING
- SHANK & OAL MANUFACTURED TO ANSI SPECIFICATIONS
- MATERIALS: STEEL, STEEL ALLOYS, STAINLESS STEELS, AND A VARIETY OF OTHER STEELS WITH A MAXIMUM OF RC 32
- BEST USED FOR BLIND HOLE TAPPING

All taps sold individually

Predator Tap sizes 3/8" and smaller have male center.

For coating information see page 8. For technical information, please see page 166.



GENERAL PURPOSE HSS HAND TAP SETS

YOUR #1 SOURCE FOR AMERICAN-MADE PREMIUM QUALITY CUTTING TOOLS



SERIES 728

HIGH SPEED STEEL - HAND TAP SETS

SIZE	H LIMIT	# OF FLUTES	ITEM#	LIST PRICE
0-80	H1	2	TT90003	60.77
1-72	H1	2	TT90019	56.51
2-56	H1	3	TT90031	52.26
* 2-56	H2	3	TT90039	48.65
2-64	H2	3	TT90047	52.26
3-48	H2	3	TT90059	37.42
3-56	H2	3	TT90063	42.04
4-40	H1	3	TT90071	33.00
* 4-40	H2	3	TT90079	30.73
4-48	H2	3	TT90087	33.00
5-40	H2	3	TT90103	30.73
5-44	H2	3	TT90111	33.12
6-32	H1	3	TT90119	29.03
* 6-32	H2	3	TT90127	25.01
6-32	H3	3	TT90135	23.55
6-40	H2	3	TT90151	25.01
8-32	H1	4	TT90163	29.03
8-32	H2	4	TT90175	25.01
* 8-32	H3	4	TT90187	24.12
8-36	H2	4	TT90203	25.01
10-24	H1	4	TT90211	25.74
10-24	H2	4	TT90223	25.74
* 10-24	H3	4	TT90235	25.01
10-32	H1	4	TT90255	25.74
10-32	H2	4	TT90267	25.74
* 10-32	H3	4	TT90279	25.01
12-24	H3	4	TT90291	26.39
12-28	H3	4	TT90299	29.03

SIZE	H LIMIT	# OF FLUTES	ITEM#	LIST PRICE
1/4-20	H1	4	TT90307	33.57
1/4-20	H2	4	TT90314	31.99
* 1/4-20	H3	4	TT90326	26.88
1/4-28	H3	4	TT90354	26.88
5/16-18	H2	4	TT90366	37.22
* 5/16-18	H3	4	TT90378	33.08
5/16-24	H3	4	TT90402	33.08
3/8-16	H2	4	TT90417	41.88
* 3/8-16	H3	4	TT90425	37.34
3/8-24	H3	4	TT90449	37.34
7/16-14	H3	4	TT90468	64.18
7/16-20	H3	4	TT90487	64.18
1/2-13	H3	4	TT90507	66.93
1/2-20	H3	4	TT90526	75.65
9/16-12	H3	4	TT90538	112.30
9/16-18	H3	4	TT90549	112.30
5/8-11	H3	4	TT90564	134.72
5/8-18	H3	4	TT90580	134.72
11/16-11	H3	4	TT90588	167.35
11/16-16	H3	4	TT90592	167.35
3/4-10	H3	4	TT90603	188.51
3/4-16	H3	4	TT90618	188.51
7/8-9	H4	4	TT90629	262.83
7/8-14	H4	4	TT90639	262.83
1-8	H4	4	TT90649	349.46
1-12	H4	4	TT90656	349.46
1-14	H4	4	TT90663	349.46

* Most Popular Size When Multiple Options Are Available

For technical information, please see pages 167-169.

GENERAL PURPOSE HSS HAND TAP SETS



YOUR #1 SOURCE FOR AMERICAN-MADE PREMIUM QUALITY CUTTING TOOLS



SERIES 758

HIGH SPEED STEEL - HAND TAP SETS - METRIC

SIZE	D LIMIT	# OF FLUTES	ITEM#	LIST PRICE
M2 x 0.4	D3	3	TT93100	81.20
M3 x 0.5	D3	3	TT93102	41.64
M4 x 0.7	D4	4	TT93104	34.42
M5 x 0.8	D4	4	TT93106	34.42
M6 x 1.0	D5	4	TT93108	36.32
M7 x 1.0	D5	4	TT93110	36.37
M8 x 1.25	D5	4	TT93112	36.37
M10 x 1.25	D5	4	TT93114	74.64
M10 x 1.50	D6	4	TT93116	74.64
M12 x 1.25	D5	4	TT93118	87.53
M12 x 1.75	D6	4	TT93120	87.53
M14 x 1.5	D6	4	TT93122	130.87
M14 x 2.0	D7	4	TT93124	130.87
M16 x 1.5	D6	4	TT93126	159.45
M16 x 2.0	D7	4	TT93128	159.45
M18 x 1.5	D6	4	TT93130	214.74
M18 x 2.5	D7	4	TT93132	214.74
M20 x 2.5	D7	4	TT93134	277.74
M24 x 3.0	D8	4	TT93136	406.42

For technical information, please see pages 167-169.



GENERAL PURPOSE HSS HAND TAPS

YOUR #1 SOURCE FOR AMERICAN-MADE PREMIUM QUALITY CUTTING TOOLS



SERIES 725
HIGH SPEED STEEL

	SIZE	H LIMIT	# OF FLUTES	TAPER ITEM#	PLUG ITEM#	BOTTOM ITEM#	LIST PRICE
*	0-80	H1	2	TT90000	TT90001	TT90002	20.27
	0-80	H2	2	-	TT90005	TT90006	20.27
	1-64	H1	2	-	TT90009	TT90010	18.85
*	1-72	H1	2	TT90016	TT90017	TT90018	18.85
	1-72	H2	2	-	TT90021	TT90022	18.85
	2-56	H1	3	TT90028	TT90029	TT90030	17.43
	2-56	H2	2	-	TT90033	TT90034	17.43
*	2-56	H2	3	TT90036	TT90037	TT90038	16.22
	2-64	H2	3	TT90044	TT90045	TT90046	17.43
	3-48	H2	2	-	TT90053	-	14.19
*	3-48	H2	3	TT90056	TT90057	TT90058	12.49
	3-56	H2	3	TT90060	TT90061	TT90062	14.03
	4-40	H1	2	-	TT90065	-	11.47
	4-40	H1	3	TT90068	TT90069	TT90070	11.03
	4-40	H2	2	-	TT90073	TT90074	11.03
*	4-40	H2	3	TT90076	TT90077	TT90078	10.26
	4-48	H2	3	TT90084	TT90085	TT90086	11.03
	4-36	H2	3	-	TT90089	-	11.03
	5-40	H1	3	-	TT90093	TT90094	11.03
	5-40	H2	2	-	TT90097	TT90098	11.03
*	5-40	H2	3	TT90100	TT90101	TT90102	10.26
	5-44	H2	3	TT90108	TT90109	TT90110	11.03
	6-32	H1	3	TT90116	TT90117	TT90118	9.69
	6-32	H2	2	-	TT90121	TT90122	9.69
*	6-32	H2	3	TT90124	TT90125	TT90126	8.31
	6-32	H3	2	-	TT90129	TT90130	8.31
	6-32	H3	3	TT90132	TT90133	TT90134	7.86
	6-32	H7	3	-	TT90137	TT90138	9.69
	6-40	H2	2	-	TT90145	-	9.69
*	6-40	H2	3	TT90148	TT90149	TT90150	8.31
	8-32	H1	3	-	TT90157	TT90158	9.69
	8-32	H1	4	TT90160	TT90161	TT90162	9.69
	8-32	H2	2	-	TT90165	TT90166	9.69
	8-32	H2	3	-	TT90169	TT90170	9.69
	8-32	H2	4	TT90172	TT90173	TT90174	8.31
	8-32	H3	2	-	TT90177	TT90178	8.31
	8-32	H3	3	-	TT90181	TT90182	8.31
*	8-32	H3	4	TT90184	TT90185	TT90186	8.03

* Most Popular Size When Multiple Options Are Available

All taps sold individually.
For technical information, please see pages 167-169.

GENERAL PURPOSE HSS HAND TAPS



YOUR #1 SOURCE FOR AMERICAN-MADE PREMIUM QUALITY CUTTING TOOLS

TAPPING



SERIES 725
HIGH SPEED STEEL

SIZE	H LIMIT	# OF FLUTES	TAPER ITEM#	PLUG ITEM#	BOTTOM ITEM#	LIST PRICE
8-32	H7	3	-	TT90189	TT90190	9.69
8-36	H1	4	-	TT90197	-	9.69
* 8-36	H2	4	TT90200	TT90201	TT90202	8.31
10-24	H1	3	-	TT90205	-	9.69
10-24	H1	4	TT90208	TT90209	TT90210	8.59
10-24	H2	2	-	TT90213	TT90214	9.69
10-24	H2	3	-	TT90217	-	9.69
10-24	H2	4	TT90220	TT90221	TT90222	8.59
10-24	H3	2	-	TT90225	TT90226	8.59
10-24	H3	3	-	TT90229	TT90230	8.59
* 10-24	H3	4	TT90232	TT90233	TT90234	8.31
10-24	H7	3	-	TT90237	TT90238	9.69
10-24	H7	4	-	TT90241	TT90242	9.69
10-32	H1	2	-	TT90245	TT90246	9.69
10-32	H1	3	-	TT90249	-	9.69
10-32	H1	4	TT90252	TT90253	TT90254	8.59
10-32	H2	2	-	TT90257	TT90258	9.69
10-32	H2	3	-	TT90261	TT90262	9.69
10-32	H2	4	TT90264	TT90265	TT90266	8.59
10-32	H3	2	-	TT90269	TT90270	8.59
10-32	H3	3	-	TT90273	TT90274	8.59
* 10-32	H3	4	TT90276	TT90277	TT90278	8.31
12-24	H3	4	TT90288	TT90289	TT90290	8.80
12-28	H3	4	TT90296	TT90297	TT90298	9.69
1/4-20	H1	3	-	TT90301	-	11.19
1/4-20	H1	4	TT90304	TT90305	TT90306	11.19
1/4-20	H2	3	-	TT90309	-	11.19
1/4-20	H2	4	TT90311	TT90312	TT90313	10.66
1/4-20	H3	2	-	TT90316	TT90317	11.19
1/4-20	H3	3	-	TT90320	TT90321	10.66
* 1/4-20	H3	4	TT90323	TT90324	TT90325	8.96
1/4-20	H5	3	-	TT90328	TT90329	11.19
1/4-20	H5	4	-	TT90332	TT90333	10.66
1/4-28	H1	4	-	TT90336	TT90337	10.66
1/4-28	H2	4	-	TT90340	TT90341	11.19
1/4-28	H3	2	-	TT90344	TT90345	11.19
1/4-28	H3	3	-	TT90348	TT90349	11.19
* 1/4-28	H3	4	TT90351	TT90352	TT90353	8.96

* Most Popular Size When Multiple Options Are Available

All taps sold individually.
For technical information, please see pages 167-169.

GENERAL PURPOSE TAPS

HAND

SPIRAL POINT

SPECIALTY

TECHNICAL



GENERAL PURPOSE HSS HAND TAPS

YOUR #1 SOURCE FOR AMERICAN-MADE PREMIUM QUALITY CUTTING TOOLS



SERIES 725
HIGH SPEED STEEL

SIZE	H LIMIT	# OF FLUTES	TAPER ITEM#	PLUG ITEM#	BOTTOM ITEM#	LIST PRICE
1/4-28	H4	4	-	TT90356	TT90357	11.19
5/16-18	H1	4	TT90359	TT90360	TT90361	12.41
5/16-18	H2	4	TT90363	TT90364	TT90365	12.41
5/16-18	H3	2	-	TT90368	TT90369	13.95
5/16-18	H3	3	-	TT90372	TT90373	12.41
* 5/16-18	H3	4	TT90375	TT90376	TT90377	11.03
5/16-18	H5	3	-	TT90380	TT90381	13.95
5/16-18	H5	4	-	TT90384	TT90385	12.41
5/16-24	H1	4	-	TT90388	TT90389	12.41
5/16-24	H2	4	-	TT90392	-	12.41
5/16-24	H3	3	-	TT90396	TT90397	12.41
* 5/16-24	H3	4	TT90399	TT90400	TT90401	11.03
5/16-24	H4	4	-	TT90404	TT90405	12.41
3/8-16	H1	3	-	TT90408	-	15.89
3/8-16	H2	4	TT90414	TT90415	TT90416	13.95
3/8-16	H3	3	-	TT90419	TT90420	13.95
* 3/8-16	H3	4	TT90422	TT90423	TT90424	12.45
3/8-16	H5	3	-	TT90427	TT90428	15.89
3/8-16	H5	4	-	TT90431	TT90432	13.95
3/8-24	H3	3	-	TT90443	TT90444	15.89
* 3/8-24	H3	4	TT90446	TT90447	TT90448	12.45
3/8-24	H4	4	-	TT90451	TT90452	13.95
7/16-14	H2	4	-	TT90459	TT90460	23.51
7/16-14	H3	3	-	TT90463	-	23.51
* 7/16-14	H3	4	TT90465	TT90466	TT90467	21.41
7/16-14	H5	4	-	TT90470	TT90471	23.51
7/16-20	H2	4	-	TT90478	TT90479	23.51
7/16-20	H3	3	-	TT90482	-	23.51
* 7/16-20	H3	4	TT90484	TT90485	TT90486	21.41
7/16-20	H5	4	-	TT90489	TT90490	23.51
1/2-13	H1	4	-	TT90493	TT90494	27.45
1/2-13	H2	4	-	TT90497	TT90498	27.45
1/2-13	H3	3	-	TT90501	TT90502	27.45
* 1/2-13	H3	4	TT90504	TT90505	TT90506	22.30
1/2-13	H5	4	-	TT90509	TT90510	27.85
1/2-20	H1	4	TT90512	TT90513	TT90514	27.45
1/2-20	H3	3	-	TT90521	-	27.45
* 1/2-20	H3	4	TT90523	TT90524	TT90525	25.22
1/2-20	H5	4	-	TT90528	TT90529	27.45

* Most Popular Size When Multiple Options Are Available

All taps sold individually.
For technical information, please see pages 167-169.

GENERAL PURPOSE HSS HAND TAPS



YOUR #1 SOURCE FOR AMERICAN-MADE PREMIUM QUALITY CUTTING TOOLS

TAPPING



SERIES 725
HIGH SPEED STEEL

SIZE	H LIMIT	# OF FLUTES	TAPER ITEM#	PLUG ITEM#	BOTTOM ITEM#	LIST PRICE
9/16-12	H2	4	-	TT90532	-	40.78
* 9/16-12	H3	4	TT90535	TT90536	TT90537	37.42
9/16-12	H5	4	-	TT90540	TT90541	40.78
9/16-18	H2	4	-	TT90544	-	40.78
* 9/16-18	H3	4	TT90546	TT90547	TT90548	37.42
9/16-18	H5	4	-	TT90551	TT90552	40.78
* 5/8-11	H3	4	TT90561	TT90562	TT90563	44.92
5/8-11	H5	4	-	TT90566	TT90567	51.65
5/8-18	H2	4	-	TT90574	TT90575	51.65
* 5/8-18	H3	4	TT90577	TT90578	TT90579	44.92
11/16-11	H3	4	TT90585	TT90586	TT90587	55.78
11/16-16	H3	4	TT90589	TT90590	TT90591	55.78
3/4-10	H2	4	-	TT90597	-	67.91
* 3/4-10	H3	4	TT90600	TT90601	TT90602	62.88
3/4-10	H5	4	-	TT90605	TT90606	67.91
3/4-16	H2	4	-	TT90612	-	67.91
* 3/4-16	H3	4	TT90615	TT90616	TT90617	62.88
3/4-16	H5	4	-	TT90620	TT90621	67.91
* 7/8-9	H4	4	TT90626	TT90627	TT90628	87.61
7/8-9	H6	4	-	TT90631	-	91.99
7/8-14	H2	4	-	TT90634	-	91.99
* 7/8-14	H4	4	TT90636	TT90637	TT90638	87.61
7/8-14	H6	4	-	TT90641	-	91.99
1-8	H2	4	-	TT90644	-	119.96
* 1-8	H4	4	TT90646	TT90647	TT90648	116.47
1-8	H6	4	-	TT90651	-	119.96
1-12	H4	4	TT90653	TT90654	TT90655	116.47
1-14	H2	4	-	TT90658	-	119.96
* 1-14	H4	4	TT90660	TT90661	TT90662	116.47
1-14	H6	4	TT90664	TT90665	TT90666	119.96
1-1/8-7	H4	4	TT90668	TT90669	TT90670	188.51
1-1/8-12	H4	4	TT90672	TT90673	TT90674	199.66
1-1/4-7	H4	4	TT90676	TT90677	TT90678	247.46
1-1/4-12	H4	6	TT90680	TT90681	TT90682	251.76
1-3/8-6	H4	4	TT90684	TT90685	TT90686	310.91
1-3/8-12	H4	6	TT90688	TT90689	TT90690	313.10
1-1/2-6	H4	4	TT90692	TT90693	TT90694	359.03
1-1/2-12	H4	6	TT90696	TT90697	TT90698	365.64

* Most Popular Size When Multiple Options Are Available

All taps sold individually.
For technical information, please see pages 167-169.

GENERAL PURPOSE TAPS

HAND

SPIRAL POINT

SPECIALTY

TECHNICAL



GENERAL PURPOSE HSS HAND TAPS

YOUR #1 SOURCE FOR AMERICAN-MADE PREMIUM QUALITY CUTTING TOOLS



SERIES 726
HIGH SPEED STEEL
STEAM OXIDE

SIZE	H LIMIT	# OF FLUTES	TAPER ITEM#	PLUG ITEM#	BOTTOM ITEM#	LIST PRICE
0-80	H1	2	TT90000S	TT90001S	TT90002S	23.31
2-56	H2	3	TT90036S	TT90037S	TT90038S	18.69
3-48	H2	3	TT90056S	TT90057S	TT90058S	14.39
4-40	H2	3	TT90076S	TT90077S	TT90078S	11.80
4-48	H2	3	TT90084S	TT90085S	TT90086S	12.69
5-40	H2	3	TT90100S	TT90101S	TT90102S	11.80
6-32	H2	3	TT90124S	TT90125S	TT90126S	9.61
6-40	H2	3	TT90148S	TT90149S	TT90150S	9.61
8-32	H3	4	TT90184S	TT90185S	TT90186S	9.28
8-36	H2	4	TT90200S	TT90201S	TT90202S	9.61
10-24	H3	4	TT90232S	TT90233S	TT90234S	9.61
10-32	H3	4	TT90276S	TT90277S	TT90278S	9.61
12-24	H3	4	TT90288S	TT90289S	TT90290S	10.14
12-28	H3	4	TT90296S	TT90297S	TT90298S	11.15
1/4-20	H3	4	TT90323S	TT90324S	TT90325S	10.30
1/4-28	H3	4	TT90351S	TT90352S	TT90353S	10.30
5/16-18	H3	4	TT90375S	TT90376S	TT90377S	12.69
5/16-24	H3	4	TT90399S	TT90400S	TT90401S	12.69
3/8-16	H3	4	TT90422S	TT90423S	TT90424S	14.31
3/8-24	H3	4	TT90446S	TT90447S	TT90448S	14.31
7/16-14	H3	4	TT90465S	TT90466S	TT90467S	24.65
7/16-20	H3	4	TT90484S	TT90485S	TT90486S	24.65
1/2-13	H3	4	TT90504S	TT90505S	TT90506S	25.66
1/2-20	H3	4	TT90523S	TT90524S	TT90525S	29.03
9/16-12	H3	4	TT90535S	TT90536S	TT90537S	43.01
9/16-18	H3	4	TT90546S	TT90547S	TT90548S	43.01
5/8-11	H3	4	TT90561S	TT90562S	TT90563S	51.65
5/8-18	H3	4	TT90577S	TT90578S	TT90579S	51.65
3/4-10	H3	4	TT90600S	TT90601S	TT90602S	72.28
3/4-16	H3	4	TT90615S	TT90616S	TT90617S	72.28
7/8-9	H4	4	TT90626S	TT90627S	TT90628S	100.78
7/8-14	H4	4	TT90636S	TT90637S	TT90638S	100.78
1-8	H4	4	TT90646S	TT90647S	TT90648S	133.87
1-12	H4	4	TT90653S	TT90654S	TT90655S	133.87
1-14	H4	4	TT90660S	TT90661S	TT90662S	133.87
1-1/8-7	H4	4	TT90668S	TT90669S	TT90670S	216.77
1-1/8-12	H4	4	TT90672S	TT90673S	TT90674S	229.62
1-1/4-7	H4	4	TT90676S	TT90677S	TT90678S	284.55
1-1/4-12	H4	6	TT90680S	TT90681S	TT90682S	289.50
1-3/8-6	H4	4	TT90684S	TT90685S	TT90686S	357.53
1-3/8-12	H4	6	TT90688S	TT90689S	TT90690S	360.04
1-1/2-6	H4	4	TT90692S	TT90693S	TT90694S	412.87
1-1/2-12	H4	6	TT90696S	TT90697S	TT90698S	420.49

STEAM OXIDE: A BLACK OXIDE TREATMENT OF NON-MEASURABLE THICKNESS IS USED TO INCREASE TAP SURFACE CAPILLARY WHERE LUBRICANT PROPERTIES ARE REQUIRED.

MATERIALS: STEEL, STEEL ALLOYS, STAINLESS STEELS, TITANIUM ALLOYS AND A WIDE RANGE OF FERROUS MATERIALS (IRON BASED).

All taps sold individually.

For technical information, please see pages 167-169.

GENERAL PURPOSE HSS HAND TAPS



YOUR #1 SOURCE FOR AMERICAN-MADE PREMIUM QUALITY CUTTING TOOLS



SERIES 727 HIGH SPEED STEEL NITRIDE & STEAM OXIDE

SIZE	H LIMIT	# OF FLUTES	PLUG ITEM#	BOTTOM ITEM#	LIST PRICE
4-40	H2	3	TT90077NS	TT90078NS	11.80
6-32	H2	3	TT90125NS	TT90126NS	9.61
6-40	H2	3	TT90149NS	TT90150NS	9.61
8-32	H3	4	TT90185NS	TT90186NS	9.28
10-24	H3	4	TT90233NS	TT90234NS	9.61
10-32	H3	4	TT90277NS	TT90278NS	9.61
1/4-20	H3	4	TT90324NS	TT90325NS	10.30
1/4-28	H3	4	TT90352NS	TT90353NS	10.30
5/16-18	H3	4	TT90376NS	TT90377NS	12.69
3/8-16	H3	4	TT90423NS	TT90424NS	14.31
3/8-24	H3	4	TT90447NS	TT90448NS	14.31
7/16-14	H3	4	TT90466NS	TT90467NS	24.65
7/16-20	H3	4	TT90485NS	TT90486NS	24.65
1/2-13	H3	4	TT90505NS	TT90506NS	25.66
1/2-20	H3	4	TT90524NS	TT90525NS	29.03
9/16-12	H3	4	TT90536NS	TT90537NS	43.01
9/16-18	H3	4	TT90547NS	TT90548NS	43.01
5/8-11	H3	4	TT90562NS	TT90563NS	51.65
5/8-18	H3	4	TT90578NS	TT90579NS	51.65
3/4-10	H3	4	TT90601NS	TT90602NS	72.28
3/4-16	H3	4	TT90616NS	TT90617NS	72.28
7/8-9	H4	4	TT90627NS	TT90628NS	100.78
7/8-14	H4	4	TT90637NS	TT90638NS	100.78
1-8	H4	4	TT90647NS	TT90648NS	133.87
1-1/8-7	H4	4	TT90669NS	TT90670NS	216.77
1-1/4-7	H4	4	TT90677NS	TT90678NS	284.55
1-1/4-12	H4	6	TT90681NS	TT90682NS	289.50
1-1/2-6	H4	4	TT90693NS	TT90694NS	412.87
1-1/2-12	H4	6	TT90697NS	TT90698NS	420.49

NITRIDE & STEAM OXIDE: A NITRIDED SURFACE FOLLOWED BY A STEAM OXIDE TREATMENT PROVIDES THE BENEFITS OF WEAR AND DUCTILITY.

MATERIALS: ALL TYPES OF GRAY, DUCTILE AND MALLEABLE CAST IRON FERROUS MATERIALS (IRON BASED).

All taps sold individually.
For technical information, please see pages 167-169.



GENERAL PURPOSE HSS HAND TAPS

YOUR #1 SOURCE FOR AMERICAN-MADE PREMIUM QUALITY CUTTING TOOLS



SERIES 755
HIGH SPEED STEEL - METRIC
UNCOATED

SIZE	D LIMIT	# OF FLUTES	TAPER ITEM#	PLUG ITEM#	BOTTOM ITEM#	LIST PRICE
M1.6 x 0.35	D3	2	-	TT93002	-	27.08
M2 x 0.4	D3	3	TT93007	TT93008	TT93009	27.08
M2.5 x 0.45	D3	3	-	TT93014	-	16.66
M3 x 0.5	D3	3	TT93016	TT93017	TT93018	13.86
M3.5 x 0.6	D4	3	-	TT93020	-	11.47
M4 x 0.7	D4	4	TT93022	TT93023	TT93024	11.47
M4.5 x 0.75	D4	4	-	TT93026	-	11.47
M5 x 0.8	D4	4	TT93028	TT93029	TT93030	11.47
M6 x 1.0	D5	4	TT93031	TT93032	TT93033	12.12
M7 x 1.0	D5	4	TT93037	TT93038	TT93039	12.12
M8 x 1.25	D5	4	TT93043	TT93044	TT93045	12.12
M10 x 1.25	D5	4	TT93046	TT93047	TT93048	24.89
M10 x 1.50	D6	4	TT93049	TT93050	TT93051	24.89
M12 x 1.25	D5	4	TT93052	TT93053	TT93054	29.19
M12 x 1.75	D6	4	TT93055	TT93056	TT93057	29.19
M14 x 1.5	D6	4	TT93058	TT93059	TT93060	43.62
M14 x 2.0	D7	4	TT93061	TT93062	TT93063	43.62
M16 x 1.5	D6	4	TT93064	TT93065	TT93066	53.15
M16 x 2.0	D7	4	TT93067	TT93068	TT93069	53.15
M18 x 1.5	D6	4	TT93070	TT93071	TT93072	71.60
M18 x 2.5	D7	4	TT93073	TT93074	TT93075	71.60
M20 x 2.5	D7	4	TT93076	TT93077	TT93078	92.59
M24 x 3.0	D8	4	TT93082	TT93083	TT93084	135.49
M27 x 3.0	D8	4	TT93085	TT93086	TT93087	234.16
M30 x 3.5	D9	4	TT93088	TT93089	TT93090	299.07
M33 x 3.5	D9	4	TT93091	TT93092	TT93093	298.26
M36 x 4.0	D9	4	TT93094	TT93095	TT93096	378.24

All taps sold individually.

For technical information, please see pages 167-169.

GENERAL PURPOSE HSS HAND TAPS



YOUR #1 SOURCE FOR AMERICAN-MADE PREMIUM QUALITY CUTTING TOOLS

TAPPING

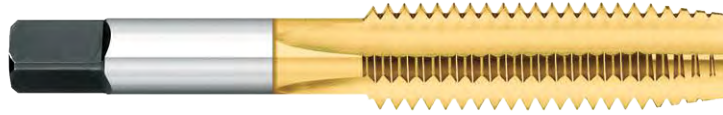

SERIES 757
HIGH SPEED STEEL - METRIC
TIN COATED

SIZE	D LIMIT	# OF FLUTES	TAPER ITEM#	PLUG ITEM#	BOTTOM ITEM#	LIST PRICE
M1.6 x 0.35	D3	2	-	TT75700	-	48.77
M2 x 0.4	D3	3	TT75702	TT75704	TT75706	48.77
M2.5 x 0.45	D3	3	-	TT75708	-	30.00
M3 x 0.5	D3	3	TT75710	TT75712	TT75714	25.01
M3.5 x 0.6	D4	3	-	TT75716	-	20.67
M4 x 0.7	D4	4	TT75718	TT75720	TT75722	20.67
M4.5 x 0.75	D4	4	-	TT75724	-	20.67
M5 x 0.8	D4	4	TT75726	TT75728	TT75730	20.67
M6 x 1.0	D5	4	TT75732	TT75734	TT75736	21.83
M7 x 1.0	D5	4	TT75738	TT75740	TT75742	21.87
M8 x 1.25	D5	4	TT75744	TT75746	TT75748	21.87
M10 x 1.25	D5	4	TT75750	TT75752	TT75754	44.82
M10 x 1.50	D6	4	TT75756	TT75758	TT75760	44.82
M12 x 1.25	D5	4	TT75762	TT75764	TT75766	52.56
M12 x 1.75	D6	4	TT75768	TT75770	TT75772	52.56
M14 x 1.5	D6	4	TT75774	TT75776	TT75778	78.60
M14 x 2.0	D7	4	TT75780	TT75782	TT75784	78.60
M16 x 1.5	D6	4	TT75786	TT75788	TT75790	95.79
M16 x 2.0	D7	4	TT75792	TT75794	TT75796	95.79
M18 x 1.5	D6	4	TT75798	TT75800	TT75802	128.96
M18 x 2.5	D7	4	TT75804	TT75806	TT75808	128.96
M20 x 2.5	D7	4	TT75810	TT75812	TT75814	166.82
M24 x 3.0	D8	4	TT75816	TT75818	TT75820	244.13
M27 x 3.0	D8	4	TT75822	TT75824	TT75826	421.95
M30 x 3.5	D9	4	TT75828	TT75830	TT75832	538.88
M33 x 3.5	D9	4	TT75834	TT75836	TT75838	537.46
M36 x 4.0	D9	4	TT75840	TT75842	TT75844	681.64

All taps sold individually.

For coating information see page 8. For technical information, please see pages 167-169.

GENERAL PURPOSE TAPS

HAND

SPIRAL POINT

SPECIALTY

TECHNICAL



GENERAL PURPOSE HSS HAND TAPS

YOUR #1 SOURCE FOR AMERICAN-MADE PREMIUM QUALITY CUTTING TOOLS

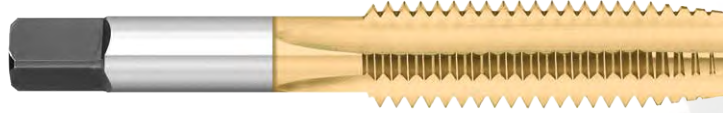

SERIES 729
HIGH SPEED STEEL
TIN COATED

SIZE	D LIMIT	# OF FLUTES	TAPER ITEM#	PLUG ITEM#	BOTTOM ITEM#	LIST PRICE
0 - 80	H1	2	TT75200	TT75201	TT75202	36.48
2 - 56	H2	3	TT75223	TT75224	TT75225	29.22
4 - 40	H2	3	TT75249	TT75250	TT75251	18.44
5 - 40	H2	3	TT75266	TT75267	TT75268	18.44
6 - 32	H3	3	TT75288	TT75289	TT75290	14.14
8 - 32	H3	4	TT75319	TT75320	TT75321	14.48
10 - 24	H3	4	TT75348	TT75349	TT75350	15.00
10 - 32	H3	4	TT75375	TT75376	TT75377	15.00
12 - 24	H3	4	TT75383	TT75384	TT75385	15.86
12 - 28	H3	4	TT75388	TT75389	TT75390	17.45
1/4 - 20	H3	4	TT75406	TT75407	TT75408	16.11
1/4 - 28	H3	4	TT75422	TT75423	TT75424	16.11
5/16 - 18	H3	4	TT75439	TT75440	TT75441	19.90
5/16 - 24	H3	4	TT75454	TT75455	TT75456	19.90
3/8 - 16	H3	4	TT75469	TT75470	TT75471	22.43
3/8 - 24	H3	4	TT75484	TT75485	TT75486	22.43
7/16 - 14	H3	4	TT75495	TT75496	TT75497	38.55
7/16 - 20	H3	4	TT75506	TT75507	TT75508	38.55
1/2 - 13	H3	4	TT75518	TT75519	TT75520	40.18
1/2 - 20	H3	4	TT75530	TT75531	TT75532	45.42
9/16 - 18	H3	4	TT75544	TT75545	TT75546	61.71
5/8 - 11	H3	4	TT75552	TT75553	TT75554	80.96
5/8 - 18	H3	4	TT75561	TT75562	TT75563	80.96
3/4 - 10	H3	4	TT75577	TT75578	TT75579	113.28
3/4 - 16	H3	4	TT75585	TT75586	TT75587	113.28
1 - 8	H4	4	TT75604	TT75605	TT75606	192.22

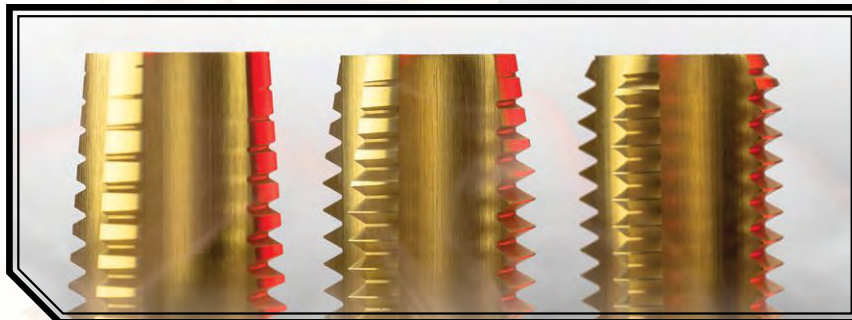

3 chamfers to choose from - Taper, Plug, & Bottom

All taps sold individually.

For coating information see page 8. For technical information, please see pages 167-169.

GENERAL PURPOSE HSS SPIRAL POINT PLUG TAPS



YOUR #1 SOURCE FOR AMERICAN-MADE PREMIUM QUALITY CUTTING TOOLS



SERIES 750 HIGH SPEED STEEL - METRIC UNCOATED

SIZE	H LIMIT	# OF FLUTES	ITEM#	LIST PRICE
0-80	H1	2	TT91000	24.97
* 0-80	H2	2	TT91001	24.97
1-64	H1	2	TT91002	22.54
* 1-64	H2	2	TT91003	22.54
1-72	H1	2	TT91004	22.54
* 1-72	H2	2	TT91005	22.54
2-56	H1	2	TT91006	21.45
* 2-56	H2	2	TT91007	19.14
2-64	H1	2	TT91008	21.45
* 2-64	H2	2	TT91009	21.45
3-48	H1	2	TT91010	15.36
* 3-48	H2	2	TT91011	15.36
3-56	H1	2	TT91012	18.81
* 3-56	H2	2	TT91013	17.11
4-40	H1	2	TT91014	14.03
* 4-40	H2	2	TT91015	12.32
4-48	H1	2	TT91016	14.27
* 4-48	H2	2	TT91017	14.03
4-36	H2	2	TT91018	14.03
5-40	H1	2	TT91019	14.03
* 5-40	H2	2	TT91020	12.32
5-44	H2	2	TT91021	14.03
6-32	H1	2	TT91022	12.32
6-32	H2	2	TT91023	10.38
* 6-32	H3	2	TT91024	10.38
6-32	H7	2	TT91025	11.76
6-40	H1	2	TT91026	11.76
* 6-40	H2	2	TT91027	11.76
8-32	H1	2	TT91028	11.76
8-32	H2	2	TT91029	10.38
* 8-32	H3	2	TT91030	10.38
8-32	H7	2	TT91031	11.76
8-36	H1	2	TT91032	11.76

SIZE	H LIMIT	# OF FLUTES	ITEM#	LIST PRICE
* 8-36	H2	2	TT91033	11.76
10-24	H1	2	TT91034	12.85
10-24	H2	2	TT91035	11.76
* 10-24	H3	2	TT91036	10.38
10-24	H7	2	TT91037	12.85
10-32	H1	2	TT91038	11.76
10-32	H2	2	TT91039	10.38
* 10-32	H3	2	TT91040	10.38
10-32	H7	2	TT91041	12.85
12-24	H1	2	TT91042	11.76
* 12-24	H3	2	TT91043	11.76
12-28	H3	2	TT91044	11.76
1/4-20	H1	2	TT91045	11.76
1/4-20	H2	2	TT91046	11.76
* 1/4-20	H3	2	TT91047	10.38
1/4-20	H3	3	TT91048	12.85
1/4-20	H5	2	TT91049	11.72
1/4-28	H5	3	TT91050	12.85
1/4-28	H1	2	TT91051	12.85
1/4-28	H2	2	TT91052	11.72
1/4-28	H2	3	TT91053	12.85
1/4-28	H3	2	TT91054	10.38
* 1/4-28	H4	2	TT91055	12.85
1/4-28	H4	3	TT91056	12.85
5/16-18	H1	2	TT91057	14.80
5/16-18	H2	2	TT91058	12.85
* 5/16-18	H3	2	TT91059	11.19
5/16-18	H3	3	TT91060	14.80
5/16-18	H5	2	TT91061	12.85
5/16-18	H5	3	TT91062	14.80
5/16-24	H1	2	TT91063	14.80
5/16-24	H2	2	TT91064	14.80
5/16-24	H2	3	TT91065	14.80

SIZE	H LIMIT	# OF FLUTES	ITEM#	LIST PRICE
* 5/16-24	H3	2	TT91066	13.06
5/16-24	H4	2	TT91067	14.80
5/16-24	H4	3	TT91068	14.80
3/8-16	H1	3	TT91069	16.58
3/8-16	H2	3	TT91070	15.41
* 3/8-16	H3	3	TT91071	13.26
3/8-16	H5	3	TT91072	16.70
3/8-24	H1	3	TT91073	16.82
3/8-24	H2	3	TT91074	16.82
* 3/8-24	H3	3	TT91075	14.27
3/8-24	H4	3	TT91076	16.82
7/16-14	H2	3	TT91077	24.61
* 7/16-14	H3	3	TT91078	22.54
7/16-14	H5	3	TT91079	24.61
7/16-20	H2	3	TT91080	24.61
* 7/16-20	H3	3	TT91081	22.54
7/16-20	H5	3	TT91082	24.61
1/2-13	H1	3	TT91083	30.12
1/2-13	H2	3	TT91084	30.12
* 1/2-13	H3	3	TT91085	22.99
1/2-13	H5	3	TT91086	27.12
1/2-20	H1	3	TT91087	30.12
1/2-20	H2	3	TT91088	30.12
* 1/2-20	H3	3	TT91089	27.00
1/2-20	H5	3	TT91090	30.12
9/16-12	H3	3	TT91091	37.54
9/16-18	H3	3	TT91092	37.54
* 5/8-11	H3	3	TT91093	51.24
5/8-11	H5	3	TT91094	51.24
5/8-18	H3	3	TT91095	51.24
* 3/4-10	H3	3	TT91096	72.28
3/4-10	H5	3	TT91097	72.28
3/4-16	H3	3	TT91098	72.28

* Most Popular Size When Multiple Options Are Available

All taps sold individually.
For technical information, please see pages 167-169.



GENERAL PURPOSE HSS SPIRAL POINT PLUG TAPS

YOUR #1 SOURCE FOR AMERICAN-MADE PREMIUM QUALITY CUTTING TOOLS



SERIES 751
HIGH SPEED STEEL
STEAM OXIDE

SIZE	H LIMIT	# OF FLUTES	ITEM#	LIST PRICE
0-80	H2	2	TT91001S	28.74
1-64	H2	2	TT91003S	25.99
1-72	H2	2	TT91005S	25.99
2-56	H2	2	TT91007S	22.05
2-64	H2	2	TT91009S	24.69
3-48	H2	2	TT91011S	17.68
3-56	H2	2	TT91013S	19.70
4-40	H2	2	TT91015S	14.19
4-48	H2	2	TT91017S	16.18
4-36	H2	2	TT91018S	16.18
5-40	H2	2	TT91020S	14.19
5-44	H2	2	TT91021S	16.18
6-32	H3	2	TT91024S	11.92
6-40	H2	2	TT91027S	13.54
8-32	H3	2	TT91030S	11.92
8-36	H2	2	TT91033S	13.54
10-24	H3	2	TT91036S	11.92
10-32	H3	2	TT91040S	11.92
12-24	H3	2	TT91043S	13.54
1/4-20	H3	2	TT91047S	11.92
1/4-28	H3	2	TT91054S	11.92
5/16-18	H3	2	TT91059S	12.89
5/16-24	H3	2	TT91066S	13.74
3/8-16	H3	3	TT91071S	15.28
3/8-24	H3	3	TT91075S	16.42
7/16-14	H3	3	TT91078S	25.99
7/16-20	H3	3	TT91081S	25.99
1/2-13	H3	3	TT91085S	26.47
1/2-20	H3	3	TT91089S	31.05
9/16-12	H3	3	TT91091S	43.18
9/16-18	H3	3	TT91092S	43.18
5/8-11	H3	3	TT91093S	58.95
5/8-18	H3	3	TT91095S	58.95
3/4-10	H3	3	TT91096S	83.15
3/4-16	H3	3	TT91098S	83.15

STEAM OXIDE: A BLACK OXIDE TREATMENT OF NON-MEASURABLE THICKNESS IS USED TO INCREASE TAP SURFACE CAPILLARY WHERE LUBRICANT PROPERTIES ARE REQUIRED.

MATERIALS: STEEL, STEEL ALLOYS, STAINLESS STEELS, TITANIUM ALLOYS AND A WIDE RANGE OF FERROUS MATERIALS (IRON BASED).



SERIES 752
HIGH SPEED STEEL
NITRIDE & STEAM OXIDE

SIZE	H LIMIT	# OF FLUTES	ITEM#	LIST PRICE
4-40	H2	2	TT91015NS	14.19
4-48	H2	2	TT91017NS	16.18
4-36	H2	2	TT91018NS	16.18
5-40	H2	2	TT91020NS	14.19
5-44	H2	2	TT91021NS	16.18
6-32	H3	2	TT91024NS	11.92
6-40	H2	2	TT91027NS	13.54
8-32	H3	2	TT91030NS	11.92
8-36	H2	2	TT91033NS	13.54
10-24	H3	2	TT91036NS	11.92
10-32	H3	2	TT91040NS	11.92
12-24	H3	2	TT91043NS	13.54
1/4-20	H3	2	TT91047NS	11.92
1/4-28	H3	2	TT91054NS	11.92
5/16-18	H3	2	TT91059NS	12.89
5/16-24	H3	2	TT91066NS	12.89
3/8-16	H3	3	TT91071NS	15.28
3/8-24	H3	3	TT91075NS	16.42
7/16-14	H3	3	TT91078NS	25.99
7/16-20	H3	3	TT91081NS	25.99
1/2-13	H3	3	TT91085NS	26.47
1/2-20	H3	3	TT91089NS	31.05
9/16-12	H3	3	TT91091NS	43.18
9/16-18	H3	3	TT91092NS	43.18
5/8-11	H3	3	TT91093NS	58.95
5/8-18	H3	3	TT91095NS	58.95
3/4-10	H3	3	TT91096NS	83.15
3/4-16	H3	3	TT91098NS	83.15

NITRIDE & STEAM OXIDE: A NITRIDED SURFACE FOLLOWED BY A STEAM OXIDE TREATMENT PROVIDES THE BENEFITS OF WEAR AND DUCTILITY.

MATERIALS: ALL TYPES OF GRAY, DUCTILE AND MALLEABLE CAST IRON FERROUS MATERIALS (IRON BASED).

All taps sold individually.

For technical information, please see pages 167-169.

GENERAL PURPOSE HSS SPIRAL POINT PLUG TAPS



YOUR #1 SOURCE FOR AMERICAN-MADE PREMIUM QUALITY CUTTING TOOLS



SERIES 760
HIGH SPEED STEEL
TIN COATED

SIZE	H LIMIT	# OF FLUTES	ITEM#	LIST PRICE
0-80	H2	2	TT99401	36.96
2-56	H2	2	TT99407	29.65
4-40	H2	2	TT99415	20.97
5-40	H2	2	TT99420	20.97
6-32	H3	2	TT99424	19.60
8-32	H3	2	TT99430	19.60
10-24	H3	2	TT99436	19.60
10-32	H3	2	TT99440	19.60
12-24	H3	2	TT99443	21.40
12-28	H3	2	TT99444	21.40
1/4-20	H3	2	TT99447	19.60
1/4-28	H3	2	TT99454	19.60
5/16-18	H3	2	TT99459	22.64
5/16-24	H3	2	TT99466	22.64
3/8-16	H3	3	TT99471	25.18
3/8-24	H3	3	TT99475	26.47
7/16-14	H3	3	TT99478	41.64
7/16-20	H3	3	TT99481	41.64
1/2-13	H3	3	TT99485	42.20
1/2-20	H3	3	TT99489	47.14
5/8-11	H3	3	TT99493	97.55
5/8-18	H3	3	TT99495	97.55
3/4-10	H3	3	TT99496	127.37
3/4-16	H3	3	TT99498	127.37

TiN COATED: AN EXCELLENT GENERAL PURPOSE WEAR COATING WITH GOOD LUBRICITY.



SERIES 762
HIGH SPEED STEEL
ALTiN COATED

SIZE	H LIMIT	# OF FLUTES	ITEM#	LIST PRICE
0-80	H2	2	TT98001	36.96
2-56	H2	2	TT98002	29.65
4-40	H2	2	TT98003	20.97
5-40	H2	2	TT98004	20.97
6-32	H3	2	TT98005	19.60
8-32	H3	2	TT98006	19.60
10-24	H3	2	TT98007	19.60
10-32	H3	2	TT98008	19.60
12-24	H3	2	TT98009	21.40
12-28	H3	2	TT98010	21.40
1/4-20	H3	2	TT98011	19.60
1/4-28	H3	2	TT98012	19.60
5/16-18	H3	2	TT98013	22.64
5/16-24	H3	2	TT98014	22.64
3/8-16	H3	3	TT98015	25.18
3/8-24	H3	3	TT98016	26.47
7/16-14	H3	3	TT98017	41.64
7/16-20	H3	3	TT98018	41.64
1/2-13	H3	3	TT98019	42.20
1/2-20	H3	3	TT98020	47.14
5/8-11	H3	3	TT98021	97.55
5/8-18	H3	3	TT98022	97.55
3/4-10	H3	3	TT98023	127.37
3/4-16	H3	3	TT98024	127.37

ALTiN COATED: A MULTI-LAYERED COATING FOR A WIDE RANGE OF HIGH SPEED STEEL APPLICATIONS FOR CAST IRON, STAINLESS STEEL, NICKEL BASED HIGH TEMPERATURE ALLOYS AND TITANIUM ALLOYS.



Massive inventory stocked with 100% ship rates

All taps sold individually.

For coating information see page 8. For technical information, please see pages 167-169.



GENERAL PURPOSE HSS SPIRAL POINT PLUG & BOTTOMING TAPS

YOUR #1 SOURCE FOR AMERICAN-MADE PREMIUM QUALITY CUTTING TOOLS

SPIRAL POINT PLUG



SERIES 780
HIGH SPEED STEEL - METRIC
UNCOATED

SIZE	D LIMIT	# OF FLUTES	ITEM#	LIST PRICE
M2 x 0.4	D3	2	TT93208	27.65
M2.5 x 0.45	D3	2	TT93214	19.82
M3 x 0.5	D3	2	TT93217	15.93
M3.5 x 0.6	D4	2	TT93220	13.74
M4 x 0.7	D4	2	TT93223	13.74
M4.5 x 0.75	D4	2	TT93226	13.74
M5 x 0.8	D4	2	TT93229	13.74
M6 x 1.0	D5	2	TT93232	13.74
M7 x 1.0	D5	2	TT93238	15.89
M8 x 1.25	D5	2	TT93244	15.89
M10 x 1.50	D6	3	TT93250	26.39
M12 x 1.75	D6	3	TT93256	33.04
M14 x 2.0	D7	3	TT93262	51.28
M16 x 2.0	D7	3	TT93268	58.09
M18 x 2.5	D7	3	TT93274	85.46
M20 x 2.5	D7	3	TT93277	112.78



SERIES 882
HIGH SPEED STEEL - METRIC
TIN COATED

SIZE	D LIMIT	# OF FLUTES	ITEM#	LIST PRICE
M2 x 0.4	D3	2	TT93208TIN	38.12
M2.5 x 0.45	D3	2	TT93214TIN	27.33
M3 x 0.5	D3	2	TT93217TIN	22.00
M3.5 x 0.6	D4	2	TT93220TIN	18.95
M4 x 0.7	D4	2	TT93223TIN	18.95
M4.5 x 0.75	D4	2	TT93226TIN	18.95
M5 x 0.8	D4	2	TT93229TIN	18.95
M6 x 1.0	D5	2	TT93232TIN	18.95
M7 x 1.0	D5	2	TT93238TIN	21.87
M8 x 1.25	D5	2	TT93244TIN	21.87
M10 x 1.50	D6	3	TT93250TIN	36.36
M12 x 1.75	D6	3	TT93256TIN	45.55
M14 x 2.0	D7	3	TT93262TIN	70.65
M16 x 2.0	D7	3	TT93268TIN	80.06
M18 x 2.5	D7	3	TT93274TIN	117.75
M20 x 2.5	D7	3	TT93277TIN	155.43

SPIRAL POINT BOTTOMING



SERIES 754
HIGH SPEED STEEL
UNCOATED

SIZE	H LIMIT	# OF FLUTES	ITEM#	LIST PRICE
0-80	H2	2	TT91201	45.98
2-56	H2	2	TT91207	35.24
3-48	H2	2	TT91211	28.28
4-40	H2	2	TT91215	22.69
5-40	H2	2	TT91220	22.69
6-32	H2	2	TT91223	19.08
6-32	H3	2	TT91224	19.08
6-40	H2	2	TT91227	21.70
8-32	H2	2	TT91229	19.08
8-32	H3	2	TT91230	19.08
10-24	H2	2	TT91235	21.70
10-24	H3	2	TT91236	19.08
10-32	H2	2	TT91239	19.08
10-32	H3	2	TT91240	19.08
12-24	H3	2	TT91243	21.70
1/4-20	H3	2	TT91247	19.08
1/4-28	H3	2	TT91254	19.08
5/16-18	H3	2	TT91259	20.58
5/16-24	H3	2	TT91266	20.58



SERIES 756
HIGH SPEED STEEL
TIN COATED

SIZE	H LIMIT	# OF FLUTES	ITEM#	LIST PRICE
0-80	H2	2	TT92202	62.07
2-56	H2	2	TT92209	47.57
3-48	H2	2	TT92212	38.17
4-40	H2	2	TT92216	30.63
5-40	H2	2	TT92221	30.63
6-32	H2	2	TT92224	25.76
6-32	H3	2	TT92225	25.76
6-40	H2	2	TT92228	29.30
8-32	H2	2	TT92230	25.76
8-32	H3	2	TT92231	25.76
10-24	H2	2	TT92236	29.30
10-24	H3	2	TT92237	25.76
10-32	H2	2	TT92240	25.76
10-32	H3	2	TT92241	25.76
12-24	H3	2	TT92244	29.30
1/4-20	H3	2	TT92248	25.76
1/4-28	H3	2	TT92255	25.76
5/16-18	H3	2	TT92260	27.79
5/16-24	H3	2	TT92267	27.79

SPIRAL POINT BOTTOMING TAPS ARE RECOMMENDED FOR USE WHERE CLOSE GAGING IS REQUIRED.

All taps sold individually.

For coating information see page 8. For technical information, please see pages 167-169.

GENERAL PURPOSE HSS STI TAPS • OVERSIZE TAPS



YOUR #1 SOURCE FOR AMERICAN-MADE PREMIUM QUALITY CUTTING TOOLS

STI - SPIRAL POINT PLUG



SERIES 770
HIGH SPEED STEEL

SIZE	H LIMIT	# OF FLUTES	ITEM#	LIST PRICE
4-40	H1	2	TT92315	30.08
5-40	H1	2	TT92320	30.08
6-32	H2	2	TT92324	30.30
6-40	H2	2	TT92327	30.30
8-32	H2	2	TT92330	30.60
10-24	H2	2	TT92336	31.16
10-32	H2	2	TT92340	31.71
12-24	H2	2	TT92343	31.71
1/4-20	H2	2	TT92347	31.71
1/4-28	H2	2	TT92354	32.23
5/16-18	H3	3	TT92360	40.74
5/16-24	H2	3	TT92368	41.25
3/8-16	H3	3	TT92371	50.15
3/8-24	H2	3	TT92375	50.75
7/16-14	H3	3	TT92378	55.01
7/16-20	H3	3	TT92381	55.01
1/2-13	H3	3	TT92385	61.24
1/2-20	H3	3	TT92389	61.24

STI - HAND PLUG & BOTTOMING



SERIES 783
HIGH SPEED STEEL

SIZE	H LIMIT	# OF FLUTES	PLUG ITEM#	BOTTOM ITEM#	LIST PRICE
4-40	H1	3	TT78302	TT78303	26.82
5-40	H1	3	TT78304	TT78305	26.82
6-32	H2	3	TT78306	TT78307	27.29
6-40	H1	3	TT78308	TT78309	27.29
8-32	H2	3	TT78310	TT78311	27.93
10-24	H2	3	TT78312	TT78313	27.93
10-32	H2	3	TT78314	TT78315	29.05
12-24	H2	3	TT78316	TT78317	29.05
1/4-20	H2	3	TT78318	TT78319	29.18
1/4-28	H2	3	TT78320	TT78321	29.18
5/16-18	H3	4	TT78322	TT78323	31.50
5/16-24	H2	4	TT78324	TT78325	31.50
3/8-16	H3	4	TT78326	TT78327	34.21
3/8-24	H2	4	TT78328	TT78329	34.21
7/16-14	H3	4	TT78330	TT78331	47.06
7/16-20	H3	4	TT78332	TT78333	47.06
1/2-13	H3	4	TT78334	TT78335	52.81
1/2-20	H3	4	TT78336	TT78337	52.81

STI TAPS ARE OVERSIZE SO THAT THEY WILL PRODUCE THREADS THAT WILL ACCEPT HELICAL COIL WIRE SCREW THREAD INSERTS THAT HAVE THE SAME SIZE AND PITCH. MATERIALS: ALUMINUM AND NON-FERROUS MATERIALS

+.005 OVERSIZE SPIRAL POINT PLUG



SERIES 764
HIGH SPEED STEEL

SIZE	H LIMIT	# OF FLUTES	ITEM#	LIST PRICE
6-32	H11	2	TT91732	15.56
8-32	H11	2	TT91734	15.56
10-24	H11	2	TT91736	16.93
10-32	H11	2	TT91738	16.93
1/4-20	H11	2	TT91749	19.30
5/16-18	H11	2	TT91761	22.17
3/8-16	H11	3	TT91772	25.18
7/16-14	H11	3	TT91779	37.82
1/2-13	H11	3	TT91786	46.02
5/8-11	H11	3	TT91794	78.43

+.005 OVERSIZE HAND PLUG



SERIES 766
HIGH SPEED STEEL

SIZE	H LIMIT	# OF FLUTES	ITEM#	LIST PRICE
6-32	H11	3	TT90931	12.93
8-32	H11	4	TT90933	12.93
10-24	H11	4	TT90935	14.31
10-32	H11	4	TT90937	14.31
1/4-20	H11	4	TT90940	17.06
5/16-18	H11	4	TT90946	21.49
3/8-16	H11	4	TT90950	24.67
7/16-14	H11	4	TT90954	37.15
1/2-13	H11	4	TT90958	41.90
5/8-11	H11	4	TT90966	78.90

THESE OVERSIZE TAPS CAN BE USED ON A WIDE RANGE OF MATERIALS. PRIMARILY USED WHERE PARTS ARE GOING TO BE PLATED AFTER TAPPING.

All taps sold individually.
For technical information, please see pages 167-169.



GENERAL PURPOSE HSS COMBINATION DRILL & TAPS

YOUR #1 SOURCE FOR AMERICAN-MADE PREMIUM QUALITY CUTTING TOOLS



SERIES 707
HIGH SPEED STEEL

SIZE	SHANK DIAMETER	OVERALL LENGTH	DRILL LENGTH	DRILL SIZE	THREAD LENGTH	# OF FLUTES	ITEM#	LIST PRICE
4-40	.141	1-7/8	1/4	0.0890	3/8	2	TT70701	46.24
5-40	.141	1-15/16	9/32	0.1015	13/32	2	TT70703	46.24
6-32	.141	2	5/16	0.1110	7/16	2	TT70705	46.24
8-32	.168	2-5/32	13/32	0.1360	1/2	2	TT70707	46.24
10-24	.194	2-13/32	7/16	0.1540	5/8	2	TT70709	46.24
10-32	.194	2-13/32	7/16	0.1610	5/8	2	TT70711	46.24
12-24	.220	2-13/32	1/2	0.1800	21/32	2	TT70713	49.98
1/4-20	.255	2-9/16	9/16	0.2055	25/32	2	TT70715	46.24
1/4-28	.255	2-9/16	9/16	0.2188	25/32	2	TT70717	46.24
5/16-18	.318	2-29/32	3/4	0.2660	15/16	2	TT70719	68.28
5/16-24	.318	2-29/32	3/4	0.2770	15/16	2	TT70721	68.28
3/8-16	.381	3-15/32	29/32	0.3230	1-1/16	2	TT70723	82.98
3/8-24	.381	3-15/32	29/32	0.3390	1-1/16	2	TT70725	82.98
7/16-14	.323	3-27/32	1-3/32	0.3770	1-1/4	2	TT70727	99.31
7/16-20	.323	3-27/32	1-3/32	0.3937	1-1/4	2	TT70729	99.31
1/2-13	.367	4-3/16	1-1/4	0.4331	1-3/8	2	TT70731	112.07
1/2-20	.367	4-3/16	1-1/4	0.4531	1-3/8	2	TT70733	112.07

PITCH DIAMETER AND THREAD TOLERANCES ARE DESIGNED TO PRODUCE A CLASS 2B FIT.



SERIES 708
HIGH SPEED STEEL
METRIC

SIZE	SHANK DIAMETER	OVERALL LENGTH	DRILL LENGTH	DRILL SIZE	THREAD LENGTH	# OF FLUTES	ITEM#	LIST PRICE
M4 x 0.7	.168	2-5/32	13/32	0.1310	1/2	2	TT70830	50.88
M5 x 0.8	.194	2-13/32	7/16	0.1660	5/8	2	TT70832	50.88
M6 x 1.0	.255	2-17/32	9/16	0.1980	25/32	2	TT70834	50.88
M8 x 1.25	.318	2-29/32	3/4	0.2670	15/16	2	TT70836	92.18
M10 x 1.50	.381	3-15/32	29/32	0.3360	1-1/16	2	TT70838	105.33
M12 x 1.75	.367	4-3/16	1-1/4	0.4050	1-3/8	2	TT70840	105.33

PITCH DIAMETER AND THREAD TOLERANCES ARE DESIGNED TO PRODUCE A CLASS 6H FIT.

All taps sold individually.

For technical information, please see pages 167-169.

GENERAL PURPOSE HSS PULLEY TAPS • EXTENSION TAPS



YOUR #1 SOURCE FOR AMERICAN-MADE PREMIUM QUALITY CUTTING TOOLS

TAPPING

PULLEY - PLUG



SERIES 747 HIGH SPEED STEEL

SIZE	H LIMIT	# OF FLUTES	OVERALL LENGTH	ITEM#	LIST PRICE
1/4-20	H3	4	6	TT92722	91.28
1/4-20	H3	4	8	TT92723	112.85
5/16-18	H3	4	6	TT92730	96.26
5/16-18	H3	4	8	TT92731	116.20
3/8-16	H3	4	6	TT92738	107.86
3/8-16	H3	4	8	TT92739	129.44
3/8-16	H3	4	10	TT92740	162.65
7/16-14	H3	4	6	TT92746	114.52
7/16-14	H3	4	8	TT92747	149.37
1/2-13	H3	4	6	TT92754	116.20

SIZE	H LIMIT	# OF FLUTES	OVERALL LENGTH	ITEM#	LIST PRICE
1/2-13	H3	4	8	TT92755	152.68
1/2-13	H3	4	10	TT92756	187.53
1/2-13	H3	4	12	TT92757	230.68
5/8-11	H3	4	6	TT92762	154.36
5/8-11	H3	4	8	TT92763	200.81
5/8-11	H3	4	10	TT92764	252.30
5/8-11	H3	4	12	TT92765	295.44
3/4-10	H3	4	10	TT92772	295.44
3/4-10	H3	4	12	TT92773	351.86

SMALL SHANK EXTENSION - SPIRAL POINT PLUG



SERIES 749 HIGH SPEED STEEL

SIZE	H LIMIT	OVERALL LENGTH	NC/NF	THREAD LENGTH	SQUARE LENGTH	SHANK DIAMETER	SQUARE	# OF FLUTES	ITEM#	LIST PRICE
6-32	H3	6	NC	11/16	3/16	0.097	0.073	2	TT94101	92.61
8-32	H3	6	NC	3/4	1/4	0.123	0.092	2	TT94102	90.72
10-24	H3	6	NC	7/8	1/4	0.136	0.102	2	TT94103	85.04
10-32	H3	6	NF	7/8	1/4	0.136	0.102	2	TT94104	85.04
1/4-20	H3	6	NC	1	5/16	0.185	0.139	2	TT94105	116.03
1/4-28	H3	6	NF	1	5/16	0.185	0.139	2	TT94106	116.03
5/16-18	H3	6	NC	1-1/8	3/8	0.240	0.180	2	TT94107	121.79
5/16-24	H3	6	NF	1-1/8	3/8	0.240	0.180	2	TT94108	121.79
3/8-16	H3	6	NC	1-1/4	7/16	0.275	0.206	3	TT94109	131.20
3/8-24	H3	6	NF	1-1/4	7/16	0.275	0.206	3	TT94110	131.20
7/16-14	H3	6	NC	1-7/16	13/32	0.323	0.242	3	TT94111	150.41
7/16-20	H3	6	NF	1-7/16	13/32	0.323	0.242	3	TT94112	150.41
1/2-13	H3	6	NC	1-21/32	7/16	0.367	0.275	3	TT94113	157.88
1/2-20	H3	6	NF	1-21/32	7/16	0.367	0.275	3	TT94114	157.88
5/8-11	H3	6	NC	1-13/16	9/16	0.480	0.360	3	TT94115	203.99
5/8-18	H3	6	NF	1-13/16	9/16	0.480	0.360	3	TT94116	203.99
3/4-10	H3	6	NC	2	11/16	0.590	0.442	3	TT94117	264.93
3/4-16	H3	6	NF	2	11/16	0.590	0.442	3	TT94118	264.93

SMALL SHANK EXTENSIONS: LONG REACH SMALL SHANKS ALLOW FOR DEEPER TAPPING

All taps sold individually.
For technical information, please see pages 167-169.

GENERAL PURPOSE TAPS

HAND

SPIRAL POINT

SPECIALTY

TECHNICAL



GENERAL PURPOSE HSS SPIRAL FLUTE TAPS

YOUR #1 SOURCE FOR AMERICAN-MADE PREMIUM QUALITY CUTTING TOOLS

52° HELIX - SEMI BOTTOMING



SERIES 761
HIGH SPEED STEEL

SIZE	H LIMIT	# OF FLUTES	ITEM#	LIST PRICE
3 -48	H2	2	TT76101	42.20
3-56	H2	2	TT76103	42.20
4-40	H2	2	TT76105	34.72
4-48	H2	2	TT76107	34.72
5-40	H3	2	TT76109	34.72
5-44	H3	2	TT76111	34.72
6-32	H3	2	TT76113	28.19
6-40	H3	2	TT76115	28.19
8-32	H3	3	TT76117	28.19
8-36	H3	3	TT76119	28.19
10-24	H3	3	TT76121	28.19
10-32	H3	3	TT76123	28.19
12-24	H3	3	TT76125	30.60
12-28	H3	3	TT76127	30.60
1/4-20	H3	3	TT76129	30.60
1/4-28	H3	3	TT76131	30.60
5/16-18	H3	3	TT76133	37.69
5/16-24	H3	3	TT76135	37.69
3/8-16	H3	3	TT76137	43.49
3/8-24	H3	3	TT76139	43.49
7/16-14	H3	3	TT76141	65.19
7/16-20	H3	3	TT76143	65.19
1/2-13	H3	3	TT76145	78.47
1/2-20	H3	3	TT76147	78.47
9/16-12	H3	4	TT76149	130.90
9/16-18	H3	4	TT76151	130.90
5/8-11	H3	4	TT76153	170.82
5/8-18	H3	4	TT76155	170.82
3/4-10	H3	4	TT76157	218.65
3/4-16	H3	4	TT76159	218.65



SERIES 763
HIGH SPEED STEEL - METRIC

SIZE	D LIMIT	# OF FLUTES	ITEM#	LIST PRICE
M3 x 0.5	D3	2	TT76349	35.71
M3.5 x 0.6	D4	3	TT76351	28.92
M4 x 0.7	D4	3	TT76353	28.92
M4.5 x 0.75	D4	3	TT76355	28.92
M5 x 0.8	D4	3	TT76357	28.92
M6 x 1.0	D5	3	TT76359	31.59
M8 x 1.25	D5	3	TT76361	38.93
M10 x 1.5	D6	3	TT76363	67.30
M12 x 1.75	D6	3	TT76365	81.00

- 2 - 2 $\frac{1}{2}$ THREAD CHAMFER
- CAN BE USED FOR PLUG OR BOTTOMING APPLICATIONS
- ALLOWS FOR TAPPING CLOSE TO BOTTOM IN BLIND HOLES
- CAN BE USED FOR THROUGH OR BLIND HOLES
- CUTS MORE EFFICIENTLY THAN BOTTOMING TAPS
- SLIGHTLY LONGER CHAMFER DISTRIBUTES CUTTING OVER GREATER NUMBER OF TEETH FOR INCREASED PRODUCTION
- MATERIALS: FOR TAPPING IN RELATIVELY DEEP HOLES IN COPPER, BRASS, ALUMINUM AND OTHER SOFT DUCTILE MATERIALS



Spiral flute taps provide proper chip evacuation in blind holes

All taps sold individually.

GENERAL PURPOSE HSS STRAIGHT & TAPER PIPE TAPS



YOUR #1 SOURCE FOR AMERICAN-MADE PREMIUM QUALITY CUTTING TOOLS

TAPPING

STRAIGHT PIPE - NPS



SERIES 792
HIGH SPEED STEEL
UNCOATED

SIZE	# OF FLUTES	ITEM#	LIST PRICE
1/8-27	4	TT94201	63.39
1/4-18	4	TT94202	70.13
3/8-18	4	TT94203	92.31
1/2-14	4	TT94204	146.84
3/4-14	5	TT94205	205.37
1-11-1/2	5	TT94206	312.07



SERIES 888
HIGH SPEED STEEL
TIN COATED

SIZE	# OF FLUTES	ITEM#	LIST PRICE
1/8-27	4	TT94201TIN	94.97
1/4-18	4	TT94202TIN	105.07
3/8-18	4	TT94203TIN	138.29
1/2-14	4	TT94204TIN	219.94
3/4-14	5	TT94205TIN	307.64
1-11-1/2	5	TT94206TIN	467.50

EXTENSION TAPER PIPE - NPT



SERIES 793
HIGH SPEED STEEL
UNCOATED

SIZE	OVERALL LENGTH	# OF FLUTES	ITEM#	LIST PRICE
1/8-27	6	4	TT94221	118.82
1/4-18	6	4	TT94223	136.96
3/8-18	6	4	TT94225	185.30
1/2-14	6	4	TT94227	297.37

EXTENSION TAPER PIPE - NPT



SERIES 890
HIGH SPEED STEEL
TIN COATED

SIZE	OVERALL LENGTH	# OF FLUTES	ITEM#	LIST PRICE
1/8-27	6	4	TT94221TIN	177.99
1/4-18	6	4	TT94223TIN	205.20
3/8-18	6	4	TT94225TIN	277.61
1/2-14	6	4	TT94227TIN	445.46

All taps sold individually.

For coating information see page 8. For technical information, please see pages 167-169.

GENERAL PURPOSE TAPS

HAND

SPIRAL POINT

SPECIALTY

TECHNICAL



GENERAL PURPOSE HSS TAPER PIPE TAPS

YOUR #1 SOURCE FOR AMERICAN-MADE PREMIUM QUALITY CUTTING TOOLS

NPT



SERIES 775
HIGH SPEED STEEL
UNCOATED



SERIES 777
HIGH SPEED STEEL
STEAM-OXIDE

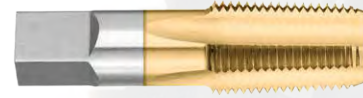

SERIES 878
HIGH SPEED STEEL
TIN COATED

SIZE	# OF FLUTES	UNCOATED	LIST PRICE	STEAM OXIDE	LIST PRICE	TIN	LIST PRICE
1/16-27	4	TT93400	39.66	TT93400S	45.64	TT93400TIN	51.61
* 1/8-27	4	TT93401	39.66	TT93401S	45.64	TT93401TIN	51.61
1/8-27	4	TT93402	39.66	TT93402S	45.64	TT93402TIN	51.61
1/4-18	4	TT93406	43.92	TT93406S	50.49	TT93406TIN	57.11
3/8-18	4	TT93408	57.80	TT93408S	66.48	TT93408TIN	75.12
1/2-14	4	TT93410	91.92	TT93410S	105.71	TT93410TIN	119.47
3/4-14	5	TT93412	128.58	TT93412S	147.87	TT93412TIN	167.17
1-11-1/2	5	TT93414	195.40	TT93414S	224.66	TT93414TIN	234.25
1-1/4-11-1/2	5	TT93416	278.51	TT93416S	320.28	TT93416TIN	362.05
1-1/2-11-1/2	7	TT93418	373.57	TT93418S	429.65	TT93418TIN	485.64
2-11-1/2	7	TT93420	508.16	TT93420S	584.39	TT93420TIN	660.63

* Small Shank

NPT - INTERRUPTED



SERIES 785
HIGH SPEED STEEL
UNCOATED



SERIES 786
HIGH SPEED STEEL
STEAM-OXIDE



SERIES 880
HIGH SPEED STEEL
TIN COATED

SIZE	# OF FLUTES	UNCOATED	LIST PRICE	STEAM OXIDE	LIST PRICE	TIN	LIST PRICE
* 1/8-27	5	TT93601	61.54	TT93601S	70.78	TT93601TIN	80.02
1/8-27	5	TT93602	61.54	TT93602S	70.78	TT93602TIN	80.02
1/4-18	5	TT93606	68.07	TT93606S	78.25	TT93606TIN	88.48
3/8-18	5	TT93608	86.12	TT93608S	99.01	TT93608TIN	111.94
1/2-14	5	TT93610	136.96	TT93610S	157.50	TT93610TIN	178.04
3/4-14	5	TT93612	199.31	TT93612S	229.18	TT93612TIN	259.09
1-11-1/2	5	TT93614	302.87	TT93614S	348.30	TT93614TIN	393.72
1-1/4-11-1/2	5	TT93616	428.91	TT93616S	493.25	TT93616TIN	557.58
1-1/2-11-1/2	7	TT93618	575.32	TT93618S	661.61	TT93618TIN	747.90
2-11-1/2	7	TT93620	777.51	TT93620S	894.14	TT93620TIN	

* Small Shank

All taps sold individually.

For coating information see page 8. For technical information, please see pages 167-169.

GENERAL PURPOSE HSS TAPER PIPE TAPS



YOUR #1 SOURCE FOR AMERICAN-MADE PREMIUM QUALITY CUTTING TOOLS

TAPPING

NPTF DRYSEAL



SERIES 787
HIGH SPEED STEEL
UNCOATED

SIZE	# OF FLUTES	ITEM#	LIST PRICE
* 1/16-27	4	TT93800	43.66
1/8-27	4	TT93801	43.66
1/8-27	4	TT93802	43.66
1/4-18	4	TT93806	48.30
3/8-18	4	TT93808	63.56
1/2-14	4	TT93810	101.12
3/4-14	5	TT93812	141.42
1-11-1/2	5	TT93814	214.91
1-1/4-11-1/2	5	TT93816	306.36
1-1/2-11-1/2	7	TT93818	410.91
2-11-1/2	7	TT93820	558.99

* Small Shank



SERIES 883
HIGH SPEED STEEL
TIN COATED

SIZE	# OF FLUTES	ITEM#	LIST PRICE
* 1/16-27	4	TT93800TIN	65.41
1/8-27	4	TT93801TIN	65.41
1/8-27	4	TT93802TIN	65.41
1/4-18	4	TT93806TIN	72.37
3/8-18	4	TT93808TIN	95.23
1/2-14	4	TT93810TIN	151.44
3/4-14	5	TT93812TIN	211.86
1-11-1/2	5	TT93814TIN	321.95
1-1/4-11-1/2	5	TT93816TIN	458.91
1-1/2-11-1/2	7	TT93818TIN	615.59
2-11-1/2	7	TT93820TIN	837.37

* Small Shank

NPTF DRYSEAL - INTERRUPTED



SERIES 788
HIGH SPEED STEEL
UNCOATED

SIZE	# OF FLUTES	ITEM#	LIST PRICE
* 1/8-27	5	TT94001	67.68
1/8-27	5	TT94002	67.68
1/4-18	5	TT94006	74.86
3/8-18	5	TT94008	94.71
1/2-14	5	TT94010	150.66
3/4-14	5	TT94012	219.21
1-11-1/2	5	TT94014	333.13
1-1/4-11-1/2	5	TT94016	471.76
1-1/2-11-1/2	7	TT94018	632.87
2-11-1/2	7	TT94020	855.25

* Small Shank



SERIES 884
HIGH SPEED STEEL
TIN COATED

SIZE	# OF FLUTES	ITEM#	LIST PRICE
* 1/8-27	5	TT94001TIN	101.42
1/8-27	5	TT94002TIN	101.42
1/4-18	5	TT94006TIN	112.16
3/8-18	5	TT94008TIN	141.90
1/2-14	5	TT94010TIN	225.65
3/4-14	5	TT94012TIN	328.40
1-11-1/2	5	TT94014TIN	499.05
1-1/4-11-1/2	5	TT94016TIN	706.74
1-1/2-11-1/2	7	TT94018TIN	947.99
2-11-1/2	7	TT94020TIN	1281.16

* Small Shank

All taps sold individually.

For coating information see page 8. For technical information, please see pages 167-169.

PIPE TAPS

TECHNICAL



GENERAL PURPOSE HSS THREAD FORMING TAPS

YOUR #1 SOURCE FOR AMERICAN-MADE PREMIUM QUALITY CUTTING TOOLS



SERIES 876
HIGH SPEED STEEL
UNCOATED

SIZE	H LIMIT	LUBE GROOVES	1.5 ITEM#	2.5 ITEM#	4.0 ITEM#	LIST PRICE
0-80	H2	0	TT88301	TT82800	-	33.87
0-80	H3	0	TT88303	TT82802	-	33.87
1-64	H3	0	-	TT82804	-	33.87
1-72	H3	0	TT88307	TT82806	-	33.87
2-56	H3	0	TT88309	TT82808	-	33.64
2-56	H4	0	TT88311	TT82810	-	33.64
2-64	H3	0	-	TT82814	-	33.64
3-48	H3	0	-	TT82818	-	33.64
3-56	H3	0	-	TT82820	-	33.64
3-56	H5	0	-	TT82822	-	33.64
4-40	H3	0	TT88321	TT82824	TT82823	30.32
4-40	H5	0	TT88323	TT82826	TT82825	30.32
4-48	H4	0	-	TT82828	-	30.32
5-40	H4	0	-	TT82832	TT82831	30.32
5-44	H4	0	-	TT82836	-	30.32
6-32	H3	1	TT88331	TT82840	TT82839	24.99
6-32	H5	1	TT88333	TT82842	TT82841	24.99
6-40	H4	1	-	TT82846	TT82845	24.99
8-32	H3	1	TT88337	TT82850	TT82849	24.99
8-32	H5	1	TT88339	TT82852	TT82851	24.99
8-32	H7	1	-	TT82854	TT82853	24.99
8-36	H4	1	-	TT82856	TT82855	24.99
10-24	H5	1	-	TT82858	TT82857	24.03
10-24	H7	1	-	TT82860	TT82859	24.03
10-32	H3	1	TT88347	TT82862	TT82861	24.03
10-32	H5	1	TT88349	TT82864	TT82863	24.03
12-24	H5	2	-	TT82866	TT82865	24.03
12-28	H4	2	-	TT82870	TT82869	24.03
1/4-20	H5	2	TT88355	TT82872	TT82871	25.52
1/4-20	H8	2	TT88357	TT82874	TT82873	25.52
1/4-28	H4	2	TT88359	TT82878	TT82877	25.52
1/4-28	H6	2	TT88361	TT82880	TT82879	25.52
5/16-18	H8	2	TT88365	TT82884	TT82883	28.34
5/16-18	H5	2	-	TT82882	TT82881	28.34
5/16-24	H5	2	TT88367	TT82886	TT82885	28.34
5/16-24	H7	2	TT88369	TT82888	TT82887	28.34
3/8-16	H6	2	TT88371	TT82890	TT82889	32.34
3/8-16	H8	2	TT88373	TT82892	TT82891	32.34
3/8-24	H5	2	TT88375	TT82894	TT82893	32.34
3/8-24	H7	2	TT88377	TT82896	TT82895	32.34
7/16-14	H7	4	-	TT82898	TT82897	49.21
7/16-14	H9	4	-	TT82902	TT82901	49.21
7/16-20	H5	4	-	TT82904	TT82903	49.21
7/16-20	H8	4	-	TT82906	TT82905	49.21
1/2-13	H7	6	-	TT82908	TT82907	55.04
1/2-13	H10	6	-	TT82910	TT82909	55.04
1/2-20	H5	6	-	TT82912	TT82911	55.04
1/2-20	H8	6	-	TT82914	TT82913	55.04

PLUG TAP SIZES 3/8" AND SMALLER HAVE MALE CENTERS



SERIES 898
HIGH SPEED STEEL - METRIC
UNCOATED

SIZE	D LIMIT	LUBE GROOVES	1.5 ITEM#	2.5 ITEM#	4.0 ITEM#	LIST PRICE
M1.6 x 0.35	D5	0	-	TT89690	-	27.86
M1.7 x 0.35	D5	0	-	TT89692	-	27.86
M2 x 0.4	D5	0	TT88380	TT89694	-	27.86
M2.5 x 0.45	D6	0	TT88382	TT89696	-	27.86
M3 x 0.5	D6	0	TT88384	TT89802	-	27.86
M3.5 x 0.6	D7	1	TT88386	TT89698	TT89697	25.14
M4 x 0.7	D7	1	TT88388	TT89804	TT89803	25.14
M5 x 0.8	D8	1	TT88390	TT89806	TT89805	25.14
M6 x 1.0	D9	2	TT88392	TT89808	TT89807	26.67
M8 x 1.25	D10	2	TT88394	TT89810	TT89809	30.51
M10 x 1.5	D11	2	TT88396	TT89812	TT89811	34.33
M12 x 1.75	D12	4	TT88398	TT89814	TT89813	59.23

PLUG TAP SIZES M10 AND SMALLER HAVE MALE CENTERS

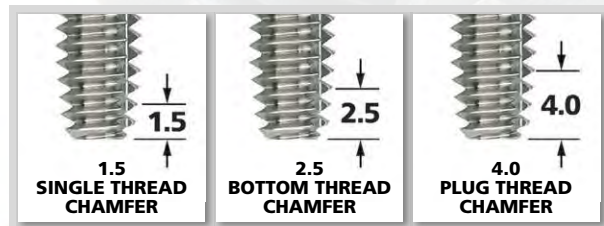

- **SINGLE THREAD – 1.5 Thread Chamfer**
For maximum thread length in blind holes due to its short chamfer
- **BOTTOM – 2.5 Thread Chamfer**
For blind hole tapping
- **PLUG – 4.0 Thread Chamfer**
For through hole tapping
- **THREAD FORMING**
Taps have no flutes or cutting edges & provide chipless tapping
- **LUBE GROOVES**
For lubrication & venting in blind holes
- **MATERIALS:**
aluminum, brass, copper, zinc, most ductile materials producing stringy chips are great for uncoated thread forming taps

For technical information, please see pages 170, 171.

All taps sold individually

GENERAL PURPOSE HSS THREAD FORMING TAPS



YOUR #1 SOURCE FOR AMERICAN-MADE PREMIUM QUALITY CUTTING TOOLS



SERIES 776
HIGH SPEED STEEL
TIN COATED



SERIES 798
HIGH SPEED STEEL - METRIC
TIN COATED

SIZE	H LIMIT	LUBE GROOVES	1.5 ITEM#	2.5 ITEM#	4.0 ITEM#	LIST PRICE
0-80	H2	0	TT88401	TT92800	-	42.33
0-80	H3	0	TT88403	TT92802	-	42.33
1-64	H3	0	-	TT92804	-	42.33
1-72	H3	0	TT88407	TT92806	-	42.33
2-56	H3	0	TT88409	TT92808	-	42.05
2-56	H4	0	TT88411	TT92810	-	42.05
2-64	H3	0	-	TT92814	-	42.05
3-48	H3	0	-	TT92818	-	42.05
3-56	H3	0	-	TT92820	-	42.05
3-56	H5	0	-	TT92822	-	42.05
4-40	H3	0	TT88421	TT92824	TT92823	37.91
4-40	H5	0	TT88423	TT92826	TT92825	37.91
4-48	H4	0	-	TT92828	-	37.91
5-40	H4	0	-	TT92832	TT92831	37.91
5-44	H4	0	-	TT92836	-	37.91
6-32	H3	1	TT88431	TT92840	TT92839	31.23
6-32	H5	1	TT88433	TT92842	TT92841	31.23
6-40	H4	1	-	TT92846	TT92845	31.23
8-32	H3	1	TT88437	TT92850	TT92849	31.23
8-32	H5	1	TT88439	TT92852	TT92851	31.23
8-32	H7	1	-	TT92854	TT92853	31.23
8-36	H4	1	-	TT92856	TT92855	31.23
10-24	H5	1	-	TT92858	TT92857	30.05
10-24	H7	1	-	TT92860	TT92859	30.05
10-32	H3	1	TT88447	TT92862	TT92861	30.05
10-32	H5	1	TT88449	TT92864	TT92863	30.05
12-24	H5	2	-	TT92866	TT92865	30.05
12-28	H4	2	-	TT92870	TT92869	30.05
1/4-20	H5	2	TT88455	TT92872	TT92871	31.91
1/4-20	H8	2	TT88457	TT92874	TT92873	31.91
1/4-28	H4	2	TT88459	TT92878	TT92877	31.91
1/4-28	H6	2	TT88461	TT92880	TT92879	31.91
5/16-18	H8	2	TT88465	TT92884	TT92883	35.43
5/16-18	H5	2	-	TT92882	TT92881	35.43
5/16-24	H5	2	TT88467	TT92886	TT92885	35.43
5/16-24	H7	2	TT88469	TT92888	TT92887	35.43
3/8-16	H6	2	TT88471	-	-	35.42
3/8-16	H8	2	TT88473	-	-	35.42
3/8-16	H6	2	-	TT92890	TT92889	40.43
3/8-16	H8	2	-	TT92892	TT92891	40.43
3/8-24	H5	2	TT88475	TT92894	TT92893	40.43
3/8-24	H7	2	TT88477	TT92896	TT92895	40.43
7/16-14	H7	4	-	TT92898	TT92897	61.52
7/16-14	H9	4	-	TT92902	TT92901	61.52
7/16-20	H5	4	-	TT92904	TT92903	61.52
7/16-20	H8	4	-	TT92906	TT92905	61.52
1/2-13	H7	6	-	TT92908	TT92907	68.80
1/2-13	H10	6	-	TT92910	TT92909	68.80
1/2-20	H5	6	-	TT92912	TT92911	68.80
1/2-20	H8	6	-	TT92914	TT92913	68.80

SIZE	D LIMIT	LUBE GROOVVES	1.5 ITEM#	2.5 ITEM#	4.0 ITEM#	LIST PRICE
M1.6 x 0.35	D5	0	-	TT89790	-	33.92
M1.7 x 0.35	D5	0	-	TT89792	-	33.92
M2 x 0.4	D5	0	TT88580	TT89794	-	33.92
M2.5 x 0.45	D6	0	TT88582	TT89796	-	33.92
M3 x 0.5	D6	0	TT88584	TT79802	-	33.92
M3.5 x 0.6	D7	1	TT88586	TT89798	TT89797	31.43
M4 x 0.7	D7	1	TT88588	TT79804	TT79803	31.43
M5 x 0.8	D8	1	TT88590	TT79806	TT79805	31.43
M6 x 1.0	D9	2	TT88592	TT79808	TT79807	33.33
M8 x 1.25	D10	2	TT88594	TT79810	TT79809	38.15
M10 x 1.5	D11	2	TT88596	TT79812	TT79811	42.90
M12 x 1.75	D12	4	TT88598	TT79814	TT79813	74.05

PLUG TAP SIZES M10 AND SMALLER HAVE MALE CENTERS

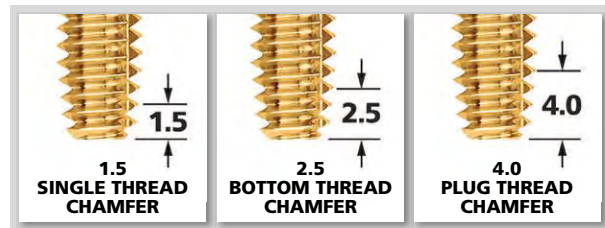

- **SINGLE THREAD – 1.5 Thread Chamfer**
For maximum thread length in blind holes due to its short chamfer
- **BOTTOM – 2.5 Thread Chamfer**
For blind hole tapping
- **PLUG – 4.0 Thread Chamfer**
For through hole tapping
- **THREAD FORMING**
Taps have no flutes or cutting edges & provide chipless tapping
- **LUBE GROOVES**
For lubrication & venting in blind holes
- **MATERIALS:**
lead, stainless steels, carbon steels, die cast aluminum, most ductile materials producing stringy chips are great for Tin coated forming taps

For technical information, please see pages 170, 171.

For coating information see page 8.

PLUG TAP SIZES 3/8" AND SMALLER HAVE MALE CENTERS

All taps sold individually



GENERAL PURPOSE CARBON STEEL DIES

YOUR #1 SOURCE FOR AMERICAN-MADE PREMIUM QUALITY CUTTING TOOLS



HEXAGON RETHREADING

SERIES 795
CARBON STEEL

SIZE	ACROSS FLATS	THICKNESS	ITEM#	LIST PRICE
1/4-20	19/32	1/4	TE80529	28.09
1/4-28	19/32	1/4	TE80532	28.09
5/16-18	11/16	5/16	TE80537	32.76
5/16-24	11/16	5/16	TE80540	32.76
3/8-16	25/32	3/8	TE80544	36.27
3/8-24	25/32	3/8	TE80547	36.27
7/16-14	7/8	7/16	TE80550	44.45
7/16-20	7/8	7/16	TE80553	44.45
1/2-13	1-1/16	1/2	TE80555	49.16
1/2-20	1-1/16	1/2	TE80557	49.16
9/16-12	1-1/16	1/2	TE80559	52.63
9/16-18	1-1/16	1/2	TE80561	52.63
5/8-11	1-1/4	5/8	TE80563	54.99
5/8-18	1-1/4	5/8	TE80566	54.99
11/16-11	1-7/16	3/4	TE80568	60.85
11/16-16	1-7/16	3/4	TE80569	60.85

SIZE	ACROSS FLATS	THICKNESS	ITEM#	LIST PRICE
3/4-10	1-7/16	3/4	TE80571	67.88
3/4-16	1-7/16	3/4	TE80573	67.88
7/8-9	1-5/8	7/8	TE80575	73.70
7/8-14	1-5/8	7/8	TE80577	73.70
1-8	1-13/16	1	TE80579	83.08
1-12	1-13/16	1	TE80581	83.08
1-14	1-13/16	1	TE80583	83.08
1-1/8-7	2	1	TE80584	95.93
1-1/8-12	2	1	TE80585	95.93
1-1/4-7	2-3/16	1	TE80586	105.31
1-1/4-12	2-3/16	1	TE80587	105.31
1-3/8-6	2-3/8	1	TE80588	198.92
1-3/8-12	2-3/8	1	TE80589	198.92
1-1/2-6	2-9/16	1	TE80590	222.30
1-1/2-12	2-9/16	1	TE80591	222.30



HEXAGON RETHREADING METRIC

SERIES 796
CARBON STEEL

SIZE	ACROSS FLATS	ITEM#	LIST PRICE
M3 x 0.5	1	TE80601	21.40
M4 x 0.7	1	TE80602	20.82
M5 x 0.8	1	TE80603	20.82
M6 x 1.0	1	TE80604	20.82
M7 x 1.0	1	TE80605	21.40
M8 x 1.25	1	TE80606	20.82
M10 x 1.25	1	TE80607	20.82
M10 x 1.50	1	TE80608	20.82
M12 x 1.25	1	TE80609	20.82

SIZE	ACROSS FLATS	ITEM#	LIST PRICE
M12 x 1.75	1	TE80610	20.82
M14 x 1.50	1-7/16	TE80611	32.31
M14 x 2.0	1-7/16	TE80612	32.31
M16 x 1.50	1-7/16	TE80613	32.31
M16 x 2.0	1-7/16	TE80614	32.31
M18 x 1.50	1-7/16	TE80615	32.31
M18 x 2.50	1-7/16	TE80616	32.31
M20 x 2.5	1-13/16	TE80617	67.46
M24 x 3.0	1-13/16	TE80618	67.46

Dies sold individually.

GENERAL PURPOSE CARBON STEEL DIES



TAPPING

YOUR #1 SOURCE FOR AMERICAN-MADE PREMIUM QUALITY CUTTING TOOLS



NPT HEXAGON RETHREADING

SERIES 797
CARBON STEEL

SIZE	ACROSS FLATS	THICKNESS	ITEM#	LIST PRICE
1/8-27 NPT	1-1/16	3/8	TE80701	38.83
1/4 - 18 NPT	1-1/4	5/8	TE80702	43.05
3/8 - 18 NPT	1-7/16	5/8	TE80703	59.53

SIZE	ACROSS FLATS	THICKNESS	ITEM#	LIST PRICE
1/2 - 14 NPT	1-5/8	3/4	TE80704	86.01
3/4 - 14 NPT	2	13/16	TE80705	106.34
1 - 11-1/2 NPT	2-3/8	1	TE80706	205.86



ADJUSTABLE ROUND SPLIT

SERIES 790
CARBON STEEL

SIZE	OUTSIDE DIAMETER	ITEM#	LIST PRICE
6 - 32	1	TE80113	47.92
8 - 32	1	TE80116	47.92
10 - 24	1	TE80119	47.92
10 - 32	1	TE80121	47.92
1/4 - 20	1	TE80127	47.92
1/4 - 20	1-1/2	TE80128	78.41
1/4 - 28	1	TE80130	47.92
1/4 - 32	1	TE80134	47.92
5/16 - 18	1	TE80135	47.92
5/16 - 18	1-1/2	TE80136	78.41
5/16 - 24	1	TE80138	47.92
5/16 - 24	1-1/2	TE80139	78.41
5/16 - 32	1	TE80141	47.92

SIZE	OUTSIDE DIAMETER	ITEM#	LIST PRICE
3/8 - 16	1	TE80142	47.92
3/8 - 16	1-1/2	TE80143	78.41
3/8 - 24	1	TE80145	47.92
3/8 - 24	1-1/2	TE80146	78.41
7/16 - 14	1	TE80148	47.92
7/16 - 14	1-1/2	TE80149	78.41
7/16 - 20	1	TE80151	47.92
1/2 - 13	1-1/2	TE80154	78.41
1/2 - 20	1-1/2	TE80156	78.41
9/16 - 12	1-1/2	TE80158	78.41
9/16 - 18	1-1/2	TE80160	78.41
5/8 - 11	1-1/2	TE80162	78.41
5/8 - 18	1-1/2	TE80165	78.41

DIES

Dies sold individually.

TECHNICAL



GENERAL PURPOSE HSS DIES

YOUR #1 SOURCE FOR AMERICAN-MADE PREMIUM QUALITY CUTTING TOOLS



ADJUSTABLE ROUND SPLIT

SERIES 794
HIGH SPEED STEEL

SIZE	OUTSIDE DIAMETER	ITEM#	LIST PRICE
4-40	1	TE80810	89.68
5-40	13/16	TE80811	60.85
5-44	13/16	TE80812	60.85
6-32	13/16	TE80813	60.85
6-32	1	TE80814	73.70
6-40	13/16	TE80815	60.85
8-32	13/16	TE80816	60.85
8-32	1	TE80817	73.70
10-24	13/16	TE80818	60.85
10-24	1	TE80819	73.70
10-32	13/16	TE80820	60.85
10-32	1	TE80821	73.70
12-24	13/16	TE80822	60.85
12-24	1	TE80823	73.70
12-28	13/16	TE80824	60.85
1/4-20	13/16	TE80825	60.85
1/4-20	1	TE80826	73.70
1/4-20	1-1/2	TE80827	120.51
1/4-28	13/16	TE80828	60.85
1/4-28	1	TE80829	73.70
1/4-28	1-1/2	TE80830	120.51
5/16-18	13/16	TE80831	60.85
5/16-18	1	TE80832	73.70
5/16-18	1-1/2	TE80833	120.51
5/16-24	13/16	TE80834	60.85
5/16-24	1	TE80835	73.70

SIZE	OUTSIDE DIAMETER	ITEM#	LIST PRICE
5/16-24	1-1/2	TE80836	120.51
3/8-16	1	TE80837	73.70
3/8-16	1-1/2	TE80838	120.51
3/8-24	1	TE80839	73.70
3/8-24	1-1/2	TE80840	120.51
7/16-14	1	TE80841	73.70
7/16-14	1-1/2	TE80842	120.51
7/16-20	1	TE80843	73.70
7/16-20	1-1/2	TE80844	120.51
1/2-13	1	TE80845	73.70
1/2-13	1-1/2	TE80846	120.51
1/2-20	1	TE80847	73.70
1/2-20	1-1/2	TE80848	120.51
9/16-12	1-1/2	TE80849	120.51
9/16-18	1-1/2	TE80850	120.51
5/8-11	1-1/2	TE80851	120.51
5/8-11	2	TE80852	163.81
5/8-18	1-1/2	TE80853	120.51
5/8-18	2	TE80854	163.81
3/4-10	1-1/2	TE80855	120.51
3/4-10	2	TE80856	163.81
3/4-16	1-1/2	TE80857	120.51
3/4-16	2	TE80858	163.81
7/8-9	2	TE80859	163.81
7/8-14	2	TE80860	163.81

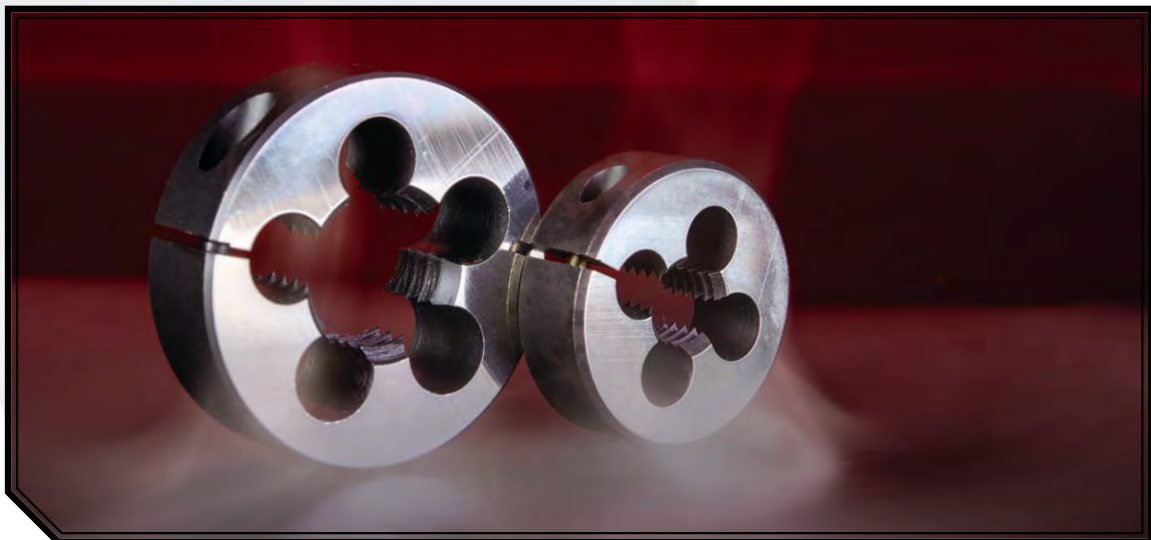

Dies sold individually.

GENERAL PURPOSE TAP HANDLES & DIE STOCKS



YOUR #1 SOURCE FOR AMERICAN-MADE PREMIUM QUALITY CUTTING TOOLS

T - HANDLE TAP WRENCHES



SERIES 801

SIZE	ITEM#	LIST PRICE
0 - 1/4	TE78701	17.76
1/4-1/2	TE78702	26.61

DIE STOCKS



SERIES 789

SIZE	ITEM#	LIST PRICE
1 OD	TE78909	54.86
1-1/2 OD	TE78910	89.86
2 OD	TE78911	158.19

Tools sold individually.



HIGH PERFORMANCE TAPS TECHNICAL INFORMATION

Predator

YOUR #1 SOURCE FOR AMERICAN-MADE PREMIUM QUALITY CUTTING TOOLS

SPEED CHART					
MATERIAL / TYPE	HARDNESS		CUTTING SPEED (fpm)		CUTTING FLUID*
	Bhn	Rc	SPIRAL POINT	SPIRAL FLUTE	
ALUMINUM ALLOYS					
UNALLOYED - 1000 SERIES	-	-	80	60	WS, CO
CAST - 360, A380	-	-	60	45	WS, CO
WROUGHT - 2000-7000 SERIES	-	-	80	60	WS, CO
BRASS					
HIGH-LEADED, FREE CUTTING - C34000, C36000	-	-	60	45	WS
NAVAL, RED - C46400-C46700, C23000	-	-	60	45	WS
CAST IRON					
PEARLITIC, GRAY CAST IRON, FERRITIC - A48 CLASS 20, CLASS 25, CLASS 40	< 253	< 25	20	15	WS
MALLEABLE - ASTM A47 GRADE 32510, SAE J158 GRADE M3210	< 253	< 25	15	12	CO
NICKEL ALLOYS					
NICKEL BASE ALLOY, WROUGHT & CAST - NICKEL 200, MONEL ALLOY 400	< 253	< 25	15	12	CO
HIGH TEMPERATURE ALLOY, WROUGHT & CAST - INCONEL 600, 718, HASTALLOY B & C	253 - 390	25 - 42	10	10	CO
STEEL					
LOW CARBON - 1010, 1018, 1029, 1513, 1522	< 190	< 10	55	40	WS, CO
MEDIUM CARBON - 1030, 1040, 1045, 1050	< 208	< 15	35	25	WS, CO
HIGH CARBON - 1050, 1070, 1080, 1090, 1561, 1572	< 253	< 25	15	12	CO
HIGH STRENGTH STEEL - 4140, 4340	327 - 390	35 - 42	10	10	CO
STAINLESS STEEL					
AUSTENITIC - SAE (300 SERIES)	< 253	< 25	20	15	CO
MARTENSITIC & FERRITIC - 400 SERIES, 416, 420F, 446	253 - 301	25 - 32	15	12	CO
HARDENED - 15-5PH, 17-4PH, A286	< 327 - 390	< 35 - 42	10	10	CO
TITANIUM ALLOYS					
ALPHA & ALPHA-BETA ALLOYS ANNEALED - Ti-6Al-4V	253 - 301	25 - 32	10	10	CO
ALPHA & ALPHA-BETA ALLOYS SOLUTION TREATED & AGED - Ti-6Al-6V	327 - 390	35 - 42	8	8	CO
TOOL STEEL					
HOT WORK, COLD WORK & MOLD - A2, D2, H10, H14, P2, P13	190 - 253	10 - 25	20	15	CO
HOT WORK, COLD WORK & MOLD - A2, D2, H10, H14, P2, P13	327 - 390	35 - 42	15	12	CO

Your individual manufacturing conditions will greatly influence speeds.

* WS - Water Soluble
CO - Cutting Oil

In most instances cutting fluid manufacturers recommend specific fluid for different materials.

GENERAL PURPOSE TAPS TECHNICAL INFORMATION



YOUR #1 SOURCE FOR AMERICAN-MADE PREMIUM QUALITY CUTTING TOOLS

MACHINE SCREW TAPS (NC & NF)

SIZE	OVERALL LENGTH	THREAD LENGTH	SQUARE LENGTH	SHANK DIAMETER	SQUARE
#0 (.060)	1-5/8	5/16	3/16	.141	.110
#1 (.073)	1-11/16	3/8	3/16	.141	.110
#2 (.066)	1-3/4	7/16	3/16	.141	.110
#3 (.099)	1-13/16	1/2	3/16	.141	.110
#4 (.112)	1-7/8	9/16	3/16	.141	.110
#5 (.125)	1-15/16	5/8	3/16	.141	.110
#6 (.138)	2	11/16	3/16	.141	.110
#8 (.164)	2-1/8	3/4	1/4	.168	.131
#10 (.190)	2-3/8	7/8	1/4	.194	.152
#12 (.216)	2-3/8	15/16	9/32	.220	.165

FRACTIONAL SIZE TAPS (NC & NF)

SIZE	OVERALL LENGTH	THREAD LENGTH	SQUARE LENGTH	SHANK DIAMETER	SQUARE
1/4	2-1/2	1	5/16	.255	.191
5/16	2-23/32	1-1/8	3/8	.318	.238
3/8	2-15/16	1-1/4	7/16	.381	.286
7/16	3-5/32	1-7/16	13/32	.323	.242
1/2	3-3/8	1-21/32	7/16	.367	.275
9/16	3-19/32	1-21/32	1/2	.429	.322
5/8	3-13/16	1-13/16	9/16	.480	.360
11/16	4-1/32	1-13/16	5/8	.542	.406
3/4	4-1/4	2	11/16	.590	.442
7/8	4-11/16	2-7/32	3/4	.697	.523
1	5-1/8	2-1/2	13/16	.800	.600
1-1/8	5-7/16	2-9/16	7/8	.896	.672
1-1/4	5-3/4	2-9/16	1	1.021	.766
1-3/8	6-1/16	3	1-1/16	1.108	.831
1-1/2	6-3/8	3	1-1/8	1.233	.925

PIPE TAPS - STRAIGHT & TAPER

SIZE	OVERALL LENGTH	THREAD LENGTH	SQUARE LENGTH	SHANK DIAMETER	SQUARE
1/16 - 27	2-1/8	11/16	3/8	.3125	.234
1/8 - 27	2-1/8	3/4	3/8	.3125(SS)	.234
1/8 - 27	2-1/8	3/4	3/8	.4375(LS)	.328
1/4 - 18	2-7/16	1-1/16	7/16	.5625	.421
3/8 - 18	2-9/16	1-1/16	1/2	.7000	.531
1/2 - 14	3-1/8	1-3/8	5/8	.6875	.515
3/4 - 14	3-1/4	1-3/8	11/16	.9063	.679
1 - 11-1/2	3-3/4	1-3/4	13/16	1.1250	.843
1-1/4 - 11-1/2	4	1-3/4	15/16	1.3125	.984
1-1/2 - 11-1/2	4-1/4	1-3/4	1	1.5000	1.125
2 - 11-1/2	4-1/2	1-3/4	1-1/8	1.8750	1.406

(SS) = SMALL SHANK (LS) = LARGE SHANK

PULLEY TAPS

SIZE	THREAD LENGTH	SQUARE LENGTH	SHANK DIAMETER	SQUARE	NECK LENGTH	GROUND LENGTH
1/4	1	5/16	.255	.191	3/8	1-1/2
5/16	1-1/8	3/8	.318	.238	3/8	1-9/16
3/8	1-1/4	7/16	.381	.286	3/8	1-5/8
7/16	1-7/16	1/2	.444	.333	7/16	1-11/16
1/2	1-21/32	9/16	.507	.380	1/2	1-11/16
5/8	1-13/16	11/16	.633	.475	5/8	2
3/4	2	3/4	.759	.569	3/4	2-1/4

SEE PAGE 167 FOR OVERALL LENGTHS AVAILABLE.

SMALL SHANK EXTENSION TAPS

SIZE	NC/NF	THREAD LENGTH	SQUARE LENGTH	SHANK DIAMETER	SQUARE
6 - 32	NC	11/16	3/16	0.097	0.073
8 - 32	NC	3/4	1/4	0.123	0.092
10 - 24	NC	7/8	1/4	0.136	0.102
10 - 32	NF	7/8	1/4	0.136	0.102
1/4 - 20	NC	1	5/16	0.185	0.139
1/4 - 28	NF	1	5/16	0.185	0.139
5/16 - 18	NC	1-1/8	3/8	0.240	0.180
5/16 - 24	NF	1-1/8	3/8	0.240	0.180
3/8 - 16	NC	1-1/4	7/16	0.275	0.206
3/8 - 24	NF	1-1/4	7/16	0.275	0.206
7/16 - 14	NC	1-7/16	13/32	0.323	0.242
7/16 - 20	NF	1-7/16	13/32	0.323	0.242
1/2 - 13	NC	1-21/32	7/16	0.367	0.275
1/2 - 20	NF	1-21/32	7/16	0.367	0.275
5/8 - 11	NC	1-13/16	9/16	0.480	0.360
5/8 - 18	NF	1-13/16	9/16	0.480	0.360
3/4 - 10	NC	2	11/16	0.590	0.442
3/4 - 16	NF	2	11/16	0.590	0.442

METRIC TAPS

SIZE	OVERALL LENGTH	THREAD LENGTH	SQUARE LENGTH	SHANK DIAMETER	SQUARE	INCH BLANK
M1.6 x 0.35	1-5/8	5/16	3/16	.141	.110	#0
M2 x 0.40	1-3/4	7/16	3/16	.141	.110	#2
M2.5 x 0.45	1-13/16	1/2	3/16	.141	.110	#3
M3 x 0.50	1-15/16	5/8	3/16	.141	.110	#5
M3.5 x 0.60	2	11/16	3/16	.141	.110	#6
M4 x 0.70	2-1/8	3/4	1/4	.168	.131	#8
M4.5 x 0.75	2-3/8	7/8	1/4	.194	.152	#10
M5 x 0.80	2-3/8	7/8	1/4	.194	.152	#10
M6 x 1	2-1/2	1	5/16	.255	.191	1/4
M6.3 x 1	2-1/2	1	5/16	.255	.191	1/4
M7 x 1	2-23/32	1-1/8	3/8	.318	.238	5/16
M8 x 1.25	2-23/32	1-1/8	3/8	.318	.238	5/16
M10 x 1.50	2-15/16	1-1/4	7/16	.381	.286	3/8
M12 x 1.75	3-3/8	1-21/32	7/16	.367	.275	1/2
M14 x 2	3-19/32	1-21/32	1/2	.429	.322	9/16
M16 x 2	3-13/16	1-13/16	9/16	.480	.360	5/8
M18 x 2.50	4-1/32	1-13/16	5/8	.542	.406	11/16
M20 x 2.50	4-15/32	2	11/16	.652	.489	13/16
M24 x 3	4-29/32	2-7/32	3/4	.760	.570	15/16
M30 x 3.50	5-7/16	2-9/16	1	1.021	.766	1-3/16
M36 x 4	6-1/16	3	1-1/8	1.233	.925	1-7/16



GENERAL PURPOSE TAPS TECHNICAL INFORMATION

YOUR #1 SOURCE FOR AMERICAN-MADE PREMIUM QUALITY CUTTING TOOLS

TAP RECOMMENDATIONS FOR CLASSES 2B & 3B UNIFIED INCH SCREW THREADS

SIZE	THREADS PER INCH		RECOMMENDED TAP LIMITS		INTERNAL THREAD PITCH DIAMETER LIMITS		
	NC UC	NF UNF	CLASS 2B	CLASS 3B	MIN. ALL CLASSES (BASIC)	MAX CLASS 2B	MAX CLASS 3B
0	–	80	H2	H1	.0519	.0542	.0536
1	64	–	H2	H1	.0629	.0655	.0648
1	–	72	H2	H1	.0640	.0665	.0659
2	56	–	H2	H1	.0744	.0772	.0765
2	–	64	H2	H1	.0759	.0786	.0779
3	48	–	H2	H1	.0855	.0885	.0877
3	–	56	H2	H1	.0874	.0902	.0895
4	40	–	H2	H2	.0958	.0991	.0982
4	–	48	H2	H1	.0985	.1016	.1008
5	40	–	H2	H2	.1088	.1121	.1113
5	–	44	H2	H1	.1102	.1134	.1126
6	32	–	H3	H2	.1177	.1214	.1204
6	–	40	H2	H1	.1218	.1252	.1243
8	32	–	H3	H2	.1437	.1475	.1465
8	–	36	H2	H1	.1460	.1496	.1487
10	24	–	H3	H3	.1629	.1672	.1661
10	–	32	H3	H2	.1697	.1736	.1726
12	24	–	H3	H3	.1889	.1933	.1922
12	–	28	H3	H3	.1928	.1970	.1959
1/4	20	–	H5	H3	.2175	.2223	.2211
1/4	–	28	H4	H3	.2268	.2311	.2300
5/16	18	–	H5	H3	.2764	.2817	.2803
5/16	–	24	H4	H3	.2854	.2902	.2890
3/8	16	–	H5	H3	.3344	.3401	.3387
3/8	–	24	H4	H3	.3479	.3528	.3516
7/16	14	–	H5	H3	.3911	.3972	.3957
7/16	–	20	H5	H3	.4050	.4104	.4091
1/2	13	–	H5	H3	.4500	.4565	.4548
1/2	–	20	H5	H3	.4675	.4731	.4717
9/16	12	–	H5	H3	.5084	.5152	.5135
9/16	–	18	H5	H3	.5264	.5323	.5308
5/8	11	–	H5	H3	.5660	.5732	.5714
5/8	–	18	H5	H3	.5889	.5949	.5934
3/4	10	–	H5	H5	.6850	.6927	.6907
3/4	–	16	H5	H3	.7094	.7159	.7143
7/8	9	–	H6	H4	.8028	.8110	.8089
7/8	–	14	H6	H4	.8286	.8356	.8339

The above recommended taps normally produce the Class of Thread indicated in average materials when used with reasonable care. However, if the tap specified does not give a satisfactory gage fit in the work, a choice of some other limit tap will be necessary.

GENERAL PURPOSE TAPS TECHNICAL INFORMATION



YOUR #1 SOURCE FOR AMERICAN-MADE PREMIUM QUALITY CUTTING TOOLS

TAP RECOMMENDATIONS FOR CLASSES 2B & 3B UNIFIED INCH SCREW THREADS

SIZE	THREADS PER INCH		RECOMMENDED TAP LIMITS		INTERNAL THREAD PITCH DIAMETER LIMITS		
	NC UC	NF UNF	CLASS 2B	CLASS 3B	MIN. ALL CLASSES (BASIC)	MAX CLASS 2B	MAX CLASS 3B
1	8	–	H6	H4	.9188	.9276	.9254
1	–	12	H6	H4	.9459	.9535	.9516
1	NS		H6	H4	.9536	.9609	.9590
1 1/8	7	–	H8	H4	1.0332	1.0416	.10393
1 1/8	–	12	H6	H4	1.0709	1.0787	.10768
1 1/4	7	–	H8	H4	1.1572	1.1668	1.1644
1 1/4	–	12	H6	H4	1.1959	1.2309	1.2019
1 3/8	6	–	H8	H4	1.2667	1.2771	1.2745
1 3/8	–	12	H6	H4	1.3209	1.3291	1.3270
1 1/2	6	–	H8	H4	1.3917	1.4022	1.3996
1 1/2	–	12	H6	H4	1.4459	1.4542	1.4522

TAP RECOMMENDATIONS FOR CLASS 6H METRIC SCREW THREADS

THREAD SIZE		RECOMMENDED TAP LIMIT NUMBER	INTERNAL THREAD - PRODUCT LIMITS - CLASS 6H			
NOMINAL DIA. (MM)	PITCH (MM)		PITCH DIAMETER (MM)		PITCH DIAMETER (MM)	
			MIN.	MAX.	MIN.	MAX.
1.6	.35	D3	1.373	1.458	.05406	.05740
2	.4	D3	1.740	1.830	.06850	.07205
2.5	.45	D3	2.208	2.303	.08693	.09067
3	.5	D3	2.675	2.775	.10531	.10925
3.5	.6	D4	3.110	3.222	.12244	.12685
4	.7	D4	3.545	3.663	.13957	.14421
4.5	.75	D4	4.013	4.131	.15789	.16264
5	.8	D4	4.480	4.605	.17638	.18130
6	1	D5	5.350	5.500	.21063	.21654
7	1	D5	6.350	6.500	.25000	.25591
8	1.25	D5	7.188	7.348	.28299	.28929
10	1.5	D6	9.026	9.206	.35935	.36244
12	1.75	D6	10.863	11.063	.42758	.43555
14	2	D7	12.701	12.913	.50004	.50839
16	2	D7	14.701	14.913	.57878	.58713
20	2.5	D7	18.376	18.600	.72346	.73228
24	3	D8	22.051	22.316	.86815	.87858
30	3.5	D9	27.727	28.007	1.09161	1.10264
36	4	D9	33.402	33.702	1.31504	1.32685



THREAD FORMING TAPS TECHNICAL INFORMATION

YOUR #1 SOURCE FOR AMERICAN-MADE PREMIUM QUALITY CUTTING TOOLS

PRE TAP HOLE SIZE				
TAP SIZE	TPI	75% THREAD	65% THREAD	NEAREST DRILL SIZE
0	80	0.054	0.055	#54 or 1.4mm
1	64	0.066	0.067	#51 or 1.7mm
1	72	0.067	0.068	#51 or 1.75mm
2	56	0.078	0.079	#47 or 2.0mm
2	64	0.079	0.080	2.0mm
3	48	0.090	0.091	2.3mm
3	56	0.091	0.092	2.3mm
4	40	0.100	0.101	#39
4	48	0.103	0.104	#37
5	40	0.113	0.114	#33 or 2.9mm
5	44	0.114	0.115	#33 or 2.9mm
6	32	0.124	0.125	3.1mm
6	40	0.126	0.127	1/8" or 3.2mm
8	32	0.149	0.150	#25 or 3.8mm
8	36	0.151	0.152	#24
10	24	0.170	0.172	11/64"
10	32	0.175	0.176	#16 or .176"
12	24	0.196	0.198	#9 or 5.0mm
12	28	0.199	0.201	#7 or 5.1mm
1/4	20	0.225	0.227	5.75mm
1/4	28	0.233	0.235	"A"
5/16	18	0.285	0.287	7.25mm
5/16	24	0.292	0.294	.293"
3/8	16	0.344	0.347	"S" or 11/32"
3/8	24	0.355	0.357	9.0mm
7/16	14	0.402	0.405	"Y"
7/16	20	0.414	0.416	"Z" or 10.5mm
1/2	13	0.462	0.466	.463"

PRE TAP HOLE SIZE - METRIC				
TAP SIZE	PITCH	75% THREAD	65% THREAD	NEAREST DRILL SIZE
M1.6	0.35	0.057	0.058	1.45mm
M1.7	0.35	0.061	0.062	1.55mm
M2	0.4	0.072	0.073	1.85mm
M2.5	0.45	0.091	0.092	2.30mm
M3	0.5	0.110	0.111	#35
M3.5	0.6	0.128	0.129	#30
M4	0.7	0.145	0.146	3.70mm
M5	0.8	0.183	0.184	#14
M6	1	0.218	0.220	5.50mm
M8	1.25	0.291	0.294	7.40mm
M10	1.5	0.365	0.368	9.30mm
M12	1.75	0.439	0.442	7/16"

WHERE TO USE THREAD FORMING TAPS

Materials particularly well suited for thread forming include aluminum, brass, copper, lead, stainless steel, carbon steel, cast steel, leaded steel and zinc. In general, any material which produces a stringy chip is a good candidate for cold forming threads. If the chips are powdery, the material may be too brittle. Forming taps generate threads without producing chips. The threads produced are much stronger than those created by cut taps because of the displacements of the grain of the metal in the workpiece. Cutting taps produce chips which may interfere with the tapping process.

MAJOR ADVANTAGES TO THREAD FORMING

- Chipless Tapping – no chip removal problems in blind holes.
- Stronger Threads – the grain flow of formed threads follows the contour of the thread in steel and stainless steel, resulting in greater thread strength.
- Better Thread Gaging – forming taps create their own lead therefore the possibility of producing oversized threads is greatly reduced.
- Stronger Taps – the absence for the need for flutes results in a stronger more solid tap.
- Longer Tap Life – forming taps last 3 to 20 times longer because they have no cutting edge to dull.
- More Efficient Production – longer tap life, less tap breakage and faster tapping speeds (up to 2X faster than cutting taps).
- Ideal for Non-Lead Screw Tappers – the ability to form their own lead makes forming taps well suited for NC machines or other machines without lead screws.

THREAD FORMING TAPS TECHNICAL INFORMATION



YOUR #1 SOURCE FOR AMERICAN-MADE PREMIUM QUALITY CUTTING TOOLS

SPEED CHART FOR THREAD FORMING TAPS			
MATERIAL / TYPE	HARDNESS		FORMING SPEED (fpm)
	Bhn	Rc	
ALUMINUM ALLOYS			
UNALLOYED - 1000 SERIES	-	-	80
CAST - 360, A380	-	-	60
WROUGHT - 2000-7000 SERIES	-	-	80
BRASS			
HIGH-LEADED, FREE CUTTING - C34000, C36000	-	-	60
NAVAL, RED - C46400-C46700, C23000	-	-	60
NICKEL ALLOYS			
NICKEL BASE ALLOY, WROUGHT & CAST - NICKEL 200, MONEL ALLOY 400	< 253	< 25	15
STEEL			
LOW CARBON - 1010, 1018, 1029, 1513, 1522	< 190	< 10	55
MEDIUM CARBON - 1030, 1040, 1045, 1050	< 208	< 15	35
HIGH CARBON - 1050, 1070, 1080, 1090, 1561, 1572	< 253	< 25	15
STAINLESS STEEL			
AUSTENITIC - SAE (300 SERIES)	< 253	< 25	20
MARTENSITIC & FERRITIC - 400 SERIES, 416, 420F, 446	253 - 301	25 - 32	15
TITANIUM ALLOYS			
ALPHA & ALPHA-BETA ALLOYS ANNEALED - Ti-6Al-4V	253 - 301	25 - 32	10
TOOL STEEL			
HOT WORK, COLD WORK & MOLD - A2, D2, H10, H14, P2, P13	190 - 253	10 - 25	20

CALCULATING TAP DRILL SIZES - THREAD FORMING TAPS	
$\text{DRILL SIZE} = \text{MAJOR DIAMETER} - [(0.0068 \times \text{desired \% of thread}) \div \text{Threads Per Inch}]$	
$\text{DRILL SIZE (mm)} = \text{MAJOR DIAMETER} - [(0.0068 \times \text{desired \% of thread} \times \text{Pitch (mm)})]$	

GUIDELINES FOR USING THREAD FORMING TAPS

PRE-TAP HOLE SIZE - Thread Forming taps require a larger pre-tap hole size than a cutting tap. Tapping with too small of a pre-tap hole size results in excessive tap wear, torque and possible tap breakage.

LUBRICATION - Thread Forming Taps require good lubrication. Cutting oils are generally preferred because of their lubricity compared to water soluble coolants.



GENERAL PURPOSE SOLID CARBIDE SPOT DRILLS

YOUR #1 SOURCE FOR AMERICAN-MADE PREMIUM QUALITY CUTTING TOOLS



**90° POINT
SERIES 187
UNCOATED**

DIA	SHANK	FL LENGTH	OAL	ITEM#	LIST PRICE
1/8	1/8	5/8	2	TC18708	32.64
3/16	3/16	3/4	2	TC18712	38.84
1/4	1/4	3/4	2-1/2	TC18716	47.17
3/8	3/8	1	3	TC18724	77.19
1/2	1/2	1	3	TC18732	125.33
5/8	5/8	1-1/4	3	TC18740	223.11
3/4	3/4	1-3/4	4	TC18748	299.58



**120° POINT
SERIES 188
UNCOATED**

DIA	SHANK	FL LENGTH	OAL	ITEM#	LIST PRICE
1/8	1/8	5/8	2	TC18808	32.64
3/16	3/16	3/4	2	TC18812	38.84
1/4	1/4	3/4	2-1/2	TC18816	47.17
3/8	3/8	1	3	TC18824	77.19
1/2	1/2	1	3	TC18832	125.33
5/8	5/8	1-1/4	3	TC18840	223.11
3/4	3/4	1-3/4	4	TC18848	299.58



**142° POINT
SERIES 189
UNCOATED**

DIA	SHANK	FL LENGTH	OAL	ITEM#	LIST PRICE
1/8	1/8	5/8	2	TC18908	32.64
3/16	3/16	3/4	2	TC18912	38.84
1/4	1/4	3/4	2-1/2	TC18916	47.17
3/8	3/8	1	3	TC18924	77.19
1/2	1/2	1	3	TC18932	125.33
5/8	5/8	1-1/4	3	TC18940	223.11
3/4	3/4	1-3/4	4	TC18948	299.58

TOLERANCES	SHANK
ALL SIZES	-.0001, -.0004 ISO H6

For technical information, please see pages 208 - 209.

GENERAL PURPOSE SOLID CARBIDE SPOT DRILLS



YOUR #1 SOURCE FOR AMERICAN-MADE PREMIUM QUALITY CUTTING TOOLS



90° POINT
SERIES 287
ALTIN COATED

DIA	SHANK	FL LENGTH	OAL	ITEM#	LIST PRICE
1/8	1/8	5/8	2	TC28708	40.79
3/16	3/16	3/4	2	TC28712	48.56
1/4	1/4	3/4	2-1/2	TC28716	59.24
3/8	3/8	1	3	TC28724	93.74
1/2	1/2	1	3	TC28732	163.18
5/8	5/8	1-1/4	3	TC28740	285.25
3/4	3/4	1-3/4	4	TC28748	374.48



120° POINT
SERIES 288
ALTIN COATED

DIA	SHANK	FL LENGTH	OAL	ITEM#	LIST PRICE
1/8	1/8	5/8	2	TC28808	40.79
3/16	3/16	3/4	2	TC28812	48.56
1/4	1/4	3/4	2-1/2	TC28816	59.24
3/8	3/8	1	3	TC28824	93.74
1/2	1/2	1	3	TC28832	163.18
5/8	5/8	1-1/4	3	TC28840	285.25
3/4	3/4	1-3/4	4	TC28848	374.48



142° POINT
SERIES 289
ALTIN COATED

DIA	SHANK	FL LENGTH	OAL	ITEM#	LIST PRICE
1/8	1/8	5/8	2	TC28908	40.79
3/16	3/16	3/4	2	TC28912	48.56
1/4	1/4	3/4	2-1/2	TC28916	59.24
3/8	3/8	1	3	TC28924	93.74
1/2	1/2	1	3	TC28932	163.18
5/8	5/8	1-1/4	3	TC28940	285.25
3/4	3/4	1-3/4	4	TC28948	374.48

TOLERANCES	SHANK
ALL SIZES	-.0001, -.0004 ISO H6

For coating information see page 8. For technical information, please see pages 208 - 209.



GENERAL PURPOSE SOLID CARBIDE DRILLS

YOUR #1 SOURCE FOR AMERICAN-MADE PREMIUM QUALITY CUTTING TOOLS

STUB LENGTH - 135° SPLIT POINT - 15° HELIX

SERIES 200
UNCOATED



SERIES 201
ALTiN COATED



FRACTIONAL SIZES

SIZE	FLUTE LENGTH	OAL	UNCOATED	LIST PRICE	ALTiN	LIST PRICE
1/32	3/8	1-1/2	TC20002	19.92	TC29002	24.91
3/64	3/8	1-1/2	TC20003	19.92	TC29003	24.91
1/16	13/32	1-1/2	TC20004	18.82	TC29004	23.50
5/64	7/16	1-1/2	TC20005	19.92	TC29005	24.91
3/32	1/2	1-1/2	TC20006	21.95	TC29006	27.43
7/64	5/8	2	TC20007	24.91	TC29007	31.14
1/8	3/4	2	TC20008	26.59	TC29008	33.22
9/64	3/4	2	TC20009	29.46	TC29009	36.79
5/32	7/8	2	TC20010	33.00	TC29010	41.21
11/64	7/8	2	TC20011	38.96	TC29011	48.72
3/16	7/8	2	TC20012	40.06	TC29012	50.09
13/64	1-1/8	2-1/2	TC20013	46.29	TC29013	57.86
7/32	1-1/8	2-1/2	TC20014	51.37	TC29014	64.22
15/64	1-1/4	2-1/2	TC20015	58.13	TC29015	72.66
1/4	1-1/4	2-1/2	TC20016	61.09	TC29016	76.37
17/64	1-1/4	2-1/2	TC20017	68.86	TC29017	86.04

FRACTIONAL SIZES

SIZE	FLUTE LENGTH	OAL	UNCOATED	LIST PRICE	ALTiN	LIST PRICE
9/32	1-1/4	2-1/2	TC20018	71.73	TC29018	89.67
19/64	1-1/4	2-1/2	TC20019	80.57	TC29019	100.75
5/16	1-1/4	2-1/2	TC20020	84.85	TC29020	106.01
21/64	1-3/8	3	TC20021	92.54	TC29021	115.68
11/32	1-3/8	3	TC20022	101.19	TC29022	126.46
23/64	1-3/8	3	TC20023	113.12	TC29023	141.39
3/8	1-3/8	3	TC20024	119.97	TC29024	149.96
25/64	1-3/8	3	TC20025	140.51	TC29025	175.62
13/32	1-3/8	3	TC20026	153.89	TC29026	192.36
27/64	1-3/8	3	TC20027	167.40	TC29027	209.23
7/16	1-3/8	3	TC20028	175.09	TC29028	218.86
29/64	1-3/8	3	TC20029	203.14	TC29029	253.93
15/32	1-3/8	3	TC20030	211.66	TC29030	264.58
31/64	1-3/8	3	TC20031	217.63	TC29031	272.04
1/2	1-3/8	3	TC20032	218.11	TC29032	272.62

NOTE: SIZES 7/64" AND UNDER ARE NOT SPLIT.

LETTER SIZES

SIZE	FLUTE LENGTH	OAL	UNCOATED	LIST PRICE	ALTiN	LIST PRICE
A	1-1/4	2-1/2	TC20101	58.66	TC29101	73.32
B	1-1/4	2-1/2	TC20102	61.09	TC29102	76.37
C	1-1/4	2-1/2	TC20103	61.53	TC29103	76.94
D	1-1/4	2-1/2	TC20104	62.32	TC29104	77.87
E	1-1/4	2-1/2	TC20105	61.09	TC29105	76.37
F	1-1/4	2-1/2	TC20106	67.98	TC29106	84.94
G	1-1/4	2-1/2	TC20107	72.04	TC29107	90.06
H	1-1/4	2-1/2	TC20108	73.59	TC29108	92.01
I	1-1/4	2-1/2	TC20109	74.82	TC29109	93.55
J	1-1/4	2-1/2	TC20110	76.81	TC29110	96.03
K	1-1/4	2-1/2	TC20111	77.52	TC29111	96.86
L	1-1/4	2-1/2	TC20112	81.94	TC29112	102.39
M	1-1/4	2-1/2	TC20113	83.57	TC29113	104.51

LETTER SIZES

SIZE	FLUTE LENGTH	OAL	UNCOATED	LIST PRICE	ALTiN	LIST PRICE
N	1-1/4	2-1/2	TC20114	88.83	TC29114	111.00
O	1-3/8	3	TC20115	93.64	TC29115	117.05
P	1-3/8	3	TC20116	97.22	TC29116	121.51
Q	1-3/8	3	TC20117	100.75	TC29117	125.93
R	1-3/8	3	TC20118	105.17	TC29118	131.45
S	1-3/8	3	TC20119	112.02	TC29119	140.06
T	1-3/8	3	TC20120	116.03	TC29120	145.05
U	1-3/8	3	TC20121	121.78	TC29121	152.21
V	1-3/8	3	TC20122	134.85	TC29122	168.55
W	1-3/8	3	TC20123	145.23	TC29123	181.54
X	1-3/8	3	TC20124	158.53	TC29124	198.15
Y	1-3/8	3	TC20125	163.83	TC29125	204.77
Z	1-3/8	3	TC20126	177.56	TC29126	221.91

For coating information see page 8. For technical information, please see pages 208 - 209.

DIAMETER TOLERANCE +.0000, -.0005

GENERAL PURPOSE SOLID CARBIDE DRILLS



YOUR #1 SOURCE FOR AMERICAN-MADE PREMIUM QUALITY CUTTING TOOLS

DRILLING

STUB LENGTH - 135° SPLIT POINT - 15° HELIX

SERIES 200
UNCOATED



SERIES 201
ALTiN COATED



WIRE SIZES						WIRE SIZES							
SIZE	FLUTE LENGTH	OAL	UNCOATED	LIST PRICE	ALTiN	LIST PRICE	SIZE	FLUTE LENGTH	OAL	UNCOATED	LIST PRICE	ALTiN	LIST PRICE
#1	1-1/4	2-1/2	TC20201	53.14	TC29201	66.43	#31	3/4	2	TC20231	25.93	TC29231	32.38
#2	1-1/4	2-1/2	TC20202	53.14	TC29202	66.43	#32	3/4	2	TC20232	25.93	TC29232	32.38
#3	1-1/8	2-1/2	TC20203	53.14	TC29203	66.43	#33	3/4	2	TC20233	25.66	TC29233	32.11
#4	1-1/8	2-1/2	TC20204	52.56	TC29204	65.72	#34	3/4	2	TC20234	25.44	TC29234	31.80
#5	1-1/8	2-1/2	TC20205	46.95	TC29205	58.66	#35	3/4	2	TC20235	25.44	TC29235	31.80
#6	1-1/8	2-1/2	TC20206	46.95	TC29206	58.66	#36	5/8	2	TC20236	25.44	TC29236	31.80
#7	1-1/8	2-1/2	TC20207	45.58	TC29207	56.98	#37	5/8	2	TC20237	24.12	TC29237	30.17
#8	1-1/8	2-1/2	TC20208	45.41	TC29208	56.76	#38	5/8	2	TC20238	23.68	TC29238	29.59
#9	1-1/8	2-1/2	TC20209	45.41	TC29209	56.76	#39	5/8	2	TC20239	23.68	TC29239	29.59
#10	1-1/8	2-1/2	TC20210	45.41	TC29210	56.76	#40	5/8	2	TC20240	22.79	TC29240	28.53
#11	1-1/8	2-1/2	TC20211	44.26	TC29211	55.35	#41	5/8	2	TC20241	22.79	TC29241	28.53
#12	1-1/8	2-1/2	TC20212	44.26	TC29212	55.35	#42	1/2	1-1/2	TC20242	22.17	TC29242	27.69
#13	7/8	2	TC20213	42.71	TC29213	53.40	#43	1/2	1-1/2	TC20243	22.17	TC29243	27.69
#14	7/8	2	TC20214	41.65	TC29214	52.08	#44	1/2	1-1/2	TC20244	21.02	TC29244	26.28
#15	7/8	2	TC20215	40.99	TC29215	51.19	#45	1/2	1-1/2	TC20245	20.36	TC29245	25.44
#16	7/8	2	TC20216	40.99	TC29216	51.19	#46	1/2	1-1/2	TC20246	20.36	TC29246	25.44
#17	7/8	2	TC20217	38.96	TC29217	48.72	#47	1/2	1-1/2	TC20247	20.36	TC29247	25.44
#18	7/8	2	TC20218	36.62	TC29218	45.80	#48	7/16	1-1/2	TC20248	20.36	TC29248	25.44
#19	7/8	2	TC20219	35.87	TC29219	44.83	#49	7/16	1-1/2	TC20249	19.48	TC29249	24.34
#20	7/8	2	TC20220	34.32	TC29220	42.93	#50	7/16	1-1/2	TC20250	19.48	TC29250	24.34
#21	7/8	2	TC20221	34.32	TC29221	42.93	#51	7/16	1-1/2	TC20251	18.82	TC29251	23.50
#22	7/8	2	TC20222	33.00	TC29222	41.21	#52	7/16	1-1/2	TC20252	18.82	TC29252	23.50
#23	7/8	2	TC20223	33.00	TC29223	41.21	#53	13/32	1-1/2	TC20253	19.92	TC29253	24.91
#24	7/8	2	TC20224	32.77	TC29224	40.99	#54	13/32	1-1/2	TC20254	19.92	TC29254	24.91
#25	7/8	2	TC20225	31.01	TC29225	38.74	#55	13/32	1-1/2	TC20255	19.92	TC29255	24.91
#26	7/8	2	TC20226	31.01	TC29226	38.74	#56	3/8	1-1/2	TC20256	19.92	TC29256	24.91
#27	7/8	2	TC20227	31.01	TC29227	38.74	#57	3/8	1-1/2	TC20257	19.92	TC29257	24.91
#28	3/4	2	TC20228	29.46	TC29228	36.79	#58	3/8	1-1/2	TC20258	19.92	TC29258	24.91
#29	3/4	2	TC20229	29.46	TC29229	36.79	#59	3/8	1-1/2	TC20259	19.92	TC29259	24.91
#30	3/4	2	TC20230	27.87	TC29230	34.85	#60	3/8	1-1/2	TC20260	19.92	TC29260	24.91

NOTE: SIZES 31 - 60 ARE NOT SPLIT.

For coating information see page 8. For technical information, please see pages 208 - 209.

DIAMETER TOLERANCE +.0000, -.0005

DRILLS
CARBIDE DRILLS
COBALT DRILLS
HSS DRILLS
AEROSPACE
SILVER & DEMING
SPECIALTY
TECHNICAL DRILL SETS



GENERAL PURPOSE SOLID CARBIDE DRILLS

YOUR #1 SOURCE FOR AMERICAN-MADE PREMIUM QUALITY CUTTING TOOLS

JOBBER LENGTH - 118° SPLIT POINT - 25° HELIX

SERIES 190
UNCOATED



SERIES 191
ALTIM COATED



DRILLS
 CARBIDE DRILLS
 COBALT DRILLS
 HSS DRILLS
 AEROSPACE
 SILVER & DEMING
 SPECIALTY DRILL SETS
 TECHNICAL

FRACTIONAL SIZES						FRACTIONAL SIZES							
SIZE	FLUTE LENGTH	OAL	UNCOATED	LIST PRICE	ALTIM	LIST PRICE	SIZE	FLUTE LENGTH	OAL	UNCOATED	LIST PRICE	ALTIM	LIST PRICE
1/32	5/16	1-1/4	TC19002	18.73	TC79002	23.41	9/32	2-1/8	3-1/2	TC19018	67.54	TC79018	84.45
3/64	3/4	1-1/2	TC19003	18.73	TC79003	23.41	19/64	2-3/8	3-3/4	TC19019	75.88	TC79019	94.83
1/16	3/4	1-1/2	TC19004	17.71	TC79004	22.13	5/16	2-3/8	3-3/4	TC19020	79.82	TC79020	99.74
5/64	7/8	1-3/4	TC19005	18.73	TC79005	23.41	21/64	2-1/2	4	TC19021	87.10	TC79021	108.88
3/32	1	2	TC19006	20.63	TC79006	25.80	11/32	2-1/2	4	TC19022	95.23	TC79022	119.04
7/64	1-1/4	2-1/4	TC19007	23.45	TC79007	29.33	23/64	2-3/4	4-1/4	TC19023	106.49	TC79023	133.13
1/8	1-1/4	2-1/4	TC19008	25.00	TC79008	31.27	3/8	2-3/4	4-1/4	TC19024	112.94	TC79024	141.17
9/64	1-3/8	2-1/2	TC19009	27.69	TC79009	34.63	25/64	2-7/8	4-1/2	TC19025	132.25	TC79025	165.28
5/32	1-3/8	2-1/2	TC19010	31.05	TC79010	38.83	13/32	2-7/8	4-1/2	TC19026	144.83	TC79026	181.05
11/64	1-5/8	2-3/4	TC19011	36.66	TC79011	45.85	27/64	2-7/8	4-1/2	TC19027	157.51	TC79027	196.87
3/16	1-5/8	2-3/4	TC19012	37.72	TC79012	47.13	7/16	2-7/8	4-1/2	TC19028	164.80	TC79028	206.05
13/64	1-3/4	3	TC19013	43.55	TC79013	54.46	29/64	3	4-3/4	TC19029	191.21	TC79029	239.00
7/32	1-3/4	3	TC19014	48.32	TC79014	60.42	15/32	3	4-3/4	TC19030	199.21	TC79030	248.99
15/64	2	3-1/4	TC19015	54.73	TC79015	68.38	31/64	3	4-3/4	TC19031	204.82	TC79031	256.05
1/4	2	3-1/4	TC19016	57.51	TC79016	71.86	1/2	3	4-3/4	TC19032	205.26	TC79032	256.58
17/64	2-1/8	3-1/2	TC19017	64.75	TC79017	80.96							

NOTE: SIZES 7/64" AND UNDER ARE NOT SPLIT.

METRIC SIZES						METRIC SIZES							
SIZE	FLUTE LENGTH	OAL	UNCOATED	LIST PRICE	ALTIM	LIST PRICE	SIZE	FLUTE LENGTH	OAL	UNCOATED	LIST PRICE	ALTIM	LIST PRICE
0.7	12	31	TC19307	23.28	TC79307	29.11	3.0	32	57	TC19330	32.07	TC79330	40.06
0.8	12	31	TC19308	23.28	TC79308	29.11	3.1	32	57	TC19331	32.07	TC79331	40.06
0.9	16	38	TC19309	23.28	TC79309	29.11	3.2	32	57	TC19332	32.07	TC79332	40.06
1.0	16	38	TC19310	23.28	TC79310	29.11	3.3	32	57	TC19333	32.07	TC79333	40.06
1.1	19	38	TC19311	23.28	TC79311	29.11	3.4	35	63	TC19334	34.81	TC79334	43.55
1.2	19	38	TC19312	23.28	TC79312	29.11	3.5	35	63	TC19335	34.81	TC79335	43.55
1.3	19	38	TC19313	23.28	TC79313	29.11	4.0	35	63	TC19340	42.85	TC79340	53.53
1.4	19	38	TC19314	23.28	TC79314	29.11	4.5	41	70	TC19345	45.89	TC79345	57.38
1.5	19	38	TC19315	23.45	TC79315	29.33	5.0	44	75	TC19350	50.75	TC79350	63.47
1.6	19	38	TC19316	23.45	TC79316	29.33	5.5	44	75	TC19355	60.12	TC79355	75.13
1.7	19	38	TC19317	23.45	TC79317	29.33	6.0	50	82	TC19360	63.56	TC79360	79.42
1.8	22	38	TC19318	23.45	TC79318	29.33	6.5	50	82	TC19365	101.24	TC79365	126.55
1.9	22	38	TC19319	23.45	TC79319	29.33	7.0	54	89	TC19370	110.87	TC79370	138.61
2.0	22	44	TC19320	24.91	TC79320	31.14	7.5	60	95	TC19375	114.49	TC79375	143.11
2.1	22	44	TC19321	24.91	TC79321	31.14	8.0	60	95	TC19380	121.11	TC79380	151.37
2.2	25	50	TC19322	24.91	TC79322	31.14	8.5	63	100	TC19385	149.52	TC79385	186.88
2.3	25	50	TC19323	24.91	TC79323	31.14	9.0	70	100	TC19390	169.75	TC79390	212.19
2.4	25	50	TC19324	24.91	TC79324	31.14	9.5	70	108	TC19395	193.69	TC79395	242.14
2.5	25	50	TC19325	28.62	TC79325	35.78	10.0	73	114	TC19400	222.44	TC79400	278.05
2.6	32	57	TC19326	28.62	TC79326	35.78	10.5	73	114	TC19405	248.77	TC79405	310.96
2.7	32	57	TC19327	28.62	TC79327	35.78	11.0	73	114	TC19410	295.98	TC79410	370.01
2.8	32	57	TC19328	28.62	TC79328	35.78	11.5	76	120	TC19415	304.86	TC79415	381.10
2.9	32	57	TC19329	28.62	TC79329	35.78	12.0	76	120	TC19420	338.34	TC79420	422.97

NOTE: ALL DIMENSIONS IN TABLE ARE METRIC
NOTE: SIZES 3.1 AND UNDER ARE NOT SPLIT

For coating information see page 8. For technical information, please see pages 208 - 209.

DIAMETER TOLERANCE +.0000, -.0005

GENERAL PURPOSE SOLID CARBIDE DRILLS



YOUR #1 SOURCE FOR AMERICAN-MADE PREMIUM QUALITY CUTTING TOOLS

JOBBER LENGTH - 118° SPLIT POINT - 25° HELIX

SERIES 190
UNCOATED



SERIES 191
ALTiN COATED



LETTER SIZES						LETTER SIZES							
SIZE	FLUTE LENGTH	OAL	UNCOATED	LIST PRICE	ALTiN	LIST PRICE	SIZE	FLUTE LENGTH	OAL	UNCOATED	LIST PRICE	ALTiN	LIST PRICE
A	2	3-1/4	TC19101	55.21	TC79101	68.99	N	2-3/8	3-3/4	TC19114	91.25	TC79114	104.51
B	2	3-1/4	TC19102	57.51	TC79102	71.86	O	2-3/8	3-3/4	TC19115	96.51	TC79115	110.16
C	2	3-1/4	TC19103	57.95	TC79103	72.44	P	2-3/8	3-3/4	TC19116	99.74	TC79116	114.36
D	2	3-1/4	TC19104	58.66	TC79104	73.32	Q	2-1/2	4	TC19117	105.92	TC79117	118.51
E	2	3-1/4	TC19105	57.51	TC79105	71.86	R	2-1/2	4	TC19118	109.17	TC79118	123.72
F	2	3-1/4	TC19106	68.27	TC79106	79.95	S	2-1/2	4	TC19119	116.53	TC79119	131.80
G	2-1/8	3-1/2	TC19107	73.84	TC79107	84.76	T	2-3/4	4-1/4	TC19120	120.61	TC79120	136.49
H	2-1/8	3-1/2	TC19108	75.79	TC79108	86.62	U	2-3/4	4-1/4	TC19121	126.44	TC79121	143.24
I	2-1/8	3-1/2	TC19109	77.25	TC79109	88.03	V	2-3/4	4-1/4	TC19122	137.02	TC79122	158.66
J	2-1/8	3-1/2	TC19110	82.12	TC79110	90.42	W	2-7/8	4-1/2	TC19123	143.92	TC79123	170.89
K	2-1/8	3-1/2	TC19111	82.31	TC79111	91.17	X	2-7/8	4-1/2	TC19124	157.24	TC79124	186.49
L	2-1/8	3-1/2	TC19112	82.67	TC79112	96.38	Y	2-7/8	4-1/2	TC19125	162.36	TC79125	192.76
M	2-3/8	3-3/4	TC19113	83.15	TC79113	98.32	Z	2-7/8	4-1/2	TC19126	201.49	TC79126	208.88

WIRE SIZES						WIRE SIZES							
SIZE	FLUTE LENGTH	OAL	UNCOATED	LIST PRICE	ALTiN	LIST PRICE	SIZE	FLUTE LENGTH	OAL	UNCOATED	LIST PRICE	ALTiN	LIST PRICE
#1	1-3/4	3	TC19201	50.04	TC79201	62.54	#31	1-1/4	2-1/4	TC19231	24.38	TC79231	30.48
#2	1-3/4	3	TC19202	50.04	TC79202	62.54	#32	1-1/4	2-1/4	TC19232	24.38	TC79232	30.48
#3	1-3/4	3	TC19203	50.04	TC79203	62.54	#33	1-1/4	2-1/4	TC19233	24.16	TC79233	30.21
#4	1-3/4	3	TC19204	49.51	TC79204	61.88	#34	1-1/4	2-1/4	TC19234	23.98	TC79234	29.95
#5	1-3/4	3	TC19205	44.17	TC79205	55.26	#35	1-1/4	2-1/4	TC19235	23.98	TC79235	29.95
#6	1-3/4	3	TC19206	44.17	TC79206	55.26	#36	1-1/4	2-1/4	TC19236	23.98	TC79236	29.95
#7	1-3/4	3	TC19207	42.93	TC79207	53.67	#37	1-1/4	2-1/4	TC19237	22.70	TC79237	28.40
#8	1-3/4	3	TC19208	42.71	TC79208	53.40	#38	1-1/4	2-1/4	TC19238	22.31	TC79238	27.87
#9	1-3/4	3	TC19209	42.71	TC79209	53.40	#39	1-1/4	2-1/4	TC19239	22.31	TC79239	27.87
#10	1-5/8	2-3/4	TC19210	42.71	TC79210	53.40	#40	1	2	TC19240	21.47	TC79240	26.81
#11	1-5/8	2-3/4	TC19211	41.70	TC79211	52.08	#41	1	2	TC19241	21.47	TC79241	26.81
#12	1-5/8	2-3/4	TC19212	41.70	TC79212	52.08	#42	1	2	TC19242	20.85	TC79242	26.06
#13	1-5/8	2-3/4	TC19213	40.19	TC79213	50.27	#43	1	2	TC19243	20.85	TC79243	26.06
#14	1-5/8	2-3/4	TC19214	39.18	TC79214	48.98	#44	1	2	TC19244	19.79	TC79244	24.74
#15	1-5/8	2-3/4	TC19215	38.56	TC79215	48.19	#45	7/8	1-3/4	TC19245	19.21	TC79245	23.98
#16	1-5/8	2-3/4	TC19216	38.56	TC79216	48.19	#46	7/8	1-3/4	TC19246	19.21	TC79246	23.98
#17	1-5/8	2-3/4	TC19217	36.66	TC79217	45.85	#47	7/8	1-3/4	TC19247	19.21	TC79247	23.98
#18	1-5/8	2-3/4	TC19218	34.50	TC79218	43.11	#48	7/8	1-3/4	TC19248	19.21	TC79248	23.98
#19	1-5/8	2-3/4	TC19219	33.75	TC79219	42.18	#49	7/8	1-3/4	TC19249	18.33	TC79249	22.92
#20	1-3/8	2-1/2	TC19220	32.29	TC79220	40.37	#50	7/8	1-3/4	TC19250	18.33	TC79250	22.92
#21	1-3/8	2-1/2	TC19221	32.29	TC79221	40.37	#51	3/4	1-1/2	TC19251	17.71	TC79251	22.13
#22	1-3/8	2-1/2	TC19222	31.05	TC79222	38.83	#52	3/4	1-1/2	TC19252	17.71	TC79252	22.13
#23	1-3/8	2-1/2	TC19223	31.05	TC79223	38.83	#53	3/4	1-1/2	TC19253	18.73	TC79253	23.41
#24	1-3/8	2-1/2	TC19224	30.83	TC79224	38.56	#54	3/4	1-1/2	TC19254	18.73	TC79254	23.41
#25	1-3/8	2-1/2	TC19225	29.15	TC79225	36.48	#55	3/4	1-1/2	TC19255	18.73	TC79255	23.41
#26	1-3/8	2-1/2	TC19226	29.15	TC79226	36.48	#56	3/4	1-1/2	TC19256	18.73	TC79256	23.41
#27	1-3/8	2-1/2	TC19227	29.15	TC79227	36.48	#57	3/4	1-1/2	TC19257	18.73	TC79257	23.41
#28	1-3/8	2-1/2	TC19228	27.69	TC79228	34.63	#58	3/4	1-1/2	TC19258	18.73	TC79258	23.41
#29	1-3/8	2-1/2	TC19229	27.69	TC79229	34.63	#59	3/4	1-1/2	TC19259	18.73	TC79259	23.41
#30	1-1/4	2-1/4	TC19230	26.24	TC79230	32.82	#60	3/4	1-1/2	TC19260	18.73	TC79260	23.41

NOTE: SIZES 31-60 ARE NOT SPLIT.

For coating information see page 8. For technical information, please see pages 208 - 209.

DIAMETER TOLERANCE +.0000, -.0005



GENERAL PURPOSE SOLID CARBIDE DRILLS

YOUR #1 SOURCE FOR AMERICAN-MADE PREMIUM QUALITY CUTTING TOOLS

STRAIGHT FLUTE - 140° SPLIT POINT

SERIES 195
UNCOATED



SERIES 196
ALTiN COATED



FRACTIONAL SIZES

SIZE	FLUTE LENGTH	OAL	UNCOATED	LIST PRICE	ALTiN	LIST PRICE
1/8	3/4	2	TC19508	29.15	TC79508	36.44
9/64	3/4	2	TC19509	33.35	TC79509	41.65
5/32	7/8	2	TC19510	37.32	TC79510	46.69
11/64	7/8	2	TC19511	41.43	TC79511	51.77
3/16	7/8	2	TC19512	38.25	TC79512	47.79
13/64	1-1/8	2-1/2	TC19513	49.74	TC79513	62.24
7/32	1-1/8	2-1/2	TC19514	55.88	TC79514	69.88
15/64	1-1/4	2-1/2	TC19515	58.97	TC79515	73.72
1/4	1-1/4	2-1/2	TC19516	55.79	TC79516	69.74
17/64	1-1/4	2-1/2	TC19517	77.56	TC79517	96.91
9/32	1-1/4	2-1/2	TC19518	80.61	TC79518	100.80
19/64	1-1/4	2-1/2	TC19519	85.34	TC79519	106.67

FRACTIONAL SIZES

SIZE	FLUTE LENGTH	OAL	UNCOATED	LIST PRICE	ALTiN	LIST PRICE
5/16	1-1/4	2-1/2	TC19520	88.38	TC79520	110.47
21/64	1-3/8	3	TC19521	95.01	TC79521	118.73
11/32	1-3/8	3	TC19522	105.39	TC79522	131.72
23/64	1-3/8	3	TC19523	115.28	TC79523	144.13
3/8	1-3/8	3	TC19524	114.31	TC79524	142.89
25/64	1-3/8	3	TC19525	141.39	TC79525	176.72
13/32	1-3/8	3	TC19526	135.29	TC79526	169.13
27/64	1-3/8	3	TC19527	171.56	TC79527	214.40
7/16	1-3/8	3	TC19528	167.32	TC79528	209.15
15/32	1-3/8	3	TC19530	186.18	TC79530	232.73
1/2	1-3/8	3	TC19532	201.72	TC79532	252.17

LETTER SIZES

SIZE	FLUTE LENGTH	OAL	UNCOATED	LIST PRICE	ALTiN	LIST PRICE
A	1-1/4	2-1/2	TC19601	58.97	TC79601	73.72
B	1-1/4	2-1/2	TC19602	58.97	TC79602	73.72
C	1-1/4	2-1/2	TC19603	58.97	TC79603	73.72
D	1-1/4	2-1/2	TC19604	58.97	TC79604	73.72
E	1-1/4	2-1/2	TC19605	55.79	TC79605	69.74
F	1-1/4	2-1/2	TC19606	77.56	TC79606	96.91
G	1-1/4	2-1/2	TC19607	77.56	TC79607	96.91
H	1-1/4	2-1/2	TC19608	77.56	TC79608	96.91
I	1-1/4	2-1/2	TC19609	80.61	TC79609	100.80
J	1-1/4	2-1/2	TC19610	80.61	TC79610	100.80
K	1-1/4	2-1/2	TC19611	80.61	TC79611	100.80
L	1-1/4	2-1/2	TC19612	85.34	TC79612	106.67
M	1-1/4	2-1/2	TC19613	85.34	TC79613	106.67

LETTER SIZES

SIZE	FLUTE LENGTH	OAL	UNCOATED	LIST PRICE	ALTiN	LIST PRICE
N	1-1/4	2-1/2	TC19614	88.38	TC79614	110.47
O	1-3/8	3	TC19615	88.38	TC79615	110.47
P	1-3/8	3	TC19616	95.01	TC79616	118.77
Q	1-3/8	3	TC19617	105.39	TC79617	131.72
R	1-3/8	3	TC19618	105.39	TC79618	131.72
S	1-3/8	3	TC19619	115.28	TC79619	144.13
T	1-3/8	3	TC19620	115.28	TC79620	144.13
U	1-3/8	3	TC19621	127.87	TC79621	159.81
V	1-3/8	3	TC19622	127.87	TC79622	159.81
W	1-3/8	3	TC19623	141.39	TC79623	176.72
X	1-3/8	3	TC19624	156.45	TC79624	195.59
Y	1-3/8	3	TC19625	164.00	TC79625	204.99
Z	1-3/8	3	TC19626	171.56	TC79626	214.40

For coating information see page 8. For technical information, please see pages 208 - 209.

DIAMETER TOLERANCE +.0000, -.0005

GENERAL PURPOSE SOLID CARBIDE DRILLS



YOUR #1 SOURCE FOR AMERICAN-MADE PREMIUM QUALITY CUTTING TOOLS

DRILLING

STRAIGHT FLUTE - 140° SPLIT POINT

SERIES 195
UNCOATED



SERIES 196
ALTIM COATED



WIRE SIZES						WIRE SIZES							
SIZE	FLUTE LENGTH	OAL	UNCOATED	LIST PRICE	ALTIM	LIST PRICE	SIZE	FLUTE LENGTH	OAL	UNCOATED	LIST PRICE	ALTIM	LIST PRICE
#1	1-1/4	2-1/2	TC19701	57.38	TC79701	71.73	#16	7/8	2	TC19716	42.89	TC79716	53.62
#2	1-1/4	2-1/2	TC19702	56.36	TC79702	70.45	#17	7/8	2	TC19717	41.87	TC79717	52.34
#3	1-1/8	2-1/2	TC19703	54.11	TC79703	67.62	#18	7/8	2	TC19718	40.68	TC79718	50.84
#4	1-1/8	2-1/2	TC19704	51.10	TC79704	63.87	#19	7/8	2	TC19719	40.42	TC79719	50.53
#5	1-1/8	2-1/2	TC19705	51.68	TC79705	64.58	#20	7/8	2	TC19720	39.05	TC79720	48.81
#6	1-1/8	2-1/2	TC19706	50.93	TC79706	63.65	#21	7/8	2	TC19721	38.78	TC79721	48.50
#7	1-1/8	2-1/2	TC19707	49.03	TC79707	61.31	#22	7/8	2	TC19722	38.03	TC79722	47.57
#8	1-1/8	2-1/2	TC19708	48.32	TC79708	60.38	#23	7/8	2	TC19723	36.44	TC79723	45.54
#9	1-1/8	2-1/2	TC19709	46.86	TC79709	58.57	#24	7/8	2	TC19724	35.42	TC79724	44.30
#10	1-1/8	2-1/2	TC19710	46.16	TC79710	57.73	#25	7/8	2	TC19725	34.36	TC79725	42.98
#11	1-1/8	2-1/2	TC19711	45.36	TC79711	56.67	#26	7/8	2	TC19726	33.97	TC79726	42.45
#12	1-1/8	2-1/2	TC19712	44.52	TC79712	55.65	#27	7/8	2	TC19727	33.30	TC79727	41.65
#13	7/8	2	TC19713	43.77	TC79713	54.68	#28	3/4	2	TC19728	32.20	TC79728	40.19
#14	7/8	2	TC19714	43.46	TC79714	54.37	#29	3/4	2	TC19729	31.49	TC79729	39.36
#15	7/8	2	TC19715	43.07	TC79715	53.80	#30	3/4	2	TC19730	31.01	TC79730	38.78

DRILLS

CARBIDE DRILLS

COBALT DRILLS

HSS DRILLS

AEROSPACE

SILVER & DEMING

SPECIALTY

DRILL SETS

TECHNICAL

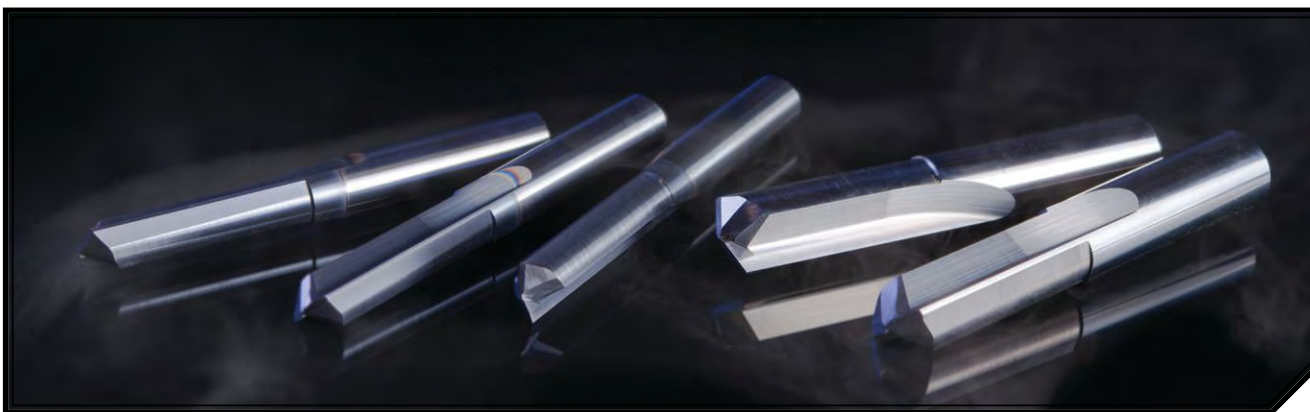

Straight flute drills excel in high rockwell and hard to machine materials

For coating information see page 8. For technical information, please see pages 208 - 209.

DIAMETER TOLERANCE	+ .0000, -.0005
--------------------	-----------------



GENERAL PURPOSE M42 COBALT DRILLS

YOUR #1 SOURCE FOR AMERICAN-MADE PREMIUM QUALITY CUTTING TOOLS

STUB LENGTH - HEAVY DUTY - 135° SPLIT POINT - TYPE "J"

SERIES 325
NAS 907 - M42 COBALT



SERIES 602
NAS 907 - M42 COBALT
ALTiN COATED



DRILLS
CARBIDE DRILLS
COBALT DRILLS
HSS DRILLS
AEROSPACE
SILVER & DEMING
SPECIALTY
DRILL SETS
TECHNICAL

FRACTIONAL SIZES								FRACTIONAL SIZES							
SIZE	FLUTE LENGTH	OAL	PKG. QTY.	UNCOATED	LIST PRICE	ALTiN	LIST PRICE	SIZE	FLUTE LENGTH	OAL	PKG. QTY.	UNCOATED	LIST PRICE	ALTiN	LIST PRICE
1/16	5/8	1-5/8	12	CD32504	2.86	CD60204	5.19	19/64	1-9/16	2-3/4	6	CD32519	11.06	CD60219	19.98
5/64	11/16	1-11/16	12	CD32505	2.86	CD60205	5.19	5/16	1-5/8	2-13/16	6	CD32520	11.86	CD60220	21.44
3/32	3/4	1-3/4	12	CD32506	2.86	CD60206	5.19	21/64	1-11/16	2-15/16	6	CD32521	13.17	CD60221	23.80
7/64	13/16	1-13/16	12	CD32507	3.24	CD60207	5.87	11/32	1-11/16	3	6	CD32522	14.22	CD60222	25.73
1/8	7/8	1-7/8	12	CD32508	3.74	CD60208	6.82	23/64	1-3/4	3-1/16	6	CD32523	16.37	CD60223	29.59
9/64	15/16	1-15/16	12	CD32509	3.74	CD60209	6.82	3/8	1-13/16	3-1/8	6	CD32524	16.37	CD60224	29.59
5/32	1	2-1/16	12	CD32510	4.12	CD60210	7.46	25/64	1-7/8	3-1/4	6	CD32525	18.72	CD60225	33.87
11/64	1-1/16	2-1/8	12	CD32511	4.67	CD60211	8.40	13/32	1-15/16	3-5/16	6	CD32526	19.35	CD60226	34.95
3/16	1-1/8	2-3/16	12	CD32512	5.47	CD60212	9.91	27/64	2	3-3/8	6	CD32527	21.46	CD60227	38.72
13/64	1-3/16	2-1/4	12	CD32513	6.27	CD60213	11.28	7/16	1-1/16	3-7/16	6	CD32528	22.04	CD60228	39.84
7/32	1-1/4	2-3/8	12	CD32514	6.90	CD60214	12.48	29/64	2-1/8	3-9/16	6	CD32529	26.46	CD60229	47.77
15/64	1-5/16	2-7/16	12	CD32515	7.40	CD60215	13.42	15/32	2-1/8	3-5/8	6	CD32530	26.46	CD60230	47.77
1/4	1-3/8	2-1/2	12	CD32516	7.70	CD60216	13.94	31/64	2-3/16	3-11/16	6	CD32531	26.46	CD60231	47.77
17/64	1-7/16	2-5/8	6	CD32517	8.79	CD60217	15.87	1/2	2-1/4	3-3/4	6	CD32532	26.46	CD60232	47.77
9/32	1-1/2	2-11/16	6	CD32518	9.55	CD60218	17.28								

LETTER SIZES								LETTER SIZES							
SIZE	FLUTE LENGTH	OAL	PKG. QTY.	UNCOATED	LIST PRICE	ALTiN	LIST PRICE	SIZE	FLUTE LENGTH	OAL	PKG. QTY.	UNCOATED	LIST PRICE	ALTiN	LIST PRICE
A	1-5/16	2-7/16	12	CD32701	8.83	CD60401	15.95	N	1-5/8	2-13/16	6	CD32714	13.42	CD60414	24.23
B	1-3/8	2-1/2	12	CD32702	9.38	CD60402	16.94	O	1-11/16	2-15/16	6	CD32715	14.85	CD60415	26.84
C	1-3/8	2-1/2	12	CD32703	9.38	CD60403	16.94	P	1-11/16	2-15/16	6	CD32716	14.85	CD60416	26.84
D	1-3/8	2-1/2	12	CD32704	9.38	CD60404	16.94	Q	1-11/16	3	6	CD32717	16.07	CD60417	29.03
E	1-3/8	2-1/2	12	CD32705	8.54	CD60405	15.48	R	1-11/16	3	6	CD32718	16.07	CD60418	29.03
F	1-7/16	2-5/8	6	CD32706	9.93	CD60406	17.92	S	1-3/4	3-1/16	6	CD32719	19.98	CD60419	36.15
G	1-7/16	2-5/8	6	CD32707	9.93	CD60407	17.92	T	1-3/4	3-1/16	6	CD32720	19.98	CD60420	36.15
H	1-1/2	2-11/16	6	CD32708	10.52	CD60408	19.04	U	1-13/16	3-1/8	6	CD32721	19.98	CD60421	36.15
I	1-1/2	2-11/16	6	CD32709	10.52	CD60409	19.04	V	1-7/8	3-1/4	6	CD32722	22.21	CD60422	40.09
J	1-1/2	2-11/16	6	CD32710	10.52	CD60410	19.04	W	1-7/8	3-1/4	6	CD32723	22.21	CD60423	40.09
K	1-1/2	2-11/16	6	CD32711	10.52	CD60411	19.04	X	1-15/16	3-5/16	6	CD32724	22.21	CD60424	40.09
L	1-9/16	2-3/4	6	CD32712	12.49	CD60412	22.55	Y	1-15/16	3-5/16	6	CD32725	22.21	CD60425	40.09
M	1-9/16	2-3/4	6	CD32713	12.49	CD60413	22.55	Z	2	3-3/8	6	CD32726	25.45	CD60426	46.01

NOTE: SIZES BELOW 1/16" ARE NOT SPLIT POINT.

All cobalt drills have identification ring on shank.
For coating information see page 8. For technical information, please see pages 210 - 211.

GENERAL PURPOSE M42 COBALT DRILLS



YOUR #1 SOURCE FOR AMERICAN-MADE PREMIUM QUALITY CUTTING TOOLS

STUB LENGTH - HEAVY DUTY - 135° SPLIT POINT - TYPE "J"

SERIES 325
NAS 907 - M42 COBALT



SERIES 602
NAS 907 - M42 COBALT
ALTiN COATED



WIRE SIZES							WIRE SIZES								
SIZE	FLUTE LENGTH	OAL	PKG. QTY.	UNCOATED	LIST PRICE	ALTiN	LIST PRICE	SIZE	FLUTE LENGTH	OAL	PKG. QTY.	UNCOATED	LIST PRICE	ALTiN	LIST PRICE
#1	1-5/16	2-7/16	12	CD32601	8.50	CD60301	15.35	#31	7/8	1-7/8	12	CD32631	3.53	CD60331	6.39
#2	1-5/16	2-7/16	12	CD32602	8.50	CD60302	15.35	#32	7/8	1-7/8	12	CD32632	3.53	CD60332	6.39
#3	1-1/4	2-3/8	12	CD32603	8.50	CD60303	15.35	#33	7/8	1-7/8	12	CD32633	3.41	CD60333	6.17
#4	1-1/4	2-3/8	12	CD32604	7.57	CD60304	13.72	#34	7/8	1-7/8	12	CD32634	3.41	CD60334	6.17
#5	1-1/4	2-3/8	12	CD32605	7.57	CD60305	13.72	#35	7/8	1-7/8	12	CD32635	3.41	CD60335	6.17
#6	1-1/4	2-3/8	12	CD32606	7.57	CD60306	13.72	#36	13/16	1-13/16	12	CD32636	3.41	CD60336	6.17
#7	1-3/16	2-1/4	12	CD32607	5.97	CD60307	10.76	#37	13/16	1-13/16	12	CD32637	3.41	CD60337	6.17
#8	1-3/16	2-1/4	12	CD32608	5.97	CD60308	10.76	#38	13/16	1-13/16	12	CD32638	3.11	CD60338	5.62
#9	1-3/16	2-1/4	12	CD32609	5.97	CD60309	10.76	#39	13/16	1-13/16	12	CD32639	3.11	CD60339	5.62
#10	1-3/16	2-1/4	12	CD32610	5.97	CD60310	10.76	#40	13/16	1-13/16	12	CD32640	3.11	CD60340	5.62
#11	1-3/16	2-1/4	12	CD32611	5.81	CD60311	10.46	#41	13/16	1-13/16	12	CD32641	2.99	CD60341	5.62
#12	1-3/16	2-1/4	12	CD32612	5.81	CD60312	10.46	#42	3/4	1-3/4	12	CD32642	2.95	CD60342	5.62
#13	1-1/8	2-3/16	12	CD32613	5.68	CD60313	10.29	#43	3/4	1-3/4	12	CD32643	2.95	CD60343	5.62
#14	1-1/8	2-3/16	12	CD32614	5.68	CD60314	10.29	#44	3/4	1-3/4	12	CD32644	2.95	CD60344	5.62
#15	1-1/8	2-3/16	12	CD32615	5.68	CD60315	10.29	#45	3/4	1-3/4	12	CD32645	2.95	CD60345	5.62
#16	1-1/8	2-3/16	12	CD32616	5.68	CD60316	10.25	#46	3/4	1-3/4	12	CD32646	2.95	CD60346	5.62
#17	1-1/8	2-3/16	12	CD32617	5.47	CD60317	9.91	#47	11/16	1-11/16	12	CD32647	2.95	CD60347	5.62
#18	1-1/16	2-1/8	12	CD32618	4.67	CD60318	8.40	#48	11/16	1-11/16	12	CD32648	2.95	CD60348	5.62
#19	1-1/16	2-1/8	12	CD32619	4.42	CD60319	7.98	#49	11/16	1-11/16	12	CD32649	2.95	CD60349	5.62
#20	1-1/16	2-1/8	12	CD32620	4.42	CD60320	7.98	#50	11/16	1-11/16	12	CD32650	2.95	CD60350	5.62
#21	1-1/16	2-1/8	12	CD32621	4.42	CD60321	7.98	#51	11/16	1-11/16	12	CD32651	2.95	CD60351	5.62
#22	1-1/16	2-1/8	12	CD32622	4.42	CD60322	7.98	#52	11/16	1-11/16	12	CD32652	2.95	CD60352	5.62
#23	1	2-1/16	12	CD32623	4.42	CD60323	7.98	#53	5/8	1-5/8	12	CD32653	3.32	CD60353	6.00
#24	1	2-1/16	12	CD32624	4.42	CD60324	7.98	#54	5/8	1-5/8	12	CD32654	3.32	CD60354	6.00
#25	1	2-1/16	12	CD32625	4.12	CD60325	7.46	#55	5/8	1-5/8	12	CD32655	3.32	CD60355	6.00
#26	1	2-1/16	12	CD32626	4.12	CD60326	7.46	#56	1/2	1-3/8	12	CD32656	3.32	CD60356	6.00
#27	1	2-1/16	12	CD32627	4.12	CD60327	7.46	#57	1/2	1-3/8	12	CD32657	3.32	CD60357	6.00
#28	15/16	1-15/16	12	CD32628	3.74	CD60328	6.82	#58	1/2	1-3/8	12	CD32658	3.53	CD60358	6.39
#29	15/16	1-15/16	12	CD32629	3.74	CD60329	6.82	#59	1/2	1-3/8	12	CD32659	3.53	CD60359	6.39
#30	15/16	1-15/16	12	CD32630	3.53	CD60330	6.39	#60	1/2	1-3/8	12	CD32660	3.53	CD60360	6.39

- AlTiN coating for use in high temperature drilling applications
- Coating allows for increased machining speeds from 50% up to 200%
- Used in drilling Stainless Steels, Nickel-based and Titanium alloys
- Not recommended for Aluminum

All cobalt drills have identification ring on shank.
For coating information see page 8. For technical information, please see pages 210 - 211.



GENERAL PURPOSE M42 COBALT DRILLS

YOUR #1 SOURCE FOR AMERICAN-MADE PREMIUM QUALITY CUTTING TOOLS

JOBBER LENGTH - HEAVY DUTY - 135° SPLIT POINT - TYPE "J"

SERIES 500
NAS 907 - M42 COBALT



SERIES 608
NAS 907 - M42 COBALT
ALTIM COATED



FRACTIONAL SIZES

SIZE	FLUTE LENGTH	OAL	PKG. QTY.	UNCOATED	LIST PRICE	ALTIM	LIST PRICE
1/16	7/8	1-7/8	12	CD50004	3.32	CD60704	5.96
5/64	1	2	12	CD50005	3.32	CD60705	5.96
3/32	1-1/4	2-1/4	12	CD50006	3.32	CD60706	5.96
7/64	1-1/2	2-5/8	12	CD50007	3.49	CD60707	6.30
1/8	1-5/8	2-3/4	12	CD50008	4.29	CD60708	7.72
9/64	1-3/4	2-7/8	12	CD50009	4.29	CD60709	7.72
5/32	2	3-1/8	12	CD50010	4.80	CD60710	8.66
11/64	2-1/8	3-1/4	12	CD50011	5.05	CD60711	9.13
3/16	2-5/16	3-1/2	12	CD50012	5.68	CD60712	10.25
13/64	2-7/16	3-5/8	12	CD50013	6.82	CD60713	12.31
7/32	2-1/2	3-3/4	12	CD50014	7.45	CD60714	13.46
15/64	2-5/8	3-7/8	12	CD50015	7.91	CD60715	14.28
1/4	2-3/4	4	12	CD50016	8.46	CD60716	15.31
17/64	2-7/8	4-1/8	6	CD50017	9.59	CD60717	17.32
9/32	2-15/16	4-1/4	6	CD50018	10.05	CD60718	18.18

FRACTIONAL SIZES

SIZE	FLUTE LENGTH	OAL	PKG. QTY.	UNCOATED	LIST PRICE	ALTIM	LIST PRICE
19/64	3-1/16	4-3/8	6	CD50019	12.24	CD60719	22.13
5/16	3-3/16	4-1/2	6	CD50020	13.04	CD60720	23.54
21/64	3-5/16	4-5/8	6	CD50021	14.43	CD60721	26.07
11/32	3-7/16	4-3/4	6	CD50022	15.86	CD60722	28.64
23/64	3-1/2	4-7/8	6	CD50023	18.17	CD60723	32.80
3/8	3-5/8	5	6	CD50024	18.17	CD60724	32.80
25/64	3-3/4	5-1/8	6	CD50025	20.66	CD60725	37.31
13/32	3-7/8	5-1/4	6	CD50026	21.54	CD60726	38.93
27/64	3-15/16	5-3/8	6	CD50027	23.81	CD60727	43.05
7/16	4-1/16	5-1/2	6	CD50028	24.36	CD60728	44.04
29/64	4-3/16	5-5/8	6	CD50029	29.24	CD60729	52.83
15/32	4-5/16	5-3/4	6	CD50030	29.79	CD60730	53.81
31/64	4-3/8	5-7/8	6	CD50031	29.95	CD60731	54.11
1/2	4-1/2	6	6	CD50032	29.95	CD60732	54.11

LETTER SIZES

SIZE	FLUTE LENGTH	OAL	PKG. QTY.	UNCOATED	LIST PRICE	ALTIM	LIST PRICE
A	2-5/8	3-7/8	12	CD50301	8.96	CD60901	16.17
B	2-3/4	4	12	CD50302	10.35	CD60902	18.65
C	2-3/4	4	12	CD50303	10.35	CD60903	18.65
D	2-3/4	4	12	CD50304	11.65	CD60904	21.01
E	2-3/4	4	12	CD50305	8.46	CD60905	15.31
F	2-7/8	4-1/8	6	CD50306	10.35	CD60906	18.65
G	2-7/8	4-1/8	6	CD50307	10.35	CD60907	18.65
H	2-7/8	4-1/8	6	CD50308	11.65	CD60908	21.01
I	2-7/8	4-1/8	6	CD50309	11.65	CD60909	21.01
J	2-7/8	4-1/8	6	CD50310	11.65	CD60910	21.01
K	2-15/16	4-1/4	6	CD50311	11.65	CD60911	21.01
L	2-15/16	4-1/4	6	CD50312	13.21	CD60912	23.88
M	3-1/16	4-3/8	6	CD50313	14.01	CD60913	25.34

LETTER SIZES

SIZE	FLUTE LENGTH	OAL	PKG. QTY.	UNCOATED	LIST PRICE	ALTIM	LIST PRICE
N	3-1/16	4-3/8	6	CD50314	14.01	CD60914	25.34
O	3-3/16	4-1/2	6	CD50315	15.48	CD60915	28.00
P	3-5/16	4-5/8	6	CD50316	16.45	CD60916	29.76
Q	3-7/16	4-3/4	6	CD50317	17.08	CD60917	30.83
R	3-7/16	4-3/4	6	CD50318	17.08	CD60918	30.83
S	3-1/2	4-7/8	6	CD50319	20.91	CD60919	37.82
T	3-1/2	4-7/8	6	CD50320	20.91	CD60920	37.82
U	3-5/8	5	6	CD50321	20.91	CD60921	37.82
V	3-5/8	5	6	CD50322	23.05	CD60922	41.68
W	3-3/4	5-1/8	6	CD50323	23.05	CD60923	41.68
X	3-3/4	5-1/8	6	CD50324	23.05	CD60924	41.68
Y	3-7/8	5-1/4	6	CD50325	24.44	CD60925	44.17
Z	3-7/8	5-1/4	6	CD50326	26.59	CD60926	48.03

NOTE: SIZES BELOW 1/16" ARE NOT SPLIT POINT.

All cobalt drills have identification ring on shank.
For coating information see page 8. For technical information, please see pages 210 - 211.

GENERAL PURPOSE M42 COBALT DRILLS



YOUR #1 SOURCE FOR AMERICAN-MADE PREMIUM QUALITY CUTTING TOOLS

JOBBER LENGTH - HEAVY DUTY - 135° SPLIT POINT - TYPE "J"

SERIES 500
NAS 907 - M42 COBALT



SERIES 608
NAS 907 - M42 COBALT
ALTiN COATED



WIRE SIZES						WIRE SIZES									
SIZE	FLUTE LENGTH	OAL	PKG. QTY.	UNCOATED	LIST PRICE	ALTiN	LIST PRICE	SIZE	FLUTE LENGTH	OAL	PKG. QTY.	UNCOATED	LIST PRICE	ALTiN	LIST PRICE
#1	2-5/8	3-7/8	12	CD50201	9.05	CD60801	16.38	#31	1-5/8	2-3/4	12	CD50231	3.83	CD60831	6.95
#2	2-5/8	3-7/8	12	CD50202	9.05	CD60802	16.38	#32	1-5/8	2-3/4	12	CD50232	3.79	CD60832	6.86
#3	2-1/2	3-3/4	12	CD50203	8.46	CD60803	15.31	#33	1-1/2	2-5/8	12	CD50233	3.66	CD60833	6.60
#4	2-1/2	3-3/4	12	CD50204	8.46	CD60804	15.31	#34	1-1/2	2-5/8	12	CD50234	3.66	CD60834	6.60
#5	2-1/2	3-3/4	12	CD50205	8.46	CD60805	15.31	#35	1-1/2	2-5/8	12	CD50235	3.66	CD60835	6.60
#6	2-1/2	3-3/4	12	CD50206	8.46	CD60806	15.31	#36	1-7/16	2-1/2	12	CD50236	3.62	CD60836	6.52
#7	2-7/16	3-5/8	12	CD50207	6.61	CD60807	11.92	#37	1-7/16	2-1/2	12	CD50237	3.62	CD60837	6.52
#8	2-7/16	3-5/8	12	CD50208	6.61	CD60808	11.92	#38	1-7/16	2-1/2	12	CD50238	3.37	CD60838	6.23
#9	2-7/16	3-5/8	12	CD50209	6.61	CD60809	11.92	#39	1-3/8	2-3/8	12	CD50239	3.37	CD60839	6.23
#10	2-7/16	3-5/8	12	CD50210	6.61	CD60810	11.92	#40	1-3/8	2-3/8	12	CD50240	3.37	CD60840	6.23
#11	2-5/16	3-1/2	12	CD50211	6.61	CD60811	11.92	#41	1-3/8	2-3/8	12	CD50241	3.32	CD60841	6.23
#12	2-5/16	3-1/2	12	CD50212	6.61	CD60812	11.92	#42	1-1/4	2-1/4	12	CD50242	3.28	CD60842	6.23
#13	2-5/16	3-1/2	12	CD50213	6.48	CD60813	11.71	#43	1-1/4	2-1/4	12	CD50243	3.28	CD60843	6.23
#14	2-3/16	3-3/8	12	CD50214	6.48	CD60814	11.71	#44	1-1/8	2-1/8	12	CD50244	3.28	CD60844	6.23
#15	2-3/16	3-3/8	12	CD50215	6.48	CD60815	11.71	#45	1-1/8	2-1/8	12	CD50245	3.28	CD60845	6.23
#16	2-3/16	3-3/8	12	CD50216	5.89	CD60816	10.68	#46	1-1/8	2-1/8	12	CD50246	3.28	CD60846	6.23
#17	2-3/16	3-3/8	12	CD50217	5.76	CD60817	10.42	#47	1	2	12	CD50247	3.28	CD60847	6.23
#18	2-1/8	3-1/4	12	CD50218	5.26	CD60818	9.52	#48	1	2	12	CD50248	3.28	CD60848	6.23
#19	2-1/8	3-1/4	12	CD50219	5.13	CD60819	9.26	#49	1	2	12	CD50249	3.28	CD60849	6.23
#20	2-1/8	3-1/4	12	CD50220	5.13	CD60820	9.26	#50	1	2	12	CD50250	3.28	CD60850	6.23
#21	2-1/8	3-1/4	12	CD50221	5.09	CD60821	9.18	#51	1	2	12	CD50251	3.28	CD60851	6.23
#22	2	3-1/8	12	CD50222	5.09	CD60822	9.18	#52	7/8	1-7/8	12	CD50252	3.28	CD60852	6.23
#23	2	3-1/8	12	CD50223	5.09	CD60823	9.18	#53	7/8	1-7/8	12	CD50253	3.66	CD60853	6.65
#24	2	3-1/8	12	CD50224	5.09	CD60824	9.18	#54	7/8	1-7/8	12	CD50254	3.66	CD60854	6.65
#25	1-7/8	3	12	CD50225	4.67	CD60825	8.40	#55	7/8	1-7/8	12	CD50255	3.66	CD60855	6.65
#26	1-7/8	3	12	CD50226	4.59	CD60826	8.32	#56	3/4	1-3/4	12	CD50256	4.12	CD60856	7.50
#27	1-7/8	3	12	CD50227	4.59	CD60827	8.32	#57	3/4	1-3/4	12	CD50257	4.12	CD60857	7.50
#28	1-3/4	2-7/8	12	CD50228	4.29	CD60828	7.80	#58	11/16	1-5/8	12	CD50258	4.12	CD60858	7.50
#29	1-3/4	2-7/8	12	CD50229	4.17	CD60829	7.55	#59	11/16	1-5/8	12	CD50259	4.12	CD60859	7.50
#30	1-5/8	2-3/4	12	CD50230	3.95	CD60830	7.08	#60	11/16	1-5/8	12	CD50260	4.12	CD60860	7.50

NOTE: SIZES BELOW 1/16" ARE NOT SPLIT POINT.

- AlTiN coating for use in high temperature drilling applications
- Coating allows for increased machining speeds from 50% up to 200%
- Used in drilling Stainless Steels, Nickel-based and Titanium alloys
- Not recommended for Aluminum

All cobalt drills have identification ring on shank.
For coating information see page 8. For technical information, please see pages 210 - 211.



GENERAL PURPOSE HSS DRILLS

YOUR #1 SOURCE FOR AMERICAN-MADE PREMIUM QUALITY CUTTING TOOLS

STUB LENGTH - HEAVY DUTY - 135° SPLIT POINT - TYPE "C"



SERIES 300
OXIDE FINISH

FRACTIONAL SIZES						FRACTIONAL SIZES					
SIZE	FLUTE LENGTH	OAL	PKG. QTY.	BLACK OXIDE	LIST PRICE	SIZE	FLUTE LENGTH	OAL	PKG. QTY.	BLACK OXIDE	LIST PRICE
1/16	5/8	1-5/8	12	CD30004	2.23	19/64	1-9/16	2-3/4	6	CD30019	5.07
5/64	11/16	1-11/16	12	CD30005	2.27	5/16	1-5/8	2-13/16	6	CD30020	5.39
3/32	3/4	1-3/4	12	CD30006	2.27	21/64	1-11/16	2-15/16	6	CD30021	6.04
7/64	13/16	1-13/16	12	CD30007	2.27	11/32	1-11/16	3	6	CD30022	6.45
1/8	7/8	1-7/8	12	CD30008	2.27	23/64	1-3/4	3-1/16	6	CD30023	6.85
9/64	15/16	1-15/16	12	CD30009	2.27	3/8	1-13/16	3-1/8	6	CD30024	7.46
5/32	1	2-1/16	12	CD30010	2.47	25/64	1-7/8	3-1/4	6	CD30025	7.91
11/64	1-1/16	2-1/8	12	CD30011	2.47	13/32	1-15/16	3-5/16	6	CD30026	8.68
3/16	1-1/8	2-3/16	12	CD30012	2.88	27/64	2	3-3/8	6	CD30027	9.16
13/64	1-3/16	2-1/4	12	CD30013	2.96	7/16	1-1/16	3-7/16	6	CD30028	10.01
7/32	1-1/4	2-3/8	12	CD30014	3.37	29/64	2-1/8	3-9/16	6	CD30029	10.62
15/64	1-5/16	2-7/16	12	CD30015	3.89	15/32	2-1/8	3-5/8	6	CD30030	11.68
1/4	1-3/8	2-1/2	12	CD30016	4.30	31/64	2-3/16	3-11/16	6	CD30031	12.12
17/64	1-7/16	2-5/8	6	CD30017	4.42	1/2	2-1/4	3-3/4	6	CD30032	12.77
9/32	1-1/2	2-11/16	6	CD30018	4.66						

LETTER SIZES						LETTER SIZES					
SIZE	FLUTE LENGTH	OAL	PKG. QTY.	BLACK OXIDE	LIST PRICE	SIZE	FLUTE LENGTH	OAL	PKG. QTY.	BLACK OXIDE	LIST PRICE
A	1-5/16	2-7/16	12	CD30301	4.66	N	1-5/8	2-13/16	6	CD30314	8.19
B	1-3/8	2-1/2	12	CD30302	4.91	O	1-11/16	2-15/16	6	CD30315	9.20
C	1-3/8	2-1/2	12	CD30303	4.91	P	1-11/16	2-15/16	6	CD30316	9.45
D	1-3/8	2-1/2	12	CD30304	4.95	Q	1-11/16	3	6	CD30317	9.85
E	1-3/8	2-1/2	12	CD30305	4.95	R	1-11/16	3	6	CD30318	10.14
F	1-7/16	2-5/8	6	CD30306	6.37	S	1-3/4	3-1/16	6	CD30319	10.54
G	1-7/16	2-5/8	6	CD30307	6.81	T	1-3/4	3-1/16	6	CD30320	10.78
H	1-1/2	2-11/16	6	CD30308	7.01	U	1-13/16	3-1/8	6	CD30321	11.64
I	1-1/2	2-11/16	6	CD30309	7.05	V	1-7/8	3-1/4	6	CD30322	12.36
J	1-1/2	2-11/16	6	CD30310	7.22	W	1-7/8	3-1/4	6	CD30323	12.81
K	1-1/2	2-11/16	6	CD30311	7.34	X	1-15/16	3-5/16	6	CD30324	13.58
L	1-9/16	2-3/4	6	CD30312	7.50	Y	1-15/16	3-5/16	6	CD30325	13.86
M	1-9/16	2-3/4	6	CD30313	7.86	Z	2	3-3/8	6	CD30326	14.35

NOTE: SIZES BELOW 1/16" ARE NOT SPLIT POINT.

For technical information, please see pages 210 - 211.

GENERAL PURPOSE HSS DRILLS



YOUR #1 SOURCE FOR AMERICAN-MADE PREMIUM QUALITY CUTTING TOOLS

DRILLING

STUB LENGTH - HEAVY DUTY - 135° SPLIT POINT - TYPE "C"



SERIES 300
OXIDE FINISH

WIRE SIZES						WIRE SIZES					
SIZE	FLUTE LENGTH	OAL	PKG. QTY.	BLACK OXIDE	LIST PRICE	SIZE	FLUTE LENGTH	OAL	PKG. QTY.	BLACK OXIDE	LIST PRICE
#1	1-5/16	2-7/16	12	CD30201	3.89	#31	7/8	1-7/8	12	CD30231	2.51
#2	1-5/16	2-7/16	12	CD30202	3.89	#32	7/8	1-7/8	12	CD30232	2.51
#3	1-1/4	2-3/8	12	CD30203	4.01	#33	7/8	1-7/8	12	CD30233	2.51
#4	1-1/4	2-3/8	12	CD30204	4.01	#34	7/8	1-7/8	12	CD30234	2.51
#5	1-1/4	2-3/8	12	CD30205	4.01	#35	7/8	1-7/8	12	CD30235	2.51
#6	1-1/4	2-3/8	12	CD30206	4.01	#36	13/16	1-13/16	12	CD30236	2.51
#7	1-3/16	2-1/4	12	CD30207	3.45	#37	13/16	1-13/16	12	CD30237	2.51
#8	1-3/16	2-1/4	12	CD30208	3.45	#38	13/16	1-13/16	12	CD30238	2.51
#9	1-3/16	2-1/4	12	CD30209	3.45	#39	13/16	1-13/16	12	CD30239	2.51
#10	1-3/16	2-1/4	12	CD30210	3.45	#40	13/16	1-13/16	12	CD30240	2.51
#11	1-3/16	2-1/4	12	CD30211	3.45	#41	13/16	1-13/16	12	CD30241	2.51
#12	1-3/16	2-1/4	12	CD30212	3.45	#42	3/4	1-3/4	12	CD30242	2.51
#13	1-1/8	2-3/16	12	CD30213	3.45	#43	3/4	1-3/4	12	CD30243	2.51
#14	1-1/8	2-3/16	12	CD30214	3.45	#44	3/4	1-3/4	12	CD30244	2.51
#15	1-1/8	2-3/16	12	CD30215	3.45	#45	3/4	1-3/4	12	CD30245	2.51
#16	1-1/8	2-3/16	12	CD30216	3.45	#46	3/4	1-3/4	12	CD30246	2.51
#17	1-1/8	2-3/16	12	CD30217	3.45	#47	11/16	1-11/16	12	CD30247	2.51
#18	1-1/16	2-1/8	12	CD30218	3.28	#48	11/16	1-11/16	12	CD30248	2.51
#19	1-1/16	2-1/8	12	CD30219	3.28	#49	11/16	1-11/16	12	CD30249	2.51
#20	1-1/16	2-1/8	12	CD30220	3.28	#50	11/16	1-11/16	12	CD30250	2.51
#21	1-1/16	2-1/8	12	CD30221	3.28	#51	11/16	1-11/16	12	CD30251	2.51
#22	1-1/16	2-1/8	12	CD30222	3.20	#52	11/16	1-11/16	12	CD30252	2.51
#23	1	2-1/16	12	CD30223	3.20	#53	5/8	1-5/8	12	CD30253	2.51
#24	1	2-1/16	12	CD30224	3.20	#54	5/8	1-5/8	12	CD30254	2.51
#25	1	2-1/16	12	CD30225	3.20	#55	5/8	1-5/8	12	CD30255	2.51
#26	1	2-1/16	12	CD30226	3.20	#56	1/2	1-3/8	12	CD30256	2.51
#27	1	2-1/16	12	CD30227	3.20	#57	1/2	1-3/8	12	CD30257	2.51
#28	15/16	1-15/16	12	CD30228	3.20	#58	1/2	1-3/8	12	CD30258	2.51
#29	15/16	1-15/16	12	CD30229	3.20	#59	1/2	1-3/8	12	CD30259	2.51
#30	15/16	1-15/16	12	CD30230	2.51	#60	1/2	1-3/8	12	CD30260	2.51

NOTE: SIZES BELOW 1/16" ARE NOT SPLIT POINT.

For technical information, please see pages 210 - 211.

DRILLS

CARBIDE
DRILLS

COBALT
DRILLS

HSS
DRILLS

AEROSPACE

SILVER &
DEMING

SPECIALTY

DRILL
SETS

TECHNICAL

DRILLING



GENERAL PURPOSE HSS DRILLS

YOUR #1 SOURCE FOR AMERICAN-MADE PREMIUM QUALITY CUTTING TOOLS

JOBBER LENGTH - HEAVY DUTY - 135° SPLIT POINT - TYPE "B"

SERIES 440
HIGH SPEED STEEL
OXIDE FINISH



SERIES 445
HIGH SPEED STEEL
BLACK & GOLD



DRILLS
CARBIDE
DRILLS
COBALT
DRILLS
HSS
DRILLS

AEROSPACE
SILVER &
DEMING
SPECIALTY
DRILL
TECHNICAL
SETS

FRACTIONAL SIZES							FRACTIONAL SIZES								
SIZE	FLUTE LENGTH	OAL	PKG. QTY.	BLACK OXIDE	LIST PRICE	BLACK & GOLD	LIST PRICE	SIZE	FLUTE LENGTH	OAL	PKG. QTY.	BLACK OXIDE	LIST PRICE	BLACK & GOLD	LIST PRICE
1/16	7/8	1-7/8	12	CD44004	1.91	CD44504	2.19	19/64	3-1/16	4-3/8	6	CD44019	6.89	CD44519	8.07
5/64	1	2	12	CD44005	1.91	CD44505	2.19	5/16	3-3/16	4-1/2	6	CD44020	7.09	CD44520	8.35
3/32	1-1/4	2-1/4	12	CD44006	1.91	CD44506	2.19	21/64	3-5/16	4-5/8	6	CD44021	8.03	CD44521	9.20
7/64	1-1/2	2-5/8	12	CD44007	1.91	CD44507	2.27	11/32	3-7/16	4-3/4	6	CD44022	8.51	CD44522	9.85
1/8	1-5/8	2-3/4	12	CD44008	1.91	CD44508	2.51	23/64	3-1/2	4-7/8	6	CD44023	8.96	CD44523	10.66
9/64	1-3/4	2-7/8	12	CD44009	2.07	CD44509	2.64	3/8	3-5/8	5	6	CD44024	9.77	CD44524	11.15
5/32	2	3-1/8	12	CD44010	2.51	CD44510	3.16	25/64	3-3/4	5-1/8	6	CD44025	10.62	CD44525	12.12
11/64	2-1/8	3-1/4	12	CD44011	2.68	CD44511	3.32	13/32	3-7/8	5-1/4	6	CD44026	11.51	CD44526	13.34
3/16	2-5/16	3-1/2	12	CD44012	3.04	CD44512	3.69	27/64	3-15/16	5-3/8	6	CD44027	12.41	CD44527	14.23
13/64	2-7/16	3-5/8	12	CD44013	3.28	CD44513	4.01	7/16	4-1/16	5-1/2	6	CD44028	13.46	CD44528	15.32
7/32	2-1/2	3-3/4	12	CD44014	3.61	CD44514	4.38	29/64	4-3/16	5-5/8	6	CD44029	14.35	CD44529	16.30
15/64	2-5/8	3-7/8	12	CD44015	3.93	CD44515	4.82	15/32	4-5/16	5-3/4	6	CD44030	15.61	CD44530	17.72
1/4	2-3/4	4	12	CD44016	4.18	CD44516	5.07	31/64	4-3/8	5-7/8	6	CD44031	16.50	CD44531	18.69
17/64	2-7/8	4-1/8	6	CD44017	5.76	CD44517	6.81	1/2	4-1/2	6	6	CD44032	17.35	CD44532	19.54
9/32	2-15/16	4-1/4	6	CD44018	6.24	CD44518	7.34								

LETTER SIZES							LETTER SIZES								
SIZE	FLUTE LENGTH	OAL	PKG. QTY.	BLACK OXIDE	LIST PRICE	BLACK & GOLD	LIST PRICE	SIZE	FLUTE LENGTH	OAL	PKG. QTY.	BLACK OXIDE	LIST PRICE	BLACK & GOLD	LIST PRICE
A	2-5/8	3-7/8	12	CD44301	4.50	CD44801	7.11	N	3-1/16	4-3/8	6	CD44314	8.51	CD44814	10.66
B	2-3/4	4	12	CD44302	4.50	CD44802	7.11	O	3-3/16	4-1/2	6	CD44315	8.51	CD44815	10.66
C	2-3/4	4	12	CD44303	4.50	CD44803	7.11	P	3-5/16	4-5/8	6	CD44316	9.61	CD44816	11.92
D	2-3/4	4	12	CD44304	4.50	CD44804	6.88	Q	3-7/16	4-3/4	6	CD44317	9.61	CD44817	12.26
E	2-3/4	4	12	CD44305	4.50	CD44805	5.73	R	3-7/16	4-3/4	6	CD44318	9.61	CD44818	12.78
F	2-7/8	4-1/8	6	CD44306	5.72	CD44806	7.68	S	3-1/2	4-7/8	6	CD44319	10.95	CD44819	13.81
G	2-7/8	4-1/8	6	CD44307	5.72	CD44807	8.31	T	3-1/2	4-7/8	6	CD44320	10.95	CD44820	15.53
H	2-7/8	4-1/8	6	CD44308	5.72	CD44808	8.48	U	3-5/8	5	6	CD44321	11.64	CD44821	15.53
I	2-7/8	4-1/8	6	CD44309	5.72	CD44809	8.48	V	3-5/8	5	6	CD44322	11.64	CD44822	15.82
J	2-7/8	4-1/8	6	CD44310	6.93	CD44810	9.00	W	3-3/4	5-1/8	6	CD44323	13.22	CD44823	19.37
K	2-15/16	4-1/4	6	CD44311	6.93	CD44811	10.03	X	3-3/4	5-1/8	6	CD44324	13.22	CD44824	22.86
L	2-15/16	4-1/4	6	CD44312	6.93	CD44812	9.68	Y	3-7/8	5-1/4	6	CD44325	14.39	CD44825	23.15
M	3-1/16	4-3/8	6	CD44313	8.51	CD44813	10.66	Z	3-7/8	5-1/4	6	CD44326	14.39	CD44826	23.67

NOTE: SIZES BELOW 1/16" ARE NOT SPLIT POINT.

For technical information, please see pages 210 - 211.

GENERAL PURPOSE HSS DRILLS



YOUR #1 SOURCE FOR AMERICAN-MADE PREMIUM QUALITY CUTTING TOOLS

DRILLING

JOBBER LENGTH - HEAVY DUTY - 135° SPLIT POINT - TYPE "B"

SERIES 440
HIGH SPEED STEEL
OXIDE FINISH



SERIES 445
HIGH SPEED STEEL
BLACK & GOLD



WIRE SIZES						WIRE SIZES									
SIZE	FLUTE LENGTH	OAL	PKG. QTY.	BLACK OXIDE	LIST PRICE	BLACK & GOLD	LIST PRICE	SIZE	FLUTE LENGTH	OAL	PKG. QTY.	BLACK OXIDE	LIST PRICE	BLACK & GOLD	LIST PRICE
#1	2-5/8	3-7/8	12	CD44201	3.89	CD44701	6.59	#31	1-5/8	2-3/4	12	CD44231	2.72	CD44731	3.28
#2	2-5/8	3-7/8	12	CD44202	3.89	CD44702	6.59	#32	1-5/8	2-3/4	12	CD44232	2.72	CD44732	3.28
#3	2-1/2	3-3/4	12	CD44203	3.61	CD44703	6.13	#33	1-1/2	2-5/8	12	CD44233	2.72	CD44733	3.28
#4	2-1/2	3-3/4	12	CD44204	3.61	CD44704	6.13	#34	1-1/2	2-5/8	12	CD44234	2.72	CD44734	3.28
#5	2-1/2	3-3/4	12	CD44205	3.61	CD44705	6.13	#35	1-1/2	2-5/8	12	CD44235	2.72	CD44735	3.28
#6	2-1/2	3-3/4	12	CD44206	3.61	CD44706	6.13	#36	1-7/16	2-1/2	12	CD44236	2.72	CD44736	3.16
#7	2-7/16	3-5/8	12	CD44207	3.41	CD44707	5.39	#37	1-7/16	2-1/2	12	CD44237	2.72	CD44737	3.16
#8	2-7/16	3-5/8	12	CD44208	3.45	CD44708	5.39	#38	1-7/16	2-1/2	12	CD44238	2.72	CD44738	3.16
#9	2-7/16	3-5/8	12	CD44209	3.45	CD44709	5.39	#39	1-3/8	2-3/8	12	CD44239	2.72	CD44739	3.16
#10	2-7/16	3-5/8	12	CD44210	3.12	CD44710	5.27	#40	1-3/8	2-3/8	12	CD44240	2.72	CD44740	3.16
#11	2-5/16	3-1/2	12	CD44211	3.12	CD44711	4.87	#41	1-3/8	2-3/8	12	CD44241	2.59	CD44741	3.16
#12	2-5/16	3-1/2	12	CD44212	3.12	CD44712	4.87	#42	1-1/4	2-1/4	12	CD44242	2.59	CD44742	3.16
#13	2-5/16	3-1/2	12	CD44213	3.45	CD44713	4.70	#43	1-1/4	2-1/4	12	CD44243	2.59	CD44743	3.16
#14	2-3/16	3-3/8	12	CD44214	3.45	CD44714	4.70	#44	1-1/8	2-1/8	12	CD44244	2.59	CD44744	3.16
#15	2-3/16	3-3/8	12	CD44215	3.45	CD44715	4.70	#45	1-1/8	2-1/8	12	CD44245	2.59	CD44745	3.16
#16	2-3/16	3-3/8	12	CD44216	3.45	CD44716	4.70	#46	1-1/8	2-1/8	12	CD44246	2.59	CD44746	3.16
#17	2-3/16	3-3/8	12	CD44217	3.45	CD44717	4.70	#47	1	2	12	CD44247	2.59	CD44747	3.16
#18	2-1/8	3-1/4	12	CD44218	3.45	CD44718	4.13	#48	1	2	12	CD44248	2.59	CD44748	3.16
#19	2-1/8	3-1/4	12	CD44219	3.28	CD44719	4.13	#49	1	2	12	CD44249	2.59	CD44749	3.16
#20	2-1/8	3-1/4	12	CD44220	3.28	CD44720	4.13	#50	1	2	12	CD44250	2.59	CD44750	3.16
#21	2-1/8	3-1/4	12	CD44221	3.08	CD44721	4.09	#51	1	2	12	CD44251	2.59	CD44751	3.16
#22	2	3-1/8	12	CD44222	3.08	CD44722	4.09	#52	7/8	1-7/8	12	CD44252	2.59	CD44752	2.96
#23	2	3-1/8	12	CD44223	3.08	CD44723	3.97	#53	7/8	1-7/8	12	CD44253	2.59	CD44753	2.96
#24	2	3-1/8	12	CD44224	3.08	CD44724	3.97	#54	7/8	1-7/8	12	CD44254	2.59	CD44754	2.96
#25	1-7/8	3	12	CD44225	3.08	CD44725	3.97	#55	7/8	1-7/8	12	CD44255	2.59	CD44755	2.96
#26	1-7/8	3	12	CD44226	3.08	CD44726	3.97	#56	3/4	1-3/4	12	CD44256	2.59	CD44756	2.96
#27	1-7/8	3	12	CD44227	3.08	CD44727	3.85	#57	3/4	1-3/4	12	CD44257	2.59	CD44757	2.96
#28	1-3/4	2-7/8	12	CD44228	3.08	CD44728	3.85	#58	11/16	1-5/8	12	CD44258	2.59	CD44758	2.96
#29	1-3/4	2-7/8	12	CD44229	2.47	CD44729	3.77	#59	11/16	1-5/8	12	CD44259	2.59	CD44759	2.96
#30	1-5/8	2-3/4	12	CD44230	2.47	CD44730	3.28	#60	11/16	1-5/8	12	CD44260	2.59	CD44760	2.96

NOTE: SIZES BELOW 1/16" ARE NOT SPLIT POINT.

For technical information, please see pages 210 - 211.

DRILLS
CARBIDE DRILLS
COBALT DRILLS
HSS DRILLS
AEROSPACE
SILVER & DEMING
SPECIALTY
TECHNICAL DRILL SETS



GENERAL PURPOSE HSS DRILLS

YOUR #1 SOURCE FOR AMERICAN-MADE PREMIUM QUALITY CUTTING TOOLS

JOBBER LENGTH - 118° POINT



SERIES 400
OXIDE FINISH

FRACTIONAL SIZES

SIZE	FLUTE LENGTH	OAL	PKG. QTY.	BLACK OXIDE	LIST PRICE
1/16	7/8	1-7/8	12	CD40004	1.91
5/64	1	2	12	CD40005	1.91
3/32	1-1/4	2-1/4	12	CD40006	1.91
7/64	1-1/2	2-5/8	12	CD40007	1.91
1/8	1-5/8	2-3/4	12	CD40008	1.91
9/64	1-3/4	2-7/8	12	CD40009	2.03
5/32	2	3-1/8	12	CD40010	2.11
11/64	2-1/8	3-1/4	12	CD40011	2.27
3/16	2-5/16	3-1/2	12	CD40012	2.47
13/64	2-7/16	3-5/8	12	CD40013	2.80
7/32	2-1/2	3-3/4	12	CD40014	3.08
15/64	2-5/8	3-7/8	12	CD40015	3.45
1/4	2-3/4	4	12	CD40016	3.53
17/64	2-7/8	4-1/8	6	CD40017	5.07
9/32	2-15/16	4-1/4	6	CD40018	5.39
19/64	3-1/16	4-3/8	6	CD40019	5.92
5/16	3-3/16	4-1/2	6	CD40020	6.16
21/64	3-5/16	4-5/8	6	CD40021	6.89
11/32	3-7/16	4-3/4	6	CD40022	7.38
23/64	3-1/2	4-7/8	6	CD40023	8.11
3/8	3-5/8	5	6	CD40024	8.51

FRACTIONAL SIZES

SIZE	FLUTE LENGTH	OAL	PKG. QTY.	BLACK OXIDE	LIST PRICE
25/64	3-3/4	5-1/8	6	CD40025	9.20
13/32	3-7/8	5-1/4	6	CD40026	10.05
27/64	3-15/16	5-3/8	6	CD40027	10.70
7/16	4-1/16	5-1/2	6	CD40028	11.68
29/64	4-3/16	5-5/8	6	CD40029	12.45
15/32	4-5/16	5-3/4	6	CD40030	13.54
31/64	4-3/8	5-7/8	6	CD40031	14.31
1/2	4-1/2	6	6	CD40032	14.92
33/64	4-13/16	6-5/8	1	CD40033	35.64
17/32	4-13/16	6-5/8	1	CD40034	37.34
35/64	4-13/16	6-5/8	1	CD40035	40.42
9/16	4-13/16	6-5/8	1	CD40036	42.32
37/64	4-13/16	6-5/8	1	CD40037	42.45
19/32	5-3/16	7-1/8	1	CD40038	43.62
39/64	5-3/16	7-1/8	1	CD40039	47.92
5/8	5-3/16	7-1/8	1	CD40040	46.78
41/64	5-3/16	7-1/8	1	CD40041	51.16
21/32	5-3/16	7-1/8	1	CD40042	49.42
43/64	5-5/8	7-5/8	1	CD40043	58.09
11/16	5-5/8	7-5/8	1	CD40044	56.84

METRIC SIZES

SIZE	FLUTE LENGTH	OAL	PKG. QTY.	BLACK OXIDE	LIST PRICE
1.00	17	41	12	CD42100	2.49
1.05	17	41	12	CD42105	2.75
1.10	19	44	12	CD42110	2.62
1.15	19	44	12	CD42115	2.66
1.20	22	48	12	CD42120	2.62
1.25	22	48	12	CD42125	2.66
1.30	22	48	12	CD42130	2.62
1.35	22	48	12	CD42135	2.75
1.40	22	48	12	CD42140	2.62
1.50	22	48	12	CD42150	2.62
1.60	22	48	12	CD42160	2.62
1.70	25	51	12	CD42170	2.66
1.80	25	51	12	CD42180	2.66
1.90	25	51	12	CD42190	2.66
2.00	25	51	12	CD42200	2.66
2.50	35	60	12	CD42250	2.79
3.00	41	70	12	CD42300	2.92
3.50	45	73	12	CD42350	3.05
4.00	54	83	12	CD42400	3.18

METRIC SIZES

SIZE	FLUTE LENGTH	OAL	PKG. QTY.	BLACK OXIDE	LIST PRICE
4.50	56	86	12	CD42450	3.57
5.00	62	92	12	CD42500	4.04
5.50	64	95	12	CD42550	4.56
6.00	70	102	12	CD42600	4.94
6.50	73	105	6	CD42650	6.32
7.00	73	105	6	CD42700	6.57
7.50	78	111	6	CD42750	7.82
8.00	81	114	6	CD42800	8.59
8.50	87	121	6	CD42850	9.84
9.00	89	124	6	CD42900	11.09
9.50	92	127	6	CD42950	11.60
10.00	95	130	6	CD43100	14.18
10.50	98	133	6	CD43105	14.18
11.00	103	140	6	CD43110	14.57
11.50	106	143	6	CD43115	16.37
12.00	111	149	6	CD43120	18.05
12.50	114	152	6	CD43125	18.44
13.00	114	152	6	CD43130	30.55

For technical information, please see pages 210 - 211.

GENERAL PURPOSE HSS DRILLS



YOUR #1 SOURCE FOR AMERICAN-MADE PREMIUM QUALITY CUTTING TOOLS

JOBBER LENGTH - 118° POINT



SERIES 400
OXIDE FINISH

LETTER SIZES						LETTER SIZES					
SIZE	FLUTE LENGTH	OAL	PKG. QTY.	BLACK OXIDE	LIST PRICE	SIZE	FLUTE LENGTH	OAL	PKG. QTY.	BLACK OXIDE	LIST PRICE
A	2-5/8	3-7/8	12	CD40301	3.45	N	3-1/16	4-3/8	6	CD40314	6.16
B	2-3/4	4	12	CD40302	3.53	O	3-3/16	4-1/2	6	CD40315	6.69
C	2-3/4	4	12	CD40303	3.53	P	3-5/16	4-5/8	6	CD40316	7.18
D	2-3/4	4	12	CD40304	3.65	Q	3-7/16	4-3/4	6	CD40317	7.46
E	2-3/4	4	12	CD40305	3.69	R	3-7/16	4-3/4	6	CD40318	7.74
F	2-7/8	4-1/8	6	CD40306	5.11	S	3-1/2	4-7/8	6	CD40319	8.11
G	2-7/8	4-1/8	6	CD40307	4.91	T	3-1/2	4-7/8	6	CD40320	8.51
H	2-7/8	4-1/8	6	CD40308	4.99	U	3-5/8	5	6	CD40321	9.20
I	2-7/8	4-1/8	6	CD40309	5.11	V	3-5/8	5	6	CD40322	9.53
J	2-7/8	4-1/8	6	CD40310	5.27	W	3-3/4	5-1/8	6	CD40323	10.14
K	2-15/16	4-1/4	6	CD40311	5.39	X	3-3/4	5-1/8	6	CD40324	10.74
L	2-15/16	4-1/4	6	CD40312	5.64	Y	3-7/8	5-1/4	6	CD40325	11.27
M	3-1/16	4-3/8	6	CD40313	5.96	Z	3-7/8	5-1/4	6	CD40326	11.51

WIRE SIZES						WIRE SIZES					
SIZE	FLUTE LENGTH	OAL	PKG. QTY.	BLACK OXIDE	LIST PRICE	SIZE	FLUTE LENGTH	OAL	PKG. QTY.	BLACK OXIDE	LIST PRICE
#1	2-5/8	3-7/8	12	CD40201	3.77	#31	1-5/8	2-3/4	12	CD40231	1.74
#2	2-5/8	3-7/8	12	CD40202	3.77	#32	1-5/8	2-3/4	12	CD40232	1.74
#3	2-1/2	3-3/4	12	CD40203	3.45	#33	1-1/2	2-5/8	12	CD40233	1.74
#4	2-1/2	3-3/4	12	CD40204	3.45	#34	1-1/2	2-5/8	12	CD40234	1.74
#5	2-1/2	3-3/4	12	CD40205	3.41	#35	1-1/2	2-5/8	12	CD40235	1.74
#6	2-1/2	3-3/4	12	CD40206	3.41	#36	1-7/16	2-1/2	12	CD40236	1.74
#7	2-7/16	3-5/8	12	CD40207	3.28	#37	1-7/16	2-1/2	12	CD40237	1.74
#8	2-7/16	3-5/8	12	CD40208	3.28	#38	1-7/16	2-1/2	12	CD40238	1.74
#9	2-7/16	3-5/8	12	CD40209	3.24	#39	1-3/8	2-3/8	12	CD40239	1.74
#10	2-7/16	3-5/8	12	CD40210	2.96	#40	1-3/8	2-3/8	12	CD40240	1.74
#11	2-5/16	3-1/2	12	CD40211	2.96	#41	1-3/8	2-3/8	12	CD40241	1.74
#12	2-5/16	3-1/2	12	CD40212	2.96	#42	1-1/4	2-1/4	12	CD40242	1.74
#13	2-5/16	3-1/2	12	CD40213	2.96	#43	1-1/4	2-1/4	12	CD40243	1.74
#14	2-3/16	3-3/8	12	CD40214	2.80	#44	1-1/8	2-1/8	12	CD40244	1.74
#15	2-3/16	3-3/8	12	CD40215	2.80	#45	1-1/8	2-1/8	12	CD40245	1.82
#16	2-3/16	3-3/8	12	CD40216	2.80	#46	1-1/8	2-1/8	12	CD40246	1.82
#17	2-3/16	3-3/8	12	CD40217	2.68	#47	1	2	12	CD40247	1.82
#18	2-1/8	3-1/4	12	CD40218	2.68	#48	1	2	12	CD40248	1.82
#19	2-1/8	3-1/4	12	CD40219	2.68	#49	1	2	12	CD40249	1.82
#20	2-1/8	3-1/4	12	CD40220	2.39	#50	1	2	12	CD40250	1.82
#21	2-1/8	3-1/4	12	CD40221	2.39	#51	1	2	12	CD40251	1.82
#22	2	3-1/8	12	CD40222	2.31	#52	7/8	1-7/8	12	CD40252	1.82
#23	2	3-1/8	12	CD40223	2.31	#53	7/8	1-7/8	12	CD40253	1.82
#24	2	3-1/8	12	CD40224	2.31	#54	7/8	1-7/8	12	CD40254	1.95
#25	1-7/8	3	12	CD40225	1.99	#55	7/8	1-7/8	12	CD40255	1.95
#26	1-7/8	3	12	CD40226	1.99	#56	3/4	1-3/4	12	CD40256	1.95
#27	1-7/8	3	12	CD40227	1.99	#57	3/4	1-3/4	12	CD40257	2.15
#28	1-3/4	2-7/8	12	CD40228	1.82	#58	11/16	1-5/8	12	CD40258	2.15
#29	1-3/4	2-7/8	12	CD40229	1.82	#59	11/16	1-5/8	12	CD40259	2.15
#30	1-5/8	2-3/4	12	CD40230	1.78	#60	11/16	1-5/8	12	CD40260	2.15

For technical information, please see pages 210 - 211.



GENERAL PURPOSE HSS DRILLS

YOUR #1 SOURCE FOR AMERICAN-MADE PREMIUM QUALITY CUTTING TOOLS

JOBBER LENGTH - 118° POINT

SERIES 406
BRIGHT FINISH



SERIES 475
TIN COATED



DRILLS
CARBIDE DRILLS
COBALT DRILLS
HSS DRILLS

AEROSPACE
SILVER & DEMING
SPECIALTY
DRILL SETS
TECHNICAL

FRACTIONAL SIZES								FRACTIONAL SIZES							
SIZE	FLUTE LENGTH	OAL	PKG. QTY.	BRIGHT	LIST PRICE	TIN	LIST PRICE	SIZE	FLUTE LENGTH	OAL	PKG. QTY.	BRIGHT	LIST PRICE	TIN	LIST PRICE
1/16	7/8	1-7/8	12	CD40604	1.91	CD47504	5.39	19/64	3-1/16	4-3/8	6	CD40619	5.92	CD47519	17.21
5/64	1	2	12	CD40605	1.91	CD47505	5.39	5/16	3-3/16	4-1/2	6	CD40620	6.16	CD47520	18.18
3/32	1-1/4	2-1/4	12	CD40606	1.91	CD47506	5.39	21/64	3-5/16	4-5/8	6	CD40621	6.89	CD47521	20.72
7/64	1-1/2	2-5/8	12	CD40607	1.91	CD47507	5.48	11/32	3-7/16	4-3/4	6	CD40622	7.38	CD47522	21.81
1/8	1-5/8	2-3/4	12	CD40608	1.91	CD47508	5.48	23/64	3-1/2	4-7/8	6	CD40623	8.11	CD47523	24.62
9/64	1-3/4	2-7/8	12	CD40609	2.03	CD47509	5.74	3/8	3-5/8	5	6	CD40624	8.51	CD47524	24.88
5/32	2	3-1/8	12	CD40610	2.11	CD47510	6.39	25/64	3-3/4	5-1/8	6	CD40625	9.20	CD47525	30.79
11/64	2-1/8	3-1/4	12	CD40611	2.27	CD47511	6.48	13/32	3-7/8	5-1/4	6	CD40626	10.05	CD47526	31.49
3/16	2-5/16	3-1/2	12	CD40612	2.47	CD47512	6.83	27/64	3-15/16	5-3/8	6	CD40627	10.70	CD47527	32.59
13/64	2-7/16	3-5/8	12	CD40613	2.80	CD47513	9.72	7/16	4-1/16	5-1/2	6	CD40628	11.68	CD47528	33.29
7/32	2-1/2	3-3/4	12	CD40614	3.08	CD47514	9.99	29/64	4-3/16	5-5/8	6	CD40629	12.45	CD47529	36.57
15/64	2-5/8	3-7/8	12	CD40615	3.45	CD47515	10.42	15/32	4-5/16	5-3/4	6	CD40630	13.54	CD47530	37.62
1/4	2-3/4	4	12	CD40616	3.53	CD47516	10.69	31/64	4-3/8	5-7/8	6	CD40631	14.31	CD47531	37.93
17/64	2-7/8	4-1/8	6	CD40617	5.07	CD47517	15.20	1/2	4-1/2	6	6	CD40632	14.92	CD47532	38.72
9/32	2-15/16	4-1/4	6	CD40618	5.39	CD47518	16.86								

LETTER SIZES								LETTER SIZES							
SIZE	FLUTE LENGTH	OAL	PKG. QTY.	BRIGHT	LIST PRICE	TIN	LIST PRICE	SIZE	FLUTE LENGTH	OAL	PKG. QTY.	BRIGHT	LIST PRICE	TIN	LIST PRICE
A	2-5/8	3-7/8	12	CD40901	3.45	CD47601	10.86	N	3-1/16	4-3/8	6	CD40914	6.16	CD47614	20.59
B	2-3/4	4	12	CD40902	3.53	CD47602	11.13	O	3-3/16	4-1/2	6	CD40915	6.69	CD47615	20.59
C	2-3/4	4	12	CD40903	3.53	CD47603	11.13	P	3-5/16	4-5/8	6	CD40916	7.18	CD47616	21.46
D	2-3/4	4	12	CD40904	3.65	CD47604	11.13	Q	3-7/16	4-3/4	6	CD40917	7.46	CD47617	21.46
E	2-3/4	4	12	CD40905	3.69	CD47605	10.69	R	3-7/16	4-3/4	6	CD40918	7.74	CD47618	22.03
F	2-7/8	4-1/8	6	CD40906	5.11	CD47606	18.35	S	3-1/2	4-7/8	6	CD40919	8.11	CD47619	27.77
G	2-7/8	4-1/8	6	CD40907	4.91	CD47607	18.35	T	3-1/2	4-7/8	6	CD40920	8.51	CD47620	29.08
H	2-7/8	4-1/8	6	CD40908	4.99	CD47608	18.35	U	3-5/8	5	6	CD40921	9.20	CD47621	29.08
I	2-7/8	4-1/8	6	CD40909	5.11	CD47609	18.35	V	3-5/8	5	6	CD40922	9.53	CD47622	29.48
J	2-7/8	4-1/8	6	CD40910	5.27	CD47610	18.48	W	3-3/4	5-1/8	6	CD40923	10.14	CD47623	34.12
K	2-15/16	4-1/4	6	CD40911	5.39	CD47611	19.89	X	3-3/4	5-1/8	6	CD40924	10.74	CD47624	36.75
L	2-15/16	4-1/4	6	CD40912	5.64	CD47612	19.89	Y	3-7/8	5-1/4	6	CD40925	11.27	CD47625	39.16
M	3-1/16	4-3/8	6	CD40913	5.96	CD47613	20.24	Z	3-7/8	5-1/4	6	CD40926	11.51	CD47626	39.59

For coating information see page 8. For technical information, please see pages 210 - 211.

GENERAL PURPOSE HSS DRILLS



YOUR #1 SOURCE FOR AMERICAN-MADE PREMIUM QUALITY CUTTING TOOLS

JOBBER LENGTH - 118° POINT

SERIES 406
BRIGHT FINISH



SERIES 475
TIN COATED



WIRE SIZES						WIRE SIZES									
SIZE	FLUTE LENGTH	OAL	PKG. QTY.	BRIGHT	LIST PRICE	TIN	LIST PRICE	SIZE	FLUTE LENGTH	OAL	PKG. QTY.	BRIGHT	LIST PRICE	TIN	LIST PRICE
#1	2-5/8	3-7/8	12	CD40801	3.77	CD47701	10.86	#31	1-5/8	2-3/4	12	CD40831	1.74	CD47731	5.48
#2	2-5/8	3-7/8	12	CD40802	3.77	CD47702	10.86	#32	1-5/8	2-3/4	12	CD40832	1.74	CD47732	5.48
#3	2-1/2	3-3/4	12	CD40803	3.45	CD47703	10.42	#33	1-1/2	2-5/8	12	CD40833	1.74	CD47733	5.48
#4	2-1/2	3-3/4	12	CD40804	3.45	CD47704	10.42	#34	1-1/2	2-5/8	12	CD40834	1.74	CD47734	5.48
#5	2-1/2	3-3/4	12	CD40805	3.41	CD47705	10.42	#35	1-1/2	2-5/8	12	CD40835	1.74	CD47735	5.48
#6	2-1/2	3-3/4	12	CD40806	3.41	CD47706	10.42	#36	1-7/16	2-1/2	12	CD40836	1.74	CD47736	5.39
#7	2-7/16	3-5/8	12	CD40807	3.28	CD47707	9.90	#37	1-7/16	2-1/2	12	CD40837	1.74	CD47737	5.39
#8	2-7/16	3-5/8	12	CD40808	3.28	CD47708	9.90	#38	1-7/16	2-1/2	12	CD40838	1.74	CD47738	5.39
#9	2-7/16	3-5/8	12	CD40809	3.24	CD47709	9.90	#39	1-3/8	2-3/8	12	CD40839	1.74	CD47739	5.39
#10	2-7/16	3-5/8	12	CD40810	2.96	CD47710	9.90	#40	1-3/8	2-3/8	12	CD40840	1.74	CD47740	5.39
#11	2-5/16	3-1/2	12	CD40811	2.96	CD47711	9.90	#41	1-3/8	2-3/8	12	CD40841	1.74	CD47741	5.39
#12	2-5/16	3-1/2	12	CD40812	2.96	CD47712	8.10	#42	1-1/4	2-1/4	12	CD40842	1.74	CD47742	5.39
#13	2-5/16	3-1/2	12	CD40813	2.96	CD47713	7.97	#43	1-1/4	2-1/4	12	CD40843	1.74	CD47743	5.39
#14	2-3/16	3-3/8	12	CD40814	2.80	CD47714	7.97	#44	1-1/8	2-1/8	12	CD40844	1.74	CD47744	5.39
#15	2-3/16	3-3/8	12	CD40815	2.80	CD47715	7.97	#45	1-1/8	2-1/8	12	CD40845	1.82	CD47745	5.39
#16	2-3/16	3-3/8	12	CD40816	2.80	CD47716	7.97	#46	1-1/8	2-1/8	12	CD40846	1.82	CD47746	5.39
#17	2-3/16	3-3/8	12	CD40817	2.68	CD47717	7.97	#47	1	2	12	CD40847	1.82	CD47747	5.39
#18	2-1/8	3-1/4	12	CD40818	2.68	CD47718	7.10	#48	1	2	12	CD40848	1.82	CD47748	5.39
#19	2-1/8	3-1/4	12	CD40819	2.68	CD47719	7.10	#49	1	2	12	CD40849	1.82	CD47749	5.39
#20	2-1/8	3-1/4	12	CD40820	2.39	CD47720	7.10	#50	1	2	12	CD40850	1.82	CD47750	5.39
#21	2-1/8	3-1/4	12	CD40821	2.39	CD47721	7.01	#51	1	2	12	CD40851	1.82	CD47751	5.39
#22	2	3-1/8	12	CD40822	2.27	CD47722	7.01	#52	7/8	1-7/8	12	CD40852	1.82	CD47752	5.39
#23	2	3-1/8	12	CD40823	2.27	CD47723	6.92	#53	7/8	1-7/8	12	CD40853	1.82	CD47753	5.39
#24	2	3-1/8	12	CD40824	2.27	CD47724	6.92	#54	7/8	1-7/8	12	CD40854	1.95	CD47754	5.39
#25	1-7/8	3	12	CD40825	1.99	CD47725	6.79	#55	7/8	1-7/8	12	CD40855	1.95	CD47755	5.39
#26	1-7/8	3	12	CD40826	1.99	CD47726	6.79	#56	3/4	1-3/4	12	CD40856	1.95	CD47756	5.39
#27	1-7/8	3	12	CD40827	1.99	CD47727	6.79	#57	3/4	1-3/4	12	CD40857	2.15	CD47757	5.39
#28	1-3/4	2-7/8	12	CD40828	1.82	CD47728	6.57	#58	11/16	1-5/8	12	CD40858	2.15	CD47758	5.39
#29	1-3/4	2-7/8	12	CD40829	1.82	CD47729	6.57	#59	11/16	1-5/8	12	CD40859	2.15	CD47759	5.39
#30	1-5/8	2-3/4	12	CD40830	1.78	CD47730	5.48	#60	11/16	1-5/8	12	CD40860	2.15	CD47760	5.39

For coating information see page 8. For technical information, please see pages 210 - 211.



GENERAL PURPOSE HSS & M42 DRILLS

YOUR #1 SOURCE FOR AMERICAN-MADE PREMIUM QUALITY CUTTING TOOLS

AIRCRAFT EXTENSION DRILLS - 6" OVERALL LENGTH - 135° SPLIT POINT



SERIES 675

HIGH SPEED STEEL - NAS 907 - TYPE "B"
OXIDE FINISH



SERIES 677

M42 COBALT - NAS 907 - TYPE "J"

FRACTIONAL SIZES

SIZE	OVERALL LENGTH	FLUTE LENGTH	PACKAGE QUANTITY	HSS	LIST PRICE	COBALT	LIST PRICE
3/32	6	1-1/4	12	CD67506	8.39	CD67706	13.89
7/64	6	1-1/2	12	CD67507	8.37	CD67707	15.74
1/8	6	1-5/8	12	CD67508	8.23	CD67708	12.91
9/64	6	1-3/4	12	CD67509	9.81	CD67709	17.65
5/32	6	2	12	CD67510	10.86	CD67710	17.65
11/64	6	2-1/8	12	CD67511	11.97	CD67711	19.44
3/16	6	2-5/16	12	CD67512	11.85	CD67712	16.35
13/64	6	2-7/16	12	CD67513	14.44	CD67713	24.07
7/32	6	2-1/2	12	CD67514	14.44	CD67714	24.69
15/64	6	2-5/8	12	CD67515	16.05	CD67715	26.23
1/4	6	2-3/4	12	CD67516	14.27	CD67716	25.61
17/64	6	2-7/8	6	CD67517	36.41	-	-
9/32	6	2-15/16	6	CD67518	37.65	-	-
19/64	6	3-1/16	6	CD67519	44.44	-	-
5/16	6	3-3/16	6	CD67520	48.14	-	-
21/64	6	3-5/16	6	CD67521	51.84	-	-
11/32	6	3-7/16	6	CD67522	51.84	-	-
23/64	6	3-1/2	6	CD67523	57.71	-	-
3/8	6	3-5/8	6	CD67524	58.63	-	-

WIRE SIZES

SIZE	OVERALL LENGTH	FLUTE LENGTH	PACKAGE QUANTITY	HSS	LIST PRICE	COBALT	LIST PRICE
#1	6	2-5/8	12	CD67601	16.66	CD67801	27.46
#2	6	2-5/8	12	CD67602	16.66	CD67802	27.46
#10	6	2-7/16	12	CD67610	12.96	CD67810	18.72
#11	6	2-5/16	12	CD67611	12.96	CD67811	18.00
#20	6	2-1/8	12	CD67620	10.80	CD67820	17.03
#21	6	2-1/8	12	CD67621	11.36	CD67821	17.03
#29	6	1-3/4	12	CD67629	12.03	CD67829	18.82
#30	6	1-5/8	12	CD67630	9.26	CD67830	12.96
#40	6	1-5/8	12	CD67640	7.59	CD67840	11.78

For technical information, please see pages 210 - 211.

GENERAL PURPOSE HSS & M42 DRILLS



YOUR #1 SOURCE FOR AMERICAN-MADE PREMIUM QUALITY CUTTING TOOLS

DRILLING

AIRCRAFT EXTENSION DRILLS - 12" OVERALL LENGTH - 135° SPLIT POINT



SERIES 680

HIGH SPEED STEEL - NAS 907 - TYPE "B"
OXIDE FINISH



SERIES 688

M42 COBALT - NAS 907 - TYPE "J"

FRACTIONAL SIZES							
SIZE	OVERALL LENGTH	FLUTE LENGTH	PACKAGE QUANTITY	HSS	LIST PRICE	COBALT	LIST PRICE
1/8	12	1-5/8	12	CD68008	23.82	CD68808	39.50
9/64	12	1-3/4	12	CD68009	24.04	CD68809	43.51
5/32	12	2	12	CD68010	24.04	CD68810	40.12
11/64	12	2-1/8	12	CD68011	27.09	CD68811	43.20
3/16	12	2-5/16	12	CD68012	26.82	CD68812	41.97
13/64	12	2-7/16	12	CD68013	30.77	CD68813	54.93
7/32	12	2-1/2	12	CD68014	30.45	CD68814	49.99
15/64	12	2-5/8	12	CD68015	34.31	CD68815	53.08
1/4	12	2-3/4	12	CD68016	37.34	CD68816	48.55
17/64	12	2-7/8	6	CD68017	43.20	-	-
9/32	12	2-15/16	6	CD68018	42.89	-	-
19/64	12	3-1/16	6	CD68019	48.00	-	-
5/16	12	3-3/16	6	CD68020	52.55	-	-
21/64	12	3-5/16	6	CD68021	57.09	-	-
11/32	12	3-7/16	6	CD68022	56.45	-	-
23/64	12	3-1/2	6	CD68023	63.95	-	-
3/8	12	3-5/8	6	CD68024	64.54	-	-
25/64	12	3-3/4	6	CD68025	72.00	-	-
13/32	12	3-7/8	6	CD68026	69.41	-	-
27/64	12	3-15/16	6	CD68027	76.54	-	-
7/16	12	4-1/16	6	CD68028	76.68	-	-
29/64	12	4-3/16	6	CD68029	86.50	-	-
15/32	12	4-5/16	6	CD68030	89.64	-	-
31/64	12	4-3/8	6	CD68031	92.95	-	-
1/2	12	4-1/2	6	CD68032	91.95	-	-

WIRE SIZES							
SIZE	OVERALL LENGTH	FLUTE LENGTH	PACKAGE QUANTITY	HSS	LIST PRICE	COBALT	LIST PRICE
#1	12	2-5/8	12	CD68101	37.36	CD68901	59.25
#10	12	2-7/16	12	CD68110	30.04	CD68910	45.67
#11	12	2-5/16	12	CD68111	30.32	CD68911	44.13
#20	12	2-1/8	12	CD68120	27.27	CD68920	40.73
#21	12	2-1/8	12	CD68121	26.77	CD68921	40.73
#29	12	1-3/4	12	CD68129	28.36	CD68929	42.28
#30	12	1-5/8	12	CD68130	26.77	CD68930	38.59
#40	12	1-3/8	12	CD68140	26.77	CD68940	42.28

For technical information, please see pages 210 - 211.

DRILLS
CARBIDE DRILLS
COBALT DRILLS
HSS DRILLS
AEROSPACE
SILVER & DEMING
SPECIALTY
DRILL SETS



GENERAL PURPOSE HSS DRILLS

YOUR #1 SOURCE FOR AMERICAN-MADE PREMIUM QUALITY CUTTING TOOLS

SILVER & DEMING - 1/2" ROUND SHANK - 118° POINT



SERIES 625
HIGH SPEED STEEL

SIZE	OAL	ITEM#	LIST PRICE
33/64	6	SD91433	37.17
17/32	6	SD91434	37.17
35/64	6	SD91435	39.24
9/16	6	SD91436	39.24
37/64	6	SD91437	42.13
19/32	6	SD91438	42.13
39/64	6	SD91439	44.28
5/8	6	SD91440	44.28
41/64	6	SD91441	46.39
21/32	6	SD91442	46.39
43/64	6	SD91443	49.32
11/16	6	SD91444	49.32
45/64	6	SD91445	49.53
23/32	6	SD91446	49.53
47/64	6	SD91447	54.03

SIZE	OAL	ITEM#	LIST PRICE
3/4	6	SD91448	54.19
49/64	6	SD91449	57.46
25/32	6	SD91450	57.46
51/64	6	SD91451	60.39
13/16	6	SD91452	60.39
53/64	6	SD91453	62.74
27/32	6	SD91454	62.74
55/64	6	SD91455	64.81
7/8	6	SD91456	64.81
57/64	6	SD91457	67.45
29/32	6	SD91458	67.45
59/64	6	SD91459	73.44
15/16	6	SD91460	73.44
61/64	6	SD91461	76.99
31/32	6	SD91462	76.99

SIZE	OAL	ITEM#	LIST PRICE
63/64	6	SD91463	85.83
1	6	SD91464	85.83
1-1/32	6	SD91466	115.16
1-1/16	6	SD91468	115.16
1-3/32	6	SD91470	122.80
1-1/8	6	SD91472	131.19
1-5/32	6	SD91474	131.19
1-3/16	6	SD91476	145.23
1-7/32	6	SD91478	160.72
1-1/4	6	SD91480	160.72
1-5/16	6	SD91484	170.01
1-3/8	6	SD91488	195.83
1-7/16	6	SD91492	215.33
1-1/2	6	SD91496	236.60

SILVER & DEMING - 1/2" SHANK - 3 FLATS - 118° POINT



SERIES 620
HIGH SPEED STEEL

SIZE	OAL	ITEM#	LIST PRICE
33/64	6	SD92533	40.52
17/32	6	SD92534	40.52
35/64	6	SD92535	43.08
9/16	6	SD92536	43.08
37/64	6	SD92537	46.30
19/32	6	SD92538	46.30
39/64	6	SD92539	48.45
5/8	6	SD92540	48.45
41/64	6	SD92541	51.67
21/32	6	SD92542	51.67
43/64	6	SD92543	53.74

SIZE	OAL	ITEM#	LIST PRICE
11/16	6	SD92544	53.74
45/64	6	SD92545	54.44
23/32	6	SD92546	54.44
47/64	6	SD92547	59.31
3/4	6	SD92548	59.31
49/64	6	SD92549	63.28
25/32	6	SD92550	63.28
51/64	6	SD92551	69.35
13/16	6	SD92552	69.35
53/64	6	SD92553	72.24
27/32	6	SD92554	72.24

SIZE	OAL	ITEM#	LIST PRICE
55/64	6	SD92555	77.08
7/8	6	SD92556	77.08
57/64	6	SD92557	79.97
29/32	6	SD92558	79.97
59/64	6	SD92559	81.87
15/16	6	SD92560	81.87
61/64	6	SD92561	85.71
31/32	6	SD92562	85.71
63/64	6	SD92563	93.93
1	6	SD92564	93.93

All S & D drills have 3" flute length.

For technical information, please see pages 210 - 211.

GENERAL PURPOSE HSS & M42 DRILLS



YOUR #1 SOURCE FOR AMERICAN-MADE PREMIUM QUALITY CUTTING TOOLS

DRILLING

SILVER & DEMING - 1/2" SHANK - 3 FLATS - 118° SPLIT POINT



SERIES 623

HIGH SPEED STEEL - BLACK & GOLD

SIZE	OAL	ITEM#	LIST PRICE
33/64	6	SD94733	47.46
17/32	6	SD94734	47.46
35/64	6	SD94735	50.27
9/16	6	SD94736	50.27
37/64	6	SD94737	53.37
19/32	6	SD94738	53.37
39/64	6	SD94739	55.47
5/8	6	SD94740	55.47
41/64	6	SD94741	58.86
21/32	6	SD94742	58.86
43/64	6	SD94743	61.38

SIZE	OAL	ITEM#	LIST PRICE
11/16	6	SD94744	61.38
45/64	6	SD94745	63.94
23/32	6	SD94746	63.94
47/64	6	SD94747	66.71
3/4	6	SD94748	66.71
49/64	6	SD94749	70.43
25/32	6	SD94750	70.43
51/64	6	SD94751	74.93
13/16	6	SD94752	74.93
53/64	6	SD94753	78.19
27/32	6	SD94754	78.19

SIZE	OAL	ITEM#	LIST PRICE
55/64	6	SD94755	80.30
7/8	6	SD94756	80.30
57/64	6	SD94757	83.81
29/32	6	SD94758	83.81
59/64	6	SD94759	90.09
15/16	6	SD94760	90.09
61/64	6	SD94761	97.03
31/32	6	SD94762	97.03
63/64	6	SD94763	101.90
1	6	SD94764	101.90

SILVER & DEMING - 1/2" ROUND SHANK - 135° SPLIT POINT



SERIES 622

M42 COBALT

SIZE	OAL	ITEM#	LIST PRICE
33/64	6	SD93633	73.94
17/32	6	SD93634	73.94
35/64	6	SD93635	88.97
9/16	6	SD93636	88.97
37/64	6	SD93637	91.99
19/32	6	SD93638	91.99
39/64	6	SD93639	94.34
5/8	6	SD93640	94.34
41/64	6	SD93641	98.97
21/32	6	SD93642	98.97
43/64	6	SD93643	100.99

SIZE	OAL	ITEM#	LIST PRICE
11/16	6	SD93644	100.99
45/64	6	SD93645	106.53
23/32	6	SD93646	106.53
47/64	6	SD93647	111.15
3/4	6	SD93648	111.15
49/64	6	SD93649	116.23
25/32	6	SD93650	116.23
51/64	6	SD93651	119.33
13/16	6	SD93652	119.33
53/64	6	SD93653	128.96
27/32	6	SD93654	128.96

SIZE	OAL	ITEM#	LIST PRICE
55/64	6	SD93655	128.96
7/8	6	SD93656	128.96
57/64	6	SD93657	133.87
29/32	6	SD93658	133.87
59/64	6	SD93659	139.65
15/16	6	SD93660	139.65
61/64	6	SD93661	147.38
31/32	6	SD93662	147.38
63/64	6	SD93663	167.24
1	6	SD93664	167.24

All S & D drills have 3" flute length.

For technical information, please see pages 210 - 211.

DRILLS
CARBIDE DRILLS
COBALT DRILLS
HSS DRILLS
AEROSPACE
SILVER & DEMING
SPECIALTY
DRILL SETS



GENERAL PURPOSE HSS DRILLS

YOUR #1 SOURCE FOR AMERICAN-MADE PREMIUM QUALITY CUTTING TOOLS

TAPER LENGTH - 118° POINT



SERIES 525
OXIDE FINISH

FRACTIONAL SIZES						FRACTIONAL SIZES					
SIZE	FLUTE LENGTH	OAL	PKG. QTY.	OXIDE	LIST PRICE	SIZE	FLUTE LENGTH	OAL	PKG. QTY.	OXIDE	LIST PRICE
3/64	1-1/8	2-1/4	12	CD52503	13.23	37/64	4-7/8	8-3/4	1	CD52537	73.19
1/16	1-3/4	3	12	CD52504	13.23	19/32	4-7/8	8-3/4	1	CD52538	73.19
5/64	2	3-3/4	12	CD52505	13.23	39/64	4-7/8	8-3/4	1	CD52539	75.83
3/32	2-1/4	4-1/4	12	CD52506	12.32	5/8	4-7/8	8-3/4	1	CD52540	75.83
7/64	2-1/2	4-5/8	12	CD52507	12.87	41/64	5-1/8	9	1	CD52541	86.34
1/8	2-3/4	5-1/8	12	CD52508	13.24	21/32	5-1/8	9	1	CD52542	86.34
9/64	3	5-3/8	12	CD52509	17.68	43/64	5-3/8	9-1/4	1	CD52543	102.12
5/32	3	5-3/8	12	CD52510	17.87	11/16	5-3/8	9-1/4	1	CD52544	102.12
11/64	3-3/8	5-3/4	12	CD52511	18.75	45/64	5-5/8	9-1/2	1	CD52545	106.80
3/16	3-3/8	5-3/4	12	CD52512	17.45	23/32	5-5/8	9-1/2	1	CD52546	106.80
13/64	3-5/8	6	12	CD52513	21.30	47/64	5-7/8	9-3/4	1	CD52547	114.86
7/32	3-5/8	6	12	CD52514	22.96	3/4	5-7/8	9-3/4	1	CD52548	114.86
15/64	3-3/4	6-1/8	12	CD52515	22.96	49/64	6	9-7/8	1	CD52549	124.44
1/4	3-3/4	6-1/8	12	CD52516	19.81	25/32	6	9-7/8	1	CD52550	124.44
17/64	3-7/8	6-1/4	6	CD52517	24.03	51/64	6-1/8	10	1	CD52551	134.35
9/32	3-7/8	6-1/4	6	CD52518	24.03	13/16	6-1/8	10	1	CD52552	134.35
19/64	4	6-3/8	6	CD52519	26.16	53/64	6-1/8	10	1	CD52553	141.47
5/16	4	6-3/8	6	CD52520	26.16	27/32	6-1/8	10	1	CD52554	141.47
21/64	4-1/8	6-1/2	6	CD52521	26.16	55/64	6-1/8	10	1	CD52555	148.47
11/32	4-1/8	6-1/2	6	CD52522	26.16	7/8	6-1/8	10	1	CD52556	148.47
23/64	4-1/4	6-3/4	6	CD52523	30.83	57/64	6-1/8	10	1	CD52557	154.76
3/8	4-1/4	6-3/4	6	CD52524	30.83	29/32	6-1/8	10	1	CD52558	154.76
25/64	4-3/8	6-3/4	6	CD52525	35.09	59/64	6-1/8	10-3/4	1	CD52559	168.23
13/32	4-3/8	7	6	CD52526	35.09	15/16	6-1/8	10-3/4	1	CD52560	168.23
27/64	4-5/8	7-1/4	6	CD52527	37.22	61/64	6-3/8	11	1	CD52561	185.69
7/16	4-5/8	7-1/4	6	CD52528	37.22	31/32	6-3/8	11	1	CD52562	185.69
29/64	4-3/4	7-1/2	6	CD52529	42.36	63/64	6-3/8	11	1	CD52563	193.56
15/32	4-3/4	7-1/2	6	CD52530	42.36	1	6-3/8	11	1	CD52564	193.56
31/64	4-3/4	7-3/4	6	CD52531	44.81	1-1/16	6-5/8	11-1/4	1	CD52568	239.85
1/2	4-3/4	7-3/4	6	CD52532	44.81	1-1/8	7-1/8	11-3/4	1	CD52572	266.98
33/64	4-3/4	8	1	CD52533	59.53	1-3/16	7-3/8	12	1	CD52576	312.90
17/32	4-3/4	8	1	CD52534	59.53	1-1/4	7-7/8	12-1/2	1	CD52580	335.12
35/64	4-7/8	8-1/4	1	CD52535	62.54	1-5/16	8-5/8	14-1/4	1	CD52584	399.89
9/16	4-7/8	8-1/4	1	CD52536	62.54	1-3/8	8-7/8	14-1/2	1	CD52588	428.87

For technical information, please see pages 210 - 211.

GENERAL PURPOSE HSS DRILLS



YOUR #1 SOURCE FOR AMERICAN-MADE PREMIUM QUALITY CUTTING TOOLS

DRILLING

TAPER LENGTH - 118° POINT



SERIES 525
OXIDE FINISH

WIRE SIZES						WIRE SIZES					
SIZE	FLUTE LENGTH	OAL	PKG. QTY.	OXIDE	LIST PRICE	SIZE	FLUTE LENGTH	OAL	PKG. QTY.	OXIDE	LIST PRICE
#1	3-3/4	6-1/8	12	CD52701	24.07	#21	3-3/8	5-3/4	12	CD52721	21.16
#2	3-3/4	6-1/8	12	CD52702	24.07	#22	3-3/8	5-3/4	12	CD52722	21.16
#3	3-5/8	6	12	CD52703	23.29	#23	3	5-3/8	12	CD52723	21.16
#4	3-5/8	6	12	CD52704	23.29	#24	3	5-3/8	12	CD52724	21.16
#5	3-5/8	6	12	CD52705	23.29	#25	3	5-3/8	12	CD52725	21.16
#6	3-5/8	6	12	CD52706	23.29	#26	3	5-3/8	12	CD52726	21.16
#7	3-5/8	6	12	CD52707	23.29	#27	3	5-3/8	12	CD52727	21.16
#8	3-5/8	6	12	CD52708	23.29	#28	3	5-3/8	12	CD52728	21.16
#9	3-5/8	6	12	CD52709	23.29	#29	3	5-3/8	12	CD52729	21.16
#10	3-5/8	6	12	CD52710	23.29	#30	3	5-3/8	12	CD52730	21.16
#11	3-5/8	6	12	CD52711	23.29	#31	2-3/4	5-1/8	12	CD52731	20.74
#12	3-5/8	6	12	CD52712	23.29	#32	2-3/4	5-1/8	12	CD52732	20.74
#13	3-3/8	5-3/4	12	CD52713	21.16	#33	2-3/4	5-1/8	12	CD52733	20.74
#14	3-3/8	5-3/4	12	CD52714	21.16	#34	2-3/4	5-1/8	12	CD52734	20.74
#15	3-3/8	5-3/4	12	CD52715	21.16	#35	2-3/4	5-1/8	12	CD52735	20.74
#16	3-3/8	5-3/4	12	CD52716	21.16	#36	2-1/2	4-5/8	12	CD52736	15.51
#17	3-3/8	5-3/4	12	CD52717	21.16	#37	2-1/2	4-5/8	12	CD52737	15.51
#18	3-3/8	5-3/4	12	CD52718	21.16	#38	2-1/2	4-5/8	12	CD52738	15.51
#19	3-3/8	5-3/4	12	CD52719	21.16	#39	2-1/2	4-5/8	12	CD52739	13.61
#20	3-3/8	5-3/4	12	CD52720	21.16	#40	2-1/2	4-5/8	12	CD52740	13.61

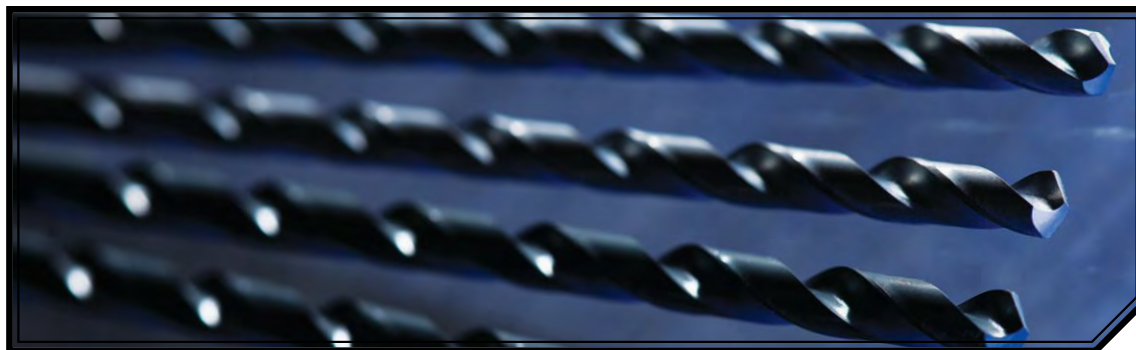

Highest quality American-Made drills outlast the competition

For technical information, please see pages 210 - 211.

TECHNICAL DRILL SETS
SPECIALTY DRILLS
SILVER & DEMING
AEROSPACE DRILLS
HSS DRILLS
COBALT DRILLS
CARBIDE DRILLS
DRILLS



GENERAL PURPOSE HSS DRILLS

YOUR #1 SOURCE FOR AMERICAN-MADE PREMIUM QUALITY CUTTING TOOLS

TAPER SHANK - 118° POINT



SERIES 550 OXIDE FINISH

FRACTIONAL SIZES

SIZE	MORSE TAPER	FLUTE LENGTH	OAL	OXIDE	LIST PRICE
3/16	1	2-1/2	5-3/4	CD55012	46.80
13/64	1	2-3/4	6	CD55013	46.80
7/32	1	2-3/4	6	CD55014	46.80
15/64	1	2-7/8	6-1/8	CD55015	46.80
1/4	1	2-7/8	6-1/8	CD55016	46.80
17/64	1	3	6-1/4	CD55017	46.80
9/32	1	3	6-1/4	CD55018	46.80
19/64	1	3-1/8	6-3/8	CD55019	49.58
5/16	1	3-1/8	6-3/8	CD55020	52.13
21/64	1	3-1/4	6-1/2	CD55021	52.13
11/32	1	3-1/4	6-1/2	CD55022	52.13
23/64	1	3-1/2	6-3/4	CD55023	53.19
3/8	1	3-1/2	6-3/4	CD55024	53.19
25/64	1	3-5/8	7	CD55025	63.19
13/32	1	3-5/8	7	CD55026	63.19
27/64	1	3-7/8	7-1/4	CD55027	68.05
7/16	1	3-7/8	7-1/4	CD55028	68.05
29/64	1	4-1/8	7-1/2	CD55029	68.05
15/32	1	4-1/8	7-1/2	CD55030	68.05
31/64	2	4-3/8	8-1/4	CD55031	74.44
1/2	2	4-3/8	8-1/4	CD55032	69.67
33/64	2	4-5/8	8-1/2	CD55033	80.32
17/32	2	4-5/8	8-1/2	CD55034	82.96
35/64	2	4-7/8	8-3/4	CD55035	87.40
9/16	2	4-7/8	8-3/4	CD55036	85.09
37/64	2	4-7/8	8-3/4	CD55037	93.05
19/32	2	4-7/8	8-3/4	CD55038	91.48
39/64	2	4-7/8	8-3/4	CD55039	96.80
5/8	2	4-7/8	8-3/4	CD55040	92.54
41/64	2	5-1/8	9	CD55041	106.38
21/32	2	5-1/8	9	CD55042	104.25
43/64	2	5-3/8	9-1/4	CD55043	114.86
11/16	2	5-3/8	9-1/4	CD55044	108.47
45/64	2	5-5/8	9-1/2	CD55045	119.11
23/32	2	5-5/8	9-1/2	CD55046	115.09
47/64	2	5-7/8	9-3/4	CD55047	127.63
3/4	2	5-7/8	9-3/4	CD55048	126.57
49/64	2	6	9-7/8	CD55049	152.54
25/32	2	6	9-7/8	CD55050	151.66
51/64	3	6-1/8	10-3/4	CD55051	166.98

FRACTIONAL SIZES

SIZE	MORSE TAPER	FLUTE LENGTH	OAL	OXIDE	LIST PRICE
13/16	3	6-1/8	10-3/4	CD55052	156.89
53/64	3	6-1/8	10-3/4	CD55053	173.79
27/32	3	6-1/8	10-3/4	CD55054	169.11
55/64	3	6-1/8	10-3/4	CD55055	190.82
7/8	3	6-1/8	10-3/4	CD55056	174.25
57/64	3	6-1/8	10-3/4	CD55057	184.02
29/32	3	6-1/8	10-3/4	CD55058	184.02
59/64	3	6-1/8	10-3/4	CD55059	186.57
15/16	3	6-1/8	10-3/4	CD55060	174.85
61/64	3	6-3/8	11	CD55061	191.66
31/32	3	6-3/8	11	CD55062	190.36
63/64	3	6-3/8	11	CD55063	203.37
1	3	6-3/8	11	CD55064	193.56
1-1/64	3	6-1/2	11-1/8	CD55065	225.04
1-1/32	3	6-1/2	11-1/8	CD55066	223.37
1-3/64	3	6-5/8	11-1/4	CD55067	234.02
1-1/16	3	6-5/8	11-1/4	CD55068	223.37
1-5/64	4	6-7/8	12-1/2	CD55069	265.87
1-3/32	4	6-7/8	12-1/2	CD55070	265.87
1-7/64	4	7-1/8	12-3/4	CD55071	276.51
1-1/8	4	7-1/8	12-3/4	CD55072	276.51
1-9/64	4	7-1/4	12-7/8	CD55073	297.81
1-5/32	4	7-1/4	12-7/8	CD55074	287.16
1-11/64	4	7-3/8	13	CD55075	297.81
1-3/16	4	7-3/8	13	CD55076	297.81
1-13/64	4	7-1/2	13-1/8	CD55077	319.06
1-7/32	4	7-1/2	13-1/8	CD55078	319.06
1-1/4	4	7-7/8	13-1/2	CD55080	333.97
1-5/16	4	8-5/8	14-1/4	CD55084	410.54
1-3/8	4	8-7/8	14-1/2	CD55088	438.17
1-7/16	4	9-1/8	14-3/4	CD55092	480.72
1-1/2	4	9-3/8	15	CD55096	504.14
1-9/16	5	9-5/8	16-5/8	CD55102	614.74
1-5/8	5	10	17	CD55106	663.67
1-11/16	5	10-1/8	17-1/8	CD55110	731.77
1-3/4	5	10-1/8	17-1/8	CD55114	778.57
1-13/16	5	10-1/8	17-1/8	CD55118	835.98
1-7/8	5	10-3/8	17-3/8	CD55122	872.13
1-15/16	5	10-3/8	17-3/8	CD55126	940.23
2	5	10-3/8	17-3/8	CD55130	974.26

Taper shank drills sold individually.

For technical information, please see pages 210 - 211.

GENERAL PURPOSE HSS DRILLS



YOUR #1 SOURCE FOR AMERICAN-MADE PREMIUM QUALITY CUTTING TOOLS

EXTRA LENGTH - 118° POINT - 12" O.A.L.



SERIES 686
BRIGHT FINISH

FRACTIONAL SIZES					FRACTIONAL SIZES				
SIZE	FLUTE LENGTH	OAL	BRIGHT	LIST PRICE	SIZE	FLUTE LENGTH	OAL	BRIGHT	LIST PRICE
1/8	9	12	CD68608	52.27	3/8	9	12	CD68624	69.80
9/64	9	12	CD68609	75.76	25/64	9	12	CD68625	105.64
5/32	9	12	CD68610	68.89	13/32	9	12	CD68626	105.64
11/64	9	12	CD68611	58.75	27/64	9	12	CD68627	105.64
3/16	9	12	CD68612	58.75	7/16	9	12	CD68628	90.22
13/64	9	12	CD68613	71.20	29/64	9	12	CD68629	110.25
7/32	9	12	CD68614	63.75	15/32	9	12	CD68630	99.20
15/64	9	12	CD68615	63.75	31/64	9	12	CD68631	101.51
1/4	9	12	CD68616	65.91	1/2	9	12	CD68632	101.51
17/64	9	12	CD68617	68.22	17/32	9	12	CD68634	128.61
9/32	9	12	CD68618	68.22	9/16	9	12	CD68636	128.61
19/64	9	12	CD68619	70.72	19/32	9	12	CD68638	160.75
5/16	9	12	CD68620	70.72	5/8	9	12	CD68640	156.18
21/64	9	12	CD68621	75.76	11/16	9	12	CD68644	165.36
11/32	9	12	CD68622	75.76	3/4	9	12	CD68648	186.26
23/64	9	12	CD68623	75.76					

SCREW EXTRACTORS



SERIES 531

SIZE	FOR SCREW & BOLT SIZES	PIPE SIZE	PKG. QTY.	ITEM#	LIST PRICE
1	3/16 - 1/4		1	CD53101	8.70
2	1/4 - 5/16		1	CD53102	9.27
3	5/16 - 7/16		1	CD53103	11.24
4	7/16 - 9/16	1/8	1	CD53104	11.91
5	9/16 - 3/4	1/4	1	CD53105	14.89
6	3/4-1	3/8	1	CD53106	32.72
7	1 - 1-3/8	1/2	1	CD53107	52.65
SET	SIZES 1-5		1	CD53113	55.97

All tools sold individually.

For technical information, please see pages 210 - 211.



GENERAL PURPOSE HSS DRILLS

YOUR #1 SOURCE FOR AMERICAN-MADE PREMIUM QUALITY CUTTING TOOLS

MECHANICS LENGTH - HEAVY DUTY - 135° SPLIT POINT - TYPE "B"



SERIES 455
BLACK & GOLD

FRACTIONAL SIZES						FRACTIONAL SIZES					
SIZE	FLUTE LENGTH	OAL	PACKAGE QUANTITY	ITEM#	LIST PRICE	SIZE	FLUTE LENGTH	OAL	PACKAGE QUANTITY	ITEM#	LIST PRICE
1/16	7/8	1-7/8	12	CD45504	2.59	19/64	2-3/8	3-7/8	6	CD45519	8.76
5/64	1	2	12	CD45505	2.80	5/16	2-1/2	4	6	CD45520	9.36
3/32	1-1/4	2-1/4	12	CD45506	2.80	21/64	2-9/16	4-1/16	6	CD45521	9.97
7/64	1-5/16	2-3/8	12	CD45507	2.88	11/32	2-5/8	4-1/8	6	CD45522	10.86
1/8	1-7/16	2-1/2	12	CD45508	3.00	23/64	2-11/16	4-3/16	6	CD45523	11.55
9/64	1-9/16	2-5/8	12	CD45509	3.08	3/8	2-11/16	4-1/4	6	CD45524	12.24
5/32	1-11/16	2-3/4	12	CD45510	3.69	25/64	2-3/4	4-5/16	6	CD45525	13.01
11/64	1-13/16	2-7/8	12	CD45511	3.77	13/32	2-13/16	4-3/8	6	CD45526	14.03
3/16	1-7/8	3	12	CD45512	4.30	27/64	2-7/8	4-7/16	6	CD45527	15.81
13/64	1-15/16	3-1/8	12	CD45513	4.66	7/16	2-15/16	4-1/2	6	CD45528	16.70
7/32	2	3-1/4	12	CD45514	5.19	29/64	3	4-5/8	6	CD45529	18.20
15/64	2-1/16	3-3/8	12	CD45515	5.55	15/32	3-1/8	4-3/4	6	CD45530	19.50
1/4	2	3-1/2	12	CD45516	5.88	31/64	3-1/4	4-7/8	6	CD45531	19.91
17/64	2-1/8	3-5/8	6	CD45517	7.38	1/2	3-3/8	5	6	CD45532	20.43
9/32	2-1/4	3-3/4	6	CD45518	7.38						

SIZES 3/16" TO 1/2" - HAVE 3 FLATS;
SIZES 27/64" AND HIGHER - HAVE 3/8" REDUCED FLATTED SHANKS



Distribution Center organized for fast order retrieval and shipment

For technical information, please see pages 210 - 211.

NOTE: SIZES BELOW 1/16" ARE NOT SPLIT POINT.

GENERAL PURPOSE M42 COBALT DRILL SETS



YOUR #1 SOURCE FOR AMERICAN-MADE PREMIUM QUALITY CUTTING TOOLS

DRILLING

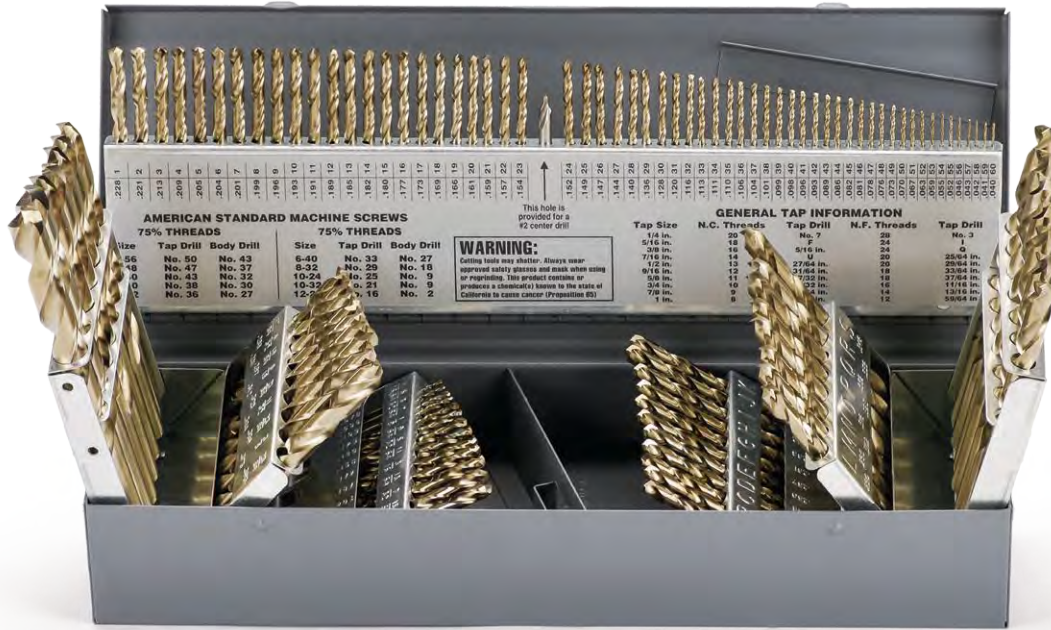

ITEM# MS99163

115 PC JOBBER DRILL SET - M42 COBALT

JOBBER DRILL SETS

DESCRIPTION	ITEM#	LIST PRICE
13PC • 1/16" - 1/4" by 64ths • Heavy Duty • 135° SP/PT	MS99151	63.26
15PC • 1/16" - 1/2" by 32nds • Heavy Duty • 135° SP/PT	MS99153	213.45
21PC • 1/16" - 3/8" by 64ths • Heavy Duty • 135° SP/PT	MS99155	232.48
26PC • A - Z • Heavy Duty • 135° SP/PT	MS99157	354.01
29PC • 1/16" - 1/2" by 64ths • Heavy Duty • 135° SP/PT	MS99159	346.49
60PC • #1 - #60 • Heavy Duty • 135° SP/PT	MS99161	302.44
115PC • 1/16" - 1/2" by 64ths • #1 - #60 • A - Z • H.D. • 135° SP/PT	MS99163	1275.53

SCREW MACHINE DRILL SET

DESCRIPTION	ITEM#	LIST PRICE
115PC • 1/16" - 1/2" by 64ths • #1 - #60 • A - Z • H.D. • 135° SP/PT	MS99165	1057.42

DRILLS
CARBIDE DRILLS
COBALT DRILLS
HSS DRILLS
AEROSPACE
SILVER & DEMING
SPECIALTY
TECHNICAL DRILL SETS

For technical information, please see pages 210 - 211.



GENERAL PURPOSE HSS DRILL SETS

YOUR #1 SOURCE FOR AMERICAN-MADE PREMIUM QUALITY CUTTING TOOLS



ITEM# MS99028

29 PC JOBBER DRILL SET - BRIGHT FINISH
HIGH SPEED STEEL



ITEM# MS99030

29 PC HEAVY DUTY DRILL SET - BLACK & GOLD
HIGH SPEED STEEL

JOBBER DRILL SETS

DESCRIPTION	ITEM#	LIST PRICE
13PC • 1/16" - 1/4" by 64ths • 118° Point • Oxided	MS99010	46.93
13PC • 1/16" - 1/4" by 64ths • 118° Point • Bright	MS99011	46.93
15PC • 1/16" - 1/2" by 32nds • 118° Point • Oxided	MS99014	131.03
15PC • 1/16" - 1/2" by 32nds • 118° Point • Bright	MS99016	131.03
15PC • 1/16" - 1/2" by 32nds • Heavy Duty • 135° SP/PT • Oxided	MS99017	144.52
21PC • 1/16" - 3/8" by 64ths • 118° Point • Oxided	MS99018	110.74
21PC • 1/16" - 3/8" by 64ths • 118° Point • Bright	MS99020	110.74
25PC • 1.0mm - 13.0mm by 0.5mm • 118° Point • Oxided	MS99050	252.90
26PC • A-Z • 118° Point • Oxided	MS99022	185.34
26PC • A-Z • 118° Point • Bright	MS99024	185.34
29PC • 1/16" - 1/2" by 64ths • 118° Point • Oxided	MS99026	180.06
29PC • 1/16" - 1/2" by 64ths • 118° Point • Bright	MS99028	180.06
29PC • 1/16" - 1/2" by 64ths • Heavy Duty • 135° SP/PT • Oxided	MS99032	224.10
29PC • 1/16" - 1/2" by 64ths • 118° Point • TIN Coated	MS99036	445.29
60PC • #1 - #60 • 118° Point • Oxided	MS99038	162.87
60PC • #1 - #60 • 118° Point • Bright	MS99040	162.87
115PC • 1/16" - 1/2" by 64ths • #1 - #60 • A - Z • 118° Point • Oxided	MS99042	517.53
115PC • 1/16" - 1/2" by 64ths • #1 - #60 • A - Z • 118° Point • Bright	MS99044	517.53

BLACK & GOLD SETS

DESCRIPTION	ITEM#	LIST PRICE
13PC • 1/16" - 1/4" by 64ths • Heavy Duty • 135° SP/PT • Black & Gold	MS99012	58.53
15PC • 1/16" - 1/2" by 32nds • Heavy Duty • 135° SP/PT • Black & Gold	MS99015	169.53
21PC • 1/16" - 3/8" by 64ths • Heavy Duty • 135° SP/PT • Black & Gold	MS99021	166.05
29PC • 1/16" - 1/2" by 64ths • Heavy Duty • 135° SP/PT • Black & Gold	MS99030	271.25
29PC • 1/16" - 1/2" by 64ths • H.D. • 135° SP/PT • Black & Gold • Plastic Case	MS99431	271.25
115PC • 1/16" - 1/2" by 64ths • Heavy Duty • 135° SP/PT • Black & Gold	MS99046	748.16

NOTE: SIZES BELOW 1/16" ARE NOT SPLIT POINT.

For coating information see page 8. For technical information, please see pages 210 - 211.

DRILLS

CARBIDE
DRILLS

COBALT
DRILLS

HSS
DRILLS

AEROSPACE

SILVER &
DEMING

SPECIALTY

DRILL
SETS

TECHNICAL

GENERAL PURPOSE HSS & M42 DRILL SETS



YOUR #1 SOURCE FOR AMERICAN-MADE PREMIUM QUALITY CUTTING TOOLS

DRILLING



ITEM# MS99302
8 PC SILVER & DEMING DRILL SET
HIGH SPEED STEEL

SILVER & DEMING SETS - 1/2" SHANK

DESCRIPTION	ITEM#	LIST PRICE
8PC • HSS • 9/16" - 1" by 16ths • 118° Point • Plastic Case	MS99302	437.60
8PC • HSS • 9/16" - 1" by 16ths • Black & Gold • 118° Split Point • Plastic Case	MS99313	555.73
8PC • 9/16" - 1" by 16ths • M42 Cobalt • 118° Split Point • Plastic Case	MS99310	902.79
33PC • HSS • 1/2" - 1" by 64ths • 118° Point • Metal Stand	MS99304	1968.68

ITEM# MS99442
29 PC MECHANICS LENGTH DRILL SET
HIGH SPEED STEEL - BLACK & GOLD



HIGH SPEED STEEL - MECHANICS LENGTH SETS

DESCRIPTION	ITEM#	LIST PRICE
15PC • 1/16" - 1/2" by 32ths • Black & Gold • Heavy Duty • 135° SP/PT • Metal Case	MS99425	159.56
29PC • 1/16" - 1/2" by 64ths • Black & Gold • Heavy Duty • 135° SP/PT • Metal Case	MS99405	294.45
29PC • 1/16" - 1/2" by 64ths • Black & Gold • Heavy Duty • 135° SP/PT • Plastic Case	MS99442	294.45

MECHANICS LENGTH: SIZES 3/16" TO 1/2" - HAVE 3 FLATS;
SIZES 27/64" AND HIGHER - HAVE 3/8" REDUCED FLATTED SHANKS

HIGH SPEED STEEL - TAP & DRILL SETS

DESCRIPTION	ITEM#	LIST PRICE
18PC • (6-32, #36), (8-32, #29), (10-24, #25), (10-32, #21), (1/4-20, #7) (5/16-18,"F"), (3/8-16, 5/16"), (7/16-14,"U"), (1/2-13, 27/64) • Metal Case	MS99201	241.42

For technical information, please see pages 210 - 211.

DRILLS

CARBIDE
DRILLS

COBALT
DRILLS

HSS
DRILLS

AEROSPACE

SILVER &
DEMING

SPECIALTY

DRILL
SETS

TECHNICAL

SETS



GENERAL PURPOSE CARBIDE COUNTERSINKS

YOUR #1 SOURCE FOR AMERICAN-MADE PREMIUM QUALITY CUTTING TOOLS

SINGLE FLUTE COUNTERSINKS



SERIES 310 - 60°
SERIES 311 - 82°
SERIES 312 - 90°
SERIES 313 - 100°

SIZE	SHANK	OAL	PKG QTY	60°-ITEM #	82°-ITEM #	90°-ITEM #	100°-ITEM #	LIST PRICE
* 1/8	1/8	1-1/2	1	CS31008	CS31108	CS31208	CS31308	27.51
* 3/16	3/16	2	1	CS31012	CS31112	CS31212	CS31312	29.39
* 1/4	1/4	2	1	CS31016	CS31116	CS31216	CS31316	33.39
3/8	1/4	2-5/8	1	CS31024	CS31124	CS31224	CS31324	60.46
1/2	1/4	2-5/8	1	CS31032	CS31132	CS31232	CS31332	74.89
5/8	3/8	2-3/4	1	CS31040	CS31140	CS31240	CS31340	109.41
3/4	3/8	2-3/4	1	CS31048	CS31148	CS31248	CS31348	154.65
1	1/2	3	1	CS31064	CS31164	CS31264	CS31364	229.25

* One Piece

THREE FLUTE COUNTERSINKS



SERIES 331 - 60°
SERIES 332 - 82°
SERIES 333 - 90°
SERIES 334 - 100°

SIZE	SHANK	OAL	PKG QTY	60°-ITEM #	82°-ITEM #	90°-ITEM #	100°-ITEM #	LIST PRICE
* 1/8	1/8	1-1/2	1	CS33108	CS33208	CS33308	CS33408	27.51
* 3/16	3/16	2	1	CS33112	CS33212	CS33312	CS33412	29.39
* 1/4	1/4	2	1	CS33116	CS33216	CS33316	CS33416	33.39
3/8	1/4	2-5/8	1	CS33124	CS33224	CS33324	CS33424	60.46
1/2	1/4	2-5/8	1	CS33132	CS33232	CS33332	CS33432	74.89
5/8	3/8	2-3/4	1	CS33140	CS33240	CS33340	CS33440	109.41
3/4	3/8	2-3/4	1	CS33148	CS33248	CS33348	CS33448	154.65
1	1/2	3	1	CS33164	CS33264	CS33364	CS33464	229.25

* One Piece

SIX FLUTE CHATTERLESS COUNTERSINKS



SERIES 366 - 60°
SERIES 367 - 82°
SERIES 368 - 90°
SERIES 369 - 100°

SIZE	SHANK	OAL	PKG QTY	60°-ITEM #	82°-ITEM #	90°-ITEM #	100°-ITEM #	LIST PRICE
* 1/8	1/8	1-1/2	1	CS36608	CS36708	CS36808	CS36908	27.51
* 3/16	3/16	2	1	CS36612	CS36712	CS36812	CS36912	29.39
* 1/4	1/4	2	1	CS36616	CS36716	CS36816	CS36916	33.39
3/8	1/4	2-5/8	1	CS36624	CS36724	CS36824	CS36924	60.46
1/2	1/4	2-5/8	1	CS36632	CS36732	CS36832	CS36932	74.89
5/8	3/8	2-3/4	1	CS36640	CS36740	CS36840	CS36940	109.41
3/4	3/8	2-3/4	1	CS36648	CS36748	CS36848	CS36948	154.65
1	1/2	3	1	CS36664	CS36764	CS36864	CS36964	229.25

* One Piece

GENERAL PURPOSE HSS COUNTERSINKS



DRILLING

YOUR #1 SOURCE FOR AMERICAN-MADE PREMIUM QUALITY CUTTING TOOLS

SINGLE FLUTE COUNTERSINKS



SERIES 505 - 60°
SERIES 510 - 82°
SERIES 515 - 90°

SIZE	SHANK	OAL	PKG QTY	60°-ITEM#	82°-ITEM#	90°-ITEM#	LIST PRICE
1/4	3/16	1-7/16	1	CD50501	CD51014	CD51523	30.20
3/8	1/4	1-21/32	1	CD50502	CD51015	CD51524	34.37
1/2	1/4	1-13/32	1	CD50503	CD51016	CD51525	43.96
3/4	1/2	1-27/32	1	CD50504	CD51017	CD51526	60.70
1	1/2	2-13/16	1	CD50505	CD51018	CD51527	94.30

FOUR FLUTE COUNTERSINKS



SERIES 521 - 60°
SERIES 523 - 82°

SIZE	SHANK	OAL	PKG. QTY	60°-ITEM#	82°-ITEM#	LIST PRICE
1/2	1/2	3-7/8	1	CD52032	CD52232	96.39
5/8	1/2	4	1	CD52040	CD52240	108.52
3/4	1/2	4-1/8	1	CD52048	CD52248	138.49
7/8	1/2	4-1/4	1	CD52056	CD52256	162.78
1	1/2	4-3/8	1	CD52064	CD52264	168.23



Real-time stock check on titancuttingtools.com

COUNTERSINKS

STANDARD COUNTERSINKS

COMBINED DRILL & COUNTERSINKS

TECHNICAL



SOLID CARBIDE & M42 COMBINED DRILL & COUNTERSINKS

YOUR #1 SOURCE FOR AMERICAN-MADE PREMIUM QUALITY CUTTING TOOLS



SERIES 3000
SOLID CARBIDE - 60°
UNCOATED

SIZE	DRILL DIA.	BODY DIA.	OVERALL LENGTH	PKG. QTY	ITEM #	LIST PRICE
00	.025	1/8	1-1/2	1	CS30020	35.36
0	1/32	1/8	1-1/2	1	CS30010	33.79
1	3/64	1/8	1-1/2	1	CS30001	30.76
2	5/64	3/16	2	1	CS30002	45.77
3	7/64	1/4	2	1	CS30003	51.63
4	1/8	5/16	2-1/8	1	CS30004	66.64
5	3/16	7/16	2-3/4	1	CS30005	105.64
6	7/32	1/2	3	1	CS30006	131.49



SERIES 3600
SOLID CARBIDE - 60°
ALTIN COATED

SIZE	DRILL DIA.	BODY DIA.	OVERALL LENGTH	PKG. QTY	ITEM #	LIST PRICE
00	.025	1/8	1-1/2	1	CS36020	44.16
0	1/32	1/8	1-1/2	1	CS36010	42.25
1	3/64	1/8	1-1/2	1	CS36001	38.44
2	5/64	3/16	2	1	CS36002	57.22
3	7/64	1/4	2	1	CS36003	64.51
4	1/8	5/16	2-1/8	1	CS36004	83.29
5	3/16	7/16	2-3/4	1	CS36005	132.06
6	7/32	1/2	3	1	CS36006	164.38



SERIES 2000
M42 COBALT - 60°
UNCOATED

SIZE	DRILL DIA.	BODY DIA.	OVERALL LENGTH	PKG. QTY	ITEM #	LIST PRICE
1	3/64	1/8	1-1/4	6	CS20001	31.83
2	5/64	3/16	1-7/8	6	CS20002	34.40
3	7/64	1/4	2	6	CS20003	35.56
4	1/8	5/16	2-1/8	6	CS20004	36.99



SERIES 3700
M42 COBALT - 60°
ALTIN COATED

SIZE	DRILL DIA.	BODY DIA.	OVERALL LENGTH	PKG. QTY	ITEM #	LIST PRICE
1	3/64	1/8	1-1/4	6	CS37001	40.15
2	5/64	3/16	1-7/8	6	CS37002	43.73
3	7/64	1/4	2	6	CS37003	47.21
4	1/8	5/16	2-1/8	6	CS37004	49.97



HSS Stocked in sizes from #00000 to #8

For coating information, please see page 8.

COUNTERSINKS

STANDARD COUNTERSINKS

COMBINED DRILL & COUNTERSINKS

TECHNICAL

HSS COMBINED DRILL & COUNTERSINKS



YOUR #1 SOURCE FOR AMERICAN-MADE PREMIUM QUALITY CUTTING TOOLS

DRILLING



SERIES 1000
HIGH SPEED STEEL - 60°
UNCOATED

SIZE	DRILL DIA.	BODY DIA.	OVERALL LENGTH	PKG. QTY	ITEM#	LIST PRICE
00000	.010	1/8	1-1/4	6	CS00050	19.39
0000	.015	1/8	1-1/4	6	CS00040	17.79
000	.020	1/8	1-1/4	6	CS00030	16.83
00	.025	1/8	1-1/4	6	CS00020	16.83
0	1/32	1/8	1-1/4	6	CS10010	17.94
1	3/64	1/8	1-1/4	6	CS10001	10.72
2	5/64	3/16	1-7/8	6	CS10002	11.22
3	7/64	1/4	2	6	CS10003	11.71
4	1/8	5/16	2-1/8	6	CS10004	12.05
5	3/16	7/16	2-3/4	1	CS10005	19.09
6	7/32	1/2	3	1	CS10006	28.68
7	1/4	5/8	3-1/4	1	CS10007	50.02
8	5/16	3/4	3-1/2	1	CS10008	69.58



SERIES 350
HIGH SPEED STEEL - 60°
ALTIN COATED

SIZE	DRILL DIA.	BODY DIA.	OVERALL LENGTH	PKG. QTY	ITEM#	LIST PRICE
00000	.010	1/8	1-1/4	6	CS35050	25.74
0000	.015	1/8	1-1/4	6	CS35040	24.09
000	.020	1/8	1-1/4	6	CS35030	23.58
00	.025	1/8	1-1/4	6	CS35020	22.50
0	1/32	1/8	1-1/4	6	CS35010	22.50
1	3/64	1/8	1-1/4	6	CS35001	17.02
2	5/64	3/16	1-7/8	6	CS35002	17.48
3	7/64	1/4	2	6	CS35003	23.81
4	1/8	5/16	2-1/8	6	CS35004	24.55
5	3/16	7/16	2-3/4	1	CS35005	34.18
6	7/32	1/2	3	1	CS35006	54.56
7	1/4	5/8	3-1/4	1	CS35007	78.42
8	5/16	3/4	3-1/2	1	CS35008	126.18

COUNTERSINKS

STANDARD COUNTERSINKS



SERIES 5000
HIGH SPEED STEEL - LONG LENGTH - 60°

SIZE	DRILL DIA.	BODY DIA.	PKG. QTY	ITEM#	LIST PRICE
1 x 3	3/64	1/8	1	CS50013	26.90
1 x 4	3/64	1/8	1	CS50014	28.08
1 x 5	3/64	1/8	1	CS50015	39.00
1 x 6	3/64	1/8	1	CS50016	51.10
2 x 3	5/64	3/16	1	CS50023	27.21
2 x 4	5/64	3/16	1	CS50024	30.78
2 x 5	5/64	3/16	1	CS50025	39.41
2 x 6	5/64	3/16	1	CS50026	51.25
3 x 3	7/64	1/4	1	CS50033	28.43
3 x 4	7/64	1/4	1	CS50034	32.41
3 x 5	7/64	1/4	1	CS50035	42.62
3 x 6	7/64	1/4	1	CS50036	51.71
4 x 4	1/8	5/16	1	CS50044	35.94

SIZE	DRILL DIA.	BODY DIA.	PKG. QTY	ITEM#	LIST PRICE
4 x 5	1/8	5/16	1	CS50045	45.89
4 x 6	1/8	5/16	1	CS50046	53.04
4-1/2 x 4	9/64	3/8	1	CS50040	40.38
4-1/2 x 5	9/64	3/8	1	CS50050	58.76
4-1/2 x 6	9/64	3/8	1	CS50060	65.66
5 x 4	3/16	7/16	1	CS50054	47.17
5 x 5	3/16	7/16	1	CS50055	54.62
5 x 6	3/16	7/16	1	CS50056	61.31
6 x 5	7/32	1/2	1	CS50065	58.70
6 x 6	7/32	1/2	1	CS50066	70.96
7 x 6	1/4	5/6	1	CS50076	132.16
8 x 6	5/16	3/4	1	CS50086	159.80

COMBINED DRILL & COUNTERSINKS

TECHNICAL

For coating information, please see page 8.



GENERAL PURPOSE DRILLS - CARBIDE TECHNICAL INFORMATION

YOUR #1 SOURCE FOR AMERICAN-MADE PREMIUM QUALITY CUTTING TOOLS

THESE VALUES ARE FOR UNCOATED TOOLS. FOR AITiN COATED TOOLS INCREASE SFM +40%

CARBIDE DRILLING - SFM & I.P.T. (INCH PER TOOTH)			
MATERIAL / TYPE	Rc HARDNESS	25° HELIX	15° HELIX STR FLT
COBALT BASE ALLOYS			
STELLITE, HS-21, HAYNES 25/188, X-40, L-605	UNDER 32 OVER 32	100 - 150 80 - 110	100 - 150 80 - 110
NICKEL BASE ALLOYS			
INCONEL-625/718, Waspalloy, RENE, HASTELLOY	UNDER 32 OVER 32	125 - 150 100 - 125	125 - 175 100 - 125
IRON BASE ALLOYS			
INCOLOY 800-802, MULTIMET N-155, TIMKIN 16-25-6, CARPENTER 22-b3	UNDER 32 OVER 32	150 - 200 150 - 175	175 - 200 150 - 200
MONEL			
MONEL-65% NICKEL	-	100 - 150	100 - 150
TITANIUM ALLOYS			
COMMERCIALLY PURE, 6Al-4V, ASTM 1/2/3, 6Al-25N-4Zr-2Mo-Si	- -	150 - 200 -	150 - 200 -
STAINLESS STEEL (PRECIPITATION)			
12/8, 15/5, 17/4, AM-350/355	UNDER 32 OVER 32	125 - 175 80 - 125	150 - 200 100 - 150
STAINLESS STEEL (AUSTENITIC)			
200 SERIES, 302, 303, 304, 316	UNDER 32 OVER 32	100 - 175 100 - 125	150 - 200 125 - 150
STAINLESS STEEL (AUSTENITIC)			
304L, 316L	UNDER 32 OVER 32	80 - 100 60 - 90	90 - 125 80 - 100
STAINLESS STEEL (MARTENSITIC)			
403, 410, 416, 440	UNDER 32 OVER 32	100 - 150 80 - 125	125 - 175 100 - 140
HIGH STRENGTH TOOL STEELS			
4140, 4340, 6150, 5210, A2, D2, P20, H11, H13, S2, O1	UNDER 32 OVER 32	100 - 175 80 - 130	125 - 175 80 - 130
MEDIUM ALLOY STEELS			
200, 250, 300	UNDER 32 OVER 32	125 - 175 100 - 150	125 - 175 100 - 150
CARBON STEELS			
1000's, 1100's, 1300's	UNDER 32 OVER 32	125 - 175 100 - 125	150 - 200 100 - 175
DUCTILE			
DUCTILE CAST IRONS	-	125 - 200	150 - 250
CAST IRONS			
GRAY CAST IRONS	-	100 - 200	150 - 250
ALUMINUM			
2014, 2024, 6061-(T1-T6) 7075, DIE CAST, EXTRUDED	- -	150 - 300 -	- -
MAGNESIUM			
	-	200 - 500	-
COPPER, COPPER ALLOYS			
	-	150 - 300	-
BRASS BRONZE			
BRASS, ALUM/BRONZE	-	150 - 300	-
BRASS BRONZE			
LOW SILICON BRONZE	-	125 - 200	-
COMPOSITES			
G-10 FIBERGLASS, GRAPHITE, GRAPHITE/EPOXY, PLASTICS	- -	150 - 300 -	150 - 300 -

GENERAL PURPOSE DRILLS - CARBIDE TECHNICAL INFORMATION



YOUR #1 SOURCE FOR AMERICAN-MADE PREMIUM QUALITY CUTTING TOOLS

THESE VALUES ARE FOR UNCOATED TOOLS. FOR AlTiN COATED TOOLS INCREASE SFM +40%

CARBIDE DRILLING – SFM & I.P.T. (INCH PER TOOTH)					
MATERIAL / TYPE	SUGGESTED CHIP LOAD PER TOOTH				
	1/16" - 1/8"	1/8" - 1/4"	1/4" - 3/8"	3/8" - 1/2"	1/2" - 5/8"
COBALT BASE ALLOYS					
STELLITE, HS-21,	.0004"-.0010"	.0008"-.0020"	.0015"-.0025"	.0020"-.0040"	.0025"-.0050"
HAYNES 25/188, X-40, L-605	.0004"-.0010"	.0005"-.0010"	.0010"-.0015"	.0010"-.0020"	.0015"-.0030"
NICKEL BASE ALLOYS					
INCONEL-625/718, WASPALLOY,	.0005"-.0015"	.0010"-.0015"	.0015"-.0025"	.0020"-.0040"	.0025"-.0050"
RENE, HASTELLOY	.0004"-.0010"	.0008"-.0015"	.0010"-.0015"	.0015"-.0030"	.0020"-.0040"
IRON BASE ALLOYS					
INCOLOY 800-802, MULTIMET N-155,	.0010"-.0015"	.0010"-.0020"	.0015"-.0035"	.0020"-.0020"	.0030"-.0060"
TIMKIN 16-25-6, CARPENTER 22-b3	.0008"-.0015"	.0010"-.0020"	.0015"-.0025"	.0020"-.0040"	.0025"-.0050"
MONEL					
MONEL-65% NICKEL	.0004"-.0010"	.0008"-.0015"	.0010"-.0015"	.0015"-.0030"	.0020"-.0040"
TITANIUM ALLOYS					
COMMERCIALLY PURE, 6Al-4V,	.0008"-.0015"	.0010"-.0020"	.0015"-.0030"	.0020"-.0040"	.0025"-.0050"
ASTM 1/2/3, 6Al-25N-4Zr-2Mo-Si	-	-	-	-	-
STAINLESS STEEL (PRECIPITATION)					
12/8, 15/5, 17/4, AM-350/355	.0005"-.0015"	.0010"-.0020"	.0015"-.0035"	.0020"-.0040"	.0025"-.0050"
	.0004"-.0010"	.0008"-.0015"	.0010"-.0015"	.0015"-.0030"	.0020"-.0040"
STAINLESS STEEL (AUSTENITIC)					
200 SERIES, 302, 303, 304, 316	.0005"-.0015"	.0010"-.0020"	.0015"-.0035"	.0020"-.0040"	.0025"-.0050"
	.0004"-.0010"	.0008"-.0015"	.0010"-.0015"	.0015"-.0030"	.0020"-.0040"
STAINLESS STEEL (AUSTENITIC)					
304L, 316L	.0004"-.0010"	.0008"-.0015"	.0010"-.0015"	.0015"-.0030"	.0020"-.0040"
	.0003"-.0008"	.0005"-.0010"	.0010"-.0015"	.0010"-.0020"	.0015"-.0030"
STAINLESS STEEL (MARTENSITIC)					
403, 410, 416, 440	.0005"-.0015"	.0010"-.0020"	.0015"-.0035"	.0020"-.0040"	.0025"-.0050"
	.0004"-.0010"	.0008"-.0015"	.0010"-.0015"	.0015"-.0030"	.0020"-.0040"
HIGH STRENGTH TOOL STEELS					
4140, 4340, 6150, 5210, A2,	.0005"-.0015"	.0010"-.0020"	.0015"-.0025"	.0015"-.0030"	.0020"-.0040"
D2, P20, H11, H13, S2, O1	.0004"-.0010"	.0010"-.0020"	.0010"-.0020"	.0015"-.0030"	.0020"-.0040"
MEDIUM ALLOY STEELS					
200, 250, 300	.0010"-.0015"	.0015"-.0025"	.0020"-.0030"	.0020"-.0040"	.0025"-.0050"
	.0005"-.0010"	.0010"-.0020"	.0010"-.0025"	.0015"-.0030"	.0020"-.0040"
CARBON STEELS					
1000's, 1100's, 1300's	.0010"-.0015"	.0015"-.0025"	.0020"-.0030"	.0020"-.0040"	.0025"-.0050"
	.0005"-.0010"	.0010"-.0020"	.0010"-.0025"	.0015"-.0035"	.0020"-.0040"
DUCTILE					
DUCTILE CAST IRONS	.0010"-.0020"	.0010"-.0030"	.0015"-.0035"	.0025"-.0040"	.0030"-.0050"
CAST IRONS					
GRAY CAST IRONS	.0010"-.0020"	.0010"-.0030"	.0015"-.0035"	.0025"-.0040"	.0030"-.0050"
ALUMINUM					
2014, 2024, 6061-(T1-T6)	.0010"-.0020"	.0015"-.0040"	.0020"-.0020"	.0030"-.0060"	.0035"-.0070"
7075, DIE CAST, EXTRUDED	-	-	-	-	-
MAGNESIUM					
	.0010"-.0020"	.0010"-.0030"	.0015"-.0035"	.0025"-.0040"	.0030"-.0050"
COPPER, COPPER ALLOYS					
	.0010"-.0020"	.0010"-.0030"	.0015"-.0035"	.0025"-.0040"	.0030"-.0050"
BRASS BRONZE					
BRASS, ALUM/BRONZE	.0010"-.0020"	.0010"-.0030"	.0015"-.0035"	.0025"-.0040"	.0030"-.0050"
BRASS BRONZE					
LOW SILICON BRONZE	.0008"-.0015"	.0010"-.0020"	.0015"-.0030"	.0020"-.0040"	.0025"-.0050"
COMPOSITES					
G-10 FIBERGLASS, GRAPHITE,	.0010"-.0020"	.0010"-.0030"	.0015"-.0035"	.0025"-.0040"	.0030"-.0050"
GRAPHITE/EPOXY, PLASTICS	-	-	-	-	-



GENERAL PURPOSE DRILLS - HSS & M42 COBALT TECHNICAL INFORMATION

YOUR #1 SOURCE FOR AMERICAN-MADE PREMIUM QUALITY CUTTING TOOLS

ELEMENT & DIMENSIONAL DRILL TOLERANCES

DIAMETER AT POINT

SIZE (INCLUSIVE)	TOLERANCE
OVER #81 TO 1/8	+0.000 TO -0.005
OVER 1/8 TO 1/4	+0.000 TO -0.007
OVER 1/4 TO 1/2	+0.000 TO -0.010
OVER 1/2 TO 1	+0.000 TO -0.012
OVER 1 TO 2	+0.000 TO -0.015
OVER 2 TO 3-1/2	+0.000 TO -0.020

SHANK DIAMETER

SIZE (INCLUSIVE)	TOLERANCE
OVER #81 TO 1/8	-0.000 TO -0.025
OVER 1/8 TO 1/4	-0.005 TO -0.030
OVER 1/4 TO 1/2	-0.005 TO -0.045
OVER 1/2 TO 2	-0.005 TO -0.030

BACK TAPER

SIZE (INCLUSIVE)	TOLERANCE PER INCH
OVER #81 TO 1/8	.0000 TO .0008
OVER 1/8 TO 1/4	.0002 TO .0008
OVER 1/4 TO 1/2	.0002 TO .0009
OVER 1/2 TO 1	.0003 TO .0011
OVER 1 TO 3-1/2	.0004 TO .0015

FLUTE LENGTH

SIZE (INCLUSIVE)	TOLERANCE
OVER #81 TO 1/8	+1/8 TO -1/16
OVER 1/8 TO 1/2	+1/8 TO -1/8
OVER 1/2 TO 1	+1/4 TO -1/8
OVER 1 TO 2	+1/4 TO -1/4
OVER 2 TO 3-1/2	+3/8 TO -3/8

OVERALL LENGTH

SIZE (INCLUSIVE)	TOLERANCE
OVER #81 TO 1/8	+1/8 TO -1/16
OVER 1/8 TO 1/2	+1/8 TO -1/8
OVER 1/2 TO 1	+1/4 TO -1/8
OVER 1 TO 2	+1/4 TO -1/4
OVER 2 TO 3-1/2	+3/8 TO -3/8

INCLUDED POINT ANGLE

SIZE (INCLUSIVE)	INCLUDED ANGLE	TOLERANCE
1/16 TO 1/2	118°	±5°
OVER 1/2 TO 1-1/2	118°	±3°
OVER 1-1/2 TO 3-1/2	118°	±2°

LIP HEIGHT

SIZE (INCLUSIVE)	TIV (TOTAL INDICATOR VARIATION)
1/16 TO 1/8	.0020
OVER 1/8 TO 1/4	.0030
OVER 1/4 TO 1/2	.0040
OVER 1/2 TO 1	.0050
OVER 1 TO 3-1/2	.0060

NOTE: 95% of drills in any one lot to fall within tolerances above.

SUGGESTED METHOD OF MEASUREMENT:

1. Rotate the drill in a vee block against a back end stop.
2. Measure the cutting lip height variation on a comparator, or with an indicator set at allocation approximately 75% of the distance from the center to the periphery of the drill.

CENTRALITY OF WEB

SIZE (INCLUSIVE)	TIV (TOTAL INDICATOR VARIATION)
1/16 TO 1/8	.0030
OVER 1/8 TO 1/4	.0040
OVER 1/4 TO 1/2	.0050
OVER 1/2 TO 1	.0070
OVER 1 TO 3-1/2	.0100

NOTE: 95% of drills in any one lot to fall within tolerances above.

SUGGESTED METHOD OF MEASUREMENT:

1. Rotate the drill in a close fitting bushing.
2. Record the difference in indicator readings of the web at the point as the drill is indexed 180°.

FLUTE SPACING

SIZE (INCLUSIVE)	TOLERANCE (TIV)	ACTUAL DEVIATION
1/16 TO 1/8	.0030	.0015
OVER 1/8 TO 1/4	.0060	.0030
OVER 1/4 TO 1/2	.0100	.0050
OVER 1/2 TO 1	.0140	.0070
OVER 1 TO 3-1/2	.0260	.0130

NOTE: 95% of drills in any one lot to fall within tolerances above.

SUGGESTED METHOD OF MEASUREMENT:

1. Place the drill in a vee block against a back end stop, and rotate it against a radial finger stop.
2. Take an indicator reading at the leading edge of the margin on the opposite flute.
3. Repeat for the other flute and note the difference between the two readings.
4. The deviation in flute spacing is equal to one-half the difference between the two readings.

GENERAL PURPOSE DRILLS - HSS & M42 COBALT TECHNICAL INFORMATION



DRILLING

YOUR #1 SOURCE FOR AMERICAN-MADE PREMIUM QUALITY CUTTING TOOLS

ALTIM COATED INCREASE SFM BY 40%

SFM & I.P.T. (INCH PER TOOTH)													
MATERIAL / TYPE	SFM			FEED in INCHES PER REVOLUTION (IPR) +/-25%									
	GENERAL PURPOSE	HSS HEAVY DUTY	COBALT	1/32"	3/32"	1/8"	5/32"	3/16"	1/4"	5/16"	3/8"	1/2"	9/16"
STEEL													
12L14, 12L15	115	115	115	.0008-.0009	.0026-.0033	.0040-.0053	.0046-.0060	.0051-.0067	.0059-.0078	.0075-.0098	.009-.0117	.0096-.0124	.0107-.0137
1005-1025, 1214, 1215, A36	98	98	98	0.0008	0.0026	0.004	0.0046	0.0051	0.0059	0.0075	0.009	0.0096	0.0107
1000'S, 1100'S	82	89	89	0.0007	.0020-.0022	.0029-.0033	.0033-.0038	.0037-.0043	.0043-.0050	.0054-.0063	.0065-.0075	.0070-.0081	.0080-.0091
4140, 4340, 52100, 8620, H11-H41, A2, D2, 01, P20, 420	30-66	33-79	33-79	.0006-.0007	.0015-.0020	.0021-.0029	.0024-.0033	.0027-.0037	.0031-.0043	.0039-.0054	.0047-.0065	.0051-.0070	.0059-.0080
STAINLESS STEEL													
200, 303, 416, 440	49	72	72	0.0007	0.0017	0.0024	0.0028	0.0031	0.0037	0.0045	0.0055	0.0059	0.0068
300 SERIES	26	36	36	0.0007	0.0022	0.0033	0.0038	0.0043	0.005	0.0063	0.0075	0.0081	0.0091
318-329, 400-446, DUPLEX	30	49	49	0.0006	0.0013	0.0017	0.002	0.0022	0.0025	0.0031	0.0039	0.0043	0.0049
CAST IRON													
GREY, G10, Gg40, J431C, A48 CLASS 20	79-98	92-115	92-115	.0006-.0008	.0013-.0026	.0021-.0040	.0024-.0046	.0027-.0051	.0031-.0059	.0039-.0075	.0047-.009	.0051-.0096	.0059-.0107
A220, A436, A439, A602, BLACK	66	72	72	0.0007	0.0017	0.0024	0.0028	0.0031	0.0037	0.0045	0.0055	0.0059	0.0068
BLACK Gts/Gtw, J434C	46	56	56	0.0007	0.0017	0.0024	0.0028	0.0031	0.0037	0.0045	0.0055	0.0059	0.0068
TITANIUM													
COMMERCIALLY PURE	75	92	92	0.0007	.0017-.0020	.0024-.0029	.0028-.0033	.0031-.0037	.0037-.0043	.0045-.0054	.0055-.0065	.0059-.0070	.0068-.0080
6Al4V, 6A14V-2SnMonel, Monel K	20-39	36-66	36-66	0.0006	.0011-.0015	.0015-.0021	.0016-.0024	.0018-.0027	.0021-.0031	.0026-.0039	.0031-.0047	.0035-.0051	.0041-.0059
NICKEL													
COMMERCIALLY PURE, 17644, 200, 5553	33	49	49	0.0007	0.0022	0.0033	0.0038	0.0043	0.005	0.0063	0.0075	0.0081	0.0091
Monel 400, Hastelloy C, Inconel 625, Waspalloy	20	23	23	0.0007	0.0017	0.0024	0.0028	0.0031	0.0037	0.0045	0.0055	0.0059	0.0068
Inconel 718, Nimonic 75-95, Rene 41, Inconel 825, A286	10	20	20	.0004-.0006	.0009-.0011	.0011-.0015	.0013-.0016	.0014-.0018	.0017-.0021	.0021-.0026	.0024-.0031	.0027-.0035	.0032-.0041
COPPER													
COMMERCIALLY PURE	108	125	125	.0007-.0008	.0022-.0026	.0033-.0040	.0038-.0046	.0043-.0051	.0050-.0059	.0063-.0075	.0075-.0090	.0081-.0096	.0091-.0107
BRASS, BRONZE 314-340, 350-370	115	131	131	.0007-.0008	.0020-.0030	.0029-.0047	.0033-.0053	.0037-.0059	.0043-.0068	.0054-.0087	.0065-.0104	.0070-.0110	.008-.0122
BRASS ALLOYED Cu+Al+Fe, LONG CHIPPING	89	89	89	0.0008	0.0026	0.004	0.0046	0.0051	0.0059	0.0075	0.009	0.0096	0.0107
High Strength Bronze	52	69	69	0.0007	.0020-.0022	.0029-.0033	.0033-.0038	.0037-.0043	.0043-.0050	.0054-.0063	.0065-.0075	.0070-.0081	.0080-.0091
ALUMINUM, MAGNESIUM													
Commercially Pure	108	108	108	0.0009	0.0033	0.0053	0.006	0.0067	0.0078	0.0098	0.0117	0.0124	0.0137
6061, T6	89-98	98	98	.0007-.0009	.0022-.0033	.0033-.0053	.0038-.0060	.0043-.0067	.0050-.0078	.0063-.0098	.0075-.0117	.0081-.0124	.0091-.0137
SYNTHETIC MATERIALS													
Thermoplastics	98	-	-	0.0009	0.0033	0.0053	0.006	0.0067	0.0078	0.0098	0.0117	0.0124	0.0137
Thermosetting Plastics	92	-	-	0.0008	0.0026	0.004	0.0046	0.0051	0.0059	0.0075	0.009	0.0096	0.0107
Reinforced Plastic Material	46	-	-	0.0007	0.002	0.0029	0.0033	0.0037	0.0043	0.0054	0.0065	0.007	0.008

TECHNICAL



GENERAL PURPOSE CARBIDE BURS

YOUR #1 SOURCE FOR AMERICAN-MADE PREMIUM QUALITY CUTTING TOOLS

SA - CYLINDRICAL



TOOL #	SIZE	SHANK	LOC	OAL	SINGLE CUT	LIST PRICE	DOUBLE CUT	LIST PRICE
* SA-61	1/16	3/32	1/4	1-1/2	TB19264	11.61	TB19280	11.61
* SA-41	1/16	1/8	1/4	1-1/2	TB19301	10.99	TB19316	10.99
* SA-41L2	1/16	1/8	1/4	2	TB19265	16.47	TB19281	16.47
* SA-41L3	1/16	1/8	1/4	3	TB19266	18.23	TB19282	18.23
* SA-63	3/32	3/32	3/8	1-1/2	TB19267	11.61	TB19283	11.61
* SA-42	3/32	1/8	7/16	1-1/2	TB19302	10.99	TB19317	10.99
* SA-42L2	3/32	1/8	7/16	2	TB19268	16.47	TB19284	16.47
* SA-42L3	3/32	1/8	7/16	3	TB19269	18.23	TB19285	18.23
* SA-43	1/8	1/8	9/16	1-1/2	TB19303	10.99	TB19318	10.99
* SA-43L2	1/8	1/8	9/16	2	TB19270	16.47	TB19286	16.47
* SA-43L3	1/8	1/8	9/16	3	TB19271	18.23	TB19287	18.23
* SA-11	1/8	1/4	1/2	2	TB19307	21.83	TB19322	21.83
* SA-12	1/8	1/4	5/8	2	TB19272	21.94	TB19288	21.94
SA-52	5/32	1/8	1/2	2	TB19304	24.19	TB19319	24.19
* SA-13	5/32	1/4	5/8	2	TB19630	30.25	TB19652	30.25
SA-53	3/16	1/8	1/2	2	TB19305	24.19	TB19320	24.19
* SA-81	3/16	3/16	1/2	2	TB19273	26.56	TB19289	26.56
* SA-14	3/16	1/4	5/8	2	TB19308	26.12	TB19323	26.12
SA-51	1/4	1/8	1/2	2	TB19306	16.31	TB19321	16.31
* SA-1	1/4	1/4	5/8	2	TB19309	18.50	TB19324	18.50
SA-1L6	1/4	1/4	1/2	6-1/2	TB19562	37.49	TB19565	37.49
* SA-1L	1/4	1/4	1	2	TB19274	28.56	TB19290	28.56
SA-2	5/16	1/4	3/4	2-1/2	TB19310	34.16	TB19325	34.16
SA-3	3/8	1/4	3/4	2-1/2	TB19311	22.90	TB19326	22.90
SA-3L6	3/8	1/4	3/4	6-3/4	TB19563	52.81	TB19566	52.81
SA-3L	3/8	1/4	1	2-3/4	TB19275	35.25	TB19291	35.25
SA-3X	3/8	1/4	1-1/2	3-1/4	TB19276	50.14	TB19292	50.14
SA-4	7/16	1/4	1	2-3/4	TB19312	53.08	TB19327	53.08
SA-5	1/2	1/4	1	2-3/4	TB19313	36.53	TB19328	36.53
SA-5L6	1/2	1/4	1	7	TB19564	82.53	TB19567	82.53
SA-6	5/8	1/4	1	2-3/4	TB19314	52.67	TB19329	52.67
SA-15	3/4	1/4	1/2	2-1/4	TB19277	80.22	TB19293	80.22
SA-16	3/4	1/4	3/4	2-1/2	TB19278	80.22	TB19294	80.22
SA-7	3/4	1/4	1	2-3/4	TB19315	82.13	TB19330	82.13
SA-9	1	1/4	1	2-3/4	TB19632	129.70	TB19654	129.70

* One Piece

SA - CYLINDRICAL - FOR ALUMINUM



TOOL #	SIZE	SHANK	LOC	OAL	ALUMA CUT	LIST PRICE
* SA-1NF	1/4	1/4	5/8	2	TB19592	26.77
SA-3NF	3/8	1/4	3/4	2-1/2	TB19593	37.41
SA-5NF	1/2	1/4	1	2-3/4	TB19594	62.50
SA-6NF	5/8	1/4	1	2-3/4	TB19595	92.88
SA-7NF	3/4	1/4	1	2-3/4	TB19596	122.03

* One Piece

For technical information, please see page 223.

GENERAL PURPOSE CARBIDE BURS



YOUR #1 SOURCE FOR AMERICAN-MADE PREMIUM QUALITY CUTTING TOOLS

DEBURRING

SB - CYLINDRICAL END CUT



TOOL #	SIZE	SHANK	LOC	OAL	SINGLE CUT	LIST PRICE	DOUBLE CUT	LIST PRICE
* SB-41	1/16	1/8	1/4	1-1/2	TB19331	14.82	TB19660	14.82
* SB-41L2	1/16	1/8	1/4	2	TB19815	18.11	TB19834	18.11
* SB-41L3	1/16	1/8	1/4	3	TB19816	20.06	TB19835	20.06
* SB-42	3/32	1/8	7/16	1-1/2	TB19332	11.72	TB19658	11.72
* SB-42L2	3/32	1/8	7/16	2	TB19817	18.11	TB19836	18.11
* SB-42L3	3/32	1/8	7/16	3	TB19818	20.06	TB19837	20.06
† SB-ECO	1/8	1/8	-	1-1/2	TB19819	8.51	-	-
* SB-43	1/8	1/8	9/16	1-1/2	TB19333	10.72	TB19656	10.72
* SB-43L2	1/8	1/8	9/16	2	TB19820	18.11	TB19839	18.11
* SB-43L3	1/8	1/8	9/16	3	TB19821	20.06	TB19840	20.06
* SB-11	1/8	1/4	1/2	2	TB19336	28.26	TB19344	28.26
* SB-12	1/8	1/4	5/8	2	TB19822	24.07	TB19841	24.07
* SB-13	5/32	1/4	5/8	2	TB19634	34.12	TB19662	34.12
* SB-14	3/16	1/4	5/8	2	TB19337	28.26	TB19345	28.26
SB-51	1/4	1/8	3/16	1-11/16	TB19334	16.35	TB19342	16.35
SB-51	1/4	1/8	1/2	2	TB19335	17.81	TB19343	17.81
* SB-1	1/4	1/4	5/8	2	TB19338	21.94	TB19346	21.94
* SB-1L	1/4	1/4	1	2	TB19823	31.42	TB19842	31.42
SB-2	5/16	1/4	3/4	2-1/2	TB19339	37.57	TB19347	37.57
SB-3	3/8	1/4	3/4	2-1/2	TB19340	26.19	TB19348	26.19
SB-3L	3/8	1/4	1	2-3/4	TB19824	38.71	TB19843	38.71
SB-3X	3/8	1/4	1-1/2	3-1/4	TB19825	51.17	TB19844	51.17
SB-4	7/16	1/4	1	2-3/4	TB19636	60.32	TB19349	60.32
SB-5	1/2	1/4	1	2-3/4	TB19341	40.21	TB19350	40.21
SB-6	5/8	1/4	1	2-3/4	TB19692	58.93	TB19351	58.93
SB-15	3/4	1/4	1/2	2-1/4	TB19826	87.89	TB19845	87.89
SB-16	3/4	1/4	3/4	2-1/2	TB19827	87.89	TB19846	87.89
SB-7	3/4	1/4	1	2-3/4	TB19638	90.50	TB19352	90.50
SB-9	1	1/4	1	2-3/4	TB19640	141.54	TB19664	141.54

* One Piece

SB - CYLINDRICAL END CUT - FOR ALUMINUM



TOOL #	SIZE	SHANK	LOC	OAL	ALUMA CUT	LIST PRICE
SB-3NF	3/8	1/4	3/4	2-1/2	TB19852	42.30
SB-5NF	1/2	1/4	1	2-3/4	TB19853	64.89
SB-6NF	5/8	1/4	1	2-3/4	TB19854	89.66
SB-7NF	3/4	1/4	1	2-3/4	TB19855	131.27

For technical information, please see page 223.

CARBIDE BURS

TECHNICAL



GENERAL PURPOSE CARBIDE BURS

YOUR #1 SOURCE FOR AMERICAN-MADE PREMIUM QUALITY CUTTING TOOLS

SC - CYLINDRICAL BALL NOSE



TOOL #	SIZE	SHANK	LOC	OAL	SINGLE CUT	LIST PRICE	DOUBLE CUT	LIST PRICE
* SC-61	3/32	3/32	3/8	1-1/2	TB19761	11.61	TB19772	11.61
* SC-41	3/32	1/8	7/16	1-1/2	TB19353	10.99	TB19367	10.99
* SC-42	1/8	1/8	9/16	1-1/2	TB19354	10.99	TB19368	10.99
* SC-42L2	1/8	1/8	9/16	2	TB19762	16.47	TB19773	16.47
* SC-42L3	1/8	1/8	9/16	3	TB19763	18.23	TB19774	18.23
* SC-11	1/8	1/4	1/2	2	TB19358	30.37	TB19372	30.37
* SC-12	1/8	1/4	5/8	2	TB19764	23.28	TB19775	23.28
SC-52	5/32	1/8	1/2	2	TB19355	24.19	TB19369	24.19
* SC-13	5/32	1/4	5/8	2	TB19642	34.73	TB19666	34.73
SC-53	3/16	1/8	1/2	2	TB19356	24.19	TB19370	24.19
* SC-81	3/16	3/16	1/2	2	TB19766	26.56	TB19777	26.56
* SC-14	3/16	1/4	5/8	2	TB19359	30.37	TB19373	30.37
SC-51	1/4	1/8	1/2	2	TB19357	16.35	TB19371	16.35
* SC-1	1/4	1/4	5/8	2	TB19360	21.98	TB19374	21.98
* SC-1L	1/4	1/4	1	2	TB19767	28.56	TB19778	28.56
SC-1L6	1/4	1/4	1/2	6-1/2	TB19568	43.66	TB19571	43.66
SC-2	5/16	1/4	3/4	2-1/2	TB19361	36.92	TB19375	36.92
SC-3	3/8	1/4	3/4	2-1/2	TB19362	26.58	TB19376	26.58
SC-3L	3/8	1/4	1	2-3/4	TB19768	38.59	TB19779	38.59
SC-3L6	3/8	1/4	3/4	6-3/4	TB19569	58.82	TB19572	58.82
SC-3X	3/8	1/4	1-1/2	3-1/4	TB19769	45.34	TB19788	45.34
SC-4	7/16	1/4	1	2-3/4	TB19363	58.32	TB19377	58.32
SC-5	1/2	1/4	1	2-3/4	TB19364	41.21	TB19378	41.21
SC-5L6	1/2	1/4	1	7	TB19570	92.56	TB19573	92.56
SC-6	5/8	1/4	1	2-3/4	TB19365	61.39	TB19379	61.39
SC-15	3/4	1/4	1/2	2-1/4	TB19770	86.12	TB19789	86.12
SC-16	3/4	1/4	3/4	2-1/2	TB19771	86.12	TB19792	86.12
SC-7	3/4	1/4	1	2-3/4	TB19366	88.48	TB19380	88.48
SC-9	1	1/4	1	2-3/4	TB19780	133.79	TB19782	133.79

* One Piece

SC - CYLINDRICAL BALL NOSE FOR ALUMINUM



TOOL #	SIZE	SHANK	LOC	OAL	ALUMA CUT	LIST PRICE
* SC-1NF	1/4	1/4	5/8	2	TB19597	26.35
SC-3NF	3/8	1/4	3/4	2-1/2	TB19598	35.12
SC-5NF	1/2	1/4	1	2-3/4	TB19599	49.78
SC-7NF	3/4	1/4	1	2-3/4	TB19600	120.67

* One Piece

For technical information, please see page 223.

GENERAL PURPOSE CARBIDE BURS



YOUR #1 SOURCE FOR AMERICAN-MADE PREMIUM QUALITY CUTTING TOOLS

DEBURRING

SD - BALL SHAPE



TOOL #	SIZE	SHANK	LOC	OAL	SINGLE CUT	LIST PRICE	DOUBLE CUT	LIST PRICE
* SD-40	1/16	1/8	1/16	1-1/2	TB19492	11.61	TB19136	11.61
* SD-61	3/32	3/32	3/32	1-1/2	TB19130	11.61	TB19137	11.61
* SD-41	3/32	1/8	3/32	1-1/2	TB19493	10.99	TB19506	10.99
* SD-42	1/8	1/8	1/8	1-1/2	TB19644	10.99	TB19507	10.99
* SD-42L2	1/8	1/8	1/8	2	TB19131	16.47	TB19138	16.47
SD-42L3	1/8	1/8	1/8	3	TB19132	18.23	TB19139	18.23
SD-11	1/8	1/4	1/8	2	TB19497	27.88	TB19510	27.88
* SD-52	5/32	1/8	5/32	1-21/32	TB19133	22.42	TB19140	22.42
* SD-53	3/16	1/8	3/16	1-11/16	TB19134	24.19	TB19508	24.19
SD-81	3/16	3/16	5/32	2	TB19135	26.56	TB19141	26.56
* SD-14	3/16	1/4	3/16	2	TB19498	27.88	TB19511	27.88
SD-51	1/4	1/8	1/4	1-3/4	TB19496	16.31	TB19509	16.31
SD-1	1/4	1/4	1/4	2	TB19499	21.37	TB19512	21.37
SD-1L6	1/4	1/4	1/4	6-1/4	TB19574	40.25	TB19577	40.25
SD-2	5/16	1/4	5/16	2-1/16	TB19500	30.02	TB19513	30.02
SD-3	3/8	1/4	3/8	2-1/8	TB19501	22.90	TB19514	22.90
SD-3L6	3/8	1/4	3/8	6-3/8	TB19575	48.41	TB19578	48.41
SD-4	7/16	1/4	7/16	2-3/16	TB19502	38.76	TB19515	38.76
SD-5	1/2	1/4	1/2	2-1/2	TB19503	31.06	TB19516	31.06
SD-5L6	1/2	1/4	1/2	6-1/2	TB19576	65.22	TB19579	65.22
SD-6	5/8	1/4	5/8	2-3/8	TB19504	48.36	TB19517	48.36
SD-7	3/4	1/4	3/4	2-1/2	TB19505	66.72	TB19518	66.72
SD-9	1	1/4	1	2-3/4	TB19646	141.54	TB19668	141.54

* One Piece

SD - BALL SHAPE FOR ALUMINUM



TOOL #	SIZE	SHANK	LOC	OAL	ALUMA CUT	LIST PRICE
* SD-1NF	1/4	1/4	1/4	2	TB19613	25.96
SD-3NF	3/8	1/4	3/8	2-1/8	TB19614	32.82
SD-5NF	1/2	1/4	1/2	2-13/64	TB19615	53.84
SD-6NF	5/8	1/4	5/8	2-5/16	TB19616	81.08

* One Piece

CARBIDE BURS

TECHNICAL

For technical information, please see page 223.



GENERAL PURPOSE CARBIDE BURS

YOUR #1 SOURCE FOR AMERICAN-MADE PREMIUM QUALITY CUTTING TOOLS

SE - EGG SHAPE



TOOL #	SIZE	SHANK	LOC	OAL	SINGLE CUT	LIST PRICE	DOUBLE CUT	LIST PRICE
* SE-61	3/32	3/32	1/8	1-1/2	TB19145	11.61	TB19153	11.61
* SE-41	1/8	1/8	7/32	1-1/2	TB19456	10.99	TB19464	10.99
* SE-41L2	1/8	1/8	7/32	2	TB19146	16.47	TB19154	16.47
* SE-41L3	1/8	1/8	7/32	3	TB19147	18.23	TB19155	18.23
SE-53	3/16	1/8	9/32	1-25/32	TB19457	24.19	TB19465	24.19
* SE-81	3/16	3/16	9/32	2	TB19148	26.56	TB19156	26.56
* SE-11	3/16	1/4	5/16	2	TB19149	23.88	TB19157	23.88
SE-51	1/4	1/8	3/8	1-7/8	TB19458	16.31	TB19466	16.31
* SE-1	1/4	1/4	3/8	2	TB19459	26.12	TB19467	26.12
SE-1L6	1/4	1/4	3/8	6-3/8	TB19150	35.25	TB19158	35.25
SE-3	3/8	1/4	5/8	2-3/8	TB19460	27.50	TB19468	27.50
SE-3L6	3/8	1/4	5/8	6-5/8	TB19151	39.50	TB19159	39.50
SE-5	1/2	1/4	7/8	2-5/8	TB19461	38.45	TB19469	38.45
SE-5L6	1/2	1/4	7/8	6-7/8	TB19152	59.26	TB19160	59.26
SE-6	5/8	1/4	1	2-3/4	TB19462	60.73	TB19470	60.73
SE-7	3/4	1/4	1	2-3/4	TB19463	84.95	TB19471	84.95

* One Piece

SE - EGG SHAPE FOR ALUMINUM



TOOL #	SIZE	SHANK	LOC	OAL	ALUMA CUT	LIST PRICE
SE-3NF	3/8	1/4	5/8	2-3/8	TB19606	36.46
SE-5NF	1/2	1/4	7/8	2-5/8	TB19607	63.46
SE-6NF	5/8	1/4	1	2-3/4	TB19608	89.89
SE-7NF	3/4	1/4	1	2-3/4	TB19609	128.64

For technical information, please see page 223.

GENERAL PURPOSE CARBIDE BURS



YOUR #1 SOURCE FOR AMERICAN-MADE PREMIUM QUALITY CUTTING TOOLS

DEBURRING

SF - ROUND NOSE TREE



TOOL #	SIZE	SHANK	LOC	OAL	SINGLE CUT	LIST PRICE	DOUBLE CUT	LIST PRICE
* SF-61	3/32	3/32	1/4	1-1/2	TB19161	11.61	TB19165	11.61
* SF-41	1/8	1/8	1/4	1-1/2	TB19381	10.99	TB19395	10.99
* SF-42	1/8	1/8	1/2	1-1/2	TB19382	10.99	TB19396	10.99
* SF-42L2	1/8	1/8	1/2	2	TB19162	16.47	TB19166	16.47
* SF-42L3	1/8	1/8	1/2	3	TB19163	18.23	TB19167	18.23
SF-53	3/16	1/8	1/2	2	TB19383	24.19	TB19397	24.19
* SF-81	3/16	3/16	1/2	2	TB19164	26.56	TB19168	26.56
SF-51	1/4	1/8	1/2	2	TB19384	16.31	TB19398	16.31
* SF-1	1/4	1/4	3/4	2	TB19385	23.82	TB19399	23.82
SF-1L6	1/4	1/4	1/2	6-1/2	TB19580	45.53	TB19583	45.53
SF-3	3/8	1/4	3/4	2-1/2	TB19386	26.58	TB19400	26.58
SF-3L6	3/8	1/4	3/4	6-3/4	TB19581	57.67	TB19584	57.67
SF-4	7/16	1/4	1	2-3/4	TB19387	55.57	TB19401	55.57
SF-13	1/2	1/4	3/4	2-1/2	TB19389	59.17	TB19402	59.17
SF-5	1/2	1/4	1	2-3/4	TB19390	39.90	TB19403	39.90
SF-5L6	1/2	1/4	1	7	TB19582	85.05	TB19585	85.05
SF-6	5/8	1/4	1	2-3/4	TB19391	61.08	TB19404	61.08
SF-7	3/4	1/4	1	2-3/4	TB19392	85.35	TB19405	85.35
SF-14	3/4	1/4	1-1/4	3	TB19393	155.42	TB19406	155.42
SF-15	3/4	1/4	1-1/2	3-1/4	TB19394	182.50	TB19407	182.50

* One Piece

SF - ROUND NOSE TREE FOR ALUMINUM



TOOL #	SIZE	SHANK	LOC	OAL	ALUMA CUT	LIST PRICE
* SF-1NF	1/4	1/4	3/4	2	TB19601	26.85
SF-3NF	3/8	1/4	3/4	2-1/2	TB19602	35.50
SF-5NF	1/2	1/4	1	2-3/4	TB19603	62.80
SF-6NF	5/8	1/4	1	2-3/4	TB19604	95.83
SF-14NF	3/4	1/4	1-1/4	3	TB19605	116.57

* One Piece

CARBIDE BURS

TECHNICAL

For technical information, please see page 223.



GENERAL PURPOSE CARBIDE BURS

YOUR #1 SOURCE FOR AMERICAN-MADE PREMIUM QUALITY CUTTING TOOLS

SG - POINTED TREE



TOOL #	SIZE	SHANK	LOC	OAL	SINGLE CUT	LIST PRICE	DOUBLE CUT	LIST PRICE
* SG-61	3/32	3/32	1/4	1-1/2	TB19930	11.61	TB19938	11.61
* SG-41	1/8	1/8	1/4	1-1/2	TB19408	10.95	TB19421	10.95
* SG-42	1/8	1/8	5/16	1-1/2	TB19409	10.95	TB19422	10.95
* SG-43	1/8	1/8	3/8	1-1/2	TB19410	10.95	TB19423	10.95
* SG-44	1/8	1/8	1/2	1-1/2	TB19411	15.24	TB19424	15.24
* SG-44L2	1/8	1/8	1/2	2	TB19931	16.47	TB19939	16.47
* SG-44L3	1/8	1/8	1/2	3	TB19932	18.23	TB19940	18.23
SG-53	3/16	1/8	1/2	2	TB19412	24.19	TB19425	24.19
* SG-81	3/16	3/16	1/2	2	TB19933	26.56	TB19941	26.56
SG-51	1/4	1/8	1/2	2	TB19413	16.31	TB19426	16.31
* SG-1	1/4	1/4	5/8	2	TB19414	24.28	TB19427	24.28
SG-1L6	1/4	1/4	1/2	6-1/2	TB19934	33.30	TB19942	33.30
SG-2	5/16	1/4	3/4	2-1/2	TB19415	38.49	TB19428	38.49
SG-3	3/8	1/4	3/4	2-1/2	TB19416	27.38	TB19429	27.38
SG-3L6	3/8	1/4	3/4	6-3/4	TB19935	41.94	TB19943	41.94
SG-13	1/2	1/4	3/4	2-1/2	TB19417	58.06	TB19430	58.06
SG-5	1/2	1/4	1	2-3/4	TB19418	40.21	TB19431	40.21
SG-5L6	1/2	1/4	1	7	TB19936	54.70	TB19944	54.70
SG-6	5/8	1/4	1	2-3/4	TB19419	62.36	TB19432	62.36
SG-7	3/4	1/4	1	2-3/4	TB19420	83.46	TB19433	83.46
SG-15	3/4	1/4	1-1/2	3-1/4	TB19937	100.28	TB19945	100.28

* One Piece

SH - FLAME SHAPE



TOOL #	SIZE	SHANK	LOC	OAL	SINGLE CUT	LIST PRICE	DOUBLE CUT	LIST PRICE
SH-41	1/8	1/8	1/4	1-1/2	TB19519	10.99	TB19525	10.99
SH41L2	1/8	1/8	1/4	2	TB19950	16.47	TB19954	16.47
* SH41L3	1/8	1/8	1/4	3	TB19951	18.23	TB19955	18.23
* SH-53	3/16	1/8	3/8	1-7/8	TB19520	24.19	TB19526	24.19
* SH-1	1/4	1/4	5/8	2	TB19810	25.81	TB19812	25.81
SH-2	5/16	1/4	3/4	2-1/2	TB19521	29.76	TB19527	29.76
* SH-2L6	5/16	1/4	3/4	6-3/4	TB19952	39.50	TB19956	39.50
SH-5	1/2	1/4	1-1/4	3	TB19522	57.67	TB19528	57.67
SH-5L6	1/2	1/4	1-1/4	7-1/4	TB19953	63.81	TB19957	63.81
SH-6	5/8	1/4	1-7/16	3-3/16	TB19523	135.95	TB19529	135.95
SH-7	3/4	1/4	1-5/8	3-3/8	TB19524	172.72	TB19530	172.72

* One Piece

For technical information, please see page 223.

GENERAL PURPOSE CARBIDE BURS



YOUR #1 SOURCE FOR AMERICAN-MADE PREMIUM QUALITY CUTTING TOOLS

DEBURRING

SJ - 60° INCLUDED ANGLE



TOOL #	SIZE	SHANK	LOC	OAL	SINGLE CUT	LIST PRICE	DOUBLE CUT	LIST PRICE
* SJ-42	1/8	1/8	3/32	1-1/2	TB19554	10.99	TB19558	10.99
* SJ-1	1/4	1/4	3/16	2	TB19555	21.37	TB19559	21.37
SJ-3	3/8	1/4	5/16	2-3/16	TB19556	26.19	TB19560	26.19
SJ-5	1/2	1/4	7/16	2-19/64	TB19557	35.92	TB19561	35.92
SJ-6	5/8	1/4	9/16	2-5/16	TB19960	43.33	TB19963	43.33
SJ-7	3/4	1/4	11/16	2-7/16	TB19961	56.83	TB19964	56.83
SJ-9	1	1/4	15/16	2-11/16	TB19962	114.32	TB19965	114.32

* One Piece

SK - 90° INCLUDED ANGLE



TOOL #	SIZE	SHANK	LOC	OAL	SINGLE CUT	LIST PRICE	DOUBLE CUT	LIST PRICE
* SK-42	1/8	1/8	1/16	1-1/2	TB19546	10.99	TB19550	10.99
* SK-1	1/4	1/4	1/8	2	TB19547	21.37	TB19551	21.37
SK-3	3/8	1/4	3/16	2-1/16	TB19548	22.10	TB19552	22.10
SK-5	1/2	1/4	1/4	2-1/8	TB19549	34.62	TB19553	34.62
SK-6	5/8	1/4	5/16	2-3/16	TB19970	43.33	TB19972	43.33
SK-7	3/4	1/4	3/8	2-1/4	TB19694	70.51	TB19695	70.51
SK-9	1	1/4	1/2	2-1/4	TB19971	107.39	TB19973	107.39

* One Piece



All orders carefully checked and inspected before being shipped

For technical information, please see page 223.

CARBIDE BURS

TECHNICAL



GENERAL PURPOSE CARBIDE BURS

YOUR #1 SOURCE FOR AMERICAN-MADE PREMIUM QUALITY CUTTING TOOLS

SL - INCLUDED ANGLE WITH RADIUS END



TOOL #	SIZE	SHANK	LOC	OAL	SINGLE CUT	LIST PRICE	DOUBLE CUT	LIST PRICE
* SL-41	1/8	1/8	3/8	1-1/2	TB19472	10.95	TB19482	10.95
* SL-42	1/8	1/8	1/2	1-1/2	TB19473	10.95	TB19483	10.95
* SL-42L2	1/8	1/8	1/2	2	TB19980	16.47	TB19992	16.47
* SL-42L3	1/8	1/8	1/2	3	TB19981	18.23	TB19993	18.23
SL-53	3/16	1/8	1/2	2	TB19474	24.19	TB19484	24.19
* SL-81	3/16	3/16	7/16	2	TB19982	26.56	TB19994	26.56
* SL-1	1/4	1/4	5/8	2	TB19475	22.25	TB19485	22.25
SL-1L6	1/4	1/4	5/8	6-5/8	TB19586	46.64	TB19589	46.64
SL-2	5/16	1/4	7/8	2-3/4	TB19476	42.55	TB19486	42.55
SL-3	3/8	1/4	1-1/16	2-15/16	TB19477	30.79	TB19487	30.79
SL-3L6	3/8	1/4	1-1/16	7-1/16	TB19587	73.49	TB19590	73.49
SL-4	1/2	1/4	1-1/8	3	TB19478	62.38	TB19488	62.38
SL-4L6	1/2	1/4	1-1/4	7-1/4	TB19588	90.03	TB19591	90.03
SL-6	5/8	1/4	1-5/16	3-3/16	TB19480	100.06	TB19490	100.06
SL-7	3/4	1/4	1-1/2	3-3/8	TB19481	136.92	TB19491	136.92

* One Piece

SL - INCLUDED ANGLE WITH RADIUS END - FOR ALUMINUM



TOOL #	SIZE	SHANK	LOC	OAL	ALUMA CUT	LIST PRICE
SL-3NF	3/8	1/4	1-1/16	2-15/16	TB19617	54.98
SL-4NF	1/2	1/4	1-1/4	3	TB19610	62.96
SL-5NF	5/8	1/4	1-3/16	3-5/16	TB19618	114.54
SL-6NF	5/8	1/4	1-5/16	3-3/16	TB19611	126.79
SL-7NF	3/4	1/4	1-1/2	3-3/8	TB19612	157.49

For technical information, please see page 223.

GENERAL PURPOSE CARBIDE BURS



YOUR #1 SOURCE FOR AMERICAN-MADE PREMIUM QUALITY CUTTING TOOLS

DEBURRING

SM - POINTED CONE

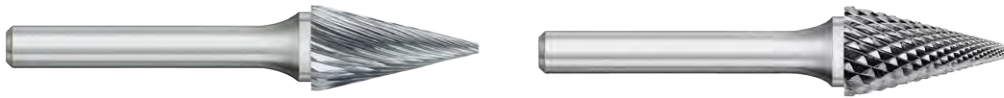

TOOL #	SIZE	SHANK	LOC	OAL	SINGLE CUT	LIST PRICE	DOUBLE CUT	LIST PRICE
* SM-61	3/32	3/32	1/4	1-1/2	TB19061	11.61	TB19064	11.61
* SM-41	1/8	1/8	11/32	1-1/2	TB19434	10.99	TB19445	10.99
* SM-42	1/8	1/8	7/16	1-1/2	TB19435	10.99	TB19446	10.99
* SM-42L2	1/8	1/8	7/16	2	TB19062	16.47	TB19065	16.47
* SM-42L3	1/8	1/8	7/16	3	TB19063	18.23	TB19066	18.23
* SM-43	1/8	1/8	5/8	1-1/2	TB19436	10.99	TB19447	10.99
SM-53	3/16	1/8	1/2	2	TB19437	24.19	TB19448	24.19
SM-51	1/4	1/8	1/2	2-1/8	TB19438	16.31	TB19449	16.31
* SM-1	1/4	1/4	1/2	2	TB19439	20.91	TB19450	20.91
* SM-2	1/4	1/4	3/4	2	TB19440	32.40	TB19451	32.40
* SM-3	1/4	1/4	1	2	TB19441	23.36	TB19452	23.36
SM-4	3/8	1/4	5/8	2-1/2	TB19442	31.13	TB19453	31.13
SM-5	1/2	1/4	7/8	2-3/4	TB19443	43.58	TB19454	43.58
SM-6	5/8	1/4	1	2-7/8	TB19444	98.43	TB19455	98.43

* One Piece

SN - INVERTED TAPER

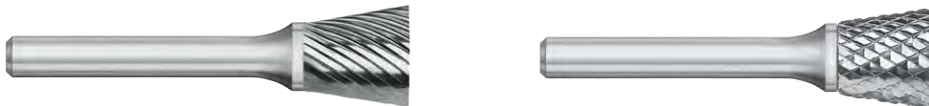

TOOL #	SIZE	SHANK	LOC	OAL	SINGLE CUT	LIST PRICE	DOUBLE CUT	LIST PRICE
* SN-61	3/32	3/32	1/8	1-1/2	TB19069	11.61	TB19075	11.61
* SN-41	3/32	1/8	1/8	1-1/2	TB19531	11.00	TB19076	11.00
* SN-42	1/8	1/8	3/16	1-1/2	TB19532	10.99	TB19537	10.99
SN-53	3/16	1/8	1/4	1-3/4	TB19533	24.19	TB19538	24.19
* SN-81	3/16	3/16	1/4	2	TB19070	26.56	TB19077	26.56
SN-51	1/4	1/8	1/4	1-3/4	TB19534	16.31	TB19539	16.31
* SN-1	1/4	1/4	5/16	2	TB19535	21.25	TB19540	21.25
SN-2	3/8	1/4	3/8	2-1/8	TB19071	29.90	TB19078	29.90
SN-4	1/2	1/4	1/2	2-1/4	TB19536	62.04	TB19541	62.04
SN-6	5/8	1/4	3/4	2-1/2	TB19072	54.88	TB19079	54.88
SN-7	3/4	1/4	5/8	2-3/8	TB19073	66.25	TB19080	66.25

* One Piece

For technical information, please see page 223.

CARBIDE BURS

TECHNICAL



GENERAL PURPOSE CARBIDE BUR SETS

YOUR #1 SOURCE FOR AMERICAN-MADE PREMIUM QUALITY CUTTING TOOLS

CARBIDE BUR SETS



ITEM# TB19542



ITEM# TB19850

SET SIZES	# OF PCS. IN SET	DIA.	SHANK DIAMETER	CASE TYPE	TYPE	ITEM#	LIST PRICE
SA-42, SA-43, SC-41, SC-42, SD-42, SE-41, SF-42, SG-42, SM-43	9 PCS.	1/8	1/8	WOOD	DOUBLE CUT	TB19542	161.90
SA-1, SC-1, SD-3, SH-1, SF-3, SA-3, SC-3, SC-5, SF-5, SA-5	10 PCS.	-	1/4	METAL	DOUBLE CUT	TB19850	304.87

For technical information, please see page 223.

DEBURRING TECHNICAL INFORMATION



YOUR #1 SOURCE FOR AMERICAN-MADE PREMIUM QUALITY CUTTING TOOLS

SELECTION BY CUT

SINGLE CUT:



Provides the best surface finish and largest contact patch on the work piece.

Demands greater operator skill since the single flute direction pulls the burr into the work piece.

USE IN - Non-hardened steel <45 HRC, Hardened Steel >45HRC, stainless steel, non-ferrous light metals, hardened cast iron >45HRC, High temp resistant metals

DOUBLE CUT:



Most popular geometry as the dual flute direction reduces the contact patch on the work piece and therefore provides easier operator control while still maintaining a good surface finish.

USE IN - Ferrous metals, Non-ferrous metals

ALUMINUM CUT:



These burs employ a coarser flute which results in improved cutting performance for aluminum and aluminum alloys.

USE IN - Non-ferrous metals, aluminum alloys, plastics

CARBIDE BURS - SPEEDS

CUTTING DIA.	SUGGESTED RPM	MAXIMUM RPM
1/16	55,000 – 85,000	90,000
1/8	35,000 – 65,000	80,000
3/16	30,000 – 55,000	70,000
1/4	25,000 – 50,000	70,000
5/16	20,000 – 40,000	67,000
3/8	18,000 – 40,000	63,000
7/16	16,000 – 38,000	58,000
1/2	14,000 – 36,000	50,000
5/8	12,000 – 25,000	40,000
3/4	10,000 – 20,000	33,000
1	7,500 – 20,000	25,000

When using double cut: Reduce speeds by 25% approximately
For stainless steel material: Increase speeds by 50% approximately.





GENERAL PURPOSE SOLID CARBIDE REAMERS

YOUR #1 SOURCE FOR AMERICAN-MADE PREMIUM QUALITY CUTTING TOOLS

STOCKED INTERMEDIATE & STANDARD SIZES



SERIES 870

DEC. EQUIV.	SIZE	SHANK DIA.	OVERALL LENGTH	FLUTE LENGTH	# OF FLUTES	ITEM#	LIST PRICE
.0400	#60	.0400	1-1/2	1/4	4	TC87046	49.69
.0410	#59	.0410	1-1/2	3/8	4	TC87047	49.69
.0420	#58	.0420	1-1/2	3/8	4	TC87048	49.69
.0430	#57	.0430	1-1/2	3/8	4	TC87049	49.69
.0440		.0440	1-1/2	3/8	4	TC87050	52.50
.0450		.0450	1-1/2	3/8	4	TC87051	52.50
.0460		.0460	1-1/2	3/8	4	TC87052	52.50
.0465	#56	.0465	1-1/2	3/8	4	TC87053	49.69
.0469	3/64	.0469	1-1/2	3/8	4	TC87054	47.21
.0470		.0470	1-1/2	3/8	4	TC87055	52.50
.0480		.0480	1-1/2	3/8	4	TC87056	52.50
.0490		.0490	1-1/2	3/8	4	TC87057	52.50
.0500		.0500	1-1/2	3/8	4	TC87058	52.50
.0510		.0510	1-1/2	3/8	4	TC87059	52.50
.0520	#55	.0520	1-1/2	3/8	4	TC87060	49.69
.0530		.0530	1-1/2	3/8	4	TC87061	52.50
.0540		.0540	1-1/2	3/8	4	TC87062	52.50
.0550	#54	.0550	1-1/2	3/8	4	TC87063	49.69
.0560		.0560	1-1/2	3/8	4	TC87064	52.50
.0570		.0570	1-1/2	3/8	4	TC87065	52.50
.0580		.0580	1-1/2	3/8	4	TC87066	52.50
.0590		.0590	1-1/2	3/8	4	TC87067	52.50
.0591	1.5mm	.0591	1-1/2	3/8	4	TC87068	52.50
.0595	#53	.0595	1-1/2	3/8	4	TC87069	49.69
.0600		.0600	1-1/2	3/8	4	TC87070	52.50
.0605		.0605	1-1/2	3/8	4	TC87071	69.81
.0610		.0610	1-1/2	3/8	4	TC87072	52.50
.0615		.0615	1-1/2	3/8	4	TC87073	58.07
.0620		.0620	1-1/2	3/8	4	TC87074	52.50
.0625	1/16	.0625	1-1/2	3/8	4	TC87075	47.21
.0630		.0630	1-1/2	3/8	4	TC87076	52.50
.0635	#52	.0635	1-1/2	3/8	4	TC87077	49.69
.0640		.0640	1-1/2	3/8	4	TC87078	52.50
.0645		.0645	1-1/2	3/8	4	TC87079	69.81
.0650		.0650	1-1/2	3/8	4	TC87080	52.50
.0660		.0660	1-3/4	1/2	4	TC87081	52.50
.0670	#51	.0670	1-3/4	1/2	4	TC87082	49.69
.0680		.0680	1-3/4	1/2	4	TC87083	52.50
.0690		.0690	1-3/4	1/2	4	TC87084	52.50
.0700	#50	.0700	1-3/4	1/2	4	TC87085	49.69

DEC. EQUIV.	SIZE	SHANK DIA.	OVERALL LENGTH	FLUTE LENGTH	# OF FLUTES	ITEM#	LIST PRICE
.0710		.0710	1-3/4	1/2	4	TC87086	52.50
.0720		.0720	1-3/4	1/2	4	TC87087	52.50
.0730	#49	.0730	1-3/4	1/2	4	TC87088	49.69
.0740		.0740	1-3/4	1/2	4	TC87089	52.50
.0750		.0750	1-3/4	1/2	4	TC87090	52.50
.0760	#48	.0760	1-3/4	1/2	4	TC87091	49.69
.0770		.0770	1-3/4	1/2	4	TC87092	52.50
.0780		.0780	1-3/4	1/2	4	TC87093	52.50
.0781	5/64	.0781	1-3/4	1/2	4	TC87094	47.21
.0785	#47	.0785	1-3/4	1/2	4	TC87095	49.69
.0787	2.0mm	.0787	1-3/4	1/2	4	TC87096	52.50
.0790		.0790	1-3/4	1/2	4	TC87097	52.50
.0800		.0800	1-3/4	1/2	4	TC87098	52.50
.0810	#46	.0810	2	1/2	4	TC87099	49.69
.0820	#45	.0820	2	1/2	4	TC87100	49.69
.0830		.0830	2	1/2	4	TC87101	52.50
.0840		.0840	2	1/2	4	TC87102	52.50
.0850		.0850	2	1/2	4	TC87103	52.50
.0860	#44	.0860	2	1/2	4	TC87104	49.69
.0870		.0870	2	1/2	4	TC87105	52.50
.0880		.0880	2	1/2	4	TC87106	52.50
.0890	#43	.0890	2	1/2	4	TC87107	49.69
.0900		.0900	2	1/2	4	TC87108	52.50
.0910		.0910	2	1/2	4	TC87109	52.50
.0915		.0915	2	1/2	4	TC87110	69.25
.0920		.0920	2	1/2	4	TC87111	52.50
.0925		.0925	2	1/2	4	TC87112	58.07
.0930		.0930	2	1/2	4	TC87113	52.50
.0935	#42	.0935	2	1/2	4	TC87114	49.69
.0938	3/32	.0938	2	1/2	4	TC87115	47.21
.0940		.0940	2	1/2	4	TC87116	52.50
.0945		.0945	2	1/2	4	TC87117	58.07
.0950		.0950	2	1/2	4	TC87118	52.50
.0960	#41	.0960	2	5/8	4	TC87119	49.69
.0970		.0970	2	5/8	4	TC87120	52.50
.0980	#40	.0980	2	5/8	4	TC87121	49.69
.0984	2.5mm	.0984	2	5/8	4	TC87122	52.50
.0990		.0990	2-1/4	5/8	4	TC87123	52.50
.0995	#39	.0995	2-1/4	5/8	4	TC87124	49.69
.1000		.1000	2-1/4	5/8	4	TC87125	52.50

For technical information, please see page 262.

DIAMETER TOLERANCE +.0003, -.0000

GENERAL PURPOSE SOLID CARBIDE REAMERS



YOUR #1 SOURCE FOR AMERICAN-MADE PREMIUM QUALITY CUTTING TOOLS

REAMING

STOCKED INTERMEDIATE & STANDARD SIZES



SERIES 870

CARBIDE REAMERS

DEC. EQUIV.	SIZE	SHANK DIA.	OVERALL LENGTH	FLUTE LENGTH	# OF FLUTES	ITEM #	LIST PRICE
.1010		.1010	2-1/4	5/8	4	TC87126	52.50
.1015	#38	.1015	2-1/4	5/8	4	TC87127	49.69
.1020		.1020	2-1/4	5/8	4	TC87128	52.50
.1030		.1030	2-1/4	5/8	4	TC87129	52.50
.1040	#37	.1040	2-1/4	5/8	4	TC87130	49.69
.1050		.1050	2-1/4	5/8	4	TC87131	52.50
.1060		.1060	2-1/4	5/8	4	TC87132	52.50
.1065	#36	.1065	2-1/4	5/8	4	TC87133	49.69
.1070		.1070	2-1/4	5/8	4	TC87134	52.50
.1080		.1080	2-1/4	5/8	4	TC87135	52.50
.1090		.1090	2-1/4	5/8	4	TC87136	54.70
.1094	7/64	.1094	2-1/4	5/8	4	TC87137	47.21
.1100	#35	.1100	2-1/4	5/8	4	TC87138	49.69
.1110	#34	.1110	2-1/4	5/8	4	TC87139	49.69
.1120		.1120	2-1/4	5/8	4	TC87140	52.50
.1130	#33	.1130	2-1/4	5/8	4	TC87141	49.69
.1140		.1140	2-1/4	5/8	4	TC87142	52.50
.1150		.1150	2-1/4	5/8	4	TC87143	52.50
.1160	#32	.1160	2-1/4	5/8	4	TC87144	52.27
.1170		.1170	2-1/4	5/8	4	TC87145	55.59
.1180		.1180	2-1/4	5/8	4	TC87146	55.59
.1181	3.0mm	.1181	2-1/4	5/8	4	TC87147	51.10
.1190		.1190	2-1/4	5/8	4	TC87148	55.59
.1200	#31	.1200	2-1/4	5/8	4	TC87149	52.27
.1210		.1210	2-1/4	5/8	4	TC87150	55.59
.1220		.1220	2-1/4	5/8	4	TC87151	55.59
.1230		.1230	2-1/4	5/8	4	TC87152	55.59
.1235		.1235	2-1/4	5/8	4	TC87153	74.03
.1240		.1240	2-1/4	5/8	4	TC87154	55.59
.1245		.1245	2-1/4	5/8	4	TC87155	61.44
.1250	1/8	.1250	2-1/4	5/8	4	TC87156	50.25
.1255		.1255	2-1/4	5/8	4	TC87157	61.44
.1260		.1260	2-1/4	5/8	4	TC87158	55.59
.1265		.1265	2-1/4	5/8	4	TC87159	74.03
.1270		.1270	2-1/4	5/8	4	TC87160	55.59
.1275		.1275	2-1/4	5/8	4	TC87161	74.03
.1280		.1280	2-1/4	5/8	4	TC87162	55.59
.1285	#30	.1285	2-1/4	5/8	4	TC87163	55.59
.1290		.1290	2-1/4	5/8	4	TC87164	55.59
.1300		.1300	2-1/2	5/8	4	TC87165	55.59

DEC. EQUIV.	SIZE	SHANK DIA.	OVERALL LENGTH	FLUTE LENGTH	# OF FLUTES	ITEM #	LIST PRICE
.1310		.1310	2-1/2	3/4	4	TC87166	63.64
.1320		.1320	2-1/2	3/4	4	TC87167	63.64
.1330		.1330	2-1/2	3/4	4	TC87168	63.64
.1340		.1340	2-1/2	3/4	4	TC87169	63.64
.1350		.1350	2-1/2	3/4	4	TC87170	63.64
.1360	#29	.1360	2-1/2	3/4	4	TC87171	59.52
.1370		.1370	2-1/2	3/4	4	TC87172	63.64
.1378	3.5mm	.1378	2-1/2	3/4	4	TC87173	63.64
.1380		.1380	2-1/2	3/4	4	TC87174	63.64
.1390		.1390	2-1/2	3/4	4	TC87175	63.64
.1400		.1400	2-1/2	3/4	4	TC87176	63.64
.1405	#28	.1405	2-1/2	3/4	4	TC87177	59.52
.1406	9/64	.1406	2-1/2	3/4	4	TC87178	57.27
.1410		.1410	2-1/2	3/4	4	TC87179	63.64
.1420		.1420	2-1/2	3/4	4	TC87180	63.64
.1430		.1430	2-1/2	3/4	4	TC87181	63.64
.1440	#27	.1440	2-1/2	3/4	4	TC87182	59.52
.1450		.1450	2-1/2	3/4	4	TC87183	63.64
.1460		.1460	2-1/2	3/4	4	TC87184	66.45
.1470	#26	.1470	2-1/2	3/4	4	TC87185	62.00
.1480		.1480	2-1/2	3/4	4	TC87186	66.45
.1490		.1490	2-1/2	3/4	4	TC87187	66.45
.1495	#25	.1495	2-1/2	3/4	4	TC87188	62.00
.1500		.1500	2-1/2	3/4	4	TC87189	66.45
.1510		.1510	2-1/2	3/4	4	TC87190	66.45
.1520	#24	.1520	2-1/2	3/4	4	TC87191	62.00
.1530		.1530	2-1/2	3/4	4	TC87192	66.45
.1540	#23	.1540	2-1/2	3/4	4	TC87193	62.00
.1545		.1545	2-1/2	3/4	4	TC87194	76.83
.1550		.1550	2-1/2	3/4	4	TC87195	66.45
.1555		.1555	2-1/2	3/4	4	TC87196	76.83
.1560		.1560	2-1/2	3/4	4	TC87197	66.45
.1562	5/32	.1562	2-1/2	3/4	4	TC87198	60.08
.1565		.1565	2-1/2	3/4	4	TC87199	76.83
.1570	#22	.1570	2-1/2	3/4	4	TC87200	62.00
.1575	4.0mm	.1575	2-1/2	3/4	4	TC87201	66.45
.1580		.1580	2-1/2	3/4	4	TC87202	66.45
.1590	#21	.1590	2-1/2	3/4	4	TC87203	62.00
.1600		.1600	2-1/2	3/4	4	TC87204	66.45
.1610	#20	.1610	2-1/2	7/8	4	TC87205	69.81

For technical information, please see page 262.

DIAMETER TOLERANCE +.0003, -.0000

TECHNICAL



GENERAL PURPOSE SOLID CARBIDE REAMERS

YOUR #1 SOURCE FOR AMERICAN-MADE PREMIUM QUALITY CUTTING TOOLS

STOCKED INTERMEDIATE & STANDARD SIZES



SERIES 870

DEC. EQUIV.	SIZE	SHANK DIA.	OVERALL LENGTH	FLUTE LENGTH	# OF FLUTES	ITEM#	LIST PRICE
.1620		.1620	2-3/4	7/8	4	TC87206	74.82
.1630		.1630	2-3/4	7/8	4	TC87207	74.82
.1640		.1640	2-3/4	7/8	4	TC87208	74.82
.1650		.1650	2-3/4	7/8	4	TC87209	69.81
.1660	#19	.1660	2-3/4	7/8	4	TC87210	69.81
.1670		.1670	2-3/4	7/8	4	TC87211	74.82
.1680		.1680	2-3/4	7/8	4	TC87212	74.82
.1690		.1690	2-3/4	7/8	4	TC87213	74.82
.1695	#18	.1695	2-3/4	7/8	4	TC87214	69.81
.1700		.1700	2-3/4	7/8	4	TC87215	74.82
.1710		.1710	2-3/4	7/8	4	TC87216	74.82
.1719	11/64	.1719	2-3/4	7/8	4	TC87217	67.29
.1720		.1720	2-3/4	7/8	4	TC87218	74.82
.1730	#17	.1730	2-3/4	7/8	4	TC87219	69.81
.1740		.1740	2-3/4	7/8	4	TC87220	74.82
.1750		.1750	2-3/4	7/8	4	TC87221	74.82
.1760		.1760	2-3/4	7/8	4	TC87222	74.82
.1770	#16	.1770	2-3/4	7/8	4	TC87223	69.81
.1772	4.5mm	.1772	2-3/4	7/8	4	TC87224	77.91
.1780		.1780	2-3/4	7/8	4	TC87225	74.82
.1790		.1790	2-3/4	7/8	4	TC87226	74.82
.1800	#15	.1800	2-3/4	7/8	4	TC87227	69.81
.1810		.1810	2-3/4	7/8	4	TC87228	74.82
.1820	#14	.1820	2-3/4	7/8	4	TC87229	69.81
.1830		.1830	2-3/4	7/8	4	TC87230	74.82
.1840		.1840	2-3/4	7/8	4	TC87231	74.82
.1850	#13	.1850	2-3/4	7/8	4	TC87232	69.81
.1855		.1855	2-3/4	7/8	4	TC87233	89.93
.1860		.1860	2-3/4	7/8	4	TC87234	74.82
.1865		.1865	2-3/4	7/8	4	TC87235	80.44
.1870		.1870	2-3/4	7/8	4	TC87236	74.82
.1875	3/16	.1875	2-3/4	7/8	4	TC87237	67.29
.1880		.1880	2-3/4	7/8	4	TC87238	74.82
.1885		.1885	2-3/4	7/8	4	TC87239	80.44
.1890	#12	.1890	2-3/4	7/8	4	TC87240	69.81
.1900		.1900	2-3/4	7/8	4	TC87241	74.82
.1910	#11	.1910	2-3/4	7/8	4	TC87242	84.88
.1920		.1920	2-3/4	7/8	4	TC87243	90.78
.1930		.1930	2-3/4	7/8	4	TC87244	90.78
.1935	#10	.1935	2-3/4	7/8	4	TC87245	84.88

DEC. EQUIV.	SIZE	SHANK DIA.	OVERALL LENGTH	FLUTE LENGTH	# OF FLUTES	ITEM#	LIST PRICE
.1940		.1940	2-3/4	7/8	4	TC87246	90.78
.1950		.1950	2-3/4	7/8	4	TC87247	90.78
.1960	#9	.1960	3	1	4	TC87248	84.88
.1969	5.0mm	.1969	3	1	4	TC87249	90.78
.1970		.1970	3	1	4	TC87250	90.78
.1980		.1980	3	1	4	TC87251	90.78
.1990	#8	.1990	3	1	4	TC87252	84.88
.2000		.2000	3	1	4	TC87253	90.78
.2010	#7	.2010	3	1	4	TC87254	84.88
.2020		.2020	3	1	4	TC87255	90.78
.2030		.2030	3	1	4	TC87256	90.78
.2031	13/64	.2031	3	1	4	TC87257	81.51
.2040	#6	.2040	3	1	4	TC87258	84.88
.2050		.2050	3	1	4	TC87259	90.78
.2055	#5	.2055	3	1	4	TC87260	84.88
.2060		.2060	3	1	4	TC87261	90.78
.2070		.2070	3	1	4	TC87262	90.78
.2080		.2080	3	1	4	TC87263	90.78
.2090	#4	.2090	3	1	4	TC87264	84.88
.2100		.2100	3	1	4	TC87265	90.78
.2110		.2110	3	1	4	TC87266	90.78
.2120		.2120	3	1	4	TC87267	90.78
.2130	#3	.2130	3	1	4	TC87268	84.88
.2140		.2140	3	1	4	TC87269	90.78
.2150		.2150	3	1	4	TC87270	90.78
.2160		.2160	3	1	4	TC87271	90.78
.2165	5.5mm	.2165	3	1	4	TC87272	95.78
.2170		.2170	3	1	4	TC87273	90.78
.2180		.2180	3	1	4	TC87274	90.78
.2188	7/32	.2188	3	1	4	TC87275	81.51
.2190		.2190	3	1	4	TC87276	90.78
.2200		.2200	3	1	4	TC87277	90.78
.2210	#2	.2210	3	1	4	TC87278	84.88
.2220		.2220	3	1	4	TC87279	90.78
.2230		.2230	3	1	4	TC87280	90.78
.2240		.2240	3	1	4	TC87281	90.78
.2250		.2250	3	1	4	TC87282	90.78
.2260		.2260	3	1	4	TC87283	99.71
.2270		.2270	3	1	4	TC87284	99.71
.2280	#1	.2280	3	1	4	TC87285	93.02

For technical information, please see page 262.

DIAMETER TOLERANCE +.0003, -.0000

GENERAL PURPOSE SOLID CARBIDE REAMERS



YOUR #1 SOURCE FOR AMERICAN-MADE PREMIUM QUALITY CUTTING TOOLS

REAMING

STOCKED INTERMEDIATE & STANDARD SIZES



SERIES 870

CARBIDE REAMERS

DEC. EQUIV.	SIZE	SHANK DIA.	OVERALL LENGTH	FLUTE LENGTH	# OF FLUTES	ITEM#	LIST PRICE
.2290		.2290	3	1	4	TC87286	93.02
.2300		.2300	3	1	4	TC87287	99.71
.2310		.2310	3	1	4	TC87288	99.71
.2320		.2320	3	1	4	TC87289	99.71
.2330		.2330	3	1	4	TC87290	99.71
.2340	A	.2340	3	1	4	TC87291	99.71
.2344	15/64	.2344	3	1	4	TC87292	89.65
.2350		.2350	3	1	4	TC87293	99.71
.2360		.2360	3	1	4	TC87294	99.71
.2362	6.0mm	.2362	3	1	4	TC87295	94.94
.2370		.2370	3	1	4	TC87296	99.71
.2380	B	.2380	3	1	4	TC87297	99.71
.2390		.2390	3	1	4	TC87298	99.71
.2400		.2400	3	1	4	TC87299	99.71
.2410		.2410	3	1	4	TC87300	99.71
.2420	C	.2420	3	1	4	TC87301	99.71
.2430		.2430	3	1	4	TC87302	99.71
.2440		.2440	3	1	4	TC87303	99.71
.2450		.2450	3	1	4	TC87304	99.71
.2460	D	.2460	3	1	4	TC87305	99.71
.2470		.2470	3	1	4	TC87306	99.71
.2480		.2480	3	1	4	TC87307	99.71
.2485		.2485	3	1	4	TC87308	111.41
.2490		.2490	3	1	4	TC87309	99.71
.2495		.2495	3	1	4	TC87310	105.84
.2500	1/4	.2500	3	1	4	TC87311	89.65
.2505		.2505	3	1	4	TC87312	105.84
.2510		.2510	3	1	4	TC87313	99.71
.2515		.2515	3	1	4	TC87314	124.00
.2520		.2520	3	1	4	TC87315	99.71
.2530		.2530	3	1	4	TC87316	99.71
.2540		.2540	3	1	4	TC87317	99.71
.2550		.2550	3	1	6	TC87318	99.71
.2559	6.5mm	.2559	3-1/4	1-1/8	6	TC87319	105.56
.2560		.2560	3-1/4	1-1/8	6	TC87320	120.63
.2570	F	.2570	3-1/4	1-1/8	6	TC87321	120.63
.2580		.2580	3-1/4	1-1/8	6	TC87322	120.63
.2590		.2590	3-1/4	1-1/8	6	TC87323	120.63
.2600		.2600	3-1/4	1-1/8	6	TC87324	120.63
.2610	G	.2610	3-1/4	1-1/8	6	TC87325	120.63

DEC. EQUIV.	SIZE	SHANK DIA.	OVERALL LENGTH	FLUTE LENGTH	# OF FLUTES	ITEM#	LIST PRICE
.2620		.2620	3-1/4	1-1/8	6	TC87326	120.63
.2630		.2630	3-1/4	1-1/8	6	TC87327	120.63
.2640		.2640	3-1/4	1-1/8	6	TC87328	120.63
.2650		.2650	3-1/4	1-1/8	6	TC87329	120.63
.2656	17/64	.2656	3-1/4	1-1/8	6	TC87330	108.65
.2660	H	.2660	3-1/4	1-1/8	6	TC87331	120.63
.2670		.2670	3-1/4	1-1/8	6	TC87332	120.63
.2680		.2680	3-1/4	1-1/8	6	TC87333	120.63
.2690		.2690	3-1/4	1-1/8	6	TC87334	120.63
.2700		.2700	3-1/4	1-1/8	6	TC87335	120.63
.2710		.2710	3-1/4	1-1/8	6	TC87336	120.63
.2720	I	.2720	3-1/4	1-1/8	6	TC87337	120.63
.2730		.2730	3-1/4	1-1/8	6	TC87338	120.63
.2740		.2740	3-1/4	1-1/8	6	TC87339	120.63
.2750		.2750	3-1/4	1-1/8	6	TC87340	120.63
.2756	7.0mm	.2756	3-1/4	1-1/8	6	TC87341	131.77
.2760		.2760	3-1/4	1-1/8	6	TC87342	120.63
.2770	J	.2770	3-1/4	1-1/8	6	TC87343	120.63
.2780		.2780	3-1/4	1-1/8	6	TC87344	120.63
.2790		.2790	3-1/4	1-1/8	6	TC87345	120.63
.2800		.2800	3-1/4	1-1/8	6	TC87346	120.63
.2810	K	.2810	3-1/4	1-1/8	6	TC87347	120.63
.2812	9/32	.2812	3-1/4	1-1/8	6	TC87348	108.65
.2820		.2820	3-1/4	1-1/8	6	TC87349	120.63
.2830		.2830	3-1/4	1-1/8	6	TC87350	120.63
.2840		.2840	3-1/4	1-1/8	6	TC87351	120.63
.2850		.2850	3-1/4	1-1/8	6	TC87352	120.63
.2860		.2860	3-1/4	1-1/8	6	TC87353	120.63
.2870		.2870	3-1/4	1-1/8	6	TC87354	120.63
.2880		.2880	3-1/4	1-1/8	6	TC87355	120.63
.2890		.2890	3-1/4	1-1/8	6	TC87356	120.63
.2900	L	.2900	3-1/4	1-1/8	6	TC87357	120.63
.2910		.2910	3-1/4	1-1/8	6	TC87358	120.63
.2920		.2920	3-1/4	1-1/8	6	TC87359	120.63
.2930		.2930	3-1/4	1-1/8	6	TC87360	120.63
.2940		.2940	3-1/4	1-1/8	6	TC87361	120.63
.2950	M	.2950	3-1/4	1-1/8	6	TC87362	120.63
.2953		.2953	3-1/4	1-1/8	6	TC87363	131.77
.2960		.2960	3-1/4	1-1/8	6	TC87364	120.63
.2969	19/64	.2969	3-1/4	1-1/8	6	TC87365	120.63

For technical information, please see page 262.

DIAMETER TOLERANCE	+ .0003, -.0000
--------------------	-----------------

TECHNICAL



GENERAL PURPOSE SOLID CARBIDE REAMERS

YOUR #1 SOURCE FOR AMERICAN-MADE PREMIUM QUALITY CUTTING TOOLS

STOCKED INTERMEDIATE & STANDARD SIZES



SERIES 870

DEC. EQUIV.	SIZE	SHANK DIA.	OVERALL LENGTH	FLUTE LENGTH	# OF FLUTES	ITEM#	LIST PRICE
.2970		.2970	3-1/4	1-1/8	6	TC87366	120.63
.2980		.2980	3-1/4	1-1/8	6	TC87367	120.63
.2990		.2990	3-1/4	1-1/8	6	TC87368	120.63
.3000		.3000	3-1/4	1-1/8	6	TC87369	120.63
.3010		.3010	3-1/4	1-1/8	6	TC87370	120.63
.3020	N	.3020	3-1/4	1-1/8	6	TC87371	120.63
.3030		.3030	3-1/4	1-1/8	6	TC87372	120.63
.3040		.3040	3-1/4	1-1/8	6	TC87373	120.63
.3050		.3050	3-1/4	1-1/8	6	TC87374	120.63
.3060		.3060	3-1/4	1-1/8	6	TC87375	120.63
.3070		.3070	3-1/4	1-1/8	6	TC87376	120.63
.3080		.3080	3-1/4	1-1/8	6	TC87377	120.63
.3090		.3090	3-1/4	1-1/8	6	TC87378	120.63
.3100		.3100	3-1/4	1-1/8	6	TC87379	120.63
.3110		.3110	3-1/4	1-1/8	6	TC87380	120.63
.3115		.3115	3-1/4	1-1/8	6	TC87381	138.51
.3120		.3120	3-1/4	1-1/8	6	TC87382	120.63
.3125	5/16	.3125	3-1/4	1-1/8	6	TC87383	120.63
.3130		.3130	3-1/4	1-1/8	6	TC87384	120.63
.3135		.3135	3-1/4	1-1/8	6	TC87385	138.51
.3140		.3140	3-1/4	1-1/8	6	TC87386	120.63
.3150	8.0mm	.3150	3-1/4	1-1/8	6	TC87387	120.63
.3160	O	.3160	3-1/4	1-1/8	6	TC87388	134.90
.3170		.3170	3-1/4	1-1/8	6	TC87389	134.90
.3180		.3180	3-1/4	1-1/8	6	TC87390	134.90
.3190		.3190	3-1/4	1-1/8	6	TC87391	134.90
.3200		.3200	3-1/4	1-1/8	6	TC87392	134.90
.3210		.3210	3-1/2	1-1/4	6	TC87393	134.90
.3220		.3220	3-1/2	1-1/4	6	TC87394	134.90
.3230	P	.3230	3-1/2	1-1/4	6	TC87395	134.90
.3240		.3240	3-1/2	1-1/4	6	TC87396	134.90
.3250		.3250	3-1/2	1-1/4	6	TC87397	134.90
.3260		.3260	3-1/2	1-1/4	6	TC87398	134.90
.3270		.3270	3-1/2	1-1/4	6	TC87399	134.90
.3280		.3280	3-1/2	1-1/4	6	TC87400	134.90
.3281	21/64	.3281	3-1/2	1-1/4	6	TC87401	136.26
.3290		.3290	3-1/2	1-1/4	6	TC87402	134.90
.3300		.3300	3-1/2	1-1/4	6	TC87403	134.90
.3310		.3310	3-1/2	1-1/4	6	TC87404	134.90
.3320	Q	.3320	3-1/2	1-1/4	6	TC87405	134.90

DEC. EQUIV.	SIZE	SHANK DIA.	OVERALL LENGTH	FLUTE LENGTH	# OF FLUTES	ITEM#	LIST PRICE
.3330		.3330	3-1/2	1-1/4	6	TC87406	134.90
.3340		.3340	3-1/2	1-1/4	6	TC87407	134.90
.3346	8.5mm	.3346	3-1/2	1-1/4	6	TC87408	134.90
.3350		.3350	3-1/2	1-1/4	6	TC87409	134.90
.3360		.3360	3-1/2	1-1/4	6	TC87410	134.90
.3370		.3370	3-1/2	1-1/4	6	TC87411	134.90
.3380		.3380	3-1/2	1-1/4	6	TC87412	134.90
.3390	R	.3390	3-1/2	1-1/4	6	TC87413	135.79
.3400		.3400	3-1/2	1-1/4	6	TC87414	134.90
.3410		.3410	3-1/2	1-1/4	6	TC87415	134.90
.3420		.3420	3-1/2	1-1/4	6	TC87416	134.90
.3430		.3430	3-1/2	1-1/4	6	TC87417	134.90
.3438	11/32	.3438	3-1/2	1-1/4	6	TC87418	136.26
.3440		.3440	3-1/2	1-1/4	6	TC87419	134.90
.3450		.3450	3-1/2	1-1/4	6	TC87420	134.90
.3460		.3460	3-1/2	1-1/4	6	TC87421	134.90
.3470		.3470	3-1/2	1-1/4	6	TC87422	134.90
.3480	S	.3480	3-1/2	1-1/4	6	TC87423	134.90
.3490		.3490	3-1/2	1-1/4	6	TC87424	134.90
.3500		.3500	3-1/2	1-1/4	6	TC87425	134.90
.3510		.3510	3-1/2	1-1/4	6	TC87426	147.16
.3520		.3520	3-1/2	1-1/4	6	TC87427	147.16
.3530		.3530	3-1/2	1-1/4	6	TC87428	147.16
.3540		.3540	3-1/2	1-1/4	6	TC87429	147.16
.3543	9.0mm	.3543	3-1/2	1-1/4	6	TC87430	153.57
.3550		.3550	3-1/2	1-1/4	6	TC87431	147.16
.3560		.3560	3-1/2	1-1/4	6	TC87432	147.16
.3570		.3570	3-1/2	1-1/4	6	TC87433	147.16
.3580	T	.3580	3-1/2	1-1/4	6	TC87434	147.16
.3590		.3590	3-1/2	1-1/4	6	TC87435	149.69
.3594	23/64	.3594	3-1/2	1-1/4	6	TC87436	145.20
.3600		.3600	3-1/2	1-1/4	6	TC87437	147.16
.3610		.3610	3-1/2	1-1/4	6	TC87438	147.16
.3620		.3620	3-1/2	1-1/4	6	TC87439	147.16
.3630		.3630	3-1/2	1-1/4	6	TC87440	147.16
.3640		.3640	3-1/2	1-1/4	6	TC87441	147.16
.3650		.3650	3-1/2	1-1/4	6	TC87442	147.16
.3660		.3660	3-1/2	1-1/4	6	TC87443	147.16
.3670		.3670	3-1/2	1-1/4	6	TC87444	147.16
.3680	U	.3680	3-1/2	1-1/4	6	TC87445	147.16

For technical information, please see page 262.

DIAMETER TOLERANCE +.0003, -.0000

GENERAL PURPOSE SOLID CARBIDE REAMERS



YOUR #1 SOURCE FOR AMERICAN-MADE PREMIUM QUALITY CUTTING TOOLS

REAMING

STOCKED INTERMEDIATE & STANDARD SIZES



SERIES 870

CARBIDE REAMERS

DEC. EQUIV.	SIZE	SHANK DIA.	OVERALL LENGTH	FLUTE LENGTH	# OF FLUTES	ITEM#	LIST PRICE
.3690		.3690	3-1/2	1-1/4	6	TC87446	147.16
.3700		.3700	3-1/2	1-1/4	6	TC87447	147.16
.3710		.3710	3-1/2	1-1/4	6	TC87448	147.16
.3720		.3720	3-1/2	1-1/4	6	TC87449	147.16
.3730		.3730	3-1/2	1-1/4	6	TC87450	147.16
.3740	9.5mm	.3740	3-1/2	1-1/4	6	TC87451	147.16
.3745		.3745	3-1/2	1-1/4	6	TC87452	178.70
.3750	3/8	.3750	3-1/2	1-1/4	6	TC87453	145.20
.3755		.3755	3-1/2	1-1/4	6	TC87454	178.70
.3760		.3760	3-1/2	1-1/4	6	TC87455	184.83
.3765		.3765	3-1/2	1-1/4	6	TC87456	193.91
.3770	V	.3770	3-1/2	1-1/4	6	TC87457	184.83
.3780		.3780	3-1/2	1-1/4	6	TC87458	184.83
.3790		.3790	3-1/2	1-1/4	6	TC87459	184.83
.3800		.3800	3-1/2	1-1/4	6	TC87460	184.83
.3810		.3810	3-1/2	1-1/4	6	TC87461	184.83
.3820		.3820	3-1/2	1-1/4	6	TC87462	184.83
.3830		.3830	3-1/2	1-1/4	6	TC87463	184.83
.3840		.3840	3-1/2	1-1/4	6	TC87464	184.83
.3850		.3850	3-1/2	1-1/4	6	TC87465	184.83
.3860	W	.3860	3-1/2	1-1/4	6	TC87466	184.83
.3870		.3870	3-1/2	1-1/4	6	TC87467	229.28
.3880		.3880	3-1/2	1-1/4	6	TC87468	229.28
.3890		.3890	3-1/2	1-1/4	6	TC87469	229.28
.3900		.3900	3-1/2	1-1/4	6	TC87470	229.28
.3906	25/64	.3906	3-1/2	1-1/4	6	TC87471	229.28
.3910		.3910	3-1/2	1-1/4	6	TC87472	229.28
.3920		.3920	3-1/2	1-1/4	6	TC87473	229.28
.3930		.3930	3-1/2	1-1/4	6	TC87474	229.28
.3937	10.0mm	.3937	3-1/2	1-1/4	6	TC87475	173.69
.3940		.3940	3-1/2	1-1/4	6	TC87476	229.28
.3950		.3950	3-1/2	1-1/4	6	TC87477	229.28
.3960		.3960	3-1/2	1-1/4	6	TC87478	229.28
.3970	X	.3970	3-1/2	1-1/4	6	TC87479	229.28
.3980		.3980	3-1/2	1-1/4	6	TC87480	229.28
.3990		.3990	3-1/2	1-1/4	6	TC87481	229.28
.4000		.4000	3-1/2	1-1/4	6	TC87482	229.28
.4010		.4010	3-1/2	1-1/4	6	TC87483	229.28
.4020		.4020	3-1/2	1-1/4	6	TC87484	229.28
.4030		.4030	3-1/2	1-1/4	6	TC87485	229.28

DEC. EQUIV.	SIZE	SHANK DIA.	OVERALL LENGTH	FLUTE LENGTH	# OF FLUTES	ITEM#	LIST PRICE
.4040	Y	.4040	3-1/2	1-1/4	6	TC87486	229.28
.4050		.4050	3-1/2	1-1/4	6	TC87487	229.28
.4060		.4060	3-1/2	1-1/4	6	TC87488	229.28
.4062	13/32	.4062	3-1/2	1-1/4	6	TC87489	166.44
.4070		.4070	3-1/2	1-1/4	6	TC87490	229.28
.4080		.4080	3-1/2	1-1/4	6	TC87491	229.28
.4090		.4090	3-1/2	1-1/4	6	TC87492	229.28
.4100		.4100	3-1/2	1-1/4	6	TC87493	229.28
.4110		.4110	3-1/2	1-1/4	6	TC87494	229.28
.4120		.4120	3-1/2	1-1/4	6	TC87495	229.28
.4130	Z	.4130	3-1/2	1-1/4	6	TC87496	229.28
.4134	10.5mm	.4134	3-1/2	1-1/4	6	TC87497	208.83
.4140		.4140	3-1/2	1-1/4	6	TC87498	229.28
.4150		.4150	3-1/2	1-1/4	6	TC87499	229.28
.4160		.4160	4	1-3/8	6	TC87500	229.28
.4170		.4170	4	1-3/8	6	TC87501	229.28
.4180		.4180	4	1-3/8	6	TC87502	229.28
.4190		.4190	4	1-3/8	6	TC87503	229.28
.4200		.4200	4	1-3/8	6	TC87504	229.28
.4210		.4210	4	1-3/8	6	TC87505	229.28
.4219	27/64	.4219	4	1-3/8	6	TC87506	188.71
.4220		.4220	4	1-3/8	6	TC87507	229.28
.4230		.4230	4	1-3/8	6	TC87508	229.28
.4240		.4240	4	1-3/8	6	TC87509	229.28
.4250		.4250	4	1-3/8	6	TC87510	229.28
.4260		.4260	4	1-3/8	6	TC87511	229.28
.4270		.4270	4	1-3/8	6	TC87512	229.28
.4280		.4280	4	1-3/8	6	TC87513	229.28
.4290		.4290	4	1-3/8	6	TC87514	229.28
.4300		.4300	4	1-3/8	6	TC87515	229.28
.4310		.4310	4	1-3/8	6	TC87516	229.28
.4320		.4320	4	1-3/8	6	TC87517	229.28
.4330		.4330	4	1-3/8	6	TC87518	229.28
.4331	11.0mm	.4331	4	1-3/8	6	TC87519	208.83
.4340		.4340	4	1-3/8	6	TC87520	229.28
.4350		.4350	4	1-3/8	6	TC87521	229.28
.4360		.4360	4	1-3/8	6	TC87522	229.28
.4365		.4365	4	1-3/8	6	TC87523	229.28
.4370		.4370	4	1-3/8	6	TC87524	229.28
.4375	7/16	.4375	4	1-3/8	6	TC87525	188.71

For technical information, please see page 262.

DIAMETER TOLERANCE +.0003, -.0000

TECHNICAL



GENERAL PURPOSE SOLID CARBIDE REAMERS

YOUR #1 SOURCE FOR AMERICAN-MADE PREMIUM QUALITY CUTTING TOOLS

STOCKED INTERMEDIATE & STANDARD SIZES



SERIES 870

DEC. EQUIV.	SIZE	SHANK DIA.	OVERALL LENGTH	FLUTE LENGTH	# OF FLUTES	ITEM#	LIST PRICE
.4380		.4380	4	1-3/8	6	TC87526	229.28
.4385		.4385	4	1-3/8	6	TC87527	273.97
.4390		.4390	4	1-3/8	6	TC87528	229.28
.4400		.4400	4	1-3/8	6	TC87529	229.28
.4410		.4410	4	1-3/8	6	TC87530	260.17
.4420		.4420	4	1-3/8	6	TC87531	260.17
.4430		.4430	4	1-3/8	6	TC87532	260.17
.4440		.4440	4	1-3/8	6	TC87533	260.17
.4450		.4450	4	1-3/8	6	TC87534	260.17
.4460		.4460	4	1-3/8	6	TC87535	260.17
.4470		.4470	4	1-3/8	6	TC87536	260.17
.4480		.4480	4	1-3/8	6	TC87537	260.17
.4490		.4490	4	1-3/8	6	TC87538	260.17
.4500		.4500	4	1-3/8	6	TC87539	260.17
.4510		.4510	4	1-3/8	6	TC87540	260.17
.4520		.4520	4	1-3/8	6	TC87541	260.17
.4528	11.5mm	.4528	4	1-3/8	6	TC87542	260.17
.4530		.4530	4	1-3/8	6	TC87543	238.45
.4531	29/64	.4531	4	1-3/8	6	TC87544	208.04
.4540		.4540	4	1-3/8	6	TC87545	260.17
.4550		.4550	4	1-3/8	6	TC87546	260.17
.4560		.4560	4	1-3/8	6	TC87547	260.17
.4570		.4570	4	1-3/8	6	TC87548	260.17
.4580		.4580	4	1-3/8	6	TC87549	260.17
.4590		.4590	4	1-3/8	6	TC87550	260.17
.4600		.4600	4	1-3/8	6	TC87551	260.17
.4610		.4610	4	1-3/8	6	TC87552	260.17
.4620		.4620	4	1-3/8	6	TC87553	260.17
.4630		.4630	4	1-3/8	6	TC87554	260.17
.4640		.4640	4	1-3/8	6	TC87555	260.17
.4650		.4650	4	1-3/8	6	TC87556	260.17
.4660		.4660	4	1-3/8	6	TC87557	260.17
.4670		.4670	4	1-3/8	6	TC87558	260.17
.4680		.4680	4	1-3/8	6	TC87559	260.17
.4688	15/32	.4688	4	1-3/8	6	TC87560	208.04
.4690		.4690	4	1-3/8	6	TC87561	274.16
.4700		.4700	4	1-3/8	6	TC87562	274.16

DEC. EQUIV.	SIZE	SHANK DIA.	OVERALL LENGTH	FLUTE LENGTH	# OF FLUTES	ITEM#	LIST PRICE
.4710		.4710	4	1-3/8	6	TC87563	274.16
.4720		.4720	4	1-3/8	6	TC87564	274.16
.4724	12.0mm	.4724	4	1-3/8	6	TC87565	264.14
.4730		.4730	4	1-3/8	6	TC87566	274.16
.4740		.4740	4	1-3/8	6	TC87567	274.16
.4750		.4750	4	1-3/8	6	TC87568	274.16
.4760		.4760	4	1-1/2	6	TC87569	274.16
.4770		.4770	4	1-1/2	6	TC87570	274.16
.4780		.4780	4	1-1/2	6	TC87571	274.16
.4790		.4790	4	1-1/2	6	TC87572	274.16
.4800		.4800	4	1-1/2	6	TC87573	274.16
.4810		.4810	4	1-1/2	6	TC87574	274.16
.4820		.4820	4	1-1/2	6	TC87575	274.16
.4830		.4830	4	1-1/2	6	TC87576	274.16
.4840		.4840	4	1-1/2	6	TC87577	274.16
.4844	31/64	.4844	4	1-1/2	6	TC87578	235.69
.4850		.4850	4	1-1/2	6	TC87579	274.16
.4860		.4860	4	1-1/2	6	TC87580	274.16
.4870		.4870	4	1-1/2	6	TC87581	330.59
.4880		.4880	4	1-1/2	6	TC87582	330.59
.4890		.4890	4	1-1/2	6	TC87583	330.59
.4900		.4900	4	1-1/2	6	TC87584	330.59
.4910		.4910	4	1-1/2	6	TC87585	330.59
.4920		.4920	4	1-1/2	6	TC87586	330.59
.4921	12.5mm	.4921	4	1-1/2	6	TC87587	330.59
.4930		.4930	4	1-1/2	6	TC87588	330.59
.4940		.4940	4	1-1/2	6	TC87589	330.59
.4950		.4950	4	1-1/2	6	TC87590	330.59
.4960		.4960	4	1-1/2	6	TC87591	330.59
.4970		.4970	4	1-1/2	6	TC87592	330.59
.4980		.4980	4	1-1/2	6	TC87593	330.59
.4990		.4990	4	1-1/2	6	TC87594	330.59
.4995		.4995	4	1-1/2	6	TC87595	330.59
.5000	1/2	.5000	4	1-1/2	6	TC87596	235.69
.5005		.5005	4	1-1/2	6	TC87597	330.59
.5010		.5010	4	1-1/2	6	TC87598	330.59
.5020		.5020	4	1-1/2	6	TC87599	330.59

For technical information, please see page 262.

DIAMETER TOLERANCE +.0003, -.0000

GENERAL PURPOSE SOLID CARBIDE REAMERS



YOUR #1 SOURCE FOR AMERICAN-MADE PREMIUM QUALITY CUTTING TOOLS

REAMING

SPECIAL SIZES



SERIES 870 QUANTITY PRICING

SIZE RANGE	SHANK	FL LGTH	OAL	1 pc	2 pcs	3-5 pcs	6-11 pcs	12-17 pcs	18-23 pcs	24-35 pcs	36-49 pcs	50-74 pcs
.0401 - .0450	0.037	3/8	1-1/2	317.94	210.35	183.43	117.40	92.93	83.16	78.27	73.35	68.48
.0451 - .0500	0.042	3/8	1-1/2	317.94	210.35	183.43	117.40	92.93	83.16	78.27	73.35	68.48
.0501 - .0570	0.046	3/8	1-1/2	320.37	212.76	185.87	119.84	95.39	85.59	80.71	75.82	70.95
.0571 - .0650	0.053	3/8	1-1/2	317.94	210.35	183.43	117.40	92.93	83.16	78.27	73.35	68.48
.0651 - .0800	0.060	1/2	1-3/4	320.37	212.76	185.87	119.84	95.39	85.59	80.71	75.82	70.95
.0801 - .0950	0.075	1/2	2	322.84	215.22	188.32	122.30	97.83	88.05	83.16	78.27	73.35
.0951 - .1150	0.090	5/8	2-1/4	327.73	220.10	193.20	127.17	102.71	92.93	88.05	83.16	78.27
.1151 - .1300	0.110	5/8	2-1/4	330.18	222.53	195.65	129.62	105.16	95.39	90.48	85.59	80.71
.1301 - .1450	0.125	3/4	2-1/2	337.49	229.89	203.00	136.95	112.53	102.71	97.83	92.93	88.05
.1451 - .1600	0.140	3/4	2-1/2	344.85	237.22	210.35	144.30	119.84	110.05	105.16	100.28	95.39
.1601 - .1750	0.155	7/8	2-3/4	352.17	244.57	217.64	151.62	127.17	117.40	112.53	107.61	102.71
.1751 - .1950	0.170	7/8	2-3/4	361.97	254.33	227.46	161.41	136.95	127.17	122.30	117.40	112.53
.1951 - .2100	0.188	1	3	381.52	273.91	247.03	180.98	156.54	146.74	141.85	136.95	132.06
.2101 - .2250	0.205	1	3	388.86	281.25	254.33	188.32	163.87	154.07	149.19	144.30	139.38
.2251 - .2400	0.220	1	3	401.09	293.50	266.59	200.53	176.10	166.30	161.41	156.54	151.62
.2401 - .2550	0.235	1	3	410.86	303.25	276.35	210.35	185.87	176.10	171.18	166.30	161.41
.2551 - .2750	0.250	1	3-1/4	435.35	327.73	300.80	234.79	210.35	200.53	195.65	190.77	185.87
.2751 - .2950	0.270	1-1/8	3-1/4	437.76	330.18	303.25	237.22	212.76	203.00	198.09	193.20	188.32
.2951 - .3150	0.290	1-1/8	3-1/4	462.21	354.60	327.73	261.68	237.22	227.46	222.53	217.64	212.76
.3151 - .3350	0.313	1-1/4	3-1/2	496.47	388.86	361.97	295.93	271.48	261.68	256.79	251.91	247.03
.3351 - .3550	0.330	1-1/4	3-1/2	501.35	398.64	366.87	300.80	276.35	266.59	261.68	256.79	251.91
.3551 - .3800	0.350	1-1/4	3-1/2	511.14	408.42	376.63	310.62	286.15	276.35	271.48	266.59	261.68
.3801 - .4100	0.375	1-1/4	4	547.82	440.23	413.32	347.30	322.84	313.03	308.17	303.25	298.36
.4101 - .4400	0.405	1-3/8	4	567.39	459.81	432.89	366.87	342.39	332.61	327.73	322.84	317.94
.4401 - .4700	0.438	1-3/8	4	596.73	489.14	462.21	396.20	371.74	361.97	357.07	352.17	347.30
.4701 - .5050	0.465	1-1/2	4	645.66	538.06	511.14	445.10	420.65	410.86	406.00	401.09	396.20
.5051 - .5400	0.500	1-1/2	4-1/2	709.24	601.64	574.74	508.71	484.24	474.45	469.57	464.68	459.81
.5401 - .5800	0.535	1-1/2	4-1/2	807.06	699.44	672.57	606.53	582.07	572.30	567.39	562.50	557.60
.5801 - .6260	0.575	1-3/4	4-1/2	885.34	777.73	750.82	684.80	660.33	650.56	645.66	640.76	635.87
.6261 - .6600	0.615	1-3/4	4-1/2	1002.73	895.11	868.22	802.19	777.73	767.92	763.05	758.17	753.27
.6601 - .7050	0.655	2	5	1149.48	1041.88	1014.95	948.92	924.48	914.68	909.79	904.92	900.01
.7051 - .7550	0.700	2	5	1247.28	1139.70	1112.77	1046.75	1022.30	1012.48	1007.62	1002.73	997.84
.7551 - .7950	0.750	2	5	1345.11	1237.52	1210.59	1144.56	1120.12	1110.35	1105.43	1100.55	1095.66
.7951 - .8450	0.750	2-1/4	5	1442.96	1335.34	1308.44	1242.40	1217.97	1208.15	1203.26	1198.39	1193.50
.8451 - .9000	0.750	2-1/4	5	1638.61	1531.02	1504.09	1438.06	1413.62	1403.81	1398.92	1394.04	1389.15
.9001 - .9600	0.875	2-1/4	5	1883.17	1775.56	1748.67	1682.63	1658.16	1648.38	1643.49	1638.61	1633.71
.9601 - 1.025	0.875	2-1/4	5	2078.82	1971.23	1944.32	1878.29	1853.82	1844.05	1839.15	1834.25	1829.36

FOR .0001" TOLERANCE, ALL SIZES ADD 20% TO ABOVE PRICING
FOR .0002" TOLERANCE FROM .5001" - 1.025", ADD 10% TO ABOVE PRICING

For technical information, please see page 262.

DIAMETER TOLERANCE +.0003, -.0000

CARBIDE REAMERS

TECHNICAL



GENERAL PURPOSE HSS REAMERS

YOUR #1 SOURCE FOR AMERICAN-MADE PREMIUM QUALITY CUTTING TOOLS

CHUCKING - STRAIGHT FLUTE STOCKED INTERMEDIATE & STANDARD SIZES



SERIES 933

DEC. EQUIV.	SIZE	SHANK DIA.	OVERALL LENGTH	FLUTE LENGTH	# OF FLUTES	ITEM #	LIST PRICE
.0135	#80	.0135	3/4	3/8	2	TR96001	43.20
.0140		.0135	3/4	3/8	2	TR94007	53.79
.0145	#79	.0145	3/4	3/8	2	TR96002	43.20
.0150		.0156	3/4	3/8	2	TR94008	53.79
.0155		.0156	3/4	3/8	2	TR94009	53.79
.0156	1/64	.0156	3/4	3/8	2	TR96003	43.20
.0160	#78	.0160	7/8	3/8	2	TR96004	43.20
.0165		.0180	7/8	3/8	2	TR94010	53.79
.0170		.0180	7/8	3/8	2	TR94011	53.79
.0175		.0180	7/8	3/8	2	TR94012	53.79
.0180	#77	.0180	7/8	3/8	2	TR96005	43.20
.0185		.0200	7/8	3/8	2	TR94013	53.79
.0190		.0200	7/8	3/8	2	TR94014	53.79
.0195		.0200	7/8	3/8	2	TR94015	53.79
.0200	#76	.0200	7/8	3/8	2	TR96006	43.20
.0205		.0210	1	1/2	3	TR94016	48.98
.0210	#75	.0210	1	1/2	3	TR96007	43.20
.0215		.0225	1	1/2	3	TR94017	48.98
.0220		.0225	1	1/2	3	TR94018	48.98
.0225	#74	.0225	1	1/2	3	TR96008	43.20
.0230		.0240	1-1/8	1/2	3	TR94019	48.98
.0235		.0240	1-1/8	1/2	3	TR94020	48.98
.0240	#73	.0240	1-1/8	1/2	3	TR96009	43.20
.0245		.0250	1-1/8	1/2	3	TR94021	48.98
.0250	#72	.0250	1-1/8	1/2	3	TR96010	43.20
.0255		.0260	1-1/4	1/2	3	TR94022	48.98
.0260	#71	.0260	1-1/4	1/2	3	TR96011	43.20
.0265		.0280	1-1/4	1/2	3	TR94023	48.98
.0270		.0280	1-1/4	1/2	3	TR94024	48.98
.0275		.0280	1-1/4	1/2	3	TR94025	48.98
.0280	#70	.0280	1-1/4	1/2	3	TR96012	43.20
.0285		.0292	1-3/8	1/2	3	TR94026	48.98
.0290		.0292	1-3/8	1/2	3	TR94027	48.98
.0292	#69	.0292	1-3/8	1/2	3	TR96013	43.20
.0295		.0310	1-3/8	1/2	3	TR94028	44.50
.0300		.0310	1-3/8	1/2	3	TR94029	44.50
.0305		.0310	1-3/8	1/2	3	TR94030	44.50
.0310	#68	.0310	1-3/8	1/2	3	TR96014	43.20
.0312	1/32	.0312	1-3/8	1/2	3	TR96015	34.06
.0315		.0320	1-3/8	1/2	3	TR94031	44.50
.0320	#67	.0320	1-3/8	1/2	3	TR96016	36.18
.0325		.0330	1-3/8	1/2	3	TR94032	44.50
.0330	#66	.0330	1-3/8	1/2	3	TR96017	36.18
.0335		.0350	1-1/2	1/2	3	TR94033	44.50

DEC. EQUIV.	SIZE	SHANK DIA.	OVERALL LENGTH	FLUTE LENGTH	# OF FLUTES	ITEM #	LIST PRICE
.0340		.0350	1-1/2	1/2	3	TR94034	44.50
.0345		.0350	1-1/2	1/2	3	TR94035	44.50
.0350	#65	.0350	1-1/2	1/2	3	TR96018	36.18
.0355		.0360	1-1/2	1/2	3	TR94036	44.50
.0360	#64	.0360	1-1/2	1/2	3	TR96019	36.18
.0365		.0370	1-1/2	1/2	3	TR94037	44.50
.0370	#63	.0370	1-1/2	1/2	3	TR96020	36.18
.0375		.0380	1-1/2	1/2	3	TR94038	44.50
.0380	#62	.0380	1-1/2	1/2	3	TR96021	36.18
.0385		.0390	1-1/2	1/2	3	TR94039	44.50
.0390	#61	.0390	1-1/2	1/2	3	TR96022	36.18
.0394	1.0mm	.0394	2-1/2	1/2	4	TR96023	36.18
.0395		.0390	2-1/2	1/2	4	TR94040	42.34
.0400	#60	.0390	2-1/2	1/2	4	TR96024	36.18
.0405		.0390	2-1/2	1/2	4	TR94041	42.34
.0410	#59	.0390	2-1/2	1/2	4	TR96025	36.18
.0415		.0390	2-1/2	1/2	4	TR94042	42.34
.0420	#58	.0390	2-1/2	1/2	4	TR96026	36.18
.0425		.0390	2-1/2	1/2	4	TR94043	42.34
.0430	#57	.0390	2-1/2	1/2	4	TR96027	36.18
.0435		.0455	2-1/2	1/2	4	TR94044	42.34
.0440		.0455	2-1/2	1/2	4	TR94045	42.34
.0445		.0455	2-1/2	1/2	4	TR94046	42.34
.0450		.0455	2-1/2	1/2	4	TR94047	42.34
.0455		.0455	2-1/2	1/2	4	TR94048	42.34
.0460		.0455	2-1/2	1/2	4	TR94049	42.34
.0465	#56	.0455	2-1/2	1/2	4	TR96028	36.18
.0469	3/64	.0455	2-1/2	1/2	4	TR96029	36.18
.0470		.0510	2-1/2	1/2	4	TR94050	42.34
.0475		.0510	2-1/2	1/2	4	TR94051	42.34
.0480		.0510	2-1/2	1/2	4	TR94052	42.34
.0485		.0510	2-1/2	1/2	4	TR94053	42.34
.0490		.0510	2-1/2	1/2	4	TR94054	42.34
.0495		.0510	2-1/2	1/2	4	TR94055	42.34
.0500		.0510	2-1/2	1/2	4	TR94056	42.34
.0505		.0510	2-1/2	1/2	4	TR94057	42.34
.0510		.0510	2-1/2	1/2	4	TR94058	42.34
.0515		.0510	2-1/2	1/2	4	TR94059	42.34
.0520	#55	.0510	2-1/2	1/2	4	TR96030	36.18
.0525		.0510	2-1/2	1/2	4	TR94060	42.34
.0530		.0510	2-1/2	1/2	4	TR94061	42.34
.0535		.0510	2-1/2	1/2	4	TR94062	42.34
.0540		.0510	2-1/2	1/2	4	TR94063	42.34
.0545		.0510	2-1/2	1/2	4	TR94064	42.34

For technical information, please see page 263.

THRU 1/2" DIAMETER	1/2" TO 5/8"	5/8" TO 1-1/2"	1-1/2" TO 2"
+ .0002, -.0000	+ .0003, -.0000	+ .0001, +.0004	+ .0002, +.0006

GENERAL PURPOSE HSS REAMERS



YOUR #1 SOURCE FOR AMERICAN-MADE PREMIUM QUALITY CUTTING TOOLS

REAMING

CHUCKING - STRAIGHT FLUTE STOCKED INTERMEDIATE & STANDARD SIZES



SERIES 933

HSS & COBALT REAMERS

DEC. EQUIV.	SIZE	SHANK DIA.	OVERALL LENGTH	FLUTE LENGTH	# OF FLUTES	ITEM#	LIST PRICE
.0550	#54	.0510	2-1/2	1/2	4	TR96031	36.18
.0555		.0510	2-1/2	1/2	4	TR94065	42.34
.0560		.0510	2-1/2	1/2	4	TR94066	42.34
.0565		.0510	2-1/2	1/2	4	TR94067	42.34
.0570		.0510	2-1/2	1/2	4	TR94068	42.34
.0575		.0510	2-1/2	1/2	4	TR94069	42.34
.0580		.0510	2-1/2	1/2	4	TR94070	42.34
.0585		.0510	2-1/2	1/2	4	TR94071	42.34
.0590		.0510	2-1/2	1/2	4	TR94072	42.34
.0591	1.5mm	.0510	2-1/2	1/2	4	TR96032	36.18
.0595	#53	.0585	2-1/2	1/2	4	TR96033	36.18
.0600		.0585	2-1/2	1/2	4	TR94073	42.34
.0605		.0585	2-1/2	1/2	4	TR94074	42.34
.0610		.0585	2-1/2	1/2	4	TR94075	42.34
.0615		.0585	2-1/2	1/2	4	TR94076	42.34
.0620		.0585	2-1/2	1/2	4	TR94077	42.34
.0625	1/16	.0585	2-1/2	1/2	4	TR96034	32.52
.0630		.0585	2-1/2	1/2	4	TR94078	37.95
.0635	#52	.0585	2-1/2	1/2	4	TR96035	32.52
.0640		.0660	3	3/4	4	TR94079	37.95
.0645		.0660	3	3/4	4	TR94080	37.95
.0650		.0660	3	3/4	4	TR94081	37.95
.0655		.0660	3	3/4	4	TR94082	37.95
.0660		.0660	3	3/4	4	TR94083	37.95
.0665		.0660	3	3/4	4	TR94084	37.95
.0670	#51	.0660	3	3/4	4	TR96036	29.11
.0675		.0660	3	3/4	4	TR94085	37.95
.0680		.0660	3	3/4	4	TR94086	37.95
.0685		.0660	3	3/4	4	TR94087	37.95
.0690		.0660	3	3/4	4	TR94088	37.95
.0695		.0660	3	3/4	4	TR94089	37.95
.0700	#50	.0660	3	3/4	4	TR96037	29.11
.0705		.0660	3	3/4	4	TR94090	37.95
.0710		.0660	3	3/4	4	TR94091	37.95
.0715		.0660	3	3/4	4	TR94092	37.95
.0720		.0660	3	3/4	4	TR94093	37.95
.0725		.0660	3	3/4	4	TR94094	37.95
.0730	#49	.0660	3	3/4	4	TR96038	29.11
.0735		.0720	3	3/4	4	TR94095	37.95
.0740		.0720	3	3/4	4	TR94096	37.95
.0745		.0720	3	3/4	4	TR94097	37.95
.0750		.0720	3	3/4	4	TR94098	37.95
.0755		.0720	3	3/4	4	TR94099	37.95
.0760	#48	.0720	3	3/4	4	TR96039	29.11

DEC. EQUIV.	SIZE	SHANK DIA.	OVERALL LENGTH	FLUTE LENGTH	# OF FLUTES	ITEM#	LIST PRICE
.0765		.0720	3	3/4	4	TR94100	37.95
.0770		.0720	3	3/4	4	TR94101	37.95
.0775		.0720	3	3/4	4	TR94102	37.95
.0780		.0720	3	3/4	4	TR94103	37.95
.0781	5/64	.0720	3	3/4	4	TR96040	29.11
.0785	#47	.0720	3	3/4	4	TR96041	29.11
.0787	2.0mm	.0720	3	3/4	4	TR96042	29.11
.0790		.0771	3	3/4	4	TR94104	37.95
.0795		.0771	3	3/4	4	TR94105	37.95
.0800		.0771	3	3/4	4	TR94106	37.95
.0805		.0771	3	3/4	4	TR94107	37.95
.0810	#46	.0771	3	3/4	4	TR96043	29.11
.0815		.0771	3	3/4	4	TR94108	37.95
.0820	#45	.0771	3	3/4	4	TR96044	29.11
.0825		.0810	3	3/4	4	TR94109	37.95
.0830		.0810	3	3/4	4	TR94110	37.95
.0835		.0810	3	3/4	4	TR94111	37.95
.0840		.0810	3	3/4	4	TR94112	37.95
.0845		.0810	3	3/4	4	TR94113	37.95
.0850		.0810	3	3/4	4	TR94114	37.95
.0855		.0810	3	3/4	4	TR94115	37.95
.0860	#44	.0810	3	3/4	4	TR96045	29.11
.0865		.0810	3	3/4	4	TR94116	37.95
.0870		.0810	3	3/4	4	TR94117	37.95
.0875		.0810	3	3/4	4	TR94118	37.95
.0880		.0810	3	3/4	4	TR94119	37.95
.0885		.0810	3	3/4	4	TR94120	37.95
.0890	#43	.0810	3	3/4	4	TR96046	29.11
.0895		.0880	3	3/4	4	TR94121	37.95
.0900		.0880	3	3/4	4	TR94122	37.95
.0905		.0880	3	3/4	4	TR94123	37.95
.0910		.0880	3	3/4	4	TR94124	37.95
.0915		.0880	3	3/4	4	TR94125	37.95
.0920		.0880	3	3/4	4	TR94126	37.95
.0925		.0880	3	3/4	4	TR94127	37.95
.0930		.0880	3	3/4	4	TR94128	37.95
.0935	#42	.0880	3	3/4	4	TR96047	29.11
.0938	3/32	.0880	3	3/4	4	TR96048	26.17
.0940		.0928	3-1/2	7/8	4	TR94129	37.95
.0945		.0928	3-1/2	7/8	4	TR94130	37.95
.0950		.0928	3-1/2	7/8	4	TR94131	37.95
.0955		.0928	3-1/2	7/8	4	TR94132	37.95
.0960	#41	.0928	3-1/2	7/8	4	TR96049	29.39
.0965		.0928	3-1/2	7/8	4	TR94133	37.95

For technical information, please see page 263.

THRU 1/2" DIAMETER	1/2" TO 5/8"	5/8" TO 1-1/2"	1-1/2" TO 2"
+ .0002, -.0000	+ .0003, -.0000	+ .0001, +.0004	+ .0002, +.0006

TECHNICAL



GENERAL PURPOSE HSS REAMERS

YOUR #1 SOURCE FOR AMERICAN-MADE PREMIUM QUALITY CUTTING TOOLS

CHUCKING - STRAIGHT FLUTE STOCKED INTERMEDIATE & STANDARD SIZES



SERIES 933

DEC. EQUIV.	SIZE	SHANK DIA.	OVERALL LENGTH	FLUTE LENGTH	# OF FLUTES	ITEM #	LIST PRICE
.0970		.0928	3-1/2	7/8	4	TR94134	37.95
.0975		.0928	3-1/2	7/8	4	TR94135	37.95
.0980	#40	.0928	3-1/2	7/8	4	TR96050	29.39
.0984	2.5mm	.0928	3-1/2	7/8	4	TR96051	29.39
.0985		.0928	3-1/2	7/8	4	TR94136	37.95
.0990		.0928	3-1/2	7/8	4	TR94137	37.95
.0995	#39	.0928	3-1/2	7/8	4	TR96052	29.39
.1000		.0950	3-1/2	7/8	4	TR94138	37.95
.1005		.0950	3-1/2	7/8	4	TR94139	37.95
.1010		.0950	3-1/2	7/8	4	TR94140	37.95
.1015	#38	.0950	3-1/2	7/8	4	TR96053	29.39
.1020		.0950	3-1/2	7/8	4	TR94141	37.95
.1025		.0950	3-1/2	7/8	4	TR94142	37.95
.1030		.0950	3-1/2	7/8	4	TR94143	37.95
.1035		.0950	3-1/2	7/8	4	TR94144	37.95
.1040	#37	.0950	3-1/2	7/8	4	TR96054	29.39
.1045		.1030	3-1/2	7/8	4	TR94145	37.95
.1050		.1030	3-1/2	7/8	4	TR94146	37.95
.1055		.1030	3-1/2	7/8	4	TR94147	37.95
.1060		.1030	3-1/2	7/8	4	TR94148	37.95
.1065	#36	.1030	3-1/2	7/8	4	TR96055	29.39
.1070		.1030	3-1/2	7/8	4	TR94149	37.95
.1075		.1030	3-1/2	7/8	4	TR94150	37.95
.1080		.1030	3-1/2	7/8	4	TR94151	37.95
.1085		.1030	3-1/2	7/8	4	TR94152	37.95
.1090		.1030	3-1/2	7/8	4	TR94153	37.95
.1094	7/64	.1030	3-1/2	7/8	4	TR96056	30.31
.1095		.1030	3-1/2	7/8	4	TR94154	32.81
.1100	#35	.1030	3-1/2	7/8	4	TR96057	30.31
.1105		.1055	3-1/2	7/8	4	TR94155	32.81
.1110	#34	.1055	3-1/2	7/8	4	TR96058	30.31
.1115		.1055	3-1/2	7/8	4	TR94156	32.81
.1120		.1055	3-1/2	7/8	4	TR94157	32.81
.1125		.1055	3-1/2	7/8	4	TR94158	32.81
.1130	#33	.1055	3-1/2	7/8	4	TR96059	30.31
.1135		.1120	3-1/2	7/8	4	TR94159	32.81
.1140		.1120	3-1/2	7/8	4	TR94160	32.81
.1145		.1120	3-1/2	7/8	4	TR94161	32.81
.1150		.1120	3-1/2	7/8	4	TR94162	32.81
.1155		.1120	3-1/2	7/8	4	TR94163	32.81
.1160	#32	.1120	3-1/2	7/8	4	TR96060	30.31
.1165		.1120	3-1/2	7/8	4	TR94164	32.81
.1170		.1120	3-1/2	7/8	4	TR94165	32.81
.1175		.1120	3-1/2	7/8	4	TR94166	32.81

DEC. EQUIV.	SIZE	SHANK DIA.	OVERALL LENGTH	FLUTE LENGTH	# OF FLUTES	ITEM #	LIST PRICE
.1180		.1120	3-1/2	7/8	4	TR94167	32.81
.1181	3.0mm	.1120	3-1/2	7/8	4	TR96061	30.31
.1185		.1120	3-1/2	7/8	4	TR94168	32.81
.1190		.1120	3-1/2	7/8	4	TR94169	32.81
.1195		.1120	3-1/2	7/8	4	TR94170	32.81
.1200	#31	.1120	3-1/2	7/8	4	TR96062	30.31
.1205		.1190	3-1/2	7/8	4	TR94171	32.81
.1210		.1190	3-1/2	7/8	4	TR94172	32.81
.1215		.1190	3-1/2	7/8	4	TR94173	32.81
.1220		.1190	3-1/2	7/8	4	TR94174	32.81
.1225		.1190	3-1/2	7/8	4	TR94175	32.81
.1230		.1190	3-1/2	7/8	4	TR94176	32.81
.1235		.1190	3-1/2	7/8	4	TR94177	32.81
.1240	O/U	.1190	3-1/2	7/8	4	TR96063	30.31
.1245		.1190	3-1/2	7/8	4	TR94178	32.81
.1247		.1190	3-1/2	7/8	4	TR94179	32.81
.1250	1/8	.1190	3-1/2	7/8	4	TR96064	27.32
.1255		.1190	3-1/2	7/8	4	TR94180	44.50
.1260	O/U	.1190	3-1/2	7/8	4	TR96065	30.31
.1265		.1190	3-1/2	7/8	4	TR94181	44.50
.1270		.1190	3-1/2	7/8	4	TR94182	44.50
.1275		.1190	3-1/2	7/8	4	TR94183	44.50
.1280		.1190	3-1/2	7/8	4	TR94184	44.50
.1285	#30	.1190	3-1/2	7/8	4	TR96066	30.31
.1290		.1275	4	1	4	TR94185	44.50
.1295		.1275	4	1	4	TR94186	44.50
.1300		.1275	4	1	4	TR94187	44.50
.1305		.1275	4	1	4	TR94188	44.50
.1310		.1275	4	1	4	TR94189	44.50
.1315		.1275	4	1	4	TR94190	44.50
.1320		.1275	4	1	4	TR94191	44.50
.1325		.1275	4	1	4	TR94192	44.50
.1330		.1275	4	1	4	TR94193	44.50
.1335		.1275	4	1	4	TR94194	44.50
.1340		.1275	4	1	4	TR94195	44.50
.1345		.1275	4	1	4	TR94196	44.50
.1350		.1275	4	1	4	TR94197	44.50
.1355		.1275	4	1	4	TR94198	44.50
.1360	#29	.1275	4	1	4	TR96067	36.18
.1365		.1350	4	1	4	TR94199	44.50
.1370		.1350	4	1	4	TR94200	44.50
.1375		.1350	4	1	4	TR94201	44.50
.1378	3.5mm	.1350	4	1	4	TR96068	36.18
.1380		.1350	4	1	4	TR94202	44.50

For technical information, please see page 263.

THRU 1/2" DIAMETER	1/2" TO 5/8"	5/8" TO 1-1/2"	1-1/2" TO 2"
+ .0002, -.0000	+ .0003, -.0000	+ .0001, +.0004	+ .0002, +.0006

GENERAL PURPOSE HSS REAMERS



YOUR #1 SOURCE FOR AMERICAN-MADE PREMIUM QUALITY CUTTING TOOLS

REAMING

CHUCKING - STRAIGHT FLUTE STOCKED INTERMEDIATE & STANDARD SIZES



SERIES 933

HSS & COBALT REAMERS

DEC. EQUIV.	SIZE	SHANK DIA.	OVERALL LENGTH	FLUTE LENGTH	# OF FLUTES	ITEM#	LIST PRICE
.1385		.1350	4	1	4	TR94203	44.50
.1390		.1350	4	1	4	TR94204	44.50
.1395		.1350	4	1	4	TR94205	44.50
.1400		.1350	4	1	4	TR94206	44.50
.1405	#28	.1350	4	1	4	TR96069	36.18
.1406	9/64	.1350	4	1	4	TR96070	36.18
.1410		.1350	4	1	4	TR94207	42.34
.1415		.1350	4	1	4	TR94208	42.34
.1420		.1350	4	1	4	TR94209	42.34
.1425		.1350	4	1	4	TR94210	42.34
.1430		.1350	4	1	4	TR94211	42.34
.1435		.1350	4	1	4	TR94212	42.34
.1440	#27	.1350	4	1	4	TR96071	36.18
.1445		.1430	4	1	4	TR94213	42.34
.1450		.1430	4	1	4	TR94214	42.34
.1455		.1430	4	1	4	TR94215	42.34
.1460		.1430	4	1	4	TR94216	42.34
.1465		.1430	4	1	4	TR94217	42.34
.1470	#26	.1430	4	1	4	TR96072	36.18
.1475		.1430	4	1	4	TR94218	42.34
.1480		.1430	4	1	4	TR94219	42.34
.1485		.1430	4	1	4	TR94220	42.34
.1490		.1430	4	1	4	TR94221	42.34
.1495	#25	.1430	4	1	4	TR96073	36.18
.1500		.1460	4	1	4	TR94222	42.34
.1505		.1460	4	1	4	TR94223	42.34
.1510		.1460	4	1	4	TR94224	42.34
.1515		.1460	4	1	4	TR94225	42.34
.1520	#24	.1460	4	1	4	TR96074	36.18
.1525		.1460	4	1	4	TR94226	42.34
.1530		.1460	4	1	4	TR94227	42.34
.1535		.1460	4	1	4	TR94228	42.34
.1540	#23	.1460	4	1	4	TR96075	36.18
.1545		.1510	4	1	4	TR94229	42.34
.1550		.1510	4	1	4	TR94230	42.34
.1555		.1510	4	1	4	TR94231	42.34
.1560		.1510	4	1	4	TR94232	42.34
.1562	5/32	.1510	4	1	4	TR96076	36.18
.1565		.1510	4	1	6	TR94233	44.50
.1570	#22	.1510	4	1	6	TR96077	36.18
.1575	4.0mm	.1510	4	1	6	TR96078	36.18
.1580		.1530	4-1/2	1-1/8	6	TR94234	44.50
.1585		.1530	4-1/2	1-1/8	6	TR94235	44.50
.1590	#21	.1530	4-1/2	1-1/8	6	TR96079	38.63

DEC. EQUIV.	SIZE	SHANK DIA.	OVERALL LENGTH	FLUTE LENGTH	# OF FLUTES	ITEM#	LIST PRICE
.1595		.1530	4-1/2	1-1/8	6	TR94236	44.50
.1600		.1530	4-1/2	1-1/8	6	TR94237	44.50
.1605		.1530	4-1/2	1-1/8	6	TR94238	44.50
.1610	#20	.1530	4-1/2	1-1/8	6	TR96080	38.63
.1615		.1595	4-1/2	1-1/8	6	TR94239	44.50
.1620		.1595	4-1/2	1-1/8	6	TR94240	44.50
.1625		.1595	4-1/2	1-1/8	6	TR94241	44.50
.1630		.1595	4-1/2	1-1/8	6	TR94242	44.50
.1635		.1595	4-1/2	1-1/8	6	TR94243	44.50
.1640		.1595	4-1/2	1-1/8	6	TR94244	44.50
.1645		.1595	4-1/2	1-1/8	6	TR94245	44.50
.1650		.1595	4-1/2	1-1/8	6	TR94246	44.50
.1655		.1595	4-1/2	1-1/8	6	TR94247	44.50
.1660	#19	.1595	4-1/2	1-1/8	6	TR96081	38.63
.1665		.1595	4-1/2	1-1/8	6	TR94248	44.50
.1670		.1595	4-1/2	1-1/8	6	TR94249	44.50
.1675		.1595	4-1/2	1-1/8	6	TR94250	44.50
.1680		.1595	4-1/2	1-1/8	6	TR94251	44.50
.1685		.1595	4-1/2	1-1/8	6	TR94252	44.50
.1690		.1595	4-1/2	1-1/8	6	TR94253	44.50
.1695	#18	.1595	4-1/2	1-1/8	6	TR96082	38.63
.1700		.1645	4-1/2	1-1/8	6	TR94254	44.50
.1705		.1645	4-1/2	1-1/8	6	TR94255	44.50
.1710		.1645	4-1/2	1-1/8	6	TR94256	44.50
.1715		.1645	4-1/2	1-1/8	6	TR94257	44.50
.1719	11/64	.1645	4-1/2	1-1/8	6	TR96083	38.63
.1720		.1645	4-1/2	1-1/8	6	TR94258	41.81
.1725		.1645	4-1/2	1-1/8	6	TR94259	41.81
.1730	#17	.1645	4-1/2	1-1/8	6	TR96084	38.63
.1735		.1704	4-1/2	1-1/8	6	TR94260	41.81
.1740		.1704	4-1/2	1-1/8	6	TR94261	41.81
.1745		.1704	4-1/2	1-1/8	6	TR94262	41.81
.1750		.1704	4-1/2	1-1/8	6	TR94263	41.81
.1755		.1704	4-1/2	1-1/8	6	TR94264	41.81
.1760		.1704	4-1/2	1-1/8	6	TR94265	41.81
.1765		.1704	4-1/2	1-1/8	6	TR94266	41.81
.1770	#16	.1704	4-1/2	1-1/8	6	TR96085	38.63
.1772	4.5mm	.1704	4-1/2	1-1/8	6	TR96086	38.63
.1775		.1755	4-1/2	1-1/8	6	TR94267	41.81
.1780		.1755	4-1/2	1-1/8	6	TR94268	41.81
.1785		.1755	4-1/2	1-1/8	6	TR94269	41.81
.1790		.1755	4-1/2	1-1/8	6	TR94270	41.81
.1795		.1755	4-1/2	1-1/8	6	TR94271	41.81
.1800	#15	.1755	4-1/2	1-1/8	6	TR96087	38.63

For technical information, please see page 263.

THRU 1/2" DIAMETER	1/2" TO 5/8"	5/8" TO 1-1/2"	1-1/2" TO 2"
+ .0002, -.0000	+ .0003, -.0000	+ .0001, +.0004	+ .0002, +.0006

TECHNICAL



GENERAL PURPOSE HSS REAMERS

YOUR #1 SOURCE FOR AMERICAN-MADE PREMIUM QUALITY CUTTING TOOLS

CHUCKING - STRAIGHT FLUTE STOCKED INTERMEDIATE & STANDARD SIZES



SERIES 933

DEC. EQUIV.	SIZE	SHANK DIA.	OVERALL LENGTH	FLUTE LENGTH	# OF FLUTES	ITEM #	LIST PRICE
.1805		.1755	4-1/2	1-1/8	6	TR94272	41.81
.1810		.1755	4-1/2	1-1/8	6	TR94273	41.81
.1815		.1755	4-1/2	1-1/8	6	TR94274	41.81
.1820	#14	.1755	4-1/2	1-1/8	6	TR96088	38.63
.1825		.1805	4-1/2	1-1/8	6	TR94275	41.81
.1830		.1805	4-1/2	1-1/8	6	TR94276	41.81
.1835		.1805	4-1/2	1-1/8	6	TR94277	41.81
.1840		.1805	4-1/2	1-1/8	6	TR94278	41.81
.1845		.1805	4-1/2	1-1/8	6	TR94279	41.81
.1850	#13	.1805	4-1/2	1-1/8	6	TR96089	38.63
.1855		.1805	4-1/2	1-1/8	6	TR94280	41.81
.1860		.1805	4-1/2	1-1/8	6	TR94281	41.81
.1865	O/U	.1805	4-1/2	1-1/8	6	TR96090	38.63
.1870		.1805	4-1/2	1-1/8	6	TR94282	41.81
.1875	3/16	.1805	4-1/2	1-1/8	6	TR96091	34.73
.1880		.1805	4-1/2	1-1/8	6	TR94283	52.77
.1885	O/U	.1805	4-1/2	1-1/8	6	TR96092	38.63
.1890	#12	.1805	4-1/2	1-1/8	6	TR96093	38.63
.1895		.1860	5	1-1/4	6	TR94284	52.77
.1900		.1860	5	1-1/4	6	TR94285	52.77
.1905		.1860	5	1-1/4	6	TR94286	52.77
.1910	#11	.1860	5	1-1/4	6	TR96094	43.25
.1915		.1860	5	1-1/4	6	TR94287	52.77
.1920		.1860	5	1-1/4	6	TR94288	52.77
.1925		.1860	5	1-1/4	6	TR94289	52.77
.1930		.1860	5	1-1/4	6	TR94290	52.77
.1935	#10	.1860	5	1-1/4	6	TR96095	43.25
.1940		.1895	5	1-1/4	6	TR94291	52.77
.1945		.1895	5	1-1/4	6	TR94292	52.77
.1950		.1895	5	1-1/4	6	TR94293	52.77
.1955		.1895	5	1-1/4	6	TR94294	52.77
.1960	#9	.1895	5	1-1/4	6	TR96096	43.25
.1965		.1895	5	1-1/4	6	TR94295	52.77
.1969	5.0mm	.1895	5	1-1/4	6	TR96097	43.25
.1970		.1895	5	1-1/4	6	TR94296	52.77
.1975		.1895	5	1-1/4	6	TR94297	52.77
.1980		.1895	5	1-1/4	6	TR94298	52.77
.1985		.1895	5	1-1/4	6	TR94299	52.77
.1990	#8	.1895	5	1-1/4	6	TR96098	43.25
.1995		.1945	5	1-1/4	6	TR94300	52.77
.2000		.1945	5	1-1/4	6	TR94301	52.77
.2005		.1945	5	1-1/4	6	TR94302	52.77
.2010	#7	.1895	5	1-1/4	6	TR96099	43.25
.2015		.1945	5	1-1/4	6	TR94303	52.77

DEC. EQUIV.	SIZE	SHANK DIA.	OVERALL LENGTH	FLUTE LENGTH	# OF FLUTES	ITEM #	LIST PRICE
.2020		.1945	5	1-1/4	6	TR94304	52.77
.2025		.1945	5	1-1/4	6	TR94305	52.77
.2030		.1945	5	1-1/4	6	TR94306	52.77
.2031	13/64	.1945	5	1-1/4	6	TR96100	43.25
.2035		.1945	5	1-1/4	6	TR94307	51.43
.2040	#6	.1945	5	1-1/4	6	TR96101	43.25
.2045		.2016	5	1-1/4	6	TR94308	51.43
.2050		.2016	5	1-1/4	6	TR94309	51.43
.2055	#5	.2016	5	1-1/4	6	TR96102	43.25
.2060		.2016	5	1-1/4	6	TR94310	51.43
.2065		.2016	5	1-1/4	6	TR94311	51.43
.2070		.2016	5	1-1/4	6	TR94312	51.43
.2075		.2016	5	1-1/4	6	TR94313	51.43
.2080		.2016	5	1-1/4	6	TR94314	51.43
.2085		.2016	5	1-1/4	6	TR94315	51.43
.2090	#4	.2016	5	1-1/4	6	TR96103	43.25
.2095		.2075	5	1-1/4	6	TR94316	51.43
.2100		.2075	5	1-1/4	6	TR94317	51.43
.2105		.2075	5	1-1/4	6	TR94318	51.43
.2110		.2075	5	1-1/4	6	TR94319	51.43
.2115		.2075	5	1-1/4	6	TR94320	51.43
.2120		.2075	5	1-1/4	6	TR94321	51.43
.2125		.2075	5	1-1/4	6	TR94322	51.43
.2130	#3	.2075	5	1-1/4	6	TR96104	43.25
.2135		.2075	5	1-1/4	6	TR94323	51.43
.2140		.2075	5	1-1/4	6	TR94324	51.43
.2145		.2075	5	1-1/4	6	TR94325	51.43
.2150		.2075	5	1-1/4	6	TR94326	51.43
.2155		.2075	5	1-1/4	6	TR94327	51.43
.2160		.2075	5	1-1/4	6	TR94328	51.43
.2165	5.5mm	.2075	5	1-1/4	6	TR96105	43.25
.2170		.2075	5	1-1/4	6	TR94329	51.43
.2175		.2075	5	1-1/4	6	TR94330	51.43
.2180		.2075	5	1-1/4	6	TR94331	51.43
.2185		.2075	5	1-1/4	6	TR94332	51.43
.2188	7/32	.2075	5	1-1/4	6	TR96106	43.25
.2190		.2173	6	1-1/2	6	TR94333	52.29
.2195		.2173	6	1-1/2	6	TR94334	52.29
.2200		.2173	6	1-1/2	6	TR94335	52.29
.2205		.2173	6	1-1/2	6	TR94336	52.29
.2210	#2	.2173	6	1-1/2	6	TR96107	44.45
.2215		.2173	6	1-1/2	6	TR94337	52.29
.2220		.2173	6	1-1/2	6	TR94338	52.29
.2225		.2173	6	1-1/2	6	TR94339	52.29

For technical information, please see page 263.

THRU 1/2" DIAMETER	1/2" TO 5/8"	5/8" TO 1-1/2"	1-1/2" TO 2"
+ .0002, -.0000	+ .0003, -.0000	+ .0001, +.0004	+ .0002, +.0006

GENERAL PURPOSE HSS REAMERS



YOUR #1 SOURCE FOR AMERICAN-MADE PREMIUM QUALITY CUTTING TOOLS

REAMING

CHUCKING - STRAIGHT FLUTE STOCKED INTERMEDIATE & STANDARD SIZES



SERIES 933

HSS & COBALT REAMERS

DEC. EQUIV.	SIZE	SHANK DIA.	OVERALL LENGTH	FLUTE LENGTH	# OF FLUTES	ITEM#	LIST PRICE
.2230		.2173	6	1-1/2	6	TR94340	52.29
.2235		.2173	6	1-1/2	6	TR94341	52.29
.2240		.2173	6	1-1/2	6	TR94342	52.29
.2245		.2173	6	1-1/2	6	TR94343	52.29
.2250		.2173	6	1-1/2	6	TR94344	52.29
.2255		.2173	6	1-1/2	6	TR94345	52.29
.2260		.2173	6	1-1/2	6	TR94346	52.29
.2265		.2173	6	1-1/2	6	TR94347	52.29
.2270		.2173	6	1-1/2	6	TR94348	52.29
.2275		.2173	6	1-1/2	6	TR94349	52.29
.2280	#1	.2173	6	1-1/2	6	TR96108	44.45
.2285		.2265	6	1-1/2	6	TR94350	52.29
.2290		.2265	6	1-1/2	6	TR94351	52.29
.2295		.2265	6	1-1/2	6	TR94352	52.29
.2300		.2265	6	1-1/2	6	TR94353	52.29
.2305		.2265	6	1-1/2	6	TR94354	52.29
.2310		.2265	6	1-1/2	6	TR94355	52.29
.2315		.2265	6	1-1/2	6	TR94356	52.29
.2320		.2265	6	1-1/2	6	TR94357	52.29
.2325		.2265	6	1-1/2	6	TR94358	52.29
.2330		.2265	6	1-1/2	6	TR94359	52.29
.2335		.2265	6	1-1/2	6	TR94360	52.29
.2340	A	.2265	6	1-1/2	6	TR96109	44.45
.2344	15/64	.2265	6	1-1/2	6	TR96110	44.45
.2345		.2265	6	1-1/2	6	TR94361	47.14
.2350		.2265	6	1-1/2	6	TR94362	47.14
.2355		.2265	6	1-1/2	6	TR94363	47.14
.2360		.2265	6	1-1/2	6	TR94364	47.14
.2362	6.0mm	.2265	6	1-1/2	6	TR96111	46.86
.2365		.2329	6	1-1/2	6	TR94365	47.14
.2370		.2329	6	1-1/2	6	TR94366	47.14
.2375		.2329	6	1-1/2	6	TR94367	47.14
.2380	B	.2329	6	1-1/2	6	TR96112	46.86
.2385		.2329	6	1-1/2	6	TR94368	47.14
.2390		.2329	6	1-1/2	6	TR94369	47.14
.2395		.2329	6	1-1/2	6	TR94370	47.14
.2400		.2329	6	1-1/2	6	TR94371	47.14
.2405		.2329	6	1-1/2	6	TR94372	47.14
.2410		.2329	6	1-1/2	6	TR94373	47.14
.2415		.2329	6	1-1/2	6	TR94374	47.14
.2420	C	.2329	6	1-1/2	6	TR96113	46.86
.2425		.2329	6	1-1/2	6	TR94375	47.14
.2430		.2329	6	1-1/2	6	TR94376	47.14
.2435		.2329	6	1-1/2	6	TR94377	47.14

DEC. EQUIV.	SIZE	SHANK DIA.	OVERALL LENGTH	FLUTE LENGTH	# OF FLUTES	ITEM#	LIST PRICE
.2440		.2329	6	1-1/2	6	TR94378	47.14
.2445		.2329	6	1-1/2	6	TR94379	47.14
.2450		.2329	6	1-1/2	6	TR94380	47.14
.2455		.2329	6	1-1/2	6	TR94381	47.14
.2460	D	.2329	6	1-1/2	6	TR96114	46.86
.2465		.2405	6	1-1/2	6	TR94382	47.14
.2470		.2405	6	1-1/2	6	TR94383	47.14
.2475		.2405	6	1-1/2	6	TR94384	47.14
.2480		.2405	6	1-1/2	6	TR94385	47.14
.2485		.2405	6	1-1/2	6	TR94386	47.14
.2490	O/U	.2405	6	1-1/2	6	TR96115	43.85
.2495		.2405	6	1-1/2	6	TR94387	47.14
.2500	1/4	.2405	6	1-1/2	6	TR96116	41.70
.2505		.2405	6	1-1/2	6	TR94388	60.14
.2510	O/U	.2405	6	1-1/2	6	TR96117	43.85
.2515		.2405	6	1-1/2	6	TR94389	60.14
.2520		.2405	6	1-1/2	6	TR94390	60.14
.2525		.2405	6	1-1/2	6	TR94391	60.14
.2530		.2405	6	1-1/2	6	TR94392	60.14
.2535		.2405	6	1-1/2	6	TR94393	60.14
.2540		.2405	6	1-1/2	6	TR94394	60.14
.2545		.2405	6	1-1/2	6	TR94395	60.14
.2550		.2405	6	1-1/2	6	TR94396	60.14
.2555		.2405	6	1-1/2	6	TR94397	60.14
.2559	6.5mm	.2405	6	1-1/2	6	TR96118	46.86
.2560		.2485	6	1-1/2	6	TR94398	60.14
.2565		.2485	6	1-1/2	6	TR94399	60.14
.2570	F	.2485	6	1-1/2	6	TR96119	46.86
.2575		.2485	6	1-1/2	6	TR94400	60.14
.2580		.2485	6	1-1/2	6	TR94401	60.14
.2585		.2485	6	1-1/2	6	TR94402	60.14
.2590		.2485	6	1-1/2	6	TR94403	60.14
.2595		.2485	6	1-1/2	6	TR94404	60.14
.2600		.2485	6	1-1/2	6	TR94405	60.14
.2605		.2485	6	1-1/2	6	TR94406	60.14
.2610	G	.2485	6	1-1/2	6	TR96120	46.86
.2615		.2485	6	1-1/2	6	TR94407	60.14
.2620		.2485	6	1-1/2	6	TR94408	60.14
.2625		.2485	6	1-1/2	6	TR94409	60.14
.2630		.2485	6	1-1/2	6	TR94410	60.14
.2635		.2485	6	1-1/2	6	TR94411	60.14
.2640		.2485	6	1-1/2	6	TR94412	60.14
.2645		.2485	6	1-1/2	6	TR94413	60.14
.2650		.2485	6	1-1/2	6	TR94414	60.14

For technical information, please see page 263.

THRU 1/2" DIAMETER	1/2" TO 5/8"	5/8" TO 1-1/2"	1-1/2" TO 2"
+ .0002, -.0000	+ .0003, -.0000	+ .0001, +.0004	+ .0002, +.0006

TECHNICAL



GENERAL PURPOSE HSS REAMERS

YOUR #1 SOURCE FOR AMERICAN-MADE PREMIUM QUALITY CUTTING TOOLS

CHUCKING - STRAIGHT FLUTE STOCKED INTERMEDIATE & STANDARD SIZES



SERIES 933

DEC. EQUIV.	SIZE	SHANK DIA.	OVERALL LENGTH	FLUTE LENGTH	# OF FLUTES	ITEM #	LIST PRICE
.2655		.2485	6	1-1/2	6	TR94415	60.14
.2656	17/64	.2485	6	1-1/2	6	TR96121	52.20
.2660	H	.2485	6	1-1/2	6	TR96122	52.20
.2665		.2485	6	1-1/2	6	TR94416	60.14
.2670		.2485	6	1-1/2	6	TR94417	60.14
.2675		.2485	6	1-1/2	6	TR94418	60.14
.2680		.2485	6	1-1/2	6	TR94419	60.14
.2685		.2485	6	1-1/2	6	TR94420	60.14
.2690		.2485	6	1-1/2	6	TR94421	60.14
.2695		.2485	6	1-1/2	6	TR94422	60.14
.2700		.2485	6	1-1/2	6	TR94423	60.14
.2705		.2485	6	1-1/2	6	TR94424	60.14
.2710		.2485	6	1-1/2	6	TR94425	60.14
.2715		.2485	6	1-1/2	6	TR94426	60.14
.2720	I	.2485	6	1-1/2	6	TR96123	52.20
.2725		.2485	6	1-1/2	6	TR94427	60.14
.2730		.2485	6	1-1/2	6	TR94428	60.14
.2735		.2485	6	1-1/2	6	TR94429	60.14
.2740		.2485	6	1-1/2	6	TR94430	60.14
.2745		.2485	6	1-1/2	6	TR94431	60.14
.2750		.2485	6	1-1/2	6	TR94432	60.14
.2755		.2485	6	1-1/2	6	TR94433	60.14
.2756	7.0mm	.2485	6	1-1/2	6	TR96124	52.20
.2760		.2485	6	1-1/2	6	TR94434	60.14
.2765		.2485	6	1-1/2	6	TR94435	60.14
.2770	J	.2485	6	1-1/2	6	TR96125	52.20
.2775		.2485	6	1-1/2	6	TR94436	60.14
.2780		.2485	6	1-1/2	6	TR94437	60.14
.2785		.2485	6	1-1/2	6	TR94438	60.14
.2790		.2485	6	1-1/2	6	TR94439	60.14
.2795		.2485	6	1-1/2	6	TR94440	60.14
.2800		.2485	6	1-1/2	6	TR94441	60.14
.2805		.2485	6	1-1/2	6	TR94442	60.14
.2810	K	.2485	6	1-1/2	6	TR96126	52.20
.2812	9/32	.2485	6	1-1/2	6	TR96127	49.55
.2815		.2792	6	1-1/2	6	TR94443	60.14
.2820		.2792	6	1-1/2	6	TR94444	60.14
.2825		.2792	6	1-1/2	6	TR94445	60.14
.2830		.2792	6	1-1/2	6	TR94446	60.14
.2835		.2792	6	1-1/2	6	TR94447	60.14
.2840		.2792	6	1-1/2	6	TR94448	60.14
.2845		.2792	6	1-1/2	6	TR94449	60.14
.2850		.2792	6	1-1/2	6	TR94450	60.14
.2855		.2792	6	1-1/2	6	TR94451	60.14

DEC. EQUIV.	SIZE	SHANK DIA.	OVERALL LENGTH	FLUTE LENGTH	# OF FLUTES	ITEM #	LIST PRICE
.2860		.2792	6	1-1/2	6	TR94452	60.14
.2865		.2792	6	1-1/2	6	TR94453	60.14
.2870		.2792	6	1-1/2	6	TR94454	60.14
.2875		.2792	6	1-1/2	6	TR94455	60.14
.2880		.2792	6	1-1/2	6	TR94456	60.14
.2885		.2792	6	1-1/2	6	TR94457	60.14
.2890		.2792	6	1-1/2	6	TR94458	60.14
.2895		.2792	6	1-1/2	6	TR94459	60.14
.2900	L	.2792	6	1-1/2	6	TR96128	52.20
.2905		.2792	6	1-1/2	6	TR94460	60.14
.2910		.2792	6	1-1/2	6	TR94461	60.14
.2915		.2792	6	1-1/2	6	TR94462	60.14
.2920		.2792	6	1-1/2	6	TR94463	60.14
.2925		.2792	6	1-1/2	6	TR94464	60.14
.2930		.2792	6	1-1/2	6	TR94465	60.14
.2935		.2792	6	1-1/2	6	TR94466	60.14
.2940		.2792	6	1-1/2	6	TR94467	60.14
.2945		.2792	6	1-1/2	6	TR94468	60.14
.2950	M	.2792	6	1-1/2	6	TR96129	52.20
.2953	7.5mm	.2792	6	1-1/2	6	TR96130	52.20
.2955		.2792	6	1-1/2	6	TR94469	60.14
.2960		.2792	6	1-1/2	6	TR94470	60.14
.2965		.2792	6	1-1/2	6	TR94471	60.14
.2969	19/64	.2792	6	1-1/2	6	TR96131	52.20
.2970		.2792	6	1-1/2	6	TR94472	53.83
.2975		.2792	6	1-1/2	6	TR94473	53.83
.2980		.2792	6	1-1/2	6	TR94474	53.83
.2985		.2792	6	1-1/2	6	TR94475	53.83
.2990		.2792	6	1-1/2	6	TR94476	53.83
.2995		.2792	6	1-1/2	6	TR94477	53.83
.3000		.2792	6	1-1/2	6	TR94478	53.83
.3005		.2792	6	1-1/2	6	TR94479	53.83
.3010		.2792	6	1-1/2	6	TR94480	53.83
.3015		.2792	6	1-1/2	6	TR94481	53.83
.3020	N	.2792	6	1-1/2	6	TR96132	52.20
.3025		.2792	6	1-1/2	6	TR94482	53.83
.3030		.2792	6	1-1/2	6	TR94483	53.83
.3035		.2792	6	1-1/2	6	TR94484	53.83
.3040		.2792	6	1-1/2	6	TR94485	53.83
.3045		.2792	6	1-1/2	6	TR94486	53.83
.3050		.2792	6	1-1/2	6	TR94487	53.83
.3055		.2792	6	1-1/2	6	TR94488	53.83
.3060		.2792	6	1-1/2	6	TR94489	53.83
.3065		.2792	6	1-1/2	6	TR94490	53.83

For technical information, please see page 263.

THRU 1/2" DIAMETER	1/2" TO 5/8"	5/8" TO 1-1/2"	1-1/2" TO 2"
+ .0002, -.0000	+ .0003, -.0000	+ .0001, +.0004	+ .0002, +.0006

GENERAL PURPOSE HSS REAMERS



YOUR #1 SOURCE FOR AMERICAN-MADE PREMIUM QUALITY CUTTING TOOLS

REAMING

CHUCKING - STRAIGHT FLUTE STOCKED INTERMEDIATE & STANDARD SIZES



SERIES 933

DEC. EQUIV.	SIZE	SHANK DIA.	OVERALL LENGTH	FLUTE LENGTH	# OF FLUTES	ITEM#	LIST PRICE
.3070		.2792	6	1-1/2	6	TR94491	53.83
.3075		.2792	6	1-1/2	6	TR94492	53.83
.3080		.2792	6	1-1/2	6	TR94493	53.83
.3085		.2792	6	1-1/2	6	TR94494	53.83
.3090		.2792	6	1-1/2	6	TR94495	53.83
.3095		.2792	6	1-1/2	6	TR94496	53.83
.3100		.2792	6	1-1/2	6	TR94497	53.83
.3105		.2792	6	1-1/2	6	TR94498	53.83
.3110		.2792	6	1-1/2	6	TR94499	53.83
.3115	O/U	.2792	6	1-1/2	6	TR96133	49.55
.3120		.2792	6	1-1/2	6	TR94500	53.83
.3125	5/16	.2792	6	1-1/2	6	TR96134	47.05
.3130		.2792	6	1-1/2	6	TR94501	63.40
.3135	O/U	.2792	6	1-1/2	6	TR96135	49.55
.3140		.2792	6	1-1/2	6	TR94502	63.40
.3145		.2792	6	1-1/2	6	TR94503	63.40
.3150	8.0mm	.2792	6	1-1/2	6	TR96136	52.20
.3155		.2792	6	1-1/2	6	TR94504	63.40
.3160	O	.2792	6	1-1/2	6	TR96137	52.20
.3165		.2792	6	1-1/2	6	TR94505	63.40
.3170		.2792	6	1-1/2	6	TR94506	63.40
.3175		.2792	6	1-1/2	6	TR94507	63.40
.3180		.2792	6	1-1/2	6	TR94508	63.40
.3185		.2792	6	1-1/2	6	TR94509	63.40
.3190		.2792	6	1-1/2	6	TR94510	63.40
.3195		.2792	6	1-1/2	6	TR94511	63.40
.3200		.2792	6	1-1/2	6	TR94512	63.40
.3205		.2792	6	1-1/2	6	TR94513	63.40
.3210		.2792	6	1-1/2	6	TR94514	63.40
.3215		.2792	6	1-1/2	6	TR94515	63.40
.3220		.2792	6	1-1/2	6	TR94516	63.40
.3225		.2792	6	1-1/2	6	TR94517	63.40
.3230	P	.2792	6	1-1/2	6	TR96138	55.81
.3235		.2792	6	1-1/2	6	TR94518	63.40
.3240		.2792	6	1-1/2	6	TR94519	63.40
.3245		.2792	6	1-1/2	6	TR94520	63.40
.3250		.2792	6	1-1/2	6	TR94521	63.40
.3255		.2792	6	1-1/2	6	TR94522	63.40
.3260		.2792	6	1-1/2	6	TR94523	63.40
.3265		.2792	6	1-1/2	6	TR94524	63.40
.3270		.2792	6	1-1/2	6	TR94525	63.40
.3275		.2792	6	1-1/2	6	TR94526	63.40
.3280		.2792	6	1-1/2	6	TR94527	63.40
.3281	21/64	.2792	6	1-1/2	6	TR96139	55.81

DEC. EQUIV.	SIZE	SHANK DIA.	OVERALL LENGTH	FLUTE LENGTH	# OF FLUTES	ITEM#	LIST PRICE
.3285		.2792	6	1-1/2	6	TR94528	63.40
.3290		.2792	6	1-1/2	6	TR94529	63.40
.3295		.2792	6	1-1/2	6	TR94530	63.40
.3300		.2792	6	1-1/2	6	TR94531	63.40
.3305		.2792	6	1-1/2	6	TR94532	63.40
.3310		.2792	6	1-1/2	6	TR94533	63.40
.3315		.2792	6	1-1/2	6	TR94534	63.40
.3320	Q	.2792	6	1-1/2	6	TR96140	55.81
.3325		.2792	6	1-1/2	6	TR94535	63.40
.3330		.2792	6	1-1/2	6	TR94536	63.40
.3335		.2792	6	1-1/2	6	TR94537	63.40
.3340		.2792	6	1-1/2	6	TR94538	63.40
.3345		.2792	6	1-1/2	6	TR94539	63.40
.3346	8.5mm	.2792	6	1-1/2	6	TR96141	55.81
.3350		.2792	6	1-1/2	6	TR94540	63.40
.3355		.2792	6	1-1/2	6	TR94541	63.40
.3360		.2792	6	1-1/2	6	TR94542	63.40
.3365		.2792	6	1-1/2	6	TR94543	63.40
.3370		.2792	6	1-1/2	6	TR94544	63.40
.3375		.2792	6	1-1/2	6	TR94545	63.40
.3380		.2792	6	1-1/2	6	TR94546	63.40
.3385		.2792	6	1-1/2	6	TR94547	63.40
.3390	R	.2792	6	1-1/2	6	TR96142	55.81
.3395		.2792	6	1-1/2	6	TR94548	63.40
.3400		.2792	6	1-1/2	6	TR94549	63.40
.3405		.2792	6	1-1/2	6	TR94550	63.40
.3410		.2792	6	1-1/2	6	TR94551	63.40
.3415		.2792	6	1-1/2	6	TR94552	63.40
.3420		.2792	6	1-1/2	6	TR94553	63.40
.3425		.2792	6	1-1/2	6	TR94554	63.40
.3430		.2792	6	1-1/2	6	TR94555	63.40
.3435		.2792	6	1-1/2	6	TR94556	63.40
.3438	11/32	.2792	6	1-1/2	6	TR96143	55.81
.3440		.3105	7	1-3/4	6	TR94557	64.33
.3445		.3105	7	1-3/4	6	TR94558	64.33
.3450		.3105	7	1-3/4	6	TR94559	64.33
.3455		.3105	7	1-3/4	6	TR94560	64.33
.3460		.3105	7	1-3/4	6	TR94561	64.33
.3465		.3105	7	1-3/4	6	TR94562	64.33
.3470		.3105	7	1-3/4	6	TR94563	64.33
.3475		.3105	7	1-3/4	6	TR94564	64.33
.3480	S	.3105	6	1-3/4	6	TR96144	56.38
.3485		.3105	7	1-3/4	6	TR94565	64.33
.3490		.3105	7	1-3/4	6	TR94566	64.33

HSS & COBALT REAMERS

For technical information, please see page 263.

THRU 1/2" DIAMETER	1/2" TO 5/8"	5/8" TO 1-1/2"	1-1/2" TO 2"
+ .0002, -.0000	+ .0003, -.0000	+ .0001, +.0004	+ .0002, +.0006

TECHNICAL



GENERAL PURPOSE HSS REAMERS

YOUR #1 SOURCE FOR AMERICAN-MADE PREMIUM QUALITY CUTTING TOOLS

CHUCKING - STRAIGHT FLUTE STOCKED INTERMEDIATE & STANDARD SIZES



SERIES 933

DEC. EQUIV.	SIZE	SHANK DIA.	OVERALL LENGTH	FLUTE LENGTH	# OF FLUTES	ITEM #	LIST PRICE
.3495		.3105	7	1-3/4	6	TR94567	64.33
.3500		.3105	7	1-3/4	6	TR94568	64.33
.3505		.3105	7	1-3/4	6	TR94569	64.33
.3510		.3105	7	1-3/4	6	TR94570	64.33
.3515		.3105	7	1-3/4	6	TR94571	64.33
.3520		.3105	7	1-3/4	6	TR94572	64.33
.3525		.3105	7	1-3/4	6	TR94573	64.33
.3530		.3105	7	1-3/4	6	TR94574	64.33
.3535		.3105	7	1-3/4	6	TR94575	64.33
.3540		.3105	7	1-3/4	6	TR94576	64.33
.3543	9.0mm	.3105	7	1-3/4	6	TR96145	56.38
.3545		.3105	7	1-3/4	6	TR94577	64.33
.3550		.3105	7	1-3/4	6	TR94578	64.33
.3555		.3105	7	1-3/4	6	TR94579	64.33
.3560		.3105	7	1-3/4	6	TR94580	64.33
.3565		.3105	7	1-3/4	6	TR94581	64.33
.3570		.3105	7	1-3/4	6	TR94582	64.33
.3575		.3105	7	1-3/4	6	TR94583	64.33
.3580	T	.3105	7	1-3/4	6	TR96146	56.38
.3585		.3105	7	1-3/4	6	TR94584	64.33
.3590		.3105	7	1-3/4	6	TR94585	64.33
.3594	23/64	.3105	7	1-3/4	6	TR96147	56.38
.3595		.3105	7	1-3/4	6	TR94586	57.64
.3600		.3105	7	1-3/4	6	TR94587	57.64
.3605		.3105	7	1-3/4	6	TR94588	57.64
.3610		.3105	7	1-3/4	6	TR94589	57.64
.3615		.3105	7	1-3/4	6	TR94590	57.64
.3620		.3105	7	1-3/4	6	TR94591	57.64
.3625		.3105	7	1-3/4	6	TR94592	57.64
.3630		.3105	7	1-3/4	6	TR94593	57.64
.3635		.3105	7	1-3/4	6	TR94594	57.64
.3640		.3105	7	1-3/4	6	TR94595	57.64
.3645		.3105	7	1-3/4	6	TR94596	57.64
.3650		.3105	7	1-3/4	6	TR94597	57.64
.3655		.3105	7	1-3/4	6	TR94598	57.64
.3660		.3105	7	1-3/4	6	TR94599	57.64
.3665		.3105	7	1-3/4	6	TR94600	57.64
.3670		.3105	7	1-3/4	6	TR94601	57.64
.3675		.3105	7	1-3/4	6	TR94602	57.64
.3680	U	.3105	7	1-3/4	6	TR96148	56.38
.3685		.3105	7	1-3/4	6	TR94603	57.64
.3690		.3105	7	1-3/4	6	TR94604	57.64
.3695		.3105	7	1-3/4	6	TR94605	57.64
.3700		.3105	7	1-3/4	6	TR94606	57.64

DEC. EQUIV.	SIZE	SHANK DIA.	OVERALL LENGTH	FLUTE LENGTH	# OF FLUTES	ITEM #	LIST PRICE
.3705		.3105	7	1-3/4	6	TR94607	57.64
.3710		.3105	7	1-3/4	6	TR94608	57.64
.3715		.3105	7	1-3/4	6	TR94609	57.64
.3720		.3105	7	1-3/4	6	TR94610	57.64
.3725		.3105	7	1-3/4	6	TR94611	57.64
.3730		.3105	7	1-3/4	6	TR94612	57.64
.3735		.3105	7	1-3/4	6	TR94613	57.64
.3740	O/U	.3105	7	1-3/4	6	TR96149	53.54
.3745		.3105	7	1-3/4	6	TR94614	57.64
.3750	3/8	.3105	7	1-3/4	6	TR96150	50.66
.3755		.3105	7	1-3/4	6	TR94615	69.37
.3760	O/U	.3105	7	1-3/4	6	TR96151	53.54
.3765		.3105	7	1-3/4	6	TR94616	69.37
.3770	V	.3105	7	1-3/4	6	TR96152	61.29
.3775		.3105	7	1-3/4	6	TR94617	69.37
.3780		.3105	7	1-3/4	6	TR94618	69.37
.3785		.3105	7	1-3/4	6	TR94619	69.37
.3790		.3105	7	1-3/4	6	TR94620	69.37
.3795		.3105	7	1-3/4	6	TR94621	69.37
.3800		.3105	7	1-3/4	6	TR94622	69.37
.3805		.3105	7	1-3/4	6	TR94623	69.37
.3810		.3105	7	1-3/4	6	TR94624	69.37
.3815		.3105	7	1-3/4	6	TR94625	69.37
.3820		.3105	7	1-3/4	6	TR94626	69.37
.3825		.3105	7	1-3/4	6	TR94627	69.37
.3830		.3105	7	1-3/4	6	TR94628	69.37
.3835		.3105	7	1-3/4	6	TR94629	69.37
.3840		.3105	7	1-3/4	6	TR94630	69.37
.3845		.3105	7	1-3/4	6	TR94631	69.37
.3850		.3105	7	1-3/4	6	TR94632	69.37
.3855		.3105	7	1-3/4	6	TR94633	69.37
.3860	W	.3105	7	1-3/4	6	TR96153	61.29
.3865		.3105	7	1-3/4	6	TR94634	69.37
.3870		.3105	7	1-3/4	6	TR94635	69.37
.3875		.3105	7	1-3/4	6	TR94636	69.37
.3880		.3105	7	1-3/4	6	TR94637	69.37
.3885		.3105	7	1-3/4	6	TR94638	69.37
.3890		.3105	7	1-3/4	6	TR94639	69.37
.3895		.3105	7	1-3/4	6	TR94640	69.37
.3900		.3105	7	1-3/4	6	TR94641	69.37
.3905		.3105	7	1-3/4	6	TR94642	69.37
.3906	25/64	.3105	7	1-3/4	6	TR96154	61.29
.3910		.3105	7	1-3/4	6	TR94643	71.15
.3915		.3105	7	1-3/4	6	TR94644	71.15

For technical information, please see page 263.

THRU 1/2" DIAMETER	1/2" TO 5/8"	5/8" TO 1-1/2"	1-1/2" TO 2"
+ .0002, -.0000	+ .0003, -.0000	+ .0001, +.0004	+ .0002, +.0006

GENERAL PURPOSE HSS REAMERS



YOUR #1 SOURCE FOR AMERICAN-MADE PREMIUM QUALITY CUTTING TOOLS

REAMING

CHUCKING - STRAIGHT FLUTE STOCKED INTERMEDIATE & STANDARD SIZES



SERIES 933

DEC. EQUIV.	SIZE	SHANK DIA.	OVERALL LENGTH	FLUTE LENGTH	# OF FLUTES	ITEM#	LIST PRICE
.3920		.3105	7	1-3/4	6	TR94645	71.15
.3925		.3105	7	1-3/4	6	TR94646	71.15
.3930		.3105	7	1-3/4	6	TR94647	71.15
.3935		.3105	7	1-3/4	6	TR94648	71.15
.3937	10.0mm	.3105	7	1-3/4	6	TR96155	61.29
.3940		.3105	7	1-3/4	6	TR94649	71.15
.3945		.3105	7	1-3/4	6	TR94650	71.15
.3950		.3105	7	1-3/4	6	TR94651	71.15
.3955		.3105	7	1-3/4	6	TR94652	71.15
.3960		.3105	7	1-3/4	6	TR94653	71.15
.3965		.3105	7	1-3/4	6	TR94654	71.15
.3970	X	.3105	7	1-3/4	6	TR96156	61.29
.3975		.3105	7	1-3/4	6	TR94655	71.15
.3980		.3105	7	1-3/4	6	TR94656	71.15
.3985		.3105	7	1-3/4	6	TR94657	71.15
.3990		.3105	7	1-3/4	6	TR94658	71.15
.3995		.3105	7	1-3/4	6	TR94659	71.15
.4000		.3105	7	1-3/4	6	TR94660	71.15
.4005		.3105	7	1-3/4	6	TR94661	71.15
.4010		.3105	7	1-3/4	6	TR94662	71.15
.4015		.3105	7	1-3/4	6	TR94663	71.15
.4020		.3105	7	1-3/4	6	TR94664	71.15
.4025		.3105	7	1-3/4	6	TR94665	71.15
.4030		.3105	7	1-3/4	6	TR94666	71.15
.4035		.3105	7	1-3/4	6	TR94667	71.15
.4040	Y	.3105	7	1-3/4	6	TR96157	63.60
.4045		.3105	7	1-3/4	6	TR94668	71.15
.4050		.3105	7	1-3/4	6	TR94669	71.15
.4055		.3105	7	1-3/4	6	TR94670	71.15
.4060		.3105	7	1-3/4	6	TR94671	71.15
.4062	13/32	.3105	7	1-3/4	6	TR96158	63.60
.4065		.3730	7	1-3/4	6	TR94672	71.15
.4070		.3730	7	1-3/4	6	TR94673	71.15
.4075		.3730	7	1-3/4	6	TR94674	71.15
.4080		.3730	7	1-3/4	6	TR94675	71.15
.4085		.3730	7	1-3/4	6	TR94676	71.15
.4090		.3730	7	1-3/4	6	TR94677	71.15
.4095		.3730	7	1-3/4	6	TR94678	71.15
.4100		.3730	7	1-3/4	6	TR94679	71.15
.4105		.3730	7	1-3/4	6	TR94680	71.15
.4110		.3730	7	1-3/4	6	TR94681	71.15
.4115		.3730	7	1-3/4	6	TR94682	71.15
.4120		.3730	7	1-3/4	6	TR94683	71.15
.4125		.3730	7	1-3/4	6	TR94684	71.15

DEC. EQUIV.	SIZE	SHANK DIA.	OVERALL LENGTH	FLUTE LENGTH	# OF FLUTES	ITEM#	LIST PRICE
.4130	Z	.3730	7	1-3/4	6	TR96159	63.60
.4134	10.5mm	.3730	7	1-3/4	6	TR96160	64.22
.4135		.3730	7	1-3/4	6	TR94685	71.15
.4140		.3730	7	1-3/4	6	TR94686	71.15
.4145		.3730	7	1-3/4	6	TR94687	71.15
.4150		.3730	7	1-3/4	6	TR94688	71.15
.4155		.3730	7	1-3/4	6	TR94689	71.15
.4160		.3730	7	1-3/4	6	TR94690	71.15
.4165		.3730	7	1-3/4	6	TR94691	71.15
.4170		.3730	7	1-3/4	6	TR94692	71.15
.4175		.3730	7	1-3/4	6	TR94693	71.15
.4180		.3730	7	1-3/4	6	TR94694	71.15
.4185		.3730	7	1-3/4	6	TR94695	71.15
.4190		.3730	7	1-3/4	6	TR94696	71.15
.4195		.3730	7	1-3/4	6	TR94697	71.15
.4200		.3730	7	1-3/4	6	TR94698	71.15
.4205		.3730	7	1-3/4	6	TR94699	71.15
.4210		.3730	7	1-3/4	6	TR94700	71.15
.4215		.3730	7	1-3/4	6	TR94701	71.15
.4219	27/64	.3730	7	1-3/4	6	TR96161	63.60
.4220		.3730	7	1-3/4	6	TR94702	66.72
.4225		.3730	7	1-3/4	6	TR94703	66.72
.4230		.3730	7	1-3/4	6	TR94704	66.72
.4235		.3730	7	1-3/4	6	TR94705	66.72
.4240		.3730	7	1-3/4	6	TR94706	66.72
.4245		.3730	7	1-3/4	6	TR94707	66.72
.4250		.3730	7	1-3/4	6	TR94708	66.72
.4255		.3730	7	1-3/4	6	TR94709	66.72
.4260		.3730	7	1-3/4	6	TR94710	66.72
.4265		.3730	7	1-3/4	6	TR94711	66.72
.4270		.3730	7	1-3/4	6	TR94712	66.72
.4275		.3730	7	1-3/4	6	TR94713	66.72
.4280		.3730	7	1-3/4	6	TR94714	66.72
.4285		.3730	7	1-3/4	6	TR94715	66.72
.4290		.3730	7	1-3/4	6	TR94716	66.72
.4295		.3730	7	1-3/4	6	TR94717	66.72
.4300		.3730	7	1-3/4	6	TR94718	66.72
.4305		.3730	7	1-3/4	6	TR94719	66.72
.4310		.3730	7	1-3/4	6	TR94720	66.72
.4315		.3730	7	1-3/4	6	TR94721	66.72
.4320		.3730	7	1-3/4	6	TR94722	66.72
.4325		.3730	7	1-3/4	6	TR94723	66.72
.4330		.3730	7	1-3/4	6	TR94724	66.72
.4331	11.0mm	.3730	7	1-3/4	6	TR96162	63.60

For technical information, please see page 263.

THRU 1/2" DIAMETER	1/2" TO 5/8"	5/8" TO 1-1/2"	1-1/2" TO 2"
+0.0002, -0.0000	+0.0003, -0.0000	+0.0001, +0.0004	+0.0002, +0.0006



GENERAL PURPOSE HSS REAMERS

YOUR #1 SOURCE FOR AMERICAN-MADE PREMIUM QUALITY CUTTING TOOLS

CHUCKING - STRAIGHT FLUTE STOCKED INTERMEDIATE & STANDARD SIZES



SERIES 933

DEC. EQUIV.	SIZE	SHANK DIA.	OVERALL LENGTH	FLUTE LENGTH	# OF FLUTES	ITEM#	LIST PRICE
.4335		.3730	7	1-3/4	6	TR94725	66.72
.4340		.3730	7	1-3/4	6	TR94726	66.72
.4345		.3730	7	1-3/4	6	TR94727	66.72
.4350		.3730	7	1-3/4	6	TR94728	66.72
.4355		.3730	7	1-3/4	6	TR94729	66.72
.4360		.3730	7	1-3/4	6	TR94730	66.72
.4365	O/U	.3730	7	1-3/4	6	TR96163	60.42
.4370		.3730	7	1-3/4	6	TR94731	66.72
.4375	7/16	.3730	7	1-3/4	6	TR96164	60.42
.4380		.3730	7	1-3/4	6	TR94732	75.67
.4385	O/U	.3730	7	1-3/4	6	TR96165	60.42
.4390		.3730	7	1-3/4	6	TR94733	75.67
.4395		.3730	7	1-3/4	6	TR94734	75.67
.4400		.3730	7	1-3/4	6	TR94735	75.67
.4405		.3730	7	1-3/4	6	TR94736	75.67
.4410		.3730	7	1-3/4	6	TR94737	75.67
.4415		.3730	7	1-3/4	6	TR94738	75.67
.4420		.3730	7	1-3/4	6	TR94739	75.67
.4425		.3730	7	1-3/4	6	TR94740	75.67
.4430		.3730	7	1-3/4	6	TR94741	75.67
.4435		.3730	7	1-3/4	6	TR94742	75.67
.4440		.3730	7	1-3/4	6	TR94743	75.67
.4445		.3730	7	1-3/4	6	TR94744	75.67
.4450		.3730	7	1-3/4	6	TR94745	75.67
.4455		.3730	7	1-3/4	6	TR94746	75.67
.4460		.3730	7	1-3/4	6	TR94747	75.67
.4465		.3730	7	1-3/4	6	TR94748	75.67
.4470		.3730	7	1-3/4	6	TR94749	75.67
.4475		.3730	7	1-3/4	6	TR94750	75.67
.4480		.3730	7	1-3/4	6	TR94751	75.67
.4485		.3730	7	1-3/4	6	TR94752	75.67
.4490		.3730	7	1-3/4	6	TR94753	75.67
.4495		.3730	7	1-3/4	6	TR94754	75.67
.4500		.3730	7	1-3/4	6	TR94755	75.67
.4505		.3730	7	1-3/4	6	TR94756	75.67
.4510		.3730	7	1-3/4	6	TR94757	75.67
.4515		.3730	7	1-3/4	6	TR94758	75.67
.4520		.3730	7	1-3/4	6	TR94759	75.67
.4525		.3730	7	1-3/4	6	TR94760	75.67
.4528	11.5mm	.3730	7	1-3/4	6	TR96166	69.28
.4530		.3730	7	1-3/4	6	TR94761	75.67
.4531	29/64	.3730	7	1-3/4	6	TR96167	69.28
.4535		.3730	7	1-3/4	6	TR94762	75.67
.4540		.3730	7	1-3/4	6	TR94763	75.67

DEC. EQUIV.	SIZE	SHANK DIA.	OVERALL LENGTH	FLUTE LENGTH	# OF FLUTES	ITEM#	LIST PRICE
.4545		.3730	7	1-3/4	6	TR94764	75.67
.4550		.3730	7	1-3/4	6	TR94765	75.67
.4555		.3730	7	1-3/4	6	TR94766	75.67
.4560		.3730	7	1-3/4	6	TR94767	75.67
.4565		.3730	7	1-3/4	6	TR94768	75.67
.4570		.3730	7	1-3/4	6	TR94769	75.67
.4575		.3730	7	1-3/4	6	TR94770	75.67
.4580		.3730	7	1-3/4	6	TR94771	75.67
.4585		.3730	7	1-3/4	6	TR94772	75.67
.4590		.3730	7	1-3/4	6	TR94773	75.67
.4595		.3730	7	1-3/4	6	TR94774	75.67
.4600		.3730	7	1-3/4	6	TR94775	75.67
.4605		.3730	7	1-3/4	6	TR94776	75.67
.4610		.3730	7	1-3/4	6	TR94777	75.67
.4615		.3730	7	1-3/4	6	TR94778	75.67
.4620		.3730	7	1-3/4	6	TR94779	75.67
.4625		.3730	7	1-3/4	6	TR94780	75.67
.4630		.3730	7	1-3/4	6	TR94781	75.67
.4635		.3730	7	1-3/4	6	TR94782	75.67
.4640		.3730	7	1-3/4	6	TR94783	75.67
.4645		.3730	7	1-3/4	6	TR94784	75.67
.4650		.3730	7	1-3/4	6	TR94785	75.67
.4655		.3730	7	1-3/4	6	TR94786	75.67
.4660		.3730	7	1-3/4	6	TR94787	75.67
.4665		.3730	7	1-3/4	6	TR94788	75.67
.4670		.3730	7	1-3/4	6	TR94789	75.67
.4675		.3730	7	1-3/4	6	TR94790	75.67
.4680		.3730	7	1-3/4	6	TR94791	75.67
.4685		.3730	7	1-3/4	6	TR94792	75.67
.4688	15/32	.3730	7	1-3/4	6	TR96168	69.28
.4690		.4355	8	2	6	TR94793	75.67
.4695		.4355	8	2	6	TR94794	75.67
.4700		.4355	8	2	6	TR94795	75.67
.4705		.4355	8	2	6	TR94796	75.67
.4710		.4355	8	2	6	TR94797	75.67
.4715		.4355	8	2	6	TR94798	75.67
.4720		.4355	8	2	6	TR94799	75.67
.4724	12.0mm	.4355	8	2	6	TR96169	69.28
.4725		.4355	8	2	6	TR94800	75.67
.4730		.4355	8	2	6	TR94801	75.67
.4735		.4355	8	2	6	TR94802	75.67
.4740		.4355	8	2	6	TR94803	75.67
.4745		.4355	8	2	6	TR94804	75.67
.4750		.4355	8	2	6	TR94805	75.67

For technical information, please see page 263.

THRU 1/2" DIAMETER	1/2" TO 5/8"	5/8" TO 1-1/2"	1-1/2" TO 2"
+ .0002, -.0000	+ .0003, -.0000	+ .0001, +.0004	+ .0002, +.0006

GENERAL PURPOSE HSS REAMERS



YOUR #1 SOURCE FOR AMERICAN-MADE PREMIUM QUALITY CUTTING TOOLS

REAMING

CHUCKING - STRAIGHT FLUTE STOCKED INTERMEDIATE & STANDARD SIZES



SERIES 933

HSS & COBALT REAMERS

DEC. EQUIV.	SIZE	SHANK DIA.	OVERALL LENGTH	FLUTE LENGTH	# OF FLUTES	ITEM#	LIST PRICE
.4755		.4355	8	2	6	TR94806	75.67
.4760		.4355	8	2	6	TR94807	75.67
.4765		.4355	8	2	6	TR94808	75.67
.4770		.4355	8	2	6	TR94809	75.67
.4775		.4355	8	2	6	TR94810	75.67
.4780		.4355	8	2	6	TR94811	75.67
.4785		.4355	8	2	6	TR94812	75.67
.4790		.4355	8	2	6	TR94813	75.67
.4795		.4355	8	2	6	TR94814	75.67
.4800		.4355	8	2	6	TR94815	75.67
.4805		.4355	8	2	6	TR94816	75.67
.4810		.4355	8	2	6	TR94817	75.67
.4815		.4355	8	2	6	TR94818	75.67
.4820		.4355	8	2	6	TR94819	75.67
.4825		.4355	8	2	6	TR94820	75.67
.4830		.4355	8	2	6	TR94821	75.67
.4835		.4355	8	2	6	TR94822	75.67
.4840		.4355	8	2	6	TR94823	75.67
.4844	31/64	.4355	8	2	6	TR96170	69.28
.4845		.4355	8	2	6	TR94824	71.15
.4850		.4355	8	2	6	TR94825	71.15
.4855		.4355	8	2	6	TR94826	71.15
.4860		.4355	8	2	6	TR94827	71.15
.4865		.4355	8	2	6	TR94828	71.15
.4870		.4355	8	2	6	TR94829	71.15
.4875		.4355	8	2	6	TR94830	71.15
.4880		.4355	8	2	6	TR94831	71.15
.4885		.4355	8	2	6	TR94832	71.15
.4890		.4355	8	2	6	TR94833	71.15
.4895		.4355	8	2	6	TR94834	71.15
.4900		.4355	8	2	6	TR94835	71.15
.4905		.4355	8	2	6	TR94836	71.15
.4910		.4355	8	2	6	TR94837	71.15
.4915		.4355	8	2	6	TR94838	71.15
.4920	12.5mm	.4355	8	2	6	TR96171	69.28
.4925		.4355	8	2	6	TR94840	71.15
.4930		.4355	8	2	6	TR94841	71.15
.4935		.4355	8	2	6	TR94842	71.15
.4940		.4355	8	2	6	TR94843	71.15
.4945		.4355	8	2	6	TR94844	71.15
.4950		.4355	8	2	6	TR94845	71.15
.4955		.4355	8	2	6	TR94846	71.15
.4960		.4355	8	2	6	TR94847	71.15

DEC. EQUIV.	SIZE	SHANK DIA.	OVERALL LENGTH	FLUTE LENGTH	# OF FLUTES	ITEM#	LIST PRICE
.4965		.4355	8	2	6	TR94848	71.15
.4970		.4355	8	2	6	TR94849	71.15
.4975		.4355	8	2	6	TR94850	71.15
.4980		.4355	8	2	6	TR94851	71.15
.4985		.4355	8	2	6	TR94852	71.15
.4990	O/U	.4355	8	2	6	TR96172	65.76
.4995		.4355	8	2	6	TR94853	71.15
.5000	1/2	.4355	8	2	6	TR96173	65.76
.5005		.4355	8	2	6	TR94854	95.74
.5010	O/U	.4355	8	2	6	TR96174	65.76
.5015		.4355	8	2	6	TR94855	95.74
.5020		.4355	8	2	6	TR94856	95.74
.5025		.4355	8	2	6	TR94857	95.74
.5030		.4355	8	2	6	TR94858	95.74
.5035		.4355	8	2	6	TR94859	95.74
.5040		.4355	8	2	6	TR94860	95.74
.5045		.4355	8	2	6	TR94861	95.74
.5050		.4355	8	2	6	TR94862	95.74
.5060		.4355	8	2	6	TR94863	95.74
.5070		.4355	8	2	6	TR94864	95.74
.5080		.4355	8	2	6	TR94865	95.74
.5090		.4355	8	2	6	TR94866	95.74
.5100		.4355	8	2	6	TR94867	95.74
.5118	13.0mm	.4355	8	2	6	TR96175	85.83
.5156	33/64	.4355	8	2	6	TR96176	85.83
.5312	17/32	.4355	8	2	6	TR96177	81.74
.5315	13.5mm	.4355	8	2	6	TR96178	85.83
.5469	35/64	.4355	8	2	8	TR96179	85.83
.5512	14.0mm	.4355	8	2	8	TR96180	85.83
.5600		.4355	8	2	8	TR94868	93.77
.5605		.4355	8	2	8	TR94869	93.77
.5610		.4355	8	2	8	TR94870	93.77
.5615	O/U	.4355	8	2	8	TR96181	85.83
.5620		.4355	8	2	8	TR94871	93.77
.5625	9/16	.4355	8	2	8	TR96182	81.74
.5630		.4355	8	2	8	TR94872	107.66
.5635	O/U	.4355	8	2	8	TR96183	85.83
.5640		.4355	8	2	8	TR94873	107.66
.5645		.4355	8	2	8	TR94874	107.66
.5650		.4355	8	2	8	TR94875	107.66
.5655		.4355	8	2	8	TR94876	107.66
.5709	14.5mm	.4355	8	2	8	TR96184	85.83
.5781	37/64	.4355	8	2	8	TR96185	85.83
.5906	15.0mm	.4355	8	2	8	TR96186	85.83

For technical information, please see page 263.

THRU 1/2" DIAMETER	1/2" TO 5/8"	5/8" TO 1-1/2"	1-1/2" TO 2"
+ .0002, -.0000	+ .0003, -.0000	+ .0001, +.0004	+ .0002, +.0006

TECHNICAL



GENERAL PURPOSE HSS REAMERS

YOUR #1 SOURCE FOR AMERICAN-MADE PREMIUM QUALITY CUTTING TOOLS

CHUCKING - STRAIGHT FLUTE STOCKED INTERMEDIATE & STANDARD SIZES



SERIES 933

DEC. EQUIV.	SIZE	SHANK DIA.	OVERALL LENGTH	FLUTE LENGTH	# OF FLUTES	ITEM#	LIST PRICE
.5938	19/32	.4355	8	2	8	TR96187	81.74
.6094	39/64	.5615	9	2-1/4	8	TR96188	100.16
.6102	15.5mm	.5615	9	2-1/4	8	TR96189	100.16
.6220		.5615	9	2-1/4	8	TR94877	108.15
.6225		.5615	9	2-1/4	8	TR94878	108.15
.6230		.5615	9	2-1/4	8	TR94879	108.15
.6235		.5615	9	2-1/4	8	TR94880	108.15
.6240	O/U	.5615	9	2-1/4	8	TR96190	100.16
.6245		.5615	9	2-1/4	8	TR94881	108.15
.6250	5/8	.5615	9	2-1/4	8	TR96191	95.74
.6255		.5615	9	2-1/4	8	TR94882	120.80
.6260	O/U	.5615	9	2-1/4	8	TR96192	103.09
.6265		.5615	9	2-1/4	8	TR94883	120.80
.6270		.5615	9	2-1/4	8	TR94884	120.80
.6275		.5615	9	2-1/4	8	TR94885	120.80
.6280		.5615	9	2-1/4	8	TR94886	120.80
.6299	16.0mm	.5615	9	2-1/4	8	TR96193	103.09
.6300		.5615	9	2-1/4	8	TR94949	120.80
.6406	41/64	.5615	9	2-1/4	8	TR96194	102.99
.6496	16.5mm	.5615	9	2-1/4	8	TR96195	108.04
.6562	21/32	.5615	9	2-1/4	8	TR96196	110.98
.6693	17.0mm	.5615	9	2-1/4	8	TR96197	116.47
.6719	43/64	.5615	9	2-1/4	8	TR96198	116.47
.6845		.5615	9	2-1/4	8	TR94887	120.80
.6850		.5615	9	2-1/4	8	TR94888	120.80
.6855		.5615	9	2-1/4	8	TR94889	120.80
.6860		.5615	9	2-1/4	8	TR94890	120.80
.6865	O/U	.5615	9	2-1/4	8	TR96199	116.42
.6870		.5615	9	2-1/4	8	TR94891	120.80
.6875	11/16	.5615	9	2-1/4	8	TR96200	110.83
.6880		.5615	9	2-1/4	8	TR94892	133.17
.6885	O/U	.5615	9	2-1/4	8	TR96201	125.17
.6890	17.5mm	.5615	9	2-1/4	8	TR96202	125.17
.6895		.5615	9	2-1/4	8	TR94893	133.17
.6900		.5615	9	2-1/4	8	TR94894	133.17
.6905		.5615	9	2-1/4	8	TR94895	133.17
.7031	45/64	.5615	9	2-1/4	8	TR96203	124.96
.7087	18.0mm	.5615	9	2-1/4	8	TR96204	124.96
.7188	23/32	.5615	9	2-1/4	8	TR96205	123.78
.7283	18.5mm	.6240	9-1/2	2-1/2	8	TR96206	129.72
.7344	47/64	.6240	9-1/2	2-1/2	8	TR96207	143.96
.7470		.6240	9-1/2	2-1/2	8	TR94896	141.49
.7475		.6240	9-1/2	2-1/2	8	TR94897	141.49
.7480	19.0mm	.6240	9-1/2	2-1/2	8	TR96208	143.86

DEC. EQUIV.	SIZE	SHANK DIA.	OVERALL LENGTH	FLUTE LENGTH	# OF FLUTES	ITEM#	LIST PRICE
.7485		.6240	9-1/2	2-1/2	8	TR94898	141.49
.7490	O/U	.6240	9-1/2	2-1/2	8	TR96209	143.86
.7495		.6240	9-1/2	2-1/2	8	TR94899	141.49
.7500	3/4	.6240	9-1/2	2-1/2	8	TR96210	124.12
.7505		.6240	9-1/2	2-1/2	8	TR94900	153.57
.7510	O/U	.6240	9-1/2	2-1/2	8	TR96211	138.31
.7515		.6240	9-1/2	2-1/2	8	TR94901	153.57
.7520		.6240	9-1/2	2-1/2	8	TR94902	153.57
.7525		.6240	9-1/2	2-1/2	8	TR94903	153.57
.7530		.6240	9-1/2	2-1/2	8	TR94904	153.57
.7540		.6240	9-1/2	2-1/2	8	TR94905	153.57
.7550		.6240	9-1/2	2-1/2	8	TR94906	153.57
.7656	49/64	.6240	9-1/2	2-1/2	8	TR96212	138.11
.7677	19.5mm	.6240	9-1/2	2-1/2	8	TR96213	138.11
.7812	25/32	.6240	9-1/2	2-1/2	8	TR96214	133.80
.7874	20.0mm	.6240	9-1/2	2-1/2	8	TR96215	147.94
.7969	51/64	.6240	9-1/2	2-1/2	8	TR96216	147.94
.8071	20.5mm	.6240	9-1/2	2-1/2	8	TR96217	147.84
.8095		.6240	9-1/2	2-1/2	8	TR94907	153.57
.8100		.6240	9-1/2	2-1/2	8	TR94908	153.57
.8105		.6240	9-1/2	2-1/2	8	TR94909	153.57
.8110		.6240	9-1/2	2-1/2	8	TR94910	153.57
.8115	O/U	.6240	9-1/2	2-1/2	8	TR96218	147.84
.8120		.6240	9-1/2	2-1/2	8	TR94911	153.57
.8125	13/16	.6240	9-1/2	2-1/2	8	TR96219	133.60
.8130		.6240	9-1/2	2-1/2	8	TR94912	169.11
.8135	O/U	.6240	9-1/2	2-1/2	8	TR96220	147.84
.8140		.6240	9-1/2	2-1/2	8	TR94913	169.11
.8145		.6240	9-1/2	2-1/2	8	TR94914	169.11
.8150		.6240	9-1/2	2-1/2	8	TR94915	169.11
.8155		.6240	9-1/2	2-1/2	8	TR94916	169.11
.8268	21.0mm	.6240	9-1/2	2-1/2	8	TR96221	147.69
.8281	53/64	.6240	9-1/2	2-1/2	8	TR96222	147.69
.8438	27/32	.6240	9-1/2	2-1/2	8	TR96223	158.31
.8465	21.5mm	.7490	10	2-5/8	8	TR96224	172.35
.8594	55/64	.7490	10	2-5/8	8	TR96225	172.35
.8661	22.0mm	.7490	10	2-5/8	8	TR96226	172.25
.8720		.6240	10	2-5/8	8	TR94917	173.47
.8725		.6240	10	2-5/8	8	TR94918	173.47
.8730		.6240	10	2-5/8	8	TR94919	173.47
.8735		.6240	10	2-5/8	8	TR94920	173.47
.8740	O/U	.7490	10	2-5/8	8	TR96227	172.25
.8745		.7490	10	2-5/8	8	TR94921	173.47
.8750	7/8	.7490	10	2-5/8	8	TR96228	161.74

For technical information, please see page 263.

THRU 1/2" DIAMETER	1/2" TO 5/8"	5/8" TO 1-1/2"	1-1/2" TO 2"
+ .0002, -.0000	+ .0003, -.0000	+ .0001, +.0004	+ .0002, +.0006

GENERAL PURPOSE HSS REAMERS



YOUR #1 SOURCE FOR AMERICAN-MADE PREMIUM QUALITY CUTTING TOOLS

REAMING

CHUCKING - STRAIGHT FLUTE STOCKED INTERMEDIATE & STANDARD SIZES



SERIES 933

DEC. EQUIV.	SIZE	SHANK DIA.	OVERALL LENGTH	FLUTE LENGTH	# OF FLUTES	ITEM#	LIST PRICE
.8755		.7490	10	2-5/8	8	TR94922	189.02
.8760	O/U	.7490	10	2-5/8	8	TR96229	176.09
.8765		.7490	10	2-5/8	8	TR94923	189.02
.8770		.7490	10	2-5/8	8	TR94924	189.02
.8775		.7490	10	2-5/8	8	TR94925	189.02
.8780		.7490	10	2-5/8	8	TR94926	189.02
.8858	22.5mm	.7490	10	2-5/8	8	TR96230	175.83
.8906	57/64	.7490	10	2-5/8	8	TR96231	175.83
.9055	23.0mm	.7490	10	2-5/8	8	TR96232	175.83
.9062	29/32	.7490	10	2-5/8	8	TR96233	174.34
.9219	59/64	.7490	10	2-5/8	8	TR96234	188.38
.9252	23.5mm	.7490	10	2-5/8	8	TR96235	188.38
.9340		.7490	10	2-5/8	8	TR94927	189.02
.9345		.7490	10	2-5/8	8	TR94928	189.02
.9350		.7490	10	2-5/8	8	TR94929	189.02
.9355		.7490	10	2-5/8	8	TR94930	189.02
.9360		.7490	10	2-5/8	8	TR94931	189.02
.9365	O/U	.7490	10	2-5/8	8	TR96236	188.13
.9370		.7490	10	2-5/8	8	TR94932	189.02
.9375	15/16	.7490	10	2-5/8	8-10	TR96237	173.98
.9380		.7490	10	2-5/8	8	TR94933	207.49
.9385	O/U	.7490	10	2-5/8	8-10	TR96238	188.13
.9390		.7490	10	2-5/8	8	TR94934	207.49
.9395		.7490	10	2-5/8	8	TR94935	207.49
.9400		.7490	10	2-5/8	8	TR94936	207.49
.9405		.7490	10	2-5/8	8	TR94937	207.49
.9449	24.0mm	.7490	10	2-5/8	8-10	TR96239	188.13
.9531	61/64	.7490	10	2-5/8	8-10	TR96240	188.13
.9646	24.5mm	.7490	10	2-5/8	8-10	TR96241	187.98
.9688	31/32	.7490	10	2-5/8	8-10	TR96242	204.83
.9843	25.0mm	.8740	10-1/2	2-3/4	8-10	TR96243	199.44
.9844	63/64	.8740	10-1/2	2-3/4	8-10	TR96244	199.44
.9970		.8740	10-1/2	2-3/4	8	TR94938	211.49
.9975		.8740	10-1/2	2-3/4	8	TR94939	211.49
.9980		.8740	10-1/2	2-3/4	8	TR94940	211.49

DEC. EQUIV.	SIZE	SHANK DIA.	OVERALL LENGTH	FLUTE LENGTH	# OF FLUTES	ITEM#	LIST PRICE
.9985		.8740	10-1/2	2-3/4	8	TR94941	211.49
.9990	O/U	.8740	10-1/2	2-3/4	8-10	TR96245	199.44
.9995		.8740	10-1/2	2-3/4	8	TR94942	211.49
1.0000	1	.8740	10-1/2	2-3/4	8-10	TR96246	196.63
1.0001	O/U	.8740	10-1/2	2-3/4	8-10	TR96247	210.82
1.0005		.8740	10-1/2	2-3/4	8	TR94943	293.75
1.0015		.8740	10-1/2	2-3/4	8	TR94944	293.75
1.0020		.8740	10-1/2	2-3/4	8	TR94945	293.75
1.0025		.8740	10-1/2	2-3/4	8	TR94946	293.75
1.0030		.8740	10-1/2	2-3/4	8	TR94947	293.75
1.0312	1-1/32	.8740	10-1/2	2-3/4	8-10	TR96248	275.04
1.0625	1-1/16	.8740	10-1/2	2-3/4	8-10	TR96249	217.92
1.0938	1-3/32	.8740	11	2-7/8	8-10	TR96250	288.32
1.1250	1-1/8	.8740	11	2-7/8	8-10	TR96251	231.05
1.1562	1-5/32	.9990	11	2-7/8	8-12	TR96252	328.27
1.1875	1-3/16	.9990	11	2-7/8	8-12	TR96253	270.65
1.2188	1-7/32	.9990	11-1/2	3	8-12	TR96254	343.87
1.2500	1-1/4	.9990	11-1/2	3	8-12	TR96255	286.27
1.2812	1-9/32	.9990	11-1/2	3	8-12	TR96256	392.22
1.3125	1-5/16	.9990	11-1/2	3	8-12	TR96257	334.57
1.3438	1-11/32	.9990	12	3-1/4	8-12	TR96258	405.89
1.3750	1-3/8	.9990	12	3-1/4	8-12	TR96259	350.72
1.4062	1-13/32	1.2490	12	3-1/4	8-12	TR96260	432.18
1.4375	1-7/16	1.2490	12	3-1/4	8-12	TR96261	375.23
1.4688	1-15/32	1.2490	12-1/2	3-1/2	8-12	TR96262	461.13
1.5000	1-1/2	1.2490	12-1/2	3-1/2	8-12	TR96263	403.41
1.5625	1-9/16	1.2490	13	3-1/2	10-12	TR96910	579.60
1.6250	1-5/8	1.2490	13	3-1/2	10-12	TR96911	579.60
1.6875	1-11/16	1.2490	13-1/2	4	10-12	TR96912	665.64
1.7500	1-3/4	1.2490	13-1/2	4	10-12	TR96913	721.41
1.8125	1-13/16	1.4990	14	4	10-12	TR96914	834.47
1.8750	1-7/8	1.4990	14	4	10-12	TR96915	766.66
1.9375	1-15/16	1.4990	14	4	10-12	TR96916	899.06
2.0000	2	1.4990	14	4	10-12	TR96917	978.45

HSS & COBALT REAMERS

For technical information, please see page 263.

THRU 1/2" DIAMETER	1/2" TO 5/8"	5/8" TO 1-1/2"	1-1/2" TO 2"
+0.0002, -.0000	+0.0003, -.0000	+0.0001, +.0004	+0.0002, +.0006



GENERAL PURPOSE M42 COBALT REAMERS

YOUR #1 SOURCE FOR AMERICAN-MADE PREMIUM QUALITY CUTTING TOOLS

CHUCKING - STRAIGHT FLUTE



SERIES 1933

SIZE	SHANK DIA.	OVERALL LENGTH	FLUTE LENGTH	# OF FLUTES	ITEM #	LIST PRICE
#80	.0135	3/4	3/8	2	TR96310	47.82
#79	.0145	3/4	3/8	2	TR96311	47.82
1/64	.0156	3/4	3/8	2	TR96312	47.82
#78	.0160	7/8	3/8	2	TR96313	47.82
#77	.0180	7/8	3/8	2	TR96314	47.82
#76	.0200	7/8	3/8	2	TR96315	47.82
#75	.0210	1	1/2	3	TR96316	47.82
#74	.0225	1	1/2	3	TR96317	47.82
#73	.0240	1-1/8	1/2	3	TR96318	47.82
#72	.0250	1-1/8	1/2	3	TR96319	47.82
#71	.0260	1-1/4	1/2	3	TR96320	47.82
#70	.0280	1-1/4	1/2	3	TR96321	47.82
#69	.0292	1-3/8	1/2	3	TR96322	47.82
#68	.0310	1-3/8	1/2	3	TR96323	47.82
1/32	.0312	1-3/8	1/2	3	TR96324	39.35
#67	.0320	1-3/8	1/2	3	TR96325	39.35
#66	.0330	1-3/8	1/2	3	TR96326	39.35
#65	.0350	1-1/2	1/2	3	TR96327	39.35
#64	.0360	1-1/2	1/2	3	TR96328	39.35
#63	.0370	1-1/2	1/2	3	TR96329	39.35
#62	.0380	1-1/2	1/2	3	TR96330	39.35
#61	.0390	1-1/2	1/2	3	TR96331	39.35
1.0mm	.0394	2-1/2	1/2	4	TR96332	38.73
#60	.0390	2-1/2	1/2	4	TR96333	38.73
#59	.0390	2-1/2	1/2	4	TR96334	38.73
#58	.0390	2-1/2	1/2	4	TR96335	38.73
#57	.0390	2-1/2	1/2	4	TR96336	38.73
#56	.0455	2-1/2	1/2	4	TR96337	38.73
3/64	.0455	2-1/2	1/2	4	TR96338	38.73
#55	.0510	2-1/2	1/2	4	TR96339	38.73
#54	.0510	2-1/2	1/2	4	TR96340	38.73
1.5mm	.0510	2-1/2	1/2	4	TR96341	38.73
#53	.0585	2-1/2	1/2	4	TR96342	38.73
1/16	.0585	2-1/2	1/2	4	TR96343	38.73
#52	.0585	2-1/2	1/2	4	TR96344	38.73
#51	.0660	3	3/4	4	TR96345	31.17
#50	.0660	3	3/4	4	TR96346	31.17
#49	.0660	3	3/4	4	TR96347	31.17
#48	.0720	3	3/4	4	TR96348	31.17
5/64	.0720	3	3/4	4	TR96349	31.17
#47	.0720	3	3/4	4	TR96350	31.17
2.0mm	.0720	3	3/4	4	TR96351	31.17
#46	.0771	3	3/4	4	TR96352	31.17
#45	.0771	3	3/4	4	TR96353	31.17
#44	.0810	3	3/4	4	TR96354	31.17
#43	.0810	3	3/4	4	TR96355	31.17
#42	.0880	3	3/4	4	TR96356	31.17
3/32	.0880	3	3/4	4	TR96357	31.17

SIZE	SHANK DIA.	OVERALL LENGTH	FLUTE LENGTH	# OF FLUTES	ITEM #	LIST PRICE
#41	.0928	3-1/2	7/8	4	TR96358	31.41
#40	.0928	3-1/2	7/8	4	TR96359	31.41
2.5mm	.0928	3-1/2	7/8	4	TR96360	31.41
#39	.0928	3-1/2	7/8	4	TR96361	31.41
#38	.0950	3-1/2	7/8	4	TR96362	31.41
#37	.0950	3-1/2	7/8	4	TR96363	31.41
#36	.1030	3-1/2	7/8	4	TR96364	31.41
7/64	.1030	3-1/2	7/8	4	TR96365	32.38
#35	.1030	3-1/2	7/8	4	TR96366	32.38
#34	.1055	3-1/2	7/8	4	TR96367	32.38
#33	.1055	3-1/2	7/8	4	TR96368	32.38
#32	.1120	3-1/2	7/8	4	TR96369	32.38
3.0mm	.1120	3-1/2	7/8	4	TR96370	32.38
#31	.1120	3-1/2	7/8	4	TR96371	32.38
.124 O/U	.1190	3-1/2	7/8	4	TR96372	32.38
1/8	.1190	3-1/2	7/8	4	TR96373	29.16
.126 O/U	.1190	3-1/2	7/8	4	TR96374	32.38
#30	.1190	3-1/2	7/8	4	TR96375	32.38
#29	.1275	4	1	4	TR96376	38.73
3.5mm	.1350	4	1	4	TR96377	38.73
#28	.1350	4	1	4	TR96378	38.73
9/64	.1350	4	1	4	TR96379	38.73
#27	.1350	4	1	4	TR96380	38.73
#26	.1430	4	1	4	TR96381	38.73
#25	.1430	4	1	4	TR96382	38.73
#24	.1460	4	1	4	TR96383	38.73
#23	.1460	4	1	4	TR96384	38.73
5/32	.1510	4	1	4	TR96385	38.73
#22	.1510	4	1	6	TR96386	38.73
4.0mm	.1510	4	1	6	TR96387	38.73
#21	.1530	4-1/2	1-1/8	6	TR96388	41.33
#20	.1530	4-1/2	1-1/8	6	TR96389	41.33
#19	.1595	4-1/2	1-1/8	6	TR96390	41.33
#18	.1595	4-1/2	1-1/8	6	TR96391	41.33
11/64	.1645	4-1/2	1-1/8	6	TR96392	41.33
#17	.1645	4-1/2	1-1/8	6	TR96393	41.33
#16	.1704	4-1/2	1-1/8	6	TR96394	41.33
4.5mm	.1704	4-1/2	1-1/8	6	TR96395	41.33
#15	.1755	4-1/2	1-1/8	6	TR96396	41.33
#14	.1755	4-1/2	1-1/8	6	TR96397	41.33
#13	.1805	4-1/2	1-1/8	6	TR96398	41.33
.1865	.1805	4-1/2	1-1/8	6	TR96399	41.33
3/16	.1805	4-1/2	1-1/8	6	TR96400	39.93
.1885	.1805	4-1/2	1-1/8	6	TR96401	41.33
#12	.1805	4-1/2	1-1/8	6	TR96402	41.33
#11	.1860	5	1-1/4	6	TR96403	49.94
#10	.1860	5	1-1/4	6	TR96404	49.94
#9	.1895	5	1-1/4	6	TR96405	49.94

For technical information, please see page 263.

THRU 1/2" DIAMETER	1/2" TO 5/8"	5/8" TO 1-1/2"
+ .0002, - .0000	+ .0003, - .0000	+ .0001, + .0004

GENERAL PURPOSE M42 COBALT REAMERS



YOUR #1 SOURCE FOR AMERICAN-MADE PREMIUM QUALITY CUTTING TOOLS

REAMING

CHUCKING - STRAIGHT FLUTE



SERIES 1933

SIZE	SHANK DIA.	OVERALL LENGTH	FLUTE LENGTH	#OF FLUTES	ITEM #	LIST PRICE
5.0mm	.1895	5	1-1/4	6	TR96406	49.94
#8	.1895	5	1-1/4	6	TR96407	49.94
#7	.1895	5	1-1/4	6	TR96408	49.94
13/64	.1945	5	1-1/4	6	TR96409	49.94
#6	.1945	5	1-1/4	6	TR96410	49.94
#5	.2016	5	1-1/4	6	TR96411	49.94
#4	.2016	5	1-1/4	6	TR96412	49.94
#3	.2075	5	1-1/4	6	TR96413	49.94
5.5mm	.2075	5	1-1/4	6	TR96414	49.94
7/32	.2075	5	1-1/4	6	TR96415	49.94
#2	.2173	6	1-1/2	6	TR96416	51.38
#1	.2173	6	1-1/2	6	TR96417	51.38
A	.2265	6	1-1/2	6	TR96418	51.38
15/64	.2265	6	1-1/2	6	TR96419	51.38
6.0mm	.2265	6	1-1/2	6	TR96420	51.62
B	.2329	6	1-1/2	6	TR96421	51.62
C	.2329	6	1-1/2	6	TR96422	51.62
D	.2329	6	1-1/2	6	TR96423	46.91
.249 O/U	.2405	6	1-1/2	6	TR96424	46.42
1/4	.2405	6	1-1/2	6	TR96425	43.87
.251 O/U	.2405	6	1-1/2	6	TR96426	46.47
6.5mm	.2405	6	1-1/2	6	TR96427	51.62
F	.2485	6	1-1/2	6	TR96428	51.62
G	.2485	6	1-1/2	6	TR96429	51.62
17/64	.2485	6	1-1/2	6	TR96430	70.00
H	.2485	6	1-1/2	6	TR96431	70.00
I	.2485	6	1-1/2	6	TR96432	70.00
7.0mm	.2485	6	1-1/2	6	TR96433	70.00
J	.2485	6	1-1/2	6	TR96434	70.00
K	.2485	6	1-1/2	6	TR96435	70.00
9/32	.2485	6	1-1/2	6	TR96436	66.49
L	.2792	6	1-1/2	6	TR96437	70.00
M	.2792	6	1-1/2	6	TR96438	70.00
7.5mm	.2792	6	1-1/2	6	TR96439	70.00
19/64	.2792	6	1-1/2	6	TR96440	70.00
N	.2792	6	1-1/2	6	TR96441	70.00
.3115	.2792	6	1-1/2	6	TR96442	66.49
5/16	.2792	6	1-1/2	6	TR96443	62.97
.3135	.2792	6	1-1/2	6	TR96444	66.49
8.0mm	.2792	6	1-1/2	6	TR96445	70.00
O	.2792	6	1-1/2	6	TR96446	70.00
P	.2792	6	1-1/2	6	TR96447	75.43
21/64	.2792	6	1-1/2	6	TR96448	75.43
Q	.2792	6	1-1/2	6	TR96449	75.43
8.5mm	.2792	6	1-1/2	6	TR96450	75.43
R	.2792	6	1-1/2	6	TR96451	75.43
11/32	.2792	6	1-1/2	6	TR96452	75.43

SIZE	SHANK DIA.	OVERALL LENGTH	FLUTE LENGTH	#OF FLUTES	ITEM #	LIST PRICE
S	.3105	6	1-3/4	6	TR96453	76.68
9.0mm	.3105	7	1-3/4	6	TR96454	76.68
T	.3105	7	1-3/4	6	TR96455	76.68
23/64	.3105	7	1-3/4	6	TR96456	76.68
U	.3105	7	1-3/4	6	TR96457	76.68
9.5mm	.3105	7	1-3/4	6	TR96458	72.79
3/8	.3105	7	1-3/4	6	TR96459	68.99
.376 O/U	.3105	7	1-3/4	6	TR96460	72.79
V	.3105	7	1-3/4	6	TR96461	93.47
W	.3105	7	1-3/4	6	TR96462	93.47
25/64	.3105	7	1-3/4	6	TR96463	93.47
10.0mm	.3105	7	1-3/4	6	TR96464	93.47
X	.3105	7	1-3/4	6	TR96465	93.47
Y	.3105	7	1-3/4	6	TR96466	93.47
13/32	.3105	7	1-3/4	6	TR96467	93.47
Z	.3730	7	1-3/4	6	TR96468	93.47
10.5mm	.3730	7	1-3/4	6	TR96469	93.47
27/64	.3730	7	1-3/4	6	TR96470	93.47
11.0mm	.3730	7	1-3/4	6	TR96471	93.47
.4365	.3730	7	1-3/4	6	TR96472	93.47
7/16	.3730	7	1-3/4	6	TR96473	93.47
.4385	.3730	7	1-3/4	6	TR96474	93.47
11.5mm	.3730	7	1-3/4	6	TR96475	107.14
29/64	.3730	7	1-3/4	6	TR96476	107.14
15/32	.3730	7	1-3/4	6	TR96477	107.14
12.0mm	.4355	8	2	6	TR96478	107.14
31/64	.4355	8	2	6	TR96479	107.14
12.5mm	.4355	8	2	6	TR96480	107.14
.499 O/U	.4355	8	2	6	TR96481	107.14
1/2	.4355	8	2	6	TR96482	107.14
.501 O/U	.4355	8	2	6	TR96483	107.14
17/32	.4355	8	2	6	TR96484	120.17
9/16	.4355	8	2	8	TR96485	120.17
19/32	.4355	8	2	8	TR96486	120.17
5/8	.5615	9	2-1/4	8	TR96487	140.24
21/32	.5615	9	2-1/4	8	TR96488	162.38
11/16	.5615	9	2-1/4	8	TR96489	161.78
23/32	.5615	9	2-1/4	8	TR96490	181.03
3/4	.6240	9	2-1/2	8	TR96491	180.98
25/32	.6240	9	2-1/2	8	TR96492	195.57
13/16	.6240	9	2-1/2	8	TR96493	194.58
27/32	.6240	9-1/2	2-1/2	8	TR96494	231.31
7/8	.7490	10	2-5/8	8	TR96495	235.86
29/32	.7490	10	2-5/8	8	TR96496	254.71
15/16	.7490	10	2-5/8	8-10	TR96497	253.77
31/32	.7490	10	2-5/8	8-10	TR96498	285.09
1	.8740	10-1/2	2-3/4	8-10	TR96499	287.02

For technical information, please see page 263.

THRU 1/2" DIAMETER	1/2" TO 5/8"	5/8" TO 1-1/2"
+ .0002, - .0000	+ .0003, - .0000	+ .0001, + .0004

HSS & COBALT REAMERS

TECHNICAL



GENERAL PURPOSE HSS REAMERS

YOUR #1 SOURCE FOR AMERICAN-MADE PREMIUM QUALITY CUTTING TOOLS

CHUCKING - STRAIGHT FLUTE - SPECIAL SIZES



SERIES 933

QUANTITY PRICING

SIZE RANGE	1	2	3-5	6-7	8-11	12-17	18-23	24-35	36-47	48-59	60-71	72-95	96+
.0135 - .0195	235.48	153.89	114.67	75.68	68.36	58.10	52.57	48.90	47.63	43.64	42.31	41.76	40.78
.0196 - .0290	214.10	139.90	104.33	68.79	62.12	54.45	47.78	44.53	41.28	39.63	39.45	39.39	39.25
.0291 - .0390	194.62	126.96	94.79	62.48	56.45	49.55	43.48	40.46	37.49	36.04	35.02	34.53	33.71
.0391 - .0624	175.91	117.12	94.79	60.26	54.33	47.09	41.43	38.49	35.50	33.32	32.80	32.68	32.46
.0626 - .1093	185.22	118.56	91.43	56.97	49.94	41.41	37.49	34.51	31.61	29.83	29.11	28.58	27.60
.1095 - .1249	182.77	116.00	85.95	49.79	43.72	40.00	32.80	29.83	29.40	28.92	28.44	27.91	27.69
.1251 - .1405	194.62	126.96	85.72	62.48	58.85	49.55	43.48	40.46	37.49	36.04	35.12	34.53	33.37
.1407 - .1561	191.67	124.96	94.90	60.59	54.33	47.46	41.43	38.49	36.33	35.50	34.70	33.88	33.03
.1563 - .1718	194.62	121.46	94.35	62.48	56.59	49.55	43.48	40.46	37.49	36.90	36.33	36.04	35.34
.1720 - .1874	186.66	116.51	94.29	58.20	52.30	46.74	41.13	38.01	37.61	37.03	36.50	35.58	35.12
.1876 - .2030	199.86	133.15	104.49	69.94	63.98	56.87	50.87	47.97	44.70	42.31	41.41	41.13	40.79
.2032 - .2187	199.86	133.15	103.37	68.86	62.93	55.71	49.63	46.76	43.72	41.13	40.61	40.12	39.93
.2189 - .2343	200.66	134.20	104.21	69.74	63.75	56.59	50.53	47.53	44.59	42.80	42.16	41.76	41.43
.2345 - .2499	200.66	134.20	99.20	64.71	58.68	51.76	45.85	42.85	39.68	39.45	38.92	38.51	38.35
.2501 - .2968	208.41	141.69	111.62	77.14	71.23	63.62	57.64	54.67	51.51	48.83	48.35	47.93	47.46
.2970 - .3124	202.62	135.96	105.87	71.27	65.29	58.10	51.99	48.93	48.73	48.31	48.07	47.75	47.46
.3126 - .3437	212.86	145.10	114.86	74.40	72.13	66.55	60.75	57.64	54.40	52.03	51.51	51.16	50.74
.3439 - .3593	212.55	145.89	115.72	81.19	75.17	70.56	60.75	58.47	55.50	52.84	52.30	51.88	51.51
.3595 - .3749	206.45	139.58	109.51	74.78	68.86	61.58	55.63	52.39	52.11	52.03	51.68	51.42	51.24
.3751 - .3905	216.10	149.49	119.60	84.75	78.78	72.21	66.06	63.06	60.15	56.97	56.66	56.18	55.71
.3907 - .4218	218.82	152.07	121.91	87.40	81.43	73.57	67.62	64.69	61.62	58.94	58.37	58.10	57.94
.4220 - .4374	214.68	148.09	117.77	83.40	77.46	69.74	63.62	60.65	60.15	59.94	59.68	58.45	57.81
.4376 - .4843	224.63	157.85	127.76	93.27	87.29	79.11	70.21	68.79	67.28	65.19	64.71	63.98	63.41
.4845 - .4999	219.34	152.61	122.48	87.84	82.02	73.89	64.88	64.69	64.16	63.91	63.41	63.19	62.99
.5001 - .5311	318.29	197.69	157.60	117.23	107.32	97.16	90.54	87.03	83.68	82.13	81.09	80.43	79.64
.5313 - .5624	316.50	195.85	155.67	115.38	105.46	95.27	88.73	85.26	81.81	80.16	79.15	78.42	78.05
.5626 - .5937	328.96	208.29	168.04	127.76	120.11	107.76	104.24	97.87	94.29	92.76	91.68	91.00	90.07
.5939 - .6249	329.42	208.62	168.42	128.15	118.24	108.18	101.50	98.31	94.68	93.17	92.04	91.43	91.03
.6251 - .6874	341.17	220.50	180.27	140.01	129.97	124.74	113.16	109.83	106.52	104.79	103.79	103.23	102.90
.6876 - .7187	352.21	231.65	191.37	150.62	140.80	130.96	124.33	121.07	117.74	116.00	114.90	114.10	113.44
.7189 - .7499	356.66	236.00	195.99	155.58	145.72	135.59	128.80	128.63	128.49	128.37	127.90	127.65	127.21
.7501 - .8124	370.71	250.14	210.08	169.72	159.72	149.70	142.98	139.60	136.26	134.60	133.62	132.85	131.95
.8126 - .8437	384.93	264.20	224.19	183.87	173.82	163.91	157.09	153.73	150.44	148.69	147.60	147.02	146.18
.8439 - .8749	388.50	267.86	227.57	187.29	177.29	167.29	160.49	157.70	156.23	152.07	150.99	150.36	147.51
.8751 - .9374	403.10	282.43	242.22	201.95	191.98	182.07	175.19	171.84	168.59	168.07	167.78	167.53	167.22
.9376 - .9687	419.84	297.40	258.99	218.82	208.79	198.75	191.98	188.62	185.32	183.77	182.52	182.13	181.12
.9689 - .9999	423.32	302.70	262.52	222.18	212.27	202.20	195.56	192.26	188.74	187.15	186.07	185.32	184.56
1.0001 - 1.0624	454.30	339.35	327.34	315.33	303.19	291.17	279.10	267.04	255.05	253.48	247.68	245.65	243.57
1.0626 - 1.1249	479.75	365.41	352.21	338.96	325.72	312.50	299.33	286.12	272.93	259.74	258.51	257.22	255.77
1.1251 - 1.1874	512.33	399.64	385.93	372.83	359.67	346.55	333.82	320.33	309.60	294.03	280.89	267.82	254.65
1.1876 - 1.2499	540.82	426.51	412.19	398.00	383.80	369.62	355.37	341.17	326.97	312.79	298.58	284.34	270.17
1.2501 - 1.3749	615.17	495.46	480.00	464.88	449.78	432.39	419.55	404.52	389.32	374.21	370.32	366.47	363.30
1.3751 - 1.4999	680.50	564.65	547.78	530.97	514.09	497.21	480.46	463.54	446.75	429.84	425.26	419.02	411.87

For technical information, please see page 263.

THRU 1/2" DIAMETER	ABOVE 1/2" TO 5/8"	ABOVE 5/8" TO 1-1/2"
+ .0002, - .0000	+ .0003, - .0000	+ .0001, + .0004

GENERAL PURPOSE M42 COBALT REAMERS



YOUR #1 SOURCE FOR AMERICAN-MADE PREMIUM QUALITY CUTTING TOOLS

REAMING

CHUCKING - STRAIGHT FLUTE - SPECIAL SIZES



SERIES 1933

QUANTITY PRICING

SIZE RANGE	1	2	3-5	6-7	8-11	12-17	18-23	24-35	36-47	48-59	60-71	72-95	96+
.0135 - .0195	340.17	179.83	133.29	86.99	75.39	63.72	56.04	52.14	48.28	46.36	45.23	43.64	43.48
.0196 - .0290	309.29	163.39	121.18	79.09	68.54	57.94	50.87	47.39	43.92	43.72	43.66	43.64	43.48
.0291 - .0390	281.19	148.65	110.20	71.83	62.25	55.70	46.27	43.12	39.93	38.35	37.41	36.72	35.87
.0391 - .0624	256.00	146.39	108.00	69.57	59.97	50.39	44.05	40.85	37.64	36.05	35.85	35.55	35.23
.0626 - .1093	257.76	143.11	104.73	66.31	56.80	47.10	40.78	37.56	34.34	32.80	32.61	32.46	32.19
.1095 - .1249	251.87	137.15	98.86	60.45	50.86	41.31	34.91	33.02	31.14	30.60	30.16	29.76	29.42
.1251 - .1405	263.26	148.58	109.75	71.83	62.25	52.69	46.27	43.12	39.93	38.35	37.41	36.72	35.87
.1407 - .1561	261.08	146.39	108.00	69.57	59.97	50.39	44.05	40.85	37.64	36.05	35.58	35.45	35.19
.1563 - .1718	263.50	148.69	110.31	72.01	62.45	52.84	46.49	43.26	40.04	38.43	38.15	37.88	37.56
.1720 - .1874	261.57	146.96	108.50	70.21	62.24	51.03	44.60	41.43	38.22	38.15	37.92	37.64	37.63
.1876 - .2030	272.29	157.60	119.12	80.82	71.26	61.58	55.29	52.06	48.84	47.23	46.27	45.67	45.42
.2032 - .2343	271.13	156.50	118.14	79.73	70.21	60.65	54.18	52.52	50.82	50.28	49.97	49.55	48.78
.2345 - .2499	266.48	152.07	113.71	75.39	65.75	56.16	49.79	49.50	49.17	48.78	48.32	47.46	46.85
.2501 - .2968	290.24	175.59	137.07	98.86	89.21	79.66	73.11	69.99	66.84	65.24	64.76	63.82	63.62
.2970 - .3124	282.93	168.16	129.79	91.43	81.77	72.23	65.91	65.50	65.09	64.79	64.24	64.15	63.70
.3126 - .3437	293.84	179.05	140.66	102.34	92.76	83.12	76.78	73.56	70.30	70.03	69.64	68.98	68.60
.3439 - .3593	294.35	179.70	141.30	102.95	93.39	83.84	77.36	74.25	71.11	70.60	70.19	70.03	69.57
.3595 - .3749	287.64	172.91	134.55	96.11	86.54	76.94	70.56	70.38	70.19	69.94	69.94	69.79	69.51
.3751 - .3905	314.17	199.52	161.17	122.80	113.16	103.62	96.94	93.88	90.83	89.21	88.23	87.64	86.82
.3907 - .4218	318.19	203.61	165.14	126.79	117.26	107.62	101.23	98.05	94.88	93.39	92.20	91.63	90.83
.4220 - .4374	311.95	197.26	158.90	120.52	110.99	101.36	94.92	91.77	88.55	87.03	86.02	85.41	84.62
.4376 - .4843	327.10	212.47	174.07	135.73	126.15	116.53	110.27	107.06	103.84	102.20	101.23	100.62	99.78
.4845 - .4999	318.85	204.11	165.78	127.40	117.74	108.22	101.87	100.14	98.39	98.12	97.77	97.57	97.41
.5001 - .5311	336.44	220.10	182.13	140.65	136.74	133.09	129.47	125.84	122.20	118.57	114.90	111.28	107.70
.5313 - .5624	338.96	223.81	187.14	145.14	140.88	136.74	132.66	128.57	124.48	120.40	116.31	112.22	108.12
.5626 - .5937	345.38	229.58	191.83	149.60	144.94	140.37	135.82	142.81	126.76	122.20	117.66	113.10	108.52
.5939 - .6249	356.30	241.09	204.45	162.10	157.74	153.73	149.70	145.67	141.65	137.53	133.52	129.47	125.44
.6251 - .6874	367.64	251.97	217.22	174.65	170.70	167.00	163.31	159.59	155.85	152.19	149.91	144.69	141.06
.6876 - .7187	378.81	262.99	225.93	183.15	179.96	176.98	173.82	170.92	168.04	165.10	162.10	161.17	160.88
.7189 - .7499	392.18	277.62	243.10	199.96	195.30	190.67	186.12	181.57	176.98	172.39	167.78	163.22	158.59
.7501 - .8124	412.88	297.39	261.34	219.66	205.92	201.52	197.08	192.68	188.30	183.87	179.42	175.02	170.63
.8126 - .8437	433.66	319.42	281.61	242.73	231.22	227.25	223.47	219.66	215.81	211.93	208.08	204.29	200.47
.8439 - .8749	456.21	340.61	303.49	262.57	247.27	242.05	236.96	231.87	226.74	221.64	216.48	211.44	206.31
.8751 - .9374	474.41	358.37	321.66	278.80	263.26	258.03	252.90	247.72	242.56	237.42	232.20	229.94	227.56
.9376 - .9687	498.72	380.26	344.00	302.24	295.94	290.33	284.34	278.48	272.49	266.52	260.63	257.64	254.87
.9689 - .9999	516.08	400.60	365.07	324.24	316.14	308.16	300.23	292.37	284.50	276.66	268.77	260.84	252.95
1.0001 - 1.0624	555.31	439.69	402.17	360.44	351.58	343.00	333.77	324.94	316.09	307.20	298.32	289.38	280.59
1.0626 - 1.1249	594.91	479.74	442.96	402.19	390.51	379.24	367.89	356.59	345.23	334.00	322.67	311.36	300.08
1.1251 - 1.1874	633.27	516.08	482.62	437.83	427.67	417.71	407.82	397.85	387.93	377.94	367.95	358.06	348.05
1.1876 - 1.2499	673.40	559.98	523.83	480.17	467.26	455.16	442.97	430.92	418.87	406.75	394.66	382.51	370.50
1.2501 - 1.3749	713.85	596.21	557.37	517.75	509.90	496.98	484.19	471.36	458.50	445.65	432.81	420.00	407.24
1.3751 - 1.4999	753.46	637.60	601.46	559.55	554.02	548.85	543.62	540.31	537.00	535.86	534.93	533.65	532.58

For technical information, please see page 263.

THRU 1/2" DIAMETER	ABOVE 1/2" TO 5/8"	ABOVE 5/8" TO 1-1/2"
+0.002, -0.000	+0.003, -0.000	+0.001, +0.004

HSS & COBALT REAMERS

TECHNICAL



GENERAL PURPOSE HSS & M42 COBALT REAMERS

YOUR #1 SOURCE FOR AMERICAN-MADE PREMIUM QUALITY CUTTING TOOLS

CHUCKING - RIGHT HAND SPIRAL - RIGHT HAND CUT



SERIES 935R

SERIES 1935R

SIZE	DEC. EQUIV.	FLUTE LENGTH	# OF FLUTES	OVERALL LENGTH	SHANK DIA.	SERIES 935R		SERIES 1935R	
						HSS	LIST PRICE	M42 COBALT	LIST PRICE
1.0mm	.0394	1/2	4	2-1/2	.0394	TR96550	41.61	TR96726	45.51
#60	.0400	1/2	4	2-1/2	.0390	TR96551	41.61	TR96727	45.51
#59	.0410	1/2	4	2-1/2	.0390	TR96552	41.61	TR96728	45.51
#58	.0420	1/2	4	2-1/2	.0390	TR96553	41.61	TR96729	45.51
#57	.0430	1/2	4	2-1/2	.0390	TR96554	41.61	TR96730	45.51
#56	.0465	1/2	4	2-1/2	.0455	TR96555	41.61	TR96731	45.51
3/64	.0469	1/2	4	2-1/2	.0455	TR96556	41.61	TR96732	45.51
#55	.0520	1/2	4	2-1/2	.0510	TR96557	41.61	TR96733	45.51
#54	.0550	1/2	4	2-1/2	.0510	TR96558	41.61	TR96734	45.51
1.5mm	.0591	1/2	4	2-1/2	.0510	TR96559	41.61	TR96735	45.51
#53	.0595	1/2	4	2-1/2	.0585	TR96560	41.61	TR96736	45.51
1/16	.0625	1/2	4	2-1/2	.0585	TR96561	41.61	TR96737	45.51
#52	.0635	1/2	4	2-1/2	.0585	TR96562	41.61	TR96738	45.51
#51	.0670	3/4	4	3	.0660	TR96563	33.48	TR96739	36.66
#50	.0700	3/4	4	3	.0660	TR96564	33.48	TR96740	36.66
#49	.0730	3/4	4	3	.0660	TR96565	33.48	TR96741	36.66
#48	.0760	3/4	4	3	.0720	TR96566	33.48	TR96742	36.66
5/64	.0781	3/4	4	3	.0720	TR96567	33.48	TR96743	36.66
#47	.0785	3/4	4	3	.0720	TR96568	33.48	TR96744	36.66
2.0mm	.0787	3/4	4	3	.0720	TR96569	33.48	TR96745	36.66
#46	.0810	3/4	4	3	.0771	TR96570	33.48	TR96746	36.66
#45	.0820	3/4	4	3	.0771	TR96571	33.48	TR96747	36.66
#44	.0860	3/4	4	3	.0810	TR96572	33.48	TR96748	36.66
#43	.0890	3/4	4	3	.0810	TR96573	33.48	TR96749	36.66
#42	.0935	3/4	4	3	.0880	TR96574	33.48	TR96750	36.66
3/32	.0938	3/4	4	3	.0880	TR96575	33.19	TR96751	36.66
#41	.0960	7/8	4	3-1/2	.0928	TR96576	33.72	TR96752	37.00
#40	.0980	7/8	4	3-1/2	.0928	TR96577	33.72	TR96753	37.00
2.5mm	.0984	7/8	4	3-1/2	.0928	TR96578	33.72	TR96754	37.00
#39	.0995	7/8	4	3-1/2	.0928	TR96579	33.72	TR96755	37.00
#38	.1015	7/8	4	3-1/2	.0950	TR96580	33.72	TR96756	37.00
#37	.1040	7/8	4	3-1/2	.0950	TR96581	33.72	TR96757	37.00
#36	.1065	7/8	4	3-1/2	.1030	TR96582	33.72	TR96758	37.00
7/64	.1094	7/8	4	3-1/2	.1030	TR96583	34.73	TR96759	38.15
#35	.1100	7/8	4	3-1/2	.1030	TR96584	34.73	TR96760	38.15
#34	.1110	7/8	4	3-1/2	.1055	TR96585	34.73	TR96761	38.15
#33	.1130	7/8	4	3-1/2	.1055	TR96586	34.73	TR96762	38.15
#32	.1160	7/8	4	3-1/2	.1120	TR96587	34.73	TR96763	38.15
3.0mm	.1181	7/8	4	3-1/2	.1120	TR96588	34.73	TR96764	38.15
#31	.1200	7/8	4	3-1/2	.1120	TR96589	34.73	TR96765	38.15
o/u	.1240	7/8	4	3-1/2	.1190	TR96590	34.73	TR96766	38.15
1/8	.1250	7/8	4	3-1/2	.1190	TR96591	31.32	TR96767	34.30
o/u	.1260	7/8	4	3-1/2	.1190	TR96592	34.73	TR96768	38.15
#30	.1285	7/8	4	3-1/2	.1190	TR96593	34.73	TR96769	38.15
#29	.1360	1	4	4	.1275	TR96594	41.61	TR96770	45.56
3.5mm	.1378	1	4	4	.1350	TR96595	41.61	TR96771	45.56

For technical information, please see page 263.

THRU 1/2" DIAMETER	1/2" TO 5/8"	5/8" TO 1-1/2"	1-1/2" TO 2"
+ .0002, -.0000	+ .0003, -.0000	+ .0001, +.0004	+ .0002, +.0006

GENERAL PURPOSE HSS & M42 COBALT REAMERS



REAMING

YOUR #1 SOURCE FOR AMERICAN-MADE PREMIUM QUALITY CUTTING TOOLS

CHUCKING - RIGHT HAND SPIRAL - RIGHT HAND CUT



SERIES 935R

SERIES 1935R

SIZE	DEC. EQUIV.	FLUTE LENGTH	# OF FLUTES	OVERALL LENGTH	SHANK DIA.	HSS	LIST PRICE	M42 COBALT	LIST PRICE
#28	.1405	1	4	4	.1350	TR96596	41.61	TR96772	45.56
9/64	.1406	1	4	4	.1350	TR96597	41.61	TR96773	45.56
#27	.1440	1	4	4	.1350	TR96598	41.61	TR96774	45.56
#26	.1470	1	4	4	.1430	TR96599	41.61	TR96775	45.56
#25	.1495	1	4	4	.1430	TR96600	41.61	TR96776	45.56
#24	.1520	1	4	4	.1460	TR96601	43.30	TR96777	45.56
#23	.1540	1	4	4	.1460	TR96602	43.30	TR96778	45.56
5/32	.1562	1	4	4	.1510	TR96603	43.30	TR96779	45.56
#22	.1570	1	6	4	.1510	TR96604	43.30	TR96780	45.56
4.0mm	.1575	1	6	4	.1510	TR96605	43.30	TR96781	45.56
#21	.1590	1-1/8	6	4-1/2	.1530	TR96606	44.40	TR96782	48.64
#20	.1610	1-1/8	6	4-1/2	.1530	TR96607	44.40	TR96783	48.64
#19	.1660	1-1/8	6	4-1/2	.1595	TR96608	44.40	TR96784	48.64
#18	.1695	1-1/8	6	4-1/2	.1595	TR96609	44.40	TR96785	48.64
11/64	.1719	1-1/8	6	4-1/2	.1645	TR96610	44.40	TR96786	48.64
#17	.1730	1-1/8	6	4-1/2	.1645	TR96611	44.40	TR96787	48.64
#16	.1770	1-1/8	6	4-1/2	.1704	TR96612	44.40	TR96788	48.64
4.5mm	.1772	1-1/8	6	4-1/2	.1704	TR96613	44.40	TR96789	48.64
#15	.1800	1-1/8	6	4-1/2	.1755	TR96614	44.40	TR96790	48.64
#14	.1820	1-1/8	6	4-1/2	.1755	TR96615	44.40	TR96791	48.64
#13	.1850	1-1/8	6	4-1/2	.1805	TR96616	44.40	TR96792	48.64
o/u	.1865	1-1/8	6	4-1/2	.1805	TR96617	44.40	TR96793	48.64
3/16	.1875	1-1/8	6	4-1/2	.1805	TR96618	42.19	TR96794	46.18
o/u	.1885	1-1/8	6	4-1/2	.1805	TR96619	44.40	TR96795	48.64
#12	.1890	1-1/8	6	4-1/2	.1805	TR96620	44.40	TR96796	48.64
#11	.1910	1-1/4	6	5	.1860	TR96621	49.74	TR96797	54.51
#10	.1935	1-1/4	6	5	.1860	TR96622	49.74	TR96798	54.51
#9	.1960	1-1/4	6	5	.1895	TR96623	49.74	TR96799	54.51
5.0mm	.1969	1-1/4	6	5	.1895	TR96624	49.74	TR96800	54.51
#8	.1990	1-1/4	6	5	.1895	TR96625	49.74	TR96801	54.51
#7	.2010	1-1/4	6	5	.1895	TR96626	49.74	TR96802	54.51
13/64	.2031	1-1/4	6	5	.1945	TR96627	49.74	TR96803	54.51
#6	.2040	1-1/4	6	5	.1945	TR96628	49.74	TR96804	54.51
#5	.2055	1-1/4	6	5	.2016	TR96629	49.74	TR96805	54.51
#4	.2090	1-1/4	6	5	.2016	TR96630	49.74	TR96806	54.51
#3	.2130	1-1/4	6	5	.2075	TR96631	49.74	TR96807	54.51
5.5mm	.2165	1-1/4	6	5	.2075	TR96632	49.74	TR96808	54.51
7/32	.2188	1-1/4	6	5	.2075	TR96633	49.74	TR96809	54.51
#2	.2210	1-1/2	6	6	.2173	TR96634	51.14	TR96810	56.05
#1	.2280	1-1/2	6	6	.2173	TR96635	51.14	TR96811	56.05
A	.2340	1-1/2	6	6	.2265	TR96636	51.14	TR96812	56.05
15/64	.2344	1-1/2	6	6	.2265	TR96637	51.14	TR96813	56.05
6.0mm	.2362	1-1/2	6	6	.2265	TR96638	51.48	TR96814	58.98
B	.2380	1-1/2	6	6	.2329	TR96639	51.48	TR96815	58.98
C	.2420	1-1/2	6	6	.2329	TR96640	51.48	TR96816	58.98
D	.2460	1-1/2	6	6	.2329	TR96641	51.48	TR96817	53.64

For technical information, please see page 263.

THRU 1/2" DIAMETER	1/2" TO 5/8"	5/8" TO 1-1/2"	1-1/2" TO 2"
+ .0002, -.0000	+ .0003, -.0000	+ .0001, +.0004	+ .0002, +.0006

HSS & COBALT REAMERS

TECHNICAL



GENERAL PURPOSE HSS & M42 COBALT REAMERS

YOUR #1 SOURCE FOR AMERICAN-MADE PREMIUM QUALITY CUTTING TOOLS

CHUCKING - RIGHT HAND SPIRAL - RIGHT HAND CUT



SERIES 935R

SERIES 1935R

SIZE	DEC. EQUIV.	FLUTE LENGTH	# OF FLUTES	OVERALL LENGTH	SHANK DIA.	SERIES 935R		SERIES 1935R	
						HSS	LIST PRICE	M42 COBALT	LIST PRICE
o/u	.2490	1-1/2	6	6	.2405	TR96642	54.94	TR96818	63.17
1/4	.2500	1-1/2	6	6	.2405	TR96643	45.88	TR96819	50.13
o/u	.2510	1-1/2	6	6	.2405	TR96644	54.94	TR96820	63.17
6.5mm	.2559	1-1/2	6	6	.2405	TR96645	51.48	TR96821	58.98
F	.2570	1-1/2	6	6	.2485	TR96646	51.48	TR96822	58.98
G	.2610	1-1/2	6	6	.2485	TR96647	51.48	TR96823	58.98
17/64	.2656	1-1/2	6	6	.2485	TR96648	57.44	TR96824	72.84
H	.2660	1-1/2	6	6	.2485	TR96649	57.44	TR96825	72.84
I	.2720	1-1/2	6	6	.2485	TR96650	57.44	TR96826	72.84
7.0mm	.2756	1-1/2	6	6	.2485	TR96651	57.44	TR96827	72.84
J	.2770	1-1/2	6	6	.2485	TR96652	57.44	TR96828	72.84
K	.2810	1-1/2	6	6	.2485	TR96653	57.44	TR96829	72.84
9/32	.2812	1-1/2	6	6	.2485	TR96654	54.51	TR96830	69.23
L	.2900	1-1/2	6	6	.2792	TR96655	57.44	TR96831	72.84
M	.2950	1-1/2	6	6	.2792	TR96656	57.44	TR96832	72.84
7.5mm	.2953	1-1/2	6	6	.2792	TR96657	57.44	TR96833	72.84
19/64	.2969	1-1/2	6	6	.2792	TR96658	57.44	TR96834	72.84
N	.3020	1-1/2	6	6	.2792	TR96659	57.44	TR96835	72.84
o/u	.3115	1-1/2	6	6	.2792	TR96660	54.51	TR96836	69.23
5/16	.3125	1-1/2	6	6	.2792	TR96661	51.67	TR96837	65.57
o/u	.3135	1-1/2	6	6	.2792	TR96662	54.51	TR96838	69.23
8.0mm	.3150	1-1/2	6	6	.2792	TR96663	57.44	TR96839	72.84
O	.3160	1-1/2	6	6	.2792	TR96664	57.44	TR96840	72.84
P	.3230	1-1/2	6	6	.2792	TR96665	61.43	TR96841	78.46
21/64	.3281	1-1/2	6	6	.2792	TR96666	61.43	TR96842	78.46
Q	.3320	1-1/2	6	6	.2792	TR96667	61.43	TR96843	78.46
8.5mm	.3346	1-1/2	6	6	.2792	TR96668	61.43	TR96844	78.46
R	.3390	1-1/2	6	6	.2792	TR96669	61.43	TR96845	78.46
11/32	.3438	1-1/2	6	6	.2792	TR96670	61.43	TR96846	78.46
S	.3480	1-3/4	6	6	.3105	TR96671	61.96	TR96847	79.52
9.0mm	.3543	1-3/4	6	7	.3105	TR96672	61.96	TR96848	79.52
T	.3580	1-3/4	6	7	.3105	TR96673	61.96	TR96849	79.52
23/64	.3594	1-3/4	6	7	.3105	TR96674	61.96	TR96850	79.52
U	.3680	1-3/4	6	7	.3105	TR96675	61.96	TR96851	79.52
9.5mm-o/u	.3740	1-3/4	6	7	.3105	TR96676	58.88	TR96852	75.48
3/8	.3750	1-3/4	6	7	.3105	TR96677	55.81	TR96853	71.59
o/u	.3760	1-3/4	6	7	.3105	TR96678	58.88	TR96854	75.48
V	.3770	1-3/4	6	7	.3105	TR96679	67.45	TR96855	100.16
W	.3860	1-3/4	6	7	.3105	TR96680	67.45	TR96856	100.16
25/64	.3906	1-3/4	6	7	.3105	TR96681	67.45	TR96857	100.16
10.0mm	.3937	1-3/4	6	7	.3105	TR96682	67.45	TR96858	100.16
X	.3970	1-3/4	6	7	.3105	TR96683	67.45	TR96859	100.16
Y	.4040	1-3/4	6	7	.3105	TR96684	69.95	TR96860	100.16
13/32	.4062	1-3/4	6	7	.3105	TR96685	69.95	TR96861	100.16
Z	.4130	1-3/4	6	7	.3730	TR96686	69.95	TR96862	100.16
10.5mm	.4134	1-3/4	6	7	.3730	TR96687	69.95	TR96863	100.16

For technical information, please see page 263.

THRU 1/2" DIAMETER	1/2" TO 5/8"	5/8" TO 1-1/2"	1-1/2" TO 2"
+ .0002, -.0000	+ .0003, -.0000	+ .0001, +.0004	+ .0002, +.0006

GENERAL PURPOSE HSS & M42 COBALT REAMERS



YOUR #1 SOURCE FOR AMERICAN-MADE PREMIUM QUALITY CUTTING TOOLS

REAMING

CHUCKING - RIGHT HAND SPIRAL - RIGHT HAND CUT



SIZE	DEC. EQUIV.	FLUTE LENGTH	# OF FLUTES	OVERALL LENGTH	SHANK DIA.	SERIES 935R		SERIES 1935R	
						HSS	LIST PRICE	M42 COBALT	LIST PRICE
27/64	.4219	1-3/4	6	7	.3730	TR96688	69.95	TR96864	100.16
11.0mm	.4331	1-3/4	6	7	.3730	TR96689	69.95	TR96865	100.16
o/u	.4365	1-3/4	6	7	.3730	TR96690	69.95	TR96866	100.16
7/16	.4375	1-3/4	6	7	.3730	TR96691	66.44	TR96867	95.11
o/u	.4385	1-3/4	6	7	.3730	TR96692	69.95	TR96868	100.16
11.5mm	.4528	1-3/4	6	7	.3730	TR96693	76.25	TR96869	114.79
29/64	.4531	1-3/4	6	7	.3730	TR96694	76.25	TR96870	114.79
15/32	.4688	1-3/4	6	7	.3730	TR96695	76.25	TR96871	114.79
12.0mm	.4724	2	6	8	.4355	TR96696	76.25	TR96872	114.79
31/64	.4844	2	6	8	.4355	TR96697	76.25	TR96873	114.79
12.5mm	.4921	2	6	8	.4355	TR96698	76.25	TR96874	114.79
o/u	.4990	2	6	8	.4355	TR96699	76.25	TR96875	114.79
1/2	.5000	2	6	8	.4355	TR96700	72.31	TR96876	109.01
o/u	.5010	2	6	8	.4355	TR96701	76.25	-	-
17/32	.5312	2	6	8	.4355	TR96702	89.91	-	-
9/16	.5625	2	8	8	.4355	TR96703	89.91	-	-
19/32	.5938	2	8	8	.4355	TR96704	89.91	-	-
5/8	.6250	2-1/4	8	9	.5615	TR96705	104.92	-	-
21/32	.6562	2-1/4	8	9	.5615	TR96706	113.62	-	-
11/16	.6875	2-1/4	8	9	.5615	TR96707	122.13	-	-
23/32	.7188	2-1/4	8	9	.5615	TR96708	143.07	-	-
3/4	.7500	2-1/2	8	9-1/2	.6240	TR96709	136.04	-	-
25/32	.7812	2-1/2	8	9-1/2	.6240	TR96710	147.43	-	-
13/16	.8125	2-1/2	8	9-1/2	.6240	TR96711	147.23	-	-
27/32	.8438	2-1/2	8	9-1/2	.6240	TR96712	182.98	-	-
7/8	.8750	2-5/8	8	10	.7490	TR96713	173.82	-	-
29/32	.9062	2-5/8	8	10	.7490	TR96714	201.60	-	-
15/16	.9375	2-5/8	8	10	.7490	TR96715	191.77	-	-
31/32	.9688	2-5/8	8	10	.7490	TR96716	215.10	-	-
1	1.0000	2-3/4	8	10-1/2	.8740	TR96717	216.76	-	-
1-1/16	1.0625	2-3/4	8	10-1/2	.8740	TR96718	240.15	-	-
1-1/8	1.1250	2-7/8	8	11	.8740	TR96719	254.77	-	-
1-3/16	1.1875	2-7/8	8	11	.9990	TR96720	298.33	-	-
1-1/4	1.2500	3	8	11-1/2	.9990	TR96721	315.66	-	-
1-5/16	1.3125	3	10	11-1/2	.9990	TR96722	368.84	-	-
1-3/8	1.3750	3-1/4	10	12	.9990	TR96723	386.88	-	-
1-7/16	1.4375	3-1/4	10	12	1.2490	TR96724	413.89	-	-
1-1/2	1.5000	3-1/2	10	12-1/2	1.2490	TR96725	444.92	-	-
1-9/16	1.5625	3-1/2	12	13	1.2490	TR96900	634.49	-	-
1-5/8	1.6250	3-1/2	12	13	1.2490	TR96901	637.72	-	-
1-11/16	1.6875	4	12	13-1/2	1.2490	TR96902	726.28	-	-
1-3/4	1.7500	4	12	13-1/2	1.2490	TR96903	732.26	-	-
1-13/16	1.8125	4	12	14	1.4990	TR96904	843.36	-	-
1-7/8	1.8750	4	12	14	1.4990	TR96905	843.36	-	-
1-15/16	1.9375	4	12	14	1.4990	TR96906	987.32	-	-
2	2.0000	4	12	14	1.4990	TR96907	987.32	-	-

For technical information, please see page 263.

THRU 1/2" DIAMETER	1/2" TO 5/8"	5/8" TO 1-1/2"	1-1/2" TO 2"
+ .0002, -.0000	+ .0003, -.0000	+ .0001, +.0004	+ .0002, +.0006

HSS & COBALT REAMERS

TECHNICAL



GENERAL PURPOSE HSS & M42 COBALT REAMERS

YOUR #1 SOURCE FOR AMERICAN-MADE PREMIUM QUALITY CUTTING TOOLS

DOWEL PIN - STRAIGHT FLUTE



SERIES 9700
HIGH SPEED STEEL

SERIES 1970
M42 COBALT

DOWEL PIN - RIGHT HAND SPIRAL - RIGHT HAND CUT



SERIES 9750
HIGH SPEED STEEL

SERIES 1975
M42 COBALT

SIZE	FLUTE LENGTH	# OF FLUTES	OVERALL LENGTH	SHANK DIA.	9700	LIST PRICE	1970	LIST PRICE	9750	LIST PRICE	1975	LIST PRICE
.1230	7/8	4	3-1/2	.1190	TR96264	30.31	TR96508	32.69	TR96950	34.73	TR96970	36.23
.1247	7/8	4	3-1/2	.1190	TR96265	30.31	TR96509	31.37	TR96951	34.73	TR96971	36.23
.1855	1-1/8	6	4-1/2	.1805	TR96266	38.68	TR96510	39.40	TR96952	44.40	TR96972	48.31
.1870	1-1/8	6	4-1/2	.1805	TR96267	38.68	TR96511	39.40	TR96953	44.40	TR96973	48.25
.2480	1-1/2	6	6	.2405	TR96268	42.19	TR96512	44.21	TR96954	46.38	TR96974	50.56
.2495	1-1/2	6	6	.2405	TR96269	42.19	TR96513	44.21	TR96955	46.38	TR96975	50.56
.3105	1-1/2	6	6	.2792	TR96270	49.55	TR96514	63.31	TR96956	54.55	TR96976	66.97
.3120	1-1/2	6	6	.2792	TR96271	49.55	TR96515	63.31	TR96957	54.55	TR96977	65.67
.3730	1-3/4	6	7	.3105	TR96272	53.50	TR96516	69.37	TR96958	58.88	TR96978	71.92
.3745	1-3/4	6	7	.3105	TR96273	53.50	TR96517	69.37	TR96959	58.88	TR96979	71.92
.4355	1-3/4	6	7	.3730	TR96274	60.38	TR96518	89.00	TR96960	69.95	TR96980	98.79
.4370	1-3/4	6	7	.3730	TR96275	60.38	TR96519	89.00	TR96961	69.95	TR96981	98.79
.4980	2	6	8	.4355	TR96276	65.76	TR96520	102.09	TR96962	76.20	TR96982	109.35
.4995	2	6	8	.4355	TR96277	65.76	TR96521	102.09	TR96963	76.20	TR96983	112.90

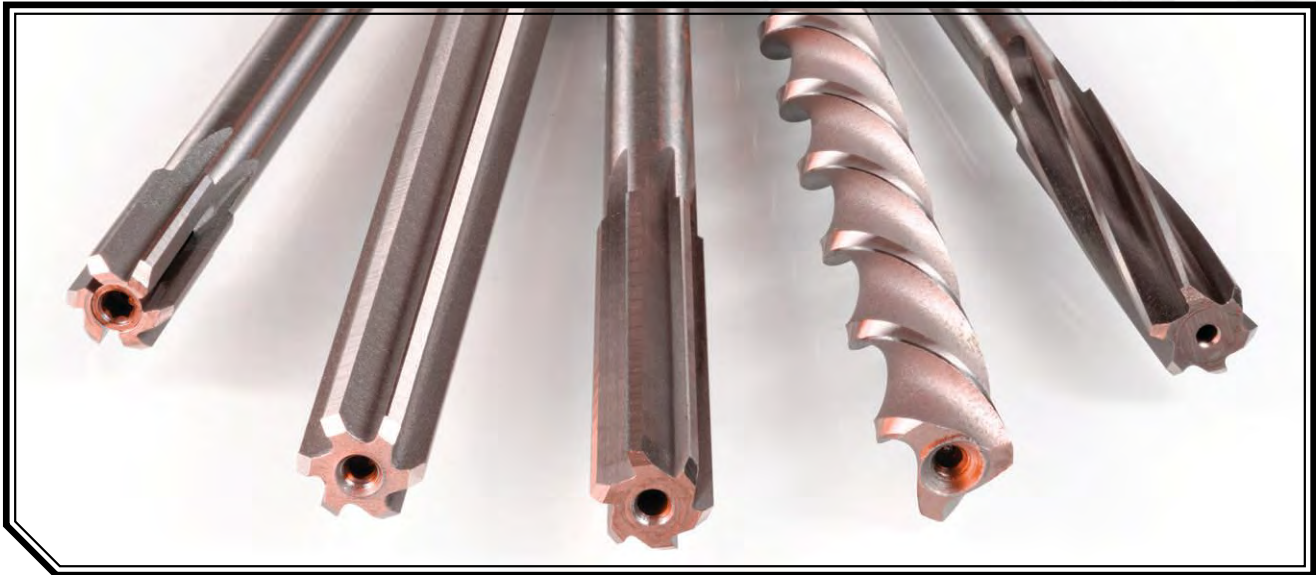

Huge assortment of HSS and M42 Cobalt Reamers for precision machining

For technical information, please see page 263.

THRU 1/2" DIAMETER	1/2" TO 5/8"	5/8" TO 1-1/2"	1-1/2" TO 2"
+0.002, -.0000	+0.003, -.0000	+0.001, +0.004	+0.002, +0.006

GENERAL PURPOSE HSS REAMERS



YOUR #1 SOURCE FOR AMERICAN-MADE PREMIUM QUALITY CUTTING TOOLS

EXPANSION - STRAIGHT FLUTE



SERIES 931

HIGH SPEED STEEL

END VIEW

SIZE	FLUTE LENGTH	# OF FLUTES	OVERALL LENGTH	SHANK DIA.	ITEM#	LIST PRICE
3/8	3/4	6	7	5/16	TR97201	183.82
13/32	3/4	6	7	5/16	TR97202	205.23
7/16	7/8	6	7	3/8	TR97203	195.80
15/32	7/8	6	8	27/64	TR97204	212.91
1/2	1	6	8	7/16	TR97205	206.96
17/32	1	6	8	7/16	TR97206	230.39
9/16	1-1/8	6	8	7/16	TR97207	224.62
19/32	1-1/8	6	8	7/16	TR97208	227.99
5/8	1-1/4	6	9	9/16	TR97209	234.67
21/32	1-1/4	6	9	9/16	TR97210	250.60
11/16	1-1/4	6	9	9/16	TR97211	264.74
23/32	1-1/4	6	9	9/16	TR97212	282.06
3/4	1-3/8	6	9-1/2	5/8	TR97213	277.80
25/32	1-3/8	8	9-1/2	5/8	TR97214	293.97
13/16	1-3/8	8	9-1/2	5/8	TR97215	320.36
27/32	1-3/8	8	9-1/2	5/8	TR97216	321.52
7/8	1-1/2	8	10	3/4	TR97217	327.33

SIZE	FLUTE LENGTH	# OF FLUTES	OVERALL LENGTH	SHANK DIA.	ITEM#	LIST PRICE
29/32	1-1/2	8	10	3/4	TR97218	361.86
15/16	1-1/2	8	10	3/4	TR97219	378.68
31/32	1-1/2	8	10	3/4	TR97220	395.79
1	1-5/8	8	10-1/2	7/8	TR97221	397.63
1-1/32	1-5/8	8	10-1/2	7/8	TR97222	580.69
1-1/16	1-5/8	8	10-1/2	7/8	TR97223	461.28
1-3/32	1-5/8	8	10-1/2	7/8	TR97224	460.29
1-1/8	1-3/4	8	11	7/8	TR97225	480.80
1-5/32	1-3/4	8	11	7/8	TR97226	511.51
1-3/16	1-3/4	8	11	1	TR97227	506.04
1-7/32	1-3/4	8	11	1	TR97228	550.69
1-1/4	1-7/8	8	11-1/2	1	TR97229	544.94
1-5/16	1-7/8	8	11-1/2	1	TR97230	562.91
1-3/8	2	8	12	1	TR97231	583.53
1-7/16	2	8	12	1-1/4	TR97232	636.11
1-1/2	2-1/8	8	12-1/2	1-1/4	TR97233	631.47

EXPANSION - TAPER SHANK - STRAIGHT FLUTE



SERIES 932

HIGH SPEED STEEL

END VIEW

SIZE	FLUTE LENGTH	# OF FLUTES	OVERALL LENGTH	MORSE TAPER #	ITEM#	LIST PRICE
3/8	3/4	6	7	1	TR97250	218.62
13/32	3/4	6	7	1	TR97251	241.84
7/16	7/8	6	7	1	TR97252	231.38
15/32	7/8	6	8	1	TR97253	236.94
1/2	1	6	8	1	TR97254	230.58
17/32	1	6	8	1	TR97255	239.72
9/16	1-1/8	6	8	1	TR97256	243.44
19/32	1-1/8	6	8	1	TR97257	264.95
5/8	1-1/4	6	9	2	TR97258	261.11
21/32	1-1/4	6	9	2	TR97259	289.17
11/16	1-1/4	6	9	2	TR97260	290.82
23/32	1-1/4	6	9	2	TR97261	310.19
3/4	1-3/8	6	9-1/2	2	TR97262	304.51
25/32	1-3/8	8	9-1/2	2	TR97263	318.49
13/16	1-3/8	8	9-1/2	2	TR97264	323.12
27/32	1-3/8	8	9-1/2	2	TR97265	358.87
7/8	1-1/2	8	10	2	TR97266	355.28

SIZE	FLUTE LENGTH	# OF FLUTES	OVERALL LENGTH	MORSE TAPER #	ITEM#	LIST PRICE
29/32	1-1/2	8	10	2	TR97267	392.39
15/16	1-1/2	8	10	3	TR97268	402.04
31/32	1-1/2	8	10	3	TR97269	418.98
1	1-5/8	8	10-1/2	3	TR97270	422.07
1-1/32	1-5/8	8	10-1/2	3	TR97271	438.18
1-1/16	1-5/8	8	10-1/2	3	TR97272	459.08
1-3/32	1-5/8	8	10-1/2	3	TR97273	503.43
1-1/8	1-3/4	8	11	3	TR97274	496.07
1-5/32	1-3/4	8	11	3	TR97275	542.13
1-3/16	1-3/4	8	11	3	TR97276	563.60
1-7/32	1-3/4	8	11	3	TR97277	585.39
1-1/4	1-7/8	8	11-1/2	4	TR97278	582.93
1-5/16	1-7/8	8	11-1/2	4	TR97279	635.69
1-3/8	2	8	12	4	TR97280	630.48
1-7/16	2	8	12	4	TR97281	667.05
1-1/2	2-1/8	8	12-1/2	4	TR97282	689.71

For technical information, please see page 263.

THRU 1/2" DIAMETER	ABOVE 1/2" TO 5/8"	ABOVE 5/8" TO 1-1/2"
+0.002, -0.000	+0.003, -0.000	+0.001, +0.004



GENERAL PURPOSE HSS REAMERS

YOUR #1 SOURCE FOR AMERICAN-MADE PREMIUM QUALITY CUTTING TOOLS

HAND - STRAIGHT FLUTE



SERIES 9000 HIGH SPEED STEEL

SIZE	DECIMAL EQUIV.	FLUTE LENGTH	# OF FLUTES	OVERALL LENGTH	SHANK DIA.	ITEM#	LIST PRICE
1/16	.0625	1	4	2	.0625	TR97606	85.78
5/64	.0781	1	4	2	.0781	TR97607	85.78
3/32	.0938	1-1/4	4	2-1/2	.0938	TR97608	85.78
7/64	.1094	1-1/4	4	2-1/2	.1094	TR97609	85.78
1/8	.1250	1-1/2	4	3	.1250	TR97610	80.87
9/64	.1406	1-5/8	4	3-1/4	.1406	TR97611	80.87
5/32	.1562	1-5/8	4	3-1/4	.1562	TR97612	87.41
11/64	.1719	1-3/4	6	3-1/2	.1719	TR97613	87.41
3/16	.1875	1-3/4	6	3-1/2	.1875	TR97614	85.78
13/64	.2031	1-7/8	6	3-3/4	.2031	TR97615	85.78
7/32	.2188	1-7/8	6	3-3/4	.2188	TR97616	94.53
15/64	.2344	2	6	4	.2344	TR97617	94.53
1/4	.2500	2	6	4	.2500	TR97618	93.96
17/64	.2656	2-1/8	6	4-1/4	.2656	TR97619	94.53
9/32	.2812	2-1/8	6	4-1/4	.2812	TR97620	101.70
19/64	.2969	2-1/4	6	4-1/2	.2969	TR97621	101.70
5/16	.3125	2-1/4	6	4-1/2	.3125	TR97622	99.44
11/32	.3438	2-3/8	6	4-3/4	.3438	TR97623	115.41
3/8	.3750	2-1/2	6	5	.3750	TR97624	112.67
13/32	.4062	2-5/8	6	5-1/4	.4062	TR97625	130.76
7/16	.4375	2-3/4	6	5-1/2	.4375	TR97626	128.11
15/32	.4688	2-7/8	6	5-3/4	.4688	TR97627	141.73
1/2	.5000	3	6	6	.5000	TR97628	136.24
17/32	.5312	3-1/8	8	6-1/4	.5312	TR97629	147.21
9/16	.5625	3-1/4	8	6-1/2	.5625	TR97630	157.46
19/32	.5938	3-3/8	8	6-3/4	.5938	TR97631	175.02
5/8	.6250	3-1/2	8	7	.6250	TR97632	169.68
21/32	.6562	3-11/16	8	7-3/8	.6562	TR97633	193.73
11/16	.6875	3-7/8	8	7-3/4	.6875	TR97634	189.03
23/32	.7188	4-1/16	8	8-1/8	.7188	TR97635	206.88
3/4	.7500	4-3/16	8	8-3/8	.7500	TR97636	198.78
25/32	.7812	4-3/8	8	8-3/4	.7812	TR97637	218.12
13/16	.8125	4-9/16	8	9-1/8	.8125	TR97638	198.78
27/32	.8438	4-11/16	8	9-3/8	.8438	TR97639	238.81
7/8	.8750	4-7/8	8	9-3/4	.8750	TR97640	240.88
29/32	.9062	5	8	10	.9062	TR97641	266.18
15/16	.9375	5-1/8	8	10-1/4	.9375	TR97642	241.07
31/32	.9688	5-5/16	8	10-5/8	.9688	TR97643	293.08
1	1.0000	5-7/16	8	10-7/8	1.0000	TR97644	291.78
1-1/8	1.1250	5-13/16	8	11-5/8	1.1250	TR97645	381.31
1-1/4	1.2500	6-1/8	8	12-1/4	1.2500	TR97646	468.24
1-3/8	1.3750	6-5/16	10	12-5/8	1.3750	TR97647	553.44
1-1/2	1.5000	6-1/2	10	13	1.5000	TR97648	653.22

For technical information, please see page 263.

THRU 1/2" DIAMETER	ABOVE 1/2" TO 5/8"	ABOVE 5/8" TO 1-1/2"
+0.002, -0.000	+0.003, -0.000	+0.001, +0.004

GENERAL PURPOSE HSS REAMERS



YOUR #1 SOURCE FOR AMERICAN-MADE PREMIUM QUALITY CUTTING TOOLS

REAMING

TAPER PIPE - LEFT HAND SPIRAL - RIGHT HAND CUT



SERIES 906
HIGH SPEED STEEL

SIZE	DIAMETER SMALL END	DIAMETER LARGE END	FLUTE LENGTH	# OF FLUTES	OVERALL LENGTH	SHANK DIAMETER	SIZE OF SQUARE	ITEM#	LIST PRICE
1/16	.2320	0.2750	3/4	6	2-1/8	.3125	.235	TR97649	112.19
1/8	.3160	0.3620	3/4	6	2-1/8	.4375	.328	TR97650	104.59
1/4	.4060	0.4720	1-1/16	6	2-7/16	.5625	.421	TR97651	119.74
3/8	.5400	0.6060	1-1/16	6	2-9/16	.7000	.531	TR97652	135.57
1/2	.6650	0.7510	1-3/8	6	3-1/8	.6875	.515	TR97653	171.27
3/4	.8760	0.9620	1-3/8	8	3-1/4	.9063	.679	TR97654	237.46
1	1.1030	1.2120	1-3/4	8	3-3/4	1.1250	.843	TR97655	349.41
1-1/4	1.4440	1.5530	1-3/4	10	4	1.3125	.984	TR97656	588.51
1-1/2	1.6840	1.7930	1-3/4	12	4-1/4	1.5000	1.125	TR97657	744.14
2	2.1590	2.2680	1-3/4	12	4-1/2	1.8750	1.406	TR97658	993.97

TAPER PIN
HIGH SPEED STEEL



SERIES 987
STRAIGHT FLUTE



SERIES 991
LEFT HAND SPIRAL
RIGHT HAND CUT



SERIES 988
LEFT HAND HELICAL
RIGHT HAND CUT

SIZE	DIAMETER SMALL END	DIAMETER LARGE END	# OF FLUTES	STRAIGHT LIST PRICE	LH-SPIRAL LIST PRICE	LH-HELICAL LIST PRICE
7/0	.0497	0.0666	4	TR97525 89.72	TR97567 93.09	TR97546 83.23
6/0	.0611	0.0806	4	TR97526 89.72	TR97568 93.09	TR97547 78.37
5/0	.0719	0.0966	4	TR97527 81.78	TR97569 89.72	TR97548 81.30
4/0	.0869	0.1142	4	TR97528 81.78	TR97570 89.72	TR97549 81.30
3/0	.1029	0.1302	4	TR97529 81.78	TR97571 89.72	TR97550 73.41
2/0	.1137	0.1462	4	TR97530 73.12	TR97572 78.37	TR97551 74.28
0	.1287	0.1638	4	TR97531 70.33	TR97573 74.90	TR97552 76.06
1	.1447	0.1798	6	TR97532 68.12	TR97574 76.06	TR97553 77.21
2	.1605	0.2008	6	TR97533 68.12	TR97575 76.06	TR97554 87.41
3	.1813	0.2294	6	TR97534 68.12	TR97576 76.06	TR97555 90.35
4	.2071	0.2604	6	TR97535 76.06	TR97577 82.94	TR97556 101.70
5	.2409	0.2994	6	TR97536 81.78	TR97578 88.47	TR97557 111.27
6	.2773	0.3540	6	TR97537 98.72	TR97579 109.01	TR97558 130.61
7	.3297	0.4220	6	TR97538 127.15	TR97580 137.83	TR97559 161.21
8	.3971	0.5050	6	TR97539 164.78	TR97581 180.30	TR97560 189.16
9	.4805	0.6066	6	TR97540 197.58	TR97582 215.09	TR97561 207.83
10	.5799	0.7216	6	TR97541 216.92	TR97583 238.43	TR97562 263.87
11	.7060	0.8780	8	TR97542 231.16	TR97584 254.35	TR97563 292.40
12	.8420	1.0500	8	TR97543 357.69	TR97585 393.43	TR97564 432.98
13	1.0090	1.2590	10	TR97544 693.77	TR97586 763.14	TR97565 1185.93
14	1.2500	1.5420	10	TR97545 1111.64	TR97587 1233.69	TR97566 1354.64

For technical information, please see page 263.

HSS & COBALT REAMERS

TECHNICAL



GENERAL PURPOSE HSS REAMERS

YOUR #1 SOURCE FOR AMERICAN-MADE PREMIUM QUALITY CUTTING TOOLS

CAPSCREW COUNTERBORES



SERIES 901 - STANDARD TOLERANCE

SIZE	PILOT SIZE	PILOT LENGTH	FLUTE SIZE	BODY LENGTH	OVERALL LENGTH	ITEM#	LIST PRICE
4	.1120	1/8	0.1830	9/16	3-7/8	TR97470	53.68
5	.1250	5/32	0.2050	5/8	4-1/8	TR97471	53.57
6	.1380	3/16	0.2270	3/4	4-5/8	TR97472	54.51
8	.1640	7/32	0.2700	3/4	5	TR97473	58.40
10	.1900	1/4	0.3120	7/8	5-1/4	TR97474	59.65
1/4	.2500	9/32	0.3800	1	5-5/8	TR97475	62.73
5/16	.3125	5/16	0.4740	1	6-1/8	TR97476	78.37
3/8	.3750	3/8	0.5690	1-1/4	6-1/2	TR97477	85.58
7/16	.4370	7/16	0.6610	1-1/4	7	TR97478	102.95
1/2	.5000	1/2	0.7550	1-1/2	7-1/2	TR97479	121.10
5/8	.6250	5/8	0.9430	1-1/2	7-5/8	TR97480	197.71
3/4	.7500	3/4	1.1310	1-5/8	7-3/4	TR97481	228.63
7/8	.8750	7/8	1.3200	1-7/8	8	TR97482	276.82
1	1.0000	1	1.5080	2	8-1/2	TR97483	367.16

SERIES 902 - 1/64 O/S TOLERANCE

SIZE	PILOT SIZE	PILOT LENGTH	FLUTE SIZE	BODY LENGTH	OVERALL LENGTH	ITEM#	LIST PRICE
4	.1270	1/8	0.1990	9/16	3-7/8	TR97484	51.48
5	.1400	5/32	0.2210	5/8	4-1/8	TR97485	53.52
6	.1530	3/16	0.2430	3/4	4-5/8	TR97486	54.51
8	.1790	7/32	0.2860	3/4	5	TR97487	58.40
10	.2050	1/4	0.3280	7/8	5-1/4	TR97488	59.65
1/4	.2650	9/32	0.3960	1	5-5/8	TR97489	62.73
5/16	.3280	5/16	0.4890	1	6-1/8	TR97490	78.37
3/8	.3900	3/8	0.5850	1-1/4	6-1/2	TR97491	85.58
7/16	.4520	7/16	0.6760	1-1/4	7	TR97492	102.95
1/2	.5150	1/2	0.7710	1-1/2	7-1/2	TR97493	120.95
5/8	.6400	5/8	0.9590	1-1/2	7-5/8	TR97494	207.48
3/4	.7650	3/4	1.1470	1-5/8	7-3/4	TR97495	228.38
7/8	.8910	7/8	1.3360	1-7/8	8	TR97496	290.34
1	1.0150	1	1.5240	2	8-1/2	TR97497	367.16

SERIES 903 - 1/32 O/S TOLERANCE

SIZE	PILOT SIZE	PILOT LENGTH	FLUTE SIZE	BODY LENGTH	OVERALL LENGTH	ITEM#	LIST PRICE
4	.1430	1/8	0.2150	9/16	3-7/8	TR97501	51.48
5	.1560	5/32	0.2370	5/8	4-1/8	TR97502	51.48
6	.1690	3/16	0.2590	3/4	4-5/8	TR97503	54.51
8	.1950	7/32	0.3020	3/4	5	TR97504	58.40
10	.2180	1/4	0.3440	7/8	5-1/4	TR97505	59.65
1/4	.2810	9/32	0.4120	1	5-5/8	TR97506	62.73
5/16	.3430	5/16	0.5040	1	6-1/8	TR97507	78.37
3/8	.4060	3/8	0.6010	1-1/4	6-1/2	TR97508	85.58
7/16	.4680	7/16	0.6910	1-1/4	7	TR97509	102.95
1/2	.5310	1/2	0.7870	1-1/2	7-1/2	TR97510	120.95
5/8	.6560	5/8	0.9750	1-1/2	7-5/8	TR97511	197.61
3/4	.7810	3/4	1.1630	1-5/8	7-3/4	TR97512	228.24
7/8	.9060	7/8	1.3520	1-7/8	8	TR97513	276.29
1	1.0310	1	1.5400	2	8-1/2	TR97514	349.26

For technical information, please see page 263.

GENERAL PURPOSE HSS REAMERS



YOUR #1 SOURCE FOR AMERICAN-MADE PREMIUM QUALITY CUTTING TOOLS

REAMING



CONSTRUCTION FLATTED SHANK

SIZE	FLUTE LENGTH	# OF FLUTES	OVERALL LENGTH	SHANK DIA.	ITEM#	LIST PRICE
3/8	2-1/2	5	4-5/8	3/8	TR97595	91.64
7/16	3-1/4	5	5-3/8	7/16	TR97596	98.90
1/2	3-3/4	5	5-7/8	1/2	TR97597	109.46
9/16	3-3/4	5	5-7/8	1/2	TR97598	113.92
5/8	4-1/4	5	6-3/8	1/2	TR97599	126.71
11/16	4-1/4	5	6-3/8	1/2	TR97600	152.01
3/4	4-1/2	5	6-7/8	1/2	TR97601	159.95
13/16	4-1/2	5	6-7/8	1/2	TR97602	159.95
7/8	4-1/2	5	6-7/8	1/2	TR97603	181.43
15/16	4-1/2	5	6-7/8	1/2	TR97604	181.43
1	4-1/2	5	6-7/8	1/2	TR97605	207.17
1-1/16	4-1/2	5	6-7/8	1/2	TR97660	243.71

SERIES 9950
HIGH SPEED STEEL
LEFT HAND SPIRAL
RIGHT HAND CUT
BLACK & GOLD
3 FLATS



SAFETY MAGNETIC HEX SHANK

SIZE	FLUTE LENGTH	# OF FLUTES	OVERALL LENGTH	HEX SHANK DIA.	ITEM#	LIST PRICE
9/16	4	5	5-1/2	1-1/16	TR99050	193.17
11/16	4-1/2	5	6-3/8	1-1/16	TR99052	233.60
13/16	5	5	7	1-1/4	TR99054	279.33
15/16	5	5	7	1-7/16	TR99056	315.62
1-1/16	5	5	7	1-5/8	TR99058	418.05
1-3/16	5	5	7	1-13/16	TR99060	538.52
1-5/16	5	5	7-7/8	2	TR99062	643.29

SERIES 996
HIGH SPEED STEEL
LEFT HAND SPIRAL
RIGHT HAND CUT
BLACK & GOLD
Magnetic Hex Shank has been
designed to protect against
danger and loss
See OSHA 29CFR Part 1926.759
(falling object protection)



BRIDGE TAPER SHANK

SIZE	FLUTE LENGTH	# OF FLUTES	OVERALL LENGTH	MORSE TAPER #	SMALL DIA.	ITEM#	LIST PRICE
7/16	5-1/8	5	9	2	.3050	TR98974	137.51
1/2	5-1/8	5	9	2	.3125	TR98976	150.99
9/16	5-1/8	5	9	2	.3430	TR97589	145.43
5/8	6-1/8	5	10	2	.3750	TR98978	159.55
11/16	7-1/8	5	11-3/4	3	.3906	TR97590	167.96
3/4	7-3/8	5	12	3	.5000	TR97591	230.57
13/16	7-3/8	5	12	3	.5000	TR97592	229.02
7/8	7-3/8	5	12	3	.5625	TR98980	250.89
15/16	7-3/8	5	12	3	.6250	TR97593	267.06
1	7-3/8	5	12	3	.6875	TR98982	290.09
1-1/16	7-3/8	5	12	3	.7500	TR97594	299.97
1-1/8	7-3/8	5	12	3	.8125	TR98984	367.35
1-3/16	7-3/8	5	12	3	.8750	TR98986	472.23
1-1/4	7-3/8	5	13	4	.9375	TR98988	538.16
1-5/16	7-3/8	5	13	4	1.000	TR98990	636.86

SERIES 9850
HIGH SPEED STEEL
LEFT HAND SPIRAL
RIGHT HAND CUT

For technical information, please see page 263.



GENERAL PURPOSE HSS REAMER SETS

YOUR #1 SOURCE FOR AMERICAN-MADE PREMIUM QUALITY CUTTING TOOLS



ITEM# TR96286
60 PC #1 - #60
HIGH SPEED STEEL

DESCRIPTION	FLUTE STYLE	ITEM#	LIST PRICE
10PC • #4 - 1/2" • Standard • Ctr Bore Set • HSS	RH Spiral	TR96307	762.95
10PC • #4 - 1/2" • 1/64" OS • Ctr Bore Set • HSS	RH Spiral	TR96308	762.95
10PC • #4 - 1/2" • 1/32" OS • Ctr Bore Set • HSS	RH Spiral	TR96309	762.95
14PC • Dowel Pin • .1230 - .4995 • HSS	Straight	TR96279	900.21
14PC • O/U • .1240 - .5010 • HSS	Straight	TR96293	776.18
20PC • #61 - #80 • HSS	Straight	TR96305	909.83
26PC • A-Z • HSS	Straight	TR96290	1384.80
29PC • 1/16" - 1/2" by 64ths • HSS	Straight	TR96283	1496.51
60PC • #1 - #60 • HSS	Straight	TR96286	2220.15

For technical information, please see page 263.

GENERAL PURPOSE M42 COBALT REAMER SETS



YOUR #1 SOURCE FOR AMERICAN-MADE PREMIUM QUALITY CUTTING TOOLS

REAMING



ITEM# TR96284

29 PC 1/16" - 1/2" BY 64ths
M42 COBALT

DESCRIPTION	FLUTE STYLE	ITEM#	LIST PRICE
14PC • Dowel Pin • .1230 - .4995 • M42 Cobalt	Straight	TR96280	1018.12
14PC • O/U • .1240 - .5010 • M42 Cobalt	Straight	TR96294	972.90
26PC • A-Z • M42 Cobalt	Straight	TR96291	1927.65
29PC • 1/16" - 1/2" by 64ths • M42 Cobalt	Straight	TR96284	1960.42
60PC • #1 - #60 • M42 Cobalt	Straight	TR96287	2410.47

HSS & COBALT REAMERS

For technical information, please see page 263.

TECHNICAL



CARBIDE REAMER TECHNICAL INFORMATION

YOUR #1 SOURCE FOR AMERICAN-MADE PREMIUM QUALITY CUTTING TOOLS

CARBIDE REAMERS - SFM & I.P.T. (INCH PER TOOTH)

MATERIAL	SFM	FEED (IPR)
ALUMINUM / ALUMINUM ALLOYS	100 - 250	.005 - .015
ALUMINUM - HIGH SILICON	80 - 200	.003 - .012
BRASS	100 - 250	.005 - .015
BRONZE	90 - 175	.003 - .012
COPPER / COPPER ALLOYS	90 - 220	.005 - .015
CAST IRON - SOFT	80 - 200	.006 - .015
CAST IRON - MEDIUM	60 - 150	.006 - .012
CAST IRON - HARD	40 - 90	.004 - .010
MAGNESIUM	100 - 250	.005 - .015
MONEL	40 - 120	.004 - .012
STEEL - CAST & FORGED	40 - 100	.003 - .010
STEEL - HEAT TREATED (35-40 Rc)	40 - 70	.004 - .008
STEEL - HEAT TREATED (40-45 Rc)	30 - 50	.002 - .006
STEEL - HEAT TREATED (45+ Rc)	15 - 40	.001 - .004

MATERIAL	SFM	FEED (IPR)
STEEL - MEDIUM CARBON	50 - 100	.005 - .010
MOLD STEEL	40 - 120	.004 - .006
TOOL STEEL	30 - 90	.004 - .006
STAINLESS STEEL - 300 SERIES	20 - 80	.004 - .008
STAINLESS STEEL - 400 SERIES	30 - 120	.005 - .010
INCONEL	20 - 60	.001 - .005
RENE	20 - 60	.002 - .006
TITANIUM	30 - 90	.002 - .008
WASPOLOY	20 - 60	.002 - .006
EPOXY FIBER	100 - 250	.005 - .015
PLASTIC	100 - 300	.005 - .015
RESIN - FIBER GLASS	100 - 300	.005 - .015
MASONITE	60 - 150	.005 - .015
PHENOLIC	60 - 100	.005 - .015



Expansive reamer inventory, always in-stock ready to ship

HSS & M42 COBALT TECHNICAL INFORMATION



YOUR #1 SOURCE FOR AMERICAN-MADE PREMIUM QUALITY CUTTING TOOLS

RECOMMENDED SPEEDS	
MATERIAL	SFM
STEEL - ALL TYPES	
60+ Rc	8 - 12
50 - 60 Rc	15 - 30
40 - 50 Rc	20 - 40
30 - 40 Rc	35 - 65
Less than 30 Rc	60 - 90
CAST IRON & MALLEABLE IRON	50 - 85
NON-FERROUS	
ALUMINUM, BRASS, BRONZE, COPPER	90 - 175
FIBER, PLASTIC, HARD RUBBER, etc.	90 - 175

Work piece hardness and machinability must be considered when setting machine speed. The feed rate plays an important part in the life expectancy of a tool and the hole finish which one is looking to attain. Improper feed rate can cause excessive tool wear as well as an inadequate hole finish.

To eliminate chatter, slow cutting speed and increase feed appropriately. Stock removal on roughing operations should not exceed 2 to 4 percent of tool diameter in most cases. Stock removal recommendations on finishing operations are .002 to .004.

For best results with brass, cast iron and some plastics, use a Left-Hand Spiral-Fluted reamer with negative shear action. This type of reamer helps prevent chips from working back into the flutes and scoring the hole. In all reaming operations, use constant-flow coolants. Soluble oil is effective for most metals; however, sulphur-based oils are recommended for stainless and certain alloy steels. Lard oil and kerosene improve the finish on aluminum.

RECOMMENDED FEEDS	
MATERIAL	FEED (IPR)
STEEL - ALL TYPES	
50+ Rc	.002 - .004
30 - 50 Rc	.004 - .008
CAST IRON & MALLEABLE IRON	.005 - .012
NON-FERROUS	
ALUMINUM, BRASS, BRONZE, COPPER	.005 - .012
FIBER, PLASTIC, HARD RUBBER, etc.	.005 - .012

RECOMMENDED STOCK REMOVAL	
REAMER DIAMETER	REMOVAL (Inches)
Up to 1/16" incl.	.003 - .005
Over 1/16" to 1/8" incl.	.004 - .008
Over 1/8" to 1/4" incl.	.006 - .012
Over 1/4" to 3/8" incl.	.008 - .014
Over 3/8" to 1/2" incl.	.010 - .015
Over 1/2" to 3/4" incl.	.012 - .018

RECOMMENDED LUBRICANTS	
MATERIAL	LUBRICANT
Steel harder than 50 Rc	Light Oil
Steel softer than 50 Rc	Light Oil for good finishes or Soluable Oil and Water
Cast Iron & Malleable Iron	Soluable Oil and Water
Non-Ferrous Materials	Soluable Oil and Water



All Titan USA Cutting Tools are 100% American-Made



GENERAL MACHINING FORMULAS

YOUR #1 SOURCE FOR AMERICAN-MADE PREMIUM QUALITY CUTTING TOOLS

Surface Feet Per Minute

$$\text{SFM} = \text{RPM} \times D \times .262$$

Revolutions Per Minute

$$\text{RPM} = \frac{\text{SFM} \times 3.82}{D}$$

Inches Per Minute

$$\text{IPM} = \text{RPM} \times \text{IPT} \times Z$$

Inches Per Tooth

$$\text{IPT} = \frac{\text{IPR}}{Z}$$

Inches Per Revolution

$$\text{IPR} = \frac{\text{IPM}}{\text{RPM}}$$

Metal Removal Rate (cu. in./min.)

$$\text{MRR} = \text{RDOC} \times \text{ADOC} \times \text{IPM}$$

Inches Per Tooth
(Chip Thinning Adjustment)

$$\text{IPT}_{\text{adj}} = \frac{\text{CT} \times D}{2 \times \sqrt{(D \times \text{RDOC}) - \text{RDOC}}}$$

Feed Rate Adjustment - Inside Arc

$$F_i = \frac{\text{IPM} \times (r_i + R)}{r_i}$$

Feed Rate Adjustment - Outside Arc

$$F_o = \frac{\text{IPM} \times (r_o + R)}{r_o}$$

Chip Thickness

$$\text{CT} = \frac{2 \times \text{IPT} \times \sqrt{(D \times \text{RDOC}) - \text{RDOC}}}{D}$$

Ball Nose Velocity Adjustment

$$V_{\text{adj}} = \frac{\text{SFM} \times 3.82}{D_{\text{eff}}}$$

Ball Nose "Effective Diameter"

$$D_{\text{eff}} = 2 \times \sqrt{\text{ADOC} \times (D - \text{ADOC})}$$

D	Tool Cutting Diameter	r_i	Part Radius (inside arc)	RDOC	Radial Depth of Cut
Z	Number of Flutes	r_o	Part Radius (outside arc)	ADOC	Axial Depth of Cut

DECIMAL EQUIVALENTS & TAP DRILL SIZES



YOUR #1 SOURCE FOR AMERICAN-MADE PREMIUM QUALITY CUTTING TOOLS

DRILL SIZE	DECIMAL INCHES	DRILL SIZE	DECIMAL INCHES	TAP SIZE	DRILL SIZE	DECIMAL INCHES	TAP SIZE	DRILL SIZE	DECIMAL INCHES	TAP SIZE	DRILL SIZE	DECIMAL INCHES	TAP SIZE
.97	.0059	.58	.0420		.27	.1440		H	.2660		17/32	.5312	5/8-11
.15mm	.0059	.57	.0430		3.7mm	.1457		6.8mm	.2677		13.5mm	.5315	
.96	.0063	1.1mm	.0433		.26	.1470	3/16-24NS	6.9mm	.2717		35/64	.5469	
.16mm	.0063	1.15mm	.0453		3.75mm	.1476	m4.5x0.75	I	.2720	5/16-24NF	14mm	.5512	m16x2
.95	.0067	.56	.0465		.25	.1495	#10-24	7	.2756	m8x1	9/16	.5625	3/8-18NPT
.17mm	.0067	3/64	.0469	#0-80	3.8mm	.1496		J	.2770		14.5mm	.5709	m16x1.5
.94	.0071	1.2mm	.0472		.24	.1520		7.1mm	.2795		37/64	.5781	5/8-18NF
.18mm	.0071	1.25mm	.0492	m1.6x0.35	3.9mm	.1535		K	.2810		15mm	.5906	
.93	.0075	1.3mm	.0512		.23	.1540		9/32	.2812	5/16-32NS	19/32	.5938	3/8-18 NPS PIPE
.19mm	.0075	.55	.0520		5/32	.1562		7.2mm	.2835		39/64	.6094	
.92	.0079	1.35mm	.0531		.22	.1570	3/16-32NS	7.25mm	.2854		15.5mm	.6102	m18x2.5
.2mm	.0079	.54	.0550		4mm	.1575		7.3mm	.2874		5/8	.6250	11/16-16NS
.91	.0083	1.4mm	.0551		.21	.1590	#10-32	L	.2900		16mm	.6299	m18x2.0
.21mm	.0083	1.45mm	.0571	m1.8x0.35	.20	.1610		7.4mm	.2913		41/64	.6406	
.90	.0087	1.5mm	.0591		4.1mm	.1614		M	.2950		16.5mm	.6496	
.22mm	.0087	.53	.0595	#1-64,72	4.2mm	.1654	m5x0.8	7.5mm	.2953		21/32	.6562	3/4-10NC
.89	.0091	1.55mm	.0610		.19	.1660		19/64	.2969		17mm	.6693	
.23mm	.0091	1/16	.0625		4.25mm	.1673		7.6mm	.2992		43/64	.6719	
.24mm	.0094	1.6mm	.0630	m2x0.4	4.3mm	.1693		N	.3020		11/16	.6875	3/4-16NF
.88	.0095	.52	.0635		.18	.1695		7.7mm	.3031		17.5mm	.6890	m20x2.5
.25mm	.0098	1.65mm	.0650		11/64	.1719		7.75mm	.3051	m9x1.25	45/64	.7031	1/2-14NPT PIPE
.87	.0100	1.7mm	.0669		.17	.1730		7.8mm	.3071		18mm	.7087	m20x2.0
.26mm	.0102	.51	.0670	#2-56	4.4mm	.1732		7.9mm	.3110		23/32	.7188	
.86	.0105	1.75mm	.0689	m2.2x0.45	.16	.1770	#12-24	5/16	.3125	3/8-16NC	18.5mm	.7283	m20x1.5
.27mm	.0106	.50	.0700	#2-64	4.5mm	.1772		8mm	.3150		47/64	.7344	1/2-14NPS PIPE
.85	.0110	1.8mm	.0709		.15	.1800		O	.3160		19mm	.7480	
.28mm	.0110	1.85mm	.0728		4.6mm	.1811		8.1mm	.3189		3/4	.7500	
.29mm	.0114	.49	.0730		.14	.1820	#12-28	8.2mm	.3228		49/64	.7656	7/8-9NC
.84	.0115	1.9mm	.0748	m2.3x.04	.13	.1850		P	.3230		19.5mm	.7677	m22x2.5
.3mm	.0118	.48	.0760		4.7mm	.1850		8.25mm	.3248		25/32	.7812	
.83	.0120	1.95mm	.0768		4.75mm	.1870		8.3mm	.3268		20mm	.7874	m22x2.0
.82	.0125	5/64	.0781		3/16	.1875		21/64	.3281		51/64	.7969	
.32mm	.0126	.47	.0785	#3-48	4.8mm	.1890		8.4mm	.3307		20.5mm	.8071	m22x1.5
.81	.0130	.2mm	.0787		.12	.1890	7/32-32NS	Q	.3320	1/8-27NPT PIPE 3/8-24NF	13/16	.8125	7/8-14NF
.34mm	.0134	2.05mm	.0807	m2.5x0.45	.11	.1910		8.5mm	.3346	m10x1.5	21mm	.8268	m24x3
.80	.0135	.46	.0810		4.9mm	.1929		8.6mm	.3386		53/64	.8281	
.35mm	.0138	.45	.0820	#3-56	.10	.1935		R	.3390		27/32	.8438	
.36mm	.0142	2.1mm	.0827		.9	.1960		8.7mm	.3425		21.5mm	.8465	
.79	.0145	2.15mm	.0846	m2.6x0.45	5mm	.1969	m6x1	11/32	.3438		55/64	.8594	
.38mm	.0150	.44	.0860	#4-36	.8	.1990		8.75mm	.3445	m10x1.25	22mm	.8661	m24x2
1/64	.0156	2.2mm	.0866		5.1mm	.2008		8.8mm	.3465		7/8	.8750	1-8NC
.4mm	.0157	2.25mm	.0886		.7	.2010	1/4-20	S	.3480	1/8-27NPS PIPE	22.25mm	.8760	
.78	.0160	.43	.0890	#4-40	13/64	.2031		8.9mm	.3504		22.5mm	.8858	m24x1.50
.42mm	.0165	2.3mm	.0906		.6	.2040		9mm	.3543	m10x1.00	57/64	.8906	
.44mm	.0173	2.35mm	.0925		5.2mm	.2047		T	.3580		23mm	.9055	
.45mm	.0177	.42	.0935	#4-48	.5	.2055		9.1mm	.3583		29/32	.9062	3/4-14NPT PIPE
.77	.0180	3/32	.0938		5.25mm	.2067	m6x0.75	23/64	.3594		59/64	.9219	
.46mm	.0181	2.4mm	.0945		5.3mm	.2087		9.2mm	.3622		23.5mm	.9252	
.48mm	.0189	.41	.0960		.4	.2090	1/4-24	9.25mm	.3642		15/16	.9375	3/4-14 NPS 1-14 NF
.5mm	.0197	2.45mm	.0965		5.4mm	.2126		9.3mm	.3661		24mm	.9449	m27x3
.76	.0200	.40	.0980		.3	.2130	1/4-28	U	.3680	7/16-14NC	61/64	.9531	
.75	.0210	2.5mm	.0984	m3x0.5	5.5mm	.2165		9.4mm	.3701		24.5mm	.9646	
.55mm	.0217	.39	.0995		7/32	.2188		9.5mm	.3740	m11x1.50	31/32	.9688	
.74	.0225	.38	.1015	#5-40	5.6mm	.2205		3/8	.3750		25mm	.9843	m27x2
.6mm	.0236	2.6mm	.1024		.2	.2210		V	.3770		63/64	.9844	1-1/8-7NC
.73	.0240	.37	.1040	#5-44	5.7mm	.2244		9.6mm	.3780		1	1.0000	
.72	.0250	2.7mm	.1063		5.75mm	.2264		9.7mm	.3819		25.5mm	1.0039	
.65mm	.0256	.36	.1065	#6-32	.1	.2280		9.75mm	.3839		1-1/64	1.0156	
.71	.0260	2.75mm	.1083		5.8mm	.2283		9.8mm	.3858		26mm	1.0236	
.7mm	.0276	7/64	.1094		5.9mm	.2323		W	.3860		1-1/32	1.0312	
.70	.0280	.35	.1100		A	.2340		9.9mm	.3898		26.5mm	1.0433	m30x3.5
.69	.0292	2.8mm	.1102		15/64	.2344		25/64	.3906	7/16-20	1-3/64	1.0469	1-1/8-12NF
.75mm	.0295	.34	.1110		6mm	.2362	m7x1	10mm	.3937	m12x1.75	1-1/16	1.0625	
.68	.0310	.33	.1130	#6-40	B	.2380		X	.3970		27mm	1.0630	
1/32	.0312	2.9mm	.1142	m3.5x0.6	6.1mm	.2402		Y	.4040		1-5/64	1.0781	
.8mm	.0315	.32	.1160		C	.2420	1/16-27 NPT PIPE	13/32	.4062		27.5mm	1.0827	
.67	.0320	3mm	.1181		6.2mm	.2441		Z	.4130		1-3/32	1.0938	
.66	.0330	.31	.1200		D	.2460		10.5mm	.4134	m12x1.25	28mm	1.1024	m30x2.0
.85mm	.0335	3.1mm	.1220		6.25mm	.2461		27/64	.4219	1/2-13	1-7/64	1.1094	1-1/4-7NC
.65	.0350	1/8	.1250	5/32-32NS	6.3mm	.2480		11mm	.4331		28.5mm	1.1220	
.9mm	.0354	3.2mm	.1260		E	.2500	1/16-27 NPS PIPE	7/16	.4375	1/4-18 NPT PIPE	1-1/8	1.1250	
.64	.0360	3.25mm	.1280		1/4	.2500		11.5mm	.4528		1-9/64	1.1406	
.63	.0370	.30	.1285	5/32-36NS	6.4mm	.2520		29/64	.4531	1/4-18NPS PIPE 1/2-20	29mm	1.1417	
.95mm	.0374	3.3mm	.1299	m4x0.70	6.5mm	.2559		15/32	.4688		1-5/32	1.1562	1-11/2NPT PIPE
.62	.0380	3.4mm	.1339		F	.2570	5/16-18NC	12mm	.4724	m14x2	29.5mm	1.1614	
.61	.0390	.29	.1360	#8-32	6.6mm	.2598		31/64	.4844	9/16-12	1-11/64	1.1719	1-1/4-12NF
1mm	.0394	3.5mm	.1378		G	.2610		12.5mm	.4921	m14x1.5			
.60	.0400	.28	.1405		6.7mm	.2638		1/2	.5000				
.59	.0410	9/64	.1406		17/64	.2656		13mm	.5118	m14x1.25			
1.05mm	.0413	3.6mm	.1417		6.75mm	.2657	m8x1.25	33/64	.5156	9/16-18			



THIS COMPLETE CATALOG NOW FITS IN YOUR POCKET

SEARCH TOOLS • CHECK STOCK • VIEW PRICING
LOG INTO YOUR ACCOUNT • PLACE ORDERS



AHB

TOOLING & MACHINERY

COMPLETE METALWORKING SOLUTIONS

(800) 991-4225

www.ahbinc.com

ISO Certified

customerservice@ahbinc.com



MADE IN THE U.S.A.