



TurnLine



COMPLETE
METALWORKING
SOLUTIONS

(800) 991-4225

www.ahbinc.com

ISO Certified

customerservice@ahbinc.com

ISO^{CO}E^{CO}TURN

Tungaloy Report No. 426-US

Cartridge Set allows the use of ISO-EcoTurn insert with **no need to swap** the toolholder





INDUSTRY 4.0
FEED the SPEED!



ISO E^{CO}TURN

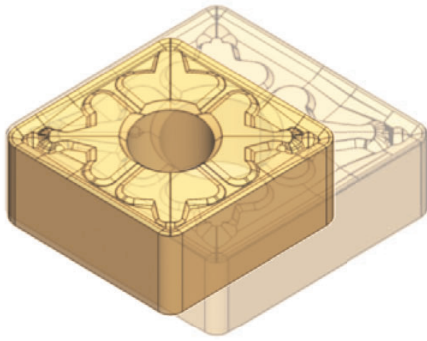

ISO E^{CO}TURN
CNMG 332E type

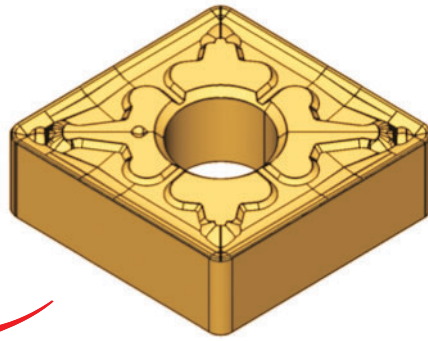



Regular size inserts
CNMG 432 type



Cost effective:
Identical cutting performance, just a smaller size

ISO-EcoTurn small sized inserts, offer an economical advantage

Cartridge Set allows more flexibility with use of ISO-EcoTurn inserts and lever-lock holders. This increases the ability to maximize potential cost efficiency and productivity

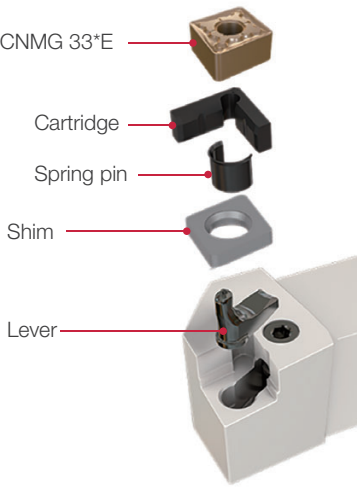
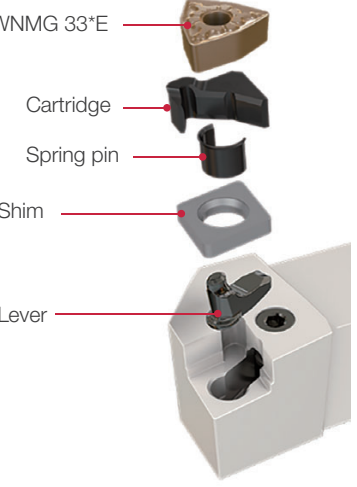
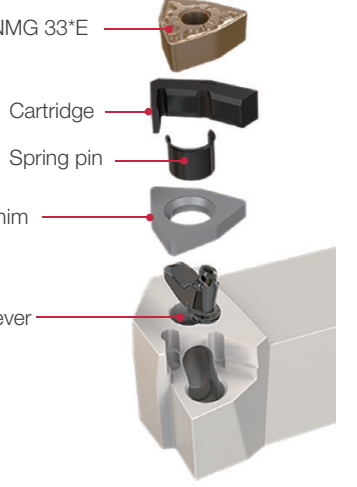
Applicable combination	CNMG 43... ↓ ISO-EcoTurn CNMG 33*E	CNMG 43... ↓ ISO-EcoTurn WNMG 33*E	WNMG 43... ↓ ISO-EcoTurn WNMG 33*E
Cartridge Set + ISO-EcoTurn Insert	 <p style="text-align: center;">New</p>	 <p style="text-align: center;">New</p>	 <p style="text-align: center;">New</p>
Detail of Cartridge Set	 <p>CNMG 33*E</p> <p>Cartridge</p> <p>Spring pin</p> <p>Shim</p> <p>Lever</p>	 <p>WNMG 33*E</p> <p>Cartridge</p> <p>Spring pin</p> <p>Shim</p> <p>Lever</p>	 <p>WNMG 33*E</p> <p>Cartridge</p> <p>Spring pin</p> <p>Shim</p> <p>Lever</p>
Cartridge Set	AD-CL-4/3-SET AD-CL-4/3-SET-S	AD-CL-4/3-W-SET	AD-WL-4/3-SET
Applicable Tool holder	PCLNR/L**4	PCLNR/L**4	PWLNR/L**4

Note: How to install the cartridge set page 11. Cartridge set cannot be assembled on Tungaloy's P-style holders. This product might correspond to the Export Trade Control Order. When you export this product, you might need apply for export licenses to the authorities in your country.

Over 75%* of the turning market only uses a depth of cut at or less than 0.118"

* Based on Tungaloy market research.

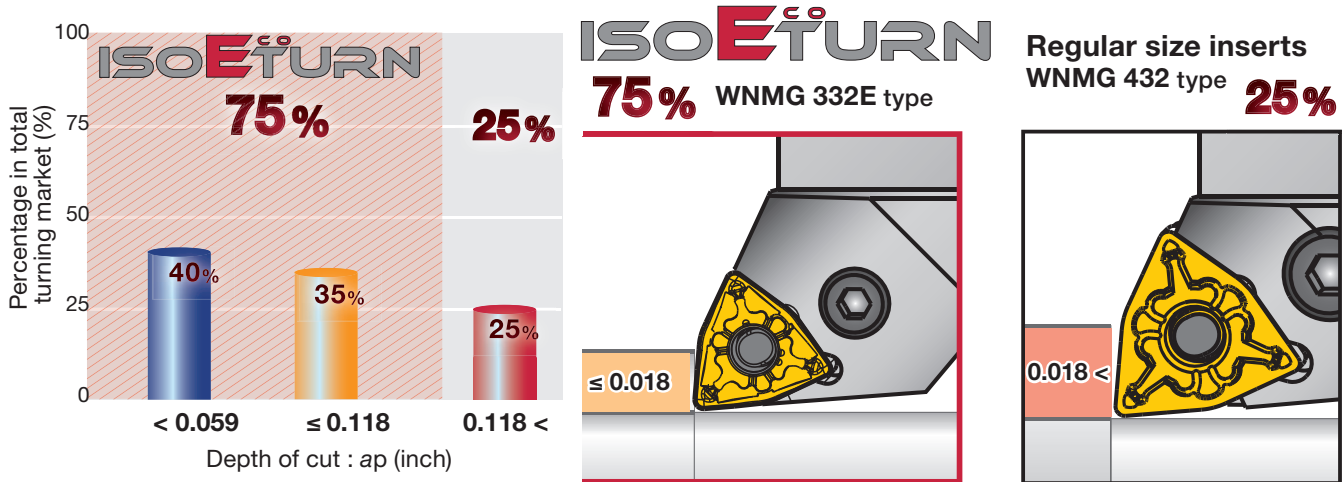

Chip control

ISO-EcoTurn inserts incorporate an identical chipbreaker geometry as regular size inserts providing the same chip removal at a depth of cut up to 0.118"m.

Workpiece : 1045
Cutting speed : $V_c = 656$ sfm
Coolant : Wet

ISO EcoTurn CNMG 332E TM

Depth of cut : ap (inch)	0.118					
	0.079					
	0.059					
	0.039					
	0.020					
Condition	0.004	0.006	0.008	0.012	0.016	
	Feed : f (ipr)					

Regular size inserts CNMG 432 TM

Depth of cut : ap (inch)	0.118					
	0.079					
	0.059					
	0.039					
	0.020					
Condition	0.004	0.006	0.008	0.012	0.016	
	Feed : f (ipr)					

Uncompromising insert performance

- Comparison of ISO-EcoTurn and regular sized inserts

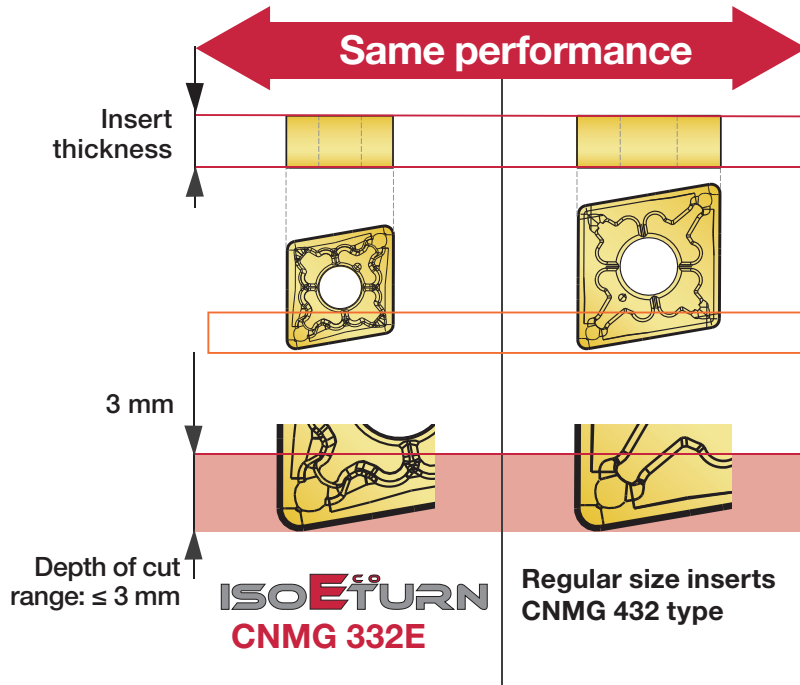

ISO-EcoTurn inserts feature the identical thickness and chipbreaker geometry as Tungaloy's regular size inserts.

These properties provide cutting performance equal to that of the regular size inserts, including chip control at a depth of cut up to 0.018".

Fracture resistance

- Even used Cartridge Set ISO-Eco Turn inserts preserve the thickness of standard inserts in order to maintain fracture resistance.

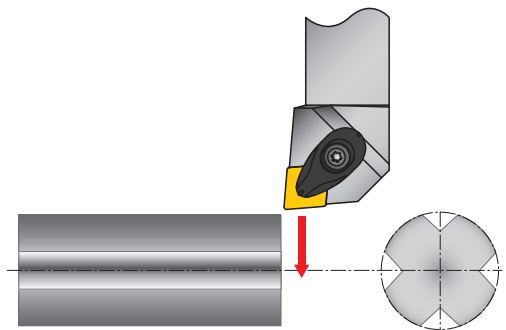
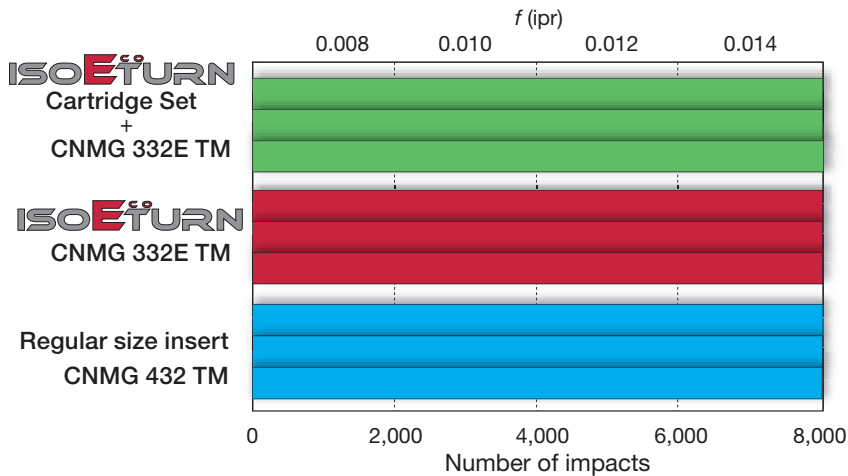

Workpiece : 1045
 Cutting speed : $V_c = 492$ sfm
 Feed : $f = 0.008 - 0.014$ ipr
 Depth of cut : $a_p = 0.118$ "
 Work process : Face turning (Interrupted)
 Coolant : Wet

A complete tooling solution is now available with ISO-EcoTurn
 For a wide range of turning applications.

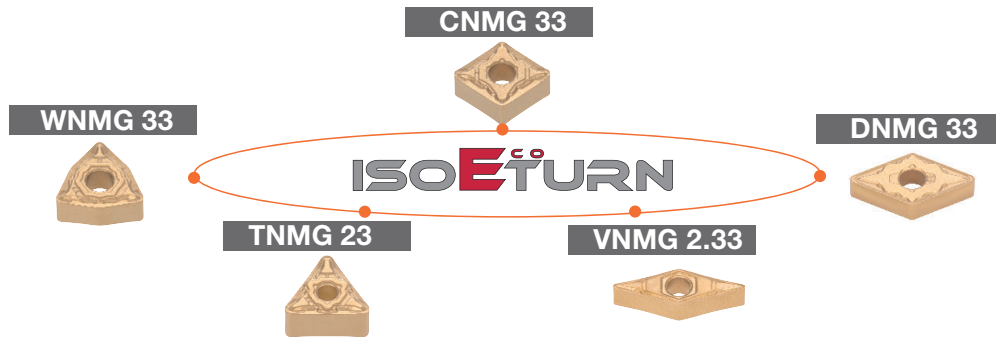

Indexing accuracy

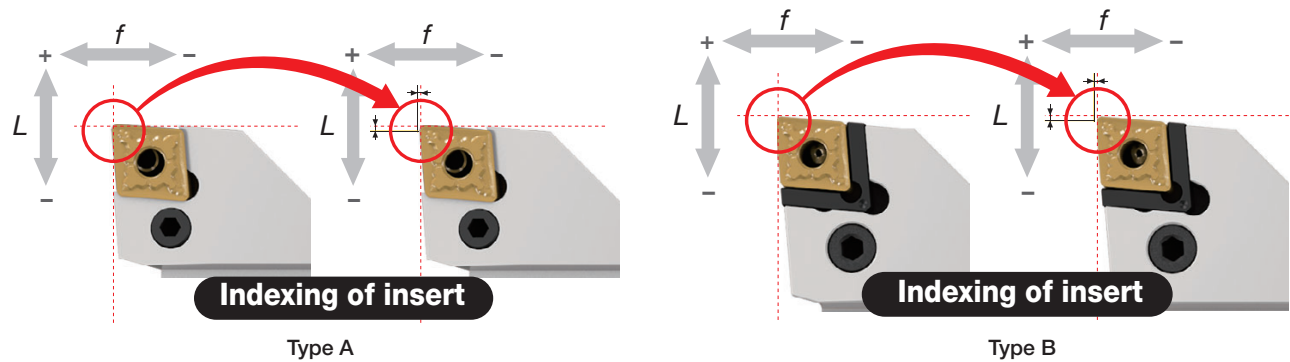

Type	Tool holder	Insert	Cartridge Set	f direction (μm)	L direction (μm)
A: ISO-EcoTURN	PCLNR**33	CNMG 333E TM	-	1	2
B: ISO-EcoTURN + Cartridge Set	PCLNR**4	CNMG 333E TM	AD-CL-4/3-SET	1.7	2.5
C: Competitor P-type tool holder	PCLNR**4	CNMG 433 TM	-	2	4

GRADES & CHIPBREAKERS

T9200 SERIES (CVD)

PREMIUMTEC

- T9205** : Good wear resistance
- T9215** : First choice for machining steel
- T9225** : Grade with a good balance of wear resistance and fracture toughness



Steel

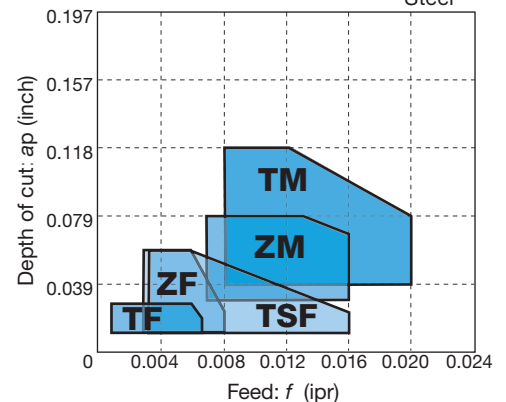

NS9530 & GT9530

(Cermet) (Coated cermet)

PREMIUMTEC

- NS9530** : Suitable for finishing to medium cutting of steel
- GT9530** : Ideal for finishing with high surface quality

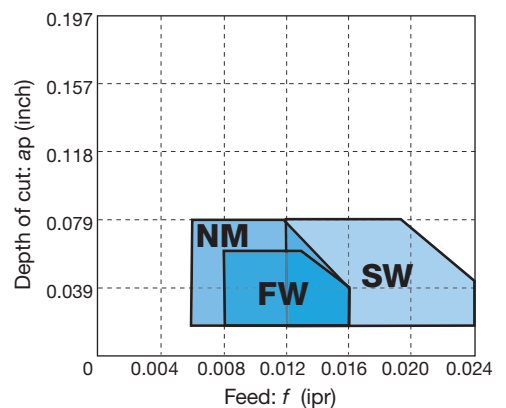

AH600 SERIES (PVD)

PREMIUMTEC

- AH630** : Good resistance to wear and fracture in machining stainless steel at low to medium cutting speed
- AH645** : High fracture resistance in machining stainless steel



Stainless

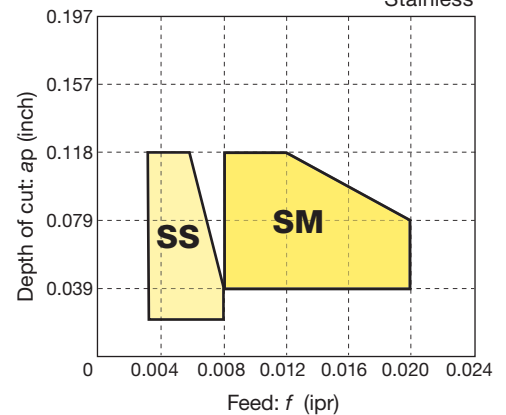

T6100 SERIES (CVD)

PREMIUMTEC

- T6120** : Good wear resistance in continuous cutting at high speed
- T6130** : High wear resistance in cutting at medium to high speed

GRADES & CHIPBREAKERS

T5100 SERIES (CVD)

PREMIUMTEC
TUNGALOY

T5115 : Stable machining in a wide range of applications from continuous to interrupted cutting

T515 (CVD)

PREMIUMTEC
TUNGALOY

T515 : Good wear resistance even in high speed machining



Cast Iron

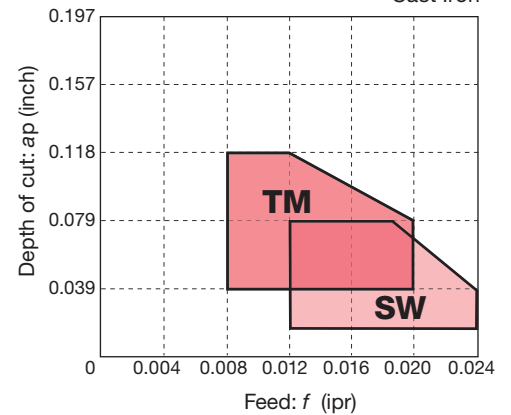

AH8000 SERIES (PVD)

PREMIUMTEC
TUNGALOY

AH8015 : Strong resistance to wear and built up edge



Stainless



Superalloys and titanium

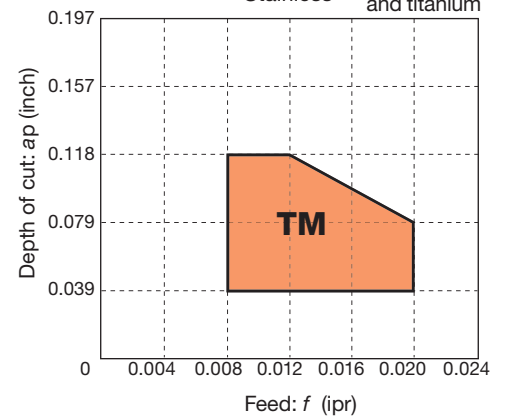

AH120 (PVD)

PREMIUMTEC
TUNGALOY

AH120 : Suitable for machining steel, stainless steel, cast iron and heat resistant alloys under general cutting conditions



Steel



Stainless



Cast Iron



Superalloys and titanium

AD-*L-4/3-* -SET

Cartridge Set for ISO-Eco Turn insert

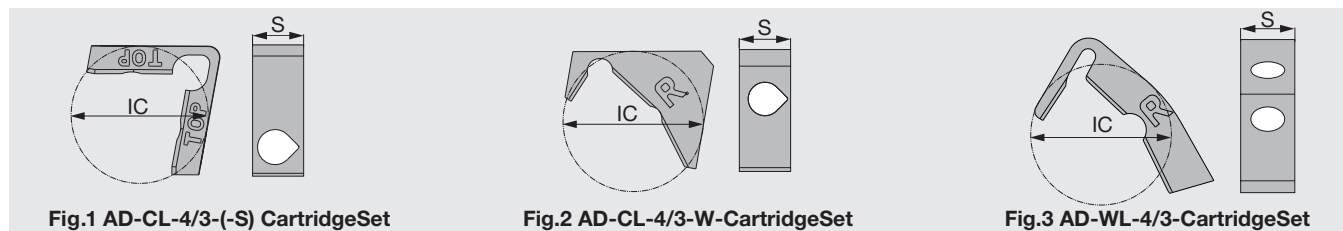

Fig.1 AD-CL-4/3-(-S) CartridgeSet

Fig.2 AD-CL-4/3-W-CartridgeSet

Fig.3 AD-WL-4/3-CartridgeSet

Inch	IC	S	Insert	Fig.
AD-CL-4/3-SET	0.5	0.186	CNM* 33*E...	1
AD-CL-4/3-SET-S	0.5	0.186	CNM* 33*E...	1
AD-CL-4/3-W-SET	0.5	0.197	WNM* 33*E...	2
AD-WL-4/3-SET	0.5	0.197	WNM* 33*E...	3

SPARE PARTS

Designation	Cartridge	Lever	Wrench
AD-CL-4/3-SET	AD-CL-4/3	LR4/3	HW3.0/5
AD-CL-4/3-SET-S	AD-CL-4/3	LR4/3-T	HW3.0/5
AD-WL-4/3-SET	AD-WL-4/3	LR4/3	HW3.0/5
AD-CL-4/3-W-SET	AD-CL-4/3-W	LR4/3	HW3.0/5

Shim	Spring pin
TCN423	-
TWN423	-
LSC42-ECO D30	LSP4

Shim and spring pin are not included

How to install the Cartridge Set

1. Remove the Shim sheet and Lever from the using toolholder (P type: Lever lock style).
 2. Install the Lever → Shim sheet → Spring Pin → Cartridge.
- Note: Use the key for easy assembly of the spring pin.
3. Offset the cutting edge position.
 4. OK to machining.

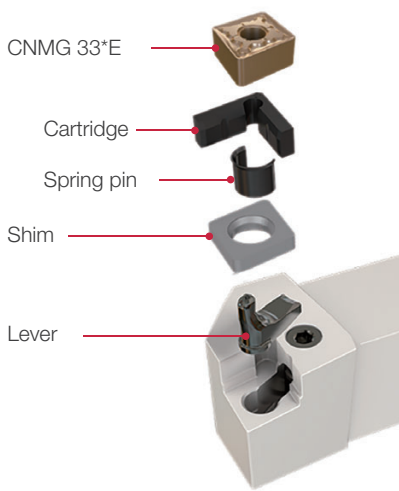

Cartridge for
CNMG 4 → Eco CNMG 3

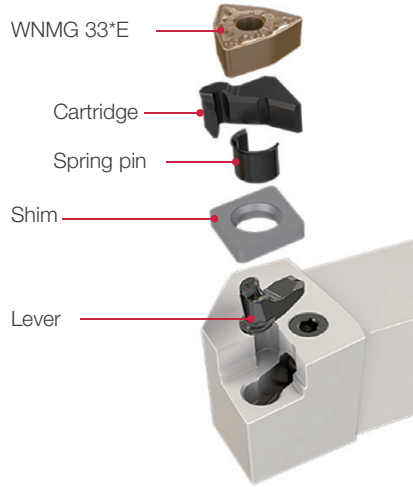

Cartridge for
CNMG 4 → Eco WNMG 3

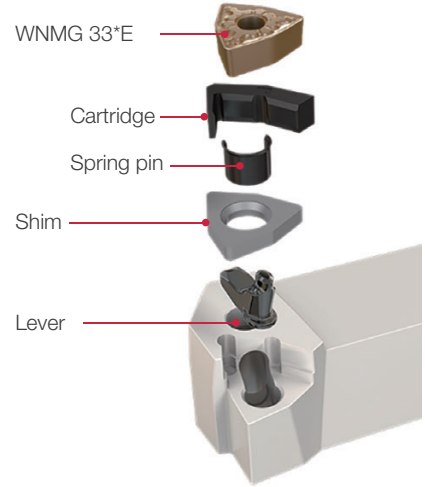

Cartridge for
WNMG 4 → Eco WNMG 3

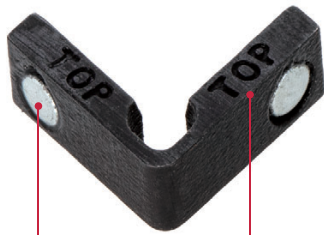

Magnet ID marking

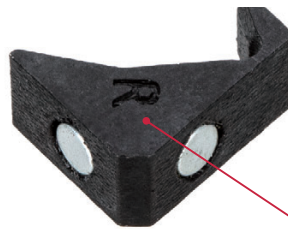

Make sure to place the "R" side face up when using the right-hand insert



Ensures TOP side is placed face up for both right- and left-hand inserts

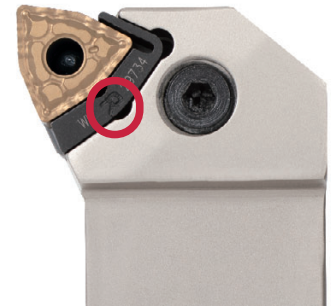
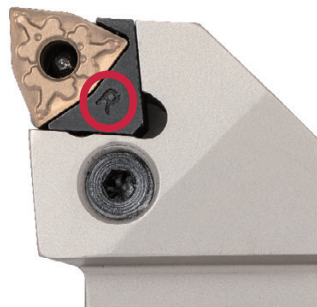

Note: Cartridge set cannot be assembled on Tungaloy's P-style holders.
This product might correspond to the Export Trade Control Order.
When you export this product, you might need apply for export licenses to the authorities in your country.

Insert NEGATIVE TYPE

- : Continuous cutting
- ◐ : Light interrupted cutting
- ✱ : Heavy interrupted cutting

CN



Rhombic, 80° with hole

	P	M	K	N	S	H																																			
●	●	●	●	●	●	●	●	●	●	●	●	●	●	●	●	●	●	●	●	●	●	●	●	●	●	●	●	●	●	●	●	●	●	●	●	●	●	●	●		
◐																																									
✱																																									

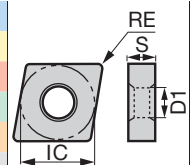

Application	Chipbreaker	Designation	Coated											Coated cermet		Cermet	Dimension (inch)						
			T9205	T9215	T9225	T9105	T9115	T9125	T6120	T6130	AH630	AH645	AH120	AH8015	T515	T5115	GT9530	AT9530	NS9530	RE	IC	S	D1
Precision finishing		TF CNMG 330.5E TF	●	●																0.008	0.375	0.187	0.15
		CNMG 331E TF	●	●																0.016	0.375	0.187	0.15
		CNMG 332E TF	●	●																0.032	0.375	0.187	0.15
Finishing		TSF CNMG 330.5E TSF	●	●															0.008	0.375	0.187	0.15	
		CNMG 331E TSF	●	●	▲	▲										●	●	●	0.016	0.375	0.187	0.15	
		CNMG 332E TSF	●	●	▲	▲										●	●	●	0.032	0.375	0.187	0.15	
Finishing (wiper)		FW CNMG 331E FW	●	●	●	▲	▲	▲								●		●	0.016	0.375	0.187	0.15	
		CNMG 332E FW	●	●	●	▲	▲	▲								●		●	0.031	0.375	0.187	0.15	
Finishing		ZF CNMG 331E ZF	●	●		▲	▲												0.016	0.375	0.187	0.15	
Finishing to medium cutting (wiper)		SW CNMG 332E SW	●	●	●	▲	▲	▲							●				0.031	0.375	0.187	0.15	
		CNMG 333E SW	●	●	●	▲	▲	▲							●				0.047	0.375	0.187	0.15	

* Please contact our sales representative for your inquiries about the program adjustment when using SW/FW for machining of radius shape or for taper machining.

- : Line up
- ▲ : To be discontinued

Insert NEGATIVE TYPE

- : Continuous cutting
- ◐ : Light interrupted cutting
- ✳ : Heavy interrupted cutting

CN

Rhombic, 80° with hole

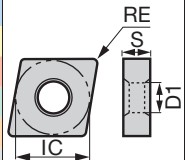

	P Steel	M Stainless	K Cast iron	N Non-ferrous	S Superalloys	H Hard materials	T9205	T9215	T9225	T9105	T9115	T9125	T6120	T6130	AH630	AH645	AH120	AH8015	T515	T5115	GT9530	AT9530	NS9530				
●	●	◐	●	◐			●	●	✳	●	◐	◐	◐	✳	✳	✳	✳	◐					●	●	●		
◐		●	●	●												●	●	●	●								
●			●															●	●					●	●	●	
			●	●															●	●				●	●	●	
			●															●	●					●	●	●	

Application	Chipbreaker	Designation	Coated										Coated cermet		Cermet	Dimension (inch)												
			T9205	T9215	T9225	T9105	T9115	T9125	T6120	T6130	AH630	AH645	AH120	AH8015	T515	T5115	GT9530	AT9530	NS9530	RE	IC	S	D1					
Finishing		SS CNMG 331E SS													●	●									0.016	0.375	0.187	0.15
		CNMG 332E SS														●	●									0.031	0.375	0.187
Medium cutting		TM CNMG 331E TM		●	●		▲	▲		●	●	●					●	●	●						0.016	0.375	0.187	0.15
		CNMG 332E TM		●	●		▲	▲		●	●	●					●	●	●						0.031	0.375	0.187	0.15
		CNMG 333E TM		●	●		▲	▲		●	●	●					●	●	●						0.047	0.375	0.187	0.15
Finishing to medium cutting		ZM CNMG 332E ZM		●	●		▲	▲																	0.031	0.375	0.187	0.15
Medium cutting		SM CNMG 331E SM												●	●	●									0.016	0.375	0.187	0.15
		CNMG 332E SM												●	●	●									0.031	0.375	0.187	0.15
		CNMG 333E SM												●	●	●									0.047	0.375	0.187	0.15
Finishing to medium cutting		- CNMA331E																●							0.016	0.375	0.187	0.15
		CNMA332E																●							0.031	0.375	0.187	0.15
		CNMA333E																●							0.047	0.375	0.187	0.15
		CNMA334E																●							0.063	0.375	0.187	0.15

- : Line up
- ▲ : To be discontinued

Insert NEGATIVE TYPE

- : Continuous cutting
- ◐ : Light interrupted cutting
- ✱ : Heavy interrupted cutting

DN



Material	T9205	T9215	T9225	T9105	T9115	T9125	T6120	T6130	AH630	AH645	AH120	AH8015	T515	T5115	GT9530	AT9530	NS9530	
P Steel	●	●	✱	●	●	✱	●	✱	✱	✱	●	●	●	●	●	●	●	●
M Stainless	●	●		●	●		●	●	●	✱	●	●	●	●	●	●	●	●
K Cast iron	●	●		●	●		●	●	●	✱	●	●	●	●	●	●	●	●
N Non-ferrous																		
S Superalloys											●	●						
H Hard materials																		

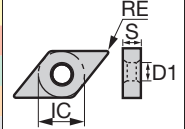

Application	Chipbreaker	Designation	Coated												Coated cermet		Cermet	Dimension (inch)					
			T9205	T9215	T9225	T9105	T9115	T9125	T6120	T6130	AH630	AH645	AH120	AH8015	T515	T5115	GT9530	AT9530	NS9530	RE	IC	S	D1
Precision finishing		TF DNMG 330.5E TF	●	●															0.008	0.375	0.187	0.15	
		DNMG 331E TF	●	●																0.016	0.375	0.187	0.15
		DNMG 332E TF	●	●																0.032	0.375	0.187	0.15
Finishing		TSF DNMG 330.5E TSF	●	●															0.008	0.375	0.187	0.15	
		DNMG 331E TSF	●	●		▲	▲								●	●	●		0.016	0.375	0.187	0.15	
		DNMG 332E TSF	●	●		▲	▲								●	●	●		0.032	0.375	0.187	0.15	
		DNMG 333E TSF	●	●		▲	▲								●	●	●		0.047	0.375	0.187	0.15	
Finishing (wiper)		FW DNMG 331E FW	●			▲													0.016	0.375	0.187	0.15	
		DNMG 332E FW	●			▲													0.031	0.375	0.187	0.15	
Finishing		ZF DNMG 331E ZF	●	●		▲	▲												0.016	0.375	0.187	0.15	
Finishing to medium cutting (wiper)		SW DNMG 332E SW	●			▲													0.031	0.375	0.187	0.15	
		DNMG 333E SW	●			▲													0.047	0.375	0.187	0.15	

* Please contact our sales representative for your inquiries about the program adjustment when using SW/FW for machining of radius shape or for taper machining.

- : Line up
- ▲ : To be discontinued

Insert NEGATIVE TYPE

- : Continuous cutting
- ◐ : Light interrupted cutting
- ✳ : Heavy interrupted cutting

DN

Rhombic, 55°
with hole

	P Steel	M Stainless	K Cast iron	N Non-ferrous	S Superalloys	H Hard materials																			
	●	●	◐	●	●	●		●	◐	◐	◐	◐	◐		◐										

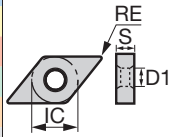

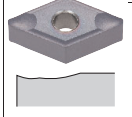
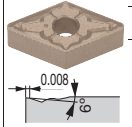
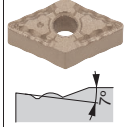
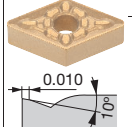
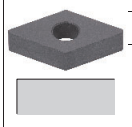
Application	Chipbreaker	Designation	Coated											Coated cermet		Cermet	Dimension (inch)						
			T9205	T9215	T9225	T9105	T9115	T9125	T6120	T6130	AH630	AH645	AH120	AH8015	T515	T5115	GT9530	AT9530	NS9530	RE	IC	S	D1
Finishing		SS DNMG 331E SS								●	●								0.016	0.375	0.187	0.15	
		DNMG 332E SS									●	●								0.031	0.375	0.187	0.15
Medium cutting		TM DNMG 331E TM	●	●		▲	▲												0.016	0.375	0.187	0.15	
		DNMG 332E TM	●	●		▲	▲													0.031	0.375	0.187	0.15
		DNMG 333E TM	●	●		▲	▲													0.047	0.375	0.187	0.15
Finishing to medium cutting		ZM DNMG 332E ZM	●	●		▲	▲												0.031	0.375	0.187	0.15	
Medium cutting		SM DNMG 331E SM						●	●	●									0.016	0.375	0.187	0.15	
		DNMG 332E SM						●	●	●										0.031	0.375	0.187	0.15
Finishing to medium cutting		- DNMA 331E																●	0.016	0.375	0.187	0.15	
		DNMA 332E																	●	0.031	0.375	0.187	0.15
		DNMA 333E																	●	0.047	0.375	0.187	0.15

- : Line up
- ▲ : To be discontinued

Insert NEGATIVE TYPE

- : Continuous cutting
- ◐ : Light interrupted cutting
- ✳ : Heavy interrupted cutting

TN



Triangular, 60° with hole

P Steel	●	◐	◐	✳	●	◐	◐	✳	◐	✳	●	◐	◐	◐	◐	◐	◐	◐	◐	◐
M Stainless	●	◐	●	◐	◐	◐	◐	◐	◐	◐	◐	◐	◐	◐	◐	◐	◐	◐	◐	◐
K Cast iron	◐	◐	◐	◐	◐	◐	◐	◐	◐	◐	◐	◐	◐	◐	◐	◐	◐	◐	◐	◐
N Non-ferrous	◐	◐	◐	◐	◐	◐	◐	◐	◐	◐	◐	◐	◐	◐	◐	◐	◐	◐	◐	◐
S Superalloys	◐	◐	◐	◐	◐	◐	◐	◐	◐	◐	◐	◐	◐	◐	◐	◐	◐	◐	◐	◐
H Hard materials																				

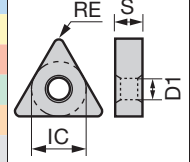

Application	Chipbreaker	Designation	Coated												Coated cermet		Cermet	Dimension (inch)					
			T9205	T9215	T9225	T9105	T9115	T9125	T6120	T6130	AH630	AH645	AH120	AH8015	T515	T5115	GT9530	AT9530	NS9530	RE	IC	S	D1
Precision finishing		TF TNMG 230.5E TF	●	●															0.008	0.25	0.187	0.089	
		TNMG 231E TF	●	●																0.016	0.25	0.187	0.089
		TNMG 232E TF	●	●																0.032	0.25	0.187	0.089
Finishing		TSF TNMG 230.5E TSF	●	●															0.008	0.25	0.187	0.089	
		TNMG 231E TSF	●	●	▲	▲										●	●	●	0.016	0.25	0.187	0.089	
		TNMG 232E TSF	●	●	▲	▲										●	●	●	0.032	0.25	0.187	0.089	
Finishing (wiper)		FW TNMG 231E FW	●			▲													0.016	0.25	0.187	0.089	
		TNMG 232E FW	●			▲														0.031	0.25	0.187	0.089
Finishing to medium cutting (wiper)		SW TNMG 232E SW	●			▲													0.031	0.25	0.187	0.089	
		TNMG 233E SW	●			▲														0.047	0.25	0.187	0.089

* Please contact our sales representative for your inquiries about the program adjustment when using SW/FW for machining of radius shape or for taper machining.

- : Line up
- ▲ : To be discontinued

Insert NEGATIVE TYPE

● : Continuous cutting
 ● : Light interrupted cutting
 ✱ : Heavy interrupted cutting

TN



P Steel	●	●●	●●✱	●	●●	●●✱	●	✱	●	●	●	●	●	●	●	●	●	●	●	●
M Stainless	●	●●	●	●	●	●	●	●	●	●	●	●	●	●	●	●	●	●	●	●
K Cast iron	●●	●●	●●	●●	●●	●●	●●	●●	●●	●●	●●	●●	●●	●●	●●	●●	●●	●●	●●	●●
N Non-ferrous																				
S Superalloys																				
H Hard materials																				

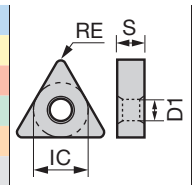

Application	Chipbreaker	Designation	Coated										Coated cermet	Cermet	Dimension (inch)								
			T9205	T9215	T9225	T9105	T9115	T9125	T6120	T6130	AH630	AH645	AH120	AH8015	T515	T5115	GT9530	AT9530	NS9530	RE	IC	S	D1
Finishing		SS TNMG 231E SS								●	●								0.016	0.25	0.187	0.089	
		TNMG 232E SS									●	●								0.031	0.25	0.187	0.089
Medium cutting		TM TNMG 231E TM	●	●	▲	▲													0.016	0.25	0.187	0.089	
		TNMG 232E TM	●	●	▲	▲														0.031	0.25	0.187	0.089
		TNMG 233E TM	●	●	▲	▲														0.047	0.25	0.187	0.089
			SM TNMG 231E SM						●	●	●									0.016	0.25	0.187	0.089
		TNMG 232E SM						●	●	●									0.031	0.25	0.187	0.089	
Finishing to medium cutting		- TNMA231E												●					0.016	0.25	0.187	0.089	
		TNMA232E												●						0.031	0.25	0.187	0.089
		TNMA233E												●						0.047	0.25	0.187	0.089

● : Line up
 ▲ : To be discontinued

Reference pages : External toolholders → [P.28](#)

Insert NEGATIVE TYPE

- : Continuous cutting
- ◐ : Light interrupted cutting
- ⊛ : Heavy interrupted cutting

VN

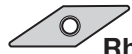

Rhombic, 35°
with hole

	P	M	K	N	S	H														
Steel	●	◐	◐	◐	◐	◐	◐	◐	◐	◐	◐	◐	◐	◐	◐	◐	◐	◐	◐	◐
Stainless	◐	◐	◐	◐	◐	◐	◐	◐	◐	◐	◐	◐	◐	◐	◐	◐	◐	◐	◐	◐
Cast iron	◐	◐	◐	◐	◐	◐	◐	◐	◐	◐	◐	◐	◐	◐	◐	◐	◐	◐	◐	◐
Non-ferrous	◐	◐	◐	◐	◐	◐	◐	◐	◐	◐	◐	◐	◐	◐	◐	◐	◐	◐	◐	◐
Superalloys	◐	◐	◐	◐	◐	◐	◐	◐	◐	◐	◐	◐	◐	◐	◐	◐	◐	◐	◐	◐
Hard materials	◐	◐	◐	◐	◐	◐	◐	◐	◐	◐	◐	◐	◐	◐	◐	◐	◐	◐	◐	◐

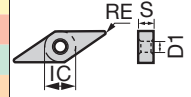

Application	Chipbreaker	Designation	Coated										Coated cermet		Cermet	Dimension (inch)								
			T9205	T9215	T9225	T9105	T9115	T9125	T6120	T6130	AH630	AH645	AH120	AH8015	T515	T5115	GT9530	AT9530	NS9530	RE	IC	S	D1	
Precision finishing		TF VNMG 2.330.5E TF	●	●																0.008	0.281	0.187	0.15	
		VNMG 2.331E TF	●	●																	0.016	0.281	0.187	0.15
		VNMG 2.332E TF	●	●																		0.032	0.281	0.187
Finishing		TSF VNMG 2.330.5E TSF	●	●	▲	▲										●	●	●		0.008	0.281	0.187	0.15	
		VNMG 2.331E TSF	●	●	▲	▲											●	●	●		0.016	0.281	0.187	0.15
		VNMG 2.332E TSF	●	●	▲	▲											●	●	●		0.031	0.281	0.187	0.15
Medium cutting		SS VNMG 2.331E SS						●	●	●	●									0.016	0.281	0.187	0.15	
		VNMG 2.332E SS						●	●	●	●										0.031	0.281	0.187	0.15
Finishing to medium cutting		TM VNMG 2.331E TM	●	●	▲	▲														0.016	0.281	0.187	0.15	
		VNMG 2.332E TM	●	●	▲	▲															0.031	0.281	0.187	0.15
Finishing to medium cutting		SM VNMG 2.331E SM						●	●	●	●									0.016	0.281	0.187	0.15	
		VNMG 2.332E SM						●	●	●	●										0.031	0.281	0.187	0.15
Finishing to medium cutting		- VNMA 2.331E													●					0.016	0.281	0.187	0.15	
		VNMA 2.332E													●						0.031	0.281	0.187	0.15

- : Line up
- ▲ : To be discontinued

Reference pages : External toolholders → **P.26** - Internal toolholders → **P.30**

Insert **NEGATIVE TYPE**

● : Continuous cutting
● : Light interrupted cutting
✱ : Heavy interrupted cutting

WN



Trigon, 80° with hole

Material	T9205	T9215	T9225	T9105	T9115	T9125	T6120	T6130	AH630	AH645	AH120	AH8015	T515	T5115	GT9530	AT9530	NS9530								
P Steel	●	●	●✱	●	●	●✱	●	✱	●✱	✱	●	●	●	●		●	●								
M Stainless		●	●																						
K Cast iron	●	●		●	●							●	●	●	●	●	●								
N Non-ferrous																									
S Superalloys												●	●												
H Hard materials																									

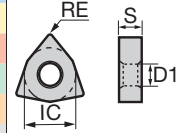

Application	Chipbreaker	Designation	Coated											Coated cermet	Cermet	Dimension (inch)						
			T9205	T9215	T9225	T9105	T9115	T9125	T6120	T6130	AH630	AH645	AH120	AH8015	T515	T5115	GT9530	AT9530	NS9530	RE	IC	S
Precision finishing		TF WNMG 330.5E TF	●	●															0.008	0.375	0.187	0.15
		WNMG 331E TF	●	●															0.016	0.375	0.187	0.15
		WNMG 332E TF	●	●															0.032	0.375	0.187	0.15
Finishing		TSF WNMG 330.5E TSF	●	●															0.008	0.375	0.187	0.15
		WNMG 331E TSF	●	●		▲	▲									●	●	●	0.016	0.375	0.187	0.15
		WNMG 332E TSF	●	●		▲	▲									●	●	●	0.032	0.375	0.187	0.15
		WNMG 333E TSF	●	●		▲	▲									●		●	0.047	0.375	0.187	0.15
Finishing (wiper)		FW WNMG 331E FW	●	●	●	▲	▲	▲							●		●	0.016	0.375	0.187	0.15	
		WNMG 332E FW	●	●	●	▲	▲	▲							●		●	0.031	0.375	0.187	0.15	
Finishing		ZF WNMG 331E ZF	●	●		▲	▲											0.016	0.375	0.187	0.15	
Finishing to medium cutting (wiper)		SW WNMG 332E SW	●	●	●	▲	▲	▲					●					0.031	0.375	0.187	0.15	
		WNMG 333E SW	●	●	●	▲	▲	▲					●					0.047	0.375	0.187	0.15	
		* Wiper																				

* Please contact our sales representative for your inquiries about the program adjustment when using SW/FW for machining of radius shape or for taper machining.

● : Line up
▲ : To be discontinued

Insert NEGATIVE TYPE

- : Continuous cutting
- ◐ : Light interrupted cutting
- ✱ : Heavy interrupted cutting

WN



**Trigon, 80°
with hole**

	P Steel	M Stainless	K Cast iron	N Non-ferrous	S Superalloys	H Hard materials	T9205	T9215	T9225	T9105	T9115	T9125	T6120	T6130	AH630	AH645	AH120	AH8015	T515	T5115	GT9530	AT9530	NS9530
●		●●	●●●				●	●	●	●	●	●	●	●	●	●	●	●	●	●	●	●	●
◐																							
✱																							

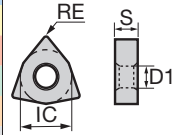

Application	Chipbreaker	Designation	Coated										Coated cermet		Cermet	Dimension (inch)															
			T9205	T9215	T9225	T9105	T9115	T9125	T6120	T6130	AH630	AH645	AH120	AH8015	T515	T5115	GT9530	AT9530	NS9530	RE	IC	S	D1								
Finishing		SS WNMG 331E SS													●	●									0.016	0.375	0.187	0.15			
		WNMG 332E SS														●	●										0.031	0.375	0.187	0.15	
		WNMG 333E SS														●	●											0.047	0.375	0.187	0.15
Medium cutting		TM WNMG 331E TM		●	●	▲	▲																				0.016	0.375	0.187	0.15	
		WNMG 332E TM		●	●	▲	▲																					0.031	0.375	0.187	0.15
		WNMG 333E TM		●	●	▲	▲																					0.047	0.375	0.187	0.15
Finishing to medium cutting		NM WNMG 333E NM			●		▲																				0.047	0.375	0.187	0.15	
		ZM WNMG 332E ZM		●	●	▲	▲																					0.031	0.375	0.187	0.15
Medium cutting		SM WNMG 331E SM											●	●	●												0.016	0.375	0.187	0.15	
		WNMG 332E SM											●	●	●												0.031	0.375	0.187	0.15	
		WNMG 333E SM											●	●	●												0.047	0.375	0.187	0.15	
Finishing to medium cutting		- WNMA 331E																		●							0.016	0.375	0.187	0.15	
		WNMA 332E																		●							0.031	0.375	0.187	0.15	
		WNMA 333E																		●							0.047	0.375	0.187	0.15	
		WNMA 334E																		●							0.063	0.375	0.187	0.15	

- : Line up
- ▲ : To be discontinued

Reference pages : External toolholders → P.22 - Internal toolholders → P.29

External toolholders

ACLNR/L-Eco

Double-clamp toolholder with 95° approach angle, for negative 80° rhombic inserts

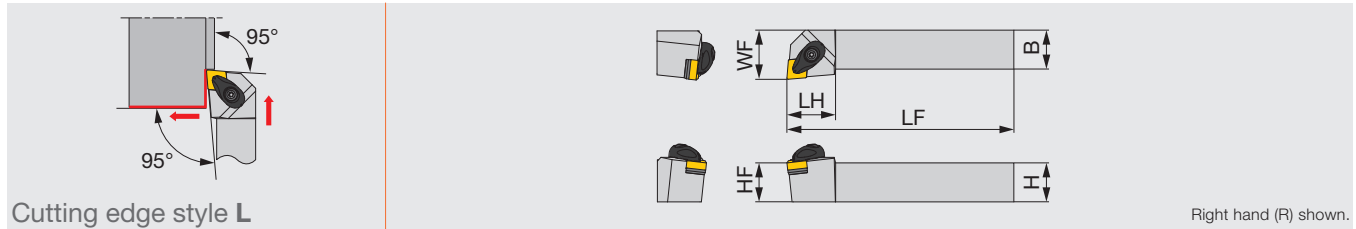

Inch	H	B	LF	LH	HF	WF	RE**	Insert	Torque*
ACLNR/L1233-A	0.750	0.750	4.500	0.900	0.750	1.000	0.031	CN**33...	3.0
ACLNR/L1633-A	1.000	1.000	6.000	1.000	1.000	1.250	0.031	CN**33...	3.0

*Torque: Recommended torque (lb-f) for clamping
 **RE: The holder measurements are true with this insert radius

SPARE PARTS							
Designation	Clamp	Clamp screw	Spring	Spring pin	Shim	Shim screw	Wrench
ACLNR/L**-A	ACP3S-E	ACS-5W	BP-7	SP-2.5	ASC322	CSTB-3.5	T-15F

TUNG T^{URN}JET PCLNR/L-CHP-Eco

Lever-lock toolholder with 95° approach angle, for negative 80° rhombic inserts, with high pressure coolant capability

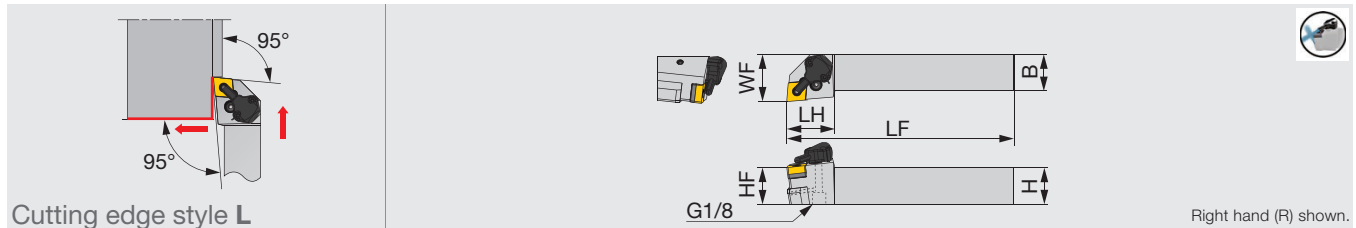

Inch	H	B	LF	LH	HF	WF	RE**	Insert	Torque*
PCLNR/L1233-CHP	0.750	0.750	4.500	1.300	0.750	1.250	0.031	CN**33...	2.0
PCLNR/L1633-CHP	1.000	1.000	6.000	1.300	1.000	1.250	0.031	CN**33...	2.0

*Torque: Recommended torque (lb-f) for clamping
 **RE: The holder measurements are true with this insert radius

SPARE PARTS					
Designation	Shim	Clamping screw	Wrench 1	Spring pin	Lever
PCLNR/L**-CHP	LSC317	LCS3	P-2.5	LSP3	LCL33

SPARE PARTS						
Designation	Coolant unit	Mounting screw	Wrench 2	O-ring	Coolant screw	Wrench 3
PCLNR/L**-CHP	CU-CW-CHP	SRM3	T-8F	OR6.4X0.9N	SRM4X4TL360	P-2

PCLNR/L-Eco

Lever-lock toolholder with 95° approach angle, for negative 80° rhombic inserts

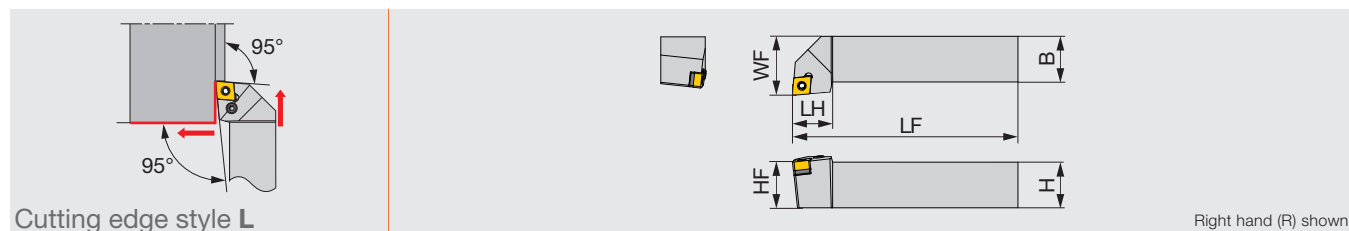

Inch	H	B	LF	LH	HF	WF	RE**	Insert	Torque*
PCLNR/L1233	0.750	0.750	4.500	0.813	0.750	1.000	0.031	CN**33...	2.0
PCLNR/L1633	1.000	1.000	6.000	0.813	1.000	1.250	0.031	CN**33...	2.0

*Torque: Recommended torque (lb-f) for clamping

**RE: The holder measurements are true with this insert radius

SPARE PARTS

Designation	Shim	Clamping screw	Wrench	Spring pin	Lever
PCLNR/L**	LSC317	LCS3	P-2.5	LSP3	LCL33

AWLNR/L-Eco

Double-clamp toolholder with 95° approach angle, for negative 80° trigon inserts

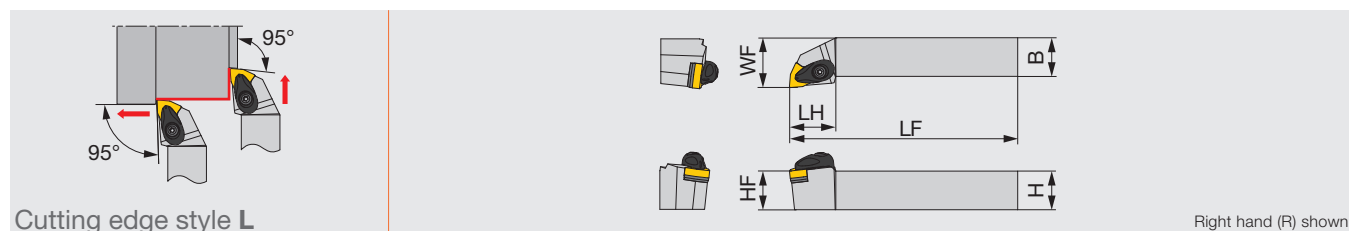

Inch	H	B	LF	LH	HF	WF	RE**	Insert	Torque*
AWLNR/L1233-A	0.750	0.750	4.500	1.125	0.750	1.000	0.031	WN**33...	3.0
AWLNR/L1633-A	1.000	1.000	6.000	1.125	1.000	1.250	0.031	WN**33...	3.0

*Torque: Recommended torque (lb-f) for clamping

**RE: The holder measurements are true with this insert radius

SPARE PARTS

Designation	Clamp	Clamp screw	Spring	Spring pin	Shim	Shim screw	Wrench
AWLNR/L**-A	ACP3S-E	ACS-5W	BP-7	SP-2.5	ASW322	CSTB-3.5	T-15F

PWLN^R/L-CHP

Lever-lock toolholder with 95° approach angle, for negative 80° trigon inserts, with high pressure coolant capability

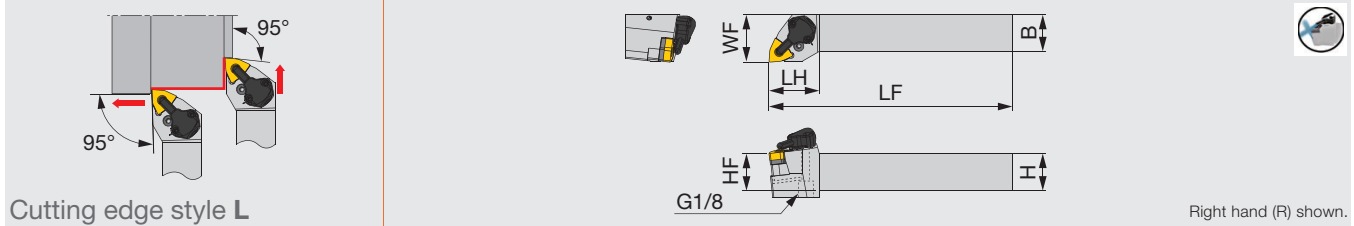

Inch	H	B	LF	LH	HF	WF	RE**	Insert	Torque*
PWLN ^R /L1233-CHP	0.750	0.750	4.500	1.969	0.750	1.250	0.031	WN**33...	2.0
PWLN ^R /L1633-CHP	1.000	1.000	6.000	1.969	1.000	1.250	0.031	WN**33...	2.0

*Torque: Recommended torque (lb-f) for clamping
 **RE: The holder measurements are true with this insert radius

SPARE PARTS					
Designation	Shim	Clamping screw	Wrench 1	Spring pin	Lever
PWLN ^R /L**-CHP	LSW312	LCS3	P-2.5	LSP3	LCL3

SPARE PARTS						
Designation	Coolant unit	Mounting screw	Wrench 2	O-ring	Coolant screw	Wrench 3
PWLN ^R /L**-CHP	CU-CW-CHP	SRM3	T-8F	OR6.4X0.9N	SRM4X4TL360	P-2

PWLN^R/L-Eco

Lever-lock toolholder with 95° approach angle, for negative 80° trigon inserts

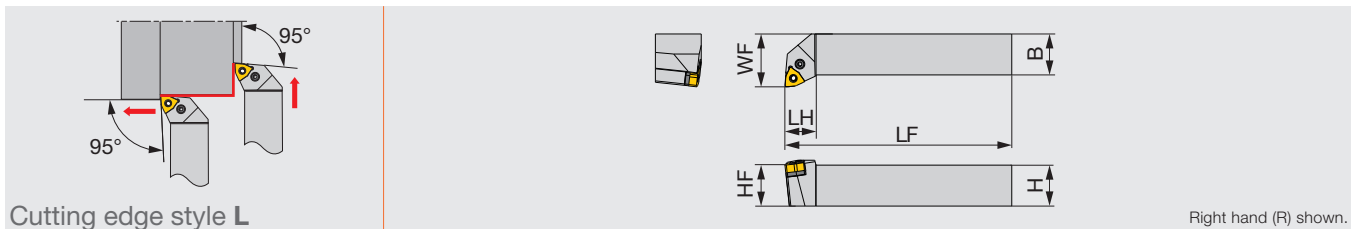

Inch	H	B	LF	LH	HF	WF	RE**	Insert	Torque*
PWLN ^R /L1233	0.750	0.750	4.500	0.625	0.750	1.000	0.031	WN**33...	2.0
PWLN ^R /L1633	1.000	1.000	6.000	0.719	1.000	1.250	0.031	WN**33...	2.0

*Torque: Recommended torque (lb-f) for clamping
 **RE: The holder measurements are true with this insert radius

SPARE PARTS					
Designation	Shim	Clamping screw	Wrench	Spring pin	Lever
PWLN ^R /L**	LSW312	LCS3	P-2.5	LSP3	LCL3

ADJNR/L-Eco

Double-clamp toolholder with 93° approach angle, for negative 55° rhombic inserts

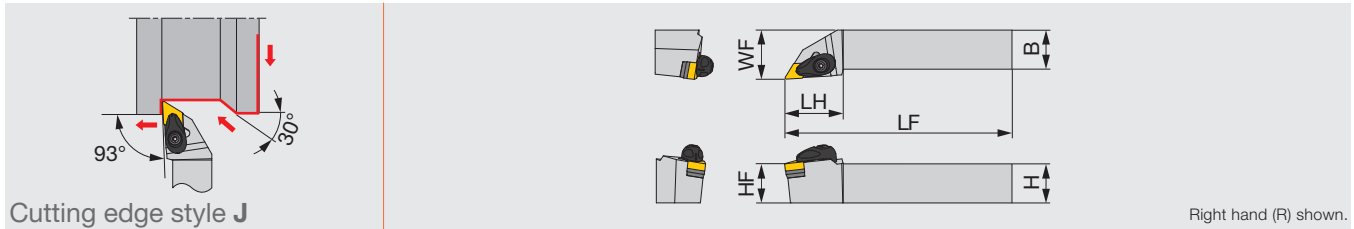

Inch	H	B	LF	LH	HF	WF	RE**	Insert	Torque*
ADJNR/L1233-A	0.750	0.750	4.500	1.250	0.750	1.000	0.031	DN**33...	3.0
ADJNR/L1633-A	1.000	1.000	6.000	1.250	1.000	1.250	0.031	DN**33...	3.0

*Torque: Recommended torque (lb-f) for clamping

**RE: The holder measurements are true with this insert radius

SPARE PARTS

Designation	Clamp	Clamp screw	Spring	Spring pin	Shim	Shim screw	Wrench
ADJNR/L**-A	ACP3S-E	ACS-5W	BP-7	SP-2.5	ASD322	CSTB-3.5	T-15F

TUNG T^{URN}JET

PDJNR/L-CHP-Eco

Lever-lock toolholder with 93° approach angle, for negative 55° rhombic inserts, with high pressure coolant capability

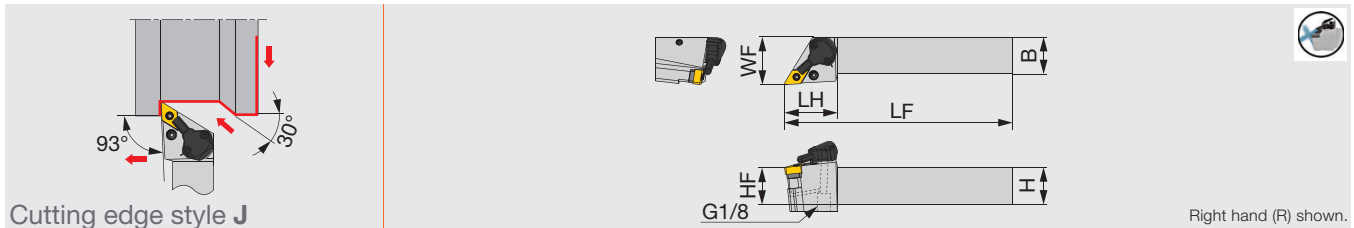

Inch	H	B	LF	LH	HF	WF	RE**	Insert	Torque*
PDJNR/L1233-CHP	0.750	0.750	4.500	1.420	0.750	1.250	0.031	DN**33...	2.0
PDJNR/L1633-CHP	1.000	1.000	6.000	1.420	1.000	1.250	0.031	DN**33...	2.0

*Torque: Recommended torque (lb-f) for clamping

**RE: The holder measurements are true with this insert radius

SPARE PARTS

Designation	Shim	Clamping screw	Wrench 1	Spring pin	Lever
PDJNR/L**-CHP	ELSD32	LCS3	P-2.5	LSP3	LCL33L

SPARE PARTS

Designation	Coolant unit	Mounting screw	Wrench 2	O-ring	Coolant screw	Wrench 3
PDJNR/L**-CHP	CU-D-CHP	SRM3	T-8F	OR6.4X0.9N	SRM4X4TL360	P-2

PDJNR/L-Eco

Lever-lock toolholder with 93° approach angle, for negative 55° rhombic inserts

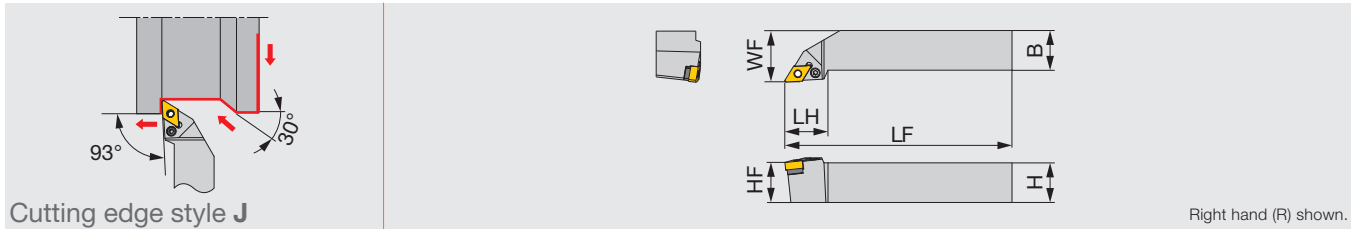

Inch	H	B	LF	LH	HF	WF	RE**	Insert	Torque*
PDJNR/L1033	0.625	0.625	4.000	1.125	0.625	0.875	0.031	DN**33...	2.0
PDJNR/L1233	0.750	0.750	4.500	1.125	0.750	1.000	0.031	DN**33...	2.0
PDJNR/L1633	1.000	1.000	6.000	1.125	1.000	1.250	0.031	DN**33...	2.0

*Torque: Recommended torque (lb-f) for clamping

**RE: The holder measurements are true with this insert radius

SPARE PARTS

Designation	Shim	Clamping screw	Wrench	Spring pin	Lever
PDJNR/L**	ELSD32	LCS3	P-2.5	LSP3	LCL33L

ADQNR/L-Eco

Double-clamp toolholder with 107.5° approach angle, for negative 55° rhombic inserts

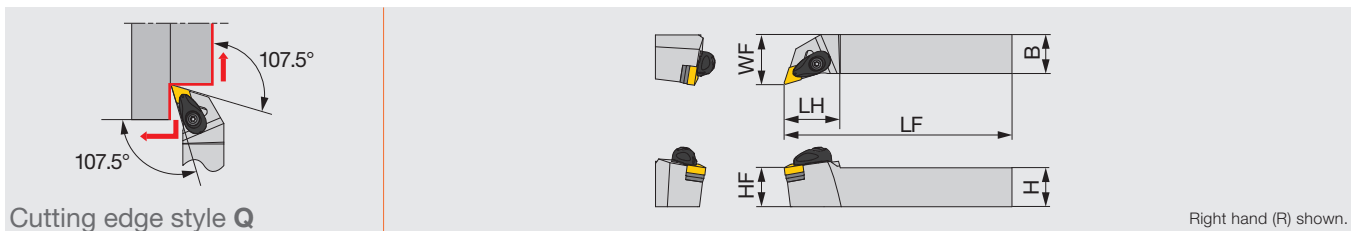

Inch	H	B	LF	LH	HF	WF	RE**	Insert	Torque*
ADQNR/L1233-A	0.750	0.750	4.500	1.150	0.750	1.000	0.031	DN**33...	2.2
ADQNR/L1633-A	1.000	1.000	6.000	1.150	1.000	1.250	0.031	DN**33...	2.2

*Torque: Recommended torque (lb-f) for clamping

**RE: The holder measurements are true with this insert radius

SPARE PARTS

Designation	Clamp	Clamp screw	Spring	Spring pin	Shim	Shim screw	Wrench
ADQNR/L**-A	ACP3S-E	ACS-5W	BP-7	SP-2.5	ASD322	CSTB-3.5	T-15F

AVJNR/L-Eco

Double-clamp toolholder with 93° approach angle, for negative 35° rhombic inserts

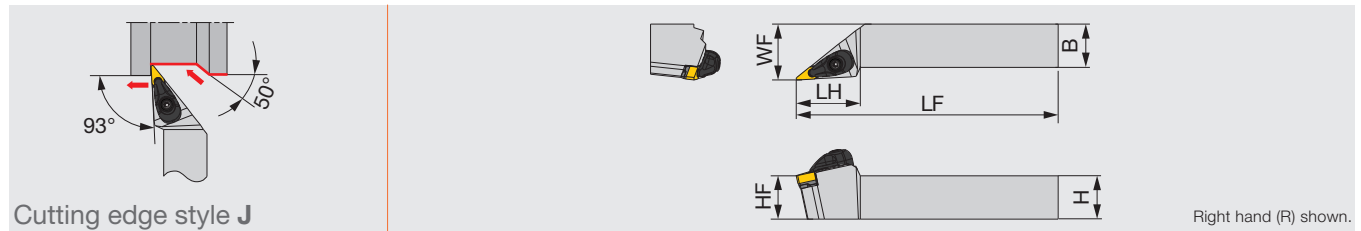

Cutting edge style J

Right hand (R) shown.

Inch	H	B	LF	LH	HF	WF	RE**	Insert	Torque*
AVJNR/L122.33-A	0.750	0.750	4.500	1.500	0.750	1.000	0.031	VN**2.33...	3.0
AVJNR/L162.33-A	1.000	1.000	6.000	1.500	1.000	1.250	0.031	VN**2.33...	3.0

*Torque: Recommended torque (lb-ft) for clamping

**RE: The holder measurements are true with this insert radius

SPARE PARTS

Designation	Clamp	Clamp screw	Spring	Spring pin	Shim	Shim screw	Wrench
AVJNR/L**-A	ACP3L-E	ACS-5W	BP-7	SP-2.5	ASV222	CSTB-3.0	T-15F

TUNG^{TURN}TJET

PVJNR/L-CHP

Lever-lock toolholder with 93° approach angle, for negative 35° rhombic inserts, with high pressure coolant capability

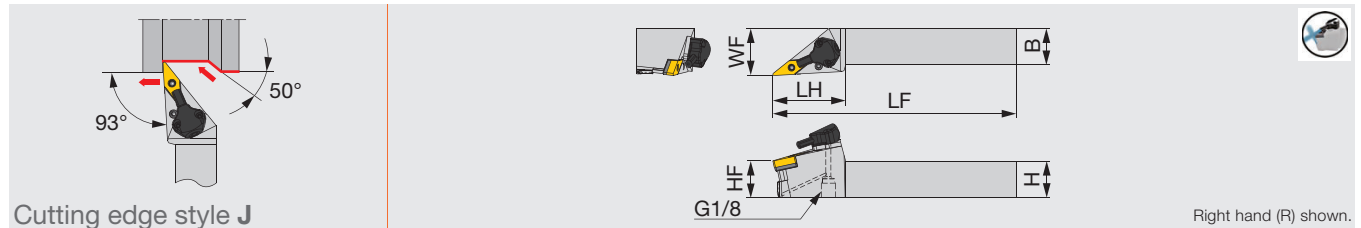

Cutting edge style J

Right hand (R) shown.

Inch	H	B	LF	LH	HF	WF	RE**	Insert	Torque*
PVJNR/L122.33-CHP	0.750	0.750	4.500	2.000	0.750	1.250	0.031	VN**2.33...	2
PVJNR/L162.33-CHP	1.000	1.000	6.000	2.000	1.000	1.250	0.031	VN**2.33...	2

*Torque: Recommended torque (lb-ft) for clamping

**RE: The holder measurements are true with this insert radius

SPARE PARTS

Designation	Shim	Clamping screw	Wrench 1	Spring pin	Lever
PVJNR/L**-CHP	LSV212	LCS3V	P-2.5	LSP3	LCL3V

SPARE PARTS

Designation	Coolant unit	Mounting screw	Wrench 2	O-ring	Coolant screw	Wrench 3
PVJNR/L**-CHP	CU-V-CHP	SRM3	T-8F	OR6.4X0.9N	SRM4X4TL360	P-2

AVQNR/L-Eco

Double-clamp toolholder with 117.5° approach angle, for negative 35° rhombic inserts

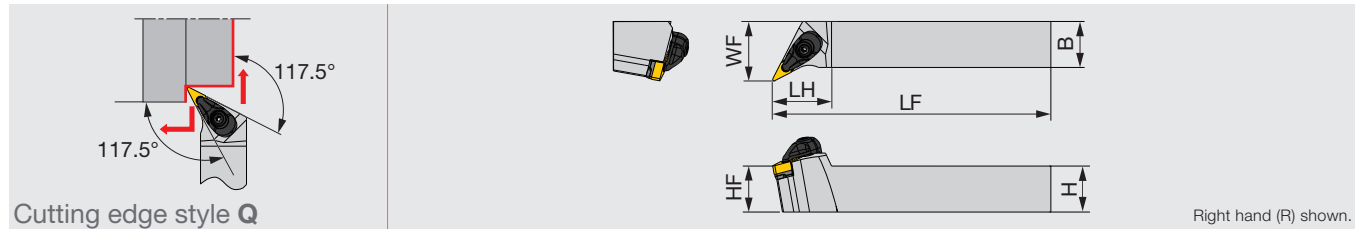

Inch	H	B	LF	LH	HF	WF	RE**	Insert	Torque*
AVQNR/L122.33-A	0.750	0.750	4.500	1.250	0.750	1.000	0.031	VN**2.33...	3.0
AVQNR/L162.33-A	1.000	1.000	6.000	1.250	1.000	1.250	0.031	VN**2.33...	3.0

*Torque: Recommended torque (lb-f) for clamping

**RE: The holder measurements are true with this insert radius

SPARE PARTS

Designation	Clamp	Clamp screw	Spring	Spring pin	Shim	Shim screw	Wrench
AVQNR/L*-A	ACP3L-E	ACS-5W	BP-7	SP-2.5	ASV222	CSTB-3.0	T-15F

AVVNN-Eco

Double-clamp toolholder with 72.5° approach angle, for negative 35° rhombic inserts

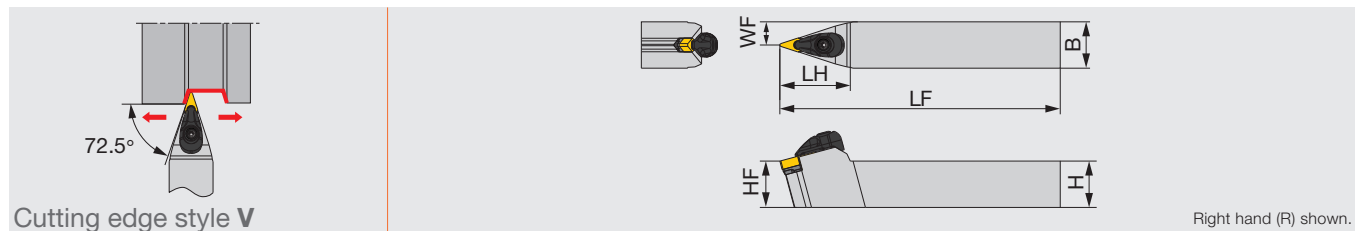

Inch	H	B	LF	LH	HF	WF	RE**	Insert	Torque*
AVVNN122.33-A	0.750	0.750	4.500	1.500	0.750	0.375	0.031	VN**2.33...	3.0
AVVNN162.33-A	1.000	1.000	6.000	1.500	1.000	0.500	0.031	VN**2.33...	3.0

*Torque: Recommended torque (lb-f) for clamping

**RE: The holder measurements are true with this insert radius

SPARE PARTS

Designation	Clamp	Clamp screw	Spring	Spring pin	Shim	Shim screw	Wrench
AVVNN*-A	ACP3L-E	ACS-5W	BP-7	SP-2.5	ASV222	CSTB-3.0	T-15F

PTGNR/L-Eco

Lever-lock toolholder with 91° approach angle, for negative triangular inserts

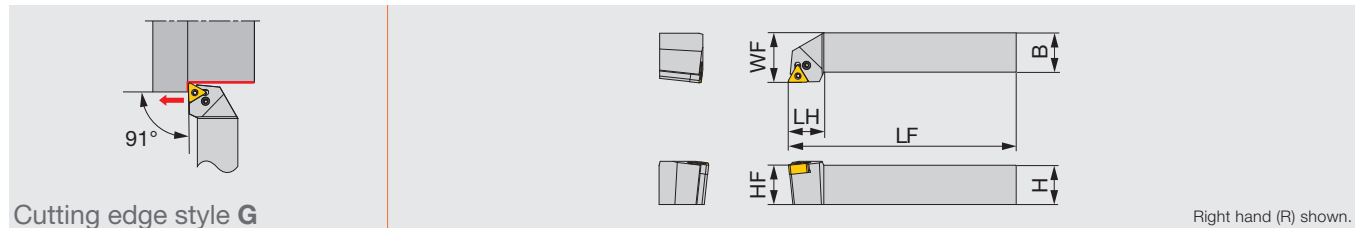

Inch	H	B	LF	LH	HF	WF	RE**	Insert	Torque*
PTGNR/L1223	0.750	0.750	4.500	0.750	1.000	1.000	0.031	TN**23...	2.0
PTGNR/L1623	1.000	1.000	6.000	0.750	1.000	1.250	0.031	TN**23...	2.0

*Torque: Recommended torque (lb-ft) for clamping

**RE: The holder measurements are true with this insert radius

SPARE PARTS

Designation	Clamping screw	Wrench	Lever
PTGNR/L**	LCS23A	P-2.5	LCL23

TUNG^{URN}TJET

PTGNR/L-CHP

Lever-lock toolholders with 91° approach angle, for negative 60° triangular inserts, with high pressure coolant capability

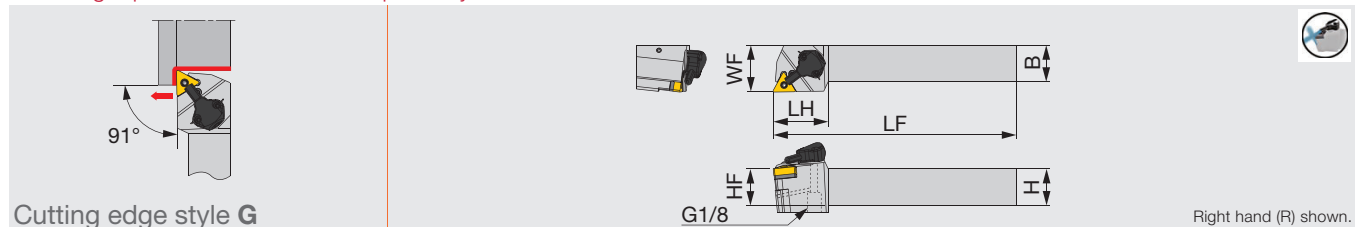

Inch	H	B	LF	LH	HF	WF	RE**	Insert	Torque*
PTGNR/L1223-CHP	0.750	0.750	4.500	1.500	0.750	1.250	0.031	TN**23...	2.0
PTGNR/L1623-CHP	1.000	1.000	6.000	1.500	1.000	1.250	0.031	TN**23...	2.0

*Torque: Recommended torque (lb-ft) for clamping

**RE: The holder measurements are true with this insert radius

SPARE PARTS

Designation	Shim	Clamping screw	Wrench 1	Spring pin	Lever
PTGNR/L**-CHP	-	LCS23A	P-2.5	LSP3	LCL23

SPARE PARTS

Designation	Coolant unit	Mounting screw	Wrench 2	O-ring	Coolant screw	Wrench 3
PTGNR/L**-CHP	CU-CW-CHP	SRM3	T-8F	OR6.4X0.9N	SRM4X4TL360	P-2

Internal toolholders

A-ACLNR/L-Eco

Double-clamp boring bar, for negative 80° rhombic inserts

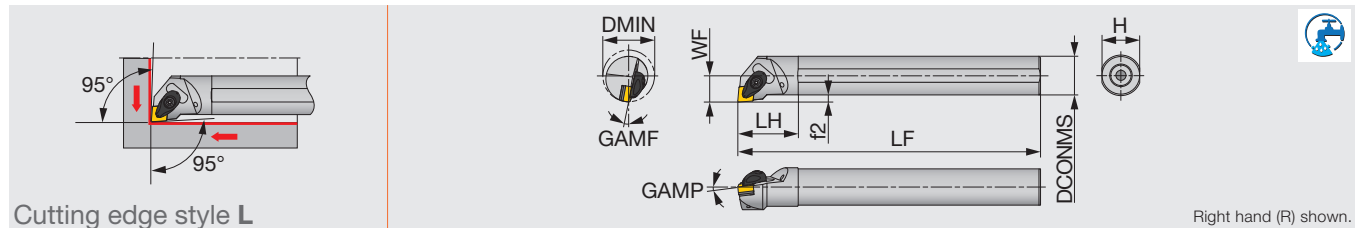

Inch	Material	DMIN	DCONMS	WF	LF	LH	H	f2	GAMP	GAMP	RE**	Insert	Torque*
A16-ACLNR/L33-D20	Steel	1.250	1.000	0.672	12.000	1.750	0.906	0.172	-6	-13	0.031	CN**33...	3
A20-ACLNR/L33-D25	Steel	1.560	1.250	0.859	14.000	1.938	1.188	0.234	-6	-10	0.031	CN**33...	3

*Torque: Recommended torque (lb-ft) for clamping

**RE: The holder measurements are true with this insert radius

SPARE PARTS

Designation	Clamp	Clamp screw	Spring	Spring pin	Shim	Shim screw	Wrench
A**-ACLNR/L33...	ACP3S-E	ACS-5W	BP-7	SP-2.5	ASC322	CSTB-3.5	T-15F

A-AWLNR/L-Eco

Double-clamp boring bar, for negative 80° trigon inserts

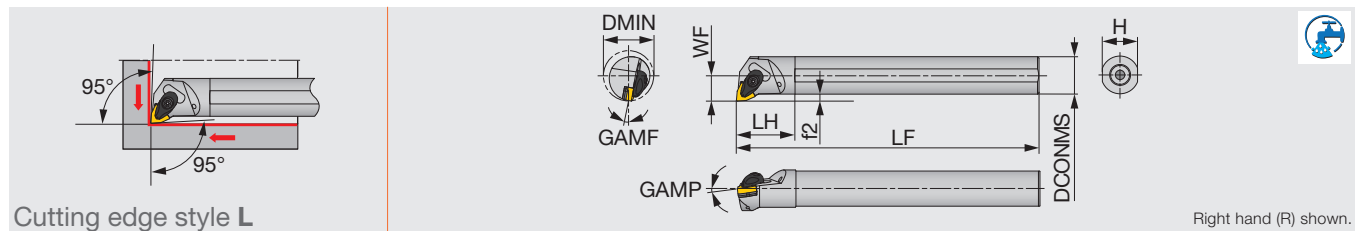

Inch	Material	DMIN	DCONMS	WF	LF	LH	H	f2	GAMP	GAMP	RE**	Insert	Torque*
A16-AWLNR/L33-D20	Steel	1.250	1.000	0.672	12.000	1.750	0.906	0.172	-6	-13	0.031	WN**33...	3
A20-AWLNR/L33-D25	Steel	1.560	1.250	0.859	14.000	1.938	1.188	0.234	-6	-10	0.031	WN**33...	3

*Torque: Recommended torque (lb-ft) for clamping

**RE: The holder measurements are true with this insert radius

SPARE PARTS

Designation	Clamp	Clamp screw	Spring	Spring pin	Shim	Shim screw	Wrench
A**-AWLNR/L33...	ACP3S-E	ACS-5W	BP-7	SP-2.5	ASW322	CSTB-3.5	T-15F

A-ADUNR/L-Eco

Double-clamp boring bar, for negative 55° rhombic inserts

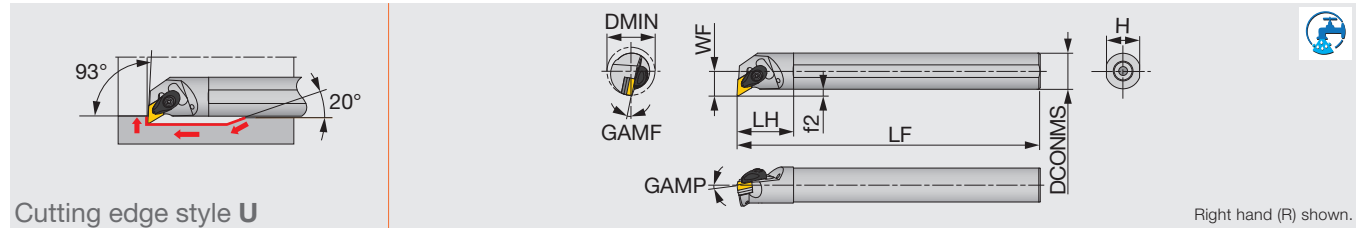

Cutting edge style U

Right hand (R) shown.

Inch	Material	DMIN	DCONMS	WF	LF	LH	H	f2	GAMP	GAMF	RE**	Insert	Torque*
A16-ADUNR/L33-D20	Steel	1.250	1.000	0.672	12.000	1.750	0.906	0.172	-6	-13	0.031	DN**33...	3
A20-ADUNR/L33-D25	Steel	1.560	1.250	0.859	14.000	1.938	1.188	0.234	-6	-11	0.031	DN**33...	3

*Torque: Recommended torque (lb-ft) for clamping

**RE: The holder measurements are true with this insert radius

SPARE PARTS

Designation	Clamp	Clamp screw	Spring	Spring pin	Shim	Shim screw	Wrench
A**-ADUNR/L33...	ACP3S-E	ACS-5W	BP-7	SP-2.5	ASD322	CSTB-3.5	T-15F

A-PVUNR/L-Eco

Lever-lock boring bar, for negative 35° rhombic inserts

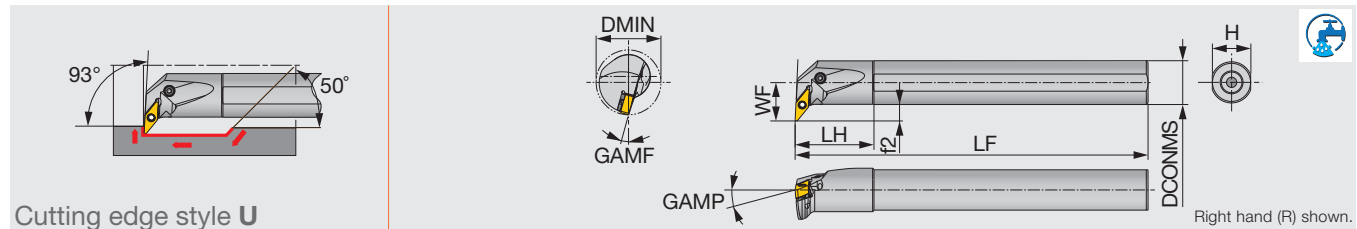

Cutting edge style U

Right hand (R) shown.

Inch	Material	DMIN	DCONMS	WF	LF	LH	H	f2	GAMP	GAMF	RE**	Insert	Torque*
A16-PVUNR/L2.33-D20	Steel	1.250	1.000	0.672	12.000	1.750	0.906	0.167	-6	-13	0.031	VN**2.33**E...	3.0
A16-PVUNR/L2.33-D24	Steel	1.500	1.000	0.859	12.000	1.750	0.906	0.354	-6	-10	0.031	VN**2.33**E...	3.0
A20-PVUNR/L2.33-D26	Steel	1.643	1.250	0.859	14.000	2.000	1.188	0.229	-6	-10	0.031	VN**2.33**E...	3.0

*Torque: Recommended torque (lb-ft) for clamping

**RE: The holder measurements are true with this insert radius

SPARE PARTS

Designation	Clamping screw	Wrench	Lever	Shim	Spring pin	Oil supply attachment*	Screw for oil hole*
A16-PVUNR/L2.33-D20	LCS3V	P-2.5	LCL3V	LSV212	LSP3	EA-25	SSHM4-5
A16-PVUNR/L2.33-D24	LCS3V	P-2.5	LCL3V	LSV212	LSP3	EA-25	SSHM4-5
A20-PVUNR/L2.33-D26	LCS3V	P-2.5	LCL3V	LSV212	LSP3	EA-32	SSHM4-5

*Optional

■ Economical sized insert bring benefits in small diameter ID Turning

- The new VNMG233 insert combined with a P-type holder can turn and profile an inner diameter as small as $\phi 1.250''$.

A16-PVUNR/L2.33-D20



- ISO-EcoTurn also offers a holder line for a minimum working diameter of $\phi 1.500''$ with VNMG2.33 insert. This holder makes an excellent alternative to a standard holder with VNMG33 insert, whose minimum working diameter is also $\phi 1.500''$.

A16-PVUNR/L2.33-D24

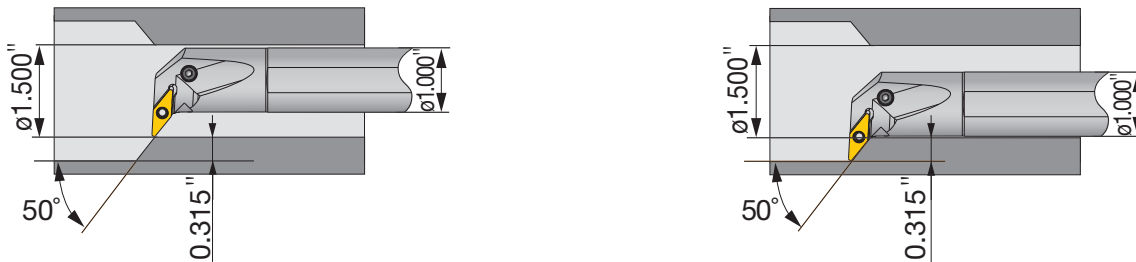

C-ACLNR/L

Turning a double-clamp toolholder with 95° approach angle. For negative 80° rhombic insert.

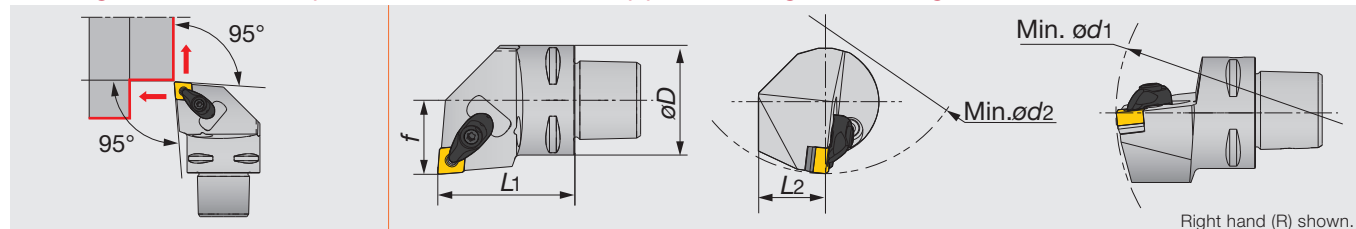

Metric	øD	L1	L2	f	ød1	ød2	rε**	Insert
C4ACLNR/L27050-0904N	40	50	25	27	140	110	0.8	CN**0904.../CN**33
C6ACLNR/L45065-0904N	63	65	35	45	190	110	0.8	CN**0904.../CN**33

Applicable for 7 MPa pressure coolant.

SPARE PARTS									
Designation	Clamp	Clamping screw	Coolant parts	Shim	Shim screw	Spring	Spring 1	Wrench	Wrench 1
C*ACLNR/L*-0904N	ACP3S-E	ACS-5W	SATZ-M10X1-M5	ASC322	CSTB-3.5	BP-7	SP-2.5	-	T-15F

C-ACMNN

Turning a double-clamp toolholder with 95° approach angle. For negative 80° rhombic insert.

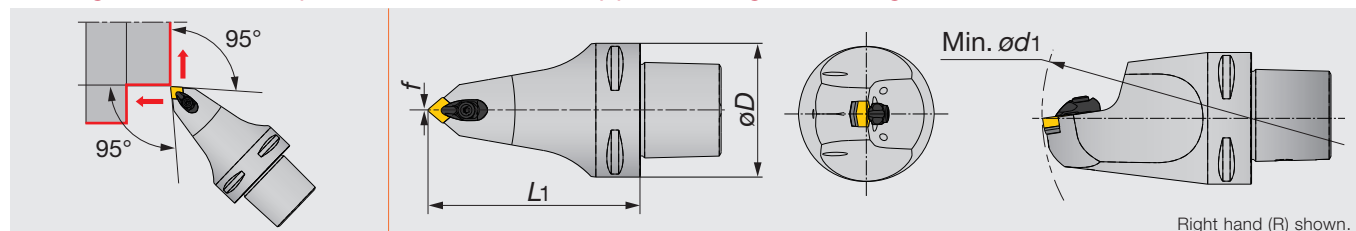

Metric	øD	L1	L2	f	ød1	ød2	rε**	Insert
C6ACMNN00100-0904N	63	100	-	0	110	-	0.8	CN**0904.../CN**33
C6ACMNN00140-0904N	63	140	-	0	110	-	0.8	CN**0904.../CN**33

Applicable for 7 MPa pressure coolant.

SPARE PARTS									
Designation	Clamp	Clamping screw	Coolant parts	Shim	Shim screw	Spring	Spring 1	Wrench	Wrench 1
C6ACMNN*-0904N	ACP3S-E	ACS-5W	-	ASC322	CSTB-3.5	BP-7	SP-2.5	-	T-15F

C-ADJNR/L

Turning a double-clamp toolholder with 93° approach angle. For negative 55° rhombic insert.

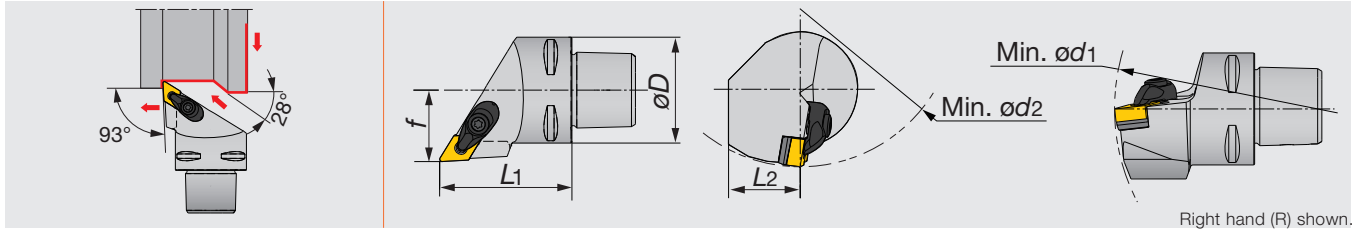

Metric	øD	L1	L2	f	ød1	ød2	re**	Insert
C4ADJNR/L27050-1104N	40	50	25	27	145	110	0.8	DN**1104.../DN**33
C6ADJNR/L45065-1104N	63	65	35	45	190	119	0.8	DN**1104.../DN**33

Applicable for 7 MPa pressure coolant.

SPARE PARTS									
Designation	Clamp	Clamping screw	Coolant parts	Shim	Shim screw	Spring	Spring 1	Wrench	Wrench 1
C*ADJNR/L*-1104N	ACP3S-E	ACS-5W	SATZ-M10X1-M5	ASD322	CSTB-3.5	BP-7	SP-2.5	-	T-15F

C-AWLNR/L

Turning a double-clamp toolholder with 95° approach angle. For negative 80° trigon inserts.

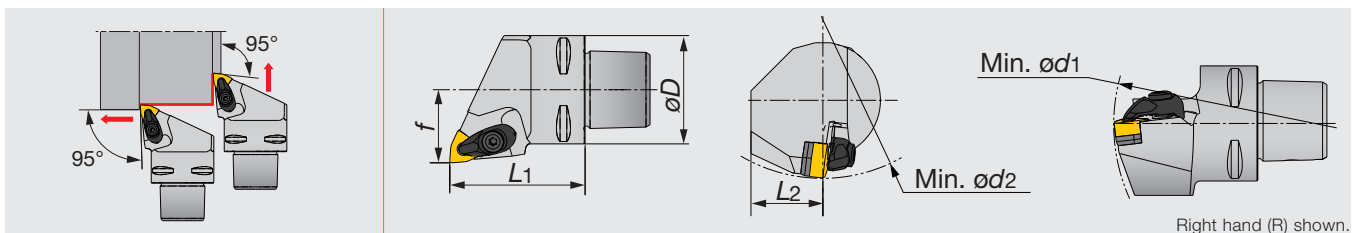

Metric	øD	L1	L2	f	ød1	ød2	re**	Insert
C4AWLNR/L27050-0604N	40	50	25	27	140	110	0.8	WN**0604.../CN**33

Applicable for 7 MPa pressure coolant.

SPARE PARTS									
Designation	Clamp	Clamping screw	Coolant parts	Shim	Shim screw	Spring	Spring 1	Wrench	Wrench 1
C4AWLNR/L27050-0604N	ACP3S-E	ACS-5W	-	ASW322	CSTB-3.5	BP-7	SP-2.5	-	T-15F

C-AVJNR/L

Turning A double-clamp toolholder with 93° approach angle. For negative 35° rhombic insert.

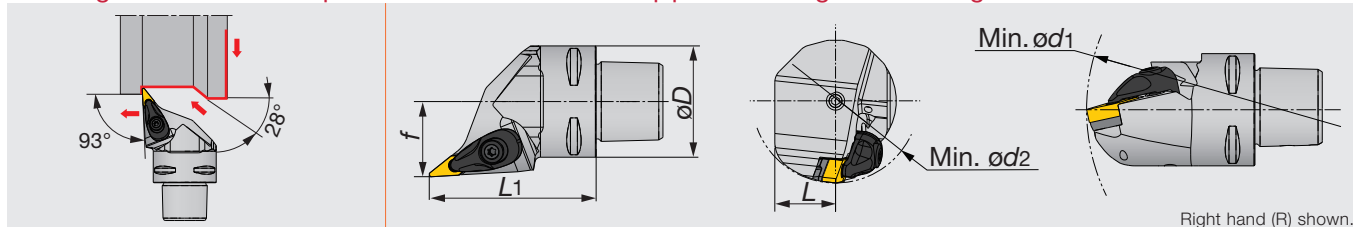

Metric	øD	L1	L2	f	ød1	ød2	rc**	Insert
C4AVJNR/L27060-1204N	40	60	20	27	140	55	0.8	VN**1204.../VN**2.33
C6AVJNR/L45065-1204N	63	65	31.5	45	190	81	0.8	VN**1204.../VN**2.33

Applicable for 7 MPa pressure coolant.

SPARE PARTS

Designation	Clamp	Clamping screw	Coolant parts	Shim	Shim screw	Spring	Spring 1	Wrench	Wrench 1
C4AVJNR/L27060-1204N	ACP3L-E	ACS-5W	-	ASV222	CSTB-3	BP-7	SP-2.5	T-9F	T-15F
C6AVJNR/L45065-1204N	ACP3L-E	ACS-5W	SATZ-M10X1-M5	ASV222	CSTB-3	BP-7	SP-2.5	T-9F	T-15F

C-PTJNR/L

Lever lock type toolholder with 93° approach angle. For negative 60° triangular insert.

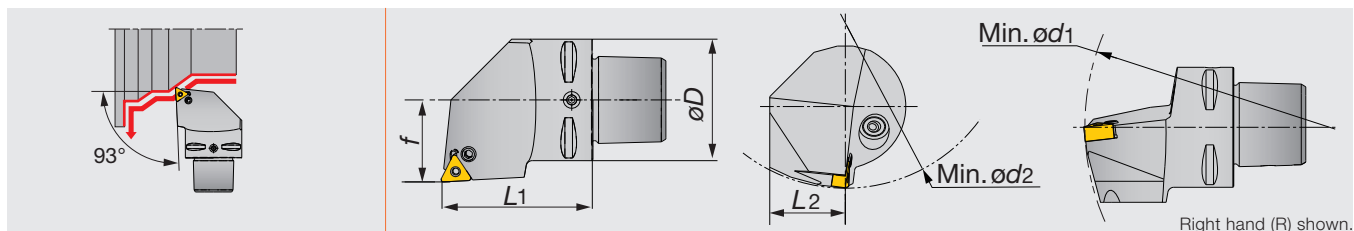

Metric	øD	L1	L2	f	ød1	ød2	rc**	Insert
C4PTJNR/L27050-1104N	40	50	25	27	140	110	0.8	TN**1104.../TN**23

Applicable for 7 MPa pressure coolant.

SPARE PARTS

Designation	Clamping screw	Lever	Wrench 1
C4PTJNR/L27050-1104N	LCS23A	LCL23	P-2.5

C-PCLNR/L-CHP

Lever lock type toolholder with 95° approach angle. For negative 80° rhombic insert.

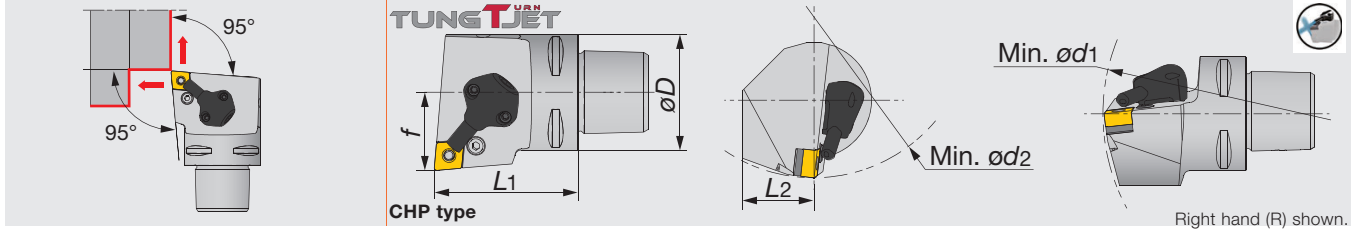

Metric	øD	L1	L2	f	ød1	ød2	rε**	Insert
C4PCLNR/L27050-0904-CHP	40	50	25	27	140	110	0.8	CN**0904.../CN**33
C6PCLNR/L45065-0904-CHP	63	65	35	45	190	110	0.8	CN**0904.../CN**33

Applicable for 14 MPa pressure coolant

SPARE PARTS					SPARE PARTS					
Designation	Shim	Clamping screw	Spring pin	Lever	Wrench 1	Designation	Coolant unit	Mounting screw	Wrench 2	O-ring
C*PCLNR/L**-0904-CHP	LSC317	LCS3	LSP3	LCL33	P-2.5	C*PCLNR/L**-0904-CHP	CU-CW-CHP	SRM3	T-8F	OR6.4X0.9N

C-PDJNR/L-CHP

Lever lock type toolholder with 93° approach angle. For negative 55° rhombic insert.

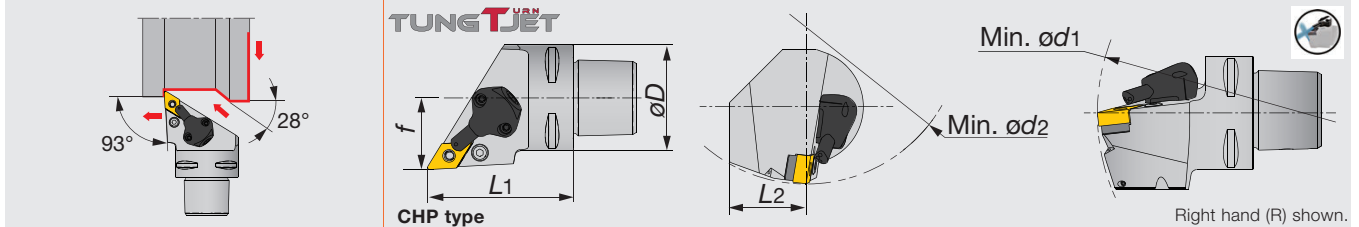

Metric	øD	L1	L2	f	ød1	ød2	rε**	Insert
C4PDJNR/L27055-1104-CHP	40	55	27	27	145	110	0.8	DN**1104.../DN**33
C6PDJNR/L45065-1104-CHP	63	65	35	45	195	95	0.8	DN**1104.../DN**33

Applicable for 14 MPa pressure coolant

SPARE PARTS					SPARE PARTS					
Designation	Shim	Clamping screw	Spring pin	Lever	Wrench 1	Designation	Coolant unit	Mounting screw	Wrench 2	O-ring
C*PDJNR/L**-1104-CHP	ELSD32	LCS3	LSP3	LCL33	P-2.5	C*PDJNR/L**-1104-CHP	CU-D-CHP	SRM3	T-8F	OR6.4X0.9N

C-PDMNL-CHP

Lever lock type toolholder with 93° approach angle. For negative 55° rhombic insert.

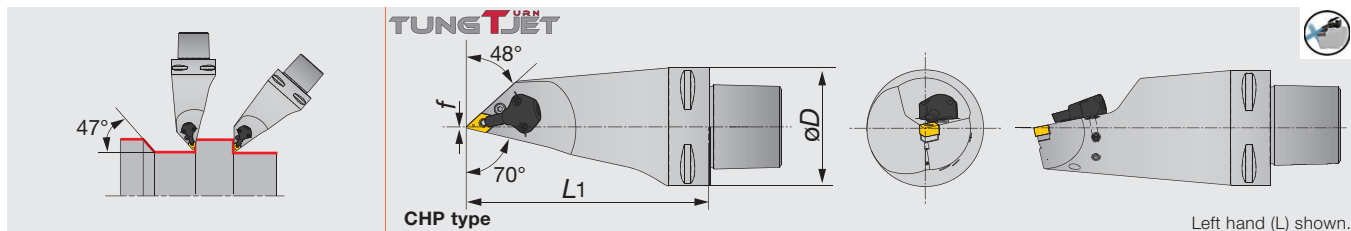

Left hand (L) shown.

Metric	øD	L1	L2	f	ød1	ød2	rc**	Insert
C6PDMNL00130-1104-CHP	63	130	-	0	-	-	0.8	DN**1104.../DN**33

Applicable for 14 MPa pressure coolant.

SPARE PARTS						SPARE PARTS				
Designation	Shim	Clamping screw	Spring pin	Lever	Wrench 1	Designation	Coolant unit	Mounting screw	Wrench 2	O-ring
C6PDMNL00130-1104-CHP	ELSD32	LCS3	LSP3	LCL33L	P-2.5	C6PDMNL00130-1104-CHP	CU-D-CHP	SRM3	T-8F	OR6.4X0.9N

C-PVJNR/L-CHP

Lever lock type toolholder with 93° approach angle. For negative 35° rhombic inserts.

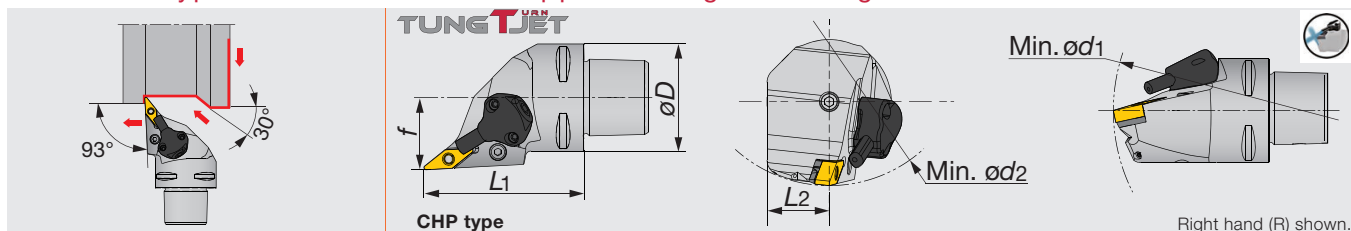

Right hand (R) shown.

Metric	øD	L1	L2	f	ød1	ød2	rc**	Insert
C4PVJNR/L27060-1204-CHP	40	60	20	27	140	90	0.8	VN**1204.../VN**2.33
C6PVJNR/L45065-1204-CHP	63	65	31.5	45	190	81	0.8	VN**1204.../VN**2.33

Applicable for 14 MPa pressure coolant.

SPARE PARTS						SPARE PARTS					
Designation	Shim	Clamping screw	Spring pin	Lever	Wrench 2	Designation	Coolant unit	Mounting screw	Wrench 2	O-ring	
C*PVJNR/L*-1204-CHP	LSV212	LCS3V	LSP3	LCL3V	P-2.5	P-3	C*PVJNR/L*-1204-CHP	CU-V-CHP	SRM3	T-8F	OR6.4X0.9N

STANDARD CUTTING CONDITIONS



Steel

Application	Chipbreaker	Grades	Cutting speed Vc (sfm)			Depth of cut ap (inch)	Feed f (ipr)
			Low carbon steels Alloy steels	Medium carbon steels Alloy steels	High carbon steels Alloy steels		
Precision finishing	TF	T9215	492 - 1312	492 - 1312	394 - 984	0.004 - 0.02	0.001 - 0.006
		T9225	394 - 984	394 - 984	328 - 820		
Finishing	TSF	NS9530	492 - 820	262 - 722	262 - 591	0.008 - 0.059	0.003 - 0.016
		GT9530	492 - 984	262 - 820	262 - 656		
		AT9530	492 - 984	262 - 820	262 - 656		
		T9215	492 - 1312	492 - 1312	394 - 984		
		T9225	394 - 984	394 - 984	328 - 820		
	ZF	T9215	492 - 1312	492 - 1312	394 - 984	0.008 - 0.059	0.003 - 0.008
Finishing (Wiper)	FW	T9205	591 - 1312	591 - 1312	492 - 1148	0.008 - 0.059	0.003 - 0.016
		T9215	492 - 1312	492 - 1312	394 - 984		
		T9225	394 - 984	394 - 984	328 - 820		
		NS9530	492 - 820	262 - 722	262 - 591	0.02 - 0.059	0.008 - 0.016
		GT9530	492 - 984	262 - 820	262 - 656		
Finishing to medium cutting	ZM	T9215	492 - 1312	492 - 1312	394 - 984	0.028 - 0.079	0.006 - 0.016
Finishing to medium cutting (Wiper)	SW	T9205	591 - 1312	591 - 1312	492 - 1148	0.02 - 0.079	0.012 - 0.024
		T9215	492 - 1312	492 - 1312	394 - 984		
		T9225	394 - 984	394 - 984	328 - 820		
Finishing to medium cutting	NM	T9225	394 - 984	394 - 984	328 - 820	0.02 - 0.079	0.006 - 0.016
Medium cutting	TM	T9215	492 - 1312	492 - 1312	394 - 984	0.039 - 0.118	0.008 - 0.02
		T9225	394 - 984	394 - 984	328 - 820		



Stainless

Application	Chipbreaker	Grades	Cutting speed Vc (sfm)			Depth of cut ap (inch)	Feed f (ipr)
			Austenitic	Ferritic / Martensitic	Precipitation hardened		
Finishing	SS	AH630	295 - 623	361 - 689	197 - 295	0.02 - 0.118	0.003 - 0.008
		AH645	230 - 492	295 - 558	-		
Medium cutting	SM	T6120	459 - 787	525 - 919	262 - 492	0.039 - 0.118	0.008 - 0.02
		T6130	328 - 656	394 - 787	230 - 361		
		AH630	295 - 623	361 - 689	197 - 295		



Cast Iron



Application	Chipbreaker	Grades	Cutting speed Vc (sfm)		Depth of cut ap (inch)	Feed f (ipr)
			Grey cast irons	Ductile cast irons		
Finishing to medium cutting (Wiper)	SW	T5115	459 - 1312	459 - 1214	0.02 - 0.079	0.012 - 0.024
Medium cutting	TM	T515	492 - 2297	459 - 1214	0.039 - 0.118	0.008 - 0.02



Superalloys and titanium

Application	Chipbreaker	Grades	Cutting speed Vc (sfm)		Depth of cut ap (inch)	Feed f (ipr)
			Titanium alloys	Ni-base alloys		
Medium cutting	TM	AH8015	66 - 492	66 - 328	0.039 - 0.118	0.008 - 0.02

PRACTICAL EXAMPLES

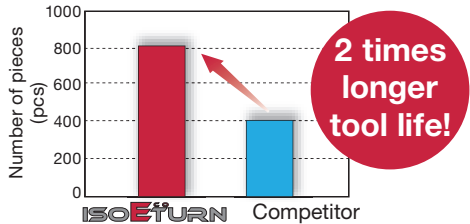
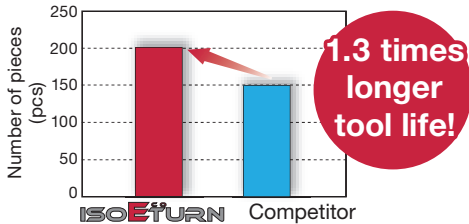
Workpiece type		Machine part	Shaft
Toolholder		AWLNR1633-A	ADJNR1633-A
Insert		WNMG 332E TM	DNMG 332E TSF
Grade		T9215	T9215
Workpiece material		low alloy steel	1045
		 P	 P
Cutting conditions	Cutting speed: V_c (sfm)	787	853
	Feed : f (ipr)	0.004 - 0.01	0.008
	Depth of cut : a_p (inch)	0.039	0.039
	Machining	External face turning	External turning
	Coolant	Wet	Wet
Results		 <p>2 times longer tool life!</p>	 <p>1.3 times longer tool life!</p>
		<p>ISO-EcoTurn insert has demonstrated excellent chip control at 1 mm depth of cut. With T9215 grade, tool life has been doubled over the competitor's regular sized CNMG 43 insert.</p>	<p>ISO-EcoTurn insert in T9215 grade has increased tool life by 1.3 times over the competitor's regular sized DNMG 43 insert with added machining stability.</p>



MEMO

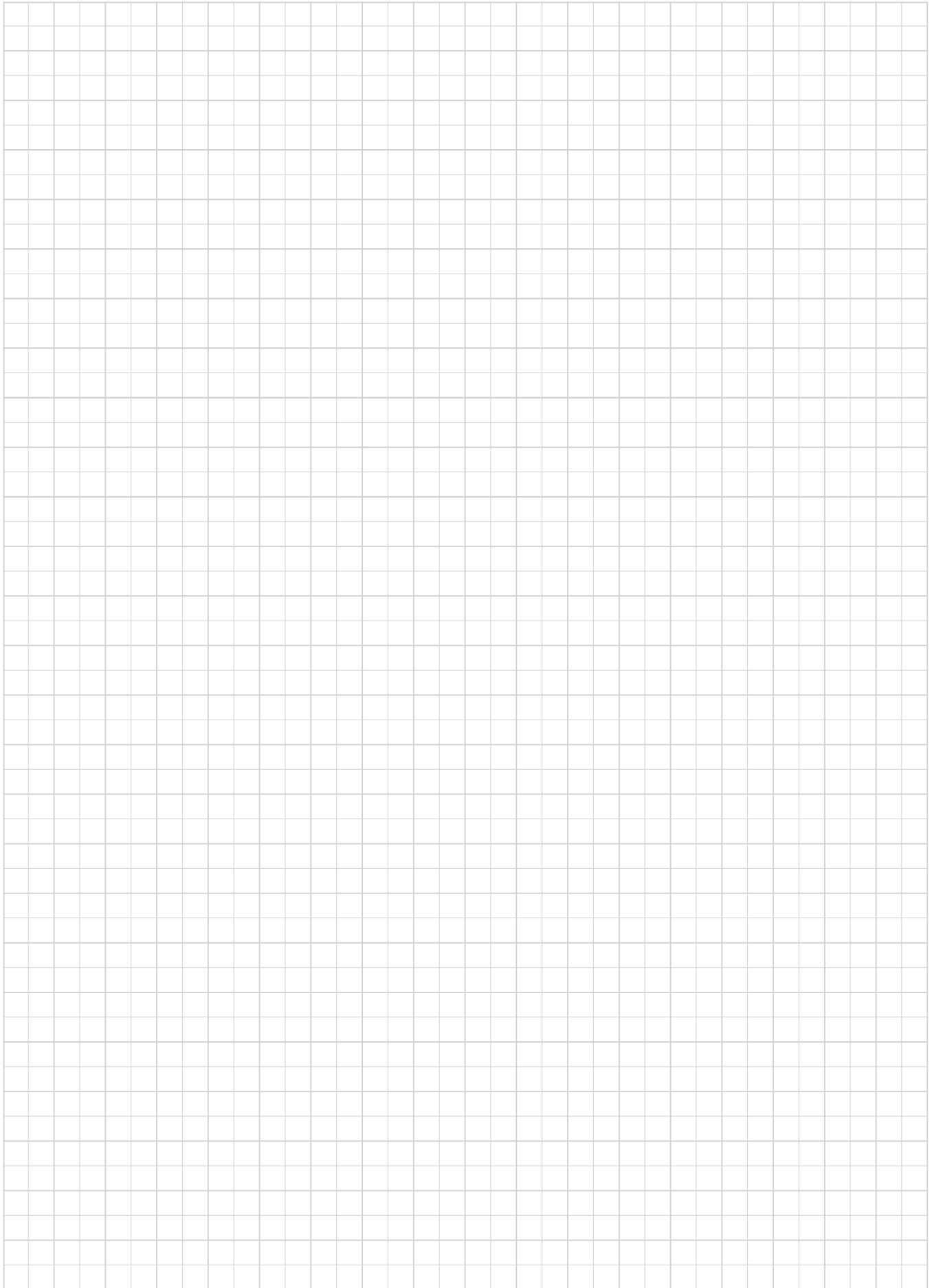

Tungaloy America, Inc.

3726 N Ventura Drive, Arlington Heights, IL 60004, U.S.A.

Inside Sales: +1-888-554-8394

Technical Support: +1-888-554-8391

Fax: +1-888-554-8392

www.tungaloy.com/us

Tungaloy Canada

432 Elgin St. Unit 3, Brantford, Ontario N3S 7P7, Canada

Phone: +1-519-758-5779 Fax: +1-519-758-5791

www.tungaloy.com/ca

Tungaloy de Mexico S.A.

C Los Arellano 113, Parque Industrial Siglo XXI

Aguascalientes, AGS, Mexico 20290

Phone: +52-449-929-5410 Fax: +52-449-929-5411

www.tungaloy.com/mx

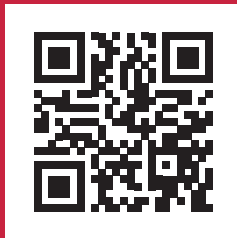

Scan for instant
web access



www.tungaloy.com/us

follow us at:

facebook.com/tungaloyamerica

twitter.com/tungaloy

instagram.com/tungaloyamerica

linkedin.com/company/tungaloy-america

To see Tungaloy products in action visit:



www.youtube.com/tungaloycorporation

Distributed by:

**COMPLETE
METALWORKING
SOLUTIONS**

(800) 991-4225
www.ahbinc.com
ISO Certified
customerservice@ahbinc.com

FIND US ON THE CLOUD!
machingcloud.com

