



TV Carb

Catalog 2013
Turning • Milling • End Mills



introducing

MAXICOOL™

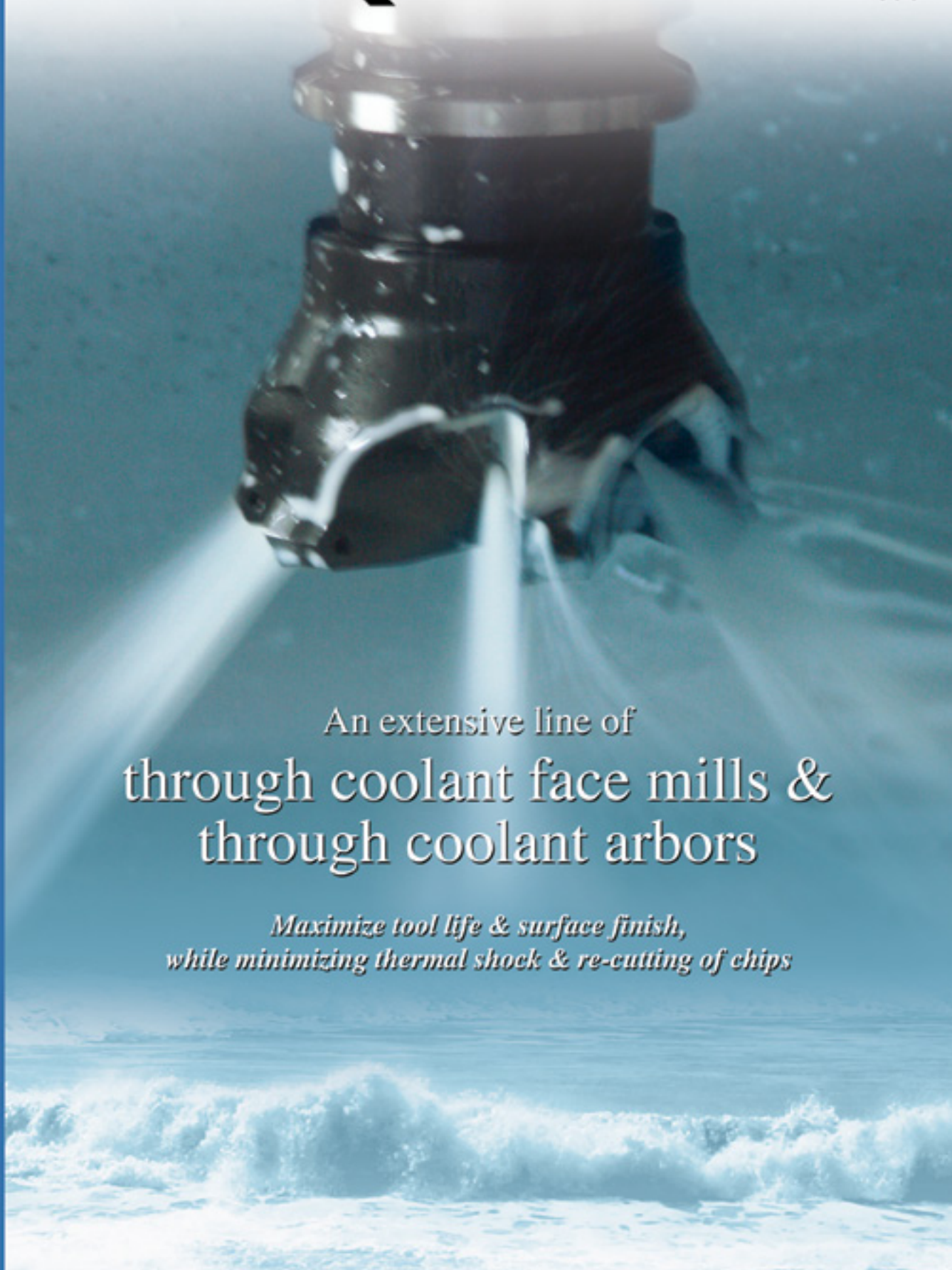

An extensive line of
through coolant face mills &
through coolant arbors

*Maximize tool life & surface finish,
while minimizing thermal shock & re-cutting of chips*

RP15TC (P10-P25, K10-K25)

Grade for highest cutting speeds for fine to medium turning, $V_c = 590 - 980$ sfm. Due to the special K coating this grade is extremely wear resistant. For continuous cut. As alternative, also applicable with cast iron.

RP25K (P15-P35, M15-M35)

(Universal Turning Grade.) Main grade for machining steel materials and easily machinable stainless steels at medium cutting speeds. $V_c = 490 - 720$ sfm, for light interrupted cut. This general purpose grade is characterized by the properties of high durability and excellent toughness across a wide range of applications.

RP40K (P25-P40, M25-M40)

A combination of an extremely tough carbide with the new "Nanolock MT-CVD layer". Guarantees maximum performance in heavy interrupted cutting. $V_c =$ up to 490 sfm.

RM35D (M25-M35)

Main grade for turning of austenitic stainless steels at medium to high cutting speeds, $V_c =$ up to 490 sfm. Applicable also for super alloys.

RK10 (K05-K20)

Cast iron turning grade for the area K10. Optimal for machining GG and GGG materials. Possible cutting speeds for GG up to V_c 1200 sfm. Perfectly suitable for dry machining.

RK20 (K10-K25)

Cast iron turning grade for the area K15. Optimal for machining GG and GGG materials. Possible cutting speeds for GG up to V_c 1200 sfm. Perfectly suitable for dry machining.

AS15 (S05-S20)

Special submicron grade for machining super alloys such as Inconel, titanium, etc., particularly suitable for interrupted cut. Also suitable for austenitic stainless steel.

AS15F (S05-S20)







A submicron grade with thin PVD-coating and special cutting edges guarantee high performance on small components.



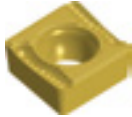
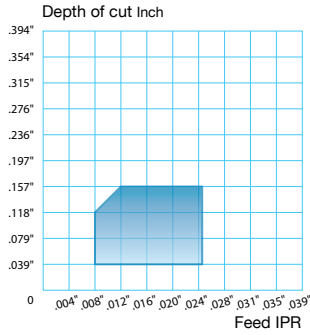

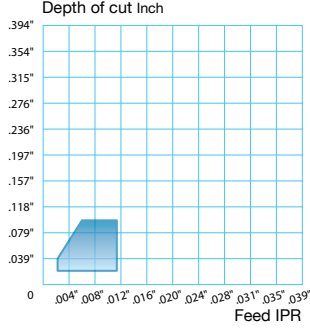
TK10MP (N05-N20, S05-S10)

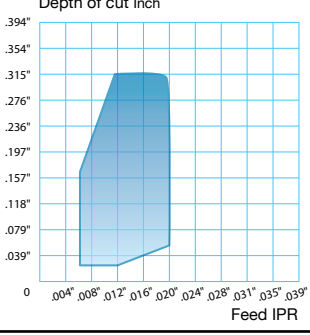

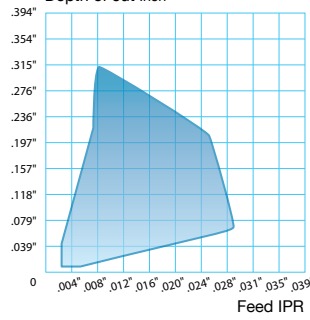
The ideal grade for working aluminum materials and other non-ferrous metals. Thanks to a very thin micropulse plasma CVD TiAlN coating is also excellent for finish machining of stainless steels and grey cast iron.

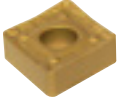
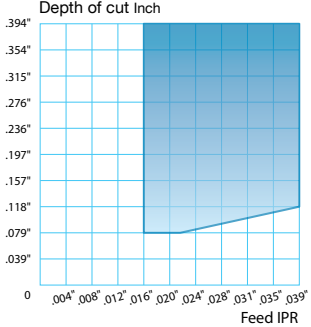
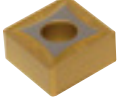
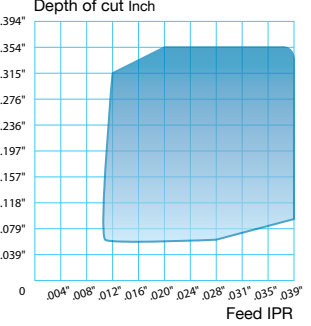

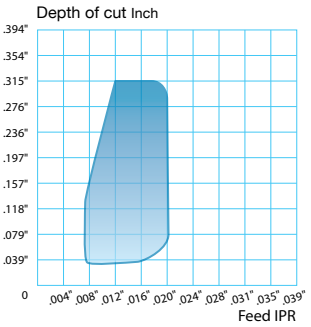
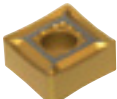
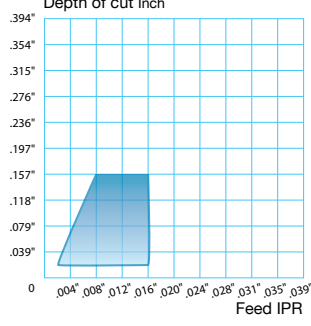
RTK20 (N05-N15)

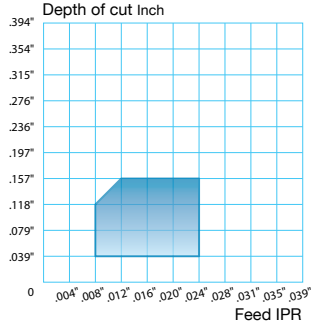
Classic micro-grain uncoated hard metal grade for machining aluminum materials and other Non Ferrous metals as well as grey cast iron at medium to high cutting speeds, even under unfavourable machining conditions.

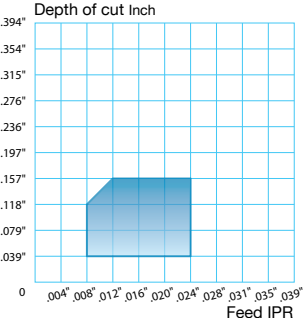
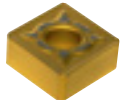
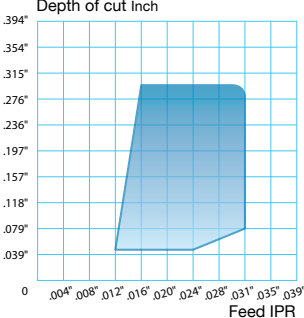
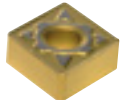
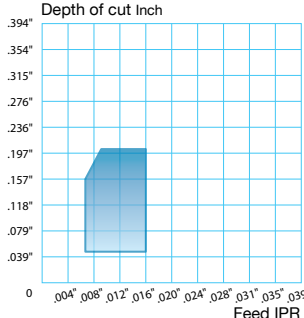
Positive Geometry		Parameters	Applications	Description
 SCT	P	DOC 0.040" - 0.157" FPR 0.008" - 0.025"		SCT – Copy turning and general machining for tool and die steel as well as stainless. Free cutting geometry allows for higher feed rates, especially suitable for swiss style machines.
	M			
 TMF	P	DOC 0.010" - 0.085" FPR 0.002" - 0.011"		TMF – Finishing geometry for steel and stainless in the ISO positive style inserts. Produces excellent finishes at light depth of cut and feeds.
	M			
 TMU	P	DOC 0.030" - 0.315" FPR 0.006" - 0.020"		TMU – General purpose machining in the ISO positive style insert geometries. Excellent all around performance in all steel and stainless steel materials.
	M			
 RAL	M	DOC 0.012" - 0.315" FPR 0.003" - 0.029"		RAL – Main chipbreaker for aluminum, brass, copper etc. Up-sharp polished edges delivers high shearing action and reduces built up edge. May also be used for light finishing in stainless steel and titanium alloys.
	N			
	S			

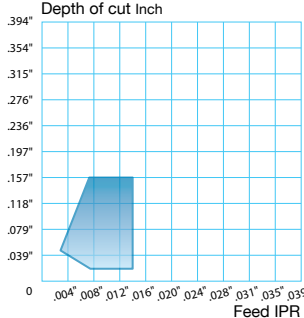
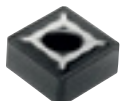
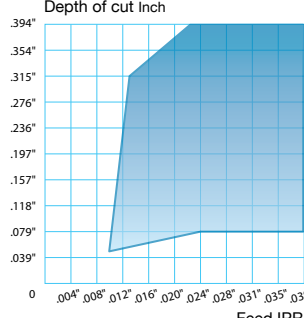
Negative Geometry		Parameters	Applications	Description		
 <p>HR</p>	P	<p>DOC 0.079" - 0.472"</p> <p>FPR 0.016" - 0.063"</p>		<p>HR – Single sided insert for extreme roughing in steel and stainless. Extra strong design for high feeds and depths of cut.</p>		
 <p>GR</p>	P	<p>DOC 0.050" - 0.354"</p> <p>FPR 0.010" - 0.039"</p>		<p>GR – Double sided roughing geometry for all steels. Stable cutting edge can take interruptions at elevated feed rates and depths of cut.</p>		
 <p>TMU</p>	P	<p>DOC 0.030" - 0.315"</p> <p>FPR 0.006" - 0.020"</p>		<p>TMU – Universal geometry for turning steel. Available in ANSI negative and ISO positive style inserts. The "go-to" edge for most applications.</p>		
	K					
 <p>MFM</p>	P	<p>DOC 0.020" - 0.157"</p> <p>FPR 0.003" - 0.016"</p>		<p>MFM – Finishing geometry for ANSI negative inserts. Produces excellent results at low depth of cut and low feed rates. May be used in steel and stainless steel.</p>		
 <p>STU</p>	P	<p>DOC 0.040" - 0.157"</p> <p>FPR 0.008" - 0.025"</p>		<p>STU – Like the SCT edge except chipgroove is on both sides of the radius thereby eliminating the need for right and left hand inserts. May be used for internal and external machining as well as facing. Free cutting design delivers great performance at high feed rates. Available in grades to machine steel, stainless and high temperature alloys.</p>		
	M					
	S					

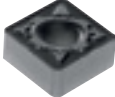
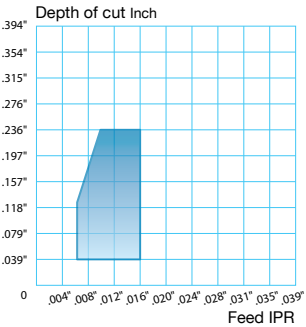
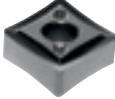
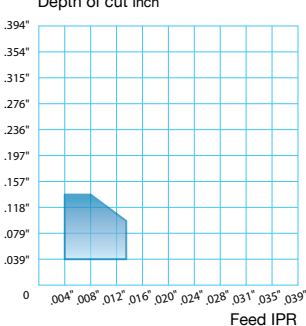
Negative Geometry		Parameters	Applications	Description
 SCT	P	DOC 0.040" - 0.157" FPR 0.008" - 0.025"		SCT – Copy turning and general machining of tool and die steel as well as stainless. Free cutting geometry allows for higher feed rates, especially suitable for swiss style machines.
	M			
 MMR	M	DOC 0.050" - 0.300" FPR 0.012" - 0.031"		MMR – Stainless steel roughing in the negative ANSI insert series. Edge prep is perfect for use in gummy materials and is strong enough to withstand interrupted cuts. May be used in high temperature alloys.
	M			
 MM	M	DOC 0.050" - 0.197" FPR 0.006" - 0.016"		MM – Medium machining for stainless steel and high temperature alloys. Freer cutting than the MMR edge, produces excellent surface finishes.
	M			
 MMF	M	DOC 0.030" - 0.157" FPR 0.003" - 0.014"		MMF – Finish machining of stainless steel at low depth of cut and low feed rates.
	M			
 GRK	K	DOC 0.050" - 0.394" FPR 0.010" - 0.040"		GRK – Medium to rough machining in cast iron materials. The strong cutting edge holds up well in interrupted cuts and provides for the best surface finishes.
	K			

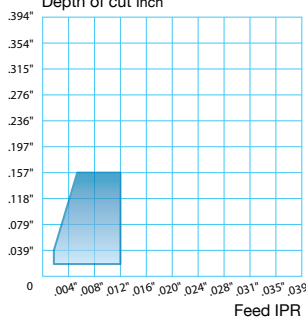
Negative Geometry		Parameters	Applications	Description
 HTR	M	DOC 0.039" - 0.236" FPR 0.006" - 0.016"		HTR – Our first choice for roughing high temperature alloys, titanium and stainless steel. Excellent chip control and cutting performance handles interrupted cuts at higher feed rates.
	S			
 HTM	M	DOC 0.040" - 0.130" FPR 0.004" - 0.014"		HTM – The best edge for general machining of high temperature alloys, titanium and stainless steel. Positive edge style is very free cutting and produces excellent surface finishes. The best choice for materials such as Inconel, Waspaloy etc.
	S			
 HTF	M	DOC 0.020" - 0.157" FPR 0.003" - 0.012"		HTF – The finishing edge for the high temperature alloy series. May be used in titanium and stainless steel in light depth of cut and light feed applications.
	S			

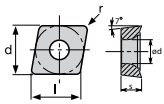

CCGT-...-SCT

Designation	l	d	s	d'	r	RP15K	RP25K	RP40K	RM35D
CCGT-21.51L-SCT	.252	1/4	.094	.110	1/64	●	●	●	●
CCGT-21.51R-SCT					1/32	●	●	●	●
CCGT-21.52L-SCT	.381	3/8	.156	.173	1/64	●	●	●	●
CCGT-21.52R-SCT					1/32	●	●	●	●
CCGT-32.51L-SCT	.504	1/2	.187	.217	1/64	●	●	●	●
CCGT-32.51R-SCT					1/32	●	●	●	●
CCGT-32.52L-SCT	.504	1/2	.187	.217	1/32	●	●	●	●
CCGT-32.52R-SCT					3/64	●	●	●	●
CCGT-432L-SCT	.504	1/2	.187	.217	1/32	●	●	●	●
CCGT-432R-SCT					3/64	●	●	●	●
CCGT-433L-SCT	.504	1/2	.187	.217	1/32	●	●	●	●
CCGT-433R-SCT					3/64	●	●	●	●

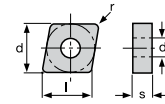
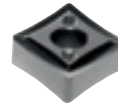

CNGG-...-HTM

Designation	l	d	s	d'	r	RP15TC	RP25K	RP40K	AS15
CNGG-431-HTM	.504	1/2	.187	.203	1/64	●	●	●	●
CNGG-432-HTM					1/32	●	●	●	●
CNGG-433-HTM					3/64	●	●	●	●

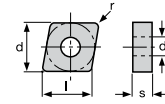
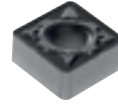

CNGG-...-HTR

Designation	l	d	s	d'	r	RP15TC	RP25K	RP40K	AS15
CNGG-432-HTR	.504	1/2	.187	.203	1/32	●	●	●	●
CNGG-433-HTR					3/64	●	●	●	●

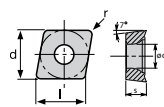

CCMT-...-TMF

Designation	l	d	s	d'	r	RP15TC	RP25K	RP40K	RM35D
CCMT-21.51-TMF	.252	1/4	.094	.110	1/64	●	●	●	●
CCMT-21.52-TMF					1/32	●	●	●	●
CCMT-32.51-TMF	.381	3/8	.156	.173	1/64	●	●	●	●
CCMT-32.52-TMF					1/32	●	●	●	●
CCMT-431-TMF	.504	1/2	.187	.217	1/64	●	●	●	●

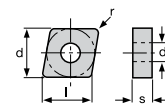
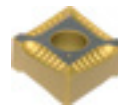

CNGG-...-STU

Designation	l	d	s	d'	r	RP15TC	RP25K	RP40K	AS15
CNGG-432-STU	.504	1/2	.187	.203	1/32	●	●	●	●

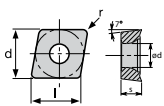

CCMT-...-TMU

Designation	l	d	s	d'	r	RP15TC	RP25K	RP40K	RM35D
CCMT-21.50.5-TMU	.252	1/4	.094	.110	.008	●	●	●	●
CCMT-21.51-TMU					1/64	●	●	●	●
CCMT-21.52-TMU	.381	3/8	.156	.173	1/32	●	●	●	●
CCMT-32.51-TMU					1/64	●	●	●	●
CCMT-32.52-TMU	.504	1/2	.187	.217	1/32	●	●	●	●
CCMT-431-TMU					1/64	●	●	●	●
CCMT-432-TMU	.504	1/2	.187	.217	1/64	●	●	●	●
CCMT-432-TMU					1/32	●	●	●	●

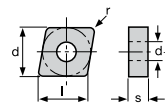
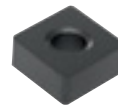

CNMA- ...

Designation	l	d	s	d'	r	RP15TC	RP25K	RP40K	RK10	RK20
CNMA-432	.504	1/2	.187	.203	1/32	●	●	●	●	●
CNMA-433					3/64	●	●	●	●	
CNMA-644	.760	3/4	.250	.312	1/16	●	●	●	●	●

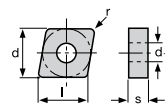
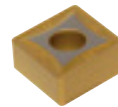

CNMG-...-GR

Designation	l	d	s	d'	r	RP15TC	RP25K	RP40K	RK10	RK20
CNMG-432-GR	.504	1/2	.187	.203	1/32	●	●	●	●	●
CNMG-433-GR					3/64	●	●	●	●	
CNMG-434-GR					1/16	●	●	●	●	
CNMG-542-GR	.634	5/8	.250	.250	1/32	●	●	●	●	●
CNMG-543-GR					3/64	●	●	●	●	
CNMG-544-GR	.760	3/4	.250	.312	1/16	●	●	●	●	●
CNMG-643-GR					3/64	●	●	●	●	
CNMG-644-GR					1/16	●	●	●	●	
CNMG-646-GR	.760	3/4	.250	.312	3/32	●	●	●	●	●
CNMG-646-GR					1/16	●	●	●	●	

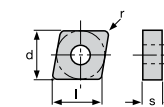
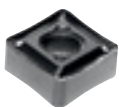

CNGG-...-HTF

Designation	l	d	s	d'	r	RP15TC	RP25K	RP40K	AS15
CNGG-431-HTF	.504	1/2	.187	.203	1/64	●	●	●	●
CNGG-432-HTF					1/32	●	●	●	●
CNGG-433-HTF					3/64	●	●	●	●

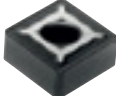
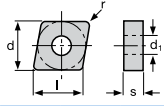
Designation	l	d	s	d'	r	CNMG-...-GRK	
						RK10	RK20
CNMG-432-GRK					1/32		● ●
CNMG-433-GRK	.504	1/2	.187	.203	3/64		● ●
CNMG-434-GRK					1/16		● ●
CNMG-543-GRK	.634	5/8	.250	.250	3/64		● ●
CNMG-544-GRK					1/16		● ●

Designation	l	d	s	d'	r	CNMG-...-MMR			
						RP15TC	RP25K	RP40K	RM35D
CNMG-432-MMR					1/32				●
CNMG-433-MMR	.504	1/2	.187	.203	3/64				●
CNMG-543-MMR	.634	5/8	.250	.250	3/64				●
CNMG-643-MMR	.760	3/4	.250	.312	3/64				●

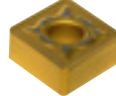
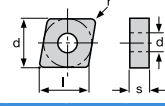
Designation	l	d	s	d'	r	CNMG-...-HTM			
						RP15TC	RP25K	RP40K	AS15
CNMG-431-HTM					1/64		●	●	
CNMG-432-HTM	.504	1/2	.187	.203	1/32		●	●	
CNMG-433-HTM					3/64		●	●	

Designation	l	d	s	d'	r	CNMG-...-SCT			
						RP15TC	RP25K	RP40K	RM35D
CNMG-431-L-SCT					1/64		●	●	●
CNMG-431R-SCT							●	●	●
CNMG-432L-SCT	.504	1/2	.187	.203	1/32		●	●	●
CNMG-432R-SCT							●	●	●
CNMG-433L-SCT							●	●	●
CNMG-433R-SCT					3/64		●	●	●

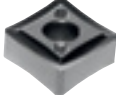
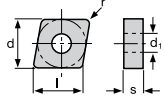
Designation	l	d	s	d'	r	CNMG-...-MFM				
						RP15TC	RP25K	RP40K	RK10	RK20
CNMG-431-MFM	.504	1/2	.187	.203	1/64	●	●	●	●	●
CNMG-432-MFM					1/32	●	●			

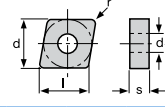
Designation	l	d	s	d'	r	CNMG-...-TMF			
						RP15TC	RP25K	RP40K	RM35D
CNMG-431-TMF	.504	1/2	.187	.203	1/64	●	●		
CNMG-432-TMF					1/32	●	●		

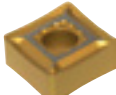
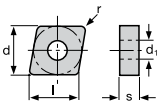
Designation	l	d	s	d'	r	CNMG-...-MM			
						RP15TC	RP25K	RP40K	RM35D
CNMG-432-MM	.504	1/2	.187	.203	1/32			●	
CNMG-433-MM					3/64			●	
CNMG-543-MM	.634	5/8	.250	.250	3/64			●	

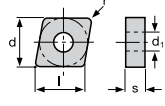
Designation	l	d	s	d'	r	CNMG-...-TMU			
						RP15TC	RP25K	RP40K	
CNMG-322-TMU	.382	3/8	.125	.150	1/32		●	●	
CNMG-432-TMU					1/32	●	●		
CNMG-433-TMU	.504	1/2	.187	.203	3/64	●	●	●	
CNMG-434-TMU					1/16	●	●	●	
CNMG-542-TMU					1/32	●	●	●	
CNMG-543-TMU	.634	5/8	.250	.250	3/64	●	●	●	
CNMG-544-TMU					1/16	●	●	●	
CNMG-643-TMU					3/64	●	●	●	
CNMG-644-TMU	.760	3/4	.250	.312	1/16	●	●	●	

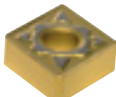
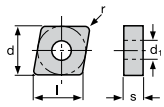
Designation	l	d	s	d'	r	CNMG-...-MMF			
						RP15TC	RP25K	RP40K	RM35D
CNMG-321-MMF	.382	3/8	.125	.150	1/64			●	
CNMG-431-MMF					1/64			●	
CNMG-432-MMF	.504	1/2	.187	.203	1/32			●	
CNMG-433-MMF					3/64			●	

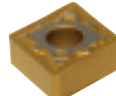
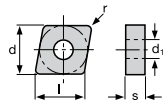
Designation	l	d	s	d'	r	CNMG-...-WIP			
						RP15TC	RP25K	RP40K	
CNMG-432-WIP	.504	1/2	.187	.203	1/32	●	●		
CNMG-433-WIP					3/64	●	●		

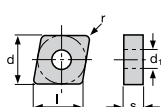

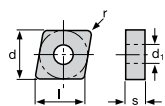
Designation	l	d	s	d ¹	r	CNMM-...-HDR				
						RP15TC	RP25K	RP40K	RK10	RK20
CNMM-856-HDR	1.015	1.0	.312	.359	3/32	●	●	●		
CNMM-866-HDR	1.015	1.0	.375	.359	3/32	●	●	●		

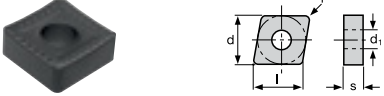

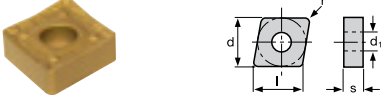
Designation	l	d	s	d ¹	r	CNMM-...-HR				
						RP15TC	RP25K	RP40K	RK10	RK20
CNMM-432-HR					1/32	●	●	●		
CNMM-433-HR	.504	1/2	.187	.203	3/64	●	●	●		
CNMM-543-HR					3/64	●	●	●		
CNMM-544-HR	.634	5/8	.250	.250	1/16	●	●	●		
CNMM-643-HR					3/64	●	●	●		
CNMM-644-HR	.760	3/4	.250	.312	1/16	●	●	●		
CNMM-646-HR					3/32	●	●	●		

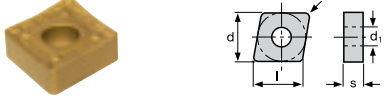

Designation	l	d	s	d ¹	r	CNMM-...-SR				
						RP15TC	RP25K	RP40K	RK10	RK20
CNMM-644-SR	.760	3/4	.250	.312	1/16	●	●	●		●
CNMM-646-SR					3/32		●	●		●

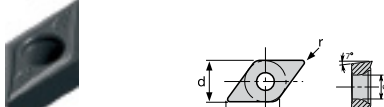

Designation	l	d	s	d ¹	r	DCGT-...				
						AS15F				
DCGT-21.50.2	.305	1/4	.094	.148	.003	●				
DCGT-21.50.6					.006	●				
DCGT-32.50.6					.006	●				
DCGT-32.50.9	.457	3/8	.156	.173	.014	●				

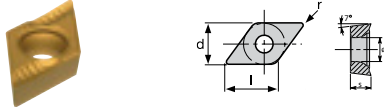

Designation	l	d	s	d ¹	r	DCGT-...-SCT				
						RP15K	RP15TC	RP25K	RP40K	RM35D
DCGT-21.51L-SCT	.305	1/4	.094	.148	1/64	●		●	●	●
DCGT-21.51R-SCT						●		●	●	●
DCGT-32.51L-SCT					1/64	●		●	●	●
DCGT-32.51R-SCT						●		●	●	●
DCGT-32.52L-SCT	.457	3/8	.156	.173		●		●	●	●
DCGT-32.52R-SCT					1/32	●		●	●	●

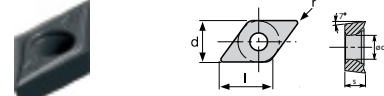

Designation	l	d	s	d ¹	r	DCGT-...-SCT				
						AS15F				
DCGT-21.50.2FL-SCT					.003	●				
DCGT-21.50.2FR-SCT					.003	●				
DCGT-21.50.6FL-SCT	.305	1/4	.094	.148	.006	●				
DCGT-21.50.6FR-SCT					.006	●				
DCGT-32.50.6FL-SCT					.006	●				
DCGT-32.50.6FR-SCT	.457	3/8	.156	.173	.006	●				
DCGT-32.50.9FL-SCT					.014	●				
DCGT-32.50.9FR-SCT					.014	●				

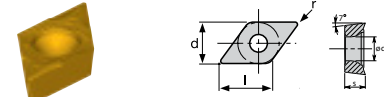

Designation	l	d	s	d ¹	r	DCMT-...-TMF				
						RP15TC	RP25K	RP40K		
DCMT-21.51-TMF	.305	1/4	.094	.148	1/64	●	●			
DCMT-32.51-TMF	.457	3/8	.156	.173	1/64	●	●			

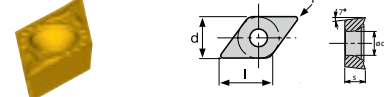

Designation	l	d	s	d ¹	r	DCMT-...-TMU				
						RP15TC	RP25K			
DCMT-21.51-TMU	.305	1/4	.094	.148	1/64	●	●			
DCMT-32.51-TMU					1/64	●	●			
DCMT-32.52-TMU	.457	3/8	.156	.173	1/32	●	●			

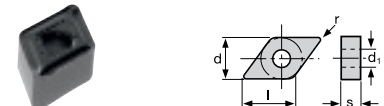

Designation	l	d	s	d ¹	r	DNGG-...-HTF				
						RP15TC	RP25K	RP40K	AS15	
DNGG-431-HTF					1/64				●	
DNGG-432-HTF	.610	1/2	.187	.203	1/32				●	
DNGG-433-HTF					3/64				●	
DNGG-441-HTF					1/64				●	
DNGG-442-HTF	.610	1/2	.250	.203	1/32				●	
DNGG-443-HTF					3/64				●	

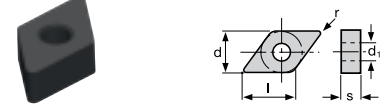

Designation	l	d	s	d ¹	r	DNMA- ...				
						RP15TC	RP25K	RP40K	RK10	RK20
DNMA-432	.610	1/2	.250	.203	1/32					●
DNMA-433					3/64					●

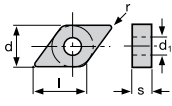
Designation	l	d	s	d'	r	DNMG...-GR			
						RP15TC	RP25K	RP40K	
DNMG-432-GR	.610	1/2	.187	.203	1/32	●	●	●	
DNMG-433-GR					3/64	●	●	●	
DNMG-442-GR					1/32	●	●	●	
DNMG-443-GR	.610	1/2	.250	.203	3/64	●	●	●	
DNMG-444-GR					1/16	●	●	●	

Designation	l	d	s	d'	r	DNMG...-MMF			
						RP15TC	RP25K	RP40K	RM35D
DNMG-331-MMF	.457	3/8	.187	.156	1/64				●
DNMG-441-MMF					1/64				●
DNMG-442-MMF	.610	1/2	.250	.203	1/32				●

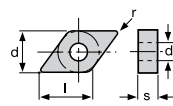
Designation	l	d	s	d'	r	DNMG...-GRK			
DNMG-432-GRK	.610	1/2	.187	.203	1/32				●
DNMG-433-GRK					3/64				●
DNMG-442-GRK	.610	1/2	.250	.203	1/32				●
DNMG-443-GRK					3/64				●

Designation	l	d	s	d'	r	DNMG...-MMR			
						RP15TC	RP25K	RP40K	RM35D
DNMG-442-MMR	.610	1/2	.250	.203	1/32				●
DNMG-443-MMR					3/64				●

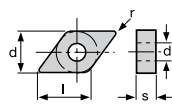
Designation	l	d	s	d'	r	DNMG...-HTM			
						RP15TC	RP25K	RP40K	AS15
DNMG-431-HTM					1/64				●
DNMG-432-HTM	.610	1/2	.187	.203	1/32				●
DNMG-433-HTM					3/64				●
DNMG-441-HTM					1/64				●
DNMG-442-HTM	.610	1/2	.250	.203	1/32				●
DNMG-443-HTM					3/64				●

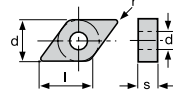
Designation	l	d	s	d'	r	DNMG...-SCT			
						RP15TC	RP25K	RP40K	RM35D
DNMG-331L-SCT					1/64	●	●	●	
DNMG-331R-SCT					1/64	●	●	●	
DNMG-332L-SCT	.457	3/8	.187	.156	1/32	●	●	●	
DNMG-332R-SCT					1/32	●	●	●	
DNMG-431L-SCT					1/64				●
DNMG-431R-SCT	.610	1/2	.187	.203	1/64				●
DNMG-432L-SCT					1/32				●
DNMG-432R-SCT					1/32				●
DNMG-441L-SCT					1/64	●	●	●	
DNMG-441R-SCT	.610	1/2	.250	.203	1/64	●	●	●	
DNMG-442L-SCT					1/32	●	●	●	
DNMG-442R-SCT					1/32	●	●	●	

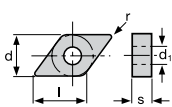
Designation	l	d	s	d'	r	DNMG...-MFM			
						RP15TC	RP25K	RP40K	RK10 RK20
DNMG-331-MFM	.457	3/8	.187	.156	1/64	●	●	●	●
DNMG-332-MFM					1/32	●	●	●	●
DNMG-432-MFM	.610	1/2	.187	.203	1/32		●		
DNMG-441-MFM	.610	1/2	.250	.203	1/64	●	●	●	
DNMG-442-MFM					1/32	●	●	●	

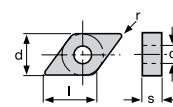
Designation	l	d	s	d'	r	DNMG...-TMF			
						RP15TC	RP25K		
DNMG-331-TMF	.457	3/8	.187	.156	1/64	●	●		
DNMG-332-TMF					1/32	●	●		
DNMG-431-TMF	.610	1/2	.187	.203	1/64	●	●		
DNMG-432-TMF					1/32	●	●		
DNMG-441-TMF	.610	1/2	.250	.203	1/64	●	●		
DNMG-442-TMF					1/32	●	●		

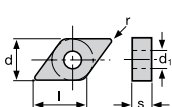
Designation	l	d	s	d'	r	DNMG...-MM			
						RP15TC	RP25K	RP40K	RM35D
DNMG-332-MM	.457	3/8	.187	.156	1/32				●
DNMG-432-MM	.610	1/2	.187	.203	1/32				●
DNMG-442-MM	.610	1/2	.250	.203	1/32				●
DNMG-443-MM					3/64				●

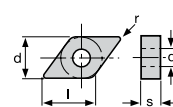
Designation	l	d	s	d'	r	DNMG...-TMU			
						RP15TC	RP25K	RP40K	
DNMG-332-TMU	.457	3/8	.187	.156	1/32	●	●	●	
DNMG-432-TMU	.610	1/2	.187	.203	1/32	●	●	●	
DNMG-433-TMU					3/64	●	●	●	
DNMG-442-TMU					1/32	●	●	●	
DNMG-443-TMU	.610	1/2	.250	.203	3/64	●	●	●	
DNMG-444-TMU					1/16	●	●	●	

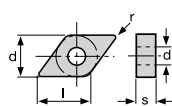

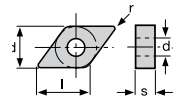
DNMG-...-WIP																
Designation	l	d	s	d ¹	r											
DNMG-443-WIP	.610	1/2	.250	.203	3/64	<table border="1"> <tr><th>RP15TC</th><th>RP25K</th><th></th><th></th><th></th></tr> <tr><td>●</td><td>●</td><td></td><td></td><td></td></tr> </table>	RP15TC	RP25K				●	●			
RP15TC	RP25K															
●	●															

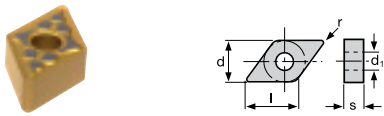

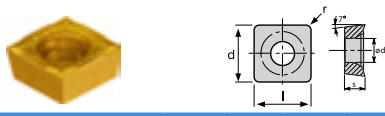
SCMT-...-TMF																
Designation	l	d	s	d ¹	r											
SCMT-32.51-TMF	.375	3/8	.156	.173	1/64	<table border="1"> <tr><th>RP15TC</th><th>RP25K</th><th>RP40K</th><th></th><th></th></tr> <tr><td>●</td><td>●</td><td></td><td></td><td></td></tr> </table>	RP15TC	RP25K	RP40K			●	●			
RP15TC	RP25K	RP40K														
●	●															
SCMT-32.52-TMF					1/32	<table border="1"> <tr><th>RP15TC</th><th>RP25K</th><th>RP40K</th><th></th><th></th></tr> <tr><td>●</td><td>●</td><td></td><td></td><td></td></tr> </table>	RP15TC	RP25K	RP40K			●	●			
RP15TC	RP25K	RP40K														
●	●															

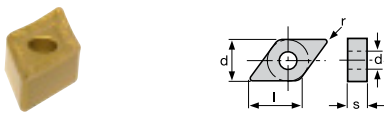

DNMM-...-HR																
Designation	l	d	s	d ¹	r											
DNMM-442-HR					1/32	<table border="1"> <tr><th>RP15TC</th><th>RP25K</th><th>RP40K</th><th></th><th></th></tr> <tr><td>●</td><td>●</td><td>●</td><td></td><td></td></tr> </table>	RP15TC	RP25K	RP40K			●	●	●		
RP15TC	RP25K	RP40K														
●	●	●														
DNMM-443-HR	.610	1/2	.250	.203	3/64	<table border="1"> <tr><th>RP15TC</th><th>RP25K</th><th>RP40K</th><th></th><th></th></tr> <tr><td>●</td><td>●</td><td>●</td><td></td><td></td></tr> </table>	RP15TC	RP25K	RP40K			●	●	●		
RP15TC	RP25K	RP40K														
●	●	●														
DNMM-444-HR					1/16	<table border="1"> <tr><th>RP15TC</th><th>RP25K</th><th>RP40K</th><th></th><th></th></tr> <tr><td>●</td><td>●</td><td>●</td><td></td><td></td></tr> </table>	RP15TC	RP25K	RP40K			●	●	●		
RP15TC	RP25K	RP40K														
●	●	●														

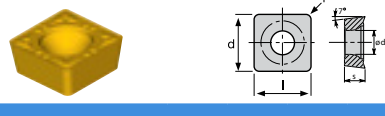

SCMT-...-TMU																
Designation	l	d	s	d ¹	r											
SCMT-32.52-TMU	.375	3/8	.156	.173	1/32	<table border="1"> <tr><th>RP15TC</th><th>RP25K</th><th>RP40K</th><th></th><th></th></tr> <tr><td>●</td><td>●</td><td></td><td></td><td></td></tr> </table>	RP15TC	RP25K	RP40K			●	●			
RP15TC	RP25K	RP40K														
●	●															
SCMT-432-TMU	.500	1/2	.187	.217	1/32	<table border="1"> <tr><th>RP15TC</th><th>RP25K</th><th>RP40K</th><th></th><th></th></tr> <tr><td>●</td><td>●</td><td></td><td></td><td></td></tr> </table>	RP15TC	RP25K	RP40K			●	●			
RP15TC	RP25K	RP40K														
●	●															
SCMT-433-TMU					3/64	<table border="1"> <tr><th>RP15TC</th><th>RP25K</th><th>RP40K</th><th></th><th></th></tr> <tr><td>●</td><td>●</td><td></td><td></td><td></td></tr> </table>	RP15TC	RP25K	RP40K			●	●			
RP15TC	RP25K	RP40K														
●	●															



RCMX- ...																		
Designation	l	d	s	d ¹	r													
RCMX-1003MO	--	.394	.125	.150	--	<table border="1"> <tr><th>RP15TC</th><th>RP25K</th><th>RP40K</th><th>AS15</th><th>RK10</th><th>RK20</th></tr> <tr><td></td><td></td><td>●</td><td></td><td></td><td></td></tr> </table>	RP15TC	RP25K	RP40K	AS15	RK10	RK20			●			
RP15TC	RP25K	RP40K	AS15	RK10	RK20													
		●																
RCMX-1204MO	--	.472	.187	.165	--	<table border="1"> <tr><th>RP15TC</th><th>RP25K</th><th>RP40K</th><th>AS15</th><th>RK10</th><th>RK20</th></tr> <tr><td></td><td>●</td><td>●</td><td>●</td><td></td><td></td></tr> </table>	RP15TC	RP25K	RP40K	AS15	RK10	RK20		●	●	●		
RP15TC	RP25K	RP40K	AS15	RK10	RK20													
	●	●	●															
RCMX-1606MO	--	.630	.250	.205	--	<table border="1"> <tr><th>RP15TC</th><th>RP25K</th><th>RP40K</th><th>AS15</th><th>RK10</th><th>RK20</th></tr> <tr><td></td><td>●</td><td>●</td><td></td><td>●</td><td>●</td></tr> </table>	RP15TC	RP25K	RP40K	AS15	RK10	RK20		●	●		●	●
RP15TC	RP25K	RP40K	AS15	RK10	RK20													
	●	●		●	●													
RCMX-2006MO	--	.787	.250	.256	--	<table border="1"> <tr><th>RP15TC</th><th>RP25K</th><th>RP40K</th><th>AS15</th><th>RK10</th><th>RK20</th></tr> <tr><td></td><td>●</td><td>●</td><td></td><td></td><td></td></tr> </table>	RP15TC	RP25K	RP40K	AS15	RK10	RK20		●	●			
RP15TC	RP25K	RP40K	AS15	RK10	RK20													
	●	●																
RCMX-2507MO	--	.984	.311	.283	--	<table border="1"> <tr><th>RP15TC</th><th>RP25K</th><th>RP40K</th><th>AS15</th><th>RK10</th><th>RK20</th></tr> <tr><td></td><td>●</td><td>●</td><td></td><td></td><td></td></tr> </table>	RP15TC	RP25K	RP40K	AS15	RK10	RK20		●	●			
RP15TC	RP25K	RP40K	AS15	RK10	RK20													
	●	●																
RCMX-3209MO	--	1.260	.375	.374	--	<table border="1"> <tr><th>RP15TC</th><th>RP25K</th><th>RP40K</th><th>AS15</th><th>RK10</th><th>RK20</th></tr> <tr><td></td><td>●</td><td>●</td><td></td><td></td><td></td></tr> </table>	RP15TC	RP25K	RP40K	AS15	RK10	RK20		●	●			
RP15TC	RP25K	RP40K	AS15	RK10	RK20													
	●	●																

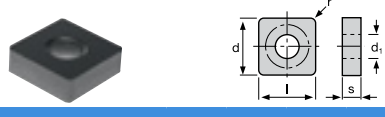

SNMA- ...																		
Designation	l	d	s	d ¹	r													
SNMA-432					1/32	<table border="1"> <tr><th>RP15TC</th><th>RP25K</th><th>RP40K</th><th></th><th>RK10</th><th>RK20</th></tr> <tr><td></td><td></td><td></td><td></td><td>●</td><td>●</td></tr> </table>	RP15TC	RP25K	RP40K		RK10	RK20					●	●
RP15TC	RP25K	RP40K		RK10	RK20													
				●	●													
SNMA-433	.500	1/2	.187	.203	3/64	<table border="1"> <tr><th>RP15TC</th><th>RP25K</th><th>RP40K</th><th></th><th>RK10</th><th>RK20</th></tr> <tr><td></td><td></td><td></td><td></td><td>●</td><td>●</td></tr> </table>	RP15TC	RP25K	RP40K		RK10	RK20					●	●
RP15TC	RP25K	RP40K		RK10	RK20													
				●	●													
SNMA-434					1/16	<table border="1"> <tr><th>RP15TC</th><th>RP25K</th><th>RP40K</th><th></th><th>RK10</th><th>RK20</th></tr> <tr><td></td><td></td><td></td><td></td><td>●</td><td>●</td></tr> </table>	RP15TC	RP25K	RP40K		RK10	RK20					●	●
RP15TC	RP25K	RP40K		RK10	RK20													
				●	●													
SNMA-644	.750	3/4	.250	.312	1/16	<table border="1"> <tr><th>RP15TC</th><th>RP25K</th><th>RP40K</th><th></th><th>RK10</th><th>RK20</th></tr> <tr><td></td><td></td><td></td><td></td><td></td><td>●</td></tr> </table>	RP15TC	RP25K	RP40K		RK10	RK20						●
RP15TC	RP25K	RP40K		RK10	RK20													
					●													
SNMA-856	1.000	1.0	.313	.359	3/32	<table border="1"> <tr><th>RP15TC</th><th>RP25K</th><th>RP40K</th><th></th><th>RK10</th><th>RK20</th></tr> <tr><td></td><td></td><td></td><td></td><td></td><td>●</td></tr> </table>	RP15TC	RP25K	RP40K		RK10	RK20						●
RP15TC	RP25K	RP40K		RK10	RK20													
					●													

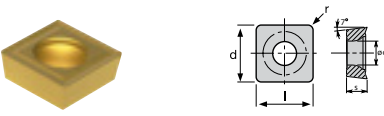

SCMT- ...																
Designation	l	d	s	d ¹	r											
SCMT-431	.500	1/2	.187	.217	1/64	<table border="1"> <tr><th>RP15TC</th><th>RP25K</th><th>RP40K</th><th></th><th></th></tr> <tr><td></td><td></td><td>●</td><td></td><td></td></tr> </table>	RP15TC	RP25K	RP40K					●		
RP15TC	RP25K	RP40K														
		●														

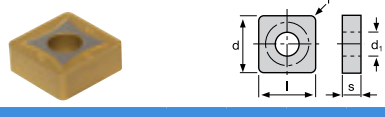

SNMG-...-GR																
Designation	l	d	s	d ¹	r											
SNMG-432-GR					1/32	<table border="1"> <tr><th>RP15TC</th><th>RP25K</th><th>RP40K</th><th></th><th></th></tr> <tr><td>●</td><td>●</td><td>●</td><td></td><td></td></tr> </table>	RP15TC	RP25K	RP40K			●	●	●		
RP15TC	RP25K	RP40K														
●	●	●														
SNMG-433-GR	.500	1/2	.187	.203	3/64	<table border="1"> <tr><th>RP15TC</th><th>RP25K</th><th>RP40K</th><th></th><th></th></tr> <tr><td>●</td><td>●</td><td>●</td><td></td><td></td></tr> </table>	RP15TC	RP25K	RP40K			●	●	●		
RP15TC	RP25K	RP40K														
●	●	●														
SNMG-643-GR	.750	3/4	.250	.312	3/64	<table border="1"> <tr><th>RP15TC</th><th>RP25K</th><th>RP40K</th><th></th><th></th></tr> <tr><td>●</td><td>●</td><td>●</td><td></td><td></td></tr> </table>	RP15TC	RP25K	RP40K			●	●	●		
RP15TC	RP25K	RP40K														
●	●	●														
SNMG-644-GR					1/16	<table border="1"> <tr><th>RP15TC</th><th>RP25K</th><th>RP40K</th><th></th><th></th></tr> <tr><td>●</td><td>●</td><td>●</td><td></td><td></td></tr> </table>	RP15TC	RP25K	RP40K			●	●	●		
RP15TC	RP25K	RP40K														
●	●	●														

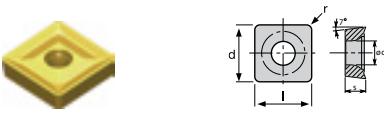

SCMT- ...-BSR																
Designation	l	d	s	d ¹	r											
SCMT-864-BSR					1/16	<table border="1"> <tr><th>RP15TC</th><th>RP25K</th><th>RP40K</th><th></th><th></th></tr> <tr><td>●</td><td>●</td><td>●</td><td></td><td></td></tr> </table>	RP15TC	RP25K	RP40K			●	●	●		
RP15TC	RP25K	RP40K														
●	●	●														
SCMT-866-BSR	1.000	1.0	.375	.339	3/32	<table border="1"> <tr><th>RP15TC</th><th>RP25K</th><th>RP40K</th><th></th><th></th></tr> <tr><td>●</td><td>●</td><td>●</td><td></td><td></td></tr> </table>	RP15TC	RP25K	RP40K			●	●	●		
RP15TC	RP25K	RP40K														
●	●	●														

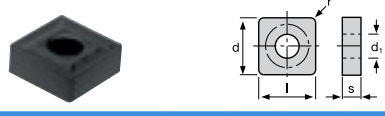

SNMG-...-GRK																		
Designation	l	d	s	d ¹	r													
SNMG-432-GRK					1/32	<table border="1"> <tr><th>RP15TC</th><th>RP25K</th><th>RP40K</th><th></th><th>RK10</th><th>RK20</th></tr> <tr><td></td><td></td><td></td><td></td><td>●</td><td>●</td></tr> </table>	RP15TC	RP25K	RP40K		RK10	RK20					●	●
RP15TC	RP25K	RP40K		RK10	RK20													
				●	●													
SNMG-433-GRK	.500	1/2	.187	.203	3/64	<table border="1"> <tr><th>RP15TC</th><th>RP25K</th><th>RP40K</th><th></th><th>RK10</th><th>RK20</th></tr> <tr><td></td><td></td><td></td><td></td><td>●</td><td>●</td></tr> </table>	RP15TC	RP25K	RP40K		RK10	RK20					●	●
RP15TC	RP25K	RP40K		RK10	RK20													
				●	●													
SNMG-643-GRK	.750	3/4	.250	.312	3/64	<table border="1"> <tr><th>RP15TC</th><th>RP25K</th><th>RP40K</th><th></th><th>RK10</th><th>RK20</th></tr> <tr><td></td><td></td><td></td><td></td><td>●</td><td>●</td></tr> </table>	RP15TC	RP25K	RP40K		RK10	RK20					●	●
RP15TC	RP25K	RP40K		RK10	RK20													
				●	●													
SNMG-644-GRK					1/16	<table border="1"> <tr><th>RP15TC</th><th>RP25K</th><th>RP40K</th><th></th><th>RK10</th><th>RK20</th></tr> <tr><td></td><td></td><td></td><td></td><td>●</td><td>●</td></tr> </table>	RP15TC	RP25K	RP40K		RK10	RK20					●	●
RP15TC	RP25K	RP40K		RK10	RK20													
				●	●													
SNMG-866-GRK	1.000	1.0	.375	.359	3/32	<table border="1"> <tr><th>RP15TC</th><th>RP25K</th><th>RP40K</th><th></th><th>RK10</th><th>RK20</th></tr> <tr><td></td><td>●</td><td></td><td></td><td></td><td></td></tr> </table>	RP15TC	RP25K	RP40K		RK10	RK20		●				
RP15TC	RP25K	RP40K		RK10	RK20													
	●																	

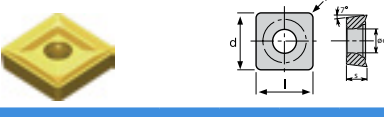

SCMT- ...-CPR																
Designation	l	d	s	d ¹	r											
SCMT-866-CPR	1.000	1.0	.375	.339	3/32	<table border="1"> <tr><th>RP15TC</th><th>RP25K</th><th>RP40K</th><th></th><th></th></tr> <tr><td></td><td>●</td><td>●</td><td></td><td></td></tr> </table>	RP15TC	RP25K	RP40K				●	●		
RP15TC	RP25K	RP40K														
	●	●														

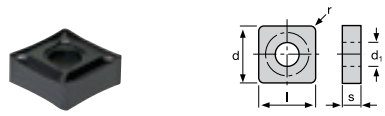

SNMG-...-HTF																		
Designation	l	d	s	d ¹	r													
SNMG-432-HTF	.500	1/2	.187	.203	1/32	<table border="1"> <tr><th>RP15TC</th><th>RP25K</th><th>RP40K</th><th>AS15</th><th></th><th></th></tr> <tr><td></td><td></td><td></td><td>●</td><td></td><td></td></tr> </table>	RP15TC	RP25K	RP40K	AS15						●		
RP15TC	RP25K	RP40K	AS15															
			●															
SNMG-433-HTF					3/64	<table border="1"> <tr><th>RP15TC</th><th>RP25K</th><th>RP40K</th><th>AS15</th><th></th><th></th></tr> <tr><td></td><td></td><td></td><td>●</td><td></td><td></td></tr> </table>	RP15TC	RP25K	RP40K	AS15						●		
RP15TC	RP25K	RP40K	AS15															
			●															

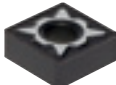
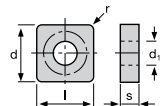
SNMG-...-HTR						
Designation	l	d	s	d'	r	
SNMG-432-HTR	.500	1/2	.187	.203	1/32	●
SNMG-433-HTR					3/64	●

SNMM						
Designation	l	d	s	d'	r	
SNMM-854	1.000	1.0	.313	.359	1/16	●
SNMM-856					3/32	●

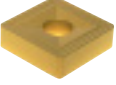
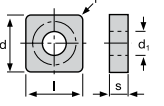
SNMG-...-MFM						
Designation	l	d	s	d'	r	
SNMG-321-MFM	.375	3/8	.125	.150	1/64	●

SNMM-...-HDR						
Designation	l	d	s	d'	r	
SNMM-644-HDR	.750	3/4	.250	.312	1/16	●
SNMM-646-HDR					3/32	●

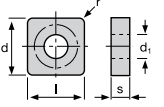
SNMG-...-MM						
Designation	l	d	s	d'	r	
SNMG-432-MM	.500	1/2	.187	.203	1/32	●
SNMG-433-MM					3/64	●

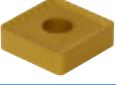
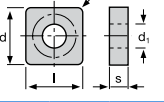
SNMM-...-HR						
Designation	l	d	s	d'	r	
SNMM-432-HR	.500	1/2	.187	.203	1/32	●
SNMM-433-HR					3/64	●
SNMM-543-HR	.625	5/8	.250	.250	3/64	●
SNMM-544-HR					1/16	●
SNMM-643-HR					3/64	●
SNMM-644-HR	.750	3/4	.250	.312	1/16	●
SNMM-646-HR					3/32	●
SNMM-648-HR					1/8	●

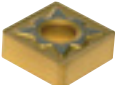
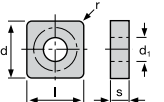
SNMG-...-MMF						
Designation	l	d	s	d'	r	
SNMG-321-MMF	.375	3/8	.125	.150	1/64	●

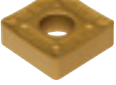
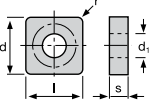
SNMG-...-MMR						
Designation	l	d	s	d'	r	
SNMG-432-MMR	.500	1/2	.187	.203	1/32	●
SNMG-433-MMR					3/64	●
SNMG-643-MMR	.750	3/4	.250	.312	3/64	●

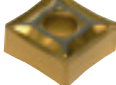
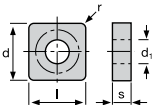
TCGT-...-SCT						
Designation	l	d	s	d'	r	
TCGT-21.51L-SCT	.433	1/4	.094	.110	1/64	●
TCGT-21.51R-SCT					1/64	●
TCGT-32.51L-SCT					1/64	●
TCGT-32.51R-SCT	.650	3/8	.156	.173	1/32	●
TCGT-32.52L-SCT					1/32	●
TCGT-32.52R-SCT					1/32	●

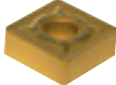
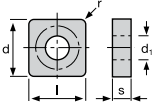
SNMG-...-TMF						
Designation	l	d	s	d'	r	
SNMG-431-TMF	.500	1/2	.187	.203	1/64	●

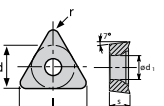
SNMG-...-TMU						
Designation	l	d	s	d'	r	
SNMG-432-TMU	.500	1/2	.187	.203	1/32	●
SNMG-433-TMU					3/64	●
SNMG-542-TMU	.625	5/8	.250	.250	1/32	●
SNMG-643-TMU	.750	3/4	.250	.312	3/64	●

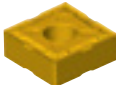
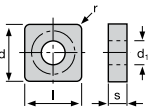
TCMT-...-TMF						
Designation	l	d	s	d'	r	
TCMT-21.50.5-TMF	.433	1/4	.094	.110	.008	●
TCMT-21.51-TMF					1/64	●

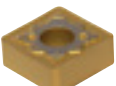
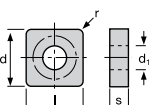

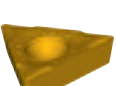
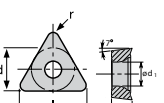
TCMT-...-TMU						
Designation	l	d	s	d ¹	r	
TCMT-21.51-TMU	.433	1/4	.094	.110	1/64	● ●
TCMT-21.52-TMU					1/32	● ●
TCMT-32.51-TMU	.650	3/8	.156	.173	1/64	● ●
TCMT-32.52-TMU					1/32	● ●

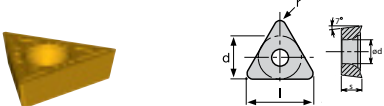

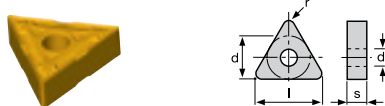
TNMG-...-TMF						
Designation	l	d	s	d ¹	r	
TNMG-331-TMF	.650	3/8	.187	.150	1/64	● ●
TNMG-332-TMF					1/32	● ●

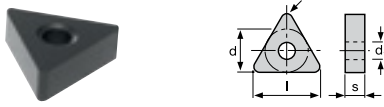

TNMA- ...						
Designation	l	d	s	d ¹	r	
TNMA-332	.650	3/8	.187	.150	1/32	● ●
TNMA-333					3/64	● ●
TNMA-432	.866	1/2	.187	.203	1/16	● ●

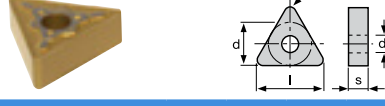

TNMG-...-TMU						
Designation	l	d	s	d ¹	r	
TNMG-332-TMU					1/32	● ● ●
TNMG-333-TMU	.650	3/8	.187	.150	3/64	● ● ●
TNMG-334-TMU					1/16	● ● ●
TNMG-432-TMU	.866	1/2	.187	.203	1/32	● ● ●
TNMG-433-TMU					3/64	● ● ●

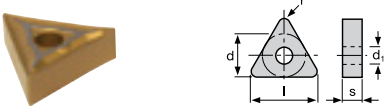

TNMG-...-MFM						
Designation	l	d	s	d ¹	r	
TNMG-331-MFM					1/64	● ●
TNMG-332-MFM	.650	3/8	.187	.150	1/32	● ●
TNMG-333-MFM					3/64	●

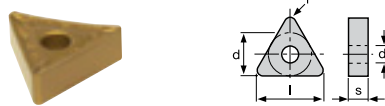

TNMM-...-HR						
Designation	l	d	s	d ¹	r	
TNMM-332-HR	.650	3/8	.187	.150	1/32	● ●
TNMM-432-HR					1/32	● ●
TNMM-433-HR	.866	1/2	.187	.203	3/64	● ●

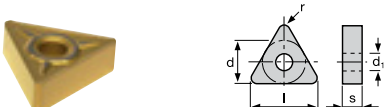

TNMG-...-MM						
Designation	l	d	s	d ¹	r	
TNMG-332-MM	.650	3/8	.187	.150	1/32	●
TNMG-333-MM					3/64	●
TNMG-432-MM	.866	1/2	.187	.203	1/32	●
TNMG-433-MM					3/64	●

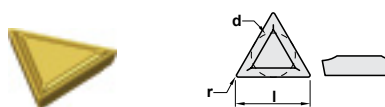

TPMR-...-TMP						
Designation	l	d	s	d ¹	r	
TPMR-221-TMP	.433	1/4	.125	--	1/64	● ● ●
TPMR-222-TMP					1/32	● ● ●
TPMR-321-TMP	.650	3/8	.125	--	1/64	● ● ●
TPMR-322-TMP					1/32	● ● ●

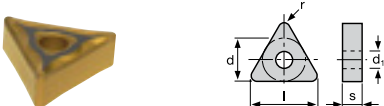

TNMG-...-MMF						
Designation	l	d	s	d ¹	r	
TNMG-331-MMF	.650	3/8	.187	.150	1/64	● ●
TNMG-332-MMF					1/32	● ●

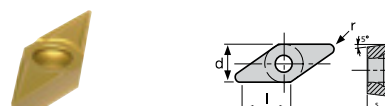

VBMT						
Designation	l	d	s	d ¹	r	
VBMT-331					1/64	● ●
VBMT-332	.653	3/8	.187	.173	1/32	● ●
VBMT-333					3/64	● ●

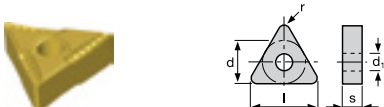

TNMG-...-SCT						
Designation	l	d	s	d ¹	r	
TNMG-331L-SCT					1/64	● ● ● ●
TNMG-331R-SCT	.650	3/8	.187	.150		● ● ● ●
TNMG-332L-SCT					1/32	● ● ● ●
TNMG-332R-SCT						● ● ● ●

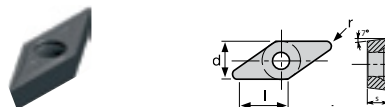

VCGT						
Designation	l	d	s	d ¹	r	
VCGT-220.2	.437	1/4	.125	.110	.003	●
VCGT-220.6					.006	●

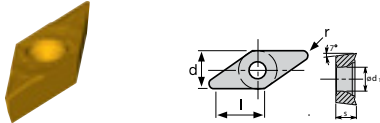

VCMT-...-TMF						
Designation	l	d	s	d'	r	
VCMT-221-TMF	.437	1/4	.125	.110	1/64	RP15TC ● RP25K ● RP40K
VCMT-331-TMF					1/64	● ●
VCMT-332-TMF	.653	3/8	.187	.173	1/32	● ●

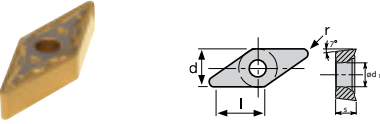

VCMT-...-TMU						
Designation	l	d	s	d'	r	
VCMT-331-TMU					1/64	RP15TC ● RP25K ● RP40K
VCMT-332-TMU	.653	3/8	.187	.173	1/32	● ●

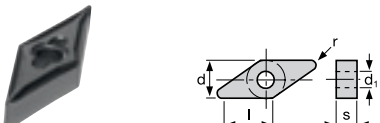

VNMG-...-HTF						
Designation	l	d	s	d'	r	
VNMG-331-HTF	.653	3/8	.187	.150	1/64	AS15 ●
VNMG-332-HTF					1/32	●

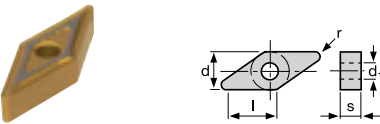

VNMG-...-MFM						
Designation	l	d	s	d'	r	
VNMG-332-MFM	.653	3/8	.187	.150	1/32	RP15TC ● RP25K ● RP40K

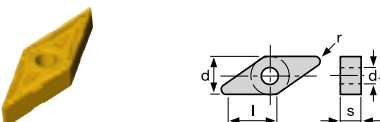

VNMG-...-TMF						
Designation	l	d	s	d'	r	
VNMG-331-TMF					1/64	RP15TC ● RP25K ● RP40K
VNMG-332-TMF	.653	3/8	.187	.150	1/32	● ●

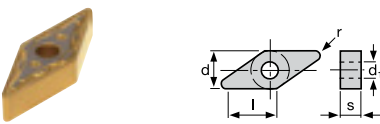

VNMG-...-TMU						
Designation	l	d	s	d'	r	
VNMG-332-TMU					1/32	RP15TC ● RP25K ● RP40K
VNMG-333-TMU	.653	3/8	.187	.150	3/64	● ● ●

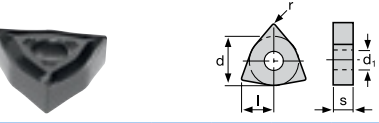

WNGG-...-HTF						
Designation	l	d	s	d'	r	
WNGG-332-HTF	.256	3/8	.187	.150	1/32	AS15 ●
WNGG-431-HTF					1/64	●
WNGG-432-HTF	.339	1/2	.187	.203	1/32	●
WNGG-433-HTF					3/64	●

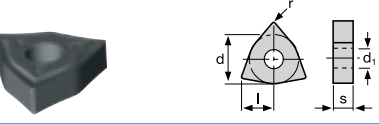

WNGG-...-HTM						
Designation	l	d	s	d'	r	
WNGG-431-HTM					1/64	AS15 ●
WNGG-432-HTM	.339	1/2	.187	.203	1/32	●
WNGG-433-HTM					3/64	●

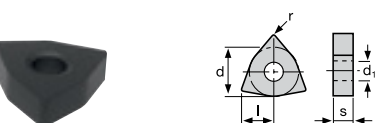

WNMA- ...						
Designation	l	d	s	d'	r	
WNMA-432	.339	1/2	.187	.203	1/32	RP15TC ● RP25K ● RP40K ● RK10 ● RK20
WNMA-433					3/64	● ●

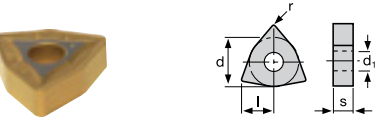

WNMG-...-GR						
Designation	l	d	s	d'	r	
WNMG-432-GR					1/32	RP15TC ● RP25K ● RP40K
WNMG-433-GR	.339	1/2	.187	.203	3/64	● ● ●
WNMG-434-GR					1/16	● ● ●

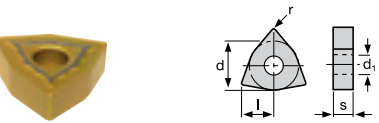

WNMG-...-GRK						
Designation	l	d	s	d'	r	
WNMG-432-GRK					1/32	● ● ● ● ●
WNMG-433-GRK	.339	1/2	.187	.203	3/64	● ● ● ● ●

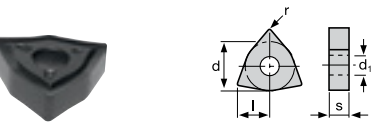

WNMG-...-HTM						
Designation	l	d	s	d'	r	
WNMG-431-HTM					1/64	RP25K ● AS15 ●
WNMG-432-HTM	.339	1/2	.187	.203	1/32	● ● ● ● ●
WNMG-433-HTM					3/64	● ● ● ● ●

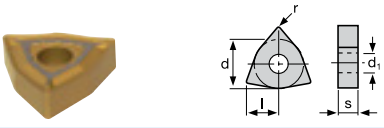

Designation	l	d	s	d'	r	WNMG-...-MFM			
						RP15TC	RP25K	RP40K	RM35D
WNMG-331-MFM	.256	3/8	.187	.150	1/64	●	●	●	●
WNMG-332-MFM					1/32	●	●	●	
WNMG-431-MFM	.339	1/2	.187	.203	1/64	●	●	●	●
WNMG-432-MFM					1/32	●	●	●	
WNMG-433-MFM					3/64	●			

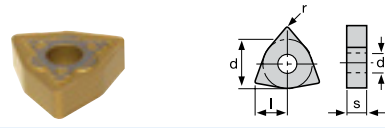

Designation	l	d	s	d'	r	WNMG-...-TMU			
						RP15TC	RP25K	RP40K	
WNMG-332-TMU	.256	3/8	.187	.150	1/32	●	●	●	
WNMG-432-TMU					1/32	●	●	●	
WNMG-433-TMU	.339	1/2	.187	.203	3/64	●	●	●	
WNMG-434-TMU					1/16	●	●	●	

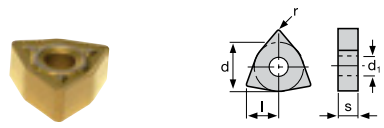

Designation	l	d	s	d'	r	WNMG-...-MM			
						RP15TC	RP25K	RP40K	RM35D
WNMG-332-MM	.256	3/8	.187	.150	1/32				●
WNMG-432-MM					1/32			●	
WNMG-433-MM	.339	1/2	.187	.203	3/64				●
WNMG-434-MM					1/16			●	

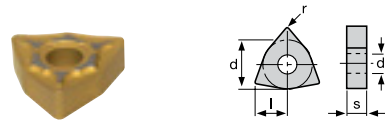

Designation	l	d	s	d'	r	WNMG-...-WIP			
						RP15TC	RP25K	RP40K	
WNMG-432-WIP	.339	1/2	.187	.203	1/32	●	●	●	
WNMG-433-WIP					3/64	●	●	●	

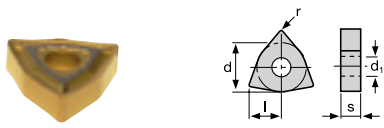

Designation	l	d	s	d'	r	WNMG-...-MMF			
						RP15TC	RP25K	RP40K	RM35D
WNMG-432-MMF	.339	1/2	.187	.203	1/32			●	

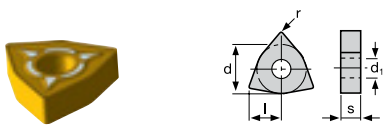

Designation	l	d	s	d'	r	WNMG-...-MMR			
						RP15TC	RP25K	RP40K	RM35D
WNMG-432-MMR	.339	1/2	.187	.203	1/32				●
WNMG-433-MMR					3/64			●	

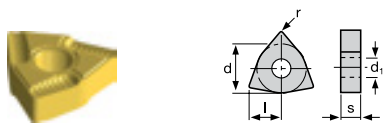

Designation	l	d	s	d'	r	WNMG-...-SCT			
						RP15TC	RP25K	RP40K	RM35D
WNMG-431L-SCT					1/64	●	●	●	●
WNMG-431R-SCT					1/64	●	●	●	●
WNMG-432L-SCT	.339	1/2	.187	.203	1/32	●	●	●	●
WNMG-432R-SCT					1/32	●	●	●	●
WNMG-433L-SCT					3/64	●	●	●	
WNMG-433R-SCT	3/64					●	●	●	

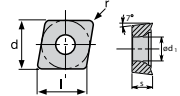
CCGT...-RAL						
Designation	l	d	s	d'	r	
CCGT-21.50.5-RAL	.252	1/4	.094	.110	.008	● ●
CCGT-21.51-RAL					1/64	● ●
CCGT-32.50.5-RAL					.008	● ●
CCGT-32.51-RAL	.382	3/8	.156	.173	1/64	● ●
CCGT-32.52-RAL					1/32	● ●
CCGT-431-RAL	.504	1/2	.187	.217	1/64	● ●
CCGT-432-RAL					1/32	● ●

VCGT...-RAL						
Designation	l	d	s	d'	r	
VCGT-220.5-RAL	.437	1/4	.125	.110	.008	● ●
VCGT-221-RAL					1/64	● ●
VCGT-330.5-RAL					.008	● ●
VCGT-331-RAL	.654	3/8	.187	.173	1/64	● ●
VCGT-332-RAL					1/32	● ●
VCGT-333-RAL					3/64	● ●
VCGT-43.58-RAL	.870	1/2	.219	.217	.118	● ●

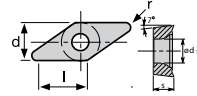
DCGT...-RAL						
Designation	l	d	s	d'	r	
DCGT-21.50.5-RAL	.305	1/4	.094	.148	.008	● ●
DCGT-21.51-RAL					1/64	● ●
DCGT-32.50.5-RAL					.008	● ●
DCGT-32.51-RAL	.457	3/8	.156	.173	1/64	● ●
DCGT-32.52-RAL					1/32	● ●

VPGT...-RAL						
Designation	l	d	s	d'	r	
VPGT-43.54-RAL	.870	1/2	.219	.217	1/16	● ●

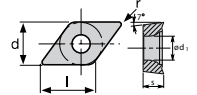
RCGT...-RAL						
Designation	l	d	s	d'	r	
RCGT-0602MO-RAL	--	6mm	.094	.110	--	● ●
RCGT-0803MO-RAL	--	8mm	.125	.134	--	● ●
RCGT-1003MO-RAL	--	10mm	.125	.157	--	● ●

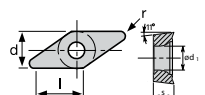
WCGT...-RAL						
Designation	l	d	s	d'	r	
WCGT-32.50.5-RAL					.008	● ●
WCGT-32.51-RAL	.256	3/8	.156	.173	1/64	● ●
WCGT-32.52-RAL					1/32	● ●
WCGT-431-RAL	.339	1/2	.187	.217	1/64	● ●
WCGT-432-RAL					1/32	● ●

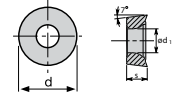
SCGT...-RAL						
Designation	l	d	s	d'	r	
SCGT-432-RAL	.500	1/2	.187	.217	1/32	● ●

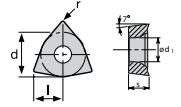

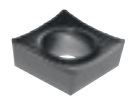
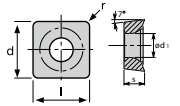

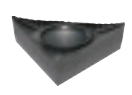
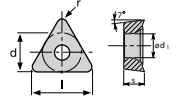
TCGT...-RAL						
Designation	l	d	s	d'	r	
TCGT-21.51-RAL	.433	1/4	.094	.110	1/64	● ●
TCGT-32.51-RAL	.650	3/8	.156	.173	1/64	● ●

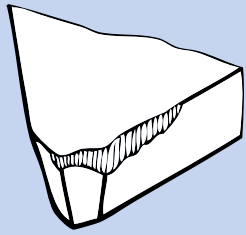

Cutting Data for Turning Applications

P	Work Material		Condition	Hardness HB	Grade	RP15TC		RP25K		RP40K			
					FEED (in ipr)	.004"	.008"	.008"	.016"	.008"	.016"		
					Material Grp.	Cutting Speeds vc ft/min (vc for T = 15 minutes)							
P	Unalloyed steel, cast steel and free cutting steel	< 0.25% C	annealed	125	1	1599	1300	1177	956	670	550		
		≥ 0.25% C	annealed	190	2	1563	1219	1050	816	570	467		
		< 0.55% C	heat-treated	250	3	1362	1047	952	731	570	420		
		≥ 0.55% C	annealed	220	4	1203	894	809	601	420	350		
		≥ 0.55% C	heat-treated	300	5	920	663	605	436	305	250		
	Low alloy steel and cast steel		annealed	200	6	1258	952	868	657	460	375		
			heat-treated	275	7	1203	894	809	601	420	350		
			heat-treated	300	8	1056	774	702	514	360	295		
			heat-treated	350	9	920	663	605	436	305	250		
	High alloy steel, cast steel & tool steel		annealed	200	10	1258	952	868	657	460	375		
			heat-treated	325	11	920	663	605	436	305	250		
M	Work Material		Condition	Hardness HB	Grade	RP25K		RM35D		AS15			
					FEED (in ipr)		.006	.012	.008	.016	.004	.008	
					Material Grp.	Cutting Speeds vc ft/min (vc for T = 15 minutes)							
	M	400 Series Stainless steel and cast steel	ferritic / martensitic	180	12			585	488	360	295		
martensitic			230	13			471	390	360	295			
300 Series Stainless steel		austenitic	200	14					450	370	820 590		
K	Work Material		Condition	Hardness HB	Grade	RK10			RK20				
					FEED (in ipr)	.004	.008	.016	.004	.008	.016		
					Material Grp.	Cutting Speeds vc ft/min (vc for T = 15 minutes)							
	Grey cast iron		ferritic/pearlitic	180	15	1105	884	709	1000	804	631		
			pearlitic	260	16	744	575	445	675	510	405		
	Nodular cast iron		ferritic	160	17	1183	975	803	1020	875	720		
			pearlitic	250	18	637	504	397	580	450	360		
	Malleable cast iron		ferritic	130	19	1580	1329	1118	1375	1175	1080		
		pearlitic	230	20	1105	884	709	1000	804	631			
N	Work Material		Condition	Hardness HB	Grade	TK10MP			RTK20				
					FEED (in ipr)		.006	.012	.006	.012			
					Material Grp.	Cutting Speeds vc ft/min (vc for T = 15 minutes)							
	Aluminum alloys wrought			60-100	21-22				1600	1300	1300	1100	
	Cast aluminum alloys			75-130	23-25				2000	1500	1800	1400	
Copper & copper alloys			90-110	26-28				1800	1600	1625	1450		
Non metallic materials				29-30				1200	900	975	870		
S	Work Material		Condition	Hardness HB	Grade	RM35D		AS15		TK10MP			
					FEED (in ipr)	.004	.008	.002	.006	.002	.004		
					Material Grp.	Cutting Speeds vc ft/min (vc for T = 15 minutes)							
	High-temperature alloys, super alloys	Fe - based	annealed	180	31	150	90	250	130				
			age hardened	280	32	100	70	220	95				
			annealed	250	33	120	90	250	150				
		Ni - or Co - based	age hardened	350	34	70	40	95	65				
			cast	320	35	100	70	160	195				
	Titanium, Ti alloys	pure titanium	annealed		36			300	150	120	100		
		alpha+beta	alloys age hardened		37			250	130	115	100		



Flank Wear

General criteria for end of tool life, characterized by an admissible amount of flank wear. Figures usually relate to a tool life of $T = 15$ min.

- Remedy:**
- select more wear resistant grade
 - reduce cutting speed

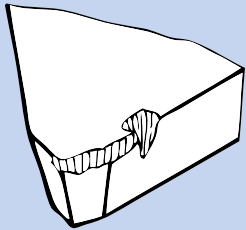

Notch Wear

Occurs locally in the area of the primary cutting edge where it contacts the workpiece surface. Caused by hard surface layers and work-hardened burrs, especially on austenitic stainless steels. Danger of breakage!

- Remedy:**
- strengthen cutting edge
 - select smaller approach angle (45°)
 - reduce feed

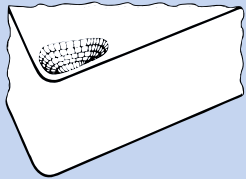

Crater Wear

Wear on the rake face, primarily characterized by crater depth. Not a tool-life criterion with modern coated carbide Inserts and positive chipbreaker geometries.

- Remedy:**
- use coated carbide grades
 - select positive Insert geometries
 - reduce cutting speed

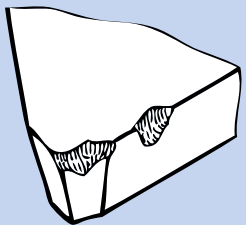

Edge Chipping

Minor chipping along the cutting edge, usually accompanied by flank wear and therefore not always identifiable. Danger of breakage! Edge chipping outside the cutting area is the result of chip impact due to unfavorable chip removal.

- Remedy:**
- select tougher grade
 - use Insert with stronger cutting edge geometry
 - reduce feed when starting the cut

- Damage Caused by Chip Impact:**
- varying feed
 - change chipbreaker geometry
 - change approach angle

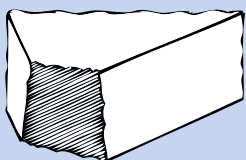

Insert breakage

Insert breakage usually means damage to tool and workpiece. Causes are varied and depend on machine and workpiece. Often originates in notches or excessive wear.

- Remedy:**
- select tougher grade
 - use Insert with stronger cutting edge geometry
 - select chipbreaker geometry for heavier chip sections
 - reduce feed and possibly also depth of cut

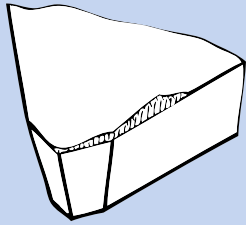

Built-Up Edges

Edge build-up occurs on the rake face as a result of the work material welding together with the cutting material, especially when cutting difficult-to-machine materials. From time to time the built-up edge will break off and may cause damage to the cutting edge. Built-up edges result in poor surface finish.

- Remedy:**
- increase cutting speed
 - use coated carbides or cermets
 - select positive cutting edge geometry
 - use cutting fluid

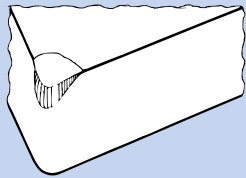

Plastic Deformation

Caused by overloading of the cutting edge combined with high machining temperatures. Danger of breakage!

- Remedy:**
- reduce cutting speed
 - lower feed
 - use a more wear-resistant carbide grade

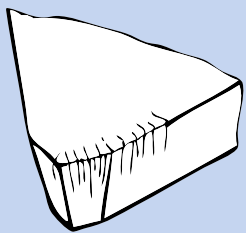

Thermal Cracks

Small cracks running across the cutting edge, caused by thermal shock loads in interrupted cutting operations, particularly in milling.

Danger of breakage!

- Remedy:**
- use grade with greater resistance to thermal shock
 - use compressed air to remove chips in slot milling

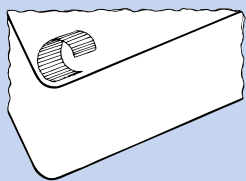

Chip Control

Effective chip control is essential for trouble-free operation. Key factors are work material, feed, and depth of cut. Too-short chips result in vibrations and cutting edge overloading.

Danger of breakage!

- Remedy:**
- avoid too small depths of cut below 1x radius, except in finishing
 - if chips too long: select chipbreaker geometry for smaller chip sections or increase feed
 - if chips too short: select chipbreaker geometry for larger chip section or reduce feed
 - when form turning shoulders, check sequence of operations

Surface Finish

Surface roughness is a tool-life criteria often applied in finishing operations. It is affected by the configuration and condition of the cutting point, the cutting conditions, and the rigidity of the machining setup.

- Remedy:**
- increase cutting speed
 - reduce feed
 - avoid vibrations
 - increase radius
 - use cutting fluid

Chatter Marks

Chatter marks or surface damage due to unfavorable chip flow call for special measures.

- Remedy:**
- vary feed slightly
 - select different chipbreaker geometry
 - change approach angle
 - check rigidity of tool and holding system

Shape & Dimensional Accuracy

Shape and dimensional accuracy are affected by the condition of the overall machine-part-tool setup.

- Remedy:**
- select grade with adequate wear resistance
 - keep cutting forces low
 - check cutting parameters, including machining allowance
 - avoid unbalance
 - check rigidity of tool and work holding

Vibrations, Instability

Vibrations in the workpiece usually occur with thin-walled parts and non-rigid setups. Unbalance and excessive cutting forces also cause problems.

- Remedy:**
- select larger approach angle for the tool
 - change turning frequency (rpm)
 - use positive geometries
 - reduce chip cross section
 - use smaller radii

Burring

Burring cannot always be avoided when cutting steel workpieces. Chamfering operations should therefore be planned where possible.

- Remedy:**
- select Inserts with positive geometry
 - reduce approach angle
 - use sharpest possible cutting edges, e.g., cermets
 - check sequence of operations

Finishing

In finish turning exacting demands are placed on surface finish and part accuracy.

To determine approximately the surface finish to be expected in turning with feeds > .004", the following formula for theoretical roughness height R_{th} can be used:

$$R_{th} \approx \frac{125000 \times f^2}{r} \text{ [} \mu\text{in]}$$



Radius	Theoretical roughness height R_{th} for feed f :					
	.004	.005	.006	.008	.010	.013
.016	125	200	300	500	800	---
.031	63	100	150	250	400	700
.047	---	63	100	175	250	450
.063	---	---	75	125	200	350

If the theoretical roughness height R_{th} is assumed to be roughly equal to R_z , the ten-point height (ISO), the roughness average R_a can be inferred, which however does not show a fixed relationship to R_z . A conversion ratio of $R_z : R_a \sim 4 : 1$ is generally appropriate.

Approximate reference values for the ratio R_z to R_a

R_z μin	63	100	160	250	400	640	1000
R_a μin	16	24	40	63	100	160	250

Note:

Good surfaces are achieved with:

- higher cutting speeds
- Inserts with sharp cutting edges
- positive rake angles and chipbreaker geometries
- use of cermets
- rigid machining setups
- use of easily machinable work materials
- use of cutting fluid

Surface characteristics in the inch system (μin)

AA - arithmetic average $\hat{=}$ R_a

CLA - centerline average $\hat{=}$ R_a

RMS - root mean square $\hat{=}$ $1.1 \times AA$

1 $\mu\text{in} = 0.025 \mu\text{m}$

1 $\mu\text{m} = 40 \mu\text{in}$

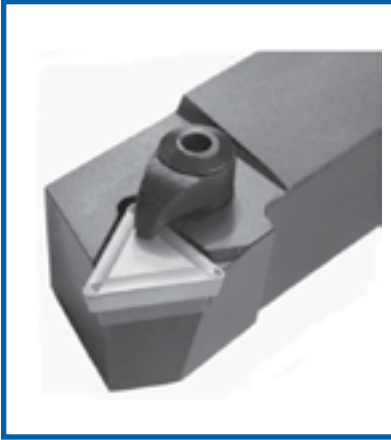

(C) Top Clamp

The classic positive insert clamping system is designed to hold flat positive inserts, both with additional or sintered chipbreaker.

PG... 28

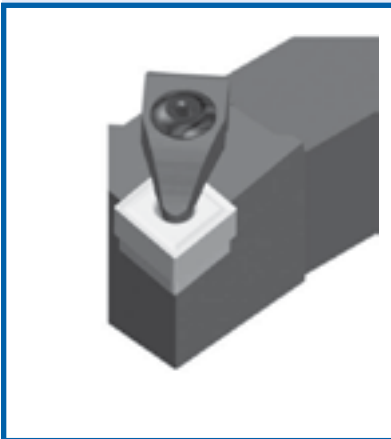

(D) Dimple Lock

The "D" clamping system avoids insert movement during high feed or heavily interrupted machining, due to its accurate indexing that holds the insert securely clamped.

PG... 29



(M) Double Lock

The double lock system offers good rigidity in negative inserts clamping. It is the first choice for center hole negative ceramic and cermet inserts.

PG... 31

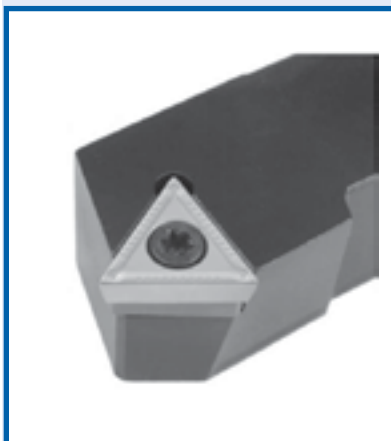

(S) Center Screw

Since the advent of the TORX screw, it has been possible to hold with complete safety positive inserts with center hole. Our range covers all the screw fixing permutations.

PG... 37

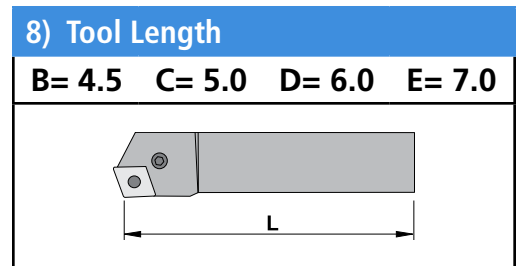
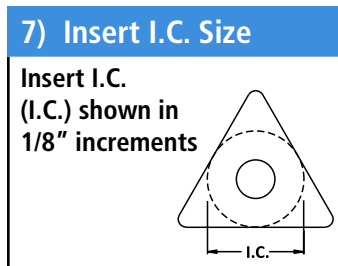
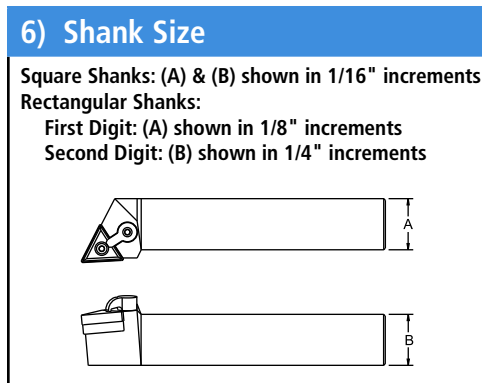
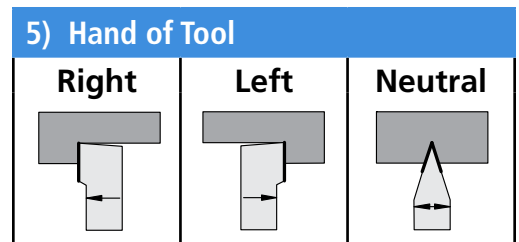
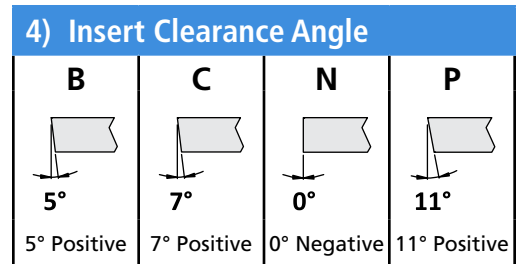
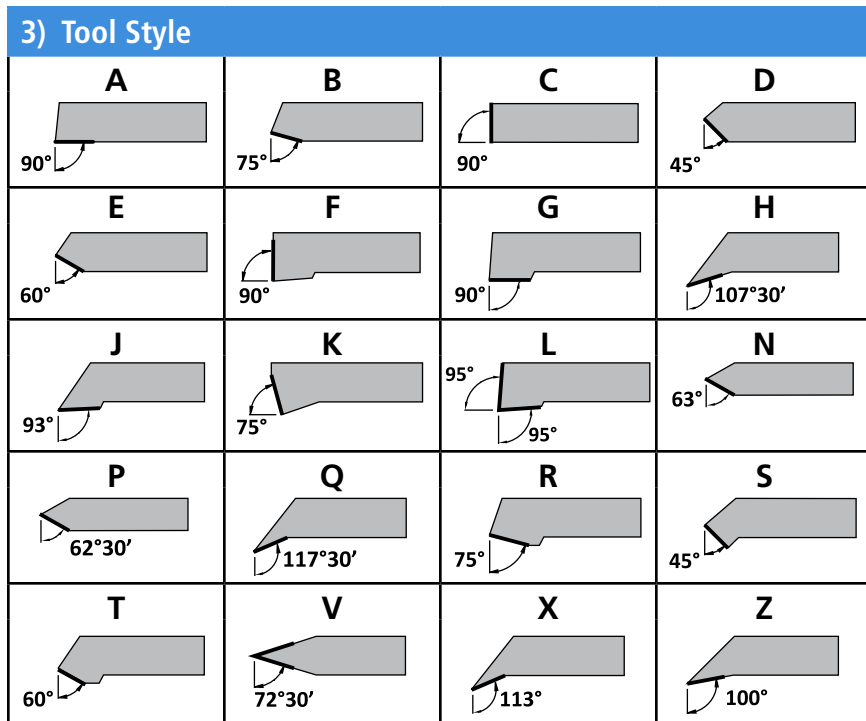
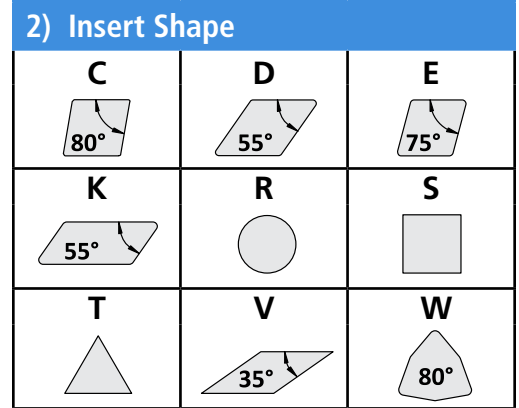
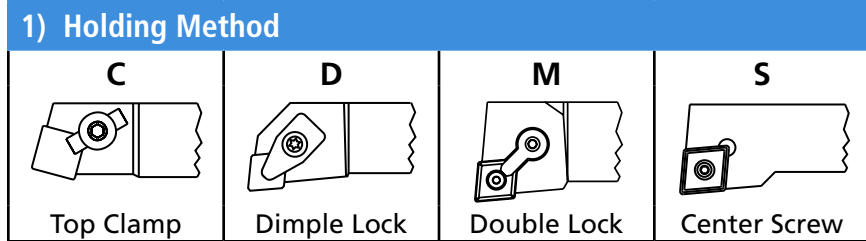

Please Note: Cutter Designation
 R/L - Please choose right or left hand designation.
 Example ordering code: MCFNR 12-4B

Top Clamp Toolholders

<p>CKJN 93°</p> <p>page 28 KNUX...</p>	<p>CTFP 90°</p> <p>TP..32</p>	<p>CTCO 90°</p> <p>TP..32.. TP..43..</p>	<p>CTEP 60°</p> <p>TP..22.. TP..32..</p>	<p>CTGP 90°</p> <p>TP..22.. TP..32..</p>	<p>CTCP 90°</p> <p>page 28 TP..32.. TP..43..</p>
---	--------------------------------------	---	---	---	---

Dimple Lock Toolholders

<p>DCLN 95°</p> <p>page 29 CN.. 43.. CN.. 54.. CN.. 64..</p>	<p>DDJN 93°</p> <p>page 29 DN.. 43..</p>	<p>DSDN 45°</p> <p>page 29 SNM.. 43.. SNM.. 54.. SNM.. 64..</p>	<p>DSRN 75°</p> <p>page 29 SNM.. 43.. SNM.. 54.. SNM.. 64..</p>	<p>DSSN 45°</p> <p>page 30 SNM.. 43.. SNM.. 64..</p>	<p>DTGN 90°</p> <p>page 30 TNM.. 33.. TNM.. 43..</p>
<p>DTJN 93°</p> <p>page 30 TNM.. 33.. TNM.. 43..</p>	<p>DVJN 93°</p> <p>page 30 VN.. 33..</p>	<p>DWLN 95°</p> <p>page 30 WNMG 43..</p>			

Double Lock Toolholders

<p>MCFN 90°</p> <p>page 31 CN.. 43.. CN.. 54.. CN.. 64..</p>	<p>MCGN 90°</p> <p>page 31 CN.. 43.. CN.. 54.. CN.. 64..</p>	<p>MCKN 75°</p> <p>page 31 CN.. 43.. CN.. 54.. CN.. 64..</p>	<p>MCLN 95°</p> <p>page 31 CN.. 43.. CN.. 54.. CN.. 64..</p>	<p>MCMN 50°</p> <p>page 32 CN.. 43.. CN.. 54.. CN.. 64..</p>	<p>MCRN 75°</p> <p>page 32 CN.. 43.. CN.. 54.. CN.. 64..</p>
<p>MDJN 45°</p> <p>page 32 DN.. 33.. DN.. 43.. DN.. 54..</p>	<p>MDPN 62° 30'</p> <p>page 32 DN.. 43.. DN.. 54..</p>	<p>MDQN 117° 30'</p> <p>page 33 DN.. 43..</p>	<p>MRGN</p> <p>page 33 RNMG 32.. RNMG 64.. RNMG 43.. RNMG 86.. RNMG 54..</p>	<p>MSDN 45°</p> <p>page 33 SNM.. 32.. SNM.. 43.. SNM.. 54.. SNM.. 64..</p>	<p>MSKN 75°</p> <p>page 33 SNM.. 43.. SNM.. 54.. SNM.. 64..</p>

Double Lock Toolholders *continued....*

<p>MTGN 90°</p> <p>page 35</p> <p>TNM. 22.. TNM. 54.. TNM. 33.. TNM. 66.. TNM. 43..</p>	<p>MTJN 93°</p> <p>page 35</p> <p>TNM. 33.. TNM. 43.. TNM. 54.. TNM. 66..</p>	<p>MTRN 75°</p> <p>page 36</p> <p>TNM. 33.. TNM. 43.. TNM. 54..</p>	<p>MVJN 93°</p> <p>page 36</p> <p>VN.. 33.. VN.. 43..</p>	<p>MVVN 72° 30'</p> <p>page 36</p> <p>VN.. 33.. VN.. 43..</p>	<p>MWLN 95°</p> <p>page 36</p> <p>WNM. 33.. WNM. 43..</p>
<p>MSRN 75°</p> <p>page 34</p> <p>SN.. 43.. SN.. 54.. SN.. 64..</p>	<p>MSSN 45°</p> <p>page 34</p> <p>SN.. 43.. SN.. 54.. SN.. 64..</p>	<p>MTAN 90°</p> <p>page 34</p> <p>TNM. 22.. TNM. 33.. TNM. 43.. TNM. 54..</p>	<p>MTCN 90°</p> <p>page 34</p> <p>TNM. 33.. TNM. 43..</p>	<p>MTENN 60°</p> <p>page 35</p> <p>TNM. 22.. TNM. 33.. TNM. 43.. TNM. 54..</p>	<p>MTFN 90°</p> <p>page 35</p> <p>TNM. 33.. TNM. 43.. TNM. 54..</p>

Center Screw Toolholders

<p>SCLC 95°</p> <p>page 37</p> <p>CC.. 21.5.. CC.. 32.5.. CC.. 43..</p>	<p>SDJC 93°</p> <p>page 37</p> <p>DC.. 21.5.. DC.. 32.5..</p>	<p>SDPC 62° 30'</p> <p>page 37</p> <p>DC.. 21.5.. DC.. 32.5..</p>	<p>SRDC</p> <p>page 37</p> <p>RC.. 0803MO RC.. 10T3MO RC.. 1204MO</p>	<p>SRGC</p> <p>page 37</p> <p>RC.. 10T3MO RC.. 1204MO</p>	<p>SRSC</p> <p>page 38</p> <p>RC.. 10T3MO RC.. 1204MO</p>
<p>SSDC 45°</p> <p>page 38</p> <p>SC.. 32.5.. SC.. 43..</p>	<p>STDC 45°</p> <p>page 38</p> <p>TC.. 21.5.. TC.. 32.5..</p>	<p>STFC 90°</p> <p>page 38</p> <p>TC.. 21.5.. TC.. 32.5..</p>	<p>STGC 90°</p> <p>page 38</p> <p>TC.. 21.5.. TC.. 32.5..</p>	<p>STTC 60°</p> <p>page 38</p> <p>TC.. 32.5..</p>	<p>SVHC 107° 30'</p> <p>page 39</p> <p>VC.. 33..</p>
<p>SVJC 93°</p> <p>page 39</p> <p>VC.. 33..</p>	<p>SVVC 72° 30'</p> <p>page 39</p> <p>VC.. 33..</p>	<p>SVJB 93°</p> <p>page 39</p> <p>VB.. 33..</p>	<p>SVVB 72° 30'</p> <p>page 39</p> <p>VB.. 33..</p>		

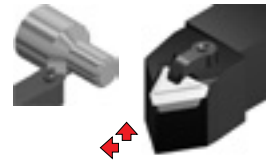
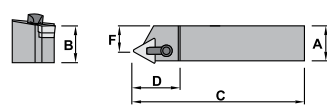
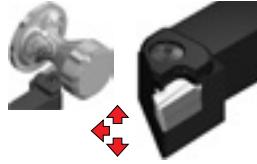
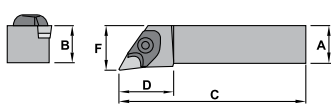

CKJN 93°

Designation	A	B	C	D	F
Insert: KNUX-1604		Lead Angle: -3° Entering Angle: 93°			
CKJNR/L 12-3B	.750	.750	5.0	1.340	1.000
CKJNR/L 16-3D	1.000	1.000	6.0	1.340	1.250
CKJNR/L 20-3E	1.250	1.250	7.0	1.340	1.500
Spare Parts					
CKJNR 12-3.	C-2316	C-1614	W-35232	C-4295	C-4203 C-4204
CKJNR 16-3. / 20-3.					C-3226 C-4012
CKJNL 12-3.	C-2326	C-1614	W-35232	C-4295	C-4203 C-4204
CKJNL 16-3. / 20-3.					C-3236

CTEP 60°

Designation	A	B	C	D	F
Insert: TP_-22_		Lead Angle: 30° Entering Angle: 60°			
CTEPR/L 08-2J	.500	.500	3.5	.875	.281
CTEPR/L 10-2B	.625	.625	4.5	.875	.406
Insert: TP_-32_		Lead Angle: 30° Entering Angle: 60°			
CTEPR/L 12-3B	.750	.750	4.5	1.250	.437
CTEPR/L 16-3D	1.000	1.000	6.0	1.250	.719
Spare Parts					
Insert: TP_-22_	CL-7	XNS-34	W-35222	--	--
Insert: TP_-32_	CL-20	XNS-47 XNS-48	W-35226	C-3116	C-4002

For Inserts please refer to page 15

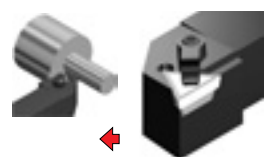
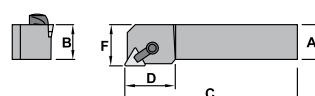
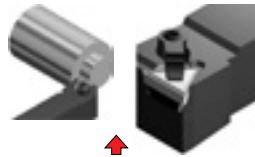
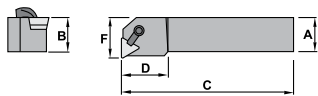

CTFP 90°

Designation	A	B	C	D	F
Insert: TP_-32_		Lead Angle: 0° Entering Angle: 90°			
CTFPR/L 10-3B	.625	.625	4.5	1.000	.875
CTFPR/L 12-3B	.750	.750	4.5	1.000	1.000
CTFPR/L 16-3D	1.000	1.000	6.0	1.000	1.250
Spare Parts					
Insert: TP_-32_	CL-20	XNS-47 XNS-48	W-35226	C-3116	C-4002

For Inserts please refer to page 15

CTGP 90°

Designation	A	B	C	D	F
Insert: TP_-22_		Lead Angle: 0° Entering Angle: 90°			
CTGPR/L 10-2B	.625	.625	4.5	1.062	.875
Insert: TP_-32_		Lead Angle: 0° Entering Angle: 90°			
CTGPR/L 10-3B	.625	.625	4.5	1.062	.875
CTGPR/L 12-3B	.750	.750	4.5	1.062	1.000
CTGPR/L 16-3D	1.000	1.000	6.0	1.250	1.250
Spare Parts					
Insert: TP_-22_	CL-7	XNS-34	W-35222	--	--
Insert: TP_-32_	CL-20	XNS-47 XNS-48	W-35226	C-3116	C-4002

For Inserts please refer to page 15

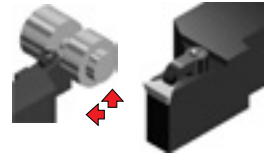
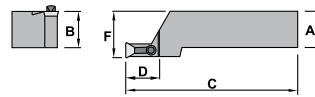
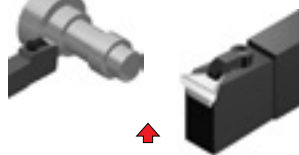
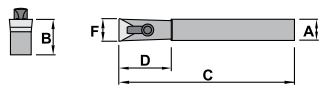

CTCO 90°

Designation	A	B	C	D	F
Insert: TP_-32_		Lead Angle: 0° Entering Angle: 90°			
CTCO N 08-3	.500	.500	3.5	1.016	.627
CTCO N 44-3	.500	1.000	8.0	1.016	.627
Insert: TP_-43_		Lead Angle: 0° Entering Angle: 90°			
CTCO N 12-4	.750	.750	4.5	1.375	.843
CTCO N 64-4	.750	1.000	8.0	1.375	.843
Spare Parts					
Insert: TP_-32_	CL-7	XNS-34 XNS-48	W-35226	C-3116	C-4002
Insert: TP_-43_	CL-22	XNS-47	W-35232	C-3400	C-4012

For Inserts please refer to page 15

CTCP 90°

Designation	A	B	C	D	F
Insert: TP_-32_		Lead Angle: 0° Entering Angle: 90°			
CTCPR/L 12-3B	.750	.750	4.5	1.125	1.000
Insert: TP_-43_		Lead Angle: 0° Entering Angle: 90°			
CTCPR/L 16-4D	1.000	1.000	6.0	1.375	1.250
CTCPR/L 20-4D	1.250	1.250	6.0	1.375	1.500
Spare Parts					
Insert: TP_-32_	CL-22	XNS-47	W-35226	C-3116	C-4002
Insert: TP_-43_	CL-12	XNS-510	W-35232	C-3400	C-4012

For Inserts please refer to page 15

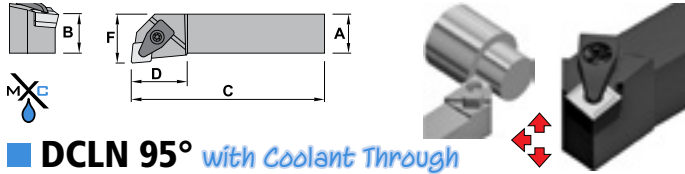

DCLN 95° with Coolant Through

Designation	A	B	C	D	F	
<i>Insert: CNM_-43_ Lead Angle: -5° Entering Angle: 95°</i>						
DCLNR/L 12-4BA	.750	.750	4.5	1.250	1.000	
DCLNR/L 16-4DA	1.000	1.000	6.0	1.250	1.250	
DCLNR/L 20-4DA	1.250	1.250	6.0	1.250	1.500	
<i>Insert: CNM_-54_ Lead Angle: -5° Entering Angle: 95°</i>						
DCLNR/L 20-5DA	1.250	1.250	6.0	1.375	1.500	
DCLNR/L 24-5EA	1.500	1.500	7.0	1.375	2.000	
<i>Insert: CNM_-64_ Lead Angle: -5° Entering Angle: 95°</i>						
DCLNR/L 20-6DA	1.250	1.250	6.0	1.653	1.500	
DCLNR/L 24-6EA	1.500	1.500	7.0	1.653	2.000	
Spare Parts						
Insert: CNM_-43_	ICSN-432	C-1160	C-2312			
Insert: CNM_-54_	ICSN-533	C-1180	C-2318	C-1907	C-4295 W-35232	
Insert: CNM_-64_	C-3619	C-1182	C-2319			

For Inserts please refer to page 9-11

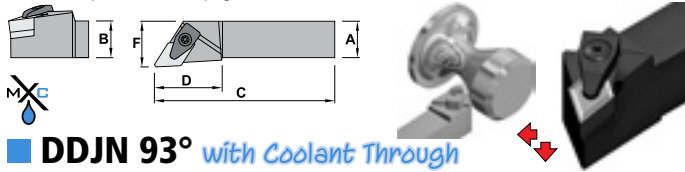

DDJN 93° with Coolant Through

Designation	A	B	C	D	F	
<i>Insert: DNM_-43_ Lead Angle: -3° Entering Angle: 93°</i>						
DDJNR/L 12-4BA	.750	.750	4.5	1.535	1.000	
DDJNR/L 16-4DA	1.000	1.000	6.0	1.535	1.250	
DDJNR/L 20-4DA	1.250	1.250	6.0	1.535	1.500	
DDJNR/L 24-4EA	1.500	1.500	7.0	1.535	2.000	
Spare Parts						
Insert: DNM_-43_	IDSN-432	C-1160	C-2312	C-1907	C-4295 W-35232	

For Inserts please refer to page 11-13

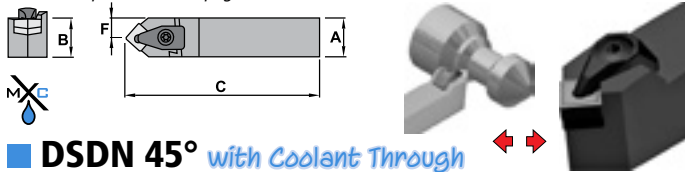

DSDN 45° with Coolant Through

Designation	A	B	C	F	
<i>Insert: SNM_-43_ Lead Angle: 45° Entering Angle: 45°</i>					
DSDNN 12-4BA	.750	.750	4.5	1.375	
DSDNN 16-4DA	1.000	1.000	6.0	1.375	
<i>Insert: SNM_-54_ Lead Angle: 45° Entering Angle: 45°</i>					
DSDNN 20-5DA	1.250	1.250	6.0	1.375	
<i>Insert: SNM_-64_ Lead Angle: 45° Entering Angle: 45°</i>					
DSDNN 20-6DA	1.250	1.250	6.0	1.535	
DSDNN 24-6EA	1.500	1.500	7.0	1.653	
Spare Parts					
Insert: SNM_-43_	ISSN-432	C-1160	C-2312		
Insert: SNM_-54_	ISSN-533	C-1180	C-2318	C-1907 C-4295 W-35232	
Insert: SNM_-64_	C-3519	C-1182	C-2319		

For Inserts please refer to page 13-14

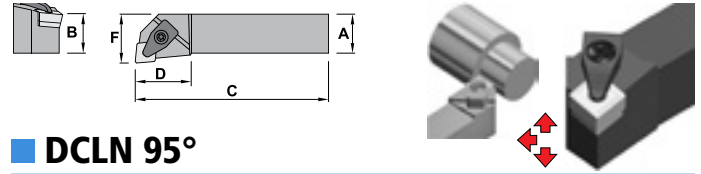

DCLN 95°

Designation	A	B	C	D	F
<i>Insert: CNM_-43_ Lead Angle: -5° Entering Angle: 95°</i>					
DCLNR/L 12-4B	.750	.750	4.5	1.250	1.000
DCLNR/L 16-4D	1.000	1.000	6.0	1.250	1.250
DCLNR/L 20-4D	1.250	1.250	6.0	1.250	1.500
<i>Insert: CNM_-54_ Lead Angle: -5° Entering Angle: 95°</i>					
DCLNR/L 20-5D	1.250	1.250	6.0	1.375	1.500
DCLNR/L 24-5E	1.500	1.500	7.0	1.375	2.000
<i>Insert: CNM_-64_ Lead Angle: -5° Entering Angle: 95°</i>					
DCLNR/L 20-6D	1.250	1.250	6.0	1.653	1.500
DCLNR/L 24-6E	1.500	1.500	7.0	1.653	2.000
Spare Parts					
Insert: CNM_-43_	ICSN-432	C-1160	C-2312		
Insert: CNM_-54_	ICSN-533	C-1180	C-2318	C-1907	C-4295 W-35232
Insert: CNM_-64_	C-3619	C-1182	C-2319		

For Inserts please refer to page 9-11

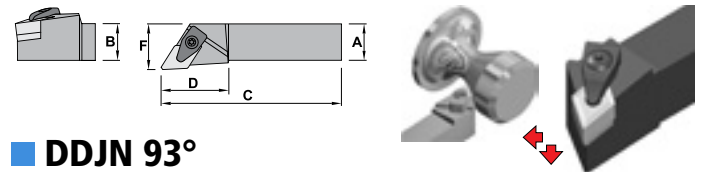

DDJN 93°

Designation	A	B	C	D	F
<i>Insert: DNM_-43_ Lead Angle: -3° Entering Angle: 93°</i>					
DDJNR/L 12-4B	.750	.750	4.5	1.535	1.000
DDJNR/L 16-4D	1.000	1.000	6.0	1.535	1.250
DDJNR/L 20-4D	1.250	1.250	6.0	1.535	1.500
DDJNR/L 24-4E	1.500	1.500	7.0	1.535	2.000
Spare Parts					
Insert: DNM_-43_	IDSN-432	C-1160	C-2312	C-1907	C-4295 W-35232

For Inserts please refer to page 11-13

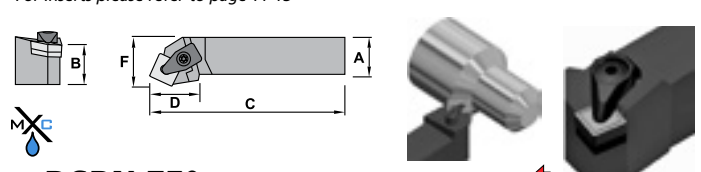

DSRN 75° with Coolant Through

Designation	A	B	C	D	F
<i>Insert: SNM_-43_ Lead Angle: 15° Entering Angle: 75°</i>					
DSRNR/L 12-4BA	.750	.750	4.5	1.375	.880
DSRNR/L 16-4DA	1.000	1.000	6.0	1.375	1.130
<i>Insert: SNM_-54_ Lead Angle: 15° Entering Angle: 75°</i>					
DSRNR/L 20-5DA	1.250	1.250	6.0	1.375	1.353
<i>Insert: SNM_-64_ Lead Angle: 15° Entering Angle: 75°</i>					
DSRNR/L 20-6DA	1.250	1.250	6.0	1.375	1.321
Spare Parts					
Insert: SNM_-43_	ISSN-432	C-1160	C-2312		
Insert: SNM_-54_	ISSN-533	C-1180	C-2318	C-1907	C-4295 W-35232
Insert: SNM_-64_	C-3519	C-1182	C-2319		

For Inserts please refer to page 13-14

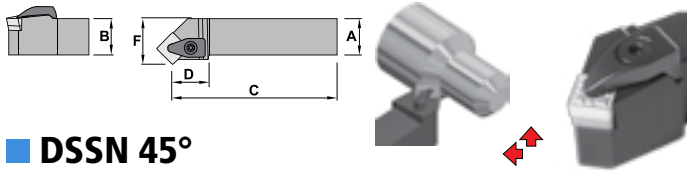

DSSN 45°

Designation	A	B	C	D	F	
<i>Insert: SNM_-43_ Lead Angle: 45° Entering Angle: 45°</i>						
DSSNR/L 12-4B	.750	.750	4.5	1.457	1.000	
DSSNR/L 16-4D	1.000	1.000	6.0	1.457	1.250	
DSSNR/L 20-4D	1.250	1.250	6.0	1.457	1.500	
<i>Insert: SNM_-64_ Lead Angle: 45° Entering Angle: 45°</i>						
DSSNR/L 20-6D	1.250	1.250	6.0	1.772	1.500	
DSSNR/L 24-6E	1.500	1.500	7.0	1.772	2.000	
Spare Parts						
Insert: SNM_-43_	ISSN-432	C-1160	C-2312	C-1907	C-4295	W-35232
Insert: SNM_-64_	C-3519	C-1182	C-2319			

For Inserts please refer to page 13-14

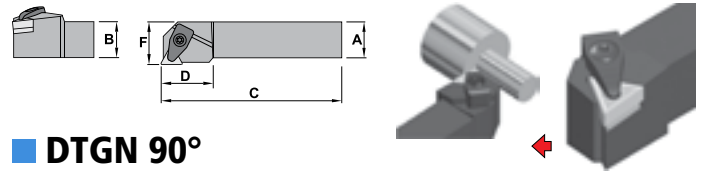

DTGN 90°

Designation	A	B	C	D	F	
<i>Insert: TNM_-33_ Lead Angle: 0° Entering Angle: 90°</i>						
DTGNR/L 12-3B	.750	.750	4.5	1.102	1.000	
DTGNR/L 16-3D	1.000	1.000	6.0	1.102	1.250	
<i>Insert: TNM_-43_ Lead Angle: 0° Entering Angle: 90°</i>						
DTGNR/L 16-4D	1.000	1.000	6.0	1.338	1.250	
DTGNR/L 20-4D	1.250	1.250	6.0	1.338	1.500	
Spare Parts						
Insert: TNM_-33_	ITSN-322	C-1150	C-2308	C-1915	C-4294	W-35225
Insert: TNM_-43_	ITSN-433	C-1160	C-2312	C-1907	C-4295	W-35232

For Inserts please refer to page 15

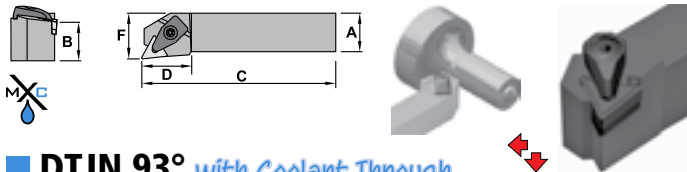

DTJN 93° with Coolant Through

Designation	A	B	C	D	F	
<i>Insert: TNM_-33_ Lead Angle: -3° Entering Angle: 93°</i>						
DTJNR/L 12-3BA	.750	.750	4.5	1.250	1.000	
DTJNR/L 16-3DA	1.000	1.000	6.0	1.250	1.250	
<i>Insert: TNM_-43_ Lead Angle: -3° Entering Angle: 93°</i>						
DTJNR/L 16-4DA	1.000	1.000	6.0	1.375	1.250	
DTJNR/L 20-4DA	1.250	1.250	6.0	1.375	1.500	
DTJNR/L 24-4EA	1.500	1.500	7.0	1.375	2.000	
Spare Parts						
Insert: TNM_-33_	ITSN-322	C-1150	C-2308	C-1915	C-4294	W-35225
Insert: TNM_-43_	ITSN-433	C-1160	C-2312	C-1907	C-4295	W-35232

For Inserts please refer to page 15

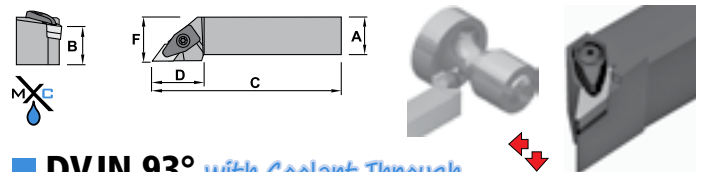

DVJN 93° with Coolant Through

Designation	A	B	C	D	F	
<i>Insert: VNM_-33_ Lead Angle: -3° Entering Angle: 93°</i>						
DVJNR/L 12-3BA	.750	.750	4.5	1.750	1.000	
DVJNR/L 16-3DA	1.000	1.000	6.0	1.750	1.250	
DVJNR/L 20-3DA	1.250	1.250	6.0	1.750	1.500	
DVJNR/L 24-3EA	1.500	1.500	7.0	1.750	2.000	
Spare Parts						
Insert: VNM_-33_	IVSN-322	C-1150	C-2308	C-1915	C-4294	W-35225

For Inserts please refer to page 16

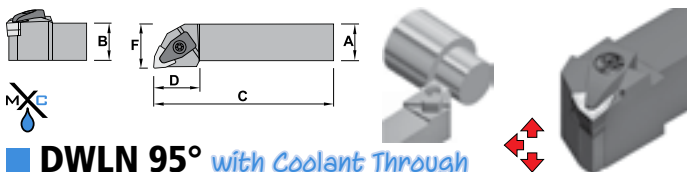

DWLN 95° with Coolant Through

Designation	A	B	C	D	F	
<i>Insert: WNM_-43_ Lead Angle: -5° Entering Angle: 95°</i>						
DWLNR/L 12-4BA	.750	.750	4.5	1.250	1.000	
DWLNR/L 16-4DA	1.000	1.000	6.0	1.250	1.250	
DWLNR/L 20-4DA	1.250	1.250	6.0	1.250	1.500	
DWLNR/L 24-4EA	1.500	1.500	7.0	1.250	2.000	
Spare Parts						
Insert: WNM_-43_	IWSN-432	C-1160	C-2312	C-1907	C-4295	W-35232

For Inserts please refer to page 16-17

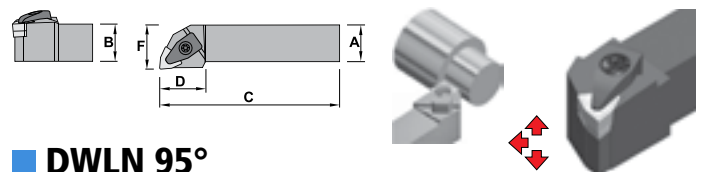

DWLN 95°

Designation	A	B	C	D	F	
<i>Insert: WNM_-43_ Lead Angle: -5° Entering Angle: 95°</i>						
DWLNR/L 12-4B	.750	.750	4.5	1.250	1.000	
DWLNR/L 16-4D	1.000	1.000	6.0	1.250	1.250	
DWLNR/L 20-4D	1.250	1.250	6.0	1.250	1.500	
DWLNR/L 24-4E	1.500	1.500	7.0	1.250	2.000	
Spare Parts						
Insert: WNM_-43_	IWSN-432	C-1160	C-2312	C-1907	C-4295	W-35232

For Inserts please refer to page 16-17

Spare Parts: Shim Shim Screw Clamp Clamp Screw Spring Key

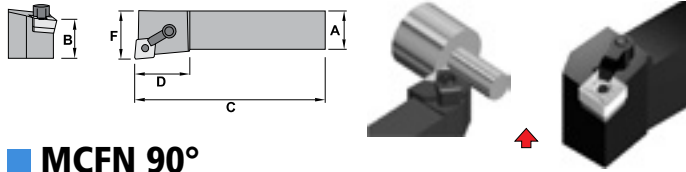

MCFN 90°

Designation	A	B	C	D	F	
<i>Insert: CNM_-43_ Lead Angle: 0° Entering Angle: 90°</i>						
MCFNR/L 12-4B	.750	.750	4.5	1.120	1.000	
MCFNR/L 16-4D	1.000	1.000	6.0	1.120	1.250	
MCFNR/L 20-4D	1.250	1.250	6.0	1.120	1.500	
MCFNR/L 85-4D	1.000	1.250	6.0	1.120	1.250	
<i>Insert: CNM_-54_ Lead Angle: 0° Entering Angle: 90°</i>						
MCFNR/L 16-5D	1.000	1.000	6.0	1.250	1.250	
MCFNR/L 20-5D	1.250	1.250	6.0	1.250	1.500	
MCFNR/L 24-5D	1.500	1.500	6.0	1.250	2.000	
<i>Insert: CNM_-64_ Lead Angle: 0° Entering Angle: 90°</i>						
MCFNR/L 16-6D	1.000	1.000	6.0	1.310	1.250	
MCFNR/L 20-6D	1.250	1.250	6.0	1.310	1.500	
MCFNR/L 24-6D	1.500	1.500	6.0	1.310	2.000	
Spare Parts						
Insert: CNM_-43_	ICSN-432	NL-46	W-35222	CL-20	XNS-48	W-35226
Insert: CNM_-54_	ICSN-533	NL-58	W-35226	CL-12	XNS-510	W-35232
Insert: CNM_-64_	ICSN-633	NL-68	W-35228	CL-12	XNS-510	W-35232

For Inserts please refer to page 9-11

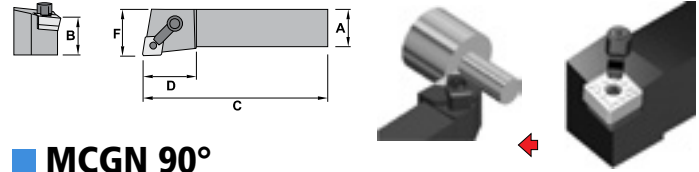

MCGN 90°

Designation	A	B	C	D	F	
<i>Insert: CNM_-43_ Lead Angle: 0° Entering Angle: 90°</i>						
MCGNR/L 12-4B	.750	.750	4.5	1.120	1.000	
MCGNR/L 16-4D	1.000	1.000	6.0	1.120	1.250	
MCGNR/L 20-4D	1.250	1.250	6.0	1.120	1.500	
MCGNR/L 24-4D	1.500	1.500	6.0	1.250	2.000	
<i>Insert: CNM_-54_ Lead Angle: 0° Entering Angle: 90°</i>						
MCGNR/L 16-5D	1.000	1.000	6.0	1.500	1.250	
MCGNR/L 20-5D	1.250	1.250	6.0	1.500	1.500	
MCGNR/L 24-5D	1.500	1.500	6.0	1.500	2.000	
<i>Insert: CNM_-64_ Lead Angle: 0° Entering Angle: 90°</i>						
MCGNR/L 20-6D	1.250	1.250	6.0	1.650	1.500	
MCGNR/L 24-6D	1.500	1.500	6.0	1.650	2.000	
Spare Parts						
Insert: CNM_-43_	ICSN-432	NL-46	W-35222	CL-20	XNS-48	W-35226
Insert: CNM_-54_	ICSN-533	NL-58	W-35226	CL-12	XNS-510	W-35232
Insert: CNM_-64_	ICSN-633	NL-68	W-35228	CL-12	XNS-510	W-35232

For Inserts please refer to page 9-11

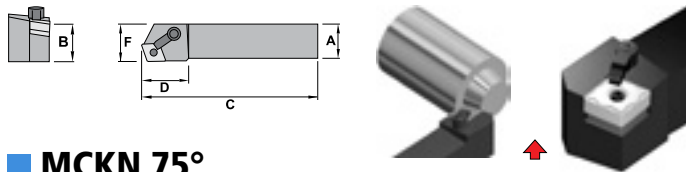

MCKN 75°

Designation	A	B	C	D	F	
<i>Insert: CNM_-43_ Lead Angle: 15° Entering Angle: 75°</i>						
MCKNR/L 12-4B	.750	.750	4.5	1.200	1.000	
MCKNR/L 16-4D	1.000	1.000	6.0	1.200	1.250	
MCKNR/L 20-4D	1.250	1.250	6.0	1.200	1.500	
<i>Insert: CNM_-54_ Lead Angle: 15° Entering Angle: 75°</i>						
MCKNR/L 16-5D	1.000	1.000	6.0	1.350	1.250	
MCKNR/L 20-5D	1.250	1.250	6.0	1.350	1.500	
<i>Insert: CNM_-64_ Lead Angle: 15° Entering Angle: 75°</i>						
MCKNR/L 16-6D	1.000	1.000	6.0	1.470	1.250	
MCKNR/L 20-6D	1.250	1.250	6.0	1.470	1.500	
MCKNR/L 24-6D	1.500	1.500	6.0	1.470	2.000	
Spare Parts						
Insert: CNM_-43_	ICSN-432	NL-46	W-35222	CL-20	XNS-48	W-35226
Insert: CNM_-54_	ICSN-533	NL-58	W-35226	CL-12	XNS-510	W-35232
Insert: CNM_-64_	ICSN-633	NL-68	W-35228	CL-12	XNS-510	W-35232

For Inserts please refer to page 9-11

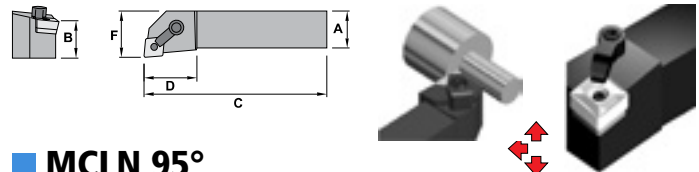

MCLN 95°

Designation	A	B	C	D	F	
<i>Insert: CNM_-43_ Lead Angle: -5° Entering Angle: 95°</i>						
MCLNR/L 12-4B	.750	.750	4.5	1.130	1.000	
MCLNR/L 16-4D	1.000	1.000	6.0	1.130	1.250	
MCLNR/L 20-4D	1.250	1.250	6.0	1.130	1.500	
MCLNR/L 85-4D	1.000	1.250	6.0	1.130	1.250	
<i>Insert: CNM_-54_ Lead Angle: -5° Entering Angle: 95°</i>						
MCLNR/L 16-5D	1.000	1.000	6.0	1.470	1.250	
MCLNR/L 20-5D	1.250	1.250	6.0	1.470	1.500	
MCLNR/L 24-5D	1.500	1.500	6.0	1.470	2.000	
<i>Insert: CNM_-64_ Lead Angle: -5° Entering Angle: 95°</i>						
MCLNR/L 16-6D	1.000	1.000	6.0	1.510	1.250	
MCLNR/L 20-6D	1.250	1.250	6.0	1.510	1.500	
MCLNR/L 24-6D	1.500	1.500	6.0	1.510	2.000	
MCLNR/L 24-6E	1.500	1.500	7.0	1.510	2.000	
MCLNR/L 85-6D	1.000	1.250	6.0	1.510	1.250	
MCLNR/L 86-6E	1.000	1.500	7.0	1.510	1.250	
Spare Parts						
Insert: CNM_-43_	ICSN-432	NL-46	W-35222	CL-20	XNS-48	W-35226
Insert: CNM_-54_	ICSN-533	NL-58	W-35226	CL-12	XNS-510	W-35232
Insert: CNM_-64_	ICSN-633	NL-68	W-35228	CL-12	XNS-510	W-35232

For Inserts please refer to page 9-11

Spare Parts: Shim Shim Pin Shim Pin Key Clamp Clamp Screw Clamp Screw Key

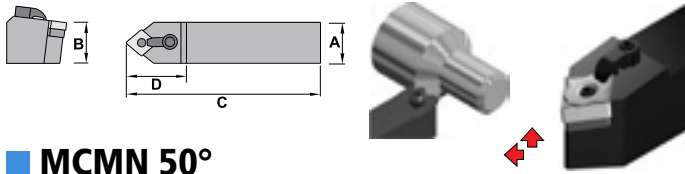

MCMN 50°

Designation	A	B	C	D	
Insert: CNM_-43_		Lead Angle: 40° Entering Angle: 50°			
MCMNN 12-4B	.750	.750	4.5	1.280	
MCMNN 16-4D	1.000	1.000	6.0	1.280	
MCMNN 20-4D	1.250	1.250	6.0	1.390	
MCMNN 85-4D	1.000	1.250	6.0	1.280	
Insert: CNM_-54_		Lead Angle: 40° Entering Angle: 50°			
MCMNN 16-5D	1.000	1.000	6.0	1.750	
MCMNN 20-5D	1.250	1.250	6.0	1.610	
MCMNN 24-5D	1.500	1.500	6.0	1.610	
Insert: CNM_-64_		Lead Angle: 40° Entering Angle: 50°			
MCMNN 24-6D	1.500	1.500	6.0	1.670	
Spare Parts					
Insert: CNM_-43_	ICSN-432	NL-46	W-35222	CL-20	XNS-48 W-35226
Insert: CNM_-54_	ICSN-533	NL-58	W-35226	CL-12	XNS-510 W-35232
Insert: CNM_-64_	ICSN-633	NL-68	W-35228	CL-12	

For Inserts please refer to page 9-11

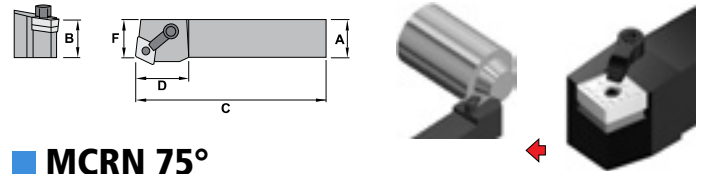

MCRN 75°

Designation	A	B	C	D	F
Insert: CNM_-43_		Lead Angle: 15° Entering Angle: 75°			
MCRNR/L 12-4B	.750	.750	4.5	1.180	.878
MCRNR/L 16-4D	1.000	1.000	6.0	1.180	1.128
MCRNR/L 20-4D	1.250	1.250	6.0	1.180	1.318
Insert: CNM_-54_		Lead Angle: 15° Entering Angle: 75°			
MCRNR/L 16-5D	1.000	1.000	6.0	1.351	1.101
MCRNR/L 20-5D	1.250	1.250	6.0	1.351	1.351
Insert: CNM_-64_		Lead Angle: 15° Entering Angle: 75°			
MCRNR/L 20-6D	1.250	1.250	6.0	1.351	1.318
MCRNR/L 24-6D	1.500	1.500	6.0	1.351	1.818
Spare Parts					
Insert: CNM_-43_	ICSN-432	NL-46	W-35222	CL-20	XNS-48 W-35226
Insert: CNM_-54_	ICSN-533	NL-58	W-35226	CL-12	XNS-510 W-35232
Insert: CNM_-64_	ICSN-633	NL-68	W-35228	CL-12	

For Inserts please refer to page 9-11

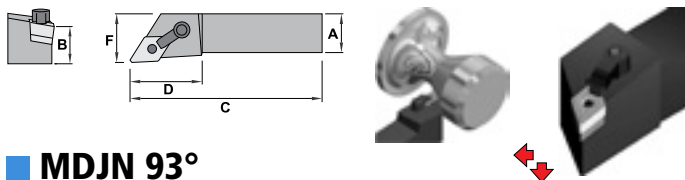

MDJN 93°

Designation	A	B	C	D	F
Insert: DN_-33_		Lead Angle: -3° Entering Angle: 93°			
MDJNR/L 8-3A	.500	.500	4.0	1.062	.625
MDJNR/L 10-3B	.625	.625	4.5	1.250	.875
Insert: DN_-43_		Lead Angle: -3° Entering Angle: 93°			
MDJNR/L 12-4B	.750	.750	4.5	1.500	1.000
MDJNR/L 16-4D	1.000	1.000	6.0	1.500	1.250
MDJNR/L 20-4D	1.250	1.250	6.0	1.500	1.500
MDJNR/L 24-4D	1.500	1.500	6.0	1.500	2.000
MDJNR/L 85-4D	1.000	1.250	6.0	1.500	1.250
Insert: DN_-54_		Lead Angle: -3° Entering Angle: 93°			
MDJNR/L 16-5D	1.000	1.000	6.0	1.440	1.250
MDJNR/L 20-5D	1.250	1.250	6.0	1.440	1.500
MDJNR/L 24-5D	1.500	1.500	6.0	1.440	2.000
MDJNR/L 85-5D	1.000	1.250	6.0	1.440	1.250
Spare Parts					
Insert: DNM_-33_	--	NL-33L	W-35218	CL-7	XNS-36 W-35222
Insert: DNM_-43_	IDSN-432	NL-46	W-35222	CL-20	XNS-48 W-35226
Insert: DNM_-54_	IDSN-533	NL-58	W-35226	CL-12	XNS-510 W-35232

For Inserts please refer to page 11-13

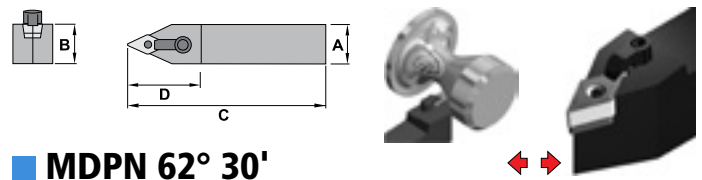

MDPN 62° 30'

Designation	A	B	C	D	
Insert: DN_-43_		Lead Angle: 27° 30' Entering Angle: 62° 30'			
MDPNN 12-4B	.750	.750	4.5	1.620	
MDPNN 16-4D	1.000	1.000	6.0	1.620	
MDPNN 20-4D	1.250	1.250	6.0	1.620	
Insert: DN_-54_		Lead Angle: 27° 30' Entering Angle: 62° 30'			
MDPNN 16-5D	1.000	1.000	6.0	1.880	
MDPNN 20-5D	1.250	1.250	6.0	1.880	
MDPNN 24-5E	1.500	1.500	7.0	1.880	
MDPNN 85-5D	1.000	1.250	6.0	1.880	
MDPNN 86-5D	1.000	1.500	6.0	1.880	
Spare Parts					
Insert: ...12-4B				CL-22	
Insert: DNM_-43_- ...16-4D/20-4D	IDSN-432	NL-46	W-35222	CL-20	XNS-48 W-35226
Insert: DNM_-54_	IDSN-533	NL-58	W-35226	CL-12	XNS-510 W-35232

For Inserts please refer to page 11-13



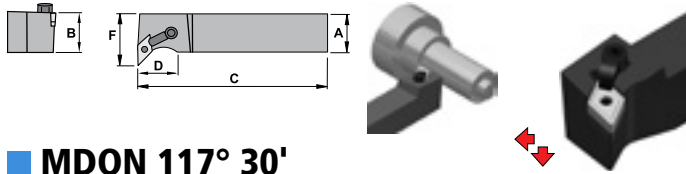

MDQN 117° 30'

Designation	A	B	C	D	F
Insert: DN_-43_		Lead Angle: -7° 30'		Entering Angle: 117° 30'	
MDQNR/L 12-4B	.750	.750	4.5	1.370	1.00
MDQNR/L 16-4D	1.000	1.000	6.0	1.370	1.25
MDQNR/L 20-4D	1.250	1.250	6.0	1.370	1.50
MDQNR/L 24-4E	1.500	1.500	7.0	1.370	2.00
Spare Parts					
Insert: DNN_-43_	IDSN-432	NL-46	W-35222	CL-20	XNS-48 W-35226

For Inserts please refer to page 11-13

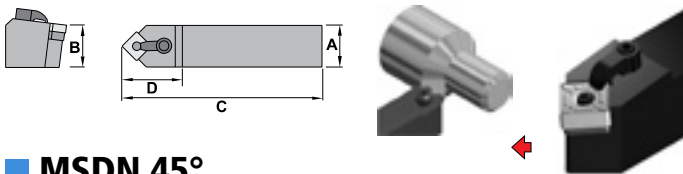

MSDN 45°

Designation	A	B	C	D	
Insert: SNM_-32_		Lead Angle: 45°		Entering Angle: 45°	
MSDNN 8-3A	.500	.500	4.0	1.00	
MSDNN 10-3B	.625	.625	4.5	1.00	
Insert: SNM_-43_		Lead Angle: 45°		Entering Angle: 45°	
MSDNN 12-4B	.750	.750	4.5	1.30	
MSDNN 16-4D	1.000	1.000	6.0	1.30	
MSDNN 85-4D	1.000	1.250	6.0	1.30	
Insert: SNM_-54_		Lead Angle: 45°		Entering Angle: 45°	
MSDNN 16-5D	1.000	1.000	6.0	1.50	
MSDNN 20-5D	1.250	1.250	6.0	1.50	
MSDNN 85-5D	1.000	1.250	6.0	1.50	
Insert: SNM_-64_		Lead Angle: 45°		Entering Angle: 45°	
MSDNN 16-6D	1.000	1.000	6.0	1.73	
MSDNN 20-6D	1.250	1.250	6.0	1.75	
MSDNN 24-6E	1.500	1.500	7.0	1.75	
MSDNN 85-6D	1.000	1.250	6.0	1.75	
Spare Parts					
Insert: SNM_-32_	ISSN-322	NL-34	W-35218	CL-6	XNS-36 W-35222
Insert: SNM_-43_	ISSN-432	NL-46	W-35222	CL-20	XNS-48 W-35226
Insert: SNM_-54_	ISSN-533	NL-58	W-35226	CL-12	XNS-510 W-35232
Insert: SNM_-64_	ISSN-633	NL-68	W-35228		

For Inserts please refer to page 13-14

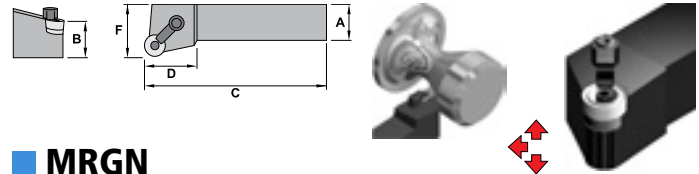

MRGN

Designation	A	B	C	D	F
Insert: RNMG-32		Lead Angle: 45°		Entering Angle: 45°	
MRGNR/L 12-3B	.750	.750	4.5	.81	1.000
Insert: RNMG-43		Lead Angle: 45°		Entering Angle: 45°	
MRGNR/L 12-4B	.750	.750	4.5	1.06	1.000
MRGNR/L 16-4D	1.000	1.000	6.0	1.06	1.250
MRGNR/L 20-4D	1.250	1.250	6.0	1.06	1.500
MRGNR/L 85-4D	1.000	1.250	6.0	1.06	1.250
MRGNR/L 86-4D	1.000	1.500	6.0	1.06	1.250
Insert: RNMG-54		Lead Angle: 45°		Entering Angle: 45°	
MRGNR/L 16-5D	1.000	1.000	6.0	1.25	1.250
MRGNR/L 20-5D	1.250	1.250	6.0	1.25	1.500
Insert: RNMG-64		Lead Angle: 45°		Entering Angle: 45°	
MRGNR/L 16-6D	1.000	1.000	6.0	1.38	1.250
MRGNR/L 20-6D	1.250	1.250	6.0	1.38	1.500
MRGNR/L 24-6E	1.500	1.500	7.0	1.38	2.000
Insert: RNMG-86		Lead Angle: 45°		Entering Angle: 45°	
MRGNR/L 24-8E	1.500	1.500	7.0	1.44	2.000
Spare Parts					
Insert: RNMG-32	--	NL-33	W-35218	CL-20	XNS-48 W-35226
Insert: RNMG-43	IRSN-43	NL-46	W-35222		
Insert: RNMG-54	IRSN-53	NL-58	W-35226	CL-12	XNS-510 W-35232
Insert: RNMG-64	IRSN-63	NL-68	W-35228		
Insert: RNMG-86	IRSN-84	NL-810	W-35232	CL-30	

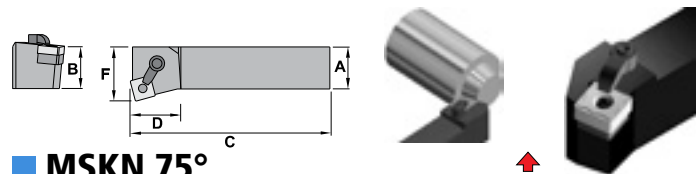

MSKN 75°

Designation	A	B	C	D	F
Insert: SNM_-43_		Lead Angle: 15°		Entering Angle: 75°	
MSKNR/L 12-4B	.750	.750	4.5	1.22	1.000
MSKNR/L 16-4D	1.000	1.000	6.0	1.22	1.250
Insert: SNM_-54_		Lead Angle: 15°		Entering Angle: 75°	
MSKNR/L 16-5D	1.000	1.000	6.0	1.41	1.250
MSKNR/L 20-5D	1.250	1.250	6.0	1.41	1.500
MSKNR/L 85-5D	1.000	1.250	6.0	1.41	1.250
Insert: SNM_-64_		Lead Angle: 15°		Entering Angle: 75°	
MSKNR/L 20-6D	1.250	1.250	6.0	1.50	1.500
MSKNR/L 24-6E	1.500	1.500	7.0	1.50	2.000
Spare Parts					
Insert: SNM_-43_	ISSN-432	NL-46	W-35222	CL-20	XNS-48 W-35226
Insert: SNM_-54_	ISSN-533	NL-58	W-35226	CL-12	XNS-510 W-35232
Insert: SNM_-64_	ISSN-633	NL-68	W-35228		

For Inserts please refer to page 13-14

Spare Parts: Shim Shim Pin Shim Pin Key Clamp Clamp Screw Clamp Screw Key

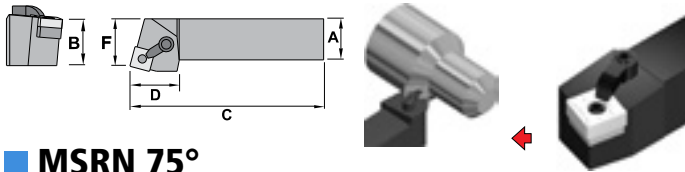

MSRN 75°

Designation	A	B	C	D	F	
Insert: SNM_-43_		Lead Angle: 15° Entering Angle: 75°				
MSRNR/L 12-4B	.750	.750	4.5	1.25	.880	
MSRNR/L 16-4D	1.000	1.000	6.0	1.25	1.130	
Insert: SNM_-54_		Lead Angle: 15° Entering Angle: 75°				
MSRNR/L 16-5D	1.000	1.000	6.0	1.50	1.103	
MSRNR/L 20-5D	1.250	1.250	6.0	1.50	1.353	
Insert: SNM_-64_		Lead Angle: 15° Entering Angle: 75°				
MSRNR/L 20-6D	1.250	1.250	6.0	1.59	1.321	
MSRNR/L 24-6E	1.500	1.500	7.0	1.59	1.821	
Spare Parts						
Insert: SNM_-43_	ISSN-432	NL-46	W-35222	CL-20	XNS-48	W-35226
Insert: SNM_-54_	ISSN-533	NL-58	W-35226	CL-12	XNS-510	W-35232
Insert: SNM_-64_	ISSN-633	NL-68	W-35228	CL-12	XNS-510	W-35232

For Inserts please refer to page 13-14

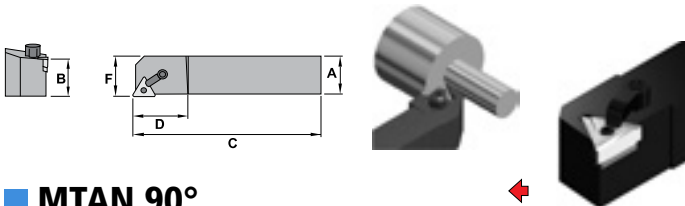

MTAN 90°

Designation	A	B	C	D	F	
Insert: TNM_-22_		Lead Angle: 0° Entering Angle: 90°				
MTANR/L 8-2A	.500	.500	4.0	.875	.500	
Insert: TNM_-33_		Lead Angle: 0° Entering Angle: 90°				
MTANR/L 12-3B	.750	.750	4.5	1.06	.750	
MTANR/L 16-3D	1.000	1.000	6.0	1.06	1.000	
Insert: TNM_-43_		Lead Angle: 0° Entering Angle: 90°				
MTANR/L 16-4D	1.000	1.000	6.0	1.22	1.000	
Insert: TNM_-54_		Lead Angle: 0° Entering Angle: 90°				
MTANR/L 20-5D	1.250	1.250	6.0	1.43	1.250	
MTANR/L 24-5D	1.500	1.500	6.0	1.43	1.500	
Spare Parts						
Insert: TNM_-22_	--	NL-23	W-35216	CL-7	XNS-34	W-35222
Insert: TNM_-33_	ITSN-322	NL-34L	W-35218	CL-20	XNS-48	W-35226
Insert: TNM_-43_	ITSN-433	NL-46	W-35222	CL-12	XNS-510	W-35232
Insert: TNM_-54_	ITSN-533	NL-58	W-35226	CL-12	XNS-510	W-35232

For Inserts please refer to page 15

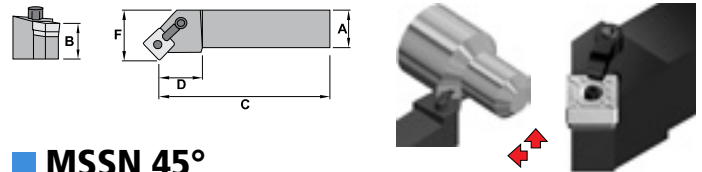

MSSN 45°

Designation	A	B	C	D	F	
Insert: SNM_-43_		Lead Angle: 45° Entering Angle: 45°				
MSSNR/L 12-4B	.750	.750	4.5	1.23	.675	
MSSNR/L 16-4D	1.000	1.000	6.0	1.23	.925	
Insert: SNM_-54_		Lead Angle: 45° Entering Angle: 45°				
MSSNR/L 16-5D	1.000	1.000	6.0	1.38	.847	
MSSNR/L 20-5D	1.250	1.250	6.0	1.38	1.097	
Insert: SNM_-64_		Lead Angle: 45° Entering Angle: 45°				
MSSNR/L 20-6D	1.250	1.250	6.0	1.47	1.011	
MSSNR/L 24-6E	1.500	1.500	7.0	1.47	1.511	
MSSNR/L 86-6E	1.000	1.500	7.0	1.47	.761	
Spare Parts						
Insert: SNM_-43_	ISSN-432	NL-46	W-35222	CL-20	XNS-48	W-35226
Insert: SNM_-54_	ISSN-533	NL-58	W-35226	CL-12	XNS-510	W-35232
Insert: SNM_-64_	ISSN-633	NL-68	W-35228	CL-12	XNS-510	W-35232

For Inserts please refer to page 13-14

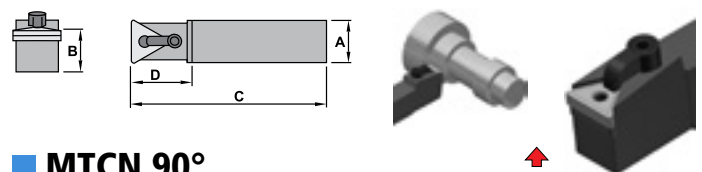

MTCN 90°

Designation	A	B	C	D		
Insert: TNM_-33_		Lead Angle: 0° Entering Angle: 90°				
MTCNN 44-3F	.500	1.000	8.0	1.000		
Insert: TNM_-43_		Lead Angle: 0° Entering Angle: 90°				
MTCNN 12-4B	.750	.750	4.5	1.375		
MTCNN 64-4F	.750	1.000	8.0	1.375		
MTCNN 66-4F	.750	1.500	8.0	1.375		
Spare Parts						
Insert: TNM_-33_	ITSN-322	NL-34L	W-35218	CL-20	XNS-48	W-35226
Insert: TNM_-43_	ITSN-433	NL-46	W-35222	CL-12	XNS-510	W-35232

For Inserts please refer to page 15

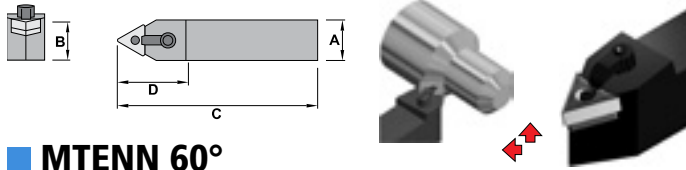

MTENN 60°

Designation	A	B	C	D	
<i>Insert: TNM_-22_ Lead Angle: 30° Entering Angle: 60°</i>					
MTENN 8-2A	.500	.500	4.0	1.000	
<i>Insert: TNM_-33_ Lead Angle: 30° Entering Angle: 60°</i>					
MTENN 10-3B	.625	.625	4.5	1.125	
MTENN 12-3B	.750	.750	4.5	1.300	
MTENN 16-3D	1.000	1.000	6.0	1.300	
<i>Insert: TNM_-43_ Lead Angle: 30° Entering Angle: 60°</i>					
MTENN 16-4D	1.000	1.000	6.0	1.500	
<i>Insert: TNM_-54_ Lead Angle: 30° Entering Angle: 60°</i>					
MTENN 20-5D	1.250	1.250	6.0	1.732	
<i>Insert: TNM_-66_ Lead Angle: 30° Entering Angle: 60°</i>					
MTENN 24-6E	1.500	1.500	7.0	2.086	
Spare Parts					
Insert: TNM_-22_	--	NL-23L	W-35216	CL-7	XNS-34 W-35222
Insert: ...10-3B				CL-6	XNS-36 W-35222
Insert: TNM_-12-3B/33_	ITSN-322	NL-34L	W-35218	CL-20	XNS-48 W-35226
Insert: TNM_-43_	ITSN-433	NL-46	W-35222	CL-20	XNS-48 W-35226
Insert: TNM_-54_	ITSN-533	NL-58	W-35226		
Insert: TNM_-64_	ITSN-637	NL-68L	W-35228	CL-12	XNS-510 W-35232

For Inserts please refer to page 15

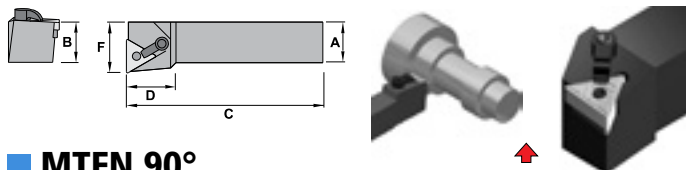

MTFN 90°

Designation	A	B	C	D	F
<i>Insert: TNM_-33_ Lead Angle: 0° Entering Angle: 90°</i>					
MTFNR/L 12-3B	.750	.750	4.5	1.00	1.000
MTFNR/L 16-3D	1.000	1.000	6.0	1.00	1.250
<i>Insert: TNM_-43_ Lead Angle: 0° Entering Angle: 90°</i>					
MTFNR/L 16-4D	1.000	1.000	6.0	1.00	1.250
MTFNR/L 20-4D	1.250	1.250	6.0	1.00	1.500
MTFNR/L 85-4D	1.000	1.250	6.0	1.00	1.250
MTFNR/L 86-4D	1.000	1.500	6.0	1.00	1.250
<i>Insert: TNM_-54_ Lead Angle: 0° Entering Angle: 90°</i>					
MTFNR/L 16-5D	1.000	1.000	6.0	1.44	1.250
MTFNR/L 20-5D	1.250	1.250	6.0	1.44	1.500
MTFNR/L 24-5E	1.500	1.500	7.0	1.44	2.000
MTFNR/L 85-5D	1.000	1.250	6.0	1.44	1.250
MTFNR/L 86-5D	1.000	1.500	6.0	1.44	1.250
Spare Parts					
Insert: TNM_-33_	ITSN-322	NL-34L	W-35218	CL-20	XNS-48 W-35226
Insert: TNM_-43_	ITSN-433	NL-46	W-35222		
Insert: TNM_-54_	ITSN-533	NL-58	W-35226	CL-12	XNS-510 W-35232

For Inserts please refer to page 15

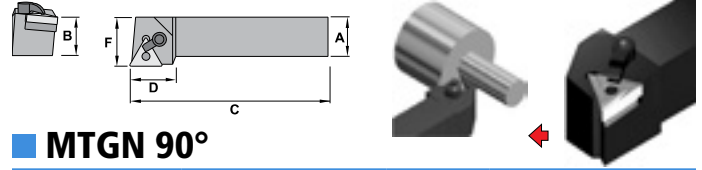

MTGN 90°

Designation	A	B	C	D	F
<i>Insert: TNM_-22_ Lead Angle: 0° Entering Angle: 90°</i>					
MTGNR/L 8-2A	.500	.500	4.0	.875	.625
<i>Insert: TNM_-33_ Lead Angle: 0° Entering Angle: 90°</i>					
MTGNR/L 10-3B	.625	.625	4.5	1.000	.875
MTGNR/L 12-3B	.750	.750	4.5	1.060	1.000
MTGNR/L 16-3D	1.000	1.000	6.0	1.060	1.250
<i>Insert: TNM_-43_ Lead Angle: 0° Entering Angle: 90°</i>					
MTGNR/L 16-4C	1.000	1.000	5.0	1.375	1.250
MTGNR/L 16-4D	1.000	1.000	6.0	1.220	1.250
MTGNR/L 20-4D	1.250	1.250	6.0	1.220	1.500
MTGNR/L 85-4D	1.000	1.250	6.0	1.220	1.250
MTGNR/L 86-4D	1.000	1.500	6.0	1.220	1.250
<i>Insert: TNM_-54_ Lead Angle: 0° Entering Angle: 90°</i>					
MTGNR/L 16-5D	1.000	1.000	6.0	1.440	1.250
MTGNR/L 20-5D	1.250	1.250	6.0	1.440	1.500
MTGNR/L 24-5E	1.500	1.500	7.0	1.440	2.000
MTGNR/L 85-5D	1.000	1.250	6.0	1.440	1.250
MTGNR/L 86-5D	1.000	1.500	6.0	1.440	1.250
<i>Insert: TNM_-66_ Lead Angle: 0° Entering Angle: 90°</i>					
MTGNR/L 24-6E	1.500	1.500	7.0	1.500	2.000
Spare Parts					
Insert: TNM_-22_	--	NL-23	W-35216	CL-7	XNS-34 W-35222
Insert: TNM_-33_	ITSN-322	NL-34L	W-35218		
Insert: TNM_-43_	ITSN-433	NL-46	W-35222	CL-20	XNS-48 W-35226
Insert: TNM_-54_	ITSN-533	NL-58	W-35226		
Insert: TNM_-66_	ITSN-637	NL-68L	W-35228	CL-12	XNS-510 W-35232

For Inserts please refer to page 15

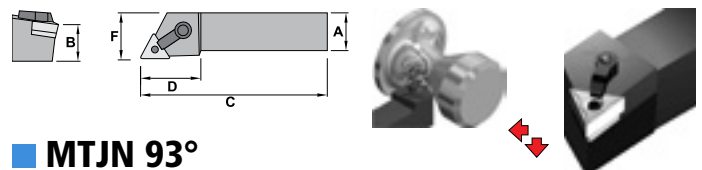

MTJN 93°

Designation	A	B	C	D	F
<i>Insert: TNM_-33_ Lead Angle: -3° Entering Angle: 93°</i>					
MTJNR/L 12-3B	.750	.750	4.5	1.030	1.000
MTJNR/L 16-3D	1.000	1.000	6.0	1.030	1.250
<i>Insert: TNM_-43_ Lead Angle: -3° Entering Angle: 93°</i>					
MTJNR/L 16-4D	1.000	1.000	6.0	1.250	1.250
MTJNR/L 20-4D	1.250	1.250	6.0	1.250	1.500
<i>Insert: TNM_-54_ Lead Angle: -3° Entering Angle: 93°</i>					
MTJNR/L 20-5D	1.250	1.250	6.0	1.440	1.500
<i>Insert: TNM_-66_ Lead Angle: -3° Entering Angle: 93°</i>					
MTJNR/L 24-6E	1.500	1.500	7.0	1.625	2.000
Spare Parts					
Insert: TNM_-33_	ITSN-322	NL-34L	W-35218	CL-20	XNS-48 W-35226
Insert: TNM_-43_	ITSN-433	NL-46	W-35222		
Insert: TNM_-54_	ITSN-533	NL-58	W-35226		
Insert: TNM_-66_	ITSN-637	NL-68L	W-35228	CL-12	XNS-510 W-35232

For Inserts please refer to page 15

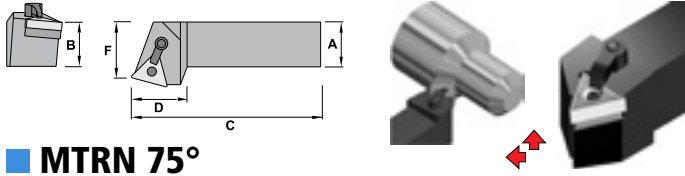

MTRN 75°

Designation	A	B	C	D	F	
Insert: TNM_-33_		Lead Angle: 15° Entering Angle: 75°				
MTRNR/L 12-3B	.750	.750	4.5	1.160	.855	
MTRNR/L 16-3D	1.000	1.000	6.0	1.160	1.105	
Insert: TNM_-43_		Lead Angle: 15° Entering Angle: 75°				
MTRNR/L 16-4D	1.000	1.000	6.0	1.380	1.048	
MTRNR/L 20-4D	1.250	1.250	6.0	1.380	1.298	
Insert: TNM_-54_		Lead Angle: 15° Entering Angle: 75°				
MTRNR/L 20-5D	1.250	1.250	6.0	1.560	1.252	
MTRNR/L 24-5E	1.500	1.500	7.0	1.560	1.752	
Spare Parts						
Insert: TNM_-33_	ITSN-322	NL-34L	W-35218	CL-20	XNS-48	W-35226
Insert: TNM_-43_	ITSN-433	NL-46	W-35222			
Insert: TNM_-54_	ITSN-533	NL-58	W-35226	CL-12	XNS-510	W-35232

For Inserts please refer to page 15

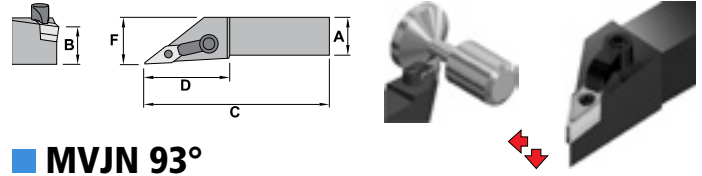

MVJN 93°

Designation	A	B	C	D	F	
Insert: VN_-33_		Lead Angle: -3° Entering Angle: 93°				
MVJNR/L 12-3B	.750	.750	4.5	1.620	1.000	
MVJNR/L 16-3D	1.000	1.000	6.0	1.620	1.250	
MVJNR/L 20-3D	1.250	1.250	6.0	1.620	1.500	
Insert: VN_-43_		Lead Angle: -3° Entering Angle: 93°				
MVJNR/L 16-4D	1.000	1.000	6.0	1.880	1.250	
MVJNR/L 20-4D	1.250	1.250	6.0	1.880	1.500	
MVJNR/L 24-4E	1.500	1.500	7.0	1.880	2.000	
MVJNR/L 85-4D	1.000	1.250	6.0	1.880	1.250	
MVJNR/L 86-4D	1.000	1.500	6.0	1.880	1.250	
Spare Parts						
Insert: VN_-33_	IVSN-322	NL-34L	W-35218	CL-22	XNS-48	W-35226
Insert: VN_-43_	IVSN-433	NL-46	W-35222	CL-30	XNS-510	W-35232

For Inserts please refer to page 16

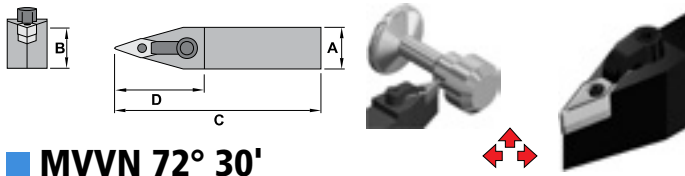

MVVN 72° 30'

Designation	A	B	C	D		
Insert: VN_-33_		Lead Angle: 17.5° Entering Angle: 72.5°				
MVVNN 12-3B	.750	.750	4.5	1.620		
MVVNN 16-3D	1.000	1.000	6.0	1.620		
MVVNN 20-3D	1.250	1.250	6.0	1.620		
MVVNN 24-3E	1.500	1.500	7.0	1.620		
Insert: VN_-43_		Lead Angle: 17.5° Entering Angle: 72.5°				
MVVNN 16-4D	1.000	1.000	6.0	2.060		
MVVNN 20-4D	1.250	1.250	6.0	2.060		
MVVNN 24-4E	1.500	1.500	7.0	2.060		
Spare Parts						
Insert: VN_-33_	IVSN-322	NL-34L	W-35218	CL-22	XNS-48	W-35226
Insert: VN_-43_	IVSN-433	NL-46	W-35222	CL-30	XNS-510	W-35232

For Inserts please refer to page 16

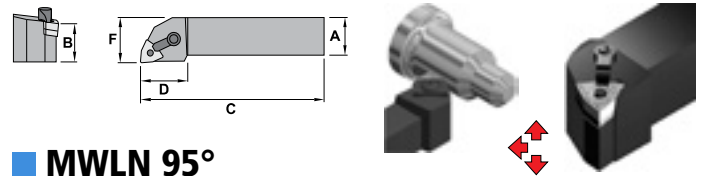

MWLN 95°

Designation	A	B	C	D	F	
Insert: WNM_-33_		Lead Angle: -5° Entering Angle: 95°				
MWLN/L 12-3B	.750	.750	4.5	1.000	1.000	
MWLN/L 16-3D	1.000	1.000	6.0	1.000	1.250	
Insert: WNM_-43_		Lead Angle: -5° Entering Angle: 95°				
MWLN/L 12-4B	.750	.750	4.5	1.070	1.000	
MWLN/L 16-4D	1.000	1.000	6.0	1.070	1.250	
MWLN/L 20-4D	1.250	1.250	6.0	1.070	1.500	
MWLN/L 24-4E	1.500	1.500	7.0	1.070	2.000	
Spare Parts						
Insert: WNMG-33_	IWSN-322	NL-34L	W-35218	CL-6	XNS-36	W-35222
Insert: WNMG-43_	IWSN-433	NL-46	W-35222	CL-20	XNS-48	W-35226

For Inserts please refer to page 16-17

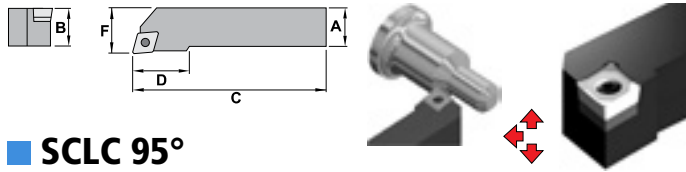

SCLC 95°

Designation	A	B	C	D	F
<i>Insert: CC_-21.5</i>		<i>Lead Angle: -5° Entering Angle: 95°</i>			
SCLCR/L 6-2I	.375	.375	2.5	.390	.500
<i>Insert: CC_-32.5</i>		<i>Lead Angle: -5° Entering Angle: 95°</i>			
SCLCR/L 8-3J	.500	.500	3.5	.630	.625
SCLCR/L 10-3A	.625	.625	4.0	.630	.750
SCLCR/L 12-3B	.750	.750	4.5	.630	1.000
SCLCR/L 16-3D	1.000	1.000	6.0	.630	1.250
<i>Insert: CC_-43</i>		<i>Lead Angle: -5° Entering Angle: 95°</i>			
SCLCR/L 12-4B	.750	.750	4.5	1.000	1.000
SCLCR/L 16-4D	1.000	1.000	6.0	1.000	1.250
SCLCR/L 20-4D	1.250	1.250	6.0	1.000	1.500
Spare Parts					
Insert: CC_-21.5_	--	--	W-37016	C-1225	
Insert: ..8-3J				C-1440	
Insert: CC_- ..10-3A	--	--	W-37032	C-1240	
32.5_ ..12-3B					
..16-3D					
Insert: CC_-43_	C-3614	C-1760	C-5517	C-1540	

For Inserts please refer to page 9

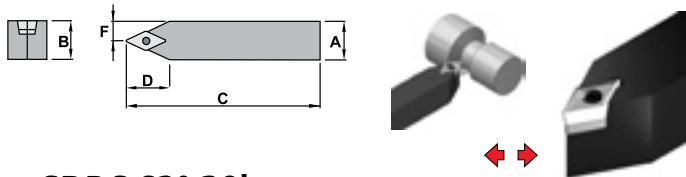

SDPC 62° 30'

Designation	A	B	C	D	F
<i>Insert: DC_-21.5</i>		<i>Lead Angle: 27.5° Entering Angle: 62.5°</i>			
SDPCN 6-2I	.375	.375	2.5	.370	.197
SDPCN 8-2J	.500	.500	3.5	.492	.260
<i>Insert: DC_-32.5</i>		<i>Lead Angle: 27.5° Entering Angle: 62.5°</i>			
SDPCN 10-3A	.625	.625	4.0	.630	.323
SDPCN 12-3B	.750	.750	4.5	.744	.382
SDPCN 16-3D	1.000	1.000	6.0	.984	.520
Spare Parts					
Insert: DC_-21.5_	--	--	W-37016	C-1225	
Insert: DC_-32.5_	C-3714	C-1750	C-5516	C-1335	

For Inserts please refer to page 11

Spare Parts:	Shim	Shim Screw Bushing	Key	Insert Screw
---------------------	------	--------------------	-----	--------------

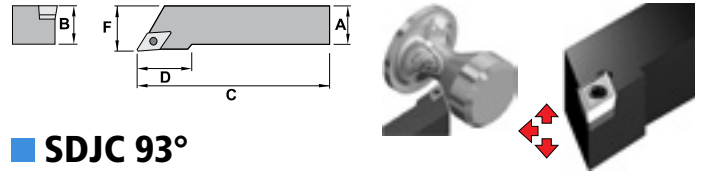

SDJC 93°

Designation	A	B	C	D	F
<i>Insert: DC_-21.5</i>		<i>Lead Angle: -3° Entering Angle: 93°</i>			
SDJCR/L 6-2I	.375	.375	2.5	.590	.500
SDJCR/L 8-2J	.500	.500	3.5	.670	.625
SDJCR/L 10-2A	.625	.625	4.0	.670	.750
SDJCR/L 12-2B	.750	.750	4.5	.708	1.000
<i>Insert: DC_-32.5</i>		<i>Lead Angle: -3° Entering Angle: 93°</i>			
SDJCR/L 12-3B	.750	.750	4.5	1.000	1.000
SDJCR/L 16-3D	1.000	1.000	6.0	1.100	1.250
Spare Parts					
Insert: DC_-21.5_	--	--	W-37016	C-1225	
Insert: DC_-32.5_	C-3714	C-1750	C-5516	C-1335	

For Inserts please refer to page 11

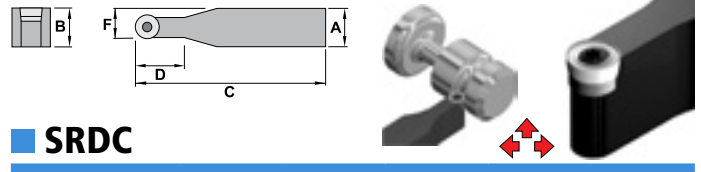

SRDC

Designation	A	B	C	D	F
<i>Insert: RC_-0803MO</i>		<i>Lead Angle: 45° Entering Angle: 45°</i>			
SRDCN 8-08J	.500	.500	3.5	.50	.407
<i>Insert: RC_-10T3MO</i>		<i>Lead Angle: 45° Entering Angle: 45°</i>			
SRDCN 10-10A	.625	.625	4.0	.63	.510
SRDCN 12-10B	.750	.750	4.5	1.00	.570
<i>Insert: RC_-1204MO</i>		<i>Lead Angle: 45° Entering Angle: 45°</i>			
SRDCN 16-12D	1.000	1.000	6.0	1.00	.756
SRDCN 20-12D	1.250	1.250	6.0	1.00	.861
Spare Parts					
Insert: RC_-0803	--	--	W-37022	C-1230	
Insert: RC_-10T3	C-3811				
Insert: RC_-1204	C-3814	C-1750	C-5516	C-1335	

For Inserts please refer to page 13

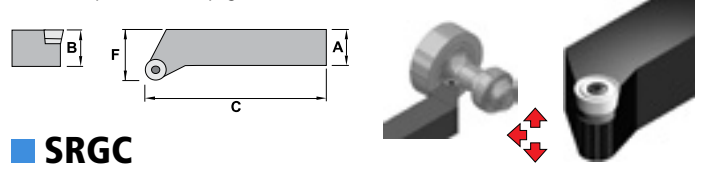

SRGC

Designation	A	B	C	F
<i>Insert: RC_-10T3MO</i>		<i>Lead Angle: 45° Entering Angle: 45°</i>		
SRGCR/L 12-10B	.750	.750	4.5	1.000
SRGCR/L 16-10D	1.000	1.000	6.0	1.250
<i>Insert: RC_-1204MO</i>		<i>Lead Angle: 45° Entering Angle: 45°</i>		
SRGCR/L 16-12D	1.000	1.000	6.0	1.250
SRGCR/L 85-12D	1.000	1.250	6.0	1.250
SRGCR/L 20-12D	1.250	1.250	6.0	1.500
Spare Parts				
Insert: RC_-10T3	C-3811			
Insert: RC_-1204	C-3814	C-1750	C-5516	C-1335

For Inserts please refer to page 13

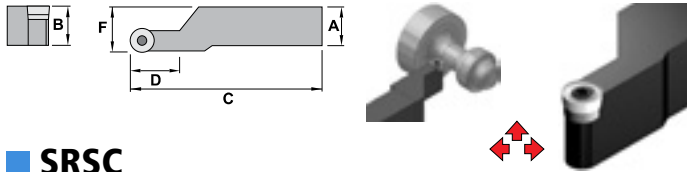

SRSC

Designation	A	B	C	D	F
<i>Insert: RC_-10T3MO</i>		<i>Lead Angle: 45° Entering Angle: 45°</i>			
SRSCR/L 16-10D	1.000	1.000	6.0	.750	1.250
SRSCR/L 20-10D	1.250	1.250	6.0	.750	1.500
<i>Insert: RC_-1204MO</i>		<i>Lead Angle: 45° Entering Angle: 45°</i>			
SRSCR/L 12-12B	.750	.750	4.5	.750	1.000
SRSCR/L 16-12D	1.000	1.000	6.0	1.000	1.250
SRSCR/L 20-12D	1.250	1.250	6.0	1.000	1.500
Spare Parts					
Insert: RC_-10T3	C-3811				
Insert: RC_-1204	C-3814	C-1750	C-5516	C-1335	

For Inserts please refer to page 13

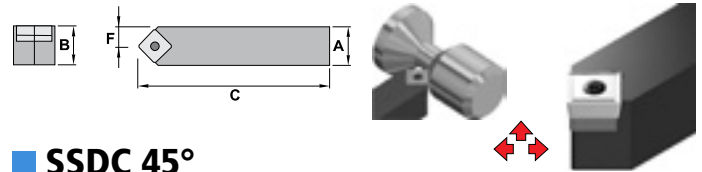

SSDC 45°

Designation	A	B	C	F
<i>Insert: SC_-32.5</i>		<i>Lead Angle: 45° Entering Angle: 45°</i>		
SSDCN 8-3J	.500	.500	3.5	.263
SSDCN 10-3A	.625	.625	4.0	.325
<i>Insert: SC_-43</i>		<i>Lead Angle: 45° Entering Angle: 45°</i>		
SSDCN 12-4B	.750	.750	4.5	.388
Spare Parts				
Insert: SC_-32.5	--	--	W-37032	C-1240
Insert: SC_-43	C-3514	C-1760	C-5517	C-1540

For Inserts please refer to page 13

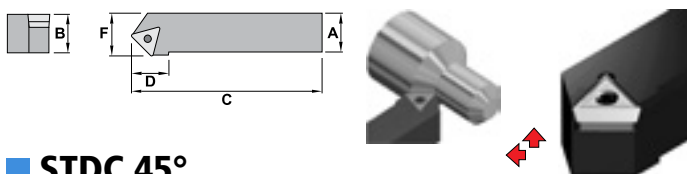

STDC 45°

Designation	A	B	C	D	F
<i>Insert: TC_-21.5</i>		<i>Lead Angle: 45° Entering Angle: 45°</i>			
STDCR/L 6-2I	.375	.375	2.5	.410	.433
STDCR/L 8-2J	.500	.500	3.5	.570	.512
<i>Insert: TC_-32.5</i>		<i>Lead Angle: 45° Entering Angle: 45°</i>			
STDCR/L 10-3A	.625	.625	4.0	1.000	.669
STDCR/L 12-3B	.750	.750	4.5	1.000	.866
STDCR/L 16-3D	1.000	1.000	6.0	1.000	1.063
Spare Parts					
Insert: TC_-21.5_	--	--	W-37016	C-1225	
Insert: TC_-32.5_	C-3414	C-1750	C-5516	C-1335	

For Inserts please refer to page 14-15

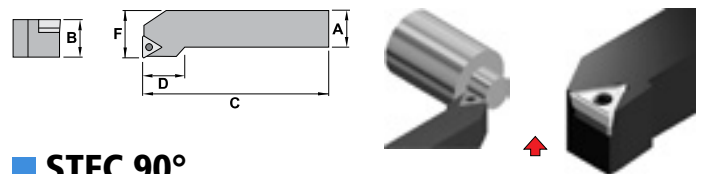

STFC 90°

Designation	A	B	C	D	F
<i>Insert: TC_-21.5</i>		<i>Lead Angle: 0° Entering Angle: 90°</i>			
STFCR/L 6-2I	.375	.375	2.5	.400	.500
STFCR/L 8-2J	.500	.500	3.5	.689	.625
<i>Insert: TC_-32.5</i>		<i>Lead Angle: 0° Entering Angle: 90°</i>			
STFCR/L 10-3A	.625	.625	4.0	1.000	.750
STFCR/L 12-3B	.750	.750	4.5	1.000	1.000
STFCR/L 16-3D	1.000	1.000	6.0	1.000	1.250
Spare Parts					
Insert: TC_-21.5_	--	--	W-37016	C-1225	
Insert: TC_-32.5_	C-3414	C-1750	C-5516	C-1335	

For Inserts please refer to page 14-15

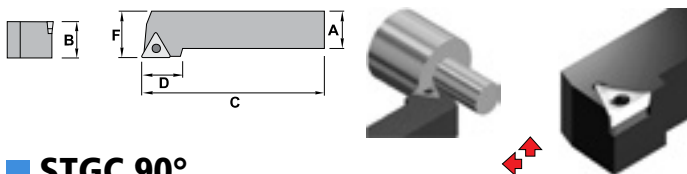

STGC 90°

Designation	A	B	C	D	F
<i>Insert: TC_-21.5</i>		<i>Lead Angle: 0° Entering Angle: 90°</i>			
STGCR/L 6-2I	.375	.375	2.5	.500	.500
STGCR/L 8-2J	.500	.500	3.5	.560	.625
<i>Insert: TC_-32.5</i>		<i>Lead Angle: 0° Entering Angle: 90°</i>			
STGCR/L 10-3A	.625	.625	4.0	1.000	.750
STGCR/L 12-3B	.750	.750	4.5	1.000	1.000
STGCR/L 16-3D	1.000	1.000	6.0	1.000	1.250
Spare Parts					
Insert: TC_-21.5_	--	--	W-37016	C-1225	
Insert: TC_-32.5_	C-3414	C-1750	C-5516	C-1335	

For Inserts please refer to page 14-15

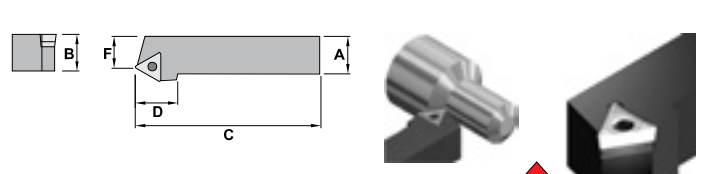

STTC 60°

Designation	A	B	C	D	F
<i>Insert: TC_-32.5</i>		<i>Lead Angle: 30° Entering Angle: 60°</i>			
STTCR/L 12-3B	.750	.750	4.5	1.000	.718
STTCR/L 16-3D	1.000	1.000	6.0	1.000	.860
Spare Parts					
Insert: TC_-32.5_	C-3414	C-1750	C-5516	C-1335	

For Inserts please refer to page 14-15

Spare Parts:					
---------------------	--	--	--	--	--

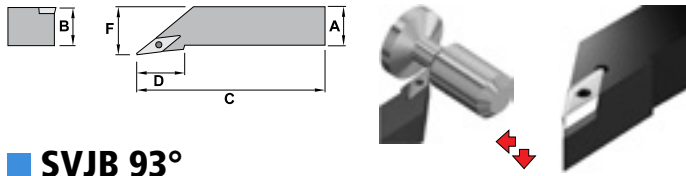

SVJB 93°

Designation	A	B	C	D	F
Insert: VBMT-33_		Lead Angle: -3° Entering Angle: 93°			
SVJBR/L 12-3B	.750	.750	4.5	1.614	1.000
SVJBR/L 16-3D	1.000	1.000	6.0	1.614	1.250
Spare Parts					
Insert: VBMT-33_	C-3718	C-1750	C-5516	C-1335	

For Inserts please refer to page 15-16

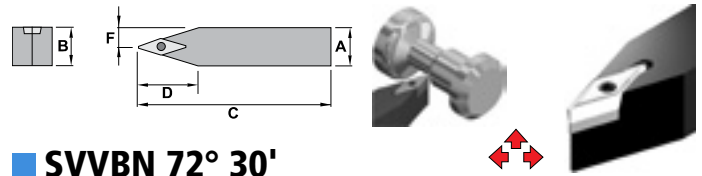

SVVBN 72° 30'

Designation	A	B	C	D	F
Insert: VBMT-33_		Lead Angle: 17.5° Entering Angle: 72.5°			
SVVBN 12-3B	.750	.750	4.5	1.212	.398
SVVBN 16-3D	1.000	1.000	6.0	1.610	.523
Spare Parts					
Insert: VBMT-33_	C-3718	C-1750	C-5516	C-1335	

For Inserts please refer to page 15-16

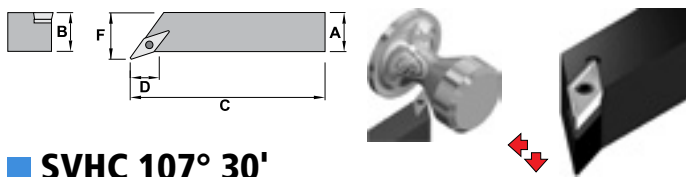

SVHC 107° 30'

Designation	A	B	C	D	F
Insert: VC_-33_		Lead Angle: -17.5° Entering Angle: 107.5°			
SVHCR/L 12-3B	.750	.750	4.5	.740	1.000
SVHCR/L 16-3D	1.000	1.000	6.0	.756	1.250
Spare Parts					
Insert: VC_-33_	C-3718	C-1750	C-5516	C-1335	

For Inserts please refer to page 15-16

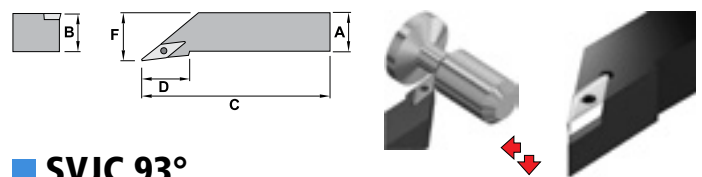

SVJC 93°

Designation	A	B	C	D	F
Insert: VC_-33_		Lead Angle: -3° Entering Angle: 93°			
SVJCR/L 12-3B	.750	.750	4.5	1.614	1.000
SVJCR/L 16-3D	1.000	1.000	6.0	1.614	1.250
SVJCR/L 20-3D	1.250	1.250	6.0	1.614	1.500
Spare Parts					
Insert: VC_-33_	C-3718	C-1750	C-5516	C-1335	

For Inserts please refer to page 15-16

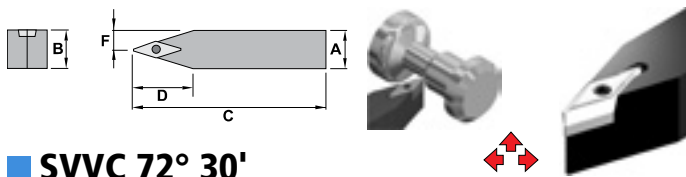

SVVC 72° 30'

Designation	A	B	C	D	F
Insert: VC_-33_		Lead Angle: 17.5° Entering Angle: 72.5°			
SVVCN 12-3B	.750	.750	4.5	1.212	.398
SVVCN 16-3D	1.000	1.000	6.0	1.610	.523
SVVCN 20-3D	1.250	1.250	6.0	2.008	.648
Spare Parts					
Insert: VC_-33_	C-3718	C-1750	C-5516	C-1335	

For Inserts please refer to page 15-16

Spare Parts:				
	Shim	Shim Screw Bushing	Key	Insert Screw

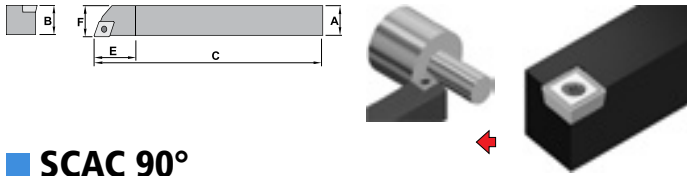

SCAC 90°

Designation	A	B	C	E	F
Insert: CC <u>-21.5</u>		Lead Angle: 0° Entering Angle: 90°			
SCACR/L 04.5-2D	.281	.281	6.0	.440	.281
SCACR/L 05-2D	.312	.312	6.0	.440	.312
SCACR/L 06-2D	.375	.375	6.0	.440	.375
Insert: CC <u>-32.5</u>		Lead Angle: 0° Entering Angle: 90°			
SCACR/L 08-3D	.500	.500	6.0	.620	.500
SCACR/L 10-3D	.625	.625	6.0	.500	.625
Spare Parts					
Insert: CC <u>-21.5</u>	W-37019		C-1225		
Insert: CC <u>-32.5</u>	W-37032		C-1240		

For Inserts please refer to page 9

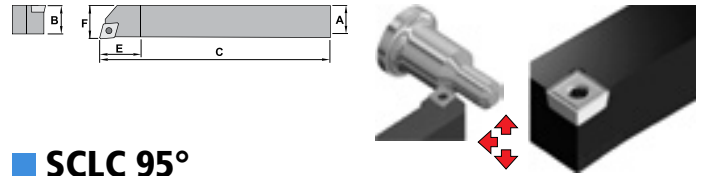

SCLC 95°

Designation	A	B	C	E	F
Insert: CC <u>-21.5</u>		Lead Angle: -5° Entering Angle: 95°			
SCLCR/L 04.5-2D	.281	.281	6.0	.500	.281
SCLCR/L 05-2D	.312	.312	6.0	.500	.312
SCLCR/L 06-2D	.375	.375	6.0	.500	.375
Insert: CC <u>-32.5</u>		Lead Angle: -5° Entering Angle: 95°			
SCLCR/L 08-3D	.500	.500	6.0	.620	.500
SCLCR/L 10-3D	.625	.625	6.0	.787	.625
Spare Parts					
Insert: CC <u>-21.5</u>	W-37019		C-1225		
Insert: CC <u>-32.5</u>	W-37032		C-1240		

For Inserts please refer to page 9

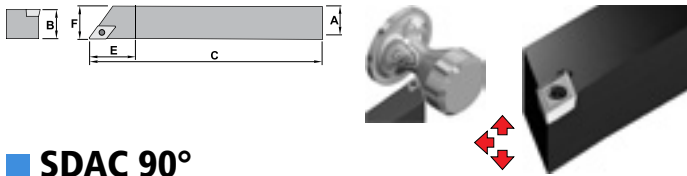

SDAC 90°

Designation	A	B	C	E	F
Insert: DC <u>-21.5</u>		Lead Angle: 0° Entering Angle: 90°			
SDACR/L 06-2D	.375	.375	6.0	.625	.375
SDACR/L 08-2D	.500	.500	6.0	.625	.500
Insert: DC <u>-32.5</u>		Lead Angle: 0° Entering Angle: 90°			
SDACR/L 08-3D	.500	.500	6.0	.875	.500
SDACR/L 10-3D	.625	.625	6.0	.875	.625
Spare Parts					
Insert: DC <u>-21.5</u>	W-37019		C-1225		
Insert: DC <u>-32.5</u>	W-37032		C-1240		

For Inserts please refer to page 11

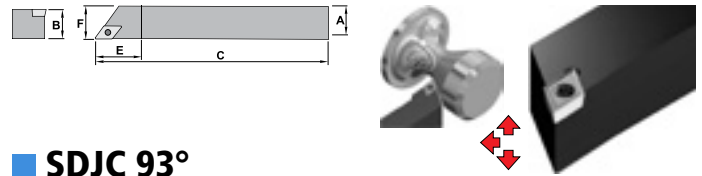

SDJC 93°

Designation	A	B	C	E	F
Insert: DC <u>-21.5</u>		Lead Angle: -3° Entering Angle: 93°			
SDJCR/L 06-2D	.375	.375	6.0	.625	.375
SDJCR/L 08-2D	.500	.500	6.0	.625	.500
Insert: DC <u>-32.5</u>		Lead Angle: -3° Entering Angle: 93°			
SDJCR/L 08-3D	.500	.500	6.0	.750	.500
SDJCR/L 10-3D	.625	.625	6.0	.750	.625
Spare Parts					
Insert: DC <u>-21.5</u>	W-37019		C-1225		
Insert: DC <u>-32.5</u>	W-37032		C-1240		

For Inserts please refer to page 11

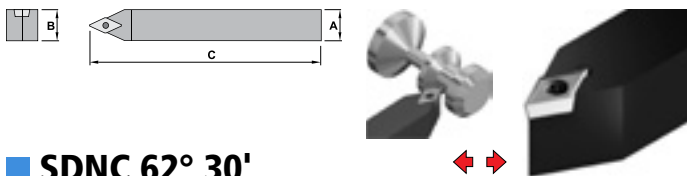

SDNC 62° 30'

Designation	A	B	C
Insert: DC <u>-21.5</u>		Lead Angle: 27.5° Entering Angle: 62.5°	
SDNCN 06-2D	.375	.375	6.0
SDNCN 08-2D	.500	.500	6.0
Insert: DC <u>-32.5</u>		Lead Angle: 27.5° Entering Angle: 62.5°	
SDNCN 08-3D	.500	.500	6.0
SDNCN 10-3D	.625	.625	6.0
Spare Parts			
Insert: DC <u>-21.5</u>	W-37019		C-1225
Insert: DC <u>-32.5</u>	W-37032		C-1240

For Inserts please refer to page 11

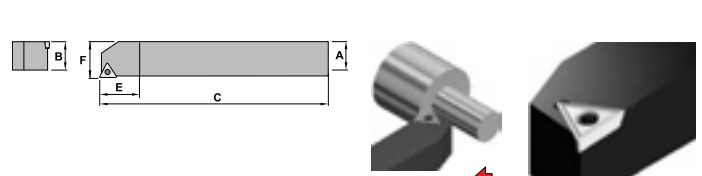

STAC 90°

Designation	A	B	C	E	F
Insert: TC <u>-21.5</u>		Lead Angle: 0° Entering Angle: 90°			
STACR/L 06-2D	.375	.375	6.0	.625	.375
STACR/L 08-2D	.500	.500	6.0	.625	.500
STACR/L 10-2D	.625	.625	6.0	.625	.625
Insert: TC <u>-32.5</u>		Lead Angle: 0° Entering Angle: 90°			
STACR/L 10-3D	.625	.625	6.0	.750	.625
Spare Parts					
Insert: TC <u>-21.5</u>	W-37019		C-1225		
Insert: TC <u>-32.5</u>	W-37032		C-1240		

For Inserts please refer to page 14-15

Spare Parts: Key Insert Screw

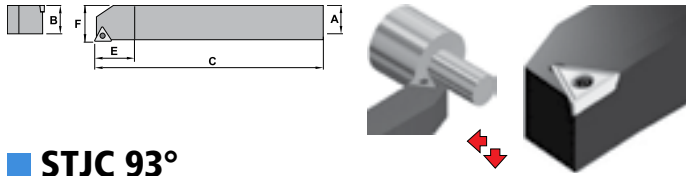

STJC 93°

Designation	A	B	C	E	F
Insert: TC_-21.5_		Lead Angle: -3°		Entering Angle: 93°	
STJCR/L 06-2D	.375	.375	6.0	.625	.375
STJCR/L 08-2D	.500	.500	6.0	.625	.500
STJCR/L 10-2D	.625	.625	6.0	.625	.625
Spare Parts					
Insert: TC_-21.5_	W-37019		C-1225		

For Inserts please refer to page 14-15

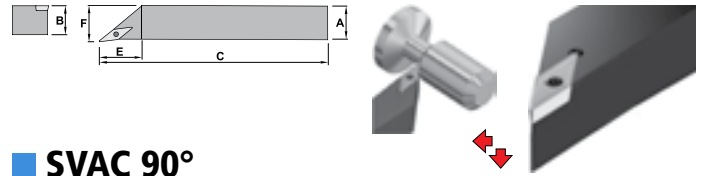

SVAC 90°

Designation	A	B	C	E	F
Insert: VC_-22_		Lead Angle: 0°		Entering Angle: 90°	
SVACR/L 06-2D	.375	.375	6.0	.875	.375
SVACR/L 08-2D	.500	.500	6.0	.875	.500
Insert: VC_-33_		Lead Angle: 0°		Entering Angle: 90°	
SVACR/L 10-3D	.625	.625	6.0	1.375	.625
Spare Parts					
Insert: VC_-22_	W-37019		C-1225		
Insert: VC_-33_	W-37032		C-1240		

For Inserts please refer to page 15-16

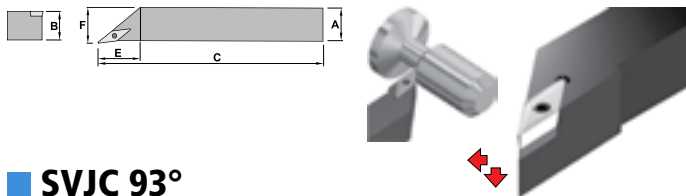

SVJC 93°

Designation	A	B	C	E	F
Insert: VC_-22_		Lead Angle: -3°		Entering Angle: 93°	
SVJCR/L 06-2D	.375	.375	6.0	.940	.375
SVJCR/L 08-2D	.500	.500	6.0	.940	.500
Insert: VC_-33_		Lead Angle: -3°		Entering Angle: 93°	
SVJCR/L 10-3D	.625	.625	6.0	1.181	.625
Spare Parts					
Insert: VC_-22_	W-37019		C-1225		
Insert: VC_-33_	W-37032		C-1240		

For Inserts please refer to page 15-16

Precision Ground Small Radius Inserts for Swiss Machine Applications

Ground 35 & 55 degree inserts with radii starting at .003"

1/4 and 3/8 IC inserts in two chipbreaker configurations for high performance close tolerance work.

AS15F grade for long tool life in all steel and stainless steel materials as well as hi-temp alloys and titanium.





(C) Clamp Lock

The classic positive insert clamping system is designed to hold flat positive inserts, both with additional or sintered chipbreaker.

PG... 45

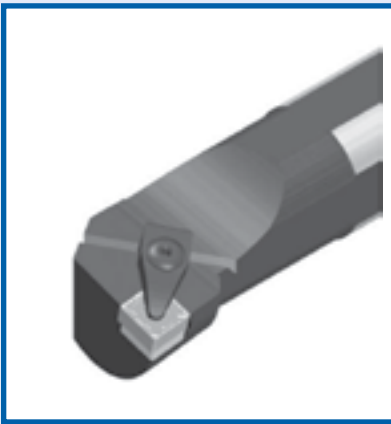

(D) Dimple Lock

The "D" clamping system avoids insert movement during high feed or heavily interrupted machining, due to its accurate indexing that holds the insert securely clamped.

PG... 45



(M) Double Lock

The double lock system offers good rigidity in negative insert clamping, it is the first choice for center hole negative carbide and ceramic inserts.

PG... 46



(S) Center Screw

Since the advent of the TORX screw it has been possible to hold with complete safety positive inserts with center hole. Our range covers all the screw fixing permutations.

PG... 49

S	16	T	-	M	T	U	N	R	-	3
1	2	3		4	5	6	7	8		9

1) Bar Type	
A	Steel Shank with Internal Coolant
H	Anti-Vibration Shank (Heavy Metal)
J	Anti-Vibration Shank (Heavy Metal with Internal Coolant)
S	Steel Shank

2) Bar Diameter, Inch			
06	0.375	20	1.250
08	0.500	24	1.500
10	0.625	28	1.750
12	0.750	32	2.000
16	1.000	40	2.500

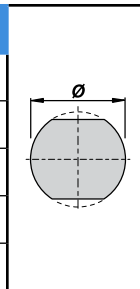

3) Bar Length, Inch			
H	4.0	M	6.0
J	4.5	R	8.0
K	5.0	S	10.0
		T	12.0
		U	14.0
		V	16.0

4) Holding Method			
C	D	M	S
Top Clamp	Dimple Lock	Double Lock	Center Screw

5) Insert Shape			
C 	D 	E 	K
S 	T 	V 	W

6) Bar Style		
F 	K 	L
Q 	U 	U-EX

8) Hand of Tool		
Left 	Right 	Neutral

7) Insert Clearance Angle			
B 	C 	N 	P
5° Positive	7° Positive	0° Negative	11° Positive

9) Insert I.C. Size
Insert I.C. (I.C.) shown in 1/8" increments <div style="text-align: center;"></div>

Please Note: Cutter Designation

R/L - Please choose right or left hand designation.
 Example ordering code: S16T-DCLNR-4

Clamp Lock Boring Bars

Dimple Lock Boring Bars

CSKP 75°

page 45 SP.. 43..
SP.. 63..

CTFP 90°

page 45 TP.. 32..
TP.. 43..

DCLN 95°

page 45 CN.. 43..

DDUN 93°

page 45 DN.. 43..

Double Lock Boring Bars

MCLN 95°

page 46 CN.. 43..
CN.. 54..
CN.. 64..

MDUN 93°

page 46 DN.. 43..
DN.. 54..

MSKN 75°

page 47 SNM.. 43..
SNM.. 54..
SNM.. 64..

MTUN 93°

page 47 TNM.. 33..
TNM.. 43..
TNM.. 54..

MTFN 90°

page 47 TNM.. 33..
TNM.. 43..

MVUN 93°

page 48 VN.. 33..
VN.. 43..

MWLN 95°

page 48 WNMG
43..

Center Screw Boring Bars

SCLC 95°

page 49 CC.. 21.5..
CC.. 32.5..
CC.. 43..

SDUC 93°

page 49 DC.. 21.5..
DC.. 32.5..

SDUC 93° -EX

page 49 DC.. 21.5..
DC.. 32.5..

SSKC 75°

page 50 SC.. 32.5..

STFC 90°

page 50 TC.. 21.5..
TC.. 32.5..

SVQC 107° 30'

page 50 VC.. 33..

SVUC 93°

page 50 VC.. 22..
VC.. 33..

SVUB 93°

page 50 VB.. 33..

Sets

SET-SCLC-I 95°

page 51 CC.. 21.5..

SET-SDUC-I 93°

page 51 DC.. 21.5..

SET-SDQC-I 107° 30'

page 51 DC.. 21.5..

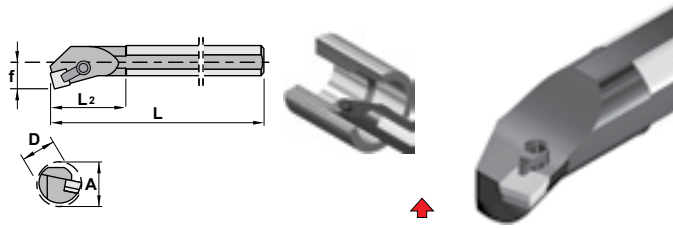

CSKP 75°

Designation	Min. Bore A	D	L	L ²	f
<i>Insert: SP_-42_</i>		<i>Lead Angle: 15° Entering Angle: 75°</i>			
S16T-CSKPR/L-4	1.180	1.000	12.0	2.50	0.640
S20U-CSKPR/L-4	1.154	1.250	14.0	3.00	0.765
S24U-CSKPR/L-4	1.800	1.500	14.0	3.00	0.890
S28U-CSKPR/L-4	2.040	1.750	14.0	4.00	1.015
<i>Insert: SP_-63_</i>		<i>Lead Angle: 15° Entering Angle: 75°</i>			
S24U-CSKPR/L-6	2.060	1.500	14.0	3.00	0.890
S28U-CSKPR/L-6	2.340	1.750	14.0	3.00	1.015
S32V-CSKPR/L-6	2.580	2.000	16.0	4.00	1.281
S40V-CSKPR/L-6	3.080	2.500	16.0	4.00	1.531
Spare Parts					
S16T	-	-		XNS-47	
SP_-42_			CL-20		W-35226
S20U	C-3112	C-4002		XNS-48	
S24U				XNS-47	
S28U					
SP_-63_			CL-22	XNS-48	W-35232
S24U	C-3119	C-4012			
S28U					
S32V					
S40V					

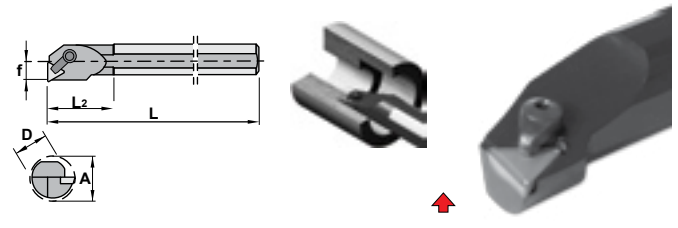

CTFP 90°

Designation	Min. Bore A	D	L	L ²	f
<i>Insert: TP_-32_</i>		<i>Lead Angle: 0° Entering Angle: 90°</i>			
S16T-CTFPR/L-3	1.220	1.000	12.0	2.50	.640
S20U-CTFPR/L-3	1.600	1.250	14.0	3.00	.765
S24U-CTFPR/L-3	1.840	1.500	14.0	3.00	.890
S28U-CTFPR/L-3	2.100	1.750	14.0	4.00	1.015
<i>Insert: TP_-43_</i>		<i>Lead Angle: 0° Entering Angle: 90°</i>			
S24U-CTFPR/L-4	2.120	1.500	14.0	3.00	.890
S28U-CTFPR/L-4	2.380	1.750	14.0	3.00	1.015
S32V-CTFPR/L-4	2.620	2.000	16.0	4.00	1.281
S40V-CTFPR/L-4	3.120	2.500	16.0	4.00	1.531
Spare Parts					
S16T	-	-	CL-7	XNS-34	
TP_-32_					W-35222
S20U	C-3116	C-4002		XNS-36	
S24U			CL-6		
S28U					
TP_-43_			CL-20	XNS-48	W-35226
S24U	C-3122	C-4012		XNS-47	
S28U					
S32V					
S40V					

For Inserts please refer to page 15

Dimple Lock Boring Bars

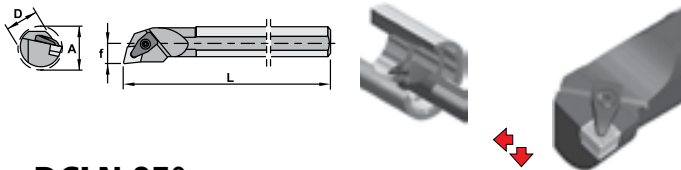

DCLN 95°

Designation	Min. Bore A	D	L	L ²	f
<i>Insert: CNM_-43_</i>		<i>Lead Angle: -5° Entering Angle: 95°</i>			
S16T-DCLNR/L-4	1.280	1.000	12.0	2.50	.640
S20U-DCLNR/L-4	1.530	1.250	14.0	3.00	.765
S24U-DCLNR/L-4	1.780	1.500	14.0	3.00	.890
Spare Parts					
<i>Insert: CNM_-43_</i>					
S16T...	C-3612	C-1765	C-2312	C-1907	C-4295
S20U... & S24U...	ICSN-432	C-1160			W-35232

For Inserts please refer to page 9-11

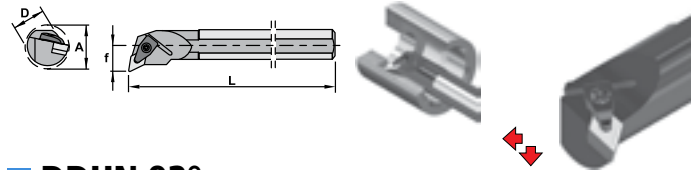

DDUN 93°

Designation	Min. Bore A	D	L	L ²	f
<i>Insert: DNM_-43_</i>		<i>Lead Angle: -3° Entering Angle: 93°</i>			
S20U-DDUNR/L-4	1.530	1.250	14.0	2.50	.765
S24U-DDUNR/L-4	1.780	1.500	14.0	3.00	.890
Spare Parts					
<i>Insert: DNM_-43_</i>					
S20U...	IDSN-432	C-1161	C-2312	C-1907	C-4295
S24U...	IDSN-432	C-1160			W-35232

For Inserts please refer to page 11-13

Spare Parts: Shim Shim Screw Clamp Clamp Screw Spring Key

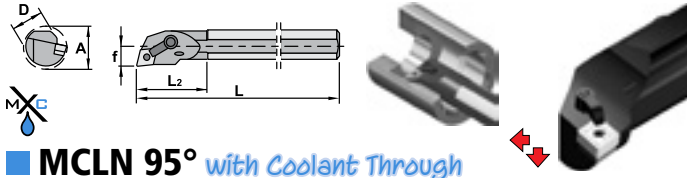

MCLN 95° with Coolant Through

Designation	Min. Bore A	D	L	L ²	f	
Insert: CNM_-43_ Lead Angle: -5° Entering Angle: 95°						
A16T-MCLNR/L-4	1.280	1.000	12.0	2.50	.640	
A20U-MCLNR/L-4	1.530	1.250	14.0	3.00	.765	
A24U-MCLNR/L-4	1.780	1.500	14.0	3.00	.890	
A28U-MCLNR/L-4	2.030	1.750	14.0	4.00	1.015	
Insert: CNM_-54_ Lead Angle: -5° Entering Angle: 95°						
A32V-MCLNR/L-5	2.562	2.000	16.0	4.00	1.281	
Insert: CNM_-64_ Lead Angle: -5° Entering Angle: 95°						
A32V-MCLNR/L-6	2.562	2.000	16.0	4.00	1.281	
Spare Parts						
Insert: A16T..	--	NL-44	W-35222	CL-20	XNS-47	W-35226
CNM_-43_- A20/24/28 U	ICSN-432	NL-46	W-35222	CL-20	XNS-48	W-35226
Insert: CNM_-54_	ICSN-533	NL-58	W-35226	CL-12	XNS-510	W-35232
Insert: CNM_-64_	ICSN-633	NL-68	W-35228			

For Inserts please refer to page 9-11

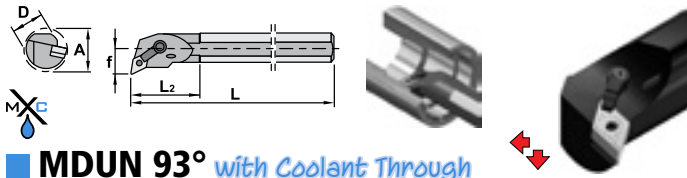

MDUN 93° with Coolant Through

Designation	Min. Bore A	D	L	L ²	f	
Insert: DN_-43_ Lead Angle: -3° Entering Angle: 93°						
A16T-MDUNR/L-4	1.750	1.000	12.0	2.50	.875	
A20U-MDUNR/L-4	2.000	1.250	14.0	3.00	1.000	
A24U-MDUNR/L-4	2.250	1.500	14.0	3.00	1.125	
A32V-MDUNR/L-4	3.000	2.000	16.0	4.00	1.500	
Spare Parts						
Insert: DNM_-43_						
A16T...	--	NL-44	W-35222	CL-20	XNS-47	W-35226
A20/24 U /32 V	IDSN-432	NL-46	W-35222	CL-20	XNS-48	W-35226

For Inserts please refer to page 11-13

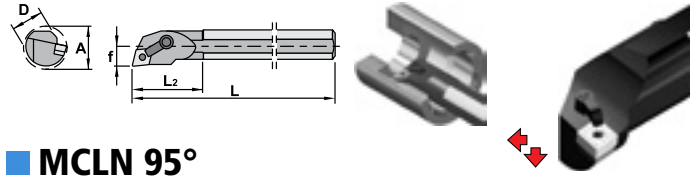

MCLN 95°

Designation	Min. Bore A	D	L	L ²	f	
Insert: CNM_-43_ Lead Angle: -5° Entering Angle: 95°						
S16T-MCLNR/L-4	1.280	1.000	12.0	2.50	.640	
S20U-MCLNR/L-4	1.530	1.250	14.0	3.00	.765	
S24U-MCLNR/L-4	1.780	1.500	14.0	3.00	.890	
S28U-MCLNR/L-4	2.030	1.750	14.0	4.00	1.015	
S32V-MCLNR/L-4	2.562	2.000	16.0	4.00	1.281	
S40V-MCLNR/L-4	3.062	2.500	16.0	4.00	1.531	
Insert: CNM_-54_ Lead Angle: -5° Entering Angle: 95°						
S32V-MCLNR/L-5	2.562	2.000	16.0	4.00	1.281	
S40V-MCLNR/L-5	3.062	2.500	16.0	4.00	1.531	
Insert: CNM_-64_ Lead Angle: -5° Entering Angle: 95°						
S32V-MCLNR/L-6	2.562	2.000	16.0	4.00	1.281	
S40V-MCLNR/L-6	3.062	2.500	16.0	4.00	1.531	
Spare Parts						
Insert: S16T..	--	NL-44	W-35222	CL-20	XNS-47	W-35226
CNM_-S20/24/28 U / 43_- S32/40 V	ICSN-432	NL-46	W-35222	CL-20	XNS-48	W-35226
Insert: CNM_-54_	ICSN-533	NL-58	W-35226	CL-12	XNS-510	W-35232
Insert: CNM_-64_	ICSN-633	NL-68	W-35228			

For Inserts please refer to page 9-11

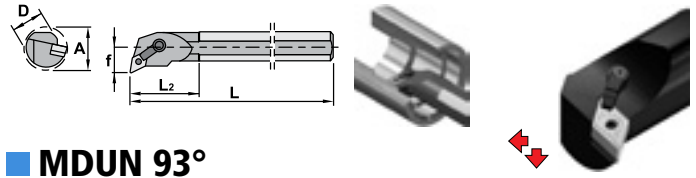

MDUN 93°

Designation	Min. Bore A	D	L	L ²	f	
Insert: DN_-43_ Lead Angle: -3° Entering Angle: 93°						
S16T-MDUNR/L-4	1.750	1.000	12.0	2.50	.875	
S20U-MDUNR/L-4	2.000	1.250	14.0	3.00	1.000	
S24U-MDUNR/L-4	2.250	1.500	14.0	3.00	1.125	
S32V-MDUNR/L-4	3.000	2.000	16.0	4.00	1.500	
Insert: DN_-54_ Lead Angle: -3° Entering Angle: 93°						
S32V-MDUNR/L-5	3.000	2.000	16.0	4.00	1.500	
S40V-MDUNR/L-5	3.500	2.500	16.0	4.00	1.750	
Spare Parts						
Insert: S16T...	--	NL-44	W-35222	CL-20	XNS-47	W-35226
DNM_-S20/24 U / 43_- S32 V	IDSN-432	NL-46	W-35222	CL-20	XNS-48	W-35226
Insert: DNM_-54_	IDSN-533	NL-58	W-35226	CL-12	XNS-510	W-35232

For Inserts please refer to page 11-13



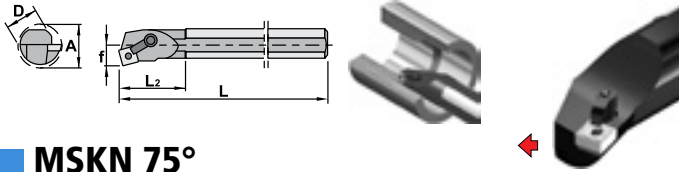

MSKN 75°

Designation	Min. Bore A	D	L	L ²	f
Insert: SNM_-43_		Lead Angle: 15° Entering Angle: 75°			
S20U-MSKNR/L-4	1.530	1.250	14.0	3.00	.765
S24U-MSKNR/L-4	1.780	1.500	14.0	3.00	.890
Insert: SNM_-54_		Lead Angle: 15° Entering Angle: 75°			
S32V-MSKNR/L-5	2.562	2.000	16.0	4.00	1.281
Insert: SNM_-64_		Lead Angle: 15° Entering Angle: 75°			
S32V-MSKNR/L-6	2.562	2.000	16.0	4.00	1.281
S40V-MSKNR/L-6	3.062	2.500	16.0	4.00	1.531
Spare Parts					
Insert: SNM_-43_	ISSN-432	NL-46	W-35222	CL-20	XNS-48 W-35226
Insert: SNM_-54_	ISSN-533	NL-58	W-35226	CL-12	XNS-510 W-35232
Insert: SNM_-64_	ISSN-633	NL-68	W-35228		

For Inserts please refer to page 13-14

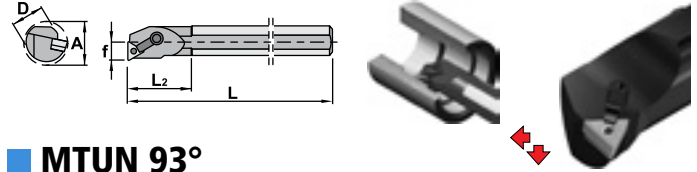

MTUN 93°

Designation	Min. Bore A	D	L	L ²	f
Insert: TNM_-33_		Lead Angle: -3° Entering Angle: 93°			
S16T-MTUNR/L-3	1.280	1.000	12.0	2.50	.640
S20U-MTUNR/L-3	1.530	1.250	14.0	3.00	.765
Insert: TNM_-43_		Lead Angle: -3° Entering Angle: 93°			
S24U-MTUNR/L-4	1.780	1.500	14.0	3.00	.890
Spare Parts					
Insert: S16T...	--	NL-33L	W-35218	CL-20	XNS-47 W-35226
TNM_-33_ S20U...	ITSN-322	NL-34L			XNS-48
Insert: TNM_-43_	ITSN-433	NL-46	W-35222	CL-20	XNS-48 W-35226

For Inserts please refer to page 15

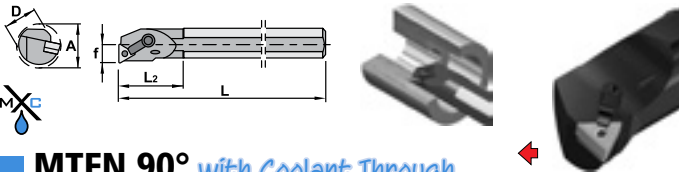

MTFN 90° with Coolant Through

Designation	Min. Bore A	D	L	L ²	f
Insert: TNM_-33_		Lead Angle: 0° Entering Angle: 90°			
A16T-MTFNR/L-3	1.280	1.000	12.0	2.50	.640
A20U-MTFNR/L-3	1.530	1.250	14.0	3.00	.765
Insert: TNM_-43_		Lead Angle: 0° Entering Angle: 90°			
A24U-MTFNR/L-4	1.780	1.500	14.0	3.00	.890
A28U-MTFNR/L-4	2.030	1.750	14.0	4.00	1.015
A32V-MTFNR/L-4	2.562	2.000	16.0	4.00	1.281
Spare Parts					
Insert: A16T...	--	NL-33L	W-35218	CL-20	XNS-47 W-35226
TNM_-33_ A20U...	ITSN-322	NL-34L			XNS-48
Insert: TNM_-43_	ITSN-433	NL-46	W-35222	CL-20	XNS-48 W-35226

For Inserts please refer to page 15

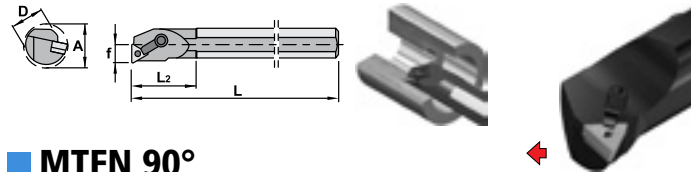

MTFN 90°

Designation	Min. Bore A	D	L	L ²	f
Insert: TNM_-33_		Lead Angle: 0° Entering Angle: 90°			
S16T-MTFNR/L-3	1.280	1.000	12.0	2.50	.640
S20U-MTFNR/L-3	1.530	1.250	14.0	3.00	.765
S24U-MTFNR/L-3	1.780	1.500	14.0	3.00	.890
Insert: TNM_-43_		Lead Angle: 0° Entering Angle: 90°			
S20U-MTFNR/L-4	1.530	1.250	14.0	3.00	.765
S24U-MTFNR/L-4	1.780	1.500	14.0	3.00	.890
S28U-MTFNR/L-4	2.030	1.750	14.0	4.00	1.015
S32V-MTFNR/L-4	2.562	2.000	16.0	4.00	1.281
S40V-MTFNR/L-4	3.062	2.500	16.0	4.00	1.531
Insert: TNM_-54_		Lead Angle: 0° Entering Angle: 90°			
S32V-MTFNR/L-5	2.562	2.000	16.0	4.00	1.281
Spare Parts					
Insert: S16T...	--	NL-33L	W-35218	CL-20	XNS-47 W-35226
TNM_-33_ S20/24 U...	ITSN-322	NL-34L			XNS-48
Insert: TNM_-43_	ITSN-433	NL-46	W-35222	CL-20	XNS-48 W-35226
Insert: TNM_-54_	ITSN-533	NL-58	W-35226	CL-12	XNS-510 W-35232

For Inserts please refer to page 15



MVUN 93° with Coolant Through

Designation	Min. Bore A	D	L	L ²	f	
<i>Insert: VN_-33_ Lead Angle: -3° Entering Angle: 93°</i>						
A16T-MVUNR/L-3	2.000	1.000	12.0	2.50	1.000	
A20U-MVUNR/L-3	2.250	1.250	14.0	3.00	1.125	
A24U-MVUNR/L-3	2.500	1.500	14.0	3.00	1.250	
Spare Parts						
<i>Insert: VN_-33_</i>						
A16T...	IVSN-322	NL-34L	W-35218	CL-22	XNS-47	W-35226
A20U... & A24U...	IVSN-322	NL-34L			XNS-48	

For Inserts please refer to page 16

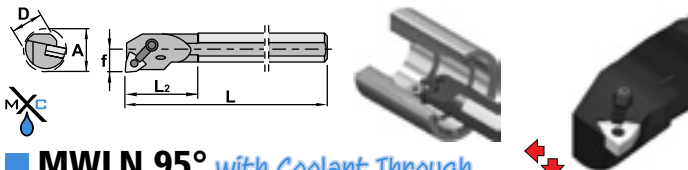

MWLN 95° with Coolant Through

Designation	Min. Bore A	D	L	L ²	f	
<i>Insert: WNM_-43_ Lead Angle: -5° Entering Angle: 95°</i>						
A16T-MWLNLR/L-4	1.280	1.000	12.0	2.50	.640	
A20U-MWLNLR/L-4	1.530	1.250	14.0	3.00	.765	
A24U-MWLNLR/L-4	1.780	1.500	14.0	3.00	.890	
Spare Parts						
<i>Insert: WNM_-43_</i>						
A16T...	--	NL-44	W-35222	CL-20	XNS-47	W-35226
A20U... & A24U...	IWSN-433	NL-46			XNS-48	

For Inserts please refer to page 16-17

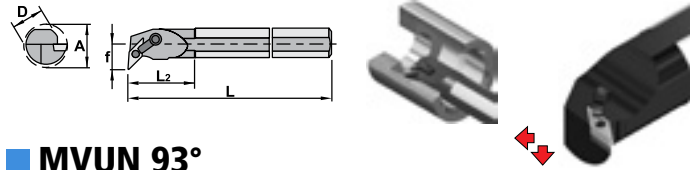

MVUN 93°

Designation	Min. Bore A	D	L	L ²	f	
<i>Insert: VN_-33_ Lead Angle: -3° Entering Angle: 93°</i>						
S16T-MVUNR/L-3	2.000	1.000	12.0	2.50	1.000	
S20U-MVUNR/L-3	2.250	1.250	14.0	3.00	1.125	
S24U-MVUNR/L-3	2.500	1.500	14.0	3.00	1.250	
<i>Insert: VN_-43_ Lead Angle: -3° Entering Angle: 93°</i>						
S32V-MVUNR/L-4	3.250	2.000	16.0	4.00	1.500	
S40V-MVUNR/L-4	3.750	2.500	16.0	4.00	1.750	
Spare Parts						
<i>Insert: S16T..</i>						
VN_-33_	IVSN-322	NL-34L	W-35218	CL-22	XNS-47	W-35226
	S20/24 U				XNS-48	
<i>Insert: VN_-43_</i>						
	IVSN-433	NL-46	W-35222	CL-12	XNS-510	W-35232

For Inserts please refer to page 16

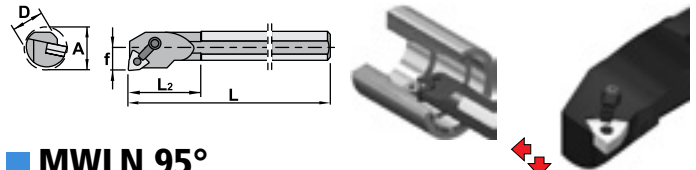

MWLN 95°

Designation	Min. Bore A	D	L	L ²	f	
<i>Insert: WNM_-43_ Lead Angle: -5° Entering Angle: 95°</i>						
S16T-MWLNLR/L-4	1.280	1.000	12.0	2.50	.640	
S20U-MWLNLR/L-4	1.530	1.250	14.0	3.00	.765	
S24U-MWLNLR/L-4	1.780	1.500	14.0	3.00	.890	
Spare Parts						
<i>Insert: WNM_-43_</i>						
S16T...	--	NL-44	W-35222	CL-20	XNS-47	W-35226
S20U... & S24U...	IWSN-433	NL-46			XNS-48	

For Inserts please refer to page 16-17



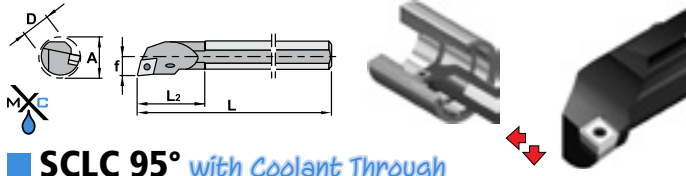

SCLC 95° with Coolant Through

Designation	Min. Bore A	D	L	L ²	f
<i>Insert: CC_-21.5_ Lead Angle: -5° Entering Angle: 95°</i>					
A06M-SCLCR/L-2	.500	.375	6.0	.830	.250
A08M-SCLCR/L-2	.625	.500	6.0	.910	.312
A10R-SCLCR/L-2	.812	.625	8.0	1.060	.406
<i>Insert: CC_-32.5_ Lead Angle: -5° Entering Angle: 95°</i>					
A10R-SCLCR/L-3	.812	.625	8.0	1.060	.406
A12S-SCLCR/L-3	1.000	.750	10.0	1.580	.500
Spare Parts					
Insert: CC_-21.5_	--	--	W-37019	C-1425	
Insert: CC_-32.5_	--	--	W-37032	C-1440	

For Inserts please refer to page 9

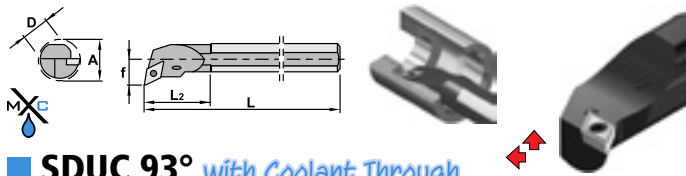

SDUC 93° with Coolant Through

Designation	Min. Bore A	D	L	L ²	f
<i>Insert: DC_-21.5_ Lead Angle: -3° Entering Angle: 93°</i>					
A06M-SDUCR/L-2	.750	.375	6.0	.830	.375
A08M-SDUCR/L-2	.875	.500	6.0	.910	.438
A10R-SDUCR/L-2	1.000	.625	8.0	1.060	.500
<i>Insert: DC_-32.5_ Lead Angle: -3° Entering Angle: 93°</i>					
A12S-SDUCR/L-3	1.250	.750	10.0	1.580	.625
Spare Parts					
Insert: A06M... DC_-21.5_ A08M / A10R...	--	--	W-37019	C-1425	
Insert: DC_-32.5_	--	--	W-37032	C-1240	

For Inserts please refer to page 11

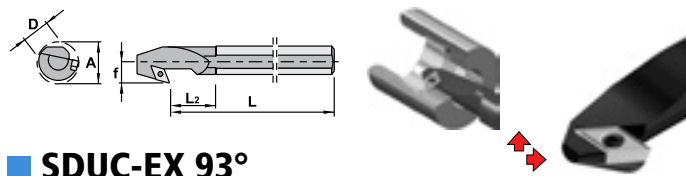

SDUC-EX 93°

Designation	Min. Bore A	D	L	L ²	f
<i>Insert: DC_-21.5_ Lead Angle: -3° Entering Angle: 93°</i>					
S12S-SDUCR/L-2EX	1.250	.750	10.0	.760	.625
S16T-SDUCR/L-2DX	1.500	1.000	12.0	1.000	.750
<i>Insert: DC_-32.5_ Lead Angle: -3° Entering Angle: 93°</i>					
S20U-SDUCR/L-3X	1.750	1.250	14.0	1.270	.765
Spare Parts					
Insert: DC_-21.5_	--	--	W-37019	C-1225	
Insert: DC_-32.5_	C-3714	C-1750	C-5516	C-1335	

For Inserts please refer to page 11

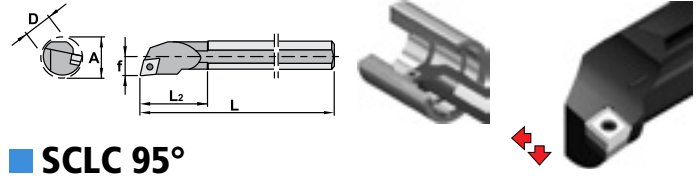

SCLC 95°

Designation	Min. Bore A	D	L	L ²	f
<i>Insert: CC_-21.5_ Lead Angle: -5° Entering Angle: 95°</i>					
S06M-SCLCR/L-2	.500	.375	6.0	.830	.250
S08M-SCLCR/L-2	.625	.500	6.0	.910	.312
S10R-SCLCR/L-2	.812	.625	8.0	1.060	.406
<i>Insert: CC_-32.5_ Lead Angle: -5° Entering Angle: 95°</i>					
S10R-SCLCR/L-3	.812	.625	8.0	1.060	.406
S12S-SCLCR/L-3	1.000	.750	10.0	1.580	.500
S16T-SCLCR/L-3	1.280	1.000	12.0	1.810	.640
<i>Insert: CC_-43_ Lead Angle: -5° Entering Angle: 95°</i>					
S16T-SCLCR/L-4	1.280	1.000	12.0	3.000	.640
S20U-SCLCR/L-4	1.530	1.250	14.0	3.000	.765
S24V-SCLCR/L-4	1.780	1.500	15.75	3.000	.890
Spare Parts					
Insert: CC_-21.5_	--	--	W-37019	C-1425	
Insert: CC_-32.5_	--	--	W-37032	C-1440	
Insert: S16T... CC_-43_ S20/24 U...	--	--	W-37036	C-1250	
	C-3614	C-1760	C-5517	C-1540	

For Inserts please refer to page 9

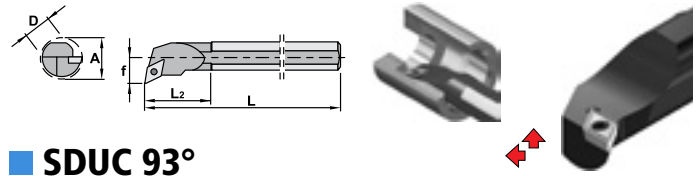

SDUC 93°

Designation	Min. Bore A	D	L	L ²	f
<i>Insert: DC_-21.5_ Lead Angle: -3° Entering Angle: 93°</i>					
S06M-SDUCR/L-2	.750	.375	6.0	.830	.375
S08M-SDUCR/L-2	.875	.500	6.0	.910	.438
S10R-SDUCR/L-2	1.000	.625	8.0	1.060	.500
<i>Insert: DC_-32.5_ Lead Angle: -3° Entering Angle: 93°</i>					
S12S-SDUCR/L-3	1.250	.750	10.0	1.580	.625
S16T-SDUCR/L-3	1.500	1.000	12.0	1.810	.750
S20U-SDUCR/L-3	1.750	1.250	14.0	1.890	.875
Spare Parts					
Insert: S06M... DC_-21.5_ S08M / S10R...	--	--	W-37019	C-1425	
				C-1225	
Insert: S12S... DC_-32.5_ S16T...	--	--	W-37032	C-1240	
				C-1335	
	C-3714	C-1750	C-5516	C-1335	

For Inserts please refer to page 11

Spare Parts: Shim Bushing Key Shim Screw

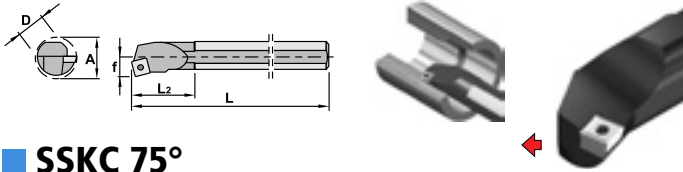

SSKC 75°

Designation	Min. Bore A	D	L	L ²	f
Insert: SC _-32.5		Lead Angle: 15° Entering Angle: 75°			
S10R-SSKCR/L-3	.812	.625	8.0	1.060	.406
S12S-SSKCR/L-3	1.000	.750	10.0	1.580	.500
S16T-SSKCR/L-3	1.280	1.000	12.0	1.810	.640
Spare Parts					
Insert: SC _-32.5					
S10R...	W-37032			C-1440	
S12S... & S16T				C-1240	

For Inserts please refer to page 13

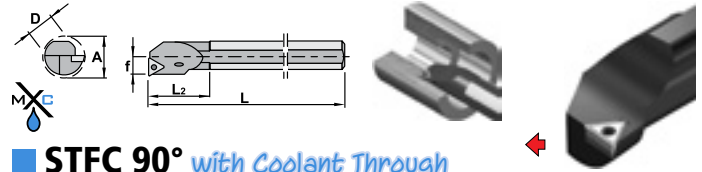

STFC 90° with Coolant Through

Designation	Min. Bore A	D	L	L ²	f
Insert: TC _-21.5		Lead Angle: 0° Entering Angle: 90°			
A06M-STFCR/L-2	.500	.375	6.0	.850	.250
A08M-STFCR/L-2	.625	.500	6.0	.800	.312
A10R-STFCR/L-2	.812	.625	8.0	.960	.406
A12S-STFCR/L-2	1.000	.750	10.0	1.420	.500
Spare Parts					
Insert: TC _-21.5					
A06M... & A08M...	--			W-37019 C-1425	
A10R... & A12S...	--			W-37019 C-1225	

For Inserts please refer to page 14-15

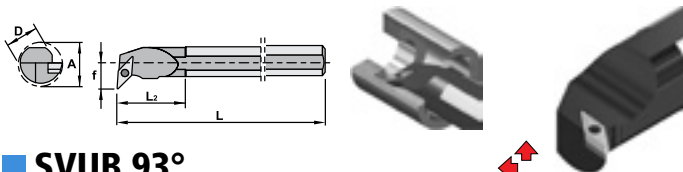

SVUB 93°

Designation	Min. Bore A	D	L	L ²	f
Insert: VB _-33		Lead Angle: -3° Entering Angle: 93°			
S20U-SVUBR/L-3	2.000	1.250	14.0	3.000	1.000
S24V-SVUBR/L-3	2.250	1.500	15.75	3.000	1.125
S32W-SVUBR/L-3	2.750	2.000	17.75	4.000	1.375
Spare Parts					
Insert: VB _-33					
	C-3718	C-1750	C-5516	C-1335	

For Inserts please refer to page 15-16

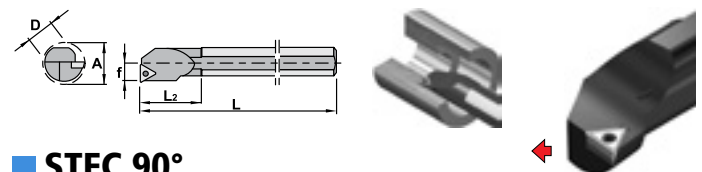

STFC 90°

Designation	Min. Bore A	D	L	L ²	f
Insert: TC _-21.5		Lead Angle: 0° Entering Angle: 90°			
S06M-STFCR/L-2	.500	.375	6.0	.850	.250
S08M-STFCR/L-2	.625	.500	6.0	.800	.312
S10R-STFCR/L-2	.812	.625	8.0	.960	.406
S12S-STFCR/L-2	1.000	.750	10.0	1.420	.500
Insert: TC _-32.5		Lead Angle: 0° Entering Angle: 90°			
S16T-STFCR/L-3	1.280	1.000	12.0	1.930	.640
S20U-STFCR/L-3	1.530	1.250	14.0	1.970	.765
S24V-STFCR/L-3	1.780	1.500	15.75	2.360	.890
Spare Parts					
Insert: TC _-21.5					
S06M... & S08M...	--			W-37019 C-1425	
S10R... & S12S...	--			W-37019 C-1225	
Insert: TC _-32.5					
S16T...	--			W-37032 C-1240	
S20U... & S24V...	C-3414	C-1750	C-5516	C-1335	

For Inserts please refer to page 14-15

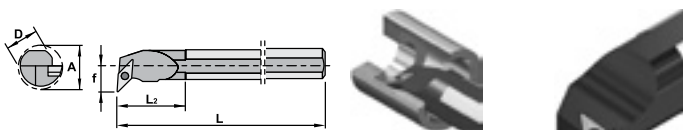

SVUC 93°

Designation	Min. Bore A	D	L	L ²	f
Insert: VC _-22		Lead Angle: -3° Entering Angle: 93°			
S10R-SVUCR/L-2	.867	.625	8.0	1.060	.500
S12S-SVUCR/L-2	1.060	.750	10.0	1.580	.625
S16T-SVUCR/L-2	1.300	1.000	12.0	1.810	.750
Insert: VC _-33		Lead Angle: -3° Entering Angle: 93°			
S20U-SVUCR/L-3	2.000	1.250	14.0	3.000	1.000
S24V-SVUCR/L-3	2.250	1.500	15.75	3.000	1.125
S32W-SVUCR/L-3	2.750	2.000	17.75	4.000	1.375
Spare Parts					
Insert: VC _-22					
	--	--	W-37019		C-1225
Insert: VC _-33					
	C-3718	C-1750	C-5516	C-1335	

For Inserts please refer to page 15-16

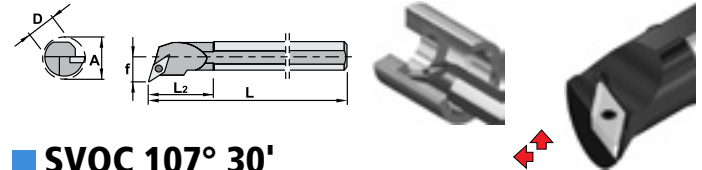

SVQC 107° 30'

Designation	Min. Bore A	D	L	L ²	f
Insert: VC _-33		Lead Angle: -17.5° Entering Angle: 107.5°			
S16T-SVQCR/L-3	1.375	1.000	12.0	.91	.750
S20U-SVQCR/L-3	1.625	1.250	14.0	1.06	.875
S24V-SVQCR/L-3	2.000	1.500	15.75	1.37	1.063
Spare Parts					
Insert: VC _-33					
S16T...	--			W-37032 C-1240	
S20U... & S24V	C-3718	C-1750	C-5516	C-1335	

For Inserts please refer to page 15-16

TV Carb Boring Bar Sets

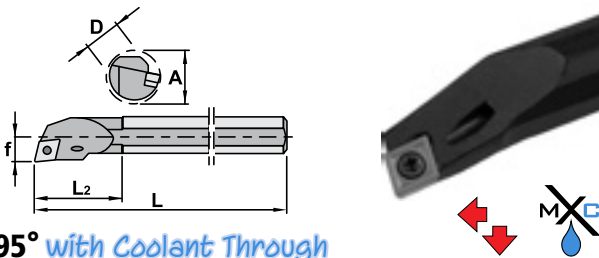

SCLC 95° with Coolant Through

Designation	Min. Bore A	D	L	L2	f
Insert: CC.-21.5-		Lead Angle: -5° Entering Angle: 95°			
A05H-SCLCR/L-2	.310	.313	4.0	.98	.171
A06J-SCLCR/L-2	.470	.375	4.5	1.25	.234
A08K-SCLCR/L-2	.550	.500	5.0	1.49	.281
A10M-SCLCR/L-2	.700	.625	6.0	1.96	.359
Spare Parts					
Insert:	A05H... & A06J...			C-1425	
CC.-21.5-	A08K... & A10M...	W-37019		C-1225	

For Inserts please refer to page 9

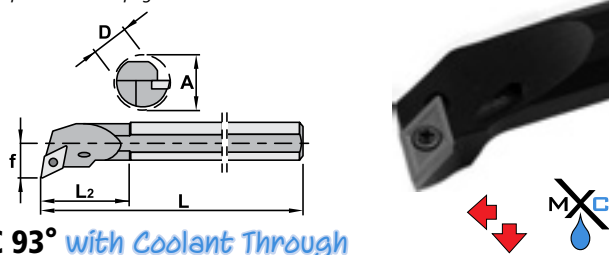

SDUC 93° with Coolant Through

Designation	Min. Bore A	D	L	L2	f
Insert: DC.-21.5.		Lead Angle: -3° Entering Angle: 93°			
A06J-SDUCR/L-2	.470	.375	4.5	1.25	.266
A08K-SDUCR/L-2	.550	.500	5.0	1.49	.368
A10M-SDUCR/L-2	.700	.625	6.0	1.96	.433
Spare Parts					
Insert:	A06J...			C-1425	
DC.-21.5-	A08K... & A10M...	W-37019		C-1225	

For Inserts please refer to page 11

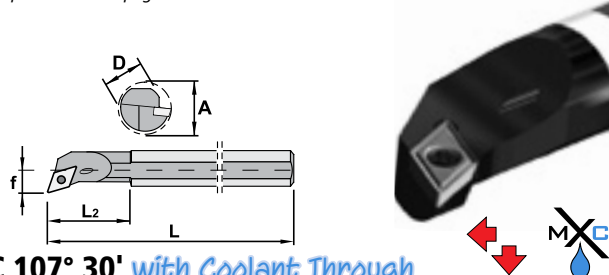

SDQC 107° 30' with Coolant Through

Designation	Min. Bore A	D	L	L2	f
Insert: DC.-21.5		Lead Angle: -17.5° Entering Angle: 107.5°			
A06J-SDQCR/L-2	.470	.375	4.5	1.25	.266
A08K-SDQCR/L-2	.550	.500	5.0	1.49	.368
A10M-SDQCR/L-2	.700	.625	6.0	1.96	.433
Spare Parts					
Insert:	A06J...			C-1425	
DC.-21.5-	A08K... & A10M...	W-37019		C-1225	

For Inserts please refer to page 11

SET-SCLCR/L-I

- Shank Diameter Range: 5/16" - 5/8"
- Minimum Bore Diameter: .310"
- With coolant through
- Profiling boring bar for semi-finishing and finishing operations
- Kit Contains:
 - 1-A05H-SCLCR/L-2
 - 1-A06J-SCLCR/L-2
 - 1-A08K-SCLCR/L-2
 - 1-A10M-SCLCR/L-2



SET-SDUCR/L-I

- Shank Diameter Range: 3/8" - 5/8"
- Minimum Bore Diameter: .470"
- With coolant through
- Profiling and copying boring bar for semi-finishing and finishing operations
- Kit Contains:
 - 1-A06J-SDUCR/L-2
 - 1-A08K-SDUCR/L-2
 - 1-A10M-SDUCR/L-2



SET-SDQCR/L-I

- Shank Diameter Range: 3/8" - 5/8"
- Minimum Bore Diameter: .470"
- With coolant through
- Profiling and copying boring bar for semi-finishing and finishing operations
- Kit Contains:
 - 1-A06J-SDQCR/L-2
 - 1-A08K-SDQCR/L-2
 - 1-A10M-SDQCR/L-2



TyCarb

High Performance Milling

Welcome to the **TyCarb High Performance Milling** product offering. A comprehensive range of advanced milling cutter technologies, engineered into every **TyCarb** product made.

TyCarb Inserts & Tooling utilize industry-leading carbide substrates and high performance coatings. Indexable carbide, PCD and TFC inserts provide milling solutions for every material application.

TyCarb Solid Carbide tools feature an impressive collection of roughing and finishing geometries to suit every machine type.

MaxiCool™ Shell Mill Adaptors feature through-coolant designs to work seamlessly with TyCarb milling cutters – delivering coolant directly to the critical cutting point of the tool





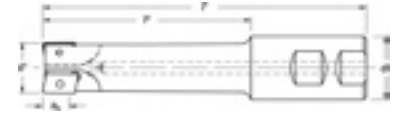
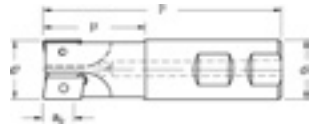

Standard Length End Mills with Coolant Through

Designation	d ¹	d ²	l ¹	l ²	Max. ap	flutes
<i>Insert: XDET-090308 / XDHT-0903_-AL</i>						
TXD90-0500C	.500	.625	3.00	1.09	.33	1
TXD90-0625C	.625	.625	3.00	1.09	.33	2
TXD90-0750C	.750	.750	3.50	1.47	.33	2
TXD90-0750FC	.750	.750	3.50	1.47	.33	3
TXD90-0875C	.875	.750	3.50	1.47	.33	3
TXD90-1000C	1.000	.750	3.50	1.47	.33	3
TXD90-1000-4C	1.000	1.000	4.00	1.72	.33	3
TXD90-1000FC	1.000	1.000	4.00	1.72	.33	4
TXD90-1250C	1.250	1.250	4.00	1.72	.33	5
TXD90-1500C	1.500	1.250	4.40	2.12	.33	5
<i>Insert: XPET-160412 / XPHT-1604_- / XPNT-160412-SR / XPNX-160412</i>						
TXP90-0750C	.750	.750	3.50	1.47	.55	1
TXP90-1000C	1.000	.750	3.70	1.67	.55	2
TXP90-1000-4C	1.000	1.000	4.00	1.72	.55	2
TXP90-1250C	1.250	1.250	4.00	1.72	.55	3
TXP90-1500C	1.500	1.250	4.40	2.12	.55	3
TXP90-1500FC	1.500	1.250	4.40	2.12	.55	4
TXP90-2000EMC	2.000	1.250	4.00	1.72	.55	4

Remember to use COPASLIP® anti-seize compound on all insert screws

Featuring:

- Cylindrical Shanks
- Coolant through
- Extra long shanks

Specifically designed for:

- Milling Chucks
- Hydraulic Chucks
- Shrink-fit Systems

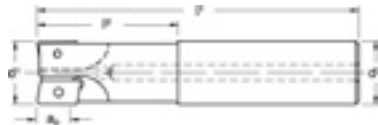

Standard Length Cylindrical Shank End Mills with Coolant Through

Designation	d ¹	d ²	l ¹	l ²	Max. ap	flutes
<i>Insert: XDET-090308 / XDHT-0903_-AL</i>						
TXD90CY-0625C	.625	.625	3.00	1.09	.33	2
TXD90CY-0750C	.750	.750	3.50	1.46	.33	2
TXD90CY-1000-4C	1.000	1.000	4.00	1.71	.33	3
<i>Insert: XPET-160412 / XPHT-1604_- / XPNT-160412-SR / XPNX-160412</i>						
TXP90CY-1000-4C	1.000	1.000	4.00	1.71	.55	2
TXP90CY-1250-5C	1.250	1.250	4.00	1.71	.55	3
TXP90CY-1500-5C	1.500	1.250	4.50	2.00	.55	4

Remember to use COPASLIP® anti-seize compound on all insert screws

Extended Length End Mills with Coolant Through

Designation	d ¹	d ²	l ¹	l ²	Max. ap	flutes
<i>Insert: XDET-090308 / XDHT-0903_-AL</i>						
TXD90-0500-XLC	.500	.625	3.91	2.00	.33	1
TXD90-0625-XLC	.625	.750	4.53	2.50	.33	2
TXD90-0750-LC	.750	.750	3.78	1.75	.33	2
TXD90-0750-XLC	.750	1.000	4.81	2.53	.33	2
TXD90-0750-XXLC	.750	1.000	6.31	4.03	.33	2
TXD90-1000-4XXLC	1.000	1.000	8.00	2.25	.33	3
<i>Insert: XPET-160412 / XPHT-1604_- / XPNT-160412-SR / XPNX-160412</i>						
TXP90-1000-4LC	1.000	1.000	5.28	3.00	.55	2
TXP90-1000-4XXLC	1.000	1.000	8.00	2.25	.55	2
TXP90-1000-5LC	1.000	1.250	5.00	2.72	.55	2
TXP90-1000-5XLC	1.000	1.250	6.40	4.12	.55	2
TXP90-1000-5XXLC	1.000	1.250	8.40	6.12	.55	2
TXP90-1250-LC	1.250	1.250	5.00	2.72	.55	3
TXP90-1250-XLC	1.250	1.250	6.40	4.12	.55	3
TXP90-1250-XXLC	1.250	2.000	9.25	6.00	.55	3
TXP90-1250-5XXLC	1.250	1.250	10.00	3.00	.55	3
TXP90-1500-LC	1.500	1.250	6.00	3.72	.55	3
TXP90-1500-XLC	1.500	2.000	7.25	4.00	.55	3
TXP90-1500-5XXLC	1.500	1.250	10.00	7.72	.55	3
TXP90-1500-XXLC	1.500	2.000	9.25	6.00	.55	3

Remember to use COPASLIP® anti-seize compound on all insert screws

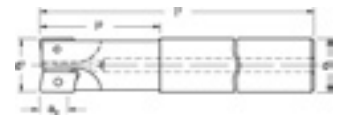

Extended Length Cylindrical Shank End Mills with Coolant Through

Designation	d ¹	d ²	l ¹	l ²	Max. ap	flutes
<i>Insert: XDET-090308 / XDHT-0903_-AL</i>						
TXD90CY-0625-XXLC	.625	.625	6.00	2.00	.33	2
TXD90CY-0750-XXLC	.750	.750	8.00	2.00	.33	2
TXD90CY-1000-4XXLC	1.000	1.000	8.00	2.25	.33	3
<i>Insert: XPET-160412 / XPHT-1604_- / XPNT-160412-SR / XPNX-160412</i>						
TXP90CY-1000-4XXLC	1.000	1.000	8.00	2.25	.55	2
TXP90CY-1250-5XXLC	1.250	1.250	10.00	3.00	.55	3
TXP90CY-1500-5XXLC	1.500	1.250	10.00	7.50	.55	3

Remember to use COPASLIP® anti-seize compound on all insert screws



TX90 Square Shoulder Milling Cutters

Featuring:

- Specifically designed for aluminum machining
- Allows for full depths of cut and wider widths of cut
- Optimized speeds and feeds while lowering horsepower consumption

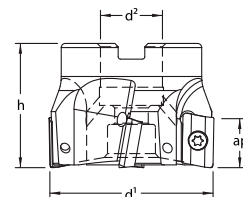
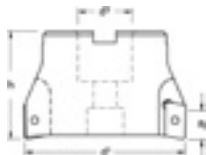

Coarse Pitch Face Mills for Aluminum with Coolant Through

Designation	d ¹	d ²	h	Max. ap	flutes	lbs.
<i>Insert: XPET-160412 / XPHT-1604__ / XPNT-160412-SR / XPNX-160412</i>						
TXP90-2000AL-3	2.000	.750	1.50	.55	3	.60
TXP90-2500AL-3	2.500	1.000	2.00	.55	3	1.15
TXP90-3000AL-3	3.000	1.000	2.00	.55	3	1.90
TXP90-4000AL-4X	4.000	1.250	2.00	.55	4	2.70
Standard Non-Through coolant						
TXP90-4000AL-4	4.000	1.500	2.00	.55	4	2.85
TXP90-5000AL-5	5.000	1.500	2.00	.55	5	4.80
TXP90-6000AL-6	6.000	2.000	2.50	.55	6	8.45

Remember to use COPASLIP® anti-seize compound on all insert screws



Screw-On Milling Cutters

Designation	d ¹	d ¹ mm	g	l ¹	Max. ap	flutes
<i>Insert: XDET-090308 / XDHT-0903__-AL</i>						
TXD90-0500-TS	.500	12.70	M6	1.10	.33	1
TXD90-0625-TS	.625	15.87	M8	1.10	.33	2
TXD90-0750-TS	.750	19.05	M10	1.18	.33	2
TXD90-0984-TS	.984	25.00	M12	1.18	.33	3
TXD90-1000-TS	1.000	25.40	M12	1.50	.33	3
TXD90-1260-TS	1.260	32.00	M16	1.57	.33	5
<i>Insert: XPET-160412 / XPHT-1604__ / XPNT-160412-SR / XPNX-160412</i>						
TXP90-0975-TS	.975	24.77	M12	1.50	.55	2
TXP90-0984-TS	.984	25.00	M12	1.18	.55	2
TXP90-1000-TS	1.000	25.40	M12	1.50	.55	2
TXP90-1250-TS	1.250	31.75	M16	1.75	.55	3
TXP90-1260-TS	1.260	32.00	M16	1.57	.55	3
TXP90-1378-TS	1.378	35.00	M16	1.57	.55	3
TXP90-1500-TS	1.500	38.10	M16	1.75	.55	3
TXP90-1575-TS	1.575	40.00	M16	1.57	.55	4

Remember to use COPASLIP® anti-seize compound on all insert screws

Standard Series Face Mills with Coolant Through

Designation	d ¹	d ²	h	Max. ap	flutes	lbs.
<i>Insert: XDET-090308 / XDHT-0903__-AL</i>						
TXD90-1500SM	1.500	.750	1.75	.33	5	.55
TXD90-2000	2.000	.750	1.50	.33	7	.70
<i>Insert: XPET-160412 / XPHT-1604__ / XPNT-160412-SR / XPNX-160412</i>						
TXP90-1500SM	1.500	.750	1.75	.55	4	.45
TXP90-2000	2.000	.750	1.50	.55	4	.60
TXP90-2000F	2.000	.750	1.50	.55	5	.60
TXP90-2500	2.500	1.000	1.75	.55	5	1.30
TXP90-3000	3.000	1.000	2.00	.55	6	2.25
TXP90-4000	4.000	1.250	2.00	.55	7	3.20
Standard Non-Through coolant						
TXP90-4000F	4.000	1.500	2.00	.55	8	3.35
TXP90-5000	5.000	1.500	2.00	.55	8	5.15
TXP90-6000	6.000	1.500	2.00	.55	9	7.65
TXP90-6000F	6.000	2.000	2.50	.55	10	7.95
TXP90-8000*	8.000	2.500	2.50	.55	12	14.00

*Cutter supplied with 4 holes on a 4" bolt circle

Remember to use COPASLIP® anti-seize compound on all insert screws

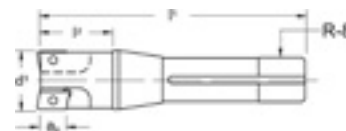

R-8 Shank End Mills

Designation	d ¹	Shank	l ¹	l ²	Max. ap	flutes
<i>Insert: XPET-160412 / XPHT-1604__ / XPNT-160412-SR / XPNX-160412</i>						
TXP90-1250-R8	1.250	R-8	5.63	1.50	.55	3
TXP90-1500-R8	1.500	R-8	5.63	1.50	.55	3
TXP90-2000-R8	2.000	R-8	5.63	1.50	.55	3

Remember to use COPASLIP® anti-seize compound on all insert screws

Spare Parts			
Insert: XD..090308 Series	TX8-687	W-45511	W-37022
Insert: XP..1604__ Series	TX15-388	W-45526	W-37032

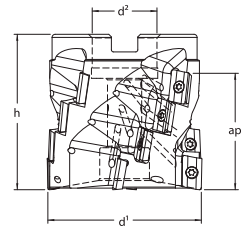
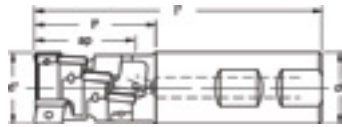

Helical End Mills with Coolant Through for Profiling & Milling

Designation	d ¹	d ²	l ¹	l ²	Max. ap	flutes	No. of inserts
<i>Insert: XDET-090308 / XDHT-0903__-AL</i>							
THXD90-1000	1.000	1.000	4.00	1.72	1.30	2	8
THXD90-1250	1.250	1.250	4.49	2.21	1.30	3	12
THXD90-1500	1.500	1.250	4.84	2.56	1.61	3	15
<i>Insert: XPET-160412 / XPHT-1604__ / XPNT-160412-SR / XPNX-160412</i>							
THXP90-1250	1.250	1.250	4.63	2.35	1.15	2	4
THXP90-1250L	1.250	1.250	4.84	2.56	1.70	2	6
THXP90-1500	1.500	1.250	5.01	2.73	1.17	3	6
THXP90-1500L	1.500	1.250	5.01	2.73	1.70	3	9
THXP90-1750	1.750	1.250	5.01	2.73	1.17	3	6
THXP90-2000EM	2.000	1.250	5.25	2.97	2.25	3	12

Remember to use COPASLIP® anti-seize compound on all insert screws

Helical Shell Mills with Coolant Through for Profiling & Milling

Designation	d ¹	d ²	h	Max. ap	flutes	No. of inserts
<i>Insert: XPET-160412 / XPHT-1604__ / XPNT-160412-SR / XPNX-160412</i>						
THXP90-2000	2.000	.750	2.00	1.17	3	6
THXP90-2000L	2.000	.750	2.50	1.65	3	9
THXP90-2500	2.500	1.000	2.50	1.65	3	9
THXP90-2500L	2.500	1.000	3.00	2.13	3	12
THXP90-3000	3.000	1.250	3.00	2.25	4	16

Remember to use COPASLIP® anti-seize compound on all insert screws

Spare Parts			
Insert: XD..090308 Series	TX8-687	W-45511	W-37022
Insert: XP..1604__ Series	TX15-388	W-45526	W-37032

Inserts for TX90 & THX90 Square Shoulder Milling Cutters

Inserts with optimized geometries and large selection of radii from 1/32" - 1/8" for steel, cast steel and aluminum alloys. Very effective with high metal removal rates in medium and heavy duty milling.



Designation	l	d	s	d ¹	X	r	RP35AP	RP35MP	RP40AP	RP40MP	TK15MC	RK15MC	TK10M	TP30MC	TP35MP	TK30MD	
XDET-090308	.381	1/4	1/8	.110	15°	1/32	●	●	●	●							
XDHT-090302-AL						.008								●			
XDHT-090304-AL						1/64								●			
XDHT-090308-AL	.381	1/4	1/8	.110		1/32								●			
XDHT-090316-AL						1/16								●			
XPET-160412	.635	3/8	3/16	.173	11°	3/64		●	●	●							
XPNT-160412						3/64									●	●	
XPNT-160412-SR	.635	3/8	3/16	.173		3/64									●	●	
XPNX-160412	.635	3/8	3/16	.173		3/64							●		●	●	
XPHT-160408						1/32										●	
XPHT-160412						3/64					●				●	●	
XPHT-160416	.635	3/8	3/16	.173		1/16									●	●	●
XPHT-160432						1/8									●	●	
XPHT-160408-AL						1/32									●		
XPHT-160412-AL						3/64									●		
XPHT-160416-AL						1/16									●		
XPHT-160420-AL	.635	3/8	3/196	.173		5/64									●		
XPHT-160424-AL						3/32									●		
XPHT-160432-AL						1/8									●		

-AL inserts designed specifically for aluminum



TyCarb PCD Milling Program

With the TyCarb line of adjustable milling tools for aluminum and non-ferrous metals you can achieve the best possible finishes with the best and most advanced TFC and PCD grades on the market today. The TCP90 cutter is specifically designed for the highest speeds and least amount of cutting pressures, combined with Becker TFC diamond you will achieve excellent tool life.

This range includes many wiper geometries for all of your application requirements. The CDC90 tool is a low cost adjustable milling tool for aluminum and non-ferrous materials with a large range of wiper geometries and corner radii to choose from. These tools also include the outstanding performance of the Becker TFC and PCD diamond grades.





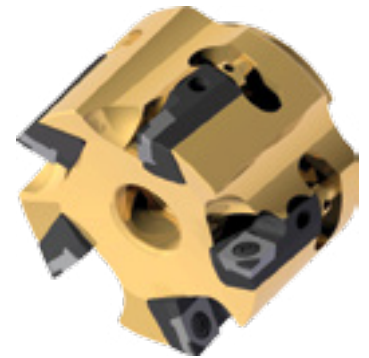
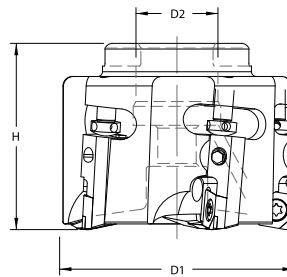

Aluminum face milling cutter program engineered for high speed machining of all non-ferrous materials

- New advanced milling cutter program engineered for high speed machining of non-ferrous materials
- Ultra precise finishing with unique wiper radius PCD / TFC inserts and micro-adjustable cartridges
- Milling cutter bodies made from lightweight 7075-T6 aviation grade aluminum
- MaxiCool through coolant enabled for maximum chip evacuation and temperature control
- New TFC diamond grade for extreme tool life!

Engineered for High Speed Machining!



TCP90 Face Mills for PCD / TFC Milling Applications

Designation	D1	D2	H	Flutes	Insert	Cartridge	Cartridge Clamp Screw	Insert Torx Screw	Height Adj. Screw
TCP90-2000-AL	2.00	.75	2.00	3	CPGX-32.51...	BC10X50	M5 SHBS	TX15-951	HAS6823
TCP90-2500-AL	2.50	1.00	2.00	5					
TCP90-3000-AL	3.00	1.00	2.00	7					
TCP90-4000-AL	4.00	1.25	2.00	10					
TCP90-5000-AL	5.00	1.50	2.50	11					
TCP90-6000-AL	6.00	1.50	2.50	13					
TCP90-8000-AL	8.00	2.00	2.50	16					

CPGX Milling Insert with Wiper

Designation	d	d ¹	s	l	l ¹	r	TFC	PDC-CU-S
							PD	DP
CPGX-32.51PDR	.375	.173	.156	.382	.169	.016	●	●
CPGX-32.51NWR							●	●
CPGX-32.51FLW							●	●
CPGX-32.51SFR							●	●

Application: TCP90 Milling Cutter

Milling the face of a cast aluminum oil pan.
Material is A380 Aluminum consisting of 9% silicon.

Cutting Data:

4.00" diameter cutter (Z=10)
8000 RPM (through tool coolant)
213 IPM feed rate
0.040 - 0.080" D.O.C.
32 RMS

Part life:

PDC-S= 2,500 pieces
TFC= 13,500 pieces

**540% Increase
in tool life using TFC!**

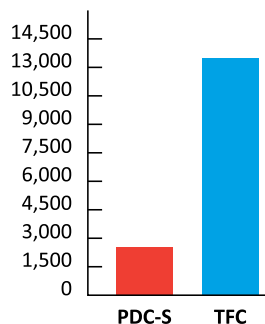

Chipbreaker Information

PDR	Crown radius wiper. Suitable for general purpose applications with stable set-ups.
NWR	Full radius insert with no wiper facet. Suitable for unstable set-ups or thin wall parts. Excellent for sealing surfaces.
FLW	Flat wiper facet for general machining and unstable set-ups.
SFR	Very large crown radius wiper facet. Suitable for super finishing on very stable thick wall parts.



TCP90 Face Mills for PCD Milling Applications

PDC-CU-S

Performance: Polycrystalline carbide reinforced diamond of coarse grit size, good edge sharpness and low cutting pressure allowing close tolerances. Best performances for milling. High flank wear resistance and toughness.

Application: Finishing, general purpose and milling of all non-metallics with medium to high content of abrasive reinforcement or silicon.

TFC

Performance: Solid diamond with no structure. Cutting edge is extremely sharp and without micro fractures generating no cutting pressure, allowing burr-free results with tolerances close to zero. Extremely flank wear resistant with maximum thermal conductivity, and good toughness.

Application: Super finishing to roughing of all nonferrous metals and non-metallics with abrasive reinforcement or silicon. (HSC - High Tech)

Security Features

Insert Double Lock

Secondary insert step locks against matching step on insert cartridge

Designed to act as a double lock in conjunction with the tapered insert screw

Cartridge Dovetail Lock

Insert cartridge is fitted into cutter body with dovetail design

Centrifugal forces acting on insert cartridge are neutralized by wedge profile of cartridge and matching shape on cutter body

Enclosed Cartridge Clamping Screw

Unique cartridge shrouds cartridge clamp screw within steel body

Potential screw breakage is contained within steel of cartridge – the screw has no place to eject

Performance Features

Micro Adjustable

Easily pre-set cartridges to within microns

All new milling cutters are factory pre-set in height to within ± 0.0004 with a master gauge insert

Through Coolant Enabled

Coolant ports are directed at the cutting edge to extend tool life and improve surface finishes

Wiper Radius

Unique wiper is a compound radius that outperforms traditional wiper flats

With every insert in the cutter loaded with the wiper radius, super finishing is easily attained

Coolant Caps

- Optional Coolant Caps available for larger cutter diameters to provide 360° direct coolant supply at the cutting edge
- Balanced by design and mounted securely to maintain constant coolant supply at maximum RPM
- Made from the same lightweight 7075-T6 aviation grade aluminum as cutter bodies for reliable long term use and service

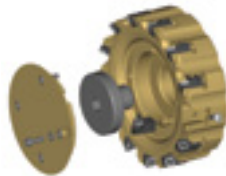

Cutter Designation	Thru Coolant Cap Screw	Coolant Cap	Mounting Cap Screw	Lock Washer	Washer
TCP90-5000-AL	CCS-125	CTP-125	SHCS-M4	LW-M4	W-M4
TCP90-6000-AL	CCS-160	CTP-160	SHCS-M5	LW-M5	W-M5
TCP90-8000-AL	--	CTP-200	SHCS-M8	LW-M8	W-M8

When ordering Coolant Caps, Mounting Cap Screws and Washers are included. Thru Coolant Cap Screw must be purchased separately.

Materials	Conditions of Chip Removal	Application Range - Cutting Speed N01 - N40		
		N01 - N20 (HSC)	N20 - N30 (HSC)	N25 - N40 (HSC)
N Nonferrous metals Aluminum alloys without silicon	High-Speed Milling	3.2µin - 100µin	100µin - 200µin	200µin - 400µin
	continuous	TFC	PDC-CU-S / TFC	PDC-CU-S / TFC
	heavily + slightly interrupted	PDC-CU-S / TFC	PDC-CU-S / TFC	PDC-CU-S
N Nonferrous metals Aluminum alloys with less than 12% silicon	continuous	2600-14625	2600-13000	2600-8125
	heavily + slightly interrupted	PDC-CU-S / TFC	PDC-CU-S / TFC	PDC-CU-S
	continuous	2600-1300	2600-11375	2600-8775
N Nonferrous metals Copper and copper alloys brass, bronze, precious metals	continuous	2600-13000	2600-11375	2600-8775
	heavily + slightly interrupted	PDC-CU-S / TFC	PDC-CU-S / TFC	PDC-CU-S
	continuous	2600-9750	2600-8125	2275-7150
N Non-metallics with re-inforcement (GFK/CFK/Graphite)	heavily + slightly interrupted	PDC-CU-S / TFC	PDC-CU-S / TFC	PDC-CU-S
	continuous	2600-9750	2600-8125	2275-7150
	continuous	TFC	PDC-CU-S / TFC	PDC-CU-S
		1000-7000	700-6000	500-5000
		PDC-CU-S / TFC	PDC-CU-S / TFC	PDC-CU-S
		1000-7000	700-6000	500-5000

Coolant: Flood or through coolant | Proper wiper radius required for application

The TyCarb CDC90 milling cutter is one of the most economical height adjustable milling cutters using PCD on the market. This milling cutter was designed for performance and economy in mind. With the use of the high quality Becker PCD and TFC diamond tipped milling blades, superior part quality is quite easily achievable.

The milling blades are available with 3 different radii, 2 different wiper configurations, 3 different cutting edge lengths and for chip control problems, 2 different chipbreakers lasered right into the cutting edge.

CDC90 Features

- Easily adjustable axially to maintain tolerance within microns
- Rigid clamping system
- Strong and stable insert location
- MaxiCool through coolant capable
- Ground shanks for use in hydraulic and shrink-fit holders



BFMW Milling Blade with wiper, for Face Milling Only

Designation	PDC-CU-S			TFC			l	l'	r
	Neutral	CB1	CB2	Neutral	CB1	CB2			
BFMW-280504-3.5	●		●	●	●				.016
BFMW-280508-3.5	●		●	●	●		.900	.140	.031
BFMW-280516-3.5	●		●	●	●				.063

$fz = .001 - .012 \text{ in}$ $ap = .003 - .08 \text{ in}$

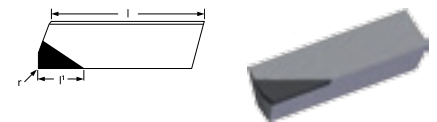

CDC90 End Mills with Coolant Through

Designation	Dimensions					Insert	Spare Parts Locking & Adjusting Screw
	d1	d2	l1	l2	Fl		
CDC90-1000-EM-ED2	1.000	.750	4.00	1.65	2	"BF" STYLE	EMV-32LH
CDC90-1250-EM-ED3	1.250	1.000	4.00	1.65	3		
CDC90-1500-EM-ED4	1.500	1.250	4.00	1.65	4		
CDC90-2000-EM-ED5	2.000	1.250	4.00	1.65	5		

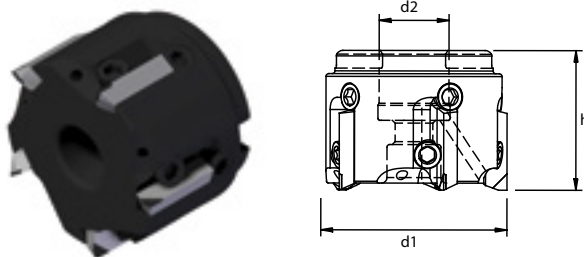

BFSM Milling Blade no wiper, Face and Shoulder Milling

Designation	PDC-CU-S			TFC			l	l'	r
	Neutral	CB1	CB2	Neutral	CB1	CB2			
BFSM-280504-5.5				●	●				.016
BFSM-280508-5.5				●	●		.900	.220	.031
BFSM-280516-5.5				●	●				.063

$fz = .001 - .012 \text{ in}$ $ap = .004 - .16 \text{ in}$

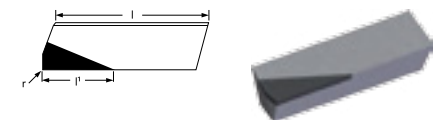

CDC90 Face Mills with Coolant Through

Designation	Dimensions				Insert	Spare Parts Locking & Adjusting Screw
	d1	d2	h	Fl		
CDC90-2000-SM-ED5	2.000	.750	1.50	5	"BF" STYLE	EMV-32LH

BSM Milling Blade no wiper, Shoulder Milling Only

Designation	PDC-CU-S			TFC			l	l'	r
	Neutral	CB1	CB2	Neutral	CB1	CB2			
BSM-280504-8.0	●		●						.016
BSM-280508-8.0	●		●				.900	.315	.031
BSM-280516-8.0	●		●						.063

$fz = .002 - .016 \text{ in}$ $ap = .010 - .24 \text{ in}$

Application

High speed milling of:

- Aluminum alloys
- Copper alloys
- Plastic materials
- Can be used for edge and slot milling, as well as axial plunge milling
- Excellent for deep cavity work
- Suitable for soft non-ferrous materials
- Up to .500" depth of cut
- Exceptionally high feed rates (over 200 IPM)
- Maximum metal removal on any machine
- Wide range of product available

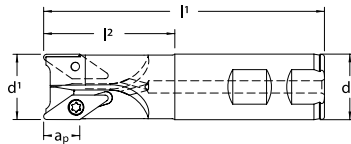

End Mills Optimized

Design for Aluminum with *Coolant Through*

Designation	d ¹	d ²	l ¹	l ²	Max. ap	Max Plunge	flutes
<i>Insert: VPGT-221-ALM</i>							
TVP90-0750C	.750	.750	3.28	1.25	.40	.200	2
TVP90-1000XC	1.000	1.000	4.28	2.00	.40	.200	3
<i>Insert: VPGT-333-ALM / VPGT-33PPFR-ALM*</i>							
TVP90-1000C	1.000	1.000	4.28	2.00	.53	.250	2
TVP90-1250C	1.250	1.250	4.28	2.00	.53	.250	2
TVP90-1500C	1.500	1.250	4.28	2.00	.53	.250	3

* To provide necessary clearance when using VPGT-33PPFR-ALM inserts, the cutter body must be relieved

Remember to use COPASLIP® anti-seize compound on all insert screws

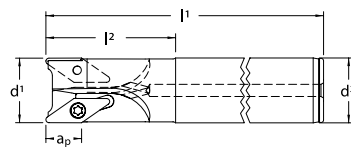

Extra Length End Mills

Optimized Design for Aluminum with *Coolant Through*

Designation	d ¹	d ²	l ¹	l ²	Max. ap	Max Plunge	flutes
<i>Insert: VPGT-221-ALM</i>							
TVP90CY-0750-XLC	.750	.750	6.75	1.25	.40	.200	2
TVP90CY-1000X-XLC	1.000	1.000	8.00	2.00	.40	.200	3
<i>Insert: VPGT-333-ALM / VPGT-33PPFR-ALM*</i>							
TVP90CY-1000-XLC	1.000	1.000	8.00	2.00	.53	.250	2
TVP90CY-1250-XLC	1.250	1.250	8.00	2.00	.53	.250	2
TVP90CY-1500-XLC	1.500	1.250	8.00	2.00	.53	.250	3

* To provide necessary clearance when using VPGT-33PPFR-ALM inserts, the cutter body must be relieved

Remember to use COPASLIP® anti-seize compound on all insert screws

Features / Benefits

- High positive geometry insert with wave shape topography eliminates edge build-up and provides efficient chip removal
- End mills designed with coolant holes directed toward cutting edges
- Insert grade TK10MP is specifically designed for the machining of aluminum and non-ferrous materials that require high cutting speeds

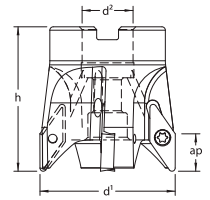

Face Mills Optimized

Design for Aluminum with *Coolant Through*

Designation	d ¹	d ²	h	Max. ap	Max Plunge	No. of inserts
<i>Insert: VPGT-333-ALM / VPGT-33PPFR-ALM*</i>						
TVP90-2000	2.000	.750	2.12	.53	.250	4
<i>Insert: VCGT-43.58-ALM</i>						
TVC90-2000	2.000	.750	2.12	.59	.300	3
TVC90-2500	2.500	1.000	2.12	.59	.300	4
TVC90-3000	3.000	1.000	2.12	.59	.300	5
Standard Non-Through Coolant						
TVC90-4000	4.000	1.500	2.12	.59	.300	6

* To provide necessary clearance when using VPGT-33PPFR-ALM inserts, the cutter body must be relieved

Remember to use COPASLIP® anti-seize compound on all insert screws

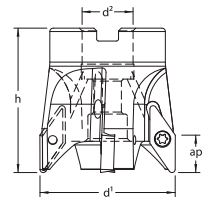

Face Mills Optimized

Design for Aluminum with *Coolant Through*

Designation	d ¹	d ²	h	Max. ap	Max Plunge	No. of inserts
<i>Insert: VCGT-43.58-ALM</i>						
TVC90-2500AL-3	2.500	1.000	2.12	.59	.300	3
TVC90-3000AL-3	3.000	1.000	2.12	.59	.300	3
Standard Non-Through Coolant						
TVC90-4000AL-4	4.000	1.500	2.12	.59	.300	4

Remember to use COPASLIP® anti-seize compound on all insert screws

Spare Parts

Insert: VPGT-221-ALM	TX8-1625	W-45511	W-37022
Insert: VPGT-33...-ALM	TX15-1640	W-45526	W-37032
Insert: VCGT-43.58-ALM	TX20-1250	W-45531	W-37036

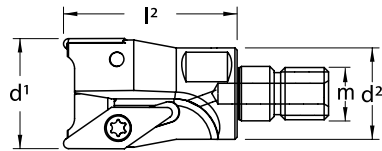

Screw-On Milling Cutters Optimized Design for Aluminum

Designation	d ¹	d ²	l ²	m	Max. ap	Max Plunge	flutes
<i>Insert: VPGT-221-ALM</i>							
Standard Non-Through Coolant							
TVP90-0750-TS	.750	.709	1.18	M10	.40	.200	2
Through Coolant Enabled							
TVP90-1000XC-TS	1.000	.827	1.57	M12	.40	.200	3
<i>Insert: VPGT-333-ALM / VPGT-33PPFR-ALM*</i>							
TVP90-1000C-TS	1.000	.827	1.57	M12	.53	.250	2
TVP90-1250C-TS	1.250	1.142	1.97	M16	.53	.250	2
TVP90-1500C-TS	1.500	1.142	1.97	M16	.53	.250	3

* To provide necessary clearance when using VPGT-33PPFR-ALM inserts, the cutter body must be relieved

Remember to use COPASLIP® anti-seize compound on all insert screws

Designation	l	d	s	d ¹	r	VCGT-...	
						TK10MP	TK10M
VCGT-43.58-ALM	.870	1/2	.219	.216	1/8	●	●

Designation	l	d	s	d ¹	r	VPGT-...	
						TK10MP	TK10M
VPGT-221-ALM	.437	1/4	.125	.110	1/64	●	●
VPGT-333-ALM	.654	3/8	.187	.173	3/64	●	●
VPGT-33PPFR-ALM					--	●	●

Spare Parts			
Insert: VPGT-221-ALM	TX8-1625	W-45511	W-37022
Insert: VPGT-33...-ALM	TX15-1640	W-45526	W-37032
Insert: VCGT-43.58-ALM	TX20-1250	W-45531	W-37036

TS45F Super Positive Milling Cutters

Super milling cutter with 45° entering angle that decreases cutting forces and allows a high feed on limited capacity machines. Inserts are mounted using Torx® locking screws for uninterrupted chip flow.

TS45F cutters use thicker inserts, allowing for high feed rates. This face milling cutter works well on steels, stainless steels, alloyed steels, cast iron and aluminum alloys.

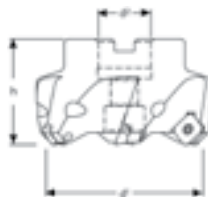
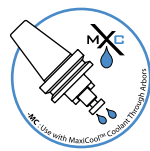

Face Mills

Designation	d ¹	d ²	h	Flutes	lbs
<i>Insert: SEKT-43 / SEKW-43</i>					
Through Coolant Enabled					
TS45F-20SE43X	2.000	.750	1.75	4	1.05
TS45F-25SE43X	2.500	1.000	2.00	5	2.00
TS45F-30SE43X	3.000	1.000	2.00	6	2.65
TS45F-40SE43X	4.000	1.250	2.00	7	3.50
Standard Non-Through Coolant					
TS45F-50SE43X	5.000	1.500	2.00	8	5.95
TS45F-60SE43X	6.000	1.500	2.00	9	8.90

Remember to use COPASLIP® anti-seize compound on all insert screws

Spare Parts			
Insert: SE...-43	TX20-072	W-45531	W-37036

Designation	l	d	s	d ¹	r	SEKT/SEHT					
						TP25MP	TP30MC	TP35MP	TP25M	TM45MP	TK15MC
SEKT-43AFSN	.500	1/2	.187	.218	--		●	●	●		
SEHT-43-AFSN-TMK	.500	1/2	.187	.218	--					●	

Designation	l	d	s	d ¹	r	SEKW-...					
						TP25MP	TP30MC	TP35MP	TP25M	TM45MP	TK15MC
SEKW-43AFEN	.500	1/2	.187	.218	--					●	
SEKW-43AFSN	.500	1/2	.187	.218	--	●	●	●	●	●	●

Designation	l	d	s	d ¹	r	SEHT-...					
						TK10MP	TK10M	TP35MP	TP25M	TM45MP	RK15MC
SEHT-43-AFFN-RAL	.500	1/2	.187	.218	--	●	●				

-RAL inserts designed specifically for aluminum

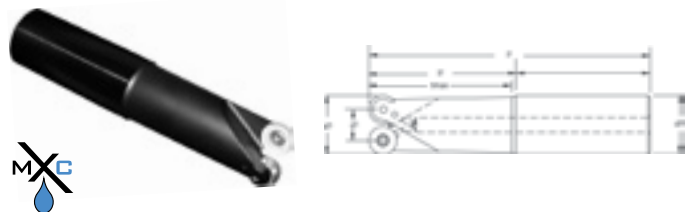
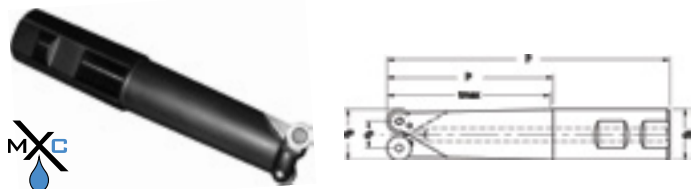

End Mills with Coolant Through using 15° Positive Inserts for Profiling & Contouring

Cylindrical Shank End Mills with Coolant Through using 15° Positive Inserts for Profiling & Contouring

Designation	d ³	d ¹	d ²	l ¹	l ²	t _{max}	ramp angle	flutes
<i>Insert: RDGT-0802MOT / RDMT-0802MOT / RDMW-0802MOT</i>								
TR360-0500-36	.500	.185	.625	3.65	1.74	1.64	10°	1
TR360-0500-44	.500	.185	.625	4.40	2.49	2.39	10°	1
TR360-0500-51	.500	.185	.625	5.15	3.24	3.14	10°	1
TR360-0625-36A	.625	.310	.625	3.65	1.74	1.74	10°	1
TR360-0625-36	.625	.310	.625	3.65	1.74	1.74	60°	2
TR360-0625-44A	.625	.310	.625	4.40	2.49	2.49	10°	1
TR360-0625-44	.625	.310	.625	4.40	2.49	2.49	60°	2
TR360-0625-52A	.625	.310	.750	5.28	3.25	3.14	10°	1
TR360-0625-52	.625	.310	.750	5.28	3.25	3.14	60°	2
TR360-0625-60	.625	.310	.750	6.03	4.00	3.89	60°	2
TR360-0625-70	.625	.310	1.000	7.03	4.75	1.65	60°	2
TR360-0750-37X	.750	.435	.750	3.78	1.75	1.74	22°	2
TR360-0750-45X	.750	.435	.750	4.53	2.50	2.40	22°	2
TR360-0750-55X	.750	.435	1.000	5.53	3.25	3.06	22°	2
TR360-0750-70X	.750	.435	1.000	7.03	4.75	4.56	22°	2
TR360-1000R08-47	1.000	.685	1.000	4.78	2.50	2.50	10°	3
TR360-1000R08-55	1.000	.685	1.000	5.53	3.25	3.25	10°	3
TR360-1000R08-67	1.000	.685	1.000	6.78	4.50	4.50	10°	3
TR360-1250R08-47	1.250	.935	1.250	4.78	2.50	2.50	6°	5
TR360-1250R08-62	1.250	.935	1.250	6.28	4.00	4.00	6°	5
<i>Insert: RDGT-1003MOT / RDMT-1003MOT / RDMW-1003MOT</i>								
TR360-0750-37	.750	.356	.750	3.78	1.75	1.74	40°	2
TR360-0750-45	.750	.356	.750	4.53	2.50	2.49	40°	2
TR360-0750-55	.750	.356	1.000	5.53	3.25	3.06	40°	2
TR360-0750-62	.750	.356	1.000	6.28	4.00	3.81	40°	2
TR360-0750-70	.750	.356	1.000	7.03	4.75	4.56	40°	2
TR360-1000-52X	1.000	.606	1.000	5.28	3.00	2.94	17°	2
TR360-1000-67X	1.000	.606	1.250	6.78	4.50	4.44	17°	2
TR360-1000-74X	1.000	.606	1.250	7.46	5.19	5.12	17°	2
TR360-1000R10-40	1.000	.606	1.000	4.00	1.71	1.71	86°	3
TR360-1000R10-52	1.000	.606	1.000	5.28	3.00	3.00	94°	3
TR360-1000R10-67	1.000	.606	1.000	6.78	4.50	4.50	97°	3
TR360-1250R10-40	1.250	.856	1.250	4.00	1.71	1.71	105°	4
TR360-1250R10-52	1.250	.856	1.250	5.28	3.00	3.00	109°	4
TR360-1250R10-67	1.250	.856	1.250	6.78	4.50	4.50	119°	4
<i>Insert: RDMT-1204MOT-X / RDMW-1204MOT-X</i>								
TR360-1000-47	1.000	.528	1.000	4.78	2.50	2.49	50°	2
TR360-1000-55	1.000	.528	1.000	5.53	3.25	3.19	50°	2
TR360-1000-64	1.000	.528	1.250	6.40	4.12	3.93	50°	2
TR360-1000-71	1.000	.528	1.250	7.15	4.87	4.68	50°	2
TR360-1250-54	1.250	.778	1.250	5.40	3.12	3.11	23°	2
TR360-1250-61	1.250	.778	1.250	6.15	3.87	3.86	23°	2
TR360-1250-72	1.250	.778	1.500	7.25	4.56	4.34	23°	2
TR360-1250-80	1.250	.778	1.500	8.00	5.31	5.09	23°	2
TR360-1500-56X	1.500	1.028	1.250	5.65	3.37	3.25	27°	3
TR360-1500-71X	1.500	1.028	1.250	7.15	4.87	4.75	27°	3
<i>Insert: RDMT-1605MOT-X / RDMW-1605MOT-X</i>								
TR360-1500-54	1.500	.870	1.250	5.40	3.12	3.11	27°	2
TR360-1500-61	1.500	.870	1.250	6.15	3.87	3.86	27°	2
TR360-1500-72	1.500	.870	1.500	7.25	4.56	4.56	27°	2
TR360-1500-80	1.500	.870	1.500	8.00	5.31	5.31	27°	2

Remember to use COPASLIP® anti-seize compound on all insert screws

Designation	d ³	d ¹	d ²	l ¹	l ²	t _{max}	ramp angle	flutes
<i>Insert: RDGT-0802MOT / RDMT-0802MOT / RDMW-0802MOT</i>								
TR360CY-0500-36	.500	.185	.625	3.65	1.74	1.64	10°	1
TR360CY-0500-51	.500	.185	.625	5.15	3.24	3.14	10°	1
TR360CY-0625-36	.625	.310	.625	3.65	1.74	1.74	60°	2
TR360CY-0625-44	.625	.310	.625	4.40	2.49	2.49	60°	2
TR360CY-0625-60	.625	.310	.750	6.03	4.00	3.89	60°	2
TR360CY-0750-37X	.750	.435	.750	3.78	1.75	1.74	22°	2
TR360CY-0750-45X	.750	.435	.750	4.53	2.50	2.49	22°	2
TR360CY-0750-62X	.750	.435	.750	6.28	4.25	4.24	22°	2
TR360CY-1250R08-62	1.250	.935	1.250	6.28	4.00	4.00	6°	5
<i>Insert: RDMT-1204MOT-X / RDMW-1204MOT-X</i>								
TR360CY-1000-47	1.000	.528	1.000	4.78	2.50	2.49	50°	2
TR360CY-1000-71	1.000	.528	1.250	7.15	4.87	4.68	50°	2

Remember to use COPASLIP® anti-seize compound on all insert screws



Face Mills using 15° Positive Inserts for Copying & Face Milling with Coolant Through

Designation	d	d ¹	d ²	h	ramp angle	flutes	lbs
<i>Insert: RDGT-0802MOT / RDMT-0802MOT / RDMW-0802MOT</i>							
TR360-2RD08	2.000	1.685	.750	1.63	1.8°	7	.85
<i>Insert: RDGT-1003MOT / RDMT-1003MOT / RDMW-1003MOT</i>							
TR360-2RD10	2.000	1.606	.750	1.63	4	5	.65
TR360-2.5DR10	2.500	2.106	1.000	1.75	3	6	1.20
TR360-3RD10	3.000	2.608	1.000	2.00	2.5°	8	2.00
<i>Insert: RDMT-1204MOT-X / RDMW-1204MOT-X</i>							
TR360-2RD12	2.000	1.528	.750	1.63	10°	4	.65
TR360-2RD12F	2.000	1.528	.750	1.63	10°	5	.65
TR360-2.5RD12F	2.500	2.028	1.000	1.75	8°	6	1.20
TR360-3RD12F	3.000	2.528	1.000	2.00	5°	7	2.00
<i>Insert: RDMT-1605MOT-X / RDMW-1605MOT-X</i>							
TR360-2RD16	2.000	1.370	.750	1.63	12°	3	.55
TR360-2.5RD16	2.500	1.870	1.000	1.75	8°	4	1.05
TR360-3RD16	3.000	2.370	1.000	2.00	11°	5	1.65
TR360-4RD16	4.000	3.370	1.250	2.00	7°	6	2.55
Standard Non Through Coolant							
TR360-6RD16	6.000	5.370	1.500	2.00	7°	7	6.65
TR360-8RD16*	8.000	7.370	2.000	2.50	8°	8	12.75

* Cutter supplied with 4 holes on a 4" bolt circle

Remember to use COPASLIP® anti-seize compound on all insert screws

TR360 Copy Milling Cutters

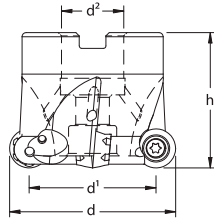

Face Mills using 7° Positive Inserts for Milling, Duplicating, & Drilling with *Coolant Through*

Designation	d	d ¹	d ²	h	ramp angle	flutes	lbs
<i>Insert: RCMT-1606MOT-X</i>							
TR360-2RC16	2.000	1.370	.750	1.63	12°	3	.60
TR360-2.5RC16	2.500	1.870	1.000	1.75	8°	4	1.10
TR360-3RC16	3.000	2.370	1.000	2.00	11°	5	1.70
TR360-3RC16X	3.000	2.370	1.250	2.00	11°	5	2.60
TR360-4RC16	4.000	3.370	1.250	2.00	7°	7	2.60
TR360-4RC16X	4.000	3.370	1.500	2.00	7°	7	2.65
<i>Standard Non Through Coolant</i>							
TR360-6RC16	6.000	5.370	1.500	2.00	7°	9	6.60
TR360-6RC16X	6.000	5.370	2.000	2.50	7°	9	7.15
TR360-8RC16*	8.000	7.370	2.000	2.50	8°	11	14.25

* Cutter supplied with 4 holes on a 4" bolt circle

Remember to use COPASLIP® anti-seize compound on all insert screws



Screw-On Milling Cutters using 15° Positive Inserts for Copying & Face Milling

Designation	d	d mm	d ¹	g	l ¹	flutes
<i>Insert: RDGT-0802MOT / RDMT-0802MOT / RDMW-0802MOT</i>						
TR360-0500-TS	.500	12.70	.185	M6	1.10	1
TR360-0500L-TS	.500	12.70	.185	M8	2.00	1
TR360-0625-TS	.625	15.87	.310	M8	1.10	2
TR360-0750-TS	.750	19.05	.435	M10	1.18	2
TR360-1000R08-TS	1.000	25.40	.685	M12	1.50	3
TR360-1250R08-TS	1.250	31.75	.935	M16	1.75	5
<i>Insert: RDGT-1003MOT / RDMT-1003MOT / RDMW-1003MOT</i>						
TR360-0984-TS	.984	25.00	.591	M12	1.18	2
TR360-1000R10-TS	1.000	25.40	.606	M12	1.50	3
TR360-1181-TS	1.181	30.00	.787	M16	1.57	3
TR360-1250R10-TS	1.250	31.75	.856	M16	1.75	4
<i>Insert: RDMT-1204MOT-X / RDMW-1204MOT-X</i>						
TR360-0945-TS	.945	24.00	.472	M12	1.18	2
TR360-1000-TS	1.000	25.40	.528	M12	1.50	2
TR360-1250-TS	1.250	31.75	.778	M16	1.75	2
TR360-1378-TS	1.378	35.00	.906	M16	1.57	3
TR360-1500-TS	1.500	38.10	1.028	M16	1.75	3
TR360-1575-TS	1.575	40.00	1.102	M16	1.57	4
<i>Insert: RDMT-1605MOT-X / RDMW-1605MOT-X</i>						
TR360-1260-TS	1.260	32.00	.630	M16	1.57	2

Remember to use COPASLIP® anti-seize compound on all insert screws

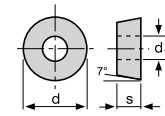

Designation	l	d	s	d ¹	r	TP30AP	TP30MP	TM30MP	TP35MC
RCMT-1606MOT-X*	--	.630	1/4	.217	--	●	●	●	●

*Inserts have integrated anti-rotation lock

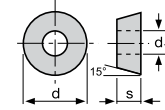

Designation	l	d	s	d ¹	r	TK10M
RDGT-0802MO-AL	--	.315	3/32	.134	--	●
RDGT-0803MO-AL	--	.315	1/8	.134	--	●
RDGT-1003MO-AL	--	.394	1/8	.173	--	●

-AL inserts designed specifically for aluminum

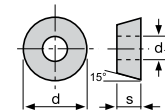

Designation	l	d	s	d ¹	r	TP30AP	TP30MP	TM30MP	TP35MC
RDMT-0802MOT	--	.315	3/32	.134	--	●	●	●	●
RDMT-1003MOT	--	.394	1/8	.173	--	●	●	●	●
RDMT-1204MOT-X*	--	.472	3/16	.173	--	●	●	●	●
RDMT-1605MOT-X*	--	.630	7/32	.217	--	●	●	●	●

*Inserts have integrated anti-rotation lock

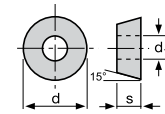

Designation	l	d	s	d ¹	r	TP30AP	TP30MP	TM30MP	TP35MC
RDMW-0802MOT	--	.315	3/32	.134	--	●	●	●	●
RDMW-1003MOT	--	.394	1/8	.173	--	●	●	●	●
RDMW-1204MOT-X*	--	.472	3/16	.173	--	●	●	●	●
RDMW-1605MOT-X*	--	.630	7/32	.217	--	●	●	●	●
RDMW-2006MOT-X*	--	.787	1/4	.259	--	●	●	●	●

*Inserts have integrated anti-rotation lock

Spare Parts			
Insert: RD...0802MOT	TX8-013	W-45511	W-37022
Insert: RD...1003MOT	TX15-951	W-45526	W-37032
Insert: RD...1204MOT-X	TX15-388	W-45526	W-37032
Insert: RD...1605MOT-X	TX20-072	W-45531	W-37036
Insert: RC...1606MOT-X	TX20-072	W-45531	W-37036

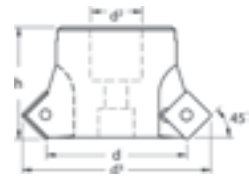
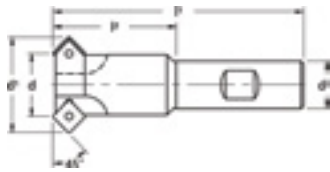

End Mills

Designation	d	d ¹	d ²	l ¹	l ²	Flutes	Chamfer Min-Max
Regular Length							
<i>Insert: SDMT-322</i>							
TSD45-0625	.625	1.130	.750	3.00	.97	2	.67 - 1.11
TSD45-0750	.750	1.255	.750	3.30	1.27	2	.79 - 1.235
TSD45-1000	1.000	1.505	.750	4.00	1.97	2	1.04 - 1.48
TSD45-1250	1.250	1.755	1.250	4.00	1.72	3	1.29 - 1.73
<i>Insert: SPMT-432 / SPMW-432</i>							
TSP45-1500	1.500	2.182	1.250	4.00	1.72	3	1.54 - 2.11
Extended Length							
<i>Insert: SDMT-322</i>							
TSD45-0625-L	.625	1.130	.750	8.00	1.49	2	.67 - 1.11
TSD45-1000-L	1.000	1.505	1.000	8.00	1.49	2	1.04 - 1.48

Remember to use COPASLIP® anti-seize compound on all insert screws

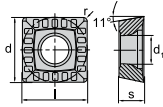
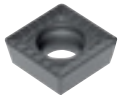

Designation	l	d	s	d ¹	r	SPMT...			
						TP25MP	TP30MC	TP35MP	TP25M
SPMT-432-SN-P	.500	1/2	.187	.205	1/32	●			

Face Mills

Designation	d	d ¹	d ²	h	Flutes	Chamfer Min-Max
<i>Insert: SPMT-432 / SPMW-432</i>						
TSP45-2000	2.000	2.680	.750	1.60	4	2.04 - 2.66

Remember to use COPASLIP® anti-seize compound on all insert screws

Spare Parts			
Insert: SDM-322	TX15-951	W-45526	W-37032
Insert: SPM-432	TX20-072	W-45531	W-37036

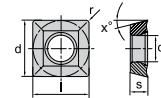
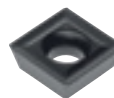

Designation	l	d	s	d ¹	r	x	SDMT/SPMT			
							TP25MP	TP30MC	TP35MP	TP25M
SDMT-322	.375	3/8	.125	.159	1/32	15°	●			●
SPMT-432-SN	.500	1/2	.187	.218	1/32	11°		●	●	

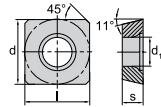
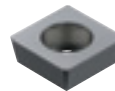

Designation	l	d	s	d ¹	r	SPMW...			
						RK15MC	TK15MC		
SPMW-432	.500	1/2	.187	.205	1/32	●	●		

TT30E / TT45E Chamfer & Countersink Milling Cutters

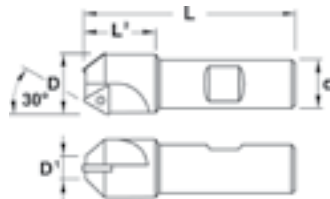

Style "A" - 30°

Designation	D	D ¹	d	L	L ²	Flutes
<i>Insert: TCM_-21.5_</i>						
TT30E-062TC2	.625	.213	.500	2.75	.94	1
TT30E-102TC2	1.020	.622	.750	3.54	1.18	2

Remember to use COPASLIP® anti-seize compound on all insert screws



Style "B" - 45°

Designation	D	D ¹	d	L	L ²	Flutes
<i>Insert: TCM_-21.5_</i>						
TT45E-062TC2	.625	.047	.500	2.75	.94	1
TT45E-083TC2	.830	.244	.750	3.54	1.10	2

Remember to use COPASLIP® anti-seize compound on all insert screws

TCMT



Designation	l	d	s	d ¹	r	TCMT...			
						RP25K			
TCMT-21.51-TMU	.433	1/4	3/32	.110	1/64	●			
TCMT-21.52-TMU					1/32	●			

Spare Parts		
Insert: TCM_-21.5_	TX7-1425	W-37019

The TPC cutter permits the machine operator to drill and side mill with the same tool. Drilling depths of 3/4 of the insert height are possible. (Deeper holes are attainable, but chip evacuation is extremely important.)

Enclosed pockets are an ideal application for the TPC end mill. Several different insert styles are available, both in coated and uncoated milling grades.

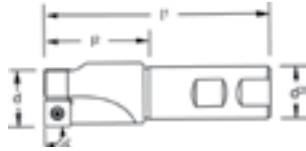

Standard Length End Mills for Drilling and Milling

Designation	d	d ²	l ¹	l ²	Flutes
<i>Insert: SDMT-322</i>					
TPC-0730	.730	.750	3.03	1.00	1
TPC-1000	1.000	1.000	3.50	1.25	2
TPC-1000-3	1.000	.750	3.25	1.25	2
<i>Insert: SPMT-432 / SPMW-432</i>					
TPC-1250	1.250	1.000	4.00	1.50	2
TPC-1500	1.500	1.250	4.00	1.50	2

Remember to use COPASLIP® anti-seize compound on all insert screws

Extended Length End Mills for Drilling and Milling

Designation	d	d ²	l ¹	l ²	Flutes
<i>Insert: SDMT-322</i>					
TPC-0730-XL	.730	.750	3.53	1.50	1
TPC-1000-XL	1.000	1.000	4.31	2.03	2
<i>Insert: SPMT-432 / SPMW-432</i>					
TPC-1250-XL	1.250	1.000	4.81	2.50	2
TPC-1500-XL	1.500	1.250	5.40	3.00	2

Remember to use COPASLIP® anti-seize compound on all insert screws

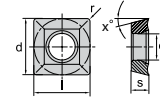
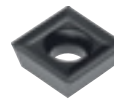

Designation	l	d	s	d ¹	r	x	SDMT/SPMT			
							TP25MP	TP30MC	TP35MP	TP25M
SDMT-322	.375	3/8	.125	.159	1/32	15°	●			●
SPMT-432-SN	.500	1/2	.187	.218	1/32	11°		●	●	

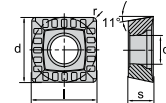
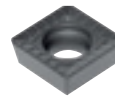

Designation	l	d	s	d ¹	r	SPMT-...				
						TP25MP	TP30MC	TP35MP	TP25M	
SPMT-432-SN-P	.500	1/2	.187	.205	1/32		●			

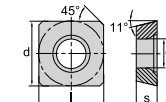
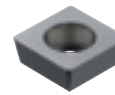

Designation	l	d	s	d ¹	r	SPMW-...			
						RK15MC	TK15MC		
SPMW-432	.500	1/2	.187	.205	1/32	●	●		

Spare Parts			
Insert: SDM-322	TX15-951	W-45526	W-37032
Insert: SPM-432	TX20-072	W-45526	W-37032

TCCBE Counterbore Milling Cutters

Range*: 1/4" to 3/4" or M6 to M16 not inclusive

- Positive insert geometry for smooth cutting action
- Recommended for use on N/C machining centers and conventional milling machines

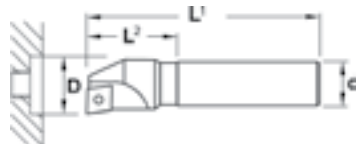

End Mills for Counterboring - INCH

Designation	Cap Screw Size	D	d	L ¹	L ²
<i>Insert: CCM_-21.5_</i>					
TCCBE-025-CC2	1/4	.406	.500	3.00	.59
TCCBE-031-CC2	5/16	.500	.500	3.00	.74
<i>Insert: CCM_-32.5_</i>					
TCCBE-037-CC3	3/8	.594	.625	3.50	1.18
TCCBE-050-CC3	1/2	.781	.625	3.50	1.26
TCCBE-062-CC3	5/8	.969	.750	3.50	1.26
TCCBE-075-CC3	3/4	1.188	.750	3.50	1.26

Remember to use COPASLIP® anti-seize compound on all insert screws

End Mills for Counterboring - METRIC

Designation	Cap Screw Size	D	d	L ¹	L ²
<i>Insert: CCM_-21.5_</i>					
TCCBE-M6-CC2	M6	11	12	85	15
TCCBE-M8-CC2	M8	14	12	85	19
<i>Insert: CCM_-32.5_</i>					
TCCBE-M10-CC3	M10	17	16	95	30
TCCBE-M12-CC3	M12	19	16	95	32
TCCBE-M14-CC3	M14	22	16	95	32
TCCBE-M16-CC3	M16	25	16	95	32

Remember to use COPASLIP® anti-seize compound on all insert screws

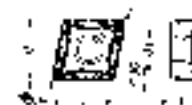
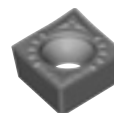

Designation	l	d	s	d ¹	r	CCMT-...			
						RP25K			
CCMT-21.51-TMU	.254	1/4	3/32	.114	1/64	●			
CCMT-21.52-TMU					1/32	●			
CCMT-32.51-TMU	.380	3/8	5/32	.173	1/64	●			
CCMT-32.52-TMU					1/32	●			



90° ISO Milling Cutters

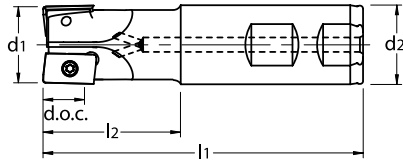

90° ISO End Mills - EMP90 Std. Length with Coolant Through

Cutter Body No.	d ¹	d ²	l ¹	l ²	d.o.c	fl
<i>Inserts: APHT-1003-PDFR-RAL / APKT-1003-PDSR-BM / APKT-1003-PDSR-BP</i>						
EMP90-A10-050WCI	0.500	.625	3.00	1.09	.33	1
EMP90-A10-062WCI	0.625	.625	3.00	1.09	.33	2
EMP90-A10-075WDI	0.750	.750	3.50	1.46	.33	2
EMP90-A10-075WDFI	0.750	.750	3.50	1.46	.33	3
EMP90-A10-100WEI	1.000	1.000	4.00	1.71	.33	3
EMP90-A10-100WEFI	1.000	1.000	4.00	1.71	.33	4
EMP90-A10-125WFI	1.250	1.250	4.00	1.71	.33	5
EMP90-A10-150WFI	1.500	1.250	4.00	1.71	.33	6
<i>Inserts: APHT-1604-PDFR-RAL / APKT-160416-SR-BP / APKT-160424-SR-BP / APKT-160432-SR-BP / APKT-1604-PDSR</i>						
EMP90-A16-075WDI	0.750	.750	3.50	1.47	.55	1
EMP90-A16-100WDI	1.000	1.000	4.00	1.71	.55	2
EMP90-A16-125WDI	1.250	1.250	4.00	1.71	.55	3
EMP90-A16-150WDI	1.500	1.250	4.00	1.71	.55	3

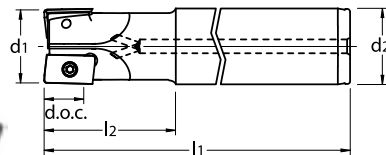

90° ISO End Mills - EMP90 Long Length with Coolant Through

Cutter Body No.	d ¹	d ²	l ¹	l ²	d.o.c	fl
<i>Inserts: APHT-1003-PDFR-RAL / APKT-1003-PDSR-BM / APKT-1003-PDSR-BP</i>						
EMP90-A10-050SCI-XL	0.500	.625	4.00	2.09	.33	1
EMP90-A10-062SCI-XL	0.625	.625	4.00	2.09	.33	2
EMP90-A10-075SDI-XL	0.750	.750	5.00	2.96	.33	2
EMP90-A10-100SEI-XL	1.000	1.000	6.00	3.71	3.3	3
<i>Inserts: APHT-1604-PDFR-RAL / APKT-160416-SR-BP / APKT-160424-SR-BP / APKT-160432-SR-BP / APKT-1604-PDSR</i>						
EMP90-A16-100SEI-XXL	1.000	1.000	8.00	2.62	.55	2
EMP90-A16-125SFI-XXL	1.250	1.250	8.00	2.62	.55	3
EMP90-A16-150SFI-XXL	1.500	1.250	8.00	---	.55	3

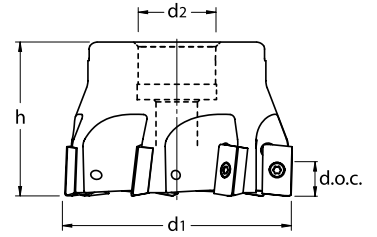

90° ISO Face Mills - FMP90

Cutter Body No.	d ¹	d ²	h	d.o.c	fl
<i>Inserts: APHT-1003-PDFR-RAL / APKT-1003-PDSR-BM / APKT-1003-PDSR-BP</i>					
FMP90-A10-200AA	2.000	.750	1.500	.33	7
<i>Inserts: APHT-1604-PDFR-RAL / APKT-160416-SR-BP / APKT-160432-SR-BP / APKT-1604-PDSR</i>					
FMP90-A16-200AA	2.000	.750	1.50	.55	5
FMP90-A16-250AB	2.500	1.000	1.75	.55	6
FMP90-A16-300ABF	3.000	1.000	2.00	.55	7
FMP90-A16-400AD	4.000	1.500	2.00	.55	8
FMP90-A16-500AD	5.000	1.500	2.00	.55	9
FMP90-A16-600AE	6.000	2.000	2.50	.55	10

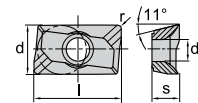

Inserts	l	s	d	d ¹	r	APKT-...							
						TK10MP	TK10M	TM45MP	TP25MP	TP35MP	TK15MC	RK15MC	
APHT-1003PDFR-RAL	.431	.138	.262	.110	.020	●	●						
APKT-1003PDSR-BM	.431	.138	.262	.110	.020			●					
APKT-1003PDSR-BP	.431	.138	.262	.110	.020				●	●	●	●	●
Inserts	l	s	d	d ¹	r								
APHT-1604-PDFR-RAL	.642	.207	.375	.177	.031	●							
APKT-160416-SR-BP	.642	.207	.375	.177	.062					●			
APKT-160424-SR-BP	.642	.207	.375	.177	.094					●			
APKT-160432-SR-BP	.642	.207	.375	.177	.125					●			
APKT-1604-PDSR-BM	.642	.207	.375	.177	.031			●					
APKT-1604-PDSR-BP	.642	.207	.375	.177	.031				●	●	●	●	●

-RAL inserts designed specifically for aluminum

Spare Parts			
Insert: AP.-10..	TX8-687	W-45511	W-37022
Insert: AP.-16..	TX15-388	W-45526	W-37032

Modular tool design offering many combinations:

- Cylindrical Shank holders
- Complete range of extensions & reducers
- Milling cutters with M6, M8, & M10 thread-on shanks
- Strong connection between the adaptor and the screw-on mill by means of a cylindrical fit, face contact and a thread-on screw
- Common holder for different applications, thereby reducing inventories

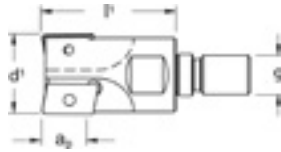

Screw-On Milling Cutters

Designation	d ¹	d ¹ mm	g	l ¹	Max. ap	flutes
<i>Insert: XDET-090308 / XDHT-0903...-AL</i>						
TXD90-0500-TS	.500	12.70	M6	1.10	.33	1
TXD90-0625-TS	.625	15.87	M8	1.10	.33	2
TXD90-0750-TS	.750	19.05	M10	1.18	.33	2
TXD90-0984-TS	.984	25.00	M12	1.18	.33	3
TXD90-1000-TS	1.000	25.40	M12	1.50	.33	3
TXD90-1260-TS	1.260	32.00	M16	1.57	.33	5
<i>Insert: XPET-160412 / XPHT-1604... / XPNT-160412-SR / XPNX-160412</i>						
TXP90-0975-TS	.975	24.77	M12	1.50	.55	2
TXP90-0984-TS	.984	25.00	M12	1.18	.55	2
TXP90-1000-TS	1.000	25.40	M12	1.50	.55	2
TXP90-1250-TS	1.250	31.75	M16	1.75	.55	3
TXP90-1260-TS	1.260	32.00	M16	1.57	.55	3
TXP90-1378-TS	1.378	35.00	M16	1.57	.55	3
TXP90-1500-TS	1.500	38.10	M16	1.75	.55	3
TXP90-1575-TS	1.575	40.00	M16	1.57	.55	4

Remember to use COPASLIP® anti-seize compound on all insert screws

Spare Parts			
Insert: XD...090308-...	TX8-687	W-45511	W-37022
Insert: XP...1604...-	TX15-388	W-45526	W-37032
Insert: RD...0802MOT	TX8-013	W-45511	W-37022
Insert: RD...1003MOT	TX15-951	W-45526	W-37032
Insert: RD...1204MOT-X	TX15-388	W-45526	W-37032
Insert: RD...1605MOT-X	TX20-072	W-45531	W-37036
Insert: VPGT-221-ALM	TX8-1625	W-45511	W-37022
Insert: VPGT-33...-ALM	TX15-1640	W-45526	W-37032

Screw-On Milling Cutters using 15° Positive Inserts for Copying & Face Milling

Designation	d	d mm	d ¹	g	l ¹	flutes
<i>Insert: RDGT-0802MOT / RDMT-0802MOT / RDMW-0802MOT</i>						
TR360-0500-TS	.500	12.70	.185	M6	1.10	1
TR360-0500L-TS	.500	12.70	.185	M8	2.00	1
TR360-0625-TS	.625	15.87	.310	M8	1.10	2
TR360-0750-TS	.750	19.05	.435	M10	1.18	2
TR360-1000R08-TS	1.000	25.40	.685	M12	1.50	3
TR360-1250R08-TS	1.250	31.75	.935	M16	1.75	5
<i>Insert: RDGT-1003MOT / RDMT-1003MOT / RDMW-1003MOT</i>						
TR360-0984-TS	.984	25.00	.591	M12	1.18	2
TR360-1000R10-TS	1.000	25.40	.606	M12	1.50	3
TR360-1181-TS	1.181	30.00	.787	M16	1.57	3
TR360-1250R10-TS	1.250	31.75	.856	M16	1.75	4
<i>Insert: RDMT-1204MOT-X / RDMW-1204MOT-X</i>						
TR360-0945-TS	.945	24.00	.472	M12	1.18	2
TR360-1000-TS	1.000	25.40	.528	M12	1.50	2
TR360-1250-TS	1.250	31.75	.778	M16	1.75	2
TR360-1378-TS	1.378	35.00	.906	M16	1.57	3
TR360-1500-TS	1.500	38.10	1.028	M16	1.75	3
TR360-1575-TS	1.575	40.00	1.102	M16	1.57	4
<i>Insert: RDMT-1605MOT-X / RDMW-1605MOT-X</i>						
TR360-1260-TS	1.260	32.00	.630	M16	1.57	2

Remember to use COPASLIP® anti-seize compound on all insert screws

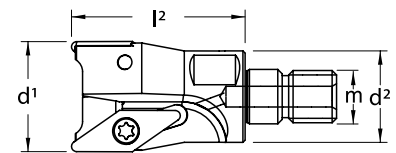

Screw-On Milling Cutters Optimized Design for Aluminum

Designation	d ¹	d ²	l ²	m	Max. ap	Max Plunge	flutes
<i>Insert: VPGT-221-ALM</i>							
Standard Non-Through Coolant							
TVP90-0750-TS	.750	.709	1.18	M10	.40	.200	2
Through Coolant Enabled							
TVP90-1000XC-TS	1.000	.827	1.57	M12	.40	.200	3
<i>Insert: VPGT-333-ALM / VPGT-33PPFR-ALM*</i>							
Through Coolant Enabled							
TVP90-1000C-TS	1.000	.827	1.57	M12	.53	.250	2
TVP90-1250C-TS	1.250	1.142	1.97	M16	.53	.250	2
TVP90-1500C-TS	1.500	1.142	1.97	M16	.53	.250	3
* To provide necessary clearance when using VPGT-33PPFR-ALM inserts, the cutter body must be relieved							

Remember to use COPASLIP® anti-seize compound on all insert screws

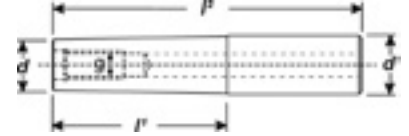
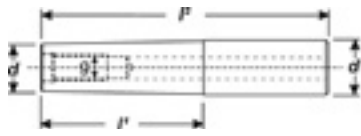

Weldon Straight Shanks

Designation	g	d	d'	l'	l''
SS050-M6-2	M6	.382	.500	2.00	3.78
SS050-M6-3	M6	.382	.500	3.00	4.78
SS063-M8-2	M8	.512	.625	2.00	3.90
SS063-M8-3	M8	.512	.625	3.00	4.90
SS063-M8-4	M8	.512	.625	4.00	5.90
SS075-M10-3	M10	.709	.750	3.00	5.03
SS075-M10-5	M10	.709	.750	5.00	7.03
SS100-M12-3*	M12	.827	1.000	3.00	5.28
SS125-M12-5*	M12	.827	1.250	5.00	7.28
SS125-M16-3*	M16	1.142	1.250	3.00	5.28
SS125-M16-5*	M16	1.142	1.250	5.00	7.28
SS125-M16-7*	M16	1.142	1.250	7.00	9.28

* With internal coolant supply

Cylindrical Straight Shanks

Designation	g	d	d'	l'	l''
SS050CY-M6-2	M6	.382	.500	2.00	3.78
SS050CY-M6-3	M6	.382	.500	3.00	4.78
SS063CY-M8-2	M8	.512	.625	2.00	3.90
SS063CY-M8-3	M8	.512	.625	3.00	4.90
SS063CY-M8-4	M8	.512	.625	4.00	5.90
SS075CY-M10-3	M10	.709	.750	3.00	5.03
SS075CY-M10-5	M10	.709	.750	5.00	7.03
SS100CY-M12-3*	M12	.827	1.000	3.00	5.28
SS125CY-M12-5*	M12	.827	1.250	5.00	7.28
SS125CY-M16-3*	M16	1.142	1.250	3.00	5.28
SS125CY-M16-5*	M16	1.142	1.250	5.00	7.28
SS125CY-M16-7*	M16	1.142	1.250	7.00	9.28

* With internal coolant supply

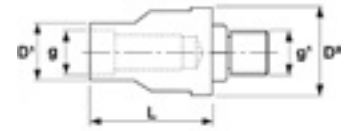
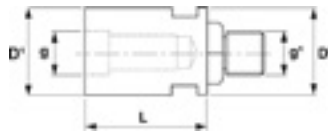

Extensions

Designation	g	g'	D1	D2	L
EX-M6	M6	M6	.382	.382	.98
EX-M8	M8	M8	.512	.512	1.18
EX-M10	M10	M10	.709	.709	1.37
EX-M12*	M12	M12	.827	.827	1.57
EX-M16*	M16	M16	1.142	1.142	1.57

* With internal coolant supply

Reducers

Designation	g	g'	D1	D2	L
RD-M8/M6	M6	M8	.382	.512	.98
RD-M10/M8	M8	M10	.512	.709	1.18
RD-M12/M10	M10	M12	.709	.827	1.38
RD-M16/M12*	M12	M16	.827	1.142	1.57

* With internal coolant supply

TV Carb

NEW! 1/2"

diameter capacity milling chucks!



- ✓ Slender 1.10" outside diameter of locknut
- ✓ Amazing 185 ft-lb gripping force
- ✓ Available in CV40, HSK-A63 and Straight Shank tools
- ✓ Precise to 0.0002" T.I.R.
(3xD away from the nose of the chuck)
- ✓ Precision made in Italy
- ✓ Chucks with 3/4" & 1-1/4" capacity also available

TV Carb Milling Chucks

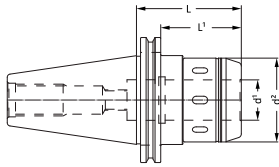

CV40 Milling Chucks

Designation	d ¹	d ²	L	L ¹
CV40MC-0500-2.50			2.50	1.25
CV40MC-0500-4.00	.500	1.10	4.00	2.75
CV40MC-0500-6.00			6.00	4.75
CV40MC-0750-3.00	.750	1.89	3.00	2.25
CV40MC-0750-5.00			5.00	4.25
CV40MC-1250-4.25	1.250	2.59	4.25	--
CV40MC-1250-5.50			5.50	--

CV50 Milling Chucks

Designation	d ¹	d ²	L	L ¹
CV50MC-0750-3.00	.750	1.89	3.00	2.25
CV50MC-0750-6.00			6.00	4.56
CV50MC-1250-3.25	1.250	2.59	3.25	2.50
CV50MC-1250-6.50			6.50	5.75

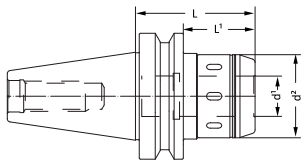

BT40 Milling Chucks

Designation	d ¹	d ²	L	L ¹
BT40MC-0750-2.50	.750	1.89	2.50	1.45
BT40MC-1250-3.50	1.250	2.59	3.50	---

BT50 Milling Chucks

Designation	d ¹	d ²	L	L ¹
BT50MC-0750-3.25	.750	1.89	3.25	1.85
BT50MC-1250-3.75	1.250	2.59	3.75	2.25

Collets for Milling Chucks - Inch

Designation	OD Dia.	ID Dia.	L
MC050-0125		1/8	
MC050-0188		3/16	
MC050-0250	1/2	1/4	1.73
MC050-0312		5/16	
MC050-0375		3/8	
MC075-0250		1/4	
MC075-0312		5/16	
MC075-0375		3/8	
MC075-0437	3/4	7/16	1.97
MC075-0500		1/2	
MC075-0563		9/16	
MC075-0625		5/8	

HSK-A63 Milling Chucks

Designation	d ¹	d ²	L	L ¹
HSK-A63MC-0500-2.75	.500	1.10	2.75	1.73
HSK-A63MC-0500-4.00			4.00	2.91
HSK-A63MC-0750-3.50	.750	1.89	3.50	2.32
HSK-A63MC-0750-5.00			5.00	3.90
HSK-A63MC-1250-4.50	1.250	2.60	4.50	--

HSK-A100 Milling Chucks

Designation	d ¹	d ²	L	L ¹
HSK-A100MC-0750-4.00	.750	1.89	4.00	2.80
HSK-A100MC-0750-6.00			6.00	4.86
HSK-A100MC-1250-4.50	1.250	2.60	4.50	3.19
HSK-A100MC-1250-6.50			6.50	4.86



1/2" Capacity Straight Shank Milling Chucks

Designation	d ¹	d ²	d ³	OAL
SS075MC-0500-7.00			.750	7.00
SS100MC-0500-7.00	.500	1.10	1.000	7.00
SS100MC-0500-9.00			1.000	9.00

3/4" Capacity Straight Shank Milling Chucks

Designation	d ¹	d ²	d ³	OAL
SS100MC-0750-9.00	.750	1.89	1.000	9.00
SS125MC-0750-9.00			1.250	9.00

Collets for Milling Chucks - Inch

Designation	OD Dia.	ID Dia.	L
MC125-0250		1/4	
MC125-0312		5/16	
MC125-0375		3/8	
MC125-0437		7/16	
MC125-0500		1/2	
MC125-0563	1.1/4	9/16	2.48
MC125-0625		5/8	
MC125-0750		3/4	
MC125-0875		7/8	
MC125-1000		1	

Metric Milling Chuck Collets available on request

Coolant through shell arbors used with coolant through face mills are designed to **BLAST AWAY** the effects of thermal shock!

- Maximize cutting parameters!
- Maximize insert life!
- Maximize profits!
- Minimize thermal shock!
- Minimize possible re-cutting of chips!
- Superior surface finishes!

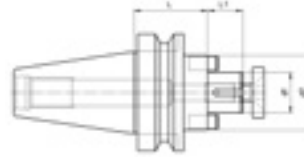
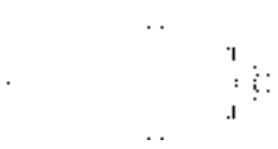

CV40 with Coolant Through

Designation	d ¹	d ²	L	L ¹	lbs
CV40SM-0750-2.00	.750	1.570	2.000	.680	1.540
CV40SM-0750-4.00			4.000		1.980
CV40SM-1000-2.00	1.000	1.960	2.000	.680	1.980
CV40SM-1000-4.00			4.000		2.640
CV40SM-1250-2.25	1.250	2.360	2.250	.680	3.300
CV40SM-1250-4.00			4.000		3.960
CV40SM-1500-2.25	1.500	2.750	2.250	.940	5.720
CV40SM-1500-4.00			4.000		6.380

BT40 with Coolant Through

Designation	d ¹	d ²	L	L ¹	lbs
BT40SM-0750-2.00	.750	1.570	2.000	.680	1.540
BT40SM-0750-4.00			4.000		3.960
BT40SM-1000-2.00	1.000	1.960	2.000	.680	1.980
BT40SM-1000-4.00			4.000		4.840
BT40SM-1250-2.25	1.250	2.360	2.250	.680	3.300
BT40SM-1250-4.00			4.000		5.940

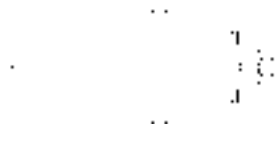

CV50 with Coolant Through

Designation	d ¹	d ²	L	L ¹	lbs
CV50SM-0750-2.00			2.000		5.060
CV50SM-0750-4.00	.750	1.570	4.000	.680	6.160
CV50SM-0750-6.00			6.000		9.900
CV50SM-1000-2.00			2.000		5.500
CV50SM-1000-4.00	1.000	1.960	4.000	.680	6.820
CV50SM-1000-6.00			6.000		12.100
CV50SM-1250-2.25			2.250		7.480
CV50SM-1250-4.00	1.250	2.360	4.000	.680	8.800
CV50SM-1250-6.00			6.000		14.300
CV50SM-1500-2.25			2.250		8.360
CV50SM-1500-4.00	1.500	3.460	4.000	.940	9.460
CV50SM-1500-6.00			6.000		16.500

HSK-A63 Shell Mill Holders with Coolant Through

Designation	d ¹	d ²	L	L ¹
HSK-A63SM-0750-2.00	.750	1.575	2.000	
HSK-A63SM-0750-4.00			4.000	
HSK-A63SM-1000-2.00	1.000	1.969	2.000	.689
HSK-A63SM-1000-4.00			4.000	
HSK-A63SM-1250-2.25	1.250	2.362	2.250	
HSK-A63SM-1250-4.00			4.000	

HSK-A100 Shell Mill Holders with Coolant Through

Designation	d ¹	d ²	L	L ¹
HSK-A100SM-0750-2.25	.750	1.575	2.250	
HSK-A100SM-0750-4.00			4.000	
HSK-A100SM-1000-2.25	1.000	1.969	2.250	.689
HSK-A100SM-1000-4.00			4.000	
HSK-A100SM-1250-2.50	1.250	2.362	2.500	
HSK-A100SM-1250-4.00			4.000	
HSK-A100SM-1500-2.50	1.500	3.465	2.500	.945
HSK-A100SM-1500-4.00			4.000	

CUSTOM SOLUTIONS

Made to Order

In addition to our extensive line up of milling cutters, we offer our customers the option of customized single and multiple pocket tooling.

We have the technical expertise and equipment to create special tools to suit your specific applications with short lead times and competitive pricing.



1 Insert Shape			
H	O	P	R
S	T	C	D
E	M	V	W
L	A	B	K

2 Side Clearance	
A	B
C	D
E	F
G	N
	Special
P	X

4 Insert Style	
N	R
F	A
M	G
B	T
	Special
C	X

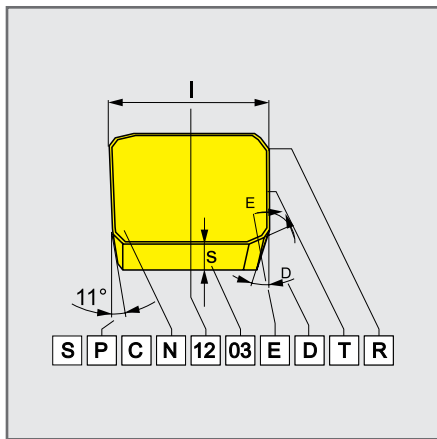

	ISO	1	2	3	4
		S	P	G	N
		S	P	K	N
	ANSI	1	2	3	4
		S	P	G	
		S	P	K	N

3 Tolerances

SYMBOL	Tolerances [mm]			Tolerances [Inch]		
	m(±)	s(±)	d = I.C	m	s	d = I.C. (±)
A	0.005	0.025	0.025	0.0002	0.001	0.0010
F	0.005	0.025	0.013	0.0002	0.001	0.0005
C	0.013	0.025	0.025	0.0005	0.001	0.0010
H	0.013	0.025	0.013	0.0005	0.001	0.0005
E	0.0125	0.025	0.025	0.0010	0.001	0.0010
G	0.025	0.130	0.025	0.0010	0.005	0.0010
J	0.005	0.025	0.05/0.13	0.0002	0.001	0.002/0.005
K	0.013	0.025	0.05/0.13	0.0005	0.001	0.002/0.005
L	0.025	0.025	0.05/0.13	0.0010	0.001	0.002/0.005
M	0.08/0.18	0.130	0.05/0.13	0.003/0.007	0.005	0.002/0.005
N	0.08/0.18	0.025	0.05/0.13	0.003/0.007	0.001	0.002/0.005
U	0.05/0.38	0.130	0.08/0.25	0.005/0.015	0.005	0.003/0.010

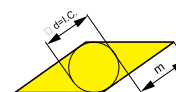
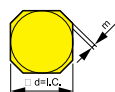
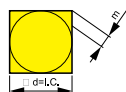
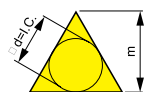

d=I.C		Cutting Edge Length						
mm	Inch	R	S	T	C	D	V	W
3,97	5/32"			06				
5,00	-	05						
5,56	7/32"			09				03
6,00	-	06						
6,35	1/4"			11	06	07		04
8,00	-	08						
9,525	3/8"	09	09	16	09	11	16	06
10,0	-	10						
12,0	-	12						
12,7	1/2"	12	12	22	12	15		08
15,875	5/8"	15	15	27	16			
16,0	-	16						
19,05	3/4"	19	19	33	19			
20,0	-	20						
25,0	-	25						
25,4	1"	25	25		25			
31,75	1 1/4"	31						
32,0	-	32						

6 Thickness		
Symbol	s	
	mm	Inch
01	1,59	1/16"
T1	1,98	5/64"
02	2,38	3/32"
03	3,18	1/8"
T3	3,97	5/32"
04	4,76	3/16"
05	5,56	7/32"
06	6,35	1/4"
07	7,94	5/16"
09	9,52	3/8"

7 Cutting Edge Angle		Clearance Angle	
A	45	A	3
D	60	B	5
E	75	C	7
F	85	D	15
P	90	E	20
Z	Spec./ Espec.	F	25
		G	30
		N	0
		P	11
		Z	Spec./ Espec.
ZZ- Spec./ Espec.			

5	6	7	8	9
12	03	08		
12	03	ED	S	R
5A	6A	7A	8	9
4	2	2		
4	2	ED	S	R

ANSI

Inscribed Circle 5A		
Symbol	d=I.C	
	mm	Inch/Pal.
1	3,175	1/8"
(1.2)	3,969	5/32"
(1.5)	4,763	5/16"
(1.8)	5,556	7/32"
2	6,350	1/4"
(2.5)	7,938	5/16"
3	9,525	3/8"
4	12,700	1/2"
5	15,875	5/8"
6	19,050	3/4"
7	22,225	7/8"
8	25,400	1"
10	31,750	1-1/4"

Thickness 6A		
Symbol	s	
	mm	Inch/Pal.
1	1,588	1/16"
(1.2)	1,984	5/64"
(1.5)	2,381	3/32"
2	3,175	1/8"
(2.5)	3,969	5/32"
3	4,763	3/16"
(3.5)	5,556	7/32"
4	6,350	1/4"
5	7,938	5/16"
6	9,525	3/8"
7	11,113	7/16"
8	12,700	1/2"
9	14,288	9/16"
10	15,875	5/8"

Nose Radius 7A		
Symbol	r	
	mm	Inch/Pal.
0	0,050	1/512"
(0.2)	0,099	1/256"
(0.5)	0,198	1/128"
1	0,397	1/64"
2	0,794	1/32"
3	1,191	3/64"
4	1,588	1/16"
5	1,984	5/64"
6	2,381	3/32"
7	2,778	7/64"
8	3,175	1/8"
10	3,969	5/32"
12	4,763	3/16"
14	5,556	7/32"
16	6,350	1/4"
x	other/resto	

8 Cutting Edge Condition			
	F Sharp Edges		E Rounded Edges
	T Edges with Facet		S Rounded Edges with Facet
	K Edges with Double Facet		P Rounded Edge with Double Facet

9 Feed Direction	
R	
L	
N	

Coated Grades			05	10	15	20	25	30	35	40	45	50	
TK15MC	K15-K30 An extremely hard carbide substrate with a MT-CVD multilayer coating ideal for dry machining of all cast-irons.	P											
		M											
		K											
		N											
		S											
		H											
RK15MC	K15-K25, H10-H20 A cutting material grade specifically for cast iron milling. Finest grade carbide coated with TeraSpeed (AlTiN) for high-performance cast iron machining, high cutting speeds and dry machining.	P											
		M											
		K											
		N											
		S											
		H											
RP35AP	P15-P35, M15-M35 AlCrN PVD coating with a strong substrate for light roughing to finishing at med to high cutting speeds for materials in steel and stainless classification.	P											
		M											
		K											
		N											
		S											
		H											
RP35MP	P20-P35, M20-M40 A tough grade with TiAlN supernitride PVD coating used in roughing of steel and stainless when good wear resistance is required.	P											
		M											
		K											
		N											
		S											
		H											
RP40AP	P25-P40, M25-M40, S35-S45 AlCrN coating and extra-strong substrate combine for a first class grade used in the machining of austenitic stainless steel and hi-temp alloys such as Inconel and Hastalloy and titanium.	P											
		M											
		K											
		N											
		S											
		H											
RP40MP	P30-P40, M30-M40, S30-S40 Very tough strong grade with TiAlN supernitride coating. Used in roughing applications in steel but also machining 300 series stainless steel and difficult to cut aerospace alloys.	P											
		M											
		K											
		N											
		S											
		H											
TM30MP	M20-M35, S20-S35 Grade with premium AlCrN coating delivers exceptional performance in all steels at high SFM. Fine grain substrate is tough enough to handle roughing cuts and is excellent in semi-finishing to finishing applications.	P											
		M											
		K											
		N											
		S											
		H											
TM45MP	M30-M45, S30-S40 Extremely tough, relatively fine-grained carbide substrate with thin, smooth and tough PVD-multilayer coating. Ideal grade for milling austenitic stainless steels at low to medium cutting speeds and wet machining.	P											
		M											
		K											
		N											
		S											
		H											
TK10MP	M10-M20, K10-K30, N05-N20, H10-H20 The ideal grade for working aluminum materials and other non-ferrous metals. Thanks to a very thin micro pulse plasma CVD TiAlN coating it is also excellent for finish machining of stainless steels and grey cast iron. As well as hardened steels.	P											
		M											
		K											
		N											
		S											
		H											

Coated Grades			05	10	15	20	25	30	35	40	45	50	
TP30MP	P25-P35 TiAlN super nitride coating over a high quality carbide substrate is an excellent performer in all steel applications as well as 400 series stainless steel. Post coating process smooths out the cutting edge to help improve tool life and part finishes.	P											
		M											
		K											
		N											
		S											
		H											
TP30MC	P25-P40 The very tough carbide substrate guarantees this universal steel milling grade's high machining security for a wide range of steel material. A modern MT-CVD multilayer Al ₂ O ₃ – coating ensures successful dry machining.	P											
		M											
		K											
		N											
		S											
		H											
TP25MP	P15-P30, M20-M30 Highly wear resistant PVD coated grade with high toughness for wet and dry milling of steel, cast steel and stainless steel with high cutting speeds and low to medium depths of cut and chip loads..	P											
		M											
		K											
		N											
		S											
		H											
TP30AP	P20-P35, M25-M35 Grade with premium AlCrN coating delivers exceptional performance in all steels at high SFM. Fine grain substrate is tough enough to handle roughing cuts and is excellent in semi-finishing to finishing applications.	P											
		M											
		K											
		N											
		S											
		H											
TP35MC	P25-P40, M25-M40, K25-K40 TiN-MT TiCN-Al ₂ O ₃ by CVD. Coating thickness 4-7 microns. For use on steel, alloyed steel and cast iron. With its aluminum oxide coating, the grade TP35MC is recommended every time wear characteristics are more important than toughness.	P											
		M											
		K											
		N											
		S											
		H											
TP35MP	P20-P40, M20-M40 Very tough Nanotop PVD AlTiN gradient coating carbide grade especially for milling tool steels. Ideal for dry milling at low to medium cutting speeds for roughing.	P											
		M											
		K											
		N											
		S											
		H											

Uncoated Grades			05	10	15	20	25	30	35	40	45	50	
TK10M	K15-K25, N05-N15 Uncoated milling grade with high wear resistance for machining grey cast iron, aluminum and non-ferrous metals with medium to high cutting speeds.	P											
		M											
		K											
		N											
		S											
		H											
TP25M	P25-P35, K20-K30 Wear-resistant, uncoated multiple-application material with high strength, for wet and dry milling of alloyed materials (cast iron, in some cases also nodular cast iron). Moderate cutting speeds with low to medium depths of cut and low to medium chip loads.	P											
		M											
		K											
		N											
		S											
		H											

Designation	l	d	s	d ¹	r	APHT-...-RAL	
						TK10MP	TK10M
APHT-1003PDFR-RAL	.431	.260	.138	.110	.020	●	●
APHT-1604PDFR-RAL	.681	3/8	.207	.177	1/32	●	●

-RAL inserts designed specifically for aluminum

Designation	l	d	s	d ¹	r	APKT-...-TMK	
						TM40MP	TM45MP
APKT-1003PDSR-TMK	.431	.260	.138	.110	.020	●	●
APKT-1604PDSR-TMK	.681	3/8	.207	.177	1/32	●	●

Designation	l	d	s	d ¹	r	APKT-...-SR					
						TP25MP	TP30MC	TP35MP	TP25M	RK15MC	TK15MC
APKT-1003PDSR-SR	.431	.260	.138	.110	.020	●	●	●	●	●	●
APKT-1604PDSR-SR					1/32	●	●	●	●	●	●
APKT-160416PDSR-SR					1/16	●	●	●	●	●	●
APKT-160424PDSR-SR	.681	3/8	.207	.177	3/32	●	●	●	●	●	●
APKT-160432PDSR-SR					1/8	●	●	●	●	●	●

Designation	l	d	s	d ¹	r	HNGX-...	
						RK15MC	TK15MC
HNGX-090520ZZN					.079	●	●
HNGX-090530ZZN	.371	.643	.221	.127	.119	●	●

Designation	l	d	s	d ¹	r	ODHT-...			
						TP25MP	TP30MC	TP35MP	TP25M
ODHT-060508ZZ	.261	5/8	.221	.218	1/32	●	●	●	●

Designation	l	d	s	d ¹	r	ODMW-...					
						TP25MP	TP30MC	TP35MP	TP25M	RK15MC	TK15MC
ODMW-060508SN	.261	5/8	.221	.218	1/32	●	●	●	●	●	●

Designation	l	d	s	d ¹	r	OFER-...			
						TP30MC	TP35MP	TP35MP	TP25M
OFER-070405-SN	.294	.719	.187	--	--	●	●	●	●
OFER-070405-SN-SR					--	●	●	●	●

Designation	l	d	s	d ¹	r	RCMT-...-MOT			
						TP30AP	TP30MP	TM30MP	TP35MC
RCMT-1606MOT-X*	--	.630	1/4	.217	--	●	●	●	●

*Inserts have integrated anti-rotation lock

Designation	l	d	s	d ¹	r	RDGT-...-AL			
						TK10M	TK10M	TK10M	TK10M
RDGT-0802MO-AL	--	.315	3/32	.134	--	●	●	●	●
RDGT-0803MO-AL	--	.315	1/8	.134	--	●	●	●	●
RDGT-1003MO-AL	--	.394	1/8	.173	--	●	●	●	●

-AL inserts designed specifically for aluminum

Designation	l	d	s	d ¹	r	RDMT-...-MOT			
						TP30AP	TP30MP	TM30MP	TP35MC
RDMT-0802MOT	--	.315	3/32	.134	--	●	●	●	●
RDMT-1003MOT	--	.394	1/8	.173	--	●	●	●	●
RDMT-1204MOT-X*	--	.472	3/16	.173	--	●	●	●	●
RDMT-1605MOT-X*	--	.630	7/32	.217	--	●	●	●	●

*Inserts have integrated anti-rotation lock

Designation	l	d	s	d ¹	r	RDMW-...-MOT			
						TP30AP	TP30MP	TM30MP	TP35MC
RDMW-0802MOT	--	.315	3/32	.134	--	●	●	●	●
RDMW-1003MOT	--	.394	1/8	.173	--	●	●	●	●
RDMW-1204MOT-X*	--	.472	3/16	.173	--	●	●	●	●
RDMW-1605MOT-X*	--	.630	7/32	.217	--	●	●	●	●
RDMW-2006MOT-X*	--	.787	.250	.259	--	●	●	●	●

*Inserts have integrated anti-rotation lock

Designation	l	d	s	d ¹	r	SCKT-...-ACTN			
						TP25MP	TP30MC	TP35MP	TP25M
SCKT-1205-ACTN	.500	1/2	.221	.218	--	●	●	●	●

Designation	l	d	s	d ¹	r	SDHT-...			
						TP25MP	TP30MC	TP35MP	TP25M
SDHT-43AESN	.500	1/2	.187	.218	--	●	●	●	●
SDHT-53AESN	.625	5/8	.187	.218	--	●	●	●	●



Designation	l	d	s	d ¹	r	SDHT-...-RAL							
						TK10MP	TK10M						
SDHT-43AEFN-RAL	.500	1/2	.187	.218	--	●	●						
SDHT-53AEFN-RAL	.625	5/8	.187	.218	--	●							

-RAL inserts designed specifically for aluminum

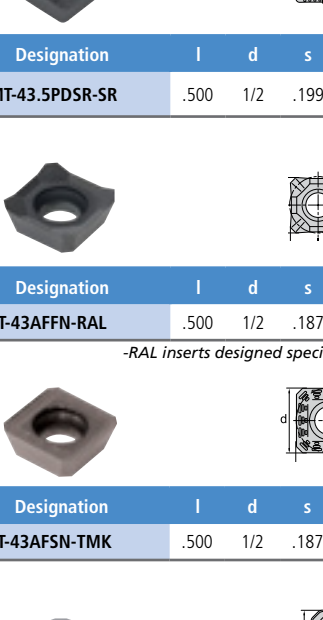

Designation	l	d	s	d ¹	r	SEKR-...						
						TP25MP	TP30MC	TP35MP	TP25M	TM45MP	TK12MC	
SEKR-42AFSN	.500	1/2	.125	--	.056	●	●	●				
SEKR-43AFSN	.500	1/2	.187	--	.056	●	●					

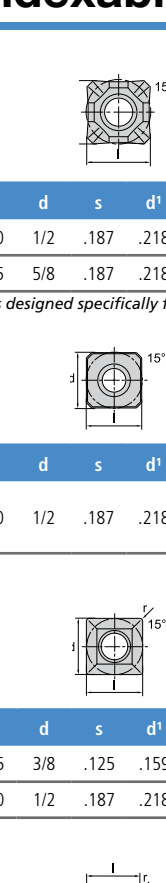

Designation	l	d	s	d ¹	r	SDHW-...						
						TP25MP	TP30MC	TP35MP	TP25M	RK15MC	TK15MC	
SDHW-43AEEN	.500	1/2	.187	.218	--					●	●	
SDHW-43AESN						●	●					

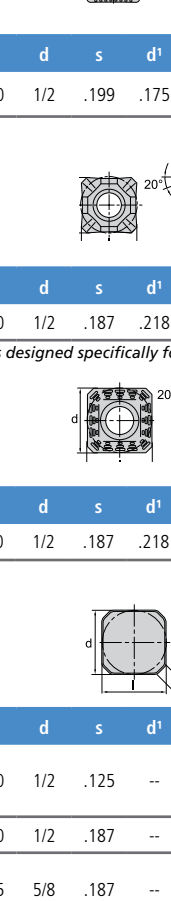

Designation	l	d	s	d ¹	r	SEKR-...-TMK						
						TP25MP	TP30MC	TP35MP	TP25M	TM45MP	TK12MC	
SEKR-42AFSN-TMK	.500	1/2	.125	--	.056					●		
SEKR-43AFSN-TMK	.500	1/2	.187	--	.056					●		

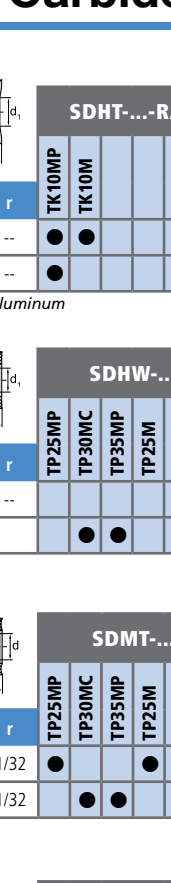

Designation	l	d	s	d ¹	r	SDMT-...						
						TP25MP	TP30MC	TP35MP	TP25M			
SDMT-322	.375	3/8	.125	.159	1/32	●			●			
SDMT-432-SN	.500	1/2	.187	.218	1/32		●	●				

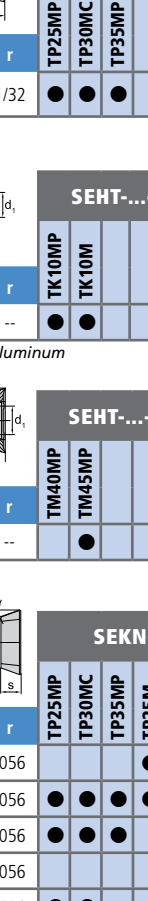

Designation	l	d	s	d ¹	r	SEKT-...						
						TP25MP	TP30MC	TP35MP	TP25M	TM45MP	TK12MC	
SEKT-43AFSN	.500	1/2	.187	.218	--		●	●	●			



Designation	l	d	s	d ¹	r	SDMT-...						
						TP25MP	TP30MC	TP35MP				
SDMT-43.5PDSR-SR	.500	1/2	.199	.175	1/32	●	●	●				

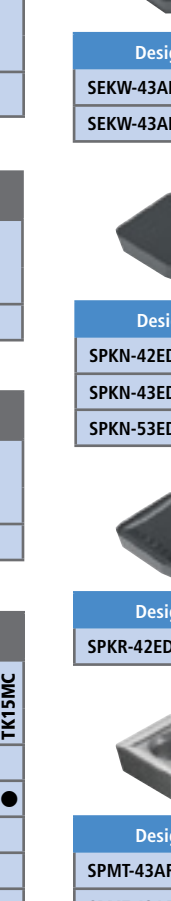

Designation	l	d	s	d ¹	r	SEKW-...						
						TP25MP	TP30MC	TP35MP	TP25M	TM45MP	TK12MC	
SEKW-43AFEN	.500	1/2	.187	.218	--	●	●	●	●	●	●	
SEKW-43AFSN	.500	1/2	.187	.218	--	●	●	●	●	●	●	

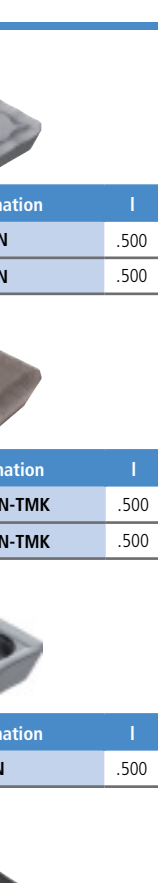

Designation	l	d	s	d ¹	r	SEHT-...-RAL						
						TK10MP	TK10M					
SEHT-43AFFN-RAL	.500	1/2	.187	.218	--	●	●					

-RAL inserts designed specifically for aluminum

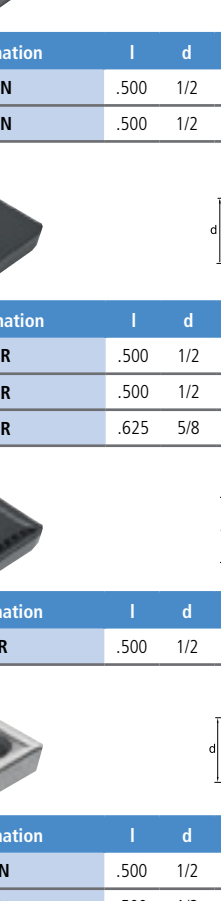

Designation	l	d	s	d ¹	r	SPKN-...						
						TP25MP	TP30MC	TP35MP	TP25M	TM45MP	TK12MC	
SPKN-42EDSR	.500	1/2	.125	--	--	●	●		●	●		
SPKN-43EDSR	.500	1/2	.187	--	--					●		
SPKN-53EDSR	.625	5/8	.187	--	--	●	●		●	●		

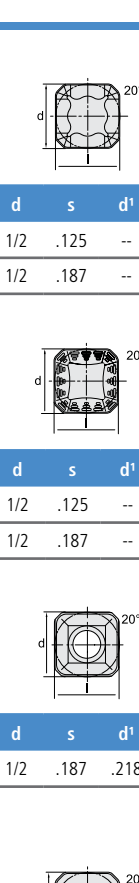

Designation	l	d	s	d ¹	r	SEHT-...-TMK						
						TM40MP	TM45MP					
SEHT-43AFSN-TMK	.500	1/2	.187	.218	--		●					

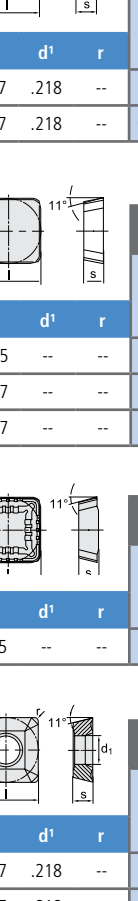

Designation	l	d	s	d ¹	r	SPKR-...						
						TP25MP	TP30MC	TP35MP	TP25M	TM45MP	TK12MC	
SPKR-42EDSR	.500	1/2	.125	--	--		●					

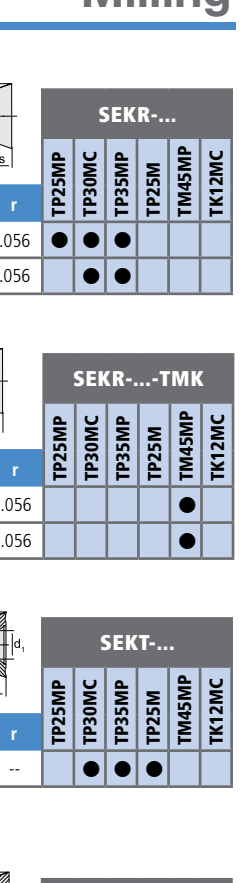

Designation	l	d	s	d ¹	r	SEKN-...						
						TP25MP	TP30MC	TP35MP	TP25M	TM45MP	TK15MC	
SEKN-42AFEN	.500	1/2	.125	--	.056				●	●		
SEKN-42AFSN					.056	●	●	●	●		●	
SEKN-43AFSN	.500	1/2	.187	--	.056	●	●					
SEKN-53AFEN	.625	5/8	.187	--	.056					●		
SEKN-53AFSN					.056	●	●					



Designation	l	d	s	d ¹	r	SPMT-...						
						TP25MP	TP30MC	TP35MP	TP25M	TM45MP	TK12MC	
SPMT-43AFEN	.500	1/2	.187	.218	--		●					
SPMT-43AFSN	.500	1/2	.187	.218	--		●	●				

SPMT-...						
Designation	l	d	s	d ¹	r	
SPMT-432-SN-P	.500	1/2	.187	.205	1/32	●

XPET-160412						
Designation	l	d	s	d ¹	r	
XPET-160412	.635	3/8	.187	.173	3/64	● ● ● ● ●

SPMW-...						
Designation	l	d	s	d ¹	r	
SPMW-432	.500	1/2	.187	.205	1/32	● ●

XPHT-1604..						
Designation	l	d	s	d ¹	r	
XPHT-160408					1/32	● ●
XPHT-160412	.635	3/8	.187	.173	3/64	● ● ● ●
XPHT-160416					1/16	● ● ● ●
XPHT-160432					1/8	● ● ● ●

TPKN-...						
Designation	l	d	s	d ¹	r	
TPKN-32PDER	.650	3/8	.125	--	--	● ●
TPKN-32PDSR						● ● ● ●
TPKN-43PDER	.866	1/2	.187	--	--	● ●
TPKN-43PDSR						● ● ● ●

XPHT-1604.. -AL						
Designation	l	d	s	d ¹	r	
XPHT-160408-AL					1/32	● ●
XPHT-160412-AL					3/64	● ● ● ●
XPHT-160416-AL	.635	3/8	.187	.173	1/16	● ● ● ●
XPHT-160420-AL					5/64	● ● ● ●
XPHT-160424-AL					3/32	● ● ● ●
XPHT-160432-AL					1/8	● ● ● ●

-AL inserts designed specifically for aluminum

VCGT-...						
Designation	l	d	s	d ¹	r	
VCGT-43.58-ALM	.870	1/2	.219	.216	1/8	● ●

VPGT-...						
Designation	l	d	s	d ¹	r	
VPGT-221-ALM	.437	1/4	.125	.110	1/64	● ●
VPGT-333-ALM					3/64	● ● ● ●
VPGT-33PPFR-ALM	.654	3/8	.187	.173	--	● ● ● ●

XPNT-160412						
Designation	l	d	s	d ¹	r	
XPNT-160412	.635	3/8	.187	.173	3/64	● ● ● ● ●

XDET-090308						
Designation	l	d	s	d ¹	r	
XDET-090308	.381	1/4	1/8	.110	1/32	● ● ● ●

XPNT-160412-SR						
Designation	l	d	s	d ¹	r	
XPNT-160412-SR	.635	3/8	.187	.173	3/64	● ● ● ● ●

XDHT-...						
Designation	l	d	s	d ¹	r	
XDHT-090302-AL					.008	● ●
XDHT-090304-AL					1/64	● ● ● ●
XDHT-090308-AL	.381	1/4	1/8	.110	1/32	● ● ● ●
XDHT-090316-AL					1/16	● ● ● ●

XPNX-160412						
Designation	l	d	s	d ¹	r	
XPNX-160412	.635	3/8	.187	.173	3/64	● ● ● ● ●

-AL inserts designed specifically for aluminum

Designation	l	d	s	l'	d'	r	PCD				
							TFC	PDC	PDC-S	PDC-CU-S	
APKW-100302PDR						.008			●		
APKW-100304PDR	.431	1/4	.138	.150	.110	.016			●		
APKW-100308PDR						.032			●		
APKW-160404PDR						.016			●		
APKW-160408PDR	.681	3/8	.207	.150	.177	.031			●		

Designation	l	d	s	l'	d'	r	CBN				
							PBC-10	PBC-15	PBC-25	PBC-40	
APKW-100302PDR						.008	●		●		
APKW-100304PDR	.431	1/4	.138	.150	.110	.016	●		●		

Designation	l	d	s	l'	d'	r	PCD				
							TFC	PDC	PDC-S	PDC-CU-S	
RDHX-0501MO	-	.197	.059	-	.079	-			●		
RDHX-0702MO	-	.276	.094	-	.106	-			●		
RDHX-1003MO	-	.394	.125	-	.150	-			●		
RDHX-12T3MO	-	.472	.156	-	.150	-			●		

Designation	l	d	s	l'	d'	r	CBN				
							PBC-10	PBC-15	PBC-25	PBC-40	
RDHX-0702MOT-VM	-	.276	.094	-	.106	-	●	●	●		
RDHX-1003MOT-VM	-	.394	.125	-	.150	-	●	●	●		
RDHX-12T3MOT-VM	-	.472	.156	-	.150	-	●	●	●		

Designation	l	d	s	l'	d'	r	PCD				
							TFC	PDC	PDC-S	PDC-CU-S	
SEHW-43AFN-4	.500	1/2	.187	.157	.217	-			●		
SEHW-43AFN-6				.236					●		

Designation	l	d	s	l'	d'	r	CBN				
							PBC-10	PBC-15	PBC-25	PBC-40	
RNGN-090300-E-SE	-	3/8	.125	-	-	-	●			●	
RNGN-090300-F-SE	-			-	-	-		●	●		
RNGN-120400-E-SE	-	1/2	.187	-	-	-	●			●	
RNGN-120400-F-SE	-			-	-	-		●	●		

Designation	l	d	s	l'	d'	r	PCD				
							TFC	PDC	PDC-S	PDC-CU-S	
SEKN-42AFN-4	.500	1/2	.125	.157	-	-			●		
SEKN-42AFN-6				.236					●		

Designation	l	d	s	l'	d'	r	CBN				
							PBC-10	PBC-15	PBC-25	PBC-40	
SPKN-42EDRT-MW	.500	1/2	.125	.157	-	-	●		●		

Designation	l	d	s	l'	d'	r	PCD				
							TFC	PDC	PDC-S	PDC-CU-S	
TPKN-32PDR-4	.650	3/8	.125	.157	-	-			●		

Designation	l	d	s	l'	d'	r	CBN				
							PBC-10	PBC-15	PBC-25	PBC-40	
TPKN-32PDRT-MW	.650	3/8	.125	.157	-	-	●		●		

Designation	l	d	s	l'	d'	r	PCD				
							TFC	PDC	PDC-S	PDC-CU-S	
XDHW-090308	.381	1/4	.125	.150	.110	.031	●		●		
XPHW-160408	.635	3/8	.187		.173		●		●		

Designation	l	d	s	l'	d'	r	CBN				
							PBC-10	PBC-15	PBC-25	PBC-40	
XDHW-090308	.381	1/4	.125	.150	.110	.031	●		●		
XPHW-160408	.635	3/8	.187		.173		●		●		

Designation	l	d	s	l'	d'	r	PCD				
							TFC	PDC	PDC-S	PDC-CU-S	
XDHW-090308-GS	.381	1/4	.125	.381	.110	.031			●		
XPHW-160412-GS	.635	3/8	.187	.635	.173	.047			●		

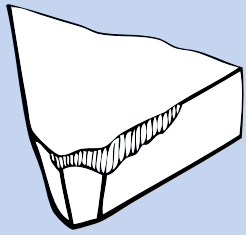

Flank Wear

General criteria for end of tool life, characterized by an admissible amount of flank wear

- Remedy:**
- select more wear resistant grade
 - reduce cutting speed

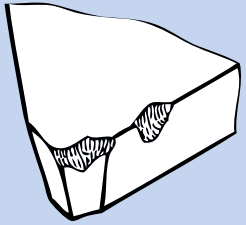

Edge Chipping

Minor chipping along the cutting edge, usually accompanied by flank wear and therefore not always identifiable. Danger of breakage! Edge chipping outside the cutting area is the result of chip impact due to unfavorable chip removal.

- Remedy:**
- select tougher grade
 - use insert with stronger cutting edge geometry
 - reduce feed when starting the cut

Damage caused by chip impact:

- vary feed
- change chipbreaker geometry
- change cutting edge angle

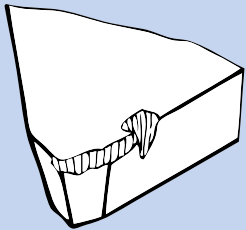

Notch Wear

Occurs locally in the area of the primary cutting edge where it contacts the workpiece surface. Caused by hard surface layers and work-hardened burrs, especially on austenitic stainless steels. Danger of breakage!

- Remedy:**
- strengthen cutting edge
 - select smaller cutting edge angle (45°)
 - reduce feed

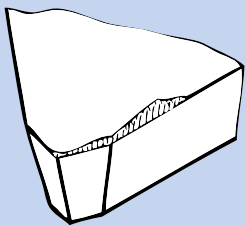

Built-Up Edges

Edge build-up occurs on the rake face as a result of the work material welding together with the cutting material, especially when cutting difficult-to-machine materials.

From time to time the built-up edge will break off and may cause damage to the cutting edge. Built-up edges result in poor surface finish.

- Remedy:**
- increase cutting speed
 - use coated grade
 - select positive cutting edge geometry
 - use cutting fluid

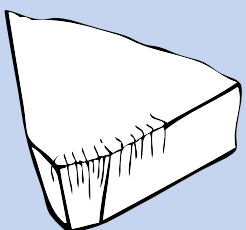

Thermal Cracks

Small cracks running across the cutting edge, caused by thermal shock loads in interrupted cutting operations, particularly in milling. Danger of breakage!

- Remedy:**
- use grade with greater resistance to thermal shock
 - check use of cutting fluid; cutting fluid should not generally be used for milling, except with special grades for wet milling, e.g. TN450, aluminum and titanium alloys, and high-temperature materials
 - use compressed air to remove chips in slot milling

Cutting Ratios and Undeformed Chip Thickness in Milling

Valid for $a_e < 0.3 d_1$

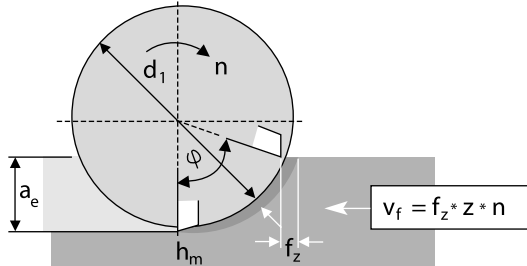

$$f_z = h_m * \sqrt{\frac{d_1}{a_e}} \quad h_m = f_z * \sqrt{\frac{a_e}{d_1}}$$

At least 2 cutting edges in the working area of the feed motion angle ϕ

Valid for $a_p < 0.3 d_1$

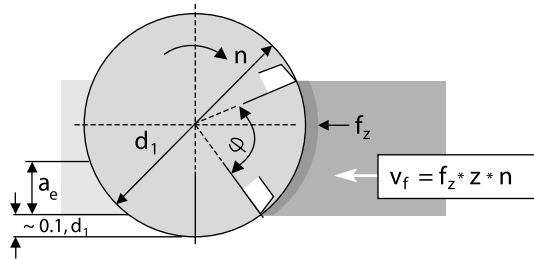

min. cutter diameter $d_1 \approx 1.25 * a_e$

max. width of cut $a_e \approx 0.8 * d_1$

Valid for $a_p < 0.3$

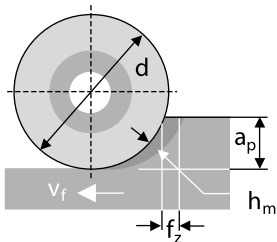

$$f_z = h_m * \sqrt{\frac{d}{a_p}}$$

$$h_m = f_z * \sqrt{\frac{a_p}{d}}$$

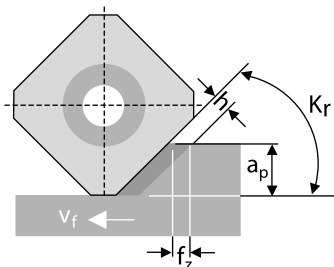

$$f_z = h * \sin \chi_r$$

$$h = f_z * \sin \chi_r$$



Cutting Data for TX90/ISO Milling Cutters

ANSI ISO 513	Cutting Data for TA90 / TX90 Milling Cutters				COATED									UNCOATED					
	Cutter	Max ap	Carbide Insert		TP25MP TP30MP TP30MC	TP35MC RP35AP RP35MP	TP35MP RP40AP RP40MP							TP25M					
					feed per tooth *(inch)														
P	TXD90/EMP/FMP	.33	XD..-09/AP..-10		.003 .006 .008	.003 .006 .008	.003 .007 .009								.003 .006 .009				
	TXP90/EMP/FMP	.55	XP..-16/AP..-16		.003 .006 .009	.003 .006 .009	.003 .007 .010								.003 .006 .009				
	Work Material	Condition	Hardness HB	Mat. Gr.	vc *(sfm)														
	Carbon steel, Unalloyed steel, cast steel and free cutting steel	< 0.25% C annealed	125	1	1080	820	685	915	705	605	620	540	505				555	490	455
		> 0.25% C annealed	190	2	820	635	555	620	490	425	455	375	360				390	325	295
		< 0.55% C heat-treated	250	3	685	520	475	520	390	360	375	325	295				325	260	225
		> 0.55% C annealed	220	4	705	555	475	540	425	360	390	360	325				360	275	260
	Low alloy steel and cast steel	heat-treated	300	5	605	425	375	455	325	275	325	275	260				275	225	195
		annealed	200	6	785	605	490	605	455	375	455	375	360				390	325	295
		heat-treated	275	7	605	475	390	455	360	295	360	295	275				295	260	225
		heat-treated	300	8	520	390	340	390	295	260	295	260	225				260	195	180
	High alloy steel, cast steel & tool steel	heat-treated	350	9	475	340	295	360	260	225	260	180	210				225	160	130
		annealed	200	10	605	475	425	455	360	325	390	340	295				360	275	260
		heat-treated	325	11	390	310	260	295	225	195	260	180	210				225	160	130
	400 series stainless	FE / MA	200	12	770	570	490	590	440	375	425	375	340				375	295	275
MA		240	13.1	670	475	390	505	360	295	360	295	275				325	260	225	
MA / PH		330	13.2	325	225	195	260	180	145	180	145	130				160	130	110	
M	Cutting Data for TA90 / TX90 Milling Cutters				COATED									UNCOATED					
	Cutter	Max ap	Carbide Insert		TP25MP RP35AP	RP35MP TP35MP	RP40AP TM45MP							TP25M					
					feed per tooth *(inch)														
	TXD90/EMP/FMP	.33	XD..-09/AP..-10		.003 .006 .008	.003 .006 .008	.003 .007 .009								.003 .006 .009				
	TXP90/EMP/FMP	.55	XP..-16/AP..-16		.003 .006 .009	.003 .006 .009	.003 .007 .010								.003 .006 .009				
	Work Material	Condition	Hardness HB	Mat. Gr.	vc *(sfm)														
	300 Series	AU	180	14.1	785	655	520	720	590	520	655	555	520				390	260	225
Stainless	DU	230	14.2	620	520	440	590	490	440	520	455	440				295	195	180	
Duplex	S-AU	200	14.3	455	390	325	425	360	325	390	340	325				210	160	130	
Stainless	AU-PH	330	14.4	390	325	260	360	295	260	325	275	260				195	130	110	
K	Cutting Data for TA90 / TX90 Milling Cutters				COATED									UNCOATED					
	Cutter	Max ap	Carbide Insert		RK15MC	TK15MC							TK10M						
					feed per tooth *(inch)														
	TXD90/EMP/FMP	.33	XD..-09/AP..-10		.003 .005 .007	.003 .005 .007									.008 .005 .002				
	TXP90/EMP/FMP	.55	XP..-16/AP..-16		.004 .006 .008	.005 .010 .014									.005 .010 .012				
	Work Material	Condition	Hardness HB	Mat. Gr.	vc *(sfm)														
	Grey cast iron	ferrit./pearl.	180	15	1245	915	785	965	705	605							440	325	275
pearlitic		260	16	950	720	620	735	555	475							325	260	225	
Nodular cast iron	ferritic	160	17	1045	785	655	820	605	490							390	295	245	
	pearlitic	250	18	785	455	325	605	360	260							275	195	130	
Malleable cast iron	ferritic	130	19	1080	655	520	835	490	390							390	245	160	
	pearlitic	230	20	820	520	390	635	410	295							310	195	130	



Cutting Data for TX90/ISO Milling Cutters

ANSI ISO 513	Cutting Data for TA90 / TX90 Milling Cutters				COATED			UNCOATED						
	Cutter	Max ap	Carbide Insert		TK10MP			TK10M						
N					feed per tooth *(inch)									
	TXD90/EMP/FMP	.33	XD..-09/AP..-10		.003	.005	.007				.003	.005	.007	
	TXP90/EMP/FMP	.55	XP..-16/AP..-16		.004	.009	.012				.004	.009	.012	
	Work Material		Condition	Hardness HB	Mat. Gr.	vc*(sfm)								
	Wrought	Non AG		60	21	5425	3115	2620				2785	2000	1670
		AG		100	22	2020	1640	1310				1390	1000	835
	Cast alumi- num alloys	Non Ag		75	23	5245	3115	2120				2785	2000	1670
		Si < 12%	AG	90	24	2950	1800	1475				2230	1640	1390
			Si > 12%		130	25	2130	1310	980				1390	900
	Copper & Copper alloys	Pb > 1%		110	26	1510	1000	800				1210	820	655
			90	27	1400	855	700				1115	685	555	
			100	28	1000	700	500				835	505	390	
S					COATED									
	Cutter	Max ap	Carbide Insert		TP35MP RP35AP RP35MP			TM45MP RP40AP RP40MP						
					feed per tooth *(inch)									
	TXD90/EMP/FMP	.33	XD..-09/AP..-10		-	.002	.004	-	.002	.004				
	TXP90/EMP/FMP	.55	XP..-16/AP..-16		.003	.005	.006	.003	.005	.006				
	Work Material		Condition	Hardness HB	Mat. Gr.	vc *(sfm)								
	High Temp	G	200	31	130	95	75	95	75	55				
	Alloy FE	AG	280	32	100	75	65	75	55	45				
	High Temp	G	250	33	80	55	45	55	45	35				
	Alloy	AG	350	34	65	45	35	45	35	30				
Ni / Co	GO	320	35	-	-	-	-	-	-					
Titanium alloys			36	-	-	-	225	145	110					
TiAL6V4	AG		37	-	-	-	180	110	95					

The cutting data given is valid for slot milling with full width of cut $ae = 100\%$ of the cutter diameter.

For peripheral and shoulder milling with the TX90 end mill, the figures in the table should be converted using the following correction factors:

Ratio $ae : d1$	fz factor	SFPM factor
2%	3.5	1.6
5%	3	1.5
10%	2	1.4
20%	1.5	1.3
$\geq 40\%$	1	1.1

ANSI ISO 513	Cutting Data for THA90 / THX90 Milling Cutters				COATED									UNCOATED		
	Cutter		Carbide Insert		TP25MP TP30MP TP30MC			RP35MP TP35MC RP35AP			TP35MP RP40AP RP40MP			TP25M		
					feed per tooth *(inch)											
P	THXD90 ¹⁾		XD..-09..		--	.003	.005	--	.003	.005	--	.003	.005			
	THXP90 ¹⁾		XP..-16..		.005	.010	.013	.005	.010	.013	.005	.010	.014	.003	.006	.009
	Work Material	Condition	Hardness HB	Mat. Gr.	vc *(sfm)											
	Carbon steel, Unalloyed steel, cast steel and free cutting steel	< 0.25% C annealed	125	1	1085	820	690	920	720	625	625	555	490	555	490	460
		> 0.25% C annealed	190	2	820	655	555	625	490	425	460	390	360	390	325	295
		< 0.55% C heat-treated	250	3	690	525	490	525	390	360	390	325	295	325	260	230
		> 0.55% C annealed	220	4	720	555	490	540	425	360	425	360	325	360	275	260
		heat-treated	300	5	625	425	390	460	325	275	360	295	260	275	230	195
	Low alloy steel and cast steel	annealed	200	6	785	625	490	605	460	375	460	390	360	390	325	295
		heat-treated	275	7	625	490	390	460	360	295	360	295	260	295	260	230
		heat-treated	300	8	525	390	360	390	295	260	325	260	230	260	195	180
		heat-treated	350	9	490	360	295	360	260	230	260	180	130	230	160	130
	High alloy steel, cast steel & tool steel	annealed	200	10	625	490	425	460	360	325	425	360	295	360	275	260
		heat-treated	325	11	390	310	230	295	230	195	260	180	130	230	160	130
	400 series stainless	FE / MA	200	12	785	590	490	590	440	375	425	390	325	375	295	275
MA		240	13.1	690	480	390	505	360	295	360	295	260	325	260	230	
MA / PH		330	13.2	360	245	195	260	180	145	180	145	130	160	130	115	
M	Cutting Data for THA90 / THX90 Milling Cutters				COATED									UNCOATED		
	Cutter		Carbide Insert		TP30MC			RP35MP TP35MP			RP40MP RP40AP TM45MP			TP25M		
					feed per tooth *(inch)											
	THXD90 ¹⁾		XD..-09..		-	.003	.005	-	.003	.005	-	.003	.005	-	-	-
	THXP90 ¹⁾		XP..-16..		.003	.007	.010	.003	.007	.010	.003	.007	.010	.003	.007	.010
	Work Material	Condition	Hardness HB	Mat. Gr.	vc *(sfm)											
	300 Series	AU	180	14.1	690	425	295	525	325	230	390	230	195	325	195	130
Stainless	DU	230	14.2	555	360	230	425	260	195	310	195	160	260	160	115	
Duplex	S-AU	200	14.3	425	275	195	325	195	160	230	160	130	195	115	80	
Stainless	AU-PH	330	14.4	360	210	160	295	160	130	195	145	115	160	95	65	
K	Cutting Data for THA90 / THX90 Milling Cutters				COATED									UNCOATED		
	Cutter		Carbide Insert		RK15MC			TK15MC			TK10M					
					feed per tooth *(inch)											
	THXD90 ¹⁾		XD..-09..		.003	.006	.007	.003	.006	.008				.004	.007	.009
	THXP90 ¹⁾		XP..-16..		.003	.006	.009	.005	.010	.014				.004	.011	.016
	Work Material	Condition	Hardness HB	Mat. Gr.	vc *(sfm)											
	Grey cast iron	ferrit./pearl.	180	15	1215	885	720	985	720	590				460	325	260
pearlitic		260	16	985	690	590	755	555	490				325	260	230	
Nodular cast iron	ferritic	160	17	950	720	555	820	625	490				390	295	245	
	pearlitic	250	18	855	490	360	625	360	260				360	275	195	
Malleable cast iron	ferritic	130	19	1015	625	325	820	490	425				490	390	260	
	pearlitic	230	20	785	525	360	655	425	295				425	310	195	



Cutting Data for THX90 Helical Milling Cutters

ANSI ISO 513	Cutting Data for THA90 / THX90 Milling Cutters				COATED						UNCOATED			
	Cutter		Carbide Insert		TK10MP						TK10M			
N	THXD90 ¹⁾		XDH..-09-AL		.003	.005	.007					.004	.007	.009
	THXP90 ¹⁾		XPH..-16-AL		.004	.009	.012					.004	.009	.012
	Work Material	Condition	Hardness HB	Mat. Gr.	vc *(sfm)									
	Wrought	Non AG	60	21	5425	3115	2620					2950	1965	1640
		AG	100	22	2020	1640	1310					1475	980	820
	Cast alumi- num alloys	Non Ag	75	23	5245	3115	2120					2950	1965	1640
		Si < 12% AG	90	24	2950	1800	1475					2295	1640	1310
		Si > 12%	130	25	2130	1310	980					1475	915	655
	Copper & Cop- per alloys	Pb > 1%	110	26	1510	1000	800					1310	820	655
			90	27	1400	855	700					1115	685	520
		100	28	1000	700	500					820	520	390	
S	Cutter		Carbide Insert		TP35MP RP35AP RP35MP			TM45MP RP40AP RP40MP						
	THXD90 ¹⁾		XDH..-09-AL		-	.002	.004	-	.002	.004				
	THXP90 ¹⁾		XPH..-16-AL		.003	.005	.006	.003	.005	.006				
	Work Material	Condition	Hardness HB	Mat. Gr.	vc *(sfm)									
	High Temp	G	200	31	130	95	75	95	75	55				
	Alloy FE	AG	280	32	100	75	65	75	55	45				
	High Temp	G	250	33	80	55	45	55	45	35				
	Alloy	AG	350	34	65	45	35	45	35	30				
	Ni / Co	GO	320	35	-	-	-	-	-	-				
	Titanium alloys			36	-	-	-	225	145	110				
TiAL6V4	AG		37	-	-	-	180	110	95					

The feeds per tooth (fz) are valid for face milling with width of cut $a_e \geq 0.4 d_1$ and max. depth of cut (ap). For smaller widths and depths of cut, the figures in the table should be converted using correction factors (d = dia. over insert, d_1 = cutter dia.). The axial feed in plunge milling should be reduced by approximately 40%.

E. - Ratio $a_e : d_1$	0.05	0.1	0.2	0.4
fz - Factor	3	2	1.5	1
vc - Factor	1.5	1.4	1.3	1.2

Example:
fz, nom = 0.19 fz, eff = 0.19 x 2 = 0.38 mm / z
vc, nom = 150 vc, eff = 150 x 1.4 = 210 m / min

Example:
fz, nom = .007 fz, eff = .007 x 2 = .014 IPT / z
vc, nom = 492 vc, eff = 492 x 1.4 = 689 SFM



Cutting Data for TS45F Facemills

ANSI ISO 513	Cutting Data for TS45F Facemills				COATED									UNCOATED						
	Cutter		Carbide Insert		TP25MP			TP30MC			TP35MP			TP25M						
P	TS45F		SE..-43..		.006	.013	.018	.006	.013	.018	.006	.013	.018				.006	.013	.018	
	Work Material	Condition	Hardness HB	Mat. Gr.	vc *(sfm)															
	Carbon steel, Unalloyed	< 0.25% C	annealed	125	1	1345	1065	915	1180	915	785	820	705	655				720	635	590
		> 0.25% C	annealed	190	2	1065	820	705	820	620	450	590	490	455				650	425	390
	steel, cast steel and free cutting steel	< 0.55% C	heat-treated	250	3	900	685	605	685	520	455	490	425	390				425	325	295
		> 0.55% C	annealed	220	4	915	705	605	705	540	455	520	455	425				455	360	325
			heat-treated	300	5	770	555	475	590	425	360	425	360	325				360	295	260
	Low alloy steel and cast steel		annealed	200	6	1030	770	635	785	590	490	590	490	455				520	425	390
			heat-treated	275	7	770	605	520	590	455	390	455	390	360				390	325	295
			heat-treated	300	8	685	520	425	520	390	325	390	325	295				325	260	225
			heat-treated	350	9	605	425	360	455	325	260	325	225	195				295	195	160
	High alloy steel, cast steel & tool steel		annealed	200	10	770	620	555	590	475	425	520	440	390				455	360	325
			heat-treated	325	11	520	390	325	390	295	225	325	225	180				295	195	160
	400 series stainless		FE / MA	200	12	980	915	635	750	570	490	555	490	455				490	390	360
		MA	240	13.1	850	620	520	655	475	390	455	390	360				425	325	295	
		MA / PH	330	13.2	425	310	260	325	245	195	225	195	180				210	160	145	
M	TS45F		SE..-43..		.005	.010	.014	.005	.010	.014	.005	.010	.014				.005	.010	.014	
	Work Material	Condition	Hardness HB	Mat. Gr.	vc *(sfm)															
	300 Series	AU	180	14.1	850	520	390	655	390	295	490	295	225				390	260	195	
	Stainless	DU	230	14.2	685	455	310	520	310	225	425	225	180				325	245	180	
	Duplex	S-AU	200	14.3	520	360	245	390	225	180	325	180	130				245	180	130	
	Stainless	AU-PH	330	14.4	455	275	210	325	195	145	245	145	110				195	145	110	
	K	TS45F		SE..-43		.007	.010	.020	.004	.009	.012							.001	.010	.018
Work Material		Condition	Hardness HB	Mat. Gr.	vc *(sfm)															
Grey cast iron		ferrit./pearl.	180	15	1570	1145	820	1245	915	770							1100	900	610	
		pearlitic	260	16	1210	915	685	950	705	605							750	610	505	
Nodular cast iron		ferritic	160	17	1375	915	685	1065	770	635							925	570	495	
		pearlitic	250	18	885	655	490	770	475	375							670	450	325	
Malleable cast iron		ferritic	130	19	1115	850	655	1065	635	505							925	570	495	
		pearlitic	230	20	915	685	520	850	520	425							670	450	325	



Cutting Data for TS45F Milling Cutters

ANSI ISO 513	Cutting Data for TS45F Milling Cutters				COATED			UNCOATED						
	Cutter		Carbide Insert		TK10MP			TK10M						
N	TS45F				SEHT-43-ALC			feed per tooth *(inch)						
	TS45F				SEHT-43-ALC			.006	.014	.020	.006	.014	.020	
	Work Material		Condition		Hardness HB	Mat. Gr.	vc *(sfm)							
	Wrought	Non AG		60	21	8200	4920	3935			3280	2460	1965	
		AG		100	22	4100	2460	1965			1640	1180	980	
	Cast alumi- num alloys	Non Ag		75	23	8200	4920	3935			3280	2460	1965	
		Si ≤ 12%	AG		90	24	4265	2620	1965			2620	1965	1640
			Si ≥ 12%		130	25	2620	2130	1640			1640	1145	820
	Copper & Cop- per alloys	Pb > 1%		110	26									
				90	27									
		100	28											
Non Metals					29									
					30									
S	COATED				TK45MP			TK10MP						
	Cutter		Carbide Insert		TK45MP			TK10MP						
	TS45F				SE..-43..			feed per tooth *(inch)						
	TS45F				SE..-43..			.004	.006	.008	.004	.006	.008	
	Work Material		Condition		Hardness HB	Mat. Gr.	vc *(sfm)							
	High Temp	G		200	31	205	160	145						
	Alloy FE	AG		280	32	160	130	110						
	High Temp	G		250	33	110	80	65						
	Alloy	AG		350	34	80	65	45						
	Ni / Co	GO		320	35	90	70	55						
Titanium alloys					36				310	195	155			
TiAL6V4	AG			37					275	180	135			

The feeds per tooth fz are valid for a width of cut ae ≥ 0.4 d1 (cutter dia.).
 In the case of smaller widths of cut the feed fz should be increased, e.g. for ae : d1 = 0.2 by a factor of 1.5.



Cutting Data for TR360 Milling Cutters

ANSI ISO 513	Cutting Data for TR360 Milling Cutters				COATED													
	Cutter	Max ap	Carbide Insert		TP30AP			TP30MP			TP35MC							
P	TR360 ¹⁾	.157 / .197	RD.. 08/10...		.003	.006	.008	.003	.006	.008	.003	.006	.008					
		.236	RD.. 12...		.004	.009	.012	.004	.009	.012	.004	.009	.012					
		.315	RC / RD.. 16...		.005	.010	.014	.005	.010	.014	.005	.010	.014					
	Work Material		Condition	Hardness HB	Mat. Gr.	vc *(sfm)												
	Carbon steel, Unalloyed steel, cast steel and free cutting steel	< 0.25% C	annealed	125	1	1345	1065	915	1180	915	785	820	705	655				
		> 0.25% C	annealed	190	2	1065	820	705	820	620	540	590	490	455				
		< 0.55% C	heat-treated	250	3	900	685	605	685	520	455	490	425	390				
		> 0.55% C	annealed	220	4	915	705	605	705	540	455	520	455	425				
			heat-treated	300	5	770	555	455	590	425	360	425	360	295				
	Low alloy steel and cast steel		annealed	200	6	1030	770	635	785	590	490	590	490	455				
			heat-treated	275	7	770	605	520	590	455	390	455	390	360				
			heat-treated	300	8	685	520	425	520	390	325	390	325	260				
			heat-treated	350	9	605	425	360	455	325	260	325	225	180				
High alloy steel, cast steel & tool steel		annealed	200	10	770	620	555	590	475	425	520	440	390					
		heat-treated	325	11	520	390	325	390	295	225	325	225	180					
400 series stainless		FE / MA	200	12	980	915	635	750	750	490	555	490	455					
		MA	240	13.1	850	625	520	655	475	390	455	390	360					
		MA / PH	330	13.2	425	310	260	325	245	195	225	195	180					
M	TR360 ¹⁾	.157 / .197	RD.. 08/10...		.003	.006	.008	.003	.006	.008	.003	.006	.008					
		.236	RD.. 12...		.004	.009	.012	.004	.009	.012	.004	.009	.012					
		.315	RC / RD.. 16...		.005	.010	.014	.005	.010	.014	.005	.010	.014					
	Work Material		Condition	Hardness HB	Mat. Gr.	vc *(sfm)												
	300 Series	AU	180	14.1	850	720	490	785	655	455	685	590	390					
	Stainless	DU	230	14.2	720	590	425	620	605	410	555	490	310					
	Duplex	S-AU	200	14.3	555	455	325	455	440	310	425	360	225					
	Stainless	AU-PH	330	14.4	425	360	245	390	325	225	340	295	195					
	K	TR360 ¹⁾	.157 / .197	RD.. 08/10...					.003	.006	.008							
			.236	RD.. 12...					.004	.009	.012							
			.315	RC / RD.. 16...					.005	.010	.014							
		Work Material		Condition	Hardness HB	Mat. Gr.	vc *(sfm)											
		Grey cast iron	ferrit/pearl.	180	15				1245	915	770							
260				16				950	705	605								
Nodular cast iron			ferritic	160	17				1065	770	635							
			pearlitic	250	18				770	475	390							
Malleable cast iron			ferritic	130	19				1065	635	520							
		pearlitic	230	20				850	520	425								

ANSI ISO 513	Cutting Data for TR360 Milling Cutters				UNCOATED							
	Cutter	Max ap	Carbide Insert		TK10M							
N	TR360 ¹⁾	.157 / .197	RD.. 08/10...		.003	.006	.008					
	Work Material		Condition	Hardness HB	Mat. Gr.	vc *(sfm)						
	Wrought	Non AG		60	21	3280	2460	1965				
		AG		100	22	1640	1180	980				
	Cast aluminum alloys	Non Ag		75	23	3280	2460	1965				
		Si < 12%	AG		90	24	2620	1965	1640			
			Si > 12%			130	25	1640	1145	820		
	Copper & Copper alloys	Pb > 1%				110	26	1475	1310	980		
						90	27	1310	820	655		
						100	28	980	655	455		
Non Metals						29	1965	1475	980			
						30	1965	1475	980			
				COATED								
S	Cutter	Max ap	Carbide Insert		TP30AP		TP30MP					
	feed per tooth *(inch)											
S	TR360 ¹⁾	.157 / .197	RD.. 08/10...		.003	.005	.006	.003	.005	.006		
		.236	RD.. 12...		.004	.006	.007	.004	.006	.007		
		.315	RC / RD.. 16...		.005	.007	.009	.005	.007	.009		
	Work Material		Condition	Hardness HB	Mat. Gr.	vc *(sfm)						
	High Temp	G		200	31	205	160	145	120	95	80	
	Alloy FE	AG		280	32	160	130	110	95	75	65	
	High Temp	G		250	33	110	80	65	75	60	50	
	Alloy	AG		350	34	80	65	45	65	45	40	
	Ni / Co	GO		320	35	90	70	55	65	45	40	
	Titanium alloys					36	-	-	-	260	160	130
TiAL6V4	AG				37	-	-	-	225	150	110	

fz-factor for ratio ae:d ¹				
ap	0.05	0.1	0.2	0.4
5% of d	9	6.3	4.3	3.2
10% of d	6.3	4.3	3.2	2.2
20% of d	4.3	3.2	2.2	1.6
40% of d	3.2	4.2	1.6	1.1

SFPM Factors for various fz factors	
fz factor	SFPM factor
9	1.6
6.3	1.5
4.3	1.4
3.2	1.3
2.2	1.2
1.6	1.1
1.1	1

1) The feeds per tooth fz are valid for face milling with width of cut $ae \geq 0.4 d_1$ and max. depth of cut ap. For smaller widths and depths of cut, the figures in the table should be converted using correction factors ($d = \text{dia. of insert}$, $d_1 = \text{cutter dia.}$). The axial feed in plunge milling should be reduced by approximately 40%.

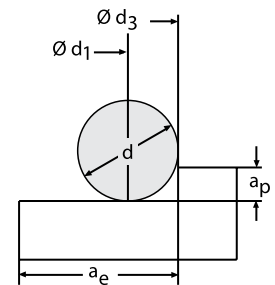

Legend

- ae - width of cut
- ap - depth of cut
- d - insert diameter
- Ø d¹ - effective cutter diameter
- Ø d³ - nominal cutter diameter



Cutting Data for TV90

ANSI ISO 513	Cutting Data for TV90 Milling Cutters				COATED			UNCOATED			
	Cutter	Max ap	Carbide Insert		TK10MP			TK10M			
N	feed per tooth *(inch)										
	TV90 Face Mill	.50	VCGT / VPGT		.008	.010	.012	.008	.010	.012	
	TV90 End Mill	.38	VCGT / VPGT		.006	.008	.010	.006	.008	.010	
	Work Material	Condition	Hardness HB	Mat. Gr.	vc *(sfm)						
	Wrought	Non AG	60	21	4920	3600	2900	3200	2400	1900	
		AG	100	22	2600	2000	1400	1600	1200	1000	
	Cast aluminum alloys	Non Ag	75	23	4000	3500	3000	3500	2500	2000	
		Si ≤ 12%	AG	90	24	3100	2800	2000	2600	2000	1500
		Si ≥ 12%		130	25	-	-	-	-	-	-
	Copper & Copper alloys	Pb > 1%		110	26	-	-	-	-	-	-
			90	27	1900	1640	1400	1500	1250	900	
			100	28	1180	980	--	800	600	--	

TPC Plunge Mills

ANSI ISO 513	Material	TPC Plunge Mills					
		DRILLING	SFPM		MILLING	SFPM	
		Feed	Coated	Uncoated	Feed 1)	Coated	Uncoated
P	Steel, unalloyed low carbon	.003 - .008	299 - 673	260 - 585	.003 - .012	325 - 731	260 - 585
	Steel, unalloyed or low-alloy	.003 - .008	262 - 598	228 - 520	.003 - .012	284 - 650	228 - 520
	Steel alloy and tool steels	.003 - .008	224 - 523	195 - 455	.003 - .012	244 - 569	195 - 455
	High tensile steels	.003 - .008	224 - 448	195 - 390	.003 - .012	244 - 488	195 - 390
M	Corrosion-resistant steel	.002 - .006	187 - 523	163 - 455	.003 - .010	203 - 569	163 - 455
	Cast steel, medium strength	.002 - .006	224 - 448	195 - 390	.003 - .010	244 - 488	195 - 390
K	Grey cast iron, medium hardness	.003 - .013	262 - 448	228 - 390	.003 - .015	284 - 488	228 - 390
N	Brass	.003 - .008	374 - 673	325 - 585	.004 - .010	406 - 731	325 - 585
	Mg-alloyed	.003 - .005	1121 - 2990	975 - 2600	.004 - .006	1219 - 3250	975 - 2600
	Si-alloyed	.002 - .005	934 - 2243	813 - 1950	.002 - .006	1016 - 2438	813 - 1950
	Al-alloyed, hypo-eutectic	.003 - .006	1121 - 3737	975 - 3250	.004 - .008	1219 - 4063	975 - 3250
	Al-alloyed, hypo-eutectic Si>12%	.003 - .006	1121 - 1869	975 - 1625	.004 - .008	1219 - 2031	975 - 1625

1) The feeds per tooth fz are valid for a width of cut ae > 40% of the cutter diameter. In the case of smaller widths of cut, the feed fz should be increased as per the following table:

Ratio ae : d1	fz Factor
5%	3
10%	2
20%	1.5
> 40%	1

Legend:
 ae = width of cut
 d1 = cutter diameter
 Feed = fz in inches per tooth
 SFPM = Cutting speeds in SFPM (Surface feet per minute)

Cutting Data for TCP90/ECO Milling Cutters

Materials	Conditions of Chip Removal	Application Range - Cutting Speed N01 - N40		
		N01 - N20 (HSC)	N20 - N30 (HSC)	N25 - N40 (HSC)
N Nonferrous metals Aluminum alloys without silicon	High-Speed Milling	100 µin - 200 µin	100 µin - 200 µin	100 µin - 200 µin
	unstable (varied depth)	PDC-CU-S / TFC 2600-14625	PDC-CU-S / TFC 2600-13000	PDC-CU-S / TFC 2600-8125
	continuous	PDC-CU-S / TFC 2600-14625	PDC-CU-S / TFC 2600-13000	PDC-CU-S / TFC 2600-8125
	heavily + slightly interrupted	PDC-CU-S / TFC 2600-14625	PDC-CU-S / TFC 2600-13000	PDC-CU-S / TFC 2600-8125
N Nonferrous metals Aluminum alloys with less than 12% silicon	unstable (varied depth)	PDC-CU-S / TFC 2600-13000	PDC-CU-S / TFC 2600-11375	PDC-CU-S / TFC 2600-8775
	continuous	PDC-CU-S / TFC 2600-13000	PDC-CU-S / TFC 2600-11375	PDC-CU-S / TFC 2600-8775
	heavily + slightly interrupted	PDC-CU-S / TFC 2600-13000	PDC-CU-S / TFC 2600-11375	PDC-CU-S / TFC 2600-8775
N Nonferrous metals Aluminum alloys with greater than 12% silicon	unstable (varied depth)	PDC-CU-S / TFC 2600-9750	PDC-CU-S / TFC 2275-8125	PDC-CU-S / TFC 1950-4875
	continuous	PDC-CU-S / TFC 2600-9750	PDC-CU-S / TFC 2275-8125	PDC-CU-S / TFC 1950-4875
	heavily + slightly interrupted	PDC-CU-S / TFC 2600-9750	PDC-CU-S / TFC 2275-8125	PDC-CU-S / TFC 1950-4875
N Nonferrous metals Copper and copper alloys brass, bronze, precious metals	unstable (varied depth)	PDC-CU-S / TFC 2600-9750	PDC-CU-S / TFC 2600-8125	PDC-CU-S / TFC 2275-7150
	continuous	PDC-CU-S / TFC 2600-9750	PDC-CU-S / TFC 2600-8125	PDC-CU-S / TFC 2275-7150
	heavily + slightly interrupted	PDC-CU-S / TFC 2600-9750	PDC-CU-S / TFC 2600-8125	PDC-CU-S / TFC 2275-7150
Coolant: Flood or through coolant				

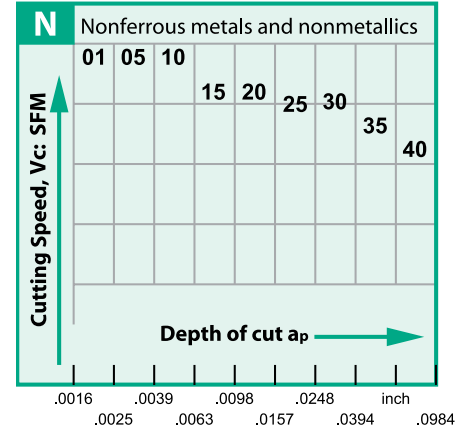

GP END MILLS



GP High Performance 4 Flute End Mills

TyCarb GP High Performance end mills feature Differential flute spacing to achieve virtually chatter free machining in a wide range of materials. Excellent results can be achieved on all steels from carbon to alloy as well as stainless and even exotic materials. With the unique design of these tools as well as the superior TiAlN coating you can expect excellent levels of performance in your machining applications.

- Differential flute spacing
- Superior TiAlN PVD coating
- Available with Cylindrical or Weldon style shanks
- Available with square end as well as wide range of radius choices

GP High Performance 4 Flute Ball Nose End Mills

TyCarb GP High Performance 4 flute ball nose end mills feature Differential flute spacing to achieve virtually chatter free machining in a wide range of materials. Excellent results can be achieved on all steels from carbon to alloy as well as stainless and even exotic materials. With the unique design of these tools as well as the superior TiAlN coating you can expect excellent levels of performance in your machining applications.

- Differential flute spacing
- Superior TiAlN PVD coating
- Available with Cylindrical or Weldon style shanks

GP 2 Flute End Mills

TyCarb two flute end mills are designed for plunging, slotting and applications where increased chip clearance at higher feed rates are required in heavy peripheral machining applications. TyCarb 2 Flute GP end mills are used in general milling application in low to medium carbon steels, cast iron, easy to machine stainless steels, composites, plastics, aluminum, aluminum and copper alloys as well as brass and bronze.

- Available with Cylindrical or Weldon style shanks
- Superior TiAlN PVD coating

Recommended Cutting Parameters

Work Material	Type of Cut	Axial DOC	Radial DOC	Speed (SFM)	Feed (Inches Per Tooth)						
					1/8	1/4	3/8	1/2	5/8	3/4	1
Low Carbon Steels <= 38 Rc 1018, 12L14, 8620	Slotting Peripheral - Rough	1 x D	1 x D	350	0.0008	0.0016	0.0024	0.0032	0.0040	0.0048	0.0064
		1.5 x D	.5 x D	425	0.0010	0.0020	0.0030	0.0040	0.0050	0.0060	0.0080
Medium Carbon Steels <= 38 Rc 4140, 4340	Slotting Peripheral - Rough	1 x D	1 x D	325	0.0006	0.0013	0.0020	0.0027	0.0034	0.0040	0.0054
		1.5 x D	.5 x D	375	0.0008	0.0017	0.0026	0.0035	0.0044	0.0053	0.0070
Tool and Die Steels <= 38 Rc A2, D2, O1, S7, P20, H13	Slotting Peripheral - Rough	1 x D	1 x D	325	0.0006	0.0013	0.0020	0.0027	0.0034	0.0040	0.0054
		1.5 x D	.5 x D	375	0.0008	0.0017	0.0026	0.0035	0.0044	0.0053	0.0070
Tool Steels 39 Rc to 48 Rc	Slotting Peripheral - Rough	.75 x D	1 x D	225	0.0005	0.0010	0.0015	0.0020	0.0025	0.0030	0.0040
		1 x D	.5 x D	275	0.0006	0.0012	0.0017	0.0023	0.0029	0.0035	0.0046
Easy to machine stainless steel 416, 410, 302, 303	Slotting Peripheral - Rough	1 x D	1 x D	300	0.0006	0.0012	0.0018	0.0025	0.0031	0.0037	0.0050
		1.5 x D	.5 x D	375	0.0008	0.0016	0.0024	0.0032	0.0040	0.0048	0.0064
Moderately difficult stainless steels 304, 316, Invar, Kovar	Slotting Peripheral - Rough	.75 x D	1 x D	275	0.0005	0.0011	0.0016	0.0022	0.0027	0.0033	0.0044
		1.5 x D	.5 x D	350	0.0007	0.0015	0.0023	0.0032	0.0037	0.0045	0.0064
Difficult to machine stainless steels 316L, 17-4 PH, 15-5 PH, 13-8 PH	Slotting Peripheral - Rough	.5 x D	1 x D	250	0.0004	0.0009	0.0012	0.0018	0.0022	0.0027	0.0036
		1 x D	.5 x D	300	0.0005	0.0011	0.0016	0.0022	0.0028	0.0033	0.0044
Cast Iron Grey	Slotting Peripheral - Rough	1 x D	1 x D	400	0.0006	0.0012	0.0019	0.0025	0.0031	0.0038	0.0050
		1.5 x D	.5 x D	500	0.0007	0.0015	0.0023	0.0030	0.0037	0.0046	0.0060
Cast Iron Ductile	Slotting Peripheral - Rough	1 x D	1 x D	300	0.0006	0.0012	0.0018	0.0023	0.0029	0.0035	0.0046
		1.5 x D	.5 x D	400	0.0007	0.0014	0.0021	0.0028	0.0035	0.0042	0.0056
Cast Iron Malleable	Slotting Peripheral - Rough	.75 x D	1 x D	250	0.0004	0.0008	0.0012	0.0015	0.0019	0.0023	0.0030
		1 x D	.75 x D	325	0.0005	0.0011	0.0016	0.0022	0.0027	0.0033	0.0044
Titanium Alloys	Slotting Peripheral - Rough	.5 x D	1 x D	250	0.0005	0.0010	0.0015	0.0020	0.0025	0.0030	0.0040
		1 x D	.5 x D	300	0.0006	0.0012	0.0017	0.0023	0.0029	0.0035	0.0046
High Temperature Alloys Inconel, Haynes, Stellite, Hastalloy	Slotting Peripheral - Rough	.25 x D	1 x D	70	0.0004	0.0008	0.0012	0.0015	0.0019	0.0024	0.0030
		1 x D	.25 x D	95	0.0005	0.0009	0.0014	0.0018	0.0022	0.0028	0.0036



GP4 Variable Flute End Mills

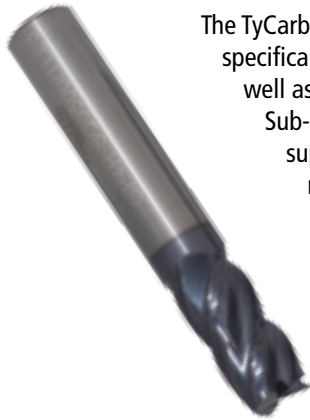

The TyCarb GP Series of 4 flute end mills have been specifically designed for today's difficult materials as well as the modern machinery now available. From Sub-Micron Carbide Rod to differential fluting and superior PVD coating the GP Series excels in difficult materials and applications.

The Unique design enables true chatter-free machining. Excellent performance is achievable in slotting as well as profiling applications. The GP family is ideal for heavily interrupted cuts and when machining stainless, titanium as well as other materials that generate high temperatures.



4 Flute End Mills

(Variable Flute / Center Cutting)

Designation	Cutter Dia.	Shank Dia.	Length of Cut	OAL	Corner Radius	UP25	TL25
GP4R-SQ0125	1/8	1/8	1/4	1-1/2	--	●	●
GP4R-SQ0125-015	1/8	1/8	1/4	1-1/2	.015	●	●
GP4R-SQ0187	3/16	3/16	5/8	2	--	●	●
GP4R-SQ0187-015	3/16	3/16	5/8	2	.015	●	●
GP4R-SQ0250	1/4	1/4	3/4	2-1/2	--	●	●
GP4R-SQ0250-020	1/4	1/4	3/4	2-1/2	.020	●	●
GP4R-SQ0312	5/16	5/16	13/16	2-1/2	--	●	●
GP4R-SQ0312-020	5/16	5/16	13/16	2-1/2	.020	●	●
GP4R-SQ0375	3/8	3/8	7/8	2-1/2	--	●	●
GP4R-SQ0375-020	3/8	3/8	7/8	2-1/2	.020	●	●
GP4E-SQ0375	3/8	3/8	1-1/8	3	--	●	●
GP4E-SQ0375-020	3/8	3/8	1-1/8	3	.020	●	●
GP4R-SQ0437	7/16	7/16	1	2-3/4	--	●	●
GP4R-SQ0500	1/2	1/2	1	3	--	●	●
GP4R-SQ0500-030	1/2	1/2	1	3	.030	●	●
GP4E-SQ0500	1/2	1/2	1-1/4	3	--	●	●
GP4E-SQ0500-030	1/2	1/2	1-1/4	3	.030	●	●
GP4R-SQ0562	9/16	9/16	1-1/4	3-1/2	--	●	●
GP4R-SQ0625	5/8	5/8	1-1/4	3-1/2	--	●	●
GP4R-SQ0625-030	5/8	5/8	1-1/4	3-1/2	.030	●	●
GP4R-SQ0625-060	5/8	5/8	1-1/4	3-1/2	.060	●	●
GP4E-SQ0625	5/8	5/8	1-5/8	3-1/2	--	●	●
GP4E-SQ0625-030	5/8	5/8	1-5/8	3-1/2	.030	●	●
GP4S-SQ0750	3/4	3/4	7/8	3	--	●	●
GP4S-SQ0750-030	3/4	3/4	7/8	3	.030	●	●
GP4R-SQ0750	3/4	3/4	1-1/2	4	--	●	●
GP4R-SQ0750-030	3/4	3/4	1-1/2	4	.030	●	●
GP4R-SQ0750-060	3/4	3/4	1-1/2	4	.060	●	●
GP4R-SQ0750-125	3/4	3/4	1-1/2	4	.125	●	●
GP4R-SQ1000	1	1	1-1/2	4	--	●	●
GP4R-SQ1000-030	1	1	1-1/2	4	.030	●	●
GP4R-SQ1000-060	1	1	1-1/2	4	.060	●	●
GP4R-SQ1000-125	1	1	1-1/2	4	.125	●	●

4 Flute End Mills

(Variable Flute / Center Cutting / Weldon)

Designation	Cutter Dia.	Shank Dia.	Length of Cut	OAL	Corner Radius	UP25	TL25
GP4RW-SQ0500	1/2	1/2	1	3	--	●	●
GP4RW-SQ0500-030	1/2	1/2	1	3	.030	●	●
GP4EW-SQ0500	1/2	1/2	1-1/4	3	--	●	●
GP4EW-SQ0500-030	1/2	1/2	1-1/4	3	.030	●	●
GP4RW-SQ0625	5/8	5/8	1-1/4	3-1/2	--	●	●
GP4RW-SQ0625-030	5/8	5/8	1-1/4	3-1/2	.030	●	●
GP4RW-SQ0625-060	5/8	5/8	1-1/4	3-1/2	.060	●	●
GP4EW-SQ0625	5/8	5/8	1-5/8	3-1/2	--	●	●
GP4EW-SQ0625-030	5/8	5/8	1-5/8	3-1/2	.030	●	●
GP4SW-SQ0750	3/4	3/4	7/8	3	--	●	●
GP4SW-SQ0750-030	3/4	3/4	7/8	3	.030	●	●
GP4RW-SQ0750	3/4	3/4	1-1/2	4	--	●	●
GP4RW-SQ0750-030	3/4	3/4	1-1/2	4	.030	●	●
GP4RW-SQ0750-060	3/4	3/4	1-1/2	4	.060	●	●
GP4RW-SQ0750-125	3/4	3/4	1-1/2	4	.125	●	●
GP4RW-SQ1000	1	1	1-1/2	4	--	●	●
GP4RW-SQ1000-030	1	1	1-1/2	4	.030	●	●
GP4RW-SQ1000-060	1	1	1-1/2	4	.060	●	●
GP4RW-SQ1000-125	1	1	1-1/2	4	.125	●	●

TL25 Grade has a thick titanium aluminum nitride (TiAlN) PVD coating designed for the most demanding, dry machining applications. Due to its exceptional balance of wear and toughness this grade enables sharp edges and consistent controlled wear rates.

UP25 This uncoated carbide grade is made from high quality fine grade materials. UP25 is used for general purpose machining of all steels including stainless.



GP Ball Nose Series End Mills are manufactured to the same stringent standards as our regular 4 flute cutters. Differential pitch and superior PVD coatings ensure trouble free performance on even the most difficult materials. These end mills are available with either Cylindrical or Weldon shanks



4 Flute Ball Nose End Mills (Variable Flute)

Designation	Cutter Dia.	Shank Dia.	Length of Cut	OAL	Corner Radius	TL25
GP4RC-BN0250	1/4	1/4	3/4	2-1/2	-	●
GP4RC-BN0312	5/16	5/16	13/16	2-1/2	-	●
GP4RC-BN0375	3/8	3/8	7/8	2-1/2	-	●
GP4RC-BN0500	1/2	1/2	1	3	-	●
GP4RC-BN0625	5/8	5/8	1-1/4	3-1/2	-	●
GP4RC-BN0750	3/4	3/4	1-1/2	4	-	●
GP4RC-BN1000	1	1	1-1/2	4	-	●

4 Flute Ball Nose End Mills (Variable Flute/Weldon)

Designation	Cutter Dia.	Shank Dia.	Length of Cut	OAL	Corner Radius	TL25
GP4RW-BN0500	1/2	1/2	1	3	-	●
GP4RW-BN0625	5/8	5/8	1-1/4	3-1/2	-	●
GP4RW-BN0750	3/4	3/4	1-1/2	4	-	●
GP4RW-BN1000	1	1	1-1/2	4	-	●



TyCarb GP Series 2 flute end mills are designed for general milling applications in low to medium carbon steels, cast iron, easy to machine stainless steels as well as aluminum, brass, bronze and copper alloys. Manufactured with square corners they are available with either cylindrical or Weldon shanks.



2 Flute End Mills (Center Cutting)

Designation	Cutter Dia.	Shank Dia.	Length of Cut	OAL	Corner Radius	TL25
GP2R-SQ0250	1/4	1/4	3/4	2-1/2	-	●
GP2R-SQ0312	5/16	5/16	13/16	2-1/2	-	●
GP2R-SQ0375	3/8	3/8	7/8	2-1/2	-	●
GP2R-SQ0437	7/16	7/16	1	2-3/4	-	●
GP2R-SQ0500	1/2	1/2	1	3	-	●
GP2R-SQ0562	9/16	9/16	1-1/4	3-1/2	-	●
GP2R-SQ0625	5/8	5/8	1-1/4	3-1/2	-	●
GP2R-SQ0750	3/4	3/4	1-1/2	4	-	●
GP2R-SQ0875	7/8	7/8	1-1/2	4	-	●
GP2R-SQ1000	1	1	1-1/2	4	-	●

2 Flute End Mills (Center Cutting/Weldon)

Designation	Cutter Dia.	Shank Dia.	Length of Cut	OAL	Corner Radius	TL25
GP2RW-SQ0500	1/2	1/2	1	3	-	●
GP2RW-SQ0625	5/8	5/8	1-1/4	3-1/2	-	●
GP2RW-SQ0750	3/4	3/4	1-1/2	4	-	●
GP2RW-SQ0875	7/8	7/8	1-1/2	4	-	●
GP2RW-SQ1000	1	1	1-1/2	4	-	●



Orion End Mills for Aluminum



Orion End Mills are ideal for high performance milling in all types of Aluminum including high silicon, extruded as well as die cast parts.

Due to the unique and polished flute configuration, the Orion end mills are designed for aggressive chip evacuation under extremely heavy chip loads. Orion end mills are capable of speeds in excess of 2,000 SFM when run in a balanced assembly. Orion End Mills are available as 2 flute, 3 flute as well as 3 flute Rougher/Finishers

UK20 This uncoated carbide grade is made from high quality fine grade materials. Due to its exceptional balance of wear and toughness this grade enables sharp edges and consistent controlled wear rates. UK20 is used for general purpose machining of aluminum and non-ferrous materials.

Recommended Cutting Parameters		Application			Uncoated & Coated	Cutting Speed (Vc) Maximum Feed per Tooth for Side Milling Operations* Cutting Diameter						
		Side Milling		Slotting		1/4"	5/16"	3/8"	1/2"	5/8"	3/4"	1"
		Axial Depth	Radial Depth	Max. Axial Depth								
Tool Series	Material	ap	ae	ap	SFM							
ORION	Aluminum Alloys	1.5 x D	0.5 x D	1 x D	1000 - 2000 SFM	.0023 - .0043	.0028 - .0055	.0034 - .006	.0045 - .008	.0056 - .0095	.0068 - .011	.0090 - .013
	Aluminum with High Silicon	1.5 x D	0.5 x D	1 x D	700 - 2000 SFM	.0018 - .0043	.0023 - .0050	.0027 - .0052	.0036 - .0061	.0045 - .0075	.0054 - .0081	.0072 - .0110
	other Non-Ferrous materials	1.5 x D	0.5 x D	1 x D	750 - 1500 SFM	.0018 - .0043	.0023 - .0050	.0027 - .0052	.0036 - .0061	.0045 - .0075	.0054 - .0081	.0072 - .0110

* Feed per tooth in slotting applications should not exceed 80% of feed per tooth for side milling

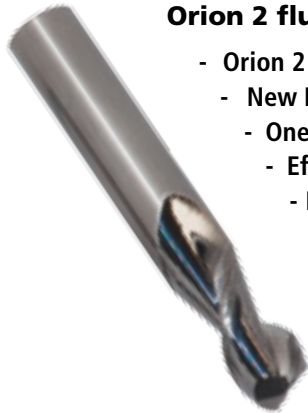

Orion 2 flute End Mills for Aluminum

- Orion 2 flute End Mills specifically designed for Aluminum
- New Polished flute design for effective chip evacuation
- One tool for roughing, semi-finishing as well as finishing operations
- Effective for slotting up to 1xD axial depth
 - For Side or profile milling capable of 0.5xD radial and 1.5xD axial depth
 - Cutting speeds only limited by your machine (Tool Balancing for Higher speeds recommended)
- Multiple length and radius tools available



ORION 2 Flute Solid Carbide End Mills (Center Cutting)

Designation	Cutter Diameter	Length of Cut	OAL	Corner Radius	UK20 Uncoated
OR2RC-SQ0125	1/8	3/8	1-1/2	-	●
OR2EC-SQ0125	1/8	1/2	1-1/2	-	●
OR2LC-SQ0125	1/8	3/4	2-1/2	-	●
OR2RC-SQ0187	3/16	5/16	2	-	●
OR2EC-SQ0187	3/16	9/16	2	-	●
OR2RC-SQ0250	1/4	1/2	2-1/2	-	●
OR2RC-SQ0250-015	1/4	1/2	2-1/2	.015	●
OR2RC-SQ0250-030	1/4	1/2	2-1/2	.030	●
OR2RC-SQ0250-060	1/4	1/2	2-1/2	.060	●
OR2EC-SQ0250	1/4	3/4	2-1/2	-	●
OR2EC-SQ0250-015	1/4	3/4	2-1/2	.015	●
OR2LC-SQ0250	1/4	1-1/8	2-1/2	-	●
OR2LC-SQ0250-015	1/4	1-1/8	2-1/2	.015	●
OR2RC-SQ0312	5/16	5/8	2-1/2	-	●
OR2RC-SQ0312-030	5/16	5/8	2-1/2	.030	●
OR2LC-SQ0312	5/16	1-1/8	3	-	●
OR2RC-SQ0375	3/8	3/4	2-1/2	-	●
OR2RC-SQ0375-030	3/8	3/4	2-1/2	.030	●
OR2EC-SQ0375	3/8	1-1/8	3	-	●
OR2EC-SQ0375-030	3/8	1-1/8	3	.030	●
OR2LC-SQ0375	3/8	2	4	-	●
OR2LC-SQ0375-030	3/8	2	4	.030	●

Designation	Cutter Diameter	Length of Cut	OAL	Corner Radius	UK20 Uncoated
OR2RC-SQ0500	1/2	1	3	-	●
OR2RC-SQ0500-030	1/2	1	3	.030	●
OR2EC-SQ0500	1/2	1-1/4	3	-	●
OR2EC-SQ0500-030	1/2	1-1/4	3	.030	●
OR2EC-SQ0500-060	1/2	1-1/4	3	.060	●
OR2LC-SQ0500	1/2	2	4	-	●
OR2LC-SQ0500-030	1/2	2	4	.030	●
OR2RC-SQ0625	5/8	1-1/4	3-1/2	-	●
OR2RC-SQ0625-030	5/8	1-1/4	3-1/2	.030	●
OR2RC-SQ0625-060	5/8	1-1/4	3-1/2	.060	●
OR2EC-SQ0625	5/8	1-5/8	3-1/2	-	●
OR2EC-SQ0625-030	5/8	1-5/8	3-1/2	.030	●
OR2LC-SQ0625	5/8	2	4	-	●
OR2RC-SQ0750	3/4	1-1/2	4	-	●
OR2RC-SQ0750-030	3/4	1-1/2	4	.030	●
OR2EC-SQ0750	3/4	1-3/4	4	-	●
OR2EC-SQ0750-030	3/4	1-3/4	4	.030	●
OR2LC-SQ0750	3/4	3	6	-	●
OR2RC-SQ1000	1	1-1/2	4	-	●
OR2EC-SQ1000	1	2	4	-	●
OR2EC-SQ1000-030	1	2	4	.030	●
OR2LC-SQ1000	1	3	6	-	●

UK20 This uncoated carbide grade is made from high quality fine grade materials. Due to its exceptional balance of wear and toughness this grade enables sharp edges and consistent controlled wear rates. UK20 is used for general purpose machining of aluminum and non-ferrous materials.

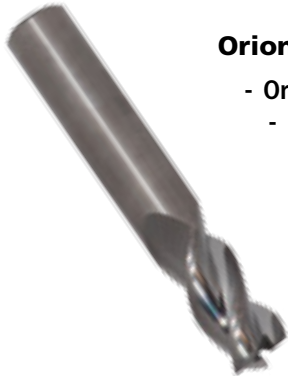

Orion 3 flute End Mills for Aluminum

- Orion 3 flute End Mills specifically designed for Aluminum
- Differential flute spacing for chatter free performance
- New Polished flute design for effective chip evacuation
- One tool for roughing, semi-finishing as well as finishing operations
- Effective for slotting up to 1xD axial depth
- For Side or profile milling capable of 0.5xD radial and 1.5xD axial depth
- Cutting speeds only limited by your machine (Tool Balancing for Higher speeds recommended)



ORION 3 Flute Solid Carbide End Mills (Variable Flute / Center Cutting)

Designation	Cutter Diameter	Length of Cut	OAL	Corner Radius	UK20 Uncoated
OR3RC-SQ0125	1/8	3/8	1-1/2	-	●
OR3EC-SQ0125	1/8	1/2	1-1/2	-	●
OR3LC-SQ0125	1/8	3/4	2-1/2	-	●
OR3RC-SQ0187	3/16	5/16	2	-	●
OR3EC-SQ0187	3/16	9/16	2	-	●
OR3RC-SQ0250	1/4	1/2	2-1/2	-	●
OR3RC-SQ0250-015	1/4	1/2	2-1/2	.015	●
OR3EC-SQ0250	1/4	3/4	2-1/2	-	●
OR3EC-SQ0250-015	1/4	3/4	2-1/2	.015	●
OR3LC-SQ0250	1/4	1-1/8	2-1/2	-	●
OR3LC-SQ0250-015	1/4	1-1/8	2-1/2	.015	●
OR3RC-SQ0312	5/16	5/8	2-1/2	-	●
OR3RC-SQ0312-030	5/16	5/8	2-1/2	.030	●
OR3LC-SQ0312	5/16	1-1/8	3	-	●
OR3RC-SQ0375	3/8	3/4	2-1/2	-	●
OR3RC-SQ0375-030	3/8	3/4	2-1/2	.030	●
OR3EC-SQ0375	3/8	1-1/8	3	-	●
OR3EC-SQ0375-030	3/8	1-1/8	3	.030	●
OR3LC-SQ0375	3/8	2	4	-	●
OR3LC-SQ0375-030	3/8	2	4	.030	●
OR3RC-SQ0500	1/2	1	3	-	●
OR3RC-SQ0500-030	1/2	1	3	.030	●

Designation	Cutter Diameter	Length of Cut	OAL	Corner Radius	UK20 Uncoated
OR3EC-SQ0500	1/2	1-1/4	3	-	●
OR3EC-SQ0500-030	1/2	1-1/4	3	.030	●
OR3LC-SQ0500	1/2	2	4	-	●
OR3LC-SQ0500-030	1/2	2	4	.030	●
OR3RC-SQ0625	5/8	1-1/4	3-1/2	-	●
OR3RC-SQ0625-030	5/8	1-1/4	3-1/2	.030	●
OR3EC-SQ0625	5/8	1-5/8	3-1/2	-	●
OR3EC-SQ0625-030	5/8	1-5/8	3-1/2	.030	●
OR3LC-SQ0625	5/8	2	4	-	●
OR3LC-SQ0625-030	5/8	2	4	.030	●
OR3RC-SQ0750	3/4	1-1/2	4	-	●
OR3RC-SQ0750-030	3/4	1-1/2	4	.030	●
OR3EC-SQ0750	3/4	1-3/4	4	-	●
OR3EC-SQ0750-030	3/4	1-3/4	4	.030	●
OR3LC-SQ0750	3/4	3	6	-	●
OR3LC-SQ0750-030	3/4	3	6	.030	●
OR3RC-SQ1000	1	1-1/2	4	-	●
OR3RC-SQ1000-030	1	1-1/2	4	.030	●
OR3EC-SQ1000	1	2	4	-	●
OR3EC-SQ1000-030	1	2	4	.030	●
OR3LC-SQ1000	1	3	6	-	●
OR3LC-SQ1000-030	1	3	6	.030	●



3 Flute Roughing End Mills (Variable Flute / Center Cutting)

Cylindrical Shank	Weldon Shank	Cutter Diameter	Shank Diameter	Length of Cut	OAL	Chamfer	UK20 Uncoated
RCOR3RC-SQ0250-C10	-	1/4	1/4	3/4	2-1/2	.010	●
RCOR3RC-SQ0375-C10	-	3/8	3/8	7/8	2-1/2	.010	●
RCOR3EC-SQ0500-C20	RCOR3EW-SQ0500-C20	1/2	1/2	1-1/4	3	.020	●
RCOR3RC-SQ0625-C30	RCOR3RW-SQ0625-C30	5/8	5/8	1-1/4	3-1/2	.030	●
RCOR3RC-SQ0750-C30	RCOR3RW-SQ0750-C30	3/4	3/4	1-1/2	4	.030	●
RCOR3RC-SQ1000-C30	RCOR3RW-SQ1000-C30	1	1	1-1/2	4	.030	●

Orion 3 Flute Roughing End Mills for Aluminum

- Orion 3 flute Roughing End Mills specifically designed for Aluminum
- Orion 3 flute design feature differential flute spacing for chatter free performance
- New Polished flute design for effective chip evacuation
- Designed for aggressive feed rates while maintaining excellent surface finishes
- Specially designed chipbreaker creates smaller chips and reduces cutting loads on lighter duty machines



4 Flute Roughing End Mills

Rougher/Finisher

The New TyCarb Rougher / Finisher is recommended for use in most materials from carbon, tool, die, alloy steels as well as cast iron and even stainless steel. The unique chipbreaker and flute configuration achieves higher productivity with less H.P. than other High Performance end mills. The specially designed chipbreaker creates smaller chips, ensuring rapid evacuation and helping reduce potential tool chatter. Added features include Differential flute spacing to achieve even higher productivity.

- Differential flute spacing
- Cutting edges protected with 45 deg. chamfer
- Next generation AlCrN PVD coating
- Available with Cylindrical or Weldon style shanks



4 Flute Roughing End Mills

(Variable Flute / Center Cutting)

Designation	Cutter Diameter	Shank Diameter	Length of Cut	OAL	Chamfer	TL30 Coated
RC4RC-SQ0250-C10	1/4	1/4	3/4	2-1/2	.010	●
RC4RC-SQ0375-C10	3/8	3/8	7/8	2-1/2	.010	●
RC4EC-SQ0500-C20	1/2	1/2	1-1/4	3	.020	●
RC4RC-SQ0625-C30	5/8	5/8	1-1/4	3-1/2	.030	●
RC4RC-SQ0750-C30	3/4	3/4	1-1/2	4	.030	●
RC4RC-SQ1000-C30	1	1	1-1/2	4	.030	●

4 Flute Roughing End Mills

(Variable Flute / Center Cutting / Weldon)

Designation	Cutter Diameter	Shank Diameter	Length of Cut	OAL	Chamfer	TL30 Coated
RC4EW-SQ0500-C20	1/2	1/2	1-1/4	3	.020	●
RC4RW-SQ0625-C30	5/8	5/8	1-1/4	3-1/2	.030	●
RC4RW-SQ0750-C30	3/4	3/4	1-1/2	4	.030	●
RC4RW-SQ1000-C30	1	1	1-1/2	4	.030	●

Recommended Cutting Parameters

Work Material	Type of Cut	Axial DOC	Radial DOC	Speed (SFM)	Feed (Inches Per Tooth)						
					1/8	1/4	3/8	1/2	5/8	3/4	1
Low Carbon Steels <= 38 Rc 1018, 12L14, 8620	Slotting Peripheral - Rough	1 x D 1.5 x D	1 x D .5 x D	350 425	0.0008	0.0016	0.0024	0.0032	0.0040	0.0048	0.0064
					0.0010	0.0020	0.0030	0.0040	0.0050	0.0060	0.0080
Medium Carbon Steels <= 38 Rc 4140, 4340	Slotting Peripheral - Rough	1 x D 1.5 x D	1 x D .5 x D	325 375	0.0006	0.0013	0.0020	0.0027	0.0034	0.0040	0.0054
					0.0008	0.0017	0.0026	0.0035	0.0044	0.0053	0.0070
Tool and Die Steels <= 38 Rc A2, D2, O1, S7, P20, H13	Slotting Peripheral - Rough	1 x D 1.5 x D	1 x D .5 x D	325 375	0.0006	0.0013	0.0020	0.0027	0.0034	0.0040	0.0054
					0.0008	0.0017	0.0026	0.0035	0.0044	0.0053	0.0070
Tool Steels 39 Rc to 48 Rc	Slotting Peripheral - Rough	.75 x D 1 x D	1 x D .5 x D	225 275	0.0005	0.0010	0.0015	0.0020	0.0025	0.0030	0.0040
					0.0006	0.0012	0.0017	0.0023	0.0029	0.0035	0.0046
Easy to machine stainless steel 416, 410, 302, 303	Slotting Peripheral - Rough	1 x D 1.5 x D	1 x D .5 x D	300 375	0.0006	0.0012	0.0018	0.0025	0.0031	0.0037	0.0050
					0.0008	0.0016	0.0024	0.0032	0.0040	0.0048	0.0064
Moderately difficult stainless steels 304, 316, Invar, Kovar	Slotting Peripheral - Rough	.75 x D 1.5 x D	1 x D .5 x D	275 350	0.0005	0.0011	0.0016	0.0022	0.0027	0.0033	0.0044
					0.0007	0.0015	0.0023	0.0032	0.0037	0.0045	0.0064
Difficult to machine stainless steels 316L, 17-4 PH, 15-5 PH, 13-8 PH	Slotting Peripheral - Rough	.5 x D 1 x D	1 x D .5 x D	250 300	0.0004	0.0009	0.0012	0.0018	0.0022	0.0027	0.0036
					0.0005	0.0011	0.0016	0.0022	0.0028	0.0033	0.0044
Cast Iron Grey	Slotting Peripheral - Rough	1 x D 1.5 x D	1 x D .5 x D	400 500	0.0006	0.0012	0.0019	0.0025	0.0031	0.0038	0.0050
					0.0007	0.0015	0.0023	0.0030	0.0037	0.0046	0.0060
Cast Iron Ductile	Slotting Peripheral - Rough	1 x D 1.5 x D	1 x D .5 x D	300 400	0.0006	0.0012	0.0018	0.0023	0.0029	0.0035	0.0046
					0.0007	0.0014	0.0021	0.0028	0.0035	0.0042	0.0056
Cast Iron Malleable	Slotting Peripheral - Rough	0.75 x D 1 x D	1 x D .75 x D	250 325	0.0004	0.0008	0.0012	0.0015	0.0019	0.0023	0.0030
					0.0005	0.0011	0.0016	0.0022	0.0027	0.0033	0.0044
Titanium Alloys	Slotting Peripheral - Rough	.5 x D 1 x D	1 x D .5 x D	250 300	0.0005	0.0010	0.0015	0.0020	0.0025	0.0030	0.0040
					0.0006	0.0012	0.0017	0.0023	0.0029	0.0035	0.0046
High Temperature Alloys Inconel, Haynes, Stellite, Hastalloy	Slotting Peripheral - Rough	.25 x D 1 x D	1 x D .25 x D	70 95	0.0004	0.0008	0.0012	0.0015	0.0019	0.0024	0.0030
					0.0005	0.0009	0.0014	0.0018	0.0022	0.0028	0.0036

TyCarb 2² - 4 Flute Roughing/Finisher End Mills



TyCarb 2² End Mills

The TyCarb 2² High Performance end mills are specifically designed with 2 roughing flutes and 2 Finishing flutes to operate at roughing cutter parameters while achieving excellent surface finish. The eccentric relief and differential flute spacing design make this tool suitable for a wide variety of materials carbon, die, alloy and stainless steels as well as exotic materials.

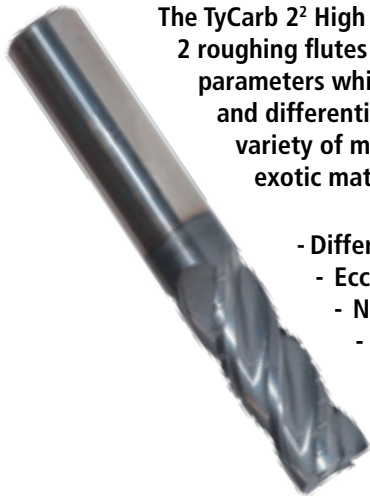

- Differential flute spacing
- Eccentric relief flute design
- Next generation AlCrN PVD coating
- Available with Cylindrical or Weldon style shanks
- Cutting edges protected with a 45 degree chamfer

2²



4 Flute Rougher/Finisher End Mills (Variable Flute / Center Cutting)

Designation	Cutter Diameter	Shank Diameter	Length of Cut	OAL	Chamfer	TL30 Coated
SM4RC-SQ0250-C10	1/4	1/4	3/4	2-1/2	.010	●
SM4RC-SQ0375-C10	3/8	3/8	7/8	2-1/2	.010	●
SM4EC-SQ0500-C20	1/2	1/2	1-1/4	3	.020	●
SM4RC-SQ0625-C30	5/8	5/8	1-1/4	3-1/2	.030	●
SM4RC-SQ0750-C30	3/4	3/4	1-1/2	4	.030	●
SM4RC-SQ1000-C30	1	1	1-1/2	4	.030	●

4 Flute Rougher/Finisher End Mills (Variable Flute / Center Cutting / Weldon)

Designation	Cutter Diameter	Shank Diameter	Length of Cut	OAL	Chamfer	TL30 Coated
SM4EW-SQ0500-C20	1/2	1/2	1-1/4	3	.020	●
SM4RW-SQ0625-C30	5/8	5/8	1-1/4	3-1/2	.030	●
SM4RW-SQ0750-C30	3/4	3/4	1-1/2	4	.030	●
SM4RW-SQ1000-C30	1	1	1-1/2	4	.030	●

Recommended Cutting Parameters

Work Material	Type of Cut	Axial DOC	Radial DOC	Speed (SFM)	Feed (Inches Per Tooth)						
					1/8	1/4	3/8	1/2	5/8	3/4	1
Low Carbon Steels <= 38 Rc 1018, 12L14, 8620	Slotting	1 x D	1 x D	350	0.0008	0.0016	0.0024	0.0032	0.0040	0.0048	0.0064
	Peripheral - Rough	1.5 x D	.5 x D	425	0.0010	0.0020	0.0030	0.0040	0.0050	0.0060	0.0080
Medium Carbon Steels <= 38 Rc 4140, 4340	Slotting	1 x D	1 x D	325	0.0006	0.0013	0.0020	0.0027	0.0034	0.0040	0.0054
	Peripheral - Rough	1.5 x D	.5 x D	375	0.0008	0.0017	0.0026	0.0035	0.0044	0.0053	0.0070
Tool and Die Steels <= 38 Rc A2, D2, O1, S7, P20, H13	Slotting	1 x D	1 x D	325	0.0006	0.0013	0.0020	0.0027	0.0034	0.0040	0.0054
	Peripheral - Rough	1.5 x D	.5 x D	375	0.0008	0.0017	0.0026	0.0035	0.0044	0.0053	0.0070
Tool Steels 39 Rc to 48 Rc	Slotting	.75 x D	1 x D	225	0.0005	0.0010	0.0015	0.0020	0.0025	0.0030	0.0040
	Peripheral - Rough	1 x D	.5 x D	275	0.0006	0.0012	0.0017	0.0023	0.0029	0.0035	0.0046
Easy to machine stainless steel 416, 410, 302, 303	Slotting	1 x D	1 x D	300	0.0006	0.0012	0.0018	0.0025	0.0031	0.0037	0.0050
	Peripheral - Rough	1.5 x D	.5 x D	375	0.0008	0.0016	0.0024	0.0032	0.0040	0.0048	0.0064
Moderately difficult stainless steels 304, 316, Invar, Kovar	Slotting	.75 x D	1 x D	275	0.0005	0.0011	0.0016	0.0022	0.0027	0.0033	0.0044
	Peripheral - Rough	1.5 x D	.5 x D	350	0.0007	0.0015	0.0023	0.0032	0.0037	0.0045	0.0064
Difficult to machine stainless steels 316L, 17-4 PH, 15-5 PH, 13-8 PH	Slotting	.5 x D	1 x D	250	0.0004	0.0009	0.0012	0.0018	0.0022	0.0027	0.0036
	Peripheral - Rough	1 x D	.5 x D	300	0.0005	0.0011	0.0016	0.0022	0.0028	0.0033	0.0044
Cast Iron Grey	Slotting	1 x D	1 x D	400	0.0006	0.0012	0.0019	0.0025	0.0031	0.0038	0.0050
	Peripheral - Rough	1.5 x D	.5 x D	500	0.0007	0.0015	0.0023	0.0030	0.0037	0.0046	0.0060
Cast Iron Ductile	Slotting	1 x D	1 x D	300	0.0006	0.0012	0.0018	0.0023	0.0029	0.0035	0.0046
	Peripheral - Rough	1.5 x D	.5 x D	400	0.0007	0.0014	0.0021	0.0028	0.0035	0.0042	0.0056
Cast Iron Malleable	Slotting	0.75 x D	1 x D	250	0.0004	0.0008	0.0012	0.0015	0.0019	0.0023	0.0030
	Peripheral - Rough	1 x D	.75 x D	325	0.0005	0.0011	0.0016	0.0022	0.0027	0.0033	0.0044
Titanium Alloys	Slotting	.5 x D	1 x D	250	0.0005	0.0010	0.0015	0.0020	0.0025	0.0030	0.0040
	Peripheral - Rough	1 x D	.5 x D	300	0.0006	0.0012	0.0017	0.0023	0.0029	0.0035	0.0046
High Temperature Alloys Inconel, Haynes, Stellite, Hastalloy	Slotting	.25 x D	1 x D	70	0.0004	0.0008	0.0012	0.0015	0.0019	0.0024	0.0030
	Peripheral - Rough	1 x D	.25 x D	95	0.0005	0.0009	0.0014	0.0018	0.0022	0.0028	0.0036



High Feed End Mills



High Feed End Mills

- TyCarb High Feed end mills are designed for roughing to semi-finish applications
- Significantly reduces machining time in hardened materials
- TyCarb High Feed end mills are capable of feed rates up to 0.029 IPT
 - Effective for Z axis machining including pocketing, face milling, helical ramping as well as circular interpolation
- Now available with next generation AlCrN PVD coating
- Excellent in long reach applications

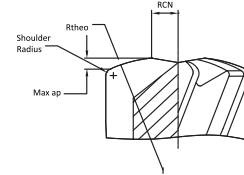
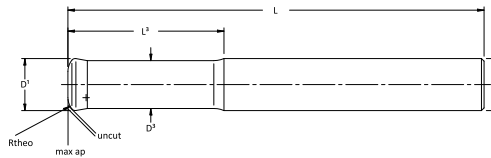

High Feed End Mills

Designation	D ¹	D	Rtheo	Uncut	Max ap	L	L ³	D ³	Flutes	TL30 Coated
HF4RC-DR0250-034	1/4	1/4	.034	.006	.013	2.50	.750	.210	4	●
HF4RC-DR0312-042	5/16	5/16	.042	.008	.017	3.00	1.00	.270	4	●
HF4RC-DR0375-051	3/8	3/8	.051	.010	.020	3.50	1.25	.340	4	●
HF4RC-DR0500-070	1/2	1/2	.070	.013	.028	4.00	1.50	.460	4	●
HF4RC-DR0625-085	5/8	5/8	.085	.016	.033	4.00	1.50	.590	4	●
HF5RC-DR0625-085	5/8	5/8	.085	.016	.033	4.00	1.50	.590	5	●
HF5RC-DR0750-100	3/4	3/4	.100	.019	.040	5.00	2.00	.710	5	●

High Feed End Mills - Technical Programming Information

Cutter Dia. INCH	Max ap	Rtheo	Shoulder	RCN	Material Uncut	Circular Interpolation		Length of travel to max ap per deg		
						Smallest	Largest	deg	2 deg	3 deg
1/4	.013	.034	.020	.064	.006	.378	.500	.762	.381	.254
5/16	.017	.042	.024	.080	.008	.472	.625	.953	.476	.317
3/8	.020	.051	.030	.096	.010	.567	.750	1.143	.572	.381
1/2	.027	.070	.040	.126	.013	.752	1.000	1.525	.762	.508
5/8	.033	.085	.049	.160	.016	.945	1.250	1.906	.953	.635
3/4	.040	.100	.059	.192	.019	1.134	1.500	2.287	1.143	.762
Feed % Reduction:								100%	70%	50%

All dimensions are shown in inch

	Work Material	Axial DOC	Radial DOC	Speed SFM		Recommended Feed Inches per Tooth					
				Min	Max	1/4"	5/16"	3/8"	1/2"	5/8"	3/4"
P	Medium Carbon Steels ≤ 38 Rc 4140, 4340	0.05 x D	0.50 x D	500	650	.010" - .014"	.012" - .016"	.016" - .020"	.020" - .025"	.022" - .027"	.024" - .029"
	Tool and Die Steels ≤ 38 Rc A2, D2, O1, S7, P20, H13	0.05 x D	0.50 x D	480	600	.010" - .014"	.012" - .016"	.016" - .020"	.020" - .025"	.022" - .027"	.024" - .029"
	Tool Steels 39 Rc to 48 Rc	0.05 x D	0.50 x D	375	525	.006" - .010"	.008" - .012"	.012" - .014"	.016" - .020"	.017" - .022"	.018" - .024"
	Easy to machine stainless steel 416, 410, PH Stainless	0.05 x D	0.50 x D	250	375	.006" - .010"	.008" - .012"	.012" - .014"	.016" - .020"	.017" - .022"	.018" - .024"
H	Hardened Tool Steels 48 - 53 Rc	0.05 x D	0.50 x D	350	500	.008" - .012"	.010" - .014"	.014" - .018"	.018" - .022"	.020" - .024"	.020" - .027"

*When using Max ap, please use lower end of feed range

SPECIALS

From simple modifications to standard lines of tooling, to completely engineered tooling solutions - we have the skill and experience to deliver quality products to increase productivity

- Solid Carbide Tooling
- Custom Drills & Taper Mills
- Virtually Unlimited Form Tools
- Coolant Through G-Drills, Step Drills & Ball Tools
- Special Radii
- Reamers
- Jig Boring Tools
- Forming Tools
- Dovetail Cutters
- Porting Tools
- Coolant Through
- Advanced Coating Capability

TV Carb

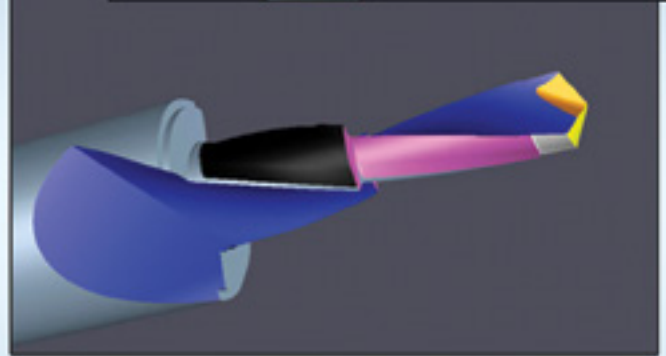
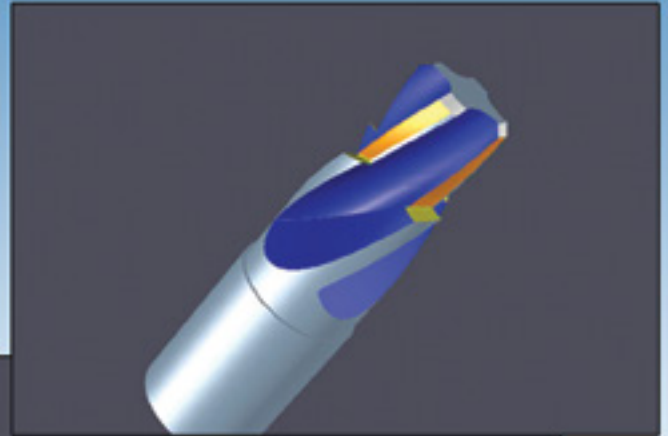

TV Carb



Rani Tool Corp.

205 Kelsey St., Unit #103, Newington, CT 06111

Tel: (888) 554-RANI or (860) 665-7771 • Fax: (860) 665-7319

E-mail: sales@ranitool.com • www.ranitool.com

Available From: