

ULTRA-DEX

THE **ULTIMATE** INDEXABLE
METALWORKING SOURCE

Proudly Made in Flushing, MI USA

2017 / 2018



HOLDING

DRILLING



INSERTS +
HARDWARE



BORING

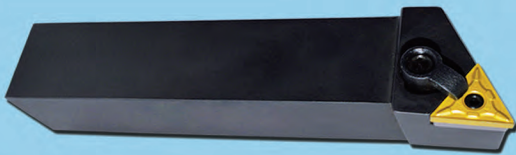

TURNING

MILLING



CUSTOM DESIGN & BUILD
DETAIL WORK / REPAIRS

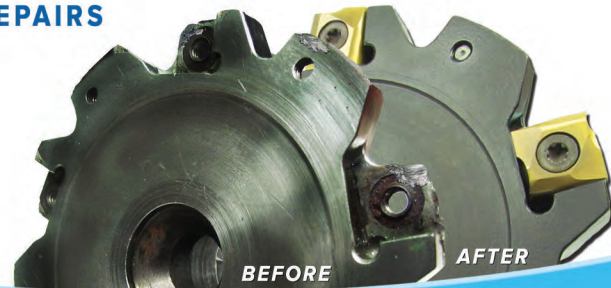

ARCH
GLOBAL PRECISION
« « « « LEARN MORE

AMERICAN MANUFACTURING
SERVING THE WORLD

INTRODUCTION / DIRECTORY

Ultra-Dex prides itself on delivering the highest quality and the best value products to our customers. Continuing to prove American manufacturers can compete with imported products, through experienced personnel, using the latest technology and machining processes. As many of our satisfied customers have come to know, our passion is providing excellent products proudly made in the USA, at a great price.

Thank you for choosing Ultra-Dex

Jeff Cederstrom
President

Pat Mulcahy
VP of Operations, Ultra-Dex / ARCH Specials

Gregg Bishop
Director of Operations, Ultra-Dex

Mike Tipton
Plant Manager, Ultra-Dex

Dane Carnell
Plant Manager Ultra-Dex / ARCH Specials

Tom Hensel
Director of Sales & Marketing



Celebrating 28+ Years in the Tooling Industry!
Bringing You High Quality, Low Cost, American Made Tooling since 1988

A **TURNING** pgs 4-19
Square Shank Indexable Tools

B **BORING** pgs 20-127

NOMENCLATURE p20

STEEL p22

Boring Bar Kits p41

Reduced Neck p42

PULLBACK p46

Series Style Bars

p25, p27, p44, p45

HYBRID p48

CARBIDE p50

Metric p51

Reduced Neck p69

PULLBACK p46

Solid Small Boring p70

Services / Coolant Adapters p71

Series Style Bars p55

p56, p63, p69

HEAVY METAL p72

MODULAR p76

Bars p77

Heads p79

PULLBACK p89

CHATTER-FREE p92

Standard Bars p94

Solid Bars p96

Standard "CFT Style" Bars p97

Standard Heads p99

Serrated "CFT Style" Bars p111

Serrated Bars p112

Serrated Heads p114

ULTRA-ADJUST p122

C **MILLING** pgs 128-141
Indexable Milling Cutters

PATRIOT Mills p128

End Mills p133

Face Mills p134

Round Mills p135

PATRIOT Counterbores p136

Chamfer Mills p139

ISO Mills p140

D **DRILLING** pgs 142-151
Indexable Drills

PATRIOT 3xD Drills p142

Chamfer Drills p145

2.5xD Drills p146

2xD Drills p147

4xD Drills p148

CUSTOM Order Drills p150

E **TOOL HOLDING** pgs 152-187

CAT40 p153

CAT50 p159

HSK40A, 50A, 63A p168

HSK 80A, 100A, 125A p173

STRAIGHT SHANK p182

CAT Retention Knobs p165

HSK Coolant Tubes p178

Tool Bushings p180

Shrink-Fit Extensions p179

ER Collets p184

F **INSERTS** pgs 188-203

G **HARDWARE +** pgs 204-211

Hardware p204

Surface Plate Centers p206

Services Including Repairs p208

Ordering and Shipping p210

ULTRA-DEX

SQUARE SHANK TURNING TOOLS

.625" - 1.50" Shank Sizes

Insert Quick Pick

CNMG pg 8-10

DNMG pg 11

RNMG pg 12

SNMG pg 12-14

TNMG pg 14-16

VNMG pg 17









WNMG pg 18



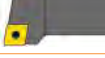















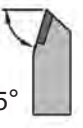

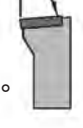
A

TURNING

Insert Holding		Insert Shape		Hand of Tool		Insert Size	
M	Clamp and Lock Pin	C	80° Diamond 	L	Left 	2	1/4" IC
N	Top Notch Clamp	D	55° Diamond 	R	Right 	3	3/8" IC
S	Screw Lock Only	T	60° Triangle 	N	Neutral 	4	1/2" IC
D	PULLBACK Clamp	S	90° Square 			5	5/8" IC
		V	35° Diamond 			6	3/4" IC
		W	80° Trigon 				
		R	Round 				

S C L C R 16 - 4 C

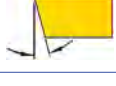
Lead Angle		
A 90° 	F 90° 	L 95° 
S 45° 	G 90° 	M 50° 
P 107.5° 	V 72.5° 	D 45° 
J 93° 	Y 85° 	E 60° 
K 75° 	R 75° 	T 27.5° 

Insert Clearance Angle		
B	5°	
C	7°	
D	15°	
N	0°	
P	11°	

Shank Dimension	
08	.500"
10	.625"
12	.750"
16	1.000"
20	1.250"
24	1.500"
1212	12mm
1616	16mm

Qualified Surface & Length	
A	4"
B	4.5"
C	5"
D	6"
E	7"



A

TURNING

New!

UNDERCUT & PROFILING SQUARE SHANK

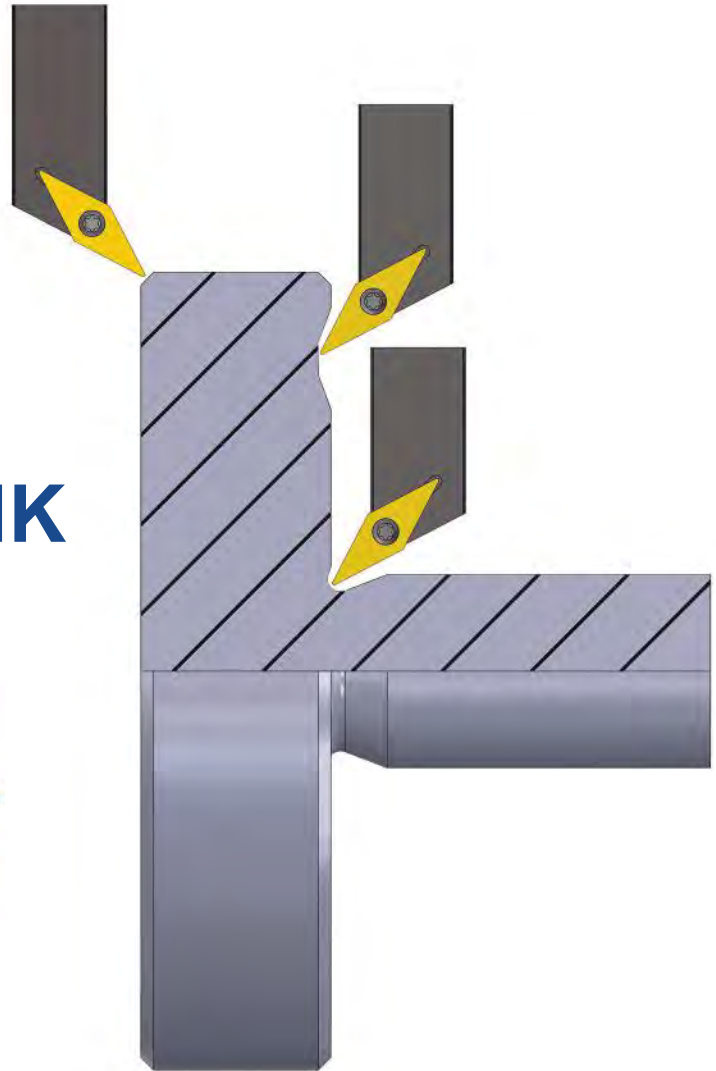

MICHIGAN MADE

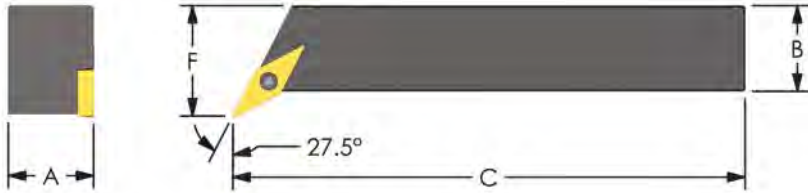

Positive 35° Diamond (-27.5° Lead)

No Coolant

Designation	A/B	C	F	Insert	Screw	Price
SVTBR/L 12-2B	.750	4.5	.935	VBMT 21.51	MTS-2.5L	\$55.59
SVTBR/L 12-3B	.750	4.5	.935	VBMT 331	MTS-3.5L	\$55.59
SVTBR/L 16-3B	1.00	4.5	.935		MTS-3.5L	\$60.56

New! SWISS STYLE SQUARE SHANK



A

TURNING

- Proper Insert Alignment For Swiss Processes
- Accepts Standard ISO Inserts
- Specials Available Upon Request

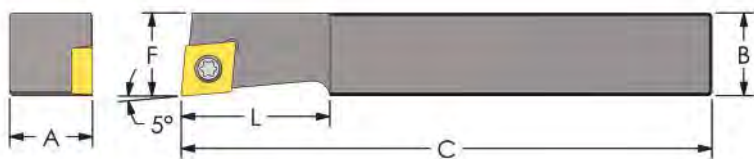

Positive 80° Diamond (-5° Lead) No Coolant

Designation	A/B	C	L	F	Insert	Screw	Price
SCLCR/L 08-3A	.500	4	.865	.500	CCMT 32.51	MTS-35	\$61.65
SCLCR/L 10-3A	.625	4	1.120	.625		MTS-35	\$66.52

Designation	A/B (mm)	C (mm)	L (mm)	F (mm)	Insert	Screw	Price
SCLCR/L 1212-3A	12	100	22	12	CCMT 32.51	MTS-35	\$61.65
SCLCR/L 1616-3A	16	100	28	16		MTS-35	\$66.52

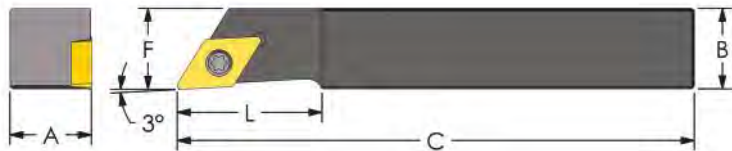

Positive 55° Diamond (-3° Lead) No Coolant

Designation	A/B	C	L	F	Insert	Screw	Price
SDJCR/L 08-3A	.500	4	.865	.500	DCMT 32.51	MTS-35	\$61.65
SDJCR/L 10-3A	.625	4	1.120	.625		MTS-35	\$66.52

Designation	A/B (mm)	C (mm)	L (mm)	F (mm)	Insert	Screw	Price
SDJCR/L 1212-3A	12	100	22	12	DCMT 32.51	MTS-35	\$61.65
SDJCR/L 1616-3A	16	100	28	16		MTS-35	\$66.52

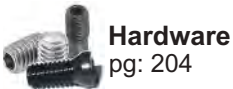

Hardware
pg: 204



Inserts
pg: 188



Proudly Made in Flushing, MI USA

SQUARE Shank (80° Diamond)

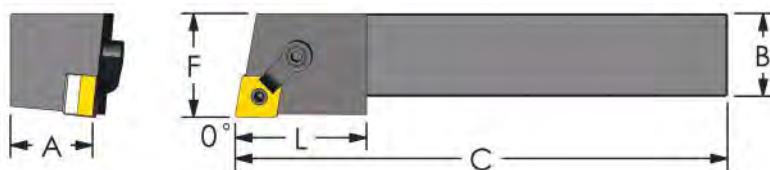

Negative 80° Diamond (0° Lead)

No Coolant

Designation	A/B	C	L	F	Insert	Shim	Lock Pin	Clamp	Screw	Price
MCGNR/L 12-4B	.750	4.5	1.300	1.000	CNMG 432	ICSN-433	NL-46	CL-20	XNS-48	\$61.45
MCGNR/L 16-4D	1.000	6	1.600	1.250		ICSN-433	NL-46	CL-20	XNS-48	\$66.94
MCGNR/L 20-4D	1.250	6	1.600	1.500		ICSN-433	NL-46	CL-20	XNS-48	\$73.52
MCGNR/L 24-4D	1.500	6	1.600	2.000		ICSN-433	NL-46	CL-20	XNS-48	\$97.66
MCGNR/L 16-5D	1.000	6	1.600	1.250	CNMG 543	ICSN-533	NL-58	CL-12	XNS-510	\$66.94
MCGNR/L 20-5D	1.250	6	1.600	1.500		ICSN-533	NL-58	CL-12	XNS-510	\$73.52
MCGNR/L 24-5D	1.500	6	1.600	2.000		ICSN-533	NL-58	CL-12	XNS-510	\$97.66
MCGNR/L 20-6D	1.250	6	1.600	1.500	CNMG 643	ICSN-633	NL-68	CL-12	XNS-510	\$73.52
MCGNR/L 24-6D	1.500	6	1.600	2.000		ICSN-633	NL-68	CL-12	XNS-510	\$97.66

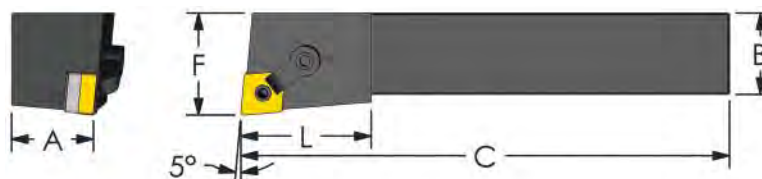

Negative 80° Diamond (-5° Lead)

No Coolant

Designation	A/B	C	L	F	Insert	Shim	Lock Pin	Clamp	Screw	Price
MCLNR/L 12-4B	.750	4.5	1.300	1.000	CNMG 432	ICSN-433	NL-46	CL-20	XNS-48	\$61.45
MCLNR/L 16-4D	1.000	6	1.600	1.250		ICSN-433	NL-46	CL-20	XNS-48	\$66.94
MCLNR/L 20-4D	1.250	6	1.600	1.500		ICSN-433	NL-46	CL-20	XNS-48	\$73.52
MCLNR/L 16-5D	1.000	6	1.600	1.250	CNMG 543	ICSN-533	NL-58	CL-12	XNS-510	\$66.94
MCLNR/L 20-5D	1.250	6	1.600	1.570		ICSN-533	NL-58	CL-12	XNS-510	\$73.52
MCLNR/L 24-5D	1.500	6	1.600	2.000		ICSN-533	NL-58	CL-12	XNS-510	\$97.66
MCLNR/L 16-6D	1.000	6	1.600	1.250	CNMG 643	ICSN-633	NL-68	CL-12	XNS-510	\$66.94
MCLNR/L 20-6D	1.250	6	1.600	1.570		ICSN-633	NL-68	CL-12	XNS-510	\$73.52
MCLNR/L 24-6D	1.500	6	1.600	2.000		ICSN-633	NL-68	CL-12	XNS-510	\$97.66
MCLNR/L 24-6E	1.500	7	1.600	2.000		ICSN-633	NL-68	CL-12	XNS-510	\$97.66

A

TURNING

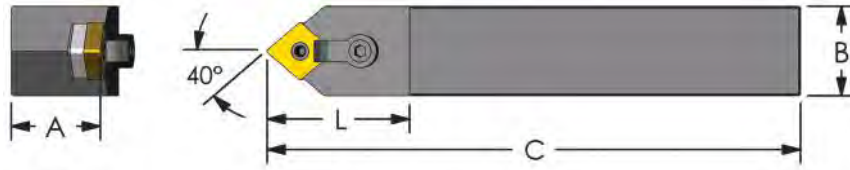

A

TURNING

Negative 80° Diamond (40° Lead)

No Coolant

Designation Neutral	A/B	C	L	Insert	Shim	Lock Pin	Clamp	Screw	Price
MCMNN 12-4B	.750	4.5	1.300	CNMG 432	ICSN-433	NL-46	CL-20	XNS-48	\$61.45
MCMNN 16-4D	1.000	6	1.600		ICSN-433	NL-46	CL-20	XNS-48	\$66.94
MCMNN 20-4D	1.250	6	1.600		ICSN-433	NL-46	CL-20	XNS-48	\$73.52
MCMNN 16-5D	1.000	6	1.600	CNMG 543	ICSN-533	NL-58	CL-12	XNS-510	\$66.94
MCMNN 20-5D	1.250	6	1.600		ICSN-533	NL-58	CL-12	XNS-510	\$73.52
MCMNN 24-5D	1.500	6	1.600		ICSN-533	NL-58	CL-12	XNS-510	\$97.66
MCMNN 24-6D	1.500	6	2.050	CNMG 643	ICSN-633	NL-68	CL-12	XNS-510	\$97.66
MCMNN 24-6E	1.500	7	2.050		ICSN-633	NL-68	CL-12	XNS-510	\$97.66

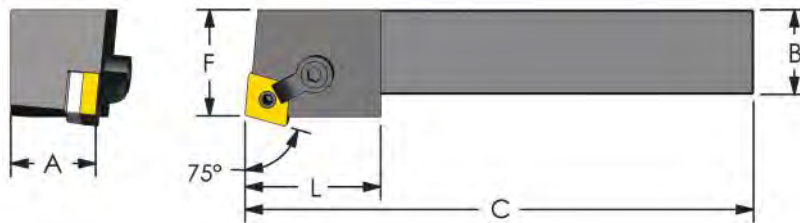

Negative 80° Diamond (75° Lead)

No Coolant

Designation	A/B	C	L	F	Insert	Shim	Lock Pin	Clamp	Screw	Price
MCRNR/L 12-4B	.750	4.5	1.300	.750	CNMG 432	ICSN-433	NL-46	CL-20	XNS-48	\$61.45
MCRNR/L 16-4C	1.000	5	1.600	1.250		ICSN-433	NL-46	CL-20	XNS-48	\$66.94
MCRNR/L 16-4D	1.000	6	1.600	1.250		ICSN-433	NL-46	CL-20	XNS-48	\$66.94
MCRNR/L 20-4D	1.250	6	1.600	1.500		ICSN-433	NL-46	CL-20	XNS-48	\$73.52
MCRNR/L 24-4D	1.500	6	1.600	2.000		ICSN-433	NL-46	CL-20	XNS-48	\$97.66
MCRNR/L 16-5D	1.000	6	1.600	1.250	CNMG 543	ICSN-533	NL-58	CL-12	XNS-510	\$66.94
MCRNR/L 20-5D	1.250	6	1.600	1.500		ICSN-533	NL-58	CL-12	XNS-510	\$73.52
MCRNR/L 16-6D	1.000	6	1.600	1.250	CNMG 643	ICSN-633	NL-68	CL-12	XNS-510	\$66.94
MCRNR/L 20-6D	1.250	6	1.600	1.500		ICSN-633	NL-68	CL-12	XNS-510	\$73.52
MCRNR/L 24-6D	1.500	6	1.600	2.000		ICSN-633	NL-68	CL-12	XNS-510	\$97.66

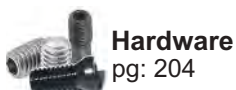

Hardware
pg: 204



Inserts
pg: 188



ULTRADEXUSA.com

SQUARE Shank (80° Diamond)

MADE IN USA

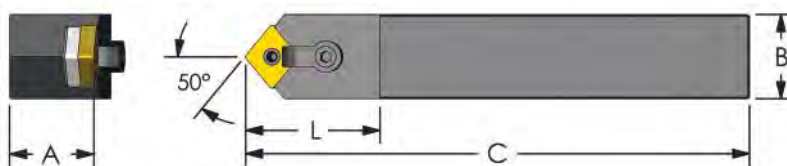

Negative 80° Diamond (50° Lead)

No Coolant

Designation Neutral	A/B	C	L	Insert	Shim	Lock Pin	Clamp	Screw	Price
MCYNN 12-4B	.750	4.5	1.300	CNMG 432	ICSN-433	NL-46	CL-20	XNS-48	\$61.45
MCYNN 16-4D	1.000	6	1.600		ICSN-433	NL-46	CL-20	XNS-48	\$66.94
MCYNN 20-4D	1.250	6	1.600		ICSN-433	NL-46	CL-20	XNS-48	\$73.52
MCYNN 16-5D	1.000	6	1.600	CNMG 543	ICSN-533	NL-58	CL-12	XNS-510	\$66.94
MCYNN 20-5D	1.250	6	1.600		ICSN-533	NL-58	CL-12	XNS-510	\$73.52
MCYNN 16-6D	1.000	6	2.050	CNMG 643	ICSN-633	NL-68	CL-12	XNS-510	\$66.94
MCYNN 20-6D	1.250	6	2.050		ICSN-633	NL-68	CL-12	XNS-510	\$73.52
MCYNN 24-6D	1.500	6	2.050		ICSN-633	NL-68	CL-12	XNS-510	\$97.66

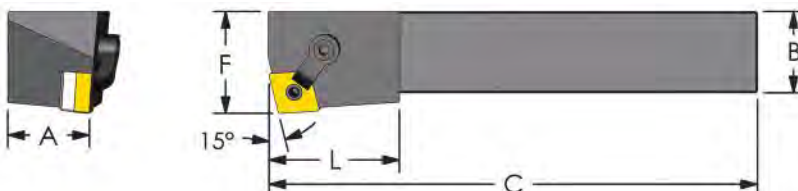

Negative 80° Diamond (15° Lead)

No Coolant

Designation	A/B	C	L	F	Insert	Shim	Lock Pin	Clamp	Screw	Price
MCKNR/L 12-4B	.750	4.5	1.300	1.000	CNMG 432	ICSN-433	NL-46	CL-20	XNS-48	\$61.45
MCKNR/L 16-4D	1.000	6	1.600	1.250		ICSN-433	NL-46	CL-20	XNS-48	\$66.94
MCKNR/L 20-4D	1.250	6	1.600	1.500		ICSN-433	NL-46	CL-20	XNS-48	\$73.52
MCKNR/L 16-5D	1.000	6	1.600	1.250	CNMG 543	ICSN-533	NL-58	CL-12	XNS-510	\$66.94
MCKNR/L 20-5D	1.250	6	1.600	1.500		ICSN-533	NL-58	CL-12	XNS-510	\$73.52
MCKNR/L 16-6D	1.000	6	1.600	1.250	CNMG 643	ICSN-633	NL-68	CL-12	XNS-510	\$66.94
MCKNR/L 20-6D	1.250	6	1.600	1.500		ICSN-633	NL-68	CL-12	XNS-510	\$73.52
MCKNR/L 24-6D	1.500	6	1.600	2.000		ICSN-633	NL-68	CL-12	XNS-510	\$97.66
MCKNR/L 24-6E	1.500	7	1.600	2.000		ICSN-633	NL-68	CL-12	XNS-510	\$97.66

A

TURNING

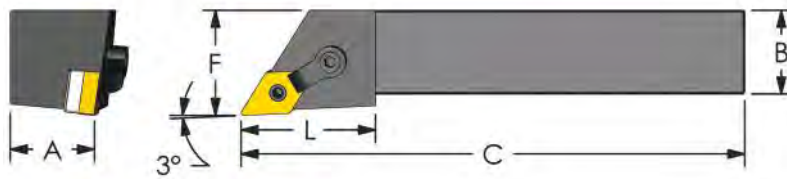

A

Negative 55° Diamond (3° Lead)

No Coolant

Designation	A/B	C	L	F	Insert	Shim	Lock Pin	Clamp	Screw	Price
MDJNR/L 12-4B	.750	4.5	1.770	1.000	DNMG 432	IDSN-433	NL-46	CL-20	XNS-48	\$87.78
MDJNR/L 16-4D	1.000	6	1.600	1.250		IDSN-433	NL-46	CL-20	XNS-48	\$98.75
MDJNR/L 20-4D	1.250	6	1.600	1.500		IDSN-433	NL-46	CL-20	XNS-48	\$113.02
MDJNR/L 24-4D	1.500	6	1.600	2.000		IDSN-433	NL-46	CL-20	XNS-48	\$118.50
MDJNR/L 16-5D	1.000	6	1.600	1.250	DNMG 543	IDSN-533	NL-58	CL-12	XNS-510	\$98.75
MDJNR/L 20-5D	1.250	6	1.600	1.500		IDSN-533	NL-58	CL-12	XNS-510	\$113.02
MDJNR/L 24-5D	1.500	6	2.050	2.000		IDSN-533	NL-58	CL-12	XNS-510	\$118.50

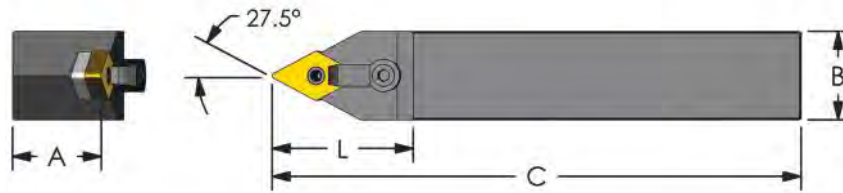

Negative 55° Diamond (27.5° Lead)

No Coolant

Designation Neutral	A/B	C	L	Insert	Shim	Lock Pin	Clamp	Screw	Price
MDPNN 12-4B	.750	4.5	1.770	DNMG 432	IDSN-433	NL-46	CL-22	XNS-48	\$95.47
MDPNN 16-4D	1.000	6	1.600		IDSN-433	NL-46	CL-22	XNS-48	\$99.86
MDPNN 20-4D	1.250	6	1.600		IDSN-433	NL-46	CL-22	XNS-48	\$110.83
MDPNN 16-5D	1.000	6	2.050	DNMG 543	IDSN-533	NL-58	CL-12	XNS-510	\$99.86
MDPNN 20-5D	1.250	6	2.050		IDSN-533	NL-58	CL-12	XNS-510	\$110.83
MDPNN 24-5D	1.500	6	2.050		IDSN-533	NL-58	CL-12	XNS-510	\$118.50
MDPNN 24-5E	1.500	7	2.050		IDSN-533	NL-58	CL-12	XNS-510	\$118.50



Hardware
pg: 204



Inserts
pg: 188

ULTRA-DEX

Proudly Made in Flushing, MI USA

TURNING

SQUARE Shank (Round / Square)

A

TURNING

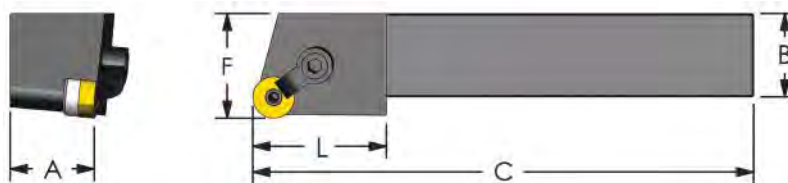

Negative Round (0° Lead)

No Coolant

Designation	A/B	C	L	F	Insert	Shim	Lock Pin	Clamp	Screw	Price
MRGNR/L 12-3B	.750	4.5	1.300	1.000	RNMG 32	IRSN-32	NL-34	CL-6	XNS-36	\$61.45
MRGNR/L 12-4B	.750	4.5	1.300	1.000	RNMG 43	IRSN-43	NL-46	CL-20	XNS-59	\$61.45
MRGNR/L 16-4D	1.000	6	1.600	1.250		IRSN-43	NL-46	CL-20	XNS-59	\$66.94
MRGNR/L 20-4D	1.250	6	1.600	1.500		IRSN-43	NL-46	CL-20	XNS-59	\$73.52
MRGNR/L 16-5D	1.000	6	1.600	1.250	RNMG 54	IRSN-53	NL-58	CL-12	XNS-510	\$66.94
MRGNR/L 20-5D	1.250	6	1.600	1.500		IRSN-53	NL-58	CL-12	XNS-510	\$73.52
MRGNR/L 16-6D	1.000	6	1.600	1.250	RNMG 64	IRSN-63	NL-68	CL-12	XNS-510	\$66.94
MRGNR/L 20-6D	1.250	6	1.600	1.500		IRSN-63	NL-68	CL-12	XNS-510	\$73.52
MRGNR/L 24-6D	1.500	6	1.600	2.000		IRSN-63	NL-68	CL-12	XNS-510	\$97.66

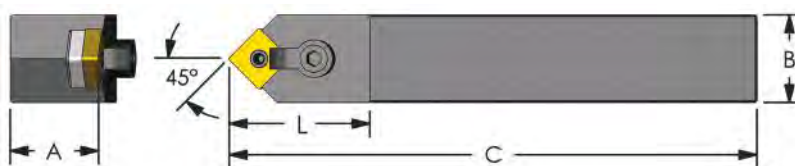

Negative Square (45° Lead)

No Coolant

Designation Neutral	A/B	C	L	Insert	Shim	Lock Pin	Clamp	Screw	Price
MSDNN 12-4B	.750	4.5	1.300	SNMG 432	ISSN-433	NL-46	CL-20	XNS-48	\$61.45
MSDNN 16-4D	1.000	6	1.600		ISSN-433	NL-46	CL-20	XNS-48	\$66.94
MSDNN 16-5D	1.000	6	1.600	SNMG 543	ISSN-533	NL-58	CL-12	XNS-510	\$66.94
MSDNN 20-5D	1.250	6	1.600		ISSN-533	NL-58	CL-12	XNS-510	\$73.52
MSDNN 16-6D	1.000	6	1.600	SNMG 643	ISSN-633	NL-68	CL-12	XNS-510	\$66.94
MSDNN 20-6D	1.250	6	1.600		ISSN-633	NL-68	CL-12	XNS-510	\$73.52
MSDNN 24-6D	1.500	6	1.600		ISSN-633	NL-68	CL-12	XNS-510	\$97.66

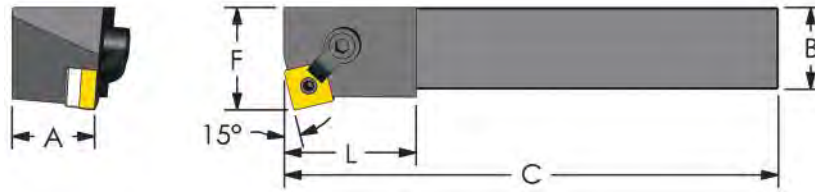

A

Negative Square (15° Lead) End Cutting

No Coolant

Designation	A/B	C	L	F	Insert	Shim	Lock Pin	Clamp	Screw	Price
MSKNR/L 12-4B	.750	4.5	1.300	1.000	SNMG 432	ISSN-433	NL-46	CL-20	XNS-48	\$61.45
MSKNR/L 16-4D	1.000	6	1.600	1.250		ISSN-433	NL-46	CL-20	XNS-48	\$66.94
MSKNR/L 16-5D	1.000	6	1.600	1.250	SNMG 543	ISSN-533	NL-58	CL-12	XNS-510	\$66.94
MSKNR/L 20-5D	1.250	6	1.600	1.500		ISSN-533	NL-58	CL-12	XNS-510	\$73.52
MSKNR/L 20-6D	1.250	6	1.600	1.500	SNMG 643	ISSN-633	NL-68	CL-12	XNS-510	\$73.52
MSKNR/L 24-6D	1.500	6	1.600	2.000		ISSN-633	NL-68	CL-12	XNS-510	\$97.66

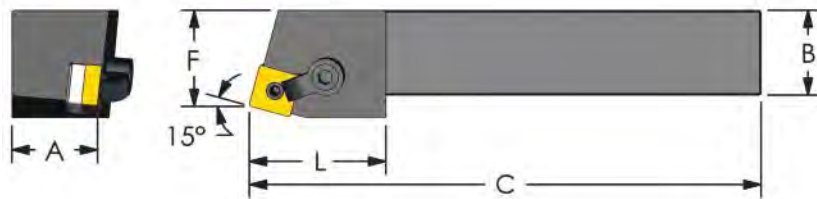

Negative Square (15° Lead) Side Cutting

No Coolant

Designation	A/B	C	L	F	Insert	Shim	Lock Pin	Clamp	Screw	Price
MSRNR/L 12-4B	.750	4.5	1.300	.880	SNMG 432	ISSN-433	NL-46	CL-20	XNS-48	\$61.45
MSRNR/L 16-4D	1.000	6	1.600	1.130		ISSN-433	NL-46	CL-20	XNS-48	\$66.94
MSRNR/L 20-4D	1.250	6	1.600	1.380		ISSN-433	NL-46	CL-20	XNS-48	\$73.52
MSRNR/L 16-5D	1.000	6	1.600	1.103	SNMG 543	ISSN-533	NL-58	CL-12	XNS-510	\$66.94
MSRNR/L 20-5D	1.250	6	1.600	1.353		ISSN-533	NL-58	CL-12	XNS-510	\$73.52
MSRNR/L 16-6D	1.000	6	1.600	1.071	SNMG 643	ISSN-633	NL-68	CL-12	XNS-510	\$66.94
MSRNR/L 20-6D	1.250	6	1.600	1.315		ISSN-633	NL-68	CL-12	XNS-510	\$73.52
MSRNR/L 24-6D	1.500	6	1.600	1.821		ISSN-633	NL-68	CL-12	XNS-510	\$97.66



Hardware
pg: 204



Inserts
pg: 188

ULTRA-DEX

ULTRADEXUSA.com

TURNING

A

TURNING

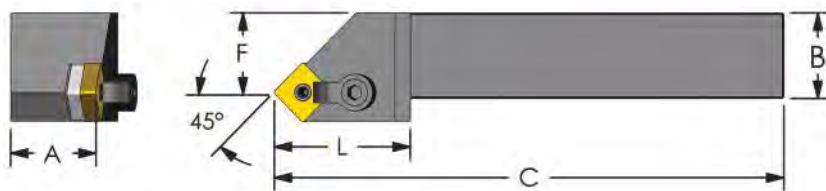

Negative Square (45° Lead)

No Coolant

Designation	A/B	C	L	F	Insert	Shim	Lock Pin	Clamp	Screw	Price
MSSNR/L 12-4B	.750	4.5	1.300	.675	SNMG 432	ISSN-433	NL-46	CL-20	XNS-48	\$61.45
MSSNR/L 16-4D	1.000	6	1.600	.925		ISSN-433	NL-46	CL-20	XNS-48	\$66.94
MSSNR/L 16-5D	1.000	6	1.600	.847	SNMG 543	ISSN-533	NL-58	CL-12	XNS-510	\$66.94
MSSNR/L 20-5D	1.250	6	1.600	1.097		ISSN-533	NL-58	CL-12	XNS-510	\$73.52
MSSNR/L 20-6D	1.250	6	1.600	1.011	SNMG 643	ISSN-633	NL-68	CL-12	XNS-510	\$73.52
MSSNR/L 24-6D	1.500	6	1.600	1.511		ISSN-633	NL-68	CL-12	XNS-510	\$97.66



Negative Triangle (30° Lead)

No Coolant

Designation Neutral	A/B	C	L	Insert	Shim	Lock Pin	Clamp	Screw	Price
MTENN 10-3B	.625	4.5	1.120	TNMG 332	ITSN-323	NL-34L	CL-6	XNS-36	\$53.77
MTENN 12-3B	.750	4.5	1.300		ITSN-323	NL-34L	CL-6	XNS-36	\$61.45
MTENN 12-4B	.750	4.5	1.770	TNMG 432	ITSN-433	NL-46	CL-20	XNS-48	\$61.45
MTENN 16-4D	1.000	6	1.600		ITSN-433	NL-46	CL-20	XNS-48	\$66.94
MTENN 20-5D	1.250	6	1.600	TNMG 543	ITSN-533	NL-58	CL-9	XNS-510	\$73.52
MTENN 24-5D	1.500	6	1.600		ITSN-533	NL-58	CL-9	XNS-510	\$97.66



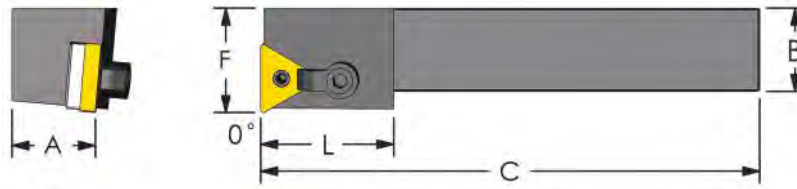

Negative Triangle (0° Lead) End Cutting

No Coolant

Designation	A/B	C	L	F	Insert	Shim	Lock Pin	Clamp	Screw	Price
MTFNR/L 12-3B	.750	4.5	1.300	1.000	TNMG 332	ITSN-323	NL-34L	CL-6	XNS-36	\$61.45
MTFNR/L 16-3D	1.000	6	1.600	1.250		ITSN-323	NL-34L	CL-6	XNS-36	\$66.94
MTFNR/L 16-4D	1.000	6	1.600	1.250	TNMG 432	ITSN-433	NL-46	CL-20	XNS-48	\$66.94
MTFNR/L 20-4D	1.250	6	1.600	1.500		ITSN-433	NL-46	CL-20	XNS-48	\$73.52
MTFNR/L 16-5D	1.000	6	1.600	1.250	TNMG 543	ITSN-533	NL-58	CL-12	XNS-510	\$66.94
MTFNR/L 20-5D	1.250	6	1.600	1.500		ITSN-533	NL-58	CL-12	XNS-510	\$73.52
MTFNR/L 24-5D	1.500	6	1.600	2.000		ITSN-533	NL-58	CL-12	XNS-510	\$97.66
MTFNR/L 24-6D	1.500	6	1.600	2.000		TNMG 663	ITSN-636	NL-68L	CL-12	XNS-510

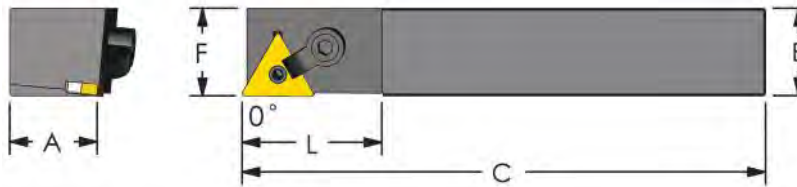

Negative Triangle (0° Lead) Side Cutting

No Coolant

Designation	A/B	C	L	F	Insert	Shim	Lock Pin	Clamp	Screw	Price
MTANR/L 12-3B	.750	4.5	1.300	.750	TNMG 332	ITSN-323	NL-34L	CL-6	XNS-36	\$66.94
MTANR/L 16-3D	1.000	6	1.600	1.000		ITSN-323	NL-34L	CL-6	XNS-36	\$69.13
MTANR/L 16-4D	1.000	6	1.600	1.000	TNMG 432	ITSN-433	NL-46	CL-20	XNS-48	\$69.13
MTANR/L 20-5D	1.250	6	1.600	1.250	TNMG 543	ITSN-533	NL-58	CL-12	XNS-510	\$75.72
MTANR/L 24-5D	1.500	6	1.600	1.500		ITSN-533	NL-58	CL-12	XNS-510	\$98.75
MTANR/L 24-6D	1.500	6	1.600	1.500	TNMG 663	ITSN-636	NL-68L	CL-12	XNS-510	\$98.75

SAME DAY SHIPPING!

On orders placed before 3:30pm EST
SEE PAGE 210 for more details...

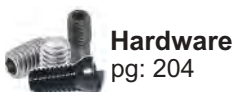
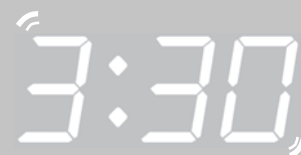

Hardware
pg: 204



Inserts
pg: 188

ULTRA-DEX

Proudly Made in Flushing, MI USA

A

TURNING

SQUARE Shank (Triangle)

A

TURNING

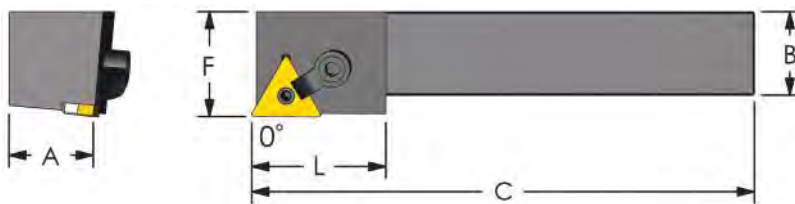

Negative Triangle (0° Lead) Side Cutting TNMG

No Coolant

Designation	A/B	C	L	F	Insert	Shim	Lock Pin	Clamp	Screw	Price
MTGNR/L 10-3B	.625	4.5	1.120	.875	TNMG 332	ITSN-323	NL-34L	CL-6	XNS-36	\$53.77
MTGNR/L 12-3B	.750	4.5	1.300	1.000		ITSN-323	NL-34L	CL-6	XNS-36	\$61.45
MTGNR/L 16-3D	1.000	6	1.600	1.250		ITSN-323	NL-34L	CL-6	XNS-36	\$66.94
MTGNR/L 16-4D	1.000	6	1.600	1.250	TNMG 432	ITSN-433	NL-46	CL-20	XNS-48	\$66.94
MTGNR/L 20-4D	1.250	6	1.600	1.500		ITSN-433	NL-46	CL-20	XNS-48	\$73.52
MTGNR/L 24-4D	1.500	6	1.600	2.000		ITSN-433	NL-46	CL-20	XNS-48	\$88.88
MTGNR/L 24-4E	1.500	7	1.600	2.000		ITSN-433	NL-46	CL-20	XNS-48	\$88.88
MTGNR/L 16-5D	1.000	6	1.600	1.250	TNMG 543	ITSN-533	NL-58	CL-9	XNS-510	\$66.94
MTGNR/L 20-5D	1.250	6	1.600	1.500		ITSN-533	NL-58	CL-9	XNS-510	\$73.52
MTGNR/L 24-5D	1.500	6	1.600	2.000		ITSN-533	NL-58	CL-9	XNS-510	\$97.66

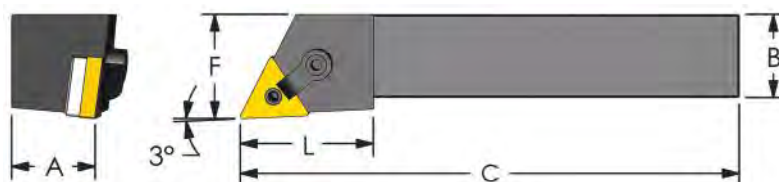

Negative Triangle (3° Lead)

No Coolant

Designation	A/B	C	L	F	Insert	Shim	Lock Pin	Clamp	Screw	Price
MTJNR/L 12-3B	.750	4.5	1.300	1.000	TNMG 332	ITSN-323	NL-34L	CL-21	XNS-48	\$61.45
MTJNR/L 16-3D	1.000	6	1.600	1.250		ITSN-323	NL-34L	CL-21	XNS-48	\$66.94
MTJNR/L 16-4D	1.000	6	1.600	1.250	TNMG 432	ITSN-433	NL-46	CL-20	XNS-48	\$66.94
MTJNR/L 20-4D	1.250	6	1.600	1.500		ITSN-433	NL-46	CL-20	XNS-48	\$73.52
MTJNR/L 16-5D	1.000	6	1.600	1.250	TNMG 543	ITSN-533	NL-58	CL-9	XNS-510	\$66.94
MTJNR/L 20-5D	1.250	6	1.600	1.500		ITSN-533	NL-58	CL-9	XNS-510	\$73.52
MTJNR/L 24-5D	1.500	6	1.600	2.000		ITSN-533	NL-58	CL-9	XNS-510	\$97.66
MTJNR/L 24-6D	1.500	6	1.600	2.000	TNMG 663	ITSN-636	NL-68L	CL-12	XNS-510	\$97.66

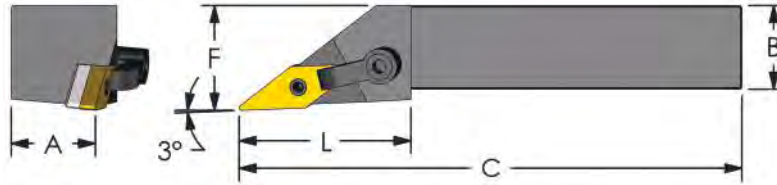

Negative 35° Diamond (-3° Lead)

No Coolant

Designation	A/B	C	L	F	Insert	Shim	Lock Pin	Clamp	Screw	Price
MVJNR/L 12-3B	.750	4.5	1.770	1.000	VNMG 332	IVSN-322	NL-34L	CL-22	XNS-48	\$100.95
MVJNR/L 16-3D	1.000	6	1.600	1.250		IVSN-322	NL-34L	CL-22	XNS-48	\$105.34
MVJNR/L 20-3D	1.250	6	1.600	1.500		IVSN-322	NL-34L	CL-22	XNS-48	\$111.92
MVJNR/L 16-4D	1.000	6	2.050	1.250	VNMG 432	IVSN-432	NL-46	CL-30	XNS-510	\$105.34
MVJNR/L 20-4D	1.250	6	2.050	1.500		IVSN-432	NL-46	CL-30	XNS-510	\$111.92
MVJNR/L 24-4D	1.500	6	2.050	2.000		IVSN-432	NL-46	CL-30	XNS-510	\$125.09

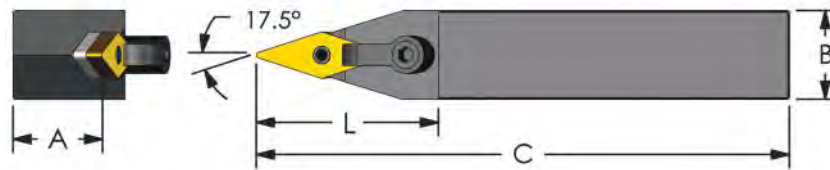

Negative 35° Diamond (17.5° Lead)

No Coolant

Designation Neutral	A/B	C	L	Insert	Shim	Lock Pin	Clamp	Screw	Price
MVVNN 12-3B	.750	4.5	1.770	VNMG 332	IVSN-322	NL-34L	CL-30	XNS-510	\$100.95
MVVNN 16-3D	1.000	6	2.050		IVSN-322	NL-34L	CL-30	XNS-510	\$105.34
MVVNN 20-3D	1.250	6	2.050		IVSN-322	NL-34L	CL-30	XNS-510	\$111.92
MVVNN 24-3D	1.500	6	2.050		IVSN-322	NL-34L	CL-30	XNS-510	\$125.09
MVVNN 16-4D	1.000	6	2.050	VNMG 432	IVSN-433	NL-46	CL-30	XNS-510	\$105.34
MVVNN 20-4D	1.250	6	2.050		IVSN-433	NL-46	CL-30	XNS-510	\$111.92
MVVNN 24-4D	1.500	6	2.050		IVSN-433	NL-46	CL-30	XNS-510	\$125.09

DON'T THROW IT AWAY!
Send Us Your Damaged Tooling for Repair

See **pg. 208**
For More
Details

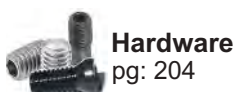



A

TURNING

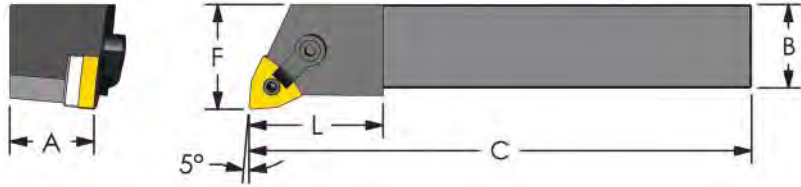

Negative Trigon (-5° Lead)

No Coolant

Designation	A/B	C	L	F	Insert	Shim	Lock Pin	Clamp	Screw	Price
MWLNRL 12-3B	.750	4.5	1.300	1.000	WNMG 332	IWSN-322	NL-34L	CL-6	XNS-36	\$61.45
MWLNRL 12-4B	.750	4.5	1.300	1.000	WNMG 432	IWSN-433	NL-46	CL-20	XNS-48	\$61.45
MWLNRL 16-4D	1.000	6	1.600	1.250		IWSN-433	NL-46	CL-20	XNS-48	\$66.94
MWLNRL 20-4D	1.250	6	1.600	1.500		IWSN-433	NL-46	CL-20	XNS-48	\$73.52
MWLNRL 24-4D	1.500	6	1.600	2.000		IWSN-433	NL-46	CL-20	XNS-48	\$97.66

P★TRIOT

HIGH PERFORMANCE
Starting on pages

New!



PATRIOT High Performance Indexable Milling Cutters
pg 128



PATRIOT High Performance Inserts
pg 199



PATRIOT High Performance Counterbore Tools
pg 136



PATRIOT High Performance Indexable Drills
pg 142



New!

SQUARE SHANK

Threading/Grooving Top Notch & Laydown



A

TURNING

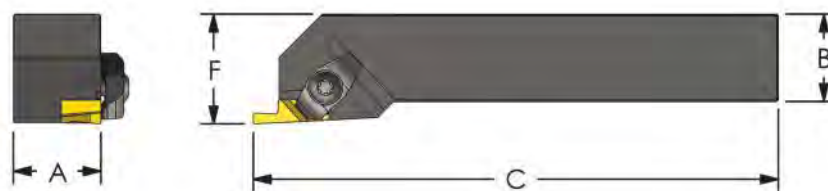

Threading/Grooving Top Notch

No Coolant

Designation	A/B	C	L	F	Insert	RH Clamp	LH Clamp	Clamp Screw	Price
NSR/L 12-3B	.750	4.5	1.300	1.000	NG 3R/3L	CM-72	CM-73	10-32	\$68.44
NSR/L 16-3D	1.000	6	1.600	1.250		CM-72	CM-73	10-32	\$74.56

Threading/Grooving Top Notch

No Coolant

Designation	A/B	C	L	F	Insert	RH Clamp	LH Clamp	Clamp Screw	Price
NSR/L 12-4B	.750	4.5	1.300	1.000	NG 4R/4L	CM-72	CM-73	10-32	\$68.44
NSR/L 16-4D	1.000	6	1.600	1.250		CM-72	CM-73	10-32	\$74.56

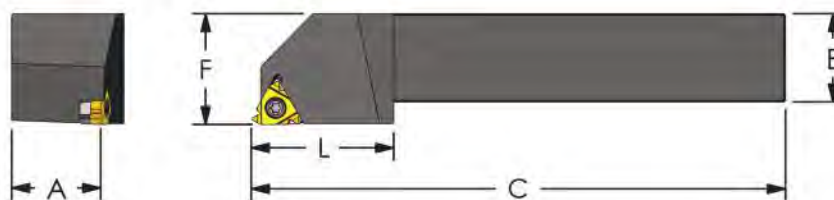

Threading/Grooving Laydown

No Coolant

Designation	A/B	C	L	F	Insert	Insert Screw	Anvil Screw	Anvil Right	Anvil Left	Price
LSSR/L 12-3B	.750	4.5	1.300	1.000	3 IL/IR	SA3T	SY3T	YE3	YI3	\$65.02
LSSR/L 16-3D	1.000	6	1.600	1.250		SA3T	SY3T	YE3	YI3	\$70.83

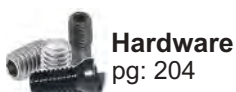

Hardware
pg: 204



Inserts
pg: 188



Proudly Made in Flushing, MI USA

Boring Bar NOMENCLATURE

BORING

M	Metric
Bar Type	
A	Solid Steel Bar with Coolant
C	Carbide Bar
D	Chatter-Free with Coolant
E	Carbide Bar with Coolant
HM	Solid Heavy Metal with Coolant
J	Solid Heavy Metal
R	Carbide Reinforced Steel Bar
S	Solid Steel Bar

Bar Length	
F	3"
G	3.5"
H	4"
J	4.5"
K	5"
M	6"
Q	7"
R	8"
X	9"
S	10"
T	12"
U	14"
V	16"
W	20"

Insert Clearance Angle		
B	5°	
C	7°	
D	15°	
N	0°	
P	11°	

Alternate F Dim.	
138	.138"
167	.167"
203	.203"
281	.281"

M - **E** **10** **Q** **S** **C** **L** **C** **R** **2** **-281**

Bar Diameter	
02.5	.156" (5/32")
03	.187" (3/16")
03.5	.218" (7/32")
04	.250" (1/4")
05	.312" (5/16")
06	.375" (3/8")
08	.500" (1/2")
10	.625" (5/8")
12	.750" (3/4")
16	1.000" (1")
20	1.250" (1 1/4")
24	1.500" (1 1/2")
28	1.750" (1 3/4")
32	2.000" (2")

Insert Holding	
M	Clamp and Lock Pin
N	Top Notch Clamp
S	Screw Lock Only
D	PULLBACK Clamp

Insert Shape	
C	80° Diamond
D	55° Diamond
T	60° Triangle
S	90° Square
V	35° Diamond
W	80° Trigon
R	Round

Lead Angle	
F	0°
J	-52°
K	15°
L	-5°
N	27.5°
Q	-17.5°
U	-3°
X	5°

Insert Size	
1.2	5/32" IC
1.5	3/16" IC
1.8	7/32" IC
2	1/4" IC
2.5	5/16" IC
3	3/8" IC
4	1/2" IC

Hand of Bar	
L	Left
R	Right

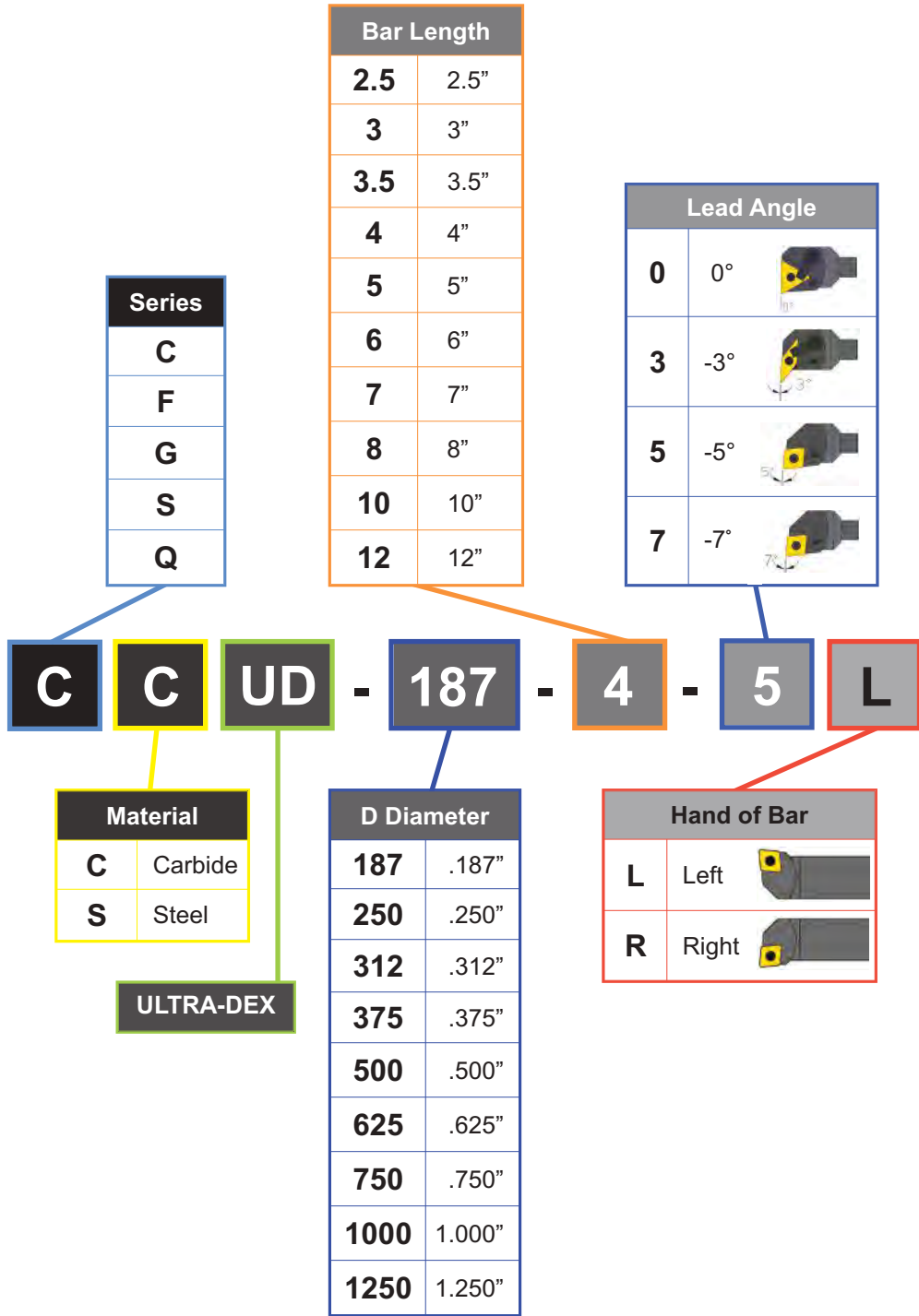

Series Style Boring Bars
 pgs 25, 27, 44, 45, 55, 56, 63, 69

ULTRA-DEX

STEEL BORING BARS

The **ECONOMICAL CHOICE** for general machining

4:1 Ratio

.156" - 2" Diameters

Other Pages of Interest

pg 41 **Boring Kits**

pg 42 **Reduced Neck**

pg 46 **Pullback Clamp**



B

BORING

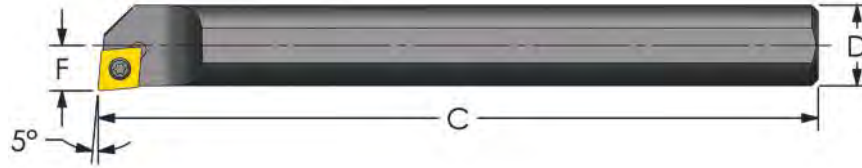

4:1 Ratio

Positive 80° Diamond (-5° Lead)

No Coolant

Designation	D Dia.	C OAL	F	Min Bore	Insert	Insert Screw	Key	Price
S02.5G SCLDR/L1.2 *	.156	3.5	.090	.175	CDHB 1.20.60	MTS-182	T-6	\$48.28
S03G SCLDR/L1.2 *	.187	3.5	.102	.205		MTS-183	T-6	\$48.28
S03.5G SCLDR/L1.5 *	.218	3.5	.125	.245	CDGW 1.510	MTS-184	T-6	\$48.28
S04G SCLDR/L1.5 *▲	.250	3.5	.172	.312		MTS-184	T-6	\$48.28
S05G SCLPR/L1.8 *▲	.312	3.5	.219	.395	CPMT 1.81.20.5	MTS-224	T-7	\$48.28
S06K SCLPR/L2 ▲	.375	5	.250	.460	CPMT 21.51	MTS-255	T-7	\$53.77
S08M SCLPR/L2 ▲	.500	6	.312	.600		MTS-255	T-7	\$60.35
S10Q SCLPR/L2	.625	7	.406	.760		MTS-255	T-7	\$74.61
S08M SCLPR/L3	.500	6	.344	.625	CPMT 32.51	MTS-35	T-15	\$60.35
S10Q SCLPR/L3	.625	7	.406	.760		MTS-35	T-15	\$74.61
S12Q SCLPR/L3	.750	7	.500	.920		MTS-35	T-15	\$85.59
S16R SCLPR/L3	1.000	8	.625	1.185		MTS-35	T-15	\$118.50
S06K SCLCR/L2 ▲	.375	5	.250	.460	CCMT 21.51	MTS-255	T-7	\$53.77
S08M SCLCR/L2 ▲	.500	6	.312	.600		MTS-255	T-7	\$60.35
S10Q SCLCR/L2	.625	7	.406	.760		MTS-255	T-7	\$74.61
S08M SCLCR/L3	.500	6	.344	.625	CCMT 32.51	MTS-35	T-15	\$60.35
S10Q SCLCR/L3	.625	7	.406	.760		MTS-35	T-15	\$74.61
S12Q SCLCR/L3	.750	7	.500	.920		MTS-35	T-15	\$85.59
S12S SCLCR3	.750	10	.500	.920		MTS-35	T-15	\$92.17
S16R SCLCR/L3	1.000	8	.625	1.185		MTS-35	T-15	\$118.50
S16T SCLCR3	1.000	12	.625	1.185		MTS-35	T-15	\$133.86
S20U SCLCR/L4	1.250	14	.765	1.465	CCMT 432	MTS-4	T-20	\$184.34
S24U SCLCR/L4	1.500	14	.890	1.730		MTS-4	T-20	\$206.28

Also available in: Hybrid pg: 49 Carbide pg: 53 Heavy Metal pg: 73 Chatter-Free pg: 96, 99, 114

▲ F Dimension Changed to Current Industry Standard

Minimum Clearance

No Coolant

Designation	D Dia.	C OAL	F	Min Bore	Insert	Insert Screw	Key	Price
S04G SCLDR/L1.5-138 *	.250	3.5	.138	.275	CDGW 1.510	MTS-184	T-6	\$48.28
S05G SCLPR/L1.8-167 *	.312	3.5	.167	.340	CPMT 1.81.20.5	MTS-224	T-7	\$48.28
S06K SCLPR/L2-203	.375	5	.203	.410	CPMT 21.51	MTS-255	T-7	\$53.77
S08M SCLPR/L2-281	.500	6	.281	.560		MTS-255	T-7	\$60.35
S06K SCLCR/L2-203	.375	5	.203	.410	CCMT 21.51	MTS-255	T-7	\$53.77
S08M SCLCR/L2-281	.500	6	.281	.560		MTS-255	T-7	\$60.35

Minimum Clearance Bars are intended for light machining with minimum bore clearance. Max depth of cut .015" - .020"

* bars .312 and smaller do not have flats

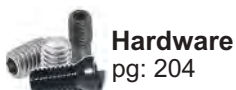

Hardware
pg: 204



Inserts
pg: 188

ULTRA-DEX

Proudly Made in Flushing, MI USA

B

BORING

Steel Boring Bars (Positive)

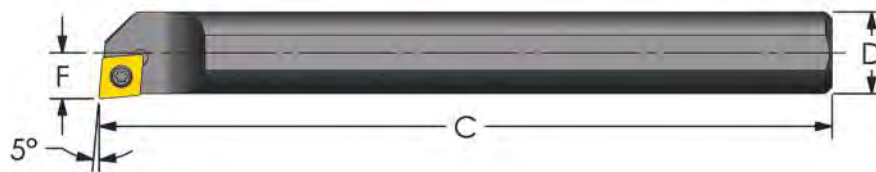

4:1 Ratio

Positive 80° Diamond (-5° Lead)

Coolant Thru

Designation	D Dia.	C OAL	F	Min Bore	Insert	Insert Screw	Key	Price
A04G SCLDR/L1.5 *▲	.250	3.5	.172	.312	CDGW 1.510	MTS-184	T-6	\$65.84
A05G SCLPR/L1.8 *▲	.312	3.5	.219	.395	CPMT 1.81.20.5	MTS-224	T-7	\$65.84
A06K SCLPR/L2 ▲	.375	5	.250	.460	CPMT 21.51	MTS-255	T-7	\$71.33
A08M SCLPR/L2 ▲	.500	6	.312	.600		MTS-255	T-7	\$77.91
A10Q SCLPR/L2	.625	7	.406	.760		MTS-255	T-7	\$95.47
A08M SCLPR/L3	.500	6	.344	.625	CPMT 32.51	MTS-35	T-15	\$77.91
A10Q SCLPR/L3	.625	7	.406	.760		MTS-35	T-15	\$95.47
A12Q SCLPR/L3	.750	7	.500	.920		MTS-35	T-15	\$111.92
A16R SCLPR/L3	1.000	8	.625	1.185		MTS-35	T-15	\$148.13
A06K SCLCR/L2 ▲	.375	5	.250	.460	CCMT 21.51	MTS-255	T-7	\$71.33
A08M SCLCR/L2 ▲	.500	6	.312	.600		MTS-255	T-7	\$77.91
A10Q SCLCR/L2	.625	7	.406	.760		MTS-255	T-7	\$95.47
A08M SCLCR/L3	.500	6	.344	.625	CCMT 32.51	MTS-35	T-15	\$77.91
A10Q SCLCR/L3	.625	7	.406	.760		MTS-35	T-15	\$95.47
A12Q SCLCR/L3	.750	7	.500	.920		MTS-35	T-15	\$111.92
A16R SCLCR/L3	1.000	8	.625	1.185		MTS-35	T-15	\$148.13
A20U SCLCR/L4	1.250	14	.765	1.465	CCMT 432	MTS-4	T-20	\$231.53
A24U SCLCR/L4	1.500	14	.890	1.730		MTS-4	T-20	\$262.25

Also available in: Carbide pg: 54,55 Heavy Metal pg: 73 Modular pg: 69 Chatter-Free pg: 96, 99, 114

▲ F Dimension Changed to Current Industry Standard

Minimum Clearance

Coolant Thru

Designation	D Dia.	C OAL	F	Min Bore	Insert	Insert Screw	Key	Price
A04G SCLDR/L1.5-138 *	.250	3.5	.138	.275	CDGW 1.510	MTS-184	T-6	\$65.84
A05G SCLPR/L1.8-167 *	.312	3.5	.167	.340	CPMT 1.81.20.5	MTS-224	T-7	\$65.84
A06K SCLPR/L2-203	.375	5	.203	.410	CPMT 21.51	MTS-255	T-7	\$71.33
A08M SCLPR/L2-281	.500	6	.281	.560		MTS-255	T-7	\$77.91
A06K SCLCR/L2-203	.375	5	.203	.410	CCMT 21.51	MTS-255	T-7	\$71.33
A08M SCLCR/L2-281	.500	6	.281	.560		MTS-255	T-7	\$77.91

Minimum Clearance Bars are intended for light machining with minimum bore clearance. Max depth of cut .015" - .020"
 *bars .312 and smaller do not have flats

B

BORING

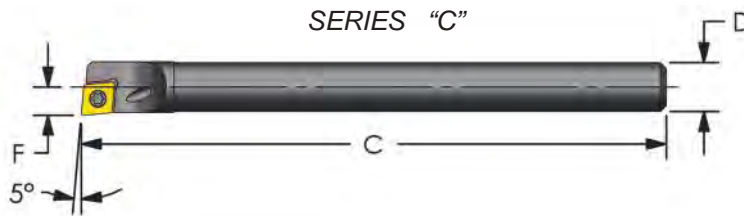

Positive 80° Diamond (-5° Lead)

4:1 Ratio
Coolant Thru

Designation	D Dia.	C OAL	F	Min Bore	Insert	Insert Screw	Key	Price
CSUD-180/187-2 1/2-5R *	.187	2.5	.104	.208	CDHB 1.20.60.5	MTS-183	T-6	\$75.72
CSUD-187-2 1/2-5R *	.187	2.5	.116	.230		MTS-183	T-6	\$75.72
CSUD-250-3-5R *	.250	3	.145	.285		MTS-184	T-6	\$75.72

Also available in: **Carbide pg: 56**

*bars do not have flats

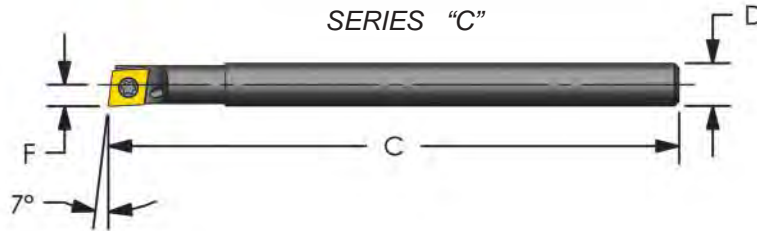

Positive 80° Diamond (-7° Lead)

4:1 Ratio
Coolant Thru

Designation	D Dia.	C OAL	F	Min Bore	Insert	Insert Screw	Key	Price
CSUD-165/187-21/2-7R *	.187	2.5	.095	.180	CDHB 1.20.60.5	MTS-183	T-6	\$75.72

Also available in: **Carbide pg: 55**

*bars do not have flats

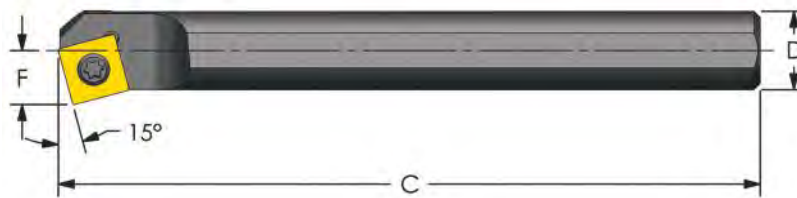

Positive Square (15° Lead)

4:1 Ratio
No Coolant

Designation	D Dia.	C OAL	F	Min Bore	Insert	Insert Screw	Key	Price
S06K SSKCR2	.375	5	.250	.460	SCMT 21.51	MTS-255	T-7	\$59.25
S08M SSKCR3	.500	6	.344	.625	SCMT 32.51	MTS-35	T-15	\$66.94
S10Q SSKCR3	.625	7	.406	.760		MTS-35	T-15	\$83.39
S12Q SSKCR3	.750	7	.500	.920		MTS-35	T-15	\$95.47
S16R SSKCR4	1.000	8	.625	1.185	SCMT 432	MTS-4	T-20	\$131.67

Also available in: **Carbide pg: 56**

Modular pg: 80

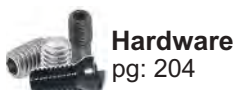

Steel Boring Bars (Positive)

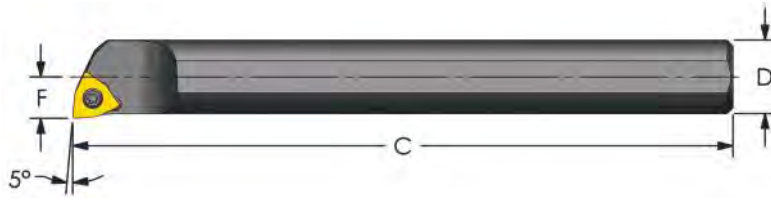

4:1 Ratio

Positive Trigon (-5° Lead)

No Coolant

Designation	D Dia.	C OAL	F	Min Bore	Insert	Insert Screw	Key	Price
S03G SWLCR1.2 *	.187	3.5	.102	.205	WCMT 1.210.5	MTS-183	T-6	\$53.77
S04G SWLCR1.2 *▲	.250	3.5	.172	.312		MTS-184	T-6	\$53.77
S05G SWLCR1.5 *▲	.312	3.5	.219	.395	WCMT 1.51.50.5	MTS-2	T-6	\$53.77
S06K SWLCR/L2 ▲	.375	5	.250	.460	WCMT 21.51	MTS-255	T-7	\$53.77
S08M SWLCR/L2 ▲	.500	6	.312	.600		MTS-255	T-7	\$60.35
S10Q SWLCR/L2	.625	7	.406	.760		MTS-255	T-7	\$74.61
S10Q SWLCR/L3	.625	7	.406	.760	WCMT 32.51	MTS-35	T-15	\$74.61
S12Q SWLCR/L3	.750	7	.500	.920		MTS-35	T-15	\$85.59
S16R SWLCR/L3	1.000	8	.625	1.185		MTS-35	T-15	\$118.50

Also available in: Carbide pg: 57 Heavy Metal pg: 74

▲ F Dimension Changed to Current Industry Standard

Minimum Clearance

No Coolant

Designation	D Dia.	C OAL	F	Min Bore	Insert	Insert Screw	Key	Price
S04G SWLCR1.2-138 *	.250	3.5	.138	.275	WCMT 1.210.5	MTS-184	T-6	\$53.77
S05G SWLCR1.5-167 *	.312	3.5	.167	.342	WCMT 1.51.50.5	MTS-2	T-6	\$53.77
S06K SWLCR/L2-203	.375	5	.203	.410	WCMT 21.51	MTS-255	T-7	\$53.77
S08M SWLCR/L2-281	.500	6	.281	.560		MTS-255	T-7	\$60.35

Minimum Clearance Bars are intended for light machining with minimum bore clearance. Max depth of cut .015" - .020"

* bars .312 and smaller do not have flats

4:1 Ratio

Positive Trigon (-5° Lead)

Coolant Thru

Designation	D Dia.	C OAL	F	Min Bore	Insert	Insert Screw	Key	Price
A06K SWLCR/L2 ▲	.375	5	.250	.460	WCMT 21.51	MTS-255	T-7	\$71.33
A08M SWLCR/L2 ▲	.500	6	.312	.600		MTS-255	T-7	\$77.91
A10Q SWLCR/L2	.625	7	.406	.760		MTS-255	T-7	\$95.47
A10Q SWLCR/L3	.625	7	.406	.760	WCMT 32.51	MTS-35	T-15	\$95.47
A12Q SWLCR/L3	.750	7	.500	.920		MTS-35	T-15	\$111.92
A16R SWLCR/L3	1.000	8	.625	1.185		MTS-35	T-15	\$148.13

Also available in: Carbide pg: 58 Heavy Metal pg: 74 Modular pg: 80

▲ F Dimension Changed to Current Industry Standard

Minimum Clearance

Coolant Thru

Designation	D Dia.	C OAL	F	Min Bore	Insert	Insert Screw	Key	Price
A06K SWLCR/L2-203	.375	5	.203	.410	WCMT 21.51	MTS-255	T-7	\$71.33
A08M SWLCR/L2-281	.500	6	.281	.560		MTS-255	T-7	\$77.91

Minimum Clearance Bars are intended for light machining with minimum bore clearance. Max depth of cut .015" - .020"

* bars .312 and smaller do not have flats

B

BORING

SERIES "F, Q, S"



4:1 Ratio

Positive Triangle (0° Lead)

Coolant Thru

Designation	D Dia.	C OAL	F	Min Bore	Insert	Insert Screw	Key	Price
FSUD-250-4-0R *	.250	4	.156	.300	TDHB 1.280.750.5	MTS-224	T-7	\$70.22
QSUD-375-5-0R *	.375	5	.221	.438	TPCB 220.5	ETS 4-40	T-10	\$75.72
SSUD-500-6-0R *	.500	6	.339	.668	TD 320.5	ETS 4-40	T-10	\$75.72
SSUD-625-7-0R *	.625	7	.393	.731		ETS 4-40	T-10	\$82.30

*bars do not have flats

SERIES "G, Q, S"

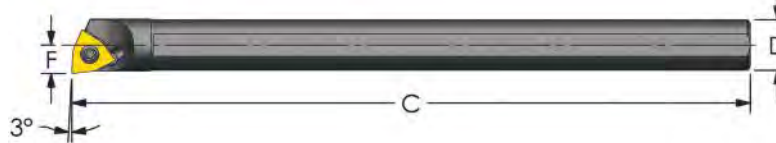

4:1 Ratio

Positive Trigon (-3° Lead)

Coolant Thru

Designation	D Dia.	C OAL	F	Min Bore	Insert	Insert Screw	Key	Price
GSUDW-187-4-3R/L	.187	4	.126	.260	WPGT 1.511	MTS-184	T-6	\$70.22
GSUDW-250-4-3R/L	.250	4	.143	.285		MTS-184	T-6	\$70.22
GSUDW-312-4-3R/L	.312	4	.174	.347		MTS-184	T-6	\$70.22
QSUDW-375-5-3R/L	.375	5	.211	.415	WPGT 21.50	MTS-255	T-7	\$75.72
QSUDW-500-6-3R/L	.500	6	.273	.540		MTS-255	T-7	\$82.30
SSUDW-625-7-3R/L	.625	7	.345	.675	WPMT 32.51	MTS-35	T-15	\$82.30
SSUDW-750-8-3R/L	.750	8	.407	.800		MTS-35	T-15	\$88.88

Also available in: **Carbide pg: 56**

SERIES "F, Q, S"

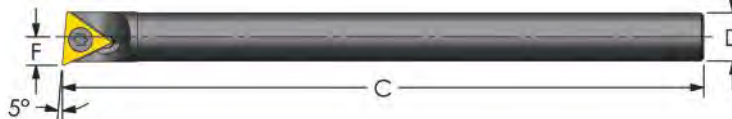

4:1 Ratio

Positive Triangle (-5° Lead)

Coolant Thru

Designation	D Dia.	C OAL	F	Min Bore	Insert	Insert Screw	Key	Price
FSUD-187-3 1/2-5R *	.187	3.5	.123	.275	TDHB 1.280.750.5	MTS-224	T-7	\$70.22
FSUD-250-4-5R *	.250	4	.156	.300		MTS-224	T-7	\$70.22
FSUD-312-4-5R *	.312	4	.187	.360		MTS-224	T-7	\$70.22
QSUD-375-5-5R/L *	.375	5	.221	.438	TPCB 220.5	ETS 4-40	T-10	\$75.72
QSUD-500-6-5R *	.500	6	.296	.563		ETS 4-40	T-10	\$82.30
SSUD-500-6-5R *	.500	6	.339	.668	TD 320.5	ETS 4-40	T-10	\$75.72
SSUD-625-4-5R *	.625	4	.393	.731		ETS 4-40	T-10	\$75.72
SSUD-625-7-5R *	.625	7	.393	.731		ETS 4-40	T-10	\$82.30
SSUD-750-4-5R *	.750	4	.460	.855		ETS 4-40	T-10	\$82.30
SSUD-750-8-5R *	.750	8	.460	.855		ETS 4-40	T-10	\$88.88
SSUD-1000-10-5R *	1.000	10	.585	1.105		ETS 4-40	T-10	\$127.28
SSUD-1250-12-5R *	1.250	12	.710	1.355		ETS 4-40	T-10	\$166.78

Also available in: **Carbide pg: 63**

*bars do not have flats

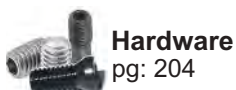

Steel Boring Bars (Positive)

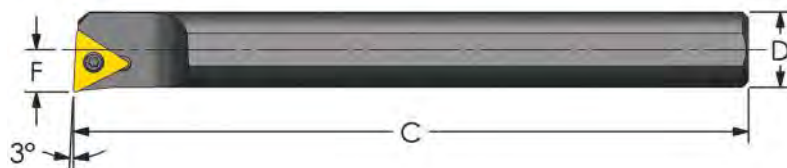

4:1 Ratio

No Coolant

Positive Triangle (-3° Lead)

Designation	D Dia.	C OAL	F	Min Bore	Insert	Insert Screw	Key	Price
S04G STUCR/L1.2 *▲	.250	3.5	.172	.312	TCMT 1.21.20.5	MTS-184	T-6	\$48.28
S05G STUCR/L1.2 *▲	.312	3.5	.219	.395		MTS-184	T-6	\$48.28
S06K STUCR/L1.2 ▲	.375	5	.250	.460		MTS-184	T-6	\$53.77
S06K STUCR/L2 ▲	.375	5	.250	.460	TCMT 21.51	MTS-255	T-7	\$53.77
S08M STUCR/L2 ▲	.500	6	.312	.600		MTS-255	T-7	\$60.35
S10Q STUCR/L2	.625	7	.406	.760		MTS-255	T-7	\$74.61
S12Q STUCR/L3	.750	7	.500	.920	TCMT 32.51	MTS-35	T-15	\$85.59
S16R STUCR/L3	1.000	8	.625	1.185		MTS-35	T-15	\$118.50
S06K STUPR/L2 ▲	.375	5	.250	.460	TPMT 21.51	MTS-255	T-7	\$53.77
S08M STUPR/L2 ▲	.500	6	.312	.600		MTS-255	T-7	\$60.35
S10Q STUPR/L2	.625	7	.406	.760		MTS-255	T-7	\$74.61
S12Q STUPR/L3	.750	7	.500	.920	TPMT 32.51	MTS-35	T-15	\$85.59
S16R STUPR/L3	1.000	8	.625	1.185		MTS-35	T-15	\$118.50

Also available in: **Carbide pg: 59** **Heavy Metal pg: 75**

▲ F Dimension Changed to Current Industry Standard

Minimum Clearance

No Coolant

Designation	D Dia.	C OAL	F	Min Bore	Insert	Insert Screw	Key	Price
S04G STUCR/L1.2-138 *	.250	3.5	.138	.275	TCMT 1.21.20.5	MTS-184	T-6	\$48.28
S05G STUCR/L1.2-167 *	.312	3.5	.167	.340		MTS-184	T-6	\$48.28
S06K STUCR/L1.2-203	.375	5	.203	.410		MTS-184	T-6	\$53.77
S06K STUCR/L2-203	.375	5	.203	.410	TCMT 21.51	MTS-255	T-7	\$53.77
S08M STUCR/L2-281	.500	6	.281	.560		MTS-255	T-7	\$60.35
S06K STUPR/L2-203	.375	5	.203	.410	TPMT 21.51	MTS-255	T-7	\$53.77
S08M STUPR/L2-281	.500	6	.281	.560		MTS-255	T-7	\$60.35

Minimum Clearance Bars are intended for light machining with minimum bore clearance. Max depth of cut .015" - .020"
 * bars .312 and smaller do not have flats

B

BORING

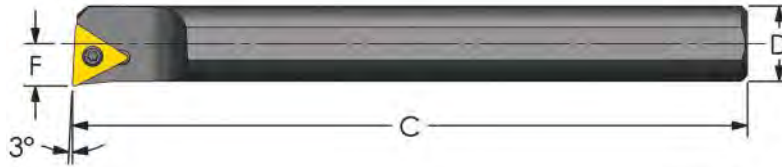

4:1 Ratio

Positive Triangle (-3° Lead)

Coolant Thru

Designation	D Dia.	C OAL	F	Min Bore	Insert	Insert Screw	Key	Price
A04G STUCR/L1.2 *▲	.250	3.5	.172	.312	TCMT 1.21.20.5	MTS-184	T-6	\$65.84
A05G STUCR/L1.2 *▲	.312	3.5	.219	.395		MTS-184	T-6	\$65.84
A06K STUCR/L1.2 ▲	.375	5	.250	.460		MTS-184	T-6	\$71.33
A06K STUCR/L2 ▲	.375	5	.250	.460	TCMT 21.51	MTS-255	T-7	\$71.33
A08M STUCR/L2 ▲	.500	6	.312	.600		MTS-255	T-7	\$77.91
A10Q STUCR/L2	.625	7	.406	.760		MTS-255	T-7	\$95.47
A12Q STUCR/L3	.750	7	.500	.920	TCMT 32.51	MTS-35	T-15	\$111.92
A16R STUCR/L3	1.000	8	.625	1.185		MTS-35	T-15	\$148.13
A06K STUPR/L2 ▲	.375	5	.250	.460	TPMT 21.51	MTS-255	T-7	\$71.33
A08M STUPR/L2 ▲	.500	6	.312	.600		MTS-255	T-7	\$77.91
A10Q STUPR/L2	.625	7	.406	.760		MTS-255	T-7	\$95.47
A12Q STUPR/L3	.750	7	.500	.920	TPMT 32.51	MTS-35	T-15	\$111.92
A16R STUPR/L3	1.000	8	.625	1.185		MTS-35	T-15	\$148.13

Also available in: Carbide pg: 60 Heavy Metal pg: 75 Modular pg: 81 Chatter-Free pg: 100, 115

▲ F Dimension Changed to Current Industry Standard

Minimum Clearance

Coolant Thru

Designation	D Dia.	C OAL	F	Min Bore	Insert	Insert Screw	Key	Price
A04G STUCR/L1.2-138 *	.250	3.5	.138	.275	TCMT 1.21.20.5	MTS-184	T-6	\$65.84
A05G STUCR/L1.2-167 *	.312	3.5	.167	.340		MTS-184	T-6	\$65.84
A06K STUCR/L1.2-203	.375	5	.203	.410		MTS-184	T-6	\$71.33
A06K STUCR/L2-203	.375	5	.203	.410	TCMT 21.51	MTS-255	T-7	\$71.33
A08M STUCR/L2-281	.500	6	.281	.560		MTS-255	T-7	\$77.91
A06K STUPR/L2-203	.375	5	.203	.410	TPMT 21.51	MTS-255	T-7	\$71.33
A08M STUPR/L2-281	.500	6	.281	.560		MTS-255	T-7	\$77.91

Minimum Clearance Bars are intended for light machining with minimum bore clearance. Max depth of cut .015" - .020"

* bars .312 and smaller do not have flats

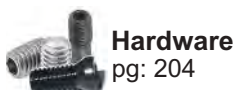

ULTRADEXUSA.com

B

BORING

Steel Boring Bars (Positive)

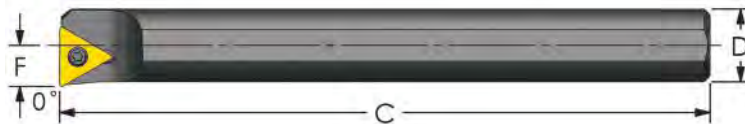

4:1 Ratio

No Coolant

Positive Triangle (0° Lead)

Designation	D Dia.	C OAL	F	Min Bore	Insert	Insert Screw	Key	Price
S04G STFCR/L1.2 *▲	.250	3.5	.172	.312	TCMT 1.21.20.5	MTS-184	T-6	\$48.28
S05G STFCR/L1.2 *▲	.312	3.5	.219	.395		MTS-184	T-6	\$48.28
S06K STFCR/L1.2 ▲	.375	5	.250	.460		MTS-184	T-6	\$53.77
S06K STFCR2 ▲	.375	5	.250	.460	TCMT 21.51	MTS-255	T-7	\$53.77
S08M STFCR2 ▲	.500	6	.312	.600		MTS-255	T-7	\$60.35
S10Q STFCR2	.625	7	.406	.760		MTS-255	T-7	\$74.61
S12Q STFCR3	.750	7	.500	.920	TCMT 32.51	MTS-35	T-15	\$85.59
S16R STFCR3	1.000	8	.625	1.185		MTS-35	T-15	\$118.50
S06K STFPR2 ▲	.375	5	.250	.460	TPMT 21.51	MTS-255	T-7	\$53.77
S08M STFPR2 ▲	.500	6	.312	.600		MTS-255	T-7	\$60.35
S10Q STFPR2	.625	7	.406	.760		MTS-255	T-7	\$74.61
S12Q STFPR3	.750	7	.500	.920	TPMT 32.51	MTS-35	T-15	\$85.59
S16R STFPR3	1.000	8	.625	1.185		MTS-35	T-15	\$118.50

Also available in: **Carbide pg: 61**

▲ F Dimension Changed to Current Industry Standard

Minimum Clearance

No Coolant

Designation	D Dia.	C OAL	F	Min Bore	Insert	Insert Screw	Key	Price
S04G STFCR/L1.2-138 *	.250	3.5	.138	.275	TCMT 1.21.20.5	MTS-184	T-6	\$48.28
S05G STFCR/L1.2-167 *	.312	3.5	.167	.340		MTS-184	T-6	\$48.28
S06K STFCR/L1.2-203	.375	5	.203	.410		MTS-184	T-6	\$53.77
S06K STFCR2-203	.375	5	.203	.410	TCMT 21.51	MTS-255	T-7	\$53.77
S08M STFCR2-281	.500	6	.281	.560		MTS-255	T-7	\$60.35
S06K STFPR2-203	.375	5	.203	.410	TPMT 21.51	MTS-255	T-7	\$53.77
S08M STFPR2-281	.500	6	.281	.560		MTS-255	T-7	\$60.35

Minimum Clearance Bars are intended for light machining with minimum bore clearance. Max depth of cut .015" - .020"

* bars .312 and smaller do not have flats

SAME DAY SHIPPING!

On orders placed before 3:30pm EST

SEE PAGE 210 for more details...

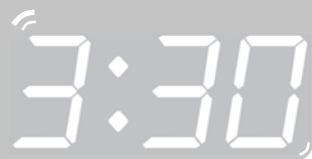

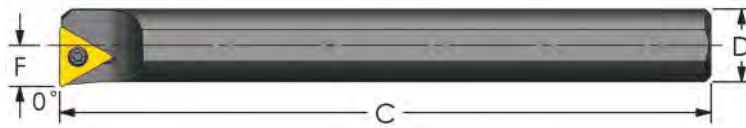

4:1 Ratio

Positive Triangle (0° Lead)

Coolant Thru

Designation	D Dia.	C OAL	F	Min Bore	Insert	Insert Screw	Key	Price
A06K STFCR2 ▲	.375	5	.250	.460	TCMT 21.51	MTS-255	T-7	\$71.33
A08M STFCR2 ▲	.500	6	.312	.600		MTS-255	T-7	\$77.91
A10Q STFCR2	.625	7	.406	.760		MTS-255	T-7	\$95.47
A12Q STFCR3	.750	7	.500	.920	TCMT 32.51	MTS-35	T-15	\$111.92
A16R STFCR3	1.000	8	.625	1.185		MTS-35	T-15	\$148.13
A06K STFPR2 ▲	.375	5	.250	.460	TPMT 21.51	MTS-255	T-7	\$71.33
A08M STFPR2 ▲	.500	6	.312	.600		MTS-255	T-7	\$77.91
A10Q STFPR2	.625	7	.406	.760		MTS-255	T-7	\$95.47
A12Q STFPR3	.750	7	.500	.920	TPMT 32.51	MTS-35	T-15	\$111.92
A16R STFPR3	1.000	8	.625	1.185		MTS-35	T-15	\$148.13

Also available in: Carbide pg: 62 Modular pg: 81 Chatter-Free pg: 100, 115

▲ F Dimension Changed to Current Industry Standard

Minimum Clearance

Coolant Thru

Designation	D Dia.	C OAL	F	Min Bore	Insert	Insert Screw	Key	Price
A06K STFCR2-203	.375	5	.203	.410	TCMT 21.51	MTS-255	T-7	\$71.33
A08M STFCR2-281	.500	6	.281	.560		MTS-255	T-7	\$77.91
A06K STFPR2-203	.375	5	.203	.410	TPMT 21.51	MTS-255	T-7	\$71.33
A08M STFPR2-281	.500	6	.281	.560		MTS-255	T-7	\$77.91

Minimum Clearance Bars are intended for light machining with minimum bore clearance. Max depth of cut .015" - .020"
 * bars .312 and smaller do not have flats

ANYTHING you can imagine...

CAN BE DONE!

SEE PAGE 209 for info on our CUSTOM DESIGN & BUILDS

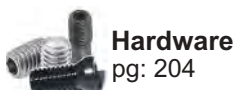

Proudly Made in Flushing, MI USA

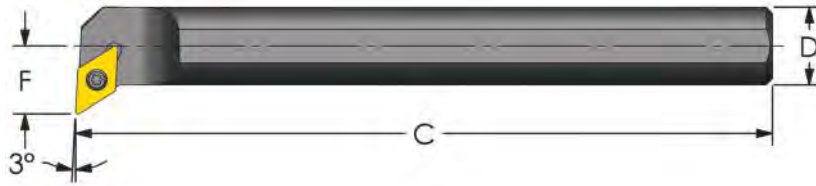

4:1 Ratio

Positive 55° Diamond (-3° Lead) Profiling

No Coolant

Designation	D Dia.	C OAL	F	Min Bore	Insert	Insert Screw	Key	Price
S06K SDUCR/L2	.375	5	.375	.585	DCMT 21.51	MTS-255	T-7	\$65.84
S08M SDUCR/L2	.500	6	.437	.720		MTS-255	T-7	\$74.61
S10Q SDUCR/L2	.625	7	.500	.850		MTS-255	T-7	\$91.08
S12Q SDUCR/L3	.750	7	.625	1.050	DCMT 32.51	MTS-35	T-15	\$103.14
S16R SDUCR/L3	1.000	8	.750	1.310		MTS-35	T-15	\$139.36

S12Q SDUPR/L3	.750	7	.625	1.050	DPMT 32.51	MTS-35	T-15	\$103.14
S16R SDUPR/L3	1.000	8	.750	1.310		MTS-35	T-15	\$139.36

Also available in: **Carbide pg: 64**

Positive 55° Diamond (-3° Lead) Profiling

Coolant Thru

Designation	D Dia.	C OAL	F	Min Bore	Insert	Insert Screw	Key	Price
A06K SDUCR/L2	.375	5	.375	.585	DCMT 21.51	MTS-255	T-7	\$77.91
A08M SDUCR/L2	.500	6	.437	.720		MTS-255	T-7	\$84.49
A10Q SDUCR/L2	.625	7	.500	.850		MTS-255	T-7	\$103.14
A12Q SDUCR/L3	.750	7	.625	1.050	DCMT 32.51	MTS-35	T-15	\$119.61
A16R SDUCR/L3	1.000	8	.750	1.310		MTS-35	T-15	\$155.81

A12Q SDUPR/L3	.750	7	.625	1.050	DPMT 32.51	MTS-35	T-15	\$119.61
A16R SDUPR/L3	1.000	8	.750	1.310		MTS-35	T-15	\$155.81

Also available in: **Carbide pg: 64** **Modular pg: 81** **Chatter-Free pg: 96, 101, 116**



Visit ultradexusa.com

for further information including videos and additional images of our products

Be the first to know when our **NEWEST** products are released!

CHECK FOR MONTHLY SPECIALS!





Proudly made in this 36,000 sq. ft. facility
located in Flushing, Michigan



B

BORING

Need even MORE reach? With NO chatter?



Try our **CHATTER-FREE** Boring Bars with internal dampening technology, tunable with the adjust of a dial.

Available in
Standard + Serrated
Connections
SEE PAGE
92

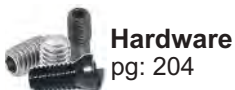

Hardware
pg: 204



Inserts
pg: 188



ULTRADEXUSA.com

MADE IN MICHIGAN

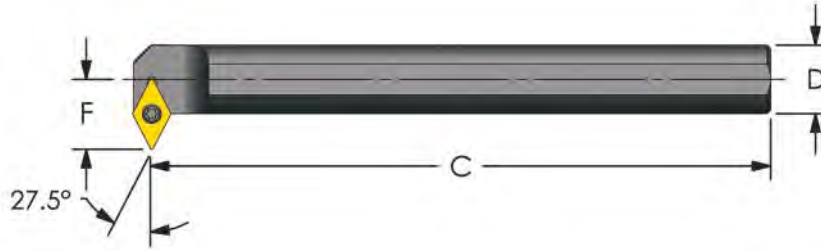

4:1 Ratio

Positive 55° Diamond (27.5° Lead) Profiling

No Coolant

Designation	D Dia.	C OAL	F	Min Bore	Insert	Insert Screw	Key	Price
S10Q SDNCR2	.625	6.86	.562	.920	DCMT 21.51	MTS-255	T-7	\$91.08
S12Q SDNCR3	.750	6.80	.765	1.190	DCMT 32.51	MTS-35	T-15	\$103.14
S16R SDNCR3	1.00	7.80	.890	1.450		MTS-35	T-15	\$139.36

Also available in: Carbide pg: 65 Modular pg: 82 Chatter-Free pg: 116

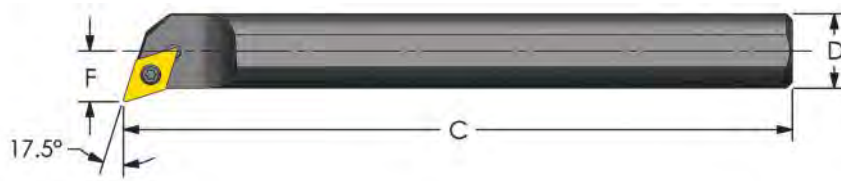

4:1 Ratio

Positive 55° Diamond (-17.5° Lead) Profiling

No Coolant

Designation	D Dia.	C OAL	F	Min Bore	Insert	Insert Screw	Key	Price
S06K SDQCR2	.375	5	.281	.490	DCMT 21.51	MTS-255	T-7	\$65.84
S08M SDQCR2	.500	6	.341	.620		MTS-255	T-7	\$74.61
S10Q SDQCR2	.625	7	.406	.760		MTS-255	T-7	\$91.08

Also available in: Carbide pg: 65 Modular pg: 82

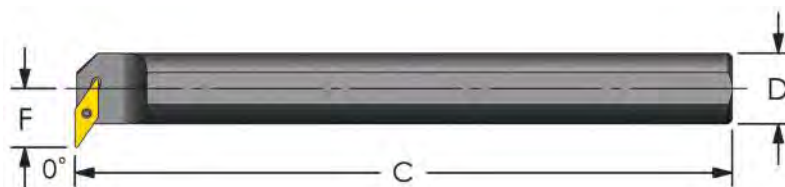

4:1 Ratio

Positive 35° Diamond (0° Lead) Profiling

No Coolant

Designation	D Dia.	C OAL	F	Min Bore	Insert	Insert Screw	Key	Price
S10Q SVFBR2	.625	7	.500	.850	VBMT 21.51	MTS-2.5L	T-7	\$91.08
S12Q SVFBR2	.750	7	.625	1.050		MTS-2.5L	T-7	\$103.14
S16X SVFBR3	1.000	9	.750	1.310	VBMT 331	MTS-3.5L	T-15	\$139.36

B

BORING

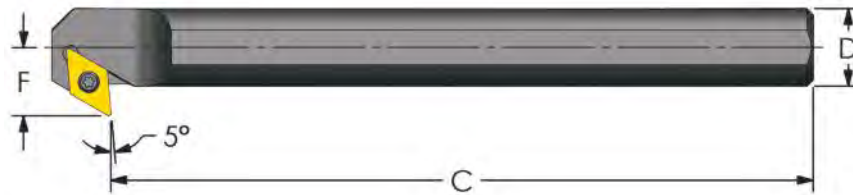

Positive 55° Diamond (5° Lead) Back Facing

4:1 Ratio

No Coolant

Designation	D Dia.	C OAL	F	Min Bore	Insert	Insert Screw	Key	Price
S06J SDXCR/L2	.375	4.5	.375	.585	DCMT 21.51	MTS-255	T-7	\$65.84
S08M SDXCR/L2	.500	6	.437	.720		MTS-255	T-7	\$74.61
S10M SDXCR/L2	.625	6	.500	.850		MTS-255	T-7	\$91.08
S12Q SDXCR/L3	.750	7	.625	1.050	DCMT 32.51	MTS-35	T-15	\$103.14
S16X SDXCR/L3	1.000	9	.750	1.310		MTS-35	T-15	\$139.36

Also available in: Carbide pg: 66

Positive 55° Diamond (5° Lead) Back Facing

Coolant Thru

Designation	D Dia.	C OAL	F	Min Bore	Insert	Insert Screw	Key	Price
A06J SDXCR/L2	.375	4.5	.375	.585	DCMT 21.51	MTS-255	T-7	\$77.91
A08M SDXCR/L2	.500	6	.437	.720		MTS-255	T-7	\$84.49
A10M SDXCR/L2	.625	6	.500	.850		MTS-255	T-7	\$103.14
A12Q SDXCR/L3	.750	7	.625	1.050	DCMT 32.51	MTS-35	T-15	\$119.61
A16X SDXCR/L3	1.000	9	.750	1.310		MTS-35	T-15	\$155.81

Also available in: Carbide pg: 66 Modular pg: 83 Chatter-Free pg: 117

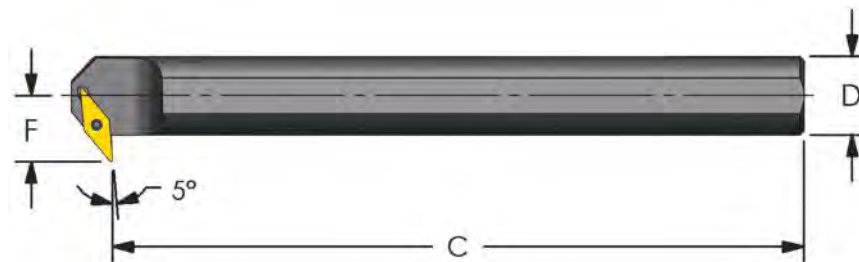

Positive 35° Diamond (5° Lead) Back Facing

4:1 Ratio

No Coolant

Designation	D Dia.	C OAL	F	Min Bore	Insert	Insert Screw	Key	Price
S12Q SVXBR2	.750	6.6	.625	1.050	VBMT 21.51	MTS-2.5L	T-7	\$103.14
S16X SVXBR3	1.000	9	.875	1.435	VBMT 331	MTS-3.5L	T-15	\$139.36



Hardware
pg: 204



Inserts
pg: 188

ULTRA-DEX

Proudly Made in Flushing, MI USA

B

BORING

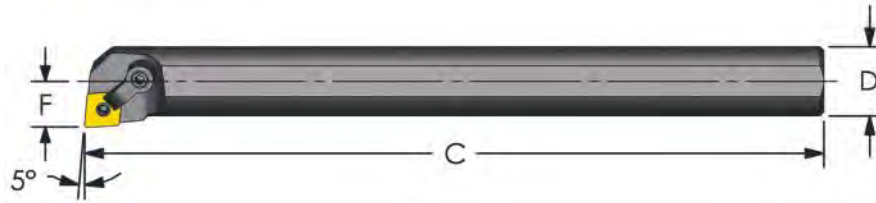

4:1 Ratio

Negative 80° Diamond (-5° Lead)

No Coolant

Designation	D Dia.	C OAL	F	Min Bore	Insert	Shim Seat	Clamp	Clamp Screw	Lock Pin	Price
S12R MCLNR/L3	.750	8	.500	.920	CNMG 322	--	CL-7	XNS-36	NL-33	\$107.53
S16S MCLNR/L3	1.000	10	.640	1.200		--	CL-7	XNS-36	NL-33	\$140.45
S16S MCLNR/L4	1.000	10	.640	1.200	CNMG 432	--	CL-20	XNS-47	NL-44	\$140.45
S20S MCLNR/L4	1.250	10	.765	1.470		ICSN-433	CL-20	XNS-47	NL-46	\$162.39
S20U MCLNR/L4	1.250	14	.765	1.470		ICSN-433	CL-20	XNS-47	NL-46	\$208.48
S24U MCLNR/L4	1.500	14	.890	1.730		ICSN-433	CL-20	XNS-47	NL-46	\$235.91
S32V MCLNR/L4	2.000	16	1.281	2.400		ICSN-433	CL-20	XNS-47	NL-46	\$266.64

Also available in: Hybrid pg: 49

Negative 80° Diamond (-5° Lead)

Coolant Thru

Designation	D Dia.	C OAL	F	Min Bore	Insert	Shim Seat	Clamp	Clamp Screw	Lock Pin	Price
A12R MCLNR/L3	.750	8	.500	.920	CNMG 322	--	CL-7	XNS-36	NL-33	\$139.36
A16S MCLNR/L3	1.000	10	.640	1.200		--	CL-7	XNS-36	NL-33	\$176.66
A16S MCLNR/L4	1.000	10	.640	1.200	CNMG 432	--	CL-20	XNS-47	NL-44	\$176.66
A20S MCLNR/L4	1.250	10	.765	1.470		ICSN-433	CL-20	XNS-47	NL-46	\$198.61
A20U MCLNR/L4	1.250	14	.765	1.470		ICSN-433	CL-20	XNS-47	NL-46	\$258.95
A24U MCLNR/L4	1.500	14	.890	1.730		ICSN-433	CL-20	XNS-47	NL-46	\$294.06
A32V MCLNR/L4	2.000	16	1.281	2.400		ICSN-433	CL-20	XNS-47	NL-46	\$328.08

Also available in: Carbide pg: 67 Modular pg: 84 Chatter-Free pg: 102

DON'T THROW IT AWAY!

Send Us Your Damaged Tooling for Repair

See **pg. 208**
For More
Details

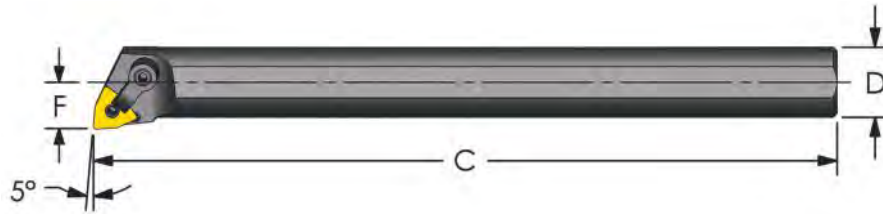

4:1 Ratio

Negative Trigon (-5° Lead)

No Coolant

Designation	D Dia.	C OAL	F	Min Bore	Insert	Shim Seat	Clamp	Clamp Screw	Lock Pin	Price
S12R MWLNR/L3	.750	8	.500	.920	WNMG 332	--	CL-7	XNS-36	NL-33L	\$107.53
S16S MWLNR/L3	1.000	10	.640	1.200		--	CL-7	XNS-36	NL-33L	\$140.45
S16S MWLNR/L4	1.000	10	.640	1.200	WNMG 432	--	CL-20	XNS-47	NL-44	\$140.45
S20S MWLNR/L4	1.250	10	.765	1.470		IWSN-433	CL-20	XNS-47	NL-46	\$162.39
S20U MWLNR/L4	1.250	14	.765	1.470		IWSN-433	CL-20	XNS-47	NL-46	\$197.51
S24U MWLNR/L4	1.500	14	.890	1.730		IWSN-433	CL-20	XNS-47	NL-46	\$235.91
S32V MWLNR/L4	2.000	16	1.281	2.400		IWSN-433	CL-20	XNS-47	NL-46	\$266.64

Also available in: Hybrid pg: 49

Negative Trigon (-5° Lead)

Coolant Thru

Designation	D Dia.	C OAL	F	Min Bore	Insert	Shim Seat	Clamp	Clamp Screw	Lock Pin	Price
A12R MWLNR/L3	.750	8	.500	.920	WNMG 332	--	CL-7	XNS-36	NL-33L	\$139.36
A16S MWLNR/L3	1.000	10	.640	1.200		--	CL-7	XNS-36	NL-33L	\$176.66
A16S MWLNR/L4	1.000	10	.640	1.200	WNMG 432	--	CL-20	XNS-47	NL-44	\$176.66
A20S MWLNR/L4	1.250	10	.765	1.470		IWSN-433	CL-20	XNS-47	NL-46	\$198.61
A20U MWLNR/L4	1.250	14	.765	1.470		IWSN-433	CL-20	XNS-47	NL-46	\$258.95
A24U MWLNR/L4	1.500	14	.890	1.730		IWSN-433	CL-20	XNS-47	NL-46	\$294.06
A32V MWLNR/L4	2.000	16	1.281	2.400		IWSN-433	CL-20	XNS-47	NL-46	\$328.08

Also available in: Carbide pg: 67 Modular pg: 85 Chatter Free pg: 104

2xD 2.5xD 3xD 4xD INDEXABLE DRILLS

BEST Value in the Industry!
SEE Page 142

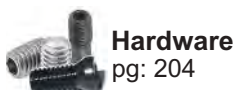

ULTRADEXUSA.com

B

BORING

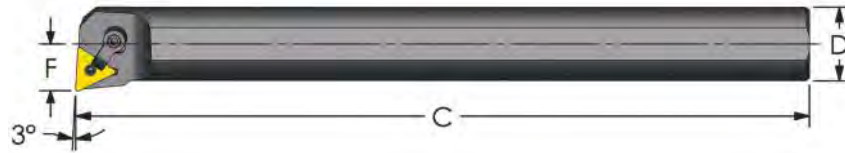

4:1 Ratio

Negative Triangle (-3° Lead)

No Coolant

Designation	D Dia.	C OAL	F	Min Bore	Insert	Shim Seat	Clamp	Clamp Screw	Lock Pin	Price
S16S MTUNR3	1.000	10	.640	1.200	TNMG 332	--	CL-7	XNS-36	NL-33L	\$140.45
S20S MTUNR3	1.250	10	.765	1.470		ITSN-323	CL-7	XNS-36	NL-34L	\$162.39
S20U MTUNR3	1.250	14	.765	1.470		ITSN-323	CL-7	XNS-36	NL-34L	\$208.48
S24U MTUNR4	1.500	14	.890	1.730	TNMG 432	ITSN-433	CL-20	XNS-47	NL-46	\$235.91

Also available in: Modular pg: 86 Chatter-Free pg: 104

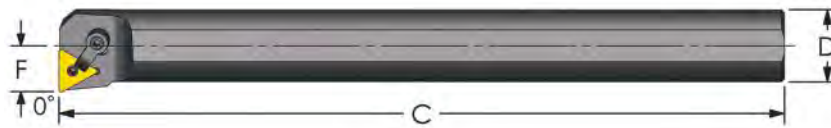

4:1 Ratio

Negative Triangle (0° Lead)

No Coolant

Designation	D Dia.	C OAL	F	Min Bore	Insert	Shim Seat	Clamp	Clamp Screw	Lock Pin	Price
S16S MTFNR3	1.000	10	.640	1.200	TNMG 332	--	CL-7	XNS-36	NL-33L	\$140.45
S20S MTFNR3	1.250	10	.765	1.470		ITSN-323	CL-7	XNS-36	NL-34L	\$162.39
S20U MTFNR3	1.250	14	.765	1.470		ITSN-323	CL-7	XNS-36	NL-34L	\$208.48
S24U MTFNR4	1.500	14	.890	1.730	TNMG 432	ITSN-433	CL-20	XNS-47	NL-46	\$235.91

Also available in: Modular pg: 86

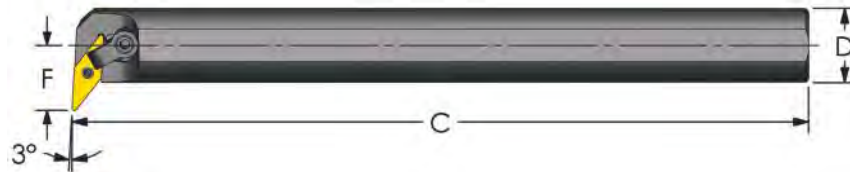

4:1 Ratio

Negative 35° Diamond (-3° Lead) Profiling

No Coolant

Designation	D Dia.	C OAL	F	Min Bore	Insert	Shim Seat	Clamp	Clamp Screw	Lock Pin	Price
S16S MVUNR3	1.000	10	.875	1.435	VNMG 332	IVSN-322	CL-20	XNS-47	NL-34L	\$187.64
S20T MVUNR3	1.250	12	1.000	1.705		IVSN-322	CL-20	XNS-47	NL-34L	\$237.01
S24U MVUNR3	1.500	14	1.120	1.960		IVSN-322	CL-20	XNS-47	NL-34L	\$272.12

Also available in: Modular pg: 88 Chatter-Free pg: 106

B

BORING

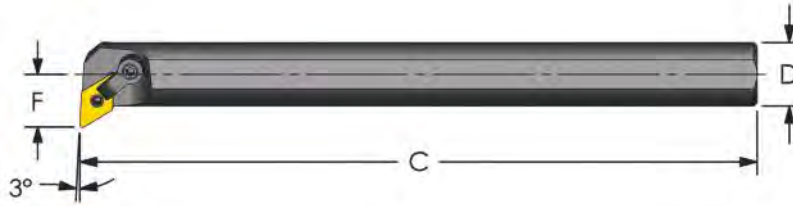

Negative 55° Diamond (-3° Lead) Profiling

4:1 Ratio

No Coolant

Designation	D Dia.	C OAL	F	Min Bore	Insert	Shim Seat	Clamp	Clamp Screw	Lock Pin	Price
S12R MDUNR/L3	.750	8	.625	1.050	DNMG 332	--	CL-7	XNS-36	NL-33L	\$129.48
S16S MDUNR/L3	1.000	10	.750	1.310		--	CL-7	XNS-36	NL-33L	\$165.69
S20T MDUNR/L3	1.250	12	1.000	1.700		IDSN-322	CL-7	XNS-36	NL-34L	\$237.01
S20T MDUNR/L4	1.250	12	1.000	1.700	DNMG 432	IDSN-433	CL-22	XNS-48	NL-46	\$237.01
S24U MDUNR/L4	1.500	14	1.125	1.960		IDSN-433	CL-22	XNS-48	NL-46	\$272.12

Negative 55° Diamond (-3° Lead) Profiling

Coolant Thru

Designation	D Dia.	C OAL	F	Min Bore	Insert	Shim Seat	Clamp	Clamp Screw	Lock Pin	Price
A12R MDUNR/L3	.750	8	.625	1.050	DNMG 332	--	CL-7	XNS-36	NL-33L	\$149.23
A16S MDUNR/L3	1.000	10	.750	1.310		--	CL-7	XNS-36	NL-33L	\$186.53
A20T MDUNR/L3	1.250	12	1.000	1.700		IDSN-322	CL-7	XNS-36	NL-34L	\$264.44
A20T MDUNR/L4	1.250	12	1.000	1.700	DNMG 432	IDSN-433	CL-22	XNS-48	NL-46	\$264.44
A24U MDUNR/L4	1.500	14	1.125	1.960		IDSN-433	CL-22	XNS-48	NL-46	\$303.94

Also available in: Modular pg: 87 Chatter-Free pg: 105

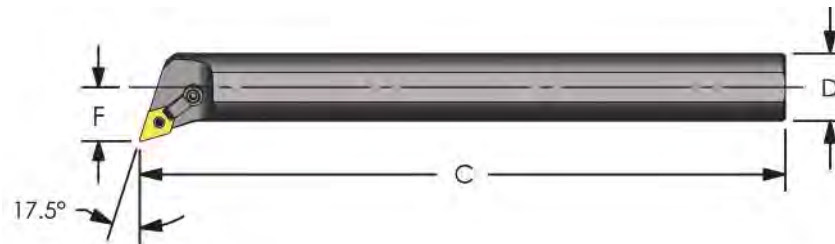

Negative 55° Diamond (-17.5° Lead) Profiling

4:1 Ratio

No Coolant

Designation	D Dia.	C OAL	F	Min Bore	Insert	Shim Seat	Clamp	Clamp Screw	Lock Pin	Price
S20T MDQNR/L4	1.250	12	1.000	1.700	DNMG 432	IDSN-433	CL-22	XNS-48	NL-46	\$237.01
S24U MDQNR/L4	1.500	14	1.125	1.960		IDSN-433	CL-22	XNS-48	NL-46	\$272.12

Negative 55° Diamond (-17.5° Lead) Profiling

Coolant Thru

Designation	D Dia.	C OAL	F	Min Bore	Insert	Shim Seat	Clamp	Clamp Screw	Lock Pin	Price
A20T MDQNR/L4	1.250	12	1.000	1.700	DNMG 432	IDSN-433	CL-22	XNS-48	NL-46	\$264.44
A24U MDQNR/L4	1.500	14	1.125	1.960		IDSN-433	CL-22	XNS-48	NL-46	\$303.94

Also available in: Modular pg: 87

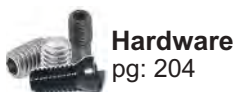

Hardware
pg: 204



Inserts
pg: 188



Proudly Made in Flushing, MI USA

B

BORING

Steel Boring Bars (Threading / Grooving)

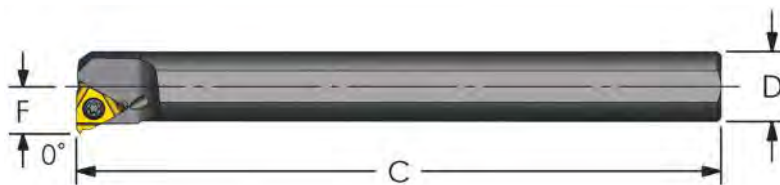

4:1 Ratio

Threading/Grooving Laydown

Coolant Thru

Designation Right Hand	D Dia.	C OAL	F	L	Min Bore	Insert	Insert Screw	Anvil Screw	Anvil	Price
A08M LSER2-N	.500	6	.210	2.000	.490	2IR	SR34505	--	--	\$95.47
A08M LSER2	.500	6	.308	--	.588		SR34505	--	--	\$84.49
A10Q LSER2	.625	7	.371	--	.721		SR34505	--	--	\$103.14
A12Q LSER3	.750	7	.510	--	.935	3IR	MTS-35	--	--	\$119.61
A16R LSER3	1.000	8	.650	--	1.210		SA3T	SY3T	YI3	\$164.59
Designation Left Hand	D Dia.	C OAL	F	L	Min Bore	Insert	Insert Screw	Anvil Screw	Anvil	Price
A12Q LSEL3	.750	7	.510	--	.935	3IL	MTS-35	--	--	\$119.61
A16R LSEL3	1.000	8	.650	--	1.210		SA3T	SY3T	YE3	\$164.59

Also available in: Carbide pg: 68 Modular pg: 90 Chatter-Free pg: 96, 108, 121

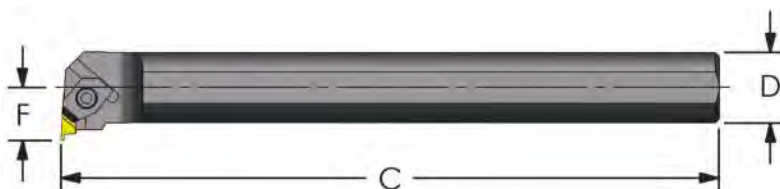

4:1 Ratio

Threading/Grooving Top Notch

No Coolant

Designation Right Hand	D Dia.	C OAL	F	Min Bore	Insert	Clamp	Clamp Screw	Price
S08M NER2	.500	6	.437	.730	NG 2L	CM-147	6-32	\$141.55
S10Q NER2	.625	7	.500	1.000		CM-75	6-32	\$132.77
S12Q NER2	.750	7	.562	1.120		CM-75	6-32	\$136.06
S16R NER3	1.000	8	.688	1.180	NG 3L	CM-73	10-32	\$181.05
Designation Left Hand	D Dia.	C OAL	F	Min Bore	Insert	Clamp	Clamp Screw	Price
S08M NEL2	.500	6	.437	.730	NG 2R	CM-146	6-32	\$141.55
S10Q NEL2	.625	7	.500	1.000		CM-74	6-32	\$132.77
S12Q NEL2	.750	7	.562	1.120		CM-74	6-32	\$136.06
S16R NEL3	1.000	8	.688	1.180	NG 3R	CM-72	10-32	\$181.05

Also available in: Carbide pg: 68 Modular pg: 91 Chatter-Free pg: 109, 121

See pg 203 for our



Top Notch Grooving Inserts

B

BORING



Steel Boring Bar Kits

Coolant Thru



Order No.: PDBK-356

- (1) A06K SCLCR2 (3/8" Bar)
- (1) A08M SCLCR2 (1/2" Bar)
- (1) A10Q SCLCR2 (5/8" Bar)
- (5) CCMT 21.51 UD51

\$224.28



Order No.: PDBK-671

- (1) A10Q SCLCR3 (5/8" Bar)
- (1) A12Q SCLCR3 (3/4" Bar)
- (1) A16R SCLCR3 (1" Bar)
- (5) CCMT 32.51 UD51

\$293.40

Mini-Steel Boring Bar Kits

No Coolant



Order No.: PDBK-MINI

- (1) S03G SCLDR1.2
- (1) S03.5G SCLDR1.5
- (1) S04G SCLDR1.5
- (1) S05G SCLPR1.8

- (2) CDHB 1.20.60 UD51
- (2) CDGW 1.510 UD51
- (2) CPMT 1.81.20.5 UD51

ONLY \$196.41

Right Hand Bar	D Dia.	C OAL	F	Min. Bore
S03G SCLDR1.2 *	.187	3.5	.102	.205
S03.5G SCLDR1.5 *	.218	3.5	.125	.245
S04G SCLDR1.5-138 *	.250	3.5	.138	.275
S05G SCLPR1.8-167 *	.312	3.5	.167	.340

* bars .312 and smaller do not have flats

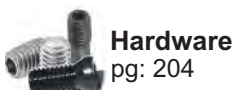

Hardware
pg: 204



Inserts
pg: 188



ULTRADEXUSA.com

B

BORING



REDUCED NECK BORING BARS

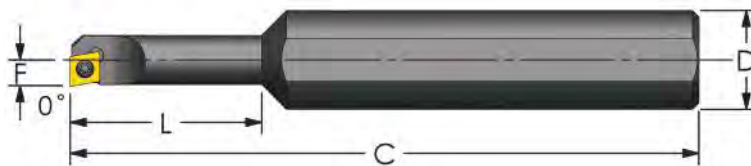

Positive 80° Diamond (0° Lead) Reduced Neck

No Coolant

Designation	D Dia.	C OAL	L Neck Length	F	Min Bore	Insert	Insert Screw	Key	Price
SCFDR2-5	.625	4	.500	.138	.276	CDGW 1.510	MTS-184	T-6	\$83.39
SCFDR2-15	.625	4	1.000	.138	.276		MTS-184	T-6	\$83.39
SCFDR2-25	.625	4	.750	.167	.334		MTS-184	T-6	\$83.39
SCFDR2-35	.625	4	1.250	.167	.334		MTS-184	T-6	\$83.39
SCFDR2-45	.625	4	1.000	.203	.450		MTS-184	T-6	\$83.39
SCFDR2-55	.625	4	1.500	.203	.450		MTS-184	T-6	\$83.39

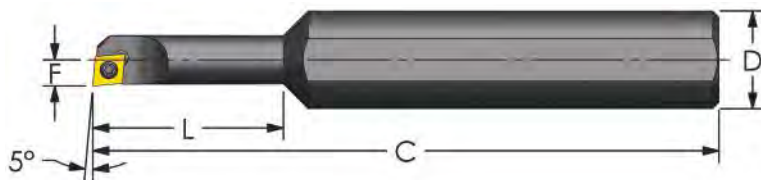

Positive 80° Diamond (-5° Lead) Reduced Neck

No Coolant

Designation	D Dia.	C OAL	L Neck Length	F	Min Bore	Insert	Insert Screw	Key	Price
SCLDR2-5	.625	4	.500	.138	.276	CDGW 1.510	MTS-184	T-6	\$83.39
SCLDR2-15	.625	4	1.000	.138	.276		MTS-184	T-6	\$83.39
SCLDR2-25	.625	4	.750	.167	.334		MTS-184	T-6	\$83.39
SCLDR2-35	.625	4	1.250	.167	.334		MTS-184	T-6	\$83.39
SCLDR2-45	.625	4	1.000	.203	.450		MTS-184	T-6	\$83.39
SCLDR2-55	.625	4	1.500	.203	.450		MTS-184	T-6	\$83.39

B

BORING

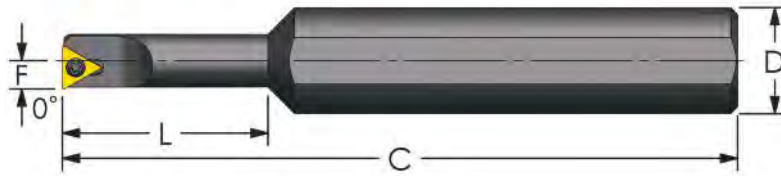

Positive Triangle (0° Lead) Reduced Neck

No Coolant

Designation	D Dia.	C OAL	L Neck Length	F	Min Bore	Insert	Insert Screw	Key	Price
STFCR2-5	.625	4	.500	.138	.276	TCMT 1.21.20.5	MTS-184	T-6	\$83.39
STFCR2-15	.625	4	1.000	.138	.276		MTS-184	T-6	\$83.39
STFCR2-25	.625	4	.750	.167	.334		MTS-184	T-6	\$83.39
STFCR2-35	.625	4	1.250	.167	.334		MTS-184	T-6	\$83.39
STFCR2-45	.625	4	1.000	.203	.450		MTS-184	T-6	\$83.39
STFCR2-55	.625	4	1.500	.203	.450		MTS-184	T-6	\$83.39

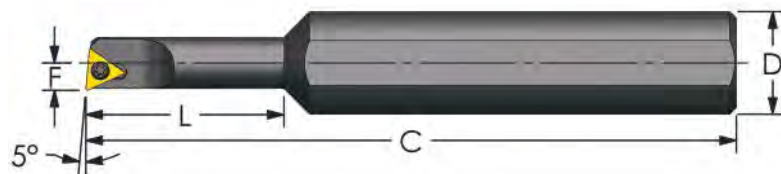

Positive Triangle (-5° Lead) Reduced Neck

No Coolant

Designation	D Dia.	C OAL	L Neck Length	F	Min Bore	Insert	Insert Screw	Key	Price
STLCR2-5	.625	4	.500	.138	.276	TCMT 1.21.20.5	MTS-184	T-6	\$83.39
STLCR2-15	.625	4	1.000	.138	.276		MTS-184	T-6	\$83.39
STLCR2-25	.625	4	.750	.167	.334		MTS-184	T-6	\$83.39
STLCR2-35	.625	4	1.250	.167	.334		MTS-184	T-6	\$83.39
STLCR2-45	.625	4	1.000	.203	.450		MTS-184	T-6	\$83.39
STLCR2-55	.625	4	1.500	.203	.450		MTS-184	T-6	\$83.39



Visit ultradexusa.com

for further information including videos and additional images of our products

Be the first to know when our **NEWEST** products are released!

CHECK FOR MONTHLY SPECIALS!

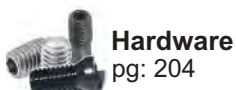

Hardware
pg: 204



Inserts
pg: 188

ULTRA-DEX

Proudly Made in Flushing, MI USA

B

BORING

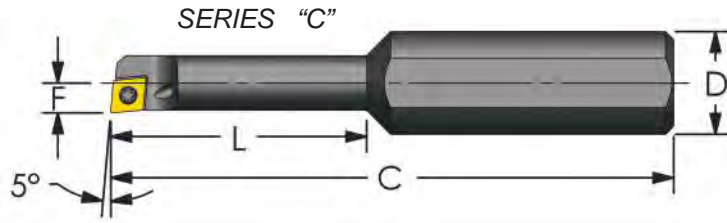

Positive 80° Diamond (-5° Lead) Reduced Neck

Coolant Thru

Designation	D Dia.	Head Dia.	C OAL	L Neck Length	F	Min Bore	Insert	Insert Screw	Key	Price
CSUD-180/375-1/2-5R	.375	.180	2.5	.500	.104	.208	CDHB 1.20.60.5	MTS-183	T-6	\$114.11
CSUD-180/375-1-5R	.375	.180	2.5	1.000	.104	.208		MTS-183	T-6	\$114.11
CSUD-203/375-1/2-5R	.375	.203	2.5	.500	.116	.230		MTS-183	T-6	\$114.11
CSUD-203/375-1-5R	.375	.203	2.5	1.000	.116	.230		MTS-183	T-6	\$114.11
CSUD-250/375-1 1/4-5R	.375	.250	2.5	1.250	.145	.285		MTS-183	T-6	\$110.83
CSUD-180/500-1/2-5R	.500	.180	2.75	.500	.104	.208		MTS-183	T-6	\$118.50
CSUD-180/500-1-5R	.500	.180	2.75	1.000	.104	.208		MTS-183	T-6	\$118.50
CSUD-203/500-1/2-5R	.500	.203	2.75	.500	.116	.230		MTS-183	T-6	\$123.99
CSUD-203/500-1-5R	.500	.203	2.75	1.000	.116	.230		MTS-183	T-6	\$118.50
CSUD-250/500-3/4-5R	.500	.250	2.75	.750	.145	.285		MTS-184	T-6	\$118.50
CSUD-250/500-1 1/4-5R	.500	.250	2.75	1.250	.145	.285		MTS-184	T-6	\$118.50

Also available in: Carbide pg: 69

SAME DAY SHIPPING!

On orders placed before 3:30pm EST

SEE PAGE 210 for more details...

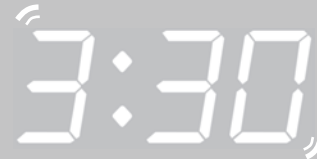

More! Series Style Boring Bars

...pgs **25, 27, 45, 55, 56, 63, 69**

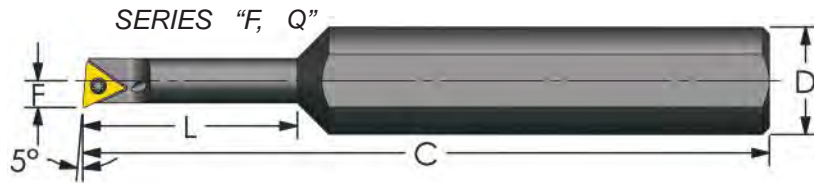

Positive Triangle (-5° Lead) Reduced Neck

Coolant Thru

Designation	D Dia.	Head Dia.	C OAL	L Neck Length	F	Min Bore	Insert	Insert Screw	Key	Price	
FSUD-203/500-1/2-5R	.500	.203	3	.500	.126	.275	TDHB 1.280.750.5	MTS-224	T-7	\$108.63	
FSUD-203/500-1-5R	.500	.203	3	1.000	.126	.275		MTS-224	T-7	\$117.41	
FSUD-250/500-3/4-5R	.500	.259	3	.750	.156	.300		MTS-224	T-7	\$114.11	
FSUD-312/500-1-5R	.500	.321	3	1.000	.187	.360		MTS-224	T-7	\$108.63	
FSUD-312/500-1 1/2-5R	.500	.321	3	1.500	.187	.360		MTS-224	T-7	\$117.41	
FSUD-203/625-1/2-5R	.625	.203	4	.500	.126	.275		TPCB 220.5	MTS-224	T-7	\$125.09
FSUD-250/625-3/4-5R	.625	.259	4	.750	.156	.300			MTS-224	T-7	\$114.11
FSUD-250/625-1 1/4-5R	.625	.259	4	1.250	.156	.300			MTS-224	T-7	\$114.11
FSUD-312/625-1-5R	.625	.321	4	1.000	.187	.360			MTS-224	T-7	\$114.11
QSUD-375/500-1 1/8-5R	.500	.390	3.75	1.125	.221	.438	TPCB 220.5		ETS 4-40	T-10	\$108.63
QSUD-375/500-1 7/8-5R	.500	.390	3.75	1.875	.221	.438			ETS 4-40	T-10	\$108.63
QSUD-375/625-1 1/8-5R	.625	.390	4.25	1.125	.221	.438		ETS 4-40	T-10	\$118.50	
QSUD-375/625-1 7/8-5R	.625	.390	4.25	1.875	.221	.438		ETS 4-40	T-10	\$118.50	
QSUD-375/750-1 1/2-5R	.750	.390	4	1.500	.221	.438		ETS 4-40	T-10	\$127.28	
QSUD-625/750-2 1/2-5R	.750	.635	4.5	2.500	.353	.688		ETS 4-40	T-10	\$139.36	

Also available in: Carbide pg: 69

Several HSK machine connection sizes available!

Starting on pg 168

HSK 40, 50, 63, 80, 100, 125

+ We do CUSTOM builds

for any other size and style



ULTRADEXUSA.com

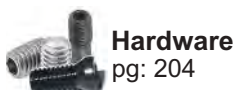

ULTRA-DEX

PULLBACK CLAMP BORING BARS

- Increased Rigidity in Clamping
- Faster Insert Indexing

Unlike conventional "CL" Barrel clamp systems, which requires a lockpin and clamp for proper clamping; our new system only requires the PULLBACK clamp. This clamp is an all-in-one solution that naturally draws the insert back into the center of the pocket creating maximum rigidity and allowing faster indexing.

**MICHIGAN
MADE**

Clamp Assembly Designations...

PB3-CA

3 I.C. Insert Clamp, Clamp Screw, Spring

PB4-CA

4 I.C. Insert Clamp, Clamp Screw, Spring



B

BORING

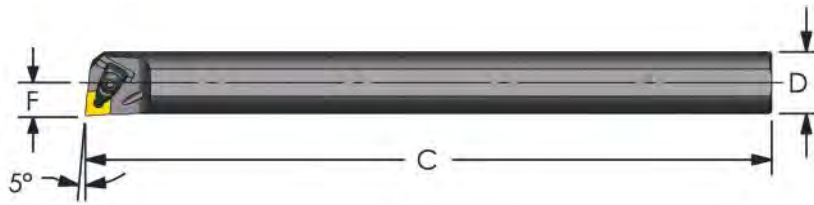

4:1 Ratio

Steel Negative 80° Diamond (-5° Lead)

Coolant Thru

Designation	D Dia.	C OAL	F	Min Bore	Insert	Shim	Shim Screw	Clamp Assy.	Price
A16S DCLNR4	1.000	10	.640	1.200	CNMG 432	--	--	PB4-CA	\$262.25
A20U DCLNR4	1.250	14	.765	1.470		ICSN 433	PB4-SS	PB4-CA	\$284.19
A24U DCLNR4	1.500	14	.890	1.730		ICSN 433	PB4-SS	PB4-CA	\$371.97

Carbide Shank

Coolant Thru 8:1 Ratio

Designation	D Dia.	C OAL	F	Min Bore	Insert	Shim	Shim Screw	Clamp Assy.	Price
E16T DCLNR4	1.000	12	.640	1.200	CNMG 432	--	--	PB4-CA	\$724.19
E20U DCLNR4	1.250	14	.765	1.470		ICSN 433	PB4-SS	PB4-CA	\$1,324.37

Also available in: [Modular pg: 89](#) [Chatter-Free pg: 118](#)

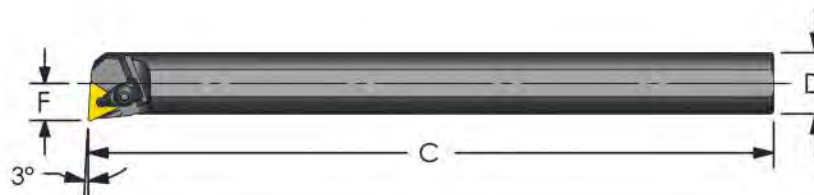

4:1 Ratio

Steel Negative Triangle (-3° Lead)

Coolant Thru

Designation	D Dia.	C OAL	F	Min Bore	Insert	Shim	Shim Screw	Clamp Assy.	Price
A16S DTUNR4	1.000	10	.640	1.200	TNMG 432	--	--	PB4-CA	\$262.25
A20U DTUNR4	1.250	14	.765	1.470		ITSN-433	PB4-SS	PB4-CA	\$284.19
A24U DTUNR4	1.500	14	.890	1.730		ITSN-433	PB4-SS	PB4-CA	\$371.97

Also available in: [Modular pg: 89](#) [Chatter-Free pg: 119](#)

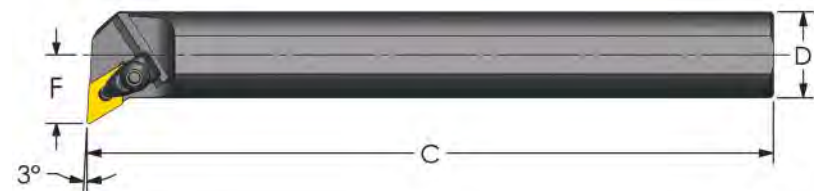

4:1 Ratio

Steel Negative 55° Diamond (-3° Lead)

Coolant Thru

Designation	D Dia.	C OAL	F	Min Bore	Insert	Shim	Shim Screw	Clamp Assy.	Price
A20T DDUNR4	1.250	12	1.000	1.700	DNMG 432	IDSN 433	PB4-SS	PB4-CA	\$306.14
A24U DDUNR4	1.500	14	1.125	1.965		IDSN 433	PB4-SS	PB4-CA	\$393.92

Carbide Shank

Coolant Thru 8:1 Ratio

Designation	D Dia.	C OAL	F	Min Bore	Insert	Shim	Shim Screw	Clamp Assy.	Price
E20U DDUNR4	1.250	14	1.000	1.700	DNMG 432	IDSN 433	PB4-SS	PB4-CA	\$1,324.37

Also available in: [Modular pg: 89](#) [Chatter-Free pg: 118](#)

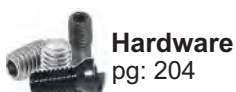

ULTRA-DEX

HYBRID BORING BARS

Steel Reinforced with Carbide

30% More Rigid than Steel Bars

up to **35%** Less Cost than our Carbide Bars

5:1 Ratio

.625" - 1.5" Diameters

MADE IN MICHIGAN

THE BEST OF BOTH WORLDS



ECONOMICAL COST OF STEEL

+

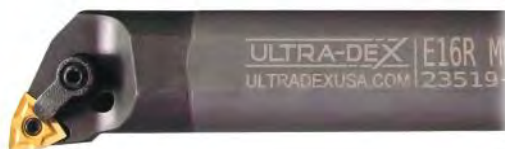

HIGH RIGIDITY OF CARBIDE



B

BORING

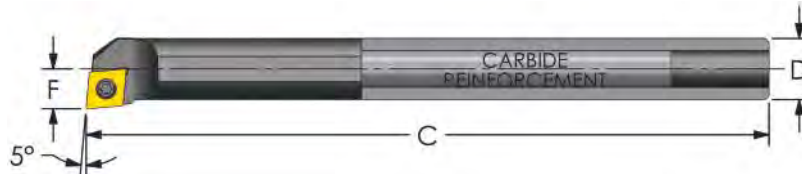

5:1 Ratio

Positive 80° Diamond (-5° Lead) Carbide Reinforced

No Coolant

Designation	D Dia.	C OAL	F	Min Bore	Insert	Insert Screw	Key	Price
R10Q SCLCR3	.625	7	.406	.770	CCMT 32.51	MTS-35	T-15	\$213.97
R12S SCLCR3	.750	10	.500	.930		MTS-35	T-15	\$262.25
R16T SCLCR3	1.000	12	.625	1.200		MTS-35	T-15	\$386.23
R20U SCLCR4	1.250	14	.765	1.470	CCMT 432	MTS-4	T-20	\$668.23
R24U SCLCR4	1.500	14	.890	1.760		MTS-4	T-20	\$833.91

Steel pg: 23 Carbide pg: 53 Heavy Metal pg: 73 Modular pg: 79 Chatter-Free pg: 96, 99, 114

Please allow one week for processing and delivery.

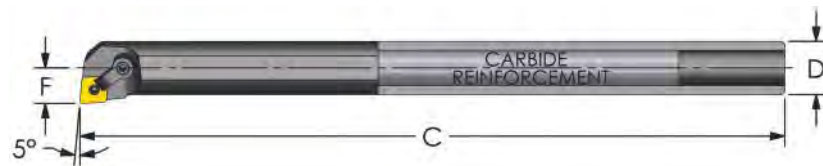

5:1 Ratio

Negative 80° Diamond (-5° Lead) Carbide Reinforced

No Coolant

Designation	D Dia.	C OAL	F	Min Bore	Insert	Shim Seat	Clamp	Clamp Screw	Lock Pin	Price
R12S MCLNR3	.750	10	.500	.963	CNMG 322	--	CL-7	XNS-36	NL-33	\$290.78
R16T MCLNR3	1.000	12	.640	1.240		--	CL-7	XNS-36	NL-33	\$404.89
R16T MCLNR4	1.000	12	.640	1.240	CNMG 432	--	CL-20	XNS-47	NL-44	\$404.89
R20U MCLNR4	1.250	14	.765	1.470		ICSN-433	CL-20	XNS-47	NL-46	\$675.91
R24U MCLNR4	1.500	14	.890	1.760		ICSN-433	CL-20	XNS-47	NL-46	\$852.57

Also available in: Steel pg: 36 Carbide pg: 67 Modular pg: 84 Chatter-Free pg: 102

Please allow one week for processing and delivery.

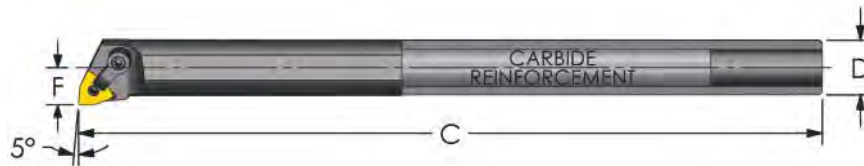

5:1 Ratio

Negative Trigon (-5° Lead) Carbide Reinforced

No Coolant

Designation	D Dia.	C OAL	F	Min Bore	Insert	Shim Seat	Clamp	Clamp Screw	Lock Pin	Price
R12S MWLNR3	.750	10	.500	.963	WNMG 332	--	CL-7	XNS-36	NL-33L	\$290.78
R16T MWLNR3	1.000	12	.640	1.240		--	CL-7	XNS-36	NL-33L	\$404.89
R16T MWLNR4	1.000	12	.640	1.240	WNMG 432	--	CL-20	XNS-47	NL-44	\$404.89
R20U MWLNR4	1.250	14	.765	1.470		IWSN-433	CL-20	XNS-47	NL-46	\$675.91
R24U MWLNR4	1.500	14	.890	1.760		IWSN-433	CL-20	XNS-47	NL-46	\$852.57

Also available in: Steel pg: 37 Carbide pg: 67 Modular pg: 85 Chatter-Free pg: 104

Please allow one week for processing and delivery.

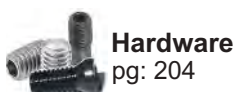

Hardware
pg: 204



Inserts
pg: 188



ULTRADEXUSA.com

B

BORING

ULTRA-DEX

CARBIDE BORING BARS

MAXIMUM RIGIDITY / EFFICIENCY

For use in **TOUGHER** applications

**MICHIGAN
MADE**

8:1 Ratio

.156" - 1.5" Diameters

Other Pages of Interest

pg **69** **Reduced Neck**

pg **70** **Solid Small Boring**

pg **71** **Cut-off / Extra Flat Service**

pg **71** **Steel Coolant Adapter**



B

BORING



METRIC CARBIDE BORING BARS

New!

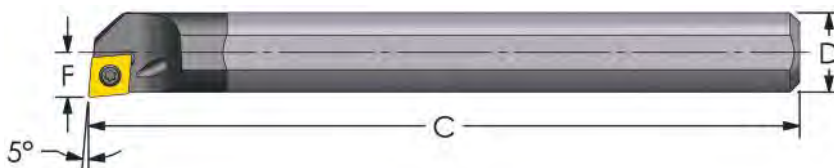

Positive 80° Diamond (-5° Lead)

8:1 Ratio
Coolant Thru

Designation	D Dia. (mm)	C OAL (mm)	F (mm)	Min Bore (mm)	Insert	Insert Screw	Key	Price
M-E06H SCLCR/L04 *	6	100	3.5	7	CDGW 1.510	MTS-184	T-6	\$158.90
M-E08K SCLCR/L06 *	8	125	6	11	CCMT 21.51	MTS-255	T-7	\$166.94
M-E10M SCLCR/L06	10	150	7	13		MTS-255	T-7	\$189.81
M-E12Q SCLCR/L06	12	180	9	16	CCMT 32.51	MTS-255	T-7	\$208.73
M-E16R SCLCR/L09	16	200	11	20		MTS-35	T-15	\$320.06
M-E20S SCLCR/L09	20	250	13	25		MTS-35	T-15	\$444.02
M-E25T SCLCR/L09	25	300	17	32	MTS-35	T-15	\$723.12	

New!

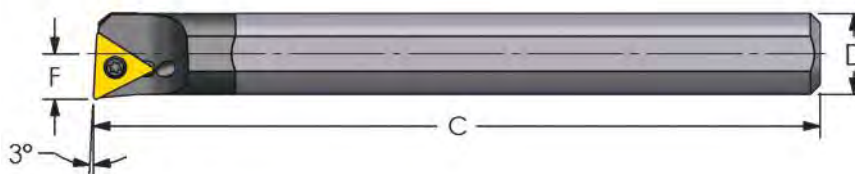

Positive Triangle (-3° Lead)

8:1 Ratio
Coolant Thru

Designation	D Dia. (mm)	C OAL (mm)	F (mm)	Min Bore (mm)	Insert	Insert Screw	Key	Price
M-E06H STUCR/L06 *	6	100	3.5	7	TCMT 1.21.20.5	MTS-184	T-6	\$158.90
M-E08K STUCR/L06 *	8	125	6	11		MTS-184	T-6	\$166.94
M-E10M STUCR/L11	10	150	7	13	TCMT 21.51	MTS-255	T-7	\$189.81
M-E12Q STUCR/L11	12	180	9	16		MTS-255	T-7	\$208.73
M-E16R STUCR/L11	16	200	11	20	TCMT 32.51	MTS-255	T-7	\$320.06
M-E20S STUCR/L16	20	250	13	25		MTS-35	T-15	\$444.02
M-E25T STUCR/L16	25	300	17	32		MTS-35	T-15	\$723.12

*bars 8mm and smaller do not have flats

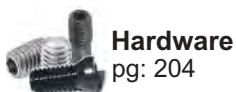

Hardware
pg: 204



Inserts
pg: 188



Proudly Made in Flushing, MI USA

B

BORING

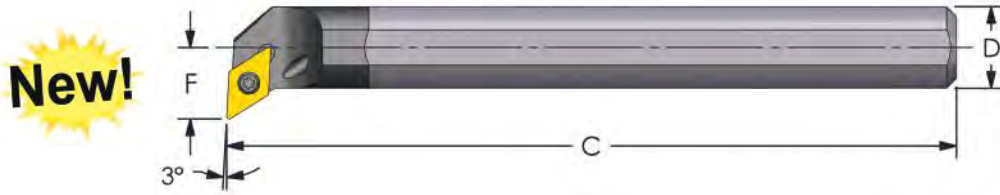

8:1 Ratio

Positive 55° Diamond (-3° Lead) Profiling

Coolant Thru

Designation	D Dia. (mm)	C OAL (mm)	F (mm)	Min Bore (mm)	Insert	Insert Screw	Key	Price
M-E10M SDUCR/L07	10	150	9	15	DCMT 21.51	MTS-255	T-7	\$198.17
M-E12Q SDUCR/L07	12	180	11	18		MTS-255	T-7	\$243.22
M-E16R SDUCR/L07	16	200	13	22		MTS-255	T-7	\$328.42
M-E20S SDUCR/L11	20	250	15	27	DCMT 32.51	MTS-35	T-15	\$453.43
M-E25T SDUCR/L11	25	300	18	33		MTS-35	T-15	\$739.84

B

BORING

SERIOUSLY HARD-HITTING
INDEXABLE DRILLS

SEE PAGE
142

NEW

- ★ Diameter range (.562 - 2.125" 3xD)
- ★ Hardened high quality tool steel and electroless nickel coated for rigidity, wear resistance and reduced chip wash
- ★ New and improved 4-edge insert design to provide excellent chip control with lower spindle loads
- ★ Same insert can be used as inboard and outboard insert + No risk of mixing up inner and outer
- ★ Engineered flute design optimized for superior chip evacuation and rigidity
- ★ Able to offset and drill into slant workpieces without pre-drilling
- ★ 2-part internal coolant system for high-efficient drilling
- ★ X-offset design to adjust diameter size on turning centers, and optimize tolerances on machining centers

! USE THE RIGHT SET SCREW
FLAT POINT, NOT CUP POINT !

Carbide Boring Bars (Positive)

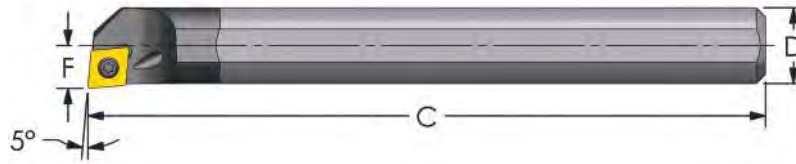

8:1 Ratio

No Coolant

Positive 80° Diamond (-5° Lead)

Designation	D Dia.	C OAL	F	Min Bore	Insert	Insert Screw	Key	Price
C02.5G SCLDR/L1.2 *	.156	3.5	.090	.175	CDHB 1.20.60	MTS-182	T-6	\$142.64
C03H SCLDR/L1.2 *	.187	4	.102	.205		MTS-183	T-6	\$142.64
C03.5H SCLDR/L1.5 *	.218	4	.125	.245	CDGW 1.510	MTS-184	T-6	\$142.64
C04H SCLDR/L1.5 *▲	.250	4	.172	.312		MTS-184	T-6	\$142.64
C05K SCLPR/L1.8 *▲	.312	5	.219	.395	CPMT 1.81.20.5	MTS-224	T-7	\$142.64
C06M SCLPR/L2 ▲	.375	6	.250	.460	CPMT 21.51	MTS-255	T-7	\$163.50
C08J SCLPR/L2 ▲	.500	4.5	.312	.600		MTS-255	T-7	\$184.34
C08R SCLPR/L2 ▲	.500	8	.312	.600	MTS-255	T-7	\$211.77	
C08J SCLPR/L3	.500	4.5	.344	.625	CPMT 32.51	MTS-35	T-15	\$184.34
C08R SCLPR/L3	.500	8	.344	.625		MTS-35	T-15	\$211.77
C06M SCLCR/L2 ▲	.375	6	.250	.460	CCMT 21.51	MTS-255	T-7	\$163.50
C08J SCLCR/L2 ▲	.500	4.5	.312	.600		MTS-255	T-7	\$184.34
C08R SCLCR/L2 ▲	.500	8	.312	.600	MTS-255	T-7	\$211.77	
C08J SCLCR/L3	.500	4.5	.344	.625	CCMT 32.51	MTS-35	T-15	\$184.34
C08R SCLCR/L3	.500	8	.344	.625		MTS-35	T-15	\$211.77

Also available in: [Steel pg: 23](#) [Hybrid pg: 49](#) [Heavy Metal pg: 73](#)

▲ F Dimension Changed to Current Industry Standard

Minimum Clearance

No Coolant

Designation	D Dia.	C OAL	F	Min Bore	Insert	Insert Screw	Key	Price
C04H SCLDR/L1.5-138 *	.250	4	.138	.275	CDGW 1.510	MTS-184	T-6	\$142.64
C05K SCLPR/L1.8-167 *	.312	5	.167	.340	CPMT 1.81.20.5	MTS-224	T-7	\$142.64
C06M SCLPR/L2-203	.375	6	.203	.410	CPMT 21.51	MTS-255	T-7	\$163.50
C08J SCLPR/L2-281	.500	4.5	.281	.560		MTS-255	T-7	\$184.34
C08R SCLPR/L2-281	.500	8	.281	.560	MTS-255	T-7	\$211.77	
C06M SCLCR/L2-203	.375	6	.203	.410	CCMT 21.51	MTS-255	T-7	\$163.50
C08J SCLCR/L2-281	.500	4.5	.281	.560		MTS-255	T-7	\$184.34
C08R SCLCR/L2-281	.500	8	.281	.560	MTS-255	T-7	\$211.77	

Minimum Clearance Bars are intended for light machining with minimum bore clearance. Max depth of cut .015" - .020"

* bars .312 and smaller do not have flats

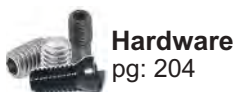

Hardware
pg: 204



Inserts
pg: 188



ULTRADEXUSA.com

B

BORING

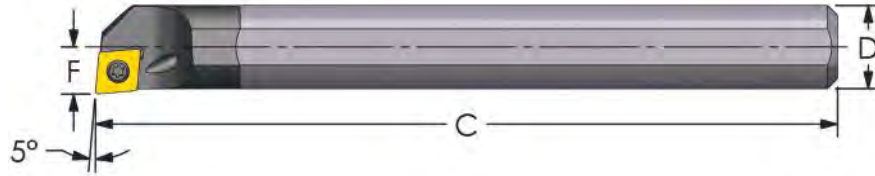

8:1 Ratio

Positive 80° Diamond (-5° Lead)

Coolant Thru

Designation	D Dia.	C OAL	F	Min Bore	Insert	Insert Screw	Key	Price
E02.5G SCLDR/L1.2 *	.156	3.5	.090	.175	CDHB 1.20.60	MTS-182	T-6	\$160.20
E03H SCLDR/L1.2 *	.187	4	.102	.205		MTS-183	T-6	\$160.20
E03.5H SCLDR/L1.5 *	.218	4	.125	.245	CDGW 1.510	MTS-184	T-6	\$160.20
E04H SCLDR/L1.5 *▲	.250	4	.172	.312		MTS-184	T-6	\$160.20
E05K SCLPR/L1.8 *▲	.312	5	.219	.395	CPMT 1.81.20.5	MTS 224	T-7	\$160.20
E06M SCLPR/L2 ▲	.375	6	.250	.460	CPMT 21.51	MTS-255	T-7	\$179.95
E08J SCLPR/L2 ▲	.500	4.5	.312	.600		MTS-255	T-7	\$201.89
E08R SCLPR/L2 ▲	.500	8	.312	.600		MTS-255	T-7	\$228.23
E10Q SCLPR/L2	.625	7	.406	.770		MTS-255	T-7	\$284.19
E10S SCLPR/L2	.625	10	.406	.770		MTS-255	T-7	\$345.64
E08J SCLPR/L3	.500	4.5	.344	.625		CPMT 32.51	MTS-35	T-15
E08R SCLPR/L3	.500	8	.344	.625	MTS-35		T-15	\$228.23
E10Q SCLPR/L3	.625	7	.406	.760	MTS-35		T-15	\$284.19
E10S SCLPR/L3	.625	10	.406	.760	MTS-35		T-15	\$345.64
E12Q SCLPR/L3	.750	7	.500	.920	MTS-35		T-15	\$356.61
E12S SCLPR/L3	.750	10	.500	.920	MTS-35		T-15	\$412.57
E16R SCLPR/L3	1.000	8	.625	1.185	MTS-35		T-15	\$527.78
E16T SCLPR/L3	1.000	12	.625	1.185	MTS-35		T-15	\$671.52

Also available in: Steel pg: 24 Heavy Metal pg: 73 Modular pg: 79 Chatter-Free pg: 96, 99, 114

▲ F Dimension Changed to Current Industry Standard

Minimum Clearance

Coolant Thru

Designation	D Dia.	C OAL	F	Min Bore	Insert	Insert Screw	Key	Price
E04H SCLDR/L1.5-138 *	.250	4	.138	.270	CDGW 1.510	MTS-184	T-6	\$160.20
E05K SCLPR/L1.8-167 *	.312	5	.167	.340	CPMT 1.81.20.5	MTS 224	T-7	\$160.20
E06M SCLPR/L2-203	.375	6	.203	.410	CPMT 21.51	MTS-255	T-7	\$179.95
E08J SCLPR/L2-281	.500	4.5	.281	.560		MTS-255	T-7	\$201.89
E08R SCLPR/L2-281	.500	8	.281	.560		MTS-255	T-7	\$228.23

Minimum Clearance Bars are intended for light machining with minimum bore clearance. Max depth of cut .015" - .020"

* bars .312 and smaller do not have flats

continued on next page...



! USE THE RIGHT SET SCREW
FLAT POINT, NOT CUP POINT !

Carbide Boring Bars (Positive)

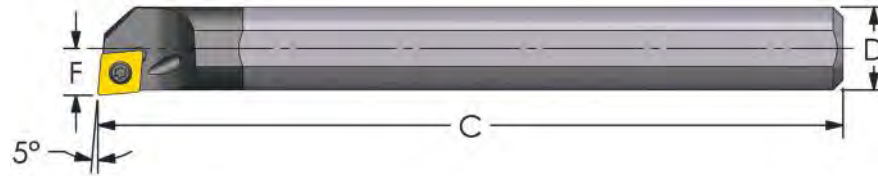

8:1 Ratio

Positive 80° Diamond (-5° Lead)

Coolant Thru

Designation	D Dia.	C OAL	F	Min Bore	Insert	Insert Screw	Key	Price
E06M SCLCR/L2 ▲	.375	6	.250	.460	CCMT 21.51	MTS-255	T-7	\$179.95
E08J SCLCR/L2 ▲	.500	4.5	.312	.600		MTS-255	T-7	\$201.89
E08R SCLCR/L2 ▲	.500	8	.312	.600		MTS-255	T-7	\$228.23
E10Q SCLCR/L2	.625	7	.406	.760		MTS-255	T-7	\$284.19
E10S SCLCR/L2	.625	10	.406	.760		MTS-255	T-7	\$345.64
E08J SCLCR/L3	.500	4.5	.344	.625	CCMT 32.51	MTS-35	T-15	\$201.89
E08R SCLCR/L3	.500	8	.344	.625		MTS-35	T-15	\$228.23
E10Q SCLCR/L3	.625	7	.406	.760		MTS-35	T-15	\$284.19
E10S SCLCR/L3	.625	10	.406	.760		MTS-35	T-15	\$345.64
E12Q SCLCR/L3	.750	7	.500	.920		MTS-35	T-15	\$356.61
E12S SCLCR/L3	.750	10	.500	.920	MTS-35	T-15	\$412.57	
E16R SCLCR/L3	1.000	8	.625	1.185	CCMT 432	MTS-35	T-15	\$527.78
E16T SCLCR/L3	1.000	12	.625	1.185		MTS-35	T-15	\$671.52
E20U SCLCR/L3	1.250	14	.765	1.465		MTS-35	T-15	\$1,254.16
E20U SCLCR/L4	1.250	14	.765	1.465		MTS-4	T-20	\$1,254.16
E24U SCLCR/L4	1.500	14	.890	1.730		MTS-4	T-20	\$1,514.21

New!

Also available in: Steel pg: 24 Heavy Metal pg: 73 Modular pg: 79 Chatter-Free pg: 96, 99, 114

▲ F Dimension Changed to Current Industry Standard

Minimum Clearance

Coolant Thru

Designation	D Dia.	C OAL	F	Min Bore	Insert	Insert Screw	Key	Price
E06M SCLCR/L2-203	.375	6	.203	.410	CCMT 21.51	MTS-255	T-7	\$179.95
E08J SCLCR/L2-281	.500	4.5	.281	.560		MTS-255	T-7	\$201.89
E08R SCLCR/L2-281	.500	8	.281	.560		MTS-255	T-7	\$228.23

Minimum Clearance Bars are intended for light machining with minimum bore clearance. Max depth of cut .015" - .020"

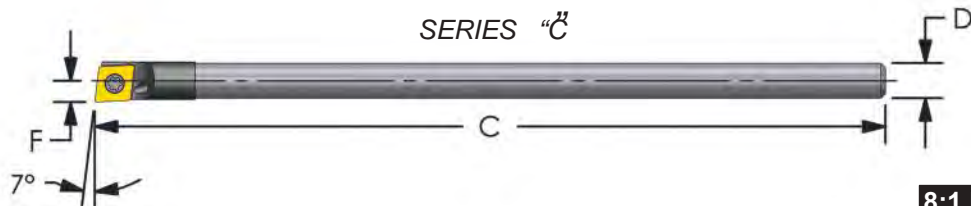

8:1 Ratio

Positive 80° Diamond (-7° Lead)

Coolant Thru

Designation	D Dia.	C OAL	F	Min Bore	Insert	Insert Screw	Key	Price
CCUD-165/156-6-7R *	.156	6	.095	.180	CDHB 1.20.60.5	MTS-183	T-6	\$203.00

Also available in: Steel pg: 25

* bars .312 and smaller do not have flats

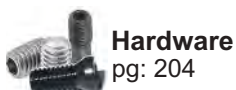

Hardware
pg: 204



Inserts
pg: 188

Proudly Made in Flushing, MI USA

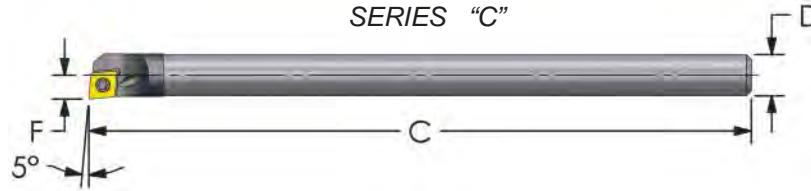

8:1 Ratio

Positive 80° Diamond (-5° Lead)

Coolant Thru

Designation	D Dia.	C OAL	F	Min Bore	Insert	Insert Screw	Key	Price
CCUD-180/187-4-5R *	.187	4	.104	.208	CDHB 1.20.60.5	MTS-183	T-6	\$190.92
CCUD-180/187-6-5R *	.187	6	.104	.208		MTS-183	T-6	\$203.00
CCUD-187-4-5R *	.187	4	.111	.222		MTS-183	T-6	\$190.92
CCUD-187-6-5R *	.187	6	.111	.222		MTS-183	T-6	\$203.00
CCUD-250-4-5R *	.250	4	.145	.285		MTS-184	T-6	\$190.92
CCUD-250-6-5R *	.250	6	.145	.285		MTS-184	T-6	\$203.00
CCUD-312-5-5R *	.312	5	.185	.360		MTS-184	T-6	\$203.00
CCUD-250-4-5R-1.5 *	.250	4	.145	.285		CDGW 1.510	MTS-184	T-6

New!

Also available in: [Steel pg: 25](#)

* bars .312 and smaller do not have flats

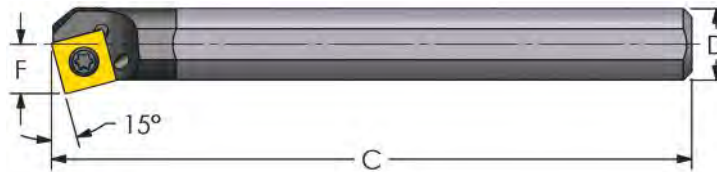

8:1 Ratio

Positive Square (15° Lead)

Coolant Thru

Designation	D Dia.	C OAL	F	Min Bore	Insert	Insert Screw	Key	Price
E08R SSKCR3	.500	8	.344	.625	SCMT 32.51	MTS-35	T-15	\$228.23
E10S SSKCR3	.625	10	.406	.760		MTS-35	T-15	\$345.64

Also available in: [Steel pg: 25](#) [Modular pg: 80](#)

SERIES "G, Q," S

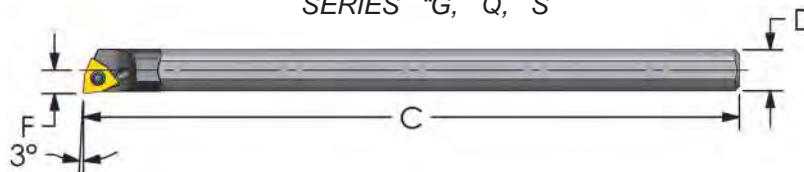

8:1 Ratio

Positive Trigon (-3° Lead)

Coolant Thru

Designation	D Dia.	C OAL	F	Min Bore	Insert	Insert Screw	Key	Price
GCUDW-187-6-3R/L	.187	6	.126	.260	WPGT 1.511	MTS-184	T-6	\$190.92
GCUDW-250-6-3R/L	.250	6	.143	.285		MTS-184	T-6	\$190.92
GCUDW-312-6-3R/L	.312	6	.174	.374		MTS-184	T-6	\$190.92
QCUDW-375-6-3R/L	.375	6	.211	.415	WPGT 21.50	MTS-255	T-7	\$216.16
QCUDW-500-8-3R/L	.500	8	.273	.540		MTS-255	T-7	\$279.70
SCUDW-625-10-3R	.625	10	.345	.675	WPMT 32.51	MTS-35	T-15	\$483.89
SCUDW-750-10-3R	.750	10	.407	.800		MTS-35	T-15	\$526.68

Also available in: [Steel pg: 27](#)

B

BORING

! USE THE RIGHT SET SCREW
FLAT POINT, NOT CUP POINT !

Carbide Boring Bars (Positive)

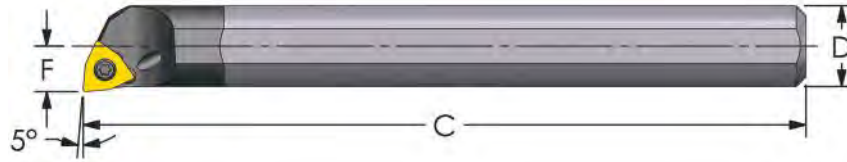

8:1 Ratio

Positive Trigon (-5° Lead)

No Coolant

Designation	D Dia.	C OAL	F	Min Bore	Insert	Insert Screw	Key	Price
C03H SWLCR1.2 *	.187	4	.102	.205	WCMT 1.210.5	MTS-183	T-6	\$155.81
C04H SWLCR1.2 *▲	.250	4	.172	.312		MTS-184	T-6	\$155.81
C05K SWLCR1.5 *▲	.312	5	.219	.395	WCMT 1.51.50.5	MTS-2	T-6	\$155.81
C06M SWLCR/L2 ▲	.375	6	.250	.460	WCMT 21.51	MTS-255	T-7	\$163.50
C08J SWLCR/L2 ▲	.500	4.5	.312	.600		MTS-255	T-7	\$184.34
C08R SWLCR/L2 ▲	.500	8	.312	.600		MTS-255	T-7	\$211.77

Also available in: [Steel pg: 26](#) [Heavy Metal pg: 74](#)

▲ F Dimension Changed to Current Industry Standard

Minimum Clearance

No Coolant

Designation	D Dia.	C OAL	F	Min Bore	Insert	Insert Screw	Key	Price
C04H SWLCR1.2-138 *	.250	4	.138	.275	WCMT 1.210.5	MTS-184	T-6	\$155.81
C05K SWLCR1.5-167 *	.312	5	.167	.345	WCMT 1.51.50.5	MTS-2	T-6	\$155.81
C06M SWLCR/L2-203	.375	6	.203	.400	WCMT 21.51	MTS-255	T-7	\$163.50
C08J SWLCR/L2-281	.500	4.5	.281	.560		MTS-255	T-7	\$184.34
C08R SWLCR/L2-281	.500	8	.281	.560		MTS-255	T-7	\$211.77

Minimum Clearance Bars are intended for light machining with minimum bore clearance Max depth of cut .015" - .020"

* bars .312 and smaller do not have flats

WE DO CUSTOM DESIGN & BUILDS

See pg 209 for more details

ultra-dex.com



ULTRADEXUSA.com

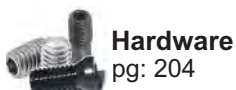

Hardware
pg: 204



Inserts
pg: 188

B

BORING

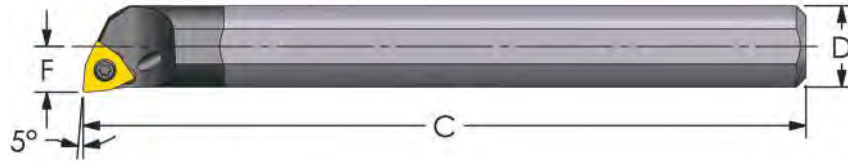

8:1 Ratio

Positive Trigon (-5° Lead)

Coolant Thru

Designation	D Dia.	C OAL	F	Min Bore	Insert	Insert Screw	Key	Price
E03H SWLCR1.2 *	.187	4	.102	.205	WCMT 1.210.5	MTS-183	T-6	\$171.17
E04H SWLCR1.2 *▲	.250	4	.172	.395		MTS-184	T-6	\$171.17
E05K SWLCR1.5 *▲	.312	5	.219	.410	WCMT 1.51.50.5	MTS-2	T-6	\$171.17
E06M SWLCR/L2 ▲	.375	6	.250	.460	WCMT 21.51	MTS-255	T-7	\$179.95
E08J SWLCR/L2 ▲	.500	4.5	.312	.600		MTS-255	T-7	\$201.89
E08R SWLCR/L2 ▲	.500	8	.312	.600		MTS-255	T-7	\$228.23
E10Q SWLCR/L2	.625	7	.406	.760		MTS-255	T-7	\$284.19
E10S SWLCR/L2	.625	10	.406	.760		MTS-255	T-7	\$345.64
E10Q SWLCR/L3	.625	7	.406	.760	WCMT 32.51	MTS-35	T-15	\$284.19
E10S SWLCR/L3	.625	10	.406	.760		MTS-35	T-15	\$345.64
E12Q SWLCR/L3	.750	7	.500	.920		MTS-35	T-15	\$356.61
E12S SWLCR/L3	.750	10	.500	.920		MTS-35	T-15	\$412.57
E16R SWLCR/L3	1.000	8	.625	1.185		MTS-35	T-15	\$527.78
E16T SWLCR/L3	1.000	12	.625	1.185		MTS-35	T-15	\$671.52

Also available in: Steel pg: 26 Heavy Metal pg: 74 Modular pg: 80

▲ F Dimension Changed to Current Industry Standard

Minimum Clearance

Coolant Thru

Designation	D Dia.	C OAL	F	Min Bore	Insert	Insert Screw	Key	Price
E04H SWLCR1.2-138 *	.250	4	.138	.275	WCMT 1.210.5	MTS-184	T-6	\$171.17
E05K SWLCR1.5-167 *	.312	5	.167	.345	WCMT 1.51.50.5	MTS-2	T-6	\$171.17
E06M SWLCR/L2-203	.375	6	.203	.410	WCMT 21.51	MTS-255	T-7	\$179.95
E08J SWLCR/L2-281	.500	4.5	.281	.560		MTS-255	T-7	\$201.89
E08R SWLCR/L2-281	.500	8	.281	.560		MTS-255	T-7	\$228.23

Minimum Clearance Bars are intended for light machining with minimum bore clearance. Max depth of cut .015" - .020"

* bars .312 and smaller do not have flats

SAME DAY SHIPPING!

On orders placed before 3:30pm EST

SEE PAGE 210 for more details...



! USE THE RIGHT SET SCREW
FLAT POINT, NOT CUP POINT !

Carbide Boring Bars (Positive)

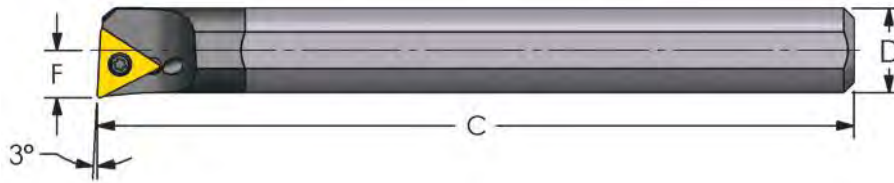

8:1 Ratio

Positive Triangle (-3° Lead)

No Coolant

Designation	D Dia.	C OAL	F	Min Bore	Insert	Insert Screw	Key	Price
C04H STUCR/L1.2 *▲	.250	4	.172	.312	TCMT 1.21.20.5	MTS-184	T-6	\$142.64
C05K STUCR/L1.2 *▲	.312	5	.219	.395		MTS-184	T-6	\$142.64
C06M STUCR/L1.2 ▲	.375	6	.250	.460		MTS-184	T-6	\$170.08
C06M STUCR/L2 ▲	.375	6	.250	.460	TCMT 21.51	MTS-255	T-7	\$170.08
C08J STUCR/L2 ▲	.500	4.5	.312	.600		MTS-255	T-7	\$184.34
C08R STUCR/L2 ▲	.500	8	.312	.600		MTS-255	T-7	\$211.77
C06M STUPR/L2 ▲	.375	6	.250	.460	TPMT 21.51	MTS-255	T-7	\$170.08
C08J STUPR/L2 ▲	.500	4.5	.312	.600		MTS-255	T-7	\$184.34
C08R STUPR/L2 ▲	.500	8	.312	.600		MTS-255	T-7	\$211.77

Also available in: Steel pg: 28 Heavy Metal pg: 75

▲ F Dimension Changed to Current Industry Standard

Minimum Clearance

No Coolant

Designation	D Dia.	C OAL	F	Min Bore	Insert	Insert Screw	Key	Price
C04H STUCR/L1.2-138 *	.250	4	.138	.275	TCMT 1.21.20.5	MTS-184	T-6	\$142.64
C05K STUCR/L1.2-167 *	.312	5	.167	.340		MTS-184	T-6	\$142.64
C06M STUCR/L1.2-203	.375	6	.203	.410		MTS-184	T-6	\$170.08
C06M STUCR/L2-203	.375	6	.203	.410	TCMT 21.51	MTS-255	T-7	\$170.08
C08J STUCR/L2-281	.500	4.5	.281	.560		MTS-255	T-7	\$184.34
C08R STUCR/L2-281	.500	8	.281	.570		MTS-255	T-7	\$211.77
C06M STUPR/L2-203	.375	6	.203	.410	TPMT 21.51	MTS-255	T-7	\$170.08
C08J STUPR/L2-281	.500	4.5	.281	.560		MTS-255	T-7	\$184.34
C08R STUPR/L2-281	.500	8	.281	.560		MTS-255	T-7	\$211.77

Minimum Clearance Bars are intended for light machining with minimum bore clearance. Max depth of cut .015" - .020"

* bars .312 and smaller do not have flats

DON'T THROW IT AWAY!

Send Us Your Damaged Tooling for Repair

See [pg. 208](#)
For More
Details

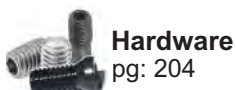

Hardware
pg: 204



Inserts
pg: 188

Proudly Made in Flushing, MI USA

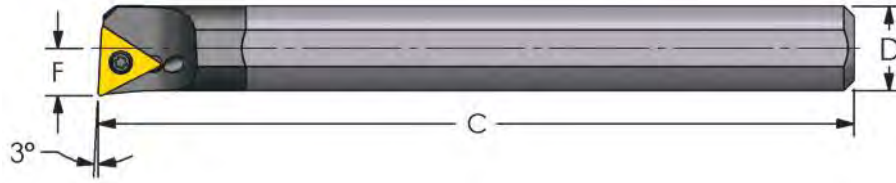

8:1 Ratio

Positive Triangle (-3° Lead)

Coolant Thru

Designation	D Dia.	C OAL	F	Min Bore	Insert	Insert Screw	Key	Price
E04H STUCR/L1.2 *▲	.250	4	.172	.312	TCMT 1.21.20.5	MTS-184	T-6	\$160.20
E05K STUCR/L1.2 *▲	.312	5	.219	.395		MTS-184	T-6	\$160.20
E06M STUCR/L1.2 ▲	.375	6	.250	.460		MTS-184	T-6	\$179.95
E06M STUCR/L2 ▲	.375	6	.250	.460	TCMT 21.51	MTS-255	T-7	\$179.95
E08J STUCR/L2 ▲	.500	4.5	.312	.600		MTS-255	T-7	\$201.89
E08R STUCR/L2 ▲	.500	8	.312	.600		MTS-255	T-7	\$228.23
E10Q STUCR/L2	.625	7	.406	.760		MTS-255	T-7	\$284.19
E10S STUCR/L2	.625	10	.406	.760	TCMT 32.51	MTS-255	T-7	\$345.64
E12Q STUCR/L3	.750	7	.500	.920		MTS-35	T-15	\$356.61
E12S STUCR/L3	.750	10	.500	.920		MTS-35	T-15	\$412.57
E16R STUCR/L3	1.000	8	.625	1.185		MTS-35	T-15	\$527.78
E16T STUCR/L3	1.000	12	.625	1.185		MTS-35	T-15	\$671.52
E06M STUPR/L2 ▲	.375	6	.250	.460	TPMT 21.51	MTS-255	T-7	\$179.95
E08J STUPR/L2 ▲	.500	4.5	.312	.600		MTS-255	T-7	\$201.89
E08R STUPR/L2 ▲	.500	8	.312	.600		MTS-255	T-7	\$228.23
E10Q STUPR/L2	.625	7	.406	.760		MTS-255	T-7	\$284.19
E10S STUPR/L2	.625	10	.406	.760	TPMT 32.51	MTS-255	T-7	\$345.64
E12Q STUPR/L3	.750	7	.500	.920		MTS-35	T-15	\$356.61
E12S STUPR/L3	.750	10	.500	.920		MTS-35	T-15	\$412.57
E16R STUPR/L3	1.000	8	.625	1.185		MTS-35	T-15	\$527.78
E16T STUPR/L3	1.000	12	.625	1.185	MTS-35	T-15	\$671.52	

Also available in: Steel pg: 29 Heavy Metal pg: 75 Modular pg: 81 Chatter-Free pg: 100, 115

▲ F Dimension Changed to Current Industry Standard

Minimum Clearance

Coolant Thru

Designation	D Dia.	C OAL	F	Min Bore	Insert	Insert Screw	Key	Price
E04H STUCR/L1.2-138 *	.250	4	.138	.275	TCMT 1.21.20.5	MTS-184	T-6	\$160.20
E05K STUCR/L1.2-167 *	.312	5	.167	.340		MTS-184	T-6	\$160.20
E06M STUCR/L1.2-203	.375	6	.203	.410		MTS-184	T-6	\$179.95
E06M STUCR/L2-203	.375	6	.203	.410	TCMT 21.51	MTS-255	T-7	\$179.95
E08J STUCR/L2-281	.500	4.5	.281	.560		MTS-255	T-7	\$201.89
E08R STUCR/L2-281	.500	8	.281	.560		MTS-255	T-7	\$228.23
E06M STUPR/L2-203	.375	6	.203	.410	TPMT 21.51	MTS-255	T-7	\$179.95
E08J STUPR/L2-281	.500	4.5	.281	.560		MTS-255	T-7	\$201.89
E08R STUPR/L2-281	.500	8	.281	.560		MTS-255	T-7	\$228.23

Minimum Clearance Bars are intended for light machining with minimum bore clearance. Max depth of cut .015" - .020"

* bars .312 and smaller do not have flats

B

BORING

! USE THE RIGHT SET SCREW
FLAT POINT, NOT CUP POINT !

Carbide Boring Bars (Positive)

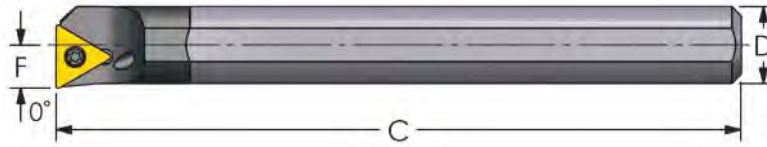

Positive Triangle (0° Lead)

8:1 Ratio

No Coolant

Designation	D Dia.	C OAL	F	Min Bore	Insert	Insert Screw	Key	Price
C06M STFPR2 ▲	.375	6	.250	.460	TPMT 21.51	MTS-255	T-7	\$163.50
C08J STFPR2 ▲	.500	4.5	.312	.600		MTS-255	T-7	\$184.34
C08R STFPR2 ▲	.500	8	.312	.600		MTS-255	T-7	\$211.77
C06M STFCR2 ▲	.375	6	.250	.460	TCMT 21.51	MTS-255	T-7	\$163.50
C08J STFCR2 ▲	.500	4.5	.312	.600		MTS-255	T-7	\$184.34
C08R STFCR2 ▲	.500	8	.312	.600		MTS-255	T-7	\$211.77

Also available in: [Steel pg: 30](#)

▲ F Dimension Changed to Current Industry Standard

Minimum Clearance

No Coolant

Designation	D Dia.	C OAL	F	Min Bore	Insert	Insert Screw	Key	Price
C06M STFPR2-203	.375	6	.203	.410	TPMT 21.51	MTS-255	T-7	\$163.50
C08J STFPR2-281	.500	4.5	.281	.560		MTS-255	T-7	\$184.34
C08R STFPR2-281	.500	8	.281	.560		MTS-255	T-7	\$211.77
C06M STFCR2-203	.375	6	.203	.410	TCMT 21.51	MTS-255	T-7	\$163.50
C08J STFCR2-281	.500	4.5	.281	.560		MTS-255	T-7	\$184.34
C08R STFCR2-281	.500	8	.281	.560		MTS-255	T-7	\$211.77

Minimum Clearance Bars are intended for light machining with minimum bore clearance. Max depth of cut .015" - .020"



WE DO SPECIALS!
CAT40/50/60, BT, HSK...
ANY type ANY size

CALL FOR PRICING
810-638-5388

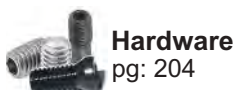

ULTRADEXUSA.com

B

BORING

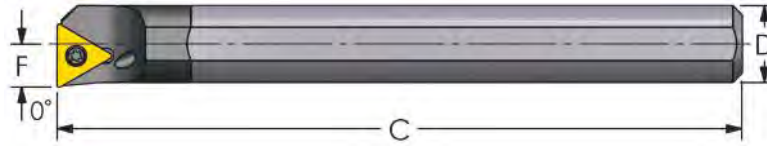

8:1 Ratio

Positive Triangle (0° Lead)

Coolant Thru

Designation	D Dia.	C OAL	F	Min Bore	Insert	Insert Screw	Key	Price
E06M STFPR2 ▲	.375	6	.250	.460	TPMT 21.51	MTS-255	T-7	\$179.95
E08J STFPR2 ▲	.500	4.5	.312	.600		MTS-255	T-7	\$201.89
E08R STFPR2 ▲	.500	8	.312	.600		MTS-255	T-7	\$228.23
E10Q STFPR2	.625	7	.406	.760		MTS-255	T-7	\$284.19
E10S STFPR2	.625	10	.406	.760		MTS-255	T-7	\$345.64
E12Q STFPR3	.750	7	.500	.920	TPMT 32.51	MTS-35	T-15	\$356.61
E12S STFPR3	.750	10	.500	.920		MTS-35	T-15	\$412.57
E16R STFPR3	1.000	8	.625	1.185		MTS-35	T-15	\$527.78
E16T STFPR3	1.000	12	.625	1.185		MTS-35	T-15	\$671.52
E06M STFCR2 ▲	.375	6	.250	.460		TCMT 21.51	MTS-255	T-7
E08J STFCR2 ▲	.500	4.5	.312	.600	MTS-255		T-7	\$201.89
E08R STFCR2 ▲	.500	8	.312	.600	MTS-255		T-7	\$228.23
E10Q STFCR2	.625	7	.406	.760	MTS-255		T-7	\$284.19
E10S STFCR2	.625	10	.406	.760	MTS-255		T-7	\$345.64
E12Q STFCR3	.750	7	.500	.920	TCMT 32.51	MTS-35	T-15	\$356.61
E12S STFCR3	.750	10	.500	.920		MTS-35	T-15	\$412.57
E16R STFCR3	1.000	8	.625	1.185		MTS-35	T-15	\$527.78
E16T STFCR3	1.000	12	.625	1.185		MTS-35	T-15	\$671.52

Also available in: Steel pg: 31 Chatter-Free pg: 100, 115

▲ F Dimension Changed to Current Industry Standard

Minimum Clearance

Coolant Thru

Designation	D Dia.	C OAL	F	Min Bore	Insert	Insert Screw	Key	Price
E06M STFPR2-203	.375	6	.203	.410	TPMT 21.51	MTS-255	T-7	\$179.95
E08J STFPR2-281	.500	4.5	.281	.560		MTS-255	T-7	\$201.89
E08R STFPR2-281	.500	8	.281	.560		MTS-255	T-7	\$228.23
E06M STFCR2-203	.375	6	.203	.410	TCMT 21.51	MTS-255	T-7	\$179.95
E08J STFCR2-281	.500	4.5	.281	.560		MTS-255	T-7	\$201.89
E08R STFCR2-281	.500	8	.281	.560		MTS-255	T-7	\$228.23

Minimum Clearance Bars are intended for light machining with minimum bore clearance. Max depth of cut .015" - .020"



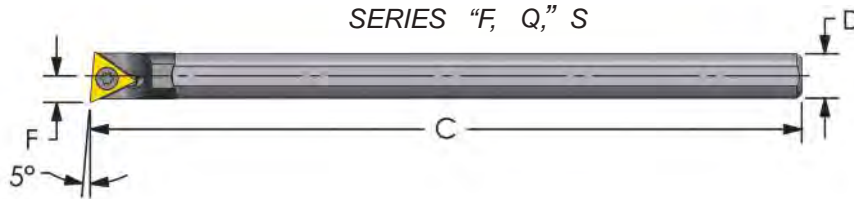

8:1 Ratio

Positive Triangle (-5° Lead)

Coolant Thru

Designation	D Dia.	C OAL	F	Min Bore	Insert	Insert Screw	Key	Price
FCUD-187-4-5R *	.187	4	.126	.275	TDHB 1.280.750.5	MTS-224	T-7	\$177.75
FCUD-187-6-5R *	.187	6	.126	.275		MTS-224	T-7	\$207.39
FCUD-250-4-5R *	.250	4	.156	.300		MTS-224	T-7	\$177.75
FCUD-250-6-5R *	.250	6	.156	.300		MTS-224	T-7	\$190.92
FCUD-312-4-5R *	.312	4	.187	.360		MTS-224	T-7	\$177.75
FCUD-312-6-5R *	.312	6	.187	.360		MTS-224	T-7	\$190.92
QCUD-375-6-5R	.375	6	.228	.438	TPCB 220.5	ETS 4-40	T-10	\$216.16
QCUD-375-10-5R	.375	10	.228	.438		ETS 4-40	T-10	\$237.01
QCUD-500-8-5R	.500	8	.296	.563		ETS 4-40	T-10	\$278.70
SCUD-625-6-5R	.625	6	.393	.731	TD 320.5	ETS 4-40	T-10	\$278.70
SCUD-625-10-5R	.625	10	.393	.731		ETS 4-40	T-10	\$483.89
SCUD-750-10-5R	.750	10	.460	.855		ETS 4-40	T-10	\$420.25
SCUD-1000-12-5R	1.000	12	.585	1.105		ETS 4-40	T-10	\$592.52

Also available in: **Steel pg: 27**

*bars .312 and smaller do not have flats

Need even MORE reach? With NO chatter?



Try our **CHATTER-FREE** Boring Bars with internal dampening technology, tunable with the adjust of a dial.

Available in
Standard + Serrated
Connections
SEE PAGE
92

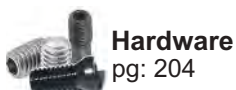

Hardware
pg: 204



Inserts
pg: 188

ULTRA-DEX

Proudly Made in Flushing, MI USA

B

BORING

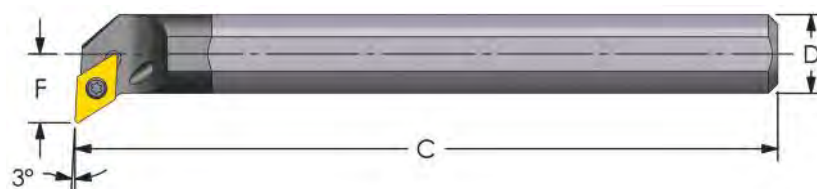

8:1 Ratio

Positive 55° Diamond (-3° Lead) Profiling

No Coolant

Designation	D Dia.	C OAL	F	Min Bore	Insert	Insert Screw	Key	Price
C06M SDUCR/L2	.375	6	.375	.585	DCMT 21.51	MTS-255	T-7	\$171.17
C08J SDUCR/L2	.500	4.5	.437	.720		MTS-255	T-7	\$199.70
C08R SDUCR/L2	.500	8	.437	.720		MTS-255	T-7	\$227.14

Also available in: [Steel pg: 32](#)

Positive 55° Diamond (-3° Lead) Profiling

Coolant Thru

Designation	D Dia.	C OAL	F	Min Bore	Insert	Insert Screw	Key	Price
E06M SDUCR/L2	.375	6	.375	.585	DCMT 21.51	MTS-255	T-7	\$188.73
E08J SDUCR/L2	.500	4.5	.437	.720		MTS-255	T-7	\$208.48
E08R SDUCR/L2	.500	8	.437	.720		MTS-255	T-7	\$238.11
E10Q SDUCR/L2	.625	7	.500	.850		MTS-255	T-7	\$292.97
E10S SDUCR/L2	.625	10	.500	.850		MTS-255	T-7	\$355.51
E12Q SDUCR/L3	.750	7	.625	1.050	DCMT 32.51	MTS-35	T-15	\$365.39
E12S SDUCR/L3	.750	10	.625	1.050		MTS-35	T-15	\$422.45
E16R SDUCR/L3	1.000	8	.750	1.310		MTS-35	T-15	\$542.04
E16T SDUCR/L3	1.000	12	.750	1.310		MTS-35	T-15	\$689.07
E12Q SDUPR/L3	.750	7	.625	1.050	DPMT 32.51	MTS-35	T-15	\$365.39
E12S SDUPR/L3	.750	10	.625	1.050		MTS-35	T-15	\$422.45
E16R SDUPR/L3	1.000	8	.750	1.310		MTS-35	T-15	\$542.04
E16T SDUPR/L3	1.000	12	.750	1.310		MTS-35	T-15	\$689.07

Also available in: [Steel pg: 32](#) [Modular pg: 81](#) [CFT pg: 96, 101, 116](#)

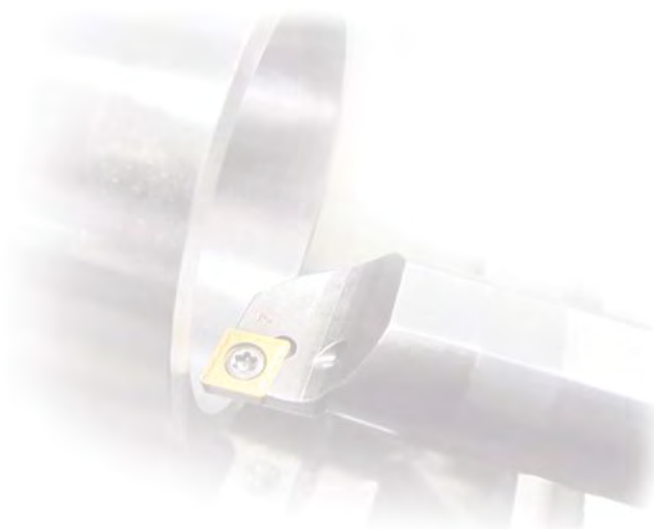

! USE THE RIGHT SET SCREW
FLAT POINT, NOT CUP POINT !

Carbide Boring Bars (Positive)

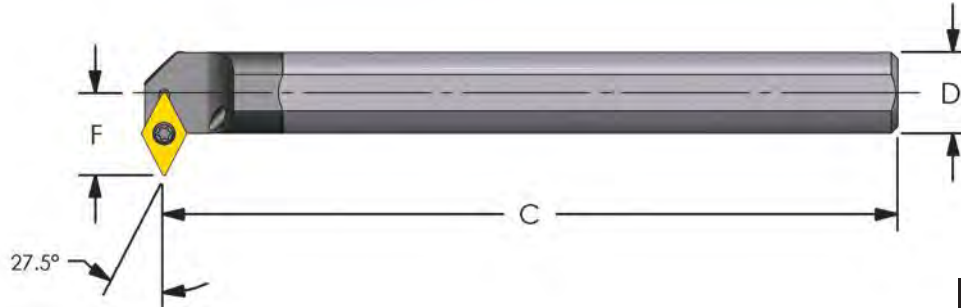

8:1 Ratio

Positive 55° Diamond (27.5° Lead) Profiling

Coolant Thru

Designation	D Dia.	C OAL	F	Min Bore	Insert	Insert Screw	Key	Price
E10Q SDNCR2	.625	6.86	.562	.920	DCMT 21.51	MTS-255	T-7	\$292.97
E12S SDNCR3	.750	9.80	.765	1.190	DCMT 32.51	MTS-35	T-15	\$422.45

Also available in: [Steel pg: 34](#) [Modular pg: 82](#) [Chatter-Free pg: 116](#)

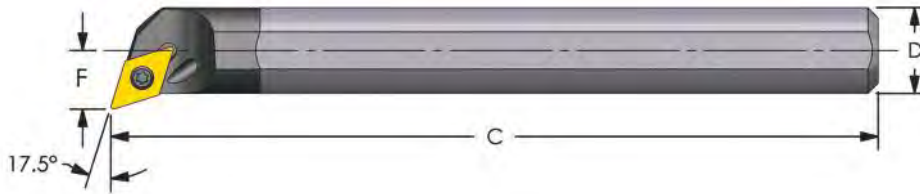

8:1 Ratio

Positive 55° Diamond (-17.5° Lead) Profiling

Coolant Thru

Designation	D Dia.	C OAL	F	Min Bore	Insert	Insert Screw	Key	Price
E06M SDQCR2	.375	6	.281	.490	DCMT 21.51	MTS-255	T-7	\$188.73
E08R SDQCR2	.500	8	.341	.620		MTS-255	T-7	\$238.11
E10S SDQCR2	.625	10	.406	.760		MTS-255	T-7	\$355.51

Also available in: [Steel pg: 34](#) [Modular pg: 82](#)

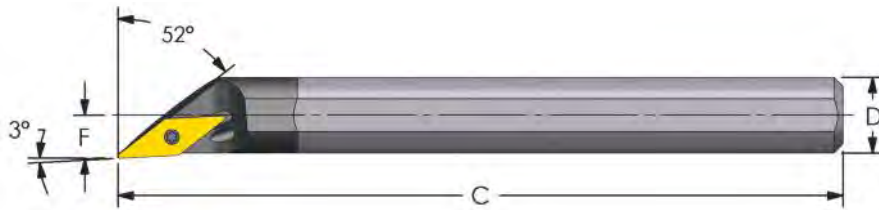

8:1 Ratio

Positive 35° Diamond (-52° Lead) Profiling

Coolant Thru

Designation	D Dia.	C OAL	F	Min Bore	Insert	Insert Screw	Key	Price
E06M SVJBR2	.375	6	.223	.445	VBMT 21.51	MTS-2.5L	T-7	\$188.73
E08R SVJBR2	.500	8	.285	.570		MTS-2.5L	T-7	\$238.11
E10S SVJBR2	.625	10	.348	.700		MTS-2.5L	T-7	\$355.51
E12S SVJBR3	.750	10	.421	.840	VBMT 331	MTS-3.5L	T-15	\$422.45

Also available in: [Modular pg: 83](#)

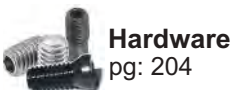

Hardware
pg: 204



Inserts
pg: 188

MADE HERE

ULTRA-DEX

ULTRADEXUSA.com

B

BORING

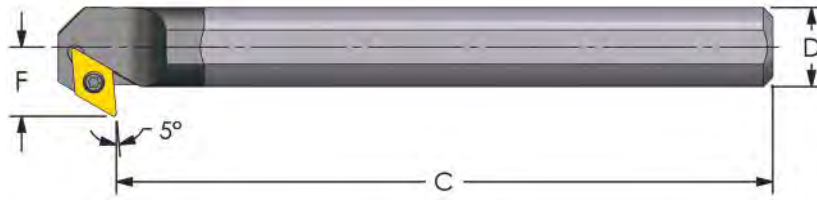

8:1 Ratio

Positive 55° Diamond (5° Lead) Back Facing

No Coolant

Designation	D Dia.	C OAL	F	Min Bore	Insert	Insert Screw	Key	Price
C06M SDXCR/L2	.375	6	.375	.585	DCMT 21.51	MTS-255	T-7	\$171.17
C08J SDXCR/L2	.500	4.5	.437	.720		MTS-255	T-7	\$199.70
C08R SDXCR/L2	.500	8	.437	.720		MTS-255	T-7	\$227.14

Also available in: [Steel pg: 35](#)

Positive 55° Diamond (5° Lead) Back Facing

Coolant Thru

Designation	D Dia.	C OAL	F	Min Bore	Insert	Insert Screw	Key	Price
E06M SDXCR/L2	.375	6	.375	.585	DCMT 21.51	MTS-255	T-7	\$188.73
E08J SDXCR/L2	.500	4.5	.437	.720		MTS-255	T-7	\$208.48
E08R SDXCR/L2	.500	8	.437	.720		MTS-255	T-7	\$238.11
E10Q SDXCR/L2	.625	7	.500	.850		MTS-255	T-7	\$292.97
E10S SDXCR/L2	.625	10	.500	.850		MTS-255	T-7	\$355.51
E12Q SDXCR/L3	.750	7	.625	1.050	DCMT 32.51	MTS-35	T-15	\$365.39
E12S SDXCR/L3	.750	10	.625	1.050		MTS-35	T-15	\$422.45
E16R SDXCR/L3	1.000	8	.750	1.310		MTS-35	T-15	\$542.04
E16T SDXCR/L3	1.000	12	.750	1.310		MTS-35	T-15	\$689.07

Also available in: [Steel pg: 35](#) [Modular pg: 83](#) [Chatter-Free pg: 117](#)

Braze Joints **GUARANTEED**



Against Failure

*If the bar has been altered by anyone other than Ultra-Dex the warranty will be void.

B

BORING

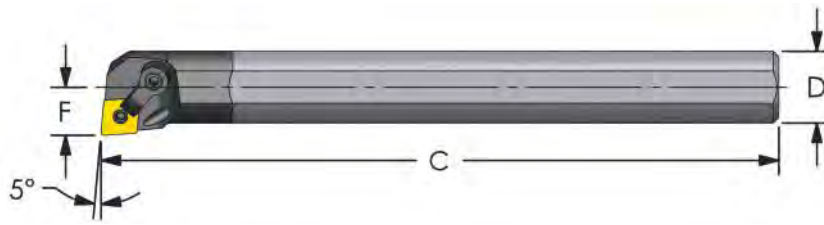

8:1 Ratio

Negative 80° Diamond (-5° Lead)

Coolant Thru

Designation	D Dia.	C OAL	F	Min Bore	Insert	Shim Seat	Clamp	Clamp Screw	Lock Pin	Price
E12Q MCLNR/L3	.750	7	.500	.920	CNMG 322	--	CL-7	XNS-36	NL-33	\$387.33
E12S MCLNR/L3	.750	10	.500	.920		--	CL-7	XNS-36	NL-33	\$446.59
E16R MCLNR/L3	1.000	8	.640	1.200		--	CL-7	XNS-36	NL-33	\$559.60
E16T MCLNR/L3	1.000	12	.640	1.200		--	CL-7	XNS-36	NL-33	\$702.24
E16R MCLNR/L4	1.000	8	.640	1.200	CNMG 432	--	CL-20	XNS-47	NL-44	\$559.60
E16T MCLNR/L4	1.000	12	.640	1.200		--	CL-20	XNS-47	NL-44	\$702.24
E20U MCLNR/L4	1.250	14	.765	1.470		ICSN-433	CL-20	XNS-47	NL-46	\$1,300.22
E24U MCLNR/L4	1.500	14	.890	1.730		ICSN-433	CL-20	XNS-47	NL-46	\$1,549.28

Also available in: [Steel pg: 36](#) [Hybrid pg: 49](#) [Modular pg: 84](#) [Chatter-Free pg: 102](#)

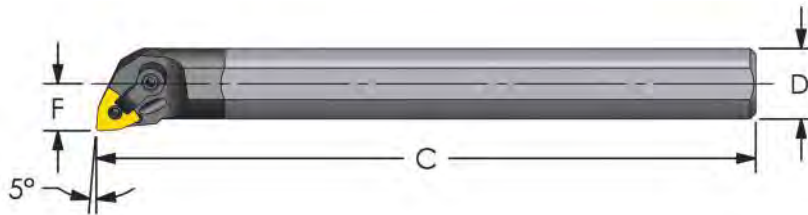

8:1 Ratio

Negative Trigon (-5° Lead)

Coolant Thru

Designation	D Dia.	C OAL	F	Min Bore	Insert	Shim Seat	Clamp	Clamp Screw	Lock Pin	Price
E12Q MWLNR/L3	.750	7	.500	.920	WNMG 332	--	CL-7	XNS-36	NL-33L	\$387.33
E12S MWLNR/L3	.750	10	.500	.920		--	CL-7	XNS-36	NL-33L	\$446.59
E16R MWLNR/L3	1.000	8	.640	1.200		--	CL-7	XNS-36	NL-33L	\$559.60
E16T MWLNR/L3	1.000	12	.640	1.200		--	CL-7	XNS-36	NL-33L	\$702.24
E16R MWLNR/L4	1.000	8	.640	1.200	WNMG 432	--	CL-20	XNS-47	NL-44	\$559.60
E16T MWLNR/L4	1.000	12	.640	1.200		--	CL-20	XNS-47	NL-44	\$702.24
E20U MWLNR/L4	1.250	14	.765	1.470		IWSN-433	CL-20	XNS-47	NL-46	\$1,300.22
E24U MWLNR/L4	1.500	14	.890	1.730		IWSN-433	CL-20	XNS-47	NL-46	\$1,549.28

Also available in: [Steel pg: 37](#) [Hybrid pg: 49](#) [Modular pg: 85](#) [Chatter-Free pg: 104](#)

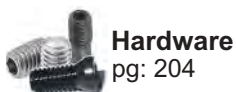

Hardware
pg: 204



Inserts
pg: 188



Proudly Made in Flushing, MI

B

BORING

Carbide Boring Bars (Threading / Grooving)

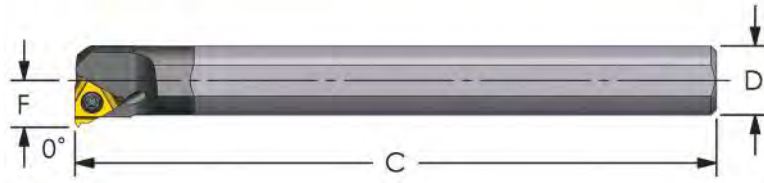

8:1 Ratio

Threading/Grooving Laydown

Coolant Thru

Designation Right Hand	D Dia.	C OAL	F	Min Bore	Insert	Insert Screw	Anvil Screw	Anvil	Price
E08R LSER2	.500	8	.308	.588	2IR	SR34505L	--	--	\$238.11
E10Q LSER2	.625	7	.371	.721		SR34505L	--	--	\$294.06
E12Q LSER3	.750	7	.510	.935	3IR	MTS-35	--	--	\$387.33
E12S LSER3	.750	10	.510	.935		MTS-35	--	--	\$446.59
E16R LSER3	1.000	8	.650	1.210		SA3T	SY3T	YI3	\$559.60
E16T LSER3	1.000	12	.650	1.210		SA3T	SY3T	YI3	\$702.24

Designation Left Hand	D Dia.	C OAL	F	Min Bore	Insert	Insert Screw	Anvil Screw	Anvil	Price
E08R LSEL2	.500	8	.308	.588	2IL	SR34505L	--	--	\$238.11
E10Q LSEL2	.625	7	.371	.721		SR34505L	--	--	\$294.06
E12Q LSEL3	.750	7	.510	.935	3IL	MTS-35	--	--	\$387.33
E12S LSEL3	.750	10	.510	.935		MTS-35	--	--	\$446.59
E16R LSEL3	1.000	8	.650	1.210		SA3T	SY3T	YE3	\$559.60
E16T LSEL3	1.000	12	.650	1.210		SA3T	SY3T	YE3	\$702.24

Also available in: [Steel pg: 40](#) [Modular pg: 90](#) [Chatter-Free pg: 96, 108, 121](#)

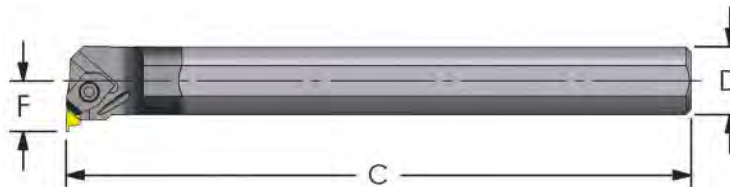

8:1 Ratio

Threading/Grooving Top Notch

Coolant Thru

Designation Right Hand	D Dia.	C OAL	F	Min Bore	Insert	Clamp	Clamp Screw	Price
E08R NER2	.500	8	.437	.730	NG 2L	CM-147	6-32	\$324.79
E10S NER2	.625	10	.500	1.000		CM-75	6-32	\$445.48
E12S NER2	.750	10	.562	1.120		CM-75	6-32	\$519.00
Designation Left Hand	D Dia.	C OAL	F	Min Bore	Insert	Clamp	Clamp Screw	Price
E08R NEL2	.500	8	.437	.730	NG 2R	CM-146	6-32	\$324.79
E10S NEL2	.625	10	.500	1.000		CM-74	6-32	\$445.48
E12S NEL2	.750	10	.562	1.120		CM-74	6-32	\$519.00

Also available in: [Steel pg: 40](#) [Modular pg: 91](#) [Chatter-Free pg: 109, 121](#)

See pg 203 for our



Top Notch Grooving Inserts

B

BORING

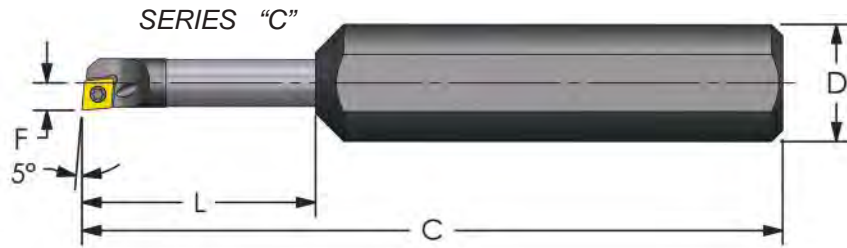

Positive 80° Diamond (-5° Lead) Reduced Neck

Coolant Thru

Designation	D Dia.	Head Dia.	C OAL	L Neck Length	F	Min Bore	Insert	Insert Screw	Key	Price
CCUD-180/500-7/8-5R	.500	.189	2.38	.875	.104	.208	CDHB 1.20.60.5	MTS-183	T-6	\$255.66
CCUD-203/500-1-5R	.500	.210	2.5	1.000	.119	.230		MTS-183	T-6	\$255.66
CCUD-180/625-7/8-5R	.625	.189	3	.875	.104	.208		MTS-183	T-6	\$283.09
CCUD-203/625-1-5R	.625	.210	3.5	1.000	.119	.230		MTS-183	T-6	\$255.66
CCUD-250/625-1 1/4-5R	.625	.260	3	1.250	.145	.285		MTS-184	T-6	\$273.22

Also available in: Steel pg: 44

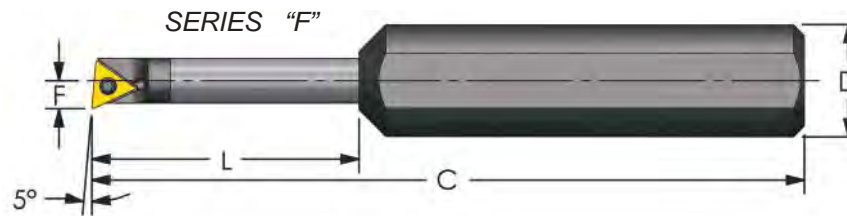

Positive Triangle (-5° Lead) Reduced Neck

Coolant Thru

Designation	D Dia.	Head Dia.	C OAL	L Neck Length	F	Min Bore	Insert	Insert Screw	Key	Price
FCUD-250/500-1 1/4-5R	.500	.260	2.75	1.250	.156	.300	TDHB 1.280.750.5	MTS-224	T-7	\$242.50
FCUD-312/500-3 1/8-5R	.500	.322	4.63	3.125	.187	.360		MTS-224	T-7	\$247.98
FCUD-250/625-1 1/4-5R	.625	.260	4	1.250	.156	.300		MTS-224	T-7	\$255.66
FCUD-312/625-1 1/2-5R	.625	.322	4	1.500	.187	.360		MTS-224	T-7	\$255.66

Also available in: Steel pg: 45

SAME DAY SHIPPING!

On orders placed before 3:30pm EST
SEE PAGE 210 for more details...

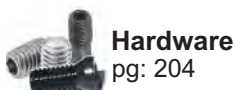
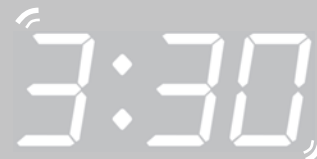

Hardware
pg: 204



Inserts
pg: 188



ULTRADEXUSA.com

B

BORING



SOLID CARBIDE SMALL BORING BARS

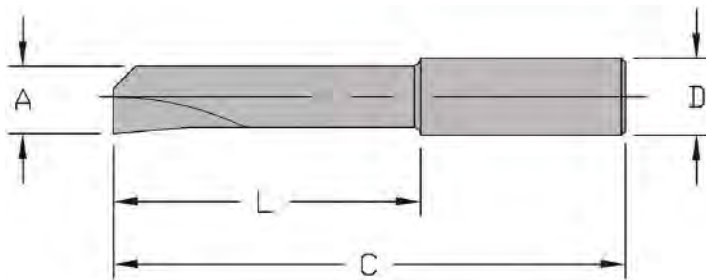

8:1 Ratio

No Coolant

Positive 80° Diamond

Designation	A Min Hole Dia.	L Max Depth	D Shank Dia.	C OAL	Price by Grade		
					UD5	UD51	UD52
UD125-060-188R	.060	.188	.125	1.500	\$21.95	\$24.69	\$25.24
UD125-080-375R	.080	.375	.125		\$21.95	\$24.69	\$25.24
UD125-090-500R	.090	.500	.125		\$21.95	\$24.69	\$25.24
UD125-120-625R	.120	.625	.125		\$21.95	\$24.69	\$25.24
UD188-150-750R	.150	.750	.188	2.000	\$26.33	\$29.63	\$30.18
UD188-180-1.00R	.180	1.000	.188		\$26.33	\$29.63	\$30.18
UD250-210-1.25R	.210	1.250	.250	2.500	\$34.02	\$41.15	\$42.80
UD250-240-1.25R	.240	1.250	.250		\$35.11	\$42.24	\$43.89
UD312-270-1.25R	.270	1.250	.312		\$42.80	\$49.93	\$51.58
UD312-300-1.25R	.300	1.250	.312		\$42.80	\$49.93	\$51.58
UD375-330-1.50R	.330	1.500	.375		\$59.25	\$66.38	\$68.03
UD375-360-1.50R	.360	1.500	.375		\$59.25	\$66.38	\$68.03

UD5 Uncoated – Used for machining carbon alloy steels, this grade of insert provides excellent toughness and wear resistance.

UD51 General purpose Tin (CVD) coated steel grade - used for roughing and semi-finishing of carbon alloy and stainless steel.

UD52 Tough general purpose steel grade with multi-layer titanium aluminum nitride coating for alloy steel, aluminum alloys, austenitic stainless and carbon steels, copper alloys and exotic alloys.

B

BORING



The following services are for **Carbide** bars only:

Cut-Off Service	Extra-Flat Service
up to 3/8" diameter: \$15	up to 5/16" diameter: \$19
1/2" diameter: \$20	3/8" - 1/2" diameter: \$24
5/8" diameter: \$25	5/8" - 3/4" diameter: \$29
3/4" diameter: \$30	1" - 2" diameter: \$51
1" diameter: \$45	
1 1/4" diameter: \$55	
1 1/2" diameter: \$80	
1 3/4" diameter: \$90	
2" diameter: \$105	

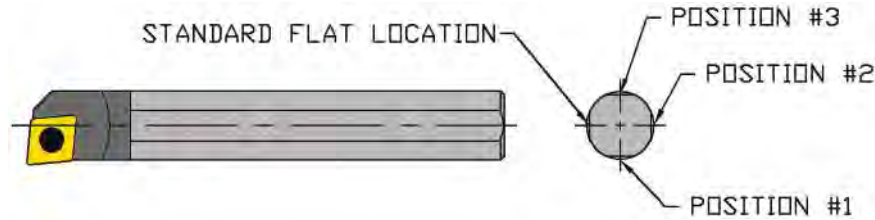

Ordering is easy, Use part # "Cut-Off" and specify the length in the item description
Use part # "Extra-Flat" and specify the location in the item description

Have us braze on a steel coolant adapter
to any **Carbide** Boring Bar 1/2" or larger!



Comes with 1/16-27 NPT (or) 1/8-27 NPT
Plastic loc-line NOT included

Item Designations:
Coolant Adapter - 1/16
Coolant Adapter - 1/8

Designation Depends on the Diameter of the Bar:
Coolant Adapter-1/16 for 1/2" Diameter Bars
Coolant Adapter-1/8 for 5/8" Diameter Bars and Larger

ONLY
\$39.95

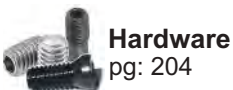

Hardware
pg: 204



Inserts
pg: 188



Proudly Made in Flushing, MI USA

B

BORING

ULTRA-DEX

HEAVY METAL BORING BARS

B

BORING

Vibration DAMPENING

Help Reduce Chatter in your Application

- Machine Deeper Bores
- Achieve Better Precision and Finish

.187" - .750" Diameters

6:1 Ratio



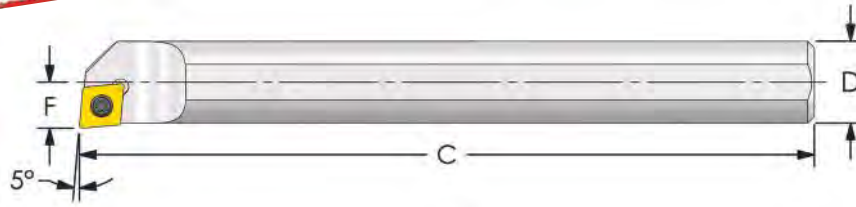

6:1 Ratio

Positive 80° Diamond (-5° Lead)

No Coolant

Designation	D Dia.	C OAL	F	Min Bore	Insert	Insert Screw	Key	Price
J03F SCLDR/L1.2 *	.187	3	.102	.205	CDHB 1.20.60	MTS-182	T-6	\$108.63
J04F SCLDR/L1.5-138 * ■	.250	3	.138	.275	CDGW 1.510	MTS-184	T-6	\$119.61

J05H SCLPR/L1.8-167 * ■	.312	4	.167	.340	CPMT 1.81.20.5	MTS-224	T-7	\$145.94
-------------------------	------	---	------	------	----------------	---------	-----	----------

Also available in: Steel pg: 23 Hybrid pg: 49 Carbide pg: 53

Positive 80° Diamond (-5° Lead)

Coolant Thru

Designation	D Dia.	C OAL	F	Min Bore	Insert	Insert Screw	Key	Price
HM06J SCLPR/L2-203 ■	.375	4.5	.203	.410	CPMT 21.51	MTS-255	T-7	\$143.75
HM06Q SCLPR/L2-203 ■	.375	7	.203	.410		MTS-255	T-7	\$188.73
HM08J SCLPR/L2-281 ■	.500	4.5	.281	.560		MTS-255	T-7	\$185.44
HM08Q SCLPR/L2-281 ■	.500	7	.281	.560		MTS-255	T-7	\$256.76
HM10J SCLPR/L2	.625	4.5	.406	.760		MTS-255	T-7	\$240.30
HM10Q SCLPR/L2	.625	7	.406	.760	MTS-255	T-7	\$320.40	
HM10J SCLPR/L3	.625	4.5	.406	.760	CPMT 32.51	MTS-35	T-15	\$240.30
HM10Q SCLPR/L3	.625	7	.406	.760		MTS-35	T-15	\$320.40
HM12J SCLPR/L3	.750	4.5	.500	.920		MTS-35	T-15	\$342.34
HM12Q SCLPR/L3	.750	7	.500	.920		MTS-35	T-15	\$475.11

HM06J SCLCR/L2-203 ■	.375	4.5	.203	.410	CCMT 21.51	MTS-255	T-7	\$143.75
HM06Q SCLCR/L2-203 ■	.375	7	.203	.410		MTS-255	T-7	\$188.73
HM08J SCLCR/L2-281 ■	.500	4.5	.281	.560		MTS-255	T-7	\$185.44
HM08Q SCLCR/L2-281 ■	.500	7	.281	.560		MTS-255	T-7	\$256.76
HM10J SCLCR/L2	.625	4.5	.406	.760		MTS-255	T-7	\$240.30
HM10Q SCLCR/L2	.625	7	.406	.760	MTS-255	T-7	\$320.40	
HM10J SCLCR/L3	.625	4.5	.406	.760	CCMT 32.51	MTS-35	T-15	\$240.30
HM10Q SCLCR/L3	.625	7	.406	.760		MTS-35	T-15	\$320.40
HM12J SCLCR/L3	.750	4.5	.500	.920		MTS-35	T-15	\$342.34
HM12Q SCLCR/L3	.750	7	.500	.920		MTS-35	T-15	\$475.11

Also available in: Steel pg: 24 Carbide pg: 54, 55 Modular pg: 79 Chatter-Free pg: 96, 99, 114

- Minimum Clearance Bars are intended for light machining with minimum bore clearance. Max depth of cut .015" - .020"
- * bars .312 and smaller do not have flats

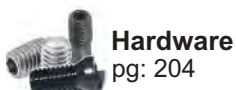

Hardware
pg: 204



Inserts
pg: 188



ULTRADEXUSA.com

B

BORING

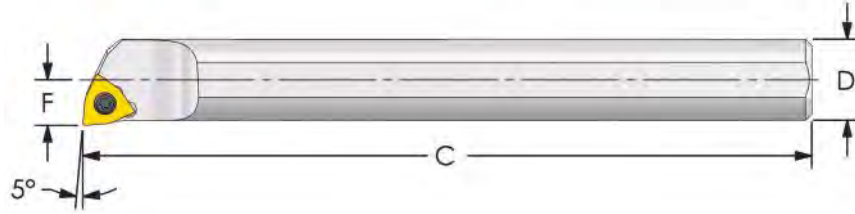

6:1 Ratio

Positive Trigon (-5° Lead)

No Coolant

Designation	D Dia.	C OAL	F	Min Bore	Insert	Insert Screw	Key	Price
J03F SWLCR1.2 *	.187	3	.102	.205	WCMT 1.210.5	MTS-183	T-6	\$108.63
J04F SWLCR1.2-138 * ■	.250	3	.138	.275		MTS-184	T-6	\$119.61
J05H SWLCR1.5-167 * ■	.312	4	.167	.342	WCMT 1.51.50.5	MTS-2	T-6	\$145.94

Also available in: Steel pg: 26 Carbide pg: 57

Positive Trigon (-5° Lead)

Coolant Thru

Designation	D Dia.	C OAL	F	Min Bore	Insert	Insert Screw	Key	Price
HM06J SWLCR/L2-203 ■	.375	4.5	.203	.410	WCMT 21.51	MTS-255	T-7	\$143.75
HM06Q SWLCR/L2-203 ■	.375	7	.203	.410		MTS-255	T-7	\$188.73
HM08J SWLCR/L2-281 ■	.500	4.5	.281	.560		MTS-255	T-7	\$185.44
HM08Q SWLCR/L2-281 ■	.500	7	.281	.560		MTS-255	T-7	\$256.76
HM10J SWLCR/L2	.625	4.5	.406	.760	WCMT 32.51	MTS-255	T-7	\$240.30
HM10Q SWLCR/L2	.625	7	.406	.760		MTS-255	T-7	\$320.40
HM10J SWLCR/L3	.625	4.5	.406	.760		MTS-35	T-15	\$240.30
HM10Q SWLCR/L3	.625	7	.406	.760		MTS-35	T-15	\$320.40
HM12J SWLCR/L3	.750	4.5	.500	.920		MTS-35	T-15	\$342.34
HM12Q SWLCR/L3	.750	7	.500	.920		MTS-35	T-15	\$475.11

Also available in: Steel pg: 26 Carbide pg: 58 Modular pg: 80

■ Minimum Clearance Bars are intended for light machining with minimum bore clearance. Max depth of cut .015" - .020"
 * bars .312 and smaller do not have flats

ANYTHING you can imagine...

CAN BE DONE!



SEE PAGE 209 for info on our **CUSTOM DESIGN & BUILDS**

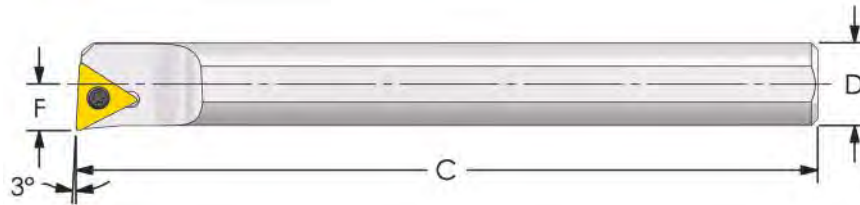

Positive Triangle (-3° Lead)

6:1 Ratio

No Coolant

Designation	D Dia.	C OAL	F	Min Bore	Insert	Insert Screw	Key	Price
J04F STUCR/L1.2-138 * ■	.250	3	.138	.275	TCMT 1.21.20.5	MTS-184	T-6	\$119.61
J05H STUCR/L1.2-167 * ■	.312	4	.167	.340		MTS-184	T-6	\$145.94

Also available in: [Steel pg: 28](#) [Carbide pg: 59](#)

Positive Triangle (-3° Lead)

Coolant Thru

Designation	D Dia.	C OAL	F	Min Bore	Insert	Insert Screw	Key	Price	
HM06J STUCR/L1.2-203 ■	.375	4.5	.203	.410	TCMT 1.21.20.5	MTS-184	T-6	\$143.75	
HM06Q STUCR/L1.2-203 ■	.375	7	.203	.410		MTS-184	T-6	\$188.73	
HM06J STUPR/L2-203 ■	.375	4.5	.203	.410	TPMT 21.51	MTS-255	T-7	\$143.75	
HM06Q STUPR/L2-203 ■	.375	7	.203	.410		MTS-255	T-7	\$188.73	
HM08J STUPR/L2-281 ■	.500	4.5	.281	.560		MTS-255	T-7	\$185.44	
HM08Q STUPR/L2-281 ■	.500	7	.281	.560		MTS-255	T-7	\$256.76	
HM10J STUPR/L2	.625	4.5	.406	.760		MTS-255	T-7	\$240.30	
HM10Q STUPR/L2	.625	7	.406	.760		MTS-255	T-7	\$320.40	
HM12J STUPR/L3	.750	4.5	.500	.920		TPMT 32.51	MTS-35	T-15	\$342.34
HM12Q STUPR/L3	.750	7	.500	.920			MTS-35	T-15	\$475.11

HM06J STUCR/L2-203 ■	.375	4.5	.203	.410	TCMT 21.51	MTS-255	T-7	\$143.75
HM06Q STUCR/L2-203 ■	.375	7	.203	.410		MTS-255	T-7	\$188.73
HM08J STUCR/L2-281 ■	.500	4.5	.281	.560		MTS-255	T-7	\$185.44
HM08Q STUCR/L2-281 ■	.500	7	.281	.560		MTS-255	T-7	\$256.76
HM10J STUCR/L2	.625	4.5	.406	.760	TCMT 21.51	MTS-255	T-7	\$240.30
HM10Q STUCR/L2	.625	7	.406	.760		MTS-255	T-7	\$320.40
HM12J STUCR/L3	.750	4.5	.500	.920	TCMT 32.51	MTS-35	T-15	\$342.34
HM12Q STUCR/L3	.750	7	.500	.920		MTS-35	T-15	\$475.11

Also available in: [Steel pg: 29](#) [Carbide pg: 60](#) [Modular pg: 81](#) [Chatter-Free pg: 100, 115](#)

■ Minimum Clearance Bars are intended for light machining with minimum bore clearance. Max depth of cut .015" - .020"
 * bars .312 and smaller do not have flats

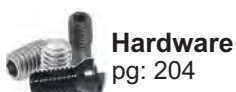

Hardware
pg: 204



Inserts
pg: 188

ULTRA-DEX

Proudly Made in Flushing, MI USA

ULTRA-DEX

MODULAR BORING BARS

Endless Possibilities...

MADE IN MICHIGAN

...and the convenience of ONE Bar with 28 different insert style configurations

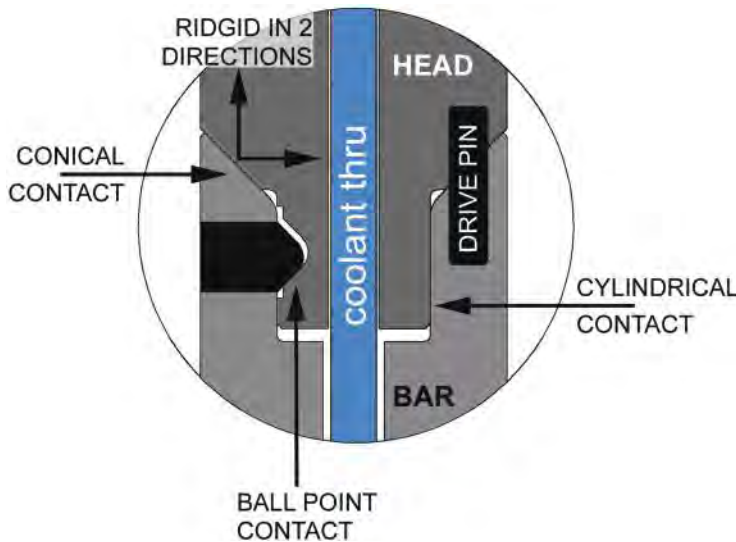

This rigid, high-precision Modular Boring Bar connection is designed with great accuracy to provide a secure union between the bar and the head. The system has internal coolant supply in all components as well.

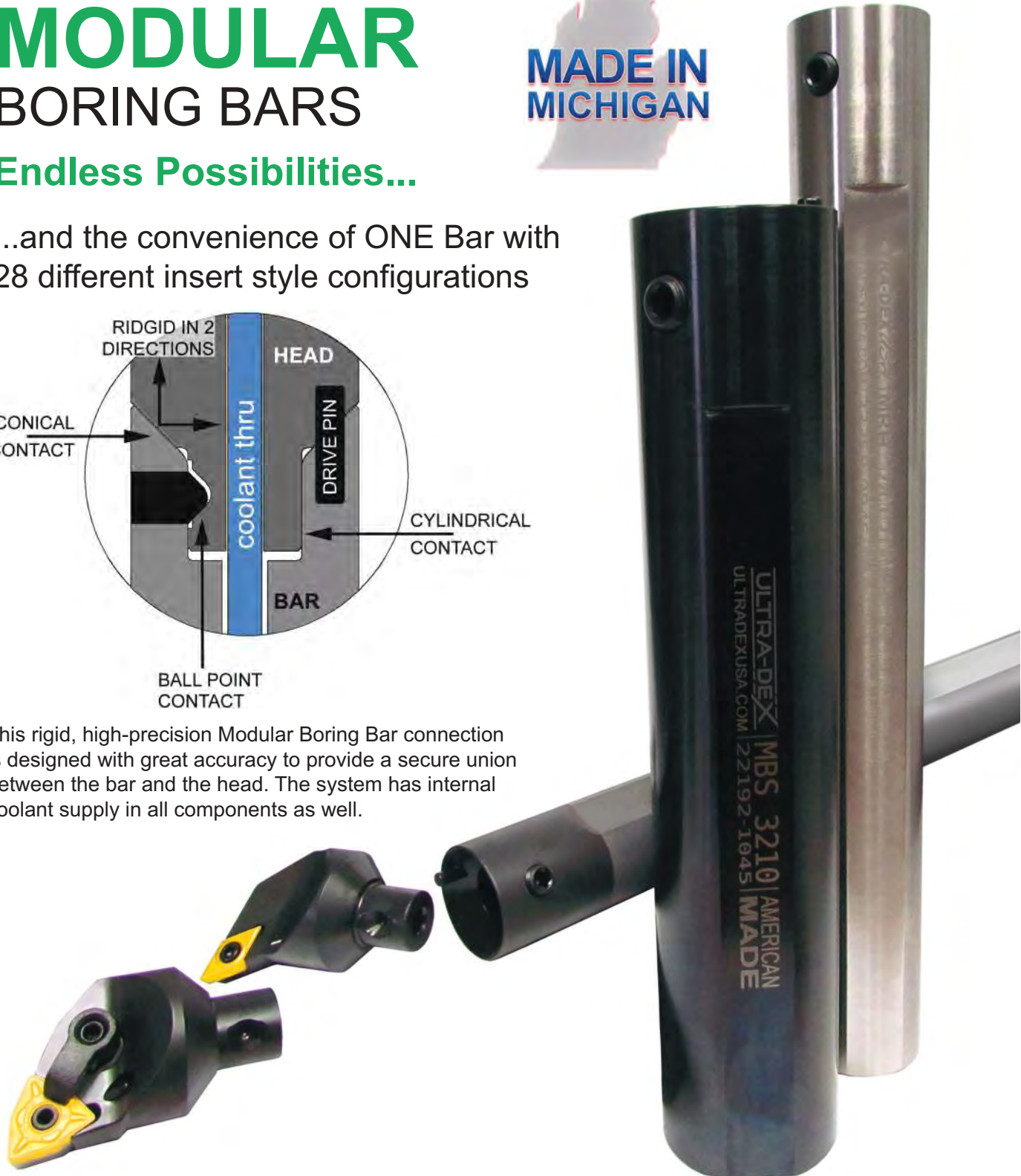

B

BORING

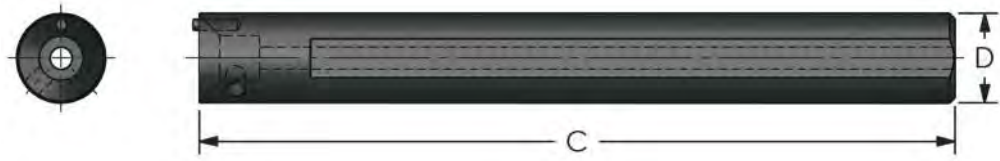

Steel Shank

4:1 Ratio
Coolant Thru

Designation	D Dia.	C OAL	Min Bore	Set Screw	Price
MBS 1295	.750	9.5	.930	MH12S	\$136.06
MBS 1612	1.000	11.5	1.200	MH16S	\$159.11
MBS 2014	1.250	14	1.500	MH20S	\$206.28
MBS 2414	1.500	14	1.710	MH24S	\$229.33
MBS 2816	1.750	16	2.010	MH28S	\$273.22
MBS 3210	2.000	10	2.400	MH32S	\$240.30
MBS 3220	2.000	20	2.400	MH32S	\$359.90
MBS 4012*	2.500	12	2.930	MH32S	\$410.37
MBS 4024*	2.500	24	2.930	MH32S	\$624.34
MBS 4828*	3.000	28	3.460	MH32S	\$765.88

* 2.5" and 3" bars take 2" heads

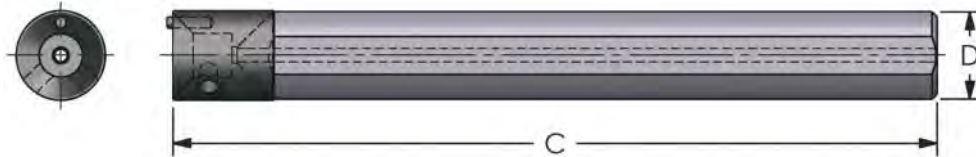

Carbide Shank

8:1 Ratio
Coolant Thru

Designation	D Dia.	C OAL	Min Bore	Set Screw	Price
MB 1295	.750	9.5	.920	MH12S	\$465.23
MB 1220M	20mm	241mm	.930	MH12S	\$539.85
MB 1612	1.000	11.5	1.185	MH16S	\$698.95
MB 2014	1.250	14	1.465	MH20S	\$1,355.11
MB 2414	1.500	14	1.730	MH24S	\$1,593.21
MB 2816	1.750	16	2.010	MH28S	\$2,737.64
MB 3220	2.000	20	2.400	MH32S	\$4,559.08

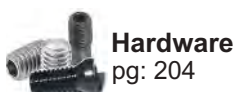

Hardware
pg: 204



Inserts
pg: 188



ULTRADEXUSA.com

B

BORING

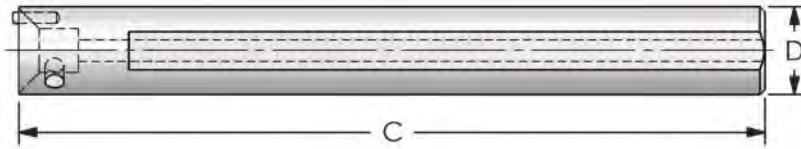

6:1 Ratio

Heavy Metal Shank

Coolant Thru

Designation	D Dia.	C OAL	Min Bore	Set Screw	Price
MBH 1212	.750	12	.930	MH12S	\$492.67
MBH 1612	1.000	12	1.200	MH16S	\$742.84
MBH 2012	1.250	12	1.500	MH20S	\$1,133.46
MBH 2412	1.500	12	1.710	MH24S	\$1,480.20
MBH 2414	1.500	14	1.710	MH24S	\$2,977.94
MBH 2812	1.750	12	2.010	MH28S	\$1,900.44
MBH 2816 *	1.750	16	2.010	MH28S	\$4,275.99
MBH 3212	2.000	12	2.400	MH32S	\$2,365.67
MBH 3218 *	2.000	18	2.400	MH32S	\$5,420.42
MBH 4024 **	2.500	24	2.900	MH32S	\$11,054.80
MBH 4828 **	3.000	28	3.300	MH32S	\$16,692.47

* non-stock item; call for delivery

* 2.5" and 3" bars take 2" heads

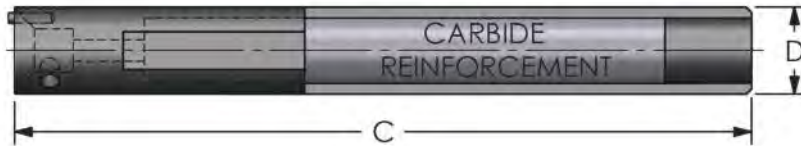

5:1 Ratio

Hybrid Shank

No Coolant

Designation	D Dia.	C OAL	Min Bore	Set Screw	Price
MBR 1295	.750	9.5	.930	MH12S	\$388.43
MBR 1612	1.000	11.5	1.200	MH16S	\$459.75
MBR 2014	1.250	14	1.500	MH20S	\$777.96
MBR 2414	1.500	14	1.710	MH24S	\$1,063.24
MBR 2816	1.750	16	2.010	MH28S	\$1,809.37

Please allow one week for processing and delivery.

B

BORING



Modular Head Nomenclature

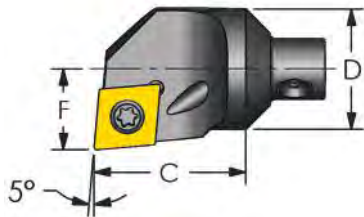
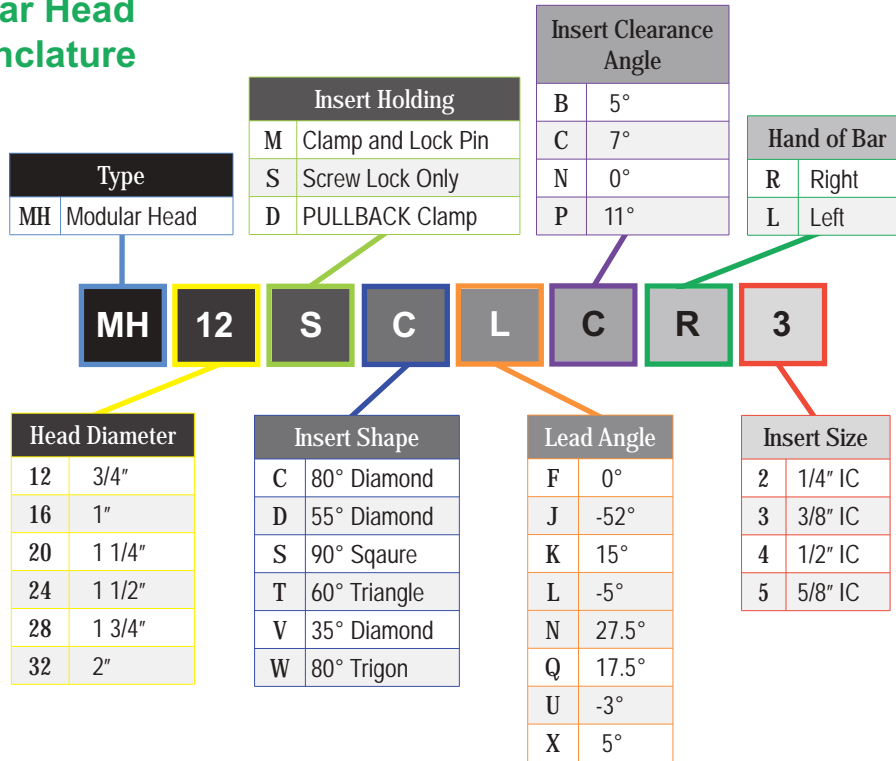

**Positive 80° Diamond
(-5° Lead)
Coolant Thru**

Designation	D Dia.	C OAL	F	Min Bore	Insert	Insert Screw	Key	Price
MH12 SCLCR/L3	.750	.940	.500	.920	CCMT 32.51	MTS-35	T-15	\$75.72
MH16 SCLCR/L3	1.000	1.000	.625	1.185		MTS-35	T-15	\$86.69
MH12 SCLPR/L3	.750	.940	.500	.920	CPMT 32.51	MTS-35	T-15	\$75.72
MH16 SCLPR/L3	1.000	1.000	.625	1.185		MTS-35	T-15	\$86.69
MH20 SCLCR4	1.250	1.300	.765	1.465	CCMT 432	MTS-4	T-20	\$119.61
MH24 SCLCR4	1.500	1.520	.890	1.730		MTS-4	T-20	\$141.55
MH28 SCLCR4	1.750	1.770	1.015	2.000		MTS-4	T-20	\$163.50
MH32 SCLCR4	2.000	2.030	1.281	2.400		MTS-4	T-20	\$196.41

Steel pg: 24 Hybrid pg: 49 Carbide pg: 54, 55 Heavy Metal pg: 73 Chatter-Free pg: 96, 99, 114

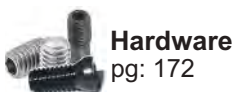

Hardware
pg: 172



Inserts
pg: 162



Proudly Made in Flushing, MI USA

B

BORING

Modular Boring Heads (Positive)

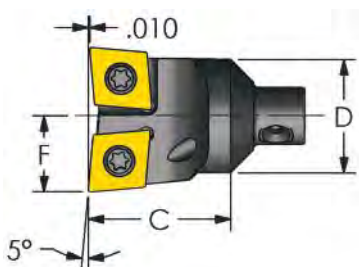

**Positive 80° Diamond
(-5° Lead) Turn & Bore
Coolant Thru**

Designation	D Dia.	C OAL	F	Min Bore	Insert	Insert Screw	Key	Price
MH12 SCLCR/L3T	.750	.940	.500	1.020	CCMT 32.51	MTS-35	T-15	\$97.66
MH16 SCLCR/L3T	1.000	1.000	.625	1.270		MTS-35	T-15	\$109.63

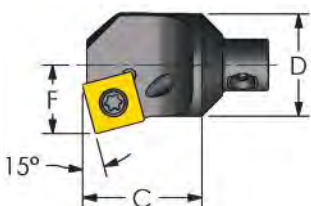

**Positive Square
(15° Lead)
Coolant Thru**

Designation	D Dia.	C OAL	F	Min Bore	Insert	Insert Screw	Key	Price
MH12 SSKCR3	.750	.875	.500	.920	SCMT 32.51	MTS-35	T-15	\$75.72
MH16 SSKCR4	1.000	.935	.625	1.185	SCMT 432	MTS-4	T-20	\$86.69

Also available in: [Steel pg: 25](#) [Carbide pg: 56](#)

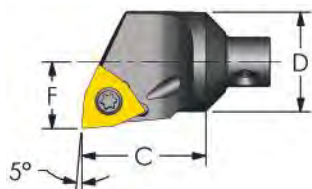

**Positive Trigon
(-5° Lead)
Coolant Thru**

Designation	D Dia.	C OAL	F	Min Bore	Insert	Insert Screw	Key	Price
MH12 SWLCR/L3	.750	.940	.500	.920	WCMT 32.51	MTS-35	T-15	\$75.72
MH16 SWLCR/L3	1.000	1.000	.625	1.185		MTS-35	T-15	\$86.69

Also available in: [Steel pg: 26](#) [Carbide pg: 58](#) [Heavy Metal pg: 74](#)

SAME DAY SHIPPING!

On orders placed before 3:30pm EST
SEE PAGE 210 for more details...



B

BORING

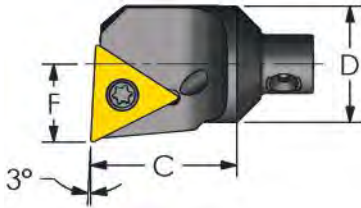

**Positive Triangle
(-3° Lead)
Coolant Thru**

Designation	D Dia.	C OAL	F	Min Bore	Insert	Insert Screw	Key	Price
MH12 STUCR/L3	.750	.940	.500	.920	TCMT 32.51	MTS-35	T-15	\$75.72
MH16 STUCR/L3	1.000	1.000	.625	1.185		MTS-35	T-15	\$86.69

Also available in: Steel pg: 29 Carbide pg: 60 Heavy Metal pg: 75 Chatter-Free pg: 100, 115

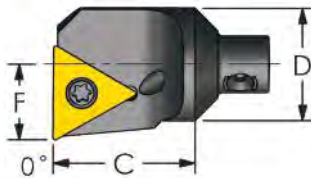

**Positive Triangle
(0° Lead)
Coolant Thru**

Designation	D Dia.	C OAL	F	Min Bore	Insert	Insert Screw	Key	Price
MH12 STFPCR/L3	.750	.940	.500	.920	TCMT 32.51	MTS-35	T-15	\$75.72
MH16 STFPCR/L3	1.000	1.000	.625	1.185		MTS-35	T-15	\$86.69

Also available in: Steel pg: 30 Carbide pg: 61 Chatter-Free pg: 115

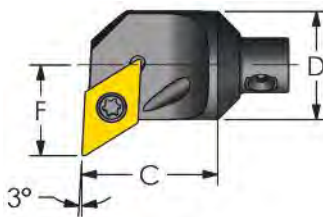

**Positive 55° Diamond
(-3° Lead) Profiling
Coolant Thru**

Designation	D Dia.	C OAL	F	Min Bore	Insert	Insert Screw	Key	Price
MH12 SDUCR/L3	.750	.940	.625	1.050	DCMT 32.51	MTS-35	T-15	\$86.69
MH16 SDUCR/L3	1.000	1.000	.750	1.310		MTS-35	T-15	\$97.66
MH20 SDUCR3-8	1.250	1.300	.800	1.500		MTS-35	T-15	\$119.61
MH20 SDUCR/L3	1.250	1.300	1.000	1.700		MTS-35	T-15	\$119.61
MH24 SDUCR/L3	1.500	1.520	1.120	1.960		MTS-35	T-15	\$141.55
MH28 SDUCR/L3	1.750	1.770	1.250	2.230		MTS-35	T-15	\$163.50
MH32 SDUCR/L3	2.000	2.030	1.375	2.500		MTS-35	T-15	\$196.41

Also available in: Steel pg: 32 Carbide pg: 64 Chatter-Free pg: 96, 101, 116

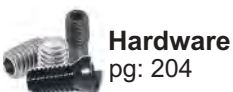

Hardware
pg: 204



Inserts
pg: 188



Modular Boring Heads (Positive)

B

BORING

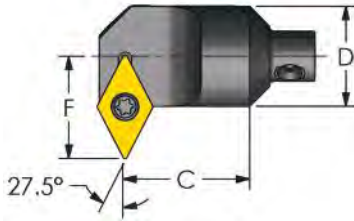

**Positive 55° Diamond
(27.5° Lead) Profiling
Coolant Thru**

Designation	D Dia.	C OAL	F	Min Bore	Insert	Insert Screw	Key	Price
MH12 SDNCR3	.750	.940	.765	1.190	DCMT 32.51	MTS-35	T-15	\$93.27
MH16 SDNCR3	1.000	1.000	.890	1.450		MTS-35	T-15	\$104.24

Also available in: Steel pg: 34 Carbide pg: 65 Chatter-Free pg: 116

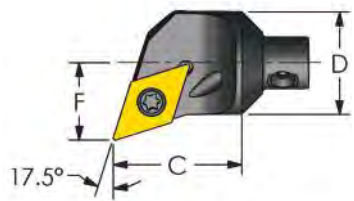

**Positive 55° Diamond
(-17.5° Lead) Profiling
Coolant Thru**



Designation	D Dia.	C OAL	F	Min Bore	Insert	Insert Screw	Key	Price
MH12 SDQCR/L3	.750	.940	.562	1.000	DCMT 32.51	MTS-35	T-15	\$86.69
MH16 SDQCR/L3	1.000	1.000	.625	1.185		MTS-35	T-15	\$97.66

Also available in: Steel pg: 34 Carbide pg: 65

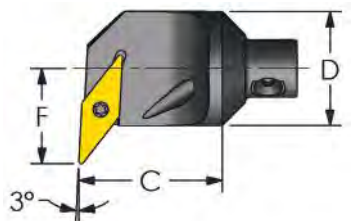

**Positive 35° Diamond
(-3° Lead) Profiling
Coolant Thru**

Designation	D Dia.	C OAL	F	Min Bore	Insert	Insert Screw	Key	Price
MH12 SVUBR/L2	.750	.940	.625	1.045	VBMT 21.51	MTS-2.5L	T-7	\$86.69
MH16 SVUBR/L3	1.000	1.000	.875	1.435	VBMT 331	MTS-3.5L	T-15	\$97.66



Visit ultradexusa.com

for further information including videos and additional images of our products

Be the first to know when our **NEWEST** products are released!

CHECK FOR MONTHLY SPECIALS!



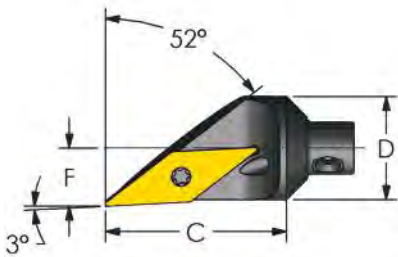

**Positive 35° Diamond
(-52° Lead) Profiling
Coolant Thru**

New!

Sizes:
MH20, MH24,
MH28, MH32



Designation	D Dia.	C OAL	F	Min Bore	Insert	Insert Screw	Key	Price
MH12 SVJBR/L3	.750	1.315	.421	.840	VBMT 331	MTS-3.5L	T-15	\$86.69
MH16 SVJBR/L3	1.000	1.375	.546	1.110		MTS-3.5L	T-15	\$97.66
MH20 SVJBR/L3	1.250	1.675	.671	1.700		MTS-3.5L	T-15	\$119.61
MH24 SVJBR/L3	1.500	1.895	.796	1.960		MTS-3.5L	T-15	\$141.55
MH28 SVJBR/L3	1.750	2.145	.921	2.230		MTS-3.5L	T-15	\$163.50
MH32 SVJBR/L3	2.000	2.405	1.046	2.500		MTS-3.5L	T-15	\$196.41

Also available in: Carbide pg: 65

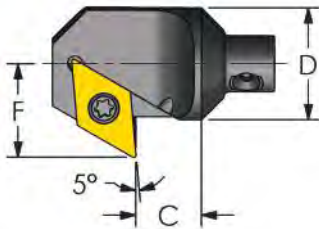

**Positive 55° Diamond
(5° Lead) Back Facing
Coolant Thru**

Designation	D Dia.	C OAL	F	Min Bore	Insert	Insert Screw	Key	Price
MH12 SDXCR/L3	.750	.440	.625	1.050	DCMT 32.51	MTS-35	T-15	\$86.69
MH16 SDXCR/L3	1.000	.525	.750	1.310		MTS-35	T-15	\$97.66

Also available in: Steel pg: 35 Carbide pg: 66 Chatter-Free pg: 117

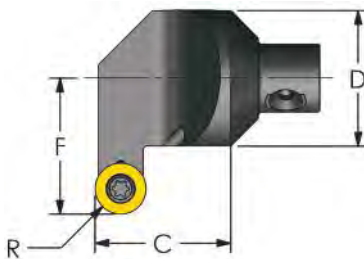

**Positive Round
Coolant Thru**

Designation	D Dia.	C OAL	F	R	Min Bore	Insert	Screw	Price
MH16 SRNCR/L3	1.000	1.000	1.000	.188	1.560	RCMT 32.5	MTS-35	\$86.69
MH24 SRNCR/L4	1.500	1.520	1.250	.250	2.090	RCMT 43	MTS-4	\$141.55

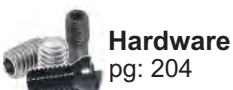

Hardware
pg: 204



Inserts
pg: 188

ULTRA-DEX

Proudly Made in Flushing, MI USA

B

BORING

Modular Boring Bars (Negative)

B

BORING

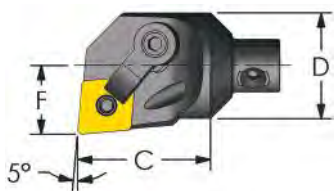

**Negative 80° Diamond
(-5° Lead)
Coolant Thru**

Designation	D Dia.	C OAL	F	Min Bore	Insert	Shim	Clamp	Clamp Screw	Lock Pin	Price
MH12 MCLNR/L3	.750	.940	.500	.920	CNMG 322	--	CL-7	XNS-36	NL-33	\$97.66
MH16 MCLNR/L3	1.000	1.000	.640	1.200		--	CL-7	XNS-36	NL-33	\$108.63
MH16 MCLNR/L4	1.000	1.000	.640	1.200	CNMG 432	--	CL-20	XNS-47	NL-44	\$108.63
MH20 MCLNR/L4	1.250	1.300	.765	1.470		ICSN-433	CL-20	XNS-47	NL-46	\$141.55
MH24 MCLNR/L4	1.500	1.520	.890	1.730		ICSN-433	CL-20	XNS-47	NL-46	\$163.50
MH28 MCLNR/L4	1.750	1.770	1.015	1.995		ICSN-433	CL-20	XNS-47	NL-46	\$185.44
MH32 MCLNR/L4	2.000	2.030	1.281	2.400		ICSN-433	CL-20	XNS-47	NL-46	\$218.36
MH32 MCLNR/L5	2.000	2.030	1.281	2.400	CNMG 543	ICSN-533	CL-12	XNS-510	NL-58	\$218.36

Also available in: [Steel pg: 36](#) [Hybrid pg: 49](#) [Carbide pg: 67](#) [Chatter-Free pg: 102](#)

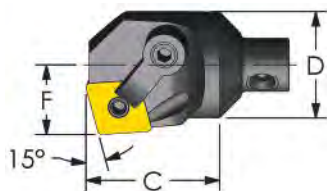

**Negative 80° Diamond
(15° Lead)
Coolant Thru**

Designation	D Dia.	C OAL	F	Min Bore	Insert	Shim	Clamp	Clamp Screw	Lock Pin	Price
MH12 MCKNR/L3	.750	.875	.490	.910	CNMG 322	--	CL-7	XNS-36	NL-33	\$97.66
MH16 MCKNR/L3	1.000	.935	.630	1.190		--	CL-7	XNS-36	NL-33	\$108.63
MH20 MCKNR/L4	1.250	1.210	.755	1.455	CNMG 432	ICSN-433	CL-20	XNS-47	NL-46	\$141.55
MH24 MCKNR/L4	1.500	1.430	.880	1.720		ICSN-433	CL-20	XNS-47	NL-46	\$163.50
MH28 MCKNR/L4	1.750	1.680	1.005	1.985		ICSN-433	CL-20	XNS-47	NL-46	\$185.44
MH32 MCKNR/L4	2.000	1.940	1.271	2.390		ICSN-433	CL-20	XNS-47	NL-46	\$218.36

**CUSTOM MODULAR
HEADS AVAILABLE!**

CALL: 810-638-5388

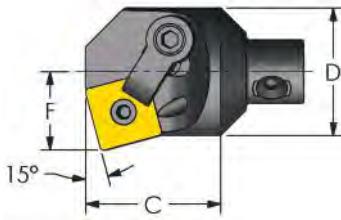

**Negative Square
(15° Lead)
Coolant Thru**

Designation	D Dia.	C OAL	F	Min Bore	Insert	Shim	Clamp	Clamp Screw	Lock Pin	Price
MH16 MSKNR4	1.000	1.060	.630	1.190	SNMG 432	--	CL-20	XNS-47	NL-44	\$108.63
MH20 MSKNR4	1.250	1.210	.755	1.455		ISSN-432	CL-20	XNS-47	NL-46	\$141.55
MH24 MSKNR4	1.500	1.430	.880	1.720		ISSN-432	CL-20	XNS-47	NL-46	\$163.50
MH32 MSKNR4	2.000	1.680	1.271	2.390		ISSN-432	CL-20	XNS-47	NL-46	\$218.36

Also available in: **Chatter-Free pg: 103**

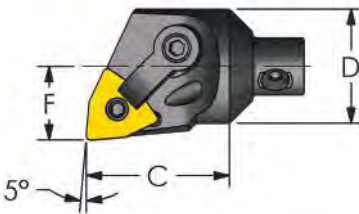

**Negative Trigon
(-5° Lead)
Coolant Thru**



Designation	D Dia.	C OAL	F	Min Bore	Insert	Shim	Clamp	Clamp Screw	Lock Pin	Price
MH12 MWLNR/L3	.750	.940	.500	.920	WNMG 332	--	CL-7	XNS-36	NL-33L	\$97.66
MH16 MWLNR/L3	1.000	1.000	.640	1.200		--	CL-7	XNS-36	NL-33L	\$108.63
MH16 MWLNR/L4	1.000	1.000	.640	1.240	WNMG 432	--	CL-20	XNS-47	NL-44	\$108.63
MH20 MWLNR/L4	1.250	1.300	.765	1.470		IWSN-433	CL-20	XNS-47	NL-46	\$141.55
MH24 MWLNR/L4	1.500	1.520	.890	1.730		IWSN-433	CL-20	XNS-47	NL-46	\$163.50
MH28 MWLNR/L4	1.750	1.770	1.015	1.995		IWSN-433	CL-20	XNS-47	NL-46	\$185.44
MH32 MWLNR/L4	2.000	2.030	1.281	2.400		IWSN-433	CL-20	XNS-47	NL-46	\$218.36

Also available in: **Steel pg: 36** **Hybrid pg: 49** **Carbide pg: 67** **Chatter-Free pg: 104**

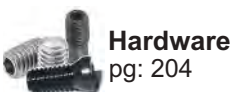

Hardware
pg: 204



Inserts
pg: 188



ULTRADEXUSA.com

B

BORING

Modular Boring Heads (Negative)

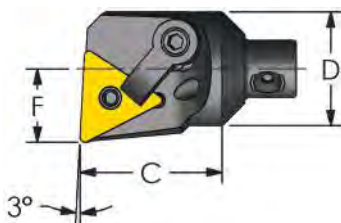

**Negative Triangle
(-3° Lead)
Coolant Thru**

Designation	D Dia.	C OAL	F	Min Bore	Insert	Shim	Clamp	Clamp Screw	Lock Pin	Price
MH12 MTUNR/L3	.750	.940	.500	.920	TNMG 332	--	CL-7	XNS-36	NL-33L	\$97.66
MH16 MTUNR/L3	1.000	1.000	.640	1.200		--	CL-7	XNS-36	NL-33L	\$108.63
MH20 MTUNR/L3	1.250	1.300	.765	1.470		ITSN-323	CL-7	XNS-36	NL-34L	\$141.55
MH24 MTUNR/L3	1.500	1.520	.890	1.470		ITSN-323	CL-7	XNS-36	NL-34L	\$163.50
MH20 MTUNR/L4	1.250	1.300	.765	1.730	TNMG 432	ITSN-433	CL-20	XNS-47	NL-46	\$141.55
MH24 MTUNR/L4	1.500	1.520	.890	1.730		ITSN-433	CL-20	XNS-47	NL-46	\$163.50
MH28 MTUNR/L4	1.750	1.770	1.015	1.995		ITSN-433	CL-20	XNS-47	NL-46	\$185.44
MH32 MTUNR/L4	2.000	2.030	1.281	2.400		ITSN-433	CL-20	XNS-47	NL-46	\$218.36

Also available in: [Steel pg: 38](#) [Chatter-Free pg: 104](#)

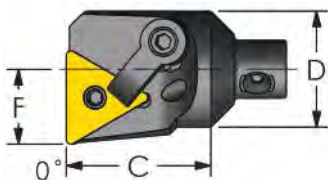

**Negative Triangle
(0° Lead)
Coolant Thru**

Designation	D Dia.	C OAL	F	Min Bore	Insert	Shim	Clamp	Clamp Screw	Lock Pin	Price
MH12 MTFNR/L3	.750	.940	.500	.920	TNMG 332	--	CL-7	XNS-36	NL-33L	\$97.66
MH16 MTFNR/L3	1.000	1.000	.640	1.200		--	CL-7	XNS-36	NL-33L	\$108.63
MH20 MTFNR/L3	1.250	1.300	.765	1.470		ITSN-323	CL-7	XNS-36	NL-34L	\$141.55
MH24 MTFNR/L3	1.500	1.520	.890	1.730		ITSN-323	CL-7	XNS-36	NL-34L	\$163.50
MH20 MTFNR/L4	1.250	1.300	.765	1.470	TNMG 432	ITSN-433	CL-20	XNS-47	NL-46	\$141.55
MH24 MTFNR/L4	1.500	1.520	.890	1.730		ITSN-433	CL-20	XNS-47	NL-46	\$163.50
MH28 MTFNR/L4	1.750	1.770	1.015	1.995		ITSN-433	CL-20	XNS-47	NL-46	\$185.44
MH32 MTFNR/L4	2.000	2.030	1.281	1.995		ITSN-433	CL-20	XNS-47	NL-46	\$218.36

Also available in: [Steel pg: 38](#)



B

BORING

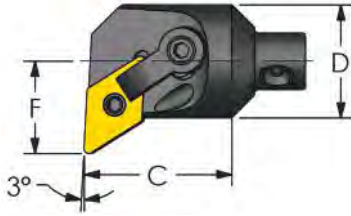

**Negative 55° Diamond
(-3° Lead) Profiling
Coolant Thru**

Designation	D Dia.	C OAL	F	Min Bore	Insert	Shim	Clamp	Clamp Screw	Lock Pin	Price
MH12 MDUNR/L3	.750	.940	.625	1.050	DNMG 332	--	CL-7	XNS-36	NL-33L	\$108.63
MH16 MDUNR/L3	1.000	1.000	.750	1.310		--	CL-7	XNS-36	NL-33L	\$119.61
MH20 MDUNR4-7	1.250	1.300	.775	1.475	DNMG 432	IDSN-433	CL-22	XNS-48	NL-46	\$152.52
MH20 MDUNR/L4	1.250	1.300	1.000	1.700		IDSN-433	CL-22	XNS-48	NL-46	\$152.52
MH24 MDUNR/L4	1.500	1.520	1.120	1.960		IDSN-433	CL-22	XNS-48	NL-46	\$174.47
MH28 MDUNR/L4	1.750	1.770	1.250	2.250		IDSN-433	CL-22	XNS-48	NL-46	\$196.41
MH32 MDUNR/L4	2.000	2.030	1.375	2.500		IDSN-433	CL-22	XNS-48	NL-46	\$229.33

Also available in: Steel pg: 39 Chatter-Free pg: 105

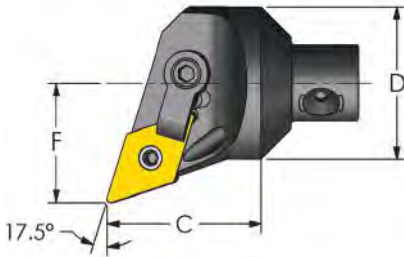

**Negative 55° Diamond
(-17.5° Lead) Profiling
Coolant Thru**

Designation	D Dia.	C OAL	F	Min Bore	Insert	Shim	Clamp	Clamp Screw	Lock Pin	Price
MH20 MDQNR/L4	1.250	1.300	1.000	1.700	DNMG 432	IDSN-433	CL-22	XNS-48	NL-46	\$152.52
MH24 MDQNR/L4	1.500	1.520	1.120	1.960		IDSN-433	CL-22	XNS-48	NL-46	\$174.47
MH28 MDQNR/L4	1.750	1.770	1.250	2.250		IDSN-433	CL-22	XNS-48	NL-46	\$196.41
MH32 MDQNR/L4	2.000	2.030	1.281	2.400		IDSN-433	CL-22	XNS-48	NL-46	\$229.33

Also available in: Steel pg: 39

SAME DAY SHIPPING!

On orders placed before 3:30pm EST
SEE PAGE 210 for more details...

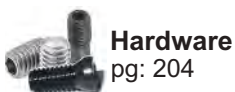
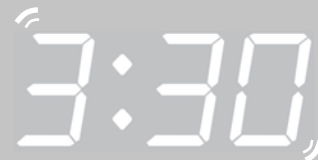

Hardware
pg: 204



Inserts
pg: 188



Proudly Made in Flushing, MI USA

B

BORING

Modular Boring Heads (Negative)

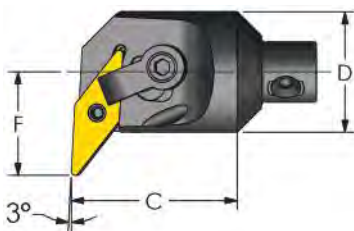

**Negative 35° Diamond
(-3° Lead) Profiling
Coolant Thru**

Designation	D Dia.	C OAL	F	Min Bore	Insert	Shim	Clamp	Clamp Screw	Lock Pin	Price
MH16 MVUNR/L3	1.000	1.300	.875	1.435	VNMG 332	IVSN-322	CL-20	XNS-47	NL- 34L	\$119.61
MH20 MVUNR/L3	1.250	1.300	1.000	1.700		IVSN-322	CL-20	XNS-47	NL- 34L	\$152.52
MH24 MVUNR/L3	1.500	1.520	1.120	2.000		IVSN-322	CL-20	XNS-47	NL -34L	\$174.47
MH28 MVUNR/L3	1.750	1.770	1.250	2.250		IVSN-322	CL-20	XNS-47	NL -34L	\$196.41
MH32 MVUNR/L3	2.000	2.030	1.375	2.500		IVSN-322	CL-20	XNS-47	NL-34L	\$229.33
MH28 MVUNR/L4	1.750	1.770	1.250	2.250	VNMG 432	IVSN-432	CL-22	XNS-48	NL-46	\$196.41
MH32 MVUNR/L4	2.000	2.030	1.375	2.500		IVSN-432	CL-22	XNS-48	NL-46	\$229.33

Also available in: Steel pg: 38 Chatter-Free pg: 106

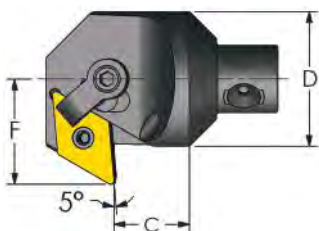

**Negative 55° Diamond
(5° Lead) Back Facing
Coolant Thru**

Designation	D Dia.	C OAL	F	Min Bore	Insert	Shim	Clamp	Clamp Screw	Lock Pin	Price
MH20 MDXNR/L4	1.250	.700	1.000	1.700	DNMG 432	IDSN-433	CL-22	XNS-48	NL-46	\$163.50
MH24 MDXNR/L4	1.500	.650	1.120	1.960		IDSN-433	CL-22	XNS-48	NL-46	\$185.44
MH28 MDXNR/L4	1.750	.780	1.250	2.250		IDSN-433	CL-22	XNS-48	NL-46	\$207.39
MH32 MDXNR/L4	2.000	.780	1.500	2.620		IDSN-433	CL-22	XNS-48	NL-46	\$240.30

BEST Value in the industry!

See **pg 152** for our directory on all of the tool holders we offer.



See **pg 46** for more info
on our PULLBACKS

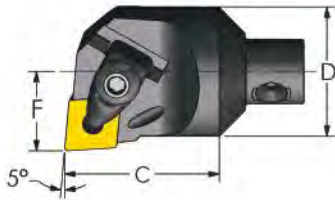

PULLBACK Clamp
Negative 80° Diamond
(-5° Lead)
Coolant Thru

Designation	D Dia.	C OAL	F	Min Bore	Insert	Shim	Shim Screw	Clamp Assy.	Price
MH16 DCLNR4	1.000	1.500	.640	1.200	CNMG 432	--	--	PB4-CA	\$194.22
MH20 DCLNR4	1.250	1.500	.765	1.470		ICSN-433	PB4-SS		\$227.14
MH24 DCLNR4	1.500	1.520	.890	1.730		ICSN-433	PB4-SS		\$276.51
MH28 DCLNR4	1.750	1.770	1.015	1.995		ICSN-433	PB4-SS		\$298.45
MH32 DCLNR4	2.000	2.030	1.281	2.400		ICSN-433	PB4-SS		\$331.37

Also available in: [Steel pg: 47](#) [Carbide pg: 47](#) [Chatter-Free pg: 118](#)

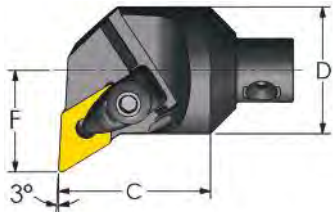

PULLBACK Clamp
Negative 55° Diamond
(-3° Lead)
Coolant Thru



Designation	D Dia.	C OAL	F	Min Bore	Insert	Shim	Shim Screw	Clamp Assy.	Price
MH20 DDUNR4	1.250	1.500	1.000	1.700	DNMG 432	IDSN-433	PB4-SS	PB4-CA	\$227.14
MH24 DDUNR4	1.500	1.520	1.120	1.960		IDSN-433	PB4-SS		\$276.51
MH28 DDUNR4	1.750	1.770	1.250	2.250		IDSN-433	PB4-SS		\$298.45
MH32 DDUNR4	2.000	2.030	1.375	2.500		IDSN-433	PB4-SS		\$331.37

Also available in: [Steel pg: 47](#) [Carbide pg: 47](#) [Chatter-Free pg: 118](#)

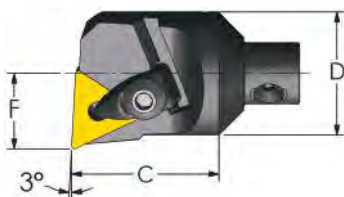

PULLBACK Clamp
Negative Triangle
(-3° Lead)
Coolant Thru

Designation	D Dia.	C OAL	F	Min Bore	Insert	Shim	Shim Screw	Clamp Assy.	Price
MH20 DTUNR4	1.250	1.500	.765	1.470	TNMG 432	ITSN-433	PB4-SS	PB4-CA	\$227.14
MH24 DTUNR4	1.500	1.520	.890	1.730		ITSN-433	PB4-SS		\$276.51
MH28 DTUNR4	1.750	1.770	1.015	1.995		ITSN-433	PB4-SS		\$298.45
MH32 DTUNR4	2.000	2.030	1.281	2.400		ITSN-433	PB4-SS		\$331.37

Also available in: [Steel pg: 47](#) [Carbide pg: 47](#) [Chatter-Free pg: 119](#)

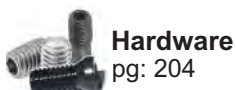

Hardware
pg: 204



Inserts
pg: 188



ULTRADEXUSA.com

B

BORING

Modular Boring Heads (Threading / Grooving)

B

BORING

Threading / Grooving Modular Head Nomenclature

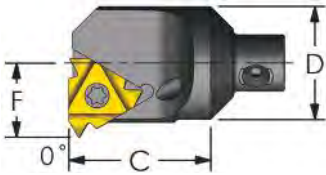
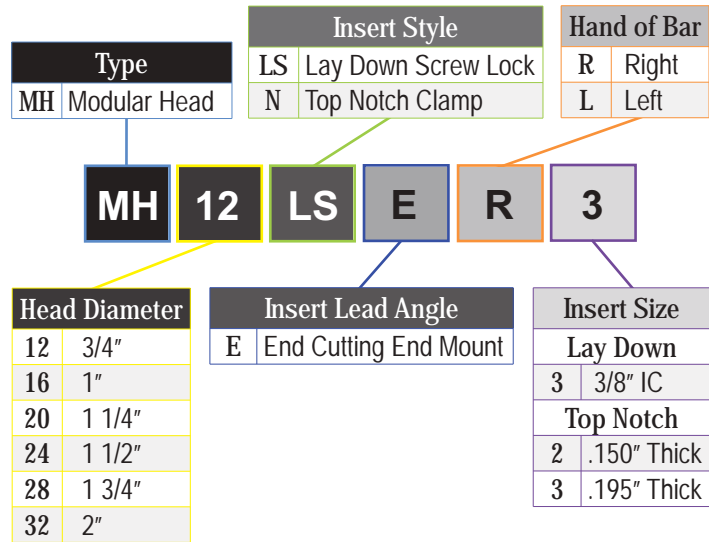

Threading / Grooving
Laydown
Coolant Thru



Designation Right Hand	D Dia.	C OAL	F	Min Bore	Insert	Insert Screw	Anvil Screw	Anvil	Price
MH12 LSER3	.750	.940	.510	.930	3IR	MTS-35	--	--	\$97.66
MH16 LSER3	1.000	1.000	.650	1.210		SA3T	SY3T	YI3	\$119.61
MH20 LSER3	1.250	1.300	.770	1.470		SA3T	SY3T	YI3	\$152.52
MH24 LSER3	1.500	1.520	.900	1.740		SA3T	SY3T	YI3	\$174.47
MH28 LSER3	1.750	1.770	1.090	2.070		SA3T	SY3T	YI3	\$196.41
MH32 LSER3	2.000	2.030	1.281	2.400		SA3T	SY3T	YI3	\$229.33

Designation Left Hand	D Dia.	C OAL	F	Min Bore	Insert	Insert Screw	Anvil Screw	Anvil	Price
MH12 LSEL3	.750	.940	.510	.930	3IL	MTS-35	--	--	\$97.66
MH16 LSEL3	1.000	1.000	.650	1.210		SA3T	SY3T	YE3	\$119.61
MH20 LSEL3	1.250	1.300	.770	1.470		SA3T	SY3T	YE3	\$152.52
MH24 LSEL3	1.500	1.520	.900	1.740		SA3T	SY3T	YE3	\$174.47
MH28 LSEL3	1.750	1.770	1.090	2.070		SA3T	SY3T	YE3	\$196.41
MH32 LSEL3	2.000	2.030	1.281	2.400		SA3T	SY3T	YE3	\$229.33

Also available in: Steel pg: 40 Carbide pg: 68 Chatter-Free pg: 96, 108, 121

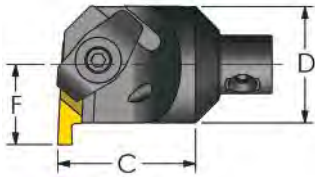

Threading / Grooving
Top Notch
Coolant Thru

Designation Right Hand	D Dia.	C OAL	F	Min Bore	Insert	Clamp	Clamp Screw	Price
MH12 NER2	.750	.920	.562	1.120	NG 2L	CM-75	6-32	\$108.63
MH16 NER2	1.000	1.180	.688	1.380		CM-75	6-32	\$119.61
MH16 NER3	1.000	1.180	.688	1.380	NG 3L	CM-73	10-32	\$119.61
MH20 NER3	1.250	1.300	.875	1.750		CM-73	10-32	\$154.72
MH24 NER3	1.500	1.520	1.000	2.000		CM-73	10-32	\$178.86
MH28 NER3	1.750	1.770	1.125	2.250		CM-73	10-32	\$203.00
MH32 NER3	2.000	2.030	1.250	2.500		CM-73	10-32	\$239.20

Designation	D Dia.	C OAL	F	Min Bore	Insert	Clamp	Clamp Screw	Price
MH12 NEL2	.750	.920	.562	1.120	NG 2R	CM-74	6-32	\$108.63
MH16 NEL2	1.000	1.180	.688	1.380		CM-74	6-32	\$119.61
MH16 NEL3	1.000	1.180	.688	1.380	NG 3R	CM-72	10-32	\$119.61
MH20 NEL3	1.250	1.300	.875	1.750		CM-72	10-32	\$154.72
MH24 NEL3	1.500	1.520	1.000	2.000		CM-72	10-32	\$178.86
MH28 NEL3	1.750	1.770	1.125	2.250		CM-72	10-32	\$203.00
MH32 NEL3	2.000	2.030	1.250	2.500		CM-72	10-32	\$239.20

Steel pg: 40 Carbide pg: 68 Chatter-Free pg: 109, 121

CUSTOM MODULAR HEADS AVAILABLE!

CALL: 810-638-5388

See pg 203 for our



Top Notch Grooving Inserts

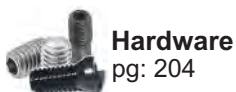

Hardware
pg: 204



Inserts
pg: 188



Proudly Made in Flushing, MI USA

B

BORING

ULTRA-DEX

CHATTER-FREE BORING BARS



Tunable Internal Dampening Technology...

provides optimal dynamic stability yielding significant increases in machining performance. Most importantly, the bars pay for themselves quickly by increasing speed and precision. Additionally, you can leave Chatter-Free Tooling “CFT” in the machine and use it for deep or shallow bore applications, thus reducing changeover and setup time.

5:1 Ratio up to **14:1 Ratio**

- Fully tunable boring bar (arrives pre-tuned)
- Labeled dial for ease of tuning
- Quick setup flat located on connection end of bar
- Solves difficult deep boring applications
- Increase surface finish
- Increase output by more aggressive cutting
- Increase tool life from reduced vibration
- Multiple head configurations



B

BORING



- p96 SOLID Bars
- p98 Modular Head Nomenclature



STANDARD (Pin) Connection

- p94 Modular Bars
- p97 "CFT Style" Modular Bars
- p99 Modular Heads



SERRATED Connection

- p112 Modular Bars
- p111 "CFT Style" Modular Bars
- p114 Modular Heads



Proper Workholding Using the Split Collar System

To assure the best rigidity of the boring bar, the split collar system is the best holder. This process is achieved by locking the bar 360° on the diameter.

Other workholding, like set-screws, damage the structural surface of the bar and are NOT recommended.



For more information download the Chatter-Free brochure or request a physical copy at www.ultradexusa.com

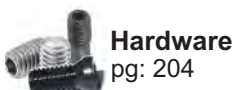

Hardware
pg: 204



Inserts
pg: 188



ULTRADEXUSA.com

B

BORING

STANDARD Chatter-Free Boring Bars (English)

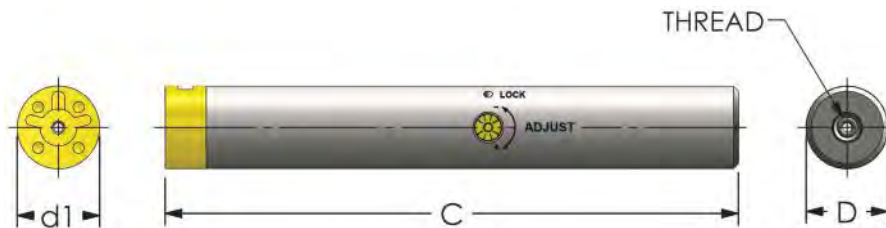

Modular Chatter-Free Bars

Coolant Thru

Designation	D Dia.	d1 (Coupling)	C OAL	Min Bore	Head Bolts	Thread	Price
5:1 Ratio							
CFT B1500-9	1.500	1.500	9	1.760	10-24 HB	1/8-27 NPT	\$1,157.60
CFT B2000-12	2.000	2.000	12	2.400	1/4-20 HB	1/8-27 NPT	\$1,406.67
CFT B2500-16	2.500	2.500	16	2.800	5/16-18 HB	1/8-27 NPT	\$1,913.60
7:1 Ratio							
CFT B1000-10	1.000	1.000	10	1.200	8-32 HB	1/8-27 NPT	\$888.77
CFT B1250-12	1.250	1.250	12	1.470	10-24 HB	1/8-27 NPT	\$993.02
CFT B1500-15	1.500	1.500	15	1.760	10-24 HB	1/8-27 NPT	\$1,157.60
CFT B1750-18	1.750	1.750	18	2.010	1/4-20 HB	1/8-27 NPT	\$1,327.67
CFT B2000-20	2.000	2.000	20	2.400	1/4-20 HB	1/8-27 NPT	\$1,406.67
CFT B2500-27	2.500	2.500	27	2.800	5/16-18 HB	1/4-18 NPT	\$1,913.60
CFT B3000-31	3.000	2.500	31	3.525	5/16-18 HB	1/4-18 NPT	\$2,304.23
10:1 Ratio							
CFT B1000-14	1.000	1.000	14	1.200	8-32 HB	1/8-27 NPT	\$1,716.10
CFT B1250-16	1.250	1.250	16	1.470	10-24 HB	1/8-27 NPT	\$1,869.71
CFT B1500-19	1.500	1.500	19	1.760	10-24 HB	1/8-27 NPT	\$1,919.10
CFT B1750-23	1.750	1.750	23	2.010	1/4-20 HB	1/8-27 NPT	\$2,024.43
CFT B2000-26	2.000	2.000	26	2.400	1/4-20 HB	1/8-27 NPT	\$2,134.16
CFT B2500-33	2.500	2.500	33	2.800	5/16-18 HB	1/4-18 NPT	\$2,909.91
CFT B3000-40	3.000	2.500	40	3.525	5/16-18 HB	1/4-18 NPT	\$4,222.22
CFT B4000-50	4.000	2.500	50	4.350	5/16-18 HB	1/4-18 NPT	\$7,465.69
12:1 Ratio							
CFT B1000-16	1.000	1.000	16	1.200	8-32 HB	--	\$3,805.26
CFT B1250-18	1.250	1.250	18	1.470	10-24 HB	--	\$4,710.50
CFT B1500-22	1.500	1.500	22	1.760	10-24 HB	--	\$5,806.65
CFT B1750-25	1.750	1.750	25	2.010	1/4-20 HB	--	\$7,098.12
CFT B2000-29	2.000	2.000	29	2.400	1/4-20 HB	--	\$8,904.19
14:1 Ratio							
CFT B1000-18	1.000	1.000	18	1.200	8-32 HB	--	\$7,419.60
CFT B1250-21	1.250	1.250	21	1.470	10-24 HB	--	\$8,842.74
CFT B1500-25	1.500	1.500	25	1.760	10-24 HB	--	\$10,262.58
CFT B1750-29	1.750	1.750	29	2.010	1/4-20 HB	--	\$11,940.27
CFT B2000-33	2.000	2.000	33	2.400	1/4-20 HB	--	\$15,296.77

B

BORING

STANDARD Chatter-Free Boring Bars (Metric)

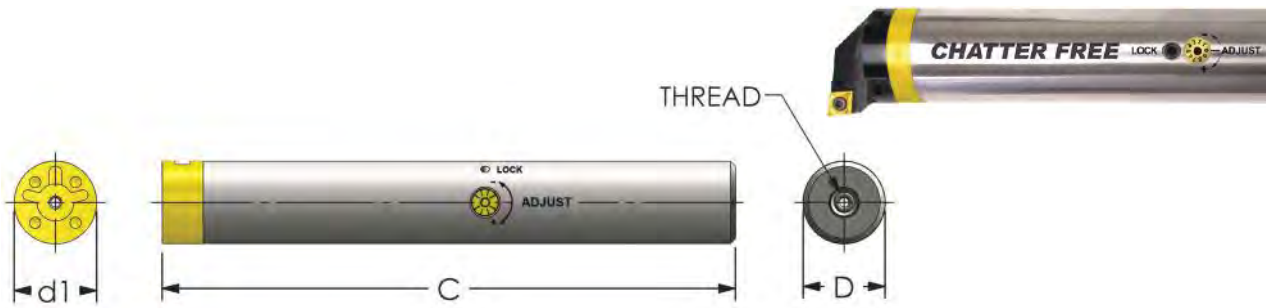

Modular Chatter-Free Bars

Coolant Thru

Designation	D Dia.	d1 (Coupling)	C OAL	Min Bore	Head Bolts	Thread	Price
7:1 Ratio							
CFT B25MM-250	25mm	1.000	250mm	1.200	8-32 HB	1/8-27 NPT	\$888.77
CFT B32MM-320	32mm	1.250	320mm	1.470	10-24 HB	1/8-27 NPT	\$993.02
CFT B40MM-400	40mm	1.500	400mm	1.760	10-24 HB	1/8-27 NPT	\$1,157.60
CFT B50MM-500	50mm	2.000	500mm	2.400	1/4-20 HB	1/8-27 NPT	\$1,406.67
CFT B60MM-600	60mm	2.000	600mm	2.830	1/4-20 HB	1/8-27 NPT	\$1,913.60
10:1 Ratio							
CFT B25MM-325	25mm	1.000	325mm	1.200	8-32 HB	1/8-27 NPT	\$1,716.10
CFT B32MM-416	32mm	1.250	416mm	1.470	10-24 HB	1/8-27 NPT	\$1,869.71
CFT B40MM-520	40mm	1.500	520mm	1.760	10-24 HB	1/8-27 NPT	\$1,919.10
CFT B50MM-650	50mm	2.000	650mm	2.400	1/4-20 HB	1/8-27 NPT	\$2,134.16
CFT B60MM-780	60mm	2.000	780mm	2.830	1/4-20 HB	1/8-27 NPT	\$2,909.91
12:1 Ratio							
CFT B32MM-480	32mm	1.250	480mm	1.470	10-24 HB	--	\$4,710.50
CFT B40MM-600	40mm	1.500	600mm	1.760	10-24 HB	--	\$5,806.65
CFT B50MM-750	50mm	2.000	750mm	2.400	1/4-20 HB	--	\$8,904.19
14:1 Ratio							
CFT B32MM-544	32mm	1.250	544mm	1.470	10-24 HB	--	\$8,842.74
CFT B40MM-680	40mm	1.500	680mm	1.760	10-24 HB	--	\$10,262.58
CFT B50MM-850	50mm	2.000	850mm	2.400	1/4-20 HB	--	\$15,296.77

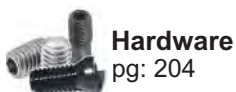

Hardware
pg: 204



Inserts
pg: 188

ULTRA-DEX

Proudly Made in Flushing, MI USA

B

BORING

SOLID Chatter-Free Boring Bars



SOLID Positive 80° Diamond (-5° Lead)

8:1 Ratio
Coolant Thru

Designation	D Dia.	C OAL	F	Min Bore	Insert	Insert Screw	Key	Price
D08R SCLCR2	.500	8	.281	.580	CCMT 21.51	MTS-255	T-7	\$652.87
D10X SCLCR3	.625	9	.406	.770	CCMT 32.51	MTS-35	T-15	\$707.73
D12S SCLCR3	.750	10	.500	.930		MTS-35	T-15	\$762.59

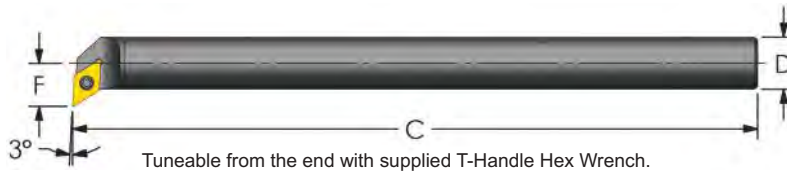

SOLID Positive 55° Diamond (-3° Lead)

8:1 Ratio
Coolant Thru

Designation	D Dia.	C OAL	F	Min Bore	Insert	Insert Screw	Key	Price
D08R SDUCR2	.500	8	.437	.730	DCMT 21.51	MTS-255	T-7	\$652.87
D10X SDUCR2	.625	9	.500	.850		MTS-255	T-7	\$707.73
D12S SDUCR3	.750	10	.625	1.050	DCMT 32.51	MTS-35	T-15	\$762.59

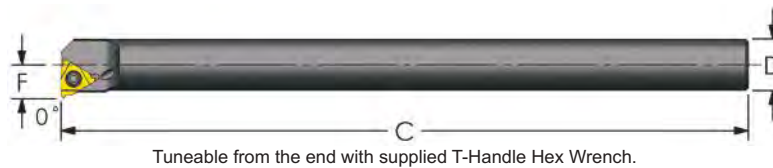

SOLID Threading/Grooving Laydown

8:1 Ratio
Coolant Thru

Designation	D Dia.	C OAL	F	Min Bore	Insert	Insert Screw	Price
D12S LSER3	.750	10	.510	.935	3IR	MTS-35	\$762.59

B

BORING

MADE IN MICHIGAN



In addition to our Chatter-Free bars, we offer a solid carbide or steel alternative with the same connection! These solid bars fit all heads following this page with the ending “-CFT” designation.

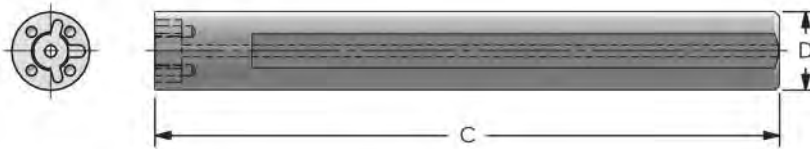

B

BORING

Steel Shank

4:1 Ratio
Coolant Thru

Designation	D Dia.	C OAL	Min Bore	Head Bolts	Price
A1000-12	1.000	12	1.200	8-32	\$175.56
A1250-14	1.250	14	1.500	10-24	\$227.14
A1500-14	1.500	14	1.710	10-24	\$251.28
A1750-16	1.750	16	2.010	1/4-20	\$299.55
A2000-20	2.000	20	2.400	1/4-20	\$395.01
A2500-12	2.500	12	2.900	5/16-18	\$452.07
A2500-24	2.500	24	2.900	5/16-18	\$646.29
A3000-18 *	3.000	18	3.525	5/16-18	\$741.74

* 3" bar takes 2.5" head

Carbide Shank

8:1 Ratio
Coolant Thru

Designation	D Dia.	C OAL	Min Bore	Head Bolts	Price
E1000-12	1.000	12	1.200	8-32	\$1,024.83
E1250-14	1.250	14	1.500	10-24	\$1,787.43
E1500-14	1.500	14	1.710	10-24	\$2,115.50
E1750-16	1.750	16	2.010	1/4-20	\$3,173.25
E2000-20	2.000	20	2.400	1/4-20	\$4,701.72

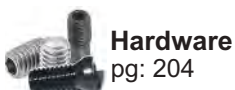

Hardware
pg: 204



Inserts
pg: 188

ULTRA-DEX

ULTRADEXUSA.com

Chatter-Free Modular Boring Bar NOMENCLATURE

B

BORING

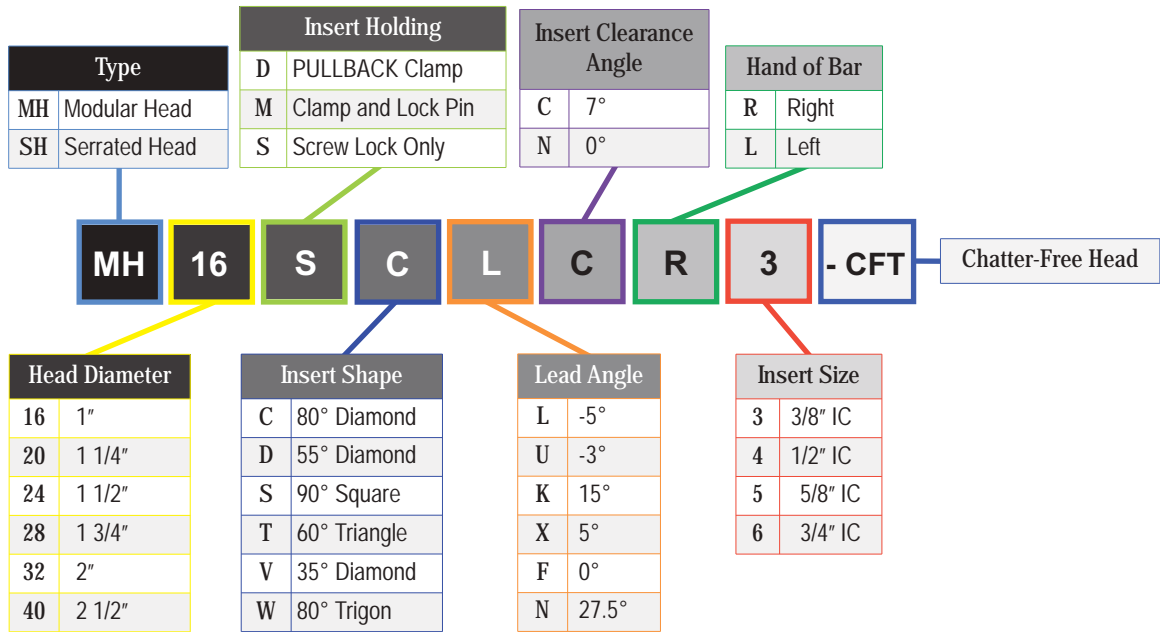

Threading / Grooving

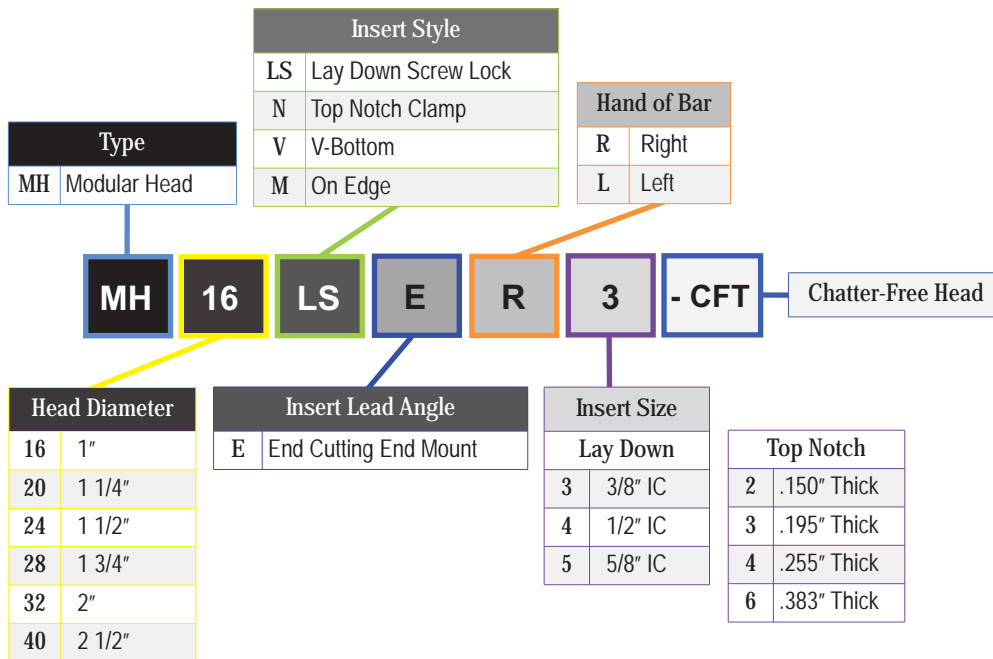

STANDARD Chatter-Free Heads (Positive)

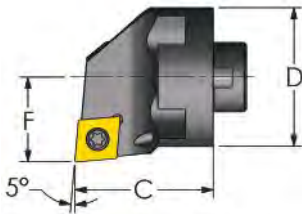

Positive 80° Diamond
(-5° Lead)
Coolant Thru

Designation Right Hand	D Dia.	C OAL	F	Min Bore	Insert	Insert Screw	Key	Price
MH16 SCLCR3-CFT	1.000	.790	.625	1.200	CCMT 32.51	MTS-35	T-15	\$168.98
MH20 SCLCR3-CFT	1.250	1.250	.765	1.470		MTS-35	T-15	\$174.47
MH24 SCLCR3-CFT	1.500	1.250	.890	1.760		MTS-35	T-15	\$185.44
MH28 SCLCR3-CFT	1.750	1.250	1.015	2.030		MTS-35	T-15	\$207.39
MH24 SCLCR4-CFT	1.500	1.250	.890	1.760	CCMT 432	MTS-4	T-20	\$229.33
MH28 SCLCR4-CFT	1.750	1.250	1.015	2.030		MTS-4	T-20	\$251.28
MH32 SCLCR4-CFT	2.000	1.625	1.281	2.400		MTS-4	T-20	\$229.33
MH40 SCLCR4-CFT	2.500	1.625	1.500	2.800		MTS-4	T-20	\$251.28

Designation Left Hand	D Dia.	C OAL	F	Min Bore	Insert	Insert Screw	Key	Price
MH16 SCLCL3-CFT	1.000	.790	.625	1.200	CCMT 32.51	MTS-35	T-15	\$179.95
MH20 SCLCL3-CFT	1.250	1.250	.765	1.470		MTS-35	T-15	\$185.44
MH24 SCLCL3-CFT	1.500	1.250	.890	1.760		MTS-35	T-15	\$196.41
MH28 SCLCL3-CFT	1.750	1.250	1.015	2.030		MTS-35	T-15	\$218.36
MH32 SCLCL4-CFT	2.000	1.625	1.281	2.400	CCMT 432	MTS-4	T-20	\$240.30
MH40 SCLCL4-CFT	2.500	1.625	1.500	2.800		MTS-4	T-20	\$262.25

Steel pg: 24

Hybrid pg: 49

Carbide pg: 54, 55

Heavy Metal pg: 73

Modular pg: 79

Serrated Chatter-Free pg: 114

2xD 2.5xD 3xD 4xD INDEXABLE DRILLS

BEST Value in the Industry!
SEE Page 142



For use with
"STANDARD"
Chatter-Free Bars
pgs 94-95,97

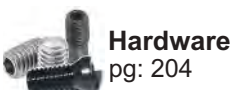

Hardware
pg: 204



Inserts
pg: 188

ULTRA-DEX

Proudly Made in Flushing, MI USA

B

BORING

STANDARD Chatter-Free Heads (Positive)

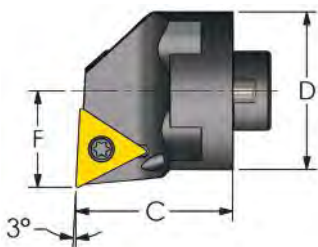

**Positive Triangle
(-3° Lead)
Coolant Thru**



For use with
“STANDARD”
Chatter-Free Bars
pgs 94-95,97

Designation Right Hand	D Dia.	C OAL	F	Min Bore	Insert	Insert Screw	Key	Price
MH16 STUCR2-CFT	1.000	.790	.625	1.200	TCMT 21.51	MTS-255	T-7	\$168.98
MH20 STUCR3-CFT	1.250	1.250	.765	1.470		MTS-35	T-15	\$174.47
MH24 STUCR3-CFT	1.500	1.250	.890	1.760		MTS-35	T-15	\$185.44
MH28 STUCR3-CFT	1.750	1.250	1.015	2.030		MTS-35	T-15	\$207.39
MH32 STUCR3-CFT	2.000	1.625	1.281	2.400		MTS-35	T-15	\$229.33
MH40 STUCR3-CFT	2.500	1.625	1.500	2.800		MTS-35	T-15	\$251.28

Designation Left Hand	D Dia.	C OAL	F	Min Bore	Insert	Insert Screw	Key	Price
MH16 STUCL2-CFT	1.000	.790	.625	1.200	TCMT 21.51	MTS-255	T-7	\$190.92
MH20 STUCL3-CFT	1.250	1.250	.765	1.470		MTS-35	T-15	\$196.41
MH24 STUCL3-CFT	1.500	1.250	.890	1.760		MTS-35	T-15	\$207.39
MH28 STUCL3-CFT	1.750	1.250	1.015	2.030		MTS-35	T-15	\$229.33
MH32 STUCL3-CFT	2.000	1.625	1.281	2.400		MTS-35	T-15	\$251.28
MH40 STUCL3-CFT	2.500	1.625	1.500	2.800		MTS-35	T-15	\$273.22

Also available in: Steel pg: 29 Carbide pg: 60 Heavy Metal pg: 75 Modular pg: 81

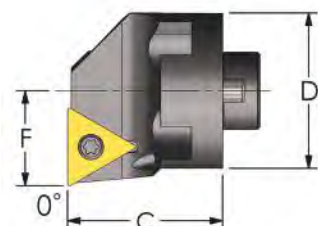

**Positive Triangle
(0° Lead)
Coolant Thru**



Designation Right Hand	D Dia.	C OAL	F	Min Bore	Insert	Insert Screw	Key	Price
MH16 STFCR2	1.000	.790	.625	1.200	TCMT 21.51	MTS-255	T-7	\$168.98
MH20 STFCR3	1.250	1.250	.765	1.470		MTS-35	T-15	\$174.47
MH24 STFCR3	1.500	1.250	.890	1.760		MTS-35	T-15	\$185.44
MH28 STFCR3	1.750	1.250	1.015	2.030		MTS-35	T-15	\$207.39
MH32 STFCR3	2.000	1.625	1.281	2.400		MTS-35	T-15	\$229.33
MH40 STFCR3	2.500	1.625	1.500	2.800		MTS-35	T-15	\$251.28

Designation Left Hand	D Dia.	C OAL	F	Min Bore	Insert	Insert Screw	Key	Price
MH16 STFCL2	1.000	.790	.625	1.200	TCMT 21.51	MTS-255	T-7	\$190.92
MH20 STFCL3	1.250	1.250	.765	1.470		MTS-35	T-15	\$196.41
MH24 STFCL3	1.500	1.250	.890	1.760		MTS-35	T-15	\$207.39
MH28 STFCL3	1.750	1.250	1.015	2.030		MTS-35	T-15	\$229.33
MH32 STFCL3	2.000	1.625	1.281	2.400		MTS-35	T-15	\$251.28
MH40 STFCL3	2.500	1.625	1.500	2.800		MTS-35	T-15	\$273.22

Also available in: Steel pg: 31 Carbide pg: 62 Modular pg: 81

B

BORING

STANDARD Chatter-Free Heads (Positive)

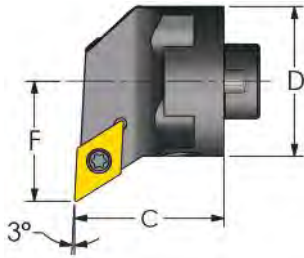

**Positive 55° Diamond
(-3° Lead) Profiling
Coolant Thru**

Designation Right Hand	D Dia.	C OAL	F	Min Bore	Insert	Insert Screw	Key	Price
MH16 SDUCR3-CFT	1.000	.790	.750	1.300	DCMT 32.51	MTS-35	T-15	\$168.98
MH20 SDUCR3-CFT	1.250	1.250	1.000	1.675		MTS-35	T-15	\$174.47
MH24 SDUCR3-CFT	1.500	1.250	1.120	1.920		MTS-35	T-15	\$185.44
MH28 SDUCR3-CFT	1.750	1.250	1.250	2.175		MTS-35	T-15	\$207.39
MH32 SDUCR3-CFT	2.000	1.625	1.375	2.425		MTS-35	T-15	\$229.33
MH40 SDUCR3-CFT	2.500	1.625	1.500	2.800		MTS-35	T-15	\$251.28

Designation Left Hand	D Dia.	C OAL	F	Min Bore	Insert	Insert Screw	Key	Price
MH16 SDUCL3-CFT	1.000	.790	.750	1.300	DCMT 32.51	MTS-35	T-15	\$179.95
MH20 SDUCL3-CFT	1.250	1.250	1.000	1.675		MTS-35	T-15	\$185.44
MH24 SDUCL3-CFT	1.500	1.250	1.120	1.920		MTS-35	T-15	\$196.41
MH28 SDUCL3-CFT	1.750	1.250	1.250	2.175		MTS-35	T-15	\$218.36
MH32 SDUCL3-CFT	2.000	1.625	1.375	2.425		MTS-35	T-15	\$240.30
MH40 SDUCL3-CFT	2.500	1.625	1.500	2.800		MTS-35	T-15	\$262.25

Also available in: Steel pg: 32 Carbide pg: 64 Modular pg: 81 Serrated Chatter-Free pg: 116

B

BORING

SAME DAY SHIPPING!

On orders placed before 3:30pm EST
SEE PAGE 210 for more details...

3:30



For use with
"STANDARD"
Chatter-Free Bars
pgs 94-95,97

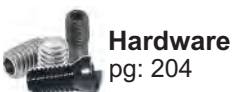

Hardware
pg: 204



Inserts
pg: 188



STANDARD Chatter-Free Heads (Negative)

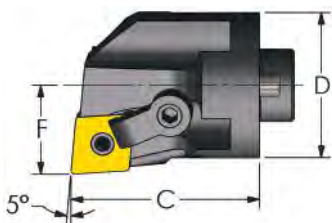

Negative 80° Diamond
(-5° Lead)
Coolant Thru

B

BORING

Designation Right Hand	D Dia.	C OAL	F	Min Bore	Insert	Shim	Clamp	Clamp Screw	Lock Pin	Price
MH16 MCLNR4-CFT	1.000	1.625	.640	1.200	CNMG 432	--	CL-20	XNS-47	NL-44	\$179.95
MH20 MCLNR4-CFT	1.250	1.625	.765	1.470		ICSN-433	CL-20	XNS-47	NL-46	\$185.44
MH24 MCLNR4-CFT	1.500	1.625	.890	1.760		ICSN-433	CL-20	XNS-47	NL-46	\$196.41
MH28 MCLNR4-CFT	1.750	1.625	1.015	2.010		ICSN-433	CL-20	XNS-47	NL-46	\$201.89
MH32 MCLNR4-CFT	2.000	1.625	1.281	2.400		ICSN-433	CL-20	XNS-47	NL-46	\$229.33
MH40 MCLNR4-CFT	2.500	1.625	1.531	2.980		ICSN-433	CL-20	XNS-47	NL-46	\$246.89
MH24 MCLNR5-CFT	1.500	1.625	.890	1.760	CNMG 543	--	CL-20	XNS-47	NL-56	\$218.36
MH32 MCLNR5-CFT	2.000	1.625	1.281	2.400		ICSN-533	CL-12	XNS-510	NL-58	\$251.28
MH40 MCLNR5-CFT	2.500	1.625	1.531	2.980		ICSN-533	CL-12	XNS-510	NL-58	\$268.83
MH32 MCLNR6-CFT	2.000	1.625	1.281	2.400	CNMG 643	ICSN-633	CL-12	XNS-59	NL-68	\$273.22
MH40 MCLNR6-CFT	2.500	1.625	1.531	3.030		ICSN-633	CL-12	XNS-59	NL-68	\$290.78

Designation Left Hand	D Dia.	C OAL	F	Min Bore	Insert	Shim	Clamp	Clamp Screw	Lock Pin	Price
MH16 MCLNL4-CFT	1.000	1.625	.640	1.200	CNMG 432	--	CL-20	XNS-47	NL-44	\$201.89
MH20 MCLNL4-CFT	1.250	1.625	.765	1.470		ICSN-433	CL-20	XNS-47	NL-46	\$207.39
MH24 MCLNL4-CFT	1.500	1.625	.890	1.760		ICSN-433	CL-20	XNS-47	NL-46	\$218.36
MH28 MCLNL4-CFT	1.750	1.625	1.015	2.010		ICSN-433	CL-20	XNS-47	NL-46	\$223.84
MH32 MCLNL4-CFT	2.000	1.625	1.281	2.400		ICSN-433	CL-20	XNS-47	NL-46	\$251.28
MH40 MCLNL4-CFT	2.500	1.625	1.531	2.980		ICSN-433	CL-20	XNS-47	NL-46	\$268.83
MH24 MCLNL5-CFT	1.500	1.625	.890	1.760	CNMG 543	--	CL-20	XNS-47	NL-56	\$240.30
MH32 MCLNL5-CFT	2.000	1.625	1.281	2.400		ICSN-533	CL-12	XNS-510	NL-58	\$273.22
MH40 MCLNL5-CFT	2.500	1.625	1.531	2.980		ICSN-533	CL-12	XNS-510	NL-58	\$290.78
MH32 MCLNL6-CFT	2.000	1.625	1.281	2.400	CNMG 643	ICSN-633	CL-12	XNS-59	NL-68	\$295.17
MH40 MCLNL6-CFT	2.500	1.625	1.531	3.030		ICSN-633	CL-12	XNS-59	NL-68	\$312.72

Also available in: Steel pg: 36 Hybrid pg: 49 Carbide pg: 67 Modular pg: 84



For use with
"STANDARD"
Chatter-Free Bars
pgs 94-95,97

STANDARD Chatter-Free Heads (Negative)

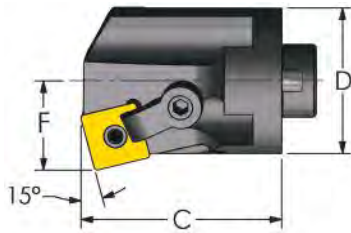

Negative Square
(15° Lead)
Coolant Thru

Designation Right Hand	D Dia.	C OAL	F	Min Bore	Insert	Shim	Clamp	Clamp Screw	Lock Pin	Price
MH20 MSKNR4-CFT	1.250	1.744	.765	1.470	SNMG 432	ISSN-433	CL-20	XNS-47	NL-46	\$185.44
MH24 MSKNR4-CFT	1.500	1.744	.890	1.760		ISSN-433	CL-20	XNS-47	NL-46	\$196.41
MH28 MSKNR4-CFT	1.750	1.744	1.015	2.010		ISSN-433	CL-20	XNS-47	NL-46	\$201.89
MH32 MSKNR4-CFT	2.000	1.744	1.281	2.400		ISSN-433	CL-20	XNS-47	NL-46	\$229.33
MH40 MSKNR4-CFT	2.500	1.804	1.531	3.030		ISSN-433	CL-20	XNS-47	NL-46	\$246.89
MH32 MSKNR5-CFT	2.000	1.744	1.281	2.400	SNMG 543	ISSN-533	CL-12	XNS-510	NL-58	\$251.28
MH40 MSKNR5-CFT	2.500	1.804	1.531	3.030		ISSN-533	CL-12	XNS-510	NL-58	\$268.83
MH32 MSKNR6-CFT	2.000	1.744	1.281	2.400	SNMG 643	ISSN-633	CL-12	XNS-510	NL-68	\$273.22
MH40 MSKNR6-CFT	2.500	1.804	1.531	3.030		ISSN-633	CL-12	XNS-510	NL-68	\$290.78

Designation Left Hand	D Dia.	C OAL	F	Min Bore	Insert	Shim	Clamp	Clamp Screw	Lock Pin	Price
MH20 MSKNL4-CFT	1.250	1.744	.765	1.470	SNMG 432	ISSN-433	CL-20	XNS-47	NL-46	\$207.39
MH24 MSKNL4-CFT	1.500	1.744	.890	1.760		ISSN-433	CL-20	XNS-47	NL-46	\$218.36
MH28 MSKNL4-CFT	1.750	1.744	1.015	2.010		ISSN-433	CL-20	XNS-47	NL-46	\$223.84
MH32 MSKNL4-CFT	2.000	1.744	1.281	2.400		ISSN-433	CL-20	XNS-47	NL-46	\$251.28
MH40 MSKNL4-CFT	2.500	1.804	1.531	3.030		ISSN-433	CL-20	XNS-47	NL-46	\$268.83
MH32 MSKNL5-CFT	2.000	1.744	1.281	2.400	SNMG 543	ISSN-533	CL-12	XNS-510	NL-58	\$273.22
MH40 MSKNL5-CFT	2.500	1.804	1.531	3.030		ISSN-533	CL-12	XNS-510	NL-58	\$290.78
MH32 MSKNL6-CFT	2.000	1.744	1.281	2.400	SNMG 643	ISSN-633	CL-12	XNS-510	NL-68	\$295.17
MH40 MSKNL6-CFT	2.500	1.804	1.531	3.030		ISSN-633	CL-12	XNS-510	NL-68	\$312.72

Also available in: Modular pg: 85



For use with
"STANDARD"
Chatter-Free Bars
pgs 94-95,97

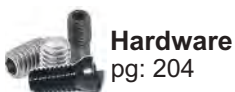

Hardware
pg: 204



Inserts
pg: 188

ULTRA-DEX

Proudly Made in Flushing, MI USA **103**

B

BORING

STANDARD Chatter-Free Heads (Negative)

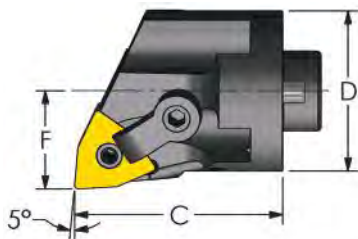

**Negative Trigon
(-5° Lead)
Coolant Thru**

Designation Right Hand	D Dia.	C OAL	F	Min Bore	Insert	Shim	Clamp	Clamp Screw	Lock Pin	Price
MH16 MWLNR4-CFT	1.000	1.625	.640	1.200	WNMG 432	--	CL-20	XNS-47	NL-44	\$179.95
MH20 MWLNR4-CFT	1.250	1.625	.765	1.470		IWSN-433	CL-20	XNS-47	NL-46	\$185.44
MH24 MWLNR4-CFT	1.500	1.625	.890	1.760		IWSN-433	CL-20	XNS-47	NL-46	\$196.41
MH28 MWLNR4-CFT	1.750	1.625	1.015	2.010		IWSN-433	CL-20	XNS-47	NL-46	\$201.89
MH32 MWLNR4-CFT	2.000	1.625	1.281	2.400		IWSN-433	CL-20	XNS-47	NL-46	\$229.33
MH40 MWLNR4-CFT	2.500	1.625	1.500	2.980		IWSN-433	CL-20	XNS-47	NL-46	\$246.89

Designation Left Hand	D Dia.	C OAL	F	Min Bore	Insert	Shim	Clamp	Clamp Screw	Lock Pin	Price
MH16 MWLNL4-CFT	1.000	1.625	.640	1.200	WNMG 432	--	CL-20	XNS-47	NL-44	\$201.89
MH20 MWLNL4-CFT	1.250	1.625	.765	1.470		IWSN-433	CL-20	XNS-47	NL-46	\$207.39
MH24 MWLNL4-CFT	1.500	1.625	.890	1.760		IWSN-433	CL-20	XNS-47	NL-46	\$218.36
MH28 MWLNL4-CFT	1.750	1.625	1.015	2.010		IWSN-433	CL-20	XNS-47	NL-46	\$223.84
MH32 MWLNL4-CFT	2.000	1.625	1.281	2.400		IWSN-433	CL-20	XNS-47	NL-46	\$251.28
MH40 MWLNL4-CFT	2.500	1.625	1.500	2.980		IWSN-433	CL-20	XNS-47	NL-46	\$268.83

Also available in: Steel pg: 37 Hybrid pg: 49 Carbide pg: 67 Modular pg: 85

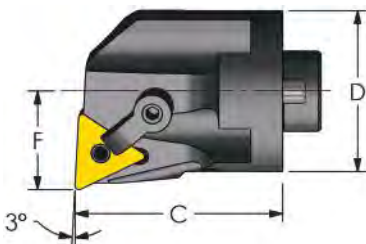

**Negative Triangle
(-3° Lead)
Coolant Thru**

Designation Right Hand	D Dia.	C OAL	F	Min Bore	Insert	Shim	Clamp	Clamp Screw	Lock Pin	Price
MH16 MTUNR3-CFT	1.000	1.625	.640	1.200	TNMG 332	--	CL-7	XNS-36	NL-33L	\$179.95
MH20 MTUNR3-CFT	1.250	1.625	.765	1.470		ITSN-323	CL-7	XNS-36	NL-34L	\$185.44
MH24 MTUNR4-CFT	1.500	1.625	.890	1.760	TNMG 432	ITSN-433	CL-20	XNS-47	NL-46	\$196.41
MH28 MTUNR4-CFT	1.750	1.625	1.015	2.010		ITSN-433	CL-20	XNS-47	NL-46	\$201.89
MH32 MTUNR4-CFT	2.000	1.625	1.281	2.400		ITSN-433	CL-20	XNS-47	NL-46	\$229.33
MH40 MTUNR4-CFT	2.500	1.625	1.531	2.900		ITSN-433	CL-20	XNS-47	NL-46	\$246.89

Also available in: Steel pg: 38 Modular pg: 86

B

BORING

STANDARD Chatter-Free Heads (Negative)

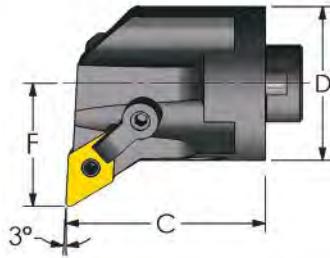

Negative 55° Diamond
(-3° Lead)
Coolant Thru

Designation Right Hand	D Dia.	C OAL	F	Min Bore	Insert	Shim	Clamp	Clamp Screw	Lock Pin	Price
MH16 MDUNR3-CFT	1.000	1.625	.750	1.300	DNMG 332	--	CL-7	XNS-36	NL-33L	\$179.95
MH20 MDUNR3-CFT	1.250	1.625	1.000	1.705		IDSN-322	CL-7	XNS-36	NL-34L	\$185.44
MH24 MDUNR3-CFT	1.500	1.625	1.125	2.000		IDSN-322	CL-7	XNS-36	NL-34L	\$196.41
MH28 MDUNR3-CFT	1.750	1.625	1.250	2.250		IDSN-322	CL-7	XNS-36	NL-34L	\$218.36
MH32 MDUNR3-CFT	2.000	1.625	1.375	2.500		IDSN-322	CL-7	XNS-36	NL-34L	\$240.30
MH40 MDUNR3-CFT	2.500	1.625	1.500	2.950		IDSN-322	CL-7	XNS-36	NL-34L	\$262.25
MH20 MDUNR4-CFT	1.250	1.625	1.000	1.705	DNMG 432	IDSN-433	CL-20	XNS-48	NL-46	\$185.44
MH24 MDUNR4-CFT	1.500	1.625	1.125	2.000		IDSN-433	CL-22	XNS-48	NL-46	\$196.41
MH28 MDUNR4-CFT	1.750	1.625	1.250	2.250		IDSN-433	CL-22	XNS-48	NL-46	\$218.36
MH32 MDUNR4-CFT	2.000	1.625	1.375	2.500		IDSN-433	CL-22	XNS-48	NL-46	\$240.30
MH40 MDUNR4-CFT	2.500	1.625	1.500	2.950		IDSN-433	CL-22	XNS-48	NL-46	\$262.25

Designation Left Hand	D Dia.	C OAL	F	Min Bore	Insert	Shim	Clamp	Clamp Screw	Lock Pin	Price
MH16 MDUNL3-CFT	1.000	1.625	.750	1.300	DNMG 332	--	CL-7	XNS-36	NL-33L	\$201.89
MH20 MDUNL3-CFT	1.250	1.625	1.000	1.705		IDSN-322	CL-7	XNS-36	NL-34L	\$207.39
MH24 MDUNL3-CFT	1.500	1.625	1.125	2.000		IDSN-322	CL-7	XNS-36	NL-34L	\$218.36
MH28 MDUNL3-CFT	1.750	1.625	1.250	2.250		IDSN-322	CL-7	XNS-36	NL-34L	\$240.30
MH32 MDUNL3-CFT	2.000	1.625	1.375	2.500		IDSN-322	CL-7	XNS-36	NL-34L	\$262.25
MH40 MDUNL3-CFT	2.500	1.625	1.500	2.950		IDSN-322	CL-7	XNS-36	NL-34L	\$284.19
MH20 MDUNL4-CFT	1.250	1.625	1.000	1.705	DNMG 432	IDSN-433	CL-20	XNS-48	NL-46	\$207.39
MH24 MDUNL4-CFT	1.500	1.625	1.125	2.000		IDSN-433	CL-22	XNS-48	NL-46	\$218.36
MH28 MDUNL4-CFT	1.750	1.625	1.250	2.250		IDSN-433	CL-22	XNS-48	NL-46	\$240.30
MH32 MDUNL4-CFT	2.000	1.625	1.375	2.500		IDSN-433	CL-22	XNS-48	NL-46	\$262.25
MH40 MDUNL4-CFT	2.500	1.625	1.500	2.950		IDSN-433	CL-22	XNS-48	NL-46	\$284.19

Also available in: Steel pg: 39 Modular pg: 87



For use with
"STANDARD"
Chatter-Free Bars
pgs 94-95,97

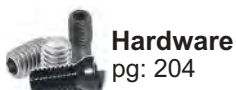

STANDARD Chatter-Free Heads (Negative)

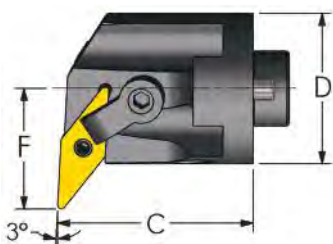

Negative 35° Diamond
(-3° Lead)
Coolant Thru

B

BORING

Designation Right Hand	D Dia.	C OAL	F	Min Bore	Insert	Shim	Clamp	Clamp Screw	Lock Pin	Price
MH16 MVUNR3-CFT	1.000	1.625	.875	1.435	VNMG 332	IVSN-322	CL-20	XNS-47	NL-34L	\$179.95
MH20 MVUNR3-CFT	1.250	1.625	1.000	1.705		IVSN-322	CL-20	XNS-47	NL-34L	\$185.44
MH24 MVUNR3-CFT	1.500	1.625	1.125	2.000		IVSN-322	CL-20	XNS-47	NL-34L	\$196.41
MH28 MVUNR3-CFT	1.750	1.625	1.250	2.250		IVSN-322	CL-20	XNS-47	NL-34L	\$218.36
MH32 MVUNR3-CFT	2.000	1.625	1.375	2.500		IVSN-322	CL-20	XNS-47	NL-34L	\$240.30
MH40 MVUNR3-CFT	2.500	1.625	1.750	3.250		IVSN-322	CL-20	XNS-47	NL-34L	\$262.25
MH40 MVUNR4-CFT	2.500	1.625	1.750	3.250	VNMG 432	IVSN-432	CL-22	XNS-48	NL-46	\$262.25

Designation Left Hand	D Dia.	C OAL	F	Min Bore	Insert	Shim	Clamp	Clamp Screw	Lock Pin	Price
MH16 MVUNL3-CFT	1.000	1.625	.875	1.435	VNMG 332	IVSN-322	CL-20	XNS-47	NL-34L	\$201.89
MH20 MVUNL3-CFT	1.250	1.625	1.000	1.705		IVSN-322	CL-20	XNS-47	NL-34L	\$207.39
MH24 MVUNL3-CFT	1.500	1.625	1.125	2.000		IVSN-322	CL-20	XNS-47	NL-34L	\$218.36
MH28 MVUNL3-CFT	1.750	1.625	1.250	2.250		IVSN-322	CL-20	XNS-47	NL-34L	\$240.30
MH32 MVUNL3-CFT	2.000	1.625	1.375	2.500		IVSN-322	CL-20	XNS-47	NL-34L	\$262.25
MH40 MVUNL3-CFT	2.500	1.625	1.750	3.250		IVSN-322	CL-20	XNS-47	NL-34L	\$284.19
MH40 MVUNL4-CFT	2.500	1.625	1.750	3.250	VNMG 432	IVSN-432	CL-22	XNS-48	NL-46	\$284.19

Also available in: Steel pg: 38 Modular pg: 88

MADE HERE



For use with
"STANDARD"
Chatter-Free Bars
pgs 94-95,97

DON'T THROW IT AWAY!

Send Us Your Damaged Tooling for Repair

See **pg. 208**
For More
Details

STANDARD Chatter-Free Heads (Negative)

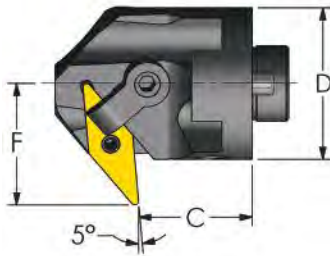

Negative 35° Diamond
(5° Lead) Back Facing
Coolant Thru

Designation Right Hand	D Dia.	C OAL	F	Min Bore	Insert	Shim	Clamp	Clamp Screw	Lock Pin	Price
MH16 MVXNR3-CFT	1.000	.940	.875	1.435	VNMG 332	IVSN-322	CL-20	XNS-47	NL-34L	\$190.92
MH20 MVXNR3-CFT	1.250	1.000	1.000	1.705		IVSN-322	CL-20	XNS-47	NL-34L	\$196.41
MH24 MVXNR3-CFT	1.500	1.120	1.125	2.000		IVSN-322	CL-20	XNS-47	NL-34L	\$207.39
MH28 MVXNR3-CFT	1.750	1.120	1.250	2.250		IVSN-322	CL-20	XNS-47	NL-34L	\$212.87
MH32 MVXNR3-CFT	2.000	1.120	1.375	2.500		IVSN-322	CL-20	XNS-47	NL-34L	\$240.30
MH40 MVXNR3-CFT	2.500	1.120	1.750	3.250		IVSN-322	CL-20	XNS-47	NL-34L	\$262.25

Designation Left Hand	D Dia.	C OAL	F	Min Bore	Insert	Shim	Clamp	Clamp Screw	Lock Pin	Price
MH16 MVXNL3-CFT	1.000	.940	.875	1.435	VNMG 332	IVSN-322	CL-20	XNS-47	NL-34L	\$212.87
MH20 MVXNL3-CFT	1.250	1.000	1.000	1.705		IVSN-322	CL-20	XNS-47	NL-34L	\$218.36
MH24 MVXNL3-CFT	1.500	1.120	1.125	2.000		IVSN-322	CL-20	XNS-47	NL-34L	\$229.33
MH28 MVXNL3-CFT	1.750	1.120	1.250	2.250		IVSN-322	CL-20	XNS-47	NL-34L	\$234.81
MH32 MVXNL3-CFT	2.000	1.120	1.375	2.500		IVSN-322	CL-20	XNS-47	NL-34L	\$262.25
MH40 MVXNL3-CFT	2.500	1.120	1.750	3.250		IVSN-322	CL-20	XNS-47	NL-34L	\$284.19

WE DO CUSTOM DESIGN & BUILDS

See pg 209 for more details

ultra-dex.com



For use with
"STANDARD"
Chatter-Free Bars
pgs 94-95,97

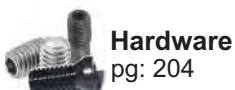

Hardware
pg: 204



Inserts
pg: 188

ULTRA-DEX

Proudly Made in Flushing, MI USA 107

B

BORING

STANDARD Chatter-Free Heads (Threading / Grooving)

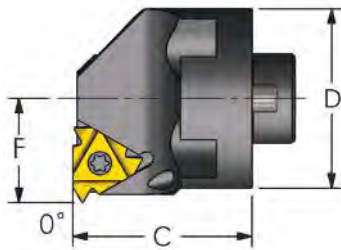

Threading / Grooving
Laydown
Coolant Thru

B

BORING

Designation Right Hand	D Dia.	C OAL	F	Min Bore	Insert	Insert Screw	Anvil Screw	Anvil	Price
MH16 LSER3-CFT	1.000	1.625	.650	1.200	3IR	SA3T	SY3T	YI3	\$190.92
MH20 LSER3-CFT	1.250	1.625	.770	1.450		SA3T	SY3T	YI3	\$196.41
MH24 LSER3-CFT	1.500	1.625	.900	1.650		SA3T	SY3T	YI3	\$206.28
MH28 LSER3-CFT	1.750	1.625	1.090	2.020		SA3T	SY3T	YI3	\$221.64
MH32 LSER3-CFT	2.000	1.625	1.281	2.400		SA3T	SY3T	YI3	\$245.78
MH24 LSER4-CFT	1.500	1.625	.978	1.782	4IR	SA4T	SY4T	YI4	\$206.28
MH28 LSER4-CFT	1.750	1.625	1.090	2.020		SA4T	SY4T	YI4	\$221.64
MH32 LSER4-CFT	2.000	1.625	1.281	2.400		SA4T	SY4T	YI4	\$245.78
MH32 LSER5-CFT	2.000	1.625	1.281	2.400	5IR	SA5T	SY5T	YI5	\$245.78
MH40 LSER5-CFT	2.500	1.625	1.530	2.800		SA5T	SY5T	YI5	\$267.73

Designation Left Hand	D Dia.	C OAL	F	Min Bore	Insert	Insert Screw	Anvil Screw	Anvil	Price
MH16 LSEL3-CFT	1.000	1.625	.650	1.200	3IL	SA3T	SY3T	YE3	\$212.87
MH20 LSEL3-CFT	1.250	1.625	.770	1.450		SA3T	SY3T	YE3	\$218.36
MH24 LSEL3-CFT	1.500	1.625	.900	1.650		SA3T	SY3T	YE3	\$228.23
MH28 LSEL3-CFT	1.750	1.625	1.090	2.020		SA3T	SY3T	YE3	\$243.59
MH32 LSEL3-CFT	2.000	1.625	1.281	2.400		SA3T	SY3T	YE3	\$267.73
MH24 LSEL4-CFT	1.500	1.625	.978	1.782	4IL	SA4T	SY4T	YE4	\$228.23
MH28 LSEL4-CFT	1.750	1.625	1.090	2.020		SA4T	SY4T	YE4	\$243.59
MH32 LSEL4-CFT	2.000	1.625	1.281	2.400		SA4T	SY4T	YE4	\$267.73
MH32 LSEL5-CFT	2.000	1.625	1.281	2.400	5IL	SA5T	SY5T	YE5	\$267.73
MH40 LSEL5-CFT	2.500	1.625	1.530	2.800		SA5T	SY5T	YE5	\$289.67

Also available in: Steel pg: 40 Carbide pg: 68 Modular pg: 90 Serrated Chatter-Free pg: 121



For use with
"STANDARD"
Chatter-Free Bars
pgs 94-95,97

STANDARD Chatter-Free Heads (Threading / Grooving)

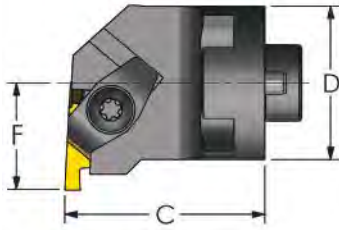

Threading / Grooving
Top Notch
Coolant Thru



Designation Right Hand	D Dia.	C OAL	F	Min Bore	Insert	Clamp	Screw	Price
MH20 NER3-CFT	1.250	1.625	.875	1.750	NG 3L	CM-73	10-32	\$185.44
MH24 NER3-CFT	1.500	1.625	1.000	2.000		CM-73	10-32	\$195.31
MH28 NER3-CFT	1.750	1.625	1.125	2.250		CM-73	10-32	\$210.67
MH32 NER3-CFT	2.000	1.625	1.250	2.410		CM-73	10-32	\$234.81
MH28 NER4-CFT	1.750	1.625	1.250	2.500	NG 4L	CM-73	10-32	\$210.67
MH32 NER4-CFT	2.000	1.625	1.375	2.750		CM-73	10-32	\$234.81
MH40 NER4-CFT	2.500	1.625	1.625	3.250		CM-73	10-32	\$251.28
MH28 NER6-CFT	1.750	1.625	1.250	2.500	NG 6L	CM-121	10-32	\$210.67
MH32 NER6-CFT	2.000	1.625	1.375	2.750		CM-121	10-32	\$234.81
MH40 NER6-CFT	2.500	1.625	1.625	3.250		CM-121	10-32	\$251.28

Designation Left Hand	D Dia.	C OAL	F	Min Bore	Insert	Clamp	Screw	Price
MH20 NEL3-CFT	1.250	1.625	.875	1.750	NG 3R	CM-72	10-32	\$207.39
MH24 NEL3-CFT	1.500	1.625	1.000	2.000		CM-72	10-32	\$217.26
MH28 NEL3-CFT	1.750	1.625	1.125	2.250		CM-72	10-32	\$232.62
MH32 NEL3-CFT	2.000	1.625	1.250	2.410		CM-72	10-32	\$256.76
MH28 NEL4-CFT	1.750	1.625	1.250	2.500	NG 4R	CM-72	10-32	\$232.62
MH32 NEL4-CFT	2.000	1.625	1.375	2.750		CM-72	10-32	\$256.76
MH40 NEL4-CFT	2.500	1.625	1.625	3.250		CM-72	10-32	\$273.22
MH28 NEL6-CFT	1.750	1.625	1.250	2.500	NG 6R	CM-120	10-32	\$232.62
MH32 NEL6-CFT	2.000	1.625	1.375	2.750		CM-120	10-32	\$256.76
MH40 NEL6-CFT	2.500	1.625	1.625	3.250		CM-120	10-32	\$273.22

Also available in: Steel pg: 40 Carbide pg: 68 Modular pg: 91 Serrated Chatter-Free pg: 121



For use with
"STANDARD"
Chatter-Free Bars
pgs 94-95,97

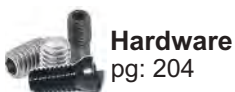

Hardware
pg: 204



Inserts
pg: 188



STANDARD Chatter-Free Heads (Threading / Grooving)

B

BORING

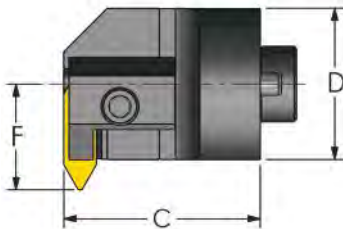

Threading / Grooving
V-Bottom
Coolant Thru

Designation Right Hand	D Dia.	C OAL	F	Min Bore	Insert	Clamp	Screw	Price
MH16 VE84R-CFT	1.000	1.625	.687	1.350	VE84 / VE85	CL-85	MTS 526	\$223.84
MH20 VE84R-CFT	1.250	1.625	.875	1.600		CL-85	MTS 526	\$229.33
MH24 VE84R-CFT	1.500	1.625	1.000	1.850		CL-85	MTS 526	\$240.30
Designation Left Hand	D Dia.	C OAL	F	Min Bore	Insert	Clamp	Screw	Price
MH16 VE84L-CFT	1.000	1.625	.687	1.350	VE84 / VE85	CL-84	MTS 526	\$249.08
MH20 VE84L-CFT	1.250	1.625	.875	1.600		CL-84	MTS 526	\$256.76
MH24 VE84L-CFT	1.500	1.625	1.000	1.850		CL-84	MTS 526	\$266.64

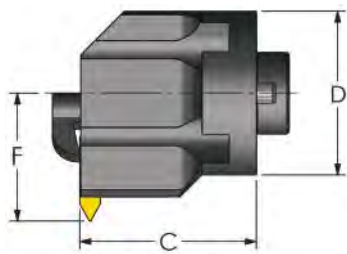

Threading / Grooving
On Edge
Coolant Thru

Designation Right Hand	D Dia.	C OAL	F	Min Bore	Insert	Clamp	Screw	Lock Pin	Price
MH24 MTHOR4-CFT	1.500	1.625	1.173	2.625	TNMA 43	CL-7	XNS-36	NL-44	\$195.31
MH28 MTHOR4-CFT	1.750	1.625	1.298	2.750		CL-7	XNS-36	NL-44	\$210.67
MH32 MTHOR4-CFT	2.000	1.625	1.423	2.875		CL-7	XNS-36	NL-44	\$234.81
Designation Left Hand	D Dia.	C OAL	F	Min Bore	Insert	Clamp	Screw	Lock Pin	Price
MH24 MTHOL4-CFT	1.500	1.625	1.173	2.625	TNMA 43	CL-7	XNS-36	NL-44	\$217.26
MH28 MTHOL4-CFT	1.750	1.625	1.298	2.750		CL-7	XNS-36	NL-44	\$232.62
MH32 MTHOL4-CFT	2.000	1.625	1.423	2.875		CL-7	XNS-36	NL-44	\$256.76



For use with
"STANDARD"
Chatter-Free Bars
pgs 94-95,97

SERRATED “CFT Style” Boring Bars



In addition to our Chatter-Free bars, we offer a solid carbide or steel alternative with the same connection! These solid bars fit all heads following this page with the beginning “SH” designation.

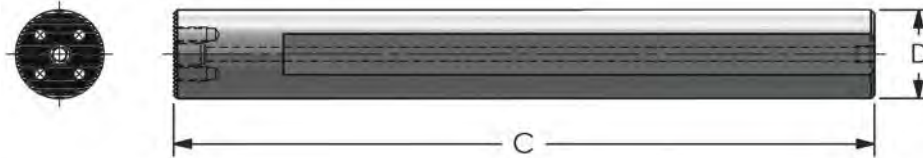

4:1 Ratio

Steel Shank

Coolant Thru

Designation	D Dia.	d1 (Coupling) mm	C OAL	Min Bore	Head Bolts	Price
AS1000-12	1.000	25mm	12	1.260	8-32	\$351.12
AS1250-14	1.250	32mm	14	1.575	10-24	\$442.20
AS1500-14	1.500	32mm	14	1.968	10-24	\$539.85
AS1750-16	1.750	40mm	16	2.010	1/4-20	\$599.10
AS2000-20	2.000	40mm	20	2.400	1/4-20	\$790.02
AS2500-12	2.500	40mm	12	2.800	1/4-20	\$904.13
AS2500-24	2.500	40mm	24	2.800	1/4-20	\$1,292.56

8:1 Ratio

Carbide Shank

Coolant Thru

Designation	D Dia.	d1 (Coupling) mm	C OAL	Min Bore	Head Bolts	Price
ES1000-12	1.000	25mm	12	1.260	8-32	\$1,200.39
ES1250-14	1.250	32mm	14	1.575	10-24	\$2,014.55
ES1500-14	1.500	32mm	14	1.968	10-24	\$2,366.77
ES1750-16	1.750	40mm	16	2.010	1/4-20	\$3,472.80
ES2000-20	2.000	40mm	20	2.400	1/4-20	\$5,096.73

B

BORING

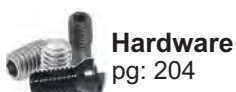

SERRATED Chatter-Free Boring Bars (English)

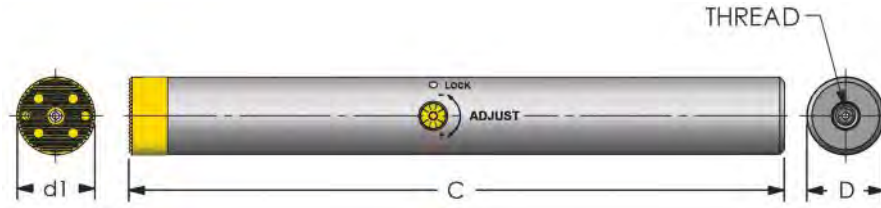

Modular Chatter-Free Bars

Coolant Thru

Designation	D Dia.	d1 (Coupling)	C OAL	Min Bore	Head Bolts	Thread	Price
5:1 Ratio							
SCFT B1500-9	1.500	32mm	9	1.968	10-24 HB	1/8-27 NPT	\$1,157.60
SCFT B2000-12	2.000	40mm	12	2.400	1/4-20 HB	1/8-27 NPT	\$1,406.67
SCFT B2500-16	2.500	40mm	16	2.800	1/4-20 HB	1/8-27 NPT	\$1,913.60
7:1 Ratio							
SCFT B1000-10	1.000	25mm	10	1.260	8-32 HB	1/8-27 NPT	\$888.77
SCFT B1250-12	1.250	32mm	12	1.575	10-24 HB	1/8-27 NPT	\$993.02
SCFT B1500-15	1.500	32mm	15	1.968	10-24 HB	1/8-27 NPT	\$1,157.60
SCFT B1750-18	1.750	40mm	18	2.010	1/4-20 HB	1/8-27 NPT	\$1,327.67
SCFT B2000-20	2.000	40mm	20	2.400	1/4-20 HB	1/8-27 NPT	\$1,406.67
SCFT B2500-27	2.500	40mm	27	2.800	1/4-20 HB	1/4-18 NPT	\$1,913.60
10:1 Ratio							
SCFT B1000-14	1.000	25mm	14	1.260	8-32 HB	1/8-27 NPT	\$1,783.04
SCFT B1250-16	1.250	32mm	16	1.575	10-24 HB	1/8-27 NPT	\$1,992.61
SCFT B1500-19	1.500	32mm	19	1.968	10-24 HB	1/8-27 NPT	\$2,095.75
SCFT B1750-23	1.750	40mm	23	2.010	1/4-20 HB	1/8-27 NPT	\$2,484.17
SCFT B2000-26	2.000	40mm	26	2.400	1/4-20 HB	1/8-27 NPT	\$2,720.09
SCFT B2500-33	2.500	40mm	33	2.800	1/4-20 HB	1/4-18 NPT	\$3,419.03
12:1 Ratio							
SCFT B1000-16	1.000	25mm	16	1.260	8-32 HB	--	\$4,004.96
SCFT B1250-18	1.250	32mm	18	1.575	10-24 HB	--	\$4,959.57
SCFT B1500-22	1.500	32mm	22	1.968	10-24 HB	--	\$6,111.68
SCFT B1750-25	1.750	40mm	25	2.010	1/4-20 HB	--	\$7,472.27
SCFT B2000-29	2.000	40mm	29	2.400	1/4-20 HB	--	\$9,372.71
14:1 Ratio							
SCFT B1000-18	1.000	25mm	18	1.260	8-32 HB	--	\$7,809.13
SCFT B1250-21	1.250	32mm	21	1.575	10-24 HB	--	\$9,304.68
SCFT B1500-25	1.500	32mm	25	1.968	10-24 HB	--	\$10,802.43
SCFT B1750-29	1.750	40mm	29	2.010	1/4-20 HB	--	\$12,567.90
SCFT B2000-33	2.000	40mm	33	2.400	1/4-20 HB	--	\$16,101.05

B

BORING

SERRATED Chatter-Free Boring Bars (Metric)

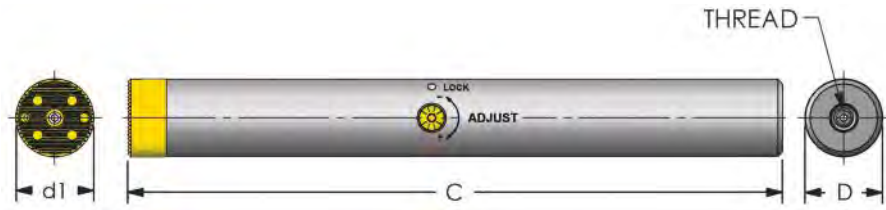

Modular Chatter-Free Bars

Coolant Thru

Designation	D Dia.	d1 (Coupling)	C OAL	Min Bore	Head Bolts	Thread	Price
7:1 Ratio							
SCFT B25MM-250	25mm	25mm	250mm	1.260	8-32 HB	1/8-27 NPT	\$888.77
SCFT B32MM-320	32mm	32mm	320mm	1.575	10-24 HB	1/8-27 NPT	\$993.02
SCFT B40MM-400	40mm	40mm	400mm	1.968	1/4-20 HB	1/8-27 NPT	\$1,157.60
SCFT B50MM-500	50mm	40mm	500mm	2.400	1/4-20 HB	1/8-27 NPT	\$1,406.67
SCFT B60MM-600	60mm	40mm	600mm	2.830	1/4-20 HB	1/8-27 NPT	\$1,913.60
10:1 Ratio							
SCFT B25MM-325	25mm	25mm	325mm	1.260	8-32 HB	1/8-27 NPT	\$1,783.04
SCFT B32MM-416	32mm	32mm	416mm	1.575	10-24 HB	1/8-27 NPT	\$1,992.61
SCFT B40MM-520	40mm	40mm	520mm	1.968	1/4-20 HB	1/8-27 NPT	\$2,095.75
SCFT B50MM-650	50mm	40mm	650mm	2.400	1/4-20 HB	1/8-27 NPT	\$2,720.09
SCFT B60MM-780	60mm	40mm	780mm	2.830	1/4-20 HB	1/8-27 NPT	\$3,419.03
12:1 Ratio							
SCFT B32MM-480	32mm	32mm	480mm	1.260	10-24 HB	--	\$4,959.57
SCFT B40MM-600	40mm	40mm	600mm	1.575	1/4-20 HB	--	\$6,111.68
SCFT B50MM-750	50mm	40mm	750mm	1.968	1/4-20 HB	--	\$9,372.71
14:1 Ratio							
SCFT B32MM-544	32mm	32mm	544mm	1.260	10-24 HB	--	\$9,304.68
SCFT B40MM-680	40mm	40mm	680mm	1.575	1/4-20 HB	--	\$10,802.43
SCFT B50MM-850	50mm	40mm	850mm	1.968	1/4-20 HB	--	\$16,101.05

MADE IN MICHIGAN



Hardware
pg: 204



Inserts
pg: 188

ULTRA-DEX

ULTRADEXUSA.com 113

B

BORING

SERRATED Chatter-Free Heads (Positive)

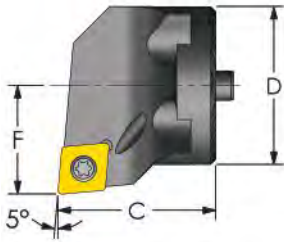

Positive 80° Diamond
(-5° Lead)
Coolant Thru

Designation Right Hand	D Dia.	Coupling Size	C OAL	F	Min Bore	Insert	Insert Screw	Key	Price
SH16 SCLCR3	.984	25mm	.787	.669	1.260	CCMT 32.52	MTS-35	T-15	\$211.77
SH20 SCLCR3	1.260	32mm	1.260	.866	1.575		MTS-35	T-15	\$217.26
SH24 SCLCR4	1.575	40mm	1.496	1.063	1.968	CCMT 432	MTS-4	T-20	\$231.53

Designation Left Hand	D Dia.	Coupling Size	C OAL	F	Min Bore	Insert	Insert Screw	Key	Price
SH16 SCLCL3	.984	25mm	.787	.669	1.260	CCMT 32.52	MTS-35	T-15	\$211.77
SH20 SCLCL3	1.260	32mm	1.260	.866	1.575		MTS-35	T-15	\$217.26
SH24 SCLCL4	1.575	40mm	1.496	1.063	1.968	CCMT 432	MTS-4	T-20	\$231.53

Steel pg: 24

Hybrid pg: 49

Carbide pg: 54, 55

Heavy Metal pg: 73

Modular pg: 79

Standard Chatter-Free pg: 99

SAME DAY SHIPPING!

On orders placed before 3:30pm EST

SEE PAGE 210 for more details...

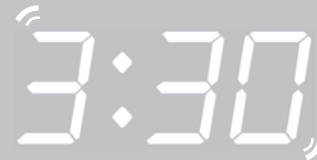

For use with
"SERRATED"
Chatter-Free Bars
pgs 111-113

SERRATED Chatter-Free Heads (Positive)

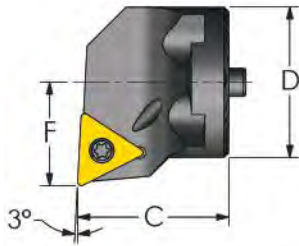

**Positive Triangle
(-3° Lead)
Coolant Thru**

Designation Right Hand	D Dia.	Coupling Size	C OAL	F	Min Bore	Insert	Insert Screw	Key	Price
SH16 STUCR2	.984	25mm	.787	.669	1.260	TCMT 21.51	MTS-255	T-7	\$211.77
SH20 STUCR3	1.260	32mm	1.260	.866	1.575	TCMT 32.52	MTS-35	T-15	\$217.26
SH24 STUCR3	1.575	40mm	1.496	1.063	1.968		MTS-35	T-15	\$231.53

Designation Left Hand	D Dia.	Coupling Size	C OAL	F	Min Bore	Insert	Insert Screw	Key	Price
SH16 STUCL2	.984	25mm	.787	.669	1.260	TCMT 21.51	MTS-255	T-7	\$211.77
SH20 STUCL3	1.260	32mm	1.260	.866	1.575	TCMT 32.52	MTS-35	T-15	\$217.26
SH24 STUCL3	1.575	40mm	1.496	1.063	1.968		MTS-35	T-15	\$231.53

Steel pg: 29 Carbide pg: 60 Heavy Metal pg: 75 Modular pg: 81 Standard Chatter-Free pg: 100

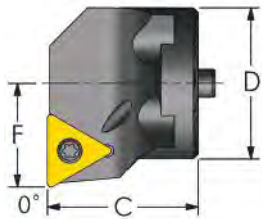

**Positive Triangle
(0° Lead)
Coolant Thru**

Designation Right Hand	D Dia.	Coupling Size	C OAL	F	Min Bore	Insert	Insert Screw	Key	Price
SH16 STFCR2	.984	25mm	.787	.669	1.260	TCMT 21.51	MTS-255	T-7	\$211.77
SH20 STFCR3	1.260	32mm	1.260	.866	1.575	TCMT 32.52	MTS-35	T-15	\$217.26
SH24 STFCR3	1.575	40mm	1.496	1.063	1.968		MTS-35	T-15	\$231.53

Designation Left Hand	D Dia.	Coupling Size	C OAL	F	Min Bore	Insert	Insert Screw	Key	Price
SH16 STFCL2	.984	25mm	.787	.669	1.260	TCMT 21.51	MTS-255	T-7	\$211.77
SH20 STFCL3	1.260	32mm	1.260	.866	1.575	TCMT 32.52	MTS-35	T-15	\$217.26
SH24 STFCL3	1.575	40mm	1.496	1.063	1.968		MTS-35	T-15	\$231.53

Also available in: Steel pg: 31 Carbide pg: 62



For use with
"SERRATED"
Chatter-Free Bars
pgs 111-113

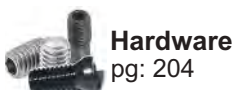

Hardware
pg: 204



Inserts
pg: 188



SERRATED Chatter-Free Heads (Positive)

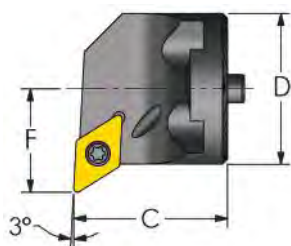

**Positive 55° Diamond
(-3° Lead) Profiling
Coolant Thru**

Designation Right Hand	D Dia.	Coupling Size	C OAL	F	Min Bore	Insert	Insert Screw	Key	Price
SH16 SDUCR3	.984	25mm	.787	.669	1.260	DCMT 32.52	MTS-35	T-15	\$211.77
SH20 SDUCR3	1.260	32mm	1.260	.866	1.575		MTS-35	T-15	\$217.26
SH24 SDUCR3	1.575	40mm	1.260	1.063	1.968		MTS-35	T-15	\$231.53

Designation Left Hand	D Dia.	Coupling Size	C OAL	F	Min Bore	Insert	Insert Screw	Key	Price
SH16 SDUCL3	.984	25mm	.787	.669	1.260	DCMT 32.52	MTS-35	T-15	\$211.77
SH20 SDUCL3	1.260	32mm	1.260	.866	1.575		MTS-35	T-15	\$217.26
SH24 SDUCL3	1.575	40mm	1.260	1.063	1.968		MTS-35	T-15	\$231.53

Also available in: Steel pg: 27 Carbide pg: 54 Modular pg: 72 Standard Chatter-Free pg: 91

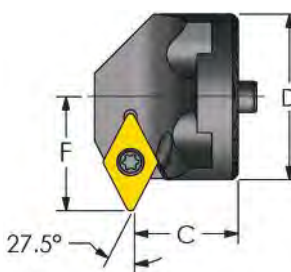

**Positive 55° Diamond
(27.5° Lead) Profiling
Coolant Thru**

Designation Right Hand	D Dia.	Coupling Size	C OAL	F	Min Bore	Insert	Insert Screw	Key	Price
SH16 SDNCR2	.984	25mm	.591	.709	1.299	DCMT 21.51	MTS-255	T-7	\$211.77
SH20 SDNCR3	1.260	32mm	.787	.866	1.575	DCMT 32.52	MTS-35	T-15	\$217.26
SH24 SDNCR3	1.575	40mm	.787	1.063	1.968		MTS-35	T-15	\$231.53

Designation Left Hand	D Dia.	Coupling Size	C OAL	F	Min Bore	Insert	Insert Screw	Key	Price
SH16 SDNCL2	.984	25mm	.591	.709	1.299	DCMT 21.51	MTS-255	T-7	\$211.77
SH20 SDNCL3	1.260	32mm	.787	.866	1.575	DCMT 32.52	MTS-35	T-15	\$217.26
SH24 SDNCL3	1.575	40mm	.787	1.063	1.968		MTS-35	T-15	\$231.53

Also available in: Steel pg: 28 Carbide pg: 55 Modular pg: 72



For use with
"SERRATED"
Chatter-Free Bars
pgs 111-113

B

BORING

SERRATED Chatter-Free Heads (Positive)

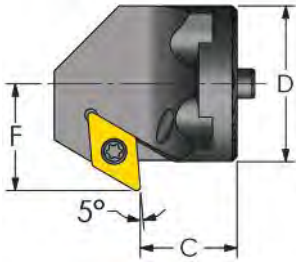

Positive 55° Diamond
(5° Lead) Back Facing
Coolant Thru



Designation Right Hand	D Dia.	Coupling Size	C OAL	F	Min Bore	Insert	Insert Screw	Key	Price
SH16 SDXCR2	.984	25mm	.591	.709	1.299	DCMT 21.51	MTS-255	T-7	\$211.77
SH20 SDXCR3	1.260	32mm	.787	.866	1.575	DCMT 32.52	MTS-35	T-15	\$217.26
SH24 SDXCR3	1.575	40mm	.787	1.063	1.968		MTS-35	T-15	\$231.53

Designation Left Hand	D Dia.	Coupling Size	C OAL	F	Min Bore	Insert	Insert Screw	Key	Price
SH16 SDXCL2	.984	25mm	.591	.709	1.299	DCMT 21.51	MTS-255	T-7	\$211.77
SH20 SDXCL3	1.260	32mm	.787	.866	1.575	DCMT 32.52	MTS-35	T-15	\$217.26
SH24 SDXCL3	1.575	40mm	.787	1.063	1.968		MTS-35	T-15	\$231.53

Also available in: Steel pg: 35 Carbide pg: 66 Modular pg: 83

B

BORING

Proudly made in this 36,000 sq. ft. facility

located in Flushing, Michigan



For use with
"SERRATED"
Chatter-Free Bars
pgs 111-113

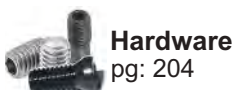

Hardware
pg: 204



Inserts
pg: 188



PULLBACK Serrated Chatter-Free Heads

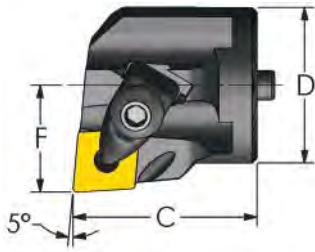

PULLBACK Clamp
Negative 80° Diamond
(-5° Lead)
Coolant Thru

Designation Right Hand	D Dia.	Coupling Size	C OAL	F	Min Bore	Insert	Shim Seat	Shim Screw	Clamp Assy.	Price
SH20 DCLNR4	1.260	32mm	1.496	.866	1.575	CNMG 432	ICSN-433	PB4-SS	PB4-CA	\$267.73
SH24 DCLNR4	1.575	40mm	1.496	1.063	1.968		ICSN-433	PB4-SS	PB4-CA	\$278.70

Designation Left Hand	D Dia.	Coupling Size	C OAL	F	Min Bore	Insert	Shim Seat	Shim Screw	Clamp Assy.	Price
SH20 DCLNL4	1.260	32mm	1.496	.866	1.575	CNMG 432	ICSN-433	PB4-SS	PB4-CA	\$267.73
SH24 DCLNL4	1.575	40mm	1.496	1.063	1.968		ICSN-433	PB4-SS	PB4-CA	\$278.70

Also available in: Steel pg: 47 Carbide pg: 47 Modular pg: 89

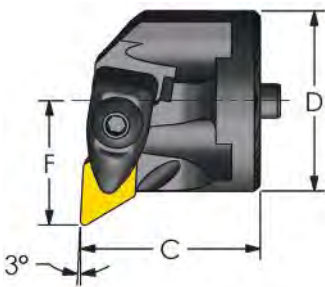

PULLBACK Clamp
Negative 55° Diamond
(-3° Lead)
Coolant Thru

Designation Right Hand	D Dia.	Coupling Size	C OAL	F	Min Bore	Insert	Shim Seat	Shim Screw	Clamp Assy.	Price
SH20 DDUNR3	1.260	32mm	1.260	.866	1.575	DNMG 332	IDSN-322	PB3-SS	PB3-CA	\$267.73
SH24 DDUNR4	1.575	40mm	1.260	1.063	1.968	DNMG 432	IDSN-433	PB4-SS	PB4-CA	\$278.70

Designation Left Hand	D Dia.	Coupling Size	C OAL	F	Min Bore	Insert	Shim Seat	Shim Screw	Clamp Assy.	Price
SH20 DDUNL3	1.260	32mm	1.260	.866	1.575	DNMG 332	IDSN-322	PB3-SS	PB3-CA	\$267.73
SH24 DDUNL4	1.575	40mm	1.260	1.063	1.968	DNMG 432	IDSN-433	PB4-SS	PB4-CA	\$278.70

Also available in: Steel pg: 47 Carbide pg: 47 Modular pg: 89



For use with
"SERRATED"
 Chatter-Free Bars
 pgs 111-113

B

BORING

PULLBACK Serrated Chatter-Free Heads

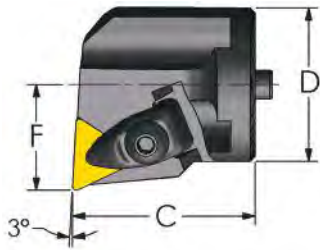

PULLBACK Clamp
Negative Triangle
(-3° Lead)
Coolant Thru

Designation Right Hand	D Dia.	Coupling Size	C OAL	F	Min Bore	Insert	Shim Seat	Shim Screw	Clamp Assy.	Price
SH20 DTUNR3	1.260	32mm	1.496	.866	1.575	TNMG 332	ITSN-323	PB3-SS	PB3-CA	\$267.73
SH24 DTUNR3	1.575	40mm	1.496	1.063	1.968		ITSN-323	PB3-SS	PB3-CA	\$278.70

Designation Left Hand	D Dia.	Coupling Size	C OAL	F	Min Bore	Insert	Shim Seat	Shim Screw	Clamp Assy.	Price
SH20 DTUNL3	1.260	32mm	1.496	.866	1.575	TNMG 332	ITSN-323	PB3-SS	PB3-CA	\$267.73
SH24 DTUNL3	1.575	40mm	1.496	1.063	1.968		ITSN-323	PB3-SS	PB3-CA	\$278.70

Also available in: Steel pg: 47 Carbide pg: 47 Modular pg: 89

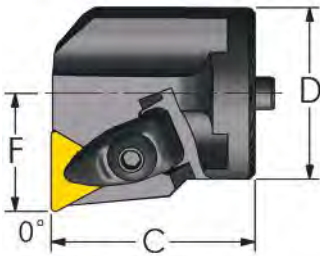

PULLBACK Clamp
Negative Triangle
(0° Lead)
Coolant Thru

Designation Right Hand	D Dia.	Coupling Size	C OAL	F	Min Bore	Insert	Shim Seat	Shim Screw	Clamp Assy.	Price
SH20 DTFNR3	1.260	32mm	1.496	.866	1.575	TNMG 332	ITSN-323	PB3-SS	PB3-CA	\$267.73
SH24 DTFNR3	1.575	40mm	1.496	1.063	1.968		ITSN-323	PB3-SS	PB3-CA	\$278.70

Designation Left Hand	D Dia.	Coupling Size	C OAL	F	Min Bore	Insert	Shim Seat	Shim Screw	Clamp Assy.	Price
SH20 DTFNL3	1.260	32mm	1.496	.866	1.575	TNMG 332	ITSN-323	PB3-SS	PB3-CA	\$267.73
SH24 DTFNL3	1.575	40mm	1.496	1.063	1.968		ITSN-323	PB3-SS	PB3-CA	\$278.70



For use with
"SERRATED"
Chatter-Free Bars
pgs 111-113

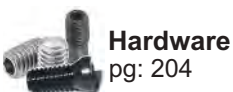

Hardware
pg: 204



Inserts
pg: 188

ULTRA-DEX

Proudly Made in Flushing, MI USA **119**

B

BORING

PULLBACK Serrated Chatter-Free Heads

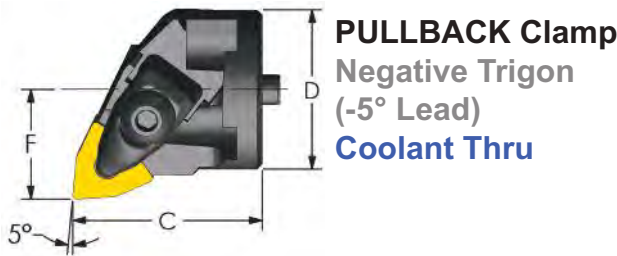

Designation Right Hand	D Dia.	Coupling Size	C OAL	F	Min Bore	Insert	Shim Seat	Shim Screw	Clamp Assy.	Price
SH20 DWLNR4	1.260	32mm	1.496	.866	1.575	WNMG 432	IWSN-433	PB4-SS	PB4-CA	\$267.73
SH24 DWLNR4	1.575	40mm	1.496	1.063	1.968		IWSN-433	PB4-SS	PB4-CA	\$278.70
Designation Left Hand	D Dia.	Coupling Size	C OAL	F	Min Bore	Insert	Shim Seat	Shim Screw	Clamp Assy.	Price
SH20 DWLNL4	1.260	32mm	1.496	.866	1.575	WNMG 432	IWSN-433	PB4-SS	PB4-CA	\$267.73
SH24 DWLNL4	1.575	40mm	1.496	1.063	1.968		IWSN-433	PB4-SS	PB4-CA	\$278.70

PULLBACKs Also Available In:

 **STEEL** pg 46

 **CARBIDE** pg 46

 **MODULAR** pg 89



For use with
"SERRATED"
Chatter-Free Bars
pgs 111-113

DON'T THROW IT AWAY!
Send Us Your Damaged Tooling for Repair



See **pg. 208**
For More
Details

SAME DAY SHIPPING!

On orders placed before 3:30pm EST
SEE PAGE 210 for more details...

3:30

B

BORING

SERRATED Chatter-Free Heads (Threading / Grooving)

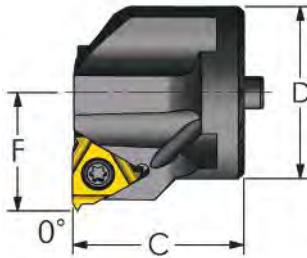

Threading / Grooving
Laydown
Coolant Thru

Designation Right Hand	D Dia.	Coupling Size	C OAL	F	Min Bore	Insert	Insert Screw	Anvil Screw	Anvil	Price
SH16 LSER3	.984	25mm	.984	.669	1.260	3IR	SA3T	SY3T	YI3	\$285.29
SH20 LSER3	1.260	32mm	1.260	.866	1.575		SA3T	SY3T	YI3	\$312.72
SH24 LSER3	1.575	40mm	1.496	1.063	1.968		SA3T	SY3T	YI3	\$329.18
SH20 LSER4	1.260	32mm	1.260	.866	1.575	4IR	SA4T	SY4T	YI4	\$312.72
SH24 LSER4	1.575	40mm	1.496	1.063	1.968		SA4T	SY4T	YI4	\$329.18

Designation Left Hand	D Dia.	Coupling Size	C OAL	F	Min Bore	Insert	Insert Screw	Anvil Screw	Anvil	Price
SH16 LSEL3	.984	25mm	.984	.669	1.260	3IL	SA3T	SY3T	YE3	\$285.29
SH20 LSEL3	1.260	32mm	1.260	.866	1.575		SA3T	SY3T	YE3	\$312.72
SH24 LSEL3	1.575	40mm	1.496	1.063	1.968		SA3T	SY3T	YE3	\$329.18
SH20 LSEL4	1.260	32mm	1.260	.866	1.575	4IL	SA4T	SY4T	YE4	\$312.72
SH24 LSEL4	1.575	40mm	1.496	1.063	1.968		SA4T	SY4T	YE4	\$329.18

Also available in: Steel pg: 40 Carbide pg: 68 Modular pg: 90 Standard Chatter-Free pg: 108

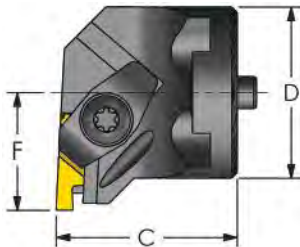

Threading / Grooving
Top Notch
Coolant Thru



Designation Right Hand	D Dia.	Coupling Size	C OAL	F	Min Bore	Insert	Clamp	Screw	Price
SH20 NER3	1.260	32mm	1.340	.866	1.730	NG 3L	CM-73	10-32	\$301.75
SH24 NER3	1.575	40mm	1.575	1.102	2.210		CM-73	10-32	\$317.11
SH24 NER4	1.575	40mm	1.575	1.102	2.210	NG 4L	CM-73	10-32	\$317.11

Designation Left Hand	D Dia.	Coupling Size	C OAL	F	Min Bore	Insert	Clamp	Screw	Price
SH20 NEL3	1.260	32mm	1.340	.866	1.730	NG 3R	CM-72	10-32	\$301.75
SH24 NEL3	1.575	40mm	1.575	1.102	2.210		CM-72	10-32	\$317.11
SH24 NEL4	1.575	40mm	1.575	1.102	2.210	NG 4R	CM-72	10-32	\$317.11

Also available in: Steel pg: 40 Carbide pg: 68 Modular pg: 91 Standard Chatter-Free pg: 109

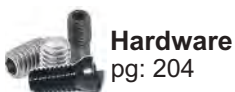

ULTRA-DEX

ULTRA-ADJUST BORING BARS

**Bore Diameters from
.750" - 2.625"**

- Precision Adjustments!

Featuring a graduated adjustment dial in every unit. With each graduation representing .0005" of adjustment per side.

- Indexable Cartridges Available in:

80° Diamond and Triangle Inserts

- Machine Connection Available in:

CAT40, Straight Shank and R8

We Do...

**ULTRA-ADJUST Special Orders
for any size, any shank type!**

Contact your local distributor for pricing.



B

BORING



Holder		Shank Diameter	
SS	Straight-Shank	075	.750" (3/4")
CT40	CAT40 Holder	100	1.000" (1")
R8	R8 Holder	125	1.250" (1 1/4")
		150	1.500" (1 1/2")

Boring Bar

SS **100** **UA** - **A** - **950** - **1000**

Ultra-Adjust

Cartridge Size	
2	#2 Cartridge
2L	#2 Long Cartridge
A	A Cartridge
AL	A Long Cartridge
C	C Cartridge

Projection	
650	6.5"
800	8.0"
850	8.5"
950	9.5"

Min Bore	
075	.750"
1000	1.000"
1187	1.187"
1375	1.375"
1562	1.562"
1750	1.750"
1843	1.843"
1875	1.875"
2063	2.063"
2250	2.250"
2437	2.437"

ULTRA-ADJUST Unit

UA **U** **2L**

Ultra-Adjust

Unit

Cartridge Size	
2	#2 Cartridge
2L	#2 Long Cartridge
A	A Cartridge
AL	A Long Cartridge
C	C Cartridge

B

BORING

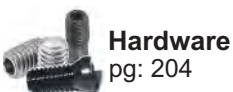

Hardware
pg: 204



Inserts
pg: 188



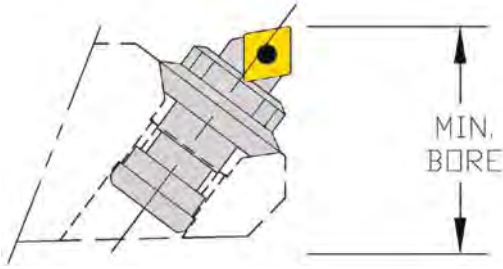

Positive 80° Diamond (0° Lead) Ultra-Adjust Unit

Designation	Cartridge Size	Min Bore	Cartridge	Insert	Insert Screw	Price
UAU2	2	.750	CA2 SCFDR1.2	CDHB 1.20.60	MTS-184	\$104.24
UAU2L	2L	.880	CA2L SCFDR1.2		MTS-184	\$104.24



1. Purchase unit and boring bar based on min bore and bore range requirements.
2. Insert unit into boring bar making sure to align flange with groove in bar.
3. Insert lock screw through bottom side and tighten.

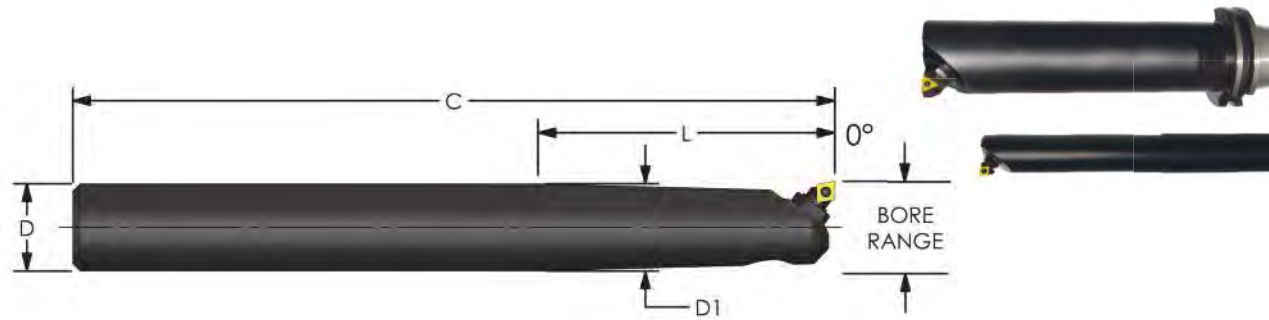

Positive 80° Diamond (0° Lead) Straight Shank Boring Bar

Designation	Cartridge Size	Bore Range Min / Max	D Shank Dia.	D1 Bar Dia.	C OAL	L Cutting Depth	Price
SS075UA-2-650-075	2	.750 - .900	.750	.740	6.5	2.5	\$104.24
	2L	.880 - 1.060	.750	.740	6.5	2.5	
SS100UA-2-850-075	2	.750 - .900	1.000	.740	8.5	3.375	\$119.61
	2L	.880 - 1.060	1.000	.740	8.5	3.375	

Unit Sold Separately

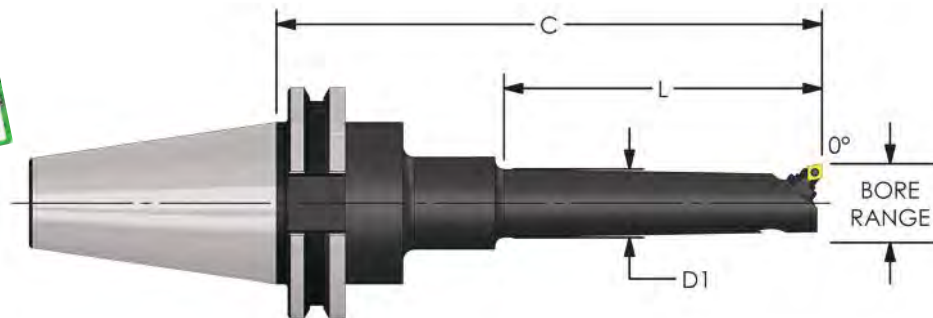

Positive 80° Diamond (0° Lead) CAT40 Boring Bar

Designation	Cartridge Size	Bore Range Min / Max	D1 Bar Dia.	C Projection	L Cutting Depth	Price
CT40UA-2-850-075	2	.750 - .900	.740	5.875	3.375	\$326.98
	2L	.880 - 1.060	.740	5.875	3.375	

Unit Sold Separately

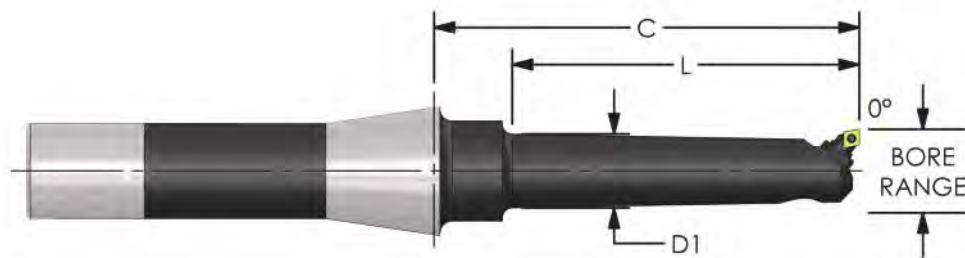

Positive 80° Diamond (0° Lead) R8 Boring Bar

Designation	Cartridge Size	Bore Range Min / Max	D1 Bar Dia.	C Projection	L Cutting Depth	Price
R8UA-2-850-075	2	.750 - .900	.740	4.250	3.375	\$262.25
	2L	.880 - 1.060	.740	4.250	3.375	

Unit Sold Separately

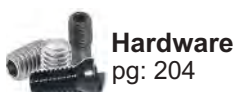

Hardware
pg: 204



Inserts
pg: 188



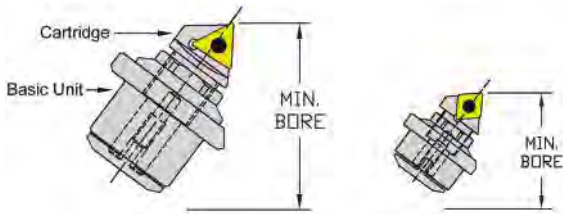

Basic Unit

Designation	Cartridge Size	Min Bore	Price
UAUA	A / AL	1.000	\$149.23
UAUC	C	1.875	\$179.95

Unit/Cartridge Sold Separately

Cartridge

Designation	Cartridge Size	Min Bore	Insert	Insert Screw	Price
CAA SCLPR1.8	A	1.000	CPMT 1.81.21	MTS-224	\$133.86
CAAL SCLPR1.8	AL	1.092		MTS-224	\$133.86
CAC STUPR2	C	1.875	TPMT 21.51	MTS-255	\$171.17

Unit/Cartridge Sold Separately



1. Purchase a basic unit, cartridge and boring bar based off min bore and bore range requirements.
2. Thread cartridge into basic unit until bottoms out.
3. Insert 6 springs and retainer. Tighten lock screw making sure to align retainer flange to groove in cartridge and unit. Firmly tighten screw.
4. Insert assembly into boring bar and tighten head screws.

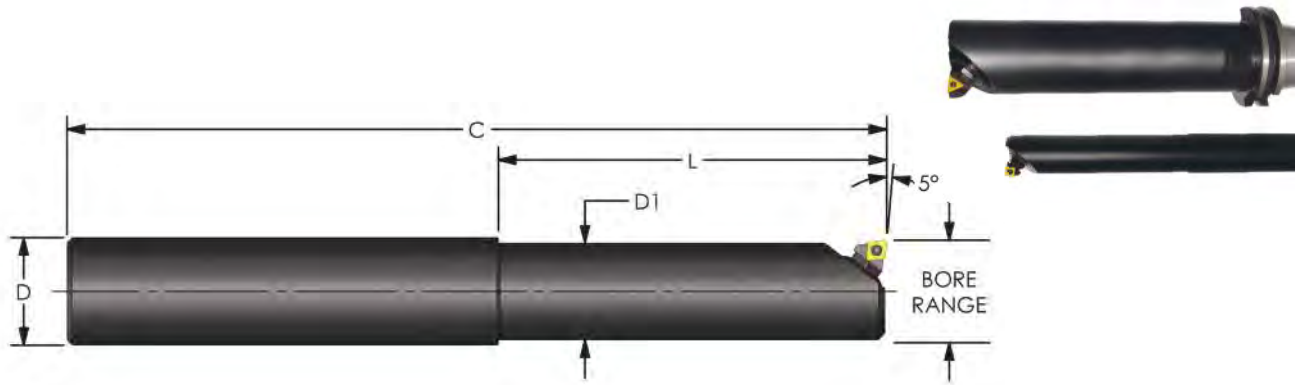

Positive 80° Diamond (-5° Lead) Straight Shank Boring Bar

Designation	Cartridge Size	Bore Range Min / Max	D Shank Dia.	D1 Bar Dia.	C OAL	L Cutting Depth	Price
SS100UA-A-950-1000	A	1.000 - 1.092	1.000	.938	9.5	4.5	\$207.39
	AL	1.092 - 1.187	1.000	.938	9.5	4.5	
SS125UA-A-950-1187	A	1.187 - 1.279	1.250	1.122	9.5	4.5	\$217.26
	AL	1.279 - 1.375	1.250	1.122	9.5	4.5	
SS125UA-A-950-1375	A	1.375 - 1.467	1.250	1.313	9.5	4.5	\$217.26
	AL	1.467 - 1.562	1.250	1.313	9.5	4.5	
SS150UA-A-950-1562	A	1.562 - 1.654	1.500	1.490	9.5	4.5	\$240.30
	AL	1.654 - 1.750	1.500	1.490	9.5	4.5	
SS150UA-A-950-1750	A	1.750 - 1.842	1.500	1.688	9.5	4.5	\$262.25
	AL	1.842 - 1.934	1.500	1.688	9.5	4.5	
SS150UA-A-950-1843	A	1.843 - 1.935	1.500	1.781	9.5	4.5	\$284.19

Basic Unit / Cartridge Sold Separately

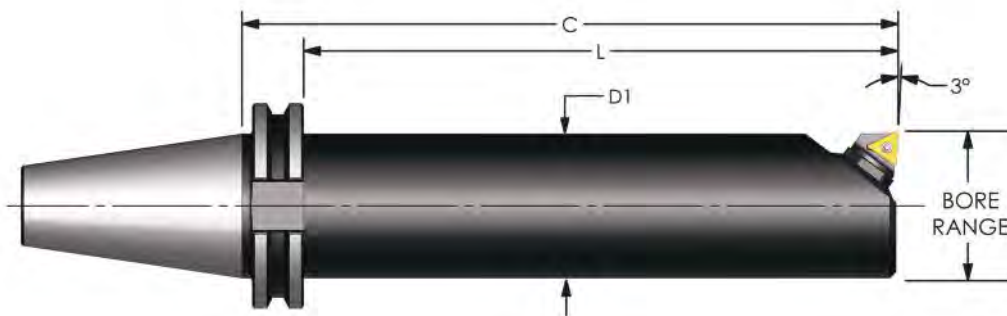

Positive Triangle (-3° Lead) CAT40 Boring Bar

Designation	Cartridge Size	Bore Range Min / Max	D1 Bar Dia.	C Projection	L Cutting Depth	Price
CT40UA-C-800-1875	C	1.875 - 2.063	1.750	8	7	\$415.86
CT40UA-C-800-2063	C	2.063 - 2.250	1.938	8	7	\$415.86
CT40UA-C-800-2250	C	2.250 - 2.437	2.125	8	7	\$415.86
CT40UA-C-800-2437	C	2.437 - 2.625	2.312	8	7	\$415.86

Basic Unit / Cartridge Sold Separately

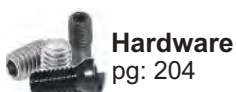

Hardware
pg: 204



Inserts
pg: 188



ULTRA-DEX

PATRIOT

New!

High-Performance Indexable Mills

- 45° Cutter for face/slot milling and chamfering
- Double sided square insert provides 8 indexes

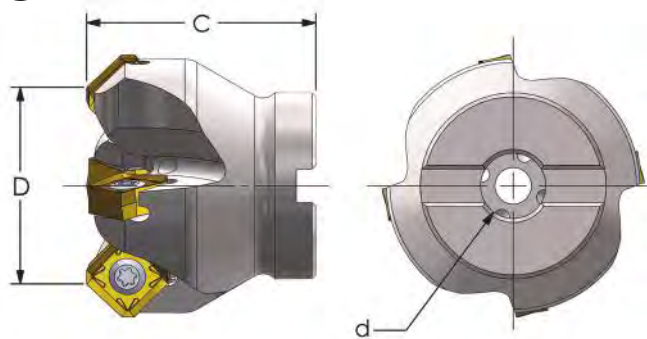

Face Mill Cutter

Coolant Thru

Designation	D	Flutes	C	d	Insert	Screw	Price
PM1-1.25-3-.500-12	1.250	3	1.750	.500	PM1 1205	PM1-4	\$252.00
PM1-1.50-4-.500-12	1.500	4	1.750	.500			\$294.00
PM1-2.00-5-.750-12	2.000	5	1.750	.750			\$327.00
PM1-2.50-6-1.00-12	2.500	6	2.000	1.000			\$389.00
PM1-3.00-8-1.00-12	3.000	8	2.000	1.000			\$502.00
PM1-4.00-10-1.25-12	4.000	10	2.000	1.250			\$613.00

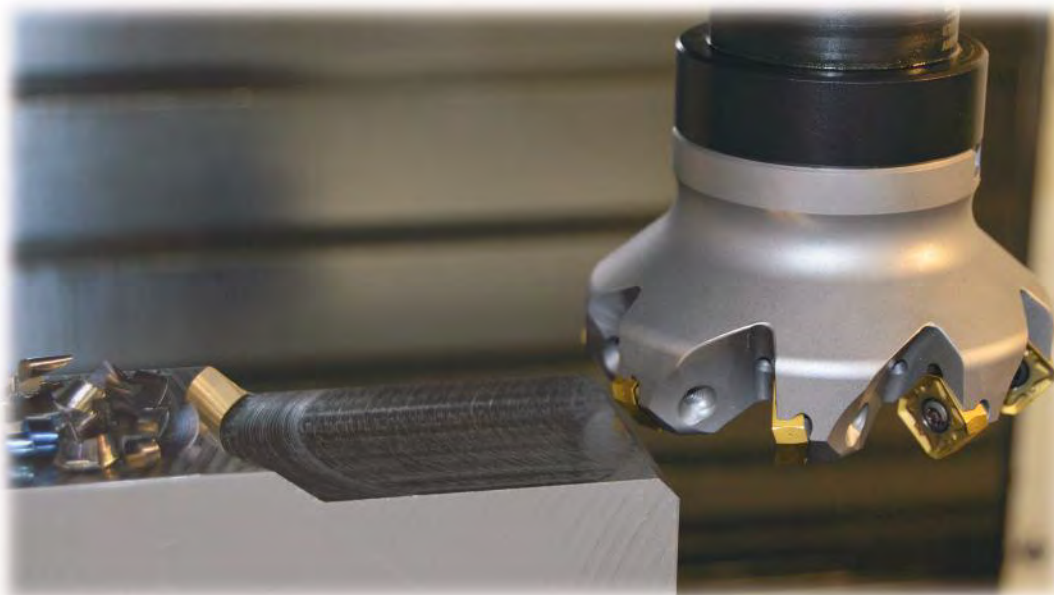



New!

- 90° Cutter for face, slot and shoulder milling
- Single sided insert provides 4 indexes



PATRIOT

C

MILLING

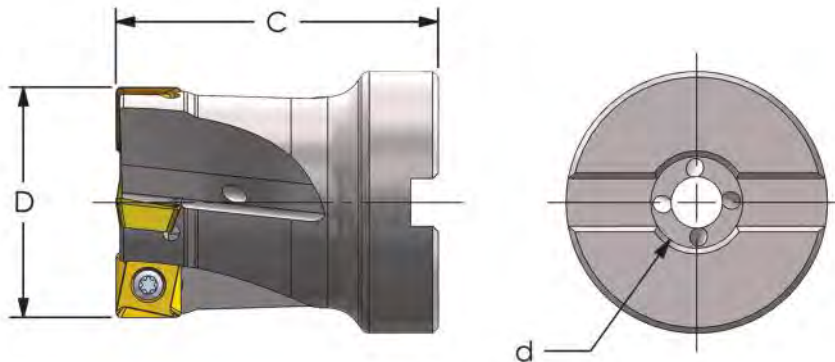

Face Mill Cutter

Coolant Thru

Designation	D	Flutes	C	d	Insert	Screw	Price
PM2-1.25-4-.500-09	1.250	4	1.750	.500	PM2 09T308	PM2-3	\$259.00
PM2-1.50-5-.500-09	1.500	5	1.750	.500			\$292.00
PM2-2.00-6-.750-09	2.000	6	1.750	.750			\$348.00
PM2-2.50-7-1.00-09	2.500	7	2.000	1.000			\$396.00
PM2-3.00-9-1.00-09	3.000	9	2.000	1.000			\$495.00

SEE PAGE 200 For Speeds and Feeds Chart

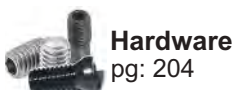

Hardware
pg: 204



Inserts
pg: 188

ULTRA-DEX



New!

- High feed cutter for face, slot, plunge milling and angled ramping
- Single sided insert provides 4 indexes

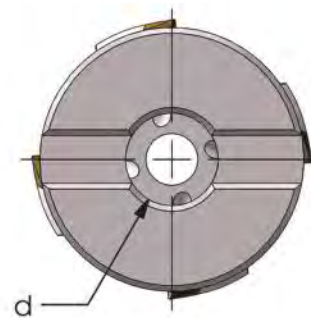
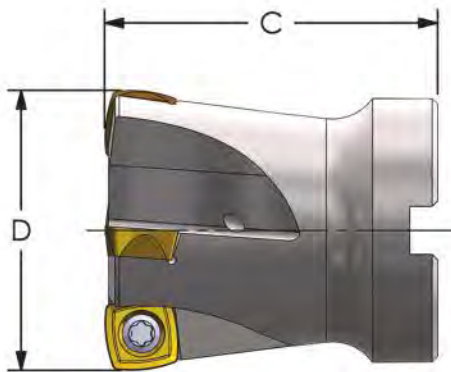

Face Mill Cutter

Coolant Thru

Designation	D	Flutes	C	d	Insert	Screw	Price
PM3-1.50-4-.500-10	1.500	4	1.750	.500			\$292.00
PM3-2.00-5-.750-10	2.000	5	1.750	.750	PM3 10T308	PM3-3.5	\$348.00
PM3-2.50-6-1.00-10	2.500	6	2.000	1.000			\$378.00

SEE PAGE 200 For Speeds and Feeds Chart



New!

- 45° Cutter for face/slot milling and chamfering
- Single sided insert provides 6 indexes

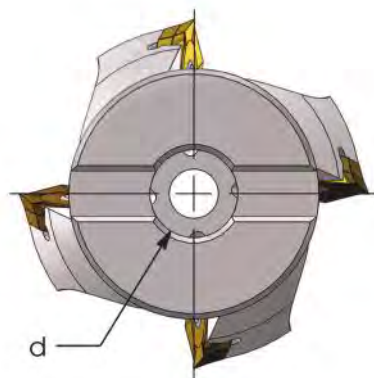
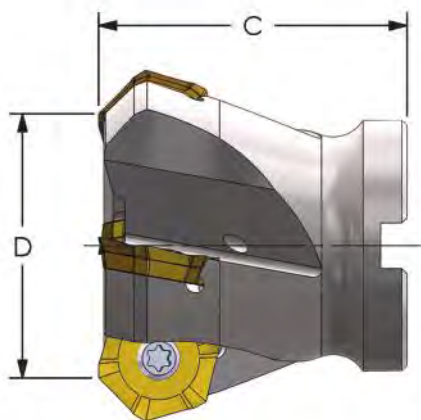

Face Mill Cutter

Coolant Thru

Designation	D	Flutes	C	d	Insert	Screw	Price
PM4-1.50-4-.500-06	1.500	4	1.750	.500	PM4 0604	PM4-4	\$294.00
PM4-2.00-5-.750-06	2.000	5	1.750	.750			\$327.00
PM4-2.50-6-1.00-06	2.500	6	2.000	1.000			\$389.00
PM4-3.00-7-1.00-06	3.000	7	2.000	1.000			\$492.00
PM4-4.00-9-1.25-06	4.000	9	2.000	1.250			\$592.00

SEE PAGE 200 For Speeds and Feeds Chart

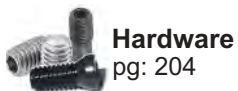

ULTRA-DEX

MILLING INDEXABLE CUTTERS

C

MILLING



Cutting Conditions

APKT 11T308

Depth of cut ↑	Feed Per Tooth (inch)			
	AP (inch)	Light	Medium	Heavy
.315	.0028	.0031	.0039	
.236	.0039	.0047	.0059	
.157	.0047	.0059	.0079	

————— f/t —————→

APKT 160408

Depth of cut ↑	Feed Per Tooth (inch)			
	AP (inch)	Light	Medium	Heavy
.472	.0028	.0031	.0039	
.315	.0039	.0047	.0059	
.197	.0047	.0059	.0079	

————— f/t —————→

MADE IN MICHIGAN

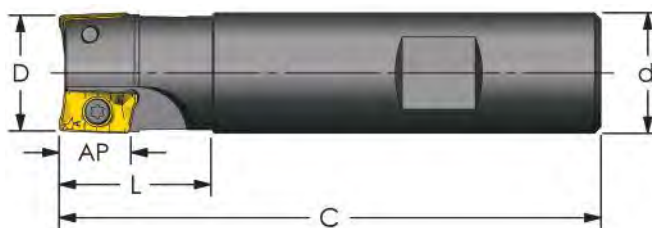

End Mill Cutters

No Coolant

Designation	D	Flutes	C OAL	L	AP	d	Insert	Screw	Price
E90AP D.500-1-W.500-11	.500	1	3.375	.975	.315	.500	APKT 11T308	SR34505	\$97.66
E90AP D.625-2-W.625-11	.625	2	3.375	.975	.315	.625		SR34505	\$97.66
E90AP D.750-2-W.750-11	.750	2	3.375	.975	.315	.750		SR34505L	\$108.63
E90AP D.750-3-W.750-11	.750	3	3.375	.975	.315	.750		SR34505L	\$130.58
E90AP D.750-3-W.750-6-11	.750	3	6.000	3.000	.315	.750		SR34505L	\$163.50
E90AP D1.00-3-W.750-11	1.000	3	4.000	1.500	.315	.750		SR34505L	\$130.58
E90AP D1.00-3-W1.00-11	1.000	3	4.000	1.500	.315	1.000		SR34505L	\$141.55
E90AP D1.00-3-W1.00-6-11	1.000	3	6.000	3.000	.315	1.000		SR34505L	\$174.47
E90AP D1.250-3-W.750-11	1.250	3	4.000	1.500	.315	.750		SR34505L	\$130.58
E90AP D1.250-3-W1.00-11	1.250	3	4.000	1.500	.315	1.000		SR34505L	\$141.55
E90AP D1.500-5-W1.00-11	1.500	5	4.000	1.500	.315	1.000	SR34505L	\$152.52	
E90AP D1.00-2-W1.00-16	1.000	2	4.000	1.750	.472	1.000	APKT 160408	SR14544	\$119.61
E90AP D1.00-2-W1.00-6-16	1.000	2	6.000	4.000	.472	1.000		SR14544	\$152.52
E90AP D1.250-2-W1.00-16	1.250	2	4.000	1.500	.472	1.000		SR14544	\$130.58
E90AP D1.250-3-W1.00-16	1.250	3	4.000	1.500	.472	1.000		SR14544	\$141.55
E90AP D1.500-3-W1.00-16	1.500	3	4.000	1.500	.472	1.000		SR14544	\$141.55

End Mill Cutters

Coolant Thru

Designation	D	Flutes	C OAL	L	AP	d	Insert	Screw	Price
E90AP D.750-2-W.750-11-C	.750	2	3.375	.975	.315	.750	APKT 11T308	SR34505L	\$125.09
E90AP D.750-3-W.750-11-C	.750	3	3.375	.975	.315	.750		SR34505L	\$147.03
E90AP D1.00-3-W1.00-11-C	1.000	3	4.000	1.500	.315	1.000	APKT 160408	SR34505L	\$158.00
E90AP D1.250-3-W1.00-16-C	1.250	3	4.000	1.500	.472	1.000		SR14544	\$158.00
E90AP D1.500-3-W1.00-16-C	1.500	3	4.000	1.500	.472	1.000		SR14544	\$163.50



End Mill Holders Available In:

- CAT40** pg 154
- CAT50** pg 160
- HSK63** pg 169
- HSK100** pg 174

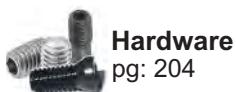

Hardware
pg: 204



Inserts
pg: 188



C
MILLING

Indexable End / Face Mill Cutters

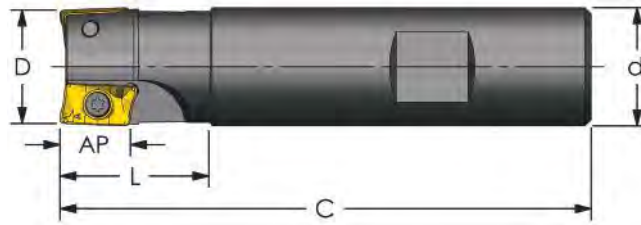

End Mill Cutters

No Coolant

Designation	D	Flutes	C	L	AP	d	Insert	Screw	Price
E90AP D.750-2-W.750-10	.750	2	3.375	.975	.394	.750	APKT 1003*	SR34505L	\$119.61
E90AP D.750-3-W.750-10	.750	3	3.375	.975	.394	.750		SR34505L	\$141.55
E90AP D.750-3-W.750-6-10	.750	3	6.000	1.500	.394	.750		SR34505L	\$163.50
E90AP D1.00-3-W.750-10	1.000	3	4.000	1.500	.394	.750		SR34505L	\$152.52
E90AP D1.00-3-W1.00-10	1.000	3	4.000	1.500	.394	1.000		SR34505L	\$152.52
E90AP D1.00-3-W1.00-6-10	1.000	3	6.000	1.500	.394	1.000		SR34505L	\$174.47
E90AP D1.250-3-W.750-10	1.250	3	4.000	1.500	.394	.750		SR34505L	\$152.52
E90AP D1.250-3-W1.00-10	1.250	3	4.000	1.500	.394	1.000		SR34505L	\$152.52
E90AP D1.00-2-W1.00-15	1.000	2	4.000	1.750	.562	1.000	ADKT 1505*	SR14544	\$152.52
E90AP D1.250-2-W1.00-15	1.250	2	4.000	1.500	.562	1.000		SR14544	\$152.52
E90AP D1.250-3-W1.00-15	1.250	3	4.000	1.500	.562	1.000		SR14544	\$152.52
E90AP D1.500-3-W1.00-15	1.500	3	4.000	1.500	.562	1.000		SR14544	\$163.50

End Mill Cutter Body Made For Competitors Inserts
* Insert NOT AVAILABLE FOR SALE

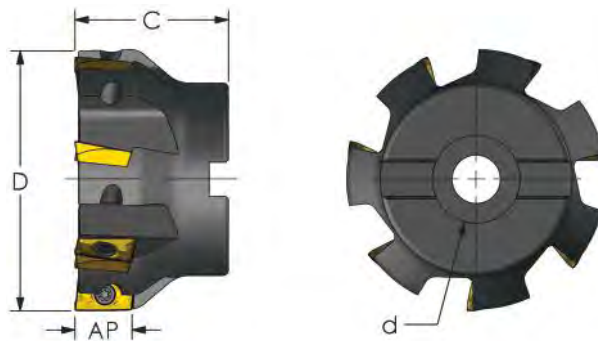

Face Mill Cutters

No Coolant

Designation	D	Flutes	C	AP	d	Inserts	Screw	Price
F90AP D2.00-5-.750-11	2.000	5	1.570	.315	.750	APKT 11T308	SR34505L	\$203.00
F90AP D2.50-7-1.00-11	2.500	7	1.750	.315	1.000		SR34505L	\$273.22
F90AP D3.00-8-1.00-11	3.000	8	1.750	.315	1.000		SR34505L	\$339.06
F90AP D2.00-5-.750-16	2.000	5	1.570	.472	.750	APKT 160408	SR14544	\$197.51
F90AP D2.50-5-1.00-16	2.500	5	1.750	.472	1.000		SR14544	\$260.05
F90AP D3.00-5-1.00-16	3.000	5	1.750	.472	1.000		SR14544	\$318.20
F90AP D3.00-7-1.00-16	3.000	7	1.750	.472	1.000		SR14544	\$339.06
F90AP D4.00-7-1.25-16	4.000	7	1.750	.472	1.250		SR14544	\$411.47



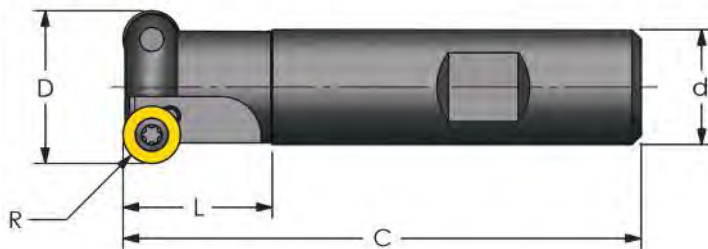

ROUND End Mill Cutters

No Coolant

Designation	D	Flutes	R	C	L	d	Insert	Screw	Price
ER-D.750-2-.750-08	.750	2	.157 / 4mm	3.380	.975	.750	RDKW 0803	MTS 3-DR	\$130.58
ER-D1.00-2-.750-08	1.000	2		3.380	1.500	.750			\$141.55
ER-D1.00-2-.750-10	1.000	2	.197 / 5mm	3.380	1.500	.750	RCKT 10T3	MTS-35	\$141.55
ER-D1.25-3-1.00-10	1.250	3		4.000	1.500	1.000		MTS-35	\$152.52
ER-D1.50-3-1.00-12	1.500	3		.236 / 6mm	4.000	1.500		1.000	RCKT 1204
Designation	D	Flutes	R	C	L	d	Insert	Screw	Price
ER-D.750-2-.750-2	.750	2	.125	3.380	.975	.750	RCMT 21.5	MTS-2.5L	\$130.58
ER-D1.00-2-.750-2	1.000	2		3.380	1.500	.750		MTS-2.5L	\$141.55
ER-D1.00-2-.750-3	1.000	2	.188	3.380	1.500	.750	RCMT 32.5	MTS 4-DR	\$141.55
ER-D1.25-2-1.00-3	1.250	2		4.000	1.500	1.000		MTS 4-DR	\$152.52
ER-D1.50-3-1.00-4	1.500	3	.250	4.000	1.500	1.000	RCMT 43	MTS-4	\$174.47

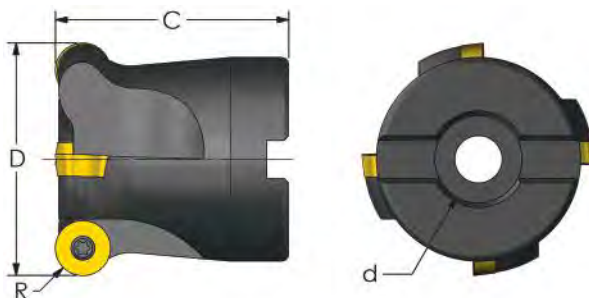

ROUND Face Mill Cutters

No Coolant

Designation	D	Flutes	R	C	d	Insert	Screw	Price
FR-D2.00-4-.750-12	2.000	4	.236 / 6mm	2.000	.750	RCKT 1204	MTS-35	\$229.33
FR-D2.00-3-.750-16	2.000	3	.315 / 8mm	2.000	.750		MTS-4	\$207.39
FR-D3.00-5-1.00-16	3.000	5		1.750	1.000	RCKT 1606	MTS-4	\$262.25
FR-D4.00-6-1.25-16	4.000	6		1.750	1.250		MTS-4	\$301.75
Designation	D	Flutes	R	C	d	Insert	Screw	Price
FR-D2.00-4-.750-4	2.000	4	.250	2.000	.750	RCMT 43	MTS-4	\$229.33
FR-D3.00-5-1.00-4	3.000	5	.250	1.750	1.000		MTS-4	\$262.25
FR-D4.00-6-1.25-4	4.000	6	.250	1.750	1.250		MTS-4	\$301.75

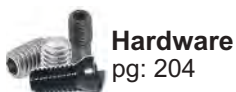

Hardware
pg: 204



Inserts
pg: 188

ULTRA-DEX

C
MILLING

ULTRA-DEX

PATRIOT

High-Performance Indexable Counterbores

New!

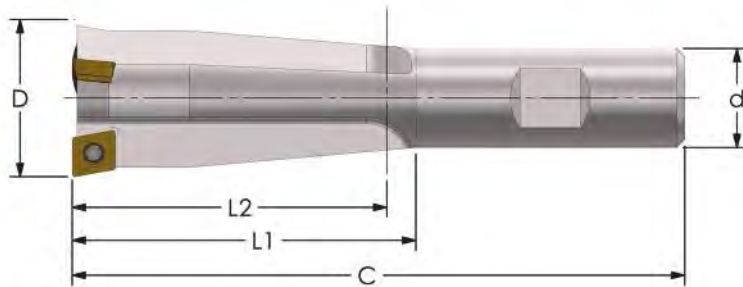

- Designed for high production of standard inch and metric size counterbores
- Newly designed insert achieves 90° bottom

PATRIOT Counterbores

Coolant Thru

Designation	C'bore Size	D	L1	L2	C	Insert	Screw	Flutes	d	Price
PC1-312-2-750-04	5/16	.500	1.345	1.000	3.375	PD1 042004	PD1-16	2	.750	\$149.67
PC1-375-2-750-04	3/8	.594	1.470	1.188	3.500	PD1 052804	PD1-2	2	.750	\$157.55
PC1-437-2-750-05	7/16	.687	1.595	1.374	3.625	PD1 052804	PD1-2	2	.750	\$165.84
PC1-500-2-750-06	1/2	.781	1.720	1.562	3.750	PD1 063306	PD1-22	2	.750	\$174.57
PC1-625-3-750-06	5/8	1.000	2.220	2.000	4.250	PD1 063306	PD1-22	3	.750	\$189.75
PC1-750-3-750-07	3/4	1.188	2.595	2.376	4.625	PD1 074006	PD1-25	3	.750	\$204.93
PC1-315-2-750-04	8mm	.591	1.470	1.182	3.500	PD1 042004	PD1-16	2	.750	\$149.67
PC1-394-2-750-05	10mm	.709	1.595	1.418	3.625	PD1 052804	PD1-2	2	.750	\$165.84
PC1-472-2-750-06	12mm	.787	1.720	1.574	3.750	PD1 063306	PD1-22	2	.750	\$174.57
PC1-630-3-750-06	16mm	1.024	2.220	2.048	4.250	PD1 063306	PD1-22	3	.750	\$189.75
PC1-787-3-750-07	20mm	1.299	2.720	2.598	4.750	PD1 074006	PD1-25	3	.750	\$204.93



Figure 1

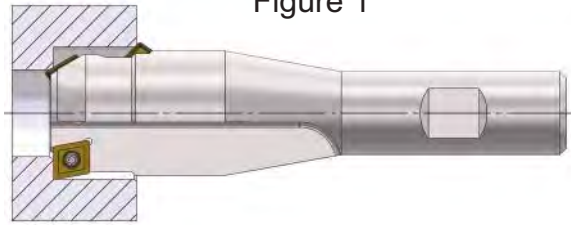
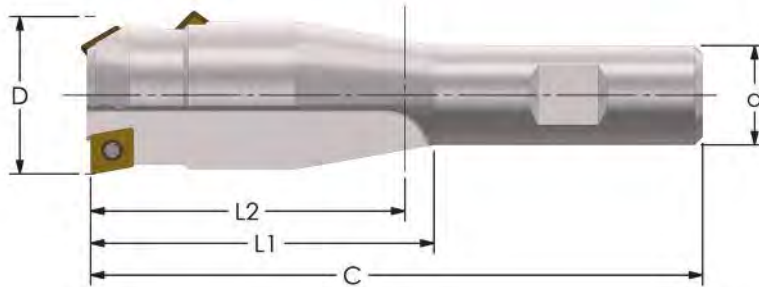
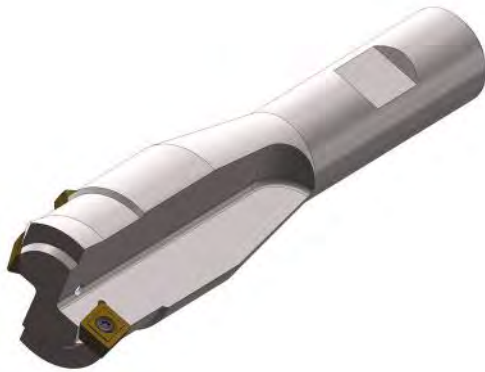
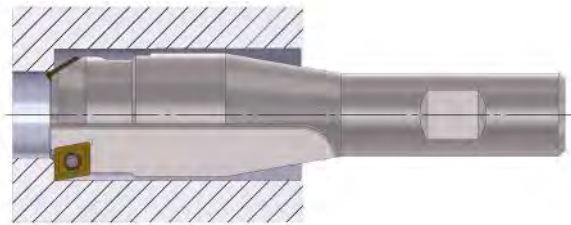

Figure 2



- Single tool to counterbore and dual chamfer in one operation
- Secondary chamfer insert can be removed for deeper application (see figure 2)

PATRIOT Counterbores

Coolant Thru

Designation	C'bore Size	D	L1	L2	C	Insert	Screw	Flutes	d	Price
PC2-312-3-750-04	5/16	.500	1.345	1.000	3.375	PD1 042004	PD1-16	3	.750	\$149.67
PC2-375-3-750-04	3/8	.594	1.470	1.188	3.500	PD1 042004	PD1-16	3	.750	\$157.55
PC2-437-3-750-05	7/16	.687	1.595	1.374	3.625	PD1 052804	PD1-2	3	.750	\$165.84
PC2-500-3-750-06	1/2	.781	1.720	1.562	3.750	PD1 063306	PD1-22	3	.750	\$174.57
PC2-625-3-750-06	5/8	1.000	2.220	2.000	4.250	PD1 063306	PD1-22	3	.750	\$189.75
PC2-750-3-750-07	3/4	1.188	2.595	2.376	4.625	PD1 074006	PD1-25	3	.750	\$204.93
PC2-315-3-750-04	8mm	.591	1.470	1.182	3.500	PD1 042004	PD1-16	3	.750	\$149.67
PC2-394-3-750-05	10mm	.709	1.595	1.418	3.625	PD1 052804	PD1-2	3	.750	\$165.84
PC2-472-3-750-06	12mm	.787	1.720	1.574	3.750	PD1 063306	PD1-22	3	.750	\$174.57
PC2-630-3-750-06	16mm	1.024	2.220	2.048	4.250	PD1 063306	PD1-22	3	.750	\$189.75
PC2-787-3-750-07	20mm	1.299	2.720	2.598	4.750	PD1 074006	PD1-25	3	.750	\$204.93

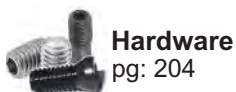

PATRIOT High Performance Indexable Counterbores

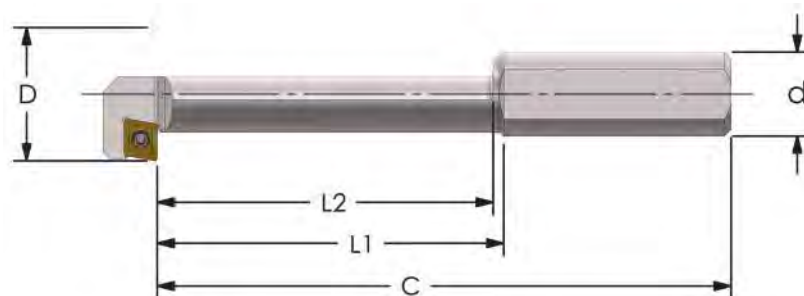
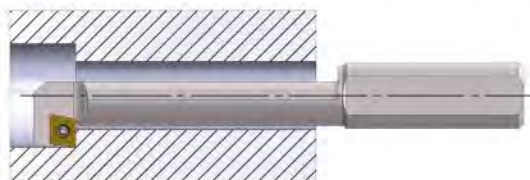

- Back Counterbore tool
- Reduces production time by eliminating a second operation

PATRIOT Counterbores

No Coolant

Designation	C'bore Size	D	L1	L2	C	Insert	Screw	Flutes	d	Price
PC3-312-1-750-04	5/16	.500	1.345	1.030	3.375	PD1 042004	PD1-16	1	.750	\$137.96
PC3-375-1-750-04	3/8	.594	1.470	1.218	3.500	PD1 042004	PD1-16	1	.750	\$145.22
PC3-437-1-750-05	7/16	.687	1.970	1.748	4.000	PD1 052804	PD1-2	1	.750	\$152.86
PC3-500-1-750-06	1/2	.781	2.220	1.983	4.250	PD1 063306	PD1-22	1	.750	\$160.91
PC3-625-1-750-06	5/8	1.000	2.720	2.530	4.750	PD1 063306	PD1-22	1	.750	\$174.90
PC3-750-1-750-07	3/4	1.188	3.095	3.000	5.125	PD1 074006	PD1-25	1	.750	\$188.89
PC3-315-1-750-04	8mm	.591	1.470	1.212	3.500	PD1 042004	PD1-16	1	.750	\$139.96
PC3-394-1-750-05	10mm	.709	1.720	1.448	3.750	PD1 052804	PD1-2	1	.750	\$152.86
PC3-472-1-750-06	12mm	.787	2.220	1.998	4.250	PD1 063306	PD1-22	1	.750	\$160.91
PC3-630-1-750-06	16mm	1.024	2.720	2.590	4.750	PD1 063306	PD1-22	1	.750	\$174.90
PC3-787-1-750-07	20mm	1.299	3.345	3.278	5.375	PD1 074006	PD1-25	1	.750	\$188.89

ULTRA-DEX



CHAMFER INDEXABLE MILLING

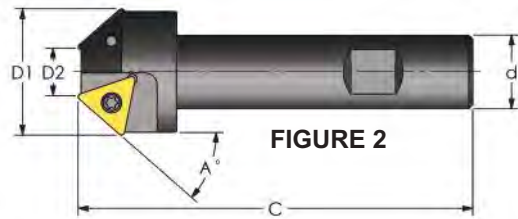
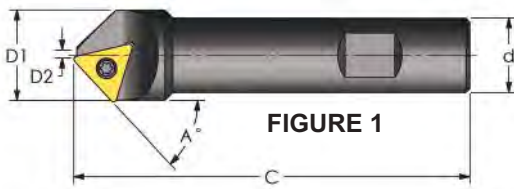

CHAMFER Mill Cutters

No Coolant

Designation	Figure	A°	D1	D2	C	d	Insert	Screw	Price
E05C-D.500-1-.750-3	1	5	.594	.500	4.000	.750	TCMT 32.52	MTS-35	\$92.17
E10C-D.500-1-.750-3	1	10	.688	.500	4.000	.750		MTS-35	\$92.17
E15C-D.500-1-.750-3	1	15	.782	.500	4.000	.750		MTS-35	\$92.17
E15C-D1.00-2-.750-3	2	15	1.280	1.000	4.000	.750		MTS-35	\$108.63
E20C-D.375-1-.750-3	1	20	.750	.375	4.000	.750		MTS-35	\$92.17
E30C-D.250-1-.750-3	1	30	.800	.250	4.000	.750		MTS-35	\$92.17
E30C-D.750-2-.750-3	2	30	1.300	.750	4.000	.750		MTS-35	\$108.63
E41C-D.188-1-.750-3	1	41	.914	.188	4.000	.750		MTS-35	\$92.17
E41C-D.562-2-.750-3	2	41	1.288	.562	4.000	.750		MTS-35	\$108.63
E45C-D.188-1-.750-3	1	45	.972	.188	4.000	.750		MTS-35	\$92.17
E45C-D.500-2-.750-3	2	45	1.290	.500	4.000	.750		MTS-35	\$108.63
E60C-D.188-2-.750-3	2	60	1.160	.188	4.000	.750		MTS-35	\$108.63

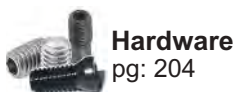

C

MILLING

ISO MILLING BARS

Engineered to fit most threaded ISO milling heads

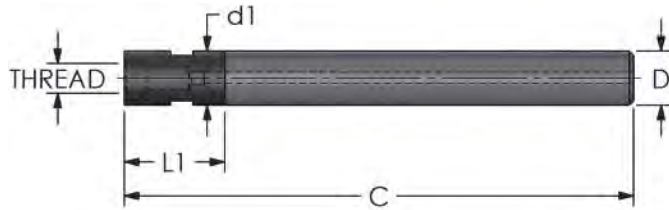

! Optional relief available (d1) CALL FOR PRICING !

Carbide ISO Milling Bar w/ Flat

Coolant Thru

Designation	C	Thread	D	d1	Price
CM06 L6.00-W.375 *	6	M6	.375	--	\$209.58
CM08 L5.00-W.500 *	5	M8	.500	.460	\$235.91
CM08 L8.00-W.500 *	8	M8	.500	.460	\$275.42
CM10 L7.00-W.750	7	M10	.750	.710	\$433.42
CM10 L10.00-W.750	10	M10	.750	.710	\$472.92

Designation	C	Thread	D	d1	Price
CM12 L7.00-W.750	7	M12	.750	.710	\$433.42
CM12 L10.00-W.750	10	M12	.750	.710	\$472.92
CM12 L8.00-W1.00	8	M12	1.000	.960	\$644.09
CM12 L12.00-W1.00	12	M12	1.000	.960	\$815.26
CM16 L14.00-W1.25 *	14	M16	1.250	1.210	\$1,434.11
CM16 L14.00-W1.500 *	14	M16	1.500	1.460	\$1,757.79

Carbide ISO Milling Bar w/o Flat

Coolant Thru

Designation	C	Thread	D	d1	Price
CM08 L8.00-C.500 *	8	M8	.500	.460	\$275.42
CM10 L7.00-C.750	7	M10	.750	.710	\$433.42
CM10 L10.00-C.750	10	M10	.750	.710	\$472.92

Designation	C	Thread	D	d1	Price
CM12 L7.00-C.750	7	M12	.750	.710	\$433.42
CM12 L10.00-C.750	10	M12	.750	.710	\$472.92
CM12 L8.00-C1.00	8	M12	1.000	.960	\$655.06
CM12 L12.00-C1.00	12	M12	1.000	.960	\$815.26
CM16 L14.00-C1.25 *	14	M16	1.250	1.210	\$1,434.11

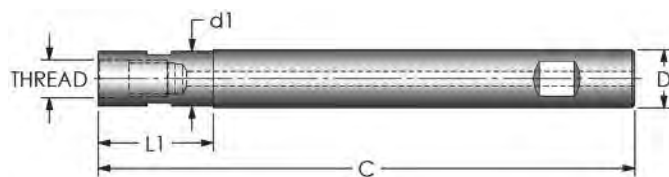

Heavy Metal ISO Milling Bar w/ Flat

Coolant Thru

Designation	C	Thread	D	d1	Price
HM06 L6.00-W.375 *	6	M6	.375	--	\$213.97
HM08 L6.00-W.500 *	6	M8	.500	.460	\$283.09
HM12 L12.00-W.750 *	12	M12	.750	.710	\$511.32
HM12 L8.00-W1.00 *	8	M12	1.000	.960	\$657.26

Designation	C	Thread	D	d1	Price
HM12 L12.00-W1.00 *	12	M12	1.000	.960	\$748.32
HM16 L12.00-W1.25 *	12	M16	1.250	1.210	\$1,164.19
HM16 L12.00-W1.500 *	12	M16	1.500	1.460	\$1,513.11

Heavy Metal ISO Milling Bar w/o Flat

Coolant Thru

Designation	C	Thread	D	d1	Price
HM06 L6.00-C.375 *	6	M6	.375	--	\$213.97
HM08 L6.00-C.500 *	6	M8	.500	.460	\$283.09
HM12 L12.00-C.750 *	12	M12	.750	.710	\$511.32

Designation	C	Thread	D	d1	Price
HM12 L8.00-C1.00 *	8	M12	1.000	.960	\$657.26
HM12 L12.00-C1.00 *	12	M12	1.000	.960	\$748.32
HM16 L12.00-C1.25 *	12	M16	1.250	1.210	\$1,164.19

* Please allow up to 1 week for processing.

New!



Metric ISO Milling Bars

Engineered to fit most threaded ISO milling heads

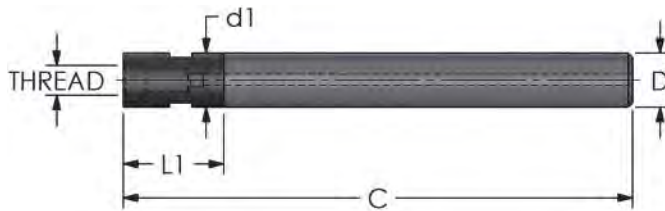

! Optional relief available (d1) CALL FOR PRICING !

Carbide ISO Milling Bar w/o Flat

Coolant Thru

Designation	C (mm)	Thread	D (mm)	d1 (mm)	Price
CM06 L150MM-C10MM	150	M6	10	-	\$221.78
CM06 L180MM-C12MM	180	M6	12	11	\$291.11
CM08 L200MM-C16MM	200	M8	16	14.5	\$374.44
CM10 L250MM-C20MM	250	M10	20	18.5	\$500.40
CM12 L300MM-C25MM	300	M12	25	23.5	\$862.69

C

MILLING

DON'T THROW IT AWAY!
 Send Us Your Damaged Tooling for Repair

See **pg. 208**
 For More
 Details

SAME DAY SHIPPING!

On orders placed before 3:30pm EST

SEE PAGE 210 for more details...

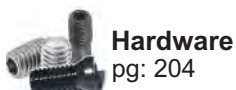

Hardware
 pg: 204



Inserts
 pg: 188



ULTRA-DEX

P★PATRIOT

3xD

New!

High-Performance
Indexable Drills

BEST Value in the Industry!

- Diameter Range (.562 - 2.125")
- Hardened High Quality tool steel & electroless nickel coated for rigidity, wear resistance & reduced chip wash
- New and Improved 4-edge insert design to provide excellent chip control with lower spindle loads
- Same insert can be used as inboard & outboard insert + No risk of mixing up inner & outer
- Engineered flute design optimized for superior chip evacuation & rigidity
- Able to offset and drill into slant workpieces without pre-drilling
- 2-port internal coolant system for high-efficient drilling
- X-offset design to adjust diameter size on turning centers, and optimize tolerances on machining centers



PATRIOT High Performance Indexable Drills

New!

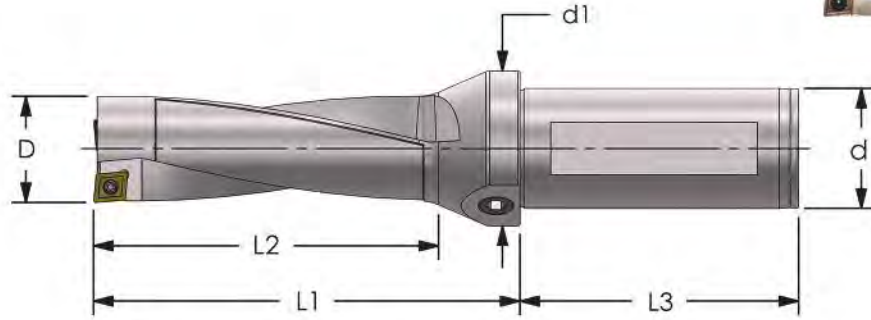

3xD Indexable Drills High Performance

Coolant Thru

Designation	D	d	d1	L3	L1	L2	Insert	Screw	Price			
PD1-0562-3D-075	.562	.750	1.120	1.900	2.747	1.804	PD1 042004	PD1-16	\$232.78			
PD1-0594-3D-075	.594				2.843	1.900		Wrench T-6-S	\$232.78			
PD1-0609-3D-075	.609				2.888	1.945		\$232.78				
PD1-0625-3D-075	.625				1.000	1.360	2.400	2.936	1.993	PD1 063306	PD1-2	\$232.78
PD1-0669-3D-075	.669 (17mm)							3.069	2.126		Wrench T-6-S	\$232.78
PD1-0687-3D-075	.687							3.122	2.179		\$232.78	
PD1-0709-3D-075	.709 (18mm)							3.187	2.244		\$232.78	
PD1-0734-3D-100	.734	3.263	2.320	\$232.78								
PD1-0750-3D-100	.750	3.311	2.368	\$263.66								
PD1-0787-3D-100	.787 (20mm)	3.422	2.479	\$263.66								
PD1-0812-3D-100	.812	1.250	1.614	2.900	3.499	2.556	PD1 074006	PD1-22	\$263.66			
PD1-0844-3D-100	.844				3.637	2.694		Wrench T-7-S	\$263.66			
PD1-0875-3D-100	.875				3.686	2.743		\$263.66				
PD1-0937-3D-125	.937				3.874	2.931		\$263.66				
PD1-0984-3D-125	.984 (25mm)				4.014	3.071		\$263.66				
PD1-1000-3D-125	1.000	4.061	3.118	\$298.45								
PD1-1062-3D-125	1.062	4.249	3.306	\$298.45								
PD1-1125-3D-125	1.125	4.436	3.493	\$298.45								
PD1-1181-3D-125	1.181 (30mm)	1.980	1.980	2.900	4.645	3.702	PD1 094508	PD1-25	\$298.45			
PD1-1250-3D-125	1.250				4.850	3.907		Wrench T-7-S	\$337.18			
PD1-1312-3D-125	1.312				5.039	4.095		\$337.18				
PD1-1375-3D-125	1.375				5.225	4.282		\$337.18				
PD1-1437-3D-125	1.437				5.413	4.470		\$337.18				
PD1-1500-3D-150	1.500	1.500	1.980	2.900	5.640	4.697		PD1 125812	PD1-5	\$385.84		
PD1-1625-3D-150	1.625				6.015	5.072			Wrench T-20-S	\$408.62		
PD1-1750-3D-150	1.750				6.390	5.447	\$425.89					
PD1-1875-3D-150	1.875				6.825	5.882	PD1 156812	PD1-6	\$483.08			
PD1-2000-3D-150	2.000				7.140	6.197		Wrench T-25-S	\$511.40			
PD1-2125-3D-150	2.125				7.515	6.572		\$560.38				

PATRIOT

D

DRILLING

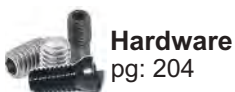

Hardware
pg: 204



Inserts
pg: 188

ULTRA-DEX

Proudly Made in Flushing, MI USA 143

SPEEDS AND FEEDS			Ø.562- .734	Ø.750- 1.437	Ø1.500- 2.125
MATERIAL	INSERT GRADE	SFM	INCH/ REV	INCH/ REV	INCH/ REV
STEEL	HP600	400-700	.002-.005	.004-.008	.004-.010
CAST IRON	HK356	350-650	.0025-.005	.004-.008	.004-.010
STAINLESS STEEL	HP600	300-600	.002-.005	.004-.008	.004-.010
ALUMINUM	HK356	800-1400	.003-.008	.004-.010	.005-.012
HEAT RESISTANT STEELS	HP600	90-250	.002-.004	.0025-.006	.0025-.0085

Indexable & Versatile

Half Cylindrical

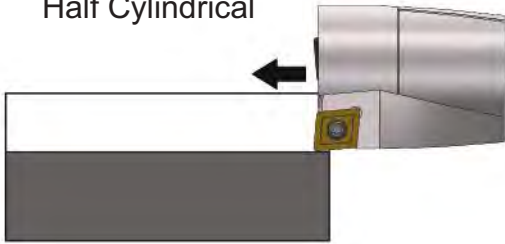

ID & OD Boring

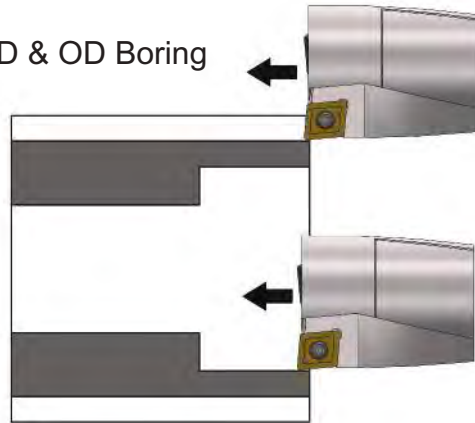

Pre-Drilling

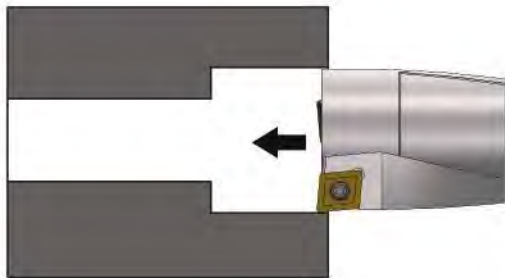

Slanted Surface

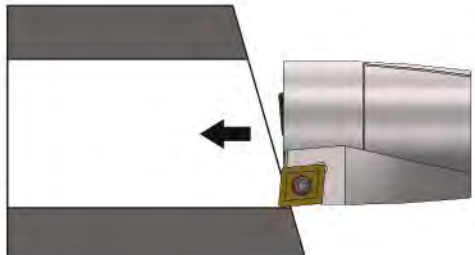

ULTRA-DEX

CHAMFER INDEXABLE DRILLS

MADE HERE

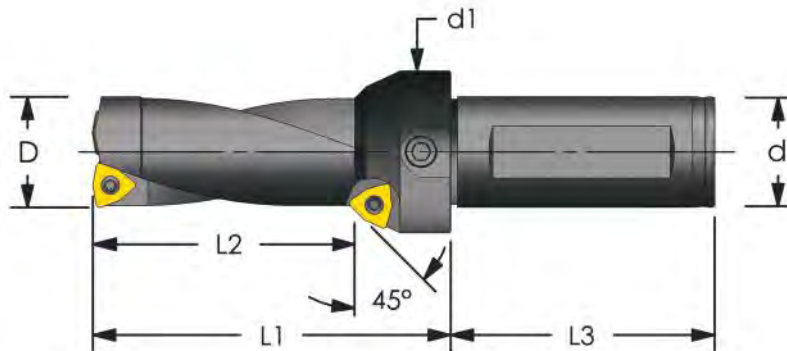

CHAMFER 2xD Indexable Drills (Coated & Uncoated)

Coolant Thru

Designation	D	d	d1	L3	L1	L2	Insert	Screw	Price * Coated	Price
UCD-0750-2D-075	.750	.750	1.220	2.000	2.810	1.748	WCMX 21.52	MTS 25-DR	\$283.09	\$241.40
UCD-1000-2D-100	1.000	1.000	1.450	2.375	3.235	2.345	WCMX 2.522	MTS 3-DR	\$331.37	\$265.53
UCD-1250-2D-125	1.250	1.250	1.730	2.619	3.886	2.710	WCMX 32.52	MTS 35-DR	\$388.43	\$313.81
UCD-1500-2D-125	1.500	1.250	1.970	2.619	4.426	3.250		MTS 35-DR	\$445.48	\$364.29
UCD-1750-2D-150	1.750	1.500	2.220	2.875	5.025	3.850	WCMX 433	MTS 4-DR	\$509.12	\$412.57
UCD-2000-2D-150	2.000	1.500	2.470	2.875	5.687	4.469		MTS 4-DR	\$640.79	\$533.26

* Coated with ION Nitride (Add -C to the end of designation)

Don't see the size chamfer drill your looking for above?

Complete the form at the end of drilling section with your specifications and fax it to us!

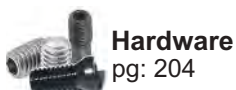

Hardware
pg: 204



Inserts
pg: 188

ULTRA-DEX

ULTRA-DEX

2xD 2.5xD 4xD INDEXABLE DRILLS

BEST Value in the Industry!

Insert pockets precisely positioned to keep cutting forces low and evenly distributed, 80° Trigon Inserts offer 3 cutting edges!

Spiral flutes to improve chip evacuation.

Coolant-Thru access is located on both the shank and the side of the drill body.

- Drills come with 1/8-27 NTP Port



	Work-piece material	SFM	Inch/ Rev
P	Steel	225-650	.0022-.006
M	Stainless Steel	250-430	.002-.006
K	Cast Iron	300-600	.0025-.009
N	Ferrite Materials	600-1100	.0038-.011
S	Heat-resistant steel	60-150	.0028-.008

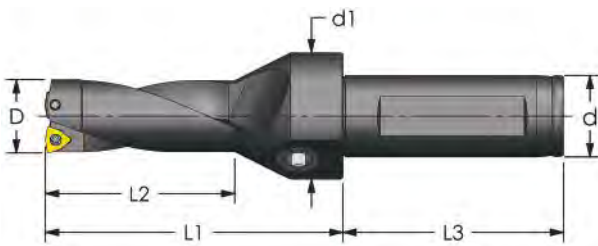

2.5xD Indexable Drills (Coated & Uncoated)

Coolant Thru

Designation	D	d	d1	L3	L1	L2	Insert	Screw	Price * Coated	Price
UD-0437-2D-063	.437					1.280	WCMT 1.211	MTS 184	\$133.86	\$120.70
UD-0468-2D-063	.468					1.310		T-6-S	\$133.86	\$120.70
UD-0500-2D-063	.500					1.340		Wrench	\$133.86	\$120.70
UD-0531-2D-063	.531	.625	.970	1.687	2.280	1.370	WCMT 1.51.51	MTS 2	\$133.86	\$120.70
UD-0562-2D-063	.562					1.400		T-6-S	\$133.86	\$120.70
UD-0593-2D-063	.593					1.430		Wrench	\$133.86	\$120.70

* Coated with ION Nitride (Add -C to the end of designation)

D

DRILLING



PLEASE REFER TO DRAWING ON LEFT

2xD Indexable Drills (Coated & Uncoated)

Coolant Thru

Designation	D	d	d1	L3	L1	L2	Insert	Screw	Price * Coated	Price						
UD-0625-2D-063	.625	.625	.987	1.687	2.280	1.375	WCMX 1.81.52	MTS-255	\$133.86	\$120.70						
UD-0656-2D-063	.656					1.406			\$133.86	\$120.70						
UD-0687-2D-063	.687					1.437			\$133.86	\$120.70						
UD-0719-2D-063	.719					1.467			\$133.86	\$120.70						
UD-0750-2D-075	.750	.750	1.220	2.000	2.810	1.748	WCMX 21.52	MTS 25-DR	\$156.91	\$133.86						
UD-0781-2D-075	.781					1.780			\$156.91	\$133.86						
UD-0812-2D-075	.812					1.811			\$156.91	\$133.86						
UD-0844-2D-075	.844					1.850			\$156.91	\$133.86						
UD-0875-2D-075	.875					1.874			\$156.91	\$133.86						
UD-0906-2D-075	.906					1.910			\$156.91	\$133.86						
UD-0937-2D-075	.937					1.935			\$156.91	\$133.86						
UD-0968-2D-075	.968					1.970			\$156.91	\$133.86						
UD-1000-2D-100	1.000					1.000			1.450	2.375	3.235	2.345	WCMX 2.522	MTS 3-DR	\$184.34	\$147.03
UD-1031-2D-100	1.031											2.375			\$184.34	\$147.03
UD-1062-2D-100	1.062	2.406	\$184.34	\$147.03												
UD-1094-2D-100	1.094	2.438	\$184.34	\$147.03												
UD-1125-2D-100	1.125	2.469	\$184.34	\$147.03												
UD-1156-2D-100	1.156	2.500	\$184.34	\$147.03												
UD-1187-2D-100	1.187	2.532	\$184.34	\$147.03												
UD-1219-2D-100	1.219	2.564	\$184.34	\$147.03												
UD-1250-2D-125	1.250	1.250	1.730	2.619	3.886		2.710	WCMX 32.52				MTS 35-DR			\$216.16	\$174.47
UD-1312-2D-125	1.312						2.771								\$216.16	\$174.47
UD-1343-2D-125	1.343					2.802	\$216.16		\$174.47							
UD-1375-2D-125	1.375					2.833	\$216.16		\$174.47							
UD-1437-2D-125	1.437					2.896	\$216.16		\$174.47							
UD-1500-2D-125	1.500		1.970	4.426	4.426	3.250	T-10-S Wrench		\$246.89	\$201.89						
UD-1562-2D-125	1.562					3.312			\$246.89	\$201.89						
UD-1625-2D-125	1.625					3.375			\$265.53	\$216.16						
UD-1687-2D-125	1.687					3.437			\$265.53	\$216.16						
UD-1750-2D-150	1.750					1.500			2.220	2.875	5.025		3.850	WCMX 433	MTS 4-DR	\$283.09
UD-1812-2D-150	1.812	3.912	\$283.09	\$229.33												
UD-1875-2D-150	1.875	3.975	\$329.18	\$268.33												
UD-1937-2D-150	1.937	4.036	\$329.18	\$268.33												
UD-2000-2D-150	2.000	4.469	\$355.51	\$296.26												
UD-2125-2D-150	2.125	2.470	5.687	5.687	4.593		T-15-S Wrench	\$387.33	\$323.69							
UD-2250-2D-150	2.250				4.717			\$414.76	\$351.12							
UD-2375-2D-150	2.375				4.840			\$441.09	\$377.45							

* Coated with ION Nitride (Add -C to the end of designation)

D
DRILLING

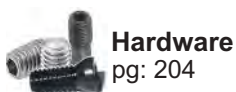

Hardware
pg: 204



Inserts
pg: 188



4xD Indexable Drills

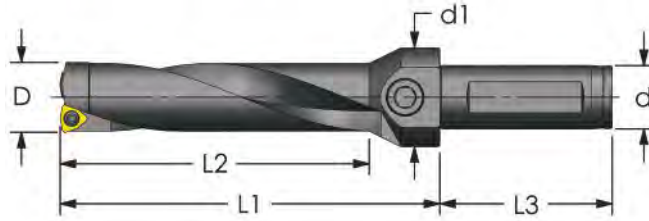

4xD Indexable Drills (Coated & Uncoated)

Coolant Thru

Designation	D	d	d1	L3	L1	L2	Insert	Screw	Price * Coated	Price						
UD-0625-4D-063	.625					2.815	WCMX 1.81.52	MTS-255 T-7-S Wrench	\$192.02	\$173.37						
UD-0656-4D-063	.656	.625	.987	1.687	3.720	2.847			\$192.02	\$173.37						
UD-0687-4D-063	.687					2.878			\$192.02	\$173.37						
UD-0719-4D-063	.719					2.911			\$192.02	\$173.37						
UD-0750-4D-075	.750									3.698	WCMX 21.52	MTS 25-DR T-8-S Wrench	\$224.94	\$192.02		
UD-0781-4D-075	.781	.750	1.220	2.000	4.763	3.729	\$224.94	\$192.02								
UD-0812-4D-075	.812					3.761	\$224.94	\$192.02								
UD-0844-4D-075	.844					3.792	\$224.94	\$192.02								
UD-0875-4D-075	.875					3.824	\$224.94	\$192.02								
UD-0906-4D-075	.906					3.855	\$224.94	\$192.02								
UD-0937-4D-075	.937					3.885	\$224.94	\$192.02								
UD-0968-4D-075	.968					3.918	\$224.94	\$192.02								
UD-1000-4D-100	1.000									4.635			WCMX 2.522	MTS 3-DR T-9-S Wrench	\$263.34	\$211.77
UD-1031-4D-100	1.031					1.000	1.450	2.375	5.685	4.666					\$263.34	\$211.77
UD-1062-4D-100	1.062									4.696					\$263.34	\$211.77
UD-1094-4D-100	1.094									4.728	\$263.34	\$211.77				
UD-1125-4D-100	1.125	4.760	\$263.34	\$211.77												
UD-1156-4D-100	1.156	4.792	\$263.34	\$211.77												
UD-1187-4D-100	1.187	4.822	\$263.34	\$211.77												
UD-1219-4D-100	1.219	4.864	\$263.34	\$211.77												
UD-1250-4D-125	1.250									5.585	WCMX 32.52	MTS 35-DR T-10-S Wrench			\$308.33	\$250.17
UD-1312-4D-125	1.312	1.250	1.730	2.619	6.760					5.646					\$308.33	\$250.17
UD-1375-4D-125	1.375									5.708			\$308.33	\$250.17		
UD-1437-4D-125	1.437					5.771	\$308.33	\$250.17								
UD-1500-4D-125	1.500					1.970	7.800	8.900	6.632	\$353.31			\$289.67			
UD-1562-4D-125	1.562								6.695	\$353.31			\$289.67			
UD-1625-4D-125	1.625								6.757	\$379.65			\$308.33			
UD-1687-4D-125	1.687									6.820			\$379.65	\$308.33		
UD-1750-4D-150	1.750									7.724			WCMX 433	MTS 4-DR T-15-S Wrench	\$404.89	\$328.08
UD-1812-4D-150	1.812					1.500	2.220	2.875	10.347	7.786	\$404.89	\$328.08				
UD-1875-4D-150	1.875	7.849	\$469.62	\$386.23												
UD-1937-4D-150	1.937	7.911	\$469.62	\$386.23												
UD-2000-4D-150	2.000	9.263	\$503.64	\$419.15												
UD-2125-4D-150	2.125	9.387	\$554.12	\$463.04												
UD-2250-4D-150	2.250	9.512	\$592.52	\$502.54												
UD-2375-4D-150	2.375	9.637	\$630.92	\$540.95												

* Coated with ION Nitride (Add -C to the end of designation)

D

DRILLING

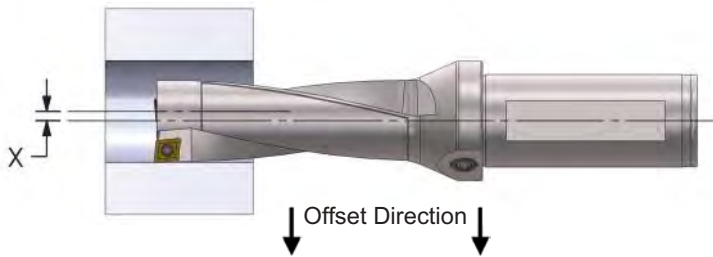

Our Drills offer the ability to offset in turning applications to help with tolerance optimization and creation of holes larger than the drill diameter.

PATRIOT

Designation	Offset (Max)
PD1-0562-3D-075	.007
PD1-0594-3D-075	.005
PD1-0609-3D-075	.005
PD1-0625-3D-075	.015
PD1-0669-3D-075	.011
PD1-0687-3D-075	.009
PD1-0709-3D-075	.007
PD1-0734-3D-100	.019
PD1-0750-3D-100	.017
PD1-0787-3D-100	.011
PD1-0812-3D-100	.009
PD1-0844-3D-100	.005
PD1-0875-3D-100	.004
PD1-0937-3D-125	.023
PD1-0984-3D-125	.019
PD1-1000-3D-125	.017
PD1-1062-3D-125	.009
PD1-1125-3D-125	.004
PD1-1181-3D-125	.035
PD1-1250-3D-125	.027
PD1-1312-3D-125	.021
PD1-1375-3D-125	.013
PD1-1437-3D-125	.008
PD1-1500-3D-150	.039
PD1-1625-3D-150	.027
PD1-1750-3D-150	.015
PD1-1875-3D-150	.051
PD1-2000-3D-150	.039
PD1-2125-3D-150	.023

STANDARD *

Designation	Offset (Max)
UD-0437-2D-063	.018
UD-0468-2D-063	.016
UD-0500-2D-063	.014
UD-0531-2D-063	.023
UD-0562-2D-063	.021
UD-0593-2D-063	.019
UD-0625-2D-063	.023
UD-0656-2D-063	.021
UD-0687-2D-063	.019
UD-0719-2D-063	.017
UD-0750-2D-075	.024
UD-0781-2D-075	.022
UD-0812-2D-075	.021
UD-0844-2D-075	.019
UD-0875-2D-075	.017
UD-0906-2D-075	.015
UD-0937-2D-075	.013
UD-0968-2D-075	.011
UD-1000-2D-100	.029
UD-1031-2D-100	.027
UD-1062-2D-100	.025
UD-1094-2D-100	.023
UD-1125-2D-100	.021
UD-1156-2D-100	.020
UD-1187-2D-100	.018
UD-1219-2D-100	.016
UD-1250-2D-125	.035
UD-1312-2D-125	.031
UD-1343-2D-125	.029
UD-1375-2D-125	.027
UD-1437-2D-125	.023
UD-1500-2D-125	.019
UD-1562-2D-125	.015
UD-1625-2D-125	.011
UD-1687-2D-125	.008
UD-1750-2D-150	.040
UD-1812-2D-150	.036
UD-1875-2D-150	.032
UD-1937-2D-150	.028
UD-2000-2D-150	.024
UD-2125-2D-150	.017
UD-2250-2D-150	.009
UD-2375-2D-150	.001

* 2XD Only

D

DRILLING

FAX TO 810.638.4001 FOR QUOTE

YOUR INFO:

COMPANY: _____

CONTACT: _____

PHONE: () _____

EXT.: _____

DATE: / /

*PREFERRED DISTRIBUTOR INFO:

COMPANY: _____

CONTACT: _____

PHONE: () _____

EXT.: _____

* If you do not have a preferred distributor, we can provide you with a list of distributors in your area to choose from.

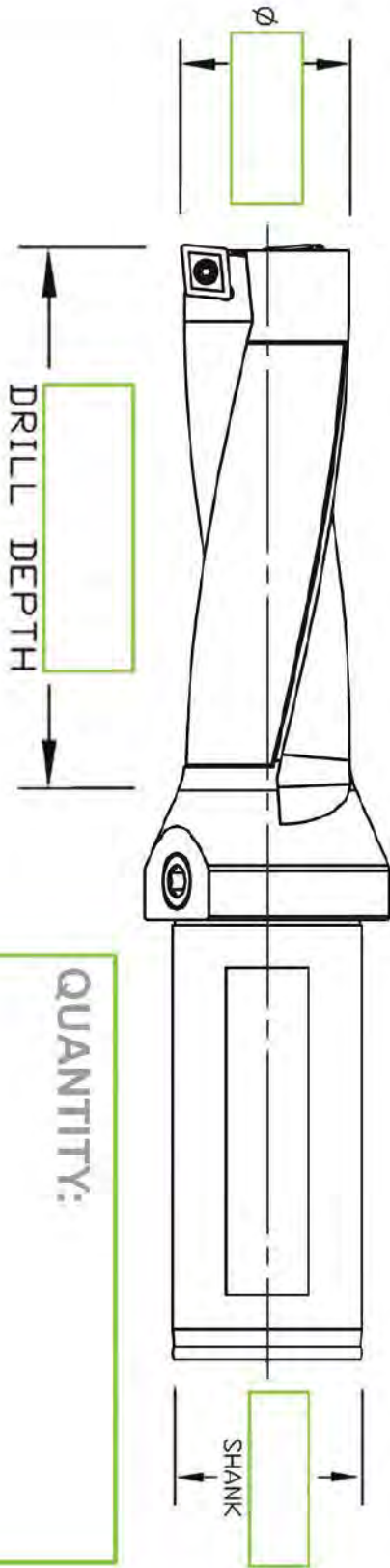

QUANTITY:

FAX TO 810.638.4001 FOR QUOTE

***PREFERRED DISTRIBUTOR INFO:**

COMPANY: _____

CONTACT: _____

PHONE: () **EXT.:** _____

* If you do not have a preferred distributor, we can provide you with a list of distributors in your area to choose from.

YOUR INFO:

COMPANY: _____

CONTACT: _____

PHONE: () **EXT.:** _____

DATE: / /

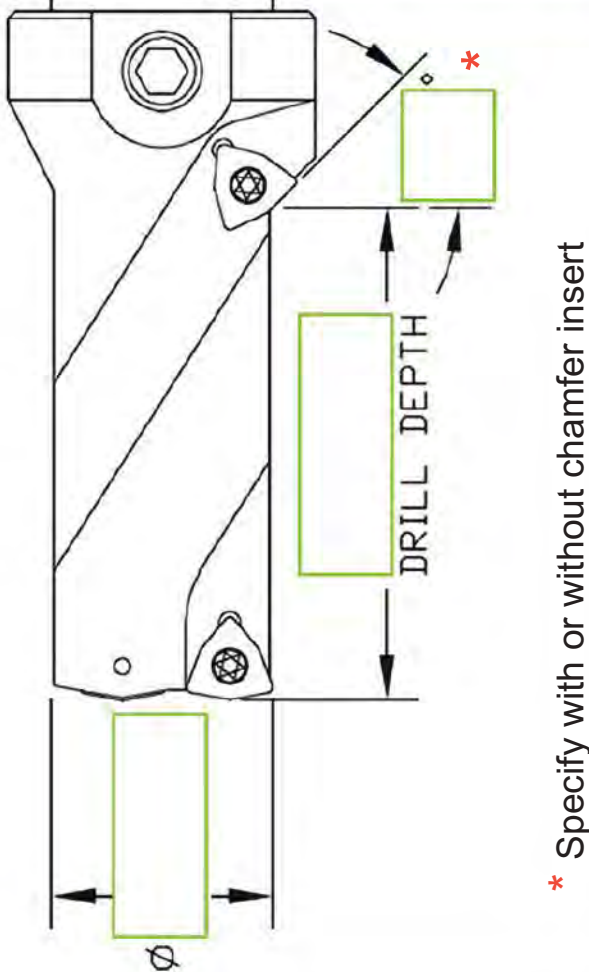
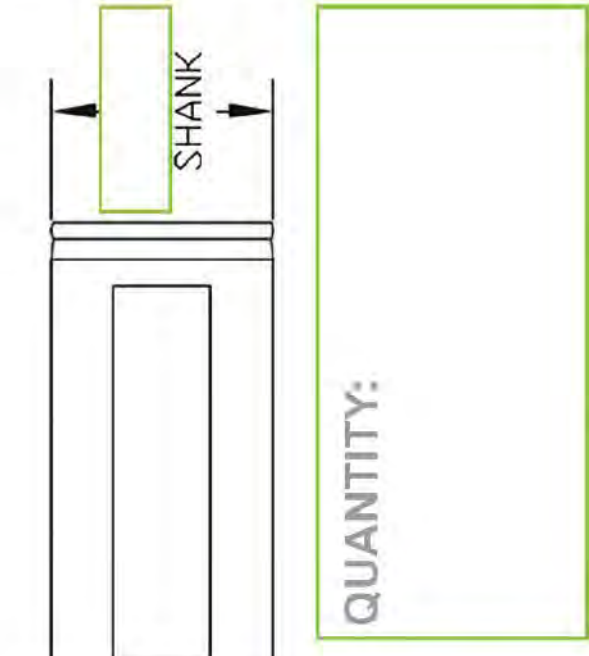

* Specify with or without chamfer insert

ULTRA-DEX

TOOL HOLDING



TOOL HOLDING

	CAT 40	CAT 50	HSK 40A	HSK 50A	HSK 63A	HSK 80A	HSK 100A	HSK 125A	Straight Shank
ER Collet Chuck	153	159	168	168	168	173	173	173	182
End Mill	154	160	--	--	169	--	174	--	--
Shell Mill	156	162	--	--	172	--	175	--	--
Shrink-Fit	157	163	--	--	170	--	176	--	--
Jacobs Taper	158	164	--	--	--	--	--	--	--
Blanks	158	164	172	172	172	175	175	175	--
Retention Knobs	165		HSK Coolant Tubes		178				
Tool Bushings	180		Shrink-Fit Extensions		179				
Collets	184		Shrink-Fit Heat Machines		206				



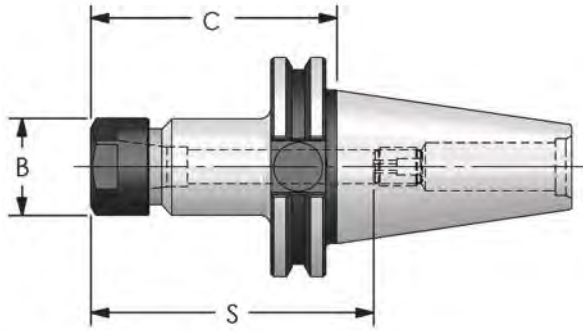

Balanced to:
G2.5 (20,000 rpm)
G6.3 (12,000 rpm)

CAT40 ER Collet Chucks

Designation	B Nut Dia.	C Proj.	S Max Depth	Collet Nut	Stop Screw	Wrench	G2 Price*	G6 Price*
CT40-ER11-250-G2/G6	.750	2.50	1.94	ER-11HN	ER-11S	ER-11W	\$122.89	\$100.95
CT40-ER11-400-G2/G6	.750	4.00	1.94	ER-11HN	ER-11S	ER-11W	\$125.09	\$103.14
CT40-ER11-600-G2/G6	.750	6.00	1.94	ER-11HN	ER-11S	ER-11W	\$141.55	\$119.61
CT40-ER16-250-G2/G6	1.100	2.50	3.00	ER-16HN	ER-16S	ER-16W	\$111.92	\$89.97
CT40-ER16-300-G2/G6	1.100	3.00	3.00	ER-16HN	ER-16S	ER-16W	\$122.89	\$100.95
CT40-ER16-400-G2/G6	1.100	4.00	3.00	ER-16HN	ER-16S	ER-16W	\$125.09	\$103.14
CT40-ER16-500-G2/G6	1.100	5.00	3.00	ER-16HN	ER-16S	ER-16W	\$131.67	\$109.73
CT40-ER16-600-G2/G6	1.100	6.00	3.00	ER-16HN	ER-16S	ER-16W	\$141.55	\$119.61
CT40-ER20-300-G2/G6	1.340	3.00	3.50	ER-20HN	ER-20S	ER-20W	\$122.89	\$100.95
CT40-ER20-400-G2/G6	1.340	4.00	3.95	ER-20HN	ER-20S	ER-20W	\$125.09	\$103.14
CT40-ER20-600-G2/G6	1.340	6.00	3.95	ER-20HN	ER-20S	ER-20W	\$141.55	\$119.61
CT40-ER20-800-G2/G6	1.340	8.00	3.95	ER-20HN	ER-20S	ER-20W	\$213.97	\$192.02
CT40-ER25-250-G2/G6	1.660	2.50	2.80	ER-25SN	ER-25S	ER-25W	\$126.19	\$104.24
CT40-ER25-400-G2/G6	1.660	4.00	4.30	ER-25SN	ER-25S	ER-25W	\$126.19	\$104.24
CT40-ER25-600-G2/G6	1.660	6.00	4.40	ER-25SN	ER-25S	ER-25W	\$137.16	\$115.22
CT40-ER32-300-G2/G6	1.980	3.00	3.45	ER-32SN	ER-32S	ER-32W	\$133.86	\$111.92
CT40-ER32-400-G2/G6	1.980	4.00	4.30	ER-32SN	ER-32S	ER-32W	\$133.86	\$111.92
CT40-ER32-600-G2/G6	1.980	6.00	4.60	ER-32SN	ER-32S	ER-32W	\$141.55	\$119.61
CT40-ER32-800-G2/G6	1.980	8.00	4.60	ER-32SN	ER-32S	ER-32W	\$230.42	\$208.48
CT40-ER40-300-G2/G6	2.250	3.00	3.30	ER-40SN	ER-40S	ER-40W	\$133.86	\$111.92
CT40-ER40-400-G2/G6	2.250	4.00	4.00	ER-40SN	ER-40S	ER-40W	\$133.86	\$111.92
CT40-ER40-600-G2/G6	2.250	6.00	4.50	ER-40SN	ER-40S	ER-40W	\$154.72	\$132.77
CT40-ER40-800-G2/G6	2.250	8.00	4.50	ER-40SN	ER-40S	ER-40W	\$230.42	\$208.48

* Add -G6 or -G2 to end of designation depending on the balance needed.
All Hardware Included. Wrenches Sold Separately.



Hardware
pg: 204



Collets
pg: 184



CAT40 End Mill Holders

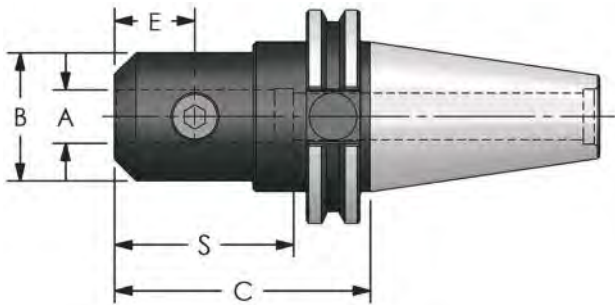

**Retention
Knobs**
pg 165



Balanced to:
G2.5 (20,000 rpm)
G6.3 (12,000 rpm)

CAT40 End Mill Holders (1/8 - 1/2")

Designation	A Inside Dia.	B Outside Dia.	C Proj.	S Max Depth	E	Set Screw	G2 Price*	G6 Price*
CT40-EM012-250-G2/G6	.125	.690	2.50	--	.19	SS10-250	\$104.24	\$82.30
CT40-EM188-250-G2/G6	.188	.750	2.50	--	.44	SS10-250	\$93.27	\$71.11
CT40-EM188-400-G2/G6	.188	.750	4.00	--	.44	SS10-250	\$119.61	\$97.66
CT40-EM250-250-G2/G6	.250	.880	2.50	--	.44	SS1/4-250	\$93.27	\$71.11
CT40-EM250-400-G2/G6	.250	.880	4.00	--	.44	SS1/4-250	\$107.53	\$85.59
CT40-EM250-600-G2/G6	.250	.880	6.00	--	.44	SS1/4-250	\$114.11	\$92.17
CT40-EM312-250-G2/G6	.312	.880	2.50	--	.44	SS1/4-250	\$93.27	\$71.11
CT40-EM312-400-G2/G6	.312	.880	4.00	--	.44	SS1/4-250	\$107.53	\$85.59
CT40-EM312-600-G2/G6	.312	.880	6.00	--	.44	SS1/4-250	\$114.11	\$92.17
CT40-EM375-250-G2/G6	.375	1.000	2.50	--	.75	SS3/8-375	\$93.27	\$71.11
CT40-EM375-400-G2/G6	.375	1.000	4.00	--	.75	SS3/8-375	\$107.53	\$85.59
CT40-EM375-600-G2/G6	.375	1.000	6.00	--	.75	SS3/8-375	\$107.53	\$85.59
CT40-EM437-250-G2/G6	.437	1.000	2.50	--	.75	SS3/8-375	\$93.27	\$71.11
CT40-EM437-400-G2/G6	.437	1.000	4.00	--	.75	SS3/8-375	\$114.11	\$92.17
CT40-EM500-262-G2/G6	.500	1.375	2.62	--	.88	SS7/16-500	\$93.27	\$71.11
CT40-EM500-400-G2/G6	.500	1.375	4.00	--	.88	SS7/16-500	\$107.53	\$85.59
CT40-EM500-600-G2/G6	.500	1.375	6.00	--	.88	SS7/16-500	\$114.11	\$92.17

* Add -G6 or -G2 to end of designation depending on the balance needed.
All Hardware Included

- Taper Ground to **AT-3** Specification
- Balanced for Less Vibration & Longer Tool Life
- T.I.R. .0002
- Hardened & Tempered to Prevent Taper Cracking
- Through Spindle Coolant Capability
- Special Length Projections Available



TOOL HOLDING

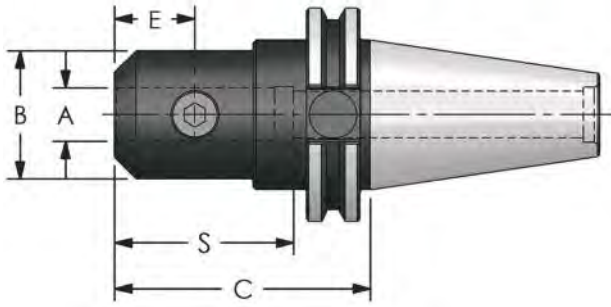

CAT40 End Mill Holders (9/16 - 1 1/2")

Balanced to:
G2.5 (20,000 rpm)
G6.3 (12,000 rpm)

Designation	A Inside Dia.	B Outside Dia.	C Proj.	S Max Depth	E	Set Screw	G2 Price*	G6 Price*
CT40-EM563-262-G2/G6	.563	1.375	2.62	2.05	.88	SS7/16-500	\$93.27	\$71.11
CT40-EM625-175-G2/G6	.625	1.750	1.75	2.10	.70	SS9/16-500	\$93.27	\$71.11
CT40-EM625-300-G2/G6	.625	1.500	3.00	2.10	.94	SS9/16-500	\$107.53	\$85.59
CT40-EM625-600-G2/G6	.625	1.500	6.00	2.10	.94	SS9/16-500	\$114.11	\$92.17
CT40-EM750-175-G2/G6	.750	1.750	1.75	2.25	.70	SS5/8-500	\$93.27	\$71.11
CT40-EM750-300-G2/G6	.750	1.750	3.00	2.30	1.00	SS5/8-500	\$107.53	\$85.59
CT40-EM750-600-G2/G6	.750	1.750	6.00	2.30	1.00	SS5/8-500	\$114.11	\$92.17
CT40-EM875-600-G2/G6	.875	2.000	6.00	2.50	1.00	SS5/8-500	\$114.11	\$92.17
CT40-EM100-175-G2/G6	1.000	1.750	1.75	2.25	.83	SS3/4-375	\$93.27	\$71.11
CT40-EM100-400-G2/G6	1.000	2.000	4.00	2.83	1.12	SS3/4-375	\$107.53	\$85.59
CT40-EM100-600-G2/G6	1.000	2.000	6.00	2.83	1.12	SS3/4-375	\$114.11	\$92.17
CT40-EM125-250-G2/G6	1.250	2.250	2.50	2.50	1.00	SS3/4-500	\$93.27	\$71.11
CT40-EM125-400-G2/G6	1.250	2.250	4.00	3.00	1.12	(2) SS3/4-500	\$107.53	\$85.59
CT40-EM125-600-G2/G6	1.250	2.250	6.00	3.00	1.12	(2) SS3/4-500	\$114.11	\$92.17
CT40-EM150-462-G2/G6	1.500	2.600	4.62	2.75	1.12	(2) SS3/4-500	\$107.53	\$85.59

* Add -G6 or -G2 to end of designation depending on the balance needed.
All Hardware Included

SAME DAY SHIPPING!

On orders placed before 3:30pm EST
SEE PAGE 210 for more details...

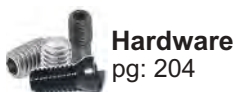
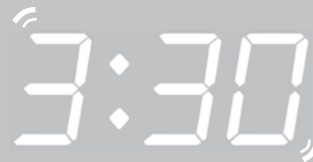

CAT40 Shell Mill Holders

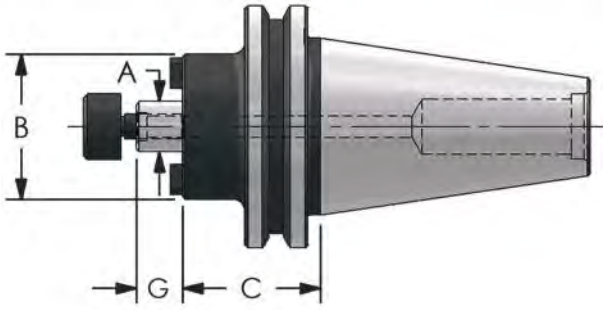

CAT40 Shell Mill Holders

Balanced to:
G6.3 (12,000 rpm)

Designation	A Pilot Dia.	B Diameter	C Projection	G	Drive Key	Lock Screw	Thread	Price
CT40-SM050-138	.500	1.438	1.38	.46	UDK 250	U5001	1/4-28	\$95.47
CT40-SM050-350	.500	1.438	3.50	.46	UDK 250	U5001	1/4-28	\$108.63
CT40-SM075-150	.750	1.750	1.50	.68	UDK 312	U5002	3/8-24	\$97.66
CT40-SM075-400	.750	1.750	4.00	.68	UDK 312	U5002	3/8-24	\$119.61
CT40-SM075-600	.750	1.750	6.00	.68	UDK 312	U5002	3/8-24	\$141.55
CT40-SM100-200	1.000	2.190	2.00	.68	UDK 375	U5003	1/2-20	\$100.95
CT40-SM100-400	1.000	2.190	4.00	.68	UDK 375	U5003	1/2-20	\$119.61
CT40-SM100-600	1.000	2.190	6.00	.68	UDK 375	U5003	1/2-20	\$158.00
CT40-SM125-212	1.250	2.750	2.12	.68	UDK 500	U5004	5/8-18	\$97.66
CT40-SM125-400	1.250	2.750	4.00	.68	UDK 500	U5004	5/8-18	\$113.02
CT40-SM150-250	1.500	3.380	2.50	.94	UDK 625	U5005	3/4-16	\$103.14
CT40-SM150-400	1.500	3.380	4.00	.94	UDK 625	U5005	3/4-16	\$117.41

All Hardware Included

- Taper Ground to **AT-3** Specification
- Balanced for Less Vibration & Longer Tool Life
- T.I.R. .0002
- Hardened & Tempered to Prevent Taper Cracking
- Through Spindle Coolant Capability
- Special Length Projections Available



Retention
Knobs
pg 165



TOOL HOLDING

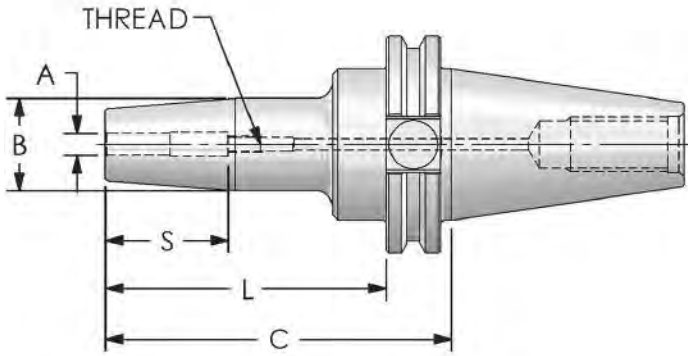

Shrink-Fit Machines Available
Call for Pricing



CAT40 Shrink-Fit Holders (Std. Length)

Balanced to:
G2.5 (20,000 rpm)

Designation	A Inside Dia.	B Outside Dia.	C Proj.	S	L	Thread	Price
CT40-SF012-400-G2	.125	.500	4.00	.79	3.25	--	\$179.95
CT40-SF188-400-G2	.188	.500	4.00	.79	3.25	--	\$168.98
CT40-SF250-400-G2	.250	.750	4.00	1.42	3.25	10-32	\$168.98
CT40-SF375-400-G2	.375	.750	4.00	1.53	3.25	1/4-28	\$168.98
CT40-SF500-400-G2	.500	1.000	4.00	1.85	3.25	7/16-20	\$174.47
CT40-SF625-400-G2	.625	1.000	4.00	1.97	3.25	9/16-18	\$174.47
CT40-SF750-400-G2	.750	1.250	4.00	2.04	3.25	5/8-18	\$185.44
CT40-SF100-400-G2	1.000	2.090	4.00	2.28	3.25	3/4-16	\$185.44
CT40-SF125-400-G2	1.250	2.090	4.00	2.28	3.25	3/4-16	\$185.44

CAT40 Shrink-Fit Holders (Ext. Length)

CT40-SF012-600-G2	.125	.750	6.00	.79	5.25	--	\$207.39
CT40-SF188-600-G2	.188	.750	6.00	.79	5.25	--	\$196.41
CT40-SF250-600-G2	.250	.750	6.00	1.42	5.25	10-32	\$196.41
CT40-SF375-600-G2	.375	1.000	6.00	1.53	5.25	1/4-28	\$196.41
CT40-SF500-600-G2	.500	1.000	6.00	1.85	5.25	7/16-20	\$196.41
CT40-SF625-600-G2	.625	1.250	6.00	1.97	5.25	9/16-18	\$201.89
CT40-SF750-600-G2	.750	1.250	6.00	2.04	5.25	5/8-18	\$201.89
CT40-SF100-600-G2	1.000	2.090	6.00	2.28	5.25	3/4-16	\$201.89
CT40-SF250-800-G2	.250	1.000	8.00	1.42	7.25	10-32	\$229.33

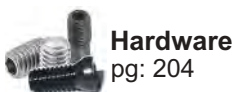

CAT40 Jacobs Taper / BLANKS

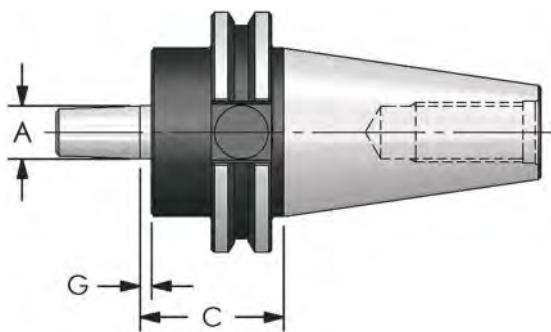

CAT40 Jacobs Taper Holders

Balanced to:
G6.3 (12,000 rpm)

Designation	Taper No.	C Projection	A Dia.	G	Taper Length	Price
CT40-JT02-150	2	1.50	.559	.125	.875	\$76.81
CT40-JT03-150	3	1.50	.811	.125	1.219	\$76.81
CT40-JT04-150	4	1.50	1.124	.125	1.656	\$76.81
CT40-JT06-150	6	1.50	.676	.125	1.000	\$76.81
CT40-JT33-150	33	1.50	.624	.125	1.000	\$79.00

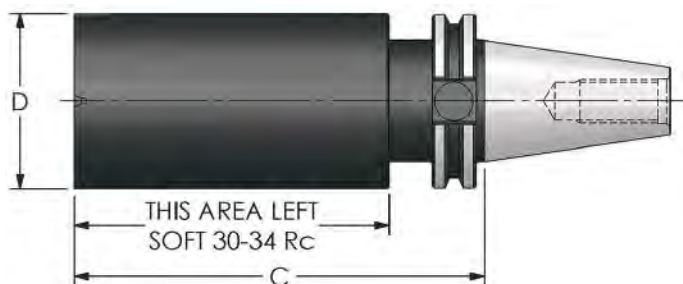

CAT40 Style Blanks

Designation	Taper	D		C		Price
		mm	Inch	mm	Inch	
CT40-BB64-150	CAT40	64	2.520	150	5.91	\$130.58
CT40-BB64-250	CAT40	64	2.520	250	9.84	\$152.52
CT40-BB100-150	CAT40	100	3.940	150	5.91	\$163.50



Retention Knobs
pg 165



M

TOOL HOLDING

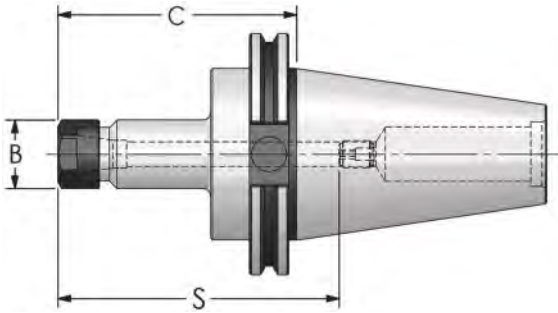

CAT50 ER Collet Chucks

Balanced to:
G2.5 (15,000 rpm)
G6.3 (12,000 rpm)

Designation	B Nut Dia.	C Proj.	S Max Depth	Collet Nut	Stop Screw	Wrench	G2 Price*	G6 Price*
CT50-ER11-600-G2/G6	.750	6.00	1.94	ER-11HN	ER-11S	ER-11W	\$252.37	\$230.42
CT50-ER16-400-G2/G6	1.100	4.00	4.50	ER-16HN	ER-16S	ER-16W	\$173.37	\$151.42
CT50-ER16-600-G2/G6	1.100	6.00	4.50	ER-16HN	ER-16S	ER-16W	\$185.44	\$163.50
CT50-ER16-800-G2/G6	1.100	8.00	4.50	ER-16HN	ER-16S	ER-16W	\$252.37	\$230.42
CT50-ER20-250-G2/G6	1.340	2.50	3.38	ER-20HN	ER-20S	ER-20W	\$173.37	\$151.42
CT50-ER20-400-G2/G6	1.340	4.00	4.00	ER-20HN	ER-20S	ER-20W	\$173.37	\$151.42
CT50-ER20-600-G2/G6	1.340	6.00	4.00	ER-20HN	ER-20S	ER-20W	\$189.83	\$167.88
CT50-ER20-800-G2/G6	1.340	8.00	4.00	ER-20HN	ER-20S	ER-20W	\$217.26	\$195.31
CT50-ER25-250-G2/G6	1.660	2.50	4.50	ER-25SN	ER-25S	ER-25W	\$177.75	\$155.81
CT50-ER25-400-G2/G6	1.660	4.00	4.50	ER-25SN	ER-25S	ER-25W	\$177.75	\$155.81
CT50-ER25-600-G2/G6	1.660	6.00	4.50	ER-25SN	ER-25S	ER-25W	\$193.12	\$171.17
CT50-ER25-800-G2/G6	1.660	8.00	4.50	ER-25SN	ER-25S	ER-25W	\$219.45	\$197.51
CT50-ER32-300-G2/G6	1.980	3.00	3.50	ER-32SN	ER-32S	ER-32W	\$174.47	\$152.52
CT50-ER32-400-G2/G6	1.980	4.00	4.00	ER-32SN	ER-32S	ER-32W	\$179.95	\$158.00
CT50-ER32-500-G2/G6	1.980	5.00	4.00	ER-32SN	ER-32S	ER-32W	\$186.53	\$164.59
CT50-ER32-600-G2/G6	1.980	6.00	4.00	ER-32SN	ER-32S	ER-32W	\$186.53	\$164.59
CT50-ER32-800-G2/G6	1.980	8.00	4.00	ER-32SN	ER-32S	ER-32W	\$257.86	\$235.91
CT50-ER40-300-G2/G6	2.500	3.00	4.00	ER-40SN	ER-40S	ER-40W	\$174.47	\$152.52
CT50-ER40-400-G2/G6	2.500	4.00	4.50	ER-40SN	ER-40S	ER-40W	\$186.53	\$164.59
CT50-ER40-500-G2/G6	2.500	5.00	4.50	ER-40SN	ER-40S	ER-40W	\$193.12	\$171.17
CT50-ER40-600-G2/G6	2.500	6.00	4.50	ER-40SN	ER-40S	ER-40W	\$198.61	\$176.66
CT50-ER40-800-G2/G6	2.500	8.00	4.50	ER-40SN	ER-40S	ER-40W	\$263.34	\$241.40

* Add -G6 or -G2 to end of designation depending on the balance needed.
All Hardware Included. Wrenches Sold Separately.



Hardware
 pg: 204



Collets
 pg: 184



CAT50 End Mill Holders

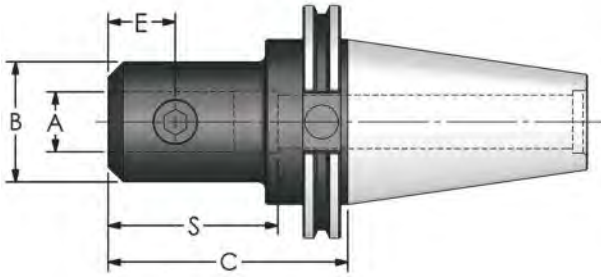

Balanced to:
G2.5 (15,000 rpm)
G6.3 (12,000 rpm)

CAT50 End Mill Holders (3/16 - 1/2")

Designation	A Inside Dia.	B Outside Dia.	C Proj.	S Max Depth	E	Set Screw	G2 Price*	G6 Price*
CT50-EM188-250-G2/G6	.188	.680	2.50	--	.44	SS10-250	\$119.61	\$98.53
CT50-EM188-400-G2/G6	.188	.680	4.00	--	.44	SS10-250	\$129.48	\$107.53
CT50-EM250-250-G2/G6	.250	.880	2.50	--	.44	SS1/4-250	\$119.61	\$98.53
CT50-EM250-400-G2/G6	.250	.880	4.00	--	.44	SS1/4-250	\$129.48	\$107.53
CT50-EM250-600-G2/G6	.250	.880	6.00	--	.44	SS1/4-250	\$141.55	\$119.61
CT50-EM312-250-G2/G6	.312	1.000	2.50	--	.44	SS1/4-250	\$119.61	\$98.53
CT50-EM312-400-G2/G6	.312	1.000	4.00	--	.44	SS1/4-250	\$129.48	\$107.53
CT50-EM312-600-G2/G6	.312	1.000	6.00	--	.44	SS1/4-250	\$141.55	\$119.61
CT50-EM375-250-G2/G6	.375	1.000	2.50	--	.75	SS3/8-375	\$119.61	\$98.53
CT50-EM375-400-G2/G6	.375	1.000	4.00	--	.75	SS3/8-375	\$129.48	\$107.53
CT50-EM375-600-G2/G6	.375	1.000	6.00	--	.75	SS3/8-375	\$141.55	\$119.61
CT50-EM437-250-G2/G6	.437	1.000	2.50	--	.75	SS3/8-375	\$119.61	\$98.53
CT50-EM437-400-G2/G6	.437	1.000	4.00	--	.75	SS3/8-375	\$151.42	\$126.19
CT50-EM437-600-G2/G6	.437	1.000	6.00	--	.75	SS3/8-375	\$162.39	\$137.16
CT50-EM500-262-G2/G6	.500	1.375	2.62	--	.88	SS7/16-500	\$119.61	\$98.53
CT50-EM500-400-G2/G6	.500	1.375	4.00	--	.88	SS7/16-500	\$129.48	\$107.53
CT50-EM500-600-G2/G6	.500	1.375	6.00	--	.88	SS7/16-500	\$141.55	\$119.61

* Add -G6 or -G2 to end of designation depending on the balance needed.
All Hardware Included



Retention
Knobs
pg 165



TOOL HOLDING

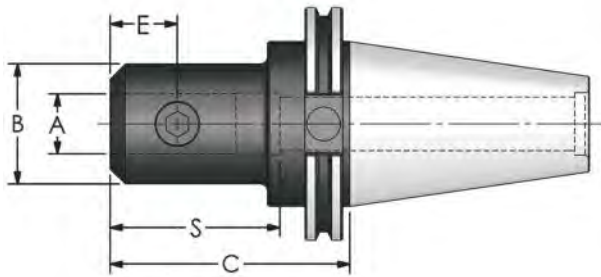

Balanced to:
G2.5 (15,000 rpm)
G6.3 (12,000 rpm)

CAT50 End Mill Holders (5/8 - 2")

Designation	A Inside Dia.	B Outside Dia.	C Proj.	S Max Depth	E	Set Screw	G2 Price*	G6 Price*
CT50-EM625-138-G2/G6	.625	2.750	1.38	--	.70	SS9/16-500	\$119.61	\$98.53
CT50-EM625-300-G2/G6	.625	1.750	3.00	--	.94	SS9/16-500	\$129.48	\$107.53
CT50-EM625-600-G2/G6	.625	1.750	6.00	--	.94	SS9/16-500	\$141.55	\$119.61
CT50-EM750-138-G2/G6	.750	2.750	1.38	--	.67	SS5/8-500	\$119.61	\$98.53
CT50-EM750-300-G2/G6	.750	1.750	3.00	--	.67	SS5/8-500	\$129.48	\$107.53
CT50-EM750-600-G2/G6	.750	1.750	6.00	--	1.00	SS5/8-500	\$141.55	\$119.61
CT50-EM875-400-G2/G6	.875	2.000	4.00	2.50	1.00	SS5/8-500	\$130.58	\$106.44
CT50-EM875-600-G2/G6	.875	2.000	6.00	2.50	1.00	SS5/8-500	\$139.36	\$114.11
CT50-EM100-138-G2/G6	1.000	2.750	1.38	2.25	.83	SS3/4-500	\$119.61	\$98.53
CT50-EM100-400-G2/G6	1.000	2.000	4.00	2.83	1.12	SS3/4-500	\$129.48	\$107.53
CT50-EM100-600-G2/G6	1.000	2.000	6.00	2.83	1.12	SS3/4-500	\$141.55	\$119.61
CT50-EM125-200-G2/G6	1.250	2.750	2.00	2.55	.88	SS3/4-750	\$126.19	\$104.24
CT50-EM125-400-G2/G6	1.250	2.750	4.00	3.00	1.12	(2) SS3/4-750	\$141.55	\$119.61
CT50-EM125-600-G2/G6	1.250	2.500	6.00	3.00	1.12	(2) SS3/4-750	\$58.00	\$136.06
CT50-EM150-200-G2/G6	1.500	2.750	2.00	2.75	1.12	SS3/4-500	\$126.19	\$104.24
CT50-EM150-450-G2/G6	1.500	2.500	4.50	2.75	1.12	(2) SS3/4-500	\$141.55	\$119.61
CT50-EM200-500-G2/G6	2.000	3.750	5.00	3.50	1.41	(2) SS1-750	\$140.45	\$115.22
CT50-EM200-800-G2/G6	2.000	3.750	8.00	3.50	1.41	(2) SS1-750	\$167.88	\$143.75

* Add -G6 or -G2 to end of designation depending on the balance needed.
All Hardware Included



- Taper Ground to **AT-3** Specification
- Balanced for Less Vibration & Longer Tool Life
- T.I.R. .0002
- Hardened & Tempered to Prevent Taper Cracking
- Through Spindle Coolant Capability
- Special Length Projections Available

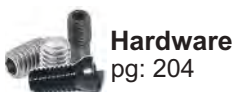

CAT50 Shell Mill Holders

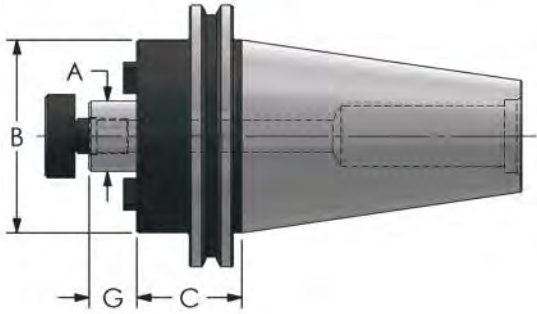

Balanced to:
G6.3 (12,000 rpm)

CAT50 Shell Mill Holders

Designation	A Pilot Dia.	B Diameter	C Projection	G	Drive Key	Lock Screw	Thread	Price
CT50-SM050-200	.500	1.560	2.00	.46	UDK 250	U5001	1/4-28	\$121.80
CT50-SM050-400	.500	1.560	4.00	.46	UDK 250	U5001	1/4-28	\$140.45
CT50-SM050-600	.500	1.560	6.00	.46	UDK 250	U5001	1/4-28	\$158.00
CT50-SM075-150	.750	2.750	1.50	.68	UDK 312	U5002	3/8-24	\$121.80
CT50-SM075-400	.750	1.750	4.00	.68	UDK 312	U5002	3/8-24	\$140.45
CT50-SM075-600	.750	1.750	6.00	.68	UDK 312	U5002	3/8-24	\$158.00
CT50-SM100-150	1.000	2.750	1.50	.68	UDK 375	U5003	1/2-20	\$121.80
CT50-SM100-400	1.000	2.750	4.00	.68	UDK 375	U5003	1/2-20	\$140.45
CT50-SM100-600	1.000	2.750	6.00	.68	UDK 375	U5003	1/2-20	\$158.00
CT50-SM125-150	1.250	2.750	1.50	.68	UDK 500	U5004	5/8-18	\$121.80
CT50-SM125-400	1.250	2.750	4.00	.68	UDK 500	U5004	5/8-18	\$140.45
CT50-SM125-600	1.250	2.750	6.00	.68	UDK 500	U5004	5/8-18	\$158.00
CT50-SM150-250	1.500	3.750	2.50	.94	UDK 625	U5005	3/4-16	\$120.70
CT50-SM150-400	1.500	3.750	4.00	.94	UDK 625	U5005	3/4-16	\$140.45
CT50-SM150-600	1.500	3.750	6.00	.94	UDK 625	U5005	3/4-16	\$159.11
CT50-SM200-250	2.000	4.440	2.50	.94	UDK 750	U5006	1-14	\$144.84
CT50-SM200-400	2.000	4.440	4.00	.94	UDK 750	U5006	1-14	\$168.98
CT50-SM200-600	2.000	4.440	6.00	.94	UDK 750	U5006	1-14	\$198.61
CT50-SM250-250*	2.500	4.880	2.50	.94	UDK 100	U5007	1-14	\$195.31
CT50-SM250-400*	2.500	4.880	4.00	.94	UDK 100	U5007	1-14	\$231.53
CT50-SM250-600*	2.500	4.880	6.00	.94	UDK 100	U5007	1-14	\$280.90

* Features x4 5/8-11 tapped holes on a 4" bolt circle.
All Hardware Included



Retention
Knobs
pg 165



M

TOOL HOLDING

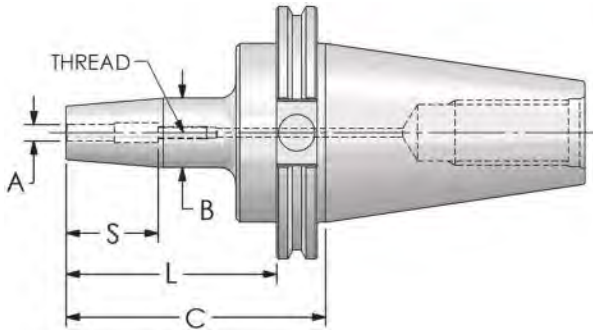

Shrink-Fit
Machines Available
Call for Pricing



CAT50 Shrink-Fit Holders (Std. Length)

Balanced to:
G2.5 (20,000 rpm)

Designation	A Inside Dia.	B Outside Dia.	C Proj.	S	L	Thread	Price
CT50-SF012-400-G2	.125	.787	4.00	.375	3.250	--	\$240.30
CT50-SF188-400-G2	.188	.750	4.00	.563	3.250	--	\$229.33
CT50-SF250-400-G2	.250	.750	4.00	1.420	3.250	10-32	\$229.33
CT50-SF375-400-G2	.375	.750	4.00	1.530	3.250	1/4-28	\$229.33
CT50-SF500-400-G2	.500	1.000	4.00	1.850	3.250	7/16-20	\$240.30
CT50-SF625-400-G2	.625	1.000	4.00	1.970	3.250	9/16-18	\$240.30
CT50-SF750-400-G2	.750	1.250	4.00	2.040	3.250	5/8-18	\$240.30
CT50-SF100-400-G2	1.000	2.090	4.00	2.280	3.250	3/4-16	\$251.28
CT50-SF125-400-G2	1.250	2.090	4.00	2.280	3.250	3/4-16	\$251.28

CAT50 Shrink-Fit Holders (Ext. Length)

CT50-SF250-600-G2	.250	.750	6.00	1.420	5.625	10-32	\$273.22
CT50-SF375-600-G2	.375	1.000	6.00	1.530	5.625	1/4-28	\$273.22
CT50-SF500-600-G2	.500	1.000	6.00	1.850	5.625	7/16-20	\$273.22
CT50-SF625-600-G2	.625	1.250	6.00	1.970	5.625	9/16-18	\$284.19
CT50-SF750-600-G2	.750	1.250	6.00	2.040	5.625	5/8-18	\$284.19
CT50-SF250-800-G2	.250	1.000	8.00	1.420	8.300	10-32	\$306.14
CT50-SF375-800-G2	.375	1.250	8.00	1.530	5.625	1/4-28	\$317.11
CT50-SF500-800-G2	.500	1.250	8.00	1.850	5.625	7/16-20	\$317.11

- BEST Possible T.I.R.
- BEST Available Gripping Power
- BEST Possible Balance
- Fastest Tool Change - In Seconds!
- Ability to Preset for Required Tool Length
- Increased Tool and Spindle Life



Hardware
pg: 204

ULTRA-DEX

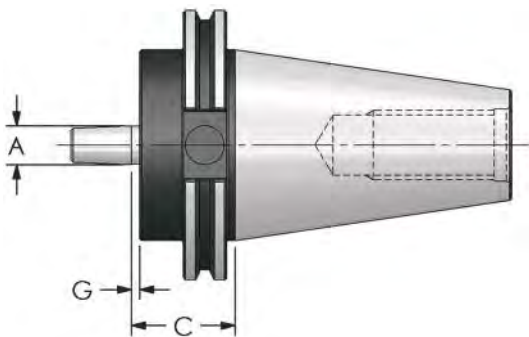

CAT50 Jacobs Taper Holders

Balanced to:
G6.3 (12,000 rpm)

Designation	Taper No.	C Projection	A Dia.	G	Taper Length	Price
CT50-JT02-150	2	1.50	.559	.125	.875	\$92.17
CT50-JT03-150	3	1.50	.811	.125	1.219	\$92.17
CT50-JT04-150	4	1.50	1.124	.125	1.656	\$92.17
CT50-JT06-150	6	1.50	.676	.125	1.000	\$92.17
CT50-JT33-150	33	1.50	.624	.125	1.000	\$103.14

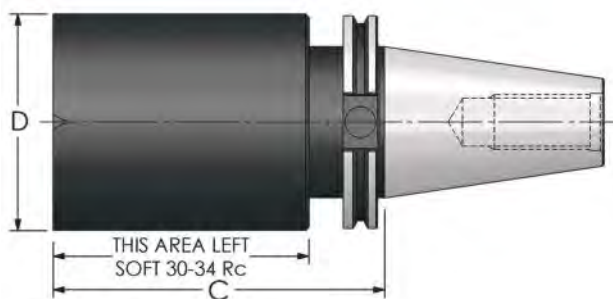

CAT50 Style Blanks

Designation	Taper	D		C		Price
		mm	Inch	mm	Inch	
CT50-BB100-150	CAT50	100	3.940	150	5.91	\$185.44
CT50-BB100-250	CAT50	100	3.940	250	9.84	\$232.62
CT50-BB150-150	CAT50	150	5.910	150	5.91	\$305.04

- Taper Ground to **AT-3** Specification
- Balanced for Less Vibration & Longer Tool Life
- T.I.R. .0002
- Hardened & Tempered to Prevent Taper Cracking
- Through Spindle Coolant Capability
- Special Length Projections Available

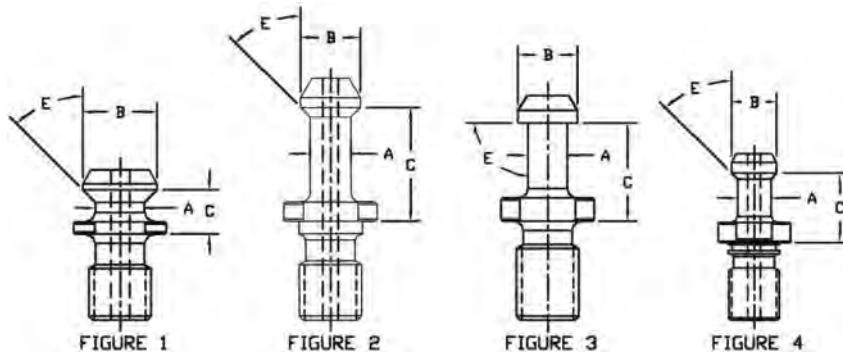

Designation	A	B	C	E	Thread	Coolant Thru	Figure	Price
PSC-475	.490	.740	.440	45°	5/8-11	YES	1	\$11.41
PS-475	.490	.740	.440	45°	5/8-11	NO	1	\$9.82
PS-532x15	.551	.747	.791	75°	5/8-11	NO	1	\$11.41
PSC-532x45	.392	.591	.984	45°	5/8-11	YES	2	\$12.01
PS-532x45	.392	.591	.984	45°	5/8-11	NO	2	\$11.41
PS-532x60	.392	.591	.984	60°	5/8-11	NO	2	\$11.41
PS-532x90	.392	.591	.984	90°	5/8-11	NO	2	\$11.41
PS-498	.392	.591	.775	90°	5/8-11	NO	3	\$12.01
PSC-552	.406	.594	1.139	45°	5/8-11	YES	2	\$14.21
PS-552	.406	.594	1.139	45°	5/8-11	NO	2	\$13.11

CAT40
Retention
Knobs



CAT50
Retention
Knobs

Designation	A	B	C	E	Thread	Coolant Thru	Figure	Price
PSC-535x45	.667	.904	1.384	45°	1-8	YES	4	\$20.79
PS-535x45	.667	.904	1.384	45°	1-8	NO	4	\$18.60
PSC-536x45	.667	.904	1.384	45°	1-8	YES	2	\$18.60
PS-536x45	.667	.904	1.384	45°	1-8	NO	2	\$16.40
PS-536x60	.667	.904	1.384	60°	1-8	NO	2	\$16.40
PS-536x90	.667	.904	1.384	90°	1-8	NO	2	\$16.40
PSC-274	.820	1.140	.700	45°	1-8	YES	1	\$19.70
PS-274	.820	1.140	.700	45°	1-8	NO	1	\$17.50
PSC-271x15	.826	1.102	1.350	15°	1-8	YES	1	\$18.60

Quick Reference Guide - Following page Machine Cross Reference

Each CAT taper machine requires its own style retention knob, on the following page is a general quick reference of the most common manufacturers. Be sure to check which knob your machine requires to ensure proper fit.

CAT40

PSC-475 Fits Cincinnati Milacron, Maho, Mazak, Matsura

PS-475 Fits Acroloc-Bayer, Maho, Mazak

PSC-532x45 Fits Amura-Seiki, Comet, Daewoo, Dah Lih, Haas, Howa Kogyo, Ikegai, Kearny-Trecker, Kia, Kitamura, Miyano, Okuma Howa, YCI

PS-532x45 Fits Amura-Seiki, Comet, Daewoo, Dah Lih, Haas, Howa Kogyo, Ikegai, Kearny-Trecker, Kia, Kitamura, Miyano, Okuma Howa, YCI

PS-532x60 Fits Hitachi-Seiki, Kia, Mitsubishi, Okuma, Matsura, Howa Kogyo, Milltronic

PS-532x90 Fits Kia, Mori Seiki

PS-498 Fits Mazak

PS-552 Fits Cincinnati Milacron

PSC-552 Fits Cincinnati Milacron

CAT50

PS-536x45 Fits Dah Lih, Haas, Ikegai, Kitamura, LeBlond Makino, YCI

PSC-536x45 Fits Haas, LeBlond Makino

PS-536x60 Fits Mitsubishi, Okuma, Matsura

PS-536x90 Fits Hitachi-Seiki, Mori Seiki, Mazak

PS-274 Fits Mazak

PSC-274 Fits Burgmaster, Devlieg, Excello, Maho, Matsura, Mazak



PLEASE NOTE: Retention knobs are available in many different types and sizes. Ultra-Dex USA has provided a list with common machines that fit each of our knobs. Due to the vast amount of machines, please check each machine to verify that you are ordering the proper knob. Retention knob dimensions for each machine can be typically found in the user manual or next to the power supply.

CAT 40 Machine Cross Reference

MANUFACTURER	DESIGNATION									
	PSC-475	PS-475	PS-532x15	PSC-532x45	PS-532x45	PS-532x60	PS-532x90	PS-498	PSC-552	PS-552
ACROLOC-BAYER	X	X								
ATRUMP				X	X					
BRIDGEPORT	X	X								
CARMAN	X	X								
CHEVALIER				X	X					
CHIRON	X	X								
CINCINNATI	X	X							X	X
COMET				X	X					
DAEWOO				X	X					
DAH LIH				X	X					
DOOSAN			X							
ENSHU				X	X	X				
EXCEL				X	X					
FADAL	X	X								
HAAS				X	X					
HAMAI				X	X					
HITACHI-SEIKI				X	X	X				
HOWA KOGYO				X	X					
HURCO	X	X		X						
IKEGAI				X	X					
JOHNFORD				X	X					
KASHAHARA				X	X					
KEARNY-TRECKER				X	X					
KIA				X	X		X			
KITAMURA				X	X					
KIWA				X	X					
LEBLOND MAKINO			X	X	X					
MAHO	X	X								
MASCO	X	X								
MATSUURA			X			X				
MAZAK	X	X								
MILLPORT				X	X					
MILLTRONICS	X					X				
MITSUBISHI						X				
MIYANO				X	X					
MORI SEIKI							X			
NOMURA						X				
OKUMA						X				
OKUMA HOWA				X	X					
Ooya				X	X					
OSAKA KIKO				X	X		X			
PRATT & WHITNEY	X			X	X					
ROKU-ROKU				X	X					
SAEILO				X	X					
SAKAZAKI				X	X	X				
SHARONA				X	X					
SHARP	X	X								
SHIZUOKA				X	X					
SHODA				X	X					
STAMA	X	X								
TAKISAWA				X	X					
TOSHIBA				X	X					
TOYAMA				X	X					
TOYO				X	X					
TOYODA				X	X					
TREE	X	X								
ULTRAMILL				X	X					
URAWA				X	X					
VULCAN				X	X					
YAM (YANG)							X			
YASDA				X	X					
YCI				X	X					

Quick Reference Guide

Each CAT taper machine requires its own style retention knob. Be sure to check which knob your machine requires to ensure proper fit.

See ultradexusa.com for more details





MANUFACTURER	DESIGNATION								
	PSC-535x45	PS-535x45	PSC-536x45	PS-536x45	PS-536x60	PS-536x90	PSC-274	PS-274	PSC-271x15
AMURA-SEIKI	X	X	X	X					
DAH LIH	X	X	X	X					
ENSHU					X				
FADAL							X	X	
HAAS	X	X	X	X					
HAMAI	X	X	X	X					
HITACHI-SEIKI					X	X			
IKEGAI	X	X	X	X					
JOHNFORD	X	X							
KITAMURA	X	X	X	X					
KURAKI	X	X	X	X					
LEBLOND MAKINO	X	X	X	X					
MIGHTY	X	X	X	X					
MILLTRONICS							X	X	
MITSUBISHI	X	X	X	X					
MORI-SEIKI						X			
OKUMA					X				

Quick Reference Guide

Each CAT taper machine requires its own style retention knob. Be sure to check which knob your machine requires to ensure proper fit.

See ultradexusa.com for more details

SAME DAY SHIPPING!

On orders placed before 3:30pm EST

SEE PAGE 210 for more details...



WE DO CUSTOM DESIGN & BUILDS

See **pg 209** for more details

ultra-dex.com



E

TOOL HOLDING



HSK40-63A ER Collet Chucks

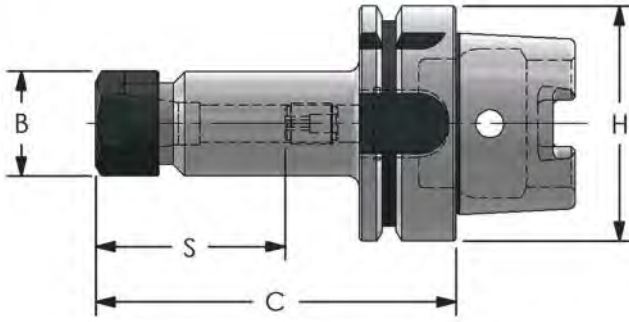

Balanced to:
G2.5 (20,000 rpm)
G6.3 (12,000 rpm)

HSK40A ER Collet Chucks

Designation	B Nut Dia.	C Proj.	S Max Depth	H	Collet Nut	Stop Screw	Wrench	G2 Price*	G6 Price*
HSK40A-ER11-250-G2/G6	.750	2.50	1.50	1.57	ER-11HN	ER-11S	ER-11W	\$228.23	\$206.28
HSK40A-ER16-300-G2/G6	1.100	3.00	1.70	1.57	ER-16HN	ER-16S	ER-16W	\$228.23	\$206.28
HSK40A-ER32-300-G2/G6	1.980	3.00	1.62	1.57	ER-32SN	ER-32S	ER-32W	\$239.20	\$217.26

HSK50A ER Collet Chucks

Designation	B Nut Dia.	C Proj.	S Max Depth	H	Collet Nut	Stop Screw	Wrench	G2 Price*	G6 Price*
HSK50A-ER16-300-G2/G6	1.100	3.00	1.61	1.97	ER-16HN	ER-16S	ER-16W	\$273.22	\$251.28
HSK50A-ER32-300-G2/G6	1.980	3.00	1.50	1.97	ER-32SN	ER-32S	ER-32W	\$284.19	\$262.25

HSK63A ER Collet Chucks

Designation	B Nut Dia.	C Proj.	S Max Depth	H	Collet Nut	Stop Screw	Wrench	G2 Price*	G6 Price*
HSK63A-ER11-600-G2/G6	.750	6.00	1.94	2.48	ER-11HN	ER-11S	ER-11W	\$256.76	\$234.81
HSK63A-ER16-400-G2/G6	1.100	4.00	3.00	2.48	ER-16HN	ER-16S	ER-16W	\$223.84	\$201.89
HSK63A-ER16-600-G2/G6	1.100	6.00	3.00	2.48	ER-16HN	ER-16S	ER-16W	\$245.78	\$223.84
HSK63A-ER32-400-G2/G6	1.980	4.00	4.30	2.48	ER-32SN	ER-32S	ER-32W	\$234.81	\$212.87
HSK63A-ER32-600-G2/G6	1.980	6.00	4.30	2.48	ER-32SN	ER-32S	ER-32W	\$256.76	\$234.81
HSK63A-ER40-400-G2/G6	2.250	4.00	4.00	2.48	ER-40SN	ER-40S	ER-40W	\$251.28	\$229.33
HSK63A-ER40-600-G2/G6	2.250	6.00	4.50	2.48	ER-40SN	ER-40S	ER-40W	\$273.22	\$251.28

* Add -G6 or -G2 to end of designation depending on the balance needed.
 All Hardware Included. Wrenches Sold Separately.



TOOL HOLDING

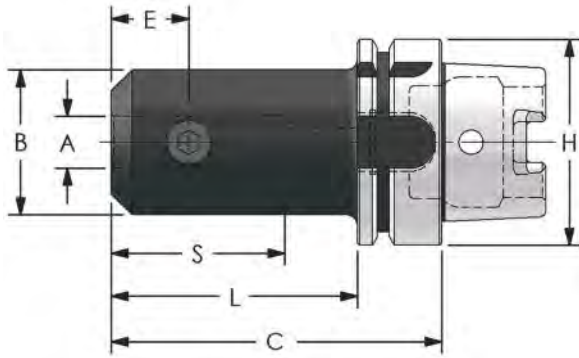

Balanced to:
G2.5 (20,000 rpm)
G6.3 (12,000 rpm)

HSK63A End Mill Holders

Designation	A Inside Dia.	B Outside Dia.	C Proj.	S Max Depth	E	H	L	Set Screw	G2 Price*	G6 Price*
HSK63A-EM250-300-G2/G6	.250	.880	3.00	--	.44	2.48	1.98	SS1/4-250	\$196.41	\$174.47
HSK63A-EM250-600-G2/G6	.250	.880	6.00	--	.44	2.48	4.98	SS1/4-250	\$240.30	\$218.36
HSK63A-EM375-300-G2/G6	.375	1.000	3.00	--	.75	2.48	1.98	SS3/8-375	\$196.41	\$174.47
HSK63A-EM375-600-G2/G6	.375	1.000	6.00	--	.75	2.48	4.98	SS3/8-375	\$240.30	\$218.36
HSK63A-EM500-300-G2/G6	.500	1.375	3.00	--	.88	2.48	1.98	SS7/16-500	\$196.41	\$174.47
HSK63A-EM500-600-G2/G6	.500	1.375	6.00	--	.88	2.48	4.98	SS7/16-500	\$240.30	\$218.36
HSK63A-EM625-300-G2/G6	.625	1.750	3.00	2.10	.94	2.48	1.98	SS9/16-500	\$196.41	\$174.47
HSK63A-EM625-600-G2/G6	.625	1.750	6.00	2.10	.94	2.48	4.98	SS9/16-500	\$240.30	\$218.36
HSK63A-EM750-300-G2/G6	.750	1.750	3.00	2.05	1.00	2.48	1.98	SS5/8-500	\$196.41	\$174.47
HSK63A-EM750-600-G2/G6	.750	1.750	6.00	2.30	1.00	2.48	4.98	SS5/8-500	\$240.30	\$218.36
HSK63A-EM100-425-G2/G6	1.000	2.250	4.25	2.83	1.12	2.48	3.23	SS3/4-500	\$207.39	\$185.44
HSK63A-EM100-600-G2/G6	1.000	2.250	6.00	2.83	1.12	2.48	4.98	SS3/4-500	\$251.28	\$229.33
HSK63A-EM125-425-G2/G6	1.250	2.250	4.25	3.00	1.12	2.48	3.23	(2) SS3/4-500	\$207.39	\$185.44
HSK63A-EM125-600-G2/G6	1.250	2.250	6.00	3.00	1.12	2.48	4.98	(2) SS3/4-500	\$251.28	\$229.33

* Add -G6 or -G2 to end of designation depending on the balance needed.
All Hardware Included

- **DIN 69893 Specification**
- Harnesses Centrifugal Forces to Increase Joint Strength
- Highest Static and Dynamic Rigidity
- Lowest Load for the Spindle Bearing
- Lowest Tool Runout
- Hardened and Tempered to Prevent Cracking
- Through Spindle Coolant Capability



pg: 204



pg: 184



HSK63A Shrink-Fit Holders (English)

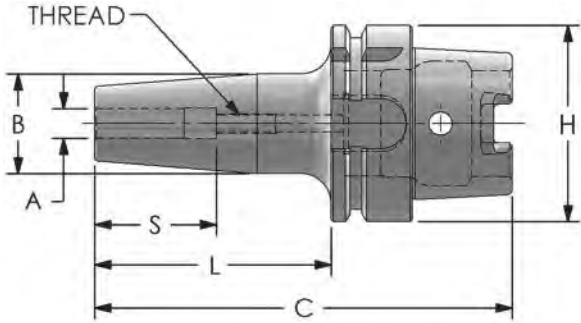

Shrink-Fit
Machines Available
Call for Pricing

HSK63A Shrink-Fit Holders (Std. Length)

Balanced to:
G2.5 (20,000 rpm)

Designation	A Inside Dia.	B Outside Dia.	C Proj.	S	L	H	Thread	Price
HSK63A-SF012-400-G2	.125	1.063	4.00	.79	2.98	2.48	--	\$240.30
HSK63A-SF188-400-G2	.188	1.063	4.00	.79	2.98	2.48	--	\$218.36
HSK63A-SF250-400-G2	.250	1.063	4.00	1.42	2.98	2.48	--	\$218.36
HSK63A-SF375-400-G2	.375	1.260	4.00	1.53	2.98	2.48	1/4-28	\$218.36
HSK63A-SF500-400-G2	.500	1.339	4.00	1.85	2.98	2.48	7/16-20	\$218.36
HSK63A-SF625-400-G2	.625	1.339	4.00	1.97	2.98	2.48	9/16-18	\$218.36
HSK63A-SF750-400-G2	.750	1.654	4.00	2.04	2.98	2.48	5/8-18	\$218.36
HSK63A-SF100-500-G2	1.000	2.087	5.00	2.28	3.98	2.48	3/4-16	\$229.33
HSK63A-SF125-500-G2	1.250	2.087	5.00	2.28	3.98	2.48	3/4-16	\$229.33

HSK63A Shrink-Fit Holders (Ext. Length)

Designation	A Inside Dia.	B Outside Dia.	C Proj.	S	L	H	Thread	Price
HSK63A-SF375-600-G2	.375	1.260	6.00	1.53	4.98	2.48	1/4-28	\$251.28
HSK63A-SF500-600-G2	.500	1.339	6.00	1.85	4.98	2.48	7/16-20	\$251.28
HSK63A-SF750-600-G2	.750	1.654	6.00	2.04	4.98	2.48	5/8-18	\$251.28
HSK63A-SF100-700-G2	1.000	2.087	7.00	2.28	5.98	2.48	3/4-16	\$262.25

- BEST Possible T.I.R.
- BEST Available Gripping Power
- BEST Possible Balance
- Fastest Tool Change - In Seconds!
- Ability to Preset for Required Tool Length
- Increased Tool and Spindle Life

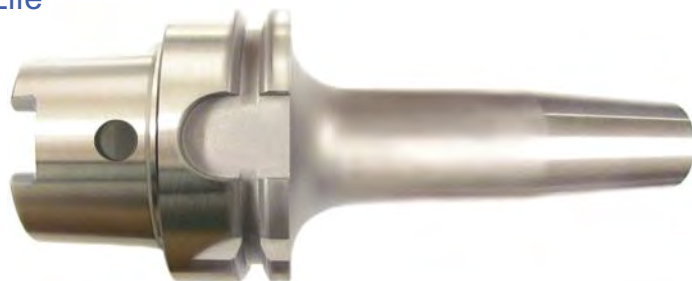

M

TOOL HOLDING

HSK63A Shrink-Fit Holders (Metric)

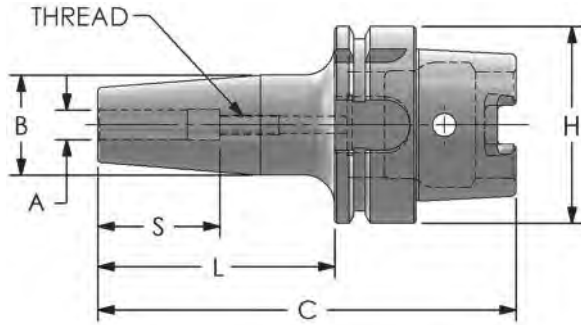

Shrink-Fit
Machines Available
Call for Pricing



METRIC

HSK63A Shrink-Fit Holders (Std. Length)

Balanced to:
G2.5 (20,000 rpm)

Designation	A Inside Dia.	B Outside Dia.	C Proj.	S	L	H	Thread	Price
HSK63A-SF06-400-G2	6mm	1.063	4.00	2.167	2.98	2.478	10-32	\$218.36
HSK63A-SF08-400-G2	8mm	1.063	4.00	1.970	2.98	2.478	1/4-28	\$218.36
HSK63A-SF10-400-G2	10mm	1.260	4.00	2.207	2.98	2.478	1/4-28	\$218.36
HSK63A-SF12-400-G2	12mm	1.260	4.00	2.404	2.98	2.478	7/16-20	\$218.36
HSK63A-SF16-400-G2	16mm	1.339	4.00	2.522	2.98	2.478	9/16-18	\$218.36
HSK63A-SF20-400-G2	20mm	1.654	4.00	2.600	2.98	2.478	5/8-18	\$218.36
HSK63A-SF25-500-G2	25mm	2.087	5.00	2.912	3.98	2.478	3/4-16	\$229.33

HSK63A Shrink-Fit Holders (Ext. Length)

Designation	A Inside Dia.	B Outside Dia.	C Proj.	S	L	H	Thread	Price
HSK63A-SF06-600-G2	6mm	1.063	6.00	2.167	4.98	2.478	10-32	\$251.28
HSK63A-SF08-600-G2	8mm	1.063	6.00	1.970	4.98	2.478	1/4-28	\$251.28
HSK63A-SF10-600-G2	10mm	1.260	6.00	2.207	4.98	2.478	1/4-28	\$251.28
HSK63A-SF12-600-G2	12mm	1.260	6.00	2.404	4.98	2.478	7/16-20	\$251.28
HSK63A-SF16-600-G2	16mm	1.260	6.00	2.522	4.98	2.478	9/16-18	\$251.28
HSK63A-SF20-600-G2	20mm	1.654	6.00	2.600	4.98	2.478	5/8-18	\$251.28
HSK63A-SF25-700-G2	25mm	2.087	7.00	2.912	5.98	2.478	3/4-16	\$251.28

In-House BALANCING SERVICE
available for all types of shanks!

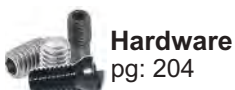

Hardware
pg: 204

ULTRA-DEX

Proudly Made in Flushing, MI USA 171

U

TOOL HOLDING

HSK63A Shell Mill Holders / BLANKS

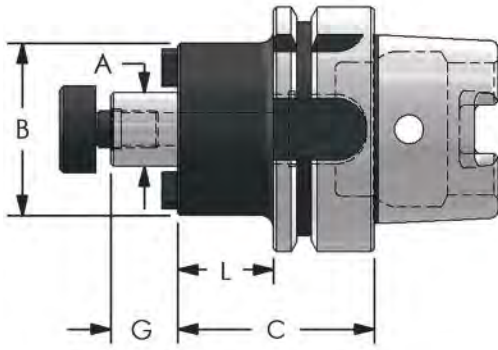

HSK63A Shell Mill Holders

Balanced to:
G6.3 (12,000 rpm)

Designation	A Pilot Dia.	B Dia.	C Proj.	G	H	L	Drive Key	Lock Screw	Thread	Price
HSK63A-SM075-200	.750	1.750	2.00	.68	2.48	.98	UDK 312	U5002	3/8-24	\$251.28
HSK63A-SM100-250	1.000	2.190	2.50	.68	2.48	1.48	UDK 375	U5003	1/2-20	\$256.76
HSK63A-SM125-250	1.250	2.750	2.50	.68	2.48	1.48	UDK 500	U5004	5/8-18	\$267.73
HSK63A-SM150-250	1.500	3.380	2.50	.94	2.48	1.48	UDK 625	U5005	3/4-16	\$284.19

All Hardware Included

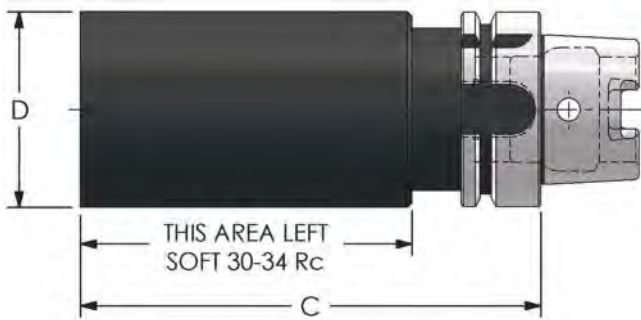

HSK Style Blanks

Designation	Taper	D		C		Price
		mm	Inch	mm	Inch	
HSK40A-BB50-120	HSK40A	50	1.970	120	4.72	\$174.47
HSK50A-BB50-150	HSK50A	50	1.970	150	5.91	\$185.44
HSK50A-BB75-200	HSK50A	75	2.950	200	7.87	\$229.33
HSK50A-BB100-125	HSK50A	100	3.940	125	4.92	\$229.33
HSK63A-BB64-150	HSK63A	64	2.520	150	5.91	\$229.33
HSK63A-BB64-250	HSK63A	64	2.520	250	9.84	\$251.28
HSK63A-BB89-89	HSK63A	89	3.500	89	3.50	\$251.28
HSK63A-BB125-150	HSK63A	125	4.920	150	5.91	\$325.89



TOOL HOLDING

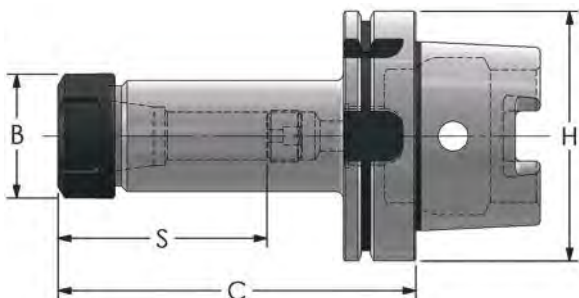

Balanced to:
G2.5 (15,000 rpm)
G6.3 (12,000 rpm)

HSK80A ER Collet Chucks

Designation	B Nut Dia.	C Proj.	S Max Depth	H	Collet Nut	Stop Screw	Wrench	G2 Price*	G6 Price*
HSK80A-ER16-400-G2/G6	1.100	4.00	2.40	3.15	ER-16N	ER-16S	ER-16W	\$328.08	\$306.14
HSK80A-ER32-400-G2/G6	1.980	4.00	2.05	3.15	ER-32N	ER-32S	ER-32W	\$339.06	\$317.11

HSK100A ER Collet Chucks

Designation	B Nut Dia.	C Proj.	S Max Depth	H	Collet Nut	Stop Screw	Wrench	G2 Price*	G6 Price*
HSK100A-ER16-400-G2/G6	1.100	4.00	3.00	3.93	ER-16HN	ER-16S	ER-16W	\$284.19	\$262.25
HSK100A-ER16-600-G2/G6	1.100	6.00	3.00	3.93	ER-16HN	ER-16S	ER-16W	\$306.14	\$284.19
HSK100A-ER32-400-G2/G6	1.980	4.00	4.30	3.93	ER-32SN	ER-32S	ER-32W	\$300.65	\$278.70
HSK100A-ER32-600-G2/G6	1.980	6.00	4.30	3.93	ER-32SN	ER-32S	ER-32W	\$322.59	\$300.65
HSK100A-ER40-400-G2/G6	2.250	4.00	4.00	3.93	ER-40SN	ER-40S	ER-40W	\$306.14	\$284.19
HSK100A-ER40-600-G2/G6	2.250	6.00	4.50	3.93	ER-40SN	ER-40S	ER-40W	\$328.08	\$306.14

HSK125A ER Collet Chucks

Designation	B Nut Dia.	C Proj.	S Max Depth	H	Collet Nut	Stop Screw	Wrench	G2 Price*	G6 Price*
HSK125A-ER16-500-G6	1.100	5.00	3.10	4.92	ER-16HN	ER-16S	ER-16W	--	\$532.17
HSK125A-ER40-500-G6	2.250	5.00	2.80	4.92	ER-40SN	ER-40S	ER-40W	--	\$543.14

* Add -G6 or -G2 to end of designation depending on the balance needed.

All Hardware Included. Wrenches Sold Separately.



- **DIN 69893 Specification**
- Harnesses Centrifugal Forces to Increase Joint Strength
- Highest Static and Dynamic Rigidity
- Lowest Load for the Spindle Bearing
- Lowest Tool Runout
- Hardened and Tempered to Prevent Cracking
- Through Spindle Coolant Capability



Hardware
pg: 204



Collets
pg: 184



HSK100A End Mill Holders

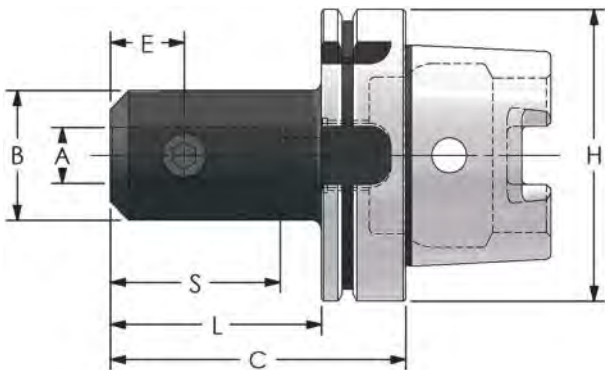

Balanced to:
G2.5 (15,000 rpm)
G6.3 (12,000 rpm)

HSK100A End Mill Holders

Designation	A Inside Dia.	B Outside Dia.	C Proj.	S Max Depth	E	H	L	Set Screw	G2 Price*	G6 Price*
HSK100A-EM250-400-G2/G6	.250	.880	4.00	--	.44	3.94	2.86	SS1/4-250	\$240.30	\$218.36
HSK100A-EM250-600-G2/G6	.250	.880	6.00	--	.44	3.94	4.86	SS1/4-250	\$284.19	\$262.25
HSK100A-EM375-400-G2/G6	.375	1.000	4.00	--	.75	3.94	2.86	SS3/8-375	\$240.30	\$218.36
HSK100A-EM375-600-G2/G6	.375	1.000	6.00	--	.75	3.94	4.86	SS3/8-375	\$284.19	\$262.25
HSK100A-EM500-400-G2/G6	.500	1.375	4.00	--	.88	3.94	2.86	SS7/16-500	\$240.30	\$218.36
HSK100A-EM500-600-G2/G6	.500	1.375	6.00	--	.88	3.94	4.86	SS7/16-500	\$284.19	\$262.25
HSK100A-EM625-400-G2/G6	.625	1.750	4.00	2.10	.94	3.94	2.86	SS9/16-500	\$240.30	\$218.36
HSK100A-EM625-600-G2/G6	.625	1.750	6.00	2.10	.94	3.94	4.86	SS9/16-500	\$284.19	\$262.36
HSK100A-EM750-400-G2/G6	.750	1.750	4.00	2.50	1.00	3.94	2.86	SS5/8-500	\$240.30	\$218.36
HSK100A-EM750-600-G2/G6	.750	1.750	6.00	2.50	1.00	3.94	4.86	SS5/8-500	\$284.19	\$262.25
HSK100A-EM100-400-G2/G6	1.000	2.250	4.00	2.83	1.12	3.94	2.86	SS3/4-500	\$240.30	\$218.36
HSK100A-EM100-600-G2/G6	1.000	2.250	6.00	2.83	1.12	3.94	4.86	SS3/4-500	\$284.19	\$262.25
HSK100A-EM125-425-G2/G6	1.250	2.250	4.25	3.00	1.12	3.94	3.11	(2) SS3/4-500	\$262.25	\$240.30
HSK100A-EM125-600-G2/G6	1.250	2.250	6.00	3.00	1.12	3.94	4.86	(2) SS3/4-500	\$328.08	\$306.14
HSK100A-EM150-450-G2/G6	1.500	2.750	4.50	2.75	1.12	3.94	3.36	SS3/4-500	\$284.19	\$262.25
HSK100A-EM200-550-G2/G6	2.000	3.750	5.50	3.50	1.41	3.94	4.36	SS1-750	\$306.14	\$284.19

* Add -G6 or -G2 to end of designation depending on the balance needed.

All Hardware Included

- **DIN 69893 Specification**
- Harnesses Centrifugal Forces to Increase Joint Strength
- Highest Static and Dynamic Rigidity
- Lowest Load for the Spindle Bearing
- Lowest Tool Runout
- Hardened and Tempered to Prevent Cracking
- Through Spindle Coolant Capability



M

TOOL HOLDING

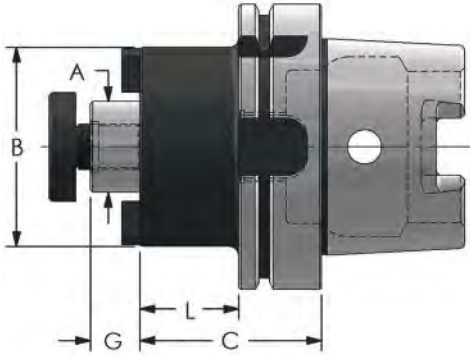

HSK100A Shell Mill Holders

Balanced to:
G6.3 (12,000 rpm)

Designation	A Pilot Dia.	B Dia.	C Proj.	G	H	L	Drive Key	Lock Screw	Thread	Price
HSK100A-SM075-200	.750	1.750	2.00	.68	3.94	.86	UDK 312	U5002	3/8-24	\$295.17
HSK100A-SM100-200	1.000	2.190	2.00	.68	3.94	.86	UDK 375	U5003	1/2-20	\$295.17
HSK100A-SM125-250	1.250	2.750	2.50	.68	3.94	1.36	UDK 500	U5004	5/8-18	\$306.14
HSK100A-SM150-250	1.500	3.380	2.50	.94	3.94	1.36	UDK 625	U5005	3/4-16	\$306.14
HSK100A-SM200-300	2.000	4.440	3.00	.94	3.94	1.86	UDK 750	U5006	1-14	\$339.06

All Hardware Included

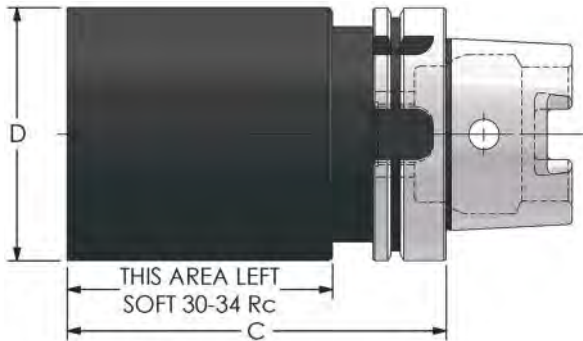

HSK Style Blanks

Designation	Taper	D		C		Price
		mm	Inch	mm	Inch	
HSK80A-BB80-250	HSK80A	80	3.150	250	9.84	\$284.19
HSK80A-BB150-200	HSK80A	150	5.910	200	7.87	\$361.00
HSK100A-BB100-150	HSK100A	100	3.940	150	5.91	\$273.22
HSK100A-BB100-250	HSK100A	100	3.940	250	9.84	\$328.08
HSK100A-BB150-250	HSK100A	150	5.910	250	9.84	\$426.84
HSK125A-BB125-305	HSK125A	125	4.920	305	12.01	\$525.59
HSK125A-BB150-200	HSK125A	150	5.910	200	7.87	\$547.53

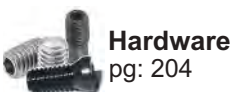

HSK100A Shrink-Fit Holders (English)

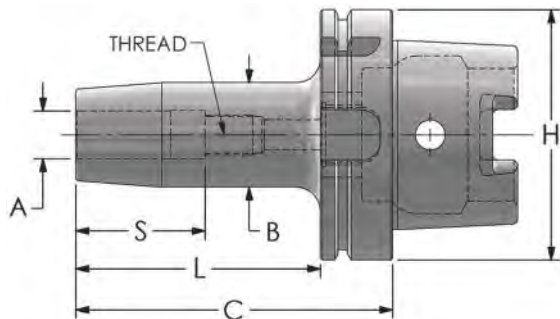

Shrink-Fit
Machines Available
Call for Pricing

HSK100A Shrink-Fit Holders (Std. Length)

Balanced to:
G2.5 (15,000 rpm)

Designation	A Inside Dia.	B Outside Dia.	C Proj.	S	L	H	Thread	Price
HSK100A-SF012-400-G2	.125	1.060	4.00	.79	2.86	3.93	--	\$382.95
HSK100A-SF188-400-G2	.188	1.060	4.00	.79	2.86	3.93	--	\$361.00
HSK100A-SF250-400-G2	.250	1.060	4.00	1.42	2.86	3.93	10-32	\$361.00
HSK100A-SF375-400-G2	.375	1.260	4.00	1.53	2.86	3.93	1/4-28	\$361.00
HSK100A-SF500-400-G2	.500	1.340	4.00	1.85	2.86	3.93	7/16-20	\$361.00
HSK100A-SF625-400-G2	.625	1.340	4.00	1.97	2.86	3.93	9/16-18	\$361.00
HSK100A-SF750-500-G2	.750	1.650	5.00	2.04	3.86	3.93	5/8-18	\$371.97
HSK100A-SF100-500-G2	1.000	2.090	5.00	2.28	3.86	3.93	3/4-16	\$371.97
HSK100A-SF125-500-G2	1.250	2.090	5.00	2.28	3.86	3.93	3/4-16	\$371.97

HSK100A Shrink-Fit Holders (Ext. Length)

Designation	A Inside Dia.	B Outside Dia.	C Proj.	S	L	H	Thread	Price
HSK100A-SF375-600-G2	.375	1.260	6.00	1.53	4.86	3.93	1/4-28	\$382.95
HSK100A-SF500-600-G2	.500	1.340	6.00	1.85	4.86	3.93	7/16-20	\$382.95
HSK100A-SF750-700-G2	.750	1.650	7.00	2.04	5.86	3.93	5/8-18	\$393.92
HSK100A-SF100-700-G2	1.000	2.090	7.00	2.28	5.86	3.93	3/4-16	\$393.92
HSK100A-SF125-700-G2	1.250	2.090	7.00	2.28	5.86	3.93	3/4-16	\$393.92

- BEST Possible T.I.R.
- BEST Available Gripping Power
- BEST Possible Balance
- Fastest Tool Change - In Seconds!
- Ability to Preset for Required Tool Length
- Increased Tool and Spindle Life



M

TOOL HOLDING

HSK100A Shrink-Fit Holders (Metric)

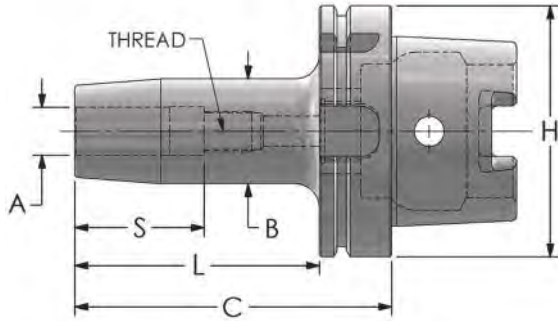

Shrink-Fit
Machines Available
Call for Pricing



METRIC

HSK100A Shrink-Fit Holders (Std. Length)

Balanced to:
G2.5 (15,000 rpm)

Designation	A Inside Dia.	B Outside Dia.	C Proj.	S	L	H	Thread	Price
HSK100A-SF06-400-G2	6mm	1.063	4.00	2.167	2.98	3.934	10-32	\$361.00
HSK100A-SF08-400-G2	8mm	1.063	4.00	1.970	2.98	3.934	1/4-28	\$361.00
HSK100A-SF10-400-G2	10mm	1.260	4.00	2.207	2.98	3.934	1/4-28	\$361.00
HSK100A-SF12-400-G2	12mm	1.260	4.00	2.404	2.98	3.934	7/16-20	\$361.00
HSK100A-SF16-400-G2	16mm	1.339	4.00	2.522	2.98	3.934	9/16-18	\$361.00
HSK100A-SF20-500-G2	20mm	1.654	5.00	2.600	3.98	3.934	5/8-18	\$371.97
HSK100A-SF25-500-G2	25mm	2.087	5.00	2.912	3.98	3.934	3/4-16	\$371.97
HSK100A-SF32-500-G2	32mm	2.087	5.00	2.912	3.98	3.934	3/4-16	\$371.97

HSK100A Shrink-Fit Holders (Ext. Length)

Designation	A Inside Dia.	B Outside Dia.	C Proj.	S	L	H	Thread	Price
HSK100A-SF06-600-G2	6mm	1.063	6.00	2.167	4.98	3.934	10-32	\$382.95
HSK100A-SF08-600-G2	8mm	1.063	6.00	1.970	4.98	3.934	1/4-28	\$382.95
HSK100A-SF10-600-G2	10mm	1.260	6.00	2.207	4.98	3.934	1/4-28	\$382.95
HSK100A-SF12-600-G2	12mm	1.260	6.00	2.404	4.98	3.934	7/16-20	\$382.95
HSK100A-SF16-600-G2	16mm	1.260	6.00	2.522	4.98	3.934	9/16-18	\$382.95
HSK100A-SF20-700-G2	20mm	1.654	7.00	2.600	5.98	3.934	5/8-18	\$393.92
HSK100A-SF25-700-G2	25mm	2.087	7.00	2.912	5.98	3.934	3/4-16	\$393.92
HSK100A-SF32-700-G2	32mm	2.087	7.00	2.912	5.98	3.934	3/4-16	\$393.92



WE DO SPECIALS!
CAT40/50/60, BT, HSK...
ANY type ANY size

CALL FOR PRICING
810-638-5388



HSK Coolant Tubes

Designation	Description	Price
HSK40A-CT	HSK40A Coolant Tube	\$36.54
HSK50A-CT	HSK50A Coolant Tube	\$40.60
HSK63A-CT	HSK63A Coolant Tube	\$21.40
HSK80A-CT	HSK80A Coolant Tube	\$41.70
HSK100A-CT	HSK100A Coolant Tube	\$29.36
HSK125A-CT	HSK125A Coolant Tube	\$44.99



HSK Coolant Tube Sockets

Designation	Description	Price
HSK40A-S	HSK40A Coolant Tube Socket (3/8" Drive)	\$55.97
HSK50A-S	HSK50A Coolant Tube Socket (3/8" Drive)	\$57.60
HSK63A-S	HSK63A Coolant Tube Socket (3/8" Drive)	\$31.83
HSK80A-S	HSK80A Coolant Tube Socket (3/8" Drive)	\$68.58
HSK100A-S	HSK100A Coolant Tube Socket (1/2" Drive)	\$38.41
HSK125A-S	HSK125A Coolant Tube Socket (1/2" Drive)	\$38.41

SAME DAY SHIPPING!

On orders placed before 3:30pm EST
SEE PAGE 210 for more details...

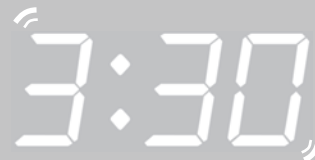

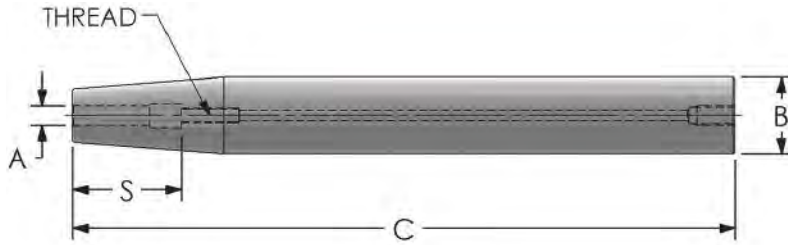

Shrink-Fit Extensions

Designation	A	B	C	S	Thread	Price
SS050-SF012-463	.125	.500	4.63	.79	--	\$136.06
SS075-SF012-463	.125	.750	4.63	.79	--	\$141.55
SS075-SF012-663	.125	.750	6.63	.79	--	\$152.52
SS100-SF012-863	.125	1.000	8.63	.79	--	\$174.47
SS050-SF188-463	.188	.500	4.63	.79	--	\$125.09
SS075-SF188-463	.188	.750	4.63	.79	--	\$130.58
SS075-SF188-663	.188	.750	6.63	.79	--	\$141.55
SS100-SF188-863	.188	1.000	8.63	.79	--	\$163.50
SS075-SF250-463	.250	.750	4.63	1.42	10-32	\$130.58
SS075-SF250-663	.250	.750	6.63	1.42	10-32	\$141.55
SS100-SF250-863	.250	1.000	8.63	1.42	10-32	\$163.50
SS075-SF375-463	.375	.750	4.63	1.53	1/4-28	\$130.58
SS100-SF375-663	.375	1.000	6.63	1.53	1/4-28	\$141.55
SS125-SF375-900	.375	1.250	9.00	1.53	1/4-28	\$196.41
SS100-SF500-463	.500	1.000	4.63	1.85	7/16-20	\$147.03
SS100-SF500-663	.500	1.000	6.63	1.85	7/16-20	\$158.00
SS125-SF500-900	.500	1.250	9.00	1.85	7/16-20	\$196.41
SS100-SF625-463	.625	1.000	4.63	1.97	9/16-18	\$147.03
SS125-SF625-700	.625	1.250	7.00	1.97	1/4-28	\$174.47
SS125-SF750-500	.750	1.250	5.00	2.04	5/8-18	\$152.52
SS125-SF750-700	.750	1.250	7.00	1.42	5/8-18	\$196.41



Shrink-Fit Machines Available
Call for Pricing



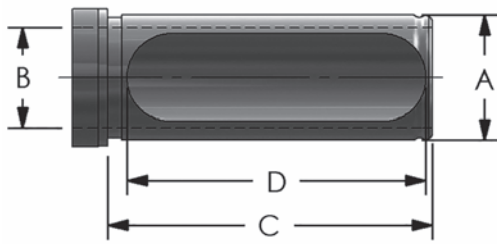

“C” Style Tool Bushings

Designation	A Dia.	B Bore Size	C Length Under Head	D Length of Slot	Price
UT-12C-037	1.250	.375	3.250	2.75	\$75.72
UT-12C-050	1.250	.500	3.250	2.75	\$75.72
UT-12C-062	1.250	.625	3.250	2.75	\$75.72
UT-12C-075	1.250	.750	3.250	2.75	\$75.72
UT-12C-100	1.250	1.000	3.250	2.75	\$75.72
UT-13C-037	1.500	.375	3.375	3.00	\$85.59
UT-13C-050	1.500	.500	3.375	3.00	\$85.59
UT-13C-062	1.500	.625	3.375	3.00	\$85.59
UT-13C-075	1.500	.750	3.375	3.00	\$85.59
UT-13C-100	1.500	1.000	3.375	3.00	\$85.59
UT-13C-125	1.500	1.250	3.375	3.00	\$85.59

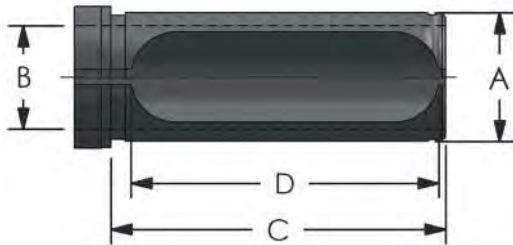

“CX” Style Tool Bushings

Designation	A Dia.	B Bore Size	C Length Under Head	D Length of Slot	Price
UT-12CX-037	1.250	.375	3.250	2.75	\$97.66
UT-12CX-050	1.250	.500	3.250	2.75	\$97.66
UT-12CX-062	1.250	.625	3.250	2.75	\$97.66
UT-12CX-075	1.250	.750	3.250	2.75	\$97.66
UT-12CX-100	1.250	1.000	3.250	2.75	\$97.66
UT-13CX-037	1.500	.375	3.375	3.00	\$119.61
UT-13CX-050	1.500	.500	3.375	3.00	\$119.61
UT-13CX-062	1.500	.625	3.375	3.00	\$119.61
UT-13CX-075	1.500	.750	3.375	3.00	\$119.61
UT-13CX-100	1.500	1.000	3.375	3.00	\$119.61
UT-13CX-125	1.500	1.250	3.375	3.00	\$119.61

New!

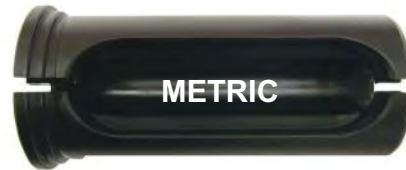
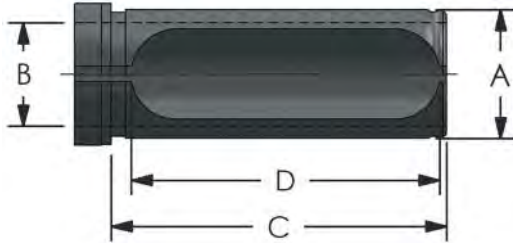

METRIC Tool Bushings

Designation	A Dia.	B Bore Size	C Length Under Head	D Length of Slot	Price
UT-73CX-10MM	1.500	10mm	3.375	3.00	\$133.12
UT-73CX-12MM	1.500	12mm	3.375	3.00	\$133.12
UT-73CX-16MM	1.500	16mm	3.375	3.00	\$133.12
UT-73CX-20MM	1.500	20mm	3.375	3.00	\$133.12
UT-73CX-25MM	1.500	25mm	3.375	3.00	\$133.12
UT-93CX-10MM	40mm	10mm	3.375	3.00	\$152.60
UT-93CX-12MM	40mm	12mm	3.375	3.00	\$152.60
UT-93CX-16MM	40mm	16mm	3.375	3.00	\$152.60
UT-93CX-20MM	40mm	20mm	3.375	3.00	\$152.60
UT-93CX-25MM	40mm	25mm	3.375	3.00	\$152.60

DON'T THROW IT AWAY!
 Send Us Your Damaged Tooling for Repair

See **pg. 208**
 For More
 Details



TOOL HOLDING

Straight Shank Collet Chucks (Steel)

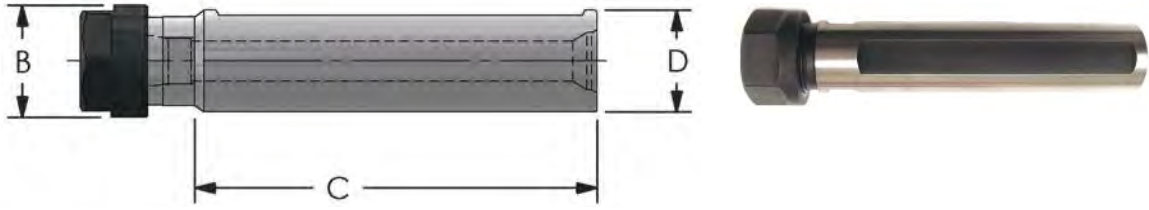

Straight Shank Collet Chucks (English)

Coolant Thru

Designation	Series	Range	B Dia.	C OAL	D Dia.	Collet Nut	Screw	Collet Wrench	Price
SS075-ER16-250	ER16	.020" - .406" (.5mm - 10mm) 1/32" - 13/32"	1.100	2.5	.750	ER-16HN	ER-16S	ER-16W	\$65.78
SS075-ER16-400	ER16		1.100	4	.750	ER-16HN	ER-16S	ER-16W	\$71.26
SS100-ER16-250	ER16		1.100	2.5	1.000	ER-16HN	ER-16S	ER-16W	\$65.78
SS100-ER16-400	ER16		1.100	4	1.000	ER-16HN	ER-16S	ER-16W	\$71.26
SS100-ER16-600	ER16		1.100	6	1.000	ER-16HN	ER-16S	ER-16W	\$76.76
SS075-ER20-250	ER20	.020" - .500" (.5mm - 13mm) 1/32" - 1/2"	1.340	2.5	.750	ER-20HN	ER-20S	ER-20W	\$65.78
SS075-ER20-400	ER20		1.340	4	.750	ER-20HN	ER-20S	ER-20W	\$71.26
SS100-ER20-250	ER20		1.340	2.5	1.000	ER-20HN	ER-20S	ER-20W	\$65.78
SS100-ER20-400	ER20		1.340	4	1.000	ER-20HN	ER-20S	ER-20W	\$71.26
SS100-ER20-600	ER20		1.340	6	1.000	ER-20HN	ER-20S	ER-20W	\$76.76

Straight Shank Collet Chucks (Metric)

Coolant Thru

Designation	Series	Range	B Dia.	C OAL	D Dia.	Collet Nut	Screw	Collet Wrench	Price
SS22MM-ER16-250	ER16	.020" - .406" (.5mm - 10mm) 1/32" - 13/32"	1.100	2.5	22mm	ER-16HN	ER-16S	ER-16W	\$76.76
SS22MM-ER20-250	ER20	.020" - .500" (.5mm - 13mm) 1/32" - 1/2"	1.100	2.5	22mm	ER-20HN	ER-20S	ER-20W	\$76.76

All Hardware Included. Wrenches Sold Separately.

- Adjustable Stop Screw Allows Drills to be Pre-Set
- Balanced for Less Vibration & Longer Tool Life
- T.I.R. .0002
- Hardened & Tempered to Prevent Cracking
- Balanced Nuts (G2.5 at 15,000 RPM)
- Special Lengths Available



M

TOOL HOLDING

Straight Shank Collet Chucks (Carbide)

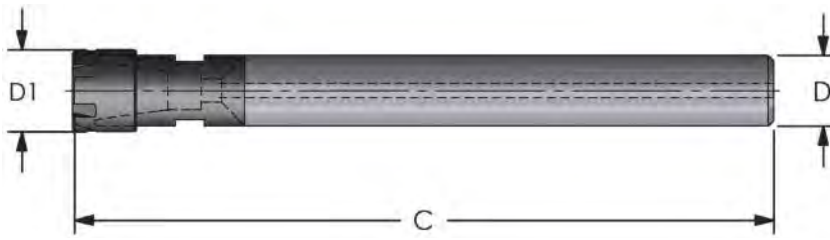

Straight Shank Collet Chucks (w/ Flat)

Coolant Thru

Designation	Series	Range	Collet Nut	C OAL	D Dia.	D1 Dia.	Price
ST1/2 X 8.000 ER11 C W	ER11	.062 -.250	ER11-MN	8	.500	.625	\$269.92
ST5/8 X 7.000 ER11 C W	ER11	(1.5mm - 6.4mm)	ER11-MN	7	.625	.625	\$323.69
ST5/8 X 10.000 ER11 C W	ER11	1/16" - 1/4"	ER11-MN	10	.625	.625	\$379.65
ST5/8 X 7.000 ER16 C W	ER16	.062 -.406 (1.5mm - 10.3mm) 1/16" - 13/32"	ER16-MN	7	.625	.875	\$323.69
ST5/8 X 10.000 ER16 C W	ER16		ER16-MN	10	.625	.875	\$379.65
ST3/4 X 7.000 ER16 C W	ER16		ER16-MN	7	.750	.875	\$401.59
ST3/4 X 10.000 ER16 C W	ER16		ER16-MN	10	.750	.875	\$433.42
ST1 X 8.000 ER16 C W	ER16		ER16-MN	8	1.000	.875	\$580.45
ST1 X 12.000 ER16 C W	ER16		ER16-MN	12	1.000	.875	\$726.38
ST5/8 X 7.000 ER20 C W	ER20	.094 -.500 (2.4mm - 13mm) 3/32" - 1/2"	ER20-MN	7	.625	1.125	\$323.69
ST5/8 X 10.000 ER20 C W	ER20		ER20-MN	10	.625	1.125	\$379.65
ST3/4 X 7.000 ER20 C W	ER20		ER20-MN	7	.750	1.125	\$401.59
ST3/4 X 10.000 ER20 C W	ER20		ER20-MN	10	.750	1.125	\$433.42
ST1 X 8.000 ER20 C W	ER20		ER20-MN	8	1.000	1.125	\$580.45
ST1 X 12.000 ER20 C W	ER20		ER20-MN	12	1.000	1.125	\$726.38

Straight Shank Collet Chucks (w/o Flat)

Coolant Thru

Designation	Series	Range	Collet Nut	C OAL	D Dia.	D1 Dia.	Price
ST1/2 X 5.000 ER11 C	ER11	.062 -.250 (1.5mm - 6.4mm) 1/16" - 1/4"	ER11-MN	5	.500	.625	\$269.92
ST1/2 X 8.000 ER11 C	ER11		ER11-MN	8	.500	.625	\$269.92
ST5/8 X 7.000 ER11 C	ER11		ER11-MN	7	.625	.625	\$323.69
ST5/8 X 10.000 ER11 C	ER11		ER11-MN	10	.625	.625	\$379.65
ST5/8 X 7.000 ER16 C	ER16	.062 -.406 (1.5mm - 10.3mm) 1/16" - 13/32"	ER16-MN	7	.625	.875	\$323.69
ST5/8 X 10.000 ER16 C	ER16		ER16-MN	10	.625	.875	\$379.65
ST3/4 X 7.000 ER16 C	ER16		ER16-MN	7	.750	.875	\$401.59
ST3/4 X 10.000 ER16 C	ER16		ER16-MN	10	.750	.875	\$433.42
ST1 X 8.000 ER16 C	ER16		ER16-MN	8	1.000	.875	\$580.45
ST1 X 12.000 ER16 C	ER16		ER16-MN	12	1.000	.875	\$726.38
ST5/8 X 7.000 ER20 C	ER20	.094 -.500 (2.4mm - 13mm) 3/32" - 1/2"	ER20-MN	7	.625	1.125	\$323.69
ST5/8 X 10.000 ER20 C	ER20		ER20-MN	10	.625	1.125	\$379.65
ST3/4 X 7.000 ER20 C	ER20		ER20-MN	7	.750	1.125	\$401.59
ST3/4 X 10.000 ER20 C	ER20		ER20-MN	10	.750	1.125	\$433.42
ST1 X 8.000 ER20 C	ER20		ER20-MN	8	1.000	1.125	\$580.45
ST1 X 12.000 ER20 C	ER20		ER20-MN	12	1.000	1.125	\$726.38

All Hardware Included. Wrenches Sold Separately.



Hardware
pg: 204



Collets
pg: 184

ULTRA-DEX

Proudly Made in Flushing, MI USA 183

EM

TOOL HOLDING

STANDARD (INCH) ER COLLETS

Standard .0002 T.I.R

	ER11	ER16	ER20	ER25	ER32	ER40
1/16"	ER11C-0625* \$16.40	ER16C-0625 \$14.21	-	-	-	-
3/32"	ER11C-0937* \$16.40	ER16C-0937* \$14.21	ER20C-0937 \$14.21	-	ER32C-0937 \$15.31	-
1/8"	ER11C-1250* \$16.40	ER16C-1250* \$14.21	ER20C-1250* \$14.21	ER25C-1250 \$15.31	ER32C-1250* \$15.31	ER40C-1250* \$17.50
5/32"	ER11C-1562* \$16.40	ER16C-1562* \$14.21	ER20C-1562* \$14.21	ER25C-1562* \$15.31	ER32C-1562 \$15.31	ER40C-1562 \$17.50
3/16"	ER11C-1875* \$16.40	ER16C-1875* \$14.21	ER20C-1875* \$14.21	ER25C-1875* \$15.31	ER32C-1875* \$15.31	ER40C-1875* \$17.50
7/32"	ER11C-2187* \$16.40	ER16C-2187* \$14.21	ER20C-2187* \$14.21	ER25C-2187* \$15.31	ER32C-2187 \$15.31	ER40C-2187 \$17.50
1/4"	ER11C-2500* \$16.40	ER16C-2500* \$14.21	ER20C-2500* \$14.21	ER25C-2500* \$15.31	ER32C-2500* \$15.31	ER40C-2500* \$17.50
9/32"	-	ER16C-2812* \$14.21	ER20C-2812* \$14.21	ER25C-2812 \$15.31	ER32C-2812 \$15.31	ER40C-2812 \$17.50
5/16"	-	ER16C-3125* \$14.21	ER20C-3125* \$14.21	ER25C-3125* \$15.31	ER32C-3125* \$15.31	ER40C-3125* \$17.50
11/32"	-	ER16C-3437* \$14.21	ER20C-3437 \$14.21	ER25C-3437 \$15.31	ER32C-3437 \$14.58	ER40C-3437 \$17.50
3/8"	-	ER16C-3750* \$14.21	ER20C-3750* \$14.21	ER25C-3750* \$15.31	ER32C-3750* \$15.31	ER40C-3750* \$17.50
13/32"	-	ER16C-4062 \$14.21	ER20C-4062 \$14.21	ER25C-4062 \$15.31	ER32C-4062 \$15.31	ER40C-4062 \$17.50
7/16"	-	-	ER20C-4375* \$14.21	ER25C-4375* \$15.31	ER32C-4375* \$15.31	ER40C-4375 \$17.50
15/32"	-	-	ER20C-4687 \$14.21	ER25C-4687 \$15.31	ER32C-4687 \$15.31	ER40C-4687 \$17.50
1/2"	-	-	ER20C-5000* \$14.21	ER25C-5000* \$15.31	ER32C-5000* \$15.31	ER40C-5000* \$17.50
17/32"	-	-	-	ER25-5312 \$15.31	ER32C-5312 \$15.31	ER40C-5312 \$17.50
9/16"	-	-	-	ER25-5625* \$15.31	ER32C-5625* \$15.31	ER40C-5625 \$17.50
19/32"	-	-	-	ER25-5937 \$15.31	ER32C-5937 \$15.31	ER40C-5937 \$17.50
5/8"	-	-	-	ER25-6250* \$15.31	ER32C-6250* \$15.31	ER40C-6250* \$17.50
21/32"	-	-	-	-	ER32C-6562 \$15.31	ER40C-6562 \$17.50
11/16"	-	-	-	-	ER32C-6875 \$15.31	ER40C-6875 \$17.50
23/32"	-	-	-	-	ER32C-7187 \$15.31	ER40C-7187 \$17.50
3/4"	-	-	-	-	ER32C-7500* \$15.31	ER40C-7500* \$17.50
13/16"	-	-	-	-	-	ER40C-8125 \$17.50
7/8"	-	-	-	-	-	ER40C-8750* \$17.50
1"	-	-	-	-	-	ER40C-1000* \$17.50

Designation	Description	Price
ER11CS	7 pcs (items with "*" in ER11 section included)	\$104.13
ER16CS	10 pcs (items with "*" in ER16 section included)	\$131.62
ER20CS	10 pcs (items with "*" in ER20 section included)	\$131.62
ER25CS	10 pcs (items with "*" in ER25 section included)	\$142.59
ER32CS	10 pcs (items with "*" in ER32 section included)	\$142.59
ER40CS	10 pcs (items with "*" in ER40 section included)	\$153.56

These collets are currently manufactured by our partners in the tooling industry and not by Ultra-Dex at this time.

Prices are subject to change without notice.



STANDARD (METRIC) ER COLLETS Standard .0002 T.I.R



	ER11	ER16	ER20	ER25	ER32	ER40
1mm	ER11C-1MM* \$16.40	ER16C-1MM* \$14.21	ER20C-1MM \$15.31	-	-	-
2mm	ER11C-2MM* \$16.40	ER16C-2MM* \$14.21	ER20C-2MM* \$15.31	ER25C-2MM* \$14.21	-	-
3mm	ER11C-3MM* \$16.40	ER16C-3MM* \$14.21	ER20C-3MM* \$15.31	ER25C-3MM* \$15.31	ER32C-3MM* \$15.31	ER40C-3MM* \$17.50
4mm	ER11C-4MM* \$16.40	ER16C-4MM* \$14.21	ER20C-4MM* \$15.31	ER25C-4MM* \$15.31	ER32C-4MM* \$15.31	ER40C-4MM* \$17.50
5mm	ER11C-5MM* \$16.40	ER16C-5MM* \$14.21	ER20C-5MM* \$15.31	ER25C-5MM* \$15.31	ER32C-5MM* \$15.31	ER40C-5MM* \$17.50
6mm	ER11C-6MM* \$16.40	ER16C-6MM* \$14.21	ER20C-6MM* \$15.31	ER25C-6MM* \$15.31	ER32C-6MM* \$15.31	ER40C-6MM* \$17.50
7mm	ER11C-7MM \$16.40	ER16C-7MM \$14.21	ER20C-7MM \$15.31	ER25C-7MM \$15.31	ER32C-7MM \$15.31	ER40C-7MM \$17.50
8mm	-	ER16C-8MM* \$14.21	ER20C-8MM* \$15.31	ER25C-8MM* \$15.31	ER32C-8MM* \$15.31	ER40C-8MM* \$17.50
9mm	-	ER16C-9MM \$14.21	ER20C-9MM \$15.31	ER25C-9MM \$15.31	ER32C-9MM \$15.31	ER40C-9MM \$17.50
10mm	-	ER16C-10MM* \$14.21	ER20C-10MM* \$15.31	ER25C-10MM* \$15.31	ER32C-10MM* \$15.31	ER40C-10MM* \$17.50
11mm	-	-	ER20C-11MM \$15.31	ER25C-11MM \$15.31	ER32C-11MM \$15.31	ER40C-11MM \$17.50
12mm	-	-	ER20C-12MM* \$15.31	ER25C-12MM* \$15.31	ER32C-12MM* \$15.31	ER40C-12MM* \$17.50
13mm	-	-	ER20C-13MM \$15.31	ER25C-13MM \$15.31	ER32C-13MM \$15.31	ER40C-13MM \$17.50
14mm	-	-	ER20C-14MM* \$15.31	ER25C-14MM* \$15.31	ER32C-14MM* \$15.31	ER40C-14MM* \$17.50
15mm	-	-	-	ER25C-15MM \$15.31	ER32C-15MM \$15.31	ER40C-15MM \$17.50
16mm	-	-	-	ER25-16MM* \$15.31	ER32C-16MM* \$15.31	ER40C-16MM* \$17.50
17mm	-	-	-	ER25-17MM \$15.31	ER32C-17MM \$15.31	ER40C-17MM \$17.50
18mm	-	-	-	-	ER32C-18MM* \$15.31	ER40C-18MM* \$17.50
19mm	-	-	-	-	ER32C-19MM \$15.31	ER40C-19MM \$17.50
20mm	-	-	-	-	ER32C-20MM* \$15.31	ER40C-20MM* \$17.50
21mm	-	-	-	-	ER32C-21MM \$15.31	ER40C-21MM \$17.50
22mm	-	-	-	-	-	ER40C-22MM* \$17.50
23mm	-	-	-	-	-	ER40C-23MM \$17.50
24mm	-	-	-	-	-	ER40C-24MM* \$17.50
25mm	-	-	-	-	-	ER40C-25MM \$17.50
26mm	-	-	-	-	-	ER40C-26MM* \$17.50

Designation	Description	Price
ER11MCS	6 pcs (items with "*" in ER11 section included)	\$88.57
ER16MCS	8 pcs (items with "*" in ER16 section included)	\$102.29
ER20MCS	9 pcs (items with "*" in ER20 section included)	\$115.07
ER25MCS	10 pcs (items with "*" in ER25 section included)	\$127.86
ER32MCS	11 pcs (items with "*" in ER32 section included)	\$151.56
ER40MCS	14 pcs (items with "*" in ER40 section included)	\$220.54

These collets are currently manufactured by our partners in the tooling industry and not by Ultra-Dex at this time.

Steel Sealed STANDARD (INCH) ER COLLETS



	ER16	ER20	ER25	ER32	ER40
1/8"	ER16C-SS-1250 \$21.07	ER20C-SS-1250 \$21.07	ER25C-SS-1250 \$21.91	ER32C-SS-1250 \$22.90	ER40C-SS-1250 \$28.69
5/32"	ER16C-SS-1562 \$21.07	ER20C-SS-1562 \$21.07	ER25C-SS-1562 \$21.91	ER32C-SS-1562 \$22.90	ER40C-SS-1562 \$28.69
3/16"	ER16C-SS-1875 \$21.07	ER20C-SS-1875 \$21.07	ER25C-SS-1875 \$21.91	ER32C-SS-1875 \$22.90	ER40C-SS-1875 \$28.69
7/32"	ER16C-SS-2187 \$21.07	ER20C-SS-2187 \$21.07	ER25C-SS-2187 \$21.91	ER32C-SS-2187 \$22.90	ER40C-SS-2187 \$28.69
1/4"	ER16C-SS-2500 \$21.07	ER20C-SS-2500 \$21.07	ER25C-SS-2500 \$21.91	ER32C-SS-2500 \$22.90	ER40C-SS-2500 \$28.69
9/32"	ER16C-SS-2812 \$21.07	ER20C-SS-2812 \$21.07	ER25C-SS-2812 \$21.91	ER32C-SS-2812 \$22.90	ER40C-SS-2812 \$28.69
5/16"	ER16C-SS-3125 \$21.07	ER20C-SS-3125 \$21.07	ER25C-SS-3125 \$21.91	ER32C-SS-3125 \$22.90	ER40C-SS-3125 \$28.69
11/32"	ER16C-SS-3437 \$21.07	ER20C-SS-3437 \$21.07	ER25C-SS-3437 \$21.91	ER32C-SS-3437 \$22.90	ER40C-SS-3437 \$28.69
3/8"	ER16C-SS-3750 \$21.07	ER20C-SS-3750 \$21.07	ER25C-SS-3750 \$21.91	ER32C-SS-3750 \$22.90	ER40C-SS-3750 \$28.69
13/32"	ER16C-SS-4062 \$21.07	ER20C-SS-4062 \$21.07	ER25C-SS-4062 \$21.91	ER32C-SS-4062 \$22.90	ER40C-SS-4062 \$28.69
7/16"	-	ER20C-SS-4375 \$21.07	ER25C-SS-4375 \$21.91	ER32C-SS-4375 \$22.90	ER40C-SS-4375 \$28.69
15/32"	-	ER20C-SS-4687 \$21.07	ER25C-SS-4687 \$21.91	ER32C-SS-4687 \$22.90	ER40C-SS-4687 \$28.69
1/2"	-	ER20C-SS-5000 \$21.07	ER25C-SS-5000 \$21.91	ER32C-SS-5000 \$22.90	ER40C-SS-5000 \$28.69
17/32"	-	-	ER25C-SS-5312 \$21.91	ER32C-SS-5312 \$22.90	ER40C-SS-5312 \$28.69
9/16"	-	-	ER25C-SS-5625 \$21.91	ER32C-SS-5625 \$22.90	ER40C-SS-5625 \$28.69
19/32"	-	-	ER25C-SS-5937 \$21.91	ER32C-SS-5937 \$22.90	ER40C-SS-5937 \$28.69
5/8"	-	-	ER25C-SS-6250 \$21.91	ER32C-SS-6250 \$22.90	ER40C-SS-6250 \$28.69
21/32"	-	-	-	ER32C-SS-6562 \$22.90	ER40C-SS-6562 \$28.69
11/16"	-	-	-	ER32C-SS-6875 \$22.90	ER40C-SS-6875 \$28.69
23/32"	-	-	-	ER32C-SS-7187 \$22.90	ER40C-SS-7187 \$28.69
3/4"	-	-	-	ER32C-SS-7500 \$22.90	ER40C-SS-7500 \$28.69
13/16"	-	-	-	-	ER40C-SS-8125 \$28.69
7/8"	-	-	-	-	ER40C-SS-8750 \$28.69
1"	-	-	-	-	ER40C-SS-1000 \$28.69

These collets are currently manufactured by our partners in the tooling industry and not by Ultra-Dex at this time.



TOOL HOLDING

Steel Sealed STANDARD (METRIC) ER COLLETS

New!

	ER16	ER20	ER25	ER32	ER40
4mm	ER16C-SS-4MM \$21.07	ER20C-SS-4MM \$21.07	ER25C-SS-4MM \$21.91	ER32C-SS-4MM \$22.90	-
5mm	ER16C-SS-5MM \$21.07	ER20C-SS-5MM \$21.07	ER25C-SS-5MM \$21.91	ER32C-SS-5MM \$22.90	-
6mm	ER16C-SS-6MM \$21.07	ER20C-SS-6MM \$21.07	ER25C-SS-6MM \$21.91	ER32C-SS-6MM \$22.90	ER40C-SS-6MM \$28.69
7mm	ER16C-SS-7MM \$21.07	ER20C-SS-7MM \$21.07	ER25C-SS-7MM \$21.91	ER32C-SS-7MM \$22.90	ER40C-SS-7MM \$28.69
8mm	ER16C-SS-8MM \$21.07	ER20C-SS-8MM \$21.07	ER25C-SS-8MM \$21.91	ER32C-SS-8MM \$22.90	ER40C-SS-8MM \$28.69
9mm	ER16C-SS-9MM \$21.07	ER20C-SS-9MM \$21.07	ER25C-SS-9MM \$21.91	ER32C-SS-9MM \$22.90	ER40C-SS-9MM \$28.69
10mm	ER16C-SS-10MM \$21.07	ER20C-SS-10MM \$21.07	ER25C-SS-10MM \$21.91	ER32C-SS-10MM \$22.90	ER40C-SS-10MM \$28.69
11mm	-	ER20C-SS-11MM \$21.07	ER25C-SS-11MM \$21.91	ER32C-SS-11MM \$22.90	ER40C-SS-11MM \$28.69
12mm	-	ER20C-SS-12MM \$21.07	ER25C-SS-12MM \$21.91	ER32C-SS-12MM \$22.90	ER40C-SS-12MM \$28.69
13mm	-	ER20C-SS-13MM \$21.07	ER25C-SS-13MM \$21.91	ER32C-SS-13MM \$22.90	ER40C-SS-13MM \$28.69
14mm	-	-	ER25C-SS-14MM \$21.91	ER32C-SS-14MM \$22.90	ER40C-SS-14MM \$28.69
15mm	-	-	ER25C-SS-15MM \$21.91	ER32C-SS-15MM \$22.90	ER40C-SS-15MM \$28.69
16mm	-	-	ER25C-SS-16MM \$21.91	ER32C-SS-16MM \$22.90	ER40C-SS-16MM \$28.69
17mm	-	-	-	ER32C-SS-17MM \$22.90	ER40C-SS-17MM \$28.69
18mm	-	-	-	ER32C-SS-18MM \$22.90	ER40C-SS-18MM \$28.69
19mm	-	-	-	ER32C-SS-19MM \$22.90	ER40C-SS-19MM \$28.69
20mm	-	-	-	ER32C-SS-20MM \$22.90	ER40C-SS-20MM \$28.69
21mm	-	-	-	ER32C-SS-21MM \$22.90	ER40C-SS-21MM \$28.69
22mm	-	-	-	-	ER40C-SS-22MM \$28.69
23mm	-	-	-	-	ER40C-SS-23MM \$28.69
24mm	-	-	-	-	ER40C-SS-24MM \$28.69
25mm	-	-	-	-	ER40C-SS-25MM \$28.69
26mm	-	-	-	-	ER40C-SS-26MM \$28.69

These collets are currently manufactured by our partners in the tooling industry and not by Ultra-Dex at this time.

TOOL HOLDING

Insert NOMENCLATURE / Speed & Feeds

Inscribe Circle Size

INCH	Diameter of Inscribed Circle (Inch)	METRIC						
		R	W	V	D	E	S	T
1.2 (5)	.156		02		04	03	03	06
1.28	.160							07
1.5 (6)	.187		L3	08	05	04	04	08
1.8 (7)	.219		03	09	06	05	05	09
2	.250		04	11	07	06	06	11
2.5	.313		05	13	09	08	07	13
3	.375	09	06	16	11	09	09	16
4	.500	12	08	22	15	12	12	22
5	.625		10		19	16	15	27
6	.750	19	13		23	19	19	33
8.00mm	08	08						
10.00mm	10	10						
12.00mm	12	12						
16.00mm	16	16						

Shape	Tolerance
A Rectangle	Insert I.C. Thickness
C 80° Diamond	F = ± .002 to ± .004 ± .002
D 55° Diamond	G = ± .001 ± .005
S Square	H = ± .005 ± .001
T Triangle	K = ± .005 ± .001
V 35° Diamond	M = ± .002 to ± .007* ± .005
W 80° Trigon	
R Round	

*Exact tolerance is determined by the size of the insert

INCH (ANSI)

T N M G

METRIC (ISO)

T N M G

4 3 2

11 T3 08

Thickness

INCH	Thickness	METRIC
0.6	.040	T0
0.75	.046	--
1	1/16	01
1.2	5/64	T1
1.5	3/32	02
2	1/8	03
2.5	5/32	T3
3	3/16	04
4	1/4	06

Clearance Angle	Type
B 5° Positive	A With hole, without chipbreaker
C 7° Positive	B Countersink on one side, with hole
D 15° Positive	G Chipbreaker on both sides, with hole
N 0° Negative	T Chipbreaker & ISO countersink one side, with hole
P 11° Positive	W ISO Countersink on one side, with hole
	X Special Design

Insert Speed & Feed Information

Material	Turning		Milling*		Drilling	
	SFM	Inch/ Rev	SFM	Inch/ Rev	SFM	Inch/ Rev
P Mild Steel Annealed Alloy Steel Hardened Alloy Steel Cast Steel	490-1200	.004-.031	250-800	.003-.015	225-650	.0022-.006
	490-980					
	180-500					
	180-650					
M Stainless Steel	280-810	.004-.015	200-600	.003-.015	250-430	.002-.006
K Low Cast Iron High Cast Iron	590-1240	.004-.024	325-600	.004-.016	300-600	.0025-.009
	360-700					
N Alum. Alloy Un-heat Treated Alum. Alloy Heat Treated Cast Alum. & Copper Alloy	850-1980	.004-.018	860-1800	.007-.018	600-1100	.0038-.011
	550-1650					
	360-950					
S Heat Resistant Steels	100-300	.002-.006	100-300	.0024-.008	60-150	.0028-.008
K Cast Iron (CBN INSERTS)	400-600	.002-.020				
H Hardened Material (CBN INSERTS)	450-950	.002-.011				

*For APKT inserts refer to the chart on pg 201 for cutting conditions.

MATERIAL	FINISHING	MEDIUM	ROUGHING
P	CX2, LX6, SP1, SP2, SX1, ZX3	CX1, LX3, ZP1	CP2, LX2
M	CM1, CM3, CX2, LX6, ZM1	CM1, CM2, LX3	LX2
K	ZX3	ZK1, ZK2	
S		CS1	
N	SX1, ZN1	CN1, LX2, LX3	

T

INSERTS

New! HIGH PERFORMANCE GRADES AVAILABLE *

○ Good
◐ Better
● Best



Grade	Description	Material					
		Steel	Stainless Steel	Cast Iron	Ferrite Materials	Heat-Resistant Steel	Hardened Metal
		P	M	K	N	S	H
UD51	General purpose Tin (CVD) coated steel grade - used for roughing and semi-finishing of carbon alloy and stainless steel.	●	○	○		◐	
UD52	Tough general purpose steel grade with multi-layer titanium aluminum nitride coating for alloy steel, aluminum alloys, austenitic stainless and carbon steels, copper alloys and exotic alloys.	●	○			●	
HP230 *	Productive steel turning grade under stable conditions.	●	○	◐			
HP250 *	Universal steel turning grade-The best in efficiency and productivity.	●	○	◐			
UD21	Multi-layer titanium aluminum nitride grade. Excellent for machining cast iron.			●			
HM240 *	Stainless steel turning grade. Finishing to light roughing.	○	●				
HM250 *	Turning grade for wide application in the stainless steel range. Finishing to roughing.	◐	●			○	
HS220 *	Excellent for heat resistance and titanium alloys		○			●	
UD2	Uncoated - Used to cut cast iron, aluminum, non-ferrous alloys, non-metals and most high temp alloys. Provides excellent wear resistance.			○	◐		
HN432 *	Ideal grade for aluminum. Low tendency for adhesion.			◐	●		
UD22	Tin coated insert. Suitable for semi-finishing and finishing of high temp alloys. Intended for cast iron machining.			●		◐	
UD32	TiAlN coated insert. Used in high speed medium load applications of stainless steel and finishing to semi-finishing of high temperature alloys.	◐	●	○	○	●	
HK036 *	Stability in a wide range of applications with long tool life. First choice for turning cast iron.			●			
UD5C	Uncoated cermet grade for semi-finishing and finishing applications at medium to high cutting speeds on carbon and alloyed steels. Also used on stainless. Normally used without coolant.		○	○			
UD5CT	TiAlN coated cermet grade performs extremely well for semi-finish and finish applications in alloyed steels, stainless and high carbon steels.	●	◐	◐			
UD1	Uncoated - Designed with a polished surface and large rake angle. Intended for machining aluminum and other non-ferrous alloys. Also works well for semi machining on cast iron.		◐		●		
HP470 *	Suitable for demanding steel milling applications, interrupted cut.	●	◐				
HM470 *	Stainless steel milling grade. PVD, TiAlN coating.	◐	●				
HS470 *	First choice for milling heat-resistant alloys.		○			●	
HS480 *	Extremely heat-resistant tough grade for milling titanium.					●	
HK430 *	Milling grade for cast iron.			●			
HP600 *	Super tough substrate with PVD coating. Excellent for drilling steel and stainless steel.	●	◐	○	○	○	
HK356 *	Stable cutting performance for drilling cast iron. Suitable for aluminum. Recommended for mild structural steel, difficult chip controlled steel.	◐	●	●	◐	◐	
UD2CBN	A Polycrystalline Cubic Boron Nitride (PCBN) Insert for cast iron, gray cast iron, chilled cast, and powder metal with long tool life. Coolant not recommended for use.			●			◐
UD5CBN	A Polycrystalline Cubic Boron Nitride (PCBN) Insert for precision finishing of hardened steels 50-65 rockwell. Coolant not recommended for use.			◐			●
UD2PCD	Polycrystalline Diamond with Carbide Reinforced Diamond, Sharpness and Low Cutting Pressure allowing tight tolerances. Finishing of all non-ferrous metals and non-metallics.				●		
UD25	Uncoated - Used to cut aluminum, brass, copper, nickel base alloys, titanium and non-ferrous materials.			○	○		
UD204	A PVD TiAlN coated fine grain substrate. Excellent for light to medium feeds on cast iron and semi-finishing to finishing of high temperature alloys. Excellent for high SFM.	◐		●		◐	
UD404	A PVD TiAlN coated tough general purpose grade. Well suited for milling alloy steels, stainless steel, high temperature alloy steels and hardened steels up to 60 Rc.	●	●	◐		●	
UD602	A CVD coating of TiAl ₂ O ₃ & TiN on a tough substrate. It is suitable for light to heavy milling of alloy steel and non alloy steel, even under unfavorable condition.	◐	◐			◐	



Hardware
pg: 204

T
INSERTS

Turning Inserts



ZX3



CDGW Flat Top



CDHB Flat Top

DESIGNATION	GRADE															
	HP230	HP250	HM240	HM250	HS220	HN432	HK036	UD51	UD52	UD21	UD2	UD22	UD32	UD5C	UD5CT	UD1
CDGT 1.510.5-ZX3	-	-	-	-	-	-	-	\$8.61	\$9.05	\$9.05	\$6.91	-	-	\$8.61	\$9.82	-
CDGT 1.511-ZX3	-	-	-	-	-	-	-	\$8.61	\$9.05	\$9.05	\$7.47	-	-	\$8.61	\$9.82	-
CDGW 1.510	-	-	-	-	-	-	-	\$8.12	\$9.05	\$8.51	\$8.12	-	-	\$8.01	\$9.77	-
CDGW 1.510.5	-	-	-	-	-	-	-	\$8.12	\$9.05	\$8.51	\$8.12	-	-	\$8.01	\$9.77	-
CDGW 1.511	-	-	-	-	-	-	-	\$8.12	\$9.05	\$8.51	\$8.12	-	-	\$8.01	\$9.77	-
CDHB 1.20.60	-	-	-	-	-	-	-	\$7.79	\$8.18	\$8.12	\$6.53	-	-	\$7.30	\$8.88	-
CDHB 1.20.60.5	-	-	-	-	-	-	-	\$7.79	\$8.18	\$8.12	\$6.53	-	-	\$7.30	\$8.88	-

Inserts sold in packs of 10



CM1



CN1



CX1



CX2



ZM1



ZN1



ZX3

DESIGNATION	GRADE															
	HP230	HP250	HM240	HM250	HS220	HN432	HK036	UD51	UD52	UD21	UD2	UD22	UD32	UD5C	UD5CT	UD1
CCGT 21.50-CM1	-	-	\$13.31	-	-	-	-	-	-	-	-	-	-	-	-	-
CCGT 32.50.5-CM1	-	-	\$14.61	-	-	-	-	-	-	-	-	-	-	-	-	-
CCGT 32.50-CM1	-	-	\$14.61	-	-	-	-	-	-	-	-	-	-	-	-	-
CCGT 21.50-CN1	-	-	-	-	-	\$9.96	-	-	-	-	-	-	-	-	-	-
CCGT 21.51-CN1	-	-	-	-	-	\$9.96	-	-	-	-	-	-	-	-	-	-
CCGT 32.51-CN1	-	-	-	-	-	\$10.58	-	-	-	-	-	-	-	-	-	-
CCGT 32.52-CN1	-	-	-	-	-	\$10.58	-	-	-	-	-	-	-	-	-	-
CCMT 21.51-CX1	\$6.27	\$6.27	-	\$6.27	-	-	-	-	-	-	-	-	-	-	-	-
CCMT 21.52-CX1	-	\$6.27	-	\$6.27	-	-	-	-	-	-	-	-	-	-	-	-
CCMT 32.51-CX1	\$7.54	\$7.54	-	\$7.54	-	-	-	-	-	-	-	-	-	-	-	-
CCMT 32.52-CX1	\$7.54	\$7.54	-	\$7.54	-	-	-	-	-	-	-	-	-	-	-	-
CCMT 431-CX1	-	\$9.78	-	\$9.78	-	-	-	-	-	-	-	-	-	-	-	-
CCMT 432-CX1	-	\$9.78	-	\$9.78	-	-	-	-	-	-	-	-	-	-	-	-
CCMT 32.50-CX2	-	\$7.54	-	\$7.54	-	-	-	-	-	-	-	-	-	-	-	-
CCMT 21.51-ZM1	-	-	-	-	-	-	-	-	-	-	-	-	\$6.31	-	-	-
CCMT 32.50.5-ZM1	-	-	-	-	-	-	-	-	-	-	-	-	\$6.69	-	-	-
CCMT 32.51-ZM1	-	-	-	-	-	-	-	-	-	-	-	-	\$6.69	-	-	-
CCMT 431-ZM1	-	-	-	-	-	-	-	-	-	-	-	-	\$7.52	-	-	-
CCMT 432-ZM1	-	-	-	-	-	-	-	-	-	-	-	-	\$7.52	-	-	-
CCGX 21.50.5-ZN1	-	-	-	-	-	-	-	-	-	-	-	-	-	-	-	\$7.35
CCGX 21.51-ZN1	-	-	-	-	-	-	-	-	-	-	-	-	-	-	-	\$7.35
CCGX 32.51-ZN1	-	-	-	-	-	-	-	-	-	-	-	-	-	-	-	\$7.62
CCGX 32.52-ZN1	-	-	-	-	-	-	-	-	-	-	-	-	-	-	-	\$7.62
CCMT 21.51-ZX3	-	-	-	-	-	-	-	\$6.31	\$6.31	\$6.31	-	-	-	-	-	-
CCMT 21.52-ZX3	-	-	-	-	-	-	-	\$6.31	\$6.31	\$6.31	-	-	-	-	-	-
CCMT 32.50.5-ZX3	-	-	-	-	-	-	-	\$6.69	\$6.69	\$6.69	-	-	-	-	-	-
CCMT 32.51-ZX3	-	-	-	-	-	-	-	\$6.69	\$6.69	\$6.69	-	-	-	-	-	-
CCMT 32.52-ZX3	-	-	-	-	-	-	-	\$6.69	\$6.69	\$6.69	-	-	-	-	-	-
CCMT 431-ZX3	-	-	-	-	-	-	-	\$7.52	\$7.52	\$7.52	-	-	-	-	-	-
CCMT 432-ZX3	-	-	-	-	-	-	-	\$7.52	\$7.52	\$7.52	-	-	-	-	-	-

Inserts sold in packs of 10

T

INSERTS



LX6



DESIGNATION	GRADE															
	HP230	HP250	HM240	HM250	HS220	HN432	HK036	UD51	UD52	UD21	UD2	UD22	UD32	UD5C	UD5CT	UD1
CPMT 1.81.20.5-LX6	-	-	-	-	-	-	-	\$10.21	\$11.74	\$11.41	\$8.88	-	-	\$9.22	\$11.52	-
CPMT 1.81.21-LX6	-	-	-	-	-	-	-	\$10.21	\$11.74	\$11.41	\$8.88	-	-	\$9.22	\$11.52	-
CPMT 21.50.5-LX6	-	-	-	-	-	-	-	\$7.84	\$9.99	\$8.88	\$6.69	-	-	\$9.17	\$10.92	-
CPMT 21.51-LX6	-	-	-	-	-	-	-	\$7.84	\$9.99	\$8.88	\$6.69	-	-	\$9.17	\$10.92	-
CPMT 21.52-LX6	-	-	-	-	-	-	-	\$7.84	\$9.99	\$8.88	\$6.69	-	-	\$9.17	\$10.92	-
CPMT 32.51-LX6	-	-	-	-	-	-	-	\$8.28	\$9.99	\$9.54	\$6.97	-	-	-	-	-
CPMT 32.52-LX6	-	-	-	-	-	-	-	\$8.28	\$9.99	\$9.54	\$6.97	-	-	-	-	-

Inserts sold in packs of 10



CM1



CN1



CX1



CX2



LX6



ZM1



ZN1



ZX3

DESIGNATION	GRADE															
	HP230	HP250	HM240	HM250	HS220	HN432	HK036	UD51	UD52	UD21	UD2	UD22	UD32	UD5C	UD5CT	UD1
DCGT 21.50-CM1	-	-	\$13.65	-	-	-	-	-	-	-	-	-	-	-	-	-
DCGT 32.50-CM1	-	-	\$15.24	-	-	-	-	-	-	-	-	-	-	-	-	-
DCGT 21.50-CN1	-	-	-	-	-	\$9.96	-	-	-	-	-	-	-	-	-	-
DCGT 21.51-CN1	-	-	-	-	-	\$9.96	-	-	-	-	-	-	-	-	-	-
DCGT 32.51-CN1	-	-	-	-	-	\$11.08	-	-	-	-	-	-	-	-	-	-
DCGT 32.52-CN1	-	-	-	-	-	\$11.08	-	-	-	-	-	-	-	-	-	-
DCMT 21.51-CX1	-	\$6.27	-	\$6.27	-	-	-	-	-	-	-	-	-	-	-	-
DCMT 21.52-CX1	-	\$6.27	-	\$6.27	-	-	-	-	-	-	-	-	-	-	-	-
DCMT 31.51-CX1	\$7.85	\$7.85	-	\$7.85	-	-	-	-	-	-	-	-	-	-	-	-
DCMT 32.52-CX1	\$7.85	\$7.85	-	\$7.85	-	-	-	-	-	-	-	-	-	-	-	-
DCMT 21.50-CX2	-	\$6.27	-	\$6.27	-	-	-	-	-	-	-	-	-	-	-	-
DCMT 32.50-CX2	-	\$7.85	-	\$7.85	-	-	-	-	-	-	-	-	-	-	-	-
DCMT 21.50.5-LX6	-	-	-	-	-	-	-	\$7.47	\$9.10	\$8.12	-	-	-	-	-	-
DCMT 21.50.5-ZM1	-	-	-	-	-	-	-	-	-	-	-	-	\$5.99	-	-	-
DCMT 21.51-ZM1	-	-	-	-	-	-	-	-	-	-	-	-	\$5.99	-	-	-
DCMT 32.51-ZM1	-	-	-	-	-	-	-	-	-	-	-	-	\$7.30	-	-	-
DCMT 32.52-ZM1	-	-	-	-	-	-	-	-	-	-	-	-	\$7.30	-	-	-
DCGX 21.50.5-ZN1	-	-	-	-	-	-	-	-	-	-	-	-	-	-	-	\$7.02
DCGX 21.51-ZN1	-	-	-	-	-	-	-	-	-	-	-	-	-	-	-	\$7.02
DCGX 32.51-ZN1	-	-	-	-	-	-	-	-	-	-	-	-	-	-	-	\$7.74
DCGX 32.52-ZN1	-	-	-	-	-	-	-	-	-	-	-	-	-	-	-	\$7.74
DCMT 21.51-ZX3	-	-	-	-	-	-	-	\$5.99	\$5.99	\$5.99	-	-	-	-	-	-
DCMT 32.51-ZX3	-	-	-	-	-	-	-	\$7.30	\$7.30	\$7.30	-	-	-	-	-	-
DCMT 32.52-ZX3	-	-	-	-	-	-	-	\$7.30	\$7.30	\$7.30	-	-	-	-	-	-
DPMT 32.51-LX6	-	-	-	-	-	-	-	\$9.17	\$10.75	\$10.15	\$7.57	\$9.27	-	-	-	-
DPMT 32.52-LX6	-	-	-	-	-	-	-	\$9.17	\$10.75	\$10.15	\$7.57	\$9.27	-	-	-	-

Inserts sold in packs of 10

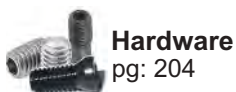

Hardware
pg: 204

Turning Inserts



CN1



CX1



LX6



ZM1



ZN1



ZX3



SCMW Flat Top

DESIGNATION	GRADE															
	HP230	HP250	HM240	HM250	HS220	HN432	HK036	UD51	UD52	UD21	UD2	UD22	UD32	UD5C	UD5CT	UD1
SCGT 32.51-CN1	-	-	-	-	-	\$10.58	-	-	-	-	-	-	-	-	-	-
SCMT 32.51-CX1	-	\$7.54	-	\$7.54	-	-	-	-	-	-	-	-	-	-	-	-
SCMT 32.52-CX1	-	\$7.54	-	\$7.54	-	-	-	-	-	-	-	-	-	-	-	-
SCMT 431-CX1	-	\$9.78	-	\$9.78	-	-	-	-	-	-	-	-	-	-	-	-
SCMT 432-CX1	-	\$9.78	-	\$9.78	-	-	-	-	-	-	-	-	-	-	-	-
SCMT 21.51-LX6	-	-	-	-	-	-	-	\$7.40	\$9.00	\$8.12	-	\$7.13	-	-	-	-
SCMT 32.51-LX6	-	-	-	-	-	-	-	-	-	-	-	\$5.99	-	-	-	-
SCMT 32.52-LX6	-	-	-	-	-	-	-	-	-	-	-	\$5.99	-	-	-	-
SCMT 32.51-ZM1	-	-	-	-	-	-	-	-	-	-	-	-	\$6.31	-	-	-
SCMT 32.52-ZM1	-	-	-	-	-	-	-	-	-	-	-	-	\$6.31	-	-	-
SCGX 32.50.5-ZN1	-	-	-	-	-	-	-	-	-	-	-	-	-	-	-	\$7.84
SCGX 32.51-ZN1	-	-	-	-	-	-	-	-	-	-	-	-	-	-	-	\$7.84
SCGX 32.52-ZN1	-	-	-	-	-	-	-	-	-	-	-	-	-	-	-	\$7.84
SCMT 32.51-ZX3	-	-	-	-	-	-	-	\$6.31	\$6.31	-	-	-	-	-	-	-
SCMT 32.52-ZX3	-	-	-	-	-	-	-	\$6.31	\$6.31	-	-	-	-	-	-	-
SCMT 431-ZX3	-	-	-	-	-	-	-	\$7.52	\$7.52	-	-	-	-	-	-	-
SCMT 432-ZX3	-	-	-	-	-	-	-	\$7.52	\$7.52	-	-	-	-	-	-	-
SCMW 21.51	-	-	-	-	-	-	-	\$5.82	\$6.31	\$6.31	\$4.61	\$5.82	-	-	-	-

Inserts sold in packs of 10



CX1



LX6



ZM1



ZN1



ZX3

DESIGNATION	GRADE															
	HP230	HP250	HM240	HM250	HS220	HN432	HK036	UD51	UD52	UD21	UD2	UD22	UD32	UD5C	UD5CT	UD1
TCMT 21.51-CX1	-	\$6.58	-	\$6.58	-	-	-	-	-	-	-	-	-	-	-	-
TCMT 21.52-CX1	-	\$6.58	-	\$6.58	-	-	-	-	-	-	-	-	-	-	-	-
TCMT 32.51-CX1	-	\$8.35	-	\$8.35	-	-	-	-	-	-	-	-	-	-	-	-
TCMT 32.52-CX1	-	\$8.35	-	\$8.35	-	-	-	-	-	-	-	-	-	-	-	-
TCMT 1.21.20.5-LX6	-	-	-	-	-	-	-	\$7.84	\$9.49	\$9.44	-	-	-	-	-	-
TCMT 21.51-ZM1	-	-	-	-	-	-	-	-	-	-	-	-	\$5.76	-	-	-
TCMT 32.51-ZM1	-	-	-	-	-	-	-	-	-	-	-	-	\$7.30	-	-	-
TCMT 32.52-ZM1	-	-	-	-	-	-	-	-	-	-	-	-	\$7.30	-	-	-
TCGX 21.50.5-ZN1	-	-	-	-	-	-	-	-	-	-	-	-	-	-	-	\$7.62
TCGX 21.51-ZN1	-	-	-	-	-	-	-	-	-	-	-	-	-	-	-	\$7.62
TCGX 32.51-ZN1	-	-	-	-	-	-	-	-	-	-	-	-	-	-	-	\$8.73
TCGX 32.52-ZN1	-	-	-	-	-	-	-	-	-	-	-	-	-	-	-	\$8.73
TCMT 21.51-ZX3	-	-	-	-	-	-	-	\$5.76	\$5.76	\$5.76	-	-	-	-	-	-
TCMT 21.52-ZX3	-	-	-	-	-	-	-	\$5.76	\$5.76	\$5.76	-	-	-	-	-	-
TCMT 32.51-ZX3	-	-	-	-	-	-	-	\$7.30	\$7.30	\$7.30	-	\$6.86	-	-	-	-
TCMT 32.52-ZX3	-	-	-	-	-	-	-	\$7.30	\$7.30	\$7.30	-	\$6.86	-	-	-	-

Inserts sold in packs of 10

T

INSERTS



LX6



DESIGNATION	GRADE															
	HP230	HP250	HM240	HM250	HS220	HN432	HK036	UD51	UD52	UD21	UD2	UD22	UD32	UD5C	UD5CT	UD1
TPMT 21.51-LX6	-	-	-	-	-	-	-	\$7.79	\$9.22	\$8.61	\$6.42	-	-	-	-	-
TPMT 21.52-LX6	-	-	-	-	-	-	-	\$7.79	\$9.22	\$8.61	\$6.42	-	-	-	-	-
TPMT 32.51-LX6	-	-	-	-	-	-	-	\$9.32	\$10.75	\$10.15	\$7.74	-	-	-	-	-
TPMT 32.52-LX6	-	-	-	-	-	-	-	\$9.32	\$10.75	\$10.15	\$7.74	-	-	-	-	-

Inserts sold in packs of 10



CP1



ZM1



ZX3

DESIGNATION	GRADE															
	HP230	HP250	HM240	HM250	HS220	HN432	HK036	UD51	UD52	UD21	UD2	UD22	UD32	UD5C	UD5CT	UD1
VBMT 331-CP1	-	\$11.54	-	-	-	-	-	-	-	-	-	-	-	-	-	-
VBMT 332-CP1	-	\$11.54	-	-	-	-	-	-	-	-	-	-	-	-	-	-
VBMT 331-ZM1	-	-	-	-	-	-	-	-	-	-	-	-	\$8.23	-	-	-
VBMT 332-ZM1	-	-	-	-	-	-	-	-	-	-	-	-	\$8.23	-	-	-
VBMT 21.50.5-ZX3	-	-	-	-	-	-	-	\$8.23	\$9.82	-	-	-	-	-	-	-
VBMT 21.51-ZX3	-	-	-	-	-	-	-	\$8.23	\$9.82	-	-	-	-	-	-	-
VBMT 331-ZX3	-	-	-	-	-	-	-	\$8.23	\$9.17	-	-	-	-	-	-	-
VBMT 332-ZX3	-	-	-	-	-	-	-	\$8.23	\$9.17	-	-	-	-	-	-	-

Inserts sold in packs of 10



CX1



LX6



ZX3

DESIGNATION	GRADE															
	HP230	HP250	HM240	HM250	HS220	HN432	HK036	UD51	UD52	UD21	UD2	UD22	UD32	UD5C	UD5CT	UD1
WCMT 21.51-CX1	-	\$6.89	-	\$6.89	-	-	-	-	-	-	-	-	-	-	-	-
WCMT 21.52-CX1	-	\$6.89	-	\$6.89	-	-	-	-	-	-	-	-	-	-	-	-
WCMT 32.51-CX1	-	\$8.03	-	\$8.03	-	-	-	-	-	-	-	-	-	-	-	-
WCMT 32.52-CX1	-	\$8.03	-	\$8.03	-	-	-	-	-	-	-	-	-	-	-	-
WCMT 21.51-LX6	-	-	-	-	-	-	-	\$8.88	\$9.49	\$10.09	\$6.97	-	-	-	-	-
WCMT 21.52-LX6	-	-	-	-	-	-	-	\$8.88	\$9.49	\$10.09	\$6.97	-	-	-	-	-
WCMT 32.51-LX6	-	-	-	-	-	-	-	\$10.75	\$12.23	\$11.47	\$9.05	-	-	-	-	-
WCMT 32.52-LX6	-	-	-	-	-	-	-	\$10.75	\$12.23	\$11.47	\$9.05	-	-	-	-	-
WCMT 1.210.5-ZX3	-	-	-	-	-	-	-	\$11.69	\$12.57	\$12.57	\$10.91	-	-	-	-	-
WCMT 1.211-ZX3	-	-	-	-	-	-	-	\$11.69	\$12.57	\$12.57	\$10.91	-	-	-	-	-
WCMT 1.51.50.5-ZX3	-	-	-	-	-	-	-	\$11.69	\$12.57	\$12.57	\$10.91	-	-	-	-	-
WCMT 1.51.51-ZX3	-	-	-	-	-	-	-	\$11.69	\$12.57	\$12.57	\$10.91	-	-	-	-	-

Inserts sold in packs of 10

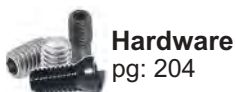

Hardware
pg: 204

Turning Inserts



CM2



CM3



CP2



CS1



CX1



ZK1



ZM1



ZP1



CNMA Flat Top

DESIGNATION	GRADE															
	HP230	HP250	HM240	HM250	HS220	HN432	HK036	UD51	UD52	UD21	UD2	UD22	UD32	UD5C	UD5CT	UD1
CNMG 321-CM2	-	-	-	\$7.54	-	-	-	-	-	-	-	-	-	-	-	-
CNMG 322-CM2	-	-	-	\$7.54	-	-	-	-	-	-	-	-	-	-	-	-
CNMG 431-CM2	-	-	-	\$9.15	-	-	-	-	-	-	-	-	-	-	-	-
CNMG 432-CM2	-	-	-	\$9.15	-	-	-	-	-	-	-	-	-	-	-	-
CNGP 431-CM3	-	-	\$16.54	-	-	-	-	-	-	-	-	-	-	-	-	-
CNGP 432-CM3	-	-	\$16.54	-	-	-	-	-	-	-	-	-	-	-	-	-
CNMG 543-CP2	-	\$16.69	-	-	-	-	-	-	-	-	-	-	-	-	-	-
CNMG 643-CP2	-	\$21.66	-	-	-	-	-	-	-	-	-	-	-	-	-	-
CNMG 431-CS1	-	-	-	-	\$9.15	-	-	-	-	-	-	-	-	-	-	-
CNMG 431-CX1	\$9.15	\$9.15	-	-	-	-	-	-	-	-	-	-	-	-	-	-
CNMG 432-CX1	\$9.15	\$9.15	-	-	-	-	-	-	-	-	-	-	-	-	-	-
CNMG 321-ZK1	-	-	-	-	-	-	-	-	-	\$6.36	-	-	-	-	-	-
CNMG 322-ZK1	-	-	-	-	-	-	-	-	-	\$6.36	-	-	-	-	-	-
CNMG 431-ZK1	-	-	-	-	-	-	-	-	-	\$8.06	-	-	-	-	-	-
CNMG 432-ZK1	-	-	-	-	-	-	-	-	-	\$8.06	-	-	-	-	-	-
CNMG 542-ZK1	-	-	-	-	-	-	-	-	-	\$10.80	-	-	-	-	-	-
CNMG 543-ZK1	-	-	-	-	-	-	-	-	-	\$10.80	-	-	-	-	-	-
CNMG 642-ZK1	-	-	-	-	-	-	-	-	-	\$13.93	-	-	-	-	-	-
CNMG 643-ZK1	-	-	-	-	-	-	-	-	-	\$13.93	-	-	-	-	-	-
CNMG 321-ZM1	-	-	-	-	-	-	-	-	-	-	-	-	\$6.36	-	-	-
CNMG 322-ZM1	-	-	-	-	-	-	-	-	-	-	-	-	\$6.36	-	-	-
CNMG 431-ZM1	-	-	-	-	-	-	-	-	-	-	-	-	\$8.06	-	-	-
CNMG 432-ZM1	-	-	-	-	-	-	-	-	-	-	-	-	\$8.06	-	-	-
CNMG 321-ZP1	-	-	-	-	-	-	-	\$6.36	\$6.36	-	-	-	-	-	-	-
CNMG 322-ZP1	-	-	-	-	-	-	-	\$6.36	\$6.36	-	-	-	-	-	-	-
CNMG 431-ZP1	-	-	-	-	-	-	-	\$8.06	\$8.06	-	-	-	-	-	-	-
CNMG 432-ZP1	-	-	-	-	-	-	-	\$8.06	\$8.06	-	-	-	-	-	-	-
CNMG 542-ZP1	-	-	-	-	-	-	-	\$10.80	\$10.80	-	-	-	-	-	-	-
CNMG 543-ZP1	-	-	-	-	-	-	-	\$10.80	\$10.80	-	-	-	-	-	-	-
CNMG 642-ZP1	-	-	-	-	-	-	-	\$13.93	\$13.93	-	-	-	-	-	-	-
CNMG 643-ZP1	-	-	-	-	-	-	-	\$13.93	\$13.93	-	-	-	-	-	-	-
CNMA 432	-	-	-	-	-	-	\$9.18	-	-	-	-	-	-	-	-	-
CNMA 433	-	-	-	-	-	-	\$9.18	-	-	-	-	-	-	-	-	-
CNMA 543	-	-	-	-	-	-	\$15.34	-	-	-	-	-	-	-	-	-
CNMA 643	-	-	-	-	-	-	\$20.05	-	-	-	-	-	-	-	-	-

Inserts sold in packs of 10



DESIGNATION	GRADE															
	HP230	HP250	HM240	HM250	HS220	HN432	HK036	UD51	UD52	UD21	UD2	UD22	UD32	UD5C	UD5CT	UD1
DNMG 331-CM2	-	-	-	\$9.31	-	-	-	-	-	-	-	-	-	-	-	-
DNMG 332-CM2	-	-	-	\$9.31	-	-	-	-	-	-	-	-	-	-	-	-
DNMG 431-CM2	-	-	-	\$11.73	-	-	-	-	-	-	-	-	-	-	-	-
DNMG 432-CM2	-	-	-	\$11.73	-	-	-	-	-	-	-	-	-	-	-	-
DNGP 431-CM3	-	-	\$18.12	-	-	-	-	-	-	-	-	-	-	-	-	-
DNGP 432-CM3	-	-	\$18.77	-	-	-	-	-	-	-	-	-	-	-	-	-
DNMG 432-CS1	-	-	-	-	\$12.35	-	-	-	-	-	-	-	-	-	-	-
DNMG 331-CX1	-	\$9.31	-	-	-	-	-	-	-	-	-	-	-	-	-	-
DNMG 332-CX1	-	\$9.31	-	-	-	-	-	-	-	-	-	-	-	-	-	-
DNMG 431-CX1	-	\$11.73	-	-	-	-	-	-	-	-	-	-	-	-	-	-
DNMG 432-CX1	\$12.35	\$11.73	-	-	-	-	-	-	-	-	-	-	-	-	-	-
DNMG 542-LX2	-	-	-	-	-	-	-	\$14.43	\$15.19	\$14.10	-	-	-	-	-	-
DNMG 543-LX2	-	-	-	-	-	-	-	\$14.43	\$15.19	\$14.10	-	-	-	-	-	-
DNMG 331-ZM1	-	-	-	-	-	-	-	-	-	-	-	-	\$8.12	-	-	-
DNMG 332-ZM1	-	-	-	-	-	-	-	-	-	-	-	-	\$8.12	-	-	-
DNMG 431-ZM1	-	-	-	-	-	-	-	-	-	-	-	-	\$9.10	-	-	-
DNMG 432-ZM1	-	-	-	-	-	-	-	-	-	-	-	-	\$9.10	-	-	-
DNMG 331-ZP1	-	-	-	-	-	-	-	\$8.12	\$8.12	-	-	-	-	-	-	-
DNMG 332-ZP1	-	-	-	-	-	-	-	\$8.12	\$8.12	-	-	-	-	-	-	-
DNMG 431-ZP1	-	-	-	-	-	-	-	\$9.10	\$9.10	-	-	-	-	-	-	-
DNMG 432-ZP1	-	-	-	-	-	-	-	\$9.10	\$9.10	-	-	-	-	-	-	-
DNMG 331-ZX2	-	-	-	-	-	-	-	-	-	\$8.12	-	-	-	-	-	-
DNMG 332-ZX2	-	-	-	-	-	-	-	-	-	\$8.12	-	-	-	-	-	-
DNMG 431-ZX2	-	-	-	-	-	-	-	-	-	\$9.10	-	-	-	-	-	-
DNMG 432-ZX2	-	-	-	-	-	-	-	-	-	\$9.10	-	-	-	-	-	-
DNMA 431	-	-	-	-	-	-	\$14.04	-	-	-	-	-	-	-	-	-
DNMA 432	-	-	-	-	-	-	\$14.04	-	-	-	-	-	-	-	-	-

Inserts sold in packs of 10



LX2



RNMA Flat Top

DESIGNATION	GRADE															
	HP230	HP250	HM240	HM250	HS220	HN432	HK036	UD51	UD52	UD21	UD2	UD22	UD32	UD5C	UD5CT	UD1
RNMG 32-LX2	-	-	-	-	-	-	-	\$6.86	\$8.61	\$7.90	-	-	-	-	-	-
RNMG 43-LX2	-	-	-	-	-	-	-	\$8.39	\$10.21	\$9.22	-	-	-	-	-	-
RNMG 54-LX2	-	-	-	-	-	-	-	\$13.39	\$14.70	\$13.61	-	-	-	-	-	-
RNMG 64-LX2	-	-	-	-	-	-	-	\$16.74	\$17.83	\$16.62	-	-	-	-	-	-
RNMA 43	-	-	-	-	-	-	\$7.02	-	-	-	-	-	-	-	-	-

Inserts sold in packs of 10

Turning Inserts



DESIGNATION	GRADE															
	HP230	HP250	HM240	HM250	HS220	HN432	HK036	UD51	UD52	UD21	UD2	UD22	UD32	UD5C	UD5CT	UD1
SNMG 543-CP2	-	\$16.69	-	-	-	-	-	-	-	-	-	-	-	-	-	-
SNMG 643-CP2	-	\$21.66	-	-	-	-	-	-	-	-	-	-	-	-	-	-
SNMG 432-CS1	-	-	-	-	\$9.31	-	-	-	-	-	-	-	-	-	-	-
SNMG 432-CX1	-	\$9.31	-	-	-	-	-	-	-	-	-	-	-	-	-	-
SNMG 643-ZK1	-	-	-	-	-	-	-	-	-	\$13.93	-	-	-	-	-	-
SNMG 644-ZK1	-	-	-	-	-	-	-	-	-	\$13.93	-	-	-	-	-	-
SNMG 431-ZM1	-	-	-	-	-	-	-	-	-	-	-	-	\$6.86	-	-	-
SNMG 432-ZM1	-	-	-	-	-	-	-	-	-	-	-	-	\$6.86	-	-	-
SNMG 431-ZP1	-	-	-	-	-	-	-	\$6.86	\$6.86	-	-	-	-	-	-	-
SNMG 432-ZP1	-	-	-	-	-	-	-	\$6.86	\$6.86	-	-	-	-	-	-	-
SNMG 542-ZP1	-	-	-	-	-	-	-	\$10.80	\$10.80	-	-	-	-	-	-	-
SNMG 543-ZP1	-	-	-	-	-	-	-	\$10.80	\$10.80	-	-	-	-	-	-	-
SNMG 643-ZP1	-	-	-	-	-	-	-	\$13.93	\$13.93	-	-	-	-	-	-	-
SNMG 644-ZP1	-	-	-	-	-	-	-	\$13.93	\$13.93	-	-	-	-	-	-	-
SNMG 431-ZX2	-	-	-	-	-	-	-	-	-	\$6.86	-	-	-	-	-	-
SNMG 432-ZX2	-	-	-	-	-	-	-	-	-	\$6.86	-	-	-	-	-	-
SNMG 543-ZX2	-	-	-	-	-	-	-	-	-	\$10.80	-	-	-	-	-	-
SNMA 432	-	-	-	-	-	-	\$9.65	-	-	-	-	-	-	-	-	-
SNMA 543	-	-	-	-	-	-	\$13.31	-	-	-	-	-	-	-	-	-

Inserts sold in packs of 10



DESIGNATION	GRADE															
	HP230	HP250	HM240	HM250	HS220	HN432	HK036	UD51	UD52	UD21	UD2	UD22	UD32	UD5C	UD5CT	UD1
TNMG 331-CM2	-	-	-	\$8.50	-	-	-	-	-	-	-	-	-	-	-	-
TNMG 332-CM2	-	-	-	\$8.50	-	-	-	-	-	-	-	-	-	-	-	-
TNMG 332-CS1	-	-	-	-	\$8.50	-	-	-	-	-	-	-	-	-	-	-
TNMG 331-CX1	\$8.50	\$8.50	-	-	-	-	-	-	-	-	-	-	-	-	-	-
TNMG 332-CX1	\$8.50	\$8.50	-	-	-	-	-	-	-	-	-	-	-	-	-	-
TNMG 431-CX1	-	\$12.69	-	-	-	-	-	-	-	-	-	-	-	-	-	-
TNMG 432-CX1	-	\$12.69	-	-	-	-	-	-	-	-	-	-	-	-	-	-
TNMG 542-LX2	-	-	-	-	-	-	-	\$13.88	\$15.19	\$14.21	-	-	-	-	-	-
TNMG 543-LX2	-	-	-	-	-	-	-	\$13.88	\$15.19	\$14.21	-	-	-	-	-	-
TNMG 331-ZM1	-	-	-	-	-	-	-	-	-	-	-	-	\$6.69	-	-	-
TNMG 332-ZM1	-	-	-	-	-	-	-	-	-	-	-	-	\$6.69	-	-	-
TNMG 431-ZM1	-	-	-	-	-	-	-	-	-	-	-	-	\$8.51	-	-	-
TNMG 432-ZM1	-	-	-	-	-	-	-	-	-	-	-	-	\$8.51	-	-	-
TNMG 331-ZP1	-	-	-	-	-	-	-	\$6.69	\$6.69	-	-	-	-	-	-	-
TNMG 332-ZP1	-	-	-	-	-	-	-	\$6.69	\$6.69	-	-	-	-	-	-	-
TNMG 431-ZP1	-	-	-	-	-	-	-	\$8.51	\$8.51	-	-	-	-	-	-	-
TNMG 432-ZP1	-	-	-	-	-	-	-	\$8.51	\$8.51	-	-	-	-	-	-	-
TNMG 331-ZX2	-	-	-	-	-	-	-	-	-	\$6.69	-	-	-	-	-	-
TNMG 332-ZX2	-	-	-	-	-	-	-	-	-	\$6.69	-	-	-	-	-	-
TNMG 431-ZX2	-	-	-	-	-	-	-	-	-	\$12.78	-	-	-	-	-	-
TNMG 432-ZX2	-	-	-	-	-	-	-	-	-	\$12.78	-	-	-	-	-	-
TNMA 332	-	-	-	-	-	-	\$7.36	-	-	-	-	-	-	-	-	-
TNMA 432	-	-	-	-	-	-	\$10.84	-	-	-	-	-	-	-	-	-
TNMA 543	-	-	-	-	-	-	\$19.14	-	-	-	-	-	-	-	-	-

Inserts sold in packs of 10



INSERTS



DESIGNATION	GRADE															
	HP230	HP250	HM240	HM250	HS220	HN432	HK036	UD51	UD52	UD21	UD2	UD22	UD32	UD5C	UD5CT	UD1
VNMG 332-CM2	-	-	-	\$12.35	-	-	-	-	-	-	-	-	-	-	-	-
VNMG 332-CS1	-	-	-	-	\$12.35	-	-	-	-	-	-	-	-	-	-	-
VNMG 331-CX1	\$12.35	\$12.35	-	-	-	-	-	-	-	-	-	-	-	-	-	-
VNMG 332-CX1	\$12.35	\$12.35	-	-	-	-	-	-	-	-	-	-	-	-	-	-
VNMG 432-LX3	-	-	-	-	-	-	-	\$12.08	\$13.27	\$11.30	\$14.15	-	-	-	-	-
VNMG 331-ZM1	-	-	-	-	-	-	-	-	-	-	-	-	\$10.43	-	-	-
VNMG 332-ZM1	-	-	-	-	-	-	-	-	-	-	-	-	\$10.43	-	-	-
VNMG 331-ZX2	-	-	-	-	-	-	-	\$10.43	\$10.43	\$10.43	-	-	-	-	-	-
VNMG 332-ZX2	-	-	-	-	-	-	-	\$10.43	\$10.43	\$10.43	-	-	-	-	-	-
VNMA 332	-	-	-	-	-	-	\$14.40	-	-	-	-	-	-	-	-	-

Inserts sold in packs of 10



DESIGNATION	GRADE															
	HP230	HP250	HM240	HM250	HS220	HN432	HK036	UD51	UD52	UD21	UD2	UD22	UD32	UD5C	UD5CT	UD1
WNMG 432-CM2	-	-	-	\$9.96	-	-	-	-	-	-	-	-	-	-	-	-
WNMG 432-CS1	-	-	-	-	\$9.96	-	-	-	-	-	-	-	-	-	-	-
WNMG 331-CX1	\$8.50	\$8.50	-	-	-	-	-	-	-	-	-	-	-	-	-	-
WNMG 332-CX1	\$8.50	\$8.50	-	-	-	-	-	-	-	-	-	-	-	-	-	-
WNMG 431-CX1	\$9.96	\$9.96	-	-	-	-	-	-	-	-	-	-	-	-	-	-
WNMG 432-CX1	\$9.96	\$9.96	-	-	-	-	-	-	-	-	-	-	-	-	-	-
WNMG 331-ZM1	-	-	-	-	-	-	-	-	-	-	-	-	\$5.99	-	-	-
WNMG 332-ZM1	-	-	-	-	-	-	-	-	-	-	-	-	\$5.99	-	-	-
WNMG 431-ZM1	-	-	-	-	-	-	-	-	-	-	-	-	\$7.74	-	-	-
WNMG 432-ZM1	-	-	-	-	-	-	-	-	-	-	-	-	\$7.74	-	-	-
WNMG 331-ZP1	-	-	-	-	-	-	-	\$7.08	\$8.95	-	-	-	-	-	-	-
WNMG 332-ZP1	-	-	-	-	-	-	-	\$5.99	\$5.99	-	-	-	-	-	-	-
WNMG 431-ZP1	-	-	-	-	-	-	-	\$7.74	\$7.74	-	-	-	-	-	-	-
WNMG 432-ZP1	-	-	-	-	-	-	-	\$7.74	\$7.74	-	-	-	-	-	-	-
WNMG 331-ZX2	-	-	-	-	-	-	-	-	-	\$8.61	-	-	-	-	-	-
WNMG 332-ZX2	-	-	-	-	-	-	-	-	-	\$5.99	-	-	-	-	-	-
WNMG 431-ZX2	-	-	-	-	-	-	-	-	-	\$7.74	-	\$7.74	-	-	-	-
WNMG 432-ZX2	-	-	-	-	-	-	-	-	-	\$7.74	-	\$7.74	-	-	-	-
WNMA 432	-	-	-	-	-	-	\$9.54	-	-	-	-	-	-	-	-	-

Inserts sold in packs of 10

Turning Inserts



SP2

Designation	UD51
WPGT 1.510-SP2	\$7.97
WPGT 1.510.5-SP2	\$7.97
WPGT 1.511-SP2	\$10.01
WPGT 21.50-SP2	\$7.90
WPGT 21.50.5-SP2	\$7.63
WPGT 21.51-SP2	\$10.01
WPMT 32.51-SP2	\$15.57
WPMT 32.52-SP2	\$15.57

Inserts sold in packs of 10



SP1



Flat Top



SX1

Designation	UD51	UD25
TDHB 1.280.750.1	\$10.41	\$11.64
TDHB 1.280.750.5	\$12.42	\$10.73
TDHB 1.280.751	\$10.86	\$11.32
TPCB 220.5	\$10.01	\$10.73
TPCB 221	\$11.64	\$10.73
TPCB 222	\$10.01	\$11.20
TPCH 220.5-SP1	\$11.42	-
TPCH 221-SP1	\$11.26	-
TD 320.5	\$13.15	-
TD 321	\$13.13	-
TD 322	\$13.13	-
TPGH 321-SX1	\$16.75	\$14.12
TPGH 322-SX1	\$14.12	\$13.51

Inserts sold in packs of 10

Series Style



Designation	UD5CBN	UD2CBN	UD2PCD
CCGW 21.51-1	\$42.41	\$42.41	\$60.40
CCGW 21.52-1	\$42.41	\$42.41	\$60.40
CCGW 32.51-2	\$64.41	\$64.41	\$62.62
CCGW 32.52-2	\$64.41	\$64.41	\$62.62



CNGA 431-2	\$64.41	\$64.41	-
CNGA 432-2	\$64.41	\$64.41	-



DCGW 21.51-1	\$42.41	\$42.41	\$61.30
DCGW 32.51-2	\$64.41	\$64.41	-
DCGW 32.52-2	\$64.41	\$64.41	-



DNGA 431-2	\$64.41	\$64.41	-
DNGA 432-2	\$64.41	\$64.41	-

Inserts sold individually



Designation	UD2PCD
CCGT 21.51-CB-1 *	\$90.48
CCGT 21.52-CB-1 *	\$90.48
CCGT 32.51-CB-1 *	\$92.40
CCGT 32.52-CB-1 *	\$100.10



DCGT 21.51-CB-1 *	\$94.33
DCGT 32.51-CB-1 *	\$100.10
DCGT 32.52-CB-1 *	\$111.71

Inserts sold individually



Designation	UD5CBN	UD2CBN	UD2PCD
TCGW 21.51-1	-	\$42.41	\$58.46
TCGW 21.52-1	\$42.41	\$42.41	\$58.46
TCGW 32.51-1	\$42.41	\$42.41	\$64.16
TCGW 32.52-1	\$42.41	\$42.41	\$64.16



TNGA 331-1	\$42.41	\$42.41	-
TNGA 332-1	\$42.41	\$42.41	-



VBGW 21.51-1	-	-	\$74.12
VBGW 21.52-1	-	-	\$74.12
VBGW 331-1	-	-	\$76.98
VBGW 332-1	-	-	\$88.38



VNGA 331-2	-	\$58.71	-
VNGA 332-2	\$58.71	\$58.71	-

Inserts sold individually



Designation	UD2PCD
TCGT 21.51-CB-1 *	\$94.33
TCGT 32.51-CB-1 *	\$98.18
TCGT 32.52-CB-1 *	\$109.73

Inserts sold individually



Designation	UD2PCD
VBGT 331-CB-1 *	\$132.83
VBGT 332-CB-1 *	\$146.30

Inserts sold individually

* Medium to Finish Machining

T

INSERTS



PATRIOT

High-Performance Drill Inserts

SEE PAGE 143
For All Available
Compatible Drills



SEE PAGE 144
For Speeds and Feeds



PD1

Designation	HP600	HK356
PD1 042004	\$8.57	\$8.57
PD1 052804	\$8.57	\$8.57
PD1 063306	\$8.68	\$8.68
PD1 074006	\$9.12	\$9.12
PD1 094508	\$10.28	\$10.28
PD1 125812	\$11.79	\$11.79
PD1 156812	\$12.86	\$12.86

Inserts sold in packs of 10

Drilling (ISO Standard)



Designation	UD51	UD52	UD2	UD21	UD32
WCMX 1.81.52	\$7.52	\$9.22	\$7.52	\$9.22	\$8.34
WCMX 21.52	\$7.52	\$9.22	\$7.52	\$9.22	\$8.34
WCMX 2.522	\$7.52	\$9.22	\$7.52	\$9.22	\$8.34
WCMX 32.52	\$8.18	\$9.88	\$8.18	\$9.88	\$9.10
WCMX 433	\$8.18	\$10.21	\$8.18	\$10.21	\$9.10

Inserts sold in packs of 10

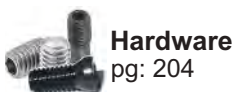

Hardware
pg: 204





SEE PAGES 128-131
For all Available
Compatible Mills



High-Performance MILLING Inserts



HCX



SCX

Designation	HP470	HM470	HS470	HS480	HK430	HN432
PM1 1205-HCX	\$19.32	-	-	-	-	-
PM1 1205-SCX	-	\$19.32	\$26.70	-	\$19.32	-

Inserts sold in packs of 10



HCX



SCX



CCX



LCX

Designation	HP470	HM470	HS470	HS480	HK430	HN432
PM2 09T308-HCX	\$11.10	-	-	-	-	-
PM2 09T308-SCX	-	\$11.10	\$17.94	\$17.94	-	-
PM2 09T308-CCX	-	-	-	-	\$11.10	-
PM2 09T308-LCX	-	-	-	-	-	\$13.52

Inserts sold in packs of 10



HCX



SCX

Designation	HP470	HM470	HS470	HS480	HK430	HN432
PM3 10T308-HCX	\$11.52	-	-	-	\$11.52	-
PM3 10T308-SCX	-	\$11.52	\$14.40	\$15.50	-	-

Inserts sold in packs of 10



HCX



SCX



LCX

Designation	HP470	HM470	HS470	HS480	HK430	HN432
PM4 0604-HCX	\$13.52	-	-	-	\$13.52	-
PM4 0604-SCX	-	\$13.52	\$16.93	-	-	-
PM4 0604-LCX	-	-	-	-	-	\$18.30

Inserts sold in packs of 10

	SFM	PM1		PM2		PM3		PM4	
		Inch/Rev	Ap (Inch)	Inch/Rev	Ap (Inch)	Inch/Rev	Ap (Inch)	Inch/Rev	Ap (Inch)
STEEL	200-720	.004-.020	.007-.236	.002-.010	.004-.157	.004-.020	.003-.031	.004-.015	.011-.150
STAINLESS STEEL	200-650	.003-.016	.007-.236	.002-.010	.004-.157	.004-.020	.003-.031	.004-.010	.011-.150
CAST IRON	350-1050	.003-.017	.007-.236	.002-.010	.004-.157	-	-	.003-.012	.011-.150
NON FERROUS	<6500	-	-	.002-.011	.004-.157	-	-	.004-.015	.011-.150
HEAT RESISTANT	80-250	.003-.010	.007-.236	.002-.006	.004-.157	.004-.020	.003-.031	.002-.005	.007-.150
TITANIUM	80-250	-	.007-.236	.002-.006	.004-.157	.004-.020	.003-.031	-	-

Prices are subject to change without notice.



Milling (ISO Standard)



Designation	UD1	UD404	UD602
RDKW 0803	-	\$5.60	\$5.60
RCKT 10T3	\$5.38	\$5.38	\$5.38
RCKT 1204	\$6.42	\$6.42	\$6.42
RCKT 1606	-	\$9.27	\$9.27

Inserts sold in packs of 10



Designation	UD51	UD52	UD2	UD21	UD22
RCMT 21.5	\$7.96	\$9.17	\$6.54	\$8.67	\$7.35
RCMT 32.5	\$8.78	\$10.48	\$8.34	\$7.35	\$9.66
RCMT 43	\$10.31	\$12.23	\$8.45	\$11.35	\$9.88

Inserts sold in packs of 10



Designation	Radius	UD1	UD204	UD404	UD602
APKT 11T304-PF	.015	-	\$8.51	\$8.51	\$8.51
APKT 11T308-PF	.031	-	\$8.51	\$8.51	-
APKT 11T316-PF	.062	-	\$8.51	\$8.51	-
APKT 160408-PF	.031	-	-	\$10.15	\$10.15
APKT 11T304-PM	.015	-	\$8.51	\$8.51	\$8.51
APKT 11T308-PM	.031	-	\$8.51	\$8.51	\$8.51
APKT 11T312-PM	.046	-	-	\$8.51	-
APKT 11T316-PM	.062	-	\$8.51	\$8.51	-
APKT 160408-PM	.031	-	\$10.15	\$10.15	\$10.15
APKT 11T304-PR	.015	-	\$8.51	\$8.51	\$8.51
APKT 11T304-AL	.015	\$8.51	-	-	-
APKT 11T308-AL	.031	\$8.51	-	-	-
APKT 160408-AL	.031	\$10.15	-	-	-

Finish

Semi-Rough

Rough

Aluminum

Inserts sold in packs of 10

APKT 11T308



Depth of cut ↑

Feed Per Tooth (inch)

AP (inch)	Light	Medium	Heavy
.315	.0028	.0031	.0039
.236	.0039	.0047	.0059
.157	.0047	.0059	.0079

f/t →

APKT 160408



Depth of cut ↑

Feed Per Tooth (inch)

AP (inch)	Light	Medium	Heavy
.472	.0028	.0031	.0039
.315	.0039	.0047	.0059
.197	.0047	.0059	.0079

f/t →



Hardware
pg: 204

ULTRA-DEX

ULTRADEXUSA.com 201

T

INSERTS

Threading Inserts

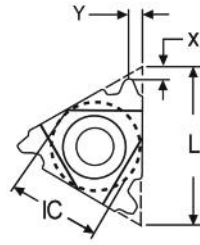

American Acme

Designation		I.C.	L	Pitch (tpi)	h (min)	X	Y	Anvil Right	Anvil Left	Price
Right Hand	Left Hand									
3IR16ACME	3IL16ACME	3/8"	.630	16	.036	.040	.040	Y13	YE3	\$15.04
3IR14ACME	3IL14ACME	3/8"	.630	14	.041	.040	.050	Y13	YE3	\$15.04
3IR12ACME	3IL12ACME	3/8"	.630	12	.047	.050	.050	Y13	YE3	\$15.04
3IR10ACME	3IL10ACME	3/8"	.630	10	.060	.050	.050	Y13	YE3	\$15.04
3IR8ACME	3IL8ACME	3/8"	.630	8	.072	.060	.060	Y13	YE3	\$15.04

Inserts sold in packs of 10

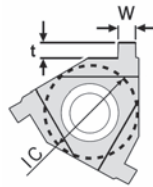

Grooving

Designation	I.C.	W	t	Anvil Right	Price
Right Hand					
3IR NG W.031	3/8"	.031	.050	Y13M-1.5N	\$15.04
3IR NG W.047	3/8"	.047	.070	Y13M-1.5N	\$15.04
3IR NG W.062	3/8"	.062	.080	Y13M-1.5N	\$15.04
3IR NG W.093	3/8"	.093	.070	Y13	\$15.04

Inserts sold in packs of 10

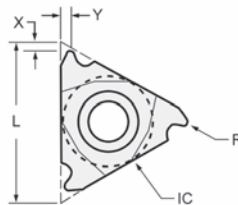

Partial Profile 60°

Designation		I.C.	L	Pitch (mm)	Pitch (tpi)	r	X	Y	Anvil Right	Anvil Left	Price
Right Hand	Left Hand										
2JIRA60	2JILA60	1/4"	.630	.7-1.5	36-18	.004	.040	.045	Y13	YE3	\$10.15
2JIR12UN	2JIL12UN	1/4"	.630	1.0-2.0	28-12	.004	.030	.035	Y13	YE3	\$10.15
3IRA60	3ILA60	3/8"	.630	.05-1.5	48-16	.002	.030	.040	Y13	YE3	\$13.71
3IRG60	3ILG60	3/8"	.630	1.75-3.0	14-8	.006	.050	.070	Y13	YE3	\$13.71
3IRAG60	3ILAG60	3/8"	.630	.05-3.0	48-8	.002	.050	.070	Y13	YE3	\$13.71
3JIRA60	-	3/8" SCB	.630	.05-1.5	48-16	.002	.020	.030	Y13	-	\$13.71
3JIRG60	-	3/8" SCB	.630	1.75-3.0	14-8	.006	.040	.060	Y13	-	\$13.71
3JIRAG60	-	3/8" SCB	.630	.05-3.0	48-8	.002	.040	.060	Y13	-	\$13.71

Inserts sold in packs of 10

T

INSERTS

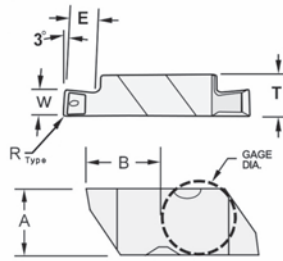

Top Notch Grooving

Designation		A	B	E	R	T	W	Price
Right Hand	Left Hand							
NG-2R W.031	NG-2L W.031	.219	.270	.050	.002 / .005	.150	.031	\$23.05
NG-2R W.062	NG-2L W.062	.219	.270	.110	.005 / .010	.150	.062	\$23.05
NG-2R W.094	NG-2L W.094	.219	.270	.110	.005 / .010	.150	.094	\$23.05
NG-3R W.062	NG-3L W.062	.344	.405	.120	.005 / .010	.195	.062	\$23.05
NG-3R W.094	NG-3L W.094	.344	.405	.180	.005 / .010	.195	.094	\$23.05
NG-3R W.125	NG-3L W.125	.344	.405	.180	.005 / .010	.195	.125	\$23.05
NG-4R W.125	NG-4L W.125	.453	.636	.250	.005 / .010	.255	.125	\$33.31
NG-4R W.189	NG-4L W.189	.453	.636	.250	.020 / .025	.255	.189	\$33.31
NG-4R W.250	NG-4L W.250	.453	.636	.250	.020 / .025	.255	.250	\$33.31
NG-6R W.281	NG-6L W.281	.453	.636	.250	.030 / .035	.383	.281	\$36.76
NG-6R W.375	NG-6L W.375	.453	.636	.250	.030 / .035	.383	.375	\$36.76

Inserts sold individually

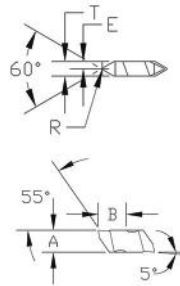

Top Notch Threading

Designation		A	B	E	R	T	Ext. TPI	Int. TPI	Price
Right Hand	Left Hand								
NTP-2R	NTP-2L	.219	.266	.075	.003/.005	.150	8-36	1-20	\$19.92
NTP-3R	NTP-3L	.344	.400	.098	.005/.008	.195	6-20	5-12	\$20.79
NTP-4R	NTP-4L	.453	.629	.128	.005/.008	.255	4-20	4-12	\$26.78

Inserts sold individually

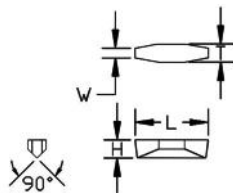

V-Bottom

Designation	T	L	Radius	TPI	Price
V84-NV	.250	1.000	.006/.008	5-20	\$22.83
V84-NV-.010R	.250	1.000	.010	4-20	\$24.59
V84-NV-.020R	.250	1.000	.020	4-12	\$24.59
V84-NV-.025R	.250	1.000	.025	4-8	\$24.59
V84-NV-.038R	.250	1.000	.038	4-6	\$24.59
V85-NV	.312	1.000	.006/.008	5-20	\$24.59

Inserts sold individually

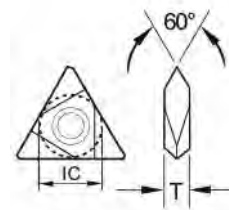

On Edge

Designation	I.C.	T	Radius	TPI	Price
TNMA-43NV	.500	.187	.003/.005	5-24	\$21.84
TNMA-43NV .010	.500	.187	.001	4-20	\$24.24
TNMC-43NV	.500	.187	.003/.005	5-24	\$21.84
TNMC-43NV .010	.500	.187	.001	4-20	\$24.24

Inserts sold individually



Hardware
pg: 204

Boring Bars

Shim Seat	Price Each	Insert Screws	Price Each	Key	Price Each	Clamp	Price Each	Lock Pin	Price Each	Clamp Screw	Price Each
ICSN-433	\$4.34	MTS-182	\$2.36	T-6	\$3.13	CL-6	\$3.95	NL-33	\$2.19	XNS-36	\$1.65
ICSN-533	\$5.32	MTS-183	\$2.36	T-7	\$2.86	CL-7	\$3.95	NL-33L	\$2.19	XNS-47	\$1.65
ICSN-633	\$6.14	MTS-184	\$2.36	T-10	\$4.83	CL-9	\$3.95	NL-34	\$2.19	XNS-48	\$1.65
ISSN-432	\$4.28	MTS-2	\$2.14	T-15	\$2.86	CL-12	\$3.95	NL-34L	\$2.19	XNS-510	\$1.65
ISSN-433	\$4.28	MTS-224	\$2.36	T-20	\$2.91	CL-19	\$4.94	NL-44	\$2.19	XNS-58	\$1.65
ISSN-533	\$5.05	MTS-255	\$2.36	sold in QTY 5		CL-20	\$3.95	NL-46	\$2.03	XNS-59	\$1.65
ISSN-633	\$5.99	MTS-35	\$2.36			CL-21	\$9.18	NL-56	\$2.47	sold in QTY 5	
IDSN-322	\$3.45	MTS-2.5L	\$2.14			CL-22	\$9.66	NL-58	\$2.19		
IDSN-433	\$3.95	ETS 4-40	\$2.36			CL-30	\$6.97	NL-68	\$2.47		
IDSN-533	\$5.99	sold in QTY 5				CL-84	\$21.89	NL-68L	\$4.88		
ITSN-323	\$3.01	MTS-3.5L	\$6.36			CL-85	\$21.89	sold in QTY 5			
ITSN-433	\$4.88	MTS-4	\$7.47			sold in QTY 1					
ITSN-533	\$6.26	MTS-526	\$8.56								
ITSN-636	\$8.51	sold in QTY 1									
IVSN-322	\$3.51										
IVSN-432	\$4.66										
IVSN-433	\$4.66										
IWSN-322	\$3.95										
IWSN-433	\$5.38										
IRSN-32	\$3.84										
IRSN-43	\$3.45										
IRSN-53	\$5.54										
IRSN-63	\$6.26										

Laydown Threaders

Anvil Screw	Price Each	Insert Screw	Price Each
SY3T	\$1.75	SA3T	\$2.52
SY4T	\$2.19	SA4T	\$3.45
SY5T	\$3.51	SA5T	\$6.04

sold in QTY 5

sold in QTY 5

Top Notch

Anvil	Price Each	Clamp	Price Each
YI3	\$15.53	CM-72	\$9.22
YE3	\$15.53	CM-73	\$9.22
YI4	\$26.17	CM-74	\$14.65
YI3M-1.5N	\$25.45	CM-75	\$14.65
YE4	\$26.17	CM-120	\$12.35
YI5	\$42.36	CM-121	\$12.35
YE5	\$42.36	CM-146	\$38.13
sold in QTY 1		CM-147	\$38.13

sold in QTY 1

sold in QTY 1

Pullback

Shim Screw	Price Each	Clamp Screw	Price Each
PB3-SS	\$2.30	6-32	\$0.49
PB4-SS	\$2.30	10-32	\$0.49
		MTS-526	\$8.56

sold in QTY 5

sold in QTY 1

Chatter-Free

Head Bolts	Price Each
8-32 HB	\$1.65
10-24 HB	\$1.65
1/4-20 HB	\$1.92
5/16-18 HB	\$2.19

sold in QTY 1

Modular

Set Screws	Price Each
MH12S	\$1.26
MH16S	\$1.54
MH20S	\$1.84
MH24S	\$2.12
MH28S	\$2.40
MH32S	\$2.69

sold in QTY 2

Drilling

Wrench	Price Each
T-6-S	\$3.95
T-7-S	\$3.79
T-8-S	\$3.95
T-9-S	\$4.49
T-10-S	\$4.49
T-15-S	\$4.49
T-25-S	\$8.01

sold in QTY 1

Insert Screw	Price Each
MTS-184	\$2.36
MTS-2	\$2.14
MTS-255	\$2.36
MTS 25-DR	\$2.14
MTS 3-DR	\$2.14
MTS 35-DR	\$2.52
MTS 4-DR	\$2.14

sold in QTY 5

Insert Screw	Price Each
PD1-16	\$4.45
PD1-2	\$4.05
PD1-22	\$4.05
PD1-25	\$4.05
PD1-35	\$4.05
PD1-5	\$4.75
PD1-6	\$6.75

sold in QTY 5



End Mill Holders

Set Screws	Price Each
SS10-250	\$2.47
SS1/4-250	\$2.47
SS3/8-375	\$2.47
SS7/16-500	\$3.90
SS9/16-500	\$7.57
SS5/8-500	\$7.57
SS3/4-375	\$8.37
SS3/4-500	\$8.37
SS1-750	\$8.88

sold in QTY 5

Shell Mill Holders

Arbor Screws	Price Each
U5001	\$8.22
U5002	\$8.77
U5003	\$10.96
U5004	\$14.25
U5005	\$20.83
U5006	\$26.32
U5007	\$36.19
AS1/4-100	\$1.25
AS3/8-125	\$1.25
AS1/2-150	\$2.50

sold in QTY 1

ER Collet Chuck Holders

Nut	Price Each
ER-11HN	\$17.45
ER-16HN	\$18.54
ER-20HN	\$20.74
ER-25SN	\$24.03
ER-32SN	\$26.23
ER-40SN	\$30.62
ER-11MN	\$18.76
ER-16MN	\$20.12
ER-20MN	\$22.31

sold in QTY 1

Adj. Screw	Price Each
ER-11S	\$6.14
ER-16S	\$6.48
ER-20S	\$7.25
ER-25S	\$8.45
ER-32S	\$9.22
ER-40S	\$10.75

sold in QTY 1

Wrench	Price Each
ER-11MW	\$32.59
ER-16MW	\$32.59
ER-16W	\$12.08
ER-20MW	\$36.92
ER-20W	\$12.08
ER-25W	\$13.27
ER-32W	\$15.19
ER-40W	\$21.62

sold in QTY 1

Milling

Insert Screw	Price Each
SR34505	\$2.14
SR14544	\$2.14
SR34505L	\$2.36

sold in QTY 5

Insert Screw	Price Each
PM1-4	\$8.88
PM2-3	\$6.71
PM3-35	\$8.18
PM4-4	\$7.08

sold in QTY 5

SERIOUSLY HARD-HITTING INDEXABLE DRILLS

SEE PAGE 142

NEW

- ★ Diameter range (.562 - 2.125" 3xD)
- ★ Hardened high quality tool steel and electroless nickel coated for rigidity, wear resistance and reduced chip wash
- ★ New and improved 4-edge insert design to provide excellent chip control with lower spindle loads
- ★ Same insert can be used as inboard and outboard insert + No risk of mixing up inner and outer
- ★ Engineered flute design optimized for superior chip evacuation and rigidity
- ★ Able to offset and drill into slant workpieces without pre-drilling
- ★ Z-port internal coolant system for high-efficient drilling
- ★ X-offset design to adjust diameter size on turning centers, and optimize tolerances on machining centers



Surface Plate Centers



Mounted Surface Plate Center Features:

- Spring Lever Loading
- Accuracy of .0002"
- Thumb wheel locks for easy adjustment
- All parts are replaceable
- For Horizontal applications only
- A frames slide to adjust for part length
- Shaft is bolted to surface plate

Inspect:

- Run out
- Slot depths
- Face dish
- Squareness
- Groove locations

Measure:
Horizontal
or Vertical

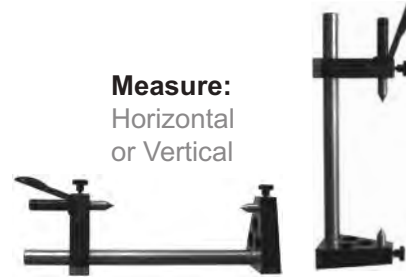

Horizontal Accuracy of .0002"
Vertical Accuracy of .0008"



SPC - 718

Designation	Capacity	Size	Grade	Price
SPC-718	6-7/8 x 16"	--	--	\$1,136.75
SPC-714	6-7/8 x 13-1/2"	12 x 18"	B	\$1,324.39
SPC-722	6-7/8 x 20"	18 x 24"	B	\$1,490.07
SPC-722A	6-7/8 x 20"	18 x 24"	A	\$1,778.65
SPC-832	12 x 32"	24 x 36"	B	\$3,022.93
SPC-832A	12 x 32"	24 x 36"	A	\$3,595.64
Oak Storage Box	SPC-718 Only			\$163.50

Designation	Description	Price
CA-01	Standard Center (Fixed)	\$44.99
CB-01	Standard Center (Fixed) - 832 Only	\$51.58
CA-02	Standard Center (Spring)	\$50.47
CB-02	Standard Center (Spring) - 832 Only	\$57.06
CA-01C	Full Carbide Tipped Center (Fixed)	\$125.09
CA-02C	Full Carbide Tipped Center (Spring)	\$131.67
CA-03	1 1/2" dia. Bull Nose Center (Fixed)	\$70.22
CB-03	1 1/2" dia. Bull Nose Center (Fixed) - 832 Only	\$76.81
CA-04	1 1/2" dia. Bull Nose Center (Spring)	\$73.52
CB-04	1 1/2" dia. Bull Nose Center (Spring) - 832 Only	\$80.10
CA-08	Lever, for spring loader	\$19.75
CA-09	Spring Cap	\$19.75
CA-10	3/4" Long Lock Knob with Brass Tip	\$8.78
CA-11	1 1/2" Long Lock Knob with Brass Tip	\$9.89
CA-12	2 1/2" Long Lock Knob with Brass Tip	\$13.17
CA-13	Internal Spring	\$4.39

Prices are subject to change without notice.

BL BEAMER LASER SYSTEMS

*Have You Left
Your Mark?*



**MADE IN
USA**



**The POWER, SOFTWARE
& CONTROLS To Mark
EVERYTHING!**

www.beamerlaser.com

For more details

G

+

Introducing

QUICK PIC QUOTING



**SAVE up to 75% OFF
the cost of new tooling!**

AFTER

- Full line of in-stock hardware
- Capable of repairing ANY manufacturer and insert type
- Experienced with HSK, KM, CAPTO, and all standard machine tapers
- All tools are brought back to original manufacturers specifications
- 4 week standard, Same day rush service available

**Save Time & Money
Involved with Shipping**

Simply take a pic of your damaged tool...

It's that easy!

- Include your Name and Contact Information
- Reference your Distributor

EMAIL as attachment: repairs@ultra-dex.com (or) **Text:** 989-233-6482

Detail Work



**WE CAN
MACHINE
ANYTHING!**

Custom Design & Build

Let us finish your vision...

in bringing your napkin sketches to real working tools



Bring Your Ideas to Reality!

Our experienced engineering staff allows us to design specialized tooling to perform multiple operations



- Milling Cutters
- Cartidges
- Trepan Tools
- Form Inserts & Blades
- Drill & Counter Bore Tools
- Chuck Jaws
- Tool Holders
- Boring Bars
- Multi-Diameter Boring Tools
- Broaching Tools
- Collets
- Modifications of Standard Tools

Our attention to cost effective machining saves you time & money

+ we maintain all necessary equipment for completing all of your manufacturing needs

+ More! SPECIALIZING IN Indexable Tooling

With Over 28 Years of experience in the design & build, and repair of indexable tooling, we offer the following quality manufacturing services:

Complete Grinding Department:
CNC, OD, ID, AD Surface Grinding + Jig and Centerless Grinding



Complete Lathe Department:
A full line of CNC Turning Centers + Manual Engine Lathes



Complete Milling Department:
A full line of CNC Machining Centers + Manual Knee Mills With Prototrak Controllers



Complete Wire EDM Department:
We offer the newest technology with our wire EDM Services specializing in Solid Carbide Form Inserts



Other Services: In-House Heat Treat, Black Oxide, and Laser Engraving



Order By:



8am - 6pm (EST)
Monday - Thursday

8am - 5pm (EST)
Friday

(810) 638-5388



24 hours a day, every day

(810) 638-4001



24 hours a day, every day

sales@ultradexusa.com



**In-Stock Items are Shipped SAME DAY
if order is placed before 3:30pm EST**

Terms: Net 30 Days from the date of invoice.

Note: Prices in the catalog are subject to change without notice.
Any photographic and/or typographic error(s) in this catalog are subject to correction.

Standard Shipping Method (UPS Ground)

Overnight, 2 Day or 3 Day are alternate services available upon request

Claim on Damaged (or) Lost Shipment:

Any claims for discrepancies in shipments must be made within 2 business days of receipt of merchandise. Any damages on the exterior of the package must be claimed through the commercial carrier. UPS 1-800-742-5877. Keep damaged goods and containers until advised to dispose. Inform us so we can re-ship your merchandise and place a claim.

Individual items weighing over 150lbs do not apply as they will be shipped via UPS Freight, other restrictions may apply. Truck Shipments: We are not responsible for items damaged or lost by motor freight carriers. Check your order carefully upon arrival. All damages or shortages must be noted on the delivery receipt. Failure to note damages will result in a later damage claim being denied.



UPS Ground transit times are indicated on the map below.

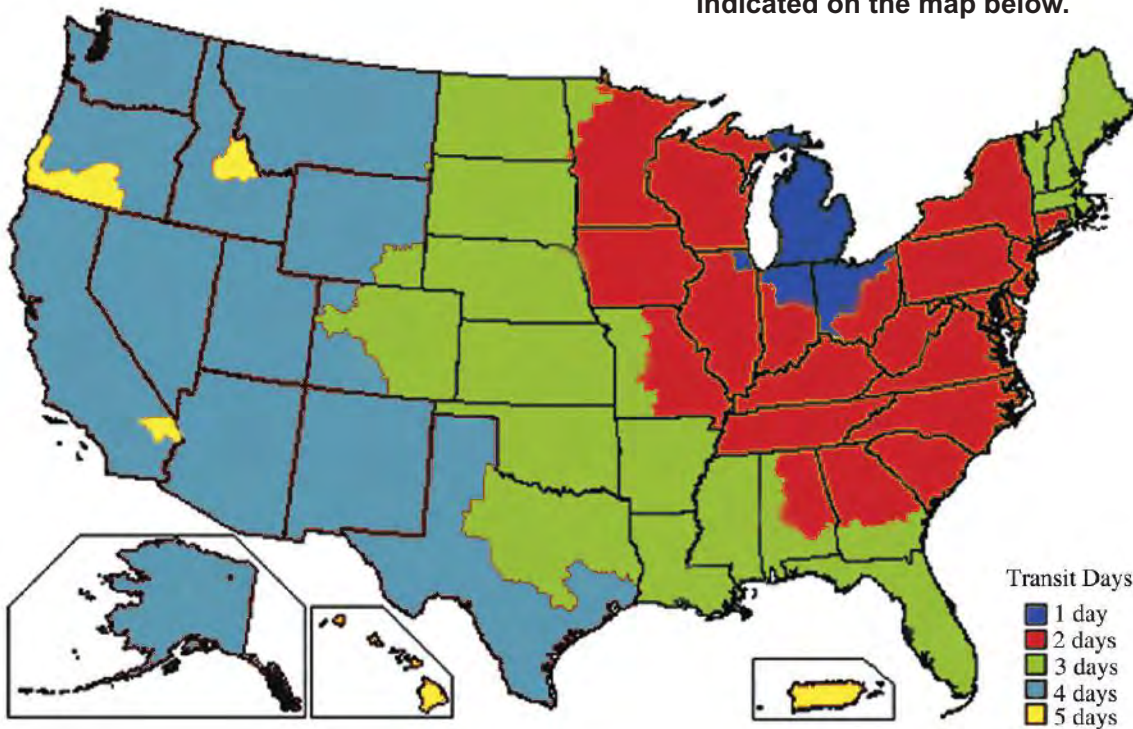

Return Policy

Special Orders can not be returned or cancelled. Items to be returned, have to be within 60 days of purchase and must be approved by Ultra-Dex and assigned a RGA number. Once a RGA number has been assigned, the merchandise must be returned within 4 weeks to Ultra-Dex. Items will be subject to a 15% restocking fee.

All Items are subject to Inspection



Our Affiliates:



7144 Sheridan Rd • Flushing, MI 48433
Call: 810-638-5388 • Fax: 810-638-4001

sales@ULTRADEXUSA.COM

COMMITTED TO:

- ✓ Highest Quality
- ✓ Lowest Price
- ✓ Best Service
- ✓ USA Made

Distributed By:

2017 / 2018 CATALOG

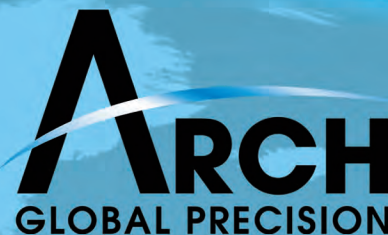

Together we can help you!

We are a family of American Made products and services guided by the goal to be your ultimate source for precision metalworking tools. The same strong and complimentary relationships between our companies exist with our customers. Working together, we provide the best products at the best prices with superior customer service.

Discover ARCH at www.archglobalprecision.com