



VERMONT TAP & DIE



TOOLING & MACHINERY

COMPLETE METALWORKING SOLUTIONS

(800) 991-4225

www.ahbinc.com

ISO Certified

customerservice@ahbinc.com

GREENFIELD THREADING



Taps And Dies



a product of



Greenfield Industries' tradition of excellence has stood the test of time. Since 1834 the mission remains the same, provide the highest quality cutting tools at the greatest value possible. As part of the TDC Group, that mission is easily fulfilled with direct access to the finest raw materials from our own mines. These materials are then refined in our own mills and made into the raw material used in manufacturing Greenfield's unparalleled drills, end mills, taps, dies and other specially manufactured tools.

This catalog showcases the range of taps available along with machining parameters. Various coatings are available for our taps designed for specific applications.

This catalog is also available to download at our website, www.gfii.com. There you will find catalogs and supplements to our other globally recognized brands.

For more information, contact our Customer Service at 800-348-2885 or by email at standard.distributors@gfii.com, or visit the our web site, www.gfii.com.

Greenfield is moving from 302 to 302A tap styles beginning August 1st, 2015. Look for this rolling change in your orders and continue to enjoy the superior quality and reliability you have always known in Greenfield!

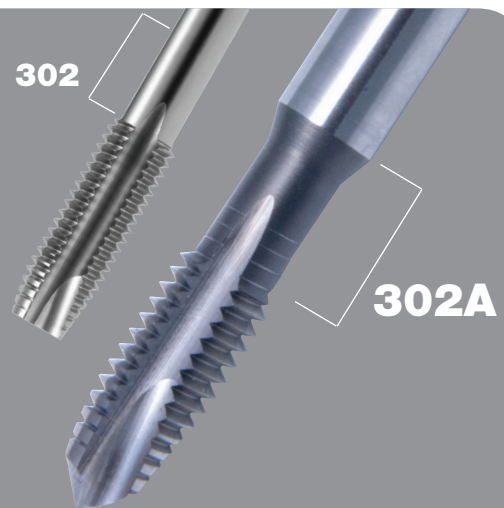



VERMONT TAP & DIE



We are proud to announce the combination of our Greenfield Threading brand with Vermont Tap & Die. Greenfield Industries' centuries old **dedication** to our customers has brought these two products lines together, creating a **commitment** of high-quality taps and dies. This provides you, our customer, the confidence that you are receiving the quality and reliability you expect from the

Greenfield family of tools.

All taps in the Greenfield Threading line are designed to machine a broad range of materials and are manufactured out of premium high speed steel.

In the ever-changing demands of industry and technology, we are continuously researching and finding ways to provide our customers with **all of your cutting tool needs.**





Reference Information

Index by Style Number

300	37
330	37
335	38
377	28
380	34
382	30
383	32
1381	36
1382	36
1383	34
1384	34
1385	34
1386	34
1750	32
1790	32
6382	30 32
A1	36
ELPTT	27
FTGP	24
HTGP	7
HTGPL	10
HTHM	6
PTS	27
PTT	25
PTTI	26
SFGP	22
SFGP+5	23
SFHD	21
SFS	20
SPAR	18
SPGP	12
SPGP+5	15
SPGPX	16
SPGPX+5	16
SPHD	19
SPLS	17
SPS	11

Metal Cutting Safety

Information to read before using Greenfield Threading products

Modern metalcutting operations involve high energy, high spindle or cutter speeds, and high temperatures and cutting forces. Hot, flying chips may be projected from the workpiece during metalcutting. Although advanced cutting tool materials are designed and manufactured to withstand the high cutting forces and temperatures that normally occur in these operations, they are susceptible to fragmenting in service, particularly if they are subjected to over-stress, severe impact, or otherwise abused. Therefore, precautions should be taken to adequately protect workers, observers, and equipment against hot, flying chips, fragmented cutting tools, broken workpieces, or other similar projectiles. Machines should be fully guarded and personal protective equipment should be used at all times.

When grinding advanced cutting tool materials, a suitable means for collection and disposal of dust, mist, or sludge should be provided. Overexposure to dust or mist containing metallic particles can be hazardous to health, particularly if exposure continues over an extended period of time, and may cause eye, skin, and mucous membrane irritation and temporary or permanent respiratory disease. Certain existing pulmonary and skin conditions may be aggravated by exposure to dust or mist. Adequate ventilation, respiratory protection, and eye protection should be provided when grinding, and workers should avoid breathing of and prolonged skin contact with dust or mist.

General Industry Safety and Health Regulations, Part 1910, U.S. Department of Labor, published in Title 29 of the Code of Federal Regulations should be consulted. Obtain a copy from Greenfield and read the applicable Material Safety Data Sheet before grinding.

Cutting tools are only one part of the worker /machine-tool system. Many variables exist in machining operations, including the metal removal rate; the workpiece size, shape, strength and rigidity; the chucking and fixturing; the load carrying capability of centers; the cutter and spindle speed and torque limitations; the holder and boring bar overhang; the available power; and the condition of the tooling and the machine. A safe metalcutting operation must take all of these variables, and others, into consideration.

Greenfield has no control over the end use of its products or the environment into which those products are placed. Greenfield urges that its customers adhere to the recommended standards of use of their metalcutting machines and tools, and that they follow procedures that ensure safe metalcutting operations. The information included throughout this catalog under the heading "Technical Data" and other recommendations on machining practices referred to herein are only advisory in nature and do not constitute representations or warranties and are not necessarily appropriate for any particular work environment or application.

TIN - TiCN

Recommendations

Surface Treatments for Taps

	Recommended Applications	Precautions
TiN (Titanium Nitride)	For ferrous and non-metallic materials: free-machining steels and irons, high tensile steels, tough machining steels, plastics, hard rubber, and fiber. The hard, smooth finish increases tool life, improves finish, and allows higher speeds.	Use with caution in titanium, titanium alloys, and aluminum die casting due to tendency to gall.
TiCN (Titanium Carbonitride)	For ferrous and non-ferrous materials: cast iron, aluminum, stainless steel, brass, abrasive materials, high-silicon automotive aluminum, glass-filled plastics, and composites. The hard, smooth finish increases tool life and improves finish.	Use with caution in titanium and titanium alloys due to tendency to gall.



Style Number	Description	Page
Machine Taps for Through or Blind Holes		
HTHM	CNC Straight Flute Hand Tap for Cast Iron and Harder Materials.	6
HTGP	General Purpose Straight Flute Hand Tap	7-9
HTGP Sets	General Purpose Straight Flute Hand Tap Sets	14
HTGPL	General Purpose Left-Hand Straight Flute Hand Tap	10
Spiral Point Taps for Through Holes		
SPS	CNC Spiral Point Tap for Steels and Stainless Steel	11
SPGP	General Purpose Spiral Point Tap	12-13
SPGP Sets	General Purpose Spiral Point Tap Set	14
NEW SPGP+5	General Purpose Spiral Point <i>plus 5</i> Tap	15
SPGPX	6" Extended Length General Purpose Spiral Point Tap	16
NEW SPGPX+5	6" Extended Length General Purpose Spiral Point <i>plus 5</i> Tap	16
SPLS	Low Shear General Purpose Spiral Point Tap	17
SPAR	Spiral Point Tap for Aerospace Fasteners	18
SPHD	CNC Heavy-Duty Spiral Point	19
Spiral Flute Taps for Blind Holes		
SFS	CNC Spiral Flute Tap for Steels and Stainless Steel.	20
SFHD	CNC Heavy-Duty Spiral Flute Tap	21
SFGP	High-Spiral General Purpose Spiral Flute Tap	22
NEW SFGP+5	High-Spiral General Purpose Spiral Flute <i>plus 5</i> Tap	23
Thread Forming Taps		
FTGP	General Purpose Thread Forming Tap	24
Pipe Taps		
PTT	NPT/NPTF Medium Hook Taper Pipe Tap	25
PTTI	NPT/NPTF Medium Hook Interrupted Thread Taper Pipe Tap	26
PTS	NPS/NPSM/NPSC and NPSF Medium Hook Straight Pipe	27
ELPTT	CNC Extra Length Medium Hook Taper Pipe Tap with Machine Tap Shank	27
Dies		
377	Hexagon Rethreading Dies, Carbon Steel	28-29
382, 6382	Round Adjustable Dies, Carbon Steel and High-Speed Steel	30-32
1750, 1790	Die Stocks for Round Adjustable Dies	32
T&RAD Sets	Tap & Round Adjustable Die Set	33
1386	Little Giant® Two-Piece Die Systems	34-35
1381, 1382, A1	Accessories for Little Giant® Two-Piece Dies	36
300, 330	Tap Wrenches	37
335	Screw Extractors	38
Sets		
NEW	All available / Cost Saving Sets	55-56
Index by Order Number		
	Full index	60-65
Technical Information		
	Tap / Drill Recommendations	4
	Pipe Tap Recommendations	25
	Tapping Speeds	39-41
	Tap Nomenclature	42-43
	Standard Tap Marking System	44
	302 / 302A / 311 Standard Tap Dimensions	45-47
	Thread Limits – Taper Pipe Taps – Ground Thread	47
	Thread Limits – Fractional Taps – Ground Thread	48
	Thread Limits – Machine Screw Taps – Ground Thread	49
	Thread Limits – Metric Taps – Ground Thread	50
	Basic Thread Dimensions – Fractional Sizes	51-52
	Basic Thread Dimensions – Machine Screw Sizes	53
	Quick Shipment Program – Special Taps – Ground Thread	54
	Decimal Equivalent Chart	inside back cover





Color Code: Machine Screw, Fractional, and Metric Sizes

Tap Size & Pitch		Cutting Taps		Forming Taps		Tap Size & Pitch		Cutting Taps		Forming Taps	
		drill size	decimal inch	drill size	decimal inch			drill size	decimal inch	drill size	decimal inch
inch	metric					inch	metric				
0-80		3/64	.0469	54	.0550		M12 x 1,75	10,2	.4016	11,2	.4409
	M1,6 x 0,35	1,25	.0492	1,45	.0571		M12 x 1,25	10,8	.4252	11,5	.4528
	M1,8 x 0,35	1,45	.0571	1,65	.0650	1/2-13		27/64	.4219	15/32	.4688
1-64		53	.0595	51	.0670	1/2-20		29/64	.4531	12,25	.4823
1-72		53	.0595	51	.0670		M14 x 2	12,0	.4724	33/64	.5156
	M2 x 0,4	1,6	.0630	1,8	.0709	9/16-12		31/64	.4844	17/32	.5312
2-56		50	.0700	5/64	.0781	9/16-18		33/64	.5156	13,5	.5315
2-64		50	.0700	47	.0785	5/8-11		17/32	.5312	14,75	.5807
	M2,2 x 0,45	1,75	.0689	2,0	.0787	5/8-18		37/64	.5781	15,25	.6004
	M2,5 x 0,45	2,05	.0807	2,3	.0906		M16 x 2	14,0	.5512	19/32	.5938
3-48		47	.0785	43	.0890		M16 x 1,5	14,5	.5709	15,25	.6004
3-56		46	.0810	2,3	.0906		M18 x 2,5	15,5	.6102	39/64	.6094
4-40		43	.0890	38	.1015		M18 x 1,5	16,5	.6496	17,25	.6791
4-48		42	.0935	2,6	.1024	3/4-10		21/32	.6562	45/64	.7031
	M3 x 0,5	2,5	.0984	7/64	.1094	3/4-16		11/16	.6875	23/32	.7188
5-40		38	.1015	33	.1130		M20 x 2,5	17,5	.6890		
5-44		37	.1040	2,9	.1142		M20 x 1,5	18,5	.7283		
	M3,5 x 0,6	2,9	.1142	3,2	.1260		M22 x 2,5	19,5	.7677		
6-32		36	.1065	1/8	.1250		M22 x 1,5	20,5	.8071		
6-40		33	.1130	3,25	.1280	7/8-9		49/64	.7656		
	M4 x 0,7	3,3	.1299	3,7	.1457	7/8-14		13/16	.8125		
8-32		29	.1360	25	.1495		M24 x 3	21,0	.8268		
8-36		29	.1360	24	.1520		M24 x 2	22,0	.8661		
	M4,5 x 0,75	3,7	.1457	4,1	.1614	1-8		7/8	.8750		
10-24		26	.1470	11/64	.1719	1-12		59/64	.9219		
10-32		21	.1590	16	.1770		M27 x 3	24,0	.9449		
	M5 x 0,8	4,2	.1654	14	.1820		M27 x 2	25,0	.9843		
12-24		16	.1770	8	.1990	1-1/8-7		63/64	.9844		
12-28		15	.1800	7	.2010	1-1/8-12		1-3/64	1.0469		
	M6 x 1	5,0	.1969	7/32	.2188		M30 x 3,5	26,5	1.0433		
1/4-20		7	.2010	1	.2280		M30 x 2	28,0	1.1024		
1/4-28		3	.2130	15/64	.2340	1-1/4-7		1-7/64	1.1094		
	M7 x 1	6,0	.2362	F	.2570	1-1/4-12		1-11/64	1.1719		
5/16-18		F	.2570	L	.2900		M33 x 3,5	29,5	1.1614		
5/16-24		I	.2720	M	.2950		M33 x 2	31,0	1.2205		
	M8 x 1,25	6,7	.2638	7,4	.2913	1-3/8-6		1-7/32	1.2188		
	M8 x 1	7,0	.2756	19/64	.2969	1-3/8-12		1-19/64	1.2969		
3/8-16		5/16	.3125	S	.3480		M36 x 4	32,0	1.2598		
3/8-24		Q	.3320	T	.3580		M36 x 3	33,0	1.2992		
	M10 x 1,5	8,5	.3346	U	.3680	1-1/2-6		1-11/32	1.3438		
	M10 x 1,25	8,7	.3425	9,4	.3701	1-1/2-12		1-27/64	1.4219		
7/16-14		U	.3680	Y	.4040		M39 x 4	35,0	1.3780		
7/16-20		25/64	.3906	Z	.4130		M39 x 3	36,0	1.4173		

**FORM
TAPS
NOT
AVAILABLE
IN
THESE
SIZES**

✓ = BEST Performance * Also Suitable

Icon	Material	Hardness	Surface Treatment Suggestion		
			TiN	TiCN	TiAlN
M	Austenitic Stainless Steel	< 35 HRc		*	✓
	Martensitic Stainless Steel	< 35 HRc		*	✓
	Martensitic Stainless Steel	>= 35 HRc			✓
	PH Stainless Steel	< 35 HRc		*	✓
	PH Stainless Steel	<= 35 HRc		*	✓
S	Ni, Co, Fe Based Super Alloys				✓
	Titanium				✓
P	Alloy Steel	16-23 HRc	*	*	✓
	Alloy Steel	23-38 HRc	*	*	✓
	Alloy Steel	> 38 HRc		*	✓
	Carbon Steel	16-23 HRc	*	*	✓
	Carbon Steel	23-38 HRc	*	*	✓
	Carbon Steel	> 38 HRc		*	✓
	Low Carbon Steel	13-23 HRc	*	*	✓
	Low Carbon Steel	23-38 HRc	*	*	✓
	Low Carbon Steel	> 38 HRc		*	✓
K	Gray Cast Iron	18-22 HRc		*	✓
	Nodular Cast Iron	22-32 HRc	*	✓	
N	Aluminum	< 10% Si	*	✓	
	Aluminum	> 10% Si	*	✓	
H	Hardened Steel	>45 HRc		*	✓

Surface Treatment

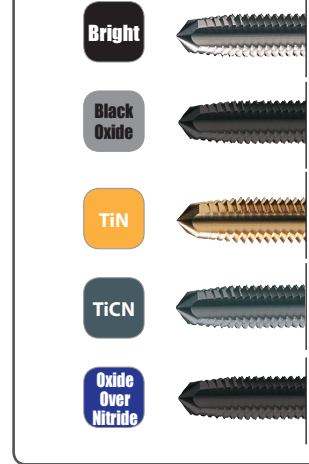

Additional treatments available upon request.

Base Material

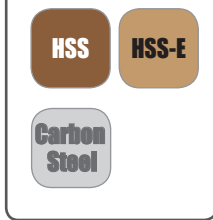

Applications

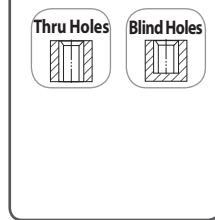

Geometry

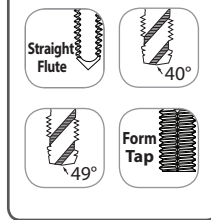

Chamfers

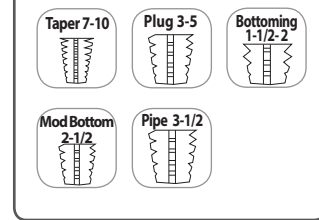

Styles

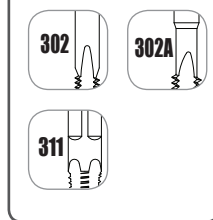

Pipe



CNC Straight Flute
Cast Iron and Harder Materials

Machine Tap for Through or Blind Holes



Style: **HTHM**

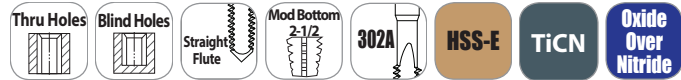

Note
Tapping speeds -
see page 39-41.

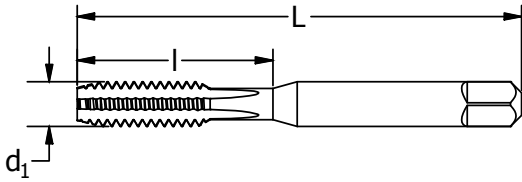

diameter & pitch	thread form	d ₁ in	number of flutes	H-limit	L in	I in	order number	
							Oxide over Nitride	TiCN
10-24	UNC	.1900	4	H3	2.375	.875	330259	—
10-32	UNF	.1900	4	H3	2.375	.875	330260	—
1/4-20	UNC	.2500	4	H3	2.500	1.000	330261	300216
1/4-20	UNC	.2500	4	H5	2.500	1.000	330278	—
1/4-28	UNF	.2500	4	H3	2.500	1.000	330262	—
5/16-18	UNC	.3125	4	H3	2.719	1.125	330263	300217
5/16-18	UNC	.3125	4	H5	2.719	1.125	330279	—
5/16-24	UNF	.3125	4	H3	2.719	1.125	330264	—
3/8-16	UNC	.3750	4	H3	2.938	1.250	330265	—
3/8-16	UNC	.3750	4	H5	2.938	1.250	330280	—
7/16-14	UNC	.4375	4	H3	3.156	1.438	330267	—
7/16-14	UNC	.4375	4	H5	3.156	1.438	330281	—
1/2-13	UNC	.5000	4	H3	3.375	1.656	330269	—
1/2-13	UNC	.5000	4	H5	3.375	1.656	330283	—
1/2-20	UNF	.5000	4	H5	3.375	1.656	330284	—
3/4-16	UNF	.7500	6	H5	4.250	2.000	330290	—

Metric - CNC Straight Flute
Cast Iron and Harder Materials

Style: **HTHM**

diameter & pitch	d ₁ mm	number of flutes	D-limit	L in	I in	order number	
						Oxide over Nitride	TiCN
M5 x 0.8	5.00	4	D4	2.375	.875	330291	—
M6 x 1	6.00	4	D5	2.500	1.000	330292	—
M8 x 1.25	8.00	4	D5	2.719	1.125	330293	—
M10 x 1.5	10.00	4	D6	2.938	1.250	330294	300218
M12 x 1.25	12.00	4	D6	3.375	1.656	330295	—
M12 x 1.75	12.00	4	D6	3.375	1.656	330296	300219
M14 x 1.5	14.00	4	D6	3.594	1.656	330298	—



Machine Tap for Through or Blind Holes

Style: **HTGP**

General Purpose
Straight Flute

P **N**

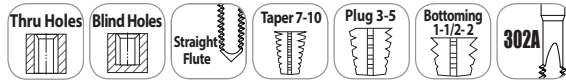

HSS **Bright** **TiN** **TiCN** **Black Oxide**

Note

Tapping speeds - see page 39-41.

Set consists of one each taper, plug, bottoming chamfer.

* #0 - #3 and 7/8" and larger: 302 blank style.

Sets available - see page 14.

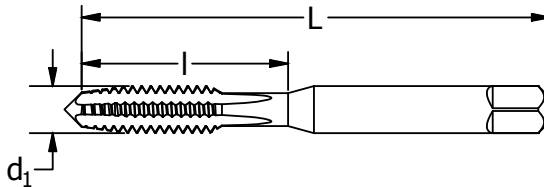

order number

diameter & pitch	thrd form	d ₁ in	no. flts	H-limit	L in	l in	taper		plug				bottoming		set	
							Bright	TiN	Bright	Oxide	TiN	TiCN	Bright	TiN	Bright	TiN
*0-80	UNF	.0600	2	H1	1.625	0.313	330004	—	330016	—	—	—	330066	—	—	—
*0-80	UNF	.0600	2	H2	1.625	0.313	—	—	300041	—	300047	—	300058	300054	—	—
*1-64	UNC	.0730	2	H1	1.688	0.375	330005	—	330017	—	—	—	330067	—	—	—
*1-72	UNF	.0730	2	H1	1.688	0.375	330006	—	300165	—	—	—	330068	—	—	—
*2-56	UNC	.0860	2	H2	1.750	0.438	—	—	330018	—	—	—	330069	—	—	—
*2-56	UNC	.0860	3	H1	1.750	0.438	330007	—	330019	—	—	—	300264	—	—	—
*2-56	UNC	.0860	3	H2	1.750	0.438	300272	300278	300280	—	300286	330035	300299	300294	341573	174511
*2-64	UNF	.0860	3	H2	1.750	0.438	330008	—	330020	—	—	—	330070	—	—	—
*3-48	UNC	.0990	3	H2	1.813	0.500	300512	339044	300520	—	300526	—	300538	339045	341599	355802
*3-56	UNF	.0990	3	H2	1.813	0.500	300637	339046	300645	—	339047	—	300652	339048	341607	355803
4-40	UNC	.1120	2	H1	1.875	0.563	—	—	330021	—	—	—	—	—	—	—
4-40	UNC	.1120	2	H2	1.875	0.563	—	—	300769	—	—	—	300778	—	—	—
4-40	UNC	.1120	3	H2	1.875	0.563	300819	300815	300827	—	300823	330036	300835	300831	341623	174530
4-48	UNF	.1120	3	H2	1.875	0.563	300934	300930	300942	—	300948	—	300959	300955	341649	174531
5-40	UNC	.1250	2	H2	1.938	0.625	—	—	301007	—	—	—	301015	—	—	—
5-40	UNC	.1250	3	H2	1.938	0.625	301056	301052	301064	—	301060	—	301072	301078	341664	174536
5-44	UNF	.1250	3	H2	1.938	0.625	301171	301177	301189	—	—	—	301197	301193	341672	174537
6-32	UNC	.1380	2	H2	2.000	0.688	—	—	301247	—	—	—	301254	—	—	—
6-32	UNC	.1380	2	H3	2.000	0.688	—	—	301270	—	—	—	301288	—	—	—
6-32	UNC	.1380	3	H2	2.000	0.688	301320	—	301338	—	330062	—	301346	—	341698	—
6-32	UNC	.1380	3	H3	2.000	0.688	301353	301359	301361	330037	301367	330038	301379	301375	341706	174538
6-40	UNF	.1380	3	H2	2.000	0.688	301478	301474	301486	—	301482	—	301494	301490	341714	174539
8-32	UNC	.1640	2	H1	2.125	0.750	—	—	330022	—	—	—	—	—	—	—
8-32	UNC	.1640	2	H2	2.125	0.750	—	—	301544	—	—	—	301551	—	—	—
8-32	UNC	.1640	2	H3	2.125	0.750	—	—	301577	—	—	—	301585	—	—	—
8-32	UNC	.1640	3	H2	2.125	0.750	—	—	301635	—	—	—	301643	—	—	—
8-32	UNC	.1640	3	H3	2.125	0.750	—	—	301668	—	—	—	301676	—	—	—
8-32	UNC	.1640	4	H2	2.125	0.750	301718	—	301726	—	330063	—	301734	—	341730	—
8-32	UNC	.1640	4	H3	2.125	0.750	301742	301748	301759	330039	301755	330040	301767	301763	341748	174544
8-36	UNF	.1640	4	H2	2.125	0.750	301924	301920	301933	—	301938	—	301940	301946	341755	174545

continued on next page

**General Purpose
Straight Flute**

Machine Tap for Through or Blind Holes

Style: HTGP (continued)



Machine Taps

Spiral Point Taps

Spiral Flute Taps

Thread Forming Taps

Pipe Taps

Dies

Technical Info

Sets

Index

diameter & pitch	thrd form	d ₁ in	no. flts	H-limit	L in	I in	order number									
							taper		plug				bottoming		set	
							Bright	TiN	Bright	Oxide	TiN	TiCN	Bright	TiN	Bright	TiN
10-24	UNC	.1900	2	H2	2.375	0.875	—	—	301999	—	—	—	—	—	—	—
10-24	UNC	.1900	2	H3	2.375	0.875	—	—	302021	—	—	—	302039	—	—	—
10-24	UNC	.1900	3	H3	2.375	0.875	—	—	302112	—	—	—	302120	—	—	—
10-24	UNC	.1900	4	H2	2.375	0.875	302161	—	302179	—	—	—	302187	—	341771	—
10-24	UNC	.1900	4	H3	2.375	0.875	302195	302191	302203	330041	302209	330042	302211	302217	341789	174508
10-32	UNF	.1900	2	H2	2.375	0.875	—	—	302260	—	—	—	302278	—	—	—
10-32	UNF	.1900	2	H3	2.375	0.875	—	—	302294	—	—	—	302302	—	—	—
10-32	UNF	.1900	3	H3	2.375	0.875	—	—	302385	—	330045	—	302393	—	—	—
10-32	UNF	.1900	4	H2	2.375	0.875	302435	—	302443	—	—	—	302450	—	341805	—
10-32	UNF	.1900	4	H3	2.375	0.875	302468	302464	302476	330043	302472	330044	302484	302480	341813	174509
12-24	UNC	.2160	4	H3	2.375	0.938	302526	302522	302534	—	302530	—	302542	302548	341821	174510
12-28	UNF	.2160	4	H3	2.375	0.938	302583	—	302591	—	330046	—	302609	330079	341839	—
1/4-20	UNC	.2500	2	H3	2.500	1.000	—	—	326004	—	—	—	326012	—	—	—
1/4-20	UNC	.2500	3	H2	2.500	1.000	—	—	330024	—	—	—	—	—	—	—
1/4-20	UNC	.2500	3	H3	2.500	1.000	—	—	326160	—	—	—	326178	—	—	—
1/4-20	UNC	.2500	3	H5	2.500	1.000	—	—	330025	—	—	—	—	—	—	—
1/4-20	UNC	.2500	4	H1	2.500	1.000	305008	—	305016	—	—	—	305024	—	330080	—
1/4-20	UNC	.2500	4	H2	2.500	1.000	305033	—	305040	—	—	—	305057	—	342514	—
1/4-20	UNC	.2500	4	H3	2.500	1.000	305065	305061	305073	330047	305079	330048	305081	305087	342522	174506
1/4-20	UNC	.2500	4	H5	2.500	1.000	—	—	305107	—	305103	—	305115	305111	—	—
1/4-20	UNC	.2500	4	H11	2.500	1.000	—	—	330026	—	—	—	—	—	—	—
1/4-28	UNF	.2500	2	H3	2.500	1.000	—	—	326087	—	—	—	326095	—	—	—
1/4-28	UNF	.2500	3	H3	2.500	1.000	—	—	326244	—	326240	—	326251	—	—	—
1/4-28	UNF	.2500	4	H2	2.500	1.000	—	—	305198	—	—	—	305206	305209	—	—
1/4-28	UNF	.2500	4	H3	2.500	1.000	305214	305210	305222	330049	305228	330051	305230	305236	342530	174507
5/16-18	UNC	.3125	2	H3	2.719	1.125	—	—	326285	—	—	—	326293	—	—	—
5/16-18	UNC	.3125	3	H3	2.719	1.125	—	—	326368	—	—	—	326376	—	—	—
5/16-18	UNC	.3125	4	H2	2.719	1.125	—	—	305370	—	—	—	305388	—	—	—
5/16-18	UNC	.3125	4	H3	2.719	1.125	305396	305392	305404	330052	305403	330053	305412	305418	342555	174532
5/16-18	UNC	.3125	4	H5	2.719	1.125	—	—	305438	—	—	—	305446	—	—	—
5/16-18	UNC	.3125	4	H11	2.719	1.125	—	—	330027	—	—	—	—	—	—	—
5/16-24	UNF	.3125	3	H3	2.719	1.125	—	—	326442	—	—	—	326459	—	—	—
5/16-24	UNF	.3125	4	H3	2.719	1.125	305511	305517	305529	—	305525	—	305537	305533	342563	174533
5/16-24	UNF	.3125	4	H4	2.719	1.125	—	—	305552	—	—	—	305560	—	—	—
3/8-16	UNC	.3750	3	H3	2.938	1.250	—	—	326525	—	326521	—	326533	326539	—	—
3/8-16	UNC	.3750	4	H2	2.938	1.250	—	—	305677	—	—	—	305685	—	—	—
3/8-16	UNC	.3750	4	H3	2.938	1.250	305693	305699	305701	330055	305707	330057	305719	305715	342589	174528
3/8-16	UNC	.3750	4	H5	2.938	1.250	—	—	305735	—	305731	—	305743	305749	—	—
3/8-24	UNF	.3750	3	H3	2.938	1.250	—	—	326608	—	—	—	326616	—	—	—
3/8-24	UNF	.3750	4	H3	2.938	1.250	305818	305814	305826	330058	305822	—	305834	305830	342597	174529
7/16-14	UNC	.4375	4	H3	3.156	1.438	305990	305996	306006	—	306002	—	306014	306010	342605	174540
7/16-14	UNC	.4375	4	H5	3.156	1.438	—	—	306030	—	306036	—	306048	306044	—	—
7/16-20	UNF	.4375	4	H3	3.156	1.438	306113	306119	306121	—	306127	—	306139	306135	342613	174541
7/16-20	UNF	.4375	4	H5	3.156	1.438	—	—	306154	—	306157	—	306162	306165	—	—
1/2-13	UNC	.5000	3	H3	3.375	1.656	—	—	326681	—	—	—	326699	—	—	—
1/2-13	UNC	.5000	4	H1	3.375	1.656	—	—	306246	—	—	—	—	—	—	—
1/2-13	UNC	.5000	4	H3	3.375	1.656	306295	306291	306303	330059	306309	330060	306311	306317	342621	174504
1/2-13	UNC	.5000	4	H5	3.375	1.656	—	—	306337	—	—	—	306345	306341	—	—
1/2-20	UNF	.5000	3	H3	3.375	1.656	—	—	326707	—	—	—	—	—	—	—
1/2-20	UNF	.5000	4	H3	3.375	1.656	306444	306440	306451	—	306457	—	306469	306465	342639	174505
1/2-20	UNF	.5000	4	H5	3.375	1.656	—	—	306485	—	—	—	—	—	—	—
9/16-12	UNC	.5625	4	H3	3.594	1.656	306626	306622	306634	—	306630	—	306642	306648	342647	174546
9/16-18	UNF	.5625	4	H3	3.594	1.656	306741	—	306758	—	306754	—	306766	306762	342654	—

continued on next page



Machine Tap for Through or Blind Holes

Style: **HTGP** (continued)

General Purpose
Straight Flute

diameter & pitch	thrd form	d ₁ in	no. flts	H-limit	L in	I in	order number									
							taper		plug		bottoming		set			
							Bright	TiN	Bright	Oxide	TiN	TiCN	Bright	TiN	Bright	TiN
5/8-11	UNC	.6250	4	H3	3.813	1.813	306923	306929	306931	330061	306937	—	306949	306945	342662	174534
5/8-11	UNC	.6250	4	H5	3.813	1.813	—	—	306964	—	—	—	306972	306978	—	—
5/8-18	UNF	.6250	4	H3	3.813	1.813	307046	307042	307053	—	307059	—	307061	307067	342670	174535
11/16-11	UNS	.6875	4	H3	4.031	1.813	307160	—	307178	—	—	—	307186	—	342688	—
11/16-16	UNS	.6875	4	H3	4.031	1.813	307194	—	307202	—	—	—	307210	—	342696	—
3/4-10	UNC	.7500	4	H3	4.250	2.000	307343	307349	307350	—	307356	—	307368	307364	342704	174513
3/4-16	UNF	.7500	4	H3	4.250	2.000	307467	307463	307475	—	307471	—	307483	307489	342712	174514
*7/8-9	UNC	.8750	4	H4	4.468	2.219	307707	307703	307715	—	307711	—	307723	307729	342720	174543
*7/8-14	UNF	.8750	4	H4	4.468	2.219	307822	307828	307830	—	307836	—	307848	307844	342738	174542
*1-8	UNC	1.0000	4	H4	5.125	2.500	308069	308065	308077	—	308073	—	308085	308081	342746	174503
*1-12	UNF	1.0000	4	H4	5.125	2.500	308184	—	308192	—	330065	—	308200	—	—	—
*1-14	UNS	1.0000	4	H4	5.125	2.500	308275	—	308283	—	—	—	308291	—	342761	—
*1-1/8-7	UNC	1.1250	4	H4	5.438	2.563	308424	—	308432	—	—	—	308440	—	—	—
*1-1/8-12	UNF	1.1250	4	H4	5.438	2.563	308457	—	308465	—	—	—	308473	—	—	—
*1-1/4-7	UNC	1.2500	4	H4	5.750	2.563	308549	—	308556	—	—	—	308564	—	—	—
*1-1/4-12	UNF	1.2500	6	H4	5.750	2.563	308572	—	308580	—	—	—	308598	—	—	—
*1-3/8-6	UNC	1.3750	4	H4	6.063	3.000	—	—	308671	—	—	—	—	—	—	—
*1-3/8-12	UNF	1.3750	6	H4	6.063	3.000	—	—	308705	—	—	—	308713	—	—	—
*1-1/2-6	UNC	1.5000	4	H4	6.375	3.000	308788	—	308796	—	—	—	308804	—	—	—
*1-1/2-12	UNF	1.5000	6	H4	6.375	3.000	308812	—	308820	—	—	—	308838	—	—	—

Style: **HTGP**

Metric - General Purpose
Straight Flute

diameter & pitch	d ₁ mm	no. flts	D-limit	L in	I in	order number							
						taper		plug		bottoming		set	
						Bright	TiN	Bright	TiN	Bright	TiN	Bright	TiN
M1.6 x 0.35	1.60	2	D3	1.625	.313	—	—	328018	—	330071	—	—	—
M2 x 0.4	2.00	3	D3	1.750	.438	328067	328684	328075	328685	328083	328686	174516	343502
M2.5 x 0.45	2.50	3	D3	1.813	.500	328158	328688	328166	328689	328174	328690	174559	343503
M3 x 0.5	3.00	3	D3	1.938	.625	328182	328691	328190	328188	328208	328205	174519	343504
M3.5 x 0.6	3.50	3	D4	2.000	.688	328240	—	328257	328693	328265	—	174560	—
M4 x 0.7	4.00	4	D4	2.125	.750	328273	328695	328281	328287	328299	328295	174520	343506
M4.5 x 0.75	4.50	4	D4	2.375	.875	328331	—	328349	328697	328356	—	174561	—
M5 x 0.8	5.00	4	D4	2.375	.875	328364	328698	328372	328378	328380	328386	174521	343508
M6 x 1.0	6.00	4	D5	2.500	1.000	328422	328699	328430	328436	328448	328444	174522	343509
M7 x 1.0	7.00	4	D5	2.719	1.125	330009	—	328497	—	330072	—	—	—
M8 x 1.0	8.00	4	D5	2.719	1.125	330010	—	330028	—	330073	—	—	—
M8 x 1.25	8.00	4	D5	2.719	1.125	328547	328703	328554	328550	328562	328568	174524	343511
M10 x 1.25	10.00	4	D5	2.938	1.250	330011	—	330029	—	330074	—	—	—
M10 x 1.5	10.00	4	D6	2.938	1.250	328604	328704	328612	328618	328620	328626	174548	343512
M12 x 1.25	12.00	4	D5	3.375	1.656	330012	—	330030	—	330075	—	—	—
M12 x 1.75	12.00	4	D6	3.375	1.656	328661	328705	328679	328675	328687	328683	174549	343513
M14 x 1.5	14.00	4	D6	3.594	1.656	330013	—	330031	—	330076	—	—	—
M14 x 2.0	14.00	4	D7	3.594	1.656	328752	328706	328760	328707	328778	328708	174550	343514
M16 x 1.5	16.00	4	D6	3.813	1.813	330014	—	330032	—	330077	—	—	—
M16 x 2.0	16.00	4	D7	3.813	1.813	328810	328709	328828	328710	328836	328711	174551	343515
M18 x 1.5	18.00	4	D6	4.031	1.813	330015	—	330033	—	—	—	—	—
M18 x 2.5	18.00	4	D7	4.031	1.813	328877	—	328885	—	328893	—	174552	—
M20 x 1.5	20.00	4	D6	4.469	2.000	—	—	330034	—	330078	—	—	—
M20 x 2.5	20.00	4	D7	4.469	2.000	328935	—	328943	328716	328950	328717	174553	—
M24 x 3.0	24.00	4	D8	4.906	2.219	329057	—	329065	328719	329073	328720	—	—
M30 x 3.5	30.00	4	D9	5.438	2.563	—	—	329180	—	—	—	—	—

**General Purpose Left-Hand
Straight Flute**

Machine Tap for Through or Blind Holes



Style: **HTGPL**



Note
Tapping speeds - see
page 39-41.

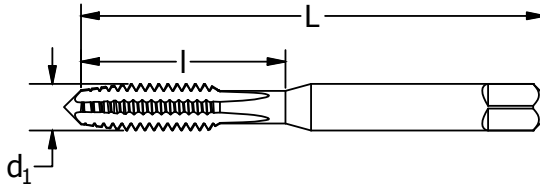
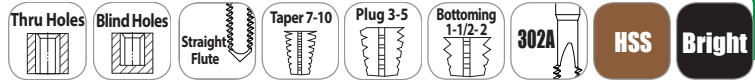

diameter & pitch	thread form	d ₁ in	number of flutes	H- limit	L in	I in	order number			
							taper Bright	plug Bright	bottoming Bright	set taper/plug/bottom
6-32	UNC	.1380	3	H3	2.000	.688	—	313010	313028	—
8-32	UNC	.1640	4	H3	2.125	.750	313036	313044	313051	341912
10-24	UNC	.1900	4	H3	2.375	.875	313069	313077	313085	—
10-32	UNF	.1900	4	H3	2.375	.875	313093	313102	313119	341938
1/4-20	UNC	.2500	4	H3	2.500	1.000	—	317516	—	—
1/4-28	UNF	.2500	4	H3	2.500	1.000	317532	317540	317557	318779
5/16-18	UNC	.3125	4	H3	2.719	1.125	—	317573	—	—
5/16-24	UNF	.3125	4	H3	2.719	1.125	—	317607	—	—
3/8-16	UNC	.3750	4	H3	2.938	1.250	—	317631	—	—
3/8-24	UNF	.3750	4	H3	2.938	1.250	—	317664	—	—
7/16-20	UNF	.4375	4	H3	3.156	1.438	—	317722	—	—
1/2-13	UNC	.5000	4	H3	3.375	1.656	—	317755	—	—
1/2-20	UNF	.5000	4	H3	3.375	1.656	—	317789	—	—
5/8-18	UNF	.6250	4	H3	3.813	1.813	—	317904	—	—
3/4-10	UNC	.7500	4	H3	4.250	2.000	—	317995	—	—
3/4-16	UNF	.7500	4	H3	4.250	2.000	—	318027	—	—

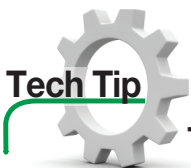

Tech Tip
The Proper Use of Lubricants in Tapping

Applying the proper lubricants in tapping operations can result in longer tap life, increased production, better workpiece size control, smoother and more accurate threads, less resharpening, and more efficient chip removal. Generally, for best tap performance, straight cutting oil should be used. For non-ferrous and non-metallic materials, a coolant or a cutting fluid (light oil or soluble oil) is recommended.

Often, machining centers are equipped with a coolant or a cutting fluid that contains enough water and oil to provide adequate cooling and lubrication for a variety of tools and workpieces. However, most soluble blends are not suitable for tapping applications. Tapping, especially with thread-forming taps, requires more lubrication than cooling. A coolant or cutting fluid might lack the lubrication necessary to obtain acceptable tool life and part finish. Get recommendations from a coolant specialist.

After you select the proper lubricant, choose the right method of application and pressure. For tapping, use multiple nozzles around the tap. Nozzles should be as close to the surface of the part as possible, positioned at an angle close to the axis of the tool, and should point directly into the hole to flush chips from the flutes. For horizontal tapping, where the tap is stationary and the workpieces rotate, consider using two streams of lubricant, one on each side of the tap.

Whether you are tapping vertically, horizontally, or at an angle, make sure the lubricant reaches the cutting lands of the tap at all times, especially at the point or chamfered sections. Brushing or squirting oil or fluid onto the tap does not provide sufficient lubrication. In fact, heavy viscosity oil may cause the chips to stick or cling to a tap, increasing the chance of breakage. In addition, if the lubricant is automatically applied only on the forward motion of the tap, time the application of the lubricant so that it will reach the hole before the tap starts to cut, particularly with machines on which the cutting fluid is automatically shut off when the tap reverses. For maximum effectiveness, it is better to force the lubricant into the hole under pressure, which will vary depending on the tapping method, hole depth, and tapping speed.

Keep tapping lubricants as clean as possible using a filtering system or other equipment. Dust and other foreign particles can contaminate oil and decrease its effectiveness. Thoroughly clean machines and oil tanks when adding new lubricant and at regular intervals to ensure optimum results.



Spiral Point Taps for Through Holes

Style: **SPS**

CNC Spiral Point
Steels and Stainless Steels



Note
Tapping speeds - see page 39-41.

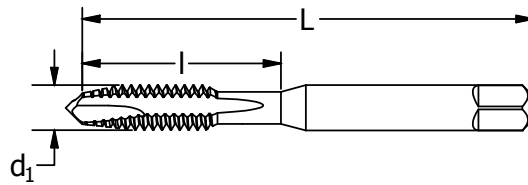

diameter & pitch	thread form	d ₁ in	number of flutes	H-limit	L in	I in	order number
4-40	UNC	.1120	2	H2	1.875	.563	330302
6-32	UNC	.1380	2	H3	2.000	.688	330309
8-32	UNC	.1640	3	H3	2.125	.750	330310
8-32	UNC	.1640	3	H5	2.125	.750	330333
10-24	UNC	.1900	3	H3	2.375	.875	330311
10-32	UNF	.1900	3	H3	2.375	.875	330312
1/4-20	UNC	.2500	3	H3	2.500	1.000	330313
1/4-20	UNC	.2500	3	H5	2.500	1.000	330336
5/16-18	UNC	.3125	3	H3	2.719	1.125	330315
5/16-24	UNF	.3125	3	H3	2.719	1.125	330316
3/8-16	UNC	.3750	3	H3	2.938	1.250	330317
1/2-13	UNC	.5000	3	H3	3.375	1.656	330321

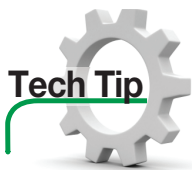

Tech Tip

How to request Made-to-Order taps:

Information required for every order:

- quantity
- ordering number

Information required for some orders, depending on tool style:

- exact tool size
- threads per inch
- pitch
- thread form
- right-hand or left-hand configuration
- limit
- pitch diameter
- class of fit
- chamfer
- number of chamfered threads
- chamfer angle
- number of lube grooves
- short projections

Other features available:

- surface treatment
- special hook
- male centers removed
- special back tape
- recessed neck
- shank flats
- special shank diameter
- special rake
- thread relief
- interrupted threads
- controlled root
- ETTCO notch
- shank grooves

Machine Taps
Spiral Point Taps
Spiral Flute Taps
Thread Forming Taps
Pipe Taps
Dies
Technical Info
Sets
Index

General Purpose
Spiral Point - Inch

Spiral Point Taps for Through Holes



Style: **SPGP**

P N



Note
Tapping speeds - see page 39-41.
* #0 - #3: 302 blank style.
Sets available - see page 14.

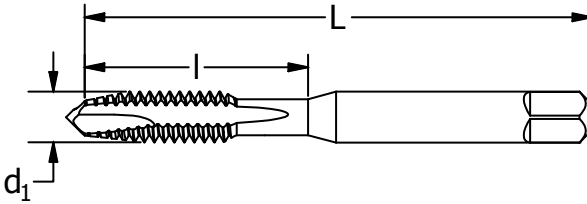

diameter & pitch	thread form	d ₁ in	# of flutes	H-limit	L in	I in	order number					
							plug				bottoming	
							Bright	Black Oxide	TiN	TiCN	Bright	TiN
*0-80	UNF	.0600	2	H1	1.625	.313	356002	—	—	—	—	—
*0-80	UNF	.0600	2	H2	1.625	.313	356027	330100	356023	330148	356035	—
*1-64	UNC	.0730	2	H2	1.688	.375	356068	—	356061	—	—	—
*1-72	UNF	.0730	2	H1	1.688	.375	356084	—	—	—	—	—
*1-72	UNF	.0730	2	H2	1.688	.375	356102	—	356106	—	—	—
*2-56	UNC	.0860	2	H2	1.750	.438	356142	330101	356148	330149	356159	—
*2-64	UNF	.0860	2	H2	1.750	.438	356183	—	—	—	—	—
*3-48	UNC	.0990	2	H2	1.813	.500	356225	—	356221	—	—	—
*3-56	UNF	.0990	2	H2	1.813	.500	356266	—	356262	—	—	—
4-40	UNC	.1120	2	H1	1.875	.563	356308	—	—	—	—	—
4-40	UNC	.1120	2	H2	1.875	.563	356324	330102	356320	330150	356332	356338
4-48	UNF	.1120	2	H2	1.875	.563	356365	—	356361	—	—	—
5-40	UNC	.1250	2	H2	1.938	.625	356407	330103	356403	330151	356415	—
6-32	UNC	.1380	2	H1	2.000	.688	356421	—	—	—	—	—
6-32	UNC	.1380	2	H2	2.000	.688	356422	330104	356486	—	356498	—
6-32	UNC	.1380	2	H3	2.000	.688	356506	330105	356502	330152	356514	356510
6-32	UNC	.1380	2	H7	2.000	.688	359005	—	—	—	—	—
6-40	UNF	.1380	2	H2	2.000	.688	356548	—	356544	—	—	—
8-32	UNC	.1640	2	H2	2.125	.750	356589	330106	356858	—	—	—
8-32	UNC	.1640	2	H3	2.125	.750	356633	330107	356602	330153	356634	356635
8-32	UNC	.1640	2	H7	2.125	.750	359047	—	330138	—	—	—
8-36	UNF	.1640	2	H2	2.125	.750	356647	—	330139	—	—	—
10-24	UNC	.1900	2	H1	2.375	.875	356662	—	—	—	—	—
10-24	UNC	.1900	2	H2	2.375	.875	356688	—	330140	—	—	—
10-24	UNC	.1900	2	H3	2.375	.875	356704	—	356703	330154	356712	356718
10-24	UNC	.1900	2	H7	2.375	.875	359088	—	330141	—	—	—
10-32	UNF	.1900	2	H2	2.375	.875	356746	—	356742	—	—	—
10-32	UNF	.1900	2	H3	2.375	.875	356761	—	356767	330155	356779	356775
10-32	UNF	.1900	2	H7	2.375	.875	359120	—	330142	—	—	—
12-24	UNC	.2160	2	H3	2.375	.938	356803	330108	356809	330156	—	—
12-28	UNF	.2160	2	H3	2.375	.938	356845	—	356841	—	—	—
1/4-20	UNC	.2500	2	H1	2.500	1.000	357009	—	330143	—	—	—
1/4-20	UNC	.2500	2	H2	2.500	1.000	357025	330109	357021	—	—	—
1/4-20	UNC	.2500	2	H3	2.500	1.000	357041	330110	357047	—	357058	357054
1/4-20	UNC	.2500	2	H5	2.500	1.000	357066	—	357062	—	—	—
1/4-20	UNC	.2500	2	H11	2.500	1.000	330111	—	—	—	—	—
1/4-20	UNC	.2500	3	H3	2.500	1.000	357082	330112	357088	330157	—	—
1/4-20	UNC	.2500	3	H5	2.500	1.000	357108	—	357101	—	—	—
1/4-20	UNC	.2500	3	H13	2.500	1.000	358494	—	358490	—	—	—
1/4-28	UNF	.2500	2	H2	2.500	1.000	330113	—	—	—	—	—
1/4-28	UNF	.2500	2	H3	2.500	1.000	357165	330114	357161	—	357173	357179
1/4-28	UNF	.2500	3	H2	2.500	1.000	330115	—	—	330158	—	—

continued on next page



Spiral Point Taps for Through Holes

Style: **SPGP** (continued)

General Purpose
Spiral Point - Inch

diameter & pitch	thread form	d ₁ in	# of flutes	H-limit	L in	I in	order number					
							Bright	Black Oxide	plug TiN	bottoming TiN		
5/16-18	UNC	.3125	2	H1	2.719	1.125	357249	—	—	—	—	—
5/16-18	UNC	.3125	2	H2	2.719	1.125	357264	—	330144	—	—	—
5/16-18	UNC	.3125	2	H3	2.719	1.125	357280	330116	357286	—	357298	357294
5/16-18	UNC	.3125	2	H5	2.719	1.125	357306	—	330145	—	—	—
5/16-18	UNC	.3125	3	H3	2.719	1.125	357322	330117	357328	330159	300016	—
5/16-18	UNC	.3125	3	H5	2.719	1.125	357348	—	357344	—	—	—
5/16-18	UNC	.3125	3	H13	2.719	1.125	358510	—	—	—	—	—
5/16-24	UNF	.3125	2	H1	2.719	1.125	357363	—	—	—	—	—
5/16-24	UNF	.3125	2	H3	2.719	1.125	357405	330118	357401	—	357413	—
5/16-24	UNC	.3125	3	H4	2.719	1.125	330119	—	—	330160	—	—
3/8-16	UNC	.3750	3	H2	2.938	1.250	357504	—	330146	—	—	—
3/8-16	UNC	.3750	3	H3	2.938	1.250	357520	330120	357526	330161	—	—
3/8-16	UNC	.3750	3	H5	2.938	1.250	357546	—	357542	—	—	—
3/8-24	UNF	.3750	3	H1	2.938	1.250	357561	—	—	—	—	—
3/8-24	UNF	.3750	3	H2	2.938	1.250	357587	—	—	—	—	—
3/8-24	UNF	.3750	3	H3	2.938	1.250	357603	330121	357609	330162	—	—
3/8-24	UNF	.3750	3	H4	2.938	1.250	357629	—	—	—	—	—
7/16-14	UNC	.4375	3	H2	3.156	1.438	357660	—	—	—	—	—
7/16-14	UNC	.4375	3	H3	3.156	1.438	357686	330122	357682	—	—	—
7/16-14	UNC	.4375	3	H5	3.156	1.438	357702	—	—	—	—	—
7/16-20	UNF	.4375	3	H3	3.156	1.438	357769	—	357765	330163	—	—
7/16-20	UNF	.4375	3	H5	3.156	1.438	357785	—	—	—	—	—
1/2-13	UNC	.5000	3	H2	3.375	1.656	357819	—	—	—	—	—
1/2-13	UNC	.5000	3	H3	3.375	1.656	357827	330123	357823	330164	—	—
1/2-13	UNC	.5000	3	H5	3.375	1.656	357835	—	357831	—	—	—
1/2-20	UNF	.5000	3	H3	3.375	1.656	357868	330125	357864	330165	—	—
5/8-11	UNC	.6250	3	H3	3.813	1.813	357926	330126	357922	330166	—	—
5/8-11	UNC	.6250	3	H5	3.813	1.813	357934	—	357930	—	—	—
5/8-18	UNF	.6250	3	H3	3.813	1.813	357942	330128	—	—	—	—
3/4-10	UNC	.7500	3	H3	4.250	2.000	357967	330129	357963	330167	—	—
3/4-10	UNC	.7500	3	H5	4.250	2.000	357975	—	—	—	—	—
3/4-16	UNF	.7500	3	H3	4.250	2.000	330130	—	—	—	—	—

Machine Taps
Spiral Point Taps
Spiral Flute Taps
Thread Forming Taps
Pipe Taps
Dies
Technical Info
Sets
Index

Style: **SPGP**

General Purpose
Spiral Point - Metric

diameter & pitch	d ₁ mm	number of flutes	D-limit	L mm	I mm	order number		
						Bright	plug TiN	TiCN
M1.6 x 0.35	1.60	2	D3	1.625	.313	360755	—	—
M1.8 x 0.35	1.80	2	D3	1.688	.375	330131	—	—
M2 x 0.4	2.00	2	D3	1.750	.438	360771	360774	—
M2.2 x 0.45	2.20	2	D3	1.750	.438	330132	—	—
M2.5 x 0.45	2.50	2	D3	1.813	.500	360797	—	—
M3 x 0.5	3.00	2	D3	1.938	.625	360805	360801	330168
M3.5 x 0.6	3.50	2	D4	2.000	.688	360821	—	—
M4 x 0.7	4.00	2	D4	2.125	.750	360839	360835	330169
M4.5 x 0.75	4.50	2	D4	2.375	.875	360854	—	—
M5 x 0.8	5.00	2	D4	2.375	.875	360862	360868	330170
M6 x 1.0	6.00	2	D5	2.500	1.000	360888	360884	330171
M7 x 1.0	7.00	2	D5	2.719	1.125	360904	—	—
M8 x 1.0	8.00	2	D5	2.719	1.125	330133	—	—
M8 x 1.25	8.00	2	D5	2.719	1.125	360920	360926	330172
M10 x 1.25	10.00	3	D5	2.938	1.250	330134	—	—
M10 x 1.5	10.00	3	D6	2.938	1.250	360946	360942	330173
M12 x 1.25	12.00	3	D5	3.375	1.656	330135	330147	—
M12 x 1.75	12.00	3	D6	3.375	1.656	360961	360967	330174
M14 x 1.5	14.00	3	D6	3.594	1.656	330136	—	—
M14 x 2	14.00	3	D7	3.594	1.656	360995	—	—
M16 x 1.5	16.00	3	D6	3.813	1.813	330137	—	—
M16 x 2	16.00	3	D7	3.813	1.813	361019	—	—
M20 x 2.5	20.00	3	D7	4.469	2.000	361050	—	—



SET

Styles: **HTGP** and **SPGP**

Machine Taps

303SET Plug Hand Tap Set (10-Piece)	
style	sizes
H3, 4 Flute	1/4-20, 1/4-28, 5/16-18, 5/16-24, 3/8-16, 3/8-24, 7/16-14, 7/16-20, 1/2-13, 1/2-20

HTGP	
order number	
330082	

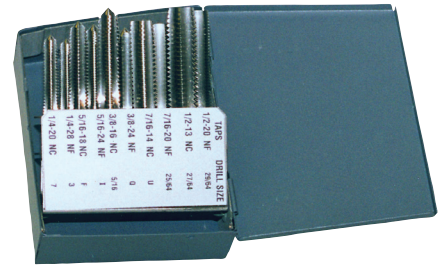

Spiral Point Taps

HT18 Jobber Drill, Plug Hand Tap Set (18-Piece)	
style	sizes
Jobber (Bright)	5/16, 27/64, LET-F, LET-U, #7, #21, #25, #29, #36
H3, 4 Flute	1/4-20, 5/16-18, 3/8-16, 7/16-14, 1/2-13, 6-32, 8-32, 10-24, 10-32

HTGP	
order number	
330083	

Spiral Flute Taps

HT18T Jobber Drill, Plug Hand Tap Set - TiN (18-Piece)	
style	sizes
Jobber (Titanium)	5/16, 27/64, #7, #21, #25, #29, #36, LET-F, LET-U
H3, 4 Flute	1/4-20, 5/16-18, 3/8-16, 7/16-14, 1/2-13, 6-32, 8-32, 10-24, 10-32

HTGP	
order number	
330084	

Thread Forming Taps

GT18 Jobber Drill, Plug Spiral PT Tap Set (18-Piece)	
style	sizes
Jobber (Bright)	5/16, 27/64, LET-F, LET-U, #7, #21, #25, #29, #36
H3, 2 Flute	1/4-20, 5/16-18, 6-32, 8-32, 10-24, 10-32
H3, 3 Flute	3/8-16, 7/16-14, 1/2-13

SPGP	
order number	
330085	

Pipe Taps

HT36 Jobber Drill, Plug NC/NF Hand Tap Set (36-Piece)	
style	sizes
Jobber (Bright)	5/16, 25/64, 27/64, 29/64, LET-F, LET-I, LET-Q, LET-U, #3, #7, #15, #16, #21, #25, #29, #33, #36
H2, 3 Flute	6-40
H2, 4 Flute	8-36
H3, 3 Flute	6-32
H3, 4 Flute	1/4-20, 1/4-28, 5/16-18, 5/16-24, 3/8-16, 3/8-24, 7/16-14, 7/16-20, 1/2-13, 1/2-20, 8-32, 10-24, 10-32, 12-24, 12-28,

HTGP	
order number	
330086	

Dies

Technical Info

68 Screw Machine Drill, Plug Hand Tap Set (20-Piece)	
style	sizes
Screw Mach (Bright)	5/16, 27/64, #7, #25, #29, #36, #39, #44, LET-F, LET-U
H2, 3 Flute	4-40, 5-40
H3, 3 Flute	6-32
H3, 4 Flute	1/4-20, 5/16-18, 3/8-16, 7/16-14, 1/2-13, 8-32, 10-24

HTGP	
order number	
330087	

Sets

HM18 Jobber Drill, Plug Hand Tap Set (18-Piece)	
style	sizes
Jobber (Black Oxide)	2.05, 2.50, 2.90, 3.30, 4.20, 5.00, 6.70, 8.5, 10.20
D3, 3 Flute	M2.5x0.45, M3x0.5
D4, 3 Flute	M3.5x0.6, M4x0.7,
D4, 4 Flute	M5x0.8
D5, 4 Flute	M6X1.0, M8X1.25,
D6, 4 Flute	M10x1.5, M12x1.75

HTGP	
order number	
330088	

Index



Spiral Point Taps for Through Holes

Style: **SPGP+5**

General Purpose
Spiral Point *plus 5* - Inch

NEW

P N



Note
Tapping speeds - see page 39-41.

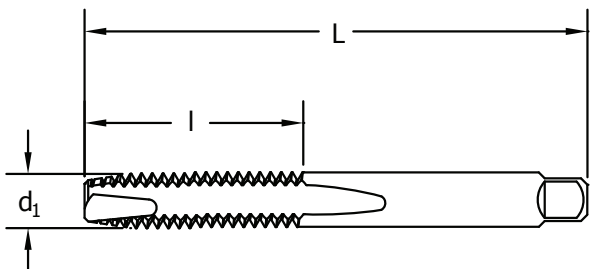

diameter & pitch	thread form	d ₁ mm	number of flutes	H-limit	L in	I in	order number	
							Bright plug	Black Oxide
1/4-20	UNC	.2500	3	H11	2.500	1.000	313500	313555
1/4-28	UNF	.2500	3	H11	2.500	1.000	313501	313556
5/16-18	UNC	.3125	3	H11	2.719	1.125	313502	313557
5/16-24	UNF	.3125	3	H11	2.719	1.125	313503	313558
3/8-16	UNC	.3750	3	H11	2.938	1.250	313504	313559
3/8-24	UNF	.3750	3	H11	2.938	1.250	313505	313560
7/16-14	UNC	.4375	3	H11	3.156	1.438	313506	313561
7/16-20	UNF	.4375	3	H11	3.156	1.438	313507	313562
1/2-13	UNC	.5000	3	H11	3.375	1.656	313508	313563
1/2-20	UNF	.5000	3	H11	3.375	1.656	313509	313564
5/8-11	UNC	.6250	3	H11	3.813	1.813	313510	313565
5/8-18	UNF	.6250	3	H11	3.813	1.813	313511	313566
3/4-10	UNC	.7500	4	H11	4.250	2.000	313512	313567
3/4-16	UNF	.7500	4	H11	4.250	2.000	313513	313568

Style: **SPGP+5**

Metric - General Purpose
Spiral Point *plus 5* - Metric

d ₁ diameter & pitch	number of flutes	D-limit	L in	I in	order number	
					Bright plug	Black Oxide
M6x1	3	D11	2.500	1.00	313514	313569
M8x1	3	D11	2.719	1.125	313515	313570
M8x1.25	3	D11	2.719	1.125	313516	313571
M10x1	3	D11	2.938	1.25	313517	313572
M10x1.25	3	D11	2.938	1.25	313518	313573
M10x1.5	3	D11	2.938	1.25	313519	313574
M12x1.25	3	D11	3.375	1.656	313520	313575
M12x1.5	3	D11	3.375	1.656	313521	313576
M12x1.75	3	D11	3.375	1.656	313522	313577
M16x1.5	3	D11	3.813	1.813	313523	313578
M16x2	3	D11	3.813	1.813	313524	313579

Machine Taps
Spiral Point Taps
Spiral Flute Taps
Thread Forming Taps
Pipe Taps
Dies
Technical Info
Sets
Index

General Purpose
Extended Length (6")

Spiral Point Taps for Through Holes

Style: **SPGPX**



Note
Tapping speeds - see page 39-41.

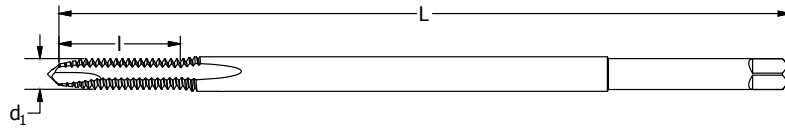

diameter & pitch	thread form	d ₁ in	number of flutes	H-limit	L in	I in	order number
8-32	UNC	.1640	2	H3	6.000	.750	918932
10-24	UNC	.1900	2	H3	6.000	.875	918934
10-32	UNF	.1900	2	H3	6.000	.875	918935
1/4-20	UNC	.2500	2	H3	6.000	1.000	918936
1/4-28	UNF	.2500	2	H3	6.000	1.000	918937
5/16-18	UNC	.3125	2	H3	6.000	1.125	918938
5/16-24	UNF	.3125	2	H3	6.000	1.125	918939
3/8-16	UNC	.3750	3	H3	6.000	1.250	918940
3/8-24	UNF	.3750	3	H3	6.000	1.250	918941

NEW

General Purpose - Inch
Extended Length (6") **plus 5**

Style: **SPGPX+5**



Note
Tapping speeds - see page 39-41.

diameter & pitch	thread form	d ₁ in	number of flutes	H-limit	L in	I in	order number	
							Bright	Black Oxide
1/4-20	UNC	.2500	3	H11	6"	1.0000	313544	313599
5/16-18	UNC	.3125	3	H11	6"	1.1250	313545	313600
3/8-16	UNC	.3750	3	H11	6"	1.2500	313546	313601
7/16-14	UNC	.4375	3	H11	6"	1.4375	313547	313602
1/2-13	UNC	.5000	3	H11	6"	1.6562	313548	313603
5/8-11	UNC	.6250	3	H11	6"	1.8125	313549	313604

NEW

General Purpose - Metric
Extended Length (6") **plus 5**

Style: **SPGPX+5**



Note
Tapping speeds - see page 39-41.

d ₁ diameter & pitch	number of flutes	D-limit	L in	I in	order number	
					Bright	Black Oxide
M6x1	3	D11	6"	1.0000	313550	313605
M8x1.25	3	D11	6"	1.1250	313551	313606
M10x1.5	3	D11	6"	1.2500	313552	313607
M12x1.75	3	D11	6"	1.6562	313553	313608
M16x2	3	D11	6"	1.8125	313554	313609



Spiral Point Taps for Through Holes

Style: **SPLS**

General Purpose
Low Shear



Note
Tapping speeds - see page 39-41.

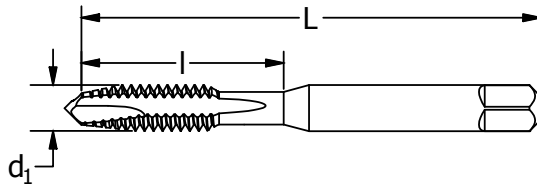

diameter & pitch	thread form	d ₁ in	number of flutes	H-limit	L in	I in	order number
4-40	UNC	.1120	2	H2	1.875	.563	330175
5-40	UNC	.1250	2	H2	1.938	.625	330176
6-32	UNC	.1380	2	H3	2.000	.688	330177
8-32	UNC	.1640	2	H3	2.125	.750	330178
10-24	UNF	.1900	2	H3	2.375	.875	330179
10-32	UNC	.1900	2	H3	2.375	.875	330180
12-24	UNC	.2160	2	H3	2.375	.938	330181
1/4-20	UNC	.2500	2	H1	2.500	1.000	330182
1/4-20	UNC	.2500	2	H2	2.500	1.000	330183
1/4-20	UNC	.2500	2	H3	2.500	1.000	330184
1/4-20	UNC	.2500	2	H11	2.500	1.000	330185
1/4-28	UNF	.2500	2	H3	2.500	1.000	330186
5/16-18	UNC	.3125	2	H3	2.719	1.125	330187
5/16-24	UNF	.3125	2	H3	2.719	1.125	330188
3/8-16	UNC	.3750	3	H3	2.938	1.250	330189
7/16-14	UNC	.4375	3	H3	3.156	1.438	330190
1/2-13	UNC	.5000	3	H3	3.375	1.656	330191
5/8-11	UNC	.6250	3	H3	3.813	1.813	330192

Machine Taps

Spiral Point Taps

Spiral Flute Taps

Thread Forming Taps

Pipe Taps

Dies

Technical Info

Sets

Index



Note
Tapping speeds - see page 39-41.

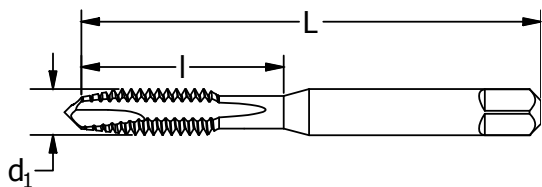

diameter & pitch	thread form	d ₁ in	number of flutes	H-limit	L in	I in	order number plug - TiN
6-32	UNC	.1380	3	H3	2.000	.688	285057
8-32	UNC	.1640	3	H3	2.125	.750	285107
10-24	UNC	.1900	3	H3	2.375	.875	285156
10-32	UNF	.1900	3	H3	2.375	.875	285206
10-32	UNF	.1900	3	H5	2.375	.875	285222
1/4-20	UNC	.2500	3	H3	2.500	1.000	285255
1/4-28	UNF	.2500	3	H3	2.500	1.000	285354
1/4-28	UNF	.2500	3	H5	2.500	1.000	285370
5/16-18	UNC	.3125	3	H3	2.719	1.125	285404
5/16-24	UNF	.3125	3	H3	2.719	1.125	285453
5/16-24	UNF	.3125	3	H5	2.719	1.125	285479
3/8-16	UNC	.3750	3	H3	2.938	1.250	285503
3/8-16	UNC	.3750	3	H5	2.938	1.250	285552
3/8-24	UNF	.3750	3	H5	2.938	1.250	285628
7/16-14	UNC	.4375	3	H3	3.156	1.438	285651
7/16-20	UNF	.4375	3	H3	3.156	1.438	285701
1/2-13	UNC	.5000	3	H5	3.375	1.656	285801
1/2-20	UNF	.5000	3	H3	3.375	1.656	285859



Spiral Point Taps for Through Holes

Style: **SPHD**

Spiral Point Taps
CNC Heavy-Duty



Note
Tapping speeds - see page 39-41.

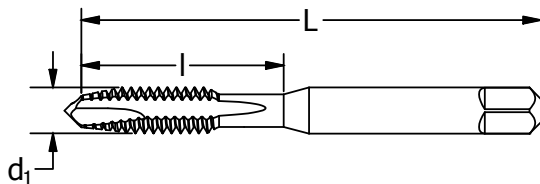

diameter & pitch	thread form	d ₁ in	number of flutes	H-limit	L in	I in	order number	
							Bright	TiN
6-32	UNC	.1380	3	H3	2.000	.688	282108	280108
8-32	UNC	.1640	3	H3	2.125	.750	282157	280157
10-24	UNC	.1900	3	H3	2.375	.875	282207	280207
10-32	UNF	.1900	3	H3	2.375	.875	282256	280256
1/4-20	UNC	.2500	3	H3	2.500	1.000	282306	280306
1/4-20	UNC	.2500	3	H5	2.500	1.000	282355	280355
1/4-28	UNF	.2500	3	H3	2.500	1.000	282405	280405
5/16-18	UNC	.3125	3	H3	2.719	1.125	282454	280454
5/16-18	UNC	.3125	3	H5	2.719	1.125	282470	280470
5/16-24	UNF	.3125	3	H3	2.719	1.125	282504	280504
3/8-16	UNC	.3750	3	H3	2.938	1.250	282553	280553
3/8-16	UNC	.3750	3	H5	2.938	1.250	282603	280603
3/8-24	UNF	.3750	3	H3	2.938	1.250	282652	280652
1/2-13	UNC	.5000	3	H3	3.375	1.656	282801	280801
1/2-13	UNC	.5000	3	H5	3.375	1.656	282850	280850
1/2-20	UNF	.5000	3	H3	3.375	1.656	282901	280901
5/8-11	UNC	.6250	3	H3	3.813	1.813	282959	280959

Style: **SPHD**

Metric - Spiral Point Taps
CNC Heavy-Duty

diameter & pitch	d ₁ mm	number of flutes	D-limit	L in	I in	order number	
						Bright	TiCN
M6 x 1.0	6.00	3	D5	2.500	1.000	272550	—

Machine Taps
Spiral Point Taps
Spiral Flute Taps
Thread Forming Taps
Pipe Taps
Dies
Technical Info
Sets
Index

CNC Spiral Flute
Steels and Stainless Steels

Spiral Flute Taps for Blind Holes



Style: **SFS**



Note
Tapping speeds - see page 39-41.

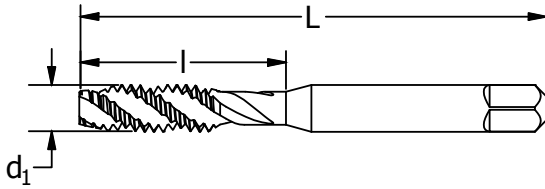

diameter & pitch	thread form	d ₁ in	number of flutes	H-limit	L in	I in	order number
10-32	UNF	.1900	3	H3	2.375	.875	330465
1/4-20	UNC	.2500	3	H3	2.500	1.000	330466
1/4-20	UNC	.2500	3	H5	2.500	1.000	330489
5/16-18	UNC	.3125	3	H3	2.719	1.125	330468
5/16-18	UNC	.3125	3	H5	2.719	1.125	330490
3/8-16	UNC	.3750	3	H3	2.938	1.250	330470
3/8-16	UNC	.3750	3	H5	2.938	1.250	330491
1/2-13	UNC	.5000	3	H3	3.375	1.656	330474
1/2-13	UNC	.5000	3	H5	3.375	1.656	330494
1/2-20	UNF	.5000	3	H5	3.375	1.656	330495
5/8-11	UNC	.6250	4	H3	3.813	1.813	330478
5/8-11	UNC	.6250	4	H5	3.813	1.813	330496

Metric - CNC Spiral Flute
Steels and Stainless Steels

Style: **SFS**

diameter & pitch	d ₁ mm	number of flutes	D-limit	L in	I in	order number
M4 x 0.7	4.00	3	D4	2.125	.750	330498
M5 x 0.8	5.00	3	D4	2.375	.875	330499
M6 x 1	6.00	3	D5	2.500	1.000	330502
M8 x 1.25	8.00	3	D5	2.719	1.125	330503
M10 x 1.5	10.00	3	D6	2.938	1.250	330504
M12 x 1.75	12.00	3	D6	3.375	1.656	330505



Spiral Flute Taps for Blind Holes

Style: **SFHD**

Spiral Flute
CNC Heavy-Duty



Note
Tapping speeds - see
page 39-41.

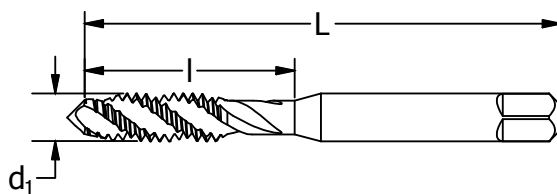
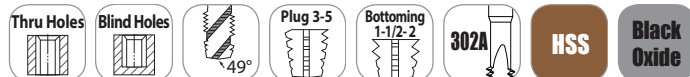

diameter & pitch	thread form	d ₁ in	number of flutes	H-limit	L in	l in	order number	
							plug Black Oxide	bottoming Black Oxide
6-32	UNC	.1380	3	H3	2.000	.688	281957	282005
8-32	UNC	.1640	3	H3	2.125	.750	282054	282104
10-24	UNC	.1900	3	H3	2.375	.875	282062	282120
10-32	UNF	.1900	3	H3	2.375	.875	282153	282203
1/4-20	UNC	.2500	3	H3	2.500	1.000	282252	282302
1/4-28	UNF	.2500	3	H3	2.500	1.000	282351	282401
5/16-18	UNC	.3125	3	H3	2.719	1.125	282450	282501
5/16-24	UNF	.3125	3	H3	2.719	1.125	282468	282526
3/8-16	UNC	.3750	3	H3	2.938	1.250	282559	282609
3/8-24	UNF	.3750	3	H3	2.938	1.250	282567	282625
1/2-13	UNC	.5000	3	H3	3.375	1.656	282757	282807
1/2-20	UNF	.5000	3	H3	3.375	1.656	282765	282823

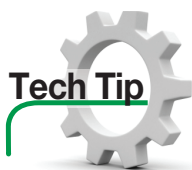

Tech Tip

Ground Thread Tap Limits

All standard ground thread taps made to USCTI Tables 327 and 329 will be marked **G** to designate ground thread. **G** will be followed by **H** to designate above basic or **L** for below basic and a numeral to designate the pitch diameter limits. For example: **G H3** indicates a ground thread tap with pitch diameter limits .0010" to .0015" over basic. See table at right.

For taps over 1-1/2" diameter with H or L limit numbers, divide the H or L limit number by 2 to get the amount (in thousandths of an inch) the maximum tap pitch diameter is over basic for the H series or under basic for the L series. In H series taps, the tolerance shown in USCTI Table 331, Column D, subtracted from the maximum pitch diameter will give the minimum pitch diameter. In L series taps the tolerance shown in Table 331, Column D, added to the minimum pitch diameter will give the maximum pitch diameter. These taps will be marked with the appropriate H or L limit number.

Pitch Diameter Limits

for taps through 1" diameter

L1 =	basic to basic - .0005
H1 =	basic to basic + .0005
H2 =	basic + .0005 to basic + .0010
H3 =	basic + .0010 to basic + .0015
H4 =	basic + .0015 to basic + .0020
H5 =	basic + .0020 to basic + .0025
H6 =	basic + .0025 to basic + .0030

for taps over 1" diameter through 1-1/2" diameter

H4 =	basic + .0010 to basic + .0020
------	--------------------------------

Machine Taps
Spiral Point Taps
Spiral Flute Taps
Thread Forming Taps
Pipe Taps
Dies
Technical Info
Sets
Index

General Purpose Spiral Flute
High-Spiral - Inch

Spiral Flute Taps for Blind Holes



Style: **SFGP**



Note
Tapping speeds - see page 39-41.

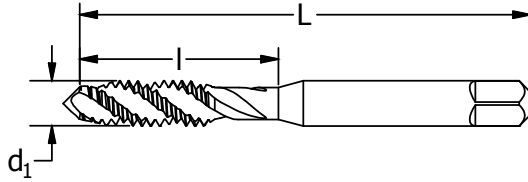

diameter & pitch	thread form	d ₁ in	number of flutes	H-limit	L in	I in	order number			
							plug		bottoming	
							Bright	TiN	Bright	TiN
4-40	UNC	.1120	2	H2	1.875	.563	367149	—	367156	330202
6-32	UNC	.1380	2	H3	2.000	.688	367222	330193	367230	330203
8-32	UNC	.1640	3	H3	2.125	.750	367263	330194	367271	330204
10-24	UNC	.1900	3	H3	2.375	.875	367305	330195	367313	—
10-32	UNF	.1900	3	H3	2.375	.875	367321	330196	367339	330205
1/4-20	UNC	.2500	3	H3	2.500	1.000	367909	—	367917	367913
1/4-28	UNF	.2500	3	H3	2.500	1.000	367925	—	367933	—
5/16-18	UNC	.3125	3	H3	2.719	1.125	367941	—	367958	—
5/16-24	UNF	.3125	3	H3	2.719	1.125	367966	—	367974	—
3/8-16	UNC	.3750	3	H3	2.938	1.250	367982	—	367990	—
3/8-24	UNF	.3750	3	H3	2.938	1.250	368006	—	368014	—
1/2-13	UNC	.5000	3	H3	3.375	1.656	368063	—	368071	—
1/2-20	UNF	.5000	3	H3	3.375	1.656	368089	—	368097	—

General Purpose Spiral Flute
High-Spiral - Metric

Style: **SFGP**

diameter & pitch	d ₁ mm	number of flutes	D-limit	L in	I in	order number			
						plug		bottoming	
						Bright	TiCN	Bright	TiCN
M3 x 0.5	3.00	2	D3	1.938	.625	366110	—	366112	330206
M4 x 0.7	4.00	3	D4	2.125	.750	366130	330197	366132	330207
M5 x 0.8	5.00	3	D4	2.375	.875	366140	330198	366142	330208
M 6 x 1.0	6.00	3	D5	2.500	1.000	366150	330199	366152	330209
M8 x 1.25	8.00	3	D5	2.719	1.125	366160	330200	366162	330210
M10 x 1.5	10.00	3	D6	2.938	1.250	366170	330201	366172	330211
M12 x 1.75	12.00	3	D6	3.375	1.656	366180	—	366182	—



Spiral Flute Taps for Blind Holes

Style: **SFGP+5**

General Purpose Spiral Flute
Plus 5 - Inch

NEW

P N

Blind Holes Mod Bottom 2-1/2 302 HSS Bright Black Oxide

Note
Tapping speeds - see page 39-41.

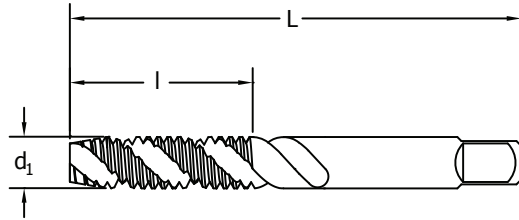

diameter & pitch	thread form	d ₁ in	number of flutes	H-limit	L in	I in	order number semi bottoming	
							Bright	Black Oxide
1/4-20	UNC	.2500	3	H11	2.500	1.000	313525	313580
1/4-28	UNF	.2500	3	H11	2.500	1.000	313526	313581
5/16-18	UNC	.3125	3	H11	2.719	1.125	313527	313582
5/16-24	UNF	.3125	3	H11	2.719	1.125	313528	313583
3/8-16	UNC	.3750	3	H11	2.938	1.250	313529	313584
3/8-24	UNF	.3750	3	H11	2.938	1.250	313530	313585
7/16-14	UNC	.4375	3	H11	3.156	1.438	313531	313586
7/16-20	UNF	.4375	3	H11	3.156	1.438	313532	313587
1/2-13	UNC	.5000	3	H11	3.375	1.656	313533	313588
1/2-20	UNF	.5000	3	H11	3.375	1.656	313534	313589
5/8-11	UNC	.6250	3	H11	3.813	1.813	313535	313590
5/8-18	UNF	.6250	3	H11	3.813	1.813	313536	313591
3/4-10	UNC	.7500	4	H11	4.250	2.000	313537	313592
3/4-16	UNF	.7500	4	H11	4.250	2.000	313538	313593

Style: **SFGP+5**

General Purpose Spiral Flute
Plus 5 - Metric

d ₁ diameter & pitch	number of flutes	D-limit	L in	I in	order number semi bottoming	
					Bright	Black Oxide
M6x1	3	D11	2.500	1.00	313539	313594
M8x1.25	3	D11	2.719	1.125	313540	313595
M10x1.5	3	D11	2.938	1.25	313541	313596
M12x1.75	3	D11	3.375	1.656	313542	313597
M16x2	3	D11	3.813	1.813	313543	313598

Machine Taps
Spiral Point Taps
Spiral Flute Taps
Thread Forming Taps
Pipe Taps
Dies
Technical Info
Sets
Index

**General Purpose
Thread Forming**

Pipe Taps

Styles: FTGP



Note
Modify tapping speeds listed on page 39-41 as follows: double the speeds versus thread cutting taps.
* #0 - #3: 302 blank style.

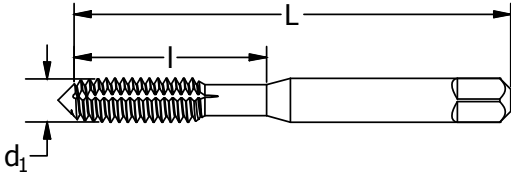

diameter & pitch	thrd form	d ₁ in	H-limit	L in	l in	order number			
						plug		bottoming	
						Bright	TiN	Bright	TiN
*0-80	UNF	.0600	H2	1.625	.313	-	-	330214	-
*2-56	UNC	.0860	H2	1.750	.438	-	-	330215	-
4-40	UNC	.1120	H3	1.875	.563	289004	-	289012	-
5-40	UNC	.1250	H3	1.938	.625	289087	-	289095	-
6-32	UNC	.1380	H3	2.000	.688	289202	287004	289210	287053
6-32	UNC	.1380	H5	2.000	.688	289228	287103	289236	287152
8-32	UNC	.1640	H3	2.125	.750	289269	287202	289277	287251
8-32	UNC	.1640	H5	2.125	.750	289285	287301	289293	287350
10-24	UNC	.1900	H4	2.375	.875	289368	287400	289376	287459
10-24	UNC	.1900	H6	2.375	.875	289384	287509	289392	287558
10-32	UNF	.1900	H4	2.375	.875	289426	-	289434	-
10-32	UNF	.1900	H6	2.375	.875	289442	287608	289459	287657
1/4-20	UNC	.2500	H4	2.500	1.000	289525	-	289533	-
1/4-20	UNC	.2500	H6	2.500	1.000	289541	287707	289558	287756
1/4-28	UNF	.2500	H4	2.500	1.000	289582	-	289590	-
5/16-18	UNC	.3125	H5	2.719	1.125	289640	-	289657	-
5/16-18	UNC	.3125	H7	2.719	1.125	289665	287905	289673	287954
3/8-16	UNC	.3750	H7	2.938	1.250	289780	288101	289798	288150
3/8-24	UNF	.3750	H5	2.938	1.250	330212	-	-	-
3/8-24	UNF	.3750	H7	2.938	1.250	330213	-	-	-
1/2-13	UNC	.5000	H8	3.375	1.656	289988	288408	289996	288457

**Metric - General Purpose
Thread Forming**

Style: FTGP

diameter & pitch	d ₁ mm	D-limit	L in	l in	order number			
					plug		bottoming	
					Bright	TiN	Bright	TiN
M3 x 0.5	3.00	D5	1.938	.625	291001	291006	291018	291014
M4 x 0.7	4.00	D6	2.125	.750	291083	291089	291091	291097
M5 x 0.8	5.00	D7	2.375	.875	291125	291123	291133	291139
M6 x 1.0	6.00	D8	2.500	1.000	291166	291162	291174	291170
M8 x 1.25	8.00	D9	2.719	1.125	291240	291246	291257	291253
M10 x 1.5	10.00	D10	2.938	1.250	291176	291287	291178	291295



Pipe Taps

Style: **PTT**

Taper Pipe
NPT/NPTF Medium Hook

P

Note
Tapping speeds - see
page 39-41.

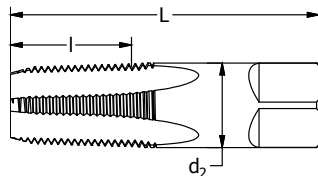

diameter & pitch	d ₂ in	number of flutes	L in	I in	order number			
					NPT Bright	NPT TiN	NPTF Bright	NPTF TiN
1/16-27	.3125	4	2.1250	0.6875	385307	385328	385323	385329
*1/8-27	.3125	4	2.1250	0.7500	385331	385357	385356	385359
1/8-27	.4375	4	2.1250	0.7500	385364	385385	385380	385386
1/4-18	.5625	4	2.4375	1.0625	385398	385409	385413	385410
3/8-18	.7000	4	2.5625	1.0625	385422	385443	385448	385444
1/2-14	.6875	4	3.1250	1.3750	385455	385458	385471	385477
3/4-14	.9063	5	3.2500	1.3750	385489	385500	385505	385501
1 - 11-1/2	1.1250	5	3.7500	1.7500	385513	385534	385539	385536
1-1/4 - 11-1/2	1.3125	5	4.0000	1.7500	385547	385680	385562	385685
1-1/2 - 11-1/2	1.5000	7	4.2500	1.7500	385570	385681	—	—
2 - 11-1/2	1.8750	7	4.5000	1.7500	385604	385682	—	—

* small shank

Taper Pipe
NPT/NPTF Medium Hook

SET

Style: **PTT**

order number
NPT Pipe Tap: 1/8 - 1" NPT
353768

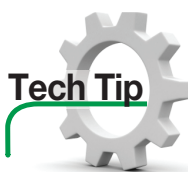

Tap Drill Recommendations - NPT, NPTF, NPSM, NPSC, NPSF Sizes

Color Code:

Wire Gage - Purple
Fractional - Red,
Letter - Blue,
and
Metric Sizes - Green

Nominal Tap Size & Pitch	NPT & NPTF		NPSM	NPSC	NPSF
	w/o reamer	w/ reamer			
1/16 - 27	C (.242)	A (.234)	—	1/4	D (.246)
1/8 - 27	Q (.332)	21/64	T (.358)	Q	R (.339)
1/4 - 18	7/16	27/64	15/32	7/16	7/16
3/8 - 18	9/16	9/16	.603*	37/64	37/64
1/2 - 14	45/64	11/16	19,0mm	23/32	.705*
3/4 - 14	29/32	57/64	61/64	59/64	59/64
1 - 11 1/2	1-9/64	1-1/8	1-13/64	1-5/32	1-5/32
1 1/4 - 11 1/2	1-31/64	1-15/32	1.546*	1-1/2	—
1 1/2 - 11 1/2	1-23/32	1-45/64	1-25/32	1-47/64	—
2 - 11 1/2	2-3/16	2-11/64	2-1/4	2-1/4	—

*special



P



Note

Tapping speeds - see page 39-41.

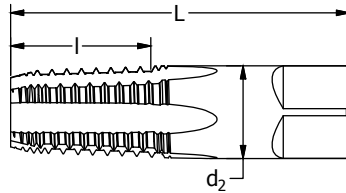

diameter & pitch	d ₂ in	number of flutes	L in	I in	order number		
					NPT Bright	NPTF Bright	NPTF TiN
*1/8-27	.3125	5	2.125	.750	—	385752	—
1/8-27	.4375	5	2.125	.750	385737	385729	385755
1/4-18	.5625	5	2.438	1.063	385760	385786	385789
3/8-18	.7000	5	2.563	1.063	385794	385810	385813
1/2-14	.6875	5	3.125	1.375	385828	385844	385847
3/4-14	.9063	5	3.250	1.375	385851	385877	385870
1-11-1/2	1.1250	5	3.750	1.750	385885	—	—

* small shank

Tech Tip

Pipe Taps

General purpose pipe taps are appropriate for threading a wide variety of materials, both ferrous and non-ferrous.

Ground thread pipe taps are standard in American Standard Pipe Form (NPT) and American Standard Dryseal Pipe Form (NPFT). NPT threads require the use of a sealer, like Teflon® tape or pipe compound. Dryseal taps are used to tap fittings which will give a pressure-tight joint without the use of a sealer.

The nominal size of a pipe tap is that of the pipe fitting to be tapped, not the actual size of the tap. The thread tapers 3/4" per foot.

All pipe taps are furnished with 2 1/2 to 3-1/2 thread chamfer.

Short projection pipe taps are made with a projection shorter than standard for taper pipe tapping where the depth of tapping is limited. Special short projection pipe taps and left hand pipe taps are available as specials.

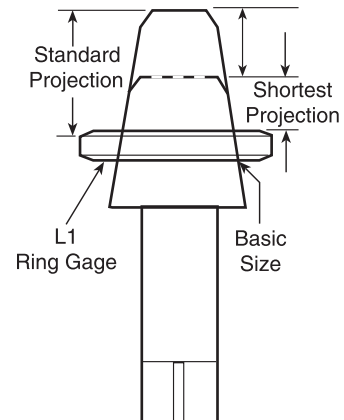



Pipe Taps

Style: **PTS**

NPS/NPSM/NPSC/NPSF

Medium Hook Straight Pipe

P

Note

Tapping speeds - see page 39-41.

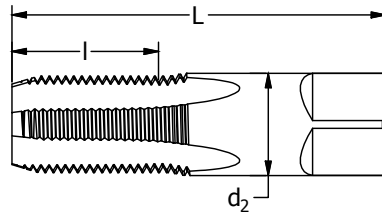

diameter & pitch	d ₂ in	number of flutes	L in	I in	order number	
					NPS/NPSM NPSC Bright	NPSF Bright
*1/8-27	.3125	4	2.125	.750	—	387212
1/8-27	.4375	4	2.125	.750	387113	387220
1/4-18	.5625	4	2.438	1.063	387121	387238
3/8-18	.7000	4	2.563	1.063	387139	387246
1/2-14	.6875	4	3.125	1.375	387147	387253

*small shank

Machine Taps

Spiral Point Taps

Spiral Flute Taps

Thread Forming Taps

Pipe Taps

Dies

Technical Info

Sets

Index

Style: **ELPTT**

CNC Extra Length Med. Hook

with Machine Tap Shanks

P

Note

Tapping speeds - see page 39-41.

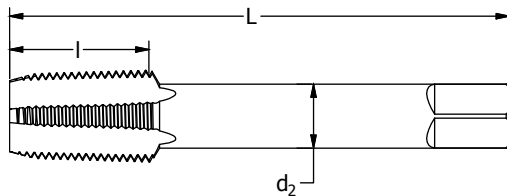

diameter & pitch	d ₂ in	number of flutes	L in	I in	order number		
					NPT Bright	NPTF Bright	NPTF TiN
1/8-27	0.318	4	3.000	.750	384524	386008	386129
1/4-18	0.480	4	3.500	1.063	384525	386024	386152
3/8-18	0.480	4	3.750	1.063	384526	386040	386186
1/2-14	0.480	4	4.375	1.375	384527	—	—
3/4-14	0.800	5	4.625	1.375	384528	—	—
1-11-1/2	0.800	5	5.250	1.750	384529	—	—

Inch - Carbon Steel
Re-threading Dies

Hexagon Dies

Style: **377**



Carbon Steel

Bright

MOST GENERAL PURPOSE MATERIALS

Note
For dressing over bruised or rusty threads.
No special holder required; use standard wrenches.



die diameter TPI & series	decimal equivalent	length across flats - in	thickness in	order number carbon steel
1/4-20 UNC	.2500	.5938	.2500	403108
1/4-28 UNF	.2500	.5938	.2500	403116
5/16-18 UNC	.3125	.6875	.3125	403124
5/16-24 UNF	.3125	.6875	.3125	403132
3/8-16 UNC	.3750	.7812	.3750	403140
3/8-24 UNF	.3750	.7812	.3750	403157
7/16-14 UNC	.4375	.8750	.4375	403165
7/16-20 UNF	.4375	.8750	.4375	403173
1/2-13 UNC	.5000	1.0625	.5000	403181
1/2-20 UNF	.5000	1.0625	.5000	403199
9/16-12 UNC	.5625	1.0625	.5000	403207
9/16-18 UNF	.5625	1.0625	.5000	403215
5/8-11 UNC	.6250	1.2500	.6250	403223
5/8-18 UNF	.6250	1.2500	.6250	403231
11/16-11 UNS	.6875	1.4375	.7500	403249
11/16-16 UNS	.6875	1.4375	.7500	403256
3/4-10 UNC	.7500	1.4375	.7500	403264
3/4-16 UNF	.7500	1.4375	.7500	403272
7/8-9 UNC	.8750	1.6250	.8750	403280
7/8-14 UNF	.8750	1.6250	.8750	403298
1-8 UNC	1.0000	1.8125	1.0000	403306
1-12 UNF	1.0000	1.8125	1.0000	403314
1-14 UNS	1.0000	1.8125	1.0000	403322
1-1/8-7 UNC	1.1250	2.0000	1.0000	403330
1-1/8-12 UNF	1.1250	2.0000	1.0000	403348
1-1/4-7 UNC	1.2500	2.1875	1.0000	403355
1-1/4-12 UNF	1.2500	2.1875	1.0000	403363
1-3/8-6 UNC	1.4100	2.3750	1.0000	403371
1-3/8-12 UNF	1.4100	2.3750	1.0000	403389
1-1/2-6 UNC	1.5000	2.5625	1.0000	403397
1-1/2-12 UNF	1.5000	2.5625	1.0000	403405

Taper - Carbon Steel
Re-threading Dies

Style: **377**

die diameter TPI & series	decimal equiv.	length across flats - in	thickness in	order number carbon steel
1/8-27 NPT	.1250	1.0625	.3750	411895
1/4-18 NPT	.2500	1.2500	.6250	411896
3/8-18 NPT	.3750	1.4375	.6250	411897
1/2-14 NPT	.5000	1.6250	.7500	411898
3/4-14 NPT	.7500	2.0000	.8125	411899
1 - 11 1/2 NPT	1.0000	2.3750	1.0000	411900

metric sizes on next page



Hexagon Dies

Style: **377**

Metric - Carbon Steel Re-threading Dies

die diameter & TPI	decimal equiv.	mm equiv.	length across flats - in	thickness in	order number carbon steel
M5 x 0.8	.1969	5.00	.5938	.2500	404808
M6 x 1	.2362	6.00	.5938	.2500	404809
M8 x 1.25	.3150	8.00	.6875	.3125	404833
M10 x 1.5	.3937	10.00	.8750	.4375	404858
M12 x 1.75	.4724	12.00	1.0125	.5000	404882
M14 x 2	.5512	14.00	1.0125	.5000	404916
M16 x 2	.6299	16.00	1.2500	.6250	404932
M20 x 2.5	.7874	20.00	1.6250	.8750	404973

SET

Style: **377**

Carbon Steel Re-threading Dies



set number	number of sizes	die sizes		order number
481	8	1/4-20 NC	1/2-13 NC	403512
		5/16-18 NC	9/16-12 NC	
		3/8-16 NC	5/8-11 NC	
		7/16-14 NC	3/4-10 NC	
482	10	1/4-20 NC	9/16-12 NC	403553
		5/16-18 NC	5/8-11 NC	
		3/8-16 NC	3/4-10 NC	
		7/16-14 NC	7/8-9 NC	
		1/2-13 NC	1-8 NC	
490	10	1/4-20 NC	1/4-28 NF	403520
		5/16-18 NC	5/16-24 NF	
		3/8-16 NC	3/8-24 NF	
		7/16-14 NC	7/16-20 NF	
		1/2-13 NC	1/2-20 NF	
492	20	1/4-20 NC	1/4-28 NF	403595
		5/16-18 NC	5/16-24 NF	
		3/8-16 NC	3/8-24 NF	
		7/16-14 NC	7/16-20 NF	
		1/2-13 NC	1/2-20 NF	
		9/16-12 NC	9/16-18 NF	
		5/8-11 NC	5/8-18 NF	
		3/4-10 NC	3/4-16 NF	
		7/8-9 NC	7/8-14 NF	
		1-8 NC	1-14 NF	
485	7	M6 x 1	M14 x 2	403522
		M8 x 1.25	M16 x 2	
		M10 x 1.5	M20 x 2.5	
		M12 x 1.75		

- Machine Taps
- Spiral Point Taps
- Spiral Flute Taps
- Thread Forming Taps
- Pipe Taps
- Dies
- Technical Info
- Sets
- Index



MOST GENERAL PURPOSE MATERIALS

Note

Use in hand-held die stocks or machine holders.

Chamfered on both faces, 2 to 3 threads on one side and 1 to 2-1/2 threads on the other for threading close to the shoulder.

Beveled screw slot to remove screw when die is used in a machine holder.

Pipe and Metric sizes after inch.

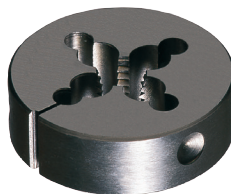

order number

die diameter TPI & series		decimal equiv.	outside dia. in	thickness in	style 382 carbon steel	style 6382 high-speed steel
0-80	UNF	.0600	.8125	.2500	401003	—
1-64	UNC	.0730	.8125	.2500	401029	—
1-72	UNF	.0730	.8125	.2500	401037	—
2-56	UNC	.0860	.8125	.2500	401045	—
2-64	UNF	.0860	.8125	.2500	401052	—
3-48	UNC	.0990	.8125	.2500	401060	—
3-56	UNF	.0990	.8125	.2500	401078	—
4-40	UNC	.1120	.8125	.2500	401102	—
4-48	UNF	.1120	.8125	.2500	401110	—
5-40	UNC	.1250	.8125	.2500	401128	400013
5-44	UNF	.1250	.8125	.2500	401129	400021
6-32	UNC	.1380	.8125	.2500	401168	400039
6-32	UNC	.1380	1.000	.3750	401409	400138
6-40	UNF	.1380	.8125	.2500	401169	400047
8-32	UNC	.1640	.8125	.2500	401177	400054
8-32	UNC	.1640	1.0000	.3750	401433	400145
8-36	UNF	.1640	.8125	.2500	400178	400062
10-24	UNC	.1900	.8125	.2500	401201	400070
10-24	UNC	.1900	1.0000	.3750	401466	400179
10-32	UNF	.1900	.8125	.2500	401227	400088
10-32	UNF	.1900	1.0000	.3750	401482	400187
12-24	UNC	.2160	.8125	.2500	401242	400096
12-24	UNC	.2160	1.0000	.3750	401490	400195
12-28	UNF	.2160	.8125	.2500	401243	400104
1/4-20	UNC	.2500	.8125	.2500	401244	400211
1/4-20	UNC	.2500	1.0000	.3750	401979	400302
1/4-20	UNC	.2500	1.5000	.5000	402209	400401
1/4-20	UNC	.2500	2.0000	.6250	402407	—
1/4-28	UNF	.2500	.8125	.2500	—	400229
1/4-28	UNF	.2500	1.0000	.3750	401995	400310
1/4-28	UNF	.2500	1.5000	.5000	402225	400419
1/4-28	UNF	.2500	2.0000	.6250	402423	—
5/16-18	UNC	.3125	.8125	.2500	—	400237
5/16-18	UNC	.3125	1.0000	.3750	402019	400328
5/16-18	UNC	.3125	1.5000	.5000	402241	400427
5/16-18	UNC	.3125	2.0000	.6250	402449	—
5/16-24	UNF	.3125	.8125	.2500	—	400245
5/16-24	UNF	.3125	1.0000	.3750	402027	400336
5/16-24	UNF	.3125	1.5000	.5000	402258	400435
5/16-24	UNF	.3125	2.0000	.6250	402456	—

continued on next page



Round Adjustable Dies

Styles: 382 and 6382 (continued)

Inch - Round Adjustable Dies

382 - Carbon Steel / 6392 - HSS

die diameter TPI & series		decimal equiv.	outside dia in	thickness in	order number	
					style 382 carbon steel	style 6382 high-speed steel
3/8-16	UNC	.3750	1.0000	.3750	402043	400344
3/8-16	UNC	.3750	1.5000	.5000	402274	400445
3/8-16	UNC	.3750	2.0000	.6250	402472	—
3/8-24	UNF	.3750	1.0000	.3750	402050	400351
3/8-24	UNF	.3750	1.5000	.5000	402282	400450
3/8-24	UNF	.3750	2.0000	.6250	402480	—
7/16-14	UNC	.4375	1.0000	.3750	402068	400369
7/16-14	UNC	.4375	1.5000	.5000	402290	400468
7/16-14	UNC	.4375	2.0000	.6250	402498	—
7/16-20	UNF	.4375	1.0000	.3750	402076	400377
7/16-20	UNF	.4375	1.5000	.5000	402308	400476
7/16-20	UNF	.4375	2.0000	.6250	402506	—
1/2-13	UNC	.5000	1.0000	.3750	402077	—
1/2-13	UNC	.5000	1.5000	.5000	402316	400484
1/2-13	UNC	.5000	2.0000	.6250	402514	—
1/2-20	UNF	.5000	1.0000	.3750	402078	—
1/2-20	UNF	.5000	1.5000	.5000	402324	400492
1/2-20	UNF	.5000	2.0000	.6250	402522	—
9/16-12	UNC	.5625	1.5000	.5000	402332	400500
9/16-12	UNC	.5625	2.0000	.6250	402530	—
9/16-18	UNF	.5625	1.5000	.5000	402340	400518
9/16-18	UNF	.5625	2.0000	.6250	402548	—
5/8-11	UNC	.6250	1.5000	.5000	402357	400526
5/8-11	UNC	.6250	2.0000	.6250	402555	400609
5/8-11	UNC	.6250	2.5000	.7500	402746	—
5/8-18	UNF	.6250	1.5000	.5000	402365	400534
5/8-18	UNF	.6250	2.0000	.6250	402563	400617
3/4-10	UNC	.7500	1.5000	.5000	402370	—
3/4-10	UNC	.7500	2.0000	.6250	402597	400625
3/4-10	UNC	.7500	2.5000	.7500	402787	—
3/4-16	UNF	.7500	1.5000	.5000	402377	—
3/4-16	UNF	.7500	2.0000	.6250	402605	400633
3/4-16	UNF	.7500	2.5000	.7500	402795	—
7/8-9	UNC	.8750	2.0000	.6250	402613	400641
7/8-9	UNC	.8750	2.5000	.7500	402803	—
7/8-14	UNF	.8750	2.0000	.6250	402621	400658
7/8-14	UNF	.8750	2.5000	.7500	402811	—
1-8	UNC	1.0000	2.0000	.6250	402625	—
1-8	UNC	1.0000	2.5000	.7500	402829	—
1-8	UNC	1.0000	3.0000	1.0000	402902	—
1-12	UNF	1.0000	2.0000	.6250	402627	—
1-12	UNF	1.0000	2.5000	.7500	402837	—
1-12	UNF	1.0000	3.0000	1.0000	402910	—
1-14	UNF	1.0000	2.0000	.6250	402630	—
1-1/8-7	UNC	1.1250	3.0000	1.0000	402936	—
1-1/8-12	UNF	1.1250	3.0000	1.0000	402944	—
1-1/4-7	UNC	1.2500	3.0000	1.0000	402951	—
1-1/4-12	UNF	1.2500	3.0000	1.0000	402969	—
1-3/8-6	UNC	1.3750	3.0000	1.0000	402977	—
1-3/8-12	UNF	1.3750	3.0000	1.0000	402985	—
1-1/2-6	UNC	1.5000	3.0000	1.0000	402993	—
1-1/2-12	UNF	1.5000	3.0000	1.0000	403009	—

pipe and metric sizes continued on next page

- Machine Taps
- Spiral Point Taps
- Spiral Flute Taps
- Thread Forming Taps
- Pipe Taps
- Dies
- Technical Info
- Sets
- Index



Pipe - Round Adjustable Dies
383 - Carbon Steel / 6382 - HSS

Styles: **383**

Machine Taps

Spiral Point Taps

Spiral Flute Taps

Thread Forming Taps

Pipe Taps

Dies

Technical Info

Sets

Index

die diameter TPI & series		decimal equiv.	outside dia in	thickness in	order number style 383 carbon steel
1/8-27	NPT	.1250	1.0000	.3750	405202
1/8-27	NPT	.1250	1.5000	.5000	405251
1/4-18	NPT	.2500	1.5000	.5000	405269
1/4-18	NPT	.2500	2.0000	.6250	405301
3/8-18	NPT	.3750	1.5000	.5000	405277
3/8-18	NPT	.3750	2.0000	.6250	405319
1/2-14	NPT	.5000	2.0000	.6250	405327

Pipe size round adjustable dies are not split.

Metric - Round Adjustable Dies
6382 - HSS

Styles: **6382** (continued)

die diameter TPI & series	decimal equiv.	mm equiv.	outside dia in	thickness in	order number style 6382 high-speed steel
M2.5 x 0.45	.0984	2.50	.8125	.2500	415721
M3 x 0.5	.1181	3.00	.8125	.2500	415724
M3.5 x 0.6	.1378	3.50	.8125	.2500	415732
M4 x 0.7	.1575	4.00	.8125	.2500	415737
M4.5 x 0.75	.1772	4.50	.8125	.2500	415742
M5 x 0.8	.1969	5.00	.8125	.2500	415747
M6 x 1	.2362	6.00	.8125	.2500	415757
M6 x 1	.2362	6.00	1.0000	.3750	415801
M7 x 1	.2756	7.00	1.0000	.3750	415807
M8 x 1.25	.3150	8.00	1.0000	.3750	415813
M10 x 1.5	.3937	10.00	1.0000	.3750	415824
M12 x 1.75	.4724	12.00	1.0000	.3750	415833
M14 x 2	.5512	14.00	1.5000	.5000	415880
M16 x 2	.6300	16.00	1.5000	.5000	415889
M18 x 2.5	.7087	18.00	1.5000	.5000	415896
M20 x 2.5	.7874	20.00	1.5000	.5000	415901

Die Stock

Round Adjustable Dies

Styles: **1750** and **1790**

Style **1750** holds round adjustable dies with three adjusting screws.

Style **1790** stocks have built-in workpiece guide and lock in place with two set screws.



product number	die o.d.	overall length	order no. style 1750
#1851	13/16	7	420514
#2	13/16	6-1/4	423008
#1852	1	10-1/2	420522
#3	1	9	423009
#1853	1-1/2	14-1/2	420548
#5	1-1/2	13-7/8	423010
#6	2	23	420555
#7	2-1/2	29	420563
#8	3	40	420571

product number	die o.d.	overall length	order no. style 1790
#13	13/16	6-1/4	423011
#14	1	13	423012
#15	1-1/2	17-3/4	423013
#16	2	26	423014



OK Jr. Tap & Die Sets with HSS Production Hand Taps and Carbon Steel Round Adjustable Dies - Inch

set number	no. of sizes	tap and die sizes	tap wrench	die stock	order number
17	7	4-40 UNC 6-32 UNC 8-32 UNC	10-24 UNC 10-32 UNF 12-24 UNC 1/4-20 UNC	329 13	423001
18	5	1/4-20 UNC 5/16-18 UNC	3/8-16 UNC 7/16-14 UNC 1/2-13 UNC	333 14	423002
25	8	0-80 UNF 1-72 UNF 2-56 UNC 3-48 UNC	4-40 UNC 6-32 UNC 8-32 UNC 10-24 UNC	329 13	423003
T4	8	2-56 UNC 3-48 UNC 4-40 UNC 6-32 UNC	8-32 UNC 10-24 UNC 10-32 UNF 12-24 UNC	0 1851	420359
26	10	4-40 UNC	4-48 UNF	329 13	420361
T6	20	1/4-20 UNC 5/16-18 UNC 3/8-16 UNC 7/16-14 UNC 1/2-13 UNC 9/16-12 UNC 5/8-11 UNC 3/4-10 UNC 7/8-9 UNC 1-8 UNC	1/4-28 UNF 5/16-24 UNF 3/8-24 UNF 7/16-20 UNF 1/2-20 UNF 9/16-18 UNF 5/8-18 UNF 3/4-16 UNF 7/8-14 UNF 1-12 UNF	7 1852	420363
28	11	1/4-20 UNC 5/16-18 UNC 3/8-16 UNC 7/16-14 UNC 1/2-13 UNC pipe size	1/4-28 UNF 5/16-24 UNF 3/8-24 UNF 7/16-20 UNF 1/2-20 UNF 1/8-27 (short shank)	333 1	423004
32	21	1/4-20 UNC 5/16-18 UNC 3/8-16 UNC 7/16-14 UNC 1/2-13 UNC 9/16-12 UNC 5/8-11 UNC 3/4-10 UNC 7/8-9 UNC 1-8 UNC pipe size	1/4-28 UNF 5/16-24 UNF 3/8-24 UNF 7/16-20 UNF 1/2-20 UNF 9/16-18 UNF 5/8-18 UNF 3/4-16 UNF 7/8-14 UNF 1-14 UNS 1/8-27 (long shank)	15 14 7 15 16	423005

continued on next column



Part Number 420363

OK Jr. Tap & Die Sets with HSS Production Hand Taps and Carbon Steel Round Adjustable Dies - Inch

set number	no. of sizes	tap and die sizes	tap wrench	die stock	screw-driver	order number
33	28 Taps 15 Dies	4-40 UNC 6-32 UNC 8-32 UNC 10-24 UNC 10-32 UNF 12-24 UNC 1/4-20 UNC 1/4-28 UNF 5/16-18 UNC 5/16-24 UNF	3/8-16 UNC 3/8-24 UNF 7/16-14 UNC 7/16-20 UNF 1/2-13 UNC 1/2-20 UNF 9/16-12 UNC 9/16-18 UNF 5/8-18 UNF 3/4-16 UNF 7/8-14 UNF 1-14 UNS 1/8-27 NPT 1/4-18NPT 3/8-18 NPT 1/2-14 NPT	329 14	14 15 16 7	423006

Tap & Die Sets with Production Hand Taps and HSS Round Adjustable Dies - Metric

set number	no. of sizes	tap and die sizes	tap wrench	die stock	screw-driver	order number
48	7	M2.5 x 0.45 M3 x 0.5 M3.5 x 0.6 M4 x 0.7 M4.5 x 0.75 M5 x 0.8 M6 x 1.0	333	1790	300	420365

Tap & Die Sets with Production Hand Taps, and HSS Round Adjustable Dies (metric sizes)

set number	no. of sizes	tap and die sizes	tap wrench	die stock	screw-driver	order number
49	5	M6 x 1.0 M7 x 1.0 M8 x 1.25 M10 x 1.5 M12 x 1.75	333	1790	300	420367

Tap & Die Sets with Production Hand Taps, Black Oxide Jobber Length Drills, and HSS Round Adjustable Dies (metric sizes)

set number	no. of sizes	tap and die sizes	drill sizes	tap wrench	die stock	screw-driver	order number
49D	5	M6 x 1.0 M7 x 1.0 M8 x 1.25 M10 x 1.5 M12 x 1.75	5.0 6.0 6.7 8.5 10.2	333	1790	300	420368

- Machine Taps
- Spiral Point Taps
- Spiral Flute Taps
- Thread Forming Taps
- Pipe Taps
- Dies
- Technical Info
- Sets
- Index

Little Giant®
Two-Piece Die System

Die Systems



Styles: **380, 1383, 1384, 1385, 1386**

Carbon Steel **Bright**

- Little Giant® Two-Piece Die System consists of these parts
Series 380 — Die
Series 1383 — Cap
Series 1384 — Guide
Series 1385 — Collet
- Inch sizes are sold as a complete assembly or in their component parts.
- Metric sizes are sold in their component parts only.
- Use with Style 1381 Little Giant® die stocks.
- Collet assembly for use with Little Giant® dies consists of a cap and a guide; order cap and guide separately, or assembled as a collet.
- Die halves are seated in the beveled cap slot and held in place by the guide, which screws into the underside of the cap.
- Die is adjusted by the set screws at either end of the slot.
- Caps of a given outside diameter are made with several different sizes of slots.
- Separate guide is required for each cutting size.
- To order separate guides, specify cutting size of the die and the size of the collet for 1/4" through 1/2" dies.
- For metric sizes where guide and collet assembly are not available, use Style 1382 Little Giant® Jr. die stock to hold dies.

Style 1386



Style 380

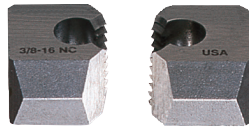

Style 1385
(combined Cap and Guide)



Style 1383



Style 1384



Inch Sizes

nominal size tpi and series	decimal equiv.	style 1386	style 380		style 1385		style 1383		style 1384
		complete assembly	die blank	die order number	collet assembly no.	order no.	cap o.d.	cap order no.	guide order no.
4-40 UNC	.1120	423019	A1	423058	A1	423100	1.250	423121	423128
6-32 UNC	.1380	423020	A1	423059	A1	423101	1.250	423121	423129
8-32 UNC	.1640	423021	A1	423060	A1	423102	1.250	423121	423130
10-24 UNC	.1900	423022	A1	423061	A1	423103	1.250	423121	423131
10-32 UNF	.1900	423023	A1	423062	A1	423103	1.250	423121	423131
12-24 UNC	.2160	423024	A1	423063	A1	423104	1.250	423121	423132
1/4-20 UNC	.2500	423025	A1	423064	A1	423105	1.250	423121	423133
1/4-20 UNC	.2500	423026	A	423065	1	423106	2.000	423122	423134
1/4-20 UNC	.2500	423027	A	423065	5	423107	2.750	423123	423135
1/4-28 UNF	.2500	423028	A1	423067	A1	423105	1.250	423121	423133
1/4-28 UNF	.2500	423029	A	423068	1	423106	2.000	423122	423134
1/4-28 UNF	.2500	423030	A	423068	5	423107	2.750	423123	423135
5/16-18 UNC	.3125	423031	A	423069	1	423108	2.000	423122	423137
5/16-18 UNC	.3125	423032	A	423069	5	423109	2.750	423123	423136
5/16-24 UNF	.3125	423033	A	423070	1	423108	2.000	423122	423137
5/16-24 UNF	.3125	423034	A	423070	5	423109	2.750	423123	423136
3/8-16 UNC	.3750	423035	B	423071	1	423110	2.000	423124	423138
3/8-16 UNC	.3750	423036	B	423071	5	423111	2.750	423125	423139
3/8-24 UNF	.3750	423037	B	423072	1	423110	2.000	423124	423138
3/8-24 UNF	.3750	423038	B	423072	5	423111	2.750	423125	423139
7/16-14 UNC	.4375	423039	B	423073	1	423112	2.000	423124	423141
7/16-14 UNC	.4375	423040	B	423073	5	423113	2.750	423125	423140
7/16-20 UNF	.4375	423041	B	423074	1	423112	2.000	423124	423141
7/16-20 UNF	.4375	423042	B	423074	5	423113	2.750	423125	423140
1/2-13 UNC	.5000	423043	B	423075	1	423114	2.000	423124	423142
1/2-13 UNC	.5000	423044	C	423076	5	423115	2.750	423126	423143
1/2-20 UNF	.5000	423045	B	423077	1	423114	2.000	423124	423142
1/2-20 UNF	.5000	423046	C	423078	5	423115	2.750	423126	423143
9/16-12 UNC	.5625	423047	C	423079	5	423116	2.750	423126	423144
9/16-18 UNF	.5625	423048	C	423080	5	423116	2.750	423126	423144
5/8-11 UNC	.6250	423049	C	423081	5	423117	2.750	423126	423145
5/8-18 UNF	.6250	423050	C	423082	5	423117	2.750	423126	423145
3/4-10 UNC	.7500	423051	C	423083	5	423118	2.750	423126	423146
3/4-16 UNF	.7500	423052	C	423084	5	423118	2.750	423126	423146
7/8-9 UNC	.8750	423053	D	423085	5	423119	2.750	423127	423147
7/8-14 UNF	.8750	423054	D	423086	5	423119	2.750	423127	423147
1-8 UNC	1.0000	423055	D	423087	5	423120	2.750	423127	423148
1-12 UNF	1.0000	423056	D	423088	5	423120	2.750	423127	423148
1-14 UNS	1.0000	423057	D	423089	5	423120	2.750	423127	423148



Die Systems

Styles: 1386 (continued)

Metric - Little Giant®
Two-Piece Die System

nominal size and tpi	decimal equiv.	mm equiv.	style 380		style 1385		style 1383		style 1384
			die blank	die order number	collet assembly no.	order no.	cap o.d.	cap order no.	guide order no.
M6 x 1	.2362	6.00	A	423090	5	*	2.750	*	423149
M8 x 1.25	.3150	8.00	A	423091	5	*	2.750	*	423150
M10 x 1.5	.3937	10.00	B	423092	5	*	2.750	*	423151
M12 x 1.75	.4724	12.00	B	423093	5	*	2.750	*	423152
M14 x 2	.5512	14.00	C	423094	5	423115	2.750	423126	423153
M16 x 2	.6300	16.00	C	423095	5	423116	2.750	423126	423154
M18 x 2.5	.7087	18.00	C	423096	5	423117	2.750	423126	423155
M20 x 2.5	.7874	20.00	C	423097	5	423118	2.750	423126	423156
M22 x 2.5	.8661	22.00	D	423098	5	423119	2.750	423127	423157
M24 x 3	.9449	24.00	D	423099	5	423120	2.750	423127	423158

*Use Style 382 Quick-Set Jr. die stock instead of collet assembly for these sizes.

SET

Style: 1386

Little Giant®
Two-Piece Die System Set

Tap & Die Sets with Collet

- Carbon steel two-piece dies and collets
- Hand taps
- Tap wrench, die stock

set no.	no. of sizes	tap & die sizes	collet no.	tap wrench	die stock	order no.	
59	7	4-40 NC 6-32 NC 8-32 NC	10-24 NC 10-32 NF 12-24 NC 1/4-20 NC	A1	T9, A1	A1	423159
510	5	1/4-20 NC 5/16-18 NC 3/8-16 NC	7/16-14 NC 1/2-13 NC	1	#5	#1	423160
511	10	1/4-20 NC 5/16-18 NC 3/8-16 NC 7/16-14 NC 1/2-13 NC	9/16-18 NC 5/8-18 NC 3/4-16 NC 7/8-14 NC 1-8 NC	5	#5, #7	5A	423161
512	10	1/4-20 NC 5/16-18 NC 3/8-16 NC 7/16-14 NC 1/2-13 NC	1/4-28 NF 5/16-24 NF 3/8-24 NF 7/16-20 NF 1/2-20 NF	1	#5	#1	423162
513	20	1/4-20 NC 5/16-18 NC 3/8-16 NC 7/16-14 NC 1/2-13 NC 9/16-12 NC 5/8-11 NC 3/4-10 NC 7/8-9 NC 1-8 NC	1/4-28 NF 5/16-24 NF 3/8-24 NF 7/16-20 NF 1/2-20 NF 9/16-18 NF 5/8-18 NF 3/4-16 NF 7/8-14 NF 1-14 NS	1,5	#5, #7	#1, #5B	423163
514	7	M6 x 1 M8 x 1.25 M10 x 1.5 M12 x 1.75	M14 x 2 M16 x 2 M18 x 2.5	5	#6	#5	423164

Tap & Die Set without Collet

- Carbon steel Quick-Set two-piece dies and guides.
- HSS production hand taps
- Tap wrenches
- Die stock to hold dies without collet

set no.	# of sizes	tap & die sizes	tap wrench	die stock	order no.	
58	20	1/4-20 NC 5/16-18 NC 3/8-16 NC 7/16-14 NC 1/2-13 NC 9/16-12 NC 5/8-11 NC 3/4-10 NC 7/8-9 NC 1-8 NC	1/4-28 NF 5/16-24 NF 3/8-24 NF 7/16-20 NF 1/2-20 NF 9/16-18 NF 5/8-18 NF 3/4-16 NF 7/8-14 NF 1-14NS	#5, #7	#1, #5	423165



Little Giant® Accessories

Two-Piece Die with collet

Die Systems

Style: **1381**



Carbon Steel **Steam Oxide**

- Use with all Series 1386 Little Giant collets with two-piece dies.
- Little Giant die stocks have center holes corresponding to the outside diameter of the Little Giant collets.



stock no.	collet no.	collet capacity	length of stock	order number
#A1	A1	1-1/4	7-1/2	423166
#1	1	2	14-1/2	423167
#5	5	2-3/4	23	423168
#5A	5	2-3/4	26	423169
#5B	5	2-3/4	29	423170

Little Giant Jr.® Accessories

Two-Piece Die without collet

Style: **1382**

Carbon Steel **Steam Oxide**

- Use with all Series 380 Little Giant two-piece dies without collet.
- Little Giant Jr. die stocks are designed to use Little Giant dies without collets.
- Double slots enable use of two different size blanks in the same stock.
- Dies fit directly into the stock and are held in place by a screw guide.

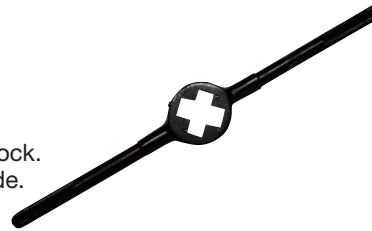

stock no.	cutting size	die blank size	guide no.	cutting size range	length of stock	order number
#1	1/4 to 5/16	A	1	1/4 to 1/2	14-1/2	423171
	3/8 to 1/2	B				
#5	9/16 to 3/4	C	5	9/16 to 1	26	423172
	7/8 to 1	D				

Little Giant® Accessories

Spanner Wrench

Style: **A1**

- Because A1 guides are so small and round instead of square, a standard wrench cannot be used.
- Fits into two holes to turn guide.

stock no.	collet no.	collet capacity	order number
#A1	A1	1-1/4	423173



Accessories

Style: 300

Dies - Tap Wrenches
Standard Straight

Note
Used for hand tapping



product number	mach screw	tap size ranges			overall length	order number
		fractional	metric	pipe		
0	0 to 14	1/16 to 1/4	M1.5 to M6.3		7	420910
14	0 to 14	1/16 to 3/8	M1.5 to M10	—	9	423015
5	8 to 14	5/32 to 1/2	M4 to M12.5	1/8	11	420936
6	8 to 14	5/32 to 3/4	M4 to M19	1/8 to 1/4	15	420944
7	—	1/4 to 1-1/8	M12 to M28	1/8 to 3/4	19	420951
8	—	3/4 to 1-5/8	M19 to M40	3/8 to 1-1/4	40	420977
22	—	1 to 2-1/2	M25 to M56	3/4 to 2	54	423016

Style: 330

Dies - Tap Wrenches
Plain T-Handle

Note
Used for hand tapping in out-in-the-open jobs



product number	mach screw	tap size ranges			overall length	order number
		fractional	metric			
T9	0 to 14	1/16 to 1/4	M1.5 to M6.3	2-3/4	420845	
T10	12 to 14	7/32 to 1/2	M5.5 to M12.5	3-5/8	421852	

Dies - Tap Wrenches
Slip T-Handle

Note
Used for hand tapping or in difficult spaces requiring a slip handle



product number	mach screw	tap size ranges			overall length	order number
		fractional	metric			
T11	0 to 14	1/16 to 1/4	M1.5 to M6.3	2-3/4	420803	
T12	12 to 14	7/32 to 1/2	M5.5 to M12.5	3-5/8	420829	

Dies - Tap Wrenches
Combination Ratchet and Slip T-Handle

Note
Used for hand tapping in difficult spaces needing ratchet drive



product number	mach screw	tap size ranges			overall length	order number
		fractional	metric			
T13	0 to 14	1/16 to 1/4	M1.5 to M6.3	3-3/4	420860	
T14	12 to 14	7/32 to 1/2	M5.5 to M12.5	5	420878	

Dies - Tap Wrenches
Long Shank T-Handle

Note
Used for hand tapping where extra reach is required



product number	mach screw	tap size ranges			overall length	order number
		fractional	metric			
T16	0 to 14	1/16 to 1/4	M1.5 to M6.3	8-3/4	423017	
T17	12 to 14	7/32 to 1/2	M5.5 to M12.5	10-5/8	423018	

Machine Taps
Spiral Point Taps
Spiral Flute Taps
Thread Forming Taps
Pipe Taps
Dies
Technical Info
Sets
Index



Screw Extractors

Style: 335



extractor number	small end	large end	OAL	screw & bolt size	pipe size	drill size	order number
# 1	1/16	1/8	2	3/16 - 1/4	-	5/64	421909
# 2	3/32	13/64	2-3/8	1/4 - 5/16	-	7/64	421917
# 3	1/8	1/4	2-11/16	5/16 - 7/16	-	5/32	421925
# 4	3/16	11/32	3	7/16 - 9/16	-	1/4	421933
# 5	1/4	7/16	3-3/8	9/16 - 3/4	1/8, 1/4	9/32	421941
# 6	3/8	19/32	3-3/4	3/4 - 1	3/8	13/32	421958
# 7	1/2	25/32	4-1/8	1 - 1-3/8	-	17/32	421966

Accessories

Screw Extractors

SET

Style: 335

extractor number	order number
# 15 Set 5 pieces sizes # 1 thru # 5	422006

- Machine Taps
- Spiral Point Taps
- Spiral Flute Taps
- Thread Forming Taps
- Pipe Taps
- Dies
- Technical Info
- Sets
- Index



Tapping Speeds

Consider these factors when trying to determine the best tapping speeds.

- Material to be tapped
- Length of chamfer on tap
- Percentage of full thread to be cut
- Length of hole (depth of thread)
- Pitch of thread
- Cutting fluids
- Machine equipment
- Horizontal or vertical tapping

The best and most efficient operating speeds for taps cannot be calculated with the same certainty as for many other metalcutting tools. With other tools, the feed per revolution can be set at any desired point and can be varied as conditions demand. Taps, on the other hand, must always be advanced at a rate equal to one pitch for every revolution. The style of tap may vary the conditions. For example, with a bottoming tap, the first thread on each land cuts the full height of thread, while, with a taper or starting tap, a number of threads do their share of the cutting before the full height of thread is reached.

The depth of thread also varies, depending on the pitch. The coarser the thread, the greater the advance of the tap per revolution and the greater the amount of material removed.

The method of feeding the tap, and the type of equipment for driving, also influence the permissible speeds. If taps are mechanically fed at the proper rate of advance, they can be operated at higher speeds than if they are required to feed themselves and pull some part of the machine along with them.

Speeds may be modified to take into account any or all of the factors listed above. Speeds must be lowered as the length of thread increases, because, in deep thread holes, the accumulated chips increase friction and interfere with lubrication.

Bottoming taps must be run slower than plug taps.

Tapping of full height of thread calls for slower speed than if the commercial 75% height only is required.

Coarse-thread taps in the larger diameters should be run more slowly than fine-thread taps of the same diameters.

The quantity and quality of cutting fluid may affect the permissible speeds as much as 100%.

Taper threaded taps, such as pipe taps, should be operated from 1/2 to 3/4 the speed of a straight thread tap of comparable major diameter.

Tapping Definitions

- SFM = Surface Feet per Minute
- RPM = Revolutions Per Minute
- IPM = Inches Per Minute
- TPI = Threads Per Inch
- S m/m = Surface Meters per Minute
- p = 3.1416
- mm/m = Millimeters per Minute
- P = Pitch (1/ No of Threads Per Inch)

Suggested Speeds for Uncoated and Coated Taps

Work Material	Speed-feet-per-minute	
	Uncoated Tap	Coated Tap
Alloy Steels:		
125-225 Bhn	30-60	60-120
225-325 Bhn	20-45	40-90
325-425 Bhn	10-35	20-70
Aluminum Alloys	75-150	150-300
Carbon Steels, 225 Bhn or less:		
low carbon (.10-.25C)	50-75	100-150
medium carbon (.30-.55C)	40-65	80-130
high carbon (.60-.95C)	30-55	90-110
Cast Iron		
ductile, annealed	40-60	80-120
ductile, as cast	20-45	40-90
gray (class 20, 25)	40-80	80-160
gray (class 30-50)	25-50	50-100
malleable, 200 Bhn or less	30-60	60-120
Copper Alloys	40-100	80-200
Graphites & Carbons	5-10	10-20
High-Temperature Alloys:		
cobalt base (Haynes alloys)	3-8	5-16
iron base (Incoloy, A-286	7-15	15-30
nickel base (Hastelloy, Inconel)	4-10	8-20
Magnesium	100-150	150-200
Plastics	25-50	50-100
Stainless Steels	15-35	30-70
Titanium:		
pure	25-55	50-110
alloys (Ti-6Al-4V)	10-25	20-50
Tool Steels:		
200-275 Bhn	15-30	30-60
300-350 Bhn	10-25	20-50
40-50 Rc	5-15	10-30
Zinc Alloys	100-150	150-250

**Success of coated taps in non-ferrous materials depends on the machining conditions used.*

Tapping Formula

Inch Sizes

$$\begin{aligned} \text{SFM} &= (\text{RPM} \times \text{tool diameter}) / 3.82 \\ &\text{or } 0.26 \times \text{RPM} \times \text{tool diameter} \\ \text{RPM} &= (3.82 \times \text{SFM}) / \text{tool diameter} \\ \text{IPM} &= \text{RPM} / \text{TPI}^* \\ &\text{or } *P \times \text{RPM} \end{aligned}$$

Metric Sizes

$$\begin{aligned} \text{S m/m} &= (\text{p} \times \text{tool diameter} \times \text{RPM}) / 1000 \\ \text{RPM} &= (\text{m/m} \times 1000) / \text{p} \times \text{tool diameter} \\ \text{mm/m} &= \text{mm P} \times \text{RPM} \end{aligned}$$





Tapping Speeds

Tapping Information (continued)

UNC/UNF and NPT/NPTF Sizes

Machine Taps	UNC UNF Tap Size	NPT NPTF Taper Pipe	Surface Feet per Minute (SFM)																	
			5'	10'	15'	20'	25'	30'	40'	50'	60'	70'	80'	90'	100'	110'	120'	130'	140'	150'
	0		318	637	955	1273	1592	1910	2546	3183	3820	4456	5093	5729	6366	7003	7639	8276	8913	9549
	1		273	546	819	1046	1308	1570	2093	2617	3140	3663	4186	4710	5233	5756	6279	6805	7326	1849
Spiral Point Taps	2		212	424	637	888	1110	1333	1777	2221	2665	3109	3554	3999	4442	4886	5330	5774	6218	6662
	3		191	382	573	772	964	1157	1543	1929	2315	2701	3086	3472	3858	4244	4629	5015	5401	5787
	4		174	347	521	682	853	1023	1364	1705	2046	2387	2728	3069	3411	3751	4092	4434	4775	5115
	5		147	294	441	611	764	917	1222	1528	1833	2139	2445	2750	3056	3361	3667	3973	4278	4584
	6		136	273	409	553	691	829	1106	1382	1859	1935	2212	2488	2766	3042	3318	3595	3871	4148
	8		119	239	358	466	583	699	932	1165	1398	1631	1864	2097	2330	2563	2796	3029	3262	3495
	10		101	201	302	402	502	603	804	1005	1205	1406	1607	1808	2009	2210	2411	2612	2813	3014
	12		87	174	260	354	442	531	707	884	1061	1238	1415	1592	1769	1945	2122	2300	2476	2653
Spiral Flute Taps	1/4		76	153	229	306	382	458	611	764	917	1070	1222	1375	1528	1681	1833	1986	2139	2292
	5/16		62	123	185	245	306	367	489	611	733	856	978	1100	1222	1345	1467	1589	1711	1833
	3/8		50	101	151	204	255	305	407	509	611	713	815	917	1019	1120	1222	1324	1426	1528
	7/16	1/8	43	87	130	175	219	262	349	437	524	611	698	786	873	960	1048	1135	1222	1310
	1/2	—	38	76	115	153	191	229	305	382	458	535	611	688	764	840	917	993	1070	1146
Thread Forming Taps	9/16	1/4	34	68	102	137	172	206	274	342	410	478	547	616	683	752	820	888	952	1020
	5/8	—	32	64	96	122	153	183	244	306	367	428	489	550	611	672	733	794	856	917
	11/16	3/8	28	55	83	111	138	167	222	278	333	389	444	500	556	611	667	722	778	833
	3/4	—	25	51	76	102	128	153	203	255	305	357	407	458	509	560	611	662	713	764
	7/8	1/2	22	43	65	87	109	131	175	218	262	306	350	392	437	480	524	568	611	655
Pipe Taps	1	—	19	38	57	76	96	115	153	191	230	268	305	344	382	420	458	497	535	573
	1 1/8	3/4	17	34	51	68	84	102	136	170	204	238	272	306	340	373	407	441	475	509
	1 1/4	—	15	31	46	61	76	92	122	153	183	214	244	275	305	336	367	397	428	458
	1 3/8	1	14	28	42	56	69	83	111	139	167	194	222	250	278	306	333	361	389	417
	1 1/2	—	13	25	38	51	63	76	102	127	153	178	204	229	255	280	305	331	356	382
	1 5/8	—	12	23	35	47	59	71	94	118	141	165	188	212	235	259	282	306	329	353
	1 3/4	—	11	22	33	44	55	65	87	109	131	153	175	196	218	240	262	284	306	327
	1 7/8	—	10	20	30	41	51	61	81	102	122	143	163	183	204	224	244	265	285	306
	2	—	9	19	29	38	48	57	76	96	115	134	153	172	191	210	229	248	267	287

Dies

Metric Sizes

Tap Size	Surface Feet per Minute (SFM)																	
	5'	10'	15'	20'	25'	30'	40'	50'	60'	70'	80'	90'	100'	110'	120'	130'	140'	150'
M1	490	979	1469	1959	2449	2938	3918	4897	5877	6856	7836	8815	9795	10774	11754	12733	13713	14692
M2	242	484	725	967	1209	1451	1934	2418	2901	3385	3868	4352	4835	5319	5803	6286	6770	7253
M3	162	324	486	647	809	971	1295	1619	1942	2266	2590	2914	3237	3561	3885	4208	4532	4856
M3.5	138	277	415	554	692	830	1107	1384	1661	1938	2214	2491	2768	3045	3322	3599	3875	4152
M4	122	243	365	487	608	730	973	1217	1460	1703	1946	2190	2433	2676	2920	3163	3406	3650
M5	97	194	291	388	485	582	776	970	1163	1357	1551	1745	1939	2133	2327	2521	2715	2905
M6	81	162	243	324	405	486	647	809	971	1133	1295	1457	1619	1781	1942	2104	2266	2428
M7	69	138	208	277	346	415	554	692	830	969	1107	1246	1384	1522	1661	1799	1938	2076
M8	61	121	182	243	303	364	485	606	728	849	970	1091	1213	1334	1455	1577	1698	1819
M10	48	97	145	194	242	291	388	485	582	679	776	873	970	1067	1163	1260	1357	1454
M12	40	81	121	162	202	243	324	405	486	567	647	728	809	890	971	1052	1133	1214
M14	35	69	104	139	173	208	277	347	416	485	555	624	693	763	832	901	971	1040
M16	30	61	91	121	152	182	243	303	364	424	485	546	606	667	728	788	849	910
M18	27	54	81	108	135	162	216	269	323	377	431	485	539	593	647	700	754	808
M20	24	49	73	97	121	146	194	243	291	340	388	437	485	534	582	631	680	728
M22	22	44	66	88	110	132	176	221	265	309	353	397	441	485	529	573	618	662
M24	20	40	61	81	101	121	162	202	243	283	323	364	404	445	485	526	566	606
M27	18	36	54	72	90	108	144	180	216	252	287	323	359	395	431	467	503	539
M30	16	32	49	65	81	97	129	162	194	226	259	291	323	356	388	420	453	485



Use this table to match the hardness of your workpiece material to the correct tap.

10 M/M Ball 3000 Kg	120° Cone 150 Kg	1/16" Ball 100 Kg	Model C	1000 Lb. per Sq. In.	10 M/M Ball 3000 Kg	120° Cone 150 Kg	1/16" Ball 100 Kg	Model C	1000 Lb. per Sq. In.
Brinell	Rockwell C	Rockwell B	Shore Scleroscope	Tensile Strength	Brinell	Rockwell C	Rockwell B	Shore Scleroscope	Tensile Strength
800	72	—	100	—	276	30	105	42	136
780	71	—	99	—	269	29	104	41	132
760	70	—	98	—	261	28	103	40	129
745	68	—	97	367	258	27	102	39	127
725	67	—	96	357	255	26	102	39	125
712	66	—	95	350	249	25	101	38	123
682	65	—	93	337	245	24	100	37	119
668	64	—	91	326	240	23	99	36	117
652	63	—	89	318	237	23	99	35	115
626	62	—	87	306	229	22	98	34	113
614	61	—	85	299	224	21	97	33	110
601	60	—	83	292	217	20	96	33	107
590	59	—	81	290	211	19	95	32	104
576	57	—	79	281	206	18	94	32	102
552	56	—	76	270	203	17	94	31	100
545	55	—	75	268	200	16	93	31	98
529	54	—	74	259	196	15	92	30	96
514	53	120	72	254	191	14	92	30	94
502	52	119	70	247	187	13	91	29	92
495	51	119	69	244	185	12	91	29	91
477	49	118	67	233	183	11	90	28	90
461	48	117	66	227	180	10	89	28	89
451	47	117	65	223	175	9	88	27	86
444	46	116	64	219	170	7	87	27	84
427	45	115	62	209	167	6	87	27	82
415	44	115	60	204	165	5	86	26	81
401	43	114	58	196	163	4	85	26	80
388	42	114	57	191	160	3	84	25	78
375	41	113	55	184	156	2	83	25	76
370	40	112	54	182	154	1	82	25	75
362	39	111	53	179	152	—	82	24	74
351	38	111	51	173	150	—	81	24	74
346	37	110	50	170	147	—	80	24	72
341	37	110	49	168	145	—	79	23	71
331	36	109	47	163	143	—	79	23	70
323	35	109	46	158	141	—	78	23	69
311	34	108	46	153	140	—	77	22	69
301	33	107	45	148	135	—	75	22	67
293	32	106	44	144	130	—	72	22	65
285	31	105	43	140					

Machine
Taps

Spiral Point
Taps

Spiral Flute
Taps

Thread Forming
Taps

Pipe Taps

Dies

Technical Info

Sets

Index



Definitions

Nomenclature

Tap Nomenclature

Bottoming Tap

A tap having a chamfer length of 1-2 threads.

Chamfer

The tapering of the threads at the front end of each land of a chaser, tap or die by cutting away and relieving the crest of the first few teeth to distribute the cutting action over several teeth.

Chamfer Angle

The angle formed between the chamfer and the axis of the tap or die by cutting away and relieving the crest of the first few teeth to distribute the cutting action over several teeth.

Crest

The surface of the thread which joins the flanks of the thread and is farthest from the cylinder or cone from which the thread projects.

Flank

The part of a helical thread surface which connects the crest and the root and which is theoretically a straight line in an axial plane section.

Flute

The longitudinal channel formed in a tap to create cutting edges on the thread profile and to provide chip spaces and cutting fluid passage.

Hand of Threads

A thread, when viewed axially, winds in a clockwise and receding direction for LEFT-HAND THREADS and counter-clockwise and receding direction for RIGHT-HAND THREADS.

Hook, Chordal

A concave face having an angle of inclination specified between a chord passing through the root and crest of a thread form at the cutting face, and a radial line through the crest at the cutting edge.

Hook, Tangential

A concave face having an angle of inclination specified between a line tangent to the hook surface at the cutting edge and a radial line to the same point.

Hook Angle

The angle of inclination of a concave face, usually specified either as CHORDAL HOOK or TANGENTIAL HOOK.

Interrupted Thread Tap

A tap having an odd number of lands with alternate teeth in the thread helix removed. In some cases alternate teeth are removed only for a portion of the thread length.

Land

One of the threaded sections between the flutes of a tap.

continued on next page

Illustration of Tap Terms

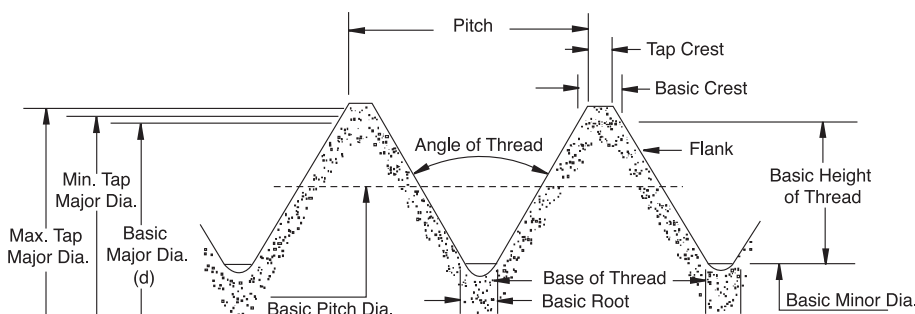

Tap Chamfers

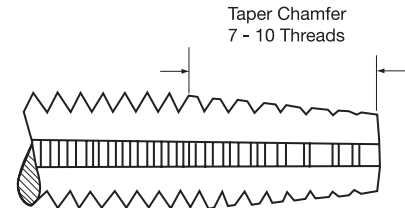

Taper (7 to 10 pitches) – The taper chamfer has the longest standard chamfer ensuring easier starting. It requires less tapping torque because of more working teeth.

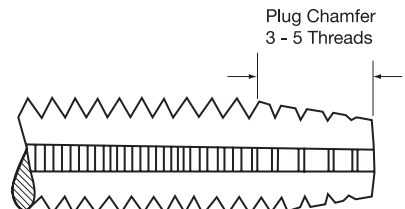

Plug (3 to 5 pitches) – The most common chamfer for use by hand or machine in through or blind holes. This chamfer is more efficient than a bottoming or modified-bottoming chamfer.

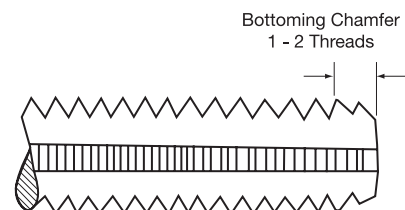

Bottoming (1 to 2 pitches) – For threading close to the bottom of blind holes, the bottoming chamfer is the least efficient chamfer available.

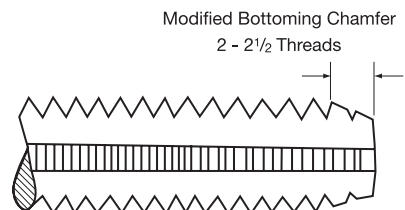

Modified-Bottoming (2 to 2 1/2 pitches) – This short chamfer allows for threading close to the bottom of blind holes. Due to the slightly longer chamfer and more working teeth, this chamfer is more efficient than a bottoming chamfer.

- Machine Taps
- Spiral Point Taps
- Spiral Flute Taps
- Thread Forming Taps
- Pipe Taps
- Dies
- Technical Info
- Sets
- Index

Lead of Thread

The distance a screw thread advances axially in one complete turn. On a single start tap the lead and pitch are identical. On a multiple start tap the lead is the multiple of the pitch.

Major Diameter

The diameter of the major cylinder or cone, at a given position on the axis, that bounds the crests of an external thread or the roots of an internal thread.

Minor Diameter

The diameter of the minor cylinder or cone, at a given position on the axis, that bounds the roots of an external thread or the crests of an internal thread.

Pitch Diameter

The diameter of an imaginary cylinder or cone, at a given point on the axis, of such a diameter and location of its axis that its surface would pass through the thread in such a manner as to make the thread ridge and the thread groove equal and, therefore, is located equidistant between the sharp major and minor cylinders or cones of a given thread form. On a theoretically perfect thread, these widths are equal to one half of the basic pitch (measured parallel to the axis). See illustration below

Plug Tap

A tap with 3 to 5 chamfered threads.

Spiral Point

The angular fluting in the cutting face of the land at the chamfered end. It is formed at an angle with respect to the tap axis of opposite hand to that of rotation. Its length is usually greater than the chamfer length and its angle with respect to the tap axis is usually made great enough to direct the chips ahead of the tap. The tap may or may not have longitudinal flutes.

Square

Four driving flats parallel to the axis on a tap shank forming a square or square with round corners.

Taper Tap

A tap having a chamfer length of 7 to 10 threads.

Pitch Diameter

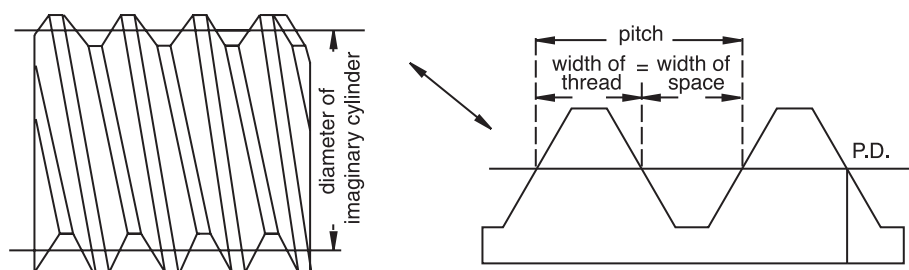

Tap End Views

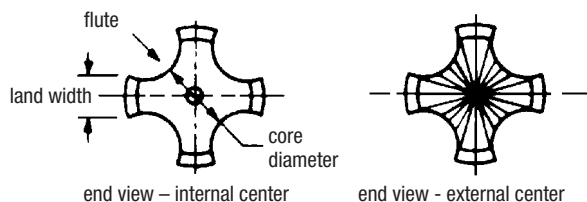

Screw Thread Tolerances

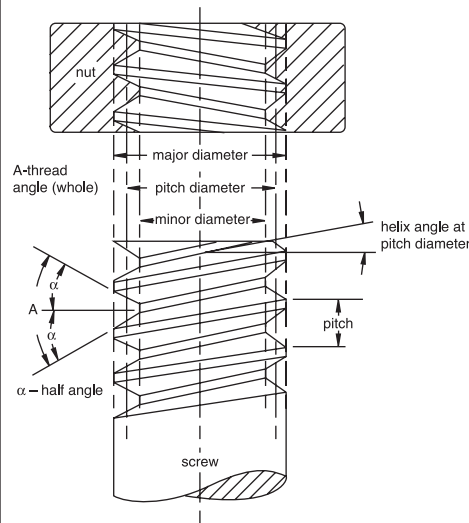

It is generally recognized that, in mass production, it is impossible to reproduce in exact detail the theoretically perfect product as laid out on the drawing board. The allowed slight variation between the theoretically perfect product and each unit of the actual product is called the TOLERANCE.

Allowance

An intentional difference in correlated dimensions of mating parts. It is the minimum clearance or maximum interference between such parts.

Angle of Thread

The angle included between the flanks of the thread measured in an axial plane.

Half Angle of Thread

The angle included between a flank of the thread and the normal (90°) to the axis, measured in an axial plane.

Lead of Thread

The distance a screw thread advances axially in one turn. On a single-thread screw the lead and pitch are identical. On a double thread the lead is 2X pitch, on a triple thread the lead is 3X pitch, etc.

Major Diameter

The largest diameter of a straight screw thread.

Minor Diameter

The smallest diameter of a straight screw thread.

Pitch

The distance from a point on a screw thread to a corresponding point on the next thread measured parallel to the axis. The pitch in inches = $\frac{1}{\text{no. of threads per inch}}$

Machine Taps

Spiral Point Taps

Spiral Flute Taps

Thread Forming Taps

Pipe Taps

Dies

Technical Info

Sets

Index



Definitions

Standard Tap Marking System

Taps, dies, and other threading tools will be marked with the nominal size, number of threads per inch, and the proper symbol to identify the thread form. The symbols below are

in agreement with the ASME B1.7 1965 (R 1972) Standard on nomenclature, definitions and letter symbols for screw threads and other national standards.

Symbol	Reference
ACME-C	Acme Thread-Centralizing
ACME-G	Acme Thread-General Purpose
AMO	American Standard Microscope Objective Thread
ANPT	Aeronautical National Form Taper Pipe Thread (Ground Thread Tap marked NPT)
BA	British Association Standard Thread
BSF	British Standard Fine Thread Series
BSPP	British Standard Pipe (Parallel) Thread
BSPT	British Standard Taper Pipe Thread
BSW	British Standard Whitworth Coarse Thread Series
M	Metric Standard Threads
N	American National 8, 12 and 16 Thread Series (8N, 12N, 16N)
N BUTT	American Buttress Thread
NC	American National Coarse Thread Series
NEF	American National Extra-Fine Thread Series
NF	American National Fine Thread Series
NGO	National Gas Outlet Thread (specify right or left hand)
NGS	National Gas Straight Thread
NGT	National Gas Taper Thread (See also "SGT")
NH	American National Hose Coupling & Firehose Coupling Threads
NPS	For Tap marking Only (See NPSC, NPSM)
NPSC	American National Standard Straight Pipe Thread in Pipe Couplings (Tap Marked NPS)
NPSF	Dryseal American National Standard Fuel Internal Straight Pipe Thread
NPSH	American National Standard Straight Pipe Thread for Hose Couplings
NPSI	Dryseal American National Standard Intermediate Internal Straight Pipe Thread
NPSL	American National Standard Straight Pipe Thread for Loose-Fitting Mechanical Joints with locknuts.
NPSM	American National Standard Straight Pipe Threads for Free-Fitting Mechanical Joints for Fixtures (Tap Marked NPS)
NPT	American National Standard Taper Pipe Thread (see ANPT, NPTR)

Symbol	Reference
NPTF	Dryseal American National Standard Taper Pipe Thread
NPTR	American National Standard Taper Pipe Thread for Railing Joints (Tap Marked NPT)
NR	American National Thread with a 0.108p to 0.144p Controlled Root Radius
NS	American National Thread-Special
PTF-SAE	Short Dryseal SAE Short Taper Pipe Thread
SGT	Special Gas Taper Thread
SPL-PTF	Dryseal Special Taper Pipe Thread
STI	Special Thread for Helical Coil Wire Screw Thread Inserts
Stub Acme	Stub Acme Thread
*UN	Unified Constant-Pitch Thread Series
*UNC	Unified Coarse Thread Series
*UNEF	Unified Extra-Fine Thread Series
*UNF	Unified Fine Thread Series
UNJ	Unified Thread Series with a 0.150lp to 0.18042p Controlled Root Radius on External Thread only.
UNJC	Unified Coarse Thread Series with a 0.150lp to 0.18042p Controlled Root Radius on External Thread only.
UNJF	Unified Fine Thread Series with a 0.150lp to 0.18042p Controlled Root Radius on External Thread only.
UNM	Unified Miniature Thread Series
UNR	Unified Constant-pitch Thread Series with a 0.108p to 0.144p Controlled Root Radius
UNRC	Unified Coarse Thread Series with a 0.108p to 0.144p Controlled Root Radius
UNRF	Unified Fine Thread Series with a 0.108p to 0.144p Controlled Root Radius
*UNS	Unified Thread-Special
V	A 60 "V" thread with Truncated Crest and Root. The theoretical "V" Form is usually flattened to the user's specifications.

*Taps are not marked with "U", but with the symbol for the corresponding American Standard thread form with which it is compatible.

Machine Taps

Spiral Point Taps

Spiral Flute Taps

Thread Forming Taps

Pipe Taps

Dies

Technical Info

Sets

Index



Technical Information
302 / 302A Specifications

Standard Tap Dimensions
Ground Thread

USCTI Table 302

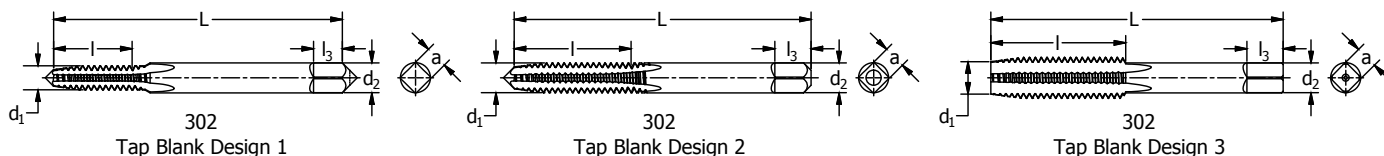

USCTI Table 302A

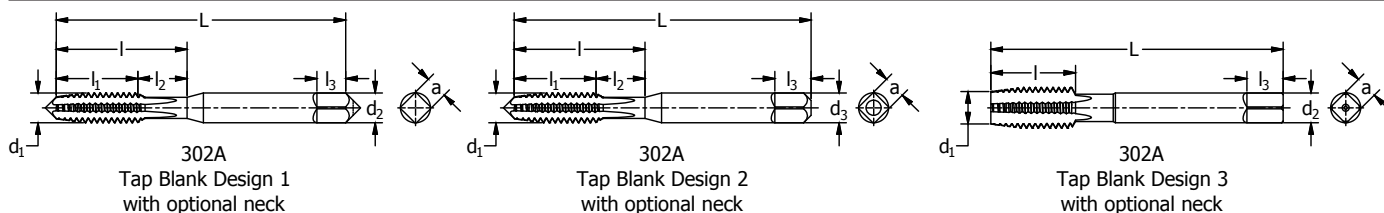

Fractional Sizes

nominal inch diameter d_1		nominal diameter range over to (inclusive)		tap blank design (see above)	overall length L	thread length l	optional length short thd l_1	optional length neck l_2	square length l_3	shank diameter d_2	square size a
fractional	decimal	over	to (inclusive)	(see above)	L	l	l_1	l_2	l_3	d_2	a
1/4	.2500	.223	.260	2	2.500	1.000	.630	.380	.310	.255	.191
5/16	.3125	.260	.323	2	2.719	1.125	.690	.440	.380	.318	.238
3/8	.3750	.323	.395	2	2.938	1.250	.750	.500	.440	.381	.286
7/16	.4375	.395	.448	3	3.156	1.438	.880	—	.410	.323	.242
1/2	.5000	.448	.510	3	3.375	1.656	.940	—	.440	.367	.275
9/16	.5625	.510	.573	3	3.594	1.656	.000	—	.500	.429	.322
5/8	.6250	.573	.635	3	3.813	1.813	.090	—	.560	.480	.360
11/16	.6875	.635	.709	3	4.031	1.813	1.090	—	.630	.542	.406
3/4	.7500	.709	.760	3	4.250	2.000	1.220	—	.690	.590	.442
13/16	.8125	.760	.823	3	4.470	2.000	1.220	—	.690	.652	.489
7/8	.8750	.823	.885	3	4.688	2.219	1.340	—	.750	.697	.523
15/16	.9375	.885	.948	3	4.910	2.220	1.340	—	.750	.760	.570
1	1.0000	.948	1.010	3	5.125	2.500	1.500	—	.810	.800	.600
1-1/16	1.0625	1.010	1.073	3	5.130	2.500	—	—	.880	.896	.672
1-1/8	1.1250	1.073	1.135	3	5.438	2.563	—	—	.880	.896	.672
1-3/16	1.1875	1.135	1.198	3	5.440	2.560	—	—	1.000	1.021	.766
1-1/4	1.2500	1.198	1.260	3	5.750	2.563	—	—	1.000	1.021	.766
1-5/16	1.3125	1.260	1.323	3	5.750	2.560	—	—	1.060	1.108	.831
1-3/8	1.3750	1.323	1.385	3	6.063	3.000	—	—	1.060	1.108	.831
1-7/16	1.4375	1.358	1.448	3	6.060	3.000	—	—	1.130	1.233	.925
1-1/2	1.5000	1.448	1.510	3	6.375	3.000	—	—	1.130	1.233	.925
1-5/8	1.6250	1.510	1.635	3	6.690	3.190	—	—	1.130	1.305	.979
1-3/4	1.7500	1.635	1.760	3	7.000	3.190	—	—	1.250	1.430	1.072
1-7/8	1.8750	1.760	1.885	3	7.310	3.560	—	—	1.250	1.519	1.139
2	2.0000	1.885	2.010	3	7.630	3.560	—	—	1.380	1.644	1.233

Machine Screw Sizes

nominal inch diameter d_1		nominal diameter range over to (inclusive)		tap blank design (see above)	overall length L	thread length l	optional length short thd l_1	optional length neck l_2	square length l_3	shank diameter d_2	square size a
MS#	decimal	over	to (inclusive)	(see above)	L	l	l_1	l_2	l_3	d_2	a
0	.0600	.052	.065	1	1.625	.313	—	—	.190	.141	.110
1	.0730	.065	.078	1	1.688	.375	—	—	.190	.141	.110
2	.0860	.078	.091	1	1.750	.438	—	—	.190	.141	.110
3	.0990	.091	.104	1	1.813	.500	—	—	.190	.141	.110
4	.1120	.104	.117	1	1.875	.563	.310	.250	.190	.141	.110
5	.1250	.117	.130	1	1.938	.625	.310	.310	.190	.141	.110
6	.1380	.130	.145	1	2.000	.688	.380	.310	.190	.141	.110
8	.1640	.145	.171	1	2.125	.750	.380	.380	.250	.168	.131
10	.1900	.171	.197	1	2.375	.875	.500	.380	.250	.194	.152
12	.2160	.197	.223	1	2.375	.938	.500	.440	.280	.220	.165

Machine Taps
Spiral Point Taps
Spiral Flute Taps
Thread Forming Taps
Pipe Taps
Dies
Technical Info
Sets
Index



Metric Sizes

	nominal diameter range		tap blank design (see above)	overall length L	thread length l	optional length		square length l₃	shank diameter d₂	square size a	
	mm	decimal				over	to (inclusive)				short thd l₁
M1.6	.063	.052	.065	1	1.625	.313	—	—	.190	.141	.110
M1.8	.071	.065	.078	1	1.688	.375	—	—	.190	.141	.110
M2	.079	.078	.091	1	1.750	.438	—	—	.190	.141	.110
M2.2	.087	.078	.091	1	1.750	.438	—	—	.190	.141	.110
M2.5	.098	.091	.104	1	1.813	.500	—	—	.190	.141	.110
M3	.118	.117	.130	1	1.938	.625	.310	.310	.190	.141	.110
M3.5	.138	.130	.145	1	2.000	.688	.380	.310	.190	.141	.110
M4	.158	.145	.171	1	2.125	.750	.380	.380	.250	.168	.131
M4.5	.177	.171	.197	1	2.375	.875	.500	.380	.250	.194	.152
M5	.197	.171	.197	1	2.375	.875	.500	.440	.250	.194	.152
M6	.236	.223	.260	2	2.500	1.000	.630	.380	.310	.255	.191
M7	.276	.260	.323	2	2.719	1.125	.690	.440	.380	.318	.238
M8	.315	.260	.323	2	2.719	1.125	.690	.440	.380	.318	.238
M10	.394	.323	.395	2	2.938	1.250	.750	.500	.440	.381	.286
M12	.472	.448	.510	3	3.375	1.656	.940	—	.440	.367	.275
M14	.551	.510	.573	3	3.594	1.656	1.000	—	.500	.429	.322
M16	.630	.573	.635	3	3.813	1.813	1.090	—	.560	.480	.360
M18	.709	.635	.709	3	4.031	1.813	1.090	—	.630	.542	.406
M20	.787	.760	.823	3	4.469	2.000	1.220	—	.690	.652	.489
M22	.866	.823	.885	3	4.690	2.220	1.340	—	.750	.697	.523
M24	.945	.885	.948	3	4.906	2.219	1.340	—	.750	.760	.570
M25	.984	.948	1.010	3	5.130	2.500	1.500	—	.810	.800	.600
M27	1.063	1.010	1.073	3	5.130	2.500	—	—	.880	.896	.672
M30	1.181	1.135	1.198	3	5.438	2.563	—	—	1.000	1.021	.766

Standard Tap Dimension Tolerances

nominal diameter range (in.)		overall length L	thread length l	tolerances (in.)		
over	to (inc.)			square length l₃	shank diameter d₂	square size a
.0520	.2230	+/- .031	+/- .047	+/- .031	-.0015	-.004
.2230	.5100	+/- .031	+/- .063	+/- .031	-.0015	-.004
.5100	.6350	+/- .031	+/- .094	+/- .031	-.0015	-.006
.6350	1.0100	+/- .031	+/- .094	+/- .031	-.0020	-.006
1.0100	1.5100	+/- .063	+/- .094	+/- .063	-.0020	-.008
1.5100	2.0100	+/- .063	+/- .125	+/- .063	-.0030	-.008
2.0100	4.0100	+/- .063	+/- .125	+/- .063	-.0030	-.010

Machine Taps
Spiral Point Taps
Spiral Flute Taps
Thread Forming Taps
Pipe Taps
Dies
Technical Info
Sets
Index

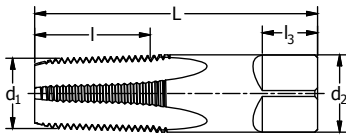

311
Pipe Tap Blank Design 1

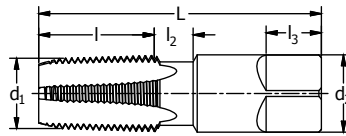

311
Pipe Tap Blank Design 2
with optional neck

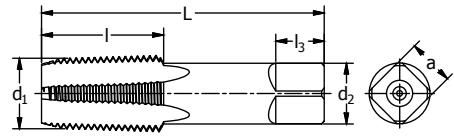

311
Pipe Tap Blank Design 3

Inch Pipe Tap Sizes

nominal inch diameter d1		tap blank design	overall length	thread length	optional neck length	square length	shank diameter	square size
fractional	decimal	(see above)	L	l1	l2	l3	d2	a
1/16	.0625	1 or 2	2.130	.690	.375	.380	.3125	.234
1/8	.1250	1	2.130	.750	—	.380	.3125	.234
1/8	.1250	1 or 2	2.130	.750	.375	.380	.4375	.328
1/4	.2500	1 or 2	2.440	1.060	.375	.440	.5625	.421
3/8	.3750	1 or 2	2.560	1.060	.375	.500	.7000	.531
1/2	.5000	1	3.130	1.380	—	.630	.6875	.515
3/4	.7500	1	3.250	1.380	—	.690	.9063	.679
1	1.0000	1	3.750	1.750	—	.810	1.1250	.843
1-1/4	1.2500	1	4.000	1.750	—	.940	1.3125	.984
1-1/2	1.5000	1	4.250	1.750	—	1.000	1.5000	1.125
2	2.0000	3	4.500	1.750	—	1.130	1.8750	1.406

Standard Pipe Tap Dimension Tolerances

nominal inch diameter d1		overall length	thread length	square length	shank diameter	square size
fractional	decimal	L	l1	l3	d2	a
1/16	.0625	+/- .031	+/- .063	+/- .031	-.0015	-.004
1/8	.1250	+/- .031	+/- .063	+/- .031	-.0015	-.004
1/8	.1250	+/- .031	+/- .063	+/- .031	-.0015	-.004
1/4	.2500	+/- .031	+/- .063	+/- .031	-.0020	-.006
3/8	.3750	+/- .031	+/- .063	+/- .031	-.0020	-.006
1/2	.5000	+/- .031	+/- .063	+/- .031	-.0020	-.006
3/4	.7500	+/- .031	+/- .063	+/- .031	-.0020	-.006
1	1.0000	+/- .063	+/- .094	+/- .063	-.0020	-.008
1-1/4	1.2500	+/- .063	+/- .094	+/- .063	-.0030	-.008
1-1/2	1.5000	+/- .063	+/- .125	+/- .063	-.0030	-.008
2	2.0000	+/- .063	+/- .125	+/- .063	-.0030	-.008

Thread Limits – Taper Pipe Taps – Ground Thread

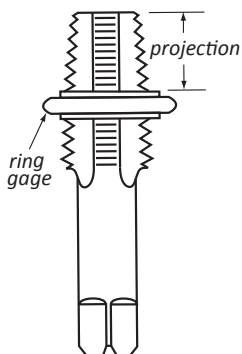

nominal tap size (inch)	threads per inch	projection (inch)	projection tolerance +/- inch	taper per foot (inch)		ring gage thickness	tap drill size NPT,ANPT,NFTF
				min.	max		
1/16	27	.312	.063	.719	.781	.160	C
1/8	27	.312	.063	.719	.781	.1615	Q
1/4	18	.459	.063	.719	.781	.2278	7/16
3/8	18	.454	.063	.719	.781	.240	9/16
1/2	14	.579	.063	.719	.781	.320	45/64
3/4	14	.565	.063	.719	.781	.339	29/32
1	11-1/2	.678	.094	.719	.781	.400	1 9/64
1-1/4	11-1/2	.686	.094	.719	.781	.420	1 31/64
1-1/2	11-1/2	.699	.094	.719	.781	.420	1 23/32
2	11-1/2	.667	.094	.719	.781	.436	2 3/16

Machine Taps
Spiral Point Taps
Spiral Flute Taps
Thread Forming Taps
Pipe Taps
Dies
Technical Info
Sets
Index



Thread Limits

Unified and American National Form

Fractional Taps – Ground Thread

Lead Tolerance

A maximum lead error of + / - .0005" in 1" of thread is permitted.

Angle Tolerance

Threads Per Inch	Error in Half Angle
6 to 9 inclusive	25' + / -
10 to 28 inclusive	30' + / -

Pitch Diameter Limits

for taps through 1" diameter:

- H1 = basic to basic plus .0005"
- H2 = basic plus .0005" to basic plus .001"
- H3 = basic plus .001" to basic plus .0015"
- H4 = basic plus .0015" to basic plus .002"
- H5 = basic plus .002" to basic plus .0025"
- H6 = basic plus .0025" to basic plus .003"

for Taps over 1" Diameter Through 1-1/2" diameter:

- H4 = basic plus .001" to basic plus .002"

Formulae (Approximate)

Max. Major Diameter = Basic Major Diameter + A*
 Min. Major Diameter = Max. Major Diameter - B*
**See USCTI Table 331.*

Thread Limits

nom size	threads per inch			major diameter			basic pitch dia	pitch diameter limits											
	NC UNC	NF UNF	NS UNS	basic	min	max		H1 limit		H2 limit		H3 limit		H4 limit		H5 limit		H6 limit	
								min	max	min	max	min	max	min	max	min	max	min	max
1/4	20	-	-	.2500	.2540	.2550	.2175	.2175	.2180	.2180	.2185	.2185	.2190	-	-	.2195	.2200	-	-
1/4	-	28	-	.2500	.2525	.2535	.2268	.2268	.2273	.2273	.2278	.2278	.2283	.2283	.2288	-	-	-	-
5/16	18	-	-	.3125	.3170	.3180	.2764	.2764	.2769	.2769	.2774	.2774	.2779	-	-	.2784	.2789	-	-
5/16	-	24	-	.3125	.3155	.3165	.2854	.2854	.2859	.2859	.2864	.2864	.2869	.2869	.2874	-	-	-	-
3/8	16	-	-	.3750	.3800	.3810	.3344	.3344	.3349	.3349	.3354	.3354	.3359	-	-	.3364	.3369	-	-
3/8	-	24	-	.3750	.3780	.3790	.3479	.3479	.3484	.3484	.3489	.3489	.3494	.3494	.3499	-	-	-	-
7/16	14	-	-	.4375	.4435	.4445	.3911	-	-	.3916	.3921	.3921	.3926	-	-	.3931	.3936	-	-
7/16	-	20	-	.4375	.4415	.4425	.4050	-	-	-	.4060	.4065	.4065	-	-	.4070	.4075	-	-
1/2	13	-	-	.5000	.5065	.5075	.4500	.4500	.4505	.4505	.4510	.4510	.4515	-	-	.4520	.4525	-	-
1/2	-	20	-	.5000	.5040	.5050	.4675	.4675	.4680	.4680	.4685	.4685	.4690	-	-	.4695	.4700	-	-
9/16	12	-	-	.5625	.5690	.5700	.5084	-	-	.5089	-	-	.5099	-	-	.5104	.5109	-	-
9/16	-	18	-	.5625	.5670	.5680	.5264	-	-	.5269	.5274	.5274	.5279	-	-	.5284	.5289	-	-
5/8	11	-	-	.6250	.6320	.6330	.5660	-	-	.5665	.5670	.5670	.5675	-	-	.5680	.5685	-	-
5/8	-	18	-	.6250	.6295	.6305	.5889	-	-	.5894	.5899	.5899	.5904	-	-	.5909	.5914	-	-
11/16	-	-	11	.6875	.6945	.6955	.6285	-	-	-	-	.6295	.6300	-	-	-	-	-	-
11/16	-	-	16	.6875	.6925	.6935	.6469	-	-	-	-	.6479	.6484	-	-	-	-	-	-
3/4	10	-	-	.7500	.7575	.7590	. -	-	.6855	.6855	.6860	.6860	.6865	-	-	.6870	.6875	-	-
3/4	-	16	-	.7500	.7550	.7560	.7094	.7094	.7099	.7099	.7104	.7104	.7109	-	-	.7114	.7119	-	-
7/8	9	-	-	.8750	.8835	.8850	.8028	-	-	-	-	-	-	.8043	.8048	-	-	.8053	.8058
7/8	-	14	-	.8750	.8810	.8820	.8286	-	-	.8291	.8296	-	-	.8301	.8306	-	-	.8311	.8316
1	8	-	-	1.0000	1.0095	1.0110	.9188	-	-	.9193	.9198	-	-	.9203	.9208	-	-	.9213	.9218
1	-	12	-	1.0000	1.0065	1.0075	.9459	-	-	-	-	-	-	.9474	.9479	-	-	-	-
1	-	-	14	1.0000	1.0060	1.0070	.9536	-	-	-	-	-	-	.9551	.9556	-	-	-	-
1 1/8	7	-	-	1.1250	1.1350	1.1370	1.0322	-	-	-	-	-	-	1.0332	1.0342	-	-	-	-
1-1/8	-	12	-	1.1250	1.1320	1.1325	1.0709	-	-	-	-	-	-	1.0719	1.0729	-	-	-	-
1-1/4	7	-	-	1.2500	1.2600	1.2620	1.1572	-	-	-	-	-	-	1.1582	1.1592	-	-	-	-
1-1/4	-	12	-	1.2500	1.2565	1.2575	1.1959	-	-	-	-	-	-	1.1969	1.1979	-	-	-	-
1-3/8	6	-	-	1.3750	1.3870	1.3890	1.2667	-	-	-	-	-	-	1.2677	1.2687	-	-	-	-
1-3/8	-	12	-	1.3750	1.3815	1.3825	1.3209	-	-	-	-	-	-	1.3219	1.3229	-	-	-	-
1-1/2	6	-	-	1.5000	1.5120	1.5140	1.3917	-	-	-	-	-	-	1.3927	1.3937	-	-	-	-
1 1/2	-	12	-	1.5000	1.5070	1.5075	1.4459	-	-	-	-	-	-	1.4469	1.4479	-	-	-	-



Machine Screw Taps – Ground Thread

Lead Tolerance

A maximum lead error of + / - .0005" in 1" of thread is permitted.

Angle Tolerance

Threads Per Inch Error in Half Angle
20 to 80 inclusive 30' + / -

Pitch Diameter Limits

H1 = basic to basic + .0005" to basic + .001"
H2 = basic + .0005" to basic + .001"
H3 = basic + .001" to basic + .0015"
H7 = basic + .003" to basic + .0035"

Formulae

Max. Major Diameter= Basic Major Diameter + A
Min. Major Diameter= Max. Major Diameter - B

A = Constant to add: 45% of the theoretical truncation to nearest .0005"
B = Major diameter tolerance.

Thread Limits

nom size	threads per inch			major diameter			basic pitch dia	pitch diameter limits							
	NC UNC	NF UNF	NS UNS	basic	min	max		H1 limit		H2 limit		H3 limit		H7 limit	
								min	max	min	max	min	max	min	max
0	-	80	-	.0600	.0605	.0615	.0519	.0519	.0524	.0524	.0529	-	-	-	-
1	64	-	-	.0730	.0735	.0745	.0629	.0629	.0634	.0634	.0639	-	-	-	-
1	-	72	-	.0730	.0735	.0745	.0640	.0640	.0645	.0645	.0650	-	-	-	-
2	56	-	-	.0860	.0865	.0875	.0744	.0744	.0749	.0749	.0754	-	-	-	-
2	-	64	-	.0860	.0865	.0875	.0759	-	-	.0764	.0769	-	-	-	-
3	48	-	-	.0990	.1000	.1010	.0855	.0855	.0860	.0860	.0865	-	-	-	-
3	-	56	-	.0990	.0995	.1005	.0874	.0874	.0879	.0879	.0884	-	-	-	-
4	-	-	36	.1120	.1135	.1145	.0940	-	-	.0945	.0950	-	-	-	-
4	40	-	-	.1120	.1135	.1145	.0958	.0958	.0963	.0963	.0968	-	-	-	-
4	-	48	-	.1120	.1130	.1140	.0985	.0985	.0990	.0990	.0995	-	-	-	-
5	40	-	-	.1250	.1265	.1275	.1088	.1088	.1093	.1093	.1098	-	-	-	-
5	-	44	-	.1250	.1260	.1270	.1102	-	-	.1107	.1112	-	-	-	-
6	32	-	-	.1380	.1400	.1410	.1177	.1177	.1182	.1182	.1187	.1187	.1192	.1207	.1212
6	-	40	-	.1380	.1395	.1405	.1218	.1218	.1223	.1223	.1228	-	-	-	-
8	32	-	-	.1640	.1660	.1670	.1437	.1437	.1442	.1442	.1447	.1447	.1452	.1467	.1472
8	-	36	-	.1640	.1655	.1665	.1460	-	-	.1465	.1470	-	-	-	-
10	24	-	-	.1900	.1930	.1940	.1629	.1629	.1634	.1634	.1639	.1639	.1644	.1659	.1664
10	-	32	-	.1900	.1920	.1930	.1697	.1697	.1702	.1702	.1707	.1707	.1712	.1727	.1732
12	24	-	-	.2160	.2190	.2200	.1889	-	-	-	-	.1899	.1904	-	-
12	-	28	-	.2160	.2185	.2195	.1928	-	-	-	-	.1938	.1943	-	-





Thread Limits

Metric Taps

Ground Thread

General

These tables and formulae are used in determining the limits and tolerances for ground thread metric taps unless otherwise specified. They apply only to metric threads having a 60° form with a P/8 flat at the major diameter of the basic thread form.

Note: When the tap major diameter must be determined from a specific tap pitch diameter, the minimum major diameter equals the maximum specified tap pitch diameter minus constant Y, plus the basic size height of thread (.64952P), plus constant W.

Lead Tolerance

A maximum lead error of + / - .0005" in 1" of thread is permitted.

Angle Tolerance

Pitch mm	Deviation in Half Angle
over 0.25 to 2.5 inclusive	30' + / -
over 2.5 to 4 inclusive	25' + / -
over 4 to 6 inclusive	20' + / -

Formulae

- Max. Major Diameter = Min. + X
- Min. Major Diameter = Basic + W
- Max. Pitch Diameter = Basic + Y
- Min. Pitch Diameter = Max. - Z
- W = Constant to add to Basic Major Diameter (.080P converted to inches)
- X = Major Diameter Tolerance
- Y = Amount over Basic for Maximum Pitch Diameter
- Z = Pitch Diameter Tolerance

Values for W, X, Y and Z (inches)

pitch mm	inch equivalent	W	X	Y	Y	Y	Y	Z	Z	Z	Z
		inch	inch	M1.6 thru M6.3	over M6.3 thru M25	over M25 thru M90	over M90	M1.6 thru M6.3	over M6.3 thru M25	over M25 thru M90	over M90
0.3	.01181	.0009	.0010	.0015	.0015	.0020	.0020	.0006	.0006	.0008	.0008
0.35	.01378	.0011	.0010	.0015	.0015	.0020	.0020	.0006	.0006	.0008	.0008
0.4	.01575	.0013	.0010	.0015	.0020	.0020	.0020	.0006	.0006	.0008	.0010
0.45	.01772	.0014	.0010	.0015	.0020	.0020	.0020	.0006	.0008	.0008	.0010
0.5	.01968	.0016	.0010	.0015	.0020	.0020	.0025	.0006	.0008	.0010	.0010
0.6	.02362	.0019	.0010	.0020	.0020	.0025	.0025	.0008	.0008	.0010	.0010
0.7	.02756	.0022	.0016	.0020	.0020	.0025	.0025	.0008	.0008	.0010	.0010
0.75	.02953	.0024	.0016	.0020	.0025	.0025	.0030	.0008	.0010	.0010	.0012
0.8	.03150	.0025	.0016	.0020	.0025	.0025	.0030	.0008	.0010	.0010	.0012
0.9	.03543	.0028	.0016	.0020	.0025	.0025	.0030	.0008	.0010	.0010	.0012
1	.03937	.0032	.0016	.0025	.0025	.0030	.0030	.0010	.0010	.0012	.0012
1.25	.04921	.0039	.0025	.0025	.0025	.0030	.0035	.0010	.0012	.0012	.0016
1.5	.05906	.0047	.0025	.0025	.0030	.0030	.0035	.0010	.0012	.0012	.0016
1.75	.06890	.0055	.0025	—	.0030	.0035	.0040	—	.0012	.0016	.0016
2	.07874	.0063	.0025	—	.0035	.0035	.0040	—	.0016	.0016	.0016
2.5	.09843	.0079	.0025	—	.0035	.0040	.0045	—	.0016	.0016	.0020
3	.11811	.0095	.0039	—	.0040	.0040	.0050	—	.0016	.0020	.0020
3.5	.13780	.0110	.0039	—	.0040	.0045	.0050	—	.0016	.0020	.0020
4	.15748	.0126	.0039	—	.0040	.0045	.0055	—	.0020	.0020	.0025
4.5	.17717	.0142	.0039	—	—	.0050	.0055	—	.0020	.0020	.0025
5	.19685	.0158	.0039	—	—	.0050	.0060	—	—	.0025	.0025
5.5	.21654	.0158	.0039	—	—	.0050	.0060	—	—	.0025	.0025
6	.23622	.0189	.0039	—	—	.0055	.0060	—	—	.0025	.0025



Technical Information

Fractional Sizes

Basic Thread Dimensions

nominal size & TPI	basic major diameter	basic pitch diameter	basic minor diameter	max minor diameter Class 3B internal thread
1/16	64	.0625	.0524	.0422
3/32	48	.0938	.0803	.0667
1/8	40	.1250	.1088	.0925
5/32	32	.1563	.1360	.1157
5/32	36	.1563	.1382	.1202
3/16	24	.1875	.1604	.1334
3/16	32	.1875	.1672	.1469
7/32	24	.2188	.1917	.1646
7/32	32	.2188	.1985	.1782
1/4	20	.2500	.2175	.1850
1/4	24	.2500	.2229	.1959
1/4	28	.2500	.2268	.2036
1/4	32	.2500	.2297	.2094
5/16	18	.3125	.2764	.2403
5/16	20	.3125	.2800	.2476
5/16	24	.3125	.2854	.2584
5/16	32	.3125	.2922	.2719
3/8	16	.3750	.3344	.2938
3/8	20	.3750	.3425	.3100
3/8	24	.3750	.3479	.3209
3/8	32	.3750	.3547	.3344
7/16	14	.4375	.3911	.3447
7/16	20	.4375	.4050	.3726
7/16	24	.4375	.4104	.3834
7/16	28	.4375	.4143	.3911
1/2	12	.5000	.4459	.3918
1/2	13	.5000	.4500	.4001
1/2	20	.5000	.4675	.4351
1/2	24	.5000	.4729	.4459
1/2	28	.5000	.4768	.4536
9/16	12	.5625	.5084	.4542
9/16	18	.5625	.5264	.4903
9/16	24	.5625	.5354	.5084
5/8	11	.6250	.5660	.5069
5/8	12	.6250	.5709	.5168
5/8	18	.6250	.5889	.5528
5/8	24	.6250	.5979	.5709
11/16	11	.6875	.6285	.5694
11/16	12	.6875	.6334	.5793
11/16	16	.6875	.6469	.6063
11/16	24	.6875	.6604	.6334
3/4	10	.7500	.6850	.6201
3/4	12	.7500	.6959	.6418

nominal size & TPI	basic major diameter	basic pitch diameter	basic minor diameter	max minor diameter Class 3B internal thread
3/4	16	.7500	.7094	.6688
3/4	20	.7500	.7175	.6850
13/16	12	.8125	.7584	.7042
13/16	16	.8125	.7719	.7313
13/16	20	.8125	.7800	.7475
7/8	9	.8750	.8028	.7307
7/8	12	.8750	.8209	.7668
7/8	14	.8750	.8286	.7822
7/8	16	.8750	.8344	.7938
7/8	18	.8750	.8389	.8028
7/8	20	.8750	.8425	.8100
15/16	12	.9375	.8834	.8293
15/16	16	.9375	.8969	.8563
15/16	20	.9375	.9050	.8725
1	8	1.0000	.9188	.8376
1	12	1.0000	.9459	.8918
1	14	1.0000	.9536	.9072
1	16	1.0000	.9594	.9188
1	20	1.0000	.9675	.9350
1 1/16	12	1.0625	1.0084	.9543
1 1/16	16	1.0625	1.0219	.9813
1 1/16	18	1.0625	1.0264	.9903
1 1/8	7	1.1250	1.0322	.9394
1 1/8	8	1.1250	1.0438	.9626
1 1/8	12	1.1250	1.0709	1.0168
1 1/8	16	1.1250	1.0844	1.0438
1 1/8	18	1.1250	1.0889	1.0528
1 3/16	12	1.1875	1.1334	1.0793
1 3/16	16	1.1875	1.1469	1.1063
1 3/16	18	1.1875	1.1514	1.1153
1 1/4	7	1.2500	1.1572	1.0644
1 1/4	8	1.2500	1.1688	1.0876
1 1/4	12	1.2500	1.1959	1.1418
1 1/4	16	1.2500	1.2094	1.1688
1 1/4	18	1.2500	1.2139	1.1778
1 5/16	12	1.3125	1.2584	1.2043
1 5/16	16	1.3125	1.2719	1.2313
1 5/16	18	1.3125	1.2764	1.2403
1 3/8	6	1.3750	1.2667	1.1585
1 3/8	8	1.3750	1.2938	1.2126
1 3/8	12	1.3750	1.3209	1.2668
1 3/8	16	1.3750	1.3344	1.2938
1 3/8	18	1.3750	1.3389	1.3028

continued on next page

- Machine Taps
- Spiral Point Taps
- Spiral Flute Taps
- Thread Forming Taps
- Pipe Taps
- Dies
- Technical Info
- Sets
- Index



Basic Thread Dimensions

Fractional Sizes (continued)

Machine Taps

Spiral Point Taps

Spiral Flute Taps

Thread Forming Taps

Pipe Taps

Dies

Technical Info

Sets

Index

nominal size & TPI	basic major diameter	basic pitch diameter	basic minor diameter	max minor diameter Class 3B internal thread
1 7/16 12	1.4375	1.3834	1.3293	1.3573
1 7/16 16	1.4375	1.3969	1.3563	1.3783
1 7/16 18	1.4375	1.4014	1.3653	1.3855
1 1/2 6	1.5000	1.3917	1.2835	1.3396
1 1/2 8	1.5000	1.4188	1.3376	1.3797
1 1/2 12	1.5000	1.4459	1.3918	1.4198
1 1/2 16	1.5000	1.4594	1.4188	1.4408
1 1/2 18	1.5000	1.4639	1.4278	1.4480
1 1/2 16	1.5625	1.5219	1.4813	1.5033
1 1/2 18	1.5625	1.5264	1.4903	1.5105
1 5/8 6	1.6250	1.5167	1.4085	1.4646
1 5/8 8	1.6250	1.5438	1.4626	1.5047
1 5/8 12	1.6250	1.5709	1.5168	1.5448
1 5/8 16	1.6250	1.5844	1.5438	1.5658
1 5/8 18	1.6250	1.5889	1.5528	1.5730
1 11/16 16	1.6875	1.6469	1.6063	1.6283
1 11/16 18	1.6875	1.6514	1.6153	1.6355
1 3/4 5	1.7500	1.6201	1.4902	1.5575
1 3/4 8	1.7500	1.6688	1.5876	1.6297
1 3/4 12	1.7500	1.6959	1.6418	1.6698
1 3/4 16	1.7500	1.7094	1.6688	1.6908
1 13/16 16	1.8125	1.7719	1.7313	1.7533
1 7/8 8	1.8750	1.7938	1.7126	1.7547
1 7/8 12	1.8750	1.8209	1.7668	1.7948
1 7/8 16	1.8750	1.8344	1.7938	1.8158
1 15/16 16	1.9375	1.8969	1.8563	1.8783
2 4 1/2	2.0000	1.8557	1.7113	1.7861
2 8	2.0000	1.9188	1.8376	1.8797
2 12	2.0000	1.9459	1.8918	1.9198
2 16	2.0000	1.9594	1.9188	1.9408
2 1/16 16	2.0625	2.0219	1.9813	2.0033
2 1/8 8	2.1250	2.0438	1.9626	2.0047
2 1/8 12	2.1250	2.0709	2.0168	2.0448
2 1/8 16	2.1250	2.0844	2.0438	2.0658
2 3/16 16	2.1875	2.1469	2.1063	2.1283
2 1/4 4 1/2	2.2500	2.1057	1.9613	2.0361
2 1/4 8	2.2500	2.1688	2.0876	2.1297
2 1/4 12	2.2500	2.1959	2.1418	2.1698
2 1/4 16	2.2500	2.2094	2.1688	2.1908
2 5/16 16	2.3125	2.2719	2.2313	2.2533
2 3/8 12	2.3750	2.3209	2.2668	2.2948
2 3/8 16	2.3750	2.3344	2.2938	2.3158

nominal size & TPI	basic major diameter	basic pitch diameter	basic minor diameter	max minor diameter Class 3B internal thread
2 7/16 16	2.4375	2.3969	2.3563	2.3783
2 1/2 4	2.5000	2.3376	2.1752	2.2594
2 1/2 8	2.5000	2.4188	2.3376	2.3797
2 1/2 12	2.5000	2.4459	2.3918	2.4198
2 1/2 16	2.5000	2.4594	2.4188	2.4408
2 5/8 12	2.6250	2.5709	2.5168	2.5448
2 5/8 16	2.6250	2.5844	2.5438	2.5658
2 3/4 4	2.7500	2.5876	2.4252	2.5094
2 3/4 8	2.7500	2.6688	2.5876	2.6297
2 3/4 12	2.7500	2.6959	2.6418	2.6698
2 3/4 16	2.7500	2.7094	2.6688	2.6908
2 7/8 12	2.8750	2.8209	2.7668	2.7948
2 7/8 16	2.8750	2.8344	2.7938	2.8158
3 4	3.0000	2.8376	2.6752	2.7594
3 8	3.0000	2.9188	2.8376	2.8797
3 12	3.0000	2.9459	2.8918	2.9198
3 16	3.0000	2.9594	2.9188	2.9408
3 1/8 12	3.1250	3.0709	3.0168	3.0448
3 1/8 16	3.1250	3.0844	3.0438	3.0658
3 1/4 4	3.2500	3.0876	2.9252	3.0094
3 1/4 8	3.2500	3.1688	3.0876	3.1297
3 1/4 12	3.2500	3.1959	3.1418	3.1698
3 1/4 16	3.2500	3.2094	3.1688	3.1908
3 3/8 12	3.3750	3.3209	3.2668	3.2948
3 3/8 16	3.3750	3.3344	3.2938	3.3158
3 3/8 4	3.5000	3.3376	3.1752	3.2594
3 1/2 8	3.5000	3.4188	3.3376	3.3797
3 1/2 12	3.5000	3.4459	3.3918	3.4198
3 1/2 16	3.5000	3.4594	3.4188	3.4408
3 5/8 12	3.6250	3.5709	3.5168	3.5448
3 5/8 16	3.6250	3.5844	3.5438	3.5658
3 3/4 4	3.7500	3.5876	3.4252	3.5094
3 3/4 8	3.7500	3.6688	3.5876	3.6297
3 3/4 12	3.7500	3.6959	3.6418	3.6698
3 3/4 16	3.7500	3.7094	3.6688	3.6908
3 7/8 12	3.8750	3.8209	3.7669	3.7948
3 7/8 16	3.8750	3.8344	3.7938	3.8158
4 4	4.0000	3.8376	3.6752	3.7594
4 8	4.0000	3.9188	3.8376	3.8797
4 12	4.0000	3.9459	3.8918	3.9198
4 16	4.0000	3.9594	3.9188	3.9408
4 16	1.8125	1.7719	1.7313	1.7533



Thread Dimensions

nominal size & TPI		basic major diameter	basic pitch diameter	basic minor diameter	max minor diameter Class 3B internal thread	nominal size & TPI		basic major diameter	basic pitch diameter	basic minor diameter	max minor diameter Class 3B internal thread
0	80	.0600	.0519	.0438	.0514	6	32	.1380	.1177	.0974	.1140
1	64	.0730	.0629	.0527	.0623	6	36	.1380	.1200	.1019	.1165
1	72	.0730	.0640	.0550	.0635	6	40	.1380	.1218	.1055	.1186
2	56	.0860	.0744	.0628	.0737	8	32	.1640	.1437	.1234	.1389
2	64	.0860	.0759	.0657	.0753	8	36	.1640	.1460	.1279	.1416
3	48	.0990	.0855	.0719	.0845	8	40	.1640	.1478	.1315	.1437
3	56	.0990	.0874	.0758	.0865	10	24	.1900	.1629	.1359	.1516
4	32	.1120	.0917	.0714	.0880	10	28	.1900	.1668	.1436	.1604
4	36	.1120	.0940	.0759	.0919	10	30	.1900	.1684	.1467	.1630
4	40	.1120	.0958	.0795	.0939	10	32	.1900	.1697	.1494	.1641
4	48	.1120	.0985	.0849	.0968	12	24	.2160	.1889	.1619	.1807
5	40	.1250	.1088	.0925	.1062	12	28	.2160	.1928	.1696	.1857
5	44	.1250	.1102	.0955	.1079	12	32	.2160	.1957	.1754	.1895
						14	20	.2420	.2095	.1770	.1987
						14	24	.2420	.2149	.1879	.2059

Constants for Finding Pitch Diameter and Minor Diameter of Screw Threads

Basic Pitch Diameter = Basic Major Diameter – Constant for Basic Pitch Diameter for TPI

Basic Minor Diameter = Basic Major Diameter – Constant for Basic Minor Diameter for TPI

threads per inch	pitch in	pitch mm	constant for basic pitch dia.		constant for basic minor dia.		threads per inch	pitch in	pitch mm	constant for basic pitch dia.		constant for basic minor dia.	
			Unified	ISO	Unified	ISO				Unified	ISO		
-	.0079	0.2	-	.00511	-	.01022	18	.0555	-	.03608	-	.07216	-
-	.0088	0.225	-	.00575	-	.01150	-	.0590	1.5	-	.03836	-	.07672
-	.0098	0.25	-	.00639	-	.01278	16	.0625	-	.04060	-	.08120	-
-	.0118	0.3	-	.00767	-	.01534	-	.0689	1.75	-	.04475	-	.08950
80	.0125	-	.00812	-	.01624	-	14	.0714	-	.04639	-	.09278	-
-	.0138	0.35	-	.00895	-	.01790	13	.0769	-	.04996	-	.09992	-
72	.0139	-	.00902	-	.01804	-	-	.0787	2.0	-	.05117	-	.10228
64	.0156	-	.01015	-	.02030	-	12	.0833	-	.05413	-	.10826	-
-	.0157	0.4	-	.01023	-	.02046	11.5	.0869	-	.05648	-	.11296	-
-	.0177	0.45	-	.01151	-	.02302	11	.0909	-	.05905	-	.11810	-
56	.0178	-	.01160	-	.02320	-	-	.0984	2.5	-	.06393	-	.12786
-	.0197	0.5	-	.01279	-	.02558	10	.1000	-	.06495	-	.12990	-
48	.0208	-	.01353	-	.02706	-	9	.1111	-	.07217	-	.14434	-
44	.0227	-	.01476	-	.02952	-	-	.1181	3.0	-	.07672	-	.15344
-	.0236	0.6	-	.01534	-	.03068	8	.1250	-	.08119	-	.16238	-
40	.0250	-	.01624	-	.03248	-	-	.1378	3.5	-	.08950	-	.17900
-	.0275	0.7	-	.01790	-	.03580	7	.1428	-	.09279	-	.18558	-
36	.0278	-	.01804	-	.03608	-	-	.1575	4.0	-	.10229	-	.20458
-	.0295	0.75	-	.01918	-	.03836	6	.1667	-	.10825	-	.21650	-
32	.0312	-	.02030	-	.04060	-	-	.1772	4.5	-	.11507	-	.23014
-	.0315	0.8	-	.02046	-	.04092	5	.1968	-	.12786	-	.25572	-
28	.0357	-	.02320	-	.04640	-	4.5	.2000	-	.12990	-	.25980	-
27	.0370	-	.02406	-	.04812	-	-	.2165	5.5	-	.14064	-	.28128
-	.0394	1.0	-	.02557	-	.05114	4	.2222	-	.14434	-	.28868	-
24	.0417	-	.02706	-	.05412	-	-	.2362	6.0	-	.15343	-	.30353
-	.0492	1.25	-	.03196	-	.06392	4	.2500	-	.16238	-	.32476	-
20	.0500	-	.03248	-	.06496	-							

Machine Taps
Spiral Point Taps
Spiral Flute Taps
Thread Forming Taps
Pipe Taps
Dies
Technical Info
Sets
Index



Ground Thread

Quick Shipment Program - Special Taps

Prices for special taps are available upon request. Special taps can be furnished in quantities to meet your specific requirements. All special metric taps will produce internal threads which conform to ISO, ISO modified, and the

obsolete OMFS thread systems and are manufactured to USCTI standard blank dimensions to fit the tap holders and machine spindles now in use in the USA.

Call Customer Service at 800.348.2885 for your quote.

General

The following tables and formulae are used in determining the limits and tolerances for ground thread taps having special diameter or special pitch or both and having a thread lead angle not in excess of 5%, unless otherwise specified. This table does not apply to the diameter and pitch combinations shown in Tables 327 and 329.

Note: When the tap major diameter must be determined from a specific tap pitch diameter, the maximum major diameter = the minimum specified pitch diameter - constant C, + constant A.

Lead Tolerance

A maximum lead error of + / - .0005" in 1" of thread is permitted.

Angle Tolerance

Threads Per Inch	Error in Half Angle
4 to 5-1/2 inclusive	20' + / -
6 to 9 inclusive	25' + / -
10 to 80 inclusive	30' + / -

Formulae

- Max. Major Diameter = Basic Major Diameter + A
- Min. Major Diameter = Max. Major Diameter - B
- Max. Pitch Diameter = Min. Pitch Diameter + D
- Min. Pitch Diameter = Basic Pitch Diameter + C

A = constant to add:

- 35% of the theoretical truncation for 4 to 5 threads per inch
- 40% for 5-1/2 to 12 threads per inch
- 45% for 13 to 80 threads per inch
- to nearest .005" for 8 or more threads per inch

B = Major diameter tolerance

C = Amount over basic for minimum pitch diameter

D = Pitch diameter tolerance

Values for A, B, C, and D

threads per inch	A	B	C thru 5/8"	C over 5/8" thru 2-1/2"	C over 2-1/2"	D thru 1"	D over 1" thru 1-1/2"	D over 1-1/2" thru 2-1/2"	D over 2-1/2"
80	.0015	.0010	.0005	.0010	.0015	.0005	.0010	.0010	.0015
56	.0015	.0010	.0005	.0010	.0015	.0005	.0010	.0010	.0015
48	.0020	.0010	.0005	.0010	.0015	.0005	.0010	.0010	.0015
44	.0020	.0010	.0005	.0010	.0015	.0005	.0010	.0010	.0015
40	.0025	.0010	.0005	.0010	.0015	.0005	.0010	.0010	.0015
36	.0025	.0010	.0005	.0010	.0015	.0005	.0010	.0010	.0015
32	.0030	.0010	.0010	.0010	.0015	.0005	.0010	.0010	.0015
28	.0035	.0010	.0010	.0010	.0015	.0005	.0010	.0010	.0015
24	.0040	.0010	.0010	.0010	.0015	.0005	.0010	.0015	.0015
20	.0050	.0010	.0010	.0010	.0015	.0005	.0010	.0015	.0015
18	.0055	.0010	.0010	.0010	.0015	.0005	.0010	.0015	.0015
16	.0060	.0010	.0010	.0010	.0015	.0005	.0010	.0015	.0020
14	.0070	.0010	.0010	.0015	.0015	.0005	.0010	.0015	.0020
13	.0075	.0010	.0010	.0015	.0015	.0005	.0010	.0015	.0020
12	.0075	.0010	.0010	.0015	.0015	.0005	.0010	.0015	.0020
11	.0080	.0010	.0010	.0015	.0020	.0005	.0010	.0015	.0020
10	.0090	.0015	-	.0015	.0020	.0005	.0010	.0015	.0020
9	.0100	.0015	-	.0015	.0020	.0005	.0010	.0015	.0020
8	.0110	.0015	-	.0015	.0020	.0005	.0010	.0015	.0020
7	.0120	.0020	-	.0015	.0020	.0010	.0010	.0020	.0025
6	.0140	.0020	-	.0015	.0020	.0010	.0010	.0020	.0025
5 1/2	.0160	.0025	-	.0015	.0020	.0010	.0015	.0020	.0025
5	.0160	.0025	-	.0015	.0020	.0010	.0015	.0020	.0025
4 1/2	.0170	.0025	-	.0015	.0020	.0010	.0015	.0020	.0025
4	.0190	.0025	-	.0015	.0020	.0010	.0015	.0020	.0025

For intermediate pitches use value for next coarser pitch



See product specific page for additional information

set number	no. of pieces	H-limit / flutes	sizes	case type	order number HTGP / SPGP
Hand Tap - Straight Flute, General Purpose					
	3		See product page for set - Includes Taper, Plug, and Bottoming Tap		see product page
Plug Hand Tap					
303SET	10	H3, 4	1/4-20, 1/4-28, 5/16-18, 5/16-24, 3/8-16, 3/8-24, 7/16-14, 7/16-20, 1/2-13, 1/2-20	metal	330082
Jobber Drill (Bright), Plug Hand Tap					
HT18	18	H3, 4	1/4-20, 5/16-18, 3/8-16, 7/16-14, 1/2-13, 6-32, 8-32, 10-24, 10-32		330083
		Jobber	5/16, 27/64, LET-F, LET-U, #7, #21, #25, #29, #36		
Jobber Drill (Titanium), Plug Hand Tap - TiN					
HT18T	18	H3, 4	1/4-20, 5/16-18, 3/8-16, 7/16-14, 1/2-13, 6-32, 8-32, 10-24, 10-32		330084
		Jobber	5/16, 27/64, #7, #21, #25, #29, #36, LET-F, LET-U		
Jobber Drill (Bright), Plug Spiral PT Tap					
GT18	18	H3, 2	1/4-20, 5/16-18, 6-32, 8-32, 10-24, 10-32		330085
		H3, 3	3/8-16, 7/16-14, 1/2-13		
		Jobber	5/16, 27/64, LET-F, LET-U, #7, #21, #25, #29, #36		
Jobber Drill (Bright), Plug NC/NF Hand Tap					
HT36	36	H2, 3	6-40		330086
		H2, 4	8-36		
		H3, 4	6-32		
		H3, 3	1/4-20, 1/4-28, 5/16-18, 5/16-24, 3/8-16, 3/8-24, 7/16-14, 7/16-20, 1/2-13, 1/2-20, 8-32, 10-24, 10-32, 12-24, 12-28		
		Jobber	5/16, 25/64, 27/64, 29/64, LET-F, LET-I, LET-Q, LET-U, #3, #7, #15, #16, #21, #25, #29, #33, #36		
Screw Machine Drill (Bright), Plug Hand Tap					
68	20	H2, 3	4-40, 5-40		330087
		H3, 3	6-32		
		H3, 4	1/4-20, 5/16-18, 3/8-16, 7/16-14, 1/2-13, 8-32, 10-24		
		Screw Machine	5/16, 27/64, #7, #25, #29, #36, #39, #44, LET-F, LET-U		
Jobber Drill (Black Oxide), Plug Hand Tap					
HM18	18	D3, 3	M2.5x0.45, M3x0.5		330088
		D4, 3	M3.5x0.6, M4x0.7		
		D4, 4	M5x0.8		
		D5, 4	M6X1.0, M8X1.25		
		D6, 4	M10x1.5, M12x1.75		
		Jobber	2.05, 2.50, 2.90, 3.30, 4.20, 5.00, 6.70, 8.5, 10.20		

set number	no. of sizes	die sizes	case type	order number
Taper Pipe Sets - NPT/NPTF Medium Hook				
		NPT Pipe Tap: 1/8 - 1" NPT	wood	Style: PTT 353768
Re-threading Dies - Carbon Steel				
481	8	Course Thrd (UNC): 1/4-20, 5/16-18, 3/8-16, 7/16-14, 1/2-13, 9/16-12, 5/8-11, 3/4-10	metal	Style: 377 403512
482	10	Course Thrd (UNC): 1/4-20, 5/16-18, 3/8-16, 7/16-14, 1/2-13, 9/16-12, 5/8-11, 3/4-10, 7/8-9, 1-8	metal	403553
490	10	Course Thrd (UNC): 1/4-20, 5/16-18, 3/8-16, 7/16-14, 1/2-13 Fine Thrd (UNF): 1/4-28, 5/16-24, 3/8-24, 7/16-20, 1/2-20	metal	403520
492	20	Course Thrd (UNC): 1/4-20, 5/16-18, 3/8-16, 7/16-14, 1/2-13, 9/16-12, 5/8-11, 3/4-10, 7/8-9, 1-8 Fine Thrd (UNF): 1/4-28, 5/16-24, 3/8-24, 7/16-20, 1/2-20, 9/16-18, 5/8-18, 3/4-16, 7/8-14, 1-14	metal	403595
485	7	M6 x 1, M8 x 1.25, M10 x 1.5, M12 x 1.75, M14 x 2, M16 x 2, M20 x 2.5	metal	403522



- Machine Taps
- Spiral Point Taps
- Spiral Flute Taps
- Thread Forming Taps
- Pipe Taps
- Dies
- Technical Info
- Sets
- Index



Sets
Cost Saving / Organize

Set (continued)

See product specific page for additional information

Machine Taps	set number	no. of sizes	tap & die sizes	tap wrench	die stock	order number	
	OK Jr. Tap & Die Sets: HSS Production Hand Taps / Carbon Steel Round Adjustable Dies - Inch						
	17	7	Course Thrd (UNC): 4-40, 6-32, 8-32, 10-24, 12-24, 1/4-20 Fine Thrd (UNF): 10-32	329	13	423001	
	18	5	Course Thrd (UNC): 1/4-20, 5/16-18, 3/8-16, 7/16-14, 1/2-13	333	14	423002	
	25	8	Course Thrd (UNC): 2-56, 3-48, 4-40, 6-32, 8-32, 10-24 Fine Thrd (UNF): 0-80, 1-72	329	13	423003	
	T4	8	Course Thrd (UNC): 2-56, 3-48, 4-40, 6-32, 8-32, 10-24, 12-24 Fine Thrd (UNF): 10-32	0	1851	420359	
	26	10	Course Thrd (UNC): 4-40 Fine Thrd (UNF): 4-48	329	13	420361	
	T6	20	Course Thrd (UNC): 1/4-20, 5/16-18, 3/8-16, 7/16-14, 1/2-13, 9/16-12, 5/8-11, 3/4-10, 7/8-9, 1-8 Fine Thrd (UNF): 1/4-28, 5/16-24, 3/8-24, 7/16-20, 1/2-20, 9/16-18, 5/8-18, 3/4-18, 7/8-14, 1-12	7	1852	420363	
	28	11	Course Thrd (UNC): 1/4-20, 5/16-18, 3/8-16, 7/16-14, 1/2-13 Fine Thrd (UNF): 1/4-28, 5/16-24, 3/8-24, 7/16-20, 1/2-20 Pipe Size (Short shank): 1/8-27	333	1	423004	
	32	21	Course Thrd (UNC): 1/4-20, 5/16-18, 3/8-16, 7/16-14, 1/2-13, 9/16-12, 5/8-11, 3/4-10, 7/8-9, 1-8 Fine Thrd (UNF): 1/4-28, 5/16-24, 3/8-24, 7/16-20, 1/2-20, 9/16-18, 5/8-18, 3/4-16, 7/8-14 UNS: 1-14 Pipe Size (Long shank): 1/8-27	15 7	14 15 16	423005	
	33	28 Taps 15 Dies	Course Thrd (UNC): 4-40, 6-32, 8-32, 10-24, 12-24, 1/4-20, 5/16-18, 3/8-16, 7/16-14, 1/2-13, 9/16-12 Fine Thrd (UNF): 10-32, 1/4-28, 5/16-24, 3/8-24, 7/16-20, 1/2-20, 9/16-18, 5/8-18, 3/4-16, 7/8-14 UNS: 1-14 Pipe Size: 1/8-27, 1/4-18, 3/8-18, 1/2-14	329	14 15 16 7	423006	
	Tap & Die Set: with Production Hand Taps and HSS Round Adjustable Dies - Metric						
	48	7	M2.5 x 0.45, M3 x 0.5, M3.5 x 0.6, M4 x 0.7, M4.5 x 0.75, M5 x 0.8, M6 x 1.0 Screwdriver: 300	333	1790	420365	
	49	5	M6 x 1.0, M7 x 1.0, M8 x 1.25, M10 x 1.5, M12 x 1.75 Screwdriver: 300	333	1790	420367	
	Tap & Die Set: with Production Hand Taps, Black Oxide Jobber Length Drills, and HSS Round Adjustable Dies - Metric						
	49D	5	M6 x 1.0, M7 x 1.0, M8 x 1.25, M10 x 1.5, M12 x 1.75 Drill Sizes: 5.0, 6.0, 6.7, 8.5, 10.2 Screwdriver: 300	333	1790	420368	
Technical Info	set number	no. of sizes	tap & die sizes	collet number	tap wrench	die stock	order number
	Tap & Die Set: without Collet						
	59	7	Course Thrd (UNC): 4-40, 6-32, 8-32, 10-24, 12-24, 1/4-20 NC Fine Thrd (UNF): 10-32	A1	T9, A1	A1	423159
	510	5	Course Thrd (UNC): 1/4-20, 5/16-18, 3/8-16, 7/16-14, 1/2-13	1	#5, #7	#1	423160
	511	10	Course Thrd (UNC): 1/4-20, 5/16-18, 3/8-16, 7/16-14, 1/2-13, 9/16-18, 5/8-18, 3/4-16, 7/8-14, 1-8	5	#5	5A	423173
	512	10	Course Thrd (UNC): 1/4-20, 5/16-18, 3/8-16, 7/16-14, 1/2-13 Fine Thrd (UNF): 1/4-28, 5/16-24, 3/8-24, 7/16-20, 1/2-20	1	#5	#1	423162
	513	20	Course Thrd (UNC): 1/4-20, 5/16-18, 3/8-16, 7/16-14, 1/2-13, 9/16-12, 5/8-11, 3/4-10, 7/8-9, 1-8 Fine Thrd (UNF): 1/4-28, 5/16-24, 3/8-24, 7/16-20, 1/2-20, 9/16-18, 5/8-18, 3/4-16, 7/8-14, 1-14	1, 5	#5 #7	#1 #5B	423163
	514	7	M6 x 1, M8 x 1.25, M10 x 1.5, M12 x 1.75, M14 x 2, M16 x 2, M18 x 2.5	5	#6	#5	423164
	58	20	Course Thrd (UNC): 1/4-20, 5/16-18, 3/8-16, 7/16-14, 1/2-13, 9/16-12, 5/8-11, 3/4-10, 7/8-9, 1-8 Fine Thrd (UNF): 1/4-28, 5/16-24, 3/8-24, 7/16-20, 1/2-20, 9/16-18, 5/8-18, 3/4-16, 7/8-14 UNS: 1-14	—	#5 #7	#1 #5	423165
	Screw Extractors						
	15 Set	5 pcs.	Sizes: #1 through #5	—	—	—	Style: 335 422006



Index by Part Number
Reference Information

Index

Order Number	Style	Page Number	Order Number	Style	Page Number	Order Number	Style	Page Number	Order Number	Style	Page Number	Order Number	Style	Page Number
174503	HTGP	9	282104	SFHD	21	287608	FTGP	24	291295	FTGP	24	301482	HTGP	7
174504	HTGP	8	282108	SPHD	19	287657	FTGP	24	300016	SPGP	13	301486	HTGP	7
174505	HTGP	8	282120	SFHD	21	287707	FTGP	24	300041	HTGP	7	301490	HTGP	7
174506	HTGP	8	282153	SFHD	21	287756	FTGP	24	300047	HTGP	7	301494	HTGP	7
174507	HTGP	8	282157	SPHD	19	287905	FTGP	24	300054	HTGP	7	301544	HTGP	7
174508	HTGP	8	282203	SFHD	21	287954	FTGP	24	300058	HTGP	7	301551	HTGP	7
174509	HTGP	8	282207	SPHD	19	288101	FTGP	24	300165	HTGP	7	301577	HTGP	7
174510	HTGP	8	282252	SFHD	21	288150	FTGP	24	300216	HTHM	6	301585	HTGP	7
174511	HTGP	7	282256	SPHD	19	288408	FTGP	24	300217	HTHM	6	301635	HTGP	7
174513	HTGP	9	282302	SFHD	21	288457	FTGP	24	300218	HTHM	6	301643	HTGP	7
174514	HTGP	9	282306	SPHD	19	289004	FTGP	24	300219	HTHM	6	301668	HTGP	7
174516	HTGP	9	282351	SFHD	21	289012	FTGP	24	300264	HTGP	7	301676	HTGP	7
174519	HTGP	9	282355	SPHD	19	289087	FTGP	24	300272	HTGP	7	301718	HTGP	7
174520	HTGP	9	282401	SFHD	21	289095	FTGP	24	300278	HTGP	7	301726	HTGP	7
174521	HTGP	9	282405	SPHD	19	289202	FTGP	24	300280	HTGP	7	301734	HTGP	7
174522	HTGP	9	282450	SFHD	21	289210	FTGP	24	300286	HTGP	7	301742	HTGP	7
174524	HTGP	9	282454	SPHD	19	289228	FTGP	24	300294	HTGP	7	301748	HTGP	7
174528	HTGP	8	282468	SFHD	21	289236	FTGP	24	300299	HTGP	7	301755	HTGP	7
174529	HTGP	8	282470	SPHD	19	289269	FTGP	24	300512	HTGP	7	301759	HTGP	7
174530	HTGP	7	282501	SFHD	21	289277	FTGP	24	300520	HTGP	7	301763	HTGP	7
174531	HTGP	7	282504	SPHD	19	289285	FTGP	24	300526	HTGP	7	301767	HTGP	7
174532	HTGP	8	282526	SFHD	21	289293	FTGP	24	300538	HTGP	7	301920	HTGP	7
174533	HTGP	8	282553	SPHD	19	289368	FTGP	24	300637	HTGP	7	301924	HTGP	7
174534	HTGP	9	282559	SFHD	21	289376	FTGP	24	300645	HTGP	7	301933	HTGP	7
174535	HTGP	9	282567	SFHD	21	289384	FTGP	24	300652	HTGP	7	301938	HTGP	7
174536	HTGP	7	282603	SPHD	19	289392	FTGP	24	300769	HTGP	7	301940	HTGP	7
174537	HTGP	7	282609	SFHD	21	289426	FTGP	24	300778	HTGP	7	301946	HTGP	7
174538	HTGP	7	282625	SFHD	21	289434	FTGP	24	300815	HTGP	7	301999	HTGP	8
174539	HTGP	7	282652	SPHD	19	289442	FTGP	24	300819	HTGP	7	302021	HTGP	8
174540	HTGP	8	282757	SFHD	21	289459	FTGP	24	300823	HTGP	7	302039	HTGP	8
174541	HTGP	8	282765	SFHD	21	289525	FTGP	24	300827	HTGP	7	302112	HTGP	8
174542	HTGP	9	282801	SPHD	19	289533	FTGP	24	300831	HTGP	7	302120	HTGP	8
174543	HTGP	9	282807	SFHD	21	289541	FTGP	24	300835	HTGP	7	302161	HTGP	8
174544	HTGP	7	282823	SFHD	21	289558	FTGP	24	300930	HTGP	7	302179	HTGP	8
174545	HTGP	7	282850	SPHD	19	289582	FTGP	24	300934	HTGP	7	302187	HTGP	8
174546	HTGP	8	282901	SPHD	19	289590	FTGP	24	300942	HTGP	7	302195	HTGP	8
174548	HTGP	9	282959	SPHD	19	289640	FTGP	24	300948	HTGP	7	302203	HTGP	8
174549	HTGP	9	285057	SPAR	18	289657	FTGP	24	300955	HTGP	7	302209	HTGP	8
174550	HTGP	9	285107	SPAR	18	289665	FTGP	24	300959	HTGP	7	302211	HTGP	8
174551	HTGP	9	285156	SPAR	18	289673	FTGP	24	301007	HTGP	7	302217	HTGP	8
174552	HTGP	9	285206	SPAR	18	289780	FTGP	24	301015	HTGP	7	302260	HTGP	8
174553	HTGP	9	285222	SPAR	18	289798	FTGP	24	301052	HTGP	7	302278	HTGP	8
174559	HTGP	9	285255	SPAR	18	289988	FTGP	24	301056	HTGP	7	302294	HTGP	8
174560	HTGP	9	285354	SPAR	18	289996	FTGP	24	301060	HTGP	7	302302	HTGP	8
174561	HTGP	9	285370	SPAR	18	291001	FTGP	24	301064	HTGP	7	302385	HTGP	8
272550	SPHD	19	285404	SPAR	18	291006	FTGP	24	301072	HTGP	7	302393	HTGP	8
280108	SPHD	19	285453	SPAR	18	291014	FTGP	24	301078	HTGP	7	302435	HTGP	8
280157	SPHD	19	285479	SPAR	18	291018	FTGP	24	301171	HTGP	7	302443	HTGP	8
280207	SPHD	19	285503	SPAR	18	291083	FTGP	24	301177	HTGP	7	302450	HTGP	8
280256	SPHD	19	285552	SPAR	18	291089	FTGP	24	301189	HTGP	7	302468	HTGP	8
280306	SPHD	19	285628	SPAR	18	291091	FTGP	24	301193	HTGP	7	302472	HTGP	8
280355	SPHD	19	285651	SPAR	18	291097	FTGP	24	301197	HTGP	7	302476	HTGP	8
280405	SPHD	19	285701	SPAR	18	291123	FTGP	24	301247	HTGP	7	302480	HTGP	8
280454	SPHD	19	285801	SPAR	18	291125	FTGP	24	301254	HTGP	7	302484	HTGP	8
280470	SPHD	19	285859	SPAR	18	291133	FTGP	24	301270	HTGP	7	302526	HTGP	8
280504	SPHD	19	287004	FTGP	24	291139	FTGP	24	301288	HTGP	7	302530	HTGP	8
280553	SPHD	19	287053	FTGP	24	291162	FTGP	24	301320	HTGP	7	302534	HTGP	8
280603	SPHD	19	287103	FTGP	24	291166	FTGP	24	301338	HTGP	7	302542	HTGP	8
280652	SPHD	19	287152	FTGP	24	291170	FTGP	24	301346	HTGP	7	302548	HTGP	8
280801	SPHD	19	287202	FTGP	24	291174	FTGP	24	301353	HTGP	7	302583	HTGP	8
280850	SPHD	19	287251	FTGP	24	291176	FTGP	24	301359	HTGP	7	302591	HTGP	8
280901	SPHD	19	287301	FTGP	24	291178	FTGP	24	301361	HTGP	7	302609	HTGP	8
280959	SPHD	19	287350	FTGP	24	291240	FTGP	24	301367	HTGP	7	305008	HTGP	8
281957	SFHD	21	287400	FTGP	24	291246	FTGP	24	301375	HTGP	7	305016	HTGP	8
282005	SFHD	21	287459	FTGP	24	291253	FTGP	24	301379	HTGP	7	305024	HTGP	8
282054	SFHD	21	287509	FTGP	24	291257	FTGP	24	301474	HTGP	7	305033	HTGP	8
282062	SFHD	21	287558	FTGP	24	291287	FTGP	24	301478	HTGP	7	305040	HTGP	8

- Machine Taps
- Spiral Point Taps
- Spiral Flute Taps
- Thread Forming Taps
- Pipe Taps
- Dies
- Technical Info
- Sets
- Index



Index

Reference Information

Machine Taps

Spiral Point Taps

Spiral Flute Taps

Thread Forming Taps

Pipe Taps

Dies

Technical Info

Sets

Index

Order Number	Style	Page Number	Order Number	Style	Page Number	Order Number	Style	Page Number	Order Number	Style	Page Number	Order Number	Style	Page Number
305057	HTGP	8	306165	HTGP	8	307830	HTGP	9	313519	SPGP+5	15	313586	SFGP+5	23
305065	HTGP	8	306246	HTGP	8	307836	HTGP	9	313520	SPGP+5	15	313587	SFGP+5	23
305073	HTGP	8	306295	HTGP	8	307844	HTGP	9	313521	SPGP+5	15	313588	SFGP+5	23
305079	HTGP	8	306303	HTGP	8	307848	HTGP	9	313522	SPGP+5	15	313589	SFGP+5	23
305081	HTGP	8	306309	HTGP	8	308065	HTGP	9	313523	SPGP+5	15	313590	SFGP+5	23
305087	HTGP	8	306311	HTGP	8	308069	HTGP	9	313524	SPGP+5	15	313591	SFGP+5	23
305103	HTGP	8	306317	HTGP	8	308073	HTGP	9	313525	SFGP+5	23	313592	SFGP+5	23
305107	HTGP	8	306337	HTGP	8	308077	HTGP	9	313526	SFGP+5	23	313593	SFGP+5	23
305111	HTGP	8	306341	HTGP	8	308081	HTGP	9	313527	SFGP+5	23	313594	SFGP+5	23
305115	HTGP	8	306345	HTGP	8	308085	HTGP	9	313528	SFGP+5	23	313595	SFGP+5	23
305198	HTGP	8	306444	HTGP	8	308184	HTGP	9	313529	SFGP+5	23	313596	SFGP+5	23
305206	HTGP	8	306451	HTGP	8	308192	HTGP	9	313530	SFGP+5	23	313597	SFGP+5	23
305209	HTGP	8	306457	HTGP	8	308200	HTGP	9	313531	SFGP+5	23	313598	SFGP+5	23
305214	HTGP	8	306465	HTGP	8	308275	HTGP	9	313532	SFGP+5	23	313599	SPGPX+5	16
305222	HTGP	8	306469	HTGP	8	308283	HTGP	9	313533	SFGP+5	23	313600	SPGPX+5	16
305228	HTGP	8	306485	HTGP	8	308291	HTGP	9	313534	SFGP+5	23	313601	SPGPX+5	16
305230	HTGP	8	306626	HTGP	8	308424	HTGP	9	313535	SFGP+5	23	313602	SPGPX+5	16
305236	HTGP	8	306630	HTGP	8	308432	HTGP	9	313536	SFGP+5	23	313603	SPGPX+5	16
305370	HTGP	8	306634	HTGP	8	308440	HTGP	9	313537	SFGP+5	23	313604	SPGPX+5	16
305388	HTGP	8	306642	HTGP	8	308457	HTGP	9	313538	SFGP+5	23	313605	SPGPX+5	16
305396	HTGP	8	306648	HTGP	8	308465	HTGP	9	313539	SFGP+5	23	313606	SPGPX+5	16
305403	HTGP	8	306741	HTGP	8	308473	HTGP	9	313540	SFGP+5	23	313607	SPGPX+5	16
305404	HTGP	8	306754	HTGP	8	308549	HTGP	9	313541	SFGP+5	23	313608	SPGPX+5	16
305412	HTGP	8	306758	HTGP	8	308556	HTGP	9	313542	SFGP+5	23	313609	SPGPX+5	16
305418	HTGP	8	306762	HTGP	8	308564	HTGP	9	313543	SFGP+5	23	317516	HTGPL	10
305438	HTGP	8	306766	HTGP	8	308572	HTGP	9	313544	SPGPX+5	16	317532	HTGPL	10
305446	HTGP	8	306923	HTGP	9	308580	HTGP	9	313545	SPGPX+5	16	317540	HTGPL	10
305511	HTGP	8	306929	HTGP	9	308598	HTGP	9	313546	SPGPX+5	16	317557	HTGPL	10
305525	HTGP	8	306931	HTGP	9	308598	HTGP	9	313547	SPGPX+5	16	317573	HTGPL	10
305529	HTGP	8	306937	HTGP	9	308705	HTGP	9	313548	SPGPX+5	16	317607	HTGPL	10
305533	HTGP	8	306945	HTGP	9	308713	HTGP	9	313549	SPGPX+5	16	317631	HTGPL	10
305537	HTGP	8	306949	HTGP	9	308788	HTGP	9	313550	SPGPX+5	16	317664	HTGPL	10
305552	HTGP	8	306964	HTGP	9	308796	HTGP	9	313551	SPGPX+5	16	317722	HTGPL	10
305560	HTGP	8	306972	HTGP	9	308804	HTGP	9	313552	SPGPX+5	16	317755	HTGPL	10
305677	HTGP	8	306978	HTGP	9	308812	HTGP	9	313553	SPGPX+5	16	317789	HTGPL	10
305685	HTGP	8	307042	HTGP	9	308820	HTGP	9	313554	SPGPX+5	16	317904	HTGPL	10
305693	HTGP	8	307046	HTGP	9	308838	HTGP	9	313555	SPGP+5	15	317995	HTGPL	10
305701	HTGP	8	307053	HTGP	9	313010	HTGPL	10	313556	SPGP+5	15	318027	HTGPL	10
305707	HTGP	8	307059	HTGP	9	313028	HTGPL	10	313557	SPGP+5	15	318779	HTGPL	10
305715	HTGP	8	307061	HTGP	9	313036	HTGPL	10	313558	SPGP+5	15	326004	HTGP	8
305719	HTGP	8	307067	HTGP	9	313044	HTGPL	10	313559	SPGP+5	15	326012	HTGP	8
305731	HTGP	8	307160	HTGP	9	313051	HTGPL	10	313560	SPGP+5	15	326087	HTGP	8
305735	HTGP	8	307178	HTGP	9	313069	HTGPL	10	313561	SPGP+5	15	326095	HTGP	8
305743	HTGP	8	307186	HTGP	9	313077	HTGPL	10	313562	SPGP+5	15	326160	HTGP	8
305749	HTGP	8	307194	HTGP	9	313085	HTGPL	10	313563	SPGP+5	15	326178	HTGP	8
305818	HTGP	8	307202	HTGP	9	313093	HTGPL	10	313564	SPGP+5	15	326240	HTGP	8
305822	HTGP	8	307210	HTGP	9	313102	HTGPL	10	313565	SPGP+5	15	326244	HTGP	8
305826	HTGP	8	307343	HTGP	9	313119	HTGPL	10	313566	SPGP+5	15	326251	HTGP	8
305830	HTGP	8	307349	HTGP	9	313500	SPGP+5	15	313567	SPGP+5	15	326285	HTGP	8
305834	HTGP	8	307350	HTGP	9	313501	SPGP+5	15	313568	SPGP+5	15	326293	HTGP	8
305990	HTGP	8	307356	HTGP	9	313502	SPGP+5	15	313569	SPGP+5	15	326368	HTGP	8
306002	HTGP	8	307364	HTGP	9	313503	SPGP+5	15	313570	SPGP+5	15	326376	HTGP	8
306006	HTGP	8	307368	HTGP	9	313504	SPGP+5	15	313571	SPGP+5	15	326442	HTGP	8
306010	HTGP	8	307463	HTGP	9	313505	SPGP+5	15	313572	SPGP+5	15	326459	HTGP	8
306014	HTGP	8	307467	HTGP	9	313506	SPGP+5	15	313573	SPGP+5	15	326521	HTGP	8
306030	HTGP	8	307471	HTGP	9	313507	SPGP+5	15	313574	SPGP+5	15	326525	HTGP	8
306036	HTGP	8	307475	HTGP	9	313508	SPGP+5	15	313575	SPGP+5	15	326533	HTGP	8
306044	HTGP	8	307483	HTGP	9	313509	SPGP+5	15	313576	SPGP+5	15	326539	HTGP	8
306048	HTGP	8	307489	HTGP	9	313510	SPGP+5	15	313577	SPGP+5	15	326608	HTGP	8
306113	HTGP	8	307703	HTGP	9	313511	SPGP+5	15	313578	SPGP+5	15	326616	HTGP	8
306121	HTGP	8	307707	HTGP	9	313512	SPGP+5	15	313579	SPGP+5	15	326681	HTGP	8
306127	HTGP	8	307711	HTGP	9	313513	SPGP+5	15	313580	SFGP+5	23	326699	HTGP	8
306135	HTGP	8	307715	HTGP	9	313514	SPGP+5	15	313581	SFGP+5	23	326707	HTGP	8
306139	HTGP	8	307723	HTGP	9	313515	SPGP+5	15	313582	SFGP+5	23	328018	HTGP	9
306154	HTGP	8	307729	HTGP	9	313516	SPGP+5	15	313583	SFGP+5	23	328067	HTGP	9
306157	HTGP	8	307822	HTGP	9	313517	SPGP+5	15	313584	SFGP+5	23	328075	HTGP	9
306162	HTGP	8	307828	HTGP	9	313518	SPGP+5	15	313585	SFGP+5	23	328083	HTGP	9



Index by Part Number
Reference Information

Index

Order Number	Style	Page Number	Order Number	Style	Page Number	Order Number	Style	Page Number	Order Number	Style	Page Number	Order Number	Style	Page Number
328158	HTGP	9	328717	HTGP	9	330055	HTGP	8	330138	SPGP	12	330205	SFGP	22
328166	HTGP	9	328719	HTGP	9	330057	HTGP	8	330139	SPGP	12	330206	SFGP	22
328174	HTGP	9	328720	HTGP	9	330058	HTGP	8	330140	SPGP	12	330207	SFGP	22
328182	HTGP	9	328752	HTGP	9	330059	HTGP	8	330141	SPGP	12	330208	SFGP	22
328188	HTGP	9	328760	HTGP	9	330060	HTGP	8	330142	SPGP	12	330209	SFGP	22
328190	HTGP	9	328778	HTGP	9	330061	HTGP	9	330143	SPGP	12	330210	SFGP	22
328205	HTGP	9	328810	HTGP	9	330062	HTGP	7	330144	SPGP	13	330211	SFGP	22
328208	HTGP	9	328828	HTGP	9	330063	HTGP	7	330145	SPGP	13	330212	FTGP	24
328240	HTGP	9	328836	HTGP	9	330065	HTGP	9	330146	SPGP	13	330213	FTGP	24
328257	HTGP	9	328877	HTGP	9	330066	HTGP	7	330147	SPGP	13	330214	FTGP	24
328265	HTGP	9	328885	HTGP	9	330067	HTGP	7	330148	SPGP	12	330215	FTGP	24
328273	HTGP	9	328893	HTGP	9	330068	HTGP	7	330149	SPGP	12	330259	HTHM	6
328281	HTGP	9	328935	HTGP	9	330069	HTGP	7	330150	SPGP	12	330260	HTHM	6
328287	HTGP	9	328943	HTGP	9	330070	HTGP	7	330151	SPGP	12	330261	HTHM	6
328295	HTGP	9	328950	HTGP	9	330071	HTGP	9	330152	SPGP	12	330262	HTHM	6
328299	HTGP	9	329057	HTGP	9	330072	HTGP	9	330153	SPGP	12	330263	HTHM	6
328331	HTGP	9	329065	HTGP	9	330073	HTGP	9	330154	SPGP	12	330264	HTHM	6
328349	HTGP	9	329073	HTGP	9	330074	HTGP	9	330155	SPGP	12	330265	HTHM	6
328356	HTGP	9	329180	HTGP	9	330075	HTGP	9	330156	SPGP	12	330267	HTHM	6
328364	HTGP	9	330004	HTGP	7	330076	HTGP	9	330157	SPGP	12	330269	HTHM	6
328372	HTGP	9	330005	HTGP	7	330077	HTGP	9	330158	SPGP	12	330278	HTHM	6
328378	HTGP	9	330006	HTGP	7	330078	HTGP	9	330159	SPGP	13	330279	HTHM	6
328380	HTGP	9	330007	HTGP	7	330079	HTGP	8	330160	SPGP	13	330280	HTHM	6
328386	HTGP	9	330008	HTGP	7	330080	HTGP	8	330161	SPGP	13	330281	HTHM	6
328422	HTGP	9	330009	HTGP	9	330082	HTGP	14	330162	SPGP	13	330283	HTHM	6
328430	HTGP	9	330010	HTGP	9	330083	HTGP	14	330163	SPGP	13	330284	HTHM	6
328436	HTGP	9	330011	HTGP	9	330084	HTGP	14	330164	SPGP	13	330290	HTHM	6
328444	HTGP	9	330012	HTGP	9	330085	SPGP	14	330165	SPGP	13	330291	HTHM	6
328448	HTGP	9	330013	HTGP	9	330086	HTGP	14	330166	SPGP	13	330292	HTHM	6
328497	HTGP	9	330014	HTGP	9	330087	HTGP	14	330167	SPGP	13	330293	HTHM	6
328547	HTGP	9	330015	HTGP	9	330088	HTGP	14	330168	SPGP	13	330294	HTHM	6
328550	HTGP	9	330016	HTGP	7	330100	SPGP	12	330169	SPGP	13	330295	HTHM	6
328554	HTGP	9	330017	HTGP	7	330101	SPGP	12	330170	SPGP	13	330296	HTHM	6
328562	HTGP	9	330018	HTGP	7	330102	SPGP	12	330171	SPGP	13	330298	HTHM	6
328568	HTGP	9	330019	HTGP	7	330103	SPGP	12	330172	SPGP	13	330302	SPS	11
328604	HTGP	9	330020	HTGP	7	330104	SPGP	12	330173	SPGP	13	330309	SPS	11
328612	HTGP	9	330021	HTGP	7	330105	SPGP	12	330174	SPGP	13	330310	SPS	11
328618	HTGP	9	330022	HTGP	7	330106	SPGP	12	330175	SPLS	17	330311	SPS	11
328620	HTGP	9	330024	HTGP	8	330107	SPGP	12	330176	SPLS	17	330312	SPS	11
328626	HTGP	9	330025	HTGP	8	330108	SPGP	12	330177	SPLS	17	330313	SPS	11
328661	HTGP	9	330026	HTGP	8	330109	SPGP	12	330178	SPLS	17	330315	SPS	11
328675	HTGP	9	330027	HTGP	8	330110	SPGP	12	330179	SPLS	17	330316	SPS	11
328679	HTGP	9	330028	HTGP	9	330111	SPGP	12	330180	SPLS	17	330317	SPS	11
328683	HTGP	9	330029	HTGP	9	330112	SPGP	12	330181	SPLS	17	330321	SPS	11
328684	HTGP	9	330030	HTGP	9	330113	SPGP	12	330182	SPLS	17	330333	SPS	11
328685	HTGP	9	330031	HTGP	9	330114	SPGP	12	330183	SPLS	17	330336	SPS	11
328686	HTGP	9	330032	HTGP	9	330115	SPGP	12	330184	SPLS	17	330465	SFS	20
328687	HTGP	9	330033	HTGP	9	330116	SPGP	13	330185	SPLS	17	330466	SFS	20
328688	HTGP	9	330034	HTGP	9	330117	SPGP	13	330186	SPLS	17	330468	SFS	20
328689	HTGP	9	330035	HTGP	7	330118	SPGP	13	330187	SPLS	17	330470	SFS	20
328690	HTGP	9	330036	HTGP	7	330119	SPGP	13	330188	SPLS	17	330474	SFS	20
328691	HTGP	9	330037	HTGP	7	330120	SPGP	13	330189	SPLS	17	330478	SFS	20
328693	HTGP	9	330038	HTGP	7	330121	SPGP	13	330190	SPLS	17	330489	SFS	20
328695	HTGP	9	330039	HTGP	7	330122	SPGP	13	330191	SPLS	17	330490	SFS	20
328697	HTGP	9	330040	HTGP	7	330123	SPGP	13	330192	SPLS	17	330491	SFS	20
328698	HTGP	9	330041	HTGP	8	330125	SPGP	13	330193	SFGP	22	330494	SFS	20
328699	HTGP	9	330042	HTGP	8	330126	SPGP	13	330194	SFGP	22	330495	SFS	20
328703	HTGP	9	330043	HTGP	8	330128	SPGP	13	330195	SFGP	22	330496	SFS	20
328704	HTGP	9	330044	HTGP	8	330129	SPGP	13	330196	SFGP	22	330498	SFS	20
328705	HTGP	9	330045	HTGP	8	330130	SPGP	13	330197	SFGP	22	330499	SFS	20
328706	HTGP	9	330046	HTGP	8	330131	SPGP	13	330198	SFGP	22	330502	SFS	20
328707	HTGP	9	330047	HTGP	8	330132	SPGP	13	330199	SFGP	22	330503	SFS	20
328708	HTGP	9	330048	HTGP	8	330133	SPGP	13	330200	SFGP	22	330504	SFS	20
328709	HTGP	9	330049	HTGP	8	330134	SPGP	13	330201	SFGP	22	330505	SFS	20
328710	HTGP	9	330051	HTGP	8	330135	SPGP	13	330202	SFGP	22	339044	HTGP	7
328711	HTGP	9	330052	HTGP	8	330136	SPGP	13	330203	SFGP	22	339045	HTGP	7
328716	HTGP	9	330053	HTGP	8	330137	SPGP	13	330204	SFGP	22	339046	HTGP	7

Machine Taps

Spiral Point Taps

Spiral Flute Taps

Thread Forming Taps

Pipe Taps

Dies

Technical Info

Sets

Index



Index

Reference Information

Machine Taps

Spiral Point Taps

Spiral Flute Taps

Thread Forming Taps

Pipe Taps

Dies

Technical Info

Sets

Index

Order Number	Style	Page Number	Order Number	Style	Page Number	Order Number	Style	Page Number	Order Number	Style	Page Number	Order Number	Style	Page Number
339047	HTGP	7	356102	SPGP	12	357165	SPGP	12	360862	SPGP	13	385357	PTT	25
339048	HTGP	7	356106	SPGP	12	357173	SPGP	12	360868	SPGP	13	385359	PTT	25
341573	HTGP	7	356142	SPGP	12	357179	SPGP	12	360884	SPGP	13	385364	PTT	25
341599	HTGP	7	356148	SPGP	12	357249	SPGP	13	360888	SPGP	13	385380	PTT	25
341607	HTGP	7	356159	SPGP	12	357264	SPGP	13	360904	SPGP	13	385385	PTT	25
341623	HTGP	7	356183	SPGP	12	357280	SPGP	13	360920	SPGP	13	385386	PTT	25
341649	HTGP	7	356221	SPGP	12	357286	SPGP	13	360926	SPGP	13	385398	PTT	25
341664	HTGP	7	356225	SPGP	12	357294	SPGP	13	360942	SPGP	13	385409	PTT	25
341672	HTGP	7	356262	SPGP	12	357298	SPGP	13	360946	SPGP	13	385410	PTT	25
341698	HTGP	7	356266	SPGP	12	357306	SPGP	13	360961	SPGP	13	385413	PTT	25
341706	HTGP	7	356308	SPGP	12	357322	SPGP	13	360967	SPGP	13	385422	PTT	25
341714	HTGP	7	356320	SPGP	12	357328	SPGP	13	360995	SPGP	13	385443	PTT	25
341730	HTGP	7	356324	SPGP	12	357344	SPGP	13	361019	SPGP	13	385444	PTT	25
341748	HTGP	7	356332	SPGP	12	357348	SPGP	13	361050	SPGP	13	385448	PTT	25
341755	HTGP	7	356338	SPGP	12	357363	SPGP	13	366110	SFGP	22	385455	PTT	25
341771	HTGP	8	356361	SPGP	12	357401	SPGP	13	366112	SFGP	22	385458	PTT	25
341789	HTGP	8	356365	SPGP	12	357405	SPGP	13	366130	SFGP	22	385471	PTT	25
341805	HTGP	8	356403	SPGP	12	357413	SPGP	13	366132	SFGP	22	385477	PTT	25
341813	HTGP	8	356407	SPGP	12	357504	SPGP	13	366140	SFGP	22	385489	PTT	25
341821	HTGP	8	356415	SPGP	12	357520	SPGP	13	366142	SFGP	22	385500	PTT	25
341839	HTGP	8	356421	SPGP	12	357526	SPGP	13	366150	SFGP	22	385501	PTT	25
341912	HTGPL	10	356422	SPGP	12	357542	SPGP	13	366152	SFGP	22	385505	PTT	25
341938	HTGPL	10	356486	SPGP	12	357546	SPGP	13	366160	SFGP	22	385513	PTT	25
342514	HTGP	8	356498	SPGP	12	357561	SPGP	13	366162	SFGP	22	385534	PTT	25
342522	HTGP	8	356502	SPGP	12	357578	SPGP	13	366170	SFGP	22	385536	PTT	25
342530	HTGP	8	356506	SPGP	12	357603	SPGP	13	366172	SFGP	22	385539	PTT	25
342555	HTGP	8	356510	SPGP	12	357609	SPGP	13	366180	SFGP	22	385547	PTT	25
342563	HTGP	8	356514	SPGP	12	357629	SPGP	13	366182	SFGP	22	385562	PTT	25
342589	HTGP	8	356544	SPGP	12	357660	SPGP	13	367149	SFGP	22	385570	PTT	25
342597	HTGP	8	356548	SPGP	12	357682	SPGP	13	367156	SFGP	22	385604	PTT	25
342605	HTGP	8	356589	SPGP	12	357686	SPGP	13	367222	SFGP	22	385680	PTT	25
342613	HTGP	8	356602	SPGP	12	357702	SPGP	13	367230	SFGP	22	385681	PTT	25
342621	HTGP	8	356633	SPGP	12	357765	SPGP	13	367263	SFGP	22	385682	PTT	25
342639	HTGP	8	356634	SPGP	12	357769	SPGP	13	367271	SFGP	22	385685	PTT	25
342647	HTGP	8	356635	SPGP	12	357785	SPGP	13	367305	SFGP	22	385729	PTTI	26
342654	HTGP	8	356647	SPGP	12	357819	SPGP	13	367313	SFGP	22	385737	PTTI	26
342662	HTGP	9	356662	SPGP	12	357823	SPGP	13	367321	SFGP	22	385752	PTTI	26
342670	HTGP	9	356688	SPGP	12	357827	SPGP	13	367339	SFGP	22	385755	PTTI	26
342688	HTGP	9	356703	SPGP	12	357831	SPGP	13	367909	SFGP	22	385760	PTTI	26
342696	HTGP	9	356704	SPGP	12	357835	SPGP	13	367913	SFGP	22	385786	PTTI	26
342704	HTGP	9	356712	SPGP	12	357864	SPGP	13	367917	SFGP	22	385789	PTTI	26
342712	HTGP	9	356718	SPGP	12	357868	SPGP	13	367925	SFGP	22	385794	PTTI	26
342720	HTGP	9	356742	SPGP	12	357922	SPGP	13	367933	SFGP	22	385810	PTTI	26
342738	HTGP	9	356746	SPGP	12	357926	SPGP	13	367941	SFGP	22	385813	PTTI	26
342746	HTGP	9	356761	SPGP	12	357930	SPGP	13	367958	SFGP	22	385828	PTTI	26
342761	HTGP	9	356767	SPGP	12	357934	SPGP	13	367966	SFGP	22	385844	PTTI	26
343502	HTGP	9	356775	SPGP	12	357942	SPGP	13	367974	SFGP	22	385847	PTTI	26
343503	HTGP	9	356779	SPGP	12	357963	SPGP	13	367982	SFGP	22	385851	PTTI	26
343504	HTGP	9	356803	SPGP	12	357967	SPGP	13	367990	SFGP	22	385870	PTTI	26
343506	HTGP	9	356809	SPGP	12	357975	SPGP	13	368006	SFGP	22	385877	PTTI	26
343508	HTGP	9	356841	SPGP	12	358490	SPGP	12	368014	SFGP	22	385885	PTTI	26
343509	HTGP	9	356845	SPGP	12	358494	SPGP	12	368063	SFGP	22	386008	ELPTT	27
343511	HTGP	9	356858	SPGP	12	358510	SPGP	13	368071	SFGP	22	386024	ELPTT	27
343512	HTGP	9	357009	SPGP	12	359005	SPGP	12	368089	SFGP	22	386040	ELPTT	27
343513	HTGP	9	357021	SPGP	12	359047	SPGP	12	368097	SFGP	22	386129	ELPTT	27
343514	HTGP	9	357025	SPGP	12	359088	SPGP	12	384524	ELPTT	27	386152	ELPTT	27
343515	HTGP	9	357041	SPGP	12	359120	SPGP	12	384525	ELPTT	27	386186	ELPTT	27
353768	PTT	25	357047	SPGP	12	360755	SPGP	13	384526	ELPTT	27	387113	PTS	27
355802	HTGP	7	357054	SPGP	12	360771	SPGP	13	384527	ELPTT	27	387121	PTS	27
355803	HTGP	7	357058	SPGP	12	360774	SPGP	13	384528	ELPTT	27	387139	PTS	27
356002	SPGP	12	357062	SPGP	12	360797	SPGP	13	384529	ELPTT	27	387147	PTS	27
356023	SPGP	12	357066	SPGP	12	360801	SPGP	13	385307	PTT	25	387212	PTS	27
356027	SPGP	12	357082	SPGP	12	360805	SPGP	13	385323	PTT	25	387220	PTS	27
356035	SPGP	12	357088	SPGP	12	360821	SPGP	13	385328	PTT	25	387238	PTS	27
356061	SPGP	12	357101	SPGP	12	360835	SPGP	13	385329	PTT	25	387246	PTS	27
356068	SPGP	12	357108	SPGP	12	360839	SPGP	13	385331	PTT	25	387253	PTS	27
356084	SPGP	12	357161	SPGP	12	360854	SPGP	13	385356	PTT	25	400013	6382	30



Index by Part Number
Reference Information

Index

Order Number	Style	Page Number	Order Number	Style	Page Number	Order Number	Style	Page Number	Order Number	Style	Page Number	Order Number	Style	Page Number
400021	6382	30	401433	382	30	403009	382	31	415813	6382	32	423031	1386	34
400039	6382	30	401466	382	30	403108	377	28	415824	6382	32	423032	1386	34
400047	6382	30	401482	382	30	403116	377	28	415833	6382	32	423033	1386	34
400054	6382	30	401490	382	30	403124	377	28	415880	6382	32	423034	1386	34
400062	6382	30	401979	382	30	403132	377	28	415889	6382	32	423035	1386	34
400070	6382	30	401995	382	30	403140	377	28	415896	6382	32	423036	1386	34
400088	6382	30	402019	382	30	403157	377	28	415901	6382	32	423037	1386	34
400096	6382	30	402027	382	30	403165	377	28	420359	Set	33	423038	1386	34
400104	6382	30	402043	382	31	403173	377	28	420361	Set	33	423039	1386	34
400138	6382	30	402050	382	31	403181	377	28	420363	Set	33	423040	1386	34
400145	6382	30	402068	382	31	403199	377	28	420365	Set	33	423041	1386	34
400178	382	30	402076	382	31	403207	377	28	420367	Set	33	423042	1386	34
400179	6382	30	402077	382	31	403215	377	28	420368	Set	33	423043	1386	34
400187	6382	30	402078	382	31	403223	377	28	420514	1750	32	423044	1386	34
400195	6382	30	402209	382	30	403231	377	28	420522	1750	32	423045	1386	34
400211	6382	30	402225	382	30	403249	377	28	420548	1750	32	423046	1386	34
400229	6382	30	402241	382	30	403256	377	28	420555	1750	32	423047	1386	34
400237	6382	30	402258	382	30	403264	377	28	420563	1750	32	423048	1386	34
400245	6382	30	402274	382	31	403272	377	28	420571	1750	32	423049	1386	34
400302	6382	30	402282	382	31	403280	377	28	420803	330	37	423050	1386	34
400310	6382	30	402290	382	31	403298	377	28	420829	330	37	423051	1386	34
400328	6382	30	402308	382	31	403306	377	28	420845	330	37	423052	1386	34
400336	6382	30	402316	382	31	403314	377	28	420860	330	37	423053	1386	34
400344	6382	31	402324	382	31	403322	377	28	420878	330	37	423054	1386	34
400351	6382	31	402332	382	31	403330	377	28	420910	300	37	423055	1386	34
400369	6382	31	402340	382	31	403348	377	28	420936	300	37	423056	1386	34
400377	6382	31	402357	382	31	403355	377	28	420944	300	37	423057	1386	34
400401	6382	30	402365	382	31	403363	377	28	420951	300	37	423058	380	34
400419	6382	30	402370	382	31	403371	377	28	420977	300	37	423059	380	34
400427	6382	30	402377	382	31	403389	377	28	421852	330	37	423060	380	34
400435	6382	30	402407	382	30	403397	377	28	421909	335	38	423061	380	34
400445	6382	31	402423	382	30	403405	377	28	421917	335	38	423062	380	34
400450	6382	31	402449	382	30	403512	377	29	421925	335	38	423063	380	34
400468	6382	31	402456	382	30	403520	377	29	421933	335	38	423064	380	34
400476	6382	31	402472	382	31	403522	377	29	421941	335	38	423065	380	34
400484	6382	31	402480	382	31	403553	377	29	421958	335	38	423067	380	34
400492	6382	31	402498	382	31	403595	377	29	421966	335	38	423068	380	34
400500	6382	31	402506	382	31	404808	377	29	422006	335	38	423069	380	34
400518	6382	31	402514	382	31	404809	377	29	423001	Set	33	423070	380	34
400526	6382	31	402522	382	31	404833	377	29	423002	Set	33	423071	380	34
400534	6382	31	402530	382	31	404858	377	29	423003	Set	33	423072	380	34
400609	6382	31	402548	382	31	404882	377	29	423004	Set	33	423073	380	34
400617	6382	31	402555	382	31	404916	377	29	423005	Set	33	423074	380	34
400625	6382	31	402563	382	31	404932	377	29	423006	Set	33	423075	380	34
400633	6382	31	402597	382	31	404973	377	29	423008	1750	32	423076	380	34
400641	6382	31	402605	382	31	405202	383	32	423009	1750	32	423077	380	34
400658	6382	31	402613	382	31	405251	383	32	423010	1750	32	423078	380	34
401003	382	30	402621	382	31	405269	383	32	423011	1790	32	423079	380	34
401029	382	30	402625	382	31	405277	383	32	423012	1790	32	423080	380	34
401037	382	30	402627	382	31	405301	383	32	423013	1790	32	423081	380	34
401045	382	30	402630	382	31	405319	383	32	423014	1790	32	423082	380	34
401052	382	30	402746	382	31	405327	383	32	423015	300	37	423083	380	34
401060	382	30	402787	382	31	411895	377	28	423016	300	37	423084	380	34
401078	382	30	402795	382	31	411896	377	28	423017	330	37	423085	380	34
401102	382	30	402803	382	31	411897	377	28	423018	330	37	423086	380	34
401110	382	30	402811	382	31	411898	377	28	423019	1386	34	423087	380	34
401128	382	30	402829	382	31	411899	377	28	423020	1386	34	423088	380	34
401129	382	30	402837	382	31	411900	377	28	423021	1386	34	423089	380	34
401168	382	30	402902	382	31	415721	6382	32	423022	1386	34	423090	380	35
401169	382	30	402910	382	31	415724	6382	32	423023	1386	34	423091	380	35
401177	382	30	402936	382	31	415732	6382	32	423024	1386	34	423092	380	35
401201	382	30	402944	382	31	415737	6382	32	423025	1386	34	423093	380	35
401227	382	30	402951	382	31	415742	6382	32	423026	1386	34	423094	380	35
401242	382	30	402969	382	31	415747	6382	32	423027	1386	34	423095	380	35
401243	382	30	402977	382	31	415757	6382	32	423028	1386	34	423096	380	35
401244	382	30	402985	382	31	415801	6382	32	423029	1386	34	423097	380	35
401409	382	30	402993	382	31	415807	6382	32	423030	1386	34	423098	380	35

- Machine Taps
- Spiral Point Taps
- Spiral Flute Taps
- Thread Forming Taps
- Pipe Taps
- Dies
- Technical Info
- Sets
- Index



DRILL SIZE	DECIMAL INCHES	DRILL SIZE	DECIMAL INCHES	DRILL SIZE	DECIMAL INCHES	DRILL SIZE	DECIMAL INCHES	DRILL SIZE	DECIMAL INCHES	DRILL SIZE	DECIMAL INCHES
0.30mm	.0118	1.40mm	.0551	3.20mm	.1260	7/32	.2188	8.60mm	.3386	37/64	.5781
0.32mm	.0126	1.45mm	.0571	30	.1285	5.60mm	.2205	R	.3390	14.75mm	.5807
80	.0135	1.50mm	.0591	3.30mm	.1299	2	.2210	8.70mm	.3425	15.00mm	.5906
0.35mm	.0138	53	.0595	3.40mm	.1339	5.70mm	.2244	11/32	.3438	19/32	.5938
79	.0145	1.55mm	.0610	29	.1360	1	.2280	8.80mm	.3465	15.25mm	.6004
0.38mm	.0150	1/16	.0625	3.50mm	.1378	5.80mm	.2283	S	.3480	39/64	.6094
1/64	.0156	1.60mm	.0630	28	.1405	5.90mm	.2323	8.90mm	.3504	15.50mm	.6102
0.40mm	.0157	52	.0635	9/64	.1406	A	.2340	9.00mm	.3543	15.75mm	.6201
78	.0160	1.65mm	.0650	3.60mm	.1417	15/64	.2344	T	.3580	5/8	.6250
0.42mm	.0165	1.70mm	.0669	27	.1440	6.00mm	.2362	9.10mm	.3583	16.00mm	.6299
0.45mm	.0177	51	.0670	3.70mm	.1457	B	.2380	23/64	.3594	16.25mm	.6398
77	.0180	1.75mm	.0689	26	.1470	6.10mm	.2402	9.20mm	.3622	41/64	.6406
0.48mm	.0189	50	.0700	25	.1495	C	.2420	9.30mm	.3661	16.50mm	.6496
0.50mm	.0197	1.80mm	.0709	3.80mm	.1496	6.20mm	.2441	U	.3680	21/32	.6562
76	.0200	1.85mm	.0728	24	.1520	D	.2460	9.40mm	.3701	16.75mm	.6594
75	.0210	49	.0730	3.90mm	.1535	6.30mm	.2480	9.50mm	.3740	17.00mm	.6693
0.55mm	.0217	1.90mm	.0748	23	.1540	1/4	.2500	3/8	.3750	43/64	.6719
74	.0225	48	.0760	5/32	.1562	E	.2500	V	.3770	17.25mm	.6791
0.60mm	.0236	1.95mm	.0768	22	.1570	6.40mm	.2520	9.60mm	.3780	11/16	.6875
73	.0240	5/64	.0781	4.00mm	.1575	6.50mm	.2559	9.70mm	.3819	17.50mm	.6890
0.62mm	.0244	47	.0785	21	.1590	F	.2570	9.80mm	.3858	45/64	.7031
72	.0250	2.00mm	.0787	20	.1610	6.60mm	.2598	W	.3860	18.00mm	.7087
0.65mm	.0256	2.05mm	.0807	4.10mm	.1614	G	.2610	9.90mm	.3898	23/32	.7188
71	.0260	46	.0810	4.20mm	.1654	6.70mm	.2638	25/64	.3906	18.50mm	.7283
0.70mm	.0276	45	.0820	19	.1660	17/64	.2656	1.00mm	.3937	47/64	.7344
70	.0280	2.10mm	.0827	4.30mm	.1693	H	.2660	X	.3970	19.00mm	.7480
69	.0292	2.15mm	.0846	18	.1695	6.80mm	.2677	1.20mm	.4016	3/4	.7500
0.75mm	.0295	44	.0860	11/64	.1719	6.90mm	.2717	Y	.4040	49/64	.7656
68	.0310	2.20mm	.0866	17	.1730	I	.2720	13/32	.4062	19.50mm	.7677
1/32	.0312	2.25mm	.0886	4.40mm	.1732	7.00mm	.2756	Z	.4130	25/32	.7812
0.80mm	.0315	43	.0890	16	.1770	J	.2770	10.50mm	.4134	20.00mm	.7874
67	.0320	2.30mm	.0906	4.50mm	.1772	7.10mm	.2795	27/64	.4219	51/64	.7969
66	.0330	2.35mm	.0925	15	.1800	K	.2810	10.80mm	.4252	20.50mm	.8071
0.85mm	.0335	42	.0935	4.60mm	.1811	9/32	.2812	11.00mm	.4331	13/16	.8125
65	.0350	3/32	.0938	14	.1820	7.20mm	.2835	7/16	.4375	21.00mm	.8268
0.90mm	.0354	2.40mm	.0945	4.70mm	.1850	7.30mm	.2874	11.20mm	.4409	53/64	.8281
64	.0360	41	.0960	13	.1850	L	.2900	11.50mm	.4528	27/32	.8438
63	.0370	2.45mm	.0965	3/16	.1875	7.40mm	.2913	29/64	.4531	21.50mm	.8465
0.95mm	.0374	40	.0980	12	.1890	M	.2950	11.80mm	.4646	55/64	.8594
62	.0380	2.50mm	.0984	4.8mm	.1890	7.50mm	.2953	15/32	.4688	22.00mm	.8661
61	.0390	39	.0995	11	.1910	19/64	.2969	12.00mm	.4724	7/8	.8750
1.00mm	.0394	38	.1015	4.90mm	.1929	7.60mm	.2992	12.20mm	.4803	22.50mm	.8858
60	.0400	2.60mm	.1024	10	.1935	N	.3020	31/64	.4844	57/64	.8906
59	.0410	37	.1040	9	.1960	7.70mm	.3031	12.50mm	.4921	23.00mm	.9055
1.05mm	.0413	2.70mm	.1063	5.00mm	.1969	7.80mm	.3071	1/2	.5000	29/32	.9062
58	.0420	36	.1065	8	.1990	7.90mm	.3110	12.80mm	.5039	59/64	.9219
57	.0430	7/64	.1094	5.10mm	.2008	5/16	.3125	13.00mm	.5118	23.50mm	.9252
1.10mm	.0433	35	.1100	7	.2010	8.00mm	.3150	33/64	.5156	15/16	.9375
1.15mm	.0453	2.80mm	.1102	13/64	.2031	O	.3160	13.20mm	.5197	24.00mm	.9449
56	.0465	34	.1110	6	.2040	8.10mm	.3189	17/32	.5312	61/64	.9531
3/64	.0469	33	.1130	5.20mm	.2047	8.20mm	.3228	13.50mm	.5315	24.50mm	.9646
1.20mm	.0472	2.90mm	.1142	5	.2055	P	.3230	13.80mm	.5433	31/32	.9688
1.25mm	.0492	32	.1160	5.30mm	.2087	8.30mm	.3268	35/64	.5469	25.00mm	.9843
1.30mm	.0512	3.00mm	.1181	4	.2090	21/64	.3281	14.00mm	.5512	63/64	.9844
55	.0520	31	.1200	5.40mm	.2126	8.40mm	.3307	14.25mm	.5610	1	1.0000
1.35mm	.0531	3.10mm	.1220	3	.2130	Q	.3320	9/16	.5625		
54	.0550	1/8	.1250	5.50mm	.2165	8.50mm	.3346	14.50mm	.5709		

FRACTIONAL - RED

WIRE GAGE - PURPLE

LETTER - BLUE

METRIC - GREEN



**GREENFIELD
THREADING**



2501 Davis Creek Road, Seneca, SC 29678 U.S.A.

USA
 website www.gfii.com
 telephone 800.348.2885
 fax 800.892.4290
 email standard.distributors@gfii.com

International
 telephone 864.653.3904
 email international.distributors@gfii.com

TDC

Canada
www.gfii.ca
 800.348.2885
 800.387.6649
canada.distributors@gfii.com

