

FEATURING THE LATEST PRODUCTS FROM WIDIA™

ADVANCES

2020 METRIC

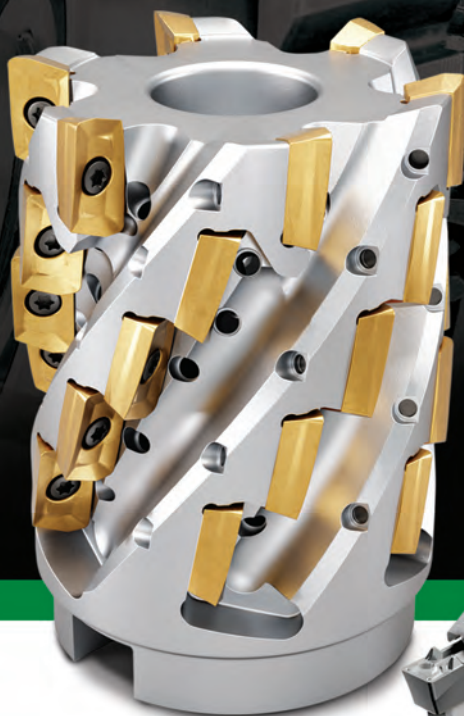

WIDIA 

INTRODUCING...

NEW PRODUCTS

VSM890™ -12

pages 4–12

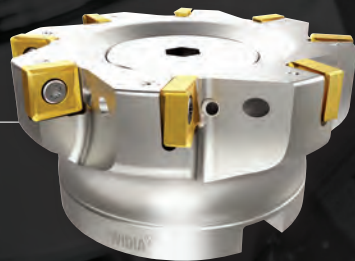

VSM

pages 34–57



New helical cutters



VXF™

pages 14–31



New cutter sizes -09 and -16



WGC

pages 142–163



New PT precision moulded
and ground inserts

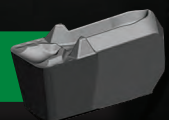

INDEXABLE MILLING

4–57

VSM890-12
VXF-07
VXF-09
VXF-12
VXF-16
VSM11
VSM17

SOLID END MILLING

58–98

The VariMill Family
70NS X-Feed
4U50
4U80
49N9
D503
General Purpose End Mills

HOLEMAKING

100–140

TDMX
Top Cut 4

TURNING

142–177

WGC
WK15CT
Tooling for Heavy-Duty Applications

ORDERING INFORMATION

178–181

Informational Icons Guide
CAS
Material Overview

TDMX™

pages 100–117



New 1.5 x D
and 12 x D bodies



FPE(M)



4U80

pages 80–81, 84–85



Weldon® shank expansion



WK15CT

pages 164–173



New Victory™ grade
for cast iron turning



VariMill™

pages 58–75



VariMill I, VariMill II, expansions



WIDIA

ALL-STAR

THE ALL-STAR PROGRAMME PROVIDES
PROVEN SOLUTIONS THAT ARE EASY
TO FIND AND ALWAYS AVAILABLE.

All-Star includes products from our most popular platforms, grades, and sizes grouped into our programme and guaranteed to be in stock with same-day shipping on orders placed before 4pm CET.

Visit widia.com to see what products are available for same day shipping through all-star.

Turning



Tapping



Holemaking



TO SEE ALL PRODUCT LINES, VISIT OUR DIGITAL RESOURCES



WIDIA NOVO™ Application
Download to your desktop or tablet:
widia.com/novo



WIDIA™ Machining Central Mobile App
Download for iOS or Android:
widia.com/en/featured/WidiaMobileApp

 youtube.com/WIDIASolutions

 linkedin.com/WIDIAProductGrp

 facebook.com/WIDIAProductGrp

To learn more, visit widia.com



Proven Solutions



Easy to Find

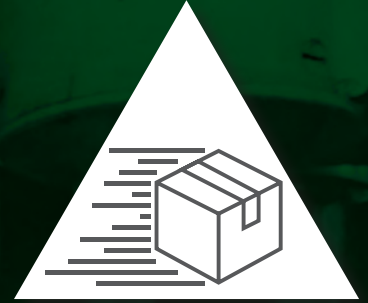

Always Available

Indexable Milling

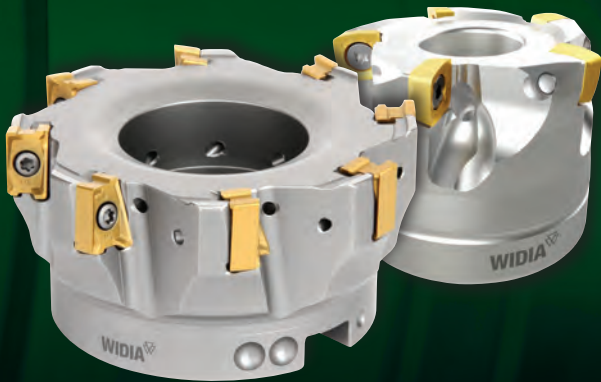

Solid End Milling



VSM890™-12



UNIQUE 8-EDGED SOLUTION FOR
SHOULDER AND FACE MILLING





VSM890™ -12

Weldon® End Mills: 32mm

Shell Mills: 40–250mm

8-Edged, Double-Sided True 90° Victory™ Shoulder-Face Mill (VSM)

Superior Metal Removal Rates (MRR) delivered through high-performance grades and chipbreakers.

Coarse, medium, and fine pitch cutter density to perfectly translate machining capability into higher productivity.

New pocket seat design for improved insert seating and great stability at roughing applications.

Applicable in a wide range of workpiece materials: aluminium, steel, cast iron, titanium, stainless steel, and high-temp alloys.

Comprehensive standard offering for cutter bodies and inserts to address light machining to heavy roughing jobs.



SNHX-MM • Universal Geometry for Medium Machining.
Corner Radii Expansion for -MM Chipbreaker



WK15CM

VSM890™ -12

0°/90° Shoulder Mills • VSM890-12

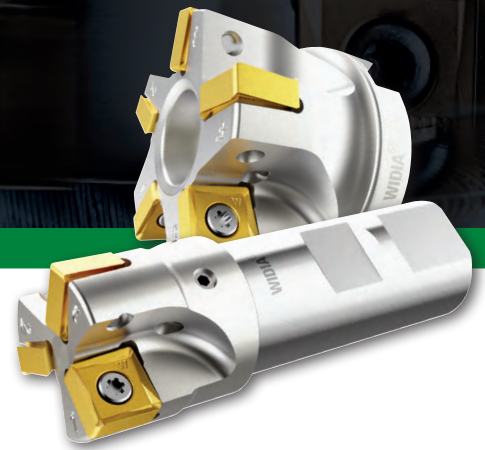

- True 90° wall and stepping down capability.
- Axial depth of cut capability; Ap1 max up to 9,8mm.
- Optimised chip gash design for proper chip evacuation.
- User-friendly pocket numbering system.
- Cutter bodies with internal coolant supply.
- Less bur creation on the workpiece.

Super-positive rake design for low machine power consumption.

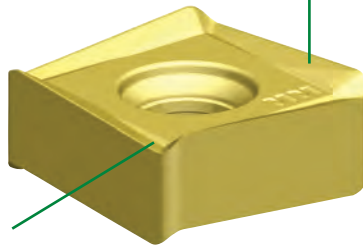

Integrated wiper facet for excellent surface floor finish.

Unique insert rake design to reduce and perfectly balance axial and radial cutting forces. Engineered for light machining to heavy roughing in all material groups.

-ALP



N

First choice for Non-Ferrous materials.

-ML

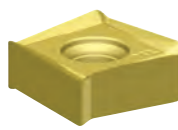

P M S

First choice for Stainless Steel, light machining, and finishing jobs.

-MM



P M K S H

First choice for general purpose in all workpiece materials. Engineered for high-feed rates.

Finishing Capabilities/Lower Cutting Forces

Geometry Strengthening/Stronger Cutting Edge Protection

Applications

1. Face milling.
2. Full slotting with 100% radial engagement.
3. Shoulder milling with stepping down and great wall finish.
4. Shoulder milling with low axial and high radial engagement.
5. Shoulder milling with low radial and high axial engagement.
6. HPC face milling. First choice to clean up castings.
7. Dynamic/trochoidal slot milling.
8. Z-axis plunge milling.
9. Z-axis contour plunge milling.
10. Z-axis zig-zag slot plunge milling.

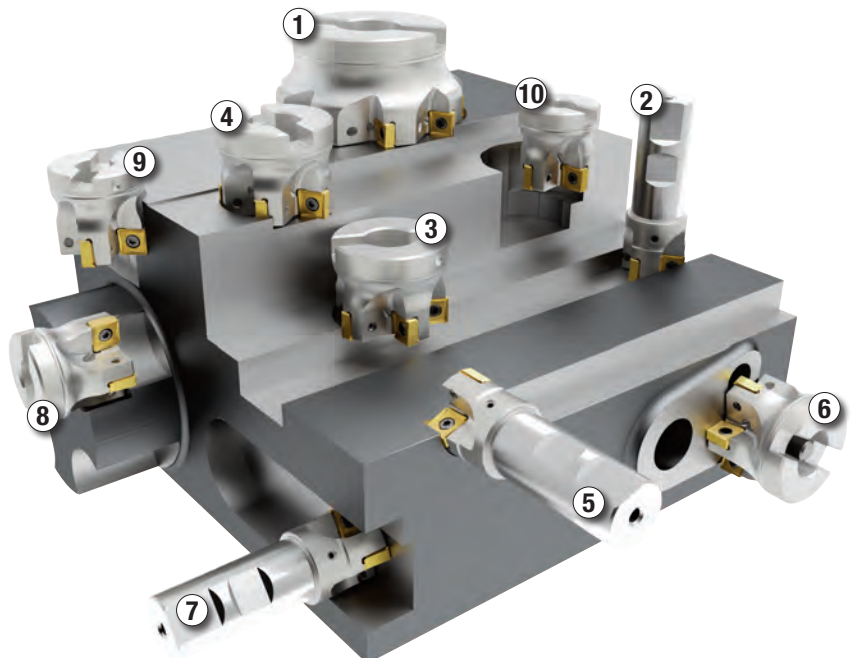

0°/90° Shoulder Mills • VSM890™ -12

Weldon® End Mills • Metric

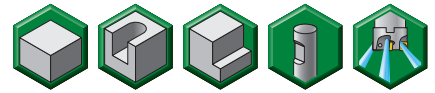
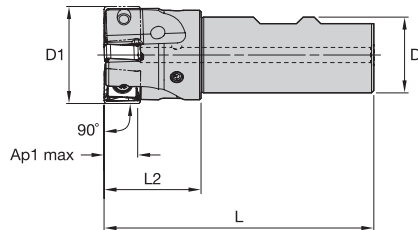

order number	catalogue number	D1	D	L	L2	Ap1 max	Z	max RPM	coolant supply	kg
6596066	VSM890D032Z03B25SN12	32	25	89	32	9,8	3	33200	Yes	0,31

Shell Mills • Metric

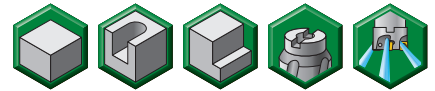
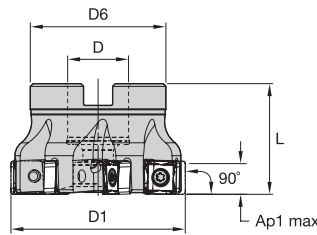

order number	catalogue number	D1	D	D6	L	Ap1 max	Z	max RPM	coolant supply	kg
6596067	VSM890D040Z04S22SN12	40	22	39	40	9,8	4	28000	Yes	0,20
6596068	VSM890D050Z04S22SN12	50	22	49	40	9,8	4	24100	Yes	0,32
6596069	VSM890D050Z05S22SN12	50	22	49	40	9,8	5	24100	Yes	0,32
6596070	VSM890D063Z05S22SN12	63	22	49	40	9,8	5	20800	Yes	0,48
6596111	VSM890D063Z07S22SN12	63	22	49	40	9,8	7	20800	Yes	0,45
6596112	VSM890D080Z05S27SN12	80	27	60	50	9,8	5	18000	Yes	0,96
6596113	VSM890D080Z07S27SN12	80	27	60	50	9,8	7	18000	Yes	1,03
6596114	VSM890D080Z09S27SN12	80	27	60	50	9,8	9	18000	Yes	1,01
6596115	VSM890D100Z06S32SN12	100	32	78	50	9,8	6	15800	Yes	1,69
6596116	VSM890D100Z08S32SN12	100	32	78	50	9,8	8	15800	Yes	1,56
6596117	VSM890D100Z11S32SN12	100	32	78	50	9,8	11	15800	Yes	1,53
6596118	VSM890D125Z07S40SN12	125	40	89	63	9,8	7	13900	Yes	2,79
6596119	VSM890D125Z10S40SN12	125	40	89	63	9,8	10	13900	Yes	2,98
6596121	VSM890D125Z14S40SN12	125	40	89	63	9,8	14	13900	Yes	2,86
6596122	VSM890D160Z08S40SN12	160	40	110	63	9,8	8	12200	Yes	4,10
6596123	VSM890D160Z12S40SN12	160	40	110	63	9,8	12	12200	Yes	4,15
6596124	VSM890D160Z16S40SN12	160	40	110	63	9,8	16	12200	Yes	8,97
6596125	VSM890D200Z10S60SN12	200	60	130	63	9,8	10	10800	Yes	5,62
6596126	VSM890D200Z14S60SN12	200	60	130	63	9,8	14	10800	Yes	5,59
6596127	VSM890D200Z22S60SN12	200	60	130	63	9,8	22	10800	Yes	5,67
6596128	VSM890D250Z16S60SN12	250	60	130	63	9,8	16	9600	Yes	8,10

FOR SPARE PARTS, PLEASE VISIT WIDIA NOVO™ OR WIDIA.COM.

MOUNTING SCREWS ARE NOT INCLUDED IN STANDARD PACKAGING.



VSM890™ -12

0°/90° Shoulder Mills • VSM890-12

Inserts • SNHX-ALP • For Aluminium and Other Non-Ferrous Alloys

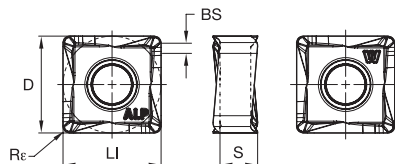

- first choice
- alternate choice

P	●			●	●	○
M	●			●	●	
K	●	○				●
N	●					
S	●			○	●	
H						●

ISO catalogue number	cutting edges	LI	S	D	BS	Re	WK15CM	WN25PM	WP25PM	WP40PM	WS40PM	WU10PM
SNHX120408PNERALP	8	12,00	4,61	12,00	1,34	0,80	●	○	○	○	○	○

Inserts • SNHX-ML • Precision Finishing and Light Machining

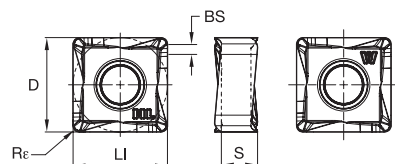

- first choice
- alternate choice

P	●			●	●	○
M	●			●	●	
K	●	○				●
N	●					
S	●			○	●	
H						●

ISO catalogue number	cutting edges	LI	S	D	BS	Re	WK15CM	WN25PM	WP25PM	WP40PM	WS40PM	WU10PM
SNHX120408PNERML	8	12,00	4,61	12,00	1,34	0,80	○	○	●	○	○	○

0°/90° Shoulder Mills • VSM890™ -12

Inserts • SNHX-MM • Universal Geometry for Medium Machining

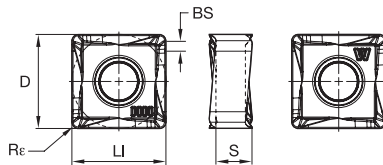

- first choice
- alternate choice

P	●			●	●	○
M	●			●	●	
K	●	○				●
N		●				
S			●	○	●	
H						●

ISO catalogue number	cutting edges	LI	S	D	BS	Re	WK15CM	WN25PM	WP25PM	WP40PM	WS40PM	WU10PM
SNHX120408PNSRMM	8	12,00	4,61	12,00	1,34	0,80	6667462	I	6596431	6596432	6596433	6596400
SNHX120416PNSRMM	8	12,00	4,58	12,00	1,00	1,60	6712874	I	6712875	6712876	6712877	I

For M4000 cartridge milling system, please see page 12.

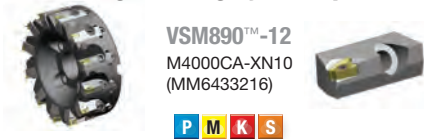

VSM890™-12
M4000CA-XN10
(MM6433216)



Insert Selection Guide

Material Group	Light Machining		General Purpose		Heavy Machining	
	Geometry	Grade	Geometry	Grade	Geometry	Grade
P1-P2	SNHX-ML	WS40PM	SNHX-MM	WP40PM	SNHX-MM	WP40PM
P3-P4	SNHX-ML	WS40PM	SNHX-MM	WP40PM	SNHX-MM	WP40PM
P5-P6	SNHX-ML	WP25PM	SNHX-MM	WP40PM	SNHX-MM	WP40PM
M1-M2	SNHX-ML	WS40PM	SNHX-ML	WS40PM	SNHX-MM	WS40PM
M3	SNHX-ML	WS40PM	SNHX-ML	WS40PM	SNHX-MM	WS40PM
K1-K2	SNHX-MM	WK15CM	SNHX-MM	WK15CM	SNHX-MM	WK15CM
K3	SNHX-MM	WK15CM	SNHX-MM	WK15CM	SNHX-MM	WK15CM
N1-N2	SNHX-ALP	WN25PM	SNHX-ALP	WN25PM	SNHX-ALP	WN25PM
N3	SNHX-ALP	WN25PM	SNHX-ALP	WN25PM	SNHX-ALP	WN25PM
S1-S2	SNHX-ML	WP25PM	SNHX-ML	WS40PM	SNHX-MM	WS40PM
S3	SNHX-ML	WS40PM	SNHX-ML	WS40PM	SNHX-MM	WS40PM
S4	SNHX-ML	WS40PM	SNHX-ML	WS40PM	SNHX-MM	WS40PM
H1	SNHX-MM	WU10PM	SNHX-MM	WU10PM	-	-



VSM890™ -12

0°/90° Shoulder Mills • VSM890-12

Recommended Starting Speeds [m/min]*

Material Group		WK15CM	WN25PM	WP25PM	WP40PM	WS40PM	WU10PM
P	1	- - -	- - -	330 285 270	295 260 245	- - -	- - -
	2	- - -	- - -	275 240 200	250 215 180	- - -	- - -
	3	- - -	- - -	255 215 175	230 195 160	- - -	- - -
	4	- - -	- - -	225 185 150	205 170 135	- - -	- - -
	5	- - -	- - -	185 170 150	170 155 135	170 145 120	- - -
	6	- - -	- - -	165 125 100	150 115 90	150 110 80	- - -
M	1	- - -	- - -	205 180 165	195 170 155	210 170 140	- - -
	2	- - -	- - -	185 160 130	175 150 125	180 145 120	- - -
	3	- - -	- - -	140 120 95	130 115 90	145 110 85	- - -
K	1	420 385 340	- - -	230 205 185	- - -	- - -	295 265 240
	2	335 295 275	- - -	180 160 150	- - -	- - -	230 205 190
	3	280 250 230	- - -	150 135 120	- - -	- - -	195 175 160
N	1	- - -	1075 945 875	- - -	- - -	- - -	- - -
	2	- - -	945 875 760	- - -	- - -	- - -	- - -
	3	- - -	945 875 760	- - -	- - -	- - -	- - -
S	1	- - -	- - -	40 35 25	- - -	40 35 25	- - -
	2	- - -	- - -	40 35 25	- - -	40 35 25	- - -
	3	- - -	- - -	50 40 25	- - -	50 40 25	- - -
	4	- - -	- - -	70 50 35	- - -	60 50 30	- - -
H	1	- - -	- - -	- - -	- - -	- - -	160 130 90

NOTE: FIRST choice starting speeds are in **bold** type. As the average chip thickness increases, the speed should be decreased.
 *Material groups P, M, K, and H show recommended starting speeds for dry machining. For wet machining, reduce speed by 20%.
 *Material groups N and S show recommended starting speeds for wet machining. Not recommended for dry machining.

Recommended Starting Feeds [mm]

Light Machining	General Purpose	Heavy Machining
-----------------	-----------------	-----------------

Insert Geometry	Programmed Feed per Tooth (fz) as a % of Radial Depth of Cut (ae)															Insert Geometry
	5%			10%			20%			30%			40-100%			
.E..ALP	0,12	0,28	0,43	0,08	0,20	0,31	0,06	0,15	0,23	0,06	0,13	0,20	0,05	0,12	0,18	.E..ALP
.E..ML	0,17	0,32	0,60	0,13	0,23	0,44	0,09	0,18	0,33	0,08	0,15	0,28	0,08	0,14	0,26	.E..ML
.S..MM	0,23	0,36	0,82	0,17	0,26	0,59	0,13	0,20	0,44	0,11	0,17	0,38	0,10	0,16	0,35	.S..MM

NOTE: Use "Light Machining" values as starting feed rate.

Best Practices

True 90° roughing tool with embedded finishing capabilities all in one tool.

Best-in-class wall finish with VSM890-12 in axial stepping-down jobs. For many shop floor setups, no additional finishing is required resulting in shorter machining time and lower tooling cost.

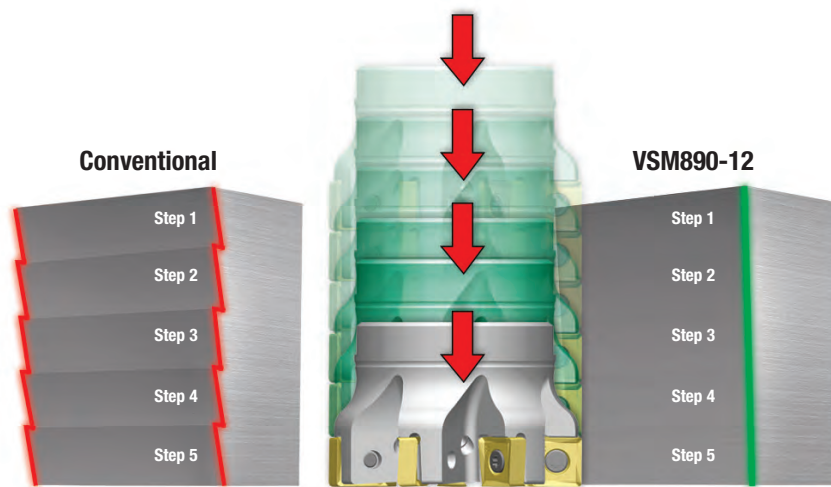

Excellent wall finish with VSM890-12



- Unstable setup.
- Low spindle power.
- High axial depth of cut A_p1 .
- Low feed rate.
- Machining aluminium.
- Driven tools.



- Regular setup.
- Regular spindle power.
- Medium feed rate.



- Rigid setup.
- High spindle power.
- Low axial depth of cut A_p1 .
- High feed rate.
- Boost productivity and cut into cycle time.

Machining Stability



VSM890™ -12

0°/90° Shoulder Mills • VSM890-12

VSM890-12 Z-Axis Plunge Milling

cutting diameter (D1)	Y max	X
32	8,9	28,68
40	8,9	33,27
50	8,9	38,25
63	8,9	43,89
80	8,9	50,31
100	8,9	56,95
125	8,9	64,29
160	8,9	73,34
200	8,9	82,48
250	8,9	92,65

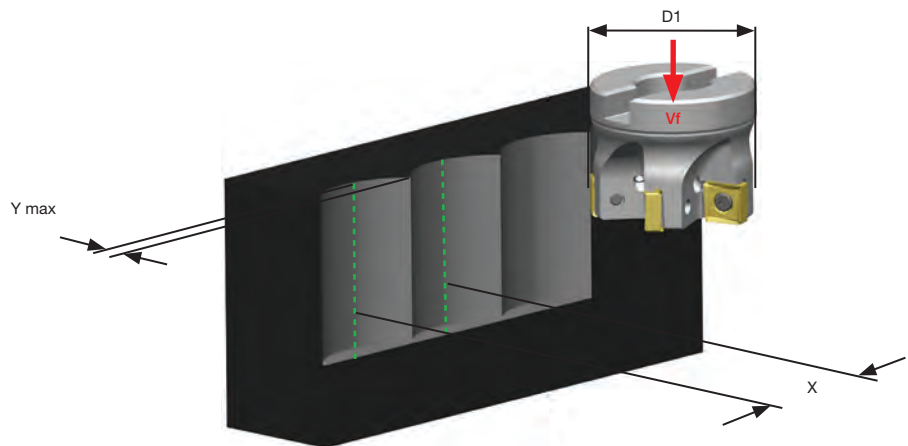

VSM890-12 Ap1 max at Full Slotting, 100% Radial Cutter Engagement

D1 diameter	Recommended Cutter Density Z	Ap1 max		
		Grey Cast Iron EN-GJL-250 EN-JL1040 GG25	Steel AISI 4140 1.7225 42CrMo4	Stainless Steel AISI 316L, 1.4404, X2CrNiMo1810
40	4	8,0	6,5	5,0
50	4	8,0	6,5	5,0
63	5	8,0	6,5	5,0
80	5	8,0	6,5	5,0
100	6	8,0	6,5	5,0

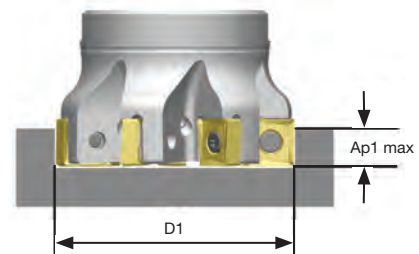

VSM890-12 Cartridge for M4000

M4000CA-SNHX12
(MM6602179)

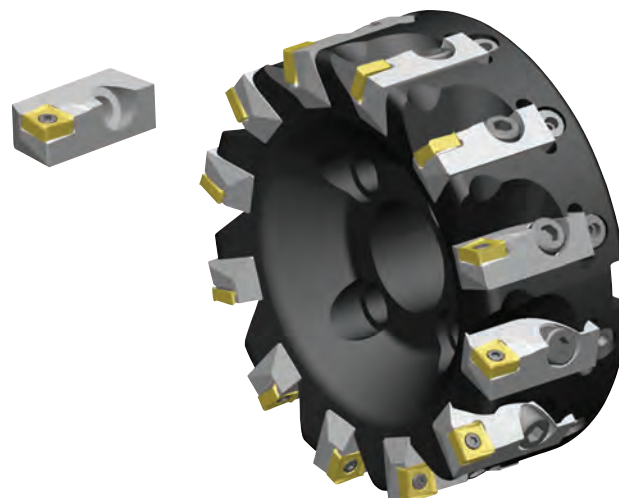

WIDIA 



WIDIA™ Victory™

WS40PM

Breakthrough in the latest substrate and coating technology to boost productivity in **stainless steels and high-temp alloys**



Advanced Milling Grade for Titanium

Multilayer PVD AlTiN-TiN Coating

- Improved chemical and abrasive wear resistance.
- Consistent tool life performance.
- Primarily for wet machining. Also great results in dry machining.

New Medium-Grained Substrate

- Minimises tendency for thermal cracking.
- Excellent fatigue resistance and edge strength.
- Rich in cobalt content for improved toughness.

VXF™

VICTORY™ X-FEED™



NEXT LEVEL OF HIGH-FEED MILLING



VXF is a high-feed productivity booster designed to establish new industry standards with market-leading milling grades like WS40PM.





VXF™ -07

Ap1 max: 0,9mm
fz max: 1,2mm/z



VXF™ -09

Ap1 max: 1,5mm
fz max: 2,0 mm/z

VXF™ -12

Ap1 max: 2,5mm
fz max: 3,0 mm/z



VXF™ -16

Ap1 max: 3,5mm
fz max: 2,0 mm/z

Optimised cutter body and chip gash design perfectly serves high-feed requirements.

PSTS inserts for powerful low cost per edge high-feed milling.

Cutters with internal coolant supply.

Nickel-plated surface protection.

- 16.5° lead angle redistributes cutting forces in the spindle z-axis direction.
- Greatly reduces tool deflection and vibrations for improved tool life.
- Suitable for long tool reach.
- Unique integrated radial wiping facet to achieve a nice wall finish at pocket and helical interpolation milling.
- Durable cutting edges qualified to machine a wide range of materials.
- WS40PM — best-in-class milling grade for machining stainless steel and HTA.



Perfect combination of round and square insert style.

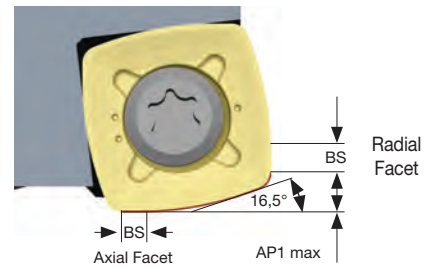

Specifically engineered chipbreakers for powerful high-feed milling.



-MM

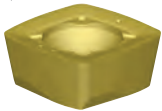

P M S

First choice for Soft Steel, Stainless Steel, and High-Temp Alloys. Best fit for pocketing and profiling operations.

VXF-07

-MH

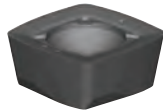

P H

First choice for P3 and P4 materials. Stronger edge protection for heavy roughing jobs and hardened steel up to 48HRc.



-MM



P M S

First choice for Soft Steel, Stainless Steel, and High-Temp Alloys. Best fit for pocketing and profiling operations.

VXF-09

-MH

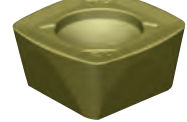

P

First choice for P3 and P4 materials. Stronger edge protection for heavy roughing jobs.

-MM

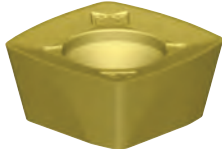

P M S

First choice for Soft Steel, Stainless Steel, and High-Temp Alloys. Best fit for pocketing and profiling operations.

VXF-12

-MH



P

First choice for P3 and P4 materials. Stronger edge protection for heavy roughing jobs.



VXF-16

-MM

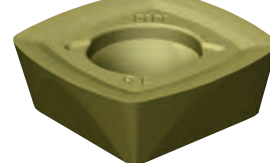

P M S

First choice for soft steel, stainless steel, and high-temp alloys. Best fit for pocketing and profiling operations.

Lower Cutting Forces

Geometry Strengthening/Stronger Cutting Edge Protection

High-Feed Mills • VXF-07, VXF-09, VXF-12, and VXF-16

Comprehensive standard offering at one glance
to match all shop-floor needs for high-feed milling.

VXF-07



VXF-09



VXF-12



VXF-16

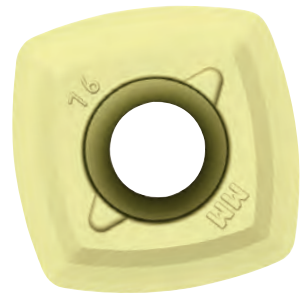

VXF Platform	Ap1 max (Metric)	fz max (Metric)
07	0,9mm	< 1,2mm
09	1,5mm	< 2,0mm
12	2,5mm	< 3,0mm
16	3,5mm	< 2,0mm

Applications

1. Face milling.
2. 3D profile milling.
3. Pocket milling into full material.
4. Helical interpolation into full material.
5. Deep pocket milling into full material.
6. Dynamic/trochoidal milling.
7. Aggressive ramp milling.
8. Contour Milling.
9. Face milling deep cavities with long tool reach.
10. Z-axis contour plunge milling.

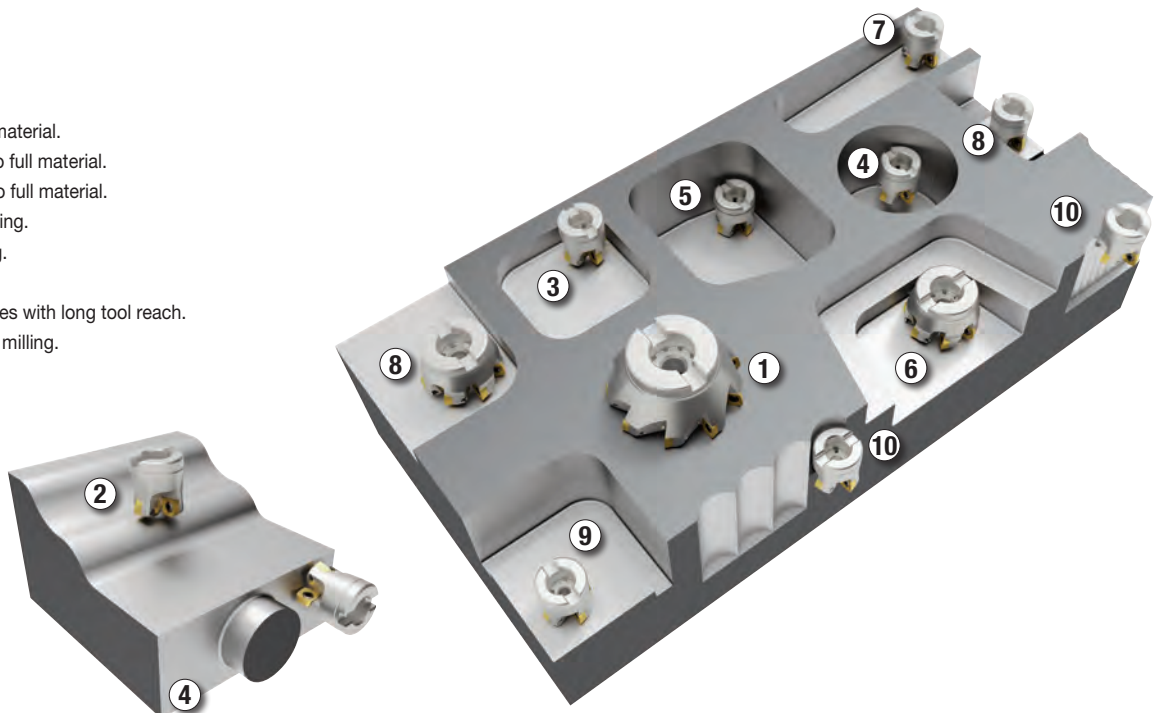

Screw-On End Mills • Metric

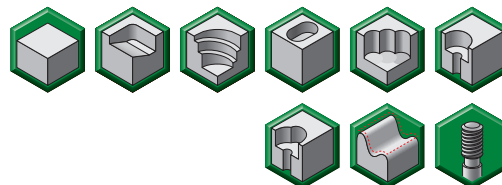
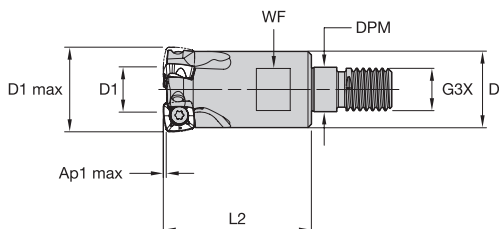

order number	catalogue number	D1 max	D1	D	DPM	G3X	L2	WF	Ap1 max	Z	max ramp angle	max RPM	coolant supply	kg
6597130	VXF016Z02M08XP07	16	7	13	8,5	M8	25	10	0,9	2	5.9°	65000	Yes	0,02
6597151	VXF020Z03M10XP07	20	11	18	10,5	M10	35	15	0,9	3	3.4°	57000	Yes	0,07
6597152	VXF025Z04M12XP07	25	16	21	12,5	M12	35	17	0,9	4	2.2°	49000	Yes	0,09
6597153	VXF032Z05M16XP07	32	23	29	17,0	M16	43	24	0,9	5	1.4°	41500	Yes	0,22

Cylindrical End Mills • Metric

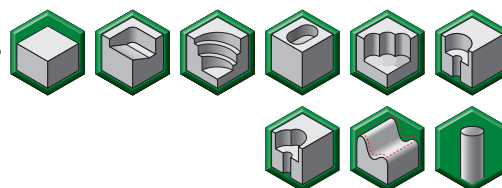
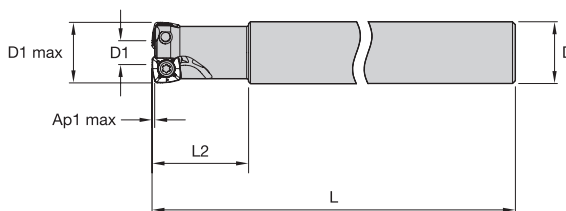

order number	catalogue number	D1 max	D1	D	L	L2	Ap1 max	Z	max ramp angle	max RPM	coolant supply	kg
6597154	VXF016Z02A16XP07L180	16	7	16	180	25	0,9	2	5.9°	65000	Yes	0,24
6597155	VXF018Z02A18XP07L180	18	9	18	180	25	0,9	2	5.4°	61000	Yes	0,31
6597156	VXF020Z03A20XP07L190	20	11	20	190	32	0,9	3	3.4°	57000	Yes	0,41
6597157	VXF025Z04A25XP07L200	25	16	25	200	40	0,9	4	2.2°	49000	Yes	0,69

Shell Mills • Metric

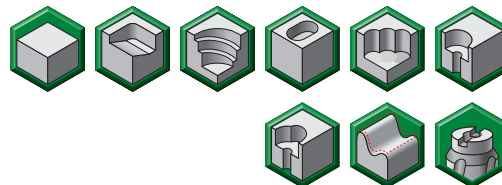
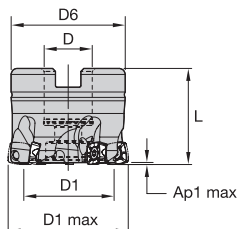

order number	catalogue number	D1 max	D1	D	D6	L	Ap1 max	Z	max ramp angle	max RPM	coolant supply	kg
6597158	VXF040Z05S16XP07	40	31	16	37	32	0,9	5	1.0°	35000	Yes	0,19
6597159	VXF050Z07S22XP07	50	41	22	42	40	0,9	7	.7°	31300	Yes	0,32

FOR SPARE PARTS, PLEASE VISIT WIDIA_NOVO™ OR WIDIA.COM.

MOUNTING SCREWS ARE NOT INCLUDED IN STANDARD PACKAGING.

Inserts • XPPT-MM • Best Fit for Pocketing and Profiling Operations

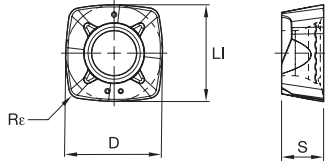

- first choice
- alternate choice

P	●	●	○	
M	●	●	●	
K	○			●
N	●			
S	●	○	●	
H				●

ISO catalogue number	cutting edges	LI	S	D	Re	WP25PM	WP40PM	WS40PM	WU10PM
XPPT070308ERMM	4	7,30	3,17	7,30	0,80	6595819	6595820		

Inserts • XPPW-MH • Dedicated Geometry for Heavy Roughing

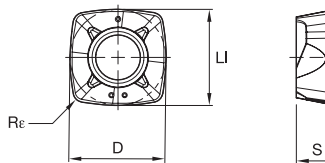

- first choice
- alternate choice

P	●	●	○	
M	●	●	●	
K	○			●
N	●			
S	●	○	●	
H				●

ISO catalogue number	cutting edges	LI	S	D	Re	WP25PM	WP40PM	WS40PM	WU10PM
XPPW070310SRMH	4	7,30	3,17	7,30	1,00	6595770	6595769		

For M4000 cartridge milling system, please see page 12.



Insert Selection Guide

Material Group	Light Machining		General Purpose		Heavy Machining	
	Geometry	Grade	Geometry	Grade	Geometry	Grade
P1-P2	XPPT-MM	WP25PM	XPPT-MM	WS40PM	XPPW-MH	WP40PM
P3-P4	XPPT-MM	WP25PM	XPPT-MM	WS40PM	XPPW-MH	WP40PM
P5-P6	XPPT-MM	WP25PM	XPPT-MM	WS40PM	XPPW-MH	WP40PM
M1-M2	XPPT-MM	WS40PM	XPPT-MM	WS40PM	XPPW-MH	WP40PM
M3	XPPT-MM	WS40PM	XPPT-MM	WS40PM	XPPW-MH	WP40PM
K1-K2	XPPW-MH	WU10PM	XPPW-MH	WU10PM	XPPW-MH	WU10PM
K3	XPPW-MH	WU10PM	XPPW-MH	WU10PM	XPPW-MH	WU10PM
S1-S2	XPPT-MM	WP25PM	XPPT-MM	WS40PM	-	-
S3	XPPT-MM	WS40PM	XPPT-MM	WS40PM	-	-
S4	XPPT-MM	WS40PM	XPPT-MM	WS40PM	-	-
H1	XPPW-MH	WU10PM	XPPW-MH	WU10PM	-	-



Recommended Starting Speeds [m/min]*

Material Group		WP25PM			WP40PM			WS40PM			WU10PM		
P	1	395	340	325	355	310	295	-	-	-	-	-	-
	2	330	290	240	300	260	215	-	-	-	-	-	-
	3	305	260	210	275	235	190	-	-	-	-	-	-
	4	270	220	180	245	205	160	-	-	-	-	-	-
	5	220	205	180	205	185	160	205	175	145	-	-	-
	6	200	150	120	180	140	110	180	130	95	-	-	-
M	1	245	215	200	235	205	185	250	205	170	-	-	-
	2	220	190	155	210	180	150	215	175	145	-	-	-
	3	170	145	115	155	140	110	175	130	100	-	-	-
K	1	275	245	220	-	-	-	-	-	-	355	320	290
	2	215	190	180	-	-	-	-	-	-	275	245	230
	3	180	160	145	-	-	-	-	-	-	235	210	190
S	1	50	40	30	50	40	35	50	40	30	-	-	-
	2	50	40	30	50	40	35	50	40	30	-	-	-
	3	60	50	30	60	50	35	60	50	30	-	-	-
	4	85	60	40	80	60	40	70	60	35	-	-	-
H	1	145	110	85	-	-	-	-	-	-	190	155	110

NOTE: FIRST choice starting speeds are in **bold** type. As the average chip thickness increases, the speed should be decreased.
 *Material groups P, M, K, and H show recommended starting speeds for dry machining. For wet machining, reduce speed by 20%.
 *Material groups N and S show recommended starting speeds for wet machining. Not recommended for dry machining.

Recommended Starting Feeds [mm]

Light Machining	General Purpose	Heavy Machining
-----------------	-----------------	-----------------

At 0,60 Axial Depth of Cut (AP1)

Insert Geometry	Recommended Starting Feed per Tooth (Fz) in Relation to % of Radial Engagement (ae)															Insert Geometry
	5%			10%			20%			30%			40-100%			
.E..MM	0,46	1,32	2,43	0,32	0,89	1,53	0,24	0,65	1,09	0,21	0,56	0,94	0,19	0,52	0,85	.E..MM
.S..MH	0,84	1,84	3,12	0,59	1,21	1,85	0,43	0,87	1,30	0,38	0,75	1,12	0,34	0,69	1,02	.S..MH

At 0,90 Axial Depth of Cut (AP1)

Insert Geometry	Recommended Starting Feed per Tooth (Fz) in Relation to % of Radial Engagement (ae)															Insert Geometry
	5%			10%			20%			30%			40-100%			
.E..MM	0,42	1,21	2,20	0,30	0,83	1,41	0,22	0,60	1,01	0,19	0,52	0,87	0,18	0,48	0,79	.E..MM
.S..MH	0,78	1,68	2,79	0,55	1,12	1,71	0,40	0,81	1,21	0,35	0,70	1,04	0,32	0,64	0,94	.S..MH

At 0,70 Axial Depth of Cut (AP1)

Insert Geometry	Recommended Starting Feed per Tooth (Fz) in Relation to % of Radial Engagement (ae)															Insert Geometry
	5%			10%			20%			30%			40-100%			
.E..MM	0,37	1,06	1,89	0,27	0,73	1,24	0,20	0,53	0,89	0,17	0,46	0,77	0,16	0,42	0,70	.E..MM
.S..MH	0,68	1,46	2,35	0,48	0,98	1,49	0,36	0,71	1,07	0,31	0,62	0,92	0,28	0,56	0,84	.S..MH

NOTE: Use "Light Machining" values as starting feed rate.

Screw-On End Mills • Metric

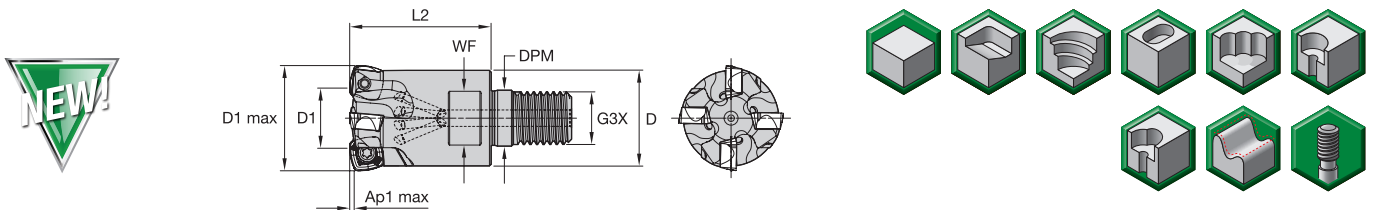

order number	catalogue number	D1 max	D1	D	DPM	G3X	L2	WF	Ap1 max	Z	max ramp angle	max RPM	coolant supply	kg
6597731	VXF025Z03M12XD09	25	11	21	12,5	M12	35	9	1,5	3	2.8°	48500	Yes	0,09
6597732	VXF032Z03M16XD09	32	18	29	17,0	M16	43	10	1,5	3	1.5°	40500	Yes	0,20
6597733	VXF032Z04M16XD09	32	18	29	17,0	M16	43	10	1,5	4	1.5°	40500	Yes	0,20
6597734	VXF035Z04M16XD09	35	21	29	17,0	M16	43	10	1,5	4	1.3°	37500	Yes	0,21
6597735	VXF042Z05M16XD09	42	28	29	17,0	M16	43	10	1,5	5	1.0°	34000	Yes	0,25

Weldon® End Mills • Metric

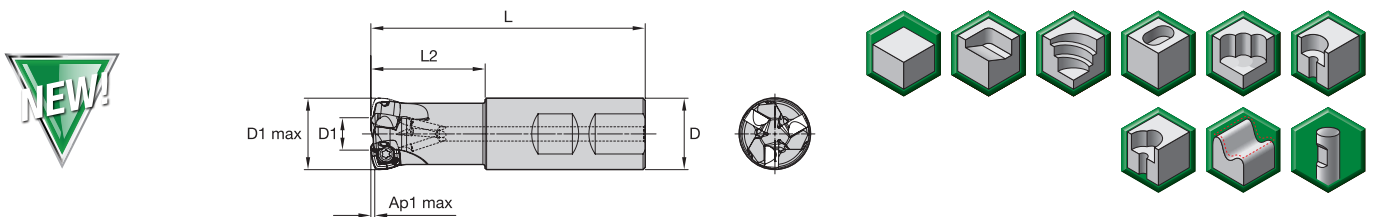

order number	catalogue number	D1 max	D1	D	L	L2	Ap1 max	Z	max ramp angle	max RPM	coolant supply	kg
6597736	VXF025Z02A25XD09	25	11	25	96	40	1,5	3	2.8°	48500	Yes	0,28
6597737	VXF032Z04B25XD09	32	18	25	96	40	1,5	4	1.5°	40500	Yes	0,36

Cylindrical End Mills • Metric

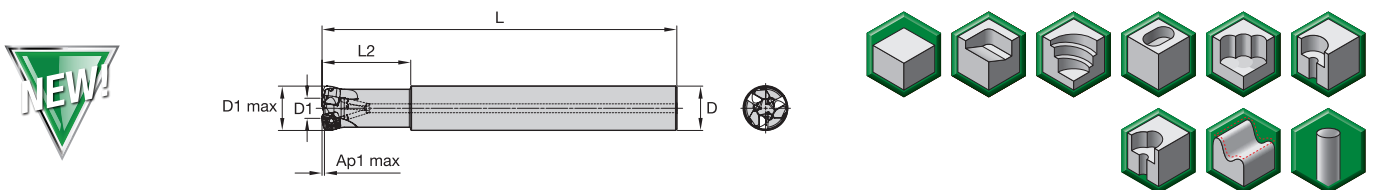

order number	catalogue number	D1 max	D1	D	L	L2	Ap1 max	Z	max ramp angle	max RPM	coolant supply	kg
6597740	VXF025Z02A25XD09L200	25	11	25	200	50	1,5	2	2.8°	48500	Yes	0,67
6597738	VXF025Z03A25XD09	25	11	25	100	32	1,5	3	2.8°	48500	Yes	0,32
6597742	VXF025Z03A25XD09L200	25	11	25	200	50	1,5	3	2.8°	48500	Yes	0,67
6597743	VXF032Z03A25XD09L200	32	18	32	200	40	1,5	3	1.5°	40500	Yes	0,75
6597739	VXF032Z04A25XD09	32	18	32	110	40	1,5	4	1.5°	40500	Yes	0,42
6597744	VXF032Z04A25XD09L200	32	18	32	200	40	1,5	4	1.5°	40500	Yes	0,75

FOR SPARE PARTS, PLEASE VISIT WIDIA NOVO™ OR WIDIA.COM.

MOUNTING SCREWS ARE NOT INCLUDED IN STANDARD PACKAGING.

Shell Mills • Metric

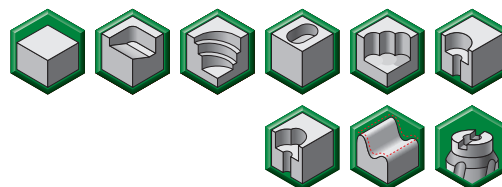
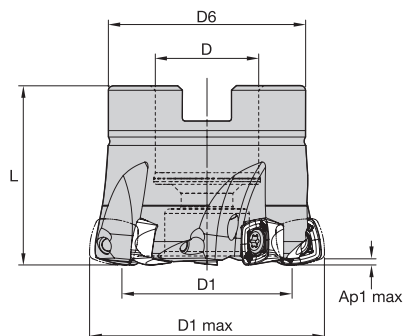

order number	catalogue number	D1 max	D1	D	D6	L	Ap1 max	Z	max ramp angle	max RPM	coolant supply	kg
6597746	VXF040Z04S16XD09	40	26	16	37	32	1,5	4	.8°	34500	Yes	0,15
6597747	VXF040Z05S16XD09	40	26	16	37	32	1,5	5	.8°	34500	Yes	0,14
6597748	VXF042Z05S16XD09	42	28	16	37	32	1,5	5	.8°	34000	Yes	0,16
6597750	VXF050Z07S22XD09	50	34	22	42	40	1,5	7	.7°	30000	Yes	0,28
6597749	VXF050Z05S22XD09	50	36	22	42	40	1,5	5	.7°	30000	Yes	0,29
6597751	VXF052Z06S22XD09	52	38	22	42	40	1,5	6	.7°	29500	Yes	0,30
6597755	VXF063Z06S22XD09	63	49	22	42	40	1,5	6	.5°	26000	Yes	0,40

FOR SPARE PARTS, PLEASE VISIT WIDIA NOVO™ OR WIDIA.COM.

MOUNTING SCREWS ARE NOT INCLUDED IN STANDARD PACKAGING.

Inserts • XDPT-MM

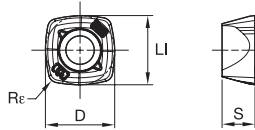

- first choice
- alternate choice

P	●	●	○
M	●	●	●
K	○	○	○
N	○	○	○
S	●	○	●
H	○	○	○

ISO catalogue number	cutting edges	LI	S	D	Re	WP25PM	WP40PM	WS40PM
XDPT090412ERMM	4	10,00	4,76	10,00	1,20	6596471	I	6596472

Inserts • XDPT-MH

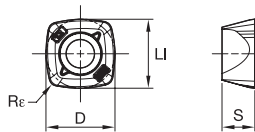

- first choice
- alternate choice

P	●	●	○
M	●	●	●
K	○	○	○
N	○	○	○
S	●	○	●
H	○	○	○

ISO catalogue number	cutting edges	LI	S	D	Re	WP25PM	WP40PM	WS40PM
XDPT090412SRMH	4	10,00	4,76	10,00	1,20	I	6596822	I

For M4000 cartridge milling system, please see page 12.



VSM890™-12
M4000CA-XN10
(MM6433216)



P M K S

Insert Selection Guide

Material Group	Light Machining		General Purpose		Heavy Machining	
	Geometry	Grade	Geometry	Grade	Geometry	Grade
P1-P2	XDPT-MM	WP25PM	XDPT-MM	WS40PM	XDPT-MH	WP40PM
P3-P4	XDPT-MM	WP25PM	XDPT-MM	WS40PM	XDPT-MH	WP40PM
P5-P6	XDPT-MM	WP25PM	XDPT-MM	WS40PM	XDPT-MH	WP40PM
M1-M2	XDPT-MM	WS40PM	XDPT-MM	WS40PM	XDPT-MH	WP40PM
M3	XDPT-MM	WS40PM	XDPT-MM	WS40PM	XDPT-MH	WP40PM
S1-S2	XDPT-MM	WP25PM	XDPT-MM	WS40PM	XDPT-MH	WP40PM
S3	XDPT-MM	WS40PM	XDPT-MM	WS40PM	XDPT-MH	WP40PM
S4	XDPT-MM	WS40PM	XDPT-MM	WS40PM	XDPT-MH	WP40PM

Recommended Starting Speeds [m/min]*

Material Group		WP25PM			WP40PM			WS40PM		
P	1	395	340	325	355	310	295	-	-	-
	2	330	290	240	300	260	215	-	-	-
	3	305	260	210	275	235	190	-	-	-
	4	270	220	180	245	205	160	-	-	-
	5	220	205	180	205	185	160	205	175	145
	6	200	150	120	180	140	110	180	130	95
M	1	245	215	200	235	205	185	250	205	170
	2	220	190	155	210	180	150	215	175	145
	3	170	145	115	155	140	110	175	130	100
S	1	50	40	30	50	40	35	50	40	30
	2	50	40	30	50	40	35	50	40	30
	3	60	50	30	60	50	35	60	50	30
	4	85	60	40	80	60	40	70	60	35

NOTE: FIRST choice starting speeds are in **bold** type. As the average chip thickness increases, the speed should be decreased.
 *Material groups P, M, K, and H show recommended starting speeds for dry machining. For wet machining, reduce speed by 20%.
 *Material groups N and S show recommended starting speeds for wet machining. Not recommended for dry machining.

Recommended Starting Feeds [mm]

Light Machining	General Purpose	Heavy Machining
-----------------	-----------------	-----------------

At 0,90 Axial Depth of Cut (AP1)

Insert Geometry	Recommended Starting Feed per Tooth (Fz) in Relation to % of Radial Engagement (ae)															Insert Geometry
	5%		10%		20%		30%		40-100%							
.E..MM	0,48	1,42	2,20	0,35	1,00	1,52	0,26	0,74	1,11	0,23	0,64	0,96	0,21	0,59	0,88	.E..MM
.S..MH	0,70	1,58	2,65	0,50	1,11	1,80	0,37	0,82	1,31	0,33	0,71	1,14	0,30	0,65	1,04	.S..MH

At 1,10 Axial Depth of Cut (AP1)

Insert Geometry	Recommended Starting Feed per Tooth (Fz) in Relation to % of Radial Engagement (ae)															Insert Geometry
	5%		10%		20%		30%		40-100%							
.E..MM	0,44	1,28	1,98	0,32	0,90	1,37	0,24	0,67	1,01	0,21	0,58	0,87	0,19	0,53	0,80	.E..MM
.S..MH	0,64	1,42	2,37	0,45	1,00	1,63	0,34	0,74	1,19	0,30	0,64	1,03	0,27	0,59	0,94	.S..MH

At 1,50 Axial Depth of Cut (AP1)

Insert Geometry	Recommended Starting Feed per Tooth (Fz) in Relation to % of Radial Engagement (ae)															Insert Geometry
	5%		10%		20%		30%		40-100%							
.E..MM	0,64	1,42	2,37	0,45	1,00	1,63	0,34	0,74	1,19	0,30	0,64	1,03	0,27	0,59	0,94	.E..MM
.S..MH	0,55	1,22	2,01	0,39	0,86	1,39	0,29	0,64	1,02	0,25	0,55	0,89	0,23	0,51	0,81	.S..MH

NOTE: Use "Light Machining" values as starting feed rate.

Screw-On End Mills • Metric

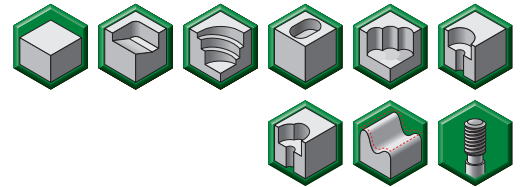
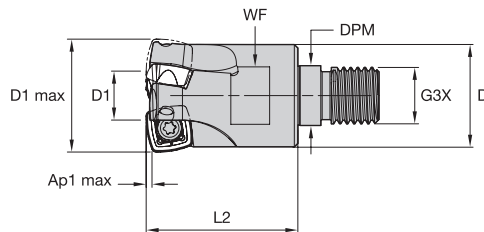

order number	catalogue number	D1 max	D1	D	DPM	G3X	L2	WF	Ap1 max	Z	max ramp angle	max RPM	coolant supply	kg
6596723	VXF032Z03M16XD12	32	14	29	17,0	M16	43	24	2,5	3	1.8°	31500	Yes	0,19

Shell Mills • Metric

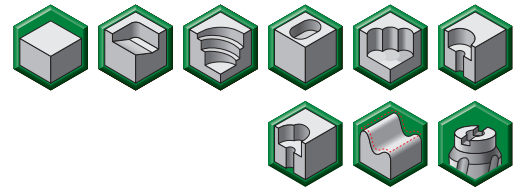
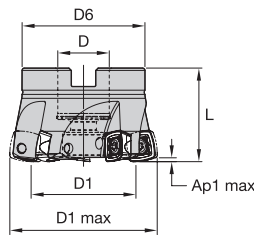

order number	catalogue number	D1 max	D1	D	D6	L	Ap1 max	Z	max ramp angle	max RPM	coolant supply	kg
6596725	VXF040Z04S22XD12	40	22	22	38	40	2,5	4	1.4°	26500	Yes	0,19
6596727	VXF042Z04S22XD12	42	24	22	38	40	2,5	4	1.3°	25500	Yes	0,21
6596728	VXF050Z04S22XD12	50	32	22	48	40	2,5	4	.9°	22500	Yes	0,31
6596729	VXF052Z05S22XD12	52	34	22	48	40	2,5	5	.8°	22000	Yes	0,32
6596730	VXF063Z05S22XD12	63	45	22	53	40	2,5	5	.6°	19500	Yes	0,47
6596732	VXF066Z06S27XD12	66	48	27	53	45	2,5	6	.5°	19000	Yes	0,55
6596733	VXF080Z06S27XD12	80	62	27	55	50	2,5	6	.5°	17000	Yes	0,87
6596734	VXF100Z07S32XD12	100	82	32	65	50	2,5	7	.3°	15000	Yes	1,34

FOR SPARE PARTS, PLEASE VISIT WIDIA NOVO™ OR WIDIA.COM.

MOUNTING SCREWS ARE NOT INCLUDED IN STANDARD PACKAGING.



Inserts • XDPT-MM • Best Fit for Pocketing and Profiling Operations

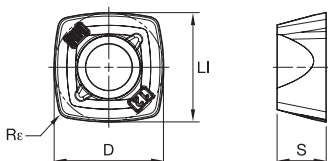

- first choice
- alternate choice

P	●	●	○
M	●	●	●
K	○	○	○
N	○	○	○
S	●	○	●
H	○	○	○

ISO catalogue number	cutting edges	LI	S	D	Rε	WP25PM	WP40PM	WS40PM
XDPT120512ERMM	4	12,70	5,56	12,70	1,20	6596438	I	6596439

Inserts • XDPT-MH • Dedicated Geometry for Heavy Roughing

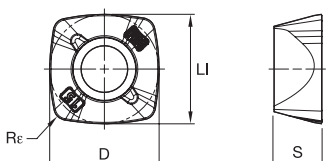

- first choice
- alternate choice

P	●	●	○
M	●	●	●
K	○	○	○
N	○	○	○
S	●	○	●
H	○	○	○

ISO catalogue number	cutting edges	LI	S	D	Rε	WP25PM	WP40PM	WS40PM
XDPT120515SRMH	4	12,70	5,56	12,70	1,50	I	6596440	I

For M4000 cartridge milling system, please see page 12.



Insert Selection Guide

Material Group	Light Machining		General Purpose		Heavy Machining	
	Geometry	Grade	Geometry	Grade	Geometry	Grade
P1-P2	XDPT-MM	WP25PM	XDPT-MM	WS40PM	XDPT-MH	WP40PM
P3-P4	XDPT-MM	WP25PM	XDPT-MM	WS40PM	XDPT-MH	WP40PM
P5-P6	XDPT-MM	WP25PM	XDPT-MM	WS40PM	XDPT-MH	WP40PM
M1-M2	XDPT-MM	WS40PM	XDPT-MM	WS40PM	XDPT-MH	WP40PM
M3	XDPT-MM	WS40PM	XDPT-MM	WS40PM	XDPT-MH	WP40PM
S1-S2	XDPT-MM	WP25PM	XDPT-MM	WS40PM	XDPT-MH	WP40PM
S3	XDPT-MM	WS40PM	XDPT-MM	WS40PM	XDPT-MH	WP40PM
S4	XDPT-MM	WS40PM	XDPT-MM	WS40PM	XDPT-MH	WP40PM

Recommended Starting Speeds [m/min]*

Material Group		WP25PM			WP40PM			WS40PM		
P	1	395	340	325	355	310	295	-	-	-
	2	330	290	240	300	260	215	-	-	-
	3	305	260	210	275	235	190	-	-	-
	4	270	220	180	245	205	160	-	-	-
	5	220	205	180	205	185	160	205	175	145
	6	200	150	120	180	140	110	180	130	95
M	1	245	215	200	235	205	185	250	205	170
	2	220	190	155	210	180	150	215	175	145
	3	170	145	115	155	140	110	175	130	100
S	1	50	40	30	50	40	35	50	40	30
	2	50	40	30	50	40	35	50	40	30
	3	60	50	30	60	50	35	60	50	30
	4	85	60	40	80	60	40	70	60	35

NOTE: FIRST choice starting speeds are in **bold** type. As the average chip thickness increases, the speed should be decreased.
 *Material groups P, M, K, and H show recommended starting speeds for dry machining. For wet machining, reduce speed by 20%.
 *Material groups N and S show recommended starting speeds for wet machining. Not recommended for dry machining.

Recommended Starting Feeds [mm]

Light Machining	General Purpose	Heavy Machining
-----------------	-----------------	-----------------

At 1,30 Axial Depth of Cut (AP1)

Insert Geometry	Recommended Starting Feed per Tooth (Fz) in Relation to % of Radial Engagement (ae)															Insert Geometry
	5%			10%			20%			30%			40-100%			
.E..MM	0,49	1,59	2,52	0,35	1,13	1,78	0,26	0,84	1,31	0,23	0,73	1,14	0,21	0,67	1,04	.E..MM
.S..MH	0,70	1,80	2,76	0,51	1,28	1,94	0,38	0,95	1,44	0,33	0,83	1,25	0,30	0,76	1,14	.S..MH

At 1,70 Axial Depth of Cut (AP1)

Insert Geometry	Recommended Starting Feed per Tooth (Fz) in Relation to % of Radial Engagement (ae)															Insert Geometry
	5%			10%			20%			30%			40-100%			
.E..MM	0,43	1,39	2,20	0,31	0,99	1,56	0,23	0,74	1,15	0,20	0,64	1,00	0,19	0,59	0,92	.E..MM
.S..MH	0,62	1,57	2,41	0,45	1,12	1,70	0,33	0,84	1,26	0,29	0,73	1,10	0,27	0,67	1,00	.S..MH

At 2,50 Axial Depth of Cut (AP1)

Insert Geometry	Recommended Starting Feed per Tooth (Fz) in Relation to % of Radial Engagement (ae)															Insert Geometry
	5%			10%			20%			30%			40-100%			
.E..MM	0,36	1,15	1,81	0,26	0,83	1,29	0,19	0,62	0,96	0,17	0,54	0,83	0,15	0,49	0,76	.E..MM
.S..MH	0,51	1,30	1,99	0,37	0,93	1,41	0,28	0,70	1,05	0,24	0,61	0,91	0,22	0,55	0,83	.S..MH

NOTE: Use "Light Machining" values as starting feed rate.



Shell Mills • Metric

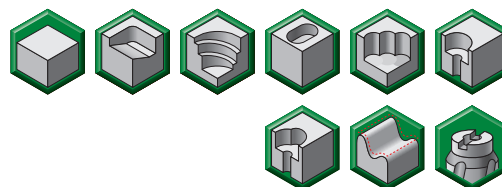
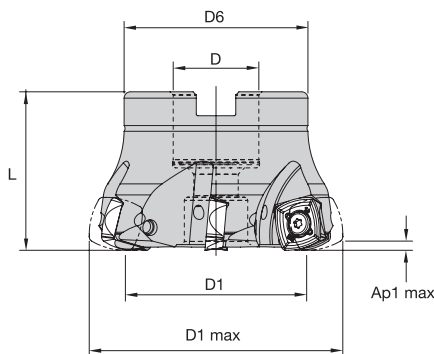

order number	catalogue number	D1 max	D1	D	D6	L	Ap1 max	Z	max ramp angle	max RPM	coolant supply	kg
6597776	VXF050Z04S22XE16	50	27	22	45	45	3,5	4	1.4°	27500	Yes	0,29
6597777	VXF063Z05S22XE16	63	40	22	47	40	3,5	5	.9°	22000	Yes	0,36
6597778	VXF080Z06S27XE16	80	57	27	58	50	3,5	6	.6°	19000	Yes	0,85
6597779	VXF100Z08S32XE16	100	77	32	68	50	3,5	8	.4°	16500	Yes	1,29
6597780	VXF125Z10S40XE16	125	102	40	84	63	3,5	10	.3°	14500	Yes	2,73

FOR SPARE PARTS, PLEASE VISIT WIDIA NOVO™ OR WIDIA.COM.

MOUNTING SCREWS ARE NOT INCLUDED IN STANDARD PACKAGING.

Inserts • XEPT-MM

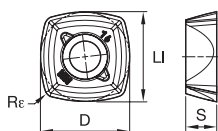

- first choice
- alternate choice

P	●	○
M	●	●
K	○	○
N	○	○
S	●	●
H	○	○

ISO catalogue number	cutting edges	LI	S	D	Re	WP25PM	WS40PM
XEPT160516ERMM	4	16,00	5,56	16,00	1,60	6596923	6596924

For M4000 cartridge milling system, please see page 12.

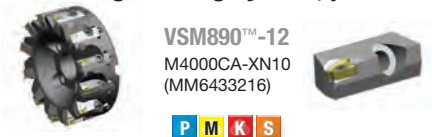

VSM890™-12
M4000CA-XN10
(MM6433216)



Insert Selection Guide

Material Group	Light Machining		General Purpose		Heavy Machining	
	Geometry	Grade	Geometry	Grade	Geometry	Grade
P1-P2	XEPT-MM	WP25PM	XEPT-MM	WS40PM	XEPT-MM	WS40PM
P3-P4	XEPT-MM	WP25PM	XEPT-MM	WS40PM	XEPT-MM	WS40PM
P5-P6	XEPT-MM	WP25PM	XEPT-MM	WS40PM	XEPT-MM	WS40PM
M1-M2	XEPT-MM	WS40PM	XEPT-MM	WS40PM	XEPT-MM	WS40PM
M3	XEPT-MM	WS40PM	XEPT-MM	WS40PM	XEPT-MM	WS40PM
S1-S2	XEPT-MM	WP25PM	XEPT-MM	WS40PM	XEPT-MM	WS40PM
S3	XEPT-MM	WS40PM	XEPT-MM	WS40PM	XEPT-MM	WS40PM
S4	XEPT-MM	WS40PM	XEPT-MM	WS40PM	XEPT-MM	WS40PM

Recommended Starting Speeds [m/min]*

Material Group	WP25PM			WS40PM			
	1	2	3	1	2	3	
P	1	395	340	325	-	-	
	2	330	290	240	-	-	
	3	305	260	210	-	-	
	4	270	220	180	-	-	
	5	220	205	180	205	175	145
	6	200	150	120	180	130	95
M	1	245	215	200	250	205	170
	2	220	190	155	215	175	145
	3	170	145	115	175	130	100
S	1	50	40	30	50	40	30
	2	50	40	30	50	40	30
	3	60	50	30	60	50	30
	4	85	60	40	70	60	35

NOTE: FIRST choice starting speeds are in **bold** type. As the average chip thickness increases, the speed should be decreased.
 *Material groups P, M, K, and H show recommended starting speeds for dry machining. For wet machining, reduce speed by 20%.
 *Material groups N and S show recommended starting speeds for wet machining. Not recommended for dry machining.

Recommended Starting Feeds [mm]

Light Machining	General Purpose	Heavy Machining
-----------------	-----------------	-----------------

At 2,00 Axial Depth of Cut (AP1)

Insert Geometry	Recommended Starting Feed per Tooth (Fz) in Relation to % of Radial Engagement (ae)															Insert Geometry
	5%			10%			20%			30%			40-100%			
.E..MM	0,40	1,28	2,18	0,29	0,92	1,54	0,21	0,68	1,14	0,19	0,60	0,99	0,17	0,55	0,91	.E..MM

At 2,50 Axial Depth of Cut (AP1)

Insert Geometry	Recommended Starting Feed per Tooth (Fz) in Relation to % of Radial Engagement (ae)															Insert Geometry
	5%			10%			20%			30%			40-100%			
.E..MM	0,36	1,15	1,95	0,26	0,83	1,38	0,19	0,62	1,03	0,17	0,54	0,89	0,15	0,49	0,82	.E..MM

At 3,50 Axial Depth of Cut (AP1)

Insert Geometry	Recommended Starting Feed per Tooth (Fz) in Relation to % of Radial Engagement (ae)															Insert Geometry
	5%			10%			20%			30%			40-100%			
.E..MM	0,30	0,98	1,66	0,22	0,71	1,18	0,17	0,53	0,88	0,14	0,46	0,76	0,13	0,42	0,70	.E..MM

NOTE: Use "Light Machining" values as starting feed rate.



Best Practices

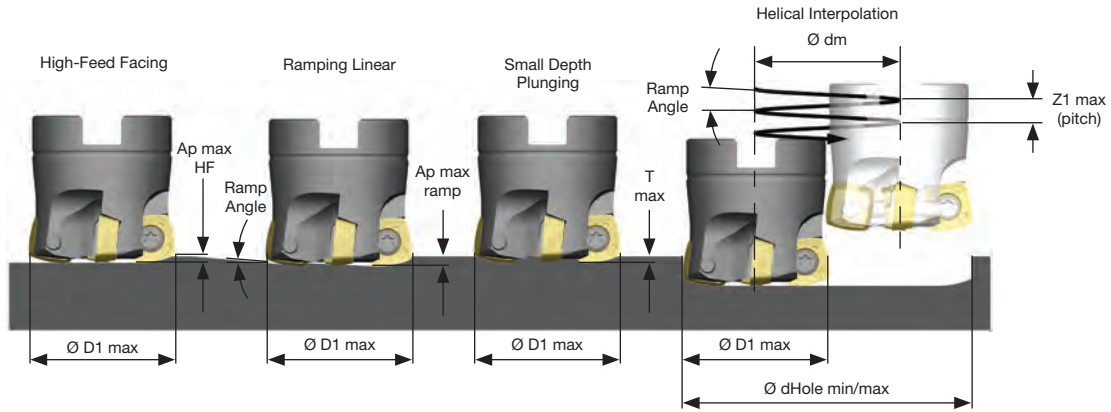

series	D1 max	High-feed Facing	Ramping Linear		Helical Interpolation			Small Depth Plunging	
		Ap max HF	Ramp Angle max	Ap max Ramp	Ramp Angle max	d Hole min	d Hole max	Z1 max Helical	T max
VXF-07	16	0,60	5,9	0,60	5,9	22,0	30,0	0,60	0,45
	18	0,60	5,4	0,60	5,4	24,0	34,0	0,60	0,45
	20	0,60	3,4	0,60	3,4	30,0	38,0	0,60	0,30
	25	0,60	2,2	0,60	2,2	40,0	48,0	0,60	0,30
	32	0,60	1,4	0,60	1,4	54,0	62,0	0,60	0,30
	40	0,60	1,0	0,60	1,0	70,0	78,0	0,60	0,30
	50	0,60	0,7	0,60	0,7	90,0	98,0	0,60	0,30
VXF-09	25	0,90	2,8	1,00	2,8	34,0	48,0	1,00	0,65
	32	0,90	1,5	1,00	1,5	48,0	62,0	1,00	0,65
	35	0,90	1,3	1,00	1,3	54,0	68,0	1,00	0,65
	40	0,90	0,8	1,00	0,8	64,0	78,0	1,00	0,65
	42	0,90	0,8	1,00	0,8	68,0	82,0	1,00	0,65
	50	0,90	0,7	1,00	0,7	84,0	98,0	1,00	0,65
	52	0,90	0,7	1,00	0,7	88,0	102,0	1,00	0,65
	63	0,90	0,5	1,00	0,7	106,0	124,0	1,00	0,65
VXF-12	32	1,30	1,8	1,80	1,8	42,0	62,0	1,80	0,80
	40	1,30	1,4	1,80	1,4	58,0	78,0	1,80	0,80
	42	1,30	1,3	1,80	1,3	62,0	82,0	1,80	0,80
	50	1,30	0,9	1,80	0,9	78,0	98,0	1,80	0,80
	52	1,30	0,8	1,80	0,8	82,0	102,0	1,80	0,80
	63	1,30	0,6	1,80	0,6	104,0	124,0	1,80	0,80
	66	1,30	0,5	1,80	0,5	110,0	130,0	1,80	0,80
	80	1,30	0,5	1,80	0,5	138,0	158,0	1,80	0,80
	100	1,30	0,3	1,80	0,3	178,0	198,0	1,80	0,80
VXF-16	50	2,00	1,4	2,50	1,4	70,0	98,0	2,50	0,70
	63	2,00	0,9	2,50	0,9	96,0	124,0	2,50	0,70
	80	2,00	0,6	2,50	0,6	130,0	158,0	2,50	0,70
	100	2,00	0,4	2,50	0,4	170,0	198,0	2,50	0,70
	125	2,00	0,3	2,50	0,3	220,0	248,0	2,50	0,70

$$\varnothing dm = \varnothing \text{Hole} - \varnothing D1 \text{ max}$$

$$Z1 = \varnothing dm \times 3,14 \times \tan \text{ramp angle. } Z1 \leq Z1 \text{ max and } \leq \text{ramp angle max}$$

$$\text{Ramp angle} = \arcsin \left(\frac{Z1}{\varnothing dm \times 3,14} \right)$$

series	D1 max	X
VXF-07	16–50	4,20
VXF-09	25–63	6,80
VXF-12	32–100	9,10
VXF-16	50–125	11,40

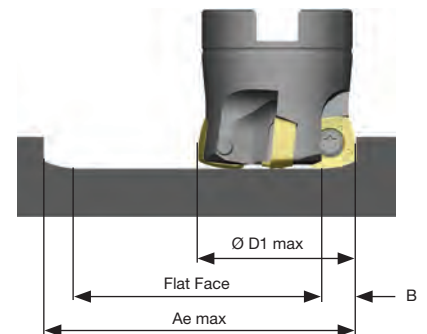

$$Ae \text{ max} \leq 2 \times \varnothing D1 \text{ max} - 2 \times B$$

$$\text{Flat Face} = Ae \text{ max} - 2 \times B$$

High-Feed Mills • VXF-07, VXF-09, VXF-12, and VXF-16

Z-Axis Plunge Milling

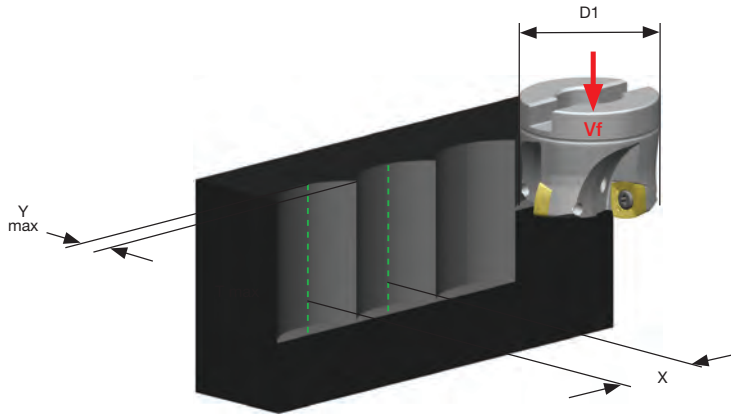

VXF-07			VXF-09			VXF-12			VXF-16		
D1 max	Y max	X	D1 max	Y max	X	D1 max	Y max	X	D1 max	Y max	X
16	3	12,49	25	6	21,35	32	9	28,77	50	13	43,86
18	3	13,41	32	6	24,98	40	9	33,40	63	13	50,99
20	3	14,28	35	6	26,38	42	9	34,46	80	13	59,02
25	3	16,24	40	6	28,56	50	9	38,41	100	13	67,26
32	3	18,65	42	6	29,39	52	9	39,34	125	13	76,31
40	3	21,07	50	6	32,49	63	9	44,09			
50	3	23,74	52	6	33,22	66	9	45,29			
			63	6	36,98	80	9	50,55			
						100	9	57,23			

Feed Rate Guide • Z-Axis Plunge Milling • fz (mm/tooth)

	Insert Geometry	Recommended Starting Feed per Tooth (Fz)			Insert Geometry	Y max
		Light Machining	General Purpose	Heavy Machining		
VXF-07	.E..MM	0,06	0,15	-	.E..MM	3,0
	.S..MH	0,10	0,20	-	.S..MH	3,0
VXF-09	.E..MM	0,07	0,20	0,30	.E..MM	6,0
	.S..MH	0,10	0,22	0,35	.S..MH	6,0
VXF-12	.E..MM	0,07	0,20	0,30	.E..MM	9,0
	.S..MH	0,10	0,25	0,35	.S..MH	9,0
VXF-16	.E..MM	0,07	0,23	0,38	.E..MM	13,0

CAM Programming

Programming Data			
insert size	insert radius	R (to be programmed)	t
07	0,8	1,4	0,4
	1,0	1,5	0,4
09	0,8	2,0	0,72
	1,2	2,3	0,67
12	1,2	2,7	0,97
	1,5	2,8	0,95
16	1,2	4,2	1,46

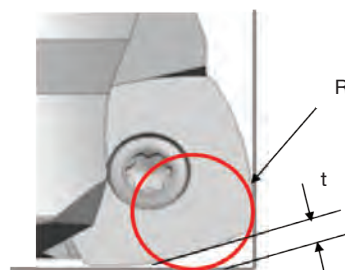

Heavy Metal Extensions

Anti-Vibration Tungsten Alloy with Through Coolant

Cylindrical Shank Extensions for Modular Heads

ERICKSON™

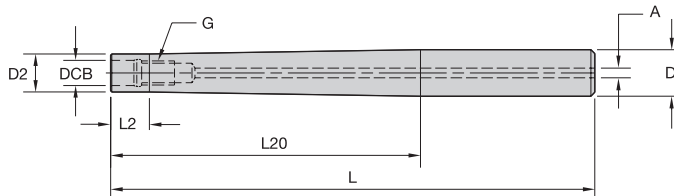

order number	catalogue number	DCB	G	D	D2	A	L	L2	L20
4160427	SS120STCHM06085M	6,5	M6	12	10	2,5	85	10	40
4160428	SS120STCHM06105M	6,5	M6	12	10	2,5	105	10	60
4160430	SS120STCHM06125M	6,5	M6	12	10	2,5	125	10	80
4160431	SS160STCHM08088M	8,5	M8	16	13	3,0	88	10	40
4160432	SS160STCHM08108M	8,5	M8	16	13	3,0	108	10	60
4160473	SS160STCHM08128M	8,5	M8	16	13	3,0	128	10	80
4160474	SS160STCHM08148M	8,5	M8	16	13	3,0	148	10	100
4160475	SS160STCHM08168M	8,5	M8	16	13	3,0	168	10	120
4160476	SS200STCHM10090M	10,5	M10	20	18	3,5	90	10	40
4160477	SS200STCHM10110M	10,5	M10	20	18	3,5	110	10	60
4160478	SS200STCHM10130M	10,5	M10	20	18	3,5	130	10	80
4160479	SS200STCHM10150M	10,5	M10	20	18	3,5	150	10	100
4160480	SS200STCHM10170M	10,5	M10	20	18	3,5	170	10	130
order number	catalogue number	DCB	G	D	D ₂	A	L	L ₁	L ₂₀
5672985	M-21-M12-CA25-131	12,50	M12	25	21	5	131	12	75
5672468	M-21-M12-CA25-156	12,50	M12	25	21	5	156	12	100
5672986	M-21-M12-CA25-181	12,50	M12	25	21	5	181	12	125
5672831	M-21-M12-CA25-206	12,50	M12	25	21	5	206	12	150
5672987	M-21-M12-CA25-231	12,50	M12	25	21	5	231	12	175
5672832	M-29-M16-CA32-160	17,00	M16	32	29	5	160	16	100
5672988	M-29-M16-CA32-210	17,00	M16	32	29	5	210	16	150
5673783	M-29-M16-CA32-260	17,00	M16	32	29	5	260	16	200
5672989	M-29-M16-CA32-310	17,00	M16	32	29	5	310	16	250

NOTE: Cylindrical shank extensions can be used with all modular heads found in several product family series.

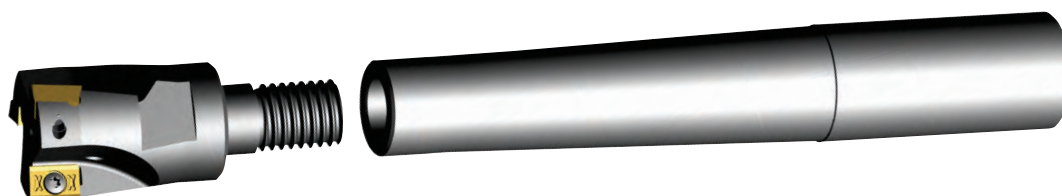

WIDIA 

Compatible with all Standard ER Collet Chucks and ER Driven Units

Solid ER Collets

Threaded solid ER collets turn CNC lathe machines into multitasking machines by providing access of any small diameter screw-on milling cutter to ER driven units.

These new solid ER collets increase machine utilisation through modular flexibility.

The short projection from the face of the collet nut provides rigid toolholding and a smaller required machine envelope.

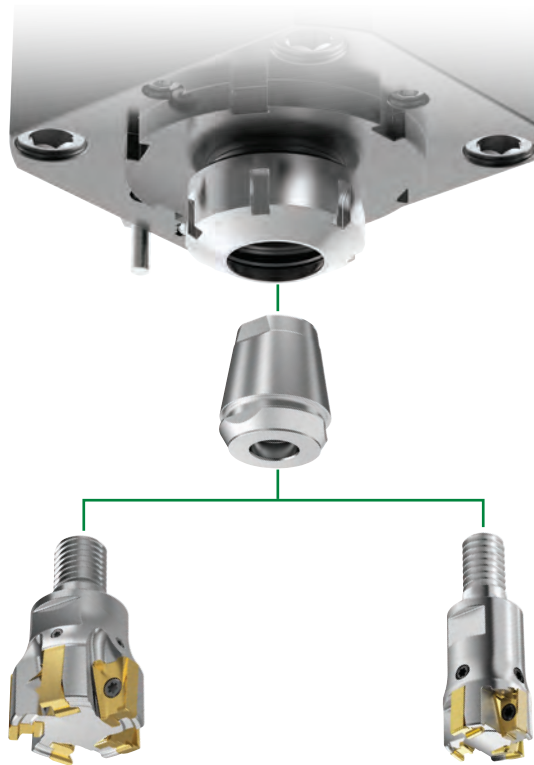

ERICKSON™

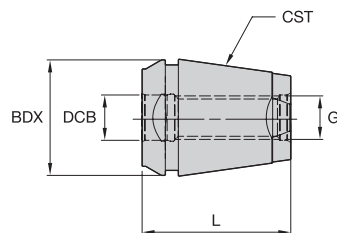

order number	catalogue number	CST	DCB	G	BDX	L
6587968	ER25STM08	ER25	9	M8	26	35
6587969	ER25STM10	ER25	11	M10	26	35
6587970	ER25STM12	ER25	13	M12	26	35
6588001	ER32STM08	ER32	9	M8	33	41
6588002	ER32STM10	ER32	11	M10	33	41
6588003	ER32STM12	ER32	13	M12	33	41
6588004	ER32STM16	ER32	17	M16	33	41
6588005	ER40STM08	ER40	9	M8	41	47
6588006	ER40STM10	ER40	11	M10	41	47
6588007	ER40STM12	ER40	13	M12	41	47
6588008	ER40STM16	ER40	17	M16	41	47

VSM

VICTORY™ SHOULDER
MILLS EXPANSION



THE MOST VERSATILE 90°
SHOULDER MILL PLATFORM
IN THE WIDIA™ PORTFOLIO

GRESSEL grepos-5X



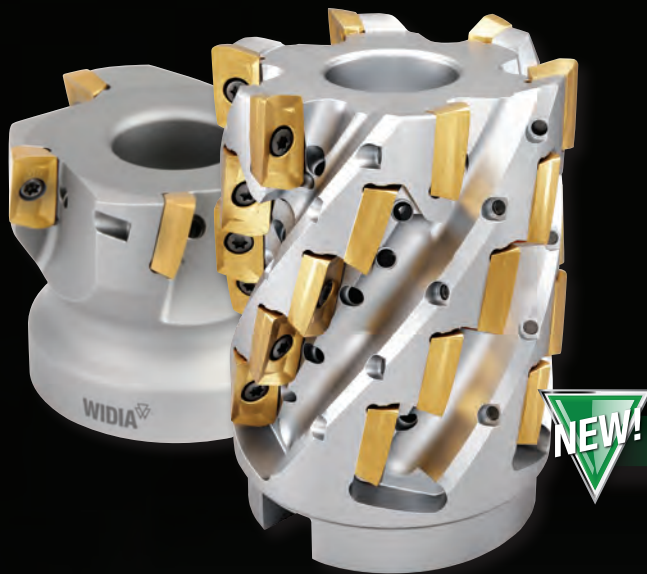

VSM11™

Ap Capabilities: Up to 11mm

Screw-On End Mills: 16–40mm

Weldon® End Mills: 12–32mm

Cylindrical End Mills: 12–32mm

Shell Mills: 40–125mm

M4000 Cartridge Milling System: 125–315mm

VSM11H Helical Cutters

Ap Capabilities: Up to 50mm

Weldon End Mills: 25–32mm

Shell Mills: 40–50mm



VSM17™

Ap Capabilities: Up to 16,4mm

Screw-On End Mills: 25–40mm

Weldon End Mills: 25–40mm

Cylindrical End Mills: 25–40mm

Shell Mills: 40–160mm

M4000 Cartridge Milling System: 125–315mm

VSM17H Helical Cutters

Ap Capabilities: 75mm

Shell Mills: 50–80mm

WIDIA 

widia.com

VSM11™

0°/90° Shoulder Mills • VSM11



- True 90° shoulder milling platform; up to Ap1 max = 11mm.
- Aggressive ramping capability up to 10° with end mills with a diameter of 16mm.
- Optimised chip gash for improved cutter stability and chip flow.
- Well-guided internal coolant supply to the cutting edge.
- Best-in-class milling grade WS40PM boosts productivity when machining stainless steel and high-temp alloys.

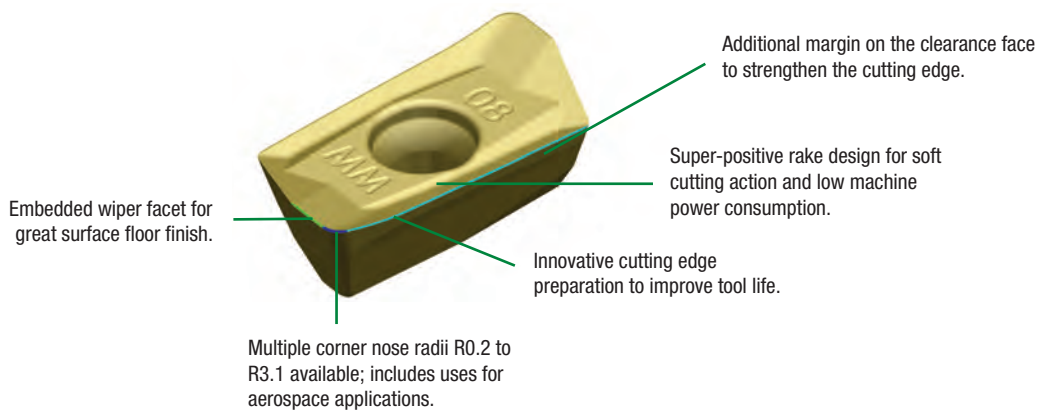

Geometries for all material groups in shoulder milling applications.

-ALP



N

Roughing and finishing of aluminium alloys.
High precision.
Periphery ground.

-PCD



N

Roughing and finishing of aluminium alloys. Abrasive non-ferrous materials. High precision. Periphery ground.

-ML



P M S H

Light machining and finishing.
First choice for stainless steel and titanium. Periphery ground.

-MM



P M K S H

Medium machining.
First choice for general purpose.
Precision pressed to size.

-MH



P M K S

First choice for heavy-duty machining.
Steel and cast iron materials.
Precision pressed to size.

Finishing Capabilities/Lower Cutting Forces

Geometry Strengthening



0°/90° Shoulder Mills • VSM11™

Screw-On End Mills • Metric

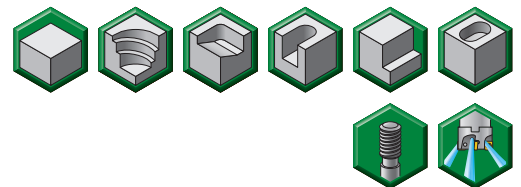
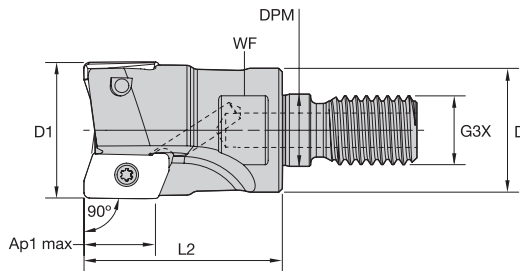

order number	catalogue number	D1	D	DPM	G3X	L2	WF	Ap1 max	Z	max ramp angle	max RPM	coolant supply	kg
5417011	VSM11D016Z02M08XD11	16	13	8,5	M8	25	10	11,5	2	10.0°	41400	Yes	0,02
5417013	VSM11D020Z03M10XD11	20	18	10,5	M10	28	15	11,6	3	7.8°	35100	Yes	0,05
5417015	VSM11D025Z04M12XD11	25	21	12,5	M12	32	17	11,5	4	5.3°	30200	Yes	0,08
5417017	VSM11D032Z04M16XD11	32	29	17,0	M16	40	24	11,4	4	3.6°	25800	Yes	0,18
5417019	VSM11D040Z06M16XD11	40	29	17,0	M16	40	24	11,4	6	2.6°	22600	Yes	0,24

Weldon® End Mills • Metric

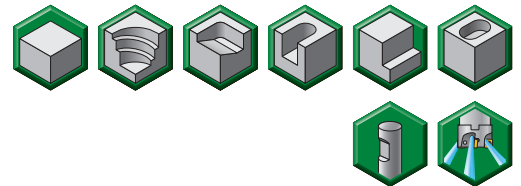
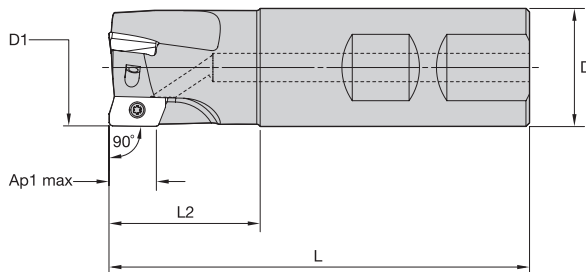

order number	catalogue number	D1	D	L	L2	Ap1 max	Z	max ramp angle	max RPM	coolant supply	kg
5416454	VSM11D012Z01B16XD11	12	16	70	21	11,7	1	3.7°	53100	Yes	0,08
6616467	VSM11D016Z02B12XD11	16	12	67	21	11,5	2	10.0°	41400	Yes	0,05
5416455	VSM11D016Z02B16XD11	16	16	70	21	11,5	2	10.0°	41400	Yes	0,09
6171449	VSM11D018Z02B16XD11	18	16	70	21	11,6	2	—	39000	Yes	0,09
6616468	VSM11D020Z03B16XD11	20	16	79	30	11,6	3	7.8°	35100	Yes	0,11
5416457	VSM11D020Z02B20XD11	20	20	81	30	11,6	2	7.8°	35100	Yes	0,15
5416458	VSM11D020Z03B20XD11	20	20	81	30	11,6	3	7.8°	35100	Yes	0,16
6171501	VSM11D022Z03B20XD11	22	20	81	30	11,5	3	—	33460	Yes	0,17
6616469	VSM11D025Z03B20XD11	25	20	82	31	11,5	3	5.3°	30200	Yes	0,18
5416459	VSM11D025Z03B25XD11	25	25	88	31	11,5	3	5.3°	30200	Yes	0,27
5416480	VSM11D025Z04B25XD11	25	25	88	31	11,5	4	5.3°	30200	Yes	0,28
5416481	VSM11D030Z04B25XD11	30	25	88	31	11,5	4	3.2°	26900	Yes	0,30
6616470	VSM11D032Z04B25XD11	32	25	96	40	11,4	4	3.6°	25800	Yes	0,35
6616481	VSM11D032Z05B25XD11	32	25	96	39	11,4	5	3.6°	25800	Yes	0,36
5416482	VSM11D032Z04B32XD11	32	32	100	39	11,4	4	3.6°	25800	Yes	0,51
5416483	VSM11D032Z05B32XD11	32	32	100	39	11,4	5	3.6°	25800	Yes	0,52

NOTE: Weldon type not recommended for finishing operations.



Cylindrical End Mills (Regular and Long Version) • Metric

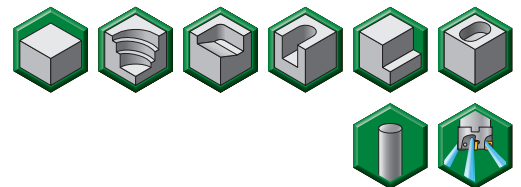
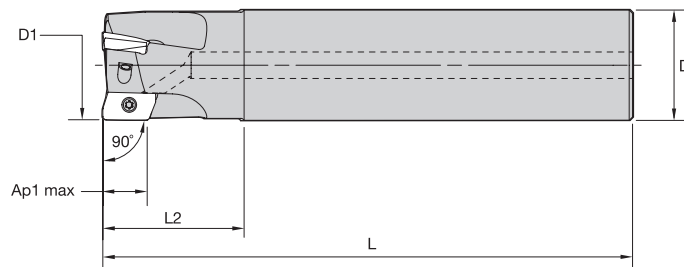

order number	catalogue number	D1	D	L	L2	Ap1 max	Z	max ramp angle	max RPM	coolant supply	kg
5416632	VSM11D012Z01A16XD11L100	12	16	100	25	11,7	1	3.7°	53100	Yes	0,13
5416633	VSM11D016Z02A16XD11L100	16	16	100	31	11,5	2	10.0°	41400	Yes	0,12
5416700	VSM11D016Z02A16XD11L170	16	16	170	25	11,5	2	10.0°	41400	Yes	0,23
5416701	VSM11D018Z02A16XD11L170	18	16	170	25	11,6	2	9.7°	37900	Yes	0,23
5416634	VSM11D020Z02A20XD11L110	20	20	110	31	11,6	2	7.8°	35100	Yes	0,22
5416702	VSM11D020Z02A20XD11L170	20	20	170	41	11,6	2	7.8°	35100	Yes	0,35
5416635	VSM11D020Z03A20XD11L110	20	20	110	31	11,6	3	7.8°	35100	Yes	0,23
5416703	VSM11D020Z03A20XD11L170	20	20	170	41	11,6	3	7.8°	35100	Yes	0,36
6171502	VSM11D022Z03A20XD11L110	22	20	110	31	11,5	3	—	33460	Yes	0,24
5416704	VSM11D022Z03A20XD11L170	22	20	170	30	11,5	3	6.6°	32900	Yes	0,37
5416636	VSM11D025Z03A25XD11L120	25	25	120	33	11,5	3	5.3°	30200	Yes	0,39
5416705	VSM11D025Z03A25XD11L210	25	25	210	50	11,5	3	5.3°	30200	Yes	0,70
5416637	VSM11D025Z04A25XD11L120	25	25	120	33	11,5	4	5.3°	30200	Yes	0,40
5416706	VSM11D025Z04A25XD11L210	25	25	210	50	11,5	4	5.3°	30200	Yes	0,72
6171503	VSM11D032Z03A25XD11L130	32	25	130	41	11,4	3	—	25800	Yes	0,37
5416638	VSM11D032Z03A32XD11L130	32	32	130	41	11,4	3	3.6°	25800	Yes	0,70
5416707	VSM11D032Z03A32XD11L250	32	32	250	65	11,4	3	3.6°	25800	Yes	1,39
5416639	VSM11D032Z05A32XD11L130	32	32	130	41	11,4	5	3.6°	25800	Yes	0,71

Shell Mills • Metric

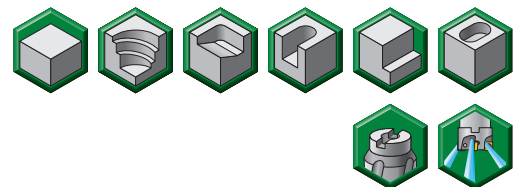
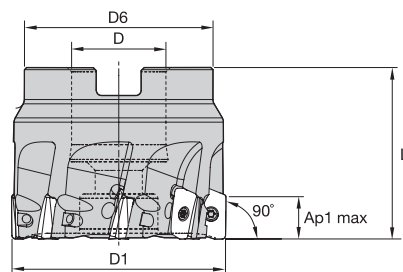

order number	catalogue number	D1	D	D6	L	Ap1 max	Z	max ramp angle	max RPM	coolant supply	kg
5416316	VSM11D040Z04S016XD11	40	16	37	40	11,4	4	2.6°	22600	Yes	0,22
5416317	VSM11D040Z06S016XD11	40	16	37	40	11,4	6	2.6°	22600	Yes	0,22
5416318	VSM11D050Z05S022XD11	50	22	44	40	11,3	5	1.9°	19900	Yes	0,33
5416319	VSM11D050Z08S022XD11	50	22	44	40	11,3	8	1.9°	19900	Yes	0,33
5416340	VSM11D063Z06S022XD11	63	22	44	40	11,3	6	1.5°	17500	Yes	0,50
5416341	VSM11D063Z09S022XD11	63	22	44	40	11,3	9	1.5°	17500	Yes	0,52
5416342	VSM11D080Z08S027XD11	80	27	60	50	11,3	8	1.1°	15300	Yes	1,14
5416345	VSM11D100Z09S032XD11	100	32	80	50	11,3	9	.9°	13600	Yes	1,79
5416347	VSM11D125Z011S040XD11	125	40	80	63	11,3	11	.7°	12100	Yes	3,01

Helical End Mills with Weldon® Shank

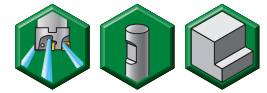
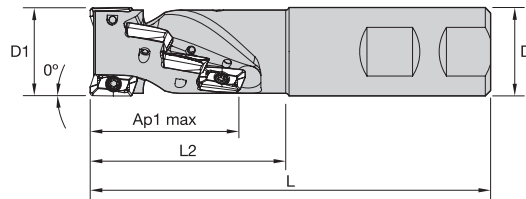

order number	catalogue number	D1	D	L	L2	Ap1 max	Z	Z U	max ramp angle	max RPM	coolant supply	kg
6738387	VSM11H025Z02B25XD11	25	25	113	56	43	8	2	4,5°	30000	Yes	0,32
6738389	VSM11H032Z03B32XD11	32	32	117	56	42	12	3	3,2°	26500	Yes	0,56
6738411	VSM11H032Z04B32XD11	32	32	117	56	42	16	4	3,2°	26500	Yes	0,55

NOTE: Z = number of pockets; ZU = number of flutes.

Helical Shell Mills

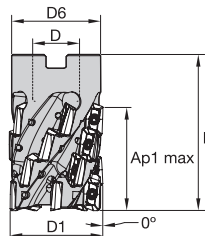

order number	catalogue number	D1	D	D6	L	Ap1 max	Z	Z U	max ramp angle	max RPM	coolant supply	kg
6738412	VSM11H040Z04S016XD11	40	16	37	60	42	16	4	2,4°	22100	Yes	0,30
6738413	VSM11H040Z05S016XD11	40	16	37	60	42	20	5	2,4°	22100	Yes	0,29
6738414	VSM11H050Z04S022XD11	50	22	44	70	51	20	4	1,8°	19800	Yes	0,58
6378415	VSM11H050Z06S022XD11	50	22	44	70	51	30	6	1,8°	19800	Yes	0,55

NOTE: Z = number of pockets; ZU = number of flutes.

VSM11™

0°/90° Shoulder Mills • VSM11

Inserts • XDCT-ALP

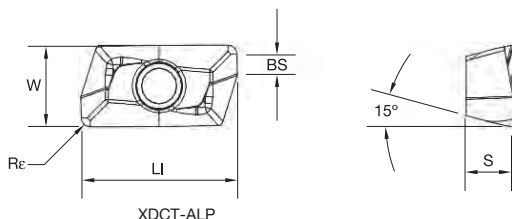

● first choice
○ alternate choice

P	●							○	●		○	●
M	●							○	●	●	●	●
K	●	●	●					○	○			
N	●			●	●							
S	●							○	●	●	●	●
H												

ISO catalogue number	cutting edges	LI	BS	S	W	Re	hm	WDN10U	WK15CM	WK15PM	WN10HM	WN25PM	WP25PM	WP35CM	WP40PM	WS30PM	WS40PM	WU35PM
XDCT110402PDFRALP	2	13,42	2,29	4,00	6,90	0,20	—	●	●		○	○	○	○	○	○	○	○
XDCT110404PDFRALP	2	13,43	2,09	4,00	6,90	0,40	0,02	●	●		○	○	○	○	○	○	○	○
XDCT110408PDFRALP	2	13,44	1,69	4,00	6,90	0,80	0,02	●	●		○	○	○	○	○	○	○	○
XDCT110412PDFRALP	2	13,44	1,29	4,00	6,90	1,20	0,02	●	●		○	○	○	○	○	○	○	○
XDCT110416PDFRALP	2	13,44	0,88	4,00	6,89	1,60	0,02	●	●		○	○	○	○	○	○	○	○
XDCT110420PDFRALP	2	13,44	0,49	4,00	6,89	2,00	—	●	●		○	○	○	○	○	○	○	○
XDCT110424PDFRALP	2	13,44	0,16	4,00	6,88	2,40	0,02	●	●		○	○	○	○	○	○	○	○
XDCT110432PDFRALP	2	12,86	—	4,00	6,89	3,20	0,02	●	●		○	○	○	○	○	○	○	○

Inserts • XDCW-PCD

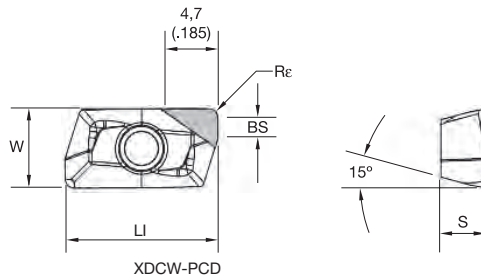

● first choice
○ alternate choice

P	●							○	●		○	●
M	●							○	●	●	●	●
K	●	●	●					○	○			
N	●			●	●							
S	●							○	●	●	●	●
H												

ISO catalogue number	cutting edges	LI	BS	S	W	Re	hm	WDN10U	WK15CM	WK15PM	WN10HM	WN25PM	WP25PM	WP35CM	WP40PM	WS30PM	WS40PM	WU35PM
XDCW110404PDFRPCD	1	13,41	2,22	4,00	6,90	0,40	0,02	5415420										
XDCW110408PDFRPCD	1	13,42	1,80	4,00	6,90	0,80	0,02	5415421										

VSM11™

0°/90° Shoulder Mills • VSM11

Inserts • XDCT-ML

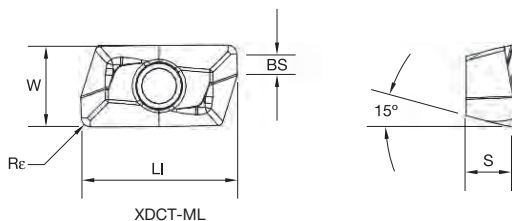

● first choice
○ alternate choice

P	●								○	●		○	●
M	●								○	●		●	●
K	●	●	●						○	○			
N	●			●	●								
S	●								○	●	●	●	●
H													

ISO catalogue number	cutting edges	LI	BS	S	W	Re	hm	WDN10U	WK15CM	WK15PM	WN10HM	WN25PM	WP25PM	WP35CM	WP40PM	WS30PM	WS40PM	WU35PM
XDCT110404PDERML	2	13,43	2,09	4,00	6,90	0,40	0,04	●	●	●	●	○	○	○	○	○	○	○
XDCT110408PDERML	2	13,44	1,69	4,00	6,90	0,80	0,04	●	●	●	●	○	○	○	○	○	○	○
XDCT110412PDERML	2	13,44	1,29	4,00	6,90	1,20	—	●	●	●	●	○	○	○	○	○	○	○
XDCT110416PDERML	2	13,44	0,88	4,00	6,89	1,60	0,04	●	●	●	●	○	○	○	○	○	○	○
XDCT110420PDERML	2	13,44	0,49	4,00	6,89	2,00	—	●	●	●	●	○	○	○	○	○	○	○
XDCT110424PDERML	2	13,44	0,16	4,00	6,88	2,40	—	●	●	●	●	○	○	○	○	○	○	○
XDCT110432PDERML	2	12,86	—	4,00	6,89	3,20	—	●	●	●	●	○	○	○	○	○	○	○

Inserts • XDPT-MM

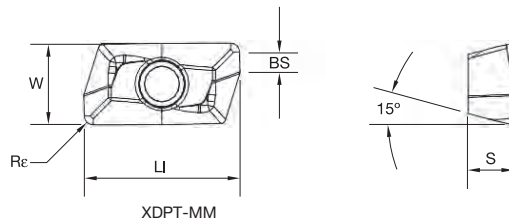

● first choice
○ alternate choice

P	●								○	○	○	○	○	○	○	○
M	●								○	○	○	○	○	○	○	○
K	●	●	●	●	●	●	●	●	○	○	○	○	○	○	○	○
N	●	●	●	●	●	●	●	●	○	○	○	○	○	○	○	○
S	●	●	●	●	●	●	●	●	○	○	○	○	○	○	○	○
H	●	●	●	●	●	●	●	●	○	○	○	○	○	○	○	○

ISO catalogue number	cutting edges	LI	BS	S	W	Re	hm	WDN10U	WK15CM	WK15PM	WN10HM	WN25PM	WP25PM	WP35CM	WP40PM	WS30PM	WS40PM	WU35PM
XDPT110404PDSRMM	2	13,49	2,06	4,13	6,94	0,39	0,06	●	●	●	●	○	○	○	○	○	○	○
XDPT110408PDSRMM	2	13,50	1,66	4,13	6,94	0,78	0,06	●	●	●	●	○	○	○	○	○	○	○
XDPT110412PDSRMM	2	13,44	1,29	4,00	6,90	1,20	0,06	●	●	●	●	○	○	○	○	○	○	○
XDPT110416PDSRMM	2	13,51	0,85	4,13	6,95	1,60	0,06	●	●	●	●	○	○	○	○	○	○	○
XDPT110420PDSRMM	2	13,51	0,45	4,13	6,95	2,00	0,06	●	●	●	●	○	○	○	○	○	○	○
XDPT110424PDSRMM	2	13,37	—	4,01	6,94	2,40	0,06	●	●	●	●	○	○	○	○	○	○	○
XDPT110431PDSRMM	2	12,94	—	4,01	6,94	3,10	0,06	●	●	●	●	○	○	○	○	○	○	○

VSM11™

0°/90° Shoulder Mills • VSM11

Inserts • XDPT-MH

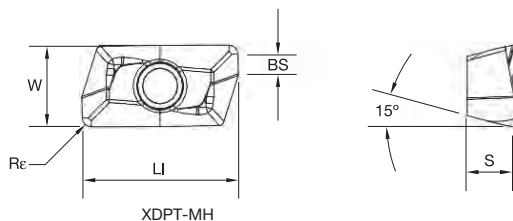

- first choice
- alternate choice

P	●								○	●					
M	●								○	●					●
K	●		●	●					○	○					
N	●				●	●									
S	●								●	○	●	●	●		
H															

ISO catalogue number	cutting edges	LI	BS	S	W	Re	hm	WDN10U	WK15CM	WK15PM	WN10HM	WN25PM	WP35CM	WP40PM	WS30PM	WS40PM	WU35PM
XDPT110408PDSRMH	2	13,44	1,68	4,00	6,90	0,79	0,13	●	●	○	○	○	○	○	○	○	○
XDPT110412PDSRMH	2	13,44	1,29	4,00	6,90	1,20	0,13	●	●	○	○	○	○	○	○	○	○
XDPT110416PDSRMH	2	13,44	0,90	4,00	6,90	1,59	0,13	●	●	○	○	○	○	○	○	○	○

Insert Selection Guide

Material Group	Light Machining		General Purpose		Heavy Machining	
	Geometry	Grade	Geometry	Grade	Geometry	Grade
P1-P2	XDCT-ML	WP40PM	XDPT-MM	WP40PM	XDPT-MH	WP40PM
P3-P4	XDCT-ML	WP40PM	XDPT-MM	WP40PM	XDPT-MH	WP40PM
P5-P6	XDPT-MM	WP25PM	XDPT-MM	WP35CM	XDPT-MH	WP40PM
M1-M2	XDCT-ML	WS40PM	XDPT-MM	WS40PM	XDPT-MH	WS40PM
M3	XDCT-ML	WS40PM	XDPT-MM	WS40PM	XDPT-MH	WS40PM
K1-K2	XDCT-ML	WK15CM	XDPT-MM	WK15CM	XDPT-MH	WK15CM
K3	XDCT-ML	WP35CM	XDPT-MM	WP35CM	XDPT-MH	WP35CM
N1-N2	XDCT-ALP	WN10HM	XDCT-ALP	WN25PM	XDCT-ALP	WN25PM
N3	XDCW-PCD	WDN10U	XDCW-PCD	WDN10U	XDCW-PCD	WDN10U
S1-S2	XDCT-ML	WP25PM	XDPT-MM	WS40PM	XDPT-MH	WS40PM
S3	XDCT-ML	WS40PM	XDPT-MM	WS40PM	XDPT-MH	WS40PM
S4	XDCT-ML	WS40PM	XDPT-MM	WS40PM	XDPT-MH	WS40PM
H1	XDCT-ML	WP25PM	XDPT-MM	WP25PM	-	-



Recommended Starting Speeds [m/min]*

Material Group		WDN10U	WK15CM			WK15PM			WN10HM			WN25PM			WP25PM		
P	1	—	—	—	—	—	—	—	—	—	—	—	—	—	330	285	270
	2	—	—	—	—	—	—	—	—	—	—	—	—	—	275	240	200
	3	—	—	—	—	—	—	—	—	—	—	—	—	—	255	215	175
	4	—	—	—	—	—	—	—	—	—	—	—	—	—	225	185	150
	5	—	—	—	—	—	—	—	—	—	—	—	—	—	185	170	150
	6	—	—	—	—	—	—	—	—	—	—	—	—	—	165	125	100
M	1	—	—	—	—	—	—	—	—	—	—	—	—	205	180	165	
	2	—	—	—	—	—	—	—	—	—	—	—	—	185	160	130	
	3	—	—	—	—	—	—	—	—	—	—	—	—	140	120	95	
K	1	—	—	—	420	385	340	270	245	215	—	—	—	230	205	185	
	2	—	—	—	335	295	275	210	190	175	—	—	—	180	160	150	
	3	—	—	—	280	250	230	175	160	145	—	—	—	150	135	120	
N	1	4010	3505	2990	—	—	—	—	—	—	795	695	600	1075	945	875	
	2	1600	1495	1400	—	—	—	—	—	—	795	695	600	945	875	760	
	3	1600	1495	1400	—	—	—	—	—	—	560	485	420	945	875	760	
S	1	—	—	—	—	—	—	—	—	—	—	—	—	—	—	—	
	2	—	—	—	—	—	—	—	—	—	—	—	—	—	40	35	25
	3	—	—	—	—	—	—	—	—	—	—	—	—	—	40	35	25
	4	—	—	—	—	—	—	—	—	—	—	—	—	—	50	40	25
H	1	—	—	—	—	—	—	—	—	—	—	—	—	70	50	35	
H	1	—	—	—	—	—	—	—	—	—	—	—	—	120	90	70	

Material Group		WP35CM			WP40PM			WS30PM			WS40PM			WU35PM		
P	1	455	395	370	295	260	245	—	—	—	—	—	—	260	230	215
	2	280	255	230	250	215	180	—	—	—	—	—	—	220	190	160
	3	255	230	205	230	195	160	—	—	—	—	—	—	200	170	140
	4	190	175	160	205	170	135	—	—	—	—	—	—	180	150	120
	5	260	230	210	170	155	135	—	—	—	170	145	120	150	135	120
	6	160	135	110	150	115	90	—	—	—	150	110	80	130	100	80
M	1	205	185	155	195	170	155	225	200	185	210	170	140	170	150	135
	2	185	160	140	175	150	125	205	180	145	180	145	120	155	130	110
	3	145	130	115	130	115	90	155	135	105	145	110	85	115	100	80
K	1	295	265	240	—	—	—	—	—	—	—	—	—	—	—	—
	2	235	210	190	—	—	—	—	—	—	—	—	—	—	—	—
	3	195	175	160	—	—	—	—	—	—	—	—	—	—	—	—
N	1	—	—	—	—	—	—	—	—	—	—	—	—	—	—	—
	2	—	—	—	—	—	—	—	—	—	—	—	—	—	—	—
	3	—	—	—	—	—	—	—	—	—	—	—	—	—	—	—
S	1	—	—	—	—	—	—	45	40	30	40	35	25	35	30	25
	2	—	—	—	—	—	—	45	40	30	40	35	25	35	30	25
	3	—	—	—	—	—	—	55	45	30	50	40	25	45	35	25
	4	—	—	—	—	—	—	70	60	40	60	50	30	60	45	30
H	1	—	—	—	—	—	—	—	—	—	—	—	—	—	—	—

NOTE: FIRST choice starting speeds are in **bold** type. As the average chip thickness increases, the speed should be decreased.
 *Material groups P, M, K, and H show recommended starting speeds for dry machining. For wet machining, reduce speed by 20%.
 *Material groups N and S show recommended starting speeds for wet machining. Not recommended for dry machining.

Recommended Starting Feeds [mm]

Light Machining	General Purpose	Heavy Machining
-----------------	-----------------	-----------------

Insert Geometry	Programmed Feed per Tooth (fz) as a % of Radial Depth of Cut (ae)															Insert Geometry
	5%			10%			20%			30%			40-100%			
.F..PCD	0,12	0,18	0,29	0,08	0,13	0,21	0,06	0,10	0,16	0,06	0,09	0,14	0,05	0,08	0,12	.F..PCD
.F..ALP	0,12	0,22	0,31	0,08	0,16	0,23	0,06	0,12	0,17	0,06	0,10	0,15	0,05	0,10	0,14	.F..ALP
.E..ML	0,17	0,27	0,36	0,13	0,20	0,26	0,10	0,15	0,19	0,08	0,13	0,17	0,08	0,12	0,16	.E..ML
.S..MM	0,23	0,32	0,47	0,17	0,23	0,34	0,13	0,17	0,25	0,11	0,15	0,22	0,10	0,14	0,20	.S..MM
.S..MH	0,23	0,37	0,56	0,17	0,27	0,40	0,13	0,20	0,30	0,11	0,17	0,26	0,10	0,16	0,24	.S..MH

NOTE: Use "Light Machining" values as starting feed rate.



VSM11™

0°/90° Shoulder Mills • VSM11

Best Practices

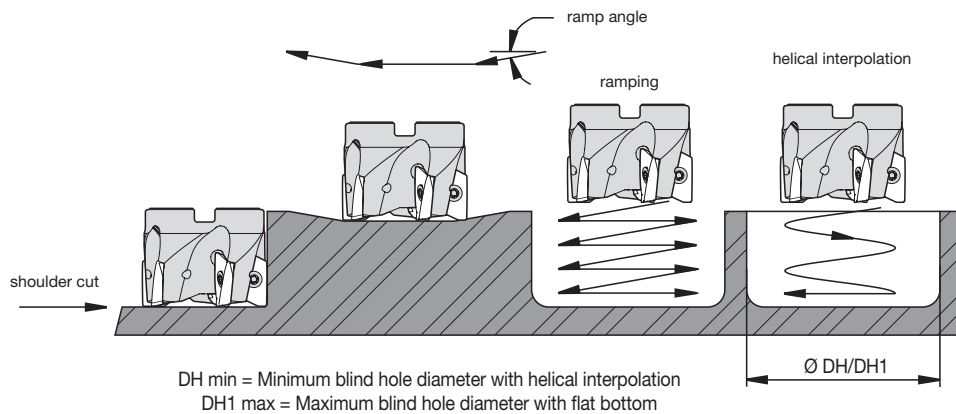

cutting diameter (D1)	max RPM	max ramp angle to steel body interference	max flat-bottom hole diameter (DH1 max)	min hole diameter (DH min)
16	41400	10.00°	32,00	19,00
20	35100	7.80°	40,00	27,00
25	30200	5.30°	50,00	37,00
32	25800	3.60°	64,00	51,00
40	22600	2.60°	80,00	67,00
50	19900	2.00°	100,00	87,00
63	17500	2.00°	126,00	113,00
80	15300	1.00°	160,00	147,00
100	13600	0.90°	200,00	187,00
125	12100	0.70°	250,00	237,00

NOTE: For DH1 max, subtract the insert corner radius from the max hole diameter.

Modification Instructions for Use of Larger Radii Inserts (Shoulder Mills and Helical Mills)

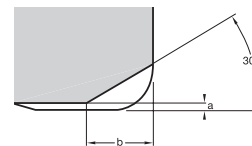

insert corner radius	material to remove	
	a	b
2,0-3,2mm	0,2mm	1,8mm

NOTE: Standard milling cutters will accept insert nose radii up to 1,6mm without modification.

VSM11 Z-Axis Plunging

cutting diameter (D1)	Z max	Y
16	6,4	15,68
18	6,4	17,23
20	6,4	18,66
22	6,4	19,98
25	6,4	21,82
32	6,4	25,60
40	6,4	29,33
50	6,4	33,41
63	6,4	38,07
80	6,4	43,41
100	6,4	48,95
125	6,4	55,10
160	6,4	62,71

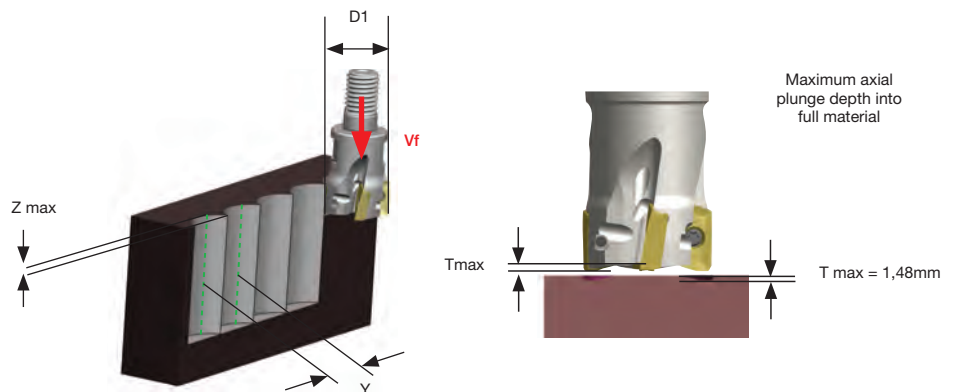

Aerospace Solutions from WIDIA™

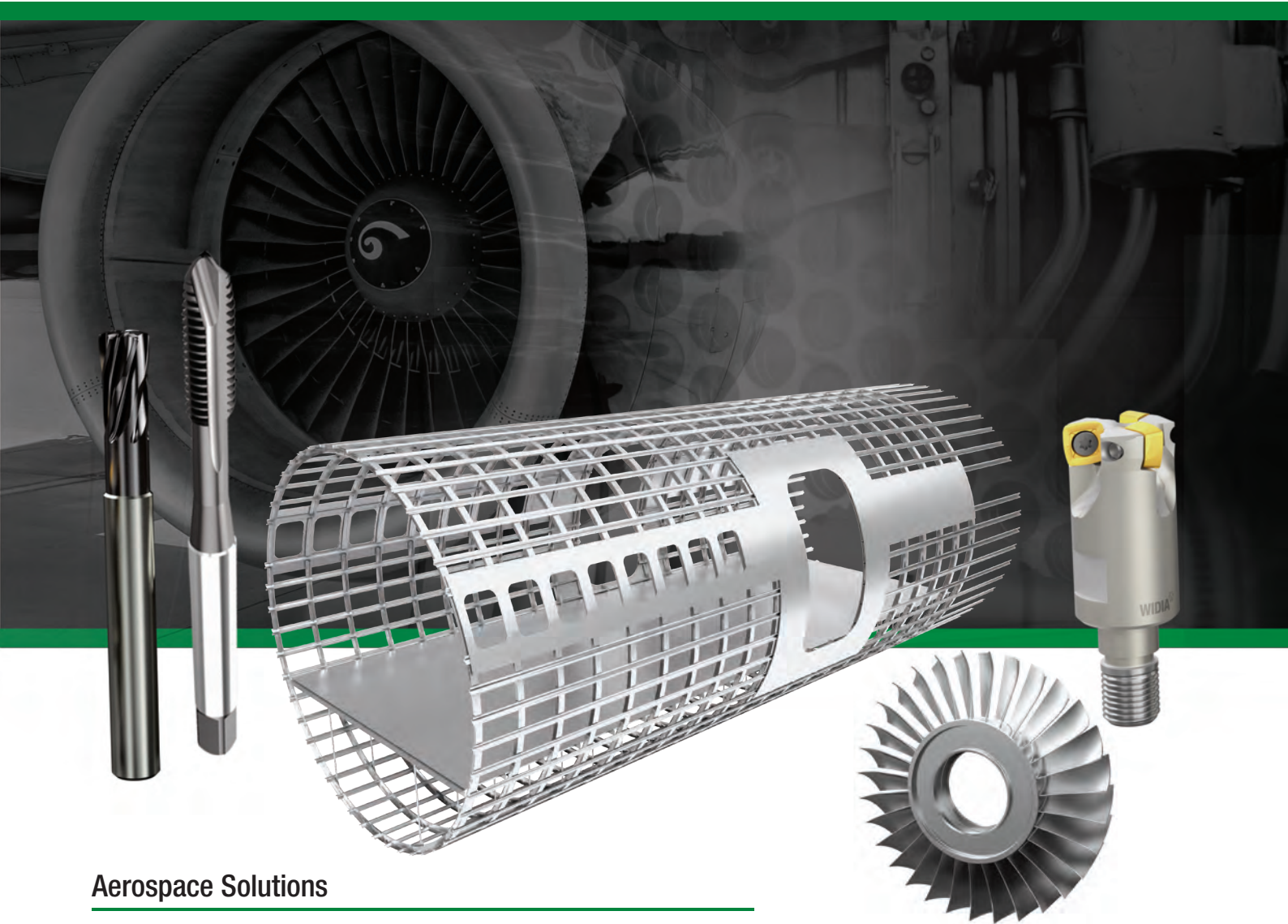

Aerospace Solutions

VXF™, X-Feed™ for titanium and the aerospace fastener tap, were created to fill the growing need for high-performance tooling in the aerospace industry

Visit WIDIA.com to learn more about our new tooling and machining strategies from WIDIA machining experts.

WIDIA™ GTD 

WIDIA 

WIDIA™ HANITA 

VSM17™





0°/90° Shoulder Mills • VSM17

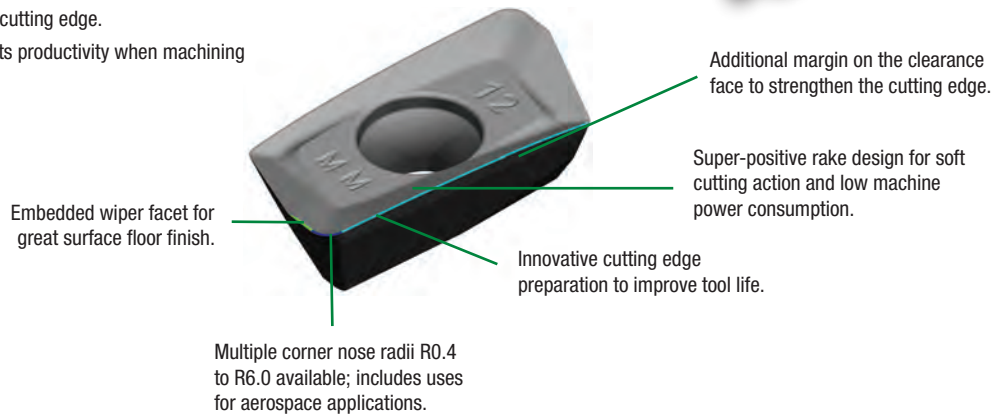

- True 90° shoulder milling platform; up to $A_{p1} \text{ max} = 16\text{mm}$.
- Aggressive ramping capability up to 8.8° with end mills with a diameter of 25mm.
- Optimised chip gash for improved cutter stability and chip flow.
- Well-guided internal coolant supply to the cutting edge.
- Best-in-class milling grade WS40PM boosts productivity when machining stainless steel and high-temp alloys.



Geometries for all material groups in shoulder milling applications.

<p>-ALP</p>  <p>N</p> <p>Roughing and finishing of aluminium alloys. High precision. Periphery ground.</p>	<p>-ML</p>  <p>P M S H</p> <p>Light machining and finishing. First choice for stainless steel and titanium. Periphery ground.</p>	<p>-MM</p>  <p>P M K S H</p> <p>Medium machining. First choice for general purpose. Precision pressed to size.</p>	<p>-MH</p>  <p>P M K S</p> <p>First choice for heavy-duty machining. Steel and cast iron materials. Precision pressed to size.</p>
--	---	--	--

Finishing Capabilities/Lower Cutting Forces

Geometry Strengthening

2x Higher Metal Removal Rate!



Specifications	Before VSM	WIDIA™
Workpiece	-	K2 – Ductile Iron
Insert	-	XDPT170408PESRMM
Grade	-	WK15CM
Cutter	-	VSM17D080Z7S27XD17
Diameter	-	80mm
No. cutting edges (z)	6	7
Vc	160 m/min	210 m/min
Feed rate (fz)	0,078mm	0,11mm
Vf	298 mm/min	665 mm/min
Ap	3mm	3mm
ae	60mm	60mm
MRR	54 cm ³ /min	120 cm³/min
Coolant	Dry	Dry



0°/90° Shoulder Mills • VSM17™

Screw-On End Mills • Metric

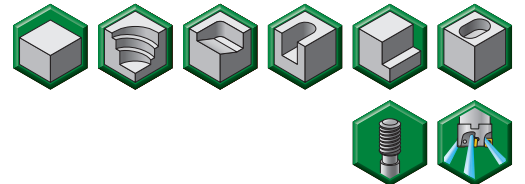
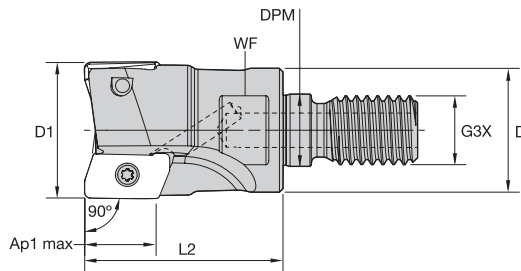

order number	catalogue number	D1	D	DPM	G3X	L2	WF	Ap1 max	Z	max ramp angle	max RPM	coolant supply	kg
5988091	VSM17D025Z02M12XD17	25	21	12,5	M12	35	17	16,4	2	8.8°	41800	Yes	0,08
5988092	VSM17D032Z03M16XD17	32	29	17,0	M16	40	24	16,3	3	5.7°	34700	Yes	0,17
5988131	VSM17D40Z03M016XD17	40	29	17,0	M16	40	24	16,2	3	4.0°	29800	Yes	0,20
5988093	VSM17D040Z04M16XD17	40	29	17,0	M16	40	24	16,2	4	4.0°	29800	Yes	0,20

Weldon® End Mills • Metric

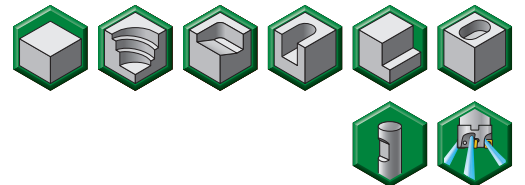
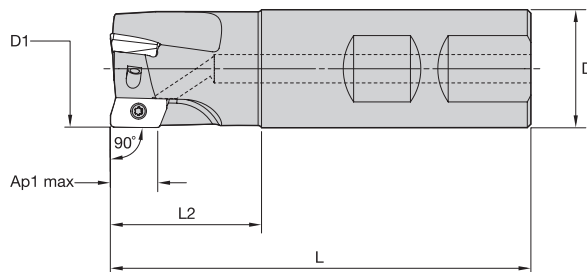

order number	catalogue number	D1	D	L	L2	Ap1 max	Z	max ramp angle	max RPM	coolant supply	kg
5988102	VSM17D025Z02B25XD17	25	25	90	33	16,4	2	8.8°	41800	Yes	0,26
5988103	VSM17D032Z03B32XD17	32	32	100	39	16,3	3	5.7°	34700	Yes	0,48
5988104	VSM17D040Z04B40XD17	40	40	110	39	16,2	4	4.0°	29800	Yes	0,87

NOTE: Weldon type not recommended for finishing operations.

Cylindrical End Mills (Regular and Long Version) • Metric

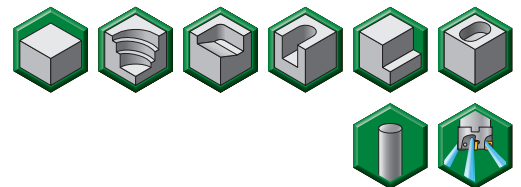
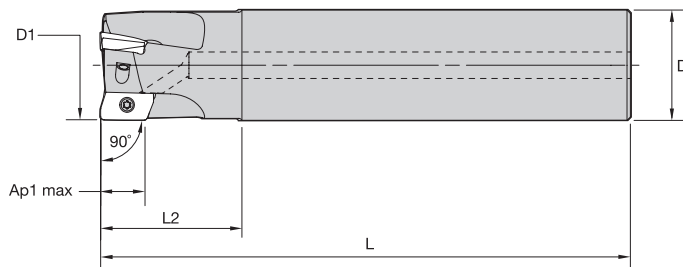

order number	catalogue number	D1	D	L	L2	Ap1 max	Z	max ramp angle	max RPM	coolant supply	kg
5988055	VSM17D025Z02A25XD17L110	25	25	110	44	16,4	2	8.8°	41800	Yes	0,32
5988056	VSM17D025Z02A25XD17L170	25	25	170	44	16,4	2	8.8°	41800	Yes	0,54
5988107	VSM17D032Z02A32XD17L120	32	32	120	50	16,3	2	5.7°	34700	Yes	0,60
5988108	VSM17D032Z02A32XD17L210	32	32	210	50	16,3	2	5.7°	34700	Yes	1,14
5988057	VSM17D032Z03A32XD17L120	32	32	120	50	16,3	3	5.7°	34700	Yes	0,60
5988058	VSM17D032Z03A32XD17L210	32	32	210	50	16,3	3	5.7°	34700	Yes	1,13
5988109	VSM17D040Z03A32XD17L130	40	32	130	50	16,2	3	4.0°	29800	Yes	0,77
5988110	VSM17D040Z03A32XD17L250	40	32	250	50	16,2	3	4.0°	29800	Yes	1,49
5988059	VSM17D040Z04A32XD17L130	40	32	130	50	16,2	4	4.0°	29800	Yes	0,77
5988060	VSM17D040Z04A32XD17L250	40	32	250	50	16,2	4	4.0°	29800	Yes	1,49

Shell Mills • Metric

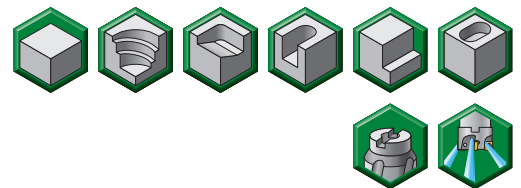
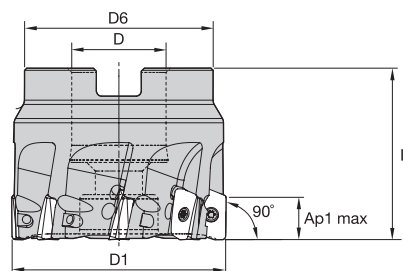

order number	catalogue number	D1	D	D6	L	Ap1 max	Z	max ramp angle	max RPM	coolant supply	kg
5988094	VSM17D040Z04S16XD17	40	16	37	40	16,2	4	4.0°	29800	Yes	0,19
5988095	VSM17D050Z04S22XD17	50	22	45	40	16,1	4	3.0°	25800	Yes	0,28
5988096	VSM17D050Z05S22XD17	50	22	45	40	16,1	5	3.0°	25800	Yes	0,29
5988134	VSM17D050Z06S22XD17	50	22	45	40	16,1	6	3.0°	25800	Yes	0,28
5988097	VSM17D063Z05S22XD17	63	22	50	40	16,0	5	2.1°	22400	Yes	0,45
5988135	VSM17D063Z06S22XD17	63	22	50	40	16,0	6	2.1°	22400	Yes	0,45
5988098	VSM17D080Z06S27XD17	80	27	60	50	15,9	6	1.6°	19500	Yes	0,98
5988133	VSM17D080Z07S27XD17	80	27	60	50	15,9	7	1.6°	19500	Yes	0,96
5988099	VSM17D100Z08S32XD17	100	32	80	50	15,8	8	1.2°	17200	Yes	1,63
5988100	VSM17D125Z09S40XD17	125	40	90	63	15,7	9	.9°	15200	Yes	2,94
5988101	VSM17D160Z12S40XD17	160	40	100	63	15,8	12	.7°	13300	Yes	3,66

Helical Shell Mills

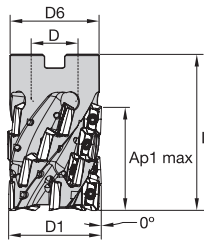

order number	catalogue number	D1	D	D6	L	Ap1 max	Z	Z U	max ramp angle	max RPM	coolant supply
6740674	VSM17H050Z04S022XD17	50	22	44	80	60	16	4	3,0°	25600	Yes
6740675	VSM17H050Z05S022XD17	50	22	44	80	60	20	5	3,0°	25600	Yes
6740676	VSM17H063Z04S027XD17	63	27	60	100	75	20	4	2,1°	22300	Yes
6740677	VSM17H063Z05S027XD17	63	27	60	100	75	30	5	2,1°	22300	Yes
6740678	VSM17H080Z05S032XD17	80	32	78	100	75	30	5	1,6°	18000	Yes

NOTE: Z = number of pockets; ZU = number of flutes.

VSM17™

0°/90° Shoulder Mills • VSM17

Inserts • XDCT-ML

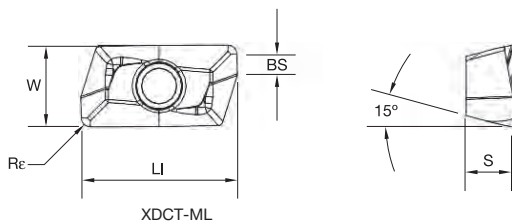

● first choice
○ alternate choice

P	■	■	■	○	●	●	○	●
M	■	■	■	○	●	●	○	●
K	■	■	■	○	○	○	○	○
N	■	■	■	○	○	○	○	○
S	■	■	■	○	○	○	○	○
H	■	■	■	○	○	○	○	○

ISO catalogue number	cutting edges	LI	BS	S	W	Re	hm	WK15CM	WK15PM	WN10HM	WN25PM	WP25PM	WP35CM	WP40PM	WS40PM	WU35PM
XDCT170404PEERML	2	19,15	2,62	4,90	9,60	0,40	0,04	■	■	■	○	●	●	○	○	○
XDCT170408PEERML	2	19,15	2,22	4,90	9,60	0,80	0,04	■	■	■	○	●	●	○	○	○
XDCT170412PEERML	2	19,16	1,82	4,90	9,60	1,20	0,04	■	■	■	○	●	●	○	○	○
XDCT170416PEERML	2	19,17	1,42	4,90	9,60	1,60	0,04	■	■	■	○	●	●	○	○	○
XDCT170420PEERML	2	19,17	1,01	4,90	9,60	2,00	0,04	■	■	■	○	●	●	○	○	○
XDCT170424PEERML	2	19,17	0,63	4,90	9,60	2,40	0,04	■	■	■	○	●	●	○	○	○
XDCT170432PEERML	2	18,85	—	4,89	9,59	3,20	0,04	■	■	■	○	●	●	○	○	○
XDCT170440PEERML	2	18,33	—	4,87	9,59	4,00	0,04	■	■	■	○	●	●	○	○	○
XDCT170460PEERML	2	17,02	—	4,80	9,56	6,00	0,04	■	■	■	○	●	●	○	○	○

Inserts • XDCT-ALP

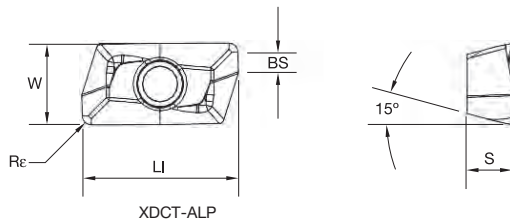

● first choice
○ alternate choice

P	■	■	■	○	●	●	○	●
M	■	■	■	●	○	●	●	●
K	■	●	●	○	○	■	■	■
N	■	■	●	●	■	■	■	■
S	■	■	■	●	○	●	●	●
H	■	■	■	■	■	■	■	■

ISO catalogue number	cutting edges	LI	BS	S	W	Re	hm	WK15CM	WK15PM	WN10HM	WN25PM	WP25PM	WP35CM	WP40PM	WS40PM	WU35PM
XDCT170404PEFRALP	2	19,15	2,62	4,90	9,60	0,40	0,02	■	■	6007341	6007220	■	■	■	■	■
XDCT170408PEFRALP	2	19,15	2,22	4,90	9,60	0,80	0,02	■	■	6007345	6007344	■	■	■	■	■
XDCT170412PEFRALP	2	19,16	1,82	4,90	9,60	1,20	0,02	■	■	6007342	6001537	■	■	■	■	■
XDCT170416PEFRALP	2	19,17	1,42	4,90	9,60	1,60	0,02	■	■	6001256	6001254	■	■	■	■	■
XDCT170420PEFRALP	2	19,17	1,01	4,90	9,60	2,00	0,02	■	■	6001252	6001254	■	■	■	■	■
XDCT170424PEFRALP	2	19,17	0,63	4,90	9,60	2,40	0,02	■	■	6001240	6001240	■	■	■	■	■
XDCT170432PEFRALP	2	18,85	—	4,88	9,59	3,20	0,02	■	■	6001238	6001240	■	■	■	■	■
XDCT170440PEFRALP	2	18,33	—	4,87	9,59	4,00	0,02	■	■	6001238	6001240	■	■	■	■	■
XDCT170460PEFRALP	2	17,02	—	4,80	9,56	6,00	0,02	■	■	6118070	6001240	■	■	■	■	■

VSM17™

0°/90° Shoulder Mills • VSM17

Inserts • XDPT-MM

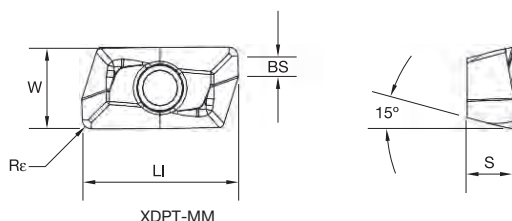

● first choice
○ alternate choice

P	■	■	■	■	○	●	●	○	●
M	■	■	■	■	○	●	●	○	●
K	■	■	■	■	○	○	○	○	○
N	■	■	■	■	○	○	○	○	○
S	■	■	■	■	○	○	○	○	○
H	■	■	■	■	○	○	○	○	○

ISO catalogue number	cutting edges	LI	BS	S	W	Re	hm	WK15CM	WK15PM	WN10HM	WN25PM	WP25PM	WP35CM	WP40PM	WS40PM	WU35PM
XDPT170404PESRMM	2	19,15	2,52	4,90	9,60	0,40	0,10	■	■	■	■	○	●	○	○	○
XDPT170408PESRMM	2	19,15	2,15	4,90	9,60	0,80	0,10	5987948	6242460	■	■	■	■	5987946	5987689	■
XDPT170412PESRMM	2	19,16	1,77	4,90	9,60	1,20	0,10	5988138	5988138	■	■	■	■	5987949	5987947	5987946
XDPT170416PESRMM	2	19,17	1,38	4,90	9,60	1,60	0,10	5988153	5988153	■	■	■	■	5987946	6180212	5987950
XDPT170420PESRMM	2	19,17	0,99	4,90	9,60	2,00	0,10	■	■	■	■	■	■	5987946	6180213	5988152
XDPT170424PESRMM	2	19,17	0,62	4,90	9,60	2,40	0,10	■	■	■	■	■	■	5987946	6180213	5988152
XDPT170432PESRMM	2	18,85	—	4,89	9,59	3,20	0,10	■	■	■	■	■	■	5988206	5988205	■
XDPT170440PESRMM	2	18,33	—	4,87	9,59	4,00	0,10	■	■	■	■	■	■	5988970	5988969	■

Inserts • XDPT-MH

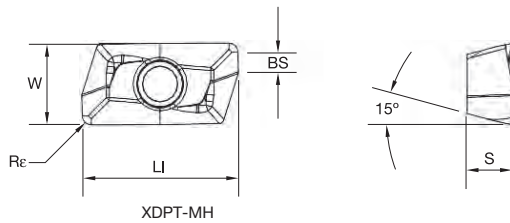

- first choice
- alternate choice

P	●	○	○	○	○	○	○	○
M	●	○	○	○	○	○	○	○
K	●	○	○	○	○	○	○	○
N	○	○	○	○	○	○	○	○
S	○	○	○	○	○	○	○	○
H	○	○	○	○	○	○	○	○

ISO catalogue number	cutting edges	LI	BS	S	W	Re	hm	WK15CM	WK15PM	WN10HM	WN25PM	WP35CM	WP40PM	WS40PM	WU35PM
XDPT170408PESRMH	2	19,15	2,10	4,91	9,60	0,80	0,13	5989053	●	○	○	○	○	○	○
XDPT170412PESRMH	2	19,16	1,73	4,91	9,60	1,20	0,13	5981817	○	○	○	○	○	○	○

Insert Selection Guide

Material Group	Light Machining		General Purpose		Heavy Machining	
	Geometry	Grade	Geometry	Grade	Geometry	Grade
P1-P2	XDCT-ML	WP40PM	XDPT-MM	WP40PM	XDPT-MH	WP40PM
P3-P4	XDCT-ML	WP40PM	XDPT-MM	WP40PM	XDPT-MH	WP40PM
P5-P6	XDPT-MM	WP25PM	XDPT-MM	WP35CM	XDPT-MH	WP40PM
M1-M2	XDCT-ML	WS40PM	XDPT-MM	WS40PM	XDPT-MM	WS40PM
M3	XDCT-ML	WS40PM	XDPT-MM	WS40PM	XDPT-MH	WS40PM
K1-K2	XDPT-MM	WK15CM	XDPT-MM	WK15CM	XDPT-MH	WK15CM
K3	XDPT-MM	WP35CM	XDPT-MM	WP35CM	XDPT-MH	WP35CM
N1-N2	XDCT-ALP	WN10HM	XDCT-ALP	WN25PM	XDCT-ALP	WN25PM
N3	XDCT-ALP	WN10HM	XDCT-ALP	WN25PM	XDCT-ALP	WN25PM
S1-S2	XDCT-ML	WP25PM	XDPT-MM	WS40PM	XDPT-MM	WS40PM
S3	XDCT-ML	WS40PM	XDPT-MM	WS40PM	XDPT-MM	WS40PM
S4	XDCT-ML	WS40PM	XDPT-MM	WS40PM	XDPT-MM	WS40PM
H1	-	-	-	-	-	-

VSM17™

0°/90° Shoulder Mills • VSM17

Recommended Starting Speeds [m/min]*

Material Group		WK15CM	WK15PM	WN10HM	WN25PM	WP25PM	WP35CM	WP40PM	WS40PM	WU35PM
P	1	— — —	— — —	— — —	— — —	330 285 270	455 395 370	295 260 245	— — —	260 230 215
	2	— — —	— — —	— — —	— — —	275 240 200	280 255 230	250 215 180	— — —	220 190 160
	3	— — —	— — —	— — —	— — —	255 215 175	255 230 205	230 195 160	— — —	200 170 140
	4	— — —	— — —	— — —	— — —	225 185 150	190 175 160	205 170 135	— — —	180 150 120
	5	— — —	— — —	— — —	— — —	185 170 150	260 230 210	170 155 135	170 145 120	150 135 120
	6	— — —	— — —	— — —	— — —	165 125 100	160 135 110	150 115 90	150 110 80	130 100 80
M	1	— — —	— — —	— — —	— — —	205 180 165	205 185 155	195 170 155	210 170 140	170 150 135
	2	— — —	— — —	— — —	— — —	185 160 130	185 160 140	175 150 125	180 145 120	155 130 110
	3	— — —	— — —	— — —	— — —	140 120 95	145 130 115	130 115 90	145 110 85	115 100 80
K	1	420 385 340	270 245 215	— — —	— — —	230 205 185	295 265 240	— — —	— — —	— — —
	2	335 295 275	210 190 175	— — —	— — —	180 160 150	235 210 190	— — —	— — —	— — —
	3	280 250 230	175 160 145	— — —	— — —	150 135 120	195 175 160	— — —	— — —	— — —
N	1	— — —	— — —	795 695 600	1075 945 875	— — —	— — —	— — —	— — —	— — —
	2	— — —	— — —	795 695 600	945 875 760	— — —	— — —	— — —	— — —	— — —
	3	— — —	— — —	560 485 420	945 875 760	— — —	— — —	— — —	— — —	— — —
S	1	— — —	— — —	— — —	— — —	40 35 25	— — —	— — —	40 35 25	35 30 25
	2	— — —	— — —	— — —	— — —	40 35 25	— — —	— — —	40 35 25	35 30 25
	3	— — —	— — —	— — —	— — —	50 40 25	— — —	— — —	50 40 25	45 35 25
	4	— — —	— — —	— — —	— — —	70 50 35	— — —	— — —	60 50 30	60 45 30
H	1	— — —	— — —	— — —	— — —	120 90 70	— — —	— — —	— — —	— — —

NOTE: FIRST choice starting speeds are in **bold** type. As the average chip thickness increases, the speed should be decreased.
 *Material groups P, M, K, and H show recommended starting speeds for dry machining. For wet machining, reduce speed by 20%.
 *Material groups N and S show recommended starting speeds for wet machining. Not recommended for dry machining.

Recommended Starting Feeds [mm]

Insert Geometry	Programmed Feed per Tooth (fz) as a % of Radial Depth of Cut (ae)															Insert Geometry
	5%			10%			20%			30%			40-100%			
	Light Machining	General Purpose	Heavy Machining	Light Machining	General Purpose	Heavy Machining	Light Machining	General Purpose	Heavy Machining	Light Machining	General Purpose	Heavy Machining	Light Machining	General Purpose	Heavy Machining	
.F..ALP	0,12	0,23	0,40	0,08	0,17	0,29	0,06	0,13	0,22	0,06	0,11	0,19	0,05	0,10	0,18	.F..ALP
.E..ML	0,16	0,35	0,46	0,12	0,25	0,33	0,09	0,19	0,25	0,08	0,16	0,22	0,07	0,15	0,20	.E..ML
.S..MM	0,16	0,40	0,64	0,12	0,29	0,46	0,09	0,22	0,34	0,08	0,19	0,30	0,07	0,18	0,28	.S..MM
.S..MH	0,23	0,46	0,74	0,17	0,33	0,54	0,13	0,25	0,40	0,11	0,22	0,35	0,10	0,20	0,32	.S..MH

NOTE: Use "Light Machining" value as starting feed rate.

Best Practices

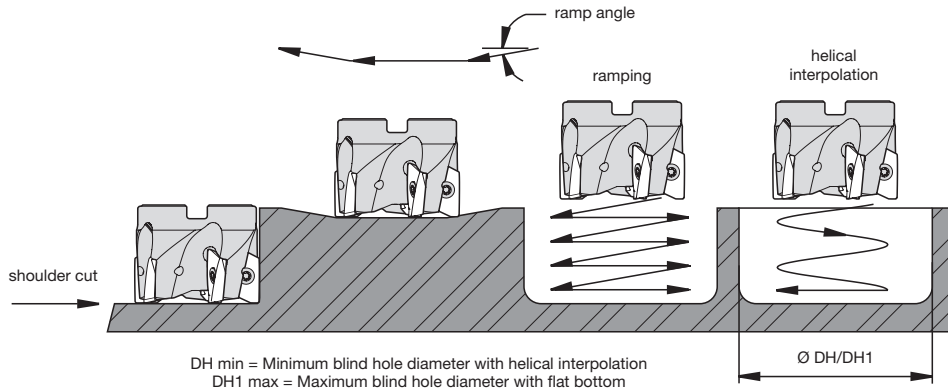

Modification Instructions for Use of Larger Radii Inserts (Shoulder Mills and Helical Mills)

cutting diameter (D1)	max RPM	max ramp angle to steel body interference	max flat-bottom hole diameter (DH1 max)	min hole diameter (DH min)
25	41800	8,8°	50	32
32	34700	5,7°	64	46
40	29800	4,0°	80	62
50	25800	3,0°	100	82
63	22400	2,1°	126	108
80	19500	1,6°	160	142
100	17200	1,2°	200	182
125	15200	0,9°	150	132
160	13300	0,7°	320	302

NOTE: For DH1 max, subtract the insert corner radius from the max hole diameter.

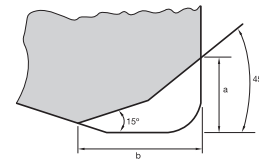

insert corner radius	material to remove	
	a	b
2,4–4,0mm	2	3
4,0–6,0mm	4	5

NOTE: Standard milling cutters will accept insert nose radii up to 1,6mm without modification.

VSM17 Z-Axis Plunging

cutting diameter (D1)	Z max	Y
25	9	24,00
32	9	28,77
40	9	33,41
50	9	38,42
63	9	44,09
80	9	50,56
100	9	57,24
125	9	64,62
160	9	73,73

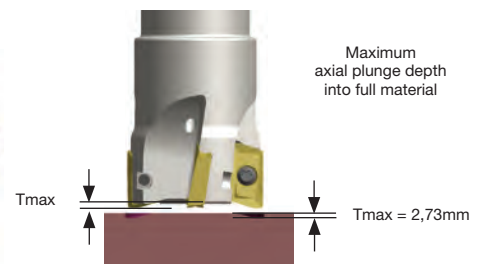
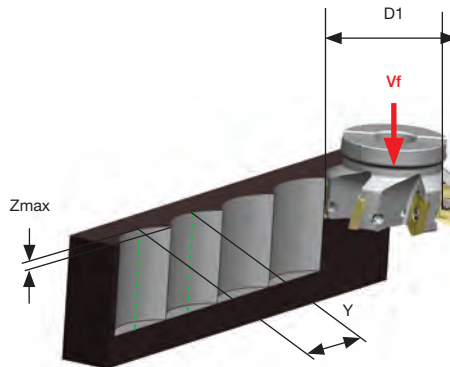

WIDIA-HANITA™

A SOLID FOUNDATION THE VARIMILL™ FAMILY

The WIDIA-Hanita VariMill family continues to provide leading-edge solutions for some of the most advanced applications in the general engineering, aerospace, and defense industries. These industries require complex machining techniques in some of the most exotic materials.

VariMill I™ Line Expansion



Series 4777 Series 47N7

This 4-flute geometry is designed with unequal flute spacing for plunging, slotting, and profiling at the highest possible feed rates for a wide range of materials.





VariMill II™ Line Expansion

Series 5777
Series 577C
Series 57NC
Series 57N8

This 5-flute geometry is designed with unequal flute spacing for advanced milling jobs in a wide range of materials.



VariMill III™

This 7-flute geometry is designed with unequal flute spacing and is designed to provide the highest Metal Removal Rates (MRR) and extended tool life in the most demanding materials in the aerospace industry.

WIDIA™ HANITA 

widia.com

VariMill I™ • Series 4777 • Metric

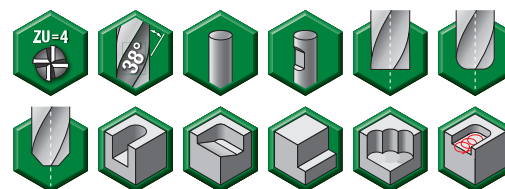
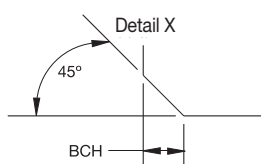
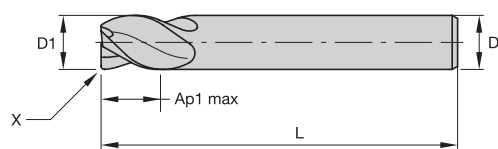

- first choice
- alternate choice

P	●
M	●
K	●
N	○
S	○
H	○

WIDIA HANITA

catalogue number	D1	D	length of cut Ap1 max	length L	Rε	BCH	SS	WP15PE
477704001T	4,0	6	12,00	55	0,20	—	—	5576753
477704002T	4,0	6	12,00	55	—	0,40	—	5576751
4777040Z2T	4,0	6	12,00	55	—	—	—	5576754
477705002T	5,0	6	13,00	57	—	0,40	—	5576755
477705012T	5,0	6	13,00	57	0,20	—	—	5576757
4777050Z2T	5,0	6	13,00	57	—	—	—	5576758
477706002T	6,0	6	13,00	57	—	0,40	—	5576759
477706002W	6,0	6	13,00	57	—	0,40	W	5576760
477706012T	6,0	6	13,00	57	0,20	—	—	5576761
4777060R2TE	6,0	6	13,00	57	0,50	—	—	6471861
4777060R2TJ	6,0	6	13,00	57	1,00	—	—	6471862
4777060Z2T	6,0	6	13,00	57	—	—	—	5576762
477707003T	7,0	8	16,00	63	—	0,40	—	5576763
477707013T	7,0	8	16,00	63	0,20	—	—	5576765
4777070Z3T	7,0	8	16,00	63	—	—	—	5576766
477708003T	8,0	8	16,00	63	—	0,40	—	5576767
477708003W	8,0	8	16,00	63	—	0,40	W	5576768
477708013T	8,0	8	16,00	63	0,20	—	—	5576769
4777080R3TE	8,0	8	16,00	63	0,50	—	—	6471863
4777080R3TJ	8,0	8	16,00	63	1,00	—	—	6471864
4777080R3TK	8,0	8	16,00	63	1,50	—	—	6471865
4777080R3TM	8,0	8	16,00	63	2,00	—	—	6471866
4777080Z3T	8,0	8	16,00	63	—	—	—	5576770
477709004T	9,0	10	19,00	72	—	0,50	—	5576771
477709014T	9,0	10	19,00	72	0,20	—	—	5576773
4777090Z4T	9,0	10	19,00	72	—	—	—	5576774
477710004T	10,0	10	22,00	72	—	0,50	—	5576775
477710004W	10,0	10	22,00	72	—	0,50	W	5576776
477710024T	10,0	10	22,00	72	0,30	—	—	5576777
4777100R4TE	10,0	10	22,00	72	0,50	—	—	6471867
4777100R4TJ	10,0	10	22,00	72	1,00	—	—	6471868
4777100R4TK	10,0	10	22,00	72	1,50	—	—	6471869

High-Performance Solid Carbide End Mills • VariMill™

VariMill I™ • Series 4777 • Metric

(continued)

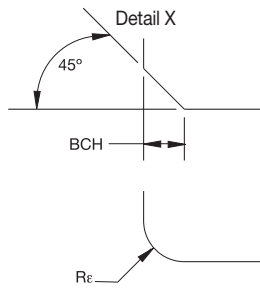
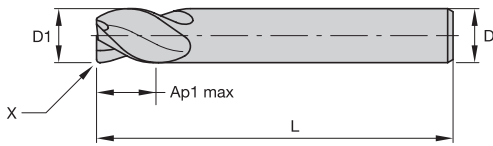

- first choice
- alternate choice

P		●
M		●
K		●
N		●
S		○
H		○

catalogue number	D1	D	length of cut Ap1 max	length L	Re	BCH	SS	WP15PE
4777100R4TM	10,0	10	22,00	72	2,00	—	—	6471870
4777100R4TN	10,0	10	22,00	72	2,50	—	—	6471871
4777100Z4T	10,0	10	22,00	72	—	—	—	5576778
4777110Z5T	11,0	12	26,00	83	—	—	—	5576779
477712005T	12,0	12	26,00	83	—	0,50	—	5576790
477712005W	12,0	12	26,00	83	—	0,50	W	5576791
477712025T	12,0	12	26,00	83	0,30	—	—	5576792
4777120R5TE	12,0	12	26,00	83	0,50	—	—	6471872
4777120R5TJ	12,0	12	26,00	83	1,00	—	—	6471873
4777120R5TK	12,0	12	26,00	83	1,50	—	—	6471874
4777120R5TM	12,0	12	26,00	83	2,00	—	—	6471875
4777120R5TN	12,0	12	26,00	83	2,50	—	—	6471876
4777120R5TP	12,0	12	26,00	83	3,00	—	—	6471877
4777120Z5T	12,0	12	26,00	83	—	—	—	5576793
477714014W	14,0	14	26,00	83	—	0,50	W	5576795
477714015T	14,0	14	26,00	83	—	0,50	—	5576794
477716006T	16,0	16	32,00	92	—	0,50	—	5576796
477716006W	16,0	16	32,00	92	—	0,50	W	5576797
477716026T	16,0	16	32,00	92	0,30	—	—	5576798
4777160R6TJ	16,0	16	32,00	92	1,00	—	—	6471878
4777160R6TM	16,0	16	32,00	92	2,00	—	—	6471879
4777160R6TP	16,0	16	32,00	92	3,00	—	—	6471880
4777160R6TQ	16,0	16	32,00	92	4,00	—	—	6471891
4777160Z6T	16,0	16	32,00	92	—	—	—	5576799
477718018T	18,0	18	32,00	92	—	0,50	—	5576810
477720007T	20,0	20	38,00	104	—	0,50	—	5576812
477720007W	20,0	20	38,00	104	—	0,50	W	5576813
47772002T	20,0	20	38,00	104	0,30	—	—	5576814
4777200R7TP	20,0	20	38,00	104	3,00	—	—	6471892
477725008T	25,0	25	45,00	121	—	0,50	—	5576816
477725008W	25,0	25	45,00	121	—	0,50	W	5576817
4777250R8TR	25,0	25	45,00	121	5,00	—	—	6471893

NOTE: SS = Shank Style
W = Weldon®

End Mill Tolerances

D1	tolerance e8	D	tolerance h6 + / -
≤ 3	-0,014/-0,028	≤ 3	0/0,006
> 3-6	-0,020/-0,038	> 3-6	0/0,008
> 6-10	-0,025/-0,047	> 6-10	0/0,009
> 10-18	-0,032/-0,059	> 10-18	0/0,011
> 18-30	-0,040/-0,073	> 18-30	0/0,013

VariMill™

High-Performance Solid Carbide End Mills • VariMill

VariMill I™ • Series 47N7 • Metric

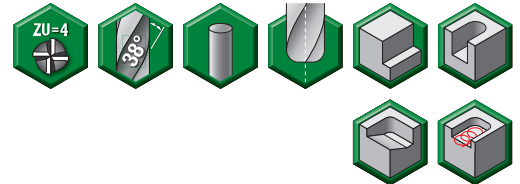
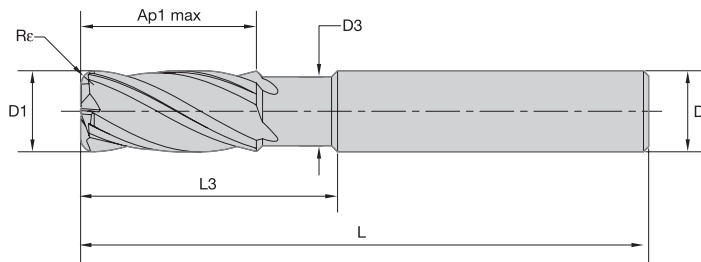

● first choice
○ alternate choice

P	●	●
M	●	●
K	○	○
N		
S	○	○
H	●	●

WIDIA HANITA

catalogue number	D1	D	D3	length of cut Ap1 max	L3	length L	Rε	SS	WP15PE	TiAlN-LT
47N704002LT	4,0	6	3,60	12,00	16,00	55	0,40	—	—	3462450
47N704012LT	4,0	6	3,60	12,00	16,00	55	0,50	—	—	3462451
47N704022LT	4,0	6	3,60	12,00	16,00	55	1,00	—	—	3462453
47N705002LT	5,0	6	4,60	13,00	18,00	57	0,50	—	—	3462454
47N705012LT	5,0	6	4,60	13,00	18,00	57	1,00	—	—	3462455
47N706002LT	6,0	6	5,50	13,00	21,00	57	0,50	—	—	3462457
47N706012LT	6,0	6	5,50	13,00	21,00	57	1,00	—	—	3462459
47N706022LT	6,0	6	5,50	13,00	21,00	57	1,50	—	—	3462461
47N7060C2W	6,0	6	5,50	13,00	21,00	57	—	W	6522658	—
47N7060R2TK	6,0	6	5,50	13,00	21,00	57	1,50	—	6522659	—
47N708003LT	8,0	8	7,50	16,00	27,00	63	0,50	—	—	3462462
47N708013LT	8,0	8	7,50	16,00	27,00	63	1,00	—	—	3462464
47N708023LT	8,0	8	7,50	16,00	27,00	63	1,50	—	—	3462466
47N708033LT	8,0	8	7,50	16,00	27,00	63	2,00	—	—	3462467
47N7080C3W	8,0	8	7,50	16,00	27,00	63	—	W	6522660	—
47N7080R3TK	8,0	8	7,50	16,00	27,00	63	1,50	—	6522681	—
47N710004LT	10,0	10	9,50	22,00	32,00	72	0,50	—	—	3462468
47N710014LT	10,0	10	9,50	22,00	32,00	72	1,00	—	—	3462470
47N710024LT	10,0	10	9,50	22,00	32,00	72	1,50	—	—	3462472
47N710034LT	10,0	10	9,50	22,00	32,00	72	2,00	—	—	3462473
47N7100C4W	10,0	10	9,50	22,00	32,00	72	—	W	6522682	—
47N7100R4TK	10,0	10	9,50	22,00	32,00	72	1,50	—	6522683	—
47N712005LT	12,0	12	11,50	26,00	38,00	83	0,50	—	—	3462475
47N712015LT	12,0	12	11,50	26,00	38,00	83	1,00	—	—	3462477
47N712025LT	12,0	12	11,50	26,00	38,00	83	1,50	—	—	3462479
47N712035LT	12,0	12	11,50	26,00	38,00	83	2,00	—	—	3462480
47N712045LT	12,0	12	11,50	26,00	38,00	83	4,00	—	—	3462482
47N7120C5W	12,0	12	11,50	26,00	38,00	83	—	W	6522684	—
47N7120R5TK	12,0	12	11,50	26,00	38,00	83	1,50	—	6522685	—
47N7120R5TP	12,0	12	11,50	26,00	38,00	83	3,00	—	6522686	—
47N716006LT	16,0	16	15,00	32,00	44,00	92	1,00	—	—	3462484
47N716016LT	16,0	16	15,00	32,00	44,00	92	2,00	—	—	3462486

WIDIA

High-Performance Solid Carbide End Mills • VariMill™

VariMill I™ • Series 47N7 • Metric

(continued)

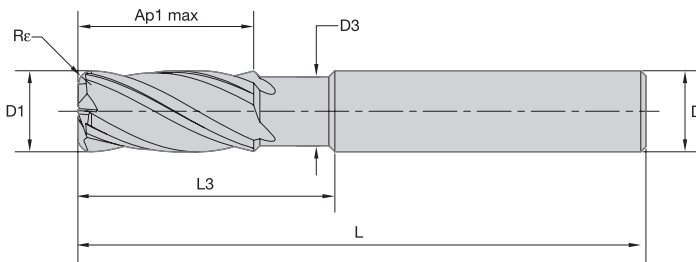

● first choice
○ alternate choice

P	●	●
M	●	●
K	○	○
N		
S	○	○
H	●	●

catalogue number	D1	D	D3	length of cut Ap1 max	L3	length L	Rε	SS	WP15PE	TiAlN-LT
47N716026LT	16,0	16	15,00	32,00	44,00	92	4,00	—	—	3462488
47N7160C6W	16,0	16	15,00	32,00	44,00	92	—	W	6522687	—
47N7160R6TE	16,0	16	15,00	32,00	44,00	92	0,50	—	6522688	—
47N7160R6TP	16,0	16	15,00	32,00	44,00	92	3,00	—	6522689	—
47N720007LT	20,0	20	19,00	38,00	55,00	104	1,00	—	—	3462490
47N720007MT	20,0	20	19,00	38,00	55,00	104	1,00	—	3462491	—
47N720017LT	20,0	20	19,00	38,00	55,00	104	2,00	—	—	3462492
47N7200C7W	20,0	20	19,00	38,00	55,00	104	—	W	6522690	—
47N7200R7TE	20,0	20	19,00	38,00	55,00	104	0,50	—	6522701	—
47N7200R7TP	20,0	20	19,00	38,00	55,00	104	3,00	—	6522702	—
47N7200R7TR	20,0	20	19,00	38,00	55,00	104	5,00	—	6522703	—

NOTE: SS = Shank Style
W = Weldon®

End Mill Tolerances

D1	tolerance e8	D	tolerance h6 + / -
≤ 3	-0,014/-0,028	≤ 3	0/0,006
> 3-6	-0,020/-0,038	> 3-6	0/0,008
> 6-10	-0,025/-0,047	> 6-10	0/0,009
> 10-18	-0,032/-0,059	> 10-18	0/0,011
> 18-30	-0,040/-0,073	> 18-30	0/0,013

VariMill II™ • Series 5777 • Metric

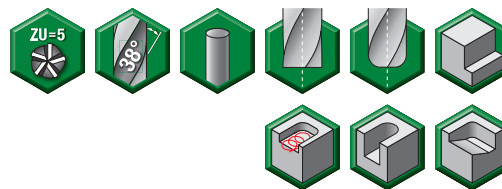
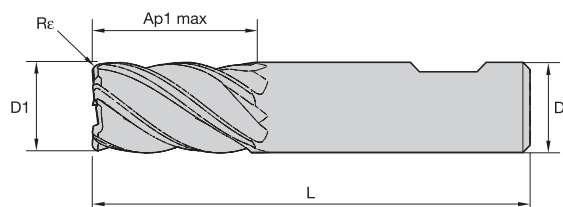

- first choice
- alternate choice

P	●
M	●
K	●
N	●
S	○
H	○

WIDIA HANITA

catalogue number	D1	D	length of cut Ap1 max	length L	Rε	SS	WP15PE
577704002MT	4,0	6	11,00	55	0,25	—	3524587
577704012MT	4,0	6	11,00	55	—	—	3524586
577705002MT	5,0	6	13,00	57	0,25	—	3524588
577706002ET	6,0	6	13,00	57	0,50	—	6525049
577706002JT	6,0	6	13,00	57	1,00	—	6525050
577706002MT	6,0	6	13,00	57	0,40	—	3524590
577706012MT	6,0	6	13,00	57	—	—	3524589
577708003JT	8,0	8	19,00	63	1,00	—	6525181
577708003KT	8,0	8	19,00	63	1,50	—	6525182
577708003MT	8,0	8	19,00	63	0,50	—	3524593
577708013MT	8,0	8	19,00	63	—	—	3524592
577710004JT	10,0	10	22,00	72	1,00	—	6525183
577710004KT	10,0	10	22,00	72	1,50	—	6525184
577710004MT	10,0	10	22,00	72	0,50	—	3524596
577710014MT	10,0	10	22,00	72	—	—	3524595
577712005MT	12,0	12	26,00	83	0,75	—	3524598
577712015ET	12,0	12	26,00	73	0,50	—	6525185
577712015JT	12,0	12	26,00	73	1,00	—	6525186
577712015KT	12,0	12	26,00	73	1,50	—	6525187
577712015MT	12,0	12	26,00	83	—	—	3524597
577712015NT	12,0	12	26,00	73	2,50	—	6525188
577716006JT	16,0	16	32,00	92	1,00	—	6525189
577716006MT	16,0	16	32,00	92	0,75	—	3524601
577716006MW	16,0	16	32,00	92	0,75	W	3524620

High-Performance Solid Carbide End Mills • VariMill™

VariMill II™ • Series 5777 • Metric

(continued)

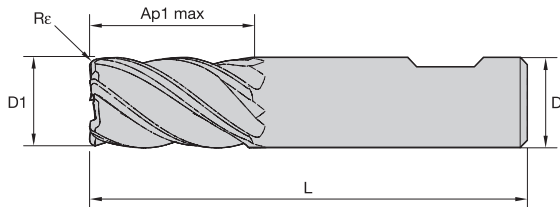

- first choice
- alternate choice

P		●
M		●
K		●
N		●
S		○
H		○

catalogue number	D1	D	length of cut Ap1 max	length L	Rε	SS	WP15PE
577716006PT	16,0	16	32,00	92	3,00	—	6525190
577716006QT	16,0	16	32,00	92	4,00	—	6525201
577716016MT	16,0	16	32,00	92	—	—	3524600
577720007MT	20,0	20	38,00	104	0,75	—	3524605
577720007PT	20,0	20	38,00	104	3,00	—	6525202
577720017MT	20,0	20	38,00	104	—	—	3524603
577725008MT	25,0	25	45,00	121	0,75	—	3524606
577725008RT	25,0	25	45,00	121	5,00	—	6525203

NOTE: SS = Shank Style
W = Weldon®

End Mill Tolerances

D1	tolerance e8	D	tolerance h6 + / -
≤ 3	-0,014/-0,028	≤ 3	0/0,006
> 3-6	-0,020/-0,038	> 3-6	0/0,008
> 6-10	-0,025/-0,047	> 6-10	0/0,009
> 10-18	-0,032/-0,059	> 10-18	0/0,011
> 18-30	-0,040/-0,073	> 18-30	0/0,013

VariMill II™ • Series 577C • Metric

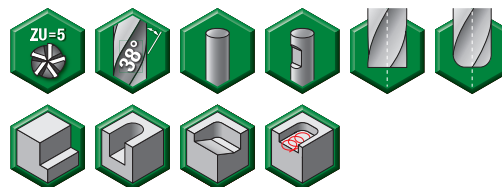
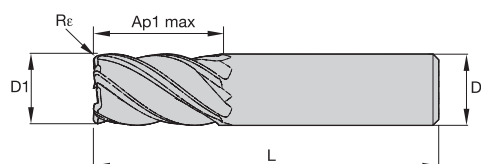

● first choice
○ alternate choice

WIDIA HANITA

P	●
M	●
K	●
N	○
S	○
H	●

catalogue number	D1	D	length of cut Ap1 max	length L	Re	SS	WP15PE
577C04002T	4,0	6	11,00	55	0,25	—	5578866
577C04002W	4,0	6	11,00	55	0,25	W	5578867
577C04012T	4,0	6	11,00	55	—	—	5578868
577C05002T	5,0	6	13,00	57	0,25	—	5578990
577C05002W	5,0	6	13,00	57	0,25	W	5578991
577C050R2TE	5,0	6	13,00	57	0,50	—	6519448
577C06002T	6,0	6	13,00	57	0,40	—	5578992
577C06002W	6,0	6	13,00	57	0,40	W	5578993
577C06012T	6,0	6	13,00	57	—	—	5578994
577C060R2TE	6,0	6	13,00	57	0,50	—	6519449
577C060R2TJ	6,0	6	13,00	57	1,00	—	6519450
577C07003T	7,0	8	16,00	63	0,40	—	5578995
577C08003T	8,0	8	19,00	63	0,50	—	5578997
577C08003W	8,0	8	19,00	63	0,50	W	5578998
577C08013T	8,0	8	19,00	63	—	—	5578999
577C080R3TJ	8,0	8	19,00	63	1,00	—	6519481
577C080R3TK	8,0	8	19,00	63	1,50	—	6519482
577C09004T	9,0	10	19,00	72	0,50	—	5579021
577C10004MW	10,0	10	22,00	72	0,50	W	3881111
577C10004T	10,0	10	22,00	72	0,50	—	5579023
577C10004W	10,0	10	22,00	72	0,50	W	5579024
577C10014T	10,0	10	22,00	72	—	—	5579025
577C100R4TJ	10,0	10	22,00	72	1,00	—	6519483
577C100R4TK	10,0	10	22,00	72	1,50	—	6519484
577C100R4TM	10,0	10	22,00	72	2,00	—	6519485
577C12005MW	12,0	12	26,00	83	0,75	W	3881112
577C12005T	12,0	12	26,00	83	0,75	—	5579026
577C12005W	12,0	12	26,00	83	0,75	W	5579027
577C12015T	12,0	12	26,00	83	—	—	5579028
577C120R5TE	12,0	12	26,00	83	0,50	—	6519486
577C120R5TJ	12,0	12	26,00	83	1,00	—	6519487
577C120R5TK	12,0	12	26,00	83	1,50	—	6519488

High-Performance Solid Carbide End Mills • VariMill™

VariMill II™ • Series 577C • Metric

(continued)

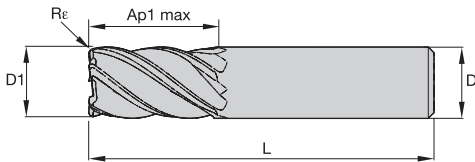

- first choice
- alternate choice

P	●
M	●
K	●
N	○
S	○
H	●

catalogue number	D1	D	length of cut Ap1 max	length L	Re	SS	WP15PE
577C120R5TM	12,0	12	26,00	83	2,00	—	6519489
577C120R5TN	12,0	12	26,00	83	2,50	—	6519490
577C120R5TP	12,0	12	26,00	83	3,00	—	6519491
577C14004T	14,0	14	26,00	83	0,75	—	5579029
577C14004W	14,0	14	26,00	83	0,75	W	5579040
577C14014T	14,0	14	26,00	83	—	—	5579041
577C16006MW	16,0	16	32,00	92	0,75	W	3881113
577C16006T	16,0	16	32,00	92	0,75	—	5579042
577C16006W	16,0	16	32,00	92	0,75	W	5579043
577C16016T	16,0	16	32,00	92	—	—	5579044
577C160R6TE	16,0	16	32,00	92	0,50	—	6519492
577C160R6TJ	16,0	16	32,00	92	1,00	—	6519493
577C160R6TM	16,0	16	32,00	92	2,00	—	6519497
577C160R6TP	16,0	16	32,00	92	3,00	—	6519499
577C160R6TQ	16,0	16	32,00	92	4,00	—	6519500
577C18008T	18,0	18	32,00	92	0,75	—	5579045
577C20007T	20,0	20	38,00	104	0,75	—	5579047
577C20007W	20,0	20	38,00	104	0,75	W	5579048
577C20017T	20,0	20	38,00	104	—	—	5579049
577C200R7TJ	20,0	20	38,00	104	1,00	—	6519501
577C200R7TM	20,0	20	38,00	104	2,00	—	6519502
577C200R7TP	20,0	20	38,00	104	3,00	—	6519503
577C200R7TQ	20,0	20	38,00	104	4,00	—	6519504
577C200R7TR	20,0	20	38,00	104	5,00	—	6519505
577C25008T	25,0	25	45,00	121	0,75	—	5579060
577C25008W	25,0	25	45,00	121	0,75	W	5579061
577C250R8TM	25,0	25	45,00	121	2,00	—	6519506
577C250R8TP	25,0	25	45,00	121	3,00	—	6519507
577C250R8TQ	25,0	25	45,00	121	4,00	—	6519508
577C250R8TR	25,0	25	45,00	121	5,00	—	6519509

NOTE: SS = Shank Style
W = Weldon®

End Mill Tolerances

D1	tolerance e8	D	tolerance h6 + / -
≤ 3	-0,014/-0,028	≤ 3	0/0,006
> 3-6	-0,020/-0,038	> 3-6	0/0,008
> 6-10	-0,025/-0,047	> 6-10	0/0,009
> 10-18	-0,032/-0,059	> 10-18	0/0,011
> 18-30	-0,040/-0,073	> 18-30	0/0,013



VariMill II™ • Series 57NC • Metric

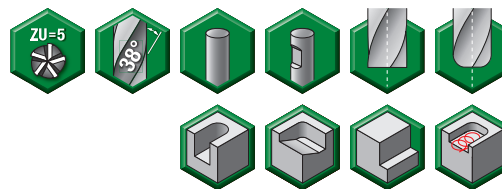
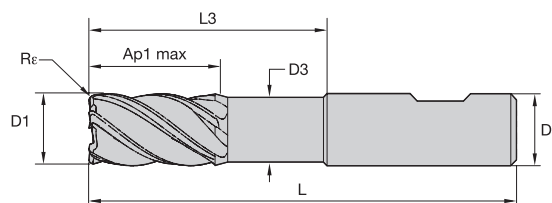

- first choice
- alternate choice

P	●
M	●
K	●
N	○
S	○
H	○

WIDIA HANITA

catalogue number	D1	D	D3	length of cut Ap1 max	L3	length L	Re	SS	WS15PE
57NC06002T	6,0	6	5,64	13,00	18,00	63	—	—	5598906
57NC06022T	6,0	6	5,64	13,00	18,00	63	0,50	—	5598907
57NC06032T	6,0	6	5,64	13,00	18,00	63	1,00	—	5598909
57NC06042W	6,0	6	5,64	13,00	18,00	63	1,50	W	5599071
57NC060R2TK	6,0	6	5,64	13,00	17,82	63	1,50	—	6569491
57NC08003T	8,0	8	7,52	19,00	24,00	76	—	—	5599072
57NC08023T	8,0	8	7,52	19,00	24,00	76	0,50	—	5599073
57NC08023W	8,0	8	7,52	19,00	24,00	76	0,50	W	5599074
57NC08033T	8,0	8	7,52	19,00	24,00	76	1,00	—	5599075
57NC08033W	8,0	8	7,52	19,00	24,00	76	1,00	W	5599076
57NC08053W	8,0	8	7,52	19,00	24,00	76	2,00	W	5599077
57NC080R3TK	8,0	8	7,52	19,00	24,00	76	1,50	—	6569492
57NC080R3TM	8,0	8	7,52	19,00	24,00	76	2,00	—	6569493
57NC10004T	10,0	10	9,40	22,00	30,00	76	—	—	5599078
57NC10024T	10,0	10	9,40	22,00	30,00	76	0,50	—	5599079
57NC10024W	10,0	10	9,40	22,00	30,00	76	0,50	W	5599080
57NC10034T	10,0	10	9,40	22,00	30,00	76	1,00	—	5599081
57NC10034W	10,0	10	9,40	22,00	30,00	76	1,00	W	5599082
57NC10054T	10,0	10	9,40	22,00	30,00	76	2,00	—	5599083
57NC100R4TK	10,0	10	9,40	22,00	30,00	76	1,50	—	6569494
57NC12005T	12,0	12	11,28	26,00	36,00	83	—	—	5599085
57NC12025T	12,0	12	11,28	26,00	36,00	83	0,50	—	5599086
57NC12025W	12,0	12	11,28	26,00	36,00	83	0,50	W	5599087
57NC12035T	12,0	12	11,28	26,00	36,00	83	1,00	—	5599088
57NC12055T	12,0	12	11,28	26,00	36,00	83	2,00	—	5599090
57NC12055W	12,0	12	11,28	26,00	36,00	83	2,00	W	5599091
57NC120R5TK	12,0	12	11,28	26,00	36,00	83	1,50	—	6569495
57NC120R5TP	12,0	12	11,28	26,00	36,00	83	3,00	—	6569496
57NC16006T	16,0	16	15,04	32,00	48,00	100	—	—	5599092
57NC16026T	16,0	16	15,04	32,00	48,00	100	0,50	—	5599093
57NC16026W	16,0	16	15,04	32,00	48,00	100	0,50	W	5598905
57NC16036T	16,0	16	15,04	32,00	48,00	100	1,00	—	5599094

High-Performance Solid Carbide End Mills • VariMill™

VariMill II™ • Series 57NC • Metric

(continued)

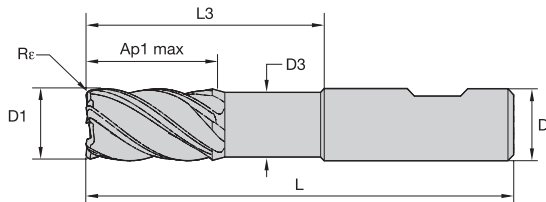

- first choice
- alternate choice

P	●
M	●
K	●
N	○
S	○
H	○

catalogue number	D1	D	D3	length of cut Ap1 max	L3	length L	Re	SS	WS15PE
57NC16036W	16,0	16	15,04	32,00	48,00	100	1,00	W	5599095
57NC16056T	16,0	16	15,04	32,00	48,00	100	2,00	—	5599096
57NC16076T	16,0	16	15,04	32,00	48,00	100	3,00	—	5599098
57NC16076W	16,0	16	15,04	32,00	48,00	100	3,00	W	5599099
57NC160R6TQ	16,0	16	15,04	32,00	48,00	100	4,00	—	6569497
57NC20007T	20,0	20	18,80	38,00	60,00	115	—	—	5599100
57NC20027T	20,0	20	18,80	38,00	60,00	115	0,50	—	5599101
57NC20027W	20,0	20	18,80	38,00	60,00	115	0,50	W	5599102
57NC20037T	20,0	20	18,80	38,00	60,00	115	1,00	—	5599103
57NC20037W	20,0	20	18,80	38,00	60,00	115	1,00	W	5599104
57NC20057T	20,0	20	18,80	38,00	60,00	115	2,00	—	5599105
57NC20077T	20,0	20	18,80	38,00	60,00	115	3,00	—	5599107
57NC20077W	20,0	20	18,80	38,00	60,00	115	3,00	W	5599108
57NC20087T	20,0	20	18,80	38,00	60,00	115	4,00	—	5599109
57NC200R7TR	20,0	20	18,80	38,00	60,00	115	5,00	—	6569498
57NC25008T	25,0	25	23,50	45,00	75,00	135	—	—	5599111
57NC25028T	25,0	25	23,50	45,00	75,00	135	0,50	—	5599112
57NC25038T	25,0	25	23,50	45,00	75,00	135	1,00	—	5599114
57NC25038W	25,0	25	23,50	45,00	75,00	135	1,00	W	5599115
57NC25058T	25,0	25	23,50	45,00	75,00	135	2,00	—	5599116
57NC25078T	25,0	25	23,50	45,00	75,00	135	3,00	—	5599118
57NC25088T	25,0	25	23,50	45,00	75,00	135	4,00	—	5599120

NOTE: SS = Shank Style
W = Weldon

End Mill Tolerances

D1	tolerance e8	D	tolerance h6 + / -
≤ 3	-0,014/-0,028	≤ 3	0/0,006
> 3-6	-0,020/-0,038	> 3-6	0/0,008
> 6-10	-0,025/-0,047	> 6-10	0/0,009
> 10-18	-0,032/-0,059	> 10-18	0/0,011
> 18-30	-0,040/-0,073	> 18-30	0/0,013



VariMill II™ • Series 57N8 • Metric

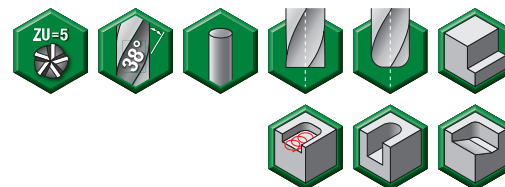
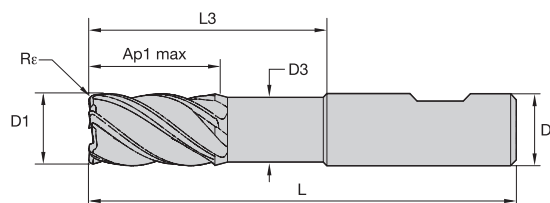

- first choice
- alternate choice

P	<input type="radio"/>
M	<input checked="" type="radio"/>
K	<input checked="" type="radio"/>
N	<input type="radio"/>
S	<input checked="" type="radio"/>
H	<input type="radio"/>

WIDIA HANITA

catalogue number	D1	D	D3	length of cut Ap1 max	L3	length L	Re	SS	WS15PE
57N806002MT	6,0	6	5,60	13,00	18,00	63	—	—	3524626
57N806022MT	6,0	6	5,60	13,00	18,00	63	0,50	—	3524627
57N8060R2MTG	6,0	6	5,64	13,00	18,00	63	0,75	—	6492821
57N808003MT	8,0	8	7,50	19,00	24,00	76	—	—	3524629
57N808023MT	8,0	8	7,50	19,00	24,00	76	0,50	—	3524631
57N8080R3MTG	8,0	8	7,52	19,00	24,00	76	0,75	—	6492822
57N8080R3MTK	8,0	8	7,52	19,00	24,00	76	1,50	—	6492825
57N810004MT	10,0	10	9,40	22,00	30,00	76	—	—	3524632
57N810024MT	10,0	10	9,40	22,00	30,00	76	0,50	—	3524643
57N810034MT	10,0	10	9,40	22,00	30,00	76	1,00	—	3524644
57N810054MT	10,0	10	9,40	22,00	30,00	76	2,00	—	3524645
57N8100R4MTG	10,0	10	9,40	22,00	30,00	76	0,75	—	6492823
57N8100R4MTK	10,0	10	9,40	22,00	30,00	76	1,50	—	6492826
57N812025MT	12,0	12	11,28	26,00	36,00	83	0,50	—	3524647
57N812035MT	12,0	12	11,28	26,00	36,00	83	1,00	—	3524648
57N812055MT	12,0	12	11,28	26,00	36,00	83	2,00	—	3524649
57N8120R5MTK	12,0	12	11,28	26,00	36,00	83	1,50	—	6492827
57N8120R5MTN	12,0	12	11,28	26,00	36,00	83	2,50	—	6492829
57N8120R5MTP	12,0	12	11,28	26,00	36,00	83	3,00	—	6492830
57N816006MT	16,0	16	15,05	32,00	48,00	100	—	—	3524650
57N816026MT	16,0	16	15,05	32,00	48,00	100	0,50	—	3524651
57N816026MW	16,0	16	15,05	32,00	48,00	100	0,50	W	3562867
57N816036MT	16,0	16	15,05	32,00	48,00	100	1,00	—	3524652
57N816076MT	16,0	16	15,05	32,00	48,00	100	3,00	—	3524654

High-Performance Solid Carbide End Mills • VariMill™

VariMill II™ • Series 57N8 • Metric

(continued)

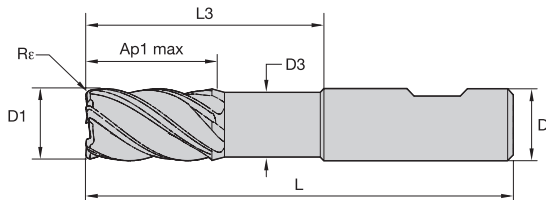

- first choice
- alternate choice

P	<input type="radio"/>
M	<input checked="" type="radio"/>
K	<input checked="" type="radio"/>
N	<input type="radio"/>
S	<input checked="" type="radio"/>
H	<input type="radio"/>



catalogue number	D1	D	D3	length of cut Ap1 max	L3	length L	Re	SS	WS15PE
57N816076MW	16,0	16	15,05	32,00	48,00	100	3,00	W	3524692
57N8160R6MTQ	16,0	16	15,04	32,00	48,00	100	4,00	—	6492832
57N820027MW	20,0	20	18,80	38,00	60,00	115	0,50	W	3524693
57N8200R7MTJ	20,0	20	18,80	38,00	60,00	115	1,00	—	6492824
57N8200R7MTR	20,0	20	18,80	38,00	60,00	115	5,00	—	6492833
57N8250R8MTP	25,0	25	23,50	45,00	75,00	135	3,00	—	6492831
57N8250R8MTR	25,0	25	23,50	45,00	75,00	135	5,00	—	6492834

NOTE: SS = Shank Style
W = Weldon®

End Mill Tolerances



D1	tolerance e8	D	tolerance h6 + / -
≤ 3	-0,014/-0,028	≤ 3	0/0,006
> 3-6	-0,020/-0,038	> 3-6	0/0,008
> 6-10	-0,025/-0,047	> 6-10	0/0,009
> 10-18	-0,032/-0,059	> 10-18	0/0,011
> 18-30	-0,040/-0,073	> 18-30	0/0,013

Application Data • VariMill I™ • Series 4777 • Metric

Material Group																			
	Side Milling (A) and Slotting (B)			WP15PE			Recommended feed per tooth (fz = mm/th) for side milling (A). For slotting (B), reduce fz by 20%.												
	A		B	Cutting Speed – vc m/min			D1 – Diameter												
	ap	ae	ap	min	–	max	mm	4,0	5,0	6,0	8,0	10,0	12,0	14,0	16,0	18,0	20,0	25,0	
P	0	1,5 x D	0,5 x D	1 x D	150	–	200	fz	0,028	0,036	0,044	0,060	0,072	0,083	0,092	0,101	0,108	0,114	0,124
	1	1,5 x D	0,5 x D	1 x D	150	–	200	fz	0,028	0,036	0,044	0,060	0,072	0,083	0,092	0,101	0,108	0,114	0,124
	2	1,5 x D	0,5 x D	1 x D	140	–	190	fz	0,028	0,036	0,044	0,060	0,072	0,083	0,092	0,101	0,108	0,114	0,124
	3	1,5 x D	0,5 x D	1 x D	120	–	160	fz	0,023	0,030	0,036	0,050	0,061	0,070	0,079	0,087	0,095	0,101	0,114
	4	1,5 x D	0,5 x D	0,75 x D	90	–	150	fz	0,021	0,027	0,033	0,045	0,054	0,062	0,070	0,077	0,083	0,088	0,098
	5	1,5 x D	0,5 x D	1 x D	60	–	100	fz	0,019	0,024	0,029	0,040	0,048	0,056	0,063	0,070	0,076	0,081	0,091
M	6	1,5 x D	0,5 x D	0,75 x D	50	–	75	fz	0,016	0,020	0,025	0,034	0,040	0,047	0,052	0,057	0,061	0,065	0,071
	1	1,5 x D	0,5 x D	1 x D	90	–	115	fz	0,023	0,030	0,036	0,050	0,061	0,070	0,079	0,087	0,095	0,101	0,114
	2	1,5 x D	0,5 x D	1 x D	60	–	80	fz	0,019	0,024	0,029	0,040	0,048	0,056	0,063	0,070	0,076	0,081	0,091
K	3	1,5 x D	0,5 x D	1 x D	60	–	70	fz	0,016	0,020	0,025	0,034	0,040	0,047	0,052	0,057	0,061	0,065	0,071
	1	1,5 x D	0,5 x D	1 x D	120	–	150	fz	0,028	0,036	0,044	0,060	0,072	0,083	0,092	0,101	0,108	0,114	0,124
	2	1,5 x D	0,5 x D	1 x D	110	–	140	fz	0,023	0,030	0,036	0,050	0,061	0,070	0,079	0,087	0,095	0,101	0,114
S	3	1,5 x D	0,5 x D	1 x D	110	–	130	fz	0,019	0,024	0,029	0,040	0,048	0,056	0,063	0,070	0,076	0,081	0,091
	1	1,5 x D	0,3 x D	0,3 x D	50	–	90	fz	0,023	0,030	0,036	0,050	0,061	0,070	0,079	0,087	0,095	0,101	0,114
	2	1,5 x D	0,3 x D	0,3 x D	25	–	40	fz	0,013	0,016	0,019	0,026	0,032	0,037	0,042	0,046	0,050	0,054	0,061
	3	1,5 x D	0,5 x D	1 x D	60	–	80	fz	0,019	0,024	0,029	0,040	0,048	0,056	0,063	0,070	0,076	0,081	0,091
H	4	1,5 x D	0,5 x D	1 x D	50	–	60	fz	0,016	0,021	0,026	0,037	0,045	0,052	0,058	0,064	0,069	0,074	0,084
	1	1,5 x D	0,5 x D	0,75 x D	80	–	140	fz	0,021	0,027	0,033	0,045	0,054	0,062	0,070	0,077	0,083	0,088	0,098

NOTE: Lower value of cutting speed is used for high stock removal applications or for higher hardness (machinability) within group.
Higher value of cutting speed is used for finishing applications or for lower hardness (machinability) within group.
Above parameters are based on ideal conditions. For smaller taper machining centres, please adjust parameters accordingly on >12mm diameters.



Application Data • VariMill I • Series 47N7 • WP15PE • Metric

Material Group																
	Side Milling (A) and Slotting (B)			WP15PE			Recommended feed per tooth (fz = mm/th) for side milling (A). For slotting (B), reduce fz by 20%.									
	A		B	Cutting Speed – vc m/min			D1 – Diameter									
	ap	ae	ap	min	–	max	mm	4,0	6,0	8,0	10,0	12,0	16,0	20,0		
P	1	1,5 x D	0,5 x D	1 x D	150	–	200	fz	0,028	0,044	0,060	0,072	0,083	0,101	0,114	
	2	1,5 x D	0,5 x D	1 x D	140	–	190	fz	0,028	0,044	0,060	0,072	0,083	0,101	0,114	
	3	1,5 x D	0,5 x D	1 x D	120	–	160	fz	0,023	0,036	0,050	0,061	0,070	0,087	0,101	
	4	1,5 x D	0,5 x D	0,75 x D	90	–	150	fz	0,021	0,033	0,045	0,054	0,062	0,077	0,088	
	5	1,5 x D	0,5 x D	1 x D	60	–	100	fz	0,019	0,029	0,040	0,048	0,056	0,070	0,081	
	6	1,5 x D	0,5 x D	0,75 x D	50	–	75	fz	0,016	0,025	0,034	0,040	0,047	0,057	0,065	
M	1	1,5 x D	0,5 x D	1 x D	90	–	115	fz	0,023	0,036	0,050	0,061	0,070	0,087	0,101	
	2	1,5 x D	0,5 x D	1 x D	60	–	80	fz	0,019	0,029	0,040	0,048	0,056	0,070	0,081	
	3	1,5 x D	0,5 x D	1 x D	60	–	70	fz	0,016	0,025	0,034	0,040	0,047	0,057	0,065	
K	1	1,5 x D	0,5 x D	1 x D	120	–	150	fz	0,028	0,044	0,060	0,072	0,083	0,101	0,114	
	2	1,5 x D	0,5 x D	1 x D	110	–	130	fz	0,023	0,036	0,050	0,061	0,070	0,087	0,101	
	3	1,5 x D	0,5 x D	1 x D	100	–	130	fz	0,019	0,029	0,040	0,048	0,056	0,070	0,081	
S	1	1,5 x D	0,3 x D	0,3 x D	50	–	90	fz	0,023	0,036	0,050	0,061	0,070	0,087	0,101	
	2	1,5 x D	0,3 x D	0,3 x D	25	–	40	fz	0,013	0,019	0,026	0,032	0,037	0,046	0,054	
	3	1,5 x D	0,5 x D	1 x D	60	–	80	fz	0,019	0,029	0,040	0,048	0,056	0,070	0,081	
	4	1,5 x D	0,5 x D	1 x D	50	–	60	fz	0,016	0,026	0,037	0,045	0,052	0,064	0,074	
H	1	1,5 x D	0,5 x D	0,75 x D	80	–	140	fz	0,021	0,033	0,045	0,054	0,062	0,077	0,088	

NOTE: Lower value of cutting speed is used for high stock removal applications or for higher hardness (machinability) within group.
Higher value of cutting speed is used for finishing applications or for lower hardness (machinability) within group.
Above parameters are based on ideal conditions. For smaller taper machining centres, please adjust parameters accordingly on >12mm diameters.



High-Performance Solid Carbide End Mills • VariMill™

Application Data • VariMill I™ • Series 47N7 • TiAlN-LT • Metric

Material Group															
	Side Milling (A) and Slotting (B)			TiAlN			Recommended feed per tooth (fz = mm/th) for side milling (A). For slotting (B), reduce fz by 20%.								
	A		B	Cutting Speed – vc m/min			D1 – Diameter								
	ap	ae	ap	min		max	mm	4,0	6,0	8,0	10,0	12,0	16,0	20,0	
P	1	1,5 x D	0,5 x D	1 x D	150	–	200	fz	0,028	0,044	0,060	0,072	0,083	0,101	0,114
	2	1,5 x D	0,5 x D	1 x D	140	–	190	fz	0,028	0,044	0,060	0,072	0,083	0,101	0,114
	3	1,5 x D	0,5 x D	1 x D	120	–	160	fz	0,023	0,036	0,050	0,061	0,070	0,087	0,101
	4	1,5 x D	0,5 x D	0,75 x D	90	–	150	fz	0,021	0,033	0,045	0,054	0,062	0,077	0,088
	5	1,5 x D	0,5 x D	1 x D	60	–	100	fz	0,019	0,029	0,040	0,048	0,056	0,070	0,081
	6	1,5 x D	0,5 x D	0,75 x D	50	–	75	fz	0,016	0,025	0,034	0,040	0,047	0,057	0,065
M	1	1,5 x D	0,5 x D	1 x D	90	–	115	fz	0,023	0,036	0,050	0,061	0,070	0,087	0,101
	2	1,5 x D	0,5 x D	1 x D	60	–	80	fz	0,019	0,029	0,040	0,048	0,056	0,070	0,081
	3	1,5 x D	0,5 x D	1 x D	60	–	70	fz	0,016	0,025	0,034	0,040	0,047	0,057	0,065
K	1	1,5 x D	0,5 x D	1 x D	120	–	150	fz	0,028	0,044	0,060	0,072	0,083	0,101	0,114
	2	1,5 x D	0,5 x D	1 x D	110	–	130	fz	0,023	0,036	0,050	0,061	0,070	0,087	0,101
	3	1,5 x D	0,5 x D	1 x D	100	–	130	fz	0,019	0,029	0,040	0,048	0,056	0,070	0,081
S	1	1,5 x D	0,3 x D	0,3 x D	50	–	90	fz	0,023	0,036	0,050	0,061	0,070	0,087	0,101
	2	1,5 x D	0,3 x D	0,3 x D	25	–	40	fz	0,013	0,019	0,026	0,032	0,037	0,046	0,054
	3	1,5 x D	0,5 x D	1 x D	60	–	80	fz	0,019	0,029	0,040	0,048	0,056	0,070	0,081
	4	1,5 x D	0,5 x D	1 x D	50	–	60	fz	0,016	0,026	0,037	0,045	0,052	0,064	0,074
H	1	1,5 x D	0,5 x D	0,75 x D	80	–	140	fz	0,021	0,033	0,045	0,054	0,062	0,077	0,088

NOTE: Lower value of cutting speed is used for high stock removal applications or for higher hardness (machinability) within group.
Higher value of cutting speed is used for finishing applications or for lower hardness (machinability) within group.
Above parameters are based on ideal conditions. For smaller taper machining centres, please adjust parameters accordingly on >12mm diameters.

Application Data • VariMill II™ • Series 5777 • Metric



Material Group																
	Side Milling (A) and Slotting (B)			WP15PE			Recommended feed per tooth (fz = mm/th) for side milling (A). For slotting (B), reduce fz by 20%.									
	A		B	Cutting Speed – vc m/min			D1 – Diameter									
	ap	ae	ap	min		max	mm	4,0	6,0	8,0	10,0	12,0	16,0	20,0	25,0	
P	1	1,5 x D	0,5 x D	1 x D	150	–	200	fz	0,028	0,044	0,060	0,072	0,083	0,101	0,114	0,124
	2	1,5 x D	0,5 x D	1 x D	140	–	190	fz	0,028	0,044	0,060	0,072	0,083	0,101	0,114	0,124
	3	1,5 x D	0,5 x D	1 x D	120	–	160	fz	0,023	0,036	0,050	0,061	0,070	0,087	0,101	0,114
	4	1,5 x D	0,5 x D	0,75 x D	90	–	150	fz	0,021	0,033	0,045	0,054	0,062	0,077	0,088	0,098
	5	1,5 x D	0,5 x D	1 x D	60	–	100	fz	0,019	0,029	0,040	0,048	0,056	0,070	0,081	0,091
	6	1,5 x D	0,5 x D	0,75 x D	50	–	75	fz	0,016	0,025	0,034	0,040	0,047	0,057	0,065	0,071
M	1	1,5 x D	0,5 x D	1 x D	90	–	115	fz	0,023	0,036	0,050	0,061	0,070	0,087	0,101	0,114
	2	1,5 x D	0,5 x D	1 x D	60	–	80	fz	0,019	0,029	0,040	0,048	0,056	0,070	0,081	0,091
	3	1,5 x D	0,5 x D	1 x D	60	–	70	fz	0,016	0,025	0,034	0,040	0,047	0,057	0,065	0,071
K	1	1,5 x D	0,5 x D	1 x D	120	–	150	fz	0,028	0,044	0,060	0,072	0,083	0,101	0,114	0,124
	2	1,5 x D	0,5 x D	1 x D	110	–	130	fz	0,023	0,036	0,050	0,061	0,070	0,087	0,101	0,114
	3	1,5 x D	0,5 x D	1 x D	100	–	130	fz	0,019	0,029	0,040	0,048	0,056	0,070	0,081	0,091
S	1	1,5 x D	0,3 x D	0,3 x D	50	–	90	fz	0,023	0,036	0,050	0,061	0,070	0,087	0,101	0,114
	2	1,5 x D	0,3 x D	0,3 x D	25	–	40	fz	0,013	0,019	0,026	0,032	0,037	0,046	0,054	0,061
	3	1,5 x D	0,5 x D	1 x D	60	–	80	fz	0,019	0,029	0,040	0,048	0,056	0,070	0,081	0,091
	4	1,5 x D	0,5 x D	1 x D	50	–	60	fz	0,016	0,026	0,037	0,045	0,052	0,064	0,074	0,084
H	1	1,5 x D	0,5 x D	0,75 x D	80	–	140	fz	0,021	0,033	0,045	0,054	0,062	0,077	0,088	0,098

NOTE: Lower value of cutting speed is used for high-stock removal applications or for higher hardness (machinability) within group.
Higher value of cutting speed is used for finishing applications or for lower hardness (machinability) within group.
Above parameters are based on ideal conditions. For smaller taper machining centers, please adjust parameters accordingly on > 12mm diameters.

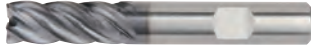
Application Data • VariMill II™ • Series 577C • Metric

Material Group																					
	Side Milling (A) and Slotting (B)			WP15PE			Recommended feed per tooth (fz = mm/th) for side milling (A). For slotting (B), reduce fz by 20%.														
	A		B	Cutting Speed – vc m/min			D1 – Diameter														
	ap	ae	ap	min		max	mm	6,0	8,0	10,0	12,0	14,0	16,0	18,0	20,0	25,0					
P	0	1,5 x D	0,5 x D	1 x D	150	–	200	fz	0,044	0,060	0,072	0,083	0,092	0,101	0,108	0,114	0,124				
	1	1,5 x D	0,5 x D	1 x D	150	–	200	fz	0,044	0,060	0,072	0,083	0,092	0,101	0,108	0,114	0,124				
	2	1,5 x D	0,5 x D	1 x D	140	–	190	fz	0,044	0,060	0,072	0,083	0,092	0,101	0,108	0,114	0,124				
	3	1,5 x D	0,5 x D	1 x D	120	–	160	fz	0,036	0,050	0,061	0,070	0,079	0,087	0,095	0,101	0,114				
	4	1,5 x D	0,5 x D	0,75 x D	90	–	150	fz	0,033	0,045	0,054	0,062	0,070	0,077	0,083	0,088	0,098				
M	1	1,5 x D	0,5 x D	1 x D	60	–	100	fz	0,029	0,040	0,048	0,056	0,063	0,070	0,076	0,081	0,091				
	2	1,5 x D	0,5 x D	1 x D	90	–	115	fz	0,036	0,050	0,061	0,070	0,079	0,087	0,095	0,101	0,114				
	3	1,5 x D	0,5 x D	1 x D	60	–	80	fz	0,029	0,040	0,048	0,056	0,063	0,070	0,076	0,081	0,091				
K	1	1,5 x D	0,5 x D	1 x D	60	–	70	fz	0,025	0,034	0,040	0,047	0,052	0,057	0,061	0,065	0,071				
	2	1,5 x D	0,5 x D	1 x D	120	–	150	fz	0,044	0,060	0,072	0,083	0,092	0,101	0,108	0,114	0,124				
	3	1,5 x D	0,5 x D	1 x D	110	–	140	fz	0,036	0,050	0,061	0,070	0,079	0,087	0,095	0,101	0,114				
S	1	1,5 x D	0,3 x D	0,3 x D	110	–	130	fz	0,029	0,040	0,048	0,056	0,063	0,070	0,076	0,081	0,091				
	1	1,5 x D	0,3 x D	0,3 x D	50	–	90	fz	0,036	0,050	0,061	0,070	0,079	0,087	0,095	0,101	0,114				
	2	1,5 x D	0,3 x D	0,3 x D	25	–	40	fz	0,019	0,026	0,032	0,037	0,042	0,046	0,050	0,054	0,061				
	3	1,5 x D	0,3 x D	1 x D	60	–	80	fz	0,029	0,040	0,048	0,056	0,063	0,070	0,076	0,081	0,091				
H	1	1,5 x D	0,5 x D	1 x D	50	–	60	fz	0,026	0,037	0,045	0,052	0,058	0,064	0,069	0,074	0,084				
	2	1,5 x D	0,5 x D	0,75 x D	80	–	140	fz	0,033	0,045	0,054	0,062	0,070	0,077	0,083	0,088	0,098				
	2	1,5 x D	0,2 x D	0,5 x D	70	–	120	fz	0,025	0,034	0,040	0,047	0,052	0,057	0,061	0,065	0,071				



Application Data • VariMill II • Series 57NC • Metric

Material Group																					
	Side Milling (A) and Slotting (B)			WS15PE			Recommended feed per tooth (fz = mm/th) for side milling (A). For slotting (B), reduce fz by 20%.														
	A		B	Cutting Speed – vc m/min			D1 – Diameter														
	ap	ae	ap	min		max	mm	6,0	8,0	10,0	12,0	14,0	16,0	18,0	20,0	25,0					
P	5	1,5 x D	0,5 x D	1 x D	60	–	100	fz	0,029	0,040	0,048	0,056	0,063	0,070	0,076	0,081	0,091				
	6	1,5 x D	0,5 x D	0,75 x D	50	–	75	fz	0,025	0,034	0,040	0,047	0,052	0,057	0,061	0,065	0,071				
M	1	1,5 x D	0,5 x D	1 x D	90	–	115	fz	0,036	0,050	0,061	0,070	0,079	0,087	0,095	0,101	0,114				
	2	1,5 x D	0,5 x D	1 x D	60	–	80	fz	0,029	0,040	0,048	0,056	0,063	0,070	0,076	0,081	0,091				
	3	1,5 x D	0,5 x D	1 x D	60	–	70	fz	0,025	0,034	0,040	0,047	0,052	0,057	0,061	0,065	0,071				
K	1	1,5 x D	0,5 x D	1 x D	120	–	150	fz	0,044	0,060	0,072	0,083	0,092	0,101	0,108	0,114	0,124				
	2	1,5 x D	0,5 x D	1 x D	110	–	140	fz	0,036	0,050	0,061	0,070	0,079	0,087	0,095	0,101	0,114				
	3	1,5 x D	0,5 x D	1 x D	110	–	130	fz	0,029	0,040	0,048	0,056	0,063	0,070	0,076	0,081	0,091				
S	1	1,5 x D	0,3 x D	0,3 x D	50	–	90	fz	0,036	0,050	0,061	0,070	0,079	0,087	0,095	0,101	0,114				
	2	1,5 x D	0,3 x D	0,3 x D	25	–	40	fz	0,019	0,026	0,032	0,037	0,042	0,046	0,050	0,054	0,061				
	3	1,5 x D	0,5 x D	1 x D	60	–	80	fz	0,029	0,040	0,048	0,056	0,063	0,070	0,076	0,081	0,091				
	4	1,5 x D	0,5 x D	1 x D	50	–	60	fz	0,026	0,037	0,045	0,052	0,058	0,064	0,069	0,074	0,084				
H	1	1,5 x D	0,5 x D	0,75 x D	80	–	140	fz	0,033	0,045	0,054	0,062	0,070	0,077	0,083	0,088	0,098				
	2	1,5 x D	0,2 x D	0,5 x D	70	–	120	fz	0,025	0,034	0,040	0,047	0,052	0,057	0,061	0,065	0,071				

NOTE: Lower value of cutting speed is used for high stock removal applications or for higher hardness (machinability) within group.
 Higher value of cutting speed is used for finishing applications or for lower hardness (machinability) within group.
 Above parameters are based on ideal conditions. For smaller taper machining centres, please adjust parameters accordingly on >12mm diameters.

High-Performance Solid Carbide End Mills • VariMill™

Application Data • VariMill II™ • Series 57N8 • Metric

Material Group															
		Side Milling (A) and Slotting (B)				WS15PE			Recommended feed per tooth (fz = mm/th) for side milling (A). For slotting (B), reduce fz by 20%.						
		A		B		Cutting Speed – vc m/min			D1 – Diameter						
		ap	ae	ap	min		max	mm	6,0	8,0	10,0	12,0	16,0	20,0	25,0
P	1	1,5 x D	0,5 x D	1 x D	150	–	200	fz	0,044	0,060	0,072	0,083	0,101	0,114	0,124
	2	1,5 x D	0,5 x D	1 x D	140	–	190	fz	0,044	0,060	0,072	0,083	0,101	0,114	0,124
	3	1,5 x D	0,5 x D	1 x D	120	–	160	fz	0,036	0,050	0,061	0,070	0,087	0,101	0,114
	4	1,5 x D	0,5 x D	0,75 x D	90	–	150	fz	0,033	0,045	0,054	0,062	0,077	0,088	0,098
	5	1,5 x D	0,5 x D	1 x D	60	–	100	fz	0,029	0,040	0,048	0,056	0,070	0,081	0,091
	6	1,5 x D	0,5 x D	0,75 x D	50	–	75	fz	0,025	0,034	0,040	0,047	0,057	0,065	0,071
M	1	1,5 x D	0,5 x D	1 x D	90	–	115	fz	0,036	0,050	0,061	0,070	0,087	0,101	0,114
	2	1,5 x D	0,5 x D	1 x D	60	–	80	fz	0,029	0,040	0,048	0,056	0,070	0,081	0,091
	3	1,5 x D	0,5 x D	1 x D	60	–	70	fz	0,025	0,034	0,040	0,047	0,057	0,065	0,071
K	1	1,5 x D	0,5 x D	1 x D	120	–	150	fz	0,044	0,060	0,072	0,083	0,101	0,114	0,124
	2	1,5 x D	0,5 x D	1 x D	110	–	130	fz	0,036	0,050	0,061	0,070	0,087	0,101	0,114
	3	1,5 x D	0,5 x D	1 x D	100	–	130	fz	0,029	0,040	0,048	0,056	0,070	0,081	0,091
S	1	1,5 x D	0,3 x D	0,3 x D	50	–	90	fz	0,036	0,050	0,061	0,070	0,087	0,101	0,114
	2	1,5 x D	0,3 x D	0,3 x D	25	–	40	fz	0,019	0,026	0,032	0,037	0,046	0,054	0,061
	3	1,5 x D	0,5 x D	1 x D	60	–	80	fz	0,029	0,040	0,048	0,056	0,070	0,081	0,091
	4	1,5 x D	0,5 x D	1 x D	50	–	60	fz	0,026	0,037	0,045	0,052	0,064	0,074	0,084
H	1	1,5 x D	0,5 x D	0,75 x D	80	–	140	fz	0,033	0,045	0,054	0,062	0,077	0,088	0,098

NOTE: Lower value of cutting speed is used for high-stock removal applications or for higher hardness (machinability) within group.
 Higher value of cutting speed is used for finishing applications or for lower hardness (machinability) within group.
 Above parameters are based on ideal conditions. For smaller taper machining centers, please adjust parameters accordingly on diameters >12mm diameters.

70NS

VICTORY™ X-FEED™



PRODUCTIVITY IMPROVED IN
HIGH-FEED MILLING OF STAINLESS
STEEL AND TITANIUM MATERIALS





70NS Series

Designed for high feed rates.

6 flutes and 3 x D diameter neck reach.

Designed for circular plunging and ramping, 3D machining, face milling, and pocketing applications.

Stainless steel and high-temp alloys.

Improved tool life due to reduced radial forces.

Larger radial engagement vs. standard ball nose end mills.



5–10%
Radial engagement



55%
Radial engagement

WIDIA HANITA 

WIDIA 
widia.com

Series 70NS • Stainless Steel/High-Temp • Metric

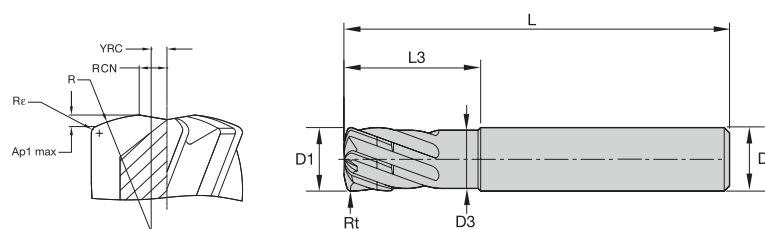

- first choice
- alternate choice

P		
M		●
K		
N		
S		●
H		

WIDIA HANITA

catalogue number	D1	D	D3	L3	length L	R _ε	R _t	AITiN-MT
70NS06002	6,0	6	5,50	17,75	63	0,38	0,67	6441882
70NS08003	8,0	8	7,50	23,75	76	0,50	0,89	6441883
70NS10004	10,0	10	9,00	29,50	89	0,63	1,12	6441884
70NS12005	12,0	12	11,00	35,50	100	0,75	1,34	6441885
70NS16006	16,0	16	15,00	47,50	110	1,00	1,79	6441886
70NS20007	20,0	20	19,00	59,50	125	1,25	2,23	6441887
70NS25008	25,0	25	23,50	74,25	150	1,56	2,90	6441888

NOTE: YRC = distance from centre line to the crown of the R radius.
 RCN = distance from centre line to the start of the cutting edge. This dimension can also help determine the minimum circle size when helical ramping.
 R = the head radius size.
 R_ε = the shoulder radius or radius at the corner of the cutter.

End Mill Tolerances



D1	tolerance e8	D	tolerance h6 + / -
≤ 3	-0,014/-0,028	≤ 3	0/0,006
> 3-6	-0,020/-0,038	> 3-6	0/0,008
> 6-10	-0,025/-0,047	> 6-10	0/0,009
> 10-18	-0,032/-0,059	> 10-18	0/0,011
> 18-30	-0,040/-0,073	> 18-30	0/0,013

High-Performance Solid Carbide End Mills • High Feed

Programming Data

70NS Metric															
Geometrical Parameters									Ramping Guide for Circular and Linear Interpolation						
									Circular Interpolation		Linear Interpolation				
									Allowed Range of Hole Diameter		Calculated Length (mm) per Ramp Angle				
diameter	Ap1 max	Rfm	Rt	Rc	Xfm	Yfm	YD	Number	Smallest	Largest	Ramp Angle (degree)				
[mm]	[mm]	[mm]	[mm]	[mm]	[mm]	[mm]	[mm]	flutes			1	2	3	4	5
6	0,32	6	0,67	0,375	0,338	0,75	1,26	6	8,52	12	18,12	9,06	6,03	4,52	3,61
8	0,42	8	0,89	0,500	0,450	1,00	1,68	6	11,36	16	24,16	12,08	8,05	6,03	4,82
10	0,53	10	1,12	0,625	0,562	1,25	2,10	6	14,2	20	30,20	15,09	10,06	7,54	6,02
12	0,63	12	1,34	0,750	0,674	1,50	2,52	6	17,04	24	36,24	18,11	12,07	9,05	7,23
16	0,84	16	1,79	1,000	0,915	2,00	3,36	6	22,72	32	48,31	24,15	16,09	12,06	9,64
20	1,05	20	2,23	1,250	1,124	2,50	4,20	6	28,4	40	60,39	30,19	20,11	15,08	12,05
25	1,25	25	2,90	1,5625	1,405	3,1250	5,25	6	35,5	50	70,61	35,80	23,85	17,88	14,29
Recommended Feed											30%	30%	30%	30%	10%

Application Data • Series 70NS • Stainless Steel/High-Temp • Metric

Material Group														
		Profile Milling		AlTiN-MT			Recommended Feed Per Tooth (fz = mm/th) for 3D milling/profiling (A)							
		A		Cutting Speed – Vc m/min			D1 – Diameter							
		ap	ae	min		max	mm	6,0	8,0	10,0	12,0	16,0	20,0	25,0
M	1	0,05 x D	0,55 x D	90	–	115	fz	0,300	0,400	0,500	0,540	0,720	0,900	1,125
	2	0,05 x D	0,55 x D	60	–	80	fz	0,240	0,320	0,400	0,480	0,640	0,800	1,000
	3	0,05 x D	0,55 x D	60	–	70	fz	0,240	0,320	0,400	0,480	0,640	0,800	1,000
S	1	0,05 x D	0,55 x D	50	–	90	fz	0,270	0,360	0,450	0,500	0,650	0,800	1,000
	2	0,05 x D	0,55 x D	50	–	80	fz	0,240	0,320	0,400	0,480	0,600	0,700	0,900
	3	0,05 x D	0,55 x D	25	–	40	fz	0,180	0,240	0,300	0,350	0,430	0,500	0,600
	4	0,05 x D	0,55 x D	50	–	60	fz	0,210	0,280	0,350	0,420	0,560	0,700	0,875

NOTE: Lower value of cutting speed is used for high stock removal applications or for higher hardness (machinability) within group.

Higher value of cutting speed is used for finishing applications or for lower hardness (machinability) within group.

Above parameters are based on ideal conditions. For smaller taper machining centres, please adjust parameters accordingly on diameters greater than 12mm.

4U50 & 4U80



AEROSPACE ROUGHING





4U50

Shallow pitch rougher.

4–6 flutes with variable spacing.

Short length of cut and 3 x D diameter neck length.

Stainless steel and high-temp alloys.

Centre cutting.



4U80

Shallow pitch rougher.

4–6 flutes with variable spacing.

Regular length of cut.

Stainless steel and high-temp alloys.

Centre cutting.



New Weldon® shank



WIDIA HANITA 

WIDIA 
widia.com

High-Performance Roughers

High-Performance Solid Carbide End Mills • Roughing

Series 4U50 • Metric

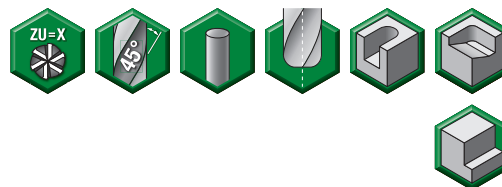
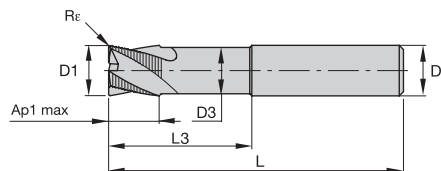

- first choice
- alternate choice

WIDIA HANITA

P	
M	●
K	
N	
S	●
H	

catalogue number	D1	D	D3	length of cut Ap1 max	L3	length L	Rε	ZU	WS15PE
4U50M060R2TC	6,0	6	5,64	6,00	18,00	57	0,30	4	6431403
4U50M080R3TC	8,0	8	7,52	8,00	24,00	63	0,30	4	6431404
4U50M100R4TE	10,0	10	9,40	10,00	30,00	72	0,50	4	6431405
4U50M120R5TE	12,0	12	11,28	12,00	36,00	83	0,50	4	6431406
4U50M160R6TE	16,0	16	15,04	16,00	48,00	92	0,50	6	6431407
4U50M200R7TG	20,0	20	18,80	20,00	60,00	104	1,00	6	6431408
4U50M250R8TG	25,0	25	23,50	25,00	75,00	121	1,00	6	6431409



End Mill Tolerances

D1	tolerance d11	D	tolerance h6 + / -
≤ 3	-0,020/-0,080	≤ 3	0/-0,006
> 3-6	-0,030/-0,105	> 3-6	0/-0,008
> 6-10	-0,040/-0,130	> 6-10	0/-0,009
> 10-18	-0,050/-0,160	> 10-18	0/-0,011
> 18-30	-0,065/-0,195	> 18-30	0/-0,013

WIDIA

High-Performance Solid Carbide End Mills • Roughing

Application Data • Series 4U50 • Metric

Material Group																	
	Side Milling (A) and Slotting (B)				WS15PE			Recommended feed per tooth (fz = mm/th) for side milling (A). For slotting (B), reduce fz by 20%.									
	A		B		Cutting Speed – Vc m/min			D1 – Diameter									
	ap	ae	ap	min	–	max	mm	6,0	8,0	10,0	12,0	14,0	16,0	18,0	20,0	25,0	
M	1	0,8 x D	0,5 x D	0,75 x D	90	–	115	fz	0,036	0,050	0,061	0,070	0,079	0,087	0,095	0,101	0,114
	2	0,8 x D	0,4 x D	0,75 x D	60	–	80	fz	0,029	0,040	0,048	0,056	0,063	0,070	0,076	0,081	0,091
	3	0,8 x D	0,4 x D	0,75 x D	60	–	70	fz	0,025	0,034	0,040	0,047	0,052	0,057	0,061	0,065	0,071
S	1	0,8 x D	0,4 x D	0,75 x D	50	–	90	fz	0,036	0,050	0,061	0,070	0,079	0,087	0,095	0,101	0,114
	2	0,8 x D	0,25 x D	0,3 x D	25	–	40	fz	0,019	0,026	0,032	0,037	0,042	0,046	0,050	0,054	0,061
	3	0,8 x D	0,4 x D	0,75 x D	60	–	80	fz	0,029	0,040	0,048	0,056	0,063	0,070	0,076	0,081	0,091
	4	0,8 x D	0,3 x D	0,3 x D	50	–	60	fz	0,026	0,037	0,045	0,052	0,058	0,064	0,069	0,074	0,084

NOTE: Lower value of cutting speed is used for high stock removal applications or for higher hardness (machinability) within group.

Higher value of cutting speed is used for finishing applications or for lower hardness (machinability) within group.

Above parameters are based on ideal conditions. For smaller taper machining centres, please adjust parameters accordingly on diameters greater than 12mm.

High-Performance Roughers

High-Performance Solid Carbide End Mills • Roughing

Series 4U80 • Metric

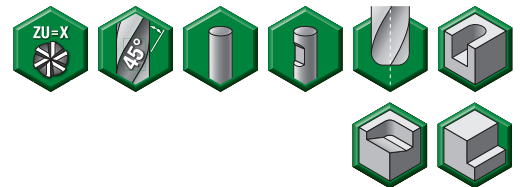
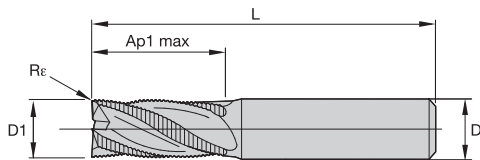

● first choice
○ alternate choice

P		
M	●	●
K		
N		
S	●	●
H		
		NEW!

WIDIA HANITA

catalogue number	D1	D	length of cut Ap1 max	length L	Re	ZU	SS	WS15PE	AITiN-MW
4U80M060R2TC	6,0	6	13,00	57	0,30	4	—	6431246	—
4U80M060R2WC	6,0	6	13,00	57	0,30	4	W	—	6652714
4U80M080R3TC	8,0	8	16,00	63	0,30	4	—	6431247	—
4U80M080R3WC	8,0	8	16,00	63	0,30	4	W	—	6652715
4U80M100R4TE	10,0	10	22,00	72	0,50	4	—	6431248	—
4U80M100R4WE	10,0	10	22,00	72	0,50	4	W	—	6652716
4U80M120R5TE	12,0	12	26,00	83	0,50	4	—	6431249	—
4U80M120R5WE	12,0	12	26,00	83	0,50	4	W	—	6652717
4U80M160R6TE	16,0	16	32,00	92	0,50	6	—	6431250	—
4U80M160R6WE	16,0	16	32,00	92	0,50	6	W	—	6652718
4U80M200R7TG	20,0	20	38,00	104	1,00	6	—	6431401	—
4U80M250R8TG	25,0	25	45,00	121	1,00	6	—	6431402	—

NOTE: SS = Shank Style
W = Weldon®



End Mill Tolerances

D1	tolerance d11	D	tolerance h6 + / -
≤ 3	-0,020/-0,080	≤ 3	0/-0,006
> 3-6	-0,030/-0,105	> 3-6	0/-0,008
> 6-10	-0,040/-0,130	> 6-10	0/-0,009
> 10-18	-0,050/-0,160	> 10-18	0/-0,011
> 18-30	-0,065/-0,195	> 18-30	0/-0,013

WIDIA

High-Performance Solid Carbide End Mills • Roughing

Application Data • Series 4U80 • Metric

Material Group																				
	Side Milling (A) and Slotting (B)				WS15PE/ALTIN-MW			Recommended feed per tooth (fz = mm/th) for side milling (A). For slotting (B), reduce fz by 20%.												
	A		B		Cutting Speed – Vc m/min			D1 – Diameter												
	ap	ae	ap	min	–	max	mm	6,0	8,0	10,0	12,0	14,0	16,0	18,0	20,0	25,0				
M	1	1 x D	0,5 x D	0,75 x D	90	–	115	fz	0,036	0,050	0,061	0,070	0,079	0,087	0,095	0,101	0,114			
	2	1 x D	0,5 x D	0,75 x D	60	–	80	fz	0,029	0,040	0,048	0,056	0,063	0,070	0,076	0,081	0,091			
	3	1 x D	0,5 x D	0,75 x D	60	–	70	fz	0,025	0,034	0,040	0,047	0,052	0,057	0,061	0,065	0,071			
S	1	1 x D	0,3 x D	0,75 x D	50	–	90	fz	0,036	0,050	0,061	0,070	0,079	0,087	0,095	0,101	0,114			
	2	1 x D	0,3 x D	0,3 x D	25	–	40	fz	0,019	0,026	0,032	0,037	0,042	0,046	0,050	0,054	0,061			
	3	1 x D	0,4 x D	0,75 x D	60	–	80	fz	0,029	0,040	0,048	0,056	0,063	0,070	0,076	0,081	0,091			
	4	1 x D	0,4 x D	0,75 x D	50	–	60	fz	0,026	0,037	0,045	0,052	0,058	0,064	0,069	0,074	0,084			

NOTE: Lower value of cutting speed is used for high stock removal applications or for higher hardness (machinability) within group.

Higher value of cutting speed is used for finishing applications or for lower hardness (machinability) within group.

Above parameters are based on ideal conditions. For smaller taper machining centres, please adjust parameters accordingly on diameters greater than 12mm.

49N9

LINE EXPANSION



ALUMINIUM ROUGHING





49N9 Series

3-Flute, 40 degree helix.

Coarse cord style roughing profile.

Protective chamfer configuration.

Extended neck for long-reach applications.

Centre cutting.

Chamfered pitch.

WIDIA HANITA 

WIDIA 
widia.com

High-Performance Solid Carbide End Mills

High-Performance Solid Carbide End Mills • Aluminium

Series 49N9 • Metric

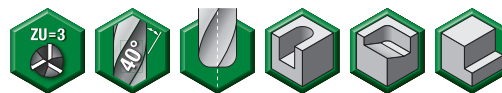
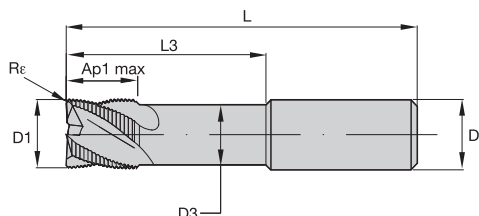

- first choice
- alternate choice

P	
M	
K	
N	●
S	
H	

WIDIA HANITA

catalogue number	D1	D	D3	length of cut Ap1 max	L3	length L	Re	UNCOATED
49N906002..	6,0	6	5,00	8,00	18,00	57	0,25	2510324
49N90601R2BT	6,0	6	5,00	13,00	18,00	57	0,25	6590507
49N908003..	8,0	8	7,00	10,00	24,00	63	0,25	2510325
49N90801R3BT	8,0	8	7,00	16,00	24,00	63	0,25	6590508
49N910004..	10,0	10	9,00	12,00	30,00	72	0,50	2510326
49N91001R4ET	10,0	10	9,00	22,00	30,00	72	0,50	6590509
49N912005..	12,0	12	11,00	15,00	36,00	83	0,50	2510327
49N91201R5ET	12,0	12	11,00	26,00	36,00	83	0,50	6590510
49N916006..	16,0	16	14,80	20,00	48,00	92	1,00	2510328
49N91601R6JT	16,0	16	14,80	32,00	48,00	92	1,00	6590521
49N920007..	20,0	20	18,70	24,00	60,00	104	1,00	2510329
49N92001R7JT	20,0	20	18,70	38,00	60,00	104	1,00	6590522



End Mill Tolerances

D1	tolerance e8	D	tolerance h6 + / -
≤ 3	-0,014/-0,028	≤ 3	0/0,006
> 3-6	-0,020/-0,038	> 3-6	0/0,008
> 6-10	-0,025/-0,047	> 6-10	0/0,009
> 10-18	-0,032/-0,059	> 10-18	0/0,011
> 18-30	-0,040/-0,073	> 18-30	0/0,013

WIDIA

High-Performance Solid Carbide End Mills • Aluminium

Application Data • Series 49N9 • Metric

Material Group															
	Side Milling (A) and Slotting (B)				Uncoated			Recommended feed per tooth (fz = mm/th) for side milling (A). For slotting (B), reduce fz by 20%.							
	A		B		Cutting Speed – vc m/min			D1 – Diameter							
	ap	ae	ap	min	–	max	mm	6,0	8,0	10,0	12,0	16,0	18,0	20,0	
N	1	1 x D	0,5 x D	1 x D	500	–	2000	fz	0,072	0,096	0,120	0,144	0,192	0,216	0,240
	2	1 x D	0,5 x D	1 x D	500	–	1500	fz	0,065	0,086	0,108	0,130	0,173	0,194	0,216
	3	1 x D	0,5 x D	1 x D	500	–	1500	fz	0,050	0,067	0,084	0,101	0,134	0,151	0,168
	4	1 x D	0,5 x D	1 x D	400	–	750	fz	0,058	0,077	0,096	0,115	0,154	0,173	0,192
	5	1 x D	0,5 x D	1 x D	250	–	1000	fz	0,065	0,086	0,108	0,130	0,173	0,194	0,216

NOTE: For cutting aluminium with high silicon, TiCN coating is recommended.

Multiply ap for milling machine spindle with ceramic bearings by 0,5.

Above parameters are based on ideal conditions. For smaller taper machining centers, please adjust parameters accordingly on diameters greater than 12mm.

D503

LINE EXPANSION



HIGH-PERFORMANCE FINISHING





Series D503, D513

3-flute, 45° helix.

Centre cutting.

WIDIA HANITA 

WIDIA 
widia.com

High-Performance Solid Carbide End Mills

High-Performance Solid Carbide End Mills • Finishing

Series D503 D513 • Metric

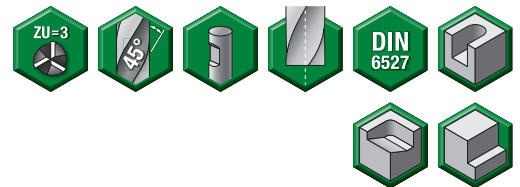
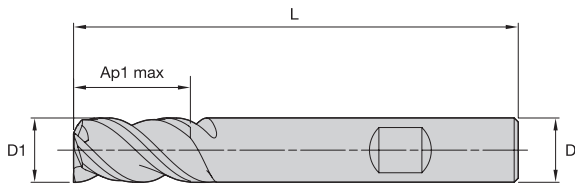

● first choice

○ alternate choice

P	●	●
M	●	●
K	●	●
N	○	○
S	●	●
H	●	●

WIDIA HANITA

catalogue number	D1	D	length of cut Ap1 max	length L	SS	TIALN	TIALN-RW
D50302002RW	2,0	6	3,00	50	W	1661574	-
D503025C2W	2,5	6	3,00	50	W	6613012	-
D50303002RW	3,0	6	4,00	50	W	1661578	-
D503030C2W	3,0	6	4,00	50	W	6613013	-
D51303002RW	3,0	6	7,00	57	W	1661680	-
D513035C2W	3,5	6	7,00	57	W	6613014	-
D50304002RW	4,0	6	5,00	54	W	1661583	-
D503040C2W	4,0	6	5,00	54	W	6613015	-
D51304002RW	4,0	6	8,00	57	W	1661684	-
D50305002RW	5,0	6	6,00	54	W	-	1661588
D51305002RW	5,0	6	10,00	57	W	1661688	-
D50306002RW	6,0	6	7,00	54	W	1661593	-
D503060C2W	6,0	6	7,00	54	W	6613016	-
D51306002RW	6,0	6	10,00	57	W	1661692	-
D503080C3W	8,0	8	9,00	58	W	6613017	-
D50308003RW	8,0	8	9,00	58	W	1661603	-
D51308003RW	8,0	8	16,00	63	W	1661701	-
D503100C4W	10,0	10	11,00	66	W	6613018	-
D51310004RW	10,0	10	19,00	72	W	1661710	-
D503120C5W	12,0	12	12,00	73	W	6613019	-
D51312005RW	12,0	12	22,00	83	W	1661715	-
D51314014RW	14,0	14	22,00	83	W	-	1661720
D51316006RW	16,0	16	26,00	92	W	1661725	-

NOTE: SS = Shank Style
W = Weldon



End Mill Tolerances

D1	tolerance e8	D	tolerance h6 + / -
≤ 3	-0,014/-0,028	≤ 3	0/-0,006
> 3-6	-0,020/-0,038	> 3-6	0/-0,008
> 6-10	-0,025/-0,047	> 6-10	0/-0,009
> 10-18	-0,032/-0,059	> 10-18	0/-0,011
> 18-30	-0,040/-0,073	> 18-30	0/-0,013

WIDIA

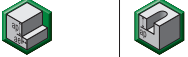

High-Performance Solid Carbide End Mills • Finishing

Application Data • Series D503 • Metric

Material Group																				
	Side Milling (A) and Slotting (B)			TiAlN			Recommended feed per tooth (fz = mm/th) for side milling (A). For slotting (B), reduce fz by 20%.													
	A		B	Cutting Speed – vc m/min		mm	D1 – Diameter													
	ap	ae	ap	min	max		2,0	3,0	4,0	5,0	6,0	8,0	10,0	12,0	14,0	16,0	18,0	20,0		
P	0	0,75 x D	0,4 x D	0,5 x D	150	–	200	fz	0,014	0,021	0,028	0,036	0,044	0,060	0,072	0,083	0,092	0,101	0,108	0,114
	1	0,75 x D	0,4 x D	0,5 x D	150	–	200	fz	0,014	0,021	0,028	0,036	0,044	0,060	0,072	0,083	0,092	0,101	0,108	0,114
	2	0,75 x D	0,4 x D	0,5 x D	140	–	190	fz	0,014	0,021	0,028	0,036	0,044	0,060	0,072	0,083	0,092	0,101	0,108	0,114
	3	0,75 x D	0,4 x D	0,5 x D	120	–	160	fz	0,011	0,017	0,023	0,030	0,036	0,050	0,061	0,070	0,079	0,087	0,095	0,101
	4	0,75 x D	0,4 x D	0,3 x D	90	–	150	fz	0,010	0,016	0,021	0,027	0,033	0,045	0,054	0,062	0,070	0,077	0,083	0,088
	5	0,75 x D	0,4 x D	0,5 x D	60	–	100	fz	0,009	0,014	0,019	0,024	0,029	0,040	0,048	0,056	0,063	0,070	0,076	0,081
M	6	0,75 x D	0,4 x D	0,3 x D	50	–	75	fz	0,008	0,012	0,016	0,020	0,025	0,034	0,040	0,047	0,052	0,057	0,061	0,065
	1	0,75 x D	0,4 x D	0,5 x D	90	–	115	fz	0,011	0,017	0,023	0,030	0,036	0,050	0,061	0,070	0,079	0,087	0,095	0,101
	2	0,75 x D	0,4 x D	0,5 x D	60	–	80	fz	0,009	0,014	0,019	0,024	0,029	0,040	0,048	0,056	0,063	0,070	0,076	0,081
K	3	0,75 x D	0,4 x D	0,5 x D	60	–	70	fz	0,008	0,012	0,016	0,020	0,025	0,034	0,040	0,047	0,052	0,057	0,061	0,065
	1	0,75 x D	0,4 x D	0,5 x D	120	–	150	fz	0,014	0,021	0,028	0,036	0,044	0,060	0,072	0,083	0,092	0,101	0,108	0,114
	2	0,75 x D	0,4 x D	0,5 x D	110	–	140	fz	0,011	0,017	0,023	0,030	0,036	0,050	0,061	0,070	0,079	0,087	0,095	0,101
S	3	0,75 x D	0,4 x D	0,5 x D	110	–	130	fz	0,009	0,014	0,019	0,024	0,029	0,040	0,048	0,056	0,063	0,070	0,076	0,081
	1	0,75 x D	0,4 x D	0,3 x D	50	–	90	fz	0,011	0,017	0,023	0,030	0,036	0,050	0,061	0,070	0,079	0,087	0,095	0,101
	2	0,75 x D	0,4 x D	0,3 x D	25	–	40	fz	0,006	0,009	0,013	0,016	0,019	0,026	0,032	0,037	0,042	0,046	0,050	0,054
	3	0,75 x D	0,4 x D	0,3 x D	60	–	80	fz	0,009	0,014	0,019	0,024	0,029	0,040	0,048	0,056	0,063	0,070	0,076	0,081
H	4	0,75 x D	0,4 x D	0,5 x D	50	–	60	fz	0,007	0,011	0,016	0,021	0,026	0,037	0,045	0,052	0,058	0,064	0,069	0,074
	1	0,75 x D	0,4 x D	0,3 x D	80	–	140	fz	0,010	0,016	0,021	0,027	0,033	0,045	0,054	0,062	0,070	0,077	0,083	0,088

NOTE: Lower value of cutting speed is used for high stock removal applications or for higher hardness (machinability) within group.
 Higher value of cutting speed is used for finishing applications or for lower hardness (machinability) within group.
 Above parameters are based on ideal conditions. For smaller taper machining centres, please adjust parameters accordingly on greater than 12mm diameters.

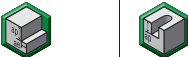
Application Data • Series D513 • Metric

Material Group																				
	Side Milling (A) and Slotting (B)			TiAlN			Recommended feed per tooth (fz = mm/th) for side milling (A). For slotting (B), reduce fz by 20%.													
	A		B	Cutting Speed – vc m/min		mm	D1 – Diameter													
	ap	ae	ap	min	max		2,0	3,0	4,0	5,0	6,0	8,0	10,0	12,0	14,0	16,0	18,0	20,0		
P	0	1,25 x D	0,2 x D	0,25 x D	150	–	200	fz	0,014	0,021	0,028	0,036	0,044	0,060	0,072	0,083	0,092	0,101	0,108	0,114
	1	1,25 x D	0,2 x D	0,25 x D	150	–	200	fz	0,014	0,021	0,028	0,036	0,044	0,060	0,072	0,083	0,092	0,101	0,108	0,114
	2	1,25 x D	0,2 x D	0,25 x D	140	–	190	fz	0,014	0,021	0,028	0,036	0,044	0,060	0,072	0,083	0,092	0,101	0,108	0,114
	3	1,25 x D	0,2 x D	0,25 x D	120	–	160	fz	0,011	0,017	0,023	0,030	0,036	0,050	0,061	0,070	0,079	0,087	0,095	0,101
	4	1,25 x D	0,2 x D	0,25 x D	90	–	150	fz	0,010	0,016	0,021	0,027	0,033	0,045	0,054	0,062	0,070	0,077	0,083	0,088
	5	1,25 x D	0,2 x D	0,25 x D	60	–	100	fz	0,009	0,014	0,019	0,024	0,029	0,040	0,048	0,056	0,063	0,070	0,076	0,081
M	6	1,25 x D	0,2 x D	0,25 x D	50	–	75	fz	0,008	0,012	0,016	0,020	0,025	0,034	0,040	0,047	0,052	0,057	0,061	0,065
	1	1,25 x D	0,2 x D	0,25 x D	90	–	115	fz	0,011	0,017	0,023	0,030	0,036	0,050	0,061	0,070	0,079	0,087	0,095	0,101
	2	1,25 x D	0,2 x D	0,25 x D	60	–	80	fz	0,009	0,014	0,019	0,024	0,029	0,040	0,048	0,056	0,063	0,070	0,076	0,081
K	3	1,25 x D	0,2 x D	0,25 x D	60	–	70	fz	0,008	0,012	0,016	0,020	0,025	0,034	0,040	0,047	0,052	0,057	0,061	0,065
	1	1,25 x D	0,2 x D	0,25 x D	120	–	150	fz	0,014	0,021	0,028	0,036	0,044	0,060	0,072	0,083	0,092	0,101	0,108	0,114
	2	1,25 x D	0,2 x D	0,25 x D	110	–	140	fz	0,011	0,017	0,023	0,030	0,036	0,050	0,061	0,070	0,079	0,087	0,095	0,101
S	3	1,25 x D	0,2 x D	0,25 x D	110	–	130	fz	0,009	0,014	0,019	0,024	0,029	0,040	0,048	0,056	0,063	0,070	0,076	0,081
	1	1,25 x D	0,2 x D	0,25 x D	50	–	90	fz	0,011	0,017	0,023	0,030	0,036	0,050	0,061	0,070	0,079	0,087	0,095	0,101
	2	1,25 x D	0,2 x D	0,25 x D	25	–	40	fz	0,006	0,009	0,013	0,016	0,019	0,026	0,032	0,037	0,042	0,046	0,050	0,054
	3	1,25 x D	0,2 x D	0,25 x D	60	–	80	fz	0,009	0,014	0,019	0,024	0,029	0,040	0,048	0,056	0,063	0,070	0,076	0,081
H	4	1,25 x D	0,2 x D	0,25 x D	50	–	60	fz	0,007	0,011	0,016	0,021	0,026	0,037	0,045	0,052	0,058	0,064	0,069	0,074
	1	1,25 x D	0,2 x D	0,25 x D	80	–	140	fz	0,010	0,016	0,021	0,027	0,033	0,045	0,054	0,062	0,070	0,077	0,083	0,088

NOTE: Lower value of cutting speed is used for high stock removal applications or for higher hardness (machinability) within group.
 Higher value of cutting speed is used for finishing applications or for lower hardness (machinability) within group.
 Above parameters are based on ideal conditions. For smaller taper machining centres, please adjust parameters accordingly on >12mm diameters.



GP

4-FLUTE RADIUS END MILLS



THE EVOLUTION OF A SOLID
CARBIDE END MILL REVOLUTION

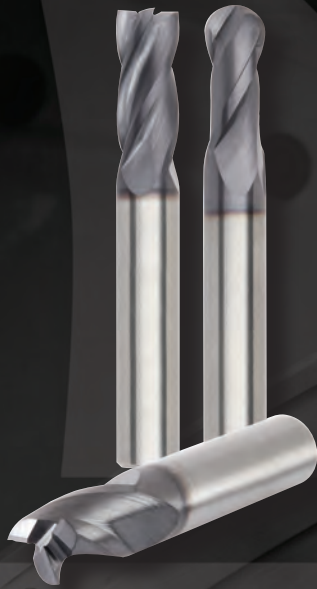

GP 4-Flute Radius End Mills

WIDIA-Hanita general purpose end mills offer plunging, slotting, and profiling for a wide range of materials and applications. Designed to provide high metal removal rates and excellent surface conditions at a value price. A wide range of diameters, lengths, and corner styles (such as chamfered, sharp edge, and ball nose) are available from stock.

Radius Series — 4004/4014/4024

- Centre cutting.
- Steel, stainless steel, and cast iron.
- Radius corner for extended tool life.
- Regular, long, and extra long length of cut.

The WIDIA-Hanita™ solid carbide end mill product lines have built a strong ongoing reputation of continuous development and diversification.

WIDIA™ HANITA™ 

WIDIA™ 
widia.com

General Purpose Solid Carbide End Mills

General Purpose Solid Carbide End Mills • Roughing/Finishing

Series 4004 4014 4024 • Radius • Metric

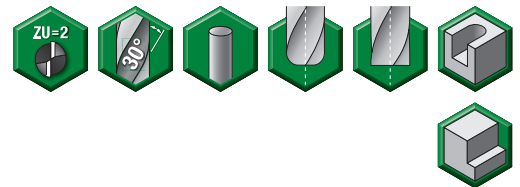
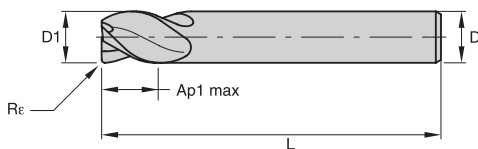

● first choice

○ alternate choice

WIDIA HANITA

P	●
M	●
K	●
N	
S	
H	

catalogue number	D1	D	length of cut Ap1 max	length L	Re	TIALN
40040200T006R050	2,0	3	6,30	38	0,50	6337590
40040300T009R050	3,0	3	9,50	38	0,50	6337731
40040300T009R100	3,0	3	9,50	38	1,00	6337732
40140300T019R050	3,0	3	19,00	63	0,50	6337892
40240300T025R050	3,0	3	25,00	75	0,50	6338335
40040400T011R050	4,0	4	11,00	50	0,50	6337733
40040400T011R100	4,0	4	11,00	50	1,00	6337734
40140400T019R050	4,0	4	19,00	63	0,50	6337893
40140400T019R100	4,0	4	19,00	63	1,00	6337894
40240400T031R050	4,0	4	31,00	75	0,50	6338336
40240400T031R100	4,0	4	31,00	75	1,00	6338337
40040500T013R050	5,0	5	13,00	50	0,50	6337735
40140500T030R050	5,0	5	30,00	75	0,50	6337895
40140500T030R100	5,0	5	30,00	75	1,00	6337896
40040600T016R100	6,0	6	16,00	50	1,00	6337737
40040600T016R050	6,0	6	16,00	50	0,50	6337736
40140600T028R050	6,0	6	28,00	75	0,50	6337897
40140600T028R100	6,0	6	28,00	75	1,00	6337898
40240600T038R050	6,0	6	38,00	100	0,50	6338338
40240600T038R100	6,0	6	38,00	100	1,00	6338339
40040800T020R100	8,0	8	20,00	50	1,00	6337739
40040800T020R050	8,0	8	20,00	50	0,50	6337738
40140800T028R050	8,0	8	28,00	75	0,50	6337899
40140800T028R100	8,0	8	28,00	75	1,00	6337900
40240800T041R050	8,0	8	41,00	100	0,50	6338340
40240800T041R100	8,0	8	41,00	100	1,00	6338341
40041000T022R050	10,0	10	22,00	72	0,50	6337740
40041000T022R100	10,0	10	22,00	72	1,00	6337741
40141000T032R100	10,0	10	32,00	89	1,00	6337912
40141000T032R050	10,0	10	32,00	89	0,50	6337911
40241000T045R050	10,0	10	45,00	100	0,50	6338342
40241000T045R100	10,0	10	45,00	100	1,00	6338343

WIDIA

General Purpose Solid Carbide End Mills • Roughing/Finishing

Series 4004 4014 4024 • Radius • Metric

(continued)

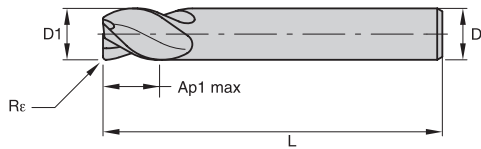

- first choice
- alternate choice

P	●	●
M	●	●
K	●	●
N	●	
S	●	
H	●	

catalogue number	D1	D	length of cut Ap1 max	length L	Re	TIALN
40041200T025R100	12,0	12	25,00	89	1,00	6337743
40041200T025R050	12,0	12	25,00	89	0,50	6337742
40141200T045R050	12,0	12	45,00	100	0,50	6337913
40141200T045R100	12,0	12	45,00	100	1,00	6337914
40241200T075R050	12,0	12	75,00	150	0,50	6338344
40241200T075R100	12,0	12	75,00	150	1,00	6338345
40041600T032R100	16,0	16	32,00	92	1,00	6337745
40041600T032R050	16,0	16	32,00	92	0,50	6337744
40141600T056R100	16,0	16	56,00	110	1,00	6337916
40141600T056R050	16,0	16	56,00	110	0,50	6337915
40241600T075R050	16,0	16	75,00	150	0,50	6338346
40241600T075R100	16,0	16	75,00	150	1,00	6338347
40242000T075R050	20,0	20	75,00	150	0,50	6338349

NOTE: Refer to the NOVO™ app for the complete GP end mill offering.



End Mill Tolerances

D1	tolerance e8	D	tolerance h6 + / -
≤ 3	-0,014/-0,028	≤ 3	0/0,006
> 3-6	-0,020/-0,038	> 3-6	0/0,008
> 6-10	-0,025/-0,047	> 6-10	0/0,009
> 10-18	-0,032/-0,059	> 10-18	0/0,011
> 18-30	-0,040/-0,073	> 18-30	0/0,013

General Purpose Solid Carbide End Mills

General Purpose Solid Carbide End Mills • Roughing/Finishing

Application Data • 4004 4014 4024 Series • TiAlN • Metric

Material Group																						
	Side Milling (A) and Slotting (B)				TiAlN		Recommended feed per tooth (fz = mm/th) for side milling (A). For slotting (B), reduce fz by 20%.															
	A		B		Cutting Speed – Vc m/min		D1 – Diameter															
	ap	ae	ap	min	max	mm	1,0	2,0	3,0	4,0	5,0	6,0	8,0	10,0	12,0	14,0	16,0	18,0	20,0			
P	0	Ap1 max	0,1 x D	0,5 x D	150	–	200	fz	0,007	0,014	0,021	0,028	0,036	0,044	0,060	0,072	0,083	0,092	0,101	0,108	0,114	
	1	Ap1 max	0,1 x D	0,5 x D	150	–	200	fz	0,007	0,014	0,021	0,028	0,036	0,044	0,060	0,072	0,083	0,092	0,101	0,108	0,114	
	2	Ap1 max	0,1 x D	0,5 x D	140	–	190	fz	0,007	0,014	0,021	0,028	0,036	0,044	0,060	0,072	0,083	0,092	0,101	0,108	0,114	
	3	Ap1 max	0,1 x D	0,5 x D	120	–	160	fz	0,006	0,011	0,017	0,023	0,030	0,036	0,050	0,061	0,070	0,079	0,087	0,095	0,101	
M	4	Ap1 max	0,1 x D	0,5 x D	90	–	150	fz	0,005	0,010	0,016	0,021	0,027	0,033	0,045	0,054	0,062	0,070	0,077	0,083	0,088	
	1	Ap1 max	0,1 x D	0,5 x D	90	–	115	fz	0,006	0,011	0,017	0,023	0,030	0,036	0,050	0,061	0,070	0,079	0,087	0,095	0,101	
K	2	Ap1 max	0,1 x D	0,5 x D	60	–	80	fz	0,005	0,009	0,014	0,019	0,024	0,029	0,040	0,048	0,056	0,063	0,070	0,076	0,081	
	1	Ap1 max	0,1 x D	0,5 x D	120	–	150	fz	0,007	0,014	0,021	0,028	0,036	0,044	0,060	0,072	0,083	0,092	0,101	0,108	0,114	
K	2	Ap1 max	0,1 x D	0,5 x D	110	–	140	fz	0,006	0,011	0,017	0,023	0,030	0,036	0,050	0,061	0,070	0,079	0,087	0,095	0,101	

NOTE: Lower value of cutting speed is used for high stock removal applications or for higher hardness (machinability) within group.

Higher value of cutting speed is used for finishing applications or for lower hardness (machinability) within group.

Above parameters are based on ideal conditions. For smaller taper machining centres, please adjust parameters accordingly on greater than 12mm diameters.

The NOVO™ Application Provides the Digital Power

To Get Information Quicker Than Ever Before.

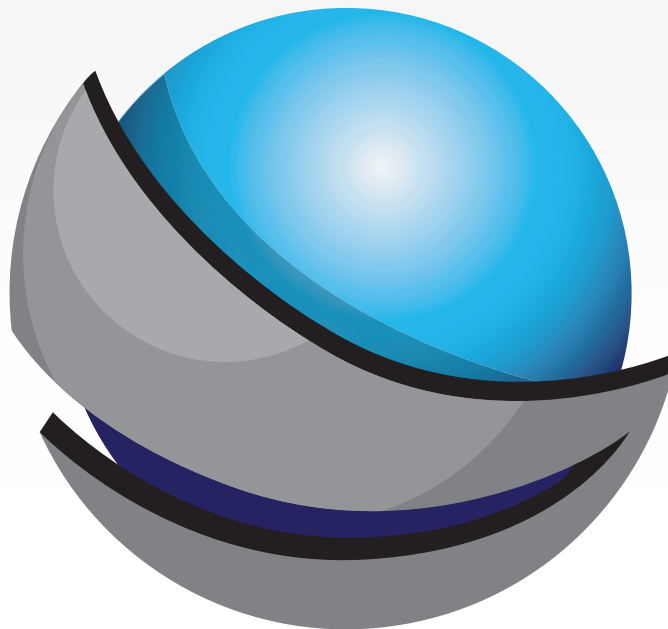
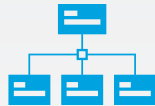

Export Compatibility to Mastercam®

Select tools, save into “job lists”.

Interactive feed & speed calculators.

Find inventory availability.

Download 2-D and 3-D models.

Easy interface with many CAM and tool management data systems.

TDMX

TOP DRILL™ MODULAR X



STABILITY AND RELIABILITY COMBINED INTO ONE MODULAR DRILL SYSTEM

WIDIA™ TOP DRILL Modular X (TDMX) is the ultimate choice for high-demanding drilling applications when stability and reliability are required.





Platform

Standard cutter bodies in 1.5 x D, 3 x D, 5 x D, 8 x D, and 12 x D.

Insert diameter range from 16mm up to 40mm.

One geometry and grade to cover steel and cast iron applications.

Easy to Apply

Front clamping design. No need to disassemble the body from the holder to change insert.

Easy insert nomenclature logic to identify the targeted material group.

Increased Stability and Performance

Highly engineered pocket seat design to ensure maximum stability, even in challenging applications like cross hole, inclined entry/exit, and interrupted cuts.

Suitable for high feed rates.

Flanged shank for higher rigidity.

Polished flutes for improved chip evacuation.

Brand new WP40PD grade for longer tool life in steel and cast iron applications.



FPE: P, M, K Flat bottom drilling, stacked plates, piloting for deep-hole drilling.
New 1.5 x D and 12 x D bodies



TDMX — TOP DRILL™ Modular X

Modular Drills • TOP DRILL Modular X

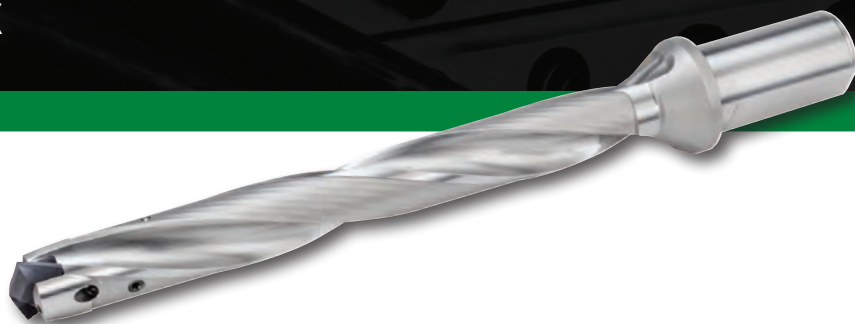

- Augmented insert stability thanks to the highly engineered pocket seat design.
- Front clamping for an easy insert change, without disassembling the holder from the machine spindle.
- Diameter range from 16mm up to 40mm.
- L/D ratio of 1.5 x D, 3 x D, 5 x D, 8 x D, and 12 x D.

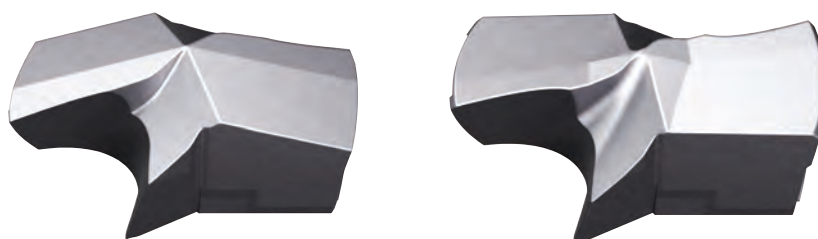

One geometry to cover two material groups in modular drilling.

PK(M)

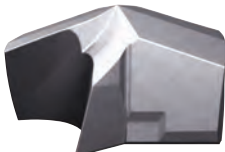

P K

First choice for Steel and Cast Iron drilling.

NEW!

FPE(M)



P M K

Flat bottom drilling, stacked plates, piloting for deep-hole drilling.

TDMX — Tube Sheet Drilling

P Steel

Material: Fe510/1.0553/A441
Condition: rough surface

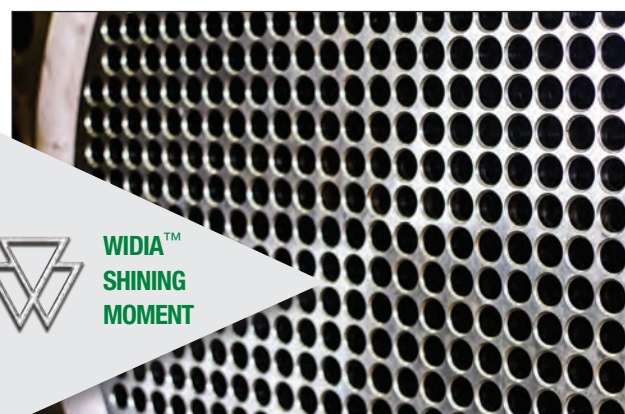

Specifications	Competitor	WIDIA
Diameter (mm)	25,6	25,6
Grade	—	WP40PD
Geometry	—	PK
Vc (m/min)	100	100
n (rev/min)	1,247	1,247
f (mm/rev)	0,33	0,35
Vf (mm/min)	400	437
LOC (mm)	50	50
Coolant	Internal Emulsion	Internal Emulsion
Tool Life (m)	30	48



Modular Drills • TOP DRILL™ Modular X

TDMX Body — Technical Details

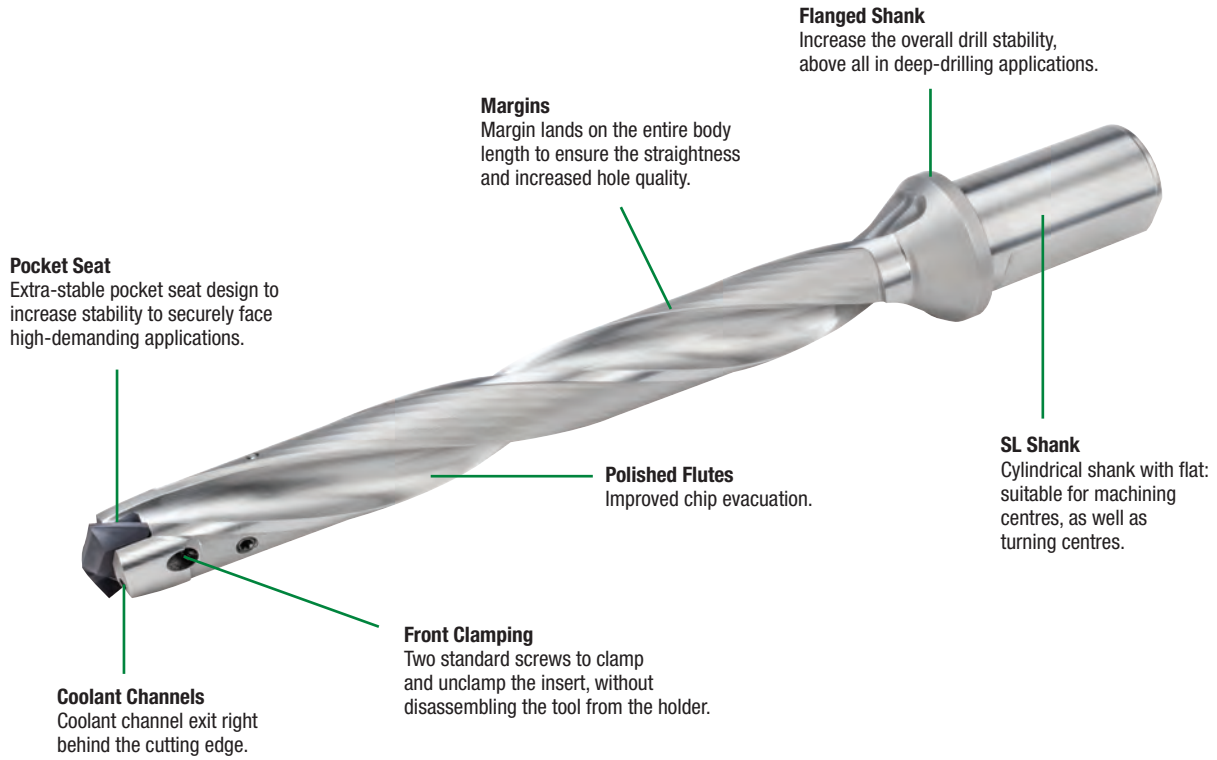

TDMX Pocket Seat — Technical Details

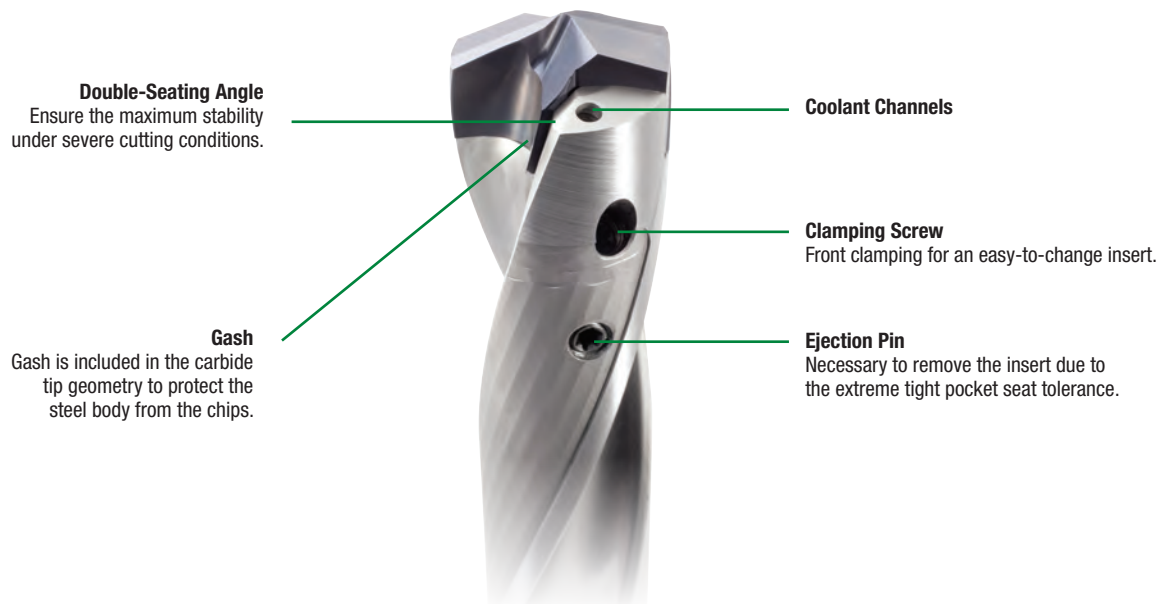

TDMX — TOP DRILL™ Modular X

Modular Drills • TOP DRILL Modular X

TDMX Components

Drilling is not always a simple, straightforward job. Workpiece instability, vibrations, and chip control are just a few challenges typically encountered in drilling applications. In addition to these challenges, the cost per hole becomes a critical subject in many shops with pressure to achieve sustainable production at the lowest cost possible. The TOP DRILL Modular X (TDMX) holemaking solution is able to address such machining applications and economic requirements with ease.

Tube sheets, baffles, I-beams, valves, axles, and track drive units are just a few examples of components that can be machined with more confidence thanks to the TDMX drill, its material-specific inserts, and optimised body design.

The combination of an extra stable pocket seat design, reinforced cutting corners, and a through grade, ensures increased process reliability and consequently longer tool life associated, with better hole quality.

The WP40PD grade provides the right toughness to face even the most unstable cutting conditions while also suitable for MQL applications.

The PK(M) point geometry is designed to operate high feed rates and provide the right guidance for improved hole straightness.

The FPE(M) flat bottom geometry is the solution to address the most challenging operations such as thin stack plate drilling, half holes, and any other applications where the standard 140° shows limits. FPE(M) can also be used as pilot for deep-hole drills.



Baffles

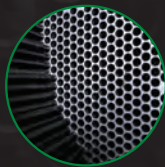

Tube Sheets

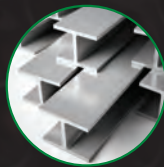

I-Beams



Valves

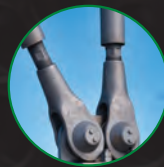

Cable Tensioner
- Post Tension System



Axles



Track Drive
Components

Longer tool life, reliability, and increased chip control on a steel structural component for a high-voltage electrical line customer

19-224648

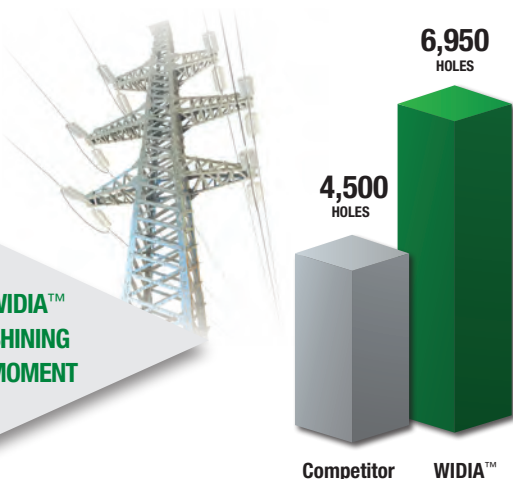

Specifications	Competitor	WIDIA
Tool body	Dia. 17mm 3 x D	TDMX
Insert	—	TDMX
Grade	—	WP40PD
Diameter	17,99mm	18mm
L/D Ratio	1.5 x D	3 x D
LOC	20mm (.787")	20mm (.787")
Cutting Speed Vc	70m/min (210 SFM)	70m/min 210sfm
Feed Rate in	0,25mm/rev (.0098 IPR)	.25mm/rev (.0098ipr)
Coolant	Internal MQL	
Tool Life	4500 Holes	6950 Holes

Assembling and Disassembling Instructions

Assembly

1 Insert positioning

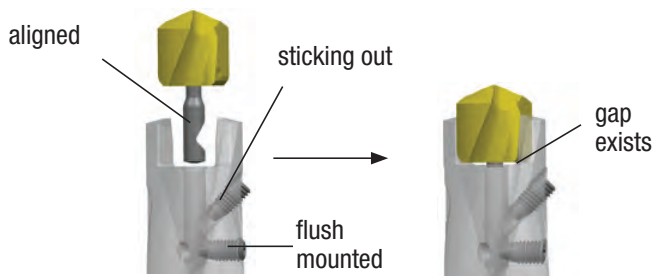

2 Insert clamping

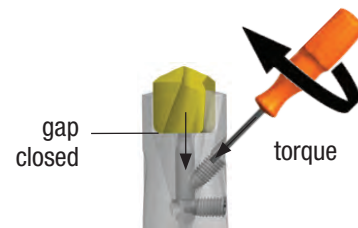

Drill diameter	Torque
ø 16–19,999mm	1,5 Nm
ø 20–23,999mm	2,1 Nm
ø 24–27,999mm	3,0 Nm
ø 28–40,000mm	4,5 Nm

Disassembly

1 Clamping screw loosening

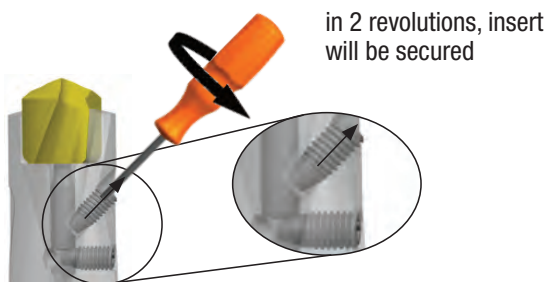

2 Insert pushing out

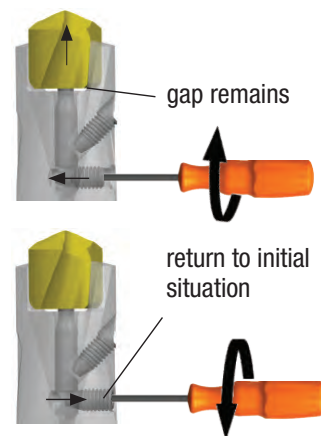

3 Further clamping screw loosening

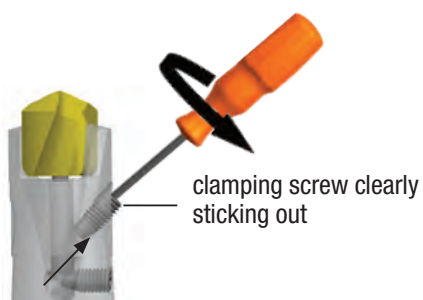

4 Insert removal



TDMX — TOP DRILL™ Modular X

Modular Drills • TOP DRILL Modular X

TDMX • 1.5 x D • Side Lock Shank • Metric

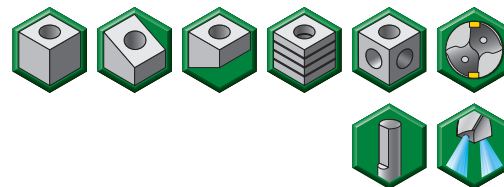
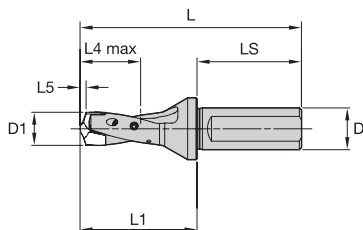

order number	catalogue number	SSC	D1	D1 max	LS	D	L	L1	L4 max
6680951	TDMX160R1SL20M	A	16,000	16,999	50	20	106	56	26
6680952	TDMX170R1SL20M	B	17,000	17,999	50	20	109	59	27
6680953	TDMX180R1SL25M	C	18,000	18,999	56	25	118	62	29
6680954	TDMX190R1SL25M	D	19,000	19,999	56	25	121	65	30
6680955	TDMX200R1SL25M	E	20,000	20,999	56	25	124	68	32
6680956	TDMX210R1SL25M	F	21,000	21,999	56	25	127	71	33
6680957	TDMX220R1SL25M	G	22,000	22,999	56	25	130	74	35
6680958	TDMX230R1SL25M	H	23,000	23,999	56	25	133	77	36
6680959	TDMX240R1SL32M	I	24,000	24,999	60	32	140	80	38
6680960	TDMX250R1SL32M	J	25,000	25,999	60	32	143	83	39
6680971	TDMX260R1SL32M	K	26,000	26,999	60	32	146	86	41
6680972	TDMX270R1SL32M	L	27,000	27,999	60	32	149	89	42
6680973	TDMX280R1SL32M	M	28,000	28,999	60	32	152	92	44
6680974	TDMX290R1SL32M	N	29,000	29,999	60	32	155	95	45
6680975	TDMX300R1SL32M	O	30,000	30,999	60	32	158	98	47
6680976	TDMX310R1SL32M	P	31,000	31,999	60	32	161	101	48

NOTE: SSC = Pocket Seat Reference. To correspond with the SSC on the inserts.
L5 is dependent on the insert.

Modular Drills • TOP DRILL™ Modular X

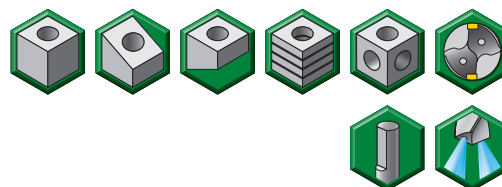
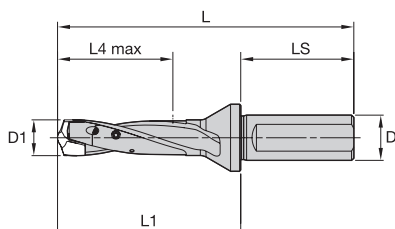
TDMX • 3 x D • Side Lock Shank • Metric

order number	catalogue number	SSC	D1	D1 max	LS	D	L	L1	L4 max
6572091	TDMX160R3SL20M	A	16,000	16,999	50	20	131	81	51
6572092	TDMX170R3SL20M	B	17,000	17,999	50	20	136	86	54
6572093	TDMX180R3SL25M	C	18,000	18,999	56	25	146	90	57
6572094	TDMX190R3SL25M	D	19,000	19,999	56	25	151	95	60
6572096	TDMX200R3SL25M	E	20,000	20,999	56	25	155	99	63
6572097	TDMX210R3SL25M	F	21,000	21,999	56	25	160	104	66
6572098	TDMX220R3SL25M	G	22,000	22,999	56	25	164	108	69
6572099	TDMX230R3SL25M	H	23,000	23,999	56	25	169	113	72
6572100	TDMX240R3SL32M	I	24,000	24,999	60	32	177	117	75
6572101	TDMX250R3SL32M	J	25,000	25,999	60	32	182	122	78
6572102	TDMX260R3SL32M	K	26,000	26,999	60	32	186	126	81
6572104	TDMX270R3SL32M	L	27,000	27,999	60	32	191	131	84
6572105	TDMX280R3SL32M	M	28,000	28,999	60	32	195	135	87
6572106	TDMX290R3SL32M	N	29,000	29,999	60	32	200	140	90
6572107	TDMX300R3SL32M	O	30,000	30,999	60	32	204	144	93
6572108	TDMX310R3SL32M	P	31,000	31,999	60	32	209	149	96
6572109	TDMX320R3SL40M	Q	32,000	33,999	70	40	228	158	102
6572110	TDMX340R3SL40M	R	34,000	35,999	70	40	237	167	108
6572121	TDMX360R3SL40M	S	36,000	37,999	70	40	246	176	114
6572122	TDMX380R3SL40M	T	38,000	40,000	70	40	255	185	120

NOTE: SSC = Pocket Seat Reference. To correspond with the SSC on the inserts.
L5 is dependent on the insert.

TDMX — TOP DRILL™ Modular X

Modular Drills • TOP DRILL Modular X

TDMX • 5 x D • Side Lock Shank • Metric

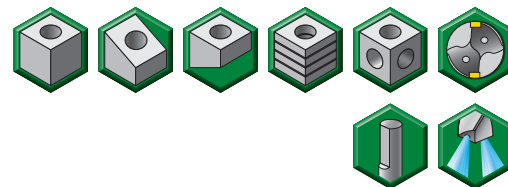
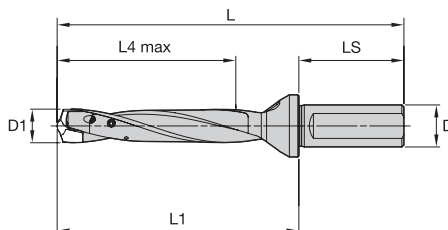

order number	catalogue number	SSC	D1	D1 max	LS	D	L	L1	L4 max
6572125	TDMX160R5SL20M	A	16,000	16,999	50	20	165	115	85
6572126	TDMX170R5SL20M	B	17,000	17,999	50	20	172	122	90
6572127	TDMX180R5SL25M	C	18,000	18,999	56	25	184	128	95
6572128	TDMX190R5SL25M	D	19,000	19,999	56	25	191	135	100
6572129	TDMX200R5SL25M	E	20,000	20,999	56	25	197	141	105
6572130	TDMX210R5SL25M	F	21,000	21,999	56	25	204	148	110
6572141	TDMX220R5SL25M	G	22,000	22,999	56	25	210	154	115
6572142	TDMX230R5SL25M	H	23,000	23,999	56	25	217	161	120
6572143	TDMX240R5SL32M	I	24,000	24,999	60	32	227	167	125
6572144	TDMX250R5SL32M	J	25,000	25,999	60	32	234	174	130
6572145	TDMX260R5SL32M	K	26,000	26,999	60	32	240	180	135
6572146	TDMX270R5SL32M	L	27,000	27,999	60	32	247	187	140
6572147	TDMX280R5SL32M	M	28,000	28,999	60	32	253	193	145
6572148	TDMX290R5SL32M	N	29,000	29,999	60	32	260	200	150
6572149	TDMX300R5SL32M	O	30,000	30,999	60	32	266	206	155
6572150	TDMX310R5SL32M	P	31,000	31,999	60	32	273	213	160
6572151	TDMX320R5SL40M	Q	32,000	33,999	70	40	296	226	170
6572152	TDMX340R5SL40M	R	34,000	35,999	70	40	309	239	180
6572153	TDMX360R5SL40M	S	36,000	37,999	70	40	322	252	190
6572154	TDMX380R5SL40M	T	38,000	40,000	70	40	335	265	200

NOTE: SSC = Pocket Seat Reference. To correspond with the SSC on the inserts.
L5 is dependent on the insert.

Modular Drills • TOP DRILL™ Modular X

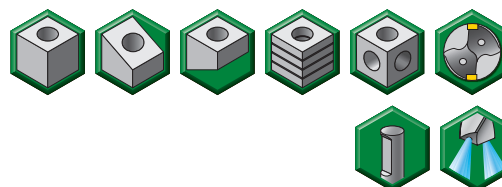
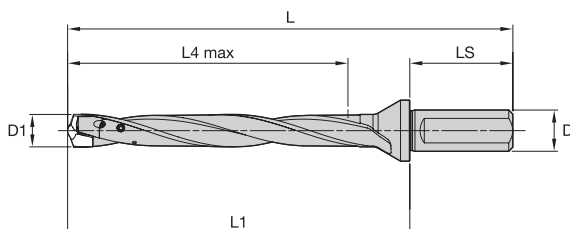
TDMX • 8 x D • Side Lock Shank • Metric

order number	catalogue number	SSC	D1	D1 max	LS	D	L	L1	L4 max
6572155	TDMX160R8SL20M	A	16,000	16,999	50	20	216	166	136
6572156	TDMX170R8SL20M	B	17,000	17,999	50	20	226	176	144
6572157	TDMX180R8SL25M	C	18,000	18,999	56	25	241	185	152
6572158	TDMX190R8SL25M	D	19,000	19,999	56	25	251	195	160
6572159	TDMX200R8SL25M	E	20,000	20,999	56	25	260	204	168
6572160	TDMX210R8SL25M	F	21,000	21,999	56	25	270	214	176
6572171	TDMX220R8SL25M	G	22,000	22,999	56	25	279	223	184
6572172	TDMX230R8SL25M	H	23,000	23,999	56	25	289	233	192
6572173	TDMX240R8SL32M	I	24,000	24,999	60	32	302	242	200
6572174	TDMX250R8SL32M	J	25,000	25,999	60	32	312	252	208
6572175	TDMX260R8SL32M	K	26,000	26,999	60	32	321	261	216
6572176	TDMX270R8SL32M	L	27,000	27,999	60	32	331	271	224
6572177	TDMX280R8SL32M	M	28,000	28,999	60	32	340	280	232
6572178	TDMX290R8SL32M	N	29,000	29,999	60	32	350	290	240
6572179	TDMX300R8SL32M	O	30,000	30,999	60	32	359	299	248
6572180	TDMX310R8SL32M	P	31,000	31,999	60	32	369	309	256
6572181	TDMX320R8SL40M	Q	32,000	33,999	70	40	398	328	272
6572182	TDMX340R8SL40M	R	34,000	35,999	70	40	417	347	288
6572183	TDMX360R8SL40M	S	36,000	37,999	70	40	436	366	304
6572184	TDMX380R8SL40M	T	38,000	40,000	70	40	455	385	320

NOTE: SSC = Pocket Seat Reference. To correspond with the SSC on the inserts.
L5 is dependent on the insert.

TDMX — TOP DRILL™ Modular X

Modular Drills • TOP DRILL Modular X

TDMX • 12 x D • Flanged Round Shank • Metric

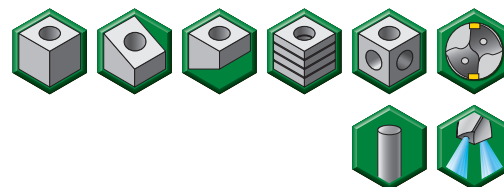
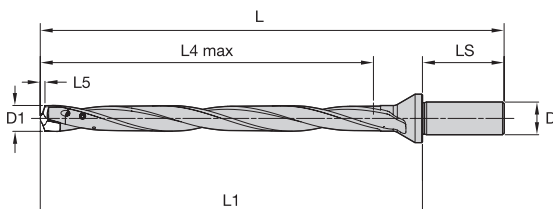

order number	catalogue number	SSC	D1	D1 max	LS	D	L	L1	L4 max
6681017	TDMX160R12SF20M	A	16,000	16,999	50	20	284	234	204
6681018	TDMX170R12SF20M	B	17,000	17,999	50	20	298	248	216
6681019	TDMX180R12SF25M	C	18,000	18,999	56	25	317	261	228
6681020	TDMX190R12SF25M	D	19,000	19,999	56	25	331	275	240
6681041	TDMX200R12SF25M	E	20,000	20,999	56	25	344	288	252
6681042	TDMX210R12SF25M	F	21,000	21,999	56	25	358	302	264
6681043	TDMX220R12SF25M	G	22,000	22,999	56	25	371	315	276
6681044	TDMX230R12SF25M	H	23,000	23,999	56	25	385	329	288
6681045	TDMX240R12SF32M	I	24,000	24,999	60	32	402	342	300
6681046	TDMX250R12SF32M	J	25,000	25,999	60	32	416	356	312
6681047	TDMX260R12SF32M	K	26,000	26,999	60	32	429	369	324
6681049	TDMX270R12SF32M	L	27,000	27,999	60	32	443	383	336
6681050	TDMX280R12SF32M	M	28,000	28,999	60	32	456	396	348
6681051	TDMX290R12SF32M	N	29,000	29,999	60	32	470	410	360
6681052	TDMX300R12SF32M	O	30,000	30,999	60	32	483	423	372
6681053	TDMX310R12SF32M	P	31,000	31,999	60	32	497	437	384

NOTE: SSC = Pocket Seat Reference. To correspond with the SSC on the inserts.
L5 is dependent on the insert.

Modular Drills • TOP DRILL™ Modular X

TDMX • Inserts • PK(M)

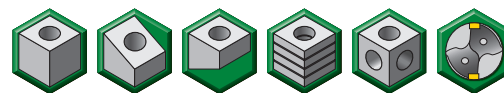
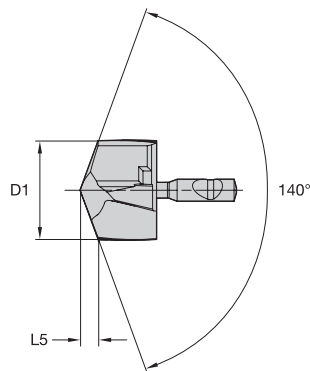

- first choice
- alternate choice

P	●
M	○
K	●
N	
S	
H	

catalogue number	D1	L5	SSC	WP40PD
TDMX16000PKM	16,00	3,21	A	6568446
TDMX16200PKM	16,20	3,25	A	6568447
TDMX16281PKM	16,28	3,26	A	6568448
TDMX16500PKM	16,50	3,30	A	6568449
TDMX16667PKM	16,67	3,33	A	6568450
TDMX17000PKM	17,00	3,39	B	6568461
TDMX17064PKM	17,06	3,41	B	6568462
TDMX17463PKM	17,46	3,48	B	6568464
TDMX17500PKM	17,50	3,49	B	6568465
TDMX17600PKM	17,60	3,50	B	6568467
TDMX17800PKM	17,80	3,54	B	6568471
TDMX17859PKM	17,86	3,55	B	6568472
TDMX18000PKM	18,00	3,58	C	6568473
TDMX18255PKM	18,26	3,64	C	6568474
TDMX18500PKM	18,50	3,68	C	6568475
TDMX18651PKM	18,65	3,71	C	6568476
TDMX18800PKM	18,80	3,74	C	6568477
TDMX19000PKM	19,00	3,78	D	6568478
TDMX19050PKM	19,05	3,78	D	6568479
TDMX19200PKM	19,20	3,81	D	6568480
TDMX19270PKM	19,27	3,82	D	6568481
TDMX19450PKM	19,45	3,86	D	6568482
TDMX19500PKM	19,50	3,87	D	6568483
TDMX19700PKM	19,70	3,90	D	6568484
TDMX19840PKM	19,84	3,93	D	6568485
TDMX20000PKM	20,00	3,97	E	6568813
TDMX20100PKM	20,10	3,99	E	6568814
TDMX20200PKM	20,20	4,01	E	6568815
TDMX20239PKM	20,24	4,02	E	6568816
TDMX20300PKM	20,30	4,03	E	6568817
TDMX20400PKM	20,40	4,05	E	6568818
TDMX20500PKM	20,50	4,06	E	6568819
TDMX20600PKM	20,60	4,08	E	6568820
TDMX20650PKM	20,65	4,09	E	6568841
TDMX20700PKM	20,70	4,10	E	6568842
TDMX20800PKM	20,80	4,12	E	6568843

TDMX — TOP DRILL™ Modular X

Modular Drills • TOP DRILL Modular X

TDMX • Inserts • PK(M)

(continued)

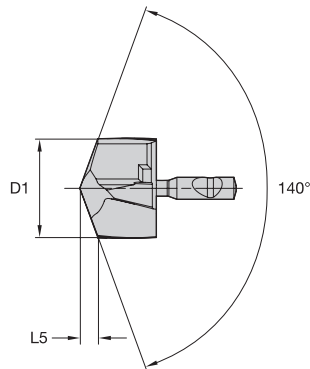

- first choice
- alternate choice

P	<input checked="" type="checkbox"/>
M	<input type="checkbox"/>
K	<input checked="" type="checkbox"/>
N	<input type="checkbox"/>
S	<input type="checkbox"/>
H	<input type="checkbox"/>

catalogue number	D1	L5	SSC	WP40PD
TDMX20900PKM	20,90	4,14	E	6568844
TDMX21000PKM	21,00	4,16	F	6568845
TDMX21430PKM	21,43	4,23	F	6568846
TDMX21500PKM	21,50	4,25	F	6568847
TDMX22000PKM	22,00	4,35	G	6568848
TDMX22225PKM	22,23	4,39	G	6568849
TDMX22450PKM	22,45	4,44	G	6568850
TDMX22500PKM	22,50	4,44	G	6568851
TDMX23000PKM	23,00	4,54	H	6568852
TDMX23500PKM	23,50	4,63	H	6568853
TDMX23813PKM	23,81	4,68	H	6568854
TDMX24000PKM	24,00	4,73	I	6568856
TDMX24500PKM	24,50	4,82	I	6568857
TDMX24605PKM	24,61	4,84	I	6568858
TDMX25000PKM	25,00	4,91	J	6568859
TDMX25400PKM	25,40	4,99	J	6568860
TDMX25500PKM	25,50	5,01	J	6568861
TDMX25670PKM	25,67	5,04	J	6568862
TDMX25700PKM	25,70	5,04	J	6568863
TDMX25760PKM	25,76	5,05	J	6568864
TDMX25796PKM	25,80	5,06	J	6568865
TDMX26000PKM	26,00	5,11	K	6568866
TDMX26192PKM	26,19	5,15	K	6568867
TDMX26400PKM	26,40	5,18	K	6568868
TDMX26500PKM	26,50	5,20	K	6568869
TDMX26589PKM	26,59	5,22	K	6568870
TDMX27000PKM	27,00	5,29	L	6568871
TDMX27500PKM	27,50	5,38	L	6568872
TDMX27780PKM	27,78	5,43	L	6568873
TDMX28000PKM	28,00	5,49	M	6568874
TDMX28176PKM	28,18	5,52	M	6568875
TDMX28500PKM	28,50	5,58	M	6568876
TDMX28575PKM	28,58	5,59	M	6568877
TDMX29000PKM	29,00	5,67	N	6568878
TDMX29367PKM	29,37	5,74	N	6568879
TDMX29500PKM	29,50	5,76	N	6568880

Modular Drills • TOP DRILL™ Modular X

TDMX • Inserts • PK(M)

(continued)

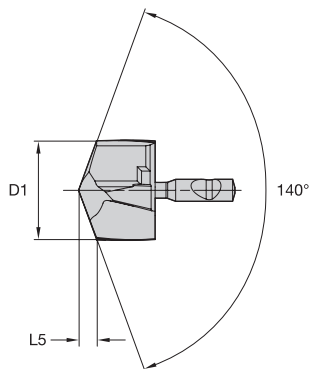

● first choice
○ alternate choice

P	●
M	○
K	●
N	
S	
H	

catalogue number	D1	L5	SSC	WP40PD
TDMX29764PKM	29,76	5,81	N	6568891
TDMX30000PKM	30,00	5,87	O	6568892
TDMX30163PKM	30,16	5,90	O	6568893
TDMX30500PKM	30,50	5,96	O	6568896
TDMX30955PKM	30,96	6,04	O	6568897
TDMX31000PKM	31,00	6,05	P	6568898
TDMX31500PKM	31,50	6,14	P	6568899
TDMX31750PKM	31,75	6,18	P	6568900
TDMX32000PKM	32,00	6,25	Q	6568901
TDMX32500PKM	32,50	6,34	Q	6568902
TDMX33000PKM	33,00	6,43	Q	6568903
TDMX33338PKM	33,34	6,49	Q	6568904
TDMX34000PKM	34,00	6,61	R	6568905
TDMX34130PKM	34,13	6,64	R	6568906
TDMX34925PKM	34,93	6,78	R	6568907
TDMX35000PKM	35,00	6,79	R	6568908
TDMX35500PKM	35,50	6,89	R	6568909
TDMX36000PKM	36,00	7,00	S	6568910
TDMX36500PKM	36,50	7,09	S	6568911
TDMX37000PKM	37,00	7,18	S	6568912
TDMX37500PKM	37,50	7,27	S	6568913
TDMX38000PKM	38,00	7,36	T	6568914
TDMX38100PKM	38,10	7,38	T	6568915
TDMX38500PKM	38,50	7,46	T	6568916
TDMX39000PKM	39,00	7,55	T	6568917
TDMX39289PKM	39,29	7,60	T	6568918
TDMX39500PKM	39,50	7,64	T	6568919
TDMX40000PKM	40,00	7,73	T	6568920

NOTE: SSC = Pocket Seat Reference. To correspond with the SSC on the toolholder.

Metric tolerance

D1	tolerance k8
8-10	0,000/+0,022
>10-17	0,000/+0,027
>17-18	0,000/+0,027
>18-21	0,000/+0,033



TDMX — TOP DRILL™ Modular X

Modular Drills • TOP DRILL Modular X

TDMX • Inserts • FPE(M)

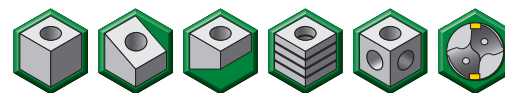

- first choice
- alternate choice

P	●
M	○
K	●
N	
S	
H	

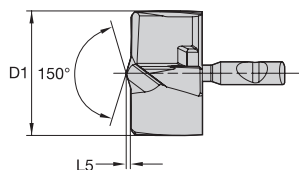

catalogue number	D1	L5	SSC	WP40PD
TDMX16000FPEM	16,00	1,16	A	6693048
TDMX16281FPEM	16,28	1,17	A	6693049
TDMX16500FPEM	16,50	1,17	A	6693050
TDMX16667FPEM	16,67	1,17	A	6693111
TDMX17000FPEM	17,00	1,18	B	6693112
TDMX17064FPEM	17,06	1,18	B	6693113
TDMX17500FPEM	17,50	1,19	B	6693114
TDMX18000FPEM	18,00	1,28	C	6693115
TDMX18500FPEM	18,50	1,28	C	6693116
TDMX19000FPEM	19,00	1,29	D	6693117
TDMX19050FPEM	19,05	1,29	D	6693118
TDMX19500FPEM	19,50	1,30	D	6693119
TDMX19840FPEM	19,84	1,31	D	6693120
TDMX20000FPEM	20,00	1,39	E	6693131
TDMX20500FPEM	20,50	1,40	E	6693132
TDMX21000FPEM	21,00	1,40	F	6693133
TDMX21500FPEM	21,50	1,41	F	6693134
TDMX22000FPEM	22,00	1,50	G	6693135
TDMX22500FPEM	22,50	1,51	G	6693136
TDMX23000FPEM	23,00	1,51	H	6693137
TDMX23500FPEM	23,50	1,52	H	6693138
TDMX24000FPEM	24,00	1,61	I	6693139
TDMX24500FPEM	24,50	1,62	I	6693140
TDMX25000FPEM	25,00	1,62	J	6693151
TDMX25400FPEM	25,40	1,63	J	6693152
TDMX25500FPEM	25,50	1,63	J	6693153
TDMX26000FPEM	26,00	1,72	K	6693154
TDMX26400FPEM	26,40	1,72	K	6693194
TDMX26500FPEM	26,50	1,72	K	6693155
TDMX27000FPEM	27,00	1,73	L	6693156
TDMX27500FPEM	27,50	1,74	L	6693157
TDMX28000FPEM	28,00	1,83	M	6693158
TDMX28500FPEM	28,50	1,83	M	6693160
TDMX29000FPEM	29,00	1,84	N	6693161
TDMX29500FPEM	29,50	1,85	N	6693162
TDMX30000FPEM	30,00	1,93	O	6693163



Modular Drills • TOP DRILL™ Modular X

TDMX • Inserts • FPE(M)

(continued)

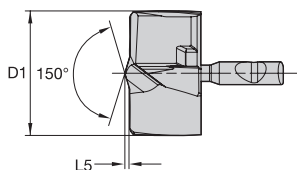

- first choice
- alternate choice

P	●
M	○
K	●
N	
S	
H	

catalogue number	D1	L5	SSC	WP40PD
TDMX30500FPEM	30,50	1,94	O	6693164
TDMX31000FPEM	31,00	1,94	P	6693165
TDMX31500FPEM	31,50	1,95	P	6693166
TDMX31750FPEM	31,75	1,95	P	6693167
TDMX32000FPEM	32,00	2,08	Q	6693168
TDMX32500FPEM	32,50	2,08	Q	6693169
TDMX33000FPEM	33,00	2,09	Q	6693170
TDMX34000FPEM	34,00	2,10	R	6693181
TDMX35000FPEM	35,00	2,11	R	6693182
TDMX35500FPEM	35,50	2,12	R	6693183
TDMX36000FPEM	36,00	2,29	S	6693184
TDMX36500FPEM	36,50	2,29	S	6693185
TDMX37000FPEM	37,00	2,30	S	6693186
TDMX37500FPEM	37,50	2,30	S	6693187
TDMX38000FPEM	38,00	2,31	T	6693188
TDMX38100FPEM	38,10	2,31	T	6693189
TDMX38500FPEM	38,50	2,32	T	6693190
TDMX39000FPEM	39,00	2,32	T	6693191
TDMX39500FPEM	39,50	2,33	T	6693192
TDMX40000FPEM	40,00	2,33	T	6693193

NOTE: SSC = Pocket Seat Reference. To correspond with the SSC on the toolholder.



Metric tolerance	
D1	tolerance k8
8-10	0,000/+0,022
>10-17	0,000/+0,027
>17-18	0,000/+0,027
>18-21	0,000/+0,033



TDMX — TOP DRILL™ Modular X



Modular Drills • TOP DRILL Modular X

Application Data • PK(M) • WP40PD • Metric

Material Group										
		Cutting Speed – Vc Range – m/min			Recommended Feed Rate (f) by Diameter					
		min	Starting Value	max	Tool Diameter (mm)	16,0	20,0	25,0	32,0	40,0
P	1	90	125	170	mm/r	0,19–0,45	0,25–0,48	0,25–0,52	0,28–0,57	0,29–0,60
	2	105	140	180	mm/r	0,23–0,46	0,28–0,50	0,30–0,52	0,33–0,57	0,35–0,60
	3	50	75	100	mm/r	0,23–0,46	0,28–0,50	0,30–0,52	0,33–0,57	0,35–0,60
	4	50	75	100	mm/r	0,19–0,45	0,22–0,48	0,25–0,50	0,28–0,55	0,29–0,58
	5	50	65	80	mm/r	0,16–0,32	0,18–0,36	0,22–0,42	0,24–0,46	0,25–0,48
	6	50	65	80	mm/r	0,16–0,32	0,18–0,36	0,22–0,42	0,24–0,46	0,25–0,48
M	1	40	80	110	mm/r	0,11–0,26	0,13–0,28	0,13–0,32	0,14–0,35	0,15–0,37
	2	35	55	75	mm/r	0,11–0,26	0,13–0,28	0,13–0,32	0,14–0,35	0,15–0,37
	3	20	35	50	mm/r	0,11–0,26	0,13–0,28	0,13–0,32	0,14–0,35	0,15–0,37
K	1	60	95	170	mm/r	0,25–0,48	0,28–0,52	0,32–0,56	0,35–0,62	0,37–0,65
	2	60	75	90	mm/r	0,25–0,48	0,28–0,52	0,32–0,56	0,35–0,62	0,37–0,65
	3	40	65	90	mm/r	0,21–0,44	0,23–0,48	0,25–0,50	0,28–0,55	0,29–0,58

NOTE: Through coolant recommended for greater than 3 x D applications.
Material group M is recommended for secondary applications.

Application Data • FPE(M) • WP40PD • Metric

Material Group										
		Cutting Speed – Vc Range – m/min			Recommended Feed Rate (f) by Diameter					
		min	Starting Value	max	Tool Diameter (mm)	16,0	20,0	25,0	32,0	40,0
P	1	110	140	170	mm/r	0,17–0,25	0,19–0,29	0,23–0,38	0,26–0,43	0,33–0,76
	2	100	120	140	mm/r	0,19–0,25	0,22–0,29	0,29–0,38	0,32–0,43	0,33–0,76
	3	80	100	120	mm/r	0,15–0,23	0,17–0,25	0,23–0,34	0,26–0,38	0,33–0,66
	4	70	90	110	mm/r	0,13–0,23	0,14–0,25	0,18–0,34	0,21–0,38	0,26–0,66
M	1	40	60	80	mm/r	0,11–0,17	0,13–0,20	0,16–0,25	0,18–0,28	0,21–0,31
	2	35	55	70	mm/r	0,11–0,17	0,13–0,20	0,16–0,25	0,18–0,28	0,21–0,31
	3	20	40	60	mm/r	0,11–0,17	0,13–0,20	0,16–0,25	0,18–0,28	0,21–0,31
K	1	90	135	175	mm/r	0,19–0,25	0,22–0,29	0,29–0,38	0,32–0,43	0,33–0,76
	2	80	120	140	mm/r	0,19–0,25	0,22–0,29	0,29–0,38	0,32–0,43	0,33–0,76
	3	70	110	125	mm/r	0,18–0,26	0,21–0,29	0,23–0,37	0,25–0,42	0,27–0,57
S	1	20	40	60	mm/r	0,11–0,17	0,13–0,20	0,16–0,25	0,18–0,28	0,21–0,31
	3	15	30	45	mm/r	0,11–0,17	0,13–0,20	0,16–0,25	0,18–0,28	0,21–0,31

NOTE: Through coolant recommended for greater than 3 x D applications.
Material group M is recommended for secondary applications.

Modular Drills • TOP DRILL™ Modular X

TDMX Application Notes • Power and Coolant Requirements

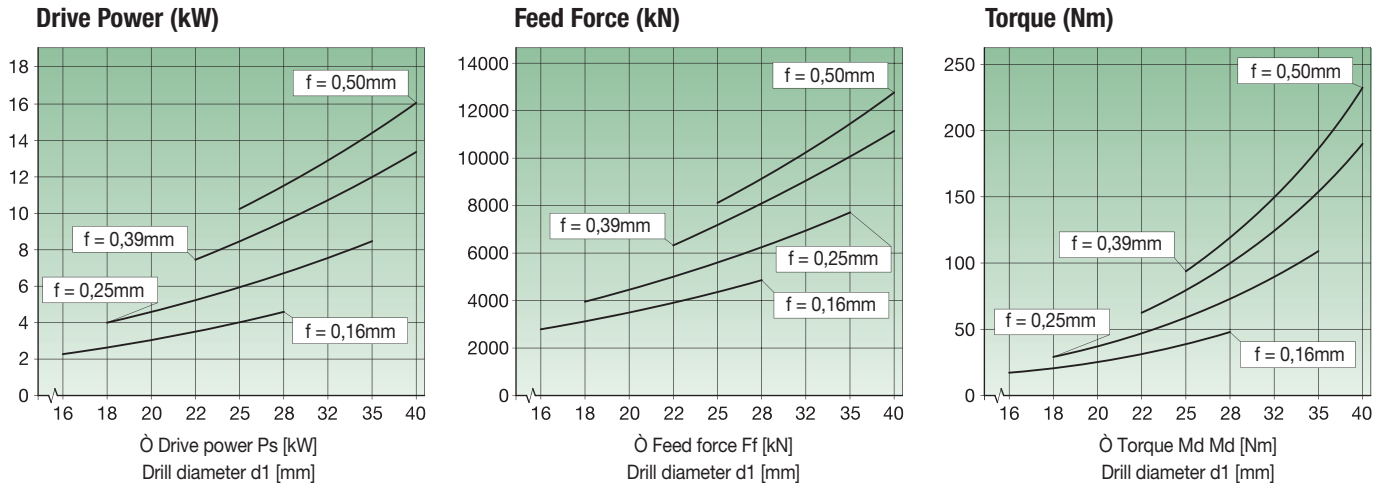

NOTE: The diagrams above are used to determine the drive power, feed force, and torque. They are based on cutting force measurement in tempered steels in Cgr. 6. Tensile strength: $R_m = 600 \text{ N/mm}^2$. The base cutting speed used is: $vc = 80 \text{ m/min}$.

TDMX • Regrinding Length • FPE(M) • Metric

SSC	diameter range D	L min.	L new
A	16-16,999	9,8	10,8
B	17-17,999	9,8	10,8
C	18-18,999	10,6	11,7
D	19-19,999	10,6	11,7
E	20-20,999	11,4	12,6
F	21-21,999	11,4	12,6
G	22-22,999	12,1	13,4
H	23-23,999	12,1	13,4
I	24-24,999	13,0	14,4
J	25-25,999	13,0	14,4
K	26-26,999	13,8	15,3
L	27-27,999	13,8	15,3
M	28-28,999	14,8	16,4
N	29-29,999	14,8	16,4
O	30-30,999	15,6	17,3
P	31-31,999	15,6	17,3
Q	32-33,999	17,8	19,7
R	34-35,999	17,8	19,7
S	36-37,999	19,4	21,5
T	38-40,000	19,4	21,5

NOTE: SSC = Pocket Seat Reference. To correspond with the SSC on the inserts.

TDMX • Regrinding Length • PK(M) • Metric

SSC	diameter range D	L min.	L new
A	16-16,999	11,2	12,5
B	17-17,999	11,2	12,5
C	18-18,999	12,2	13,6
D	19-19,999	12,2	13,6
E	20-20,999	13,2	14,7
F	21-21,999	13,2	14,7
G	22-22,999	14,2	15,8
H	23-23,999	14,2	15,8
I	24-24,999	15,2	16,9
J	25-25,999	15,2	16,9
K	26-26,999	16,2	18
L	27-27,999	16,2	18
M	28-28,999	17,2	19,1
N	29-29,999	17,2	19,1
O	30-30,999	18,2	20,2
P	31-31,999	18,2	20,2
Q	32-33,999	20,1	22,3
R	34-35,999	20,1	22,3
S	36-37,999	22,1	24,5
T	38-40,000	22,1	24,5

The following coolant pressure is recommended:

relative drilling depth	coolant pressure
1-3 x D	8 bars
5 x D	12 bars
7 x D	20 bars
10 x D	30 bars

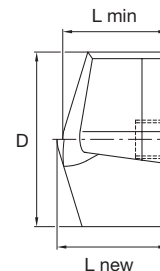

TOP CUT 4™



THE NEXT GENERATION
OF INDEXABLE DRILLING





One Comprehensive Platform

Standard diameter range covering 12–68mm
in 2 x D, 3 x D, 4 x D, and 5 x D.

Four real cutting edges on each insert for entire platform.

Eight insert sizes to cover complete diameter range.

Easy to Apply

No risk of mixing up inner and outer insert due to clear
visual differences.

Easy-to-change inserts, laser marked with geometries and grades.

Easy-to-use nomenclature guide enabling the tool body and the
related insert selection to avoid order failures.

Highly Versatile

Breadth of application capabilities include through and cross holes,
inclined entry and exit opportunity, 45° corner, half cylindrical,
concave, or chain drilling.

Various geometries and grades available.

WIDIA™ Top Cut 4™ (TC4) portfolio is a broad offering for
customers looking for a versatile indexable drilling platform.

Top Cut 4™

Indexable Drills • Top Cut 4



- 2x four true cutting edges.
- Cutting edge profile of central and periphery insert work together, leading to high stabilisation of the drill, preventing drifting of the tool even on irregular surfaces.
- X-offset design to adjust diameter size on turning machines and optimise tolerances on machining centres.
- Apply where speed and economy are prime considerations.
- Four grades to achieve higher tool life at accelerated speeds:
 - WU25CH grade for highest metal removal rate in general applications.
 - WU40PH grade for high toughness demands.
 - WPK10CH grade for high-speed applications.
 - WN10PH grade specific for aluminium and other non-ferrous materials.

Chip Flute Exit

Steeper chip flute exit to reduce the overall length and increase rigidity.

Coolant Channels

Enhanced coolant holes to get more lubrication at the cutting edge.

SL Shank Style

Metric portfolio: shank sizes are 20mm, 25mm, 32mm, and 40mm, based on the cutting diameter for all the L/D ratios.

Insert Positioning

Optimised insert positioning to achieve the maximum drill stability, hole tolerance, and surface quality, above all in deep-drilling applications.

Gash

Improved gash design on both insert pocket seats for a better chip evacuation.

Top Cut 4 Inserts Expansion — Long Chip Materials — Non-Ferrous Materials.

-V34

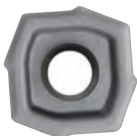

P K

First choice for machining Steel, Cast Iron, and short chipping materials. Suitable for severe cutting conditions.

-V36

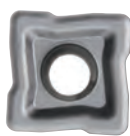

P M K

First choice for Stainless Steel. Suitable for deep drilling and where low power consumption is required.

-V36 WN10PH



N

First choice for Non-Ferrous materials.

-V38



P M S

Ideal for long chipping materials.

Top Cut 4 Bodies Upgrade

Diameter 30mm, 4 x D example

Current

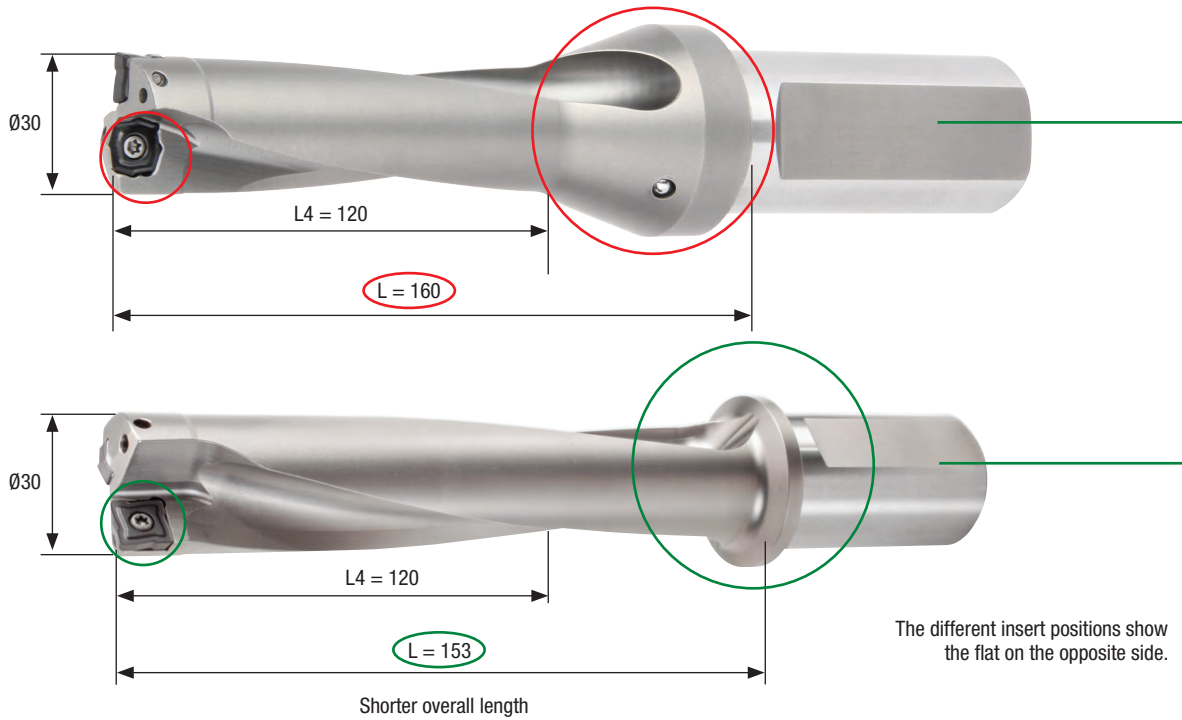

Gash
Optimised gash for improved chip flow and more precise **insert pocket seat positioning**.



Top Cut 4™

Indexable Drills • Top Cut 4

-V36 WN10PH for Non-Ferrous Materials

Productivity

- Perfect combination of edge preparation and grade for aluminium machining.
- TiB₂ based coating specific for non-ferrous materials.
- Optimal chip control and no built-up edge, even in very soft aluminiums.

Performance

- High cutting speed capability thanks to the state-of-the-art TiB₂ coating.
- The WN10PH grade geometry is available on the inboard insert, as well as on the outboard insert.
- Better general hole quality (surface and dimension) thanks to edge preparation and coating combination when compared to a standard universal insert.
- Longer and predictable tool life leads to avoiding the generation of built-up edge.

Technical Details

- PSTS inserts.
- Positive and sharp cutting edge.
- First choice for aluminium and other non-ferrous materials.
- Periphery insert with wiper land.



Top Cut 4 Inserts Expansion — Non-Ferrous Materials.

-V36 WN10PH



N

First choice for Non-Ferrous materials.

Hole Quality — Surface Finish

Diameter: 30mm 4 x D hole
Material: GAISI 7 Mg

-V36 WN10PH

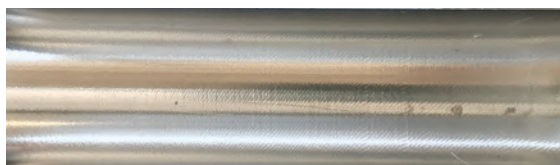

Standard multipurpose grade and geometry

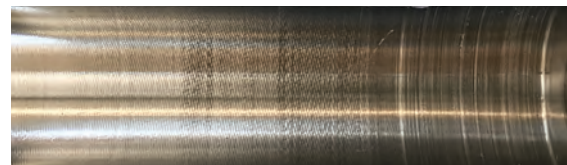

WIDIA 

-V38 Chipbreaker

Productivity

- Eliminates the formation of bird-nesting on the tool in long chip materials drilling.
- Improves the chip formation dramatically to guarantee a smooth chip flow.
- No machine stops due to bad chip evacuation on low carbon steels, stainless steels, and titanium — high process reliability.

Performance

- Larger feed rate window compared to the -V36 geometry when applied to low carbon steels and stainless steel.
- -V38 geometry is available on the inboard insert, as well as on the outboard insert.
- Better general hole quality (surface and dimension) thanks to the improved chip flow:
 - No drifting of the tool body causing deviation in the hole size.
 - No contact of the chips with the hole surface causing bad finishing.

Technical Details

- PSTS inserts.
- Special edge geometry for more effective chipbreaking action.
- First choice for low carbon steel, stainless steel, and super alloys.
- Periphery insert with wiper land.



-V38 Chipbreaker Application Areas

The new -V38 geometry is the first choice when:

- The drilling application with Top Cut 4™ platform bodies and inserts is applied to:
 - Low carbon steel (typically P0 and P1).
 - Stainless steels, such as AISI304, AISI316, and similar materials.
 - Titanium alloys, like Grade 2 and Grade 5.
- Bird-nesting on the tool body is an issue.
- Vibrations are generated due to a bad chip flow. Chip can't evacuate from the hole and generates big noise during machining.
- Bad surface quality caused by the chip in contact with the hole.
- Bigger hole size. Bad chip flow can generate tool drifting.
- Lower power consumption and less torque are needed.

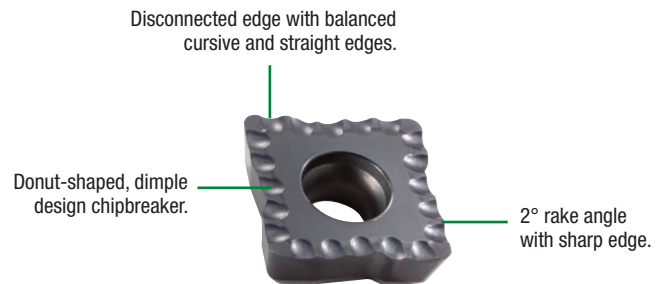

Top Cut 4 Inserts Expansion — Long Chip Materials.

-V38



Ideal for long chip materials.



Top Cut 4™

Indexable Drills • Top Cut 4

TC4 • 2 x D • SLR Shanks • Metric

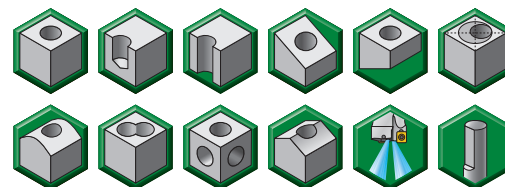
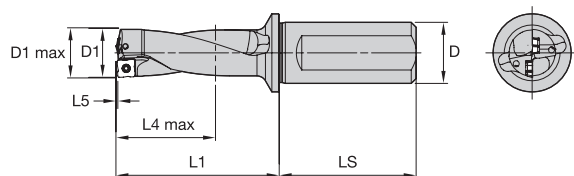

order number	catalogue number	D1	D1 max	D	L1	L4 max	L5	LS	SSC	periphery insert	centre insert
5537778	TCF120R2SLR20MA	12,00	12,50	20	43,4	24,4	0,43	50,00	A	TCF040204AP	TCF040203AC
5537779	TCF125R2SLR20MA	12,50	13,00	20	44,5	25,5	0,45	50,00	A	TCF040204AP	TCF040203AC
5537860	TCF127R2SLR20MA	12,70	13,20	20	45,9	25,9	0,46	50,00	A	TCF040204AP	TCF040203AC
5537861	TCF130R2SLR20MA	13,00	13,50	20	46,5	26,5	0,47	50,00	A	TCF040204AP	TCF040203AC
5537862	TCF135R2SLR20MA	13,50	14,00	20	48,5	27,5	0,48	50,00	A	TCF040204AP	TCF040203AC
5577828	TCF140R2SLR25MB	14,00	14,50	25	48,5	28,5	0,49	56,00	B	TCF050204BP	TCF060203BC
5577829	TCF145R2SLR25MB	14,50	15,00	25	49,5	29,5	0,52	56,00	B	TCF050204BP	TCF060203BC
5577920	TCF150R2SLR25MB	15,00	15,50	25	51,5	30,5	0,55	56,00	B	TCF050204BP	TCF060203BC
5577921	TCF155R2SLR25MB	15,50	16,00	25	53,6	31,6	0,56	56,00	B	TCF050204BP	TCF060203BC
5577922	TCF160R2SLR25MB	16,00	16,50	25	54,6	32,6	0,58	56,00	B	TCF050204BP	TCF060203BC
5577923	TCF165R2SLR25MB	16,50	17,00	25	56,6	33,6	0,60	56,00	B	TCF050204BP	TCF060203BC
5577924	TCF170R2SLR25MB	17,00	17,50	25	57,6	34,6	0,61	56,00	B	TCF050204BP	TCF060203BC
5577925	TCF175R2SLR25MB	17,50	18,00	25	59,6	35,6	0,63	56,00	B	TCF050204BP	TCF060203BC
5577926	TCF180R2SLR25MB	18,00	18,50	25	60,6	36,6	0,64	56,00	B	TCF050204BP	TCF060203BC
5577927	TCF185R2SLR25MB	18,50	19,00	25	62,7	37,7	0,65	56,00	B	TCF050204BP	TCF060203BC
5578820	TCF190R2SLR25MC	19,00	19,50	25	63,7	38,7	0,68	56,00	C	TCF070306CP	TCF070304CC
5578821	TCF195R2SLR25MC	19,50	20,00	25	65,7	39,7	0,71	56,00	C	TCF070306CP	TCF070304CC
5578822	TCF200R2SLR25MC	20,00	20,50	25	66,7	40,7	0,72	56,00	C	TCF070306CP	TCF070304CC
5578823	TCF205R2SLR25MC	20,50	21,00	25	68,7	41,7	0,74	56,00	C	TCF070306CP	TCF070304CC
5578824	TCF210R2SLR25MC	21,00	21,50	25	70,8	42,8	0,75	56,00	C	TCF070306CP	TCF070304CC
5578825	TCF220R2SLR25MC	22,00	22,50	25	73,8	44,8	0,78	56,00	C	TCF070306CP	TCF070304CC
5578826	TCF225R2SLR25MC	22,50	23,00	25	74,8	45,8	0,79	56,00	C	TCF070306CP	TCF070304CC
5578827	TCF230R2SLR25MC	23,00	23,50	25	76,8	46,8	0,80	56,00	C	TCF070306CP	TCF070304CC
5537167	TCF240R2SLR25MD	24,00	25,00	25	76,9	48,9	0,87	56,00	D	TCF080308DP	TCF090305DC
5537168	TCF250R2SLR32MD	25,00	26,00	32	80,9	50,9	0,91	60,00	D	TCF080308DP	TCF090305DC
5537169	TCF260R2SLR32MD	26,00	27,00	32	83,9	52,9	0,94	60,00	D	TCF080308DP	TCF090305DC
5537820	TCF265R2SLR32MD	26,50	27,50	32	86,0	54,0	0,95	60,00	D	TCF080308DP	TCF090305DC
5537821	TCF270R2SLR32MD	27,00	28,00	32	87,0	55,0	0,97	60,00	D	TCF080308DP	TCF090305DC
5537822	TCF280R2SLR32MD	28,00	29,00	32	90,0	57,0	0,99	60,00	D	TCF080308DP	TCF090305DC
5537823	TCF290R2SLR32MD	29,00	30,00	32	93,0	59,0	1,02	60,00	D	TCF080308DP	TCF090305DC
5537937	TCF300R2SLR32ME	30,00	31,00	32	93,1	61,1	1,09	60,00	E	TCF100408EP	TCF120405EC
5537938	TCF310R2SLR32ME	31,00	32,00	32	96,1	63,1	1,12	60,00	E	TCF100408EP	TCF120405EC
5537939	TCF320R2SLR32ME	32,00	33,00	32	99,2	65,2	1,15	60,00	E	TCF100408EP	TCF120405EC
5537940	TCF330R2SLR40ME	33,00	34,00	40	103,2	67,2	1,18	70,00	E	TCF100408EP	TCF120405EC
5537941	TCF340R2SLR40ME	34,00	35,00	40	106,2	69,2	1,21	70,00	E	TCF100408EP	TCF120405EC
5537942	TCF350R2SLR40ME	35,00	36,00	40	109,2	71,2	1,24	70,00	E	TCF100408EP	TCF120405EC
5537943	TCF360R2SLR40ME	36,00	37,00	40	112,3	73,3	1,27	70,00	E	TCF100408EP	TCF120405EC
5578539	TCF370R2SLR40MF	37,00	38,00	40	115,3	75,3	1,35	70,00	F	TCF120412FP	TCF150406FC
5578600	TCF375R2SLR40MF	37,50	38,50	40	116,4	76,4	1,36	70,00	F	TCF120412FP	TCF150406FC
5578601	TCF380R2SLR40MF	38,00	39,00	40	118,4	77,4	1,38	70,00	F	TCF120412FP	TCF150406FC

TC4 • 2 x D • SLR Shanks • Metric

(continued)

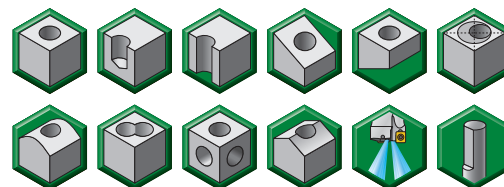
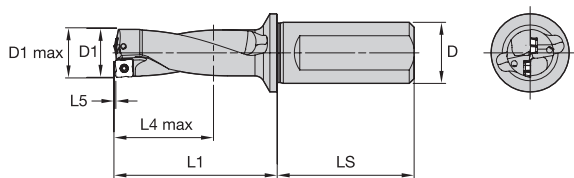

order number	catalogue number	D1	D1 max	D	L1	L4 max	L5	LS	SSC	periphery insert	centre insert
5578602	TCF390R2SLR40MF	39,00	40,00	40	121,4	79,4	1,41	70,00	F	TCF120412FP	TCF150406FC
5578603	TCF400R2SLR40MF	40,00	41,00	40	123,4	81,4	1,45	70,00	F	TCF120412FP	TCF150406FC
5578604	TCF410R2SLR40MF	41,00	42,00	40	126,5	83,5	1,48	70,00	F	TCF120412FP	TCF150406FC
5578605	TCF420R2SLR40MF	42,00	43,00	40	129,5	85,5	1,51	70,00	F	TCF120412FP	TCF150406FC
5578606	TCF430R2SLR40MF	43,00	44,00	40	132,5	87,5	1,53	70,00	F	TCF120412FP	TCF150406FC
5578607	TCF440R2SLR40MF	44,00	45,00	40	135,6	89,6	1,56	70,00	F	TCF120412FP	TCF150406FC
5578608	TCF450R2SLR40MF	45,00	46,00	40	138,6	91,6	1,59	70,00	F	TCF120412FP	TCF150406FC
5578694	TCF460R2SLR40MG	46,00	47,00	40	136,7	93,7	1,67	70,00	G	TCF150512GP	TCF180508GC
5578695	TCF470R2SLR40MG	47,00	48,00	40	139,7	95,7	1,70	70,00	G	TCF150512GP	TCF180508GC
5578696	TCF480R2SLR40MG	48,00	49,00	40	142,7	97,7	1,73	70,00	G	TCF150512GP	TCF180508GC
5578697	TCF490R2SLR40MG	49,00	50,00	40	145,8	99,8	1,76	70,00	G	TCF150512GP	TCF180508GC
5578698	TCF500R2SLR40MG	50,00	51,00	40	147,8	101,8	1,79	70,00	G	TCF150512GP	TCF180508GC
5578699	TCF505R2SLR40MG	50,50	51,50	40	149,8	102,8	1,80	70,00	G	TCF150512GP	TCF180508GC
5578710	TCF510R2SLR40MG	51,00	52,00	40	150,8	103,8	1,81	70,00	G	TCF150512GP	TCF180508GC
5578711	TCF520R2SLR40MG	52,00	53,00	40	153,8	105,8	1,84	70,00	G	TCF150512GP	TCF180508GC
5578712	TCF530R2SLR40MG	53,00	54,00	40	156,9	107,9	1,87	70,00	G	TCF150512GP	TCF180508GC
5578713	TCF540R2SLR40MG	54,00	55,00	40	159,9	109,9	1,89	70,00	G	TCF150512GP	TCF180508GC
5578714	TCF550R2SLR40MG	55,00	56,00	40	161,9	111,9	1,92	70,00	G	TCF150512GP	TCF180508GC
5578715	TCF560R2SLR40MG	56,00	57,00	40	164,9	113,9	1,94	70,00	G	TCF150512GP	TCF180508GC
5538613	TCF570R2SLR40MH	57,00	58,00	40	162,1	116,1	2,06	70,00	H	TCF180614HP	TCF210608HC
5538614	TCF580R2SLR40MH	58,00	59,00	40	165,1	118,1	2,09	70,00	H	TCF180614HP	TCF210608HC
5538615	TCF590R2SLR40MH	59,00	60,00	40	168,1	120,1	2,12	70,00	H	TCF180614HP	TCF210608HC
5538616	TCF600R2SLR40MH	60,00	61,00	40	170,1	122,1	2,15	70,00	H	TCF180614HP	TCF210608HC
5538617	TCF610R2SLR40MH	61,00	62,00	40	173,2	124,2	2,18	70,00	H	TCF180614HP	TCF210608HC
5538618	TCF620R2SLR40MH	62,00	63,00	40	176,2	126,2	2,20	70,00	H	TCF180614HP	TCF210608HC
5538619	TCF630R2SLR40MH	63,00	64,00	40	179,2	128,2	2,23	70,00	H	TCF180614HP	TCF210608HC
5538630	TCF640R2SLR40MH	64,00	65,00	40	181,3	130,3	2,26	70,00	H	TCF180614HP	TCF210608HC
5538631	TCF650R2SLR40MH	65,00	66,00	40	184,3	132,3	2,28	70,00	H	TCF180614HP	TCF210608HC
5538632	TCF660R2SLR40MH	66,00	67,00	40	187,3	134,3	2,31	70,00	H	TCF180614HP	TCF210608HC
5538633	TCF670R2SLR40MH	67,00	68,00	40	189,3	136,3	2,33	70,00	H	TCF180614HP	TCF210608HC
5538634	TCF680R2SLR40MH	68,00	69,00	40	192,4	138,4	2,36	70,00	H	TCF180614HP	TCF210608HC

NOTE: SSC = Pocket Seat Reference. To correspond with the SSC on the inserts.

WARNING

During through-hole operations, a slug or disc is produced as the tool breaks through the workpiece. When the drill is stationary and the workpiece is rotating, this slug may be hurled from the chuck by centrifugal force. Provide adequate shielding to protect bystanders.

Top Cut 4™

Indexable Drills • Top Cut 4

TC4 • 3 x D • SLR Shanks • Metric

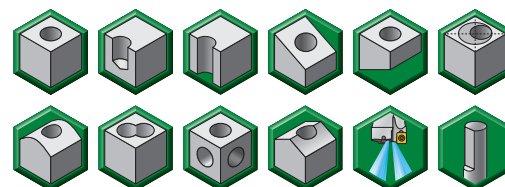
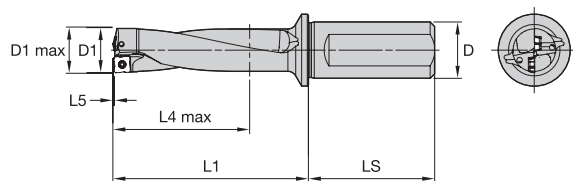

order number	catalogue number	D1	D1 max	D	L1	L4 max	L5	LS	SSC	periphery insert	centre insert
5537863	TCF120R3SLR20MA	12,00	12,50	20	55,4	36,4	0,43	50,00	A	TCF040204AP	TCF040203AC
5537864	TCF125R3SLR20MA	12,50	13,00	20	57,0	38,0	0,45	50,00	A	TCF040204AP	TCF040203AC
5537866	TCF127R3SLR20MA	12,70	13,20	20	58,6	38,6	0,46	50,00	A	TCF040204AP	TCF040203AC
5537867	TCF130R3SLR20MA	13,00	13,50	20	59,5	39,5	0,47	50,00	A	TCF040204AP	TCF040203AC
5537868	TCF135R3SLR20MA	13,50	14,00	20	61,0	41,0	0,48	50,00	A	TCF040204AP	TCF040203AC
5577928	TCF140R3SLR25MB	14,00	14,50	25	62,5	42,5	0,49	56,00	B	TCF050204BP	TCF060203BC
5577929	TCF145R3SLR25MB	14,50	15,00	25	64,0	44,0	0,52	56,00	B	TCF050204BP	TCF060203BC
5577930	TCF150R3SLR25MB	15,00	15,50	25	66,5	45,5	0,55	56,00	B	TCF050204BP	TCF060203BC
5577931	TCF155R3SLR25MB	15,50	16,00	25	69,1	47,1	0,56	56,00	B	TCF050204BP	TCF060203BC
5577932	TCF160R3SLR25MB	16,00	16,50	25	70,6	48,6	0,58	56,00	B	TCF050204BP	TCF060203BC
5577933	TCF165R3SLR25MB	16,50	17,00	25	73,1	50,1	0,60	56,00	B	TCF050204BP	TCF060203BC
5577934	TCF170R3SLR25MB	17,00	17,50	25	74,6	51,6	0,61	56,00	B	TCF050204BP	TCF060203BC
5577935	TCF175R3SLR25MB	17,50	18,00	25	77,1	53,1	0,63	56,00	B	TCF050204BP	TCF060203BC
5577936	TCF180R3SLR25MB	18,00	18,50	25	78,6	54,6	0,64	56,00	B	TCF050204BP	TCF060203BC
5577937	TCF185R3SLR25MB	18,50	19,00	25	81,2	56,2	0,65	56,00	B	TCF050204BP	TCF060203BC
5578828	TCF190R3SLR25MC	19,00	19,50	25	82,7	57,7	0,68	56,00	C	TCF070306CP	TCF070304CC
5578829	TCF195R3SLR25MC	19,50	20,00	25	85,2	59,2	0,71	56,00	C	TCF070306CP	TCF070304CC
5578830	TCF200R3SLR25MC	20,00	20,50	25	86,7	60,7	0,72	56,00	C	TCF070306CP	TCF070304CC
5578831	TCF205R3SLR25MC	20,50	21,00	25	89,2	62,2	0,74	56,00	C	TCF070306CP	TCF070304CC
5578832	TCF210R3SLR25MC	21,00	21,50	25	91,8	63,8	0,75	56,00	C	TCF070306CP	TCF070304CC
5578833	TCF220R3SLR25MC	22,00	22,50	25	95,8	66,8	0,78	56,00	C	TCF070306CP	TCF070304CC
5578834	TCF225R3SLR25MC	22,50	23,00	25	97,3	68,3	0,79	56,00	C	TCF070306CP	TCF070304CC
5578835	TCF230R3SLR25MC	23,00	23,50	25	99,8	69,8	0,80	56,00	C	TCF070306CP	TCF070304CC
5537824	TCF240R3SLR25MD	24,00	25,00	25	100,9	72,9	0,87	56,00	D	TCF080308DP	TCF090305DC
5537825	TCF250R3SLR32MD	25,00	26,00	32	105,9	75,9	0,91	60,00	D	TCF080308DP	TCF090305DC
5537826	TCF260R3SLR32MD	26,00	27,00	32	109,9	78,9	0,94	60,00	D	TCF080308DP	TCF090305DC
5537827	TCF265R3SLR32MD	26,50	27,50	32	112,5	80,5	0,95	60,00	D	TCF080308DP	TCF090305DC
5537828	TCF270R3SLR32MD	27,00	28,00	32	114,0	82,0	0,97	60,00	D	TCF080308DP	TCF090305DC
5537829	TCF280R3SLR32MD	28,00	29,00	32	118,0	85,0	0,99	60,00	D	TCF080308DP	TCF090305DC
5537830	TCF290R3SLR32MD	29,00	30,00	32	122,0	88,0	1,02	60,00	D	TCF080308DP	TCF090305DC
5537944	TCF300R3SLR32ME	30,00	31,00	32	123,1	91,1	1,09	60,00	E	TCF100408EP	TCF120405EC
5537945	TCF310R3SLR32ME	31,00	32,00	32	127,1	94,1	1,12	60,00	E	TCF100408EP	TCF120405EC
5537946	TCF320R3SLR32ME	32,00	33,00	32	131,2	97,2	1,15	60,00	E	TCF100408EP	TCF120405EC
5537947	TCF330R3SLR40ME	33,00	34,00	40	136,2	100,2	1,18	70,00	E	TCF100408EP	TCF120405EC
5537948	TCF340R3SLR40ME	34,00	35,00	40	140,2	103,2	1,21	70,00	E	TCF100408EP	TCF120405EC
5537949	TCF350R3SLR40ME	35,00	36,00	40	144,2	106,2	1,24	70,00	E	TCF100408EP	TCF120405EC
5537950	TCF360R3SLR40ME	36,00	37,00	40	148,3	109,3	1,27	70,00	E	TCF100408EP	TCF120405EC
5578609	TCF370R3SLR40MF	37,00	38,00	40	152,3	112,3	1,35	70,00	F	TCF120412FP	TCF150406FC
5578610	TCF375R3SLR40MF	37,50	38,50	40	153,9	113,9	1,36	70,00	F	TCF120412FP	TCF150406FC
5578611	TCF380R3SLR40MF	38,00	39,00	40	156,4	115,4	1,38	70,00	F	TCF120412FP	TCF150406FC

TC4 • 3 x D • SLR Shanks • Metric

(continued)

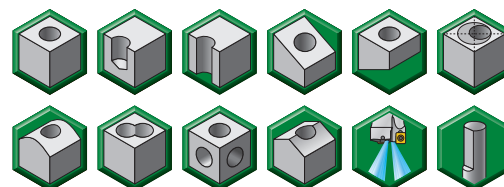
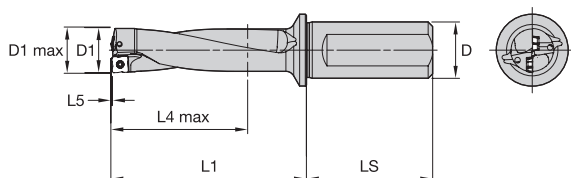

order number	catalogue number	D1	D1 max	D	L1	L4 max	L5	LS	SSC	periphery insert	centre insert
5578612	TCF390R3SLR40MF	39,00	40,00	40	160,4	118,4	1,41	70,00	F	TCF120412FP	TCF150406FC
5578613	TCF400R3SLR40MF	40,00	41,00	40	163,4	121,4	1,45	70,00	F	TCF120412FP	TCF150406FC
5578614	TCF410R3SLR40MF	41,00	42,00	40	167,5	124,5	1,48	70,00	F	TCF120412FP	TCF150406FC
5578615	TCF420R3SLR40MF	42,00	43,00	40	171,5	127,5	1,51	70,00	F	TCF120412FP	TCF150406FC
5578616	TCF430R3SLR40MF	43,00	44,00	40	175,5	130,5	1,53	70,00	F	TCF120412FP	TCF150406FC
5578617	TCF440R3SLR40MF	44,00	45,00	40	179,6	133,6	1,56	70,00	F	TCF120412FP	TCF150406FC
5578618	TCF450R3SLR40MF	45,00	46,00	40	183,6	136,6	1,59	70,00	F	TCF120412FP	TCF150406FC
5578716	TCF460R3SLR40MG	46,00	47,00	40	182,7	139,7	1,67	70,00	G	TCF150512GP	TCF180508GC
5578717	TCF470R3SLR40MG	47,00	48,00	40	186,7	142,7	1,70	70,00	G	TCF150512GP	TCF180508GC
5578718	TCF480R3SLR40MG	48,00	49,00	40	190,7	145,7	1,73	70,00	G	TCF150512GP	TCF180508GC
5578719	TCF490R3SLR40MG	49,00	50,00	40	194,8	148,8	1,76	70,00	G	TCF150512GP	TCF180508GC
5578720	TCF500R3SLR40MG	50,00	51,00	40	197,8	151,8	1,79	70,00	G	TCF150512GP	TCF180508GC
5578721	TCF505R3SLR40MG	50,50	51,50	40	200,3	153,3	1,80	70,00	G	TCF150512GP	TCF180508GC
5578722	TCF510R3SLR40MG	51,00	52,00	40	201,8	154,8	1,81	70,00	G	TCF150512GP	TCF180508GC
5578723	TCF520R3SLR40MG	52,00	53,00	40	205,8	157,8	1,84	70,00	G	TCF150512GP	TCF180508GC
5578724	TCF530R3SLR40MG	53,00	54,00	40	209,9	160,9	1,87	70,00	G	TCF150512GP	TCF180508GC
5578726	TCF540R3SLR40MG	54,00	55,00	40	213,9	163,9	1,89	70,00	G	TCF150512GP	TCF180508GC
5578727	TCF550R3SLR40MG	55,00	56,00	40	216,9	166,9	1,92	70,00	G	TCF150512GP	TCF180508GC
5578728	TCF560R3SLR40MG	56,00	57,00	40	220,9	169,9	1,94	70,00	G	TCF150512GP	TCF180508GC
5538635	TCF570R3SLR40MH	57,00	58,00	40	219,1	173,1	2,06	70,00	H	TCF180614HP	TCF210608HC
5538636	TCF580R3SLR40MH	58,00	59,00	40	223,1	176,1	2,09	70,00	H	TCF180614HP	TCF210608HC
5538637	TCF590R3SLR40MH	59,00	60,00	40	227,1	179,1	2,12	70,00	H	TCF180614HP	TCF210608HC
5538638	TCF600R3SLR40MH	60,00	61,00	40	230,1	182,1	2,15	70,00	H	TCF180614HP	TCF210608HC
5538639	TCF610R3SLR40MH	61,00	62,00	40	234,2	185,2	2,18	70,00	H	TCF180614HP	TCF210608HC
5538640	TCF620R3SLR40MH	62,00	63,00	40	238,2	188,2	2,20	70,00	H	TCF180614HP	TCF210608HC
5538641	TCF630R3SLR40MH	63,00	64,00	40	242,2	191,2	2,23	70,00	H	TCF180614HP	TCF210608HC
5538642	TCF640R3SLR40MH	64,00	65,00	40	245,3	194,3	2,26	70,00	H	TCF180614HP	TCF210608HC
5538643	TCF650R3SLR40MH	65,00	66,00	40	249,3	197,3	2,28	70,00	H	TCF180614HP	TCF210608HC
5538644	TCF660R3SLR40MH	66,00	67,00	40	253,3	200,3	2,31	70,00	H	TCF180614HP	TCF210608HC
5538645	TCF670R3SLR40MH	67,00	68,00	40	256,3	203,3	2,33	70,00	H	TCF180614HP	TCF210608HC
5538646	TCF680R3SLR40MH	68,00	69,00	40	260,4	206,4	2,36	70,00	H	TCF180614HP	TCF210608HC

NOTE: SSC = Pocket Seat Reference. To correspond with the SSC on the inserts.

WARNING

During through-hole operations, a slug or disc is produced as the tool breaks through the workpiece. When the drill is stationary and the workpiece is rotating, this slug may be hurled from the chuck by centrifugal force. Provide adequate shielding to protect bystanders.

Top Cut 4™

Indexable Drills • Top Cut 4

TC4 • 4 x D • SLR Shanks • Metric

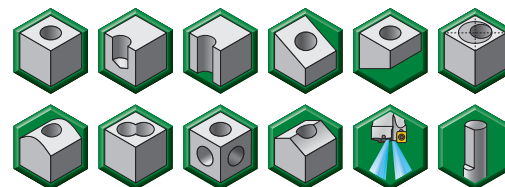
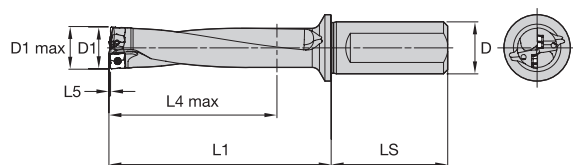

order number	catalogue number	D1	D1 max	D	L1	L4 max	L5	LS	SSC	periphery insert	centre insert
5537869	TCF120R4SLR20MA	12,00	12,50	20	67,4	48,4	0,43	50,00	A	TCF040204AP	TCF040203AC
5537870	TCF125R4SLR20MA	12,50	13,00	20	69,5	50,5	0,45	50,00	A	TCF040204AP	TCF040203AC
5537871	TCF127R4SLR20MA	12,70	13,20	20	71,3	51,3	0,46	50,00	A	TCF040204AP	TCF040203AC
5537872	TCF130R4SLR20MA	13,00	13,50	20	72,5	52,5	0,47	50,00	A	TCF040204AP	TCF040203AC
5537873	TCF135R4SLR20MA	13,50	14,00	20	75,5	54,5	0,48	50,00	A	TCF040204AP	TCF040203AC
5577938	TCF140R4SLR25MB	14,00	14,50	25	76,5	56,5	0,49	56,00	B	TCF050204BP	TCF060203BC
5577939	TCF145R4SLR25MB	14,50	15,00	25	78,5	58,5	0,52	56,00	B	TCF050204BP	TCF060203BC
5577940	TCF150R4SLR25MB	15,00	15,50	25	81,5	60,5	0,55	56,00	B	TCF050204BP	TCF060203BC
5577941	TCF155R4SLR25MB	15,50	16,00	25	84,6	62,6	0,56	56,00	B	TCF050204BP	TCF060203BC
5577942	TCF160R4SLR25MB	16,00	16,50	25	86,6	64,6	0,58	56,00	B	TCF050204BP	TCF060203BC
5577943	TCF165R4SLR25MB	16,50	17,00	25	89,6	66,6	0,60	56,00	B	TCF050204BP	TCF060203BC
5577944	TCF170R4SLR25MB	17,00	17,50	25	91,6	68,6	0,61	56,00	B	TCF050204BP	TCF060203BC
5577945	TCF175R4SLR25MB	17,50	18,00	25	94,6	70,6	0,63	56,00	B	TCF050204BP	TCF060203BC
5577946	TCF180R4SLR25MB	18,00	18,50	25	96,6	72,6	0,64	56,00	B	TCF050204BP	TCF060203BC
5577947	TCF185R4SLR25MB	18,50	19,00	25	99,7	74,7	0,65	56,00	B	TCF050204BP	TCF060203BC
5578836	TCF190R4SLR25MC	19,00	19,50	25	101,7	76,7	0,68	56,00	C	TCF070306CP	TCF070304CC
5578837	TCF195R4SLR25MC	19,50	20,00	25	104,7	78,7	0,71	56,00	C	TCF070306CP	TCF070304CC
5578838	TCF200R4SLR25MC	20,00	20,50	25	106,7	80,7	0,72	56,00	C	TCF070306CP	TCF070304CC
5578839	TCF205R4SLR25MC	20,50	21,00	25	109,7	82,7	0,74	56,00	C	TCF070306CP	TCF070304CC
5578840	TCF210R4SLR25MC	21,00	21,50	25	112,8	84,8	0,75	56,00	C	TCF070306CP	TCF070304CC
5578841	TCF220R4SLR25MC	22,00	22,50	25	117,8	88,8	0,78	56,00	C	TCF070306CP	TCF070304CC
5578842	TCF225R4SLR25MC	22,50	23,00	25	119,8	90,8	0,79	56,00	C	TCF070306CP	TCF070304CC
5578843	TCF230R4SLR25MC	23,00	23,50	25	122,8	92,8	0,80	56,00	C	TCF070306CP	TCF070304CC
5537831	TCF240R4SLR25MD	24,00	25,00	25	124,9	96,9	0,87	56,00	D	TCF080308DP	TCF090305DC
5537832	TCF250R4SLR32MD	25,00	26,00	32	130,9	100,9	0,91	60,00	D	TCF080308DP	TCF090305DC
5537833	TCF260R4SLR32MD	26,00	27,00	32	135,9	104,9	0,94	60,00	D	TCF080308DP	TCF090305DC
5537834	TCF265R4SLR32MD	26,50	27,50	32	139,0	107,0	0,95	60,00	D	TCF080308DP	TCF090305DC
5537835	TCF270R4SLR32MD	27,00	28,00	32	141,0	109,0	0,97	60,00	D	TCF080308DP	TCF090305DC
5537836	TCF280R4SLR32MD	28,00	29,00	32	146,0	113,0	0,99	60,00	D	TCF080308DP	TCF090305DC
5537837	TCF290R4SLR32MD	29,00	30,00	32	151,0	117,0	1,02	60,00	D	TCF080308DP	TCF090305DC
5537951	TCF300R4SLR32ME	30,00	31,00	32	153,1	121,1	1,09	60,00	E	TCF100408EP	TCF120405EC
5537952	TCF310R4SLR32ME	31,00	32,00	32	158,1	125,1	1,12	60,00	E	TCF100408EP	TCF120405EC
5537953	TCF320R4SLR32ME	32,00	33,00	32	163,2	129,2	1,15	60,00	E	TCF100408EP	TCF120405EC
5537954	TCF330R4SLR40ME	33,00	34,00	40	165,2	133,2	1,18	70,00	E	TCF100408EP	TCF120405EC
5537955	TCF340R4SLR40ME	34,00	35,00	40	174,2	137,2	1,21	70,00	E	TCF100408EP	TCF120405EC
5537956	TCF350R4SLR40ME	35,00	36,00	40	179,2	141,2	1,24	70,00	E	TCF100408EP	TCF120405EC
5537957	TCF360R4SLR40ME	36,00	37,00	40	184,3	145,3	1,27	70,00	E	TCF100408EP	TCF120405EC
5578619	TCF370R4SLR40MF	37,00	38,00	40	189,3	149,3	1,35	70,00	F	TCF120412FP	TCF150406FC
5578620	TCF375R4SLR40MF	37,50	38,50	40	191,4	151,4	1,36	70,00	F	TCF120412FP	TCF150406FC
5578621	TCF380R4SLR40MF	38,00	39,00	40	194,4	153,4	1,38	70,00	F	TCF120412FP	TCF150406FC

TC4 • 4 x D • SLR Shanks • Metric

(continued)

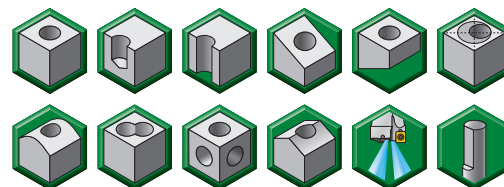
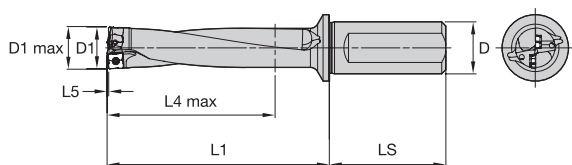

order number	catalogue number	D1	D1 max	D	L1	L4 max	L5	LS	SSC	periphery insert	centre insert
5578622	TCF390R4SLR40MF	39,00	40,00	40	199,4	157,4	1,41	70,00	F	TCF120412FP	TCF150406FC
5578623	TCF400R4SLR40MF	40,00	41,00	40	203,4	161,4	1,45	70,00	F	TCF120412FP	TCF150406FC
5578624	TCF410R4SLR40MF	41,00	42,00	40	208,5	165,5	1,48	70,00	F	TCF120412FP	TCF150406FC
5578625	TCF420R4SLR40MF	42,00	43,00	40	213,5	169,5	1,51	70,00	F	TCF120412FP	TCF150406FC
5578626	TCF430R4SLR40MF	43,00	44,00	40	218,5	173,5	1,53	70,00	F	TCF120412FP	TCF150406FC
5578627	TCF440R4SLR40MF	44,00	45,00	40	223,6	177,6	1,56	70,00	F	TCF120412FP	TCF150406FC
5578628	TCF450R4SLR40MF	45,00	46,00	40	228,6	181,6	1,59	70,00	F	TCF120412FP	TCF150406FC
5578729	TCF460R4SLR40MG	46,00	47,00	40	228,7	185,7	1,67	70,00	G	TCF150512GP	TCF180508GC
5578730	TCF470R4SLR40MG	47,00	48,00	40	233,7	189,7	1,70	70,00	G	TCF150512GP	TCF180508GC
5578731	TCF480R4SLR40MG	48,00	49,00	40	238,7	193,7	1,73	70,00	G	TCF150512GP	TCF180508GC
5578732	TCF490R4SLR40MG	49,00	50,00	40	243,8	197,8	1,76	70,00	G	TCF150512GP	TCF180508GC
5578733	TCF500R4SLR40MG	50,00	51,00	40	247,8	201,8	1,79	70,00	G	TCF150512GP	TCF180508GC
5578734	TCF505R4SLR40MG	50,50	51,50	40	250,8	203,8	1,80	70,00	G	TCF150512GP	TCF180508GC
5578735	TCF510R4SLR40MG	51,00	52,00	40	252,8	205,8	1,81	70,00	G	TCF150512GP	TCF180508GC
5578736	TCF520R4SLR40MG	52,00	53,00	40	257,8	209,8	1,84	70,00	G	TCF150512GP	TCF180508GC
5578737	TCF530R4SLR40MG	53,00	54,00	40	262,9	213,9	1,87	70,00	G	TCF150512GP	TCF180508GC
5578738	TCF540R4SLR40MG	54,00	55,00	40	267,9	217,9	1,89	70,00	G	TCF150512GP	TCF180508GC
5578739	TCF550R4SLR40MG	55,00	56,00	40	271,9	221,9	1,92	70,00	G	TCF150512GP	TCF180508GC
5578750	TCF560R4SLR40MG	56,00	57,00	40	276,9	225,9	1,94	70,00	G	TCF150512GP	TCF180508GC
5538647	TCF570R4SLR40MH	57,00	58,00	40	276,1	230,1	2,06	70,00	H	TCF180614HP	TCF210608HC
5538648	TCF580R4SLR40MH	58,00	59,00	40	281,1	234,1	2,09	70,00	H	TCF180614HP	TCF210608HC
5538649	TCF590R4SLR40MH	59,00	60,00	40	286,1	238,1	2,12	70,00	H	TCF180614HP	TCF210608HC
5538650	TCF600R4SLR40MH	60,00	61,00	40	290,1	242,1	2,15	70,00	H	TCF180614HP	TCF210608HC
5538651	TCF610R4SLR40MH	61,00	62,00	40	295,2	246,2	2,18	70,00	H	TCF180614HP	TCF210608HC
5538652	TCF620R4SLR40MH	62,00	63,00	40	300,2	250,2	2,20	70,00	H	TCF180614HP	TCF210608HC
5538653	TCF630R4SLR40MH	63,00	64,00	40	305,2	254,2	2,23	70,00	H	TCF180614HP	TCF210608HC
5538654	TCF640R4SLR40MH	64,00	65,00	40	309,3	258,3	2,26	70,00	H	TCF180614HP	TCF210608HC
5538655	TCF650R4SLR40MH	65,00	66,00	40	314,3	262,3	2,28	70,00	H	TCF180614HP	TCF210608HC
5538656	TCF660R4SLR40MH	66,00	67,00	40	319,3	266,3	2,31	70,00	H	TCF180614HP	TCF210608HC
5538657	TCF670R4SLR40MH	67,00	68,00	40	323,3	270,3	2,33	70,00	H	TCF180614HP	TCF210608HC
5538658	TCF680R4SLR40MH	68,00	69,00	40	328,4	274,4	2,36	70,00	H	TCF180614HP	TCF210608HC

NOTE: SSC = Pocket Seat Reference. To correspond with the SSC on the inserts.

WARNING

During through-hole operations, a slug or disc is produced as the tool breaks through the workpiece. When the drill is stationary and the workpiece is rotating, this slug may be hurled from the chuck by centrifugal force. Provide adequate shielding to protect bystanders.

Top Cut 4™

Indexable Drills • Top Cut 4

TC4 • 5 x D • SLR Shanks • Metric

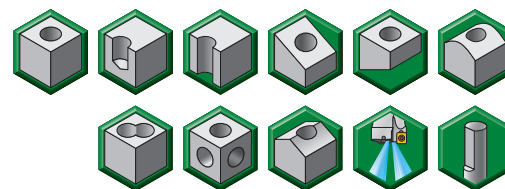
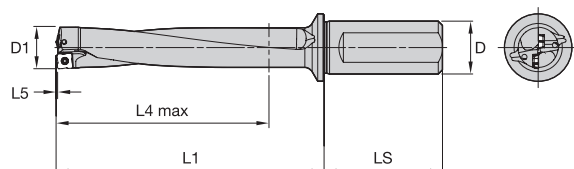

order number	catalogue number	D1	D	L1	L4 max	L5	LS	SSC	periphery insert	centre insert
5537874	TCF120R5SLR20MA	12,00	20	79,4	60,4	0,43	50,00	A	TCF040204AP	TCF040203AC
5537875	TCF125R5SLR20MA	12,50	20	82,0	63,0	0,45	50,00	A	TCF040204AP	TCF040203AC
5537876	TCF127R5SLR20MA	12,70	20	84,0	64,0	0,46	50,00	A	TCF040204AP	TCF040203AC
5537877	TCF130R5SLR20MA	13,00	20	85,5	65,5	0,47	50,00	A	TCF040204AP	TCF040203AC
5537878	TCF135R5SLR20MA	13,50	20	89,0	68,0	0,48	50,00	A	TCF040204AP	TCF040203AC
5577948	TCF140R5SLR25MB	14,00	25	90,5	70,5	0,49	56,00	B	TCF050204BP	TCF060203BC
5577949	TCF145R5SLR25MB	14,50	25	93,0	73,0	0,52	56,00	B	TCF050204BP	TCF060203BC
5577950	TCF150R5SLR25MB	15,00	25	96,5	75,5	0,55	56,00	B	TCF050204BP	TCF060203BC
5577951	TCF155R5SLR25MB	15,50	25	100,1	78,1	0,56	56,00	B	TCF050204BP	TCF060203BC
5577952	TCF160R5SLR25MB	16,00	25	102,6	80,6	0,58	56,00	B	TCF050204BP	TCF060203BC
5577953	TCF165R5SLR25MB	16,50	25	106,1	83,1	0,60	56,00	B	TCF050204BP	TCF060203BC
5577954	TCF170R5SLR25MB	17,00	25	108,6	85,6	0,61	56,00	B	TCF050204BP	TCF060203BC
5577955	TCF175R5SLR25MB	17,50	25	112,1	88,1	0,63	56,00	B	TCF050204BP	TCF060203BC
5577956	TCF180R5SLR25MB	18,00	25	114,6	90,6	0,64	56,00	B	TCF050204BP	TCF060203BC
5577957	TCF185R5SLR25MB	18,50	25	118,2	93,2	0,65	56,00	B	TCF050204BP	TCF060203BC
5578844	TCF190R5SLR25MC	19,00	25	120,7	95,7	0,68	56,00	C	TCF070306CP	TCF070304CC
5578845	TCF195R5SLR25MC	19,50	25	124,2	98,2	0,71	56,00	C	TCF070306CP	TCF070304CC
5578846	TCF200R5SLR25MC	20,00	25	126,7	100,7	0,72	56,00	C	TCF070306CP	TCF070304CC
5578847	TCF205R5SLR25MC	20,50	25	130,2	103,2	0,74	56,00	C	TCF070306CP	TCF070304CC
5578848	TCF210R5SLR25MC	21,00	25	133,8	105,8	0,75	56,00	C	TCF070306CP	TCF070304CC
5578849	TCF220R5SLR25MC	22,00	25	139,8	110,8	0,78	56,00	C	TCF070306CP	TCF070304CC
5578850	TCF225R5SLR25MC	22,50	25	142,3	113,3	0,79	56,00	C	TCF070306CP	TCF070304CC
5578851	TCF230R5SLR25MC	23,00	25	145,8	115,8	0,80	56,00	C	TCF070306CP	TCF070304CC
5537838	TCF240R5SLR25MD	24,00	25	148,9	120,9	0,87	56,00	D	TCF080308DP	TCF090305DC
5537839	TCF250R5SLR32MD	25,00	32	155,9	125,9	0,91	60,00	D	TCF080308DP	TCF090305DC
5537840	TCF260R5SLR32MD	26,00	32	161,9	130,9	0,94	60,00	D	TCF080308DP	TCF090305DC
5537841	TCF265R5SLR32MD	26,50	32	165,5	133,5	0,95	60,00	D	TCF080308DP	TCF090305DC
5537842	TCF270R5SLR32MD	27,00	32	168,0	136,0	0,97	60,00	D	TCF080308DP	TCF090305DC
5537843	TCF280R5SLR32MD	28,00	32	174,0	141,0	0,99	60,00	D	TCF080308DP	TCF090305DC
5537844	TCF290R5SLR32MD	29,00	32	180,0	146,0	1,02	60,00	D	TCF080308DP	TCF090305DC
5537958	TCF300R5SLR32ME	30,00	32	183,1	151,1	1,09	60,00	E	TCF100408EP	TCF120405EC
5537959	TCF310R5SLR32ME	31,00	32	189,1	156,1	1,12	60,00	E	TCF100408EP	TCF120405EC
5537960	TCF320R5SLR32ME	32,00	32	195,2	161,2	1,15	60,00	E	TCF100408EP	TCF120405EC
5537961	TCF330R5SLR40ME	33,00	40	202,2	166,2	1,18	70,00	E	TCF100408EP	TCF120405EC
5537962	TCF340R5SLR40ME	34,00	40	208,2	171,2	1,21	70,00	E	TCF100408EP	TCF120405EC
5537963	TCF350R5SLR40ME	35,00	40	214,2	176,2	1,24	70,00	E	TCF100408EP	TCF120405EC
5537964	TCF360R5SLR40ME	36,00	40	220,3	181,3	1,27	70,00	E	TCF100408EP	TCF120405EC
5578629	TCF370R5SLR40MF	37,00	40	226,3	186,3	1,35	70,00	F	TCF120412FP	TCF150406FC
5578640	TCF375R5SLR40MF	37,50	40	228,9	188,9	1,36	70,00	F	TCF120412FP	TCF150406FC
5578641	TCF380R5SLR40MF	38,00	40	232,4	191,4	1,38	70,00	F	TCF120412FP	TCF150406FC

TC4 • 5 x D • SLR Shanks • Metric

(continued)

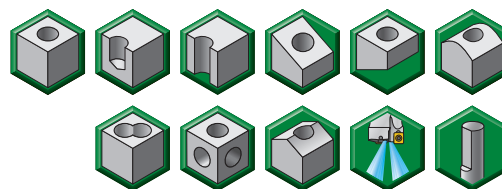
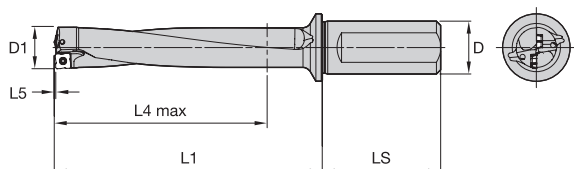

order number	catalogue number	D1	D	L1	L4 max	L5	LS	SSC	periphery insert	centre insert
5578642	TCF390R5SLR40MF	39,00	40	238,4	196,4	1,41	70,00	F	TCF120412FP	TCF150406FC
5578643	TCF400R5SLR40MF	40,00	40	243,4	201,4	1,45	70,00	F	TCF120412FP	TCF150406FC
5578644	TCF410R5SLR40MF	41,00	40	249,5	206,5	1,48	70,00	F	TCF120412FP	TCF150406FC
5578645	TCF420R5SLR40MF	42,00	40	255,5	211,5	1,51	70,00	F	TCF120412FP	TCF150406FC
5578646	TCF430R5SLR40MF	43,00	40	261,5	216,5	1,53	70,00	F	TCF120412FP	TCF150406FC
5578647	TCF440R5SLR40MF	44,00	40	267,6	221,6	1,56	70,00	F	TCF120412FP	TCF150406FC
5578648	TCF450R5SLR40MF	45,00	40	273,6	226,6	1,59	70,00	F	TCF120412FP	TCF150406FC
5578751	TCF460R5SLR40MG	46,00	40	274,7	231,7	1,67	70,00	G	TCF150512GP	TCF180508GC
5578752	TCF470R5SLR40MG	47,00	40	280,7	236,7	1,70	70,00	G	TCF150512GP	TCF180508GC
5578753	TCF480R5SLR40MG	48,00	40	286,7	241,7	1,73	70,00	G	TCF150512GP	TCF180508GC
5578754	TCF490R5SLR40MG	49,00	40	292,8	246,8	1,76	70,00	G	TCF150512GP	TCF180508GC
5578755	TCF500R5SLR40MG	50,00	40	297,8	251,8	1,79	70,00	G	TCF150512GP	TCF180508GC
5578756	TCF505R5SLR40MG	50,50	40	301,3	254,3	1,80	70,00	G	TCF150512GP	TCF180508GC
5578757	TCF510R5SLR40MG	51,00	40	303,8	256,8	1,81	70,00	G	TCF150512GP	TCF180508GC
5578758	TCF520R5SLR40MG	52,00	40	309,8	261,8	1,84	70,00	G	TCF150512GP	TCF180508GC
5578759	TCF530R5SLR40MG	53,00	40	315,9	266,9	1,87	70,00	G	TCF150512GP	TCF180508GC
5578760	TCF540R5SLR40MG	54,00	40	321,9	271,9	1,89	70,00	G	TCF150512GP	TCF180508GC
5578761	TCF550R5SLR40MG	55,00	40	326,9	276,9	1,92	70,00	G	TCF150512GP	TCF180508GC
5578762	TCF560R5SLR40MG	56,00	40	332,9	281,9	1,94	70,00	G	TCF150512GP	TCF180508GC
5538659	TCF570R5SLR40MH	57,00	40	333,1	287,1	2,06	70,00	H	TCF180614HP	TCF210608HC
5538680	TCF580R5SLR40MH	58,00	40	339,1	292,1	2,09	70,00	H	TCF180614HP	TCF210608HC
5538681	TCF590R5SLR40MH	59,00	40	345,1	297,1	2,12	70,00	H	TCF180614HP	TCF210608HC
5538682	TCF600R5SLR40MH	60,00	40	350,1	302,1	2,15	70,00	H	TCF180614HP	TCF210608HC
5538683	TCF610R5SLR40MH	61,00	40	356,2	307,2	2,18	70,00	H	TCF180614HP	TCF210608HC
5538684	TCF620R5SLR40MH	62,00	40	362,2	312,2	2,20	70,00	H	TCF180614HP	TCF210608HC
5538685	TCF630R5SLR40MH	63,00	40	368,2	317,2	2,23	70,00	H	TCF180614HP	TCF210608HC
5538686	TCF640R5SLR40MH	64,00	40	373,3	322,3	2,26	70,00	H	TCF180614HP	TCF210608HC
5538687	TCF650R5SLR40MH	65,00	40	379,3	327,3	2,28	70,00	H	TCF180614HP	TCF210608HC
5538688	TCF660R5SLR40MH	66,00	40	385,3	332,3	2,31	70,00	H	TCF180614HP	TCF210608HC
5538689	TCF670R5SLR40MH	67,00	40	390,3	337,3	2,33	70,00	H	TCF180614HP	TCF210608HC
5538700	TCF680R5SLR40MH	68,00	40	396,4	342,4	2,36	70,00	H	TCF180614HP	TCF210608HC

NOTE: SSC = Pocket Seat Reference. To correspond with the SSC on the inserts.

WARNING

During through-hole operations, a slug or disc is produced as the tool breaks through the workpiece. When the drill is stationary and the workpiece is rotating, this slug may be hurled from the chuck by centrifugal force. Provide adequate shielding to protect bystanders.

Top Cut 4™

Indexable Drills • Top Cut 4

TC4 • Centre Inserts • Aluminium • V36

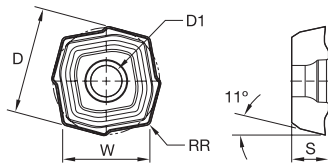

- first choice
- alternate choice

P	●	●	●	●
M	●	●	●	●
K	●	●	●	●
N	●	●	●	●
S	●	●	●	●
H	●	●	●	●

catalogue number	D	D1	W	S	RR	SSC	WPK10CH	WU25CH	WU40PH	WN10PH
TCF040203ACV36	4,47	2,10	3,65	2,00	0,300	A	●	●	●	6407887
TCF060203BCV36	6,00	2,40	4,90	2,40	0,300	B	●	●	●	6372041
TCF070304CCV36	7,59	2,60	6,20	2,80	0,400	C	●	●	●	6372042
TCF090305DCV36	9,55	2,80	7,80	3,00	0,500	D	●	●	●	6372045
TCF120405ECV36	12,00	3,40	9,80	3,60	0,500	E	●	●	●	6372047
TCF150406FCV36	14,94	4,80	12,20	4,20	0,600	F	●	●	●	6346757
TCF180508GCV36	17,88	6,00	14,60	5,40	0,800	G	●	●	●	6407890
TCF210608HCV36	21,68	7,50	17,70	6,50	0,800	H	●	●	●	6372049

NOTE: SSC = Pocket Seat Reference. To correspond with the SSC on the toolholder.

Indexable Drills • Top Cut 4™

TC4 • Periphery Inserts • Aluminium • V36

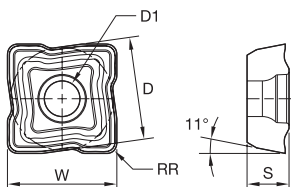

- first choice
- alternate choice

P	●	●	●	●
M	●	●	●	●
K	●	●	●	●
N	●	●	●	●
S	●	●	●	●
H	●	●	●	●

catalogue number	D	D1	W	S	RR	SSC	WPK10CH	WU25CH	WU40PH	WN10PH
TCF040204APV36	4,14	2,10	4,40	2,00	0,400	A	●	●	●	6407888
TCF050204BPV36	5,07	2,40	5,40	2,40	0,400	B	●	●	●	6371850
TCF070306CPV36	6,67	2,60	7,10	2,80	0,600	C	●	●	●	6372043
TCF080308DPV36	8,08	2,80	8,60	3,00	0,800	D	●	●	●	6372044
TCF100408EPV36	9,96	3,40	10,60	3,60	0,800	E	●	●	●	6372046
TCF120412FPV36	12,59	4,80	13,40	4,20	1,200	F	●	●	●	6348893
TCF150512GPV36	15,13	6,00	16,10	5,40	1,200	G	●	●	●	6407889
TCF180614HPV36	18,04	7,50	19,20	6,50	1,400	H	●	●	●	6372048

NOTE: SSC = Pocket Seat Reference. To correspond with the SSC on the toolholder.

Top Cut 4™

Indexable Drills • Top Cut 4

TC4 • Centre Inserts • Long Chip Materials • V38

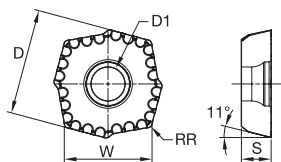

- first choice
- alternate choice

P	●	●	●
M	●	●	●
K	●	●	●
N	○	○	○
S	○	○	○
H	○	○	○

catalogue number	D	D1	W	S	RR	SSC	WPK10CH	WU25CH	WU40PH
TCF040203ACV38	4,47	2,10	3,65	2,00	0,300	A	●	●	6429458
TCF060203BCV38	6,00	2,40	4,90	2,40	0,300	B	●	●	6429459
TCF070304CCV38	7,59	2,60	6,20	2,80	0,400	C	●	●	6429460
TCF090305DCV38	9,55	2,80	7,80	3,00	0,500	D	●	●	6429461
TCF120405ECV38	12,00	3,40	9,80	3,60	0,500	E	●	●	6429462
TCF150406FCV38	14,94	4,80	12,20	4,20	0,600	F	●	●	6429463
TCF180508GCV38	17,88	6,00	14,60	5,40	0,800	G	●	●	6324383
TCF210608HCV38	21,68	7,50	17,70	6,50	0,800	H	●	●	6429464

NOTE: SSC = Pocket Seat Reference. To correspond with the SSC on the toolholder.

TC4 • Periphery Inserts • Long Chip Materials • V38

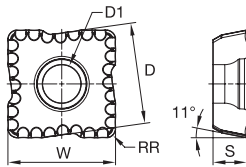

- first choice
- alternate choice

P	●	●	●
M	●	●	●
K	●	●	●
N			
S			
H			

catalogue number	D	D1	W	S	RR	SSC	WPK10CH	WU25CH	WU40PH
TCF040204APV38	4,14	2,10	4,40	2,00	0,400	A	●	●	●
TCF050204BPV38	5,07	2,40	5,40	2,40	0,400	B	●	●	●
TCF070306CPV38	6,67	2,60	7,10	2,80	0,600	C	●	●	●
TCF080308DPV38	8,08	2,80	8,60	3,00	0,800	D	●	●	●
TCF100408EPV38	9,96	3,40	10,60	3,60	0,800	E	●	●	●
TCF120412FPV38	12,59	4,80	13,40	4,20	1,200	F	●	●	●
TCF150512GPV38	15,13	6,00	16,10	5,40	1,200	G	●	●	●
TCF180614HPV38	18,04	7,50	19,20	6,50	1,400	H	●	●	●

NOTE: SSC = Pocket Seat Reference. To correspond with the SSC on the toolholder.

Top Cut 4™

Indexable Drills • Top Cut 4

Top Cut 4 • Insert Selection Guide

Material Group	Geometry	Stable Cutting Conditions		Unstable Cutting Conditions		Interrupted Cutting Conditions	
		periphery insert	centre insert	periphery insert	centre insert	periphery insert	centre insert
P1	V38	WU25CH	WU40PH	WU40PH	WU40PH	WU40PH	WU40PH
P2-P4	V34	WPK10CH	WU40PH	WU25CH	WU40PH	WU40PH	WU40PH
P5-P6	V36	WU25CH	WU40PH	WU40PH	WU40PH	WU40PH	WU40PH
M1-M3	V36	WU25CH	WU40PH	WU40PH	WU40PH	WU40PH	WU40PH
K1-K3	V34	WPK10CH	WU40PH	WU40PH	WU40PH	WU40PH	WU40PH
N1-N4	V36	WN10PH	WN10PH	WN10PH	WN10PH	WN10PH	WN10PH
S1-S4	V38	WU40PH	WU40PH	WU40PH	WU40PH	WU40PH	WU40PH

Top Cut 4 • Cutting Data • Metric

							Metric				
							Recommended Feed Rate per Revolution				
Material Group	Geometry	Grade		Cutting Speed – Vc m/min			Tool Diameter	12,00–13,99 Insert Size A	14,00–18,99 Insert Size B	19,00–23,99 Insert Size C	24,00–29,99 Insert Size D
		centre	periphery	min	Start	max					
P0	-V38	WU40PH	WU25CH	120	180	260	mm/rev	0,06–0,08	0,08–0,11	0,10–0,13	0,11–0,14
P1	-V38	WU40PH	WU25CH	120	180	260	mm/rev	0,06–0,10	0,08–0,13	0,10–0,15	0,11–0,16
P2	-V34	WU40PH	WU25CH	120	190	280	mm/rev	0,06–0,10	0,08–0,15	0,10–0,16	0,11–0,17
P3	-V34	WU40PH	WPK10CH	120	200	310	mm/rev	0,08–0,15	0,10–0,16	0,11–0,18	0,12–0,20
P4	-V34	WU40PH	WPK10CH	120	190	310	mm/rev	0,08–0,15	0,10–0,16	0,11–0,18	0,12–0,20
P5	-V36	WU40PH	WU25CH	120	180	250	mm/rev	0,06–0,10	0,08–0,14	0,10–0,15	0,11–0,16
P6	-V36	WU40PH	WU25CH	120	160	210	mm/rev	0,06–0,10	0,08–0,14	0,10–0,15	0,11–0,16
M1	-V38	WU40PH	WU40PH	120	160	240	mm/rev	0,06–0,11	0,07–0,11	0,08–0,12	0,10–0,14
M2	-V36	WU40PH	WU40PH	110	140	210	mm/rev	0,06–0,10	0,07–0,11	0,08–0,12	0,10–0,14
M3	-V36	WU40PH	WU40PH	100	120	200	mm/rev	0,06–0,10	0,07–0,11	0,08–0,12	0,10–0,14
K1	-V34	WU25CH	WPK10CH	120	200	280	mm/rev	0,08–0,14	0,08–0,16	0,10–0,18	0,12–0,24
K2	-V34	WU40PH	WPK10CH	100	180	260	mm/rev	0,08–0,14	0,08–0,16	0,10–0,18	0,12–0,24
K3	-V34	WU40PH	WPK10CH	100	170	240	mm/rev	0,08–0,14	0,08–0,16	0,10–0,18	0,12–0,24
N1	-V36	WN10PH	WN10PH	250	350	500	mm/rev	0,06–0,10	0,08–0,14	0,10–0,15	0,11–0,16
N2	-V36	WN10PH	WN10PH	150	300	450	mm/rev	0,06–0,10	0,08–0,14	0,10–0,15	0,11–0,16
N3	-V36	WN10PH	WN10PH	80	120	150	mm/rev	0,06–0,10	0,07–0,11	0,08–0,12	0,10–0,14
S3	-V38	WU40PH	WU40PH	20	30	45	mm/rev	0,08–0,12	0,08–0,13	0,10–0,15	0,12–0,19
S4	-V38	WU40PH	WU40PH	35	40	65	mm/rev	0,08–0,12	0,08–0,13	0,10–0,15	0,12–0,19

Material Group	Geometry	Grade		Cutting Speed – Vc m/min			Tool Diameter	30,00–36,99 Insert Size E	37,00–45,99 Insert Size F	46,00–56,99 Insert Size G	57,00–68,00 Insert Size H
		centre	periphery	min	Start	max					
P0	-V38	WU40PH	WU25CH	120	180	260	mm/rev	0,13–0,16	0,15–0,18	0,16–0,23	0,17–0,24
P1	-V38	WU40PH	WU25CH	120	180	260	mm/rev	0,13–0,17	0,15–0,19	0,16–0,24	0,17–0,25
P2	-V34	WU40PH	WU25CH	120	190	280	mm/rev	0,13–0,20	0,15–0,21	0,16–0,28	0,17–0,30
P3	-V34	WU40PH	WPK10CH	120	200	310	mm/rev	0,16–0,24	0,16–0,24	0,18–0,30	0,19–0,32
P4	-V34	WU40PH	WPK10CH	120	190	310	mm/rev	0,14–0,22	0,16–0,24	0,18–0,30	0,19–0,32
P5	-V36	WU40PH	WU25CH	120	180	250	mm/rev	0,13–0,18	0,15–0,20	0,16–0,28	0,17–0,30
P6	-V36	WU40PH	WU25CH	120	160	210	mm/rev	0,13–0,18	0,15–0,20	0,16–0,28	0,17–0,29
M1	-V38	WU40PH	WU40PH	120	160	240	mm/rev	0,12–0,17	0,14–0,21	0,16–0,23	0,16–0,24
M2	-V36	WU40PH	WU40PH	110	140	210	mm/rev	0,12–0,17	0,14–0,21	0,16–0,23	0,16–0,24
M3	-V36	WU40PH	WU40PH	100	120	200	mm/rev	0,12–0,17	0,14–0,21	0,16–0,23	0,16–0,24
K1	-V34	WU25CH	WPK10CH	120	200	280	mm/rev	0,14–0,26	0,16–0,30	0,18–0,32	0,20–0,36
K2	-V34	WU40PH	WPK10CH	100	180	260	mm/rev	0,14–0,26	0,16–0,30	0,18–0,32	0,20–0,36
K3	-V34	WU40PH	WPK10CH	100	170	240	mm/rev	0,14–0,26	0,16–0,30	0,18–0,32	0,20–0,36
N1	-V36	WN10PH	WN10PH	250	350	500	mm/rev	0,13–0,18	0,15–0,20	0,16–0,28	0,17–0,30
N2	-V36	WN10PH	WN10PH	150	300	450	mm/rev	0,13–0,18	0,15–0,20	0,16–0,28	0,17–0,30
N3	-V36	WN10PH	WN10PH	80	120	150	mm/rev	0,12–0,17	0,14–0,21	0,16–0,23	0,16–0,24
S3	-V38	WU40PH	WU40PH	20	30	45	mm/rev	0,14–0,21	0,16–0,24	0,18–0,26	0,20–0,30
S4	-V38	WU40PH	WU40PH	35	40	65	mm/rev	0,14–0,21	0,16–0,24	0,18–0,26	0,20–0,30

NOTE: All speed conditions are for stable conditions. For unstable conditions, it is suggested to reduce starting speeds by 10%. For interrupted cuts, reduce by 20%.

For 4 x D, it is highly recommended to start with feed and speed values reduced by 10% less than above data.

For 5 x D, diameter range 12–23,99mm (insert sizes A to C), it is highly recommended to start with feed and speed values reduced by 20% less than above data.

For 5 x D, diameter range 25–68mm (insert sizes D to H), it is highly recommended to start with feed and speed values reduced by 15% less than above data.

For 4 x D and 5 x D, it is recommended to reduce feed rate during entry and exit by 30–50%.

Top Cut 4 • Drill Depth • X-Offset Capabilities • Hole Tolerance

Insert size	Diameter range mm	2 x D/3 x D			4 x D			5 x D		
		X-offset value max. in mm	D1 max value mm	Hole tolerance mm	X-offset value max. in mm	D1 max value mm	Hole tolerance mm	X-offset value max. in mm	D1 max value mm	Hole tolerance mm
A	12,00–13,99	0,5	D1 + 1mm	+/- 0,20	0,5	D1 + 1mm	+/- 0,35	–	–	+/- 0,35
B	14,00–18,99	0,5	D1 + 1mm	+/- 0,20	0,5	D1 + 1mm	+/- 0,35	–	–	+/- 0,35
C	19,00–23,99	0,5	D1 + 1mm	+/- 0,20	0,5	D1 + 1mm	+/- 0,35	–	–	+/- 0,35
D	24,00–29,99	0,8	D1 + 1,6mm	+/- 0,20	0,8	D1 + 1mm	+/- 0,35	–	–	+/- 0,35
E	30,00–36,99	0,8	D1 + 1,6mm	+/- 0,20	0,8	D1 + 1mm	+/- 0,35	–	–	+/- 0,35
F	37,00–45,99	0,8	D1 + 1,6mm	+/- 0,25	0,8	D1 + 1mm	+/- 0,38	–	–	+/- 0,38
G	46,00–56,99	1	D1 + 2mm	+/- 0,25	0,8	D1 + 1mm	+/- 0,38	–	–	+/- 0,38
H	57,00–68,00	1	D1 + 2mm	+/- 0,28	0,8	D1 + 1mm	+/- 0,42	–	–	+/- 0,42

Top Cut 4™

Indexable Drills • Top Cut 4

Feed Force Requirement

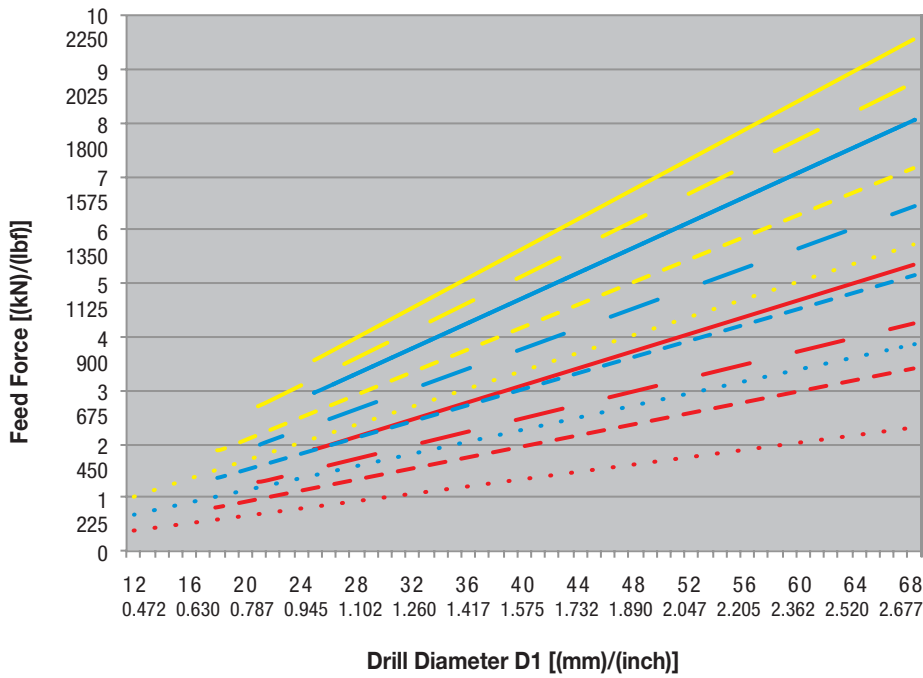

Stainless Steel 304

- f = 0.20
.0079 IPR
- - f = 0.18
.0071 IPR
- - - f = 0.15
.0059 IPR
- f = 0.12
.0047 IPR

Steel 4140

- f = 0.25
.0098 IPR
- - f = 0.20
.0079 IPR
- - - f = 0.16
.0063 IPR
- f = 0.12
.0047 IPR

Cast Iron GG25

- f = 0.25
.0098 IPR
- - f = 0.20
.0079 IPR
- - - f = 0.16
.0059 IPR
- f = 0.12
.0047 IPR

Torque Requirement

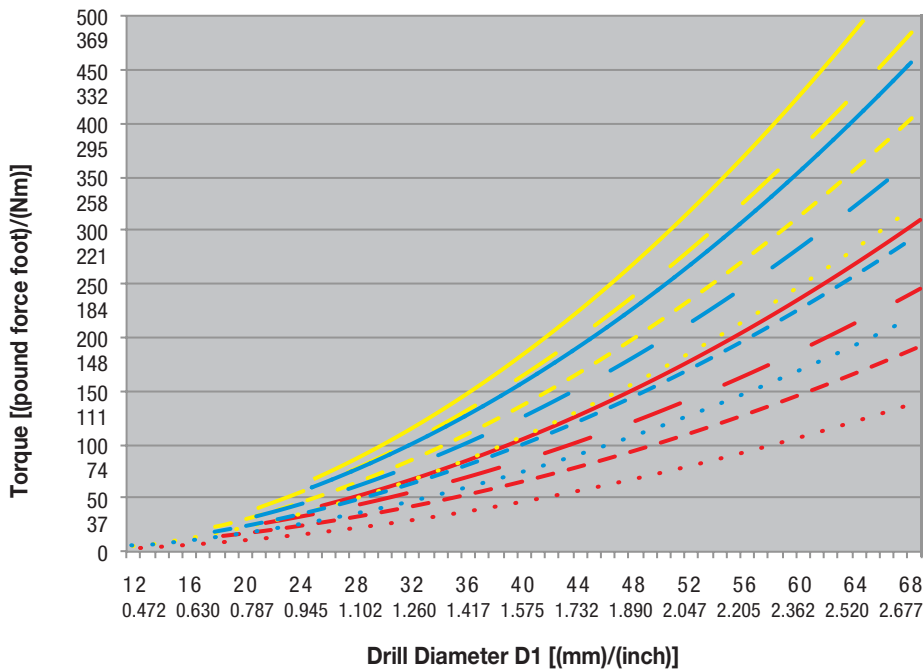

Stainless Steel 304

- f = 0.20
.0079 IPR
- - f = 0.18
.0071 IPR
- - - f = 0.15
.0059 IPR
- f = 0.12
.0047 IPR

Steel 4140

- f = 0.25
.0098 IPR
- - f = 0.20
.0079 IPR
- - - f = 0.16
.0059 IPR
- f = 0.12
.0047 IPR

Cast Iron GG25

- f = 0.25
.0098 IPR
- - f = 0.20
.0079 IPR
- - - f = 0.16
.0059 IPR
- f = 0.12
.0047 IPR



Power Requirement — Steel

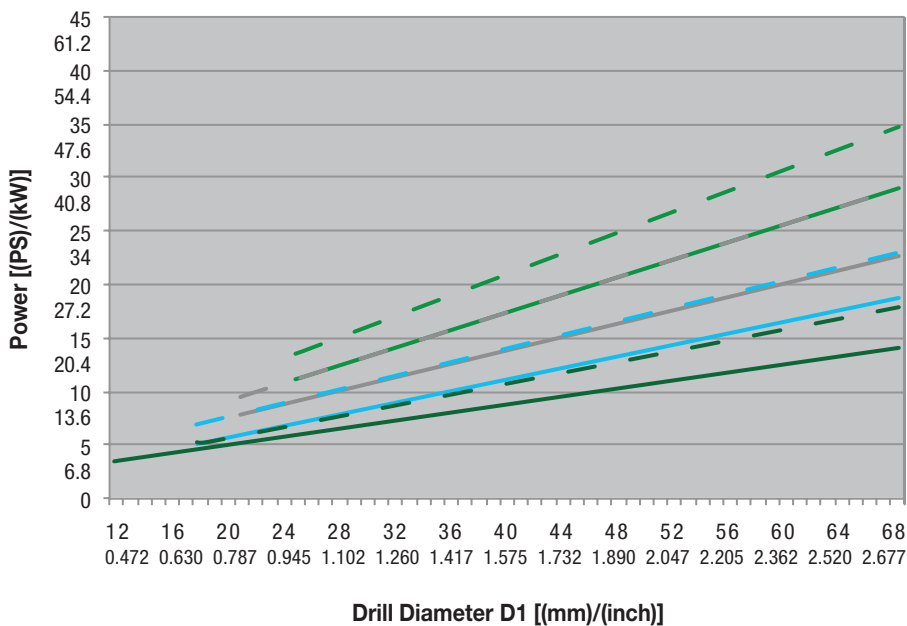

Steel 4140

- f = 0.25 (160 m/min), f = .0098, IPR (525 SFM)
- - f = 0.25 (200 m/min), f = .0098, IPR (656 SFM)
- f = 0.16 (160 m/min), f = .0063, IPR (525 SFM)
- - f = 0.16 (200 m/min), f = .0063, IPR (656 SFM)
- f = 0.12 (160 m/min), f = .0047, IPR (525 SFM)
- - f = 0.12 (200 m/min), f = .0047, IPR (656 SFM)
- f = 0.20 (160 m/min), f = .0079, IPR (525 SFM)
- - f = 0.20 (200 m/min), f = .0079, IPR (656 SFM)

Power Requirement — Stainless Steel

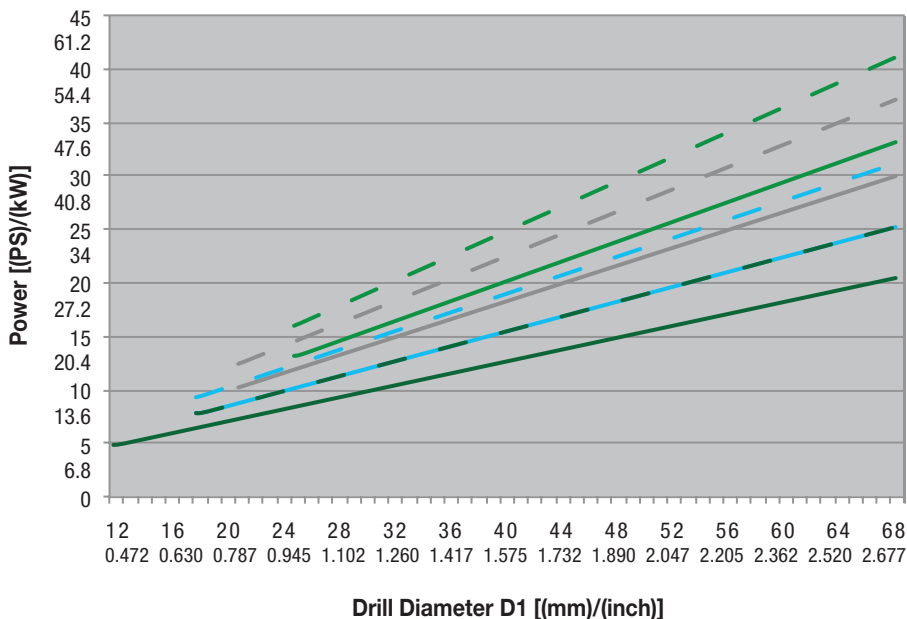

Stainless Steel 304

- f = 0.20 (160 m/min), f = .0079, IPR (525 SFM)
- - f = 0.20 (200 m/min), f = .0079, IPR (656 SFM)
- f = 0.15 (160 m/min), f = .0059, IPR (525 SFM)
- - f = 0.15 (200 m/min), f = .0059, IPR (656 SFM)
- f = 0.12 (160 m/min), f = .0047, IPR (525 SFM)
- - f = 0.12 (200 m/min), f = .0047, IPR (656 SFM)
- f = 0.18 (160 m/min), f = .0071, IPR (525 SFM)
- - f = 0.18 (200 m/min), f = .0071, IPR (656 SFM)



Top Cut 4™

Indexable Drills • Top Cut 4

Power Requirement — Cast Iron

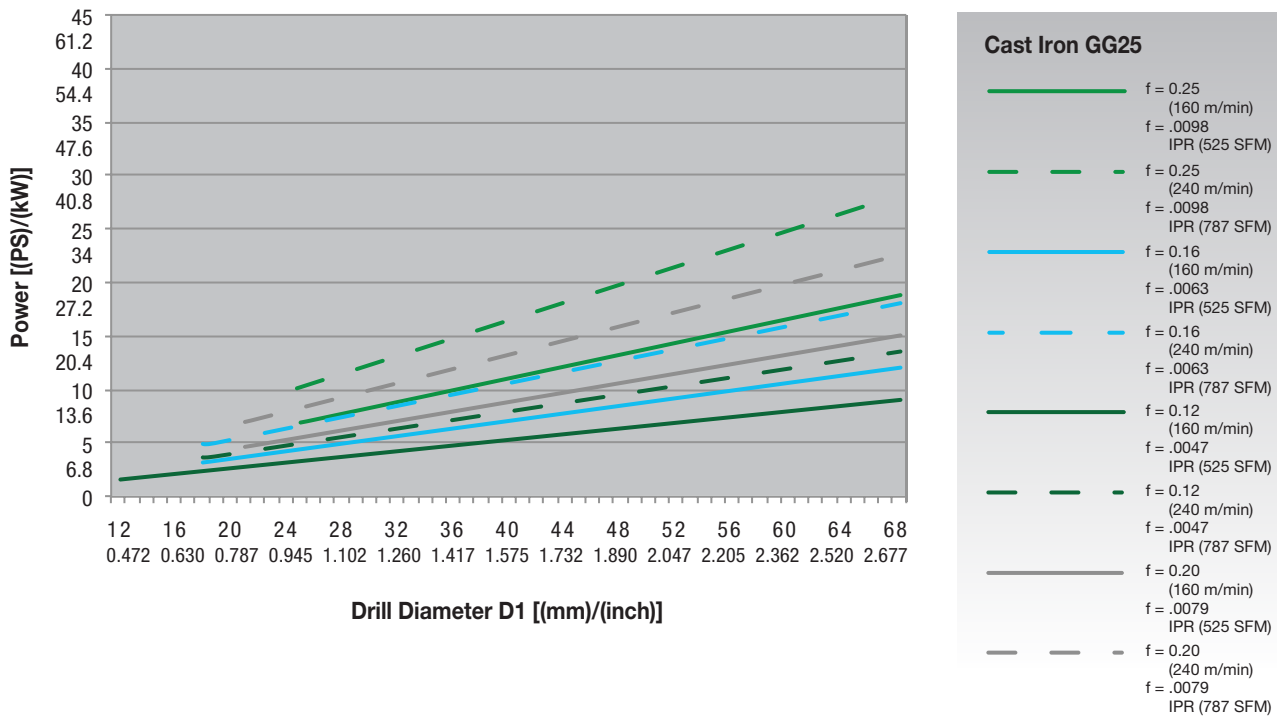

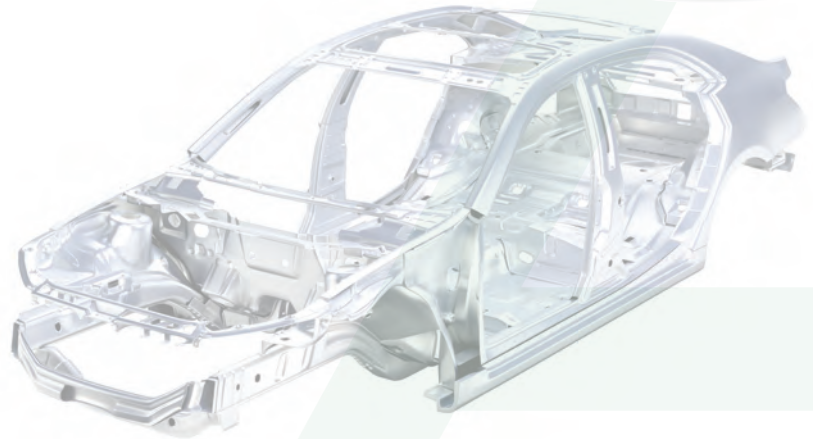

Flange

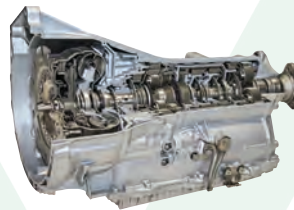

Transmission



Connecting Rod

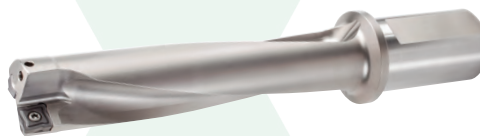

WIDIA™ manufactures tools to meet application needs in steel, cast iron, and aluminium automotive components.

TO SEE ALL PRODUCT LINES, VISIT OUR DIGITAL RESOURCES



WIDIA NOVO™ Application
Download to your desktop or tablet:
widia.com/novo



WIDIA™ Machining Central Mobile App
Download for iOS or Android:
widia.com/en/featured/WidiaMobileApp

WGC

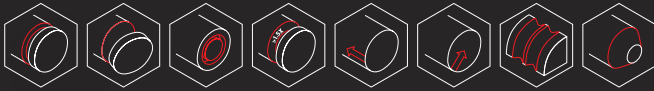

THE MOST VERSATILE TOOL IN THE
MARKET FOR GROOVING, PROFILING,
AND CUT-OFF OPERATIONS

4 BENEFITS IN 1

VERSATILE

GROOVING, PROFILING,
AND CUT-OFF OPERATIONS

SIMPLE

EASY TO SELECT
AND APPLY

STABLE

TRIPLE-V SEATING FOR
SECURE CLAMPING

PRODUCTIVE

LOW CUTTING FORCES IN
THROUGH COOLANT FOR
BETTER CHIP EVACUATION



Grooving

First choice for external grooving applications in most workpiece materials.

Through coolant capability and efficient coolant delivery for enhanced productivity.

Available in integral and modular style toolholders.

Groove width: 2–10mm.

Cut-Off

Specially engineered chipbreakers for effective parting/cut-off and deep grooving.

Positive geometry for lower forces.

Secure seating offers greatest stability.

Groove width: 1,4–8mm.

Profiling

Full radius chipbreaker for multi-directional turning and generating complex profiles.

Rigid design ensures smooth surface finish.

Groove width: 2–8mm.



New precision ground grooving and cut-off inserts

WIDIA 

widia.com

WGC

Grooving and Cut-Off • WGC

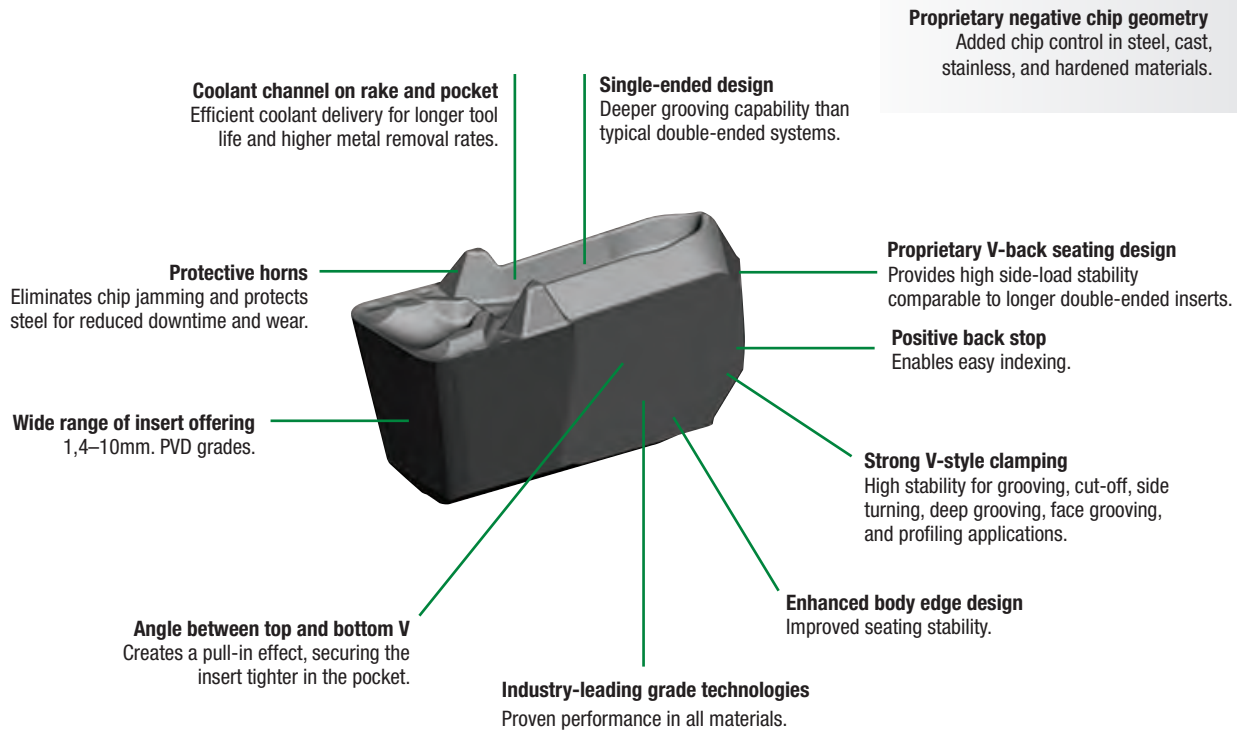

Grooving

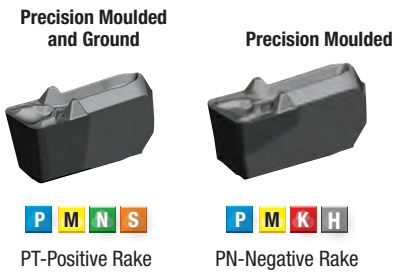

Cut-Off

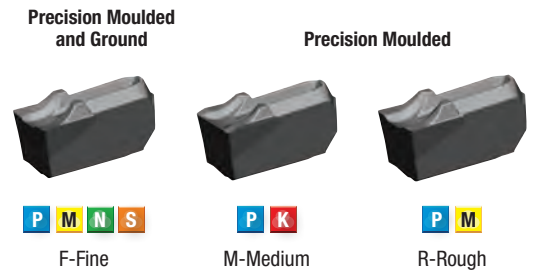

Profiling



NOTE: Use the NOVO™ software to select appropriate toolholder and insert.

WGC Grooving — Competitive Edge

P Steel – P1
Type of cut: Plain
Coolant: External emulsion

19-224222











Specifications	Competitor	WIDIA WGC
Workpiece Diameter (mm)	84.5	84.5
Geometry & Grade	-	PT WU25PT
Speed (Vc) (m/min)	100	100
Spindle Speed n (RPM)	377	377
Feed (mm/rev)	0.05	0.05
Grooving Depth	10.2	10.2
Tool Life – No. of Components	5	6

Annual Savings 9%

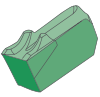

WGC – QUICK FACTS

INSERTS

APPLICATION	TYPES	GROOVE WIDTH	INSERT GEOMETRY	MATERIALS
Grooving		2.0mm–10.13mm .079–0.399"	PT-Positive Rake	
			PN-Negative Rake	
Cut-Off		1.4mm–8.0mm 0.055-0.315"	F-Fine	
			M-Medium	
			R-Rough	
Profiling		2.0mm–8.0mm 0.079-0.315"	PC-Full Radius	

APPLICATIONS



GEOMETRY

4 BENEFITS IN 1

Versatility

Single-sided, versatile grooving and cut-off solution with smooth surface finish

Productivity

Through coolant capability with precise delivery for low cutting forces and better chip evacuation

Stability

In challenging applications due to V-shaped edges

Simplicity

Easy to select and apply

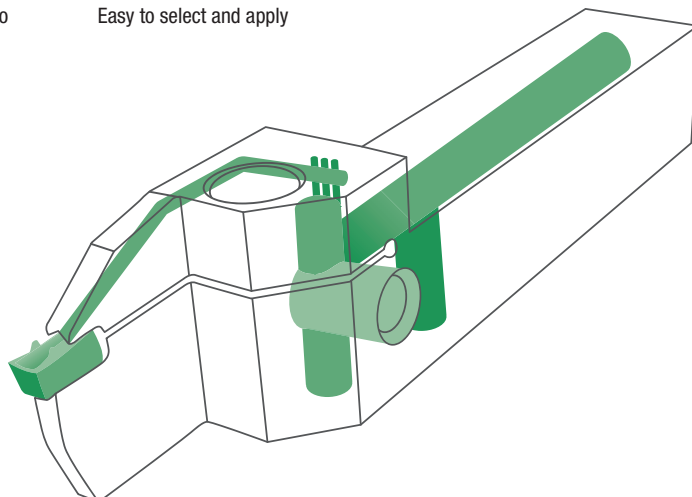

INDUSTRY



How Do Catalogue Numbers Work?

Each character in our catalogue number signifies a specific trait of that product. Use the following key columns and corresponding images to easily identify which attributes apply.

WG0312M03U02PT

W	G	0312	M	03	U	02	PT
Family Name	Insert Type	Groove Width	Unit	Seat Size	Tolerance	Corner Radius	Chipbreaker/ Edge Condition
WGC	G = Square R = Full Radius	Metric = 1/100mm Inch = 1/1000"	M = Metric I = Inch		U = Precision Moulded P = Precision Ground		PT = Groove-Turn Universal Positive PN = Groove-Turn Universal Negative

seat size (SSC)	groove width	
	mm	inch
1B	1,40	.055
1F	1,60–1,99	.063–.078
02	2,00–2,99	.079–.117
03	3,00–3,99	.118–.156
04	4,00–4,99	.157–.196
05	5,00–5,99	.197–.235
06	6,00–7,99	.236–.314
08	8,00–8,99	.315–.353
10	9,00–10,12	.354–.398

*.312" = seat size 08

mm	
00	full radius
01	0,1
02	0,2
04	0,4
08	0,8
12	1,2

inch	
00	full radius
05	.008
1	.016
2	.032
3	.047

WC030M03N00F02

W	C	030	M	03	N	00	F	02
Family Name	Insert Type	Cutting Edge Width	Unit	Seat Size	Hand of Insert	Approach Angle	Chipbreaker	Corner Radius
WGC	C = Cut-Off		M = Metric I = Inch		N = Neutral L = Left hand R = Right hand	00 = Neutral 06 = 6°	F = Cut-Off Low Feed M = Cut-Off Fine R = Cut-Off Rough	

	mm	inch
014	1,4	.055
020	2,0	.079
030	3,0	.118
040	4,0	.157
050	5,0	.197
060	6,0	.236
070	7,0	.279
080	8,0	.315

	mm	inch
1B	1,4	.055
1F	2,0	.079
02	3,0	.118
03	4,0	.157
04	5,0	.197
05	6,0	.236
06	7,0	.279
08	8,0	.315

	mm	inch
01	0,1	.004
02	0,2	.008
04	0,4	.016

Grooving and Cut-Off • WGC

Integral Straight • Metric

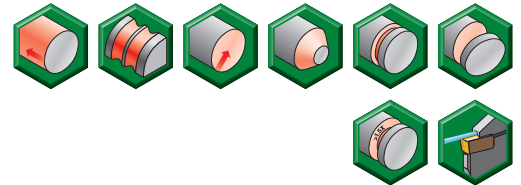
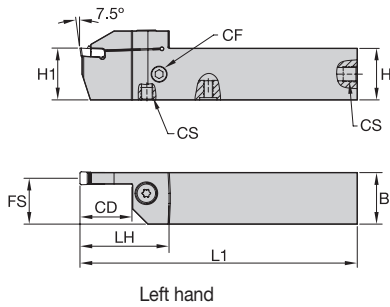

order number	catalogue number	SSC	CD	H1	H	B	H2	L1	FS	LH	CF	CS
right hand												
6461946	WGCSMR2020K0216	2	16	20	20	20	27	125	19	31	—	—
6461948	WGCSMR2525M0216	2	16	25	25	25	32	150	24	31	—	—
6461950	WGCSMR2020K0222	2	22	20	20	20	29	125	19	38	—	—
6461952	WGCSMR2525M0226	2	26	25	25	25	34	150	24	42	—	—
6462003	WGCSMR2020K0316C	3	16	20	20	20	29	125	19	37	M8X1	M8X1
6462004	WGCSMR2525M0316C	3	16	25	25	25	34	150	24	37	G 1/8	G 1/8
6462005	WGCSMR2020K0322C	3	22	20	20	20	30	125	19	43	M8X1	M8X1
6462006	WGCSMR2525M0326C	3	26	25	25	25	35	150	24	47	G 1/8	G 1/8
6462007	WGCSMR2020K0416C	4	16	20	20	20	29	125	18	37	M8X1	M8X1
6462008	WGCSMR2525M0416C	4	16	25	25	25	34	150	23	37	G 1/8	G 1/8
6462009	WGCSMR2020K0422C	4	22	20	20	20	30	125	18	43	M8X1	M8X1
6462010	WGCSMR2525M0426C	4	26	25	25	25	35	150	23	47	G 1/8	G 1/8
6462061	WGCSMR3232P0426C	4	26	32	32	32	42	170	30	47	G 1/8	G 1/8
6462062	WGCSMR3232P0432C	4	32	32	32	32	42	170	30	53	G1/8-28	G1/8-28
6462063	WGCSMR2525M0516C	5	16	25	25	25	34	150	23	37	G 1/8	G 1/8
6462064	WGCSMR2525M0526C	5	26	25	25	25	35	150	23	47	G1/8-28	G1/8-28
6462065	WGCSMR3232P0526C	5	26	32	32	32	42	170	30	47	G 1/8	G 1/8
6462066	WGCSMR3232P0532C	5	32	32	32	32	42	170	30	53	G 1/8	G 1/8
6462067	WGCSMR2525M0616C	6	16	25	25	25	34	150	22	37	G 1/8	G 1/8
6462068	WGCSMR2525M0626C	6	26	25	25	25	35	150	22	47	G1/8-28	G1/8-28
6462069	WGCSMR3232P0626C	6	26	32	32	32	42	170	29	47	G 1/8	G 1/8
6462070	WGCSMR3232P0632C	6	32	32	32	32	44	170	29	55	G 1/8	G 1/8
6462071	WGCSMR4040R0640C	6	40	40	40	40	52	200	37	63	G 1/8	G 1/8
6462072	WGCSMR2525M0826C	8	26	25	25	25	36	150	21	49	G 1/8	G 1/8
6462073	WGCSMR3232P0826C	8	26	32	32	32	43	170	28	49	G 1/8	G 1/8
6462074	WGCSMR3232P0832C	8	32	32	32	32	44	170	28	55	G 1/8	G 1/8
6462075	WGCSMR4040R0840C	8	40	40	40	40	52	200	36	63	G1/8-28	G1/8-28
6462076	WGCSMR3232P1032C	10	32	32	32	32	44	170	28	55	G 1/8	G 1/8
6462077	WGCSMR4040R1040C	10	40	40	40	40	52	200	36	63	G 1/8	G 1/8
left hand												
6461954	WGCSML2020K0216	2	16	20	20	20	27	125	19	31	—	—
6461956	WGCSML2525M0216	2	16	25	25	25	32	150	24	31	—	—
6461958	WGCSML2020K0222	2	22	20	20	20	29	125	19	38	—	—
6461960	WGCSML2525M0226	2	26	25	25	25	34	150	24	42	—	—
6462078	WGCSML2020K0316C	3	16	20	20	20	29	125	19	37	M8X1	M8X1
6462079	WGCSML2525M0316C	3	16	25	25	25	34	150	24	37	G 1/8	G 1/8
6462080	WGCSML2020K0322C	3	22	20	20	20	30	125	19	43	M8X1	M8X1
6462091	WGCSML2525M0326C	3	26	25	25	25	35	150	24	47	G 1/8	G 1/8
6462092	WGCSML2020K0416C	4	16	20	20	20	29	125	18	37	M8X1	M8X1



Integral Straight • Metric

(continued)

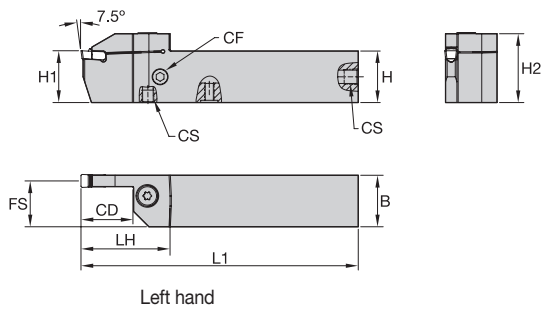

order number	catalogue number	SSC	CD	H1	H	B	H2	L1	FS	LH	CF	CS
6462093	WGCSML2525M0416C	4	16	25	25	25	34	150	23	37	G 1/8	G 1/8
6462094	WGCSML2020K0422C	4	22	20	20	20	30	125	18	43	M8X1	M8X1
6462095	WGCSML2525M0426C	4	26	25	25	25	35	150	23	47	G 1/8	G 1/8
6462096	WGCSML3232P0426C	4	26	32	32	32	42	170	30	47	G1/8-28	G1/8-28
6462097	WGCSML3232P0432C	4	32	32	32	32	42	170	30	53	G 1/8	G 1/8
6462098	WGCSML2525M0516C	5	16	25	25	25	34	150	23	37	G1/8-28	G1/8-28
6462099	WGCSML2525M0526C	5	26	25	25	25	35	150	23	47	G 1/8	G 1/8
6462100	WGCSML3232P0526C	5	26	32	32	32	42	170	30	47	G 1/8	G 1/8
6462101	WGCSML3232P0532C	5	32	32	32	32	42	170	30	53	G 1/8	G 1/8
6462102	WGCSML2525M0616C	6	16	25	25	25	34	150	22	37	G 1/8	G 1/8
6462103	WGCSML2525M0626C	6	26	25	25	25	35	150	22	47	G 1/8	G 1/8
6462104	WGCSML3232P0626C	6	26	32	32	32	42	170	29	47	G 1/8	G 1/8
6462105	WGCSML3232P0632C	6	32	32	32	32	44	170	29	55	G 1/8	G 1/8
6462106	WGCSML4040R0640C	6	40	40	40	40	52	200	37	63	G1/8-28	G1/8-28
6462107	WGCSML2525M0826C	8	26	25	25	25	36	150	21	49	G1/8-28	G1/8-28
6462108	WGCSML3232P0826C	8	26	32	32	32	43	170	28	49	G 1/8	G 1/8
6462109	WGCSML3232P0832C	8	32	32	32	32	44	170	28	55	G1/8-28	G1/8-28
6462110	WGCSML4040R0840C	8	40	40	40	40	52	200	36	63	G 1/8	G 1/8
6462111	WGCSML3232P1032C	10	32	32	32	32	44	170	28	55	G 1/8	G 1/8
6462112	WGCSML4040R1040C	10	40	40	40	40	52	200	36	63	G 1/8	G 1/8

NOTE: SSC = Pocket Seat Reference. To correspond with the SSC on the insert.

WGC Modular Toolholders

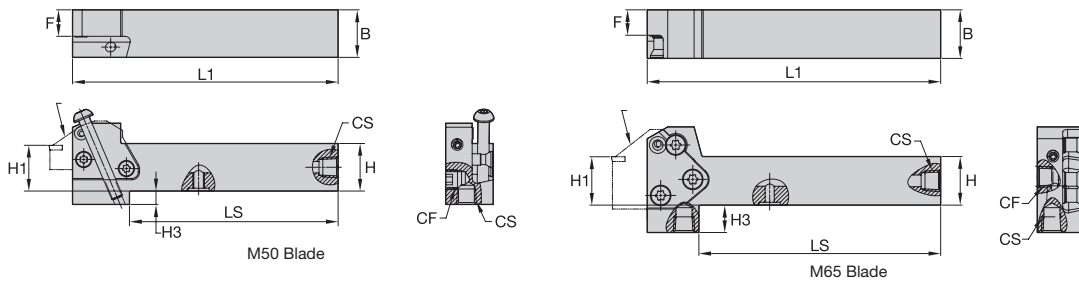
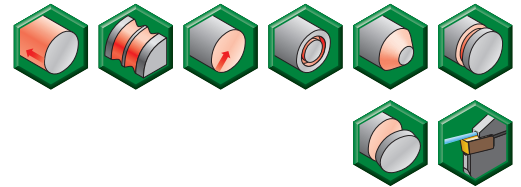

order number	catalogue number	B	H	H1	L1	F	CS	CF	LS	H3	blade size
right hand											
6499222	WGCMSR2525M50C	25	25	25	138,75	13,84	G 1/8-28	G 1/8-28	109,00	7,00	50
6499223	WGCMSR2525M65C	25	25	25	150,00	13,00	G 1/8-28	G 1/8-28	122,00	—	65
6499224	WGCMSR3232P50C	32	32	32	158,75	20,08	G 1/8-28	G 1/8-28	133,62	—	50
6499225	WGCMSR3232P65C	32	32	32	170,00	20,00	G 1/8-28	G 1/8-28	142,00	21,75	65
left hand											
6499226	WGCMSL2525M50C	25	25	25	138,75	13,84	G 1/8-28	G 1/8-28	109,00	7,00	50
6499227	WGCMSL2525M65C	25	25	25	150,00	13,00	G 1/8-28	G 1/8-28	122,00	29,00	65
6499228	WGCMSL3232P50C	32	32	32	158,75	20,08	G 1/8-28	G 1/8-28	133,62	—	50
6499229	WGCMSL3232P65C	32	32	32	170,00	20,00	G 1/8-28	G 1/8-28	142,00	21,75	65

NOTE: WGCMS...: Right-hand holder uses right-hand blades.
 WGCME...: Right-hand holder uses left-hand blades.
 M50 blade and clamp screw torque equals 71–88 in. lbs. (8–10 Nm).
 M65 blade and clamp screw torque equals 159–177 in. lbs. (18–20 Nm).

WGC Modular Toolholders

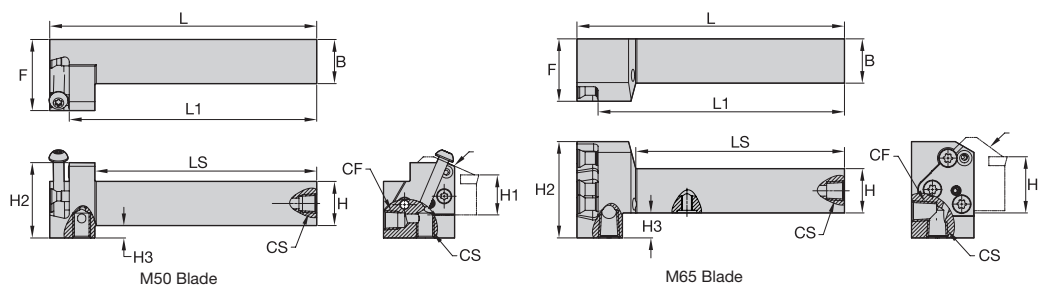
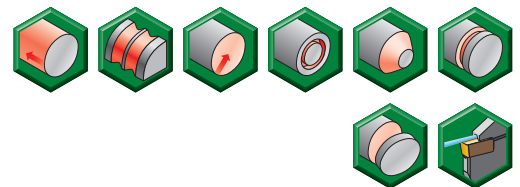

order number	catalogue number	B	H	H1	L	L1	LS	F	CS	CF	H2	H3	blade size
right hand													
6498953	WGCMER2525M65C	25	25	25	150,00	138,15	117,00	35,00	G 1/8-28	G 1/8-28	54,00	14,00	65
6498954	WGCMER2525M50C	25	25	25	150,25	139,25	125,25	40,00	G 1/8-28	G 1/8-28	42,41	7,00	50
6498955	WGCMER3232P65C	32	32	32	170,00	158,15	137,00	35,00	G 1/8-28	G 1/8-28	54,00	7,00	65
6498956	WGCMER3232P50C	32	32	32	170,25	159,25	145,25	40,00	G 1/8-28	G 1/8-28	42,41	—	50
left hand													
6498957	WGCME2525M65C	25	25	25	150,00	138,15	117,00	35,00	G 1/8-28	G 1/8-28	54,00	14,00	65
6498958	WGCME2525M50C	25	25	25	150,25	139,25	125,25	40,00	G 1/8-28	G 1/8-28	42,41	7,00	50
6498959	WGCME3232P65C	32	32	32	170,00	158,15	137,00	35,00	G 1/8-28	G 1/8-28	54,00	7,00	65
6498960	WGCME3232P50C	32	32	32	170,25	159,25	145,25	40,00	G 1/8-28	G 1/8-28	42,41	—	50

NOTE: WGCMS.: Right-hand holder uses right-hand blades.
 WGCME.: Right-hand holder uses left-hand blades.
 M50 blade and clamp screw torque equals 71–88 in. lbs. (8–10 Nm).
 M65 blade and clamp screw torque equals 159–177 in. lbs. (18–20 Nm).

Grooving and Cut-Off • WGC

WGC Modular Blades

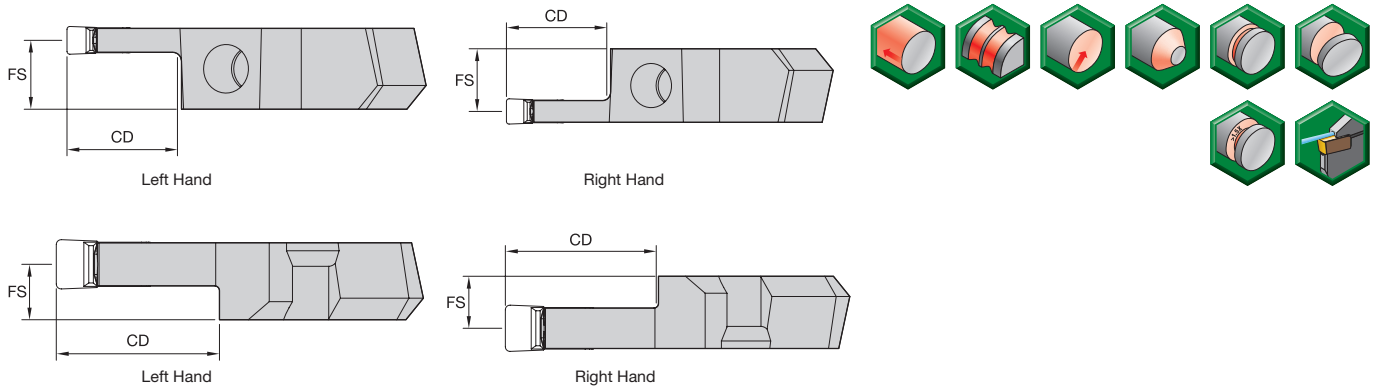

order number	catalogue number	SSC	CD	FS	blade size
right hand					
6498457	WGCM50R1F12M	1F	12,0	11,00	50
6498458	WGCM50R0212M	2	12,0	10,88	50
6498459	WGCM50R0216M	2	16,0	10,88	50
6498460	WGCM50R0312MC	3	12,0	10,43	50
6498861	WGCM50R0322MC	3	22,0	10,43	50
6498862	WGCM50R0412MC	4	12,0	9,93	50
6498863	WGCM50R0422MC	4	22,0	9,93	50
6498864	WGCM50R0432MC	4	32,0	9,93	50
6498865	WGCM50R0512MC	5	12,0	9,43	50
6498866	WGCM50R0516MC	5	16,0	9,43	50
6498867	WGCM50R0526MC	5	26,0	9,43	50
6498868	WGCM50R0532MC	5	32,0	9,43	50
6498869	WGCM65R0616MC	6	16,0	9,88	65
6498870	WGCM65R0626MC	6	26,0	9,88	65
6498881	WGCM65R0632MC	6	32,0	9,88	65
6498882	WGCM65R0816MC	8	16,0	9,00	65
6498883	WGCM65R0826MC	8	26,0	9,00	65
left hand					
6498884	WGCM50L1F12M	1F	12,0	11,00	50
6498885	WGCM50L0212M	2	12,0	10,88	50
6498886	WGCM50L0216M	2	16,0	10,88	50
6498887	WGCM50L0312MC	3	12,0	10,43	50
6498888	WGCM50L0322MC	3	22,0	10,43	50
6498889	WGCM50L0412MC	4	12,0	9,93	50
6498890	WGCM50L0422MC	4	22,0	9,93	50
6498891	WGCM50L0432MC	4	32,0	9,93	50
6498892	WGCM50L0512MC	5	12,0	9,43	50
6498893	WGCM50L0516MC	5	16,0	9,43	50
6498894	WGCM50L0526MC	5	26,0	9,43	50
6498895	WGCM50L0532MC	5	32,0	9,43	50
6498896	WGCM65L0616MC	6	16,0	9,88	65
6498897	WGCM65L0626MC	6	26,0	9,88	65
6498898	WGCM65L0632MC	6	32,0	9,88	65
6498899	WGCM65L0816MC	8	16,0	9,00	65
6498900	WGCM65L0826MC	8	26,0	9,00	65

NOTE: SSC = Pocket Seat Reference. To correspond with the SSC on the insert.
Through the pocket coolant available in seat sizes 3 and higher.

Blade Holders • Metric

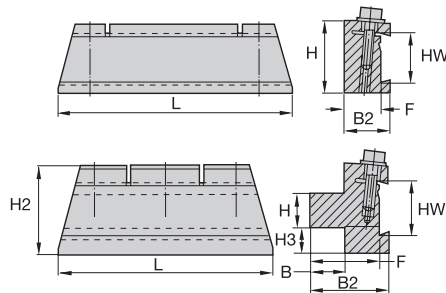

order number	catalogue number	HW	H	B	F	H2	B2	H3	L
2007826	12251222000	26	20,0	18,0	33,0	40	38	8	100
2021635	12251222500	32	25,0	20,0	35,0	50	40	10	125
2008159	12251233200	53	32,0	25,0	50,0	82	57	30	160
2021723	12251234000	53	40,0	40,0	58,0	82	65	22	160

Double-Ended Cut-Off Blade

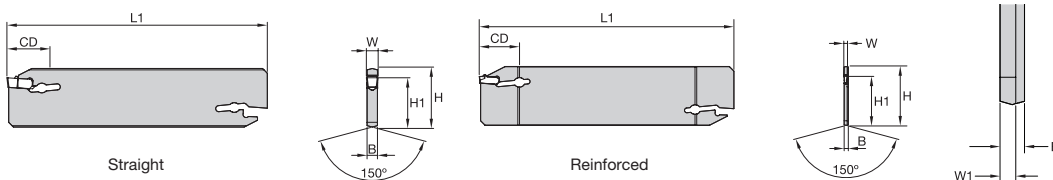

order number	catalogue number	SSC	H	W	W1	H1	L1	B	CD
neutral hand									
6498987	WGCBSN19G1B14	1B	19	1,4	1,15	15,5	90	1,80	14
6498988	WGCBSN26J1B15	1B	26	1,4	1,15	21,5	110	1,80	15
6498989	WGCBSN19G1F16	1F	19	1,6	1,30	15,5	90	1,80	16
6498990	WGCBSN26J1F17	1F	26	1,6	1,30	21,5	110	1,80	17
6499211	WGCBSN19G0220	2	19	2,0	—	15,5	90	1,65	20
6499212	WGCBSN26J0230	2	26	2,0	—	21,5	110	1,65	30
6499213	WGCBSN32M0250	2	32	2,0	—	25,1	150	1,65	50
6499214	WGCBSN26J0340	3	26	3,0	—	21,5	110	2,40	40
6499215	WGCBSN32M0350	3	32	3,0	—	25,1	150	2,40	50
6499216	WGCBSN26J0440	4	26	4,0	—	21,5	110	3,40	40
6499217	WGCBSN32M0450	4	32	4,0	—	25,1	150	3,40	50
6499218	WGCBSN32M0560	5	32	5,0	—	25,1	150	4,40	60
6499219	WGCBSN32M0660	6	32	6,0	—	25,1	150	5,40	60
6499220	WGCBSN32M0860	8	32	8,0	—	25,1	150	7,00	60
6499221	WGCBSN52X08120	8	53	8,0	—	45,3	260	7,00	120

NOTE: SSC = Pocket Seat Reference. To correspond with the SSC on the insert.

Grades and Grade Descriptions

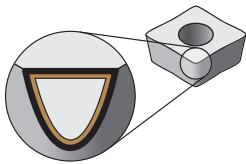

Coatings provide high-speed capability and are engineered for finishing to heavy roughing.

P	Steel
M	Stainless Steel
K	Cast Iron
N	Non-Ferrous
S	High-Temp Alloys
H	Hardened Materials

wear resistance ← → toughness

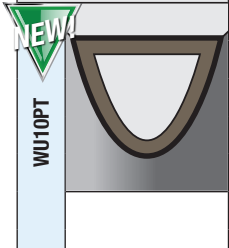
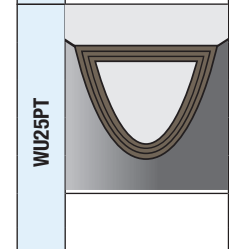
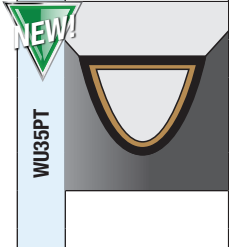
Coating	Grade Description		05	10	15	20	25	30	35	40	45		
 <p>WU10PT</p>	<p>Composition: An advanced multilayer PVD coating over a very deformation-resistant unalloyed carbide substrate. The new and improved coating improves edge stability with wide range speed and feed capabilities.</p> <p>Application: The WU10PT™ grade is ideal for finishing to general machining of most workpiece materials at a wide range of speed and feed capabilities. Excellent for machining most steels, stainless steels, cast irons, non-ferrous materials, and super alloys with improved edge toughness and higher cutting speed/feed capability.</p>	P											
		M											
		K											
		N											
		S											
		H											
 <p>WU25PT</p>	<p>Composition: An advanced PVD-TiAlN-coated grade with a tough, ultra-fine grain, unalloyed substrate.</p> <p>Application: For general-purpose machining of most steels, stainless steels, high-temperature alloys, titanium, irons, and non-ferrous materials. Speeds may vary from low to medium and will handle interruptions and high feed rates.</p>	P											
		M											
		K											
		N											
		S											
		H											
 <p>WU35PT</p>	<p>Composition: A multilayer PVD coated carbide grade with an advanced AlTiN-TiN coating over a super-tough substrate.</p> <p>Application: WU35PT is an excellent grade for machining stainless steels, all types of steels, super alloys in turning, and cut-off applications. The substrate provides improved toughness while the coating layers offer excellent abrasion resistance and dependability at a wide range of speeds and feeds. Improved edge toughness provides security in interrupted cuts.</p>	P											
		M											
		K											
		N											
		S											
		H											

Cut-Off Inserts • F Precision Moulded • Metric

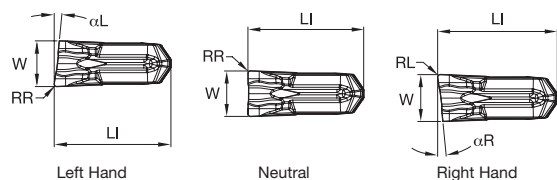

- first choice
- alternate choice

P	●
M	●
K	○
N	○
S	●
H	

catalogue number	SSC	W	W tol ±	LI	αR	αL	RR	RL	WU25PT
WC014M1BL06F01	1B	1,40	0,050	9,00	—	6	0,15	—	6470544
WC014M1BN00F01	1B	1,40	0,050	9,00	—	—	0,15	0,15	6470545
WC014M1BR06F01	1B	1,40	0,050	9,02	6	—	—	0,15	6470546
WC020M02L06F02	2	2,00	0,050	9,00	—	6	0,20	—	6470547
WC020M02N00F02	2	2,00	0,050	9,00	—	—	0,20	0,20	6470548
WC020M02R06F02	2	2,00	0,050	9,00	6	—	—	0,20	6470549
WC030M03L06F02	3	3,00	0,075	9,60	—	6	0,20	—	6470550
WC030M03N00F02	3	3,00	0,075	9,63	—	—	0,20	0,20	6470561
WC030M03R06F02	3	3,00	0,075	9,60	6	—	—	—	6470562
WC040M04L06F02	4	4,00	0,075	10,19	—	6	0,20	—	6470563
WC040M04N00F02	4	4,00	0,075	10,19	—	—	0,20	0,20	6470564
WC040M04R06F02	4	4,00	0,075	10,19	6	—	—	0,20	6470565
WC050M05N00F03	5	5,00	0,075	12,24	—	—	0,30	0,30	6470566

NOTE: SSC = Pocket Seat Reference. To correspond with the SSC on the toolholder.

Grooving and Cut-Off • WGC

Cut-Off Inserts • M Precision Moulded • Metric

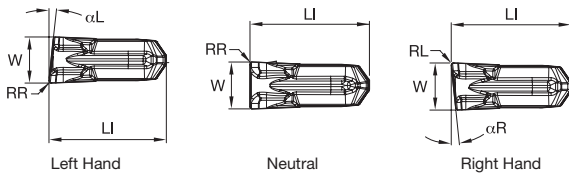

- first choice
- alternate choice

P	●
M	●
K	○
N	○
S	●
H	

catalogue number	SSC	W	W tol ±	LI	αR	αL	RR	RL	WU25PT
WC014M1BL06M02	1B	1,40	0,050	9,02	—	6	—	0,20	6461828
WC014M1BN00M01	1B	1,40	0,050	9,01	—	—	0,15	0,15	6461829
WC014M1BR06M02	1B	1,40	0,050	9,02	6	—	—	0,20	6461830
WC020M02L06M02	2	2,00	0,050	8,97	—	6	—	0,20	6461861
WC020M02N00M02	2	2,00	0,050	8,98	—	—	0,20	0,20	6461862
WC020M02R06M02	2	2,00	0,050	9,00	6	—	—	0,20	6461863
WC030M03L06M02	3	3,00	0,075	9,61	—	6	—	0,20	6461864
WC030M03N00M02	3	3,00	0,075	9,60	—	—	0,20	0,20	6461865
WC030M03R06M02	3	3,00	0,075	9,61	6	—	—	0,20	6461866
WC040M04L06M02	4	4,00	0,075	10,19	—	6	0,20	—	6461867
WC040M04N00M02	4	4,00	0,075	10,20	—	—	0,20	0,20	6461868
WC040M04R06M02	4	4,00	0,050	10,20	6	—	—	0,20	6461869
WC050M05N00M03	5	5,00	0,075	12,25	—	—	0,30	0,30	6461870
WC060M06N00M03	6	6,00	0,075	14,59	—	—	0,30	0,30	6461881
WC080M08N00M04	8	8,00	0,075	17,46	—	—	0,40	0,40	6461882

NOTE: SSC = Pocket Seat Reference. To correspond with the SSC on the toolholder.

Cut-Off Inserts • R Precision Moulded • Metric

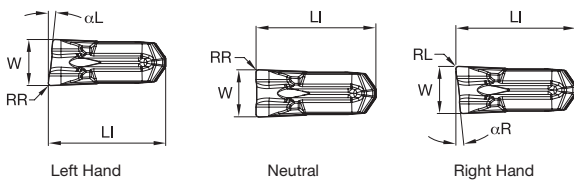

- first choice
- alternate choice

P	●
M	●
K	○
N	○
S	●
H	

catalogue number	SSC	W	W tol ±	LI	αR	αL	RR	RL	WU25PT
WC020M02L06R02	2	2,00	0,050	8,97	—	6	0,20	—	6470426
WC020M02N00R02	2	2,00	0,050	8,98	—	—	0,20	0,20	6470427
WC020M02R06R02	2	2,00	0,050	8,97	6	—	—	0,20	6470428
WC030M03L06R02	3	3,00	0,075	9,61	—	6	0,20	—	6470429
WC030M03N00R02	3	3,00	0,075	9,60	—	—	0,20	0,20	6470430
WC030M03R06R02	3	3,00	0,075	9,61	6	—	—	0,20	6470461
WC040M04N00R02	4	4,00	0,075	10,20	—	—	0,20	0,20	6470462
WC050M05N00R03	5	5,00	0,075	12,25	—	—	0,30	0,30	6470463
WC060M06N00R03	6	6,00	0,075	14,59	—	—	0,30	0,30	6470464
WC080M08N00R04	8	8,00	0,075	17,46	—	—	0,40	0,40	6470465

NOTE: SSC = Pocket Seat Reference. To correspond with the SSC on the toolholder.

Grooving Inserts • PT Precision Moulded • Metric

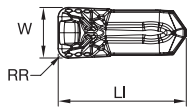

- first choice
- alternate choice

P	●
M	●
K	○
N	○
S	●
H	

catalogue number	SSC	W	W tol ±	RR	LI	WU25PT
WG0212M02U02PT	2	2,13	0,050	0,20	8,97	6461734
WG0251M02U02PT	2	2,51	0,050	0,20	8,97	6461735
WG0312M03U02PT	3	3,13	0,075	0,20	9,60	6461736
WG0312M03U04PT	3	3,13	0,075	0,40	9,60	6461737
WG0412M04U04PT	4	4,13	0,075	0,40	10,19	6461738
WG0412M04U08PT	4	4,13	0,075	0,80	10,19	6461739
WG0512M05U04PT	5	5,13	0,075	0,40	12,25	6461740
WG0512M05U08PT	5	5,13	0,075	0,80	12,25	6461821
WG0612M06U04PT	6	6,13	0,075	0,40	14,59	6461822
WG0612M06U08PT	6	6,13	0,075	0,80	14,59	6461823
WG0712M06U08PT	6	7,13	0,075	0,80	14,59	6461824
WG0812M08U08PT	8	8,13	0,075	0,80	17,45	6461825
WG0812M08U12PT	8	8,13	0,075	1,20	17,45	6461826
WG1012M10U12PT	10	10,13	0,075	1,20	20,75	6461827

NOTE: SSC = Pocket Seat Reference. To correspond with the SSC on the toolholder.

Grooving Inserts • PT Precision Ground • Metric

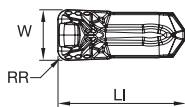

- first choice
- alternate choice

P	●
M	●
K	○
N	○
S	●
H	

catalogue number	SSC	W	W tol ±	RR	LI	WU25PT
WG0200M02P02PT	2	2,00	0,025	0,20	8,92	6741598
WG0300M03P02PT	3	3,00	0,025	0,20	9,55	6741599
WG0300M03P04PT	3	3,00	0,025	0,40	9,55	6741600
WG0400M04P04PT	4	4,00	0,025	0,40	10,15	6741611
WG0400M04P08PT	4	4,00	0,025	0,80	10,15	6741612
WG0500M05P04PT	5	5,00	0,025	0,40	12,18	6741613
WG0500M05P08PT	5	5,00	0,025	0,08	12,20	6741614
WG0600M06P04PT	6	6,00	0,025	0,40	14,53	6741615
WG0600M06P08PT	6	6,00	0,025	0,80	14,54	6741616

NOTE: SSC = Pocket Seat Reference. To correspond with the SSC on the toolholder.

Grooving and Cut-Off • WGC

Grooving Inserts • PN Precision Moulded • Metric

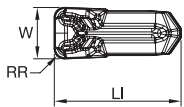

- first choice
- alternate choice

P	●
M	●
K	○
N	○
S	●
H	

catalogue number	SSC	W	W tol ±	RR	LI	WU25PT
WG0212M02U02PN	2	2,13	0,050	0,20	8,97	6470850
WG0251M02U02PN	2	2,51	0,050	0,20	8,97	6471041
WG0312M03U02PN	3	3,13	0,075	0,20	9,60	6471042
WG0312M03U04PN	3	3,13	0,075	0,40	9,60	6471043
WG0412M04U04PN	4	4,13	0,075	0,40	10,20	6471044
WG0412M04U08PN	4	4,13	0,075	0,80	10,20	6471045
WG0512M05U04PN	5	5,13	0,075	0,40	12,24	6471046
WG0512M05U08PN	5	5,13	0,075	0,80	12,24	6471047
WG0612M06U04PN	6	6,13	0,075	0,40	14,59	6471048
WG0612M06U08PN	6	6,13	0,075	0,80	14,59	6471049
WG0812M08U08PN	8	8,13	0,075	0,80	17,46	6471050
WG0812M08U12PN	8	8,13	0,075	1,20	17,46	6471062
WG1012M10U12PN	10	10,13	0,075	1,20	20,75	6471064

NOTE: SSC = Pocket Seat Reference. To correspond with the SSC on the toolholder.

Grooving Inserts • PC Full Radius Precision Ground • Metric

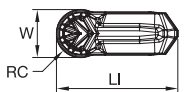

- first choice
- alternate choice

P	●
M	●
K	○
N	○
S	●
H	

catalogue number	SSC	W	W tol ±	RC	LI	WU25PT
WR0200M02P00PC	2	2,00	0,025	1,00	8,91	6470467
WR0300M03P00PC	3	3,00	0,025	1,50	9,54	6470468
WR0400M04P00PC	4	4,00	0,025	2,00	10,13	6470469
WR0500M05P00PC	5	5,00	0,025	2,50	12,18	6470470
WR0600M06P00PC	6	6,00	0,025	3,00	14,52	6470481
WR0800M08P00PC	8	8,00	0,025	4,00	17,41	6470482

NOTE: SSC = Pocket Seat Reference. To correspond with the SSC on the toolholder.

Plunge feed rates

- first choice
- alternate choice

P Steel	K Cast Iron	S High-Temp Alloys
M Stainless Steel	N Non-Ferrous	H Hardened Materials

Chip Control	Description	Insert Geometry	Seat Size (SSC)	Corner Radius mm	Starting Conditions mm	Plunge Feed Rates mm/rev						
						0,05	0,10	0,15	0,20	0,25	0,30	0,35
-PT 	Positive rake angle for lower cutting forces.		1F	0,2	0,06	0,05	0,10	0,15	0,20	0,25	0,30	0,35
			2	0,2	0,08	0,05	0,10	0,15	0,20	0,25	0,30	0,35
			3	0,2	0,09	0,05	0,10	0,15	0,20	0,25	0,30	0,35
			4	0,4	0,11	0,05	0,10	0,15	0,20	0,25	0,30	0,35
			4	0,4	0,12	0,05	0,10	0,15	0,20	0,25	0,30	0,35
			5	0,4	0,15	0,05	0,10	0,15	0,20	0,25	0,30	0,35
			6	0,8	0,16	0,05	0,10	0,15	0,20	0,25	0,30	0,35
			6	0,4	0,15	0,05	0,10	0,15	0,20	0,25	0,30	0,35
			8	0,8	0,20	0,05	0,10	0,15	0,20	0,25	0,30	0,35
			8	1,2	0,22	0,05	0,10	0,15	0,20	0,25	0,30	0,35
-PN 	Stable negative cutting edge allowing for more aggressive applications.		1F	0,2	0,06	0,05	0,10	0,15	0,20	0,25	0,30	0,35
			2	0,2	0,08	0,05	0,10	0,15	0,20	0,25	0,30	0,35
			3	0,2	0,09	0,05	0,10	0,15	0,20	0,25	0,30	0,35
			4	0,4	0,11	0,05	0,10	0,15	0,20	0,25	0,30	0,35
			4	0,4	0,12	0,05	0,10	0,15	0,20	0,25	0,30	0,35
			5	0,4	0,15	0,05	0,10	0,15	0,20	0,25	0,30	0,35
			6	0,8	0,16	0,05	0,10	0,15	0,20	0,25	0,30	0,35
			6	0,4	0,15	0,05	0,10	0,15	0,20	0,25	0,30	0,35
			8	0,8	0,20	0,05	0,10	0,15	0,20	0,25	0,30	0,35
			8	1,2	0,22	0,05	0,10	0,15	0,20	0,25	0,30	0,35
10	1,2	0,24	0,05	0,10	0,15	0,20	0,25	0,30	0,35			

Cut-Off Feed Rates

Geometry	Description	Insert Geometry	Seat Size (SSC)	Starting Conditions mm	Cut-Off Feed Rates mm/rev							
					0,05	0,10	0,15	0,20	0,25	0,30	0,35	0,40
-F 	Positive geometry for reduced cutting forces.		1B	0,06	0,05	0,10	0,15	0,20	0,25	0,30	0,35	0,40
			2	0,07	0,05	0,10	0,15	0,20	0,25	0,30	0,35	0,40
			3	0,09	0,05	0,10	0,15	0,20	0,25	0,30	0,35	0,40
			4	0,11	0,05	0,10	0,15	0,20	0,25	0,30	0,35	0,40
			5	0,13	0,05	0,10	0,15	0,20	0,25	0,30	0,35	0,40
-M 	Stable cutting edge for aggressive feed rates. Primarily in cast iron.		1B	0,06	0,05	0,10	0,15	0,20	0,25	0,30	0,35	0,40
			2	0,07	0,05	0,10	0,15	0,20	0,25	0,30	0,35	0,40
			3	0,09	0,05	0,10	0,15	0,20	0,25	0,30	0,35	0,40
			4	0,11	0,05	0,10	0,15	0,20	0,25	0,30	0,35	0,40
			5	0,14	0,05	0,10	0,15	0,20	0,25	0,30	0,35	0,40
			6	0,16	0,05	0,10	0,15	0,20	0,25	0,30	0,35	0,40
-R 	Most stable cutting edge for steel.		2	0,10	0,05	0,10	0,15	0,20	0,25	0,30	0,35	0,40
			3	0,14	0,05	0,10	0,15	0,20	0,25	0,30	0,35	0,40
			4	0,16	0,05	0,10	0,15	0,20	0,25	0,30	0,35	0,40
			5	0,19	0,05	0,10	0,15	0,20	0,25	0,30	0,35	0,40
			6	0,21	0,05	0,10	0,15	0,20	0,25	0,30	0,35	0,40
			8	0,23	0,05	0,10	0,15	0,20	0,25	0,30	0,35	0,40

NOTE: For cut-off inserts with a lead angle, maximum feed rate should be reduced by up to 40%.

Maximum Feed Rate Values

Data above is for P and K material groups. Maximum feed rates should be adjusted by multiplying max feed rate values by following factors for shown material groups.	Material Group	Feed Factor
	M	0.8
	N	1.2
	S	0.8
	H	0.5

I.D. and Face Grooving
For I.D. and face grooving applications, reduce feed rate by 20%.

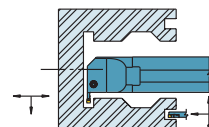

Turn and profile feed rates

Seat Size 1F

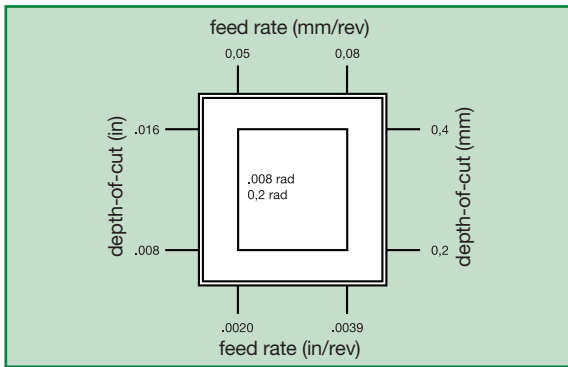

Seat Size 2

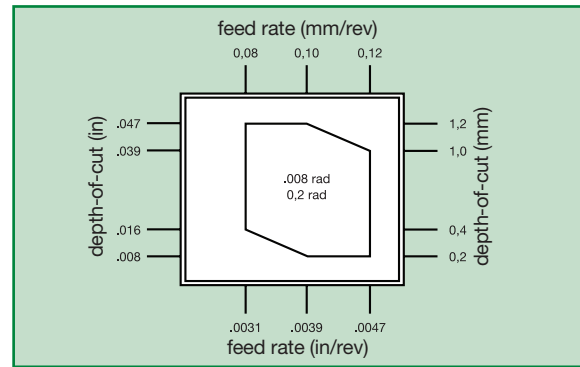

Seat Size 3

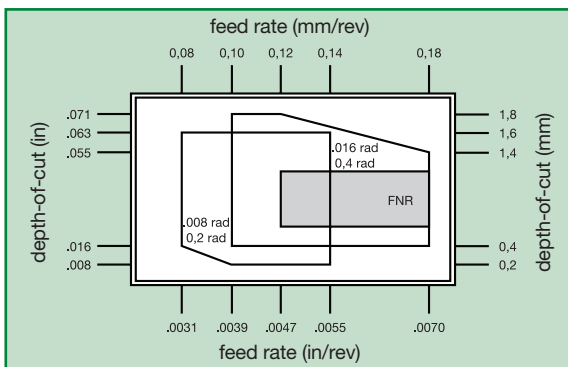

Seat Size 4

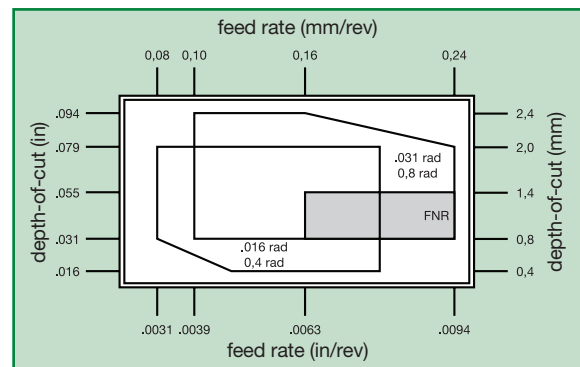

Seat Size 5

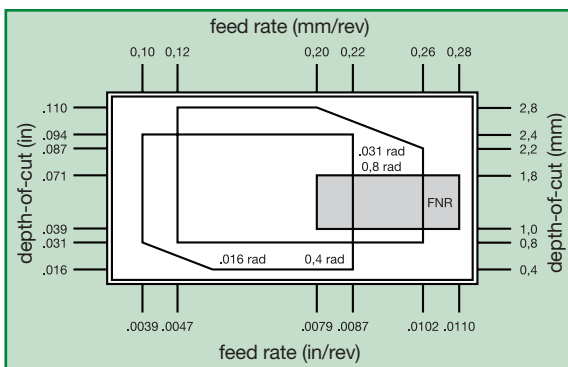

Seat Size 6

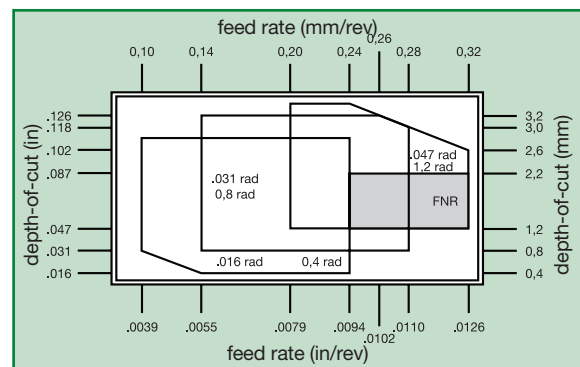

Seat Size 8

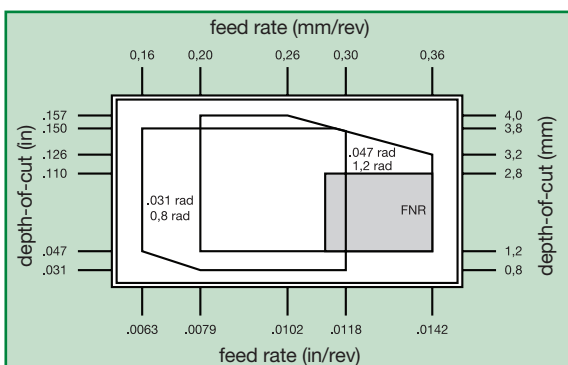

Seat Size 10

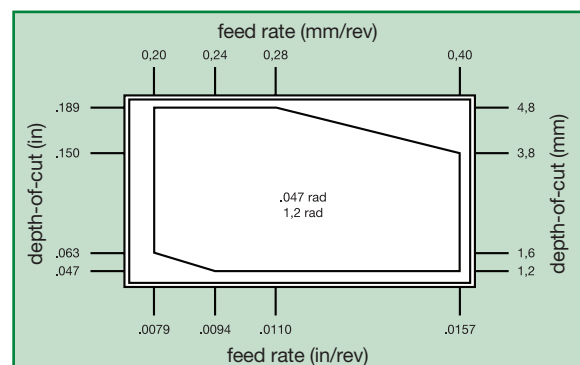

* FNR = Full Nose Radius





Recommended Starting Speeds • Metric

Material Group		WU25PT		
P	0-1	110	225	270
	2	110	160	260
	3	110	125	235
	4	60	90	160
	5	100	160	210
	6	85	120	185
M	1	90	170	245
	2	90	150	245
	3	90	140	210
K	1	100	145	225
	2	70	120	170
	3	50	85	120
N	1-2	120	440	780
	3	—	—	—
	4	100	290	490
	5	70	135	195
	6	100	170	245
S	1	8	40	60
	2	8	30	75
	3	15	40	75
	4	8	50	110

NOTE: FIRST choice starting speeds are in **bold** type.
As the average chip thickness increases, the speed should be decreased.

Grooving and Cut-Off • WGC

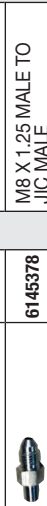
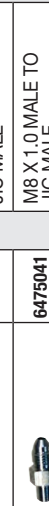
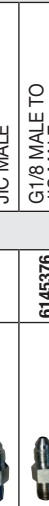
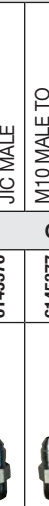
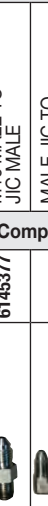
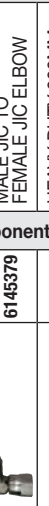
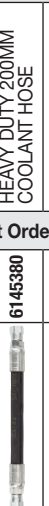
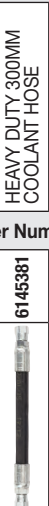
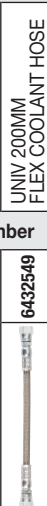
Coolant Kit

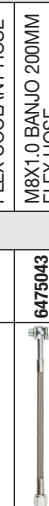
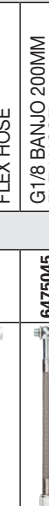
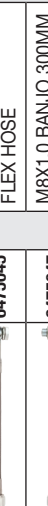
Kit Description	Order Number	Shank Size	Coolant Pressure	Component Description														
				Component Order Number														
				6145374	6145375	6145378	6475041	6145376	6145377	6145379	6145380	6145381	6432549	6432550	6475043	6475045	6475047	6475049
<i>Universal 200mm flex hose coolant kit</i>	6475019	12–40mm 1/2–1-1/2"	200 Bar 2,901 psi															
					•	•	•	•	•	•			•					
<i>Universal 300mm flex hose coolant kit</i>	6475021	12–40mm 1/2–1-1/2"	200 Bar 2,901 psi	•	•	•	•	•	•					•				
<i>M8x1.0 banjo 200mm flex hose coolant kit</i>	6475023	12–20mm 1/2–3/4"	200 Bar 2,901 psi					•	•	•					•			
<i>M8x1.0 banjo 300mm flex hose coolant kit</i>	6475025	12–20mm 1/2–3/4"	200 Bar 2,901 psi					•	•	•							•	
<i>G 1/8 banjo 200mm flex hose coolant kit</i>	6475027	25–40mm 1–1-1/2"	200 Bar 2,901 psi					•	•	•						•		
<i>G 1/8 banjo 300mm flex hose coolant kit</i>	6475029	25–40mm 1–1-1/2"	200 Bar 2,901 psi					•	•	•								•
<i>Universal 200mm heavy-duty coolant kit</i>	6145372	25–40mm 1–1-1/2"	350 Bar* 5,076 psi*	•	•			•	•	•	•							
<i>Universal 300mm heavy-duty coolant kit</i>	6145373	25–40mm 1–1-1/2"	350 Bar* 5,076 psi*	•	•			•	•	•		•						

* Max pressure for seat size O2 holders is 200 bar/2901 psi.

Individual Kit Component List



order number	catalogue number	description
6145374	1-16NPTF-JIC	Straight fitting, 1/16 NPTF male thread to JIC male thread
6145375	1-8NPTF-JIC	Straight fitting, 1/8 NPTF male thread to JIC male thread
6145378	M8X1.25-JIC	Straight fitting, M8 x 1.25 male thread to JIC male thread
6475041	M8X1-JIC	Straight fitting, M8 x 1.0 male thread to JIC male thread
6145376	G18-JIC	Straight fitting, G 1/8 male thread to JIC male thread
6145377	M10X1.5-JIC	Straight fitting, M10 x 1.5 male thread to JIC male thread
6145379	JICM-JICF-ELB	Elbow fitting, male JIC thread to female JIC thread
6145380	COOL-HOSE-200-HD	Heavy Duty 200mm Coolant hose with JIC female fitting both ends
6145381	COOL-HOSE-300-HD	Heavy Duty 300mm Coolant hose with JIC female fitting both ends
6432549	COOL-HOSE-200-FLEX	Flexible braided 200mm Coolant hose with JIC female fitting both ends
6432550	COOL-HOSE-300-FLEX	Flexible braided 300mm Coolant hose with JIC female fitting both ends
6475043	M8X1-BAN-JIC-HOSE-200	Flexible braided 200mm Coolant hose, M8 x 1.0 male thread to JIC female thread. Contains (1) M8x1.0 banjo bolt and (2) M8 bonded washers
6475045	G18-BAN-JIC-HOSE-200	Flexible braided 200mm Coolant hose, G 1/8 male thread to JIC female thread. Contains (1) G 1/8 banjo bolt and (2) G 1/8 bonded washers
6475047	M8X1-BAN-JIC-HOSE-300	Flexible braided 300mm Coolant hose, M8 x 1.0 male thread to JIC female thread. Contains (1) M8x1.0 banjo bolt and (2) M8 bonded washers
6475049	G18-BAN-JIC-HOSE-300	Flexible braided 300mm Coolant hose, G 1/8 male thread to JIC female thread. Contains (1) G 1/8 banjo bolt and (2) G 1/8 bonded washers

Individual Kit Component List



The items shown below are not part of any coolant kits shown on previous pages.

order number	catalogue number	description
6145382	M6X1-JIC	Straight fitting, M6 x 1.0 male thread to JIC male thread
6145383	JICM-JICM-STR	Straight fitting, JIC male thread to JIC male thread
6145386	G14-G18-RED	Straight fitting, G 1/4 male thread to G 1/8th male thread
6475058	R18-JIC	Straight fitting, 1/8 BSPT male thread to JIC male thread
6475059	R14-JIC	Straight fitting, 1/4 BSPT male thread to JIC male thread

Coolant Spare Parts

Included in kits; part of components.

order number	catalogue number	description
6475051	M8X1-BAN-BOLT	Banjo bolt, M8 x 1.0 male thread
6475053	G18-BAN-BOLT	Banjo bolt, G1/8 male thread
6475060	M6-BON-WASHER	M6 bonded washer
6475055	M8-BON-WASHER	M8 bonded washer
6475061	M10-BON-WASHER	M10 bonded washer
6475056	G18-BON-WASHER	G 1/8 bonded washer

Grooving and Cut-Off • WGC

Internal Coolant Delivery Guidelines

1. WGC system capable of 5076 psi (350 bar).
2. Toolholder delivered with four entry holes.
3. A quality filtration system is necessary to prevent blockages in the toolholder that will affect coolant flow and performance.
4. Machines without a proper filtering system may require modification or an inline filter.
 - For pressure >1015 psi [70 bar], use 10–20 µm filter.
 - For pressure <1015 psi [70 bar], 50–100 µm.
 - Using fine filters in low-pressure applications may affect flow rate.

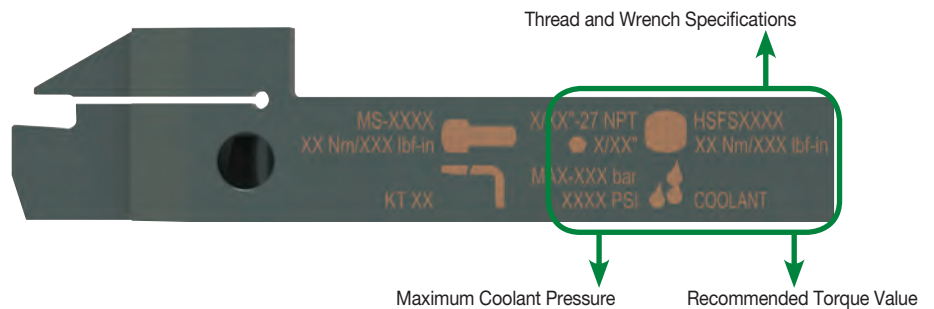
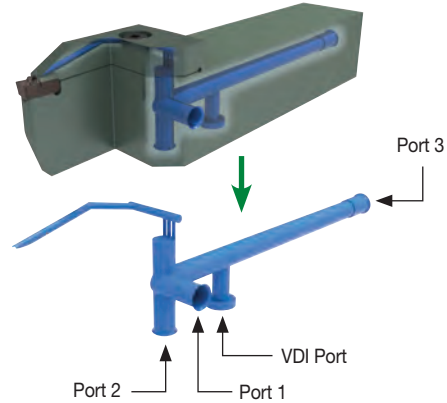

General Safety Guidelines

1. All safety doors and mechanisms must be in place before trying out the internal coolant to avoid any danger to the operator in the event of a failure.
2. Use the correct pipe fittings to connect the holders to the system. Ensure the maximum pressure recommended for the fittings are not exceeded.
3. While implementing pressure >1160 psi [80 bar], increase the pressure in steps to ensure proper functioning of insert clamping and leak-free joints.
4. While indexing inserts, ensure the pocket is free from chips and/or dirt. Also, inspect the insert and make sure there are no blockages in the coolant canal.
5. Periodically check all hoses and fittings for damage and wear for proper functioning of the system. This check should also include filters.

Internal Coolant Delivery Performance

Internal coolant offers a clear advantage in tool life and chip forming/evacuation vs. external coolant in difficult conditions and in high-pressure coolant.

Example: Chipbreaking in plunging of steel.

Flood Coolant



Material steel ST52;
Insert size 6mm; f = 0,25 mm/U

Internal Coolant



1,087 psi
(75 bar)



2,900 psi
(200 bar)

Low Pressure — If performance is at risk due to low coolant pressure, apply internal coolant in combination with external coolant to increase volume.

Recommendation to improve tool life and/or productivity: Apply high pressure coolant: 80–350 bar recommended.

VDI Assemblies

The WGC internal coolant delivery can be leveraged with VDI holding systems with both traditional or Quick-Change coolant connections.

WK15CT



NEW VICTORY™ GRADE
FOR CAST IRON TURNING

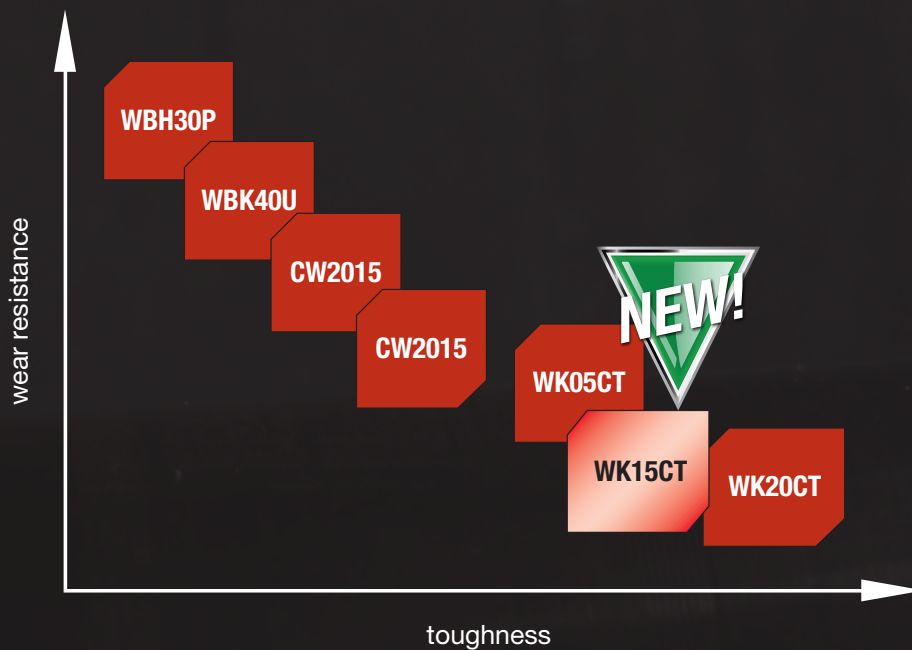



Coating

NEW: Substrate and Victory™ coating.

Multilayer CVD coating of TiCN and Al₂O₃ with pre and post-coat treatment providing improved edge toughness and long predictable tool life at elevated cutting speeds.



Machining Capabilities

Developed to perform in roughing, semi-finishing, and finishing in all types of grey cast iron.

Also suitable for: Different types of nodular iron



WK15CT in cast iron turning not only helps in cost reduction, but also cycle time reduction through improved cutting parameters and better productivity.

WK15CT

High-Performance Inserts • WIDIA™ Victory™



WK15CT provides consistent performance at high cutting speeds and feeds in machining grey cast iron and ductile irons in roughing to finishing applications.

Features:

- Improved productivity and reduced cycle times.
- Post-coat grinding provides secure seating surface.
- A multi-layer CVD coated grade with TiN-TiCN-Al₂O₃ over a wear-resistant substrate specially developed to give consistent performance and superior tool life while machining cast irons.
- The wear-resistant substrate resists deformation while machining at elevated cutting speeds.
- The thick CVD coating with post-coat treatment provides long and consistent tool life.
- Can be applied in both continuous and lightly interrupted cuts for grey and ductile irons.

Post-coat treatment improves edge toughness and provides long predictable tool life.

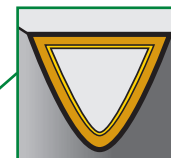

TiN-TiCN-Al₂O₃

Wear-resistant coating provides better tool life at elevated cutting speeds.

WK15CT replaces the old grades TN5120, HK150. Available in most popular geometries in both negative and positive ISO insert styles.

Negative style inserts	Geometry
CNMA	MA
CNMG	STD, -5, -RH
WNMA	MA
WNMG	STD, -5, -RH
TNMA	MA
TNMG	STD, -RH
SNMA	MA
SNMG	STD
DNMG	STD, -RH

Positive style inserts	Geometry
CCMT	STD, MP
DCMT	STD
SCMT	MP
TCMT	MP
VBMT	STD
VCMT	STD



High-Performance Inserts • WIDIA™ Victory™

CCMT

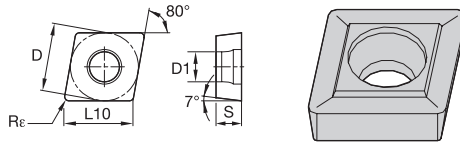

- first choice
- alternate choice

P	<input type="radio"/>
M	<input type="radio"/>
K	<input checked="" type="radio"/>
N	<input type="radio"/>
S	<input type="radio"/>
H	<input type="radio"/>

ISO catalogue number	D	L10	S	Rε	D1	WK15CT
CCMT060204	6,35	6,45	2,38	0,4	2,80	6671876
CCMT090304	9,53	9,67	3,18	0,4	4,40	6671877
CCMT09T304	9,53	9,67	3,97	0,4	4,40	6613610
CCMT09T308	9,53	9,67	3,97	0,8	4,40	6613604

CCMT-MP

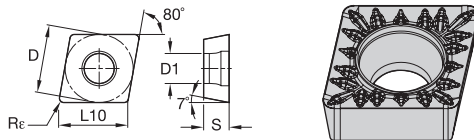

- first choice
- alternate choice

P	<input type="radio"/>
M	<input type="radio"/>
K	<input checked="" type="radio"/>
N	<input type="radio"/>
S	<input type="radio"/>
H	<input type="radio"/>

ISO catalogue number	D	L10	S	Rε	D1	WK15CT
CCMT120408MP	12,70	12,90	4,76	0,8	5,50	6730909
CCMT120412MP	12,70	12,90	4,76	1,2	5,50	6730910

CNMA

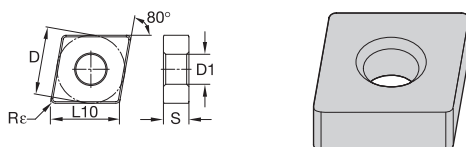

- first choice
- alternate choice

P	<input type="radio"/>
M	<input type="radio"/>
K	<input checked="" type="radio"/>
N	<input type="radio"/>
S	<input type="radio"/>
H	<input type="radio"/>

ISO catalogue number	D	L10	S	Rε	D1	WK15CT
CNMA120408	12,70	12,90	4,76	0,8	5,16	6287922
CNMA120412	12,70	12,90	4,76	1,2	5,16	6287923

WK15CT

High-Performance Inserts • WIDIA™ Victory™

CNMG

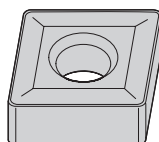
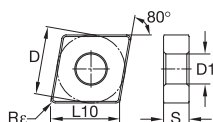

- first choice
- alternate choice

P	<input type="radio"/>
M	<input type="radio"/>
K	<input checked="" type="radio"/>
N	<input type="radio"/>
S	<input type="radio"/>
H	<input type="radio"/>

ISO catalogue number	D	L10	S	Rε	D1	WK15CT
CNMG120404	12,70	12,90	4,76	0,4	5,16	6613606

CNMG-5

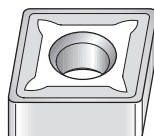
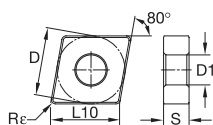

- first choice
- alternate choice

P	<input type="radio"/>
M	<input type="radio"/>
K	<input checked="" type="radio"/>
N	<input type="radio"/>
S	<input type="radio"/>
H	<input type="radio"/>

ISO catalogue number	D	L10	S	Rε	D1	WK15CT
CNMG120408-5	12,70	12,90	4,76	0,8	5,16	6287924
CNMG120412-5	12,70	12,90	4,76	1,2	5,16	6287925

CNMG-RH

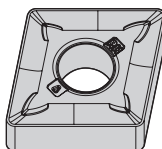
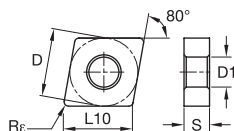

- first choice
- alternate choice

P	<input type="radio"/>
M	<input type="radio"/>
K	<input checked="" type="radio"/>
N	<input type="radio"/>
S	<input type="radio"/>
H	<input type="radio"/>

ISO catalogue number	D	L10	S	Rε	D1	WK15CT
CNMG120408RH	12,70	12,90	4,76	0,8	5,16	6288264
CNMG120412RH	12,70	12,90	4,76	1,2	5,16	6288265

High-Performance Inserts • WIDIA™ Victory™

DCMT

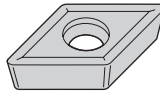
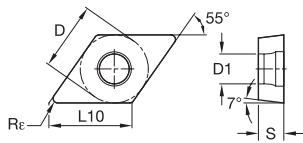

- first choice
- alternate choice

P	<input type="radio"/>
M	<input type="radio"/>
K	<input checked="" type="radio"/>
N	<input type="radio"/>
S	<input type="radio"/>
H	<input type="radio"/>

ISO catalogue number	D	L10	S	Rε	D1	WK15CT
DCMT11T308	9,53	11,63	3,97	0,8	4,45	6671913

DNMG

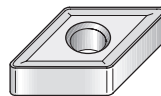
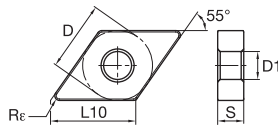

- first choice
- alternate choice

P	<input type="radio"/>
M	<input type="radio"/>
K	<input checked="" type="radio"/>
N	<input type="radio"/>
S	<input type="radio"/>
H	<input type="radio"/>

ISO catalogue number	D	L10	S	Rε	D1	WK15CT
DNMG150608	12,70	15,50	6,35	0,8	5,16	6671912

DNMG-RH

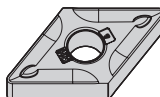
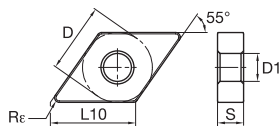

- first choice
- alternate choice

P	<input type="radio"/>
M	<input type="radio"/>
K	<input checked="" type="radio"/>
N	<input type="radio"/>
S	<input type="radio"/>
H	<input type="radio"/>

ISO catalogue number	D	L10	S	Rε	D1	WK15CT
DNMG150608RH	12,70	15,50	6,35	0,8	5,16	6730880
DNMG150612RH	12,70	15,50	6,35	1,2	5,16	6730901

WK15CT

High-Performance Inserts • WIDIA™ Victory™

SCMT-MP

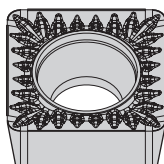
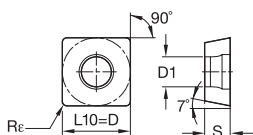

- first choice
- alternate choice

P	<input type="radio"/>
M	<input type="radio"/>
K	<input checked="" type="radio"/>
N	<input type="radio"/>
S	<input type="radio"/>
H	<input type="radio"/>

ISO catalogue number	D	L10	S	Rε	D1	WK15CT
SCMT09T304MP	9,53	9,53	3,97	0,4	4,40	6730906
SCMT09T308MP	9,53	9,53	3,97	0,8	4,40	6730907
SCMT120408MP	12,70	12,70	4,76	0,8	5,50	6730908

SNMA

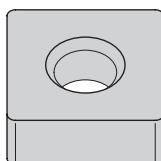
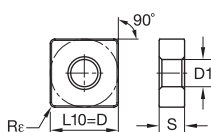

- first choice
- alternate choice

P	<input type="radio"/>
M	<input type="radio"/>
K	<input checked="" type="radio"/>
N	<input type="radio"/>
S	<input type="radio"/>
H	<input type="radio"/>

ISO catalogue number	D	L10	S	Rε	D1	WK15CT
SNMA120408	12,70	12,70	4,76	0,8	5,16	6287926
SNMA120412	12,70	12,70	4,76	1,2	5,16	6287927

SNMG

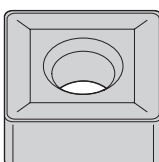
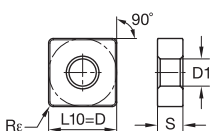

- first choice
- alternate choice

P	<input type="radio"/>
M	<input type="radio"/>
K	<input checked="" type="radio"/>
N	<input type="radio"/>
S	<input type="radio"/>
H	<input type="radio"/>

ISO catalogue number	D	L10	S	Rε	D1	WK15CT
SNMG120408	12,70	12,70	4,76	0,8	5,16	6613608

TCMT-MP

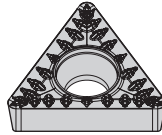
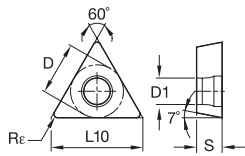

- first choice
- alternate choice

P	<input type="checkbox"/>	<input type="checkbox"/>
M	<input type="checkbox"/>	<input type="checkbox"/>
K	<input checked="" type="checkbox"/>	<input type="checkbox"/>
N	<input type="checkbox"/>	<input type="checkbox"/>
S	<input type="checkbox"/>	<input type="checkbox"/>
H	<input type="checkbox"/>	<input type="checkbox"/>

ISO catalogue number	D	L10	S	Rε	D1	WK15CT
TCMT110208MP	6,35	11,00	2,38	0,8	2,80	6730905
TCMT16T308MP	9,53	16,50	3,97	0,8	4,40	6730904

TNMA

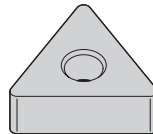
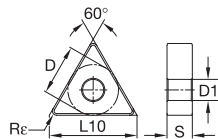

- first choice
- alternate choice

P	<input type="checkbox"/>	<input type="checkbox"/>
M	<input type="checkbox"/>	<input type="checkbox"/>
K	<input checked="" type="checkbox"/>	<input type="checkbox"/>
N	<input type="checkbox"/>	<input type="checkbox"/>
S	<input type="checkbox"/>	<input type="checkbox"/>
H	<input type="checkbox"/>	<input type="checkbox"/>

ISO catalogue number	D	L10	S	Rε	D1	WK15CT
TNMA160408	9,53	16,50	4,76	0,8	3,81	6287930
TNMA160412	9,53	16,50	4,76	1,2	3,81	6287951

TNMG

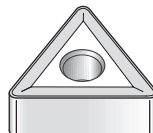
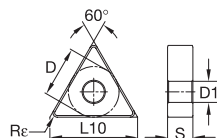

- first choice

P	<input type="checkbox"/>	<input type="checkbox"/>
M	<input type="checkbox"/>	<input type="checkbox"/>
K	<input checked="" type="checkbox"/>	<input type="checkbox"/>
N	<input type="checkbox"/>	<input type="checkbox"/>
S	<input type="checkbox"/>	<input type="checkbox"/>
H	<input type="checkbox"/>	<input type="checkbox"/>

ISO catalogue number	D	L10	S	Rε	D1	WK15CT
TNMG160404	9,53	16,50	4,76	0,4	3,81	6671911
TNMG160408	9,53	16,50	4,76	0,8	3,81	6617524
TNMG160412	9,53	16,50	4,76	1,2	3,81	6671880

WK15CT

High-Performance Inserts • WIDIA™ Victory™

TNMG-RH

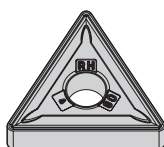
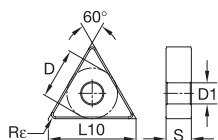

- first choice
- alternate choice

P	<input type="radio"/>
M	<input type="radio"/>
K	<input checked="" type="radio"/>
N	<input type="radio"/>
S	<input type="radio"/>
H	<input type="radio"/>

ISO catalogue number	D	L10	S	Rε	D1	WK15CT
TNMG160408RH	9,53	16,50	4,76	0,8	3,81	6673946

VBMT

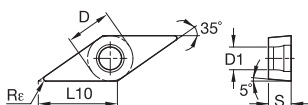

- first choice
- alternate choice

P	<input type="radio"/>
M	<input type="radio"/>
K	<input checked="" type="radio"/>
N	<input type="radio"/>
S	<input type="radio"/>
H	<input type="radio"/>

ISO catalogue number	D	L10	S	Rε	D1	WK15CT
VBMT160408	9,53	16,61	4,76	0,8	4,40	6671879

VCMT

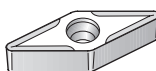
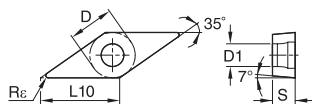

- first choice
- alternate choice

P	<input type="radio"/>
M	<input type="radio"/>
K	<input checked="" type="radio"/>
N	<input type="radio"/>
S	<input type="radio"/>
H	<input type="radio"/>

ISO catalogue number	D	L10	S	Rε	D1	WK15CT
VCMT16T308	9,53	16,61	3,97	0,8	4,40	6672411

High-Performance Inserts • WIDIA™ Victory™

WNMA

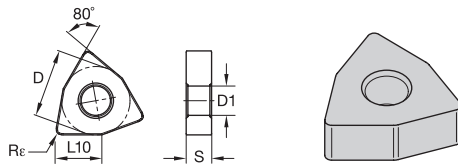

- first choice
- alternate choice

P	<input type="radio"/>
M	<input type="radio"/>
K	<input checked="" type="radio"/>
N	<input type="radio"/>
S	<input type="radio"/>
H	<input type="radio"/>

ISO catalogue number	D	L10	S	Re	D1	WK15CT
WNMA080408	12,70	8,69	4,76	0,8	5,16	6288267
WNMA080412	12,70	8,69	4,76	1,2	5,16	6288268

WNMG-5

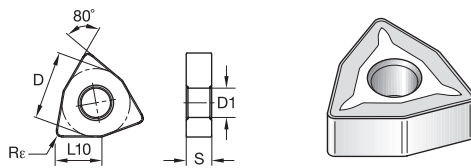

- first choice
- alternate choice

P	<input type="radio"/>
M	<input type="radio"/>
K	<input checked="" type="radio"/>
N	<input type="radio"/>
S	<input type="radio"/>
H	<input type="radio"/>

ISO catalogue number	D	L10	S	Re	D1	WK15CT
WNMG080408-5	12,70	8,69	4,76	0,8	5,16	6613603

WNMG-RH

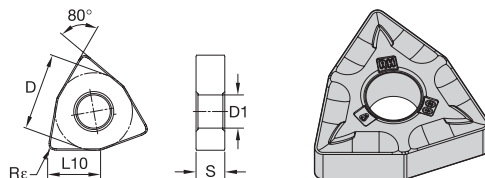

- first choice
- alternate choice

P	<input type="radio"/>
M	<input type="radio"/>
K	<input checked="" type="radio"/>
N	<input type="radio"/>
S	<input type="radio"/>
H	<input type="radio"/>

ISO catalogue number	D	L10	S	Re	D1	WK15CT
WNMG060408RH	9,53	6,52	4,76	0,8	3,81	6673948
WNMG080408RH	12,70	8,69	4,76	0,8	5,16	6290495
WNMG080412RH	12,70	8,69	4,76	1,2	5,16	6288269



WIDIA™ Tools for Railway Wheel Machining

WIDIA offers toolholders and indexable inserts for all types of wheel lathes being used in the Industry.

- The tooling for wheelset reprofiling/reconditioning has been developed in close cooperation with machine tool builders and railway workshops.
- The wheel profile wears during usage and also due to skidding, mismatched wheels, etc.
- Different chipbreaker profile and grades are available to machine the wheels with different wear condition.
- The upended design of inserts enhances the insert strength and the chipbreakers are designed to provide optimum performance with efficient chipbreaking while machining the profile.
- The toolholders adopt the robust lever clamping system.

WIDIA tooling solutions for heavy-duty turning have a proven history of success in these extremely demanding applications around the world. Customers looking for maximum material removal and improved productivity can rely on WIDIA to provide the right tool, inserts, and grades for their workpiece, machine tool, and applications.

Railway Holders

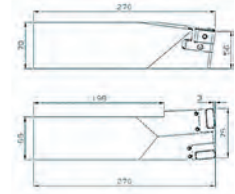
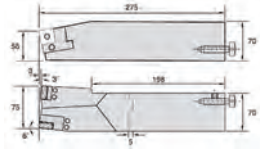
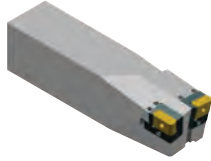
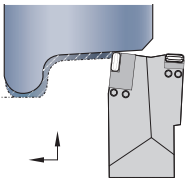

Right Hand Toolholder
69 391 458 10

Left Hand Toolholder
69 391 458 21

catalogue number	description	insert	turning cassette	facing cassette	retaining screw	allen key 1	locking screw	allen key 2	adjusting screw
Right Hand									
69 391 458 20	LS compound tool holder (LH)	LNUX 30 19 40	69 393 186 20	69 393 220 20	73 085 863	73 398 965	73 398 589	73 398 931	73 398 577
Left Hand									
69 391 458 20	LS compound tool holder (LH)	LNUX 30 19 40	69 393 186 20	69 393 220 20	73 085 863	73 398 965	73 398 589	73 398 931	73 398 577

*Additional sizes available as specials.

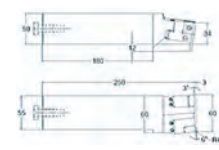
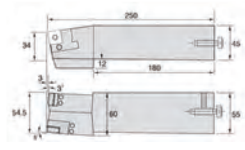
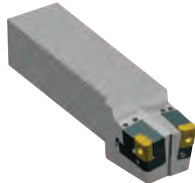
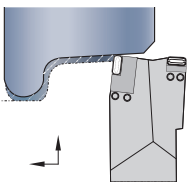

Right Hand Toolholder
69 391 431 10

Left Hand Toolholder
69 391 431 20

catalogue number	description	insert	turning cassette	facing cassette	retaining screw	allen key 1	locking screw	allen key 2	adjusting screw
Right Hand									
69 391 431 10	LS compound tool holder (RH)	LNUX 30 19 40	69 393 186 10	-	73 085 863	73 398 965	-	-	73 398 577
Left Hand									
69 391 431 20	LS compound tool holder (LH)	LNUX 30 19 40	69 393 186 20	-	73 085 863	73 398 965	-	-	73 398 577

*Additional sizes available as specials.

Tooling for Heavy-Duty Applications

Railway Tooling

Railway Cassettes for Toolholders: Turning

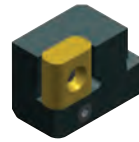
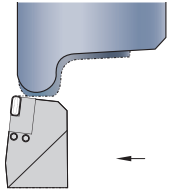

Turning Cassette
69 393 187 10



Turning Cassette
69 393 186 10

catalogue number	description	insert	lever	clamp	allen screw
Right Hand					
69 393 186 10	Turning Cassette (RH)	LNUX 30 19 40	214 85 667	214 85 627	73 398 965
69 393 187 10	Turning Cassette (RH)	LNUX 19 19 40	214 85 667	214 85 627	73 398 965
Left Hand					
69 393 186 20	Turning Cassette (LH)	LNUX 19 19 40	214 85 667	214 85 627	73 398 965
69 393 188 20	Turning Cassette (LH)	LNUX 30 19 40	214 85 667	214 85 627	73 398 965

*Additional sizes available as specials.

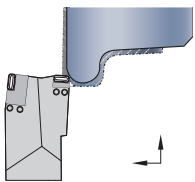

Facing Cassette
69 393 189 20

Railway Cassettes for Toolholders: Facing

catalogue number	description	insert	lever	clamp	allen screw
Right Hand					
69 393 190 10	Facing Cassette (RH)	LNUX 30 19 40	214 85 667	214 85 627	73 398 965
69 393 220 10	Facing Cassette (RH)	LNUX 19 19 40	214 85 667	214 85 627	73 398 965
Left Hand					
69 393 189 20	Facing Cassette (LH)	LNUX 19 19 40	214 85 667	214 85 627	73 398 965
69 393 221 20	Facing Cassette (LH)	LNUX 30 19 40	214 85 667	214 85 627	73 398 965

*Additional sizes available as specials.

*Spare parts are the same for both facing and turning cassettes.

Inserts

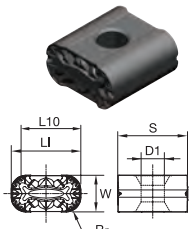

LNUX191940RRP

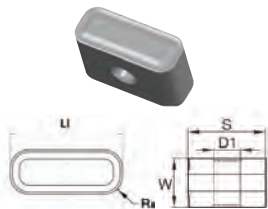

LNUX191940-16,
LNUX301940-16

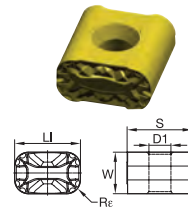

LNUX191940-13,
LNUX301940-13



LNUX191940T,
LNUX301940T

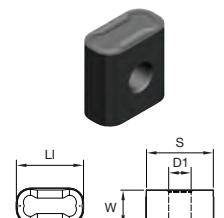

LNUX191940DB

catalogue number	w/t	LI	S	R	D1
LNUX191940-13	10	19,05	19,05	4	6,35
LNUX191940-16	10	19,05	19,05	4	6,35
LNUX191940DB	10	19,05	19,05	4	6,35
LNUX191940RRP	10	19,05	19,05	4	6,35
LNUX191940T	10	19,05	19,05	1	6,35
LNUX301940-13	12	30	19,05	4	6,35
LNUX301940-16	12	30	19,05	4	6,35
LNUX301940T	12	30	19,05	4	6,35

WIDIA™ Tools for Bar Peeling Applications

Bar peeling is a unique and economical machining operation for the production of cylindrical surfaces on blank bars (e.g., round bars, wires, blocks, and pipes) with high surface finishes and dimensional accuracies.

During the bar peeling process, scales, cracks, and sand inclusion are removed. Bar peeling is faster than conventional turning. Used when high volumes, high quality, and high productivity with good surface finish are required.



New bar peeling machines demand high performance from cutting tools. WIDIA offers a wide variety of inserts in different grades for cost-effective bar peeling operations in different types of steels, stainless steels, etc. WIDIA also offers toolholders and cartridges for bar peeling as a custom solution.

- Ideal in high feed rate applications, WIDIA bar peeling tools enable economical machining operations for the production of cylindrical surfaces on bright bars.
- High surface finishes, dimensional accuracy, and most efficient removal of scales, cracks, sand enclosures, and other errors.

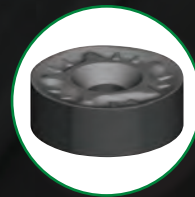
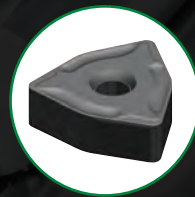
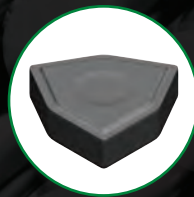
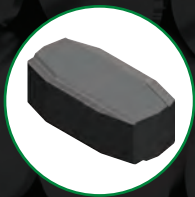

Application Range of WIDIA™ Bar Peeling Tools

Bar peeling machines require a high level of utilisation and demand high performance from the cutting tools. WIDIA offers specially developed WIDIA tools with indexable inserts for bar peeling, which are capable of meeting these demands, making manufacturing more cost-efficient.

WIDIA Victory™ CVD Coated Grades

WP15CT

Coated carbide. MT-CVD/CVD — TiN-TiCN-Al₂O₃-ZrCN. Good balance of wear resistance and toughness properties. High productivity machining on smooth to lightly interrupted cuts. For steels.

WP25CT

Coated carbide. MT-CVD/CVD — TiN-TiCN-Al₂O₃-ZrCN. Good toughness properties. Excellent first choice for steel machining, high productivity metal removal for all but the harshest interrupted cuts.

WP35CT

Coated carbide. MT-CVD/CVD — TiN-TiCN-Al₂O₃-ZrCN. Proven on all roughing and heavy roughing operations, wet or dry, on interrupted and uninterrupted cuts.















WM25CT

Coated carbide. MT-CVD/CVD — TiN-TiCN-Al₂O₃-ZrCN. Good balance of wear resistance and toughness properties. Light and medium machining. For austenitic stainless steel AISI series.





















For more information on heavy-duty tooling, contact your local sales representative.

Informational Icons Guide

Indexable Milling Icons





















 Counterboring	 Spiral Circular	 Face Milling	 Helical Milling	 Plunge Milling
 Ramping	 Slotting: Square End	 Side Milling/ Shoulder Milling: Square End	 3D Profiling: Inclined Square End Mill	 Pocketing
 Cylindrical/Plain Shank	 Weldon® Shank	 Screw-On Shank	 Shell Mill	 Through Coolant

Solid End Milling Icons









 Ramping: Blank	 Slotting: Square End	 Slotting: Square End with AP Dimension	 Side Milling/ Shoulder Milling: Square End	 Side Milling/ Shoulder Milling: Square End with AE/AP Dimension
 3D Profiling	 3D Profiling: 3D Profiling with AE/AP Dimensions	 Trochoidal Milling	 Corner Style: Corner Radius	 Corner Style: Square End
 Corner Style: Torus	 Cylindrical/Plain Shank	 Helix Angle: 20°	 Helix Angle: 30°	 Helix Angle: 40°
 Helix Angle: 45°	 DIN 6527	 ZU-X Tool Dimensions: Flute Configuration: X (Variable)	 ZU-3 Tool Dimensions: Flute Configuration: 3	 ZU-6 Tool Dimensions: Flute Configuration: 6

Informational Icons Guide

Holemaking Icons

 Drilling	 Drilling: Inclined Entry	 Drilling: Inclined Exit	 Drilling: X-Offset	 Drilling: Stacked Plates
 Drilling: Convex	 Drilling: Blind	 Chain Drilling	 Drilling: Cross Hole	 Drilling: Half Cylinder
 Drilling: Corner Drilling 45°	 Drilling Depth: 1x	 Drilling Depth: 3x	 Drilling Depth: 5x	 Drilling Depth: 8x
 Drilling Depth: 12x	 Flat Shank	 Shank: Cylindrical Plain	 Through Coolant: Radial: Drilling	 Through Coolant: Radial: Indexable Drilling
 Tool Dimensions: 2-Flute/2-Margin/Coolant				

Turning Icons

 Turning	 Profiling	 Facing	 Face Grooving	 Chamfering
 Grooving	 Cut-off	 Deep Grooving	 Through Coolant: Grooving	

DIN – German Institute for Standardisation
 ISO – International Standardisation Organisation

Customer Application Support (CAS)

Get fast and reliable answers to your toughest metalcutting problems.

Our Customer Application Support (CAS) Team is the metalworking industry's leading help desk resource for tooling application solutions and problem resolution.

- Easy access to proven metalworking expertise.
- Service level excellence.
- Best-in-class application support tools and technology.

Easy access to proven metalworking expertise!

WIDIA™ Customer Application Engineers assist customers and engineering groups throughout the world with expert tool selection and application recommendations for the entire range of WIDIA tooling.

Service Level Excellence:

- Fast telephone response.
- Quick technical solutions.
- Efficient case management.

Services Provided:

- Tooling selection.
- Operating parameters.
- Troubleshooting.
- Process optimisation.
- Hardware support.

Best-in-Class Support Tools and Technology:

- Tooling performance experts.
- Materials database.
- Application calculators.

ORIGINATING COUNTRY	LANGUAGE	TEL	FAX	EMAIL
Australia	English	001-724-539-6921 *	001-724-539-6830 *	ap.techsupport@widia.com
Austria	German	0800 291630	0049-911-9735-429 *	eu.techsupport@widia.com
Belgium	English/French	0800 80410	0049-911-9735-429 *	eu.techsupport@widia.com
China	Chinese	400-889-2237	+86-21-5899985 *	w-cn.techsupport@widia.com
Denmark	English	808 89295	001-724-539-6830 *	na.techsupport@widia.com
Finland	English	0800 919413	001-724-539-6830 *	na.techsupport@widia.com
France	French	080 5540 379	0049-911-9735-429 *	eu.techsupport@widia.com
Germany	German	0800 1015774	0911-9735-429*	eu.techsupport@widia.com
India	English	1 800 103 5227	—	in.techsupport@widia.com
Israel	English	1809 449907	001-724-539-6830 *	na.techsupport@widia.com
Italy	Italian	800 916568	02 89512146 *	eu.techsupport@widia.com
Japan	English	001-724539-6921 *	001-724-539-6830 *	ap.techsupport@widia.com
Korea (South)	English	001-724539-6921 *	001-724-539-6830 *	ap.techsupport@widia.com
Malaysia	English	001-724539-6921 *	001-724-539-6830 *	ap.techsupport@widia.com
Netherlands	English	0800 0201131	001-724-539-6830 *	na.techsupport@widia.com
New Zealand	English	001-724539-6921 *	001-724-539-6830 *	ap.techsupport@widia.com
Norway	English	800 10081	001-724-539-6830 *	na.techsupport@widia.com
Poland	Polish	00800 4411943	06166 56504 *	eu.techsupport@widia.com
Russia (landline)	Russian	8800 5556395	0048 6166 56504 *	eu.techsupport@widia.com
Russia (cell phone)	Russian	+7 8005556395	0048 6166 56504 *	eu.techsupport@widia.com
Singapore	English	001-724539-6921 *	001-724-539-6830 *	ap.techsupport@widia.com
South Africa	English	0800 981644	001-724-539-6830 *	na.techsupport@widia.com
Sweden	English	020798794	001-724-539-6830 *	na.techsupport@widia.com
Taiwan	English	001-724539-6921 *	001-724-539-6830 *	ap.techsupport@widia.com
Thailand	English	001-724539-6921 *	001-724-539-6830 *	ap.techsupport@widia.com
United Kingdom	English	0800 028 2996	001-724-539-6830 *	na.techsupport@widia.com
Ukraine	Russian	800502665	0048 6166 56504 *	eu.techsupport@widia.com
USA	English	888 539 5145	001-724-539-6830 *	na.techsupport@widia.com

*Noted phone and fax numbers are not toll free.



Material Overview • DIN

DIN

P Steel	K Cast Iron	S High-Temp Alloys
M Stainless Steel	N Non-Ferrous	H Hardened Materials

material group	description	content	tensile strength RM (MPa)*	hardness (HB)	hardness (HRC)	material number
P0	Low-Carbon Steels, Long Chipping	C <0,25%	<530	<125	–	–
P1	Low-Carbon Steels, Short Chipping, Free Machining	C <0,25%	<530	<125	–	C15, Ck22, ST37-2, S235JR, 9SMnPb28, GS38
P2	Medium- and High-Carbon Steels	C >0,25%	>530	<220	<25	ST52, S355JR, C35, GS60, Cf53
P3	Alloy Steels and Tool Steels	C >0,25%	600–850	<330	<35	16MnCr5, Ck45, 21CrMoV5-7, 38SMn28
P4	Alloy Steels and Tool Steels	C >0,25%	850–1400	340–450	35–48	100Cr6, 30CrNiMo8, 42CrMo4, C70W2, S6525, X120Mn12
P5	Ferritic, Martensitic, and PH Stainless Steels	–	600–900	<330	<35	100Cr6, 30CrNiMo8, 42CrMo4, C70W2, S6525, X120Mn12
P6	High-Strength Ferritic, Martensitic, and PH Stainless Steels	–	900–1350	350–450	35–48	X102CrMo17, G-X120Cr29
M1	Austenitic Stainless Steel	–	<600	130–200	–	X5CrNi 18 10, X2CrNiMo 17 13 2, G-X25CrNiSi18 9, X15CrNiSi 20 12
M2	High-Strength Austenitic Stainless and Cast Stainless Steels	–	600–800	150–230	<25	X2CrNiMo 13 4, X5NiCr 32 21, X5CrNiNb 18 10, G-X15CrNi 25-20
M3	Duplex Stainless Steel	–	<800	135–275	<30	X8CrNiMo27 5, X2CrNiMoN22 5 3, X20CrNiSi25 4, G-X40CrNiSi27 4
K1	Grey Cast Iron	–	125–500	120–290	<32	GG15, GG25, GG30, GG40, GTW40
K2	Low- and Medium-Strength Ductile Irons (Nodular Irons) and Compacted Graphite Irons (CGI)	–	<600	130–260	<28	GGG40, GTS35
K3	High-Strength Ductile Irons and Austempered Ductile Iron (ADI)	–	>600	180–350	<43	GGG60, GTW55, GTS65
N1	Wrought Aluminium	–	–	–	–	AlMg1, Al99.5, AlCuMg1, AlCuBiPb, AlMgSi1, AlMgSiPb
N2	Low-Silicon Aluminium Alloys and Magnesium Alloys	Si <12,2%	–	–	–	GAISiCu4, GDAISi10Mg
N3	High-Silicon Aluminium Alloys and Magnesium Alloys	Si >12,2%	–	–	–	G-ALSi12, G-AISi17Cu4, G-AISi21CuNiMg
N4	Copper-, Brass-, Zinc-Based on Machinability Index Range of 70–100	–	–	–	–	CuZn40, Ms60, G-CuSn5ZnPb, CuZn37, CuSi3Mn
N5	Nylon, Plastics, Rubbers, Phenolics, Resins, Fibreglass	–	–	–	–	Lexan®, Hostalen™, Polystyrol, Makralon
N6	Carbon, Graphite Composites, CFRP	–	–	–	–	CFK, GFK
N7	Metal Matrix Composites (MMC)	–	–	–	–	–
S1	Iron-Based, Heat-Resistant Alloys	–	500–1200	160–260	25–48	X1NiCrMoCu32 28 7, X12NiCrSi36 16, X5NiCrAlTi31 20, X40CoCrNi20 20
S2	Cobalt-Based, Heat-Resistant Alloys	–	1000–1450	250–450	25–48	Haynes® 188, Stellite® 6,21,31
S3	Nickel-Based, Heat-Resistant Alloys	–	600–1700	160–450	<48	INCONEL® 690, INCONEL 625, Hastelloy®, Nimonic® 75
S4	Titanium and Titanium Alloys	–	900–1600	300–400	33–48	Ti1, TiAl5Sn2, TiAl6V4, TiAl4Mo4Sn2
H1	Hardened Materials	–	–	–	44–48	GX260NiCr42, GX330NiCr42, GX300CrNiSi952, GX300CrMo153, Hardox® 400
H2	Hardened Materials	–	–	–	48–55	–
H3	Hardened Materials	–	–	–	56–60	–
H4	Hardened Materials	–	–	–	>60	–

WIDIA™ Digital Solutions

Tools and Resources at Your Fingertips

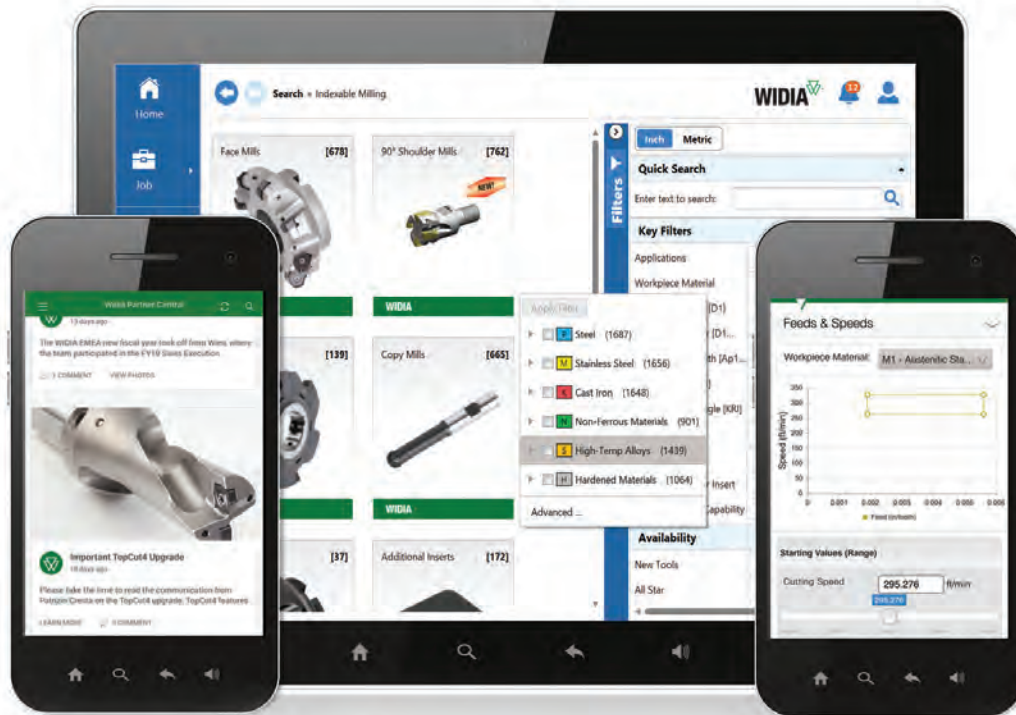

**WIDIA
Machining
Central**



**WIDIA
NOVO™**

PRODUCT DATA

- Tooling Dimensional Data
- Feeds and Speeds
- Inventory Availability
- ...and More!

ELECTRONIC CATALOGUE

- Complete cutting tool assortment, cutting data, and 2D/3D models.
- Build cutting tool assemblies for easy import into CAD/CAM software, pre-setters, and tool management systems.

DOWNLOAD THE WIDIA MOBILE APPS TODAY!



WIDIA.COM



facebook.com/WIDIAProductGrp



youtube.com/WIDIASolutions



twitter.com/WIDIAProductGrp

WIDIA 



The ALL-STAR Programme Features Only the Most Popular Platforms, Grades, and Sizes.

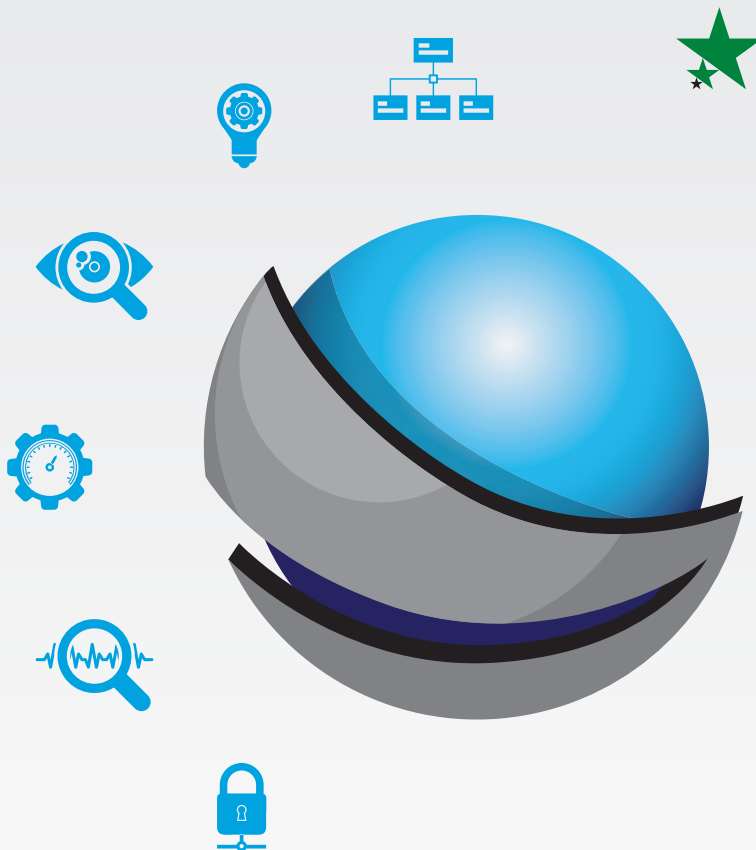

Find regional
All-Star product
availability using
the All-Star filter.

For The Complete Offering Visit the WIDIA NOVO™
Electronic Tool Catalogue or WIDIA.COM.

Download the NOVO app for PC or tablet on widia.com



Find your Local WIDIA Authorised Distributor

WIDIA™ brand cutting tools are available exclusively through a specialised network of Authorised Distributor partners whom you can count on to deliver much more than products. Our distributors know us, and more importantly, they know you. They know better than anyone in the industry how to put the global power of WIDIA to work for you — in your industry, in your region, and for your business.

WIDIA distributor partners provide technical expertise that you can count on. They will show you how to:

- Significantly reduce cycle time.
- Improve machine tool utilisation.
- Achieve measurable productivity improvements.
- Take advantage of proven supply chain solutions.
- Access local inventory and best-in-class technical support.
- Request onsite demonstrations of the latest tooling technology.

And with thousands of turning, milling, holemaking, tapping, and tooling systems products available from WIDIA, you'll find everything you need from one single source.

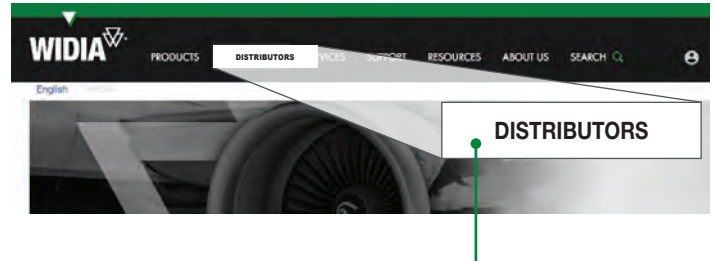

Find your Local WIDIA Authorised Distributor by accessing our distributor finder at widia.com.

IMPORTANT SAFETY INSTRUCTIONS: READ BEFORE USING THE TOOLS IN THIS CATALOGUE

METALCUTTING SAFETY

Projectile and Fragmentation Hazards

Modern metalcutting operations involve high spindle and cutter speeds and high temperatures and cutting forces. Hot metal chips may fly off the workpiece during metalcutting. Although cutting tools are designed and manufactured to withstand high cutting forces and temperatures, they can sometimes fragment, particularly if they are subjected to over-stress, severe impact, or other abuse.

To avoid injury:

- Always wear appropriate personal protective equipment, including safety goggles, when operating metalcutting machines or working nearby.
- Always make sure all machine guards are in place.

Breathing and Skin Contact Hazards

Grinding carbide or other advanced cutting tool materials produces dust or mist containing metallic particles. Breathing this dust or mist — especially over an extended period — can cause temporary or permanent lung disease or make existing medical conditions worse. Contact with this dust or mist can irritate eyes, skin, and mucous membranes and may make existing skin conditions worse.

To avoid injury:

- Always wear breathing protection and safety goggles when grinding.
- Provide ventilation control and collect and properly dispose of dust, mist, or sludge from grinding.
- Avoid skin contact with dust or mist.

For more information, read the applicable Material Safety Data Sheet provided by WIDIA and consult General Industry Safety and Health Regulations, Part 1910, Title 29 of the Code of Federal Regulations.

These safety instructions are general guidelines. Many variables affect machining operations. It is impossible to cover every specific situation. The technical information included in this catalogue and recommendations on machining practices may not apply to your particular operation.

For more information, consult the WIDIA Metalcutting Safety booklet, available free from WIDIA at +1 724 539 5747 or fax +1 724 539 5439. For specific product safety and environmental questions, contact our Corporate Environmental Health and Safety Office at +1 724 539 5066 or fax +1 724 539 5372.

NOVO, Stellite, TDMX, Top Cut 4, TOP DRILL, VariMill, VariMill I, VariMill II, VariMill III, Victory, VSM11, VSM11H, VSM17, VSM17H, VSM490-10, VSM490-15, VSM890, VSM890-12, VXF, WIDIA, WIDIA-Hanita, WU10PT, and X-Feed are trademarks of Kennametal, Inc. and are used as such herein. The absence of a product, service name, or logo from this list does not constitute a waiver of Kennametal's trademark or other intellectual property rights concerning that name or logo.

Hardox® is a registered trademark of SSAB Technology AB Corporation.
Hastelloy® and Haynes® is a registered trademarks of Haynes International, Inc. Corporation.
Hostalen® is a registered trademark of HOECHST GMBH.
INCONEL® and NIMONIC® are registered trademarks of Special Metals Corporation.
Lexan® is a registered trademark of Sabic Innovative Plastics IP B.V. Company.
Weldon® is a registered trademark of Weldon Tool Company.

©Copyright 2019 by Kennametal Inc., Latrobe, PA 15650. All rights reserved.



ADVANCES

2020 METRIC

WORLD HEADQUARTERS

WIDIA Products Group

Kennametal Inc.

1600 Technology Way

Latrobe, PA 15650 USA

Tel: 1 800 979 4342

w-na.service@widia.com

EUROPEAN HEADQUARTERS

WIDIA Products Group

Kennametal Europe GmbH

Rheingoldstrasse 50

CH 8212 Neuhausen am Rheinfall

Switzerland

Tel: +41 52 6750 100

w-ch.service@widia.com

ASIA-PACIFIC HEADQUARTERS

WIDIA Products Group

Kennametal (Singapore) Pte. Ltd.

3A International Business Park

Unit #01-02/03/05, ICON@IBP

Singapore 609935

Tel: +65 6265 9222

w-sg.service@widia.com

INDIA HEADQUARTERS

WIDIA Products Group

REGD OFFICE: WIDIA India Tooling Pvt Ltd

CIN: U28110KA2018PTC119396

Survey No 11 Nagasandra

Adjacent to Nagasandra Metro Station

Bengaluru-Pune National Highway

Bengaluru-560073 India

Tel: +91 80 2839 4321

w-in.service@widia.com