

PROVEN SOLUTIONS | ALWAYS AVAILABLE

ALL-STAR

AMERICAS | VOL 1

TECHNICAL DATA



COMPLETE
METALWORKING
SOLUTIONS

(800) 991-4225

www.ahbinc.com

ISO Certified

customerservice@ahbinc.com

WIDIA

The All-Star Program reinforces the core qualities of the WIDIA™ diamond — providing proven solutions that are easy to find and always available.

With All-Star, customers can benefit from product reliability and quick delivery to increase machine utilization.



 ALL-STAR



PROVEN SOLUTIONS

Products included in the All-Star program were chosen based on their proven performance and popularity. These industry-leading solutions combine versatility and productivity to deliver savings.



EASY TO FIND

It is easy to recommend All-Star on-the-go or in the shop while using tools like the NOVO™ tool advisor or the Machining Central app. To view All-Star products on widia.com, use the All-Star filter.



Available to download in the app store!

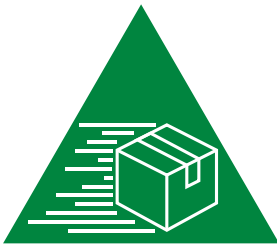

ALWAYS AVAILABLE

All-Star products are held to the highest availability standards. This means products that are flagged as All-Star feature same-day shipping for all orders received before 6pm EST.

TO SEE ALL PRODUCTS LINES, VISIT OUR DIGITAL RESOURCES



WIDIA NOVO™ Application
Download to your desktop or tablet:
widia.com/novo



WIDIA™ Machining Central Mobile App
Download for iOS or Android:
widia.com/en/featured/WidiaMobileApp

TECH DATA

INDEXABLE MILLING

Pages F4–F45

Shoulder Milling
Face Milling
90° High-Speed Cutting
Copy Milling



SOLID END MILLING

Pages F46–F79

High-Performance Solid Carbide End Mills
General Purpose Solid Carbide End Mills



HOLEMAKING

Pages F80–F95

Solid Carbide Drills
Indexable Drills
Modular Drills



TAPPING

Pages F96–F107

General Purpose Production Taps
High Performance • GT Series
VariTap™

TURNING

Pages F108–F131

High-Performance Inserts
Grooving and Cut-Off
Specialty Turning



TO SEE ALL PRODUCTS LINES, VISIT OUR DIGITAL RESOURCES



WIDIA NOVO™ Application
Download to your desktop or tablet:
widia.com/novo



WIDIA™ Machining Central Mobile App
Download for iOS or Android:
widia.com/en/featured/WidiaMobileApp

WIDIA 

INDEXABLE MILLING

SHOULDER MILLING

Pages F6–F16

VSM890™

VSM490-15™

VSM490-10™

VSM17™

VSM11™

M690



90° HIGH-SPEED CUTTING

Pages F18–F20

VHSC

FACE MILLING

Pages F22–F27

M1200 Mini
M1200



COPY MILLING

Pages F28–F45

VXF™
M370™
M200™
M100™



TO SEE ALL PRODUCTS LINES, VISIT OUR DIGITAL RESOURCES



WIDIA NOVO™ Application
Download to your desktop or tablet:
widia.com/novo



WIDIA™ Machining Central Mobile App
Download for iOS or Android:
widia.com/en/featured/WidiaMobileApp

0°/90° SHOULDER MILLS

VSM890

Page F8

8-Edged, Double-Sided 0° Victory™
Shoulder-Face Mill



VSM490-15 & VSM490-10

Pages F9–F10

4-Edged, Double-Sided 0° Victory Shoulder-Face Mill





VSM17 & VSM11

Pages F11–F13

2-Edged, 0° Victory™ Shoulder Mill (VSM)

M690

Pages F14–F16

4-Edged 90° Shoulder Mill



TO SEE ALL PRODUCTS LINES, VISIT OUR DIGITAL RESOURCES



WIDIA NOVO™ Application
Download to your desktop or tablet:
widia.com/novo



WIDIA™ Machining Central Mobile App
Download for iOS or Android:
widia.com/en/featured/WidiaMobileApp

WIDIA 

INDEXABLE MILLING

SOLID END MILLING

HOLEMAKING

TAPPING

TURNING

Insert Selection Guide

Material Group	Light Machining		General Purpose		Heavy Machining	
	Geometry	Grade	Geometry	Grade	Geometry	Grade
P1-P2	SNHX-ML	WS40PM	SNPX-MM	WP40PM	SNPX-MM	WP40PM
P3-P4	SNHX-ML	WS40PM	SNPX-MM	WP40PM	SNPX-MM	WP40PM
P5-P6	SNHX-ML	WP25PM	SNPX-MM	WP35CM	SNPX-MM	WP40PM
M1-M2	SNHX-ML	WS40PM	SNHX-ML	WS40PM	SNPX-MM	WS40PM
M3	SNHX-ML	WS40PM	SNHX-ML	WS40PM	SNPX-MM	WS40PM
K1-K2	SNPX-MM	WK15PM	SNPX-MM	WK15CM	SNPX-MM	WK15CM
K3	SNPX-MM	WK15PM	SNPX-MM	WP35CM	SNPX-MM	WP35CM
N1-N2	SNHX-ALP	WN25PM	SNHX-ALP	WN25PM	SNHX-ALP	WN25PM
N3	SNHX-ALP	WN25PM	SNHX-ALP	WN25PM	SNHX-ALP	WN25PM
S1-S2	SNHX-ML	WP25PM	SNHX-ML	WS40PM	SNPX-MM	WS40PM
S3	SNHX-ML	WS40PM	SNHX-ML	WS40PM	SNPX-MM	WS40PM
S4	SNHX-ML	WS40PM	SNHX-ML	WS40PM	SNPX-MM	WS40PM
H1	SNHX-MM	WU10PM	SNHX-MM	WU10PM	-	-

Recommended Starting Speeds [SFM]*

Material Group		★			★			★			★			★					
		WK15CM	WK15PM	WN25PM	WP25PM	WP35CM	WP40PM	WS40PM	WU10PM										
P	1	-	-	-	-	-	-	1085	935	885	1495	1295	1215	970	855	805	-	-	-
	2	-	-	-	-	-	-	900	785	655	920	835	755	820	705	590	-	-	-
	3	-	-	-	-	-	-	835	705	575	835	755	675	755	640	525	-	-	-
	4	-	-	-	-	-	-	740	605	490	625	575	525	675	560	445	-	-	-
	5	-	-	-	-	-	-	605	560	490	855	755	690	560	510	445	560	475	395
	6	-	-	-	-	-	-	540	410	330	525	445	360	490	375	295	490	360	260
M	1	-	-	-	-	-	-	675	590	540	675	605	510	640	560	510	690	560	460
	2	-	-	-	-	-	-	605	525	425	605	525	460	575	490	410	590	475	395
	3	-	-	-	-	-	-	460	395	310	475	425	375	425	375	295	475	360	280
K	1	1380	1265	1115	885	805	705	-	-	-	755	675	605	970	870	785	-	-	-
	2	1100	970	900	690	625	575	-	-	-	590	525	490	770	690	625	-	-	-
	3	920	820	755	575	525	475	-	-	-	490	445	395	640	575	525	640	575	525
N	1	-	-	-	-	-	-	3525	3100	2870	-	-	-	-	-	-	-	-	-
	2	-	-	-	-	-	-	3100	2870	2495	-	-	-	-	-	-	-	-	-
	3	-	-	-	-	-	-	3100	2870	2495	-	-	-	-	-	-	-	-	-
S	1	-	-	-	-	-	-	-	-	-	130	115	80	-	-	-	130	115	80
	2	-	-	-	-	-	-	-	-	-	130	115	80	-	-	-	130	115	80
	3	-	-	-	-	-	-	-	-	-	165	130	80	-	-	-	165	130	80
	4	-	-	-	-	-	-	-	-	-	230	165	115	-	-	-	195	165	100
H	1	-	-	-	-	-	-	-	-	-	-	-	-	-	-	-	525	425	295

NOTE: FIRST choice starting speeds are in **bold** type. As the average chip thickness increases, the speed should be decreased.
 *Material groups P, M, K, and H show recommended starting speeds for dry machining. For wet machining, reduce speed by 20%.
 *Material groups N and S show recommended starting speeds for wet machining. Not recommended for dry machining.

Recommended Starting Feeds [IPT]

Insert Geometry	Programmed Feed per Tooth (fz) as a % of Radial Depth of Cut (ae)															Insert Geometry			
	Light Machining			General Purpose			Heavy Machining												
	5%	10%	20%	30%	40-100%		5%	10%	20%	30%	40-100%		5%	10%	20%	30%	40-100%		
.E..ALP	.005	.010	.015	.003	.007	.011	.003	.005	.008	.002	.005	.007	.002	.004	.006	.002	.003	.004	.E..ALP
.E..ML	.007	.012	.023	.005	.009	.017	.004	.007	.012	.003	.006	.011	.003	.005	.010	.003	.004	.005	.E..ML
.S..MM	.009	.014	.032	.007	.010	.023	.005	.008	.017	.004	.007	.015	.004	.006	.014	.004	.005	.006	.S..MM

NOTE: Use "Light Machining" values as starting feed rate.

= ALL-STAR PORTFOLIO PRODUCT. ALL-STAR PRODUCTS ARE PROVEN SOLUTIONS THAT ARE ALWAYS AVAILABLE.

Insert Selection Guide

Material Group	Light Machining		General Purpose		Heavy Machining	
	Geometry	Grade	Geometry	Grade	Geometry	Grade
P1-P2	XNGU-ML	WP40PM	XNPU-MM	WP40PM	XNPU-MM	WP40PM
P3-P4	XNGU-ML	WP40PM	XNPU-MM	WP40PM	XNPU-MM	WP40PM
P5-P6	XNGU-MM	WP25PM	XNPU-MM	WP35CM	XNPU-MM	WP40PM
M1-M2	XNGU-ML	WS40PM	XNGU-ML	WS40PM	XNPU-MM	WS40PM
M3	XNGU-ML	WS40PM	XNGU-ML	WS40PM	XNPU-MM	WS40PM
K1-K2	XNPU-MM	WK15PM	XNGU-MH	WK15CM	XNGU-MH	WK15CM
K3	XNPU-MM	WK15PM	XNGU-MH	WP35CM	XNGU-MH	WP35CM
N1-N2	XNGU-ALP	WN25PM	XNGU-ALP	WN25PM	XNGU-ALP	WN25PM
N3	XNGU-ALP	WN25PM	XNGU-ALP	WN25PM	XNGU-ALP	WN25PM
S1-S2	XNGU-ML	WP25PM	XNGU-ML	WS40PM	XNPU-MM	WS40PM
S3	XNGU-ML	WS40PM	XNGU-ML	WS40PM	XNPU-MM	WS40PM
S4	XNGU-ML	WS40PM	XNGU-ML	WS40PM	XNPU-MM	WS40PM
H1	-	-	-	-	-	-

Recommended Starting Speeds [SFM]*

Material Group		★ WK15CM			★ WK15PM			★ WN25PM			★ WP25PM			★ WP35CM			★ WP40PM			★ WS40PM			★ WU35PM		
		1	2	3	1	2	3	1	2	3	1	2	3	1	2	3	1	2	3	1	2	3	1	2	3
P	1	-	-	-	-	-	-	-	-	-	1085	935	885	1495	1295	1215	970	855	805	-	-	-	855	755	705
	2	-	-	-	-	-	-	-	-	-	900	785	655	920	835	755	820	705	590	-	-	-	720	625	525
	3	-	-	-	-	-	-	-	-	-	835	705	575	835	755	675	755	640	525	-	-	-	655	560	460
	4	-	-	-	-	-	-	-	-	-	740	605	490	625	575	525	675	560	445	-	-	-	590	490	395
	5	-	-	-	-	-	-	-	-	-	605	560	490	855	755	690	560	510	445	560	475	395	490	445	395
	6	-	-	-	-	-	-	-	-	-	540	410	330	525	445	360	490	375	295	490	360	260	425	330	260
M	1	-	-	-	-	-	-	-	-	-	675	590	540	675	605	510	640	560	510	690	560	460	560	490	445
	2	-	-	-	-	-	-	-	-	-	605	525	425	605	525	460	575	490	410	590	475	395	510	425	360
	3	-	-	-	-	-	-	-	-	-	460	395	310	475	425	375	425	375	295	475	360	280	375	330	260
K	1	1380	1265	1115	885	805	705	-	-	-	755	675	605	970	870	785	-	-	-	-	-	-	-	-	-
	2	1100	970	900	690	625	575	-	-	-	590	525	490	770	690	625	-	-	-	-	-	-	-	-	-
	3	920	820	755	575	525	475	-	-	-	490	445	395	640	575	525	-	-	-	-	-	-	-	-	-
N	1	-	-	-	-	-	-	3525	3100	2870	-	-	-	-	-	-	-	-	-	-	-	-	-	-	-
	2	-	-	-	-	-	-	3100	2870	2495	-	-	-	-	-	-	-	-	-	-	-	-	-	-	-
	3	-	-	-	-	-	-	3100	2870	2495	-	-	-	-	-	-	-	-	-	-	-	-	-	-	-
S	1	-	-	-	-	-	-	-	-	-	130	115	80	-	-	-	130	115	100	130	115	80	115	100	80
	2	-	-	-	-	-	-	-	-	-	130	115	80	-	-	-	130	115	100	130	115	80	115	100	80
	3	-	-	-	-	-	-	-	-	-	165	130	80	-	-	-	165	130	100	165	130	80	150	115	80
	4	-	-	-	-	-	-	-	-	-	230	165	115	-	-	-	215	165	115	195	165	100	195	150	100
H	1	-	-	-	-	-	-	-	-	-	395	295	230	-	-	-	-	-	-	-	-	-	-	-	-

NOTE: FIRST choice starting speeds are in **bold** type. As the average chip thickness increases, the speed should be decreased.
 *Material groups P, M, K, and H show recommended starting speeds for dry machining. For wet machining, reduce speed by 20%.
 *Material groups N and S show recommended starting speeds for wet machining. Not recommended for dry machining.

Recommended Starting Feeds [IPT]

Insert Geometry	Programmed Feed per Tooth (fz) as a % of Radial Depth of Cut (ae)														Insert Geometry	
	Light Machining				General Purpose				Heavy Machining				Insert Geometry			
	5%	10%	20%	30%	5%	10%	20%	30%	40-100%							
.E..ALP	.005	.008	.012	.003	.006	.009	.002	.004	.007	.002	.004	.006	.002	.004	.005	.E..ALP
.E..ML	.007	.012	.018	.005	.009	.013	.004	.006	.010	.003	.006	.008	.003	.005	.008	.E..ML
.S..MM	.008	.015	.024	.006	.011	.017	.005	.008	.013	.004	.007	.011	.004	.007	.010	.S..MM
.S..MH	.009	.017	.028	.006	.012	.020	.005	.009	.015	.004	.008	.013	.004	.007	.012	.S..MH

NOTE: Use "Light Machining" values as starting feed rate.

★ = ALL-STAR PORTFOLIO PRODUCT. ALL-STAR PRODUCTS ARE PROVEN SOLUTIONS THAT ARE ALWAYS AVAILABLE.

INDEXABLE MILLING
 SOLID END MILLING
 HOLEMAKING
 TAPPING
 TURNING

INDEXABLE MILLING

SOLID END MILLING

HOLEMAKING

TAPPING

TURNING

Insert Selection Guide

Material Group	Light Machining		General Purpose		Heavy Machining	
	Geometry	Grade	Geometry	Grade	Geometry	Grade
P1-P2	XNGU-ML	WP40PM	XNPU-MM	WP40PM	XNPU-MM	WP40PM
P3-P4	XNGU-ML	WP40PM	XNPU-MM	WP40PM	XNPU-MM	WP40PM
P5-P6	XNGU-MM	WP25PM	XNPU-MM	WP35CM	XNPU-MM	WP40PM
M1-M2	XNGU-ML	WS40PM	XNGU-ML	WS40PM	XNPU-MM	WS40PM
M3	XNGU-ML	WS40PM	XNGU-ML	WS40PM	XNPU-MM	WS40PM
K1-K2	XNPU-ML	WK15PM	XNGU-MH	WK15CM	XNGU-MH	WK15CM
K3	XNPU-MM	WK15PM	XNGU-MH	WP35CM	XNGU-MH	WP35CM
N1-N2	XNGU-ALP	WN25PM	XNGU-ALP	WN25PM	XNGU-ALP	WN25PM
N3	XNGU-ALP	WN25PM	XNGU-ALP	WN25PM	XNGU-ALP	WN25PM
S1-S2	XNGU-ML	WP25PM	XNGU-ML	WS40PM	XNPU-MM	WS40PM
S3	XNGU-ML	WS40PM	XNGU-ML	WS40PM	XNPU-MM	WS40PM
S4	XNGU-ML	WS40PM	XNGU-ML	WS40PM	XNPU-MM	WS40PM
H1	XNGU-ML	WU10PM	XNGU-MM	WU10PM	-	-

Recommended Starting Speeds [SFM]*

Material Group		★ WK15PM			★ WN25PM			★ WP25PM			★ WP35CM			★ WP40PM			★ WS40PM			WU10PM		
		1	2	3	1	2	3	1	2	3	1	2	3	1	2	3	1	2	3	1	2	3
P	1	-	-	-	-	-	-	1085	935	885	1495	1295	1215	970	855	805	-	-	-	-	-	-
	2	-	-	-	-	-	-	900	785	655	920	835	755	820	705	590	-	-	-	-	-	-
	3	-	-	-	-	-	-	835	705	575	835	755	675	755	640	525	-	-	-	-	-	-
	4	-	-	-	-	-	-	740	605	490	625	575	525	675	560	445	-	-	-	-	-	-
	5	-	-	-	-	-	-	605	560	490	855	755	690	560	510	445	560	475	395	-	-	-
	6	-	-	-	-	-	-	540	410	330	525	445	360	490	375	295	490	360	260	-	-	-
M	1	-	-	-	-	-	-	675	590	540	675	605	510	640	560	510	690	560	460	-	-	-
	2	-	-	-	-	-	-	605	525	425	605	525	460	575	490	410	590	475	395	-	-	-
	3	-	-	-	-	-	-	460	395	310	475	425	375	425	375	295	475	360	280	-	-	-
K	1	1380	1265	1115	885	805	705	-	-	-	755	675	605	970	870	785	-	-	-	970	870	785
	2	1100	970	900	690	625	575	-	-	-	590	525	490	770	690	625	-	-	-	755	675	625
	3	920	820	755	575	525	475	-	-	-	490	445	395	640	575	525	-	-	-	640	575	525
N	1	-	-	-	-	-	-	3525	3100	2870	-	-	-	-	-	-	-	-	-	-	-	-
	2	-	-	-	-	-	-	3100	2870	2495	-	-	-	-	-	-	-	-	-	-	-	-
	3	-	-	-	-	-	-	3100	2870	2495	-	-	-	-	-	-	-	-	-	-	-	-
S	1	-	-	-	-	-	-	-	-	-	130	115	80	-	-	-	130	115	80	-	-	-
	2	-	-	-	-	-	-	-	-	-	130	115	80	-	-	-	130	115	80	-	-	-
	3	-	-	-	-	-	-	-	-	-	165	130	80	-	-	-	165	130	80	-	-	-
	4	-	-	-	-	-	-	-	-	-	230	165	115	-	-	-	195	165	100	-	-	-
H	1	-	-	-	-	-	-	-	-	-	-	-	-	-	-	-	-	-	-	525	425	295

NOTE: FIRST choice starting speeds are in **bold** type. As the average chip thickness increases, the speed should be decreased.
 *Material groups P, M, K, and H show recommended starting speeds for dry machining. For wet machining, reduce speed by 20%.
 *Material groups N and S show recommended starting speeds for wet machining. Not recommended for dry machining.

Recommended Starting Feeds [IPT]

Insert Geometry	Programmed Feed per Tooth (fz) as a % of Radial Depth of Cut (ae)															Insert Geometry								
	Light Machining			General Purpose			Heavy Machining			Light Machining			General Purpose				Heavy Machining							
	5%	10%	20%	5%	10%	20%	5%	10%	20%	5%	10%	20%	5%	10%	20%	5%	10%	20%	5%	10%	20%	5%	10%	20%
.E..ALP	.005	.009	.013	.003	.007	.009	.003	.005	.007	.002	.004	.006	.002	.004	.006	.E..ALP								
.E..ML	.007	.011	.015	.005	.008	.011	.004	.006	.008	.003	.005	.007	.003	.005	.006	.E..ML								
.S..MM	.009	.014	.018	.007	.010	.013	.005	.007	.010	.004	.006	.008	.004	.006	.008	.S..MM								
.S..MH	.009	.016	.022	.007	.012	.016	.005	.009	.012	.004	.008	.010	.004	.007	.010	.S..MH								

NOTE: Use "Light Machining" values as starting feed rate.

★ = ALL-STAR PORTFOLIO PRODUCT. ALL-STAR PRODUCTS ARE PROVEN SOLUTIONS THAT ARE ALWAYS AVAILABLE.

Insert Selection Guide

Material Group	Light Machining		General Purpose		Heavy Machining	
	Geometry	Grade	Geometry	Grade	Geometry	Grade
P1-P2	XDCT-ML	WP40PM	XDPT-MM	WP40PM	XDPT-MH	WP40PM
P3-P4	XDCT-ML	WP40PM	XDPT-MM	WP40PM	XDPT-MH	WP40PM
P5-P6	XDPT-MM	WP25PM	XDPT-MM	WP35CM	XDPT-MH	WP40PM
M1-M2	XDCT-ML	WS40PM	XDPT-MM	WS40PM	XDPT-MM	WS40PM
M3	XDCT-ML	WS40PM	XDPT-MM	WS40PM	XDPT-MH	WS40PM
K1-K2	XDPT-MM	WK15CM	XDPT-MM	WK15CM	XDPT-MH	WK15CM
K3	XDPT-MM	WP35CM	XDPT-MM	WP35CM	XDPT-MH	WP35CM
N1-N2	XDCT-ALP	WN10HM	XDCT-ALP	WN25PM	XDCT-ALP	WN25PM
N3	XDCT-ALP	WN10HM	XDCT-ALP	WN25PM	XDCT-ALP	WN25PM
S1-S2	XDCT-ML	WP25PM	XDPT-MM	WS40PM	XDPT-MM	WS40PM
S3	XDCT-ML	WS40PM	XDPT-MM	WS40PM	XDPT-MM	WS40PM
S4	XDCT-ML	WS40PM	XDPT-MM	WS40PM	XDPT-MM	WS40PM
H1	-	-	-	-	-	-

Recommended Starting Speeds [SFM]*

Material Group		★			★			★			★			★								
		WK15CM	WK15PM	WN10HM	WN25PM	WP25PM	WP35CM	WP40PM	WS40PM	WU35PM												
P	1	-	-	-	-	-	1085	935	885	1495	1295	1215	970	855	805	-	-	-	855	755	705	
	2	-	-	-	-	-	900	785	655	920	835	755	820	705	590	-	-	-	720	625	525	
	3	-	-	-	-	-	835	705	575	835	755	675	755	640	525	-	-	-	655	560	460	
	4	-	-	-	-	-	740	605	490	625	575	525	675	560	445	-	-	-	590	490	395	
	5	-	-	-	-	-	605	560	490	855	755	690	560	510	445	560	475	395	490	445	395	
	6	-	-	-	-	-	540	410	330	525	445	360	490	375	295	490	360	260	425	330	260	
M	1	-	-	-	-	-	675	590	540	675	605	510	640	560	510	690	560	460	560	490	445	
	2	-	-	-	-	-	605	525	425	605	525	460	575	490	410	590	475	395	510	425	360	
	3	-	-	-	-	-	460	395	310	475	425	375	425	375	295	475	360	280	375	330	260	
K	1	1380	1265	1115	885	805	705	-	-	-	755	675	605	970	870	785	-	-	-	-	-	
	2	1100	970	900	690	625	575	-	-	-	590	525	490	770	690	625	-	-	-	-	-	
	3	920	820	755	575	525	475	-	-	-	490	445	395	640	575	525	-	-	-	-	-	
N	1	-	-	-	-	-	2605	2275	1965	3525	3100	2870	-	-	-	-	-	-	-	-	-	
	2	-	-	-	-	-	2605	2275	1965	3100	2870	2495	-	-	-	-	-	-	-	-	-	
	3	-	-	-	-	-	1835	1590	1375	3100	2870	2495	-	-	-	-	-	-	-	-	-	
S	1	-	-	-	-	-	-	-	-	130	115	80	-	-	-	-	130	115	80	115	100	80
	2	-	-	-	-	-	-	-	-	130	115	80	-	-	-	-	130	115	80	115	100	80
	3	-	-	-	-	-	-	-	-	165	130	80	-	-	-	-	165	130	80	150	115	80
	4	-	-	-	-	-	-	-	-	230	165	115	-	-	-	-	195	165	100	195	150	100
H	1	-	-	-	-	-	-	-	-	395	295	230	-	-	-	-	-	-	-	-	-	

NOTE: FIRST choice starting speeds are in **bold** type. As the average chip thickness increases, the speed should be decreased.
 *Material groups P, M, K, and H show recommended starting speeds for dry machining. For wet machining, reduce speed by 20%.
 *Material groups N and S show recommended starting speeds for wet machining. Not recommended for dry machining.

Recommended Starting Feeds [IPT]

Insert Geometry	Programmed Feed per Tooth (fz) as a % of Radial Depth of Cut (ae)															Insert Geometry
	Light Machining					General Purpose					Heavy Machining					
	5%			10%		20%			30%		40-100%					
.F..ALP	.005	.009	.016	.003	.007	.012	.003	.005	.009	.002	.004	.008	.002	.004	.007	.F..ALP
.E..ML	.007	.014	.019	.005	.010	.013	.004	.008	.010	.003	.007	.009	.003	.006	.008	.E..ML
.S..MM	.007	.016	.026	.005	.012	.018	.004	.009	.014	.003	.008	.012	.003	.007	.011	.S..MM
.S..MH	.009	.019	.030	.007	.013	.021	.005	.010	.016	.004	.009	.014	.004	.008	.013	.S..MH

NOTE: Use "Light Machining" value as starting feed rate.

★ = ALL-STAR PORTFOLIO PRODUCT. ALL-STAR PRODUCTS ARE PROVEN SOLUTIONS THAT ARE ALWAYS AVAILABLE.

INDEXABLE MILLING
SOLID END MILLING
HOLEMAKING
TAPPING
TURNING

INDEXABLE MILLING

SOLID END MILLING

HOLEMAKING

TAPPING

TURNING

Insert Selection Guide

Material Group	Light Machining		General Purpose		Heavy Machining	
	Geometry	Grade	Geometry	Grade	Geometry	Grade
P1-P2	XDCT-ML	WP40PM	XDPT-MM	WP40PM	XDPT-MH	WP40PM
P3-P4	XDCT-ML	WP40PM	XDPT-MM	WP40PM	XDPT-MH	WP40PM
P5-P6	XDPT-MM	WP25PM	XDPT-MM	WP35CM	XDPT-MH	WP40PM
M1-M2	XDCT-ML	WS40PM	XDPT-MM	WS40PM	XDPT-MH	WS40PM
M3	XDCT-ML	WS40PM	XDPT-MM	WS40PM	XDPT-MH	WS40PM
K1-K2	XDCT-ML	WK15CM	XDPT-MM	WK15CM	XDPT-MH	WK15CM
K3	XDCT-ML	WP35CM	XDPT-MM	WP35CM	XDPT-MH	WP35CM
N1-N2	XDCT-ALP	WN10HM	XDCT-ALP	WN25PM	XDCT-ALP	WN25PM
N3	XDCW-PCD	WDN10U	XDCW-PCD	WDN10U	XDCW-PCD	WDN10U
S1-S2	XDCT-ML	WP25PM	XDPT-MM	WS40PM	XDPT-MH	WS40PM
S3	XDCT-ML	WS40PM	XDPT-MM	WS40PM	XDPT-MH	WS40PM
S4	XDCT-ML	WS40PM	XDPT-MM	WS40PM	XDPT-MH	WS40PM
H1	XDCT-ML	WP25PM	XDPT-MM	WP25PM	-	-

Recommended Starting Speeds [SFM]*

Material Group		WDN10U			WK15CM			WK15PM			WN10HM			WN25PM			WP25PM		
		P	1	-	-	-	-	-	-	-	-	-	-	-	-	-	-	-	1085
	2	-	-	-	-	-	-	-	-	-	-	-	-	-	-	-	900	785	655
	3	-	-	-	-	-	-	-	-	-	-	-	-	-	-	-	835	705	575
	4	-	-	-	-	-	-	-	-	-	-	-	-	-	-	-	740	605	490
	5	-	-	-	-	-	-	-	-	-	-	-	-	-	-	-	605	560	490
	6	-	-	-	-	-	-	-	-	-	-	-	-	-	-	-	540	410	330
M	1	-	-	-	-	-	-	-	-	-	-	-	-	-	-	-	675	590	540
	2	-	-	-	-	-	-	-	-	-	-	-	-	-	-	-	605	525	425
	3	-	-	-	-	-	-	-	-	-	-	-	-	-	-	-	460	395	310
K	1	-	-	-	1380	1265	1115	885	805	705	-	-	-	-	-	-	755	675	605
	2	-	-	-	1100	970	900	690	625	575	-	-	-	-	-	-	590	525	490
	3	-	-	-	920	820	755	575	525	475	-	-	-	-	-	-	490	445	395
N	1	13155	11500	9810	-	-	-	-	-	-	2605	2275	1965	3525	3100	2870	-	-	-
	2	5250	4905	4595	-	-	-	-	-	-	2605	2275	1965	3100	2870	2495	-	-	-
	3	5250	4905	4595	-	-	-	-	-	-	1835	1590	1375	3100	2870	2495	-	-	-
S	1	-	-	-	-	-	-	-	-	-	-	-	-	-	-	-	130	115	80
	2	-	-	-	-	-	-	-	-	-	-	-	-	-	-	-	130	115	80
	3	-	-	-	-	-	-	-	-	-	-	-	-	-	-	-	165	130	80
	4	-	-	-	-	-	-	-	-	-	-	-	-	-	-	-	230	165	115
H	1	-	-	-	-	-	-	-	-	-	-	-	-	-	-	-	395	295	230

Material Group		WP35CM			WP40PM			WS30PM			WS40PM			WU35PM		
		P	1	1495	1295	1215	970	855	805	-	-	-	-	-	-	855
	2	920	835	755	820	705	590	-	-	-	-	-	-	720	625	525
	3	835	755	675	755	640	525	-	-	-	-	-	-	655	560	460
	4	625	575	525	675	560	445	-	-	-	-	-	-	590	490	395
	5	855	755	690	560	510	445	-	-	-	560	475	395	490	445	395
	6	525	445	360	490	375	295	-	-	-	490	360	260	425	330	260
M	1	675	605	510	640	560	510	740	655	605	690	560	460	560	490	445
	2	605	525	460	575	490	410	675	590	475	590	475	395	510	425	360
	3	475	425	375	425	375	295	510	445	345	475	360	280	375	330	260
K	1	970	870	785	-	-	-	-	-	-	-	-	-	-	-	-
	2	770	690	625	-	-	-	-	-	-	-	-	-	-	-	-
	3	640	575	525	-	-	-	-	-	-	-	-	-	-	-	-
N	1	-	-	-	-	-	-	-	-	-	-	-	-	-	-	-
	2	-	-	-	-	-	-	-	-	-	-	-	-	-	-	-
	3	-	-	-	-	-	-	-	-	-	-	-	-	-	-	-
S	1	-	-	-	-	-	-	150	130	100	130	115	80	115	100	80
	2	-	-	-	-	-	-	150	130	100	130	115	80	115	100	80
	3	-	-	-	-	-	-	180	150	100	165	130	80	150	115	80
	4	-	-	-	-	-	-	230	195	130	195	165	100	195	150	100
H	1	-	-	-	-	-	-	-	-	-	-	-	-	-	-	-

NOTE: FIRST choice starting speeds are in **bold** type. As the average chip thickness increases, the speed should be decreased.
 *Material groups P, M, K, and H show recommended starting speeds for dry machining. For wet machining, reduce speed by 20%.
 *Material groups N and S show recommended starting speeds for wet machining. Not recommended for dry machining.

 = ALL-STAR PORTFOLIO PRODUCT. ALL-STAR PRODUCTS ARE PROVEN SOLUTIONS THAT ARE ALWAYS AVAILABLE.

Recommended Starting Feeds [IPT]

Light Machining	General Purpose	Heavy Machining
-----------------	-----------------	-----------------

Insert Geometry	Programmed Feed per Tooth (fz) as a % of Radial Depth of Cut (ae)														Insert Geometry	
	5%		10%		20%		30%		40-100%							
.F..PCD	.005	.007	.011	.003	.005	.008	.003	.004	.006	.002	.003	.005	.002	.003	.005	.F..PCD
.F..ALP	.005	.009	.013	.003	.006	.009	.003	.005	.007	.002	.004	.006	.002	.004	.005	.F..ALP
.E..ML	.007	.011	.014	.005	.008	.010	.004	.006	.008	.003	.005	.007	.003	.005	.006	.E..ML
.S..MM	.009	.013	.019	.007	.009	.013	.005	.007	.010	.004	.006	.009	.004	.006	.008	.S..MM
.S..MH	.009	.014	.022	.007	.010	.016	.005	.008	.012	.004	.007	.010	.004	.006	.009	.S..MH

NOTE: Use "Light Machining" values as starting feed rate.

★ INDEXABLE MILLING

★ SOLID END MILLING

★ HOLEMAKING

★ TAPPING

★ TURNING

INDEXABLE MILLING
 SOLID END MILLING
 HOLEMAKING
 TAPPING
 TURNING

Insert Selection Guide

Material Group	Light Machining		General Purpose		Heavy Machining	
	Geometry	Grade	Geometry	Grade	Geometry	Grade
P1-P2	.E..ML	TN6540	.S..MM	TN6540	.S..MH	TN6540
P3-P4	.E..ML	TN7535	.S..MM	TN6540	.S..MH	TN6540
P5-P6	.E..ML	TN7535	.S..MM	TN6540	.S..MH	TN6540
M1-M2	.E..ML	TN6540	.S..MM	TN6540	.S..MH	TN6540
M3	.E..ML	TN7535	.S..MM	TN7535	.S..MH	TN7535
K1-K2	.E..ML	WK15CM	.E..ML	WK15CM	.S..MH	WK15CM
K3	.E..ML	WK15CM	.S..MM	TN6525	.S..MH	TN6525
N1-N2	.ALP	THM-U	.E..ML	THM-U	.S..ML	THM-U
N3	.ALP	THM-U	.E..ML	THM-U	.S..ML	THM-U
S1-S2	.E..ML	TN6540	.S..MM	TN6540	.S..MM	TN6540
S3	.E..ML	TN6540	.S..MM	WS30PM	.S..MM	TN6540
S4	.E..ML	TN6540	.S..MM	WS30PM	.S..MM	TN6540
H1	.S..MM	WS30PM	.S..MM	WS30PM	.S..MM	WS30PM

Recommended Starting Speeds [SFM]

Material Group	TN2510			★ TN6520			TN6525			★ TN6540			TN7525			
	P	1	-	-	-	-	-	1115	870	770	985	770	655	1115	855	770
	2	-	-	-	-	-	870	690	590	690	525	460	855	690	590	
	3	-	-	-	-	-	770	590	510	590	460	375	770	590	510	
	4	-	-	-	-	-	640	460	395	490	360	295	640	460	395	
	5	-	-	-	-	-	855	640	540	655	490	410	855	640	540	
	6	-	-	-	-	-	560	445	360	445	330	280	560	445	360	
M	1	-	-	-	-	-	525	330	215	360	215	165	670	605	510	
	2	-	-	-	-	-	330	215	130	215	130	115	605	525	460	
	3	-	-	-	-	-	345	215	150	230	130	115	475	425	375	
K	1	1150	985	820	1230	870	625	755	670	605	605	560	490	1035	770	655
	2	985	820	690	1065	690	525	590	525	490	475	425	375	885	655	540
	3	820	690	540	820	625	445	490	445	395	425	395	345	655	540	460
N	1	-	-	-	-	-	-	-	-	-	-	-	-	-	-	-
	2	-	-	-	-	-	-	-	-	-	-	-	-	-	-	-
	3	-	-	-	-	-	-	-	-	-	-	-	-	-	-	-
S	1	-	-	-	-	-	-	-	-	130	100	80	-	-	-	-
	2	-	-	-	-	-	-	-	-	65	50	35	-	-	-	-
	3	-	-	-	-	-	-	-	-	195	115	80	-	-	-	-
	4	-	-	-	-	-	-	-	-	165	80	65	-	-	-	-
H	1	380	300	195	-	-	-	-	-	-	-	-	-	-	-	-
	2	380	300	195	-	-	-	-	-	-	-	-	-	-	-	-
	3	280	210	150	-	-	-	-	-	-	-	-	-	-	-	-

Material Group	TN7535			WK15CM			WS30PM			★ WS40PM			TT125			THM-U		
	P	1	1490	1295	1215	-	-	-	-	-	-	-	-	1180	985	820	-	-
	2	920	835	755	-	-	-	-	-	-	-	-	855	690	590	-	-	-
	3	835	755	670	-	-	-	-	-	-	-	-	855	690	590	-	-	-
	4	625	575	525	-	-	-	-	-	-	-	-	720	590	490	-	-	-
	5	855	755	690	-	-	-	-	-	560	475	395	870	640	540	-	-	-
	6	525	445	360	-	-	-	-	-	490	360	260	395	295	245	-	-	-
M	1	670	605	510	-	-	-	740	655	605	690	560	460	1310	855	590	-	-
	2	605	525	460	-	-	-	670	590	475	590	475	395	885	560	395	-	-
	3	475	425	375	-	-	-	510	445	345	475	360	280	870	575	395	-	-
K	1	970	870	785	1380	1265	1115	-	-	-	-	-	605	510	425	625	560	490
	2	770	690	625	1100	970	900	-	-	-	-	-	490	395	345	-	-	-
	3	640	575	525	920	820	755	-	-	-	-	-	395	345	280	-	-	-
N	1	-	-	-	-	-	-	-	-	-	-	-	-	-	-	6560	3935	3280
	2	-	-	-	-	-	-	-	-	-	-	-	-	-	-	4475	2675	2180
	3	-	-	-	-	-	-	-	-	-	-	-	-	-	-	2625	1640	1310
S	1	-	-	-	-	-	-	150	130	100	130	115	80	-	-	-	-	-
	2	-	-	-	-	-	-	150	130	100	130	115	80	-	-	-	-	-
	3	-	-	-	-	-	-	180	150	100	165	130	80	-	-	-	-	-
	4	-	-	-	-	-	-	280	195	130	195	165	100	-	-	-	-	-
H	1	-	-	-	-	-	-	445	330	245	-	-	-	-	-	-	-	-
	2	-	-	-	-	-	-	-	-	-	-	-	-	-	-	-	-	-
	3	-	-	-	-	-	-	-	-	-	-	-	-	-	-	-	-	-

NOTE: FIRST choice starting speeds are in **bold** type.
As the average chip thickness increases, the speed should be decreased.

★ = ALL-STAR PORTFOLIO PRODUCT. ALL-STAR PRODUCTS ARE PROVEN SOLUTIONS THAT ARE ALWAYS AVAILABLE.

Recommended Starting Feeds [IPT]

Light Machining	General Purpose	Heavy Machining
-----------------	-----------------	-----------------

Insert Geometry	Programmed Feed per Tooth (fz) as a % of Radial Depth of Cut (ae)														Insert Geometry	
	5%		10%		20%		30%		40-100%							
.F..ALP	.005	.009	.019	.003	.007	.013	.003	.005	.010	.002	.004	.009	.002	.004	.008	.F..ALP
.E..ML	.005	.014	.022	.003	.010	.016	.003	.007	.012	.002	.006	.010	.002	.006	.010	.E..ML
.S..MM	.005	.016	.027	.003	.012	.020	.003	.009	.015	.002	.008	.013	.002	.007	.012	.S..MM
.S..MH	.009	.021	.033	.007	.015	.024	.005	.011	.018	.004	.010	.016	.004	.009	.014	.S..MH

NOTE: Use "Light Machining" value as starting feed rate.

★ INDEXABLE MILLING

★ SOLID END MILLING

★ HOLEMAKING

★ TAPPING

★ TURNING

Insert Selection Guide

Material Group	Light Machining		General Purpose		Heavy Machining	
	Geometry	Grade	Geometry	Grade	Geometry	Grade
P1-P2	.E..ML	TN6540	.S..MM	TN6540	.S..MH	TN6540
P3-P4	.E..ML	TN7535	.S..MM	TN6540	.S..MH	TN6540
P5-P6	.E..ML	TN7535	.S..MM	TN6540	.S..MH	TN6540
M1-M2	.E..ML	TN6540	.S..MM	TN6540	.S..MH	TN6540
M3	.E..ML	TN7535	.S..MM	TN7535	.S..MH	TN7535
K1-K2	.E..ML	WK15CM	.E..ML	WK15CM	.S..MH	WK15CM
K3	.E..ML	WK15CM	.S..MM	WK15CM	.S..MH	WK15CM
N1-N2	-	-	-	-	-	-
N3	-	-	-	-	-	-
S1-S2	.E..ML	TN6540	.S..MM	TN6540	.S..MM	TN6540
S3	.E..ML	TN6540	.S..MM	TN6540	.S..MM	TN6540
S4	.E..ML	TN6540	.S..MM	TN6540	.S..MM	TN6540
H1	.S..MM	TN6540	.S..MM	TN6540	.S..MM	TN6540

Recommended Starting Speeds [SFM]

Material Group		TN2510		TN6540			TN7525			TN7535			WK15CM			
P	1	-	-	-	985	770	655	1115	855	770	1490	1295	1215	-	-	-
	2	-	-	-	690	525	460	855	690	590	920	835	755	-	-	-
	3	-	-	-	590	460	375	770	590	510	835	755	670	-	-	-
	4	-	-	-	490	360	295	640	460	395	625	575	525	-	-	-
	5	-	-	-	655	490	410	855	640	540	855	755	690	-	-	-
	6	-	-	-	445	330	280	560	445	360	525	445	360	-	-	-
M	1	-	-	-	360	215	165	670	605	510	670	605	510	-	-	-
	2	-	-	-	215	130	115	605	525	460	605	525	460	-	-	-
	3	-	-	-	230	130	115	475	425	375	475	425	375	-	-	-
K	1	1150	985	820	605	560	490	1035	770	655	970	870	785	1380	1265	1115
	2	985	820	690	475	425	375	885	655	540	770	690	625	1100	970	900
	3	820	690	540	425	395	345	655	540	460	640	575	525	920	820	755
N	1	-	-	-	-	-	-	-	-	-	-	-	-	-	-	-
	2	-	-	-	-	-	-	-	-	-	-	-	-	-	-	-
	3	-	-	-	-	-	-	-	-	-	-	-	-	-	-	-
S	1	-	-	-	130	100	80	-	-	-	-	-	-	-	-	-
	2	-	-	-	65	50	35	-	-	-	-	-	-	-	-	-
	3	-	-	-	195	115	80	-	-	-	-	-	-	-	-	-
	4	-	-	-	165	80	65	-	-	-	-	-	-	-	-	-
H	1	380	300	195	-	-	-	-	-	-	-	-	-	-	-	-
	2	380	300	195	-	-	-	-	-	-	-	-	-	-	-	-
	3	280	210	150	-	-	-	-	-	-	-	-	-	-	-	-

NOTE: FIRST choice starting speeds are in **bold** type.
As the average chip thickness increases, the speed should be decreased.

Recommended Starting Feeds [IPT]

Insert Geometry	Programmed Feed per Tooth (fz) as a % of Radial Depth of Cut (ae)															Insert Geometry
	Light Machining					General Purpose					Heavy Machining					
	5%			10%			20%			30%			40-100%			
.E..ML	.007	.019	.032	.005	.014	.023	.004	.010	.017	.003	.009	.015	.003	.008	.014	.E..ML
.S..MM	.008	.021	.035	.006	.015	.025	.004	.011	.019	.004	.010	.016	.003	.009	.015	.S..MM
.S..MH	.009	.023	.037	.007	.017	.027	.005	.013	.020	.004	.011	.017	.004	.010	.016	.S..MH

NOTE: Use "Light Machining" value as starting feed rate.

= ALL-STAR PORTFOLIO PRODUCT. ALL-STAR PRODUCTS ARE PROVEN SOLUTIONS THAT ARE ALWAYS AVAILABLE.

WIDIA™ Digital Solutions

Tools and Resources at Your Fingertips

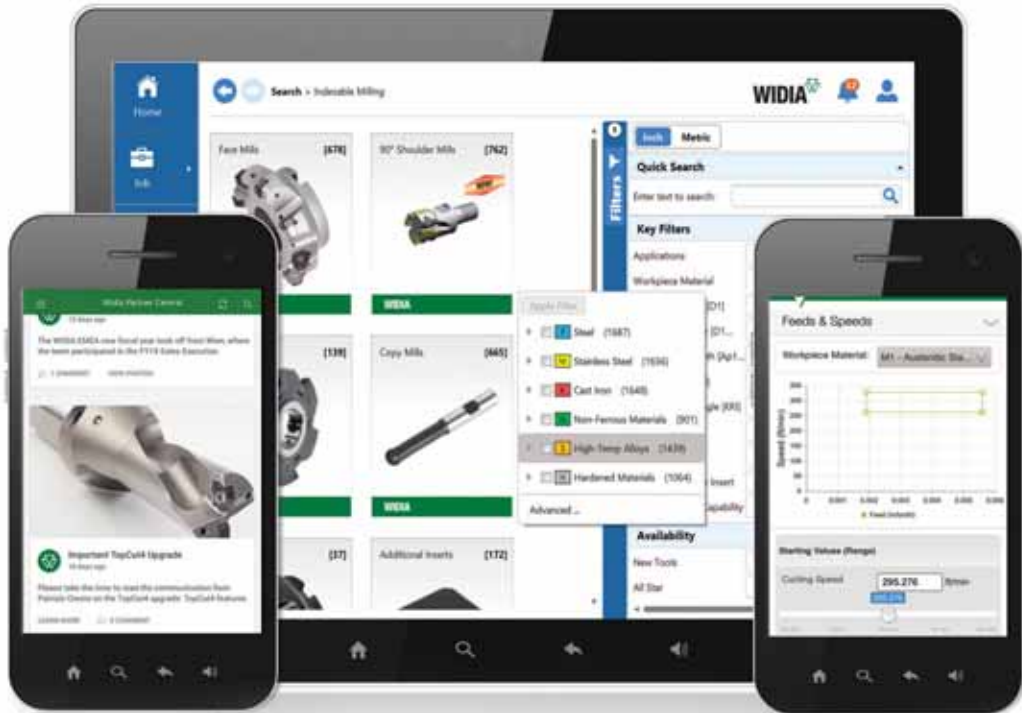

**WIDIA
Machining
Central**



**WIDIA
NOVO™**



**WIDIA
Partner
Central**

PRODUCT DATA

- Tooling Dimensional Data
- Feeds and Speeds
- Inventory Availability
- ...and More!

ELECTRONIC CATALOG

- Complete cutting tool assortment, cutting data, and 2D/3D models.
- Build cutting tool assemblies for easy import into CAD/CAM software, pre-setters, and tool management systems.

PARTNER RESOURCES

- News and updates about our products and services.
- Partner Resources — training, product sheets, marketing templates, campaign collateral, emails, branding elements, merchandise, upcoming webinars, etc.

DOWNLOAD THE WIDIA MOBILE APPS TODAY!



WIDIA.COM



facebook.com/WIDIAProductGrp



youtube.com/WIDIASolutions



twitter.com/WIDIAProductGrp

WIDIA 

90° HIGH-SPEED CUTTING MILLS

VHSC

Page F20

Developed to achieve high-speed cutting of
aluminum components



AEROSPACE TECHNOLOGY



VHSC milling tools are designed for true HSC pocketing and profiling of aluminum alloy components in the aerospace industry, making it a first choice for components like airframe floor brackets.



WIDIA™ offers machining strategies and innovative tooling technology specifically engineered for the aerospace industry to increase productivity and reduce costs.

TO SEE ALL PRODUCTS LINES, VISIT OUR DIGITAL RESOURCES



WIDIA NOVO™ Application
Download to your desktop or tablet:
widia.com/novo



WIDIA™ Machining Central Mobile App
Download for iOS or Android:
widia.com/en/featured/WidiaMobileApp

Insert Selection Guide

Material Group	Light Machining		General Purpose		Heavy Machining	
	Geometry	Grade	Geometry	Grade	Geometry	Grade
N1-N2	.F..ALP	WN10HM	.F..ALP	WN10HM	.E..ALP	WN10HM
N3	.F..ALP	WN10HM	.F..ALP	WN10HM	.E..ALP	WN10HM

Recommended Starting Speeds [SFM]

Material Group	WN10HM			
	N	1	9640	5880
	2	9640	5880	2860
	3	5230	2775	1565

NOTE: FIRST choice starting speeds are in **bold** type.
As the average chip thickness increases, the speed should be decreased.

Recommended Starting Feeds [IPT]

Insert Geometry	Programmed Feed per Tooth (fz) as a % of Radial Depth of Cut (ae)															Insert Geometry
	5%			10%			20%			30%			40-100%			
.F..ALP	.005	.018	.032	.003	.013	.023	.003	.010	.017	.002	.009	.015	.002	.008	.014	.F..ALP
.E..ALP	.006	.020	.037	.004	.014	.027	.003	.011	.020	.003	.009	.017	.003	.009	.016	.E..ALP

NOTE: Use "Light Machining" values as starting feed rate.

 = ALL-STAR PORTFOLIO PRODUCT. ALL-STAR PRODUCTS ARE PROVEN SOLUTIONS THAT ARE ALWAYS AVAILABLE.

Machining Central App from WIDIA™

The fastest, easiest way to get feeds and speeds.

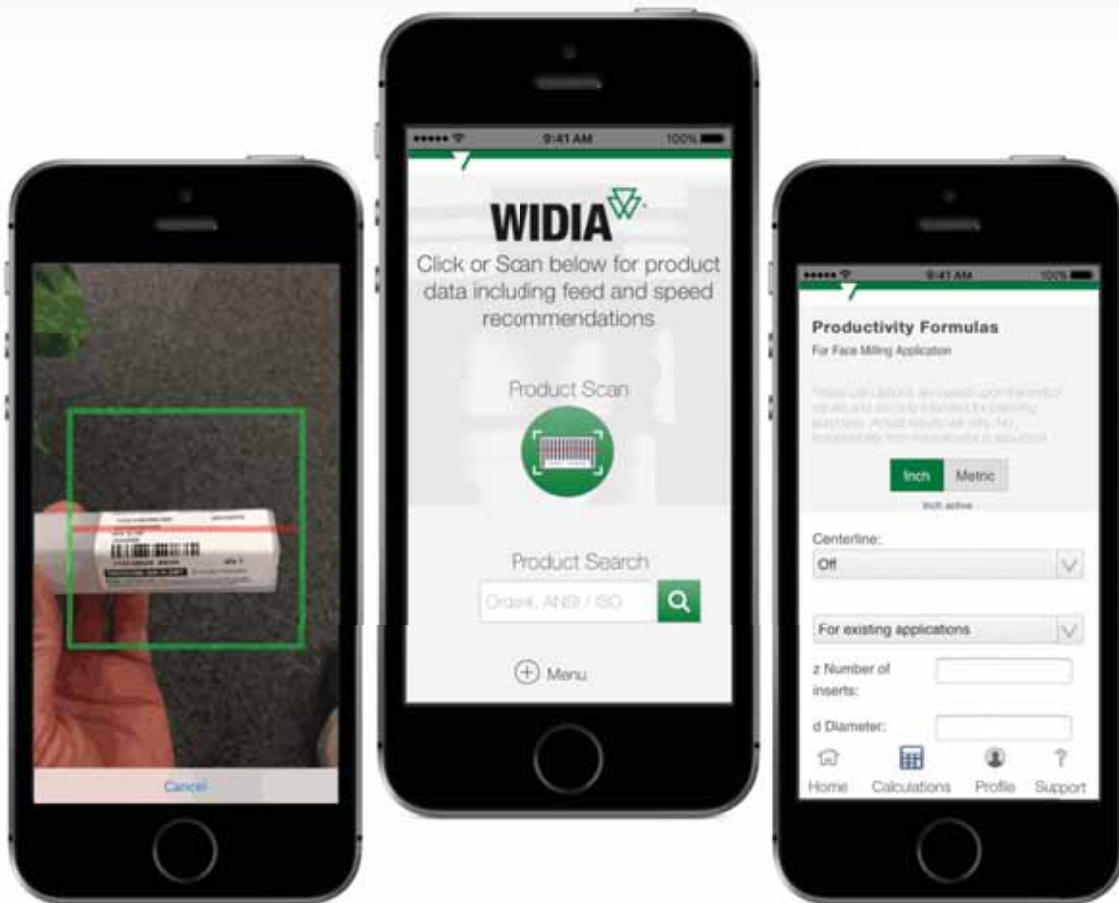

SCAN

With the new WIDIA app, product data is just a quick scan away. Now, when you're on the floor and need to quickly access the speeds and feeds of your favorite WIDIA tool, the WIDIA app gives you reliable information in just a few seconds.



SEARCH

Don't have a barcode? The new WIDIA app includes another simple search technique — just type the tool's corresponding order number or the ANSI or ISO catalog number into the search bar. You'll get the same reliable data as if you'd scanned the tool's barcode. It's simple and quick — no interruption in production!



CALCULATE

Have a specific machining need that our recommended speeds and feeds don't quite address? Try out our three NOVO™ based calculators. Both end milling and face milling calculators are available. Simply fill in the blank fields, and our calculators will quickly provide the data you need.

DOWNLOAD THE WIDIA MACHINING CENTRAL MOBILE APP

widia.com



WIDIA 

FACE MILLS

M1200 MINI

Pages F24–F25

- .500 IC
- $Ap1_{max}$ up to .185"



M1200

Pages F26–F27

- .625 IC
- $Ap1_{max}$ up to .240"

TURBINE BLADE MACHINING WITH M1200 MINI

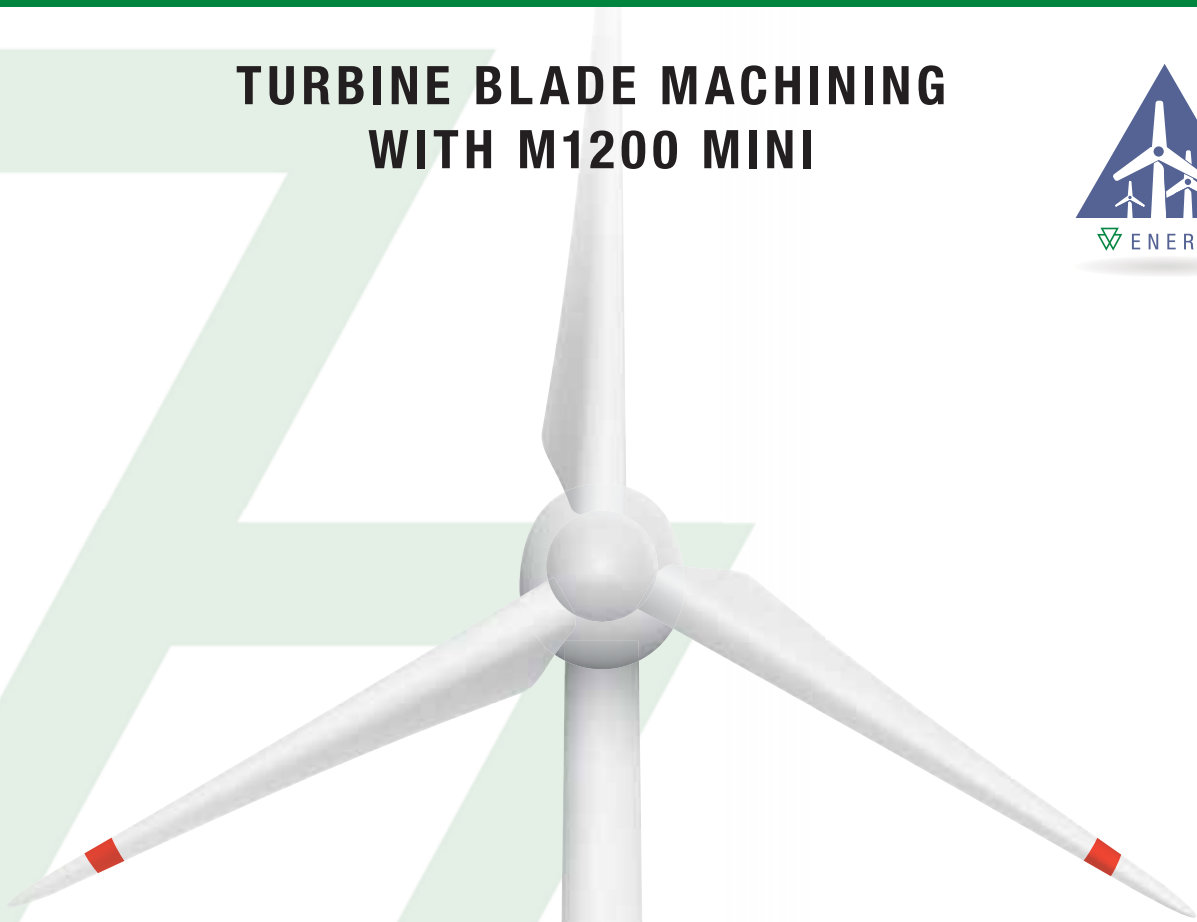

M1200 MINI HF



12 True
Cutting
Edges



15° Lead

Insert HN.J0704

Ap1 max = 0.068"

High Feed Face Mill

M1200 MINI 45°



12 True
Cutting
Edges



45° Lead

Insert HN.J0704

Ap1 max = 0.138"

M1200 MINI 30°



12 True
Cutting
Edges



60° Lead

Insert HN.J0704

Ap1 max = 0.185"

For Higher Axial DOC

TO SEE ALL PRODUCTS LINES, VISIT OUR DIGITAL RESOURCES



WIDIA NOVO™ Application
Download to your desktop or tablet:
widia.com/novo



WIDIA™ Machining Central Mobile App
Download for iOS or Android:
widia.com/en/featured/WidiaMobileApp

WIDIA 

INDEXABLE MILLING

SOLID END MILLING

HOLEMAKING

TAPPING

TURNING

Insert Selection Guide

Material Group	Light Machining		General Purpose		Heavy Machining	
	Geometry	Grade	Geometry	Grade	Geometry	Grade
P1-P2	.E..LD	WP40PM	.S..GD	WP40PM	.S..HD	WP40PM
P3-P4	.E..LD	WP25PM	.S..GD	WP35CM	.S..HD	WP35CM
P5-P6	.E..LD	WP25PM	.S..GD	WP35CM	.S..HD	WP35CM
M1-M2	.E..LD	WP25PM	.S..GD	WP25PM	.S..HD	WP25PM
M3	.E..LD	WP35CM	.S..GD	WP35CM	.S..HD	WP35CM
K1-K2	.E..LD	TN6510	.S..GD	WK15CM	.S..HD	WK15CM
K3	.E..LD	WP35CM	.S..GD	WP35CM	.S..HD	WP35CM
N1-N2	.F..LDJ	TN6501	.F..LDJ	TN6501	.F..LDJ	TN6501
N3	.F..LDJ	TN6501	.F..LDJ	TN6501	.F..LDJ	TN6501
S1-S2	.E..LD	WS30PM	.S..GD	WS30PM	.S..HD	WP25PM
S3	.E..LD	WS30PM	.S..GD	WS30PM	.S..GD	WS30PM
S4	.E..LD	WS30PM	.S..GD	WS30PM	.S..HD	WP40PM
H1	-	-	-	-	-	-

Recommended Starting Speeds [SFM]

Material Group	TN6510			TN6520			TN6525			TN6540			TN7535			WK15CM			
	P	1	-	-	-	-	-	1340	1045	925	1180	925	785	1790	1555	1460	-	-	-
	2	-	-	-	-	-	1045	830	710	830	630	550	1105	1000	905	-	-	-	
	3	-	-	-	-	-	925	710	610	710	550	450	1000	905	805	-	-	-	
	4	-	-	-	-	-	770	550	475	590	430	355	750	690	630	-	-	-	
	5	-	-	-	-	-	1025	770	650	785	590	490	1025	905	830	-	-	-	
	6	-	-	-	-	-	670	535	430	535	395	335	630	535	430	-	-	-	
M	1	-	-	-	-	-	630	395	260	430	260	200	805	725	610	-	-	-	
	2	-	-	-	-	-	395	260	155	260	155	140	725	630	550	-	-	-	
	3	-	-	-	-	-	415	260	180	275	155	140	570	510	450	-	-	-	
K	1	1570	1140	845	1475	1045	750	905	805	725	725	670	590	1165	1045	940	1655	1520	1340
	2	1380	925	670	1280	830	630	710	630	590	570	510	450	925	830	750	1320	1165	1080
	3	1105	845	650	985	750	535	590	535	475	510	475	415	770	690	630	1105	985	905
N	1	-	-	-	-	-	-	-	-	-	-	-	-	-	-	-	-	-	-
	2	-	-	-	-	-	-	-	-	-	-	-	-	-	-	-	-	-	-
	3	-	-	-	-	-	-	-	-	-	-	-	-	-	-	-	-	-	-
S	1	-	-	-	-	-	-	-	-	155	120	95	-	-	-	-	-	-	-
	2	-	-	-	-	-	-	-	-	80	60	40	-	-	-	-	-	-	-
	3	-	-	-	-	-	-	-	-	235	140	95	-	-	-	-	-	-	-
	4	-	-	-	-	-	-	-	-	200	95	80	-	-	-	-	-	-	-
H	1	475	360	230	-	-	-	-	-	-	-	-	-	-	-	-	-	-	-
	2	475	360	230	-	-	-	-	-	-	-	-	-	-	-	-	-	-	-
	3	380	260	150	-	-	-	-	-	-	-	-	-	-	-	-	-	-	-

Material Group	WP25PM			WP35CM			WS30PM			WP40PM			WS40PM			TN6501			THM-U		
	P	1	1295	1120	1060	1790	1555	1460	-	-	-	970	855	805	-	-	-	-	-	-	-
	2	1080	940	785	1105	1000	905	-	-	-	820	705	590	-	-	-	-	-	-	-	-
	3	1000	845	690	1000	905	805	-	-	-	755	640	525	-	-	-	-	-	-	-	-
	4	890	725	590	750	690	630	-	-	-	675	560	445	-	-	-	-	-	-	-	-
	5	725	670	590	1025	905	830	-	-	-	560	510	445	560	475	395	-	-	-	-	-
	6	650	490	395	630	535	430	-	-	-	490	375	295	490	360	260	-	-	-	-	-
M	1	805	710	650	805	725	610	890	785	725	640	560	510	690	560	460	-	-	-	-	-
	2	725	630	510	725	630	550	805	710	570	575	490	410	590	475	395	-	-	-	-	-
	3	550	475	370	570	510	450	610	535	415	425	375	295	475	360	280	-	-	-	-	-
K	1	905	805	725	1165	1045	940	-	-	-	-	-	-	-	-	-	-	-	-	-	-
	2	710	630	590	925	830	750	-	-	-	-	-	-	-	-	-	-	-	-	-	-
	3	590	535	475	770	690	630	-	-	-	-	-	-	-	-	-	-	-	-	-	-
N	1	-	-	-	-	-	-	-	-	-	-	-	-	7870	4720	3935	7870	4720	3935	-	-
	2	-	-	-	-	-	-	-	-	-	-	-	-	5370	3210	2615	5370	3210	2615	-	-
	3	-	-	-	-	-	-	-	-	-	-	-	-	3150	1970	1570	3150	1970	1570	-	-
S	1	155	140	95	-	-	-	180	155	120	-	-	-	130	115	80	-	-	-	-	-
	2	155	140	95	-	-	-	180	155	120	-	-	-	130	115	80	-	-	-	-	-
	3	200	155	95	-	-	-	215	180	120	-	-	-	165	130	80	-	-	-	-	-
	4	275	200	140	260	200	130	335	235	155	-	-	-	195	165	100	-	-	-	-	-
H	1	475	355	275	-	-	-	-	-	-	-	-	-	-	-	-	-	-	-	-	-
	2	-	-	-	-	-	-	-	-	-	-	-	-	-	-	-	-	-	-	-	-
	3	-	-	-	-	-	-	-	-	-	-	-	-	-	-	-	-	-	-	-	-

NOTE: FIRST choice starting speeds are in **bold** type.
As the average chip thickness increases, the speed should be decreased.

= ALL-STAR PORTFOLIO PRODUCT. ALL-STAR PRODUCTS ARE PROVEN SOLUTIONS THAT ARE ALWAYS AVAILABLE.

Recommended Starting Feeds [IPT]

Light Machining	General Purpose	Heavy Machining
-----------------	-----------------	-----------------

Insert Geometry	Programmed Feed per Tooth (fz) as a % of Radial Depth of Cut (ae)														Insert Geometry	
	5%		10%		20%		30%		40-100%							
F..LDJ	.019	.035	.072	.014	.025	.051	.010	.019	.038	.009	.016	.033	.008	.015	.030	F..LDJ
E..LD	.019	.055	.112	.014	.039	.079	.010	.029	.058	.009	.025	.051	.008	.023	.046	E..LD
S..GD	.036	.093	.153	.026	.066	.106	.019	.049	.078	.017	.042	.068	.015	.039	.062	S..GD
S..HD	.036	.093	.153	.026	.066	.106	.019	.049	.078	.017	.042	.068	.015	.039	.062	S..HD

NOTE: Use "Light Machining" value as starting feed rate.

★ INDEXABLE MILLING

★ SOLID END MILLING

★ HOLEMAKING

★ TAPPING

★ TURNING

Insert Selection Guide

Material Group	Light Machining		General Purpose		Heavy Machining	
	Geometry	Grade	Geometry	Grade	Geometry	Grade
P1-P2	.E..LD	WP40PM	.S..GD	WP40PM	.S..HD	WP40PM
P3-P4	.E..LD	WP25PM	.S..GD	WP35CM	.S..HD	WP35CM
P5-P6	.E..LD	WP25PM	.S..GD	WP35CM	.S..HD	WP35CM
M1-M2	.E..LD	WP25PM	.S..GD	WP25PM	.S..HD	WP25PM
M3	.E..LD	WP35CM	.S..GD	WP35CM	.S..HD	WP35CM
K1-K2	.E..LD	TN6520	.S..GD	WK15CM	.S..HD	WK15CM
K3	.E..LD	WP35CM	.S..GD	WP35CM	.S..HD	WP35CM
N1-N2	.F..LDJ	TN6501	.F..LDJ	TN6501	.F..LDJ	TN6501
N3	.F..LDJ	TN6501	.F..LDJ	TN6501	.F..LDJ	TN6501
S1-S2	.E..LD	WS30PM	.S..GD	WS30PM	.S..HD	WP25PM
S3	.E..LD	WS30PM	.S..GD	WS30PM	.S..HD	WP40PM
S4	.E..LD	WS30PM	.S..GD	WS30PM	.S..HD	WP40PM
H1	-	-	-	-	-	-

Recommended Starting Speeds [SFM]

Material Group	★ TN6520			★ TN6525			★ TN6540			★ TN7535			★ WK15CM			★ WP25PM			
	P	1	-	-	1340	1045	925	1180	925	785	1790	1555	1460	-	-	-	1295	1120	1060
2		-	-	1045	830	710	830	630	550	1105	1000	905	-	-	-	1080	940	785	
3		-	-	925	710	610	710	550	450	1000	905	805	-	-	-	1000	845	690	
4		-	-	770	550	475	590	430	355	750	690	630	-	-	-	890	725	590	
5		-	-	1025	770	650	785	590	490	1025	905	830	-	-	-	725	670	590	
6		-	-	670	535	430	535	395	335	630	535	430	-	-	-	650	490	395	
M	1	-	-	630	395	260	430	260	200	805	725	610	-	-	-	805	710	650	
	2	-	-	395	260	155	260	155	140	725	630	550	-	-	-	725	630	510	
	3	-	-	415	260	180	275	155	140	570	510	450	-	-	-	550	475	370	
K	1	1475	1045	750	905	805	725	725	670	590	1165	1045	940	1655	1520	1340	905	805	725
	2	1280	830	630	710	630	590	570	510	450	925	830	750	1320	1165	1080	710	630	590
	3	985	750	535	590	535	475	510	475	415	770	690	630	1105	985	905	590	535	475
N	1	-	-	-	-	-	-	-	-	-	-	-	-	-	-	-	-	-	-
	2	-	-	-	-	-	-	-	-	-	-	-	-	-	-	-	-	-	-
	3	-	-	-	-	-	-	-	-	-	-	-	-	-	-	-	-	-	-
S	1	-	-	-	-	-	155	120	95	-	-	-	-	-	-	155	140	95	
	2	-	-	-	-	-	80	60	40	-	-	-	-	-	-	155	140	95	
	3	-	-	-	-	-	235	140	95	-	-	-	-	-	-	200	155	95	
	4	-	-	-	-	-	200	95	80	-	-	-	-	-	-	275	200	140	
H	1	-	-	-	-	-	-	-	-	-	-	-	-	-	-	475	355	275	
	2	-	-	-	-	-	-	-	-	-	-	-	-	-	-	-	-	-	
	3	-	-	-	-	-	-	-	-	-	-	-	-	-	-	-	-	-	

Material Group	WS30PM			★ WP35CM			★ WP40PM			★ WS40PM			WK25YM			★ TN6501			★ THM-U		
	P	1	-	-	1790	1555	1460	970	855	805	-	-	-	-	-	-	-	-	-	-	-
2		-	-	1105	1000	905	820	705	590	-	-	-	-	-	-	-	-	-	-	-	-
3		-	-	1000	905	805	755	640	525	-	-	-	-	-	-	-	-	-	-	-	-
4		-	-	750	690	630	675	560	445	-	-	-	-	-	-	-	-	-	-	-	-
5		-	-	1025	905	830	560	510	445	560	475	395	-	-	-	-	-	-	-	-	-
6		-	-	630	535	430	490	375	295	490	360	260	-	-	-	-	-	-	-	-	-
M	1	890	785	725	805	725	610	640	560	510	690	560	460	-	-	-	-	-	-	-	-
	2	805	710	570	725	630	550	575	490	410	590	475	395	-	-	-	-	-	-	-	-
	3	610	535	415	570	510	450	425	375	295	475	360	280	-	-	-	-	-	-	-	-
K	1	-	-	1165	1045	940	-	-	-	-	-	-	3170	2880	2560	-	-	-	750	670	590
	2	-	-	925	830	750	-	-	-	-	-	-	2510	2240	2090	-	-	-	-	-	-
	3	-	-	770	690	630	-	-	-	-	-	-	2110	1870	1720	-	-	-	-	-	-
N	1	-	-	-	-	-	-	-	-	-	-	-	-	-	-	7870	4720	3935	7870	4720	3935
	2	-	-	-	-	-	-	-	-	-	-	-	-	-	5370	3210	2615	5370	3210	2615	
	3	-	-	-	-	-	-	-	-	-	-	-	-	3150	1970	1570	3150	1970	1570		
S	1	180	155	120	-	-	-	-	-	130	115	80	-	-	-	-	-	-	-	-	-
	2	180	155	120	-	-	-	-	-	130	115	80	-	-	-	-	-	-	-	-	-
	3	215	180	120	-	-	-	-	-	165	130	80	-	-	-	-	-	-	-	-	-
	4	335	235	155	260	200	130	-	-	195	165	100	-	-	-	-	-	-	-	-	-
H	1	-	-	-	-	-	-	-	-	-	-	-	-	-	-	-	-	-	-	-	-
	2	-	-	-	-	-	-	-	-	-	-	-	-	-	-	-	-	-	-	-	-
	3	-	-	-	-	-	-	-	-	-	-	-	-	-	-	-	-	-	-	-	-

NOTE: FIRST choice starting speeds are in **bold** type.
As the average chip thickness increases, the speed should be decreased.

★ = ALL-STAR PORTFOLIO PRODUCT. ALL-STAR PRODUCTS ARE PROVEN SOLUTIONS THAT ARE ALWAYS AVAILABLE.

Recommended Starting Feeds [IPT]

Light Machining	General Purpose	Heavy Machining
-----------------	-----------------	-----------------

Insert Geometry	Programmed Feed per Tooth (fz) as a % of Radial Depth of Cut (ae)														Insert Geometry	
	5%		10%		20%		30%		40-100%							
.F..LDJ	.007	.013	.026	.005	.009	.019	.004	.007	.014	.003	.006	.012	.003	.006	.011	.F..LDJ
.E..LD	.007	.020	.040	.005	.014	.029	.004	.011	.021	.003	.009	.019	.003	.008	.017	.E..LD
.S..GD	.010	.033	.053	.007	.024	.038	.006	.018	.028	.005	.015	.025	.004	.014	.023	.S..GD
.S..HD	.013	.033	.053	.009	.024	.038	.007	.018	.028	.006	.015	.025	.006	.014	.023	.S..HD
.S..Ceramic	.007	.013	.020	.005	.009	.014	.004	.007	.011	.003	.006	.009	.003	.006	.008	.S..Ceramic

NOTE: Use "Light Machining" value as starting feed rate.

★ INDEXABLE MILLING

★ SOLID END MILLING

★ HOLEMAKING

★ TAPPING

★ TURNING

COPY MILLS

VXF™

Page F30

4-Edged, Victory™ X-Feed™ Mill



M370™

Pages F31–F32

Double-sided high-feed rougher
with 6 edges per insert.





M200™

Pages F34–F37

8 cutting edges

M100™

Pages F38–F45

Thick inserts for reliability and higher MRR



TO SEE ALL PRODUCTS LINES, VISIT OUR DIGITAL RESOURCES



WIDIA NOVO™ Application
Download to your desktop or tablet:
widia.com/novo



WIDIA™ Machining Central Mobile App
Download for iOS or Android:
widia.com/en/featured/WidiaMobileApp

Insert Selection Guide

Material Group	Light Machining		General Purpose		Heavy Machining	
	Geometry	Grade	Geometry	Grade	Geometry	Grade
P1-P2	XDPT-MM	WP25PM	XDPT-MM	WS40PM	XDPT-MH	WP40PM
P3-P4	XDPT-MM	WP25PM	XDPT-MM	WS40PM	XDPT-MH	WP40PM
P5-P6	XDPT-MM	WP25PM	XDPT-MM	WS40PM	XDPT-MH	WP40PM
M1-M2	XDPT-MM	WS40PM	XDPT-MM	WS40PM	XDPT-MH	WP40PM
M3	XDPT-MM	WS40PM	XDPT-MM	WS40PM	XDPT-MH	WP40PM
S1-S2	XDPT-MM	WP25PM	XDPT-MM	WS40PM	XDPT-MH	WP40PM
S3	XDPT-MM	WS40PM	XDPT-MM	WS40PM	XDPT-MH	WP40PM
S4	XDPT-MM	WS40PM	XDPT-MM	WS40PM	XDPT-MH	WP40PM

Recommended Starting Speeds [SFM]*

Material Group	WP25PM			WP40PM			WS40PM			
		1295	1115	1065	1165	1015	970	-	-	-
P	2	1085	950	785	985	855	705	-	-	-
	3	1000	855	690	900	770	625	-	-	-
	4	885	720	590	805	675	525	-	-	-
	5	720	675	590	675	605	525	675	575	475
	6	655	490	395	590	460	360	590	425	310
	1	805	705	655	770	675	605	820	675	560
M	2	720	625	510	690	590	490	705	575	475
	3	560	475	375	510	460	360	575	425	330
	1	165	130	100	165	130	115	165	130	100
S	2	165	130	100	165	130	115	165	130	100
	3	195	165	100	195	165	115	195	165	100
	4	280	195	130	260	195	130	230	195	115

NOTE: FIRST choice starting speeds are in **bold** type. As the average chip thickness increases, the speed should be decreased.
 *Material groups P, M, K, and H show recommended starting speeds for dry machining. For wet machining, reduce speed by 20%.
 *Material groups N and S show recommended starting speeds for wet machining. Not recommended for dry machining.

Recommended Starting Feeds [IPT]

At .020 Axial Depth of Cut (AP1)

Light Machining	General Purpose	Heavy Machining
-----------------	-----------------	-----------------

Insert Geometry	Recommended Starting Feed per Tooth (Fz) in Relation to % of Radial Engagement (ae)														Insert Geometry				
	5%				10%				20%				30%				40-100%		
.E..MM	.020	.058	.109	.14	.039	.067	.10	.028	.047	.009	.025	.041	.008	.022	.037	.E..MM			
.S..MH	.036	.080	.141	.25	.052	.080	.019	.037	.056	.016	.032	.048	.015	.029	.043	.S..MH			

At .025 Axial Depth of Cut (AP1)

Insert Geometry	Recommended Starting Feed per Tooth (Fz) in Relation to % of Radial Engagement (ae)														Insert Geometry				
	5%				10%				20%				30%				40-100%		
.E..MM	.018	.051	.094	.13	.035	.059	.009	.025	.042	.008	.022	.037	.007	.020	.033	.E..MM			
.S..MH	.032	.070	.118	.23	.046	.071	.017	.033	.050	.014	.029	.043	.013	.026	.039	.S..MH			

At .035 Axial Depth of Cut (AP1)

Insert Geometry	Recommended Starting Feed per Tooth (Fz) in Relation to % of Radial Engagement (ae)														Insert Geometry				
	5%				10%				20%				30%				40-100%		
.E..MM	.015	.043	.076	.11	.029	.050	.008	.022	.036	.007	.019	.031	.006	.017	.028	.E..MM			
.S..MH	.027	.058	.093	.19	.039	.059	.014	.028	.042	.012	.024	.036	.011	.022	.033	.S..MH			

NOTE: Use "Light Machining" values as starting feed rate.

 = ALL-STAR PORTFOLIO PRODUCT. ALL-STAR PRODUCTS ARE PROVEN SOLUTIONS THAT ARE ALWAYS AVAILABLE.

Insert Selection Guide

Material Group	Light Machining		General Purpose		Heavy Machining	
	Geometry	Grade	Geometry	Grade	Geometry	Grade
P1-P2	...MM	WP40PM	...MM	WP40PM	...MM	WP40PM
P3-P4	...MM	WP25PM	...MM	WP40PM	...MH	WP40PM
P5-P6	...MM	WP25PM	...MH	WP25PM	...MH	WP40PM
M1-M2	...MM	WP25PM	...MM	WS30PM	...MM	WP40PM
M3	...MM	WP25PM	...MM	WP25PM	...MM	WP40PM
K1-K2	...MH	WK15CM	...MH	WK15CM	...MH	WK15CM
K3	...MH	TN6520	...MH	TN6520	...MH	WK15CM
N1-N2	-	-	-	-	-	-
N3	-	-	-	-	-	-
S1-S2	...MM	WP25PM	...MM	WS30PM	...MM	WP40PM
S3	...MM	WS30PM	...MM	WS30PM	...MM	WP40PM
S4	...MM	WS30PM	...MM	WP40PM	...MM	WP40PM
H1	...MH	WP25PM	-	-	-	-

Recommended Starting Speeds [SFM]

Material Group	TN6520			TN6525			★ TN7535			WK15CM			★ WP25PM			★ WS30PM			★ WP40PM			★ WS40PM			
	P	1	-	-	-	1340	1045	925	1790	1555	1460	-	-	-	1295	1120	1060	-	-	-	1165	1025	965	-	-
2		-	-	-	1045	830	710	1105	1000	905	-	-	-	1080	940	785	-	-	-	985	845	710	-	-	-
3		-	-	-	925	710	610	1000	905	805	-	-	-	1000	845	690	-	-	-	905	770	630	-	-	-
4		-	-	-	770	550	475	750	690	630	-	-	-	890	725	590	-	-	-	805	670	535	-	-	-
5		-	-	-	1025	770	650	1025	905	830	-	-	-	725	670	590	-	-	-	670	610	535	560	475	395
6		-	-	-	670	535	430	630	535	430	-	-	-	650	490	395	-	-	-	590	450	355	490	360	260
M	1	-	-	-	630	395	260	805	725	610	-	-	-	805	710	650	890	785	725	770	670	610	690	560	460
	2	-	-	-	395	260	155	725	630	550	-	-	-	725	630	510	805	710	570	690	590	490	590	475	395
	3	-	-	-	415	260	180	570	510	450	-	-	-	550	475	370	610	535	415	510	450	355	475	360	280
K	1	1475	1045	750	905	805	725	1165	1045	940	1655	1520	1340	905	805	725	-	-	-	-	-	-	-	-	-
	2	1280	830	630	710	630	590	925	830	750	1320	1165	1080	710	630	590	-	-	-	-	-	-	-	-	-
	3	985	750	535	590	535	475	770	690	630	1105	985	905	590	535	475	-	-	-	-	-	-	-	-	-
N	1	-	-	-	-	-	-	-	-	-	-	-	-	-	-	-	-	-	-	-	-	-	-	-	-
	2	-	-	-	-	-	-	-	-	-	-	-	-	-	-	-	-	-	-	-	-	-	-	-	-
	3	-	-	-	-	-	-	-	-	-	-	-	-	-	-	-	-	-	-	-	-	-	-	-	-
S	1	-	-	-	-	-	-	-	-	-	-	-	-	155	140	95	180	155	120	155	140	120	130	115	80
	2	-	-	-	-	-	-	-	-	-	-	-	-	155	140	95	180	155	120	155	140	120	130	115	80
	3	-	-	-	-	-	-	-	-	-	-	-	-	200	155	95	215	180	120	200	155	120	165	130	80
	4	-	-	-	-	-	-	-	-	-	-	-	-	275	200	140	335	235	155	260	200	140	195	165	100
H	1	-	-	-	-	-	-	-	-	-	-	-	-	475	355	275	-	-	-	-	-	-	-	-	-
	2	-	-	-	-	-	-	-	-	-	-	-	-	-	-	-	-	-	-	-	-	-	-	-	-
	3	-	-	-	-	-	-	-	-	-	-	-	-	-	-	-	-	-	-	-	-	-	-	-	-

NOTE: FIRST choice starting speeds are in **bold** type.
As the average chip thickness increases, the speed should be decreased.

Recommended Starting Feeds [IPT]

Insert Geometry	Programmed Feed per Tooth (fz) as a % of Radial Depth of Cut (ae)												Insert Geometry			
	Light Machining			General Purpose			Heavy Machining									
	5%	10%	20%	30%	40-100%		5%	10%	20%	30%	40-100%					
...MM	.035	.061	.150	.025	.044	.104	.019	.033	.076	.017	.028	.066	.015	.026	.061	...MM
...MH	.035	.092	.197	.025	.065	.134	.019	.048	.098	.017	.042	.085	.015	.038	.078	...MH

NOTE: Use "Light Machining" values as starting feed rate.

★ = ALL-STAR PORTFOLIO PRODUCT. ALL-STAR PRODUCTS ARE PROVEN SOLUTIONS THAT ARE ALWAYS AVAILABLE.

INDEXABLE MILLING
SOLID END MILLING
HOLEMAKING
TAPPING
TURNING

INDEXABLE MILLING

Insert Selection Guide

Material Group	Light Machining		General Purpose		Heavy Machining	
	Geometry	Grade	Geometry	Grade	Geometry	Grade
P1-P2	...MM	WU35PM	...MM	WP40PM	...MM	WP40PM
P3-P4	...MM	WP25PM	...MM	WP25PM	...MH	WP40PM
P5-P6	...MM	WP25PM	...MM	WP35CM	...MH	WP35CM
M1-M2	...MM	WS30PM	...MM	WU35PM	...MM	WP40PM
M3	...MM	WP25PM	...MM	WP35CM	...MM	WP40PM
K1-K2	...MH	WK15CM	...MH	WK15CM	...MH	WP20CM
K3	...MH	WK15CM	...MH	WK15CM	...MH	WP20CM
N1-N2	-	-	-	-	-	-
N3	-	-	-	-	-	-
S1-S2	...MM	WS30PM	...MM	WU35PM	...MM	WP40PM
S3	...MM	WS30PM	...MM	WU35PM	...MM	WP40PM
S4	...MM	WS30PM	...MM	WU35PM	...MM	WP40PM
H1	...MH	WP35CM	...MR	WP25PM	-	-

SOLID END MILLING

Recommended Starting Speeds [SFM]

Material Group		★ WK15CM	★ WP20CM	★ WP25PM	★ WU35PM	★ WP35CM	★ WS30PM	★ WP40PM	★ WS40PM
		P	1	- - -	2165 1910 1770	1295 1120 1060	1165 1025 965	1790 1555 1460	- - -
	2	- - -	1340 1220 1080	1080 940 785	985 845 710	1105 1000 905	- - -	985 845 710	- - -
	3	- - -	1220 1080 1000	1000 845 690	905 770 630	1000 905 805	- - -	905 770 630	- - -
	4	- - -	905 845 750	890 725 590	805 670 535	750 690 630	- - -	805 670 535	- - -
	5	- - -	1080 985 905	725 670 590	670 610 535	1025 905 830	- - -	670 610 535	560 475 395
	6	- - -	750 670 570	650 490 395	590 450 355	630 535 430	- - -	590 450 355	490 360 260
M	1	- - -	890 785 690	805 710 650	770 670 610	805 725 610	890 785 725	770 670 610	690 560 460
	2	- - -	805 690 630	725 630 510	690 590 490	725 630 550	805 710 570	690 590 490	590 475 395
	3	- - -	630 570 490	550 475 370	510 450 355	570 510 450	610 535 415	510 450 355	475 360 280
K	1	1655 1520 1340	1415 1280 1165	905 805 725	- - -	1165 1045 940	- - -	- - -	- - -
	2	1320 1165 1080	1120 1000 925	710 630 590	- - -	925 830 750	- - -	- - -	- - -
	3	1105 985 905	940 845 785	590 535 475	- - -	770 690 630	- - -	- - -	- - -
N	1	- - -	- - -	- - -	- - -	- - -	- - -	- - -	- - -
	2	- - -	- - -	- - -	- - -	- - -	- - -	- - -	- - -
	3	- - -	- - -	- - -	- - -	- - -	- - -	- - -	- - -
S	1	- - -	- - -	155 140 95	155 140 120	- - -	180 155 120	155 140 120	130 115 80
	2	- - -	- - -	155 140 95	155 140 120	- - -	180 155 120	155 140 120	130 115 80
	3	- - -	- - -	200 155 95	200 155 120	- - -	215 180 120	200 155 120	165 130 80
	4	- - -	- - -	275 200 140	260 200 140	260 200 130	335 235 155	260 200 140	195 165 100
H	1	- - -	550 450 370	475 355 275	- - -	- - -	- - -	- - -	- - -
	2	- - -	- - -	- - -	- - -	- - -	- - -	- - -	- - -
	3	- - -	- - -	- - -	- - -	- - -	- - -	- - -	- - -

NOTE: FIRST choice starting speeds are in **bold** type.
As the average chip thickness increases, the speed should be decreased.

HOLEMAKING

TAPPING

Recommended Starting Feeds [IPT]

Insert Geometry	Programmed Feed per Tooth (fz) as a % of Radial Depth of Cut (ae)															Insert Geometry	
	Light Machining			General Purpose			Heavy Machining			Light Machining			General Purpose				Heavy Machining
	5%			10%			20%			30%			40-100%				
...MM	.035	.073	.143	.026	.052	.099	.019	.039	.073	.017	.034	.063	.015	.031	.058	...MM	
...MH	.035	.093	.196	.026	.066	.134	.019	.049	.098	.017	.042	.085	.015	.039	.077	...MH	
...MR	.035	.111	.214	.026	.078	.145	.019	.057	.106	.017	.050	.092	.015	.046	.084	...MR	

NOTE: Use "Light Machining" values as starting feed rate.

★ = ALL-STAR PORTFOLIO PRODUCT. ALL-STAR PRODUCTS ARE PROVEN SOLUTIONS THAT ARE ALWAYS AVAILABLE.

Machining Central App from WIDIA™

The fastest, easiest way to get feeds and speeds.

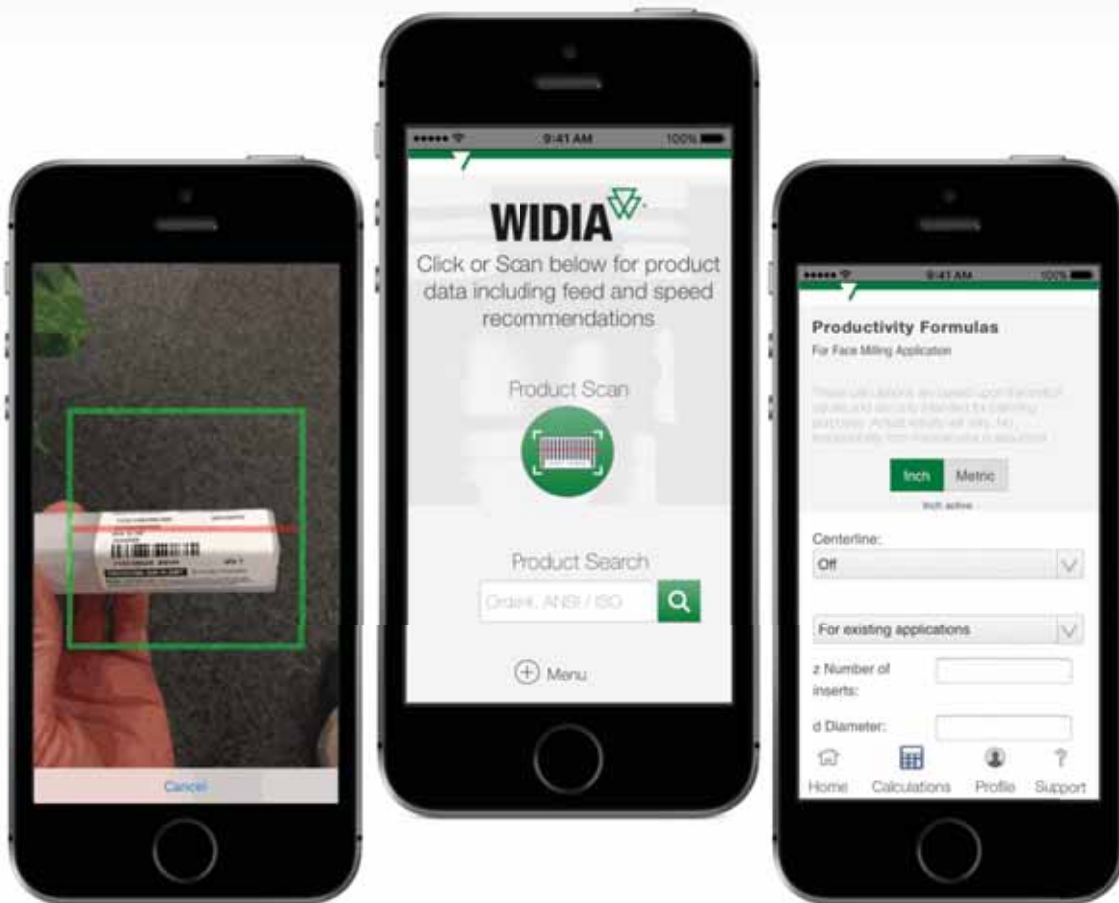

SCAN

With the new WIDIA app, product data is just a quick scan away. Now, when you're on the floor and need to quickly access the speeds and feeds of your favorite WIDIA tool, the WIDIA app gives you reliable information in just a few seconds.



SEARCH

Don't have a barcode? The new WIDIA app includes another simple search technique — just type the tool's corresponding order number or the ANSI or ISO catalog number into the search bar. You'll get the same reliable data as if you'd scanned the tool's barcode. It's simple and quick — no interruption in production!



CALCULATE

Have a specific machining need that our recommended speeds and feeds don't quite address? Try out our three NOVO™ based calculators. Both end milling and face milling calculators are available. Simply fill in the blank fields, and our calculators will quickly provide the data you need.

DOWNLOAD THE WIDIA MACHINING CENTRAL MOBILE APP

widia.com



WIDIA 

INDEXABLE MILLING

SOLID END MILLING

HOLEMAKING

TAPPING

TURNING

Insert Selection Guide

Material Group	Light Machining		General Purpose		Heavy Machining	
	Geometry	Grade	Geometry	Grade	Geometry	Grade
P1-P2	ML	WP25PM	MM	WP40PM	MM	WP40PM
P3-P4	ML	WP25PM	MM	WP25PM	MH	WP40PM
P5-P6	ML	WP35CM	MM	WP35CM	MH	WP35CM
M1-M2	ML	WP25PM	ML	WU35PM	MM	WU35PM
M3	ML	WP25PM	MM	WU35PM	MM	WU35PM
K1-K2	MH	WK15CM	MH	WK15CM	MH	WP20CM
K3	MH	WK15CM	MH	WK15CM	MH	WP25PM
N1-N2	ALP	WN25PM	ALP	WN25PM	ALP	WN25PM
N3	ALP	WN25PM	ALP	WN25PM	ALP	WN25PM
S1-S2	ML	WS30PM	MM	WS30PM	MM	WU35PM
S3	ML	WS30PM	MM	WU35PM	MM	WU35PM
S4	ML	WS30PM	MM	WU35PM	MM	WU35PM
H1	MH	WP25PM	MH	WP20CM	-	-

Recommended Starting Speeds [SFM]

Material Group	★ WK15CM			WN25PM			WP20CM			WP25PM			★ WP35CM			WP40PM			WS30PM			WU35PM		
	1	2	3	1	2	3	1	2	3	1	2	3	1	2	3	1	2	3	1	2	3	1	2	3
P	1	-	-	-	-	-	2165	1910	1770	1295	1120	1060	1790	1555	1460	1165	1025	965	1460	1260	1180	1025	905	845
	2	-	-	-	-	-	1340	1220	1080	1080	940	785	1105	1000	905	985	845	710	1200	1060	865	865	750	630
	3	-	-	-	-	-	1220	1080	1000	1000	845	690	1000	905	805	905	770	630	1120	940	770	785	670	550
	4	-	-	-	-	-	905	845	750	890	725	590	750	690	630	805	670	535	985	805	650	710	590	475
	5	-	-	-	-	-	1080	985	905	725	670	590	1025	905	830	670	610	535	805	750	650	590	535	475
	6	-	-	-	-	-	750	670	570	650	490	395	630	535	430	590	450	355	725	550	430	510	395	310
M	1	-	-	-	-	-	890	785	690	805	710	650	805	725	610	770	670	610	890	785	725	670	590	535
	2	-	-	-	-	-	805	690	630	725	630	510	725	630	550	690	590	490	805	710	570	610	510	430
	3	-	-	-	-	-	630	570	490	550	475	370	570	510	450	510	450	355	610	535	415	450	395	310
K	1	1655	1520	1340	-	-	1415	1280	1165	905	805	725	1165	1045	940	-	-	-	-	-	-	-	-	-
	2	1320	1165	1080	-	-	1120	1000	925	710	630	590	925	830	750	-	-	-	-	-	-	-	-	-
	3	1105	985	905	-	-	940	845	785	590	535	475	770	690	630	-	-	-	-	-	-	-	-	-
N	1	-	-	-	4230	3720	3445	-	-	-	-	-	-	-	-	-	-	-	-	-	-	-	-	-
	2	-	-	-	3720	3445	2995	-	-	-	-	-	-	-	-	-	-	-	-	-	-	-	-	-
	3	-	-	-	3720	3445	2995	-	-	-	-	-	-	-	-	-	-	-	-	-	-	-	-	-
S	1	-	-	-	-	-	-	-	155	140	95	-	-	-	155	140	120	180	155	120	140	120	95	
	2	-	-	-	-	-	-	-	155	140	95	-	-	-	155	140	120	180	155	120	140	120	95	
	3	-	-	-	-	-	-	-	200	155	95	-	-	-	200	155	120	215	180	120	180	140	95	
	4	-	-	-	-	-	-	-	275	200	140	260	200	130	260	200	140	335	235	155	235	180	120	
H	1	-	-	-	-	-	550	450	370	475	355	275	-	-	-	-	-	535	395	295	-	-	-	
	2	-	-	-	-	-	-	-	-	-	-	-	-	-	-	-	-	-	-	-	-	-	-	
	3	-	-	-	-	-	-	-	-	-	-	-	-	-	-	-	-	-	-	-	-	-	-	

NOTE: FIRST choice starting speeds are in **bold** type.
As the average chip thickness increases, the speed should be decreased.

★ = ALL-STAR PORTFOLIO PRODUCT. ALL-STAR PRODUCTS ARE PROVEN SOLUTIONS THAT ARE ALWAYS AVAILABLE.

Recommended Starting Feeds [IPT]

At .197 Axial Depth of Cut (ap)

Light Machining	General Purpose	Heavy Machining
-----------------	-----------------	-----------------

Insert Geometry	Programmed Feed per Tooth (fz) as a % of Radial Depth of Cut (ae)														Insert Geometry	
	5%			10%			20%			30%			40-100%			
ALP	.005	.007	.009	.003	.005	.007	.003	.004	.005	.002	.003	.004	.002	.003	.004	ALP
ML	.005	.017	.031	.004	.013	.023	.003	.009	.017	.002	.008	.015	.002	.008	.014	ML
MM	.011	.020	.036	.008	.014	.026	.006	.011	.019	.005	.009	.017	.005	.009	.015	MM
MH	.018	.023	.038	.013	.016	.027	.010	.012	.020	.009	.011	.018	.008	.010	.016	MH

At .098 Axial Depth of Cut (ap)

Insert Geometry	Programmed Feed per Tooth (fz) as a % of Radial Depth of Cut (ae)														Insert Geometry	
	5%			10%			20%			30%			40-100%			
ALP	.005	.007	.009	.003	.005	.007	.003	.004	.005	.002	.003	.004	.002	.003	.004	ALP
ML	.006	.020	.036	.004	.014	.026	.003	.011	.020	.003	.009	.017	.003	.009	.016	ML
MM	.013	.023	.041	.009	.016	.030	.007	.012	.022	.006	.011	.019	.005	.010	.018	MM
MH	.021	.026	.044	.015	.019	.031	.011	.014	.023	.010	.012	.020	.009	.011	.019	MH

At .049 Axial Depth of Cut (ap)

Insert Geometry	Programmed Feed per Tooth (fz) as a % of Radial Depth of Cut (ae)														Insert Geometry	
	5%			10%			20%			30%			40-100%			
ALP	.005	.007	.009	.003	.005	.007	.003	.004	.005	.002	.003	.004	.002	.003	.004	ALP
ML	.008	.026	.048	.006	.019	.034	.004	.014	.026	.004	.012	.022	.003	.011	.020	ML
MM	.017	.030	.054	.012	.022	.039	.009	.016	.029	.008	.014	.025	.007	.013	.023	MM
MH	.028	.035	.058	.020	.025	.041	.015	.019	.031	.013	.016	.027	.012	.015	.024	MH

At .025 Axial Depth of Cut (ap)

Insert Geometry	Programmed Feed per Tooth (fz) as a % of Radial Depth of Cut (ae)														Insert Geometry	
	5%			10%			20%			30%			40-100%			
ALP	.005	.007	.009	.003	.005	.007	.003	.004	.005	.002	.003	.004	.002	.003	.004	ALP
ML	.011	.036	.066	.008	.026	.047	.006	.019	.035	.005	.017	.030	.005	.015	.028	ML
MM	.023	.041	.075	.016	.029	.053	.012	.022	.040	.011	.019	.035	.010	.018	.032	MM
MH	.038	.048	.079	.027	.034	.056	.020	.025	.042	.018	.022	.036	.016	.020	.033	MH

NOTE: Use "Light Machining" values as starting feed rate.

INDEXABLE MILLING
SOLID END MILLING
HOLEMAKING
TAPPING
TURNING

INDEXABLE MILLING

SOLID END MILLING

HOLEMAKING

TAPPING

TURNING

Insert Selection Guide

Material Group	Light Machining		General Purpose		Heavy Machining	
	Geometry	Grade	Geometry	Grade	Geometry	Grade
P1-P2	ML	WP25PM	MM	WP40PM	MM	WP40PM
P3-P4	ML	WP25PM	MM	WP25PM	MH	WP40PM
P5-P6	ML	WP35CM	MM	WP35CM	MH	WP35CM
M1-M2	ML	WP25PM	ML	WU35PM	MM	WU35PM
M3	ML	WP25PM	MM	WU35PM	MM	WU35PM
K1-K2	MH	WK15CM	MH	WK15CM	MH	WP20CM
K3	MH	WK15PM	MH	WK15PM	MH	WP25PM
N1-N2	ALP	WN25PM	ALP	WN25PM	ALP	WN25PM
N3	ALP	WN25PM	ALP	WN25PM	ALP	WN25PM
S1-S2	ML	WS30PM	MM	WS30PM	MM	WU35PM
S3	ML	WS30PM	MM	WU35PM	MM	WU35PM
S4	ML	WS30PM	MM	WU35PM	MM	WU35PM
H1	MH	WP25PM	MH	WP20CM	-	-

Recommended Starting Speeds [SFM]

Material Group		WK15CM	★ WK15PM	WN25PM	WP20CM	★ WP25PM	WP35CM	★ WP40PM	WS30PM	★ WS40PM	★ WU35PM	
P	1	-	-	-	2165 1910 1770	1295 1120 1060	1790 1555 1460	1165 1025 965	1460 1260 1180	-	-	1025 905 845
	2	-	-	-	1340 1220 1080	1080 940 785	1105 1000 905	985 845 710	1200 1060 865	-	-	865 750 630
	3	-	-	-	1220 1080 1000	1000 845 690	1000 905 805	905 770 630	1120 940 770	-	-	785 670 550
	4	-	-	-	905 845 750	890 725 590	750 690 630	805 670 535	985 805 650	-	-	710 590 475
	5	-	-	-	1080 985 905	725 670 590	1025 905 830	670 610 535	805 750 650	560 475 395	590 535 475	510 395 310
	6	-	-	-	750 670 570	650 490 395	630 535 430	590 450 355	725 550 430	490 360 260	510 395 310	
M	1	-	-	-	890 785 690	805 710 650	805 725 610	770 670 610	890 785 725	690 560 460	670 590 535	
	2	-	-	-	805 690 630	725 630 510	725 630 550	690 590 490	805 710 570	590 475 395	610 510 430	
	3	-	-	-	630 570 490	550 475 370	570 510 450	510 450 355	610 535 415	475 360 280	450 395 310	
K	1	1655 1520 1340	1060 965 845	-	1415 1280 1165	905 805 725	1165 1045 940	-	-	-	-	
	2	1320 1165 1080	830 750 690	-	1120 1000 925	710 630 590	925 830 750	-	-	-	-	
	3	1105 985 905	690 630 570	-	940 845 785	590 535 475	770 690 630	-	-	-	-	
N	1	-	-	4230 3720 3445	-	-	-	-	-	-	-	
	2	-	-	3720 3445 2995	-	-	-	-	-	-	-	
	3	-	-	3720 3445 2995	-	-	-	-	-	-	-	
S	1	-	-	-	-	155 140 95	-	155 140 120	180 155 120	130 115 80	140 120 95	
	2	-	-	-	-	155 140 95	-	155 140 120	180 155 120	130 115 80	140 120 95	
	3	-	-	-	-	200 155 95	-	200 155 120	215 180 120	165 130 80	180 140 95	
	4	-	-	-	-	275 200 140	260 200 130	260 200 140	335 235 155	195 165 100	235 180 120	
H	1	-	-	-	550 450 370	475 355 275	-	-	535 395 295	-	-	
	2	-	-	-	-	-	-	-	-	-	-	
	3	-	-	-	-	-	-	-	-	-	-	

NOTE: FIRST choice starting speeds are in bold type.
As the average chip thickness increases, the speed should be decreased.

★ = ALL-STAR PORTFOLIO PRODUCT. ALL-STAR PRODUCTS ARE PROVEN SOLUTIONS THAT ARE ALWAYS AVAILABLE.

Recommended Starting Feeds [IPT]

At .236 Axial Depth of Cut (ap)

Light Machining	General Purpose	Heavy Machining
-----------------	-----------------	-----------------

Insert Geometry	Programmed Feed per Tooth (fz) as a % of Radial Depth of Cut (ae)														Insert Geometry	
	5%			10%			20%			30%			40-100%			
ALP	.005	.007	.009	.003	.005	.007	.003	.004	.005	.002	.003	.004	.002	.003	.004	ALP
ML	.005	.007	.013	.004	.005	.009	.003	.004	.007	.002	.003	.006	.002	.003	.006	ML
MM	.011	.020	.032	.008	.014	.023	.006	.011	.017	.005	.009	.015	.005	.009	.014	MM
MH	.018	.027	.040	.013	.020	.029	.010	.015	.022	.009	.013	.019	.008	.012	.017	MH

At .118 Axial Depth of Cut (ap)

Insert Geometry	Programmed Feed per Tooth (fz) as a % of Radial Depth of Cut (ae)														Insert Geometry	
	5%			10%			20%			30%			40-100%			
ALP	.005	.007	.009	.003	.005	.007	.003	.004	.005	.002	.003	.004	.002	.003	.004	ALP
ML	.006	.008	.015	.004	.006	.011	.003	.004	.008	.003	.004	.007	.002	.004	.006	ML
MM	.013	.023	.038	.009	.016	.027	.007	.012	.020	.006	.011	.018	.005	.010	.016	MM
MH	.021	.032	.047	.015	.023	.033	.011	.017	.025	.010	.015	.022	.009	.014	.020	MH

At .059 Axial Depth of Cut (ap)

Insert Geometry	Programmed Feed per Tooth (fz) as a % of Radial Depth of Cut (ae)														Insert Geometry	
	5%			10%			20%			30%			40-100%			
ALP	.005	.007	.009	.003	.005	.007	.003	.004	.005	.002	.003	.004	.002	.003	.004	ALP
ML	.007	.011	.020	.005	.008	.014	.004	.006	.011	.003	.005	.009	.003	.005	.008	ML
MM	.017	.030	.050	.012	.022	.035	.009	.016	.026	.008	.014	.023	.007	.013	.021	MM
MH	.028	.042	.062	.020	.030	.044	.015	.022	.033	.013	.019	.028	.012	.018	.026	MH

At .030 Axial Depth of Cut (ap)

Insert Geometry	Programmed Feed per Tooth (fz) as a % of Radial Depth of Cut (ae)														Insert Geometry	
	5%			10%			20%			30%			40-100%			
ALP	.005	.007	.009	.003	.005	.007	.003	.004	.005	.002	.003	.004	.002	.003	.004	ALP
ML	.010	.015	.027	.007	.011	.019	.005	.008	.014	.005	.007	.013	.004	.006	.012	ML
MM	.023	.041	.068	.016	.029	.049	.012	.022	.036	.011	.019	.031	.010	.018	.029	MM
MH	.038	.058	.085	.027	.041	.060	.020	.031	.045	.018	.027	.039	.016	.024	.036	MH

NOTE: Use "Light Machining" values as starting feed rate.



INDEXABLE MILLING



SOLID END MILLING



HOLEMAKING



TAPPING



TURNING

INDEXABLE MILLING

SOLID END MILLING

HOLEMAKING

TAPPING

TURNING

Insert Selection Guide

Material Group	Light Machining		General Purpose		Heavy Machining	
	Geometry	Grade	Geometry	Grade	Geometry	Grade
P1-P2	RDMT-T	TN6525	RDMT-T	TN6540	RDMW-T	TN6540
P3-P4	RDMT-T	TN6525	RDMW-T	TN6540	RDMW-T	TN6540
P5-P6	RDMT-T	TN7525	RDMT-T	TN7535	RDMW-T	TN7535
M1-M2	RDHT-T	TN7525	RDMT-T	TN6540	RDMT-T	TN6540
M3	RDHT-T	TN7525	RDMT-T	TN6540	RDMT-T	TN6540
K1-K2	RDMW-MH	TN2510	RDMW-MH	TN2510	RDMW-T	TN7535
K3	RDMW-MH	TN2510	RDMW-MH	TN2510	RDMW-T	TN7535
N1-N2	-	-	-	-	-	-
N3	-	-	-	-	-	-
S1-S2	-	-	RDMT-T	TN6540	-	-
S3	-	-	RDMT-T	TN6540	-	-
S4	-	-	RDMT-T	TN6540	RDMT-T	TN6540
H1	RDMW-MH	TN2510	RDMW-MH	TN2510	-	-

Recommended Starting Speeds [SFM]

Material Group		TN2510			TN6525			TN6540			TN7525			TN7535			TTI25		
		P	1	2165	1910	1770	1340	1045	925	1180	925	785	1340	1025	925	1790	1555	1460	1415
	2	1340	1220	1080	1045	830	710	830	630	550	1025	830	710	1105	1000	905	1025	830	710
	3	1220	1080	1000	925	710	610	710	550	450	925	710	610	1000	905	805	1025	830	710
	4	905	845	750	770	550	475	590	430	355	770	550	475	750	690	630	865	710	590
	5	1080	985	905	1025	770	650	785	590	490	1025	770	650	1025	905	830	1045	770	650
	6	750	670	570	670	535	430	535	395	335	670	535	430	630	535	430	475	355	295
M	1	890	785	690	630	395	260	430	260	200	805	725	610	805	725	610	1570	1025	710
	2	805	690	630	395	260	155	260	155	140	725	630	550	725	630	550	1060	670	475
	3	630	570	490	415	260	180	275	155	140	570	510	450	570	510	450	1045	690	475
K	1	1380	1180	985	905	805	725	725	670	590	1240	925	785	1165	1045	940	725	610	510
	2	1180	985	830	710	630	590	570	510	450	1060	785	650	925	830	750	590	475	415
	3	985	830	650	590	535	475	510	475	415	785	650	550	770	690	630	475	415	335
N	1	-	-	-	-	-	-	-	-	-	-	-	-	-	-	-	-	-	-
	2	-	-	-	-	-	-	-	-	-	-	-	-	-	-	-	-	-	-
	3	-	-	-	-	-	-	-	-	-	-	-	-	-	-	-	-	-	-
S	1	-	-	-	-	-	-	155	120	95	-	-	-	-	-	-	-	-	-
	2	-	-	-	-	-	-	80	60	40	-	-	-	-	-	-	-	-	-
	3	-	-	-	-	-	-	235	140	95	-	-	-	-	-	-	-	-	-
	4	-	-	-	-	-	-	200	95	80	-	-	-	-	-	-	-	-	-
H	1	475	360	230	-	-	-	-	-	-	-	-	-	-	-	-	-	-	-
	2	475	360	230	-	-	-	-	-	-	-	-	-	-	-	-	-	-	-
	3	380	260	150	-	-	-	-	-	-	-	-	-	-	-	-	-	-	-

NOTE: FIRST choice starting speeds are in bold type.
As the average chip thickness increases, the speed should be decreased.

 = ALL-STAR PORTFOLIO PRODUCT. ALL-STAR PRODUCTS ARE PROVEN SOLUTIONS THAT ARE ALWAYS AVAILABLE.

Recommended Starting Feeds [IPT]

At .197 Axial Depth of Cut (ap)

Light Machining	General Purpose	Heavy Machining
-----------------	-----------------	-----------------

Insert Geometry	Programmed Feed per Tooth (fz) as a % of Radial Depth of Cut (ae)														Insert Geometry	
	5%			10%			20%			30%			40-100%			
RDHT-T	.009	.015	.026	.007	.011	.018	.005	.008	.014	.004	.007	.012	.004	.007	.011	RDHT-T
RDHW-MH	.009	.017	.035	.007	.012	.025	.005	.009	.019	.004	.008	.016	.004	.007	.015	RDHW-MH
RDMT-T	.009	.015	.026	.007	.011	.018	.005	.008	.014	.004	.007	.012	.004	.007	.011	RDMT-T
RDMW-	.009	.008	.024	.007	.006	.017	.005	.004	.013	.004	.004	.011	.004	.004	.010	RDMW-
RDMW-T	.009	.022	.035	.007	.016	.025	.005	.012	.019	.004	.011	.016	.004	.010	.015	RDMW-T

At .098 Axial Depth of Cut (ap)

Insert Geometry	Programmed Feed per Tooth (fz) as a % of Radial Depth of Cut (ae)														Insert Geometry	
	5%			10%			20%			30%			40-100%			
RDHT-T	.010	.018	.030	.008	.013	.021	.006	.010	.016	.005	.008	.014	.005	.008	.013	RDHT-T
RDHW-MH	.010	.019	.040	.008	.014	.029	.006	.010	.021	.005	.009	.019	.005	.008	.017	RDHW-MH
RDMT-T	.010	.018	.030	.008	.013	.021	.006	.010	.016	.005	.008	.014	.005	.008	.013	RDMT-T
RDMW-	.010	.009	.027	.008	.007	.020	.006	.005	.015	.005	.004	.013	.005	.004	.012	RDMW-
RDMW-T	.010	.026	.040	.008	.019	.029	.006	.014	.021	.005	.012	.019	.005	.011	.017	RDMW-T

At .049 Axial Depth of Cut (ap)

Insert Geometry	Programmed Feed per Tooth (fz) as a % of Radial Depth of Cut (ae)														Insert Geometry	
	5%			10%			20%			30%			40-100%			
RDHT-T	.014	.023	.039	.010	.017	.028	.007	.012	.021	.006	.011	.018	.006	.010	.017	RDHT-T
RDHW-MH	.014	.025	.053	.010	.018	.038	.007	.014	.028	.006	.012	.025	.006	.011	.022	RDHW-MH
RDMT-T	.014	.023	.039	.010	.017	.028	.007	.012	.021	.006	.011	.018	.006	.010	.017	RDMT-T
RDMW-	.014	.012	.036	.010	.009	.026	.007	.007	.019	.006	.006	.017	.006	.005	.015	RDMW-
RDMW-T	.014	.034	.053	.010	.024	.038	.007	.018	.028	.006	.016	.025	.006	.015	.022	RDMW-T

At .025 Axial Depth of Cut (ap)

Insert Geometry	Programmed Feed per Tooth (fz) as a % of Radial Depth of Cut (ae)														Insert Geometry	
	5%			10%			20%			30%			40-100%			
RDHT-T	.019	.032	.053	.014	.023	.038	.010	.017	.028	.009	.015	.025	.008	.014	.023	RDHT-T
RDHW-MH	.019	.034	.073	.014	.025	.052	.010	.019	.039	.009	.016	.034	.008	.015	.031	RDHW-MH
RDMT-T	.019	.032	.053	.014	.023	.038	.010	.017	.028	.009	.015	.025	.008	.014	.023	RDMT-T
RDMW-	.019	.017	.049	.014	.012	.035	.010	.009	.026	.009	.008	.023	.008	.007	.021	RDMW-
RDMW-T	.019	.047	.073	.014	.033	.052	.010	.025	.039	.009	.022	.034	.008	.020	.031	RDMW-T

NOTE: Use "Light Machining" values as starting feed rate.



INDEXABLE MILLING



SOLID END MILLING



HOLEMAKING



TAPPING



TURNING

INDEXABLE MILLING

SOLID END MILLING

HOLEMAKING

TAPPING

TURNING

Insert Selection Guide

Material Group	Light Machining		General Purpose		Heavy Machining	
	Geometry	Grade	Geometry	Grade	Geometry	Grade
P1-P2	RDMT-TX	TN7525	RDMT-TX	TN6540	RDMT-TX	TN6540
P3-P4	RDMT-TX	TN7525	RDMW-TX	TN6540	RDMW-TX	TN6540
P5-P6	RDMT-TX	TN7525	RDPT-MMX	TN7535	RDPT-MMX	TN7535
M1-M2	RDHT-TX	TN7525	RDMT-TX	TN6540	RDPT-MMX	TN6540
M3	RDHT-TX	TN7525	RDMT-TX	TN6540	RDPT-MMX	TN6540
K1-K2	RDMW-TX	WK15CM	RDMW-TX	WK15CM	RDMW-TX	TN7535
K3	RDHW-MH	TN2510	RDMW-TX	WK15CM	RDMW-TX	WK15CM
N1-N2	-	-	-	-	-	-
N3	-	-	-	-	-	-
S1-S2	-	-	RDMT-TX	TN6540	-	-
S3	-	-	RDMT-TX	TN6540	-	-
S4	-	-	RDMT-TX	TN6540	RDPT-MMX	TN6540
H1	RDHW-MH	TN2510	RDHW-MH	TN2510	-	-

Recommended Starting Speeds [SFM]

Material Group		TN2510			TN6525			TN6540			TN7525			TN7535			WK15CM			WS30PM			TTI25		
		P	1	2165	1910	1770	1340	1045	925	1180	925	785	1340	1025	925	1790	1555	1460	-	-	-	-	-	-	1415
	2	1340	1220	1080	1045	830	710	830	630	550	1025	830	710	1105	1000	905	-	-	-	-	-	-	1025	830	710
	3	1220	1080	1000	925	710	610	710	550	450	925	710	610	1000	905	805	-	-	-	-	-	-	1025	830	710
	4	905	845	750	770	550	475	590	430	355	770	550	475	750	690	630	-	-	-	-	-	-	865	710	590
	5	1080	985	905	1025	770	650	785	590	490	1025	770	650	1025	905	830	-	-	-	-	-	-	1045	770	650
	6	750	670	570	670	535	430	535	395	335	670	535	430	630	535	430	-	-	-	-	-	-	475	355	295
M	1	890	785	690	630	395	260	430	260	200	805	725	610	805	725	610	-	-	-	890	785	725	1570	1025	710
	2	805	690	630	395	260	155	260	155	140	725	630	550	725	630	550	-	-	-	805	710	570	1060	670	475
	3	630	570	490	415	260	180	275	155	140	570	510	450	570	510	450	-	-	-	610	535	415	1045	690	475
K	1	1380	1180	985	905	805	725	725	670	590	1240	925	785	1165	1045	940	1655	1520	1340	-	-	-	725	610	510
	2	1180	985	830	710	630	590	570	510	450	1060	785	650	925	830	750	1320	1165	1080	-	-	-	590	475	415
	3	985	830	650	590	535	475	510	475	415	785	650	550	770	690	630	1105	985	905	-	-	-	475	415	335
N	1	-	-	-	-	-	-	-	-	-	-	-	-	-	-	-	-	-	-	-	-	-	-	-	-
	2	-	-	-	-	-	-	-	-	-	-	-	-	-	-	-	-	-	-	-	-	-	-	-	-
	3	-	-	-	-	-	-	-	-	-	-	-	-	-	-	-	-	-	-	-	-	-	-	-	-
S	1	-	-	-	-	-	-	155	120	95	-	-	-	-	-	-	-	-	-	180	155	120	-	-	-
	2	-	-	-	-	-	-	80	60	40	-	-	-	-	-	-	-	-	-	180	155	120	-	-	-
	3	-	-	-	-	-	-	235	140	95	-	-	-	-	-	-	-	-	-	215	180	120	-	-	-
	4	-	-	-	-	-	-	200	95	80	-	-	-	-	-	-	-	-	-	335	235	155	-	-	-
H	1	475	360	230	-	-	-	-	-	-	-	-	-	-	-	-	-	-	-	-	-	-	-	-	-
	2	475	360	230	-	-	-	-	-	-	-	-	-	-	-	-	-	-	-	-	-	-	-	-	-
	3	380	260	150	-	-	-	-	-	-	-	-	-	-	-	-	-	-	-	-	-	-	-	-	-

NOTE: FIRST choice starting speeds are in **bold** type.
As the average chip thickness increases, the speed should be decreased.

 = ALL-STAR PORTFOLIO PRODUCT. ALL-STAR PRODUCTS ARE PROVEN SOLUTIONS THAT ARE ALWAYS AVAILABLE.

Recommended Starting Feeds [IPT]

At .236 Axial Depth of Cut (ap)

Light Machining	General Purpose	Heavy Machining
-----------------	-----------------	-----------------

Insert Geometry	Programmed Feed per Tooth (fz) as a % of Radial Depth of Cut (ae)														Insert Geometry	
	5%			10%			20%			30%			40-100%			
RDHT-TX	.014	.013	.022	.010	.009	.016	.007	.007	.012	.006	.006	.010	.006	.006	.009	RDHT-TX
RDMT-TX	.014	.016	.027	.010	.012	.020	.007	.009	.015	.006	.008	.013	.006	.007	.012	RDMT-TX
RDPT-MMX	.014	.023	.037	.010	.016	.026	.007	.012	.020	.006	.011	.017	.006	.010	.016	RDPT-MMX
RDHW-MH	.014	.027	.042	.010	.020	.031	.007	.015	.023	.006	.013	.020	.006	.012	.018	RDHW-MH
RDMW-TX	.014	.027	.046	.010	.020	.033	.007	.015	.024	.006	.013	.021	.006	.012	.019	RDMW-TX

At .118 Axial Depth of Cut (ap)

Insert Geometry	Programmed Feed per Tooth (fz) as a % of Radial Depth of Cut (ae)														Insert Geometry	
	5%			10%			20%			30%			40-100%			
RDHT-TX	.016	.015	.025	.011	.011	.018	.009	.008	.014	.007	.007	.012	.007	.007	.011	RDHT-TX
RDMT-TX	.016	.019	.032	.011	.014	.023	.009	.010	.017	.007	.009	.015	.007	.008	.014	RDMT-TX
RDPT-MMX	.016	.026	.043	.011	.019	.031	.009	.014	.023	.007	.012	.020	.007	.011	.018	RDPT-MMX
RDHW-MH	.016	.032	.049	.011	.023	.035	.009	.017	.026	.007	.015	.023	.007	.014	.021	RDHW-MH
RDMW-TX	.016	.032	.053	.011	.023	.038	.009	.017	.028	.007	.015	.025	.007	.014	.022	RDMW-TX

At .059 Axial Depth of Cut (ap)

Insert Geometry	Programmed Feed per Tooth (fz) as a % of Radial Depth of Cut (ae)														Insert Geometry	
	5%			10%			20%			30%			40-100%			
RDHT-TX	.021	.020	.033	.015	.014	.024	.011	.011	.018	.010	.009	.016	.009	.009	.014	RDHT-TX
RDMT-TX	.021	.025	.042	.015	.018	.030	.011	.013	.022	.010	.012	.019	.009	.011	.018	RDMT-TX
RDPT-MMX	.021	.035	.056	.015	.025	.040	.011	.019	.030	.010	.016	.026	.009	.015	.024	RDPT-MMX
RDHW-MH	.021	.042	.065	.015	.030	.046	.011	.022	.034	.010	.019	.030	.009	.018	.027	RDHW-MH
RDMW-TX	.021	.042	.070	.015	.030	.050	.011	.022	.037	.010	.019	.032	.009	.018	.029	RDMW-TX

At .030 Axial Depth of Cut (ap)

Insert Geometry	Programmed Feed per Tooth (fz) as a % of Radial Depth of Cut (ae)														Insert Geometry	
	5%			10%			20%			30%			40-100%			
RDHT-TX	.028	.027	.046	.020	.020	.033	.015	.015	.024	.013	.013	.021	.012	.012	.019	RDHT-TX
RDMT-TX	.028	.034	.057	.020	.025	.041	.015	.018	.031	.013	.016	.027	.012	.015	.024	RDMT-TX
RDPT-MMX	.028	.047	.077	.020	.034	.055	.015	.025	.041	.013	.022	.036	.012	.020	.033	RDPT-MMX
RDHW-MH	.028	.058	.090	.020	.041	.064	.015	.031	.047	.013	.027	.041	.012	.024	.037	RDHW-MH
RDMW-TX	.028	.058	.097	.020	.041	.068	.015	.031	.051	.013	.027	.044	.012	.024	.040	RDMW-TX

NOTE: Use "Light Machining" values as starting feed rate.



INDEXABLE MILLING



SOLID END MILLING



HOLE MAKING



TAPPING



TURNING

Insert Selection Guide • RD1605

Material Group	Light Machining		General Purpose		Heavy Machining	
	Geometry	Grade	Geometry	Grade	Geometry	Grade
P1-P2	RDMT-TX	TN6525	RDMT-TX	TN6540	RDMT-TX	TN6540
P3-P4	RDMT-TX	TN6525	RDMW-TX	TN6540	RDMW-TX	TN6540
P5-P6	RDMT-TX	TN7525	RDMT-TX	TN7535	RDMT-TX	TN7535
M1-M2	RDMT-TX	TN6525	RDMT-TX	TN6540	RDMT-TX	TN6540
M3	RDMT-TX	TN6525	RDMT-TX	TN6540	RDMT-TX	TN6540
K1-K2	RDMW-TX	TN2510	RDMW-TX	TN7535	RDMW-TX	TN7535
K3	RDMW-TX	TN2510	RDMW-TX	TN7535	RDMW-TX	TN7535
N1-N2	-	-	-	-	-	-
N3	-	-	-	-	-	-
S1-S2	-	-	RDMT-TX	TN6540	-	-
S3	-	-	RDMT-TX	TN6540	-	-
S4	-	-	RDMT-TX	TN6540	RDMT-TX	TN6540
H1	RDMW-TX	TN2510	RDMW-TX	TN2510	-	-

Recommended Starting Speeds [SFM] • RD1605

Material Group		TN2510			TN6525			TN6540			★ TN7525			TN7535			TTI25		
		1	2	3	1	2	3	1	2	3	1	2	3	1	2	3	1	2	3
P	1	2165	1910	1770	1340	1045	925	1180	925	785	1340	1025	925	1790	1555	1460	1415	1180	985
	2	1340	1220	1080	1045	830	710	830	630	550	1025	830	710	1105	1000	905	1025	830	710
	3	1220	1080	1000	925	710	610	710	550	450	925	710	610	1000	905	805	1025	830	710
	4	905	845	750	770	550	475	590	430	355	770	550	475	750	690	630	865	710	590
	5	1080	985	905	1025	770	650	785	590	490	1025	770	650	1025	905	830	1045	770	650
	6	750	670	570	670	535	430	535	395	335	670	535	430	630	535	430	475	355	295
M	1	890	785	690	630	395	260	430	260	200	805	725	610	805	725	610	1570	1025	710
	2	805	690	630	395	260	155	260	155	140	725	630	550	725	630	550	1060	670	475
	3	630	570	490	415	260	180	275	155	140	570	510	450	570	510	450	1045	690	475
K	1	1380	1180	985	905	805	725	725	670	590	1240	925	785	1165	1045	940	725	610	510
	2	1180	985	830	710	630	590	570	510	450	1060	785	650	925	830	750	590	475	415
	3	985	830	650	590	535	475	510	475	415	785	650	550	770	690	630	475	415	335
N	1	-	-	-	-	-	-	-	-	-	-	-	-	-	-	-	-	-	-
	2	-	-	-	-	-	-	-	-	-	-	-	-	-	-	-	-	-	-
	3	-	-	-	-	-	-	-	-	-	-	-	-	-	-	-	-	-	-
S	1	-	-	-	-	-	-	155	120	95	-	-	-	-	-	-	-	-	-
	2	-	-	-	-	-	-	80	60	40	-	-	-	-	-	-	-	-	-
	3	-	-	-	-	-	-	235	140	95	-	-	-	-	-	-	-	-	-
	4	-	-	-	-	-	-	200	95	80	-	-	-	-	-	-	-	-	-
H	1	475	360	230	-	-	-	-	-	-	-	-	-	-	-	-	-	-	-
	2	475	360	230	-	-	-	-	-	-	-	-	-	-	-	-	-	-	-
	3	380	260	150	-	-	-	-	-	-	-	-	-	-	-	-	-	-	-

NOTE: FIRST choice starting speeds are in **bold** type.
As the average chip thickness increases, the speed should be decreased.

★ = ALL-STAR PORTFOLIO PRODUCT. ALL-STAR PRODUCTS ARE PROVEN SOLUTIONS THAT ARE ALWAYS AVAILABLE.

Recommended Starting Feeds [IPT] • RD1605

At .315 Axial Depth of Cut (ap)

Light Machining	General Purpose	Heavy Machining
-----------------	-----------------	-----------------

Insert Geometry	Programmed Feed per Tooth (fz) as a % of Radial Depth of Cut (ae)														Insert Geometry	
	5%			10%			20%			30%			40-100%			
RDHX-TX	.005	.014	.027	.003	.010	.020	.002	.007	.015	.002	.006	.013	.002	.006	.012	RDHX-TX
RDMT-TX	.009	.016	.033	.007	.012	.024	.005	.009	.018	.004	.008	.016	.004	.007	.014	RDMT-TX
RDMW-TX	.009	.020	.041	.007	.015	.030	.005	.011	.022	.004	.010	.019	.004	.009	.018	RDMW-TX

At .157 Axial Depth of Cut (ap)

Insert Geometry	Programmed Feed per Tooth (fz) as a % of Radial Depth of Cut (ae)														Insert Geometry	
	5%			10%			20%			30%			40-100%			
RDHX-TX	.005	.016	.032	.004	.011	.023	.003	.008	.017	.002	.007	.015	.002	.007	.014	RDHX-TX
RDMT-TX	.010	.019	.038	.008	.014	.028	.006	.010	.021	.005	.009	.018	.005	.008	.016	RDMT-TX
RDMW-TX	.010	.024	.048	.008	.017	.034	.006	.013	.026	.005	.011	.022	.005	.010	.020	RDMW-TX

At .079 Axial Depth of Cut (ap)

Insert Geometry	Programmed Feed per Tooth (fz) as a % of Radial Depth of Cut (ae)														Insert Geometry	
	5%			10%			20%			30%			40-100%			
RDHX-TX	.007	.021	.042	.005	.015	.030	.004	.011	.022	.003	.010	.019	.003	.009	.018	RDHX-TX
RDMT-TX	.014	.025	.050	.010	.018	.036	.007	.013	.027	.006	.012	.023	.006	.011	.021	RDMT-TX
RDMW-TX	.014	.031	.063	.010	.022	.045	.007	.017	.034	.006	.015	.029	.006	.013	.027	RDMW-TX

At .039 Axial Depth of Cut (ap)

Insert Geometry	Programmed Feed per Tooth (fz) as a % of Radial Depth of Cut (ae)														Insert Geometry	
	5%			10%			20%			30%			40-100%			
RDHX-TX	.009	.028	.057	.007	.020	.041	.005	.015	.030	.004	.013	.027	.004	.012	.024	RDHX-TX
RDMT-TX	.019	.034	.070	.014	.025	.050	.010	.018	.037	.009	.016	.032	.008	.015	.029	RDMT-TX
RDMW-TX	.019	.043	.088	.014	.031	.062	.010	.023	.046	.009	.020	.040	.008	.018	.037	RDMW-TX

NOTE: Use "Light Machining" values as starting feed rate.



INDEXABLE MILLING



SOLID END MILLING



HOLEMAKING



TAPPING



TURNING

INDEXABLE MILLING

SOLID END MILLING

HOLEMAKING

TAPPING

TURNING

Insert Selection Guide • RD1606

Material Group	Light Machining		General Purpose		Heavy Machining	
	Geometry	Grade	Geometry	Grade	Geometry	Grade
P1-P2	...TX	TN6525	...43M	TN6540	...43M	TN6540
P3-P4	...TX	TN6525	...TX	TN6540	...43M	TN6540
P5-P6	...TX	TN6525	...TX	TN7535	...TX	TN7535
M1-M2	...TX	TN6525	...TX	TN6540	...TX	TN6540
M3	...TX	TN6525	...TX	TN6540	...TX	TN6540
K1-K2	...43	TN2510	...TX	WK15CM	...TX	WK15CM
K3	...TX	TN6525	...TX	WK15CM	...TX	WK15CM
N1-N2	-	-	-	-	-	-
N3	-	-	-	-	-	-
S1-S2	-	-	-	-	-	-
S3	-	-	-	-	-	-
S4	...43M	TN6540	...TX	TN6540	...TX	TN6540
H1	-	-	...TX	TN2510	-	-

Recommended Starting Speeds [SFM] • RD1606

Material Group		TN2510			TN6525			★ TN6540			★ TN7525			TN7535			WK15CM		
		P	1	2165	1910	1770	1340	1045	925	1180	925	785	1340	1025	925	1790	1555	1460	-
	2	1340	1220	1080	1045	830	710	830	630	550	1025	830	710	1105	1000	905	-	-	-
	3	1220	1080	1000	925	710	610	710	550	450	925	710	610	1000	905	805	-	-	-
	4	905	845	750	770	550	475	590	430	355	770	550	475	750	690	630	-	-	-
	5	1080	985	905	1025	770	650	785	590	490	1025	770	650	1025	905	830	-	-	-
	6	750	670	570	670	535	430	535	395	335	670	535	430	630	535	430	-	-	-
M	1	890	785	690	630	395	260	430	260	200	805	725	610	805	725	610	-	-	-
	2	805	690	630	395	260	155	260	155	140	725	630	550	725	630	550	-	-	-
	3	630	570	490	415	260	180	275	155	140	570	510	450	570	510	450	-	-	-
K	1	1380	1180	985	905	805	725	725	670	590	1240	925	785	1165	1045	940	1655	1520	1340
	2	1180	985	830	710	630	590	570	510	450	1060	785	650	925	830	750	1320	1165	1080
	3	985	830	650	590	535	475	510	475	415	785	650	550	770	690	630	1105	985	905
N	1	-	-	-	-	-	-	-	-	-	-	-	-	-	-	-	-	-	-
	2	-	-	-	-	-	-	-	-	-	-	-	-	-	-	-	-	-	-
	3	-	-	-	-	-	-	-	-	-	-	-	-	-	-	-	-	-	-
S	1	-	-	-	-	-	-	155	120	95	-	-	-	-	-	-	-	-	-
	2	-	-	-	-	-	-	80	60	40	-	-	-	-	-	-	-	-	-
	3	-	-	-	-	-	-	235	140	95	-	-	-	-	-	-	-	-	-
	4	-	-	-	-	-	-	200	95	80	-	-	-	-	-	-	-	-	-
H	1	475	360	230	-	-	-	-	-	-	-	-	-	-	-	-	-	-	-
	2	475	360	230	-	-	-	-	-	-	-	-	-	-	-	-	-	-	-
	3	380	260	150	-	-	-	-	-	-	-	-	-	-	-	-	-	-	-

NOTE: FIRST choice starting speeds are in **bold** type.
As the average chip thickness increases, the speed should be decreased.

★ = ALL-STAR PORTFOLIO PRODUCT. ALL-STAR PRODUCTS ARE PROVEN SOLUTIONS THAT ARE ALWAYS AVAILABLE.

Recommended Starting Feeds [IPT] • RD1606

At .315 Axial Depth of Cut (ap)

Light Machining	General Purpose	Heavy Machining
-----------------	-----------------	-----------------

Insert Geometry	Programmed Feed per Tooth (fz) as a % of Radial Depth of Cut (ae)														Insert Geometry	
	5%			10%			20%			30%		40-100%				
...43	.018	.024	.037	.013	.017	.027	.010	.013	.020	.009	.011	.017	.008	.010	.016	...43
...TX	.018	.027	.044	.013	.020	.032	.010	.015	.024	.009	.013	.021	.008	.012	.019	...TX

At .157 Axial Depth of Cut (ap)

Insert Geometry	Programmed Feed per Tooth (fz) as a % of Radial Depth of Cut (ae)														Insert Geometry	
	5%			10%			20%			30%		40-100%				
...43	.021	.028	.043	.015	.020	.031	.011	.015	.023	.010	.013	.020	.009	.012	.018	...43
...TX	.021	.032	.051	.015	.023	.037	.011	.017	.027	.010	.015	.024	.009	.014	.022	...TX

At .079 Axial Depth of Cut (ap)

Insert Geometry	Programmed Feed per Tooth (fz) as a % of Radial Depth of Cut (ae)														Insert Geometry	
	5%			10%			20%			30%		40-100%				
...43	.028	.036	.056	.020	.026	.040	.015	.019	.030	.013	.017	.026	.012	.016	.024	...43
...TX	.028	.042	.067	.020	.030	.048	.015	.022	.036	.013	.019	.031	.012	.018	.028	...TX

At .039 Axial Depth of Cut (ap)

Insert Geometry	Programmed Feed per Tooth (fz) as a % of Radial Depth of Cut (ae)														Insert Geometry	
	5%			10%			20%			30%		40-100%				
...43	.038	.050	.078	.027	.036	.055	.020	.027	.041	.018	.023	.036	.016	.021	.033	...43
...TX	.038	.058	.093	.027	.041	.066	.020	.031	.049	.018	.027	.042	.016	.024	.039	...TX

NOTE: Use "Light Machining" values as starting feed rate.

INDEXABLE MILLING

SOLID END MILLING

HOLEMAKING

TAPPING

TURNING

SOLID END MILLING

HIGH-PERFORMANCE SOLID CARBIDE END MILLS

Pages F48–F66

- VariMill I™
- VariMill II™
- VariMill III™
- AluSurf™
- HP Finishing
- HP Roughing



GENERAL PURPOSE SOLID CARBIDE END MILLS

Pages F68–F79

- GP 2-Flute
- GP 3-Flute
- GP 4-Flute



AEROSPACE TECHNOLOGY

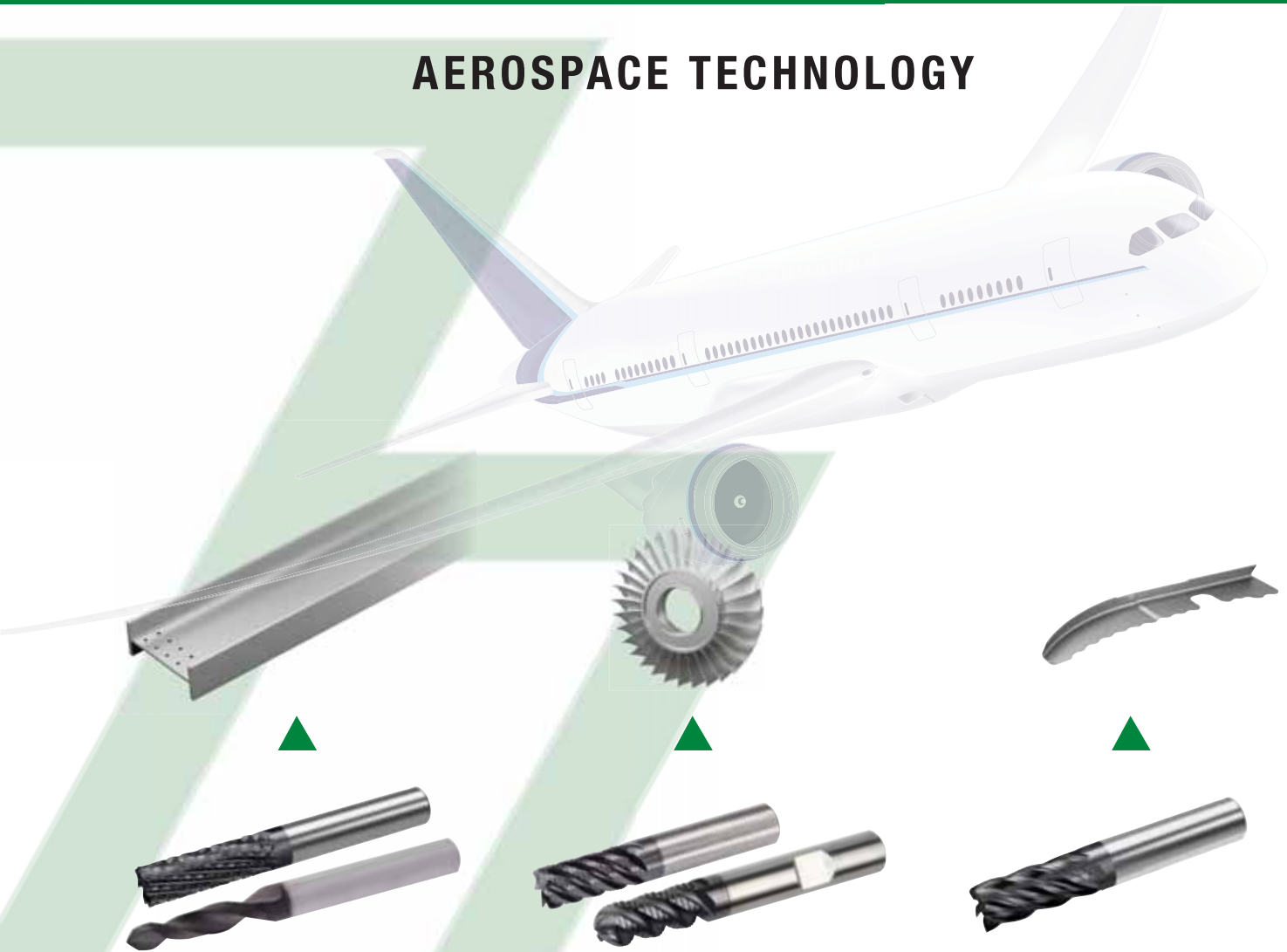

WIDIA drills for composite machining utilize PCD and diamond coatings made for the machining of aerospace CFRP (Carbon Fiber Reinforced Plastics). These coatings enable longer tool life at much higher machining speeds.

Integral Blade Rotor (IBR) machining end mills are designed to match a multi-level machining process for the airfoils, followed by the fillet feature, which works for roughing and finishing operations.

WIDIA-Hanita™ end mills produce consistent performance each and every run, allowing the production of more parts per tool and less downtime, while machining tough materials like INCONEL® depressor fine seals.



WIDIA offers machining strategies and innovative tooling technology specifically engineered for the aerospace industry to increase productivity and reduce costs.

TO SEE ALL PRODUCTS LINES, VISIT OUR DIGITAL RESOURCES



WIDIA NOVO™ Application
Download to your desktop or tablet:
widia.com/novo



WIDIA™ Machining Central Mobile App
Download for iOS or Android:
widia.com/en/featured/WidiaMobileApp

HIGH-PERFORMANCE SOLID CARBIDE

VariMill I™

Pages F50–F53

This 4-flute geometry is designed with unequal flute spacing for plunging, slotting, and profiling at the highest possible feed rates for a wide range of materials.



VariMill II™

Pages F54–F57

This 5-flute geometry is designed with unequal flute spacing for advanced milling jobs in a wide range of materials.

VariMill III™

Pages F58–F61

This 7-flute geometry is designed with unequal flute spacing and is designed to provide the highest Metal Removal Rates (MRR) and extended tool life in the most demanding materials in the aerospace industry.



ALUMINUM CARBIDE END MILLS



AluSurf™

Page F62

AluSurf end mills provide extraordinary Metal Removal Rates (MRR) by combining roughing and finishing operations for any aluminum plunging, slotting, and profiling application. Its proprietary flute geometry is designed for rigidity and improved chip evacuation generating exceptional wall-to-floor perpendicularity, even in thin wall applications.



HP ROUGHING

Pages F64–F66

Special proprietary carbide substrates and state-of-the-art surface technology, combined with unique geometries, provides end users with the capability to significantly reduce machining time with heavier and deeper cuts, fewer passes, and faster surface speed. WIDIA™ geometries are uniquely formed and fine-tuned to optimize chip form, size, and evacuation generated by a given workpiece material.

HP FINISHING

Page F63

Only the finest carbide substrates with market-leading geometries and state-of-the-art surface technology are used to ensure the highest quality finishing end mills are produced. These tools are fully compliant with NAS specifications. Whether you require higher metal removal rates, improved surface finishes, fewer passes, or longer tool life, WIDIA-Hanita™ high-performance finishing end mills deliver the reliability and consistency you can depend on during your critical finishing operations.



TO SEE ALL PRODUCTS LINES, VISIT OUR DIGITAL RESOURCES



WIDIA NOVO™ Application
Download to your desktop or tablet:
widia.com/novo



WIDIA™ Machining Central Mobile App
Download for iOS or Android:
widia.com/en/featured/WidiaMobileApp

[youtube.com/WIDIASolutions](https://www.youtube.com/WIDIASolutions)

[linkedin.com/WIDIAProductGrp](https://www.linkedin.com/WIDIAProductGrp)

[facebook.com/WIDIAProductGrp](https://www.facebook.com/WIDIAProductGrp)

WIDIA

To learn more, visit widia.com

Application Data • VariMill I™ • Series 4777 • Metric

Material Group	Side Milling (A) and Slotting (B)			Recommended feed per tooth (fz = mm/th) for side milling (A). For slotting (B), reduce fz by 20%.															
				Cutting Speed – vc m/min		D1 – Diameter													
	A		B	min	max	mm	4,0	5,0	6,0	8,0	10,0	12,0	14,0	16,0	18,0	20,0	25,0		
	ap	ae	ap																
P	0	1.5 x D	0.5 x D	1 x D	150	–	200	fz	0.028	0.036	0.044	0.060	0.072	0.083	0.092	0.101	0.108	0.114	0.124
	1	1.5 x D	0.5 x D	1 x D	150	–	200	fz	0.028	0.036	0.044	0.060	0.072	0.083	0.092	0.101	0.108	0.114	0.124
	2	1.5 x D	0.5 x D	1 x D	140	–	190	fz	0.028	0.036	0.044	0.060	0.072	0.083	0.092	0.101	0.108	0.114	0.124
	3	1.5 x D	0.5 x D	1 x D	120	–	160	fz	0.023	0.030	0.036	0.050	0.061	0.070	0.079	0.087	0.095	0.101	0.114
	4	1.5 x D	0.5 x D	0.75 x D	90	–	150	fz	0.021	0.027	0.033	0.045	0.054	0.062	0.070	0.077	0.083	0.088	0.098
	5	1.5 x D	0.5 x D	1 x D	60	–	100	fz	0.019	0.024	0.029	0.040	0.048	0.056	0.063	0.070	0.076	0.081	0.091
M	1	1.5 x D	0.5 x D	1 x D	90	–	115	fz	0.023	0.030	0.036	0.050	0.061	0.070	0.079	0.087	0.095	0.101	0.114
	2	1.5 x D	0.5 x D	1 x D	60	–	80	fz	0.019	0.024	0.029	0.040	0.048	0.056	0.063	0.070	0.076	0.081	0.091
	3	1.5 x D	0.5 x D	1 x D	60	–	70	fz	0.016	0.020	0.025	0.034	0.040	0.047	0.052	0.057	0.061	0.065	0.071
K	1	1.5 x D	0.5 x D	1 x D	120	–	150	fz	0.028	0.036	0.044	0.060	0.072	0.083	0.092	0.101	0.108	0.114	0.124
	2	1.5 x D	0.5 x D	1 x D	110	–	140	fz	0.023	0.030	0.036	0.050	0.061	0.070	0.079	0.087	0.095	0.101	0.114
	3	1.5 x D	0.5 x D	1 x D	110	–	130	fz	0.019	0.024	0.029	0.040	0.048	0.056	0.063	0.070	0.076	0.081	0.091
S	1	1.5 x D	0.3 x D	0.3 x D	50	–	90	fz	0.023	0.030	0.036	0.050	0.061	0.070	0.079	0.087	0.095	0.101	0.114
	2	1.5 x D	0.3 x D	0.3 x D	25	–	40	fz	0.013	0.016	0.019	0.026	0.032	0.037	0.042	0.046	0.050	0.054	0.061
	3	1.5 x D	0.5 x D	1 x D	60	–	80	fz	0.019	0.024	0.029	0.040	0.048	0.056	0.063	0.070	0.076	0.081	0.091
H	1	1.5 x D	0.5 x D	1 x D	50	–	60	fz	0.016	0.021	0.026	0.037	0.045	0.052	0.058	0.064	0.069	0.074	0.084
	2	1.5 x D	0.5 x D	0.75 x D	80	–	140	fz	0.021	0.027	0.033	0.045	0.054	0.062	0.070	0.077	0.083	0.088	0.098

NOTE: Lower value of cutting speed is used for high stock removal applications or for higher hardness (machinability) within group.
Higher value of cutting speed is used for finishing applications or for lower hardness (machinability) within group.
Above parameters are based on ideal conditions. For smaller taper machining centers, please adjust parameters accordingly on >12mm diameters.



Application Data • VariMill I™ • Series 4V05 4V15 4V45 4V65 • Inch

Material Group	Side Milling (A) and Slotting (B)			Recommended feed per tooth (IPT = inch/th) for side milling (A). For slotting (B), reduce IPT by 20%.															
				Cutting Speed – vc SFM		D1 – Diameter													
	A		B	min	max	frac. dec.	1/8	3/16	1/4	5/16	7/16	3/8	1/2	5/8	3/4	1	1 1/4		
	ap	ae	ap																
P	0	1.5 x D	0.5 x D	1 x D	490	–	660	IPT	.0009	.0013	.0018	.0023	.0031	.0027	.0034	.0039	.0044	.0049	.0049
	1	1.5 x D	0.5 x D	1 x D	490	–	660	IPT	.0009	.0013	.0018	.0023	.0031	.0027	.0034	.0039	.0044	.0049	.0049
	2	1.5 x D	0.5 x D	1 x D	460	–	620	IPT	.0009	.0013	.0018	.0023	.0031	.0027	.0034	.0039	.0044	.0049	.0049
	3	1.5 x D	0.5 x D	1 x D	390	–	520	IPT	.0007	.0011	.0015	.0020	.0026	.0023	.0029	.0034	.0039	.0045	.0048
	4	1.5 x D	0.5 x D	0.75 x D	300	–	490	IPT	.0007	.0010	.0014	.0017	.0023	.0020	.0026	.0030	.0034	.0039	.0040
	5	1.5 x D	0.5 x D	1 x D	200	–	330	IPT	.0006	.0009	.0012	.0016	.0021	.0018	.0023	.0027	.0031	.0036	.0039
M	1	1.5 x D	0.5 x D	1 x D	300	–	380	IPT	.0007	.0011	.0015	.0020	.0026	.0023	.0029	.0034	.0039	.0045	.0048
	2	1.5 x D	0.5 x D	1 x D	200	–	260	IPT	.0006	.0009	.0012	.0016	.0021	.0018	.0023	.0027	.0031	.0036	.0039
	3	1.5 x D	0.5 x D	1 x D	200	–	230	IPT	.0005	.0008	.0010	.0013	.0017	.0015	.0019	.0022	.0025	.0028	.0029
K	1	1.5 x D	0.5 x D	1 x D	390	–	490	IPT	.0009	.0013	.0018	.0023	.0031	.0027	.0034	.0039	.0044	.0049	.0049
	2	1.5 x D	0.5 x D	1 x D	360	–	460	IPT	.0007	.0011	.0015	.0020	.0026	.0023	.0029	.0034	.0039	.0045	.0048
	3	1.5 x D	0.5 x D	1 x D	360	–	430	IPT	.0006	.0009	.0012	.0016	.0021	.0018	.0023	.0027	.0031	.0036	.0039
S	1	1.5 x D	0.3 x D	0.3 x D	160	–	300	IPT	.0007	.0011	.0015	.0020	.0026	.0023	.0029	.0034	.0039	.0045	.0048
	2	1.5 x D	0.3 x D	0.3 x D	80	–	130	IPT	.0004	.0006	.0008	.0010	.0014	.0012	.0015	.0018	.0021	.0024	.0026
	3	1.5 x D	0.5 x D	1 x D	200	–	260	IPT	.0006	.0009	.0012	.0016	.0021	.0018	.0023	.0027	.0031	.0036	.0039
H	1	1.5 x D	0.5 x D	1 x D	160	–	200	IPT	.0005	.0008	.0011	.0014	.0019	.0017	.0021	.0025	.0028	.0033	.0036
	2	1.5 x D	0.5 x D	0.75 x D	260	–	460	IPT	.0007	.0010	.0014	.0017	.0023	.0020	.0026	.0030	.0034	.0039	.0040
H	2	1.5 x D	0.2 x D	0.5 x D	230	–	390	IPT	.0005	.0008	.0010	.0013	.0017	.0015	.0019	.0022	.0025	.0028	.0029

NOTE: Lower value of cutting speed is used for high stock removal applications or for higher hardness (machinability) within group.
Higher value of cutting speed is used for finishing applications or for lower hardness (machinability) within group.
Above parameters are based on ideal conditions. For smaller taper machining centers, please adjust parameters accordingly on >1/2" diameter.

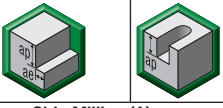

 = ALL-STAR PORTFOLIO PRODUCT. ALL-STAR PRODUCTS ARE PROVEN SOLUTIONS THAT ARE ALWAYS AVAILABLE.

Application Data • VariMill I™ • Series 4V05 • Inch

Material Group			 																			
	Side Milling (A) and Slotting (B)			TiAlN		AITiN		Recommended feed per tooth (IPT = inch/th) for side milling (A). For slotting (B), reduce IPT by 20%.														
	A		B	Cutting Speed – vc – vc SFM		Cutting Speed – vc – vc SFM		D1 – Diameter														
	ap	ae	ap	min	max	min	max	frac. dec.	1/8	3/16	1/4	5/16	3/8	7/16	1/2	5/8	3/4	1	1-1/4			
P	1	1.25 x D	0.5 x D	1 x D	490	–	660	490	–	660	IPT	.0009	.0014	.0018	.0023	.0027	.0031	.0035	.0039	.0043	.0050	.0062
	2	1.25 x D	0.5 x D	1 x D	460	–	620	460	–	620	IPT	.0009	.0014	.0018	.0023	.0027	.0031	.0035	.0039	.0043	.0050	.0062
	3	1.25 x D	0.5 x D	1 x D	390	–	520	390	–	520	IPT	.0007	.0011	.0015	.0020	.0023	.0026	.0029	.0034	.0038	.0046	.0057
	4	1.25 x D	0.5 x D	0.75 x D	300	–	490	300	–	490	IPT	.0007	.0010	.0014	.0018	.0020	.0023	.0026	.0030	.0033	.0039	.0049
	5	1.25 x D	0.5 x D	1 x D	200	–	330	200	–	330	IPT	.0006	.0009	.0012	.0016	.0018	.0021	.0023	.0027	.0030	.0036	.0046
	6	1.25 x D	0.5 x D	0.75 x D	160	–	250	160	–	250	IPT	.0005	.0008	.0010	.0013	.0015	.0017	.0019	.0022	.0024	.0028	.0036
M	1	1.25 x D	0.5 x D	1 x D	260	–	330	260	–	330	IPT	.0007	.0011	.0015	.0020	.0023	.0026	.0029	.0034	.0038	.0046	.0057
	2	1.25 x D	0.5 x D	1 x D	200	–	260	200	–	260	IPT	.0006	.0009	.0012	.0016	.0018	.0021	.0023	.0027	.0030	.0036	.0046
K	1	1.25 x D	0.5 x D	1 x D	390	–	520	390	–	520	IPT	.0009	.0014	.0018	.0023	.0027	.0031	.0035	.0039	.0043	.0050	.0062
	2	1.25 x D	0.5 x D	1 x D	360	–	460	360	–	460	IPT	.0007	.0011	.0015	.0020	.0023	.0026	.0029	.0034	.0038	.0046	.0057
S	1	1.0 x D	0.3 x D	0.3 x D	160	–	300	160	–	300	IPT	.0007	.0011	.0015	.0020	.0023	.0026	.0029	.0034	.0038	.0046	.0057
	2	1.0 x D	0.3 x D	0.3 x D	70	–	130	70	–	130	IPT	.0004	.0006	.0008	.0010	.0012	.0014	.0016	.0018	.0020	.0025	.0031
H	1	1.25 x D	0.5 x D	1 x D	150	–	210	150	–	210	IPT	.0005	.0008	.0011	.0014	.0017	.0019	.0022	.0025	.0028	.0033	.0042
	2	1.25 x D	0.5 x D	0.75 x D	260	–	460	260	–	460	IPT	.0007	.0010	.0014	.0018	.0020	.0023	.0026	.0030	.0033	.0039	.0049

NOTE: Lower value of cutting speed is used for high-stock removal applications or for higher hardness (machinability) within group.
Higher value of cutting speed is used for finishing applications or for lower hardness (machinability) within group.
Above parameters are based on ideal conditions. For smaller taper machining centers, please adjust parameters accordingly on > 1/2" diameter.

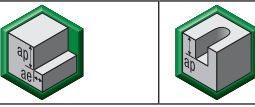

Application Data • VariMill I™ • Series 4VP5 • Inch

Material Group			 																	
	Side Milling (A) and Slotting (B)			TiAlN		Recommended feed per tooth (IPT = inch/th) for side milling (A). For slotting (B), reduce IPT by 20%.														
	A		B	Cutting Speed – vc – vc SFM		D1 – Diameter														
	ap	ae	ap	min	max	frac. dec.	1/4	3/8	1/2	5/8	3/4	1								
P	0	0.75 x D	0.5 x D	0.75 x D	490	–	660	IPT	.0018	.0027	.0034	.0039	.0044	.0049						
	1	0.75 x D	0.5 x D	0.75 x D	490	–	660	IPT	.0018	.0027	.0034	.0039	.0044	.0049						
	2	0.75 x D	0.5 x D	0.75 x D	460	–	620	IPT	.0018	.0027	.0034	.0039	.0044	.0049						
	3	0.75 x D	0.5 x D	0.75 x D	390	–	520	IPT	.0015	.0023	.0029	.0034	.0039	.0045						
	4	0.75 x D	0.5 x D	0.5 x D	300	–	490	IPT	.0014	.0020	.0026	.0030	.0034	.0039						
	5	0.75 x D	0.5 x D	0.75 x D	200	–	330	IPT	.0012	.0018	.0023	.0027	.0031	.0036						
M	1	0.75 x D	0.5 x D	0.75 x D	160	–	250	IPT	.0010	.0015	.0019	.0022	.0025	.0028						
	2	0.75 x D	0.5 x D	0.75 x D	300	–	380	IPT	.0015	.0023	.0029	.0034	.0039	.0045						
K	1	0.75 x D	0.5 x D	0.75 x D	200	–	260	IPT	.0012	.0018	.0023	.0027	.0031	.0036						
	2	0.75 x D	0.5 x D	0.75 x D	200	–	230	IPT	.0010	.0015	.0019	.0022	.0025	.0028						
S	1	0.75 x D	0.5 x D	0.75 x D	390	–	490	IPT	.0018	.0027	.0034	.0039	.0044	.0049						
	2	0.75 x D	0.5 x D	0.75 x D	360	–	460	IPT	.0015	.0023	.0029	.0034	.0039	.0045						
H	1	0.75 x D	0.5 x D	0.75 x D	360	–	430	IPT	.0012	.0018	.0023	.0027	.0031	.0036						
	1	0.75 x D	0.3 x D	0.3 x D	160	–	300	IPT	.0015	.0023	.0029	.0034	.0039	.0045						
H	1	0.75 x D	0.5 x D	0.5 x D	80	–	130	IPT	.0008	.0012	.0015	.0018	.0021	.0024						
	2	0.75 x D	0.3 x D	0.3 x D	200	–	260	IPT	.0012	.0018	.0023	.0027	.0031	.0036						
H	1	0.75 x D	0.5 x D	0.75 x D	160	–	200	IPT	.0011	.0017	.0021	.0025	.0028	.0033						
	2	0.75 x D	0.2 x D	0.75 x D	260	–	460	IPT	.0014	.0020	.0026	.0030	.0034	.0039						
H	1	0.75 x D	0.5 x D	0.5 x D	230	–	390	IPT	.0010	.0015	.0019	.0022	.0025	.0028						
	2	0.75 x D	0.2 x D	0.75 x D	230	–	390	IPT	.0010	.0015	.0019	.0022	.0025	.0028						

NOTE: Lower value of cutting speed is used for high stock removal applications or for higher hardness (machinability) within group.
Higher value of cutting speed is used for finishing applications or for lower hardness (machinability) within group.
Above parameters are based on ideal conditions. For smaller taper machining centers, please adjust parameters accordingly on diameters greater than 1/2".
Side milling applications – for longest reach (L3) tools, reduce ae by 30%.
Slot milling applications – for longest reach (L3) tools, reduce ae by 30%.



 = ALL-STAR PORTFOLIO PRODUCT. ALL-STAR PRODUCTS ARE PROVEN SOLUTIONS THAT ARE ALWAYS AVAILABLE.

Application Data • VariMill I™ • Series 4VN5 • Inch

Material Group														
	Side Milling (A) and Slotting (B)			TiAlN		Recommended feed per tooth (IPT = inch/th) for side milling (A). For slotting (B), reduce IPT by 20%.								
	A		B	Cutting Speed – vc SFM		D1 – Diameter								
	ap	ae	ap	min	max	frac. dec.	1/4	3/8	1/2	5/8	3/4	1		
P	1	0.75 x D	0.5 x D	0.75 x D	500	-	650	IPT	.0018	.0027	.0035	.0039	.0043	.0050
	2	0.75 x D	0.5 x D	0.75 x D	450	-	625	IPT	.0018	.0027	.0035	.0039	.0043	.0050
	3	0.75 x D	0.5 x D	0.75 x D	400	-	525	IPT	.0015	.0023	.0029	.0034	.0038	.0046
	4	0.75 x D	0.5 x D	0.5 x D	300	-	475	IPT	.0014	.0020	.0026	.0030	.0033	.0039
	5	0.75 x D	0.5 x D	0.75 x D	200	-	325	IPT	.0012	.0018	.0023	.0027	.0030	.0036
	6	0.75 x D	0.5 x D	0.5 x D	150	-	225	IPT	.0010	.0015	.0019	.0022	.0024	.0028
M	1	0.75 x D	0.5 x D	0.75 x D	260	-	330	IPT	.0015	.0023	.0029	.0034	.0038	.0046
	2	0.75 x D	0.5 x D	0.75 x D	200	-	260	IPT	.0012	.0018	.0023	.0027	.0030	.0036
	3	0.75 x D	0.5 x D	0.75 x D	200	-	260	IPT	.0010	.0015	.0019	.0022	.0024	.0028
K	1	0.75 x D	0.5 x D	0.75 x D	390	-	520	IPT	.0018	.0027	.0035	.0039	.0043	.0050
	2	0.75 x D	0.5 x D	0.75 x D	360	-	460	IPT	.0015	.0023	.0029	.0034	.0038	.0046
	3	0.75 x D	0.5 x D	0.75 x D	330	-	430	IPT	.0012	.0018	.0023	.0027	.0030	.0036
S	1	0.75 x D	0.3 x D	0.3 x D	150	-	275	IPT	.0015	.0023	.0029	.0034	.0038	.0046
	2	0.75 x D	0.3 x D	0.3 x D	70	-	130	IPT	.0008	.0012	.0016	.0018	.0020	.0025
	3	0.75 x D	0.5 x D	0.75 x D	160	-	260	IPT	.0012	.0018	.0023	.0027	.0030	.0036
H	3	0.75 x D	0.5 x D	0.75 x D	150	-	210	IPT	.0011	.0017	.0022	.0025	.0028	.0033
	4	0.75 x D	0.5 x D	0.5 x D	260	-	450	IPT	.0014	.0020	.0026	.0030	.0033	.0039

NOTE: Side milling applications – for longest reach (L3) tools, reduce ae by 30%.
 Slot milling applications – for longest reach (L3) tools, reduce ap by 30%.
 Lower value of cutting speed is used for high stock removal applications or for higher hardness (machinability) within group.
 Higher value of cutting speed is used for finishing applications or for lower hardness (machinability) within group.
 Above parameters are based on ideal conditions. For smaller taper machining centers, please adjust parameters accordingly on >1/2" diameter.



Application Data • VariMill I™ • Series 4VP0 • Inch

Material Group														
	Side Milling (A) and Slotting (B)			TiAlN		Recommended feed per tooth (IPT = inch/th) for side milling (A). For slotting (B), reduce IPT by 20%.								
	A		B	Cutting Speed – vc SFM		D1 – Diameter								
	ap	ae	ap	min	max	frac. dec.	1/4	3/8	1/2	5/8	3/4	1		
P	0	0.75 x D	0.5 x D	0.75 x D	490	-	660	IPT	.0018	.0027	.0034	.0039	.0044	.0049
	1	0.75 x D	0.5 x D	0.75 x D	490	-	660	IPT	.0018	.0027	.0034	.0039	.0044	.0049
	2	0.75 x D	0.5 x D	0.75 x D	460	-	620	IPT	.0018	.0027	.0034	.0039	.0044	.0049
	3	0.75 x D	0.5 x D	0.75 x D	390	-	520	IPT	.0015	.0023	.0029	.0034	.0039	.0045
	4	0.75 x D	0.5 x D	0.5 x D	300	-	490	IPT	.0014	.0020	.0026	.0030	.0034	.0039
	5	0.75 x D	0.5 x D	0.75 x D	200	-	330	IPT	.0012	.0018	.0023	.0027	.0031	.0036
M	6	0.75 x D	0.5 x D	0.5 x D	160	-	250	IPT	.0010	.0015	.0019	.0022	.0025	.0028
	1	0.75 x D	0.5 x D	0.75 x D	300	-	380	IPT	.0015	.0023	.0029	.0034	.0039	.0045
	2	0.75 x D	0.5 x D	0.75 x D	200	-	260	IPT	.0012	.0018	.0023	.0027	.0031	.0036
K	3	0.75 x D	0.5 x D	0.75 x D	200	-	230	IPT	.0010	.0015	.0019	.0022	.0025	.0028
	1	0.75 x D	0.5 x D	0.75 x D	390	-	490	IPT	.0018	.0027	.0034	.0039	.0044	.0049
	2	0.75 x D	0.5 x D	0.75 x D	360	-	460	IPT	.0015	.0023	.0029	.0034	.0039	.0045
S	3	0.75 x D	0.5 x D	0.75 x D	360	-	430	IPT	.0012	.0018	.0023	.0027	.0031	.0036
	1	0.75 x D	0.3 x D	0.3 x D	160	-	300	IPT	.0015	.0023	.0029	.0034	.0039	.0045
	2	0.75 x D	0.3 x D	0.3 x D	80	-	130	IPT	.0008	.0012	.0015	.0018	.0021	.0024
H	3	0.75 x D	0.5 x D	0.75 x D	200	-	260	IPT	.0012	.0018	.0023	.0027	.0031	.0036
	4	0.75 x D	0.5 x D	0.75 x D	160	-	200	IPT	.0011	.0017	.0021	.0025	.0028	.0033
	1	0.75 x D	0.5 x D	0.5 x D	260	-	460	IPT	.0014	.0020	.0026	.0030	.0034	.0039

NOTE: Lower value of cutting speed is used for high stock removal applications or for higher hardness (machinability) within group.
 Higher value of cutting speed is used for finishing applications or for lower hardness (machinability) within group.
 Above parameters are based on ideal conditions. For smaller taper machining centers, please adjust parameters accordingly on diameters greater than 1/2".
 Side milling applications – for longest reach (L3) tools, reduce ae by 30%.
 Slot milling applications – for longest reach (L3) tools, reduce ae by 30%.

 = ALL-STAR PORTFOLIO PRODUCT. ALL-STAR PRODUCTS ARE PROVEN SOLUTIONS THAT ARE ALWAYS AVAILABLE.

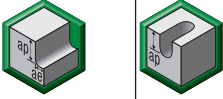

Application Data • VariMill I™ • Series 4V00 • Inch

Material Group																			
	Side Milling (A) and Slotting (B)			WP15PE		Recommended feed per tooth (IPT = inch/th) for side milling (A). For slotting (B), reduce IPT by 20%.													
	A		B	Cutting Speed — vc SFM		D1 — Diameter													
	ap	ae	ap	min	max	frac.	1/8	3/16	1/4	5/16	3/8	7/16	1/2	5/8	3/4	1	1-1/4		
P	0	1.25 x D	0.5 x D	1 x D	490	–	660	IPT	.0009	.0013	.0018	.0023	.0027	.0031	.0034	.0039	.0044	.0049	.0049
	1	1.25 x D	0.5 x D	1 x D	490	–	660	IPT	.0009	.0013	.0018	.0023	.0027	.0031	.0034	.0039	.0044	.0049	.0049
	2	1.25 x D	0.5 x D	1 x D	460	–	620	IPT	.0009	.0013	.0018	.0023	.0027	.0031	.0034	.0039	.0044	.0049	.0049
	3	1.25 x D	0.5 x D	1 x D	390	–	520	IPT	.0007	.0011	.0015	.0020	.0023	.0026	.0029	.0034	.0039	.0045	.0048
	4	1.25 x D	0.5 x D	0.75 x D	300	–	490	IPT	.0007	.0010	.0014	.0017	.0020	.0023	.0026	.0030	.0034	.0039	.0040
	5	1.25 x D	0.5 x D	1 x D	200	–	330	IPT	.0006	.0009	.0012	.0016	.0018	.0021	.0023	.0027	.0031	.0036	.0039
M	1	1.25 x D	0.5 x D	1 x D	300	–	380	IPT	.0007	.0011	.0015	.0020	.0023	.0026	.0029	.0034	.0039	.0045	.0048
	2	1.25 x D	0.5 x D	1 x D	200	–	260	IPT	.0006	.0009	.0012	.0016	.0018	.0021	.0023	.0027	.0031	.0036	.0039
K	1	1.25 x D	0.5 x D	1 x D	390	–	490	IPT	.0009	.0013	.0018	.0023	.0027	.0031	.0034	.0039	.0044	.0049	.0049
	2	1.25 x D	0.5 x D	1 x D	360	–	460	IPT	.0007	.0011	.0015	.0020	.0023	.0026	.0029	.0034	.0039	.0045	.0048
S	1	1 x D	0.3 x D	0.3 x D	160	–	300	IPT	.0007	.0011	.0015	.0020	.0023	.0026	.0029	.0034	.0039	.0045	.0048
	2	1 x D	0.3 x D	0.3 x D	80	–	130	IPT	.0004	.0006	.0008	.0010	.0012	.0014	.0015	.0018	.0021	.0024	.0026
	3	1.25 x D	0.5 x D	1 x D	200	–	260	IPT	.0006	.0009	.0012	.0016	.0018	.0021	.0023	.0027	.0031	.0036	.0039
	4	1.25 x D	0.5 x D	1 x D	160	–	200	IPT	.0005	.0008	.0011	.0014	.0017	.0019	.0021	.0025	.0028	.0033	.0036
H	1	1.25 x D	0.5 x D	0.75 x D	260	–	460	IPT	.0007	.0010	.0014	.0017	.0020	.0023	.0026	.0030	.0034	.0039	.0040
	2	1.25 x D	0.2 x D	0.5 x D	230	–	390	IPT	.0005	.0008	.0010	.0013	.0015	.0017	.0019	.0022	.0025	.0028	.0029

NOTE: Lower value of cutting speed is used for high stock removal applications or for higher hardness (machinability) within group.
Higher value of cutting speed is used for finishing applications or for lower hardness (machinability) within group.
Above parameters are based on ideal conditions. For smaller taper machining centers, please adjust parameters accordingly on >1/2" diameter.



 = ALL-STAR PORTFOLIO PRODUCT. ALL-STAR PRODUCTS ARE PROVEN SOLUTIONS THAT ARE ALWAYS AVAILABLE.

Application Data • VariMill II™ • Series 5777 • Metric

Material Group					★											
	A		B		Cutting Speed – vc m/min		Recommended feed per tooth (fz = mm/th) for side milling (A). For slotting (B), reduce fz by 20%.									
	ap	ae	ap		min	max	mm	D1 – Diameter								
								4,0	6,0	8,0	10,0	12,0	16,0	20,0	25,0	
P	1	1,5 x D	0,5 x D	1 x D	150	–	200	fz	0,028	0,044	0,060	0,072	0,083	0,101	0,114	0,124
	2	1,5 x D	0,5 x D	1 x D	140	–	190	fz	0,028	0,044	0,060	0,072	0,083	0,101	0,114	0,124
	3	1,5 x D	0,5 x D	1 x D	120	–	160	fz	0,023	0,036	0,050	0,061	0,070	0,087	0,101	0,114
	4	1,5 x D	0,5 x D	0,75 x D	90	–	150	fz	0,021	0,033	0,045	0,054	0,062	0,077	0,088	0,098
	5	1,5 x D	0,5 x D	1 x D	60	–	100	fz	0,019	0,029	0,040	0,048	0,056	0,070	0,081	0,091
	6	1,5 x D	0,5 x D	0,75 x D	50	–	75	fz	0,016	0,025	0,034	0,040	0,047	0,057	0,065	0,071
M	1	1,5 x D	0,5 x D	1 x D	90	–	115	fz	0,023	0,036	0,050	0,061	0,070	0,087	0,101	0,114
	2	1,5 x D	0,5 x D	1 x D	60	–	80	fz	0,019	0,029	0,040	0,048	0,056	0,070	0,081	0,091
	3	1,5 x D	0,5 x D	1 x D	60	–	70	fz	0,016	0,025	0,034	0,040	0,047	0,057	0,065	0,071
K	1	1,5 x D	0,5 x D	1 x D	120	–	150	fz	0,028	0,044	0,060	0,072	0,083	0,101	0,114	0,124
	2	1,5 x D	0,5 x D	1 x D	110	–	130	fz	0,023	0,036	0,050	0,061	0,070	0,087	0,101	0,114
	3	1,5 x D	0,5 x D	1 x D	100	–	130	fz	0,019	0,029	0,040	0,048	0,056	0,070	0,081	0,091
S	1	1,5 x D	0,3 x D	0,3 x D	50	–	90	fz	0,023	0,036	0,050	0,061	0,070	0,087	0,101	0,114
	2	1,5 x D	0,3 x D	0,3 x D	25	–	40	fz	0,013	0,019	0,026	0,032	0,037	0,046	0,054	0,061
	3	1,5 x D	0,5 x D	1 x D	60	–	80	fz	0,019	0,029	0,040	0,048	0,056	0,070	0,081	0,091
	4	1,5 x D	0,5 x D	1 x D	50	–	60	fz	0,016	0,026	0,037	0,045	0,052	0,064	0,074	0,084
H	1	1,5 x D	0,5 x D	0,75 x D	80	–	140	fz	0,021	0,033	0,045	0,054	0,062	0,077	0,088	0,098

NOTE: Lower value of cutting speed is used for high-stock removal applications or for higher hardness (machinability) within group.
Higher value of cutting speed is used for finishing applications or for lower hardness (machinability) within group.
Above parameters are based on ideal conditions. For smaller taper machining centers, please adjust parameters accordingly on > 12mm diameters.

Application Data • VariMill II™ • Series 577C • Metric

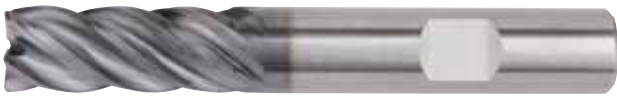
Material Group					★												
	Side Milling (A) and Slotting (B)		B		Cutting Speed – vc m/min		Recommended feed per tooth (fz = mm/th) for side milling (A). For slotting (B), reduce fz by 20%.										
	A		ap		min	max	mm	D1 – Diameter									
	ap	ae						6,0	8,0	10,0	12,0	14,0	16,0	18,0	20,0	25,0	
P	0	1,5 x D	0,5 x D	1 x D	150	–	200	fz	0,044	0,060	0,072	0,083	0,092	0,101	0,108	0,114	0,124
	1	1,5 x D	0,5 x D	1 x D	150	–	200	fz	0,044	0,060	0,072	0,083	0,092	0,101	0,108	0,114	0,124
	2	1,5 x D	0,5 x D	1 x D	140	–	190	fz	0,044	0,060	0,072	0,083	0,092	0,101	0,108	0,114	0,124
	3	1,5 x D	0,5 x D	1 x D	120	–	160	fz	0,036	0,050	0,061	0,070	0,079	0,087	0,095	0,101	0,114
	4	1,5 x D	0,5 x D	0,75 x D	90	–	150	fz	0,033	0,045	0,054	0,062	0,070	0,077	0,083	0,088	0,098
	5	1,5 x D	0,5 x D	1 x D	60	–	100	fz	0,029	0,040	0,048	0,056	0,063	0,070	0,076	0,081	0,091
M	1	1,5 x D	0,5 x D	1 x D	90	–	115	fz	0,036	0,050	0,061	0,070	0,079	0,087	0,095	0,101	0,114
	2	1,5 x D	0,5 x D	1 x D	60	–	80	fz	0,029	0,040	0,048	0,056	0,063	0,070	0,076	0,081	0,091
	3	1,5 x D	0,5 x D	1 x D	60	–	70	fz	0,025	0,034	0,040	0,047	0,052	0,057	0,061	0,065	0,071
K	1	1,5 x D	0,5 x D	1 x D	120	–	150	fz	0,044	0,060	0,072	0,083	0,092	0,101	0,108	0,114	0,124
	2	1,5 x D	0,5 x D	1 x D	110	–	140	fz	0,036	0,050	0,061	0,070	0,079	0,087	0,095	0,101	0,114
	3	1,5 x D	0,5 x D	1 x D	110	–	130	fz	0,029	0,040	0,048	0,056	0,063	0,070	0,076	0,081	0,091
S	1	1,5 x D	0,3 x D	0,3 x D	50	–	90	fz	0,036	0,050	0,061	0,070	0,079	0,087	0,095	0,101	0,114
	2	1,5 x D	0,3 x D	0,3 x D	25	–	40	fz	0,019	0,026	0,032	0,037	0,042	0,046	0,050	0,054	0,061
	3	1,5 x D	0,3 x D	1 x D	60	–	80	fz	0,029	0,040	0,048	0,056	0,063	0,070	0,076	0,081	0,091
	4	1,5 x D	0,5 x D	1 x D	50	–	60	fz	0,026	0,037	0,045	0,052	0,058	0,064	0,069	0,074	0,084
H	1	1,5 x D	0,5 x D	0,75 x D	80	–	140	fz	0,033	0,045	0,054	0,062	0,070	0,077	0,083	0,088	0,098
	2	1,5 x D	0,2 x D	0,5 x D	70	–	120	fz	0,025	0,034	0,040	0,047	0,052	0,057	0,061	0,065	0,071

NOTE: Lower value of cutting speed is used for high stock removal applications or for higher hardness (machinability) within group.
Higher value of cutting speed is used for finishing applications or for lower hardness (machinability) within group.
Above parameters are based on ideal conditions. For smaller taper machining centers, please adjust parameters accordingly on >12mm diameters.

★ = ALL-STAR PORTFOLIO PRODUCT. ALL-STAR PRODUCTS ARE PROVEN SOLUTIONS THAT ARE ALWAYS AVAILABLE.

Application Data • VariMill II™ • Series 5VOS • Inch

Series 5VOS																	
Material Group																	
	A		B		AlTiN		Recommended feed per tooth (IPT=inch/th) for side milling (A). For slotting (B), reduce IPT by 20%.										
					Cutting Speed – vc SFM		D1 – Diameter										
	ap	ae	ap		min	max	frac. dec.	3/16	1/4	5/16	3/8	7/16	1/2	5/8	3/4	1	
P	1	1.25 x D	0.5 x D	1 x D	490	–	660	IPT	.0014	.0018	.0023	.0027	.0031	.0035	.0039	.0043	.0050
	2	1.25 x D	0.5 x D	1 x D	460	–	620	IPT	.0014	.0018	.0023	.0027	.0031	.0035	.0039	.0043	.0050
	3	1.25 x D	0.5 x D	1 x D	390	–	520	IPT	.0011	.0015	.0020	.0023	.0026	.0029	.0034	.0038	.0046
	4	1.25 x D	0.5 x D	0.75 x D	300	–	490	IPT	.0010	.0014	.0018	.0020	.0023	.0026	.0030	.0033	.0039
	5	1.25 x D	0.5 x D	1 x D	200	–	330	IPT	.0009	.0012	.0016	.0018	.0021	.0023	.0027	.0030	.0036
	6	1.25 x D	0.5 x D	0.75 x D	160	–	250	IPT	.0008	.0010	.0013	.0015	.0017	.0019	.0022	.0024	.0028
M	1	1.25 x D	0.5 x D	1 x D	260	–	330	IPT	.0011	.0015	.0020	.0023	.0026	.0029	.0034	.0038	.0046
	2	1.25 x D	0.5 x D	1 x D	200	–	260	IPT	.0009	.0012	.0016	.0018	.0021	.0023	.0027	.0030	.0036
	3	1.25 x D	0.5 x D	1 x D	200	–	260	IPT	.0008	.0010	.0013	.0015	.0017	.0019	.0022	.0024	.0028
K	1	1.25 x D	0.5 x D	1 x D	390	–	520	IPT	.0014	.0018	.0023	.0027	.0031	.0035	.0039	.0043	.0050
	2	1.25 x D	0.5 x D	1 x D	360	–	460	IPT	.0011	.0015	.0020	.0023	.0026	.0029	.0034	.0038	.0046
	3	1.25 x D	0.5 x D	1 x D	330	–	430	IPT	.0009	.0012	.0016	.0018	.0021	.0023	.0027	.0030	.0036
S	1	1.0 x D	0.3 x D	0.3 x D	160	–	300	IPT	.0011	.0015	.0020	.0023	.0026	.0029	.0034	.0038	.0046
	2	1.0 x D	0.3 x D	0.3 x D	70	–	130	IPT	.0006	.0008	.0010	.0012	.0014	.0016	.0018	.0020	.0025
	3	1.25 x D	0.5 x D	1 x D	160	–	260	IPT	.0009	.0012	.0016	.0018	.0021	.0023	.0027	.0030	.0036
	4	1.25 x D	0.5 x D	1 x D	150	–	210	IPT	.0008	.0011	.0014	.0017	.0019	.0022	.0025	.0028	.0033
H	1	1.25 x D	0.5 x D	0.75 x D	260	–	460	IPT	.0010	.0014	.0018	.0020	.0023	.0026	.0030	.0033	.0039

NOTE: Lower value of cutting speed is used for high-stock removal applications or for higher hardness (machinability) within group.
Higher value of cutting speed is used for finishing applications or for lower hardness (machinability) within group.
Above parameters are based on ideal conditions. For smaller taper machining centers, please adjust parameters accordingly on > 1/2" diameter.

Application Data • VariMill II™ • Series 5VOC • Inch

Series 5VOC																
Material Group																
	Side Milling (A) and Slotting (B)				WP15PE		Recommended feed per tooth (IPT = inch/th) for side milling (A). For slotting (B), reduce IPT by 20%.									
	A		B		Cutting Speed – vc SFM		D1 – Diameter									
	ap	ae	ap		min	max	frac. dec.	3/16	1/4	5/16	3/8	1/2	5/8	3/4	1	
P	0	1.5 x D	0.5 x D	1 x D	490	–	660	IPT	.0014	.0018	.0023	.0027	.0034	.0040	.0044	.0049
	1	1.5 x D	0.5 x D	1 x D	490	–	660	IPT	.0014	.0018	.0023	.0027	.0034	.0040	.0044	.0049
	2	1.5 x D	0.5 x D	1 x D	460	–	620	IPT	.0014	.0018	.0023	.0027	.0034	.0040	.0044	.0049
	3	1.5 x D	0.5 x D	1 x D	390	–	520	IPT	.0011	.0015	.0020	.0023	.0029	.0034	.0039	.0045
	4	1.5 x D	0.5 x D	0.75 x D	300	–	490	IPT	.0010	.0014	.0018	.0020	.0026	.0030	.0034	.0039
	5	1.5 x D	0.5 x D	1 x D	200	–	330	IPT	.0009	.0012	.0016	.0018	.0023	.0027	.0031	.0036
M	1	1.5 x D	0.5 x D	1 x D	300	–	380	IPT	.0011	.0015	.0020	.0023	.0029	.0034	.0039	.0045
	2	1.5 x D	0.5 x D	1 x D	200	–	260	IPT	.0009	.0012	.0016	.0018	.0023	.0027	.0031	.0036
	3	1.5 x D	0.5 x D	1 x D	200	–	230	IPT	.0008	.0010	.0013	.0015	.0019	.0022	.0025	.0028
K	1	1.5 x D	0.5 x D	1 x D	390	–	490	IPT	.0014	.0018	.0023	.0027	.0034	.0040	.0044	.0049
	2	1.5 x D	0.5 x D	1 x D	360	–	460	IPT	.0011	.0015	.0020	.0023	.0029	.0034	.0039	.0045
	3	1.5 x D	0.5 x D	1 x D	360	–	430	IPT	.0009	.0012	.0016	.0018	.0023	.0027	.0031	.0036
S	1	1.5 x D	0.3 x D	0.3 x D	160	–	300	IPT	.0011	.0015	.0020	.0023	.0029	.0034	.0039	.0045
	2	1.5 x D	0.3 x D	0.3 x D	80	–	130	IPT	.0006	.0008	.0010	.0012	.0015	.0018	.0021	.0024
	3	1.5 x D	0.3 x D	0.3 x D	200	–	260	IPT	.0009	.0012	.0016	.0018	.0023	.0027	.0031	.0036
	4	1.5 x D	0.5 x D	1 x D	160	–	200	IPT	.0008	.0011	.0014	.0017	.0021	.0025	.0028	.0033
H	1	1.5 x D	0.5 x D	0.75 x D	260	–	460	IPT	.0010	.0014	.0018	.0020	.0026	.0030	.0034	.0039
	2	1.5 x D	0.2 x D	0.5 x D	230	–	390	IPT	.0008	.0010	.0013	.0015	.0019	.0022	.0025	.0028

NOTE: Lower value of cutting speed is used for high stock removal applications or for higher hardness (machinability) within group.
Higher value of cutting speed is used for finishing applications or for lower hardness (machinability) within group.
Above parameters are based on ideal conditions. For smaller taper machining centers, please adjust parameters accordingly on > 1/2" diameter.

= ALL-STAR PORTFOLIO PRODUCT. ALL-STAR PRODUCTS ARE PROVEN SOLUTIONS THAT ARE ALWAYS AVAILABLE.

Application Data • VariMill II™ • Series 5VNC • Inch

Material Group	Side Milling (A) and Slotting (B)		WP15PE		Recommended feed per tooth (IPT = inch/th) for side milling (A). For slotting (B), reduce IPT by 20%.											
	A		B	Cutting Speed – vc SFM			D1 – Diameter									
	ap	ae	ap	min	max	frac. dec.	1/4	5/16	3/8	1/2	5/8	3/4	1			
	ap	ae	ap	min	max	dec.	.2500	.3125	.3750	.5000	.6250	.7500	1.0000			
P	5	1.5 x D	0.5 x D	1 x D	200	–	330	IPT	.0012	.0016	.0018	.0023	.0027	.0031	.0036	
	6	1.5 x D	0.5 x D	0.75 x D	160	–	250	IPT	.0010	.0013	.0015	.0019	.0022	.0025	.0028	
M	1	1.5 x D	0.5 x D	1 x D	300	–	380	IPT	.0015	.0020	.0023	.0029	.0034	.0039	.0045	
	2	1.5 x D	0.5 x D	1 x D	200	–	260	IPT	.0012	.0016	.0018	.0023	.0027	.0031	.0036	
	3	1.5 x D	0.5 x D	1 x D	200	–	230	IPT	.0010	.0013	.0015	.0019	.0022	.0025	.0028	
K	1	1.5 x D	0.5 x D	1 x D	390	–	490	IPT	.0018	.0023	.0027	.0034	.0040	.0044	.0049	
	2	1.5 x D	0.5 x D	1 x D	360	–	460	IPT	.0015	.0020	.0023	.0029	.0034	.0039	.0045	
S	1	1.5 x D	0.5 x D	1 x D	360	–	430	IPT	.0012	.0016	.0018	.0023	.0027	.0031	.0036	
	1	1.5 x D	0.3 x D	0.3 x D	160	–	300	IPT	.0015	.0020	.0023	.0029	.0034	.0039	.0045	
	2	1.5 x D	0.3 x D	0.3 x D	80	–	130	IPT	.0008	.0010	.0012	.0015	.0018	.0021	.0024	
	3	1.5 x D	0.3 x D	0.3 x D	200	–	260	IPT	.0012	.0016	.0018	.0023	.0027	.0031	.0036	
H	1	1.5 x D	0.5 x D	0.75 x D	260	–	460	IPT	.0014	.0018	.0020	.0026	.0030	.0034	.0039	
	2	1.5 x D	0.2 x D	0.5 x D	230	–	390	IPT	.0010	.0013	.0015	.0019	.0022	.0025	.0028	

NOTE: Lower value of cutting speed is used for high stock removal applications or for higher hardness (machinability) within group.
Higher value of cutting speed is used for finishing applications or for lower hardness (machinability) within group.
Above parameters are based on ideal conditions. For smaller taper machining centers, please adjust parameters accordingly on >1/2" diameter.

Application Data • VariMill II™ ER • Series 5VOE • Inch

Material Group	Side Milling (A) and Slotting (B)		WS15PE		Recommended feed per tooth (IPT = inch/th) for side milling (A). For slotting (B), reduce IPT by 20%.											
	A		B	Cutting Speed – vc SFM			D1 – Diameter									
	ap	ae	ap	min	max	frac. dec.	3/16	1/4	3/8	1/2	5/8	3/4	1	1 1/4		
	ap	ae	ap	min	max	dec.	.1875	.2500	.3750	.5000	.6250	.7500	1.0000	1.2500		
P	5	1.5 x D	0.5 x D	1 x D	200	–	330	IPT	.0009	.0012	.0018	.0023	.0027	.0031	.0036	
	6	1.5 x D	0.5 x D	0.75 x D	160	–	250	IPT	.0008	.0010	.0015	.0019	.0022	.0025	.0028	
M	1	1.5 x D	0.5 x D	1 x D	300	–	380	IPT	.0011	.0014	.0023	.0029	.0034	.0039	.0045	
	2	1.5 x D	0.5 x D	1 x D	200	–	260	IPT	.0009	.0012	.0018	.0023	.0027	.0031	.0036	
	3	1.5 x D	0.5 x D	1 x D	200	–	230	IPT	.0008	.0010	.0015	.0019	.0022	.0025	.0028	
S	1	1.5 x D	0.3 x D	0.3 x D	160	–	300	IPT	.0011	.0014	.0023	.0029	.0034	.0039	.0045	
	2	1.5 x D	0.3 x D	0.3 x D	80	–	130	IPT	.0006	.0008	.0012	.0015	.0018	.0021	.0024	
	3	1.5 x D	0.3 x D	0.3 x D	200	–	260	IPT	.0009	.0012	.0018	.0023	.0027	.0031	.0036	
	4	1.5 x D	0.5 x D	1 x D	160	–	200	IPT	.0008	.0011	.0017	.0021	.0025	.0028	.0033	
H	1	1.5 x D	0.5 x D	0.75 x D	260	–	460	IPT	.0010	.0013	.0020	.0026	.0030	.0034	.0039	
	2	1.5 x D	0.2 x D	0.5 x D	230	–	390	IPT	.0008	.0010	.0015	.0019	.0022	.0025	.0028	

NOTE: Lower value of cutting speed is used for high stock removal applications or for higher hardness (machinability) within group.
Higher value of cutting speed is used for finishing applications or for lower hardness (machinability) within group.
Above parameters are based on ideal conditions. For smaller taper machining centers, please adjust parameters accordingly on >1/2" diameter.

 = ALL-STAR PORTFOLIO PRODUCT. ALL-STAR PRODUCTS ARE PROVEN SOLUTIONS THAT ARE ALWAYS AVAILABLE.

Application Data • VariMill II™ ER • Series 5VNE • Inch

Material Group	Side Milling (A) and Slotting (B)		WS15PE		Recommended feed per tooth (IPT = inch/th) for side milling (A). For slotting (B), reduce IPT by 20%.										
	A		B		Cutting Speed – vc SFM		D1 – Diameter								
	ap	ae	ap		min	max	frac. dec.	1/4	3/8	1/2	5/8	3/4	1	1 1/4	
	ap	ae	ap		min	max	dec.	.2500	.3750	.5000	.6250	.7500	1.0000	1.2500	
P	5	1.5 x D	0.5 x D	1 x D	200	–	330	IPT	.0012	.0018	.0023	.0027	.0031	.0036	.0039
	6	1.5 x D	0.5 x D	0.75 x D	160	–	250	IPT	.0010	.0015	.0019	.0022	.0025	.0028	.0029
M	1	1.5 x D	0.5 x D	1 x D	300	–	380	IPT	.0015	.0023	.0029	.0034	.0039	.0045	.0048
	2	1.5 x D	0.5 x D	1 x D	200	–	260	IPT	.0012	.0018	.0023	.0027	.0031	.0036	.0039
S	3	1.5 x D	0.5 x D	1 x D	200	–	230	IPT	.0010	.0015	.0019	.0022	.0025	.0028	.0029
	1	1.5 x D	0.3 x D	0.3 x D	160	–	300	IPT	.0015	.0023	.0029	.0034	.0039	.0045	.0048
	2	1.5 x D	0.3 x D	0.3 x D	80	–	130	IPT	.0008	.0012	.0015	.0018	.0021	.0024	.0026
	3	1.5 x D	0.3 x D	0.3 x D	200	–	260	IPT	.0012	.0018	.0023	.0027	.0031	.0036	.0039
H	4	1.5 x D	0.5 x D	1 x D	160	–	200	IPT	.0011	.0017	.0021	.0025	.0028	.0033	.0036
	1	1.5 x D	0.5 x D	0.75 x D	260	–	460	IPT	.0014	.0020	.0026	.0030	.0034	.0039	.0040
	2	1.5 x D	0.2 x D	0.5 x D	230	–	390	IPT	.0010	.0015	.0019	.0022	.0025	.0028	.0029

NOTE: Lower value of cutting speed is used for high stock removal applications or for higher hardness (machinability) within group.
Higher value of cutting speed is used for finishing applications or for lower hardness (machinability) within group.
Above parameters are based on ideal conditions. For smaller taper machining centers, please adjust parameters accordingly on >1/2" diameter.

Application Data • VariMill II™ Long • Series 5W1S • Inch

Material Group	Side Milling (A)		AlTiN-MT		Recommended feed per tooth (IPT = inch/th) for side milling (A).								
	A		Cutting Speed – vc SFM		D1 – Diameter								
	ap	ae	min	max	frac. dec.	1/4	5/16	3/8	1/2	5/8	3/4	1	
	ap	ae	min	max	dec.	.2500	.3125	.3750	.5000	.6250	.7500	1.0000	
P	1	Ap1 max	0.05 x D*	990	1320	IPT	.0018	.0023	.0027	.0035	.0039	.0043	.0050
	2	Ap1 max	0.05 x D*	924	1254	IPT	.0018	.0023	.0027	.0035	.0039	.0043	.0050
	3	Ap1 max	0.05 x D*	792	1056	IPT	.0015	.0020	.0023	.0029	.0034	.0038	.0046
	4	Ap1 max	0.05 x D*	594	990	IPT	.0014	.0018	.0020	.0026	.0030	.0033	.0039
	5	Ap1 max	0.05 x D*	396	660	IPT	.0012	.0016	.0018	.0023	.0027	.0030	.0036
	6	Ap1 max	0.05 x D*	330	495	IPT	.0010	.0013	.0015	.0019	.0022	.0024	.0028
M	1	Ap1 max	0.05 x D*	594	759	IPT	.0015	.0020	.0023	.0029	.0034	.0038	.0046
	2	Ap1 max	0.05 x D*	396	528	IPT	.0012	.0016	.0018	.0023	.0027	.0030	.0036
K	3	Ap1 max	0.05 x D*	396	462	IPT	.0010	.0013	.0015	.0019	.0022	.0024	.0028
	1	Ap1 max	0.05 x D*	792	990	IPT	.0018	.0023	.0027	.0035	.0039	.0043	.0050
S	2	Ap1 max	0.05 x D*	726	858	IPT	.0015	.0020	.0028	.0029	.0034	.0038	.0046
	3	Ap1 max	0.05 x D*	660	858	IPT	.0012	.0016	.0018	.0023	.0027	.0030	.0036
	1	Ap1 max	0.05 x D*	330	594	IPT	.0015	.0020	.0028	.0029	.0034	.0038	.0046
	2	Ap1 max	0.05 x D*	165	264	IPT	.0008	.0010	.0012	.0016	.0018	.0020	.0025
H	3	Ap1 max	0.05 x D*	396	528	IPT	.0012	.0016	.0018	.0023	.0027	.0030	.0036
	4	Ap1 max	0.05 x D*	330	396	IPT	.0011	.0014	.0017	.0022	.0025	.0028	.0033
	1	Ap1 max	0.05 x D*	462	528	IPT	.0014	.0018	.0020	.0026	.0030	.0033	.0039

*For the above cutting data, do not exceed an overall ae of .032".
NOTE: Lower value of cutting speed is used for high stock removal applications or for higher hardness (machinability) within group.
Higher value of cutting speed is used for finishing applications or for lower hardness (machinability) within group.
Above parameters are based on ideal conditions. For smaller taper machining centers, please adjust parameters accordingly on >1/2" diameter.

★ = ALL-STAR PORTFOLIO PRODUCT. ALL-STAR PRODUCTS ARE PROVEN SOLUTIONS THAT ARE ALWAYS AVAILABLE.

Application Data • VariMill III™ ER • Series 771E • Semi-Finishing • Metric

		Side Milling (A)		WS15PE		Recommended feed per tooth (fz = mm/th) for side milling (A).						
Material Group	A	Cutting Speed – vc m/min				D1 – Diameter						
		ap	ae	min	max	mm	10,0	12,0	16,0	18,0	20,0	
P	4	3 x D	0,1 x D	90	–	150	fz	0,054	0,062	0,077	0,083	0,088
	5	3 x D	0,1 x D	60	–	100	fz	0,048	0,056	0,070	0,076	0,081
M	1	3 x D	0,1 x D	90	–	115	fz	0,061	0,070	0,087	0,095	0,101
	2	3 x D	0,1 x D	60	–	80	fz	0,048	0,056	0,070	0,076	0,081
S	3	3 x D	0,1 x D	60	–	70	fz	0,040	0,047	0,057	0,061	0,065
	1	3 x D	0,1 x D	50	–	90	fz	0,061	0,070	0,087	0,095	0,101
	2	3 x D	0,1 x D	25	–	40	fz	0,032	0,037	0,046	0,050	0,054
	3	3 x D	0,1 x D	60	–	80	fz	0,048	0,056	0,070	0,076	0,081
H	4	3 x D	0,1 x D	50	–	60	fz	0,045	0,052	0,064	0,069	0,074
	1	3 x D	0,1 x D	80	–	140	fz	0,054	0,062	0,077	0,083	0,088
	2	3 x D	0,1 x D	70	–	120	fz	0,040	0,047	0,057	0,061	0,065

NOTE: Lower value of cutting speed is used for high stock removal applications or for higher hardness (machinability) within group.
Higher value of cutting speed is used for finishing applications or for lower hardness (machinability) within group.
Above parameters are based on ideal conditions. For smaller taper machining centers, please adjust parameters accordingly on >12mm diameters.



Application Data • VariMill III™ ER • Series 771E • Finishing • Metric

		Side Milling (A)		WS15PE		Recommended feed per tooth (fz = mm/th) for side milling (A).						
Material Group	A	Cutting Speed – vc m/min				D1 – Diameter						
		ap	ae	min	max	mm	10,0	12,0	16,0	18,0	20,0	
P	4	3 x D	0,06 x D	180	–	300	fz	0,065	0,075	0,092	0,099	0,106
	5	3 x D	0,06 x D	120	–	200	fz	0,058	0,067	0,084	0,091	0,097
M	1	3 x D	0,06 x D	180	–	230	fz	0,073	0,084	0,105	0,113	0,121
	2	3 x D	0,06 x D	120	–	160	fz	0,058	0,067	0,084	0,091	0,097
S	3	3 x D	0,06 x D	120	–	140	fz	0,048	0,056	0,068	0,073	0,078
	1	3 x D	0,06 x D	100	–	180	fz	0,073	0,084	0,105	0,113	0,121
	2	3 x D	0,06 x D	50	–	80	fz	0,038	0,045	0,056	0,060	0,065
	3	3 x D	0,06 x D	120	–	160	fz	0,058	0,067	0,084	0,091	0,097
H	4	3 x D	0,06 x D	100	–	120	fz	0,053	0,062	0,077	0,083	0,089
	1	3 x D	0,06 x D	160	–	280	fz	0,065	0,075	0,092	0,099	0,106
	2	3 x D	0,06 x D	140	–	240	fz	0,048	0,056	0,068	0,073	0,078

NOTE: Lower value of cutting speed is used for high stock removal applications or for higher hardness (machinability) within group.
Higher value of cutting speed is used for finishing applications or for lower hardness (machinability) within group.
Above parameters are based on ideal conditions. For smaller taper machining centers, please adjust parameters accordingly on >12mm diameters.



= ALL-STAR PORTFOLIO PRODUCT. ALL-STAR PRODUCTS ARE PROVEN SOLUTIONS THAT ARE ALWAYS AVAILABLE.

Application Data • VariMill III™ ER • Series 7VNX • Semi-Finishing • Inch

												
		Side Milling (A)		WS15PE			Recommended feed per tooth (IPT = inch/th) for side milling (A).					
Material Group	A	Cutting Speed – vc SFM			D1 – Diameter							
		ap	ae	min	max	frac. dec.	3/8	1/2	5/8	3/4	1	
P	4	Ap1 max	0.3 x D	300	–	490	IPT	.0020	.0026	.0030	.0034	.0039
	5	Ap1 max	0.3 x D	200	–	330	IPT	.0018	.0023	.0027	.0031	.0036
M	1	Ap1 max	0.3 x D	300	–	380	IPT	.0023	.0029	.0034	.0039	.0045
	2	Ap1 max	0.3 x D	200	–	260	IPT	.0018	.0023	.0027	.0031	.0036
S	3	Ap1 max	0.3 x D	200	–	230	IPT	.0015	.0019	.0022	.0025	.0028
	1	Ap1 max	0.3 x D	160	–	300	IPT	.0023	.0029	.0034	.0039	.0045
	2	Ap1 max	0.3 x D	80	–	130	IPT	.0012	.0015	.0018	.0021	.0024
H	3	Ap1 max	0.3 x D	200	–	260	IPT	.0018	.0023	.0027	.0031	.0036
	4	Ap1 max	0.3 x D	160	–	200	IPT	.0017	.0021	.0025	.0028	.0033
	1	Ap1 max	0.3 x D	260	–	460	IPT	.0020	.0026	.0030	.0034	.0039
	2	Ap1 max	0.3 x D	230	–	390	IPT	.0015	.0019	.0022	.0025	.0028

NOTE: Lower value of cutting speed is used for high stock removal applications or for higher hardness (machinability) within group.
 Higher value of cutting speed is used for finishing applications or for lower hardness (machinability) within group.
 Above parameters are based on ideal conditions. For smaller taper machining centers, please adjust parameters accordingly on >1/2" diameter.

Application Data • VariMill III™ ER • Series 7VNX • Finishing • Inch

												
		Side Milling (A)		WS15PE			Recommended feed per tooth (IPT = inch/th) for side milling (A).					
Material Group	A	Cutting Speed – vc SFM			D1 – Diameter							
		ap	ae	min	max	frac. dec.	3/8	1/2	5/8	3/4	1	
P	4	Ap1 max	0.06 x D	590	–	980	IPT	.0025	.0031	.0036	.0040	.0046
	5	Ap1 max	0.06 x D	390	–	660	IPT	.0022	.0028	.0033	.0037	.0043
M	1	Ap1 max	0.06 x D	590	–	750	IPT	.0027	.0035	.0041	.0046	.0054
	2	Ap1 max	0.06 x D	390	–	520	IPT	.0022	.0028	.0033	.0037	.0043
S	3	Ap1 max	0.06 x D	390	–	460	IPT	.0018	.0023	.0027	.0030	.0034
	1	Ap1 max	0.06 x D	330	–	590	IPT	.0027	.0035	.0041	.0046	.0054
	2	Ap1 max	0.06 x D	160	–	260	IPT	.0015	.0018	.0022	.0025	.0029
H	3	Ap1 max	0.06 x D	390	–	520	IPT	.0022	.0028	.0033	.0037	.0043
	4	Ap1 max	0.06 x D	330	–	390	IPT	.0020	.0026	.0030	.0034	.0040
	1	Ap1 max	0.06 x D	520	–	920	IPT	.0025	.0031	.0036	.0040	.0046
	2	Ap1 max	0.06 x D	460	–	790	IPT	.0018	.0023	.0027	.0030	.0034

NOTE: Lower value of cutting speed is used for high stock removal applications or for higher hardness (machinability) within group.
 Higher value of cutting speed is used for finishing applications or for lower hardness (machinability) within group.
 Above parameters are based on ideal conditions. For smaller taper machining centers, please adjust parameters accordingly on >1/2" diameter.

 = ALL-STAR PORTFOLIO PRODUCT. ALL-STAR PRODUCTS ARE PROVEN SOLUTIONS THAT ARE ALWAYS AVAILABLE.

Application Data • VariMill III™ ER • Series 7V1E • Semi-Finishing • Inch

Material Group	Side Milling (A)		WS15PE			Recommended feed per tooth (IPT = inch/th) for side milling (A).						
	A		Cutting Speed – vc SFM			frac. dec.	D1 – Diameter					
	ap	ae	min		max		3/8	1/2	5/8	3/4	1	
	4	3 x D	0.2 x D	300	–	490	.3750	.5000	.6250	.7500	1.0000	
P	4	3 x D	0.2 x D	300	–	490	IPT	.0020	.0026	.0030	.0034	.0039
	5	3 x D	0.2 x D	200	–	330	IPT	.0018	.0023	.0027	.0031	.0036
M	1	3 x D	0.2 x D	300	–	380	IPT	.0023	.0029	.0034	.0039	.0045
	2	3 x D	0.2 x D	200	–	260	IPT	.0018	.0023	.0027	.0031	.0036
S	3	3 x D	0.2 x D	200	–	230	IPT	.0015	.0019	.0022	.0025	.0028
	1	3 x D	0.2 x D	160	–	300	IPT	.0023	.0029	.0034	.0039	.0045
	2	3 x D	0.2 x D	80	–	130	IPT	.0012	.0015	.0018	.0021	.0024
	3	3 x D	0.2 x D	200	–	260	IPT	.0018	.0023	.0027	.0031	.0036
H	4	3 x D	0.2 x D	160	–	200	IPT	.0017	.0021	.0025	.0028	.0033
	1	3 x D	0.2 x D	260	–	460	IPT	.0020	.0026	.0030	.0034	.0039
H	2	3 x D	0.2 x D	230	–	390	IPT	.0015	.0019	.0022	.0025	.0028

NOTE: Lower value of cutting speed is used for high stock removal applications or for higher hardness (machinability) within group.
 Higher value of cutting speed is used for finishing applications or for lower hardness (machinability) within group.
 Above parameters are based on ideal conditions. For smaller taper machining centers, please adjust parameters accordingly on >1/2" diameter.

Application Data • VariMill III™ ER • Series 7V1E • Finishing • Inch



Material Group	Side Milling (A)		WS15PE			Recommended feed per tooth (IPT = inch/th) for side milling (A).						
	A		Cutting Speed – vc SFM			frac. dec.	D1 – Diameter					
	ap	ae	min		max		3/8	1/2	5/8	3/4	1	
	4	3 x D	0.06 x D	590	–	980	.3750	.5000	.6250	.7500	1.0000	
P	4	3 x D	0.06 x D <td>590</td> <td>–</td> <td>980</td> <td>IPT</td> <td>.0025</td> <td>.0031</td> <td>.0036</td> <td>.0040</td> <td>.0046</td>	590	–	980	IPT	.0025	.0031	.0036	.0040	.0046
	5	3 x D	0.06 x D <td>390</td> <td>–</td> <td>660</td> <td>IPT</td> <td>.0022</td> <td>.0028</td> <td>.0033</td> <td>.0037</td> <td>.0043</td>	390	–	660	IPT	.0022	.0028	.0033	.0037	.0043
M	1	3 x D	0.06 x D <td>590</td> <td>–</td> <td>750</td> <td>IPT</td> <td>.0027</td> <td>.0035</td> <td>.0041</td> <td>.0046</td> <td>.0054</td>	590	–	750	IPT	.0027	.0035	.0041	.0046	.0054
	2	3 x D	0.06 x D <td>390</td> <td>–</td> <td>520</td> <td>IPT</td> <td>.0022</td> <td>.0028</td> <td>.0033</td> <td>.0037</td> <td>.0043</td>	390	–	520	IPT	.0022	.0028	.0033	.0037	.0043
S	3	3 x D	0.06 x D <td>390</td> <td>–</td> <td>460</td> <td>IPT</td> <td>.0018</td> <td>.0023</td> <td>.0027</td> <td>.0030</td> <td>.0034</td>	390	–	460	IPT	.0018	.0023	.0027	.0030	.0034
	1	3 x D	0.06 x D <td>330</td> <td>–</td> <td>590</td> <td>IPT</td> <td>.0027</td> <td>.0035</td> <td>.0041</td> <td>.0046</td> <td>.0054</td>	330	–	590	IPT	.0027	.0035	.0041	.0046	.0054
	2	3 x D	0.06 x D <td>160</td> <td>–</td> <td>260</td> <td>IPT</td> <td>.0015</td> <td>.0018</td> <td>.0022</td> <td>.0025</td> <td>.0029</td>	160	–	260	IPT	.0015	.0018	.0022	.0025	.0029
	3	3 x D	0.06 x D <td>390</td> <td>–</td> <td>520</td> <td>IPT</td> <td>.0022</td> <td>.0028</td> <td>.0033</td> <td>.0037</td> <td>.0043</td>	390	–	520	IPT	.0022	.0028	.0033	.0037	.0043
H	4	3 x D	0.06 x D <td>330</td> <td>–</td> <td>390</td> <td>IPT</td> <td>.0020</td> <td>.0026</td> <td>.0030</td> <td>.0034</td> <td>.0040</td>	330	–	390	IPT	.0020	.0026	.0030	.0034	.0040
	1	3 x D	0.06 x D <td>520</td> <td>–</td> <td>920</td> <td>IPT</td> <td>.0025</td> <td>.0031</td> <td>.0036</td> <td>.0040</td> <td>.0046</td>	520	–	920	IPT	.0025	.0031	.0036	.0040	.0046
H	2	3 x D	0.06 x D <td>460</td> <td>–</td> <td>790</td> <td>IPT</td> <td>.0018</td> <td>.0023</td> <td>.0027</td> <td>.0030</td> <td>.0034</td>	460	–	790	IPT	.0018	.0023	.0027	.0030	.0034

NOTE: Lower value of cutting speed is used for high stock removal applications or for higher hardness (machinability) within group.
 Higher value of cutting speed is used for finishing applications or for lower hardness (machinability) within group.
 Above parameters are based on ideal conditions. For smaller taper machining centers, please adjust parameters accordingly on >1/2" diameter.

 = ALL-STAR PORTFOLIO PRODUCT. ALL-STAR PRODUCTS ARE PROVEN SOLUTIONS THAT ARE ALWAYS AVAILABLE.

INDEXABLE MILLING
 SOLID END MILLING
 HOLEMAKING
 TAPPING
 TURNING

Application Data • VariMill III™ ER • Series 7V2E • Finishing • Inch

Material Group												
	Side Milling (A)		WS15PE			Recommended feed per tooth (IPT = inch/th) for side milling (A).						
	A		Cutting Speed – vc SFM			D1 – Diameter						
	ap	ae	min		max	frac. dec.	3/8	1/2	5/8	3/4	1	
P	0	5 x D	0.05 x D	980	–	1310	IPT	.0033	.0041	.0047	.0053	.0059
	1	5 x D	0.05 x D	980	–	1310	IPT	.0033	.0041	.0047	.0053	.0059
	2	5 x D	0.05 x D	920	–	1250	IPT	.0033	.0041	.0047	.0053	.0059
	3	5 x D	0.05 x D	790	–	1050	IPT	.0027	.0035	.0041	.0046	.0054
	4	5 x D	0.05 x D	590	–	980	IPT	.0025	.0031	.0036	.0040	.0046
	5	5 x D	0.05 x D	390	–	660	IPT	.0022	.0028	.0033	.0037	.0043
	6	5 x D	0.05 x D	330	–	490	IPT	.0018	.0023	.0027	.0030	.0034
M	1	5 x D	0.05 x D	590	–	750	IPT	.0027	.0035	.0041	.0046	.0054
	2	5 x D	0.05 x D	390	–	520	IPT	.0022	.0028	.0033	.0037	.0043
	3	5 x D	0.05 x D	390	–	460	IPT	.0018	.0023	.0027	.0030	.0034
K	1	5 x D	0.05 x D	790	–	980	IPT	.0033	.0041	.0047	.0053	.0059
	2	5 x D	0.05 x D	720	–	920	IPT	.0027	.0035	.0041	.0046	.0054
	3	5 x D	0.05 x D	720	–	850	IPT	.0022	.0028	.0033	.0037	.0043
S	1	5 x D	0.05 x D	330	–	590	IPT	.0027	.0035	.0041	.0046	.0054
	2	5 x D	0.05 x D	160	–	260	IPT	.0015	.0018	.0022	.0025	.0029
	3	5 x D	0.05 x D	390	–	520	IPT	.0022	.0028	.0033	.0037	.0043
	4	5 x D	0.05 x D	330	–	390	IPT	.0020	.0026	.0030	.0034	.0040
H	1	5 x D	0.05 x D	520	–	920	IPT	.0025	.0031	.0036	.0040	.0046
	2	5 x D	0.06 x D	460	–	790	IPT	.0018	.0023	.0027	.0030	.0034

NOTE: Lower value of cutting speed is used for high stock removal applications or for higher hardness (machinability) within group.
 Higher value of cutting speed is used for finishing applications or for lower hardness (machinability) within group.
 Above parameters are based on ideal conditions. For smaller taper machining centers, please adjust parameters accordingly on >1/2" diameter.

 = ALL-STAR PORTFOLIO PRODUCT. ALL-STAR PRODUCTS ARE PROVEN SOLUTIONS THAT ARE ALWAYS AVAILABLE.

INDEXABLE MILLING

SOLID END MILLING

HOLEMAKING

TAPPING

TURNING

Application Data • Series 5A02 5A03 • Aluminum • Inch

Material Group	Side Milling (A) and Slotting (B)		Uncoated		Recommended feed per tooth (IPT = inch/th) for side milling (A). For slotting (B), reduce IPT by 20%.												
	A		B		Cutting Speed – vc SFM			D1 – Diameter									
	ap	ae	ap		min	max	frac. dec.	1/4	5/16	3/8	1/2	5/8	3/4	1			
	ap	ae	ap		min	max	dec.	1/4	5/16	3/8	1/2	5/8	3/4	1			
N	1	1.5 x D	0.5 x D	1 x D	1640	–	6560	IPT	.0023	.0028	.0034	.0045	.0056	.0068	.0090		
	2	1.5 x D	0.5 x D	1 x D	1640	–	4920	IPT	.0018	.0023	.0027	.0036	.0045	.0054	.0072		
	3	1.5 x D	0.5 x D	1 x D	1640	–	4920	IPT	.0016	.0020	.0024	.0032	.0039	.0047	.0063		
	4	1.5 x D	0.5 x D	1 x D	1310	–	2460	IPT	.0016	.0020	.0024	.0032	.0039	.0047	.0063		
	5	1.5 x D	0.5 x D	1 x D	820	–	3280	IPT	.0020	.0025	.0030	.0041	.0051	.0061	.0081		

NOTE: For cutting aluminum with high silicon, coating is recommended.
 For spindles with ceramic bearings, multiply ap by 0.5.
 For better surface finish, reduce feed per tooth.
 Above parameters are based on ideal conditions. For smaller taper machining centers, please adjust parameters accordingly on diameters >1/2".

Application Data • Series 5AN2 5AN3 • Aluminum • Inch

Material Group	Side Milling (A) and Slotting (B)		Uncoated		Recommended feed per tooth (IPT = inch/th) for side milling (A). For slotting (B), reduce IPT by 20%.												
	A		B		Cutting Speed – vc SFM			D1 – Diameter									
	ap	ae	ap		min	max	frac. dec.	1/8	3/16	1/4	5/16	3/8	1/2	5/8	3/4	1	
	ap	ae	ap		min	max	dec.	1/8	3/16	1/4	5/16	3/8	1/2	5/8	3/4	1	
N	1	1 x D	0.5 x D	1 x D	1640	–	6560	IPT	.0013	.0019	.0025	.0031	.0038	.0050	.0063	.0075	.0100
	2	1 x D	0.5 x D	1 x D	1640	–	4920	IPT	.0010	.0015	.0020	.0025	.0030	.0040	.0050	.0060	.0080
	3	1 x D	0.5 x D	1 x D	1640	–	4920	IPT	.0009	.0013	.0018	.0022	.0026	.0035	.0044	.0053	.0070
	4	1 x D	0.5 x D	1 x D	1310	–	2460	IPT	.0009	.0013	.0018	.0022	.0026	.0035	.0044	.0053	.0070
	5	1 x D	0.5 x D	1 x D	820	–	3280	IPT	.0011	.0017	.0023	.0028	.0034	.0045	.0056	.0068	.0090

NOTE: Side milling applications – For longest reach (L3) tools, reduce ae by 30%.
 Slot milling applications – For longest reach (L3) tools, reduce ap by 30%.
 For cutting aluminum with high silicon, coating is recommended.
 For spindles with ceramic bearings, multiply ap by 0.5.
 For better surface finish, reduce feed per tooth.
 Above parameters are based on ideal conditions. For smaller taper machining centers, please adjust parameters accordingly on diameters greater than 1/2".

= ALL-STAR PORTFOLIO PRODUCT. ALL-STAR PRODUCTS ARE PROVEN SOLUTIONS THAT ARE ALWAYS AVAILABLE.

Application Data • Series 4C05 4C15 • Inch

Material Group	Side Milling (A)		Recommended feed per tooth (IPT = inch/th) for side milling (A).												
	A		Cutting Speed – vc			D1 – Diameter									
	ap	ae	SFM		frac.	1/8	3/16	1/4	5/16	3/8	1/2	5/8	3/4	1	
	ap	ae	min	max	dec.	.1250	.1875	.2500	.3125	.3750	.5000	.6250	.7500	1.0000	
P	0	Ap1 max 0.1 x D	490	–	660	IPT	.0009	.0013	.0018	.0023	.0027	.0034	.0039	.0044	.0049
	1	Ap1 max 0.1 x D	490	–	660	IPT	.0009	.0013	.0018	.0023	.0027	.0034	.0039	.0044	.0049
	2	Ap1 max 0.1 x D	460	–	620	IPT	.0009	.0013	.0018	.0023	.0027	.0034	.0039	.0044	.0049
	3	Ap1 max 0.1 x D	390	–	520	IPT	.0007	.0011	.0015	.0020	.0023	.0029	.0034	.0039	.0045
	4	Ap1 max 0.1 x D	300	–	490	IPT	.0007	.0010	.0014	.0017	.0020	.0026	.0030	.0034	.0039
	5	Ap1 max 0.1 x D	200	–	330	IPT	.0006	.0009	.0012	.0016	.0018	.0023	.0027	.0031	.0036
M	6	Ap1 max 0.1 x D	160	–	250	IPT	.0005	.0008	.0010	.0013	.0015	.0019	.0022	.0025	.0028
	1	Ap1 max 0.1 x D	300	–	380	IPT	.0007	.0011	.0015	.0020	.0023	.0029	.0034	.0039	.0045
K	2	Ap1 max 0.1 x D	200	–	260	IPT	.0006	.0009	.0012	.0016	.0018	.0023	.0027	.0031	.0036
	3	Ap1 max 0.1 x D	200	–	230	IPT	.0005	.0008	.0010	.0013	.0015	.0019	.0022	.0025	.0028
H	1	Ap1 max 0.1 x D	390	–	490	IPT	.0009	.0013	.0018	.0023	.0027	.0034	.0039	.0044	.0049
	2	Ap1 max 0.1 x D	360	–	460	IPT	.0007	.0011	.0015	.0020	.0023	.0029	.0034	.0039	.0045
H	3	Ap1 max 0.1 x D	360	–	430	IPT	.0006	.0009	.0012	.0016	.0018	.0023	.0027	.0031	.0036
	1	Ap1 max 0.1 x D	260	–	460	IPT	.0007	.0010	.0014	.0017	.0020	.0026	.0030	.0034	.0039
H	2	Ap1 max 0.1 x D	230	–	390	IPT	.0005	.0008	.0010	.0013	.0015	.0019	.0022	.0025	.0028

NOTE: Lower value of cutting speed is used for high stock removal applications or for higher hardness (machinability) within group.
 Higher value of cutting speed is used for finishing applications or for lower hardness (machinability) within group.
 Above parameters are based on ideal conditions. For smaller taper machining centers, please adjust parameters accordingly on >1/2" diameter.

Application Data • Series 4S07 • Inch

Material Group	Side Milling (A)		Recommended feed per tooth (IPT = inch/th) for side milling (A).													
	A		Cutting Speed – vc			D1 – Diameter										
	ap	ae	SFM		frac.	1/8	3/16	1/4	5/16	3/8	1/2	5/8	3/4	1		
	ap	ae	min	max	dec.	.1250	.1875	.2500	.3125	.3750	.4375	.5000	.6250	.7500	1.0000	
P	0	1 x D 0.2 x D	490	–	660	IPT	.0009	.0013	.0018	.0023	.0027	.0031	.0034	.0039	.0044	.0049
	1	1 x D 0.2 x D	490	–	660	IPT	.0009	.0013	.0018	.0023	.0027	.0031	.0034	.0039	.0044	.0049
	2	1 x D 0.2 x D	460	–	620	IPT	.0009	.0013	.0018	.0023	.0027	.0031	.0034	.0039	.0044	.0049
	3	1 x D 0.1 x D	390	–	520	IPT	.0007	.0011	.0015	.0020	.0023	.0026	.0029	.0034	.0039	.0045
	4	1 x D 0.1 x D	300	–	490	IPT	.0007	.0010	.0014	.0017	.0020	.0023	.0026	.0030	.0034	.0039
	5	1 x D 0.1 x D	200	–	330	IPT	.0006	.0009	.0012	.0016	.0018	.0021	.0023	.0027	.0031	.0036
M	6	1 x D 0.1 x D	160	–	250	IPT	.0005	.0008	.0010	.0013	.0015	.0017	.0019	.0022	.0025	.0028
	1	1 x D 0.1 x D	300	–	380	IPT	.0007	.0011	.0015	.0020	.0023	.0026	.0029	.0034	.0039	.0045
K	2	1 x D 0.1 x D	200	–	260	IPT	.0006	.0009	.0012	.0016	.0018	.0021	.0023	.0027	.0031	.0036
	3	1 x D 0.1 x D	200	–	230	IPT	.0005	.0008	.0010	.0013	.0015	.0017	.0019	.0022	.0025	.0028
S	1	1 x D 0.1 x D	390	–	490	IPT	.0009	.0013	.0018	.0023	.0027	.0031	.0034	.0039	.0044	.0049
	2	1 x D 0.1 x D	360	–	460	IPT	.0007	.0011	.0015	.0020	.0023	.0026	.0029	.0034	.0039	.0045
H	3	1 x D 0.1 x D	360	–	430	IPT	.0006	.0009	.0012	.0016	.0018	.0021	.0023	.0027	.0031	.0036
	1	1 x D 0.1 x D	160	–	300	IPT	.0007	.0011	.0015	.0020	.0023	.0026	.0029	.0034	.0039	.0045
H	2	1 x D 0.1 x D	80	–	130	IPT	.0004	.0006	.0008	.0010	.0012	.0014	.0015	.0018	.0021	.0024
	3	1 x D 0.15 x D	200	–	260	IPT	.0006	.0009	.0012	.0016	.0018	.0021	.0023	.0027	.0031	.0036
H	4	1 x D 0.15 x D	160	–	200	IPT	.0005	.0008	.0011	.0014	.0017	.0019	.0021	.0025	.0028	.0033
	1	1 x D 0.1 x D	260	–	460	IPT	.0007	.0010	.0014	.0017	.0020	.0023	.0026	.0030	.0034	.0039

NOTE: Lower value of cutting speed is used for high stock removal applications or for higher hardness (machinability) within group.
 Higher value of cutting speed is used for finishing applications or for lower hardness (machinability) within group.
 Above parameters are based on ideal conditions. For smaller taper machining centers, please adjust parameters accordingly on >1/2" diameter.

 = ALL-STAR PORTFOLIO PRODUCT. ALL-STAR PRODUCTS ARE PROVEN SOLUTIONS THAT ARE ALWAYS AVAILABLE.

High-Performance Solid Carbide End Mills • Roughing

INDEXABLE MILLING



SOLID END MILLING

HOLEMAKING

TAPPING

TURNING

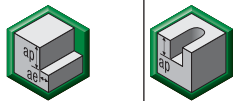
Application Data • Series 4976 • Metric

Material Group																					
	Side Milling (A) and Slotting (B)			WP15PE			Recommended feed per tooth (fz = mm/th) for side milling (A). For slotting (B), reduce fz by 20%.														
	A		B	Cutting Speed – vc m/min			D1 – Diameter														
	ap	ae	ap	min	max	mm	4,0	5,0	6,0	8,0	10,0	12,0	14,0	16,0	18,0	20,0	25,0				
P	0	1,5 x D	0,5 x D	1 x D	150	–	200	fz	0,028	0,036	0,044	0,060	0,072	0,083	0,092	0,101	0,108	0,114	0,124		
	1	1,5 x D	0,5 x D	1 x D	150	–	200	fz	0,028	0,036	0,044	0,060	0,072	0,083	0,092	0,101	0,108	0,114	0,124		
	2	1,5 x D	0,5 x D	1 x D	140	–	190	fz	0,028	0,036	0,044	0,060	0,072	0,083	0,092	0,101	0,108	0,114	0,124		
	3	1,5 x D	0,4 x D	0,75 x D	120	–	160	fz	0,023	0,030	0,036	0,050	0,061	0,070	0,079	0,087	0,095	0,101	0,114		
	4	1,5 x D	0,4 x D	0,75 x D	90	–	150	fz	0,021	0,027	0,033	0,045	0,054	0,062	0,070	0,077	0,083	0,088	0,098		
M	5	1,5 x D	0,4 x D	0,75 x D	60	–	100	fz	0,019	0,024	0,029	0,040	0,048	0,056	0,063	0,070	0,076	0,081	0,091		
	1	1,5 x D	0,4 x D	0,75 x D	90	–	115	fz	0,023	0,030	0,036	0,050	0,061	0,070	0,079	0,087	0,095	0,101	0,114		
	2	1,5 x D	0,4 x D	0,75 x D	60	–	80	fz	0,019	0,024	0,029	0,040	0,048	0,056	0,063	0,070	0,076	0,081	0,091		
K	3	1,5 x D	0,4 x D	0,75 x D	60	–	70	fz	0,016	0,020	0,025	0,034	0,040	0,047	0,052	0,057	0,061	0,065	0,071		
	1	1,5 x D	0,5 x D	1 x D	120	–	150	fz	0,028	0,036	0,044	0,060	0,072	0,083	0,092	0,101	0,108	0,114	0,124		
	2	1,5 x D	0,4 x D	1 x D	110	–	140	fz	0,023	0,030	0,036	0,050	0,061	0,070	0,079	0,087	0,095	0,101	0,114		
S	3	1,5 x D	0,4 x D	1 x D	110	–	130	fz	0,019	0,024	0,029	0,040	0,048	0,056	0,063	0,070	0,076	0,081	0,091		
	1	1,5 x D	0,3 x D	0,75 x D	50	–	90	fz	0,023	0,030	0,036	0,050	0,061	0,070	0,079	0,087	0,095	0,101	0,114		
	2	1,5 x D	0,3 x D	0,3 x D	25	–	40	fz	0,013	0,016	0,019	0,026	0,032	0,037	0,042	0,046	0,050	0,054	0,061		
H	3	1,5 x D	0,4 x D	0,75 x D	60	–	80	fz	0,019	0,024	0,029	0,040	0,048	0,056	0,063	0,070	0,076	0,081	0,091		
	4	1,5 x D	0,3 x D	0,75 x D	50	–	60	fz	0,016	0,021	0,026	0,037	0,045	0,052	0,058	0,064	0,069	0,074	0,084		
H	1	1,5 x D	0,3 x D	0,3 x D	80	–	140	fz	0,021	0,027	0,033	0,045	0,054	0,062	0,070	0,077	0,083	0,088	0,098		

NOTE: Lower value of cutting speed is used for high stock removal applications or for higher hardness (machinability) within group.
Higher value of cutting speed is used for finishing applications or for lower hardness (machinability) within group.
Above parameters are based on ideal conditions. For smaller taper machining centers, please adjust parameters accordingly on >12mm diameters.



Application Data • Series 4U70 • Metric

Material Group																					
	Side Milling (A) and Slotting (B)			WP15PE			Recommended feed per tooth (fz = mm/th) for side milling (A). For slotting (B), reduce fz by 20%.														
	A		B	Cutting Speed – vc m/min			D1 – Diameter														
	ap	ae	ap	min	max	mm	6,0	8,0	10,0	12,0	16,0	20,0	25,0								
P	3	1 x D	0,5 x D	0,75 x D	120	–	160	fz	0,036	0,050	0,061	0,070	0,087	0,101	0,114	0,124					
	4	1 x D	0,3 x D	0,75 x D	90	–	150	fz	0,033	0,045	0,054	0,062	0,077	0,088	0,098						
	5	1 x D	0,5 x D	0,75 x D	60	–	100	fz	0,029	0,040	0,048	0,056	0,070	0,081	0,091						
	6	1 x D	0,3 x D	0,3 x D	50	–	75	fz	0,025	0,034	0,040	0,047	0,057	0,065	0,071						
M	1	1 x D	0,5 x D	0,75 x D	90	–	115	fz	0,036	0,050	0,061	0,070	0,087	0,101	0,114						
	2	1 x D	0,5 x D	0,75 x D	60	–	80	fz	0,029	0,040	0,048	0,056	0,070	0,081	0,091						
	3	1 x D	0,5 x D	0,75 x D	60	–	70	fz	0,025	0,034	0,040	0,047	0,057	0,065	0,071						
K	1	1 x D	0,5 x D	1 x D	120	–	150	fz	0,044	0,060	0,072	0,083	0,101	0,114	0,124						
	2	1 x D	0,5 x D	1 x D	110	–	140	fz	0,036	0,050	0,061	0,070	0,087	0,101	0,114						
	3	1 x D	0,5 x D	1 x D	110	–	130	fz	0,029	0,040	0,048	0,056	0,070	0,081	0,091						
S	1	1 x D	0,3 x D	0,75 x D	50	–	90	fz	0,036	0,050	0,061	0,070	0,087	0,101	0,114						
	2	1 x D	0,3 x D	0,3 x D	25	–	40	fz	0,019	0,026	0,032	0,037	0,046	0,054	0,061						
	3	1 x D	0,4 x D	0,75 x D	60	–	80	fz	0,029	0,040	0,048	0,056	0,070	0,081	0,091						
	4	1 x D	0,4 x D	0,75 x D	50	–	60	fz	0,026	0,037	0,045	0,052	0,064	0,074	0,084						
H	1	1 x D	0,3 x D	0,3 x D	80	–	140	fz	0,033	0,045	0,054	0,062	0,077	0,088	0,098						
	2	1 x D	0,2 x D	0,2 x D	70	–	120	fz	0,025	0,034	0,040	0,047	0,057	0,065	0,071						
	3	1 x D	0,2 x D	0,2 x D	60	–	90	fz	0,019	0,026	0,032	0,037	0,046	0,054	0,061						

NOTE: Lower value of cutting speed is used for high stock removal applications or for higher hardness (machinability) within group.
Higher value of cutting speed is used for finishing applications or for lower hardness (machinability) within group.
For rougher tool with 6 flutes, use ap in slotting 60% of table value.
Above parameters are based on ideal conditions. For smaller taper machining centers, please adjust parameters accordingly on >12mm diameters.

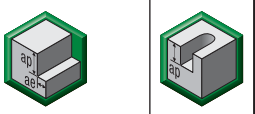

 = ALL-STAR PORTFOLIO PRODUCT. ALL-STAR PRODUCTS ARE PROVEN SOLUTIONS THAT ARE ALWAYS AVAILABLE.

Application Data • Series 4Q03 4Q05 4Q43 • Inch

Material Group																
	Side Milling (A) and Slotting (B)			WP15PE			Recommended feed per tooth (IPT = inch/th) for side milling (A). For slotting (B), reduce IPT by 20%.									
	A		B	Cutting Speed – vc SFM			D1 – Diameter									
	ap	ae	ap	min	max	frac. dec.	3/16	1/4	5/16	3/8	1/2	5/8	3/4	1		
P	0	1 x D	0.5 x D	0.75 x D	490	–	660	IPT	.0014	.0018	.0023	.0027	.0034	.0040	.0044	.0049
	1	1 x D	0.5 x D	0.75 x D	490	–	660	IPT	.0014	.0018	.0023	.0027	.0034	.0040	.0044	.0049
	2	1 x D	0.5 x D	0.75 x D	460	–	620	IPT	.0014	.0018	.0023	.0027	.0034	.0040	.0044	.0049
	3	1 x D	0.5 x D	0.75 x D	390	–	520	IPT	.0011	.0015	.0020	.0023	.0029	.0034	.0039	.0045
	4	1 x D	0.4 x D	0.5 x D	300	–	490	IPT	.0010	.0014	.0018	.0020	.0026	.0030	.0034	.0039
	5	1 x D	0.5 x D	0.75 x D	200	–	330	IPT	.0009	.0012	.0016	.0018	.0023	.0027	.0031	.0036
M	6	1 x D	0.4 x D	0.5 x D	160	–	250	IPT	.0008	.0010	.0013	.0015	.0019	.0022	.0025	.0028
	1	1 x D	0.5 x D	0.75 x D	300	–	380	IPT	.0011	.0015	.0020	.0023	.0029	.0034	.0039	.0045
	2	1 x D	0.4 x D	0.75 x D	200	–	260	IPT	.0009	.0012	.0016	.0018	.0023	.0027	.0031	.0036
K	3	1 x D	0.4 x D	0.75 x D	200	–	230	IPT	.0008	.0010	.0013	.0015	.0019	.0022	.0025	.0028
	1	1 x D	0.5 x D	0.75 x D	390	–	490	IPT	.0014	.0018	.0023	.0027	.0034	.0040	.0044	.0049
	2	1 x D	0.5 x D	0.75 x D	360	–	460	IPT	.0011	.0015	.0020	.0023	.0029	.0034	.0039	.0045
S	3	1 x D	0.4 x D	0.75 x D	360	–	430	IPT	.0009	.0012	.0016	.0018	.0023	.0027	.0031	.0036
	1	1 x D	0.3 x D	0.4 x D	160	–	300	IPT	.0011	.0015	.0020	.0023	.0029	.0034	.0039	.0045
	2	1 x D	0.3 x D	0.3 x D	80	–	130	IPT	.0006	.0008	.0010	.0012	.0015	.0018	.0021	.0024
	3	1 x D	0.4 x D	0.75 x D	200	–	260	IPT	.0009	.0012	.0016	.0018	.0023	.0027	.0031	.0036
H	4	1 x D	0.4 x D	0.75 x D	160	–	200	IPT	.0008	.0011	.0014	.0017	.0021	.0025	.0028	.0033
	1	1 x D	0.2 x D	0.3 x D	260	–	460	IPT	.0010	.0014	.0018	.0020	.0026	.0030	.0034	.0039

NOTE: Lower value of cutting speed is used for high stock removal applications or for higher hardness (machinability) within group.
Higher value of cutting speed is used for finishing applications or for lower hardness (machinability) within group.
Above parameters are based on ideal conditions. For smaller taper machining centers, please adjust parameters accordingly on >1/2" diameter.

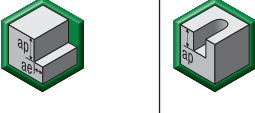
Application Data • Series 4MOR 4M4R • Inch



Material Group															
	Side Milling (A) and Slotting (B)			WP15PE			Recommended feed per tooth (IPT = inch/th) for side milling (A). For slotting (B), reduce IPT by 20%.								
	A		B	Cutting Speed – vc SFM			D1 – Diameter								
	ap	ae	ap	min	max	frac. dec.	1/4	3/8	1/2	5/8	3/4	1			
P	3	1 x D	0.5 x D	0.75 x D	390	–	520	IPT	.0015	.0023	.0029	.0034	.0039	.0045	
	4	1 x D	0.3 x D	0.75 x D	300	–	490	IPT	.0014	.0020	.0026	.0030	.0034	.0039	
	5	1 x D	0.5 x D	0.75 x D	200	–	330	IPT	.0012	.0018	.0023	.0027	.0031	.0036	
	6	1 x D	0.3 x D	0.3 x D	160	–	250	IPT	.0010	.0015	.0019	.0022	.0025	.0028	
M	1	1 x D	0.5 x D	0.75 x D	300	–	380	IPT	.0015	.0023	.0029	.0034	.0039	.0045	
	2	1 x D	0.5 x D	0.75 x D	200	–	260	IPT	.0012	.0018	.0023	.0027	.0031	.0036	
	3	1 x D	0.5 x D	0.75 x D	200	–	230	IPT	.0010	.0015	.0019	.0022	.0025	.0028	
K	1	1 x D	0.5 x D	1 x D	390	–	490	IPT	.0018	.0027	.0034	.0040	.0044	.0049	
	2	1 x D	0.5 x D	1 x D	360	–	460	IPT	.0015	.0023	.0029	.0034	.0039	.0045	
	3	1 x D	0.5 x D	1 x D	360	–	430	IPT	.0012	.0018	.0023	.0027	.0031	.0036	
S	1	1 x D	0.3 x D	0.75 x D	160	–	300	IPT	.0015	.0023	.0029	.0034	.0039	.0045	
	2	1 x D	0.3 x D	0.3 x D	80	–	130	IPT	.0008	.0012	.0015	.0018	.0021	.0024	
	3	1 x D	0.4 x D	0.75 x D	200	–	260	IPT	.0012	.0018	.0023	.0027	.0031	.0036	
	4	1 x D	0.4 x D	0.75 x D	160	–	200	IPT	.0011	.0017	.0021	.0025	.0028	.0033	
H	1	1 x D	0.3 x D	0.3 x D	260	–	460	IPT	.0014	.0020	.0026	.0030	.0034	.0039	
	2	1 x D	0.2 x D	0.2 x D	230	–	390	IPT	.0010	.0015	.0019	.0022	.0025	.0028	
	3	1 x D	0.2 x D	0.2 x D	200	–	300	IPT	.0008	.0012	.0015	.0018	.0021	.0024	

NOTE: Lower value of cutting speed is used for high stock removal applications or for higher hardness (machinability) within group.
Higher value of cutting speed is used for finishing applications or for lower hardness (machinability) within group.
Above parameters are based on ideal conditions. For smaller taper machining centers, please adjust parameters accordingly on >1/2" diameter.

 = ALL-STAR PORTFOLIO PRODUCT. ALL-STAR PRODUCTS ARE PROVEN SOLUTIONS THAT ARE ALWAYS AVAILABLE.

High-Performance Solid Carbide End Mills • Roughing

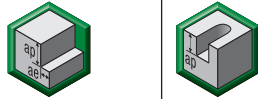
Application Data • Series 4SOR • Inch

Material Group					Recommended feed per tooth (IPT = inch/th) for side milling (A). For slotting (B), reduce IPT by 20%.									
	Side Milling (A) and Slotting (B)		WP15PE		D1 – Diameter									
	A		B		Cutting Speed – vc SFM		frac.	1/4	3/8	1/2	5/8	3/4	1	
	ap	ae	ap		min	max	dec.	.2500	.3750	.5000	.6250	.7500	1.0000	
P	0	1 x D	0.5 x D	0.5 x D	490	–	660	IPT	.0015	.0022	.0027	.0032	.0035	.0039
	1	1 x D	0.5 x D	0.5 x D	490	–	660	IPT	.0015	.0022	.0027	.0032	.0035	.0039
	2	1 x D	0.5 x D	0.5 x D	460	–	620	IPT	.0015	.0022	.0027	.0032	.0035	.0039
	3	1 x D	0.4 x D	0.5 x D	390	–	520	IPT	.0012	.0018	.0023	.0027	.0031	.0036
	4	1 x D	0.3 x D	0.4 x D	300	–	490	IPT	.0011	.0016	.0021	.0024	.0027	.0031
M	5	1 x D	0.4 x D	0.5 x D	200	–	330	IPT	.0010	.0015	.0019	.0022	.0025	.0029
	1	1 x D	0.4 x D	0.5 x D	300	–	380	IPT	.0012	.0018	.0023	.0027	.0031	.0036
	2	1 x D	0.4 x D	0.5 x D	200	–	260	IPT	.0010	.0015	.0019	.0022	.0025	.0029
K	3	1 x D	0.4 x D	0.5 x D	200	–	230	IPT	.0008	.0012	.0015	.0018	.0020	.0023
	1	1 x D	0.5 x D	0.5 x D	390	–	490	IPT	.0015	.0022	.0027	.0032	.0035	.0039
	2	1 x D	0.4 x D	0.5 x D	360	–	460	IPT	.0012	.0018	.0023	.0027	.0031	.0036
S	3	1 x D	0.4 x D	0.5 x D	360	–	430	IPT	.0010	.0015	.0019	.0022	.0025	.0029
	1	1 x D	0.5 x D	0.3 x D	160	–	300	IPT	.0012	.0018	.0023	.0027	.0031	.0036
H	3	1 x D	0.5 x D	0.4 x D	200	–	260	IPT	.0010	.0015	.0019	.0022	.0025	.0029
	1	1 x D	0.3 x D	0.3 x D	260	–	460	IPT	.0011	.0016	.0021	.0024	.0027	.0031

NOTE: Lower value of cutting speed is used for high stock removal applications or for higher hardness (machinability) within group.
 Higher value of cutting speed is used for finishing applications or for lower hardness (machinability) within group.
 Above parameters are based on ideal conditions. For smaller taper machining centers, please adjust parameters accordingly on >1/2" diameter.

 = ALL-STAR PORTFOLIO PRODUCT. ALL-STAR PRODUCTS ARE PROVEN SOLUTIONS THAT ARE ALWAYS AVAILABLE.

INDEXABLE MILLING
 SOLID END MILLING
 HOLEMAKING
 TAPPING
 TURNING

AEROSPACE TECHNOLOGY

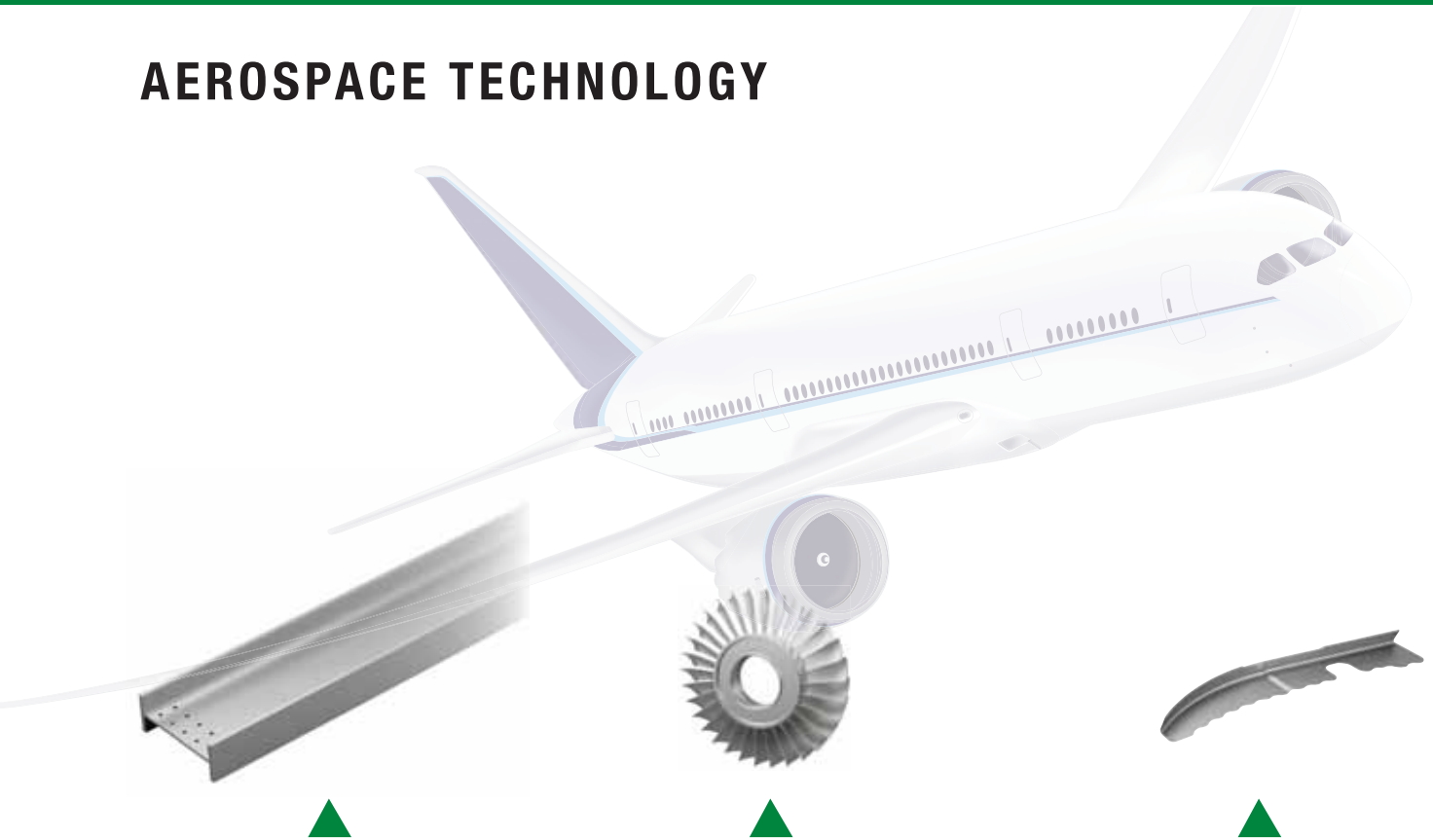

WIDIA drills for composite machining utilize PCD and diamond coatings made for the machining of aerospace CFRP (Carbon Fiber Reinforced Plastics). These coatings enable longer tool life at much higher machining speeds.



Integral Blade Rotor (IBR) machining end mills are designed to match a multi-level machining process for the airfoils, followed by the fi let feature, which works for roughing and finishing operations.



WIDIA-Hanita™ end mills produce consistent performance each and every run, allowing the production of more parts per tool and less downtime, while machining tough materials like INCONEL® depressor fine seals.



WIDIA offers machining strategies and innovative tooling technology specifically engineered for the aerospace industry to increase productivity and reduce costs.

TO SEE ALL PRODUCTS LINES, VISIT OUR DIGITAL RESOURCES



WIDIA NOVO™ Application
Download to your desktop or tablet:
widia.com/novo



WIDIA™ Machining Central Mobile App
Download for iOS or Android:
widia.com/en/featured/WidiaMobileApp



GENERAL PURPOSE SOLID CAR

2-FLUTE GP

Pages F70–F72

- Series I2S
- Series I2B



3-FLUTE GP

Pages F73–F74

- Series I3S





4-FLUTE GP

Pages F75–F79

- Series 4004/4014/4024
- Series D010
- Series 4000/4010
- Series I4S
- Series I4B
- Series I4R

WIDIA-Hanita™ General Purpose End Mills offer plunging, slotting, and profiling for a wide range of materials and applications. Designed to provide high metal removal rates and excellent surface conditions at a value price.

TO SEE ALL PRODUCTS LINES, VISIT OUR DIGITAL RESOURCES



WIDIA NOVO™ Application
Download to your desktop or tablet:
widia.com/novo



WIDIA™ Machining Central Mobile App
Download for iOS or Android:
widia.com/en/featured/WidiaMobileApp

General Purpose Solid Carbide End Mills • Roughing/Finishing

INDEXABLE MILLING



SOLID END MILLING

HOLEMAKING

TAPPING

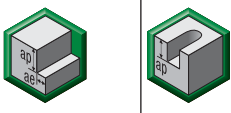

TURNING

Application Data • Series I2S..S I2S..R • TiAlN • Inch

																						
		Side Milling (A) and Slotting (B)		TiAlN		Recommended feed per tooth (IPT = inch/th) for side milling (A). For slotting (B), reduce IPT by 20%.																
Material Group	A		B	Cutting Speed – vc SFM		D1 – Diameter																
	ap	ae	ap			min	max	frac.	1/64	1/32	1/16	5/64	3/32	1/8	3/16	1/4	5/16	3/8	1/2	5/8	3/4	1
	0	Ap1 max	0.1 x D	0.5 x D	490	– 660	IPT	.0001	.0002	.0004	.0005	.0007	.0009	.0013	.0018	.0023	.0027	.0034	.0039	.0044	.0049	
P	1	Ap1 max	0.1 x D	0.5 x D	490	– 660	IPT	.0001	.0002	.0004	.0005	.0007	.0009	.0013	.0018	.0023	.0027	.0034	.0039	.0044	.0049	
	2	Ap1 max	0.1 x D	0.5 x D	460	– 620	IPT	.0001	.0002	.0004	.0005	.0007	.0009	.0013	.0018	.0023	.0027	.0034	.0039	.0044	.0049	
	3	Ap1 max	0.1 x D	0.5 x D	390	– 520	IPT	.0001	.0002	.0004	.0004	.0005	.0007	.0011	.0015	.0020	.0023	.0029	.0034	.0039	.0045	
M	4	Ap1 max	0.1 x D	0.5 x D	300	– 490	IPT	.0001	.0002	.0003	.0004	.0005	.0007	.0010	.0014	.0017	.0020	.0026	.0030	.0034	.0039	
	1	Ap1 max	0.1 x D	0.5 x D	300	– 380	IPT	.0001	.0002	.0004	.0004	.0005	.0007	.0011	.0015	.0020	.0023	.0029	.0034	.0039	.0045	
	2	Ap1 max	0.1 x D	0.5 x D	200	– 260	IPT	.0001	.0001	.0003	.0004	.0004	.0006	.0009	.0012	.0016	.0018	.0023	.0027	.0031	.0036	
K	1	Ap1 max	0.1 x D	0.5 x D	390	– 490	IPT	.0001	.0002	.0004	.0005	.0007	.0009	.0013	.0018	.0023	.0027	.0034	.0039	.0044	.0049	
	2	Ap1 max	0.1 x D	0.5 x D	360	– 460	IPT	.0001	.0002	.0004	.0004	.0005	.0007	.0011	.0015	.0020	.0023	.0029	.0034	.0039	.0045	

NOTE: Lower value of cutting speed is used for high stock removal applications or for higher hardness (machinability) within group.
Higher value of cutting speed is used for finishing applications or for lower hardness (machinability) within group.
Above parameters are based on ideal conditions. For smaller taper machining centers, please adjust parameters accordingly on >1/2" diameter.

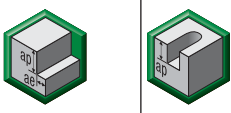

Application Data • Series I2S..S I2S..R • Uncoated • Inch

																						
		Side Milling (A) and Slotting (B)		uncoated		Recommended feed per tooth (IPT = inch/th) for side milling (A). For slotting (B), reduce IPT by 20%.																
Material Group	A		B	Cutting Speed – vc SFM		D1 – Diameter																
	ap	ae	ap			min	max	frac.	1/64	1/32	1/16	5/64	3/32	1/8	3/16	1/4	5/16	3/8	1/2	5/8	3/4	1
	0	Ap1 max	0.1 x D	0.5 x D	390	– 520	IPT	.0001	.0002	.0004	.0005	.0007	.0009	.0013	.0018	.0023	.0027	.0034	.0039	.0044	.0049	
P	1	Ap1 max	0.1 x D	0.5 x D	390	– 520	IPT	.0001	.0002	.0004	.0005	.0007	.0009	.0013	.0018	.0023	.0027	.0034	.0039	.0044	.0049	
	2	Ap1 max	0.1 x D	0.5 x D	370	– 500	IPT	.0001	.0002	.0004	.0005	.0007	.0009	.0013	.0018	.0023	.0027	.0034	.0039	.0044	.0049	

NOTE: Lower value of cutting speed is used for high stock removal applications or for higher hardness (machinability) within group.
Higher value of cutting speed is used for finishing applications or for lower hardness (machinability) within group.
Above parameters are based on ideal conditions. For smaller taper machining centers, please adjust parameters accordingly on >1/2" diameter.



 = ALL-STAR PORTFOLIO PRODUCT. ALL-STAR PRODUCTS ARE PROVEN SOLUTIONS THAT ARE ALWAYS AVAILABLE.

Application Data • Series I2S..L I2S..X • TiAlN • Inch

																			
		★	Side Milling (A)		TiAlN		Recommended feed per tooth (IPT = inch/th) for side milling (A).												
Material Group	A		Cutting Speed – vc SFM				D1 – Diameter												
	ap	ae	min	–	max	frac.	1/16	5/64	3/32	1/8	3/16	1/4	5/16	3/8	1/2	5/8	3/4	1	
P	0	Ap1 max	0.1 x D	490	–	660	dec.	.0625	.0781	.0938	.1250	.1875	.2500	.3125	.3750	.5000	.6250	.7500	1.0000
	1	Ap1 max	0.1 x D	490	–	660	IPT	.0004	.0005	.0007	.0009	.0013	.0018	.0023	.0027	.0034	.0039	.0044	.0049
	2	Ap1 max	0.1 x D	460	–	620	IPT	.0004	.0005	.0007	.0009	.0013	.0018	.0023	.0027	.0034	.0039	.0044	.0049
	3	Ap1 max	0.1 x D	390	–	520	IPT	.0004	.0004	.0005	.0007	.0011	.0015	.0020	.0023	.0029	.0034	.0039	.0045
M	4	Ap1 max	0.1 x D	300	–	490	IPT	.0003	.0004	.0005	.0007	.0010	.0014	.0017	.0020	.0026	.0030	.0034	.0039
	1	Ap1 max	0.1 x D	300	–	380	IPT	.0004	.0004	.0005	.0007	.0011	.0015	.0020	.0023	.0029	.0034	.0039	.0045
K	2	Ap1 max	0.1 x D	200	–	260	IPT	.0003	.0004	.0004	.0006	.0009	.0012	.0016	.0018	.0023	.0027	.0031	.0036
	1	Ap1 max	0.1 x D	390	–	490	IPT	.0004	.0005	.0007	.0009	.0013	.0018	.0023	.0027	.0034	.0039	.0044	.0049
	2	Ap1 max	0.1 x D	360	–	460	IPT	.0004	.0004	.0005	.0007	.0011	.0015	.0020	.0023	.0029	.0034	.0039	.0045

NOTE: Lower value of cutting speed is used for high stock removal applications or for higher hardness (machinability) within group.
 Higher value of cutting speed is used for finishing applications or for lower hardness (machinability) within group.
 Above parameters are based on ideal conditions. For smaller taper machining centers, please adjust parameters accordingly on >1/2" diameter.

Application Data • Series I2S..L I2S..X • Uncoated • Inch

																			
		★	Side Milling (A)		uncoated		Recommended feed per tooth (IPT = inch/th) for side milling (A).												
Material Group	A		Cutting Speed – vc SFM				D1 – Diameter												
	ap	ae	min	–	max	frac.	1/16	5/64	3/32	1/8	3/16	1/4	5/16	3/8	1/2	5/8	3/4	1	
P	0	Ap1 max	0.1 x D	390	–	520	IPT	.0004	.0005	.0007	.0009	.0013	.0018	.0023	.0027	.0034	.0039	.0044	.0049
	1	Ap1 max	0.1 x D	390	–	520	IPT	.0004	.0005	.0007	.0009	.0013	.0018	.0023	.0027	.0034	.0039	.0044	.0049
	2	Ap1 max	0.1 x D	370	–	500	IPT	.0004	.0005	.0007	.0009	.0013	.0018	.0023	.0027	.0034	.0039	.0044	.0049

NOTE: Lower value of cutting speed is used for high stock removal applications or for higher hardness (machinability) within group.
 Higher value of cutting speed is used for finishing applications or for lower hardness (machinability) within group.
 Above parameters are based on ideal conditions. For smaller taper machining centers, please adjust parameters accordingly on >1/2" diameter.

★ = ALL-STAR PORTFOLIO PRODUCT. ALL-STAR PRODUCTS ARE PROVEN SOLUTIONS THAT ARE ALWAYS AVAILABLE.

General Purpose Solid Carbide End Mills • Roughing/Finishing

INDEXABLE MILLING

SOLID END MILLING

HOLEMAKING

TAPPING

TURNING

Application Data • Series I2B..S I2B..R • TiAlN • Inch

Material Group	Side Milling (A) and Slotting (B)		TiAlN		Recommended feed per tooth (IPT = inch/th) for side milling (A). For slotting (B), reduce IPT by 20%.																	
	A		B		Cutting Speed – vc SFM		D1 – Diameter															
	ap	ae	ap	min	max	frac.	1/64	1/32	1/16	5/64	3/32	1/8	3/16	1/4	5/16	3/8	1/2	5/8	3/4	1		
	ap	ae	ap	min	max	dec.	.0156	.0313	.0625	.0781	.0938	.1250	.1875	.2500	.3125	.3750	.5000	.6250	.7500	1.0000		
P	0	Ap1 max	0.1 x D	0.5 x D	490	–	660	IPT	.0001	.0002	.0004	.0005	.0007	.0009	.0013	.0018	.0023	.0027	.0034	.0039	.0044	.0049
	1	Ap1 max	0.1 x D	0.5 x D	490	–	660	IPT	.0001	.0002	.0004	.0005	.0007	.0009	.0013	.0018	.0023	.0027	.0034	.0039	.0044	.0049
	2	Ap1 max	0.1 x D	0.5 x D	460	–	620	IPT	.0001	.0002	.0004	.0005	.0007	.0009	.0013	.0018	.0023	.0027	.0034	.0039	.0044	.0049
	3	Ap1 max	0.1 x D	0.5 x D	390	–	520	IPT	.0001	.0002	.0004	.0004	.0005	.0007	.0011	.0015	.0020	.0023	.0029	.0034	.0039	.0045
M	4	Ap1 max	0.1 x D	0.5 x D	300	–	490	IPT	.0001	.0002	.0003	.0004	.0005	.0007	.0010	.0014	.0017	.0020	.0026	.0030	.0034	.0039
	1	Ap1 max	0.1 x D	0.5 x D	300	–	380	IPT	.0001	.0002	.0004	.0004	.0005	.0007	.0011	.0015	.0020	.0023	.0029	.0034	.0039	.0045
K	2	Ap1 max	0.1 x D	0.5 x D	200	–	260	IPT	.0001	.0001	.0003	.0004	.0004	.0006	.0009	.0012	.0016	.0018	.0023	.0027	.0031	.0036
	1	Ap1 max	0.1 x D	0.5 x D	390	–	490	IPT	.0001	.0002	.0004	.0005	.0007	.0009	.0013	.0018	.0023	.0027	.0034	.0039	.0044	.0049
	2	Ap1 max	0.1 x D	0.5 x D	360	–	460	IPT	.0001	.0002	.0004	.0004	.0005	.0007	.0011	.0015	.0020	.0023	.0029	.0034	.0039	.0045

NOTE: Lower value of cutting speed is used for high stock removal applications or for higher hardness (machinability) within group.
Higher value of cutting speed is used for finishing applications or for lower hardness (machinability) within group.
Above parameters are based on ideal conditions. For smaller taper machining centers, please adjust parameters accordingly on >1/2" diameter.

Application Data • Series I2B..L I2B..X • TiAlN • Inch

Material Group	Side Milling (A)		TiAlN		Recommended feed per tooth (IPT = inch/th) for side milling (A).															
	A		Cutting Speed – vc SFM		D1 – Diameter															
	ap	ae	min	max	frac.	3/32	1/8	3/16	1/4	5/16	3/8	1/2	5/8	3/4	1					
	ap	ae	min	max	dec.	.0938	.1250	.1875	.2500	.3125	.3750	.5000	.6250	.7500	1.0000					
P	0	Ap1 max	0.1 x D	490	–	660	IPT	.0007	.0009	.0013	.0018	.0023	.0027	.0034	.0039	.0044	.0049			
	1	Ap1 max	0.1 x D	490	–	660	IPT	.0007	.0009	.0013	.0018	.0023	.0027	.0034	.0039	.0044	.0049			
	2	Ap1 max	0.1 x D	460	–	620	IPT	.0007	.0009	.0013	.0018	.0023	.0027	.0034	.0039	.0044	.0049			
	3	Ap1 max	0.1 x D	390	–	520	IPT	.0005	.0007	.0011	.0015	.0020	.0023	.0029	.0034	.0039	.0045			
M	4	Ap1 max	0.1 x D	300	–	490	IPT	.0005	.0007	.0010	.0014	.0017	.0020	.0026	.0030	.0034	.0039			
	1	Ap1 max	0.1 x D	300	–	380	IPT	.0005	.0007	.0011	.0015	.0020	.0023	.0029	.0034	.0039	.0045			
K	2	Ap1 max	0.1 x D	200	–	260	IPT	.0004	.0006	.0009	.0012	.0016	.0018	.0023	.0027	.0031	.0036			
	1	Ap1 max	0.1 x D	390	–	490	IPT	.0007	.0009	.0013	.0018	.0023	.0027	.0034	.0039	.0044	.0049			
	2	Ap1 max	0.1 x D	360	–	460	IPT	.0005	.0007	.0011	.0015	.0020	.0023	.0029	.0034	.0039	.0045			

NOTE: Lower value of cutting speed is used for high stock removal applications or for higher hardness (machinability) within group.
Higher value of cutting speed is used for finishing applications or for lower hardness (machinability) within group.
Above parameters are based on ideal conditions. For smaller taper machining centers, please adjust parameters accordingly on >1/2" diameter.

 = ALL-STAR PORTFOLIO PRODUCT. ALL-STAR PRODUCTS ARE PROVEN SOLUTIONS THAT ARE ALWAYS AVAILABLE.

Application Data • Series I3S..S I3S..R • TiAlN • Inch

Material Group	Side Milling (A) and Slotting (B)		Recommended feed per tooth (IPT = inch/th) for side milling (A). For slotting (B), reduce IPT by 20%.														
	A		B	Cutting Speed – vc		D1 – Diameter											
	ap	ae	ap	min	max	frac.	1/8	3/16	1/4	5/16	3/8	1/2	5/8	3/4	1		
	ap	ae	ap	min	max	dec.	.1250	.1875	.2500	.3125	.3750	.5000	.6250	.7500	1.0000		
P	0	2.0 x D	0.1 x D	0.5 x D	490	–	660	IPT	.0009	.0013	.0018	.0023	.0027	.0034	.0039	.0044	.0049
	1	2.0 x D	0.1 x D	0.5 x D	490	–	660	IPT	.0009	.0013	.0018	.0023	.0027	.0034	.0039	.0044	.0049
	2	2.0 x D	0.1 x D	0.5 x D	460	–	620	IPT	.0009	.0013	.0018	.0023	.0027	.0034	.0039	.0044	.0049
	3	2.0 x D	0.1 x D	0.5 x D	390	–	520	IPT	.0007	.0011	.0015	.0020	.0023	.0029	.0034	.0039	.0045
M	1	2.0 x D	0.1 x D	0.5 x D	300	–	490	IPT	.0007	.0010	.0014	.0017	.0020	.0026	.0030	.0034	.0039
	2	2.0 x D	0.1 x D	0.5 x D	200	–	260	IPT	.0006	.0009	.0012	.0016	.0018	.0023	.0027	.0031	.0036
K	1	2.0 x D	0.1 x D	0.5 x D	390	–	490	IPT	.0009	.0013	.0018	.0023	.0027	.0034	.0039	.0044	.0049
	2	2.0 x D	0.1 x D	0.5 x D	360	–	460	IPT	.0007	.0011	.0015	.0020	.0023	.0029	.0034	.0039	.0045

NOTE: Lower value of cutting speed is used for high stock removal applications or for higher hardness (machinability) within group.
Higher value of cutting speed is used for finishing applications or for lower hardness (machinability) within group.
Above parameters are based on ideal conditions. For smaller taper machining centers, please adjust parameters accordingly on diameters >1/2".

Application Data • Series I3S..S I3S..R • Uncoated • Inch

Material Group	Side Milling (A) and Slotting (B)		Recommended feed per tooth (IPT = inch/th) for side milling (A). For slotting (B), reduce IPT by 20%.														
	A		B	Cutting Speed – vc		D1 – Diameter											
	ap	ae	ap	min	max	frac.	1/8	3/16	1/4	5/16	3/8	1/2	5/8	3/4	1		
	ap	ae	ap	min	max	dec.	.1250	.1875	.2500	.3125	.3750	.5000	.6250	.7500	1.0000		
P	0	2.0 x D	0.1 x D	0.5 x D	490	–	660	IPT	.0009	.0013	.0018	.0023	.0027	.0034	.0039	.0044	.0049
	1	2.0 x D	0.1 x D	0.5 x D	490	–	660	IPT	.0009	.0013	.0018	.0023	.0027	.0034	.0039	.0044	.0049
	2	2.0 x D	0.1 x D	0.5 x D	460	–	620	IPT	.0009	.0013	.0018	.0023	.0027	.0034	.0039	.0044	.0049
N	1	Ap1 max	0.1 x D	0.5 x D	650	–	2600	IPT	.0013	.0019	.0025	.0031	.0038	.0050	.0063	.0075	.0100
	2	Ap1 max	0.1 x D	0.5 x D	650	–	2000	IPT	.0010	.0015	.0020	.0025	.0030	.0040	.0050	.0060	.0080
5	Ap1 max	0.1 x D	0.5 x D	650	–	2000	IPT	.0011	.0017	.0023	.0028	.0034	.0045	.0056	.0068	.0090	

NOTE: Lower value of cutting speed is used for high stock removal applications or for higher hardness (machinability) within group.
Higher value of cutting speed is used for finishing applications or for lower hardness (machinability) within group.
Above parameters are based on ideal conditions. For smaller taper machining centers, please adjust parameters accordingly on diameters >1/2".

 = ALL-STAR PORTFOLIO PRODUCT. ALL-STAR PRODUCTS ARE PROVEN SOLUTIONS THAT ARE ALWAYS AVAILABLE.

General Purpose Solid Carbide End Mills • Roughing/Finishing

INDEXABLE MILLING



SOLID END MILLING

HOLEMAKING

TAPPING



TURNING

Application Data • Series I3S..L I3S..X • TiAlN • Inch

																	
		★															
		Side Milling (A)		TiAlN		Recommended feed per tooth (IPT = inch/th) for side milling (A).											
Material Group	A		Cutting Speed – vc SFM			frac. dec.	D1 – Diameter										
	ap	ae	min	–	max		1/8	3/16	1/4	5/16	3/8	1/2	5/8	3/4	1		
P	0	2.0 x D	0.1 x D	490	–	660	IPT	.0009	.0013	.0018	.0023	.0027	.0034	.0039	.0044	.0049	
	1	2.0 x D	0.1 x D	490	–	660	IPT	.0009	.0013	.0018	.0023	.0027	.0034	.0039	.0044	.0049	
	2	2.0 x D	0.1 x D	460	–	620	IPT	.0009	.0013	.0018	.0023	.0027	.0034	.0039	.0044	.0049	
	3	2.0 x D	0.1 x D	390	–	520	IPT	.0007	.0011	.0015	.0020	.0023	.0029	.0034	.0039	.0045	
M	1	2.0 x D	0.1 x D	300	–	490	IPT	.0007	.0010	.0014	.0017	.0020	.0026	.0030	.0034	.0039	
	2	2.0 x D	0.1 x D	300	–	380	IPT	.0007	.0011	.0015	.0020	.0023	.0029	.0034	.0039	.0045	
K	1	2.0 x D	0.1 x D	200	–	260	IPT	.0006	.0009	.0012	.0016	.0018	.0023	.0027	.0031	.0036	
	2	2.0 x D	0.1 x D	390	–	490	IPT	.0009	.0013	.0018	.0023	.0027	.0034	.0039	.0044	.0049	
K	1	2.0 x D	0.1 x D	390	–	490	IPT	.0009	.0013	.0018	.0023	.0027	.0034	.0039	.0044	.0049	
	2	2.0 x D	0.1 x D	360	–	460	IPT	.0007	.0011	.0015	.0020	.0023	.0029	.0034	.0039	.0045	

NOTE: Lower value of cutting speed is used for high stock removal applications or for higher hardness (machinability) within group.
 Higher value of cutting speed is used for finishing applications or for lower hardness (machinability) within group.
 Above parameters are based on ideal conditions. For smaller taper machining centers, please adjust parameters accordingly on diameters >1/2".



Application Data • Series I3S..L I3S..X • Uncoated • Inch

																	
		★															
		Side Milling (A)		uncoated		Recommended feed per tooth (IPT = inch/th) for side milling (A).											
Material Group	A		Cutting Speed – vc SFM			frac. dec.	D1 – Diameter										
	ap	ae	min	–	max		1/8	3/16	1/4	5/16	3/8	1/2	5/8	3/4	1		
P	0	2.0 x D	0.1 x D	490	–	660	IPT	.0009	.0013	.0018	.0023	.0027	.0034	.0039	.0044	.0049	
	1	2.0 x D	0.1 x D	490	–	660	IPT	.0009	.0013	.0018	.0023	.0027	.0034	.0039	.0044	.0049	
	2	2.0 x D	0.1 x D	460	–	620	IPT	.0009	.0013	.0018	.0023	.0027	.0034	.0039	.0044	.0049	
N	1	Ap1 max	0.1 x D	650	–	2600	IPT	.0013	.0019	.0025	.0031	.0038	.0050	.0063	.0075	.0100	
	2	Ap1 max	0.1 x D	650	–	2000	IPT	.0010	.0015	.0020	.0025	.0030	.0040	.0050	.0060	.0080	
	5	Ap1 max	0.1 x D	650	–	2000	IPT	.0011	.0017	.0023	.0028	.0034	.0045	.0056	.0068	.0090	

NOTE: Lower value of cutting speed is used for high stock removal applications or for higher hardness (machinability) within group.
 Higher value of cutting speed is used for finishing applications or for lower hardness (machinability) within group.
 Above parameters are based on ideal conditions. For smaller taper machining centers, please adjust parameters accordingly on diameters >1/2".

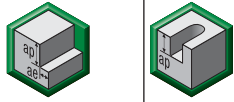

★ = ALL-STAR PORTFOLIO PRODUCT. ALL-STAR PRODUCTS ARE PROVEN SOLUTIONS THAT ARE ALWAYS AVAILABLE.

Application Data • 4004 4014 4024 Series • TiAlN • Metric

Material Group																						
	Side Milling (A) and Slotting (B)			TiAlN		Recommended feed per tooth (fz = mm/th) for side milling (A). For slotting (B), reduce fz by 20%.																
	A		B	Cutting Speed – Vc m/min		D1 – Diameter																
	ap	ae	ap	min	max	mm	1,0	2,0	3,0	4,0	5,0	6,0	8,0	10,0	12,0	14,0	16,0	18,0	20,0			
P	0	Ap1 max	0,1 x D	0,5 x D	150	–	200	fz	0,007	0,014	0,021	0,028	0,036	0,044	0,060	0,072	0,083	0,092	0,101	0,108	0,114	
	1	Ap1 max	0,1 x D	0,5 x D	150	–	200	fz	0,007	0,014	0,021	0,028	0,036	0,044	0,060	0,072	0,083	0,092	0,101	0,108	0,114	
	2	Ap1 max	0,1 x D	0,5 x D	140	–	190	fz	0,007	0,014	0,021	0,028	0,036	0,044	0,060	0,072	0,083	0,092	0,101	0,108	0,114	
	3	Ap1 max	0,1 x D	0,5 x D	120	–	160	fz	0,006	0,011	0,017	0,023	0,030	0,036	0,050	0,061	0,070	0,079	0,087	0,095	0,101	
M	4	Ap1 max	0,1 x D	0,5 x D	90	–	150	fz	0,005	0,010	0,016	0,021	0,027	0,033	0,045	0,054	0,062	0,070	0,077	0,083	0,088	
	1	Ap1 max	0,1 x D	0,5 x D	90	–	115	fz	0,006	0,011	0,017	0,023	0,030	0,036	0,050	0,061	0,070	0,079	0,087	0,095	0,101	
K	2	Ap1 max	0,1 x D	0,5 x D	60	–	80	fz	0,005	0,009	0,014	0,019	0,024	0,029	0,040	0,048	0,056	0,063	0,070	0,076	0,081	
	1	Ap1 max	0,1 x D	0,5 x D	120	–	150	fz	0,007	0,014	0,021	0,028	0,036	0,044	0,060	0,072	0,083	0,092	0,101	0,108	0,114	
	2	Ap1 max	0,1 x D	0,5 x D	110	–	140	fz	0,006	0,011	0,017	0,023	0,030	0,036	0,050	0,061	0,070	0,079	0,087	0,095	0,101	

NOTE: Lower value of cutting speed is used for high stock removal applications or for higher hardness (machinability) within group.
Higher value of cutting speed is used for finishing applications or for lower hardness (machinability) within group.
Above parameters are based on ideal conditions. For smaller taper machining centers, please adjust parameters accordingly on greater than 12mm diameters.

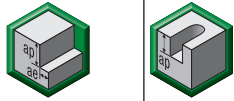
Application Data • 4004 4014 4024 Series • Uncoated • Metric



Material Group																						
	Side Milling (A) and Slotting (B)			uncoated		Recommended feed per tooth (fz = mm/th) for side milling (A). For slotting (B), reduce fz by 20%.																
	A		B	Cutting Speed – vc m/min		D1 – Diameter																
	ap	ae	ap	min	max	mm	1,0	2,0	3,0	4,0	6,0	8,0	10,0	12,0	16,0	20,0						
P	0	Ap1 max	0,1 x D	0,5 x D	120	–	160	fz	0,007	0,014	0,021	0,028	0,044	0,060	0,072	0,083	0,101	0,114				
	1	Ap1 max	0,1 x D	0,5 x D	120	–	160	fz	0,007	0,014	0,021	0,028	0,044	0,060	0,072	0,083	0,101	0,114				
	2	Ap1 max	0,1 x D	0,5 x D	112	–	152	fz	0,007	0,014	0,021	0,028	0,044	0,060	0,072	0,083	0,101	0,114				
N	1	Ap1 max	0,1 x D	0,5 x D	400	–	1600	fz	0,010	0,020	0,030	0,040	0,060	0,080	0,100	0,120	0,160	0,200				
	2	Ap1 max	0,1 x D	0,5 x D	400	–	1200	fz	0,008	0,016	0,024	0,032	0,048	0,064	0,080	0,096	0,128	0,160				
	4	Ap1 max	0,1 x D	0,5 x D	320	–	600	fz	0,007	0,014	0,021	0,028	0,042	0,056	0,070	0,084	0,112	0,140				

NOTE: Lower value of cutting speed is used for high stock removal applications or for higher hardness (machinability) within group.
Higher value of cutting speed is used for finishing applications or for lower hardness (machinability) within group.
Above parameters are based on ideal conditions. For smaller taper machining centers, please adjust parameters accordingly on >12mm diameters.

 = ALL-STAR PORTFOLIO PRODUCT. ALL-STAR PRODUCTS ARE PROVEN SOLUTIONS THAT ARE ALWAYS AVAILABLE.

General Purpose Solid Carbide End Mills • Roughing/Finishing

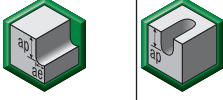
Application Data • Series D010 4000 4010 • TiAlN • Metric

Material Group																						
	Side Milling (A) and Slotting (B)			TiAlN		Recommended feed per tooth (fz = mm/th) for side milling (A). For slotting (B), reduce fz by 20%.																
	A		B	Cutting Speed – vc m/min		D1 – Diameter																
	ap	ae	ap	min	max	mm	3,0	4,0	5,0	6,0	8,0	10,0	12,0	14,0	16,0	18,0	20,0					
P	0	Ap1 max	0,1 x D	0,5 x D	150	–	200	fz	0,021	0,028	0,036	0,044	0,060	0,072	0,083	0,092	0,101	0,108	0,114			
	1	Ap1 max	0,1 x D	0,5 x D	150	–	200	fz	0,021	0,028	0,036	0,044	0,060	0,072	0,083	0,092	0,101	0,108	0,114			
	2	Ap1 max	0,1 x D	0,5 x D	140	–	190	fz	0,021	0,028	0,036	0,044	0,060	0,072	0,083	0,092	0,101	0,108	0,114			
	3	Ap1 max	0,1 x D	0,5 x D	120	–	160	fz	0,017	0,023	0,030	0,036	0,050	0,061	0,070	0,079	0,087	0,095	0,101			
M	4	Ap1 max	0,1 x D	0,5 x D	90	–	150	fz	0,016	0,021	0,027	0,033	0,045	0,054	0,062	0,070	0,077	0,083	0,088			
	1	Ap1 max	0,1 x D	0,5 x D	90	–	115	fz	0,017	0,023	0,030	0,036	0,050	0,061	0,070	0,079	0,087	0,095	0,101			
K	2	Ap1 max	0,1 x D	0,5 x D	60	–	80	fz	0,014	0,019	0,024	0,029	0,040	0,048	0,056	0,063	0,070	0,076	0,081			
	1	Ap1 max	0,1 x D	0,5 x D	120	–	150	fz	0,021	0,028	0,036	0,044	0,060	0,072	0,083	0,092	0,101	0,108	0,114			
	2	Ap1 max	0,1 x D	0,5 x D	110	–	140	fz	0,017	0,023	0,030	0,036	0,050	0,061	0,070	0,079	0,087	0,095	0,101			

NOTE: Lower value of cutting speed is used for high stock removal applications or for higher hardness (machinability) within group.
 Higher value of cutting speed is used for finishing applications or for lower hardness (machinability) within group.
 Above parameters are based on ideal conditions. For smaller taper machining centers, please adjust parameters accordingly on >12mm diameters.
 Refer to NOVO® software for slotting application information.

 = ALL-STAR PORTFOLIO PRODUCT. ALL-STAR PRODUCTS ARE PROVEN SOLUTIONS THAT ARE ALWAYS AVAILABLE.

INDEXABLE MILLING
 SOLID END MILLING
 HOLEMAKING
 TAPPING
 TURNING

Application Data • Series I4R..S I4S..S I4R..R I4S..R • TiAlN • Inch

Material Group	Side Milling (A) and Slotting (B)		TiAlN		Recommended feed per tooth (IPT = inch/th) for side milling (A). For slotting (B), reduce IPT by 20%.																	
	A		B		Cutting Speed – vc SFM		D1 – Diameter															
	ap	ae	ap	ap	min	max	frac.	1/64	1/32	1/16	5/64	3/32	1/8	3/16	1/4	5/16	3/8	1/2	5/8	3/4	1	
	ap	ae	ap	ap	min	max	dec.	.0156	.0313	.0625	.0781	.0938	.1250	.1875	.2500	.3125	.3750	.5000	.6250	.7500	1.0000	
P	0	Ap1 max	0.1 x D	0.5 x D	490	–	660	IPT	.0001	.0002	.0004	.0005	.0007	.0009	.0013	.0018	.0023	.0027	.0034	.0039	.0044	.0049
	1	Ap1 max	0.1 x D	0.5 x D	490	–	660	IPT	.0001	.0002	.0004	.0005	.0007	.0009	.0013	.0018	.0023	.0027	.0034	.0039	.0044	.0049
	2	Ap1 max	0.1 x D	0.5 x D	460	–	620	IPT	.0001	.0002	.0004	.0005	.0007	.0009	.0013	.0018	.0023	.0027	.0034	.0039	.0044	.0049
	3	Ap1 max	0.1 x D	0.5 x D	390	–	520	IPT	.0001	.0002	.0004	.0004	.0005	.0007	.0011	.0015	.0020	.0023	.0029	.0034	.0039	.0045
M	1	Ap1 max	0.1 x D	0.5 x D	300	–	490	IPT	.0001	.0002	.0003	.0004	.0005	.0007	.0010	.0014	.0017	.0020	.0026	.0030	.0034	.0039
	2	Ap1 max	0.1 x D	0.5 x D	200	–	260	IPT	.0001	.0001	.0003	.0004	.0005	.0007	.0011	.0015	.0020	.0023	.0029	.0034	.0039	.0045
K	1	Ap1 max	0.1 x D	0.5 x D	390	–	490	IPT	.0001	.0002	.0004	.0005	.0007	.0009	.0013	.0018	.0023	.0027	.0034	.0039	.0044	.0049
	2	Ap1 max	0.1 x D	0.5 x D	360	–	460	IPT	.0001	.0002	.0004	.0004	.0005	.0007	.0011	.0015	.0020	.0023	.0029	.0034	.0039	.0045

NOTE: Lower value of cutting speed is used for high stock removal applications or for higher hardness (machinability) within group.
 Higher value of cutting speed is used for finishing applications or for lower hardness (machinability) within group.
 Above parameters are based on ideal conditions. For smaller taper machining centers, please adjust parameters accordingly on >1/2" diameter.

Application Data • Series I4S..S I4S..R • Uncoated • Inch

Material Group	Side Milling (A) and Slotting (B)		uncoated		Recommended feed per tooth (IPT = inch/th) for side milling (A). For slotting (B), reduce IPT by 20%.																
	A		B		Cutting Speed – vc SFM		D1 – Diameter														
	ap	ae	ap	ap	min	max	frac.	1/16	5/64	3/32	1/8	3/16	1/4	5/16	3/8	1/2	5/8	3/4	1		
	ap	ae	ap	ap	min	max	dec.	.0625	.0781	.0938	.1250	.1875	.2500	.3125	.3750	.5000	.6250	.7500	1.0000		
P	0	Ap1 max	0.1 x D	0.5 x D	390	–	520	IPT	.0004	.0005	.0007	.0009	.0013	.0018	.0023	.0027	.0034	.0039	.0044	.0049	
	1	1.25 x D	0.1 x D	0.5 x D	390	–	520	IPT	.0004	.0005	.0007	.0009	.0013	.0018	.0023	.0027	.0034	.0039	.0044	.0049	
	2	1.25 x D	0.1 x D	0.5 x D	370	–	500	IPT	.0004	.0005	.0007	.0009	.0013	.0018	.0023	.0027	.0034	.0039	.0044	.0049	

NOTE: Lower value of cutting speed is used for high stock removal applications or for higher hardness (machinability) within group.
 Higher value of cutting speed is used for finishing applications or for lower hardness (machinability) within group.
 Above parameters are based on ideal conditions. For smaller taper machining centers, please adjust parameters accordingly on >1/2" diameter.

★ = ALL-STAR PORTFOLIO PRODUCT. ALL-STAR PRODUCTS ARE PROVEN SOLUTIONS THAT ARE ALWAYS AVAILABLE.

General Purpose Solid Carbide End Mills • Roughing/Finishing

INDEXABLE MILLING

SOLID END MILLING

HOLEMAKING

TAPPING

TURNING

Application Data • Series I4S..L I4S..X • TiAlN • Inch

		Side Milling (A)		TiAlN		Recommended feed per tooth (IPT = inch/th) for side milling (A).											
Material Group	A		Cutting Speed – vc SFM			D1 – Diameter											
	ap	ae	min	max	frac. dec.	3/32	1/8	3/16	1/4	5/16	3/8	1/2	5/8	3/4	1		
P	0	Ap1 max 0.1 x D	490	–	660	IPT	.0007	.0009	.0013	.0018	.0023	.0027	.0034	.0039	.0044	.0049	
	1	Ap1 max 0.1 x D	490	–	660	IPT	.0007	.0009	.0013	.0018	.0023	.0027	.0034	.0039	.0044	.0049	
	2	Ap1 max 0.1 x D	460	–	620	IPT	.0007	.0009	.0013	.0018	.0023	.0027	.0034	.0039	.0044	.0049	
	3	Ap1 max 0.1 x D	390	–	520	IPT	.0005	.0007	.0011	.0015	.0020	.0023	.0029	.0034	.0039	.0045	
M	1	Ap1 max 0.1 x D	300	–	490	IPT	.0005	.0007	.0010	.0014	.0017	.0020	.0026	.0030	.0034	.0039	
	2	Ap1 max 0.1 x D	200	–	260	IPT	.0004	.0006	.0009	.0012	.0016	.0018	.0023	.0027	.0031	.0036	
K	1	Ap1 max 0.1 x D	390	–	490	IPT	.0007	.0009	.0013	.0018	.0023	.0027	.0034	.0039	.0044	.0049	
	2	Ap1 max 0.1 x D	360	–	460	IPT	.0005	.0007	.0011	.0015	.0020	.0023	.0029	.0034	.0039	.0045	

NOTE: Lower value of cutting speed is used for high stock removal applications or for higher hardness (machinability) within group.
 Higher value of cutting speed is used for finishing applications or for lower hardness (machinability) within group.
 Above parameters are based on ideal conditions. For smaller taper machining centers, please adjust parameters accordingly on >1/2" diameter.

Application Data • Series I4S..L I4S..X • Uncoated • Inch

		Side Milling (A)		uncoated		Recommended feed per tooth (IPT = inch/th) for side milling (A).											
Material Group	A		Cutting Speed – vc SFM			D1 – Diameter											
	ap	ae	min	max	frac. dec.	3/32	1/8	3/16	1/4	5/16	3/8	1/2	5/8	3/4	1		
P	0	Ap1 max 0.1 x D	390	–	520	IPT	.0007	.0009	.0013	.0018	.0023	.0027	.0034	.0039	.0044	.0049	
	1	Ap1 max 0.1 x D	390	–	520	IPT	.0007	.0009	.0013	.0018	.0023	.0027	.0034	.0039	.0044	.0049	
	2	Ap1 max 0.1 x D	370	–	500	IPT	.0007	.0009	.0013	.0018	.0023	.0027	.0034	.0039	.0044	.0049	

NOTE: Lower value of cutting speed is used for high stock removal applications or for higher hardness (machinability) within group.
 Higher value of cutting speed is used for finishing applications or for lower hardness (machinability) within group.
 Above parameters are based on ideal conditions. For smaller taper machining centers, please adjust parameters accordingly on >1/2" diameter.

= ALL-STAR PORTFOLIO PRODUCT. ALL-STAR PRODUCTS ARE PROVEN SOLUTIONS THAT ARE ALWAYS AVAILABLE.

Application Data • Series I4B..S I4B..R • TiAlN • Inch

Material Group	Side Milling (A) and Slotting (B)		Recommended feed per tooth (IPT = inch/th) for side milling (A). For slotting (B), reduce IPT by 20%.																			
	A		B		Cutting Speed – vc SFM		D1 – Diameter															
	ap	ae	ap	min	max	frac. dec.	1/64	1/32	1/16	5/64	3/32	1/8	3/16	1/4	5/16	3/8	1/2	5/8	3/4	1		
	ap1 max	0.1 x D	0.5 x D																			
P	0	Ap1 max	0.1 x D	0.5 x D	490	–	660	IPT	.0001	.0002	.0004	.0005	.0007	.0009	.0013	.0018	.0023	.0027	.0034	.0039	.0044	.0049
	1	Ap1 max	0.1 x D	0.5 x D	490	–	660	IPT	.0001	.0002	.0004	.0005	.0007	.0009	.0013	.0018	.0023	.0027	.0034	.0039	.0044	.0049
	2	Ap1 max	0.1 x D	0.5 x D	460	–	620	IPT	.0001	.0002	.0004	.0005	.0007	.0009	.0013	.0018	.0023	.0027	.0034	.0039	.0044	.0049
	3	Ap1 max	0.1 x D	0.5 x D	390	–	520	IPT	.0001	.0002	.0004	.0004	.0005	.0007	.0011	.0015	.0020	.0023	.0029	.0034	.0039	.0045
	4	Ap1 max	0.1 x D	0.5 x D	300	–	490	IPT	.0001	.0002	.0003	.0004	.0005	.0007	.0010	.0014	.0017	.0020	.0026	.0030	.0034	.0039
M	1	Ap1 max	0.1 x D	0.5 x D	300	–	380	IPT	.0001	.0002	.0004	.0004	.0005	.0007	.0011	.0015	.0020	.0023	.0029	.0034	.0039	.0045
	2	Ap1 max	0.1 x D	0.5 x D	200	–	260	IPT	.0001	.0001	.0003	.0004	.0004	.0006	.0009	.0012	.0016	.0018	.0023	.0027	.0031	.0036
K	1	Ap1 max	0.1 x D	0.5 x D	390	–	490	IPT	.0001	.0002	.0004	.0005	.0007	.0009	.0013	.0018	.0023	.0027	.0034	.0039	.0044	.0049
	2	Ap1 max	0.1 x D	0.5 x D	360	–	460	IPT	.0001	.0002	.0004	.0004	.0005	.0007	.0011	.0015	.0020	.0023	.0029	.0034	.0039	.0045

NOTE: Lower value of cutting speed is used for high stock removal applications or for higher hardness (machinability) within group.
 Higher value of cutting speed is used for finishing applications or for lower hardness (machinability) within group.
 Above parameters are based on ideal conditions. For smaller taper machining centers, please adjust parameters accordingly on >1/2" diameter.

Application Data • Series I4B..L I4B..X • TiAlN • Inch

Material Group	Side Milling (A)		Recommended feed per tooth (IPT = inch/th) for side milling (A).																	
	A		Cutting Speed – vc SFM		D1 – Diameter															
	ap	ae	min	max	frac. dec.	3/32	1/8	3/16	1/4	5/16	3/8	1/2	5/8	3/4	1					
	ap1 max	0.1 x D																		
P	0	Ap1 max	0.1 x D	490	–	660	IPT	.0007	.0009	.0013	.0018	.0023	.0027	.0034	.0039	.0044	.0049			
	1	Ap1 max	0.1 x D	490	–	660	IPT	.0007	.0009	.0013	.0018	.0023	.0027	.0034	.0039	.0044	.0049			
	2	Ap1 max	0.1 x D	460	–	620	IPT	.0007	.0009	.0013	.0018	.0023	.0027	.0034	.0039	.0044	.0049			
	3	Ap1 max	0.1 x D	390	–	520	IPT	.0005	.0007	.0011	.0015	.0020	.0023	.0029	.0034	.0039	.0045			
	4	Ap1 max	0.1 x D	300	–	490	IPT	.0005	.0007	.0010	.0014	.0017	.0020	.0026	.0030	.0034	.0039			
M	1	Ap1 max	0.1 x D	300	–	380	IPT	.0005	.0007	.0011	.0015	.0020	.0023	.0029	.0034	.0039	.0045			
	2	Ap1 max	0.1 x D	200	–	260	IPT	.0004	.0006	.0009	.0012	.0016	.0018	.0023	.0027	.0031	.0036			
K	1	Ap1 max	0.1 x D	390	–	490	IPT	.0007	.0009	.0013	.0018	.0023	.0027	.0034	.0039	.0044	.0049			
	2	Ap1 max	0.1 x D	360	–	460	IPT	.0005	.0007	.0011	.0015	.0020	.0023	.0029	.0034	.0039	.0045			

NOTE: Lower value of cutting speed is used for high stock removal applications or for higher hardness (machinability) within group.
 Higher value of cutting speed is used for finishing applications or for lower hardness (machinability) within group.
 Above parameters are based on ideal conditions. For smaller taper machining centers, please adjust parameters accordingly on >1/2" diameter.

★ = ALL-STAR PORTFOLIO PRODUCT. ALL-STAR PRODUCTS ARE PROVEN SOLUTIONS THAT ARE ALWAYS AVAILABLE.

HOLEMAKING

SOLID CARBIDE DRILLS

Pages F82–F85

VarDrill™ — Best Price Performance Ratio



MODULAR DRILLS

Pages F86–F89

TOP DRILL™ Modular X (TDMX) — Extra-Stable Modular Drill

TOP DRILL M1™ (TDM1) — Versatile Modular Drilling System





INDEXABLE DRILLS

Pages F90–F95

Top Cut 4™ — Next Generation Indexable Drill

TO SEE ALL PRODUCTS LINES, VISIT OUR DIGITAL RESOURCES



WIDIA NOVO™ Application
Download to your desktop or tablet:
widia.com/novo



WIDIA™ Machining Central Mobile App
Download for iOS or Android:
widia.com/en/featured/WidiaMobileApp

SOLID CARBIDE DRILLS

VariDrill™

Pages F84–F85

VariDrill is a technologically advanced holemaking solution. These high-performance solid carbide drills were designed in Germany to provide the transportation, aerospace, general engineering, and energy industries with a tool that performs on multiple materials.





TDMX

VariDrill™

WIDIA provides a growing portfolio of drilling solutions to machine steels, stainless steels, cast iron and high-temp alloys to create components for the energy industry.

TO SEE ALL PRODUCTS LINES, VISIT OUR DIGITAL RESOURCES



WIDIA NOVO™ Application
Download to your desktop or tablet:
widia.com/novo



WIDIA™ Machining Central Mobile App
Download for iOS or Android:
widia.com/en/featured/WidiaMobileApp

Application Data • VDS2 Series • WU25PD™ • Flood Coolant • Metric

Material Group	Cutting Speed – vc Range – m/min			Tool Diameter (mm)	Recommended Feed Rate (f) by Diameter										
	min	-	max		1,0	2,0	3,0	4,0	6,0	8,0	10,0	12,0	16,0	20,0	
	P	1	60		-	100	mm/r	0,04-0,09	0,05-0,12	0,07-0,14	0,08-0,16	0,11-0,22	0,13-0,26	0,15-0,31	0,18-0,35
	2, 3, 4, 6, 7	50	-	90	mm/r	0,05-0,10	0,06-0,13	0,08-0,15	0,09-0,17	0,13-0,23	0,15-0,28	0,19-0,33	0,22-0,38	0,26-0,47	0,34-0,59
	5, 9, 10, 11	50	-	100	mm/r	0,05-0,10	0,06-0,13	0,07-0,15	0,08-0,17	0,12-0,23	0,14-0,28	0,17-0,33	0,19-0,38	0,23-0,47	0,29-0,59
	12, 13	30	-	60	mm/r	0,03-0,05	0,04-0,06	0,05-0,08	0,06-0,10	0,08-0,14	0,10-0,18	0,13-0,22	0,14-0,24	0,18-0,32	0,23-0,41
M	14, 1	30	-	50	mm/r	0,02-0,05	0,03-0,06	0,04-0,07	0,05-0,09	0,08-0,11	0,09-0,12	0,10-0,14	0,12-0,16	0,14-0,18	0,16-0,20
	14, 3	40	-	60	mm/r	0,02-0,06	0,03-0,07	0,04-0,08	0,06-0,10	0,08-0,12	0,09-0,14	0,10-0,16	0,12-0,18	0,14-0,20	0,16-0,22
	14, 2, 14, 4	30	-	50	mm/r	0,02-0,05	0,03-0,06	0,04-0,07	0,06-0,09	0,08-0,11	0,09-0,12	0,10-0,14	0,12-0,16	0,14-0,18	0,16-0,20
K	15, 16	70	-	150	mm/r	0,06-0,13	0,07-0,14	0,09-0,18	0,10-0,19	0,13-0,25	0,16-0,30	0,18-0,35	0,20-0,39	0,25-0,48	0,30-0,59
	17, 18, 19	90	-	120	mm/r	0,08-0,11	0,09-0,12	0,10-0,13	0,10-0,15	0,13-0,20	0,16-0,25	0,18-0,29	0,20-0,32	0,25-0,38	0,30-0,48
	20	80	-	120	mm/r	0,04-0,10	0,06-0,12	0,08-0,14	0,07-0,15	0,10-0,20	0,11-0,24	0,14-0,28	0,15-0,32	0,19-0,38	0,24-0,48
N	21	90	-	270	mm/r	0,05-0,12	0,06-0,13	0,08-0,14	0,10-0,16	0,12-0,20	0,16-0,24	0,20-0,28	0,24-0,32	0,28-0,40	0,32-0,48
	22, 23, 24	90	-	270	mm/r	0,04-0,08	0,06-0,12	0,08-0,16	0,10-0,20	0,12-0,24	0,16-0,28	0,20-0,32	0,24-0,36	0,28-0,44	0,32-0,52
	25	90	-	225	mm/r	0,10-0,13	0,11-0,14	0,12-0,14	0,13-0,16	0,14-0,20	0,16-0,24	0,20-0,28	0,24-0,32	0,28-0,40	0,32-0,44
	26, 27, 28	90	-	270	mm/r	0,04-0,08	0,06-0,12	0,08-0,16	0,10-0,20	0,12-0,24	0,16-0,28	0,20-0,32	0,24-0,36	0,28-0,40	0,32-0,48
S	31, 32	20	-	30	mm/r	0,01-0,04	0,02-0,05	0,03-0,06	0,04-0,08	0,06-0,10	0,08-0,12	0,09-0,13	0,10-0,14	0,12-0,16	0,14-0,18
	33, 34, 35	10	-	30	mm/r	0,01-0,03	0,02-0,03	0,02-0,04	0,03-0,06	0,05-0,08	0,07-0,10	0,08-0,11	0,09-0,12	0,10-0,14	0,11-0,16
	36	20	-	40	mm/r	0,01-0,03	0,02-0,03	0,02-0,04	0,02-0,05	0,04-0,07	0,06-0,09	0,07-0,10	0,08-0,11	0,09-0,13	0,10-0,15
	37	20	-	50	mm/r	0,01-0,03	0,02-0,03	0,02-0,04	0,03-0,06	0,05-0,08	0,07-0,10	0,08-0,11	0,09-0,12	0,10-0,14	0,11-0,16

Application Data • VDS4 Series • WU25PD™ • Through Coolant • Metric

Material Group	Cutting Speed – vc Range – m/min			Tool Diameter (mm)	Recommended Feed Rate (f) by Diameter										
	min	-	max		1,0	2,0	3,0	4,0	6,0	8,0	10,0	12,0	16,0	20,0	
	P	1	70		-	140	mm/r	0,04-0,09	0,05-0,12	0,07-0,14	0,08-0,16	0,11-0,22	0,13-0,26	0,15-0,31	0,18-0,35
	2, 3, 4, 6, 7	60	-	100	mm/r	0,05-0,10	0,06-0,13	0,08-0,15	0,09-0,17	0,13-0,23	0,15-0,28	0,19-0,33	0,22-0,38	0,26-0,47	0,34-0,59
	5, 9, 10, 11	50	-	100	mm/r	0,05-0,10	0,06-0,13	0,07-0,15	0,08-0,17	0,12-0,23	0,14-0,28	0,17-0,33	0,19-0,38	0,23-0,47	0,29-0,59
	12, 13	40	-	70	mm/r	0,03-0,05	0,04-0,06	0,05-0,08	0,06-0,10	0,08-0,14	0,10-0,18	0,13-0,22	0,14-0,24	0,18-0,32	0,23-0,41
M	14, 1	30	-	50	mm/r	0,02-0,05	0,03-0,06	0,04-0,07	0,05-0,09	0,08-0,11	0,09-0,12	0,10-0,14	0,12-0,16	0,14-0,18	0,16-0,20
	14, 3	40	-	60	mm/r	0,02-0,06	0,03-0,07	0,04-0,08	0,06-0,10	0,08-0,12	0,09-0,14	0,10-0,16	0,12-0,18	0,14-0,20	0,16-0,22
	14, 2, 14, 4	30	-	50	mm/r	0,02-0,05	0,03-0,06	0,04-0,07	0,06-0,09	0,08-0,11	0,09-0,12	0,10-0,14	0,12-0,16	0,14-0,18	0,16-0,20
K	15, 16	80	-	160	mm/r	0,07-0,14	0,08-0,15	0,10-0,20	0,11-0,22	0,14-0,28	0,18-0,34	0,21-0,40	0,23-0,44	0,28-0,54	0,34-0,67
	17, 18, 19	90	-	140	mm/r	0,09-0,13	0,10-0,14	0,11-0,14	0,12-0,17	0,14-0,23	0,18-0,28	0,21-0,32	0,23-0,36	0,28-0,43	0,34-0,54
	20	80	-	130	mm/r	0,05-0,12	0,06-0,14	0,07-0,15	0,08-0,17	0,11-0,23	0,13-0,27	0,15-0,32	0,17-0,36	0,22-0,43	0,27-0,54
N	21	90	-	315	mm/r	0,05-0,12	0,06-0,13	0,08-0,14	0,10-0,16	0,12-0,20	0,16-0,24	0,20-0,28	0,24-0,32	0,28-0,40	0,32-0,48
	22, 23, 24	90	-	270	mm/r	0,04-0,08	0,06-0,12	0,08-0,16	0,10-0,20	0,12-0,24	0,16-0,28	0,20-0,32	0,24-0,36	0,28-0,44	0,32-0,52
	25	90	-	270	mm/r	0,10-0,13	0,11-0,14	0,12-0,14	0,13-0,16	0,14-0,20	0,16-0,24	0,20-0,28	0,24-0,32	0,28-0,40	0,32-0,44
	26, 27, 28	90	-	270	mm/r	0,04-0,08	0,06-0,12	0,08-0,16	0,10-0,20	0,12-0,24	0,16-0,28	0,20-0,32	0,24-0,36	0,28-0,40	0,32-0,48
S	31, 32	20	-	30	mm/r	0,01-0,04	0,02-0,05	0,03-0,06	0,04-0,08	0,06-0,10	0,08-0,12	0,09-0,13	0,10-0,14	0,12-0,16	0,14-0,18
	33, 34, 35	10	-	30	mm/r	0,01-0,03	0,02-0,03	0,02-0,04	0,03-0,06	0,05-0,08	0,07-0,10	0,08-0,11	0,09-0,12	0,10-0,14	0,11-0,16
	36	10	-	40	mm/r	0,01-0,03	0,02-0,03	0,02-0,04	0,02-0,05	0,04-0,07	0,06-0,09	0,07-0,10	0,08-0,11	0,09-0,13	0,10-0,15
	37	10	-	40	mm/r	0,01-0,03	0,02-0,03	0,02-0,04	0,03-0,06	0,05-0,08	0,07-0,10	0,08-0,11	0,09-0,12	0,10-0,14	0,11-0,16

nominal size range	Metric tolerance D1 tolerance	D tolerance h6
1-3	0,000/-0,014 (h8)	0,000/-0,006
>3-6	0,000/-0,012 (h7)	0,000/-0,008
>6-10	0,000/-0,015 (h7)	0,000/-0,009
>10-18	0,000/-0,018 (h7)	0,000/-0,011
>18-20	0,000/-0,021 (h7)	0,000/-0,013

INDEXABLE MILLING
 SOLID END MILLING
 HOLEMAKING
 TAPPING
 TURNING

Application Data • VDS2 Series • WU25PD™ • Flood Coolant • Inch

Material Group	Cutting Speed — vc Range — SFM			Tool Diameter (inch)	Recommended Feed Rate (f) by Diameter										
	min	-	max		.0469-3/64	.0781-5/64	.125-1/8	.188-3/16	.250-1/4	.313-5/16	.375-3/8	.500-1/2	.625-5/8	.750-3/4	
	P	1	200		-	330	IPR	.002-.004	.002-.005	.003-.006	.003-.006	.004-.009	.005-.010	.006-.012	.007-.014
	2, 3, 4, 6, 7	160	-	300	IPR	.002-.004	.002-.005	.003-.006	.004-.007	.005-.009	.006-.011	.007-.013	.009-.015	.010-.018	.013-.023
	5, 9, 10, 11	160	-	330	IPR	.002-.004	.002-.005	.003-.006	.003-.007	.005-.009	.006-.011	.007-.013	.007-.015	.009-.018	.011-.023
	12, 13	100	-	200	IPR	.001-.002	.001-.002	.002-.003	.002-.004	.003-.006	.004-.007	.005-.009	.005-.010	.007-.012	.009-.016
M	14.1	100	-	160	IPR	.001-.002	.001-.002	.002-.003	.002-.004	.003-.004	.004-.005	.004-.006	.005-.006	.006-.007	.006-.008
	14.3	130	-	200	IPR	.001-.002	.001-.003	.002-.003	.002-.004	.003-.005	.004-.006	.004-.006	.005-.007	.006-.008	.006-.009
	14.2, 14.4	100	-	160	IPR	.001-.002	.001-.002	.002-.003	.002-.004	.003-.004	.004-.005	.004-.006	.005-.006	.006-.007	.006-.008
K	15, 16	230	-	490	IPR	.003-.005	.003-.005	.003-.007	.004-.008	.005-.010	.006-.012	.007-.014	.008-.015	.010-.019	.012-.023
	17, 18, 19	300	-	390	IPR	.003-.004	.003-.005	.004-.005	.004-.006	.005-.008	.006-.010	.007-.011	.008-.013	.010-.015	.012-.019
	20	260	-	390	IPR	.002-.004	.002-.005	.003-.005	.003-.006	.004-.008	.004-.009	.005-.011	.006-.013	.008-.015	.009-.019
N	21	300	-	890	IPR	.002-.005	.003-.005	.003-.006	.004-.006	.005-.008	.006-.009	.008-.011	.009-.013	.011-.016	.013-.019
	22, 23, 24	300	-	890	IPR	.002-.003	.003-.005	.003-.006	.004-.008	.005-.009	.006-.011	.008-.013	.009-.014	.011-.017	.013-.020
	25	300	-	740	IPR	.004-.005	.004-.005	.005-.006	.005-.006	.006-.008	.006-.009	.008-.011	.009-.013	.011-.016	.013-.017
	26, 27, 28	300	-	890	IPR	.002-.003	.003-.005	.003-.006	.004-.008	.005-.009	.006-.011	.008-.013	.009-.014	.011-.016	.013-.019
S	31, 32	70	-	100	IPR	.001-.002	.001-.002	.001-.002	.002-.003	.002-.004	.003-.005	.004-.005	.004-.006	.005-.006	.006-.007
	33, 34, 35	30	-	100	IPR	.001	.001	.001-.002	.001-.002	.002-.003	.003-.004	.003-.004	.004-.005	.004-.006	.004-.006
	36	70	-	130	IPR	.001	.001	.001-.002	.001-.002	.002-.003	.002-.004	.003-.004	.003-.004	.004-.005	.004-.006
	37	70	-	160	IPR	.001	.001	.001-.002	.001-.002	.002-.003	.003-.004	.003-.004	.004-.005	.004-.006	.004-.006

Application Data • VDS4 Series • WU25PD™ • Through Coolant • Inch

Material Group	Cutting Speed — vc Range — SFM			Tool Diameter (inch)	Recommended Feed Rate (f) by Diameter										
	min	-	max		.0469-3/64	.0781-5/64	.125-1/8	.188-3/16	.250-1/4	.313-5/16	.375-3/8	.500-1/2	.625-5/8	.750-3/4	
	P	1	230		-	460	IPR	.002-.004	.002-.005	.003-.006	.003-.006	.004-.009	.005-.010	.006-.012	.007-.014
	2, 3, 4, 6, 7	200	-	330	IPR	.002-.004	.002-.005	.003-.006	.004-.007	.005-.009	.006-.011	.007-.013	.009-.015	.010-.018	.013-.023
	5, 9, 10, 11	160	-	330	IPR	.002-.004	.002-.005	.003-.006	.003-.007	.005-.009	.006-.011	.007-.013	.007-.015	.009-.018	.011-.023
	12, 13	130	-	230	IPR	.001-.002	.001-.002	.002-.003	.002-.004	.003-.006	.004-.007	.005-.009	.005-.010	.007-.012	.009-.016
M	14.1	100	-	160	IPR	.001-.002	.001-.002	.002-.003	.002-.004	.003-.004	.004-.005	.004-.006	.005-.006	.006-.007	.006-.008
	14.3	130	-	200	IPR	.001-.002	.001-.003	.002-.003	.002-.004	.003-.005	.004-.006	.004-.006	.005-.007	.006-.008	.006-.009
	14.2, 14.4	100	-	160	IPR	.001-.002	.001-.002	.002-.003	.002-.004	.003-.004	.004-.005	.004-.006	.005-.006	.006-.007	.006-.008
K	15, 16	260	-	520	IPR	.003-.006	.003-.006	.004-.008	.004-.009	.006-.011	.007-.013	.008-.016	.009-.017	.011-.021	.013-.026
	17, 18, 19	290	-	460	IPR	.004-.005	.004-.005	.004-.006	.005-.007	.006-.009	.007-.011	.008-.013	.009-.014	.011-.017	.013-.021
	20	260	-	430	IPR	.002-.005	.002-.005	.003-.006	.003-.007	.004-.009	.005-.011	.006-.012	.007-.014	.009-.017	.011-.021
N	21	290	-	1030	IPR	.002-.005	.003-.005	.003-.006	.004-.006	.005-.008	.006-.009	.008-.011	.009-.013	.011-.016	.013-.019
	22, 23, 24	290	-	890	IPR	.002-.003	.003-.005	.003-.006	.004-.008	.005-.009	.006-.011	.008-.013	.009-.014	.011-.017	.013-.020
	25	290	-	890	IPR	.004-.005	.004-.005	.005-.006	.005-.006	.006-.008	.006-.009	.008-.011	.009-.013	.011-.016	.013-.017
	26, 27, 28	290	-	890	IPR	.002-.003	.003-.005	.003-.006	.004-.008	.005-.009	.006-.011	.008-.013	.009-.014	.011-.016	.013-.019
S	31, 32	70	-	100	IPR	.001-.002	.001-.002	.001-.002	.002-.003	.002-.004	.003-.005	.004-.005	.004-.006	.005-.006	.006-.007
	33, 34, 35	30	-	100	IPR	.001	.001	.001-.002	.001-.002	.002-.003	.003-.004	.003-.004	.004-.005	.004-.006	.004-.006
	36	30	-	130	IPR	.001	.001	.001-.002	.001-.002	.002-.003	.002-.004	.003-.004	.003-.004	.004-.005	.004-.006
	37	30	-	130	IPR	.001	.001	.001-.002	.001-.002	.002-.003	.003-.004	.003-.004	.004-.005	.004-.006	.004-.006

nominal size range	Inch tolerance D1 tolerance	D tolerance h6
.0394-.1181	.0000/-.0006 (h8)	.0000/-.0002
>.1181-.2362	.0000/-.0005 (h7)	.0000/-.0003
>.2362-.3937	.0000/-.0006 (h7)	.0000/-.0004
>.3937-.7087	.0000/-.0007 (h7)	.0000/-.0004
>.7087-.7874	.0000/-.0008 (h7)	.0000/-.0005

MODULAR DRILLS

TDMX

Page F88

Stability and reliability combined into one modular drill system.



TDM1

Page F89

With its high level of performance, wide application range, and proven point geometry, TDM1 modular drill systems combine all of the economic benefits of a modular drilling system with the machining performance and hole quality to tackle even your most challenging operations.

TUBE SHEET DRILLING SUCCESS



TDMX

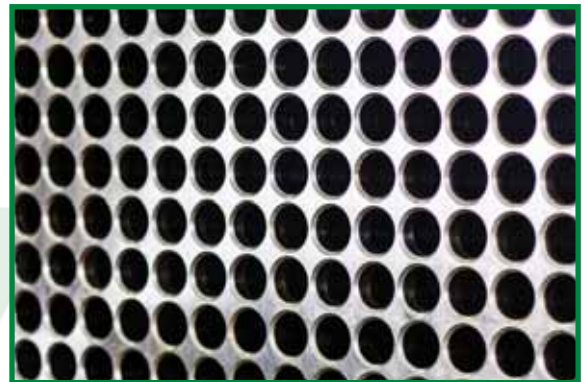

TUBE SHEET



WIDIA™
SHINING
MOMENT

**LONGER TOOL LIFE WITH LOWER SPINDLE
LOAD AND BETTER CHIP CONTROL**

Proven Solution — Tube Sheet

P Material: ST52
Condition: Pre-Drilled

	COMPETITOR	WIDIA
Insert	—	TDMX2576PKM
Diameter	25,76mm (1,014")	25,76mm (1,014")
Grade	—	WP40PD
Body	—	TDMX250SL32R5M
Length	5 x D	5 x D
Vc	100m/min (320 SFM)	100m/min (320 SFM)
RPM	1239 r/min	1239 r/min
f	0,3mm/r (.011 ipm)	0,3mm/r (.011 IPR)
Vf	371mm/min (14 ipm)	371mm/min (14 ipm)
LOC	77mm (3.03")	77mm (3.03")
Tool Life	390 holes	428 holes

TO SEE ALL PRODUCTS LINES, VISIT OUR DIGITAL RESOURCES



WIDIA NOVO™ Application
Download to your desktop or tablet:
widia.com/novo



WIDIA™ Machining Central Mobile App
Download for iOS or Android:
widia.com/en/featured/WidiaMobileApp

WIDIA 

INDEXABLE MILLING

Application Data • PK(M) • WP40PD • Metric

Material Group		Cutting Speed – Vc Range – m/min			Recommended Feed Rate (f) by Diameter					
		min	Starting Value	max	Tool Diameter (mm)	16,0	20,0	25,0	32,0	40,0
						mm/r	mm/r	mm/r	mm/r	mm/r
P	1	90	125	170	mm/r	0,19–0,45	0,25–0,48	0,25–0,52	0,28–0,57	0,29–0,60
	2	105	140	180	mm/r	0,23–0,46	0,28–0,50	0,30–0,52	0,33–0,57	0,35–0,60
	3	50	75	100	mm/r	0,23–0,46	0,28–0,50	0,30–0,52	0,33–0,57	0,35–0,60
	4	50	75	100	mm/r	0,19–0,45	0,22–0,48	0,25–0,50	0,28–0,55	0,29–0,58
	5	50	65	80	mm/r	0,16–0,32	0,18–0,36	0,22–0,42	0,24–0,46	0,25–0,48
	6	50	65	80	mm/r	0,16–0,32	0,18–0,36	0,22–0,42	0,24–0,46	0,25–0,48
M	1	40	80	110	mm/r	0,11–0,26	0,13–0,28	0,13–0,32	0,14–0,35	0,15–0,37
	2	35	55	75	mm/r	0,11–0,26	0,13–0,28	0,13–0,32	0,14–0,35	0,15–0,37
	3	20	35	50	mm/r	0,11–0,26	0,13–0,28	0,13–0,32	0,14–0,35	0,15–0,37
K	1	60	95	170	mm/r	0,25–0,48	0,28–0,52	0,32–0,56	0,35–0,62	0,37–0,65
	2	60	75	90	mm/r	0,25–0,48	0,28–0,52	0,32–0,56	0,35–0,62	0,37–0,65
	3	40	65	90	mm/r	0,21–0,44	0,23–0,48	0,25–0,50	0,28–0,55	0,29–0,58

SOLID END MILLING

Application Data • PK(M) • WP40PD • Inch

Material Group		Cutting Speed – Vc Range – SFM			Recommended Feed Rate (f) by Diameter					
		min	Starting Value	max	Tool Diameter (inch)	.630	.787	1.000	1.260	1.575
						IPR	IPR	IPR	IPR	IPR
P	1	295	410	558	IPR	.007–.018	.010–.019	.010–.020	.011–.022	.011–.024
	2	344	459	590	IPR	.009–.018	.011–.020	.012–.020	.013–.022	.014–.024
	3	164	246	328	IPR	.009–.018	.011–.020	.012–.020	.013–.022	.014–.024
	4	164	246	328	IPR	.007–.018	.009–.019	.010–.020	.011–.022	.011–.023
	5	164	213	262	IPR	.006–.013	.007–.014	.009–.017	.009–.018	.010–.019
	6	164	213	262	IPR	.006–.013	.007–.014	.009–.017	.009–.018	.010–.019
M	1	131	262	361	IPR	.004–.010	.005–.012	.005–.013	.006–.014	.006–.015
	2	115	180	246	IPR	.004–.010	.005–.012	.005–.013	.006–.014	.006–.015
	3	66	115	164	IPR	.004–.010	.005–.012	.005–.013	.006–.014	.006–.015
K	1	197	312	558	IPR	.010–.019	.011–.020	.013–.022	.014–.024	.015–.026
	2	197	246	295	IPR	.010–.019	.011–.020	.013–.022	.014–.024	.015–.026
	3	131	213	295	IPR	.008–.017	.009–.019	.010–.020	.011–.022	.011–.023

NOTE: Through coolant recommended for greater than 3 x D applications.
Material group M is recommended for secondary applications.

HOLEMAKING

TAPPING

TURNING

Application Data • UP(M) • WU25PD • Metric

Material Group		Cutting Speed – vc Range – m/min			Recommended Feed Rate							
		min	Starting Value	max	Tool Diameter (mm)	8,0	10,0	12,0	14,0	16,0	20,0	25,0
		P	1	90	125	170	mm/r	0,11–0,20	0,13–0,25	0,14–0,31	0,17–0,39	0,19–0,45
	2	105	140	180	mm/r	0,11–0,28	0,12–0,35	0,16–0,37	0,21–0,46	0,23–0,46	0,28–0,50	0,30–0,52
	3	50	75	100	mm/r	0,11–0,28	0,12–0,35	0,16–0,37	0,21–0,46	0,23–0,46	0,28–0,50	0,30–0,52
	4	50	75	100	mm/r	0,11–0,28	0,12–0,35	0,16–0,37	0,17–0,36	0,19–0,45	0,22–0,48	0,25–0,50
	5	50	65	80	mm/r	0,10–0,20	0,10–0,23	0,10–0,25	0,14–0,29	0,16–0,32	0,18–0,36	0,22–0,42
	6	50	65	80	mm/r	0,10–0,20	0,10–0,23	0,10–0,25	0,14–0,29	0,16–0,32	0,18–0,36	0,22–0,42
M	1	40	80	110	mm/r	0,06–0,22	0,08–0,23	0,09–0,24	0,10–0,25	0,11–0,26	0,13–0,28	0,13–0,32
	2	35	55	75	mm/r	0,06–0,22	0,08–0,23	0,09–0,24	0,10–0,25	0,11–0,26	0,13–0,28	0,13–0,32
	3	20	35	50	mm/r	0,06–0,22	0,08–0,23	0,09–0,24	0,10–0,25	0,11–0,26	0,13–0,28	0,13–0,32
K	1	60	95	170	mm/r	0,15–0,29	0,16–0,32	0,17–0,35	0,21–0,42	0,25–0,48	0,28–0,52	0,32–0,56
	2	60	75	90	mm/r	0,15–0,29	0,16–0,30	0,17–0,33	0,21–0,41	0,25–0,48	0,28–0,52	0,32–0,56
	3	40	65	90	mm/r	0,16–0,30	0,17–0,33	0,18–0,36	0,20–0,41	0,21–0,44	0,23–0,48	0,25–0,50

Application Data • UP(M) • WU25PD • Inch

Material Group		Cutting Speed – vc Range – SFM			Recommended Feed Rate							
		min	Starting Value	max	Tool Diameter (inch)	.315	.394	.472	.551	.630	.787	1.000
		P	1	262	410	558	IPR	.004–.008	.005–.010	.006–.012	.007–.015	.007–.018
	2	345	459	591	IPR	.004–.011	.005–.014	.006–.015	.008–.018	.009–.018	.011–.020	.012–.020
	3	164	246	328	IPR	.004–.011	.005–.014	.006–.015	.008–.018	.009–.018	.011–.020	.012–.020
	4	164	246	328	IPR	.004–.011	.005–.014	.006–.015	.007–.018	.007–.018	.009–.019	.010–.020
	5	160	210	260	IPR	.004–.008	.004–.009	.004–.010	.006–.011	.006–.013	.007–.014	.009–.017
	6	160	210	260	IPR	.004–.008	.004–.009	.004–.010	.006–.011	.006–.013	.007–.014	.009–.017
M	1	130	260	360	IPR	.002–.009	.003–.009	.004–.010	.004–.010	.004–.010	.005–.012	.006–.013
	2	110	180	250	IPR	.002–.009	.003–.009	.004–.010	.004–.010	.004–.010	.005–.012	.006–.013
	3	70	110	160	IPR	.002–.009	.003–.009	.004–.010	.004–.010	.004–.010	.005–.012	.006–.013
K	1	197	312	558	IPR	.006–.011	.006–.013	.007–.014	.008–.017	.010–.019	.011–.020	.013–.022
	2	197	246	295	IPR	.006–.011	.006–.012	.007–.013	.008–.016	.010–.019	.011–.020	.013–.022
	3	131	213	295	IPR	.006–.012	.007–.013	.007–.014	.008–.016	.008–.017	.009–.019	.010–.020

NOTE: Through coolant recommended for greater than 3 x D applications.

INDEXABLE MILLING

SOLID END MILLING

HOLEMAKING

TAPPING

TURNING

INDEXABLE DRILLS

Top Cut 4™

Pages F92–F95

The next generation of indexable drilling.



TRANSPORTATION



▲
Flange



▲
Transmission



▲
Connecting Rod



WIDIA™ manufactures tools to meet application needs in steel, cast iron, and aluminum automotive components.

TO SEE ALL PRODUCTS LINES, VISIT OUR DIGITAL RESOURCES



WIDIA NOVO™ Application
Download to your desktop or tablet:
widia.com/novo



WIDIA™ Machining Central Mobile App
Download for iOS or Android:
widia.com/en/featured/WidiaMobileApp

INDEXABLE MILLING

SOLID END MILLING

HOLEMAKING

TAPPING

TURNING

TC4 • Insert Selection Guide

Material Group	Geometry	Stable Cutting Conditions		Unstable Cutting Conditions		Interrupted Cutting Conditions	
		periphery insert	center insert	periphery insert	center insert	periphery insert	center insert
P1	V38	WU25CH	WU40PH	WU40PH	WU40PH	WU40PH	WU40PH
P2-P4	V34	WPK10CH	WU40PH	WU25CH	WU40PH	WU40PH	WU40PH
P5-P6	V36	WU25CH	WU40PH	WU40PH	WU40PH	WU40PH	WU40PH
M1-M3	V36	WU25CH	WU40PH	WU40PH	WU40PH	WU40PH	WU40PH
K1-K3	V34	WPK10CH	WU40PH	WU40PH	WU40PH	WU40PH	WU40PH
N1-N4	V36	WN10PH	WN10PH	WN10PH	WN10PH	WN10PH	WN10PH
S1-S4	V38	WU40PH	WU40PH	WU40PH	WU40PH	WU40PH	WU40PH

NOTE: All speed conditions are for stable conditions. For unstable conditions, it is suggested to reduce starting speeds by 10%. For interrupted cuts, reduce by 20%. For 4 x D, it is highly recommended to start with feed and speed values reduced by 10% less than above data. For 5 x D, diameter range .473-.938" (insert sizes A to C), it is highly recommended to start with feed and speed values reduced by 20% less than above data. For 5 x D, diameter range .969-2.5" (inserts sizes D to H), it is highly recommended to start with feed and speed values reduced by 15% less than above data. For 4 x D and 5 x D, it is recommended to reduce feed rate during entry and exit by 30-50%.

TC4 • Cutting Data • Metric

Material Group	Geometry	Grade		Cutting Speed – vc m/min			Recommended Feed Rate per Revolution				
							Tool Diameter	12,00-13,99	14,00-18,99	19,00-23,99	24,00-29,99
		center	periphery	min	Start	max		Insert Size A	Insert Size B	Insert Size C	Insert Size D
P0	-V38	WU40PH	WU25CH	120	180	260	mm/rev	0,06-0,08	0,08-0,11	0,10-0,13	0,11-0,14
P1	-V38	WU40PH	WU25CH	120	180	260	mm/rev	0,06-0,10	0,08-0,13	0,10-0,15	0,11-0,16
P2	-V34	WU40PH	WU25CH	120	190	280	mm/rev	0,06-0,10	0,08-0,15	0,10-0,16	0,11-0,17
P3	-V34	WU40PH	WPK10CH	120	200	310	mm/rev	0,08-0,15	0,10-0,16	0,11-0,18	0,12-0,20
P4	-V34	WU40PH	WPK10CH	120	190	310	mm/rev	0,08-0,15	0,10-0,16	0,11-0,18	0,12-0,20
P5	-V36	WU40PH	WU25CH	120	180	250	mm/rev	0,06-0,10	0,08-0,14	0,10-0,15	0,11-0,16
P6	-V36	WU40PH	WU25CH	120	160	210	mm/rev	0,06-0,10	0,08-0,14	0,10-0,15	0,11-0,16
M1	-V38	WU40PH	WU40PH	120	160	240	mm/rev	0,06-0,11	0,07-0,11	0,08-0,12	0,10-0,14
M2	-V38	WU40PH	WU40PH	110	140	210	mm/rev	0,06-0,10	0,07-0,11	0,08-0,12	0,10-0,14
M3	-V36	WU40PH	WU40PH	100	120	200	mm/rev	0,06-0,10	0,07-0,11	0,08-0,12	0,10-0,14
K1	-V34	WU25CH	WPK10CH	120	200	280	mm/rev	0,08-0,14	0,08-0,16	0,10-0,18	0,12-0,24
K2	-V34	WU40PH	WPK10CH	100	180	260	mm/rev	0,08-0,14	0,08-0,16	0,10-0,18	0,12-0,24
K3	-V34	WU40PH	WPK10CH	100	170	240	mm/rev	0,08-0,14	0,08-0,16	0,10-0,18	0,12-0,24
N1	-V36	WN10PH	WN10PH	250	350	500	mm/rev	0,06-0,10	0,08-0,14	0,10-0,15	0,11-0,16
N2	-V36	WN10PH	WN10PH	150	300	450	mm/rev	0,06-0,10	0,08-0,14	0,10-0,15	0,11-0,16
N3	-V36	WN10PH	WN10PH	80	120	150	mm/rev	0,06-0,10	0,07-0,11	0,08-0,12	0,10-0,14
S3	-V38	WU40PH	WU40PH	20	30	45	mm/rev	0,08-0,12	0,08-0,13	0,10-0,15	0,12-0,19
S4	-V38	WU40PH	WU40PH	35	40	65	mm/rev	0,08-0,12	0,08-0,13	0,10-0,15	0,12-0,19

Material Group	Geometry	Grade		Cutting Speed – vc m/min			Tool Diameter	Recommended Feed Rate per Revolution			
								30,00-36,99	37,00-45,99	46,00-56,99	57,00-68,00
		center	periphery	min	Start	max	Insert Size E	Insert Size F	Insert Size G	Insert Size H	
P0	-V38	WU40PH	WU25CH	120	180	260	mm/rev	0,13-0,16	0,15-0,18	0,16-0,23	0,17-0,24
P1	-V38	WU40PH	WU25CH	120	180	260	mm/rev	0,13-0,17	0,15-0,19	0,16-0,24	0,17-0,25
P2	-V34	WU40PH	WU25CH	120	190	280	mm/rev	0,13-0,20	0,15-0,21	0,16-0,28	0,17-0,30
P3	-V34	WU40PH	WPK10CH	120	200	310	mm/rev	0,16-0,24	0,16-0,24	0,18-0,30	0,19-0,32
P4	-V34	WU40PH	WPK10CH	120	190	310	mm/rev	0,14-0,22	0,16-0,24	0,18-0,30	0,19-0,32
P5	-V36	WU40PH	WU25CH	120	180	250	mm/rev	0,13-0,18	0,15-0,20	0,16-0,28	0,17-0,30
P6	-V36	WU40PH	WU25CH	120	160	210	mm/rev	0,13-0,18	0,15-0,20	0,16-0,28	0,17-0,29
M1	-V38	WU40PH	WU40PH	120	160	240	mm/rev	0,12-0,17	0,14-0,21	0,16-0,23	0,16-0,24
M2	-V38	WU40PH	WU40PH	110	140	210	mm/rev	0,12-0,17	0,14-0,21	0,16-0,23	0,16-0,24
M3	-V36	WU40PH	WU40PH	100	120	200	mm/rev	0,12-0,17	0,14-0,21	0,16-0,23	0,16-0,24
K1	-V34	WU25CH	WPK10CH	120	200	280	mm/rev	0,14-0,26	0,16-0,30	0,18-0,32	0,20-0,36
K2	-V34	WU40PH	WPK10CH	100	180	260	mm/rev	0,14-0,26	0,16-0,30	0,18-0,32	0,20-0,36
K3	-V34	WU40PH	WPK10CH	100	170	240	mm/rev	0,14-0,26	0,16-0,30	0,18-0,32	0,20-0,36
N1	-V36	WN10PH	WN10PH	250	350	500	mm/rev	0,13-0,18	0,15-0,20	0,16-0,28	0,17-0,30
N2	-V36	WN10PH	WN10PH	150	300	450	mm/rev	0,13-0,18	0,15-0,20	0,16-0,28	0,17-0,30
N3	-V36	WN10PH	WN10PH	80	120	150	mm/rev	0,12-0,17	0,14-0,21	0,16-0,23	0,16-0,24
S3	-V38	WU40PH	WU40PH	20	30	45	mm/rev	0,14-0,21	0,16-0,24	0,18-0,26	0,20-0,30
S4	-V38	WU40PH	WU40PH	35	40	65	mm/rev	0,14-0,21	0,16-0,24	0,18-0,26	0,20-0,30

NOTE: All speed conditions are for stable conditions. For unstable conditions, it is suggested to reduce starting speeds by 10%. For interrupted cuts, reduce by 20%. For 4 x D, it is highly recommended to start with feed and speed values reduced by 10% less than above data. For 5 x D, diameter range 12-23,99mm (insert sizes A to C), it is highly recommended to start with feed and speed values reduced by 20% less than above data. For 5 x D, diameter range 25-68mm (inserts sizes D to H), it is highly recommended to start with feed and speed values reduced by 15% less than above data. For 4 x D and 5 x D, it is recommended to reduce feed rate during entry and exit by 30-50%.

TC4 • Cutting Data • Inch

Material Group	Geometry	Grade		Cutting Speed – SFM			Tool Diameter	Recommended Feed Rate per Revolution			
		center	periphery	min	Start	max		.473–.531" Insert Size A	.563–.734" Insert Size B	.750–.938" Insert Size C	.969–1.156" Insert Size D
		P0	-V38	WU40PH	WU25CH	360		540	780	IPR	0.0024–0.0031
P1	-V38	WU40PH	WU25CH	360	540	780	IPR	0.0024–0.0039	0.0031–0.0051	0.0039–0.0059	0.0043–0.0063
P2	-V34	WU40PH	WU25CH	360	570	840	IPR	0.0024–0.0039	0.0031–0.0059	0.0039–0.0063	0.0043–0.0067
P3	-V34	WU40PH	WPK10CH	360	600	930	IPR	0.0031–0.0059	0.0039–0.0063	0.0043–0.0071	0.0047–0.0079
P4	-V34	WU40PH	WPK10CH	360	570	930	IPR	0.0031–0.0059	0.0039–0.0063	0.0043–0.0071	0.0047–0.0079
P5	-V36	WU40PH	WU25CH	360	540	750	IPR	0.0024–0.0039	0.0031–0.0055	0.0039–0.0059	0.0043–0.0063
P6	-V36	WU40PH	WU25CH	360	480	630	IPR	0.0024–0.0039	0.0031–0.0055	0.0039–0.0059	0.0043–0.0063
M1	-V38	WU40PH	WU40PH	360	480	720	IPR	0.0024–0.0047	0.0028–0.0051	0.0031–0.0059	0.0039–0.0063
M2	-V38	WU40PH	WU40PH	330	420	630	IPR	0.0024–0.0047	0.0028–0.0051	0.0031–0.0059	0.0039–0.0063
M3	-V36	WU40PH	WU40PH	300	360	600	IPR	0.0024–0.0047	0.0028–0.0051	0.0031–0.0059	0.0039–0.0063
K1	-V34	WU25CH	WPK10CH	360	600	840	IPR	0.0031–0.0055	0.0031–0.0063	0.0039–0.0071	0.0047–0.0094
K2	-V34	WU40PH	WPK10CH	300	540	780	IPR	0.0031–0.0055	0.0031–0.0063	0.0039–0.0071	0.0047–0.0094
K3	-V34	WU40PH	WPK10CH	300	510	720	IPR	0.0031–0.0055	0.0031–0.0063	0.0039–0.0071	0.0047–0.0094
N1	-V36	WN10PH	WN10PH	750	1050	1500	IPR	0.0024–0.0039	0.0031–0.0055	0.0039–0.0059	0.0043–0.0063
N2	-V36	WN10PH	WN10PH	450	900	1350	IPR	0.0024–0.0039	0.0031–0.0055	0.0039–0.0059	0.0043–0.0063
N3	-V36	WN10PH	WN10PH	240	360	450	IPR	0.0024–0.0039	0.0028–0.0043	0.0031–0.0047	0.0039–0.0055
S3	-V38	WU40PH	WU40PH	60	90	135	IPR	0.0031–0.0047	0.0031–0.0051	0.0039–0.0059	0.0047–0.0075
S4	-V38	WU40PH	WU40PH	105	120	195	IPR	0.0031–0.0047	0.0031–0.0051	0.0039–0.0059	0.0047–0.0075

Material Group	Geometry	Grade		Cutting Speed – SFM			Tool Diameter	Recommended Feed Rate per Revolution			
		center	periphery	min	Start	max		1.188–1.438" Insert Size E	1.469–1.750" Insert Size F	1.813–2.219" Insert Size G	2.250–2.500" Insert Size H
		P0	-V38	WU40PH	WU25CH	360		540	780	IPR	0.0051–0.0063
P1	-V38	WU40PH	WU25CH	360	540	780	IPR	0.0051–0.0071	0.0059–0.0079	0.0063–0.0106	0.0067–0.0114
P2	-V34	WU40PH	WU25CH	360	570	840	IPR	0.0051–0.0079	0.0059–0.0083	0.0063–0.0110	0.0067–0.0118
P3	-V34	WU40PH	WPK10CH	360	600	930	IPR	0.0053–0.0094	0.0063–0.0094	0.0071–0.0118	0.0075–0.0126
P4	-V34	WU40PH	WPK10CH	360	570	930	IPR	0.0055–0.0087	0.0063–0.0094	0.0071–0.0118	0.0075–0.0126
P5	-V36	WU40PH	WU25CH	360	540	750	IPR	0.0051–0.0071	0.0059–0.0079	0.0063–0.0110	0.0067–0.0118
P6	-V36	WU40PH	WU25CH	360	480	630	IPR	0.0051–0.0071	0.0059–0.0079	0.0063–0.0110	0.0067–0.0114
M1	-V38	WU40PH	WU40PH	360	480	720	IPR	0.0047–0.0079	0.0055–0.0098	0.0063–0.0110	0.0063–0.0118
M2	-V38	WU40PH	WU40PH	330	420	630	IPR	0.0047–0.0079	0.0055–0.0098	0.0063–0.0110	0.0063–0.0118
M3	-V36	WU40PH	WU40PH	300	360	600	IPR	0.0047–0.0079	0.0055–0.0098	0.0063–0.0110	0.0063–0.0118
K1	-V34	WU25CH	WPK10CH	360	600	840	IPR	0.0055–0.0102	0.0063–0.0118	0.0071–0.0126	0.0079–0.0142
K2	-V34	WU40PH	WPK10CH	300	540	780	IPR	0.0055–0.0102	0.0063–0.0118	0.0071–0.0126	0.0079–0.0142
K3	-V34	WU40PH	WPK10CH	300	510	720	IPR	0.0055–0.0102	0.0063–0.0118	0.0071–0.0126	0.0079–0.0142
N1	-V36	WN10PH	WN10PH	750	1050	1500	IPR	0.0051–0.0071	0.0059–0.0079	0.0063–0.0110	0.0067–0.0118
N2	-V36	WN10PH	WN10PH	450	900	1350	IPR	0.0051–0.0071	0.0059–0.0079	0.0063–0.0110	0.0067–0.0118
N3	-V36	WN10PH	WN10PH	240	360	450	IPR	0.0047–0.0067	0.0055–0.0083	0.0063–0.0091	0.0063–0.0094
S3	-V38	WU40PH	WU40PH	60	90	135	IPR	0.0055–0.0083	0.0063–0.0094	0.0071–0.0102	0.0079–0.0118
S4	-V38	WU40PH	WU40PH	105	120	195	IPR	0.0055–0.0083	0.0063–0.0094	0.0071–0.0102	0.0079–0.0118

NOTE: All speed conditions are for stable conditions. For unstable conditions, it is suggested to reduce starting speeds by 10%. For interrupted cuts, reduce by 20%.
 For 4 x D, it is highly recommended to start with feed and speed values reduced by 10% less than above data.
 For 5 x D, diameter range .473–.938" (insert sizes A to C), it is highly recommended to start with feed and speed values reduced by 20% less than above data.
 For 5 x D, diameter range .969–2.5" (inserts sizes D to H), it is highly recommended to start with feed and speed values reduced by 15% less than above data.
 For 4 x D and 5 x D, it is recommended to reduce feed rate during entry and exit by 30–50%.

INDEXABLE MILLING
 SOLID END MILLING
 HOLEMAKING
 TAPPING
 TURNING

TC4 • Drill Depth • X-Offset Capabilities • Hole Tolerance

Insert size	Diameter range mm (in)	2 x D/3 x D			4 x D			5 x D		
		X-offset value max. in mm (max. in inch)	D1 max value mm (in)	Hole tolerance mm (in)	X-offset value max. in mm (max. in inch)	D1 max value mm (in)	Hole tolerance mm (in)	X-offset value max. in mm (max. in inch)	D1 max value mm (in)	Hole tolerance mm (in)
A	12,00–13,99 (.473–.531)	0,5 (0.020)	D1 + 1mm (D1 + 0.039")	+/- 0.20 (+/- 0.008)	0,5 (0.020)	D1 + 1mm (D1 + 0.039")	+/- 0.35 (+/- 0.014)	–	–	+/- 0.35 (+/- 0.014)
B	14,00–18,99 (.563–.734)	0,5 (0.020)	D1 + 1mm (D1 + 0.039")	+/- 0.20 (+/- 0.008)	0,5 (0.020)	D1 + 1mm (D1 + 0.039")	+/- 0.35 (+/- 0.014)	–	–	+/- 0.35 (+/- 0.014)
C	19,00–23,99 (.750–.938)	0,5 (0.020)	D1 + 1mm (D1 + 0.039")	+/- 0.20 (+/- 0.008)	0,5 (0.020)	D1 + 1mm (D1 + 0.039")	+/- 0.35 (+/- 0.014)	–	–	+/- 0.35 (+/- 0.014)
D	24,00–29,99 (.969–1.156)	0,8 (0.031)	D1 + 1,6mm (D1 + 0.063")	+/- 0.20 (+/- 0.008)	0,8 (0.031)	D1 + 1mm (D1 + 0.039")	+/- 0.35 (+/- 0.014)	–	–	+/- 0.35 (+/- 0.014)
E	30,00–36,99 (1.188–1.438)	0,8 (0.031)	D1 + 1,6mm (D1 + 0.063")	+/- 0.20 (+/- 0.008)	0,8 (0.031)	D1 + 1mm (D1 + 0.039")	+/- 0.35 (+/- 0.014)	–	–	+/- 0.35 (+/- 0.014)
F	37,00–45,99 (1.469–1.750)	0,8 (0.031)	D1 + 1,6mm (D1 + 0.063")	+/- 0.25 (+/- 0.010)	0,8 (0.031)	D1 + 1mm (D1 + 0.039")	+/- 0.38 (+/- 0.015)	–	–	+/- 0.38 (+/- 0.015)
G	46,00–56,99 (1.813–2.219)	1 (0.039)	D1 + 2mm (D1 + 0.079")	+/- 0.25 (+/- 0.010)	0,8 (0.031)	D1 + 1mm (D1 + 0.039")	+/- 0.38 (+/- 0.015)	–	–	+/- 0.38 (+/- 0.015)
H	57,00–68,00 (2.250–2.500)	1 (0.039)	D1 + 2mm (D1 + 0.079")	+/- 0.28 (+/- 0.011)	0,8 (0.031)	D1 + 1mm (D1 + 0.039")	+/- 0.42 (+/- 0.017)	–	–	+/- 0.42 (+/- 0.017)

NOTE: All speed conditions are for stable conditions. For unstable conditions, it is suggested to reduce starting speeds by 10%. For interrupted cuts, reduce by 20%.
 For 4 x D, it is highly recommended to start with feed and speed values reduced by 10% less than above data.
 For 5 x D, diameter range .473–.938" (insert sizes A to C), it is highly recommended to start with feed and speed values reduced by 20% less than above data.
 For 5 x D, diameter range .969–2.5" (inserts sizes D to H), it is highly recommended to start with feed and speed values reduced by 15% less than above data.
 For 4 x D and 5 x D, it is recommended to reduce feed rate during entry and exit by 30–50%.

INDEXABLE MILLING

SOLID END MILLING

HOLEMAKING

TAPPING

TURNING

TC4 – QUICK FACTS

INSERTS

GRADES

WPK10CH, WU25CH, WU40PH, WN10PH

DIAMETER RANGE

.472–2.677" (12–68 mm)

STEEL BODIES

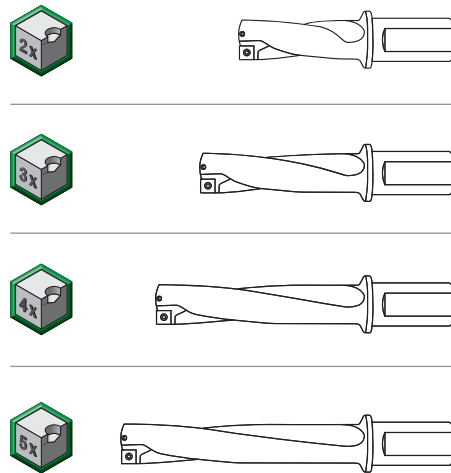

APPLICATIONS

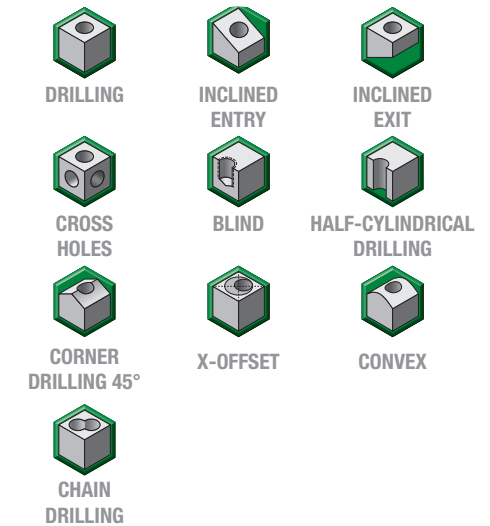

CHIP-BREAKERS

TYPE

MATERIALS

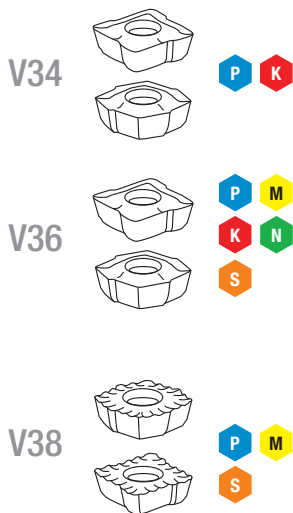

GEOMETRY

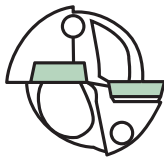

Differentiated inserts shape to avoid grade mixing between central and periphery inserts

Coolant Channels exit right behind the cutting edge to ensure the best coolant delivery

FLANGED SHANK

✓ INCH
✓ METRIC

Increase the overall drill stability above all in deep-drilling applications and suitable for machining and turning centers

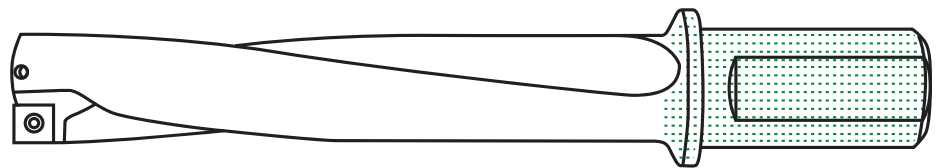

TAPPING

VARITAP™

Pages F98–F103

- Unique spiral-point geometry provides low tapping torque while pushing chips ahead of the tap in through holes.
- Manufactured from high-vanadium HSS-E to provide long and consistent tool life.
- Ideal for customers who have a variety of materials to machine.



HIGH-PERFORMANCE • GT SERIES

Pages F104–F107



- Left-hand spiral flutes to push chips ahead in through holes.
- Offer performance advantages over conventional high-speed steel taps.
- Long tap life at up to 50% higher tapping speed than HSS taps.

TO SEE ALL PRODUCTS LINES, VISIT OUR DIGITAL RESOURCES



WIDIA NOVO™ Application
Download to your desktop or tablet:
widia.com/novo



WIDIA™ Machining Central Mobile App
Download for iOS or Android:
widia.com/en/featured/WidiaMobileApp

SPIRAL-POINT HSS-E

Pages F100–F103

The most efficient taps for through holes.

- Shoots chips ahead of the cutting action to reduce overloading and clogging in flutes, protecting the workpiece.
- Advanced steam oxide finish and high-performance TiN, TiN+CrC/C, and TiCN coatings with alternate tap coatings available as stock modifications.
- Extended life in ferrous materials.

Materials:



SPIRAL-FLUTE HSS-E

Pages F100–F103

Spiral-flute taps are manufactured from high-speed steel (HSS) and are designed for blind-hole applications.

- Stronger, smoother threads.
- Displaces metal while producing no chips.
- Faster tapping speed to double production time.

Materials:





PIPE TAPS

Pages F100–F103

Materials:



Manufactured from high-speed steel and available with coolant holes.

- For through- or blind-hole tapping.
- Can be used in general machinery or CNC tapping applications.
- Store chips in their flutes during threading, which protects the workpiece.

TO SEE ALL PRODUCTS LINES, VISIT OUR DIGITAL RESOURCES





WIDIA NOVO™ Application
Download to your desktop or tablet:
widia.com/novo



WIDIA™ Machining Central Mobile App
Download for iOS or Android:
widia.com/en/featured/WidiaMobileApp

Application Data • HSS-E • Metric

Material Group		 Through Holes					 Blind Holes				
				Range – m/min					Range – m/min		
		Tap Style	Grade	min	Starting Value	max	Tap Style	Grade	min	Starting Value	max
P	P1	VT-SPO	WP42EG, WU41EG	21	27	34	VT-SFT	WP42EG, WU41EG	13	18	26
		VT-SPO	WP49EG, WU40EG	10	14	17	VT-SFT	WP49EG, WU40EG	6	9	13
	P2	VT-SPO	WP42EG, WU41EG	16	21	27	VT-SFT	WP42EG, WU41EG	11	15	22
		VT-SPO	WP49EG, WU40EG	8	11	13	VT-SFT	WP49EG, WU40EG	4	6	9
	P3	VT-SPO	WP42EG, WU41EG	9	12	15	VT-SFT	WP42EG, WU41EG	6	9	13
		VT-SPO	WP49EG, WU40EG	5	6	8	VT-SFT	WP49EG, WU40EG	2	3	4
VT-STR NPT		WU41EG	5	6	8	VT-STR NPT	WU41EG	5	6	8	
M	M1	VT-SPO	WP42EG, WU41EG	9	12	15	VT-SFT	WP42EG, WU41EG	6	9	13
		VT-SPO	WP49EG, WU40EG	5	6	8	VT-SFT	WP49EG, WU40EG	2	3	4
		VT-SFT NPT	WU41EG	5	6	8	VT-SFT NPT	WU41EG	5	6	8
	M3	VT-SFT NPT	WP49EG, WU40EG	2	3	4	VT-SFT NPT	WP49EG, WU40EG	2	3	4
		VT-SPO	WP42EG, WU41EG	7	9	11	VT-SFT	WP42EG, WU41EG	4	6	9
		VT-SPO	WP49EG, WU40EG	3	5	6	VT-SFT	WP49EG, WU40EG	2	3	4
K	K1	VT-STR NPT	WU41EG	10	14	17	VT-STR NPT	WU41EG	10	14	17
		VT-STR NPT	WU40EG	6	8	10	VT-STR NPT	WU40EG	6	8	10
N	N2	VT-SPO	WP42EG, WU41EG	21	27	34	VT-SFT	WP42EG, WU41EG	13	18	26
		VT-SPO	WP49EG, WU40EG	10	14	17	VT-SFT	WP49EG, WU40EG	6	9	13
N	N1	VT-SPO	WP42EG, WU41EG	34	46	57	VT-SFT	WP42EG, WU41EG	23	34	48
		VT-SPO	WU40EG	17	23	29	VT-SFT	WU40EG	11	15	22
	N4	VT-SPO	WP42EG, WU41EG	30	40	50	VT-SFT	WP42EG, WU41EG	19	27	39
		VT-SPO	WU40EG	15	20	25	VT-SFT	WU40EG	11	15	22
N	N4	VT-SPO	WP42EG, WU41EG	7	9	11	VT-SFT	WP42EG, WU41EG	4	6	9
		VT-SPO	WU40EG	3	5	6	VT-SFT	WU40EG	2	3	4

* Grades: WP42EG = TiCN
 WU41EG = TiN
 WP49EG = oxide
 WU40EG = bright

INDEXABLE MILLING



SOLID END MILLING

HOLEMAKING

TAPPING

TURNING

Application Data • HSS-E • Inch

Material Group		 Through Holes					 Blind Holes				
				Range – SFM					Range – SFM		
		Tap Style	Grade	min	Starting Value	max	Tap Style	Grade	min	Starting Value	max
P	1	VT-SPO	WP42EG, WU41EG	70	90	110	VT-SFT	WP42EG, WU41EG	40	60	90
		VT-SPO	WP49EG, WU40EG	30	45	60	VT-SFT	WP49EG, WU40EG	20	30	40
	2,3,4,5	VT-SPO	WP42EG, WU41EG	50	70	90	VT-SFT	WP42EG, WU41EG	40	50	70
		VT-SPO	WP49EG, WU40EG	30	35	40	VT-SFT	WP49EG, WU40EG	10	20	30
		VT-SPO	WP42EG, WU41EG	30	40	50	VT-SFT	WP42EG, WU41EG	20	30	40
		VT-SPO	WP49EG, WU40EG	20	20	30	VT-SFT	WP49EG, WU40EG	10	10	10
6,7,8,10	VT-SPO	WP42EG, WU41EG	20	20	30	VT-SFT	WP42EG, WU41EG	20	20	30	
	VT-STR NPT	WU41EG	20	20	30	VT-STR NPT	WU41EG	20	20	30	
	VT-STR NPT	WU40EG	10	10	10	VT-STR NPT	WU40EG	10	10	10	
M	14.1, 14.3	VT-SPO	WP42EG, WU41EG	30	40	50	VT-SFT	WP42EG, WU41EG	20	30	40
		VT-SPO	WP49EG, WU40EG	20	20	30	VT-SFT	WP49EG, WU40EG	10	10	10
		VT-SFT NPT	WU41EG	20	20	30	VT-SFT NPT	WU41EG	20	20	30
	14.2	VT-SFT NPT	WP49EG, WU40EG	10	10	10	VT-SFT NPT	WP49EG, WU40EG	10	10	10
		VT-SPO	WP42EG, WU41EG	20	30	40	VT-SFT	WP42EG, WU41EG	10	20	30
		VT-SPO	WP49EG, WU40EG	10	15	20	VT-SFT	WP49EG, WU40EG	7	10	10
K	15,16	VT-STR NPT	WU41EG	30	45	60	VT-STR NPT	WU41EG	30	45	60
		VT-STR NPT	WU40EG	20	25	30	VT-STR NPT	WU40EG	20	25	30
	17,18,19	VT-SPO	WP42EG, WU41EG	70	90	110	VT-SFT	WP42EG, WU41EG	40	60	90
VT-SPO		WP49EG, WU40EG	30	45	60	VT-SFT	WP49EG, WU40EG	20	30	40	
N	21,22	VT-SPO	WP42EG, WU41EG	110	150	190	VT-SFT	WP42EG, WU41EG	80	110	160
		VT-SPO	WU40EG	60	75	90	VT-SFT	WU40EG	40	50	72
	23,24	VT-SPO	WP42EG, WU41EG	100	130	160	VT-SFT	WP42EG, WU41EG	60	90	130
		VT-SPO	WU40EG	50	65	80	VT-SFT	WU40EG	40	50	70
		VT-SPO	WP42EG, WU41EG	23	30	40	VT-SFT	WP42EG, WU41EG	10	20	30
		VT-SPO	WU40EG	10	15	20	VT-SFT	WU40EG	10	10	10

* Grades: WP42EG = TiCN
 WU41EG = TiN
 WP49EG = oxide
 WU40EG = bright

★ INDEXABLE MILLING

★ SOLID END MILLING

★ HOLEMAKING

★ TAPPING

★ TURNING

INDEXABLE MILLING
 SOLID END MILLING
 HOLEMAKING
 TAPPING
 TURNING

Tap Recommendations for Classes 2B and 3B

▼ Unified Inch Screw Threads

thread size/pitch	recommended tap limits ¹		internal thread pitch diameter limits		
	class 2B	class 3B	min all classes (Basic)	max class 2B	max class 3B
0 - 80	H2	H2	0.0519	0.0542	0.0536
1 - 64	H2	H2	0.0629	0.0655	0.0648
1 - 72	H2	H2	0.0640	0.0665	0.0659
2 - 56	H2	H2	0.0744	0.0772	0.0765
2 - 64	H2	H2	0.0759	0.0786	0.0779
3 - 48	H3	H2	0.0855	0.0885	0.0877
3 - 56	H2	H2	0.0874	0.0902	0.0895
4 - 40	H3	H2	0.0958	0.0991	0.0982
4 - 48	H3	H2	0.0985	0.1016	0.1008
5 - 40	H3	H2	0.1088	0.1121	0.1113
5 - 44	H3	H2	0.1102	0.1134	0.1126
6 - 32	H3	H2	0.1177	0.1214	0.1204
6 - 40	H3	H2	0.1218	0.1252	0.1243
8 - 32	H3	H3	0.1437	0.1475	0.1465
8 - 36	H3	H3	0.1460	0.1496	0.1487
10 - 24	H3	H3	0.1629	0.1672	0.1661
10 - 32	H3	H3	0.1697	0.1736	0.1726
12 - 24	H3	H3	0.1889	0.1933	0.1922
12 - 28	H3	H3	0.1928	0.1970	0.1959
1/4 - 20	H5	H3	0.2175	0.2224	0.2211
1/4 - 28	H4	H3	0.2268	0.2311	0.2300
5/16 - 18	H5	H3	0.2764	0.2817	0.2803
5/16 - 24	H4	H3	0.2854	0.2902	0.2890
3/8 - 16	H5	H3	0.3344	0.3401	0.3387
3/8 - 24	H4	H3	0.3479	0.3528	0.3516
7/16 - 14	H5	H3	0.3911	0.3972	0.3957
7/16 - 20	H5	H3	0.4050	0.4104	0.4091
1/2 - 13	H5	H4	0.4500	0.4565	0.4548
1/2 - 20	H5	H3	0.4675	0.4731	0.4717
9/16 - 12	H5	H4	0.5084	0.5152	0.5135
9/16 - 18	H5	H3	0.5264	0.5323	0.5308
5/8 - 11	H5	H4	0.5660	0.5732	0.5714
5/8 - 18	H5	H3	0.5889	0.5949	0.5934
3/4 - 10	H5	H4	0.6850	0.6927	0.6907

¹Tap H limit selected for 3B will also produce thread to 2B.

NOTE: The above recommended taps normally produce the class of thread indicated in average materials when used with reasonable care. However, if the specified tap does not provide a satisfactory gage fit, choose an alternate tap limit.

Tap Recommendations for Classes 2B and 3B

▼ Unified Inch Screw Threads

thread size/pitch	recommended tap limits		internal thread pitch diameter limits		
	class 2B	class 3B	min all classes (Basic)	max class 2B	max class 3B
3/4 - 16	H5	H4	0.7094	0.7159	0.7143
7/8 - 9	H6	H4	0.8028	0.8110	0.8089
7/8 - 14	H6	H4	0.8286	0.8356	0.8339
1" - 8	H6	H5	0.9188	0.9276	0.9254
1" - 12	H6	H4	0.9459	0.9535	0.9516
1-1/8 - 7	H8	H6	1.0322	1.0416	1.0393
1-1/8 - 8	H8	H6	1.0438	1.0528	1.0505
1-1/8 - 12	H6	H5	1.0709	1.0787	1.0768
1-1/4 - 7	H8	H6	1.1572	1.1668	1.1644
1-1/4 - 8	H8	H6	1.1688	1.1780	1.1757
1-1/4 - 12	H6	H5	1.1959	1.2039	1.2019
1-3/8 - 6	H8	H6	1.2667	1.2771	1.2745
1-3/8 - 8	H8	H6	1.2938	1.3031	1.3008
1-3/8 - 12	H6	H5	1.3209	1.3291	1.3270
1-1/2 - 6	H8	H6	1.3917	1.4022	1.3996
1-1/2 - 8	H8	H6	1.4188	1.4283	1.4259
1-1/2 - 12	H6	H5	1.4459	1.4542	1.4522
1-3/4 - 5	H8	H7	1.6201	1.6317	1.6288
2 - 4 1/2	H8	H7	1.8557	1.8681	1.8650

*Tap H limit selected for 3B will also produce thread to 2B.

Tap Recommendations for Class 6H Metric Screw Threads

thread size		recommended tap limit number	internal thread product limits — class 6H			
nominal diameter (mm)	pitch (mm)		pitch diameter (mm)		pitch diameter (in)	
			min	max	min	max
1,6	0,35	D3	1,373	1,458	.05406	.05740
2	0,4	D3	1,740	1,830	.06850	.07205
2,5	0,45	D3	2,208	2,303	.08693	.09067
3	0,5	D3	2,675	2,775	.10531	.10925
3,5	0,6	D4	3,110	3,222	.12244	.12685
4	0,7	D4	3,545	3,663	.13957	.14421
4,5	0,75	D4	4,013	4,131	.15789	.16264
5	0,8	D4	4,480	4,605	.17638	.18130
6	1	D5	5,350	5,500	.21063	.21654
7	1	D5	6,350	6,500	.25000	.25591
8	1,25	D5	7,188	7,348	.28299	.28929
10	1,5	D6	9,026	9,206	.35535	.36244
12	1,75	D6	10,863	11,063	.42768	.43555
14	2	D7	12,701	12,913	.50004	.50839
16	2	D7	14,701	14,913	.57878	.58713
20	2,5	D7	18,376	18,600	.72346	.73228
24	3	D8	22,051	22,316	.86815	.87858
30	3,5	D9	27,727	28,007	1.09161	1.10264
36	4	D9	33,402	33,702	1.31504	1.32685

HIGH-PERFORMANCE

SPIRAL-POINT AND LEFT-HAND SPIRAL FLUTE

Page F106

Left-hand spiral flutes are designed to push the chips ahead in through holes.

- Most efficient geometry to tap through-holes.

Materials:



SPIRAL FLUTE

Page F106

Spiral-flute taps are designed to remove the chips back from the hole to prevent tap breakage.

- Optimized spiral-flute design enables blind holes to be threaded.
- Ideal for interrupted cuts.
- Best suited for blind and deep blind holes.

Materials:





FORMING TAPS

Page F106

Materials:



Forming taps produce a stronger and smoother thread.

- Stronger, smoother threads.
- Displaces metal while producing no chips.
- Faster tapping speed to double production time.

TO SEE ALL PRODUCTS LINES, VISIT OUR DIGITAL RESOURCES





WIDIA NOVO™ Application
Download to your desktop or tablet:
widia.com/novo



WIDIA™ Machining Central Mobile App
Download for iOS or Android:
widia.com/en/featured/WidiaMobileApp

Application Data • HSS-E-PM • Metric

Material Group		 Through Holes					 Blind Holes				
				Range – m/min					Range – m/min		
		Tap Style	Grade	min	Starting Value	max	Tap Style	Grade	min	Starting Value	max
P	P1	GT20	GP6520	20	30	45	GT30, GT32, GT50	GP6520	14	21	32
		GT24	WU32MG	20	30	45	GT24, GT26	WU32MG	14	21	32
	P2	GT20	GP6520	17	25	38	GT30, GT32, GT50	GP6520	12	18	26
		GT24	WU32MG	17	25	38	GT24, GT26	WU32MG	12	18	26
	P3	GT20	GP6520	12	15	20	GT30, GT32, GT50	GP6520	8	11	14
	P4	GT00	WP31MG	5	6	8	GT02, GT04	WP31MG	3	4	5
P5	GT20	GP6520	12	15	20	GT30, GT32, GT50	GP6520	8	11	14	
P6	GT00	WP31MG	6	8	10	GT02, GT04	WP31MG	4	6	7	
M	M1	GT20	GM6515	12	15	20	GT30, GT32, GT50	GM6515	8	11	14
		GT24	WU32MG	5	8	12	GT24, GT26	WU32MG	4	6	8
	M2	GT20	GM6515	9	12	16	GT30, GT32, GT50	GM6515	6	8	11
M3	GT00	WP31MG	4	5	7	GT02, GT04	WP31MG	3	4	5	
K	K1	GT40	GP6520	27	35	46	GT40, GT42	GP6520	19	25	32
	K2	GT40	GP6520	23	30	39	GT40, GT42	GP6520	16	21	27
N	N1	GT72	WN44EG	33	50	65	GT82, GT86	WN44EG	23	35	46
		GT22	WN48EG	37	55	72	GT22	WN48EG	26	39	50
	N2	GT40	GP6520	30	45	59	GT40, GT42	GP6520	21	32	41
		GT72	WN44EG	30	45	59	GT82, GT86	WN44EG	21	32	41
N4	GT22	WN38MG	33	50	65	GT22	WN38MG	23	35	46	
S	S1	GT40	GP6520	7	10	15	GT40, GT42	GP6520	5	7	11
		GT20	GP6520	8	12	18	GT30, GT32	GP6520	6	8	13
	S2, S3	GT90	WU32MG	3,3	5,0	7,5	GT92, GT94	WU32MG	2,3	3,5	5,3
GT90		WS39MG	1,7	2,5	3,8	GT92, GT94	WS39MG	1,2	1,8	2,6	
S4	GT60	WS34MG	2,7	4,0	6,0	GT62	WS34MG	1,9	2,8	4,2	
	GT60	WS30MG	1,3	2,0	3,0	GT62	WS30MG	0,9	1,4	2,1	
H	H1	GT06	WN35MG	1,3	2,0	3,0	GT06	WN35MG	0,9	1,4	2,1
	H2	GT06	WN35MG	1,0	1,5	2,3	GT06	WN35MG	0,7	1,1	1,6

INDEXABLE MILLING

SOLID END MILLING

HOLEMAKING

TAPPING

TURNING

Decimal Equivalents

drill size	decimal (in)	drill size	decimal (in)	drill size	decimal (in)	drill size	decimal (in)	drill size	decimal (in)	drill size	decimal (in)
0,30mm	.0118	54	.0550	3,10mm	.1220	5,50mm	.2165	8,50mm	.3346	9/16	.5625
0,32mm	.0126	1,40mm	.0551	1/18	.1250	7/32	.2188	8,60mm	.3386	14,50mm	.5709
80	.0135	1,45mm	.0571	3,20mm	.1260	5,60mm	.2205	R	.3390	37/64	.5781
0,35mm	.0138	1,50mm	.0591	30	.1285	2	.2210	8,70mm	.3425	14,75mm	.5807
79	.0145	53	.0595	3,30mm	.1299	5,70mm	.2244	11/32	.3438	15,00mm	.5906
0,38mm	.0150	1,55mm	.0610	3,40mm	.1339	1	.2280	8,80mm	.3465	19/32	.5938
1/64	.0156	1/16	.0625	29	.1360	5,80mm	.2283	S	.3480	15,25mm	.6004
0,40mm	.0157	1,60mm	.0630	3,50mm	.1378	5,90mm	.2323	8,90mm	.3504	39/64	.6094
78	.0160	52	.0635	28	.1405	A	.2340	9,00mm	.3543	15,50mm	.6102
0,42mm	.0165	1,65mm	.0650	9/64	.1406	15/64	.2344	T	.3580	15,75mm	.6201
0,45mm	.0177	1,70mm	.0669	3,60mm	.1417	6,00mm	.2362	9,10mm	.3583	5/8	.6250
77	.0180	51	.0670	27	.1440	B	.2380	23/64	.3594	16,00mm	.6299
0,48mm	.0189	1,75mm	.0689	3,70mm	.1457	6,10mm	.2402	9,20mm	.3622	16,25mm	.6398
0,50mm	.0197	50	.0700	26	.1470	C	.2420	9,30mm	.3661	41/64	.6406
76	.0200	1,80mm	.0709	25	.1495	6,20mm	.2441	U	.3680	16,50mm	.6496
75	.0210	1,85mm	.0728	3,80mm	.1496	D	.2460	9,40mm	.3701	21/32	.6562
0,55mm	.0217	49	.0730	24	.1520	6,30mm	.2480	9,50mm	.3740	16,75mm	.6594
74	.0225	1,90mm	.0748	3,90mm	.1535	1/4, E	.2500	3/8	.3750	17,00mm	.6693
0,60mm	.0236	48	.0760	23	.1540	6,40mm	.2520	V	.3770	43/64	.6719
73	.0240	1,95mm	.0768	5/32	.1562	6,50mm	.2559	9,60mm	.3780	17,25mm	.6791
0,62mm	.0244	5/64	.0781	22	.1570	F	.2570	9,70mm	.3819	11/16	.6875
72	.0250	47	.0785	4,00mm	.1575	6,60mm	.2598	9,80mm	.3858	17,50mm	.6890
0,65mm	.0256	2,00mm	.0787	21	.1590	G	.2610	W	.3860	45/64	.7031
71	.0260	2,05mm	.0807	20	.1610	6,70mm	.2638	9,90mm	.3898	18,00mm	.7087
0,70mm	.0276	46	.0810	4,10mm	.1614	17/64	.2656	25/64	.3906	23/32	.7188
70	.0280	45	.0820	4,20mm	.1654	H	.2660	10,00mm	.3937	18,50mm	.7283
69	.0292	2,10mm	.0827	19	.1660	6,80mm	.2677	X	.3970	47/64	.7344
0,75mm	.0295	2,15mm	.0846	4,30mm	.1693	6,90mm	.2717	10,20mm	.4016	19,00mm	.7480
68	.0310	44	.0860	18	.1695	I	.2720	Y	.4040	3/4	.7500
1/32	.0312	2,20mm	.0866	11/64	.1719	7,00mm	.2756	13/32	.4062	49/64	.7656
0,80mm	.0315	2,25mm	.0886	17	.1730	J	.2770	Z	.4130	19,50mm	.7677
67	.0320	43	.0890	4,40mm	.1732	7,10mm	.2795	10,50mm	.4134	25/32	.7812
66	.0330	2,30mm	.0906	16	.1770	K	.2810	27/64	.4219	20,00mm	.7874
0,85mm	.0335	2,35mm	.0925	4,50mm	.1772	9/32	.2812	10,80mm	.4252	51/64	.7969
65	.0350	42	.0935	15	.1800	7,20mm	.2835	11,00mm	.4331	20,50mm	.8071
0,90mm	.0354	3/32	.0938	4,60mm	.1811	7,30mm	.2874	7/16	.4375	13/16	.8125
64	.0360	2,40mm	.0945	14	.1820	L	.2900	11,20mm	.4409	21,00mm	.8268
63	.0370	41	.0960	4,70mm, 13	.1850	7,40mm	.2913	11,50mm	.4528	53/64	.8281
0,95mm	.0374	2,45mm	.0965	3/16	.1875	M	.2950	29/64	.4531	27/32	.8438
62	.0380	40	.0980	4,80mm, 12	.1890	7,50mm	.2953	11,80mm	.4646	21,50mm	.8465
61	.0390	2,50mm	.0984	11	.1910	19/64	.2969	15/32	.4688	55/64	.8594
1,00mm	.0394	39	.0995	4,90mm	.1929	7,60mm	.2992	12,00mm	.4724	22,00mm	.8661
60	.0400	38	.1015	10	.1935	N	.3020	12,20mm	.4803	7/8	.8750
59	.0410	2,60mm	.1024	9	.1960	7,70mm	.3031	31/64	.4844	22,50mm	.8858
1,05mm	.0413	37	.1040	5,00mm	.1969	7,80mm	.3071	12,50mm	.4921	57/64	.8906
58	.0420	2,70mm	.1063	8	.1990	7,90mm	.3110	1/2	.5000	23,00mm	.9055
57	.0430	36	.1065	5,10mm	.2008	5/16	.3125	12,80mm	.5039	29/32	.9062
1,10mm	.0433	7/64	.1094	7	.2010	8,00mm	.3150	13,00mm	.5118	59/64	.9219
1,15mm	.0453	35	.1100	13/64	.2031	O	.3160	33/64	.5156	23,50mm	.9252
56	.0465	2,80mm	.1102	6	.2040	8,10mm	.3189	13,20mm	.5197	15/16	.9375
3/64	.0469	34	.1110	5,20mm	.2047	8,20mm	.3228	17/32	.5312	24,00mm	.9449
1,20mm	.0472	33	.1130	5	.2055	P	.3230	13,50mm	.5315	61/64	.9531
1,25mm	.0492	2,90mm	.1142	5,30mm	.2087	8,30mm	.3268	13,80mm	.5433	24,50mm	.9646
1,30mm	.0512	32	.1160	4	.2090	21/64	.3281	35/64	.5469	31/32	.9688
55	.0520	3,00mm	.1181	5,40mm	.2126	8,40mm	.3307	14,00mm	.5512	25,00mm	.9843
1,35mm	.0531	31	.1200	3	.2130	Q	.3320	14,25mm	.5610	63/64	.9844
										1"	1.0000

■ Metric
 ■ Fractional
 ■ Wire gage
 ■ Letter size

TURNING

HIGH-PERFORMANCE INSERTS

Pages F110–F120

WIDIA™ Victory™ Inserts



SPECIALTY TURNING

Pages F110, F121–F122

Small-Hole Boring • Positive Inserts



GROOVING AND CUT-OFF

Pages F124–F131

WGC

WMT™

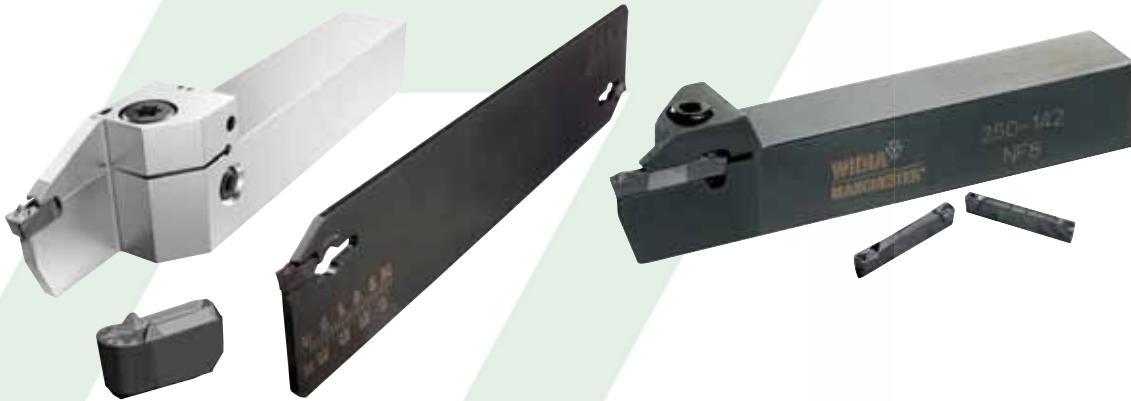

TO SEE ALL PRODUCTS LINES, VISIT OUR DIGITAL RESOURCES



WIDIA NOVO™ Application
Download to your desktop or tablet:
widia.com/novo



WIDIA™ Machining Central Mobile App
Download for iOS or Android:
widia.com/en/featured/WidiaMobileApp

HIGH-PERFORMANCE INS & SPECIALTY TURNING

HIGH-PERFORMANCE INSERTS • WIDIA™ VICTORY™

Pages F112–F120

A complete high-performance turning portfolio.

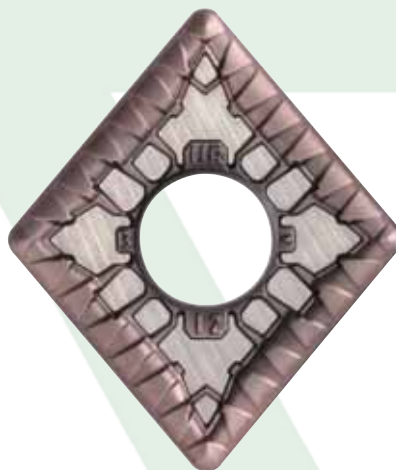

SPECIALTY TURNING

Pages F121–F122

WIDIA micro-boring bars provide accurate holemaking tooling in small diameters.

TO SEE ALL PRODUCTS LINES, VISIT OUR DIGITAL RESOURCES



WIDIA NOVO™ Application
Download to your desktop or tablet:
widia.com/novo



WIDIA™ Machining Central Mobile App
Download for iOS or Android:
widia.com/en/featured/WidiaMobileApp

WIDIA 

 youtube.com/WIDIASolutions

 linkedin.com/WIDIAProductGrp

 facebook.com/WIDIAProductGrp

To learn more, visit widia.com

AUTOMOTIVE



Breaks and Steering Success Story:
Victory™ — RH Chipbreaker

Engine Block Success Story:
Victory Grade WK15CT

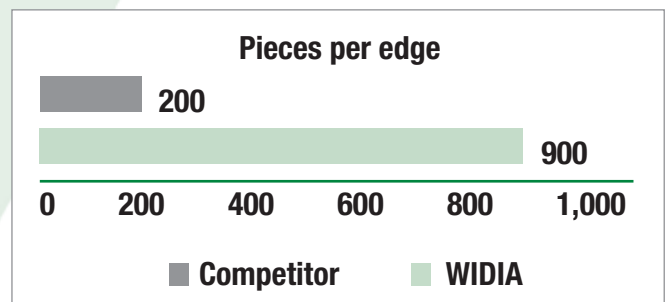
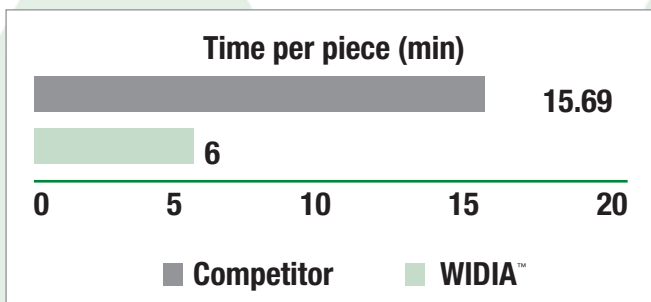

	COMPETITOR	WIDIA
Tool	—	CNMG434RH
Grade	—	WP15CT
Cutting Speed Vc	60.96 m/min (200 sfm)	39.62 m/min (130 sfm)
Feet per tooth f	0.102 mm (0.004")	0.203 mm (0.008")
Depth of cut ap	1.016 mm (0.04")	0.889 mm (0.035")
Length of cut L	101.6 mm (4")	
Number of passes	4	2
Coolant	Dry	
Time per piece	15.69	6.02

	COMPETITOR	WIDIA
Tool	—	SCMT3252
Grade	—	WK15CT
Cutting Speed Vc	152.4 m/min (500 sfm)	
Feet per tooth f	0.254 mm (0.01")	
Depth of cut ap	1.905 mm (0.075")	
Length of cut L	50.8 mm (2")	
Number of passes	1	
Coolant	External Cutting Oil	
Time per piece	200	900

Steel • Carbon, Alloy, and Tool Steels up to 450 HB (48 HRC)

▼ Step 1 • Select the insert geometry

Negative Inserts



Roughing



Medium Machining



Finishing

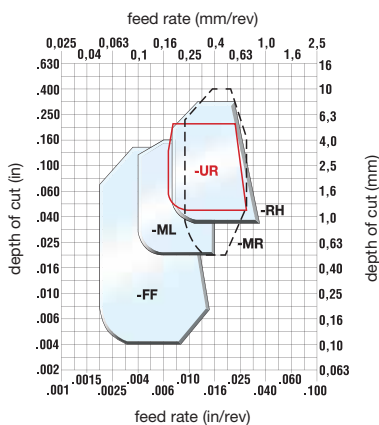

Positive Inserts



Medium Machining



Finishing

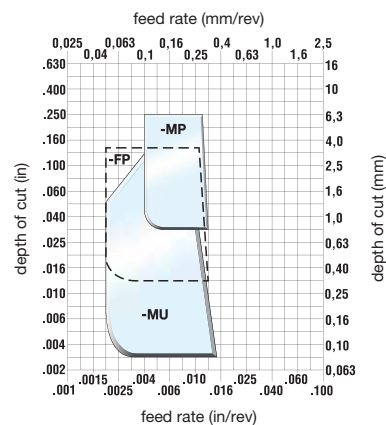

▼ Step 2 • Select the grade

cutting condition		Negative Insert Geometry				Positive Insert Geometry			
		-FF	-ML	-MR	-UR	-RH	-FP	-MU	-MP
heavily interrupted cut		WP15CT	WP25CT	WP35CT/ WP25CT	WP35CT	WP35CT	WP25CT/ WS25PT	WP35CT	WM35CT
lightly interrupted cut		WP15CT	WP25CT	WP25CT	WP35CT	WP35CT	WP25CT	WP25CT	WP25CT
varying depth of cut, casting, or forging skin		WP15CT	WP15CT	WP15CT	WP25CT/ WP15CT	WP25CT	WP15CT	WP25CT/ WP15CT	WP15CT
smooth cut, pre-turned surface		WP15CT	WP15CT	WP15CT	WP25CT/ WP15CT	WP25CT	WP15CT	WP25CT/ WP15CT	WP15CT

INDEXABLE MILLING

SOLID END MILLING

HOLEMAKING

TAPPING

TURNING

Stainless Steel • Austenitic Stainless Steels

▼ Step 1 • Select the insert geometry



Negative Wiper Inserts

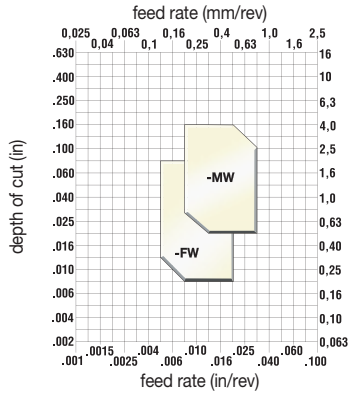

Positive Wiper Inserts

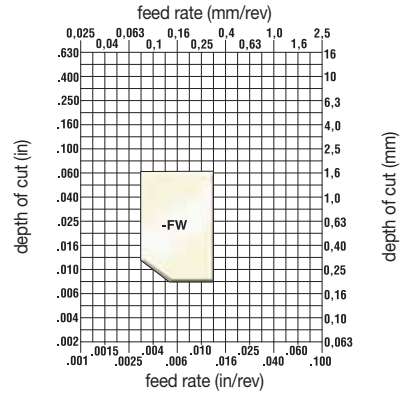

▼ Step 2 • Select the grade

cutting condition	Negative Insert Geometry		Positive Insert Geometry
	-FW	-MW	-FW
heavily interrupted cut	WM15CT	WM15CT	WM15CT
lightly interrupted cut	WM15CT	WM25CT	WM15CT
varying depth of cut, casting, or forging skin	WM15CT	WM25CT	WM15CT
smooth cut, pre-turned surface	WM15CT	WM25CT	WM15CT

▼ Step 1 • Select the insert geometry

Negative Inserts

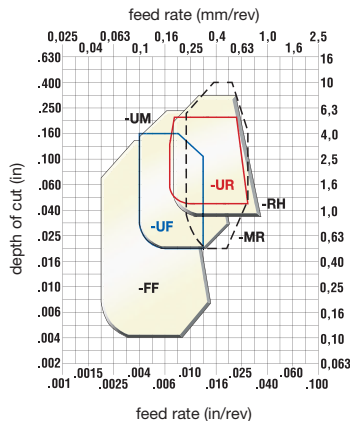
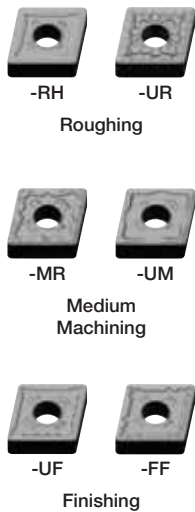



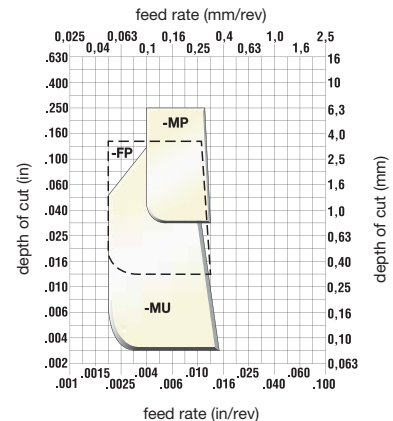
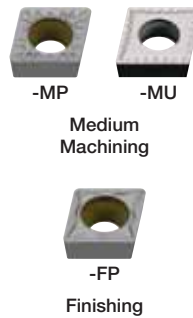

Positive Inserts







(continued)

Stainless Steel • Austenitic Stainless Steels

▼ Step 2 • Select the grade *(continued)*

cutting condition		Negative Insert Geometry					
		-FF	-UF	-MR	-UM	-RH	-UR
heavily interrupted cut		WS10PT	WM15CT	WM35CT	WM35CT	-	WM35CT
lightly interrupted cut		WS10PT	WM15CT	WM25CT	WM25CT	WM35CT	WM35CT/ WM25CT
varying depth of cut, casting, or forging skin		WM15CT	WM15CT/ WS10PT	WM15CT	WM15CT	WM35CT	WM25CT
smooth cut, pre-turned surface		WM15CT	WM15CT	WM15CT	WM15CT	-	WM15CT

cutting condition		Positive Insert Geometry		
		-FP	-MU	-MP
heavily interrupted cut		WM25CT	WM35CT/ WS25PT	WM25CT
lightly interrupted cut		WM25CT	WM25CT/ WS10PT	WM25CT
varying depth of cut, casting, or forging skin		WM25CT/ WM15CT	WM25CT	WM25CT/ WM15CT
smooth cut, pre-turned surface		WM15CT	WM25CT	WM15CT

INDEXABLE MILLING

SOLID END MILLING

HOLEMAKING

TAPPING

TURNING

Cast Iron • Gray and Ductile Irons

▼ Step 1 • Select the insert geometry



Negative Wiper Inserts

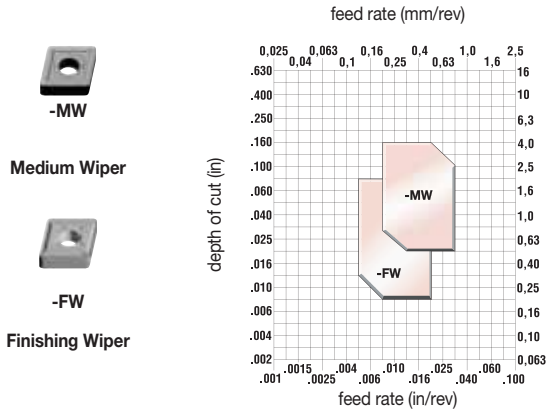

Positive Wiper Inserts

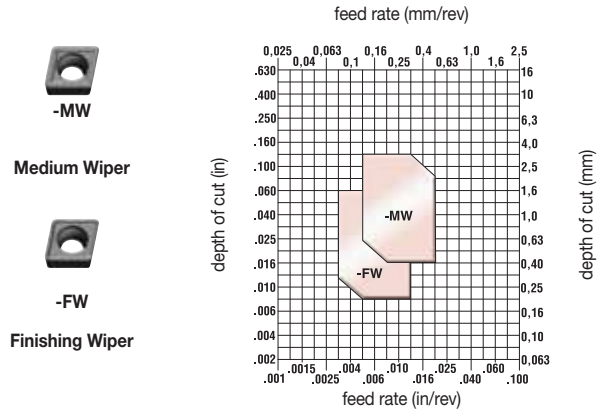

▼ Step 2 • Select the grade

cutting condition		Negative Insert Geometry		Positive Insert Geometry	
		-FW	-MW	-FW	-MW
heavily interrupted cut		-	-	-	-
lightly interrupted cut		WK05CT	WK05CT	WK05CT	WK05CT
varying depth of cut, casting, or forging skin		WK05CT	WK05CT	WK05CT	WK05CT
smooth cut, pre-turned surface		WK05CT	WK05CT	WK05CT	WK05CT

▼ Step 1 • Select the insert geometry

Negative Inserts

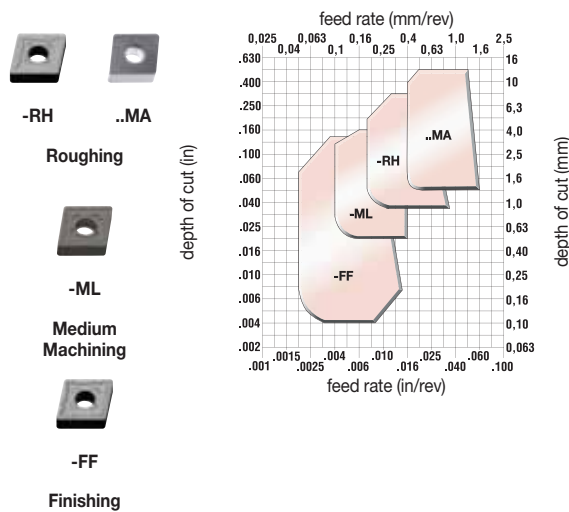

Positive Inserts

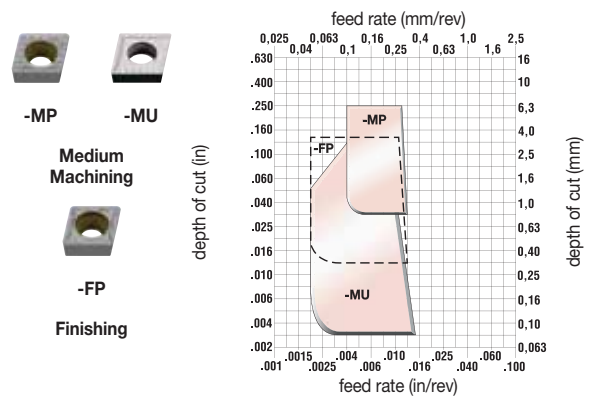

(continued)

★ INDEXABLE MILLING

★ SOLID END MILLING





★ HOLEMAKING

★ TAPPING

★ TURNING

Cast Iron • Gray and Ductile Irons

▼ Step 2 • Select the grade *(continued)*

cutting condition		Negative Insert Geometry				Positive Insert Geometry		
		-FF	-ML	-UR	..MA	-FP	-MU	-MP
heavily interrupted cut		WK20CT	WK20CT	WK20CT	WK20CT	WK20CT	WK20CT	WK20CT
lightly interrupted cut		WK20CT	WK20CT	WK20CT	WK20CT	WK20CT	WK20CT	WK20CT
varying depth of cut, casting, or forging skin		WK20CT	WK05CT	WK20CT	WK05CT	WK20CT	WK20CT	WK20CT
smooth cut, pre-turned surface		WK20CT	WK05CT	WS10PT	WK05CT	WK20CT	WK20CT/ WK05CT/ WS10PT	WK20CT

High-Temp Alloys • Iron-, Cobalt-, and Nickel-Based and Titanium Alloys

▼ Step 1 • Select the insert geometry



Negative Inserts

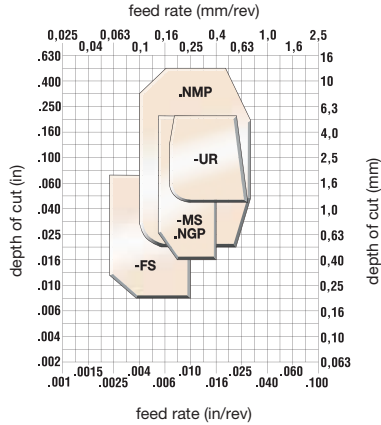
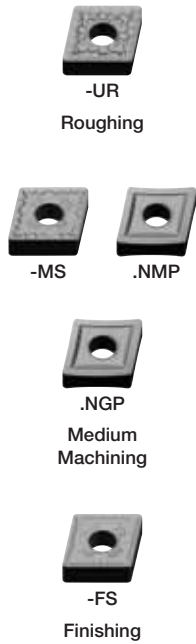

Positive Inserts

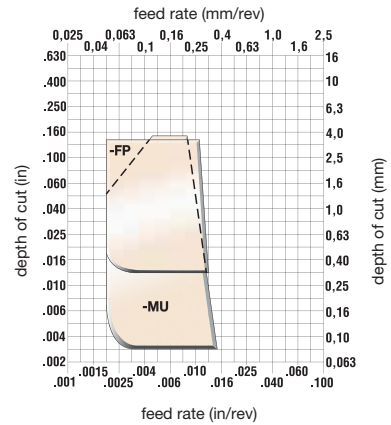

▼ Step 2 • Select the grade

cutting condition		Negative Insert Geometry				Positive Insert Geometry	
		-FS	.NGP/.NMP	-MS	-UR	-FP	-MU
heavily interrupted cut		WS25PT	WS25PT	WS25PT	WS25PT/ WM35CT	WS25PT/ WM15CT	WS25PT
lightly interrupted cut		WS10PT	WS10PT	WS25PT	WS25PT/ WM25CT	WS25PT	WS25PT
varying depth of cut, casting, or forging skin		WS10PT	WS10PT	WS10PT	WS25PT	WS10PT	WS10PT
smooth cut, pre-turned surface		WS10PT/ WU10HT	WS10PT/ WU10HT	WS10PT	WS10PT	WS10PT	WS10PT

INDEXABLE MILLING

SOLID END MILLING

HOLEMAKING

TAPPING

TURNING

Speed and Feed Chart • Ceramics • Inch

Material Group		Cutting Speed – vc SFM								
		CW2015			CW3020			CW5025		
		min	Start	max	min	Start	max	min	Start	max
ap [inch]		0.0197		0.1575	0.0197		0.0394	0.0394		0.315
f [inch]		0.0079		0.0157	0.0039		0.0197	0.0047		0.0236
P	0	-	-	-	-	-	-	-	-	-
	1	-	-	-	-	-	-	-	-	-
	2	-	-	-	-	-	-	-	-	-
	3	-	-	-	-	-	-	-	-	-
	4	-	-	-	-	-	-	-	-	-
	6	-	-	-	-	-	-	-	-	-
M	1	-	-	-	-	-	-	-	-	-
	2	-	-	-	-	-	-	-	-	-
	3	-	-	-	-	-	-	-	-	-
K	1	815	1555	2375	-	-	-	800	2500	3300
	2	980	1800	2600	-	-	-	900	1200	1600
	3	820	1310	1965	-	-	-	900	1100	1450
N	1	-	-	-	-	-	-	-	-	-
	2	-	-	-	-	-	-	-	-	-
	3	-	-	-	-	-	-	-	-	-
	4	-	-	-	-	-	-	-	-	-
	5	-	-	-	-	-	-	-	-	-
	6	-	-	-	-	-	-	-	-	-
	7	-	-	-	-	-	-	-	-	-
	8	-	-	-	-	-	-	-	-	-
S	1	-	-	-	550	650	1200	-	-	-
	2	-	-	-	550	720	1200	-	-	-
	3	-	-	-	600	820	1200	-	-	-
	4	-	-	-	-	-	-	-	-	-
H	1	200	325	450	150	275	400	-	-	-
	2	200	325	450	150	275	400	-	-	-
	3	200	325	450	150	275	400	-	-	-
	4	200	325	450	150	275	400	-	-	-

Speed and Feed Chart • PcBN PCD • Inch

Material Group		Cutting Speed – vc SFM																		
		WBH10P			WBH25P			WBH30P			WBK40U			WDN00U			WDN25U			
		min	Start	max	min	Start	max	min	Start	max	min	Start	max	min	Start	max	min	Start	max	
ap [inch]		0.004	0.020	0.004	0.020	0.003	0.016	0.008	0.080	0.008	0.079	0.008	0.079	0.008	0.079	0.004	0.010	0.004	0.010	
f [inch]		0.002	0.010	0.002	0.008	0.002	0.008	0.003	0.010	0.004	0.010	0.004	0.010	0.004	0.010	0.004	0.010	0.004	0.010	
P	0/1	-	-	-	-	-	-	-	-	-	-	-	-	-	-	-	-	-	-	
	2	-	-	-	-	-	-	-	-	-	-	-	-	-	-	-	-	-	-	
	3	-	-	-	-	-	-	-	-	-	-	-	-	-	-	-	-	-	-	
	4	-	-	-	-	-	-	-	-	-	-	-	-	-	-	-	-	-	-	
	5	-	-	-	-	-	-	-	-	-	-	-	-	-	-	-	-	-	-	
	6	-	-	-	-	-	-	-	-	-	-	-	-	-	-	-	-	-	-	
M	1	-	-	-	-	-	-	-	-	-	-	-	-	-	-	-	-	-	-	
	2	-	-	-	-	-	-	-	-	-	-	-	-	-	-	-	-	-	-	
	3	-	-	-	-	-	-	-	-	-	-	-	-	-	-	-	-	-	-	
K	1	-	-	-	-	-	-	1310	1975	2625	2125	2625	3950	-	-	-	-	-	-	
	2	-	-	-	-	-	-	-	-	-	-	-	-	-	-	-	-	-	-	
	3	-	-	-	-	-	-	-	-	-	-	-	-	-	-	-	-	-	-	
N	1	-	-	-	-	-	-	-	-	-	-	-	1600	2500	8000	1600	2500	8000	1600	2500
	2	-	-	-	-	-	-	-	-	-	-	-	-	-	1000	2000	3200	800	1700	
	3	-	-	-	-	-	-	-	-	-	-	-	800	1700	3200	800	1700	3200	800	1700
	4	-	-	-	-	-	-	-	-	-	-	-	800	1300	2400	800	1300	2400	800	1300
	5	-	-	-	-	-	-	-	-	-	-	-	1700	2500	3200	1700	2500	3200	1700	2500
	6	-	-	-	-	-	-	-	-	-	-	-	1000	1200	2400	1000	1500	2800	1000	1500
	7	-	-	-	-	-	-	-	-	-	-	-	-	-	-	-	-	-	-	-
S	1	-	-	-	-	-	-	400	525	650	-	-	-	-	-	-	-	-	-	
	2	-	-	-	-	-	-	400	525	650	-	-	-	-	-	-	-	-	-	
	3	-	-	-	-	-	-	400	525	650	-	-	-	-	-	-	-	-	-	
	4	-	-	-	-	-	-	-	-	-	-	-	-	325	600	1050	-	-	-	
H	1	275	550	850	275	525	755	200	400	725	200	400	725	-	-	-	-	-	-	
	2	275	550	850	275	525	755	200	400	725	200	400	725	-	-	-	-	-	-	
	3	275	550	850	275	525	755	200	400	725	200	400	725	-	-	-	-	-	-	
	4	275	550	850	275	525	755	200	400	725	200	400	725	-	-	-	-	-	-	

INDEXABLE MILLING
 SOLID END MILLING
 HOLEMAKING
 TAPPING
 TURNING

Speed and Feed Chart • Negative Inserts • Inch

DIN ISO 513	VDI 3323	A Finishing (doc x feed = .0394 x .0039)			B Medium (doc x feed = .0787 x .0079)			C Roughing (d.o.c. x feed = .1575 x .0098)			D Heavy roughing (d.o.c. x feed = .2362 x .0236)											
Material Group		min	Start	max	min	Start	max	min	Start	max	min	Start	max	min	Start	max						
P	Geometry	FF • ML			ML • UR • MR			ML • UR • MR			UR • MR • RH			UR • MR • RH			RH					
	DOC [in]	.0079-.0787			.0315-.1969			.0315-.1969			.0394-.3150			.0394-.3150			.0787-.5906					
	f [in]	.0020-.0079			.0663-.0157			.0663-.0157			.0079-.0236			.0079-.0236			.0157-.0394					
		WP15CT			WP15CT			WP25CT			WP15CT			WP25CT			WP25CT					
	1	1115	1605	1935	915	1310	1570	820	1180	1410	655	950	1145	590	850	1015	490	720	850	490	685	820
	2	1115	1570	1900	850	1210	1440	785	1115	1345	620	885	1045	425	620	750	360	520	620	360	490	590
	3	950	1375	1640	590	850	1015	555	785	950	520	750	915	425	590	720	360	490	590	325	455	555
	4	850	1210	1440	620	885	1045	590	820	980	425	620	750	360	490	590	295	425	520	225	325	390
	5	655	915	1115	455	655	785	425	620	750	295	425	520	245	360	425	210	295	360	180	260	310
	6	885	1275	1540	655	950	1145	620	885	1045	455	655	785	360	520	620	295	425	520	245	360	425
	7	850	1210	1440	620	885	1045	590	820	980	425	620	750	360	490	590	275	390	455	225	325	390
	8	720	1045	1245	520	750	915	490	685	820	360	490	590	275	390	455	225	325	390	210	295	360
	9	655	915	1115	455	655	785	425	620	750	295	425	520	245	360	425	210	295	360	180	260	310
	10	885	1275	1540	655	950	1145	620	885	1045	455	655	785	360	520	620	295	425	520	245	360	425
11	655	915	1115	425	620	750	390	555	655	295	425	520	245	360	425	210	295	360	180	260	310	
12	490	720	850	455	655	785	425	590	720	390	555	655	360	520	620	360	490	590	325	455	555	
13.1	425	620	750	390	555	655	360	490	590	325	455	555	295	425	520	275	390	455	245	360	425	
13.2	210	310	375	195	275	325	180	245	295	160	225	275	145	210	260	145	195	225	130	180	210	
M	Geometry	FF • UF • FW • UM			FF • UM • MW • NMP			FF • UM • MW • NMP			UM • NMP • UR • RH			UM • NMP • UR • RH			RH					
	DOC [in]	.0079-.0787			.0236-.1969			.0236-.1969			.0197-.2362			.0197-.2362			.1575-.5906					
	f [in]	.0020-.0079			.0047-.0157			.0047-.0157			.0039-.0236			.0039-.0236			.0157-.0394					
		WM15CT			WM15CT			WM25CT			WM25CT			WM35CT			WM35CT					
	14.1	590	820	980	490	720	850	455	620	750	455	655	785	360	490	590	360	490	590	-	-	-
14.2	455	655	785	425	590	720	360	520	620	360	520	620	275	390	455	275	390	455	-	-	-	
14.3	360	490	590	325	455	555	275	390	455	275	390	455	210	295	360	210	295	360	-	-	-	
14.4	295	425	520	245	360	425	225	310	360	225	325	390	180	260	310	195	260	310	-	-	-	
K	Geometry	FF • FW			MW • NMA • ML			MW • NMA • ML			UR • NMA • RH			UR • NMA • RH			UR • RH • NMA					
	DOC [in]	.0079-.0787			.0394-.3150			.0394-.3150			.0394-.3150			.0394-.3150			.0787-.5906					
	f [in]	.0020-.0079			.0079-.0236			.0079-.0236			.0047-.0236			.0047-.0236			.0098-.0472					
		WK05CT / WK20CT / WS10PT			WK05CT / WK20CT / WS10PT						WK05CT / WK20CT						WK05CT / WK20CT					
	15	950	1345	1605	750	1080	1310	-	-	-	590	850	1015	-	-	-	520	750	915	-	-	-
	16	750	1080	1310	590	820	980	-	-	-	455	655	785	-	-	-	390	555	655	-	-	-
	17	820	1180	1410	685	980	1180	-	-	-	590	820	980	-	-	-	490	720	850	-	-	-
18	785	1115	1345	620	885	1045	-	-	-	490	685	820	-	-	-	425	590	720	-	-	-	
19	1115	1605	1935	950	1345	1605	-	-	-	785	1115	1345	-	-	-	720	1015	1210	-	-	-	
20	950	1345	1605	750	1080	1310	-	-	-	590	850	1015	-	-	-	520	750	915	-	-	-	
S	Geometry	.NMP			.NMP • UM			.NMP • UM			.NMP • UR			.NMP • UR								
	DOC [in]	.0197-.0394			.0197-.0394			.0197-.0394			.0197-.2362			.0197-.2362								
	f [in]	.0039-.1969			.0039-.1969			.0039-.1969			.0039-.0236			.0039-.0236								
		WS10PT / WS25PT			WS10PT / WS25PT / WM25CT						WM25CT											
	21	180	260	310	150	210	260	-	-	-	135	195	225	-	-	-	-	-	-	-	-	-
	22	150	210	260	110	160	195	-	-	-	110	160	195	-	-	-	-	-	-	-	-	-
	23	110	155	195	90	130	155	-	-	-	80	115	140	-	-	-	-	-	-	-	-	-
	24	65	95	115	50	75	90	-	-	-	50	75	85	-	-	-	-	-	-	-	-	-
	25	70	100	120	55	80	95	-	-	-	55	75	95	-	-	-	-	-	-	-	-	-
	26	-	-	-	-	-	-	-	-	-	-	-	-	-	-	-	-	-	-	-	-	-
27	135	195	225	110	160	195	-	-	-	100	145	180	-	-	-	-	-	-	-	-	-	

INDEXABLE MILLING

SOLID END MILLING

HOLEMAKING

TAPPING

TURNING

Speed and Feed Chart • Positive Inserts • Inch

DIN ISO 513	VDI 3323	A Finishing (doc x feed = .0394 x .0039)			B Medium (doc x feed = .0787 x .0079)			C Roughing (doc x feed = .1575 x .0098)								
Material Group	Geometry DOC [in] f [in]	min	Start	max	min	Start	max	min	Start	max	min	Start	max			
		FP			FP • MP			FP • MP			MP					
P		.0079-.0787 .0020-.0079			.0118-.1775 .0315-.1378			.0118-.1775 .0315-.1378			.0276-.1969 .0047-.0157			.0276-.1969 .0047-.0157		
		WP15CT			WP15CT			WP15CT / WP25CT			WP25CT			WP35CT		
	1	1115	1605	1935	915	1310	1570	820	1180	1410	655	950	1145	590	850	1015
	2	1115	1570	1900	850	1210	1440	785	1115	1345	620	885	1045	425	620	750
	3	950	1375	1640	590	850	1015	555	785	950	520	750	915	425	590	720
	4	850	1210	1440	620	885	1045	590	820	980	425	620	750	360	490	590
	5	655	915	1115	455	655	785	425	620	750	295	425	520	245	360	425
	6	885	1275	1540	655	950	1145	620	885	1045	455	655	785	360	520	620
	7	850	1210	1440	620	885	1045	590	820	980	425	620	750	360	490	590
	8	720	1045	1245	520	750	915	490	685	820	360	490	590	275	390	455
	9	655	915	1115	455	655	785	425	620	750	295	425	520	245	360	425
	10	885	1275	1540	655	950	1145	620	885	1045	455	655	785	360	520	620
	11	655	915	1115	425	620	750	390	555	655	295	425	520	245	360	425
	12	490	720	850	455	655	785	425	590	720	390	555	655	360	520	620
13.1	425	620	750	390	555	655	360	490	590	325	455	555	295	425	520	
13.2	210	310	375	195	275	325	180	245	295	160	225	275	145	210	260	
M		FP			FP • MP			FP • MP			MP			MP		
		.0079-.0787 .0020-.0079			.0118-.1772 .0032-.1378			.0118-.1772 .0032-.1378			.0118-.1772 .0032-.1378			.0118-.1772 .0032-.1378		
		WM15CT			WM15CT			WM25CT			WM25CT			WM35CT		
	14.1	590	820	980	490	720	850	455	620	750	455	655	785	360	490	590
	14.2	455	655	785	425	590	720	360	520	620	360	520	620	275	390	455
14.3	360	490	590	325	455	555	275	390	455	275	390	455	210	295	360	
14.4	295	425	520	245	360	425	225	310	360	225	325	390	180	260	310	
K		FP			FP • MP • .CMW			FP • MP • .CMW			MP • .CMW			MP • .CMW		
		.0079-.0787 .0020-.0079			.0118-.1772 .0032-.1378			.0118-.1772 .0032-.1378			.0394-.3150 .0039-.0197			.0394-.3150 .0039-.0197		
		WK05CT / WK20CT			WK05CT / WK20CT			WK20CT			WK20CT			WK20CT		
	15	950	1345	1605	750	1080	1310	-	-	-	590	850	1015	-	-	-
	16	750	1080	1310	590	820	980	-	-	-	455	655	785	-	-	-
	17	820	1180	1410	685	980	1180	-	-	-	590	820	980	-	-	-
	18	785	1115	1345	620	885	1045	-	-	-	490	685	820	-	-	-
	19	1115	1605	1935	950	1345	1605	-	-	-	785	1115	1345	-	-	-
20	950	1345	1605	750	1080	1310	-	-	-	590	850	1015	-	-	-	

INDEXABLE MILLING

SOLID END MILLING

HOLEMAKING

TAPPING

TURNING

Speed and Feed Chart • Inch • Part 1

ANSI ISO 513	VDI 3323	Cutting Speed – vc															
		Material Group			min			Start			max						
		ap [inch]			f [inch]			min			Start			max			
P		0.002–0.012			0.002–0.012			0.002–0.012			0.002–0.012			0.002–0.012			
		0.012–0.001			0.012–0.001			0.012–0.001			0.012–0.001			0.012–0.001			
		C2			C25			C3			CG5			CG55			
		1	–	–	–	–	–	–	–	–	305	380	460	340	420	505	
		2	–	–	–	–	–	–	–	–	225	280	340	250	310	375	
		3	–	–	–	–	–	–	–	–	175	215	260	195	240	290	
		4	–	–	–	–	–	–	–	–	200	245	295	220	270	325	
		5	–	–	–	–	–	–	–	–	145	180	220	160	200	240	
		6	–	–	–	–	–	–	–	–	240	300	360	265	330	400	
		7	–	–	–	–	–	–	–	–	160	195	235	175	215	260	
		8	–	–	–	–	–	–	–	–	145	180	220	160	200	240	
		9	–	–	–	–	–	–	–	–	125	155	190	140	175	210	
		10	–	–	–	–	–	–	–	–	220	270	325	240	300	360	
		11	–	–	–	–	–	–	–	–	135	165	200	150	185	225	
12	–	–	–	–	–	–	–	–	220	270	325	240	300	360			
13.1	–	–	–	–	–	–	–	–	180	225	270	200	250	300			
13.2	–	–	–	–	–	–	–	–	135	165	200	150	185	225			
M		0.002–0.012			0.002–0.012			0.002–0.012			0.002–0.012			0.002–0.012			
		0.012–0.001			0.012–0.001			0.012–0.001			0.012–0.001			0.012–0.001			
		C2			C25			C3			CG5			CG55 **			
		14.1	180	225	270	195	240	290	205	255	310	240	300	360	265	330	400
		14.2	145	180	220	155	190	230	160	200	240	190	235	285	210	260	315
14.3	165	205	250	180	220	265	185	230	280	220	270	325	240	300	360		
14.4	100	125	150	110	135	165	120	145	175	135	165	200	150	185	225		
K		0.002–0.012			0.002–0.012			0.002–0.012			0.002–0.012			0.002–0.012			
		0.010–0.001			0.010–0.001			0.010–0.001			0.010–0.001			0.010–0.001			
		C2			C25 **			C3 **			CG5			CG55			
		15	200	250	300	220	275	330	220	275	330	230	285	345	255	315	380
		16	140	175	210	160	195	235	160	195	235	160	200	240	180	220	265
		17	230	285	345	250	310	375	250	310	375	260	325	390	290	360	435
		18	145	180	220	160	200	240	160	200	240	170	210	255	190	235	285
19	280	350	420	310	385	465	310	385	465	320	395	475	350	435	525		
20	160	200	240	180	220	265	180	220	265	180	225	270	200	250	300		
N		0.002–0.020			0.002–0.020			0.002–0.020			0.002–0.020			0.002–0.020			
		0.008–0.001			0.008–0.001			0.008–0.001			0.008–0.001			0.008–0.001			
		C2 **			C25 **			C3 **			CG5			CG55			
		21	1320	1650	1980	1320	1650	1980	1320	1650	1980	1320	1650	1980	1455	1815	2180
		22	795	990	1190	795	990	1190	795	990	1190	795	990	1190	875	1090	1310
		23	1320	1650	1980	1320	1650	1980	1320	1650	1980	1320	1650	1980	1455	1815	2180
		24	800	1000	1200	800	1000	1200	800	1000	1200	800	1000	1200	880	1100	1320
		25	225	280	340	225	280	340	225	280	340	275	340	410	300	375	450
		26	1040	1300	1560	1040	1300	1560	1040	1300	1560	465	580	700	515	640	770
		27	960	1200	1440	960	1200	1440	960	1200	1440	440	550	660	485	605	730
		28	1040	1300	1560	1040	1300	1560	1040	1300	1560	465	580	700	515	640	770
29	480	600	720	480	600	720	480	600	720	580	720	865	640	795	955		
30	440	550	660	440	550	660	440	550	660	530	660	795	585	730	880		
S		0.001–0.020			0.001–0.020			0.001–0.020			0.001–0.020			0.001–0.020			
		0.005–0.001			0.005–0.001			0.005–0.001			0.005–0.001			0.005–0.001			
		C2			C25			C3			CG5 **			CG55			
		31	115	140	170	115	140	170	115	140	170	115	140	170	125	155	190
		32	80	100	120	80	100	120	80	100	120	80	100	120	90	110	135
		33	95	115	140	95	115	140	95	115	140	95	115	140	105	130	160
		34	65	80	100	65	80	100	65	80	100	65	80	100	75	90	110
		35	75	90	110	75	90	110	75	90	110	75	90	110	80	100	120
36	–	–	–	–	–	–	–	–	–	105	130	160	120	145	175		
37	–	–	–	–	–	–	–	–	–	80	100	120	90	110	135		
H		C2			C25			C3			CG5			CG55			
		38.1	–	–	–	–	–	–	–	–	–	–	–	–	–	–	
		38.2	–	–	–	–	–	–	–	–	–	–	–	–	–	–	
		39.1	–	–	–	–	–	–	–	–	–	–	–	–	–	–	
		39.2	–	–	–	–	–	–	–	–	–	–	–	–	–	–	
		40.1	–	–	–	–	–	–	–	–	–	–	–	–	–	–	
		40.2	–	–	–	–	–	–	–	–	–	–	–	–	–	–	
		41.1	–	–	–	–	–	–	–	–	–	–	–	–	–	–	
41.2	–	–	–	–	–	–	–	–	–	–	–	–	–	–			

NOTE: Speed and feed rates and depth of cut may vary depending on materials and machining conditions including, but not limited to, tool overhang, tool size, and finished surface requirements.

A double asterisk (**) shown after the insert grade name indicates primary grade recommendations for the material shown. Insert grade names shown without the double asterisk are secondary choices.

Speed and Feed Chart • Inch • Part 2

ANSI ISO 513	VDI 3323	Cutting Speed – vc																	
		SFM																	
Material Group		min	Start	max	min	Start	max	min	Start	max	min	Start	max	min	Start	max	min	Start	max
P	ap [mm]	0.002"-0.012"			0.002"-0.012"			0.002"-0.012"			0.002"-0.012"								
	f [mm/rev]	0.012"-0.001"			0.012"-0.001"			0.012"-0.001"			0.012"-0.001"								
		CG6 **			CM1			ALO			TN7 **			CBN6			CPD1		
	1	415	515	620	180	220	265	540	675	810	650	810	975	-	-	-	-	-	-
	2	305	380	460	130	160	195	400	500	600	480	600	720	-	-	-	-	-	-
	3	235	290	350	100	125	150	305	380	460	370	460	555	-	-	-	-	-	-
	4	265	330	400	115	140	170	350	435	525	420	520	625	-	-	-	-	-	-
	5	200	245	295	85	105	130	260	320	385	305	380	460	-	-	-	-	-	-
	6	325	405	490	140	170	205	425	530	640	510	635	765	-	-	-	-	-	-
	7	215	265	320	95	115	140	280	350	420	335	415	500	-	-	-	-	-	-
	8	200	245	295	85	105	130	260	320	385	305	380	460	-	-	-	-	-	-
	9	170	210	255	75	90	110	220	275	330	265	330	400	-	-	-	-	-	-
	10	295	365	440	125	155	190	380	475	570	460	570	685	-	-	-	-	-	-
	11	180	225	270	80	95	115	240	295	355	285	355	430	-	-	-	-	-	-
12	295	365	440	125	155	190	380	475	570	460	570	685	-	-	-	-	-	-	
13.1	245	305	370	105	130	160	320	400	480	380	475	570	-	-	-	-	-	-	
13.2	180	220	265	80	95	115	235	290	350	280	350	420	-	-	-	-	-	-	
M	ap [inch]	0.002"-0.012"			0.002"-0.012"			0.002"-0.012"			0.002"-0.012"								
	f [inch]	0.012"-0.001"			0.012"-0.001"			0.012"-0.001"			0.012"-0.001"								
		CG6			CM1			ALO			TN7			CBN6			CPD1		
	14.1	305	380	460	180	220	265	345	430	520	340	420	505	-	-	-	-	-	-
	14.2	240	300	360	140	175	210	275	340	410	265	330	400	-	-	-	-	-	-
K	ap [inch]	0.002"-0.012"			0.002"-0.012"			0.002"-0.012"			0.002"-0.012"								
	f [inch]	0.010"-0.001"			0.010"-0.001"			0.010"-0.001"			0.010"-0.001"								
		CG6			CM1			ALO **			TN7			CBN6			CPD1		
	15	280	350	420	180	220	265	480	600	720	320	400	480	-	-	-	-	-	-
	16	200	245	295	125	155	190	340	420	505	225	280	340	-	-	-	-	-	-
	17	320	400	480	200	250	300	540	675	810	360	450	540	-	-	-	-	-	-
	18	210	260	315	130	160	195	350	435	525	235	290	350	-	-	-	-	-	-
19	385	480	580	245	305	370	670	835	1005	445	555	670	-	-	-	-	-	-	
20	220	275	330	140	175	210	380	470	565	255	315	380	-	-	-	-	-	-	

ANSI ISO 513	VDI 3323	Cutting Speed – vc																	
		SFM																	
Material Group		min	Start	max	min	Start	max	min	Start	max	min	Start	max	min	Start	max	min	Start	max
N	ap [inch]	0.002"-0.020"			0.002"-0.020"			0.002"-0.020"			0.002"-0.020"			0.002"-0.020"			0.002"-0.020"		
	f [inch]	0.008"-0.001"			0.008"-0.001"			0.008"-0.001"			0.008"-0.001"			0.008"-0.001"			0.008"-0.001"		
		CG6			CM1			ALO			TN7			CBN6			CPD1 **		
	21	-	-	-	1320	1650	1980	-	-	-	1320	1650	1980	-	-	-	2800	3500	4200
	22	-	-	-	795	990	1190	-	-	-	795	990	1190	-	-	-	2400	3000	3600
	23	-	-	-	1320	1650	1980	-	-	-	1320	1650	1980	-	-	-	2240	2800	3360
	24	-	-	-	800	1000	1200	-	-	-	800	1000	1200	-	-	-	1760	2200	2640
	25	-	-	-	225	280	340	-	-	-	265	330	400	-	-	-	1200	1500	1800
	26	-	-	-	330	410	495	-	-	-	640	800	960	-	-	-	1080	1350	1620
	27	-	-	-	320	400	480	-	-	-	625	780	940	-	-	-	1040	1300	1560
	28	-	-	-	330	410	495	-	-	-	640	800	960	-	-	-	1080	1350	1620
29	-	-	-	480	600	720	-	-	-	640	800	960	-	-	-	1120	1400	1680	
30	-	-	-	440	550	660	-	-	-	520	650	780	-	-	-	1080	1350	1620	
S	ap [inch]	0.001"-0.020"			0.001"-0.020"			0.001"-0.020"			0.001"-0.020"			0.001"-0.020"			0.001"-0.020"		
	f [inch]	0.005"-0.001"			0.005"-0.001"			0.005"-0.001"			0.005"-0.001"			0.005"-0.001"			0.005"-0.001"		
		CG6			CM1 **			ALO			TN7			CBN6			CPD1		
	31	-	-	-	100	120	145	-	-	-	-	-	-	-	-	-	-	-	-
	32	-	-	-	75	90	110	-	-	-	-	-	-	-	-	-	-	-	-
	33	-	-	-	80	100	120	-	-	-	-	-	-	-	-	-	-	-	-
	34	-	-	-	60	70	85	-	-	-	-	-	-	-	-	-	-	-	-
	35	-	-	-	60	75	90	-	-	-	-	-	-	-	-	-	-	-	-
36	-	-	-	90	110	135	-	-	-	-	-	-	-	-	-	-	-	-	
37	-	-	-	75	90	110	-	-	-	-	-	-	-	-	-	-	-	-	
H	ap [inch]	0.001"-0.020"			0.001"-0.020"			0.001"-0.020"			0.001"-0.020"			0.001"-0.020"			0.001"-0.020"		
	f [inch]	0.005"-0.001"			0.005"-0.001"			0.005"-0.001"			0.005"-0.001"			0.005"-0.001"			0.005"-0.001"		
		CG6			CM1			ALO			TN7			CBN6 **			CPD1		
	38.1	-	-	-	-	-	-	-	-	-	-	-	-	360	450	540	-	-	-
	38.2	-	-	-	-	-	-	-	-	-	-	-	-	340	420	505	-	-	-
	39.1	-	-	-	-	-	-	-	-	-	-	-	-	320	400	480	-	-	-
	39.2	-	-	-	-	-	-	-	-	-	-	-	-	290	360	435	-	-	-
	40.1	-	-	-	-	-	-	-	-	-	-	-	-	-	-	-	-	-	-
40.2	-	-	-	-	-	-	-	-	-	-	-	-	-	-	-	-	-	-	
41.1	-	-	-	-	-	-	-	-	-	-	-	-	-	-	-	-	-	-	
41.2	-	-	-	-	-	-	-	-	-	-	-	-	-	-	-	-	-	-	

NOTE: Speed and feed rates and depth of cut may vary depending on materials and machining conditions including, but not limited to, tool overhang, tool size, and finished surface requirements.

A double asterisk (**) shown after the insert grade name indicates primary grade recommendations for the material shown. Insert grade names shown without the double asterisk are secondary choices.

INDEXABLE MILLING
 SOLID END MILLING
 HOLEMAKING
 TAPPING
 TURNING

WIDIA™ Tools for Bar Peeling and Railroad

Look for proven solutions in
Railway and Bar Peeling applications

Bar peeling is a unique and economical machining operation for the production of cylindrical surfaces on black bars (e.g., round bars, wires, blocks and pipes) with high surface finishes and dimensional accuracy. During the bar peeling process, scales, and cracks (or other errors) are removed. This generally involves a rotating multi-tooth tool head under an application with high feed rates.



GROOVING & CUT-OFF

WGC

Pages F126–F128, F131

The most versatile tool in the market in grooving, profiling, and cut-off operations.



WMT™

Pages F129–F130

The WMT platform is the economical and reliable option for all your grooving, cut-off, turning, and profiling applications.



AUTOMOTIVE



Gears

Cylinder Housing

Brakes and Steering



WIDIA™ manufactures tools to meet application needs in steel, cast iron, and aluminum automotive components.

TO SEE ALL PRODUCTS LINES, VISIT OUR DIGITAL RESOURCES



WIDIA NOVO™ Application
Download to your desktop or tablet:
widia.com/novo



WIDIA™ Machining Central Mobile App
Download for iOS or Android:
widia.com/en/featured/WidiaMobileApp

WIDIA 

WGC Feed Rates

Plunge feed rates

- first choice
- alternate choice

P Steel	K Cast Iron	S High-Temp Alloys
M Stainless Steel	N Non-Ferrous	H Hardened Materials

Chip Control	Description	Insert Geometry	Seat Size (SSC)	Corner Radius	Starting Conditions	Plunge Feed Rates inch/rev (mm/rev)								
				in (mm)	in (mm)	.0020 (0,05)	.0040 (0,10)	.0060 (0,15)	.0080 (0,20)	.0100 (0,25)	.0120 (0,30)	.0140 (0,35)		
-PT	Positive rake angle for lower cutting forces.		1F	.008 (0,2)	.0024 (0,06)	◊								
			2	.008 (0,2)	.0031 (0,08)		◊							
			3	.008 (0,2)	.0035 (0,09)			◊						
			4	.016 (0,4)	.0043 (0,11)				◊					
				.016 (0,4)	.0047 (0,12)					◊				
			5	.031 (0,8)	.0059 (0,15)						◊			
				.016 (0,4)	.0059 (0,15)							◊		
			6	.031 (0,8)	.0071 (0,18)								◊	
				.047 (1,2)	.0079 (0,20)									◊
			8	.031 (0,8)	.0079 (0,20)									◊
.047 (1,2)	.0087 (0,22)											◊		
10	.047 (1,2)	.0094 (0,24)										◊		
-PN	Stable negative cutting edge allowing for more aggressive applications.		1F	.008 (0,2)	.0024 (0,06)	◊								
			2	.008 (0,2)	.0031 (0,08)		◊							
			3	.008 (0,2)	.0035 (0,09)			◊						
			4	.016 (0,4)	.0043 (0,11)				◊					
				.016 (0,4)	.0047 (0,12)					◊				
			5	.031 (0,8)	.0059 (0,15)						◊			
				.016 (0,4)	.0059 (0,15)							◊		
			6	.031 (0,8)	.0071 (0,18)								◊	
				.047 (1,2)	.0079 (0,20)									◊
			8	.031 (0,8)	.0079 (0,20)									◊
.047 (1,2)	.0087 (0,22)											◊		
10	.047 (1,2)	.0094 (0,24)										◊		

Cut-Off Feed Rates

Geometry	Description	Insert Geometry	Seat Size (SSC)	Starting Conditions	Cut-Off Feed Rates inch/rev (mm/rev)								
				in (mm)	.0020 (0,05)	.0040 (0,10)	.0060 (0,15)	.0080 (0,20)	.0100 (0,25)	.0120 (0,30)	.0140 (0,35)	.0160 (0,40)	
-F	Positive geometry for reduced cutting forces.		1B	.0024 (0,06)	◊								
			2	.0028 (0,07)		◊							
			3	.0035 (0,09)			◊						
			4	.0043 (0,11)				◊					
			5	.0051 (0,13)					◊				
-M	Stable cutting edge for aggressive feed rates. Primarily in cast iron.		1B	.0024 (0,06)	◊								
			2	.0028 (0,07)		◊							
			3	.0035 (0,09)			◊						
			4	.0043 (0,11)				◊					
			5	.0055 (0,14)					◊				
			6	.0063 (0,16)						◊			
-R	Most stable cutting edge for steel.		2	.0039 (0,10)			◊						
			3	.0055 (0,14)				◊					
			4	.0063 (0,16)					◊				
			5	.0075 (0,19)						◊			
			6	.0083 (0,21)							◊		
			8	.0090 (0,23)								◊	

NOTE: For cut-off inserts with a lead angle, maximum feed rate should be reduced by up to 40%.

Maximum Feed Rate Values

Data above is for P and K material groups. Maximum feed rates should be adjusted by multiplying max feed rate values by following factors for shown material groups.	Material Group	Feed Factor
	M	0.8
	N	1.2
	S	0.8
	H	0.5

I.D. and Face Grooving

For I.D. and face grooving applications, reduce feed rate by 20%.

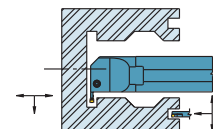

WGC FEED RATES

Turn and profile feed rates

Seat Size 1F

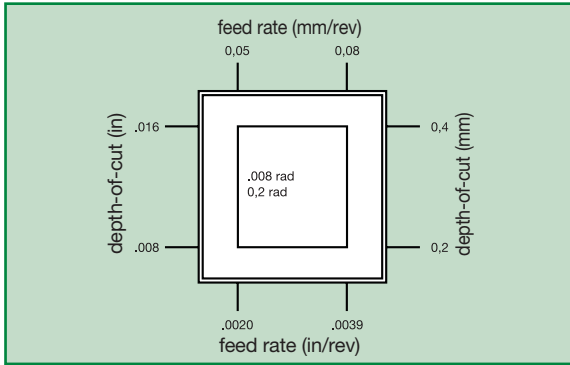

Seat Size 2

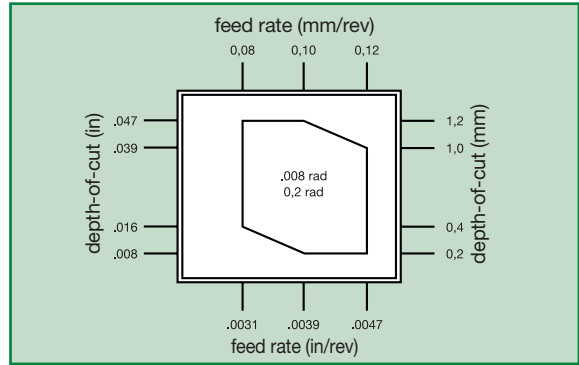

Seat Size 3

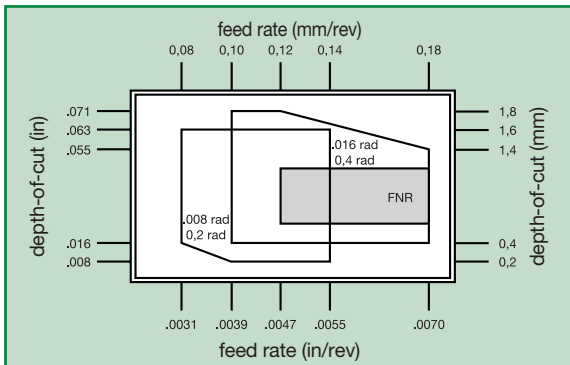

Seat Size 4

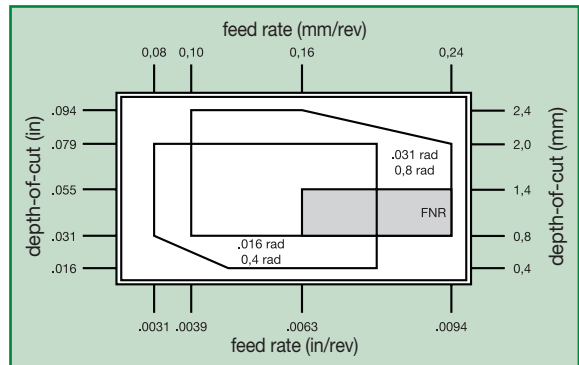

Seat Size 5

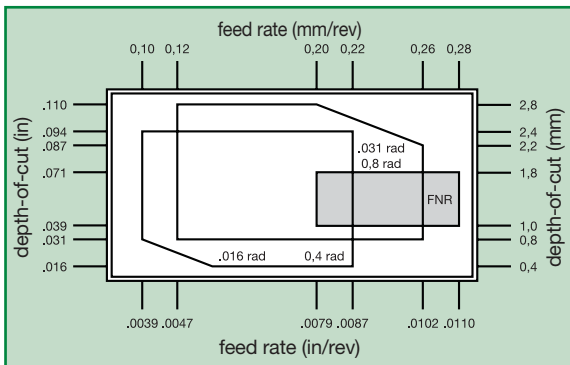

Seat Size 6

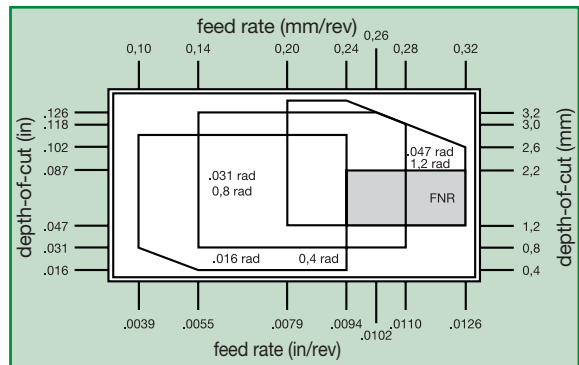

Seat Size 8

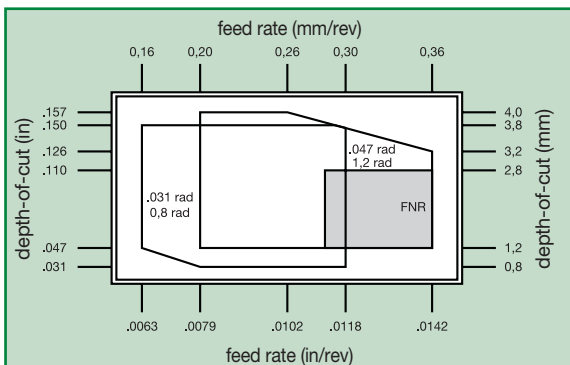

Seat Size 10

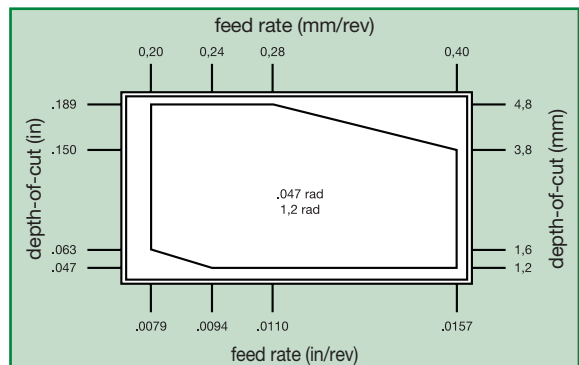

* FNR = Full Nose Radius

Recommended Starting Speeds • Inch and Metric

Maximum Feed Rate Values

Data above is for P and K material groups. Maximum feed rates should be adjusted by multiplying max feed rate values by following factors for shown material groups.	Material Group	Feed Factor
	M	0.8
	N	1.2
	S	0.8
	H	0.5

Material Group		WU25PT					
		Inch			Metric		
P	0-1	360	740	880	110	225	270
	2	360	520	880	110	160	260
	3	360	410	800	110	125	235
	4	200	290	540	60	90	160
	5	320	530	680	100	160	210
	6	280	400	600	85	120	185
M	1	300	550	800	90	170	245
	2	300	500	800	90	150	245
	3	300	450	700	90	140	210
K	1	320	480	760	100	145	225
	2	240	400	560	70	120	170
	3	160	280	400	50	85	120
N	1-2	400	1440	2560	120	440	780
	3	—	—	—	—	—	—
	4	320	960	1600	100	290	490
	5	240	440	640	70	135	195
	6	320	560	800	100	170	245
S	1	25	125	200	8	40	60
	2	25	100	250	8	30	75
	3	50	125	250	15	40	75
	4	25	175	350	8	50	110

NOTE: FIRST choice starting speeds are in **bold** type.
As the average chip thickness increases, the speed should be decreased.

Feed Values for Grooving Inserts

CM Cut-Off Medium



- Double-ended, V-bottom and top, mechanically clamped.
- Neutral, right-, and left-hand lead angles up to 12°.
- Designed to increase speed and feed.
- Chip geometry designed for excellent chip control and minimized cutting pressure on various materials.
- Ideal for 300 Series stainless steel, tool steel, titanium, INCONEL®, and other nickel-based alloys at moderate speeds and feeds.

CM-W Cut-Off Medium with Wiper



- Wiper flats where surface finish is critical.
- Double-ended, V-bottom, and top, mechanically clamped.
- Neutral, right-, and left-hand lead angles up to 12°.
- Designed to increase speed and feed.
- Chip geometry designed for excellent chip control and minimized cutting pressure on various materials.

PT Plunge, Groove, and Turn Inserts



- High positive rake geometry for low cutting force, especially in soft materials.
- Deep grooving tool for plunge and turn O.D. and face grooving operations.
- Delivers chip control over full range of DOC when turning.
- Cuts in both axial and radial directions.

PC Grooving and Profiling Inserts



- Superior chip control.
- Full nose radius geometry for plunge and contour operations.
- Effective cutting edge geometry exceeds 180° for increased versatility.

PH Plunge, Groove, and Turn Inserts



- Excellent performance in greater than 35 HRC.
- Deep grooving tool for plunge and turn O.D. and face grooving operations.
- Delivers chip control over full range of DOC when turning.
- Delivers superior chip control in interrupted cuts.

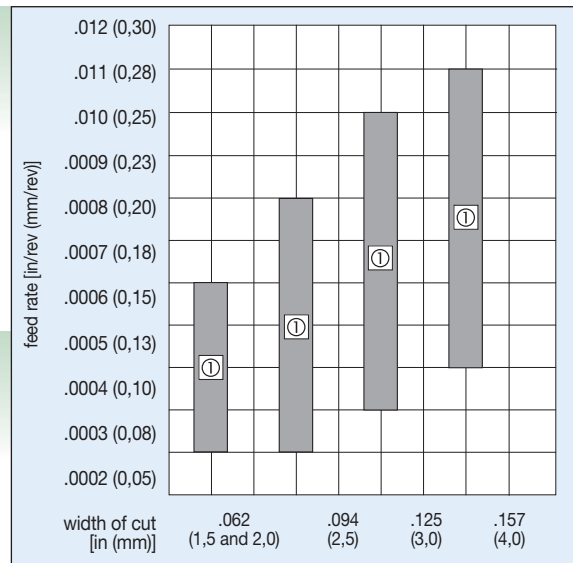

① Recommended Starting Feed

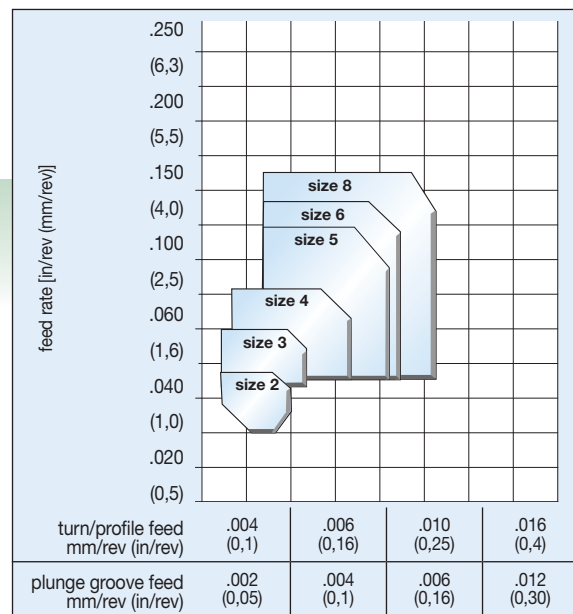
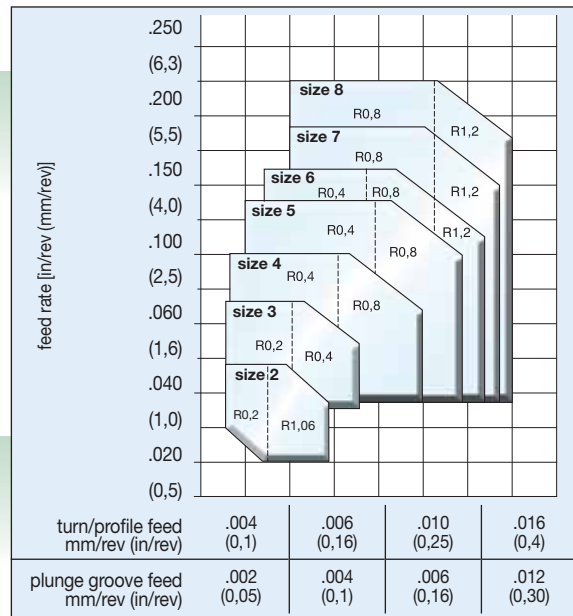

INDEXABLE MILLING



SOLID END MILLING



HOLEMAKING



TAPPING



TURNING

INDEXABLE MILLING

SOLID END MILLING

HOLEMAKING

TAPPING

TURNING

Recommended Cutting Speeds • Metric









Material Group		Cutting Speed – vc														
		WU10HT			WU10PT			WU25PT			WP10CT			WP25CT		
		min	Start	max	min	Start	max	min	Start	max	min	Start	max	min	Start	max
P	0/1	100	100	110	190	200	210	170	175	180	210	225	240	170	175	180
	2	95	95	105	180	185	190	150	160	170	210	220	230	185	195	205
	3	95	95	105	180	185	190	150	160	170	210	220	230	185	195	205
	4	70	70	75	165	170	175	135	145	155	140	145	155	125	125	135
	5	85	90	95	170	175	180	140	150	160	180	190	195	155	165	170
	6	50	50	50	140	150	160	120	125	130	70	75	80	70	75	80
M	1	70	75	80	120	125	130	120	125	130	-	-	-	-	-	-
	2	50	50	50	100	100	110	70	75	80	-	-	-	-	-	-
	3	50	50	50	95	100	105	85	90	95	-	-	-	-	-	-
K	1	85	90	95	190	200	210	155	165	170	215	225	235	180	190	195
	2	75	75	80	185	190	200	155	165	175	205	215	225	175	185	195
	3	70	75	80	170	175	180	140	150	160	210	225	240	190	200	210
N	1	70	75	80	140	150	160	110	120	130	-	-	-	-	-	-
	2	70	75	80	140	150	80	110	120	80	-	-	-	-	-	-
	3	70	75	80	140	150	80	110	120	80	-	-	-	-	-	-
	4	70	75	80	140	150	80	110	120	80	-	-	-	-	-	-
	5	70	75	80	140	150	80	110	120	80	-	-	-	-	-	-
	6	70	75	80	140	150	80	110	120	80	-	-	-	-	-	-
	7	70	75	80	140	150	120	110	120	105	-	-	-	-	-	-
S	1	20	25	30	70	75	80	60	65	65	-	-	-	-	-	-
	2	20	25	30	65	65	70	50	50	50	-	-	-	-	-	-
	3	50	50	50	100	100	110	70	75	80	-	-	-	-	-	-
	4	-	-	-	70	75	80	50	50	50	-	-	-	-	-	-
H	1	-	-	-	15	30	60	15	30	60	-	-	-	-	-	-
	2	-	-	-	15	30	60	15	30	60	-	-	-	-	-	-
	3	-	-	-	15	30	60	15	30	60	-	-	-	-	-	-
	4	-	-	-	15	30	60	15	30	60	-	-	-	-	-	-

Recommended Cutting Speeds • Inch

Material Group		Cutting Speed – vc														
		WU10HT			WU10PT			WU25PT			WP10CT			WP25CT		
		min	Start	max	min	Start	max	min	Start	max	min	Start	max	min	Start	max
P	0/1	290	300	320	620	650	680	520	550	580	670	700	740	590	625	660
	2	310	325	345	570	600	630	520	545	575	680	720	760	595	625	655
	3	310	325	345	570	600	630	520	545	575	680	720	760	595	625	655
	4	195	205	220	520	545	575	475	495	520	445	470	495	385	405	430
	5	265	275	290	520	550	580	480	500	530	580	615	645	510	540	565
	6	120	125	130	480	500	530	430	450	470	260	275	290	240	250	260
M	1	240	250	260	430	450	470	400	425	450	-	-	-	-	-	-
	2	140	150	160	310	325	340	290	300	320	-	-	-	-	-	-
	3	155	165	170	310	325	340	285	300	315	-	-	-	-	-	-
K	1	240	250	265	595	625	660	550	575	605	690	725	760	595	625	655
	2	225	235	245	610	640	675	555	585	615	665	700	735	570	600	630
	3	240	250	260	520	550	580	480	500	530	710	750	790	620	650	680
N	1	240	250	260	480	500	530	380	400	420	-	-	-	-	-	-
	2	240	250	260	480	500	530	380	400	420	-	-	-	-	-	-
	3	240	250	260	480	500	530	380	400	420	-	-	-	-	-	-
	4	240	250	260	480	500	530	380	400	420	-	-	-	-	-	-
	5	240	250	260	480	500	530	380	400	420	-	-	-	-	-	-
	6	240	250	260	480	500	530	380	400	420	-	-	-	-	-	-
	7	240	250	260	480	500	530	380	400	420	-	-	-	-	-	-
S	1	110	115	120	235	250	265	215	225	235	-	-	-	-	-	-
	2	55	60	60	195	210	220	195	210	220	-	-	-	-	-	-
	3	190	200	210	310	325	340	290	300	320	-	-	-	-	-	-
	4	100	100	110	-	-	-	-	-	-	-	-	-	-	-	-
H	1	-	-	-	60	100	200	60	100	200	-	-	-	-	-	-
	2	-	-	-	60	100	200	60	100	200	-	-	-	-	-	-
	3	-	-	-	60	100	200	60	100	200	-	-	-	-	-	-
	4	-	-	-	60	100	200	60	100	200	-	-	-	-	-	-

WGC – QUICK FACTS

INSERTS

APPLICATION	TYPES	GROOVE WIDTH	INSERT GEOMETRY	MATERIALS
Grooving		2.13mm–10.13mm 0.084-0.399"	PT-Positive Rake	
			PN-Negative Rake	
Cut-Off		1.4mm–8.0mm 0.055-0.315"	F-Fine	
			M-Medium	
			R-Rough	
Profiling		2.0mm–8.0mm 0.079-0.315"	PC-Full Radius	

APPLICATIONS

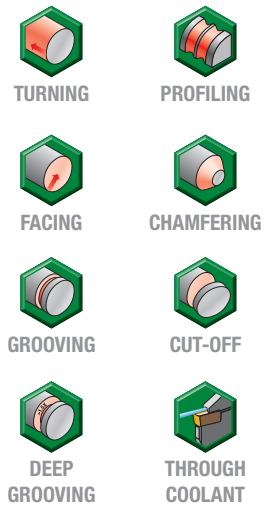

GEOMETRY

4 BENEFITS IN 1

Versatility

Single-sided, versatile grooving and cut-off solution with smooth surface finish

Productivity

Through coolant capability with precise delivery for low cutting forces and better chip evacuation

Stability

In challenging applications due to V-shaped edges

Simplicity

Easy to select and apply

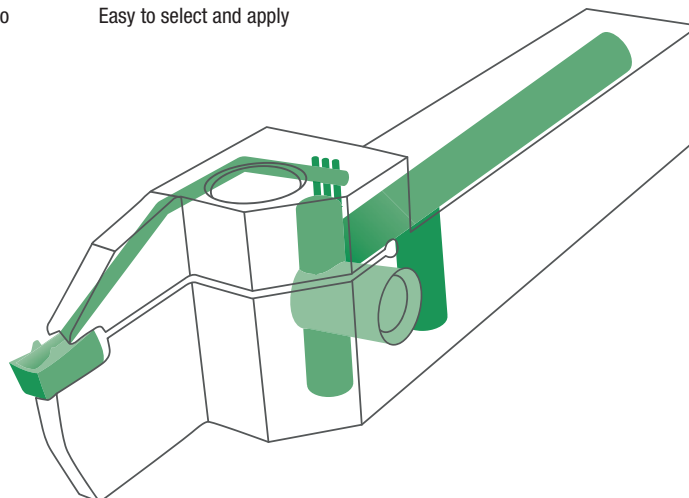

INDUSTRY



Material Overview • ANSI

ANSI

P Steel	K Cast Iron	S High-Temp Alloys
M Stainless Steel	N Non-Ferrous	H Hardened Materials

material group	description	content	tensile strength RM (MPa)*	hardness (HB)	hardness (HRC)	material number
P0	Low-Carbon Steels, Long Chipping	C <0,25%	<530	<125	–	A36, 1008, 1010, 1018 through 1029; 1108, 1117
P1	Low-Carbon Steels, Short Chipping, Free Machining	C <0,25%	<530	<125	–	10L18, 1200 Series, 1213, 12L14
P2	Medium- and High-Carbon Steels	C >0,25%	>530	<220	<25	1035, 1045, 10L45, 1050, 10L50, 1080, 1137, 1144, 11L44, 1525, 1545, 1572
P3	Alloy Steels and Tool Steels	C >0,25%	600–850	<330	<35	1300, 2000, 3000, 4000, 5000, 8000, P20, SAE: A, D, H, O, S, M, T
P4	Alloy Steels and Tool Steels	C >0,25%	850–1400	340–450	35–48	1300, 2000, 3000, 4000, 5000, 8000, P20, SAE: A, D, H, O, S, M, T
P5	Ferritic, Martensitic, and PH Stainless Steels	–	600–900	<330	<35	15–5 PH, 13–8 PH, 17–4 PH, 400 and 500 Series
P6	High-Strength Ferritic, Martensitic, and PH Stainless Steels	–	900–1350	350–450	35–48	15–5 PH, 13–8 PH, 17–4 PH, 400 and 500 Series
M1	Austenitic Stainless Steel	–	<600	130–200	–	200 Series, 301, 302, 304, 304L, 309
M2	High-Strength Austenitic Stainless and Cast Stainless Steels	–	600–800	150–230	<25	310, 316, 316L, 321, 347, 384 ASTM Cast XM-1, XM-5, XM-7, XM-21
M3	Duplex Stainless Steel	–	<800	135–275	<30	323, 329, F55, 2205, S329000
K1	Grey Cast Iron	–	125–500	120–290	<32	class 20, 25, 30, 35, 40, 45, 50, 55, 60, G1800, G3000, G3500, G4000
K2	Low- and Medium-Strength Ductile Irons (Nodular Irons) and Compacted Graphite Irons (CGI)	–	<600	130–260	<28	60-40-18, 65-45-12, 80-55-06, SAE J434:D4018, D4512, D5506, ASTM A47: Grade 32510, 35018, SAE J158: Grade M3210, M4504, M5003, M5503, M7002, ASTM A842: Grade 250, 300, 350, 400, 450
K3	High-Strength Ductile Irons and Austempered Ductile Iron (ADI)	–	>600	180–350	<43	ASTM A536:100-70-03, 120-90-02, SAE J434: D7003, SAE J158: Grade M8501AST A897: 125-80-10, 150-100-7, 175-125-4, 200-150-1, 230-185
N1	Wrought Aluminum	–	–	–	–	2025, 5050, 7050, 1000, 2017
N2	Low-Silicon Aluminum Alloys and Magnesium Alloys	Si <12,2%	–	–	–	2024, 6061, 7075
N3	High-Silicon Aluminum Alloys and Magnesium Alloys	Si >12,2%	–	–	–	–
N4	Copper-, Brass-, Zinc-Based on Machinability Index Range of 70–100	–	–	–	–	C81500
N5	Nylon, Plastics, Rubbers, Phenolics, Resins, Fiberglass	–	–	–	–	–
N6	Carbon, Graphite Composites, CFRP	–	–	–	–	Graphite, CFK, CFRP
N7	Metal Matrix Composites (MMC)	–	–	–	–	C63000
S1	Iron-Based, Heat-Resistant Alloys	–	500–1200	160–260	25–48	A-286, INCOLOY® 800 Series, A608, A567, Inconel™, INVAR®, N-155, 16-25-6, 19-9 DL; Cast: ASTM A-297, A-351, A-567, A-608
S2	Cobalt-Based, Heat-Resistant Alloys	–	1000–1450	250–450	25–48	Haynes® 25 (L605), Haynes 188, J-1570, Stellite, AiResist 213; Cast: AiResist 13, Haynes 21, MAR-M302, MAR-M509, NASA Co-W-Re, WI-52
S3	Nickel-Based, Heat-Resistant Alloys	–	600–1700	160–450	<48	Astroloy™, Hastelloy® B/C/ C-276 /X, INCONEL® 600 and 700 Series, IN102, INCOLOY 900 Series, Rene 41, Waspalloy®, Monel®, K-500, MAR-M20, NIMONIC®, UDIMET®
S4	Titanium and Titanium Alloys	–	900–1600	300–400	33–48	Pure: Ti 98.8, Ti 98.9, Ti 99.9; Alloyed: Ti 5Al-2.5Sn, Ti6Al-4V, Ti6Al-2Sn-4Zr-2Mo, Ti-3Al-8V-6Cr-4Mo-4Zr, Ti-10V-2Fe-3Al, Ti-13V-11Cr-3Al
H1	Hardened Materials	–	–	–	44–48	Tool Steel H10, H11, H13, D2, D3, 4340, P20
H2	Hardened Materials	–	–	–	48–55	Tool Steel H10, H11, H13, D2, D3, 4340, P20
H3	Hardened Materials	–	–	–	56–60	Tool Steel H10, H11, H13, D2, D3, 4340, P20
H4	Hardened Materials	–	–	–	>60	Tool Steel H10, H11, H13, D2, D3, 4340, P20

DIN

P Steel	K Cast Iron	S High-Temp Alloys
M Stainless Steel	N Non-Ferrous	H Hardened Materials

material group	description	content	tensile strength RM (MPa)*	hardness (HB)	hardness (HRC)	material number
P0	Low-Carbon Steels, Long Chipping	C <0,25%	<530	<125	–	–
P1	Low-Carbon Steels, Short Chipping, Free Machining	C <0,25%	<530	<125	–	C15, Ck22, ST37-2, S235JR, 9SMnPb28, GS38
P2	Medium- and High-Carbon Steels	C >0,25%	>530	<220	<25	ST52, S355JR, C35, GS60, Cf53
P3	Alloy Steels and Tool Steels	C >0,25%	600–850	<330	<35	16MnCr5, Ck45, 21CrMoV5-7, 38SMn28
P4	Alloy Steels and Tool Steels	C >0,25%	850–1400	340–450	35–48	100Cr6, 30CrNiMo8, 42CrMo4, C70W2, S6525, X120Mn12
P5	Ferritic, Martensitic, and PH Stainless Steels	–	600–900	<330	<35	100Cr6, 30CrNiMo8, 42CrMo4, C70W2, S6525, X120Mn12
P6	High-Strength Ferritic, Martensitic, and PH Stainless Steels	–	900–1350	350–450	35–48	X102CrMo17, G-X120Cr29
M1	Austenitic Stainless Steel	–	<600	130–200	–	X5CrNi 18 10, X2CrNiMo 17 13 2, G-X25CrNiSi18 9, X15CrNiSi 20 12
M2	High-Strength Austenitic Stainless and Cast Stainless Steels	–	600–800	150–230	<25	X2CrNiMo 13 4, X5NiCr 32 21, X5CrNiNb 18 10, G-X15CrNi 25-20
M3	Duplex Stainless Steel	–	<800	135–275	<30	X8CrNiMo27 5, X2CrNiMoN22 5 3, X20CrNiSi25 4, G-X40CrNiSi27 4
K1	Gray Cast Iron	–	125–500	120–290	<32	GG15, GG25, GG30, GG40, GTW40
K2	Low- and Medium-Strength Ductile Irons (Nodular Irons) and Compacted Graphite Irons (CGI)	–	<600	130–260	<28	GGG40, GTS35
K3	High-Strength Ductile Irons and Austempered Ductile Iron (ADI)	–	>600	180–350	<43	GGG60, GTW55, GTS65
N1	Wrought Aluminum	–	–	–	–	AlMg1, Al99.5, AlCuMg1, AlCuBiPb, AlMgSi1, ALMg-SiPb
N2	Low-Silicon Aluminum Alloys and Magnesium Alloys	Si <12,2%	–	–	–	GAISiCu4, GDAISi10Mg
N3	High-Silicon Aluminum Alloys and Magnesium Alloys	Si >12,2%	–	–	–	G-ALSi12, G-AISi17Cu4, G-AISi21CuNiMg
N4	Copper-, Brass-, Zinc-Based on Machinability Index Range of 70–100	–	–	–	–	CuZn40, Ms60, G-CuSn5ZnPb, CuZn37, CuSi3Mn
N5	Nylon, Plastics, Rubbers, Phenolics, Resins, Fiberglass	–	–	–	–	Lexan®, Hostalen™, Polystyrol, Makralon®
N6	Carbon, Graphite Composites, CFRP	–	–	–	–	CFK, GFK
N7	Metal Matrix Composites (MMC)	–	–	–	–	–
S1	Iron-Based, Heat-Resistant Alloys	–	500–1200	160–260	25–48	X1NiCrMoCu32 28 7, X12NiCrSi36 16, X5NiCrAlTi31 20, X40CoCrNi20 20
S2	Cobalt-Based, Heat-Resistant Alloys	–	1000–1450	250–450	25–48	Haynes® 188, Stellite® 6,21,31
S3	Nickel-Based, Heat-Resistant Alloys	–	600–1700	160–450	<48	INCONEL® 690, INCONEL 625, Hastelloy®, Nimonic® 75
S4	Titanium and Titanium Alloys	–	900–1600	300–400	33–48	Ti1, TiAl5Sn2, TiAl6V4, TiAl4Mo4Sn2
H1	Hardened Materials	–	–	–	44–48	GX260NiCr42, GX330NiCr42, GX300CrNiSi952, GX300CrMo153, Hardox® 400
H2	Hardened Materials	–	–	–	48–55	–
H3	Hardened Materials	–	–	–	56–60	–
H4	Hardened Materials	–	–	–	>60	–

Find your Local WIDIA Authorized Distributor

WIDIA™ brand cutting tools are available exclusively through a specialized network of Authorized Distributor partners whom you can count on to deliver much more than products. Our distributors know us, and more importantly, they know you. They know better than anyone in the industry how to put the global power of WIDIA to work for you — in your industry, in your region, and for your business.

WIDIA distributor partners provide technical expertise that you can count on. They will show you how to:

- Significantly reduce cycle time.
- Improve machine tool utilization.
- Achieve measurable productivity improvements.
- Take advantage of proven supply chain solutions.
- Access local inventory and best-in-class technical support.
- Request onsite demonstrations of the latest tooling technology.

And with thousands of turning, milling, holemaking, tapping, and tooling systems products available from WIDIA, you'll find everything you need from one single source.



Find your Local WIDIA Authorized Distributor by accessing our distributor finder at widia.com.

IMPORTANT SAFETY INSTRUCTIONS: READ BEFORE USING THE TOOLS IN THIS CATALOG

METALCUTTING SAFETY

Projectile and Fragmentation Hazards

Modern metalcutting operations involve high spindle and cutter speeds and high temperatures and cutting forces. Hot metal chips may fly off the workpiece during metalcutting. Although cutting tools are designed and manufactured to withstand high cutting forces and temperatures, they can sometimes fragment, particularly if they are subjected to over-stress, severe impact, or other abuse.

To avoid injury:

- Always wear appropriate personal protective equipment, including safety goggles, when operating metalcutting machines or working nearby.
- Always make sure all machine guards are in place.

For more information, read the applicable Material Safety Data Sheet provided by WIDIA and consult General Industry Safety and Health Regulations, Part 1910, Title 29 of the Code of Federal Regulations.

These safety instructions are general guidelines. Many variables affect machining operations. It is impossible to cover every specific situation. The technical information included in this catalog and recommendations on machining practices may not apply to your particular operation.

For more information, consult the WIDIA Metalcutting Safety booklet, available free from WIDIA at +1 724 539 5747 or fax +1 724 539 5439. For specific product safety and environmental questions, contact our Corporate Environmental Health and Safety Office at +1 724 539 5066 or fax +1 724 539 5372.

Breathing and Skin Contact Hazards

Grinding carbide or other advanced cutting tool materials produces dust or mist containing metallic particles. Breathing this dust or mist — especially over an extended period — can cause temporary or permanent lung disease or make existing medical conditions worse. Contact with this dust or mist can irritate eyes, skin, and mucous membranes and may make existing skin conditions worse.

To avoid injury:

- Always wear breathing protection and safety goggles when grinding.
- Provide ventilation control and collect and properly dispose of dust, mist, or sludge from grinding.
- Avoid skin contact with dust or mist.

AluSurr, GUN, M100, M200, M370, NOVO, Stellite, Top Cut 4, TOP DRILL, TOP DRILL M1, VariDrill, VariMill, VariMill I, VariMill II, VariMill III, VariTap, Victory, VSM11, VSM17, VSM890, VSM490-10, VSM490-15, VXF, WIDIA, WIDIA-Hanita, WMT, WU25PD, and X-Feed are trademarks of Kennametal, Inc. and are used as such herein. The absence of a product, service name, or logo from this list does not constitute a waiver of Kennametal's trademark or other intellectual property rights concerning that name or logo.

Astroloy™ is a trademark of Svedala Industries, Inc. Corporation.

Discoloy™ is a trademark of Westinghouse Electric Corporation.

Hardox® is a registered trademark of SSAB Technology AB Corporation.

Hastelloy® and Haynes® is a registered trademarks of Haynes International, Inc. Corporation.

Hostalen® is a registered trademark of HOECHST GMBH.

INCOLOY® is a registered trademark of Inco Alloys International, Inc.

INCONEL®, NIMONIC®, Monel®, and UDIMET® are registered trademarks of Special Metals Corporation.

INVAR® is a registered trademark of Imphy Alloys Joint Stock Company.

©Copyright 2019 by Kennametal Inc., Latrobe, PA 15650. All rights reserved.





VOL 1

WORLD HEADQUARTERS

WIDIA Products Group

Kennametal Inc.
1600 Technology Way
Latrobe, PA 15650 USA
Tel: 1 800 979 4342
w-na.service@widia.com

EUROPEAN HEADQUARTERS

WIDIA Products Group

Kennametal Europe GmbH
Rheingoldstrasse 50
CH 8212 Neuhausen am Rheinfall
Switzerland
Tel: +41 52 6750 100
w-ch.service@widia.com

ASIA-PACIFIC HEADQUARTERS

WIDIA Products Group

Kennametal (Singapore) Pte. Ltd.
3A International Business Park
Unit #01-02/03/05, ICON@IBP
Singapore 609935
Tel: +65 6265 9222
w-sg.service@widia.com

INDIA HEADQUARTERS

WIDIA Products Group

Kennametal India Limited
CIN: L27109KA1964PLC001546
8/9th Mile, Tumkur Road
Bangalore - 560 073
Tel: +91 80 2839 4321
w-in.service@widia.com



TOOLING & MACHINERY

COMPLETE METALWORKING SOLUTIONS

(800) 991-4225

www.ahbinc.com

ISO Certified

customerservice@ahbinc.com



widia.com